

THE FOURTH OLYMPIAD

LONDON

1908

OFFICIAL REPORT



# The Fourth Olympiad

BEING

THE OFFICIAL REPORT

## The Olympic Games of 1908

CELEBRATED IN LONDON

Under the Patronage of

His Most Gracious Majesty King Edward VII



AND BY THE SANCTION OF

The International Olympic Committee

---

Drawn up by THEODORE ANDREA COOK

AND ISSUED UNDER THE AUTHORITY OF

THE BRITISH OLYMPIC COUNCIL

Together with the Full Code of Rules in each Sport  
Complete Lists of all Competitors and Results  
— and over one hundred illustrations. —

PUBLISHED BY

THE BRITISH OLYMPIC ASSOCIATION, 108 VICTORIA STREET, LONDON, S.W.

PRINTED BY SPOTTISWOODE & CO. LTD., NEW-STREET SQUARE, E.C.  
PHOTOGRAPHS BY BOWDEN BROS., 45 ESSEX STREET, STRAND, W.C.



## PREFACE.

---

THE following pages contain the Official Report of the Olympic Games of 1908, authorised by the British Olympic Council. Every member of the Council responsible for a section of these Games has corrected the facts concerning that section in the fourth chapter. For any errors in other chapters the compiler of the Report accepts responsibility.

I desire to acknowledge my great indebtedness for assistance received in many other ways, and from very various sources, more particularly the following : *The Sporting Life*, which published a separate account of the Games that has been of great interest and value, besides many articles on the Amateur Question and kindred subjects in its own columns ; *The Sportsman* ; *The Daily Mail* ; *The Daily Telegraph* ; *The Field*, which published several accounts and diagrams that have been used in this work ; the *National Review* ; the official organ of the Lawn Tennis Association; the *Revue Olympique*, and many other newspapers, magazines, and journals. Their editors will, I trust, be good enough to accept this general expression of gratitude for useful details, too numerous and scattered to be separately acknowledged. To Messrs. Bowden Bros. the official photographers of the Games, the Council is especially indebted for the excellent series of photographs illustrating these pages, which were nearly all taken by the same photographer who represented them in the Athenian Games of 1906. A few others have been added, which were most kindly sent to me from private sources.

A glance at the Table of Contents will enable the reader to dispense with any unnecessary explanations here, for he will see that this volume is the first, so far as I am aware, which has ever contained an official report of the performances of some twenty different nationalities in twenty divisions of sport and more than a hundred separate athletic events, together with the code of rules under which each of these events was contested. Owing, in part, to the early publication of this code, there is no doubt that the attention of the world at large was far more concentrated on the Games of 1908 than had been the case at any previous celebration ; for in every civilised country Committees were formed beforehand, preliminary competitions were held, and every care was taken to select the

best available national representatives. In the number of the nations represented, in the total of the competitors, and in the excellence of the performances throughout, the events recorded in this volume stand out as composing by far the greatest international athletic gathering ever held

The Games of 1908 constituted the fourth celebration since the Olympic Games were first revived at Athens in 1896, and it may therefore be taken as a symbol of the progress made during only twelve years in the ideals originated by Baron Pierre de Coubertin and developed by the International Olympic Committee, of which he is President. In forwarding those ideals England has now borne her most direct share, and no similar opportunity is likely to occur during the lifetime of those whose privilege it was to organise the Games of 1908 in this country. But there remains the work of supporting the general Olympic movement in the future, of sending out representative British teams to other Games, and of forming a central link of communication between the great associations governing sport in this country and the controlling bodies of sport in the rest of the world. This work is being carried on by the British Olympic Association, of 108 Victoria Street, Westminster, and it is able to do so with every promise of adequate success, because of the generous response of the public in all parts of the United Kingdom to the appeal for subscriptions to the Games of 1908. To that public, therefore, my last word of thanks is hereby most heartily accorded. The chapters which follow have furnished me with the most appropriate vehicle for its expression. Such a record of the events of the past year was due, not merely to the athletes who contributed directly to its success, not merely to the visitors from so many foreign nations who honoured us with their presence, but also to the spectators in the Stadium and elsewhere in this country and to the innumerable supporters of the British Olympic Council in their arduous task of organising the meeting in a manner worthy both of our own traditions and of the history of these Games.

*May 1909.*

T. A. C.



**THE RIGHT HON. LORD DESBOROUGH OF TAPLOW.**

*President of the British Olympic Council, 1908, and  
British Representative on the International Olympic Committee.*

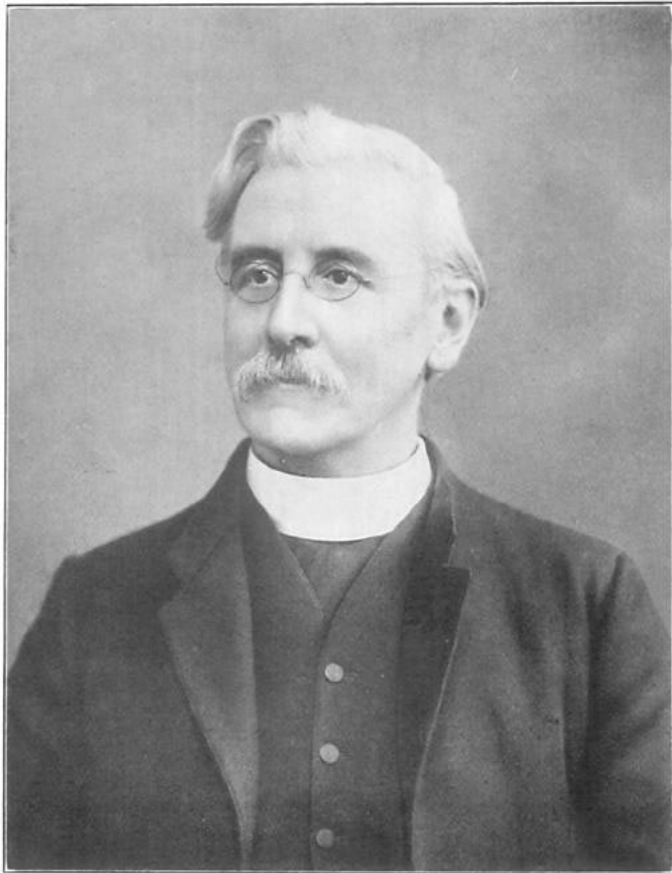

REV. R. S. DE COURCY LAFFAN.

*Hon. Secretary of the British Olympic Council, 1908, and  
British Representative on the International Olympic Committee*



## TABLE OF CONTENTS

	PAGE
PREFACE ... .. .	3
CONTENTS OF CHAPTERS ... .. .	5
LIST OF ILLUSTRATIONS ... .. .	8
THE INTERNATIONAL OLYMPIC COMMITTEE ... .. .	12
THE COUNCIL OF THE BRITISH OLYMPIC ASSOCIATION, 1908 ... .. .	13
THE COMITÉ D'HONNEUR FOR THE OLYMPIC GAMES OF 1908 IN LONDON	14
A FOREWORD AS TO ORIGINS:	
Baron Pierre de Coubertin at the Sorbonne in 1892 —The International Congress of 1894—The Revival of the Olympic Games decided—The Games of 1896 in Athens—The Invitation to hold the Games of 1908 in England ... .. .	15
CHAPTER I. PREPARATIONS :	
Lord Desborough's letter of November 27, 1906—The Agreement with the Franco-British Exhibition—The Building of the Stadium—Meeting of the International Olympic Committee at The Hague in May, 1907 ... .. .	23
CHAPTER II. GENERAL REGULATIONS FOR THE OLYMPIC GAMES OF 1908 IN LONDON ... .. .	
	29
CHAPTER III. PROGRAMME AND PRIZES OF THE OLYMPIC GAMES OF 1908 IN LONDON ... .. .	
	32
CHAPTER IV. THE OLYMPIC GAMES OF 1908 :	
Opening of the Franco-British Exhibition by H.R.H. the Prince of Wales—Visit of H.M. the King, with the President of the French Republic, to the Stadium — Opening of the Olympic Games by H.M. the King on July 13, 1908—Procession of Athletes ... .. .	45

## DETAILS OF THE COMPETITIONS :

PAGE

Archery ... ..	100
Athletics ... ..	49
Boxing ... ..	107
Cycling ... ..	113
Fencing ... ..	127
Football ... ..	173
Gymnastics ... ..	181
Hockey ... ..	197
Lacrosse ... ..	205
Lawn Tennis ... ..	209
Motor Boats ... ..	247
Polo ... ..	232
Racquets ... ..	233
Rowing ... ..	237
Shooting ... ..	254
Skating ... ..	284
Swimming ... ..	296
Tennis (Jeu de Paume) ... ..	314
Wrestling ... ..	321
Yachting ... ..	339

## CHAPTER V. THE PRIZE-LIST :

Full List of Prize Medals—Winners of Three Gold Medals—Winners of Two Gold Medals—Analysis of National Successes (1) in Athletics ; (2) in Archery, Cycling, Fencing, Gymnastics, Swimming, and Wrestling ; (3) in Lawn Tennis, Polo, Racquets, Shooting, and Tennis (Jeu de Paume) ; (4) in Motor Boats, Rowing, and Yachting ; (5) in Boxing, Football, Hockey, Lacrosse, and Skating—The Final Balance-sheet of Victories ... ..	355
---	-----

## CHAPTER VI. THE DISTRIBUTION OF GOLD MEDALS BY HER MAJESTY THE QUEEN ... ..

368

## CHAPTER VII. NOTES ON ORGANISATION :

A few Figures—The Code of Rules—Judging and International Juries—The Date of Entries—Cabled Entries—The Drawing of Heats—Equality of Olympic Representative Athletes—The Daily Programme—The Relative Value of various Divisions of the Games and different Events in them—Ideals of an Olympic Programme—Lawn Tennis, Golf, Rugby Football, Racquets, Tennis (Jeu de Paume), and Covered Court Lawn Tennis—Sculpture, Painting, Poetry, and Music—An Olympic Code of Rules for International Sport—Letters received from Official Representatives of Foreign Nations ... ..	373
--	-----



## LIST OF ILLUSTRATIONS

	FACING PAGE
THE RIGHT HON. LORD DESBOROUGH OF TAPLOW, <i>President of the British Olympic Council</i> , 1908 . . . . .	4
THE REV. R. S. DE COURCY LAFFAN, <i>Hon. Sec. of the British Olympic Council</i> , 1908 . . . . .	5
THE STADIUM ON JULY 24, 1908 . . . . .	12
PLAN OF THE STADIUM . . . . .	13
REVERSE OF THE OLYMPIC PRIZE MEDAL FOR THE GAMES OF 1908 . . . . .	20
OBVERSE OF THE OLYMPIC PRIZE MEDAL, (PERMANENT DESIGN) . . . . .	20
OBVERSE OF THE OLYMPIC COMMEMORATION MEDAL (PERMANENT DESIGN)	21
REVERSE OF THE OLYMPIC COMMEMORATION MEDAL FOR THE GAMES OF 1908	21
PRIZE DIPLOMA . . . . .	28
DIPLOMA OF MERIT . . . . .	29
KING EDWARD VII. OPENING THE OLYMPIC GAMES, JULY 13, 1908 . . . . .	48
REPRESENTATIVES OF THE UNITED KINGDOM IN THE PARADE OF ATHLETES ON JULY 13, 1908 . . . . .	49
NORWEGIAN AND SWEDISH TEAMS IN THE PARADE OF ATHLETES ON JULY 13, 1908 . . . . .	49
ATHLETICS—	
R. KERR (CANADA) WINNING THE 200 METRES . . . . .	64
START FOR THE 1,500 METRES FINAL . . . . .	64
M. W. SHEPPARD (U.S.A) WINNING THE 1,500 METRES . . . . .	64
F. C. SMITHSON (U.S.A.) WINNER OF THE 110 METRES HURDLES IN 15 SECONDS . . . . .	64
C. J. BACON (WINNER) AND R. L. HILLMAN (BOTH U.S.A.) IN THE 400 METRES HURDLES . . . . .	65
THE WATER JUMP IN THE STEEPLECHASE . . . . .	65
E. R. VOIGT (U.K.) WINNER OF THE FIVE MILES . . . . .	65
START OF THE 3,500 METRES WALKING RACE . . . . .	65
THE MARATHON RACE. H.R.H. THE PRINCESS OF WALES AT THE START AT WINDSOR . . . . .	80
THE MARATHON RACE. No. 19 (DORANDO) COMING THROUGH WILLESDEN . . . . .	80
THE MARATHON RACE. No. 26 (HAYES, U.S.A., THE WINNER) AT WILLESDEN . . . . .	80



ATHLETICS	<i>(continued)</i> —	FACING PAGE
THE MARATHON RACE. No. 8 (C. HEFFERON, OF SOUTH AFRICA, WHO WON SECOND PRIZE) COMING THROUGH RUISLIP . . . . .		80
R. C. EWRY (U.S.A.) WINNING THE STANDING HIGH JUMP . . . . .		81
F. C. IRONS (U.S.A.) WINNING THE RUNNING BROAD JUMP . . . . .		81
A. C. GILBERT (U.S.A.) TIED FOR FIRST PLACE IN THE POLE JUMP . . . . .		81
FLANAGAN'S HAMMER (U.S.A.) . . . . .		81
RALPH ROSE (U.S.A.) PUTTING THE WEIGHT . . . . .		96
THE UNITED KINGDOM TEAM (CITY OF LONDON POLICE), WINNERS IN THE TUG OF WAR . . . . .		96
WILSON, ROBERTSON, DEAKIN, AND COALES (ALL U.K.) WINNING THE FIRST HEAT OF THE 3-MILE TEAM RACE . . . . .		97
MARTIN SHERIDAN (U.S.A.), WINNER OF THE DISCUS (GREEK STYLE)		97
ARCHERY—TARGETS IN THE RAIN . . . . . 112		
MISS Q. NEWALL (U.K.), WINNER OF THE NATIONAL ROUND . . . . .		113
W. DOD (U.K.), WINNER OF THE YORK ROUND . . . . .		113
BOXING—		
A. L. OLDMAN (U.K.), WINNER OF THE HEAVY WEIGHTS . . . . .		128
J. W. H. T. DOUGLAS (U.K.), WINNER OF THE MIDDLE WEIGHTS . . . . .		128
CYCLING —		
START OF THE 100 KILOMETRES . . . . .		129
FINISH OF THE 100 KILOMETRES. WON BY C. H. BARTLETT (U.K.) . . . . .		129
THE FINAL OF THE 20 KILOMETRES . . . . .		144
SCHILLES AND AUFRAY (FRANCE), WINNERS OF THE TANDEM RACE . . . . .		144
FENCING—		
ALIBERT (FRANCE), WINNER OF THE INDIVIDUAL EPÉE . . . . .		145
THE HUNGARIANS, WINNERS OF THE SABRE-TEAM COMPETITION . . . . .		145
FOOTBALL—THE UNITED KINGDOM ELEVEN, WINNERS OF THE ASSOCIATION'S CHALLENGE TROPHY . . . . . 160		
GYMNASTICS—		
FRANCE IN THE TEAM COMPETITION . . . . .		16
EXERCISES BY THE DANISH LADIES . . . . .		161
DISPLAY BY THE DANISH LADIES . . . . .		176
DISPLAY BY THE POLYTECHNIC LADIES . . . . .		176
HOCKEY—		
FRANCE <i>v.</i> ENGLAND. THE ENGLISH CAPTAIN RUNS DOWN THE FIELD		177
GERMANY <i>v.</i> SCOTLAND. THE SCOTCH SCORE A GOAL . . . . .		17

LACROSSE—	FACING PAGE
CANADA <i>v.</i> THE UNITED KINGDOM. THE CANADIAN CAPTAIN GETS THE BALL, . . . . .	192
THE CANADIAN WINNERS CHEERING THE UNITED KINGDOM . . . . .	192
 LAWN TENNIS (GRASS)—	
R. F. DOHERTY AND G. W. HILLYARD (U.K.) WIN THE DOUBLES AGAINST M. J. G. RITCHIE AND J. C. PARKE (U.K.) . . . . .	193
O. FROITZHEIM (GERMANY), SILVER MEDAL IN THE SINGLES . . . . .	208
MRS. LAMBERT CHAMBERS (U.K.) WINS THE GOLD MEDAL, (LADIES' SINGLES) <i>v.</i> MISS D. BOOTHBY (U.K.) . . . . .	208
 MOTOR BOATS—	
“WOLSELEY-SIDDELEY” (STEERED BY THE DUKE OF WESTMINSTER) <i>v.</i> “DYLAN” (STEERED BY LORD HOWARD DE WALDEN) . . . . .	209
“WOLSELEY-SIDDELEY” IN HEAVY WEATHER . . . . .	209
 POLO—THE WINNING TEAM (ROEHAMPTON, U.K.) : C. MILLER, P. W. NICKALLS, G. MILLER, H. WILSON . . . . .	
	224
 ROWING—	
THE FINISH OF THE OLYMPIC COURSE AT HENLEY . . . . .	225
BLACKSTAFFE WINS THE SCULLS AGAINST MCCULLOCH AT HENLEY . . . . .	240
LEANDER (ON THE OUTSIDE) <i>v.</i> HUNGARY . . . . .	240
LORD DESBOROUGH'S SPEECH AT THE OLYMPIC PRIZE-GIVING AT HENLEY . . . . .	241
 SHOOTING—	
C. J. RUNDBERG (SWEDEN), WHO MADE 17 BULLS (INCLUDING TWO SIGHTERS) AT 500 YARDS . . . . .	256
MAURICE BLOOD (U.K.) . . . . .	256
THE AMERICAN TEAM (WITH GENERAL DRAIN), WINNERS OF THE TEAM COMPETITION . . . . .	257
THE REVOLVER AND PISTOL COMPETITION AT BISLEY . . . . .	257
THE UNITED KINGDOM TEAM AT THE 1,000 YARDS RANGE IN THE TEAM COMPETITION . . . . .	272
THE UNITED KINGDOM TEAM (No. 1) IN THE CLAY-PIGEON TEAM COMPETITION . . . . .	273
 SKATING—	
MR. AND MRS. SYERS (U.K.) . . . . .	288
SALCHOW (SWEDEN) . . . . .	288
HERR BURGER AND FRÄULEIN HÜBLER (GERMANY) . . . . .	289
PANIN (RUSSIA) . . . . .	289

SWIMMING—	FACING PAGE
START OF THE 200 METRES BREAST-STROKE FINAL . . . . .	304
WATER POLO FINAL. BELGIUM <i>v.</i> UNITED KINGDOM . . . . .	305
THE UNITED KINGDOM WATER POLO TEAM, WINNERS . . . . .	305
SPANDBERG (SWEDEN) IN THE HIGH DIVE . . . . .	320
TAYLOR (U.K.) WINNER OF THE TEAM RACE . . . . .	320
 WRESTLING—	
Y. SAARELA (FINLAND) <i>v.</i> W. WECKMAN (FINLAND) IN THE GRÆCO— ROMAN LIGHT HEAVY WEIGHTS. . . . .	321
RELWYSKOW (U.K.) <i>v.</i> BACON (U.K.) IN THE CATCH-AS-CATCH-CAN MIDDLE WEIGHTS . . . . .	321
 YACHTING—	
THE COMMITTEE ON BOARD THE STEAM YACHT OF THE COMMODORE OF THE CLYDE CORINTHIAN Y.C. . . . .	352
THE CREW OF THE WINNING "COBWEB" RYDE . . . . .	352
"HERA" AND "MOUCHETTE" ON THE CLYDE . . . . .	353
THE "COBWEB" WINNING AT RYDE . . . . .	353
THE DUCHESS OF WESTMINSTER DISTRIBUTING THE DIPLOMAS OF SPECIAL MERIT, JULY 25, 1908 . . . . .	368
LIEUTENANT HALSWELLE (U.K.) RECEIVING HIS GOLD MEDAL FROM QUEEN ALEXANDRA, WITH DIPLOMAS AND OAK-LEAVES, FOR THE 400 METRES, JULY 25, 1904 . . . . .	368
THE CHALLENGE CUPS PRESENTED IN 1908 FOR RACES IN THE OLYMPIC GAMES . . . . .	368
THE NORTH END OF THE STADIUM, JULY 24, 1908 . . . . .	368
QUEEN ALEXANDRA PRESENTS DORANDO WITH A GOLD CUP, JULY 25, 1908	369
AFTER WALKER'S VICTORY IN THE 100 METRES FLAT . . . . .	369
KERR OF CANADA CHEERED AFTER WINNING THE 200 METRES FLAT . . . . .	369
T. S. BATTERSBY (U.K.) IN THE RACE FOR THE 1,500 METRES SWIMMING.	384
G. C. O'KELLY (U.K.), WINNER OF THE CATCH-AS-CATCH-CAN HEAVY WEIGHTS	384
B. JONES (U.K.), WINNER OF THE 5,000 METRES CYCLING . . . . .	385
C. B. KINGSBURY (U.K.), WINNER OF THE 20 KILOMETRES CYCLING . . . . .	385
A. RUSSELL (U.K.) WINNING THE 3,200 METRES STEEPLECHASE . . . . .	400
THE WINNING TEAM IN THE CLAY BIRD SHOOTING . . . . .	400
R. GUNN (U.K.), WINNER OF THE FEATHER WEIGHT BOXING . . . . .	401
LIEUT. -COL. MILNER (U.K.), WINNER OF THE 1,000 YARDS RIFLE SHOOTING	401
VANE PENNELL (U.K.), WINNER OF THE RACQUETS DOUBLES . . . . .	416
E. V. LEMMING (SWEDEN), WINNER OF THE JAVELIN . . . . .	416
DESIGN BY A. S. COPE, A.R.A., FOR THE FOIL-DISPLAY PROGRAMME . . . . .	417
OFFICIAL MAP OF THE MARATHON RACE-COURSE . . . . .	432
HEFFERON'S PRIZE-TICKET . . . . .	433
PLAN AND SECTION OF THE FENCING GROUND . . . . .	433
BADGES USED IN THE OLYMPIC GAMES . . . . .	448
THE INTERNATIONAL FENCING CHALLENGE CUP . . . . .	449

## INTERNATIONAL OLYMPIC COMMITTEE.

*President* : M. LE BARON PIERRE DE COUBERTIN.

ARGENTINE	...	...	...	MANUEL DE LA QUINTANA.
AUSTRALIA	...	...	...	R. COOMBES.
AUSTRIA...	...	...	...	LE PRINCE ALEXANDRE DE SOLMS BRAUNFELS.
BELGIUM	...	...	...	LE COMTE H. DE BAILLET-LATOUR.
BOHEMIA	...	...	...	LE DR. JIRI GUTH.
BULGARIA	...	...	...	Son Exc. E. N. TZOKOW.
CANADA	...	...	...	
DENMARK	...	...	...	LE CAPITAINE GRUT.
FINLAND	...	...	...	LE BARON REINHOLD VON WILLEBRAND.
FRANCE	...	...	...	M. HEBRARD DE VILLENEUVE. LE COMTE ALBERT DE BERTIER DE SAUVIGNY. M. E. CALLOT.
GERMANY	...	...	...	LE GENERAL COMTE VON DER ASSEBURG.* LE COMTE C. WARTENSLEBEN. LE DR. W. GEBHARDT.
GREECE	...	...	...	LE COMTE ALEX. MERCATI.
HOLLAND	...	...	...	LE BARON F. DE TUYLL.
HUNGARY	...	...	...	LE COMTE GEZA ANDRASSY.
ITALY	...	...	...	LE COMTE BRUNETTA D'USSEAUX. LE PRINCE SCIPION BORGHESE.
MEXICO	...	...	...	MIGUEL DE BEISTEGUI.
NORWAY	...	...	...	LE CAPITAINE J. SVERRE.
PERU	...	...	...	SEÑOR DON CARLOS F. DE CANDAMO.
PORTUGAL	...	...	...	LE DR. DE LANCASTRE.
RUSSIA	...	...	...	LE COMTE DE RIBEAUPIERRE. LE PRINCE SIMON TROUBETZKOY.
SOUTH AFRICA	...	...	...	
SPAIN	...	...	...	LE COMTE DE MEJORADA DEL CAMPO. MARQUIS DE VILLAMEJOR.
SWEDEN	...	...	...	LE COLONEL BALCK. LE COMTE CLARENCE VON ROSEN.
SWITZERLAND...	...	...	...	LE BARON GODEFROY DE BLONAY.
TURKEY	...	...	...	
UNITED KINGDOM	...	...	...	LORD DESBOROUGH. REV. R. S. DE COURCY LAFFAN†
UNITED STATES	...	...	...	PROFESSOR W. M. SLOANE.

*Sec. Gen.* : LE COMTE BRUNETTA D'USSEAUX.

\* Recently deceased.

† The late Sir Howard Vincent was also a member for the United Kingdom. He took the Chair at the last day's meeting of The Hague Conference in 1906, and served on the British Olympic Council throughout its deliberations in 1907.



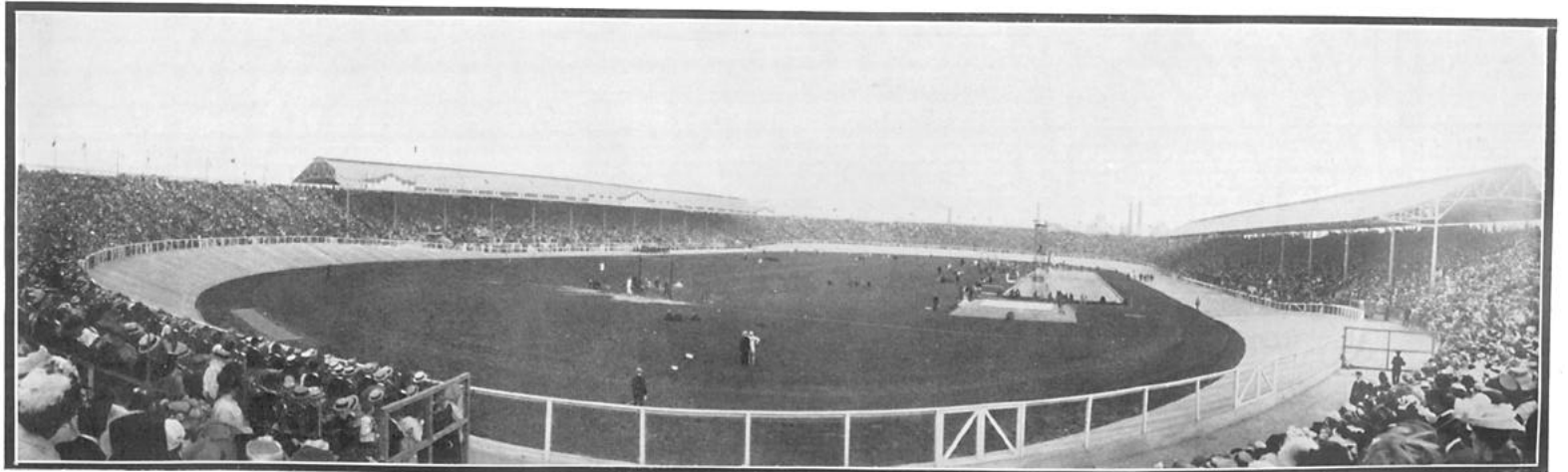

THE STADIUM ON JULY 24, 1908.

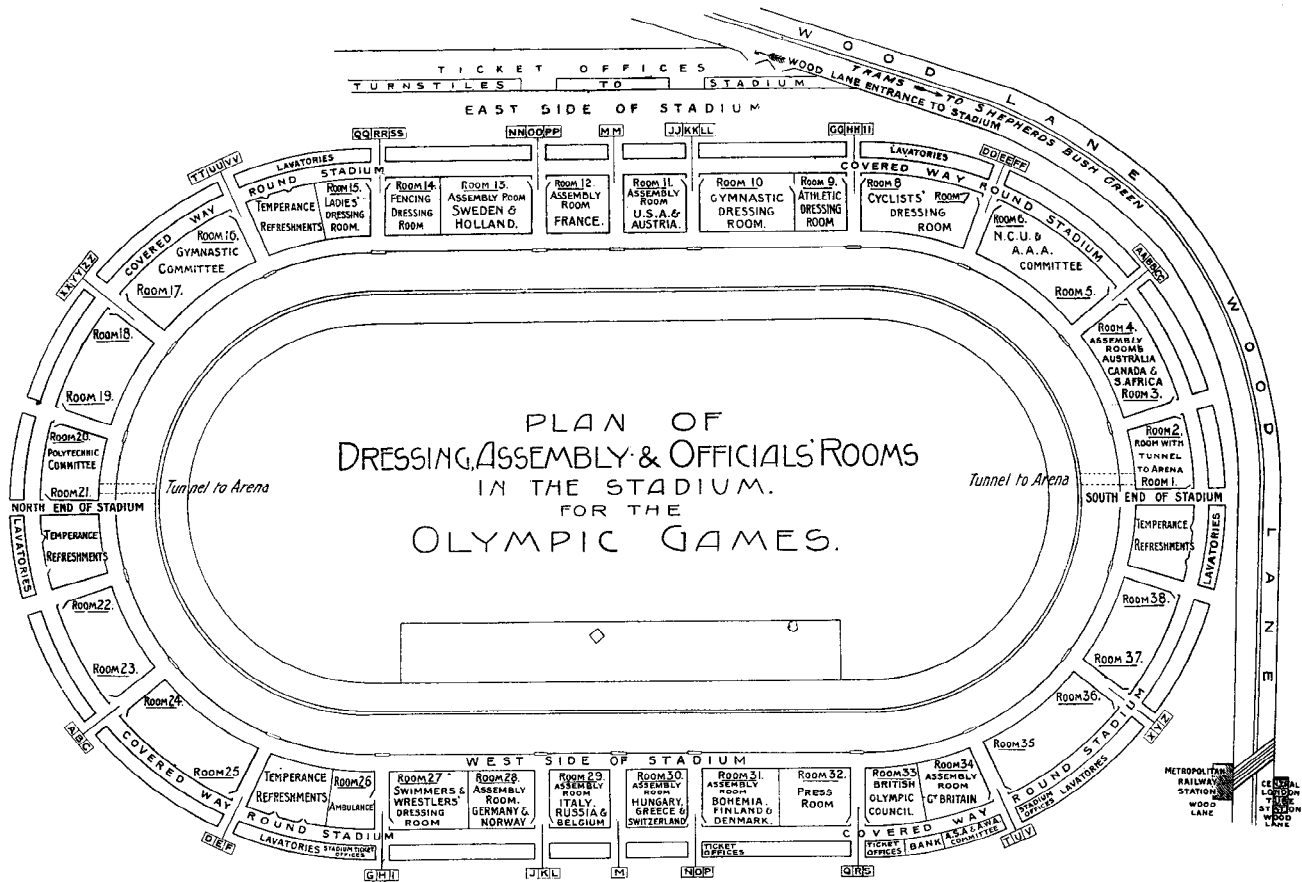

ENTRANCE GATES FROM FRANCO-BRITISH EXHIBITION

PLAN OF THE STADIUM.

## COUNCIL OF THE BRITISH OLYMPIC ASSOCIATION, 1908.

---

*Chairman* : Rt. Hon. LORD DESBOROUGH of Taplow, K.C.V.O., Ex-President, Oxford University Boat Club ; Ex-President, Oxford University Athletic Club ; Member of the International Olympic Committee.

Rt. Hon. LORD MONTAGU of Beaulieu, Automobile Club.

Maj. -Gen. Rt. Hon. LORD CHEYLESMORE, C.V.O., Chairman of Council, National Rifle Association.

Sir LEES KNOWLES, Bart., Ex-President, Cambridge University Athletic Club.

F. P. ARMSTRONG, Esq., Chairman, Motor Yacht Club.

H. BENJAMIN, Esq., Ex-President, Amateur Swimming Association.

E. A. BIEDERMANN, Esq., Hon. Sec., Tennis and Racquets Association.

J. BLAIR, Esq., Scottish Cyclists' Union.

T. W. J. BRITTEN, Esq., Hon. Treas., National Cyclists' Union.

MICHAEL J. BULGER, Esq., M.D., Irish Amateur Athletic Association,

GUY M. CAMPBELL, Esq., F.R.G.S.

THEODORE A. COOK, Esq., F.S.A., Amateur Fencing Association.

Lt. -Col. C. R. CROSSE, Sec., National Rifle Association.

J. H. DOUGLAS, Esq., President, Amateur Boxing Association.

D. S. DUNCAN, Esq., Hon. Sec., Scottish Amateur Athletic Association.

W. HAYES FISHER, Esq., President, National Skating Association.

P. L. FISHER, Esq., Hon. Sec., Amateur Athletic Association.

Major F. EGERTON GREEN, Hurlingham Club.

R. G. GRIDLEY, Esq., Hon. Sec., Amateur Rowing Association.

F. B. O. HAWES, Esq., Hon. Sec., Lacrosse Union.

W. HENRY, Esq., Hon. Sec., Royal Life Saving Society.

G. ROWLAND HILL, Esq., Past President, Rugby Football Union.

Capt. A. HUTTON, F.S.A., President, Amateur Fencing Association.

W. J. LEIGHTON, Esq., M. B., Vice-President, Irish Amateur Swimming Association.

E. LAWRENCE LEVY, Esq., Hon. Sec., Amateur Gymnastic Association.

G. R. MEWBURN, Esq., Hon. Sec., Lawn Tennis Association.

Col. G. M. ONSLOW, National Physical Recreation Society.

E. J. O'REILLY, Esq., Irish Cyclists' Association.

W. RYDER RICHARDSON, Esq., Hon. Sec., Amateur Golf Championship Committee.

G. S. ROBERTSON, Esq., British Representative Juror at Olympic Games of Athens, 1906.

C. NEWTON ROBINSON, Esq., Yacht Racing Association.

B. HECKSTALL SMITH, Esq., Sec., Yacht Racing Association.

A. E. STODDART, Esq., Sec., Queen's Club.

E. H. STONE, Esq., Sec., The Clay Bird Shooting Association.

A. H. SUTHERLAND, Esq., Chairman, Amateur Wrestling Association.

E. SYERS, Esq., Hon. Sec., Figure Skating Club.

H. M. TENNENT, Esq., Hon. Sec., Hockey Association.

F. J. WALL, Esq., F.C.I.S., Sec., Football Association.

Col. H. WALROND, Hon. Sec., Royal Toxophilite Society.

*Honorary Secretary* : Rev. R. S. DE COURCY LAFFAN, Member of International Olympic Committee, 108 Victoria Street, Westminster, London, S. W.

*Assistant Secretary* : Captain F. WHITWORTH JONES.

## COMITÉ D'HONNEUR FOR THE OLYMPIC GAMES OF 1908 IN LONDON.

<i>Country.</i>	<i>Name.</i>
AUSTRALIA ... ..	DR. W. CAMAC WILKSON. WM. HILL.
AUSTRIA ... ..	CHAS. CAMPBELL. DR. GUSTAV MAGG. H. ROBERT DEUTSCH.
BELGIUM ... ..	FELIX GRAF. BARON DE LAVELEYE. O. GREGOIRE.
BOHEMIA ... ..	A. FEYERICK. F. VAN DEN CARPUT. COUNT DR. FRANKISCH VON LÜTZOW.
CANADA ... ..	DR. KAREL GRÖS. CAPT. A. WENTWORTH FORBES. T. L. RÖSSLER OŘOVSKY.
DENMARK ... ..	LESLIE BOYD. WM. STARK. J. H. CROCKER. EMMANUEL TASSÉ.
FINLAND ... ..	CAPT. FRITZ HANSEN. IVAR NYHOLM. CAPT. H. H. BONDO. COL. S. O. MEYER.
FRANCE ... ..	AXEL FREDRIK LONDEN. GOSTA WASENIUS. FREDERIK HACKMAN.
GERMANY ... ..	D. MÉRILLON. GENERAL BRUGÈRE. D. CHARCOT.
GREECE ... ..	GEN. COUNT VON DER ASSEBURG. DR. P. MARTIN. P. JOSEPH MÜLLER.
HOLLAND ... ..	SPYRIDION LAMBROS. MILTIADES NEGROPONTES' ANASTASE METAXAS.
HUNGARY ... ..	F. CREMER. J. P. CROMMELIN. F. H. VAN DER ROYEN.
ITALY ... ..	JULES DE MUZSA. DÉSIRÉ LAUBER. ALFRED BRÜLL.
NORWAY ... ..	MARQUIS COMPANS DE BRICHANTEAU' MARQUIS CHAS. COLLOBRINI' PRINCE SCIPIO BORGHESE'
RUSSIA ... ..	CAPTAIN GRÖTTUM. A. FRISCH. CAPT. BENTZEN.
SOUTH AFRICA ... ..	COUNT DE RIBEAUPIERRE' NICOLAS DE BABINE. CHAS. DE PETION.
SWEDEN ... ..	SIDNEY FARRER. C. IMROTH. E. C. REYNOLDS.
SWITZERLAND ... ..	J. P. TAYLOR. J. S. EDSTRÖM. D. F. BURMAN. FRED. LÖWENADLER.
UNITED STATES OF AMERICA	WALTHER DE BONSTETTEN. MARCEL GUINAND. MAXIME DE STOUTZ. J. E. SULLIVAN. BARTOW S. WEEKS. GUSTAVUS T. KIRBY. GEN. J. A. DRAIN.



## A FOREWORD AS TO ORIGINS.

---

SINCE the Olympic Games of 1908 in London were held by the sanction of the International Olympic Committee, it will be appropriate to begin this Report by a brief sketch of the origin of this Committee and of the development by its President, Baron Pierre de Coubertin, of that revival of the Olympic Games of ancient Hellas which has seen its latest manifestation in this country.

For the past twenty-one years Baron de Coubertin has been deeply interested in the problems of national education, both in its widest sense and in its most patriotic application.\* His admiration had been early aroused by the system of public school life of which Arnold of Rugby was our first great exemplar. He visited Rugby School, and he travelled also to Much Wenlock, in Shropshire, where he foregathered with an ardent sympathiser with his ideals, the late Dr. W. P. Brookes. He was not without honour even in his own country, for his earliest prophecies were welcomed by such men as Count Jacques de Pourtalès and Dr. Jean Charcot, by M. Hébrard de Villeneuve and M. Paschal Grousset ('Philippe Daryl'), who warmly urged the renaissance of that royal ball-game which the whole of Europe owes to France, court tennis, or the 'Jeu de Paume,' a game inextricably interwoven with some of the most dramatic moments of French history. He took a large part also from the year 1891 in persuading French crews to attend Henley Regatta, and the fact that M. Waddington, then French Ambassador at the Court of St. James's, was an old Cambridge Blue no doubt assisted the negotiations on both sides of the Channel which closed in the agreement signed by S. Le Blanc Smith for the Amateur Rowing Association and by Pierre de Coubertin for the Union des Sociétés Françaises de Sports Athlétiques. Soon afterwards a member of the Cercle de l'Aviron in Paris won a heat of the Diamond Sculls, and a French crew beat an eight from the London Rowing Club on the Seine at Andrésy. In July, 1893, French crews were competing at Henley Regatta.

\* *Les Batailles de l'Education Physique. Une Campagne de Vingt-et-un Ans (1887-1908). Par Pierre de Coubertin. Paris, 1909.*

But Baron de Coubertin soon realised that to give sport a really national popularity in France he would be obliged to give it a thoroughly international aspect, and to induce his own countrymen to improve their methods by bringing them into contact with the athletes of other nations which had practised sport for a much longer period. By that very realisation he was brought face to face with the first system in the world's history which had solved the same problem by similar methods—the system of the Olympic Games of Ancient Hellas. He was yet more attracted—at first, perhaps, unconsciously—to the same order of ideas by the passionate interest evoked in his mind by the ruins of Olympia in Elis. He saw in them the traces of a vast manufactory of virile forces trained by the Greek nation for the highest purposes of national endeavour. Germany had dug them from the dust of ages and exhumed the material relics of classical antiquity. It remained for France to give them life, to revive their splendours in a form at once the most permanent and the most picturesque, by adapting the best of their traditions to the needs of modern civilisation in a Renaissance of the Olympic Games.

The first public utterance of the idea that had just germinated in his heart and mind was made on November 25, 1892, at a meeting of the Union des Sports Athlétiques in the Sorbonne.

'Let us export,' said M. de Coubertin, 'our oarsmen, our runners, our fencers into other lands. That is the true Free Trade of the future ; and the day it is introduced into Europe the cause of Peace will have received a new and strong ally. It inspires me to touch upon the further step I now propose, and in it I shall ask that the help you have given me hitherto you will extend again, so that together we may attempt to realise, upon a basis suitable to the conditions of our modern life, the splendid and beneficent task of reviving the Olympic Games.'

The arrow had been shot into the air. For some time no result seemed likely to follow. In 1894, however, an International Congress was organised in Paris to 'discuss and disseminate the true principles of amateur sport,' and in its preparation three gentlemen were chiefly concerned : C. Herbert, Secretary of our own Amateur Athletic Association, Professor Sloane, of Princeton, U.S.A., and Baron de Coubertin. Need I add that the eighth subject mentioned in the agenda paper referred to the possibility of reviving the Olympic Games?

On January 15, 1894, M. de Coubertin sent round a circular to all the athletic associations containing the following sentences :—

Before all things it is necessary that we should preserve in sport those characteristics of nobility and chivalry which have distinguished it in the past, so that it may continue to play the same part in the education of the peoples of to-day as it played so admirably in the days of Ancient Greece. Imperfect humanity has ever tended to transform the Olympic athlete into the paid

gladiator. But the two things are incompatible. We must choose between one formula and the other. . . . Reform is necessary, and must be discussed before we undertake it. There are compromises and there are contradictions in the amateur regulations of the present day which it will be the business of this Congress to consider. And the last subject on the agenda paper is the request that you will sanction, if not the realisation, at any rate the preparation of an international agreement that will revive the Olympic Games under modern conditions, so that every four years the athletic representatives of the world may be brought together and that the spirit of international comity may be advanced by the celebration of their chivalrous and peaceful contests.

Sir John Astley welcomed, at a dinner at the Sports Club, the prophet of the new era, in February of the same year. The Prince of Wales and the Rt. Hon. Arthur Balfour signified their approval. A visit to America had made sure, if not of active support, at least of benevolent neutrality. Sweden was the first country, through her enthusiastic protagonist, Colonel Victor Balck, to promise full support and to claim for Stockholm the honour of the first revival of the Games. The Crown Prince accepted the offer of honorary membership of the Congress to be held in June. Lieutenant Bergh and Lieutenant Drakenberg were appointed representatives of Sweden. The Duke of Sparta and the King of the Belgians gave their adhesion too. In France the Duc d'Aumale, the Baron de Courcel, and others were ready with sympathy or practical assistance.

The Congress was opened in June, 1894, in the amphitheatre of the Sorbonne by the performance of the Hymn to Apollo just discovered in the ruins of Delphi, and transcribed for the purpose by Théodore Reinach and Gabriel Fauré. Among the delegates present, besides those already mentioned, were Mr. Todd, for our National Cyclists' Union, M. Bikelas, of the Pan-hellenic Gymnastic Society, and M. Michel Bréal, who offered a cup for the Marathon Race that was to be the first of so many historic races afterwards. By its unanimous vote the Congress decided upon the revival of the Olympic Games and the institution of the International Olympic Committee. But one step remained: the choice of the first city in which the new series should begin its celebration. M. de Coubertin proposed Athens. M. Bikelas warmly welcomed the suggestion. Both turned to the task of organising the First Olympiad in the next two years, for it was agreed to fix the date for 1896.

Encouraged by the welcome given to their projects by the King of Greece and the Duke of Sparta, M. Bikelas and M. de Coubertin went to Athens in the autumn of 1894, and immediately realised that in the legacy left to the State by the Brothers Zappas they would find a nucleus for the organisation they desired. This legacy provided for the erection of a building called the Zappeion, in which physical exercises were to take place from time to time, the expenses being paid from the trust fund left in charge

of a committee. Evidently this Committee offered possibilities. Some difficulty was at first created by the antipathetic attitude of the Prime Minister ; but eventually M. de Coubertin's persistence triumphed. Public interest was aroused. M. Antonopoulo ardently supported the movement. M. Alexandre Mercati, who afterwards became Secretary of the Organising Committee, was a warm ally. Eventually the Prime Minister authorised the Committee of the Zappeion to lend its aid in the necessary organisation ; and the Duke of Sparta reconstituted the Committee with that object. appointing his brothers. Prince George and Prince Nicholas, presidents of two sub-committees.

In the public subscription that followed, M. Averoff, of Alexandria, eclipsed all precedents by promising a million drachmas for the rebuilding of the ancient Stadium.

It is not the province of this record to say more of the games of 1896 in Athens, of 1900 in Paris, or of 1904 in St. Louis, except to point out that they were the regular and official developments in the chain which led to the Games of 1908 in London, and will now be carried on to those of 1912.

After the first games in Athens were over, M. de Coubertin, as President of the International Olympic Committee, had a long interview with the Crown Prince of Greece. The suggestion had been made that all the Games in future should be held in the magnificent Stadium of white marble built by the generosity of M. Averoff upon the ancient site. But there were difficulties in the way of this, which intimately concerned the wider international developments of the scheme as supported by the International Olympic Committee, M. de Coubertin therefore suggested\* that a fresh series of Games, taking place at regular intervals between those of the original and official series, should be arranged every four years in Athens. He found that the same idea had occurred to the Crown Prince. It commended itself to everyone. The Athenian Games of 1906, which will be repeated in 1910, were its subsequent result ; and in the initiation and development of the London meeting two years later that most successful festival in Athens bore a large part; for in the English fencing-team which was present in Athens for the Tournament Lord Desborough was a distinguished member, and he was also the First British Representative appointed by His Majesty's Government for the Games in Athens. King Edward VII. with Queen Alexandra and the Prince and Princess of Wales were also in Athens on the same auspicious occasion. It was therefore with every prospect of success that the suggestion was made that the Games of 1908 should be celebrated in England.

\* See '*Une Campagne de Vingt-et-un Ans.*,' p. 128.



MEMBER OF THE  
WINNER OF FIRST PRIZE FOR  
AT THE OLYMPIC GAMES LONDON 1908.

*Isobrough*

PRESIDENT OF THE  
BRITISH OLYMPIC COUNCIL.

THOMAS BURNETT  
LONDON

OLYMPIC GAMES • LONDON • 1908

DIPLOMA

OF MERIT

AWARDED TO  
FOR  
BY THE BRITISH OLYMPIC COUNCIL  
PRESIDENT

*John Borwick*

Bernard Pictorigo

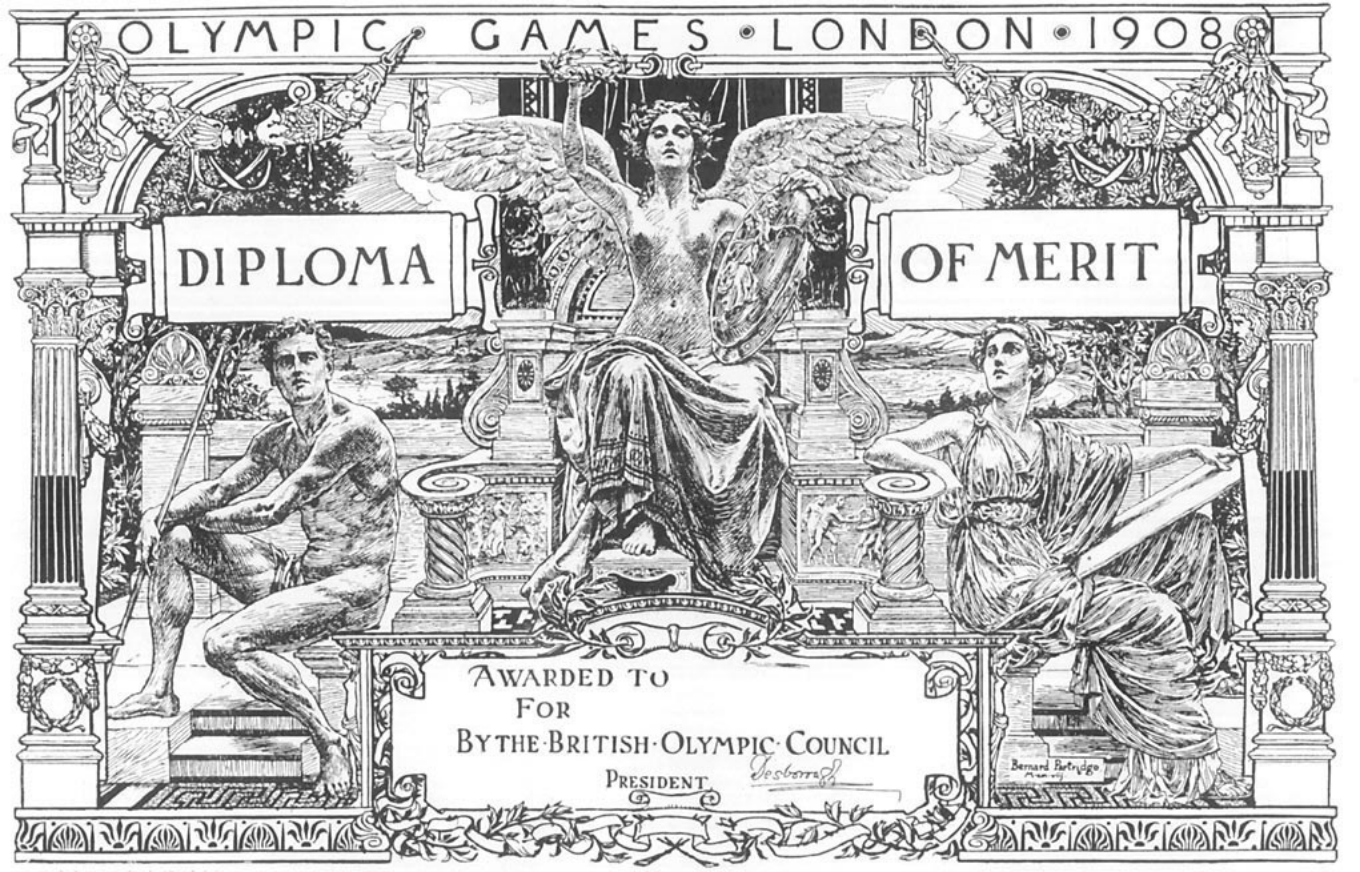

Lord Desborough was able to carry out that suggestion, not only because of the personal influence he possessed, but also because the Central Organisation from which the management of these games might be created had already come into existence in this country.

In 1904 the International Olympic Committee held its Congress in London, for which preparations were made by the late Sir Howard Vincent and the Rev. R. S. de Courcy Laffan. The King granted his gracious patronage, and the Prince of Wales received the members in Marlborough House. The sittings of Congress took place in the Mansion House, where the Lord Mayor gave a state luncheon in honour of the occasion. Among other arrangements then discussed was the proposal to hold the games of 1908 in Rome. But the most important result of the Congress, as far as concerns the immediate subject of this report, was the foundation of the British Olympic Association at a meeting held in the House of Commons in May, 1905, when Mr. W. H. Grenfell, M.P., now Lord Desborough, was elected chairman. The Association was represented at the Brussels Conference on Physical Education, held in June 1905, at the Conference held in the Comédie Française in Paris in May 1906, and it was instrumental in raising funds for assisting English competitors to attend the Athenian Games of 1906.

It was therefore with a certain amount of material to work upon that Lord Desborough returned from Athens in 1906 with the proposal that in the next two years this country should organise an International Athletic Meeting, for which Paris and St. Louis had not found four years too long a period. But what Athens had accomplished in 1896, when in two years she gave the world the first revival of the Olympic games upon her classic soil, London in her turn determined to attempt. I cannot do better than leave Lord Desborough himself to describe the position in the words he published, during the summer of 1908 in the *National Review*. They are as follows :—

The Olympic Games of 1908 had been fixed to take place at Rome, but some unexpected difficulties prevented the Italian Committee from carrying out their intention, and at the celebration of the Athenian Olympic Games in 1906 (a festival of a separate cycle organised by Greece to take place in their magnificent stadium) a meeting of the International Committee was held, and I was asked whether I thought it possible for the games to be held in London in 1908 instead of at Rome. An organisation already existed in the British Olympic Association which had been formed, with others representing each of the countries acting together, under Baron de Coubertin's scheme, and upon my return to England I addressed a letter to the great athletic and sporting associations in England, asking whether they would approve of holding the games in England and give their assistance. The answers received being entirely favourable, the British Olympic Council was formed by the election of delegates accredited by each of these great organisations, and it was decided

to accept the invitation given at Athens by the International Olympic Committee to hold the Olympic Games of 1908 in this country.

The undertaking, in any case arduous, was made more difficult by the shortness of the time at our disposal. Less than two years is a brief space in which to organise an international meeting for which, in view of the correspondence necessary with foreign countries, the ordinary period of four years has been found none too long. But we were extremely fortunate in having for our honorary secretary the Rev. R. S. de Courcy Laffan, a friend of Baron Pierre de Coubertin, whose energy and enthusiasm he shares. Whatever success attended our undertaking must be largely due to that gentleman, and to the loyal help accorded to us by the delegates of the various sporting and athletic associations composing our Council. The work has been enormous, as will be realised when it is stated that there are more than twenty separate competitions, and that for each of these separate books of rules have been drawn up, translated into French and German, and circulated in each of the competing countries. The organisation of the games themselves, the definition of the amateur qualification, the framing of the programme, the fixing of the number of competitors for each event, were all matters which have involved great thought and labour. The definition of the word 'country' also presented questions of no small difficulty. It was impossible to ignore the Olympic Games which had gone before, and the territories which had been given separate representation on the International Olympic Committee. The definition of the word 'country,' therefore, in the general regulations governing the Olympic Games, is that a 'country' is 'any territory having separate representation on the International Olympic Committee; or where no such representation exists, any territory under one and the same sovereign jurisdiction.' In Regulation 20, also, it is stated that 'Where two or more countries form part of the same sovereign state, a natural-born or fully-naturalised subject or citizen of that sovereign state may represent as competitor in the Olympic Games, either the country in which he was born, or that in which he habitually resides.'

It cannot be maintained that this is an ideal definition; it is rather one which has been thrust upon the British Olympic Council by what has already taken place in the past history of the Olympic movement.

Much, however, has been accomplished by devolution. For example, in Great Britain all the competitions in the Stadium and elsewhere were under the absolute control of the different athletic and sporting associations representing the particular sport concerned, which was responsible for their management. Similarly, with foreign countries and the colonies, each of these has an Olympic Committee of its own which is responsible for the teams representing their country. These committees forwarded the entries of competitors to the British Olympic Council, and individual entries were not accepted.

It is a well-known and generally accepted maxim of English life that undertakings such as these shall be carried out by private enterprise, and without help of any sort from the government, a distinction which other nations do not share. The British Olympic Council, therefore, had to depend absolutely upon its own efforts and upon the support of the friends of the Olympic movement, for means to fulfil its responsibilities. Those responsibilities were neither few nor light. We felt that in the country which may almost be called the mother land of athletics and sport every effort should be made to make the games worthy of the occasion and of the place where they were held. . . .

The British Olympic Council were most fortunate in the co-operation of the executive of the Franco-British Exhibition, which enabled them to provide an arena for the games which is the largest and most convenient yet constructed, and possesses several new features. It consists of a central oval of turf 700 ft.



long by 300 ft. broad, in which are decided such contests as field athletics, wrestling, lacrosse, archery, &c. Round this oval is the running track, 24 ft. wide, with a lap of 586 yards 2 feet, or exactly one-third of a mile. Surrounding this track, again, is that for cycling, 35 feet wide and 660 yards in circumference, thus providing a lap of three-eighths of a mile. An entirely novel feature is the swimming bath, a rectangle of 100 metres by 50 feet, with a depth at each end of 4 feet 6 inches, and a middle depth of 12 feet 6 inches. There is a collapsible tower of the regulation height to allow of high-diving competitions. The arena is surrounded by a stand with accommodation for 70,000 spectators, and provides dressing rooms, lavatories, etc., for the competitors in the games. The Council were most fortunate in securing this fine arena for the Games. It came about from the fact that the Franco-British Exhibition and the Olympic Games of London fell in the same year, which was a wholly undesigned and unforeseen coincidence. The executive of the exhibition had included a sports arena in their plans, and by the arrangement with the Council this was developed into the present Stadium and placed at their disposal for the purposes of the Olympic Games. The running track was laid down under the supervision of the Amateur Athletic Association, and as it was completed before Christmas, 1907, it had ample time to settle, and is a fast track upon which some records were made before the Games began.

With the object of getting through the meeting in a reasonable time, no country was allowed to enter more than a fixed number of competitors in any event, and these entries, as already stated, had to be made through the Olympic Committees, which have been organised in each country, entries from individuals not being accepted. One of the most difficult questions which has presented itself is that of the amateur definition. The Olympic Games are exclusively for amateurs, and a definition of universal application is not at present practicable, so each sport has to have a definition of its own, which is set out in the rules and regulations for that sport, the underlying principle being that an athlete is no longer an amateur if he makes money out of the sport in which he engages. In many branches of athletics a man loses his amateur status if he competes with professionals, but this does not apply to such sports as golf in which there is an open championship. As sports become more and more internationalised, an end which these international meetings will largely promote, it cannot be doubted that in time the rules and regulations which govern them will command a universal acceptance, and the codes drawn up by the British Olympic Council for the forthcoming games, and issued in French, German, and English, will form a good foundation for future international athletic conferences to work upon. One of the most laborious tasks of the British Olympic Council has been the drawing up of these regulations, which appear in the different books of rules dealing with the various competitions [and at the end of this official Report.] The introduction of the metric system is an innovation which may have proved some little inconvenience to British runners, who had to run 109·3 yards, instead of the old 100 yards, but it is of the highest importance that these measurements should be adopted in all the Olympic Games, as they have been in previous Olympic meetings, in order that successive records may be compared with each other, and that no competitors may be put at a disadvantage.

There remains a word to say on the broader aspects of the modern Olympic games. The underlying idea is that there is something in these periodical gatherings which gives promise of results more important than those to be hoped for from an ordinary athletic meeting, however representative and however extended in scope. It is well to remember at this moment that a dominant idea of the old Hellenic games was peace, and that although the superb physical efficiency they fostered naturally produced a citizen qualified in all respects

to serve his state against a foreign enemy, the Olympic Games were the expression of goodfellowship as between Greek and Greek, the one institution, indeed, which united the Hellenic race during a history which was marred throughout by internal conflict. They formed a sort of cord of unity by which the race was held together not only through their internal bickerings, through the temporary ascendancy of one state or another, the civil strife of the Peloponnesian war, and the downfall of Athens in Sicily, but through the greater disasters of foreign domination like those of Macedon and Rome. The same idea of peace and unity in connection with international athleticism is capable of a modern application. In the games in London were assembled some two thousand young men, the athletic representatives of their various races, who met each other inspired by the same ideals of physical excellence, and competed with each other in friendly rivalry. These young men are also representative of the generation into whose hands the destinies of most of the nations of the world are passing at this moment, and we may hope that their meeting thus periodically, the enthusiasm which they share, and the opportunities afforded of mutual knowledge and mutual respect, may have a beneficent effect hereafter on the cause of international peace.

## CHAPTER I.

## PREPARATIONS.

THE first step taken by the British Olympic Association on receipt of the invitation from the International Olympic Committee to hold the Games of 1908 in London was to address a circular, through Lord Desborough, its President, to the associations governing sport in England asking for their opinion upon the proposal, and stating that if it was decided to hold these Games in London the governing associations would be asked to draw up programmes and regulations, to superintend the carrying out of these programmes in each sport, and to nominate a representative to serve on the Council of the British Olympic Association for the purpose of organising the Olympic Games of 1908. By the middle of November, favourable replies having been received from the great majority of the associations, and official representatives appointed, the British Olympic Council was duly formed and a resolution was passed at the Council meeting, held on November 19, 1906, that these Olympic Games be held in London. On November 27, 1906, a letter from Lord Desborough was published in the Press, sketching the proposals of the Association, as follows :—

“ At a meeting of the Council of the British Olympic Association, held on Monday, the 19th inst., it was decided that the fourth celebration of the original series of Olympic Games should be held in London in the month of July, 1908.

“ The first of these revivals very appropriately took place in Athens in 1896, the second was held in Paris in 1900, the third in St. Louis in 1904, and for the fourth Rome was suggested as the centre; but as that did not prove practicable, the offer was made to England ; and that offer, after the approval of the various athletic bodies had been obtained: the Committee has seen its way to accept.

“ H.R.H. the Crown Prince of Greece, who so ably presided over the Games held at Athens in 1906, which were outside the original cycle of Olympic Games started in the year 1896, has sent his ‘ best wishes for the success of the London Meeting,’ and his sympathy is all the more gratifying as it was announced on the highest authority during the Olympic Games in Athens this spring that it was the intention to hold Olympic Games

every four years, beginning with 1906, in the magnificent Stadium constructed for that purpose in Athens.

“ Yet, even under all these circumstances, I should not have felt justified in making the announcement to which I ask you to give publicity to-day, were it not for the fact that I have received assurances of support—and will be no exaggeration to call it enthusiastic support—from nearly every one of those great associations which control the various branches of sport in the United Kingdom. These associations have in each case delegated an official representative to serve on the British Olympic Council, and it will be these associations, working with the Council, who will control the arrangements of the particular form of sport with which they are connected.

“ It is, of course, too early to enter into details, but as this country has been the cradle of so many forms of athletic sport, it is absolutely essential that the Olympic Games, if they are held in England, should be carried out in a manner worthy of a great athletic nation ; and the Committee would welcome any suggestions which may result from the kindness and experience of your readers. The Hon. Secretary, the Rev R. S. de Courcy Laffan, who has been doing a considerable amount of work for some years past in connection with the International Olympic Committee, will be happy to give information ‘to those who desire it, if communicated with at 119 St. George’s Road, South Belgravia, S.W.

“ Although details have not yet been considered, the Council propose to work on the following lines :—

“ (1) The events are only open to *bona fide* amateurs, and as many forms of sport will be included as may be practicable.

“ (2) A guarantee fund will be formed.

“ (3) A proposal is under consideration whereby the necessary buildings, tracks, enclosures, and an arena to seat 100,000 spectators will be provided free of expense to the Olympic Association, together with a proportion of the receipts to go towards the other expenses connected with the Games.

“ (4) The Council do not propose to pay the expenses of any competitor whatever, either for travelling or for residence in this country.

“ (5) The Prizes will consist of certificates, with gold, silver, and bronze medals, which will become the standard medals for these Games, But certain Challenge Prizes have been offered in addition by the generosity of private individuals or of societies. Among these I may instance an exact reproduction of the Pourtales Vase in the British Museum, which will be mounted on a specially designed pedestal and presented for open competition among amateur teams of épéistes by the Fencers of the United

Kingdom, as an appropriate commemoration of the fact that the King has this year graciously consented to become the patron of the Amateur Fencing Association ; and the Prize offered for the Discus by Madame de Montgomery.

“ (6) The Games will be held in July after Henley Regatta, and after the A.A.A. Championships.

“ (7) As far as possible all the competitions, including swimming, archery, fencing, wrestling, &c., will be held on the same site in which the amphitheatre for the track-athletics and cycling will be erected. But when, as in the case of rowing or of rifle-shooting, it is necessary to hold the contest elsewhere, the arrangements will be made by the association governing those sports.

“ (8) The Programme of the last Games at Athens may be seen in *Baily's Magazine* of July, 1906, but that programme will be considerably altered.

“ (9) Sub-Committees will in due course be appointed to deal with such questions as that of the Programme, of Finance, of Entertainment, and of each separate department of sports. Most important of all, perhaps, will be a set of Rules which will result from the communication between these committees and the various societies representing organised sport in other countries, which will to a large extent govern future Olympic Games. Every competitor will be officially entered by the association controlling the particular sport in which he has been chosen to represent his country, and these entries will be limited.

“ The Olympic Games were called into being ten years ago to encourage a generous athletic rivalry among the various nations which took part in them, and at the same time that more friendly feeling which comes from better acquaintance ; and it is to be hoped that the Olympic Games, if held in England, will in no degree, to say the least, fall short of those that have gone before.

“ Yours faithfully,

“ DESBOROUGH,

“ *Chairman, British Olympic Association*”

In accordance with the principles thus laid down, letters were sent to the members of the International Olympic Committee in the various countries requesting them to form committees, and to take other necessary measures to ensure the participation of their fellow-countrymen in the Olympiad in London. In response, committees were formed in France, Germany, Italy, Belgium, Holland, Greece, Sweden, Denmark, Bohemia, Hungary, Switzerland, Bulgaria, the United States of America, and in every other country which desired to send its amateurs to the English Games.

The proposal to construct the buildings and Stadium mentioned in Lord Desborough's letter had reference to the negotiations then in progress between the British Olympic Association and the Executive Committee of the Franco-British Exhibition. This agreement was finally concluded on January 14, 1907, and provided that the Exhibition Committee should construct at their own cost all the racing tracks and buildings necessary for carrying out the Olympic Games, and should provide all necessary equipment, attendants, advertisements, &c., and should advance to the British Olympic Association the sum of £2,000 for current working expenses. The proceeds of the admission of the public were to be divided between the Franco-British Exhibition and the British Olympic Association in the proportion of three to one. The details of the racing tracks and of the pond for Swimming and Diving competitions were worked out by committees of experts appointed by the British Olympic Association on the nomination of the A.A.A., the N.C.U., and the A.S.A.

The track for running events measures  $586\frac{2}{3}$  yards, that for cycling 660 yards. The measurements of the pond for Swimming and Diving are 100 metres in length by 15 metres in breadth, with a depth of 1 metre 20 to 3 metres 70.

The British associations agreed that the metric system should be used for the measurement of distances, as had hitherto been the case in the Olympic Games which had taken place at Athens, Paris, and St. Louis.

The seating accommodation for spectators according to the original plans was 66,288. The total cost of the Stadium and necessary equipment, as worked out by the Executive Committee of the Franco-British Exhibition, was to amount to at least £44,000.

The British Olympic Association opened permanent offices at 108 Victoria Street, Westminster, which are retained for the future, and here were held all the more important meetings of the British Olympic Council.

Following on these arrangements in London the International Olympic Committee met at The Hague on May 23, 24, and 25, 1907, at the Ministry of the Interior in the Salle de la Trêve, kindly placed at the disposition of the Committee by the Government of the Netherlands. The following countries were represented : Belgium (1), Bohemia (1), France (2), Germany (1), Greece (1), Holland (1), Hungary (1), Italy (1), Sweden (2), Switzerland (1), United Kingdom (3).

The Committee was received in the name of H.R.H. Prince Henry of the Netherlands (the Patron of the Meeting) by his A.D.C., Baron Van Asbeck, to whom the President, Baron Pierre de Coubertin, delivered the gold Olympic Medal for presentation to his Royal Highness.

The Committee was also received by the Minister of Foreign Affairs, M. Van Tets van Goudriaan, who gave a sympathetic address of welcome showing an intimate knowledge of, and profound sympathy with, the international significance of the Olympic movement.

Baron Pierre de Coubertin was unanimously re-elected President of the I.O.C. for the second term of ten years.

On the motion of the members for the United Kingdom it was unanimously resolved that the British Colonies in South Africa should be entitled to separate representation.

The award of the Olympic Cup for 1908 was made to the Central Association of Sweden for the Promotion of Sport.

The thanks of the I.O.C. were given to Comte Brunetta d'Usseaux for the statue of Pallas Athene, which he has presented as a Challenge Trophy for the Olympic Games of 1908 and afterwards.

The thanks of the I.O.C. were given to the English Fencers for the magnificent Challenge Cup, which they had presented for the Games of 1908 and afterwards.

Some discussion arose as to the possibility of adopting a standard medal for all Olympic Games—the one face to be permanent, the other to change with each Olympiad. It was eventually resolved to leave the form of the medal to be awarded for the Olympic Games of London entirely to the British Committee, who were requested to have in view the possibility that such a medal might be used for future Olympiads. The I.O.C. would afterwards decide whether to adopt one side of each British medal as a permanent design.

The general wish of the foreign representatives was understood to be for a medal in a case rather than one to be worn. The principle of a gold medal for all first winners was adopted, and it was decided that all competitors should have commemorative medals.

The British Committee were reminded that competitions in sculpture, music, literature, architecture and painting, the subjects chosen to be inspired by some athletic or sporting idea, should form part of the Olympiad, and the British Committee undertook to make arrangements accordingly. It was understood that no prizes beyond Olympic medals would be offered, but that an exhibition would be arranged.\*

A copy of the General Regulations, as amended, appears in these pages. The following points deserve special attention :—

The principle of English judges, with power to appoint foreign assistants, was carried unanimously.

\*Regulations for these competitions were drawn up and will be found in later pages ; but it was impossible, in the time, to carry them out.

The Greek representative suggested that there should be an International Jury of Appeal for cases in which the judges disagreed, but this did not find support in the Committee.

The time allowed for making a protest was extended to one calendar month from the distribution of prizes.

Two additional articles were added, the first investing the B.O.C. with power to make changes in the regulations, the second, specially proposed by the British members, declaring that the I.O.C. would receive special recognition at the Games.

The Programme and General Regulations for the Games of 1908 were submitted to the I.O.C. in English, French, and German, but it was understood that THE ENGLISH VERSION ALONE IS OFFICIAL.

At the conclusion of the discussion it was stated that as soon as the programme had been definitely fixed in England copies would be sent to the Olympic Committee of each country.

The B.O.C. could not undertake to embody all suggestions in their final programme, but promised to take account of them so far as it was possible to do so.

A unanimous vote of thanks was passed to the British Olympic Council for the manner in which the regulations and programme had been prepared and presented.



## CHAPTER II.

GENERAL REGULATIONS FOR THE OLYMPIC  
GAMES OF 1908 IN LONDON.

## Passed at The Hague Conference of 1907.

1. In accordance with the request of the International Olympic Committee, it has been decided to hold the International Olympic Games of 1908 in England.

2. The British Olympic Council, which is responsible for the Games, has delegated the actual management of the different sports to the associations governing them in England, who may appoint officials from other countries to assist in the several competitions.

3. The Olympic Games are exclusively confined to amateurs.

4. The definition of an amateur qualified to compete in any sport will be found in the detailed regulations under the heading of that sport.

5. The entries from each country will be limited in number. The limit number will vary for different events, and will be specified in the programme.

6. A "country" is any "territory having separate representation on the International Olympic Committee," or, where no such representation exists, "any territory under one and the same sovereign jurisdiction."

7. The amateur status of every competitor must be guaranteed by the association which, in his own country, governs the sport in which he desires to enter as a competitor, or, where no such governing association or governing club exists, by a special committee of experts appointed by the Olympic Committee of that country.

8. All entries will be made through the governing associations, or, where governing associations do not exist, by amateur clubs, through the Olympic committees of each country, who will be responsible to the British Olympic Association for the competence of such amateur clubs to guarantee that the competitors entered by them are amateurs within the conditions laid down in the British Olympic Association's regulations for the several sports, as set forth in the programme of the Olympiad.

9. There will be no entrance fee for any event.

10. The Stadium events will be held in two sections. The main portion of the Games will take place in July, 1908, but there will be a section for Winter Games in October.

11. It is proposed to close the entries at least one month before the date fixed for the event for which the entry is made.

12. The British Olympic Council reserve to themselves the right to refuse the entry of any competitor without being bound to give reasons for their decision.

13. Objections to the qualifications of a competitor must be made in writing to the secretary of the British Olympic Council at the earliest moment practicable. No such objection shall be entertained after the lapse of one calendar month from the distribution of the prizes. Every objection shall be accompanied by a deposit of one pound (£1), and if upon investigation the objection shall appear to have been made upon no reasonable ground the deposit shall be forfeited. The British Olympic Council shall decide on every objection after having heard the representative or representatives on the Honorary Committee (see Article 14) of the person making the objection.

14. An Honorary Committee, entitled the *Comité d'Honneur*, will be formed, consisting of three representatives from each competing country, to be nominated by the Olympic Committee in that country. Special seats will be reserved for them, as for the members of the International Olympic Committee, at all contests and all festivities connected with the Olympiad, and they will be distinguished by a separate badge. [N.B.—In the case of competitors not represented on the Honorary Committee, the British Olympic Council will appoint three members to act on behalf of such competitors.]

All protests to be made to the officials managing any form of contest must be made through a member or members of the Honorary Committee representing the country to which the competitor belongs who desires to make the said protest for transmission to the said officials.

Any such protest must be made to the proper official within half an hour of the termination of the contest to which it relates.

[N.B.—Sections 13 and 14 do not apply to sports like Rowing and Yachting, which have special regulations for objections and protests.]

15. The prizes will consist exclusively of Olympic medals (gold, silver, or bronze) and certificates. In cases where challenge cups or trophies have been presented they will remain in the possession of the winners until the opening of the Games of 1912. All those who take part in the Olympic Games will be presented with commemorative medals.



REVERSE OF THE OLYMPIC PRIZE MEDAL FOR THE GAMES OF 1908.  
By BERTRAM MACKENNA, A.R.A.



OBVERSE OF THE OLYMPIC PRIZE MEDAL (PERMANENT DESIGN).  
By BERTRAM MACKENNA, A.R.A.



OBVERSE OF THE OLYMPIC COMMEMORATION MEDAL  
(PERMANENT DESIGN)  
BY BERTRAM MACKENNA, A.R.A.



REVERSE OF THE OLYMPIC COMMEMORATION MEDAL  
FOR THE GAMES OF 1908.  
BY BERTRAM MACKENNA, A.R.A.

16. The British Olympic Council will make no contribution to the expenses of any competitor, foreign or British.

17. The British Olympic Council shall be invested with full power to make in case of absolute necessity such changes as may be desirable in these Regulations.

18. The members of the International Olympic Committee are specially recognised as such at these Games, apart from any other functions which they may fill.

19. Natural-born or fully naturalised subjects or citizens of a “ country ” (as defined in Section 6 of these General Regulations), or of the Sovereign State of which a “ country ” forms part, are alone eligible to represent that country as competitors in the Olympic Games.

20. Where two or more countries (as defined in Section 6 of these General Regulations), form part of the same Sovereign State, a natural-born or fully naturalised subject or citizen of that Sovereign State may represent, as a competitor in the Olympic Games, either the country in which he was born or that in which he habitually resides.

21. In cases of teams, a number of reserves, not in excess of seven, may be entered, except where otherwise provided in the Special Regulations of any sport.

**CHAPTER III.**  
**PROGRAMME AND PRIZES OF THE OLYMPIC**  
**GAMES OF 1908 IN LONDON.**

As approved at The Hague Conference of 1907.

**I.—Programme of Events.**

**ATHLETICS.\***

In the Stadium, commencing July 13, 1908.

Entries close June 12, 1908.

Prizes in each Event :—	1st Prize.	Gold Olympic Medal.			Maximum No. of Com- petitors from each Country
	2nd „	Silver „	„	„	
	3rd „	Bronze „	„	„	
100 Metres, Flat (109·3 Yards)	..	..	..	..	12
200 „ „ (218·6 „ )	..	..	..	..	12
400 „ „ (437·2 „ )	..	..	..	..	12
800 „ „ (874·4 „ )	..	..	..	..	12
1,500 „ „ (1639·5 „ )	..	..	..	..	12
110 Metres, Hurdle (120·2 Yards)	..	..	..	..	12
400 „ „ (437·2 „ )	..	..	..	..	12
3,200 „ Steeplechase (3497·6 Yards)	..	..	..	..	12
5 Miles Run (8 Kilometres) ..	..	..	..	..	12
10 Miles Walk (16 „ )	..	..	..	..	12
Marathon Race, about 25 Miles (about 40 Kilometres), on July 24, 1908					12
Standing Broad Jump	..	..	..	..	12
„ High „	..	..	..	..	12
Running Broad Jump	..	..	..	..	12
„ High „	..	..	..	..	12
Hop, Step, and Jump	..	..	..	..	12
Pole Jump	..	..	..	..	12
Throwing the Hammer	..	..	..	..	12
Putting the Weight ..	..	..	..	..	12
Tug-of-War. Teams of Eight	..	..	..	..	3 teams
3 Mile Team Race (4·8 Kilometres) ..	..	..	..	..	1 team
10 to enter, 5 to run, 3 to count.					
3,500 Metres Walk (3,825 Yards)	..	..	..	..	12
Discus. I. Free Style	..	..	..	..	12
II. As at Athens	..	..	..	..	12
Javelin. I. Free Style	..	..	..	..	12
II. With the Javelin held in the Middle	..	..	..	..	12
Relay Race, 1,600 Metres (1,749·8 Yards)	..	..	..	..	1 team
Teams of four with four reserves : Two at 200 Metres (218·726 Yards), one at 400 Metres (437·452 Yards), one at 800 Metres (874·904 Yards).					

\* In all cases the figures in brackets are approximate. The various events of the Olympic Games of 1908 are described in this Report in the order in which they appear in the Programme printed above.

## ARCHERY.

In the Stadium, on July 17, 18, and 20, 1908.

Entries close July 2, 1908

Prizes in each Event :—			Maximum No. of Com- petitors from each Country
1st Prize.	Gold Olympic Medal.		
2nd „	Silver „ „		
3rd „	Bronze „ „		
Gentlemen. — The York Round.	72 Arrows at 100 Yards (94.4 Metres),		
	48 Arrows at 80 Yards (73 Metres), 24 Arrows at 60 Yards		
	(54.8 Metres) .. .. .		30
Ladies. — The National Round.	48 Arrows at 60 Yards (54.8 Metres),		
	24 Arrows at 50 Yards (45.7 Metres) .. .. .		30
Gentlemen. —	40 Arrows at 50 Metres (54.6 Yards), shot singly, Con- tinental fashion .. .. .		30

## BOXING.

At the Northampton Institute on October 27, 1908.

Entries close September 15, 1908.

Prizes in each Event :—			
1st Prize	Gold Olympic Medal.		
2nd „	Silver „ „		
3rd „	Bronze „ „		
Five Weights.			
(a) Bantam, not exceeding	8 st. 4 lb. (52.617 kilos)	.. .. .	12
(b) Feather „ „	9 st. (57.15 kilos)	.. .. .	12
(c) Light „ „	10 st. (63.5 kilos)	.. .. .	12
(d) Middle „ „	11 st. 4 lb. (71.668 kilos)	.. .. .	12
(e) Heavy, any weight..	.. .. .	.. .. .	12

The gloves to be of a standard weight of 8 oz. each.

## CYCLING.

In the Stadium, commencing July 13, 1908.

Entries close June 12, 1908.

Prizes in each Event :—			
1st Prize.	Gold Olympic Medal.		
2nd „	Silver „ „		
3rd „	Bronze „ „		
Bicycle.			
One lap, 660 Yards (603.491 Metres)	.. .. .		12
1,000 Metres (1093.6 Yards)..	.. .. .		12
5,000 Metres (2.88 Miles) ..	.. .. .		12
20 Kilometres ( 12.427 Miles)	.. .. .		12
100 „ (62.135 Miles) ..	.. .. .		12
Pursuit Race.			
Three laps (1.807 Kilometres).	Teams of four to start.		
First three to count in each heat.	.. .. .		1 team
Tandem Bicycle.			
2,000 Metres (1.24 Miles) ..	.. .. .		6 pairs

## FENCING.

At the Fencing Ground, adjoining the Stadium,  
commencing July 16, 1908.

Entries close June 15, 1908.

Prizes, Events 1 and 2 :—

1st Prize.	Gold Olympic Medal.	
2nd „	Silver „ „	
3rd „	} Bronze „ „	Maximum No. of Competitors from each Country
4th „		
5th „		
6th „		
7th „		
8th ..		

A Challenge Cup has been presented by English Fencers to the winning Epée team.

## 1. Epée.

- (a) Individual .. .. . 12  
 (b) International Teams of Eight .. .. . 1 team  
 Out of whom four fencers are chosen for each series.

## 2. Sabre.

- (a) Individual .. .. . 12  
 (b) International Teams of Eight .. .. . 1 team  
 Out of whom four fencers are chosen for each series.

## 3. Foils.

A display, with commemorative medals for all engaged, by  
picked amateurs, two representing each nation.

## FOOTBALL (ASSOCIATION).

In the Stadium, about October 19, 1908.

Entries close September 1, 1908.

Prizes :—Gold Olympic Medals to the winning team.

A Challenge Cup has been presented by the Football Association.

## FOOTBALL (RUGBY).

In the Stadium, about October 19, 1908.

Entries close September 1, 1908.

Prizes :—Gold Olympic Medals to the winning team.

## GYMNASTICS.

In the Stadium, on July 14, 15, and 16, 1908.

Entries close June 12, 1908.

Prizes :—Individual Competition (Heptathlon).

- 1st Prize. Gold Olympic Medal.  
 2nd „ Silver „ „  
 3rd „ Bronze „ „

Team Competition.

- 1st Prize. 1 Gold Olympic Medal to the team.  
 Silver Olympic Medal to each member  
 of team.  
 2nd „ 1 Silver Olympic Medal to the team.  
 Bronze Olympic Medal to each  
 member of team.



1. Individual Competitions . . . . . 20
- Voluntary Exercises.
1. Horizontal Bar, Swinging Movements.
  2. Horizontal Bar, Slow Movements.
  3. Parallel Bars, Slow and Swinging Movements.
  4. Rings, Steady.
  5. Rings, Flying.
  6. Pommel Horse, Quick Movements.
  7. Rope Climbing.

Every competitor must take part in every item.

2. Team Competitions . . . . . 1 team
- Voluntary Mass Exercises. The exercises may be those known as free gymnastics or exercises with hand apparatus, or any combination of both or either.
- Teams of not less than 16 nor more than 40.
- Time limit, 30 minutes.
3. Displays, Non-competitive.
- With commemorative medals. Open to women.

HOCKEY.

In the Stadium, about October 19, 1908.

Entries close September 1, 1908.

Prizes :—Gold Olympic Medals to the winning team . . . . . 3 teams

LACROSSE.

In the Stadium, about October 19, 1908.

Entries close September 1, 1908.

Prizes :—Gold Olympic Medals to the winning team.

American Tournament System . . . . . 1 team

LAWN TENNIS.

I.—Grass Courts.

At the Grounds of the All England Club, Wimbledon.

Commencing July 6, 1908.

Entries close June 6, 1908.

Prizes in each Event :—

	1st Prize.	Gold Olympic Medal.						
	2nd „	Silver „ „						
	3rd „	Bronze „ „						
Men's Singles . .	. . . . .	. . . . .	. . . . .	. . . . .	. . . . .	. . . . .	. . . . .	12
„ Doubles . .	. . . . .	. . . . .	. . . . .	. . . . .	. . . . .	. . . . .	. . . . .	6 pairs
Ladies, Singles	. . . . .	. . . . .	. . . . .	. . . . .	. . . . .	. . . . .	. . . . .	12

II.—Covered Courts.

At Queen's Club, West Kensington.

Commencing May 6, 1908.

Entries close April 28, 1908.

Prizes in each Event :—

	1st Prize.	Gold Olympic Medal.		Maximum No. of Com- petitors from each Country
	2nd „	Silver „ „		
	3rd „	Bronze „ „		
Men's Singles ..	.. ..	.. ..	.. ..	12
„ Doubles	.. ..	.. ..	.. ..	6 pairs
Ladies' Singles	.. ..	.. ..	.. ..	12

MOTOR BOATS.

In Southampton Water, starting from and finishing at the "Enchantress," the Flagship of the Motor Yacht Club, on July 11.

Entries close June 27.

Prizes in each Event :—

1st Prize.	Gold Olympic Medal.
2nd „	Silver „ „
3rd „	Bronze „ „

About 40 Miles (64.3 Kilometres) : round mark-boats (as in International Cup Race).

Races will be held for the following classes :—

- (a) For Motor Boats of any length or horse-power .. .. . 3
- (b) For Motor Boats not exceeding 60 feet in length, and with a total piston area not exceeding that represented by four cylinders each of 155 mm. bore. 3
- (c) For Motor Boats exceeding 6½ Metres but not exceeding 8 Metres in length, not less than 800 Kilos. in weight in running order, but without fuel or crew on board, and with a total piston area not exceeding that represented by four cylinders each of 106 mm. bore. Boats in this class must comply with the rules of the International Sporting Club of Monaco in regard to cruisers. 3

POLO.

At Hurlingham, under Hurlingham Club-Rules.

Commencing June 15, 1908.

Final Match June 20, 1908.

Entries close June 1, 1908.

Prizes :—Gold Olympic Medals to winning team .. .. . 5 teams

RACQUETS.

At Queen's Club, West Kensington.

Commencing April 27, 1908.

Entries close April 20, 1908.

Prizes in each Event :—

	1st Prize.	Gold Olympic Medal.		
	2nd „	Silver „ „		
	3rd „	Bronze „ „		
Singles ..	.. ..	.. ..	.. ..	12
Doubles	.. ..	.. ..	.. ..	6 pairs

## ROWING.

At Henley on July 28, 1908 and following days.

Entries close :

Maximum  
No. of Com-  
petitors from  
each Country

(a) In the case of Belgium, Canada, Germany, Holland, and the United Kingdom, not later than June 30, 1908.

(b) In the case of other countries not later than June 1, 1908.

Prizes :—Gold Olympic Medals to the winners in each Event.

Eights (in best boats)	..	..	..	..	..	..	..	..	..	2
Fours	..	..	..	..	..	..	..	..	..	2
Pairs	..	..	..	..	..	..	..	..	..	2
Sculls	..	..	..	..	..	..	..	..	..	2

## SHOOTING.

1. At Bisley, on July 9, 10 and 11, 1908.

Entries close June 1, 1908.

Prizes in each Event :—

1st Prize. Gold Olympic Medal.

2nd ,, Silver ,, ,,

3rd ,, Bronze ,, ,,

## 1. Rifle Shooting.

(a) Team Competition. Teams of six .. .. . 1 team

National Military arm of any country. Distances, 200, 500, 600, 800, 900, and 1,000 Yards (182.876, 457.19, 548.628; 731.504, 822.942, and 914.38 Metres).

Targets : 1st, 2nd, and 3rd class targets.

Two sighters and fifteen shots for each competitor at each range.

(b) Individual Competition .. .. . 12

Any rifle, any sight, including telescopic.

Distance, 1,000 Yards (914.38 Metres).

Target : 1st class target.

Two sighters and twenty shots.

(c) Team Competition. Teams of six .. .. . 1 team

Any rifle. Foresight open, any kind of backsight.

Distance, 300 Metres.

Target : White target, 1 metre in diameter, divided into 10 zones, with black centre, 0.60 metre in diameter.

Each competitor fires 120 shots (40 standing, 40 kneeling, and 40 lying down), with 10 sighting shots in each position.

(d) Individual Competition .. .. . 12

Any rifle. Foresight open, any kind of backsight.

Distance, 300 Metres.

Target as in (c).

Number of shots as in (c).

## 2. Miniature Rifle Shooting.

(e) Team Competition. Teams of four .. .. . 1 team

Any breech-loading rifle shooting miniature ammunition, any sights except magnifying or telescopic.

Distances, 50 and 100 Yards (45.719 and 91.438 Metres).

## Targets :

50 Yards (45.719 Metres). 12 inches square.

Bull's eye  $1\frac{1}{2}$  inches in diameter.

100 Yards (91.438 Metres). 24 inches square.

Bull's eye 3 inches in diameter.

(One inch equals 2.54 centimetres).

Four sighters and twenty shots at each distance.

Maximum  
No. of Com-  
petitors from  
each Country

(f) Individual Competition .. .. . 12

Any breech-loading rifle shooting miniature ammunition, any sights except magnifying or telescopic.

Distances, 50 and 100 Yards (45.719 and 91.438 Metres).

Targets :

50 yards (45.719 Metres). 12 inches square.

Bull's eye  $1\frac{1}{2}$  inches in diameter.

100 Yards (91.438 Metres). 24 inches square.

Bull's eye 3 inches in diameter.

(One inch equals 2.54 centimetres).

Four sighters and forty shots at each distance.

(g) Individual Competition. Disappearing target .. .. . 12

Any breech-loading rifle shooting miniature ammunition, any sights except magnifying or telescopic.

Distance, 25 Yards (22.86 Metres).

Target, three-quarters length figure 4 inches high and  $1\frac{1}{2}$  inches wide at the widest part.

(One inch equals 2.54 centimetres.)

Two sighters and fifteen shots.

(h) Individual Competitions. Moving target .. .. . 12

Any breech-loading rifle shooting miniature ammunition, any sights except magnifying or telescopic.

Distance, 25 Yards (22.86 Metres).

Target, three-quarters length figure 4 inches high and  $1\frac{1}{2}$  inches wide at the widest part.

(One inch equals 2.54 centimetres.)

Two sighters and fifteen shots.

### 3. Revolver and Pistol Shooting.

(i) Team Competition. Teams of four .. .. . 1 team

Any revolver or pistol with open sights.

Distance, 50 Yards (45.719 Metres).

Target, white  $19\frac{3}{4}$  inches in diameter, divided into 10 zones, with central black  $7\frac{3}{4}$  inches in diameter.

(One inch equals 2.54 centimetres.)

Two sighters and sixty shots.

Position standing ; right or left hand with arm extended.

(j) Individual Competition .. .. . 12

Any revolver or pistol with open sights.

Distance, 50 Yards (45.719 Metres).

Target as in (h).

Two sighters and sixty shots.

Position standing ; right or left hand with arm extended.

## 4. Running Deer Shooting.

- (k) Team Competition. Teams of four .. .. . 1 team  
Any single, double, or repeating rifle with open sights.  
Distance, 110 Yards (100.582 Metres).  
Target : Running Deer. Bull's eye 6 inches diameter.  
(One inch equals 2.54 centimetres. )  
Two sighters and ten shots, one at each run.  
Position, any.
- (l) Individual Competition. Single Shot .. .. . 12  
Any single, double, or repeating rifle with open sights.  
Distance, 110 Yards (100.582 Metres).  
Target as in (j).  
Two sighters and ten shots, one at each run.  
Position, any.
- (m) Individual Competition. Double Shot .. .. . 12  
Two sighters and twenty shots, two at each run.  
Other conditions as (l).

## CLAY BIRD SHOOTING.

II. At the Grounds of the Uxendon Shooting School Club, on July 8,  
9, 10, and 11, 1908.

Entries close June 1, 1908.

Prizes in each Event :—

1st Prize.	Gold Olympic Medal.
2nd ,,	Silver ,, ,,
3rd ,,	Bronze ,, ,,

- |                                   |         |
|-----------------------------------|---------|
| 1. Individual Competition .. .. . | 12      |
| 2. Teams of six .. .. .           | 2 teams |

## SKATING.

At Prince's Skating Rink, commencing October 19, 1908.

Entries close September 21, 1908.

Prizes in each Event :—

1st Prize.	Gold Olympic Medal.
2nd ,,	Silver ,, ,,
3rd ,,	Bronze ,, ,,

- |  |         |
|--|---------|
| Gentlemen's Figure Skating .. .. .         | 3       |
| Ladies' Figure Skating .. .. .             | 3       |
| Pair Skating (Lady and Gentleman) .. .. .  | 3 pairs |
| Gentlemen's Special Figure Skating .. .. . | 3       |

## SWIMMING.

In the Stadium, commencing July 13, 1908.

Entries close June 12, 1908.

Prizes in each Event :—

	1st Prize.	Gold Olympic Medal.						Maximum No. of Com- petitors from each Country
	2nd „	Silver „ „						
	3rd „	Bronze „ „						
100 Metres (109.3 Yards)	..	..	..	..	..	..	..	12
400 „ (437.2 „ )	..	..	..	..	..	..	..	12
1,500 „ (1639.5 „ )	..	..	..	..	..	..	..	12
High Diving. From 5 and 10 Metre boards, firm take off	..	..	..	..	..	..	..	12
Fancy Diving. From 1 and 3 Metre spring boards	..	..	..	..	..	..	..	12
200 Metres Team Race (218.6 Yards). Teams of four	..	..	..	..	..	..	..	1 team
200 Metres, Breast Stroke (218.6 Yards)	..	..	..	..	..	..	..	12
100 „ Back Stroke (109.3 „)	..	..	..	..	..	..	..	12
Water Polo. Teams of seven	..	..	..	..	..	..	..	1 team

## TENNIS (Jeu de Paume).

At the Queen's Club, West Kensington.

Commencing May 18, 1908.

Entries close May 11, 1908.

	1st Prize.	Gold Olympic Medal.						
	2nd „	Silver „ „						
	3rd „	Bronze „ „						
Singles .. ..	..	..	..	..	..	..	..	12

## WRESTLING.

In the Stadium, commencing July 13, 1908.

Entries close June 12, 1908.

Prizes in each Event :—

	1st Prize.	Gold Olympic Medal.						
	2nd „	Silver „ „						
	3rd „	Bronze „ „						

I.—Style - Catch as catch can.

Bouts limited to 15 minutes. 5 weights :

(a) BANTAM	to 119 lbs. (54 Kilos.)	..	..	..	..	..	..	12
(b) FEATHER	„ 133 „ (60.3 „ )	..	..	..	..	..	..	12
(c) LIGHT	„ 147 „ (66.6 „ )	..	..	..	..	..	..	12
(d) MIDDLE	„ 161 „ (73 „ )	..	..	..	..	..	..	12
(e) HEAVY,	over 161 „	..	..	..	..	..	..	12

II.—Style - Græco-Roman.

Bouts limited to 20 minutes. 4 weights :

(a) LIGHT	to 147 lbs. (66.6 Kilos.)	..	..	..	..	..	..	12
(b) MIDDLE	„ 161 „ (73 „ )	..	..	..	..	..	..	12
(c) LIGHT HEAVYWEIGHT,	161 „ (93 „ )	..	..	..	..	..	..	12
(d) HEAVYWEIGHT.	Any weight over 93 Kilos.	..	..	..	..	..	..	12

## YACHT RACING.

At Ryde on July 27, 28 and 29, 1908.

Entries close June 28, 1908.

Prizes for all Classes :—

- 1st Prize. Gold Olympic Medal for helmsman,  
with Silver Olympic Medals for crew.
- 2nd Prize. Silver Olympic Medal for helmsman  
with Bronze Olympic Medals for crew.
- Gilt Commemorative Medals for owners of  
winning yachts.

Additional Prizes for 12 and 15 Metre Classes :

- 1st Prize. Gold Olympic Medal for mate or  
leading hand.
- 2nd Prize. Silver Olympic Medal for mate or  
leading hand.

1. The races will be sailed under the Yacht Racing Association's Rules, as in force in 1908, and incorporating the International Rules.

2. Measurement of yachts will be in accordance with the International Rule.

3. There will be no time allowance.

4. The Classes for which matches will be arranged are those of :

	Maximum No. of Com- petitors from each Country
6 Metres .. .. .	2 yachts
7 ,, .. .. .	2 ,,
8 ,, .. .. .	2 ,,
12 ,, .. .. .	2 ,,
15 ,, .. .. .	2 ,,

5. All races will be started from and finish at Ryde Pier, Isle of Wight.

## II.—Prizes and Awards.

Two sets of Medals were provided, the first (in gold, silver, and bronze) for winners of first, second, and third prizes in Olympic events ; the second (in silver-gilt, silver, bronze, and metal) were called Commemoration Medals, and were awarded in the manner described in later pages, one being given to each competitor with his competitor's badge, but the three higher classes being reserved for officials and others who did not compete.

The Art Committee, to whom the organisation of prizes and awards was entrusted, was composed of Mr. T. A. Cook and Mr. G. S. Robertson (members of the British Olympic Council), who were fortunate enough to obtain, in the preliminary stages of their work, the valuable assistance and advice of Mr. Thomas Brock, R.A., and Mr. A. S. Cope, A.R.A.

The commission for designing both kinds of medals was given to Mr. Bertram Mackennal, A.R.A., who also kindly gave the Council designs for the various official badges, which will be described in later pages. The

medal designs are reproduced in this Report, and were exhibited in the Royal Academy. For the Prize Medal the figure of St. George for England represented the Games of 1908. The athlete, crowned between two emblematic female figures, was designed to form a permanent side of the Olympic Prize Medal in all future meetings. In the same way, on the Commemoration Medal, the winged figure of Fame represented the Games in London, but the design of the Greek four-horsed chariot was meant to appear permanently on one side of all Olympic Commemoration Medals in the future.

In addition to these medals, Diplomas of two kinds were designed by Mr. Bernard Partridge for the Council, and are reproduced in this Report.

The first design, for prize-winners only, representing a winged Victory between the figures of Hellas and Britannia, was exhibited in the Royal Academy, and was awarded in its larger form to winners of gold medals, and in a slightly smaller form to winners of silver and bronze medals. Each winner of a gold medal also received the smaller form of this diploma for presentation to his Club or Association as a memorial of his success. The second design, representing Victory seated, was worked out in black and red, and formed a Diploma of Merit, which was awarded by the various Associations controlling each series of events in the Games to athletes who achieved a high standard of excellence without getting first, second, or third in their competition. In a certain number of restricted cases this diploma was also awarded to officials and others for services rendered to the British Olympic Council in the organisation of the Games.

It was thought right not to confuse the design in either class of medal by too long an inscription, so the event for which each prize-medal was awarded was incised upon the edge of its rim, with sufficient space left for the addition of the winner's name. The same inscription was placed on the box containing each medal. The 250 gold medals ordered by the Council were placed in red boxes, 260 silver in dark blue boxes, and 260 bronze in yellow boxes. The large diplomas accompanying gold medals were rolled up in tubes,  $20\frac{1}{2}$  inches long, of red, and the club diplomas were placed in deep crimson tubes,  $18\frac{1}{2}$  inches in length. Dark blue and yellow tubes (also  $18\frac{1}{2}$  inches long) were provided for second and third prize diplomas respectively. The diplomas of merit (of which 500 were ordered) were placed in light blue tubes, 17 inches long. The Commemorative Medals, being larger than the prize medals, were easily distinguishable, apart from the use of various coloured boxes for each class of these awards.

In addition to the Medals and Diplomas, which were the only awards that could be kept by the recipient as his personal property, the following



Challenge Cups were given, each of which was insured by the British Olympic Council for sums varying from £100 to £300 :—

- (1) The Brunetta Statuette for Rowing.
- (2) The Brunetta Trophy for Swimming.
- (3) The Football Association's Trophy.
- (4) The Gold and Silversmiths' Cup for Wrestling.
- (5) The Hurlingham Trophy for Polo.
- (6) The International Cup (reproduced from the Pourtalès Vase) for Fencing.
- (7) The Prince of Wales's Cup for Cycling.
- (8) Lord Westbury's Cup for Clay Bird Shooting.

For each of the above Cups, the following agreement, signed by each recipient and countersigned by the President of his National Association, was held by the British Olympic Council :—

OLYMPIC GAMES, LONDON, 1908.

We, the undersigned, having been awarded the Challenge Cup for ..... at the Olympic Games of London on July 25, 1908, and the same having been delivered to us by the British Olympic Council, do hereby individually and collectively engage to return the same in good order to the British Olympic Committee on or before January 1, 1912, in accordance with the Rules of the International Olympic Committee, and to be responsible for, and to repair all damage that may occur to the same between July 25, 1908, and January 1, 1912; and if at any time before January 1, 1912, the International Olympic Committee shall have ceased to exist, we hereby engage to send back the Cup to its original donor through the representatives of the British Olympic Committee appointed for that purpose.

(Signed)

Name.....

Address.....

Nationality.....

(Signed)

President of the National Association for.....

Secretary.....

Four other Challenge Cups were also presented for these Games, and the agreement for these was left to the care of the International Olympic Committee, to whose charge they were committed for future meetings.

- (1) The Greek Trophy for the Marathon Race.
- (2) The Prague Trophy for Gymnastics.
- (3) The Montgomery Statuette for Discus.
- (4) The French Vase for Yachting.

This makes a total of twelve Challenge Cups which will continue in these Games for ever ; and it was a matter of considerable satisfaction to the British Olympic Council that so large and permanent an addition to the prize list of the Games had been made on the occasion of the London meeting.

The Council felt that the principle of giving nothing except medals and diplomas to become the personal property of recipients was the right principle, and that all other prizes should be in the nature of Perpetual Challenge Cups. Their representatives on the International Olympic Committee will use their best endeavours to secure the application of this principle in all future Games in the official cycle.

## CHAPTER IV.

## THE OLYMPIC GAMES OF 1908.

THE first stanchion of the Stadium was set in its place at Shepherd's Bush on July 31, 1907. By May 1, 1908, the structure\* had been visited by the Track Committee appointed by the Amateur Athletic Association to supervise the conduct of that portion of the Olympic Games. It was composed of Messrs. C. Val Hunter, H. Venn, (G. V. A. Schofield, and P. L. Fisher (Hon. Sec.), and these gentlemen officially measured the track, stating it to be exactly 1,760 ft. in circumference, a fact which is much to the credit of Charles Perry (late of the London Athletic Club) who was the professional engaged to superintend its construction. The path was in splendid order, with magnificently planned corners; and, being entirely sheltered from the wind by the huge surrounding tiers of seats, it seemed likely to produce fast times. The length of the turf inside is 235 yards, with a width of just over 99 yards. The cinder path is 24 ft. wide, and the cycle track (which is banked at every corner) has a width of 35 ft. of concrete.†

\* The containing walls of the Stadium, supporting the rising tiers of seats, are large enough in extent to enclose seven buildings each the size of the Albert Hall.

† In the huge triangular space surrounding the Stadium beneath its tiers of seats, dressing rooms and assembly rooms were arranged for every nation. Beginning at the south end, and moving round to the east side, the first two rooms were the beginning of a tunnel admitting athletes to the arena.

3 & 4. Assembly for Australia, Canada, and South Africa.

5 & 6. N.C.U. and A.A.A. Committee Rooms.

7 & 8. Cyclists' dressing rooms.

9. Athletic dressing room.

10. Gymnastic dressing room.

11. Assembly for the U.S.A. and Austria.

12. Assembly for France.

13. Assembly for Sweden and Holland.

14. Fencing dressing room.

15. Ladies' dressing room.

16 & 17. Gymnastic Committee.

20 & 21. Polytechnic Committee.

[At this point comes the north tunnel opposite Rooms 1 & 2.]

26. Ambulance.

27. Swimmers' and Wrestlers' dressing room.

28. Assembly for Germany and Norway.

29. Assembly for Italy, Russia, and Belgium.

On May 14, 1908, the opening day of the Franco-British Exhibition, the Prince and Princess of Wales entered the Royal Box in the Stadium and formally dedicated the arena to international sport. The rain fell pitilessly during the whole afternoon, but an athletic meeting was arranged by the Finchley Harriers, under the presidency of Mr. F. W. Ashford, and the programme organised by Mr. R. Staines was excellently carried through in spite of the most unpropitious conditions.

Immediately the Prince and Princess arrived a double procession of athletes, arranged by Mr. William Henry with the help of the London Polytechnic, started from the opposite side of the track, marched round each end of the cinder path and converged towards the Royal Box. In the middle, and exactly in front of the Prince, were drawn up the members of the British Olympic Council, headed by Lord Desborough. The Prince of Wales then declared the Stadium open. The procession of athletes at once reformed and marched past, and after a display of high-diving and swimming, the programme of the day began.

On May 26 the Stadium was visited by Their Majesties the King and Queen with M. Fallières, President of the French Republic. An admirably designed procession and display were carried out by the Polytechnic.

Various meetings organised by different sporting bodies were held here on subsequent occasions, including the championships of the Amateur Athletic Association, at which there were over 22,000 spectators and a record entry of 254, including athletes from Australia, South Africa, Canada, Scotland, Ireland, and the United States. The Records broken were the Hammer Throwing and Pole Jump, and both were afterwards beaten at the Olympic Games. In the Four Miles Championship the winner did the best championship performance, but did not break record. Only one champion successfully defended his title. Soon after this the Stadium was given up to practising by the members of various representative Olympic teams, to which the public was admitted.

On Monday, July 13, His Majesty King Edward VII., Patron of the Olympic Games of 1908, with Queen Alexandra, visited the Stadium, and formally opened the Games in the presence of a large and brilliant company. The Duke and Duchess of Sparta with their children were the first to

30. Assembly for Hungary, Greece, and Switzerland.

[The Royal Box was over Rooms 29 and 30.]

31. Assembly for Bohemia, Finland, and Denmark.

32. Press room.

33. British Olympic Council and Prize Committee.

34. Assembly for the United Kingdom.

[There were also a large number of temperance refreshment rooms and other offices.]

arrive, attended by their suite and the Hon. Henry Stonor. Princess Frederick Charles of Hesse, and the Prime Minister of Nepal, attended by Sir Curzon Wylie, followed them. The American, Russian, French, and Austrian Ambassadors were also present. The Duke and Duchess of Connaught arrived soon afterwards, with Princess Patricia, and the Crown Prince and Princess of Sweden. The Prince and Princess of Wales brought Prince Henry and Prince Albert of Wales, with the Countess of Shaftesbury, Captain Viscount Crichton, Mr. Wallington, and Mr. Hansell in attendance. Princess Louise and the Duke of Argyll had preceded them a few moments before. The King and Queen, with Princess Victoria, were attended by Lady Suffield, the Countess of Antrim, the Hon. Charlotte Knollys, Sir Archibald Edmonstone, and Major-General Brocklehurst.

At half-past three their Majesties were received by Lord Desborough, Viscount Selby, Lord Blyth, Sir John Cockburn, and Mr. Imre Kiralfy on behalf of the Franco-British Exhibition. Lord Desborough then presented Baron Pierre de Coubertin to the King, who afterwards shook hands with the members of the International Olympic Committee for Bohemia, Denmark, France, Germany, Greece, Holland, Italy, Sweden, Switzerland, the United States, and the United Kingdom.

The King then entered the Royal Box, and a procession of the competing athletes at once began to march forward from the opposite side of the arena\*. The numbers representing the respective nations were as follows :—

Austria ...	...	9	Greece	...	20	Finland	...	64
Belgium	...	15	Holland	...	51	United States	...	68
Bohemia	...	23	Hungary	...	57	Australasia	...	14
Denmark	...	126	Italy ...	...	35	Canada...	...	32
France ...	...	27	Norway	...	49	South Africa	...	13
Germany	...	61	Sweden	...	111	United Kingdom	...	226

\* The following regulations, approved by a Committee representing the teams in England, were drawn up by Mr. Robert Mitchell of the London Polytechnic, an institution whose aid was invaluable to the British Olympic Council throughout the Games :—

1. *That all teams should assemble at 2 o'clock in their respective dressing rooms at the Stadium on Monday the 13th inst.*

2. *On the Parade it is expected that every athlete taking part will be in the athletic costume of his country, or of the sport in which he intends to compete. In the event of it being a wet day, it is left entirely to the discretion of the manager of each team as to what precaution should be taken for the protection of his various members.*

3. *All teams will Parade in the rear of the Stadium facing Wood Lane at 2.45 promptly, and behind their respective representatives, who will bear the flag and entablature of their country.*

4. *Each nationality will be formed up in sections of four, and will be headed eight paces in front by the bearer of its entablature or name of the country, and*

Among these teams those of Sweden, Norway, Denmark, and Finland were especially noticeable for their neat and uniform appearance, while countries in which conscription is the rule showed its influence very plainly in the military precision with which their athletes marched. The Danish ladies in gymnastic costume were loudly and deservedly applauded. A large number of other gymnasts also paraded who were to give displays without competing. The English contingents were led by an Oxford Blue, a Cambridge Blue, and a former member of the Eton Eight. The whole body of athletes was aligned in front of the Royal Box, and after the International Olympic Committee, the British Olympic Council, and the *Comité d'Honneur* had formed up just beneath it, Lord Desborough stepped forward and requested His Majesty to open the Fourth Olympiad.

The King then said: "I declare the Olympic Games of London open."

The trumpeters of the Life Guards at once sounded a fanfare, and the band of the Grenadier Guards played the National Anthem, while the flags of all nations in the line of athletes dipped in salute. All the competitors led three cheers for the King, which were joined in by some 40,000 spectators present. After the march-past of the athletes, the Games began with the first heat of the Fifteen Hundred Metres. Various heats

*four paces between the entablature and the front column by the bearer of the flag of the country.*

5. *On the sounding of the bugle the columns will march off in alphabetical order.*

6. *Each team on entering the Stadium will wheel either to the right or left on to the centre of the cinder track and march to its special flag, which will be placed on the side of the track, then wheeling on its flag march straight forward into its proper position in front of the Royal Box, which will be indicated by another flag.*

7. *On arriving in position facing the Royal Box the entablature bearer will fall back to the right side of the leading section of his team. The flag bearer to stand six paces in front of column.*

8. *The International Committee and Representatives will next parade before His Majesty, who will then declare the Stadium open. The National Anthem will then be performed by the band, all flags being lowered to the salute and three cheers will be called from the whole of the teams for His Majesty.*

9. *On the signal being given by Mr. H. Elliott, the Chief Marshal, the columns will wheel to the right, and march off in alphabetical order with the exception that America will immediately precede the British Colonial Contingents, which will precede Great Britain, who will bring up the rear.*

10. *On the march the entablature bearer will march four paces in front of the flag-bearer, who will also be four paces in front of the leading section of his column.*

11. *An interval of at least four paces should be kept between the entablature bearer and the rear rank of the preceding column.*

12. *Each column on passing the Royal Party will salute, afterwards marching right round the track and make its exit.*

13. *A full meeting of Managers and (as far as possible) the Teams, will be held at the Stadium, on Saturday, 11th, at 11.30; also on Monday, 13th, at 12 o'clock, for rehearsal.*

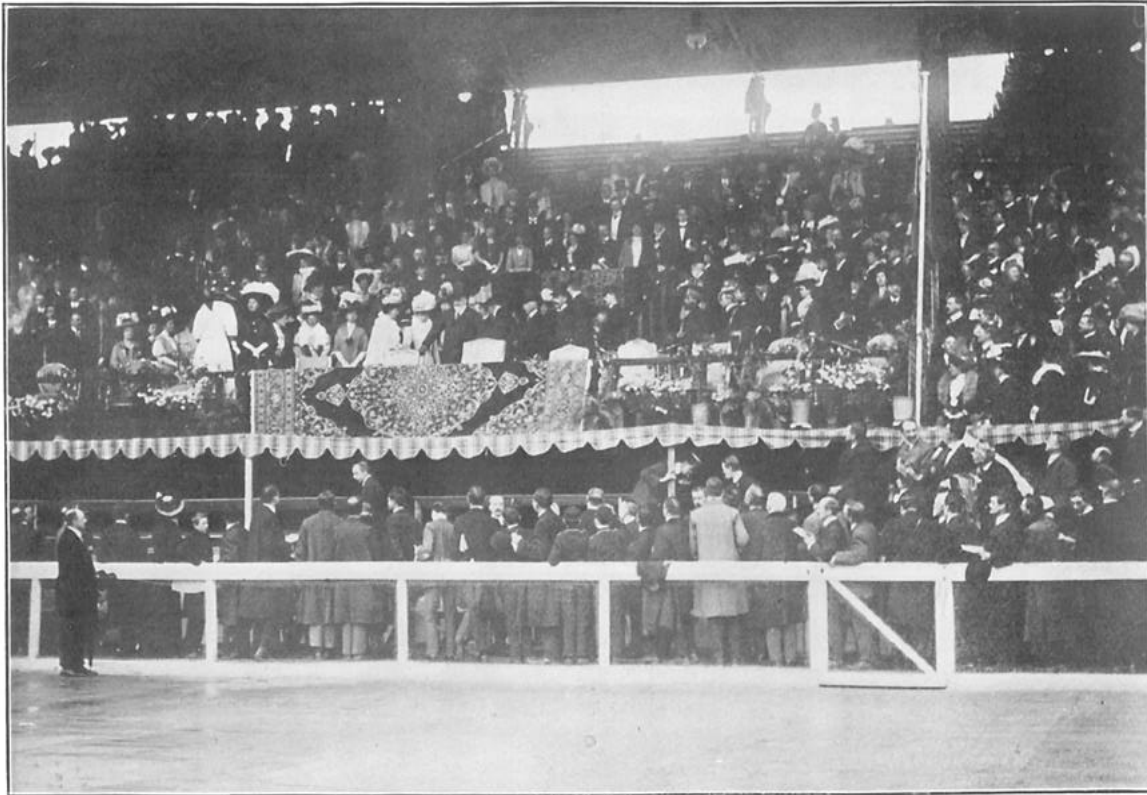

KING EDWARD VII. OPENING THE OLYMPIC GAMES, JULY 13, 1908.

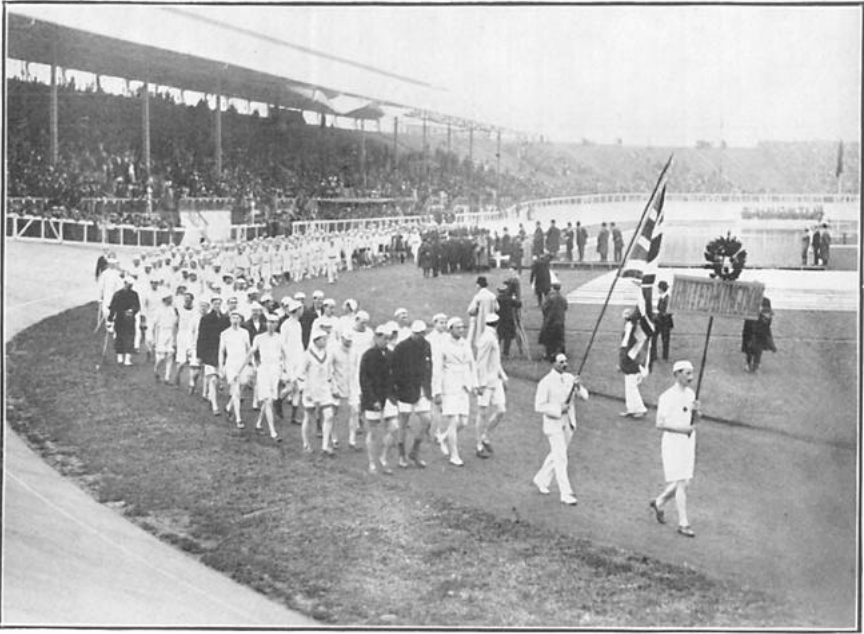

REPRESENTATIVES OF THE UNITED KINGDOM IN THE PARADE OF ATHLETES ON JULY 13, 1908.

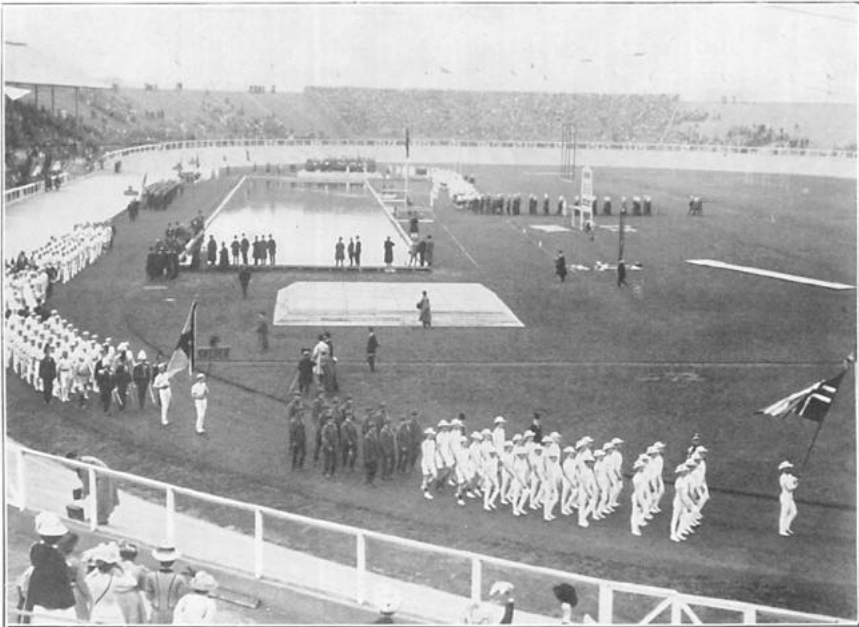

NORWEGIAN AND SWEDISH TEAMS IN THE PARADE OF ATHLETES ON JULY 13, 1908.



in bicycling and swimming completed the programme for the day. There was not much sunshine, but the rain of the morning held off during most of the afternoon.

### ATHLETICS.\*

In describing the various events grouped together under the heading of "Athletics," I have chosen the order in which they were printed in the first Official Programme of these Games. The winners came up for their prizes in the same order.

As it was impossible for all the competitors to remain in England the whole fortnight, and as this was especially the case with the gymnasts and cyclists, these two divisions of the Games were mostly completed in the first week, during which also the greater part of the field events and the long distance racing (with the exception of the Marathon Race) was carried out. This occasionally led to unavoidable hardship, as, for instance, when a man, in order to win his gold medal, had to win a heat one day and walk in the final the next; or when runners in a three-mile team race had to turn out for a five-mile race on the same day. But such occurrences were not limited to the British team, or to any single nationality; and the drawing of heats was guided by the principle of dividing the nationalities as equally as possible throughout; only when the total of the representatives of a single nation exceeded the total of preliminary heats did athletes of the same nation compete in them against each other; and, in such cases, all competitors were considered as Olympic representatives of equal value, their positions in a heat being then entirely guided by the luck of the draw. It was fortunate that the numerous heats for short distances in the second week were chiefly decided in fine weather.

The sequence of events as actually carried out in the Stadium was far too complicated to admit of any logical reproduction here; but as it occasionally had a very definite bearing upon results I have printed in the Appendix the programme for every day, with the names of the officials managing each event. The weather was unfavourable, on the whole, during the first week, but much better during the second, and very hot on the last two days.

\* For the sake of uniformity I have used the phrase "United Kingdom" to describe the British competitors throughout this Report. But it is right to say that by arrangement between the A.A.A., the Scottish A.A.A., and the Irish A.A.A., they were entered in the official athletic programme as "Great Britain and Ireland."

The order chosen for the description of events in these pages is as follows :—

I. 100 Metres, Flat	XV. Running High Jump
II. 200	XVI. Hop, Step and Jump
III. 400	XVII. Pole Jump
IV. 800	XVIII. Throwing Hammer
V. 1,500	XIX. Putting Weight
VI. 110 Metres, Hurdle	XX. Tug of War
VII. 400	XXI. 3 Mile Team Race
VIII. 3,200 Metres Steeplechase	XXII. 3,500 Metres Walk
IX. 5 Miles Run	XXIII. Discus (Greek style)
X. 10 Miles Walk	XXIV. Discus (Free style)
XI. Marathon Race	XXV. Javelin (Free style)
XII. Standing Broad Jump	XXVI. Javelin (Restricted style)
XIII. Standing High Jump	XXVII. 1,600 Metres Relay Race
XIV. Running Broad Jump	

### I.—ONE HUNDRED METRES FLAT (109·3 yards).

#### FIRST ROUND.

*Heat 1.*—E. J. Duffy, South Africa, 1; G. Scoutarides, Greece, 2; V. Henny, Holland, 3. Won easily. Time,  $11\frac{3}{5}$  sec.

*Heat 2.*—J. P. George, United Kingdom, 1; O. Guttormsen, Norway, 2. Won by 3 yards. Time,  $11\frac{3}{5}$  sec.

*Heat 3.*—N. J. Cartmell, United States, 1; G. Malfait, France, 2; A. Hoffmann, Germany, 3; E. Koops, Holland, 4. Won by 2 yards. Time, 11 sec.

*Heat 4.*—R. E. Walker, South Africa, 1; J. Konings, Belgium, 2; D. Murray, United Kingdom, 3; E. G. Kiralfy, United States, 0; E. J. C. Greven, Holland, 0. Won by 4 yards. Time, 11 sec.

*Heat 5.*—R. Cloughen, United States, 1; J. Johannsen, Norway, 2; D. Beland, Canada, 3; H. S. Harmer, United Kingdom, 0. Won by 5 yards; Harmer broke down. Time, 11 sec.

*Heat 6.*—W. W. May, United States, 1; V. Jacquemin, Belgium, 2; L. Lesca, France, 3; M. Pascalides, Greece, 4. Won by 3 yards. Time,  $11\frac{1}{5}$  sec.

*Heat 7.*—R. C. Duncan, United Kingdom, 1; K. Stenberg, Sweden, 2; H. Eicke, Germany, 0; U. Barrozz, Italy, 0; R. Stenberg, Finland, 0. Won by a yard. Time,  $11\frac{2}{5}$  sec.

*Heat 8.*—L. B. Stevens, United States, 1; K. Lindberg, Sweden, 2; H. Rehder, Germany, 0; W. Murray, United Kingdom, 0. Won by inches. Time,  $11\frac{1}{5}$  sec.

*Heat 9.*—J. W. Morton, United Kingdom, 1; A. J. Petersen, Denmark, 2; J. Hoogveld, Holland, 3. Won by 3 yards. Time,  $11\frac{1}{5}$  sec.

*Heat 10.*—R. Kerr, Canada, 1; M. Chapman, United Kingdom, 2; P. Fischer, Germany, 3. Won by 3 yards. Time, 11 sec.

*Heat 11.*—W. F. Hamilton, United States, 1; P. Simon, Hungary, 2; G. Lamotte, France, 3. H. T. Phillips, South Africa, broke down after going half a dozen yards. Hamilton won by 3 yards. Time,  $11\frac{1}{5}$  sec.

*Heat 12.*—H. J. Huff, United States, 1; H. J. Pankhurst, United Kingdom, 2; K. Fryksdal, Sweden, 3. Huff won by a yard. Time,  $11\frac{2}{5}$  sec.

*Heat 13.*—L. Robertson, United States, 1; F. Lukeman, Canada, 2; H. Meslot, France, 3; E. Schonecker, Austria, 4. Won by 3 yards. Time,  $11\frac{2}{5}$  sec.

*Heat 14.*—D. R. Sherman, United States, 1; L. Sebert, Canada, 2; H. Watson, United Kingdom, 3. Also ran :—F. Wiezner, Hungary, and H. von Bonninghausen, Germany. Won by 4 yards. Time,  $11\frac{1}{5}$  sec.

*Heat 15.*—J. A. Rector, United States, 1; G. Racz, Hungary, 2; W. Kohlmeier, Germany, 3. Rector won in the fast time of  $10\frac{4}{5}$  sec. (ties Olympic record).

*Heat 16.*—J. P. Stark, United Kingdom, 1; G. Torretta, Italy, 2. Won by 2 yards. Time,  $11\frac{4}{5}$  sec.

*Heat 17.*—P. J. Roche, United Kingdom, 1; C. Bechler, Germany, 2. Won by 2 yards. Time,  $11\frac{2}{5}$  sec.

#### SECOND ROUND.

*Heat 1.*—R. E. Walker, South Africa, 1; W. W. May, United States, 2; P. J. Roche, United Kingdom, 3; L. B. Stevens, United States, 4. A beautiful start. Walker had just got his head in front at half way, and the others could never hold him afterwards. Won by a yard. Time,  $10\frac{4}{5}$  sec. (ties Olympic record).

*Heat 2.*—R. Kerr, Canada, 1; D. R. Sherman, United States, 2; J. W. Morton, United Kingdom, 3. Kerr's stride carried him clean away from Sherman and Morton, and the Canadian won by 3 yards. Time, 11 sec.

*Heat 3.*—J. A. Rector, United States, 1; H. J. Huff, United States, 2; E. J. Duffy, South Africa, 3; R. C. Duncan, United Kingdom, 4. A one-sided heat. Rector won by 3 yards. Time,  $10\frac{4}{5}$  sec. (ties Olympic record).

*Heat 4.*—N. J. Cartmell, United States, 1; L. Robertson, United States, 2; J. P. Stark, United Kingdom, 3; J. P. George, United Kingdom, 4. Cartmell was just the faster of the Americans, and won by a foot. Time,  $11\frac{1}{5}$  sec.

#### FINAL.

R. E. Walker, South Africa	..	..	..	..	..	..	1
J. A. Rector, United States	..	..	..	..	..	..	2
R. Kerr, Canada	..	..	..	..	..	..	3
N. J. Cartmell, United States	..	..	..	..	..	..	4

Time,  $10\frac{4}{5}$  sec.

Walker started inside, Kerr outside, with the Americans in the middle. Walker led, Kerr started badly. Half way Rector just passed Walker, with the others very close up. Walker spurted magnificently, got level with Rector, ran level for some six yards, and then shot ahead and won by over three feet, with Kerr third, a shade in front of Cartmell. For the fourth time in this event the Olympic record for 100 metres, by F. W. Jarvis, of New York, at Paris in 1900, was equalled; for Rector did twice, and Walker also.

R. E. Walker, aged 19, came from Natal, where he was born, and had not been originally selected in the South African team. He was 5 ft. 7 in. high, and weighed 9 st. 4 lb. He was perfectly trained for the day of the race, and has done even faster performances since his return to South Africa.

A Diploma of Merit for the Hundred Metres was awarded to N. J. Cartmell, U.S.A.

## II.—TWO HUNDRED METRES FLAT (218·6 yards).

## FIRST ROUND.

*Heat 1.*—J. B. George, United Kingdom, 1; V. Henny, Holland, 2; Won by 10 yards. Time,  $23\frac{2}{5}$  sec.

*Heat 2.*—H. J. Huff, United States, 1; E. J. Duffy, South Africa, 2; H. J. W. Wal, Holland, 3; K. Stenborg, Sweden, 4. A splendid race for 150 yards. Won by  $1\frac{1}{2}$  yards. Time,  $22\frac{4}{5}$  sec.

*Heat 3.*—J. P. Roche, United Kingdom, 1; L. Robertson, United States, 2; F. Lukeman, Canada, 3; E. Koops, Holland, 4. Won by a yard. Time,  $22\frac{4}{5}$  sec.

*Heat 4.*—N. J. Cartmell, United States, 1; G. Racz, Hungary, 2; R. Stenberg, Finland, 3. Won by 2 yards. Time, 23 sec.

*Heat 5.*—G. W. Malfait, France, 1; R. C. Duncan, United Kingdom, 2. Won by 4 yards. Time,  $22\frac{3}{5}$  sec.

*Heat 6.*—S. Laaftman, Sweden, 1; F. Wiesner, Hungary, 2; E. J. C. Greven, Holland, 3. Won by 2 yards. Time,  $23\frac{4}{5}$  sec.

*Heat 7.*—C. Radoczy, Hungary, walked over.

*Heat 8.*—R. Cloughen, United States, 1; U. Barrozzi, Italy, 2. Won by 6 yards. Time,  $23\frac{2}{5}$  sec.

*Heat 9.*—S. Hurdsfield, United Kingdom, 1; M. Pascalides, Greece, 2. Won by  $1\frac{1}{2}$  yards. Time,  $23\frac{3}{5}$  sec.

*Heat 10.*—W. F. Hamilton, United States, 1; L. Sebert, Canada, 2; H. J. Pankhurst, United Kingdom, 3. Also ran :—P. Simon, Hungary, and F. Halbert, Hungary. Won by 3 yards. Time,  $22\frac{2}{5}$  sec.

*Heat 11.*—R. Kerr, Canada, 1; W. W. May, United States, 2; J. P. Stark, United Kingdom, 3. Also ran :—K. Lindberg, Sweden, and E. Brambilla, Italy. Won by  $2\frac{1}{2}$  yards. Time,  $22\frac{1}{5}$  sec.

*Heat 12.*—D. R. Sherman, United States, 1; J. W. Morton, United Kingdom, 2; E. Schonecker, Austria, 3; C. J. den Held, Holland, 4. Won by 2 yards. Time,  $22\frac{2}{5}$  sec.

*Heat 13.*—L. J. de B. Reed, United Kingdom, 1; A. Hoffman, Germany, 2. Won by  $2\frac{1}{2}$  yards. Time,  $23\frac{1}{5}$  sec.

*Heat 14.*—O. Guttormsen, Norway, walked over.

*Heat 15.*—G. A. Hawkins, United Kingdom, 1; H. Meslot, France, 2; J. Hoogveld, Holland, 3. When they entered the straight Hawkins came away and won by 3 yards. Time,  $22\frac{4}{5}$  sec.

## SECOND ROUND.

*Heat 1.*—R. Kerr, Canada, 1; W. F. Hamilton, United States, 2; C. Radoczy, Hungary, 3; O. Guttormsen, Norway, 4. A magnificent race. Won by 9 inches. The third man was only a foot behind Hamilton. Time,  $22\frac{2}{5}$  sec.

*Heat 2.*—N. J. Cartmell, United States, 1; D. R. Sherman, United States, 2; H. J. Huff, United States, 3. Won by  $1\frac{1}{2}$  yards; third close up. Time,  $22\frac{3}{5}$  sec.

*Heat 3.*—R. Cloughen, United States, 1; L. J. de B. Reed, United Kingdom, 2; J. P. George, United Kingdom, 3; S. Hurdsfield, United Kingdom, 4. Reed made a great race with Cloughen for 150 yards, but could not hold the American afterwards, the latter winning by a yard. Time,  $22\frac{3}{5}$  sec.

*Heat 4.*—G. A. Hawkins, United Kingdom, 1; P. J. Roche, United Kingdom, 2; G. W. Malfait, France, 3. A wonderful finish. Ten yards from the line the three were practically level, but then Hawkins just showed in front, and won by a foot. Time,  $22\frac{3}{5}$  sec.

## FINAL.

R. Kerr, Canada	..	..	..	..	..	..	..	1
R. Cloughen, United States	1	..	..	..	..	..	..	2
N. J. Cartmell, United States	..	..	..	..	..	..	..	3
G. A. Hawkins, United Kingdom	..	..	..	..	..	..	..	4
Time, $22\frac{2}{3}$ sec.								

Kerr led at the start, but as soon as they reached the straight the Americans closed up to him. Though palpably tiring, he only yielded by inches, and just got home by nine inches, with Cartmell only a foot behind Cloughen.

R. Kerr, aged 26, was born in Enniskillen, in Ireland, and went to Canada when three years old. He was 5 ft.  $7\frac{1}{2}$  in. high, and weighed 10 st. 10 lb. He won the 100 Yards and 200 Yards A.A.A. Championships of 1908 in London, and seemed slightly overtrained in the Olympic Games.

Diplomas of Merit for the Two Hundred Metres were awarded to W. F. Hamilton, U.S.A., and G. A. Hawkins, of the United Kingdom.

No one touched the Olympic record of  $21\frac{2}{5}$  seconds set for this race by A. Hahn, of Milwaukee A.C., at St. Louis in 1904. The world's record (amateur) for 220 yards (or  $1\frac{2}{5}$  yards over the 200 metres) is  $21\frac{1}{5}$  seconds by B. J. Wefers, U.S.A., on May 30, 1896.

## III.—FOUR HUNDRED METRES FLAT (437.4 yards).

## FIRST ROUND.

*Heat 1.*—E. H. Montague, United Kingdom, 1; P. H. Pilgrim, United States, 2. Only two started. Won by 12 yards. Time,  $50\frac{1}{5}$  sec.

*Heat 2.*—Void; no starters.

*Heat 3.*—E. H. Ryle, United Kingdom, ran over.

*Heat 4.*—J. B. Taylor, United States, 1; R. Penna, Italy, 2; S. Laaftman, Sweden, 3. Won by a dozen yards. Time,  $50\frac{4}{5}$  sec.

*Heat 5.*—G. Nicol, United Kingdom, 1; O. Guttormsen, Norway, 2. Won by 12 yards. Time,  $50\frac{4}{5}$  sec.

*Heat 6.*—G. W. Malfait, France, 1; D. Buddo, Canada, 2. Won by 8 yards. Time, 50 sec.

*Heat 7.*—W. C. Robbins, United States, 1; J. Nagy, Hungary, 2; N. G. Chavasse, United Kingdom, 3; V. Henny, Holland, 4. Won easily. Time,  $50\frac{2}{5}$  sec.

*Heat 8.*—W. C. Prout, United States, 1; C. M. Chavasse, United Kingdom, 2. A beautiful race. Won by 2 yards. Time,  $50\frac{2}{5}$  sec.

*Heat 9.*—H. P. Ramey, United States, 1; A. Astley, United Kingdom, 2. Won by  $1\frac{1}{2}$  yards. Time, 51 sec.

*Heat 10.*—L. Sebert, Canada, 1; M. Cartasegna, Italy, 2; V. Jacquemin, Belgium, retired. Won by 20 yards. Time,  $50\frac{1}{5}$  sec.

*Heat 11.*—J. C. Atlee, United States, 1; A. Patterson, United Kingdom, 2; G. Tarella, Italy, 3. Won by a yard. Time,  $50\frac{2}{5}$  sec.

*Heat 12.*—C. C. Davies, United Kingdom, 1; C. J. den Held, Holland, 2. Won by 4 yards. Time,  $50\frac{2}{5}$  sec.

*Heat 13.*—N. A. Merriam, United States, 1; R. C. Robb, United Kingdom, 2. Won by 2 yards. Time,  $52\frac{1}{5}$  sec.

*Heat 14.*—J. C. Carpenter, United States, 1; Dr. O. P. Triefoff, Germany, 2; K. A. Ringstrand, Sweden, 3; H. J. W. Wal, Holland, 4. Won by 10 yards. Time,  $49\frac{2}{5}$  sec.

*Heat 15.*—W. Halswelle, Great Britain, 1; F. M. de Selding, United States, 2; B. Evers, Holland, 3. De Selding made all the running until the straight, then Halswelle made his effort, and won by 10 yards. Time,  $49\frac{2}{5}$  sec., the fastest time in the First Round, and within one-fifth of a second of the Olympic record.

*Heat 16.*—G. W. Young, United Kingdom, 1; J. Hoogveld, Holland, 2. Won easily. Time,  $52\frac{2}{5}$  sec.

#### SECOND ROUND.

N.B.—In this round a tape was stretched  $2\frac{1}{5}$  yards further on than the finish, in order that times might be taken both for the 400 Metres and for the Quarter-mile.

*Heat 1.*—J. C. Carpenter, United States, 1; C. C. Davies, United Kingdom, 2; N. A. Merriam, United States, 3; G. W. Young, United Kingdom, 4. At 300 yards Davies began to cut down Carpenter's lead. He caught Merriam just before the straight, but Carpenter, slowing fast in the last thirty yards, won by three yards. Time,  $49\frac{2}{5}$  sec. Time for quarter-mile,  $49\frac{1}{5}$  sec.

*Heat 2.*—W. Halswelle, United Kingdom, 1; E. H. Montague, United Kingdom, 2; G. Nicol, United Kingdom, 3; W. C. Prout, United States, 4. Contrary to his usual custom, Halswelle went to the front at once, and was right away at the half distance. Continuing to stride out grandly, he rounded the last bend in perfect style, and won by 12 yards. Time,  $48\frac{2}{5}$  sec., beating the Olympic record of  $49\frac{1}{5}$  sec., set up by H. Hillman, at St. Louis, in 1904, by  $\frac{1}{5}$  sec. Time for the quarter-mile,  $48\frac{1}{5}$  sec., which is a fraction worse than H. C. L. Tindall's British amateur record of  $48\frac{1}{2}$  sec., made at Stamford Bridge on June 29, 1899.

*Heat 3.*—J. B. Taylor, United States, 1; H. P. Ramey, United States, 2; E. H. Ryle, United Kingdom, 3; G. W. Malfait, France, 4. The Frenchman went away with the lead, and not until 300 yards had been covered did Taylor's longer stride take him to the front. Meanwhile, Ryle was coming up fast, but could never catch the American pair. Taylor won by 5 yards. Time,  $49\frac{1}{5}$  sec.; quarter-mile,  $50\frac{1}{5}$  sec.

*Heat 4.*—W. C. Robbins, United States, 1; L. Sebert, Canada, 2; J. C. Atlee, United States, 3. Sebert was slower into his running than the Americans, and at half way he appeared right out of it. Then his stride lengthened appreciably, and, as a result, he speedily passed Atlee. But Robbins could not be caught, and won by 3 yards. Time, 49 sec.; quarter-mile,  $49\frac{1}{5}$  sec.

#### THE FINAL.

The first attempt to decide the Final resulted in "No race" being announced by the Judges.

In this country strings are not usually employed for this distance.

The A.A.A. Rule printed in the programme of the day, referring to obstruction during a race, is as follows :—

*"Any competitor wilfully jostling or running across or obstructing another competitor so as to impede his progress shall forfeit his right to be in the competition and shall not be awarded any position or prize that he would otherwise have been entitled to."*

The Rules, referring to the same subject, as laid down by the Union of which the American representative, Mr. Sullivan, was President, are as follows :—

*“Rule III—The Referee.—When in a final heat a claim of foul or interference is made, he (the referee) shall have power to disqualify the competitor who was at fault if he considers the foul intentional or due to culpable carelessness, and he shall also have the power to order a new race between such competitors as he thinks entitled to such a Privilege.”*

*“Rule XVIII.—The Course.—Each competitor shall keep in his respective position from start to finish in all races on straightaway tracks, and in all races on tracks with one or more turns he shall not cross to the inner edge of the track except when he is at least six feet in advance of his nearest competitor. After turning the last corner into the straight in any race each competitor must keep a straight course to the finish line, and not cross, either to the outside or the inside, in front of any of his opponents.”*

The official inquiry into this final heat of the Four Hundred Metres Race was held at the Garden Club, France-British Exhibition, on the evening of the day of the race. Among those present were Mr. Duxfield, Vice-President of the Amateur Athletic Association, in the chair, Sir Lees-Knowles (British Olympic Council), Mr. G. S. Robertson (British Olympic Council), Mr. Percy Fisher, Mr. Pennycook (Scottish Amateur Athletic Association), Mr. E. W. Parry, Dr. M. J. Bulger (British Olympic Council), Mr. David Scott Duncan (Hon. Secretary, Scottish Amateur Athletic Association), Mr. W. J. Basan (London Athletic Club), Mr. E. H. Pelling (Hon. Secretary, London Athletic Club), and others.

The evidence, written and signed, is as follows :—

*Olympic Games, Quarter-mile Race.*

Inquiry into the allegations of unfair competition by which Mr. W. Halswelle was said to be wilfully obstructed.

Dr. Bulger, a member of the British Olympic Council and an umpire, said :—I took up a position on the back stretch 100 yards from the start. I saw No. 3 in the draw—*i.e.* No. 3 position from the verge. . . .

At this point Mr. Moss, the Assistant-Secretary, explained that No. 1, T. C. Carpenter, drew the first position next to the verge; No. 2, W. Halswelle, drew the second position; No. 4, W. C. Robbins, drew the third position; and No. 3, J. B. Taylor, drew the fourth position.

Dr. Bulger proceeded :—About 50 yards from the start I saw No. 3, W. C. Robbins, go right across Halswelle and take Halswelle's position as No. 2. Halswelle then seemed to drop back, and came more on the outside of Robbins, and in that position he rounded the first bend. That is as far as I know of the matter.

MICHAEL J. BULGER.

*Mr. Harry Goble's Evidence.*

I am a member of the Manchester A.C., and on this occasion I acted as starter in the final heat of the Four Hundred Metres Flat Race at the Olympic Games. I was instructed by the Referee, Mr. Abraham, and other officials to caution the competitors against wilful jostling, and did so while they were on their marks. I said in case of any wilful jostling the race will be declared void, and when the race is re-run the offender will not be allowed to take part. I told them that officials were posted every few yards to notice any such jostling.

HARRY GOBLE.

Dr. Badger, a vice-president of the A. A. A., said :—I acted as an umpire, and took up a position on the bend just before entering the straight. The position of Robbins at that point was that he was leading and about a yard in front of Carpenter. Robbins and Carpenter were in such a position as to compel Halswelle to run very wide all round the bend, and as they swung into the straight Halswelle made a big effort and was gaining hard; but running up the straight the further they went the wider Carpenter went out from the verge, keeping his right shoulder sufficiently in front of Mr. Halswelle to prevent his passing. When they had run 30 yards up the straight Carpenter was about 18 inches off the outside edge of the track. I at once ran up the track, waving my hands to the judges to break the worsted.

A. ROSCOE BADGER, Vice-President, A.A.A.

Mr. David Basan :—I am a member of the A.A.A. and the London Athletic Club, and I acted as an umpire in the Four Hundred Metres Flat Race final heat. I was standing beside Dr. Badger at the bend entering the straight. I corroborate the evidence of Dr. Badger in every particular. As the competitors passed me I called the attention of the next umpire further on to the running of the competitors. In my opinion Carpenter wilfully obstructed Halswelle.

Mr. Halswelle is not a personal friend of mine, and I only know him as a competitor.

D. BASAN.

*Mr. David Scott Duncan.*

I am a member of the British Olympic Council and Secretary of the Scottish Amateur A.A. I acted as referee in the final heat of the Four Hundred Metres Flat Race at the Olympic Games. I took up my position on the cycle track immediately behind Mr. Pennycook, one of the judges, and opposite the winning-post. I watched the race carefully, and saw that thirty yards after the start Halswelle had been dispossessed of second position by Robbins. Swinging into the straight Halswelle commenced to



gain on the two men in front, whereupon Carpenter made straight for the outside edge of the track, while Robbins nipped through on the inside. The boring by Carpenter continued, and the umpires held up their hands and signalled a foul. The worsted was broken, but I do not know by whom. Three of the judges, Messrs. Parry, Pennycook, and Fisher, consulted with me, and on the evidence of the umpires the race was declared void, and the words "No race" were signalled on the telegraph board and announced by megaphone.

DAVID SCOTT DUNCAN.

We, the undersigned, being Judges of the Final of the Four Hundred Metres, declare the race void, and order the same to be re-run on Saturday next without Carpenter, he being disqualified, and further order that the race be run in strings.

PERCY L. FISHER.

C. PENNYCOOK.

E. W. PARRY.

None of the Americans appeared for the Final Heat, though Taylor and Robbins were entitled to compete. Halswelle ran over in 50 sec.

Lieutenant Wyndham Halswelle, aged 26, was born in London, of Scottish descent. In 1906 he won the 100, 220, 440, and 800 yards Scottish Championships on the same day, and won the A.A.A. 440 yards Championships in  $48\frac{1}{2}$  sec. In 1908, before the Games, he did 440 yards in  $48\frac{2}{5}$  sec., and did the same time for the 400 Metres in the second round of this event in the Olympic Games.

#### IV.—EIGHT HUNDRED METRES FLAT (874·9 yards).

##### FIRST ROUND.

*Heat 1.*—O. Bodor, Hungary, 1; G. Butterfield, United Kingdom, 2; E. Björn, Sweden, 3; J. D. Lightbody, United States, 4; F. M. Ashford, United Kingdom, 0; H. J. W. Wal, Holland, 0. Ashford led at first, followed by Butterfield, who went up on the back stretch, with Bodor and Lightbody hanging on. On the last bend Björn went up, but Bodor came with a fine rush, and finishing fast up the straight, won by 2 yards. Time, 1 min.  $58\frac{3}{5}$  sec.

*Heat 2.*—M. W. Sheppard, United States, 1; J. F. Lintott, United Kingdom, 2; J. Parkes, Canada, 3. Sheppard was nearly always at the head of affairs, and won by 4 yards. Time, 1 min. 58 sec.

*Heat 3.*—J. P. Halstead, United States, 1; J. W. Lee, United Kingdom, 2; G. N. Morphy, United Kingdom, 3; J. Nagy, Hungary, 4. Lee made play at first, then Morphy went along, but 300 yards from home Halstead came out and won a fine race with Lee by 2 yards. Time, 2 min.  $1\frac{3}{5}$  sec.

*Heat 4.*—E. Lunghi, Italy, 1; H. L. Coe, United States, 2; L. P. Jones, United States, 3; J. Parkes, Canada, 4; J. M. Lynch, Australasia, 0; J. C. English, United Kingdom, 0. Parkes and Lunghi shared the work, but the Italian began forcing the pace before the first lap was over, and in the second he came along finely, and won by 6 yards. Time, 1 min.  $57\frac{1}{5}$  sec.

*Heat 5.*—C. B. Beard, United States, 1; A. Astley, United Kingdom, 2; D. Buddo, Canada, 3; O. Quarg, Germany, 4; C. M. French, United States, 0; E. M. Dahl, Sweden, 0. Beard led off, Buddo came with a rush half-way, followed by Astley. The American, however, had a little left, and finishing strongly, he held Astley, and won a great race by two or three inches. Time, 1 min. 59 $\frac{1}{2}$  sec.

*Heat 6.*—T. H. Just, United Kingdom, 1; A. Breyneck, Germany, 2; F. G. Danielson, Sweden, 0; A. C. H. Vosbergen, Holland, 0. Danielson led. In the back straight Just drew up, and coming with one long run he won by more than 50 yards. Time, 1 min., 57 $\frac{4}{5}$  sec.

*Heat 7.*—H. Braun, Germany, 1; J. Bromilow, United States, 2; H. E. Holding, United Kingdom, 3; H. P. Ramey, United States, 0; F. Svanstrom, Finland, 0; B. Evers, Holland, 0. Bromilow led for the first quarter right into the straight, where Braun, on the inside, beat both Holding and Bromilow, and won by nearly two yards. Time, 1 min. 58 sec.

*Heat 8.*—I. F. Fairbairn-Crawford, United Kingdom, 1; K. Hellstrom; Sweden, 2; F. P. Sheehan, United States, 3; H. Sutton, Australasia, 0. Crawford soon took a lead, entered the straight with over 8 yards lead, and won by 15 yards. Time, 1 min. 57 $\frac{4}{5}$  sec.

## FINAL.

M. W. Sheppard, United States	..	..	..	..	..	1
E. Lunghi, Italy	..	..	..	..	..	2
H. Braun, Germany..	..	..	..	..	..	3
O. Bodor, Hungary ..	..	..	..	..	..	4
T. H. Just, United Kingdom	..	..	..	..	..	5
J. P. Halstead, United States	..	..	..	..	..	6
I. F. Fairbairn-Crawford, United Kingdom	..	..	..	..	..	0
C. B. Beard, United States..	..	..	..	..	..	0

Time, 1 min. 52 $\frac{4}{5}$  sec.

Fairbairn-Crawford made the pace so hot in this remarkable race that he was fifteen yards ahead in the first 200, and was done with in the first lap. Sheppard then led with Lunghi and Just close behind him. Just tired first. Lunghi hunted the leader all the way home, but was out-paced. Sheppard won by about nine yards in the splendid time of 1.52 $\frac{4}{5}$  completing the Half-mile (5 $\frac{3}{5}$  yards further) in 1.54. This beat by 3 $\frac{1}{5}$  seconds the Olympic record for 800 metres of 1.56, made by Lightbody at St. Louis in 1904, and was within  $\frac{3}{5}$  second of the world's record (amateur) of 1.53 $\frac{2}{5}$  for the Half-mile set up by C. H. Kilpatrick at New York in September, 1895. His time for the Half-mile, 1.54, was also a British record, the previous best being 1.54 $\frac{3}{5}$ , by F. J. K. Cross (O.U.A.C.). Lunghi's time in this race was 1 min. 54 $\frac{1}{5}$  sec., which also beats the previous Olympic record. The pace may be imagined from the facts that the first 400 metres were done in 53 seconds, and the quarter in 53 $\frac{2}{5}$  seconds. Braun only just beat Bodor for the third place.

Diplomas of Merit for the Eight Hundred Metres were awarded to O. Bodor, Hungary, J. P. Halstead, U.S.A., T. H. Just, U.K., C. B. Beard, U.S.A., and I. F. Fairbairn-Crawford, U.K.

M. W. Sheppard was 26 years old, born in New Jersey, U.S.A. He was 5 ft.  $8\frac{1}{2}$  in. high, and weighed 10 st. 8 lb., and had never done such fast time before. E. Lunghi, a remarkable runner, was an Italian naval student from Genoa, aged 21, 5 ft.  $10\frac{1}{2}$  in. high, and weighing 11 st. He had never approached this pace before, and was not supposed to have trained with particular severity for these Games.

#### V.—FIFTEEN HUNDRED METRES FLAT (1,640 yards).

##### FIRST ROUND.

*Heat 1.*—J. P. Sullivan, United States, 1; J. D. Lightbody, United States 2; F. Meadows, Canada, 3; F. A. Knott, United Kingdom, 4. Also ran :—J. M. Smith, United Kingdom; L. N. de L. Bonniot de Fleurac, France; N. Dahl, Norway; O. Bodor, Hungary; and J. de Keyser, Holland. This was the first race decided in the London Stadium during the Olympic Games of 1908. Meadows led the field for three-quarters of a lap. Entering on the second lap, De Fleurac was in possession. At the bell, Smith took the lead. Three hundred yards from home Lightbody rushed to the front, followed by Sullivan and Knott. Sullivan won by a good 6 yards. Time, 4 min.  $7\frac{3}{5}$  sec.

*Heat 2.*—M. W. Sheppard, United States, 1; J. P. Halstead, United States, 2; G. Butterfield, United Kingdom, 3; J. W. Lee, United Kingdom, 4. Also ran :—J. M. Lynch, Australasia; A. Hesse, Germany; and K. Neilsen, Denmark. Sheppard at once ran inside. Positions did not change very materially until the bell, when the order was Lee, Butterfield, Sheppard, Halstead. But entering the straight the Americans beat the Englishmen off, and a splendid finish between the former saw Sheppard win by a bare yard. Time, 4 min. 5 sec. The winner thus beat the Olympic record of 4 min.  $5\frac{2}{3}$  sec., done by Lightbody at St. Louis in 1904, the second man tying with the previously best figures.

*Heat 3.*—N. F. Hallows, United Kingdom, 1; E. Lunghi, Italy, 2. Also ran:—M. Cartasegna, Italy; F. H. Riley, United States; and E. Björn, Norway. Cartasegna at once went to the front, but was soon displaced by Lunghi, who led at the bell. Then Hallows, two hundred and fifty yards from home, forced his way to the front, with Lunghi a yard behind. The pair struggled right up to the tape, Hallows eventually winning by 2 yards. Time, 4 min.  $3\frac{2}{5}$  sec. Lunghi's time was 4 min.  $3\frac{4}{5}$  sec. The record set up by Sheppard in the previous heat was thus easily broken, Lunghi also being well inside the figures which were destined to stand for so short a time.

*Heat 4.*—E. V. Loney, United Kingdom, 1; H. L. Coe, United States, 2; J. McGough, United Kingdom, 3; S. Demetrios, Greece, 4. Also ran :—G. Dreher, France. McGough, whose left ankle was bandaged, set a lively pace until just before the bell. Then Loney shot by. For two hundred yards the others ran stride for stride. But running with grim determination, Loney refused to allow his opponent to get by, and as a result he won by 2 yards. Time, 4 min.  $8\frac{2}{5}$  sec.

*Heat 5.*—J. Tait, Canada, 1; J. Nagy, Hungary, 2; F. Svansson, Finland, 3. Also ran :—A. G. Ragueneau, France. The Canadian was in front, until the bell. One hundred yards further on Ragueneau attempted to go up, but finding himself easily held by Tait, he retired, and Tait won easily by 50 yards. Time, 4 min.  $12\frac{1}{5}$  sec.

*Heat 6.*—J. E. Deakin, United Kingdom, 1; A. Breyneck, Germany, 2; A. C. H. Vosbergen, Holland, 3. Deakin was always in front, and won by 75 yards. Time, 4 min.  $13\frac{3}{5}$  sec.

*Heat 7.*—H. A. Wilson, United Kingdom, 1; J. Bouin, France, 2; W. Galbraith, Canada, 3. Galbraith went away with the lead until the bell rang, when Wilson went by, and won very easily by a good 30 yards. Time, 4 min. sec.

*Heat 8.*—I. F. Fairbairn-Crawford, United Kingdom, 1; E. M. Dahl, Sweden, 2; H. Braun, Germany, 3. Also ran :—O. Larsen, Norway; F. Delloye, Belgium; E. A. Andersson, Sweden; and J. Fitzgerald, Canada. Braun and Dahl occupied the leading positions by the Press stand. At the bell the pace became much faster, when the last bend was reached Fairbairn-Crawford went up, with Dahl hanging on. Fairbairn-Crawford, finishing strongly, won by 4 yards. Time, 4 min. sec.

## FINAL.

M. W. Sheppard, United States	..	..	..	..	..	1
H. A. Wilson, United Kingdom	..	..	..	..	..	2
N. F. Hallows, United Kingdom	..	..	..	..	..	3
J. Tait, Canada	..	..	..	..	..	4
I. F. Fairbairn-Crawford, United Kingdom	..	..	..	..	..	5
J. E. Deakin, United Kingdom	..	..	..	..	..	6
J. P. Sullivan, United States	..	..	..	..	..	0
E. V. Loney, United Kingdom	..	..	..	..	..	0

Time, 4 min. sec.

A disappointing race for the United Kingdom, but full of interest. Deakin was reserving himself for the Team Race later on, and Loney could not make the pace hot enough to tire Sheppard in the last half mile. Fairbairn-Crawford did the first 500 yards in fast time, and sacrificed his chances again; but Loney was unable to take on the running, and the race was slow till the last 300 yards, which just suited Sheppard's splendid turn of speed. Here Wilson made his effort and led into the straight, followed by Hallows, but Sheppard beat them both by sheer pace and won a fine race by about 2 yards in  $4.3\frac{2}{5}$ , the same time Hallows had done in just beating Lunghi for the third heat, and over three seconds slower than Wilson had done the distance in his trials. Sheppard and Lunghi, showing the same relative form in both races, thus proved they were as good for 1,500 as for 800 metres among the finest athletes in the world.

Diplomas of Merit for the Fifteen Hundred Metres were awarded to J. P. Sullivan, U.S.A. ; J. L. Tait, Canada; E. Lunghi, Italy; E. V. Loney, U.K., and I. F. Fairbairn-Crawford, U.K.

H. A. Wilson, aged 22, born in Lincolnshire, was 5 ft. 4 in. high, and weighed 8 st. 3 lb. At the Olympic Trials he won this race in 3 min.  $59\frac{3}{5}$  sec. N. F. Hallows, of Keble College, Oxford, was not yet 22 years old, 5 ft. 9 in. tall, and weighed 9 st. 13 lb. He won the University Three Miles in 1907 and 1908, and was born at Doncaster.

## VI.—HUNDRED AND TEN METRES HURDLES (120·2 yards).

[Ten flights of 3 ft. 6 in. Hurdles, ten yards apart, on grass, beginning fifteen yards from scratch.]

## FIRST ROUND.

Heat 1.—A. H. Healey, United Kingdom, 1; H. St. A. Murray, Australasia, 2; D. A. Stupart, South Africa, 3. Healey led all the way and won by 4 yards. Time,  $15\frac{4}{5}$  sec.

Heat 2.—J. C. Garrels, United States, 1; A. Halligan, United Kingdom, 2. Garrels won by 7 yards. Time,  $16\frac{1}{5}$  sec.

Heat 3.—O. Groenings, United Kingdom, 1; G. Scoutarides, Greece, 2. Groenings was able to win by 5 yards. Time,  $16\frac{2}{5}$  sec.

Heat 4.—L. A. Kiely, United Kingdom, walked over.

Heat 5.—W. M. Rand, United States, 1; K. Powell, United Kingdom, 2; E. Savage, Canada, 3. Powell and Rand were practically level to the eighth hurdle, then Powell struck his ninth hurdle, and Rand won by 3 yards. Time,  $15\frac{4}{5}$  sec.

Heat 6.—D. W. Walters, United Kingdom, 1; O. R. Lemming, Sweden, fell. Time,  $17\frac{4}{5}$  sec.

Heat 7.—W. A. Knyvett, United Kingdom, walked over.

Heat 8.—F. Halbart, Belgium, walked over.

Heat 9.—T. J. Ahearne, United Kingdom, walked over.

Heat 10.—F. C. Smithson, United States, 1; N. Kovacs, Hungary, 2. Smithson led from the first, and won by 10 yards. Time,  $15\frac{4}{5}$  sec.

Heat 11.—E. R. J. Hussey, United Kingdom, 1; W. Blijstad, Norway, 2. The Norwegian fell. Time,  $16\frac{4}{5}$  sec.

Heat 12.—C. E. Kinahan, United Kingdom, 1; O. Guttormsen, Norway, 2. Kinahan won by 10 yards. Time,  $16\frac{4}{5}$  sec.

Heat 13.—L. V. Howe, United States, 1; E. E. Leader, United Kingdom, 2. A very fine race all the way. They took each hurdle almost simultaneously until the last, when Howe was a trifle the faster, and won by  $1\frac{1}{2}$  yards. Time,  $15\frac{1}{5}$  sec.

Heat 14.—A. B. Shaw, United States, ran over.

## SECOND ROUND.

Heat 1.—A. B. Shaw, United States, 1; E. R. J. Hussy, United Kingdom, 2; D. W. Walters, United Kingdom, 3; O. Greenings, United Kingdom, 4. Shaw led from the first hurdle, and won by a good 6 yards. Time,  $15\frac{3}{5}$  sec.

Heat 2.—F. C. Smithson, United States, 1; W. A. Knyvett, United Kingdom, 2; L. V. Howe, United States, 3. Smithson at once left the others, and won very easily. Time,  $15\frac{2}{5}$  sec. (ties Olympic record of  $15\frac{2}{5}$  sec., by Kraenzlein at Paris, 1900).

Heat 3.—W. M. Rand, United States, 1; A. H. Healey, United Kingdom, 2; L. A. Kiely, United Kingdom, 3; T. J. Ahearne, United Kingdom, 4. Healey tipped his ninth hurdle, and this cost him the race, Rand seizing the opportunity to get up and win by a foot. Time,  $15\frac{4}{5}$  sec.

Heat 4.—J. C. Garrels, United States, 1; C. E. Kinahan, United Kingdom, 2. Garrels won by 10 yards. Time,  $16\frac{1}{5}$  sec.

## FINAL.

F. C. Smithson, United States	..	..	..	..	..	1
J. C. Garrels, United States	..	..	..	..	..	2
A. B. Shaw, United States	..	..	..	..	..	3
W. M. Rand, United States	..	..	..	..	..	4

Time, 15 sec. World's Record.

The four Americans were the best in the United States, and had never met before. As Smithson had already equalled the Olympic record in the second round, it was expected he would do even better in the final. The start was excellent, but Smithson gained slightly over each hurdle in perfect style, and won by five yards, creating a world's record, although Kraenzlein's  $15\frac{1}{5}$  at Chicago, on June 18 of the same year, had been run on cinders over 120 yards, which is  $\frac{2}{3}$  of a yard shorter than Smithson's 110 metres on grass. This race was run on the last day of the Games, in fine weather, just before Her Majesty the Queen distributed the gold medals, and helped to make a worthy conclusion to the splendid performances of the past fortnight.

Forrest Smithson, 23 years old, was 6 ft. high, and weighed 12 st. 10 lb, born in Portland, Oregon, U.S.A., and had never showed such fine pace before. Garrells, of Michigan, was a year younger, and had done  $15\frac{2}{3}$  seconds, besides putting the shot and the discus—a good all-round man. Shaw, of Joliet, Illinois, had been timed at  $15\frac{2}{3}$  seconds, and was an extraordinarily clean and neat hurdler.

Diplomas of Merit for the 110 Metres Hurdles were awarded to W. M. Rand, U.S.A., and A. H. Healey, U.K.

#### VII.—FOUR HUNDRED METRES HURDLES (437·4 yards).

*[Ten flights of 3 ft. Hurdles, 35 metres apart, beginning 45 metres (49·213 yards) from the scratch mark and ending 40 metres from the finish, on grass.]*

##### FIRST ROUND.

*Heat 1.*—E. Koops, Holland, walked over.

*Heat 2.*—H. L. Coe, United States, 1; J. B. Densham, United Kingdom, 2. A great race. The American won by  $1\frac{1}{2}$  yards. Time,  $58\frac{4}{5}$  sec.

*Heat 3.*—C. J. Bacon, United States, 1; H. St. A. Murray, Australasia, 2. Murray was outpaced from the start, and Bacon won by 20 yards in 57 sec. (beating Olympic record of  $57\frac{2}{3}$  sec. by Tewkesbury, United States, at Paris, in 1904).

*Heat 4.*—F. W. Harmer, United Kingdom, walked over.

*Heat 5.*—G. Burton, United Kingdom, walked over.

*Heat 6.*—H. L. Hillman, United States, 1; G. Dubois, France, 0. Dubois retired a hundred yards from home. Time,  $59\frac{1}{5}$  sec.

*Heat 7.*—O. Groenings, United Kingdom, walked over.

*Heat 8.*—E. W. Gould, United Kingdom, walked over.

*Heat 9.*—N. Kovacs, Hungary, walked over.

*Heat 10.*—L. F. Tremeer, United Kingdom, walked over.

*Heat 11.*—Void, no starters.

*Heat 12.*—L. A. Burton, United Kingdom, 1; H. Meslot, France, 2. A great race throughout, but in the straight Burton got away and won by 3 yards. Time,  $60\frac{2}{5}$  sec.

## SECOND ROUND.

*Heat 1.*—H. L. Hillman, United States, 1; H. L. Coe, United States, 2; E. Koops, Holland, fell. Hillman beat his brother American by a score yards, in the process upsetting the previous Olympic record by  $1\frac{1}{5}$  sec. Time,  $56\frac{2}{5}$  sec.

*Heat 2.*—C. J. Bacon, United States, 1; O. Groenings, United Kingdom, and N. Kovacs, Hungary, retired. Bacon made the pace so hot that the others retired at the half distance. Time,  $58\frac{4}{5}$  sec.

*Heat 3.*—L. A. Burton, United Kingdom, 1; F. W. Harmer, United Kingdom, 2; E. W. Gould, United Kingdom, 3. Though slowing fast in the straight, Burton had such a big lead that he was able to win by 6 yards. Time, sec.

*Heat 4.*—L. F. Tremeer, United Kingdom, 1; G. Burton, United Kingdom, retired. Time,  $60\frac{3}{5}$  sec.

## FINAL.

C. J. Bacon, United States	..	..	..	..	..	1
H. L. Hillman, United States	..	..	..	..	..	2
L. F. Tremeer, United Kingdom	..	..	..	..	..	3
L. A. Burton, United Kingdom	..	..	..	..	..	0

Time, 55 sec.

The Englishmen were beaten in 150 yards, and the Americans fought out the race together at a wonderful speed, and very level. They took the last hurdle together, and Bacon won on the run-in by 6 feet in time which lowered the Olympic record for the third time in this event. The world's record (amateur) for the 440 yards hurdles (or  $2\frac{3}{5}$  yards further than this race) is  $56\frac{1}{5}$  seconds, by H. Arnold at Buffalo, U.S.A., in September, 1901, which shows that Bacon travelled faster than any athlete had done his distance over hurdles before. Groenings might have done better for the United Kingdom had he not had lumbago. Densham held the A.A.A. record of  $57\frac{4}{5}$  seconds. Hillman had hitherto done better than Bacon, who was taller and looked stronger. L. F. Tremeer was running in the Hundred Yards A.A.A. Championship of 1897.

## VIII.—THREE THOUSAND TWO HUNDRED METRES STEEPLECHASE

(22·4 yards less than 2 miles).

[*Three-foot Hurdles, every competitor to go over or through the water at the water jump.*]

*Heat 1.*—A. Russell, United Kingdom, 1; N. Cartasegna, Italy, 2; A. G. Ragueneau, France, 0; E. P. Carr, United States, 0; T. Downing, United Kingdom, 0. Downing was disqualified at the first water jump. Ragueneau and Russell led, but at two laps the Frenchman retired. Then Carr injured his ankle. Russell won easily. Time, 10 min.  $56\frac{1}{5}$  sec.

*Heat 2.*—J. L. Eisele, United States, 1; A. Lovass, Hungary, 0; L. de B. de Fleurac, France, 0; F. J. Buckley, United Kingdom, 0; J. C. English, United Kingdom, 0. De Fleurac went away at the start, but Eisele and English went up in the next lap, and the French candidate retired at the water jump, where English fell. The American now led till half a lap before the bell, when English retired leaving Eisele to finish alone. Time, 11 min.  $13\frac{3}{5}$  sec.

*Heat 3.*—W. Galbraith, Canada, 1; H. Barker, United Kingdom, 0. Barker retired. Time, 11 min.  $12\frac{2}{5}$  sec.

*Heat 4.*—A. J. Robertson, United Kingdom, 1; G. A. Dull, United States, 2; G. N. Bonhag, United States, 0; R. F. C. Yorke, United Kingdom, 0. Dull led for a lap, but in the next Robertson went ahead, Yorke was disqualified, and Bonhag retired. Robertson won by 200 yards. Time, 11 min. 10 sec.

*Heat 5.*—C. Guy Holdaway, United Kingdom, 1; J. W. Kinchin, United Kingdom, 2; R. A. Spitzer, United States, 3; C. L. Hall, United States, 4. In the third lap Holdaway went ahead with Kinchin in attendance, and the Americans were soon left a long way behind. Holdaway won easily by nearly 100 yards. Time, 11 min.  $\frac{4}{5}$  sec.

*Heat 6.*—H. Sewell, United Kingdom, 1; J. D. Lightbody, United States, 2; J. F. Fitzgerald, Canada, 0; W. Grantham, United Kingdom, 0. The Canadian went off with a rush, but was soon left, while at the first hurdle after the water jump Lightbody accidentally spiked Grantham. Over the last four hurdles Sewell and Lightbody were practically level, but on the flat, Sewell, with a yard or so advantage, finished strongly, and won by 10 yards. Time, 11 min.  $\frac{1}{5}$  sec.

#### FINAL.

A. Russell, United Kingdom	..	..	..	..	..	1
A. J. Robertson, United Kingdom	..	..	..	..	..	2
J. L. Eisele, United States	..	..	..	..	..	3
C. Guy Holdaway, United Kingdom	..	..	..	..	..	4
H. Sewell, United Kingdom	..	..	..	..	..	5
W. Galbraith, Canada	..	..	..	..	..	6

Time, 10 min.  $\frac{4}{5}$  sec.

Holdaway led at the start, but was soon displaced. Galbraith and Russell then made the pace for the first mile. Afterwards Russell and Eisele fought for the lead until the bell, when Robertson passed Eisele and was only beaten by two yards by Russell, with Eisele 25 yards behind.

Diplomas of Merit for the 3,200 Metres Steeplechase were awarded to Holdaway, U.K., Sewell, U.K., and Galbraith, Canada.

Conditions for this event differ at every meeting.

### IX.—FIVE MILES RUN (8 kilometres).

#### FIRST ROUND.

*Heat 1.*—J. F. Svanberg, Sweden (time, 25 min. 46  $\frac{1}{5}$  sec.), 1; C. Hefferon, South Africa, 2; G. B. Blake, Australasia, 3; W. Coales, United Kingdom, 0; A. G. Ragueneau, France, 0. The latter retired at a lap. Hefferon led from Coales at first, and then the order was reversed, the pair sharing the pacing. At two miles Svanberg was forcing matters, and in the next lap took the lead. At three miles there was quite a large margin between him and Hefferon, and the Swede came home a winner by 120 yards. Coales retired in the fourth mile. Intermediate times: 1 mile, 4 min. 52 sec.; 2 miles, 10 min. 2  $\frac{4}{5}$  sec.; 3 miles, 15 min. 10  $\frac{2}{5}$  sec.; 4 miles, 20 min. 29  $\frac{2}{5}$  sec.

*Heat 2.*—E. R. Voigt, United Kingdom (time, 26 min. 13  $\frac{2}{5}$  sec.), 1; F. G. Bellars, United States, 2; P. Pagliani, Italy, 3; K. Nielsen, Denmark, 4; W. W. Wakker, Holland, 0; G. Coulcumberdos, Greece, 0; E. M. Dahl, Sweden, 0. Bellars led off, with Voigt, Pagliani, Dahl, Coulcumberdos and Nielsen in close order. The latter was dropped at the mile, when the same three were ahead, with Dahl and Coulcumberdos. So the men went for another two miles. At last Voigt set the pace, and coming away at four miles, he soon had the field beaten.





ATHLETICS.—R. KERR (CANADA) WINNING THE 200 METRES.



ATHLETICS.—START FOR THE 1,500 METRES FINAL.



ATHLETICS—M. W. SHEPPARD (U.S.A.) WINNING THE 1,500 METRES.

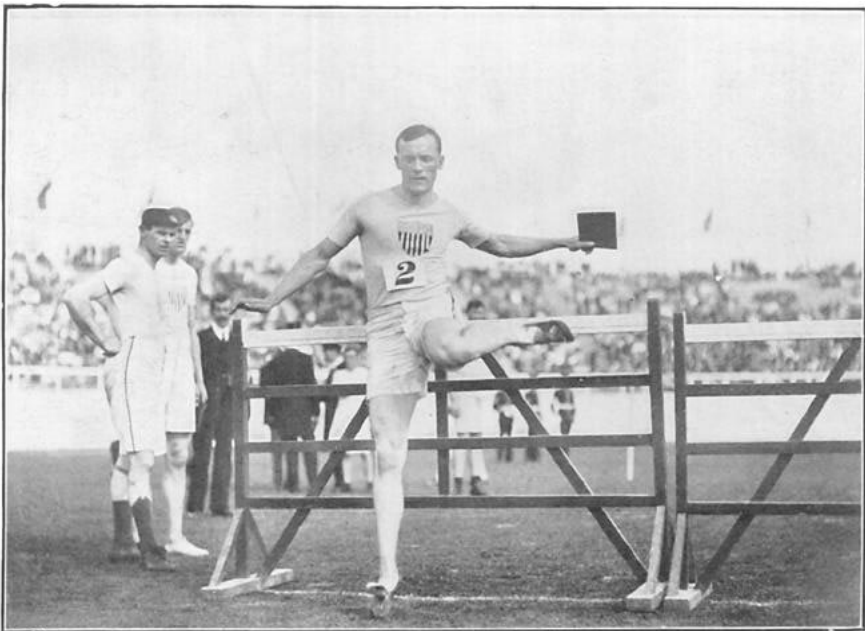

ATHLETICS.—F. C. SMITHSON (U.S.A.), WINNER OF THE 110 METRES HURDLES  
IN 15 SECONDS.

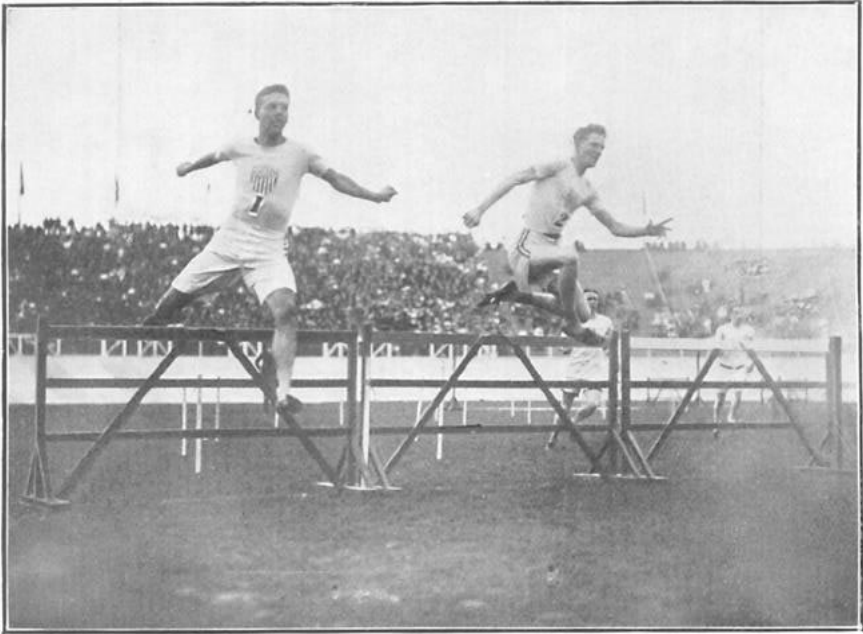

ATHLETICS.—C. J. BACON (WINNER) AND R. L. HILLMAN (BOTH U.S.A.) IN THE  
400 METRES HURDLES.



ATHLETICS.—THE WATER JUMP IN THE STEEPLECHASE.

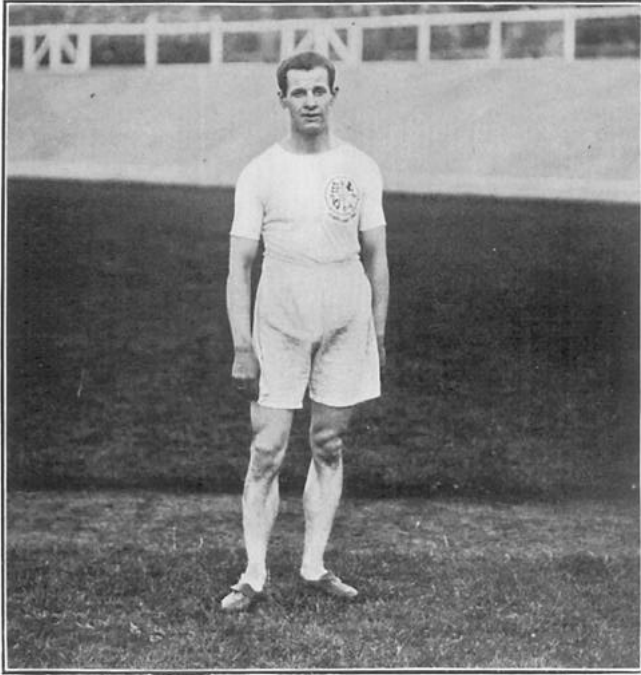

ATHLETICS.—E. R. VOIGT (U.K.) WINNER OF THE FIVE MILES.



ATHLETICS.—START OF THE 3,500 METRES WALKING RACE.

Pagliani persevered pluckily, but two laps from home Bellars led him, and finished second, 150 yards behind Voigt. Intermediate times : 1 mile, 5 min.  $6\frac{1}{5}$  sec. ; 2 miles, 10 min. 40 sec. ; 3 miles, 16 min. 6 sec. ; 4 miles, 21 min. 16 sec.

*Heat 3.*—S. L. Landqvist, Sweden (time, 27 min.  $0\frac{1}{5}$  sec.), 1 ; E. P. Carr, United States, 2 ; J. F. Jorgensen, Denmark, 3 ; C. L. Hall, United States, 4 ; P. Nettlebeck, Germany, 5 ; W. T. Braams, Holland, 0. This was a good race. Landqvist led at first, with Nettlebeck, Hall, Carr, and Jorgensen in attendance, and Carr kept up for a mile, when the Swede went gradually away, and won by 120 yards. Intermediate times : 1 mile, 5 min.  $7\frac{3}{5}$  sec. ; 2 miles, 10 min.  $32\frac{2}{5}$  sec. ; 3 miles, 15 min.  $53\frac{2}{5}$  sec. ; 4 miles, 21 min.  $26\frac{1}{5}$  sec.

*Heat 4.*—J. Murphy, United Kingdom (time, 25 min.  $59\frac{1}{5}$  sec.), 1 ; F. Meadows, Canada, 2 ; J. G. Petersson, Sweden, 3 ; P. Lijandier, France, 4 ; J. E. Deakin, United Kingdom, 0 ; J. Tait, Canada, 0 ; J. de Keyser, Holland, 0. Murphy led all the way, and Deakin soon dropped behind and retired. Murphy won by 110 yards. Intermediate times : 1 mile, 4 min.  $49\frac{3}{5}$  sec. ; 2 miles, 9 min.  $59\frac{4}{5}$  sec. ; 3 miles, 15 min.  $12\frac{2}{5}$  sec. ; 4 miles, 20 min.  $31\frac{2}{5}$  sec.

*Heat 5.*—A. J. Robertson, United Kingdom (time, 25 min.  $50\frac{1}{5}$  sec.), 1 ; J. F. Fitzgerald, Canada, 2 ; S. Stevenson, United Kingdom, 3 ; A. J. A. Wiegant, Sweden, 0 ; J. M. Lynch, Australasia, 0 ; A. C. H. Vosbergen, Holland, 0. Fitzgerald led at first, with Robertson and Wiegant next, but before the mile Robertson had gone ahead. Vosbergen retired. Robertson at four miles led by fully 70 yards. Now came a fine struggle between Fitzgerald and Stevenson. Fitzgerald, who collapsed at the post, beat Stevenson by 70 yards. Robertson won by 80 yards. Intermediate times : 1 mile, 4 min.  $52\frac{4}{5}$  sec. ; 2 miles, 10 min.  $2\frac{2}{5}$  sec. ; 3 miles, 15 min.  $18\frac{2}{5}$  sec. ; 4 miles, 20 min.  $37\frac{2}{5}$  sec.

*Heat 6.*—E. Owen, United Kingdom (time, 26 min. 12 sec.), 1 ; W. Galbraith, Canada, 2 ; I. Nejedky, Bohemia, 3 ; A. Lovas, Hungary, 0. This was a fast run race at first, Owen taking the field along, and at two miles Galbraith was beaten off. Owen won by 440 yards. Intermediate times : 1 mile, 4 min.  $46\frac{3}{5}$  sec. ; 2 miles, 9 min. 56 sec. ; 3 miles, 15 min.  $19\frac{1}{5}$  sec. ; 4 miles, 20 min. 51 sec.

## FINAL.

	m.	s.
1. E. R. Voigt, United Kingdom .. .. .	25	$11\frac{1}{5}$
2. E. Owen, United Kingdom .. .. .	25	24
3. J. F. Svanberg, Sweden .. .. .	25	$37\frac{1}{5}$
4. C. Hefferon, South Africa .. .. .	25	44
5. A. J. Robertson, United Kingdom .. .. .	26	13
6. F. Meadows, Canada .. .. .	—	—
7. J. F. Fitzgerald, Canada .. .. .	—	—
8. F. G. Bellars, United States .. .. .	—	—
9. S. L. Landqvist, Sweden .. .. .	—	—
0. J. Murphy, United Kingdom .. .. .	—	—

Time, 25 min.  $11\frac{1}{5}$  sec.

Fitzgerald and Murphy made the pace at first. At the mile Owen led, but was soon displaced by Svanberg, and afterwards by Hefferon, and these alternately took the field along until Hefferon made his effort, with two laps to go, and failed to stay. Seven hundred yards from home, Voigt spurted right away from the rest, running in beautiful style, and won by 70 yards. Owen caught Svanberg at the last corner and beat him by nearly 50 yards,

Intermediate times :	1 mile	(Owen)	$4.46\frac{1}{5}$
	2 miles	(Hefferon)	$9.54\frac{1}{5}$
	3 "	(Hefferon)	$15.5\frac{3}{5}$
	4 "	(Svanberg)	$20.19\frac{1}{5}$

The world's record (amateur) was made by A. Shrubbs, in 24 min.  $33\frac{2}{5}$  sec., at Stamford Bridge, in May, 1904.

Diplomas of Merit for the Five Miles Run were awarded to J. F. Fitzgerald, Canada, S. L. Landqvist, Sweden, A. J. Robertson, U.K., J. Murphy, U.K., F. G. Bellars, U.S.A., C. Hefferon, South Africa, and F. Meadows, Canada.

#### X.—TEN MILES WALK (16 kilometres).

*Heat 1.*—E. J. Webb, United Kingdom (time, 80 min.  $18\frac{3}{5}$  sec.), 1 ; F. T. Carter, United Kingdom, † ; E. A. Spencer, United Kingdom, † ; E. E. Lerner, United Kingdom, † (81 min.  $25\frac{2}{5}$  sec.) ; A. E. M. Rowland, Australasia (81 min.  $57\frac{3}{5}$  sec.), 5 ; T. E. Hammond, United Kingdom (83 min. 44 sec.), 6 ; P. Gunia, Germany, 7. Also competed :—J. Goetzee, Holland ; W. F. Winkelmann, Holland ; A. T. Yeoumans, United Kingdom ; P. M. Soudijn, Holland, and A. H. S. Hojme, Denmark. In the first lap Rowland went to the front, followed by Gunia and Hojme, but in the second lap Lerner took the lead, with Hojme second, Rowland being cautioned at this point. Lerner completed his first mile in 7 min.  $41\frac{1}{5}$  sec., with Webb and Carter a yard behind. At the second mile Hojme again took second place, with Carter and Webb in attendance, Lerner's time being 15 min.  $51\frac{2}{5}$  sec. In the seventh lap Webb drew out, and in the next 300 yards Gunia went up into second place. The third mile was completed by Webb in 23 min.  $41\frac{3}{5}$  sec., Carter being second, 40 yards behind; Gunia third, and Lerner fourth. In the next lap Lerner took third place, and the three Englishmen lapped Winkelmann and Goetzee, whilst Rowland also improved his position. Four miles saw Webb 70 yards ahead of Carter, 60 yards separating the latter from Lerner, Hojme and Soudijn being lapped. Webb's time was then 30 min. 20 sec. The leader reached half-distance in 39 min.  $12\frac{2}{5}$  sec., 150 yards in front of Carter. A great race was now going on between Spencer and Rowland for fourth place, the pair being 40 yards behind Lerner. Webb covered six miles in 46 min. 48 sec. ; Carter was second, 200 yards behind, Lerner another 120 yards away, and in the next lap Spencer and Rowland passed Lerner. Webb completed the seventh mile in 54 min.  $51\frac{2}{5}$  sec. At  $7\frac{1}{2}$  miles he was exactly half a lap ahead of Carter and Spencer. Webb's time at the eighth mile was 62 min. 57 sec., and at the ninth 71 min.  $21\frac{4}{5}$  sec. Spencer now drew well away from Rowland, and half a mile from home Carter eased for him, whilst in the last lap Lerner went up, and drawing level, the three Englishmen finished in a line for second place. Webb during the last mile took matters easily, and won by 180 yards.

*Heat 2.*—G. E. Lerner, United Kingdom (time, 78 min. 19 sec.), 1 ; R. Harrison, United Kingdom (78 min.  $21\frac{1}{5}$  sec.), 2 ; H. E. Kerr, Australasia (78 min.  $40\frac{1}{5}$  sec.), 3 ; W. J. Palmer, United Kingdom (79 min. 4 sec.), 4 ; G. R. J. Withers, United Kingdom (79 min.  $22\frac{3}{5}$  sec.), 5 ; S. C. A. Schofield, United Kingdom (81 min.  $7\frac{2}{5}$  sec.), 6 ; P. A. A. Ruimers, Holland (87 min.  $38\frac{4}{5}$  sec.), 7 ; E. Rath, Austria (go min.  $33\frac{1}{5}$  sec.), 8. Also started :—J. Huijgen, Holland ; J. Butler, United Kingdom ; E. Rothman, Sweden ; C. P. M. Westergaard, and G. Goulding, Canada. Rothman at once set the pace from Goulding, but at the second lap Palmer and Lerner went to the front, Palmer's mile time being 7 min.  $17\frac{2}{5}$  sec. Lerner now took the lead, with Palmer in attendance, but at two miles Palmer just led from Lerner in 14 min.  $44\frac{3}{5}$  sec., with Kerr third, 20 yards behind. Lerner

now went away, but Palmer pluckily hung on, and at  $2\frac{3}{4}$  miles he lapped Rath ; whilst in the straight for 3 miles the champion lapped the two Dutchmen, his 3 miles' time being 22 min.  $12\frac{2}{5}$  sec. Kerr was still third, 60 yards in front of Withers, Harrison fifth, and Schofield sixth. At 39 miles Rothman was lapped by the leaders, whose time at 4 miles was 29 min.  $59\frac{1}{5}$  sec. Butler was lapped in the tenth lap. The leader's time at 5 miles was 37 min. 55 sec. At 6 miles Palmer was a yard ahead of Larnar, in 46 min.  $2\frac{1}{5}$  sec. Larnar again took the lead, at 7 miles his time being 53 min.  $55\frac{3}{5}$  sec., Harrison third, 35 yards behind. In the next lap Larnar eased and brought along Harrison, and the three went on together, with Kerr fourth, 55 yards behind. Larnar drew out at eight miles, his time being 62 min.  $5\frac{3}{5}$  sec., and at nine miles 70 min. 20 sec. Keeping his men well together, Larnar took matters easily, but drew away at the bell from Harrison, Palmer being third. Kerr caught Palmer 350 yards from home, Larnar eventually winning by 6 yards.

## FINAL.

					m.	s.
1.	G. E. Larnar, United Kingdom	..	..	..	75	$57\frac{2}{5}$
2.	E. J. Webb, United Kingdom	..	..	..	77	31
3.	E. A. Spencer, United Kingdom	..	..	..	81	$20\frac{1}{5}$
4.	F. T. Carter, United Kingdom	..	..	..	81	$20\frac{1}{5}$
5.	E. E. Larnar, United Kingdom	..	..	..	84	$26\frac{1}{5}$
6.	W. J. Palmer, United Kingdom	..	..	..	—	

Spencer led off, but early in the first mile G. E. Larnar and Webb went away from the field, of whom Spencer, Palmer, and E. E. Larnar were next. In the fourth lap Carter passed E. E. Larnar. Meanwhile, Webb walked along pluckily in second place. In the sixth mile E. E. Larnar was caught again, and he took the leader along at a first-rate pace. Little further description is needed. All the men kept moving in fine style. At nine miles the leader was nearly two minutes inside the previous record, while Webb was also within the previous best. Both went steadily through the last mile, and G. E. Larnar eventually won by about 300 yards in 75 min.  $57\frac{2}{5}$  sec., against Sturgess' record of 77 min.  $38\frac{4}{5}$  sec.

The half-distance times of each man were as follows :—G. E. Larnar, 36 min. sec. ; E. J. Webb, 36 min.  $38\frac{2}{5}$  sec. ; E. A. Spencer, 39 min.  $11\frac{2}{5}$  sec. ; F. T. Carter, 39 min.  $13\frac{2}{5}$  sec. ; W. J. Palmer, 39 min. 49 sec. ; E. E. Larnar, 41 min.  $8\frac{2}{5}$  sec.

The intermediate times of Larnar and Webb in comparison with Sturgess' performances are as follows :

Miles.	Larnar.	Webb.	Sturgess.
	m. s.	m. s.	m. s.
1	7 $1\frac{1}{5}$	7 2	7 $27\frac{2}{5}$
2	14 11	14 13	15 $13\frac{1}{5}$
3	21 $20\frac{2}{5}$	21 38	22 $58\frac{1}{5}$
4	28 $43\frac{3}{5}$	29 $5\frac{2}{5}$	30 $32\frac{1}{5}$
5	36 $16\frac{2}{5}$	36 $38\frac{2}{5}$	38 $15\frac{4}{5}$
6	43 54	44 21	46 11
7	51 $37\frac{2}{5}$	52 $16\frac{2}{5}$	53 $41\frac{1}{5}$
8	59 33	60 $23\frac{2}{5}$	61 $36\frac{3}{5}$
*9	67 $37\frac{4}{5}$	67 $37\frac{4}{5}$	69 $31\frac{2}{5}$
*10	75 $57\frac{2}{5}$	75 $57\frac{2}{5}$	77 $38\frac{4}{5}$

\* Records.

The World's Records at these distances are :—

Miles.

1.	Amateur ... ..	G. E. Larner ...	6.26 ...	1904
2.	Amateur ... ..	G. E. Larner ...	13.11 $\frac{2}{3}$ ...	1904
3.	Professional ... ..	J. W. Raby ...	20.21 $\frac{1}{2}$ ...	1883
4.	Amateur ... ..	G. E. Larner ...	27.14 ...	1905
5.	Professional ... ..	J. W. Raby ...	35.10 ...	1883
10.	Professional ... ..	J. W. Raby ...	74.45 ...	1883

There is no doubt that the Ten Miles Walk was one of the best things in the Games. Both Webb and Larner walked without the semblance of doubtful action, in the fairest possible manner.

G. E. Larner, aged 33, was born at Langley, Bucks, and retired from training in 1905 owing to his duties in the Brighton Police Force, but was fortunately permitted to compete in these Games. E. J. Webb, aged 36, was born at Hackney, went to sea at twelve years old, then entered the Army, and served in the retreat to Ladysmith. After the war he joined the tobacco trade, In this race Webb did the nine miles in 68.35 $\frac{1}{5}$  and the ten in 77.31 ; both would have been records if done the day before, and the fact that they were only good enough for second place is one indication (among many similar) of the extremely high merit of these Olympic performances.

#### XI.—THE MARATHON RACE.

*[From Windsor Castle to the Olympic Stadium in Shepherd's Rush, in which 385 yards were run on the cinder track to the finish, below the Royal Box, the runner turning to his left as he entered the track on the side opposite the Royal Box. Total distance, 26 miles 385 yards, or 42.263 kilometres.]*

#### OFFICIALS.

*Referee.*—The RIGHT HON. LORD DESBOROUGH OF TAPLOW, C.V.O. *Judges.*—Messrs. A. J. EGGLESTON, W. A. BROMMAGE, H. VENN, G. DUXFIELD, J. E. K. STUDD, and J. T. GREEN. *Timekeepers.*—Messrs. W. M. BARNARD, C. J. PRATT, and G. M. TODD. *Chief Clerk of the Course.*—Mr. J. M. ANDREW. *Honorary Secretary.*—Mr. P. L. FISHER. *Chief Marshals.*—Messrs. E. BAMPFYLDE (Mayor of Windsor), R. MITCHELL and J. SULLIVAN. *Motor and Attendants' Marshal.*—Mr. I. B. DAVIDSON. *Medical Attendants and Examiners.*—Dr. M. J. BULGER, Dr. A. ROSCOE BADGER, Dr. J. SKEVINGTON, Dr. E. MOIR, Dr. T. H. E. MEGGS, Dr. E. WEAVER ADAMS, and Mr. F. MATTHEWS. *Clerks of the Course and Stewards.*—Messrs. D. M. HOGG, L. H. HARRIS, J. F. DITCHMAN and B. DAVIES, assisted by members of the Polytechnic Harriers and Cyclists. *Baggage Stewards.*—Messrs. W. FLINT, W. J. ANDREW, B. C. LONG, G. E. WALTER, G. S. DEARLING, and W. E. GURNEY.



## DISTANCE TABLE.

Start Windsor Castle, East Terrace, 700 yards from Queen Victoria's Statue.

Miles. Kilometres.

1	=	1·6	Barnespool Bridge, Eton.
2	=	3·2	Windsor Road, about 50 yards past the " Prince of Wales " P.H.
3	=	4·8	Corner of High Street, Slough, and Uxbridge Road.
4	=	6·4	On road to Uxbridge.
5	=	8	Furze Lodge, on road to Uxbridge.
6	=	9·65	135 yards past " Crooked Billet " P.H.
7	=	11·26	Near Ivy Lodge, Iver Heath.
8	=	12·87	Long Bridge, Uxbridge Moor.
9	=	14·48	The Lodge, High Street, Uxbridge.
10	=	16	Near Uxbridge Common, on road to Ickenham.
11	=	17·7	On road to Ickenham.
12	=	19·3	On Bridge Approach at Ruislip and Ickenham Station, G. W. and G. C. Railways.
13	=	20·92	On Eastcote Road, near Ruislip School.
14	=	22·53	Near Eastcote Post-office.
15	=	24·14	At Rummens Farm, near Pinner Gas Works.
16	=	25·74	On Pinner Road, opposite Penhurst Villa.
17	=	27·35	1 Hawthorne Villas.
18	=	28·96	Kenton Road, Harro'w.
19	=	30·57	Near grounds of Harrow Nursery Co.
20	=	32·18	At Sudbury and Harrow Road Station, G. C. Railway.
21	=	33·79	At Wembley and Sudbury Station, L. & N. W. Railway.
22	=	35·4	Near sixth milestone at Stonebridge Park.
23	=	37	Midland Railway, Stonebridge Park, goods offices.
24	=	38·62	No. 28, Railway Cottages, Willesden Junction.
25	=	40·23	On Wormwood Scrubs.
26	=	41·84	Entrance of Stadium, QQ. RR. SS.
26 miles		385 yards = 42·263 kilometres.	Full distance.

*Note.*—The Distance Tablets were arranged on the course the reverse of the above, thus the 25th mile from the stadium is at Barnespool Bridge, Eton

## TIME TABLE, JULY 24, 1908

(APPROXIMATE.)

START						at 2.30 p.m.
SLOUGH	...	...	...	...	...	„ 2.47 „
UXBRIDGE	...	...	...	...	...	„ 3.20 „
RUISLIP	...	...	...	...	...	„ 3.50 „
HARROW	...	...	..	...	...	„ 4.10 „
WEMBLEY (L. & N. W. Rly.)			...	...	...	„ 4.30 „
HARLESDEN (Clock Tower)			...	...	...	„ 4.45 „
WORMWOOD SCRUBS		...	...	...	...	„ 4.54 „
THE STADIUM	...	...	...	...	...	„ 5.5 „

The Association acknowledged with many thanks the kindness of the following firms in providing motor cars for the accommodation of officials :—S. F. Edge, Ltd. (Napier), The Car Supply Co., Ltd. (A. J. Pinto Leete), The Wolseley Co., Ltd. (E. H. Godbold), Mr. Ernest de Wilton, Mr. A. A. Mansell, Panhard Co. Ltd. (Mr. Ducros), Mr. H. A. Mears, and Mr. P. W. B. Tippetts.

The Association also acknowledged the valuable services of the surveyors of the various counties, boroughs and parishes traversed, and to the Metropolitan, Windsor and Bucks Police Forces for their invaluable help in the arrangements.

THE FOLLOWING INSTRUCTIONS WERE ISSUED TO  
COMPETITORS.

Last Train from Paddington for Competitors and Officials, 1.3 pm.

The Race will be under the laws of the A.A.A.

The Association will arrange as far as possible for the convenience of competitors *en route*, but accept no responsibility, and competitors must therefore arrange with their own attendants to look after their requirements.

*Costume.*—The following A.A.A. Rule will be strictly enforced :—

“ Every competitor must wear complete clothing from the shoulder to the knees (*i.e.* jersey sleeved to the elbows and loose drawers with slips). Any competitor will be excluded from taking part in the race unless properly attired.”

Competitors are requested to keep to the left side of the road.

*Baggage.*—Competitors must have their clothes packed in one bag and delivered to Baggage Car not later than 2 p.m. Each bag will be numbered and a check given to attendant of competitor. The check must be given to Baggage Attendant when bag is wanted, and it will then be dropped at

the next hotel where arrangements have been made for dressing. A Special Car will follow to carry competitors who abandon the race. Dressing accommodation has been arranged at Great Western Railway, Windsor Station, where the authorities have kindly placed all the Waiting and Cloak Rooms at our disposal.

*En route.*—Competitors and Attendants will find accommodation at the following hotels for a wash, &c. :—

Iver Heath, “ The Crooked Billet.”  
 Uxbridge, “ King’s Arms Hotel.”  
 Ruislip, “ The Poplars.”  
 “ The George Hotel.”  
 Harrow, “ Roxborough Hotel.”  
 Sudbury, “ The Swan.”

*Refreshments en route.*—The Oxo Company have been appointed Official Caterers and will supply the following free of charge to Competitors :—Oxo Athletes’ Flask, containing Oxo for immediate use. Oxo hot and cold ; Oxo and Soda, Rice Pudding, Raisins, Bananas, Soda and Milk. Stimulants will be available in cases of collapse. *Note.*—Eau de Cologne and sponges can be had for use of competitors from the Oxo representatives who will be stationed at the following positions on the route, where they will erect and manage refreshment booths :—

Ruislip, “ The Poplars.”  
 Harrow, “ Railway Bridge.”  
 Sudbury, “ The Swan.”  
 Harlesden, “ Jubilee Clock Tower.”

Dressing arrangements at the Stadium in Room 28 for all Competitors.

#### ENTRIES.

1 LYNCH, J. M. . . Australasia	19 DORANDO, P. . . Italy
2 AITKEN, W. V. . . „	20 BLAST, U. . . „
3 BLAKE, G. B. . . „	21 BLASI, U. . . „
4 BAKER, J. M. . . South Africa	22 COCCA, A. . . „
5 MOLE, A. B. . . „	23 DURANDO, P. . . „
6 STEVENS, C. E. . . „	24 FORSHAW, J. . . U.S.A.
7 VINCENT . . . „	25 HATCH, S. H. . . „
8 HEFFERON, C. . . „	26 HAYES, J. J. . . „
9 COULCUMBERDOS, G. Greece	27 LEE, J. J. . . „
10 COUTOULAKIS, A. . . „	28 LORZ, F. . . „
11 NIEMINEN . . . Finland	29 MORRISSEY, T. P. . . „
12 LIND, G. . . Russia	30 O’MARA, W. . . „
13 BRAAMS, W. T. . . Holland	31 RYAN, M. J. . . „
14 VOSBERGEN, A. C. H. „	32 THIBEAU, A. . . „
15 WAKKER, W. W. . . „	33 TEWANINA, L. . . „
16 THEUNISSEN, W. F. „	34 WELTON, A. R. . . „
17 BUFF, G. J. M. . . „	35 WOOD, W. . . „
18 CELIS, F. . . Belgium	36 MULLER, H. . . Germany

37 REISER, F. . . .	Germany	57 THOMPSON, F. B.	United Kingdom
38 NETTLEBECK, P. . .	"	58 BARNES, E. . . .	"
39 TORNROS, G. . .	Sweden	59 WYATT, A. . . .	"
40 SVANBERG, J. F. . .	"	60 APPLEBY, F. . . .	"
41 PETERSON, J. G. . .	"	61 JACK, T. . . .	"
42 LANDQUIST, S. L. . .	"	62 STEVENSON, S. . . .	"
43 LINDQVIST, J. . . .	"	63 CLARKE, W. T. . . .	"
44 BERGVALL, J. T. . .	"	64 SIMPSON, F. . . .	Canada
45 LUNDBERG, J. G. A. . .	"	65 LAWSON, H. . . .	"
46 RATH, E. . . .	Austria	66 GOLDSBORO, W. . . .	"
47 KWIETON, F. . . .	"	67 GOULDING, G. . . .	"
48 NOJEDKY . . . .	Bohemia	68 WOOD, W. . . .	"
49 HANSEN, R. C. . . .	Denmark	69 COTTER, E. . . .	"
50 JORGENSEN, J. F. . .	"	70 NOSEWORTHY, F. . . .	"
51 MERENYI, L. . . .	Hungary	71 CAFFERY, J. . . .	"
52 DUNCAN, A. . . .	United Kingdom	72 LONGBOAT, T. . . .	"
53 BEALE, J. G. . . .	"	73 LISTER, G. . . .	"
54 LORD, T. . . .	"	74 BURN, A. . . .	"
55 PRICE, J. . . .	"	75 TAIT, J. . . .	"
56 BARRETT, H. F. . . .	"		

*Railway Arrangements.*—The G. W. Railway Special Train for Competitors and friends left Paddington at 1.3 p.m., arriving at Windsor at 1.27.

RULES FOR MARATHON RACE, PRINTED IN THE PROGRAMME  
OF THE DAY.

1. The Marathon Race of 42 kilometres will be run on a course marked out on public roads by the Amateur Athletic Association, and will finish on the running track in the Stadium, where part of 1 lap will be run.

2. Each competitor must send with his entry a medical certificate of fitness to take part in the race, and must further undergo a medical examination previous to the start by the medical officer or officers appointed by the British Olympic Council.

3. A competitor must at once retire from the race if ordered to do so by a member of the medical staff appointed by the British Olympic Council to patrol the course.

4. No competitor either at the start or during the progress of the race may take or receive any drug. The breach of this rule will operate as an absolute disqualification.

5. The station of each competitor at the start will be determined by lot, and in the event of the competitors being too numerous to be started on a single line, they will be started on two or more lines.

6. Each competitor shall be allowed two attendants, who shall wear on breast and back the same distinctive number as the competitor.

7. The attendants shall during the progress of the race remain behind the competitor they are attending, or be sufficiently in front to prevent

them giving pacing assistance. Non-observance of this rule will disqualify the competitor.

8. Attendants will not be permitted to see the start of the contest, but must proceed in a body from the Attendants' Assembly Hall at Windsor to the appointed place, 5 miles (8 kilometres) from the start, and join their competitors as they pass. Upon arrival at the Stadium the attendants must leave the competitors and enter at a different gate. No attendant will be allowed on the track.

9. Any competitor whose attendant or attendants obstruct another competitor will be disqualified.

10. Each competitor must provide his own attendants and required refreshments.

11. When a competitor retires from the race, his attendants must also leave the route.

#### DESCRIPTION OF THE ROUTE.

The race starts from Windsor Castle, near East Terrace (700 yards from Queen Victoria's Statue), through Thames Street, across Thames Bridge into High Street, Eton, past Eton College and Playing Fields along Windsor Road until High Street, Slough, is reached. Road towards London for 925 yards, then turn to the left into Uxbridge Road, over Great Western Railway, through George Green ("Green Man" P.H.,  $4\frac{1}{2}$  miles), keep Langley Park on right and continue straight road to Long Bridge (River Colne). After crossing this keep to the left, cross Canal into New Windsor Street, here turn to the left for a few yards and then to the right into Windsor Street, here turn to the left, and keeping Parish Church on the left you enter High Street, Uxbridge. Here turn to the right towards London for about 500 yards, turning to the left at sign-post for Ickenham, crossing Uxbridge Common and keep to the right until Ickenham Village is reached, here turn to the left, crossing Great Western and Great Central Railways (Ruislip and Ickenham Station) for Ruislip. Keeping "The Poplars" on the right you enter Ruislip Village. Take Eastcote Road (opposite "George Hotel") and keep to the right of this and take first turning to right after passing Eastcote Post Office. Three hundred yards past Pinner Gas Works turn sharp to the right, cross Metropolitan Railway, and keep to the right until "Roxborough Hotel," Harrow, is reached. Here you re-cross the Metropolitan Railway into Lowlands Road. Run parallel with the railway until Sheepcote Lane is reached ; there turn to the right, and passing the "Mitre Hotel" on the left you reach the Harrow Road at Sudbury. Here keep to the left until Sudbury Station, L. & N. W. Railway is reached.

From here follow tram lines until the Jubilee Clock Tower at Harlesden. Here turn to the right through Station Road, across L. & N. W, Railway at Willesden Junction Station, past Railway Cottages. Take first turning to the left into Old Oak Lane. After passing under the Great Western Railway lines, turn sharp to the left across Old Oak Common and Wormwood Scrubs, keeping the footpath between the Prison and Hammersmith Infirmary into Ducane Road for Exhibition Grounds, where a special entrance will be made and a course roped for competitors to QQ RR SS entrance to Stadium.

All vehicular traffic will have to leave competitors at the Clock Tower, Harlesden, and go through High Street to the College Park Hotel, turn to the right here for the Stadium, and enter No. 4 Gate in Wood Lane.

The Race was started on the East Lawn of Windsor Castle in the following order :—

#### FIRST ROW.

20. U. Blasi, Italy. 64. F. Simpson, Canada. 66. W. Goldsboro, Canada. 72. T. Longboat, Canada. 9. G. Coulcumberdos, Greece. 58. E. Barnes, United Kingdom. 17. G. Buff, Holland. 34. A. Welton, United States. 25. S. Hatch, United States. 39. G. Tornros, Sweden. 31. M. Ryan, United States. 11. K. Nieminen, Finland. 70. F. Noseworthy, Canada. 29. T. Morrissey, United States. 14. A. Vosbergen, Holland.

#### SECOND ROW.

63. W. Clarke, United Kingdom. 37. F. Reiser, Germany. 50. J. Jorgensen, Denmark. 1. J. Lynch, Australasia. 65. H. Lawson, Canada. 73. G. Lister, Canada. 48. I. Nejedky, Bohemia. 67. G. Goulding, Canada. 62. S. Stevenson, United Kingdom. 60. F. Appleby, United Kingdom. 12. G. Lind, Russia. 59. A. Wyatt, United Kingdom. 55. J. Price, United Kingdom. 53. J. Beale, United Kingdom. 10. A. Coutoulakis, Greece.

#### THIRD ROW.

46. E. Rath, Austria. 26. J. Hayes, United States. 71. J. Caffery, Canada. 68. W. Wood, Canada. 15. W. Wakker, Holland. 43. J. Lindqvist, Sweden. 52. A. Duncan, United Kingdom. 2. W. Aitken, Australasia. 3. G. Blake, Australasia. 54. F. Lord, United Kingdom. 33. L. Tewanina, United States. 4. J. Baker, South Africa. 18. F. Celis, Belgium. 74. A. Burn, Canada. 24. J. Forshaw, United States.

#### FOURTH ROW.

19. Dorando Pietri, Italy. 42. S. Landquist, Sweden. 57. F. B. Thompson, United Kingdom. 69. E. Cotter, Canada. 13. W. Braams, Holland. 49. R. Hansen, Denmark. 56. H. Barrett, United Kingdom. 61. T. Jack, United Kingdom. 8. C. Hefferon, South Africa. 40. J. Svanberg, Sweden. 75. J. Tait, Canada.

On July 24, 1908, at about half-past two in the afternoon, the competitors, arranged in the order given above, were drawn up in four lines near the East Terrace. At a signal from Her Royal Highness the Princess of Wales,

who was present with her children, Lord Desborough fired the starting-gun, and the runners dashed off at a lively pace for the gates leading into the Town, and streamed down the hill past the Castle Walls along the road towards Barnespool Bridge, Eton, which marked the conclusion of the first mile. The leaders were W. T. Clarke and E. Barnes (both English) with A. Burn of Canada, while T. Longboat (Canada) and Dorando Pietri (Italy) were close behind. At the mile another Englishman (Jack) was leading and made the pace so hot that the distance was completed in 5 min.  $1\frac{2}{5}$  sec., fast enough for cold weather in so long a race, but not a little dangerous in the close, warm, and muggy atmosphere of that summer afternoon, when the sun was deceptively strong and there was very little air. Right at the end of the long line of competitors ran two Americans, Forshaw and Tewanina, who finished third and ninth respectively. Jack kept ahead, and finished the second mile in 10 min. 11 sec., and the third in 15 min. 42 sec., with Lord, Duncan and Price (all U.K.) running behind him, and Hefferon (South Africa), and Dorando close at hand. In the third group were Appleby, Clarke, Beale, Barnes, and Barrett (all U.K.), with Burn, Simpson, Longboat, Caffery, and Goldsboro (all Canada), Landquist of Sweden, and Nieminen of Finland. Svanberg, who finished eighth, fresher than anyone else, and attended the Ball given on the evening of the Race, was a long way back, and so was Hayes, who won. Both evidently knew something of the value of running to schedule time in hot weather over so punishing a distance.

Jack, however, persisted in the lead at four and at five miles, in spite of tiring rapidly, and as soon as he reached the body of attendants (who were awaiting the competitors five miles from the start) he stopped for rest and refreshment and never really got into his stride again. Price and Lord took on the lead, with Hefferon and Dorando (who watched each other as if they were racing alone) close behind them. Duncan's legs were troubling him, and he already had to walk. Price and Lord continued to lead, and at the tenth mile proceeded to race each other, Price gaining about 150 yards, and Hefferon passing Lord who was soon to find that he had taken too much out of himself.

At Ruislip (about halfway, thirteen miles) Price was 200 yards ahead of Hefferon, and Dorando was going easily behind Lord, who laboured in his action. Longboat and Appleby followed, and Aitken, of Australasia, looked as fresh as when he started. The list of times and leaders at various distances, given below, will supply the most important details of the next portion of the race, so it will be enough to say here that at halfway trouble had made its appearance in Clarke's knee, and had it not been for the indomitable resolution with which he answered his trainer's

appeals to keep going he would never have finished at all. As it was, he came in twelfth, ahead of all the other Englishmen, and it is a significant fact that a runner who was practically crippled beat all the rest of a team for which we had nourished such brilliant aspirations of success. As soon as Price was really tackled by Hefferon on a long uphill stretch he was beaten, and soon afterwards retired from sheer exhaustion; but Lord kept on ahead of Longboat and Dorando at fifteen miles, though he had now dropped two minutes behind Hefferon, and when Longboat challenged him his strength gave out and he had to rest before continuing. He lost ground all the way afterwards and finished fifteenth.

Not content with going easily in the lead which he held from the fifteenth mile to the twenty-fourth, Hefferon kept trying to get further away, though Longboat, behind him, had had to retire after a duel with Appleby at Harrow. At this point Hefferon, nearly three minutes ahead of Dorando, increased his pace on the up-grade and took a little more out of himself. Appleby, meanwhile, had to stop to get medical attention for his feet, and though he went on again it was clear he could not last much further. Hefferon's twenty-second mile took 8 min. 22 sec., while Dorando ran it in 7 min. 58 sec., drawing nearer all the time, with Hayes a mile behind the leader. At the Clock Tower, Harlesden, Hefferon's advantage over Dorando was reduced to two minutes, but Hayes, Welton, and Forshaw (all three Americans) looked stronger than either. The leaders and times up to now had been as follows :—

## FOUR MILES.

			h. m. s.						h. m. s.		
T. Jack	·	·	·	·	0 21 18	A. Duncan	·	·	·	·	0 21 27
J. Price	·	·	·	·	0 21 27	C. Hefferon	·	·	·	·	0 21 27
F. Lord	·	·	·	·	0 21 27	Dorando	·	·	·	·	0 21 27

## FIVE MILES.

T. Jack	·	·	·	·	0 27 1	A. Duncan	·	·	·	·	0 27 7
J. Price	·	·	·	·	0 27 7	C. Hefferon	·	·	·	·	0 27 7
F. Lord	·	·	·	·	0 27 7	Dorando	·	·	·	·	0 27 7

## SIX MILES.

F. Lord	·	·	·	·	0 33 9	Dorando	·	·	·	·	0 33 15
J. Price	·	·	·	·	0 33 9						

## SEVEN MILES.

F. Lord	·	·	·	·	0 38 57	Dorando	·	·	·	·	0 39 0
J. Price	·	·	·	·	0 38 57	C. Hefferon	·	·	·	·	0 39 10

## EIGHT MILES.

F. Lord	·	·	·	·	0 44 52	Dorando	·	·	·	·	0 44 55
J. Price	·	·	·	·	0 44 52	C. Hefferon	·	·	·	·	0 44 58



## NINE MILES.

		h. m. s.				h. m. s.	
F. Lord	.. ..	.. 0	50 50	C. Hefferon	. ..	.. 0	51 6
J. Price	.. ..	.. 0	50 50	Dorando	.. ..	.. 0	51 9

## TEN MILES.

J. Price	.. ..	.. 0	56 53	C. Hefferon	.. ..	.. 0	57 12
F. Lord	.. ..	.. 0	56 55	Dorando	.. ..	.. 0	57 13

## ELEVEN MILES.

J. Price	.. ..	.. 1	2 44	C. Hefferon	.. ..	. 1	3 15
F. Lord	.. ..	.. 1	3 10	Dorando	.. ..	.. 1	3 49

## TWELVE MILES.

J. Price	.. ..	.. 1	8 56	F. Lord	.. ..	.. 1	9 43
C. Hefferon	.. ..	.. 1	9 25	Dorando	.. ..	.. 1	10 29

## THIRTEEN MILES.

J. Price	.. ..	.. 1	15 13	F. Lord	.. ..	.. 1	15 20
C. Hefferon	.. ..	.. 1	15 54	Dorando,	fourth		

## FOURTEEN MILES.

J. Price	.. ..	.. 1	22 3	F. Lord	.. ..	.. 1	23 20
C. Hefferon	.. ..	.. 1	22 10	Dorando,	fourth		

## FIFTEEN MILES.

C. Hefferon	.. ..	.. 1	28 22	Dorando	. ..	.. 1	30 28
F. Lord	.. ..	.. 1	30 22	T. Longboat.	.. ..	.. 1	30 39

## SIXTEEN MILES.

C. Hefferon	.. ..	.. 1	35 0	Dorando	.. ..	.. 1	37 34
T. Longboat	.. ..	.. 1	37 29				

## SEVENTEEN MILES.

C. Hefferon	.. ..	.. 1	41 47	Dorando	.. ..	.. 1	44 45
T. Longboat (walking)		.. 1	44 43				

## EIGHTEEN MILES.

C. Hefferon	.. ..	.. 1	48 51	Dorando	.. ..	.. 1	52 9
-------------	-------	------	-------	---------	-------	------	------

## NINETEEN MILES.

C. Hefferon	.. ..	.. 1	55 29	Dorando	.. ..	.. 1	59 0
-------------	-------	------	-------	---------	-------	------	------

## TWENTY MILES.

C. Hefferon	.. ..	.. 2	2 26	Dorando	.. ..	.. 2	6 18
-------------	-------	------	------	---------	-------	------	------

## TWENTY-ONE MILES.

C. Hefferon	.. ..	.. 2	8 58	Dorando	.. ..	.. 2	12 16
-------------	-------	------	------	---------	-------	------	-------

## TWENTY-TWO MILES.

C. Hefferon	.. ..	.. 2	17 20	Dorando	.. ..	.. 2	20 7
-------------	-------	------	-------	---------	-------	------	------

## TWENTY-THREE MILES.

C. Hefferon	.. ..	.. 2	25 20	Dorando	.. ..	..	—
-------------	-------	------	-------	---------	-------	----	---

## TWENTY-FOUR MILES. \*

C. Hefferon	.. ..	.. 2	33 28	Dorando	.. ..	..	—
-------------	-------	------	-------	---------	-------	----	---

\* This was the last information that reached the Stadium before the finish of the Race.

The crucial point of this long and desperate struggle arrived when Dorando came in sight of Hefferon in Old Oak Common Lane. For the whole of the previous twenty-four miles the route had been more or less lined with spectators, whose ranks thickened as the race passed through towns and villages until the road had all the aspect of the Thames on Boat Race day. The crowd was enthusiastic, but orderly, and it was in response to a tremendous outburst of cheering from the huge throngs of spectators that Dorando made the fatal spurt which took him past Hefferon before they reached Wormwood Scrubs. Soon afterwards, Hayes passed the South African as well. Dorando's premature effort had so exhausted him that he could scarcely reach the entrance of the Stadium, where nearly a hundred thousand spectators were awaiting his arrival, having only heard, from the last telegraphic bulletin posted up in the arena, that a South African was ahead and an Italian second. The pages of an official Report are not the place to go too much into detail as to the finish of this race—a finish as unexpected as it was distressing.

Dorando was almost unconscious when he reached the cinder path, and turned to his right instead of his left. The slope from the archway was apparently the final stroke. He collapsed upon the track. As it was impossible to leave him there, for it looked as if he might die in the very presence of the Queen and that enormous crowd, the doctors and attendants rushed to his assistance. When he was slightly resuscitated the excitement of his compatriots was so intense that the officials did not put him on an ambulance and send him out, as they would no doubt have done under less agitating circumstances. The first fall and the first assistance rendered had, if it had been only realised, disqualified the Italian for the prize. But there was a generous idea in the heart of nearly every spectator that one who had suffered so much should not be disappointed of the finish he had so nearly reached. That idea, for the moment, dominated everything else until Dorando had staggered past the tape, followed not long afterwards by a runner who was recognised to be Hayes by the number and the American badge upon his breast. The objection to Dorando lodged by the American officials was upheld, and the race was finally given to Hayes after a discussion which took some time owing to the number of witnesses examined and the conflicting nature of much of the evidence. Meanwhile, Dorando lay between life and death for two hours and a half. The tidings that Her Majesty the Queen had given him a Gold Cup, as a token of her gracious sympathy with the courage she had watched, was the first thing that turned the scale in the Italian's favour. His heart had been more than half an inch displaced, but by the next morning he looked as well as ever.

Hefferon, of South Africa, alone divided Hayes from his two compatriots, Forshaw and Welton, who came in third and fourth respectively. Diplomas of Merit for the Marathon Race were awarded to all the following, who finished in the order and in the times subjoined :—

Name and Country.	h.	m.	s.
Dorando, Pietri, Italy (disq.) .. .. .	2	54	46 $\frac{2}{5}$
J. J. Hayes, United States .. .. .	2	55	18 $\frac{2}{5}$
C. Hefferon, South Africa .. .. .	2	56	6
J. Forshaw, United States .. .. .	2	57	10 $\frac{2}{5}$
A. R. Welton, United States .. .. .	2	59	44 $\frac{2}{5}$
W. Wood, Canada .. .. .	3	1	44
F. Simpson, Canada .. .. .	3	4	28 $\frac{1}{5}$
H. Lawson, Canada .. .. .	3	6	47 $\frac{1}{5}$
J. F. Svanberg, Sweden .. .. .	3	7	50 $\frac{3}{5}$
L. Tewanina, United States .. .. .	3	9	15
Nieminen, Finland .. .. .	3	9	50 $\frac{4}{5}$
J. Caffery, Canada .. .. .	3	12	46
W. T. Clarke, United Kingdom .. .. .	3	16	8 $\frac{3}{5}$
E. Barnes, United Kingdom .. .. .	3	17	30 $\frac{2}{5}$
S. H. Hatch, United States .. .. .	3	17	52 $\frac{2}{5}$
F. Lord, United Kingdom .. .. .	3	19	8 $\frac{3}{5}$
W. Goldsboro, Canada .. .. .	3	20	7
J. G. Beale, United Kingdom .. .. .	3	20	14
I. Nejedky, Bohemia .. .. .	3	26	26 $\frac{1}{5}$
G. Lind, Russia .. .. .	3	26	38 $\frac{2}{5}$
W. W. Wakker, Holland, .. .. .	3	28	49
G. Tornros, Sweden .. .. .	3	30	20 $\frac{1}{5}$
G. Goulding, Canada .. .. .	3	33	26 $\frac{2}{5}$
J. F. Jorgensen, Denmark .. .. .	3	47	44
A. Burn, Canada .. .. .	3	50	17
E. Rath, Austria .. .. .	3	50	30 $\frac{2}{5}$
R. C. Hansen, Denmark .. .. .	3	53	15
G. Lister, Canada .. .. .	4	22	45

The glamour surrounding Dorando's effort, and the interest added to it by the graceful action of Queen Alexandra, must not be permitted to obscure the courage with which Hayes had run a stern chase for so long a course, and had just nursed sufficient strength to make his final effort. If this were not a record confined to the events of the Olympic Games of 1908 I might point out that his success and that of his compatriots was almost as surprising to English critics as was the failure of their own team. But I shall not here enlarge upon the possible causes of either, or upon the subsequent epidemic of "Marathon Races" which attacked the civilised world from Madison Square Gardens to the Valley of the Nile. Only three of these races I need mention, all of which took place in New York. In the first Dorando beat Hayes, on an inside track with about ten laps to the mile, over the same distance. In the second, Longboat beat Dorando. In the third, Dorando beat Hayes on the Madison Square track in 2 hours 48 minutes, having run 17 miles in 99 minutes 22 seconds,

on March 15, 1909. Other races of the same kind are being decided as these pages go to press. All three of the runners just mentioned were beaten by St. Ives, a little French waiter, who did 2 hrs. 40 min. 50 secs., on April 3; and as they had before that time become professionals, I will state here the reasons why Longboat was accepted in the Olympic Games of 1908 as an amateur competitor.

Enquiries as to the eligibility of Longboat began as soon as it was realised that his previous performances entitled him to representation in the Canadian team; and these enquiries did not come from one source alone. At the meeting of the Canadian Central Olympic Committee, held at Ottawa on April 21, 1908, the following resolution was adopted :—

“ That the Board of Governors of the Canadian Amateur Athletic Union be requested to formally certify to this Committee the amateur status of Thomas Longboat, and his complete eligibility to compete in the Olympic Races in England under all the regulations and qualifications governing that contest, copies of same to be forwarded.”

In reply to this resolution a letter was received by Mr. F. L. C. Pereira, Hon. Secretary of the Canadian Central Olympic Committee, signed by Mr. William Stark, President, and Mr. H. H. Crow, Secretary-Treasurer of the Canadian Amateur Athletic Union, as follows :—

“ I beg to inform you that Longboat is registered as an amateur with the C.A.A.U. (No. 1488), and that he is an athlete of good standing, not only according to the amateur definition of the C.A.A.U., but under the regulations and qualifications laid down by the British Olympic Committee to govern entries of amateur athletes. Trusting that this assurance will be satisfactory to you, on behalf of the Canadian Amateur Athletic Union, we beg to remain, &c. . . .”

This letter is dated from Toronto on April 29, 1908.

On May 4 Colonel J. Hanbury-Williams, Chairman of the Canadian Central Olympic Committee, wrote from Ottawa as follows to the Chairman of the British Olympic Council in London, pointing out that the Canadian Amateur Athletic Union controlled the Irish-Canadian Amateur Athletic Club, of which Longboat is a member. “You will observe that the Association deem Longboat to be eligible in every particular to participate in the Games as an amateur. The C.A.A.U. is one of two great bodies which control all sport in the Dominion, and has a membership of some 750 to 800 clubs, and its Board of Governors is composed of men of high standing in athletics. One hears a great deal in conversation, and one reads a great deal in the Press, but we have to be guided by clubs of good standing, and the decision seems clear.”

After this correspondence it was evidently impossible for the British



ATHLETICS. —THE MARATHON RACE.  
H.R.H. THE PRINCESS OF WALES AT THE START AT WINDSOR.



ATHLETICS.—THE MARATHON RACE.  
NO. 19 (DORANDO) COMING THROUGH WILLESDEN.



ATHLETICS.—THE MARATHON RACE.  
NO. 26 (HAYES, U.S.A., THE WINNER) AT WILLESDEN.



ATHLETICS.—THE MARATHON RACE. NO. 8 (C. HEFFERON, OF SOUTH AFRICA  
WHO WON SECOND PRIZE) COMING THROUGH RUISLIP.



ATHLETICS.—R. C. EWRY (U.S.A.) WINNING THE  
STANDING HIGH JUMP.



ATHLETICS.—F. C. IRONS (U.S.A.) WINNING THE  
RUNNING BROAD JUMP.

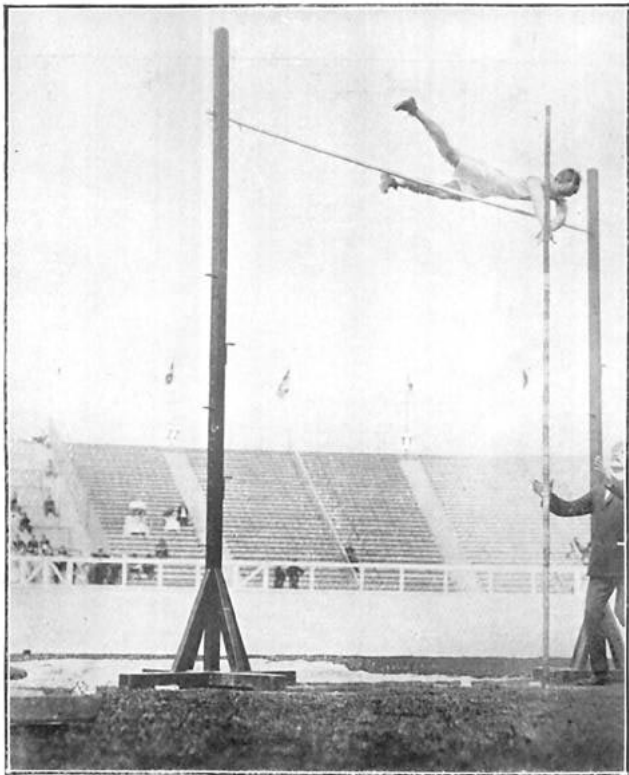

ATHLETICS.—A. C. GILBERT (U.S.A) TIED FOR  
FIRST PLACE IN THE POLE JUMP.

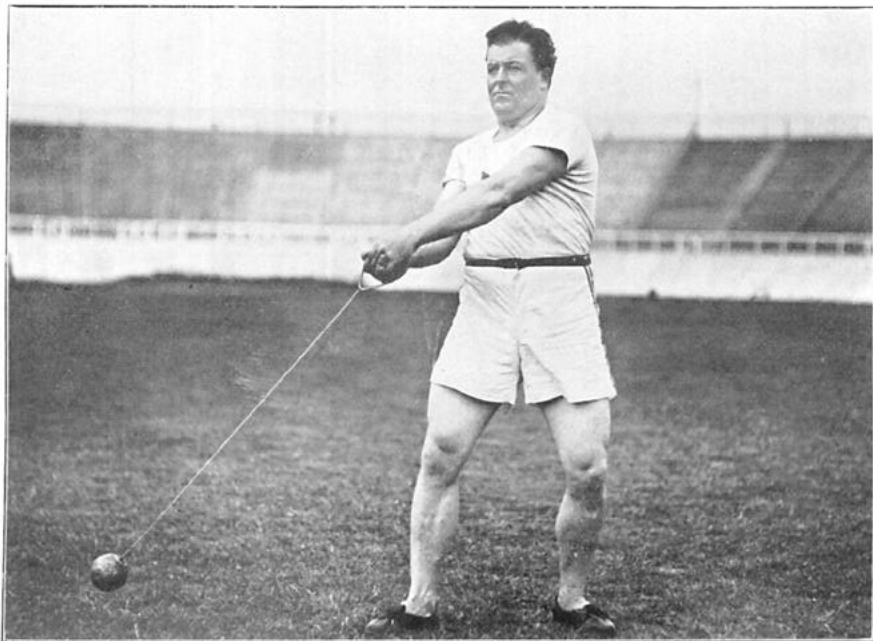

ATHLETICS.—FLANAGAN'S HAMMER (U.S.A.).



Olympic Council to refuse Longboat as a Canadian entry without the most careful consideration of any new evidence that might be subsequently produced.

Two days after the Games in London had begun, the following communication was sent to Mr. Fisher, of the Amateur Athletic Association :—

“ American Committee, Olympic Games, London.

“ 2—3 Hind Court, Fleet Street, E.C.

“ July 15, 1908.

“ P. L. Fisher, Esq.

“ 10 John Street, Adelphi, W.C.

“DEAR SIR,—Mr. Gustavus T. Kirby informs me that our protest against professional Thomas Longboat should be sent to you as Secretary,\* and should be accompanied by £1.

“ I enclose you herewith £1 1s., and you can consider the communication from our Committee men as our official protest against professional Thomas Longboat.

“ Yours truly,

(Signed) “JAMES EDWARD SULLIVAN.”

Mr. Laffan, to whom as Secretary of the British Olympic Council this letter was handed, replied that as Longboat's status had been guaranteed by the Canadian Amateur Athletic Union and the Canadian Central Olympic Committee, the British Olympic Council found themselves in presence of a conflict of statements between governing associations, and it was therefore necessary to ask for the evidence on which Longboat had been disqualified in the United States, in order that this evidence might be laid before the British Olympic Council.

\* No doubt an involuntary error on the part of Mr. Kirby. The General Regulations for the Olympic Games of 1908 were passed at The Hague in 1907, and were sent to the American Committee about a year before the Games began. Nos. 7 and 8 of these Regulations (printed in Chapter II.) deal with the amateur status of competitors, and No. 13 lays it down that :

*Objections to the qualifications of a competitor must be made in writing to the Secretary of the British Olympic Council at the earliest moment practicable.*

Mr. P. L. Fisher was the secretary of the Amateur Athletic Association, one of the twenty leading organisations through which the Council worked. In the “ General Rules ” of the Amateur Athletic Association, printed in the daily programme of events, the sentence just quoted was reproduced for the information of all competitors, and of the members of the *Comité d'Honneur* from each country. On May 8, 1908, Mr. J. E. Sullivan, secretary of the American Olympic Committee, and President of the Amateur Athletic Union of the United States, was good enough to inform the American press that “ *the question of Longboat's entry in the English Marathon will be settled by the British Olympic Council and the A.A.A. as they see fit, and we shall abide by their decision. We are going to do nothing that would for a moment detract from the success of the Games, but on the contrary will render all possible help to the fixture.*”

Mr. Laffan received the following reply :—

“ American Committee, Olympic Games.

“ London, England, 1908.

“ 2—3 Hind Court, Fleet Street, E.C.

“The Rev. R. S. de Courcy Laffan,  
108 Victoria Street, S.W.

“DEAR SIR,—Your communication of July 20 has been received and noted.

“ The A.A.U. of the United States through its officials now in London desire to acquaint you with the fact that, as a matter of record, Thomas Longboat has been declared a professional by the A.A.U. of the United States for an act committed in the United States. This is merely a matter of record.

“ May I suggest that you call upon Mr. Percy L. Fisher, Secretary of the A.A.A., to furnish you with all the information and evidence that he has received in relation to Thomas Longboat’s doings in the United States and also in Canada? I feel confident that Mr. Percy L. Fisher and the other officials of the A.A.A. can give you information in relation to one Percy Sellen, who has been competing with this Thomas Longboat in America.

“ Yours truly,

(Signed) “ J. E. SULLIVAN.”

It will be observed that this reply gives none of the facts upon which it charges Thomas Longboat with having been disqualified as an amateur. The representatives of Canada, on the other hand, declared themselves to have a complete answer as regards “one Percy Sellen,” and it is obvious that under such circumstances the burden of proof lay on the persons who challenged the amateur qualification of an athlete duly entered by his national governing body. When the governing body which enters a competitor vouches for his amateur status, and that amateur status is contested by a foreign governing body, the mere assertion of the latter body cannot be considered as concluding the case against the competitor.

All that the British Olympic Council could do under the circumstances was to notify the Canadian manager that Longboat would run under a protest from the manager of the American team. This notification was duly made. Having no evidence offered them, the British Olympic Council could not possibly have given a definite decision before the race, and would not have given one at all without a full inquiry, which would of course have taken place had Longboat won. He did not finish.

A word more is necessary with regard to the time taken by Hayes in the Marathon Race of 1908, which was 2 hr. 55 min. 18 $\frac{2}{5}$  sec. In

1896, at Athens, the race was one of 24 miles, 1,500 yards, and was won by a Greek in 2 hr. 55 min. 20 sec. In 1900, in Paris, the race (25 miles) was won by a Frenchman in 2 hr. 59 min. 45 sec. At St. Louis, in 1904, the distance was again 24 miles, 1,500 yards, and an American won in 3 hr. 28 min. 53 sec. At Athens, in 1906, the distance was 26 miles, which has remained the standard, and the race was won by Sherring, the Canadian, in less than 2 hr. 52 min., when he finished perfectly fresh ; and in no previous race of the kind are any examples of extreme exhaustion on record. Yet in England, considered to be the home of the long-distance runner, our best man took more than  $3\frac{1}{4}$  hours to get home. Probably much may be explained by the fact that July 24 was the hottest day on which a race of over 26 miles was ever attempted in this country ; and it is certainly remarkable that Beale, who finished eighteenth in 3 hr. 26 min. 26 sec., should have run 22 miles, 1,420 yards, in 2 hr. 17 min. at the end of April, in the worst possible weather, and was beaten by Duncan, who did not get within the first twenty-seven at the Stadium. Price, too, the Englishman who led at halfway on July 24, but was unable to finish, had done the fine time of 2 hr. 37 min. 13 sec. in the trial over 25 miles in May, which is less than 5 min. slower than the best professional track record for the distance. Dorando's time in March, 1909, was 2 hr. 48 min. 8 sec. for 26 miles on an indoor track ten laps to the mile. He was then a professional, and it took another professional to beat that time in the open air in England. Neither, it will be noticed, was an Englishman.

Sherring was within five minutes of the amateur track record for 26 miles at Athens, and I should therefore be inclined to say that the hot and stifling nature of the day had a great deal to do with the result of the English Marathon Race, especially in view of the fact that a Frenchman, doing the same course in England in October, finished in the Stadium, quite fresh, in 2 hr. 37 min. 23 sec., or over half an hour better than our best Englishman in July and 14 min. better than Sherring at Athens.

Nationality, taken in conjunction with the exceptional weather, has been suggested as a factor in the results. But if we analyse the first twenty-seven to finish in the Stadium in 1908 and if we take it that, owing to being used to warmer weather, the United States provided the winner, the third, the fourth, the ninth, and the fourteenth, or five in all out of their twelve entries ; even if we give South Africa the credit of being represented in these twenty-seven by the second man, out of her entry of five, we are still faced with the fact that Canada provided the fifth, sixth, seventh, eleventh, sixteenth, twenty-second, twenty-fourth, and twenty-seventh, or a record of eight out of her twelve entries, a splendid achievement and worthy

of Sherring's compatriots ; while Sweden, in Svanberg, who came in eighth, produced the strongest finisher of the lot, besides the man who came in twenty-first ; Finland sent the tenth ; Russia claimed the nineteenth ; and Denmark was represented by the twenty-third and twenty-sixth.

Other critics in search of explanations prefer to look more closely at the race itself ; and the first peculiarity that will strike any trained observer is the pace at which the first three miles were done :—5 min. 1  $\frac{2}{3}$  sec., 5 min. 9  $\frac{3}{5}$  sec., and 5 min. 31 sec. The fourth took 5 min. 36 sec., and the fifth 5 min. 43 sec. All these times were made by Jack, who did not finish, closely accompanied by Lord, who finished fifteenth. The meaning of them will become clearer when it is realised that Sherring at Athens only had to keep up an average of 6 min. 35 sec. to complete the distance 27 min. faster than Lord did it in England. The pace, in fact, was made too hot at the start ; and to this error of judgment is most probably due not merely the ill-success of British runners on a hot day, but the collapse of the Italian, and the excessive fatigue of nearly every one of the competitors except Svanberg. There was no wind, and the continuous crowd from Windsor to London still further diminished what little air there was.

## XII.—STANDING BROAD JUMP.

The Rule of the A.A.A. with regard to this event was printed in the programme as follows :—

*“ The feet of the competitor may be placed in any position, but shall leave the ground only once in making an attempt to jump. When the feet are lifted from the ground twice, or two springs are made in making the attempt, it shall count as a trial jump without result. A competitor may rock forward and back, lifting his heels and toes alternately from the ground, but may not lift either foot clear of the ground, or slide it along the ground in any direction.”*

*“ In any other respects the rule governing the Running Broad Jump shall also govern the Standing Broad Jump.”*

				ft.	in.	metres
1.	R. C. Ewry, United States	..	..	..	10 11 $\frac{1}{4}$	.. 3'33
2.	C. Tsiclitiras, Greece	..	..	..	10 7 $\frac{1}{2}$	.. 3'22
3.	M. J. Sheridan, United States	..	..	..	10 7	.. 3'22
4.	J. A. Biller, United States	..	..	..	10 6 $\frac{1}{2}$	.. 3'21
5.	O. R. B. Ekberg, Sweden	..	..	..	10 5 $\frac{3}{4}$	.. 3'19

Also competed :—F. C. Irons, United States ; E. Kooops, Holland ; L. J. Cornish, United Kingdom ; Platt Adams, United States ; L. H. G. Stafford, United Kingdom ; J. Jakobsson, Finland ; B. Evers, Holland ; W. E. B. Henderson, United Kingdom ; S. Muenz, United States ; F. Leroy Holmes, United States ; F. O. Kitching, United Kingdom ; G. Barber, Canada ; T. J. Ahearne, United Kingdom ; K. Langkjoer, Denmark ; H. Jardin, France ; Dr. A. Mallwitz, Germany ; W. H. Bleaden, United Kingdom ; J. Hoogveld, Holland ; L. Dupont, Belgium ; A. Motte, France.

Ray Ewry had won this event in Paris, St. Louis, and at the Athenian Games of 1906, and is a veteran performer about whose success there was never any doubt, except when Tsiclitiras of Pylos got near him in this event and still closer in the next. The young Greek was not 20 years old, and may still improve. Ewry's height was 6 ft. 1 in. and his weight 11 st. 8 lb. He did 11 ft.  $4\frac{7}{8}$  in. in this event at St. Louis in 1904, which is the Olympic record. The world's record (professional) is 12 ft.  $6\frac{1}{2}$  in., by W. Barker at Wigan in May, 1904. The Irish record is said to be 12 ft.  $9\frac{1}{4}$  in. by J. Chandler, but I have no official confirmation of this.

Diplomas of Merit for the Standing Broad Jump were awarded to J. A. Biller, of the United States, and O. R. B. Ekberg, of Sweden.

### XIII.—STANDING HIGH JUMP.

The Rule of the A.A.A. with regard to this event was printed in the programme as follows :—

*“ The feet of the competitor may be placed in any position, but shall leave the ground only once in making an attempt to jump. When the feet are lifted from the ground twice, or two springs are made in making the attempt, it shall count as a trial jump without result. A competitor may rock forward and backward, lifting heels and toes alternately from the ground, but may not lift either foot clear from the ground or slide it along the ground in any direction.”*

*“ With this exception the rules are similar to the Running High Jump.”*

		ft.	in.	metres
1.	R. C. Ewry, United States . . . . .	5	2	1'57
†	C. Tsiclitiras, Greece . . . . .	5	1	1'55
†	J. A. Biller, United States . . . . .	5	1	1'55
4.	F. Leroy Holmes, United States . . . . .	5	0	1'52

† Dead heat for second place, both being awarded silver medals.

Also competed :—P. Adams, United States (4 ft. 10 in.) ; G. André, France (4 ft. 10 in.) ; A. Motte, France (4 ft. 10 in.) ; L. DuPont, Belgium ; W. E. B. Henderson, United Kingdom ; W. Blijstad, Norway ; F. C. Irons, United States ; A. Mallwitz, Germany ; K. Langkjoer, Denmark (all of whom cleared 4 ft. 8 in.) ; A. E. Flaxman: United Kingdom ; L. H. G. Stafford, United Kingdom ; E. H. Hutcheon, Australia ; M. J. Sheridan, United States ; G. Barber, Canada ; K. Fryksdal, Sweden ; L. Robertson, United States ; A. Bengtsson, Sweden, and H. Jardin, France.

The Olympic record was set at 5 ft.  $4\frac{1}{4}$  in. by Ewry at Paris in 1900, but he did another inch higher next year in New York. The world's record appears to be 6 ft., which was done by J. Darby (professional) with his ankles bound together.

A Diploma of Merit for the Standing High Jump was awarded to F. L. Holmes, an American.

## XIV.—RUNNING BROAD JUMP.

The Rule of the A.A.A with regard to this event was printed in the programme as follows :

*“ Each competitor shall be allowed three jumps, and the best three competitors of the first trial shall be allowed three more tries each for the final. The farthest jump of all shall win. If any competitor fall back or step back, after jumping, or crosses the taking-off line with either foot, or so swerves aside that he pass beyond the taking-off line, such jump shall not be measured, but it shall be counted against the competitor as one jump. All jumps shall be measured to the taking-off line from the edge of the heel-mark nearest that line, along a line perpendicular to that line.”*

		ft.		in.		metres	
1.	F. C. Irons, United States	..	..	..	24	6½	.. 7.48
2.	D. Kelly, United States	..	..	..	23	3½	.. 7.09
3.	C. Bricker, Canada	..	..	..	23	3	.. 7.08
4.	E. T. Cooke, United States	..	..	..	22	10½	.. 6.97
5.	J. J. Brennan, United States	..	..	..	22	6¼	.. 6.86
6.	A. Weinstein, Germany	..	..	..	22	2¾	.. 6.77

Also competed :—E. Holics, Hungary ; W. H. Bleaden, United Kingdom ; S. H. Bellah, United States ; A. C. B. Bellerby, United Kingdom ; G. Barber, Canada ; C. Silfverstrand, Sweden ; T. J. Ahearne, United Kingdom ; C. H. Williams, United Kingdom ; J. F. O'Connell, United States ; F. Mountpleasant, United States ; B. Evers, Holland ; W. F. C. Watt, United Kingdom ; F. Luke-man, Canada ; D. Murray, United Kingdom ; H. K. Wieslander, Sweden ; H. von Bonninghausen, Germany ; J. Hoovgeld, Holland ; H. M. Olsen, Norway ; A. Hoffman, Germany ; K. A. Ringstrand, Sweden ; J. G. Macdonald, Canada ; G. Kovsdy, Hungary ; H. Gutierrez, France ; L. J. Cornish, United Kingdom.

F. C. Irons, aged 22, was 5 ft. 5 ½ in. tall, and weighed 9 st. 7 lb., and improved remarkably during practice.

The Olympic record of 24 ft. 1 in., by Prinstein, at St. Louis in 1904, was thus beaten in London ; Prinstein did 6 ¼ inches further on another occasion four years before ; and the world's record (amateur) is held by P. O'Connor who jumped 24 ft. 1 1 ¾ in. at Dublin in 1901.

Diplomas of Merit for the Running Broad Jump were awarded to E. T. Cooke and J. J. Brennan, both Americans.

## XV.—RUNNING HIGH JUMP.

The Rule of the A.A.A. with regard to this event was printed in the programme as follows :—

*“ The Judges shall decide the height of the bar at starting, and at each successive elevation. Each competitor shall be allowed three jumps at each height. At each height each competitor shall take one trial in order as on programme ; those failing shall have a second trial in similar order, after which those having failed twice shall make their third trial. Crossing the scratch without displacing the bar shall not count as one jump. All measurements shall be made from the ground to the centre of the bar. Neither diving nor somersaulting shall be permitted.”*

			ft.	in.	metres
1.	H. F. Porter, United States	.. ..	6	3	1'90
†	Con Leahy, United Kingdom	.. ..	6	2	1'88
†	Dr. S. Somody, Hungary	.. ..	6	2	1'88
†	G. Andre, France	.. ..	6	2	1'88
o.	H. A. Gidney, United States	.. ..	6	1	1'85
o.	T. Moffitt, United States	.. ..	6	1	1'85
o.	J. N. Patterson, United States	.. ..	6	0	1'83

†Dead heat for second place, all being awarded silver medals.

Also competed :—E. E. Leader, United Kingdom ; J. Haluzsiuszy, Hungary ; A. C. B. Bellerby, United Kingdom ; A. Hedenlund, jun., Sweden ; L. Pihkala, Finland ; H. M. Olsen, Norway ; P. J. Leahy, United Kingdom ; J. Garfield Macdonald, Canada ; L. Dupont, Belgium ; H. N. van Leeuwen, Holland ; F. Hellstedt, Sweden ; G. Barber, Canada ; G. H. Wilson, United Kingdom.

H. F. Porter, aged 26, was born at Bridgeport, Connecticut, and was 6 ft. 2 $\frac{1}{2}$  in. tall. He weighed 13 st. 3 lb.

The Olympic record of 6 ft. 2 $\frac{3}{4}$  in., by J. K. Baxter at Paris in 1904, was thus beaten, and Porter had done 6 ft. 3 $\frac{1}{2}$  in. before leaving America in 1908. Con Leahy, who tied with two others for second place in London with 6 ft. 2 in., is brother of P. J. Leahy, who failed in these Games, but cleared 6 ft. 4 $\frac{3}{8}$  in, in Ireland in 1898. The world's record is held by M. F. Sweeney (amateur) who did 6 ft. 5 $\frac{5}{8}$  in. at New York in 1895.

Diplomas of Merit for the Running High Jump were awarded to H. A. Gidney, T. Moffitt, and J. N. Patterson, all Americans.

#### XVI.—RUNNING HOP, STEP, AND JUMP.

The Rule of the A.A.A. with regard to this event was printed in the programme as follows :—

*“ The competitor shall first land upon the same foot with which he shall have taken off. The reverse foot shall be used for the second landing, and both feet shall be used for the third landing.”*

*“ In all other respects the rules governing the Running Broad Jump shall also govern the Running Hop, Step and Jump.”*

			ft.	in.	metres
1.	T. J. Ahearne, United Kingdom	.. ..	48	11 $\frac{1}{4}$	14'92
2.	J. Garfield Macdonald, Canada	.. ..	48	5 $\frac{3}{4}$	14'76
3.	E. Larsen, Norway	.. ..	47	2 $\frac{1}{2}$	14'39
4.	C. Bricker, Canada	.. ..	46	3	14'10
5.	Platt Adams, United States	.. ..	46	2	14'07
6.	F. Mountpleasant, United States	.. ..	45	10	13'97

Also competed :—D. Muller, Greece ; H. M. Olsen, Norway ; F. C. Irons, United States ; M. J. Sheridan, United States ; K. Fryksdal, Sweden ; C. R. Dugmore, United Kingdom ; D. A. Stupart, South Africa ; O. Guttormsen, Norway ; J. J. Brennan, United States ; D. R. Sherman, United States ; S. H. Bellah, United States ; G. M. Mayberry, United Kingdom ; M. D. Dineen, United Kingdom. Sheridan injured his foot in his first attempt, and had to retire.

This was the only success scored by the United Kingdom in the various jumps, but was a very fine performance of its kind, for it is only three inches behind the world's record (amateur), made by W. McManus at Cootamundra in New South Wales in 1887. T. J. Ahearne, aged 22, had done a long jump of 23 ft. 2½ in. in 1907. He stood 5 ft. 7 in., and weighed about 9 st. Macdonald of Nova Scotia never did so far before as he accomplished at these Games.

Diplomas of Merit for the Hop, Step and Jump were awarded to P. Adams of the United States, and C. Bricker, Canada.

### XVII.—POLE JUMP.

The Rule of the A.A.A. with regard to this event was printed in the programme as follows :—

*“ Each competitor shall be allowed three jumps at each height. Crossing the scratch without displacing the bar shall not count as one jump. All measurements shall be made from the ground to the centre of the bar. Three attempts, even if the cross-bar be not displaced, shall count as one jump.”*

*“ The Judges shall decide the height of the bar at starting and at each successive elevation.”*

		ft.	in.	metres
1.	{ E. T. Cooke, United States .. .. .	12	2	3'71
	{ A. C. Gilbert, United States .. .. .	12	2	3'71
3.	{ E. B. Archibald, Canada .. .. .	11	9	3'58
	{ C. S. Jacobs, United States .. .. .	11	9	3'58
	{ B. Soderstrom, Sweden .. .. .	11	9	3'58
	{ S. H. Bellah, United States .. .. .	11	6	3'50
	{ G. Banikas, Greece .. .. .	11	6	3'50
	{ C. Szathmary, Hungary .. .. .	11	0	3'35

The first two tied and were awarded gold medals ; the next three tied, and each received bronze medals.

Also competed :—B. Evers, Holland ; E. Countouriotis, Greece ; R. Pascarel, France ; H. de Veenhuijsen, Holland ; C. Silfverstrand, Sweden ; G. Koeger, France.

This was a very close competition. Archibald, who jumped 12 ft. 5½ in. in Canada and 12 feet in the Stadium on July 4, 1908, did not do as well as was confidently expected of him in the London Games. He was 24 years old, 12 st. 7 lb., and 6 feet tall. Although he only tied for third place he beat the Olympic record (as did four other competitors) of 11 ft. 6 in., by Dvorak, at St. Louis in 1904. The world's record (amateur) is held by W. R. Dray, who first cleared 12 ft. 5½ in. at Yale in 1907, and then got over the bar when it was raised 4 inches higher, to 12 ft. 9½ in.

No Diplomas of Merit for the Pole Jump were awarded, but S. H. Bellah, U.S.A., and G. Banikas, of Greece, equalled the previous Olympic record. E. T. Cooke was 19 years old, born in Ohio, and won the



American championship of 1907 with 12 ft. 3 in. He did well in London partly because he was one of the few competitors whose composure was not affected by the trying scenes at the finish of the Marathon Race. He weighed 10 st. 6 lb. and was 5 ft. 10½ in. tall. His compatriot, A. C. Gilbert, was 24 years old, 5 ft. 7 in. tall, and weighed 10 st. 5 lb. He had done the splendid jump of 12 ft. 7¾ in. before leaving America.

#### XVIII.—THROWING THE HAMMER.

The Rule of the A.A.A. with regard to this event was printed in the programme as follows :—

*“ The head and handle may be of any size, shape and material, provided that the length of the complete implement shall not be more than four feet (1·219 metres) and its weight not less than sixteen pounds (7·258 kilos.). The competitor may assume any position he chooses, and use either one or both hands. All throws shall be made from a circle seven feet (2·134 metres) in diameter. Each competitor shall be allowed three throws, and the best three competitors of the first trial shall be allowed three more throws each. The farthest throw of all shall win. All distances shall be measured from the circumference of the circle to the first pitch of the hammer along a line drawn from that pitch to the centre of the circle. Foul throws and letting go of the hammer in an attempt shall count as trial throws.”*

		ft.	in.	metres
1.	J. J. Flanagan, United States .. ..	170	4¼	51·92
2.	M. J. McGrath, United States .. ..	167	11	51·18
3.	C. Walsh, Canada .. ..	159	1½	48·51
4.	T. R. Nicolson, United Kingdom .. ..	157	9¾	48·09
5.	L. J. Talbot, United States .. ..	157	0¼	47·86
6.	M. F. Horr, United States .. ..	154	0¼	46·94

Also threw :—S. P. Gillis, United States (149 ft. 6½ in.) ; E. V. Lemming, Sweden ; R. H. Lindsay Watson, United Kingdom ; J. Murray, United Kingdom ; A. H. Fyffe, United Kingdom ; H. A. Leeke, United Kingdom ; E. E. B. May, United Kingdom ; R. Olsson, Sweden ; H. Agger, Denmark ; E. Mudin, Hungary ; J. Wagner, Switzerland ; L. Uetwiller, Germany.

It was expected that McGrath would win, but a broken ligament had curtailed his practice, and Flanagan scored with a magnificent throw, 2 ft. 3 in. further than his own Olympic record, made at St. Louis in 1904, and within 3 ft. 3 in. of the American amateur record he set up in 1907. With an unlimited run and follow he did 175 ft. 8 in. in New York in 1907. He was 35 years old, born in Limerick, and in 1900 he won the English championship by throwing the old style of hammer (with a wooden handle) 163 ft. 4 in. McGrath was 29 years old, born in Tipperary, and won the Canadian championship of 1907 with 173 ft. 7 in.

Diplomas of Merit for Throwing the Hammer were awarded to T. R. Nicolson, United Kingdom, and to L. J. Talbot and M. F. Horr, both Americans.

## XIX.—PUTTING THE WEIGHT.

The Rule of the A.A.A. with regard to this event was printed in the programme as follows :—

“ *The Weight shall be put from the shoulder with one hand only, and without follow from a seven feet (2·134 metres) circle. The weight shall be of iron and spherical, and shall weigh sixteen pounds (7·258 kilos.). All puts shall be measured from the circumference of the circle to the first pitch of the weight along a line drawn from that Pitch to the centre of the circle. Each competitor shall be allowed three puts, and the best three competitors of the first trial shall be allowed three more puts each. The farthest put of all shall win.*”

“ *In Throwing the Hammer and Putting the Weight crossing the scratch shall count as a try.*”

		ft.	in.	metres
1.	R. W. Rose, United States . . . . .	46	7½	14·21
2.	D. Horgan, United Kingdom . . . . .	44	8½	13·62
3.	J. C. Garrels, United States . . . . .	43	3	13·18
4.	W. W. Coe, United States . . . . .	42	10½	13·07

Also competed :—J. Halme, Finland ; L. J. Talbot, United States ; C. Lagarde, France ; H. A. Leeke, United Kingdom ; E. Barrett, United Kingdom ; I. Mudin, Hungary ; J. Sauli, Finland ; M. J. Sheridan, United States ; M. Doriza, Greece ; M. F. Horr, United States ; W. Jarvinen, Finland ; H. K. Wieslander, Sweden ; T. R. Nicolson, United Kingdom ; J. Barrett, United Kingdom ; E. Niklander, Finland ; E. Mudin, Hungary ; B. Zilliacus, Finland ; W. G. Burroughes, United States ; A. Tison, France ; N. Georgandas, Greece ; A. Halse, Norway ; M. Koczan, Hungary.

Only bad weather prevented a wonderful performance being registered by Rose, who was seen by the writer to put the weight 50 feet in practice in the Stadium soon after he had landed. As it was he did 47 ft. 2 in. in the rain, after winning the event. He made the world's record at Montreal in Canada with 49 ft. 72 in. in 1907, and his Olympic record at St. Louis in 1904 was 48 ft. 7 in. He was 22 years old, 6 ft. 5 in. tall, and weighed 16 st. 6 lb. stripped. Horgan, of Cork, was 39, stood 5 ft. 10 in., and weighed 17 st.

No Diplomas of Merit were awarded in this event.

## XX.—TUG OF WAR.

The Rule of the A.A.A. with regard to this event was printed in the programme as follows :—

“ (a) *The teams shall consist of equal numbers (8) of competitors. The rope shall be of sufficient length to allow for a ‘ pull ’ of twelve feet (3·658 metres) and for twelve feet (3·658 metres) slack at each end, together with four feet (1·219 metres) for each competitor ; it shall not be less than four inches (·102 metres) in circumference, and shall be without knots or other holdings for the hands. A centre tape shall be affixed to the centre of the rope, and six feet (1·829 metres) on each side of the centre tape two side tapes shall be affixed to the rope. A centre line shall be marked on the ground, and six feet (1·829 metres) on either side of the centre line two side lines parallel thereto. At the start the rope shall be taut, and the centre tape shall be over the centre line and the competitors shall be outside the side lines. During no part of the pull shall the rope be tied.*”

“ (b) The start shall be by word of mouth. During no part of the pull shall the foot of any competitor go beyond the centre line. A pull shall be won when one team shall have pulled the side tape of the opposing side over their own side line or a competitor of the opposing side goes over the centre line. No competitor shall wear prepared boots or shoes or boots or shoes with any projecting nails, tips, sprigs, points, hollows or projections of any kind. No competitor shall make any hole in the ground with his feet or in any other way before the start. No competitor shall wilfully touch the ground with any part of his person but his feet. All heats shall be won by two pulls out of three.”

FIRST ROUND.

Heat 1.—United Kingdom, Team II. (Liverpool Police) : C. Foden (captain), P. Philbin, J. M. Clarke, T. Butler, A. Kidd, G. Smith, T. Swindlehurst, D. McD. Lowey, and W. Greggan—beat United States : M. J. Sheridan (captain), W. G. Burroughs, A. K. Dearborn, J. J. Flanagan, M. J. McGrath, R. Rose, L. J. Talbot, W. W. Coe, and M. F. Horr.

The Police team at the word “ Heave ” pulled their opponents over with a rush. The Americans then withdrew.

Sweden, a bye.

United Kingdom, Team I., a bye.

United Kingdom, Team III., a bye.

SECOND ROUND.

Heat 1.—United Kingdom, Team II. (Liverpool Police) beat Sweden : E. Johansson, K. R. Johanson, C. E. Johansson, K. G. Nilsson, F. O. Fast, K. E. Krook, A. Almquist, and A. H. Woolgarth—by 2 pulls to 0.

Heat 2.—United Kingdom, Team I. (City Police) : H. Duke (captain), W. Hiron, F. W. Goodfellow, J. Shepherd, A. Ireton, E. Barrett, E. A. Mills, F. H. Humphreys, and F. Merriman—beat United Kingdom, Team III. (K Division Police) : T. J. Williams (captain), W. B. Tammias, W. Slade, A. Munro, E. W. Ebbage, T. Homewood, W. Chaffe, J. Woodget, and J. Dowler—by 2 pulls to 0.

This was a grand contest, the first pull being a very lengthy affair, the City scoring after the K Division had more than once recovered lost ground. In the second the City were still stronger, and they won in a rather easier manner.

FINAL.

United Kingdom, Team I. (City Police) · · · · 1			
	st. lb.		st. lb.
W. Hiron · · · ·	15 0	E. A. Mills · · · ·	15 9
F. W. Goodfellow · · · ·	15 8	A. Ireton · · · ·	14 0
E. Barrett · · · ·	15 0	F. Merriman · · · ·	16 5
J. Shepherd · · · ·	16 5	H. Duke (captain) · · · ·	—
F. H. Humphreys · · · ·	15 9		
United Kingdom, Team II. (Liverpool Police) · · · 2			
P. Philbin · · · ·	15 5	T. Swindlehurst · · · ·	17 0
J. M. Clarke · · · ·	13 0	D. McD. Lowey · · · ·	14 10
T. Butler · · · ·	15 10	W. Greggan · · · ·	14 0
A. Kidd · · · ·	15 2	C. Foden (captain) · · · ·	—
G. Smith · · · ·	15 0		
United Kingdom, Team III. (K Division Police) · · · 3			
W. B. Tammias		W. Chaffe	
W. Slade		J. Woodget	
A. Munro		J. Dowler	
E. W. Ebbage		T. J. Williams (captain)	
T. Homewood			

The contest, if severe, was not a lengthy one. The City Police held their men splendidly, and although Liverpool did their utmost in the first pull they could not make much impression on the City, who gradually gained. As a last resource, the Liverpool men tried the turn, but before they were fairly fixed at that the City had pulled them over. The second pull was an equally good one, but the Londoners had the mastery, and after a really strenuous struggle they gained a great victory by two pulls to none.

The Swedes not turning out, K Division walked over for third medals.

A few words of explanation are necessary as to a protest raised by certain members of the American Committee in the first round. The Tug of War is a game in which the English teams had carefully specialised, and they knew their business well. The Americans were magnificent athletes, but were not aware how to tie an anchor or how to place their men. They were, in fact, not used to the game at all, and were very naturally surprised to find how little their strength availed against skilful combination. The English policemen wore their ordinary duty boots, as it is their invariable custom to pull in these contests in such boots which have become too shabby for street duty. When they heard that remarks had been made as to the nature of their footwear, they offered to pull in their socks. It is right to add that the American team did not support the protest made, and it was ruled out.

The winning team owed much of their victory to the splendid coaching of Inspector Duke. He trained the men for five months, and their condition was much admired.

#### XXI.—THREE MILE TEAM RACE (4·828 kilometres).

##### FIRST ROUND.

*Heat 1.*—H. A. Wilson, A. J. Robertson, W. Coales, and J. E. Deakin, all United Kingdom, time, 15 min.  $5\frac{3}{5}$  sec., dead-heat for 1 ; P. Pagliani, Italy, 15 min.  $22\frac{3}{5}$  sec., 5 ; M. Cartesegna, Italy, 16 min. 26 sec., 6 ; A. C. H. Vosbergen, Holland, 17 min.  $15\frac{4}{5}$  sec., 7 ; W. W. Wakker, Holland, 17 min.  $46\frac{2}{5}$  sec., 8.

Also ran :—Italy, E. Giovanoli, P. Dorando, and E. Lunghi ; Holland, W. T. Braams ; United Kingdom, N. F. Hallows.

This was not an exciting race. Giovanoli led the first lap at a good pace, after which the British contingent went in front, and they were never seriously tackled, although Pagliani hung on most tenaciously. Hallows retired early in the second mile, but our other men kept together until the last lap, and coming up the straight in line finished a dead-heat ; Pagliani about 80 yards in the rear. Points : England, 6. No other team finished.

*Heat 2.*—J. Bouin, France, 14 min. 53 sec., 1 ; J. L. Eisele, United States, 14 min. 55 sec., 2 ; H. L. Trube, United States, 14 min. 55 sec., 3 ; L. de B. de Fleurac, France, 14 min. 56 sec., 4 ; G. V. Bonhag, United States, 14 min.  $56\frac{2}{5}$  sec., 5 ; J. F. Svanberg, Sweden, 14 min. 57 sec., 6 ; J. G. Peterson, Sweden, 15 min.  $14\frac{2}{5}$  sec., 7 ; E. M. Dahl, Sweden, 15 min. 21 sec., 8 ; A. J. A. Wiegant, Sweden 15 min. 33 sec., 9 ; J. Dreher, France, 15 min.  $37\frac{1}{5}$  sec., 10 ; G. A. Dull, United States, 15 min.  $37\frac{2}{5}$  sec., 11 ; S. L. Landqvist, Sweden, 15 min.  $46\frac{2}{5}$  sec., 12 ; A. Fayollat, France, 15 min.  $52\frac{1}{5}$  sec., 13 ; P. Lijandier, France, 15 min.  $56\frac{3}{5}$  sec., 14.

This was a good race. J. F. Svanberg went off with the lead, and was soon 20 yards ahead. He kept his place for the first mile, when the others drew up, the lead lying alternately between Bouin, Eisele, and Trube, who were never far apart. In the last mile de Fleurac went ahead and the pace quickened, the Swedes being left in the rear, but the Frenchmen were not to be shaken off, and in a fine last lap Bouin got clear away, and won by 20 yards; the other five practically a dead-heat. Team placings: America, 2, 3, 5—10 points; France, 1, 4, 10—15; Sweden, 6, 7, 8—21.

## FINAL.

	m.	s.
1. J. E. Deakin, United Kingdom .. ..	14	39 $\frac{3}{5}$
2. A. J. Robertson, United Kingdom .. ..	14	41
3. W. Coales, United Kingdom .. ..	14	41 $\frac{3}{5}$
4. J. L. Eisele, United States .. ..	14	41 $\frac{4}{5}$
5. H. A. Wilson, United Kingdom .. ..	14	57
6. G. V. Bonhag, United States .. ..	15	5
7. N. F. Hallows, United Kingdom .. ..	15	8
8. L. de B. de Fleurac, France .. ..	15	8 $\frac{3}{5}$
9. H. L. Trube, United States .. ..	15	11
10. G. A. Dull, United States .. ..	15	27
11. J. Dreher, France .. ..	15	40
12. H. W. Conn, United States .. ..	15	40 $\frac{1}{5}$
13. P. Lijandier, France .. ..	16	3

## TEAM PLACINGS.

UNITED KINGDOM.		UNITED STATES.		FRANCE.	
J. E. Deakin ..	1	J. L. Eisele .. ..	4	L. de Fleurac .. ..	8
A. J. Robertson ..	2	G. V. Bonhag .. ..	6	J. Dreher .. ..	11
W. Coales .. ..	3	H. L. Trube .. ..	9	P. Lijandier .. ..	13
	<hr/> 6		<hr/> 19		<hr/> 32

Robertson led for the first two laps, when Deakin went up, Coales next taking a turn, then Deakin and Robertson going again, The Americans came up ere two miles were covered, and Eisele of their team kept in the front rank. Wilson was dropped, and Hallows tailed off with the second American division. Eisele, however, refused to be left. In the last lap Deakin came away with a fine spurt, and won by thirty yards. Eisele came up the straight in good style, but Robertson, in a splendid spurt, kept beside Coales and encouraged him to stay ahead, so that the United Kingdom were thus able to score the first three places and win well. But Eisele showed fine form and great determination. It is suspected by experienced watch-holders that the time officially returned for Deakin was an error, for he won by thirty yards at least, and must have done about 14 min. 35 sec. The intermediate times were 4.42 $\frac{3}{5}$  for the first mile, and 9.44 $\frac{4}{5}$  for the second. The world's record (amateur) for three miles is 14'17 $\frac{3}{5}$ , done by A. Shrubbs at Stamford Bridge in 1903. J. E. Deakin was 29 years old, born near Stoke-on-Trent, and served in South Africa. He was 5 ft. 7 in, high, and weighed 9 st. 3 lb. A. J. Robertson was 29 also, born near Sheffield, and was a good cyclist before making his mark across country.

## XXII.—THREE THOUSAND FIVE HUNDRED METRES WALK

(Two Miles 307 Yards).

*Heat 1*.—G. E. Larner, United Kingdom (time, 15 min. 32 sec.), 1 ; H. E. Kerr, Australasia (16 min.  $2\frac{1}{5}$  sec.), 2 ; W. J. Palmer, United Kingdom (16 min. 33 sec.), 3 ; P. Gunia, Germany (16 min. 38 sec.), 4 ; S. L. Sarel, United Kingdom (17 min. 6 sec.), 5 ; A. B. S. Hojme, Denmark (17 min.  $23\frac{2}{5}$  sec.), 6 ; J. Goetzee, Holland (17 min.  $37\frac{1}{5}$  sec.), 7 ; B. C. Brown, United Kingdom, o. Larner at once went to the front, and at the second lap led Palmer and Kerr by seven yards. Shortly afterwards Brown was disqualified. In the next lap Kerr led Gunia and Palmer, with Larner 50 yards ahead. The German now began to drop back, and at the bell Larner led by 70 yards from Kerr, with Palmer next, and eventually Larner won by 120 yards.

*Heat 2*.—E. J. Webb, United Kingdom (time, 15 min.  $17\frac{1}{5}$  sec.), 1 ; C. P. M. Westergaard, Denmark (17 min. 7 sec.), 2 ; E. Rothman, Sweden (17 min.  $40\frac{1}{5}$  sec.), 3 ; W. F. Winkelmann, Holland (17 min.  $57\frac{3}{5}$  sec.), 4 ; E. Drubina, Hungary (18 min.  $44\frac{2}{5}$  sec.), 5 ; P. A. A. Ruimers, Holland (18 min.  $44\frac{2}{5}$  sec.), 6. Also competed :—R. Quinn, United Kingdom ; J. J. Reid, United Kingdom. Webb went away at once, and in the first half-lap led by 15 yards from Quinn, Westergaard, and Reid. At a mile he was a long way ahead, and at this point Reid was disqualified. The same fate befel Quinn soon afterwards, and Webb won easily. The winner's two miles' time was 14 min.  $0\frac{1}{5}$  sec.

*Heat 3*.—G. Goulding, Canada (time, 15 min. 54 sec.), 1 ; R. Harrison, United Kingdom (16 min.  $4\frac{2}{5}$  sec.), 2 ; A. E. M. Rowland, Australasia (16 min.  $8\frac{3}{5}$  sec.), 3 ; E. E. Larner, United Kingdom (16 min. 10 sec.), 4 ; J. Butler, United Kingdom (16 min. 17 sec.), 5 ; R. Wilhelm, Germany (17 min.  $33\frac{2}{5}$  sec.), 6 ; J. Huijgen, Holland (17 min. 43 sec.), 7. Goulding at once led, and in the second lap he was 20 yards ahead of Harrison, Larner, and Wilhelm, but a quarter of a mile farther on the New Zealander took second place. With a mile to go, the Canadian was 40 yards ahead of Harrison, Rowland, and Larner, seven yards covering them. In the next lap Harrison made his effort, but to no purpose, for Goulding, going on, finished very strongly, and won by 45 yards.

## FINAL.

					m. s.
1.	G. E. Larner, United Kingdom	..	..	..	14 55
2.	E. J. Webb, United Kingdom	..	..	..	15 $7\frac{2}{5}$
3.	H. E. Kerr, Australasia	..	..	..	15 $43\frac{2}{5}$
4.	G. Goulding, Canada	..	..	..	---
5.	A. E. M. Rowland, Australasia	..	..	..	---
6.	C. P. M. Westergaard, Denmark	..	..	..	---
7.	E. Rothman, Sweden	..	..	..	---

Also competed :—R. Harrison, United Kingdom ; W. J. Palmer, United Kingdom.

Webb led at a good pace, followed by Harrison and Goulding. In the second lap Larner drew up to Webb, and Harrison, who was following them closely, was ruled out. Webb and Larner now went away, Rothman being a long way behind last. The mile time was 6 min. 44 sec., Larner just ahead of Webb, with Kerr third. Larner now began to draw away, and passed the two miles in 13 min.  $43\frac{2}{5}$  sec.,  $9\frac{2}{5}$  sec. ahead of Webb. Kerr's time was approximately 14 min. 22 sec., Goulding's 14 min. 33 sec., and Rowland's 14 min. 44 sec. Coming up the straight finely, Larner won by about forty-five yards.

Larner won the A.A.A. Championship for two miles, in 1904, in 13 min. 57  $\frac{3}{5}$  sec., and has actually done the distance in 13 min. 11  $\frac{2}{5}$  sec. (a world's record) ; while he has walked 8 miles 439  $\frac{1}{2}$  yards in the hour. H. E. Kerr of New Zealand was over 6 ft. tall. A Diploma of Merit for this race was awarded to G. Moulding, of Canada.

### XXIII.—THROWING THE DISCUS (Free Style).

The Rule of the A.A.A. with regard to this event was printed in the programme as follows :—

*“ The Discus shall be 2 kilogrammes (4·4 lbs.) in weight and 22 centimetres (8·7 inches) in diameter. It shall be made of wood with a smooth iron rim, and shall be capped on each face with a smooth metal plate.*

*“ Every competitor must throw with a discus provided by the Committee.”*

#### Free Style.

*“ (a) The Discus is thrown from a circle 2·50 metres (2·733 yards) in diameter.*

*“ (b) From the centre of this circle a straight line shall be drawn in the direction in which the competitors are to throw. At an angle of forty-five degrees on either side of this line shall be drawn side lines. To constitute a valid throw the discus must first strike the ground in the space between these side lines.*

*“ (c) The method of throwing is at the absolute discretion of each competitor.*

*“ (d) The thrower must remain entirely within the circle until the discus first strikes the ground, otherwise the throw is invalid.*

*“ (e) To measure the distance thrown, a straight line is taken from the point at which the discus first strikes the ground to the centre of the circle. The distance thrown is the portion of this line which lies outside the circle.”*

			ft.	in.	metres
1.	M. J. Sheridan, United States	.. ..	134	2	.. 40·89
2.	M. H. Giffin, United States	.. ..	133	6 $\frac{1}{2}$	.. 40·70
3.	M. F. Horr, United States	.. ..	129	5	.. 39·45
4.	W. Jarvinen, Finland	.. ..	129	4 $\frac{1}{2}$	.. 39·43
5.	A. K. Dearborn, United States	.. ..	126	4 $\frac{1}{2}$	.. 38·52

This was thrown in sections. At the end of the first round Giffin was ahead with the throw given above, but in the deciding round Sheridan got in a fine throw and won.

The other competitors were :—C. Lagarde, France ; H. A. Leeke, United Kingdom ; E. E. B. May, United Kingdom ; F. Jesina, Hungary ; W. E. B. Henderson, Great Britain ; A. E. Flaxman, United Kingdom ; W. G. Burroughes, United States ; L. Pihkala, Finland ; A. Salovaara, Finland ; J. J. Flanagan, United States ; M. Koczan, Hungary ; G. Luntzer, Hungary ; M. Collins, United Kingdom ; L. Wilskman, Finland ; J. C. Garrels, United States ; H. K. Wieslander, Sweden ; M. Susterka, Bohemia, S. P. Gillis, United States ; T. Nejistrom, Sweden ; F. Soncek, Bohemia ; J. Murray, United Kingdom ; A. Tison, France ; I. Mudin, Hungary ; N. Georgandas, Greece ; E. Niklander, Finland ; J. Sauli, Finland ; L. Uetwiller, Germany ; F. Fleetwood, Sweden ; M. Doriza, Greece ; E. Barrett, United Kingdom ; U. Avattaneo, Italy ; J. Falchenberg, Norway ; L. J. Talbot, United States ; E. Welz, Germany ; E. V. Lemming, Sweden ; O. Nilsson, Sweden.

A Diploma of Merit was awarded to W. Jarvinen, of Finland.

## XXIV.—THROWING THE DISCUS (as at Athens).

The Rule of the A.A.A. with regard to this event was printed in the programme as follows :—

“ (a) *The Discus is thrown from a rectangular pedestal 80 centimetres 31  $\frac{1}{2}$  inches long and 70 centimetres 27  $\frac{1}{2}$  inches broad, sloping forward from a height of 15 centimetres (6 inches) at the back to a height of 5 centimetres (2 inches) at the front.*

“ (b) *The method of throwing is as follows :—*

“ *The thrower places himself on the pedestal with the feet apart, and holding the discus in either hand. He then grasps it with both hands and raises them without letting go the discus with either, extending the rest of his body at the same time in the same direction. After that he turns the trunk to the right and bends sharply, so as to bring the left hand, which has now left hold of the discus, to the right knee, and the right hand, still holding the discus, as far back as possible. At this moment the right foot should be forward and both legs bent ; the right foot rests full on the sole, and the left on the toes only. Then by a sharp and simultaneous extension of the whole body the thrower throws the discus forward.*

“ (c) *The thrower may leave the pedestal at the moment of throwing.*

“ (d) *The measurement of the throw shall be from the point at which the discus first strikes the ground to the centre of the front side of the pedestal.*”

			ft.	in.	metres
1.	M. J. Sheridan, United States	..	..	124 8	.. 37'99
2.	M. F. Horr, United States	..	..	122 5 $\frac{1}{2}$	.. 37'32
3.	W. Jarvinen, Finland	..	..	119 8 $\frac{1}{4}$	.. 36'48
4.	A. K. Dearborn, United States	..	..	116 11 $\frac{1}{2}$	.. 35'65

Also competed :—M. Sustera, Bohemia ; H. A. Leeke, United Kingdom ; M. Doriza, Greece ; W. G. Burroughes, United States ; W. E. B. Henderson, United Kingdom ; I. Mudin, Hungary ; N. Georgandas, Greece ; U. Avattaneo, Italy ; L. Wilskman, Finland ; J. C. Garrels, United States ; E. Mudin, Hungary ; E. E. B. May, United Kingdom ; J. Sauli, Finland ; A. E. Flaxman, United Kingdom ; L. J. Talbot, United States ; R. Rose, United States ; F. Jesina, Hungary ; E. Welz, Germany ; G. Luntzer, Hungary ; E. V. Lemming, Sweden.

At the end of the first round Sheridan led with 122 ft. 8  $\frac{3}{4}$  in., with Horr second, 120 ft. 4 in., Jarvinen third. Both the Americans went one better in the final, but the Finn could not improve.

It is considered by English scholars that the Athenian rules for the Discus are based upon a mistranslation of a corrupt text, and do not represent what the ancient Greeks actually did ; but the rules were used at Athens in 1906, and will no doubt be used there again. The results of admitting them in London show that they are unnecessary, for the same athlete won both the free and the restricted style (as in the Javelin also), and in neither case was a Greek, by whose nation the restricted rules were introduced, within the first four. Sheridan had previously thrown 128 ft. 10 $\frac{1}{2}$  in. (the Olympic record) in the Greek style at St. Louis in 1904, and won with 136 ft. at Athens in 1906. He was 27 years old, born in County Mayo, Ireland, 5 ft. 11 $\frac{1}{4}$  in. high, and weighs 12 st. 10 lb. He is a splendidly proportioned man, and won the individual all-round championship of the United States in 1905 and 1907.

A Diploma of Merit was awarded to Dearborn, of the United States.





ATHLETICS.—RALPH ROSE (U.S.A.) PUTTING THE WEIGHT.



ATHLETICS.—THE UNITED KINGDOM TEAM (CITY OF LONDON POLICE),  
WINNERS IN THE TUG OF WAR.



ATHLETICS.—WILSON, ROBERTSON, DEAKIN, AND COALES (ALL U.K.)  
WINNING THE FIRST HEAT OF THE 3-MILE TEAM RACE.



ATHLETICS.—MARTIN SHERIDAN (U.S.A.), WINNER OF THE DISCUS  
(GREEK STYLE).

## XXV.—THROWING THE JAVELIN (Free Style).

The Rule of the A.A.A. with regard to this event was printed in the programme as follows :—

“ (a) *The Javelin shall be 2·6 metres long (8·1 feet) and 800 grammes in weight (1·6 lb.). It shall be of wood with a sharp iron point, and shall have about the centre of gravity a grip formed by a binding of whipcord without knots ; it shall not be provided with a thong, and the shaft shall not be notched.*

“ *Every competitor must throw with a Javelin provided by the Committee.*

“ (b) *The throwing shall take place from behind a scratch line. The thrower may place his foot or feet upon the line, but if either foot passes the line entirely before the javelin first strikes the ground the throw is invalid.*

“ (c) *No throw shall be counted in which the point of the javelin does not strike the ground before any part of the shaft.*

“ (d) *It is open to the competitor to throw with either hand and with or without a run.*

“ (e) *The throw is measured from the point at which the point of the javelin first strikes the ground perpendicularly to the scratch line, or the scratch line produced.*

“*In the Free Style the manner of holding the javelin is left to the absolute discretion of each competitor.*

“*In the Style in which the javelin is held in the middle, the javelin must be held by the grip, and no other method of holding is admissible.*”

			ft.	in.	metres
1.	E. V. Lemming, Sweden	.. ..	178	7½	54·44
2.	M. Doriza, Greece	.. ..	168	6	51·36
3.	A. Halse, Norway	.. ..	163	1¼	49·73
4.	C. Zouras, Greece	.. ..	159	5¾	48·61

Also competed :—H. A. Leeke, United Kingdom ; W. E. B. Henderson, United Kingdom ; E. E. B. May, United Kingdom ; A. E. Flaxman, United Kingdom ; E. Barrett, United Kingdom ; J. Sauli, Finland ; J. Halme, Finland ; A. Pesonen, Finland ; N. Georgandas, Greece ; C. M. Carlsrud, Norway ; I. Mudin, Hungary ; J. Kemp, Finland ; A. Salovaara, Finland ; E. B. Jakobsson, Finland ; F. Jesina, Hungary ; G. Luntzer, Hungary ; E. Mudin, Hungary ; B. Soderstrom, Sweden ; K. Lindberg, Sweden ; O. Nilsson, Sweden ; F. Soncek, Bohemia ; J. Jakobsson, Finland ; W. Jarvinen, Finland ; L. Uetwiller, Germany ; M. Koczan, Hungary ; E. Brambilla, Italy ; J. Johanssen, Norway.

A Diploma of Merit was awarded to A. Pesonen, of Finland.

## XXVI.—THROWING THE JAVELIN (Held in the Middle).

			ft.	in.	metres
1.	E. V. Lemming, Sweden	.. ..	179	10½	54·83
2.	A. Halse, Norway	.. ..	165	11	50·57
3.	O. Nilsson, Sweden	.. ..	154	6¼	47·11
4.	A. Salovaara, Finland	.. ..	150	6¾	45·89
5.	A. Pesonen, Finland	.. ..	148	2¾	45·18

Also competed :—J. Halme, Finland ; J. Johanssen, Norway ; C. Zouras, Greece ; J. Sauli, Finland ; H. K. Wieslander, Sweden ; H. A. Leeke, United Kingdom ; L. F. Tremeer, United Kingdom ; E. B. Jakobsson, Finland ; J. Jakobsson, Finland ; E. E. B. May, United Kingdom ; C. Bechler, Germany.

It will be noticed that, as in the case of the Discus, restrictions had no effect upon the winner, for Lemming not only proved his superiority in both

classes, but made his best throw in the restricted style. Not improbably, therefore, the restrictions in both Discus and Javelin will be removed in future Games held outside Athens.

Lemming was 28 years old, born at Gothenberg, 6 ft. 3 in. tall, and weighs 14 st. He is in the Stockholm Police, and won this event at Athens with 175 ft. 6 in. His throw in London is the Olympic record, but he has done 188 feet in Sweden. Halse, of Norway, could throw 133 ft. with the left hand, and had done 178 ft. with his right before the Games.

A Diploma of Merit was awarded to A. Salovaara, of Finland.

#### XXVII.—SIXTEEN HUNDRED METRES RELAY RACE.

(10 $\frac{1}{2}$  Yards short of a Mile).

*Teams of four :—Two to run 200 Metres.*

*One, 400 Metres.*

*One, 800 Metres.*

##### FIRST ROUND.

*Heat 1.*—Hungary (P. Simon, G. Racz, J. Nagy, O. Bodor), 1; Sweden (S. Laaftman, K. Lindberg, K. Stenborg, and E. Bjorn), 2. Simon and Laaftman ran the first 200 metres for their respective countries, and the Hungarian at once took the lead. Running finely, he touched Racz 10 yards before Laaftman reached Lindberg. The latter, however, went hard after his man, and when Nagy was sent off for the 400 metres his opponent, Stenborg, was only 6 yards behind. Striding out splendidly, the Swede was in front after 100 yards of the distance had been covered, and, although Nagy went all out, the half mile was started with Bjorn possessing a three yards' advantage over Bodor. For, say, 400 metres, it was a great tussle between the pair. Then Bodor, who ran SO finely in the 800 Metres Final, went ahead. Bjorn endeavoured to catch up the Hungarian, but whereas the latter was running quite easily Bjorn was labouring. As a consequence, Bodor easily kept ahead and won by 3 yards. Time, 3 min. 32 $\frac{3}{5}$  sec. The time for the second half of the race—800 metres—was 1 min. 56 $\frac{3}{5}$  sec., so that Bodor accomplished an extremely fine performance.

*Heat 2.*—Germany (A. Hoffman, H. Eicke, Dr. O. P. Trieloff, H. Braun), 1; Holland (E. Koops, J. Hoogveld, V. Henny, B. Evers), 2. Hoffman led Koops almost immediately, and at the end of the first 200 metres Eicke was able to score 10 yards lead over Koops. At the beginning of the next stage Germany were leading by 20 yards, and Braun won by 50 yards. Time, 3 min. 43 $\frac{1}{5}$  sec.

*Heat 3.*—United States (W. F. Hamilton, N. J. Cartmell, J. B. Taylor, and M. W. Sheppard), 1; United Kingdom (G. A. Hawkins, H. J. Pankhurst, E. H. Montague, and T. H. Just), 2; Canada (F. Lukeman, D. Buddo, L. Sebert, T. Parkes), 3. Hamilton, Hawkins, and Lukeman ran the first 200 metres, and Hamilton touched his man, Cartmell, 2 yards before Lukeman reached Buddo, with Hawkins sending Pankhurst away a yard behind the Canadian. Running beautifully, Cartmell gave Taylor a 6 yards' lead from Montague and Sebert, who were released simultaneously. Taylor just about held his own, but Montague caught Sebert in the last few yards, so that the order was Sheppard, Just, and Parkes for the 800 metres. The issue cannot be said to have been in doubt for one second. Just did his very best, but the man in front of him was speedier, and not even the Light Blue's great stride could save-him from suffering defeat by 25 yards. Time, 3 min. 27 $\frac{1}{5}$  sec.

## FINAL

1. United States Team
 

W. F. Hamilton, 200 metres (218·6 yards)	.. ..	22 secs.
N. J. Cartmell, 200 metres	.. ..	22 $\frac{1}{3}$ „
J. B. Taylor, 400 metres (437·4 yards)	.. ..	49 $\frac{1}{2}$ „
M. W. Sheppard, 800 metres (874·9 yards)	.. ..	1.55 $\frac{2}{3}$ „
		Time, 3 min. 29 $\frac{2}{3}$ secs.
2. German Team :
  - A. Hoffmann, H. Eicke, Dr. O. P. Trieloff, H. Braun.
3. Hungarian Team :
  - P. Simon, G. Racz, J. Nagy, O. Bodor.

As the Americans had won the first race with which the Games opened in the Stadium, so they secured also the last race before Her Majesty the Queen distributed the gold medals, and their form in the 1,600 Metres Relay was well worthy both of this coincidence and of its position in the programme, as may be seen from the fact that their four men covered a mile all but 10 $\frac{1}{5}$  yards in less than 3 $\frac{1}{2}$  minutes, while they had won their preliminary heat two seconds faster. J. B. Taylor, a negro with a magnificent stride, died of typhoid on December 2, 1908, after his return to the United States, much regretted by all who had met him here.

The details of this final are as follows .—

The first 200 metres runners were P. Simon (Hungary), A. Hoffman (Germany), and W. F. Hamilton (United States) ; the second 200 metres, G. Racz (Hungary), H. Eicke (Germany), and N. J. Cartmell (United States) ; 400 metres, J. Nagy (Hungary), Dr. O. P. Trieloff (Germany), and J. B. Taylor (United States); 800 metres, O. Bodor (Hungary), H. Braun (Germany), and M. W. Sheppard (United States). Though drawing outside position, Hamilton was on the inside at 50 yards. Running at the top of his form, he gained yard after yard, and Cartmell started with quite 6 yards' lead of Racz and 7 of Eicke. The two chased the American with all their might, but Cartmell held his own. He drew still further ahead, and Taylor had 8 yards the best of it on starting his 400 metres. His remarkable stride widened the gap very considerably, especially in the last hundred yards. As a consequence, Melvin Sheppard—looking not quite as fit as a few days previously—was sent away with a 15 yards' lead over Bodor, with Braun 5 yards behind the Hungarian. He won by 25 yards. Meanwhile, Braun was making a great race of it with Bodor for second place. Three-parts of the way up the straight the German was only a yard behind, and with a supreme effort he caught Bodor in the last yard and won by no more than a couple of inches.

## ARCHERY.

The Archery Competitions took place on the grass in the centre of the Stadium on the mornings of July 17 and 18, when the York Round for gentlemen and the National Round for ladies were shot. On July 20 40 arrows at 50 metres (Continental style) were shot. Twenty-five ladies and eighteen gentlemen entered for England, eighteen for France, and two for the United States. Of these only four competitors from France and one from the United States were absent.

On Friday the rain was bad, and at one time stopped the shooting. There was also half a gale of wind at times, which produced very tricky eddies owing to the curved seats of the surrounding Stadium. No one began well, but Mr. Penrose's second dozen of ten hits for 56 gave him first place at the end of the first three dozen, Mr. W. Dod being a good second. On the next three dozen arrows, Mr. T. Robinson was first with 20, 82, and Mr. H. B. Richardson, the American champion (who shot the first three dozen with bad luck), was second with 14, 76. The best score made by any French competitor on either of the three dozen was M. Richez's 14, 56, on the second. At 80 yards Mr. W. Dod made a good first half of 19, 91, both Mr. Brooks-King and Mr. J. H. Bridges scoring 18, 70. On the next two dozen arrows Mr. Brooks-King was first with 21, 89, the next best scores being Mr. H. P. Nesham, 19, 75, and Mr. H. B. Richardson, 17, 73. Nothing much was done at 60 yards. On the first dozen both Mr. Dod and Mr. Bridges put in all the arrows for 66 and 60, and on the second Mr. Backhouse scored 59 and M. Salingre and Mr. Penrose 57, all with 11 hits. The ladies commenced at eleven, but had hardly begun to shoot before they had to fly for shelter, and this was the case during most of the 60 yards' shooting, the last three arrows being shot while it was raining hard, which, however, did not prevent Mrs. Boddam-Whetham from making three golds at the second end of her third dozen. On the first two dozen at 60 yards Mrs. T. N. Wilson scored 19, 105, Miss Dod 20, 104, Mrs. Hill-Lowe 20, 96, and Mrs. Appleyard 19, 95. On the next two dozen there was a considerable improvement, the best scores being Miss Dod 23, 115, Miss Q. Newall 22, 114, Mrs. Armitage 17, 107, and Mrs. T. N. Wilson 20, 102. At 50 yards two ladies, Miss Q. Newall and Mrs. Wadworth, put in all their arrows, the best first dozen being the latter's of 64, and the best second the former's of 76.

On the second day (Saturday) there were no breaks in the shooting, though it rained a little ; but the day was a decidedly unpleasant one, with

a cold and gusty wind, more trying, if anything, than the first one had been. It took some time for the shooters to find out where to aim, and the scores on the first half of the 100 yards were low, the best, 76 from 20 hits, being made by Mr. H. V. James. From the next three dozen arrows better results were obtained, Mr. W. Dod making a fine score of 23, 109, Mr. T. Robinson scoring 85 with 17 hits, and Mr. H. B. Richardson 80 with 20. At 80 yards Mr. Richardson began well, scoring 96 with 20 hits, Mr. Brooks-King making 82 with 16, and Mr. H. V. James 79 with 17. On the next two dozen Mr. James was first with 19, 81, Mr. W. Dod 17, 79, and H. P. Nesham 14, 74, being the next best totals. Three golds at one end were made at this distance by Mr. J. H. Bridges. Sixty yards was not productive of high scores, Mr. Bridges's first dozen of 68, and Mr. Dod's second of 65 being the best made. By the end of the 80 yards it was pretty clear that Mr. Dod would be first, as, though Mr. Richardson was gradually creeping up, it was hardly possible for him to pass him. The struggle for second place was, however, a close one. At the end of the 80 yards Mr. Brooks-King's score was 658 and Mr. Richardson's 648. After the first dozen at 60 they were respectively 710 and 701. After 18 arrows, 738 and 727; after 21, 749 and 748; and at the conclusion of the round, 768 and 760, Mr. Brooks-King having scored 19 with his last three arrows, and Mr. H. B. Richardson 12—a close and exciting finish. The ladies commenced better than they had done on the previous day, four making over 100 on the first two dozen of the 60 yards. Their names and scores were: Mrs. Hill-Lowe, 20, 114; Mrs. S. H. Armitage, 19, 113; Miss Q. Newall, 21, 105 (included in which were three golds at the end of the second dozen); and Mrs. T. N. Wilson, 21, 103. On the second half the scores were not quite so high, Mrs. G. Honnywill, Mrs. Hill-Lowe, and Mrs. Armitage all had twenty hits, the first-named scoring 106 and the two latter 104. At 50 yards Miss Q. Newall made a fine score of 156 and was easily first with her dozens of 82 and 74, the next best dozen being Mrs. Wadworth's first of 73 and Mrs. Hill-Lowe's second of 68.

On Monday, the 20th, the 50 metre competition took place, in which there were fifteen French, one American, and one English competitors. At the request of the French competitors several of the English who had shot in the York Round shot with them, though they did not compete for the medals. One arrow was shot at a time, and there were four shooters at each target, of which there were seven. The shooting was good, two competitors putting in all the arrows, and four only dropping one, but the winner's average was not so high as it frequently is for this class of shooting, nor did the shooters appear to be in such good form as usual. Probably shooting the York Round, and with stronger bows, had some-

what unsteadied them. A good score was made by one of the English gentlemen, Mr. Backhouse, who obtained 260 from 40 hits.

Great satisfaction was expressed by the French archers with their reception in England, and Colonel Walrond was asked by their representative to thank the English archers for the courtesy and good fellowship with which they had been received. The judges for the York Round were Le Comte Albert de Bertier de Sauvigny, Colonel Walrond, and Mr. Eyre W. Hussey, the two first named also acting for the 50 metres competition. On Saturday the French archers visited the grounds of the Royal Toxophilite Society, and spent a pleasant afternoon inspecting the grounds and hall. As a memento of their visit, M. Delacroix, the president of the Archers-Carabiniers de L'Isle de France, in the name of the Society, asked the acceptance by the Royal Toxophilite Society of two palmettes and two epinglettes to be shot for by ladies and gentlemen respectively, which were duly accepted and have since been received and shot for.

The full scores were as follows :—

#### FRIDAY.

##### LADIES.

###### *Distance scores.*

60 yards.			50 yards.		
	Hits	Scr.		Hits	Scr.
Miss Dod .. ..	43	219	Miss Q. Newall .. ..	24	134
Mrs. T. N. Wilson .. ..	39	207	Mrs. Wadworth .. ..	24	132
Miss Q. Newall .. ..	42	204	Miss Dod .. ..	23	129
Mrs. Wadworth .. ..	42	178	Miss K. G. Mudge .. ..	22	120
Mrs. S. H. Armitage .. ..	34	176	Mrs. Honnywill .. ..	23	111
Mrs. Honnywill .. ..	39	175	Mrs. Priestley Foster .. ..	20	110

##### GENTLEMEN.

100 yards.			80 yards.		
	Hits	Scr.		Hits	Scr.
Mr. T. Robinson .. ..	33	133	Mr. Brooks-King .. ..	39	159
Mr. Dod .. ..	31	129	Mr. Dod .. ..	37	157
Mr. J. B. Keyworth .. ..	34	128	Mr. Penrose .. ..	32	138
Mr. Penrose .. ..	36	126	Mr. H. B. Richardson .. ..	31	135
Mr. Brooks-King .. ..	32	126	Mr. H. P. Nesham .. ..	33	133
Mr. H. P. Nesham .. ..	28	102	Mr. J. H. Bridges .. ..	36	132
60 yards.			60 yards.		
	Hits	Scr.		Hits	Scr.
Mr. Dod .. ..	23	117	Mr. Brooks-King .. ..	22	108
Mr. J. H. Bridges .. ..	23	111	Mr. Penrose .. ..	22	100
Mr. H. B. Richardson .. ..	21	109	Major Heathcote .. ..	20	98

Totals on the day:

##### LADIES.

	Hits	Scr.		Hits	Scr.
Miss Dod .. ..	66	348	Mrs. T. N. Wilson .. ..	58	290
Miss Q. Newall .. ..	66	338	Mrs. G. Honnywill .. ..	62	286
Mrs. Wadworth .. ..	66	310	Mrs. Priestley Foster .. ..	56	278



## GENTLEMEN.

	Hits	Scr.		Hits	Scr.
Mr. Dod .. ..	91	403	Mr. J. H. Bridges .. ..	90	344
Mr. Brooks-King .. ..	93	393	Mr. H. B. Richardson .. ..	77	343
Mr. Penrose .. ..	90	364	Mr. T. Robinson .. ..	80	332

## SATURDAY.

Best Distance Scores :

## LADIES.

60 yards.	Hits	Scr.	50 yards.	Hits	Scr.
Mrs. Hill-Lowe .. ..	40	218	Miss Q. Newall .. ..	24	156
Mrs. S. H. Armitage .. ..	39	217	Mrs. Hill-Lowe .. ..	23	125
Mrs. Honnywill .. ..	40	202	Miss Dod .. ..	23	125
Miss Q. Newall .. ..	42	194	Mrs. Appleyard .. ..	23	123
Mrs. Norman Robertson .. ..	39	181	Mrs. Priestley Foster .. ..	23	119
Mrs. Wadworth .. ..	37	179	Mrs. Wadworth .. ..	20	116

## GENTLEMEN.

100 yards.	Hits	Scr.	80 yards.	Hits	Scr.
Mr. W. Dod .. ..	39	163	Mr. H. V. James .. ..	36	160
Mr. H. B. Richardson .. ..	35	149	Mr. H. B. Richardson .. ..	36	156
Mr. T. Robinson .. ..	30	134	Mr. W. Dod .. ..	34	142
Mr. Penrose .. ..	33	133	Mr. Brooks-King .. ..	33	141
Mr. H. V. James .. ..	33	133	Mr. H. P. Nesham .. ..	28	134
Mr. Pownall .. ..	34	132	Mr. J. B. Keyworth .. ..	34	128

60 yards.	Hits	Scr.	60 yards.	Hits	Scr.
Mr. J. H. Bridges .. ..	21	129	Mr. Brooks-King .. ..	22	110
Mr. H. B. Richardson .. ..	22	112	Mr. W. Dod .. ..	21	107
Mr. H. P. Nesham .. ..	21	111	Mr. Penrose .. ..	22	106

Six best scores, Saturday :

## LADIES.

	Hits	Scr.		Hits	Scr.
Miss Q. Newall .. ..	66	350	Mrs. G. Honnywill .. ..	61	301
Mrs. Hill-Lowe .. ..	63	343	Mrs. Wadworth .. ..	57	295
Mrs. S. H. Armitage .. ..	60	304	Miss Dod .. ..	60	294

## GENTLEMEN.

Mr. H. B. Richardson .. ..	93	417	Mr. R. Brooks-King .. ..	91	375
Mr. W. Dod .. ..	94	412	Mr. Penrose .. ..	85	345
Mr. H. V. James .. ..	89	383	Mr. J. H. Bridges .. ..	75	343

Highest Totals on the two days :

## LADIES.

	Hits	Scr.		Hits	Scr.
Miss Q. Newall .. ..	132	688	Mrs. Wadworth .. ..	123	605
Miss Dod .. ..	126	642	Mrs. G. Honnywill .. ..	123	587
Mrs. Hill-Lowe .. ..	118	618	Mrs. S. H. Armitage .. ..	112	582

## GENTLEMEN.

Mr. W. Dod .. ..	185	815	Mr. Penrose .. ..	175	709
Mr. R. Brooks-King .. ..	184	768	Mr. J. H. Bridges .. ..	165	687
Mr. H. B. Richardson .. ..	170	760	Mr. H. V. James .. ..	156	652

## TARGET AND SCORE LIST.

(Four dozen arrows at 60 yards and two dozen arrows at 50 yards being shot each day.)

	60 yards.		50 yards.		Total.				
	Hits	Scr.	Hits	Scr.	Hits	Scr.			
TARGET 1.									
Mrs. Appleyard, Mid-Surrey	65	281	42	222	107	503	9		
Mrs. L. Weedon, West Kent	69	301	35	197	104	498	10		
Mrs. E. H. Day, Hereford Bowmen	72	322	37	161	109	483	7		
Miss Ina Wood, West Kent	57	217	36	170	93	387	4		
Mrs. Boddam Whetham, Folkestone	67	305	47	205	114	510	11		
TARGET 2.									
Miss Q. Newall, Cheltenham	84	398	48	290	132	688	23		
Mrs. Chris. Cadman, Lonsdale	67	233	40	194	107	427	3		
Mrs. Hill-Lowe, A. of the Teme	76	390	42	228	118	618	15		
Mrs. Priestley Foster, V.W.H.	74	324	43	229	117	553	9		
Mrs. Honnywill, A. of the Weald	79	377	44	210	123	587	10		
TARGET 3.									
Miss K. G. Mudge, Dev. & Cornwall	67	237	44	228	111	465	8		
Mrs. Everett Leonard, Backwell	57	261	35	149	92	410	8		
Mrs. S. H. Armitage, Hereford Bow.	73	393	39	189	112	582	13		
Mrs. Wadworth, Hereford Bowmen	79	357	44	248	123	605	13		
Miss H. Williams, Mid-Surrey	51	179	31	137	82	316	4		
TARGET 4.									
Miss Dod, Welford Park	80	388	46	254	126	642	16		
Miss Wadworth, Hereford Bowmen	79	321	43	201	122	522	3		
Miss J. Vance, Hove Tox.	58	228	37	157	95	385	7		
Mrs. T. N. Wilson, Hampshire	75	367	37	167	112	534	8		
Mrs. Rushton, Barnacre	52	222	37	201	89	323	6		
TARGET 5.									
Mrs. S. C. Babington, Edin. Ladies	64	258	39	193	103	451	9		
Miss Thackwell, Worcestershire	65	303	39	181	104	484	11		
Miss Hyde, Worcestershire	66	256	37	163	103	419	8		
Mrs. N. Robertson, Mid-Surrey	74	328	38	172	112	500	8		
Mrs. E. Nott Bower, Royal Richmond	69	297	40	206	109	503	11		
	100 yards.	80 yards.	60 yards.	Total.	Gross				
	Hits	Scr.	Hits	Scr.	Hits	Scr.	Gold		
TARGET 6.									
Mr. H. P. Nesham, R.T.S.	51	181	61	267	41	195	153	643	7
M. Cabaret, Cie. St. Pierre Mont-	19	71	6	14	28	106	58	191	4
martre									
Mr. R. Bagnall Oakeley, R.T.S.	30	104	33	149	31	121	94	374	4
TARGET 7.									
Mr. J. B. Keyworth, Wirral	68	244	64	234	30	144	162	622	9
M. Salingre, Cie. de Soissons	11	39	40	158	36	150	87	347	6
Major R. W. Heathcote, Hamps.	34	118	44	198	40	160	118	476	7
TARGET 8.									
Mr. J. Penrose, Wiltshire	69	259	62	244	44	206	175	709	9
M. Baudoin, 1re Cie. de Mont-	16	42	26	92	17	81	59	215	4
reuil-sous-Bois									
Mr. Pownall, R.T.S.	63	237	46	184	35	111	144	532	7

	100 yards.		80 yards.		60 yards.		Total.		Gross
	Hits	Scr.	Hits	Scr.	Hits	Scr.	Hits	Scr.	Gold
TARGET 9.									
Mr. Brooks-King, West Som.	68	250	72	300	44	218	184	768	7
M. Quervel, ire Cie. d'Auber- villiers	7	21	24	90	32	130	63	241	1
Mr. H. V. James, Backwell	58	212	61	275	37	165	156	652	5

TARGET 10.									
M. Dauchez, Cie. St. Pierre Montmartre	21	95	20	86	27	99	68	280	4
M. Vernet, ire Cie. de Compiègne	30	104	36	138	37	143	103	385	5
Mr. T. Robinson, Backwell	63	267	48	188	42	192	153	647	17

TARGET 11.									
M. Grisot, Cie. de Ullysse à Paris	21	89	42	162	37	159	100	410	10
M. Berton, Cie. St. Pierre Mont- martre	28	128	38	156	29	141	95	425	8
Mr. Cornewall, H.Y.R.	37	165	42	144	33	121	112	430	7

TARGET 12.									
M. Richez, Cie. de Ullysse à Paris	38	142	43	157	29	119	110	418	3
Mr. Stopford, Devon & Cornwall	44	182	48	204	32	144	124	530	17

TARGET 13.									
Mr. Dod, Welford Park,	70	292	71	299	44	224	185	815	13
Mr. Backhouse, H.Y.R.,	28	100	54	222	40	194	122	516	9

TARGET 14.									
Mr. C. J. Perry-Keene, Devon and Cornwall	44	166	50	204	37	173	131	543	6
Mr. C. Hutton Coates, R.T.S.	36	148	47	165	26	100	109	413	3

TARGET 15.									
Mr. H. B. Richardson, National Society, U.S.A.	60	248	67	291	43	221	170	760	8
*M. Poupart, ire Cie. de Pont St. Maxence	5	19	5	17	—	—	10	36	—
Mr. J. H. Bridges, R.T.S.	54	194	67	253	44	240	165	687	15
Entered but did not shoot: MM. Vallie, Delacroix, Hardier, Lesquendien (France) and Mr. W. Bryant (United States).									

\* Did not complete the round on the first or shoot on the second day.

### MONDAY.

	50 Metres Competition.				Total.		
	Hits	Scr.	Hits	Scr.	Hits	Scr.	Gold
M. Grisot, Cie. de Ullysse à Paris	39	263	..	..	39	263	9
M. Vernet, ire Cie. de Compiègne	40	256	..	..	40	256	7
M. Cabaret, Cie. St. Pierre Montmartre à Paris	39	255	..	..	39	255	10
M. Aubras, ire Cie. de Compiègne	39	231	..	..	39	231	8
M. Quervel, ire Cie. d'Abervilliers	37	223	..	..	37	223	9
M. Dauchez, Cie. St. Pierre Montmartre à Paris	37	222	..	..	37	222	10
M. Salingre, Cie. de Soissons	39	215	..	..	39	215	7
M. Berton, Cie. St. Pierre Montmartre à Paris	40	212	..	..	40	212	8
M. Richez, Cie. de Ullysse à Paris	38	210	..	..	38	210	9

	Total		
	Hits	Scr.	Gold.
M. Baudoin, 1re Cie. Montreuil-sous-Bois .. .. .	34	206	.. 3
M. Vallie, 1re Cie. de Compiègne .. .. .	37	193	.. 5
Mr. Keyworth, Wirral .. .. .	38	190	.. 4
M. Fisseux, Cie. de St Pierre Montmartre à Paris.. .. .	37	185	.. 6
M. Delacroix, 1re Cie. d'Aubervilliers .. .. .	37	177	.. 3
Mr. H. B. Richardson, U.S. National Archery Society .. .. .	33	171	.. 4
M. Poupard, 1re Cie. Pont St. Maxence .. .. .	35	155	.. 3
M. Jay, Cie. St Pierre Montmartre .. .. .	34	134	.. —

## RESULTS.

## YORK ROUND (GENTLEMEN).

Gold Medal, Mr. W. Dod, United Kingdom. 185 hits, 815 score.  
 Silver Medal.—Mr. R. Brooks-King, United Kingdom. 184 hits, 768 score.  
 Bronze Medal.—Mr. H. B. Richardson, U.S.A. 170 hits, 760 score.  
 A Diploma of Merit was awarded to M. Berton, France.

## NATIONAL ROUND (LADIES).

Gold Medal.—Miss Q. Newall, United Kingdom. 132 hits, 688 score.  
 Silver Medal.—Miss Dod, United Kingdom. 126 hits, 642 score.  
 Bronze Medal.—Mrs. Hill-Lowe, United Kingdom. 118 hits, 618 score.

## FIFTY METRES (CONTINENTAL STYLE).

Gold Medal.—M. Grizot, France. 39 hits, 263 score, 9 Golds.  
 Silver Medal.—M. Vernet, France. 40 hits, 256 score, 7 Golds.  
 Bronze Medal.—M. Cabaret, France. 39 hits, 255 score, 10 Golds.

A Diploma of Merit for forty arrows at fifty metres was awarded to Mr. R. O. Backhouse, U.K., who scored 260 from 40 hits. He shot at the request of our French visitors, but was not competing for the medals.

## BOXING.

On October 27 the five events of the Olympic Boxing Competition were decided at the Northampton Institute, St. John-street Road, Clerkenwell. Apart from the fact that several halls of the size of that selected could easily have been filled with spectators eager to see the best amateur boxing yet exhibited in England, the arrangements could not have been improved, and the success of the event amply justified the inclusion in the Olympic programme of a competition with as ancient classical precedents as any other item could boast.

The foreign competitors and their representative officials expressed their satisfaction with everything done and with the impartiality of the judging; and the most competent critic could only select one verdict as to which any doubt was possible. For the most part our visitors were not of sufficiently high class to have a real sporting chance of victory, which made their presence all the more meritorious. But, on the other hand, Holberg, the Dane, and Baker, the Australian, were first-rate men, the latter being one of the best amateur performers ever seen in a ring. Both were so highly appreciated that, from the applause they received, it might easily have been imagined that a large Danish and Australian contingent were present among the audience. The foreign representatives assisted in the drawing of the heats. With the possible exception of the heavy weights the form shown throughout was as good as any seen by the best judges during the past thirty years.

The victory in the feather weights of the veteran, R. K. Gunn, was a very striking example of the triumph of style and science over other and more youthful qualities, for he had won his championships in 1894, '95 and '96, and he entered the ring in 1908 not an ounce heavier than he had been twelve years before, in spite of being thirty-eight years old. His hitting was naturally not so hard, but it was clean and straight, with a properly closed fist, which proved a pleasant contrast to the scrambling and swinging now grown too common. In style there was little to choose between Douglas and Baker in the middle weights. Before they met, the Australian had had to conquer W. Dees, champion in 1897, and W. Childs the holder of the championship, whereas Douglas had drawn a bye and was able to put out his French opponent in half a minute and to finish the ex-champion, R. C. Warnes, in a round and a half. The final was closely and well contested, and the verdict rightly went to the Englishman, a

first-rate cricketer, and the son of Mr, J. H. Douglas, President of the Amateur Boxing Association.

Some spectators considered that Holberg had had rather hard luck in not getting the award after a very level round with Wells and two minutes extra, in which Wells certainly did not seem very much the stronger of the two. The only holder of a championship who proved also worthy of an Olympic Gold Medal was Thomas, whose final for the bantam weights with Condon showed some of the best form at the meeting. It is fair to S. C. H. Evans, the heavy weight champion, to say that he had injured his shoulder a few days previously and could not use it capably either in attack or defence, which partly resulted in his lasting only two minutes against the hurricane tactics of Oldman, of the City Police.

Boxing began at 11.25 a.m., and lasted, with only one interval of an hour and a half, until 10.30 p.m., when the medals were distributed by Mr. J. H. Douglas, who was ably assisted throughout by Mr. E. T. Calver, Secretary of the A.B.A., and by a particularly zealous staff of officials, among them such well known and respected men in boxing circles as Mr. Vize, Mr. Angle, Mr. Eugene Corri, and Mr. Bettinson, who assisted in various parts of the proceedings. Though all the winners were English, representatives were boxing from Australia, France, Denmark, Wales, and Scotland.

The winners, all representatives of the United Kingdom, were as follows :—

I. Bantam Weights (8 st. 4 lb. and under), H. Thomas, Birmingham A.B.C.

II. Feather Weights (9 st. and under), R. K. Gunn, Surrey Commercial Docks B.C.

III. Light Weights (10 st. and under), F. Grace, Eton Mission B.C.

IV. Middle Weights (11 st. 4 lb. and under), J. W. H. T. Douglas, Mincing Lane B. and A.C. and Belsize B.C.

V. Heavy Weights (any weight), A. L. Oldham, City Police A.C.

Details of the Bouts:—

#### I. BANTAM WEIGHTS.

##### FIRST SERIES.

(1) J. Condon (Lynn A.C.) beat P. Mazior (France).

The Frenchman surprised his opponent with the agility and determination of his attack, but could never hit hard enough, and after a very plucky struggle he was stopped in the middle of the third round.

(2) W. Webb (St. Pancras B.C.) beat H. Perry (Columbia B. and A.C.).

Both fought fast for two rounds, with Webb scoring on the body, and Perry tiring his man at in-fighting. The third round was full of heavy hitting, in which Webb got the verdict on the referee's casting vote.

(3) H. Thomas (Birmingham A.B.C.) beat F. McGurk (Scottish Amateur Gymnastic Association).

The Scotchman at once started hitting as hard as he could, and rather flurried Thomas, who took a round to get used to his man ; but then he gave back most of what he had received, and in the third round steadied the persistent McGurk with a fine punch on the jaw, which did not stop the Scotchman's courageous attacks but gave Thomas the victory.

#### SEMI-FINAL.

Condon beat Webb.

Webb did better at close range, and Condon scored very prettily with straight lifts at a distance, and this alone saved the Lynn boxer from defeat in a close and exciting contest.

#### FINAL.

Thomas beat Condon.

Condon tried to force the in-fighting which did not suit him and pleased his opponent. Both were soundly punished and kept going hard the whole time all over the ring. But Condon could not stave off the Birmingham boy who won a capital bout that roused hearty applause.

The winner was nineteen years old, and won the championship in the previous April.

## II. FEATHER WEIGHTS.

### FIRST SERIES.

(1) T. Ringer (Lynn A.C.) beat L. Constant (France).

The Englishman began by using his left to good purpose, but then the Frenchman rushed him to the ropes, and gave his man little rest for two rounds. In the third Ringer scored freely, but our plucky visitor was never done with and was boxing as hard as ever when the bell rang.

(2) R. K. Gunn (Surrey Commercial Docks B.C., and Gainsford A.C.) beat E. Poillot (France).

The Frenchman led, but Gunn had knocked him down just before the end of the first round, and in the second Gunn had him on the boards twice, and out before the signal.

(3) H. Roddin (Edinburgh Amateur Gymnastic Society) beat J. Lloyd (City School of Physical Culture, Cardiff).

Both were more eager than scientific in a level first round, and through the next as well the exchanges were remarkably heavy. They began the third with almost equal vigour, but both were sufficiently punished to be very tired before the end, and Roddin just won.

(4) C. W. Morris (Polytechnic B.C.) beat E. Adams (Columbia B. and A.C.).

The two first rounds were quiet, with Adams showing more science. Then Morris made the pace with both hands, got his man into trouble and won with some ease.

### SEMI-FINALS.

(1) Morris beat Roddin.

Morris led at once, but Roddin, after steadying him, did not take advantage of his lead, and threw away a good deal in the first two rounds by boxing rather wild. As a result, Morris made up all his losses in the last round, boxed carefully and effectively, and won well.

(2) Gunn beat Ringer.

After a level first round, Gunn began scoring in the second till he was steadied with a stinger on the body and had to go slow for a bit. Recovering well in the last meeting, Gunn had his man beaten, and in spite of receiving a few hot ones from Ringer, was easily first at the finish.

## FINAL.

Gunn beat Morris.

At first Morris was quite outgeneralled by his clever opponent, but made the pace so hot in the second round that the veteran was glad enough to hear the bell ring. Again Gunn recovered completely in the interval, and skilfully keeping out of danger he scored fast and won.

The winner was thirty-eight years old, and had only once been beaten before. His first victory was the 9st competition in the German Gymnasium in 1893. He only retired from the championship of 1896 owing to his well known superiority over all comers, and since then served on the Council of the A.B.A.

## III. LIGHT WEIGHTS.

## FIRST SERIES.

(1) H. H. Johnson (Northampton Institute A. and B.C.) beat H. Hansen (Denmark).

Both were tall, the Dane having a trifle the advantage. The bout began with good work from both lefts till Johnson crossed his man on the jaw with the right, which gave the Englishman the lead in a hot contest. The same followed in the second round. In the third, Hansen stood up most pluckily to heavy punishment, and was hitting his man hard when the bell rang.

(2) M. Wells (Lynn A.C.) beat V. Holberg (Denmark).

The Dane, looking bronzed and full of muscle, gave his man plenty of work in the first round, and began the second with fine right-handed hitting after a rally. In the third Wells was fighting hard, and the Dane scored heavily on the mouth. An extra two minutes was ordered, in which there was a good deal of clinching. The verdict went to Wells.

(3) H. Holmes (Polytechnic B.C.) beat A. Bouvier (France).

Holmes used his left well against the Frenchman, who rushed and clinched at every opportunity. In the second round Bouvier was knocked clown several times and the bout was stopped.

(4) G. Jessup (Mildmay R.C.) beat F. Osborne (Victoria A. and B.C.).

Jessup rapidly asserted his superiority, and soon knocked Osborne down and out.

(5) F. Grace (Eton Mission B.C.) beat E. A. Fearman (Lynn A.C.).

Fearman's earnestness was of no avail against his adversary's skill and quickness, but he fought hard and pluckily, and lost only to superior science.

(6) F. Spiller (Gainsford A.C.) beat P. Fee (Scottish Amateur Gymnastic Association).

Spiller scored heavily in the opening round, but in the next Fee repeated his clinching tactics and improved on the in-fighting. But this was no good in the last round, which easily gave Spiller the bout.

## SECOND SERIES.

(1) F. Spiller beat G. Jessup.

Spiller had his man in trouble in the first round, and knocked him down in the second. Jessup had boxed with courage, but was counted out.

(2) F. Grace beat M. Wells.

Neither scored much after a very clever first round, and Grace did not hurt his man in the second. A very keen meeting ended in a skilful win for Grace.

(3) H. H. Johnson beat H. Holmes.

A bustling beginning ended in Holmes landing three times on his opponent's head. Then Johnson knocked him down twice. In the third round, which both boxed in most resolute fashion, the referee gave Johnson his casting vote.



SEMI-FINAL.

Spiller beat Johnson.

Spiller led at once, and though the bout was fast and interesting throughout there was never any doubt about the verdict.

FINAL.

Grace beat Spiller.

A very level first round, Grace's footwork being very good, Early in the second both were down. Spiller boxed pluckily and well, but could never score as fast as Grace. The winner was twenty-four years old, and won seven competitions out of eight in 1907.

IV. MIDDLE WEIGHTS.

FIRST SERIES.

(1) W. Childs (Cambridge Amateur B.C.) beat G. Aspa (France).

Slogging began as soon as the men faced each other, and went on all over the ring. In the second round they both worked just as hard at close quarters. In the interval the Frenchman retired with an injured thumb.

(2) R. C. Warnes (Gainsford A.C. and Surrey Commercial Docks B.C.) beat C. Morard (France).

Morard was willing and courageous but too slow, and in the second round was sent down and out with a left swing on the chin.

(3) R. L. Baker (Australia) beat W. J. Dees (Old Goldsmiths' B.C.).

A fairly level first round showed Baker's cleverness in defence. When Dees again faced the fighting in the second, Baker was all over him and knocked him down and out.

(4) J. W. H. T. Douglas (Mincing Lane B. and A.C. and Belsize B.C.) beat R. Doudelle (France).

Douglas walked into our visitor and beat him in a minute, there being little chance for the Frenchman to show his capabilities.

(5) W. Philo (Gainsford A.C.) beat A. Murdoch (Belsize B.C.).

Philo was the first to go down, but soon had his revenge, and Murdoch was dazed when the bell rang. Both received smart punishment in the second round, and in the third Philo just managed to even up the score with his left on the head. There was very little in it, and the referee's casting vote had to be called in.

SECOND SERIES.

Baker beat Childs.

The Australian made the pace very fast, and scored on the body and neck. In the second round Childs went for his man very hard, but Baker got home a heavy uppercut, and soon afterwards Child fell through the ropes from a rushing attack cleverly avoided by Baker. The Australian was clearly the superior in the last meeting.

SEMI-FINALS.

(1) Douglas beat Warnes.

In the first round Warnes did well but could never stop Douglas, who was in splendid training, and fairly staggered his opponent with a heavy left in the second, and soon afterwards Warnes went down and out.

(2) Baker beat Philo.

The Australian at once got to work and had his man finished in about a minute.

## FINAL.

Douglas beat Baker.

A beautifully matched bout produced the best boxing of the day. Both began well, and Baker gave as much as he got until the end of the first round. In the second Douglas got home a decisive blow on the jaw which took the Australian off his feet, and Baker rose slowly, to continue as pluckily as ever. In the third, he boxed cautiously and well but could never quite get the lead, and Douglas won a fine contest on points.

The winner was twenty-seven years old, and won the Public Schools' Middle Weights (for Felstead) at Aldershot, in 1901. He plays cricket for Essex and is a fine all-round athlete. Baker is the best in Australia, and was twice prevented by illness from boxing in England before the Games began.

## V. HEAVY WEIGHTS.

## FIRST SERIES.

(1) A. L. Oldman (City Police A.C.) beat I. Myrams (Manchester F. & B.C.).

Oldman did not take long in knocking his man down and out with a heavy right flush on the chin.

(2) S. C. H. Evans (Reading A.C.) beat A. Ireton (City Police A.C.).

Evans led, soon had his man in trouble, and finally finished him with a left hand swing over the heart in a short order.

(3) F. Parks (Polytechnic B.C.) beat H. Brewer (Polytechnic B.C.).

Parks won by sheer strength and weight after a punishing bout which went the three rounds and needs no further description.

## SEMI-FINAL.

Evans beat Parks.

Evans soon hit his man through the ropes and out of the ring. In the second round Parks, having recovered well, did some attacking, but was twice knocked down. In the third Parks was still aggressive, but Evans was hitting harder, and obtained the verdict by the referee's casting vote.

## FINAL.

Oldman beat Evans.

Both men began to hit at once, Evans being slightly the more eager. But when Oldman did get to work his execution was something terrific. He crossed Evans with a fine right on the jaw, got him dazed in a corner, and smashed him about a dozen times in the face before Evans could escape. A plucky effort to equalise matters failed, and Evans was down and out in two minutes.

The winner was twenty-four years old and six feet tall, having served in the Horse Guards Blue before joining the police.



ARCHERY, JULY 17, 1908.



ARCHERY.-MISS Q. NEWALL (U.K.), WINNER OF THE NATIONAL ROUND.



ARCHERY.-W. DOD (U.K.), WINNER OF THE YORK ROUND.

## CYCLING.

During most of the first week, within which the cycling events were decided, the weather was very bad, and the track was usually flooded. This may have troubled our foreign visitors, for the United Kingdom won five out of the seven events, but the English, it must be added, were peculiarly unfortunate in the number of their punctures. France scored in the Tandem race, and would have won the Thousand Metres but for the riders having exceeded a generous time limit, in spite of repeated warnings. For the same reason Schilles, one of the fastest amateurs in the world over the last 200 metres of a short course, could not score the heat he won in the Lap race. In long distances, like the Hundred Kilometres, for which H.R.H. the Prince of Wales presented a Challenge Cup, it is evident that the question of pacing must be very seriously considered whenever it is not thought wise to give special awards for laps or other purposes. No record was made in this race, as was freely stated in the Press afterwards. Nearly all the finishes were close, and aroused great enthusiasm in the crowd.

The order in which the races are here given is : I., 660 Yards' Lap ; II., 1,000 Metres ; III., 5,000 Metres ; IV., 20 Kilometres; V., 100 Kilometres ; VI., Pursuit Race; VII., Tandem Race.

## I.—ONE LAP (660 Yards = 603.491 Metres).

[Time Limit 70 seconds, Standard 46 seconds.]

## FIRST ROUND.

Heat 1.—B. Jones, United Kingdom, 1 ; D. H. Nijland, Holland, 2. Jumping with half a lap to go, Jones won with something in hand. Time, 59 sec.

Heat 2.—W. J. Bailey, United Kingdom, 1 ; F. McCarthy, Canada, 2 ; P. Seguinand, France, 3. Bailey was much too fast for his opponents, and won easily by a length. Time, 50  $\frac{2}{5}$  sec.

Heat 3.—C. B. Kingsbury, United Kingdom, 1 ; R. Katzer, Germany, 2 ; G. B. Damen, Holland, 3. Much the fastest sprinter, Kingsbury won readily by two lengths. Time, 57  $\frac{2}{5}$  sec.

Heat 4.—V. L. Johnson, United Kingdom, 1 ; J. Patou, Belgium, 2 ; R. Villepontoux, France, 3. Another easy victory for the United Kingdom, Johnson sailing away to win with a lot up his sleeve. Time, 56  $\frac{1}{5}$  sec.

Heat 5.—M. Schilles, France, and F. Shore, South Africa, competed, but the heat was declared void on account of the time limit being exceeded.

Heat 6.—E. Demangel, France, 1 ; G. F. Summers, United Kingdom, 2 ; A. Hansen, Sweden, 3. Demangel's jump was too much for Summers, who was beaten by a length. Time, 59  $\frac{4}{5}$  sec.

Heat 7.—J. J. van Spengen, Holland, 1 ; H. Martens, Germany, 2 ; J. Lavery, United Kingdom, 3. In a tremendous race the Dutchman won by inches. Time, 58  $\frac{1}{5}$  sec.

*Heat 8.*—W. Andrews, Canada, 1 ; G. Werbrouck, Belgium, 2 ; G. de la Plane, France, 3. Another brilliant race. Andrews was just the faster in the last twenty yards, and won by half a wheel. Time,  $55\frac{4}{5}$  sec.

*Heat 9.*—P. Texier, France, 1 ; T. H. E. Passmore, South Africa, 2. Passmore sprinted at the half distance, but could not ward off Texier's final rush, the Frenchman winning by a length. Time 1 min.  $1\frac{2}{5}$  sec.

*Heat 10.*—F. D. Venter, South Africa, 1 ; G. Perrin, France, 2 ; B. Goetze, Germany, 3. The South African won in taking style by slightly over a length. Time, 1 min.  $3\frac{1}{5}$  sec.

*Heat 11.*—K. Neumer, Germany, 1 ; W. F. Magee, United Kingdom, 2 ; E. Marechal, France, 3 ; A. Gerrits, Holland, 4. Neumer drew clear round the back stretch and won by two lengths. Time,  $54\frac{1}{5}$  sec.

*Heat 12.*—E. Payne, United Kingdom, 1 ; A. Poulain, France, 2 ; J. van Benthem, Belgium, 3. Poulain swerved badly in his effort to win, and could not hold Payne, who, riding very straight, got home by a length. Time,  $57\frac{1}{5}$  sec.

*Heat 13.*—D. Flynn, United Kingdom, 1 ; G. B. van Drakestein, Holland, 2 ; P. Schulze, Germany, 3. This was a desperate race, Flynn winning by the smallest possible margin. Time, 55 sec.

*Heat 14.*—L. Renard, Belgium, 1 ; G. Dreyfus, France, 2 ; W. Morton, Canada, 3 ; G. C. Anderson, United Kingdom, 4. The others were unequal to the Belgian's sprint, which gave him a very easy win. Time,  $55\frac{1}{5}$  sec.

*Heat 15.*—G. G. Cameron, United States, 1 ; L. Coeckelberg, Belgium, 2. A match in which Cameron was a little the faster in the last few yards. Time, 1 min.  $5\frac{1}{5}$  sec.

*Heat 16.*—A. Auffray, France, 1 ; A. J. Denny, United Kingdom, 2 ; P. T. Freylinck, South Africa, 3. The Frenchman came with a rush in the straight, and won by a length. Time,  $58\frac{2}{5}$  sec.

## SECOND ROUND.

*Heat 1.*—V. L. Johnson, United Kingdom, 1 ; J. J. van Spengen, Holland, 2 ; P. Texier, France, 3 ; W. Andrews, Canada, 4. The usual manoeuvring for position occurred for half a lap, but there was no question as to the winner when it came to sprinting, Johnson getting first with plenty to spare. Time,  $59\frac{1}{5}$  sec.

*Heat 2.*—E. Demangel, France, 1 ; C. B. Kingsbury, United Kingdom, 2 ; W. J. Bailey, United Kingdom, 3 ; F. D. Venter, South Africa, 4. This was expected to be an inches affair between Kingsbury and the Frenchman, but Demangel's jump was too much for the Englishman, who was beaten by two-thirds of a length. Time,  $51\frac{3}{5}$  sec.

*Heat 3.*—D. Flynn, United Kingdom, 1 ; A. Auffray, France, 2 ; G. G. Cameron, United States, 3 ; E. Payne, United Kingdom, 4. This heat produced a splendid finish, Flynn and Auffray being level almost up to the line, when the former, by a tremendous effort, gained a win by half a wheel. Time,  $54\frac{3}{5}$  sec.

*Heat 4.*—K. Neumer, Germany, 1 ; L. Renard, Belgium, 2 ; B. Jones, United Kingdom, 3. Manoeuvring for position was most pronounced in this heat, and it was not until two-thirds of the distance had been covered that the pace improved. Then Neumer "jumped" with such startling rapidity that he drew away and won easily from Renard, with Jones completely out of it. Time, 1 min.  $5\frac{3}{5}$  sec.

## FINAL.

V. L. Johnson, United Kingdom	..	..	..	..	..	1
E. Demangel, France	..	..	..	..	..	2
K. Neumer, Germany	..	..	..	..	..	3
D. Flynn, United Kingdom	..	..	..	..	..	4

Time,  $51\frac{1}{5}$  sec.

Johnson drew inside station. They moved very carefully for the first hundred yards, the Birmingham crack looking under his arm and watching the others. With a third of the lap covered, Neumer, as in his heat, started sprinting. He jumped at such a tremendous pace as to gain a six lengths' lead before Johnson noticed the manoeuvre. Then, however, he went after his man, with Demangel on the Englishman's back wheel. Neumer was caught and passed just before the straight, and then Johnson and Demangel made a capital race of it, Johnson, whose action was perfect, eventually triumphing by a few inches. There was a length between Demangel and Neumer, with Flynn close up. Time,  $51\frac{1}{5}$  sec.

Victor Johnson was born in Staffordshire, and in 1907 won 24 races out of 72, and was placed in 17 others. In 1908 he won the quarter-mile championship of the N.C.U., and on July 26 he won the kilometre championship of the world at Leipsic. In 1907 he did a mile from a standing start at the Crystal Palace in 2 min.  $3\frac{2}{5}$  sec., unpaced. His father was world's champion. Demangel is the present champion of France, and has won 58 firsts out of 114 races, being placed in 48 others.

## II.-THOUSAND METRES (1093·6 Yards).

[Time Limit 105 seconds, Standard 79 seconds.]

### FIRST ROUND.

*Heat 1.*—V. L. Johnson, United Kingdom, 1 ; G. B. van Drakestein, Holland, 2 ; G. Malatesta, Italy, 3. They were riding in a line two-thirds of a lap from the tape, but then Johnson drew clear, and won by two lengths. Time, 1 min.  $33\frac{4}{5}$  sec.

*Heat 2.*—F. D. Venter, South Africa, 1 ; A. Poulain, France, 2 ; J. Matthews, United Kingdom, 3. Matthews started sprinting with three-quarters of a lap to go, but could not stay, and in a good finish Venter beat Poulain by a wheel. Time, 1 min.  $33\frac{1}{5}$  sec.

*Heat 3.*—M. Schilles, France, 1 ; A. Hansen, Sweden, 2. There were only two starters. Schilles, who led all the way, was much the better man. He won easily by a length. Time, 1 min.  $38\frac{2}{5}$  sec.

*Heat 4.*—D. Flynn, United Kingdom, 1 ; P. Seguinaud, France, 2 ; P. Schulze, Germany, 3 ; F. McCarthy, Canada, 4. When they started moving in earnest Flynn speedily settled the issue, and won by two lengths. Time, 1 min.  $30\frac{1}{5}$  sec.

*Heat 5.*—E. Payne, United Kingdom, 1 ; D. M. Nijland, Holland, 2. Although the Dutchman made a plucky show he was beaten by 1& lengths. Time, 1 min. 32 sec.

*Heat 6.*—W. F. Magee, United Kingdom ; H. Martens, Germany ; and J. J. van Spengen, Holland, rode, but the heat was declared void owing to the time limit being exceeded.

*Heat 7.*—K. Neumer, Germany, 1 ; R. Villepontoux, France, 2 ; W. J. Bailey, United Kingdom, 3. The German worked into "jumping" position after the bell, and, sprinting splendidly, he won easily by two lengths. Time, 1 min.  $33\frac{1}{5}$  sec.

*Heat 8.*—G. G. Cameron, United States, 1 ; P. T. Freylinck, South Africa, 2 ; H. Crowther, United Kingdom, 3 ; G. Dreyfus, France, 4. Crowther was partially shut in round the bend, and the finish was left to Cameron and Freylinck, the American winning by two lengths. Time, 1 min.  $29\frac{2}{5}$  sec.

*Heat 9.*—E. Demangel, France, 1; W. Morton, Canada, 2. Only two rode, and the former won by  $2\frac{1}{2}$  lengths. Time, 1 min.  $35\frac{1}{5}$  sec.

*Heat 10.*—A. Auffray, France, rode over in 1 min.  $23\frac{3}{5}$  sec.

*Heat 11.*—W. Morisetti, Italy, rode over in 1 min.  $21\frac{2}{5}$  sec.

*Heat 12.*—B. Jones, United Kingdom, 1; E. Marechal, France, 2; B. Goetze, Germany, 3. Jones led until Marechal went to the front. Then he went all out, and a capital dust-up in the straight resulted in his winning by a length. Time, 1 min. 35 sec.

*Heat 13.*—P. Texier, France, 1. Also rode :—G. F. Summers, United Kingdom, and L. J. Weintz, United States. The pace was very moderate until two-thirds of a lap from the finish, when Summers made his effort. He, however, failed to stay, and Texier coming through, won by nearly 2 lengths. Time, 1 min. 31 sec.

*Heat 14.*—J. Lavery, United Kingdom, 1; A. Gerrits, Holland, 2. These were the only starters. They rode in close company until the usual jump, but then Lavery sailed away to win at his ease. Time, 1 min. 41 sec.

*Heat 15.*—C. B. Kingsbury, United Kingdom, 1; G. de la Plane, France, 2. Another match. Kingsbury led all the way and won with some ease, the Frenchman being unable to hold his opponent in the final burst. Time, 1 min.  $27\frac{2}{5}$  sec.

*Heat 16.*—F. Shore, South Africa, and G. Perrin, France, were the riders in this heat. Shore finished first, but the time limit having been exceeded the heat was void.

#### SECOND ROUND.

*Heat 1.*—V. L. Johnson, United Kingdom, 1; K. Neumer, Germany, 2; F. D. Venter, South Africa, 3; P. Texier, France, 4. The pace was very slow until the bell. Then it improved, and half a lap farther on the real race began, the four machines being in a bunch. When Johnson, on the inside, drew out, Neumer immediately went after him, and a great wind-up gave the United Kingdom a victory by inches. Time, 1 min.  $27\frac{2}{5}$  sec.

*Heat 2.*—M. Schilles, France, 1. Also rode :—E. Payne, United Kingdom; D. Flynn, United Kingdom; and G. G. Cameron, United States. The usual thing happened until the bell, but on the next bank Payne sprinted. He, however, made his effort too soon, for Schilles caught him just before entering the straight, and won by over a length, with the others finishing practically in a line. Time, 1 min.  $38\frac{4}{5}$  sec.

*Heat 3.*—Ben Jones, United Kingdom, 1; E. Demangel, France, 2; J. Lavery, United Kingdom, 3. Demangel led at first, with the others hanging on. There was a deal of manoeuvring before sprinting commenced, and when they swept round the final bend Jones and Demangel were wheel and wheel. So they raced to the end, Jones winning by half a wheel. Time, 1 min.  $40\frac{4}{5}$  sec.

*Heat 4.*—C. B. Kingsbury, United Kingdom, 1; W. Morisetti, Italy, 2; A. Auffray, France, 3. Kingsbury at once went to the front, with Auffray next, and Morisetti last. The Italian was first to jump, but Kingsbury overtook him, and drew ahead in the straight, to win by two lengths. Time, 1 min.  $35\frac{3}{5}$  sec.

#### FINAL.

This was declared void owing to the time limit being exceeded. Kingsbury and Johnson punctured. Schilles and Jones rode out a close finish which the Frenchman apparently won by inches, but the Judge did not officially place the riders.



## III.-FIVE THOUSAND METRES (3 Miles, 188 Yards).

[Time Limit 9 min. 25 sec., Standard 6 min. 55 sec.]

## FIRST ROUND.

*Heat 1.*—J. J. van Spengen, Holland, 1 ; D. Flynn, United Kingdom, 2 ; G. Malatesta, Italy, 3 ; P. Seguinaud, France, 4. Also rode :—W. J. Bailey, United Kingdom. Flynn and Bailey held the lead for two laps, and then Spengen went into first position, with the Frenchman last. With three laps to go, Bailey punctured. They were riding in pairs when the bell rang, with Flynn on inside position. 300 yards from home a jump came from Spengen. Flynn made up ground in the straight but was beaten by two-thirds of a length. Time, 8 min.  $39\frac{4}{5}$  sec.

*Heat 2.*—E. Marechal, France, 1 ; F. McCarthy, Canada, 2 ; A. Gerrits, Holland, 3. Also rode :—E. Demangel, France, and E. Payne, United Kingdom, Payne punctured at  $1\frac{1}{2}$  laps. Gerrits did most of the leading, with Demangel and Marechal watching him closely. The pace was very slow. At the bell Gerrits shot out for a long sprint, but was done with entering the straight, and Demangel beat his countryman by inches. He was, however, disqualified for fouling, and the race awarded to Marechal. Time, 9 min.  $1\frac{2}{3}$  sec.

*Heat 3.*—A. Auffray, France, 1 ; H. Martens, Germany, 2 ; P. T. Freylinck, South Africa, 3 ; B. Goetze, Germany, 4 ; W. Morton, Canada, 5. This heat was so slow at times that it was as much as the riders could do to keep their machines going, but two laps from the end the pace became very warm, Auffray being responsible. When the bell sounded there was a splendid race between Auffray, Martens, and Freylinck, but the Frenchman could not be held in the straight, and he won by a length. Time, 8 min.  $56\frac{4}{5}$  sec.

*Heat 4.*—G. B. van Drakestein, Holland, 1 ; W. F. Magee, United Kingdom, 2 ; P. Texier, France, 3. Also rode :—T. H. E. Passmore, South Africa, and A. Poulain, France. The race was quite without incident in the early stages. Just after the bell Drakestein surprised the others, and sprinting in great form he lasted so well as to cross the line first, though only by an inches' margin. Time, 8 min.  $42\frac{1}{2}$  sec.

*Heat 5.*—Ben Jones, United Kingdom, 1 ; K. Neumer, Germany, 2 ; L. Azrini, Italy, 3 ; Also rode :—G. B. Damen, Holland ; M. Goetze, Germany ; J. Lavery, United Kingdom ; G. de la Plane, France ; F. Shore, South Africa ; and R. Villepontoux, France. The men did nothing until the bell, but a final showing of the red flag at last roused them. However, the finish compensated for what had gone before, for the whole of the field swept round the last bend together, and although Ben Jones seemed shut in for good, he got through in the most clever manner, and shot over the line a winner by a good length. Time, 9 min.  $8\frac{1}{2}$  sec.

*Heat 6.*—C. B. Kingsbury, United Kingdom, 1 ; W. Morisetti, Italy, 2 ; D. M. Nijland, Holland, 3 ; G. Dreyfus, France, 4. Also rode :—W. Andrews, Canada, and A. E. Calvert, United Kingdom. This heat was slightly faster. Nijland set the field going after the bell, and he made a very game effort to land a victory, but Kingsbury and Morisetti were faster, and the Englishman drew out in the straight to win by a length and a half. Time, 8 min. 53 sec.

*Heat 7.*—M. Schilles, France, 1 ; C. V. Clark, United Kingdom, 2 ; W. Anderson, Canada, 3. Also rode :—G. Coeckelberg, Belgium ; R. Katzer, Germany ; G. Perrin, France ; and F. D. Venter, South Africa. This was the fastest and most interesting heat of the series, chiefly by reason of the two Frenchmen. They were always too good for the others and were splendidly placed at the bell. The race was over as soon as Schilles drew away on the inside. Clark did his very best to catch the Frenchman, but to no purpose, the latter winning rather easily by just over a length. Time, 7 min.  $55\frac{2}{3}$  sec.

## FINAL.

Ben Jones, United Kingdom	..	..	..	..	..	1
M. Schilles, France	..	..	..	..	..	2
A. Auffray, France	..	..	..	..	..	3
E. Marechal, France	..	..	..	..	..	4
C. B. Kingsbury, United Kingdom	..	..	..	..	..	5
J. J. van Spengen, Holland	..	..	..	..	..	6
G. B. van Drakestein, Holland	..	..	..	..	..	7

Time, 8 min.  $36\frac{1}{5}$  sec.

Schilles had to make the pace at first, with Kingsbury near him and Jones last. Then Marechal led, followed by the two Dutchmen, one of whom soon went to the front, where he was displaced by Auffray. With three more laps to go, Schilles led again, with Kingsbury near him, and Jones waiting behind. At the bell, Drakestein made his rush immediately, and kept ahead till the last corner, where Kingsbury had brought along Jones so well that the latter was a length ahead at the beginning of the straight. Schilles, however, came right round his field with an amazing burst of speed, and only just failed to get up in the last hundred yards of an exciting race, which Jones won by six inches. Schilles imagined he had been collided with in the last round, but no evidence was forthcoming.

Ben Jones, of Wigan, was the five miles' amateur champion, and champion of the British Empire at one and ten miles. Schilles was only twenty, and a good man both at boxing and running. Auffray won the Grand Prix de Paris in 1907.

## IV.-TWENTY KILOMETRES (12'427 Miles).

[Time Limit 40 min., Standard 27 min. 45 sec.]

## FIRST ROUND

*Heat 1.*—L. Meredith, United Kingdom, 1 ; H. Martens, Germany, 2 ; G. Werbrouck, Belgium, 3 ; A. Lapize, France, 4 ; G. B. Damen, Holland, 5 ; F. McCarthy, Canada, 6. Also rode :—D. Flynn, United Kingdom ; P. Hostein, France ; and R. Katzer, Germany. Martens led for a couple of miles. At three miles, McCarthy and Werbrouck were first and second. At the half-distance, covered in 15 min.  $57\frac{4}{5}$  sec., Flynn unfortunately punctured. Between the seventh and eighth miles, the Belgian twice endeavoured to split the field with fast sprints, but without success. At the bell Katzer led. Half a lap from home Meredith appeared to be pocketed, but came out entering the straight and won in perfect style by two lengths. Time, 33 min. 21 sec. Martens' time was 33 min.  $21\frac{1}{5}$  sec., and Werbrouck's 33 min.  $21\frac{2}{5}$  sec.

*Heat 2.*—C. B. Kingsbury, United Kingdom, 1 ; C. Brooks, United Kingdom, 2 ; F. D. Venter, South Africa, 3 ; G. C. Lutz, France, 4 ; G. B. van Drakestein, Holland, 5. Also rode :—W. Andrews, Canada ; J. van Benthem, Belgium ; F. Bonnet, France ; and P. Schulze, Germany. Bonnet (France) led for several miles. Kingsbury kept well up with the leaders. The half-distance occupied 15 min.  $47\frac{4}{5}$  sec. At the bell Andrews was just ahead. Then Kingsbury set about his task. Speedily gaining inside position, he started on one of his long sprints. For a space he was held by Brooks, Venter, and Drakestein, but down

the straight Kingsbury fairly flew, and won by a good two lengths. Time, 32 min.  $33\frac{4}{5}$  sec. Second and third men's times : Brooks, 32 min. 34 sec. ; Venter, 32 min.  $34\frac{2}{5}$  sec.

*Heat 3.*—L. J. Weintz, United States, 1 ; F. Shore, South Africa, 2 ; G. Young, Canada, 3 ; H. C. Bouffler, United Kingdom, 4 ; H. Triesbsch, Germany, 5. Also rode :—H. Cunault, France; F. G. Hamlin, United Kingdom, and D. M. Nijland, Holland. In a heavy shower Bouffler, Hamlin, and Cunault punctured. In the early stages Young and Cunault did most of the leading. Bouffler caught up again five laps after his puncture by hard riding, but the effort had taken too much out of him. At the bell the pair to join in a good finish were the United States and Canadian riders. Weintz won by two lengths. Time, 33 min.  $39\frac{4}{5}$  sec. Half-distance time, 15 min. 46 sec. Shore's time was 33 min. 40 sec., and Young's 33 min.  $45\frac{1}{5}$  sec.

*Heat 4.*—Ben Jones, United Kingdom, 1 ; G. G. Cameron, United States, 2 ; T. H. E. Passmore, South Africa, 3 ; O. Lapize, France, 4 ; H. Baumler, France, 5. Also rode :—A. Boldt, Germany ; W. Lower, United Kingdom, and J. J. van Spengen, Holland. The United Kingdom were again unfortunate in this heat, Lower puncturing at twelve laps, and the field were travelling so fast that a fresh start was out of the question. However, an able representative was left in Ben Jones, who was always in a safe position. After the half-distance (15 min. 24 sec.) the race resolved itself into repeated manoeuvrings on the banks, with the Frenchmen indulging in short, sharp bursts. Two laps before the finish the jockeying was so pronounced that the riders were almost at a standstill. Working up pace for the bell, Passmore, Cameron and Jones led at the last lap. When the real sprint commenced, these men drew away from the rest, and although Jones momentarily appeared to have lost his chance he was speedy enough to come by on the outside and win by a bare half-length. Time, 32 min. 39 sec. Cameron did 32 min.  $39\frac{1}{5}$  sec., and Passmore 32 min.  $39\frac{2}{5}$  sec. A very close finish.

*Heat 5.*—A. Hansen, Sweden, 1 ; D. C. Robertson, United Kingdom, 2 ; W. Anderson, Canada, 3 ; Also rode :—J. Santorinaios, Greece, and P. Texier, France. Texier led with several very fast laps ; but after a time he dropped back for Anderson (Canada) to take the field along. At the half-distance (16 min. 45 sec.) they were travelling very slowly. Santorinaios stole a 250 yards' lead, but Robertson and the rest were careful not to allow the Greek to get clean away. At the bell the real race commenced, and half a lap from the line an unfortunate spill occurred which resulted in Texier and the Greek being thrown, and at the same time Robertson's chances were discounted by having to ride round them. Without a doubt this cost him the race, and he was beaten by Hansen by two lengths. Time, 34 min.  $53\frac{3}{5}$  sec. Robertson's time was 34 min.  $53\frac{4}{5}$  sec., and Anderson's 34 min.  $55\frac{3}{5}$  sec.

*Heat 6.*—A. J. Denny, United Kingdom, 1 ; C. Avrillon, France, 2 ; G. A. Westerberg, Sweden, 3 ; W. Morisetti, Italy, 4. Also rode :—L. Coeckelberg, Belgium. When two miles had been negotiated, Denny punctured. This necessitated some slogging work on his part to get up again. Avrillon was invariably in front after Denny had recovered his lost ground, and at the half-distance he was leading, the time being 15 min, 31 sec. With nine laps to go, Coeckelberg's tyre punctured, and two laps further on the Belgian was again unlucky. He left the track, cut across the grass, seized another machine, and remounted, but was disqualified. Avrillon led at the bell, Denny lying second, Westerberg third, and Morisetti last. The Italian jumped in his usual fashion 300 yards from home, but failed to get away, and he had nothing to do with the magnificent finish shared by Denny and Avrillon. It was touch and go for the length of the straight, and Denny won by a wheel. Time, 33 min.  $40\frac{2}{5}$  sec. Avrillon's time was 33 min.  $40\frac{4}{5}$  sec., and Westerberg's 33 min.  $41\frac{2}{5}$  sec.

Qualified for the final as the leaders of the greatest number of laps in the three fastest heats :—G. Werbrouck, Belgium ; F. Bonnet, France ; and O. Lapize, France.

## FINAL.

C. B. KINGSBURY, UNITED KINGDOM	..	..	..	..	..	..	..	1
BEN JONES, UNITED KINGDOM	..	..	..	..	..	..	..	2
G. WERBROUCK, BELGIUM	..	..	..	..	..	..	..	3
L. J. WEINTZ, UNITED STATES	..	..	..	..	..	..	..	4
L. MEREDITH, UNITED KINGDOM								
A. J. DENNY, UNITED KINGDOM								
A. HANSEN, SWEDEN								
F. BONNET, FRANCE	..	..	..	..	..	..	..	0
O. LAPIZE, FRANCE	..	..	..	..	..	..	..	0

TIME, 34 MIN. 13  $\frac{3}{5}$  SEC.

Meredith, one of the best British riders, punctured his back tyre in the first hundred yards, and lost all chance ; and immediately afterwards Denny did the same. Bonnet led nearly all the time to, halfway (15 min. 32  $\frac{3}{5}$  sec.), with Kingsbury near him. Hansen fell within two laps of the end. Very soon after the bell Kingsbury made his spurt, hotly challenged by Jones, Werbrouck, and Weintz in one of the most exciting finishes of the Games, which Kingsbury just won by three inches. Jones thought he had been bored in the straight, but there was no evidence to that effect.

Kingsbury was the one-mile N.C.U. champion, and afterwards won the Strangers' Race in the World's Amateur Championships at Leipsic.

#### V.—THE PRINCE OF WALES'S CUP FOR A HUNDRED KILOMETRES (62·135 Miles).

[Time Limit 3 hr. 15 min., Standard 2 hr. 30 min.]

## FIRST ROUND.

Heat 1.—A. Hansen, Sweden, 1 ; G. C. Lutz, France, 2 ; S. F. Bailey, United Kingdom, 3 ; P. Texier, France, 4 ; J. H. Bishop, United Kingdom, 5 ; D. C. Robertson, United Kingdom, 6. Qualified to ride in the final as leaders in the greatest number of laps :—F. Bonnet, France, and K. Mussen, United Kingdom. Also competed :—W. Anderson, Canada ; F. McCarthy, Canada ; A. Lepere, France ; A. Boldt, Germany ; R. Katzer, Germany ; T. Santorinaios, Greece ; G. B. Damen, Holland ; G. B. van Drakestein, Holland ; and J. Norman, United Kingdom. The Canadian pair of riders were allowed to take the field along for ten laps, Bailey being close behind their back wheel. Then Texier shot to the front and caused a slight spread. At 16 laps McCarthy punctured, but his spare machine being handy, the Canadian caught up again in a couple of laps. Bishop was ahead at 19 laps. At 21 laps Lutz made a determined effort to steal a lap, but was unsuccessful. Directly afterwards McCarthy changed back to his original machine.

Then Bonnet was compelled to get another machine, and with Bishop forcing the pace and Robertson and Norman hanging on, the Frenchman was left half a lap behind. He had as companion McCarthy, of Canada, and the plucky efforts of the pair to rejoin the first division, which they did at 70 laps, was loudly cheered. At the end of an hour's racing 23 miles 1,200 yards had been covered, and at this period Anderson was leading. At the 76th lap, Lutz and Hansen gained a 300 yards' advantage. The same pair were leading at the

half-distance, when the time was 1 hr. 18 min. 59 $\frac{1}{5}$  sec., followed by Drakestein and Robertson. Then Bailey went ahead and caught the leaders.

After 96 laps Hansen, Lutz, and Bailey lapped the rest. Meanwhile the Greek had been forced to retire, and at 103 laps McCarthy followed suit. He was joined a few minutes afterwards by Katzer (Germany), and there were now fourteen men on the track. Robertson had to change mounts when the lap scorers shouted "44 to go," and was up again almost immediately. Lutz continually spurred, but the Swede and Englishman always responded easily.

At the end of two hours 45 miles 1,180 yards had been covered, Lutz still being first, Bailey second, Hansen third. There was a capital finish between Hansen, Lutz, and Bailey, in which the Swede, who came through on the inside half a lap from the line, won by no more than half a wheel from Lutz. Bailey was two lengths further off. The other placings, a lap behind, were : Texier, fourth, Bishop fifth, and Robertson sixth. Time, 2 hr. 50 min. 21 $\frac{2}{5}$  sec.

*Heat 2.*—L. Meredith, United Kingdom, 1 ; C. H. Bartlett, United Kingdom, 2 ; G. A. Westerberg, Sweden, 3 ; O. Lapize, France, 4 ; W. Andrews, Canada, 5 ; W. J. Pett, United Kingdom, 6. Qualified to ride in final as leaders in the greatest number of laps : G. Coeckelberg, Belgium, and C. A. Denny, United Kingdom. Also competed :—W. Morton, Canada ; H. L. Young, Canada ; C. Avrillon, France ; H. Cunault, France ; P. Hostein, France ; J. Madelaine, France ; B. Goetze, Germany ; H. Martens, Germany ; P. Schulze, Germany ; M. Triebisch, Germany ; D. M. Nijland, Germany ; L. Azrini, Italy ; E. G. Malatesta, Italy ; B. Parini, Italy ; T. H. E. Passmore, South Africa ; R. Jolly, United Kingdom ; D. R. Noon, United Kingdom ; L. J. Weintz, United States. There was a big field, twenty-six facing the starter. Meredith got away so badly that he had a third of a lap to catch up on the rest. This he soon accomplished ; indeed, he was leading at eight laps. Cunault and Madelaine—both Frenchmen—were lapped at five miles. A little farther on the former retired. When 23 laps of the long journey had been covered Avrillon was first, Denny second, and Azrini third. Lapize punctured at 27 laps, at which distance Meredith was forcing the pace so splendidly that retirements became rather frequent. Half an hour's riding represented a distance of 12 miles 600 yards, at which stage the order was Andrews, Meredith, Avrillon, Noon, and Pett. Avrillon was unlucky enough to sustain a puncture at 39 laps, and at 44 laps Madelaine fell and was carried off on an ambulance. Apparently it was a case of sheer exhaustion, for the rider was quite alone when the incident occurred.

The next to retire was Avrillon, and by this time only 15 riders were left on the track. Meanwhile the pace had slowed down very considerably, chiefly owing to Lapize, who kept bursting away for a few seconds and then rode up the banking. At one hour the leaders were Lapize, Denny, Meredith, Noon, and Pett, while Bartlett was close up. The distance covered was 23 miles 1,740 yards. Britain's chief hope—Meredith—was brought down a little later, and in the smash Noon and Weintz were so knocked about as to be unable to continue. Meredith, however, remounted, and at length rejoined the leaders, the feat being loudly cheered.

At the half-distance, which was timed 1 hr. 17 min. 56 $\frac{2}{5}$  sec., Coeckelberg led, followed by Parini, Andrews, Denny, and Bartlett, and Meredith and Pett were near by. Thirty-six miles and 20 yards was the distance at one and a half hours, Lapize being the leader. A nasty accident ensued, entirely through the action of one of the walking judges, who, stepping on the track, brought over Coeckelberg. The Belgian was badly cut on the thigh and head. However, he pluckily remounted, though it was apparent that the fall had taken a deal out of him. Meredith changed machines again with 56 laps to go, and 4 laps farther on Azrini had to give way for good through cramp. He was followed to the dressing-room by Parini.

During the next few laps Lapize made a most determined effort, but the Englishmen had no intention of allowing this. The two hours' distance was 47 miles 1,500 yards, Lapize still in the van. It came on to rain now, and continued for the next thirty minutes, at the end of which only nine men were riding, one of them—Coeckelberg—being half a lap to the bad. The Belgian rode gamely and made up a lot of his lost ground, but he was still 100 yards behind at the bell. Round the last bend Denny and Pett fell, but even so Great Britain supplied first and second men, Meredith winning by a short length from Bartlett. Westerberg was third, Lapize (who died away up the straight) fourth, Andrews fifth, and Pett sixth. Time, 2 hr. 43 min. 1  $\frac{2}{5}$  sec.

## FINAL.

C. H. Bartlett, United Kingdom	..	..	..	..	..	1
C. A. Denny, United Kingdom	..	..	..	..	..	2
O. Lapize, France	..	..	..	..	..	3
W. J. Pett, United Kingdom	..	..	..	..	..	4
P. Texier, France	..	..	..	..	..	5
W. Andrews, Canada	..	..	..	..	..	6
D. C. Robertson, United Kingdom	..	..	..	..	..	7
S. F. Bailey, United Kingdom	..	..	..	..	..	8

Time, 2 hr. 41 min. 48  $\frac{3}{5}$  sec.

Winners of Diplomas of Merit as leaders of the greatest number of laps :—  
P. Texier, France ; O. Lapize, France ; C. A. Denny, United Kingdom.

Also rode :—A. Hansen, Sweden ; G. C. Lutz, France ; J. H. Bishop, United Kingdom ; F. Bonnet, France ; H. Mussen, United Kingdom ; L. Meredith, United Kingdom ; G. A. Westerberg, Sweden ; G. Coeckelberg, Belgium, and H. L. Young, Canada, the latter being permitted to start, having satisfied the judges that he was not lapped in Heat 2.

The track was under water in parts when the seventeen riders made their appearance, and J. H. Bishop was wearing goggles to protect his eyes from the grit and rain. It was raining when the men were sent on their long journey. Coeckelberg (Belgium), looking quite recovered from his bad fall in Heat 2, showed the way for a few laps, with Bishop next. At nine laps he gave way to S. F. Bailey, who evidently meant to make the pace as hot as possible, for thus early they were inside record. Bailey put in all he knew for seven laps, then giving way to Bishop, who in turn let Meredith up. The latter set up a killing pace, and there were several stragglers when the board announced 146 to go.

A minute later Bishop punctured. He was riding again very quickly, but so fast was the field travelling that he was completely left. At the end of fifteen minutes' riding 6 miles 220 yards had been covered, and the leader was Bailey (Great Britain). Between laps 20 to 22 Coeckelberg made a tremendous effort to get away on his own, but Meredith and the others held him, and at 27 laps Denny was in front, Bartlett and Mussen being second and third, with Meredith and Lapize riding together. At this stage the weather improved greatly. The pace was just as good at the end of the first half-hour, by which time 12  $\frac{1}{2}$  miles had been done. The leaders were Bailey, Meredith, Robertson, Bartlett, Lapize, and Texier.

Then, through one of them puncturing, Meredith, Andrews, and Robertson all came down, while two laps later Hansen (Sweden)—another rider possessing quite a fair chance of winning—was off through the same cause. Meredith, Andrews, and Robertson were remounted immediately, but Hansen was running about for two or three minutes before a machine could be found, and then he had no chance of getting up. Meredith, too, was having a bad time, for the Continentals flew along so soon as they observed what had happened, and could not be caught.

At 50 laps Coeckelberg was dropped, and 5 laps farther on the leaders numbered only nine. Meredith was continually urging his helpers, of whom Young (Canada) did magnificent work, to go faster, and finding at last that they could not respond, he went out by himself. This did not escape Lapize's notice, and the Frenchman made the pace so terrific that Meredith gradually fell further in the rear. Coeckelberg—lapped with "102 to go"—helped the Frenchman in his labours, and half-a-dozen circuits later Meredith, in spite of plugging away in the most determined fashion, was lapped. The field immediately went dead slow, and seeing that the race was over so far as he was concerned, Meredith dismounted for good a mile later.

When the lap scorers returned the first hour's riding the distance was 24 miles 1,450 yards, and the first four were Lapize, Texier, Pett, and Bartlett. In another ten laps only seven had not been lapped. Rain again descended on the soaked riders at this point, and very soon it was almost impossible to distinguish their colours. At the half-distance the time was 1 hr. 16 min.  $47\frac{1}{5}$  sec.

Positions remained about the same during the following thirty minutes, midway through which the distance for the  $1\frac{1}{2}$  hours was announced as 36 miles 460 yards, and the race continued intensely interesting. The pace, as it was bound to do, told at last, and when over a hundred laps had been done, the leaders were taking refreshments and breathers. This was extremely fortunate for Great Britain, for when Bailey and Denny both punctured within a couple of minutes, the Continentals were apparently too tired for the moment to put in an effort. Thus the pair were both carried to the leading division by Young, the Canadian, who received cheer after cheer from the huge crowd for his sportsmanship. No sooner had Bailey and Denny recovered than Bartlett—Britain's best remaining rider—punctured. Then the Frenchmen did sprint. But Bartlett quickly remounted, and, well paced by Hansen and Young, rode superbly. Gradually he made up ground, and when, after eight stiff laps, Young left his charge, Bartlett was back again with the small band of leaders. While Bartlett was making his effort Bailey again punctured. As a consequence, the latter

was well left before the Canadian could assist, and so it happened that he was lapped with "31 to go."

The two hours' distance was 47 miles 130 yards, and lap after lap was reeled off to roars of continuous cheering. At two and a half hours, when 58 miles 100 yards was the distance, Meredith's figures had again been cut. Texier was still leading here, Bartlett, Lapize, Pett, and Denny occupying second to fifth positions. A piece of hard luck befell one of the Frenchmen—Texier—five minutes afterwards, and he had to seek another machine. This definitely placed him out of court, for the others were waiting for nobody.

Volleys of cheering greeted the leaders at every lap now, and when the board showed only "3 more," excitement rose to fever pitch, for Denny was observed to be making a last attempt to steal away. But Lapize could not be shaken off.

With two laps to go Lapize sprinted along the back straight, Denny, Pett, and Bartlett being just behind him. At about the middle of the semi-circle of the far banking he rode up the banking to the outer side of the track and slowed, so as to force the other riders to go in front, the others followed up the banking, all slowing down to a crawl, Denny in front, Lapize outside. Just before entering the straight for the last lap Bartlett "jumped" down the banking from the rear of Denny and Lapize, and made a bee line for the winning straight. Leading at the bell he finished a short length in front of Denny. No protest of any kind was made. The official winning distance was a wheel, but it looked more.

In view of some descriptions published of this race afterwards, it may be added that if any riders had been guilty of deliberately "pocketing" another, they would have been disqualified. In cycle racing finessing for positions is permissible: more races are won by clever head work than by sheer speed. "Cutting in or out" when going at full speed is not permissible, but when "crawling" and "finessing" the question does not arise. Riding up the banking and slowing down is a tactic imported from the Continent, the object being to force the other riders to go in front and give a lead before a finish.

#### VI.—PURSUIT RACE.—(Three Laps, 1,980 Yards = 1,810'473 Metres).

*[Limited to teams of four from each country, starting at opposite sides of the track in each heat, the time of the third man in each team to constitute the time for the team. The team making the fastest time shall be the winner.]*

#### FIRST ROUND.

Heat 1.—Belgium scratched to United Kingdom.

Heat 2.—United States scratched to Canada

Heat 3.—Holland drew a bye.



*Heat 4.*—Germany (H. Martens, M. Goetze, K. Neumer, R. Kater) beat France (A. Auffray, E. Demangel, E. Marechal, M. Schilles). Time : Germany, 2 min. 25 $\frac{2}{5}$  sec. ; France, 2 min. 32 sec.

## SECOND ROUND.

United Kingdom (L. Meredith, B. Jones, E. Payne, C. B. Kingsbury) beat Canada (W. Morton, W. Andrews, F. McCarthy, W. Anderson). Time : United Kingdom, 2 min. 19 $\frac{3}{5}$  sec. ; Canada, 2 min. 29 $\frac{2}{5}$  sec.

Germany (H. Martens, M. Goetze, K. Neumer, R. Kater) beat Holland (J. J. van Spengen, A. Gerrits, D. M. Nijland, G. B. van Drakestein). Time : Germany, 2 min. 31 $\frac{4}{5}$  sec. ; Holland, 2 min. 44 sec.

## FINAL.

United Kingdom (L. Meredith, B. Jones, E. Payne, C. B. Kingsbury), 1 ; Germany (H. Martens, M. Goetze, K. Neumer, R. Kater), 2. Time: United Kingdom, 2 min. 18 $\frac{3}{5}$  sec ; Germany, 2 min. 28 $\frac{3}{5}$  sec.

Canada (W. Morton, W. Andrews, F. McCarthy, and W. Anderson) were awarded third place and the bronze medals as third fastest team. Time : 2 min. 29 $\frac{3}{5}$  sec.

L. Meredith had won the Hundred Kilometres World's Amateur Championship four times, and held the five, ten, fifty, and one hundred miles' English paced records.

E. Payne was 23 years old, and held the One Mile British Empire Championship in 1906.

## VII.—TWO THOUSAND METRES TANDEM 1'24 Miles).

[TIME LIMIT 4 MIN., STANDARD 2 MIN. 22 SEC.]

## FIRST ROUND.

*Heat 1.*—C. Brooks and W. H. T. Isaacs, United Kingdom, 1 ; H. Martens and A. Boldt, Germany, 2. The pace was slow until the bell, when the British pair went by on the outside and crossed the line winners by 5 lengths. Time, 3 min. 9 $\frac{2}{5}$  sec.

*Heat 2.*—F. G. Hamlin and H. T. Johnson, United Kingdom, 1 ; P. Texier and M. Texier, France, 2. Another slow race, with Hamlin and Johnson following the tactics of their compatriots in the previous heat. They hung behind until half a lap from the finish, when a beautifully timed sprint carried them first past the line, winners by 4 lengths. Time, 3 min. 14 $\frac{4}{5}$  sec.

*Heat 3.*—M. Goetze and K. Neumer, Germany, 1 ; C. Avrillon and Guyader, France, 2 ; C. McKaig and E. C. Piercey, United Kingdom, 3. A much faster heat. McKaig and Piercey appeared to be shut in at the last bend. The other couples fought out a brilliant race up the straight, the Germans winning by a bare wheel ; 2 lengths between second and third. Time, 2 min. 5 $\frac{3}{5}$  sec.

*Heat 4.*—J. Patou and L. Coeckelberg, Belgium, 1 ; J. L. Barnard and A. Rushen, United Kingdom, 2 ; A. Hansen and G. A. Westerberg, Sweden, 3. The Swedish pair went away with the lead, with the other couples close handy. This order was observed until 300 yards from the judges, when Barnard and Rushen commenced to sprint. A victory for Great Britain seemed assured as the straight was entered, but riding at a tremendous pace, the Belgian representatives fairly jumped their opponents in the last 100 yards, and won by 1 $\frac{1}{5}$  lengths. The Swedish pair was beaten off. Time, 2 min. 25 sec.

*Heat 5.*—M. Schilles and A. Auffray, France, 1 ; F. D. Venter and P. T. Freylinck, South Africa, 2. Only two pairs started. The Frenchmen, an ideal tandem team, lead all the way. They won by one length. Time 3 min. 11 $\frac{2}{5}$  sec.

*Heat 6.*—Lapize and F. Bonnet, France, 1 ; R. Jolly and J. Norman, United Kingdom, 2. The Frenchmen at the bell stole a march on their rivals, and won by six lengths. Time, 3 min.  $6\frac{4}{5}$  sec.

*Heat 7.*—J. Matthews and L. Meredith, United Kingdom, 1 ; A. Poulain and G. Dreyfus, France, 2 ; F. McCarthy and W. Morton, Canada, 3. Racing started at the bell, and at the last bend the Englishmen had to seek the banking to clear the Frenchmen, and then, setting themselves going, they put in such a fine sprint as to have the race well won halfway up the straight. They passed the post with a two lengths' advantage. The Canadians were beaten off. Time, 2 min.  $43\frac{1}{5}$  sec.

Fastest losers.—J. L. Barnard and A. Rushen, United Kingdom, second in fourth heat.

#### SECOND ROUND.

*Heat 1.*—F. G. Hamlin and H. T. Johnson, United Kingdom, 1 ; C. Brooks and W. H. T. Isaacs, United Kingdom, 2 ; M. Goetze and K. Neumer, Germany, 3 ; J. Patou and L. Coeckelberg, Belgium, 4. The Belgian pair went away with the lead, with Hamlin and Johnson lying last. They were in the same order at the bell. Two hundred yards farther on the British crew sprinted, and the race was theirs at once ; they won by fully six lengths. Time, 2 min.  $42\frac{1}{5}$  sec.

*Heat 2.*—M. Schilles and A. Auffray, France, 1 ; J. Matthews and L. Meredith, United Kingdom, 2 ; J. L. Barnard and A. Rushen, United Kingdom, 3 ; O. Lapize and F. Bonnet, France, 4. The major portion of this race took place on the banking, the French crews manoeuvring repeatedly to tempt our representatives to assume the lead. This the latter refused to do, but just before the last banking Schilles and Auffray went by, and won by a length. Time, 2 min.  $46\frac{1}{5}$  sec.

Fastest losers.—C. Brooks and W. H. T. Isaacs, United Kingdom.

#### FINAL.

M. Schilles and A. Auffray, France	..	..	..	..	1
F. G. Hamlin and H. T. Johnson, United Kingdom	..	..	..	..	2
C. Brooks and W. H. T. Isaacs, United Kingdom	..	..	..	..	3

Time, 3 min.  $7\frac{3}{5}$  sec.

The race was run slowly but cleverly until soon after the bell, when the Frenchmen went ahead and the English could never catch them. Hamlin and Johnson considered there had been unlawful "cutting in" at the last bend, but there was not sufficient evidence forthcoming. They had tied the quarter-mile record just previously. Brooks and Isaacs had won the One Mile N.C.U. Tandem Championship in June. Schilles and Auffray had never ridden together before this race.

## FENCING.

The Fencing Competitions at the Olympic Games consisted of five events, which will be described here in the following order : Épée Individual, Épée Team Fight, Sabre Individual, Sabre Team Fight, Foil Display.

Foil play, not being in the opinion of the organisers a form of sport which is improved by competition, was given a special place in the Olympic programme, and each competing country was asked to select two representatives, to whom a medal and diploma were awarded, and a display was arranged in the Prince's Galleries, Piccadilly, by Mr. W. H. C. Staveley, which proved extremely successful.

Especial attention may be drawn to the Code of Rules drawn up for the Fencing competitions, and printed in subsequent pages of this Report. It was the first of its kind to be printed in English, French, and German, and is the most complete ever published. Its value, which is worthy of comparison with the Olympic Swimming Code, the best of its kind, is chiefly due to the care bestowed by the Olympic Committee of the Amateur Fencing Association upon the development and improvement of the first draft drawn up by one of their representatives on the British Olympic Council, and submitted by him to the International Committee at The Hague.

The competitions in épée and sabre were carried out on a special terrain close to the Stadium, the excellent planning of which was almost entirely due to Mr. A. V. Buckland. The drawing and section of the tent and its arrangements are given in later pages as an example of what can be done for open-air fencing upon gravel in the vicissitudes of our English climate. Though every sport in these Games was admirably supported by its officials, a special note is permissible on the hard and exacting work of those who assisted the judging in Fencing. France won both épée events and Hungary took both sabre prizes.

The results were satisfactory in that the two international events were won by the best teams, and, though the victory of Herr Fuchs in the sabres was so narrow that it might not be repeated, few could doubt that on the week's form M. Alibert was the best épéeist, and thoroughly deserved his success. Indeed, his feat of passing scatheless through the team fights against Britain and Belgium on behalf of his country was perhaps finer than anything he did for himself during the meeting.

As regards British fencers, it may be said on the whole that, though France won both events in the *épée*, our team, in taking second place, did well, and that the fact that three out of the eight who survived into the final pool of the individual competitions were Englishmen was most satisfactory. But the same cannot be said of the sabre contests. Our team proved to be one of the weakest, and in the individual fights one British representative alone survived to the semi-final, and he was not expected to do so well as some of the others.

Certainly nothing like the beautiful sabre play of the Hungarians, the winners, or of the Bohemians, has hitherto been seen in England, and even the French champion, the Comte de la Falaise, was almost out-classed in the final round of the individual fights. Perhaps one of the most striking features of the Hungarian play was the defence to an attack pressed home. Some of the parries were astonishing.

The choice of Mr. W. H. C. Staveley as President of the Final pool in the *Épée* Team and Individual Competitions—an honour which he also held at the Crystal Palace Tournament some years previously—was highly appreciated all over England as a tribute to the knowledge and justice of our swordsmen from those countries in which fencing has been far longer established as an international sport. H.R.H. Princess Louise, the Duke of Argyll, the Duke of Connaught, Princess Patricia of Connaught, and the Crown Prince of Sweden were among those who visited the Fencing-ground at various times during the Games.

## I.—ÉPÉE INDIVIDUAL.

### FIRST ROUND.

In the individual *épée* contest the United Kingdom was represented by Mr. C. L. Daniell, the amateur champion, Mr. M. V. Holt, Mr. R. Montgomerie, Mr. E. Seligman, Mr. Cecil H. Haig, Mr. S. Martineau, Mr. E. M. Amphlett, Mr. L. V. Fildes, Mr. J. P. Blake, Mr. R. Chalmers, Mr. P. M. Datson, and Mr. H. Davids. France had a particularly strong representation, including M. B. Gravier, the amateur champion, M. G. Bergcr, M. J. Stern, and Dr. Olivier ; and Belgium and Holland sent over such well-known swordsmen as M. Rom, M. Renard, M. Anspach, M. de Montigny, M. Bosman, M. Labouchere, and Captain Van Blijenberg. Of the British fencers who had been specially chosen for the team matches, all except Mr. Seligman were successful in the first round. Mr. Seligman's failure was unaccountable, and naturally caused disappointment. Of the other five, Mr. Davids was the sole survivor. Mr. Fildes fought well in pool No. 1, where the French champion was engaged ; and although six hits

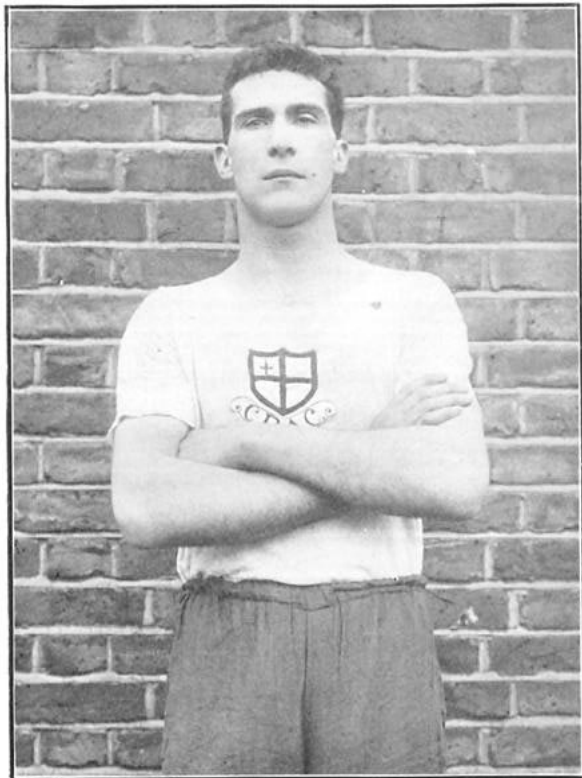

BOXING.—A. L. OLDMAN (U.K.), WINNER OF  
THE HEAVYWEIGHTS.

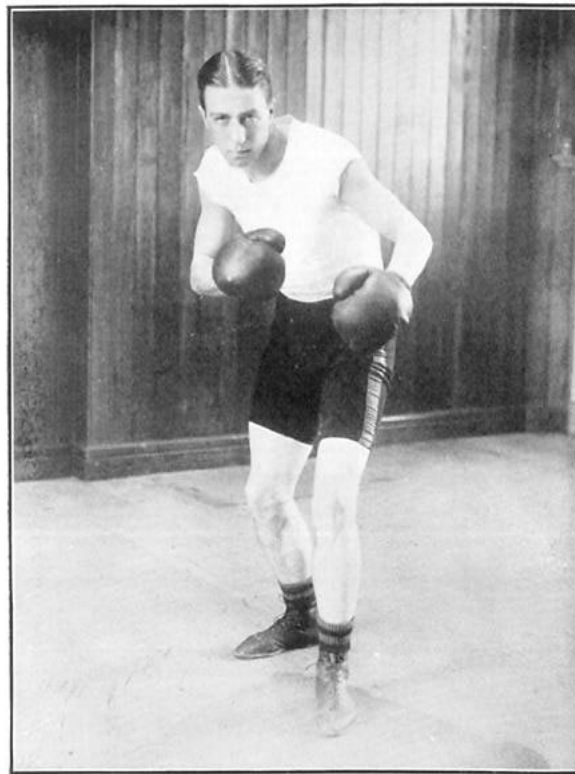

BOXING.—J. W. H. T. DOUGLAS (U.K.), WINNER OF  
THE MIDDLEWEIGHTS.

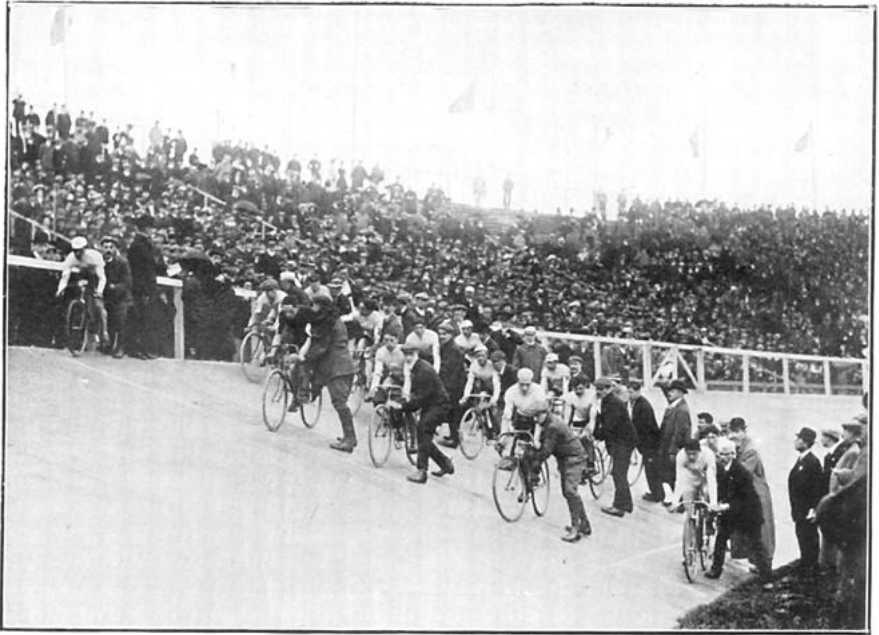

CYCLING. — START OF THE 100 KILOMETRES.



CYCLING.—FINISH OF THE 100 KILOMETRES.  
WON BY C. H. BARTLETT (U.K.).

were recorded against him, two of them were double hits. Mr. Blake did rather better in pool 3, where he tied for the fourth place with four hits against him, including a *coup double*. In pool No. 5 Mr. Davson also took the fourth place. His fight with M. Alibert, the formidable French amateur, was one of the best of the day. Mr. R. Chalmers, who lacks experience, fought pluckily in pool No. 8, and succeeded in making a tie for the third place with M. Rodocanachi, losing on the fight off. In this preliminary round France was most successful, obtaining five first places, three seconds, and two thirds. M. Dillon Kavanagh, the famous French foilist failed to arrive, and his countryman, M. Dubourdieu, failed to obtain a place in pool 7, which was won by Mr Daniell, the British champion. Belgium also came well out of the first round with two first places, four seconds, and two thirds, the record of the United Kingdom being three firsts, three seconds, and one third.

## SCORES.

## POOL 1.—JULY 17.

	Carlberg	Fildes	Gravier	Ostrup	Stohr	Tucek	Von Rosen	Total Hits Against	Winners
Carlberg ... S.		0	0	1	1	1	0	3	—
Fildes U.K.	1		1	1	X	1	X	6	—
Gravier ... F.	1	0		0	0	1	0	2	2
Ostrup ... D.	0	0	1		0	0	0	1	1
Stohr ... G.	0	X	1	1		1	1	5	—
Tucek ...Bo.	0	0	0	1	0		1	2	2
Von Rosen S.	1	X	1	1	0	0		3	—

*Jury* :—G. Breittmeyer (President), B. Cunliffe, F. Moore.

*Scorer* :—G. L. Blake.

## POOL 2.—JULY 17.

	Collignon	Gates	Jack	V. Lada	Sander	Speciale	Van Schreven	Total Hits Against	Winners
Collignon ... F.	/	1	0	0	0	0	X	2	2
Gates ... S.A.	0	/	X	1	1	1	X	5	—
Jack ... G.	1	X	/	1	0	1	1	5	—
V. Lada ... Bo.	1	0	0	/	0	0	0	1	1
Sander ... D.	1	0	1	1	/	1	0	4	—
Speciale ... I.	1	0	0	1	0	/	1	3	3
Van Schreven Hol.	X	X	0	1	1	0	/	4	—

*Jury* :—W. H. C. Staveley (President), A. Morin, Bela Nagy, G. Jacobs,  
A. Rawlinson.

*Scorer* :—C. Hancock.

## POOL 3.—JULY 17.

	Adams	Blake	Dwinger	Levison	Marais	Renard	Total Hits Against	Winners
Adams ... .. G.	/	1	0	1	1	1	4	—
Blake ... .. U.K.	0	/	X	1	1	1	4	—
Dwinger ... Hol.	1	X	/	0	1	1	4	—
Levison ... .. D.	0	0	1	/	1	0	2	2
Marais ... .. F.	0	0	0	0	/	0	0	1
Renard ... .. B.	0	0	0	1	1	/	2	2

*Jury* :—A. Pontenani (President), S. de Joux, E. B. Milnes, A. Fellows,  
C. Trueman.

*Scorer* :—Mr. Bean.



POOL 4.—JULY 17.

	Becker	Berger	Bergsland	Dina	Holt	Sarrens	Tvrsky	Van Rossem	Total Hits Against	Winners
Becker ... D.	/	1	0	1	0	X	1	0	4	—
Berger ... F.	0	/	0	0	0	0	0	0	0	1
Bergsland ... N.	1	1	/	X	1	0	0	0	4	—
Dina ... I.	0	1	X	/	0	X	0	1	4	—
Holt ... U.K.	1	1	0	1	/	0	1	0	4	2
Sarrens ... Bel.	X	1	1	X	1	/	1	0	6	—
Tvrsky ... Bo.	0	1	1	1	0	0	/	X	4	2
Van Rossem Hol.	1	1	1	0	1	1	X	/	6	—

	1	2	3	4	5	—		1	2	3	4	—
Becker ... 1	/	0	X	1	0	2	Becker ... 1	/	0	1	1	2
Bergsland 2	1	/	0	1	1	3	Dina ... 2	1	/	1	0	2
Dina ... 3	X	1	/	0	0	2	Hol ... 3	0	0	/	1	1
Holt ... 4	0	0	1	/	1	2	Tvrsky ... 4	0	1	0	/	1
Tvrsky ... 5	1	0	1	0	/	2	— — — — —	—	—	—	—	—

Jury :—J. Jenkinson (President), E. Brierley, P. Ettlinger.

Scorer :— C. Montgomerie.

## POOL 5.—JULY 17.

	Alibert	Davson	De Montigny	Krunert	P. Lada	Osier	Ceccherini	Van Loben Sels	Total Hits Against	Winners
Alibert ... F.	/	0	0	0	0	0	0	X	1	1
Davson ... U.K.	1	/	0	0	1	1	0	1	4	—
De Montigny Bel.	1	1	/	0	0	0	X	0	3	2
Krunert ... G.	1	1	1	/	X	1	1	0	6	—
P. Lada ... Bo.	1	0	1	X	/	1	1	0	5	—
Osier ... D.	1	0	1	0	0	/	0	X	3	2
Ceccherini ... I.	1	1	X	0	0	1	/	0	4	—
Van Loben Sels Hol.	X	0	1	1	1	X	1	/	6	—

*Jury* :—Dr. Nagy (President), A. Morin, W. H. C. Staveley, G. Jacobs, C. H. Biscoe.  
*Scorer* :—A. C. Amy.

## POOL 6.—JULY 17.

	Cagiati	Martineau	Naumann	Peyron	Rom	Schjebal	Total Hits Against	Winners
Cagiati... ... S.	/	0	0	X	1	0	2	2
Martineau ... U.K.	1	/	0	0	0	1	2	2
Naumann ... G.	1	1	/	1	1	0	4	—
Peyron ... S.	X	1	0	/	1	0	3	—
Rom ... ... Bel.	0	1	0	0	/	0	1	1
Schjebal ... Bo.	1	0	1	1	1	/	4	—

*Jury* :—B. Cunliffe (President), G. Breittmeyer, F. Moore, G. Alexander,  
A. Rawlinson.  
*Scorer* :—G. L. Blake.

## POOL 7.—JULY 17.

	Bosman	Von Blijenburg	Daniell	G. de Lobsdorf	Dubordieu	Foldes	Schon	Total Hits Against	Winners
Bosman ... .. Bel.		0	1	0	X	0	1	3	3
Von Blijenburg Hol.	1		1	1	1	1	X	6	—
Daniell ... .. U.K.	0	0		1	0	0	0	1	1
G. de Lobsdorf Bo.	1	0	0		0	0	1	2	2
Dubordieu ... F.	X	0	1	1		0	0	3	—
Foldes ... .. Hun.	1	0	1	1	1		1	5	—
Schon ... .. G.	0	X	1	0	1	0		3	—

On the tie for third place being fought off, Bosman beat Dubordieu and Schon.

*Jury* :—E. H. Milnes (President), D. Gordon, C. Trueman, A. Fellows, S. de Joux.

*Scorer* :—W. Bean.

## POOL 8.—JULY 17.

	Anspach	Chalmers	Tucek	De Bary	Labouchere	Biroli	Rodocanachi	Total Hits Against	Winners
Anspach Bel.		0	0	X	1	0	0	2	2
Chalmers U.K.	1		0	0	1	0	1	3	—
Tucek ... Bo.	1	1		1	1	1	1	6	—
De Bary ... G.	X	1	0		1	X	0	4	—
Labouchere Hol.	0	0	0	0		1	0	1	1
Biroli ... I.	1	1	0	X	0		1	4	—
Rodocanachi F.	1	0	0	1	1	0		3	3

On the tie for third place being fought off, Rodocanachi beat Chalmers.

*Jury* :—P. Ettlinger (President), A. Rawlinson, Van der Lille.

*Scorer* :—G. L. Blake.

## POOL 9.—JULY 18.

	Petri	Jorgensen	Lindblom	Mangiarotti	Montgomerie	Nobbs	Quenessen	Total Hits Against	Winners
Petri ... G.	/	1	1	X	1	X	1	6	—
Jorgensen .. D.	0	/	X	1	1	0	1	4	—
Lindblom S.	0	X	/	X	1	0	0	3	2
Mangiarotti I.	X	0	X	/	1	0	0	3	—
Montgomerie U.K.	0	0	0	0	/	X	0	1	1
Nobbs Canada	X	1	1	1	X	/	1	6	—
Quenessen F.	0	0	1	1	1	0	/	3	2

On the tie for second and third places being fought off, Mangiarotti was beaten by Lindblom and Quenessen.

*Jury* :—G. Breittmeyer (President), D. Gordon, E. B. Milnes.

*Scorer* :—G. H. Ramsbottom.

## POOL 10.—JULY 18.

	Amphlett	Doorman	Moldenhauer	Olivier	Sarzano	Zulavsky	Total Hits Against	Winners
Amphlett ... U.K.	/	0	0	0	0	1	1	1
Doorman ... Hol.	1	/	0	0	0	0	1	1
Moldenhauer... G.	1	1	/	1	1	0	4	—
Olivier ... F.	1	1	0	/	0	0	2	3
Sarzano ... I.	1	1	0	1	/	X	4	—
Zulavsky ... Hun.	0	1	1	1	X	/	4	—

*Jury* :—W. H. C. Staveley (President), A. Morin, H. Butterworth, B. Nagy, C. Moore.

*Scorer* :—C. Montgomerie.

## POOL 11.—JULY 18.

	Bertinetti	Branting	Haig	Le Blon	Okker	Total Hits Against	Winners
Bertinetti ... .. I.	/	0	1	0	0	1	1
Branting... .. S.	1	/	1	1	1	4	—
Haig ... .. U.K.	0	0	/	1	1	2	3
Le Blon... .. Bel.	1	0	0	/	X	2	2
Okker ... .. Hol.	1	0	0	X	/	2	—

On the tie for second and third places being fought off, Okker was beaten by Haig and Le Blon.

*Jury* :—B. Cunliffe (President), G. Alexander, G. Jacobs, F. Trueman, E. C. Brierley.

*Scorer* :—A. L. Todhunter.

## POOL 12.—JULY 18.

	Cratingius	Lippmann	Nowak	Olson	Seligman	Stuyck	Total Hits Against	Winners
Cratingius ... G.	/	1	1	0	1	1	4	—
Lippmann ... F.	0	/	0	0	0	1	1	1
Nowak ... .. I.	0	1	/	0	0	1	2	3
Olson ... .. S.	1	1	1	/	X	1	5	—
Seligman ... U.K.	0	1	1	X	/	X	4	—
Stuyck ... .. Bel.	0	0	0	0	X	/	1	1

*Jury* :—J. Jenkinson (President), W. Wright, F. Moore, S. de Joux.

*Scorer* :—A. C. Amy.

## POOL 13.—JULY 18.

	Davids	Langenhove	Lichtenfels	Toth	Stern	Total Hits Against	Winners
Davids ... .. U.K.		1	0	0	1	2	2
Langenhove ... .. Bel.	0		0	1	1	2	2
Lichtenfels ... .. G.	1	1		0	X	3	—
Toth ... .. Hun.	1	0	1		1	3	—
Stern ... .. F.	0	0	X	0		1	1

*Jury* :—G. Breittmeyer (President), E. B. Milnes, A. Pontenani, R. Doyne,  
W. H. C. Staveley.

*Scorer* :—G. Alexander.

## SECOND ROUND.

In the second round there were seven pools of five fencers and one of four, and two competitors from each pool were admitted to the semi-final round. The Belgians came well to the front, equalling the score of the French with three first places and two seconds. Half of the Frenchmen who took part in this round failed to make further progress, and among them was M. Gravier, the French champion. A similar fate befell the United Kingdom, for only three of the seven Englishmen survived, the British champion being one of those who joined the majority. His defeat was a keen disappointment to those who were interested in British swordsmanship. But there was consolation to be found in the brilliant victory of Mr. Holt and Mr. R. Montgomerie in pool No. 4, where they met the French champion, his countryman M. Marais, and M. Tvrsky, of Bohemia. The Englishmen first faced each other, and Mr. Montgomerie won the fight. But this was the only assault which Mr. Holt lost. His judgment of time and distances was never at fault, and, making good use of his long reach, he defeated each of his foreign competitors with a *coup d'arrêt* on their attack. Mr. Montgomerie lost to M. Marais and M. Tvrsky, but he defeated M. Gravier, with whom he made a tie. The fight for second place was splendidly contested, and roused the spectators to a high pitch of excitement. Both Mr. Montgomerie and the French champion fought

with great skill and determination. After a long struggle M. Gravier appeared to be hit on the body, but the judges could not agree, and the fight was accordingly resumed. Finally, Mr. Montgomerie hit his antagonist on the leg, and thus won the second place. Mr. Haig also defeated two Frenchmen in pool No. 8, Dr. Olivier and M. Quenessen, but he lost to Signor Cagiali, of Italy, and tied for the first place with Dr. Olivier. Of the others, Mr. Daniell, the English champion, began well in pool No. 5 by defeating Signor Bertinetti, of Italy, and M. V. Lada, of Bohemia. Then he had to face M. Lippman, who came second to M. Gravier for the French championship in 1908, and a well-fought assault ended in a double hit. In his last fight he met M. Lindblom, of Sweden, who, soon after coming on guard, made an attack on the lunge. Mr. Daniell seemed unprepared for it. At all events, he failed effectually to parry the attack, and was hit on the leg. With two points against him he took the third place, M. Lippman and M. Lindblom being equal firsts with one hit against each. Of the other Englishmen engaged, both Mr. Amphlett and Mr. Martineau were rather unlucky in losing their places, and Mr. Davids was unsuccessful in a particularly strong pool, in which M. Alibert and M. Berger, two leading French swordsmen, took the first and second places.

## SCORES.

## POOL I.—JULY 20.

	Le Blon	Stuyck	Stern	Doorman	Levison	Total Hits Against	Winners
Le Blon ... .. Bel.	/	0	X	0	0	1	1
Stuyck ... .. Bel.	1	/	1	1	0	3	—
Stern ... .. F.	X	0	/	0	X	2	2
Doorman... .. Hol.	1	0	1	/	0	2	—
Levison ... .. D.	1	1	X	1	/	4	—

On the tie for second place being fought off, Stern beat Doorman.

*Jury* :—W. H. C. Staveley (President), C. Hjorth, E. B. Milnes.

*Scorer* :—A. E. Syson.

## POOL 2.—JULY 20.

	Osiier	Renard	Rodocanachi	Amphlett	Ostrup	Total Hits Against	Winners
Osiier ... .. D.	/	0	0	1	1	2	—
Renard ... .. Bel.	1	/	0	0	1	2	2
Rodocanachi ... .. F.	1	1	/	0	0	2	—
Amphlett ... .. U.K.	0	1	1	/	1	3	—
Ostrup ... .. D.	0	0	1	0	/	1	1

On the tie for second place being fought off, Renard beat Osiier and Rodocanachi.

*Jury* :—G. Breittmeyer (President), F. Moore, H. Butterworth.

*Scorer* :—A. C. Amy.

## POOL 3.—JULY 20.

	Speciale	Alibert	Berger	De Lobsdorf	Davids	Total Hits Against	Winners
Speciale ... .. I.	/	1	1	1	0	3	—
Alibert ... .. F.	0	/	0	0	0	0	1
Berger ... .. F.	0	1	/	0	X	2	2
De Lobsdorf ... .. Bo.	0	1	1	/	0	2	—
Davids ... .. U.K.	1	1	X	1	/	4	—

On the tie for second place being fought off, Berger beat De Lobsdorf.

*Jury* :—Dr. Nagy (President), J. Jenkinson, G. Alexander, C. Moore, E. Brierley.

*Scorer* :—G. L. Blake.



## POOL 4.—JULY 20.

	Marais	Holt	Tvrsky	Montgomerie	Gravier	Total Hits Against	Winners
Marais ... .. F.	/	1	1	0	1	3	—
Holt ... .. U.K.	0	/	0	1	0	1	1
Tvrsky ... .. Bo.	0	1	/	0	1	2	—
Montgomerie ... .. U.K.	1	0	1	/	0	2	2
Gravier ... .. F.	0	1	0	1	/	2	—

On the tie for second place being fought off, Montgomerie beat Tvrsky and Gravier.

*Jury* :—B. Cunliffe (President), A. Pontanai, H. Pollock, G. Jacobs.

*Scorer* :—C. Montgomerie.

## POOL 5.—JULY 20.

	Bertinetti	Daniell	V. Lada	Lippmann	Lindblom	Total Hits Against	Winners
Bertinetti ... .. I.	/	1	0	1	1	3	—
Daniell ... .. U.K.	0	/	0	X	1	2	—
V. Lada ... .. Bo.	1	1	/	1	1	4	—
Lippman .. .. F.	0	X	0	/	0	1	1
Lindblom ... .. S.	0	0	0	1	/	1	1

*Jury* :—G. Breittmeyer (President), B. Cunliffe, E. B. Milnes.

*Scorer* :—G. L. Blake.

## POOL 6.—JULY 20.

	Langenhove	Bosman	Collignon	Rom	Nowak	Total Hits Against	Winners
Langenhove ... .. Bel.	/	X	0	1	1	3	—
Bosman ... .. Bel.	X	/	0	0	X	2	2
Collignon ... .. F.	1	1	/	1	0	3	—
Rom ... .. Bel.	0	1	0	/	0	1	1
Nowak ... .. I.	0	X	1	1	/	3	—

*Jury* :—Dr. Nagy (President), J. Jenkinson, P. Ettlinger.

*Scorer* :—D. Gordon.

## POOL 7.—JULY 20.

	Anspach	De Montigny	Tucek	Labouchere	Martineau	Total Hits Against	Winners
Anspach .. .. Bel.	/	0	1	0	0	1	1
De Montigny . ... Bel.	1	/	0	1	0	2	—
Tucek ... .. Bo.	0	1	/	1	1	3	—
Labouchere ... .. Hol.	1	0	0	/	1	2	2
Martineau ... .. U.K.	1	1	0	0	/	2	—

On the tie for second place being fought off, Labouchere beat De Montigny and Martineau.

*Jury* :—A. Pontenani (President), C. Moore, C. F. Clay, G. Alexander,  
H. Butterworth.

*Scorer* :—F. J. Brett.

## POOL 8.—JULY 20.

	Olivier	Cagiati	Haig	Quenessen	Total Hits Against	Winners
Olivier ... .. F.	—	0	1	0	1	1
Cagiati ... .. I.	1	—	0	1	2	—
Haig ... .. U.K.	0	1	—	0	1	1
Quenessen ... .. F.	1	0	1	—	2	—

*Jury* :—R. Doyne (President), G. Jacobs, F. Moore, A. Rawlinson, A. Morin.  
*Scorer* :—G. B. Dibblee.

## SEMI-FINAL ROUND.

Of the three Englishmen engaged in the semi-final round of the individual épée contest, Mr. M. V. Holt had the best of the luck in the draw, for Mr. R. Montgomerie and Mr. C. H. Haig were placed in by far the stronger pool. But it was a fine performance for Mr. Holt to come second to M. Anspach, the accomplished Belgian swordsman, and thus to obtain a better record than M. Lippman, Dr. Olivier, and M. Stern, three members of the famous French team. Mr. C. H. Haig's performance was even more creditable, for with M. Labouchere, the formidable Dutch *tireur gaucher*, he became second to M. Alibert, the ultimate winner, and defeated M. Bosman, M. Renard, Mr. Montgomerie, and M. Berger (the French captain), of whom the latter failed to obtain a place. Mr. Haig's success was particularly gratifying, for he has been in excellent form this year. With arm extended and point in line, he fought with spirit and confidence, and, judging his opportunities well, he obtained many hits on the arm and shoulder, with a disengage in *sixte* on the advance. But he was also skilful with his parries, and he made good use of an attack with a "bind" in *seconde*. He defeated M. Berger with this attack, but it failed against M. Alibert. Mr. R. Montgomerie, who had fought so well against the French in the team match, was again in excellent form, and made more use than is his wont of an *attaque en marchant* with opposition in *sixte*. He beat M. Labouchere with this attack, and stopped both M. Berger and M. Bosman with a hit on the sword arm. He failed to equal Mr. Haig's score by losing the bout to him, they made a simultaneous attack, but Mr. Montgomerie's point was wide. This was the fourth hit against him, but he qualified for a place in the final.

## SCORES.

POOL 1.—JULY 23.

	Montgomerie	Haig	Bosman	Rom	Alibert	Labouchere	Berger	Renard	Total Hits Against	Winners
Montgomerie U.K.	1	0	1	1	0	0	0	1	4	4
Haig ... U.K.	0	1	0	1	1	1	0	0	3	2
Bosman ... Bel.	1	1	X	X	X	1	X	X	7	—
Rom ... Bel.	0	0	X	X	X	1	X	1	5	—
Alibert ... F.	0	0	X	X	X	0	0	0	2	1
Labouchere ... Hol.	1	0	0	0	1	1	1	0	3	2
Berger ... F.	1	1	X	X	1	0	0	0	5	—
Renard ... Hol.	0	1	X	0	1	1	1	1	5	—

*Jury* :—W. H. C. Staveley (President), F. Moore, E. B. Milnes, H. Butterworth, A. Rawlinson.

*Scorer* :—G. L. Blake.

POOL 2.—JULY 23.

	Anspach	Lippmann	Holt	Olivier	Lindblom	Ostrup	Stern	Le Blon	Total Hits Against	Winners
Anspach Bel.	1	0	1	0	0	0	1	0	2	1
Lippmann F.	1	1	1	X	0	X	0	0	4	3
Holt ... U.K.	0	0	0	1	1	0	1	0	3	2
Olivier ... F.	1	X	0	0	X	1	0	0	4	4
Lindblom S.	1	1	0	X	X	X	0	1	5	—
Ostrup ... D.	1	X	1	0	X	X	0	X	5	—
Stern ... F.	0	1	0	1	1	1	1	0	4	—
Le Blon Bel.	1	1	1	1	0	X	1	1	6	—

On the tie for third and fourth places being fought off, Stern was beaten by Lippmann and Olivier, and Olivier was beaten by Lippmann.

*Jury* :—W. H. C. Staveley (President), Count de Soissons, G. Jacobs, E. B. Milnes, C. F. Clay.

*Scorer* :—G. L. Blake.

## FINAL POOL.—JULY 24. Won by Alibert (France).

	Anspach	Holt	Lippmann	Olivier	Alibert	Labouchere	Haig	Montgomerie	Total Hits Against	Places
Anspach ... Bel.	/	1	1	1	1	0	0	1	5	5
Holt ... U.K.	0	/	1	1	1	1	1	X	6	8
Lippmann ... F.	0	0	/	0	1	X	0	1	3	2
Olivier ... F.	0	0	1	/	1	1	0	0	3	3
Alibert ... F.	0	0	0	0	/	X	0	X	2	1
Labouchere Hol.	1	0	X	0	X	/	1	1	5	5
Haig ... U.K.	1	0	1	1	1	0	/	1	5	5
Montgomerie U.K.	0	X	0	1	X	0	0	/	3	4

On the tie for second, third, and fourth places being fought off, Lippmann beat Olivier and Montgomerie, and Olivier beat Montgomerie.

Jury :—W. H. C. Staveley (President), F. Rom, G. Breittmeyer, Dr. Nagy, Van Loben Sels.

Scorer :—P. Doyne.

In the final pool Mr. R. Montgomerie was again in splendid form, and he made a great bid for victory. He avenged himself for his defeat by Mr. Haig in the previous round, and he was also successful against M. Anspach, M. Lippman, and M. Labouchere ; but he was beaten by Dr. Olivier, who avoided his attack in the high line by ducking, and got in a stop hit on the body, and a *coup double* was given in his assault with Mr. Holt. Meantime M. Alibert (France) had won all his fights except one, in which he had obtained a double hit with M. Labouchere. In the last fight of the pool Mr. Montgomerie had to beat M. Alibert in order to tie with him for the first place. It was an exciting and well-contested assault. Finally Mr. Montgomerie made his swift attack with opposition in *sixte*, but M. Alibert disengaged in the low line, and both were hit. It then became the duty of the judges to decide which hit was the first to arrive, and they announced a double hit. With only two double hits

against him, M. Alibert thus won the gold medal. He fenced finely throughout, and thoroughly deserved his victory. He was carried from the ground on the shoulders of his enthusiastic compatriots. With one defeat and two double hits against him, Mr. Montgomerie tied for the second place with M. Lippman and Dr. Olivier. Seemingly exhausted by his previous effort, he lost to them both and took the fourth place. M. Lippman beat Dr. Olivier, and won the silver medal, the other competitors in the final pool receiving bronze medals. Mr. Haig again fought well, but was successful only in his assaults with Mr. Holt and M. Labouchere. Mr. Holt was less effective than on the previous day, and his only success was in his bout with M. Anspach.

## II.—ÉPÉE TEAM FIGHT.

[Eight to enter, four to fight, under the conditions published in the Rules.]

### THE BYE.

#### UNITED KINGDOM BEAT HOLLAND.

For the match with Holland Mr. C. L. Daniell, Mr. M. V. Holt, Mr. R. Montgomerie, and Mr. E. Seligman were selected to fight for the United Kingdom. It was a well-contested match, in which the Dutch team made an excellent recovery from a bad start, and only missed the chance of a tie by losing the last assault. Mr. Daniell gave his side the lead by defeating M. de Jong in the first bout, parrying his attack in "seconde" and riposting on the chest. Mr. Holt and M. Doorman never came to close quarters. They each played the game of *piquer à la main*, in which, for once, Mr. Holt came off second best. This was the only victory that Holland obtained in the first round, for Mr. Montgomerie disposed of M. Labouchere, the formidable *tireur gaucher*, with a hit on the leg after a spirited encounter, and Mr. Seligman parried M. von Rossem's attack in *sixte* and riposted on the chest. In the second round honours were divided. M. Doorman, who fenced with judgment and restraint, hit Mr. Montgomerie on the leg, and M. Labouchere defeated Mr. Seligman with a powerful attack, the latter failing to obtain a stop hit. Mr. Holt made an excellent stop on M. de Jong's attack, and Mr. Daniell defeated M. Rossem with a powerful *battement* and attack on the body. Halfway through the match the score was thus 5 to 3 in favour of the United Kingdom. In the next fight Mr. Montgomerie failed to make his point fix in a vigorous attack on M. de Jong, and lost the bout, and Mr. Seligman was hit *en pleine poitrine* by M. Doorman ; and when Mr. Daniell faced

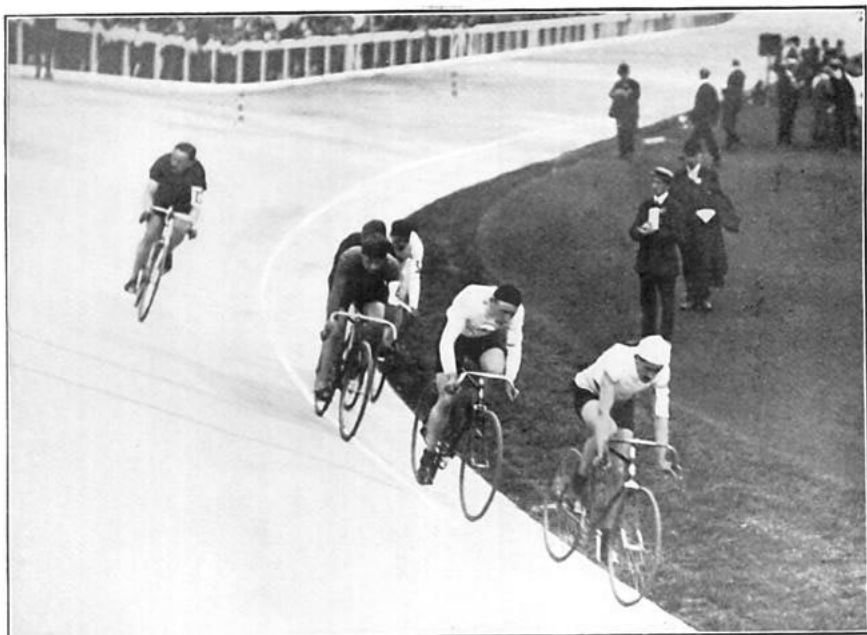

CYCLING.—THE FINAL OF THE 20 KILOMETRES.



CYCLING.—SCHILLES AND AUFFRAY (FRANCE), WINNERS OF THE TANDEM RACE.



FENCING.—ALIBERT (FRANCE), WINNER OF THE INDIVIDUAL ÉPÉE.

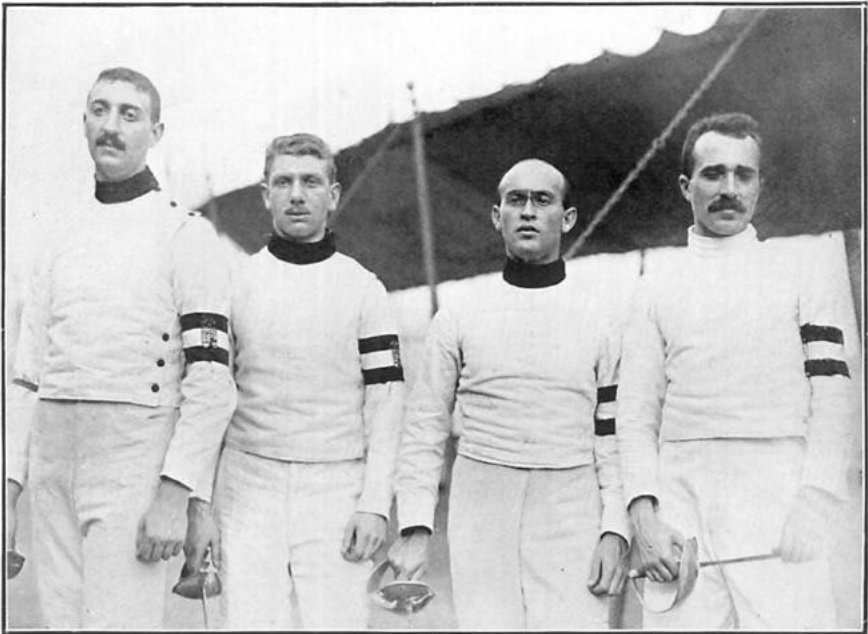

FENCING.—THE HUNGARIANS, WINNERS OF THE SABRE-TEAM FIGHT,



M. Labouchere the score was level at 5 all. It was a splendid fight, in which Mr. Daniell had the worst of the luck. Fencing in his usual correct manner, he parried M. Labouchere's attack, but his point passed on the riposte and he was hit on a *remise*. This gave the Dutch team the lead, but Mr. Holt redressed the balance by defeating M. van Rossem with a *battement* and attack on the sword hand. With but four bouts remaining, the score was again level at 6 all, and the defeat of Mr. Seligman, who was hit on the arm by M. de Jong, again gave Holland the lead. At this critical juncture Mr. Daniell was called upon to face M. Doorman, who thus far had been undefeated. In his previous fights Mr. Daniell had acted strictly on the defensive, but he now adopted offensive tactics, and he beat M. Doorman with his favourite attack *en marchant* in the high line. M. Doorman, taken by surprise, failed effectually to parry the attack, and he was hit on the mask. Mr. Holt then got a light touch on M. Labouchere's hand, and the United Kingdom were safe from defeat. In the last fight M. Rossem attacked Mr. Montgomerie with great vigour in the hope of making a tie, but after several *corps-à-corps* Mr. Montgomerie won the match with a fine stop hit.

## SCORES.

BYE.—JULY 20.

HOLLAND					v.	UNITED KINGDOM.					
—	5	6	7	8	—	—	1	2	3	4	—
1. De Jong ...	1	1	0	0	2	5. Daniell ...	0	0	1	0	1
2. Doorman ...	1	0	0	0	1	6. Holt ...	0	1	0	0	1
3. Labouchere	0	1	1	0	2	7. Montgomerie	1	1	0	0	2
4. Van Rossem	1	1	1	1	4	8. Seligman ...	1	1	1	0	3
Total fights lost ... 9						Total fights lost ... 7					

*Jury* :—G. Breittmeyer (President), A. Pontenani, C. Hjørth, W. H. C. Staveley, Dr. Nagy.

*Scorer* :—C. Montgomerie.

HUNGARY scratched to BOHEMIA.

## FIRST ROUND.

## 1. ITALY BEAT BOHEMIA.

## SCORES.

PRELIMINARY.—JULY 21.

BOHEMIA						<i>v.</i>	ITALY.					
—	5	6	7	8	—	—	1	2	3	4	—	
1. P. Lada ...	1	0	1	X	3	5. Bertinetti ...	0	1	0	1	2	
2. V. Lada ...	0	1	1	X	3	6. Mangiarotti	1	0	1	0	2	
3. Lobsdorf ...	1	0	1	1	3	7. Nowak ...	0	0	0	0	0	
4. Tvrsky ...	0	1	1	X	3	8. Olivier ...	X	X	0	X	3	
Total fights lost ... 12						Total fights lost ... 7						

*Jury* :—G. Breittmeyer (President), E. B. Milnes, W. H. C. Staveley, F. H. Townsend, R. Doyne.

*Scorer* :—C. Montgomerie.

## 2. FRANCE BEAT DENMARK.

## SCORES.

PRELIMINARY.—JULY 21.

DENMARK						<i>v.</i>	FRANCE					
—	5	6	7	8	—	—	1	2	3	4	—	
1. Levison ...	1	0	1	1	3	5. Alibert ...	0	0	1	0	1	
2. Ostrup ...	1	1	1	0	3	6. Stern ...	1	0	1	0	2	
3. Osier ...	0	0	0	1	1	7. Lippmann	0	0	1	1	2	
4. Sander ...	1	1	0	1	3	8. Gravier ...	0	1	0	0	1	
Total fights lost ... 10						Total fights lost ... 6						

*Jury* :—W. H. C. Staveley (President), E. B. Milnes, B. Cunliffe, J. Jenkinson, R. Doyne.

*Scorer* :—C. Trueman.

## 3. BELGIUM BEAT SWEDEN.

## SCORES.

PRELIMINARY.—JULY 21.

BELGIUM					v.	SWEDEN.					
—	5	6	7	8	—	—	1	2	3	4	—
1. Anspach ...	0	0	1	0	1	5. Carlberg ...	1	0	1	0	2
2. Beaurain ...	1	0	0	0	1	6. Lindblom	1	1	1	0	3
3. De Montigny	0	0	X	1	2	7. Peyron ...	0	1	X	1	3
4. Willems ...	1	1	0	0	2	8. Von Rosen	1	1	0	1	3
Total fights lost ...					6	Total fights lost ...					11

*Jury* :—Marquis of Chasseloup-Laubat (President), G. Alexander, F. Moore,  
C. F. Clay, G. Breittmeyer.

*Scorer* :—G. H. Ramsbottom.

## (4) UNITED KINGDOM BEAT GERMANY.

For the fight with Germany Mr. H. C. Haig was included in the British team, in the place of Mr. E. Seligman. The Germans have fought in several international matches since their first appearance at Athens in 1906, and they have made rapid progress in the acquisition of modern épée tactics, but they were quite overmatched by the English team. Herr Petri, a *gaucher*, fought well for his side, and defeated both Mr. Haig and Mr. Holt. Germany's only other success was in the assault between Herr Stohr and Mr. Daniell, but Herr Lichtenfels diminished the severity of the defeat by obtaining double hits with Mr. Daniell and Mr. Montgomerie.

## SCORES.

PRELIMINARY.—JULY 21.

GERMANY					v.	UNITED KINGDOM.					
—	5	6	7	8	—	—	1	2	3	4	—
1. De Bary ...	1	1	1	1	4	5. Daniell ...	0	X	0	1	2
2. Lichtenfels	X	1	1	X	4	6. Haig ...	0	0	1	0	1
3. Petri ...	1	0	0	1	2	7. Holt ...	0	0	1	0	1
4. Stohr ...	0	1	1	1	3	8. Montgomerie	0	X	0	0	1
Total fights lost ...					13	Total fights lost ...					5

*Jury* :—P. Ettlinger (President), A. Morin, G. Breittmeyer, Dr. Nagy.

*Scorer* :—C. Montgomerie.

## SEMI-FINAL ROUND.

## POOL I. —FRANCE BEAT ENGLAND.

So far as British fencers were concerned, the most interesting event of the Olympic meeting was the match between the United Kingdom and France. Since the match for the Coupe Internationale d'Épée was instituted in Paris in 1903 the French team have enjoyed a succession of victories in international meetings, broken only by a tie with the British team at Athens in 1906, in a match which the Frenchmen won on the fight off, and a draw with the Belgians at Ostend last year. But Great Britain has made a good fight against them on more than one occasion, and notably at Ostend last year, when the margin between them was only as three to two, and having regard to the improved form shown by our leading swordsmen this year there was some reason for hoping that the British team would come nearer to success than on any former occasion ; but the hope was not fulfilled. Misfortune overtook the British team in the first assault, in which Mr. Daniell faced M. Alibert, perhaps the most difficult of the French swordsmen. M. Alibert fences with the arm extended and the point in line, but he is quick to evade a "bind," and compels his opponent to give ground with a disengage in the line of *sixte* and a rapid advance. But Mr. Daniell successfully defended himself with passes of *contre de sixte* and *quarte*, and seizing an opportunity attacked with opposition in the low line. M. Alibert disengaged in the high line, and both combatants were hit on the body. The judges gave the hit against Mr. Daniell, though many of the spectators thought a *coup double* should have been given, and in a team fight there is much merit in a double hit. A similar incident occurred in the bout between Mr. Holt and M. Collignon, in which the Frenchman was the aggressor, and in this case also the judges decided against the Englishman. Mr. Haig, who also fences with point in line, adopted offensive tactics against M. Berger, but the French captain parried in *seconde* and riposted on the arm. Mr. Montgomerie then forced Dr. Olivier, and compelled him to retreat almost to the limit of *piste*. Finally, Dr. Olivier made an attack *en suivant*, but he was well stopped on the mask., and at the end of the first round the score was 3 to 1 in favour of the French team. M. Alibert quickly disposed of Mr. Haig with a hit on the arm, and then Mr. Holt faced M. Berger. Mr. Holt had the advantage in height and reach, and M. Berger's manœuvres to get within striking distance caused much amusement. For a time both combatants tried for the hand, but M. Berger, finding that his opponent was a past master in the game, adopted more ingenious tactics, and followed up a series of powerful counters of *seconde* with a sudden attack on the body. But Mr. Holt was ready with his

*coup d'arrêt* and the bout ended in a double hit. Mr. Montgomerie again came to the rescue of his side with a brilliant victory over M. Collignon, an attack with opposition in the high line arriving on the chest. Mr. Daniell was less fortunate with Dr. Olivier. He fenced patiently for an opening, and finally he attacked on the outside of the arm, but the point passed, and he was hit on the body in a counter attack. Half way through the match the French team led by six hits to three. Mr. Holt opened the third round with M. Alibert, and it was the most prolonged and keenly contested assault of the match. Mr. Holt's methods, always deliberately unorthodox, reached the point of eccentricity, but his judgment of distance was admirable, and he put the skill of his formidable adversary to the severest test. Gradually Mr. Holt was driven to the end of the track, where he made a vigorous attack in order to gain ground. M. Alibert jumped back, and Mr. Holt, thinking he was safely out of distance, momentarily lowered his blade. He was completely deceived, for M. Alibert, quick to take advantage of the opportunity, checked his retreat, and, straightening his arm with a rapid advance, got home his point full on the chest, It was a fine finish to a fine fight. Mr. Montgomerie then roused his countrymen to a high pitch of enthusiasm with a brilliant victory over the French captain. He kept a straight arm and point in line, and M. Berger sought to tire him with heavy beats on the blade ; but Mr. Montgomerie made a rapid advance, and deceiving M. Berger's *contre de seconde* with a *double*, got home his point on the body. Then followed a series of French victories, for Mr. Daniell lost to M. Collignon and M. Berger, and Mr. Haig was beaten by Dr. Olivier and M. Collignon, while Mr. Montgomerie lost his last fight to M. Alibert. The last assault went in favour of the English team, for Dr. Olivier made a desperate rush at Mr. Holt, and was promptly met with a *coup d'arrêt*.

## SCORES.

## SEMI-FINAL POOL (1).—JULY 22.

FRANCE					v.	UNITED KINGDOM.					
—	5	6	7	8	—	—	1	2	3	4	—
1. Alibert ...	0	0	0	0	0	5. Daniell ...	1	1	1	1	4
2. Berger ...	0	0	X	1	2	6. Haig ...	1	1	1	1	4
3. Collignon	0	0	0	1	1	7. Holt ...	1	X	1	0	3
4. Olivier ...	0	0	1	1	2	8. Montgomerie	1	0	0	0	1
Total fights lost ... 5						Total fights lost ... 12					

Jury :—G. de Lobsdorf (President), R. Nowak, G. Lindblom, Sander.  
Scorer :—G. L. Blake.

## POOL II.—BELGIUM BEAT ITALY.

SEMI-FINAL POOL (2).—JULY 22.

ITALY					v.	BELGIUM.					
—	5	6	7	8	—	—	1	2	3	4	—
1. Bertinetti	1	1	0	0	2	5. Anspach ...	0	0	0	0	0
2. Mangiarotti	1	0	1	X	3	6. Beaurain ...	0	1	1	1	3
3. Nowak ...	1	0	1	0	2	7. Feyerick ...	1	0	0	1	2
4. Olivier ...	1	0	0	1	2	8. Rom ...	1	X	1	0	3
Total fights lost ...					9	Total fights lost ...					8

*Jury* :—G. Breittmeyer (President), R. W. Doyne, A. Rawlinson, E. B. Milnes,  
*Scorer* :—P. Doyne.

## FINAL POOL.

## FRANCE BEAT BELGIUM.

SCORES.—JULY 23.

FRANCE					v.	BELGIUM.					
—	5	6	7	8	—	—	1	2	3	4	—
1. Alibert ...	0	0	0	0	0	5. Anspach ...	1	1	1	0	3
2. Gravier ...	0	1	0	1	2	6. Beaurain ...	1	0	0	0	1
3. Lippmann	0	1	0	1	2	7. Feyerick ...	1	1	1	0	3
4. Olivier ...	1	1	1	0	3	8. Rom ...	1	0	0	1	2
Total fights lost ...					7	Total fights lost ...					9

*Jury* :—W. H. C. Staveley (President), G. Renard, Marquis de Chasseloup-Laubat,  
 E. B. Milnes, B. Cunliffe.

*Scorer* :—G. L. Blake.

## ÉPÉE TEAM MATCHES FOR SECOND PLACE.

## (1) UNITED KINGDOM BEAT DENMARK.

The United Kingdom met Denmark in the morning, and the Danes, whose manly spirit and excellent fencing were much admired, made a gallant fight. It was fortunate for the home team that Mr. Montgomerie and Mr. Haig were again in good form, Mr. Haig lost only to M. Osier, and the only hit against Mr. Montgomerie was a double hit in his

encounter with M. Becker. Mr. Daniell won half his fights, defeating M. Osiier and M. Sander, but Mr. Holt fenced below his form and failed to win a bout. The United Kingdom led by three hits to one in the first round, but in the second and third rounds the Danes held their own, and the score was only seven to five against them when the last round began. Then Mr. Montgomerie placed his side beyond defeat by making a *coup double* with M. Becker, and in the next fight Mr. Daniell won the match by defeating M. Levison. Denmark won the last two fights, Mr. Haig losing to M. Osiier and Mr. Holt to M. Sander, and in the end the United Kingdom had a margin of only one point.

## SCORES.

## POOL FOR SECOND PLACE.—JULY 24.

DENMARK					v.	UNITED KINGDOM.					
—	5	6	7	8	—	1	2	3	4	—	
1. Becker ...	1	1	0	X	3	5. Daniell ...	0	0	1	1	2
2. Levisan ...	1	1	0	1	3	6. Haig ...	0	0	1	0	1
3. Osiier ...	0	0	0	1	1	7. Holt ...	1	1	1	1	4
4. Sander ...	0	1	0	1	2	8. Montgomerie	X	0	0	0	1
Total fights lost ...					9	Total fights lost ...					8

Jury :—Dr. Nagy (President), J. Rodocanachi, A. Pontenani, de Zulavsky, J. Doorman.

Scorer :—F. Moore.

## (2) UNITED KINGDOM BEAT BELGIUM.

This match, which took place in the afternoon after the final of the individual contest, ended in a win for the United Kingdom by nine hits to five, with three assaults unfinished. It was a result very creditable to the British team, for the Belgian swordsmen are formidable antagonists who have shown themselves to be nearly the equals of France on more than one occasion, and in their ten previous encounters with British teams at international meetings they have won seven matches and lost three. They made two changes in the team which lost to France, M. de Montigny, a clever left-handed fencer, and M. Bosmans, who depends upon well-regulated impetuosity and is an adept at "cutting the lines," taking the place of M. Beaurain and M. F. Feyerick. Mr. Egerton Castle (the captain) chose Mr. E. M. Amphlett to take the place of Mr. M. V. Holt in the British team. The choice was amply justified, for Mr. Amphlett was

in his best form, and contributed largely to the victory of his side. Both Mr. Daniell and Mr. Haig again fenced well, but Mr. Montgomerie was obviously feeling the effects of his severe trial in the individual final. Mr. Amphlett was hit on the sword arm by M. Anspach in his first fight. Mr. Daniell had a double hit with M. Bosmans, and Mr. Montgomerie failed to stop M. Rom's attack on the body. But Mr. Haig hit M. de Montigny *en pleine poitrine*, and the first round ended with three hits to two in favour of Belgium. Mr. Haig then equalised the score, for a double attack in his assault with M. Anspach was decided in favour of the Englishman. Mr. Amphlett then gave the United Kingdom a lead by a light touch on M. Bosmans' chest with a running attack, and Mr. Daniell, with a very pretty attack, hit M. de Montigny in a similar manner. But M. Rom hit Mr. Haig on the sword arm, and halfway through the match the score was five to four in favour of the United Kingdom. Mr. Montgomerie went for M. Anspach's foot, and was well stopped on the shoulder; but after a long fight with Mr. Amphlett M. de Montigny attacked with a disengage and was stopped on the neck. Mr. Daniell defeated M. Rom with a beat in *seconde* and attack on the low line, and Mr. Montgomerie stopped M. Bosmans' attack with a well-timed *coup d'arrêt* on the arm. Thus at the end of the third round the British team were safe from defeat with five hits against eight. In the first fight of the last round Mr. Amphlett beat M. Rom, and the match then being lost the remaining bouts were not contested. The United Kingdom thus won the silver medals.

## SCORES.

## POOL FOR SECOND PLACE.—JULY 24.

UNITED KINGDOM						v.	BELGIUM.						
—	5	6	7	8	—	—	1	2	3	4	—		
1. Amphlett...	1	0	0	0	1	5. Anspach ...	0	—	1	0	1		
2. Daniell ...	—	X	0	0	1	6. Bosman ...	1	X	—	1	3		
3. Haig ...	0	—	0	1	1	7. De Montigny	1	1	1	—	3		
4. Montgomerie	1	0	—	1	2	8. Rom ...	1	1	0	0	2		
Total fights lost ...						5	Total fights lost ...						9

*Jury* :—H. G. Berger (President), G. Breittmeyer, J. Rodocanachi, Van Rossem, Van Loben Sels.

*Scorer* :—G. Jacobs.



## III.—SABRE INDIVIDUAL.

In the individual sabre contests each bout was decided by three hits, and only hits above the hips were counted. The United Kingdom was represented by Mr. W. W. Marsh (the British champion), Lieut. E. Brookfield, R.N., Mr. A. C. Murray, Mr. C. A. Wilson, Mr. R. A. Badman, Mr. A. P. Chalke, Mr. D. W. Godfree, Mr. A. V. Keene, Lieut. L. Leith, R.N., and Mr. C. B. Notley. Mr. R. M. P. Willoughby, a member of the British sabre team, had not entered for the individual event, and Lieut. Feilmann, R.N., and Mr. Evan James were absentees. France sent some fine sabre players, including Comte de la Falaise (the French champion), Comte B. de Lesseps, and Comte I. de Lesseps. Both the first and second rounds were triumphs for the Hungarians, who claimed seven of the sixteen places in the semi-final round. Italy and France each obtained only two places, and though Bohemia had only one surviving representative, they had a fine sabre player in M. G. de Lobsdorf, who, it was confidently expected, would take a high place in the final. The performance of the English sabre players was extremely disappointing. Mr. Marsh showed excellent form in both rounds. He won his first pool with only one defeat against him, but he failed to get through the second, being defeated by M. G. de Lobsdorf and M. van de Voodt (Belgium), who makes remarkably good use of the point. Mr. Notley alone reached the semi-final round, and he is to be heartily congratulated upon his success.

## FIRST ROUND.

## SCORES.

## POOL I.—JULY 17.

		De Mas Matrie	Doorman	Flesch	V. Lada	Six	Tucek	Total Hits Against	Winners
De Mas Matrie ...	F.	/	0	1	1	0	1	3	—
Doorman ...	Hol.	1	/	1	0	0	0	2	2
Flesch ...	A.	0	0	/	0	0	0	0	1
V. Lada ...	Bo.	0	1	1	/	0	0	2	2
Six ...	Bel.	1	1	1	1	/	0	4	—
Tucek ...	Bo.	0	1	1	1	1	/	4	—

*Jury* :—B. Nagy (President), H. Pollock, A. Syson,  
*Scorer* :—D. Gordon.

## POOL 2.—JULY 17.

	Adam	P. Lada	Murray	Toth	V. D. Voodt	Total Hits Against	Winners
Adam ... .. G.	/	1	1	0	1	3	—
P. Lada ... .. Bo.	0	/	0	0	1	1	1
Murray ... .. U.K.	0	1	/	1	0	2	—
Toth ... .. Hun.	1	1	0	/	0	2	2
V. D. Voodt ... .. Bel.	0	0	1	1	/	2	2

On the tie for second and third places being fought off, Murray was beaten by Toth and Voodt.

*Jury* :—C. Moore (President), P. Royds, E. Brierley, W. Wright, A. G. Hall.

*Scorer* :—A. C. Amy.

## POOL 3.—JULY 17.

	Dina	Godfree	Grade	Jack	Labouchere	Renaud	Total Hits Against	Winners
Dina ... .. I.	/	0	1	1	0	1	3	—
God free ... .. U.K.	1	/	1	1	1	1	5	—
Grade ... .. Bel.	0	0	/	1	1	0	2	2
Jack ... .. G.	0	0	0	/	1	1	2	2
Labouchere ... .. Hol.	1	0	0	0	/	0	1	1
Renaud ... .. F.	0	0	1	0	1	/	2	—

On the tie for second and third places being fought off, Renaud was beaten by Grade and Jack.

*Jury* :—J. Jenkinson (President), F. J. Brett, C. Trueman, S. de Joux, A. Rawlinson.

*Scorer* :—C. Montgomerie.

## POOL 4.—JULY 17.

				Krenckle	Lateux	Lichtenfels	Marsh	Schoemaker	Total Hits Against	Winners
Krenckle	...	...	D.	/	1	1	1	0	3	—
Lateux	...	...	F.	0	/	1	1	0	2	2
Lichtenfels	...	...	G.	0	0	/	1	1	2	—
Marsh	...	...	U.K.	0	0	0	/	1	1	1
Schoemaker	...	...	Hol.	1	1	0	0	/	2	2

On the tie for second and third places being fought off, Lichtenfels was beaten by Lateux and Schoemaker.

*Jury* :—B. Cunliffe (President), A. Pontenani, F. Moore.

*Scorer* :—W. Bean.

## POOL 5.—JULY 18.

				De Jong	Langevin	A. Pirzio-Biroli	Schwartz-Nielsen	Total Hits Against	Winners
De Jong	...	...	Holl.	/	0	0	1	1	1
Langevin	...	...	F.	1	/	1	1	3	—
A. Pirzio-Biroli	...	...	I.	1	0	/	0	1	1
Schwartz-Nielsen	...	...	D.	0	0	1	/	1	1

*Jury* :—Nagy (President), J. Jenkinson, A. Rawlinson.

*Scorer* :—P. Doyne.

## POOL 6.—JULY 18.

I				De la Falaise	Petri	Szantay	Van Loben Sels	Van Towme	Total Hits Against	Winners
De la Falaise...	...	F.		0	1	0	0	0	1	1
Petri ...	...	G.	1	0	0	0	1	1	2	3
Szantay ...	...	Hun.	0	1	0	0	0	0	1	1
Van Loben Sels ...	...	Hol.	1	1	1	0	1	1	4	—
Van Towme ...	...	Bel.	1	0	1	0	0	0	2	—

*Jury* :—B. Cunliffe (President), A. H. Corble, A. Florio, S. de Joux, C. Trueman.  
*Scorer* :—G. L. Blake.

## POOL 7.—JULY 18.

I			Badman	Ceccherini	De Bary	Foldes	I. de Lesseps	Van Minden	Total Hits Against	Winner
Badman ...	...	U.K.	0	1	1	1	0	0	3	3
Ceccherini ...	...	I.	0	0	0	1	0	0	1	2
De Bary ...	...	G.	0	1	0	1	1	1	4	—
Foldes ...	...	Hun.	0	0	0	0	0	0	0	1
I. de Lesseps...	...	F.	1	1	0	1	0	1	4	—
Van Minden ...	...	Hol.	1	1	0	1	0	0	3	—

On the tie for third place being fought off, Badman beat Van Minden.

*Scorer* :—A. L. Todhunter.

## POOL 8.—JULY 18.

	Bertinetti	B. de Lesseps	Gates	Krunert	Wilson	Zulavsky	Total Hits Against	Winners
Bertinetti ... I.	/	0	0	0	0	1	1	1
B. de Lesseps ... F.	1	/	0	0	0	0	1	1
Gates ... S.A.	1	1	/	1	1	1	5	—
Krunert ... G.	1	1	0	/	1	0	3	—
Wilson ... U.K.	1	1	0	0	/	1	3	—
Zulavsky ... Hun.	0	1	0	1	0	/	2	3

*Jury* :—H. Pollock (President), E. Brierley, S. de Joux.

*Scorer* :—W. Wright

## POOL 9.—JULY 18.

	De St. Brisson	Du Bosch	Gerde	Keene	Ostrup	Von Blijenburg	Total Hits Against	Winners
De St. Brisson... F.	/	1	1	1	1	1	5	—
Du Bosch ... Bel.	0	/	1	1	1	0	3	—
Gerde ... Hun.	0	0	/	0	1	0	1	1
Keene... U.K.	0	0	1	/	1	1	3	—
Ostrup.. D.	0	0	0	0	/	1	1	1
Von Blijenburgh Hol.	0	1	1	0	0	/	2	3

*Jury* :—Dr. Nagy (President), D. Gordon, J. Jenkinson.

*Scorer* :—C. Hancock.

## POOL 10.—JULY 18.

	Anspach	Apati	Brookfield	De Lobsdorf	Mikorski	Pietro Santa	Stohr	Van Schreven	Total Hits Against	Winners
Anspach ... Bel.	/	0	1	1	1	0	0	0	3	2
Apati ... Hun.	1	/	1	1	0	0	0	0	3	2
Brookfield ... U.K.	0	0	/	1	1	1	0	1	4	—
De Lobsdorf Bo.	0	0	0	/	0	0	0	0	0	1
Mikorski ... F.	0	1	0	1	/	1	1	1	5	—
Pietro Santa I.	1	1	0	1	0	/	1	1	4	—
Stohr ... G.	1	1	1	1	0	1	/	0	4	—
Van Schreven Hol.	1	1	0	1	0	0	1	/	4	—

☞ Signifies "No fight."

Jury :—43. Cunliffe (President), A. Florio, A. H. Corble.  
Scorer :—J. Pollock.

## POOL 11—JULY 18.

	Fuchs	Lockhart Leith	Moldenhauer	Pinelli	Tvrsky	Van Hulstijn	Total Hits Against	Winners
Fuchs ... Hun.	/	0	0	0	0	0	0	1
Lockhart Leith ... U.K.	1	/	1	1	1	1	5	—
Moldenhauer ... G.	1	0	/	1	1	1	4	—
Pinelli ... I.	1	0	0	/	1	1	3	—
Tvrsky ... Bo.	1	0	0	0	/	1	2	3
Van Hulstijn ... Hol.	1	0	0	0	0	/	1	2

Jury :—C. Moore (President), F. J. Brett, A. G. Hall.  
Scorer :—A. L. Todhunter.

## POOL 12.—JULY 18.

			Chapuis	Naumann	Notley	Schjebal	Simonson	Van Rossem	Total Hits Against	Winners
Chapuis...	...	F.		0	1	1	0	0	2	—
Naumann	...	G.	1		1	1	1	1	5	—
Notley	...	U.K.	0	0		0	1	1	2	2
Schjebal	...	Bo.	0	0	1		0	1	2	2
Simonson	...	Bel.	1	0	0	1		1	3	—
Van Rossem	...	Hol.	1	0	0	0	0		1	1

*Jury* :—Dr. Nagy (President), E. Brierley, D. Gordon, A. Kerstevan, F. J. Brett.  
*Scorer* :—G. B. Dibblee.

## POOL 13.—JULY 18.

			Chalke	De Beaufort	Tucek	Nowak	Perrodon	Werkner	Schon	Total Hits Against	Winners
Chalke	U.K.			0	1	1	1	1	1	5	—
De Beaufort	Hol.		1		1	1	0	1	0	4	—
Tucek	...	Bo.	0	0		1	1	1	1	4	—
Nowak	...	I.	0	0	0		1	0	1	2	2
Perrodon...		F.	0	1	0	0		1	1	3	—
Werkner	Hun.		0	0	0	1	0		0	1	1
Schon	...	G.	0	1	0	0	0	1		2	2

*Jury* :—J. Jenkinson (President), E. Brierley, S. de Joux.  
*Scorer* :—G. Alexander.

## SECOND ROUND.

## POOL 1.—JULY 20.

	Schoemacker	Fuchs	Notley	Grade	Lateux	Total Hits Against	Winners
Schoemacker ... .. Hol.	/	0	1	1	0	2	—
Fuchs ... .. Hun.	1	/	0	0	0	1	1
Kotley ... .. U.K.	0	1	/	0	1	2	2
Grade ... .. Bel.	0	1	1	/	0	2	—
Lateux ... .. F.	1	1	0	1	/	3	—

On the tie for second place being fought off, Notley beat Schoemacker and Grade.

*Jury* :—B. Cunliffe (President), H. Pollock, E. Brierley.

*Scorer* :—A. Cresswell.

## POOL 2.—JULY 20.

	Badman	Van Rossem	Jack	Werkner	Foldes	Total Hits Against	Winners
Badman ... .. U.K.	/	1	0	1	1	3	—
Van Rossem ... .. Hol.	0	/	0	1	1	2	—
Jack ... .. G.	1	1	/	1	1	4	—
Werkner ... .. Hun.	0	0	0	/	0	0	1
Foldes ... .. Hun.	0	0	0	1	/	1	2

*Jury* :—Dr. Nagy (President), P. Royds, D. Gordon.

*Scorer* :—A. C. Amy.





FOOTBALL.—THE UNITED KINGDOM ELEVEN, WINNERS OF THE ASSOCIATION'S CHALLENGE TROPHY.

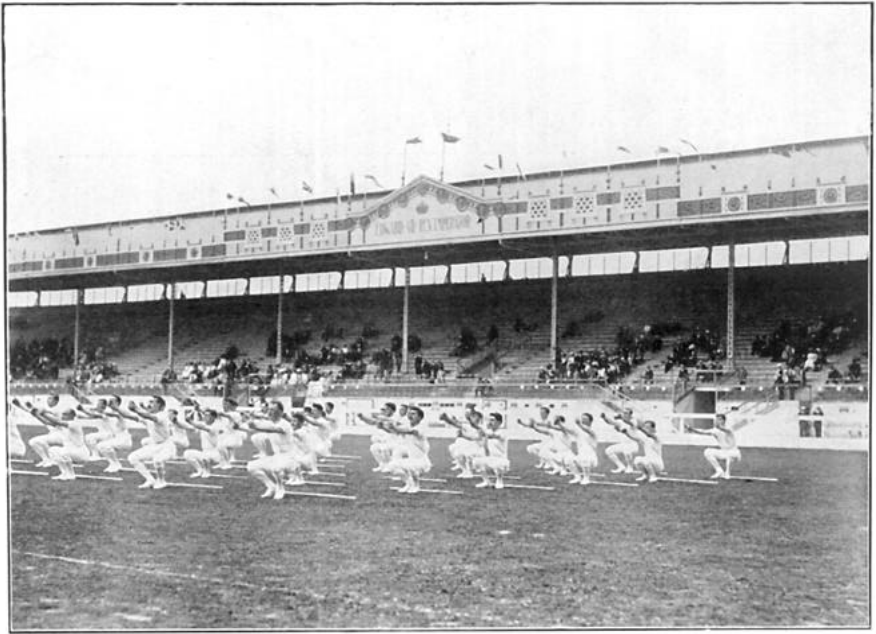

GYMNASTICS.—FRANCE IN THE TEAM COMPETITION.

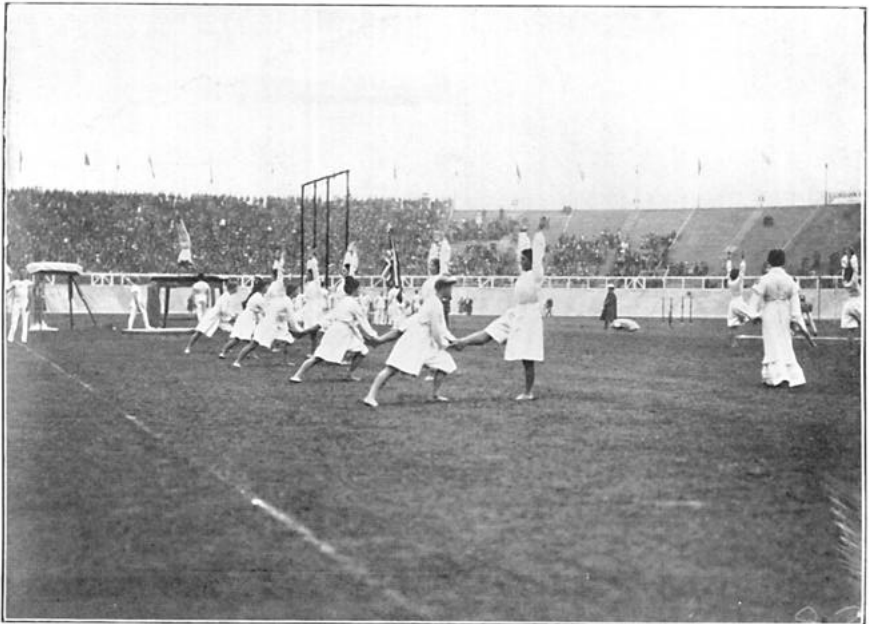

GYMNASTICS.—EXERCISES BY THE DANISH LADIES.

## POOL 3.—JULY 20.

	Van de Voodt	Marsh	Nowak	De Jong	De Lobsdorf	Total Hits Against	Winners
Van de Voodt ... .. Bel.		0	0	0	1	1	1
Marsh ... .. U. K.	1		0	0	1	2	—
Nowak ... .. I.	1	1		1	0	3	—
De Jong ... .. Hol.	1	1	0		1	3	—
De Lobsdorf ... .. Bo.	0	0	1	0		1	1

*Jury* : —C. Moore (President), A. Syson, S. de Joux.

*Scorer* : —G. L. Blake.

## POOL 4. —JULY 20.

	Zulavsky	B. de Lesseps	Tvrsky	Schjebal	Total Hits Against	Winners
Zulavsky ... .. Hun.		1	0	0	1	2
B. de Lesseps ... .. F.	0		0	0	0	1
Tvrsky ... .. Bo.	1	1		1	3	—
Schjebal ... .. Bo.	1	1	0		2	—

*Jury* : —J. Jenkinson (President), A. Pontenani, F. J. Brett,

*Scorer* : —C. Montgomerie.

## POOL 5.—JULY 20.

	P. Lada	Anspach	Gerde	Schon	Ceccherini	Total Hits Against	Winners
P. Lada .. .. . Bo.	/	0	1	0	1	2	—
Anspach .. .. . Bel.	1	/	1	1	1	4	—
Gerde .. .. . Hun.	0	0	/	0	0	0	1
Schon .. .. . G.	1	0	1	/	1	3	—
Ceccherini .. .. . I.	0	0	1	0	/	1	2

*Jury* : —Dr. Nagy (President), C. Trueman, W. Wright.

*Scorer* : —F. Moore.

## POOL 6.—JULY 20.

	Labouchere	Flesch	Szantay	Von Blijenburgh	Toth	Total Hits Against	Winners
Labouchere .. .. . Hol.	/	1	1	0	1	3	—
Flesch .. .. . A.	0	/	1	1	1	3	—
Szantay .. .. . Hun.	0	0	/	0	1	1	2
Von Blijenburgh .. .. . Hol.	1	0	1	/	1	3	—
Toth .. .. . Hun.	0	0	0	0	/	0	1

*Jury* : —J. Jenkinson (President), P. Royds, D. Gordon, A. Syson, A. H. Corble.

*Scorer* : C. Montgomerie.

## POOL 7.—JULY 20.

	V. Lada	Pirzio-Biroli	Bertinetti	Doorman	Petri	Total Hits Against	Winners
V. Lada ... .. Bo.	/	1	1	1	0	3	—
Pirzio-Biroli ... .. I.	1	/	1	1	1	4	—
Bertinetti ... .. I.	0	0	/	0	0	0	1
Doorman ... .. Hol.	0	0	1	/	1	2	2
Petri ... .. G.	1	0	1	0	/	2	—

On the tie for second place being fought off, Doorman beat Petri.

*Jury* : —C. Moore (President), A. Pontenani, S. de Joux.

*Scorer* : —A. C. Amy.

## POOL 8.—JULY 20.

	Apati	Ostrup	Schwartz-Nielsen	De la Falaise	Total Hits Against	Winners
Apati ... .. Hun.	/	1	0	0	1	—
Ostrup ... .. D.	0	/	0	1	1	2
Schwartz-Nielsen ... .. D.	1	1	/	1	3	—
De la Falaise ... .. F.	1	0	0	/	1	1

On the tie for first and second places being fought off, Apati was beaten by Ostrup and De la Falaise, and Ostrup by De la Falaise.

*Jury* : —B. Cunliffe (President), E. Brierley, F. J. Brett.

*Scorer* : —G. L. Blake.

## THE SEMI-FINAL AND FINAL ROUNDS.

Mr. C. Barry Notley, who alone of all the British sabre players reached the semi-final round, failed to make further progress, and it was generally expected that the winner of the gold medal would be either M. Fuchs, of Hungary, or M. G. de Lobsdorf, of Bohemia. The sabre play in their assault was very fine. The Hungarian is a small man, and he was at a considerable disadvantage in meeting the tall and thin Bohemian; but he fenced very cleverly, and when the time limit had expired neither of them had obtained three hits. In accordance with the rules a defeat was recorded against each of them. M. Fuchs defeated all his other opponents. M. de Lobsdorf was not as fortunate, for he was defeated by M. Toth and M. Zulavsky, both of Hungary, the latter of whom lost only to M. Fuchs, with whom he tied for the first place. The tie was decided in one hit, and M. Fuchs won the gold medal by parrying his opponent's attack and riposting with a cut on the head. M. Zulavsky gained the silver medal, and the other competitors in the final received bronze medals.

## SCORES.

POOL I.—JULY 23.

	Werkner	Notley	Bertinetti	B. de Lesseps	Szantay	De la Falaise	Fuchs	Foldes	Total Hits Against	Winners
Werkner Hun.		0	0	0	1	0	1	0	2	2
Notley U.K.	1		1	0	0	1	1	1	5	—
Bertinetti I.	1	0		0	1	0	1	1	4	—
B. de Lesseps F.	1	1	1		0	1	1	1	6	—
Szantay Hun.	0	1	0	1		1	0	0	3	3
De la Falaise F.	1	0	1	0	0		1	0	3	3
Fuchs Hun.	0	0	0	0	1	0		0	1	1
Foldes Hun.	1	0	0	0	1	1	1		4	—

Jury : —Col. Rolt (President) , B. Cunliffe, C. Trueman, Dr. Nagy, W. Wright.

Scorer : —F. Moore.

	Ceccherini	Gerde	Voodt	Toth	Zulavsky	Doorman	De Lobsdorf	Ostrup	Total Hits Against	Winners
Ceccherini .. I.	/	1	—	—	1	—	1	1	ret	ired
Gerde ... Hun.	0	/	0	1	1	0	1	0	3	—
Voodt ... Bel.	—	1	/	1	1	1	1	1	6	—
Toth ... Hun.	—	0	0	/	0	1	0	1	2	1
Zulavsky ... Hun.	0	0	0	1	/	0	1	0	2	1
Doorman ... Hol.	—	1	0	0	1	/	0	0	2	1
De Lobsdorf Bo.	0	0	0	1	0	1	/	0	2	1
Ostrup ... D.	0	1	0	0	1	1	1	/	4	—

*Jury* : —Col. Rolt (President), J. Jenkinson, D. Gordon, C. Trueman, S. de Joux.  
*Scorer* : —E. Brierley.

THE FINAL.

SCORES.—FINAL POOL.—JULY 24.

Won by Fuchs (Hungary).

	Fuchs	Werkner	Szantay	De la Falaise	Toth	Zulavsky	Doorman	De Lobsdorf	Total Hits Against	Places
Fuchs ... Hun.	/	0	0	0	0	0	0	X	1	1
Werkner ... Hun.	1	/	1	0	1	1	0	1	5	6
Szantay ... Hun.	1	0	/	0	0	1	X	1	4	4
De la Falaise F.	1	1	1	/	0	1	1	1	6	7
Toth ... Hun.	1	0	1	1	/	1	0	0	4	5
Zulavsky ... Hun.	1	0	0	0	0	/	0	0	1	2
Doorman ... Hol.	1	1	X	0	1	1	/	1	6	7
De Lobsdorf Bo.	X	0	0	0	1	1	0	/	3	3

*Jury* : —J. Jenkinson (President), H. Pollock, B. Cunliffe, A. Syson.  
*Scorer* : —G. L. Blake.

## IV.—SABRE TEAM COMPETITION.

## PRELIMINARY HEATS.

The United Kingdom were drawn against Italy, and although they were somewhat severely defeated, they fenced in far better style than the appended score seems to indicate. Mr. Marsh won his first fight with Signor Ceccherini—the only success which was obtained in the first round—and although he failed to gain another victory he had the ill-luck to lose on the odd hit. A similar fate befell Mr. Evan James, whose only win was against Signor Olivier. Mr. A. C. Murray lost his first assault with Signor Olivier, but like Mr. Montgomerie in the épée match, he saved his side from an overwhelming defeat, by winning his other three fights.

(1) ITALY BEAT THE UNITED KINGDOM.

## SCORES.

PRELIMINARY.—JULY 21.

ITALY					<i>v.</i>	UNITED KINGDOM.					
—	5	6	7	8	—	—	1	2	3	4	—
1. Bertinetti ...	0	0	1	0	1	5. James ...	1	1	0	1	3
2. Ceccherini	0	1	1	0	2	6. Marsh ...	1	0	1	1	3
3. Olivier ...	1	0	0	0	1	7. Murray ...	0	0	1	0	1
4. Biroli ...	0	0	1	0	1	8. Wilson ...	1	1	1	1	4
Total fights lost ... 5						Total fights lost ... 11					

*Jury* : —Dr. Nagy (President), A. Pontenani, A. Florio, Colonel Rolt.*Scorer* : —G. L. Blake.

(2) FRANCE BEAT BELGIUM.

## SCORES.

PRELIMINARY.—JULY 21.

BELGIUM					<i>v.</i>	FRANCE.					
—	5	6	7	8	—	—	1	2	3	4	—
1. Du Bosch ...	0	1	0	1	2	5. De la Falaise ...	1	1	0	1	3
2. Grade ...	0	0	1	1	2	6. B. de Lesseps...	0	1	0	0	1
3. Van Towme ...	1	1	1	1	4	7. Perrodon ...	1	0	0	0	1
4. Van de Voodt...	0	1	1	0	2	8. Renaud ...	0	0	0	1	1
Total fights lost ... 10						Total fights lost ... 6					

*Jury* : —Colonel Rolt (President), B. Cunliffe, J. Jenkinson, C. Moore, H. Pollock.*Scorer* : —F. Moore.



(3) BOHEMIA BEAT HOLLAND.  
SCORES.

PRELIMINARY.—JULY 21.

BOHEMIA						v.	HOLLAND.					
—	5	6	7	8	—	—	1	2	3	4	—	
1. P. Lada ...	1	1	0	1	3	5. Doorman ...	0	1	1	0	2	
2. V. Lada ...	0	1	0	1	2	6. De Jong ...	0	0	1	0	1	
3. De Lobsdorf ...	1	0	0	0	1	7. Van Rossem ...	1	1	1	1	4	
4. Schjebal ...	1	1	0	0	2	8. Van Loben Sels	0	0	1	1	2	
Total fights lost ... 8						Total fights lost ... 9						

*Jury* : —Dr. Nagy (President), B. Cunliffe, C. Moore, W. Wright, H. Brierley.*Scorer* : —F. Moore.

## (4) HUNGARY BEAT GERMANY.

This was a very remarkable match from the fact that, as far as my experience goes, it is the first time one international team has fought another without receiving a single scratch.

SCORES.

PRELIMINARY.—JULY 22.

GERMANY						v.	HUNGARY.					
—	5	6	7	8	—	—	1	2	3	4	—	
1. De Bary ...	1	1	1	—	3	5. Fuchs ...	0	—	—	0	0	
2. Kreunert ...	—	1	1	—	2	6. Gerde ...	0	0	—	—	0	
3. Petri ...	—	—	1	1	2	7. Toth ...	0	0	0	—	0	
4. Jack ...	1	—	—	1	2	8. Werkner ...	—	—	0	0	0	
Total fights lost ... 9						Total fights lost ... 0						

*Jury* : —Col. Rolt (President), D. Gordon, S. de Joux, A. Pontenani, A. Florio.*Scorer* : —F. C. Reynolds.

## SEMI-FINAL ROUND.

In the semi-final round Bohemia defeated the French team after an exciting finish. The Bohemians were secure from defeat, with the score at five to eight in their favour, when but two bouts remained to be contested. Then Comte B. de Lesseps obtained a brilliant victory over the

formidable M. G. de Lobsdorf by three hits to one, scoring each time with the point. In the last assault M. Perrodon had to defeat M. Schejbal in order to make a tie, and the excitement was intense when the score was announced as two hits against each. M. Schejbal obtained the last hit, and Bohemia secured a well-deserved victory by two points.

## (1) BOHEMIA BEAT FRANCE.

## SCORES.

SEMI-FINAL (1).—JULY 22.

BOHEMIA						<i>v.</i>	FRANCE.						
—	5	6	7	8	—	—	1	2	3	4	—		
1. P. Lada ...	1	0	1	1	3	5. De la Falaise	0	1	1	0	2		
2. V. Lada ...	0	0	1	0	1	6. B. de Lesseps	1	1	0	0	2		
3. De Lobsdorf	0	1	0	0	1	7. Perrodon ...	0	0	1	1	2		
4. Schjebal ...	1	1	0	0	2	8. Renaud ...	0	1	1	1	3		
Total fights lost ...						7	Total fights lost ...						9

*Jury* :—Col. Rolt (President), C. Moore, J. Jenkinson, E. Brierley, B. Cunliffe.

*Scorer* :—G. Jacobs.

## (2) HUNGARY BEAT ITALY.

## SCORE.

SEMI-FINAL (2).—JULY 22.

ITALY						<i>v.</i>	HUNGARY.						
—	5	6	7	8	—	—	1	2	3	4	—		
1. Bertinetti ...	0	0	1	1	2	5. Foldes ...	1	0	1	0	2		
2. Ceccherini	1	1	1	1	4	6. Fuchs ...	1	0	1	0	2		
3. Olivier ...	0	0	1	1	2	7. Gerde ...	0	0	0	1	1		
4. Biroli ...	1	1	0	1	3	8. Toth ...	0	0	0	0	0		
Total fights lost ...						11	Total fights lost ...						5

*Jury* :—Col. Rolt (President), B. Cunliffe, A. Pontenani, C. Moore, Dr. Nagy.

*Scorer* :—F. Moore.

FINAL.  
HUNGARY BEAT BOHEMIA.

SCORES.

FINAL.—JULY 23.

HUNGARY						v.	BOHEMIA.					
—	5	6	7	8	—	—	1	2	3	4	—	
1. Fuchs ...	1	0	0	0	1	5. De Lobsdorf	0	0	0	1	1	
2. Gerde ...	1	0	1	0	2	6. Tucek ...	1	1	0	1	3	
3. Toth ...	1	1	0	1	3	7. V. Lada ..	1	0	1	0	2	
4. Werkner ...	0	0	1	0	1	8. Schejbal ...	1	1	0	1	3	
Total fights lost ... 7						Total fights lost ... 9						

*Jury*:—Col. Rolt (President), B. Cunliffe, C. Truman, S. de Joux.

*Scorer*:—A. C. Amy.

## POOLS FOR SECOND PLACE.

Owing to the method of drawing heats for the team fights, in accordance with the published regulations, it was fair and necessary in these competitions that countries defeated by the winning team should meet each other and fight extra pools for the second place. The Belgians had readily agreed to this condition in the épée team matches; but the Bohemians, in the sabre-team matches, declined to accept it, forgetting that if the luck of the draw had brought them against Hungary in a preliminary round, they would not have been in the final at all. The silver medals were therefore awarded to the Italian team, who beat Germany.

SCORES.

POOL FOR SECOND PLACE.—JULY 24

GERMANY						v.	ITALY.					
—	5	6	7	8	—	—	1	2	3	4	—	
1. De Bary ...	1	0	1	1	3	5. Nowak ...	0	—	0	0	0	
2. Jack ...	—	1	X	0	2	6. Biroli ...	1	0	—	0	1	
3. Kreunert ...	1	—	1	1	3	7. Olivier ...	0	X	0	—	1	
4. Petri ...	1	1	—	0	2	8. Bertinetti ...	0	1	0	1	2	
Total fights lost ... 10						Total fights lost ... 4						

*Jury*:—Col. Rolt (President), B. Cunliffe, E. Brierley, S. de Joux, J. Jenkinson.

*Scorer*:—G. L. Blake

## V.—FOIL DISPLAY,

The Committee of the A.F.A. decided that the rules and conventions of foil-play rendered that weapon unsuitable for international competition. To base decisions purely on the hits scored encourages a degraded form of foil-play, and the differences of style in so many nations would have made it an invidious matter to take form into consideration. It was therefore decided to invite the various nations to select two representatives to take part in a foil display.

Entries were received from thirteen different countries. The selection of the United Kingdom representatives was entrusted to Mr. W. H. C. Staveley, who, after preliminary trials, submitted the names of J. Jenkinson (Amateur Champion 1902, 1903, 1904, retiring undefeated) and R. L. Montgomerie (Amateur, Champion 1905, 1908) to the A.F.A., who approved of his choice. M. Okker, of Holland, replaced, in the second bout, Herr F. Flesch, of Austria, who unfortunately could not take part in the display.

The display took place at Prince's Galleries, Piccadilly, on the evening of July 23. Miss Millicent Hall (Lady Foil Champion 1907, 1908), by special invitation, fenced with J. Jenkinson, and gave an exhibition of sound foil-play. The form shown by Montgomerie, in spite of a week's continuous épée-play, fully justified his selection, and his assault with J. Jenkinson, whose fencing was as correct and brilliant as ever, was quite equal to that of any other country. It is of interest to record that of the twelve countries who took part, eight fought in the French style, and four used the Italian arm and methods. Mr. A. S. Cope, A.R.A., drew the design for the programme cover, which is reproduced in later pages of this Report.

The programme was arranged as follows :—

## PART I.

1.	UNITED KINGDOM	...	...	...	Mr. J. Jenkinson.
	”	...	...	...	Mr. R. L. Montgomerie.
2.	HOLLAND	...	...	...	Mons. S. Okker.
	NORWAY	...	...	...	Mr. H. Bergsland.
3.	BOHEMIA	...	...	...	Herr V. Goppold de Lobsdorf.
	”	...	...	...	Herr J. Lada.
4.	DENMARK	...	...	...	Mr. Einar Levison, M.A.
	”	...	...	...	Lieut. H. Sander.
5.	BELGIUM	...	...	...	Mons. Berré.
	”	...	...	...	Mons. Dolori.
6.	ITALY...	...	...	...	Signor R. Nowak.
	” ...	...	...	...	Signor A. Olivier.

## PART II.

- |                                 |     |     |     |     |                           |
|---------------------------------|-----|-----|-----|-----|---------------------------|
| 1. SOUTH AFRICA                 | ... | ... | ... | ... | Mr. W. P. Gate.           |
| CANADA                          | ... | ... | ... | ... | Mr. P. E. Nobbs.          |
| 2. HOLLAND                      | ... | ... | ... | ... | Mons. S. Okker            |
| "                               | ... | ... | ... | ... | Mons. Dringen.            |
| 3. HUNGARY                      | ... | ... | ... | ... | Herr P. Toth.             |
| "                               | ... | ... | ... | ... | Herr B. Zulavsky.         |
| 4. GERMANY                      | ... | ... | ... | ... | Herr A. Naumann,          |
| "                               | ... | ... | ... | ... | Herr J. Erckrath de Bary. |
| 5. LADY FOIL CHAMPION OF UNITED |     |     |     |     |                           |
| KINGDOM 1907, 1908              | ... | ... | ... | ... | Miss Millicent Hall.      |
| FOIL CHAMPION OF UNITED KING-   |     |     |     |     |                           |
| DOM 1902, 1903, 1904            | ... | ... | ... | ... | Mr. J. Jenkinson          |
| 6. FRANCE                       | ... | ... | ... | ... | Mons. Quenessen.          |
| "                               | ... | ... | ... | ... | Dr. E. Olivier.           |

Mr. W. H. C. Staveley directed the assaults, and among the large and brilliant company present were General Brugère, of the French Ministry of War, Sir Cosmo Duff Gordon, Sir Frederick Pollock, M. Henri-Georges Berger, Dr. Bela Nagy, and Captain Alfred Hutton, President of the Amateur Fencing Association.

Fencing is one of those sports in which England is almost exactly in the position towards other countries which they have held towards us, until quite lately, in several other forms of sport. For if we can claim to have begun their education in some directions in which the pupil has occasionally outdone the master, it is they who have taught us all we know of fencing ; and the Olympic competitions of 1908 were the most important ever organised in this country. It is, therefore, appropriate that I should add a few words of suggestion for the future in this respect out of regard for the debt all British fencers feel to foreign swordsmen.

Team competitions, both with épée and sabre, should in future precede all individual competitions with the same weapons in the programme of the Tournament. There are several reasons for this. Many good judges attach more importance to the individual fighting ; no competitor cares to face the possibility of an individual pool and a team fight in the same afternoon ; acquaintance with individual peculiarities in sword-play would confer an undue advantage on an opponent in a team fight, and this advantage is removed by setting the individual contests last. Finally, all teams defeated by the winning team should fight off for second honours ; and in such contests it is eminently desirable that the element of luck should be as far as possible eliminated.

We had ninety-nine entries for the épée and ninety-five for the sabre individual competitions, which made it necessary to eliminate five men out of eight in the preliminary pools, and three out of five in the second round. This could be avoided by limiting the entries from each country to eight instead of twelve—quite a sufficiently representative number. Again, the total in each pool need not be limited to eight, and final pools should consist of nine, so that three swordsmen may qualify from each of three semi-final pools. When the time available is sufficiently long it is also advisable to avoid asking any competitor to fight with both épée and sabre on the same day.

With regard to the weapons used, the modern “pommeau” of the épée needs very careful consideration by any committee drawing up the measurements allowable for future contests ; and the same caution should be observed with regard to the weight of the sabres, for both the Hungarian and the Italian sabres used in 1908 were much lighter than usual, and the Hungarian sabre-play was the most brilliant feature of the Olympic competitions.

The duties of the Director of Combats and of the jury generally were stated in the original Fencing Rules, and have been amplified in the form in which they are published in this volume. They need very careful consideration in future meetings, and should be definitely codified and accepted some time before competitions begin.

## FOOTBALL.

### I.—ASSOCIATION.

#### FIRST ROUND.

Hungary and Bohemia had to scratch, owing to political trouble in the Balkans, and the eight original entries were thus reduced to six.

#### (1) DENMARK BEAT FRANCE (B) BY 9 TO 0.

##### DENMARK.

L. Drescher (Copenhagen F.C.), goal ;  
 C. Buchwald (Academicals),  
 H. Hansen (93 Club), backs •  
 H. L. Bohr (Academicals),  
 K. Middelboe (Copenhagen F.C.) (capt.),  
 N. Middelboe (Copenhagen F.C.), half-backs ;  
 N. O. Nielsen (Copenhagen F.C.),  
 A. W. Lindgreen (93 Club),  
 S. E. Nielsen (Frem F.C.),  
 V. Wolffhagen (Copenhagen F.C.),  
 M. Andersen (Frem F.C.), forwards.

##### FRANCE (B TEAM).

F. Desrousseaux (U.S. Tourquennoise), goal ;  
 J. Verlet (C.A. de Paris) (capt.),  
 Ch. Bilot (C.A. de Paris), backs ;  
 S. Dastarac (Gallia Club);  
 R. Gressier (R.C. de Calais),  
 J. Vialaret (C.R. de Paris), half-backs ;  
 P. Six (Olympique de Lillois),  
 A. Jenicot (R.C. de Roubaix),  
 H. Holgard (Amiens A.C.),  
 P. Marthaux (U.S. Boulonnaise),  
 A. Filez (U.S. Tourquennoise), forwards.

Referee : Mr. T. Kyle (Berks and Bucks). Linesmen : Messrs. E. C. Jarvis (Hampshire) and L. F. Morrison (Herts).

On the afternoon of October 19, after twelve minutes, N. Middelboe scored the first goal for the Danes. Five minutes later Wolffhagen kicked the second, and soon afterwards the third. Bohr made it four to love by half-time. Bohr and N. Middelboe again increased the total after the interval, and the Danes kept on shooting till the finish, when they won by 9 to 0. The French were not able to play their best team, and only troubled the Danish goalkeeper two or three times during the game. The turf in the centre of the Stadium was slippery, and the weather both misty and uncomfortable.

## (2) UNITED KINGDOM BEAT SWEDEN BY 12 TO 1.

## UNITED KINGDOM.

H. P. Bailey (Leicester Fosse), goal ;  
 W. S. Corbett (Birmingham),  
 H. Smith (Oxford City), backs ;  
 K. R. G. Hunt (Wolverhampton Wanderers),  
 F. W. Chapman (South Nottinghamshire),  
 R. M. Hawkes (Luton), half-backs ;  
 A. Berry (Oxford University),  
 V. J. Woodward (Tottenham Hotspur),  
 H. Stapley (Glossop),  
 C. Purnell (Clapton),  
 H. P. Hardman (Northern Nomads), forwards.

## SWEDEN.

Oscar Bengtson (Bothenburg), goal ;  
 A. Fjaestad (Stockholm),  
 T. Malm (Stockholm), backs ;  
 Sven Olsson (Gothenburg),  
 H. Lindman (Uppsala),  
 O. Olsson (Eskilstuna), half-backs ;  
 S. Almkvist (Uppsala),  
 G. Bergstroem (Gottenburg),  
 K. Gustafson (Koepings),  
 S. Olsson (Stockholm),  
 K. Ansen (Stockholm), forwards.

Referee : Mr. J. T. Ibbotson (Derbyshire). Linesmen : Mr. M. C. Frowde (Dorset) and Lieut. W. C. Clover (Army).

On the afternoon of October 20 this match was played on the grass in the middle of the Stadium, the English team being amateurs chosen by the Football Association. The Swedes were beaten by 12 goals to one, but the difference would have been by no means as great if their forwards had been able to keep cool when in front of goal instead of shooting wildly. This excitement was doubtless due to a want of experience, and nothing but time can cure it. Except when they were near goal, the forwards were good, being very fast and not to be put off their game by charging or bustling. S. Olsson and the two outsides, Ansen and Almkvist, were especially good. Circumstances were favourable to them, for as Hawkes was generally out of his place the right wing often had to deal with no one but Smith who, besides being slower than he was, cannot kick unless the ball is coming straight to him. Hunt and Chapman played a sound game, but as a rule a rush by the Swedes did not come to an end until the, shot had been taken. Although the home forwards did not play particularly well, it was soon seen that the Swedish backs and half-backs were no match for them, and when Woodward and Berry began to interchange places, the back and half-back opposed to them were bewildered. Like the home team, the Swedes were very much stronger in attack than in



defence. Their goalkeeper did many clever things, and it was not his fault that his side was so severely beaten. The Swedes ought to have scored the first goal of the match, for from a long kick to the left wing Ansen took the ball up the ground at a great pace, passing beautifully to Bergstroem, who, coming with a rush, had the misfortune to hit the post with his shot. Goals were then scored so quickly for the home team by Stapley, Woodward, Berry, and Chapman that the Swedes seemed in danger of going to pieces, but they rallied with great pluck. Taking advantage of the absence of Hawkes, who was among the forwards, the right wing ran up very quickly, and easily eluding Smith, Almkvist passed straight to the unmarked centre, only to see him shoot wildly. Before half-time the score of the home team had been increased by Purnell (twice) and Woodward. For nearly half an hour after the interval the Swedes held their own, and not only prevented the home team from scoring, but missed several good chances. At last, after they made a long and determined attack, they were rewarded with success, Bergstroem sending the ball into the net off Chapman. This was their last effort, and goals were scored in quick succession against them by Purnell (two), Hawkes (two), and Stapley.

#### SEMI-FINAL ROUND.

(1) DENMARK BEAT FRANCE (A) BY 17 TO 1

##### FRANCE (A TEAM).

M. Tillette (U.S. Boulonnaise), goal ;  
 J. Dubly (R.C. de Roubaix),  
 V. Wibaut (Olympique Lillois), backs ;  
 G. Bayrou (Gallia C. de Paris),  
 L. Schubart (Olympique Lillois),  
 C. Renaux (R.C. de Roubaix), half-backs ;  
 R. Tenouilliere (Red Star A.C. de Paris),  
 G. Cypres (C.A. de Paris),  
 A. Francois (R.C. de Roubaix),  
 G. Albert (C.A. de Paris),  
 E. Sartorius (R.C. de Roubaix), forwards.

##### DENMARK.

L. Drescher (Copenhagen F.C.), goal ;  
 C. Buchwald (Academicals),  
 H. Hansen (93 Club), backs ;  
 H. L. Bohr (Academicals),  
 K. Middelboe (Copenhagen F.C.),  
 N. Middelboe (Copenhagen F.C.), half-backs ;  
 J. Dandill (93 Club),  
 A. W. Lindgreen (93 Club),  
 S. E. Nielsen (Frem F.C.),  
 V. Wolffhagen (Copenhagen F.C.),  
 B. V. R. Rasmussen, forwards.

Referee : Mr. T. P. Campbell. Linesmen : F. Lockwood (Kent) and A. C. Hines (Notts).

In the absence of the three selected half-backs, and with a goalkeeper who was occasionally brilliant but generally most indifferent, this eleven proved to be even weaker in defence than the second team. The forwards were not bad individually, but had little idea of combination, and passed much too hard. Nor did the half-backs know how to feed them, so that they never had a chance of carrying out a serious attack, although they often took the ball into Danish quarters. As a full back Wibaut had many strong points, and could kick well. The match was merely a repetition of Denmark *v.* France (B), with the exception that the French goalkeeper was greatly inferior to Desrousseaux, and that the Danish defence, which had not been tested on Monday, was found to be sadly wanting. In both matches the Frenchmen, particularly the backs and half-backs, were by far too much given to waiting on an opponent who had the ball instead of going for him. Of the actual play there is little to be said. Denmark at once attacked, and in about five minutes Nielsen scored three goals. Then for the first time France became aggressive, but although the two Danish backs and the goalkeeper each made a Lad mistake which ought to have proved fatal, the French forwards made no attempt whatever to seize their chances. Another bad mistake by one of the Danish backs had not so fortunate an ending for his side, for Sartorius, coming clear, and running on without hesitation, shot well and at the right time, and gave the Frenchmen their only goal. Before half-time Lindgreen (twice) and Nielsen added to the Danish score. In the second half the Frenchmen occasionally made inroads into Danish territory, but could never push their attacks home, while goals were scored for Denmark by Nielsen (six), Wolffhagen (four), and N. Middelboe.

## 2) UNITED KINGDOM BEAT HOLLAND BY 4 TO 0.

### TEAMS:

#### UNITED KINGDOM.

H. P. Bailey (Leicester Fosse), goal ;  
 W. S. Corbett (Birmingham),  
 H. Smith (Oxford City), backs ;  
 K. R. G. Hunt (Wolverhampton Wanderers),  
 F. W. Chapman (South Nottinghamshire),  
 R. M. Hawkes (Luton), half-backs ;  
 A. Berry (Oxford University),  
 V. J. Woodward (Tottenham Hotspur),  
 H. Stapley (Glossop),  
 C. Purnell (Clapton)  
 H. P. Hardman (Northern Nomads), forwards.

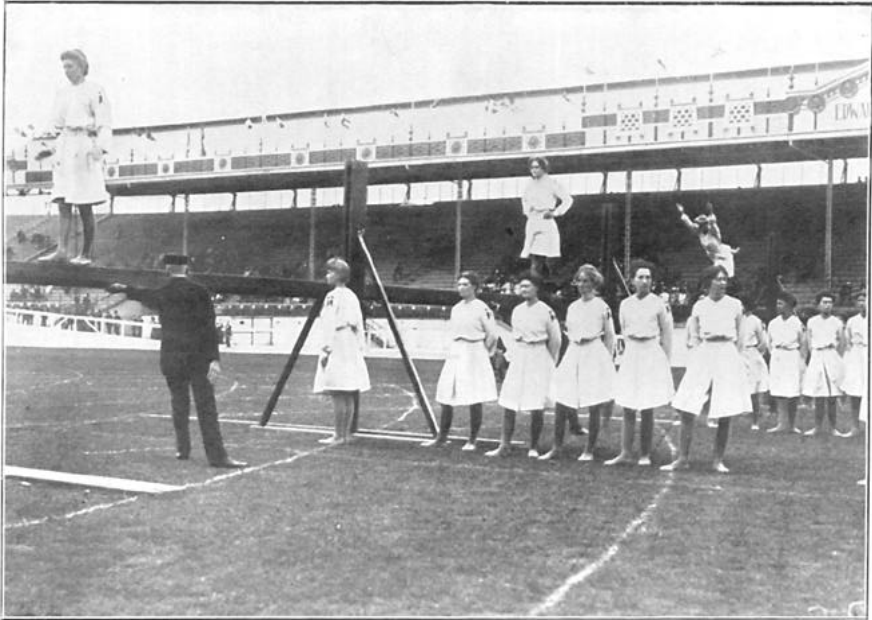

GYMNASTICS.—DISPLAY BY THE DANISH LADIES.



GYMNASTICS.—DISPLAY BY THE POLYTECHNIC LADIES.



HOCKEY.—FRANCE *v.* ENGLAND. THE ENGLISH CAPTAIN RUNS DOWN THE FIELD.

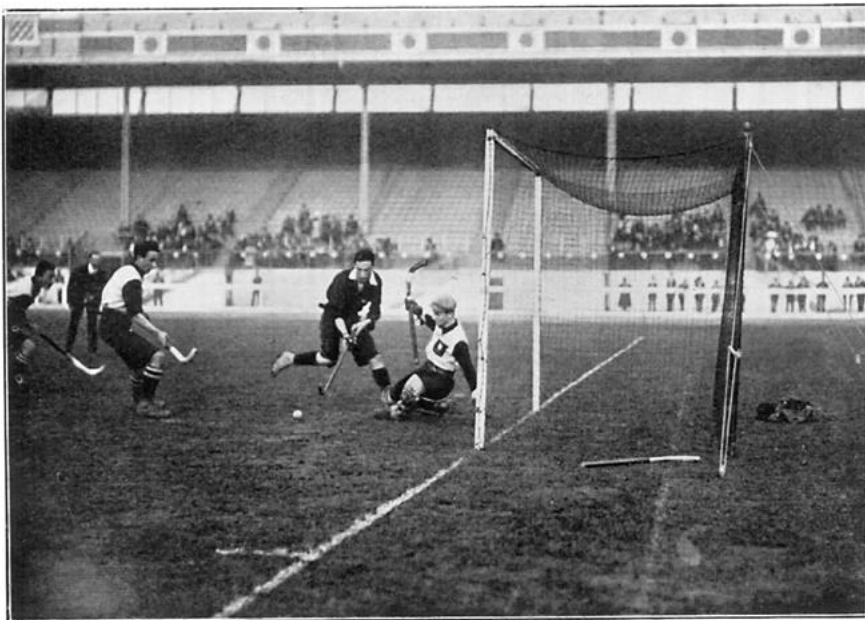

HOCKEY.—GERMANY *v.* SCOTLAND. THE SCOTCH SCORE A GOAL.

## HOLLAND.

R. Breuwkes (Dordrecht), goal ;  
 K. Hejting (H.V.V., The Hague),  
 L. Otten (Quick F.C., The Hague), backs ;  
 F. Sol (H.V.V., The Hague),  
 J. M. de Korver (Sparta, Rotterdam),  
 F. J. Mundt (H.V.V., The Hague), half-backs ;  
 J. H. Welcker (Quick F.C., The Hague),  
 E. Snetlage (Quick F.C., The Hague),  
 F. S. Reemen (Quick F.C., The Hague),  
 J. Thomee (Concordia F.C., Delft),  
 G. F. de Bruyn Kops (H.B.S., The Hague), forwards.

Referee : Mr. J. T. Howcroft. Linesmen : H. Gray (Durham) and W. E. Roberts (Sussex).

The visitors from the first created a favourable impression, being stalwart and fast, quick on the ball, and fairly clever with their feet. Their defence was very strong, the backs being cool and resourceful. The forwards had evidently been well trained in passing, but their adherence to routine was carried to excess. With a little more confidence in their own powers and better judgment in shooting they would have gone very near to winning, especially as the English team did not show to great advantage in any department, and the wing forwards alone gave evidence of international form. The Dutch goalkeeper early in the game was called upon to deal with a number of shots, but he was equal to all demands. For Holland Snetlage was often conspicuous, but he was somewhat too unselfish—a failing which developed as the game proceeded. Nothing was scored until but a few minutes remained of the first half, and so well was the Dutch goal covered that up to this point there was little promise of success for the somewhat feeble efforts of the English forwards. A lucky goal, however, now fell to the home team, Stapley back-heeling the ball somewhat speculatively and seeing it trickle into the net off the goalkeeper's hand and the post. In the second half a blunder by Corbett left the visiting forwards in possession near goal, but Bailey was able to stop the ensuing shot. Stapley scored again, being presented with a clear run between the backs after a free kick, and the same player gained another point within a few minutes by meeting one of Hardman's high middles close up. A fourth goal fell to Stapley from a pass forward by Chapman which again left him an opening between the backs. Welcker made a number of good runs and middles for Holland, but his comrades could not turn them to account, and the half-backs were not very skilful in supporting an attack, the game ending in favour of the United Kingdom by four goals to none.

## FINAL.

UNITED KINGDOM BEAT DENMARK BY 2 TO 0.

## TEAMS :

## UNITED KINGDOM.

H. P. Bailey (Leicester Fosse), goal ;  
 W. S. Corbett (Birmingham),  
 H. Smith (Oxford City), backs ;  
 K. R. G. Hunt (Wolverhampton Wanderers),  
 F. W. Chapman (South Nottinghamshire),  
 R. M. Hawkes (Luton), half-backs ;  
 A. Berry (Oxford University),  
 V. J. Woodward (Tottenham Hotspur) (capt.),  
 H. Stapley (Glossop),  
 C. Purnell (Clapton),  
 H. P. Hardman (Northern Nomads), forwards.

## DENMARK.

L. Drescher (Copenhagen F.C.), goal ;  
 C. Buchwald (Academics),  
 H. Hansen (93 Club), backs ;  
 H. L. Bohr (Academics),  
 K. Middelboe (Copenhagen F.C.) (capt.),  
 N. Middelboe (Copenhagen F.C.), half-backs ;  
 N. C. O. Nielsen (Copenhagen F.C.),  
 A. W. Lindgreen (93 Club),  
 S. E. Nielsen (Frem F.C.),  
 V. Wolffhagen (Copenhagen F.C.),  
 B. V. R. Rasmussen (forwards).

Referee : Mr. J. Lewis (Lancashire). Linesmen : Messrs. F. Styles (Northants) and H. Woollett (London).

It was the general opinion that though the United Kingdom won by two goals to none, even this slight difference in score rather flattered the winners, who did not often show real international form. Denmark, on the other hand, displayed the greatest vigour and determination, with far more pace and dash than they had against France, and they played much better together than our own men. K. Middelboe, at centre-half, fed his forwards with persistent accuracy. The first English goal was scored when Drescher slipped in the Danish net and was unable to attempt to stop Chapman, not long after the start. After this the Danish halves continually spoilt the English attacks and prevented them getting anything like a combined movement. Lindgreen had got past everyone but Bailey when Hawkes just stopped him in time. Soon after, Drescher made a clever save from Stapley. Purnell's goal was disallowed for offside play. Woodward was too carefully watched to be able to shoot.

After half-time Denmark started with a vigorous rush, and for some time had the best of the game, though their forwards did not shoot well when they had a chance. Bailey was equal to his work, and had more of it than he liked. After twenty minutes, Woodward scored for England

with a magnificent shot quite out of Drescher's reach. The Danes seemed only inspired to even greater efforts by their second reverse, and Lindgreen was loudly cheered for a long run which was only ended without a score when Bailey threw himself full-length at the ball. The game went up and down the field, and Denmark was doing more than her share of pressing when the whistle sounded, and the United Kingdom won a hard-fought game by two to love.

Holland and Sweden also played for the consolation stakes, and Holland scored two goals to one from Sweden, who were rather unlucky in not getting a second. The bronze medals therefore went to Holland, the silver to Denmark, and the gold to the United Kingdom.

These were given away on October 24 in the Stadium, before a crowd of some 8,000 spectators, by the Rt. Hon. J. Bell, the Lord Mayor of London, who attended in state with Lady Bell, the Sheriffs, and the Sword and Mace-Bearers. Among others present were Lord Kinnaird, the Right Hon. A. J. Balfour, Lord and Lady Desborough, Baron and Baroness de Tuyll, Count Brunetta d'Usseaux, Lord Roberts, V.C., and many more.

## II.—RUGBY.

Cornwall, the champion county of the previous season, was chosen by the Rugby Union Committee to represent the United Kingdom and play the Australians in the Stadium, a course which was somewhat lacking in interest, as the Australians had beaten Cornwall on a previous occasion when ten of the same men were playing ; and only three of their fifteen had ever represented this country. As was only natural, the Cornishmen were defeated, even worse than they had been at Camborne some three weeks before, and the Australians took the gold medals, after winning a game that was by no means representative of the strength of this country, by 32 points to 3.

### TEAMS :

#### THE AUSTRALIANS.

- P. Carmichael (Queensland), back ;
- C. Russell (Glebe),
- D. B. Carroll (St. George's),
- J. Hickey (Glebe),
- F. Bede-Smith (Central Western), three-quarterbacks ;
- C. McKivatt (Glebe), half-back ;
- A. J. McCabe (S. Sydney), five-eighth ;
- T. Griffen (Clebe),
- J. Barnett (Newtown),
- P. McCue (Newtown),
- I. Middleton (Glebe),
- T. Richards (Queensland),
- M. McArthur (Eastern Suburbs),
- C. McMurtrie (Central Western),
- R. R. Craig (Balmain), forwards

## UNITED KINGDOM.

E. J. Jackett (Falmouth), back ;  
 Barney Solomon (Redruth),  
 B. Solomon (Redruth),  
 F. Dean (Albion),  
 J. T. Jose (Albion), three-quarter backs ;  
 T. G. Wedge (St. Ives),  
 J. Davey (Coventry), half-backs ;  
 R. Jackett (Falmouth),  
 E. J. Jones (Plymouth),  
 A. J. Wilson (Camborne Students),  
 N. Tregurtha (St. Ives),  
 A. Laury (Redruth),  
 J. Marshall (Albion),  
 J. Willcocks (Plymouth),  
 J. Trevaskis (St. Ives), forwards.

Referee : Mr. F. C. Potter-Irwin (Rugby Union Committee).

The Colonials took the lead in the first five minutes, were ten points up in twenty minutes, and by good following up and remarkable speed outside, they scored pretty much as they liked on somewhat slippery ground in dull and rather dark weather. Cornwall had weight in the scrummages but were usually beaten for the ball, especially in the open play preferred by the Australians, who were without both their captain and vice-captain, while B. Solomon, of Redruth, took the place of Bennetts on the Cornish side. Jackett, as usual, played well at back, but was, of course, unable to turn the tide. The only try his fifteen secured was when Davey passed cleverly to B. Solomon, who ran in, but it was not converted. The Australians' last try was added by McCabe in a strong run from the centre.



## GYMNASTICS.

In the Stadium, on July 14, 15, and 16, 1908.

GYMNASTIC COMMITTEE OF THE B.O.C. :—

GUY M. CAMPBELL, F.R.G.S. ; E. LAWRENCE LEVY (Hon. Sec. Federated Amateur Gymnastic Associations of Great Britain and Ireland) ; COLONEL G. M. ONSLOW; ARTHUR G. MEARS; CHARLES J. WEST.

Prizes : Individual competition (Heptathlon).

1st Prize. Gold Olympic Medal.

2nd „ Silver „ „

3rd „ Bronze „ „

Team Competition.

1st Prize. 1 Gold Olympic Medal to the team.

Silver Olympic Medal to each member of team.

2nd „ 1 Silver Olympic Medal to the team.

Bronze Olympic Medal to each member of team.

### I.—INDIVIDUAL COMPETITIONS (20 entries allowed from each nation).

Voluntary Exercises.

1. Horizontal Bar, swinging movements.
2. Horizontal Bar, slow movements.
3. Parallel Bars, slow and swinging movements.
4. Rings, stationary.
5. Rings, swinging.
6. Pommel Horse, quick movements.
7. Rope climbing.

Every competitor must take part in every item.

### II.—TEAM COMPETITIONS (1 team to represent each country).

Voluntary Mass Exercises. The exercises may be those known as free gymnastics or exercises with hand apparatus, or any combination of both or either.

Teams of not less than 16 nor more than 40.

Time limit, 30 minutes.

### III.—DISPLAYS, NON-COMPETITIVE.

With Commemorative Medals. Open to women.

#### LIST OF COMPETITORS FOR HEPTATHLON.

BELGIUM.

Messrs. A. De Buck, J. van Guysca.

BOHEMIA.

Messrs. J. Czada, B. Honzatko.

CANADA.

Messrs. G. A. Keith, O. Elliott.

## FINLAND.

Messrs. E. Kosonen, R. Korhonen, J. Partanen, J. Saarivuori, T. Teivonen.

## FIANCE.

Messrs. E. E. Boislève, A. Castille, F. Castille, J. Castigliano, G. Charmoille, A. Costa, It. Diaz, V. Dubois, D. Foliati, E. Gauthier, F. Lekim, M. Lulu, Paulin Lemaire, J. Lux, G. Mounier, F. Nidal, G. Ratclot, J. Rolland, L. Segurra, G. Thurnheer.

## GERMANY.

Messrs. K. Borchert, A. Ehrich, P. Fischer, G. Karth, W. Kaufmann, Körting, "i"Krämer, H. Siebenhaar, A. Steuernagel, W. Weber, F. Wolf.

## HOLLAND.

Messrs. C. Becker, M. Bid, H. Blom, J. Bott, E. Bronwer, J. H. Flemer, J. Gondeket, D. Janssen, J. Kieff, A. Mok, J. Posthumus, J. slier, J. Stikkelman, H. Thysen, C. van Daalen, H. van Leeuwen, G. Westing.

## HUNGARY.

Messrs. M. Antos, E. Gellert, F. Graf, J. Nyisztor, C. Szabo, G. Szües.

## ITALY.

Messrs. G. A. Braglia, C. Otello, G. Romano.

## NORWAY.

Messrs. C. Carlsrud, P. Hol, E. Ingebretsen, M. P. Jespersen, O. Iversen, C. Ix'lath, F. Olsen, J. Skrataas.

## TURKEY.

Mr. Moullos.

## UNITED KINGDOM.

Messrs. E. Aspinall, G. Bailey, O. Bauscher, J. Cook, F. B. Dick, S. Domville, E. Dyson, W. Fergus, A. Ford, J. Graham, It. Hanley, L. Hanson, A. Hodges, S. Hodgetts, G. Meade, E. W. Potts, C. H. Smith, W. Tysall, J. A. Walters, W. Watters.

## SQUADDING OF COMPETITORS FOR THE HEPTATHLON\*

Tuesday, July 14, at 2.30.

SQUAD ORDER.	HORIZONTAL BAR, Swinging Movements.	HORIZONTAL BAR. Slow Movements.
	A	B
<b>1</b>	[664 Trippel, C., <i>Germany.</i> ]	1810 Tysall, W., <i>U.K.</i>
<b>2</b>	945 Szücs, G., <i>Hungary.</i>	[653 Schwarz, K., <i>Germany.</i> ]
<b>3</b>	[133 Franta, E., <i>Bohemia.</i> ]	[860 Gerhauser, A., <i>Hungary.</i> ]
<b>4</b>	[982 Bertinotti, R., <i>Italy.</i> ]	59 De Buck, A., <i>Belgium.</i>
<b>5</b>	376 Boislève E., <i>France.</i>	[1030 Innocenti, F., <i>Italy.</i> ]
<b>6</b>	1129 Olsen, F., <i>Norway.</i>	537 Ratelot, G., <i>France.</i>
<b>7</b>	1817 Waiters, W., <i>U.K.</i>	[642 Rank, M., <i>Germany.</i> ]
<b>8</b>	789 Slier, J., <i>Holland.</i>	1096 Carlsrud, C., <i>Norway.</i>
<b>9</b>	667 Weber, W., <i>Germany.</i>	1525 Graham, J., <i>U.K.</i> 760 van Leeuwen, H.N., <i>Holland.</i>

\* The names of competitors who did not appear are printed in square brackets,

SQUAD ORDER.		PARALLEL BARS.	RINGS, Stationary.
1		711 Bronwer, E., <i>Holland.</i>	1113 Iversen, O., <i>Norway.</i>
2		1565 Hodgetts, S., <i>U.K.</i>	730 Flemer, J., <i>Holland.</i>
3		[658 Simon, W., <i>Germany.</i> ]	1564 Hodges, A., <i>U.K.</i>
4		[934 Spécz, E., <i>Hungary.</i> ]	[641 Schönecker, <i>Germany.</i> ]
5		350 Teivonen, T., <i>Finland.</i>	819 Antos, N., <i>Hungary.</i>
6		[584 Behme, <i>Germany.</i> ]	187 Keith, <i>Canada.</i>
7		[1045 Mazzarocchi, S., <i>Italy.</i> ]	[1071 Racchetta, <i>Italy.</i> ]
8		1476 Domville, S., <i>U.K.</i>	495 Lux, J., <i>France.</i>
9		795 Thysen, H., <i>Holland.</i>	1663 Meade, G., <i>U.K.</i>
10		424 Diaz, R., <i>France.</i>	

SQUAD ORDER,		RINGS, Swinging.	VAULTING HORSE.
		E	F
1		[1029 Gubiani, M., <i>Italy.</i> ]	338 Castille, A., <i>France.</i>
2		659 Steuernagel, <i>Germany.</i>	1118 Klath, C., <i>Norway.</i>
3		735 Gondeket, J., <i>Holland.</i>	[24 Kallner, <i>Germany.</i> ]
4		1928 Watters, W., <i>U.K.</i>	779 Posthumus, <i>Holland.</i>
5		339 Saarivuori, J., <i>Finland.</i>	1539 Hanson, L., <i>U.K.</i>
6		512 Mounier, G., <i>France.</i>	135 Honzatko, B., <i>Bohemia.</i>
7		706 Blom, R., <i>Holland.</i>	569 Thurnheer, G., <i>France.</i>
8		514 Nidal, F., <i>France.</i>	1538 Hanley, R., <i>U.K.</i>
9		[1047 Mazzoncini, <i>Italy.</i> ]	[837 Dahinten, Dr., <i>Hungary.</i> ]

SQUAD ORDER.		ROPE.
		G
1		863 Graf, F., <i>Hungary.</i>
2		[1028 Gualeni, C., <i>Italy.</i> ]
3		389 Castille, F., <i>France.</i>
4		1138 Skrataas, J., <i>Norway.</i>
5		590 Borchert, K., <i>Germany.</i>
6		704 Biel, M., <i>Holland.</i>
7		1484 Dyson, E., <i>U.K.</i>
8		[602 Frauke, O., <i>Germany.</i> ]
9		1726 Potts, E., <i>U.K.</i>

Wednesday, July 15, at 2.30.

SQUAD ORDER.		HORIZONTAL BAR, Swinging Movements.	HORIZONTAL BAR, Slow Movements.
		A	B
1		79 van Guysee, J., <i>Belgium.</i>	858 Gellert, E., <i>Hungary.</i>
2		656 Siebenhaar, H., <i>Germany.</i>	810 Westing, G., <i>Holland.</i>
3		[1008 Civinini, C., <i>Italy.</i> ]	[671 Weser, W., <i>Germany.</i> ]
4		475 Lalu, M., <i>France.</i>	[1020 Fedi, A., <i>Italy.</i> ]
5		769 Mok, A., <i>Holland.</i>	395 Charmoille, <i>France.</i>
6		673 Wolf, F., <i>Germany.</i>	1114 Jespersen, M. P., <i>Norway.</i>
7		1506 Ford, A., <i>U.K.</i>	598 Ehrich, A., <i>Germany.</i>
8		1442 Cook, J., <i>U.K.</i>	793 Stikkelman, J., <i>Holland.</i>
9		310 Korhonen., <i>Finland.</i>	1370 Bauscher, O., <i>U.K.</i>

PARALLEL BARS.		RINGS, Stationary.	
<b>SQUAD ORDER.</b>			
1	175 Elliott, O., <i>Canada.</i>	311	Kosonen, E., <i>Finland.</i>
2	1780 Smith, C. H., <i>U.K.</i>	390	Castigliano, J., <i>France.</i>
3	[849 Erody, B., <i>Hungary.</i> ]	1357	Bailey, G., <i>U.K.</i>
4	617 Karth, G., <i>Germany.</i>	[876	Horvath, B., <i>Hungary.</i> ]
5	[1042 Massotti, V., <i>Italy.</i> ]	1112	Ingebretsen, E., <i>Norway.</i>
6	547 Rolland, J., <i>France.</i>	[1052	Nerozzi, S., <i>Italy.</i> ]
7	708 Bott, J., <i>Holland.</i>	618	Kaufmann, W., <i>Germany</i>
8	[522 Lemaire, P., <i>France.</i> ]	1002	Otello, C., <i>Italy.</i>
9	1035 Romano, G., <i>Italy.</i>	484	Lekim, F., <i>France.</i>
<b>SQUAD ORDER.</b>		<b>VAULTING HORSE.</b>	
1	[1124 Lem, H., <i>Norway.</i> ]	131	Czada, J., <i>Bohemia.</i>
2	747 Janssen, D., <i>Holland.</i>	993	Braglia, G. A., <i>Italy.</i>
3	[990 Borghi, P., <i>Italy.</i> ]	556	Segurra, L., <i>France.</i>
4	1351 Aspinall, E., <i>U.K.</i>	700	Becker, C., <i>Holland.</i>
5	912 Nyisztor, J., <i>Hungary.</i>	621	Krämer, T., <i>Germany.</i>
6	328 Partanen, J., <i>Finland.</i>	1471	Dick, F. B., <i>U.K.</i>
7	[1083 Tuzzi, R., <i>Italy.</i> ]	430	Dubois, V., <i>France.</i>
8	401 Costa, A., <i>France.</i>	[976	Bacchelli, E., <i>Italy.</i> ]
9	620 Körting, <i>Germany,</i>	937	Szabo, C., <i>Hungary.</i>

## ROPE.

SQUAD ORDER.	
1	716 van Daalen, C., <i>Holland.</i>
2	601 Fischer, P., <i>Germany.</i>
3	[971 Andreotti, A., <i>Italy.</i> ]
4	444 Follacci, D., <i>France.</i>
5	750 Kieff, J., <i>Holland.</i>
6	1588 Fergus, W., <i>U.K.</i>
7	451 Gauthier, E., <i>France.</i>
8	1111 Hol, P., <i>Norway.</i>
9	[995 Brambilla, E., <i>Italy.</i> ]

## LIST OF TEAM COMPETITORS.

## DENMARK.

Tuesday, July 14, at 2.30 P.M.

C. C. Andersen, H. Brédmose, J. Chievitz, A. Hansen, C. M. Hansen, I. M I-Iansen, G. R. E. Hansen, K. Holm, P. Holm, V. Hornbæk, O. Husted-Nielsen, C. C. Jensen, G. D. Jensen, J. H. Johansen, H. R. S. Klem, R. K" Madsen, V. M. Madsen, L. F. C. Nielsen, N. Turin-Nielsen, O. Olsen, N. K. Petersen, N. Philipsen, H. Rasmussen, V. Rasmussen, M. Thursen.

## UNITED KINGDOM.

*Tuesday, July 14, at 4 P.M.*

P. A. Baker, W. F. Barrett, R. Bonney, J. H. Catley, M. Clay, E. Clough, J. Cotterell, W. Cowy, G. C. Cullen, F. Denby, H. J. Drury, W. Fitt, H. Gill, A. S. Harley, A. E. Hawkins, W. O. Hoare, J. A. Horridge, H. J. Huskinson, J. W. Jones, E. Justice, N. J. Keighley, R. Laycock, R. McGaw, J. McPhail, W. Manning, W. G. Merrifield, C. J. Oldaker, G. Parrott, E. Parsons, E. F. Richardson, J. Robertson, G. J. Ross, D. Scott, J. F. Simpson, W. R. Skeeles, J. Speight, H. Stell, C. V. Suderman, W. Tilt, C. Vigurs, H. Waterman, E. Walton, E. A. Watkins, J. T. Whitaker, F. Whitehead.

## FINLAND.

*Wednesday, July 15, at 2.30 P.M.*

E. Forstrom, E. Granström, J. Kemp, T. Kyykoski, H. Lehmusto, J. Lindratu, E. Linna, Y. Linko, M. Markanen, K. E. Mikkolainen, D. Nieminen, K. K. Paasio, A. Pohjanpaa, A. Pohjonen, E. Railio, H. A. Rüpinen, A. Saarinen, A. T. Salovaara, K. V. T. Sandelin, E. Sahlstein, E. E. Sipita, V. Smeds, K. K. Soinio, K. E. Stenberg, V. E. Turi, K. M. Wegelins.

## FRANCE.

*Wednesday, July 15, at 3.15 P.M.*

L. Bogart, A. Borizée, H. de Breyne, N. Constant, C. A. Courtois, L. Delattre, A. Delecluse, L. Delecluse, G. Demarle, J. Derov, C. Desmarcheliers, Ch. Desmarcheliers, E. Dharaney, G. Donner, E. Duhamel, A. Duponcheel, P. Durin, A. Egremont, G. Guiot, L. Hennebicq, H. Hubert, D. Hudels, E. Labitte, L. Lestienne, R. Lis, V. Magnier, G. Nys, J. Parent, L. Pappé, V. Polidori, G. Pottier, A. Pinoy, L. Sandray, E. Schmoll, E. Steffe, E. Vercruyssen, H. Vergin, E. Vicogne, J. Walmée, G. Warlouzer.

## SWEDEN.

*Wednesday, July 15, at 4 P.M.*

T. Andersson, G. Asbrink, C. Bergman, C. Bertilsson, W. Carlberg, A. Cervin, H. Cedercrona, R. Degermark, C. Eriksson, C. Foleker, S. Forssman, S. Forssen, F. Geidel, E. Graufelt, C. Harlemann, N. Hellsten, G. Hözer, A. Holmberg, C. Holmberg, O. Holmberg, H. Jahnke, O. Jansson, J. Jarten, G. Johnsson, H. Jonsson, R. Jonsson, N. Kantzow, Kjellen, L. Kiristen, O. Lanner, S. Landberg, A. Ljung, O. Moberg, J. Möller, E. Nilsson, E. Norberg, T. Norberg, C. Norling, D. Norberg, D. Norling, G. Olsen, L. Pettersson, H. Rassander, S. Rosen, G. Rosenquist, C. Rydin, S. Sandberg, Albert Seger, Alex Seger, C. Silverstrand, A. Sjöbloni, B. Soevick, H. Soevick, Y. Stjernspets, K. Svensson, G. Vingquist, F. Widell, G. Wiekman, D. Wiman.

## HOLLAND.

*Thursday, July 16, at 2.30 P.M.*

C. L. J. Becker, M. Biel, J. de Boer, R. J. C. Blom, J. Bolt, E. Brouwer, C. van Daalen, J. H. Flemer, G. C. Göekel, J. Gondeket, D. Janssen, J. J. Kiefl, S. Kongin, H. N. van Leeuwen, A. Mok, A. d'Oliviera, J. J. Posthumus, J. H. A. G. Schmitt, J. Slier, J. Stikkelman, H. J. F. Thyssen, G. J. Wesling.

## NORWAY.

*Thursday, July 16, at 3.15 P.M.*

A. Amundsen, C. A. Andersen, O. F. Authen, P. A. Bersen, H. Bohne, T. Boysen, O. Bye, C. N. Carlsrud, J. Forstensen, S. Gróner, H. Halvorsen, H. Hansen, J. Hol, P. Hol, E. Ingebretsen, O. Iversen, M. Jespersen, S. Johannessen, N. Kioër, C. Klath, T. Larsen, R. Lefdahl, H. S. Leon, A. Moen, F. Olsen, C. Pedersen, H. Pedersen, B. Salvesen, J. Skrataas, H. Smevik, S. Sivertoen, A. Strand, O. Syvetsen,

## ITALY.

*Thursday, July 16, at 4 P.M.*

A Accorsi, N. Agodi, U. Agharini, A. Andreani, B. Buoizzi, F. Boltoni, V. Blo, G. Bonoti, P. Borsetti, A. Borzani, G. Calabraei, C. Celado, T. Collevati, G. Cristofori, A. Cosechini, S. Dichiarà, G. Gasperini, A. Marchi, C. Marchiandi, E. Massari, R. Nardini, G. Preti, D. Pavarri, G. Ravenna, M. Ridolfti, G. Taddio, G. Termanini, U. Savanuzzi, G. Vaccari.

## REGULATIONS AND INSTRUCTIONS FOR GYMNASTIC COMPETITORS.

## INDIVIDUAL COMPETITORS.

1. Every Competitor must have in his possession, to be produced whenever required, a Competitor's card. If competing both as an individual and in a team, two cards will be required. These cards will be forwarded to the Olympic Committees from whom they will be issued to the Competitors.

2. Competitors must assemble in the dressing-room punctually at the time stated on their cards.

3. All Competitors must be attired in full gymnastic costume, viz. : gymnastic vest (which must cover the armpits) ; long trousers to the ankles, or short trousers with stockings to the knee (tights or woven knickers not permitted) ; and light shoes.

4. Half an hour before the Competition, gongs or bells will sound, and Competitors must "fall in" in their respective squads ready to answer their names.

5. Ten minutes before the commencement of the Competition, the squads will march to their apparatus in the Arena under the guidance of their Stewards.

6. The squad to which a Competitor will be assigned and his number in squad, will be determined by lot.

The drawing will be conducted and carried out by the British Olympic Gymnastic Committee in London.

7. The order in which the squads will work on the different pieces of apparatus will also be decided by lot.

8. Competitors failing to obey the instructions of the Judges or the Stewards will render themselves liable to disqualification.

9. The apparatus used will be of the following dimensions :—

[N.B.—*No trial on the apparatus will be allowed.*]

## HORIZONTAL BARS.

1. There will be twelve bars, four made of steel, four made of steel covered with leather, and four made of wood. The leather covering will be wound round the steel bar spirally.

2. Six bars, two of steel; two of steel covered with leather, and two of wood, will be fixed at a height of 250 cms. or 8 ft. 4 in. above the ground.

3. Six bars, two of steel, two of steel covered with leather, and two of mud, will be fixed at a height of 220 cms., or 7 ft. 4 in. above the ground.

4. The length of the bars between the inside of the uprights will not be less than 220 nor exceed 230 cms. (7 ft. 4 in. to 7 ft. 8 in.).

5. The diameter of the bars will not be less than 30 nor exceed 32 mms. ( $1\frac{3}{16}$  to  $1\frac{1}{4}$  in.) absolute measurement, whether covered or not.

#### PARALLEL BARS.

1. There will be two parallel bars, one to be fixed at a height of 160 cms., or 5 ft. 4 in., above the ground, with a clear inside width between bars of 46 cms., or 18 in., the other to be fixed at a height of 148 cms., or 4 ft. 10 in., and have a clear inside width of 43 cms., or 17 in.

2. The total length of the bars will be from 280 to 300 cms. (9 ft. 4 in. to 10 ft.) but will not project beyond the uprights for more than 40 cms. or 16 in.

3. The bars will be oval in shape. The perpendicular diameter will not be less than 52 nor exceed 55 mms. ( $2\frac{1}{16}$  to  $2\frac{1}{4}$  in.); the horizontal diameter will not be less than 43 nor exceed 46 mms. ( $1\frac{1}{16}$  to  $1\frac{3}{16}$  in.).

4. The uprights and frame will be of iron.

#### RINGS.

1. The rings will be suspended from a portable scaffolding similar to that used for the horizontal bar, and will work over pulleys so as to be quickly adjustable at 10 cm. or 4 in. intervals from a height above the ground of 6 ft. to 8 ft. 4 in.

2. The height of the top bar of the scaffolding from which the rings hang will be 720 cms. (24 ft.) above the ground.

3. The height to which the rings may be raised above the ground will not be less than 180 nor exceed 250 cms. (6 ft. to 8 ft. 4 in.).

4. The rings (which will be made of iron) will be circular in shape and leather covered, with swivels for turning.

5. The thickness of the ring will not be less than 30 nor exceed 32 mms. ( $1\frac{3}{16}$  to  $1\frac{1}{4}$  in.)

N.B.—*Each competitor must generate his own swing, and this shall be included in the two minutes allotted to each competitor.*

## VAULTING HORSE.

1. There will be two vaulting horses.
2. The length of the horse will be 190 cms. (6 ft. 4 in.).
3. The width and depth of the body of the horse will be 40 cms. (16 in.).
4. The top of the saddle will be fixed at a height of four feet from the ground.
5. The length of the neck and the croup will be equal.
6. The width between pommels will not be less than 43 nor exceed 46 cms. (17 to 18 in.).
7. The pommels will be leather covered and hoop shaped.
8. The height of the pommels from the top of the horse will not be less than 11 nor exceed 12 cms, ( $4\frac{3}{8}$  to  $4\frac{1}{2}$  in.) ; the diameter of the handles will not be less than 31 nor exceed 33 mms. ( $1\frac{1}{4}$  to  $1\frac{5}{16}$  in.).
9. The neck, saddle and croup will all be of one continuous horizontal level.

## ROPE.

1. The top mark of the rope will be fixed at a height of 720 cms. or 24 ft. from the ground, and the rope will be marked off every 45 cms., or 18 in., commencing at a height of 180 cms. or 6 ft. from the ground.

The scaffolding will be 1 ft. higher than the actual rope length.

2. The diameter of the rope will be 5 cms. or 2 in.

*N.B.—The position of the body in descending shall be the same as in the ascent. Hand shall pass hand, but the arm may be bent or straight.*

*No resin, chalk, or any kindred substance may be applied to the hands or rope.*

## MATS.

Mats will surround each piece of apparatus.

## TEAM COMPETITORS.

1. Team Competitors will require to assemble and "Fall in" in a similar manner to Individual Competitors.
2. Directors of teams must, if their team work with hand apparatus, see that that apparatus is in the team's dressing room at least two hours before the time the team has to appear in the arena.

REGULATIONS AND INSTRUCTIONS FOR JUDGES, TIMEKEEPERS,  
STEWARDS AND SCORERS.

## I.—RULES FOR JUDGES.

*Assembling Time.*—Judges are requested to report themselves to the Gymnastic Committee not a minute later than 2.0 P.M. on the afternoons of Tuesday, Wednesday, and Thursday, July 14, 15, and 16, in order to



receive their Judges' Cards before they take up their positions in the arena of the Stadium at the apparatus they are to judge, which shall not be later than 2.20 P.M.

*Precedence.*— For ease of clerical and general working, alphabetical order of surnames shall settle the name of first, second and third judge.

#### INDIVIDUAL COMPETITIONS.

*Calling of Competitor's Names.*—Judges shall agree among themselves as to which one shall call the Competitors' names.

*Commencing of Judging.*—Judging commences from the moment the Competitor leaves the position of "attention," 6 or 10 feet from the apparatus (to which he goes upon his name being called), and ceases when he resumes the position of "attention" at the conclusion of his exercise, or when the Timekeeper indicates by waving a white flag that the two minutes allotted to the Competitor has elapsed.

In rope climbing judging begins the moment the body begins to leave the sitting position on the ground, and ends the moment the ascending or descending ceases to be continuous.

*Marking.*—Marks are to be awarded for :—

- (a) Successful performance of exercise attempted.
- (b) Difficulty and combination of movements.
- (c) Style and sequence.
- (d) Variety of movements,

*Penalty*— Each Judge shall deduct *one* mark from the total awarded by him to any Competitor failing to complete his exercise in the two minutes allotted, and shall show the same on his score card, thus :—

Less Penalty	...	...	...	1
			—	
Total...	...	...	...	6

*Entering Marks.*—All marks must be entered on the Judges' Card in ink, and any alteration must be initialled.

*Second Attempt.*— Judges shall not permit second attempts unless they consider a Competitor was interfered with in his first attempt, or that the first was rendered abortive through no fault of his own.

*Resumption after a Fall.*—If a Competitor, having the misfortune to, fall, *immediately* resume his position on the apparatus and complete his exercise from the point at which he fell off, such fall shall be marked as a break in sequence (losing thereby half a mark), *but no extra time shall be allowed.*

*Consultation.*— Judges shall only consult together on questions of *second attempts.*

## TEAM COMPETITIONS.

*Commencing of Judging.*— Judging commences from the moment the Timekeeper waves his flag to indicate the beginning of the competition, and ceases when the Timekeeper waves his flag to indicate that the time has elapsed, or that the instructor has signified to him that the competition is finished.

*Penalty.*— Each Judge shall deduct *fifteen* marks from the total amount awarded by him to any team if that team fails to complete its work in the half-hour allotted, and shall show the same on his score card thus :—

	135
Less Penalty    ...    ...    ...	<u>15</u>
Total    ...    ...    ...	120

## II.—RULES FOR TIMEKEEPERS.

*Assembling Time.*— Timekeepers are requested to report themselves to the Gymnastic Committee not a minute later than 2 P.M. on the afternoons of Tuesday, Wednesday, and Thursday, July 14, 15, and 16, at the British Olympic Gymnastic Committee Room in the Stadium, and accompany the Judges to their apparatus.

*Watches.*—The watches used must be stop-watches, and must be certified by a firm of repute.

## INDIVIDUAL COMPETITIONS.

*Timing.*— Except in rope climbing, which is a distance and not a time test, the time allotted to each Competitor on any piece of apparatus is two minutes.

With *Rings Stationary* the time commences from the moment when the Competitor grasps the rings.

With *Rings Swinging* when the Competitor starts to make his first run forward.

## III.—RULES FOR STEWARDS.

*Assembling Time.*—Stewards are requested to report themselves to the Gymnastic Committee not a minute later than 1.45 P.M. on the afternoons of Tuesday, Wednesday, and Thursday, July 14, 15, and 16, at the British Olympic Gymnastic Committee Room in the Stadium,

## INDIVIDUAL COMPETITIONS

*Duties.*—Stewards will act as Whips or Arena Stewards.

*Whips.*— Whips will collect Competitors into their respective squads, and see that the squads “ Fall in ” opposite their squad letter at 2 P.M. in

the afternoon. Competitors must take their place in squad according to the squad number on the Whip's list, and this number must correspond to the number on the Competitor's card.

*Arena Stewards.*—At 2.10 Arena Stewards will check the Whip's lists and the positions of the Competitors, notifying the Judges of any Competitors who may have scratched.

At 2.20 the Stewards will march the Competitors to the Judges at each piece of apparatus, and at the conclusion of work on that apparatus march the squad to the next apparatus set down on their order form.

*Collecting of Score Sheets.*—After a squad has completed its work upon any piece of apparatus, the Steward of that squad shall collect and place in the portfolio provided for the purpose the Score Cards of each of the three Judges who acted at that piece of apparatus, and then upon the proper signal march his squad to the next piece of apparatus to which it has been assigned.

While the squad is at work on this fresh piece of apparatus, the Steward will take the Score Cards received from the Judges of the last piece of apparatus to the Scorers' office, and hand the cards to the Scorer sitting below the letter corresponding to his own squad letter (receiving a voucher in exchange for the Score Cards handed in) and then return to his squad.

This carrying of Score Cards to the Scorers' office will be repeated after every change of apparatus.

When work has been completed on all the pieces of apparatus the Stewards will march their squads to the arena exits and hand them over to the Whips, who shall conduct the squads to their dressing rooms and, dismiss the Competitors.

As soon as the squads have been handed over to the Whips the Stewards shall, before themselves leaving the arena, carry the last set of Score Cards to the Scorers' office.

#### TEAM COMPETITIONS.

The work of collecting and conducting Teams to and from the arena will be carried out in a similar manner to that of the squads.

#### IV.—RULES FOR SCORERS.

*Assembling Time.*—Scorers are requested to report themselves to the Gymnastic Committee not a minute later than 2.30 P.M. on the afternoons

of Tuesday, Wednesday and Thursday, July 14, 15, and 16, at the British Olympic Gymnastic Committee Room in the Stadium.

*Scorers' Precedence.*— Mr. H. F. Barclay will be Chief Scorer, and to him all questions relating to Score Sheets and Scoring should be addressed.

In the case of the remaining Scorers precedence will be according to alphabetical order of surnames.

*Score Sheets.*— The first Scorer will have the Judges' Cards of the first squad brought to him throughout the working of each session, and so on with each successive Scorer and squad. The eighth Scorer will act as Team Scorer, the ninth and following Scorers as Second Checks.

*Duties.*— 1. To receive from the Stewards the Judges' Cards for the squad on whose behalf the Scorer is acting, and give the Steward a voucher therefor.

2. To enter the Judges' marks on the Score Sheet in the spaces provided—the first Judge's first, the second Judge's second, the third Judge's third.

3. Add the marks together and enter the result in the space opposite "Total."

4. When the Score Sheet is full the Scorer will take it, together with the Judges' Cards, to the Second Check for confirmation after signing the space marked "First Check."

*Checking.*— The Second Check will, upon satisfying himself that the marks are correctly entered and added, sign the sheet in the space marked "Second Check," and take it to the Chief Scorer for final confirmation.

In the event of an error being discovered either in entry or addition of marks, such mistake must be referred to the Chief Scorer, and if upheld the correction must be initialled by both the Second Check and Chief Scorer.

*Final Order Form.*— When the Score Sheets are duly filled up, the names of the Competitors shall be entered upon a "Final Order Form," together with the total marks awarded ; the Competitors with the highest grand total coming first, and so on.

This "Final Order Form" must be signed by at least three members of the British Olympic Gymnastic Committee before being regarded as officially correct, and conveyed to the Hon. Secretary of the British Olympic Council.

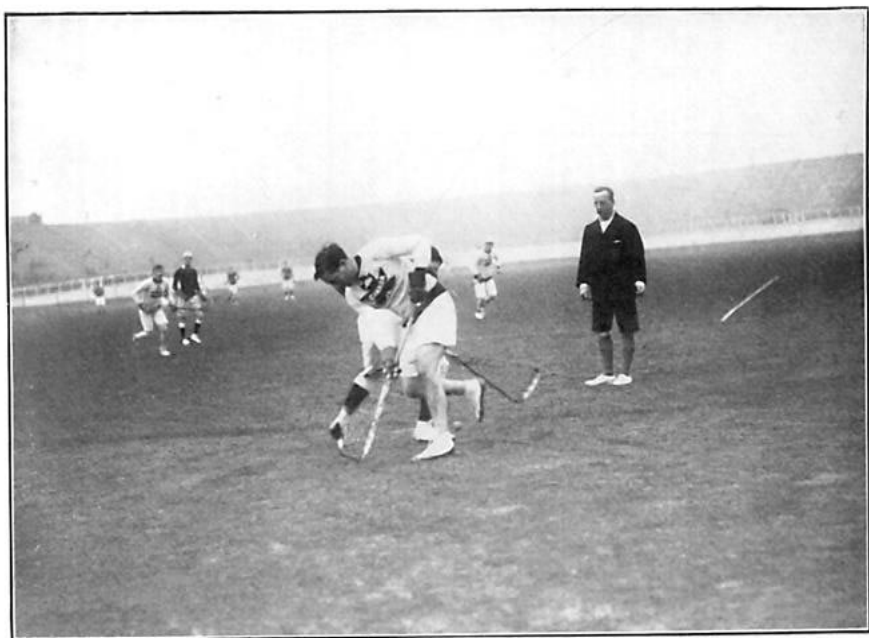

LACROSSE.—CANADA *v.* THE UNITED KINGDOM. THE CANADIAN CAPTAIN GETS THE BALL.



LACROSSE.—THE CANADIAN WINNERS CHEERING THE UNITED KINGDOM.

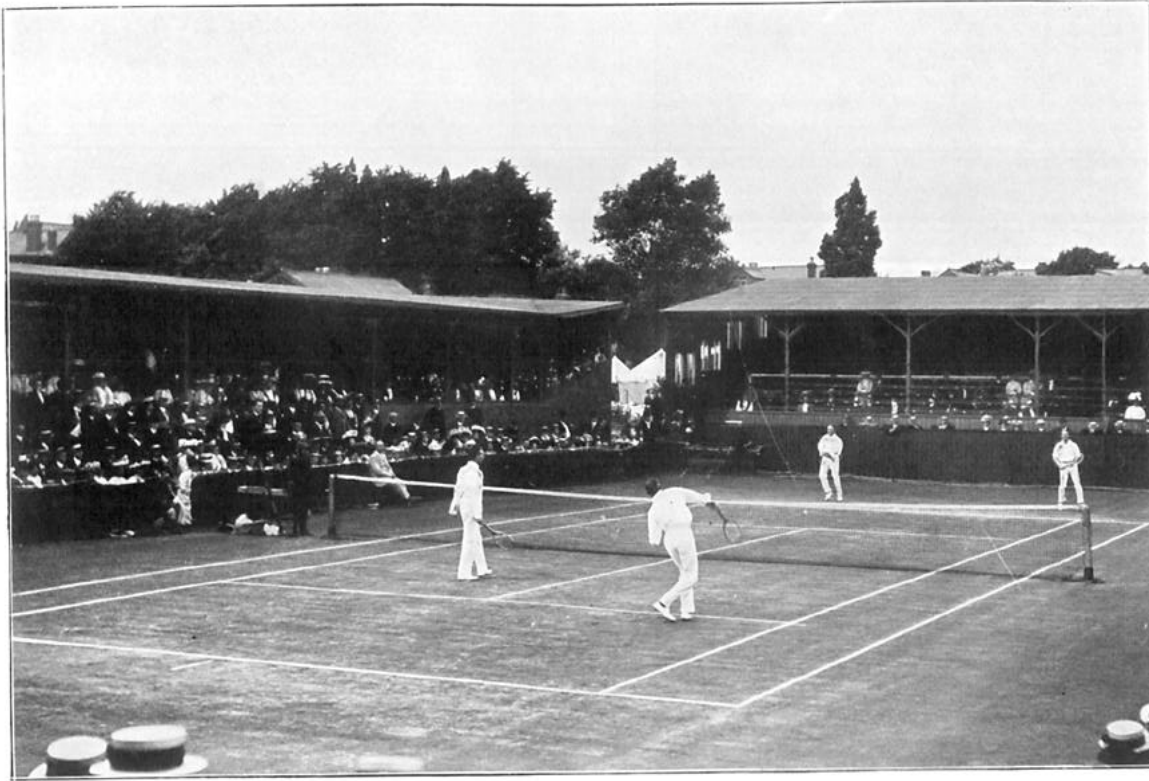

LAWN TENNIS (GRASS).— R. F. DOHERTY AND G. W. HILLYARD (U.K.) WIN THE DOUBLES  
AGAINST M. J. G. RITCHIE AND J. C. PARKE (U.K.).

Results.  
THE HEPTATHLON.  
INDIVIDUAL COMPETITION.

		Points.
1.	G. A. Braglia, Italy (Gold Medal) .. .. .	317
2.	S. W. Tysal, United Kingdom .. .. .	312
3.	B. L. Segurra, France .. .. .	297
4.	A. C. Steuernagel, Germany .. .. .	273½
5.	F. Wolf, Germany .. .. .	267
6.	S. Hodgetts, United Kingdom .. .. .	266
7.	M. Lalu, France .. .. .	258¾
8.	R. Diaz, France .. .. .	258½
9.	E. W. Potts, United Kingdom .. .. .	252½
10.	J. Rolland, France .. .. .	249½
11.	F. Nidal, France .. .. .	249
†	G. Bailey, United Kingdom .. .. .	246
†	K. Borchert, Germany .. .. .	246
14.	A. Costa, France .. .. .	241¾
15.	J. Nyisztor, Hungary .. .. .	236
†	F. B. Dick, United Kingdom .. .. .	233½
†	A. Hodges, United Kingdom .. .. .	233½
	G. Thurnheer, France .. .. .	232
	J. Castiglioni, France .. .. .	227

TEAM COMPETITION (possible points, 480).

1.	Sweden (Gold Medal) .. .. .	438
2.	Norway .. .. .	425
3.	Finland .. .. .	405
4.	Denmark .. .. .	378
5.	France .. .. .	319
6.	Italy .. .. .	316
7.	Holland .. .. .	297
8.	United Kingdom .. .. .	196

Two of the best authorities on Gymnastics in London recommend that the entire system of marking, both for Heptathlon and for Teams, should be altered on future occasions. Ten, they think, should be the maximum instead of twenty-four, and the marks should be awarded subject to

- (a) Difficulty and quality of combination.
- (b) Style and sequence.
- (c) Variety.

marking from 10 for a perfect performance down to 0 for an utter failure.

Rings, whether stationary or swinging, should in future be omitted. The staging is both costly and difficult to erect, and the exercises are very similar to those on horizontal bars.

The Rope should be a time-test as well as a distance-test, the two minutes allocated to other pieces of apparatus being adhered to in this also.

It is the first time since 1896 that an Italian has won the Heptathlon, though some authorities present were of the opinion that his overwhelming

superiority on the Vaulting-horse alone should not have prevailed against a competitor who had scored more in the majority of the other divisions of the Heptathlon. It was, in fact, suggested that each winner of one of these seven divisions should enjoy at any rate the titular distinction of championship in that event, even if a separate gold medal were not awarded for each of these seven events. There is, however, a very strong school in Gymnastics which hotly opposes any symptom of specialisation, and points with some pride to the fact that while in other games a man may specialise in one event and win the highest distinction in that alone, gymnastics, on the other hand, has hitherto awarded its best prizes only to men of convincing all-round superiority. The victory of Braglia is apparently an exception to this general rule. But there was, at any rate, one common ground of satisfaction felt by all Englishmen present at the first occasion in the history of British gymnastics when a picked body of British gymnasts, representing their country, met their colleagues from abroad in open competition. The results of this meeting were excellent ; for it produced the silver medallist and six places out of the first seventeen in the Heptathlon from among British athletes who represented a country which had hitherto been scarcely recognised as a gymnastic nation by our friendly critics on the Continent. There is no doubt that this will give a stimulus to British gymnastics in the interest and attention of the public which is well-deserved by an institution of the highest importance to national health, especially in the case of a country like the United Kingdom which is deprived of the physical benefits of military conscription. Those benefits, it may well be thought, should at least be aimed at by Englishmen who would conscientiously deplore the various drawbacks alleged to be inseparable from compulsory and universal service in the Army. At present British gymnasts retain the light-hearted spirit of recreation in a competition which is sometimes taken with a rather automatic and cold-blooded severity in the case of more military nations. We might, in fact, improve in discipline ; but there is no reason why we should not excel in execution,

It was further suggested that the introduction of a recognised code of international rules in judging would be an advantage. Rough and ready methods, even if applied with the most scrupulous honesty, cannot really replace the authoritative precedents of accumulated experience working upon universally accepted lines. It is comparatively easy for a judge to pick out the winner of a footrace, but a decision as to the relative excellence of performances on gymnastic apparatus is a very different matter. Three judges, each accustomed to the methods of his own country, may with perfect sincerity arrive at three differing conclusions as to the merits



of the same performance ; and any result of this kind is obviously to be avoided as far as possible.

The fact that no less than ninety-seven competitors got through the Heptathlon in the course of two afternoons speaks well for the good humour and interest of both competitors and officials in carrying out very complicated arrangements with scarcely any previous consultation and no rehearsal at all. It was, unfortunately, impossible for the public to appreciate the fine form shown in the details of what went on in the midst of the enormous arena, but the team work was generally very popular, especially the displays; and it was very much regretted that, by the luck of the draw, the magnificent display given by Germany did not attract the public attention it would most certainly have commanded at an earlier hour. The displays given by the Danish ladies and by the ladies of the Polytechnic were especially attractive, and formed a distinctively welcome feature of the whole fortnight in the Stadium.

I may add that the team representing the United Kingdom contained competitors from all the principal gymnasia in England, Scotland, and Wales, and the laudable desire to include them all perhaps weakened the effectiveness of the whole. Ireland was not represented either in the Team or in the Heptathlon. One consequence was that uniformity, homogeneity, and team-discipline were very naturally lacking in a collection of so many varying units which had only had two previous opportunities of rehearsal in the Stadium before the competition, and the conditions were not then favourable to getting all the men together. The Continental teams, on the other hand, consisted of men who had worked together for months and had usually been drawn from one locality, drilled to a mechanical precision, and inspired by the most serious determination to succeed. The result was not unexpected by those who knew the differences involved, but we may welcome the lesson imparted by defeat and rest assured that it will have a lasting and beneficial effect upon our national gymnastics.

In all military nations the governments support and encourage public gymnasia as a silent but most efficacious aid to that public health which is the foundation of military efficiency. We may not be " military, " but it is not therefore excusable that we should leave the invaluable results of gymnastic training so entirely to voluntary and private effort. Much, even so, has already been accomplished : rules, regulations, and gymnasia exist ; but the youth of this country has not yet been aroused to the importance of using them aright, an importance which will become far more evident in the future of the race, and may at any moment become acute in any sudden peril of the nation. Games that merely develop large

crowds of spectators are not, in fact, a national asset. Young men who do not care to serve their country in one form or another of the recognised opportunities for military duties might at least improve themselves, as citizens and as the fathers of citizens to be, by regular gymnastic exercise. It has been suggested that a part of the work which lies before the British Olympic Association in the future, and not the least valuable part, might be the encouragement and maintenance in this country of a national physical superiority among the nations of the world, which is rapidly ceasing to be a fact and will soon become a legend. The State has never wanted men more keenly than at the present time; yet it would be impossible for it to display more apathy towards the methods that other nations have so Successfully employed in making them. There are those who think that the Olympic Games should consist almost entirely of gymnastics. I am not of that opinion. But it is clear that in the schemes for general physical improvement which the Olympic Games have been revived to foster, the value of gymnastics to this country should hold a higher place both in the hearts of the people and in the councils of their ministers.

## HOCKEY.

Germany and France entered Hockey teams against the United Kingdom, which was represented by elevens from England, Scotland, Ireland, and Wales.

The first match began on the grass in the centre of the Stadium on October 29, at half-past two, in beautiful weather.

(1) SCOTLAND BEAT GERMANY BY 4 TO 0.

### TEAMS :

#### SCOTLAND,

J. Burt (Rutherglen), goal ;  
 H. Neilson (Rutherglen),  
 Capt. Foulkes (Carlton), backs ;  
 H. Fraser (Carlton),  
 A. Burt (Rutherglen),  
 A. G. Dennistoun (Edinburgh), half-backs ;  
 Dr. Stevenson (Carlton),  
 J. Laing (Hawick),  
 J. Harper-Orr (Edinburgh),  
 H. S. Walker (Edinburgh University),  
 G. J. Orchardson (Cartha), forwards.

#### GERMANY (Uhlenhorster H.C., Hamburg),

C. Ebert, goal ;  
 E. Dauelsberg,  
 A. Studemann, backs ;  
 M. Galvas,  
 A. Brehm (capt.),  
 R. Galvas, half-backs ;  
 T. Fehr,  
 F. Moding,  
 F. Uhl,  
 Fr. Diederishsen,  
 Fr. Rahe, forwards.

Umpires : Messrs. E. Fletcher and J. A. Kirkwood.

Our visitors, who all seem to have come from one club that was practically invincible at home, showed that they had been well taught, and it is easy to understand that against opponents who played by the book they would be very formidable. Like the continental football teams which played at the Stadium previously, they soon showed that their weakness lay in attack. Their backs and half-backs, and more especially their goal-

keeper, who was by far the most prominent player in the match, shone in defence, but the half-backs knew little of the art of feeding their forwards. In their turn the forwards, with the single exception of Moding on the outside left, who was extremely good in the second half, hesitated when their chances came, and only once in the match did they all act in combination. Although Scotland won easily, and were generally attacking, they did not show to any great advantage, and, more particularly in the second half, their forwards were lacking in dash. The backs and half-backs had very little to do in the way of defence, but on the few occasions when their opponents carried out an attack cleverly they made some bad mistakes; in feeding their forwards they left nothing to be desired. At the beginning of the game Scotland attacked, and from a pass by Stevenson Laing quickly scored the first goal. As a rule the forwards when near goal lost the ball by hitting too hard. A beautiful shot by Laing missed the net by a few inches, and then from a corner hit A. B. Burt scored with a hard shot from centre half. Whenever the German forwards managed to get away they took long passes very well indeed, but were by no means as good in dealing with short ones. A rush by the Scottish left wing was followed by a beautiful pass, which was missed by the other forwards, and a moment later an excellent shot by Moding at the other end was well saved. Just before half-time A. B. Burt took a pass by Laing on the run, came clear, and made no mistake, so that Scotland were leading by three goals to none. Almost the only interest in the play after the interval was the clever way in which Ebert repeatedly saved his goal. The Scots were nearly always attacking without much method or vigour, and it was not until the game was nearly over that a goal by Walker enabled them to win by four goals to none. A few minutes previously the German forwards made a series of perfect passes which took the ball to within a few feet of the goal, where the outside right missed a very easy chance.

(2) ENGLAND BEAT FRANCE BY 10 TO 1.

TEAMS:

ENGLAND,

H. I. Wood (Staffordshire), goal ;  
 H. S. Freeman (Middlesex),  
 L. C. Baillon (Northamptonshire), backs ;  
 J. Y. Robinson (Oxford University),  
 E. W. Page (Staffordshire),  
 A. H. Noble (Lancashire), half-backs ;  
 P. M. Rees (Surrey),  
 G. Logan (Surrey),  
 S. H. Shoveller (Surrey),  
 R. G. Pridmore (Warwickshire),  
 Eric Green (Middlesex), forwards.

## FRANCE.

R. Salarnier (R.C.F.), goal ;  
 L. Saulnier (C.A.I.),  
 F. Roux (R.C.F.), backs ;  
 R. P. Aublin (C.A.I.),  
 L. Gautier (S.F.),  
 R. Benoist (C.A.I.), half-backs ;  
 D. Baidet (R.C.F.),  
 D. M. Girard (R.C.F.),  
 L. Poupon (S.F.),  
 A. Bonnal (C.A.I.),  
 C. Pattin (C.A.I.), forwards.

[C.A.I. signifies Club Athletique International; R.C.F., Racing Club de France; and S.F., Stade Français.]

Umpires : Mons. E. P. Denny and Mr. T. Burman.

Beginning somewhat late in the afternoon, at the close of Scotland *v.* Germany, this match was played on a somewhat rough and slippery ground. Although one-sided, it was by no means uninteresting. The French team exhibited considerable promise, the players being severally fast, persevering, and adroit in the use of the stick. In tactics and finesse, however, they were no match for the strong English eleven, and their attacks were seldom or never durable, partly on this account and partly because their half-backs could not pass with sufficient precision to give the forwards support. Salarnier's goalkeeping was the best feature of their performance, whilst Roux was untiring in defence, and Gautier often did much to break up the concert of the English centres. During the first half the English team kept the offensive almost without intermission, the occasional French rushes being followed immediately by admirable passing on the part of the English half-backs. Salarnier, however, stopped five good shots, even frustrating Shoveller when he apparently had the goal at his mercy. Nearly a quarter of an hour had passed when Pridmore, fed by Page, dribbled through and made the first point. A general attack, beginning with a run by Green, allowed Rees to add the second; the third fell to Logan after Green had run down and middled, and to Pridmore the fourth, as the result of pretty play by the insides. In the second half Pridmore got the best of a tussle with the backs, taking them in detail, and gained the fifth goal, and Shoveller the sixth by backing up one of Pridmore's dashes. A very hot shot was sent in, by Poupon from a corner, but neatly fielded by Wood, and about this time the French forwards became somewhat troublesome by advancing more or less *en masse*, a style which was more effective than their passing. Pattin and Bonnal having dashed through in this manner, Poupon scored in the *mêlée*. The English team, however, soon replied, and Logan scored at the end of a neat dribble. Shoveller put the ball through after three

good saves by Salarner, and added the ninth goal with Pridmore's assistance, Green obtaining the tenth after a run by the opposite wing, so that England won by ten goals to one.

(3) IRELAND BEAT WALES BY 3 TO 1.

TEAMS:

WALES.

R. Turnbull (South Wales), goal ;  
 E. W. G. Richards (Abergavenny),  
 Llewellyn Evans (St. Asaph), backs ;  
 C. W. Shephard (Whitchurch),  
 R. Lyne (Newport),  
 F. Connah (Colwyn Bay), half-backs ;  
 F. G. Phillips (Newport),  
 A. A. Law (Trefant),  
 P. B. Turnbull (Cardiff),  
 J. Ralph Williams (Newport),  
 W. J. Pallott (Penarth), forwards.

IRELAND.

E. P. C. Holmes (Cliftonville), goal ;  
 H. J. Brown (Dublin University),  
 W. E. Peterson, backs ;  
 W. Graham (Monkstown),  
 W. J. H. Campbell (Dublin University),  
 H. L. Murphy (Three Rock Rovers), half-backs ;  
 E. F. Power (Three Rock Rovers),  
 G. S. Gregg (Three Rock Rovers),  
 E. P. Allman-Smith (Dublin University),  
 F. L. Robinson (Malone),  
 R. L. Kennedy (Banbridge), forwards.

Umpires : Messrs. G. H. Lings and H. J. Greening.

In this match the Welsh halves and backs were seen to great advantage on defence, especially during the early stages, Richards, Evans, Shephard, and Lyne being responsible for brilliant work. Turnbull also gave an excellent account of himself in goal, and despite clever combination on the part of the Irish forwards Wales held the lead until near the interval. When four minutes had elapsed the Welsh halves placed the forwards in possession, and good passing enabled Williams to reach the circle. Brown checked him, but before the ball was cleared Williams shot through. The Irish forwards then put their opponents to a severe test, and time after time Richards, Evans, and Shephard relieved their side. On one occasion Turnbull just managed to kick away from Gregg, who was close in, and a few minutes later a rush by the Welsh forwards was nullified by smart work by Holmes. Ireland continued to force matters, and a fine dribble, in which Gregg, Power, and Allman-Smith took part, ended in

Turnbull saving at the expense of a corner, which proved futile. Then a penalty in front of the Welsh goal was cleared by Shephard, but Ireland quickly returned, and Robinson equalised from a pass on the right. This was quickly followed by another goal, a shot by Power glancing off Turnbull's legs, so that at half-time Ireland led by two goals to one. On changing ends the Welsh forwards played well together, only to be intercepted by Peterson, Brown, and Campbell; and Holmes now and again saved fast shots. At the other end Robinson twice had an open goal, and he missed the net by a few inches. Most of the play took place in the Welsh quarters, and, after Turnbull had kicked away from Robinson, Gregg credited Ireland with a third goal. From this point the game was of a more even character, the Welsh forwards passing in brilliant style, but there was no further scoring, and Ireland won by three goals to one.

(4) ENGLAND BEAT SCOTLAND BY 6 TO 1.

TEAMS :

SCOTLAND.

J. Burt (Rutherglen), goal ;  
 H. Neilson (Rutherglen),  
 Capt. C. H. Foulkes (Carlton), backs ;  
 H. Fraser (Carlton),  
 A. Burt (Rutherglen),  
 A. G. Dennistoun (Edinburgh), half-backs ;  
 Dr. N. L. Stevenson (Carlton),  
 J. Laing (Hawick),  
 J. Harper-Orr (Edinburgh),  
 H. S. Walker (Edinburgh University),  
 G. Orchardson (Cartha), forwards.

ENGLAND.

H. I. Wood (Staffordshire), goal ;  
 H. S. Freeman (Middlesex),  
 L. C. Baillon (Northamptonshire), backs ;  
 J. Y. Robinson (Oxford University),  
 E. W. Page (Staffordshire),  
 A. H. Noble (Lancashire), half-backs ;  
 P. M. Rees (Surrey),  
 G. Logan (Surrey),  
 S. H. Shoveller (Surrey),  
 R. G. Pridmore (Warwickshire),  
 Eric Green (Middlesex), forwards.

Umpires : Messrs. H. M. Tennent and E. T. S. Wilson.

After four matches had been played at the Stadium in the space of a few hours the ground was in a bad condition when England and Scotland began their match. For some time the short passes of the English forwards met with no success because the ball travelled at a varying pace or stopped dead before it reached the man. It almost

seemed that the Scotsmen, by their more energetic methods, would have the best of the game, but when once the English forwards had accustomed themselves to the peculiarities of the ground they played a remarkable game, Shoveller and Pridmore being very conspicuous. Most of the serious attacks made by Scotland were on their right wing, but Robinson and Freeman very seldom gave the other wing any chance of distinguishing itself. The Scots made the mistake of never varying their attack, except when accident obliged them to do so ; on the other hand, their own backs never knew what the English forwards were going to do. On the whole the play of individuals was much better than could have been anticipated, and some exceedingly clever things were done on both sides. Early in the game a rush by the Scottish forwards seemed on the point of success when Robinson managed to get back, and cleared very cleverly, After about a quarter of an hour one of the Scotsmen was offside, and from a good hit by Baillon the ball came by accident to Pridmore, who was swift to seize his opportunity, and scored. Another goal to England came soon afterwards from Logan from a pass by Pridmore. Until half-time England was generally attacking, but the Scots' forwards were by no means idle. Almost immediately after the interval Shoveller made a brilliant run, and, although he could not get quite clear, the ball came to Pridmore in a good position, with the result that England were leading by three goals to none. After another attack, in which Logan, Pridmore, and the Scottish goalkeeper all distinguished themselves, the Scottish right wing made a fine run, which brought about a goal by Walker. The closing stages were in favour of England, and goals were added by Shoveller (two), and Pridmore, the home team thus winning by six goals to one.

#### FINAL.

ENGLAND BEAT IRELAND BY 8 TO 1.

ON OCTOBER 31.

TEAMS :

#### IRELAND.

E. P. C. Holmes, goal ;  
 W. E. Peterson,  
 H. J. Brown, backs ;  
 H. L. Murphy,  
 W. I. H. Campbell,  
 W. E. Graham, half-backs ;  
 R. L. Kennedy,  
 F. L. Robinson,  
 E. P. Allman-Smith,  
 G. S. Gregg,  
 C. F. Power, forwards.



## ENGLAND.

H. I. Wood, goal ;  
 L. C. Baillon,  
 H. S. Freeman, backs ;  
 A. H. Noble,  
 E. W. Page,  
 J. Y. Robinson, half-backs ;  
 E. Green,  
 R. G. Pridmore,  
 S. H. Shoveller,  
 G. Logan,  
 P. M. Rees, forwards.

Umpires : Messrs. M. Baker and E. T. S. Wilson.

At a quarter to two of a brilliant afternoon, on October 31, some six thousand spectators gathered in the Stadium to watch the final of the Hockey competition between England and Ireland. The ground had been well rolled, but had naturally suffered both from the constant use of the last few days and from the firework displays in the evenings, but in spite of this surprisingly few mistakes were made.

Ireland began in dashing fashion, and frequently looked dangerous, despite some splendid saving work by Noble. Five minutes passed by before England troubled their opposition for the first time, and then Logan shot wide from a good position. From the twenty-five yards' bully Shoveller worked out to the right before hitting up a centre, which Logan just pushed out of the reach of Holmes, and registered England's first goal. An Irish attack was broken up by Page, and at the other end a promising position for England was spoiled through Shoveller being penalised for turning in the ball—well inside the circle, too. Thirteen minutes from the commencement Robinson checked the Irish left wing beautifully, and going on, the Oxonian passed to Rees, who centred accurately for Logan to beat Holmes with a superb oblique shot. Nine minutes later Logan passed inside to Shoveller, who cleverly touched the ball for Pridmore to go through and find Ireland's net at close quarters, England leading at half-time by three goals to love. England received a startling surprise in the first minute after changing ends. Freeman stopped a hit by Gregg with his shins, from whence the ball rebounded into touch. The umpire gave a free hit, and Graham directed this so accurately that Robinson was enabled to score with a shot that gave Wood no chance whatever. Three minutes followed, and then Pridmore gave Shoveller a lovely pass. The Hampstead centre went through and shot at Holmes. Holmes saved, but failed to get the ball far enough away, and Logan nipped in smartly to increase England's advantage. Next came a wonderful goal by Pridmore at an apparently impossible angle, but by this time England had taken command of the game and won with eight goals to one.

EXTRA MATCH.  
FRANCE *v.* GERMANY

This was a friendly game played on October 30, before the Olympic competitions began, the teams being the same as before. France did most of the attacking, but the defence of Germany was excellent, and the frequent passing runs of the French forwards were of no avail. Occasionally the German forwards worked down, only to meet with a stout resistance, but when twenty-five minutes had elapsed the Germans succeeded in scoring through Moding. From this point France showed to most advantage until reaching the circle, and Germany won by one goal to none.

This interesting game is recorded here because it afforded excellent evidence of the rapid progress made in hockey by the Continental nations who entered for the Olympic competitions. Nothing better could be needed than the remarkably clever goal-keeping of Ebert of Germany and Salmier of France. Both these men had fine exercise in repelling shots directed at them, and they came out of the ordeal with honours. Both Erehm of Germany and Gautier of France are centre halves above the average. Their offensive and defensive work was admirable. Germany and France may be placed in regard to actual ability on a level with one another, and this was amply proved by the game just described, which Germany won by a goal. The Continent is young yet in hockey skill and tactics, but the glaring weakness is, of course, in the attack. Individual ability was seen, but of pretty passing and combination there was a complete absence—it is all hit and rush. The efforts to combine were crude and unfinished, but then their one mission is to learn, and they acquired not a few wrinkles by watching the British teams. They are exceedingly keen on the sport. Their improvement is slow, because they have so few opportunities of meeting strong British clubs.

As the German players were all recruited from the Uhlenhorster H.C. this club had the proud distinction of representing the Fatherland after winning the German championship. Hockey ought to have a brilliant future in that country.

## LACROSSE.

South Africa having withdrawn, the only entries left for the Lacrosse Competition were Canada and the United Kingdom, but quality made up for quantity, and though the game is not yet as well-known as it ought to be on this side of the Atlantic, there was little doubt in the spectators' minds, after seeing this match, that such graceful, fast, and skilful play would be much more widely and deeply appreciated here than has ever been the case before. Both teams were in splendid condition. It was certainly the best exposition of lacrosse ever given in this country, and, equally certainly, it was the finest effort our own players have yet made against any Canadian team. The English side was by far the strongest ever put into the field.

Special care was taken to keep the ground in as good condition as possible for the match of October 24. The only alteration that might be suggested in future tournaments is that two teams, instead of only one, might be allowed to represent each country.

The Englishmen wore red jerseys, and the Canadians had white trimmed with green, with a maple-leaf on the breast. The ground was hard beneath and slippery above, and a little hail fell after the start; but nothing prevented a very fast display, and the weather, on the whole, was good.

For the first time in the history of Canadian lacrosse a team had been selected from all parts of the Dominion to uphold the honour of the national game. The difficulties of the undertaking over so vast an area were necessarily great, and they were augmented by the compulsory amateurism required by the Olympic Council. There are still amateurs in plenty playing in Canada, but their skill is well below the professional standard. Consequently it was not until several trial games had been held that the fifteen players were chosen, and they included members of clubs as far apart as New Westminster and Montreal, a distance of 3,000 miles. Hitherto clubs such as Toronto have sent their teams on tour in this country, and they have generally been labelled "The Canadians"; but the Olympic match at the Stadium was the first encounter between the picked amateurs of the two countries, and as such it marked a distinct epoch in lacrosse. The game itself proved to be one of unusual interest, and it was hailed by a crowd, the large majority of whom had assembled to watch the subsequent football match and knew nothing of lacrosse,

with unmistakable signs of approval and enthusiasm. It is impossible that such a game as lacrosse, played in the spirit and with the ability that prevailed here, should not appeal to a sport-loving crowd such as was assembled at the Stadium. The finer points of the game were quickly appreciated, and the brilliant short passing of the Canadians and the fine running and direct attack of the Englishmen were abundantly recognised.

CANADA BEAT THE UNITED KINGDOM by 14 TO 10.

TEAMS.

(Canada in heavy type.)

C. H. SCOTT  
(West London LC)

G. MASON (Stockport L C)

**P. BRENNAN, Captain (Shamrock LC)**

H. W. RAMSEY, Captain (Woodford LC)

**T. GORMAN (Capital LC)**

E. O. DUTTON (Albert Park & Didsbury L C)

**J. BRODERICK (Cornwall LC)**

J. PARKER-SMITH (S. Manchester L C)    W. A. JOHNSON (Oxford University L C)

**E. HAMILTON (Montreal L C)**            **H. HOOBIN (Shamrock LC)**

N. H. P. WHITLEY (South Manchester LC)

**A. T. TURNBULL (Westminster LC)**

G. BUCKLAND (Old Hulmeians L C)

S. HAYES (Stockport L C)

**C. D. McKERROW (Montreal LC)**

**G. H. RENNIE (Westminster LC)**

G. ALEXANDER (Eccles L C)

**I. DUCKETT (Nationals LC)**

R.G. MARTIN (Catford L C)

**A. F. DILLON (Shamrock LC)**

E. P. JONES (West London L C)

**G. H. CAMPBELL (Dufferin of Orangeville L C)**

F. J. DIXON  
(St. Catharine's A L C)

RESERVES	{	C. J. MASON (Catford LC)	H. SHORROCKS (Old Hulmeians L C)
(U. KINGDOM)		F. S. JOHNSON (Stockport L C)	J. ALEXANDER (Eccles L C)
		V. G. GILBEY (Hampstead L C)	L. BLOCKEY (Eccles LC)

RESERVES (Canada)	{	D. McLEOD (Calgary L C)
		A. MARA (Young Torontos L C)
		J. FYON (Shamrock)

REFEREE : MR. A. NORRIS.

UMPIRES :	{	MR. ALLINGHAM.
		MR. VAL BARKER.

Lord Roberts, the Right Hon. A. J. Balfour, Baron and Baroness de Tuyll, Lady Sibyl Grey, Lord and Lady Desborough, and many others were present when the match began, and before its close the Lord Mayor arrived in state. The cheers for Canada when the winning team received from him the Olympic gold medals they had so well earned were loud and long from all parts of the crowded enclosure.

A special set of rules had been prepared in order that the conditions under which the game is played in Canada, the United States, Australia, and England might be assimilated, and the Olympic match saw the goal crease enlarged, with special restrictions that prevented an opponent from entering it ; a white ball was used, slightly heavier than English players are accustomed to and somewhat lighter than Canadians use ; the ground was hemmed in by a canvas wall ; and the time of play was divided into four quarters instead of two halves. These were innovations from an English point of view, but every endeavour had been made by the lacrosse authorities to adopt Canadian views, as some small acknowledgment to a team that had come so far.

The Code of Laws used, which differs from the usual English code, appears in later pages of this Report.

Both teams opened scratchily, and to some extent warily, for with the sides adopting somewhat different formations, both had to work into new situations. Canada was much surer of the ball than England, but her work was slow and soft, very careful and very deliberate. Turnbull obtained the ball from the first face, as he did several others, and Canada at once attacked ; then the ball made a short visit to the other end, and on its return some weak checking on England's defence enabled Canada to score the first goal in little more than a minute. Double that time was occupied before Johnson made a fine run and passed to Buckland who scored for England. Canada now pressed considerably, and, as the English defences were playing in very uncertain fashion, the score rose. Turnbull scored with a remarkable angle shot, having less than three inches to shoot at, through Scott being out of goal and checking first home in anticipation of a pass to that player. Brennan had a hand in two further points ; one knocked through as the result of a poor stop by Scott and another slipped in after the English goalkeeper had stopped with his mouth. Thus the first "twenty" found Canada leading by five goals to one. The second period was quiet for a time, the Englishmen not having yet recovered from their lethargy. There was little of that movement and athletic activity upon which the team was to rely. However, it was the home team that scored the next point, Jones just finding the inside of one of the posts. A longer game ensued, and only on the approach of half-

time were the Canadians able to get through. The second quarter had realised a goal each, and the score stood at six goals to two. The third period was remarkably prolific in scoring, for no fewer than eight points were added to the total. Five of these went to England and three to Canada, so that its conclusion saw England in a better position, and Canada's lead reduced to nine goals to seven. Hamilton had changed places with Turnbull at centre, and Whitley got the best of the face. Parker-Smith secured from the surrounding scrummage, and with a fine run enabled Jones to score a smart goal. Except that Dutton was the invader, the next game was very similar, and Jones added the finishing touch as before. Then came Canada's turn, led by the irrepressible Turnbull, who first scored with another fine angle shot, and then ran straight through Parker-Smith and scored with a very low, hard shot. As the direct result of a free throw given against England, the ball was worked behind goal and then whipped through from the lob in front—an old dodge, for which "check sticks" used to be the remedy. From now the game veered in England's favour. The team had gradually been waking up, and now at last played its true game. Rapid passing down the field from crosse to crosse whilst on the run gave Jones and Buckland their chance, and the last-named scored. Parker-Smith was soon away, and similar work enabled Buckland to score again, and then, after a slight rally by Canada, the same player once more got through in most brilliant fashion. Excitement ran high when the last period was started. Canada attacked to begin with, but Alexander, who had followed down, received the ball again from Mason, and some fine work, in which Hayes participated, enabled Jones to tip the ball in at close quarters. The next game was brief, and was taken by England as the result of further good combined work. This score brought the totals level, at nine goals. From here the English play deteriorated, and Canada, led as before by Turnbull, gradually won the match. Turnbull first enabled Brennan to knock through from a lob, and so Canada was one up. Then splendid short passing, in which the whole attack shared, was successful. Turnbull next found himself free near goal, with the inevitable result, and once again Brennan knocked through from a lob behind of Turnbull's. Hereabouts the English defence had gone to pieces, and so two Canadians were left free in front of goal, and Canada added their last point. England scored once more, which brought the concluding totals to fourteen goals to Canada and ten to England.

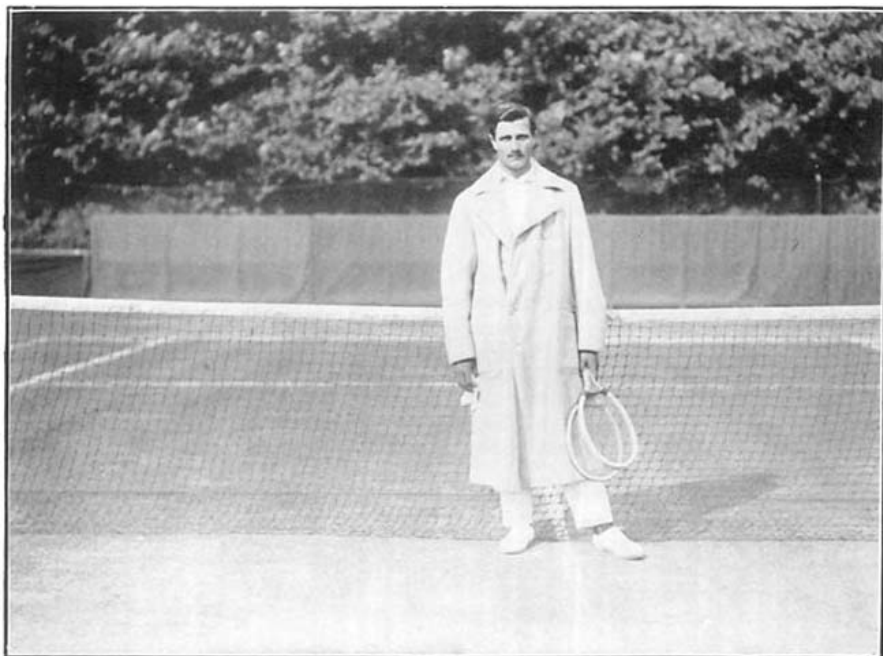

LAWN TENNIS (GRASS).—O. FROITZHEIM (GERMANY), SILVER MEDAL IN THE SINGLES.

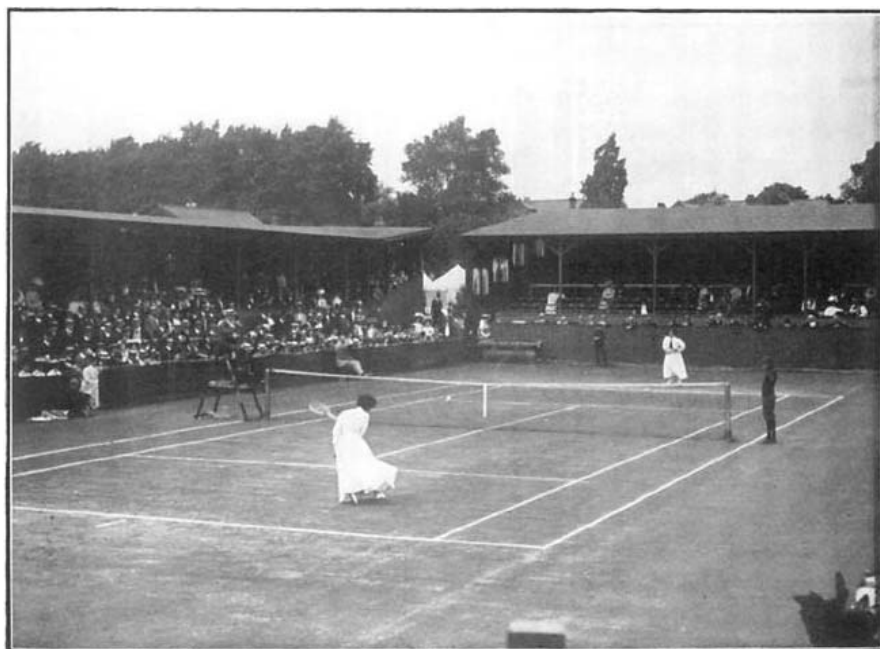

LAWN TENNIS (GRASS).—MRS. LAMBERT CHAMBERS (U.K.) WINS THE GOLD MEDAL (LADIES' SINGLES) *v.* MISS D. BOOTHBY (U.K.).

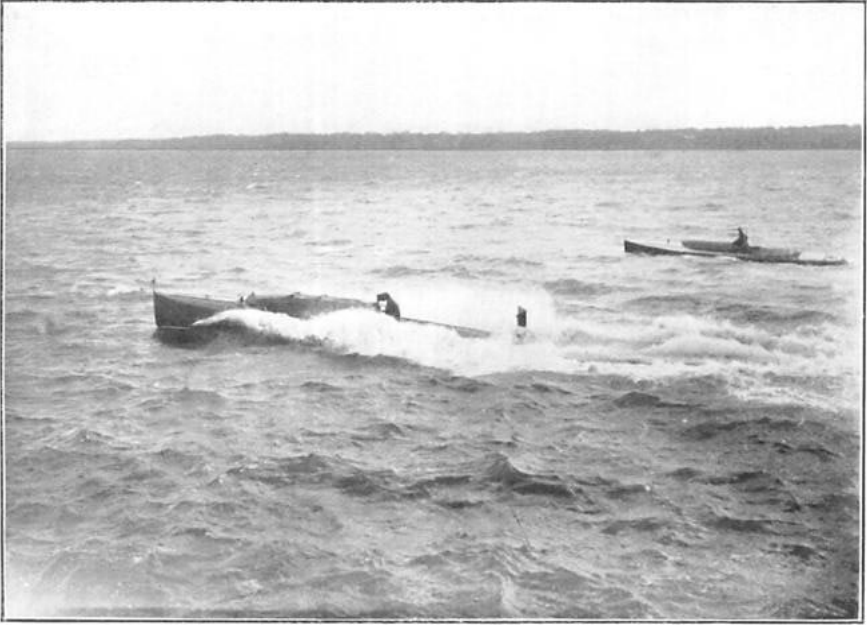

MOTOR BOATS.—“WOLSELEY-SIDDELEY” (STEERED BY THE DUKE OF WESTMINSTER)  
v. “DYLAN” (STEERED BY LORD HOWARD DE WALDEN).



MOTOR BOATS.—“WOLSELEY-SIDDELEY” IN HEAVY WEATHFR,



## LAWN TENNIS.

## I.—GRASS.

Nine different nations were represented in the Olympic Lawn Tennis Tournament held at Wimbledon early in July 1908, under a committee of management consisting of E. R. Clarke, W. H. Collins, S. A. E. Hickson, G. W. Hillyard, R. B. Hough, R. J. McNair, and G. R. Mewburn, with W. H. Collins as the Hon. Referee and G. W. Hillyard as the Hon. Manager.

In spite of the absence of Norman Brooks, H. L. Doherty, Larned, and Wilding, and of the fact that those who finally appeared to play did not constitute the most representative team for the United Kingdom, it may be said that the meeting was a very great success, and that, in spite of absentees who were regretted, such as Mrs. Sterry, or A. W. Gore (the Singles champion), we were just able to secure the gold medals for this country against a very serious attack, with the following results :—

1. Men's Singles : M. J. G. Ritchie (U. K.).
2. Men's Doubles : G. W. Hillyard and R. F. Doherty (U. K.).
3. Ladies' Singles : Mrs. Lambert Chambers (U. K.).

Details of the play and scoring are given below.

It might on another occasion be better to consider separate entries from England, Scotland, Ireland, and Wales (as was the case in some other sports), as well as from both New Zealand and Australia. As it was, New Zealand only heard of the Olympic Tournament from the Lawn Tennis Association of Australasia at too late a date to nominate their players. On the whole, too, it may be thought wise in the future to limit the competitions to grass courts, and to fix their date at some period not quite so close to the All England Championships.

But none of the drawbacks here suggested really affected the success of the meeting, which contained several very notable surprises. On the opening day the form of Froitzheim, the German, eclipsed all else. Treading the centre court at Wimbledon for the first time, he showed no signs of flinching when he faced Kenneth Powell, and after pulling up from love-forty and winning the first game, he gave a fine exhibition, which was not only stylish but effective. He played too a most sporting game, and not even Powell's apparent staleness should be allowed to detract from the merits of his victory over a player upon whom we have been setting so much store. Everything the German did he did easily.

His natural freedom of style made his game attractive to watch, and the absence of the over-anxiety and impetuosity usually so characteristic of the Continental player stamped him as much above the ordinary. Incidentally, it may be observed that he was not in the least disturbed by the passing trains.

Another attractive exhibition was that of M. Germot, of France, who played a good all-round game against H. Schomburgh (Germany) in one of the best matches of the day. His volleying was at times excellent, but Schomburgh would have run him closer still but for a desperate hurry to make a winning stroke when steadiness and a defensive stroke were required. Altogether there were five Germans playing Singles on the opening day ; Rahe, Kreuzer, and von Bissing, in addition to those already mentioned. Their third victory was won by von Bissing, whose hard and direct methods were more than a match for the Austrian, Zborzil. The latter weaved pretty patterns with a snake-like service, and did other things taking to the eye, but was none too safe. Kreuzer had a fairly easy task against Piepes, another of the Austrians. His game was infused by the greater variety, and he was in a confident mood throughout. Although beaten, Rahe did more than well against Dixon. He had his right wrist bound up, but there seemed little wrong with him after the first set, for he volleyed Dixon's forcible strokes in most able fashion. Had he beaten the older player he would have created a great surprise, and it redounds to his credit that he reached 5/1 in the second set and 4/0 in the third. A little more experience might have enabled him to thrust home this advantage, but the experience was on the other side, and becoming supremely steady at the critical moments, Dixon saved both sets and won a fine match. After finishing with their Singles, four of the Germans appeared in the Doubles. It was somewhat anomalous that the German pairs should have been called upon to meet each other in the first round, and it was probably the best possible result, under the circumstances, that Froitzheim and Schomburgh should have beaten Rahe and Kreuzer.

Like the South Africans, Kitson and Gauntlett, the Dutchmen, C. and R. van Lennep, had small cause to be enthusiastic over the draw. As was the case in the Championships Gauntlett ran up against Ritchie all too early, and was again put out—this time without making such a good fight. Kitson does not appear to possess the ideal centre-court temperament. Elsewhere he shapes very well, but neither in the Championships nor in the Olympic games did he do himself justice. His opponent in the Olympic games was Caridia, who was at the top of his form, and has seldom wrought more destruction with his back-hand volleys, which were so unexpected at times as to baffle the opposition completely. Curiously

enough, the van Lenneps both went down before Canada. "C." found R. B. Powell's volleys dropping all too short for him, and "R." was beaten in a good match by Captain Foulkes, whose placing down the side lines was the more precise. Foulkes improved considerably on his championship form, enthusiasm and quickness of decision being features of his play, but he fell in the third round before another enthusiastic and energetic player, the Rev. J. Richardson, whose success provided some consolation for South Africa.

The weather was in a fitful mood towards the end of the week, and kept people away from some of the most interesting matches. After the decisive manner in which he beat Kenneth Powell in the first round, Froitzheim, the young German champion, became the leading attraction of the tournament, and as he went from success to success it was realized that he must be ranked amongst the players of the highest class. Indeed, the majority of the critics, even those who tempered their judgment with due appreciation of the quality of the opposition, marked him out as a potential champion. He will certainly figure very largely in the future of the game.

After disposing of K. Powell, Froitzheim was called upon to meet his fellow-countryman, Oscar Kreuzer, and this brought together Germany's two best players. Froitzheim won by three sets to love, and eighteen games to eight. Kreuzer excelled in his overhead play, but, generally speaking, he was not so steady as his compatriot.

In the third round Froitzheim encountered the Irishman J. C. Parke, whose first appearance it was at Wimbledon, and here was seen the Singles match of the week, if not the match of the year. Parke, who is the Irish Rugby International, won the European Championship in 1907 when he beat Ritchie, and he has also played Gore a five-set match in the Northern Championship final. He has twice been Irish Champion, and, as his reputation had preceded him, no great surprise was created by his good form, except amongst those who had not followed his career. Parke opened his shoulders with some target practice against Tóth, the Hungarian, whom he removed from the second round with some of the hardest hitting ever seen in the game. He took pot-luck, but sufficient of his terrific drives came off to beat his astonished opponent. Then it was that he encountered Froitzheim in a match noteworthy for sustained excellence of the play on both sides.

The match was worthy of a full gallery, but, owing to the rain, the attendance was meagre when the tarpaulins had been removed from the centre court, and play began at five o'clock in the evening. There was a curious beginning, for Froitzheim, whose play was marked by all his

easy grace and perfect style, speedily won the first four games. Parke was twice seen to lose strokes by slipping up, and this was due to the difficulty of getting a proper foothold on the newly-marked white lines. The play was suspended whilst he changed his rubbers for steel points, after which he settled down to a very fine game in a great match. Keeping his feet better, he did great things with his powerful drive, and varying his methods with some admirable volleys he won the next three games. Few opponents would have maintained such commendable level-headedness as did Froitzheim against these vigorous tactics, but one of the German's most valuable assets is his imperturbability. He won the eighth game against Parke's service, but was a little shaky with his volleys in the next game, which made it 4/5 to the Irishman. Some beautiful side-line shots came to his aid, however, and by winning the tenth game Froitzheim took the set by 6/4, he undoubtedly having profited by Parke's unfortunate start.

The second set had every element of excitement to commend it, although the excitement was more with the spectators than the players, so well did the latter control themselves through the many thrilling vicissitudes. In a game of "see-saw" Froitzheim led by 2/1, after which it was 2 all, 3/2 and 4/2 to the German, and then 4 all. The struggle for the lead in the ninth game led to deuce being called three times before Parke won, and in the next game the Irishman came within a stroke of the set, only to lose after 'vantage. Two more 'vantage games took the scores to 6 all, and Parke, who at this time was very steady and had slackened his pace, led at 7/6. It was high-class play on both sides, with scarcely anything to chose between the men. By winning the fourteenth and fifteenth games Froitzheim went to 8/7, but he wavered just a little and looked like losing the set, whilst Parke took a love game against his service, and next led by 9/8. So persistently did Parke get things back that the German appeared to be in a state of perplexity, but a fine rally enabled him to win three games consecutively and secure a memorable set at 11/9. At the end it was freely said that the form shown on either side would have won the Championship in the previous week. The struggle in the third set was quite as strenuous, if not so prolonged. From 2/1 to Parke it went to 2 all, 3 all, and 4 all before remarkable play ensued in the all-important ninth game. In this it was deuce no fewer than seven times, and once Froitzheim was saved by a lucky net-cord stroke. Four times it was 'vantage to Parke, who was unable to clinch matters, and lost the game. He fought on, however, and in the last game of all Froitzheim thrice came within a stroke of match before he went out at 6/4 amidst the plaudits of the crowd.

But for the intervention of rain, Froitzheim would probably have progressed to the final without losing a set. Well as Caridia played in the fourth round, the German again gave a fine display, and, after pulling up from 1/3 and winning the first set, he made short work of the second, in which he showed Caridia that more than one man can play those superb backhand strokes. At 4/2 and 5/3 in the third set Froitzheim appeared to be sailing home to victory, but the rain came down, and on the slippery ground, he suddenly became a passive resister and nothing more. Only with the greatest difficulty could he keep his feet, and it was almost pathetic to see this fine player reduced to mediocrity through no fault of his own. Caridia won four games off the reel, and the set by 7/5, when, by merciful intervention, it was resolved to adjourn until the following day. Apparently Froitzheim had slept the better, for when the morning came he promptly polished off his man with a 6/1 fourth set. In the evening of the same day Froitzheim faced another ordeal in the way of wet weather in his semi-final with the Rev. J. Richardson, of South Africa. The referee gave him the option of playing the match or postponing it, and he preferred trying to get it through rather than risk having to play a semi-final and the final on the Saturday. Richardson raised no objection, and the two good sportsmen proceeded with the match in the wet, which worried Froitzheim far more than it did the Colonial, the German finding his steel points of little use to him, and badly losing the first set against a dashing opponent, who had evidently made up his mind to defy the elements. For the simple reason that Froitzheim could not venture up for shots he would otherwise easily have made, he lost numerous aces to an opponent who performed astonishing acrobatic feats.

But Richardson—a better player than some of his critics believe—had his time to come, for in the second set his unbridled energy led him to describe patterns that would have done credit to a champion figure-skater. Froitzheim just lobbed them back gently, and won the set by letting Richardson contribute largely to his undoing. Up to this stage the South African had relied on rubber soles, but, finding that he was losing control of his legs, he promptly changed into steel points for the third set, which, after the first two games on a side court, was transferred to the centre court, where the ground was less greasy. Although the rain continued to pelt down, and Froitzheim's friends did not disguise their great anxiety, neither player availed himself of the option to appeal to the referee for an adjournment. To the end Richardson, who played really well, was the safer on his feet, but Froitzheim was supremely cool, and eventually emerged successful.

Ritchie did his duty and duly came through the top half of the draw.

After receiving a bye in the first round, he renewed acquaintance with Gauntlett, who had taken a set off him in the Championship. This time Ritchie was in better trim, and Gauntlett not quite so good, and it was the former's match by 3 sets to love and eighteen games to six, only the second set being well contested. In the third round Ritchie beat Crawley by precisely the same score, and here again the opposition was not up to the strength expected, the Oxonian being in one of his uneven moods. Ritchie next advanced to the fourth round at the expense of Germot, who made futile efforts to obtain a foothold in the wet. After sliding about on rubber soles in a love set, Germot experimented with various pairs of shoes, and finally gave up when four games down in the second set. The rain was very hard lines for visiting players, whose form was discounted by conditions which are "foreign to them at home," if the paradox may be pardoned. Faced as he was by Eaves in the semi-final, Ritchie was not quite at his best, although he never appeared in distress, and in the end won comfortably, his superior stamina coming to his aid. In the first set Eaves was very good indeed, and by making the most of Ritchie's rather soft returns, he brought into play some delightful volleys, and won at 6/2. He was overplayed in the second set, but got his second wind in the third, which he ran very close, but it was then a gradual diminuendo.

R. B. Powell, the Championship semi-finalist, went down in the third round. In the second round he had met with unexpected opposition from Rázny, the Bohemian, who won the first set in dashing style. Rázny, a sturdily-built young man, is a fine player to watch and is possessed of rare dash. He has many excellent strokes, including a brilliant drive on the run, which was also employed by Parke. He appeared to have a chance against the Canadian, but could not steady himself sufficiently—a fault of several of the Continental players. It was Powell's misfortune to meet Caridia at his best in the third round, and also his misfortune that the first half of the match was played overnight and the second half in the morning. After losing the first set, Powell won the second well, and was going strongly when the adjournment was made, whereas he never struck the same form when the match was continued, Caridia's brilliant shots flying off his racquet in all directions. What happened to Caridia when he opposed Froitzheim has already been told. The capital match that Baron von Bissing gave Eaves in the third round should not be overlooked, and neither should the latter's smart win over Dixon in the fourth round.

The final between Froitzheim and Ritchie, played on the Saturday, drew a most gratifying attendance. The match, however, failed to come up to expectations, the chief reason being Froitzheim's unexpectedly moderate form. The German was undoubtedly handicapped by the

overnight rain having left the court damp. He was generally slow to get in his strokes. If, however, he had the idea of beating Ritchie at the latter's own game, his tactics were none too sound, for the simple reason that Ritchie, with his exceptional stamina, can outstay most men in prolonged events from the base-line. Had Froitzheim applied more power of stroke he would have been more successful, for, even as it was, he ran the first and last of three sets very close.

Prolonged rests and level scoring marked the progress of the opening set, the first two games of which went to Ritchie. Froitzheim won the third after deuce three times, and it was deuce twice in the fourth game before the German, with a fine cross-court backhand drive, made it two all. Froitzheim led for the first time at 4/3 ; Ritchie made it four all in a 'vantage game, and then going up on some weak returns, went ahead at 5/4. Excellent service enabled Froitzheim to draw level at 5 all, but the German's placing was faulty in the next two games, which went to Ritchie, who won the set at 7/5. After 3 all Ritchie's placing was too good for the German, and the set went to the home representative by 6 games to 3.

Ritchie appeared to be romping away with the third set when he reached 4/0, but at this stage Froitzheim began to fight hard, and the play became vastly entertaining, and was certainly much better in quality. Froitzheim, who opened the set very unsteadily, relieved the tedium by going out for his man, but, after winning the fifth game, he lost the sixth, Ritchie then standing at 5/1. What followed compensated in a large measure for the previous tame play, for the German stubbornly contested every game. In the seventh Ritchie was within a stroke of the match, but he lost the game. Twice in the eighth game did Ritchie come within a stroke of the match, but again he lost, and, when Froitzheim won the ninth game and pulled up to 4/5, there were distinct possibilities. A well-contested tenth game, however, was won by Ritchie, who thus secured the match and the Olympic gold medal for himself and his country. Froitzheim was clearly not himself in the final, but few will dispute the fact that he is an exceptional player, and destined to leave his mark on the game. Dr. Eaves and the Rev. J. Richardson, the beaten semi-finalists, played off for the bronze medal or third prize, and the former, whose placing was excellent, won by three sets to love, with scores of 6—2, 6—2, 6—3.

Something happened to the Ladies' Singles. Only four matches were played, and Mrs. Lambert Chambers had to win three of them to secure the gold medal. It was well, however, that the event was played, if only for the pleasure of seeing Mrs. Chambers in such excellent form. She beat Miss Greene, Miss Morton, Mrs. Winch, and Miss Boothby without losing a set, and was absolutely at her best against Miss Morton. In this

match Mrs. Chambers went up and took Miss Morton's short returns with fine skill, and the precision with which she placed her drives elicited general admiration. Had she played like this in the Championships she would have stood a fine chance. Against Miss Morton in the first round Miss Greene played a capital first set, but she did not appear too confident in the second. Mrs. Winch took the bronze medal.

R. F. Doherty's presence in the Doubles gave the event considerable interest. It was a pity that Gore and Barrett had to scratch, but other good pairs were left, notably Parke and Ritchie, who ran up against Doherty and Hillyard in the final. One by one—or should it be two by two?—the invading pairs dropped out. The first to go were Kreuzer and Rahe, who were slain by their compatriots, Froitzheim and Schomburgh, who paid the penalty for this in the next round, when they were vanquished by the South African pair, Gauntlett and Kitson. The Colonials made a fine recovery after losing the first set, and they won a match in which all four men were in a hurry. Kitson's drive, which just clears the net and travels at a tremendous pace, is a wonderful thing when it comes off, which it did time and again in the closing stages of this match. It would have been a fitting reward for their enterprise, enthusiasm, and fine sportsmanship had the South Africans come amongst the prize-winners, but their hopes were dashed to the ground in the third round, where they assumed what looked like a winning lead against Cazalet and Dixon, and were beaten on the post. Again they began in moderate form, there being too much hard hitting into the net. As Gauntlett steadied himself, however, and brought off some fine volleys, and Kitson became more accurate, they were quite a good pair, although beaten after leading in the final set. At this critical stage the steadiness of Dixon was invaluable to the winning side, whilst Cazalet showed fine judgment with his drives down the centre.

In the semi-final of the Doubles Dixon and Cazalet were beaten by Doherty and Hillyard. The first three sets were played in the rain. Somehow or other, Hillyard could do little right, whilst Cazalet and Dixon won the two sets comfortably. Doherty saved the third set by a superb effort when all seemed over, and then, with the players dripping wet, a successful appeal was made to the referee for an adjournment. There was some doubt as to whether the match would be resumed in the same evening, but, after a very long wait, the rain ceased, and the players again took the centre court. Very quickly Cazalet and Dixon went to 5/2 in the fourth set. It appeared to be any odds on them for the match, but once more Doherty was supreme in a crisis, and, although Hillyard improved, it was mainly due to the ex-champion that the match took a remarkable turn.



In a grim battle for that eighth game Dixon and Cazalet came within a stroke of the match no fewer than five times with Doherty serving ! After this game after game went with the service, and at 15/14 Cazalet and Dixon twice more came within a stroke of the match. It was a heart-breaking experience for them, the more so as a sensational set ultimately went to Doherty and Hillyard by seventeen games to fifteen. Further disappointment was in store for Cazalet and Dixon, who assumed a lead of 3/0 in the fifth and deciding set, and were again unable to clinch matters. The small crowd waxed very enthusiastic as Doherty and Hillyard pulled up to 3 all, and then won the set at 6/4 and with it a remarkable match.

Ritchie and Parke received a walk-over in the semi-final owing to the absence of Decugis, who was paired with Germot.

The final of the Doubles produced a match of uneven form, but it deservedly went to Doherty and Hillyard, the latter of whom, by his brilliant dash, made ample amends for his lapses in the semi-final. Although the match was won by three sets to love, it was finely fought out, all being 'vantage sets. Hillyard, so excellent later on, was not too good to begin with, whereas Parke and Ritchie—especially Parke—opened in most promising style. Parke did quick things at the net, and met some of Hillyard's drives with an occasional stop-shot most brilliantly played. Ritchie was in the rear with his steadying influence, and the pair went to 5/2 in capital style. The obvious duty of the opposition was to pass the active Parke, so Doherty, with the happy knack of rising to big occasions which characterised his play in all his matches, began to steer the ball most deftly over the Irishman's head and to pass him with some of the sweetest of backhand strokes. In this way four games were won off the reel, and, after Ritchie and Parke had led again at 7/6, Doherty and Hillyard won the set by 9/7. In the last game the winners were three times within a stroke of the set before they won it, and the end came with Parke lobbing a ball out of court. Parke, despite his rather erratic dash, played some fine strokes in the second set, during which Doherty occasionally wavered. Doherty and Hillyard won at 7/5, after being led by 2/1, 3/2 and 4/2. Despite the rashness which led to mistakes, Parke continued to command attention in the third set, and won many aces with his swift service. The play proceeded on the same even lines—2 all, 3 all, 4 all, 5 all, 6 all, 7 all, and, finally, 9/7 in favour of Doherty and Hillyard, who broke through Parke's service in the fifteenth game. Ritchie was not quite at his best, being uncertain in his length. The bronze medals in this event went to Dixon and Cazalet.

## DETAILS OF SCORING.

## MEN'S SINGLES.

## FIRST ROUND.

C. P. Dixon, United Kingdom, beat F. W. Rahe, Germany (6/2, 7/5, 6/4).  
 J. Cerny, Bohemia, w.o., O. Schmid, Hungary, retired.  
 E. Zsigmondy, Hungary, w.o., L. Ivanaka, Hungary, retired.  
 Baron von Bissing, Germany, w.o., G. C. Ball-Greene, United Kingdom, retired.  
 A. Zborzil, Austria, w.o., A. W. Gore, United Kingdom, retired.  
 C. von Wesseley, Austria, w.o., H. Roper Barrett, United Kingdom, retired.  
 W. V. Eaves, United Kingdom, beat R. Kinzl, Austria (6/3, 6/1, 6/0).  
 E. Toth, Hungary, beat J. Micovsky, Bohemia (6/3, 2/1), retired.  
 J. C. Parke, United Kingdom, w.o., J. Roessler-Orowsky, Bohemia, retired.  
 O. Kreuzer, Germany, beat F. Piepes, Austria (6/3, 6/1, 6/4).  
 O. Froitzheim, Germany, beat K. Powell, United Kingdom (6/3, 6/1, 6/4).  
 R. B. Powell, Canada, beat C. von Lennep, Holland (6/4, 6/1, 6/2).  
 Z. Razny, Bohemia, w.o., H. L. Doherty, United Kingdom, retired.  
 Nineteen players had byes.

## SECOND ROUND.

C. K. Vitous, Bohemia, w.o., H. M. Suckling, Canada, retired.  
 M. Germot, France, beat H. Schomburgh, Germany (7/5, 6/4, 6/2).  
 M. J. G. Ritchie, United Kingdom, beat V. R. Gauntlett, South Africa (6/1, 6/4, 6/1).  
 W. C. Crawley, United Kingdom, w.o., G. W. Hillyard, United Kingdom, retired.  
 Dixon beat D. Lauber, Hungary (6/1, 6/0, 6/0).  
 Cerny beat Zsigmondy (7/5, 6/4, 3/6, 6/0).  
 Von Bissing beat Zborzil (6/1, 6/4, 6/4).  
 Eaves w.o., von Wesseley, retired.  
 Parke beat Toth (6/1, 6/3, 6/2).  
 Froitzheim beat Kreuzer (6/2, 6/3, 6/3).  
 R. B. Powell beat Razny (2/6, 6/0, 6/4, 6/1).  
 G. A. Caridia, United Kingdom, beat H. A. Kitson, South Africa, (6/1, 6/3, 6/1).  
 Capt. J. F. Foulkes, Canada, beat R. van Lennep, Holland (6/2, 6/4, 6/3).  
 Rev. J. Richardson, South Africa, w.o., Max Decugis, France, retired.  
 D. Slava, Bohemia, w.o., J. Zemla, Bohemia, retired.  
 Capt. C. R. Brown, Canada, w.o., Z. Jansky, Bohemia, retired.

## THIRD ROUND.

Germot, w.o., Vitous, retired.  
 Ritchie beat Crawley (6/1, 6/4, 6/1).  
 Dixon beat Cerny (6/1, 6/2, 6/3).  
 Eaves beat von Bissing (8/6, 7/5, 7/5).  
 Froitzheim beat Parke (6/4, 11/9, 6/4).  
 Caridia beat Powell (6/4, 3/6, 6/4, 6/2).  
 Richardson beat Foulkes (6/2, 6/4, 6/3).  
 Brown beat Slava (6/2, 6/1, 6/2).

## FOURTH ROUND.

Ritchie beat Germot (6/0, 4/0), retired.  
 Eaves beat Dixon (6/3, 7/5, 6/3).  
 Froitzheim beat Caridia (6/4, 6/1, 5/7, 6/1).  
 Richardson beat Brown (6/3, 6/1, 6/0).

## FIFTH ROUND.

Ritchie beat Eaves (2/6, 6/1, 6/4, 6/1).  
 Froitzheim beat Richardson (2/6, 6/1, 6/4, 6/4).

## FINAL.

Ritchie beat Froitzheim (7/5, 6/3, 6/4).

Gold Medal—M. J. G. Ritchie, United Kingdom ; Silver Medal—O. Froitzheim, Germany. Bronze Medal—W. V. Eaves—United Kingdom.

## LADIES' SINGLES.

## FIRST ROUND.

Miss A. M. Morton, United Kingdom, beat Miss A. N. G. Greene, United Kingdom, (8/6 6/2).

Mlle. Czery, Hungary, w.o., Fr. F. Pietrikowski, Austria, retired.

Mrs. Winch, United Kingdom, w.o., Fr. E. Matuck, Austria, retired.

Mme. Fenwick, France, w.o., Fr. M. Amende, Austria, retired.

Mrs. Sterry, United Kingdom, w.o., Mme. Madarasz, Hungary, retired.

Three players had byes.

## SECOND ROUND.

Mrs. Chambers, United Kingdom, beat Miss Morton (6/2, 6/3).

Mrs. Winch, w.o., Mlle. Czery retired.

Mme. Fenwick, w.o., Mrs. Sterry retired.

Miss Boothby, w.o., Mrs. Hillyard retired.

## THIRD ROUND.

Mrs. Chambers beat Mrs. Winch (6/1, 6/1).

Miss Boothby, w.o., Mme. Fenwick retired.

## FINAL.

Mrs. Chambers beat Miss Boothby (6/1, 7/5).

Gold medal—Mrs. Chambers, United Kingdom. Silver Medal—Miss Boothby, United Kingdom. Bronze Medal—Mrs. Winch, United Kingdom.

## MEN'S DOUBLES.

## FIRST ROUND.

C. H. L. Cazalet and C. P. Dixon, United Kingdom, w.o., R. Kinzl and K. von Wesseley, Austria, retired.

H. Schomburgh and O. Froitzheim, Germany, beat O. Kreuzer and F. W. Rahe, Germany (6/1, 6/3, 6/3).

R. Gauntlett and H. A. Kitson, South Africa, beat J. Cerny and D. Slava, Bohemia (6/0, 6/4, 6/3).

L. Ivanka and D. Lauber, Hungary, w.o., A. W. Gore and H. Roper Barrett, United Kingdom, retired.

A. Zborzil and F. Piepes, Austria, w.o., J. Micovsky and J. Roessler Orowsky, Bohemia, retired.

Eleven pairs had byes.

## SECOND ROUND.

W. C. Crawley and K. Powell, United Kingdom, beat Capt. J. F. Foulkes and R. B. Powell, Canada (7/5, 6/3, 6/2).

G. W. Hillyard and R. F. Doherty, United Kingdom, w.o., J. Zemla and C. K., Vitous, Bohemia, retired.

Dixon and Cazalet beat C. and R. van Lennep, Holland (6/4, 6/0, 3/6, 6/2).

Kitson and Gauntlett beat Froitzheim and Schomburgh (3/6, 6/2, 7/5, 6/3).

Piepes and Zborzil, w.o., Lauber and Ivanka retired.

M. J. G. Ritchie and J. C. Parke, United Kingdom, beat E. Zsigmondy and E. Toth, Hungary (6/1, 6/0, 6/3).

Capt. C. R. Brown and H. M. Suckling, Canada, w.o., Z. Jansky and Z. Razny, Bohemia, retired.

M. Germot and Max Decugis, France, w.o., W. V. Eaves and G. C. Ball-Greene, United Kingdom, retired.

## THIRD ROUND.

Hillyard and Doherty beat Crawley and Powell (10/8 5/1, 7/9, 7/5).  
 Cazalet and Dixon beat Gauntlett and Kitson (6/2, 5/7, 2/6, 6/3, 6/3).  
 Ritchie and Parke beat Zborzil and Piepes (7/5, 6/4, 6/2).  
 Germot and Decugis, w.o., Brown and Suckling retired.

## FOURTH ROUND.

Hillyard and Doherty beat Cazalet and Dixon (5/7, 2/6, 6/4, 17/15, 6/4).  
 Ritchie and Parke, w.o., Germot and Decugis retired.

## FINAL.

Hillyard and Doherty beat Ritchie and Parke (9/7, 7/5, 9/7)  
 Gold Medals—G. W. Hillyard and R. F. Doherty, United Kingdom. Silver  
 Medals—M. J. G. Ritchie and J. C. Parke, United Kingdom. Bronze  
 Medals—C. H. L. Cazalet and C. P. Dixon, United Kingdom.

## II.—COVERED COURTS.

This competition was begun at Queen's Club on May 6, 1908 and by their success in carrying off three bronze medals, the Swedish players were the first foreign representatives to win honours in the Olympic Games.

- (1) Men's Singles. Won by A. W. Gore (United Kingdom).
- (2) Ladies' Singles. Won by Miss Eastlake Smith (United Kingdom).
- (3) Men's Doubles. Won by A. W. Gore and H. Roper Barrett (United Kingdom).

## MEN'S SINGLES.

The match between L. H. Escombe and G. Setterwall proved most interesting. Setterwall winning the toss, elected to serve. He made good use of his very powerful service, and soon annexed the first game. He then captured Escombe's service, leading 2/0. Escombe won the third and fifth games of the first set, and lost it at 6/2. In the fourth game Setterwall brought off a very fine forehand drive, and was loudly applauded. In the second set Escombe, playing better, reached 3/1, but Setterwall won the next five games and the set at 6/3. In the fourth game of this set the Swede again made a fine forehand drive, but double-faulted in the seventh. His play was better than Escombe's all round, and he volleyed brilliantly. He has a great reach, which proves most useful. In the third set Escombe commenced serving, but soon lost the first three games, the Swede winning the second with a magnificent kill. The only game Escombe won in this set was the fourth, a love game. In the sixth game Setterwall, serving grandly, won two aces outright without Escombe touching the ball. Setterwall must be congratulated on his fine game. He is a good all-round player, a fearless hitter, and has a capital temperament for match play.

An exceedingly pretty game to watch was that between W. V. Eaves and W. Boström, the volleying on the part of Eaves and Boström's ground strokes being really fine. Boström led at 3/1 in the first set, but Eaves then made it 3 all. A great struggle ensued, but Eaves ran out at 7/5. The second set was not so well fought, Boström only winning two games. In the third set Eaves reached 5/1, deuce being called no less than twelve times in the sixth game before Eaves won it. The latter's carelessness lost him the next game, and this gave courage to his opponent, who was not slow to take the advantage, and, playing in capital style, won the next three games, making it 5 all. Six all and seven all were called, when Eaves won the next two and the match. Boström has a fine service, and his backhand shots are beautifully made. He volleys well, and with more experience would be hard to beat. He played a plucky game, and was loudly applauded at the end.

Caridia was drawn against G. Setterwall, and altogether outplayed the Swedish champion ; he was playing right at the top of his form, and try as Setterwall would, he could make no impression on the brilliance of his opponent, who, as usual, relied mostly on his half volleys, which he brought off time and again with unerring accuracy and precision. It was an exhilarating match to watch, but the score of three sets to love is quite a correct index of the game.

The game between Gore and Ritchie was a very fine and protracted match, in which the standard of play was a very high one. Both men were playing at the top of their form, and it was difficult to know which to admire most, the severe and accurate driving of Gore, or the wonderful manner in which Ritchie got to the ball and returned it. The match ran to the whole five sets, and Gore just got home in the final set by 6 games to 4. A feature of the encounter was the marvellous stamina of the winner, who appeared to be playing just as strongly at the end of the match as he was at the beginning. His opponent, on the contrary, had obviously had enough of it, which is hardly to be wondered at, when one considers the enormous amount of running he had to do in order to cope with Gore's lightning drives.

Caridia and Eaves were drawn together in the semi-final of the Singles, and what looked like being an exciting game was spoilt by Eaves retiring after he had lost the first set at 7/5. This was due to the fact that the loser was obviously out of condition and suffering greatly from the heat, which was of a particularly trying nature.

Gore had not much difficulty in beating Caridia in the final of the Gentlemen's Singles by three sets to love. Caridia was very patchy, at times playing most brilliantly, at others sending the easiest of shots into

the net. Gore was not so aggressive as usual, being content to win more by his opponent's mistakes than by his usual forcing strokes. Now that it is all over we cannot help thinking that it was a pity that this competition had to be held when it was ; for public interest was conspicuous by its absence, as was shown by the very meagre attendance, which on the final day amounted only to a mere handful of spectators.

#### LADIES' SINGLES.

Miss Eastlake Smith and Miss V. Pinkney have met so often in tournament play, and are so equally matched, that an interesting game is generally the result. Of late Miss Eastlake Smith holds the advantage, and on covered courts is slightly the stronger. Her variety of strokes and powerful overhead service, delivered in orthodox style, made her very formidable on these courts. She went through without losing a set, though 5 all was called in each before she won at 7/5, 7/5.

Miss A. N. G. Greene had no difficulty in beating Miss Boothby by 6/2, 6/2. The winner was much too steady for her opponent, who seemed short of practice, and for a player of her calibre singularly inaccurate.

Mrs. Wallenberg and Miss Coles had a long and exciting struggle. No less than 22 games had to be played in the first set before the Swedish lady could win it. The second set went to Miss Coles, who was playing a particularly steady and accurate game, by 6 games to 4. The final set was an up-and-down one, for Mrs. Wallenberg took the first four games and looked to have the set at her mercy, but at this point she seemed to tire, and Miss Coles gradually overhauled and passed her. With the score at 5/4 and 40/15 in her favour, however, Miss Coles had the misfortune to sustain a severe injury to the muscles of her arm, which compelled her to retire. It was an unfortunate ending to a very fine game, and Miss Coles deserves sympathy for her bad luck. Mrs. Wallenberg is a player who relies on the brilliancy of her strokes to pull her through, and plays a very severe game, but is rather weak on her back-hand. If she could remedy this defect and acquire a little more steadiness, her game would be enormously strengthened, and she would soon be capable of holding her own in the very best company.

The semi-finals of the Ladies' Singles resulted in the victory of the British Isles in both events. Miss Greene was opposed by Mrs. Adlerstrahle, who can hardly be said to have played up to her form, as after winning the first game she could not prevent Miss Greene from winning the next nine in succession. This was due principally to the softness of her game, which is quite contrary to her usual methods, and it was not until the middle of the second set that she woke up and started

to hit. Her effort, however, came too late, as Miss Greene was playing as steadily as a rock, and had no difficulty of winning the set at 6/3.

The game between Miss Eastlake Smith and Mrs. Wallenberg was a very interesting, if not a particularly brilliant, one. The English lady was serving very finely, and her victory was due in no small measure to this factor. Mrs. Wallenberg tried hard the whole time, but was not quite a match for her opponent in the matter of experience.

The match between the two Swedish ladies for the bronze medal occasioned general surprise, as Mrs. Wallenberg was confidently expected to win fairly comfortably ; and moreover these prognostications looked perfectly justified when she won the first set in the easiest manner by 6 games to 1. From this moment a change came over the scene. Mrs. Adlerstrahle settled down and commenced to play a very steady game with such good effect that her opponent, who is nothing if not brilliant, could not keep pace with it, and lost more games than she won. Mrs. Adlerstrahle captured the second set at 6/3, and as her opponent became still more erratic in the final set, had no difficulty in winning by 6 games to 2.

The final of the Ladies' Singles between Miss Eastlake Smith and Miss Greene produced a really excellent game in which there were numerous rallies marked by sound judgment and headwork. It was a much more interesting game than most ladies' singles usually are, inasmuch as it was not fought out entirely from the base line, but intermingled with some very pretty net play. Miss Eastlake Smith won the first set by 6 games to 2, chiefly through some well-placed drives and her judgment in coming to the net at the right moment. The second set was the best of the match. Miss Eastlake Smith established a very useful lead at, 3/1, but Miss Greene playing with great pluck made it three all, by putting in some very severe and accurate returns. She was placing so well that her opponent was kept on the run the whole time, and, by seldom giving her a chance to attack, Miss Greene captured the set at 6/4. She was perhaps lucky to win the last game, as the score was called love forty against her ; but she won it chiefly through the mistakes of her rival, who was undoubtedly feeling the effects of the running about she had had. The final set was a complete reversal of the previous one ; this time Miss Eastlake Smith kept her opponent on the defensive the whole time, and playing a very fine game won six games off the reel. She thus became the first lady winner of an Olympic gold medal.

#### MEN'S DOUBLES.

G. M. Simond and G. A. Caridia *v.* G. W. Hillyard and W. V. Eaves proved a curiously uneven match. Simond on the one side and Eaves on

the other were at their best ; Hillyard began well, but ended badly, whilst Caridia was at his very worst at the beginning, giving no assistance whatever to his partner in the first two sets, and only playing slightly better in the last three. The victory of Simond and Caridia was quite unexpected, their success being due to their perseverance and the extreme steadiness of Simond, who was at his very best. Hillyard and Eaves, aided by Caridia's errors, won the first set with the loss of only two games. The second set proved longer, but went the same way at 9/7. Simond and Caridia took the third at 6/4 and the fourth at 10/8, though Hillyard and Eaves were once or twice within an ace of this at 6/5. In the fifth set Caridia was slightly better, though had it not been for Hillyard's inability to return the service at this stage of the match it must have gone the other way. Hillyard also served several double-faults, as many as three in one game, and Eaves lost his service when at 4 all. Simond then won his, and the match at 6/4 in the fifth set. In all 62 games were played, each side winning 31.

M. J. G. Ritchie and L. H. Escombe were in great form in the first set of their match against A. W. Gore and H. Roper Barrett, and did not allow their opponents a single game. The latter were settling down, however, and soon put a different complexion on the game. The second set was well fought out, but Ritchie and Escombe lost one of their service games, and, in consequence, the set. The two last sets were not very close, Gore and Barrett always holding the upper hand, and winning fairly easily. Ritchie, though rather inclined to serve double-faults, played well. Gore was certainly the better on the winning side, his sweeping forehand drive, both off the ground and on the volley, winning many aces.

Another capital game, with plenty of hard serving, clean hitting, and good volleying was that between Simond and Caridia and Setterwall and Boström. Caridia began badly, but in the fourth set was very brilliant, bringing off many of his half-volley drives, which just cleared the net. Simond played his usual sound game at first, but, feeling a tennis elbow in the last two sets, became less accurate. Setterwall made many winning shots with his service and powerful forehand drive, but was somewhat weak on the low volleys. Boström was erratic, and returned many services into the net. The score, 6/4, 9/7, 3/6, 6/2, in favour of Simond and Caridia, about represents the play. The Swedish pair were once within an ace of the second set at 7/6, but they failed to gain the necessary point, their opponents capturing this game and the next two.

The Swedish pair, Setterwall and Boström, played Ritchie and Escombe for the bronze medal, which ranks as third prize, and are to be congratulated on a fine victory. The winners took some time to settle down, but when



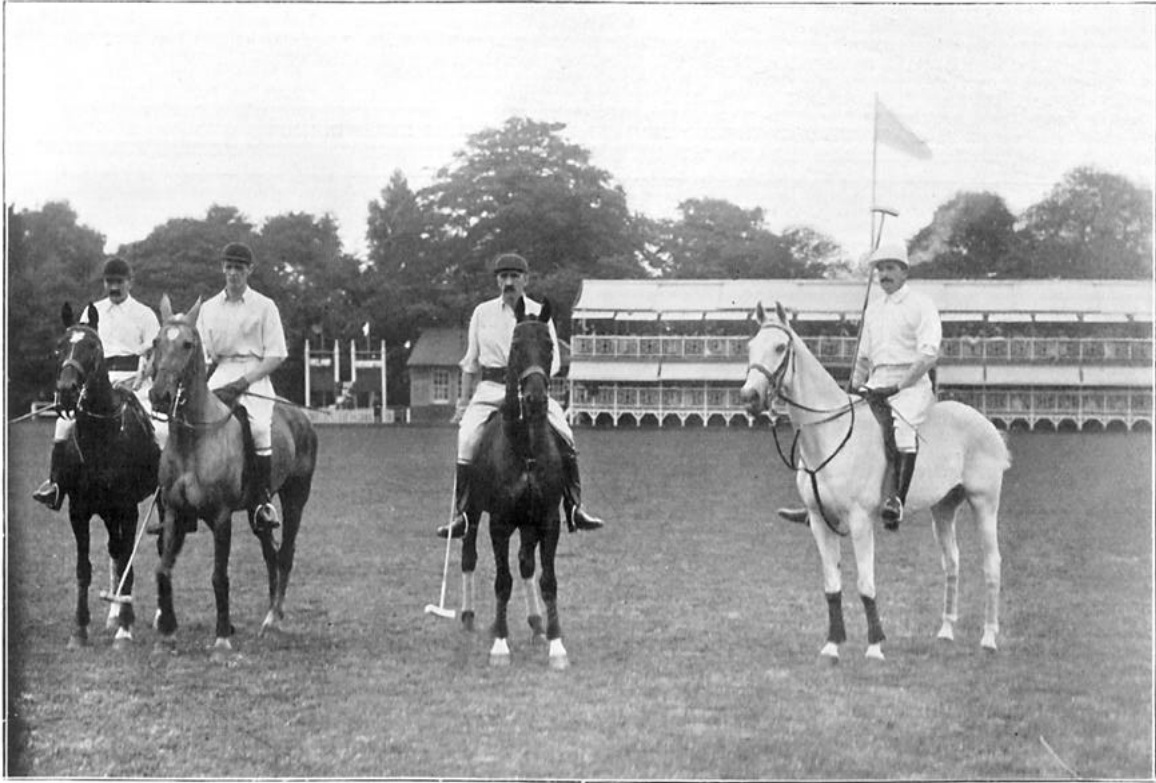

POLO.—THE WINNING TEAM (ROEHAMPTON, U.K.): C. MILLER, P. W. NICKALLS, G. MILLER, H. WILSON.

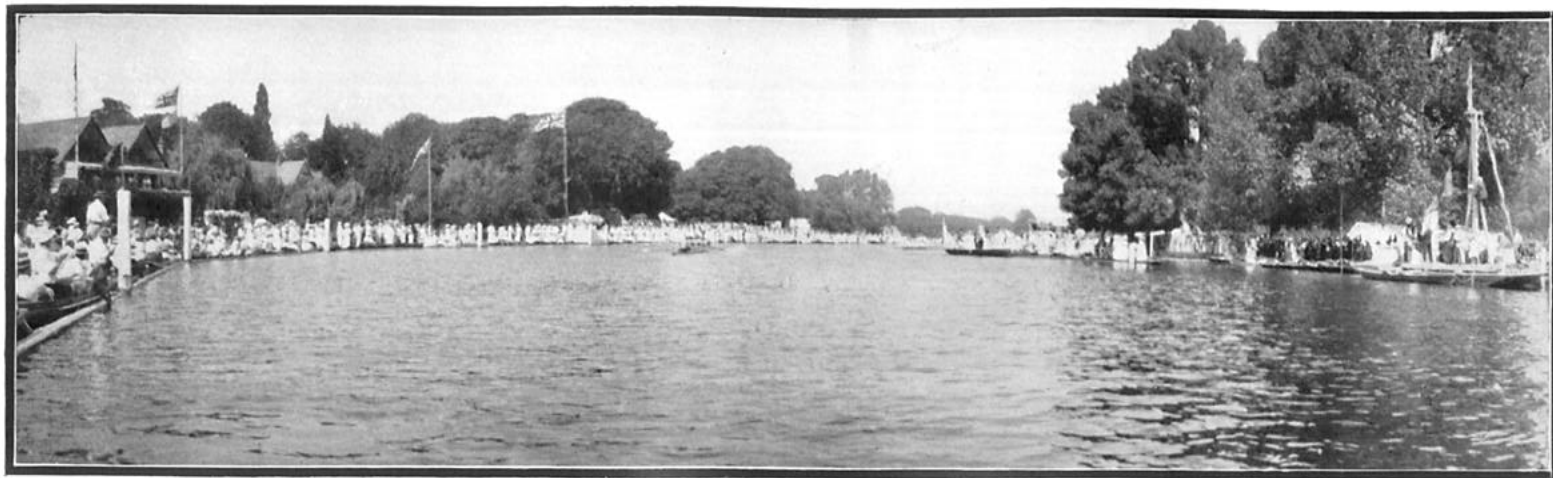

ROWING.—THE FINISH OF THE OLYMPIC COURSE AT HENLEY.

once they had got into their stride gave a very bright and invigorating display. After the score had been called two sets to one in favour of their opponents, they started to go out for everything, and played such an attractive game that they romped away with the last two sets by 6/0, 6/3.

The final of the Doubles saw Gore and Barrett opposed to Simond and Caridia, and although the former pair won by three sets to one, the tennis displayed was not of a very high standard, all the four players taking it in turns to be brilliant and then lapsing into mediocrity. Caridia played a magnificent game in the second set, and frequently nonplussed his opponents by the tactics which he adopted and the brilliance of his strokes. Unfortunately for his side he could not keep this form up, and despite the efforts of Simond, who played the most consistent game of the four, the pair could not cope with the greater accuracy of their opponents, who won as above stated.

## DETAILS OF SCORING

### MEN'S SINGLES.

#### FIRST ROUND.

A. F. Wilding, A. W. Gore, L. O. S. Poidevin had byes.  
 M. J. G. Ritchie w.o., H. Roper Barrett retired.  
 G. Setterwall beat L. H. Escombe (6/2, 6/3, 6/1).  
 G. A. Caridia, W. Boström, W. V. Eaves had byes.

#### SECOND ROUND.

Gore w.o., Wilding retired.  
 Ritchie w.o., Poidevin retired.  
 Caridia beat Setterwall (6/2, 6/1, 6/1).  
 Eaves beat Boström (7/5, 6/2, 9/7).

#### THIRD ROUND.

Gore beat Ritchie (4/6, 6/3, 5/7, 6/1, 6/4).  
 Caridia beat Eaves (7/5) retired.

#### FINAL.

A. W. Gore, United Kingdom, beat G. A. Caridia, United Kingdom (6/3, 7/5, 6/4).

### LADIES' SINGLES.

#### FIRST ROUND.

Mrs. L. Chambers, Mrs. Adlerstrahle, and Miss D. Boothby had byes.  
 Miss Greene w.o., Mrs. Winch retired.  
 Mrs. Wallenberg, Miss M. Coles, Miss G. Eastlake Smith, and Miss V. Pinckney had byes.

#### SECOND ROUND.

Mrs. Adlerstrahle w.o., Mrs. Chambers retired.  
 Miss Greene beat Miss Boothby (6/2, 6/2).  
 Mrs. Wallenberg beat Miss M. Coles (11/9, 4/6, 4/5) retired.  
 Miss Eastlake Smith beat Miss Pinckney (7/5, 7/5).

## THIRD ROUND.

Miss Greene beat Mrs. Adlerstrahle (6/1, 6/3).  
Miss Eastlake-Smith beat Mrs. Wallenberg (6/4, 6/4).

## FINAL.

Miss Eastlake Smith, United Kingdom, beat Miss A. N. G. Greene, United Kingdom (6/2, 4/6, 6/0).

## BRONZE MEDAL ROUND.

Mrs. Adlerstrahle, Sweden, beat Mrs. Wallenberg, Sweden (1/6, 6/3, 6/2).

## MEN'S DOUBLES.

## FIRST ROUND.

G. Setterwall and W. Boström a bye.  
G. M. Simond and G. A. Caridia beat G. W. Hillyard and W. V. Eaves (2/6, 7/9, 6/4, 10/8, 6/4).  
A. W. Gore and H. Roper Barrett and M. J. G. Ritchie and L. H. Escombe had byes.

## SECOND ROUND.

Simond and Caridia beat Setterwall and Boström (6/4, 9/7, 2/6, 6/2).  
Gore and Barrett beat Ritchie and Escombe (0/6, 6/4, 6/3, 6/3).

## FINAL.

A. W. Gore and H. Roper Barrett, United Kingdom, beat G. M. Simond and G. A. Caridia, United Kingdom (6/2, 2/6, 6/3, 6/3).

## BRONZE MEDAL ROUND.

G. Setterwall and W. Boström, Sweden, beat M. J. G. Ritchie and L. H. Escombe, United Kingdom, (4/6, 6/3, 1/6, 6/0, 6/3)

## MOTOR BOATS.

The Olympic races for Motor Boats were held under the auspices of the Motor Yacht Club, from their Club ship "Enchantress" in Southampton Water, on August 28 and 29.

Of all the many events held by the British Olympic Association these were the most unfortunate as regards the weather, for a strong gale was blowing from the south-west with constant downpours of rain, and the heavy sea running made racing an enterprise of some considerable risk, and robbed it of all its enjoyment, except to the most confirmed enthusiasts. That any competitors started at all was a strong testimony to their pluck and determination. It was unfortunately impossible to postpone the racing, as the fixture had originally been made for the middle of July, and postponed to allow of the return from America of the Duke of Westminster's crack forty-footer, "Wolseley-Siddeley," which had gone over to challenge for the British International Cup—at present held by the United States. Only a small proportion of the competitors decided to start their boats, and the speeds, as will be seen from the table of times, were poor in comparison with what the same boats have done before and since, and disappointing to record for so important an event. The unrestricted race produced only "Wolseley-Siddeley" and "Dylan" at the starting line, The former belongs to the Duke of Westminster and the latter to Lord Howard de Walden, both owners being at the helm of their vessels. "Daimler II." was not ready to start. The course was changed by the judges from the original one arranged round Calshot Lightship, Calshot Spit, and N.W. Netley, as it was obviously impossible to run the boats at racing speed in the sea that was running outside the Water. Both the starters had come over from Cowes during the morning, but at dead-slow speed, and by a course that kept them under the lee of the land as far as was possible. To have driven their boats fast over this outer course would have been to invite disaster. According to the Olympic rules the course for the boats had to be between 35 and 40 miles, and so it was necessary to find a new one conforming to these requirements. This was settled to lie between Bald Head, Dean's Lake, and N.W. Netley, five rounds, giving 40 nautical miles as nearly as possible. Both boats started evenly, but "Wolseley Siddeley" at once got quickly

away from her competitor. "Dylan," in fact, soon found herself in difficulties, and presently had to give up. At the end of the first round the weather became worse, and the race was declared "off," to be re-run on the following day.

Next came the race for the small racer class not exceeding 60 ft. in length, and fitted with a four-cylinder engine not exceeding 155 mm. bore, or the equivalent in other types. In this event the element of international competition should have been present, as Mr. Thubron's racer, though nominally an English entry, is a 30 ft. Pitre hull fitted with a Brasier 90 H.P. 4 cylinder motor, but she did not put in an appearance. Nor did Mr. Westmacott's "Pastime," and so "Quicksilver" (Mr. J. M. Gorham) and "Gyrinus" (Mr. Tom Thornycroft and Mr. Bernard Redwood) alone took part in the event. The latter was not, of course, built to the class, but there was nothing to prevent her competing in this as well as her own class.

At this time the sea was as bad as it had been at any time during the day, and the two boats went off literally hidden in spray. On "Gyrinus" Mr. Thornycroft had decided to take an extra hand to bail, and, as it turned out, very wisely, for "Quicksilver," not so provided, had to give up after the first round as it was found impossible to keep the water under and at the same time keep an eye on the engine. "Gyrinus," however, kept going with extraordinary regularity, and managed to average over 16 knots in spite of the fact that she went right over to the lee shore on the run from "Enchantress" to Bald Head to avoid the worst of the seas. She covered her rounds with the regularity of a machine in spite of the hopeless weather conditions, and literally jumped over the waves, at times showing half her length out of water. Her elapsed times for each of the five rounds were respectively 30 min. 0 sec., 31 min. 20 sec., 28 min. 57 sec., 29 min. 22 sec., and 29 min. 20 sec. At the finish everyone aboard "Enchantress" assembled on the upper deck to give the plucky crew of "Gyrinus" a cheer, which was assuredly well deserved. The gun went, and the first Olympic gold medal for motor-boat racing was awarded to the boat. She had certainly earned it, for her performance had been a wonderful exhibition of speed and staying power, and one, moreover, that entirely disproves the assertions of those who contend that the racing cruisers are not fit boats to run in anything but a flat calm.

The conditions that existed at Netley during the races had to be seen to be realised, and careful observers are able to say that it would have been remarkable for any 26 ft. boat to have run at 16 knots in such a sea for 40 miles, and to have accomplished that speed with a 106 mm. engine is really wonderful.

The weather on the second day of Netley Regatta was distinctly better than on the first, but the gale was still blowing and a considerable sea for small boats was running in Southampton Water.

The proceedings opened at 10.30 with the Olympic race for the 6½-8 metre racing cruisers, for which "Sea Dog" and "Gyrinus" put in appearance, "Lotus II." being again an absentee. The two first-named boats, however, got away very nicely, "Sea Dog" being first over the line by a small margin. The course was the same as that chosen on the previous day, it being still far too rough to race round Calshot, and at the end of the first round there was not a length between them; the average speed worked out at about 17 knots, very creditable, considering the state of the sea, and it really looked as if "Gyrinus" had at last met an opponent worthy of her steel—or, rather, steel and mahogany. But "Sea Dog" did not maintain her form. Just after rounding the Bald Head for the second time, her engine started missing, and, the trouble becoming worse, Mr. Warwick Wright abandoned the contest and started at half-speed for "Enchantress." He got safely as far as the After Barn, and there stopped altogether. It was very disappointing, after the hopeful position at the start, and there was the additional chagrin of seeing the boats in the next race rounding the buoy close by. There seemed some chance of drifting on to a lee shore, and so preparations were made for dropping anchor, but "Maudslay" at that moment appeared on the scene, and towed "Sea Dog" back to the ship. So once again "Gyrinus" finished a race alone for an Olympic gold medal. Her total elapsed time for the 40 sea miles was 2 hr. 28 min. 26 sec., while her best round was accomplished in 27 min. 37 sec., the speed on this lap working out at almost exactly  $17\frac{3}{4}$  knots.

Then came the race of the day. "Wolseley-Siddeley," "Daimler II.," and Mr. Thubron's "Camille" all came from their moorings to contest the third Olympic gold medal. The Duke of Westminster was once again at the helm of his boat, Capt. Sir George Clowes keeping his place as engineer, while Mr. Atkinson replaced Capt. J. F. Laycock as the other member of the crew. Just before the start, "Daimler II." showed a fine burst of speed, but just as the five-minute gun fired she developed some trouble, and, after hanging about and cruising at slow speed for some time, she turned and went away down the course without crossing the line. Meanwhile, "Wolseley-Siddeley," after waiting for "Daimler II.," in order to make a race of it, started alone, to be followed, however, shortly afterwards by "Camille." "Wolseley-Siddeley" finished her second round in 18 min. 8 sec., this representing a speed of 26.6 knots, which was as much as could be expected on such a day, and, as she had then nearly lapped

“Camille,” it seemed safe to conclude that the third gold medal would also go to an English-built boat. But it was not to be. The tide was rather past half-ebb, and “Wolseley-Siddeley” getting too close to Hamble Spit went high and dry on the soft mud, and so eliminated herself from the contest. “Daimler II.” meanwhile had retired, and so “Camille” was left to finish alone, which she did at a speed of nearly 18 knots. Her lap times were 36 min. 15 sec. (including the late start), 27 min. 5 sec., 26 min. 42 sec., 26 min. 14 sec., and 30 min. 27 sec., the speed of the best round being 18·3 knots. During the race S.Y. “Branwen” had been cruising about in readiness to offer assistance, as also was Lord Howard de Walden’s steam launch, “Rose en Soleil,” fitted in 1907 with the engines out of the racer of that name.

This finished the racing, which had proved most disappointing from both the record-breaking and spectacular points of view, but which furnished another instance of what can be got out of modern boats when handled with skill, nerve, and determination.

## RESULTS.

### OLYMPIC MOTOR BOAT RACES.

*August 28 and 29, 1908.*

Course.—Bald Head, Dean’s Lake, N.W. Netley. Five times round.

Distance 40 sea miles.

*August 28, 1908.*

*Class B.—*

GYRINUS ... .. 1st round, 29 min, 59 sec. , 2nd, 31 min.  $10\frac{4}{5}$  sec. ;  
3rd, 28 min. 57 sec. ; 4th, 29 min. 22 sec. ;  
5th, 29 min. 20 sec. Elapsed time, 2 hr.  
28 min.  $8\frac{4}{5}$  sec.

QUICKSILVER ... Retired after one round.

GYRINUS winner.

*Class A.—*

WOLSELEY-SIDDELEY 1st round, 35 min.  $34\frac{2}{3}$  sec. Gave up.

DYLAN ... .. Did not finish round.

Race postponed till next day.



August 29, 1908.

Class C.—

GYRINUS ... .. 1st round 28 min.  $1\frac{2}{5}$  sec. ; 2nd, 27 min.  $37\frac{2}{5}$  sec. ;  
3rd, 32 min.  $36\frac{1}{5}$  sec. ; 4th, 31 min. 4 sec. ;  
5th, 29 min. 7 sec. Elapsed time, 2 hr.  
28 min. 26 sec.

SEA DOG ... .. 1st round, 28 min.  $1\frac{1}{5}$  sec. Retired on next round.

GYRINUS winner.

WOLSELEY-SIDDELEY 1st round, 20 min. 24 sec. ; 2nd, 18 min. 8 sec.  
Retired. Ran on Hamble Spit.

CAMILLE ... .. 1st round, 36 min. 15 sec. ; 2nd, 27 min. 5 sec. ;  
3rd, 26 min. 42 sec.; 4th, 26 min. 14 sec. ;  
5th, 30 min. 37 sec. Elapsed time, 2 hr.  
26 min. 53 sec.

DAIMLER II. ... .. Did not run.

CAMILLE winner.

## POLO.

The Hurlingham Club presented a Challenge Cup for the winners of the Olympic Polo, and the first match began on Thursday, June 18, the players being :

## ROEHAMPTON.

Captain H. Wilson, Mr. G. A. Miller, Mr. P. W. Nickalls,  
and Mr. C. D. Miller (back).

## HURLINGHAM.

Mr. W. H. J. Jones, Mr. F. M. Freake, Mr. W. S. Buckmaster,  
and Lord Wodehouse (back).

*Umpires.*—Major MacLaren and Captain Fagan.

*Timekeeper.*—Major Blacker.

The ground was rather heavy after rain, and exchanges were fairly even until at the end of the second ten Mr. Jones scored a goal for Hurlingham. The third period opened with Roehampton attacking hotly, and Mr. Nickalls soon scored for them, and Captain Wilson hit through again before the bell rang. In the fifth ten Hurlingham had very bad luck, which lasted them till the end, when Mr. Buckmaster hit the post with a fine shot. Roehampton won by three to one, and on the following Sunday played an Irish team composed of:

Mr. A. M. Rotherham, Mr. J. McCann, Captain H. Lloyd,  
and Mr. P. O'Reilly (back).

*Umpires.*—Major MacLaren and Captain Fagan.

After Mr. George Miller and Captain Wilson had each scored for Roehampton in the opening ten, the former got three more goals in the second period. Ireland's only goal was scored by Mr. McCann just before the bell rang at the end, and Roehampton won the Gold Medals and the Challenge Cup for the United Kingdom—there being no foreign entries—by eight goals to one.

## RACQUETS.

Although no foreign players entered for the first of the Olympic competitions, which began at the Queen's Club on April 27, the entries were not entirely unrepresentative of English racquets, and the matches promised to be of interest. Unfortunately so many players either scratched or failed to make an appearance that the competition lost much of its importance. Of the four players in the semi-final round of the Singles three had not been called upon to play a match, while in the Doubles there was no match in the first round, and but one in the second round, which was also the semi-final. Bury and C. Browning had the unusual experience of qualifying for the final round without playing a match.

### THE SINGLES.

#### FIRST ROUND.

J. J. Astor, B. S. Foster, and H. M. Leaf had byes.

F. H. Browning w.o. ; E. M. Baerlein retired.

E. B. Noel beat C. Browning by three games to one, 18-14, 8-15, 15-3, 15-9 (56 aces to 41).

V. H. Pennell, E. W. Bury, and H. Brougham had byes.

If Browning had been more consistent in his service he might have given Noel a very hard game, for on the two occasions when he found a length he more than held his own. In the rallies he made only about half as many mistakes as his opponent, and if he managed to get the attack he was seldom outgeneralled. On the other hand, when he was not attacking, he was almost at the mercy of Noel, who showed great cleverness in placing the ball. Each player began with an unproductive hand, and then Noel went to 11-0, his opponent failing eight times to return the service. Browning now played with great pluck, and, aided by three bad mistakes by Noel, reached 13-12 in three hands, his service being excellent. The game was set five, and although Noel put himself out at two love by another mistake he won the game, and was at four love in the second game. He also led at 6-0 and 8-3, but Browning winning most of his aces by his service went out in two hands. The third game saw Noel again leading at 7-1, and meeting with no opposition he went out. With the score at 11-4 in Noel's favour in the fourth game Browning once more pulled up, scoring the next five aces, but this was his last effort. Noel's service accounted for thirty-four aces outright and Browning's for twenty-four.

## SECOND ROUND.

Astor w.o. ; Foster retired.

Leaf w.o. ; F. H. Browning retired.

Noel beat Pennell by three games to love, 15-12, 15-7, 15-5 (45 aces to 24).

Brougham w.o. ; Bury retired.

Pennell was not at his best in his match with Noel, and the brilliant strokes which were so much in evidence in his championships were conspicuous by their absence. He only made half a dozen serious mistakes in the rallies, hut only half as many finishing strokes as Noel, who also made few mistakes in the rallies. Except in the first game Pennell's service was by no means as good as usual, winning him only sixteen aces, while Noel's service produced twenty-seven. In the first game Pennell went to 3—0, Noel to 1—3, and the next eighteen aces were all won directly by the service, eleven of them by Noel. In two hands Pennell had worked from 6—12 to 11—12, and then Noel, getting in by a fine return of the service, ran to five love in the second game. Noel was at 8—4 and 9—4, and, getting in again at 9—7, went out. The last game was chiefly remarkable for many finishing strokes by Noel, and for some returns of the service by which each player put his opponent out.

## THIRD ROUND.

Leaf beat Astor by three games to love, 15-43, 15-5, 15-4 (45 aces to 17).

Noel beat Brougham by three games to love, 15-4, 15-12, 15-6 (45 aces to 22).

Both matches in this round were most disappointing, for Astor and Brougham were both out of form, and each of them was opposed by a player who was quick to recognise his advantage. In the first match Brougham was obviously nervous, and was frequently below the line with his first service, while his second was exceedingly weak. He often volleyed the service, and also volleyed much in the rallies; but, although he sometimes made a wonderfully effective stroke, he was generally so inaccurate that he had no chance against Noel, who had only to play a reasonably safe game to be sure of victory. When the second game was at 13—3 in favour of Noel, Brougham had only scored seven aces altogether. He then pulled himself together, and played so very much better that evidently if he can regain his form he will be a difficult man to beat in the future. For a brief space he found a length for his service. The result was that in three hands he went to 6—13, 7—13, and 12—14. He then made two good finishing strokes, and also two out of court. Noel went out and to six love in the third game. Brougham gradually drew up, but could not get beyond 6—10. In the match Noel's service accounted for twenty-two aces and Brougham's for fifteen. Astor was not himself when he met Leaf, either in the rallies or in serving or taking

service. Leaf soon saw that he had the upper hand, and from the first played a winning game with great steadiness. Leaf in the first game was at 4—1, 8—1, and 10—5, and from 10—8 went to 2—0 in the second game. The hands were now very small, averaging less than an ace each, until Leaf found himself at 7—3, and then in two hands went out. The third game was not of great interest. By his service Leaf scored twenty-six aces, while Astor could only account for twelve.

FINAL ROUND.

Noel a bye ; Leaf retired.

As Leaf had injured his hand on the previous day he was obliged to scratch, so that Noel became the winner of the first Gold Medal awarded in the Olympic Games of 1908.

THE DOUBLES.

FIRST ROUND.

V. H. Pennell and J. J. Astor a bye.

E. B. Noel and H. M. Leaf w.o. ; B. S. Foster and F. H. Browning retired.

E. M. Baerlein and E. H. Miles and E. W. Bury and C. Browning had byes.

SECOND ROUND.

Pennell and Astor beat Noel and Leaf by four games to two, 15-11, 0-15, 15-7, 9-15, 18-14, 17-15 (74 aces to 77).

Bury and C. Browning w.o. ; Baerlein and Miles retired.

SECOND ROUND.—The only match in this round provided an interesting struggle in which there was nothing to choose between the two pairs. Some of the rallies were unusually long, but this was chiefly due to the fact that much of the hitting in the first four games was high. When the score was two games all Pennell hurt his foot, but although he was thus considerably handicapped in the rallies he began to hit much harder and lower, with the result that he made many characteristic finishing strokes, often with a half volley. Noel made several mistakes, but played better racquets than any of the others, and finished more rallies, Astor and Leaf generally playing for safety. Astor was in much better form than on the previous day, and it was chiefly due to his play at a critical time that the sixth game did not go to the other pair. Leaf was not at his best, having an injured hand, but his service accounted for twenty-eight aces against twenty-one by Pennell, sixteen by Astor, and fifteen by Noel. Pennell and Astor were at nine love and 13—4 in the first game, which, however, they had to fight hard to win. They failed to score a single ace in the second game, but won the third without any difficulty. The fourth went to Noel and Leaf, thanks largely to a sequence of eleven by the latter, who came in at 4—9 and went out. Each pair had now won two games, and there was a close struggle for the lead, the score being called six all, seven all, twelve all, and thirteen all. The game was set five, with Pennell serving and Astor to follow, but the other pair each had a hand before

Astor went out. The sixth game seemed a certainty for Noel and Leaf, for the latter getting in at 2—6 ran to 13—6 with a sequence of eleven, while Noel made it 14—6. At this period Astor served very well indeed, while Pennell ended several rallies, and the game was set at fourteen, with Pennell serving and Astor to follow, as in the previous game. A splendid stroke by Noel dismissed Pennell at one love in the set. Astor made a stroke below the board at two love. Pennell put out Leaf at 1—2 by an irresistible return of the service, and Noel was prevented from scoring by a brilliant stroke by Astor, who finished the next rally in the same way, and thus ended the match.

#### FINAL ROUND.

Pennell and Astor beat Bury and Browning by four games to one, 6-15, 15-7, 16-15, 15-6, 15-7 (67 aces to 50).

FINAL ROUND.—A sudden rise in the temperature seemed to affect all the players in this match and Bury and Browning, after a most promising beginning, fell away badly, when the score was two games to one against them. Their finishing strokes were uncommonly good at first, but in the latter stages of the match they were quite overshadowed by Pennell, whose boldest strokes generally came off. The first game was at 3 all and 5 all, and Bury, getting in at 8—6, went to one love in the second game. Despite some fine strokes by Bury and Browning, Pennell finished so many rallies that the second game went to him and Astor. The third game was called 8—1 in favour of Bury and Browning, but the other pair made it 8 all. A keen struggle followed, 9 all, 13 all, and 2 all in the set being called before Pennell made the ace required to win. Again play was very even, 2 all, 3 all, and 5 all being called. Pennell then came in, and suddenly developing a very hard service and making a series of brilliant strokes in the rallies ran to 6 love in the fifth game with a sequence of sixteen. After this there was no question as to the result. Pennell's service accounted for twenty-one aces, Berry's for thirteen, Astor's for six, and Browning's for three.

Racquets, it may be noted, is always so expensive a game that, except at the public schools, the number of players is always restricted, and, out of the United Kingdom, India and the United States of America are the only countries where the game is played, which may be a reason for not including it in future programmes for the Olympic Games. E. M. Baerlein, who retired from the Olympic Singles, had won the Amateur Championship against Noel, who took the Gold Medal. Pennell, who won the Olympic Doubles, and showed fine form with Astor, had previously won the Doubles in the Amateur Championship with F. Dames Longworth, beating H. M. and C. H. Leaf in the final round.

## ROWING.

The Committee of the Amateur Rowing Association undertook, at the request of the British Olympic Council, the management of the Olympic Regatta. A Committee consisting of Mr. H. T. Steward, Chairman ; Mr. R. S. Bradshaw; the Right Hon. Lord Desborough, K.C.V.O. ; Messrs. W. A. L. Fletcher, D.S.O. ; S. D. Muttelbury ; R. Philipson ; F. I. Pitman ; S. Le Blanc Smith ; C T. Steward ; and R. G. Gridley, Hon. Sec., was appointed, and these gentlemen planned and managed the regatta, and carried out all details in connection therewith.

The regatta was held at Henley-on-Thames on July 28 and the three following days.

The Chairman of the British Olympic Council having expressed a desire that the course should be made as long as possible, a course  $1\frac{1}{2}$  miles in length was marked out with piles and booms on both sides, it being impracticable to obtain a fair course of a greater length.

There were four events, viz. Scullers, Pair-Oars, Four-Oars, and Eight-Oars.

The entries for each event were restricted to two from each country.

Eight entries were made for the eight-oared race, viz. one each from Belgium, Canada, Hungary, and Norway ; and two each from Italy and the United Kingdom.

Seven entries were made for the four-oared race, viz. one each from Belgium, Canada, Holland, Hungary, and Italy ; and two from the United Kingdom.

Five entries were made for the pair-oared race, viz. one each from Canada, Germany, and Italy : and two from the United Kingdom.

Eleven entries were made for the scullers' race, viz. one each from Belgium, Germany, and Holland ; and two each from Canada, Hungary, Italy, and the United Kingdom.

Unfortunately several of the entries were withdrawn, viz. those of Italy for the eight-oared race ; Belgium, Hungary, and Italy for the four-oared race ; Italy for the pair-oared race ; and Holland and one of the Italians for the scullers' race.

In accordance with a resolution of the British Olympic Council, the trial heats were so drawn that competitors from the same country could

not meet until the final heat in the various events. Many of the races were well contested, and every prize was won by the United Kingdom. The regatta was a great success, and concluded with an imposing ceremony at the distribution of the prizes, arranged and carried out by Lord Desborough, the Chairman, and Mr. T. A. Cook, another member of the British Olympic Council. Lady Desborough kindly presented the Gold Medals to the successful competitors, and the bronze Statuette of Pallas Athene, given by Comte Brunetta d'Usseaux, to be held by the winning eight-oared crew until the next Olympic Games.

The Committee of the Amateur Rowing Association placed on record their sincere thanks to the Committee of Henley Royal Regatta for so kindly lending all their piles, booms, stands, tents, fencing, boathouse, and rented lands, free of cost, for the purpose of the Olympic regatta, thereby saving an enormous expenditure.

In addition to the grant of a thousand pounds from the British Olympic Council, the receipts in connection with the regatta amounted to £718 12 s. 10 d., while the expenses amounted to £1,538 5s. 6d.

In order to mark out a course  $1\frac{1}{2}$  miles in length, more piles and booms than those so kindly lent by the Committee of Henley Royal Regatta were required ; and thirty additional booms and forty piles had to be purchased.

The Committee were also much indebted to the Thames Conservancy Board for their assistance in keeping the course, and for the services rendered by their officers in the general arrangements for the regatta.

The weather was fine throughout and very like that experienced at the regatta earlier in the month. The conditions were very nearly perfect, what little breeze there was being off the Berkshire shore at the start and straight up the course afterwards. Perhaps the first and last days were a little faster than the others. An analysis of the times appears on a later page. The best sculling-time to halfway was done by the German, von Gaza, on the Tuesday. The times for sculls, fours, and eights were very fast in the finals. In the nineteen races of the meeting the Bucks station was successful thirteen times, but no difference in the conditions can be stated.

The course of 1 mile 880 yards was laid out by placing the start some 270 yards lower down and the finish some 60 yards higher up stream than in the usual Henley Regatta course of about 1 mile 550 yards. It was practically straight and boomed for the whole distance, with one slight bend (near the start) on the Berks side, and another (about halfway) on the Bucks side.



## LIST OF COMPETITORS.

## SCULLERS' RACE.

## BELGIUM.

	st.	lb.
Joseph Hermans, Cercle des Regates de Bruxelles.. .. .	10	7

## CANADA.

Walter Bowler, Don Rowing Club .. .. .	9	13
L. Scholes, Toronto Rowing Club .. .. .	12	0

## GERMANY.

B. van Gaza, Wiking Club, Berlin .. .. .	12	6
--	----	---

## HUNGARY.

E. Killer, National Rowing Club .. .. .	11	4
K. Levitzky, National Rowing Club .. .. .	10	13

## ITALY.

Gino Ciabatti, Societé Canottieri "Arno," Pisa .. .. .	11	1
--	----	---

## UNITED KINGDOM.

H. T. Brackstaffe, Vesta R.C., Putney .. .. .	11	3
A. McCulloch, Leander Club .. .. .	12	4

## PAIR-OAR RACE.

## CANADA (Argonaut R.C.).

st. lb.		st. lb.
F. P. Toms (bow and steers) .. 10 10		N. B. Jackes (stroke) .. .. 10 10

## GERMANY (Deutschland Berliner Ruder Club).

st. lb.		st. lb.
Martin Hahnke (bow and steers) 12 1		Willy Düskow (stroke) .. .. 11 5

## UNITED KINGDOM (Leander Club).

st. lb.		st. lb.
G. E. Fairbairn (bow and steers) 11 8		P. Verdon (stroke) .. .. 11 7

## UNITED KINGDOM (Leander Club).

st. lb.		st. lb.
J. R. K. Fenning (bow and steers) 12 2		G. L. Thompson (stroke) .. .. 11 12

## FOUR-OAR RACE.

## CANADA (Argonaut R.C.).

st. lb.		st. lb.
G. B. Balfour (bow and steers) 12 0		3 Charles Riddy .. .. 11 12
2 B. R. Gale .. .. 12 0		G. B. Taylor (stroke) .. .. 12 3

Substitutes : J. A. Thomson, C. G. Toms.

## HOLLAND (Rosi Zeilvereiniging de Amstel, Amsterdam).

st. lb.		st. lb.
H. Höfte (bow and steers) 12 12		3 A. Wielsma .. .. 13 0
2 J. F. K. H. J. Burk.. 12 10		B. H. Croon (stroke) .. .. 13 3

## UNITED KINGDOM (Leander Club).

st. lb.		st. lb.
P. R. Filleul (bow) .. .. 10 13		3 J. R. K. Fenning .. .. 12 2
2 H. R. Barker .. .. 10 12		G. L. Thomson (str. and steers) 11 12

Substitutes : E. Majolier, G. Nickalls.

## UNITED KINGDOM (Magdalen College B.C., Oxford).

		st. lb.			st. lb.
C. R. Cudmore (bow)	.. ..	11 10	3	D. Mackinnon	.. .. 12 13
2 J. A. Gillan	.. ..	12 8		J. R. Somers-Smith (str. & strs.)	12 3

Substitutes : Hon. R. P. Stanhope, E. H. L. Southwell.

## EIGHT-OAR RACE.

## BELGIUM (Royal Club Nautique de Gand).

		st. lb.			st. lb.
Oscar Taelman (bow)	.. ..	11 3	6	Polydore Veirman	.. .. 12 1
2 Marcel Morimont	.. ..	10 11	7	Oscar de Somville	.. .. 12 3
3 Remi Orban	.. ..	12 6		Rodolphe Poma (stroke)	.. .. 11 0
4 Georges Mys	.. ..	11 0		Alfred Vanlandeghem (cox)	.. .. 8 0
5 Francois Vergucht	.. ..	11 8			

Substitutes : Guillaume Visser, Urbain, Molmans, Ferdinand Bauwens, Georges Desenfaus, Rodolphe Colpaert.

## CANADA (Argonaut R.C.).

		st. lb.			st. lb.
I. R. Robertson (bow)	.. ..	11 8	6	B. R. Gale	.. .. 12 0
2 G. F. Wright	.. ..	11 9	7	Charles Riddy	.. .. 11 12
3 J. A. Thomson	.. ..	12 2		G. B. Taylor (stroke)	.. .. 12 3
4 W. A. Lewis	.. ..	12 3		D. E. Kertland (cox)	.. .. 8 2
5 G. B. Balfour	.. ..	12 0			

Substitutes : F. P. Toms, N. B. Jackes, C. G. Torus.

## HUNGARY (Pannonia R.C. and National R.C.).

		st. lb.			st. lb.
A. Klekner (bow)	.. ..	9 10	6	J. Varady	.. .. 11 10
2 L. de Haraszty	.. ..	11 1	7	T. Wampetich	.. .. 12 0
3 A. Szebeny, jun.	.. ..	11 10		Dr. F. Kirchknopf (stroke)	.. .. 11 10
4 R. Eder, jun.	.. ..	11 10		K. Vasko (cox)	.. .. 8 4
5 A. Hautzinger	.. ..	12 7			

Substitutes : K. Levitzky, E. Killer.

## NORWAY (Norwegian Rowing Association).

		st. lb.			st. lb.
T. Krohg (bow)	.. ..	10 3	6	Hanibal Fegth	.. .. 12 2
2 Erik Bye	.. ..	12 1	7	Wilhelm Hansen	.. .. 11 3
3 Ambrosius Hoeyer.	.. ..	12 1		Andreas Knudsen (stroke)	.. .. 10 8
4 Gustav Haehre	.. ..	13 9		Einar Tensager (cox)	.. .. 8 10
5 Emil Irgens.	.. ..	14 2			

Substitutes : Jacob Jacobsen, Knut C. Langaard, Ludwig Moestue (cox).

## UNITED KINGDOM (Cambridge University B.C.).

		st. lb.			st. lb.
F. Jerwood (bow)	.. ..	11 10	6	H. E. Kitching	.. .. 12 11
2 E. W. Powell	.. ..	11 4	7	J. S. Burn	.. .. 12 5
3 O. A. Carver	.. ..	12 4		D. C. R. Stuart (stroke)	.. .. 11 2
4 E. G. Williams	.. ..	12 11		R. F. Boyle (cox)	.. .. 8 12
5 H. M. Goldsmith	.. ..	12 4			

Substitutes : P. Verdon, G. E. Fairbairn, G. L. Thomson, A. F. Kindersley, B. G. D. Scott.

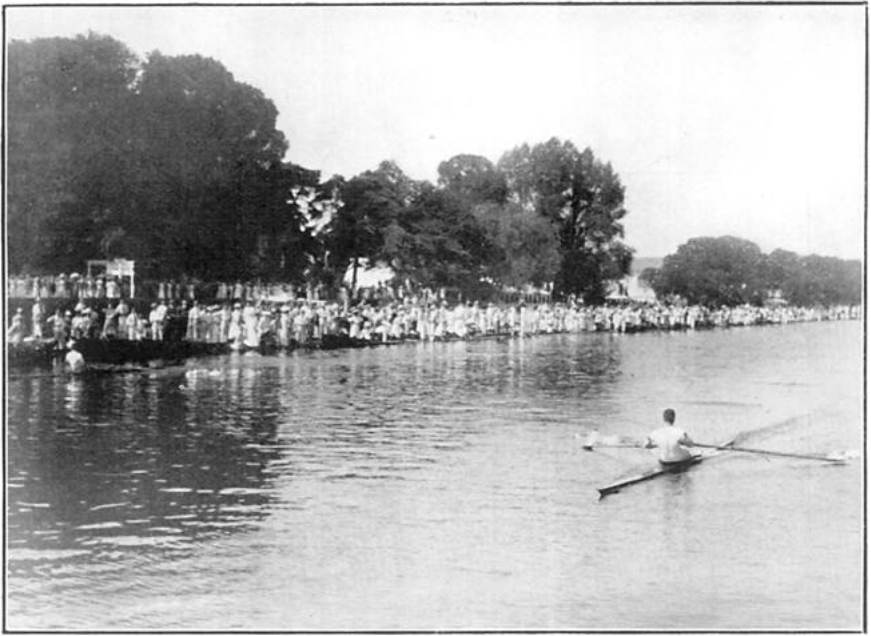

ROWING.—BLACKSTAFFE WINS THE SCULLS AGAINST McCULLOCH AT HENLEY.

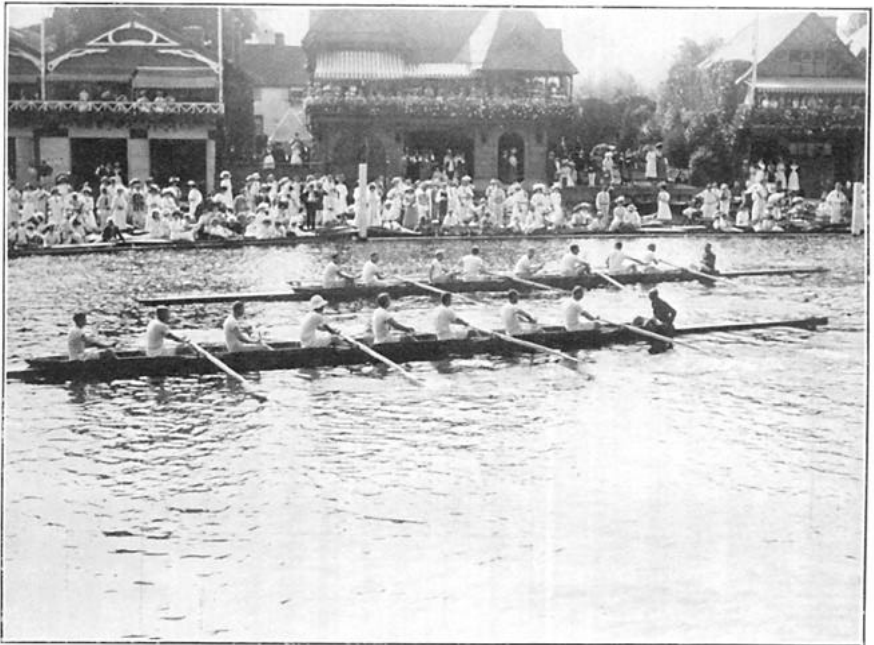

ROWING.—LEANDER (ON THE OUTSIDE) *v.* HUNGARY.

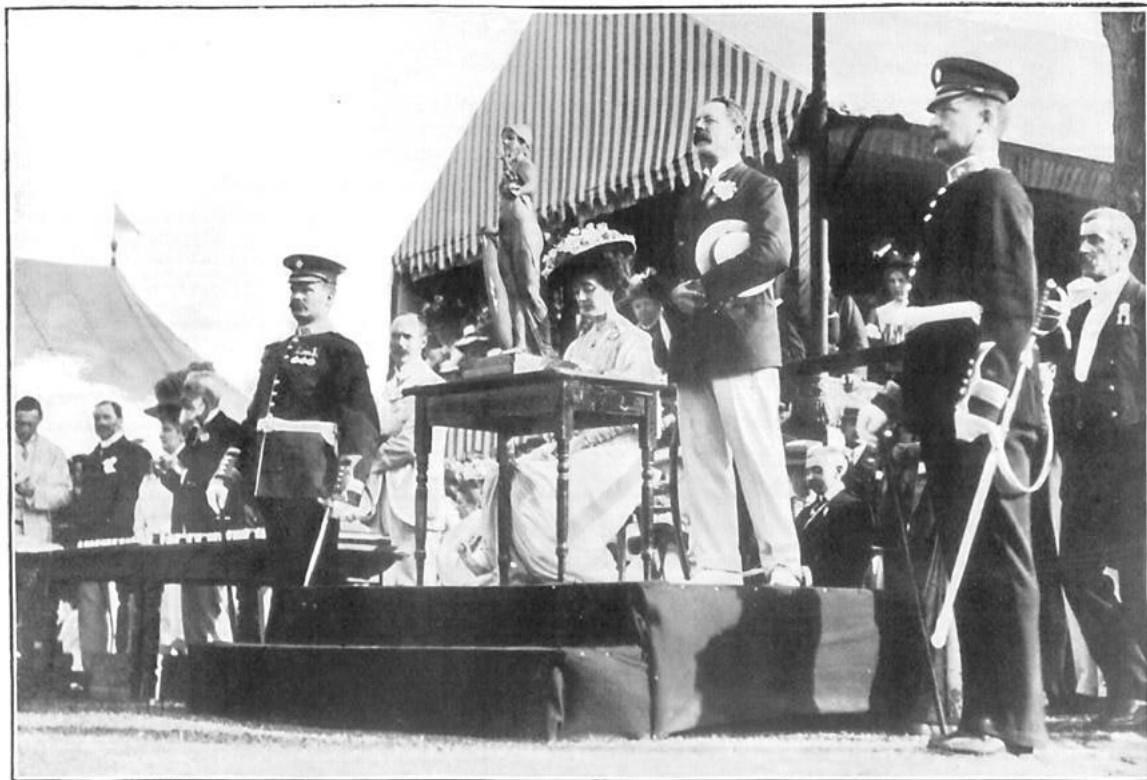

ROWING.—LORD DESBOROUGH'S SPEECH AT THE OLYMPIC PRIZE-GIVING, HENLEY.

## UNITED KINGDOM (Leander Club).

		st. lb.			st. lb.
A. C. Gladstone (bow) ..	..	11 6	6	R. H. Sanderson ..	13 6
2 F. S. Kelly ..	..	12 1	7	R. B. Etherington-Smith ..	12 7
3 B. C. Johnstone ..	..	12 11		H. C. Bucknall (stroke) ..	11 6
4 Guy Nickalls ..	..	12 6		G. S. Maclagan (cox) ..	8 8
5 C. D. Burnell ..	..	14 2			

Substitutes : P. R. Filleul, H. R. Barker, C. A. Gladstone,  
R. C. Bourne, A. W. F. Donkin.

## OFFICIALS.

*Judge*.—FREDERICK FENNER.

*Umpires*.—F. I. PITMAN, C.U.B.C., W. A. L. FLETCHER, D.S.O., O.U.B.C.

*Timekeepers*.—THEODORE A. COOK, O.U.B.C., VICTOR MANSELL.

## SCULLERS' RACE.

HEAT I.—3 P.M., JULY 28.

Bucks station.—B. VON GAZA, 12 st. 6 lb. (Red and Green), Wiking Club, Berlin, Germany ; beat

Berks station.—E. KILLER, 11 st. 4lb. (Red, White and Blue), National R.C., Hungary.

Times.—Halfway, 4.31 ; Finish, 9.35.

Won easily. The Hungarian stopped before the finish.

HEAT II.—12.30 P.M., JULY 29.

Bucks.—B. VON GAZA, Germany ; beat

Berks.—L. SCHOLLES, 12 st. (Light and Dark Blue), Toronto R.C., Canada.

Times :—Halfway, 4.38 ; Finish, 9.47.

Scholes came over with a great reputation, having beaten Kelly (the record holder for the Diamonds) some years before, but though he showed pace at the start he could not last the longer course. After leading for some distance Scholes was caught and from the half distance the German went steadily away. Scholes spurred continually, but could never catch his man, and von Gaza won a fine race by a length and a half.

HEAT III.—3.0 P.M., JULY 29.

Bucks.—K. LEVITZKY, 10 st. 13 lb. (Red, White and Blue), National R.C., Hungary ; beat

Berks.—G. CIABATTI, 11 st. 1 lb. (Blue and White), Soc. Canottieri "Arno," Pisa, Italy.

Times :—Halfway, 4.52 ; Finish, 10.8. Won easily.

HEAT IV.—4.0 P.M., JULY 29.

Bucks.—H. T. BLACKSTAFFE, 11 st. 3 lb. (Crimson and Black), Vesta R.C., United Kingdom ; beat

Berks.—W. BOWLER, 9 st. 13 lb. (Light and Dark Blue), Don R.C., Canada.

Times :—Halfway, 4.50 ; Finish, 10.3.

Bowler ran into the piles twice, and upset on the second occasion. Blackstaffe waited for him the first time, and then sculled home alone.

## HEAT V.—4.30 P.M., JULY 29.

Bucks.—A. McCULLOCH, 12 st. 4 lb. (Cerise), Leander Club, United Kingdom ; beat

Berks.—J. HERMANS, 10 st. 7 lb. (Red, Yellow and Black), Cercle des Regates de Bruxelles.

Times :—Halfway, 4.54; Finish, 10.8.

The Belgian was outpaced, but never stopped trying from start to finish, keeping very close to the booms the whole way. McCulloch won at his leisure.

## HEAT VI.—12.30 P.M., JULY 30.

Bucks.—A. McCULLOCH, United Kingdom; beat

Berks.—K. LEVITZKY, Hungary.

Times :—Halfway, 4.53 ; Finish, 10.22.

Levitzky, though outpaced all the way, never lost his pretty form from start to finish, and was loudly cheered all over the course. McCulloch won easily.

## HEAT VII.—4.4 P.M., JULY 30.

Bucks.—H. T. BLACKSTAFFE, United Kingdom ; beat

Berks.—B. VON GAZA, Germany.

Times :—Halfway, 4.46 ; Finish, 10.14.

It had been fully expected that von Gaza would give the English amateur champion a great race, but something seemed to go wrong with the German, and he stopped at the Rectory. Though Blackstaffe led slightly at the start, the boats were dead level up the island, and Gaza was leading by about a quarter of a length when he suddenly went over to the Bucks bushes. Blackstaffe spurred out of the way at once and went a length ahead. Gaza looked round in surprise, and saw the Englishman was increasing his lead. As far as could be ascertained, there had been some misadventure with von Gaza's stretcher. The pace had been very hot for the first half-mile, and perhaps his extra exertions had weakened it. He stopped sculling, and Blackstaffe went on alone.

## FINAL.—2.30 P.M., JULY 31.

Berks.—H. T. BLACKSTAFFE, United Kingdom; beat

Bucks.—A. McCULLOCH, United Kingdom.

Times :—Halfway, 4.37 ; Finish, 9.26.

This was a magnificent race the whole way, and produced as fast a time as has ever been done over the course in a sculling-boat. It was impossible to pick the winner at any time up to the last fifty yards. Blackstaffe started at 35, a more rapid rate than his opponent, who, however, went away from him so fast that he was a length and a half ahead in less than a quarter of a mile. Then the Vesta man spurred and began to go up very quickly, McCulloch appearing to take matters rather too easily. Blackstaffe never stopped improving until the gap was closed, and at half-way was about a quarter of a length ahead. He never went back. McCulloch then sculled a splendid race, but could never quite catch his

man again, for Blackstaffe answered every spurt, and raced home in very vigorous style, winning by a length and a quarter in exceptionally fine time.

Blackstaffe's career as a sculler has been remarkable. His most conspicuous successes are the winning of the London Cup in 1897, 1898, 1899, 1900, 1901, 1903, 1904, 1905, and 1908 ; the Championship of the Netherlands in 1899 ; the International Open Sculls at Amsterdam in 1908 ; the Wingfields (Amateur Championship of the Thames) in 1897, 1901, 1903, 1906, and 1908 ; the Diamonds in 1906 ; and finally, at the age of forty years, the International Sculling Championship at the Olympic Regatta of 1908.

#### PAIR-OAR RACE.

HEAT I.—4.30 P.M., JULY 28.

Berks.—J. R. K. FENNING, bow and steers, 12 st. 2 lb., G. L. THOMSON, stroke, 11 st. 12 lb. (Colour : Cerise), Leander Club, United Kingdom; beat

Bucks.—F. P. TOMS, bow and steers, 10 st. 10 lb., N. B. JACKES, stroke, 10 st. 10 lb. (Colours : Light and Dark Blue), Argonaut R.C., Canada.

Times :—Halfway, 4.38 ; Finish, 9.46.

A slight delay was caused at the start by Toms' nose bleeding, after waiting in the torrid heat. The Englishmen had a remarkably good boat, built by Bowers and Phelps, and led at start, gaining a little more when the Canadians touched the booms opposite the island. The Toronto pair spurted all the way home, but could never catch the English pair, who won easily.

HEAT II.—3.15 P.M., JULY 30.

Bucks.—G. E. FAIRBAIRN, bow and steers, 11 st. 8 lb., P. VERDON, stroke 11 st. 7 lb. (Colour : Cerise), Leander Club, United Kingdom ; beat

Berks.—M. HAHNKE, bow and steers, 12 st. 1 lb., W. DÜSKOW, stroke, 11 st. 5 lb. (Colours : White with Red Star), Deutschland Berliner R.C., Germany.

Times :—Halfway, 4.55 ; Finish, 11.5.

After rowing level for a minute, the English pair went ahead and led by a length and a half at halfway. Directly afterwards the German stroke was evidently unable to continue, and the Englishmen paddled home alone.

FINAL.—12.30. P.M., JULY 31.

Berks.—J. R. K. FENNING and G. L. THOMSON, United Kingdom ; beat

Bucks.—G. E. FAIRBAIRN and P. VERDON, United Kingdom.

Times :—Halfway, 4.36 ; Finish, 9.41.

Fenning and Thomson soon showed in front at the faster stroke, and after establishing a lead were able to keep it without extending themselves. They won fairly easily by  $2\frac{1}{2}$  lengths.

#### FOUR—OAR RACE.

HEAT I.—3.45 P.M., JULY 28.

Bucks.—UNITED KINGDOM (Magdalen College B.C., Oxford). . 1

	st.	lb.		st.	lb.
C. R. Cudmore (bow)	..	..	11	10	} D. Mackinnon .. .. 12 13
J. A. Gillan	..	..	12	8	
Substitutes	:	Hon. R. P. Stanhope, E. H. L. Southwell.			10 13
Colours : Red, Black and White.					

Berks.—CANADA (Argonaut R.C.) .. .. .		2		
	st. lb.			st. lb.
G. B. Balfour (bow and steers)	12 0		3 Charles Riddy .. .. .	11 12
2 B. R. Gale .. .. .	12 0		G. B. Taylor (stroke) .. .. .	12 3
Substitutes : J. A. Thomson, C. G. Toms.				
Colours : Light and Dark Blue.				
Times :—Halfway, 4.5 ; Finish, 8.34.				

The Canadians went away at 44, but the Magdalen four held their own at 38, helped by faulty steering on the part of our visitors. At halfway, Magdalen led and the Argonauts spurred up to them, but the Englishmen always had the pace of their opponents and finally won, in spite of being pluckily hunted all the way home, by 2  $\frac{1}{4}$  lengths in the remarkably good time of 8.34—as fast as any four has ever travelled on the Henley waters.

## HEAT II.—4.15 P.M., JULY 30.

Bucks.—UNITED KINGDOM (Leander Club)				
	st. lb.			st. lb.
P. R. Filleul (bow) .. .. .	10 13		3 J. R. K. Fenning .. .. .	12 2
2 H. R. Barker .. .. .	11 12		G. L. Thomson (str. and str.)	11 12
Substitutes : E. Majolier, G. Nickalls.				
Colour : Cerise.				

## Berks.—HOLLAND (Rosi Zeilvereeniging de Amstel, Amsterdam)

	st. lb.			st. lb.
H. Höfte (bow and steers) .. .. .	12 12		3 A. Wielsma .. .. .	13 0
2 J. F. K. H. J. Burk .. .. .	12 10		B. H. Croon (stroke) .. .. .	13 3
Colours : Blue and White.				
Times :—Halfway, 4.14 ; Finish, 9.4.				

Leander led at the start, both crews doing 37, while Holland steered rather badly. The English did not begin, however, to go away decisively until after half a mile. At the halfway point the Dutch went into the booms and Leander waited for them to get clear, after which the English four went away fast and won decisively by several lengths.

## FINAL HEAT.

MAGDALEN COLLEGE, Oxford, United Kingdom .. .. .	1
LEANDER CLUB, United Kingdom .. .. .	2
Times :—Halfway, 4.10 ; Finish, 8.34.	

Leander made a very good race of it until halfway, where the Magdalen four, steering a perfect course, were about a length ahead. From that point the Oxford crew held their own, but went so fast that every credit is due to the losers for keeping as near them as they did. Magdalen won by a length and a half in splendid time.

## EIGHT—OAR RACE.

## HEAT I.—1.0 P.M., JULY 29.

Bucks.—CANADA (Argonaut R.C.) .. .. .		1		
	st. lb.			st. lb.
1. R. Robertson (bow) .. .. .	11 8		6 B. R. Gale .. .. .	12 0
2 G. F. Wright .. .. .	11 9		7 Charles Riddy .. .. .	11 12
3 J. A. Thomson .. .. .	12 2		G. B. Taylor (stroke) .. .. .	12 3
4 W. A. Lewis .. .. .	12 3		D. E. Kertland (cox) .. .. .	8 2
5 G. B. Balfour .. .. .	12 0			
Substitutes : F. P. Toms, N. B. Jackes, C. G. Toms.				
Colours : Light and Dark Blue.				



## Berks.—NORWAY (Norwegian Rowing Association) .. 2

				st. lb.					st. lb.	
T. Krohg (bow)	..	..	10	3	6	Hanibal Fegth	..	..	12	2
2 Erik Bye	..	..	12	1	7	Wilhelm Hansen	..	..	11	3
3 Ambrosius Hoeyer	..	..	12	1	Andreas Knudsen (stroke)		..	..	10	8
4 Gustav Haehre	..	..	13	9	Einar Toensager (cox)		..	..	8	10
5 Emil Irgens	..	..	14	2						

Substitutes : Jacob Jacobsen, Knut C. Langaard, Ludwig Moestue (cox).

Colours : Red, White and Blue.

Times :—Halfway, 3.55 ; Finish, 8.6.

Both started at 39 with a good following wind which blew slightly off the bushes at the start. Canada led at once and kept a fast stroke going for longer than Norway, which resulted in their getting nearly two lengths by halfway. Norway made tremendous efforts from this point, but their strength and courage did not produce an equivalent in pace, and the Argonauts won by  $2\frac{3}{4}$  lengths.

## HEAT II.—3.20 P.M., JULY 29.

## Bucks.—UNITED KINGDOM (Leander Club) .. .. . 1

				st. lb.					st. lb.	
A. C. Gladstone (bow)	..	..	11	6	6	R. H. Sanderson	..	..	13	6
2 F. S. Kelly	..	..	12	1	7	R. B. Etherington-Smith	..	..	12	7
3 B. C. Johnstone	..	..	12	11	H. C. Bucknall (stroke)		..	..	11	6
4 Guy Nickalls	..	..	12	6	G. S. Maclagan (cox)		..	..	8	8
5 C. D. Burnell										

Substitutes : P. R. Filleul, H. R. Barker, C. A. Gladstone, R. C. Bourne, A. W. F. Donkin.

Colour : Cerise.

## Berks.—HUNGARY (Pannonia R.C. and National R.C.) .. 2

				st. lb.					st. lb.	
A. Klekner (bow)	..	..	9	10	6	J. Varady	..	..	11	10
2 L. de Haraszty	..	..	11	1	7	T. Wampetich	..	..	12	0
3 A. Szebeny, jun.	..	..	11	10	Dr. F. Kirchknopf (stroke)		..	..	11	10
4 R. Eder, jun.	..	..	11	10	K. Vasko (cox)		..	..	8	4
5 A. Hautzinger	..	..	12	7						

Substitutes : K. Levitzky, E. Killer.

Colours : Red, White and Green.

Times :—Halfway, 3.51 ; Finish, 8.10.

The English crew started at 41 to their visitors' 40 and led after the first ten strokes, but on reaching Remenham they were able to drop to 34 and still be two lengths ahead at halfway. Hungary never relaxed their efforts, but went after the leaders with the greatest determination. The gap, however, was never reduced, and Leander, rowing beautifully together with a reserve of power and pace that was most exhilarating to observe, won by about two lengths without extending themselves.

## HEAT III.—1.15 P.M., JULY 30.

## Bucks.—LEANDER CLUB, United Kingdom .. .. . 1

## Berks.—ARGONAUT R.C., Canada .. .. . 2

Times :—Halfway, 3.56 ; Finish, 8.12.

The Canadians started at 43 to Leander's 40, but were beaten for speed by the top of the island and were  $1\frac{1}{4}$  lengths behind at halfway. The English were never allowed to take it too easily, though they were usually able to stall off

all the plucky efforts made by the Argonauts, who kept on rushing at them, their stroke's spurts being splendidly backed up by his crew who worked like Trojans to the finish, and that last spurt on the Berkshire shore will not easily be forgotten as an example of indomitable courage against a much superior crew. Leander won by a length.

## HEAT IV.—3.45 P.M., JULY 30.

Berks.—BELGIUM (Royal Club Nautique de Gand)		1			st. lb.
		st. lb.			st. lb.
Oscar Taelman (bow) .. ..	11 3	6	Polydore Veirman .. ..	12	1
Marcel Morimont .. ..	10 11	7	Oscar de Somville .. ..	12	3
Remi Orban .. ..	12 6		Rodolphe Poma (stroke) ..	11	0
Georges Mys .. ..	11 0		Alfred Vanlsndeghem (cox) ..	8	0
Francois Vergucht .. ..	11 8				

Substitutes : Guillaume Visser, Urbain Molmans, Ferdinand Bauwens, Georges Desenfaus, Rodolphe Colpaert.

Colours : Red, Yellow and Black; Red and White Oars.

Bucks.—UNITED KINGDOM (Cambridge University B.C.)		2			st. lb.
		st. lb.			st. lb.
F. Jerwood (bow) .. ..	11 10	6	H. E. Kitching .. ..	12	11
E. W. Powell .. ..	11 4	7	J. S. Burn .. ..	12	5
O. A. Carver .. ..	12 4		D. C. R. Stuart (stroke) ..	11	2
E. G. Williams .. ..	12 11		R. F. Boyle (cox) .. ..	8	12
H. M. Goldsmith .. ..	12 4				

Substitutes : P. Verdon, G. E. Fairbairn, G. L. Thomson, A. F. Kindersley, B. G. D. Scott.

Colour : Light Blue.

Times :—Halfway, 3.57 ; Finish, 8.22.

Any advantage which the Belgians may have had from the slight bend in their favour in the first part of the course was counterbalanced by the wind off the bushes. They started at 43, but Cambridge University were faster at 40, and both boats went dead level all up the island. They still fought for the lead the whole way to Remenham, where the Belgian canvas was a few inches in front. Here the English faltered a trifle, but Stuart and Burn pulled them together again, and Cambridge were soon going great guns and racing splendidly. But the Ghent crew was the more perfectly together, and therefore managed to get a lead of about 20 feet at halfway and to increase it afterwards, for they were not so exhausted by their previous efforts as the Cambridge crew, who showed unmistakable signs of staleness, and in a short time began to go to pieces. There was clear water between the boats after a mile and a quarter had been rowed, and here Stuart's spurt took the last ounce out of his men, who worked with great determination, but were no longer rowing together. They had been coached for Henley in a style somewhat different from that in which they had proved so successful at Putney. They were a little stale also. The result was that when the strain came the crew disintegrated, but they never stopped shoving till the flag fell. The Belgians won a well-deserved victory by a length and a third.

A good deal of controversy as to the styles of the respective crews was aroused by this race, but it would serve no useful purpose to repeat it in these pages. It is, however, right to say that Cambridge had most of them been in training since the previous October, with very few intervals, and their college crews had not done so well in the regatta earlier in the month owing to their best oars having been reserved for this University crew at the Olympic meeting. Their eight at Putney had been composed of F. H. Jerwood (bow), G. E. Fairbairn, O. A. Carver, H. E. Kitching, J. S. Burn, E. G. Williams, E. W. Powell, D. C. R. Stuart (stroke), and R. Boyle (coxswain). They beat Oxford from Putney to Mortlake, on April 4, by  $2\frac{1}{4}$  lengths. Burn had rowed in their winning eight of the year before. E. W. Powell and D. C. R. Stuart had also won in 1907 and in 1906 as well, besides beating Harvard University at Putney in the September of the latter year.

## FINAL HEAT.—3.15 P.M., JULY 31.

Bucks.—UNITED KINGDOM (Leander Club) .. .. 1

		st. lb.				st. lb.	
A. C. Gladstone (bow)	..	11	6	6 R. H. Sanderson	..	..	13 6
2 F. S. Kelly	.. ..	12	1	7 R. B. Etherington-Smith	..	..	12 7
3 B. C. Johnstone	.. ..	12	11	H. C. Bucknall (stroke)	..	..	11 6
4 Guy Nickalls	.. ..	12	6	G. S. Maclagan (cox)	..	..	8 8
5 C. D. Burnell	.. ..	14	2				

Substitutes : P. R. Filleul, H. R. Barker, C. A. Gladstone, R. C. Boume,  
A. W. F. Donkin.

Colour : Cerise.

Berks.—BELGIUM (Royal Club Nautique de Gand) .. 2

		st. lb.				st. lb.	
Oscar Taelman (bow)	.. ..	11	3	6 Polydore Veirman	..	..	12 1
2 Marcel Morimont	.. ..	10	11	7 Oscar de Somville	..	..	12 3
3 Remi Orban	.. ..	12	6	Rodolphe Poma (stroke)	..	..	11 0
4 Georges Mys	.. ..	11	0	Alfred Vanlandeghem (cox)	..	..	8 0
5 Francois Vergucht	.. ..	11	8				

Substitutes : Guillaume Visser, Urbain Molmans, Ferdinand Bauwens,  
Georges Desenfaus, Rodolphe Colpaert.

Colours : Red, Yellow and Black ; Red and White Oars.

Times :—Halfway, 3.45 ; Finish, 7.52.

An enormous amount of interest was taken in this race, which began in splendid weather and perfect conditions. When Mr. Pitman gave the word to go, the Belgians started at their full pace and perfectly together, rowing 12, 23, and 43 in the full minute. Leander, showing beautiful precision and great power, went off at 11, 22, and 42. For an instant it looked as if the Belgians were ahead, but in the next the bows of the Leander boat had taken the lead they were never again to lose. Only, however, by about six inches did the English crew keep ahead until they had

passed the island, up which both eights went at a tremendous pace and nearly dead level. But Leander were gaining about an inch at every stroke, and though their superiority was so slight and so slowly won as to be almost heartbreaking to watch, it was still a definite superiority, and by the first signal they had half a length in hand, and were going splendidly.

Belgium was not one whit less taking to the eye, and apparently travelled even faster when they spurted suddenly at about half a mile from the start. Leander answered them at once in no uncertain fashion, and Bucknall's timely quicken brought his men three-quarters of a length ahead at halfway, which the leaders passed in 3 min. 45 sec. Once more the Belgian stroke made a great effort, and his men responded gamely, but it took too much out of them. They had faltered once before, and recovered themselves with the greatest courage. This time they rolled badly, and for a moment seemed to go to pieces. Like a flash the English crew went away from them, and, with a quarter of a length clear water between the boats, at last Leander were able for the first time to take a much-needed "breather" at a long and hard 35, which they rowed in very good style all through.

But those indomitable Belgians were never done with. They had had their "breather," too, and the next minute every Englishman's heart was in his mouth, for they rushed up their stroke to over 40 with one of those electrical spurts for which they have long been famous, and made a desperate effort to get on terms. And up they came—nearer and nearer, until that glorious effort in its turn died away. At exactly the right instant Bucknall, who was beautifully backed up by Etherington-Smith, gave his "ten strong strokes," and at the old mile post Leander were again a length and a quarter ahead, and again rowing their long, steady 35.

Not much time was left now, and the Belgians realised it. They spurted again and again as they neared the grand stand, but human nature could do no more. They were willing to the end, and they never for a moment stopped their legwork, but as a crew they had shot their bolt. Leander, keeping together, though every man was tired, swung past the finish some two lengths ahead, and Mr. Fenner's flag fell in 7 min. 52 sec. from the start. Both the Belgian coaches, to whom the rowing of their country owes so much, were on Mr. Pitman's launch *Consuta* for that historic struggle, and in the bows beside him were Baron Pierre de Coubertin, President of the International Olympic Committee, Lord Desborough, President of the British Olympic Committee, and Mr. Herbert Thomas Steward, chairman of the Olympic Regatta Committee. None of them are likely to see so great a race again for many a year to come.

This magnificent struggle between two of the finest crews I ever saw

together has, in my own opinion, finally settled the question of styles that has agitated the English world of rowing for over three years. If the Belgians had won, after having previously carried off the Grand Challenge Cup in 1906 and 1907, we should have been obliged at least to reconsider, if not to change entirely, all those principles of oarsmanship on which the crews of Eton and Radley, of Oxford and Cambridge, and of the great metropolitan clubs had founded their tuition. For, if Leander had been beaten, there would have been no doubt whatever about the real superiority of the Belgian style.

But Leander won in such fast time, and by so decisive a margin, that every hesitation has been set at rest. Perhaps there is, however, one thing that must be said. Much as we admired the Belgians in bringing over crew after crew to Henley until they were rewarded by victory twice repeated, we must admire still more the splendid race they rowed against a finer crew than they have ever met before, and the magnificently sportsmanlike way they took their honourable defeat. It was well known in English rowing circles that the Henley crews of 1906 and 1907 were not of the usual high average of excellence, for the level of oarsmanship was lower at both Universities during that period and for another year to come. But in the Leander Olympic crew a great effort had been made to pick out England's best for the first time ; and it would certainly have been difficult to suggest much improvement in their eight, which had trained hard for several months beforehand.

One of the most interesting features of a brilliant prize-giving was the terrific cheering that greeted the Belgians, beaten but not disgraced, as they advanced to receive their Commemoration Medals from Mr. W. A. L. Fletcher, D.S.O., one of the most appropriate men to hand such a reward to a crew whose sterling merits he would be among the first to appreciate. In the most graceful and charming way Mr. Maurice Lippens took an opportunity just before the closing of the ceremony to step into the open space in which Lady Desborough had just distributed the gold medals and call for three cheers from all the foreign crews for the English King and Queen and country. As the sound of those sincerely hearty salutations died away among the first notes of our own National Anthem, the Olympic Regatta came to its most fitting close.

It was a meeting that differed in very many ways from the pleasant little family party that Henley Regatta usually is. The difference did not lie so much in the increase of the crowd, for the crowd, though occasionally large, was on the average beneath what I have often seen when an American crew has been beaten for the Grand, or various college eights have raced each other all day long for the Thames Cup or the Ladies

Plate. Nor did it lie in the fact of a full programme, for sometimes there were not as many as half a dozen races in a day, and the card presented very much the appearance of those ancient regattas chronicled in Mr. H. T. Steward's invaluable history.

The main difference lay, of course, in the international flavour of every race, in the high standard of excellence of nearly every crew, in the wider outlook and more ample arrangements necessitated by a meeting that was an integral part, and one of the most successful parts, of the Olympic Games. The prize-giving emphasised this point, but it was evident from the first race of the regatta till the last; and no praise can be too high for the organising Rowing Committee, headed by Mr. Herbert Thomas Steward, which expanded its usual details in the most efficient manner to cope with new arrangements that were entirely unprecedented on the river.

The champion eight, which received, besides its gold medals and Olympic diplomas, the challenge prize of the Statuette of Pallas Athene, presented by Comte Brunetta d'Usseaux, is worthy of more detailed description than would perhaps be appropriate to this Report. But I may at least add a very few words concerning its members.

A. C. Gladstone, by far the most successful oarsman of his year at Oxford, had twice stroked his University crew, had taken his College (Christ Church) to the head of the river, and won the Grand. F. S. Kelly, who also came from Eton, as did the majority of the crew, held the record for the Diamonds over the Henley course and rowed for Oxford. B. C. Johnstone, who had equalled the record for the Silver Goblets, was in three winning Cambridge crews. Guy Nickalls, who was over forty, holds the best Henley record of any living oarsman, was a winner of the Diamonds, Wingfields, Pairs, Stewards', and Grand Challenge, besides representing his University four times at Putney. C. D. Burnell, one of the best heavy-weights Leander ever had, was also a winner of the Grand, and rowed for Oxford in their famous winning crew of 1897, besides the winning crews of 1895, 1896, and 1898. R. H. Sanderson was in the winning Cambridge crew of 1899, and in their splendid eight which won in 1900; he spent the whole of his furlough from his regiment in training for Leander in 1908. R. B. Etherington-Smith, one of the finest oars in the same two Cambridge crews, was also a first-rate sculler and was captain of this Leander crew. Bucknall, the stroke, was stroke of the winning Oxford eight of 1905 and rowed for his University again in 1906 and 1907. He proved his first-rate ability in this victory over the Belgians. They were steered by Maclagan, of Oxford, probably the best coxswain of modern times, and steersman of innumerable winning crews.

The prize-giving of the Olympic Regatta at Henley took place at

a quarter to five on July 31 in the Grand Stand enclosure. The drums and bugles of the Irish Guards, who had added so much to the picturesqueness of the Queen's prize-giving in the Stadium, came down to Henley for this occasion also. Lord Desborough, President of the British Olympic Council and member of the International Olympic Committee, opened the proceedings with a short speech. The winners of the Sculls, Pairs, Fours, and Eights then advanced, in that order, to receive their Gold Medals from Lady Desborough, their prize diplomas from Mr. F. I. Pitman and Mr. S. Le B. Smith, their club diplomas from Mr. H. T. Steward and Mr. C. T. Steward, and the Silver Oars from Mrs. W. Anker Simmons and her husband, the Mayor of Henley, assisted by Mr. L. Hannen. Afterwards, all the competitors, other than winners, received the Olympic Commemoration Medals from Mr. W. A. L. Fletcher, in the absence of Comte Brunetta d'Usseaux, who was unfortunately prevented from taking part in a ceremony to which his challenge prize had added so much distinction. At the end, the following gentlemen, together with the Reception Committee, who had all worked together to promote the success of the Regatta, were presented with Commemorative Medals by Baron Pierre de Coubertin, President of the International Olympic Committee, and Mr. R. G. Gridley, Hon. Secretary of the Amateur Rowing Association and member of the British Olympic Council :—

H. T. STEWARD  
 R. S. BRADSHAW  
 W. A. L. FLETCHER  
 S. D. MUTTLEBURY  
 R. PHILIPSON  
 F. I. PITMAN  
 S. LE BLANC SMITH  
 C. T. STEWARD  
 J. F. COOPER  
 (*Assistant Secretary*).

*Committee of  
 Management.*

F. FENNER (*Judge*).  
 F. J. ESCOMBE.  
 C. W. H. TAYLOR.  
 H. G. GOLD.  
 R. H. FORSTER.  
 R. H. LABAT, *Owner of Hibernia*.  
 J. HEWITT, *Owner of Consuta*.  
 V. MANSELL, *Official Timekeeper*.

#### RECEPTION COMMITTEE.

THE MAYOR OF HENLEY.  
 THE MAYOR OF MAIDENHEAD.  
 THE MAYOR OF READING.  
 THE MAYOR OF WINDSOR.  
 THE MAYOR OF WYCOMBE.  
 THE HON. W. F. D. SMITH.  
 SIR WILLIAM SHIPLEY.  
 SIR FRANK CRISP.  
 MR. L. HANNEN.  
 MR. H. FULLER.  
 MR. R. BRAKSPEAR.

MR. W. L. T. FOY  
 MR. R. G. FINLAY.  
 MR. FITZROY GARDNER.  
 ALDERMAN CLEMENTS.  
 MR. J. A. RAWLINS.  
 MR. H. W. WILLIS.  
 MR. E. C. DURANT.  
 MR. SHERRINGTON CHINN  
 MR. G. F. GIBBS.  
 MR. J. C. WALKER.  
 MR. W. A. HOBBS.

After Mr. Steward had proposed three cheers for Lord and Lady Desborough, Lord Desborough proposed three cheers for our foreign guests, which were most heartily given.

A very large number of entertainments were held in connection with the Olympic Regatta, which will be mentioned in a later chapter ; and on the Friday night the meeting was brought to a brilliant close at a ball which was attended by the majority of the competitors and nearly all our visitors.

#### TIMES DONE AT THE OLYMPIC REGATTA.

##### 1. *Sculls*.—Won by H. T. Blackstaffe in 9.26.

The average pace of the Henley Regatta record holder, being 14 feet per second for 1 mile, would give 71 seconds for the extra 330 yards of the Olympic Course. Adding 5 seconds for the extra fatigue, we get 8 min. 10 sec., *plus* 71 seconds, *plus* 5 seconds, or a total of 9.26 precisely Blackstaffe's time.

##### 2. *Fours*.—Won by Magdalen in 8.34.

By the same reckoning Magdalen's time for the extra 330 yards should be 65 seconds, *plus* 4 seconds for fatigue. Add this to their previous record of 7.28 for the Stewards', earlier in the month, and we get 8.37 for the Olympic Course, which they did in 8.34, showing that their speed was very high.

##### 3. *Eights*.—Won by Leander in 7.52.

The holders of the record for the Grand Challenge moved at the rate of 330 yards in 59 seconds. Adding 3 seconds for fatigue, we get 7.53 seconds for the Olympic Course. Leander won by two lengths, without being unduly pressed, in 7.52, and were therefore probably moving as fast as any eight ever covered these waters. There is not much doubt that the two crews which fought out the final were the best in Europe on the day. Certainly the Leander eight exhibited the perfection of the English style exemplified by eight as fine oarsmen as ever sat a boat ; and it must not be forgotten that the Belgian crew had won the Grand Challenge of 1906 and 1907 against the best we had to produce in those years. There were, of course, no foreign entries in the annual regatta which preceded the Olympic meeting at Henley. The only eights to which I could compare this Leander crew with the least prospects of possible inferiority are their own crews of 1893 and 1901, Third Trinity in 1902, and the University crews of Oxford in 1897 and Cambridge in 1900. But even so, the winners could perhaps have learnt a few points with advantage from our Belgian visitors : such, for example, as the delicately precise wrist play which



ensured a crisply clean finish of the blade on leaving the water ; the elastic and uniform recovery of the bodies, which was once so distinctive a feature of the best Eton crews ; and the astonishing accuracy with which the legdrive was applied by all eight men at the same instant. On the other hand, we believe that the Belgians would be improved by absorbing something of our body swing, which must, as a driving power, automatically outstay the piston action of the legs ; and also, very possibly, by combining sculling and rowing in pairs and fours with their eight-oar work, after the habit of our English oarsmen, who certainly get a knack of racing, in all sorts of craft and on every possible occasion, which must contribute to their general excellence. The Belgians used swivel-rowlocks, while our own crew retained the usual "gate-post" model which English habit has consecrated to eights after abandoning it in every other form of rowing.

## SHOOTING.

## A.—RIFLE AND PISTOL SHOOTING AT BISLEY.

## B.—CLAY BIRD SHOOTING AT UXENDON.

## A.—Rifle and Pistol Shooting.

The Council of the National Rifle Association, having been approached by the Council of the British Olympic Association with a view to the matches being held at Bisley under the management of the National Rifle Association, gladly welcomed the suggestion, and appointed the following Committee to deal with the matter and to draw up a programme of the various events :—Major-General Lord Cheylesmore, C.V.O. ; the Rt. Hon. Earl Waldegrave, V.D. ; Colonel the Hon. T. F. Fremantle, V.D. ; Mr. A. P. Humphry; Mr. G. Mortimer ; Major J. S. Oxley, V.D. ; Captain T. Ranken ; Major P. W. Richardson, V.D. ; Mr. Walter Winans ; and Mr. C. W. Wirgman.

The Committee, after much consideration, drew up a programme consisting of the following events, which it was considered would fairly represent all branches of shooting organised by the National Rifle Association,

Team	...	...	...	...	...	200, 500, 600, 800, 900 and 1,000 yards
Individual	...	...	...	...	...	1,000 yards
Team	...	...	...	...	...	300 metres
Individual	...	...	...	...	...	300
Team	..	...	...	...	...	50 and 100 yards
Individual	...	...	...	..	..	50 and 100
	...	...	...	...	...	25 yards
	...	...	...	...	...	25
Team	...	...	...	...	...	50
Individual	...	...	...	...	...	50
Team	...	...	...	..	...	150
Individual	...	...	...	...	...	110

It was decided to hold the Olympic meeting on July 9, 10, and 11, and arrangements were made for the provision of hut accommodation for the members of the various teams both before and during the competitions. The ranges were also placed at the disposal of those teams who wished to avail themselves of facilities for practice previous to the competitions, notification to this effect having been sent to the representatives of the various foreign Olympic Committees.

The members of the various teams, and individual competitors representing the various competing countries, arrived at Bisley on the following dates :—

France	...	...	...	June 29	...	22	Representatives
Sweden	...	...	...	June 29	...	21	,,
U.S.A.	...	..	...	June 29	...	20	,,
Norway	...	...	...	June 30	...	15	,,
Canada	...	...	...	June 30	...	17	,,
Finland	...	...	...	July 3	...	10	,,
Holland	...	...	...	July 8	...	14	,,
Denmark	...	...	...	July 6	...	13	,,
United Kingdom	...	...	...	July 4	...	66	,,
Greece	...	...	...	July 4	...	7	,,
Hungary	...	...	...	—	...	2	,,
Belgium	...	...	..	July 2	...	12	,,
Germany	...	...	...	—	...	1	,,
Italy	...	...	...	}	Absent		
Australia	...	...	...				

the majority taking advantage of the arrangements made for practice on the ranges, and in many cases occupying the huts belonging to the Association.

That the arrangements made were satisfactory is evinced by the numerous expressions of thanks which the Council received from the representatives of the teams who have expressed their satisfaction with the arrangements made for their comfort and the facilities afforded for practice.

The representatives of the various countries were entertained by the Chairman and Members of the Council at luncheon at the Council Club on each day of the Olympic meeting, and on the Thursday and Friday evenings a cinematograph entertainment was given in the Umbrella Tent.

The weather conditions on the first two days were most unfavourable and not at all conducive to good shooting, and although there was a decided improvement on the closing day of the meeting both the wind and light were extremely trying.

Naturally the greatest interest was centred on the International Match for teams at 200, 500, 600, 800, 900, and 1,000 yards, won by the United States, the United Kingdom being second, with Canada third. There was a large attendance of spectators on the Saturday to witness the final stage of this competition.

The other competitions, although not so attractive to the ordinary spectator, nevertheless aroused the keenest interest in those who took part.

The following table shows the competitions for which countries entered, and a full list of the scores made in the various events is appended.

		International. Teams		Individual. 1,000 yards	300 Metres. Teams	" Individual	Miniature. Teams	" Stationary. Individual	" Disappearing. "	" Moving. "	Revolver and Pistol. Teams	" " Individual	Running Deer. Teams	" { Single shot. Individual	" { Double shot. Individual
		A	B	C	D	E	F	G	H	I	J	K	L	M	
Denmark	...	x	x	x	x	x	x	x	x						
Greece	... ..	x	x	x	x	x	x	x	x	x	x		x	x	
Sweden	... ..	x	x	x	x	x	x	x	x	x	x	x	x	x	x
Norway	... ..	x	x	x	x	x	x	x	x		x	x	x	x	
France	.. ...	x	x	x	x	x	x	x	x	x	x	x	x	x	
United Kingdom		x	x	x	x	x	x	x	x	x	x	x	x	x	
Australia	...		x		x		x	x	x				x	x	
Hungary	...		x		x		x	x	x		x		x	x	
Canada	... ..	x	x	x	x										
Finland	... ..			x	x										
Holland	... ..			x	x					x	x				
U.S.A.	... ..	x	x	x	x			x	x	x	x		x	x	
Italy	... ..	x	x	x	x					x	x				
Germany	... ..		x				x		x						
Belgium	... ..		x	x						x	x				



SHOOTING —C. J. RUNDBERG (SWEDEN), WHO MADE  
17 BULLS (INCLUDING TWO SIGHTERS) AT 500 YARDS.



SHOOTING.—MAURICE BLOOD (U.K.).

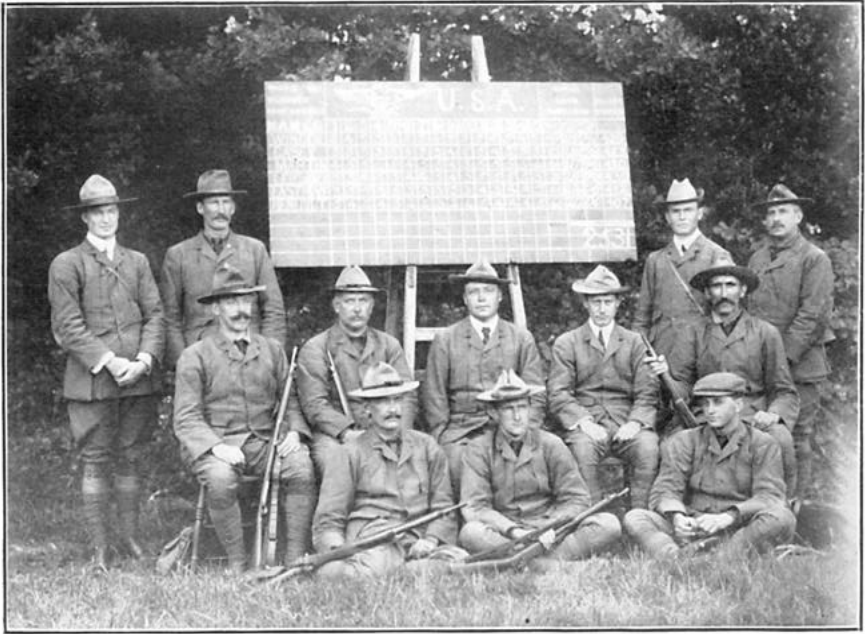

SHOOTING. —THE AMERICAN TEAM (WITH GENERAL DRAIN), WINNERS OF THE TEAM COMPETITION.



SHOOTING.—THE REVOLVER AND PISTOL COMPETITION AT BISLEY.

## (a) THE "INTERNATIONAL."

## TEAM COMPETITION.

H. P. A. S., 2,700.

	UNITED STATES	200	500	600	800	900	1,000	Grand
		yds.	yds.	yds.	yds.	yds.	yds.	Total
Winners of Olympic Gold Medal.	Leushner, Sgt. W. F. ...	71	75	73	73	67	71	430
	Martin, Maj. W. B. ..	71	74	72	73	71	69	430
	Winder, Maj. C. B. ...	69	74	72	73	72	69	429
	Casey, Capt. K.K.V. ...	74	71	69	73	67	69	423
	Eastman, Cpl. A. ...	70	74	70	71	67	60	412
	Benedict, Capt. C. S. ...	73	70	69	73	61	61	407
		428	438	425	436	405	399	2,531

	UNITED KINGDOM	200	500	600	800	900	1,000	Grand
		yds.	yds.	yds.	yds.	yds.	yds.	Total
Winners of Olympic Silver Medal.	Ommundsen, Sgt. H. ...	68	74	73	72	70	67	424
	Varley, Maj. F. E. ...	72	75	71	71	67	67	423
	Fulton, Pte. A. G. ...	71	70	71	75	65	65	417
	Richardson, Maj. P. W.	68	73	70	72	64	66	413
	Padgett, Q. M. S. ...	70	73	69	71	68	59	410
	Martin, Ar.-Sgt. ...	70	71	72	72	66	59	410
		419	436	426	433	399	383	2,497

	CANADA	200	500	600	800	900	1,000	Grand
		yds.	yds.	yds.	yds.	yds.	yds.	Total
Winners of Olympic Bronze Medal.	Smith, Sgt. W. A. ...	71	72	70	75	72	61	421
	Crowe, Capt. C. R. ...	69	66	71	74	65	70	415
	Williams, Pte. B. M. ...	71	74	70	74	67	58	414
	McInnis, Cpl. D. ...	68	73	73	74	65	60	413
	Eastcott, Pte. W. M. ...	69	63	65	70	64	61	392
	Kerr, S.-Sgt. H. ...	64	70	65	67	61	57	384
		412	418	414	434	394	367	2,439





GREECE	200 yds.	500 yds.	600 yds.	800 yds.	900 yds.	1,000 yds.	Grand Total
Theofilakis, J. ... ..	70	68	59	65	48	47	357
Mavromatis, F. ... ..	66	63	62	60	60	38	349
Theofilakis, A. ... ..	64	71	65	64	32	53	349
Orfanides, G. ... ..	60	62	59	40	48	56	325
Triantafiliades, M. ... ..	62	60	56	50	51	35	314
Rediadis, D. ... ..	62	61	56	37	43	46	305
	—	—	—	—	—	—	1,999

DENMARK	200 yds.	500 yds.	600 yds.	800 yds.	900 yds.	1,000 yds.	Grand Total
Andersen, N. ... ..	65	60	63	68	53	43	352
Christensen, K. ... ..	67	67	64	49	42	44	333
Jensen, L. P. M. ... ..	60	56	59	57	48	46	326
Laursen, N. ... ..	56	52	58	64	43	36	309
Jensen, H. ... ..	65	60	62	48	45	27	307
Olsen, O. ... ..	62	64	63	21	48	24	282
	—	—	—	—	—	—	1,909

## (b) INDIVIDUAL COMPETITION 1,000 YARDS.

Name.	H.P.S., 100.	Country	Marks.
Millner, Col. J. K. (Winner Olympic Gold Medal)	...	United Kingdom	98
Casey, Capt. K. K. V. (Winner Olympic Silver Medal)	...	United States	93
Blood, M. (Winner Olympic Bronze Medal)	...	United Kingdom	92
Barnett, R. W.	...	"	92
Ranken, Capt. T.	...	"	92
Caldwell, T.	...	"	91
Sellers, Dr. J. C.	...	"	91
Kerr, S.-Sergt. H.	...	Canada	91
Utton, Sergt.-Maj. F. W.	...	"	90
Crowe, Capt. C. R.	...	"	90
Leushner, Sgt. W. F.	...	United States	89
Brown, Ar.-Sgt. S. S.	...	Canada	89
Jeffers, Sgt. C. J.	...	United States	88
Eastman, Pte. I. L.	...	"	88
Benedict, Capt. C. S.	...	"	88
Winder, Major C. B.	...	"	87
McInnis, Corp. D.	...	Canada	87
Fremantle, Col. Hon. T. F.	...	United Kingdom	87
Whitehead, P. K.	...	"	86

<i>Name.</i>	<i>Country.</i>	<i>Marks.</i>
Boigne, Comte de ... ..	France ... ..	86
Morris, Sgt. F. H. ... ..	Canada ... ..	86
Simon, Lieut. H. E. ... ..	United States ... ..	86
Angelini, Capt. ... ..	France ... ..	85
Hopton, Col. J. ... ..	United Kingdom ... ..	84
Green, Capt. E. A. ... ..	United States ... ..	84
Hessian, J. W. ... ..	" ... ..	84
Freeborn, C.-Sgt. J. ... ..	Canada ... ..	83
Rogers, A. E. ... ..	United Kingdom ... ..	82
Colas, P. ... ..	France ... ..	82
Elmitt, Lieut. F. F. ... ..	Canada ... ..	82
Jones, Major J. M. ... ..	" ... ..	82
Bru, J. ... ..	Norway ... ..	82
Martin, Ar.-Sgt. A. ... ..	Canada ... ..	79
Jorgensen, O. ... ..	Sweden ... ..	77
Rowe, Pte. G. J. ... ..	Canada ... ..	75
Hecht, L. ... ..	France ... ..	75
Steele, Pte. A. ... ..	Canada ... ..	74
Merillon, D. ... ..	France ... ..	69
Moreaux, E. ... ..	" ... ..	67
Erdmann, G. ... ..	Norway ... ..	61
Enger, A. ... ..	" ... ..	58
Kvam, K. ... ..	" ... ..	58
Ohlsson, P. E. F. ... ..	Sweden ... ..	54
Mossberg, K. F. ... ..	" ... ..	48
Theofilakis, A. ... ..	Greece ... ..	30
Rosell, E. O. ... ..	Sweden ... ..	27
Glomnes, M. ... ..	Norway ... ..	26
Tetart, L. E. ... ..	France ... ..	21
Wagner-Hohenlobbese, Dr. E. ... ..	Germany ... ..	12

## (c) TEAM COMPETITION. 300 METRES.

H.P.A.S., 7,200.

	NORWAY	Standing	Kneeling	Prone	Grand
					Total
Winners of Olympic Gold Medals.	Helgernd, A. ... ..	259	303	312	874
	Søther, O. ... ..	274	281	310	865
	Skattebo, G. G. ... ..	247	277	317	841
	Sæter, O. ... ..	237	283	320	840
	Brathe, J. ... ..	249	272	305	826
	Liberg, E. ... ..	283	235	291	809
		—	—	—	5,055

		SWEDEN		Standing	Kneeling	Prone	Grand Total
Winners of Olympic Silver Medals.	Jonsson, G. A. ...			238	289	313	840
	Arvidsson, P. O. ...			233	268	311	812
	Jansson, A. ...			228	263	310	801
	Sjoberg, G. A. ...			210	238	312	760
	Rundberg, C. J. ...			160	265	334	759
	Gustafsson, J. ...			198	243	298	739
				—	—	—	4,711
		FRANCE		Standing	Kneeling	Prone	Grand Total
Winners of Olympic Bronze Medals.	Johnson, L. ...			225	313	298	836
	Balme, E. ...			230	250	321	801
	Parmentier, A. ...			206	264	303	773
	Courquin, A. ...			203	235	330	768
	Lecoq, M. ...			222	240	294	756
	Boigne, Comte de ...			164	237	317	718
				—	—	—	4,652
		DENMARK		Standing	Kneeling	Prone	Grand Total
	Andersen, N. ...			163	249	313	725
	Madsen, L. F. ...			240	297	279	816
	Olsen, O. ...			214	257	283	754
	Christensen K. ...			209	249	294	752
	Petersen, Chr. ...			227	224	297	748
	Schultz, H. ...			191	258	299	748
				—	—	—	4,543
		BELGIUM		Standing	Kneeling	Prone	Grand Total
	Pannier du Verger ...			217	296	313	826
	Van Asbrock ...			222	237	328	787
	Ista, E. ...			224	270	292	786
	Sauveur, H. ...			206	241	319	766
	Geens, J. ...			215	259	266	740
	Potz, E. ...			145	204	255	604
				—	—	—	4,509

UNITED KINGDOM				Standing	Kneeling	Prone	Grand Total
Wallingford, Sergt.-Major	...	...	...	188	284	317	789
Hawkins, Q. M. S. I.	...	...	...	201	268	307	776
Churcher, C. S. M. I.	...	...	...	162	270	328	760
Raddall, C. S. M. I.	...	...	...	195	246	313	754
Bostock, Q. M. S. I.	...	...	...	126	246	296	668
Brown, Ar.-S. S.	...	...	...	127	205	276	608
				—	—	—	4,355

HOLLAND				Standing	Kneeling	Prone	Grand Total
Van den Bergh, G. A.	...	...	...	176	273	302	751
Brosch, C.	...	...	...	179	234	295	708
Van Altenburg, C.	...	...	...	149	249	291	689
de Gee, A. W. J.	...	...	...	164	254	266	684
Vuurman, U.	...	...	...	145	231	277	653
Bruyaard, P. J.	...	...	...	152	186	307	645
				—	—	—	4,130

FINLAND				Standing	Kneeling	Prone	Grand Total
Nassling, F.	...	...	...	222	253	242	717
Nyman, G. R.	...	...	...	199	249	252	700
Huttunen, H.	...	...	...	184	221	239	644
Kolko, W. W.	...	...	...	209	216	217	642
Nassling, E.	...	...	...	181	190	266	637
Tuiskunen, H.	...	...	...	187	195	240	622
				—	—	—	3,962

GREECE				Standing	Kneeling	Prone	Grand Total
Theofilakis, J.	...	...	...	162	248	302	712
Triantafiliadec, M.	...	...	...	149	227	277	653
Theofilakis, A.	...	...	...	160	216	269	645
Orfanides, G.	...	...	...	117	242	263	622
Rediadis, D.	...	...	...	155	190	274	619
Mavromatis, F.	...	...	...	105	188	245	538
				—	—	—	3,789

## (d) INDIVIDUAL COMPETITION. 300 METRES.

H.P.A.S., 1,200.

Name.	Country.	H.P.S.,			Total.
		400	400	400	
		Standing.	Kneeling.	Prone.	
Helgernd, A. (Winner Olympic Gold Medal)	Norway ...	277	292	340	909
Simon, Lieut. H. E. (Winner Olympic Silver Medal)	United States ...	228	294	365	887
Sæther, O. (Winner Olympic Bronze Medal)	Norway ...	272	284	327	883
Sjoberg, G. A.	Sweden ...	251	285	338	874
Gustafsson, J.	„ ...	265	283	324	872
Brathe, J.	Norway ...	257	291	303	851
Jansson, A.	Sweden ...	235	296	312	843
Johnson, L.	France ..	250	282	303	835
Sæter, O.	Norway... ..	240	291	299	830
Wallingford, Sgt.-Maj. J. A.	United Kingdom	201	303	324	828
Blood, M.	„	201	290	334	825
Arvidsson, P. O.	Sweden ...	236	277	310	823
Erdmann, G.	Norway ...	234	277	310	821
Madsen, L. F.	Denmark ...	236	294	283	813
Jonsson, G. A.	Sweden ...	226	267	319	812
Green, Capt. E. A.	United States ...	190	276	326	792
Kolko, W. W.	Finland ...	231	269	288	788
Petersen, Chr.	Denmark ...	191	278	311	780
Kvam, K.	Norway ...	234	267	276	777
Jackson, Sgt.-Inst. A. T.	United Kingdom	187	249	335	771
Schultz, H.	Denmark ...	223	257	289	769
Waas, P. van	Holland ...	188	285	295	768
Mossberg, K. F.	Sweden ...	174	288	299	761
Skymoen, O.	Norway ...	206	240	314	760
Colas, P.	France ...	231	233	293	759
Hawkins, Q. M. S, Inst. R.	United Kingdom	189	273	301	752
Olsen, P. O.	Norway ...	222	237	293	752
Ohlsson, P. E. F.	Sweden ...	174	271	306	751
Hessian, J. W.	United States ...	176	233	337	746
Nassling, F.	Finland ...	221	244	268	733
Lecoq, M.	France ...	196	280	254	730
Ten Bruggen Cate, P.	Holland ..	216	238	271	726
Laursen, N.	Denmark ...	202	224	286	712
Angelini, Capt.	France ...	154	247	305	706
Ista, E.	Belgium ...	169	232	300	701
Rey, F.	„	169	245	284	698
Tuiskunen, H.	Finland ...	193	246	256	697
Huttunen, H.	„	204	212	270	686
Kolko, L.	„	171	236	265	672
Chancy, C.S.M. Inst. H. E.	United Kingdom	140	240	291	671
Nassling, E.	Finland ...	204	234	219	657
Liebst, P. V.	Denmark ...	187	197	261	645
Prokop, S.	Hungary ...	144	236	247	627

<i>Name.</i>	<i>Country.</i>	<i>Standing.</i>	<i>Kneeling.</i>	<i>Prone.</i>	<i>Total</i>
Nyman, G. H. ...	... Finland	... 200	166	249	615
Reilin, K. ..	.. ..	... 217	174	193	584
Hallamaa, H. ..	.. ..	... 165	181	230	576
Glomnes, M. ...	... Norway	... 250	—	313	563
Christensen, K. ...	... Denmark	... 202	—	299	501
Moricz, K. ...	... Hungary	... 122	179	189	490
Jorgensen, O. ...	... Sweden...	... —	112	308	420
Jensen, L. P. M.	... Denmark	... 46	—	275	321

## (e) MINIATURE RIFLE SHOOTING.

TEAM COMPETITION. 50 AND 100 YARDS.

H.P.A.S., 800.

	UNITED KINGDOM		50 yds.	100 yds.	Grand Total
	Winners of Olympic Gold Medals.	Matthews, M. K. ...	...	98	98
Humby, H. R. ...		...	97	97	194
Pimm, W. E. ...		...	99	93	192
Amoore, E. J. ...		...	93	96	189
—		—	—	—	771

	SWEDEN		50 yds.	100 yds.	Grand Total
	Winners of Olympic Silver Medals.	Carlberg, Lieut. W. ...	...	95	92
Schartan, Lieut. F. A. ...		...	96	90	186
Van Holst, Lieut. J. H.		...	94	90	184
Carlberg, Lieut. E. ...		...	88	92	180
—		—	—	—	737

	FRANCE		50 yds.	100 yds.	Grand Total
	Winners of Olympic Bronze Medals.	Colas, P. ...	...	96	93
Regaud, A. ...		...	91	95	186
Lecuyer, L. ...		...	85	84	169
Bonnefoy ...		...	87	79	166
—		—	—	—	710

## MINIATURE RIFLE SHOOTING.

## (f) INDIVIDUAL COMPETITION. 50 AND 100 YARDS.

H.P.S. 400.

Name.	Country	50 yds.	100 yds.	Total.
Carnell, A. A. (Winner Olympic Gold Medal) ... ..	United Kingdom ...	192	195	387
Humby, H. R. (Winner Olympic Silver Medal) ... ..	" ...	197	189	386
Barnes, G. (Winner Olympic Bronze Medal) ... ..	" ...	189	196	385
Matthews, M. K. ... ..	" ...	195	189	384
Amoore, E. J. ... ..	" ...	194	189	383
Pimm, W. E. ... ..	" ...	192	187	379
Taylor, A. E. ... ..	" ...	189	187	376
Hawkins, H. I. ... ..	" ...	185	189	374
Warner, J. ... ..	" ...	191	182	373
Carlberg, Lieut. W. ... ..	Sweden" ...	184	186	370
Wilde, A. W. ... ..	United Kingdom... ..	194	176	370
Milne, J. L. ... ..	" ...	182	186	368
Mercier, A. ... ..	France ... ..	178	188	366
Milne, W. ... ..	United Kingdom... ..	183	180	363
Orfanides, G. ... ..	Greece ... ..	180	177	357
Hill, W. ... ..	Australia ... ..	183	171	354
Tetart, L. E. ... ..	France ... ..	176	174	350
Von Holst, Lieut. J. H. ... ..	Sweden ... ..	172	177	349
Bonnefoy, H. ... ..	France ... ..	147	157	304

(g) INDIVIDUAL COMPETITION. 25 YARDS. *Disappearing.*

H.P.S., 45.

Name.	Country.	Total.
Styles, W. K. (Winner Olympic Gold Medal) ... ..	United Kingdom... ..	45
Hawkins, H. I. (Winner Olympic Silver Medal) ... ..	" ... ..	45
Amoore, E. J. (Winner Olympic Bronze Medal) ... ..	" ... ..	45
Milne, W. ... ..	" ... ..	45
Milne, J. L. ... ..	" ... ..	45
Wilde, A. W. ... ..	" ... ..	45
Carlberg, Lieut. W. ... ..	Sweden ... ..	45
Humby, H. R. ... ..	United Kingdom... ..	45
Matthews, M. K. ... ..	" ... ..	42
Von Rosen, Lieut. O. ... ..	Sweden ... ..	42
Carlberg, Lieut. E. ... ..	" ... ..	42
Fleming, A. F. ... ..	United Kingdom... ..	42
Schartan, F. A. O. ... ..	Sweden ... ..	42
Newitt, E. J. D. ... ..	United Kingdom... ..	42
Pimm, W. E. ... ..	" ... ..	39
Von Holst, Lieut. J. H. ... ..	Sweden ... ..	39
Plater, P. ... ..	United Kingdom... ..	39
Hill, W. ... ..	Australia ... ..	36
Mercier, A. ... ..	France ... ..	30
Winans, W. ... ..	United States ... ..	30
Johnson, L. ... ..	France ... ..	24
Tetart, L. E. ... ..	" ... ..	21

*(h) INDIVIDUAL COMPETITION. 25 YARDS. Moving.*

<i>Name.</i>	<i>H.P.S., 45.</i>	<i>Country.</i>	<i>Total.</i>
Fleming, A. F. (Winner Olympic Gold Medal) ... ..	...	United Kingdom ...	24
Mathews, M. K. (Winner Olympic Silver Medal) ... ..	...	„ ...	24
Marsden, W. B. (Winner Olympic Bronze Medal) ... ..	...	„ ...	24
Newitt, E. J. D. ... ..	...	„ ...	24
Plater, P. ... ..	...	„ ...	22
Pimm, W. E. ... ..	...	„ ...	21
Milne, W. ... ..	...	„ ...	21
Von Rosen, Lieut. O. ... ..	...	Sweden ...	18
Styles, W. K. ... ..	...	United Kingdom ...	17
Wilde, A. W. ... ..	...	„ ...	13
Winans, W. ... ..	...	United States ...	13
Johnson, L. ... ..	...	France ...	13
Milne, J. L. ... ..	...	United Kingdom ...	12
Mercier, A. ... ..	...	France ...	10
Tetart, L. E. ... ..	...	„ ...	9
Carlberg, Lieut. E. ... ..	...	Sweden ...	9
Carlberg, W. ... ..	...	„ ...	9
Von Holst, J. H. ... ..	...	„ ...	9
Hawkins, H. ... ..	...	United Kingdom ...	3
Amoore, E. J. ... ..	...	„ ...	3
Hill, W. ... ..	...	Australia ...	Retired
Schartan, F. A. O. ... ..	...	Sweden ...	Retired

## REVOLVER AND PISTOL.

*(i) TEAM COMPETITION. 50 YARDS.*

H.P.A.S., 2,400.

	UNITED STATES				Grand Total
Winners of Olympic Gold Medals.	Gorman, J. ... ..	...	...	...	501
	Calkins, Dr. I. R. ... ..	...	...	...	473
	Dietz, J. A. ... ..	...	...	...	472
	Axtell, C. ... ..	...	...	...	468
					1,914
	BELGIUM				Grand Total
Winners of Olympic Silver Medals.	Van Asbrock, P. ... ..	...	...	...	493
	Storms, R. ... ..	...	...	...	477
	Pannier du Verger ... ..	...	...	...	462
	Englebert, R. ... ..	...	...	...	431
					1,863



	UNITED KINGDOM	Grand Total
Winners of Olympic Bronze Medals.	Wallingford, Sergt.-Major ... ..	477
	Coles, G. It. (R.N.) ... ..	459
	Lynch-Staunton, Capt. H. G. ... ..	446
	Ellicott, W. ... ..	435
		1,817

	FRANCE	Grand Total
	Barbillat ... ..	463
	Regaud, A ... ..	440
	Moreaux, E. ... ..	436
	Depassis ... ..	411
		1,750

	SWEDEN	Grand Total
	Carlberg, W. ... ..	471
	Carlberg, E. ... ..	462
	Von Holst, H. ... ..	416
	Schartan, F. H. ... ..	383
		1,732

	HOLLAND	Grand Total
	Van der Kop, J. ... ..	449
	Van den Bergh, G. A. ... ..	401
	De Blécourt, Dr. J. J. ... ..	398
	Ten Bruggen Cate, P. ... ..	384
		1,632

	GREECE	Grand Total
	Mavromatis, F. ... ..	419
	Theofilakis, A. ... ..	401
	Theofilakis, J. ... ..	398
	Orfanides, G. ... ..	358
		1,576

## REVOLVER AND PISTOL.

## (j) INDIVIDUAL COMPETITION. 50 YARDS.

H.P.S., 600.

<i>Name.</i>	<i>Country</i>	<i>Total.</i>
Van Asbrock, P. (Winner Olympic Gold Medal) ... ..	Belgium ... ..	490
Storms, R. (Winner Olympic Silver Medal) ... ..	„ ... ..	487
Gorman, J. (Winner Olympic Bronze Medal) ... ..	United States ..	485
Axtell, C. ... ..	„ ... ..	480
Wallingford, Sgt.-Major ... ..	United Kingdom ...	467
Barbillat, — ... ..	France ... ..	466
Ellicott, W. ... ..	United Kingdom ...	458
Calkins, Dr. I. R. ... ..	United States ...	457
Dietz, J. A. ... ..	„ ... ..	455
Regaud, A. ... ..	France ... ..	451
Coles, G. H. (R.N.) ... ..	United Kingdom ...	449
Van der Kop, J. ... ..	Holland ... ..	447
Lynch-Staunton, Capt. H. G. ... ..	United Kingdom ...	443
Lane-Joynt, W. R. ... ..	„ ... ..	442
Englebert, R. ... ..	Belgium ... ..	441
Newton, Corp. W. S. ... ..	United Kingdom ...	440
Moreaux, E. ... ..	France ... ..	438
Schartan, F. A. O. ... ..	Sweden ... ..	436
Le Boutillier, T. ... ..	United States ...	436
Carlberg, W. ... ..	Sweden ... ..	432
Sayre, Dr. R. H. ... ..	United States ...	430
Depassis, J. ... ..	France ... ..	427
Wirgman, C. W. ... ..	United Kingdom ...	425
Ten Bruggen Cate, P. ... ..	Holland ... ..	421
Mavromatis, F. ... ..	Greece ... ..	419
Theofilakis, A. ... ..	Greece ... ..	409
Von Holst, F. H. ... ..	Sweden ... ..	408
Jones, P. H. (R.N.) ... ..	United Kingdom ...	407
Theofilakis, J. ... ..	Greece ... ..	406
Lecuyer, L. ... ..	France ... ..	401
Le Fevre, J. N. ... ..	United Kingdom ...	399
Rediadis, D. ... ..	Greece ... ..	397
Carlberg, E. ... ..	Sweden ... ..	396
Robion du Pont, M. ... ..	France ... ..	391
Von Rosen, O. ... ..	Sweden ... ..	386
De Blécourt, Dr. J. J. ... ..	Holland ... ..	381
Pinchart, J. ... ..	Belgium ... ..	372
Winans, W. ... ..	United States ...	368
Munday, Major H. ... ..	United Kingdom ...	358
Van den Bergh, G. A. ... ..	Holland ... ..	343
Brosch, C. ... ..	„ ... ..	337
Bashford, J. ... ..	United Kingdom ...	329
De Gee, A. W. J. ... ..	Holland ... ..	226

## (k) RUNNING DEER.

## TEAM COMPETITION.

H.P.A.S., 160.

	SWEDEN				Grand Total
	Winners of Olympic Gold Medal.	Swahn, A.	...	...	...
	Knoppel, A.	...	...	...	22
	Swahn, O. G.	...	...	...	21
	Rosell, E. O.	...	...	...	17
					86

	UNITED KINGDOM				Grand Total
	Winners of Olympic Silver Medal.	Nix, Major C. J. A.	...	...	...
	Lane-Joynt, W. R.	...	...	...	22
	Ellicott, W.	...	...	...	18
	Ranken, Capt. T.	...	...	...	18
					85

## (l) INDIVIDUAL COMPETITION, SINGLE SHOT.

H.P.S., 40.

<i>Name.</i>	<i>Country.</i>	<i>Total.</i>
Swahn, O. G. (Winner Olympic Gold Medal) ... ..	Sweden ... ..	25
Ranken, Capt. T. (Winner Olympic Silver Medal) ... ..	United Kingdom ... ..	24
Rogers, A. E. (Winner Olympic Bronze Medal) ... ..	" ... ..	24
Blood, M. ... ..	" ... ..	23
Kempster, Sgt.-Major A. J. ... ..	" ... ..	22
Lane-Joynt, W. R. ... ..	" ... ..	21
Winans, W. ... ..	United States ... ..	21
Cowan, Col. J. H. ... ..	United Kingdom ... ..	21
Milner, Col. J. K. ... ..	" ... ..	20
Nix, Major C. J. A. ... ..	" ... ..	19
Rosel, E. O. ... ..	Sweden ... ..	17
Ellicott, W. ... ..	United Kingdom ... ..	16
Tetart, L. E. ... ..	France ... ..	11
Robion du Pont, M. ... ..	" ... ..	6
Barbillat,— ... ..	" .. ..	3

## (m) INDIVIDUAL COMPETITION. DOUBLE SHOT.

Name.		H.P.S., 80.		Country.	Total.
Winans, W. (Winner Olympic Gold Medal)	...	...	...	United States	46
Ranken, Capt. T. (Winner Olympic Silver Medal)	...	...	...	United Kingdom	46
Swahn, O. G. (Winner Olympic Bronze Medal)	...	...	...	Sweden	38
Blood, M.	...	...	...	United Kingdom	34
Kempster, Sgt.-Major A. J.	...	...	...	"	34
Ellicott, W.	...	...	...	"	33
Rogers, A. E.	...	...	...	"	33
Rosel, E. O.	...	...	...	Sweden	27
Bashford, J.	...	...	...	United Kingdom	25
Cowan, Col. J. H.	...	...	...	"	24
Nix, Major C. J. A.	...	...	...	"	22
Tetart, L. E.	...	...	...	France	21
Lane-Joynt, W. R.	...	...	...	United Kingdom	20
Robion du Pont, M.	...	...	...	France	18
Millner, Col. J. K.	...	...	...	United Kingdom	15

## ANALYSIS OF RESULTS.

In the Olympic rifle competitions there were thirteen international events, and the record of the nations competing is :—

## WON BY THE UNITED KINGDOM.

- Miniature rifle team competition.
- Miniature rifle individual competition.
- Miniature competition at moving targets.
- Miniature competition at disappearing targets.
- 1,000 yards' individual competition.

## WON BY THE UNITED STATES.

- Team competition with service rifle.
- Team competition with revolvers and pistols.
- Individual competition at the running deer (double).

## WON BY SWEDEN.

- Team competition at the running deer.
- Individual competition at the running deer (single).

## WON BY NORWAY.

- Team competition at 300 metres.
- Individual competition at 300 metres.

## WON BY BELGIUM.

- Individual competition with revolver.

The record of the placings for gold, silver, and bronze Olympic medals is as follows :—

	<i>Firsts</i>	<i>Seconds</i>	<i>Thirds</i>
United Kingdom	5	7	6
U.S.A.	3	2	1
Sweden	2	2	1
Norway	2	0	1
Belgium	1	2	—
France	—	—	2
Canada	—	—	1

It will be of interest to reproduce here (from the Field, in which it was first published) two fine diagrams made at Bisley in one of the competitions just described.

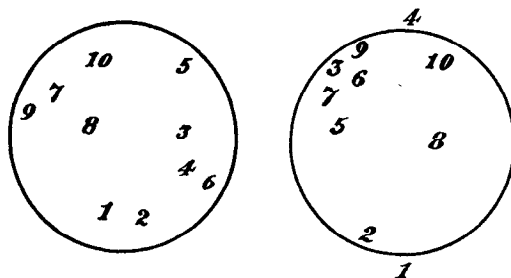

LONG RANGE INDIVIDUAL.—Twenty shots at 1,000 yards by Col. J. Millner, United Kingdom representative. Wind varied on one occasion three points or 30 inches between two shots. Elevation lowered on account of high shot, No. 10, in first target, with result No. 1 in next series struck low. Next shot with same elevation remained low. Elevation then raised, but when No. 4 struck high the average elevation was resumed and remainder were bulls.

Britain, the home of long-range practice, is a country of restricted space and compactly planned areas. As a natural consequence rifle shooting practice is only indulged in by the few, and those few unless they are very enthusiastic get but little real practice in the course of the year. Abroad, where spaces are less restricted, other conditions prevail. Short-distance practice is recognised at its proper value, and convenience of access is considered of more importance than the extensiveness of a range much farther distant. The conditions of the rifle and the cartridge have been adapted to the ranges employed, and a man becomes a shooter—it is immaterial what class of shooter, because everything follows when once a start has been made. The teams of foreign shooters demonstrated their methods in the Olympic competitions. Typical amongst the special competitions which have been organised under continental conditions is that at 300 metres. There is no particular magic about this distance, except that if one distance only were recognised for rifle practice, that distance would probably be 300 yards or 300 metres. The shooting is conducted standing, kneeling, and prone. Each has its special features, both from the sporting and utilitarian standpoints, and the members of the foreign teams demonstrated in their own persons the hold such sport gains on men of all ages. The variety of rifles employed for the work equally displayed the entrancing interest of the mechanical and theoretical sides of the pursuit of marksmanship. A receptive and appreciative attitude should be adopted towards all these matters. Long-range practice has created a limited band of very skilful shooters, life-long specialists for the most part. Miniature shooting teaches, perhaps, less,

but to an infinitely larger number. The continental 300 metres system of shooting strikes a happy mean without introducing any of the supposed disadvantages inseparable from a compromise.

Amongst incidental shooting, the work with the pistol is extremely interesting again, because more elastic conditions widen the area to which appeal is made. Great as is the interest of revolver shooting, its natural place is to follow practice with the .22 pistol, otherwise the saloon pistol, to use a term which has ceased to be familiar. The benefit derived from the use of the small calibre is the power to practice in odd places and the avoidance of the recoil and report, both of which enhance the difficulties of the initial stages.

The running deer shooting competition was rendered doubly interesting at Bisley by the introduction of a variety in which two shots must be fired during a single transit of the deer. Hitherto the magazine sporting rifle had ousted the gunmaker's double-barrel weapon, but now that two shots were required the pre-eminence of two barrels compared with one was open to demonstration. Mr. Winans was the happy victor, having made forty-four in the ties against forty-one by Capt. Ranken. His rifle was made to take a high velocity, light-weight, pointed bullet, which traverses the 110 yards' range while the deer is covering about 16 inches of its journey. The competition was very sporting, and its repetition during the ordinary Bisley meeting should bring some of our best gunmakers forward with rifles for the high velocity, light recoil, and perfectly true barrels, which are the essentials to be met.

The weather was at its worst during most of the meeting, and consequently a good deal of the spectacular effect was spoiled, and also, to some extent, the best of the shooting. On future occasions of the kind the meeting might perhaps be spread over a week, in order to give competitors who had entered for various sections of the shooting a chance to take their places. As things worked out, the home teams, being taken from men on the spot, were variously made up of specialists in every department, very little duplication occurring. The visiting teams, on the other hand, were necessarily more limited in numbers, so that their members shot in several capacities, proving, as often has been done in the case of shooting, that the master of one is master of all. The holding of several events simultaneously, though no inconvenience to the practised Bisley competitor, is a trifle confusing to the foreign visitor, with the result that his numerous scratchings sometimes slightly disorganised the arrangements which had been so carefully made beforehand. There is a wide gulf between an ordinary meeting, where each competitor is acquainted by long experience with the encyclopædic rules published by the N.R.A., and an Olympic gathering, where the ordinary routine is



SHOOTING.—THE UNITED KINGDOM TEAM AT THE 1,000 YARDS RANGE IN THE TEAM COMPETITION.



SHOOTING.—THE UNITED KINGDOM TEAM (NO. 1) IN THE CLAY-PIGEON TEAM COMPETITION.



reversed to the extent that the competitor looks for instruction from the staff on the ranges. At the next Olympic meeting the time allotted might well be double that known to be sufficient where ordinary competitors are concerned, also some means should be found for checking indiscriminate entries by the members of visiting teams for competitions in which they have but a vague intention to take part.

In international competitions of this character the United Kingdom is hardly expected to show special excellence all round. On the present occasion, with the meeting held in our own country, thoroughly good work was done under rules which were certainly not framed to suit local conditions of sport. The overwhelming pre-eminence of the home representatives at 1,000 yards, where the match or "any" rifle was allowed, emphasises the fact that no country in the world possesses such a skilled and scientific body of long-range riflemen as are represented by the match rifle shooters of Bisley. So valuable an asset may be set against inferiority wherever it may exist, but the Olympic meeting of 1908 shows comparatively few instances of the need for excuses. The international team match was won by the United States with their new short Springfield army rifle by a surplus over the Britishers of 35 points in 2,531 scored, the Canadians being third. The conditions were fifteen shots at six distances, from 200 to 1,000 yards inclusive, each team using military rifles and any ammunition. The 300 metres team competition provided a strange sight for those who had not before seen the continental system at work. Forty shots standing, kneeling, and prone constitute a somewhat lengthy programme. However, the United Kingdom, with a team from the Hythe School of Musketry, who did not use hair triggers, hand rests, and the various other refinements allowed under the regulations, did well to be sixth on the list. In the individual competition on the same lines the luck of weather made a lot of difference, according to whether the time allotted for the shooter's attendance fell during fair or foul weather. However, Sergeant-Major Wallingford and Mr. Maurice Blood attained a good position ; but Norway and Sweden again showed the great skill which marked their career throughout the meeting. An American gained the silver medal, but the conditions are by no means so strange to that country as to ours.

So much for the big gun shooting. As regards the little guns, otherwise the miniature, a set of scores have been made by the exponents of the new art which stand as a triumph for a country which so few years ago knew nothing of these things. In the team competition, for instance, but of forty shots, half at 50 and half at 100 yards, Mr. Matthews dropped only 4 points, the bulls measuring  $1\frac{1}{2}$  and 3 inches respectively, the position of the shots being judged by the centre and not the margin of the hole. Other scores were also made which were nearly as good.

I append four consecutive targets (first published in the *Field*) made by Mr. G. Barnes, of the United Kingdom, who won the Bronze medal in the individual competition at 50 and 100 yards with miniature rifles. They each comprise one sighter and ten shots with Stevens' rifle at 100 yards. Actual size of the circle *three inches*.

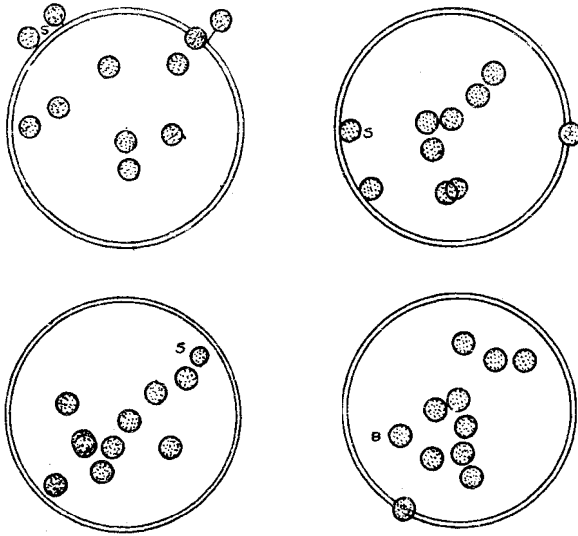

The pistol and revolver competitions were won by visiting teams, mainly because the single pistol firing .22 ammunition is not used in this country, though it gives a great advantage over the revolver, which is the sole pistol recognised in ordinary Bisley competitions. The miniature rifle clubs should certainly make pistol shooting a side line in their club competitions, and the N.R.A. might organise a yearly match with pistols free from restrictions as to nature of arm or calibre.

The shooting of the members of the American team, which came over for the Olympic meeting, created great interest, on account not only of the highly efficient design of their rifle and ammunition, but because they undoubtedly expected to compete successfully in the match rifle competitions. Their rifle was most efficiently designed on the lines of the Mauser, and the cartridge case provides accommodation for a large charge of powder, burning under the best conditions. The individual efficiency of the team as marksmen was exceedingly high, and the refined form of sights fitted to the rifle apparently gave them every opportunity of aiming as straight as those who adopt match sights and the back position.

## B.—The Clay Bird Competitions.

These competitions took place at the Uxendon Shooting School Club, situated between Wembley Park and Harrow. A railway station, at Preston Road on the Metropolitan line, adjoining the club grounds, was constructed and opened a few weeks before the meeting.

On the selected dates, July 8, 9, 10, and 11, wretched weather conditions prevailed. Heavy rains, high winds, and changeable light made shooting difficult. The specially constructed trench at Uxendon had, by careful planning, been placed so that the July sunlight should not shine in the eyes of the shooters. A more necessary precaution, in the dark weather experienced, was to insure that the birds should be clearly visible. For this purpose the "targets" thrown at Uxendon were marked with whitewash, so as to present a black and white "magpie" appearance.

### CONDITIONS OF COMPETITION.

#### INDIVIDUAL COMPETITION, TO BE SHOT IN THREE STAGES.

*First Stage.*—To be shot at thirty birds each shooter at known traps and unknown angles, on the continuous fire system, in two rounds of fifteen birds each shooter. Ties to be shot off at ten birds each shooter, if necessary.

*Second Stage.*—The competitors in the nearest proportion of half the original number, making the highest scores in the First Stage, will shoot in the Second Stage.

To be shot at twenty birds each shooter at known traps and unknown angles, on the continuous fire system, in two rounds of ten birds each shooter. Ties to be shot off at ten birds each shooter, if necessary.

*Third and Final Stage.*—The competitors, to the number of half those competing in the Second Stage, with the highest aggregate in the First and Second Stage will shoot in the Final Stage.

To be shot at twenty birds each shooter at known traps and unknown angles, on the continuous fire system, in two rounds of ten birds each, and ten birds at unknown traps and angles. Competitors stand at No. 2 mark for five birds from Nos. 1, 2, and 3 traps, and at No. 4 mark for five birds from Nos. 3, 4, and 5 traps. Ties to be shot off at ten birds each shooter at known traps and unknown angles, on the continuous fire principle.

A gold medal will be awarded to the competitor making the highest aggregate score in the three stages, and winning the Individual competition.

## TEAM COMPETITION, TO BE SHOT IN THREE STAGES

*First Stage.*—To be shot at thirty birds each shooter at known traps and unknown angles, on the continuous fire system, in three rounds of ten birds each shooter.

The order in which the teams shall shoot shall be determined by lot.

Two teams, or if necessary three teams, will shoot together, each unit completing a round of ten shots alternately. The First Stage will thus constitute a series of matches. Ties to be shot off at ten birds each shooter.

*Second Stage.*—The teams, in the nearest proportion of half the original number, making the highest scores in the First Stage, will shoot in the Second Stage.

To be shot at twenty birds each shooter at known traps and unknown angles, on the continuous fire system, in two rounds of ten birds each, and five birds at unknown traps and unknown angles, on the single fire principle. Competitors stand at No. 2 mark for five birds from Nos. 1, 2, and 3 traps, or at No. 4 mark for five birds from Nos. 3, 4 or 5 traps,

The teams will shoot in pairs, as determined by the original draw. Ties to be shot off at ten birds each shooter, on the continuous fire system.

*Third and Final Stage.*—The teams to the number of half those competing in the Second Stage, with the highest aggregate scores in the First and Second Stages, will compete in the Final Stage.

To be shot at forty birds each shooter at known traps and unknown angles, on the team system in two rounds of twenty birds each, and ten birds at unknown traps and angles, on the single fire principle, the shooter standing at No. 3 mark. Ties to be shot off at ten birds each shooter, on the single fire principle.

The winner of the match of the Third Stage will be the team making the highest score.

To each member of the team making the highest aggregate score in the three stages, and winning the Team competition, a gold medal will be presented.

## REGULATIONS FOR EXAMINATION OF CARTRIDGES.

1. Each competitor before shooting must deliver to the Clay Bird Shooting Association the official declaration form, issued to him with his numbered competitor's badge, stating that the conditions as to weight of shot charge, size of shot, and gauge of gun have been complied with.

2. For the convenience of competitors, arrangements have been made by which cartridges may be examined beforehand to ensure their compliance with the regulations. Three sample cartridges may be enclosed

for this purpose in a suitable package clearly marked with the competitor's number and name, and the same may be left at the editorial office of the *Field*, Windsor House, Bream's Buildings, Chancery Lane, London, E.C.

3. Competitors using more than one kind of ammunition may deposit three cartridges of each kind, the same to be marked, in addition to the competitor's number, with a distinguishing letter, A, B, C, &c.

4. The results obtained by examination of shot charges will be posted at Windsor House as soon as possible after the examination has been made, and at the cartridge examination tent during the meeting, identification to be by the competitor's number.

5. As provided under section 6 of the Rules and Conditions, sample cartridges will occasionally be selected from competitors on the line for the purpose of examination. The shooter will be held responsible for any failure of such cartridges to comply with the rules, notwithstanding that samples previously examined may have proved satisfactory.

NOTE.—The Rules and Conditions require only that cartridges shall not contain more than  $1\frac{1}{8}$  oz. of shot, of a size not larger than No. 6. These cartridges must not be larger, internally or externally than the nominal 12-bore size.

#### LIST OF COMPETITORS.

##### TEAMS.

*Each Team comprises 6 Shooting Members and Reserves*

##### BELGIUM.

Lt. Van Tilt, Captain ; L. Gernaert, E. Herrmann, Baron A. de Roest d'Alkemade, E. Fesingher, L. de Lunden, E. Soufart, H. Quersin, and R. Storms.

##### CANADA.

F. A. Parker, Captain ; W. H. Ewing, M. E. Fletcher, G. Beattie, G. L. Vivian, A. W. Westover, and D. McMackon.

##### FRANCE.

Baron Jaubert, M. Bucquet, E. Bejot, P. Levé, Count de Fontenay, A. Fleury, P. Lefébure, and Count S. de Rouville.

##### HOLLAND.

G. J. van der Vleit, Captain ; Baron R. T. van Pallandt Eerde, C. A. A. Dudok de Wit, jun., C. N. J. Moltzer, jun., C. M. Viruly, Baron F. A. J. C. van Voorst tot Voorst, R. de Favauge, J. W. Wilson, and Baron E. L. van Voorst tot Voorst.

##### SWEDEN.

C. E. Taube, Captain ; E. Benedicks, J. A. C. Knöppel, C. A. Knöppel, A. G. E. Ljungberg, E. O. Rosell, O. G. Swahn, and A. G. A. Swahn.

##### UNITED KINGDOM.

F. W. Moore, Captain ; A. W. Black, P. Easte, A. Maunder, C. Palmer, J. F. Pike, G. E. Pinchard, and J. M. Postans.

##### UNITED KINGDOM.

G. Whitaker, Captain ; J. H. Butt, H. P. Creasey, F. Greaves, R. Hutton, G. E. Merlin, W. B. Norris, and G. H. Skinner.

## INDIVIDUAL COMPETITORS.

E. Benedicks (Sweden)	G. E. Merlin (United Kingdom)
M. Bucquet (France)	F. W. Moore (United Kingdom)
E. Bejot (France)	W. B. Morris (United Kingdom)
J. H. Butt (United Kingdom)	G. D. Orphanides (Greece)
G. Beattie (Canada)	C. Palmer (United Kingdom)
H. P. Creasey (United Kingdom)	J. M. Postans (United Kingdom)
C. A. A. Dudok de Wit (Holland)	J. F. Pike (United Kingdom)
P. Easte (United Kingdom)	F. A. Parker (Canada)
W. H. Ewing (Canada)	Baron R. van Pallandt Eerde (Holland)
E. Fesingher (Belgium)	H. L. R. Quersin (Belgium)
R. de Favauge (Holland)	Count S. de Rouville (France)
Count de Fontenay (France)	Baron A. de Roest d'Alkemade (Belgium)
A. Fleury (France)	E. O. Rosell (Sweden)
M. E. Fletcher (Canada)	O. G. Swahn (Sweden)
L. Gernaert (Belgium)	A. G. A. Swahn (Sweden)
R. W. Huber (Finland)	E. Soufart (Belgium)
E. Herrmann (Belgium)	R. Storms (Belgium)
R. Hutton (United Kingdom)	K. Tazer (Finland)
Baron Jaubert (France)	Lt. L. Van Tilt (Belgium)
J. A. C. Knöppel (Sweden)	Baron E. L. Van Voorst tot Voorst (Holland)
G. A. Knöppel (Sweden)	Baron F. A. J. C. Van Voorst tot Voorst (Holland)
A. F. Londen (Finland)	C. M. Viruly (Holland)
A. G. E. Ljungberg (Sweden)	G. J. Van der Vleit (Holland)
L. de Lunden (Belgium)	G. L. Vivian (Canada)
P. L. Lucassen (Holland)	J. W. Wilson (Holland)
J. Laan (Holland)	P. W. Waller (Holland)
P. Levé (France)	G. Whitaker (United Kingdom)
P. Lefébure (France)	and
F. Mavrommatis (Greece)	A. W. Westover (Canada)
A. Metaxas (Greece)	
C. N. J. Moltzer (Holland)	
A. Maunder (United Kingdom)	
D. McMackon (Canada)	

A marquee was provided on the grounds for the exclusive use of competitors and their friends.

Where ties occur in the Olympic competitions, shooting off does not count in the aggregate, it determines only the precedence of teams or individuals making identical scores in the various stages of the competitions.

Spectators and others were warned that it would be dangerous to cross the barriers behind the firing lines. Officers, referees and competitors called up to shoot were alone permitted to enter the shooting enclosure.

Cartridges were on sale at the grounds.

## THE COMPETITIONS.

There were two competitions, each comprising three distinct stages. One was for Teams, the other for Individuals. Seven teams entered, each composed of six shooters and reserves. They represented Belgium, Canada, France, Holland, Sweden, and the United Kingdom, the latter

being the only country to enter two full teams. In the Individual competition the entries numbered 61, the countries represented being Belgium, Canada, Finland, France, Greece, Holland, Sweden, and the United Kingdom. In accordance with the regulations, a proportion of the competitors originally entered were eliminated at each stage, the third (final) stages being entered upon by those making the highest aggregate scores, all points counting in the final. Withdrawals of competitors left Belgium, France and Sweden without full teams. In the Individual competition there were also a number of withdrawals.

Following are the scores included at the final stage :

### TEAM COMPETITION.

#### FINAL STAGE.

Three teams, with highest aggregate scores in the two preceding stages, compete in the final stage.

First Stage, 30 birds each shooter (Team System).

Second ,, 25 ,, ,, ,, (20 Team System, 5 Single Fire).

Third ,, 50 ,, ,, ,, (40 ,, ,, 10 ,, ,, ) .

#### 1. UNITED KINGDOM (First Team). Gold Medals.

(F. W. Moore, Captain.)

Name.	First Stage.	Second Stage.	Third Stage.	Total.
	30 Birds.	25 Birds.	50 Birds.	
A. Maunder .. ..	25	18	40	83
J. F. Pike .. ..	23	22	32	77
C. Palmer .. ..	25	12	34	71
J. Postans .. ..	16	14	31	61
F. W. Moore .. ..	22	15	23	60
P. Easte .. ..	16	15	24	55
	<hr/>	<hr/>	<hr/>	<hr/>
	127	96	184 =	407

#### 2. CANADA. Silver Medals.

(F. A. Parker, Captain.)

W. H. Ewing .. ..	24	19	38	81
G. Beattie .. ..	20	18	35	73
A. W. Westover ..	22	15	35	72
M. E. Fletcher ..	18	13	34	65
G. L. Vivian .. ..	18	12	28	58
D. McMackon .. ..	12	18	26	56
	<hr/>	<hr/>	<hr/>	<hr/>
	114	95	196 =	405

#### 3. UNITED KINGDOM (Second Team). Bronze Medals.

(G. Whitaker, Captain.)

G. Whitaker .. ..	15	18	37	70
G. H. Skinner .. .	17	16	30	63
J. H. Butt .. ..	19	12	31	62
W. B. Morris .. .	18	12	32	62
H. P. Creasey .. .	20	14	25	59
R. Hutton .. ..	17	12	27	56
	<hr/>	<hr/>	<hr/>	<hr/>
	106	84	182 =	372

The final of the team match was particularly interesting. The Canadians in the earlier stages had killed 209 birds while the United Kingdom (First Team) had killed 223. In the final stage each team fired at 300 birds, and the Canadians killed 12 more than their opponents, the match thus being won by 2 birds only. The difference between two high scores, 83 to Mr. Maunder and 81 to Mr. Ewing, was sufficient to decide this extremely close match.

## INDIVIDUAL COMPETITION

### FINAL STAGE.

28 shooters, with highest aggregate scores in the two preceding stages, compete in the final stage.

First Stage, 30 birds each shooter (Team System).

Second ,, 20 ,, ,, ,, ,, ,, ,,

Third ,, 30 ,, ,, ,, ,, (20 Team System, 10 Single Fire)

	<i>Name.</i>	<i>First Stage.</i>	<i>Second Stage.</i>	<i>Third Stage.</i>	<i>Total.</i>
		30 <i>Birds.</i>	20 <i>Birds.</i>	30 <i>Birds.</i>	
1.	W. H. Ewing (Canada) ..	27	18	27	72 G. M.
2.	G. Beattie (Canada) ..	21	17	22	60 S. M.
{	A. Maunder (United Kingdom, England) ..	21	14	22	57 B. M.
	A. Metaxas (Greece) ..	21	14	22	57 ,,
	C. Palmer (United Kingdom, Wales) ..	23	12	20	55
	A. Westover (Canada) ..	21	12	22	55
	R. Hutton (United Kingdom, Ireland) ..	23	10	20	53
	J. W. Wilson (Holland) ..	20	13	20	53
	M. E. Fletcher (Canada)	22	9	22	53
	F. W. Moore (United Kingdom) ..	21	11	20	52
	G. Whitaker (United Kingdom) ..	18	9	24	51
	D. McMackon (Canada) ..	19	14	17	50
	J. F. Pike (United Kingdom) ..	22	12	16	50
	C. M. Viruly (Holland) ..	18	13	17	48
	F. Van Voorst (Holland)	18	14	15	47
	E. Van Voorst (Holland)	19	13	15	47
	H. P. Creasey (United Kingdom) ..	22	9	15	46
	P. Easte (United Kingdom) ..	18	11	17	46
	G. E. Merlin (United Kingdom) ..	18	10	17	45
	G. L. Vivian (Canada) ..	16	10	18	44
	W. B. Morris (United Kingdom) ..	10	12	22	44



<i>Name.</i>	<i>First Stage.</i> 30 <i>Birds.</i>	<i>Second Stage.</i> 20 <i>Birds.</i>	<i>Third Stage.</i> 30 <i>Birds.</i>	<i>Total.</i>
R. de Favauge (Holland)	18	11	—	Retired.
E. Bejot (France) ..	18	10	—	„
J. H. Butt (United Kingdom) .. ..	15	11	—	„
A. G. A. Swahn (Sweden)	13	9	—	„
J. Laan (Holland) ..	13	8	—	„
F. A. Parker (Canada) ..	14	5	—	„
E. Benedicks (Sweden) ..	13	6	—	„

In the Individual competition Mr. Ewing's score of 72 out of a possible 80, which included 8 out of 10 in the single fire shooting, was a meritorious performance, giving him a margin of 15 per cent over the winner of the silver medal and nearly 20 per cent. over Mr. Maunder and Mr. Metaxas, who were equal at every stage and tied for third place. The British Olympic Council decided to award a bronze medal to each of these competitors, Under the more severe conditions of the Team competition, Mr. Maunder's score of 83 out of a possible 105, or 79 per cent. of kills, was particularly noteworthy, Mr. Ewing with 81, or 77 per cent., also putting up an excellent score.

As those unfamiliar with the pastime of clay bird shooting may not appreciate the distinction, it may be explained that in shooting on the "Team System" each shooter faces three traps. The traps, which are concealed in a deep trench, throw the birds at different angles, but the position from which the bird will fly is known to the shooter. In shooting under "Single Fire" conditions the shooter has in some cases nine, and in other cases fifteen traps before him, and the bird may come from any one of them. In the scores of both competitions the results of "Single Fire" and "Team" shooting are included together.

The Right Hon. Lord Westbury, Chairman of the Committee entrusted by the Clay Bird Shooting Association with the management of these competitions, presented an Olympic Trophy to be competed for in perpetuity at the Olympic Games. The first holder of this Cup is Mr. W. H. Ewing, the Canadian winner of the Individual event.

The competitions were conducted under the management of the Clay Bird Shooting Association, and the Management Committee was as follows :—The Right Hon. Lord Westbury (Chairman), the Hon. Arthur Bligh, A. Brampton, J. Newton Hayley, W. R. Hillsdon, A. F. Kemp, Dr. W. Mitchell, H. W. Newton, Percy Newton and E. H. Stone (Hon. Sec.). Messrs. N. Coopmans, W. R. Hillsdon, H. W. Newton, Captain Pellier Johnson, and Dr. Mitchell acted as referees, and Mr. Max Baker, on behalf of the *Field* newspaper, examined and tested the cartridges used by the competitors. Invaluable assistance was rendered by these gentlemen.

Clay bird shooting, unlike the sister sport of rifle shooting, does not show the infinite variety of weapons, distances, and targets which multiply the tests of marksmanship. There is but one weapon, one distance, and one target ; consequently the programme resolves itself into two competitions, one for individuals, the other for teams. Each is divided into three stages, the more successful participants of one stage being passed over to the next, until the third or final round enables the contest to be decided. From the shooting point of view, the conditions presented at Uxendon are exceedingly difficult. Whether the speed at which the birds are flung is unusually high, or whether the wind has played pranks with their flight, the fact remains that many of the birds get out of range before the shooter can direct his aim upon them. The limit charge allowed ( $1\frac{1}{8}$  oz.) cannot, with the best of guns, be relied upon to account for so small an object as a clay bird beyond 40 yards, and the fact that first barrels are often taken at distances extreme even for the second barrel will explain why many shooters of consistent reputation failed to show their proper form. The arrangements were very complete, but the bad weather reduced the pleasantness of what would in the ordinary course have proved a most enjoyable gathering. The nationalities represented were less than were originally anticipated, for either from shortness in numbers or scratching at the last moment only four full teams eventually competed.

On the concluding day of this meeting brighter weather made the pastoral conditions a source of pleasure rather than an infliction. Shooting, of necessity, takes people far afield, and the absence of fine weather at first was a source of unqualified disappointment for those who had laboured so hard to meet all requirements. From a shooting point of view the result certainly was to bring the best men to the front ; but the difficult conditions in the early stages unduly separated the various grades of skill. The figures of a published score are often, unfortunately, more permanent than the explanation as to why they were so low. Clay bird shooting, as carried on in this country, is unduly sensitive to alterations in the traps and in the character of the background, because the rules restrict shooters to the use of a cartridge which is inefficient beyond 35 yards. With a perfect background and with traps throwing the birds just right good scores can be made, but the collapse is immediate if anything happens to delay the taking of the shots even the quarter of a second, this increasing by five or six yards the distance of the bird. The conditions prevailing at Uxendon produced this delay, and a wind blowing throughout the meeting gave the rather high-thrown birds a tumble in their flight just at the critical moment. Mr. Ewing, of Canada, most successfully mastered the difficult problem

presented. Mr. Maunder, of this country, showed in the team shoot even better form, but though doing well in individual he showed his best form in shooting a tie for third place with Mr. A. Metaxas, of Greece, this providing one of the most exciting incidents of the meeting. The obvious need in clay bird shooting is to remodel the rules by allowing charges up to  $1\frac{1}{2}$  oz. of shot to be used in 12-bore cases not exceeding  $2\frac{3}{4}$  in. in length, and to abolish the superfluous second barrel.

The Americans have proved the success, from a sporting point of view, of one cartridge adequate to the occasion as against two which are both inadequate. To see at a world's championship meeting shooters desperately firing second barrels at clay birds 70 yards away with guns containing game charges emphasises the need for a change. The double-barrel clay bird gun with full choke in both barrels is useless for outdoor sport. Being a special gun for a special purpose, there is no reason why the specialisation should not be carried the full distance, incidentally producing a useful type of wildfowl gun, and at the same time enabling the shooter, anxious to economise or to specialise still further, to use a single barrel weapon. The whole point in the argument lies in the circumstance that first-class shooters, such as those who took part in this meeting, reckon in the ordinary way to show an all-round go per cent. of kills at their own ground, dropping to, say, 80 per cent. on a strange ground having unusual characteristics. The scores given above show that 65 per cent. was the all-round form of those competing in the final stages. A return to the well-tried pigeon shooting conditions of  $2\frac{3}{4}$  in. cartridges, but with no limit of shot charge, would greatly assist clay bird shooting to take the place of pigeon shooting wherever the latter has fallen into disuse.

The question is naturally a controversial one, for though Americans and Canadians use special guns and special charges, making the shooting of clay birds an end in itself, the practice of European competitors is to make clay bird shooting the means to attaining skill in shooting game ; and much may be said in favour of both methods. Mr. F. W. Moore may be congratulated on having again captained a team to victory. As captain by right and by tradition of the English teams, ever since the Clay Bird Shooting Association instituted these competitions, he has worthily upheld his reputation in the higher duties of captain in an Olympic match. The Canadian team, who won second place, showed themselves good shooters and good sportsmen.

## SKATING.

The conduct of these competitions was entrusted by the Olympic Committee to the National Skating Association, and all details were carried out as far as possible in accordance with the regulations of the International Skating Union. A Special Olympic Committee of the N.S.A. and a Rink Committee were appointed to make all necessary arrangements.

Through the goodwill and assistance of the Duchess of Bedford the rink at Prince's Skating Club was specially opened on October 9 for the practice of competitors. This rink, at which the competitions were held, measures 200 feet by 52 feet (62 x 16m.). A substantial period for practice was thus assured.

Foreign competitors commenced practice some time earlier at the newly opened ice rink in Berlin.

For about ten hours each day the rink was devoted exclusively to the practice of competitors, and was opened for public skating for two hours each afternoon except on Sundays, when the N.S.A. invited members of the chief London skating clubs.

The N.S.A. appointed the following Special Olympic Committee : W. F. Adams, Guy M. Campbell, A. J. Davidson, F. G. Fedden, R. C. Fowler, H. D. Faith, W. Hayes Fisher (Chairman), J. K. Greig, H. Grenander, J. H. Johnson, the Earl of Lytton, F. T. Leeming, Ernest Law, E. E. Mavrogordato, J. Rankine, E. E. Syers, N. G. Thompson, H. Torromé, H. R. Yglesias.

The events were Gentlemen's Figure Skating, Ladies' Figure Skating, Pair Skating, Gentlemen's Special Figure Skating. The entries from each country being limited to three for the individual events and three pairs for the pair skating.

A preliminary notice of the competitions with the compulsory figures selected was issued before the end of the skating season of 1907-8.

Although the meeting formed part of the Olympiad, and as such was not held by a member of the I.S.U., the N.S.A. desired that the regulations should be submitted to the I.S.U., and this course was adopted, and they were approved by the council of that body. The regulations were translated into German and French. The French translation is of interest from the

point of view of novelty. The nomenclature of the figures, &c., was adopted after consultation with the Union des Sociétés Françaises des Sports Athlétiques—the Member for France of the I.S.U.

An excellent and representative entry was received. Unfortunately, Mr. Max Bohatsch and Fräulein Herz, who were chosen to represent Austria, were unable to compete ; the former being unable to take sufficient time for practice, and Fräulein Herz owing to illness. Mr. Torrome, though originally selected as a representative of the United Kingdom, skated for the Argentine, being a subject of that country.

The whole of the skating was watched with keen interest, and on the afternoon of October 29 the rink was filled to overflowing with an enthusiastic crowd of onlookers, who witnessed perhaps the most strenuous, delightful and varied display of figure skating that has ever taken place.

The thanks of the competitors and of all interested in skating are particularly due to the president of the N.S.A. for the great exertions he made, and the large amount of time he devoted both as a member of the British Olympic Council and as chairman of his committee ; to Mr. H. D. Faith for the performance of his arduous duties as secretary ; and to Mr. H. W. Page, the manager of Prince's Rink, for his valuable assistance in the deliberations of the committee, and the details of the rink arrangements.

The methods of marking, and further details as to the manner in which each competition was carried out, will be found in the Skating Regulations in later pages of this volume.

It may be noted that the International Skating Union does not recognise professionalism in either speed or figure skating.

The officials of the several competitions were as follows :—

#### REFEREE.

DR. G. H. FOWLER .. .. . United Kingdom.

#### JUDGES.

##### GENTLEMEN'S COMPETITION IN FIGURE SKATING.

HENNING GRENANDER .. .. . United Kingdom.  
 E. HÖRLE .. .. . Sweden.  
 GUSTAV HÜGEL .. .. . Switzerland.  
 G. SANDERS .. .. . Russia.  
 H. WENDT .. .. . Germany.

##### LADIES' COMPETITION IN FIGURE SKATING.

H. D. FAITH .. .. . United Kingdom.  
 E. HÖRLE .. .. . Sweden.  
 GUSTAV HÜGEL .. .. . Switzerland.  
 G. SANDERS .. .. . Russia.  
 H. WENDT .. .. . Germany.

## COMPETITION IN PAIR SKATING.

H. D. FAITH	..	..	..	..	United Kingdom.
GUSTAV HÜGEL	..	..	..	..	Switzerland.
H. TORROMÉ	..	..	..	..	United Kingdom.
G. SANDERS	..	..	..	..	Russia.
H. WENDT	..	..	..	..	Germany.

## COMPETITION IN SPECIAL FIGURES.

HENNING GRENANDER	..	..	..	..	United Kingdom.
E. HÖRLE	..	..	..	..	Sweden.
GUSTAV HÜGEL	..	..	..	..	Switzerland.
G. SANDERS	..	..	..	..	Russia.
H. WENDT	..	..	..	..	Germany.

## STEWARDS.

B. W. VAN VLOTEN, Representative of Holland.

L. MAGNUS, Representative of France.

A. J. DAVIDSON.	E. E. MAVROGORDATO.
H. D. FAITH.	S. MOSTYN.
F. G. FEDDEN.	J. RANKINE.
J. K. GREIG.	E. SYERS.
J. H. JOHNSON.	H. R. YGLESIAS.
E. LAW.	

G. S. HIRST }  
H. W. PAGE } *Timekeepers.*

Messrs. HORNUNG and BRESNIK were also present as Representatives of Austria.

The competitions were taken in the following order :—

Wednesday, October 28.—10 A.M., Ladies' Compulsory Figures.

3 P.M., Gentlemen's Compulsory Figures.

Thursday, October 29.—10:30 A.M., Special Figure Competition.

3 P.M., Ladies' Free Skating.

Gentlemen's Free Skating.

Pair Skating.

The following is the list of competitors entered at the post for the several events, the order being that of the starting numbers obtained by a draw. The Roman numerals indicate the results.

## I.—GENTLEMEN'S COMPETITION IN FIGURE SKATING

H. R. YGLESIAS *	..	..	..	United Kingdom	..	..	..	—
ULRICH SALCHOW	..	..	..	Sweden	..	..	..	I
N. PANIN *	..	..	..	Russia	..	..	..	—
IRVING BROKAW	..	..	..	United States	..	..	..	VI
H. TORROMÉ	..	..	..	Argentina	..	..	..	VII
J. KEILLER GREIG	..	..	..	United Kingdom	..	..	..	IV
H. BURGER	..	..	..	Germany (scratched).				
A. MARCH	..	..	..	United Kingdom	..	..	..	V
P. THORÉN	..	..	..	Sweden	..	..	..	III
R. JOHANSSON	..	..	..	Sweden	..	..	..	II

\*Scratched for the Free Skating.

## II.—LADIES' COMPETITION IN FIGURE SKATING.

1.	FRÖKEN MONTGOMERY .. ..	Sweden .. ..	IV
2.	MRS. GREENHOUGH SMITH .. ..	United Kingdom .. ..	III
3.	MISS LYCETT .. ..	United Kingdom .. ..	V
4.	MRS. SYERS .. ..	United Kingdom .. ..	I
5.	FRÄULEIN RENDSCHMIDT.. ..	Germany .. ..	II

## III.—COMPETITION IN PAIR SKATING.

1.	MR. and MRS. SYERS .. ..	United Kingdom .. ..	III
2.	MR. and MRS. JOHNSON .. ..	United Kingdom .. ..	II
3.	FRÄULEIN HUMBLER and HERR H. BURGER .. ..	Germany .. ..	I

## IV.—COMPETITION IN SPECIAL FIGURES.

1.	A. CUMMING .. ..	United Kingdom .. ..	II
2.	N. PANIN .. ..	Russia .. ..	I
3.	IRVING BROKAW .. ..	United States (scratched).	
4.	ULRICH SALCHOW .. ..	Sweden (scratched).	
5.	G. N. E. HALL-SAY .. ..	United Kingdom .. ..	III

The marks allotted by the several Judges to each competitor are shown in the following tables :—

## LADIES' FIGURE SKATING COMPETITION

—	FRÖKEN MONTGOMERY	MRS. G. SMITH	MISS LYCETT	MRS. E. SYERS	FRÄULEIN RENDSCHMIDT	TOTALS
FAITH ...	104·5 63 IV 167·5	129 81 II 210	87·5 76·5 V 164	147·5 108 I 255·5	116 85·5 III 201·5	584·5 414 998·5
HÖRLE ...	103·5 63 IV 166·5	125·5 81 III 206·5	93·5 58·5 V 152	150·5 85·5 I 236	125·5 85·5 II 211	598·5 373·5 972
HÜGEL ...	111·5 63 V 174·5	119 63 IV 182	97·5 90 III 187·5	163 103·5 I 266·5	112 99 II 211	603 18·5 1021·5
SANDERS...	107 63 IV 170	113 67·5 III 180·5	88 72 V 160	154 108 I 262	121·5 90 II 211·5	583·5 400·5 984
WENDT...	119 54 IV 173	118·5 63 III 181·5	102·5 54 V 156·5	152·5 90 I 242·5	138·5 81·5 II 220	631 342·5 973·5
TOTALS ...	545·5 306 XXI 851·5	605 355·5 XV 960·5	469 351 XXIII 820	767·5 495 V 1262·5	613·5 441·5 XI 1055	3000·5 1949 4949·5

GENTLEMEN'S FIGURE SKATING COMPETITION.

—	YGLESIAS	SALCHOW	PANIN	BROKAW	TORROMÉ	GREIG	MARCH	THORÉN	JOHANSSON	TOTALS
GRENANDER	107	224	215	123	127·5	190	140	192	196	1192·5
	I	133		84		70		140		
		357		207	197·5	330	224	318	336	1969·5
HÖRLE ...	148·5	253	232·5	148·5	149	201·5	166·5	247·5	235·5	1401·5
	I	147		98		98		126		
		400		246·5	247	327·5	257·5	387·5	396·5	2262·5
HÜGEL ...	149	246	232	149	140	175	145·5	243	234	1322·5
	II	147		91		91		98		
		393		240	231	273	208·5	397	381	2123·5
SANDERS ...	135·5	218	235	140	122·5	173	137	194	199·5	1184
	II	133		126		98		140		
		351		266	220·5	313	228	341	353·5	2073
WENDT ...	163·5	231·5	233	157·5	164·5	199	172	217·5	205	1347
	I	154		84		84		112		
		385·5		241·5	248·5	311	242	343·5	359	2131
TOTALS ...		1172·5		718	703·5	938·5	761	1094	1070	6457·5
		714		483	441	616	399	693	756	4102
		1886·5		XXX 1201	XXXI 1144·5	XIX 1554·5	XXIX 1160	XIV 1787	X 1826	10559·5



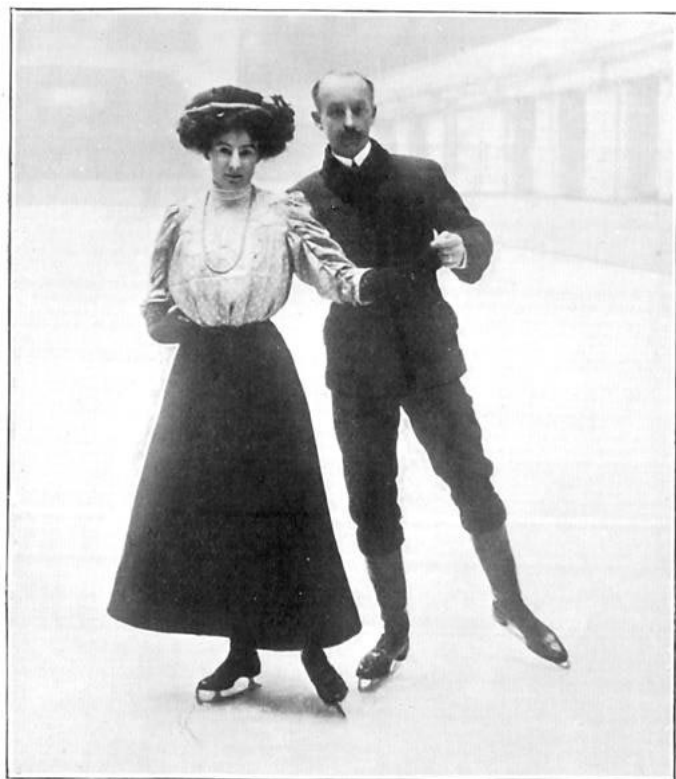

SKATING.— MR. AND MRS. SYERS (U.K.).

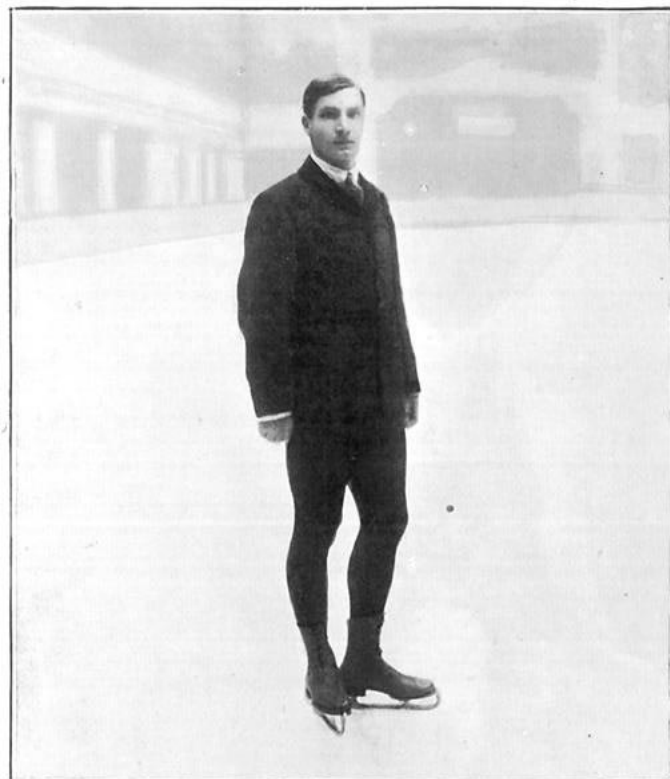

SKATING.—U. SALCHOW (SWEDEN).



SKATING.—HERR BURGER AND FRAULEIN HÜBLER (GERMANY).

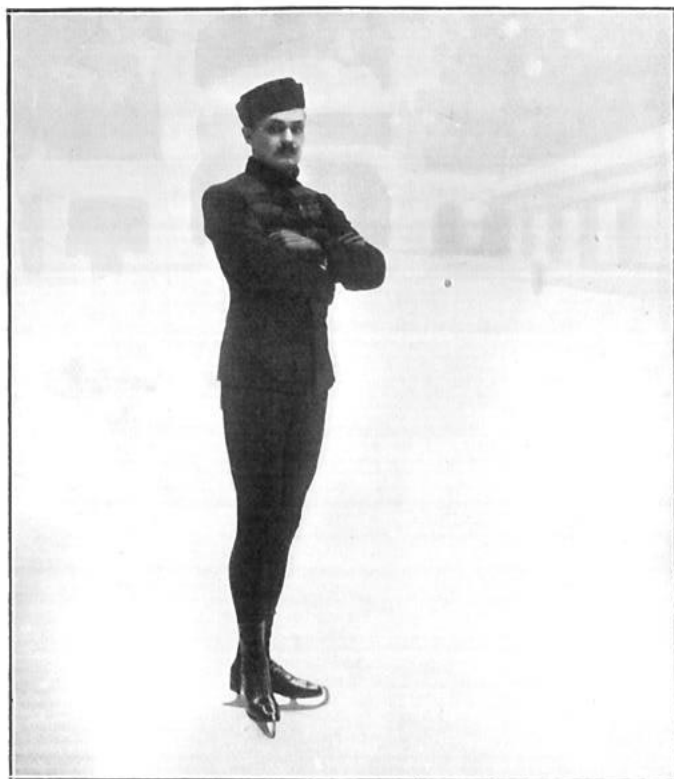

SKATING.—PANIN (RUSSIA).

## PAIR SKATING COMPETITION.

—	MR. & MRS. E. SYERS			MR. & MRS. J. H. JOHNSON			FRL. HÜBLER & HR. BURGER			TOTALS		
WENDT ...	4 II	5 9		5 II	4 9		4 I	6 10		13 15	28	
HÜGEL ...	5·5 II	6 11·5		6 II	5·5 11·5		6 I	6 12		17·5 17·5	35	
TORROMÉ ...	4 III	6 10		5·5 II	5 10·5		5 I	6 11		14·5 17	31·5	
FAITH ...	4 III	4 8		5·5 II	5 10·5		6 I	6 12		15·5 15	30·5	
SANDERS ...	4 III	5·5 9·5		5 II	5 10		5 I	6 11		14 16·5	30·5	
TOTALS ...	21·5 XIII	26·5 48		27 X	24·5 51·5		26 V	30 56		74·5 81	155·5	

## SPECIAL FIGURE COMPETITION.

—	CUMMING	PANIN	HALL-SAY	TOTALS
GRENANDER ...	32·5	44	23	99·5
HÖRLE ...	32·0	44	17	93
HÜGEL ...	37·5	44	18	99·5
WENDT ...	30·5	42	25	97·5
SANDERS ...	31·5	45	21	97·5
—	X 164	V 219	XV 104	487

The regulations of the International Skating Union do not touch on competitions in special figures. The jury, therefore, met together beforehand and allotted a mark to each figure proposed, in accordance with its supposed difficulty and novelty; a further mark was given to the figure on the ice by each judge for the manner in which it was skated; the sum of such marks yielded the total marks of each judge.

The entries for the Olympic Skating competitions were larger and more representative than on any previous occasion in England, and the presence of an American competitor was of special interest. The system

of skating and the details of competitions in America are quite different from those required by the regulations of the International Skating Union. Mr. Irving Brokaw, however, demonstrated that an American skater of the first class can, given the advantage of a competent trainer, become with two seasons' practice sufficiently expert to justify him in opposing such skaters as Salchow, Panin, and Thorén. To Mr. Brokaw belongs the distinction of being the first American to take part in an international figure skating competition, and his action will do much towards bringing American skaters into line with their fellow sportsmen of other countries.

In the gentlemen's competition, Ulrich Salchow, Sweden, has skated in London on several occasions, and won at Niagara rink in 1902 the championship of the world; to him belongs the remarkable record of having won the world's championship seven times and the championship of Europe six times. Thorén and Johanssen are both prominent Swedish skaters; Burger has won the German championship; Panin is probably the best skater that Russia has ever produced; while Messrs. Greig, March, Torromé, and Yglesias are well known to frequenters of Prince's Rink.

In the ladies' competition, Mrs. Syers won the ladies' championship of the International Skating Union in 1906 and 1907, and the Swedish Cup competition, now entitled the championship of Great Britain, in 1903 and 1904. The only occasion on which she has suffered a defeat was in the world's championship of 1902, when she was second to Herr Salchow. Fräulein Rendschmidt is a well-known member of the Berlin Skating Club, and was second in the ladies' championship of the I.S.U. Mrs. Smith holds the championship of Great Britain, and won the senior competition of the Figure Skating Club and the ladies' competition at Davos last winter. Miss Lycett and Fröken Montgomery, though not so well known as their opponents, have both had considerable experience in international competitions. As Mrs. Syers and Mrs. Smith have between them defeated the best skaters of the opposite sex in this country, it is perhaps to be regretted that the National Skating Association did not follow the example of the International Skating Union (which throws open all its figure skating competitions to both sexes), and permit those ladies to represent their country in the premier event.

The compulsory figures for the ladies' competition were commenced shortly after ten o'clock on Wednesday morning. It was soon apparent that Mrs. Syers, after a year's retirement from competitions, is still in a class by herself. The wonderful accuracy of her figures, combined with perfect carriage and movement, was the chief feature of the morning's skating. The skating of compulsory figures before judges is probably more trying to the nerves than any other form of competition. Each figure takes about a minute and five seconds to complete, and during the whole

of that time the physical and mental strain is very severe, and all the competitors, of both sexes, on Wednesday showed some evidence of this.

The opening figure was skated without difficulty by all the ladies; in the brackets Mrs. Syers made an almost perfect tracing, Mrs. Smith and Fräulein Rendschmidt also did very well. The third and by far the most difficult figure, the change loop, was rather beyond the powers of Fröken Montgomery and Miss Lycett, both of whom missed several of the loops. Mrs. Syers again made almost perfect figures; Mrs. Smith and Fräulein Rendschmidt skated this figure well, Mrs. Smith being slightly the steadier. The double three, a fairly easy figure, was skated well by all. The counters were somewhat unequally rendered, Mrs. Syers again being far in advance; Mrs. Smith, Fräulein Rendschmidt, and Fröken Montgomery did well, but Miss Lycett found difficulty with the figure as commenced by the left foot. The final figure, three change three, was now reached, and here Miss Lycett, recovering her form, did well both right and left; indeed, all the ladies excelled in this movement.

The gentlemen's competition was started at three o'clock on Wednesday afternoon. The less difficult figures were skated well by all the competitors; in fact, the judges probably were unable to separate several of them, except by having a strict regard to the form exhibited. Panin and Salchow excelled in carriage and movement. The rockers were finely skated by Salchow and Panin, the turns in each case being quite perfect. Messrs. Greig, March, and Torromé, representing Great Britain, also did well. Brokaw, who had skated the easier figures well, failed somewhat in the rockers which occasionally exhibited a change of edge. Johanssen and Thorén had no difficulty in skating this figure to the satisfaction of the judges. In the counter and double three—change—double three Salchow and Panin were difficult to separate, Panin's position being perhaps the finer, while Salchow's figures were the larger. The so-called paragraph figures loop—change—loop and bracket—change—bracket—called forth all the energies of the competitors. The figures having a higher factor of value attached to them are by so much the more important, as influencing the result, and each skater strained every nerve in order to attain the highest number of marks in them.

Panin skated the loop figures with great ease, precision, and grace; Salchow was accurate and powerful; to the others these figures, though carried through without a mistake, were evidently an exertion. The bracket figures, which were the last and most difficult of the series, proved too difficult for several of the skaters: Torromé, Yglesias, and Brokaw failed on several occasions to hold the curves after both the forward and back brackets. Salchow skated these figures of great size and with perfect

assurance, as did Panin, Thorén, and Johanssen. Greig's position in these figures was somewhat cramped.

The conclusion of the compulsory figures was not reached until nearly half-past six, but the majority of the spectators waited to the end, and followed the details with the keenest interest.

The special figure competition was skated on Thursday morning. For this event there were only three entries, Mr. N. Panin, Russia, and Messrs. Cumming and Hall-Say, Great Britain. Panin, who has made this department of skating a special study, was far in advance of his opponents, both in the difficulty of his figures, and in the ease and accuracy of their execution; he cut in the ice a series of the most perfect intaglios with almost mathematical precision. Both Cummings and Hall-Say showed some pretty figures, the former skating with much facility and accuracy. Mr. Hall-Say is not yet sufficiently experienced in the international style to do himself full justice in a competition, his form being inferior to his execution.

I reproduce here six figures (first published in the *Field*) which were skated in this Special Figure competition.

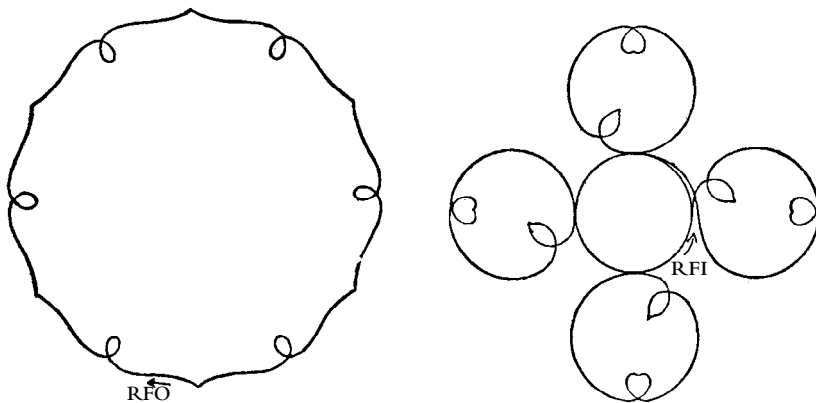

SPECIAL FIGURES SKATED BY MR. E. HALL-SAY.

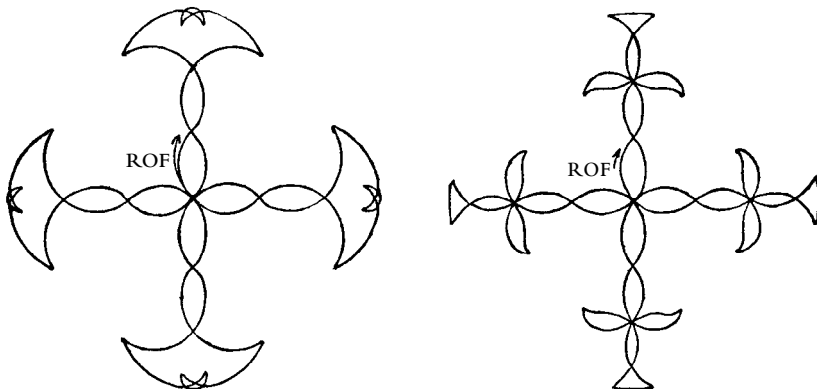

SPECIAL FIGURES SKATED BY MR. ARTHUR CUMMING.

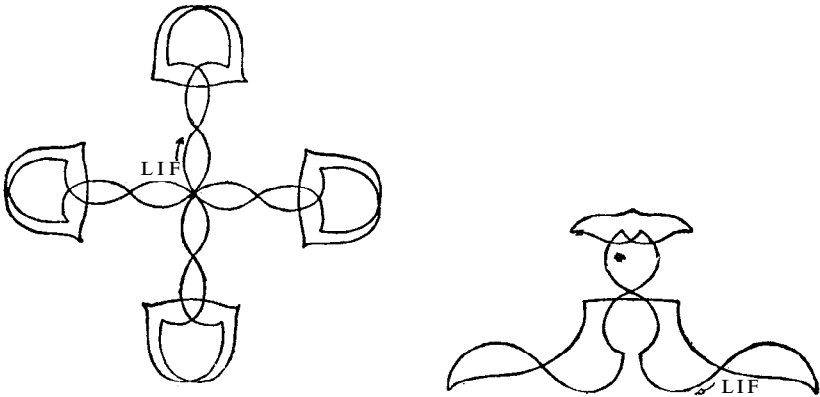

SPECIAL FIGURES SKATED BY MR. NICHOLAS PANIN.

The free skating of the ladies' competition took place on Thursday afternoon, and was the first item on the programme. The nervousness which was apparent in several of the competitors had disappeared, and all skated well. Fröken Montgomery skated first, and, save for a slight fall owing to a slip when attempting a toe-step, she skated steadily and well, though her programme did not contain any items of difficulty. Mrs. Smith came second, and skated some pretty combinations of rockers and counters, introducing graceful dance steps and what is known as the Axel Paulsen jump. Miss Lycett did not skate quite as well as on some previous occasions, seeming to lack energy to carry out fully the items of her programme; her positions were, however, good.

The free skating of Mrs. Syers, who came next, was as far in advance of that of her opponents as her compulsory figures had been. She excelled in rhythm and time-keeping, and her dance steps, pirouettes, &c., were skated without a fault. Fräulein Rendschmidt's skating was distinguished by a most engaging gaiety. She seemed quite at home on the ice, and danced through her programme in the happiest possible manner. In the result Mrs. Syers was first, Fräulein Rendschmidt second, Mrs. Smith third, Fröken Montgomery fourth, and Miss Lycett fifth.

Unfortunately the men's free skating was robbed of an interesting item by the retirement of Panin, who, feeling unwell, decided not to compete; Yglesias also withdrew. The champion Salchow was the first in the starting order, and skated with his usual power and precision. The small size of the rink appeared to inconvenience him in several figures, such as the spread eagle, in which he failed at the first attempt, but at the second trial he skated this figure finely, changing edge from outside to inside, and introducing on the change a jump with a complete revolution; some march steps, pirouettes, and a sitting pirouette were also notable items.

Mr. Brokaw's skating was varied, and introduced some novelties in the way of toe-steps and jumps which have not hitherto been seen on this side of the Atlantic; his positions, as judged by the standard of international style, were often faulty. Mr. Torromé was not in as good form as he customarily exhibits. His skating was lacking in the pace and swing which have been admired in previous years. The English representative, Greig, skated powerfully and with plenty of *élan*, but he was deficient in the lightness and grace shown by the Swedes; indeed, the common faults of our skaters is this want of grace and lightness and spontaneity. Thorén's show was delightful, and full of the buoyancy of youth. He was by far the youngest of the competitors, and as graceful as could be. His jumps and toe spins seemed to be performed without the least effort; he glided or leaped as silently as a cat. The last to skate was Johanssen, who provided the surprise of the afternoon. Short, but immensely powerful, he skated up and down and round the rink like a whirlwind; his long chains of toe spins and pirouettes, his amazing leaps, the extraordinary vigour and dash of the whole performance electrified the onlookers and called forth great applause. To those who saw the celebrated Norwegian professional, Axel Paulsen, in his prime the comparison was irresistible.

The pair skating was the last item on the programme, and this was easily won, as was anticipated, by the German pair, whose time-keeping, swing and accuracy were such that they were accorded the first place by unanimous decision of the judges. Mr. and Mrs. Syers and Mr. and Mrs. Johnson also competed in this event, the latter being second and the former third. Neither of these pairs were quite at their best. Mr. and Mrs. Syers had only been able to get a very limited amount of practice while their opponents had the advantage of a longer training in Berlin and Glasgow. But though the German pair were easily first, the whole competition produced the finest exhibition of pair skating ever seen; nor is the somewhat frigid language natural to an official Report in any way adequate to describe the beauty of the skaters' motions on the ice, and the technical accomplishment of their performance, which was so near ideal perfection that its art was hidden by a swift vitality that seemed as natural and spontaneous as the flight of swallows through the air. If control over the muscles, graceful movement, and a complete equilibrium of physical resources can ever be said to have been attained in the Olympic programme, it was to be seen in this competition; and the skating events should therefore take very high rank in any serious comparison between the various items in the Olympic Games of 1908 and previous years. The fact that these events call for not only strength but skill, both delicate and precise, not merely for natural ability but for patient and prolonged practice, and



that these qualities can be exemplified by competitors of varying ages, of both sexes, and of many different nations, is, I think, a recommendation possessed by very few sports to a similar degree in the long catalogue of first-rate international championships.

The successful appearance of ladies in these competitions suggests the consideration that since one of the chief objects of the revived Olympic Games is the physical development and amelioration of the race, it appears illogical to adhere so far to classical tradition as to provide so few opportunities for the participation of a predominant partner in the process of race-production. More events, in fact, might be open to women, whether they are permitted to compete with men or not. They have already so competed, successfully, in the case of Mrs. Syers in international skating meetings. They have competed in skating, archery, and lawn tennis in the Olympic Games. Perhaps it may be worth considering whether in future Olympiads they may not also enter for swimming, diving, and gymnastics, three branches of physical exercise in which they gave most attractive displays during the Games in London. In rifle-shooting, and possibly in other sports, they may also have a fair chance of success in open competitions. But it is not probable that in any physical exercise they will ever both demonstrate their superiority and also preserve their characteristic charm so convincingly as in such skating as was seen at Prince's during the Autumn Games of 1908.

The Figure Skating Club gave a ball at Prince's Restaurant to the foreign representatives and others on Thursday, October 29; and a banquet was held by the N.S.A. at the Holborn Restaurant on the following day, when the medals and diplomas were presented by Mrs. Hayes Fisher to the winners.

## SWIMMING.

One of the chief elements in the success of the swimming events at the Olympic Games of London was the fact that the swimming bath in which they took place was, for the first time in the history of these Games, constructed in the same arena which was used for the other important international competitions. For the plan of construction of this bath, and more especially for the original design of the tower for high diving, the hearty thanks of the British Olympic Council and of all international swimmers are due to Mr. William Henry, Chief Secretary of the Royal Life Saving Society. The tower was let down beneath the surface of the water when not required for diving and raised again in a few minutes according to the necessities of the programme. The contribution made to the general amusement of the spectators by the various displays thus rendered possible, apart from the actual prize events, was very valuable.

The most noteworthy records achieved were the following :—

Daniels (United States), 100 Metres ... ..	65 $\frac{3}{5}$ seconds
Halmay (Hungary), 100 Metres... ..	66 $\frac{1}{7}$ „
Taylor (United Kingdom), 1,500 Metres	22 min. 48 $\frac{1}{5}$ „
Battersby (United Kingdom), 1 Mile ...	24 „ 33 „

Taylor's magnificent and unexpected win for the United Kingdom in the Team race, when he beat Halmay by four yards, after being obliged to concede him ten yards out of 200, gave him the enviable position of tying with Sheppard of the United States for the greatest number of Olympic gold medals won by any single competitor in the Games, viz. three, a record upon which British swimmers deserve the heartiest congratulations. Daniels, the celebrated American swimmer, was kind enough to fill up a long wait between two races, on the last Thursday of the Games, by giving an exhibition swim of 100 metres, using the "Crawl" stroke. He accomplished the remarkable time of 67 seconds,

An instance of good sportsmanship in the Diving events deserves record here. One of the most dangerous opponents of the Swedes in the High Diving was G. F. Cane, of the United Kingdom, and in the first round he gained high marks; but in the semi-final he was unlucky enough to fall flat into the water, and was so seriously shaken as to be unable to leave his bed for some days. To mark their sense of his

abilities as a diver and their regret for his unfortunate accident, the Swedish athletes presented him with a silver cup, a trophy which will undoubtedly remain one of his most cherished possessions.

There was a strong feeling among swimmers and divers that a reform was needed in the Diving programme in order to prohibit double somersaults, to which was chiefly due the accident to G. F. Cane. No doubt the International Swimming Federation will seriously consider the matter, recognising that though a diver should know where he is at the end of one somersault, the finish of a second must be largely a matter of luck. It was also thought that difficulties might be avoided in the future if a clause were inserted forbidding a diver being signalled to by a friend upon the bank; and in future competitions, where representatives of various nations are engaged, it might be well to start all races by the report of a pistol.

I would particularly draw attention to the Swimming Code, printed with the rest of the Regulations for various sports in another part of this book; for it contains a set of illustrations, never published before these Games, of the highest value as a standard for the future judging of international events, a standard of which the want has long been felt at meetings of this description.

One important result of the Olympic Games was that a meeting was held on July 19 at the Manchester Hotel, attended by swimming representatives from England, Ireland, Wales, Belgium, Sweden, Germany, Finland, Hungary, France, and Denmark, to discuss various topics of international interest and importance to swimmers. Important decisions were registered as to the amateur definitions, jurisdiction over swimming, world's amateur records, and world's championships. The next conference was fixed for August, 1909, in Paris, and Mr. G. W. Hearn, President of the Amateur Swimming Association, was elected its Hon. Secretary.

The dinner given by British swimmers to their visitors was very successful, and the beauty of the design of its menu-card deserves special mention. Foreign swimmers particularly appreciated the Government banquet, the first function of its kind that had ever taken place.

Among other points brought to my notice by swimming authorities, I may mention that it was generally considered six would be a better limit for entries than twelve, as the latter led to too many competitors being scratched; that a competition for which only one entry was received should be declared void; and that the records made in the Olympic Games should be considered as official records for swimming.

The only addition suggested to the programme was a 500 or 600 metres Breast-stroke race, as this form of swimming is very popular all over the

world, and deserves encouragement for its general usefulness. In other respects satisfaction was universally expressed at the carefully considered "championship" nature of the programme, and the way it was carried out; for it was realised that the object of these Games has not been merely to provide any number of events to produce sport, but to find the world's champions at distances acknowledged by the various governing associations as the best for the purpose.

The events will be described here in the following order :—

- I. 100 Metres (109.3 yards).
- II. 400 Metres (437.4 yards).
- III. 1,500 Metres (1,640 yards, or 120 yards short of the Mile).
- IV. High Diving.
- V. Fancy Diving.
- VI. 800 Metres Team Race (874.9 yards).
- VII. 200 Metres Breast Stroke.
- VIII. 100 Metres Back Stroke.
- IX. Water Polo.

#### I.-ONE HUNDRED METRES (109.3 Yards).

##### FIRST ROUND.

*Heat 1.*—Z. de Halmay, Hungary, 1; T. B. Tartakover, Australia, 2; B. Benenga, Holland, 0; H. Meyboon, Belgium, 0; H. R. S. Klem, Denmark, 0; D. Baivado, Italy, 0. Once clear of his men the Hungarian came over into the centre, but did not affect the others. Tartakover went up into second place after the half-distance, but the leader won easily in 1 min.  $8\frac{1}{5}$  sec.

*Heat 2.*—O. Schiff, Austria, 1; A. Tyldesley, United Kingdom, 2; G. Meister, France, 0; Munk, Hungary, 0; G. Trubenbach, United States, 0. Schiff drew clear at the half-distance, and won by half a yard. Times: Schiff, 1 min.  $11\frac{4}{5}$  sec.; Tyldesley, 1 min. 12 sec.

*Heat 3.*—F. E. Beaurepaire, Australasia, 1; L. Benenga, Holland, 2; P. Holm, Denmark, 0; H. Hajos, Hungary, 0; R. T. Anderson, Sweden, 0. The winner drew clear at 50 metres, and won by a yard. Times: Beaurepaire, 1 min.  $11\frac{3}{5}$  sec.; Benenga, 1 min.  $13\frac{1}{5}$  sec.

*Heat 4.*—H. S. A. Julin, Sweden, 1; J. H. Derbyshire, United Kingdom, 2; R. B. Foster, United States, 0; V. Boin, Belgium, 0. The Swede held a two-yards' lead at the half-distance, when Derbyshire commenced to draw on the leader, but he was fouled later and his chances were spoilt. The leader got home in 1 min. 12 sec.; Derbyshire 1 min.  $12\frac{3}{5}$  sec.

*Heat 5.*—C. M. Daniels, United States, 1; J. Onody, Hungary, 2; G. Innocent, United Kingdom, 3; R. Andre, France, 0; H. Saxtir, Denmark, 0. At the half-distance the American had gained a six yards' lead from Onody. Shortly afterwards he looked up, and going on, won easily. Times: 1 min.  $5\frac{4}{5}$  sec.; Onody, 1 min.  $13\frac{1}{5}$  sec.

*Heat 6.*—H. J. Hebner, United States, 1; P. Radmilovic, United Kingdom, 2; F. Feyaerts, Belgium, 0; E. J. L. Cooke, Australasia, 0. At half the distance Hebner led by  $1\frac{1}{2}$  yards from Feyaerts, but the Welshman, finishing the stronger, took second place. Times: Hebner, 1 min. 11 sec.; Radmilovic, 1 min. 12 sec.

*Heat 7.*—C. W. Edwards, United Kingdom, 1; R. Zimmerman, Canada, 2; The former led throughout, and won easily. Times: 1 min.  $5\frac{4}{5}$  sec.; Zimmerman, 1 min. 35 sec.

*Heat 8.*—G. S. Dockrell, United Kingdom, swam over in 1 min.  $13\frac{1}{5}$  sec.

*Heat 9.*—L. G. Rich, United States, 1; A. Deprez, Belgium, 2. Won easily in 1 min.  $14\frac{3}{5}$  sec.; second, 1 min. 18 sec.

## SEMI-FINAL.

*Heat 1.*—Z. de Halmay, Hungary, 1; H. S. A. Julin, Sweden, 2; H. J. Hebner, United States, 3; F. Beaurepaire, Australasia, 4. Also competed:—C. W. Edwards, United Kingdom, and P. Radmilovic, United Kingdom. Both Radmilovic and Edwards started slowly. De Halmay was first to show the way, with Hebner second. At 30 sec. Halmay was drawn clear, while Beaurepaire had moved up. Radmilovic had improved his position. At the half-distance Hebner was just in front of the Hungarian, Julin being third, and Beaurepaire fourth. Then de Halmay commenced to go ahead, and swimming very powerfully, he had the race won in 10 yards. Drawing well away, he finished in tremendously powerful style, a winner by 2 yards. The others had a magnificent race for second place, and the official verdict was a touch between second, third and fourth. Time, 1 min.  $9\frac{2}{5}$  sec. Julin's time, 1 min.  $10\frac{1}{5}$  sec.; Hebner's time, 1 min.  $11\frac{4}{5}$  sec.

*Heat 2.*—C. M. Daniels, United States, 1; L. G. Rich, United States, 2; G. S. Dockrell, United Kingdom, 3; O. Schiff, Austria, 4. Also competed: A. Tyldesley, United Kingdom. Daniels touched water before any of the others, and while scarcely appearing to be swimming with the great vigour noticeable in his preliminary heat, he yet drew clear, and at the half-distance was leading by a yard from Rich, with Dockrell half a yard farther in the rear. This order was preserved to the end, Daniels, without drawing on his reserve, winning by a good yard from Rich. Dockrell, who swam splendidly, was third, and Schiff, the Austrian, fourth, no more than a touch dividing these men. Time, 1 min.  $10\frac{1}{5}$  sec. Rich did 1 min.  $10\frac{4}{5}$  sec., and Dockrell 1 min.  $11\frac{2}{5}$  sec.

## FINAL.

C. M. Daniels, United States	..	..	..	..	..	1
Z. de Halmay, Hungary	..	..	..	..	..	2
H. S. A. Julin, Sweden	..	..	..	..	..	3
L. G. Rich, United States	..	..	..	..	..	4

The Hungarian was noticeably quicker than the rest in taking the water, and this gave him such an advantage that it was not until 30 metres had been covered that Daniels, tearing through the water at a marvellous pace, drew level. It was a great race to the half-distance between Daniels, de Halmay, and Julin, but the American entered on the second half of the distance with a trifling advantage. Magnificently de Halmay struggled to hold Daniels, but all to no purpose, for the latter swam more powerfully than ever towards the end, and he finished first with half a yard advantage over the Hungarian, who was 2 yards ahead of Julin. Time, 1 min.  $5\frac{3}{5}$  sec. De Halmay's time, 1 min.  $6\frac{1}{5}$  sec.; Julin's time, 1 min. 8 sec. Both Daniels and de Halmay thus beat the world's record of 1 min.  $7\frac{1}{5}$  sec., set up by Cecil Healey, the Australian, at Hamburg, in 1906. Daniels also set up an Olympic record for the distance.

Daniels, of the New York A.C., stood 6 ft. high and weighed 10 st. 13 lb., and was holder of the British 100 yards' championship and record. In 1905 he had won the American and Canadian championships at the same distance. In 1906 he won the 100 metres.

De Halmay, of Hungary, stood 6 ft.  $1\frac{1}{2}$  in., and weighed 13 st. In 1904 he beat Daniels for the 100 yards' at the Olympic Games of St. Louis. He held the Hungarian championship, 440 yards, and won the Hungarian 100 yards in 57 seconds.

Diplomas of Merit for the 100 Metres were awarded to L. G. Rich, U.S.A.; H. J. Hebner, U.S.A.; O. Schiff, Austria; F. E. Beaurepaire, Australasia; G. S. Dockrell, United Kingdom; and J. H. Derbyshire, United Kingdom.

## II.—FOUR HUNDRED METRES (437.4 Yards).

### FIRST ROUND.

*Heat 1.*—T. S. Battersby, United Kingdom, 1; B. Lastorres, Hungary, 2; L. B. Goodwin, United States, 3; V. Anderson, Sweden, 4; H. Decoin, France, 0. Goodwin was first to show in front, followed by Lastorres, but at the first length Battersby led in 1 min. 14 sec., and at two lengths his time was 2 min.  $42\frac{2}{5}$  sec., with Lastorres 6 yards behind. Here Decoin retired. The Englishman covered his third length in 4 min.  $14\frac{2}{5}$  sec. Down the last length the Hungarian came up in fine style, but Battersby got home by 7 yards in 5 min.  $48\frac{4}{5}$  sec.; second, 5 min.  $52\frac{1}{5}$  sec.

*Heat 2.*—W. Foster, United Kingdom, 1; R. T. Andersson, Sweden, 2. The Swede at once forged to the front, but at the first length Foster led by 4 yards in 1 min.  $17\frac{3}{5}$  sec. Drawing away, he completed the half-distance in 2 min. 47 sec., and won easily by 40 yards in 5 min.  $54\frac{4}{5}$  sec.; Andersson, 6 min. 28 sec.

*Heat 3.*—T. B. Tartakover, Australasia, swam over, his time at two lengths being 3 min.  $6\frac{2}{5}$  sec., and full distance 6 min. 35 sec.

*Heat 4.*—F. E. Beaurepaire, Australasia, 1; S. Blatherwick, United Kingdom, 2; C. W. Trubenbach, United States, 3; D. Baiardo, Italy, 0. The Australian drew away at the start, and turned 3 yards in front of the Englishman in 1 min. 18 sec., and he completed the half-distance in 2 min.  $44\frac{3}{5}$  sec. 15 yards ahead. Here the Italian retired. The leader's time at the third length was 4 min.  $16\frac{1}{5}$  sec., and eventually he won by 25 yards in 5 min.  $49\frac{1}{5}$  sec.; Blatherwick, 6 min.  $16\frac{4}{5}$  sec.

*Heat 5.*—P. Radmilovic, United Kingdom, 1; A. Holm, Denmark, 2. In the first length the Welsh champion gained a 40 yards' lead in 1 min.  $23\frac{1}{5}$  sec., and going on turned two lengths in 2 min. 56 sec., winning very easily by 90 yards in 6 min. 10 sec.; Holm, 8 min.  $8\frac{4}{5}$  sec.

*Heat 6.*—H. Taylor, United Kingdom, 1; F. W. Springfield, Australasia, 2; M. Massa, Italy, 3. The British champion at once went to the front, and at the first length led by a yard in 1 min.  $19\frac{4}{5}$  sec. from Springfield, with Massa 2 yards behind. With an advantage of 3 yards Taylor reached the half-distance in 2 min.  $46\frac{1}{5}$  sec., and the third length in 4 min.  $16\frac{1}{5}$  sec., still leading by 6 yards. Taking matters easily down the last length, Taylor won by the same distance in 5 min.  $42\frac{1}{5}$  sec., Springfield, 5 min.  $57\frac{2}{5}$  sec. Massa 50 yards away.

*Heat 7.*—O. Schiff, Austria, 1; W. H. Haynes, United Kingdom, 2; J. Onody, Hungary, 3; F. W. Meiuning, Holland, 0; H. C. Saxtorph, Denmark, 0. The Austrian led Onody by a yard at the first length in 1 min.  $16\frac{2}{5}$  sec., at the second

length in 2 min.  $45\frac{1}{5}$  sec. Onody and Haynes were level, 10 yards away from Schiff, who increased his advantage to 15 yards at the third length in 4 min.  $18\frac{2}{5}$  sec., and won by 25 yards in 5 min. 51 sec.; Haynes, 6 min.  $21\frac{1}{5}$  sec.

Heat 8.—I. Zachar, Hungary, swam over in 6 min.  $9\frac{4}{5}$  sec.

Heat 9.—H. Hajos, Hungary, 1; A. T. Sharp, United Kingdom, 2. Hajos led throughout, and won easily, his times being: first length, 1 min.  $25\frac{2}{5}$  sec.; second, 2 min.  $59\frac{1}{5}$  sec.; third, 4 min.  $40\frac{2}{5}$  sec.; fourth, 6 min.  $19\frac{4}{5}$  sec. Sharp's time was 7 min.  $0\frac{2}{5}$  sec.

## SEMI-FINAL.

Heat 1.—O. Schiff, Austria, 1; H. Taylor, United Kingdom, 2; T. S. Battersby, United Kingdom, 3; B. Lastorres, Hungary, 4; H. Hajos, Hungary, 5. Battersby led from Lastorres at 50 yards, but at the first length he only possessed a foot advantage over Schiff in 1 min. 19 sec. At a length and a half Taylor had drawn level with Battersby. The latter, still forcing the pace, turned at the half-distance by a touch in 2 min.  $45\frac{4}{5}$  sec. from Taylor and Schiff. Coming down the third length Taylor went to the front, and at 250 metres he was a yard ahead of the other pair. He turned for the third time in 4 min.  $14\frac{3}{5}$  sec. Fifty metres from the finish Taylor still led by a foot from Schiff, but the latter going all out won by a touch, Battersby being 4 yards behind. Times: Schiff, 5 min.  $40\frac{3}{5}$  sec.; Taylor, 5 min. 41 sec.

Heat 2.—F. E. Beaurepaire, Australasia, 1; W. Foster, United Kingdom, 2; P. Radmilovic, United Kingdom, 3; I. Zachar, Hungary, 4. Zachar drew out at the start, and led the Australian at the first half-length by half a yard. Beaurepaire was the quicker at the turn in 1 min. 17 sec., the others being 2 yards behind. At a length and a half Beaurepaire had gained a 3 yards' lead, which he increased to  $4\frac{1}{2}$  yards at the half-distance in 2 min.  $42\frac{3}{5}$  sec. At 250 metres Radmilovic drew level with Zachar, and a few yards farther on the latter retired, Beaurepaire being now 7 yards ahead. Foster now went up and caught Radmilovic at the last turn. The young Bacup swimmer drew well away from the Welshman, but Beaurepaire, taking matters easily, won by 10 yards in 5 min. 44 sec. Foster's time was 5 min.  $52\frac{1}{5}$  sec., and the third man was 8 yards away.

## FINAL.

H. Taylor, United Kingdom	..	..	..	..	..	1
F. E. Beaurepaire, Australasia	..	..	..	..	..	2
O. Schiff, Austria	..	..	..	..	..	3
W. Foster, United Kingdom	..	..	..	..	..	4

Taylor had No. 1 station, and Beaurepaire was at No. 4. From a capital start Taylor held a slight advantage from the Australian at 50 metres, with Schiff a foot behind. The Australian now drew up and at the first length inches divided the three in 1 min. 15 sec. At 150 metres Taylor and Schiff were together, and at the half-distance Taylor was in front, his time being 2 min. 35 sec., and Schiff's 2 min. 37 sec. At  $2\frac{1}{2}$  lengths Beaurepaire was a yard and a half behind Taylor, with Schiff practically level. From here a great race was seen, both Taylor and Beaurepaire making the last turn in 4 min. 10 sec. Then Taylor came away in fine style, and at the last 50 metres he was three yards in front of Beaurepaire, Schiff being  $3\frac{1}{2}$  yards behind. Maintaining his form to the finish, Taylor won in 5 min.  $36\frac{4}{5}$  sec. Beaurepaire, 5 min.  $44\frac{1}{5}$  sec.; Schiff, 5 min. 46 sec.

H. Taylor, of the Chadderton S.C., was 23, stood 5 ft. 5 in. and weighed 10 st. 6 lb. In 1906 he won the 1,600 metres at Athens, and during the same year he won the 440 yards (salt water), 500 yards, and one mile British championships, and was again successful in 1907.

F. E. Beaurepaire, champion of Australasia, was scarcely 18 years old, 5 ft. 7 in. high, and 10 st. 5 lb. in weight. He won the quarter-mile championship of Victoria when only  $14\frac{1}{2}$  years old. His time for the quarter-mile Australian championship was 5 min. 28 sec., before leaving for England, and he had won the English half-mile championship.

O. Schiff was only 18, and very heavy for his age. He won the 400 metres at Athens in 1906 and the 500 metres championship of Austria in 1907.

Diplomas of Merit for the 400 Metres were awarded to T. S. Battersby, United Kingdom; B. Lastorres, Hungary; and W. Foster, United Kingdom.

### III.—ONE THOUSAND FIVE HUNDRED METRES (120 Yards short of the Mile).

#### FIRST ROUND.

*Heat 1.*—P. Radmilovic, United Kingdom, time, 25 min.  $2\frac{2}{5}$  sec., 1; G. Wennerstorm, Sweden, 27 min.  $15\frac{2}{5}$  sec., 2; O. Muzzi, Italy, 28 min.  $52\frac{3}{5}$  sec., 3. The British swimmer at once went to the front, and at the second length held a 20-yards' lead in 3 min.  $1\frac{2}{5}$  sec. from Wennerstorm, his time at 400 metres being 6 min. 25 sec. At the eighth length, Radmilovic was well away in 13 min.  $12\frac{4}{5}$  sec., and at the tenth length he had increased his advantage to 50 metres in 16 min.  $38\frac{1}{5}$  sec. Moving on well, he led at the twelfth length in 20 min.  $1\frac{3}{5}$  sec.. His time at the last turn was 23 min. 22 sec., and he won very easily.

*Heat 2.*—F. E. Beaurepaire, Australasia, time, 23 min.  $45\frac{4}{5}$  sec., 1; S. Blatherwick United Kingdom, 25 min.  $15\frac{2}{5}$  sec., 2; P. L. Ooms, Holland, 27 min.  $24\frac{2}{5}$  sec., 3; V. Anderson, Sweden, 27 min.  $34\frac{2}{5}$  sec., 4. Beaurepaire at once drew out from Blatherwick, and at two lengths led by 6 yards in 2 min. 50 sec. Going steadily on, he reached the 400 metres in 5 min.  $58\frac{2}{5}$  sec., and 600 in 9 min.  $10\frac{4}{5}$  sec. Blatherwick at eight lengths was over 60 metres behind, the leader's time being 12 min.  $23\frac{4}{5}$  sec. At the twelfth length Beaurepaire's time was 18 min.  $57\frac{1}{5}$  sec. Turning for the last time with over a length the lead, the Australian won easily. Anderson led Ooms by a yard, but the latter finished the stronger for third place.

*Heat 3.*—L. Moist, United Kingdom, swam over in 26 min. 52 sec.

*Heat 4.*—T. S. Battersby, United Kingdom, time, 23 min.  $42\frac{4}{5}$  sec., 1; F. W. Springfield, Australasia, 24 min.  $52\frac{2}{5}$  sec., 2; A. A. Theuriet, France, 32 min. 37 sec., 3. Battersby at once forced the pace, and at two lengths he led Springfield by  $2\frac{1}{2}$  yards in 2 min. 50 sec. The latter hung on, and was the same distance behind at 400 metres, with the time, 5 min.  $51\frac{4}{5}$  sec. Drawing quickly away, the Englishman had increased his advantage to 40 yards at 800 metres, the Frenchman being 200 metres behind. The leader's time was then 12 min.  $16\frac{2}{5}$  sec. The tenth length was completed in 15 min.  $28\frac{4}{5}$  sec. Turning for the last length in 22 min.  $5\frac{2}{5}$  sec., Battersby led by 70 metres, and the Frenchman was four lengths behind.

*Heat 5.*—J. A. Jarvis, United Kingdom, time, 25 min.  $51\frac{3}{5}$  sec., 1; J. B. Green, United States, 28 min. 9 sec., 2; R. H. Hassell, United Kingdom, 28 min.  $14\frac{4}{5}$  sec., 3. Jarvis drew steadily away, and at 200 metres led the American by 6 yards in 3 min. 6 sec., with Hassall another five yards behind. At 400



metres Jarvis had increased his advantage to 24 yards in 6 min. 50 $\frac{1}{5}$  sec. His sixth length was completed in 9 min. 56 $\frac{3}{5}$  sec., and 800 metres in 13 min. 27 $\frac{2}{5}$  sec., the Englishman being half a length in front. At the thirteenth length Jarvis led by a length, and turning for the last time in 24 min. 10 sec., he won easily by over a length. Hassall drew up well in the last two lengths.

*Heat 6.*—H. Taylor, United Kingdom, time, 23 min. 24 $\frac{2}{5}$  sec., 1; O. Schiff, Austria, 24 min. 15 $\frac{3}{5}$  sec., 2; G. Wretman, Sweden, 28 min. 40 $\frac{3}{5}$  sec., 3; E. Meyer, Holland, . At the second length Taylor led Schiff by six yards in 2 min. 46 $\frac{3}{5}$  sec., with Wretman third. At four lengths his time was 5 min. 50 $\frac{1}{5}$  sec., and here Meyer retired. Going on at a great pace, Taylor reached 800 metres 40 yards in front; his time at the tenth length being 15 min. 14 $\frac{4}{5}$  sec. With three lengths to go he was 50 metres in front, whilst the Swede was over two lengths behind. Taylor's time at the fourteenth length was 21 min. 52 $\frac{3}{5}$  sec., and he finished strongly.

*Heat 7.*—W. Foster, United Kingdom, swam over in 24 min. 33 sec.

#### SEMI-FINAL.

*Heat 1.*—H. Taylor, United Kingdom, 1; F. E. Beaufepaire, Australasia, 2; W. Foster, United Kingdom, 0; L. Moist, United Kingdom, 0. Beaufepaire went through the water at a pace that suggested a "sprint" rather than a long-distance race, and at the first length he led by five yards from Taylor, while a length farther on the Australian had a seven yards' advantage. Meanwhile Taylor was swimming beautifully, and without calling upon his reserve, he had begun to cut down the margin a length later. Gradually the distance between the pair lessened, and when the seventh length was entered upon the Colonial turned only a touch in front of his rival. Immediately afterwards Taylor was in front, and now he and the Australian had the bath to themselves, the others finding the pace too warm. Beaufepaire strove very hard to again take first position, but whereas he was obviously "all out," Taylor was swimming quite comfortably, though travelling very fast. At eight lengths—rather over half the distance—the leader's time was 11 min. 58 $\frac{2}{5}$  sec., and at this stage Beaufepaire was about 15 yards behind. As the race grew older, Taylor slowly but surely put more water between himself and his pursuer, and when at length he finished his task the Australian was quite 40 yards behind. Time, 22 min. 54 sec.; Beaufepaire did 23 min. 25 $\frac{2}{5}$  sec.

*Heat 2.*—T. S. Battersby, United Kingdom, 1; O. Schiff, Hungary, 2; J. A. Jarvis, retired. Radmilovic was also entitled to swim, but did not start. This was Battersby's race from the start, for Jarvis gave up quite early, and Schiff could never go the pace set by the Englishman. Battersby touched for the first time in 1 min. 19 sec., when he was quite clear, and swimming very steadily he had a 15 yards' advantage at four lengths, when the time was 5 min. 51 $\frac{1}{5}$  sec. Battersby did not add much to his advantage during the ensuing few lengths, but he was always swimming well within himself, and completed eight lengths in 12 min. 9 $\frac{3}{5}$  sec. The remaining lengths were quickly reeled off by the leader, and although the Hungarian kept up a stern chase, he was beaten by 70 yards. Time, 23 min. 23 sec.; Schiff's time, 24 min. 25 sec.

#### FINAL.

	min.	sec.
1. H. Taylor, United Kingdom .. .. .	22	48 $\frac{2}{5}$
2. T. S. Battersby, United Kingdom .. .. .	22	51 $\frac{1}{5}$
3. F. E. Beaufepaire, Australasia .. .. .	22	56 $\frac{1}{5}$
4. O. Schiff, Austria .. .. .	—	—

Battersby at once went to the front, and at 50 metres led Schiff and Taylor by half a yard. In the second length, the former had increased

his lead to  $1\frac{1}{2}$  yards, but at two lengths Schiff was in front. At 350 metres Battersby led Taylor by  $1\frac{1}{2}$  yards, with Beurepaire third, and at 400 metres Schiff retired. The home representatives still kept in close company, with the Australian  $1\frac{1}{2}$  yards behind. During the sixth length Battersby had gained a 2 yards' lead from Taylor, with Beurepaire another yard behind. In the next two lengths no alteration took place, the half-distance times being: Battersby, 11 min.  $20\frac{1}{5}$  sec.; Taylor, 11 min.  $22\frac{2}{5}$  sec.; Beurepaire, 11 min.  $22\frac{4}{5}$  sec. In the next length Beurepaire was  $2\frac{1}{2}$  yards behind Taylor, whilst in the twelfth length Battersby had increased his lead to 3 yards, and Taylor was 5 yards from Beurepaire. The pace was still a cracker, and in the fourteenth length Taylor went by, and led at the last turn. Fifty metres from the finish the champion had gained a  $2\frac{1}{2}$  yards' advantage. Beurepaire now made his effort, but could not make any impression on the leaders, and Taylor, all out, won by  $2\frac{1}{2}$  yards.

Battersby, finding that Taylor refused to continue for the mile, went on by himself, and, swimming strongly to the finish, set up a new record for the mile, beating Billington's time, made at Highgate in 1905, by  $9\frac{3}{5}$  seconds, for although he lost about eight seconds before re-starting he finished the mile in 24 min. 33 sec., only 17 seconds slower than Kieran's world's record.

T. S. Battersby, of the Wigan S.C., won the Mersey championship in 1907.

Diplomas of Merit for the 1,500 Metres were awarded to O. Schiff, Austria; P. Radmilovic, United Kingdom; F. W. Springfield, Australia; and W. Foster, United Kingdom.

The following table gives the leader and time at each length in the final :—

Distance. Metres.		Time. m. s.	Distance. Metres.		Time. m. s.
100	T. S. Battersby	.. 1 $20\frac{4}{5}$	1,000	T. S. Battersby	.. 15 $14\frac{1}{5}$
200	T. S. Battersby	.. 2 50	1,100	T. S. Battersby	.. 16 47
300	T. S. Battersby	.. 4 $2\frac{3}{5}$	1,200	T. S. Battersby	.. 18 $19\frac{2}{5}$
400	T. S. Battersby	.. 5 $54\frac{1}{5}$	1,300	T. S. Battersby	.. 19 $51\frac{2}{5}$
500	T. S. Battersby	.. 7 $27\frac{3}{5}$	1,400	H. Taylor	.. 21 $22\frac{4}{5}$
600	T. S. Battersby	.. 9 0	1,500	H. Taylor	.. *22 $48\frac{2}{5}$
700	T. S. Battersby	.. 10 34			
800	T. S. Battersby	.. 12 $7\frac{2}{5}$	1,600	T. S. Battersby	.. 24 25
900	T. S. Battersby	.. 13 42	1 Mile	T. S. Battersby	.. †24 33

\* Olympic Record.

† This was not officially recognised as the English record because the bath was a little short of the 110 yards, and mile records can only be made over a course of not less than 110 yards in length.



SWIMMING.—START OF THE 200-METRES BREAST-STROKE FINAL.

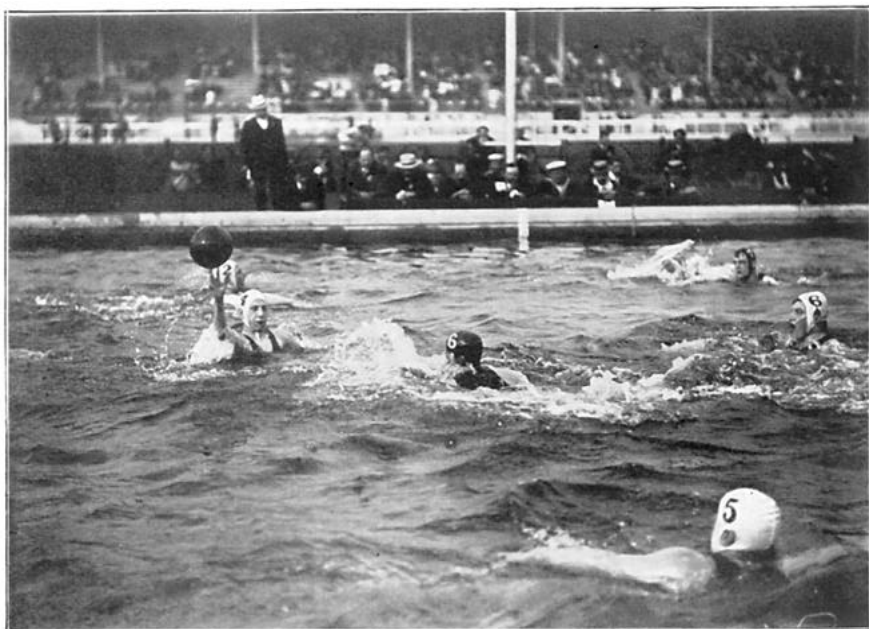

SWIMMING.—WATER POLO FINAL. BELGIUM *v.* UNITED KINGDOM.



SWIMMING.—THE UNITED KINGDOM WATER POLO TEAM, WINNERS.

## IV.—HIGH DIVING.

## FIRST ROUND.

*Heat 1.*—G. W. Geidzik, United States, 81.8 points, 1; H. Goodworth, United Kingdom, 76, 2; E. Adlerz, Sweden, 74.1, 3; O. Wetzell, Finland, 69.7, 4; H. J. Aldous, United Kingdom, 68, 5. It was quickly seen that Geidzik was winning, the American making several faultless dives. Goodworth, United Kingdom, was also in excellent form, but spoilt an otherwise pretty exhibition by failing badly at his first dive.

*Heat 2.*—H. Johanssen, Sweden, 78.4 points, 1; K. Malstrom, Sweden, 73.95, 2; W. O. Hoare, United Kingdom, 65.2, 3; J. Hiekitick, Belgium, retired. Though not diving so gracefully as did Geidzik earlier in the day, Johanssen's was a fine performance, and Malstrom was also very good. He, however, failed rather badly on one occasion, which must have made a substantial difference to his points.

*Heat 3.*—H. Loftberg, Sweden, 68.9 points, 1; H. Freyschmidt, Germany, 67.3, 2; L. D. Larsson, Sweden, 64.8, 3; W. E. Webb, United Kingdom, 57.7, 4; T. J. Collins, United Kingdom, 56.5, 5. The diving did not reach such a high standard as on the previous day. Loftberg and Freyschmidt were even throughout, the Swede just winning.

*Heat 4.*—A Spangberg, Sweden, 79.2 points, 1; H. Arbin, Sweden, 76.8, 2; G. F. Cane, United Kingdom 73.1, 3; K. G. Landqvist, Sweden, 65.7, 4. Spangberg dived splendidly, and secured a high proportion of marks.

*Heat 5.*—R. T. Anderson, Sweden, 73.55 points, 1; T. Aro, Finland, 69.5, 2; H. C. Grote, United States, 62.8, 3; A. W. Runstrom, Sweden, 57.6, 4; F. Nicolia, Germany, 54.5, 5; T. Harrington, United Kingdom, 53.15, 6. The British representative was outclassed. He dived very nicely, but did not possess the finish displayed by several of the others, of whom Anderson was in fine form.

## SEMI-FINAL.

*Heat 1.*—A. Spanberg, Sweden, 72.3 points, 1; K. Malstrom, Sweden, 67, 2; T. Aro, Finland, 62.7, 3; H. Loftberg, Sweden, 59.18, 4; H. Arbin, Sweden, 52.81, 5.

*Heat 2.*—H. Johanssen, Sweden, 80.75 points, 1; R. T. Anderson, Sweden, 66.75, 2; G. W. Geidzik, United States, 61, 3; H. Goodworth, Great Britain, 59.48, 4; Freyschmidt, Germany, 48.8, 5.

FINAL.						Points.
1.	H. Johanssen, Sweden	..	..	..	..	83.75
2.	K. Malstrom, Sweden	..	..	..	..	78.73
3.	A. Spangberg, Sweden	..	..	..	..	74.00
4.	R. T. Anderson, Sweden	..	..	..	..	68.30
5.	G. W. Geidzik, United States	..	..	..	..	56.30

There was never any doubt as to the result, Johanssen's work being of very high standard. H. Johanssen was 34, 5 ft. 7 in. high, and 11 st. 7 lb. in weight. He won the championship of Sweden in 1897 and held it, except in two years when he lived in London. In 1904 he won the King's Cup, and was second in 1907.

Diplomas of Merit for High Diving were awarded to R. T. Anderson, Sweden; G. W. Geidzik, U.S.A.; T. Aro, Finland; E Adlerz, Sweden; G. F. Cane, United Kingdom; and H. C. Grote, U.S.A.

## V.—FANCY DIVING.

## FIRST ROUND.

*Heat 1.*—G. W. Geidzik, United States, 82.8 points, 1; H. Freyschmidt, Germany, 78.1, 2; R. Zimmerman, Canada, 74, 3; H. Crank, United Kingdom, 70.3, 4; A. R. Beckett, United Kingdom, 67.5, 5.

*Heat 2.*—A. Zurner, Germany, 83.6 points, 1; H. Clarke, United Kingdom, 78.6, 2; A. J. Taylor, United Kingdom, 58.8, 3.

*Heat 3.*—R. Behrens, Germany, 83.6, 1; F. E. Errington, United Kingdom, 70.83, †; O. Wetzell, Finland, 70.83, †; K. Malstrom, Sweden, 70.3, 4; W. O. Hoare, United Kingdom, 67.8, 5. † Dead-heat for second place.

*Heat 4.*—H. E. Potts, United Kingdom, 82.5, 1; F. Nicolai, Germany, 67.1, 2; W. J. Bull, United Kingdom, 66.0, 3; C. Bonifanti, Italy, 65.8, 0; S. T. Larsson, Sweden, 64.5, 0; R. L. Baker, Australasia, 61.3, 0.

*Heat 5.*—G. Walz, Germany, 81.3 points, 1; H. C. Grote, United States, 79.5, 2; H. N. Smyrk, United Kingdom, 78.3, 3; T. A. Cross, United Kingdom, 64.5, 4.

## SEMI-FINAL.

*Heat 1.*—R. Behrens, Germany, 83.0 points, 1; G. Walz, Germany, 80.3, 2; H. E. Potts, United Kingdom, 79.6, 3; H. Freyschmidt, Germany, 79.3, 0; F. R. Errington, United Kingdom, 72.6, 0; O. Wetzell, Finland, 70.1, 0.

*Heat 2.*—G. W. Geidzik, United States, 85.6, 1; A. Zurner, Germany, 82.8, 2; F. Nicolai, Germany, 81.8, 3; H. Clark, United Kingdom, 81.1, 0; H. C. Grote, United States, 74.5, 0.

## FINAL.

	Points.
1. A. Zurner, Germany .. .. .	85.5
2. R. Behrens, Germany .. .. .	85.3
† G. W. Geidzik, United States .. .. .	80.8
† G. Walz, Germany .. .. .	80.8

A. Zurner was 18 years old, and was fourth in the high diving at Athens in 1906. For four years he won the championship of Hamburg, and won the Emperor's Cup before leaving for London.

Diplomas of Merit for Fancy Diving were awarded to H. E. Potts, United Kingdom; H. Freyschmidt, Germany; F. Nicolai, Germany; H. Clarke, United Kingdom; and H. C. Grote, U.S.A.

## VI.—EIGHT HUNDRED METRES TEAM RACE (874.9 Yards).

[Each man to swim 200 metres or 218.7 yards. Winner and fastest loser to compete in the final.]

## FIRST ROUND.

*Heat 1.*—Australasia (F. E. Beaurepaire, F. W. Springfield, R. L. Baker, T. B. Tartakover), 1; Denmark (Holm, Klem, Dam, Saxdorp), 2. Beaurepaire and Holm were the first pair, and the Australasian swam so fast that when Springfield took the water he had a 40 yards' lead. Swimming finely, he increased his team's advantage, Klem having 60 yards to go when Baker had the word to start. Though slower than Beaurepaire and Springfield, the third Antipodean was still fast enough to draw farther ahead, Dam losing another 20 yards on the two lengths. Tartakover was the fourth member of the Australasians, and he added another 10 yards to his side's lead, the winning distance being 90 yards. Times: 11 min. 35 sec.; Denmark, 12 min. 53 sec. Intermediate times of the leaders :—Beaurepaire, 2 min. 39 $\frac{1}{2}$  sec.; Springfield, 2 min. 50 $\frac{1}{2}$  sec.; Baker, 2 min. 50 $\frac{1}{2}$  sec.; Tartakover, 3 min. 6 sec.

*Heat 2.*—United Kingdom (W. Foster, P. Radmilovic, J. H. Derbyshire, H. Taylor), 1; United States (Hebner, Goodwin, Daniels, Rich), 2; Sweden (Wretman, Wennerstorm, Julin, Andersson), 3. Foster, Hebner, and Wretman were the first trio to take the water, and the former, who is quite young, performed so capably that Radmilovic was sent away with a 10 yards' lead, the Swede being another 10 yards in the rear. The distance between the first couple remained just about the same during the second 200 metres, while Sweden had steadily lost ground. Then came the crucial part of the race, for Daniels and Derbyshire were in the bath, and the Britisher had a start of just about 10 yards. But this availed him little against such a phenomenon as the American champion, who went to the front in  $1\frac{1}{2}$  lengths, and gave Rich a three yards' start of Taylor. In the first length Rich even gained on the Britisher, but Taylor would not be denied, and ploughing through the water in magnificent style, he caught and passed the States representative, and won by 7 yards. Times: 10 min.  $53\frac{2}{5}$  sec.; United States, 11 min.  $1\frac{2}{5}$  sec. Intermediate times of the leaders :—Foster, 2 min.  $43\frac{3}{5}$  sec.; Radmilovic, 2 min. 47 sec.; Daniels, 2 min. 35 sec.; Taylor, 2 min.  $39\frac{1}{5}$  sec.

*Heat 3.*—Hungary (Munk, Zachar, Lastorres, Halmay) swam over.

## FINAL.

United Kingdom (J. H. Derbyshire, P. Radmilovic, W. Foster, and H. Taylor)	.. .. .	1
Hungary (J. Munk, I. Zachar, B. Lastorres, and Z. de Halmay)	.. .. .	2
United States (H. J. Hebner, L. Goodwin, C. M. Daniels, and L. G. Rich)	.. .. .	3
Australasia (F. E. Beaurepaire, F. W. Springfield, R. L. Baker, and T. B. Tartakover)	.. .. .	4

Munk (Hungary) at once drew out, but at the first length he only led by a foot from Beaurepaire, with Hebner third, and Derbyshire last, 6 yards behind. Coming down the second length the Englishman gained considerably on the leaders, but Munk completed his second length in 2 min.  $40\frac{1}{5}$  sec., and was leading by 4 yards. Derbyshire was third. Zachar drew out by 5 yards in the next length, with Radmilovic second, but the latter tiring in the last 50 metres, Zachar finished the fourth length 8 yards ahead in 5 min.  $27\frac{1}{5}$  sec. Lastorres now established a good lead, while Foster maintained second place down the fifth length but was caught by Daniels at the turn. Coming down their next length both drew up on the leader, the little Bacup boy sticking well to the American champion. Lastorres completed his 200 metres with an advantage of 6 yards in 8 min. 10 sec., Daniels' time being 8 min.  $15\frac{1}{5}$  sec., and Foster's 8 min.  $18\frac{3}{5}$  sec. Halmay increased the gap, and went away far too fast, with Rich second and Taylor last. At the last turn the Hungarian must have been 15 yards in front of Rich, with Taylor still third, 4 yards behind. Fifty metres from home Taylor caught Rich, but Halmay from this point went all to pieces, and turned into the side in the last 20 yards. Taylor came with a great effort, and in the last few yards got in front, and won by 3 yards. Times :—Great Britain, 10 min.  $55\frac{3}{5}$  sec.; Hungary, 10 min. 59 sec.; United States, 11 min.  $2\frac{1}{5}$  sec.

In the winning British team, J. H. Derbyshire (Manchester Osborne S.C.) won the hundred yards' championships of 1898 to 1901, the 220 yards for 4 years, and the 500 and 880 yards' in 1897.

F. Radmilovic (Weston-super-Mare) is the Welsh champion, winner of the long-distance championship, and 100 yards' record holder.

Diplomas of Merit for the Team race were awarded to the Australian team.

## VII.—TWO HUNDRED METRES BREAST STROKE (218.7 Yards).

### FIRST ROUND.

*Heat 1.*—F. Holman, United Kingdom, 1; R. Rosler, Germany, 2; M. Gumpel, Sweden, 3. Holman at once drew out, and at 50 metres led by  $1\frac{1}{2}$  yards, and at the turn was 2 yards ahead of Rosler in 1 min. 31 sec. Going on well, he had an advantage of 4 yards at 150 metres, with Gumpel another 12 yards away. Continuing in capital form, Holman won easily in the fast time of 3 min.  $10\frac{3}{5}$  sec.; Rosler, 3 min. 18 sec.

*Heat 2.*—W. A. Persson, Sweden, 1; A. Baronyi, Hungary, 2; A. M. Goessling, United States, 3; H. Cederberg, Finland, 0; F. H. Naylor, United Kingdom, 0. Baronyi was first to show in front, but at half a length the American drew level, with Persson close up. At half distance Goessling and Persson turned together from Baronyi, but coming down the last length the latter took second place, but was still  $1\frac{1}{2}$  yards behind at 150 metres, with Goessling another yard away. The Hungarian now put in all he knew, but to no purpose, Persson winning by inches in 3 min.  $17\frac{3}{5}$  sec.; Baronyi, 3 min. 18 sec.

*Heat 3.*—E. Seidel, Germany, 1; H. Johanssen, Sweden, 2; A. Davies, United Kingdom, 3; P. Strauwen, Belgium, 4. At 50 metres the German led Johanssen by 2 yards, with Davies third, a yard behind. The same distance separated the first two at the turn. At 150 metres Seidel still led by 3 yards, Davies being another 7 yards behind; but the Swede again drew on the leader, who, however, won by 5 yards in 3 min.  $17\frac{1}{5}$  sec.; Johanssen, 3 min.  $21\frac{1}{5}$  sec.; third 10 yards behind.

*Heat 4.*—O. Toldy, Hungary, 1; P. Hanson, Sweden, 2; S. H. Gooday, United Kingdom, 3; A. Beretta, Italy, 4. Hanson led at 50 metres by half a yard from Toldy; Gooday third,  $1\frac{1}{2}$  yards behind. The same distance separated them at the turn, but in the next 50 yards Toldy caught and passed the Swede; Gooday  $2\frac{1}{2}$  yards away. From here a great race was seen, Toldy just getting home in 3 min.  $14\frac{2}{5}$  sec.; Hanson, 3 min. 15 sec.

*Heat 5.*—W. W. Robinson, United Kingdom, 1; P. O. Fjastad, Sweden, 2; J. H. Henrikssen, Finland, 0; E. J. L. Cooke, Australasia, 0. At 50 yards Robinson and Fjastad were level, and shortly afterwards Cooke retired. At the half distance Robinson turned with a yard and a half advantage in 1 min.  $31\frac{1}{5}$  sec.; and drawing away he won easily in 3 min. 13 sec.; Fjastad, 3 min.  $31\frac{3}{5}$  sec.

*Heat 6.*—Fabinyi, Hungary, 1; K. T. Kumfeldt, Sweden, 2; H. Klem, Denmark, 3; H. J. Jonsson, Finland, 0. The Dane drew away at the start, and at 50 metres led by a yard from the Swede; Fabinyi the same distance behind. At 70 yards Jonsson retired. Coming down the last length Kumfeldt took the lead, but Fabinyi was not yet done with, and, coming again, he won in 3 min.  $23\frac{2}{5}$  sec.; Kumfeldt, 3 min.  $24\frac{3}{5}$  sec.

*Heat 7.*—F. Courbet, Belgium, 1; P. Courtman, United Kingdom, 2; C. A. Andersson, Sweden, 3. Courbet, at 50 metres, led by half a yard from the Englishman, and at the half-distance by a yard. His advantage at 150 metres was  $2\frac{1}{2}$  yards, and the Belgian, taking matters easily, won in 3 min.  $16\frac{2}{5}$  sec.; Courtman, 3 min.  $18\frac{2}{5}$  sec.



## SEMI-FINAL.

*Heat 1.*—F. Holman, United Kingdom, 1; O. Toldy, Hungary, 2; E. Seidel, Germany, 3; Fabinyi, Hungary, 4. Toldy was the first to show in front, and at 50 metres he led Holman by half a yard; but the latter drew up, and at the half-distance they turned together in 1 min. 27 sec. Holman then went to the front and led Toldy at 150 metres by  $2\frac{1}{2}$  yards, with Seidel another  $1\frac{1}{2}$  yards away. Holman won easily by 2 yards in 3 min. 10 sec.; Toldy, 3 min.  $16\frac{2}{5}$  sec.

*Heat 2.*—W. W. Robinson, United Kingdom, 1; P. Hanson, Sweden, 2; W. A. Persson, Sweden, 3; F. Courbet, Belgium, 4. Courbet got the best of the start, but Hanson soon took the lead. The Englishman was up at the first half-length, and led at the length by 2 yards in 1 min.  $28\frac{1}{5}$  sec., with Persson third. Hanson came again, and at 150 metres he was only a yard and a half behind, but the British ex-champion won with a bit in hand in 3 min.  $11\frac{4}{5}$  sec.; Hanson, 3 min. 13 sec.

## FINAL.

							m.	s.
1.	F. Holman,	United Kingdom	..	..	..	..	3	$9\frac{1}{5}$
2.	W. W. Robinson,	United Kingdom	..	..	..	..	3	$12\frac{4}{5}$
3.	P. Hanson,	Sweden	..	..	..	..	3	$14\frac{3}{5}$
4.	O. Toldy,	Hungary	..	..	..	..	3	$15\frac{1}{5}$

The Swede was first to show in front, and at 50 metres he led Robinson by 2 yards, with Toldy a foot ahead of Holman. Robinson now went up, and caught Hanson at 80 metres, the pair turning together in 1 min. 30 sec. Coming down the second length Robinson drew out, but Holman was now putting in some very fine work, and at 150 metres he was a yard behind the leader, with Toldy just ahead of Hanson. Holman still drew on Robinson, whom he caught in the last 25 metres, whilst Hanson made another effort to get up, but the Exeter representative, swimming with a powerful stroke, finished in good form, and won by  $2\frac{1}{2}$  yards, the respective times showing the other distances.

F. Holman, of Exeter, was 5 ft.  $10\frac{1}{3}$  in. high, weighed 11 st. 3 lb., and was 25 years old. He did the fastest time at the British trials for this race in the Stadium in June, and then reserved himself for this race.

W. W. Robinson, of Liverpool, was 38 years old, 6 ft. high, and weighed 12 st. He won the championship for this event in 1903, 1904, and 1906.

P. Hanson held this championship in Sweden, together with the Swedish Life-saving Championship. He was captain of the Swedish Water Polo Team.

Diplomas of Merit for the 200 Metres Breast Stroke were awarded to O. Toldy, Hungary; E. Seidel, Germany; A. W. Persson, Sweden; and F. Courbet, Belgium.

## VIII.—ONE HUNDRED METRES BACK STROKE (109.3 Yards.)

## FIRST ROUND.

*Heat 1.*—A. Bieberstein, Germany, 1; F. A. Unwin, United Kingdom, 2; H. Jonsson, Finland, 3. The German champion at once went to the front, and led by  $1\frac{1}{2}$  yards from Unwin at 50 metres, and keeping up an excellent stroke he won in 1 min.  $25\frac{3}{5}$  sec.; Unwin, 1 min. 30 sec.; bad third.

*Heat 2.*—Max Ritter, Germany, 1; S. Willis, United Kingdom, 2; J. Henricksson, Finland, 3. At 50 metres Ritter led Willis by  $1\frac{1}{2}$  yards, and retained the same advantage to the finish. Times: Ritter, 1 min.  $33\frac{2}{5}$  sec.; Willis, 1 min.  $34\frac{2}{5}$  sec.

*Heat 3.*—C. Lewis, United Kingdom, 1; B. A. Roadenburch, Holland, 2; R. Zimmerman, Canada, 3. Lewis led by a foot at the half-distance, and won easily. Times: Lewis, 1 min.  $30\frac{1}{5}$  sec.; Roadenburch, 1 min. 36 sec.

*Heat 4.*—H. N. Haresnape, United Kingdom, 1; L. Dam, Denmark, 2; A. Beretta, Italy, 3. The Englishman held a yard advantage at 50 metres from the Dane, but the latter went up, and a good race saw Haresnape a winner by a touch in 1 min.  $26\frac{1}{5}$  sec.; Dam, 1 min.  $26\frac{2}{5}$  sec.

*Heat 5.*—S. Parvin, United Kingdom, swam over in 1 min.  $35\frac{1}{5}$  sec.

*Heat 6.*—J. R. Taylor, United Kingdom, 1; A. M. Goessling, United States, 2; G. Wretman, Sweden, 3; O. Gregoire, fils, Belgium, 0. At 50 metres Taylor led the American by 3 yards, with the Swede a yard behind, and watching his man to the finish, he won easily, the Belgian having retired at the half-distance. Times: Taylor, 1 min.  $25\frac{4}{5}$  sec.; Goessling, 1 min. 29 sec.

*Heat 7.*—G. Aurick, Germany, 1; J. G. Corlever, Holland, 2; E. Seaward, United Kingdom, 3; S. Kugler, Hungary, 0. The latter got away before the starter's word, and gained a 2 yards' lead, which he retained to the end, but was disqualified. The race was awarded to Aurick, whose time was 1 min.  $27\frac{2}{5}$  sec.

#### SEMI-FINAL.

*Heat 1.*—A. Bieberstein, Germany, 1; L. Dam Denmark, 2; M. Ritter, Germany, 3; S. Parvin, United Kingdom, 4. The winner at once drew out, and at half-distance led the Dane by half a yard, the others being together a yard and a half behind. Taking matters easily, Bieberstein beat the Dane by a yard. Parvin swam into the side at 80 metres, and was 6 yards behind. Time, 1 min.  $25\frac{3}{5}$  sec.; no second time.

*Heat 2.*—G. Aurick, Germany, 1; H. N. Haresnape, United Kingdom, 2; J. R. Taylor, United Kingdom, 3; C. Lewis, United Kingdom, 4. Haresnape led Taylor at 50 metres by a yard, but then began to cross into Aurick's water. Shortly afterwards Taylor followed suit, and each bored the other considerably. Eventually Haresnape almost won, but the verdict was against him. Times: Aurick, 1 min.  $28\frac{1}{5}$  sec.; Haresnape, 1 min.  $28\frac{4}{5}$  sec.

#### FINAL.

A. Bieberstein, Germany	..	..	..	..	..	1
L. Dam, Denmark	..	..	..	..	..	2
H. N. Haresnape, United Kingdom	..	..	..	..	..	3
G. Aurick, Germany	..	..	..	..	..	4

Bieberstein at once drew out, and at the half-distance led by one and a half yards from Haresnape, Dam being half a yard behind. At 70 metres Dam drew up, whilst the Englishman went out of his water and lost second place by a yard. Times: 1 min.  $24\frac{3}{5}$  sec.; Dam, 1 min.  $26\frac{3}{5}$  sec.; Haresnape, 1 min. 27 sec.

A. Bieberstein had held the Back Stroke championship of Germany for three years previously, and in 1907 won that of Austria as well.

Diplomas of Merit for the 100 Metres Back Stroke were awarded to C. Lewis, United Kingdom; A. M. Goessling, U.S.A.; S. Kugler, Hungary; J. R. Taylor, United Kingdom; and G. Aurick, Germany.

## IX.—WATER POLO.

## FIRST ROUND.

BELGIUM *v.* HOLLAND.

Holland went off well and at once secured, but Belgium early scored through Feyaerts. Restarting, Ruhl saved finely, and play being carried into the Belgians' quarters, K. Meyer equalised from a scrimmage. Belgium attacked strongly, and the effort resulted in their captain again netting the ball. Ooms soon after tried a fine long shot, which unfortunately struck the crossbar, but Feyaerts put on another point, and Belgium led at half-time by 3 goals to one. On changing over Pletinex got through, but sent in too low. Later, Feyaerts quickly added two goals, and eventually another. In the succeeding play Ruhl, Holland's goalkeeper, was drawn out, and Pletinex increased his side's score. Donners was unmarked, and put Belgium further ahead. Feyaerts again found the net, but time having expired the goal was disallowed. Result :—Belgium, 8 goals; Holland, 1.

Belgium.—A. Michant, V. Boin and H. Meyboom; J. Pletinex; F. Feyaerts (captain), O. Gregoire, and H. Donners.

Holland.—J. H. W. Ruhl; J. G. Cortlever and J. F. Hulswit; E. Meyer, jun.; K. Meyer, P. L. Ooms, and B. Benenga.

Hungary scratched to Sweden.

The United Kingdom and Austria drew byes.

## SEMI-FINAL.

Austria scratched to the United Kingdom.

BELGIUM *v.* SWEDEN.

Anderson shot by in the first few seconds, but the ball was quickly at the other end of the bath, and Meyboom scored for Belgium in two minutes. Other goals followed very quickly. First, Sweden equalised through their captain, Hansson, only for the Belgians to register other points owing to good work by Gregoire and Pletinex. The latter's goal should have been stopped. The Belgians were showing much the cleverer combination, and Pletinex yet again beat the Swedish goalkeeper with a shot which hit the inside of the post and bounced through. Gamely retaliating, Sweden, though outclassed, worked to the other end by sheer determination, and from a foul on Runstroen the same player credited his side with a nice goal. Half-time :—Belgium, 4 goals; Sweden, 2. The Belgians were quickly in evidence again after changing over, and Gregoire swam through and beat Kumfeldt with an unstoppable shot. Directly afterwards Feyaerts gave the Belgians their sixth point, but Sweden at once reduced the heavy margin against them, Anderson getting through very skilfully and placing the ball in the net. Gregoire, who was playing splendidly, next got clear

of everything, and made the Belgians' score 7. A minute later Meyboom rattled on the eighth, and then just before the final whistle Hansson scored for Sweden. Score :—Belgium, 8 goals; Sweden, 4.

Belgium.—A. Michant; H. Meyboom and V. Boin ; J. Pletinex; F. Feyaerts (captain), O. Gregoire, and H. Donners.

Sweden.—T. Kumfeldt; A. Runstroen and H. Julin; P. Hansson (captain); G. Wennerstroen, Robert Anderson, and E. Bergvall.

#### FINAL.

##### UNITED KINGDOM BEAT BELGIUM.

The Britishers at once dropped into a prettily combined game, and after a minute Wilkinson scored with a great shot, while just afterwards Radmilovic hit one of the posts with a terrific back-hander. However, this made little difference, as Forsyth got through, and from close in gave Michant no chance. The British continued to attack in fine style, and although Michant kept goal splendidly, Wilkinson at length registered a third point. Radmilovic followed with a fourth—a somewhat lucky point, as the ball after being thrown out by the opposition goalkeeper rebounded into the net. Then Meyboom caused Smith to make two splendid saves, but the Belgians would not be denied, and at the next attempt Gregoire got past the British keeper's defence. Cheered by this success, the Belgians improved immensely. A beautiful back-hand shot by Radmilovic was saved by Michant, and his forwards capturing the ball went through and gave Feyaerts the opportunity to beat Smith with a capital effort. This, however, was the Belgians' last success. Just before the interval Forsyth again scored. Half-time :—Great Britain, 5 goals; Belgium, 2.

After changing ends the Belgians struggled pluckily against a much superior combination, but could not prevent several further goals being registered against them. First, Radmilovic—after Wilkinson had hit the bar—scored, then Forsyth defeated Michant, while Wilkinson wound up a fine game by adding two more goals, a tenth point sent through a second after the final whistle not being allowed. Result :—

	Goals.								
Great Britain	..	..	..	..	..	..	..	..	9
Belgium	..	..	..	..	..	..	..	..	2

Great Britain.—C. S. Smith (goal); G. Nevinson and G. Cornet (backs); T. Thould (half-back); G. Wilkinson, P. Radmilovic, and C. G. Forsyth (forwards).

Belgium.—A. Michant (goal); H. Meyboom and V. Boin (backs); J. Pletinex (half-back); S. Feyaerts, O. Gregoire, and H. Donners (forwards).

## THE WINNING TEAM.

C. S. Smith (Salford S.C.), goalkeeper and captain, is 29 years of age, stands 6 ft.  $1\frac{1}{4}$  in., and weighs 16 st. 8 lb. He has played nine times for England.

G. Nevinson (Salford S.C.), back, is 25, and stands 5 ft.  $8\frac{1}{2}$  in. He has played for England six times in international games.

G. Cornet (Inverness S.C.), back, is 31, stands 6 ft.  $3\frac{1}{4}$  in., and weighs 15 st. 7 lb. He has represented Scotland twelve times in international matches.

T. Thould (Weston-super-Mare S.C.), half-back, is 22, weighs 11 $\frac{1}{2}$  st., and stands 5 ft. 10 in. He holds the swimming championship of Somerset, and played for England last year.

G. Wilkinson (Hyde Seal S.C.), forward, stands 5 ft. 8 in., and weighs 12 st. 8 lb. He possesses a remarkable goal average in the ten international games in which he has taken part.

P. Radmilovic (Weston-super-Mare S.C.), centre-forward, stands 5ft. 11 in., and weighs 12 st. In addition to representing Wales on eight occasions in international games, the Welsh captain has done many fine performances in swimming championships.

C. G. Forsyth (Salford S.C.), forward, stands 5 ft.  $10\frac{1}{2}$  in. and weighs 12 st. He has played for England four times.

## TENNIS (JEU DE PAUME).

(Under English Amateur Championship Rules.)

*President:* Right Hon. Alfred Lyttelton, K.C., M.P.

*Honorary Secretary:* Mr. E. A. Biedermann.

### RESULTS.

*Gold Medal* . . . JAY GOULD (U.S.A.).  
*Silver Medal* . . . EUSTACE H. MILES (United Kingdom).  
*Bronze Medal* . . . Hon. N. S. LYTTON (United Kingdom).

### DETAILS OF PLAY.

#### FIRST ROUND (3 contests, 5 byes).

E. H. Miles (United Kingdom) beat C. S. Sands (U.S.A.) 3 sets to 0 (6—3, 6—3, 6—3).

E. B. Noel (United Kingdom) beat C. E. Tatham (United Kingdom) 3 sets to 0 (6—2, 6—3, 6—3).

Vane Pennell (United Kingdom) beat W. M. Cazalet (United Kingdom) 3 sets to 0 (6—1, 6—4, 6—1).

#### SECOND ROUND.

Hon. N. S. Lytton (United Kingdom) beat E. A. Biedermann (United Kingdom) 3 sets to 0 (6—5, 6—1, 6—2).

A. Page (United Kingdom) beat A. Palmer (United Kingdom) 3 sets to 1 (5—6 6—4, 6—5, 6—1).

E. H. Miles (United Kingdom) beat E. B. Noel (United Kingdom) 3 sets to 0 (6—5, 6—1, 6—5).

Jay Gould (U.S.A.) beat Vane Pennell (United Kingdom) 3 sets to 0 (6—3, 6—3, 6—2).

#### SEMI-FINALS.

E. H. Miles (United Kingdom) beat Hon. N. S. Lytton (United Kingdom) 3 sets to 0 (6—4, 6—1, 6—3).

Jay Gould (U.S.A.) beat A. Page (United Kingdom) 3 sets to 0 (6—1, 6—0, 6—0).

#### FINAL.

Jay Gould (U.S.A.) beat E. H. Miles (United Kingdom) by 3 sets to 0 (6—5, 6—4, 6—4).

#### ANALYSIS OF FINAL.

*Set 1* : 4—2, 4—6, 3—5, 5—7, 1—4, 4—1, 2—4, 4—2, 4—2, 5—2, 4—1.

*Set 2* : 4—0, 3—5, 4—0, 2—4, 2—4, 4—1, 0—4, 4—2, 5—3, 4—2.

*Set 3* : 2—4, 2—4, 6—4, 2—4, 5—3, 4—1, 4—1, 2—4, 4—2, 5—3.

Jay Gould is a young American only just out of his teens, but he bids fair to become one of the greatest amateur tennis players the world has ever known. He won the Amateur Championship in 1907, and was again successful this year. He was beaten by Eustace Miles in 1906, but has since triumphed over the Englishman on four occasions.

Eustace H. Miles (Marlborough and Cambridge) won the Tennis Singles for his University in 1891 and the Doubles in 1890 and 1891. Amateur Tennis Champion in 1899, 1900, 1901, 1902, 1903, 1905, and 1906, and holder of the M.C.C. Gold Prize in 1897, 1898, 1899, 1901, 1902, 1903, 1904, 1905, 1906, and 1908. Won the U.S.A. Championship in 1900. He won the Amateur Singles Racquet Championship in 1902 and the Doubles in 1902, 1904, 1905, and 1906.

The competitions began on May 18 at Queen's Club. England was represented by nine players, and America by two, Messrs. Gould and Sands. The absence of M. de Luze, the amateur champion of France, was much regretted, as he is, in his way, an accomplished *paumier*, whose play is always attractive to watch.

In the earlier stages Messrs. Noel, Miles, Pennell, Lytton, and Page respectively defeated Messrs. Tatham, Sands, Cazalet, Biedermann, and Palmer. Mr. Cazalet is seldom seen at Queen's Club, and was playing in the match court for the first time since it had been newly painted and repaired. Under the circumstances, though he did not win a set, he played excellent tennis against Mr. Pennell and repeatedly stopped some of his best forces. The match between Mr. Sands and Mr. Miles excited no little interest. The former seemed to be more out of condition than out of practice. He failed to win a set against Mr. Miles, but he played extremely well all round at the beginning of the third set, and if he had been in sufficient training to keep up the game he then exhibited the match might well have been a close affair.

A prominent match in the second round was the one between Mr. Miles and Mr. Noel. In the first set Mr. Noel at one time looked as if he might win it ; but the luck was against him, the ball thrice finding the winning gallery off the tambour in a strangely fluky manner, strokes for which Mr. Miles was the first to apologise. In the second set Mr. Noel went somewhat to pieces, and won only one game. In the third set, however, as in the first, " five all " was called ; but the set went to Mr. Miles, who thus won the match by three sets to none, eighteen games to eleven, after some very interesting play on both sides.

The last match in the second round was played by the amateur champion, Mr. Gould, and Mr. V. Pennell, and was won by the former in an hour and twelve minutes by three sets to none, eighteen games to eight

(6-3, 6-3, 6-2). Last year in the competition for the amateur championship Mr. Pennell scored only three games against Mr. Gould, and throughout the match appeared to be outclassed at all points. This year, though he did not win a set, he put up a much stiffer game against his accomplished opponent, and played with much dash and no little skill in the first two sets, several games in which were strenuously contested. If, indeed, Mr. Pennell could play the overhand railroad service with more care and variety, and could volley with more restraint and some cut, the disparity between the two players, as a mere matter of execution, would be but slight. But as regards a general knowledge of the game, judgment, coolness, and self-control, the difference between them is marked. Mr. Gould's superiority in such matters is manifest to those who have eyes to see. His one overhand railroad service varied a good deal, and often gave his opponent the attack ; but, apart from a few good boasted forces, Mr. Pennell did not show any special aptitude for dealing with it. In the rests Mr. Gould made several mistakes—an unusual number, indeed, for him—but, on the whole, the merits of his performance far exceeded its shortcomings.

In the penultimate round Messrs. Miles and Gould beat their respective opponents, the Hon. N. S. Lytton and Mr. A. Page, by three sets to none. In his match with Mr. Miles Mr. Lytton made four games in the first set, and the opinion was generally expressed in the dedans that in that set he played very well. Mr. Page did not, of course, expect to do much against Mr. Gould on level terms, and as a matter of fact he won very few games in the three sets. But in the first set, and, indeed, until he became tired, he played with plenty of go, and was often applauded for his return of difficult strokes.

The final tie was played by Mr. Jay Gould and Mr. E. H. Miles on the afternoon of Saturday, May 23, and was won in an hour and thirty-one minutes by Mr. Gould by 3 sets to 0, 18 games to 13, 106 strokes to 90. The contrast between the attendance of spectators on this occasion and the crowd that went to see the match for the amateur championship was very marked; The latter match was somewhat of a fiasco, and the fear of seeing another display of the kind probably accounted for the absence of many familiar faces. As a matter of fact, the absentees missed seeing what proved to be in some respects an excellent match. Mr. Gould was not at the top of his form. Mr. Miles, on the other hand, though also not at his best, played much better than he did on Saturday, May 16, and with more accuracy and cleverness than he recently displayed against Mr. Pennell and Mr. Noel. He did not win a set, but he ought to have secured the first set, and he never looked like a hopeless loser at any stage



of the second and third. He started an aggressive game at once, and he obtained five out of the first seven games. Of these the second, third, and fourth were stoutly contested ; but on the whole, at the start, Mr. Gould played with less ease and resource than usual. If he was not nervous he looked anxious, which was not surprising. A bad mistake by his opponent, a decisive volley to the foot of the grille, and one of the few nick services in the match, gave him the eighth game, and he won the ninth easily enough, despite one poor return into the net (4—5). Then came a critical game, the tenth. Mr. Miles won the first stroke, and established chases worse than two and better than two. After a good rest he won the former. Losing the latter, the strokes were 30—15 in his favour. Here he had two good openings for decisive strokes, which would have given him the set ; but he broke down over both, and his opponent eventually carried off the game. The latter then won the eleventh game easily, and thus obtained the first set.

In the second set Mr. Gould won the first, third, sixth and eighth games, his opponent being credited with the second, fourth, fifth, and seventh (4 all). In the ninth game, Mr. Gould won the next stroke, after deuce had been called, by a good boasted force, and, after a capital rest, secured the game. In the tenth game Mr. Miles made an excellent stroke into the forehand corner hazard side, and found the grille once; but his opponent won the game, and therewith the second set. In the third set Mr. Miles, despite much poor service, got a lead of three games to one, but his opponent, by varied play, mostly on the floor, obtained the fifth, sixth, and seventh games. Mr. Miles did well in the eighth, which he actually won by a difficult service (4 all). But he could do no more, and Mr. Gould carried off the next two games, the tenth being a long one, and thus won the set and the match—a victory which secured for America the gold medal in the Olympic Games, just as Mr. Noel and Mr. Gore had won a similar trophy for England at racquets and lawn tennis (covered court). There is nothing surprising in Mr. Gould's complete success in the matches he has played this year at Queen's Club. The court in its present state, after being repainted, suits his service and stroke in every way. But, apart from such comparatively unimportant considerations, his success has been really due to his consistently playing the winning game—that is, the true floor game, combined with difficult service, which English amateurs have neglected, and in some cases foolishly belittled, for so many years.

Mr. Gould having won the gold medal, and the silver medal having fallen to Mr. Miles as his opponent in the final round, there remained the match for the bronze medal, for which the Hon. N. Lytton and Mr. A. Page

played on the afternoon of Thursday, May 28, the former winning by 3 sets to 0, 18 games to 10. After the first set the play was of an animated character, and the tennis often of excellent quality. Mr. Lytton, in particular, gives the impression every time he plays a match in public that when he has acquired a little more control over the ball, and has learnt to direct it well into the corners of the court, his stroke will be quite of the best. Mr. Page is still what may be termed an unformed player. On the other hand, he gets about the court untiringly, and his power of return is remarkable, based as it often is on a very correct judgment of the flight of the ball.

An interesting and valuable appreciation of Mr. Gould's play appeared in the *National Review*, from which I quote the following passages :—

The strength of a man's game in some degree is the absence of his weaknesses, and there is no weak spot in Mr. Gould's armour. Effective service, accuracy, return, quickness, knowledge and temperament are his, but what are the dominating features of his game? Not, I make bold to say, that terribly consistent railroad service, the one unattractive point of his tennis, but his attack on the floor, with its wonderful accuracy, length and direction, his command of the volley, and his general power of doing the best thing possible when in difficulties. No doubt, Mr. Gould's service is terribly effective in getting him the attack in the rest, and in preventing an opponent establishing a short chase. But it is absurd to hold that such a service need necessarily give a very great advantage against another player who does not possess it.

Service generally is weak at the present time, and so the American service seems the more valuable. Mr. Miles, for instance, has no service at all to speak of, and thus invites a player to make a good stroke to his back-hand. Mr. Gould was not slow to take advantage of this, and in the Amateur Championship one had ample opportunity of studying his stroke. From the point of view of style in certain details it has been criticised. It may be that there is too much wrist in it—the little turn of the wrist both with "Ferdinand" and Mr. Gould is very similar, and probably they use it to suit French and American balls as the case may be. Again, it is not theoretically correct that the left leg should be away from the ball, as is often the case with Mr. Gould's forehand stroke ; for it is an old dictum that the motion of the body in a tennis stroke should be like that of a correct forward stroke at cricket ; and at cricket the position of Mr. Gould's leg would be a bugbear to a public school coach. Still, in most respects, the stroke is complete, and its effect is deadly. There is a full swing, the player gets well down to the ball and hits it very near the ground with everything in the right relationship' arms and body and legs working together. The result is perfect timing, and with perfect timing all things are possible. Mr. Gould has practised so much that the stroke is almost always perfectly easy and perfectly accurate ; he can devote himself to length and direction, and it is the accuracy of all three combined, especially in dealing with a *bal à la main*, which make him so formidable. Such is his command that about nineteen out of twenty easy ones are finished irrevocably just over the net, heavily cut and restrained and often not reaching the back wall at all, and such a stroke stamps the great player.

Another point where Mr. Gould, in my opinion, excels any other amateur player is in the execution of that most difficult of strokes, the volley. To the beginner at tennis to get the ball over the net at all on the volley is a relief ; the more proficient can get it over with some degree of certainty ; the good player can on occasions do something with it ; but it is only the great player who has a

real command over it. The easy volley Mr. Gould cuts with accuracy ; with the difficult one he can at least so restrain himself that he is able to keep it off the end wall, where in nine cases out of ten the ordinary player would put it on the pent-house, and thus at once give the adversary the attack.

With Mr. Gould a volley is more often than not, indeed, an attacking and not a defensive stroke, and his skill in this department of the game is only another testimony to the manner in which constant practice and study are repaid. We have said that Mr. Gould has no weak point in his armour, and in powers of return—his wonderful timing of difficult balls off the walls is again to some extent the result of constant play—in resource, especially in the ability to do the best thing and not to try too much when in a difficult position, and in turning defence into attack by keeping the ball off the end walls—a merit the value of which is imperfectly realised—he compares favourably with anyone. Finally, he is blessed with an almost ideal temperament for match play.

One thing remains to be discussed, his service. In all his matches, as is almost too well known to repeat, he relies exclusively on the overhead railroad service, and in delivering this among amateurs he has no equal. The question of “ nicks ” apart, Mr. Gould’s service is undoubtedly a formidable weapon for four reasons : first, its deadly accuracy ; second, that while it is not necessarily very difficult to return, it is always difficult to do much with it ; thirdly, that the returning of it—the continual running after it with the ball going away from the player—is a weariness of the flesh ; and fourthly, because the slight change in the method of delivering it that Mr. Gould can make changes the length of it sufficiently to disconcert an opponent who has been volleying it well. . . .

In practically every respect except service Mr. Gould is a beautiful player ; it would stamp him as a greater player still if he became a beautiful server, and not only, as he is now, a terribly effective one.

I have tried to say something in detail of Mr. Gould’s methods and qualities. The whole welded together makes the player what he is, and how well it was shown in his recent matches. His service—this much must be admitted—gave him the attack ; then the ball was finished, perhaps, straight off with that relentless volley under the grille, or the rest was started in his favour. Then came the easy one, and it was all over. He had no need to go for the openings ; to finish the ball on the floor for him was the safer and more paying. On the hazard side his stroke gave him the attack, and the result in the end was generally a short chase or a stroke his opponent missed.

His success now points to his dominating amateur tennis for some years to come. But, after all, there is no reason England should not produce a rival to equal, if not to surpass, him. It is not likely to be a man of so tender an age. In England men do not, as a rule, begin the game very young, nor is tennis a good game for boys. Nothing is harder work for the muscles, and a hard game involves great strain, but given a man of twenty-one, with abilities for ball games equal to Mr. Gould—such a one would not be hard to find—induce him to learn and study the game properly—a far harder matter—and in a few years one might find Mr. Gould’s equal, if not his superior. The talent in this country is, we are sure, not lacking ; time and opportunity are lacking in many cases, but it is patience and application that are lacking most of all.

Though it holds even more true of tennis than of racquets that the game is too expensive and complicated ever to become popular, and is therefore confined practically to France, the United Kingdom, and America, its ancient and noble traditions will always exercise a profound attraction over many more than its skilled exponents. Great interest was

taken in the Olympic competition because Mr. Jay Gould, who had just defeated Mr. Miles for the amateur championship, would have to meet him again ; and in their match the American certainly proved himself the finest amateur player since Alfred Lyttelton ; and every experienced spectator of his match in the second round was of the opinion that Mr. Pennell put up a very fine game indeed against him.

Considering the few countries in which tennis is played, and the small number of players in the front rank anywhere, it may be suggested, without any wish to minimise the beauty or importance of one of the best and oldest ball-games in the world, that it is not quite suitable for future programmes in Olympic Games, which should consist of competitions suitable to a greater number of international entries.



SWIMMING.—SPANDBERG (SWEDEN) IN THE HIGH DIVE.



SWIMMING.—TAYLOR (U.K.), WINNER OF THE TEAM RACE.



WRESTLING.—Y. SAARELA (FINLAND) *v.* W. WECKMAN (FINLAND) IN THE GRÆCO-ROMAN LIGHT HEAVYWEIGHTS.

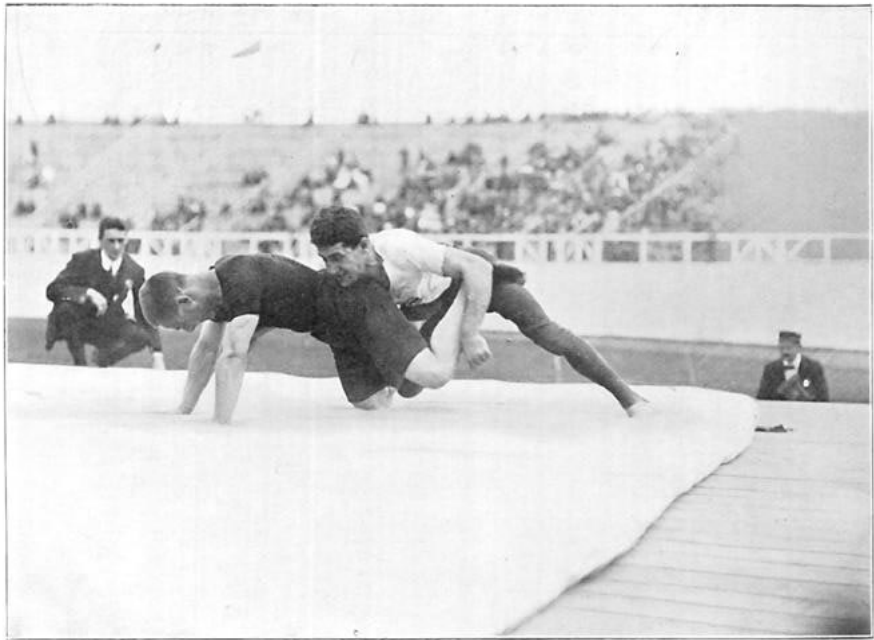

WRESTLING.—RELWYSKOW (U.K.) *v.* BACON (U.K.) IN THE CATCH-AS-CATCH-CAN MIDDLEWEIGHTS.

## WRESTLING.

## A.—CATCH-AS-CATCH-CAN.

## B—GRÆCO-ROMAN.

## RESULTS.

## A.—Catch-as-Catch-Can.

## BANTAM WEIGHT.

- I. N. MEHNERT (United States).
- II. W. J. PRESS (United Kingdom).
- III. A. COTE (Canada).
- Special Merit* : (1) F. TOMKINS (United Kingdom).
- "      "      (2) F. DAVIS (United Kingdom).

## FEATHER WEIGHT.

- I. G. S. DOLE (United States).
- II. J. P. SLIM (United Kingdom).
- III. W. MCKIE (United Kingdom).
- Special Merit* : J. A. WEBSTER (United Kingdom).

## LIGHT WEIGHT.

- I. G. DE RELWYSKOW (United Kingdom).
- II. W. WOOD (United Kingdom).
- III. A. GINGELL (United Kingdom).
- Special Merit* : G. MACKENZIE (United Kingdom).

## MIDDLE WEIGHT.

- I. S. V. BACON (United Kingdom).
- II. G. DE RELWYSKOW (United Kingdom).
- III. F. BECK (United Kingdom).
- Special Merit* : E. H. BACON (United Kingdom).

## HEAVY WEIGHT.

- I. G. C. O'KELLY (United Kingdom).
- II. J. GUNDERSEN (Norway).
- III. E. BARRETT (United Kingdom).
- Special Merit* : E. NIXSON (United Kingdom).

## B.—Græco-Roman.

## LIGHT WEIGHT.

- I. E. PORRO (Italy).
- II. N. ORLOFF (Russia).
- III. A. LINDEN (Finland).
- Special Merit* : G. H. MALMSTRÖM (Sweden).

## MIDDLE WEIGHT.

- I. F. M. MARTENSON (Sweden).
- II. M. ANDERSSON (Sweden).
- III. A. ANDERSEN (Denmark).
- Special Merit* : J. JOSEFSSON (Iceland).

**LIGHT HEAVY WEIGHT.**

- I. W. WECKMAN (Finland).
- II. Y. SAARELA (Finland).
- III. C. M. JENSEN (Denmark).
- Special Merit* : (1) H. PAYR (Hungary).
- „ „ (2) F. LARSON (Sweden).

**HEAVY HEAVY WEIGHT.**

- I. WEISZ (Hungary).
- II. PETROFF (Russia).
- III. M. JENSEN (Denmark).
- Special Merit* : (1) H. PAYR (Hungary).
- „ „ (2) E. BARRETT (United Kingdom).

In the Catch-as-Catch-Can style of Wrestling, which is much better understood and practised in this country than the Græco-Roman, a surprise awaited us in the Bantam and Feather Weights, as we made sure of capturing the prizes in these events, but G. N. Mehnert (U.S.A.) showed form quite above any other man in the whole contest, and was undoubtedly the most scientific, both in attack and defence, of any wrestler taking part in the Games. He was quick, strong, and always at work ; everything he did was marked with perfect knowledge, both in theory and execution, and nobody was within measurable distance of him.

In the Feather Weight, J. A. Webster, of the London Amateur Wrestling Club, put up a most marvellous defence, and probably stood the greatest gruelling of any man in any bout during the entire competition from G. S. Dole (U.S.A.), the winner.

In the Middle Weight, the beautifully clean work of S. V. Bacon (United Kingdom), the ultimate winner, deserves notice. His style of good, manly, stand-up wrestling should be held up as a pattern to the modern school. The bout between Andersen (Sweden) and Relwyskow (United Kingdom), also in this weight, was one of the cases where extra time would have been valuable. The judges disagreed ; the referee gave the verdict to Relwyskow. The decision was disputed by the Swedes, but it was based upon the well-accepted fact in British and U.S.A. wrestling that the man who shows the most skill throughout is to get the decision. Andersen was on top most of the time ; but the actual attacks were in nearly every case made by Relwyskow, though Andersen was about eighteen pounds the heavier.

In the Græco-Roman style of wrestling, the Rules as published in a later page of this Report would be much improved by a more complete understanding between the various countries ; as there are many rulings allowed in other countries which are not in agreement with those of the National Amateur Wrestling Association, in whose hands these competitions were placed by the British Olympic Council. In semi-finals



and finals, for instance, the time-limit should be extended from twenty minutes to half-an-hour. It should also be strictly enforced at future meetings (and in both styles) that wrestlers need not necessarily receive even one caution if the referee consider anything unfair or brutal. He should have absolute power to stop this by disqualifying a man immediately without any caution at all. As it is, a competitor may deliberately use tactics which he knows to be unfair until he is stopped doing so.

The plan of having foreign judges for the Græco-Roman bouts proved very successful, as after one or two disagreements, in which the competitors thought the judges were favouring their own nationality, a rule was made for this style of wrestling that no judge should adjudicate for his own country. This did away with any favouritism, and this suggestion came from a foreign judge. After the first day we applied this rule to the judging of all subsequent bouts, and in the Heavy Heavy Weight all the foreign judges requested that the officials should be only English.

Continuing these comments on the Græco-Roman wrestling, it may be added that the victory of A. Porro (Italy) in the Light Weight, and the success of W. Weckman (Finland), 1st, and Y. Saarela (Finland), 2nd, in the Light Heavy Weight, and the victory of Martensen (Sweden) in the Middle Weight, should be noted as having been very good.

As usual, the wrestling between the very heavy men failed to produce good results. The final bouts were decidedly poor, the wrestling being unworthy of so important a contest. By the ill-luck of the draw, one of the best wrestlers, S. M. Jensen (Denmark), was precluded from taking part, but in point of skill he should easily have been first.

We should certainly learn a lesson from the way in which our foreign friends were trained, although it must be remembered that they were over here some weeks before the Games, and had nothing to do but to get into condition, whereas some of our own men had few opportunities for really training. Nevertheless, we should take this lesson to heart ; and I should specially note the Hungarians, who were not only trained in both wrestling and swimming in the very best way, but were thoroughly under the control of Mr. Brüll, who came over with them.

Speaking generally, and the exceptions were very few indeed, the competitors in Græco-Roman wrestling proved themselves the best of sportsmen, and received adverse decisions with the best of feeling, though imperfectly acquainted with the many bars that were insisted upon in this country. The keenness of foreign competitors was, I think, often mistaken for a dissatisfaction with judging, which really did not exist.

Taken as a whole, this style of wrestling was certainly the best of its kind that has ever been seen in this country, and no such demonstrations of what

Græco-Roman wrestling actually is have ever been given in any other country before. To those who understand the game the results were decidedly satisfactory.

#### DETAILS.

##### A.—Catch-as-Catch-Can.

##### I.—BANTAM WEIGHT (119 lb. = 54 kilogrammes).

##### FIRST ROUND.

W. J. Press (United Kingdom) beat H. P. Witherall (United Kingdom).—A very sharp encounter, and after several failures Press won with a double arm roll in 5 min. 27 sec.

F. Tomkins (United Kingdom) beat W. J. Cox (United Kingdom).—Tomkins was the aggressor throughout, and he won with a drop fall in 6 min. 31 sec.

F. Davis (United Kingdom) beat F. W. Knight (United Kingdom).—Both showed great skill, and were very evenly matched. After going the full time of 15 min., Davis won on points.

G. J. Saunders (United Kingdom) beat J. E. Cox (United Kingdom) by an arm hold and press down in 4 min. 22 sec., after a very spirited encounter.

B. Sansom (United Kingdom) beat G. H. Schwan (United Kingdom).—The latter was cautioned for not wrestling. Sansom, doing all the work, won with a half-nelson in 4 min. 31 sec.

The following received byes :—G. N. Mehnert (United States), A. Cote (Canada), and H. O. Sprenger (United Kingdom).

##### SECOND ROUND.

Mehnert beat Sprenger.—The American showed much skill, and won with a press down in 4 min. 1 sec.

Cote beat Davis.—The Englishman soon went to the mat, and the Canadian, working well from the uppermost position, gained the verdict on points.

Press beat Sansom.—Press did all the work, and won with a press down after a good bout lasting 8 min. 48 sec.

Tomkins beat Saunders by means of a neck hold and press down in 4 min. 57 sec., the winner showing skill and strength.

##### THIRD ROUND.

Mehnert beat Cote.—The American, securing top position, tried a crutch hold, but failed, and after some very fast work by both, he put on a crutch hold, and with a roll won in 6 min. 40 sec.

Press beat Tomkins.—A short but sharp struggle, in which Press, with a double arm roll, won in 55 sec.

##### CONTEST FOR THIRD PRIZE.

Cote beat Tomkins.—After fencing some time for a hold, in which strong defence was shown, Tomkins secured the uppermost position with a crutch hold. Failing at this, he tried a forward hold and chancery, but Cote, stepping up, brought his opponent square on the mat in 3 min. 55 sec. At their second meeting both were cautious, and the Englishman, trying an outside click, was foiled. Cote brought his man down from a swing, and with a crutch hold and a half-nelson he levered his opponent over, and won in 8 min. 50 sec.

##### FINAL.

G. N. Mehnert (United States) beat W. J. Press (United Kingdom).

The general movements were very fast, but going to the mat both claimed falls from a roll. Even wrestling followed, in which the American tried a crutch hold and press, following with a double arm roll, but failed. Mehnert again got on a crutch hold, and quickly applying a half-nelson he secured the first fall in 11 min. 45 sec.

In the second bout Mehnert tried an outside stroke, but Press slipped away. The American, rushing in, got on a waist hold and downed his man. From a crutch he pivoted Press, but failed to bring him over. While Press was in a sitting position Mehnert rushed in and Press fell backwards, the American winning in 3 mm. 57 sec.

George N. Mehnert (United States) stands 5 ft. 3 in., weighs 118 lb., and has been wrestling some nine years. In 1901 he won the Metropolitan and American Championships, the former being an event open to a 90 miles radius of New York. These events he has now secured for six years in succession. In 1906, at St. Louis, he won the Bantam Weight Championship. He holds an unbeaten record.

W. J. Press (Hammersmith A.W.C.) stands 5 ft. 3½ in., and weighs 8 st. 5 lb. He commenced wrestling nine years ago, and won the Northampton Institute open competition in his first year.

A. Cote (Canada), who secured third place, is 27 years of age, stands 5 ft. 3 in., and weighs 8 st. 3 lb. In 1905 he was second in the 115 lb. and 125 lb. Championships of Canada, having then been wrestling some four years. He won both the above events in 1906. Since he came to the front he has not been beaten until this event.

## II.—FEATHER WEIGHT (113 lb. = 60·3 kilogrammes).

### FIRST ROUND.

A. J. Goddard (United Kingdom) beat R. Couch (United Kingdom).—Some fine head fencing was followed by Couch trying a cross buttock and both went to the mat. Goddard tried a crutch hold, but Couch bridged and gained top position. At the end of four minutes the latter tried a cross buttock, but Goddard put on a leg hold, and followed with a crutch hold. Couch bridged, and then Goddard, with a double arm roll, won in 10 min. 48 sec.

J. G. White (United Kingdom) beat W. F. Jones (United Kingdom).—White first tried an outside stroke and Jones a double leg hold. Outside strokes and hangs followed by both, and White, bridging, got out of difficulties. White, with an outside stroke, was foiled by Jones's leg and arm hold, and afterwards a quarter-nelson, but White, with a forward hold and chancery, won in 11 min. 56 sec.

G. S. Dole (United States) beat P. H. Cockings (United Kingdom).—The American tried for a leg hold, and Cockings neatly foiled his opponent with an outside stroke. Dole, however, secured the top position, and' tried a hang. Cockings went for a leg hold and roll, and Dole slipped on a half-nelson, but the Englishman bridged and got clear. Dole put on a locked half-nelson, but Cockings countered with a roll, and the American again had a half-nelson. At the expiration of time Dole gained the verdict on points.

J. A. Webster (United Kingdom) beat W. T. Adams (United Kingdom).—For the first two minutes only head fencing was seen. Then Webster, rushing in, picked up his opponent and planted him square on the mat in 2 min. 14 sec.

The following received byes :—W. Tagg, J. P. Slim, S. J. Peake, and W. McKie (United Kingdom).

### SECOND ROUND.

Slim beat Peake.—At a minute and a half they went to the mat, Slim being uppermost. Peake tried an arm roll, but Slim put on a crutch hold and spoil the effort. At five minutes both were on their feet. Peake tried a forward hold and chancery, but Slim bridged and got clear. The latter then managed a crutch hold, and beat his man in 9 min.

Dole beat Webster.—The latter rushed in, and lifting his man brought him to the mat, but on his trying a locked half-nelson the American came up. Then Dole got behind, and put on a body hold, from which Webster tried a double arm roll. From this Dole secured a head and waist hold, and for over eight minutes a great struggle was seen. At full time the verdict went to the American on points.

Tagg beat Goddard.—Tagg from behind tried a quarter-nelson, but Goddard bridged, and got on a leg and arm hold, but he was foiled. Tagg followed with a half-nelson, and won in 5 min.

McKie beat White.—The winner did all the work throughout, and towards the finish tried a cross buttock and an outside click. In the last minute he picked up his man and downed him, but unfortunately for him the fall was off the mat. Nevertheless, he won on points.

### THIRD ROUND.

Slim beat Tagg.—Tagg stepped in for a cross buttock, but Slim got out of danger with a double arm roll. The former followed with a quarter-nelson, and Slim, from a roll, gained top position. Twice the latter got on a crutch hold, and then Tagg, coming over with a quarter-nelson, broke out of danger. Slim put on a quarter-, and then a half-nelson, and the bout going the full time he gained the award on points.

Dole beat McKie.—The latter picked up his man and planted him on the mat, but Dole, coming over, tried a waist hold, and then a half-nelson. McKie then gave in, the bout having lasted 6 min.

### CONTEST FOR THIRD PRIZE.

W. McKie (United Kingdom) beat W. Tagg (United Kingdom).—It was not till after eleven minutes' fencing that the men went to the mat, and the referee cautioned them for not wrestling. McKie at once rushed in, and got on a waist hold, and gaining top position tried a crutch hold without result. He, however, secured the first bout on points. Tagg then retired, and McKie became the winner of the third prize.

### FINAL.

G. S. Dole (United States) beat J. P. Slim (United Kingdom).

Dole started with a waist hold, but Slim broke away, and the American secured top position with a leg hold. Dole tried a half-nelson, and later an arm and crutch hold, Slim getting out by the aid of a roll. Again the American put on a crutch hold, and following with a half-nelson, he won the first bout in 9 min. 28 sec.

At the second meeting Dole at once dashed in, and getting on a waist hold, came to the mat with top position. Trying an arm and crutch hold, he put on a half-nelson. Turning to a locked half-nelson, he again changed to a standing half-nelson, but time expiring, the Yale man gained a victory on points.

G. S. Dole (United States), a student of Yale University, weighs 133 lb., stands 5 ft. 3½ in., and is 23 years of age. Has been wrestling four years, winning the Inter-Collegiate Championship each year. In 1907 he secured the 125 lb. American Championship, and won the 135 lb. in 1908.

J. P. Slim (Hammersmith A.W.C.), the runner-up, commenced wrestling in 1901, and has been British Champion thrice, including the Cumberland Championship.

W. McKie (Olympic A.W.C.) is 22 years of age, stands 5 ft. 7 in., and weighs 9 st. 7 lb., and this was his first year of wrestling.

### III.—LIGHT WEIGHT (147 lb. = 66·6 kilogrammes).

#### FIRST ROUND.

J. H. Krug (United States) beat J. Hoy (United Kingdom).—With a waist hold Krug secured top position, but putting on an arm and crutch hold Hoy bridged cleverly and got clear. He then tried a leg and arm hold, and Krug followed with a crutch hold. Hoy, in trying an arm and leg hold, fell into a waist and arm hold, but, bridging, was clear. Krug put on a half-nelson, but Hoy with a double leg hold all but gained a fall, and only Krug's fine bridging saved him. At time the American was given the award.

G. de Relwyskow (United Kingdom) beat W. J. P. Henson (United Kingdom).—The former with a leg hold gained top position, but Henson tried to come up, and Relwyskow put on a waist hold and brought him down again. The latter, with a crutch and arm hold, was foiled by Henson's double leg hold. Coming to their feet, Relwyskow with a leg hold again gained top position, and won with a half-nelson in 6 min. 4 sec.

W. Wood (United Kingdom) beat G. A. Faulkner (United Kingdom).—Wood at once brought his man down with a leg hold, but Faulkner, trying a neck hold and a roll, gained top position. He then put on a crutch and arm hold, but Wood, getting clear, followed with a crutch and further arm hold and changed to a half-nelson. Then Wood had an arm hold countered by a leg hold, but the former gained the verdict on points.

The following received byes :—A. Gingell, H. Baillie, G. Mackenzie, J. McKenzie, and W. H. Shepherd (United Kingdom).

#### SECOND ROUND.

G. Mackenzie beat J. McKenzie.—After fencing for a minute and a half J. McKenzie brought his man down with a double arm hold, and his opponent, trying an arm hold, secured top position. In trying a further arm hold, J. McKenzie was cautioned. With an arm roll G. Mackenzie succeeded in 6 min. 20 sec.

Gingell beat Baillie.—Gingell tried a cross buttock, and Baillie secured top position. Then Gingell attempted a leg and arm hold, which his opponent countered with a double leg hold. When both regained their feet Baillie slipped on a waist hold, and then secured an arm roll. Gingell won with an arm roll in 10 min. 24 sec.

Relwyskow beat Shepherd.—The former, with a leg hold, secured top position, and then a waist hold, but his opponent, from a pivot, got clear. Relwyskow tried an arm and waist hold, and another fine head spin by Shepherd was seen. The former, with a leg hold, got uppermost, and after an arm and waist hold, time expired, Relwyskow gaining the award on points.

Wood beat Krug.—The American, with a waist hold, gained top position, and in trying an arm and crutch hold he was cautioned. Then Wood reversed positions, and followed with a crutch and arm hold, and continuing the crutch hold, he picked his man up and dropped him square in 6 min. 8 sec.

#### THIRD ROUND.

Relwyskow beat Gingell.—The former, with a leg hold, secured the advantage, and followed with a waist hold, and both rose to their feet. Relwyskow put on a leg hold, and turned to a crutch hold and a further arm hold. Then with an arm hold he brought his man over in 7 min. 44 sec.

Wood beat G. Mackenzie.—Fast head fencing took place for two minutes, and then Wood tried for a leg hold, but his opponent came over on top, and trying an arm hold lost his position. Wood, with a waist hold, brought his man down, and putting on a crutch hold, he turned to a further arm hold, and won in 14 min. 41 sec.

## CONTEST FOR THIRD PRIZE.

A. Gingell (United Kingdom) beat G. Mackenzie (United Kingdom).—Gingell tried a cross buttock in the first minute. His opponent countered with a waist hold, and came over with a roll into uppermost position. Gingell put on a leg and arm hold, but Mackenzie bridged and got clear. His opponent managed an arm and leg hold, and won in 6 min. 44 sec. In the second bout over three minutes were wasted, and both were cautioned. Mackenzie rushed in, and with a waist hold and an arm roll won in 5 min. 30 sec. The deciding bout saw Mackenzie on top, with a leg hold, but Gingell came out, and put on a half-nelson and crutch hold, and won in 3 min. 20 sec.

## FINAL.

G. de Relwyskow (United Kingdom) beat W. Wood (United Kingdom).

The former, from a waist hold, gained top position, and followed with an arm hold, but nothing resulted, and both came to their feet. Again Wood went to the mat from a leg hold, and Relwyskow, trying a half-nelson, turned to a quarter nelson. After a few minutes' ground work time expired, and Relwyskow gained the award on points. In the second bout the leader again took top position with a waist hold and half-nelson, followed by a further arm hold, but nothing resulted. Coming to their feet, Relwyskow put on a waist hold, and bringing his man down he tried a half-nelson. Time was called, and he again secured the verdict on points.

G. de Relwyskow, the winner, stands 5 ft. 8½ in., weighs 10 st. 3 lb., and is 20 years of age. He has been wrestling 3½ years, during which period he has won 35 open competitions. In 1907 he won the English Light Weight and Middle Weight Catch-as-Catch-Can Championships, repeating the same victories in 1908.

W. Wood (London Amateur Wrestling Society), who was second, is 20 years of age, stands 5 ft. 8 in., and weighs 10 st. 6 lb. He has been wrestling six months.

A. Gingell (Easton A.W.C.) is 25 years of age, weighs 10 st. 5 lb., and stands 5 ft. 9 in. He is a native of Bristol, and has been wrestling four years.

## IV—MIDDLE WEIGHT (161 lb. = 73 kilogrammes).

## FIRST ROUND.

A. Coleman (United Kingdom) beat A. E. Wallis (United Kingdom).—After fencing for a hold for two minutes Coleman stepped in, and slipping on a crutch hold he swung his man to the mat in 2 min. 44 sec.

E. H. Bacon (United Kingdom) beat G. A. Bradshaw (United Kingdom).—Bradshaw at once forced the work, but fell into a trap set by Bacon, who put on a double arm hold and rolled his man over in 1 min. 55 sec.

G. de Relwyskow (United Kingdom) beat H. Challstorp (Sweden).—The Swede got behind and tried a forward hold and chancery, but failed. Relwyskow, getting on a double arm lock, won from a roll in 3 min. 10 sec.

S. V. Bacon (United Kingdom) beat H. R. Chenery (United Kingdom).—A scientific bout, in which Chenery tried a cross buttock, but failed. Further, he tried a half-nelson, which resulted in Bacon following with a double arm roll. Chenery, bridging, secured the same hold, but his opponent cleverly bridged, and getting on a crutch hold he won with a roll over in 4 min. 48 sec.

The following received byes :—F. Beck (United Kingdom), J. H. Craig and F. Narganes (United States), C. G. Anderson (Sweden).

## SECOND ROUND.

Beck beat Narganes.—This was a great surprise, for after a considerable amount of fencing the American inter-collegiate champion went down from a cross buttock, and Beck won in 2 min. 49 sec.

Anderson beat Craige.—Anderson at once got behind and tried a crutch hold without effect. Craige tried an arm roll, but Anderson slipping on a half-nelson from the opposite side, the American bridged, and got clear. Waist and crutch holds followed, but each failed to gain the advantage, and going the 15 min., Anderson won on points.

S. V. Bacon beat Coleman.—At two minutes they went to the mat, Bacon securing the top position, and he tried a forward hold and chancery. It was not for several minutes that he could gain his point, for Coleman, with a strong bridge, held on, but went down in 5 min. 17 sec.

Relwyskow beat E. H. Bacon.—Once in holds, Relwyskow got the uppermost position, Bacon getting on a leg hold. The former tried an arm hold, and afterwards a crutch hold, but Bacon put on a leg hold or hank and showed good defence. Getting up, Relwyskow put on an arm hold, and brought his man to the mat. Then Bacon bridged in fine style, but went down in 6 min. 30 sec.

## THIRD ROUND.

S. V. Bacon beat Beck.—After a considerable amount of head fencing Beck from a leg hold secured top position, and tried a quarter-nelson, from which Bacon broke away. The latter then tried a crutch hold, and followed with a standing half-nelson. Beck again broke away, but from a forward hold and chancery he fell into a double arm hold, and was rolled over in 3 min. 20 sec.

Relwyskow beat Anderson.—It was only after  $9\frac{1}{2}$  minutes' finessing, in which both put in some very fine work, that they got to the mat. Then the Englishman, in trying a cross buttock, was cautioned, and Anderson secured top position. The Swede tried a waist hold, but could not bring his man over, whilst Relwyskow tried an inside click. The bout went the full time, and Relwyskow gained the verdict on points. The Swedish supporters protested that their man had done all the work. The matter was sent up to the Council to decide, and they upheld the judge's decision.

Anderson retiring, Beck walked-over for third prize.

## FINAL.

S. V. Bacon (United Kingdom) beat G. de Relwyskow (United Kingdom).

Bacon opened with a waist hold, but Relwyskow trying a crutch hold secured top position. The latter tried a leg and arm hold, and both came to their feet. Going down Bacon tried a quarter, and then a crutch hold, but his opponent, countering with a similar hold, got away. Each in turn secured the advantage, and Bacon was awarded the verdict on points at the expiration of 15 minutes. In the second bout Bacon rushed in and secured a waist hold, and later a leg hold and half-nelson. He maintained top position until the last minute. Then Relwyskow tried a leg hold, and on time being called Bacon secured the verdict.

S. V. Bacon is 22 years of age, stands 5 ft. 3 in., and weighs 10 st.  $9\frac{1}{2}$  lb. In 1904 he won the German Gymnasium Society  $10\frac{1}{2}$  st. In 1906 he won the Light Weight Cumberland Championship, and Light Weight and Middles in 1907.

## V.—HEAVY WEIGHT (over 161 lb.).

## FIRST ROUND.

L. Bruce (United Kingdom) beat A. Banbrook (United Kingdom).—After a minute's fencing the latter tried for a leg hold, but Bruce gained top position and tried a crutch hold, and later a quarter-nelson. Going on, he gained the advantage with an arm hold and half-nelson, and won in 3 min. 25 sec.

J. Gunderson (Norway) beat W. West (United Kingdom).—After a very even three minutes, West tried a cross buttock, but Gunderson escaped with a bridge. He put on a half-nelson and crutch hold, and turning to a waist hold he brought the Britisher down with a half-nelson in 6 min. 20 sec.

G. C. O'Kelly (United Kingdom) beat L. J. Talbot (United States).—The latter at once closed in, but O'Kelly got behind, put on a leg hold and an arm hold, and beat his man easily in 1 min. 20 sec.

The following received byes :—E. Barrett, F. H. Humphreys, E. E. Nixon, C. H. Brown, and H. J. Foskett (United Kingdom).

#### SECOND ROUND.

Barrett beat Brown.—At two minutes Barrett managed a strong neck hold, and brought his opponent down with a crutch hold. Brown bridged, but went down from a body press in 3 min. 20 sec.

O'Kelly beat Foskett.—Foskett first tried for a leg hold, and O'Kelly got behind and tried a neck and crutch hold. Changing to an arm and crutch hold, he turned a half-nelson, and won in 4 min. 5 sec.

Gunderson beat Humphreys.—The former with a leg hold brought his opponent down, and followed with a half-nelson and crutch hold, but the Englishman tried a roll and a combined waist and arm hold, but nothing resulted. The referee cautioned the men for not wrestling. The Norwegian, still keeping the upper position, failed with a crutch hold, but gained the award on points.

Nixon beat Bruce.—Bruce tried for a leg hold after two minutes' fencing. Nixon turned over from a half-nelson, tried the same hold, and defeated his man in 3 min. 50 sec.

#### THIRD ROUND.

Gunderson beat Nixon.—The latter went to the mat from a neck hold, and then Gunderson tried a half-nelson and crutch hold. After this much time was wasted, and the latter was cautioned for not working. Nixon tried to overcome his man, but Gunderson slipped on a half-nelson and crutch, and won in 9 min. 37 sec.

O'Kelly beat Barrett.—The Hull man, with an outside stroke, lifted Barrett off his feet, and, putting on a further arm and crutch hold, he won in 2 min. 14 sec.

#### CONTEST FOR THIRD PRIZE.

E. Barrett (United Kingdom) beat E. E. Nixon (United Kingdom).—Barrett secured a leg hold, from which he changed to a body hold. Picking up his opponent, he brought him to the mat, and won with a half-nelson and arm hold in 3 min. 4 sec. On facing each other again, a capital display of scientific wrestling was seen. Barrett got behind and applied a waist hold. Then, putting Nixon to the mat, he tried a crutch hold, Nixon bridging and getting clear. Barrett, with a waist hold, got top position, and won with a press down in 4 min. 52 sec.

#### FINAL.

G. C. O'Kelly (United Kingdom) beat J. Gunderson (Norway).

O'Kelly at once brought his opponent to the mat with a neck hold, then putting on a half-nelson and crutch hold, but the Norwegian released himself. O'Kelly again slipped on a half-nelson, and Gunderson, turning in, countered with a leg and arm hold. O'Kelly secured top position, and won with a waist hold and half-nelson in 13 min. 27 sec. In the second bout O'Kelly brought his opponent down from a forward hold and chancery. Then, trying a half-nelson, Gunderson countered with a roll. O'Kelly then pulled his man backwards, and brought him to the mat with a body hold and press down in 3 min. 35 sec.



G. C. O'Kelly (Hull A.W.C.) stands 6 ft. 3 in., weighs 15 st. 11 lb., and was 22 years of age. He comes from Cork, and was a member of the Hull Police Fire Brigade. The circumference of his neck is 22 in., and of his chest 50½ in. In 1907 he won the Heavy Weight Amateur Championship.

J. Gunderson (Norway) is 33 years of age, stands 5 ft. 10 in., and weighs 13 st. He has resided in New York for nine years, and belongs to the American Norwegian A.C. He has been wrestling seven years, but it was not until 1906 that he won the 184 lb. Metropolitan Championship. He was again successful in 1907. He won the American Championship at the same weight in 1907 and 1908.

E. Barrett (City of London Police A.C.) is 26 years of age, stands 6 ft. 1 in., and weighs 15 st. 9 lb. He is an Irishman from North Kerry. In 1906 he won the Cumberland Style Championship. In 1908 he won the British Championship. He was also a member of the successful City Police tug-of-war team.

## B.—Græco-Roman.

### I.—LIGHT WEIGHT (147 lb. = 66·6 kilogrammes).

#### FIRST ROUND.

G. H. Malmstrom (Sweden) beat G. Mackenzie (United Kingdom).—The Swede brought his man down with a double arm hold, and following with a single arm hold and press down he won in 3 min. 35 sec.

A. Linden (Finland) beat L. Hansen (Belgium).—After fencing for a hold Hansen went to the mat, but the Finn, with a strong arm hold, levered his opponent over at the second attempt in 2 min. 33 sec.

A. E. Hawkins (United Kingdom) beat C. Carlsen (Denmark).—A very sharp bout, the Britisher gaining his point from a roll in 1 min. 10 sec. So fast was the fall that the judges disagreed.

K. C. Karlsen (Denmark) beat F. Steens (Belgium).—Steens at once started pushing his man all over the mat. After five minutes' sharp work by both, the Dane got on a double arm hold, but failed to gain the fall. Steens in bringing his man over his head forgot to bridge, and put his own shoulders down at 9 min.

W. Wood (United Kingdom) beat K. Halik (Bohemia).—Halik soon gained top position, but from a roll and bridge his opponent reversed matters. Working well, Halik showed good science, but found his man too strong to bring over from an arm hold. Again Wood bridged strongly from an arm hold and rose. The bout going the full time, Wood, who was always in front, won well on points.

E. Radvany (Hungary) beat W. Ruff (United Kingdom).—The Hungarian soon put on a neck hold, but going to the mat he lost his advantage. Ruff broke away, and gained top position, but soon lost it, his opponent crossing over from a lift and arm hold. Radvany, working from a body hold, could make no headway. Twice he tried a half-nelson, but picking his man up he won with a drop fall in 18 min. 35 sec.

F. Marothi (Hungary) beat A. E. Rose (United Kingdom).—Here far too much finessing was seen, and though the Hungarian twice tried a body lift, Rose was equal to the occasion. An appeal was made against Rose for breaking the rules, but the officials decided in his favour. After a body hold and lift, Rose went down in 14 min. 59 sec. from a roll over.

A. C. Moller (Denmark) beat A. J. Whittingstall (United Kingdom).—The latter showed good form in holds, but Moller, with a neck hold, won in 3 min. 59 sec.

M. Teger (Hungary) beat J. van Moppes (Holland).—Fast fencing was seen for several minutes, but Teger, gaining top position, all but won with an arm lock and roll. Continuing to force the work with a body hold, he failed to bring his man over, and at the close won on points.

The following received byes :—E. J. Blount and G. A. Faulkner (United Kingdom), E. Porro (Italy), U. O. Bruseker (Holland), E. Lund and G. H. Persson (Sweden), and N. Orloff (Russia).

## SECOND ROUND.

Persson beat Blount.—Stepping out with an arm hold, Persson brought his opponent over with a flying mare. Gaining top position, Blount tried a double arm hold and roll, but the Swede was too strong. Persson, coming from underneath, put on an arm hold, and won with a cross body hold and press down in 7 min. 6 sec.

Orloff beat Lund.—Again there was an absence of ground work, and Orloff forced the exchanges. At ten minutes he obtained a powerful cross body hold, and though Lund bridged cleverly he went down in 10 min. 46 sec.

Linden beat Karlsen.—The Finn soon brought his man over, but the Dane bridged, and picking up Linden downed him heavily. Both bridged cleverly from a series of locks and rolls, and Linden, getting on a double arm hold, put his man down square in 4 min. 15 sec.

Malmstrom beat Bruseker.—The Swede soon gained top position, and worked for a body hold. He brought his man over, and Bruseker bridged, but from a lift he went down in 3 min. 20 sec.

Radvany beat Hawkins.—From a cross buttock the latter went down in 17 sec.

Marothi beat Wood.—The Hungarian, working from top position, was unable to get a hold on Wood for over nine minutes, and then in bringing Wood over the latter got clear. Marothi won on points.

Moller beat Faulkner.—Faulkner, going to his knees, tried a body hold, but to no purpose, and was twice brought over from an arm hold and roll. Both put in some very fast exchanges. Moller tried an arm roll, and swinging his man over, a rather doubtful fall was given. Time, 11 min. 18 sec.

Porro beat Teger.—The Italian put on a body hold without result. Twice he tried to bring his man down from an arm throw. Continuing to force the work, he twice swung the Hungarian down. Fencing for a hold, both showed very fine defence, and, going the full time, Porro won on points.

## THIRD ROUND.

Orloff beat Radvany.—The Hungarian, in trying an elbow roll, almost went down, and his opponent, putting on a strong cross chest hold, had him in difficulties, and won with a press down in 7 min. 16 sec.

Linden beat Moller.—Linden brought his man down at three minutes, and all but won, but, finishing the fall off the mat, they again took the centre. Shortly afterwards they got in holds off the mat, and later Linden went down with an arm hold without result. From an elbow roll, however, he won in 13 min. 32 sec.

Porro beat Malmstrom.—The Swede, changing from a body hold, made a hip throw from an arm hold, but fell short. He then tried an arm throw and Porro a bridge throw, the latter being a very fine movement. The Swede put on an arm and body hold and came down, and the Italian bridged. Both tried elbow rolls, and each showed skilful defence from very fast movements. The Swede was capital in his double arm throws, but Porro won on points.

G. H. Persson a bye, F. Marothi retiring.

## FOURTH ROUND.

N. Orloff (Russia) beat A. Linden (Finland).—The Russian brought his man down and at once tried for a waist hold, but was smartly countered by an arm roll, and both came off the mat. Orloff again secured top position, but on putting on a waist hold and press over his opponent bridged, and reversed things. Linden tried an arm roll, and his opponent a half-nelson, but nothing resulted. The bout went the full time, and Orloff gained the award on points.

E. Porro (Italy) beat G. H. Persson (Sweden).—The Italian picked his man up with a waist hold and fell back into a bridge throw, bringing his opponent over his head, but without result. Shortly afterwards he repeated the manœuvre, and defeated his man in 2 min. 5 sec.

## CONTEST FOR THIRD PRIZE.

A. Linden (Finland) beat G. H. Persson (Sweden).—Linden slipped out of a head hold, brought his man down with a cross buttock, and won the first bout in 50 sec. On taking the centre again both went to the mat, and Linden tried an arm hold, but Persson bridged and got clear. The Finn again put on an arm hold, and beat his opponent in 2 min. 25 sec.

## FINAL.

E. Porro (Italy) beat N. Orloff (Russia).

After two minutes' fencing, the Italian tried a cross buttock, but head fencing followed. Still forcing the pace, he tried a waist hold and later a cross buttock, but at "time" a further 10 min. was ordered. It was not till six minutes later that any important movement was seen. Then Porro tried a cross buttock, and the bout went the 30 min., during which very little mat work was seen. Porro gained the award on points. There was very little wrestling in the second bout till Orloff pulled his man to the mat. Porro broke from a waist hold and got clear, and then tried a cross buttock, followed by a waist hold. Twice he tried his back fall and bridge, and head fencing following, both were cautioned. Porro stepped in and tried the throw again, and at 20 min. gained the award on points.

E. Porro is 23 years of age, and has never been beaten. He is a sailor from Milan, and holds the 65 kilogs Championship of Italy and Europe.

## II—MIDDLE WEIGHT (161 lb. = 73 kilogrammes).

## FIRST ROUND.

J. Belmer (Holland) beat W. Gruntlmann (Germany).—The Dutchman bridged in fine style, and after getting out of difficulties he put on a double arm hold, and won with a roll in 3 min. 54 sec.

F. M. Martenson (Sweden) beat J. Jakoubek (Bohemia) with a cross chest hold and press down in 8 min. 54 sec.

M. Andersson (Sweden) beat S. V. Bacon (United Kingdom).—The Swede at once attacked, and brought Bacon over with a half-nelson, winning in 5 min. 4 sec. with an arm hold and press down.

F. Beck (United Kingdom) beat H. Challstorp (Sweden).—After six minutes' defence Beck put on a double arm hold, but found his opponent too strong to bring over. Coming to the mat, Beck all but won from a flying fall, but the judges did not agree, and after a full twenty minutes he gained the award on points.

A. A. Larson (Denmark) beat G. F. Duym (Holland).—The Dane at once rushed in, but Duym, going down, bridged cleverly. Each in turn took the uppermost position, Larson winning from a roll and press down in 18 min. 59 sec.

The following received byes :—G. A. Bradshaw (United Kingdom), E. H. Bacon (United Kingdom), J. Tyfa (Bohemia), J. Lorenz (Holland), A. Lelie (Holland), A. P. R. Frank (Sweden), A. Andersen (Denmark), J. Eriksen (Denmark), J. Josefsson (Iceland), G. Demine (Russia), M. Orosz (Hungary).

## SECOND ROUND.

Eriksen beat E. H. Bacon.—Bacon put up a stubborn defence, bridging time after time ; but, going to the mat again, the Dane won with a press down in 9 min. 30 sec.

Andersen beat Lorenz.—Though going the full time there was an absence of first-class work, and neither gained a fall. In the end the Dane gained a close verdict on points.

Frank beat Demine.—The Russian showed a strong defence, but Frank, having the advantage in height and reach, scored the quicker, and won easily on points after full time.

Josefsson beat Orosz.—After several rolls and locks the Icelander got on a neck hold, and won with a press down in 12 min. 10 sec.

Belmer beat Tyfa.—Tyfa had the advantage in height, whilst Belmer showed greater strength. After a neck hold Tyfa pivoted, and was on his back in 6 min.

Martenson beat Bradshaw.—The Swede was far too strong for the English man, who was beaten with a half-nelson in 7 min. 57 sec.

M. Andersson beat Beck.—Andersson at once secured the top position, but Beck showed clever defence. Try all he knew, the Swede failed to get a hold on him, but going the full time he won on points.

Larson beat Lelie.—A very poor pair, no ground work being seen for over nine minutes. Shortly afterwards Lelie went down from an arm hold, with no result, and after a tame bout Larson won on points.

#### THIRD ROUND.

Josefsson beat Frank.—Twice the winner got on a neck hold, but failed. With a strong arm and press over, however, he won in 2 min. 30 sec.

A. Andersen beat Belmer.—The best bout yet seen, Andersen bringing his man to the mat with a cross buttock, followed with a body hold. Belmer bridged and got out of danger, only to be beaten by a neck hold and press down in 6 min. 20 sec.

M. Andersson beat Eriksen.—A well-matched pair, each in turn showing to advantage. The Dane got on a strong cross chest hold, and won with a press down in 6 min. 22 sec.

Martenson beat Larson.—Absence of ground work marked the bout, which went the full time.

#### FOURTH ROUND.

F. M. Martenson (Sweden) beat A. Andersen (Denmark).—Over eight minutes was spent in fencing for a hold, and it was not until two minutes later that they went to the mat. At sixteen minutes Andersen with a cross buttock brought his opponent down, but the fall being off the mat it was not allowed. At twenty minutes a further ten minutes was ordered, in which the Dane going down, bridged, and rolled over. Martenson put on an arm hold and secured a fall, but off the mat. Then with a further body and neck hold he won with a press down in 24 min. 20 sec.

M. Andersson (Sweden) beat J. Josefsson (Iceland).—Slipping from a neck hold Josefsson went to the mat. Obtaining the top position the Swede tried a body hold, arm hold, and press over. Coming over with an arm lock and neck hold Josefsson got on top, but the Swede coming out with a double arm lock, his opponent bridged, and both rose. At fifteen minutes both tired, and Josefsson in trying to bring his man down all but gave a fall away. The bout went the full time, and the Swede gained the referee's casting-vote.

#### THIRD PRIZE.

This was a "walk-over" for A. Andersen, owing to the absence of J. Josefsson, through a fractured arm sustained in the fourth round.

#### FINAL.

F. M. Martenson (Sweden) beat M. Andersson (Sweden).

Following some two minutes' head fencing, Andersson tried for a cross buttock, but got off the mat. Then he tried for a head hold, but was countered by a cross buttock, and both came to the mat. Martenson tried an arm hold, and his opponent bridged and got clear. Andersson then endeavoured to obtain a head hold, but Martenson with a waist hold brought him down, and followed

with a head and arm hold, and both rose. Andersson again tried a cross buttock, but was countered by a waist hold, and going the full twenty minutes Martenson gained the award on points. On again taking the centre both went into holds, and Andersson tried a double arm hold, but Martenson broke clear. Andersson followed with an arm roll, and Martenson gained top position and followed with an arm hold, but Andersson, bridging, escaped. Martenson tried a waist hold and half-nelson, and picking his man up threw him, and won in 6 min. 25 sec.

F. M. Martenson (Sweden) is 24 years of age, and weighs 70 kilogs. When sixteen years of age he won the 65 kilogs Wrestling Championship at Malmo. He won the International Competition at Copenhagen between Sweden and Denmark in 1907.

M. Andersson (Sweden), who was second, is 21 years of age, and weighs 73 kilogs. He has been wrestling four years, and is a pupil of the winner, who beat him in 1907 for the Swedish Championship.

A. Andersen (Denmark) is 26 years of age, and weighs 70 kilogs. He commenced wrestling nine years back, and is a member of the Sparta A.C.

### III.—LIGHT HEAVY WEIGHT (205 lb. = 93 kilogrammes).

#### FIRST ROUND.

Y. Saarela (Finland) beat C. H. Nielsen (Denmark).—Saarela put on an arm hold and at once sent his man to the mat. Twice he failed to bring his man over, but getting on a half-nelson he won with a press down in 3 min. 50 sec.

F. Larson (Sweden) beat J. H. Christensen (Denmark).—Cross chest and body holds followed in quick succession by both in the first two minutes. Gaining the top position, Larson applied a bar-nelson, but to no purpose, and went to the mat. Later he came over with a body hold, but the Dane bridged. They continued to show much skill with arm holds. Going the full time, Larson gained the referee's casting-vote.

W. West (United Kingdom) beat M. Susterka (Bohemia).—After finessing for three minutes West went to the mat, but Susterka failed to get on a hold. West, working with great determination, did well from an arm hold, and slipping on a cross chest hold he won with a press down in 7 min. 29 sec.

D. Wybrands (Holland) beat G. Luntzer (Hungary).—Rushing in, Wybrands put on a strong neck hold and went down. Both tried arm locks without result. Working from a double armhold, Wybrands came in with a single arm lock, and from a side press down he won at 5 min. 33 sec.

M. du Bois (Belgium) beat H. J. Foskett (United Kingdom).—Bringing his man down with an arm hold, Bois won from a roll in 1 min. 30 sec.

The following received byes :—E. E. Nixson, A. Banbrook, and C. H. Brown (United Kingdom) ; C. M. Jensen (Denmark) ; J. van Westerop (Holland) ; A. Meessen (Belgium) ; J. Kivimaki and W. Weckman (Finland) ; E. Zamotine (Russia) ; H. Payr (Hungary) ; L. van Oosten (Holland).

#### SECOND ROUND.

Banbrook beat Meessen.—Meessen tried a body and swing, but failed, and Banbrook, slipping on a double arm lock, just failed from a roll over. Working well from the top position, he gradually brought his man over with a double arm lock, and with a press down won in 7 min. 11 sec.

Payr beat Zamotine.—Zamotine got on a double arm hold, but in the roll Payr bridged, and the former got into difficulties. Payr forced the work from top position, but the Russian showed great strength for his weight. Coming from a roll both bridged, and Payr, slipping on a strong arm hold, brought his man down in 9 min. 8 sec.

Westerop beat Kivimaki.—A very evenly-matched pair, and the Finn working well from a body hold gained top position. After eight minutes' wrestling he tried for an arm lock and roll, but to no purpose. Gaining top position again, Kivimaki from an arm lock put in great work to bring his man over in the last few minutes, but Westerop gained the award on points.

Jensen beat Oosten.—Jensen, bringing his man smartly down from an arm hold, slipped and lost the advantage, which gave Oosten the top position. Jensen applied a wrist hold, and won with a press down in 8 min. 41 sec.

Saarela beat Nixson.—Saarela put on an arm hold, came up, and rolling Nixson over, got on a cross chest hold. Although the latter bridged, he was pressed down in 2 min. 31 sec.

Larson beat Wybrands.—Larson quickly brought his man down, but with an arm lock and body hold failed to gain the fall. Later, with a half-nelson, he found Wybrands too strong to bring over. It was not till the last minute that Larson got on an arm and body hold, but time saved Wybrands, and the Swede gained the award on points.

Weckman beat West.—West put on a neck hold and went to the mat, but from a roll the Finn got on an arm roll and press down, and won in 1 min. 53 sec.

Du Bois beat Brown.—A very sharp bout, in which the winner all but won in the first few seconds, but with a double arm hold and roll he gained the award in 1 min. 35 sec.

#### THIRD ROUND.

Saarela beat Du Bois.—Fast work was the order on taking the mat, each in turn being seen to advantage. At four minutes Saarela put on a double arm lock and roll, but Du Bois bridged, and the men rose. From a roll Saarela got on an arm hold, and with a body press down he won in 12 min. 24 sec.

Jensen beat Banbrook.—Once on the mat, Jensen brought his man over with a neck hold, and though Banbrook bridged, Jensen slipped across a body hold, and won from a press down in 2 min. 28 sec.

Payr beat Westerop.—Payr at once stepped in, and getting a body hold he picked up his opponent and brought him down, and appeared to gain a fall. It was not until after eleven minutes that Westerop attempted to do any work, and, trying a neck hold and roll, Payr bridged and got clear. Much time was spent on ground work, but Payr won easily on points.

Weckman beat Larson.—Weckman was early seen to advantage, and he showed some very quick movements, always getting clear when in danger. He put on a double arm lock, and won from a roll and press down in 4 min. 10 sec.

#### FOURTH ROUND.

Saarela beat Jensen.—Jensen, with the help of a body hold, picked up his opponent, fell backwards, and almost gave away a fall. Following with a double lock, he tried a back fall, but Saarela got out of danger. The latter put on an arm and head hold, but found Jensen far too strong to bring over. From a roll Saarela got on a cross chest hold, and won with a press down in 11 min. 36 sec.

Weckman beat Payr.—Weckman, by means of a double arm lock, brought his man over too far, and the Hungarian got out of hold. After many scientific movements the Finn put on an arm and body hold, but his opponent's head slipping off the mat the shoulders came down, but in this instance the fall was not allowed, as the hold by which it was obtained was taken after the loser was over the mat. Taking the centre again, he managed the same hold, and won with a press down in 5 min. 35 sec.

#### CONTEST FOR THIRD PRIZE.

C. M. Jensen (Denmark) beat H. Payr (Hungary).—In the first bout they fenced for a minute, but, going to the mat, Jensen got on a powerful neck and

arm hold, and Payr gave in at 2 min. 4 sec. Jensen in trying an arm throw in the second bout slipped to the mat, but getting an arm hold he brought his opponent over, and won with a press down in 1 min. 40 sec.

#### FINAL.

W. Weckman (Finland) beat Y. Saarela (Finland).

Both in turn tried an arm hold and roll in the first bout, but Saarela, getting on a cross arm hold, had his opponent in difficulties, and though Weckman bridged, he went down in 4 min. 22 sec. In the second bout both tried arm rolls. Weckman complained of hurting his shoulder. Continuing, after an examination, he put on a neck and cross chest hold, and won in 5 min. 7 sec. Facing each other for the deciding bout, it was not for a minute and a half that anything material occurred. Then Saarela tried a cross buttock, but they were soon on their feet again. Saarela turned for a flying mare, but failed, and Weckman got on top. Forcing the work, he tried a drop fall, and later a roll, arm lock, and press over, without effect, but from a forward neck hold and press down he won in 16 min. 10 sec.

W. Weckman (Finland) is 25 years of age, and has been wrestling  $4\frac{1}{2}$  years. He is an engineer by profession. In 1904 he first won the Finland Championship, and at Duisberg in 1905 he won the Heavy Weight Amateur Championship of the World at this style of wrestling.

Y. Saarela, like the winner, also comes from Finland, and did a good performance to be second, as he has only been wrestling for two years.

C. M. Jensen (Denmark), who gained the bronze medal, is 25 years of age, and weighs 85 kilogs. He has taken part in several competitions during the past four years. In 1906, in Italy, he won the Heavy Heavy Weight Championship, and in 1907 and 1908 the Heavy Weight Championship of Denmark.

### IV.—HEAVY HEAVY WEIGHT (over 205 lb.).

#### FIRST ROUND.

A. Petroff (Russia) beat F. H. Humphreys (United Kingdom).—After fencing for two minutes Humphreys got on a head hold, but it was not till eight minutes that the Englishman went to his knees. Petroff tried several arm rolls, but found his opponent too strong. Trying a bar-nelson, Humphreys also failed. In the last few minutes Petroff tried a body lift, and on going the full time he gained the award on points.

R. Weisz (Hungary) beat C. M. Jensen (Denmark).—Going to the mat in the first minute, Weisz secured top position, and applying an arm hold just failed to bring his man over. Coming from an arm hold the Hungarian gained top position, and after bridging several times a fall was allowed to Weisz in 13 min. 8 sec. A protest was then lodged, as Jensen's head was off the mat, but it was over-ruled.

H. Payr (Hungary) beat E. Barrett (United Kingdom).—Barrett, quickly stepping in, brought his man down with a body hold, and following with an arm hold and press over, Payr got out with a bridge. Roll after roll followed, but Payr put on a neck hold, and won with a press down in 4 min. 37 sec.

S. M. Jensen (Denmark) a bye.

#### SECOND ROUND.

Weisz beat Jensen.—Jensen soon went to the mat, and Weisz, getting on an arm lock, just failed to complete the fall. Jensen rushed in and brought his opponent down, but to no purpose. After wrestling for twelve minutes Jensen was cautioned for back-heeling. Both did their utmost, and showed great activity considering their weight; and, going the full time, Weisz gained the award on points.

Petroff beat Payr.—After finessing for over four minutes, Payr went to the mat, and Petroff put on an arm hold, but failed to bring his man over. After eleven minutes' work Petroff got on an arm hold, and, bringing Payr over, the latter bridged and got out of difficulties. Just afterwards Petroff brought his man down, and with a cross chest hold he won in 15 min. 12 sec.

#### CONTEST FOR THIRD PRIZE.

S. M. Jensen (Denmark) beat H. Payr (Hungary).—Jensen quickly got on a double arm hold, but just failed to complete the fall. Payr twice brought his opponent over with a strong body hold, and on each occasion the latter bridged. Later Jensen managed a firm neck hold, and won his first fall in 5 min. 44 sec. Payr afterwards withdrew.

#### FINAL.

R. Weisz (Hungary) beat A. Petroff (Russia).

Weisz first tried a neck hold, but without effect. Fencing for a hold continued for over seven minutes, when both were cautioned for unnecessary striking with the hands. It was not till fifteen minutes that Weisz brought his man down, but it was off the mat. Time expiring, a further ten minutes' wrestling was ordered, and not till five minutes later did they go to the mat. At the close, Weisz gained the first award on points.

In the second bout Petroff tried for a neck hold, and went to the mat. Weisz, in top position, trying a half-nelson, the Russian protested. Working from a body hold, Weisz continued to attack, and followed with an arm lock. Coming to their feet, Petroff tried a body swing, and at sixteen minutes it became a slapping match. In the last minute Petroff kept rushing in, and during a neck hold time was called. Another ten minutes was ordered, during which nothing but fencing was seen. The award went to the Hungarian on points at the expiration of thirty minutes.

R. Weisz (Hungary) is 28 years of age, and weighs 95 kilogs. His chest measurement is 50 in., and neck 20 in. He commenced wrestling eight years back, and has won the Championship of Holland seven years in succession.

A. Petroff (Russia) is 30 years of age, and weighs 91 kilogs. He is a doctor by profession.

S. M. Jensen (Denmark), who takes the third medal, is 28, and has been wrestling ten years. In 1904 he won the International event in Holland, and in 1905 the Heavy Weight Championship at Berlin. In 1906 he won the Heavy Weight at Athens, and the All-round Championship for all weights. He won the Championship of Denmark and many other events in 1905 and 1906.



## YACHTING.

A.—THE FIRST REGATTA WAS HELD AT RYDE, ISLE OF WIGHT, JULY 27, 28, and 29, under the management of a Committee of the Yacht Racing Association :—

Messrs. C. Newton-Robinson, Member of Y.R.A and British Olympic Councils ; B. Heckstall-Smith, B.O.C., Y.R.A. ; G. Flemmich, Y.R.A. Council ; and G. H. Harrison, Y.R.A.

The signalling arrangements were controlled by a Committee of the Royal Victoria Yacht Club. The matches were governed by the Y.R.A. Rules of 1908, incorporating those of the International Yacht Racing Union.

### RESULTS.

#### I.—YACHTS OF 8-METRE CLASS.

1. COBWEB, Blair Onslow Cochrane (United Kingdom), owner, won two races out of three.
2. VINGA, Royal Gothenburg Yacht Club of Sweden, owner, won the third race.

Also Competed :

SORAIS, Duchess of Westminster (United Kingdom), owner (twice second).  
 FRAM, C. Wisbech (Norway), owner (once second).  
 SAGA, Royal Swedish Yacht Club, owner.

#### PRIZES AWARDED.

Gilt Commemorative Medal to B. O. Cochrane.  
 Silver Commemorative Medal to Royal Gothenburg Yacht Club.  
 Gold Olympic Medal to B. O. Cochrane, helmsman of Cobweb.  
 Silver Olympic Medal to C. L. Hellström, helmsman of Vinga.  
 Silver Olympic Medals to A. N. L. Wood, H. C. Sutton, J. E. Rhodes, and C. R. Campbell, crew of Cobweb.  
 Bronze Olympic Medals to E. G. Thormahlen, E. G. Wallerius, E. G. Sandberg, and J. H. Wallin, crew of Vinga (Sweden), with Diplomas in each case.

Silver Commemorative Medals were also awarded to the Duchess of Westminster and to Mr. C. Wisbech, as owners of the Sorais and Fram, and Diplomas of Merit to their helmsmen and crews.

## II.—YACHTS OF 7-METRE CLASS.

I. HEROINE, C. J. Rivett-Carnac (United Kingdom), owner, sailed over.

## PRIZES AWARDED.

Gilt Commemorative Medal to C. J. Rivett-Carnac.

Gold Olympic Medal to C. J. Rivett-Carnac, helmsman.

Silver Olympic Medal to Norman Bingley, Capt. R. T. Dixon, R.N., and Mrs. C. Rivett-Carnac, crew of Heroine. With Diplomas.

## III.—YACHTS OF 6-METRE CLASS.

I. DORMY, T. D. McMeekin (United Kingdom), owner, won two races out of three.

2. ZUT, R. Osterrieth (Belgium), owner, won the third race.

## Also Competed :

GUYONI (France), R. Delagrave, owner.

FREJA (Sweden), Royal Swedish Yacht Club, owner.

SIBINDI (United Kingdom), J. W. Leuchars, owner.

## PRIZES AWARDED.

Gilt Commemorative Medal to T. D. McMeekin, also the Challenge Vase of Sèvres China given by the President of the French Republic.

Silver Commemorative Medal to R. Osterrieth.

Gold Olympic Medal to G. U. Laws, helmsman of Dormy.

Silver Olympic Medal to Leon Huybrechts, helmsman of Zut.

Silver Olympic Medals to T. D. McMeekin and Major C. W. H. Crichton, crew of Dormy.

Bronze Olympic Medals to Louis Huybrechts, H. Weewauters, crew of Zut, with Diplomas in each case.

Silver Commemorative Medals were also awarded to J. W. Leuchars, owner of Sibindi, once second ; and R. Delagrave, owner of Guyoni, twice second, and Diplomas of Merit to their helmsmen and crews.

There were no entries in the 15-Metre Class.

## B.—MATCHES ON THE CLYDE.

In the 12-Metre Class there were no foreign entries, and as the United Kingdom representatives of this fine class of yacht were racing chiefly in Scotch waters the Committee decided, with the consent of the British Olympic Council, to hold matches for them on the Clyde instead of the Solent. These took place at Hunter's Quay on August 11 and 12,

under the management of the Y.R.A. Committee, represented by Mr. C. Newton-Robinson. The signalling arrangements were carried out by a Committee of the Clyde Corinthian Yacht Club from the steam yacht *Verve*, belonging to Mr. Robert Wyllie, the Commodore. The Royal Clyde Yacht Club kindly placed its club-house at the disposal of the B.O.C. Committee.

## RESULTS.

### IV.—YACHTS OF 12-METRE CLASS.

1. HERA, T. C. Glen Coats (United Kingdom), owner, won two races, and it was therefore unnecessary to sail the third match.
2. MOUCHETTE, Charles MacIver (United Kingdom), owner.

### PRIZES AWARDED.

Gilt Commemorative Medal to T. C. Glen Coats.  
 Silver Commemorative Medal to C. MacIver.  
 Gold Olympic Medal to T. C. Glen Coats (helmsman of *Hera*).  
 Gold Olympic Medal to J. H. Downes (mate).  
 Silver Olympic Medal to C. MacIver (helmsman of *Mouchette*).  
 Silver Olympic Medal to J. G. Kenion (mate).  
 Silver Olympic Medals to John Buchanan, J. C. Buntten, Dr. A. D. Downes, David Dunlop, John Mackenzie, Albert Martin, Gerald Tait, and J. S. Aspin, crew of *Hera*.  
 Bronze Olympic Medals to James Baxter, W. P. Davidson, J. F. Jellico, T. A. R. Littledale, C. Macleod Robertson, J. F. D. Spence, C. R. MacIver, and J. M. Adam, crew of *Mouchette*, with Diplomas in each case.

## DETAILS.

### A.—RYDE OLYMPIC MATCHES.

The first three classes of the Olympic yacht races were sailed over the Royal Victoria Yacht Club courses at Ryde, the prevailing airs being light and westerly. The competitions were for three classes, but only in the 8-metres and 6-metres were there any foreign boats entered. The conditions of the matches were that they should be exclusively Corinthian, and the crews must belong to the country represented. It was not compulsory, however, that the yachts should be built or designed in the country represented, as the Olympic principle was that the races should be a test of the skill of the men handling the boats rather than a trial of the yachts themselves. How far this idea could be carried out in an open international class is, of course, open to discussion, but whether the principle be a sound one or not the events were unquestionably of great interest

and except for the lightness of the wind proved an unqualified success in the 8-metre and 6-metre classes. In the 7-metre class Mr. C. Rivett-Carnac had gone to some trouble to train a smart crew in Heroine, and Capt. Sloane Stanley had entered an amateur crew against him. The latter, however, failed to put in an appearance, and Heroine sailed over the course for the Olympic medal. The British 8-metre boats were Cobweb and Sorais. The former, a new boat designed by Fife for the special purpose of the Olympic races, is a very smart-looking vessel of the Mariska type. She was steered by Mr. Blair Cochrane, her owner, and her crew were Col. Rhodes, Mr. H. C. Sutton, Mr. A. N. L. Wood, and Mr. C. R. Campbell. The crew of Sorais consisted of her helmsman, Capt. Hunloke, Mr. Collingwood Hughes, Capt. F. St. J. Hughes, and Mr. George Ratsey. Her new owner, the Duchess of Westminster, also sailed on board. It would be unfair to say that on the day's work the one boat was better handled than the other. Both were sailed and manoeuvred quite as well as they would have been with paid sailors to work them. Cobweb appeared the faster boat in the light airs. The Norwegian boat, Fram, was third best. She is a short-bodied vessel with scow ends and sawn-off stern. She has greater *d* measurement than the British boats, and less sail area. The Swedish boats were apparently quite of the cruiser type : they had nice enough hulls, but with their small sail area and high coach-roof cabin tops they did not make any show in the light breeze. Mr. Anker and his crew handled the Fram faultlessly, but the Swedes certainly have a lot to learn in the handling of their vessels. Turning to windward, particularly, they were not steered with any judgment. In the 6-metre class Dornly and Sibindi, from Burnham-on-Crouch, were first and second ; the first, designed by Mr. G. U. Laws, was handled by him, and her crew were Mr. McMeekin, the owner, and Major C. W. H. Crichton, a Solent yachtsman. The Belgian yacht, Zut, was third ; curiously enough this vessel was also designed by an Englishman, Mr. Linton Hope.

## JULY 27.

MATCH for Yachts of 8-metres (26·2 ft.) rating ; course, from Ryde Pier Head round No. 3 Fairway Buoy, the West Measured Mile Buoy, the Boyne Buoy off Portsmouth Spit, and back ; twice round, 16 miles.

Yacht.	Rig.	Country.	Owner.
Fram.. ..	Cutter ..	Norway .. ..	Mr. C. Wisbech.
Vinga .. ..	Sloop .. ..	Sweden .. ..	Royal Gothenburg Y.C.
Cobweb .. ..	Cutter .. ..	United Kingdom ..	Mr. Blair Cochrane.
Saga .. ..	Sloop .. ..	Sweden .. ..	Royal Swedish Y.C.
Sorais .. ..	Cutter .. ..	United Kingdom ..	Duchess of Westminster.

Wind, light, west-north-west ; start, 12 noon. The yachts started in a light north-westerly wind ; crossing the line on the starboard tack close-hauled, they

had a close reach to the Fairway Buoy west of Ryde Pier. The English boats carried jackyard-topsails, and their canvas looked very well, both having entirely new suits. The foreign competitors carried no topsails, and their canvas was not quite up to the mark. Vinga had only a bumpkin and Saga a short bowsprit, and both these Swedish vessels set a single headsail cut very low in the foot, like the old-fashioned jibs one used to see set on the Norfolk Broads many years ago. The Fram had a very large low-cut foresail, with a sheet-stick on the foot of it, and a small jib. They came to the line in a cluster. Vinga and Saga were too soon, and the latter, luffing to check her way, managed to save being over. Vinga was recalled, and had to return. Capt. Hunloke gave Sorais a perfect start as he crossed the line with a great head of speed, and a hundred yards clear of it was leading Cobweb by six lengths, the latter being just on the weather of Fram. It was only a short close haul to the Fairway Buoy, whence they reached across for the Hampshire coast in procession on the port tack. Cobweb set a big balloon jib, and it was a nice sail when not sheeted too hard. At first Sorais went away from her, but as Mr. Cochrane eased his sheets and neared the buoy his boat began to walk up on the leader very fast. They gybed round the West Measured Mile Buoy :

	H. M. S.		H. M. S.		H. M. S.
Sorais ..	12 22 0	Fram ..	12 23 0	Vinga ..	12 26 20
Cobweb ..	12 22 18	Saga ..	12 25 0		

They ran past Stokes Bay and Portsmouth to the Boyne Buoy with spinners to starboard in a light wind. Cobweb, a little more southerly, took a draught of wind past Sorais, and they luffed round the Boyne Buoy :

	H. M. S.		H. M. S.		H. M. S.
Cobweb ..	1 4 42	Fram ..	1 6 55	Vinga ..	1 14 40
Sorais ..	1 5 2	Saga ..	1 12 50		

It was now a turn to windward back to Ryde. On the first long tack on the starboard over from the Boyne to Ryde Sands the British boats dropped Fram, and the Swedish competitors were very sluggish and fell further astern. Cobweb was on the weather of Sorais as the pair fetched into Ryde Sand Head, where they dropped into a very light air indeed. Meanwhile Mr. Anker, in Fram, had seen a little breeze darkening the water by the East Sturbridge, and tacking out for it picked it up and brought the north-westerly slant with him right up to Ryde Pier. This useful lift placed Fram between Cobweb and Sorais as they completed the first round, which was timed :

	H. M. S.		H. M. S.		H. M. S.
Cobweb ..	2 2 53	Sorais ..	2 3 33	Vinga ..	2 48 31
Fram ..	2 3 16	Saga ..	2 27 16		

It was a severe blow to Sorais in her race with Cobweb to have Fram thus planted on her weather, but before they had worked to windward as far as the Fairway Buoy Sorais met Fram on the port and put her round and covered her. After this the Norwegian boat fell steadily astern. They reached from the Fairway across to the Western Measured Mile now, with a strong east-going tide, and bore away round the latter mark :

	H. M. S.		H. M. S.		H. M. S.
Cobweb ..	2 31 0	Fram ..	2 33 45	Saga ..	2 58 25
Sorais ..	2 33 0				

Vinga was then off Ryde Pier. They ran dead to the Boyne Buoy without any change :

	H. M. S.		H. M. S.		H. M. S.
Cobweb ..	3 2 45	Sorais ..	3 5 25	Fram ..	3 6 20

Cobweb and Sorais stood over to the Sand Head again on the starboard, and then the prettiest sailing of the day occurred. The pair had a lovely bout of short tacks in the shallow water off Ryde Sands, working the little boards with great smartness. Sorais was here handled to perfection, and she crept very close to Cobweb, but Mr. Blair Cochrane held his position through a trying test of handling very well, and the result was a handsome victory for Cobweb, after one of the best light weather matches held at Ryde for some years. Fram made a long tack on the port over towards the Sturbridge, whilst Sorais and Cobweb were working along Ryde Sands, but in the weight of the east-going tide this was of no use to her. The Swedish boats were only just round the Boyne Buoy at Portsmouth Spit when the leading vessels had got home to Ryde Pier. Finish :

	H. M. S.		H. M. S.		H. M. S.
Cobweb (winner)	4 1 41	Fram	.. 4 7 30	Vinga	.. 4 55 56
Sorais	.. 4 2 14	Saga	.. 4 46 11		

MATCH for Yachts of 7-metres (23 ft.) rating ; course, from Ryde Pier, round No. 2 Mother Bank Buoy, the East Measured Mile Buoy, the East Sturbridge Buoy ; twice round, 13 miles.

Yacht.	Rig.	Country.	Owner.
Heroine	.. Lug	.. United Kingdom	.. Mr. C. J. Rivett-Carnac.

The Heroine started at 12.15 p.m., and sailed one round of the course, finishing at 2.11.54.

MATCH for Yachts of the 6-metre (19.7 ft.) class ; course, same as 7-metre class, 13 miles.

Yacht.	Rig.	Country.	Owner.
Dormy	.. Gaff sail	United Kingdom	.. Mr. T. D. McMeekin.
Zut	.. Gunter lug	Belgium	.. Mr. R. Osterieth.
Freja	.. Lug	.. Sweden	.. .. Royal Swedish Yacht Club.
Guyoni	.. Gaff sail	France	.. .. M. R. Delagrave.
Sibindi	.. Gaff sail	United Kingdom	.. Mr. J. W. Leuchars.

Start, 12.30 p.m. Mr. Leuchars had the best start with Sibindi, followed by Freja, Dormy, Guyoni, and Zut. The Swedish boat could not hold her place turning to windward towards the Mother Bank. They then reached across to the Eastern Measured Mile Buoy, and Dormy obtained a considerable lead in the light airs. The French boat, too, was fast when the breeze was faintest. The first round was timed :

	H. M. S.		H. M. S.		H. M. S.
Dormy	.. 2 13 11	Sibindi	.. 2 16 24	Freja	.. 2 34 25
Guyoni	.. 2 15 4	Zut	.. 2 18 51		

In the second round there was more wind, and they had a really nice turn to windward between Ryde Pier and the Mother Bank. On this part of the course Sibindi outsailed Guyoni, and Zut also showed well ; in fact, the Belgian boat made the best time of the fleet on the second half of the course. The finish was :

	H. M. S.		H. M. S.		H. M. S.
Dormy (winner)	3 52 14	Zut	.. 3 56 20	Freja	.. 4 24 0
Sibindi	.. 3 54 6	Guyoni	.. 4 3 21		

JULY 28.

This was a very fluky day, and the racing took place in baffling airs. The arrangements were the same as on the previous day in every respect, and the events were closely contested, notwithstanding the unfortunate state of the weather.

MATCH for Yachts of 8 metres (26·2ft.) rating ; course, from Ryde Pier Head round No. 3 Fairway Buoy, the West Measured Mile Buoy, the Boyne Buoy off Portsmouth Spit, and back ; twice round, 16 miles.

Yacht.	Rig.	Country.	Owner.
Fram ..	Cutter ..	Norway ..	.. Mr. C. Wisbech.
Vinga ..	Sloop ..	Sweden ..	.. Royal Gothenburg Y.C.
Cobweb..	Cutter ..	Great Britain ..	.. Mr. Blair Cochrane.
Saga ..	Sloop ..	Sweden ..	.. Swedish Yacht Club.
Sorais ..	Cutter ..	Great Britain ..	.. Duchess of Westminster.

Wind, light, west-north-west. Start at 12 noon. The match began in an extremely light north-north-westerly wind. Saga was the leading boat, and Cobweb on the weather of Fram as they approached the line in a cluster of the starboard tack ; Sorais, under Fram's lee, had to give the Norwegian room, and Vinga was to leeward of all. It was a close start, and they all overlapped as they crossed. Cobweb and Sorais soon took the lead and were ahead at the Fairway Buoy. From here they reached in light and baffling airs across to the Hampshire shore. The English boats when passing under the lee of a disused warship were becalmed, and Fram carried a breeze past them at the west measured mile buoy, it was :

	H.M.S.		H.M.S.		H.M.	S.
Fram ..	12 33 0	Cobweb ..	12 35 3	Vinga ..	12 41	10
Sorais ..	12 34 35	Saga ..	12 39 0			

They reached and ran by Stokes Bay and the Gillkicker in very fluky airs, the three leading boats changing places repeatedly until they reached the Boyne :

	H. M. S.		H. M. S.		H. M. S.
Sorais ..	1 41 12	Cobweb ..	1 43 11	Vinga ..	1 15 16
Fram ..	1 41 13	Saga ..	1 55 15		

From the Boyne they were close hauled to Ryde Pier. Fram certainly sailed very well in the light wind for a boat of her type, and the three yachts kept quite close, sailing at practically equal speed. The first round finished :

	H. M. S.		H. M. S.		H. M. S.
Sorais ..	2 17 5	Cobweb ..	2 19 12	Saga ..	3 31 56
Fram ..	2 18 55	Vinga ..	2 55 55		

Whilst the two British boats and the Norwegian were equally matched, the Swedish craft were quite outclassed, and they could not stem the tide in the light air. Just after passing through the line at the close of the first round, an interesting little piece of sailing took place to relieve the monotony of a very tedious day. It was a dead nip to the chequered Fairway Buoy in the very lightest wind, and Sorais followed by Fram held in towards Ryde on the starboard whilst Cobweb tacked short round the flag mark, and held off on the port. Sorais soon tacked off and made the chequered buoy in the best style. Fram had gone a little too far in shore, whilst Cobweb made a poor show at fetching the buoy, and had to throw round three times. From the chequered buoy they reached across without alteration to the west measured mile and bore away.

	H. M. S.		H. M. S.		H. M. S.
Sorais ..	2 51 30	Fram ..	2 55 0	Cobweb ..	2 55 0

Sorais by clever handling had earned her position, but she was now fluked out of it by running into a stark calm off the Gillkicker, whilst Fram and Cobweb came level with her. At the Boyne they were :

	H. M. S.		H. M. S.		H. M. S.
Fram	.. 3 54 41	Sorais	.. 3 54 45	Cobweb	.. 3 56 25

The race had been absurdly fluky and unreliable throughout ; notwithstanding this it was very exciting. The trio had now to sail to windward home to Ryde Pier with a foul tide. Cobweb tried hanging very high to windward along the Portsmouth Spit. Fram made a direct line for Ryde, whilst Sorais held a course midway between the two. They were all on the starboard tack, and it was chiefly a matter of luck. It is fair to say, however, that in this case Mr. Blair Cochran's judgment was correct ; indeed, the policy of keeping well to windward of one's mark with a lee-going tide seldom proves to be wrong, and this was Cobweb's position. Although she was in the strength of the tide she could keep checking her sheets whilst she edged away across the Sturbridge Bank for Ryde Pier, and she was in luck too, for up to windward the north-westerly wind filled in upon her until she had a bone in her teeth and was romping merrily for the winning line. Her yellow hull could be descried ploughing through the apparently dead calm at a wonderful speed. Meanwhile Sorais, half inclined to hang to windward with Cobweb yet bound to keep an eye on the Fram in the lee berth, was in a sad dilemma and nearly upright from want of breeze. The low pram-like Norwegian boat, to leeward, came into a slacker tide every moment she neared the Island shore, and so drew through the lee of Sorais. Cobweb thus sailed home a winner with a well established lead, whilst Fram was just able to fetch the lee end of the line next the pier and defeat Sorais for second place by a bowsprit's length. The match ended :

	H. M. S.		H. M. S.
Cobweb (winner)	.. .. 4 35 56	Vinga	.. .. 5 16 21
Fram	.. .. 4 39 13	Saga	.. .. gave up
Sorais	.. .. 4 39 15		

MATCH for Yachts of 7-metres (23 ft.) rating ; course, from Ryde Pier round No. 2 Mother Bank Buoy, the East Measured Mile Buoy, the East Sturbridge Buoy, twice round, 13 miles ; start 12.15 p.m.

Yacht.	Rig.	Country.	Owner.
Heroine	.. Lug	.. Great Britain	.. Mr. C. J. Rivett-Carnac.

Heroine sailed over and finished her first round at 2.11.43. She was therefore returned the winner of the Olympic medal for 7-metre yachts.

MATCH for Yachts of the 6-metre (19.7 ft.) class ; course, same as 7-metre class, 13 miles.

Yacht.	Rig.	Country.	Owner.
Dormy	.. Gaff sail	.. Great Britain	.. Mr. T. D. McMeekin.
Zut	.. Gunter sail	.. Belgium	.. Mr. R. Osterrieth.
Freja	.. Lug	.. Sweden	.. Royal Swedish Yacht Club.
Guyoni	.. Gaff sail	.. France	.. Mr. R. Delagrave.
Sibindi	.. Gaff sail	.. Great Britain	.. Mr. J. W. Leuchars.

Start, 12.30 p.m. They were close hauled at the start, and Sibindi had the best of it, slipping away very fast on the port tack to windward of Freja, Dormy, and Guyoni. Zut was last. At the Mother Bank Buoy Sibindi still held a good lead, but at the East Measured Mile Buoy she was becalmed and had to drop her kedge ; she was then passed by Dormy, Guyoni, and Zut, whilst she was nipped by the tide. The order at the first Sturbridge Buoy was : Guyoni, Dormy,



Sibindi, Zut, and Freja. The turn to windward home to Ryde Pier was close work, and resulted in a dead-heat for the French boat and Dormy, the times being :

	H. M. S.		H. M. S.		H. M. S.
Dormy ..	2 6 20	Sibindi ..	2 8 1	Freja ..	2 18 30
Guyoni ..	2 6 20	Zut ..	2 9 10 ..		

Sibindi passed the leaders beating out to the Mother Bank, and the order at the weather mark was Sibindi, Zut, Guyoni, Dormy, and Freja. They next reached across to the East Measured Mile, and here Sibindi still led, and Dormy was once more in second place, Guyoni had again passed Zut. They ran to the East Sturbridge, and luffing round this mark the little blue boat was showing ahead again, the order being Dormy, Guyoni, Sibindi, Zut, and Freja. No alteration occurred in the short tacks back to Ryde Pier, and they finished :

	H. M. S.		H. M. S.
Dormy (winner) ..	.. 4 17 23	Zut ..	.. 4 19 17
Guyoni ..	.. 4 17 55	Freja ..	.. 4 36 48
Sibindi ..	.. 4 18 19		

#### JULY 29.

The concluding day of the Olympic races was very like those which preceded it, inasmuch as the breeze was very light, and there was a good deal of fluking. Late in the afternoon a true wind came from the west, and the racing was then very keen. Sailing in a true breeze of moderate strength there was very little difference in the speed of Sorais, Fram, and Cobweb, and when the wind piped up the Swedish boats woke up wonderfully. Vinga was the winner in the 8-metre class, but her position was largely due to a lucky streak of wind. Cobweb now having won two first prizes secured the first Olympic medal, and her owner and helmsman, Mr. Blair Cochrane, the helmsman's gold medal, whilst Vinga, the Swedish competitor, having won the other first of the three matches, won the second Olympic prize. Similarly in the 6-metre class the Burnham-on-Crouch boat Dormy, with two prizes, won the Olympic medal for her class, and her designer, Mr. G. Umfreville, who steered her, gained the helmsman's gold medal. Dormy also became the holder—for four years—of the Sèvres Vase presented by the French President. The Linton Hope boat Zut secured the second prize in the 6-metre class. The lack of wind throughout the regatta was, of course, most distressing, but the contest caused widespread interest, and no protest or dispute of any kind occurred to disturb the harmony of the first International small class regatta held in British waters since the formation of the International Yacht Racing Union.

MATCH for Yachts of 8-metres (26·2 ft.) rating ; course, from Ryde Pierhead round No. 3 Fairway Buoy, the West Measured Mile Buoy, the Boyne Buoy off Portsmouth Spit and back, twice round ; 16 miles.

Yacht.	Rig.	Country.	Owner.
Fram ..	Cutter ..	Norway ..	Mr. C. Wisbech.
Vinga ..	Sloop ..	Sweden ..	Royal Gothenburg Yacht Club.
Cobweb ..	Cutter ..	Great Britain ..	Mr. Blair Cochrane.
Saga ..	Sloop ..	Sweden ..	Swedish Yacht Club.
Sorais ..	Cutter ..	Great Britain ..	Duchess of Westminster.

Wind, light, west-north-west ; start, 12 noon. Saga, Fram, and Vinga were on the weather end of the line in a cluster. They were led by Cobweb, but the latter was too soon and had to bear away and gybe, thus losing her position. Sorais, to leeward of Saga, made a perfect start, with enough way to carry her

romping through the lee of the others, and after sailing a few hundred yards she was several lengths clear ahead. They had a close reach to the Fairway Buoy, and here the order was Sorais first; then the two Swedish boats, Fram and Cobweb last. The breeze being northerly, they had to beat across to the West Measured Mile Buoy in a light steady wind, with a very slight lop of sea. What sea there was was caused by-the-last of the strength of the west-going tide, but it was dying down rapidly to a glass calm. The little sea and light wind did not suit Fram, and Cobweb passed her, and the Swedish boats also did not show to advantage. The times at the West Measured Mile Buoy were :

	H. M. S.		H. M. S.		H. M. S.
Sorais ..	12 41 18	Fram ..	12 46 10	Vinga ..	12 50 18
Cobweb ..	12 42 10	Saga ..	12 48 12		

They next had a reach eastward to the Boyne Buoy, but the wind, in the heat of the noonday sun, which was intense, was dried up, leaving many oily patches of calm on the water. Sorais went skimming away through the calm with her sails full, and opened out a long lead. Fram, too, was a lively boat, considering her small sailspread, and overhauled Cobweb. At the Boyne Buoy they were :

	H.M.S.		H.M.S.		H.M.S.
Sorais ..	1 21 30	Cobweb ..	1 33 20	Saga ..	1 36 30
Fram ..	1 27 38	Vinga ..	1 35 55		

They could now reach in procession to the close of the round, being somewhat close hauled and on the starboard tack. The first round ended without any further change :

	H. M. S.		H. M. S.		H. M. S.
Sorais .	2 14 16	Cobweb ..	2 23 4	Saga ..	2 28 34
Fram .	2 21 15	Vinga ..	2 27 55		

Capt. Hunloke was destined to lose the commanding lead he had thus worked out owing to a fluke, for when Sorais neared the West Measured Mile Buoy again, the sternmost boats began to reach on to her, and they reached over much ground that the leading boat had traversed close hauled, coming up with a freshening westerly wind. They rounded the buoy :

	H. M. S.		H. M. S.		H. M. S.
Sorais ..	2 9 8	Fram ..	2 14 20	Saga ..	2 17 50
Cobweb ..	2 13 58	Vinga ..	2 16 0		

There was more fluking to follow, for whilst they were off Stokes Bay Pier the Swedish boats brought up the westerly wind to still further advantage and keeping in the line of it were carried right past Cobweb and Fram. To the eastward of the Gillkicker, about off Southsea, Vinga and Saga, if not actually leading, were abreast of Sorais. The steady breeze now filled in everywhere, and the fleet carried the fresh quartering wind down to the Boyne Buoy on Portsmouth Spit, where they arrived in a cluster.

	H. M. S.		H. M. S.		H. M. S.
Sorais ..	4 1 45	Vinga ..	4 2 21	Fram ..	4 2 45
Cobweb ..	4 2 0	Saga ..	4 2 30		

For the first time in the Olympic races the fleet were seen to be enjoying a good steady wind. They were close hauled, and began to fight it out over a foul tide from Portsmouth Spit to Ryde Pier. Sorais was sticking to Fram's weather bow, and Cobweb was planted on the weather of Vinga, and was eating out to windward, but in three short tacks they made along the south side of the Spit Sand was hardly going through the water as fast as the Swedish boat, a fact which was quite a surprise to the onlookers. Saga was still a bit sluggish, but was doing pretty well. Fram, sailing capitally in the nice breeze, crossed the Cobweb, and at length Sorais, which was still leading boat, with Fram,

Cobweb and Saga in her wake, tacked to starboard to stand across to Ryde. They were as far north as the Gillkicker sand would allow when they made their last tack. In the meanwhile Vinga, which had not gone nearly so far northerly, had made her point for Ryde across the east end of the Sturbridge Bank on the starboard tack, chancing the wind being sufficiently north of west to enable her to fetch the pier. Of course, if she could do this she would get to Ryde, having sailed nearly a mile less water than the others, which had overstood themselves a good deal whilst jockeying one another. A pretty piece of luck fell to Vinga, for the wind held so that she could comfortably sail through the finishing line full and by. She was easing the tide all the time as she neared the pier, and, creeping slowly up, she received the winning gun to the accompaniment of great cheering from the pier, the hooting of horns from the steam yachts and screeching of whistles on the launches, of which many were under way. Her victory was especially popular, as it was felt that the foreign boats had been very unfortunate in having to sail three matches in such extremely light weather. Sorais bravely led the north shore division home to the line, having shaken off the challenge of Fram, which once reached on to her enough to get her bowsprit abreast of her weather quarter. The race ended :

			H. M. S.				H. M. S.
Vinga (winner)	..	..	4 52 31	Cobweb	..	..	4 57 46
Sorais	..	..	4 56 29	Saga	..	..	5 0 45
Fram	..	..	4 57 10				

MATCH for Yachts of the 6-metre (19.7 ft.) class ; course, from Ryde Pier round No. 2 Mother Bank Buoy, the East Measured Mile Buoy, the East Sturbridge Buoy, twice round, 13 miles.

Yacht.	Rig.	Country.	Owner.
Dormy ..	Gaff sail .	Great Britain	.. Mr. T. D. McMeekin.
Zut ..	Gunter lug	Belgium ..	.. Mr. R. Osterrieth.
Freja ..	Lug ..	Sweden ..	.. Royal Swedish Yacht Club.
Guyoni ..	Gaff sail .	France ..	.. Mr. R. Delagrave.
Sibindi ..	Gaff sail .	Great Britain	.. Mr. J. W. Leuchars.

Start at 12.30 p.m. The order at the start was Sibindi, Freja, Zut, Dormy, and Guyoni. Turning to the Mother Bank Buoy the French boat went very well and made amends for a bad start, and they rounded : Sibindi, Zut, Guyoni, Freja, and Dormy last. Then Zut took the lead, and was never passed again. At the East Measured Mile it was Zut, Dormy, Sibindi, Guyoni, and Freja; but at the East Sturbridge Sibindi had just passed Dormy again. The first round ended :

	H. M. S.		H. M. S.		H. M. S.
Zut	.. 2 24 39	Guyoni	.. 2 25 53	Freja	.. 3 5 16
Dormy	.. 2 25 45	Sibindi	.. 2 26 15		

Guyoni and Sibindi both overhauled Dormy going out to the Mother Bank Buoy, then again before they were at the East Measured Mile Dormy had passed Sibindi again, but she could not catch the French boat, a very good race ended :

	H. M. S.		H. M. S.		H. M. S.
Zut (winner)	4 13 56	Dormy	.. 4 19 33	Freja	.. 4 59 51
Guyoni	.. 4 15 16	Sibindi	.. 4 19 47		

The details given above were published in the *Field*. I will add here a few notes on the six-metre boats which were contributed by

Mr. T. D. McMeekin (owner of the winning Dormy) to *The Yachting and Boating Monthly*. Dormy was steered by her designer, Mr. G. U. Laws.

"I am not permitted by Mr. Laws," writes Mr. McMeekin, "to say what is exactly the secret of his design, but one departure is the sharp stern, at first termed ugly by nearly everyone, but now beginning to be liked as it becomes more familiar.

"The boat was designed to suit conditions which are generally met with on the Crouch—light winds, smooth water, and strong tides. Dormy is a light-displacement boat, and weighs about 15 cwt. less than the other 6-metre boats belonging to the Eastern Yacht Club of England. She is an absolute submarine in anything like a popple, but the heavy scantlings, etc., are largely responsible for this. Dormy's record to date is : Eleven first, two seconds, one third, out of seventeen starts. This, against the very pick of the 6-metre fleet, is, I think, greatly to Mr. Laws' credit.

"Zut, the Belgian representative, was designed by Mr. Linton Hope and built by Hart Harden, of Kingston-on-Thames. She is practically a sister boat to Gipta. She is beautifully tuned up and handled. In their scarlet jerseys and caps her crew were always easily distinguished.

"Guyoni is quite the best of the French fleet. She is a regular ghoster, and can also do well in a hard breeze. She has a curious hollow in her lines just where her 'spoon' emerges from the water. Her sails were not what we would call well-planned or made. She will be a greatly improved boat when Messrs. Ratsey have re-rigged her. Her owner and crew handled her in excellent style.

"Freja, the Swedish boat, did not get her weather certainly, but she would do without a lot of superfluous weight in fittings and rigging. Her crew stuck to their work like real good sportsmen.

"Sibindi never seemed to get going, and had not the best of luck. She was cleverly handled by her owner, Mr. J. W. Leuchars, well known to yachtsman as the owner of that successful 52-footer Moyana. Designed by Milne, she has been greatly improved by various alterations in trim, and now takes a lot of beating. She and Dormy have sailed some very close races and there is little difference between the boats in speed."

Mr. Blair Cochrane, owner of the winning Cobweb, said in *The Yachting and Boating Monthly*, in describing his races : "One can hardly hope for more honourable men or better sailors than the Norwegian and Swedish competitors we met. They handled their boats well, and it would be impossible to meet keener sportsmen."

The Royal Victoria Yacht Club rendered the greatest possible assistance to the Olympic Regatta by managing the starting arrangements. The club also gave a ball, to which all competitors were invited, in Ryde Town Hall, on July 29. The Olympic medals were given away on this occasion by Lady Adela Cochrane. A dinner was also given to competitors by the R.V.Y.C. at the Club-house, Ryde, on July 30, presided over by the Commodore, Mr. W. B. Paget. Mr. Thomas Cochrane, Deputy-Governor of the Isle of Wight, and Lady Adela Cochrane kindly gave a garden party at Carisbrooke Castle, at which the competitors and the Y.R.A. and R.V.Y.C. Committees were presented to H.R.H. Princess Beatrice and H.R.H. Princess Christian.

## B.—CLYDE OLYMPIC MATCHES.

AUGUST 11.

The series of matches for the selected 12-metre cutters under the direction of the Olympic Committee of the Yacht Racing Association began from Hunter's Quay on Tuesday, August 11. The yachts engaged were Mr. Chas. MacIver's Mouchette, designed by Mr. Alfred Mylne, and Mr. T. C. Glen-Coats's Hera, designed by the owner. The wind was from west-north-west, tending more northerly, of moderate force, puffy at times, but steady for the most part, and there was no more than a pleasant curl on the water. Each boat had an amateur crew of ten, and the owner steered in each case. The matches were conducted by the Clyde Corinthian Yacht Club, Commodore Robert Wylie's steam yacht Verve was flagship, and a committee consisting of Messrs. W. W. Aspin, secretary, Wm. York, secretary of Royal Clyde, W. F. King, F. W. Robertson, W. R. Copland, and J. A. Gardiner were in charge of the details, and Mr. C. Newton-Robinson represented the Y.R.A.

The start was fixed for half-past eleven, and both cutters appeared then under all lower canvas, jackyarders, and jibtopsails for a free reach to Inverkip. Thence it was a beat to Dunoon, an easy reach to Kilcreggan, and a close-haul home, twice round, twenty-six miles.

Reaching down on starboard for the line, Mouchette was well on Hera's lee bow, and in this relation they luffed to the outside of the flagship, the gun meanwhile missing fire. Hera took a round turn, bore in from the right side of the line, gybed, and reached off with a decided way, whereas Mouchette headed up from leeward, wore, and gybed, and, although about her own length ahead, coming back over she was in the lee berth, and had stopped almost dead in the swing. Here they got past at once, and led to the Inverkip mark, a sharp luff below Kim effecting no change. Spinnakers were set to starboard over the last mile of the distance, and at the turn the timings were : Hera, 11.59.12 ; Mouchette, 11.59.50. On coming by the wind, Mouchette enticed Hera into a quick succession of short tacks, from which the former was evidently deriving a gradual advantage, and Hera, tiring of the process, at length broke away, and on the concluding long boards, made a substantial gain before fetching Dunoon mark. Hera, 12.38.50 ; Mouchette, 12.40.11. An easy reach to Kilcreggan was slightly in favour of Mouchette, which kept a more windward course than Hera, the difference as they stayed showing : Hera, 1.9.15 ; Mouchette 1.10.10. Fetching across to commodore, jibtopsails had to come down on the opening of the lochs, out of which there were some hard puffs of northerly wind. They were paid off as they laid for the line, and had to make a short weathering board. The first round ending :—

	H. M. S.	H. M. S.	
Hera . . . . .	1 33 0	Mouchette . . . . .	1 34 40

Hera thus began the second round with a lead of 1 min 32 sec., and on turning the home mark she streamed off free on starboard in a full topsail breeze. Taking a straighter course than before for Inverkip, they made the mark there in much shorter time, as the figures discover—Hera, 1.58.52 ; Mouchette, 2.0.25. The leader had added a little to her advantage on the reach, as she might be expected to do. The match was an equal one, turning to windward for Dunoon, with much less need for weather-bowing than on the first occasion after a couple of short legs. They lined through the firth, and in the next tack fetched close upon the mark, which they hitched as follows : Hera, 2.28.48 ; Mouchette, 2.30.26. Jibtopsails were once more set for the reach to Kilcreggan. The wind abaft

the beam Mouchette on this distance again, and in the same way, reducing the gap, the figures as they cast round being, Hera, 2.56.4 ; Mouchette, 2.57.24. The concluding distance, a clean fetch for the line in a full, hard, steady breeze, was in favour of Hera, and she romped home, winning by 1 min. 40 sec.

	H. M. S.		H. M. S.
Hera (winner) .. ..	3 19 41	Mouchette .. ..	3 21 21

## AUGUST 12.

Hera again won on the succeeding day, and thus obviated the necessity for a third trial. The day was not so fine, nor was the wind so true or weighty. It settled southerly early in the morning, holding light and steady till the afternoon, when it died away in a heavy smirr of rain, and, after a calm interval, filled in from south-west to bring the yachts to a finish after over five hours' sailing,

The start was made as before, at half-past eleven, under jackyard topsails, on a four miles' beat to Inverkip. Mouchette led in on starboard ahead and to windward of Hera, which was sent round on the line to clear her wind, Mouchette coming promptly on top of her. Unfortunately the steam yacht Hebe was somewhat in the way of Mouchette carrying on after Hera, and she was quickly stayed back to starboard, while Hera to leeward had an uninterrupted passage for her hitch to the shore. A board extending almost to the other side of the channel followed. Mouchette was first to stay, a good bit to leeward of Hera, whose opening tack had given her a fine weatherly lift. They beat from off the Cloch in short legs across Lunderstone Bay to the Inverkip mark, Mouchette breaking tack every now and again, bringing Hera after her, until at the weather mark she had regained her lost distance, and turned only 9 sec. astern. Having borne round, Mouchette luffed up on Hera, and was almost through her, and then she speedily bore under her stem, laid off the boom, and set spinnaker to port. Hera did not imitate this manoeuvre, but reached out a distance farther into the firth before squaring for the run to Dunoon. The distance went in favour of Mr. Coats's cutter, the lead having increased to 54 sec. as they bore past the lee mark, running up reaching jibtopsails on starting for Kilcreggan. Between the marks a gybe was made, spinnakers set to starboard, and carried to a hundred yards of the turn, the gap having been widened to 1 min. 17 sec. They were full-end-by in a good breeze to commodore, Mouchette decreasing the difference to 1 min. 6 sec. over the three miles. First round :

	H. M. S.		H. M. S.
Hera .. ..	1 57 9	Mouchette .. ..	1 58 15

Hera stayed sharp to resume the thresh to Inverkip, whereas Mouchette luffed the flagboat and carried through towards the shore, prior to coming about. The wind was fresher on this trip down firth. They cross-tacked awhile through mid firth, Mouchette staying with great frequency in order to draw Hera into the short tacking game. Notwithstanding this, Hera was steadily gaining in the better breeze, and at 2.40.0, on fetching the weather mark, she was 2 min. 10 sec. ahead, Making straight for the Dunoon mark down with spinnaker to port, they sailed a fast match, and came to the rounding of the flagboat as the breeze was giving way on the Cowal shore, Hera having added 12 sec. during the run. The leader dropped spinnaker, gybed, and hauled out into the Channel with a vein of cooler air. Mouchette at the gybe headed inshore, and carried spinnaker on the other side along to Kim Pier, while she was forced to avoid a flat patch, and made after Hera on a free reach. From this point on to Kilcreggan the winds were very unstable, calm and breeze alternating every few hundred yards. Rain and haze choked the Channel as they came to the mark, where Mouchette was

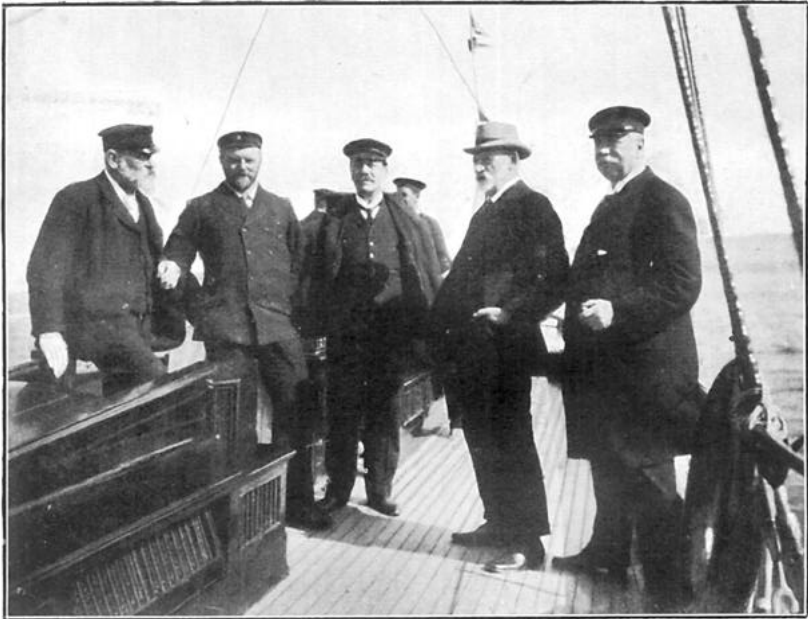

YACHTING.—THE COMMITTEE ON BOARD THE STEAM YACHT OF THE  
COMMODORE OF THE CLYDE CORINTHIAN Y.C.

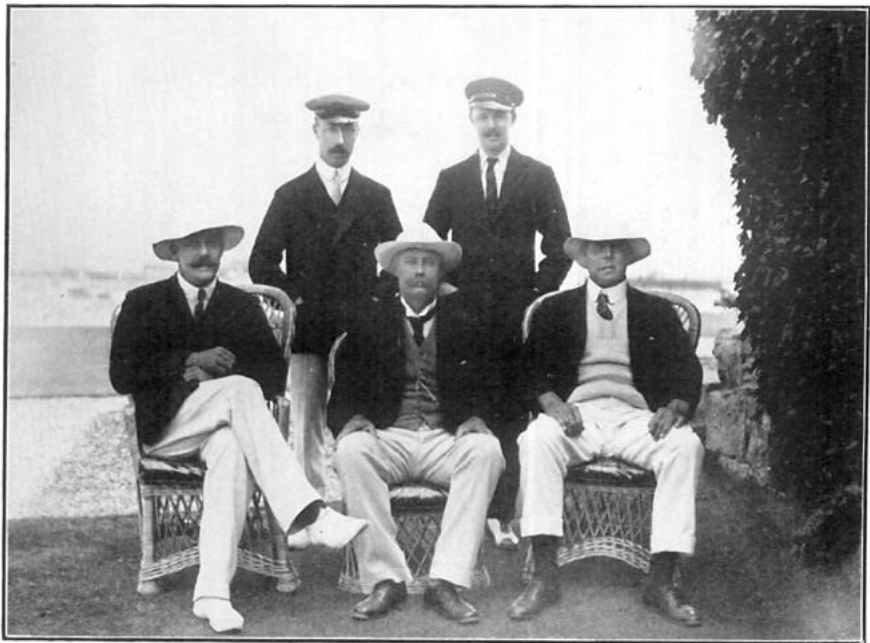

YACHTING.—THE CREW OF THE WINNING "COBWEB," RYDE.



YACHTING.—“HERA”  
AND “ MOUCHETTE ”  
ON THE CLYDE.

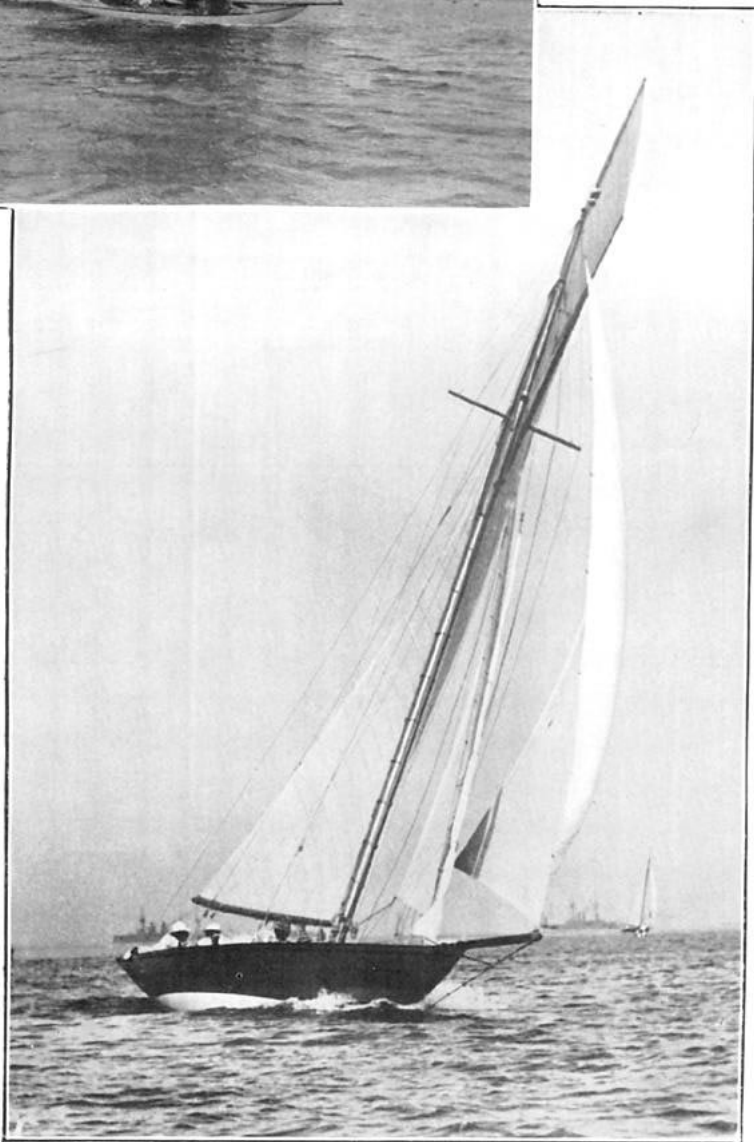

YACHTING.—THE “COBWEB” WINNING AT RYDE.



much closer on Hera. They were lucky to meet a new wind from the south-west over the distance to commodore, and in this they tacked more smartly to a finish, Hera winning by 1 min. 2 sec.

	H. M. S.	H. M. S.
Hera (winner)    ..    ..	4 47 40	Mouchette ..    ..    .. 4 48 42

After the racing was over a dinner was given by the British Olympic Council to the competitors at the Royal Clyde Yacht Club.

Mr. T. C. Glen-Coats, owner of the winning Hera, thus described his races in *The Yachting and Boating Monthly* :—

“The 12-metre class includes the Fife-designed Alachie, the Mylne-designed Mouchette and Nargie, built by Messrs. Macalister, Dumbarton, also Heatherbell and Hera, built by Messrs. Robertson, Sandbank, and Macalister, Dumbarton, respectively from designs by the writer. The boats have won good opinions in the Clyde this year, and the class is now firmly established. It seems surprising that it has not been built to elsewhere. Under Olympic Rules, only two vessels of the same nationality were allowed to compete. At the time of the Clyde Fortnight Mouchette and Hera had won most prizes, the latter boat having, as a matter of fact, started in more races than any of the others. These two were therefore chosen, and the owners set about getting together their amateur crews. And after all it so happened that in this there was an International element, the majority of Mouchette’s crew being Mersey men, while Hera’s crew, without exception, belonged to the Clyde. The conditions were as follows : Races were to be the best out of three to be sailed on the Clyde on August 11, 12, and 13.

“The course sailed was the usual Corinthian one—viz. Hunter’s Quay, Inverkip, Dunoon, and Kilcreggan, twice round ; twenty-six miles. On the first day the wind was strong and pretty steady. Hera seemed to get the advantage of what luck was going when the breeze was puffy on the broad reach to Inverkip. After this the wind remained true and of good strength, and the sailing was as close and exciting as one could wish. Hera was ahead and managed to hold her position, but Mouchette pressed her very hard all round the course. At the end of the first round 1 min. 30 sec. separated the two boats and at the finish the difference was 1 min. 37 sec. The distinguishing feature of this race was the extraordinary number of short tacks made during the first heat from Inverkip to Dunoon. Immediately on rounding the Inverkip mark Mouchette stayed to get her wind clear; we stayed to try and cover her; and this began the most exciting series of short tacking that I have ever seen or taken part in. Something like thirty short tacks were made by both yachts within a very few minutes, and a trading schooner which came between us was the ultimate means of putting an end to it. It has been a case of Lee—O ! all the time, and seldom time to make the sheets fast.

“Mouchette got the better of us in the short tacks, and had come uncomfortably close. She seemed to gain slightly every time, being apparently rather the faster in stays. Though we were never at such close quarters again, she pressed us hard all round the course. There was plenty of excitement till the finish and hard work for the crews, the verdict being that, apart from the unique conditions of amateur crews, it was one of the best races of the season.

“The second race was equally interesting, and in the final heat from Kilcreggan home to finish as close and exciting as could be wished for. The wind was light or moderate and fairly steady in strength and direction till it suddenly failed in the middle of the second round. Hera was again lucky in getting advantage of position in the beat to Inverkip very early in the race. There was another

bout of short tacking in which Hera again had none the best of it, though reaching and running she generally made a trifling gain, as on the previous day. In the beat on the second round, working more independently and in longer boards, Hera was more successful, and at Dunoon mark held a two and a half minutes' lead. Then the wind failed, and an anxious time we had of it to Kilcreggan mark. It was pretty much of a drift at times, but Mouchette closed up steadily. Carrying her way better, she very nearly got the mark ahead of us, but, managing to squeeze round a couple of lengths in front of her, we succeeded in saving the race.

“It seemed by no means all over, however. A freshening westerly wind made it a beat to finish, and we were soon once more both moving briskly and in close company. Mouchette more than once was as nearly as possible through our lee, and a memorable race ended in a win for Hera by 62 sec.”

It has been suggested that in the yacht racing of future Olympic Games it might be better to select a fleet of “one-design” boats in the waters where the Games are held, and let all the crews entered draw lots for them every day, with the proviso that no crew should have the same boat twice. When the “Solent one-design” class was flourishing this could easily have been done here, and no doubt owners would have lent their boats, for there were more than twenty in commission at once, as nearly alike as possible.

CHAPTER V.  
THE PRIZE LIST.

---

THE OLYMPIC GAMES OF 1908.

FULL LIST OF PRIZE MEDALS.

ATHLETICS (Stadium).		<i>Gold.</i>	<i>Silver.</i>	<i>Bronze.</i>
(1)	100 Metres .. ..	R. E. Walker, South Africa ..	J. A. Rector, U.S.A. .. ..	R Kerr, Canada.
(2)	200 " .. ..	R. Kerr, Canada .. ..	R. Cloughen, U.S.A. .. ..	N. J. Cartmell, U.S.A.
(3)	400 " .. ..	W. Halswelle, U.K. .. ..		
(4)	800 " .. ..	M. W. Sheppard, U.S.A. .. ..	E. Lunghi, Italy .. ..	H. Braun, Germany.
(5)	1,500 " .. ..	M. W. Sheppard, U.S.A. .. ..	H. A. Wilson, U.K. .. ..	N. F. Hallows, U.K.
(6)	110 " Hurdles .. ..	F. C. Smithson, U.S.A. .. ..	J. C. Garrels, U.S.A. .. ..	A. B. Shaw, U.S.A.
(7)	400 " .. ..	C. J. Bacon, U.S.A. .. ..	H. L. Hillman, U.S.A. .. ..	L. F. Tremeer, U.K.
(8)	3,200 " Steeplechase.. ..	A. Russell, U.K. .. ..	A. J. Robertson, U.K. .. ..	J. L. Eisele, U.S.A.
(9)	Five Miles Run .. ..	E. R. Voigt, U.K. .. ..	E. Owen, U.K. .. ..	J. F. Svanberg, Sweden.
(10)	Ten Miles Walk .. ..	G. E. Lamer, U.K. .. ..	E. J. Webb, U.K. .. ..	E. A. Spencer, U.K.
(11)	Marathon Race .. ..	J. J. Hayes, U.S.A. .. ..	C. Hefferon, South Africa .. ..	J. Forshaw, U.S.A.
(12)	Standing Broad Jump.. ..	R. C. Ewry, U.S.A. .. ..	C. Tsilitiras, Greece .. ..	M. F. Sheridan, U.S.A.
(13)	" High " .. ..	R. C. Ewry, U.S.A. .. ..	C. Tsilitiras, Greece, and J. A. Billar, U.S.A. (tied)	
(14)	Running Broad " .. ..	F. C. Irons, U.S.A. .. ..	D. J. Kelly, U.S.A. .. ..	C. Bricker, Canada.
(15)	" High " .. ..	H. F. Porter, U.S.A. .. ..	C. Leahy, U.K., G. Andre, France, and E. Somody, Hungary (tied)	
(16)	Hop, Step and Jump .. ..	T. J. Aheame, U.K. .. ..	J. Garfield Macdonald, Canada..	E. Larsen, Norway.
(17)	Pole Jump .. ..	A. C. Gilbert, U.S.A., and E. T. Cooke, U.S.A. (tied)	.. .. .	E. Archibald, Canada; B. Sodorstrom, Sweden; and C. S. Jacobs, U.S.A. (tied)
(18)	Throwing Hammer .. ..	J. J. Flanagan, U.S.A. .. ..	M. J. McGrath, U.S.A. .. ..	C. Walsh, Canada.
(19)	Putting Weight.. ..	R. Rose, U.S.A. .. ..	D. Horgan, U.K. .. ..	J. C. Garrels, U.S.A.
(20)	Tug of War .. ..	United Kingdom, No. 1 team ..	United Kingdom, No. 2 team ..	United Kingdom, No. 3 team.
(21)	Three Mile Team Race .. ..	United Kingdom .. ..	U.S.A. .. ..	France;

2

355

I. ATHLETICS (continued).		<i>Gold.</i>		<i>Silver.</i>		<i>Bronze.</i>	
(22)	3,500 Metres Walk .. ..	G. E. Lamer, U.K. .. ..	E. J. Webb, U.K. .. ..	H. E. Kerr, Australasia.			
(23)	Discus, Free Style .. ..	M. J. Sheridan, U.S.A. .. ..	M. H. Griffin, U.S.A. .. ..	M. F. Horr, U.S.A.			
(24)	„ Greek „ .. ..	M. J. Sheridan, U.S.A. .. ..	M. F. Horr, U.S.A. .. ..	W. Jarvinen, Finland.			
(25)	Javelin, Free „ .. ..	E. V. Lemming, Sweden .. ..	M. Doriza, Greece .. ..	A. Halse, Norway.			
(26)	„ Restricted Style .. ..	E. V. Lemming, Sweden.. ..	A. Halse, Norway .. ..	O. Nilsson, Norway.			
(27)	Relay Race, 1,600 Metres .. ..	United States .. ..	Germany .. ..	Hungary.			
II. ARCHERY (Stadium).							
(28)	York Round .. ..	W. Dod, U. K. .. ..	R. Brooks-King, U.K. .. ..	H. B. Richardson, U.S.A.			
(29)	National Round .. ..	Miss Q. Newall, U.K. .. ..	Miss Dod, U.K. .. ..	Mrs. Hill-Lowe, U.K.			
(30)	40 Arrows, 50 Metres .. ..	M. Grisot, France .. ..	M. Vernet, France .. ..	M. Cabaret, France.			
III. BOXING.							
(31)	Bantam Weight .. ..	H. Thomas, U.K. .. ..	J. Condon, U.K. .. ..	W. Webb, U.K.			
(32)	Feather Weight.. ..	R. K. Gunn, U.K. .. ..	C. W. Morris, U.K. .. ..	H. Roddin, U.K.			
(33)	Light Weight .. ..	F. Grace, U.K. .. ..	F. Spiller, U.K. .. ..	H. H. Johnson, U.K.			
(34)	Middle Weight .. ..	J. W. H. T. Douglas, U.K. .. ..	R. L. Baker, Australia .. ..	W. Philo, U.K.			
(35)	Heavy Weight .. ..	A. L. Oldman, U.K. .. ..	S. C. H. Evans, U.K. .. ..	F. Parks, U.K.			
IV. CYCLING (Stadium).							
(36)	660 Yards (lap) .. ..	V. L. Johnson, U.K. .. ..	E. Demangel, France .. ..	K. Neumer, Germany.			
(37)	1,000 Metres .. ..	Declared void.					
(38)	5,000 „ .. ..	B. Jones, U.K. .. ..	M. Schilles, France .. ..	A. Auffray, France.			
(39)	20 Kilometres .. ..	C. B. Kingsbury, U.K. .. ..	B. Jones, U.K. .. ..	G. Werbrouck, Belgium.			
(40)	100 „ .. ..	C. H. Bartlett, U.K. .. ..	C. A. Denny, U.K. .. ..	O. Lapize, France.			
(41)	Three Laps Pursuit Team Race	United Kingdom .. ..	Germany .. ..	Canada.			
(42)	2,000 Metres Tandem .. ..	M. Schilles and A. Auffray, France	F. G. Hamlin and H. T. Johnson, U.K.	C. Brooks and W. H. T. Isaacs, U.K.			
V. FENCING (Stadium).							
(43)	Epee, Individual .. ..	Alibert, France .. ..	Lippmann, France .. ..	Olivier, France.			
(44)	„ Teams .. ..	France .. ..	United Kingdom .. ..				
(45)	Sabre Individual .. ..	Dr. Fuchs, Hungary .. ..	Zulavsky, Hungary .. ..	De Lobsdorf, Bohemia.			
(46)	„ Teams .. ..	Hungary .. ..	Italy .. ..				

				<i>Gold.</i>					<i>Silver</i>			<i>Bronze</i>
	VI. FOOTBALL (Stadium, October).											
(47)	Association	..	..	..	United Kingdom.							
(48)	Rugby	..	..	..	Australasia.							
	VII. GYMNASTICS (Stadium).											
(49)	Heptathlon	..	..	..	G. A. Braglia, Italy	..	..	S. W. Tysal, U.K.	..	..	B. L. Segurra, France.	
(50)	Teams	..	..	..	Sweden	..	..	Norway.				
	VIII. HOCKEY (Stadium, October).											
(51)					United Kingdom.							
	IX. LACROSSE (Stadium, October).											
(52)	X. LAWN TENNIS.				Canada.							
(53)	Grass, Singles (Men)	..	..	..	M. J. G. Ritchie, U.K.	..	..	O. Froitzheim, Germany	..	..	W. V. Eaves, U.K.	
(54)	"	..	..	..	G. W. Hillyard and R. F. Doherty, U.K.	..	..	M. J. G. Ritchie and J. C. Parke, U.K.	..	..	C. H. L. Cazalet and C. P. Dixon, U.K.	
(55)	"	Singles (Ladies)	..	..	Mrs. Lambert Chambers, U.K.	..	..	Miss A. Boothby, U.K.	..	..	Mrs. Winch, U.K.	
(56)	Covered Court, Singles, Men	..	..	..	A. W. Gore, U.K.	..	..	G. A. Caridia, U.K.				
(57)	"	"	Doubles	..	A. W. Gore and H. Roper Barrett, U.K.	..	..	G. M. Simond and G. A. Caridia, U.K.	..	..	G. Setterwall and G. Bostrom, Sweden,	
(58)	"	"	Singles, Ladies	..	Miss Eastlake Smith, U.K.	..	..	Miss A. N. G. Green, U.K.	..	..	Mrs. Adlerstrahle, Sweden.	
	XI. MOTORBOATS.											
(59)	Class A	..	..	..	M. Thubron's Camille, France.							
(60)	"	B	..	..	Mr. T. Thornycroft's Gyrimus, U.K.							
(61)	"	C	..	..	Mr. T. Thornycroft's Gyrimus, U.K.							
	XII. POLO.											
(62)	XIII. RACQUETS.				Roehampton, U.K.							
(63)	Singles	..	..	..	E. B. Noel, U.K.	..	..	H. M. Leaf, U.K.				
(64)	Doubles	..	..	..	V. H. Pennell and J. J. Astor, U.K.	..	..	C. Browning and E. W. Bury, U.K.				

				<i>Gold.</i>	<i>Silver.</i>	<i>Bronze.</i>
XIV. ROWING.						
(65)	Sculls	..	..	H. T. Blackstaffe, Vesta R.C. U.K.		
(66)	Pairs	..	..	J. R. K. Fenning and G. L. Thomson, Leander Club, U.K.		
(67)	Fours	..	..	Magdalen College B.C., Oxford, U.K.		
(68)	Eights	..	..	Leander Club, U.K.		
XV. SHOOTING.						
(69)	National Rifle Teams	..	..	U.S.A. .. .. .	United Kingdom .. .. .	Canada.
(70)	Open Indiv. Rifles, 1,000 Yds.			Col. J. K. Millner, U.K. .. .. .	Captain K. K. V. Casey, U.S.A.	M. Blood, U.K.
(71)	" Rifle Teams	..	..	Norway .. .. .	Sweden .. .. .	France.
(72)	" Indiv. Rifles, 300 Metres			A. Helgerud, Norway .. .. .	Lieut. H. E. Simon, U.S.A. .. .. .	O. Soether, Norway.
(73)	Miniature Rifle Teams			United Kingdom .. .. .	Sweden .. .. .	France.
(74)	Indiv. Min. Rifles, 50 and 100 Yards			A. A. Carnell, U.K. .. .. .	H. R. Humby, U.K. .. .. .	G. Barnes, U.K.
(75)	Min. Rifles, Disap. Target	..	..	W. K. Styles, U.K. .. .. .	H. I. Hawkins, U.K. .. .. .	E. J. Amooore, U.K.
(76)	" " Moving Target	..	..	A. F. Fleming, U.K. .. .. .	M. K. Matthews, U.K. .. .. .	W. B. Marsden, U.K.
(77)	Revolver, Teams	..	..	U.S.A. .. .. .	Belgium .. .. .	United Kingdom.
(78)	" " Individual	..	..	P. van Asbroek, Belgium .. .. .	R. Storms, Belgium .. .. .	J. Gorman, U.S.A.
(79)	Running Deer, Teams	..	..	Sweden .. .. .	United Kingdom.	
(80)	" " Individual	..	..	O. G. Swahn, Sweden .. .. .	Captain T. Ranken, U.K. .. .. .	A. E. Rogers, U.K.
(81)	" " Double Shot	..	..	W. Winans, U.S.A. .. .. .	Captain T. Ranken, U.K. .. .. .	O. G. Swahn, Sweden.
(82)	Clay Birds, Individual	..	..	W. H. Ewing, Canada .. .. .	G. Beattie, Canada .. .. .	A. Maunder, U.K., and A. Metaxas, Greece.
(83)	" " Teams	..	..	United Kingdom, No. 1 team .. .. .	Canada .. .. .	United Kingdom, No. 2 team.
XVI. SKATING.						
(84)	Gentlemen's Figure Skating	..	..	U. Salchow, Sweden .. .. .	R. Johansson, Sweden .. .. .	P. Thoren, Sweden.
(85)	Ladies' Figure Skating	..	..	Mrs. E. Syers, U.K. .. .. .	Frll. Rendschmidt, Germany .. .. .	Mrs. Greenhough Smith, U.K.
(86)	Pair Skating	..	..	Frll. Hübler and Herr Burger, Germany.	Mr. and Mrs. Johnson, U.K. .. .. .	Mr. and Mrs. E. Syers, U.K.
(87)	Special Figures	..	..	N. Panin, Russia .. .. .	A. Cumming, U.K. .. .. .	G. N. E. Hall-Say, U.K.
SWIMMING (Stadium).						
(88)	100 Metres	..	..	C. M. Daniels, U.S.A. .. .. .	Z. de Halmay, Hungary .. .. .	H. S. A. Julin, Sweden.
(89)	400 "	..	..	H. Taylor, U.K. .. .. .	F. E. Beaurepaire, Australasia .. .. .	O. Schiff, Austria.

				<i>Gold.</i>		<i>Silver.</i>		<i>Bronze.</i>			
(90)	1,500 Metres	..	..	..	H. Taylor, U.K.	..	..	T. S. Battersby, U.K.	..	..	F. E. Beaurepaire, Australasia.
(91)	High Diving	..	..	..	H. Johannsen, Sweden	..	..	K. Malstrom, Sweden	..	..	A. Spanberg, Sweden.
(92)	Fancy	..	..	..	A. Zurner, Germany	..	..	R. Behrens, Germany	..	..	G. Walz, Germany, and G. W. Geidzik, U.S. (tied)
(93)	800 Metres, Team	..	..	..	United Kingdom	..	..	Hungary	..	..	U.S.A.
(94)	200 ,, Breast Stroke	..	..	..	F. Holman, U.K.	..	..	W. W. Robinson, U.K.	..	..	P. Hanson, Sweden.
(95)	100 ,, Back Stroke	..	..	..	A. Bieberstein, Germany	..	..	L. Dam, Denmark	..	..	H. N. Haresnape, U.K.
(96)	Water Polo	..	..	..	United Kingdom	..	..	Belgium.			

#### XVIII. TENNIS (Jeu de Paume).

(97)					Jay Gould, U.S.A.	..	..	E. H. Miles, U.K.	..	..	Hon. N. S. Lytton, U.K.
------	--	--	--	--	-------------------	----	----	-------------------	----	----	-------------------------

#### XIX. WRESTLING (Stadium).

(98)	Catch-as-Catch-Can,	Bantam			G. N. Mehnert, U.S.A.	..	..	W. J. Press, U.K.	..	..	A. Côté, Canada.
(99)	"	"	Feather		G. S. Dole, U.S.A.	..	..	J. P. Slim, U.K.	..	..	W. McKie, U.K.
(100)	"	"	Light	..	G. de Relwyskow, U.K.	..	..	W. Wood, U.K.	..	..	A. Gingell, U.K.
(101)	"	"	Middle	..	S. V. Bacon, U.K.	..	..	G. de Relwyskow, U.K.	..	..	F. Beck, U.K.
(102)	"	"	Heavy	..	G. C. O'Kelly, U.K.	..	..	J. Gunderson, Norway	..	..	E. Barrett, U.K.
(103)	Græco-Roman,	Light	..	..	E. Porro, Italy	..	..	N. Orloff, Russia	..	..	A. Linden, Finland.
(104)	"	Middle	..	..	F. M. Martenson, Sweden	..	..	M. Andersson, Sweden	..	..	A. Andersen, Denmark.
(105)	"	Light-Heavy	..	..	W. Weckman, Finland	..	..	Y. Saarela, Finland	..	..	C. M. Jensen, Denmark.
(106)	"	Heavy-Heavy	..	..	R. Weisz, Hungary	..	..	A. Petroff, Russia	..	..	S. M. Jensen, Denmark.

#### XX. YACHTING.

(107)	8-Metres	..	..	..	B. O. Cochrane (Cobweb, U.K.)			C. L. Hellström (Vinga, Sweden)
(108)	7-Metres	..	..	..	C. J. Rivett-Carnac (Heroine, U.K.)			
(109)	6-Metres	..	..	..	G. U. Laws (Dormy, U.K.)			Leon Huybrechts (Zut, Belgium)
(110)	12-Metres	..	..	..	T. C. Glen-Coats (Hera, U.K.)	..	..	C. MacIver (Mouchette, U.K.)

Total of Nations Winning Prizes—**18.** Total of Events for which Prizes were Won—**109.**

## WINNERS OF THREE GOLD MEDALS.

M. W. Sheppard, U.S.A.	{	800 Metres Flat .. ..	Athletics
		1,500 Metres Flat .. ..	"
		1,600 Metres Relay Race .. ..	"
H. Taylor, U.K.	.. {	400 Metres .. ..	Swimming
		1,500 Metres .. ..	"
		200 Metres Team Race .. ..	"

## WINNERS OF TWO GOLD MEDALS.

A. W. Gore, U.K.	.. {	Covered Singles .. ..	Lawn Tennis
		Covered Doubles .. ..	"
B. Jones, U.K.	.. {	5,000 Metres .. ..	Cycling
		Three Laps Team Pursuit Race .. ..	"
C. B. Kingsbury, U.K.	.. {	20 Kilometres .. ..	"
		Three Laps Team Pursuit Race .. ..	"
G. E. Larnar, U.K.	.. {	Ten Miles Walk .. ..	Athletics
		3,500 Metres Walk .. ..	"
T. Thornycroft, U. K.	.. {	Class B. .. ..	Motorboats
		Class C. .. ..	"
R. C. Ewry, U.S.A.	.. {	Standing Broad Jump .. ..	Athletics
		Standing High Jump .. ..	"
M. J. Sheridan, U.S. A.	.. {	Discus, Free Style .. ..	"
		Discus, Greek Style .. ..	"
M. Alibert, France	.. {	Individual Epée .. ..	Fencing
		Epée Team .. ..	"
H. Fuchs, Hungary	.. {	Individual Sabre .. ..	"
		Sabre Team .. ..	"
A. Helgerud, Norway	.. {	300 Metres, Team Competition .. ..	Shooting
		300 Metres, Individual Competition .. ..	"
E. V. Lemming, Sweden	{	Javelin, Free Style .. ..	Athletics
		Javelin, Restricted .. ..	"
A. Swahn, Sweden	.. {	Running Deer, Team .. ..	Shooting
		Running Deer, Single Shot .. ..	"

## THE FIVE DIVISIONS OF THE PRIZE LIST.

In analysing the Prize List, various divisions must be made.

(a) The first will contain the 27 events under the important heading of Athletics.

(b) The second will contain the six other sports which were decided in the Stadium between July 13 and July 25 inclusive, namely, Archery, Cycling, Fencing, Gymnastics, Swimming, and Wrestling.

(c) In the third will be placed all those competitions which had been decided by June 25, but had taken place in various localities outside the Stadium.

The first three of these divisions contained the prize-winners who received their awards from Her Majesty the Queen in the Stadium on July 25, 1908.

(d) The fourth division will include all events decided between July 25 and October 1 outside the Stadium.

(e) The fifth division contains what may be called the Autumn Sports—some of which, like Boxing or Skating, took place outside the Stadium, while others, like Football, Hockey, and Lacrosse, were decided on the grass in the centre of the Stadium. All were concluded during the month of October.

The separate totals of honours gained in each of these five divisions will first be set out, and the complete score of each nation in the whole Games will then be given.



## A.—ATHLETICS.

	<i>Firsts.</i>	<i>Seconds.</i>	<i>Thirds.</i>
U.S.A. :—			
800 Metres .. ..	100 Metres .. ..	200 Metres.	
1,500 ,, .. ..	200 ,, .. ..	110 ,, Hurdles.	
110 ,, Hurdles ..	110 ,, Hurdles ..	Marathon.	
400 ,, ,, ..	400 ,, ,, ..	3,200 Metres Steeplechase	
Marathon .. ..	Standing High Jump $\frac{1}{2}$	Pole Jump, $\frac{1}{3}$ .	
Standing Broad Jump	Running Broad Jump ..	Standing Broad Jump.	
,, High ,,	Hammer. . . . .	,, High ,,	
Running Broad Jump	Discus, Free Style ..	Weight.	
,, High ,,	,, Greek ,, ..	Discus, Free Style.	
{ Pole Jump, $\frac{1}{2}$			
,, ,, $\frac{1}{2}$			
Hammer.			
Weight.			
Discus, Free Style.			
,, Greek ,,			
1,600 Metres Relay.			
Totals .. <b>15</b>	<b>8 <math>\frac{1}{2}</math></b>	<b>8 <math>\frac{1}{3}</math></b>	
United Kingdom :—			
400 Metres .. ..	1,500 Metres .. ..	1,500 Metres.	
3,200 ,, Steeplech.	3,200 ,, Steeplechase	400 ,, Hurdles.	
5 Miles Run .. ..	5 Miles Run .. ..	10 Miles Walk.	
10 ,, Walk .. ..	10 ,, Walk .. ..	Tug-of-War.	
Hop, Step, and Jump	Running High Jump, $\frac{1}{3}$		
Tug-of-War .. ..	Weight.		
3 Mile Team Race ..	Tug-of-War.		
3,500 Metres Walk ..	3 Miles Team Race.		
.. ..	3,500 Metres Walk.		
Totals .. <b>8</b>	<b>8 <math>\frac{1}{3}</math></b>	<b>4</b>	
Sweden :—			
Javelin, Free Style ..	.. ..	5 Miles Run.	
,, Restricted .. ..	.. ..	Pole Jump, $\frac{1}{3}$ .	
		Javelin, Restricted.	
Canada :—			
200 Metres .. ..	Hop, Step, and Jump ..	100 Metres.	
		Running Broad Jump.	
		Pole Jump, $\frac{1}{3}$ .	
		Hammer.	
South Africa :—			
100 Metres .. ..	.. ..	Marathon.	
Greece :—			
	Standing Broad Jump.		
	,, High ,, $\frac{1}{2}$		
	Javelin, Free Style.		
Norway :—			
	Javelin, Restricted ..	Javelin, Free Style.	
		Hop, Step and Jump.	
Italy :—			
	800 Metres.		
Germany :—			
	1,600 Metres Relay.		
France :—			
	Running High Jump, $\frac{1}{3}$	3 Mile Team Race.	
Hungary :—			
	Running High Jump, $\frac{1}{3}$	1,600 Metres Relay.	
Australia :—			
		3,500 Metres Walk.	
Finland :—			
		Discus, Greek Style.	

B.—STADIUM EVENTS (OTHER THAN ATHLETICS) INCLUDING ARCHERY, CYCLING, FENCING, GYMNASTICS,  
SWIMMING, AND WRESTLING.

		<i>Firsts.</i>		<i>Seconds.</i>		<i>Thirds.</i>		
United Kingdom	Archery ..	York Round ..	..	Archery ..	York Round ..	..	Archery ..	National Round
	" ..	National Round ..	..	" ..	National Round ..	..	Cycling ..	Tandem Race
	Cycling ..	660 Yards ..	..	Cycling ..	20 Kilometres ..	..	Swimming	100 Metres, Back
	" ..	5,000 Metres ..	..	" ..	100 ..	..	Wrestling	Catch-as-Catch-Can,
	" ..	20 Kilometres ..	..	" ..	Tandem Race ..	..		Feather
	" ..	100 " ..	..	Fencing ..	Epée, Individual, $\frac{1}{3}$ ..	..	" ..	Light
	" ..	Pursuit Race ..	..	" ..	" Teams ..	..	" ..	Middle
	Swimming	400 Metres ..	..	Gymnastics	Hepthalon ..	..	" ..	Heavy
	"	1,500 " ..	..	Swimming	1,500 Metres			
	"	200 " Team ..	..	Wrestling	200 " Breast			
	"	200 " Breast ..	..		Catch-as-Catch-Can,			
	"	Water Polo ..	..		Bantam			
	Wrestling	Catch-as-Catch-Can, Light		"	Feather			
	"	" Middle		"	Light			
	"	" Heavy		"	Middle			
Totals ..	<b>15</b>			<b>13<math>\frac{1}{3}</math></b>			<b>7</b>	
France ..	Archery ..	Continental Style ..	..	Archery ..	Continental Style ..	..	Archery ..	Continental Style
	Cycling ..	Tandem Race ..	..	Cycling ..	660 Yards ..	..	Cycling ..	5,000 Metres
	Fencing	Epée, Individual ..	..	" ..	5,000 Metres ..	..	" ..	100 Kilometres
	"	" Teams ..	..	Fencing ..	Epée, Individual ..	..	Fencing ..	Epée, Individual
							Gymnastics	Heptathlon
Totals ..	<b>4</b>			<b>4</b>			<b>5</b>	
Sweden ..	Gymnastics	Teams ..	..	Swimming	High Diving ..	..	Swimming	High Diving
	Swimming	High Diving ..	..	Wrestling	Græco-Roman, Middle ..	..	"	100 Metres
	Wrestling	Græco-Roman, Middle ..	..	" ..	" ..	..	"	200 " Breast
Totals ..	<b>3</b>			<b>2</b>			<b>3</b>	

	<i>Firsts.</i>						<i>Seconds.</i>						<i>Thirds.</i>		
Hungary ..	Fencing ..	" ..	Wrestling	Sabre, Individual ..	" Teams ..	Græco-Roman, Heavy-Heavy	Fencing ..	Swimming	"	Sabre, Individual	100 Metres	200 ,,	Teams		
Totals ..	<b>3</b>						<b>3</b>							<b>0</b>	
United States ..	Swimming	Wrestling		100 Metres	Catch-as-Catch-Can,	Bantam Feather	.. ..	.. ..	.. ..	.. ..	.. ..	.. ..	.. ..	Archery ..	York Round
														Swimming	200 Metres, Teams
														"	Fancy Diving, $\frac{1}{2}$
Totals ..	<b>3</b>						<b>0</b>							<b>2 <math>\frac{1}{2}</math></b>	
Germany ..	Swimming	"		Fancy Diving ..	100 Metres, Back ..		Cycling ..	Swimming	Pursuit Race ..	Fancy Diving ..				Cycling ..	660 Yards
Italy ..	Gymnastics	Wrestling		Heptathlon ..	Græco-Roman, Light		Fencing ..		Sabre, Teams					Swimming	Fancy Diving, $\frac{1}{2}$
Finland ..	"			"	Light-Heavy		Wrestling	Græco-Roman, Light-Heavy						Wrestling ..	Græco-Roman, Light
Russia ..							Wrestling	Græco-Roman, Light-Heavy							
Norway ..							Gymnastics	Teams							
							Wrestling	Catch-as-Catch-Can, Heavy							
Denmark ..							Swimming	100 Metres, Back						Wrestling ..	Græco-Roman, Middle
														" ..	" Light-Heavy
														" ..	" Heavy-Heavy
Australasia ..							Swimming	400 Metres						Swimming	1,500 Metres
Belgium ..							"	Water Polo						Cycling ..	20 Kilometres
Canada ..														Wrestling	Catch-as-Catch-Can, Bantam
Austria ..														Cycling ..	Pursuit Race
														Swimming	400 Metres
Bohemia ..														Fencing ..	Sabres, Individual

C.—COMPETITIONS BEFORE JUNE 25, 1909, OUTSIDE THE STADIUM, INCLUDING LAWN TENNIS, POLO, RACQUETS, SHOOTING, AND TENNIS (Jeu de Paume).

		<i>Firsts.</i>				<i>Seconds.</i>				<i>Thirds.</i>			
United Kingdom	Lawn Tennis	Grass, Men's Singles ..	Grass, Men's Doubles ..	Lawn Tennis	Grass, Men's Doubles ..	Lawn Tennis	Grass, Men's Singles ..	Lawn Tennis	Grass, Men's Singles ..	Lawn Tennis	Grass, Men's Doubles ..	Lawn Tennis	Grass, Men's Doubles ..
	"	" " Ladies' Singles ..	" " Ladies' Singles ..	"	" " Ladies' Singles ..	"	Covered, Men's Singles ..	"	" Ladies' Singles ..	"	" Ladies' Singles ..	"	" Ladies' Singles ..
	"	Covered, Men's Singles ..	" " Doubles ..	"	" " Doubles ..	"	" " Doubles ..	Shooting ..	Open Indiv., 1,000 Yds.	"	Indiv. Min. Rifles, 50 Yds.	"	Min. Rifles, Disappearing Target
	"	" " Ladies, Singles ..	Racquets ..	Racquets ..	Singles ..	"	"	"	"	"	"	"	"
	Polo ..	"	"	"	Doubles ..	"	"	"	"	"	"	"	"
	Racquets ..	Singles ..	"	Shooting ..	National Rifle, Teams ..	"	"	"	"	"	"	"	"
	"	Doubles ..	"	"	Indiv. Min. Rifles, 50 Yds.	"	"	"	"	"	"	"	"
	Shooting ..	Open, Indiv., 1,000 Yds.	"	"	Min. Rifles, Disap. Target	"	"	"	"	"	"	"	"
	"	Miniature Rifles, Team ..	"	"	" " Moving Target ..	"	"	"	"	"	"	"	"
	"	" " Indiv., 50 Yds.	"	"	Running Deer, Teams ..	"	"	"	"	"	"	"	"
	"	" " Disap. Target	"	"	" " Indiv. ..	"	"	"	"	"	"	"	"
	"	" " Moving Target	"	"	" " Double ..	"	"	"	"	"	"	"	"
	"	Clay birds, Teams	"	"	Shot	"	"	"	"	"	"	"	"
				Tennis (Jeu de Paume)									
	<b>Totals ..</b>	<b>15</b>		<b>15</b>				<b>12</b>					
United States ..	Shooting ..	National Rifle, Teams ..	Shooting ..	Shooting ..	Open, Indiv., 1,000 Yds.	Shooting ..	Revolver, Individual	Shooting ..	Revolver, Individual				
	"	Revolver, Teams ..	"	"	" " 300 Metres	"	"	"	"				
	"	Running Deer, Double Shot	"	"		"	"	"	"				
	Tennis (Jeu de Paume)												
	<b>Totals ..</b>	<b>4</b>		<b>2</b>			<b>1</b>						
Sweden ..	Shooting ..	Running Deer, Teams ..	Shooting ..	Shooting ..	Open Rifle, Teams ..	Lawn Tennis	Covered, Men's Doubles	Lawn Tennis	Covered, Men's Doubles				
	"	" " Indiv. ..	"	"	Min. Rifle, Teams ..	"	" Ladies' Singles	"	" Ladies' Singles				
	"	" " " " " " " " " "	"	"	" " " " " " " " " "	Shooting ..	Running Deer, Double Shot	Shooting ..	Running Deer, Double Shot				
	<b>Totals ..</b>	<b>2</b>		<b>2</b>				<b>3</b>					
Norway ..	Shooting ..	Open Rifle, Teams ..	"	"	"	Shooting ..	Open, Indiv., 300 Metres	Shooting ..	Open, Indiv., 300 Metres				
	"	Open, Indiv., 300 Metres	"	"	"	"	"	"	"				
Canada ..	Shooting ..	Clay Birds, Individual ..	Shooting ..	Shooting ..	Clay Birds, Individual ..	Shooting ..	National Rifle, Teams	Shooting ..	National Rifle, Teams				
	"	" " " " " " " " " "	"	"	" " " " " " " " " "	"	"	"	"				
Belgium ..	Shooting ..	Revolver, Individual ..	Shooting ..	Shooting ..	Revolver, Individual ..	Shooting ..	Revolver, Individual	Shooting ..	Revolver, Individual				
	"	" " " " " " " " " "	"	"	" " " " " " " " " "	"	"	"	"				
Germany ..	"	" " " " " " " " " "	"	"	" " " " " " " " " "	"	"	"	"				
France ..	"	" " " " " " " " " "	"	"	" " " " " " " " " "	"	"	"	"				
Greece ..	"	" " " " " " " " " "	"	"	" " " " " " " " " "	"	"	"	"				

D.—COMPETITIONS OUTSIDE THE STADIUM FROM JUNE 25 TO OCTOBER 1, INCLUDING MOTORBOATS, ROWING, AND YACHTING.

		<i>Firsts.</i>				<i>Seconds.</i>				<i>Thirds.</i>				
United Kingdom	Motorboats	Class B												
	"	" C												
	Rowing	..	..	..	..	Yachting	..	..	..	..	12-Metre Boats			
	"	..	..	..	..									
	"	..	..	..	..									
	"	..	..	..	..									
	Yachting	..	..	..	..	7-Metre Boats								
	"	..	..	..	..	8-Metre Boats								
	"	..	..	..	..	6-Metre Boats								
	"	..	..	..	..	12-Metre Boats								
Totals	..	<b>10</b>				<b>1</b>				<b>0</b>				
France	..	..	..	..	..	Motorboats	Class A							
Sweden	..	..	..	..	..	..	..	..	..	..	Yachting	..	..	8-Metre Boats
Belgium	..	..	..	..	..	..	..	..	..	..	"	..	..	6-Metre Boats

E.—THE AUTUMN SPORTS IN OCTOBER, INCLUDING BOXING, FOOTBALL, HOCKEY, LACROSSE, AND SKATING.

		<i>Firsts.</i>				<i>Seconds.</i>				<i>Thirds.</i>				
United Kingdom	Boxing	..	..	..	..	Boxing	..	..	..	..	Boxing	..	..	Bantam
	"	..	..	..	..	"	..	..	..	..	"	..	..	Feather
	"	..	..	..	..	"	..	..	..	..	"	..	..	Light
	"	..	..	..	..	"	..	..	..	..	"	..	..	Middle
	"	..	..	..	..	"	..	..	..	..	"	..	..	Heavy
	Football	..	..	..	..	Association	..	..	..	..	Skating	..	..	Ladies' Figure
	Hockey	..	..	..	..	..	..	..	..	..	"	..	..	Pairs
	Skating	..	..	..	..	Ladies' Figure	..	..	..	..	"	..	..	Special Figures
Totals	..	<b>8</b>				<b>6</b>				<b>8</b>				
Australia	..	..	..	..	..	Football	..	..	..	..	Boxing	..	..	Middle
Canada	..	..	..	..	..	Lacrosse								
Sweden	..	..	..	..	..	..	..	..	..	..	Skating	..	..	Men's Figure
Germany	..	..	..	..	..	..	..	..	..	..	Skating	..	..	Men's Figure
Russia	..	..	..	..	..	..	..	..	..	..	Skating	..	..	Ladies' Figure
		..	..	..	..	..	..	..	..	..	..	..	..	Men's Figure

In the whole programme of the Games, out of the total of 109 first prizes, 93 seconds, and 81 thirds, the value of the proportion won by each of the eighteen nations may be estimated by counting 5 for each first, 3 for each second, and 1 for each third. The results would then stand as follows :—

I. UNITED KINGDOM.		Firsts	Seconds	Thirds	II. UNITED STATES.		Firsts	Seconds	Thirds
VALUE	A	8	$8\frac{1}{3}$	4	VALUE	A	15	$8\frac{1}{2}$	$8\frac{1}{3}$
	B	15	$13\frac{1}{3}$	7		B	3	0	$2\frac{1}{2}$
	C	15	15	$11\frac{1}{2}$		C	4	2	1
	D	10	1	0		D	—	—	—
	E	8	6	8		E	—	—	—
Totals ...		56	$43\frac{2}{3}$	$30\frac{1}{2}$	Totals ...		22	$10\frac{1}{2}$	$11\frac{5}{6}$

III. SWEDEN.		Firsts	Seconds	Thirds
VALUE	A	2	0	$2\frac{1}{3}$
	B	3	2	3
	C	2	2	3
	D	0	1	0
	E	1	1	1
Totals ...		8	6	$9\frac{1}{3}$

IV. FRANCE.		Firsts	Seconds	Thirds
VALUE 46	A	0	$\frac{1}{3}$	1
	B	4	4	5
	C	0	0	2
	D	1	0	0
	E	—	—	—
Totals ...		5	$4\frac{1}{3}$	8

V. CANADA.		Firsts	Seconds	Thirds
VALUE	A	1	1	$3\frac{1}{3}$
	B	0	0	2
	C	1	2	1
	D	—	—	—
	E	1	0	0
Totals ...		3	3	$6\frac{1}{3}$

VI. GERMANY.		Firsts	Seconds	Thirds
VALUE	A	0	1	0
	B	2	2	$1\frac{1}{3}$
	C	0	1	0
	D	—	—	—
	E	1	1	0
Totals ...		3	5	$1\frac{1}{2}$

VII. HUNGARY.		Firsts	Seconds	Thirds
VALUE	A	0	$\frac{1}{3}$	1
	B	3	3	0
	C	—	—	—
	D	—	—	—
	E	—	—	—
Totals ...		3	$3\frac{1}{3}$	1

VIII. NORWAY.		Firsts	Seconds	Thirds
VALUE 19	A	0	1	2
	B	0	2	0
	C	2	0	1
	D	—	—	—
	E	—	—	—
Totals ...		2	3	3

IX. ITALY.				IX. BELGIUM.					
	Firsts	Seconds	Thirds		Firsts	Seconds	Thirds		
Value 14	A	0	1	0	VALUE 14	A	—	—	—
	B	2	1	0		B	0	1	1
	C	—	—	—		C	1	2	0
	D	—	—	—		D	0	1	0
Totals ...	2	2	0	Totals ...	1	4	1		

—	Firsts	Seconds	Thirds	Value
XL Australasia .. ...	1	2	2	11
XI. Greece ... ..	0	3 $\frac{1}{2}$	$\frac{1}{2}$	11
XIII. Russia ... ..	1	2	0	9
XIII. Finland ... ..	1	1	2	9
XV. South Africa ... ..	1	0	1	6
XVI. Denmark ... ..	0	1	3	5
XVII. Austria ... ..	0	0	1	1
XVII. Bohemia ... ..	0	0	1	1

N.B.—Fractions occur in the above totals owing to dead heats for second and third places. Each scores  $\frac{1}{2}$  in the only dead heat which occurred for a first place. Out of the 110 events on the programme, one was declared void and no prizes given. Compared with the amount of entries sent in by each competing nation the ten best results work out as follows, the total of prizes being 283:—

—	Number of Prizes	Number of Entries
United Kingdom ... ..	130 $\frac{1}{6}$	839
United States ... ..	44 $\frac{1}{3}$	160
Sweden ... ..	23 $\frac{1}{3}$	204
France ... ..	17 $\frac{1}{3}$	363
Canada ... ..	12 $\frac{1}{3}$	67
Germany... ..	9 $\frac{1}{2}$	110
Hungary... ..	7 $\frac{1}{3}$	153
Norway ... ..	8	64
Italy ... ..	4	115
Belgium... ..	6	88

## CHAPTER VI.

THE DISTRIBUTION OF GOLD MEDALS BY  
HER MAJESTY THE QUEEN.

As will have been seen in the complete prize list which precedes this chapter, the whole of the long programme, containing twenty various sports, had not been finished by July 25. Apart from those events especially appropriate to the autumn months, such as hockey or skating, there were other sports, such as yachting, rowing, or motor-boating, which were fixed for a date in the summer later than July 25. But by that day the competitions in athletics, archery, cycling, fencing, gymnastics, lawn tennis, polo, racquets, shooting, swimming, tennis (*Jeu de Paume*), and wrestling had been concluded, and there were therefore eighty-three events for which the Olympic Gold Medal could be handed to each winner by the Queen. He received at the same time, from officials whose names are given in the "Daily Programme" at the beginning of the Appendix, the prize diploma, a diploma for his club, and a bunch of oak leaves, which had been graciously sent from Windsor Forest for the purpose by His Majesty the King. Each was tied with a small silken Union Jack, and the precedent so gracefully set with the olive leaves presented by the King of Greece in Athens was thus carried out in our own country with the appropriate symbol of the national oak.

The proceedings on this the last day of the Games in the Stadium were somewhat difficult to arrange with due regard both to what was expected on so dignified an occasion and to what might be considered as legitimately appropriate for the entertainment of a crowd of spectators. More than 80,000 ticket-holders had been admitted on the previous day, and thousands had been unable to get seats at all. The concourse had been larger than any seen before within one building in this country. Within the experience of police-officers who had seen the Derby Day, the Boat-race, and many of our greatest Reviews, no greater crowd has gathered for one single event in England than that which assembled on the Marathon Day outside the Stadium and all along the roads from Windsor, for





THE DUCHESS OF WESTMINSTER DISTRIBUTING THE DIPLOMAS  
OF SPECIAL MERIT, JULY 25, 1908.

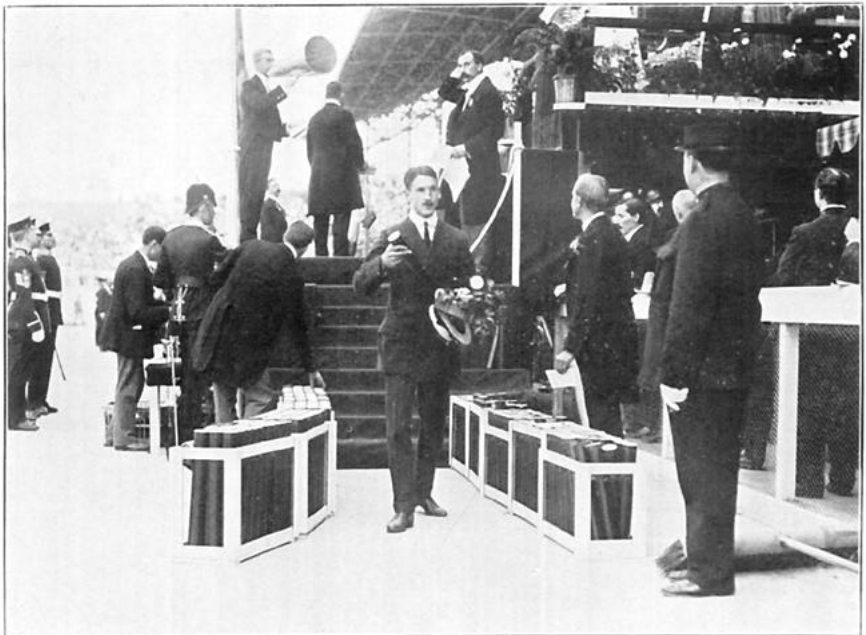

LIEUTENANT HALSWELLE RECEIVING HIS GOLD MEDAL FROM QUEEN ALEXANDRA,  
WITH DIPLOMAS AND OAKLEAVES, FOR THE 400 METRES, JULY 25, 1908.



THE CHALLENGE CUPS PRESENTED IN 1908 FOR RACES IN THE OLYMPIC GAMES,

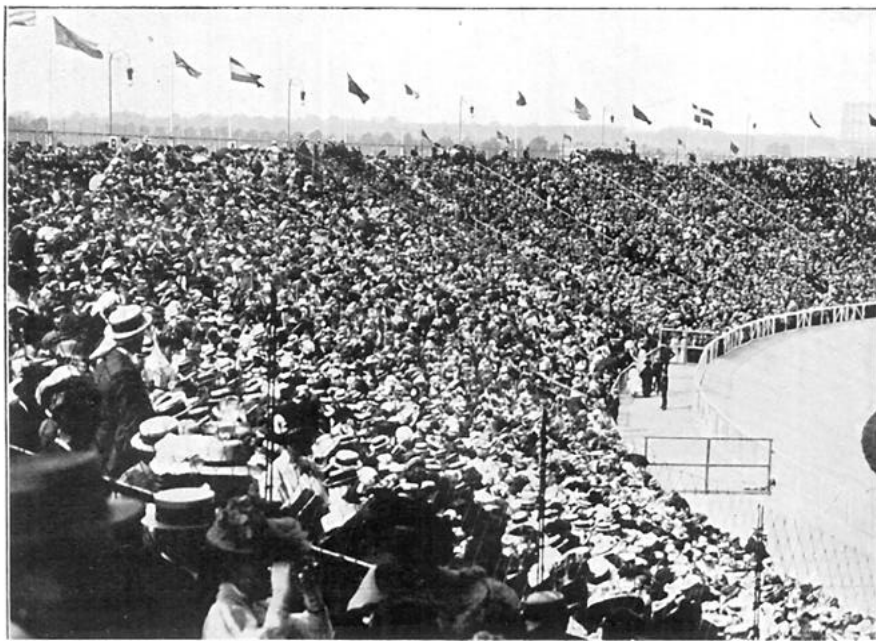

THE NORTH END OF THE STADIUM, JULY 24, 1908.

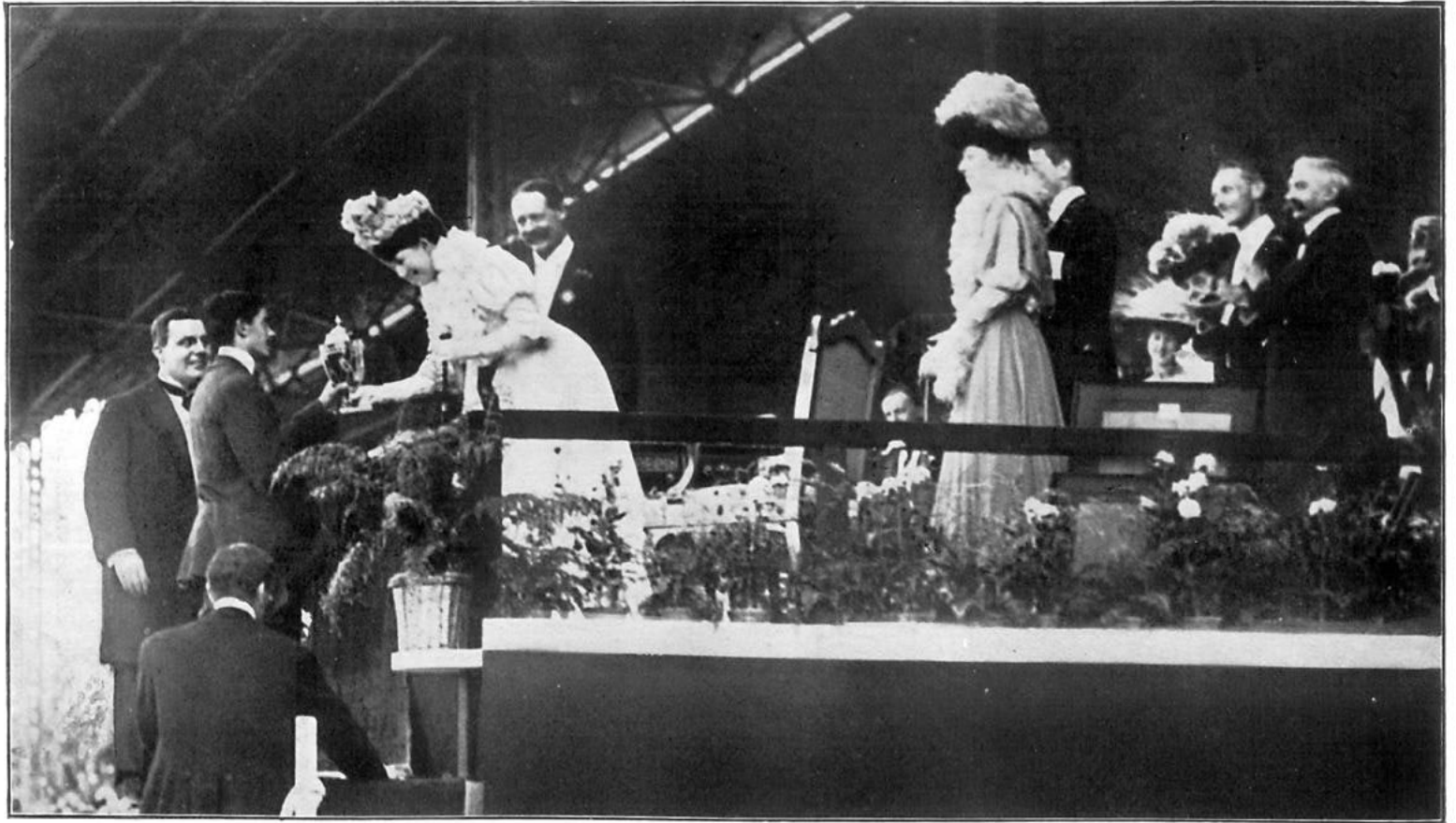

QUEEN ALEXANDRA PRESENTS DORANDO WITH A GOLD CUP, JULY 25, 1908.



AFTER WALKER'S VICTORY IN THE 100 METRES.



KERR OF CANADA CHEERED AFTER WINNING THE 200 METRES.

twenty-six miles, into London. It was fully expected that as many as before would be present in the Stadium on the Saturday. Fortunately the weather was fine. Fortunately, too, Her Majesty, on her appearance and before she went away, received the welcoming cheers of a larger number of her subjects than had ever greeted her in one place before. Nor was the athletic merit of the events she witnessed unworthy of so interesting a day. We saw, almost without realising the marvel on which we looked, a man covering 110 metres of ground and ten flights of hurdles in faster time than any human being had been able to accomplish the feat before that day. His terrific pace was only visible when it was observed that he finished four yards ahead of an athlete who had equalled the previous record for the world. It was a fact significant of much that had gone before. The limitation of entries, large as was their eventual total, had had the valuable result of substituting quality for quantity. No one started who had not been selected by his country as one of her best twelve in each particular event. As a consequence many men whom we saw "beaten out of sight" in the preliminary heats were champions in their own country. It was difficult to realise the high average level of all the performances without remembering this. But in the hurdle race it became striking; in the 1,500 metres swimming race on the same afternoon it was almost equally clear, for in this the second man after waiting eight seconds at the finish was still able to go on and complete the full mile in time better than the British amateur record. And if on the Friday afternoon that vast amphitheatre, crammed from roof to floor, had beheld in the finish of the Marathon Race the utmost limit to which virile resolution in the athlete's struggle for success can strain the endurance of the human frame, on Saturday we beheld one of the most extraordinary instances of perfect skill and speed to which careful training and unimpaired energy can exalt a healthy man. No better introduction could have been wished to the ceremony of the prize-giving.

That ceremony was, for purposes of convenience, divided into two parts; and the separate processions involved were organised and marshalled by those officials from the Polytechnic to whom the Olympic Council had already been indebted for so much good work of the same nature. Her Majesty did not arrive till four o'clock. At a quarter-past two the first processions, containing winners of second and third prizes and diplomas of merit, together with a few of the recipients of the commemorative medals, were lined up on the east side of the track, and the band of the Grenadier Guards, placed at the north-west corner of the cycle-track, played a selection from the national anthems of all the competing nations. At half-past two the bugles of the Irish Guards, who were present twenty-four

strong, under Drum-Major F. C. James, blew the advance, and the drums and fifes immediately followed with a march. Across the angle of the great central expanse, from Block MM to the south-western corner of the running-track, the scarlet uniforms of a line of non-commissioned officers of the Irish Guards and the Grenadier Guards stood out against the vivid green of the turf and served as a directing line for the advancing athletes. Over the four prize-tables on the cycle-track, beneath the Royal Box, presided the Duchess of Rutland, the Duchess of Westminster, Katharine Duchess of Westminster, and Lady Desborough, assisted by marshals chosen from the British Olympic Council.\* During the distribution of these awards the band of the Grenadiers played a selection of national tunes and folk-songs, and by half-part three the first part of the day's proceedings was over.

Just before four o'clock the rise of the Royal Standard in front of the Royal Box gave the signal for the National Anthem as the Queen came in with Princess Victoria and the Crown Prince and Princess of Sweden, attended by Lord Desborough, Baron Pierre de Coubertin, Colonel Balck, Baron de Tuyll, and others. The numbers had hardly been hoisted at the end of the Relay Race which gave the Americans the privilege of seeing their national flag the last one to be hoisted on the pole beyond the swimming-bath, when the winners of the gold medals began to assemble along the cycle-track at the east, and the Grenadiers' band played "See the Conquering Hero Comes." Immediately its notes had died away the bugles of the Irish Guards sounded the advance, and the victors of the Olympic Games of 1908 began to move along the scarlet-lined passage that led them towards the Royal Box, marching to the lilting strains of the Irish drums and fifes.

The Queen stood in a square space built out from the Royal Box, and well in view of the many thousands of spectators, as the line of men slowly came up to her in all the various costumes appropriate to their different victories" the boots and cords of the polo player, the khaki uniforms of the rifle shots, the neat white tunics of the fencers, the shorts and jersey of the runner. They were led by the winner of the Hundred Metres (the event which happened to come first in the printed programme), and the cheers that greeted Walker, of South Africa, gave echoing promise of the shouts to come. As the rest followed him one; after another, the spectators realised that they were looking at the finest procession of athletes which had ever passed before a Queen.

When the gold medals were all distributed, an addition was made, by

\* The names of all who assisted are given in the "Daily Programme," in the Appendix.

the Queen's wish, to the published programme ; and at the moment chosen by Her Majesty Dorando was called up to the Royal Box to receive the gold cup that must have been more than a consolation for his defeat, and marked, in a better way than any other, the sympathy felt by every spectator of Friday's stirring episodes for the courage that had so desperately fought against overwhelming physical exhaustion. The card accompanying the trophy bore the following words in the Queen's own hand :—

For P. DORANDO,  
In Remembrance of the Marathon Race  
From Windsor to the Stadium.  
From Queen Alexandra.

Immediately afterwards Her Majesty proceeded to her final task, the distribution of the challenge cups. The cheering Americans placed Hayes on a table beside the bronze statuette of the dying Pheidippides, presented by the Greek Olympic Committee, a statuette which was far more nearly a record of the actual results to one of the competitors of 1908 than anyone could have previously imagined possible. As they carried Hayes round the running-track the signaller from H.M.S. *Buzzard*, whose duty it had been to hoist the winning flags of various nations during the Games, noticing that the Stars and Stripes were not represented in the informal but hearty little procession that surrounded the Marathon winner, ran up to them with the flag just before they reached the American stand, where the cheers drowned even the enthusiastic plaudits with which Hayes had been greeted in other parts of the arena. The French fencers looked particularly smart in their fighting costume as they came up under the conduct of their captain, Mr. H. G. Berger, to receive the bronze reproduction of the Pourtalès Vase that will commemorate their victory for the next four years. The Prague Trophy, owing to its tremendous weight, needed the assistance of two muscular Guardsmen before even its gymnastic winners could bear it down into the arena. At last the long list was finished. The ceremony concluded with the presentation of the Olympic Cup by Her Majesty the Queen to the Crown Prince of Sweden. This Cup, the gift of Baron Pierre de Coubertin, from whose hands the Queen received it on this occasion, had been awarded in 1907 to the Stewards of Henley Regatta, and in 1908 to the Central Association of Sweden for the Promotion of Sport, as recorded in Chapter I.

The prize-winners of July 25, as they passed from before the Queen, had lined up in front of the swimming-bath ; at five o'clock the long roll of the Irish drums signalled that the prize-giving was over; and, as they

ceased, three clear notes sounded on the bugles. Lord Desborough moved to the front of the Royal Box and called for "Three Cheers for the Queen." They were given with a will from every part of that brilliantly crowded space, and as they died away the strains of the National Anthem rose into the air. The majority of the events in the greatest and most widely representative athletic gathering ever seen in this or any other country were over. As the athletes themselves dispersed, many of us who watched them felt that we were never likely to look upon so splendid a set of men again.



## CHAPTER VII.

## NOTES ON ORGANISATION.

WITHOUT going into too many details, it may be useful for the benefit of future meetings to sketch the outlines of the more important parts of the work undertaken by the British Olympic Council in organising the Games of 1908 in London. Even from what has appeared in previous pages it will be easily realised that their task was no light one, for they had to deal with Athletics, Archery, Boxing, Cycling, Fencing, Football (Association and Rugby), Gymnastics, Hockey, Lacrosse, Lawn-Tennis (on grass and in covered courts), Motorboats, Polo, Racquets, Rowing, Shooting (including revolvers, running deer and clay birds), Skating, Swimming, Tennis (Jeu de Paume), Wrestling, and Yacht-racing. Organising these twenty main divisions of an amateur athletic meeting open to the world was a very serious business to carry out in less than two years ; and the correspondence in several languages which had to be dealt with by the Honorary Secretary, the Rev. R. S. de Courcy Laffan, and his Staff, was enormous. The total of the more important letters exceeded ten thousand. We had some three thousand entries, and at least 300,000 spectators must have visited the Stadium alone. Eight hundred officials were necessary for the various Divisions of the Games. Seven official banquets were organised in London by the British Olympic Council alone, attended by nearly 3,500 persons ; and these are entirely separate from many other dinners and entertainments given in connection with the Games. The work of arranging all this could not be fairly begun until early in 1907, and the British Olympic Council, which sat continuously through the Olympic Games, had met nearly every fortnight previously for some eighteen months, while Sub-Committees dealt with various details during the whole period.

The first result of the Council's labours was that they were able to submit a detailed programme to the International Olympic Committee at The Hague in the spring of 1907, and this programme was discussed for the greater part of a week by the representatives of the various nations, in the same buildings which were the scene of the Peace Conference soon afterwards.

Though the programme suggested for London was of course based on those programmes which had been carried out at the previous Olympic Games in St. Louis (1904), Paris (1900), and Athens (1896), the main principle laid down for 1908 was that no competition should be sanctioned which was not practised by several different nations. For this reason Pelota, Baseball, and Cricket (for example) were rejected from the British Olympic programme, because the practice of these games was too restricted in character for the purposes of an international competition. Even this programme would probably be still further shortened on a future occasion.

It will be seen, therefore, that the British Olympic Council were working under the direct sanction of the International Olympic Committee, which laid down the principles on which we should arrange the international meeting in London and left us to carry out the details. This is why we included such typically Olympic contests as the javelin, the discus, or the Marathon Race, which had already taken place at previous Games ; and this also is why all the distances were measured in metres, instead of the yards and feet usual in this country. With these principles before us, it was our first care to draw up as quickly as possible a complete code of Olympic rules for every Olympic competition. That code was printed and published in three languages, and sent to all the competing nations in the year before the Games began. It contains full details, and in several cases elaborate diagrams, of all the sports concerned. It is the first published code for twenty different kinds of sport under which more than twenty different nations agreed, through their representatives and over the signatures of their athletes, to compete together. It can be obtained in English, French, or German, and is reprinted in full in this volume.

There were, in all, 109 events in the Olympic Games of 1908. These events were grouped under twenty great divisions, each controlled for the British Olympic Council by the Association governing that particular sport in this country. It must be clear that the details of so complicated a programme could never have been carried out unless the executive power had been entrusted to these great governing Associations, which had already proved, at many previous International meetings, their competence to control such details. This principle of control was heartily approved of by Mr. James Sullivan, for instance, before the English Games began ; and we are given to understand that on this principle similar meetings are managed in the United States, for which nation he was an official representative in London. The enormous amount of work done for the good of these Games by the officials in the governing Associations of the United Kingdom can hardly be estimated.

It was continuous for over two years. It was given freely and ungrudgingly for the credit of this country, and for the assistance and proper treatment of our visitors. So large an area of sporting activities has never before been covered by officials of so much tried experience and special knowledge.

Few greater tributes to the English love of fair play have ever been placed on record than the decision of the International Olympic Committee that the whole of the arrangements for judging these games should be placed in the hands of our great governing associations. No question is more difficult than this of the fair judging of so many different competitions in which so many various nations are competing ; and much of its difficulty must inevitably remain until an International Olympic Code of Sport has become a matter of internationally accepted fact. In describing some of the events in Chapter IV. of this Report, I have occasionally inserted a few suggestions made by the authorities in control of the event on which comment of this kind appeared advisable. But it should clearly be understood that these comments are not so much criticisms of the past as indications of the line on which future improvement may be possible. Nor would it be appropriate in this place to consider in detail the delicate problems involved by international juries. Provided the nation holding the games is given full powers to employ either its own judges or foreign judges, using its discretion in each event as to selecting one or the other class, or as to utilising both, it is probable that many difficulties will disappear; for the greater spread of detailed knowledge entailed by these great international meetings must inevitably result in a gradually increasing measure of harmoniously sympathetic co-operation. Some events are obviously more difficult to judge than others, owing to the question of personal opinion being closely involved ; for instance, in diving, in fencing, or in gymnastics, the "form" of the competitor must often be taken into account, even when the details involved in the actual accomplishment of a particular movement are not almost too minute for one observer to be able thoroughly to satisfy himself concerning it. In judgments such as these, it is, at present, unavoidable that one nation—and therefore the nation holding the games—should alone be authorised to pronounce verdicts through representatives appointed and guaranteed by itself; for, under any other system, those verdicts must inevitably differ according to the differing customs of jurors of different nationalities, until we reach the ideal period when a code accepted by all nations is recognised as governing every decision in every form of sport. Until that time arrives, the only likelihood of complete success for a jury composed of different nationalities would be presented

in the case of such sports as running, jumping, shooting or rowing, in which the verdict depends upon the actual visible fact of one man having run or jumped better than another. But even then, it would be very difficult to know where to draw the line in composing a jury of different nationalities ; for nations excluded from it might have a legitimate cause of complaint which would increase the difficulties of organisation to an overwhelming extent. When, however, the nation holding the games is recognised as being the sole authority responsible for providing competent officials for every event, and is understood to be at liberty to choose those officials with the sole view of securing the most competent for each particular occasion, then it is probable that a fair level of working excellence will be attained, as was attained in London, throughout a long and complicated programme. It is probable that fencing offered as much difficulty, as far as judging was concerned, to the English organisers, as any other division of sport, for nearly every Englishman proficient enough to judge was necessarily competing. Owing to the comparative rarity of fencing as a sport in this country, we were therefore glad to rely a good deal on foreign assistance ; but we found that very few foreign judges could guarantee beforehand their presence on a given day or could appear, even when in London on that day, at a given hour during the Tournament ; and this difficulty is likely to be accentuated in future meetings. One remedy suggested has been a grant of money towards the expenses of visiting judges; but this has obvious dangers, and the whole matter needs careful consideration. The rule preventing fencing-judges of the same nationality as either of the teams engaged from taking any official part in the competitions between those teams worked well, and should be maintained, as did the rule eliminating any official co-operation on the part of professionals, which seems equally essential in the future ; but the rule preventing a competitor from acting as a judge might well be relaxed, if necessary, after his defeat, for instance, in an individual pool.

Scarcely less important than the question of judges is that of the entries for Olympic Games. Something concerning them has already been said in earlier chapters, and it should be observed that the limitation of the number of entries eligible in each event from each nation was imposed for the first time in 1908. It will be impossible to neglect so important a precedent in the future. But there is another equally vital point. The date up to which entries are legitimate is a matter that no Olympic Committee of the future can afford to leave uncertain.

When the question arose of fixing the date of the closing of the entries the British Olympic Council had before it the request of the American Committee that the closing of entries be put as late as possible in order to

give the American organisers the fullest possible opportunity of selecting their team. With great reluctance, knowing the mass of work to be got through, the Secretary of the British Olympic Council and his colleague in the office consented to the date of June 12 on the understanding that on that date all the entries should be on their table, and that they should be able on that day to begin immediately the work of registration and classification.

In order to meet the needs of competitors from beyond the Atlantic, whether from the United States or from Canada, it was decided in March 1908 that entries for any number of competitors might be received before the date fixed for the closing of the entries, but that a cable must on that date be sent reducing these entries to the number to which any country was entitled. This was also done entirely out of consideration for Transatlantic competitors in the first instance, and although it would have considerably added to the work of the British Olympic Council Offices, yet as we should have been able still to begin to deal with entries on June 13 it was felt that it was a concession which ought to be made.

Finally, about the middle of May, Lord Desborough received a letter from Mr. Sullivan pointing out the great difficulties under which the United States laboured in making their entry, as their last Try-Outs could not be held before June 6, and again requesting that cable entries should be allowed.

The Minute of the Council on this subject is dated May 25, 1908, and runs as follows :—

“ After considerable discussion in view of the gravity of the case as affecting the participation of American competitors, it was decided that the Hon. Secretary should inform all Olympic Committees that cable entries would be accepted for all sports.”

Accordingly the bare names of the American Competitors were received in the office of the British Olympic Council on June 10. The Entry Forms themselves for the Athletic events were received here, some on June 22 and some as late as June 30, and in a large number of cases the rule that a separate form must be filled in for each event by each competitor (which is printed in leaded type on every form) was only complied with after the arrival of the Manager of the American Team in London some two days before the Games began. Anyone who has had any experience of dealing with entries and scrutinising their validity must know how immensely the work of the office was complicated and increased by the acceptance of cable entries, by the delay in sending in the entry forms, and by the irregularity in filling them up. Nor was even this all. It was only by a special concession, which we were very glad to be able to make to so

courteous a visitor as General Drain, that the American Rifle team, whose entries arrived too late, were permitted to compete at all.

The arrangement of the programme was very largely determined by the fact that we were continually reminded by European committees that their men could not remain during the whole period of the Games. This made it necessary that the sprints should be put in one week and the long-distance races in another; and this was another reason why it was so important to get the entries early, so that we might know the number of heats necessary, and draw up the details of the daily programme in good time, and thus enable Continental competitors to make arrangements to be in London for their particular event ; for, unlike the American team, the majority of our foreign visitors were unable to be here during the whole fortnight of the Games in the Stadium.

The British Olympic Council, however, naturally accepted all these difficulties, knowing that most of them are inevitable in any large meeting of this kind, and being especially anxious to make things as easy as was legitimately possible for all our visitors without exception. Our experience goes to show that though the Central Organising Committee of the nation holding the games must invariably be given full authority either to accept or reject entries in whatever manner it may see fit, yet the principle of entering by cable for these games is wholly disadvantageous, both to the competitors of the country in which the games are held and to its visitors. The importance of the various contests practically involves the fact that the best national representatives in each event are well known to their own countrymen some time beforehand, and the interval of four years gives ample time for the discovery and development of fresh talent that may have appeared since the last meeting. The Athenian cycle may in some cases reduce this period to as little as two years. A man who is likely to beat the whole of the rest of the world in any particular athletic event is not likely to have remained undiscovered until as late as three months before the date of any given international meeting. It would therefore seem wise in future games to insist upon the official entry-forms arriving duly filled up at the office of the Central Committee at least six weeks before the date fixed for the opening of the competitions to which they refer.

This leads me to a question intimately connected with the entries, viz. the drawing of heats.

Our own view of all the athletes entered for the Games of 1908 from every nation, including our own, was that each was a picked Olympic competitor. The official representative of one of the competing nations expressed the opinion that the athletes representing his own country should have been divided up by our authorities into various classes according to

their known merit or their previous form. One difficulty of doing this would have been that no one who was not well acquainted with the sporting conditions of that particular country—who was not, in fact, a compatriot of the athletes involved—would have been able to make such a classification in a satisfactory way. It is not the custom here in any form of sport. We do not, for instance, pick out the favourite for the Derby and give him the inside position at the start. We determined that no classification was possible or desirable in the case either of our own Olympic athletes or of any others. Even if it had taken place it would have provided no guide whatever, in previous form, to the results of the Hundred or Two Hundred Metres Flat ; to the splendid performances of Lunghi, the Italian ; to the failure of every English competitor in the Marathon ; to the double victory of Sheppard in the Half-Mile and the Mile. These results were contrary both to popular expectation and to previous form ; and sport in general would lose half its interest were not such results so frequently possible, so often seen.

The method of drawing preliminary heats postulated the equality of all competitors from the same nation, and aimed at avoiding, as far as possible, the competition between athletes of the same nation in the same preliminary heat. It was therefore only when the total of competitors from the same nation exceeded the total of the preliminary heats that two competitors of the same nation appeared in the same heat, and a glance at the detailed results in previous pages will show that this occurred as often in the case of English competitors as in those of any other nation, an occurrence only natural from the inevitable fact that the country holding the games would be obviously likely to enter more competitors than any other country. When twelve competitors are admissible from each nation, and only eight preliminary heats are necessary, it is certain that in some cases two representatives of the same nation must run together. It would be impossible for any nation to select which those two were to be, in a satisfactory manner, and still more impossible for the nation holding the games to make that selection. The inevitable doubling can therefore only be left to "the luck of the draw." And so we left it. One result was that three of our best men in the Hundred Metres came against Kerr, Walker, and Huff, and that our three best men in the Quarter were drawn together in a heat which produced the fastest time for the event. There were similarly accidental hardships in the case of other countries. But I know of no method by which they can be fairly avoided.

The arrangement of the time-table for each day (which could not be undertaken at all until we knew the exact number of entries, and therefore of heats, in each event) was a matter almost as complicated and delicate

as any which exercised the patience and ingenuity of our various Sub-Committees ; and in taking into account the value of various performances the influence of the daily programme (printed in the Appendix) should never be neglected by the impartial critic. This was particularly evident in the long-distance races which had to be nearly all decided during the first week, with the exception of the Marathon Race. The first heats of the Three Miles Team Race, for instance, followed the Fifteen Hundred Metres, while the final preceded the Five Miles. Or again, to take an instance from the English competitors alone, which can no doubt be paralleled from the experience of other countries, Deakin had four tough races in forty-eight hours, and A. J. Robertson had to run second (with Eisele behind him) in the steeplechase final, at 2.30, when the Five Miles Final was run at 5.30 on the same afternoon. A peculiar kind of endurance was, in fact, necessitated ; for not only was every race of a very much higher class than that usually seen in ordinary athletic gatherings, but a man who obtained a gold medal had to win his final (perhaps over so long a distance as the ten-mile walk) within some twenty-four hours of succeeding in his preliminary heat in the same arduous event. This, however, is again one of the inevitable difficulties of a meeting which cannot take more than a comparatively restricted period of time, a period which in London was certainly prolonged as far as any of our visitors could possibly have stayed. I may add that if we had spread out the various classes of events over a longer period of time, the nation that would have been chiefly benefited would have been the United Kingdom, for all our athletes were on the spot. We decided to keep events of the same class within as short a period of time as possible in order that we might afford the greatest facilities for attendance to the greatest number of competing nations.

Though the attention of the general public and the energies of at least one nation were concentrated chiefly upon the events which took place in the Stadium, and even upon one division of those events, it would be manifestly erroneous to attribute an overwhelming superiority in value, in the Olympic Games, either to a section which included athletics only or to a division which contained archery, cycling, fencing, gymnastics, swimming, and wrestling as well. In considering the full prize list of events decided from April to October 1908, I have, therefore, divided the twenty sections of the whole games into five main divisions, so that the superiority of each nation can be decided in the division on which that particular nation had determined to concentrate its energy. It is evident to some critics, though not to all, that some of these divisions, and a few of these sections, are so overwhelmingly superior in their athletic value



that a victory in them should count at least three times as much as any other victory in the final balance-sheet. But opinion is far from unanimous on this question ; and even if it were unanimous from the point of view of appraising comparative athletic values, we should still be faced with the difficulty that while in athletics a nation can win twenty-seven first prizes, in rowing it can only win four, in football only two, in polo only one. It would be a hard task to prove that that one victory in polo deserved no greater recognition than, let us say, a victory in hurling the discus—a victory, in fact, obtained in one out of twenty-seven possible opportunities in a single department. In other words, the score possible for athletics is automatically and accidentally different from the score possible for polo, though each is only one division out of the twenty divisions of the Games. Here, again, we are faced with an inevitable difficulty, which is chiefly evident in the recurring fact that the nation which holds the games is almost certain to come out at the top of the full prize-list by sheer weight of numbers. It can enter more competitors than than other nation. In analysing the prize-list I have, therefore, been careful to add the number of entries made by each nation to the total of prizes it secured ; for it is the object of the modern Olympic movement, as we understand it in England, not so much to encourage specialisation in any single branch of sport, still less in any particular event, as to throw open to the widest field of competition the widest athletic programme consonant with international representation. This is why, in our opinion, an Olympic programme should never be arranged, by the nation responsible for the Games, solely with a view to exhibiting the greatest number of different sports in which the inhabitants of that nation are accustomed to compete among themselves ; still less, we think, should an Olympic programme endeavour to include every one of the various manifestations of physical energy known to each and all of the different nations expected to compete. The programme should contemplate, if we are right, a well-considered list of first-rate contests, in some of which every competing nation could enter its representatives, and in all of which at least six different nations (in the Olympic sense of the word “ nation ”) were well known to be able to send representatives. Even on these lines certain sentimental considerations must invariably, and rightly, enlarge the rigid framework of the first idea ; but after every legitimate concession has been made to sentiment, the remaining possibilities should strictly be segregated in a class by themselves—a class open, indeed, to the enjoyment of all visitors to these Games, and recognised by the award of commemorative medals, but a class that does not reach the standard exacted of winners of Olympic prize medals in open and equal competition against the world.

It need not be imagined that these principles would unduly restrict any Olympic programme in the future ; for the spread of various forms of sport all over the world has been enormous even in the comparatively few years since the Olympic Games were first revived in Athens. Lawn tennis, to take but one example, has become popular everywhere, and can now safely command representative international entries at any duly accredited meeting. Golf has made the same progress ; but, in this country at any rate, some of its chief votaries are not yet ready to acknowledge its fitness for Olympic competition. A code of rules was drawn up for the games of 1908, which appears in this volume ; but owing to the loss of certain early correspondence in connection with the subject, addressed by the British Olympic Council to the Royal and Ancient Golf Club, it was found impossible to carry out the events originally planned. Football has also spread very widely, in both forms of the game; but the Rugby Union authorities also did not apparently expect strong competition from abroad, and were not in a good position to produce a strong team at the very beginning of their season, which was the date fixed for the autumn games. The result was that the French entry, which arrived at the last moment, was practically alone, and their team could actually have claimed the gold medals as a matter of law had they appeared. But before the date of play they most courteously agreed to the suggestion that late entries should be permitted, in order to produce a game, and the Rugby Union then proceeded to find an English fifteen. The Anglo-Welsh team who had been playing in New Zealand and Australia were invited to defend the medals, but the letter never reached them, and Cornwall, the champion county of the past' season, were then asked to play and consented to do so. It was discovered, later on, that the Australians, who were in this country at the time, were also ready to play, and in the end it was the Australians who won a competition that scarcely reached the standard of the rest of the games, for the French were after all unable to send over a Rugby team as well as the two Association elevens who represented them.

Apart from the competitions just mentioned, the only ones I have heard seriously criticised as unlikely, for various reasons, to be repeated on similar occasions are Racquets, Real Tennis (Jeu de Paume), and Covered Court Lawn Tennis ; and when I say " criticised," I do not desire to convey in any way either that objections were made to the conduct of these competitions in 1908, or that these competitions are not intrinsically worthy to form a part in any programme, but simply that experience seems to show that it would be unwise to include them in the future, chiefly in view of the sound principle that every item in an Olympic programme

should be genuinely open to international competition on a fairly wide scale and at a fairly convenient season.

The suggestion that the Olympic programme for 1908 should include competitions in sculpture, painting, poetry, and music was inevitably postponed because of the short time we had to organise the games in London ; but it is hoped that the regulations drawn up for our Council by the highest authorities on these subjects may prove of value to future organisers, who will be well advised to announce the holding of these competitions at least three years before the opening of the games at which the results will be exhibited.

The rules for the various sports which are included in these pages are submitted, with every deference, to the athletic authorities of the rest of the world as the best which our governing associations could produce in each case. Under the sanction of the International Olympic Committee they proved practicable and successful in 1908. It is hoped that they may form the basis of an international code of sport which shall eventually govern all competitions in every celebration of the Olympic Games in future ; and inasmuch as any such code must be in the nature of a compromise, it is believed that the foundations on which such a working compromise may be built up are here, for the first time, provided for general adaptation and discussion. These rules form perhaps the most valuable contribution made to the international sport of the future by those who organised the games of 1908, and I shall therefore conclude this chapter by appending a few of the letters received by the British Olympic Council from the official representatives of the various countries whose athletes competed under the rules thus drawn up. There were many others, but I have been provided with the most typical examples by the Secretary of the Council, and they are as follows :—

“Brunkebergstorg 12,

“Stockholm :

“14th August, 1908.

“To the President of the  
British Olympic Association, London.

“SIR,— I am instructed by the Swedish Olympic Committee of 1908 to express to you their sincere thanks for the great hospitality and kindness shown to the Swedish Olympic Competitors, and to state at the same time how greatly they appreciated the goodwill and fair play which governed the spirit in which the games were conducted.

“My Committee earnestly hope that, as a result of the Competitions, the strong ties of friendship already existing between British and Swedish sportsmen may have been further strengthened, and that it may serve as an inducement to British sportsmen and athletes to visit Sweden in the near future, where at all times they will be assured of a hearty welcome.

“I have the honour to be, Sir,

“Your obedient servant,

(Signed) “ VIKTOR BALCK.”

“ Rue de l'Université, 3,

“ Athènes :

“ 11/24 Août, 1908.

“MONSIEUR LE PRÉSIDENT.— A l'occasion de la clôture de vos Jeux Athlétiques j'ai l'honneur de vous exprimer à vous, ainsi qu'aux honorables membres du British Olympic Council et aux officiels, les vifs remerciements de notre Comité de l'accueil courtois dont vous avez fait preuve en faveur de nos représentants officiels et des attentions dont vous avez comblé les participants hellènes.

“Nous saisissons l'occasion pour vous exprimer nos sincères félicitations du succès qui a couronné votre brillante réunion sportive.

“Veuillez agréer, Monsieur le Président, l'assurance de notre considération la plus distinguée.

“Par ordre de S.A.R le Prince Royal des Hellènes, Duc de Sparte, Président du Comité des Jeux Olympiques.

“ LE SECRÉTAIRE GÉNÉRAL, p.o.

“Rt. Hon. Lord Desborough,  
Président du Council of  
British Olympic Association,  
108 Victoria Street, S.W.”

“Comité des Jeux Olympiques à Athènes sous la présidence de

“S.A.R. le Prince Royal de Grèce,

“le 28 *Juillet*, 1908.

“ Monsieur,—Comme délégué du Comité des Jeux Olympiques à Athènes j'ai l'honneur de vous exprimer mes plus sincères remerciements de la bonté et des amiables attentions dont vous avez comblé ses représentants et les athlètes helléniques.

“Veuillez agréer, Monsieur, l'assurance de ma haute considération.

(Signed) “MILT. M. NEGROPONTES.”

“ Paris, le 21 *Octobre*, 1908.

“MY DEAR COLLEAGUE AND FRIEND,—I transmit herewith a letter that the Marquis Compans de Brichanteau, President of the Italian Committee, for the IVth Olympiad is begging me to send to you.

“ I have nothing to add to the feelings he is expressing in the name of His Majesty the King of Italy, in the name of the Italian People, of the Committee and the Athletes that came to London ; and I associate with by sending to you and the Committee my best thanks for his cordial hospitality.

“ With the President of our Committee I acknowledge kindly that the B.O.C. was always guided by the highest mind of justice and impartiality in the organisation and unfolding of the IVth Olympiad.

“ May I beg you will kindly accept, my dear friend, for you and for our dear colleague, the Rev. R. S. de Courcy Laffan, as for all your colleagues of the B.O.C., the feelings of my grateful and affectionate remembrance?

“(Signed) COMTE EUGÈNE BRUNETTA D'USSEAUX,

“Commissaire Général d'Italie à la IV<sup>me</sup> Olympiade.

“Lord Desborough of Taplow.”



T. S. BATTERSBY (U.K.), IN THE RACE FOR THE 1,500 METRES (SILVER MEDAL),  
BEAT BRITISH RECORD FOR THE MILE.



WRESTLING —CATCH-AS-CATCH-CAN. HEAVY-WEIGHT FINAL.  
G. C. O'KELLY(U.K.), WINNER.



CYCLING.—5,000 METRES FINAL. B. JONES (U.K.), WINNER.



CYCLING.—20 KILOMETRES. C. B. KINGSBURY (U.K.), WINNER.

*Translation.*

" Rome :

" October 12th, 1908.

" To His Excellency Lord Desborough of Taplow, K.C.V.O.,

" President of the British Olympic Council,

" London.

" With my heart still full of the grateful recollection of the many proofs of sympathy and good-will lavished upon the Italian Committee, over which I had the honour to preside, permit me, Your Excellency, in view of the approaching end of the IVth Olympiad to fulfil the pleasant duty of offering you the homage of our most cordial thanks in the name of all my colleagues.

" The manifestation of esteem and fraternity with which the Italian Competitors were at all times surrounded during their unforgettable sojourn in London, but more especially in the moments when they felt the most need of comfort, help, and protection, will for ever remain engraved on their hearts and ours; that high spirit of equity and justice which at all times and with so much serenity inspired your governing Committee will never, we assure your Excellency, cease to be remembered and admired by us.

" Of such manifestations we comprehend all the high value inasmuch as they go beyond our own personalities, and afford fresh confirmation of the traditional generous hospitality of Great Britain, and strengthen more and more those bonds of solidarity which, independently of our excellent international relations—and it is the good fortune we most desire—draw together as brothers in all circumstances the English and Italian people.

" The echo of these cordial testimonies has reached and from every point of view delighted His August Majesty our beloved King, whose enlightened thought and the nobility of whose soul always stir with enthusiasm wherever the hearts of Italians beat. The King has followed with lively interest—and he was informed on our arrival in our country of all the particulars and of all your kindness—the development of the magnificent and splendidly impressive proof of international prowess and of the rapid progress which is so full of promise and assurance for the physical education of the younger generations.

" Permit me once more to address you, illustrious President, the warm expression of the emotion of my heart, while at the same time I ask you to act as interpreter of our unanimous feelings of devoted gratitude towards the unsurpassable Rev. de Courcy Laffan and the sympathetic Captain Jones, who loaded us with delicate and affectionate courtesies.

" With profoundest respect to Your Excellency,

" I remain,

" The President of the Italian Committee,

" (Signed) MARQUIS CARLO COMPANS DI BRICHANTEAU.

" Member of the National Parliament."

" V. Praze, dne 26te Oct., 1908.

" To the British Olympic Council,

" 108 Victoria St.,

" London, S.W.

" GENTLEMEN,—By the festival meeting of the Bohemian Olympic Committee, the 24th of October, 1908, it was unanimously decided to express to the British Olympic Council our best thanks for the hospitality to the Bohemian Olympic expedition at London in July last, and at the same time to congratulate you for the excellent success and arrangement of the Olympic Games.

" The Bohemian Olympic Committee regret only that it was impossible to participate in the Winter Games.

" Yours truly,

" (Signed) DR. JIRI GUTH,

" President of the Bohemian Olympic Committee in Prague."

BB

"Government House, Ottawa,  
" 30th Nov., 1908

" MY DEAR LORD DESBOROUGH,—Now that the Olympic Games are over and our victorious Lacrosse team is back, my Committee and I wish to send you a personal message of gratitude for all you have done.

" We feel that had it not been for your gallant and successful efforts Canada would have missed the opportunity of a great athletic competition which, whether it brought success or failure to those who took part in it, must tend to an improvement in sport, and especially amateur sport.

" Our representatives would also like to send a message of gratitude for all the kindness and hospitality extended to them while in the Old Country, and they hope that you will extend to all the members of your Committee who have worked so hard their sincere appreciation of all that was done for them.

" We hope that the day may come when this country will be selected as the place for a celebration of these sports, and if so I am asked to assure you that Canadians feel sure that their visitors will receive a most hearty welcome, and will, we hope, carry away with them a pleasant impression of this Great Dominion.

" We are acknowledging the handsome medals which have been sent to us, and informing you of their distribution.

"Believe me, with kind regards,  
"Yours sincerely,  
"(Signed) J. HANBURY WILLIAMS."

"Budapest : 4th Dec., 1908.

" To the Right Hon. Lord Desborough,  
" Chairman of the British Olympic Council.

"MY LORD,—In the name of the Hungarian Olympic Council, I beg to convey to your Lordship and the members of the British Olympic Council our sincerest thanks for the hearty and hospitable reception afforded us during our visit to London for the Olympic Games of 1908.

" It is not so much the success achieved by the members of our Association as the absolute equality and sportsmanlike treatment shown to all foreign competitors which will be treasured as an undying remembrance of the historic meeting. Nothing could have been more gratifying to us than the fairness with which every detail of the games was arranged and conducted ; and we have learned from the able Committee working under the guidance of Your Lordship and the British Council, the acme of sportsmanlike fair play, and can realise to the full why Great Britain, which has always been the ideal of Hungarian athletes, is known as the home of sport—in the truest sense of the word. We Hungarians shall always look back with the greatest pride and affection to the happy days spent in your hospitable capital, with their constant reminders of the duties and pleasures of genuine sportsmen.

" With renewed expressions of our profound gratitude,

"I remain,  
"Your Lordship's obedient servant,  
"(Signed) JULES DE MUZSA.  
"Member of Parliament.  
"Acting President of H.C.C."



“ Johannesburg,

“ *March 22, 1909.*

“ Right Honourable Lord Desborough of Taplow,

“ Chairman of the British Olympic Association, London.

“MY LORD,—I have the honour to inform you that I have been instructed by the General Olympic Committee for South Africa, to convey to you their appreciation of the splendid manner in which the Olympic Games were conducted.

The South African Competitors, without exception, have acknowledged the fairness in which all competitions were decided.

“I have the honour to be, my Lord,

“Your obedient servant,

“(Signed) T. PALMER,

Honorary Secretary.”

## CHAPTER VIII.

## FINANCE AND ENTERTAINMENT.

MANY suggestions have been made for providing the large sum of money necessary to carry out adequately any celebration of the Olympic Games in modern times. If the question of finance has proved difficult in the past, that difficulty is not likely to diminish in the future, for Olympic balance-sheets, like other budgets, are in the habit of proving their healthy existence by a vigorous growth. Different nations have naturally solved the problem in different ways ; but in England we have hitherto been deprived of one form of assistance which is common, I believe, to the rest of the world ; for we never have been able to count upon any financial contribution from the public funds through the channels of official administration nor have we been able to avail ourselves of the patronage of the Government in raising money, by any officially-supported scheme, for these objects.

When we were first faced with the necessity for providing an adequate arena, with adequate surroundings, for the Games of 1908, I must confess that my own suggestions were limited to the discovery of a sufficiently public-spirited and enthusiastic millionaire who would hand over £80,000 to the British Olympic Council on the understanding that, as trustees for the appropriate expenditure of the total, we should make every effort to return as much of it as possible. I still believe that this would be the ideal procedure. But unfortunately men are generally obliged to carry out ideal schemes by sternly limited and practical methods, and as we possessed neither an Averoff to build our Stadium, nor a Government to issue either bonds or stamps on our behalf, we had to look around us for the possibilities presented. Fortune favoured us to the extent that the year previously fixed for the Olympic Games of London was soon afterwards selected as the date of the Franco-British Exhibition ; and the organisation of this Exhibition had been vested in the versatile and imaginatively-creative personality of Mr. Imre Kiralfy. Among the many attractions his inventive brain had devised was an enormous arena for the display of various kinds of sport. Just as, ten years before, Baron Pierre de Coubertin and M. Bikelas

had found in the Zappeion the nucleus for the first games in modern Athens, so Lord Desborough and his associates discovered in the Sports-Arena of the Franco-British Exhibition the nucleus of the Stadium for our Olympic Games.

With goodwill on both sides, the necessary bargain was soon struck, and an enormous oval amphitheatre in steel and concrete was built to accommodate some 80,000 people round the racing-tracks, the swimming-bath, and the central expanse of open turf which were all necessary for the proper conduct of the main items in the programme. It was but natural that since the Exhibition authorities had pledged themselves to provide the funds necessary for the construction of this arena in accordance with the desires of the British Olympic Council, they should have obtained and exercised control over the admittance of the public to the building thus erected, while the authority of the Council was equally naturally limited to the executive arrangements connected with the performance of the Games. This sounds simple enough in theory, especially as each side in the bargain was notoriously anxious to assist the other. But in practice it developed several serious difficulties, which are—as in the case of the competitions described in earlier pages—only mentioned here as a guidance for the future, and without the least desire either to criticise the past or arouse needless controversy. They can be very briefly stated.

The executive authorities of the France-British Exhibition were naturally not so conversant with the exigencies of a great international sporting meeting as the members of the British Olympic Council, and they rightly considered the Stadium to be a very valuable asset in the attractiveness of the Exhibition as a whole, an asset which had eventually cost quite £60,000, if not more, and which had therefore to be so worked as to ensure a return at least, if not a fair profit, on the outlay. It was hoped that everyone who went to see the Exhibition in the latter half of July would certainly go into the Stadium as well, and also that many who were first attracted to the Stadium would pass out of it into the Exhibition. This was a very legitimate and natural hypothesis ; but it led to the installation of a large number of entrances and turn-stiles connecting the Stadium with the Exhibition, and to a system of checks and counter-checks, which occasionally proved annoying to those unfamiliar with the complicated problem to be solved. It was obvious that people who only paid a shilling to enter the Exhibition could not be given free admittance to the Stadium, and that spectators who paid to see the sports could not thereby claim uncontrolled admittance to the Exhibition. On the other hand, the mere proximity of the Exhibition to the Stadium was an advantage which everyone connected with the Games was ready to appreciate,

for it not only enabled the athletes, the officials, and the spectators to fill up pauses in the programme with profitable and delightful visits to the sights outside, but it gave them facilities in such buildings as the Imperial Sports Club or the Garden Club for rest, refreshment, and inter-communication which could never have been so luxuriously provided within the building that itself contained the arena of the sports. The arrangement of the safeguards necessary for the proper enjoyment of these facilities was necessarily quite novel and unprecedented ; and it will therefore be permissible to say that it occasionally showed signs of wear and tear, and sometimes broke down almost completely. But on the whole the extremely complicated organisation worked efficiently enough, and its deficiencies were more hardly felt by the casual spectator than either by the athletes or the officials of the Games ; and since this Record is primarily connected with the Games, and only secondarily with the Exhibition in so far as the two came into contact, I may dismiss in these pages the question of the spectators with very few remarks indeed.

In the first place it was discovered that the advantage, imagined by foreign critics to be the pre-eminent asset of London's Games, namely, our national love of sport, turned out, curiously enough, to be rather harmful than otherwise to the Stadium attendances. The reason was that we are so accustomed, as a nation, to attend innumerable sporting meetings of every description all through the year that the addition of one more to the crowded calendar was at first scarcely understood. The Boat-race, the Derby, the Final Cup Tie, the great matches of the Cricket-season, the University Sports, the Amateur Athletic Championships, Henley Regatta, and many fixtures more, were to be seen as easily in 1908 as in any other year, and they attracted no fewer crowds of every class in that year than they did before. Apart, therefore, from all questions of time and money, it must be remembered that we were offering only one more entertainment to a public already nearly sated with such shows, and to a nation which only began to realise the extraordinary nature of the Games themselves when they were nearly over. The meeting was never adequately advertised by the Exhibition authorities, who must have thought they needed no advertisement, and the prices of the seats were at first placed so high that whole blocks remained empty. This was a matter, of course, in which the British Olympic Council could not unduly press their views, for they took the Stadium as a gift from the Exhibition authorities, and were naturally obliged to allow those authorities a fairly free hand in the methods they chose to recoup themselves for their expenditure. But it soon became obvious that prices which ranged from £8. 8s. for a box on the opening day to 2s. 6d. for an upper row any morning other than the first or last

were much too high, even for the western side along the swimming-bath ; and though prices were originally given at 6d. for standing room on the east side, the other seats on that side were at first also fixed at much too high a figure.\* The lack of advertisement seriously affected advance bookings, and the rain of the first week discouraged even Londoners from coming in large numbers. Nor could appeals in the newspapers after the Games began convince the public that only a fortnight was given them for seeing the greatest athletic gathering in the history of the world. Yet on Marathon Day at least 90,000 persons were in the Stadium looking on, and those outside were offering from 10s. to £5 for a seat. A total of at least 300,000 persons must have seen the Games in all, which means more in England than, for instance, it might do in Athens, where the whole available population within reach of the sports came to see them every day. The English audience, on the whole, changed from day to day, with a few notable exceptions, and we may therefore consider that in spite of every difficulty a creditable proportion of our population saw the Games of 1908, in so far as those carried out in the Stadium are concerned. And I am not taking into account now either the spectators who witnessed all the Olympic events in other places during the year, or the enormous crowd that watched the Marathon Race all the way from Windsor to the very gates of the Stadium. But the Exhibition authorities cannot possibly have been able to recoup themselves for their expenditure,

\* In considering the question of the spectators at these Games, many points will occur to the reader which are not strictly within my province ; such as the provision of cushions and backs for the seats ; easy methods of obtaining cheap programmes and plenty of them ; and other matters. But one must at any rate be mentioned in these pages ; it is the recurrent difficulty of all Olympic Games ; it has never yet been satisfactorily solved ; and it concerns the presence, within the actual central space of the arena, of persons who have no real right to be there, and who obstruct the view of the spectators. Sometimes this obstruction is caused by athletes who either are waiting their turn to compete in the event which other people are thus prevented from seeing, or have remained in the arena after their own competition in order to observe more closely the performances of others. But more often the trouble was due to the presence, round some exciting field-contest or swimming-race, of officials who had nothing to do in that particular event, or even of wholly unauthorised persons who had no business there whatever. Even the complete system of badges and cards instituted in the Stadium in London did not seem capable of preventing recurrent annoyance from these various sources ; and the only remedy I can suggest for future meetings is that a staff of officials should be especially appointed, whose duty it should be, during the whole continuance of the Games, to clear the arena of everyone not actively engaged in competing or supervising competitions. The judges connected with each competition should also make it a part of their duty to see that the immediate neighbourhood of each field-event should be kept as absolutely free from all obstruction as if it were a course cleared for a race,

and the proportion of the gate-money and other receipts handed to the British Olympic Council only came to a little over £6,000 sterling, out of which they had to provide more than £1,200 for extra police supervision, messengers, telegraph boards, carpentry, technical equipments connected with the various sports, and insurance.

It may be thought that this would leave a comfortable balance. But besides the seven divisions of the Games decided in the Stadium in the summer, and the three divisions carried out there in the autumn, we had to make provision for the adequate arrangement of Boxing, Lawn-Tennis, Motor-Boats, Polo, Racquets, Rowing, Shooting, Skating, Tennis (Jeu de Paume), and Yachting, all of which took place outside the Stadium. Some of these latter, owing partly to the nature of a particular sport, partly to the excellent management of its organisers, and partly to the generosity of its governing Association, cost the British Olympic Council little or nothing; but grants to the various governing bodies had to be made to the extent of nearly £2,250, and when the circumstances are considered this will be realised to be as low a sum as could possibly have been required. Nor has anything yet been said of the prize-list. Considering that every first prize was a gold medal, specially designed, and that replicas in silver and bronze were added as second and third prizes, together with diplomas, it will be easily understood that £2,200 was the minimum expenditure essential under this head, for it included also a very large number of silver and bronze commemorative medals, and nearly a thousand different badges, comprising about nine various designs, each bearing distinct lettering. This money, however, will have been well spent if it emphasises the desire of the British Olympic Council that all prizes to be kept by competitors in these Games in the future should consist of medals, with their accompanying diplomas, only; and that all cups and trophies should be in the nature of challenge-cups, which should continue in the official cycle of these Games in perpetuity. In the first case, the future cost of both prizes and commemorative medals can be much reduced by the adoption of a permanent design for one side of each medal, as was suggested at The Hague Conference of 1907 by the International Olympic Committee; and in the second case, the provision of twelve perpetual challenge-cups during the one year of 1908 has gone far towards the completion of a list that should never be too long.

Continuing my sketch of the inevitable expenses of organisation I now come to the essential item of the central office. The chief work done there, in the case of the Games of 1908, as it must always be in every future celebration, was without price and beyond any adequate remuneration, and though this Report is issued by the Council I may perhaps be

permitted to express the admiration felt by all its members for the unremitting labours of their President, Lord Desborough ; their Secretary, the Rev. R. S. de Courcy Laffan, and his assistant, Captain F. Whitworth Jones. But the mere cost of stationery and printing amounted to over £2,000, and general expenses, including postage, telephones, and cables, came to £550 more. Taking the total of such expenses as may conveniently be called Administrative, it is no less than £4,410 ; and by this time the least mathematical reader will have discovered that we are several thousand pounds ahead of the total of the Stadium receipts mentioned above.

It should be said that £2,000 of these receipts had been advanced to us beforehand ; but it must be already clear that the total of our most necessary liabilities before the Games began was considerably more than that, without taking into account any preparation for hospitality or entertainment. For some time, I must confess, the financial outlook seemed a little black, for though the few cases of individual generosity in the way of subscriptions before the Easter of 1908 were most deeply appreciated, the total of these would have barely sufficed, even with the strictest economy, to carry out the athletic portion of the Games alone; and nothing else would have been possible. But we never despaired of the Republic of Sportsmanship, and our blackest hour was just before the dawn ; for thanks to the generous intervention of Lord Northcliffe, a spirited appeal issued by the *Daily Mail* at the very last moment produced the most liberal results. It is not my province here to mention any individual subscriptions, but I can say that the country at large seemed suddenly to have realised its obligations, and the total of the subscription-list from all sources finally reached nearly £16,000.

From what has gone before and from the balance-sheet given herewith, it will be observed that, apart from an expenditure of £60,000 (in rough figures) on the erection of the Stadium by the France-British Exhibition, the British Olympic Council had to provide £15,213 for the various expenses immediately concerned with the organisation of the Games of 1908. My estimate, therefore, of about £80,000 as the cost of carrying out one of these celebrations, from the beginning and in its entirety, in the future is scarcely in excess of the sum which such a celebration has already involved ; and expansion is the law of life. I have only gone into such details in this question in the hope that they may be of use to those who are facing the task of organising and financing the Games of 1912, and afterwards.

## BRITISH OLYMPIC ASSOCIATION.

## REVENUE ACCOUNT,

From NOVEMBER 27, 1906, TO DECEMBER 31, 1908.

		£	s.	d.	£	s.	d.		
To Administrative Expenses—								By Donations ...	£ s. d. £ s. d.
Rent, House-keeper, &c. ...	373	0	4					„ Stadium Receipts ...	6,007 16 6
Salaries ...	1,317	5	10					Less—	
Printing and Stationery ...	2,068	10	6					Insurance	
Postage, Telephone, Cables, &c. ...	291	14	0					Premium	312 10 6
Carriage and Traveling Expenses	94	10	2					„ Interest on Deposit ...	5,695 6 0
General Expenses ...	265	0	6						44 16 1
				4,410	1	4			
To Games Expenses—									
Equipment, Police Supervision, Messengers, &c.	979	17	5						
Medals, Badges, Diplomas, &c.	2,200	6	0						
Entertainments	5,271	12	6						
Grant to Governing Bodies for the conduct of the Games ...	2,231	17	11						
				10,683	13	10			
To Audit Fee ...									
„ Depreciation of Furniture ...									
Balance carried to Balance Sheet ...									
				6,377	15	9			
				£ 21,591	13	3			
								£ 21,591	13 3

I now turn to the more attractive portion of this chapter, which was necessarily preceded by those financial considerations without which it would have never existed, and by the consideration of the Balance-sheet, on which the sum of £5,271 is the largest individual item of expenditure. That item was involved by entertainments, and it would be a sad misunderstanding of the ideal of the modern revival of the Olympic Games if any captious critic should object to that expenditure. For the knowledge of one another's habits, the possibilities of mutual friendship, the opportunities of mutual courtesy are among the greatest assets which the modern Olympic movement can possess, and its enduring value can never be depreciated by anyone who heard, as so many of us heard several times over in 1908, the national anthems of more than twenty different nations shouted in chorus at a dinner attended by some five hundred of their picked athletic representatives.

The British Olympic Council was itself far more deeply conscious of its defects than any of its kindly critics could have been. If in the Games



themselves the lateness of the entries had necessitated a concentrated effort at the last moment which militated against contentment, even if it was never allowed to degenerate into confusion, so in our efforts to entertain our guests we were necessarily handicapped by the unavoidable fact that only a few days before the Games began could we dispose of sufficient money to begin adequate preparations. Then, however, the Secretary and the Committee, under the energetic direction and example of their Chairman, Mr. Guy M. Campbell, took up their task with vigour, and the first result was the Reception of athletes and officials of all nations represented at the Games, which was held in the Grafton Galleries on the evening of July 11. A very large number attended in spite of the fact that the invitations had necessarily to be sent out at very short notice, and it was often very difficult to discover the addresses to which they should be sent. These difficulties were observable in nearly all the entertainments in London, and the suggestion has in consequence been made that an official should be appointed by the Central Committee of the country holding the sports, whose sole duty should be the organising of this side of the Games, and under him should be formed a Sub-Committee composed of other officials, each of whom should be responsible for one of the visiting nations, and in touch with the representative officials of that nation and with its athletes. By this means it would always be possible both to know the right people to invite and to discover their correct addresses. For the lack of this, many involuntary errors and omissions were no doubt made by the Council in 1908 ; but their difficulties were most kindly recognised, and their shortcomings most generously pardoned by visitors who were themselves, in most cases, not without experience of the peculiarities of the situation.

In the course of the evening of July 11, in the Grafton Galleries, M. Ch. Cazalet, President of the Fédération des Sociétés de Gymnastique de France, presented to the British Olympic Council, in a brilliant speech on behalf of the French Government, a magnificent vase from the national manufactory at Sèvres. Lord Desborough returned the cordial thanks of the Council, and the episode closed with the singing of the Marseillaise.

On Monday evening, July 13, Sir John Bell, the Rt. Hon. the Lord Mayor, and the Lady Mayoress, supported by the sheriffs and the official staff of the City of London, received the Olympic competitors and officials at the Mansion House, and a brilliant concourse of representatives of all nations availed themselves of the civic hospitality, including all the members of the International Olympic Committee present in London, except Baron de Coubertin, whose health prevented him from attending.

In the King's Hall of the Holborn Restaurant, the Council organised

banquets to the competitors and officials, which took place on July 14, attended by 520 persons ; on July 16, attended by 400 persons ; on July 17, attended by 525 persons ; on July 21, attended by 525 persons ; and on July 23, attended by 497 persons.

On Friday evening, July 24, a banquet was given on behalf of His Majesty's Government by the Rt. Hon. Lewis Harcourt, M.P., at the Grafton Galleries. Mr. Harcourt was supported by the Rt. Hon. Sir Edward Grey, M.P., Secretary of State for Foreign Affairs, and the guests included, in addition to members of the International Olympic Committee, the Comité d'Honneur, and the British Olympic Council, the diplomatic representatives of various countries at the Court of St. James's, and the Agents-General for the Colonies. Acceptances and refusals at the last moment introduced some confusion in the order of seating, and interfered with the full adoption of the principle of alternating foreign guests with British hosts ; but considering the enormous pressure under which the organisers had to work I have no doubt that generous allowance was made for these defects by the guests of the nation. The toast of His Majesty the King was proposed by Sir Edward Grey, who stated that in the welcome offered by Mr. Harcourt, on behalf of the Government, to the representatives of the nations competing in the games, the Ministers of the Crown knew that they were doing something with which the King himself was in the heartiest sympathy. The toast of the Olympic Games, proposed by Lord Desborough, was responded to by Baron Pierre de Coubertin in a most interesting and valuable speech which will be found in the concluding pages of this volume. Before dinner was over, Lord Desborough was able to announce the gracious intention of Her Majesty the Queen to present a special cup to Dorando Pietri ; and Count Bosdari, Secretary of the Italian Embassy, expressed the gratitude of his compatriots to Her Majesty.

Invitations for this banquet were sent to the diplomatic representatives of the various countries, to all members of the three Olympic Committees, and to certain other distinguished foreigners. I give, in alphabetical order, the names of those who were expected to be present :—

Asseburg, General Graf von der	Britten, Mr. T. W. J.
Ballerini, Chevalier	Brugère, M. le Général
Balck, Colonel Viktor	Bulger, Dr. M. J.
Benjamin, Mr. H.	Burman, Mr. B. F.
Berger, Mr. H. G.	Campbell, Baron
Bentzen, Captain	Campbell, Mr. Guy M.
Biedermann, Mr. E. A.	Campbell, Mr. C.
Blair, Mr. J.	Collins, Capt. Muirhead, R.N., C.M.G.
Bosdari, Count de	Cook, Mr. Theodore A.
Boyd, Mr. Leslie	Coubertin, Baron Pierre de

Cremer, Mr. F.	Martin, Dr. P.
Crocker, Mr. J. H.	McCabe, Hon. J. B.
Dahl, Captain	Mercati, Count Alexander
Desborough, The Rt. Hon. Lord, K.C.V.O.	Metaxas, Mr. A.
Douglas, Mr. J. H.	Mewburn, Mr. G. S.
Fisher, Mr. W. Hayes	Montagu of Beaulieu, The Rt. Hon. Lord
Fisher, Mr. P. L.	Müller, Mr. J.
Forbes, Captain A. Wentworth	Muzsa, Monsieur de
Friis, Baron C. A. Beck	Nander, Mr. K.
Frisch, Captain	Negropontes, Mr. Miltiades
Gautier, Comte Albert	Noble, Mr. S. R.
Gothot, Monsieur	Nova Scotia, The Agent General for
Grey, The Rt. Hon. Sir Edward, M.P.	Nyholm, Direktor Ivan
Grottum, Captain	Onslow, Colonel G. M.
Hackman, Mr. F.	Osborne, Mr. J.
Hansen, Captain	Reeves, The Hon. W. P.
Harcourt, The Rt. Hon. Lewis, M.P.	Refaat Bey, His Excellency Monsieur
Hawes, Mr. F. B.	Reynolds, Mr. C. L.
Henry, Mr. W.	Reynolds, Mr. E. C.
Herwijnen, Baron Greickke von	Robertson, Mr. G. S.
Hill, Mr. W.	Robinson, Mr. C. Newton
Hutton, Captain A.	Rom, Monsieur
Jakhelln, Monsieur	Romanos, Monsieur Athos
Jones, Captain F. W.	Royen, Mr. T. H. van
Kessler, Mr. George A.	Sandow, Mr. Eugen
Kirby, Mr. G. P.	Selby, Mr. W.
Knowles, Sir Lees, Bart.	Stark, Mr. W.
Labouchere, Mr.	Stone, Mr. E. H.
Laffan, Rev. R. S. de Courcy	Stoutz, Monsieur Maxime de
Laubat, Marquis de Chasseloup	Sullivan, Mr. J. E.
Laube, Count C. E.	Sverrè, Captain
Lauber, Monsieur Désiré	Syers, Mr. E.
Laveleye, Baron de	Tuyll, Baron F. W. de
Lieftinch, Mr.	Wall, Mr. F. J.
Leighton, Dr. W. J.	Wilkinson, Dr. Carnac
Levy, Mr. E. L.	Willebrand, Baron Rheinhold von
Löwenadler, Mr. F.	

On the same evening (July 24) a ball was given at the Holborn Restaurant, which was attended by 1,575 ladies and gentlemen.

This concluded the more official entertainments of the Summer Games, but in the autumn two more dinners were given in the Holborn Restaurant, on October 20 and October 31, which were attended respectively by 349 and 497 persons, and the more important speeches delivered at the final banquet will be found in the Appendix.

In addition to the above, drives were organised for the entertainment of competitors and their friends to various places of interest in and near London, and to Hampton Court, of which 478 persons availed themselves. On various occasions 807 lunches were provided for our guests, and

several of the theatres and halls were good enough to offer free admissions, while in other cases the cost of seats was defrayed by the British Olympic Council.

On July 15 a banquet was given by the Worshipful Company of Fishmongers in their historic hall to the more important of the officials and those interested in the Olympic Games ; and on July 20 a similar dinner was given by the Lyceum Club.

The various Governing Associations also joined, on their own behalf, in the general efforts to entertain our visitors. On May 29 the Queen's Club gave a dinner to the foreign representatives and other competitors in tennis, racquets, and covered-court lawn tennis. On July 11 the Lawn Tennis Association gave a similar dinner, and on July 18 the Amateur Swimming Association gave a remarkably successful banquet, as did the Amateur Athletic Association on July 22.

The work of the Council in London in these directions was very notably assisted by the Polytechnic, which organised a special Housing and Reception Committee for the benefit of foreign competitors, with Mr. J. E. K. Studd as President, Mr. Robert Mitchell as Chairman, Mr. L. H. Harris as Hon. Secretary, six members of the British Olympic Council, and many other gentlemen, including Mr. D. M. Hogg and Mr. V. R. Hoare. Its main objects were to provide a list of hotels and boarding-houses from which our visitors might select suitable accommodation before their arrival, and also to confer honorary membership of the Polytechnic Institute upon all competitors during their stay in England. This latter privilege gave them the free use of the swimming-bath, gymnasium, refreshment-rooms, and other facilities in the Polytechnic building in Regent Street, including the possibility of using that address for letters and other purposes. It also opened to them a splendid recreation-ground of some twenty acres for cricket, running, lawn tennis, and other sports, and the Polytechnic boathouse and boats at Grove Park, Chiswick. Arrangements were also made for excursions to Windsor, Oxford, Cambridge, Stratford-on-Avon, and other places ; and a bureau of general information was organised that proved of the greatest service.

As a result of the successful arrangement of the procession and display at the Stadium on the occasion of the visit of his Majesty the King and President Fallières, Mr. Robert Mitchell was asked, on behalf of the Polytechnic, to arrange the display and procession on the occasion of the opening of the Olympic Games, which proved a great success. The course for the Marathon Race was also planned by the Hon. Secretary of the Polytechnic Harriers, and the members of the athletic sections of the Polytechnic contributed largely not only to the number of officials for the

race, but also to its general arrangements. The Polytechnic received the hearty thanks of the British Olympic Council, through their president, for the valuable assistance they rendered in so many ways throughout the Games.

Outside London nearly every form of sport arranged in various parts of England had its own celebration of the event and its special welcome to visiting athletes. Though all deserve mention, I will select the festivities organised in connection with the Olympic Regatta at Henley, not merely as typical of the rest, but as having probably been more brilliant than any others, owing partly to the natural facilities of so beautiful a site, and partly to the energy of Mr. W. Anker Simmons, the Mayor of Henley, enthusiastically supported by his neighbours. He secured the co-operation of the Mayors of Maidenhead, Reading, Windsor, and Wycombe, together with a strong and capable reception committee. Its programme was opened with a municipal reception of competitors and officials in Henley Town Hall on the evening of July 24, and an open-air concert the next evening in the lovely grounds of the Phyllis Court Club. On the 26th Lord Desborough gave a luncheon at Taplow Court, and on the 27th another luncheon was given by the Phyllis Court Club, while Sir Frank Crisp gave yet a third on the 28th. On July 29 a lunch and dinner were given by the Hon. W. F. D. Smith, M.P., at Greenlands, and on July 30 there was another lunch at Greenlands, and a concert in the evening on Mr. Foy's lawn. On Friday, July 31, a municipal banquet took place in the grounds of the Lawns Club, and a most successful ball was given in the Town Hall on the same evening. On August 1 a banquet was given by Mr. G. A. Kessler at Bourne End, followed by an illuminated *fête* upon the Thames which exceeded in magnificence anything yet attempted in connection with these festivities, and on August 2 Lord Michelham gave a garden party at Strawberry Hill. Besides all this there were entertainments of various kinds at Park Place, Holme Park, Crowsley Park, Grey's Court, and Bird Place, and on August 1 there was a luncheon at Windsor. The town of Henley, the river, and the bridge were beautifully illuminated from July 25 to July 31, and the band of the Royal Irish Fusiliers played all the week.

The series of events connected with the Summer Games would be incompletely chronicled were I not to mention the special service in St. Paul's Cathedral, arranged by the Ven. the Archdeacon of London for athletes attending the Olympic Games, on Sunday morning, July 19. The sermon was preached by the Right Rev. the Bishop of Pennsylvania.

Finally, I may add that, in the last days of October, the Autumn Games were brightened by the dinners of the English Lacrosse Union, the

Hockey Association, and the National Skating Association, and by the ball of the Figure-Skating Club.

Returning for a moment to the balance-sheet, it will be noticed that, owing to the generosity of subscribers to the Games, a handsome balance was left over, after all expenditure immediately connected with the celebrations of 1908 had been provided for. It will not be inappropriate that the more important section of this Report should close with a short sketch of the uses to which that balance will be put ; for it will be in strict pursuance of the object the writer has set before himself from the beginning that he should point out the benefits likely to accrue to future years from the experience obtained in 1908. It is, as far as possible, to secure these benefits that the balance from the Olympic Fund of 1908 has been handed over to the British Olympic Association.

I have already described the foundation of the British Olympic Association, and sketched its opportunities of activity up to the period of the formation of the Council for the organisation of the Olympic Games in London. It would be a great mistake to imagine that with the closing of those Games the Association's energies have ceased. They have but been redoubled ; for by the innumerable influences called into being during the strenuous year of 1908 the Association has become the central body through which British sport is brought into contact with Foreign sport, and it has therefore proved its right to the support, financial and otherwise, of all who believe that friendly international competition is a thing to be desired.

Apart from supporting the modern revival of the Olympic Games under the sanction of the International Olympic Committee, the objects of the British Olympic Association are to secure that the views of our great governing associations shall have due weight in the organisation of all future Games ; to co-operate in promoting uniform laws for the control and regulation of these Games ; and to facilitate the attendance of properly-selected representatives of this country in future Olympic Games; in other approved International Meetings, and in Athletic Congresses.

The Council of the Association consists, first, of the members for the United Kingdom on the International Olympic Committee, and secondly of the representative nominated, under given conditions, by each of the following governing bodies :—

The Amateur Athletic Association.	The Amateur Gymnastic Association.
The Amateur Rowing Association.	The National Skating Association.
The Amateur Swimming Association.	The National Rifle Association.
The National Cyclists' Union.	The Amateur Wrestling Association.
The Football Association.	The Lawn Tennis Association.
The Rugby Football Union.	The Yacht Racing Association.
The Amateur Fencing Association.	The Amateur Boxing Association.



3,200 METRES STEEPLE CHASE. THE FINISH. A. RUSSELL (U.K.), FIRST;  
A. J. ROBERTSON (U.K.), SECOND.



CLAY BIRD SHOOTING AT UXENDON. TEAM COMPETITION.  
UNITED KINGDOM (NO. 1 TEAM), FIRST.  
J. M. POSTANS, J. F. PIKE, P. EASTE.  
A. MAUNDER, F. W. MOORE (CAPT.), C. PALMER.

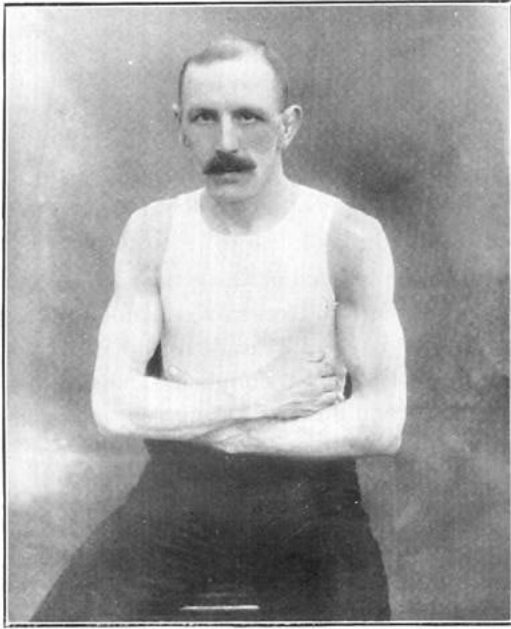

BOXING.— R. GUNN, FEATHERWEIGHT CHAMPION.



SHOOTING.—LIEUT.-COL. MILLNER (U.K.), CHAMPION OF THE WORLD AT 1,000 YARDS :  
WINNER OF OLYMPIC GOLD MEDAL WITH 98 OUT OF A POSSIBLE 100.



The Hockey Association.	The Irish Amateur Athletic Association.
The English Lacrosse Union.	The Scottish Cyclists' Union.
The Royal Toxophilite Society.	The Irish Cyclists' Association.
The Clay Bird Shooting Association.	The Irish Amateur Swimming Association.
The Tennis and Rackets Association.	The Marylebone Cricket Club.
The Royal Automobile Club.	The Royal and Ancient Golf Club of St. Andrews.
The Hurlingham Club.	
The Scottish Amateur Athletic Association.	

Representatives on the Council may also be nominated by the Royal Life Saving Society, the National Physical Recreation Society, the Incorporated British College of Physical Education, the Motor Yacht Club, the Boat Clubs and Athletic Clubs of Oxford and Cambridge Universities, the Directors of the Military and the Naval Gymnasia, and others.

The Association is therefore broadly based upon the largest conception of the possibilities of international sport. Such a body has never existed, in this form, before, and there is every reason to predict for it a wide and ever-increasing sphere of useful and beneficent effectiveness.

## CHAPTER IX.

## ATHLETICS.

## PROGRAMME.

1. 100 metres Flat (109·3 yards).
2. 200 metres Flat (218·6 yards).
3. 400 metres Flat (437·2 yards).
4. 800 metres Flat (874·4 yards).
5. 1,500 metres Flat (1,639·5 yards).
6. 110 metres Hurdle (120·2 yards).
7. 400 metres Hurdle (437·2 yards).
8. 3,200 metres Steeplechase (3,497·6 yards).
9. 5 miles Run (8 kilometres).
10. 10 miles Walk (16 kilometres).
11. Marathon Race (**25 miles**) (40 kilometres).
12. Standing Broad Jump.
13. Standing High Jump.
14. Running Broad Jump.
15. Running High Jump.
16. Hop, Step and Jump.
17. Pole Jump.
18. Throwing the Hammer.
19. Putting the Weight.
20. Tug of War (Teams of eight).
21. Three-mile Team Race (4·8 kilometres). Five to run, three to count.
22. 3,500 metres Walk (3,825 yards).
23. Discus. I. Free style. II. As at Athens.
24. Javelin. I. Free style. II. With the Javelin held in the middle.
25. Relay Race, 1,600 metres (1,749·8 yards). (Teams of four, with four reserves), 2 at 200 metres (218·726 yards) 1 at 400 metres (437·452 yards), 1 at 800 metres (874·904 yards).

## PROGRAMME, RULES, AND CONDITIONS OF COMPETITION.

---

---

Each country competing shall be allowed to enter not more than 12 competitors for events 1-19 inclusive, and 22, 23, and 24.

No. 20. 3 teams.

Nos. 21 and 25. 1 team each.

The competition shall be held under the Laws and Rules of the Amateur Athletic Association of England, who shall appoint all the Officials and be responsible for the conduct of each competition.

A Starter shall be appointed, also two or more Judges and a Referee, for each race and competition.

Judges and Referees so appointed shall have sole control over the competitors after the start, with power to disqualify, and their decision shall be final.

Every competition shall be confined to Amateurs.

The following is the Amateur definition of the Amateur Athletic Association:

“An Amateur is one who has never competed for a money prize, or monetary consideration, or for any declared wager or staked bet; who has never engaged in, assisted in, or taught any athletic exercise as a means of pecuniary gain; and who has never taken part in any competition with anyone who is not an Amateur.”

### ENTRIES OF FOREIGN ATHLETES.

“All entries will be made through the Governing Associations, or, where Governing Associations do not exist, by Amateur Clubs, through the Olympic Committee of each country, who will be responsible to the British Olympic Council for the competence of such Amateur Clubs to guarantee that the competitors entered by them are amateurs within the conditions laid down in the British Olympic Council's Regulations for the several sports, as set forth in the Programme of the Olympiad.”

## GENERAL RULES.

Every competitor shall wear a sleeved jersey and loose drawers to the knees, and any competitor shall be excluded unless properly attired. A copy of this Rule shall be placed in a conspicuous place in every dressing room used by the competitors.

Any competitor wilfully jostling or running across or obstructing another competitor so as to impede his progress shall forfeit his right to be in the competition, and shall not be awarded any position or prize that he would otherwise have been entitled to.

Every competitor shall be supplied with and wear on back and front during competition a distinctive number corresponding to his number in the programme.

## STATIONS.

In level races the competitors shall ballot for their respective stations at the start, and each competitor shall take the station assigned to him by the ballot.

No attendant shall accompany any competitor on the mark or in the race, nor shall any competitor be allowed, without the permission of the Referee or Judges, to receive assistance or refreshment from anyone during the progress of a race, but this rule does not apply to the Marathon Race (40 kilometres).

## STARTING.

All races shall be started by the report of a pistol, and a start shall only be made to the actual report.

All questions as to the starting of a race shall be in the absolute discretion of the Starter, whose decision shall be final.

The Starter shall place the competitors on their respective marks in their respective stations, and shall for this purpose have the assistance of such marksmen as may be necessary.

No competitor shall touch the ground in front of his mark with any part of his body.

## PROTESTS.

Objections and Protests shall be made in accordance with sections 13 and 14 of the General Regulations, which are as follows :—

“13. Objections to the qualifications of a competitor must be made in writing to the Secretary of the British Olympic Council at the earliest moment practicable. No such objection shall be entertained after the lapse of one calendar month from the distribution of the prizes. Every

objection shall be accompanied by a deposit of one pound (£1), and if upon investigation the objection shall appear to have been made upon no reasonable ground the deposit shall be forfeited. The British Olympic Council shall decide on every objection after having heard the representative or representatives on the Honorary Committee (see Article 14) of the person making the objection.

“14. An Honorary Committee will be formed, consisting of three representatives from each competing country, to be nominated by the Olympic Committee in that country. Special seats will be reserved for them, as for the members of the International Olympic Committee, at all contests and all festivities connected with the Olympiad, and they will be distinguished by a separate badge. [N.B.—In the case of competitors not represented on the Honorary Committee, the British Olympic Council will appoint three members to act on behalf of such competitors.]

“All protests to be made to the Officials managing any form of contest must be made through a member or members of the Honorary Committee representing the country to which the competitor belongs who desires to make the said protest for transmission to the said Officials.

“Any such protest must be made to the proper Official within half an hour of the termination of the contest to which it relates.”

### THE RUNNING HIGH JUMP.

The Judges shall decide the height of the bar at starting, and at each successive elevation. Each competitor shall be allowed three jumps at each height. At each height each competitor shall take one trial in order as on programme; those failing shall have a second trial in similar order, after which those having failed twice shall make their third trial. Crossing the scratch without displacing the bar shall not count as one jump. All measurements shall be made from the ground to the centre of the bar. Neither diving nor somersaulting shall be permitted.

### THE STANDING HIGH JUMP.

The feet of the competitor may be placed in any position, but shall leave the ground only once in making an attempt to jump. When the feet are lifted from the ground twice, or two springs are made in making the attempt, it shall count as a trial jump without result. A competitor may rock forward and backward, lifting heels and toes alternately from the ground, but may not lift either foot clear from the ground or slide it along the ground in any direction.

With this exception the rules are similar to the Running High Jump.

### THE RUNNING BROAD JUMP.

Each competitor shall be allowed three jumps, and the best three competitors of the first trial shall be allowed three more tries each for the final. The farthest jump of *all* shall win. If any competitor fall back or step back, after jumping, or crosses the taking-off line with either foot, or so swerves aside that he pass beyond the taking-off line, such jump shall not be measured, but it shall be counted against the competitor as one jump. All jumps shall be measured to the taking-off line from the edge of the heel-mark nearest that line, along a line perpendicular to that line.

### THE STANDING BROAD JUMP.

The feet of the competitor may be placed in any position, but shall leave the ground only once in making an attempt to jump. When the feet are lifted from the ground twice, or two springs are made in making the attempt, it shall count as a trial jump without result. A competitor may rock forward and back, lifting heels and toes alternately from the ground, but may not lift either foot clear of the ground, or slide it along the ground in any direction.

In any other respects the rule governing the Running Broad Jump shall also govern the Standing Broad Jump.

### THE POLE JUMP.

Each competitor shall be allowed three jumps at each height. Crossing the scratch without displacing the bar shall not count as one jump. All measurements shall be made from the ground to the centre of the bar. Three attempts, even if the cross-bar be not displaced, shall count as one jump.

The Judges shall decide the height of the bat at starting and at each successive elevation.

### RUNNING HOP, STEP AND JUMP.

The competitor shall first land upon the same foot with which he shall have taken off. The reverse foot shall be used for the second landing, and both feet shall be used for the third landing.

In all other respects the rules governing the Running Broad Jump shall also govern the Running Hop, Step and Jump.

### THROWING THE HAMMER.

The head and handle may be of any size, shape and material, provided that the length of the complete implement shall not be more than *four feet*

(1.219 metres) and its weight not less than *sixteen pounds* (7.258 kilos). The competitor may assume any position he chooses, and use either one or both hands. All throws shall be made from a circle *seven feet* (2.134 metres) in diameter. Each competitor shall be allowed three throws, and the best three competitors of the first trial shall be allowed three more throws each. The farthest throw of *all* shall win. All distances shall be measured from the circumference of the circle to the first pitch of the hammer along a line drawn from that pitch to the centre of the circle. Foul throws and letting go of the hammer in an attempt shall count as trial throws.

### PUTTING THE WEIGHT.

The Weight shall be put from the shoulder with one hand only, and without follow from a *seven feet* (2.134 metres) circle. The weight shall be of iron and spherical, and shall weigh *sixteen pounds* (7.258 kilos). All puts shall be measured from the circumference of the circle to the first pitch of the weight along a line drawn from that pitch to the centre of the circle. Each competitor shall be allowed three puts, and the best three competitors of the first trial shall be allowed three more puts each. The farthest put of *all* shall win.

In Throwing the Hammer and Putting the Weight crossing the scratch shall count as a try.

### HURDLE RACE.

110 METRES.

The Hurdle Race shall be over ten flights of hurdles on a level grass course of 110 metres (120 yards) straight. The hurdles shall stand 3ft. 6in. (1.06 metre) from the ground, and shall have level top-rails, and shall be placed 9.144 metres (10 yards) apart. The first flight of hurdles shall be 13.716 metres (15 yards) from scratch. Each competitor shall have his own line of hurdles, and shall keep to that line throughout the race.

400 METRES.

The hurdles shall stand .914 metre (3 feet) from the ground, with straight top bars, and each competitor shall keep his own flight of hurdles throughout.

There shall be 10 flights of hurdles.

The first hurdle shall be placed 45 metres (49.213 yards) from the scratch mark, and the remaining hurdles shall be 35 metres (38.277 yards) apart, and the distance from the last hurdle to the winning post shall be 40 metres (43.745 yards).

## STEEPLECHASING.

For Steeplechases the hurdles shall not be higher than 3ft. (.914 metre). Every competitor shall go over or through the water; and anyone who jumps to one side or the other of the water jump shall be disqualified.

## WALKING RACE.

In Walking Races, cautions and disqualifications shall be left to the decision of the Judges of Walking, who may appoint assistants if necessary, A disqualified competitor shall at once leave the track.

## TUG OF WAR.

(a) The teams shall consist of equal numbers (8) of competitors. The rope shall be of sufficient length to allow for a "pull" of twelve feet (3.658 metres) and for twelve feet (3.658 metres) slack at each end, together with four feet (1.219 metres) for each competitor; it shall not be less than four inches (.102 metres) in circumference, and shall be without knots or other holdings for the hands. A centre tape shall be affixed to the centre of the rope, and six feet (1.829 metres) on each side of the centre tape two side tapes shall be affixed to the rope. A centre line shall be marked on the ground, and six feet (1.829 metres) on either side of the centre line two side lines parallel thereto. At the start the rope shall be taut, and the centre tape shall be over the centre line and the competitors shall be outside the side lines. During no part of the pull shall the rope be tied.

(b) The start shall be by word of mouth. During no part of the pull shall the foot of any competitor go beyond the centre line. A pull shall be won when one team shall have pulled the side tape of the opposing side over their own side line or a competitor of the opposing side goes over the centre line. No competitor shall wear prepared boots or shoes or boots or shoes with any projecting nails, tips, sprigs, points, hollows or projections of any kind. No competitor shall make any hole in the ground with his feet or in any other way before the start. No competitor shall wilfully touch the ground with any part of his person but his feet. All heats shall be won by two pulls out of three.

## DISCUS.

The Discus shall be 2 kilogrammes (4.4 lbs.) in weight and 22 centimetres (8.7 inches) in diameter. It shall be made of wood with a smooth iron rim, and shall be capped on each face with a smooth metal plate.

Every competitor must throw with a discus provided by the Committee.



### I. Free Style.

(a) The discus is thrown from a circle 2.50 metres (2.733 yards) in diameter.

(b) From the centre of this circle a straight line shall be drawn in the direction in which the competitors are to throw. At an angle of forty-five degrees on either side of this line shall be drawn side lines. To constitute a valid throw the discus must first strike the ground in the space between these side lines.

(c) The method of throwing is at the absolute discretion of each competitor.

(d) The thrower must remain entirely within the circle until the discus first strikes the ground, otherwise the throw is invalid.

(e) To measure the distance thrown, a straight line is taken from the point at which the discus first strikes the ground to the centre of the circle. The distance thrown is the portion of this line which lies outside the circle.

### II. Throwing the Discus "as at Athens."

(a) The discus is thrown from a rectangular pedestal 80 centimetres ( $31\frac{1}{2}$  inches) long and 70 centimetres ( $27\frac{1}{2}$  inches) broad, sloping forward from a height of 15 centimetres (6 inches) at the back to a height of 5 centimetres (2 inches) at the front.

(b) The method of throwing is as follows :—

The thrower places himself on the pedestal with the feet apart, and holding the discus in either hand. He then grasps it with both hands and raises them without letting go the discus with either, extending the rest of his body at the same time in the same direction. After that he turns the trunk to the right and bends sharply, so as to bring the left hand, which has now left hold of the discus, to the right knee, and the right hand, still holding the discus, as far back as possible. At this moment the right foot should be forward and both legs bent; the right foot rests full on the sole, and the left on the toes only. Then by a sharp and simultaneous extension of the whole body the thrower throws the discus forward.

(c) The thrower may leave the pedestal at the moment of throwing.

(d) The measurement of the throw shall be from the point at which the discus first strikes the ground to the centre of the front side of the pedestal.

### THROWING THE JAVELIN.

(a) The Javelin shall be 2.6 metres long (8.1 feet) and 800 grammes in weight (1.6 lb.). It shall be of wood with a sharp iron point, and shall

have about the centre of gravity a grip formed by a binding of whipcord without knots; it shall not be provided with a thong, and the shaft shall not be notched.

Every competitor must throw with a javelin provided by the Committee.

(b) The throwing shall take place from behind a scratch line. The thrower may place his foot or feet upon the line, but if either foot passes the line entirely before the javelin first strikes the ground the throw is invalid.

(c) No throw shall be counted in which the point of the javelin does not strike the ground before any part of the shaft.

(d) It is open to the competitors to throw with either hand and with or without a run.

(e) The throw is measured from the point at which the point of the javelin first strikes the ground perpendicularly to the scratch line, or the scratch line produced.

In the *Free Style* the manner of holding the javelin is left to the absolute discretion of each competitor.

In the *Style in which the javelin is held in the middle*, the javelin must be held by the grip, and no other method of holding is admissible.

## MARATHON RACE.

1. The Marathon race of 40 kilometres will be run on a course marked out on public roads by the Amateur Athletic Association and will finish on the running track in the Stadium, where the last  $\frac{1}{3}$  mile will be run (1 lap=536 metres).

2. Each competitor must send with his entry a medical certificate of fitness to take part in the race, and must further undergo a medical examination previous to the start by the medical officer or officers appointed by the British Olympic Council.

3. A competitor must at once retire from the race if ordered to do so by a member of the medical staff appointed by the British Olympic Council to patrol the course.

4. No competitor either at the start or during the progress of the race may take or receive any drug. The breach of this rule will operate as an absolute disqualification.

5. The station of each competitor at the start will be determined by lot, and in the event of competitors being too numerous to be started on a single line, they will be started on two or more lines.

6. Each competitor shall be allowed two attendants, who shall wear on the arm the same distinctive number as the competitor.

7. The attendants shall during the progress of the race remain behind the competitor they are attending or be sufficiently in front to prevent them giving pacing assistance. Non-observance of this rule will disqualify the competitor.

8. Attendants will not be permitted at the start of the contest, but must proceed to an appointed place about 5 miles (8 kilometres) from the start and join their competitors as they pass. Upon arrival at the Stadium the attendants must leave the competitors and enter at a different gate. No attendant will be allowed on the track.

9. Any competitor whose attendant or attendants obstruct another competitor will be disqualified.

10. Each competitor must provide his own attendants and required refreshments.

---

N O T E .

The measurement of the Track is taken 12 inches from the inside edge.

The direction of running will be left hand inside.

# ARCHERY.

## PROGRAMME.

	Maximum No. of Competitors from each Country
<b>Gentlemen.—The York Round.</b> 72 arrows at 100 yards (91.4 metres), 48 arrows at 80 yards (73 metres), 24 arrows at 60 yards (54.8 metres).	<b>30</b>
<b>Ladies—The National Round.</b> 48 arrows at 60 yards (54.8 metres) 24 arrows at 50 yards (45.7 metres).	<b>30</b>
<b>Gentlemen.</b> —40 arrows at 50 metres (54.5 yards), shot singly Continental fashion.	<b>30</b>

## RULES AND CONDITIONS OF COMPETITION.

---

---

1. The Judges and necessary officials will be appointed by the Royal Toxophilite Society.
2. The Ladies will shoot each day the National Round, viz.: four dozen arrows at 60 yards; two dozen arrows at 50 yards. The Gentlemen, the National York Round, viz.: six dozen arrows at 100 yards; four dozen arrows at 80 yards; and two dozen arrows at 60 yards. Three arrows to be shot at each end.
3. The targets will be placed farther apart than the specified distances, but at the proper distances marks will be fixed, from which alone the Archers are to shoot.
4. The targets will measure four feet in diameter, and the centre of the gold shall be four feet from the ground.
5. The Captains will be placed No. 3 at each target—to take charge of the targets and to score, assisted by No. 4.
6. Every Archer's arrows must be clearly and distinctively marked with his or her name or initials, so that the owner may have no difficulty in claiming them or the Captain in distinguishing them. Archers must not draw their arrows from the target till the Captain has called on them to declare their hits, and has scored them. If an arrow be drawn by its owner before it is scored, it shall not be allowed to count or to be measured as a gold.
7. If from any cause an Archer is not prepared to shoot before all have shot, such Archer shall lose the benefit of that end.

8. Gentlemen will not be allowed to smoke at the Ladies' targets, and it is particularly requested that no person will divert the attention of the Archers shooting by talking: and, while the Archers are in the act of shooting, no one (except the Archers) will be allowed to stand in front of the *white line* behind the targets.

9. No persons, except competitors whilst shooting, will be allowed in front of the targets.

10. The value of the rings on the target shall be :—

Gold	...	...	...	...	...	...	9
Red	...	...	...	...	...	...	7
Blue	...	...	...	...	...	...	5
Black	...	...	...	...	...	...	3
White	...	...	...	...	...	...	1

If an arrow touch two colours it shall be scored as in that of the higher value. Should any dispute arise as to whether an arrow touch the higher colour, the matter shall be decided by the Captain of the Target, subject to an appeal to the Judge.

11. In the case of ties, if two or more have an equal score, the prize shall be adjudged to the one who has the greatest number of hits. If hits and score be equal, the prize shall be adjudged to the competitor who has the highest score at the longest range. If there still be a tie the prize shall be adjudged to the competitor who has the greatest number of hits at the longest range.

12. If, owing to the state of the weather, the full number of arrows are not shot on the first day, the deficient number shall, if possible, be shot on the second day. No prizes will be awarded unless one complete round is shot.

13. No shooting will be allowed except when competing for the prizes.

14. No Archer shall move forward before all have shot their arrows, and the signal is given to advance.

15. If any doubt or dispute shall arise on any point connected with the shooting, the matter shall be referred to the Judges, whose decision shall be final.

## ARCHERY.

### RULES FOR SHOOTING IN THE CONTINENTAL FASHION.

---

#### I.-CONDITIONS FOR COMPETITION WITH ENGLISH TARGETS.

1. Shooting shall take place at 50 metres. Each competitor must in turn shoot one arrow at each end.
2. The targets (of straw) will be placed in two parallel lines 54 metres apart. The shooting marks will be fixed 4 metres in front of each target.
3. On each line the distance between targets will be 3 metres, from edge to edge.
4. The centre of the gold of each target will be 1 metre 40 from the ground (about).
5. Each target will be 1 metre 40 in diameter, and will be divided into concentric circles of different colours with value as follows:

Gold	...	...	...	...	...	...	9
Red	...	...	...	...	...	...	7
Blue	...	...	...	...	...	...	5
Black	...	...	...	...	...	...	3
White	...	...	...	...	...	...	1

6. If an arrow touch two colours it shall be scored as in that of the higher value.

#### II.—SHOOTING REGULATIONS.

1. The competitors will be divided into squads of not more than 8. One pair of targets will be allotted to each squad, and the order of shooting in each squad will be settled by lot.
2. All the squads must complete shooting at each end at the same time.
3. Each squad will have an authorised marker, and will be under the control of a Captain, who in each case will shoot as No. 3.

4. No Archer may draw his arrow from the target until authorised by the Captain, who must not allow this to be done until he has seen that the hits have been properly scored.

5. Squads must move from target to target in an orderly way on a signal given by the official in charge, who must satisfy himself that every squad has finished shooting before giving the signal. To insure this the Captain of each squad should advance to the shooting mark and raise his bow above his head as soon as the last member of his squad has finished shooting.

The following points must be particularly observed :—

(i) No one is allowed on the shooting ground, except the competitors, markers, and properly authorised officials.

(ii) While the Archers are shooting, no one (except the Archer) is allowed to stand in advance of the line of targets.

(iii) It is particularly requested that no person will divert the attention of the Archers shooting, by any noise or talking.

(iv) The rules usually observed by Companies of Archers must be scrupulously adhered to, and the authorised officials are required to see that this is strictly done.

### III.—REMARKS ON THE DISTRIBUTION OF PRIZES AT ARCHERY COMPETITIONS.

In the case of a tie between two or more competitors the advantage lies with the Archer who has the largest number of hits.

In the case of a tie in both points and hits, the advantage lies with the Archer having most golds.



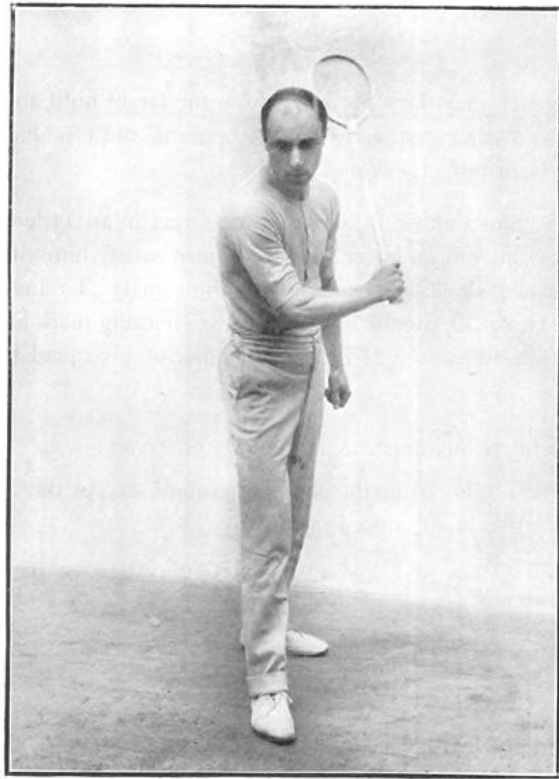

RACQUETS.—VANE PENNELL (U.K.).



ATHLETICS.—E. V. LEMMING (SWEDEN), WINNER OF THE JAVELIN.

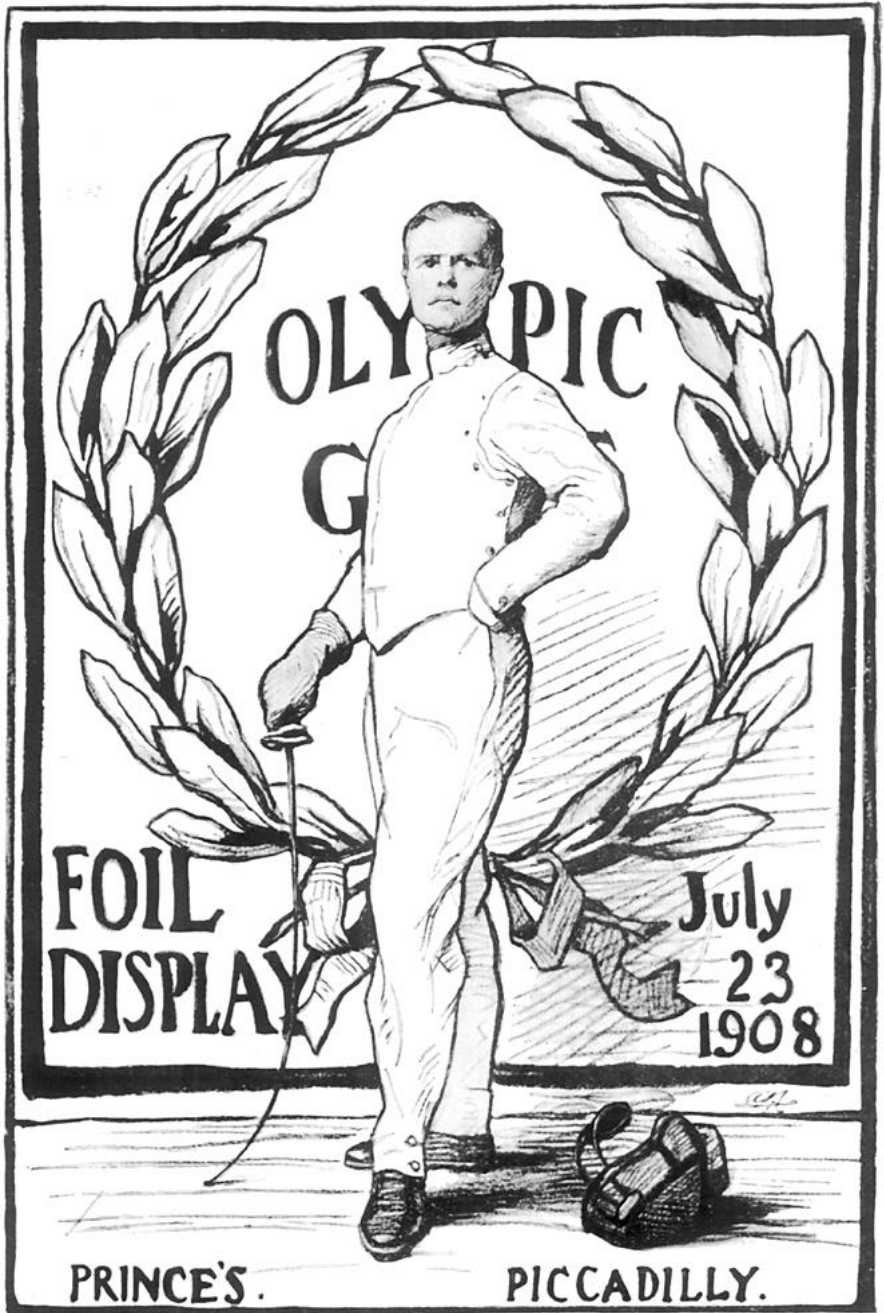

DESIGN BY A. S. COPE, A.R.A.

# BOXING.

(Under the management of the Amateur Boxing Association.)

---



---

## P R O G R A M M E .

ENTRIES CLOSE: 15 SEPTEMBER, 1908.

1st	...	...	Gold Olympic Medal.
2nd	„	...	Silver „ „
3rd	„	...	Bronze „ „

### Five Weights.

	Maximum No. of competitors from each country.
(a) Bantam, not exceeding 8 st. 4 lb. (52·617 kilos).	<b>12</b>
(b) Feather „ „ 9 st. (57·15 kilos).	<b>12</b>
(c) Light „ „ 10 st. (63·5 kilos).	<b>12</b>
(d) Middle „ „ 11 st. 4 lb. (71·668 kilos).	<b>12</b>
(e) Heavy, any weight.	<b>12</b>

## DEFINITION OF AN AMATEUR

An Amateur is one who has never competed for a money prize, staked bet, or declared wager; who has not competed with or against a Professional for any prize, and who has never taught, pursued, or assisted in the practice of athletic exercises as a means of obtaining a livelihood or pecuniary gain.

---

## RULES OF THE AMATEUR BOXING ASSOCIATION.

---

1. In all Olympic competitions the ring shall be roped, and not less than 12-ft. or more than 20-ft. square.

2. Competitors to box in light boots or shoes (without spikes or in socks, knickerbockers, breeches or trousers, and jerseys. The gloves to be of a standard weight of 8 oz. each (226.8 grammes).

3. Weights to be, for Olympic Competitions :—

Bantam, not exceeding	8 st. 4 lb.
Feather	„ 9 st.
Light	„ 10 st.
Middle	„ 11 st. 4 lb.
Heavy, any weight.	

Competitors to weigh on the day of competition in boxing costume, without gloves.

4. In all Olympic competitions the number of rounds to be contested shall be three. The duration of the first two rounds shall be three minutes each, and of the third four minutes, with an interval of one minute between each round. A timekeeper (who shall be stationed beside the referee) shall be appointed.

5. A competitor who draws a bye shall be bound to spar for the specified time with any opponent approved of by the judges and referee.

6. Each competitor shall be attended by one second only, and no advice or coaching shall be given to a competitor by his second, or by any other person, during the progress of the bout.

7. In all Olympic competitions bouts shall be decided by two judges and a referee, who shall be stationed apart from each other. The judges shall award at the end of each of the first two rounds five marks and at the end of the third round seven marks to the better man, and a lesser number

to the other man according to his merits. When the men are equal the maximum number must be given to each. At the end of each bout the judges' scoring papers shall be collected by an official appointed for that purpose, and in cases where the judges agree, such official shall announce their decision, but should the judges disagree, the official shall so inform the referee.

8. The referee shall give his vote when the judges disagree, or he can order further rounds limited to two minutes each. Two of the three opinions must agree before a winner can be declared, otherwise an extra round is compulsory. The decision of the judges or referee, as the case may be, shall be final and without appeal.

9. Marks shall be awarded for "attack," as follows :—Direct clean hits with the knuckle part of the glove of either hand, on any part of the front or sides of the head, or body above the belt; and for "defence": guarding, slipping, ducking, counter hitting, or getting away. Where competitors are otherwise equal, the majority of marks shall be given to the one who does most of the leading off, or who displays the better style.

10. The referee shall have power to disqualify a competitor for any of the following acts :—For hitting below the belt, for hitting with the open glove, the inside or "butt" of the hand or with the wrist or elbow; for striking a competitor when he is down; for holding, butting, shouldering, intentionally falling without receiving a blow, wrestling or roughing, or for any other act he may deem foul.

11. In the event of a competitor being down, his opponent shall retire out of distance, and shall not recommence boxing until told to do so by the referee. A man is to be considered down even when he is on one or both feet, if at the same time any other part of his body is touching the ground. The referee shall be empowered to stop a round if in his opinion a man is outclassed or unfit to continue, and that man shall be deemed to have lost the bout.

12. In all competitions any competitor failing to resume sparring when time is called shall lose the bout.

13. The breaking of any of these rules by a competitor or his second shall render such competitor liable to disqualification.

14. The judges and referee shall decide (1) the interpretation of any of these rules ; (2) any question not provided for in these rules.

# CYCLING.

---

## PROGRAMME.

### BICYCLE.

One lap (660 yards—603.491 metres).

12

1,000 metres (1,093.6 yards).

12

5,000 metres (2.88 miles).

12

20 kilometres (12.427 miles).

12

100 kilometres (62.135 miles).

12

Pursuit Race.

1 team

3 laps (1.807 kilometres). Teams of four to start.

First three to count in each heat.

### TANDEM BICYCLE.

2,000 metres (1.24 miles).

6 pairs

## RULES AND CONDITIONS OF COMPETITION.

---

To be held in London commencing on 13th July, 1908.

### PROGRAMME-CYCLING.

To be run under the Rules, Regulations, and Management of the National Cyclists' Union of England and Wales.

The track measures 660 yards (3-8th mile) and is 30 to 35 feet wide.

*(The measurement is taken 12 inches from the inside edge.)*

### EVENTS.

#### Single Bicycle.

1. One lap (660 yards—603.491 metres).
2. 1,000 metres (1,093.6 yards).
3. 5,000 metres (2.88 miles).
4. 20 kilometres (12.427 miles).
5. 100 kilometres (62.135 miles).

#### Pursuit Team Race.

6. Three laps (1.807 kilometres).

#### Tandem Bicycle.

7. 2,000 metres (1.24 miles).

The races are exclusively confined to amateurs holding licences of the National Cyclists' Union or of any Federation affiliated to the Union Cycliste Internationale; or, where no such governing body exists, by special permit from the Olympic Committee of the country. In countries where no Federation exists, the N.C.U. definition of an amateur will apply :—

“An amateur is one who has never engaged in, nor assisted in, nor taught any athletic exercise for money or other remuneration, nor knowingly competed with or against a professional for a prize of any description or in public.”

All entries are free and must be made in proper form through the Governing Associations, or, where no governing associations exist, by Amateur Clubs through the Olympic Committee of the country, to the British Olympic Council, 108 Victoria Street, London, S.W. Entries received direct from intending competitors will not be recognised. Entries must reach the Hon. Sec. on or before 12th June, 1908. Entries from each country will be limited in events Nos. 1-5 to 12 riders, in No. 6 to one team of four, and No. 7 to six pairs of two riders. The British Olympic Council reserve to themselves the right to refuse the Entry of any Competitor without being bound to give reasons for their decision.

Objections to the qualifications of a competitor must be made in writing to the Honorary Secretary of the British Olympic Council at the earliest moment practicable. No such objection shall be entertained after the lapse of one calendar month from the distribution of the prizes. Every objection shall be accompanied by a deposit of one pound (£1), and if upon investigation the objection shall appear to have been made upon no reasonable ground the deposit shall be forfeited. The British Olympic Council shall decide on every objection after having heard the representative or representatives on the Honorary Committee of the person making the objection.

An Honorary Committee will be formed, consisting of three representatives from each competing country, to be nominated by the Olympic Committee in that country. Special seats will be reserved for them, as for the members of the International Olympic Committee, at all contests and all festivities connected with the Olympiad, and they will be distinguished by a separate badge. (N.B.—In the case of competitors not represented on the Honorary Committee, the British Olympic Council will appoint three members to act on behalf of such competitors.)

All protests to be made to the officials managing any form of contest must be made in writing through a member or members of the Honorary Committee representing the country to which the competitor belongs who desires to make the said protest for transmission to the said officials.

Any such protest must be made to the proper official within half an hour of the termination of the contest to which it relates.

The British Olympic Council will make no contribution to the expenses of any competitor, Foreign or British.

The British Olympic Council shall be invested with full power to make, in case of absolute necessity, such changes as may be desirable in these Regulations.

No alterations shall be made in the programme on the day of the race except under pressure of extreme and unforeseen circumstances.

Time limits will be fixed for events No. 1 to 5 and also for No. 7. Time standards will be fixed by the Judge and Timekeeper on the dates of the races for each event. Any competitor beating standard time will be awarded a Special Merit Diploma. Similar diplomas will also be awarded to the three competitors leading for the greatest number of laps in the 20 and 100 Kilometres races.

The Pursuit Team race will be limited to teams of four from each country. The race will be run in heats, second and third rounds if necessary, and the final. The teams will be started in each heat at opposite sides of the track, and the time of the third man in each team at



the end of the mile shall be taken and shall constitute the time for the team. The team making the fastest time shall be deemed the winner of the heat, and shall be qualified to start in the next round, and the teams making the fastest time in the second or third rounds shall compete in the final.

When the number of competitors is not a power of two, there shall be Byes in the first round; the number of Byes shall be equal to, the difference between the number of competitors and the next highest power of two, and the number of pairs that shall meet in the first round shall be equal to the difference between the number of competitors and the next lower power of two.

All entries must be made on the official form.

## PROGRAMME REGULATIONS.

### OFFICIALS.

The Officials shall consist of Judge, Assistant Judge, Umpires, Starter, Timekeeper or Timekeepers, Clerks of the Course, Lapscorers, and the Members of the Race Committee (including the Secretary of the Meeting).

It shall be the duty of the Race Committee to appoint officials, to conduct generally the business of the Meeting, and to adjudicate on any points not provided for, to see that the various officials are at their respective posts before the first race is started, and to provide for any contingency that may arise.

The Judge, Assistant Judge, Umpires, Starter, and Timekeepers shall not be permitted to compete in any race with which they are officially connected.

The Judge and Starter shall have the power to disqualify competitors without any protest being lodged by any competitor.

### JUDGES.

It shall be the duty of the Judge, or Assistant Judge, to declare the placed men in every heat, and where there are more riders than prizes to officially place one rider more than there are prizes; to instruct the Umpires; to give judgment on protests received by them; to act as they may think fit in cases of misconduct by attendants; and to disqualify any competitors who have become liable to disqualification. Their decisions shall in all cases be final. The jurisdiction of a Judge extends to all questions arising with regard to the conduct of a race on the track, such as placings, fouls, protests, &c., but does not include the power to give a decision whether a competitor is properly entered or eligible for a race, or is an amateur, or professional, or any such-like question, which should be

decided by the British Olympic Council, under section 13 of the General Regulations, in consultation with the N.C.U. The fact of a competitor, ineligible to start, being declared the winner by the Judge gives him no claim to the race should it be subsequently shown that he should not have been allowed to ride, and, under such circumstances, the prize must be returned.

In starting scratch races the Judge shall give his instructions to the competitors and attendants, and shall see that the men are placed in position, after having caused them to draw lots, and every competitor shall go to the mark so drawn; and any refusing to do so shall be liable to be disqualified by the Judge.

#### UMPIRES.

It shall be the duty of the Umpires to watch the riding and to report to the Judge any competitor or competitors whose riding they consider unfair; and it shall also be the duty of the Umpires to watch the starting and to report to the Starter any competitor or competitors whose starting they consider unfair.

#### STARTER.

It shall be the duty of the Starter, when it has been reported to him by a Clerk of the Course that all the competitors are ready, to see that the Timekeeper is warned, and before starting the men to say "Mount"; in a few seconds after to say "Are you ready?" and if no reply to the contrary be given, to effect the start by report of pistol.

In case of a false start, the competitors shall be called back by the Starter and re-started. Any competitor refusing to obey the Starter shall be at once disqualified by him.

#### COMPETITORS.

Every competitor shall receive in the dressing room a ticket bearing a number corresponding with his number on the programme, which ticket must be worn by him in a conspicuous place on his back during the race.

Competitors may dismount during the race at their pleasure and may run with their machines, but they must keep to the extreme **outside** of the track whenever dismounted.

A Competitor overtaking another must always pass on the outside, unless the rider who is passed be dismounted, or has retired from the contest, or is riding wide, and must be a clear machine's length ahead before taking ground in front of his opponent. Riders must allow room for their opponents to pass on the outside, and any competitor infringing this rule, or being otherwise guilty of foul or unfair riding, shall be liable to disqualification.

If a cycle becomes disabled in the course of a race, the rider shall be allowed to use another, provided the substituted machine be not disapproved of by the Judge.

#### ENCLOSURE.

None but the officials of the meeting and the competitors and attendants actually engaged in any contest shall be allowed within the enclosure, except by special permission of the Secretary of the meeting.

Competitors and their attendants shall be allowed within the enclosure only during the time between the heat preceding and that in which they are engaged.

No machines may be left in the enclosure.

#### ATTENDANTS.

Each competitor shall be allowed to have his own attendant to accompany him to the start, and the attendant shall remain near the point at which he started his man until the conclusion of the heat, when he shall leave the enclosure.

#### OF HEATS.

Any competitor giving his name as a starter in any heat must compete in that heat, unless he has the sanction of the Judge to do otherwise.

Any competitor qualifying in a heat must ride in the final or semi-final heat, unless he has the sanction of the Judge to do otherwise.

When a qualified rider of any heat or tie does not compete in the final the Judge shall have power to allow the next in that heat to compete in his stead.

No one shall be permitted to compete in any trial heat other than that in which his name is printed on the programme, and no made-up, late, or supplementary heats or trials shall be permitted under any circumstances.

#### STARTING.

A bell shall be rung at the dressing-room before each heat, and after sufficient time has been allowed for competitors to get to their allotted marks a start shall be effected.

**No competitor shall be allowed to start unless he wear half sleeves and complete clothing from the shoulders to the knees, and the Judge has power to order off the track any competitor who is not decently attired.**

Attendants, when pushing off competitors, must keep both feet behind the mark from which the competitor actually starts. Should the attendants cross such mark with either foot while starting such competitor, the competitor shall be liable to disqualification.

Any competitor starting before the signal may be put back at the discretion of the Starter, not exceeding ten yards for the race in question; and on a repetition of the offence shall be disqualified. It shall be the duty of each competitor to see that he starts from his proper mark, and in default he may be disqualified for the race in question.

As far as possible the times on the programme shall be adhered to, but no heat may be started before the stated time, except with the consent of all the competitors in such heat.

In all races where more than one competitor starts, lots will be drawn by the competitors to decide who shall take precedence, counting from the inside of the track. The numbers of non-starters will be placed on the board in the preliminary heats.

### PROTESTS.

Any objection respecting foul riding, starting off a wrong mark, or other such offence committed during the race shall be made to the Judge as soon as possible after the heat, and before the distribution of prizes.

In the event of a protest or objection being lodged against a successful competitor, his prize shall be withheld until the Judge shall have decided whether he is, or is not, entitled to the same. In the latter case, the first prize shall be given to the second man, the second prize to the third man, and so on.

No form of toe clip or strap shall be permitted to be used which does not allow the feet to be easily withdrawn without unfastening.

# FENCING.

---

## P R O G R A M M E .

	Maximum No. of Competitors from each country.
<b>I. Épée.</b>	
<b>A. Individual</b> ...   ...   ...   ...   ...	<b>12</b>
<b>B. International Teams of 8</b> ...   ...	<b>1 team</b>
Out of whom four fencers are chosen for each series.	
<b>II. Sabre.</b>	
<b>A. Individual</b> ...   ...   ...   ...   ...	<b>12</b>
<b>B. International Teams of 8</b> ...   ...	<b>1 team</b>
Out of whom four fencers are chosen for each series.	
<b>III. Foils.</b>	
A display (with commemorative medals for all engaged) by picked amateurs, two representing each nation.	

- 
- I. PRIZES.
  - II. ORGANISATION.
  - III. GENERAL RULES. (Épée and Sabre.)
  - IV. SPECIAL RULES. (Épée.)
  - V. SPECIAL RULES. (Épée Teams.)
  - VI. SPECIAL RULES. (Sabre.)
  - VII. SPECIAL RULES. (Sabre Teams.)
- 

*Passed by the Amateur Fencing Association at their Meetings of  
October 22, 1907, and January 20, 1908.*

## I.—PRIZES.

---

### Épée

INDIVIDUAL.—1st. Gold Medal (and Certificate).  
 2nd. Silver Medal.  
 3, 4, 5, 6, 7, 8. Bronze Medals.

TEAMS.—1st. Eight Gold Medals (and Certificates).  
 2nd. Eight Silver Medals.

TEAMS.—The Winners will hold the International Challenge Vase presented by English Fencers to the winning Épée team in these Games in 1908, 1912, 1916, &c., &c.

### Sabre.

INDIVIDUAL.—1st. Gold Medal (and Certificate).  
 2nd. Silver Medal.  
 3, 4, 5, 6, 7, 8. Bronze Medals.

TEAMS.—As in Épée (without Cup).

---

## II.—ORGANISATION.

The Committee of the Amateur Fencing Association of Great Britain and Ireland has been charged by the British Olympic Council with the details of the Fencing Tournament at the Olympic Games of 1908 in London. In the following Regulations the words "the Committee" signify those members appointed by the A.F.A. Committee present at the Games for this purpose, who may be distinguished by a special badge.

Only those fencers will be admitted to take part in the Tournament whose names have been accepted beforehand by the British

Olympic Council through the official entries made according to the rules for these Games. (See also Rules 2, 44, and 45-)

The Rules for the *Épée* and *Sabre* competitions drawn up by the Committee, accepted before the Games by the representatives of each competing Nation, and printed in the official programme of the Games, are accepted by each competitor who enters for the Tournament, and will not be altered, except in case of grave necessity, of which the Committee alone will be the judge.

All entries close on June 15, 1908.

### III.—GENERAL RULES (*Épée* and *Sabre*).

The following definition of an amateur shall obtain :—

I, An amateur is one who has never competed for a money prize or monetary consideration or for any declared wager or staked bet, who has never engaged in, assisted in, or taught any form of fencing as a means of pecuniary gain.

Provided as follows :—

(a) *Schoolmasters or school-teachers giving instruction in any form of fencing to their school pupils as part of their school duties, and receiving no extra remuneration therefor, shall not thereby forfeit their amateur status.*

(b) *This article shall not apply to commissioned officers (past or present) of the Army, Navy, or Auxiliary Forces of any station in respect of any work done by them in their capacity as officers.*

(c) *Fencers who have competed for money prizes awarded in competitions limited to the Naval and Military Forces of their country do not thereby forfeit their amateur status.*

(d) *A fencing club or association may cause the actual travelling-fare of any member of such club or association competing at a fencing competition, to and from such competition, or any part of such fare, to be paid out of the funds at the disposal of such club or association, without thereby causing such member to forfeit his amateur status ; but, save as aforesaid, a competitor who receives expenses shall forfeit his amateur status.*

2. The English Committee pays no expenses to any competitors in this Tournament. Entries must be made before June 15, 1908, and are only accepted by the British Olympic Council in accordance with their regulations. The number of entries accepted rests entirely with the British Olympic Council. Entries are not accepted from individual competitors. Twelve entries only may be sent in by each country for each individual Competition, eight from each country for each Team Competition, and two representative foil players.

3A. No professional shall take any part in the juries or competitions or organisation of this Tournament.

3B. Any fencer who, at, or within one year after, these Games, is proved to the satisfaction of the British Olympic Council to have infringed Rule 1 (as above) must be disqualified, and any prize taken by him must be returned to the Council, and may be awarded to another competitor. The disqualification, under these circumstances, of any member of a team disqualifies the whole team.

4. Each competitor, by the fact of his entry, has agreed to accept without question the decisions of the Jury in the competitions in which he is engaged, as well as the Rules governing them. (See Rule 21.)

5. Every fencer must do his best to win the best place possible to him in each competition. Any agreement between fencers made with the object of altering what would otherwise have been the result of a pool will lead to their disqualification for the whole Tournament.

6. The Jury has the power to alter the order of the assaults (see Rules 28, 29, 30) if they should think it necessary to secure the observance of Rule 5, above.



7. If a fencer withdraws, or is disqualified, or is unable from any cause to continue the contest in the course of any pool, the result of all his previous contests shall be deleted from the score-sheet as if they had never existed. But if, before a competitor becomes unable to continue, or withdraws from grave reasons satisfactory to the President of the Jury, he has already obtained a place or won the pool (even if all the subsequent assaults were counted as defeats) then his previous assaults remain as scored, in order to qualify him for a prize, or for the next round.

8. Breaches of these Regulations, and any other acts of disloyalty to the spirit of amateur fencing, will be brought before the notice of the Committee, who have the power to disqualify the offending competitor.

9. Any objections or claims must be handed *in writing* to a member of Committee, if required. The Committee's decisions are final and without appeal. No such objection or claim shall be sent in after 7 P.M. on July 24, 1908. (*See also* Rule 44.)

10. All competitors must satisfy the Committee and the President of their Jury that they wear clothing which is either white or distinctively light in colour, and which thoroughly protects all vulnerable parts of the body.

11. A fencer may keep the ground he gains on his adversary. Each fencer shall have 15 metres space behind him in which to retire if necessary. If a fencer reaches the line marked 3 metres from the limit of the space allowed behind him, he is warned by the President of the Jury who shall call "Three Metres!" If both his feet pass the limit after this, a hit is scored against him. The position of each fencer on the ground is decided at the beginning of each bout by lot, or toss of the coin, at the option of a competitor or on demand.

12. No fencer may change his weapon from one hand to the other during a bout, except in cases where a serious accident to his sword-arm has been acknowledged by the Jury to necessitate such change.

13. No competitor shall guard himself, or obstruct his adversary, with the arm which he is not using for his weapon.

14. A "corps à corps" is produced when the fencers are in actual bodily contact.

JURIES.

15. A bout can only be stopped by the President of the Jury calling "Halt!" This he may do (a) on perceiving any irregularity in the conduct of either or both of the fencers; (b) after the fencers are in actual bodily contact, subject to the provision that a hit delivered immediately after such contact and before the word "Halt!" may be good, inasmuch as the "corps à corps" is not, in itself, illegal; (c) when either of the fencers is disarmed or loses the free use of his weapon owing to its being caught in any part of his adversary's clothing, or in his guard, or between his arm and body, or under his foot, &c., subject to the provision that a hit which was the immediate cause of a fencer being: thus disarmed or losing the free use of his weapon may be good; (d) when either fencer is in any way wounded, or unable or unwilling to continue (*see* Rule 7); (e) when time is up. (*See* Rules 42 and 57.)

16. A disarm and subsequent hit in one movement must count as a hit.

17. The President of the Jury can stop any bout in which he considers that the proper character of an épée or sabre contest is endangered, though the "corps à corps" is not *per se* forbidden,

18. The President may disqualify any fencer who persists in improper conduct after due warning (*see* Rule 46), but such disqualification should only be enforced after consultation with the Committee. Any fencer who, owing to his improper conduct, is thus disqualified, will have that bout scored against him.

19. The National Olympic Committee of each competing Nation will nominate persons whom they consider competent to serve on juries for the Épée and Sabre before the Com-

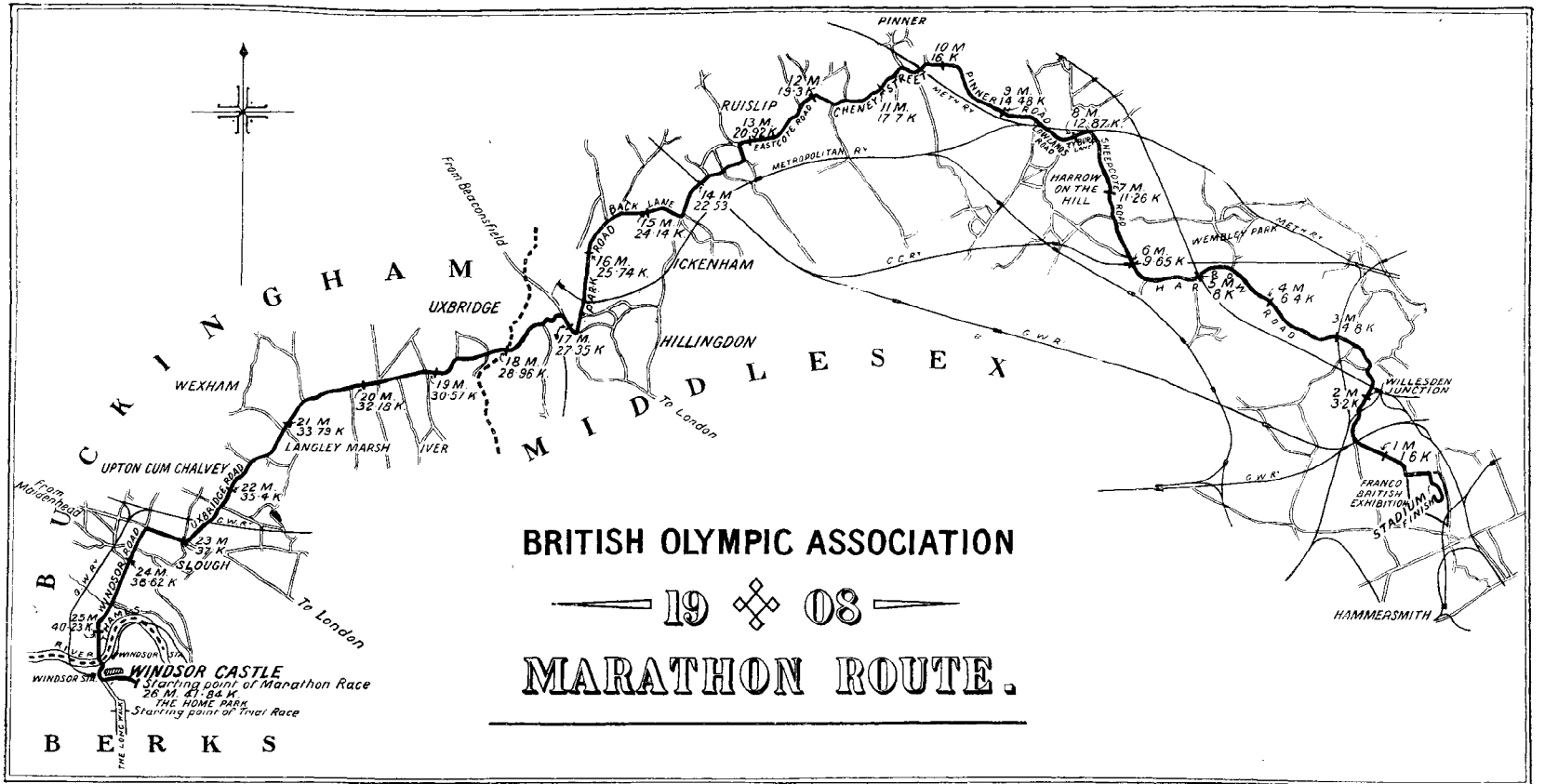

OFFICIAL MAP OF THE MARATHON RACE COURSE.

# OLYMPIC GAMES, LONDON, 1908.

## PRIZE GIVING.

No. **9**

*Hefferon*

JULY 25th.

HEFFERON'S TICKET FOR A DIPLOMA OF MERIT IN THE FIVE MILES RACE.

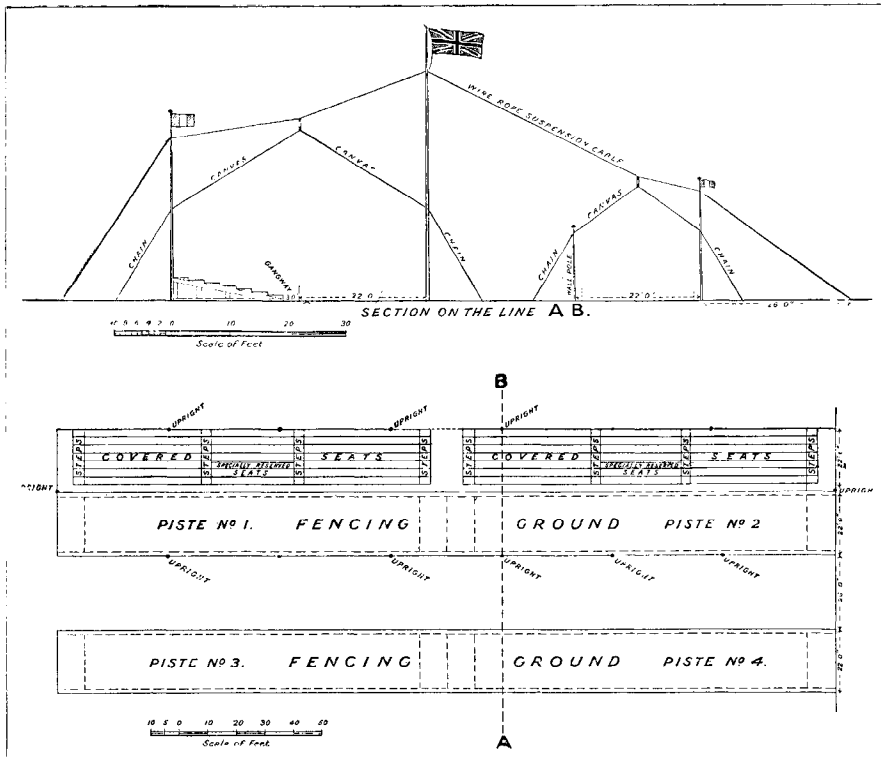

PLAN AND SECTION OF THE FENCING GROUND (DESIGNED BY A. V. BUCKLAND).

petitions begin. With these nominations before them, the Committee in London charged with the Olympic Fencing Tournament will select three jurors (including a President) for every pool found necessary in the individual competitions, who will be responsible for the proper conduct of that pool. If the competitors desire five jurors instead of three (and the total of the Jury must always be either three or five, including the President) then the Committee will do their best to select two additional jurors. JURIES

20. Whether the total of the Jury be three or five, there shall be a President appointed from among them by the Committee, who shall be responsible for the proper conduct, according to these Regulations, of each pool or team fight which he is authorised by the Committee to control. All jurors serving in this Tournament will receive a commemorative Medal and a special Badge.

21. Any member of a Jury must warn the President by making a sign only without speaking that a hit has been scored. But the President alone may stop (or start) a bout, and the President alone may announce to the scorer that a fencer has been hit, or that both fencers have been hit in one bout; and if the word "Halt" is called by any member of the Jury other than the President, a hit given at the same moment as or immediately after the word "Halt" may be held good. No fencer need stop fighting until he is told to do so by the President's order to halt.

22. Neither the fencers engaged, nor any other unauthorised person present, may speak to any member of the Jury concerning the result of a fight in progress, unless the President shall of his own free will have specifically requested a fencer to give information. The President's decisions are in all circumstances to be final (in accordance with Rule 4), but when the President disagrees with the majority of his Jury, the fight must be continued.

23. If the light should be too bad for fencing, or if any other grave reason should occur to stop any bout or series of bouts in progress, the bout or the series shall be stopped by the President

of the Jury on receiving the consent of the majority of the competitors in that pool or team fight, and shall be adjourned to a time and place which must be fixed as soon as possible by the Committee and communicated without delay to the competitors concerned. The Jury and President should, if possible, remain the same. (See also Rule 48 and "Special Recommendations" No. 3 (a) (b) (c).)

24. A fencer who is late in answering his name when the score-sheet of each pool is being made up will be scratched, unless good and sufficient reason is given to the Committee for his temporary absence. He cannot be replaced, and the other competitors will reap the benefit of his absence. In team fights the Captain is responsible for the completion of his team from the eight names officially entered. (See Rule 44.)

25. In the individual championships at épée or sabre no pool (preliminary or otherwise) shall contain more than ten fencers; and out of it no more than one half of the fencers shall pass into the next round. The number of fencers to qualify in each pool for the next round shall be determined by the Committee. The numbers recommended are three or four to qualify out of preliminary pools of seven or eight.

26. Fencers in semi-final or final pools of the individual championships shall be those only who have done best in the previous pools. Such final pools should contain eight or nine fencers.

27. The Committee issue special scoring-sheets for each pool, and these alone will be recognised in awarding prizes. Each pool should have a scorer (who may also keep the time, if necessary) approved by the President, but not a member of the Jury. The scorer will sign the score-sheet and be responsible for it to the President, who will sign it also (with the rest of the Jury) and duly hand it to a member of the Committee as soon as the pool is finished.

28. In the individual championships for épée and sabre each fencer is given a number, and the order of the bouts will be as follows :—

In a Pool of five (5).

(1) 1 v. 4	(2) 2 v. 3	(3) 4 v. 5	(4) 1 v. 2
(5) 3 v. 5	(6) 2 v. 4	(7) 1 v. 5	(8) 3 v. 4
(9) 2 v. 5	(10) 1 v. 3		

In a Pool of six (6).

(1) 1 v. 4	(2) 2 v. 5	(3) 3 v. 6	(4) 1 v. 5
(5) 2 v. 6	(6) 3 v. 4	(7) 1 v. 6	(8) 2 v. 3
(9) 4 v. 5	(10) 1 v. 2	(11) 3 v. 5	(12) 4 v. 6
(13) 1 v. 3	(14) 2 v. 4	(15) 5 v. 6	

In a Pool of seven (7).

(1) 1 v. 4	(2) 2 v. 5	(3) 3 v. 6	(4) 1 v. 7
(5) 5 v. 4	(6) 2 v. 3	(7) 6 v. 7	(8) 1 v. 5
(9) 3 v. 4	(10) 2 v. 6	(11) 5 v. 7	(12) 1 v. 3
(13) 4 v. 6	(14) 2 v. 7	(15) 3 v. 5	(16) 1 v. 6
(17) 2 v. 4	(18) 3 v. 7	(19) 5 v. 6	(20) 1 v. 2
(21) 4 v. 7			

In a Pool of eight (8).

(1) 1 v. 5	(2) 2 v. 6	(3) 3 v. 7	(4) 4 v. 8
(5) 1 v. 6	(6) 2 v. 7	(7) 3 v. 8	(8) 4 v. 5
(9) 1 v. 7	(10) 2 v. 8	(11) 3 v. 5	(12) 4 v. 6
(13) 1 v. 8	(14) 2 v. 5	(15) 3 v. 6	(16) 4 v. 7
(17) 1 v. 2	(18) 3 v. 4	(19) 5 v. 6	(20) 7 v. 8
(21) 1 v. 3	(22) 2 v. 4	(23) 5 v. 7	(24) 6 v. 8
(25) 1 v. 4	(26) 2 v. 3	(27) 5 v. 8	(28) 6 v. 7

29. The scoring-sheet of an individual pool at épée (or sabre \*) will be made up as follows :—

X = lost, O = won, ‡ = double hit or "coup double.

	1	2	3	4	5	6	7	8	Totals of Fights lost
Name 1		O	X	O	O	‡	O	X	3
" 2	X		X	‡	O	‡	X	‡	6
" 3	O	O		O	‡	X	O	O	2
" 4	X	‡	X		O	O	X	O	4
" 5	X	X	‡	X		O	O	‡	5
" 6	‡	‡	O	X	X		O	O	4
" 7	X	O	X	O	X	X		X	5
" 8	O	‡	X	X	‡	X	O		5

In the above pool, if a *preliminary*, Nos. 2, 5, 7, 8 would be eliminated, and Nos. 1, 3, 4, 6 would pass into the next round. (See Rule 25.)

If a *final*, No. 3 is the winner, No. 1 is second, Nos. 4 and 6 would fight for third place, if they desired.

It will be noticed that when No. 3 fought against No. 4, No. 3 was the winner, and O was therefore placed in the column beneath 4 on No. 3's line, while X was also placed in the column beneath 3 on No. 4's line. In the same way Nos. 1 and 6 fought a double hit, so ‡ is placed in No. 1's line beneath 6, and another ‡ is placed in No. 6's line beneath 1.

All ties for the last qualifying place in preliminary pools for individual championships at épée must be fought off in one hit and with the sabre in three hits above the imaginary line (see 60) unless one or more fencers (among those who have tied) withdraw for reasons considered good and sufficient by the President of the Jury, when the others may, if necessary, be reckoned as having

\* There are no double hits in sabre-scoring, except under Rule 57.



qualified. Ties for other places may be fought off in the same way, if the fencers wish it, in final pools.

30. In the International team-fights at épée (and sabre \*)

Team A (or C) is numbered 1, 2, 3, 4.

Team B (or D) is numbered 5, 6, 7, 8.

The order of the bouts in each fight is as follows :—

(1) 1 v. 5	(2) 2 v. 6	(3) 3 v. 7	(4) 4 v. 8
(5) 1 v. 6	(6) 2 v. 7	(7) 3 v. 8	(8) 4 v. 5
(9) 1 v. 7	(10) 2 v. 8	(11) 3 v. 5	(12) 4 v. 6
(13) 1 v. 8	(14) 2 v. 5	(15) 3 v. 6	(16) 4 v. 7

The scoring-sheets of team pools will be made up as follows :—

For Team A :—

		X = lost,    O = won,    ‡ = double hit.				
Team A		5	6	7	8	Totals of Fights lost
Name 1		X	X	O	O	2
„ 2		O	X	‡	O	2
„ 3		‡	X	O	O	2
„ 4		O	X	O	O	1

Team A's total = 7 defeats.

For Team B :—

Team B		1	2	3	4	Totals of Fights lost
Name 5		O	X	‡	X	3
„ 6		O	O	O	O	0
„ 7		X	‡	X	X	4
„ 8		X	X	X	X	4

Team B's total = 11 defeats.

The winner of this team-fight is therefore Team A.

\* There are no double hits in sabre-scoring, except under Rule 57.

It will be noticed, as before, that Team A No. 2 lost his fight against Team B No. 6, so that No. 2 receives the mark X in the column beneath 6 on his line in Team A's score-sheet, and No. 6 receives the mark O in the column beneath 2 on his line in Team B's score-sheet.

There were only two double hits: in the fight between Team A No. 2 and Team B No. 7, and in the fight between Team B No. 5 and Team A No. 3.

---

#### IV.—SPECIAL RULES (Épée).

31. Every épée shall have the *pointe d'arrêt* (or *bouton marqueur*) approved by the Committee.

32. At least fifteen minutes before a pool begins every fencer shall submit his weapon to the officials appointed for that purpose, who shall, if necessary, see that the *pointe d'arrêt* is properly affixed by the *prévôt* appointed for that purpose, and who may refuse any weapon of which they disapprove. Only the *pointe d'arrêt* (or *bouton marqueur*) which is in accordance with these Rules may be employed.

33. The *pointe d'arrêt* (or *bouton marqueur*) is used as a help to the Jury and the President, who alone has the power to say whether a hit is valid or not. Any fencer deliberately soiling the point of his weapon (*e.g.* by rubbing it on the ground) runs the risk of disqualification by the President of the Jury.

34. Any suitable white or light coloured gloves or shoes may be worn, but no projections of any kind except very small nails are allowed on the soles of the boots, and the gloves may not have guards of polished leather or metal.

35. Masks, throat-pieces, gloves, trousers, and thigh-pieces must be strong enough to protect the wearer against wounds from a *pointe d'arrêt*, and a fencer may be refused admission by the Committee if he has no throat-piece, or if his costume appears in any way dangerous or undesirable.

36. Fencers in individual pools need not wear their distinctive national colours.

37. (a) *Épées* may be mounted in the French or the Italian manner; if the blade is not fixed in the centre of the shell, it must not be more than 35 millimètres off the centre.

No part of the weapon or its attachment must extend outside or beyond the shell or guard.

(b) The hilt should be sufficiently rough to give the fencer's hand a firm hold upon it and to avoid his being disarmed too easily,

(c) If the hilt is mounted in the French manner, its total length, including the pommel, must be less than 220 millimètres, and, without the pommel, must be less than 180 millimètres.\* The hilt is meant to balance the sword, not to increase the effective length of the weapon; and, in consequence, the Committee forbid the use of any arrangement which would permit the hand being placed further off the shell or guard than is usual, and would thereby increase the effective length of the weapon; for instance, the end of the pommel furthest from, the point must not be bent, and it must not contain any device which would permit a fencer to hold it firmly in his hand and thereby lengthen his weapon.

(d) If the hilt is mounted in the Italian manner its total length, including the pommel, must be less than 220 millimètres.

Mounting a sword in the Italian (or any similar) manner is not meant to increase the effective length of the weapon by placing the hand further off the shell or guard than is usual. With such mounting the extremity of the thumb, when fully extended, must not in any case be more than 20 millimètres from the inside of the shell or guard,

(e) The screw at the end of the pommel, in the case of swords (whether French or Italian) which have blades screwed into the hilt, need not be included in the measurement of 220 millimètres given above (section *c*) for the total length of the hilt; but the external diameter of this screw must be less than 17 millimètres, and when once it is screwed home into the pommel it must not extend more than 12 millimètres beyond the end of the pommel.

---

\* These figures may require revision from time to time according to the change in weapons.

(f) The shell or guard must be circular, with a smooth, continuous, convex surface, without flanges, projecting rims, holes, or any outstanding roughness. The chord of the arc representing the curve of the shell or guard must be between 30 and 50 millimètres. The diameter of the circle described by the shell or guard must be between 128 and 132 millimètres.

(g) The length of the blade must be as nearly as possible 880 millimètres. The blade must be triangular. Four-sided blades for an épée are not allowed, Colichemardes are not allowed. The blade must be sufficiently straight and rigid, strong and of good steel in order to avoid accidents as far as possible, and if there be any curve the chord of its arc must be less than 30 millimètres.

The rectangular portion of the blade where it terminates in the metal button must present, in section, sides of at least 2 millimètres each.

(h) The total weight of the épée must be between 470 and 770 grammes.\*

(k) An arrangement for attaching the sword to the hand is allowable, and therefore martingales or handstraps are allowable, always provided that no part of them shows outside the circular shell or guard, and that no part of them forms a loop in which the point of an adversary's sword may be entangled. Further, the martingale is only allowed on condition that it is not long enough to enable the pommel alone of the sword to be held firmly in the palm of the hand, because, in that case, the assistance the martingale thereby affords would increase the effective length of the weapon (section c) more than is usual. The martingale or handstrap must be so arranged that the part enveloping the hand or wrist of the fencer and the part enveloping the hilt of his weapon would (when detached) be portions of one continuous piece of material.

(l) All weapons must be of an orthodox known model, and all abnormally made weapons may be refused by the Committee.

(m) No fencer may use any weapons which have not rigorously complied with these conditions in every particular. Only three

\* These figures may require modification in future.

millimètres grace is allowed in the various measurements (or three grammes in the weights) as laid down above.

38. Assaults are to be settled in one hit. The fencer who receives the fewest hits in any pool is the winner of that pool. Ties are to be fought off in one hit.

39. Fencers are to be put on guard by the President in such a fashion that, when their arms are extended, the points of the swords are about 30 centimètres apart. The President alone can give the word "Go!" or call a halt. (*See Rules 15, 43, 57.*)

40. All hits that would, if the sword had a sharp point, cause a punctured wound, are valid, wherever they take effect.

41. If two fencers are touched at the same moment, both hits shall be scored ("coup double," *i.e.* a hit is scored against each fencer). But if both fencers are hit and there was any appreciable interval of time between the two hits, or if the hits were delivered in such different lines that there was an appreciable difference in the distance the two points must have traversed, or in the positions of the body respectively reached, then the President and Jury must take account of these considerations by deciding that only one of the fencers shall have a hit scored against him.

42. If no score is made after ten minutes' fight, there will be a halt called for two minutes, and if in the subsequent five minutes no hit is scored, a hit shall be placed against the names of both fencers. The scorer (who keeps the time) must inform the President when a bout should be stopped or restarted under these circumstances. (*See Rules 15, 57, 69.*)

---

## V.—SPECIAL RULES (Épée Teams).

43. Each competing country shall be represented by one team of eight men only. Each fencer in an international team must wear his national colours on his unemployed arm.

44. The Captain (who shall be one of the team of eight) shall be responsible to the Committee for the proper conduct

of his team in every respect, and shall alone be the mouth-piece of any representations they may desire to make to the Committee. Out of the eight names sent in beforehand, only four fencers shall be chosen to represent each country in each team-fight. (See Rule 2.)

45. Except in case of accidents incurred in the course of a fight and recognised as serious by the President and Jury (when the Captain shall have the right to substitute another of the eight entered), the composition of the teams shall remain the same throughout one heat in the Tournament. But their composition can be modified at the beginning of each heat; thus, Team A will keep the same fencers throughout its fight with Team B (except in case of accident as aforesaid), but Team A may change its fencers, and substitute others (from the eight entered as aforesaid) in its fights against C, D, or E; and *vice versa*.

46. If in the course of team-fight, a competitor withdraws for reasons considered by the Committee to be insufficient, then the fencer will be considered to have lost all his bouts except those which he had fought and won before such withdrawal. Any fencer disqualified by the Committee in a team-fight will be considered to have lost every bout in that heat, and will be unable to engage in any other heat as a member of his team. This will, of course, involve that each of the bouts in which his name occurs will be scored as a victory to his adversary.

47. Each bout is decided by a single hit, according to the rules for the individual épée championships. (See Rules 31-42.)

48. Juries will be composed and will act in accordance with the regulations laid down in Rules 15 to 23, with the exception that whether the total of the Jury (including the President) be three or five, no juror shall be of the same nationality as either of the teams competing in the bouts they judge, except with the consent of the Captains of the two teams engaged.

49. The Committee will arrange the system according to which the various teams shall meet each other as soon as the entries have all been received, and will notify the Olympic Committee of each country beforehand as to these arrangements.

After June 15, 1908, no other team may enter, and any team which does not appear to fence at the time appointed will be scratched.

50. In a fight between two teams, the winning team shall be that which has the least number of hits registered against it, As soon as one team has had nine hits scored against it, the Captain may admit defeat by withdrawal, if he pleases, but he has the right to complete the round if he desires to do so. (See Rule 30.)

51. In a fight between two teams, when the number of hits received by each is equal, they shall resume their team-fight immediately, from the beginning, as if it had never taken place, with the same members of each team (except as provided for cases of serious accident in Rule 45); and the team-fight shall continue until one team has established over the other a superiority in points satisfactory to the Jury and President, who shall remain the same, as far as possible, however often it may be necessary to begin the team-fight over again.

---

## VI.—SPECIAL RULES (Sabre).

52. Hits with the sabre can be scored (a) with the point, (b) with the edge, which extends along the whole of one side of the blade and for 20 centimètres from the point along the other side.

53. (a) The total weight of the sabre must be between 470 and 780 grammes. The effective length of the blade must be as near as possible 880 millimètres. The blade should be either straight, or, if slightly curved, the chord of its arc must not be longer than 40 millimètres. The colichemarde formation is not allowed. The blade should be neither too stiff nor exaggeratedly weak.

(b) The maximum length of the hilt (omitting the screw in those weapons which have the blade screwed into the hilt) must be 220 millimètres. The shell or guard must have no opening in which the point of an adversary's sword can be entangled; it must be large enough to protect the hand and wrist. The maximum

dimensions of the shell or guard must be :—at the back, towards the edge of the blade, 150 millimètres; and towards the flat of the blade (perpendicular to the edge) 140 millimètres.

(c) Only three millimètres' grace is allowed in the various measurements (or three grammes in the weights) as laid down above.

(d) All weapons must be of an orthodox known model, and all abnormally made weapons may be refused by the Committee.

(e) No fencer may use any weapons which have not rigorously complied with these conditions in every particular.

54. Fencers with the sabre must wear clothes that are either white or of a very light colour; a strong and thickly padded helmet with a throat-piece, to protect both head and neck; the elbow and wrist of the sword-arm should be carefully guarded, and the gloves thickly padded.

55. Pools for the individual championship must be fought according to the rules for the same pools in the épée, with the exception of *the method of scoring hits*.

56. In each bout the loser will be the fencer who has first been hit *three times* above the imaginary horizontal line drawn at the hip-joints. No hit anywhere else will score. A stroke that hits any other part of the body below this line will stop the bout.

57. If after five minutes' fight neither fencer has been hit three times, according to Rule 56 (above), then a halt will be called for two minutes; and if neither has been hit three times when the subsequent three minutes have elapsed, then the bout shall score against both fencers. (*See Rules 15 and 69.*)

58. Thrusts with the point only count, as in the case of the épée, when they are cleanly delivered in such a way that the point, if sharp, would have penetrated the uncovered skin; but it must be noted that an apparent thrust may pass the adversary's body and become in reality a cut, if the true edge is pressed against his body, but not if the edge touches in passing, merely by accident.



59. Cuts only count when they reach an adversary with the true edge in such a way that the edge, if sharp, would have cut the uncovered skin. No hit shall count if it only arrives after breaking through a properly-formed parry, or if the cut has substantially been delivered on the adversary's sword, though in addition reaching the body. (*See Rules 67 and 68.*)

60. The winner of a bout shall be the fencer who has won the greatest number of victories involving three hits each. When two or more fencers tie in the number of bouts they have won, they shall fight off the tie for three hits above the imaginary line.

61. A fencer who does not parry, or (except in the case covered by Rule 66 (c)) does not follow out the phrase, and thereby produces what in *épée-play* would be called a "coup double," has a hit scored against him.

62. In *sabre-play* the initiation of any definite threatening movement commences the attack, and that attack continues so long as the movement (or series of movements) is continuously maintained. A riposte is an attack initiated immediately after a parry by the player who has made the parry. When both fencers make an initial movement of aggression at the same time and produce what is called in *épée-play* a "coup double," no hit is scored against either of them. If, in a case of this kind, one of the simultaneous hits is made on a forbidden portion of the body (*see Rule 56*), no hit is scored against either, unless the Jury should be firmly persuaded that this hit was deliberately aimed at the forbidden portion, in which case the President shall have power to award it against the fencer making it.

63. The stop-hit is a counter-attack made upon the opponent's attack. If a player, who attempts to make a stop-hit, hits his adversary and is himself untouched, or if he hits his opponent an appreciable interval of time before he is himself touched, the hit is in his favour. If he is hit simultaneously the hit is in favour of his opponent, except in the case covered by Rule 66 (c).

64. The time-hit is a counter-attack made with opposition upon the opponent's attack in such a way that it parries the attack on which it is made. Hence it follows (in accordance with Rule 11)

that a hit made by a time attack is only valid if the player who attempts it is absolutely untouched, and in case of simultaneous hits the hit is in favour of the fencer who delivers the original attack.

65. Remise and Redoublement d'Attaque.—The remise is a renewal of the attack made in the same line as the original attack. The redoublement d'attaque is a renewal of the attack made with a change of line.

- (a) The remise or redoublement, made on an opponent who ripostes immediately after a parry, must be made with sufficient opposition to parry the riposte in such a way that the fencer who attempts it is absolutely untouched. In the event of mutual hits the riposte only is valid.
- (b) If after a parry there is a distinct pause followed by a riposte (riposte à temps perdu) and a remise or a redoublement d'attaque delivered simultaneously, the resulting hits are both invalid. If the remise or redoublement is made before the riposte à temps perdu, the remise or redoublement only is valid; if after the riposte, the riposte only is valid.
- (c) If the riposte is composed of several feints, the remise or redoublement, to be valid, must be delivered before the final, except in the case covered by Rule 66 (c).

66. Simultaneous Hits.—In the event of simultaneous hits either the attacker or the defender or both may be at fault.

- (a) The attacker is at fault and the hit is against him
  - (1) If after attempting an attack on the blade which is deceived he continues his attack.
  - (2) If he tries to parry a stop-hit and does not succeed, but nevertheless continues his attack.
  - (3) If in the execution of a feint he meets his opponent's parry, and notwithstanding his opponent's riposte continues the attack.

(4) If he makes a remise or redoublement d'attaque on the immediate riposte of his opponent.

(5) If in attacking he runs on the point of his opponent, who had his arm fully extended when the attack was initiated.

(b) The defender is at fault and the hit is against him

(1) If he makes a stop-hit on a simple attack.

(2) If he fails to riposte immediately after his parry, and his opponent seizes the opportunity to make a remise or a redoublement d'attaque before the riposte.

(3) If he attempts a time-hit, but does not use sufficient opposition to cover himself completely.

(c) Both are at fault and no hit is scored

If one player makes several feints and the other, after trying to parry the first feints, makes a stop-hit. The resulting hits, if simultaneous, are invalid.

67. Fencers with the sabre must not deliver cuts too heavily.

68. Play automatically ceases, and hits occurring subsequently and before play is recommenced are invalid, upon

(a) Bodily contact between the players.

(b) The weapon of either player becoming engaged in the weapon or clothing of the other.

(c) The blade of either player reaching his opponent whether resulting in a valid hit or not.

But the President has power to award an otherwise valid hit against the player hit, if he has, in the President's opinion, brought about the cessation of play under this Rule on purpose to render such a hit invalid, or in case any of the events specified in this Rule occur upon (or immediately before) the delivery of an otherwise valid hit, and, in the President's opinion, such occurrence was

accidental and did not disadvantageously affect the player hit. The President would use this power, for example, in the not uncommon case of a hit occurring before he had had time to call "Halt" owing to a previous hit.

69. In keeping the score-sheets (*see* Rules 28, 29, 30) of sabre-pools (whether individual fights or team-fights) the mark O shall not be placed against a fencer's name (involving the placing of the mark X against his adversary's name) until he has won the three hits as described above (*see* Rule 56). It will also be noted that the mark ‡, signifying a double hit in épée-play, should not appear on the score-sheet of any sabre competition, except in the case provided for in Rule 57 (above), when each fencer has exceeded the time-limit fixed for the bout. (*See* Rule 15.)

---

## VII.—SPECIAL RULES (Sabre teams).

70. The bouts in sabre-team fights will be regulated by exactly the same rules for hits as those enforced in the individual sabre championships. (*See* Rules 52-69.)

71. The arrangements for each sabre-team competition will be exactly the same as those for the international épée-team fights, as provided for in Rules 19 to 24, 43 to 49, and 51, (*See also* Rule 30.)



BADGES FOR THE OLYMPIC GAMES OF 1908.



THE INTERNATIONAL FENCING CHALLENGE CUP.

Presented by British Fencers for competition at the Olympic Games of 1908 and every fourth year afterwards for ever. This Cup, made by Messrs. Mappin & Webb, is a faithful reproduction of the Ionic Amphora of the Fifth Century B.C., called the Pourtales Vase, in the British Museum, mounted on a Pedestal set with bas-reliefs representing the fight of the Horatii and Curiatii, designed by Jane E. Cook and modelled by Edwin Godwin and A. Hollinshead.

## SPECIAL RECOMMENDATIONS.

---

1. Corrections may be made in the Code by the Committee.

2. It is urgently requested that in accordance with Rule 19, the names of competent jurors, who have promised to be present at the Games, shall be sent in to the Committee, through the Secretary of the British Olympic Council, before June 15, in order that arrangements may be as far as possible completed before the Games begin. Jurors will receive a special badge and Commemorative Medal.

3. (a) If a jurymen has not seen an incident on which his opinion is requested, he shall have no vote on the question as to whether a hit has resulted from that incident. A jurymen voting must only give his opinion as to the validity of a hit, and must not change his opinion, or vote, after any discussion which may be initiated by the President.

(b) Objections must be lodged by a competitor in the individual competitions or by the captain of a team after the completion of a match, and not during its progress, to the Comité d'Honneur of his own country, and only a member of his Comité d'Honneur can bring it before the Games Committee of the A.F.A. for adjudication. (See Rules 9 and 17.)

(c) Instructions to jurymen :—

The President shall satisfy himself before each bout that each weapon used by a competitor bears the official stamps of the Committee.

The jurors selected by the Committee under Rule 19 will be notified by the Committee of the day and hour they are required to attend on the ground, and of the pool or match for which they are selected. All information as to the attendance of jurors will be obtainable at the Committee's office on the ground.

The President of a jury is not under any circumstances to allow a competitor or spectator to argue a point with the jury.

All ties under Rule 29 must be fought off immediately.

4. The *pointe d'arret* (à *pointe unique*) is selected for use in the competitions, and a sample is herewith enclosed.

5. Competitors are again warned that unsuitable clothing may prove as certain a bar to their admission as unorthodox weapons. (See Rules 10, 34, 35.) Adequate Throat-pieces will be insisted on.

6. (a) All weapons to be used by competitors must be submitted to the Committee for approval, who will place their official stamps on the weapons found to comply with the Rules.

Competitors must submit their weapons requiring to be approved at least one hour before the commencement of a pool or match.

(b) Competitors are particularly warned to attend ready to fence on the ground at least a quarter of an hour before the time fixed for the commencement of a pool or match, as any competitor arriving late will be disqualified unless under special circumstances. (See Rule 24.)

(c) Competitors are requested to satisfy themselves as to the time of their bout by enquiry at the Committee's office on the ground, as the failure to receive a notice cannot be considered by the Committee as an excuse for non-attendance.

7. No entries can be received under any circumstances after June 15, 1908.

8. The fencing will begin on or about Saturday, July 18, with the Preliminary *Epée* Pools. The prizes will be given away on Saturday, July 25.

9. In the case of *épée* and *sabre* teams the captain counts as one of the eight men officially entered. Although only four fencers can take part in each round of the team-competitions, substitutes can only be provided (when a change is necessary or advisable) from the eight names previously entered, and in accordance with Rules 24, 44, 45 ; no exception to this will be admitted.

If the captain fences, he ceases to be captain and appoints one of his team who is not fighting in that match as his substitute for that match.

10. If the number of the competing teams is 4, 8, or 16, they shall meet in pairs, as follows :—

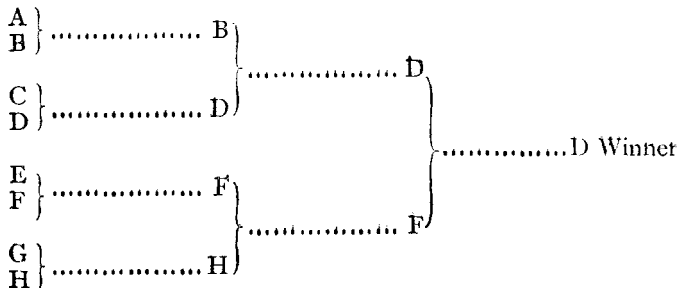



If there are five competing teams, there will be one bye at the top and two byes at the bottom of the list, as follows :—

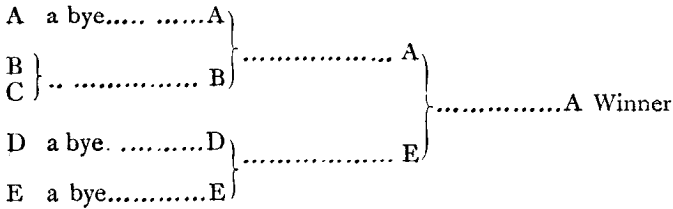

If there are six teams there will be one bye at the top and one bye at the bottom.

If there are seven teams there will be one bye at the bottom.

If there are nine teams there will be three byes at the top and four byes at the bottom, as follows :—

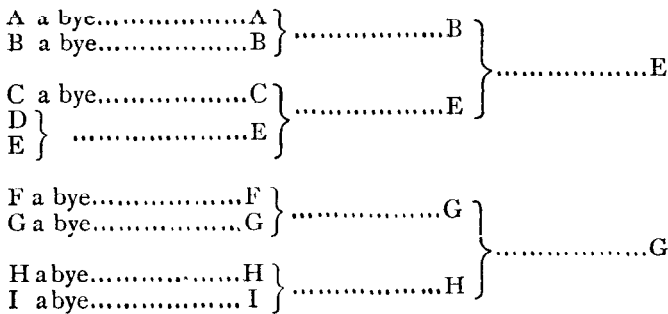

With ten teams, three byes at the top and three at the bottom.

With eleven teams, two byes at the top and three at the bottom.

With twelve teams, two byes at the top and two at the bottom.

11. On or before July 1, 1908 every Olympic Committee will be formally notified by the Games Committee of the A.F.A. (through the Secretary of the British Olympic Council) of the exact date of the Fencing competitions.

12. Ignorance of the conditions published in the Code, the "Observations," or these "Special Recommendations," will not be held as any excuse for contravention of the Regulations.

## OBSERVATIONS ON THE FENCING CODE.

November 1907.

1. The following is sent with the Fencing Rules, not as a part of those Rules, but as a note for the information of intending competitors.

2. The enclosed Code has been approved by the Committee of the Amateur Fencing Association of the United Kingdom for use at the Olympic Games of 1908 in London, under the control of the British Olympic Council.

3. The Code will not be changed (except under circumstances of especial gravity, of which this Committee alone will be the judge) after April 15th, 1908.

4. Before April 1st, 1908, the Committee will decide exactly what form of *pointe d'arrêt* (or *bouton marqueur*) will be used in the Tournament of July 1908, and will forward on April 15th a specimen to the Olympic Committee of each nation competing, together with *special recommendations* as to clothing, &c., not mentioned in the Code.

5. Intending Competitors from all nations are reminded that their entries can only be forwarded to the British Olympic Council before June 15th, 1908, and by the Olympic Council of each competing nation.

6. The Games will begin on July 13th, and the fencing will probably take place soon after that date ; but every Olympic Council will be formally notified by the Committee of the Amateur Fencing Association (through the Secretary of the British Olympic Council) before July 1st, 1908 of the exact date of all the fencing competitions, the exact order of the various pools and team fights, and the times at which each competitor must present himself.

7. The names of the gentlemen selected as jurors by each National Olympic Council must also reach the British Olympic Council *before the Games begin*, for jurors whose names have not been received by that date may not be accepted for the competitions of July.

8. The Rules with regard to measurements and mountings, &c., of swords or sabres will be strictly observed, and should be carefully read by all competitors who may desire to practise beforehand with the weapons allowed by the Committee. It must be taken for granted that all competitors have provided themselves with weapons in accordance with these Rules, for no swords or sabres can be provided by the Committee in those cases where the competitors' own weapons do not conform exactly to these Rules.

9. Competitors must bring their *épées* without a *pointe d'arrêt* (or *bouton marqueur*), in order that the same *pointe d'arrêt* (or *bouton marqueur*) may be affixed to the weapons of all competitors by the *Prévôt* appointed for that purpose by the Committee.

10. It will be taken for granted that every competitor has read the Code of Rules governing the Competitions, together with these "Observations," and the "Special Recommendations," and ignorance of the published conditions will not be held to excuse any contravention of the Regulations of the Tournament.

(For the BRITISH OLYMPIC COUNCIL)

(Signed) ALFRED HUTTON,

(Signed) THEODORE A. COOK.

## MEASUREMENTS OF WEAPONS.

The Fencing Committee have already issued several warnings concerning the strictness of the Olympic Rules with regard to the measurements of weapons. They are most anxious that no visitors should be disappointed by the refusal of their weapons in London. They therefore beg to point out that, in the newest épées and sabres they have just received from Paris, the following breaches of the Olympic Rules occur, and that épées or sabres of these measurements would *not* be accepted for use in the Olympic Tournament.

June 15, 1908. For the Committee.

ALFRED HUTTON.

THEODORE A. COOK.

(1) See Rule 53 (*b*), English version.

New sabres from Paris have hilts too large. The shell should measure as shown in the diagram :—

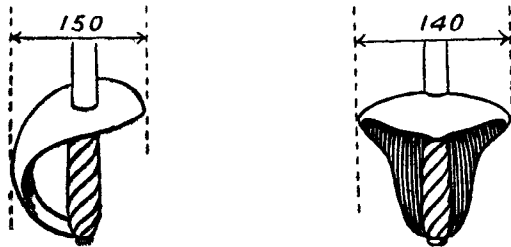

(2) See Rule 37 (*g*), English version.

New épées from Paris have the blade too small near the button.

They must be two millimetres at least at the point shown in the diagram :—

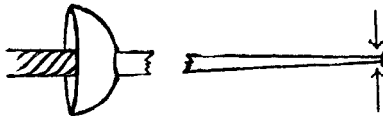

(3) See Rule 37 (*d*), English version.

The handle of an épée, measured from the point where the blade meets the outside of the shell, must not be longer than 220 milli-

metres, as shown in the diagram. (When the screw sometimes used at the end of the handle exceeds 17 millimetres in external diameter, it must be included in the above measurement of 220.)

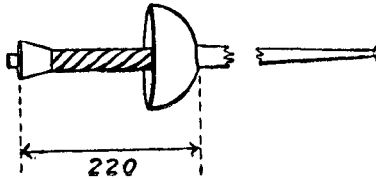

## DUTIES OF JURIES.

1. The Games Committee will appoint (for each Team Fight or Pool) a President and two Jurors, and, if the Competitors so desire, two additional Jurors, from the list of Jurors if possible, shall be further appointed by the Committee. (See Rule 15.)

2. The President of a Jury will be responsible for the proper conduct of the Fighting (Rule 20). He, only, can start a Fight with the word "Go," or stop it by calling "Halt" (Rules 15, 20, and 39). He, only, is to warn a Competitor, by calling "Limit," that he is within three metres of the limit line (Rule 11).

3. The President shall satisfy himself that the Competitors are wearing suitable clothing, masks, gloves, and shoes, and are using weapons bearing the official stamp of the Committee (Rules 10, 34, 35, 37, and 53).

4. The President may disqualify a Competitor for improper conduct (Rule 16).

5. The President of a Jury is not under any circumstances to allow a Competitor to argue a point with the Jury.

6. The President's decision is final, but when it is not in accordance with the opinion of the Jury as a whole the fight must be resumed (Rule 22).

7. No Member of a Jury, except the President, can stop a Fight. If a Juror wishes a bout stopped he must warn the President by sign only raising the hand, and not by voice (Rule 21).

8. If a Juror has not seen an incident on which his opinion is requested, he shall have no vote on the question as to whether a hit has resulted from that incident. A Juror voting will only give his opinion as to what he saw occur, and must not change his opinion, or vote, after any discussion which may be initiated by the President. (See Rules 15 to 23.)

## FINAL NOTES.

Owing to the number of entries in the Individual Competitions, it is necessary that the contests shall commence on Friday, July 17.

The result of the draw for the Team Fights and Individual Competitions will be published at the Olympic Fencing Ground at the Franco-British Exhibition, on Thursday afternoon, July 16, at 4 p.m., and Competitors are required to present their weapons for the approval of the Committee on that afternoon.

The Preliminary Rounds for both Épée and Sabre will be commenced at 11 a.m. on Friday, July 17. Each Pool will consist of seven or eight Competitors, of whom the four leaders will qualify for further fighting.

The Committee has decided that, in the Team Competitions, the teams defeated by the winners shall fight off for second place on Friday, July 24.

*Competitors are again warned that a Fencer who is late for his Pool will be disqualified.*

For the convenience of Competitors, the Committee has arranged to open an Information Bureau at the Sword Club, No. 1 Durham House Street, Strand, W.C. (adjoining the Tivoli Music Hall), from July 13 to Friday, July 17.

# ASSOCIATION FOOTBALL COMPETITION.

---

## GENERAL REGULATIONS.

1. The Competition shall be under the control and management of the Council of the Football Association (England), whose decision on all matters relating to the Competition shall be final and without appeal. They shall appoint the Referees and Linesmen in all matches.

2. The Competition shall be played according to the Laws of the Game as promulgated by the Football Association (England) and accepted by the Fédération Internationale de Football Association.

3. Each country competing shall be entitled to enter four teams (11 players a team). [England, Scotland, Ireland, and Wales is deemed to be one country—Great Britain,]

4. The Competition shall be confined to Amateurs.

5. All entries shall be made by the governing Associations (or, where governing Associations do not exist, by Amateur Clubs) through the Olympic Committee in each country, who will be responsible to the British Olympic Council for the competence of such Associations or Clubs to guarantee that the competitors so entered are Amateurs in accordance with the following definition :—

An Amateur player is one who does not receive remuneration or consideration of any sort above his necessary hotel and travelling expenses actually paid, or who is not registered as a Professional.

6. Entries shall be in writing, on the authorised forms, and must be received by the British Olympic Council, 108 Victoria Street, Westminster, London, on or before the 1st September, 1908.

7. The number of names which may be comprised in each entry from which the team and reserves shall be finally selected shall not exceed 33.

and the final nominations of each team and its reserves must be received by the British Olympic Council in London not later than the 4th October, 1908.

8. The National Association of the country whose team is declared the winners shall receive the Challenge Trophy presented by The Football Association (England), and shall hold the same in trust for, and shall be responsible for its return to, the International Olympic Committee on or before the 31st May, 1909, in good order and condition. The members of the winning team shall each receive gold Olympic Medals.

9. The Competition shall commence on or about the 19th October, 1908, at the Stadium of the British Olympic Association, London.

---

## RULES OF THE COMPETITION.

1. The Competition shall be conducted in the following manner :— The competing teams shall be drawn in couples. These couples shall compete, and the winners shall be drawn and shall compete in the same manner, and this shall be continued until the end of the Competition.

2. Each team shall compete in its National (Association Football) colours. Where the colours of two competing teams are the same, one of the teams shall play in such colours as may be decided by the Council.

3. Players of each representative team may be changed during the series of matches.

4. The duration of each match shall be one hour and a half, and the Referee shall allow for time wasted or lost through accident or other cause.

5. Should a match result in a draw, an extra half hour must be played. Should a match result in a draw after it has been played for two hours, it must be replayed as the Council may determine.

6. The dimensions of the field of play shall be—length, 115 yards ; breadth, 75 yards.



## THE LAWS OF THE GAME.

---

1. The game should be played by eleven players on each side. The field of play shall be as shown in the plan at the end of these Laws, subject to the following provisions :—The dimensions of the field of play shall be—maximum length, 130 yards ; minimum length, 100 yards ; maximum breadth, 100 yards ; minimum breadth, 50 yards. The field of play shall be marked by boundary lines. The lines at each end are the goal-lines and the lines at the sides are the touch-lines. The touch-lines shall be drawn at right angles with the goal-lines. A flag, with a staff not less than 5 feet high, shall be placed at each corner. A half-way line shall be marked out across the field of play. The centre of the field of play shall be indicated by a suitable mark, and a circle with a 10 yards' radius shall be made round it. The goals shall be upright posts fixed on the goal-lines, equidistant from the corner flag-staffs, 8 yards apart, with a bar across them 8 feet from the ground. The maximum width of the goal posts and the maximum depth of the cross-bar shall be 5 inches. Lines shall be marked 6 yards from each goal-post at right angles to the goal-lines for a distance of 6 yards, and these shall be connected with each other by a line parallel to the goal-lines ; the space within these lines shall be the goal-area. Lines shall be marked 18 yards from each goal-post at right angles to the goal-lines for a distance of 18 yards, and these shall be connected with each other by a line parallel to the goal-lines ; the space within these lines shall be the penalty area. A suitable mark shall be made opposite the centre of each goal, 12 yards from the goal-line ; this shall be the penalty kick mark. The circumference of the ball shall not be less than 27 inches nor more than 28 inches. The outer casing of the ball must be of leather, and no material shall be used in the construction of the ball which would constitute a danger to the players. In International matches the dimensions of the field of play shall be—maximum length, 120 yards ; minimum length, 110 yards ; maximum breadth, 80 yards ; minimum breadth, 70 yards ; and at the commencement of the game the weight of the ball shall be from 13 to 15 ounces.

2. The duration of the game shall be 90 minutes, unless otherwise mutually agreed upon. The winners of the toss shall have the option of kick-off or choice of goals. The game shall be commenced by a place-kick from the centre of the field of play in the direction of the opponents goal-line ; the opponents shall not approach within 10 yards of the ball until it is kicked off, nor shall any player on either side pass the centre of the ground in the direction of his opponents' goal until the ball is kicked off.

3. Ends shall only be changed at half-time. The interval at half-time shall not exceed five minutes, except by consent of the Referee. After a goal is scored the losing side shall kick off, and after the change of ends at half-time the ball shall be kicked off by the opposite side from that which originally did so ; and always as provided in Law 2.

4. Except as otherwise provided by these Laws, a goal shall be scored when the ball has passed between the goal-posts under the bar, not being thrown, knocked on, nor carried by any player of the attacking side. If from any cause during the progress of the game the bar is displaced, the Referee shall have power to award a goal if in his opinion the ball would have passed under the bar if it had not been displaced. The ball is in play if it rebounds from a goal-post, cross-bar, or a corner flag-staff into the field of play. The ball is in play if it touches the Referee or a Linesman when in the field of play. The ball is out of play when it has crossed the goal-line or touch-line, either on the ground or in the air.

5. When the ball is in touch, a player of the opposite side to that which played it out shall throw it in from the point on the touch-line where it left the field of play. The player throwing the ball must stand on the touch-line facing the field of play, and shall throw the ball in over his head with both hands in any direction, and it shall be in play when thrown in. A goal shall not be scored from a throw-in, and the thrower shall not again play until the ball has been played by another player. This Law is complied with if the player has any part of both feet on the line when he throws the ball in.

6. When a player plays the ball, or throws it in from touch, any player of the same side who at such moment of playing or throwing-in is nearer to his opponents' goal-line is out of play, and may not touch the ball himself, nor in any way whatever interfere with an opponent, or with the play, until the ball has been again played, unless there are at such moment of playing or throwing-in at least three of his opponents nearer

their own goal-line. A player is not out of play when the ball is kicked off from goal, when a corner-kick is taken when the ball has been last played by an opponent, or when he himself is within his own half of the field of play at the moment the ball is played or thrown in from touch by any player of the same side.

7. When the ball is played behind the goal-line by a player of the opposite side, it shall be kicked off by any one of the players behind whose goal-line it went, within that half of the goal-area nearest the point where the ball left the field of play ; but, if played behind by any one of the side whose goal-line it is, a player of the opposite side shall kick it from within one yard of the nearest corner flag-staff. In either case an opponent shall not be allowed within six yards of the ball until it is kicked off.

8. The goal-keeper may, within his own half of the field of play, use his hands, but shall not carry the ball. The goal-keeper shall not be charged except when he is holding the ball, or obstructing an opponent, or when he has passed outside the goal area. The goal-keeper may be changed during the game, but notice of such change must first be given to the Referee.

9. Neither tripping, kicking, nor jumping at a player shall be allowed. A player (the goal-keeper excepted) shall not intentionally handle the ball. A player shall not use his hands to hold or push an opponent. Charging is permissible, but it must not be violent or dangerous. A player shall not be charged from behind unless he is intentionally obstructing an opponent.

10. When a free kick has been awarded, the kicker's opponents shall not approach within 6 yards of the ball unless they are standing on their own goal-line. The ball at least must be rolled over before it shall be considered played—i.e. it must make a complete circuit or travel the distance of its circumference. The kicker shall not play the ball a second time until it has been played by another player. The kick-off (except as provided by Law 2), corner-kick, and goal-kicks shall be free kicks within the meaning of this Law.

11. A goal may be scored from a free kick which is awarded because of any infringement of Law 9, but not from any other free kick.

12. A player shall not wear any nails, except such as have their heads driven in flush with the leather, or metal plates or projections, or gutta-percha on his boots, or on his shin guards. If bars or studs on the

soles or heels of the boots are used, they shall not project more than half an inch, and shall have all their fastenings driven in flush with the leather. Bars shall be transverse and flat, not less than half an inch in width, and shall extend from side to side of the boot. Studs shall be round in plan, not less than half an inch in diameter, and in no case conical or pointed. Any player discovered infringing this Law shall be prohibited from taking further part in the match. The Referee shall, if required, examine the players' boots before the commencement of a match.

13. A Referee shall be appointed, whose duties shall be to enforce the Laws and decide all disputed points; and his decision on points of fact connected with the play shall be final. He shall also keep a record of the game, and act as timekeeper. In the event of any ungentlemanly behaviour on the part of any of the players, the offender or offenders shall be cautioned, and if any further offence is committed, or in case of violent conduct without any previous caution, the Referee shall have power to order the offending player or players off the field of play, and shall transmit the name or names of such player or players to his or their National Association, who shall deal with the matter. The Referee shall have power to allow for time wasted, to suspend the game when he thinks fit, and to terminate the game whenever, by reason of darkness, interference by spectators, or other cause, he may deem necessary ; but in all cases in which a game is so terminated he shall report the same to the Association under whose jurisdiction the game was played, who shall have full power to deal with the matter. The Referee shall have power to award a free kick in any case in which he thinks the conduct of a player dangerous, or likely to prove dangerous, but not sufficiently so as to justify him in putting in force the greater powers invested in him. The power of the Referee extends to 30 offences committed when the play has been temporarily suspended, and when the ball is out of play.

14. Two Linesmen shall be appointed, whose duty (subject to the decision of the Referee) shall be to decide when the ball is out of play, and which side is entitled to the corner-kick, goal-kick, or throw in ; and to assist the Referee in carrying out the game in accordance with the Laws. In the event of any undue interference or improper conduct by a Linesman, the Referee shall have power to order him off the field of play and appoint a substitute, and report the circumstances to the National Association having jurisdiction over him, who shall deal with the matter.

15. In the event of a supposed infringement of the Laws, the ball shall be in play until a decision has been given.

16. In the event of any temporary suspension of play from any cause, the ball not having gone into touch or behind the goal-line, the Referee shall throw the ball down where it was when play was suspended, and it shall be in play when it has touched the ground. If the ball goes into touch or behind the goal-line before it is played by a player, the Referee shall again throw it down. The players on either side shall not play the ball until it has touched the ground.

17. In the event of any infringement of Laws 5, 6, 8, 10, or 16, or of a player being sent off the field under Law 13, a free kick shall be awarded to the opposite side, from the place where the infringement occurred. In the event of any intentional infringement of Law 9 outside the penalty area, or by the attacking side within the penalty area, a free kick shall be awarded to the opposite side from the place where the infringement occurred. In the event of any intentional infringement of Law 9 by the defending side within the penalty area the Referee shall award the opponents a penalty kick which shall be taken from the penalty kick mark under the following conditions :—All players, with the exception of the player taking the penalty kick and the opponents' goal-keeper, shall be outside the penalty area. The opponents goal-keeper shall not advance beyond his goal-line. The ball must be kicked forward. The ball shall be in play when the kick is taken, and a goal may be scored from a penalty kick ; but the ball shall not be again played by the kicker until it has been played by another player. If necessary, time of play shall be extended to admit of the penalty kick being taken. A free kick shall also be awarded to the opposite side if the ball is not kicked forward, or is played a second time by the player who takes the penalty kick until it has been played by another player. The Referee may refrain from putting the provisions of this Law into effect in cases where he is satisfied that by enforcing them he would be giving an advantage to the offending side. If when a penalty kick is taken the ball passes between the goal-posts, under the bar, the goal shall not be nullified by reason of any infringement by the defending side.

# PLAN OF THE FIELD OF PLAY

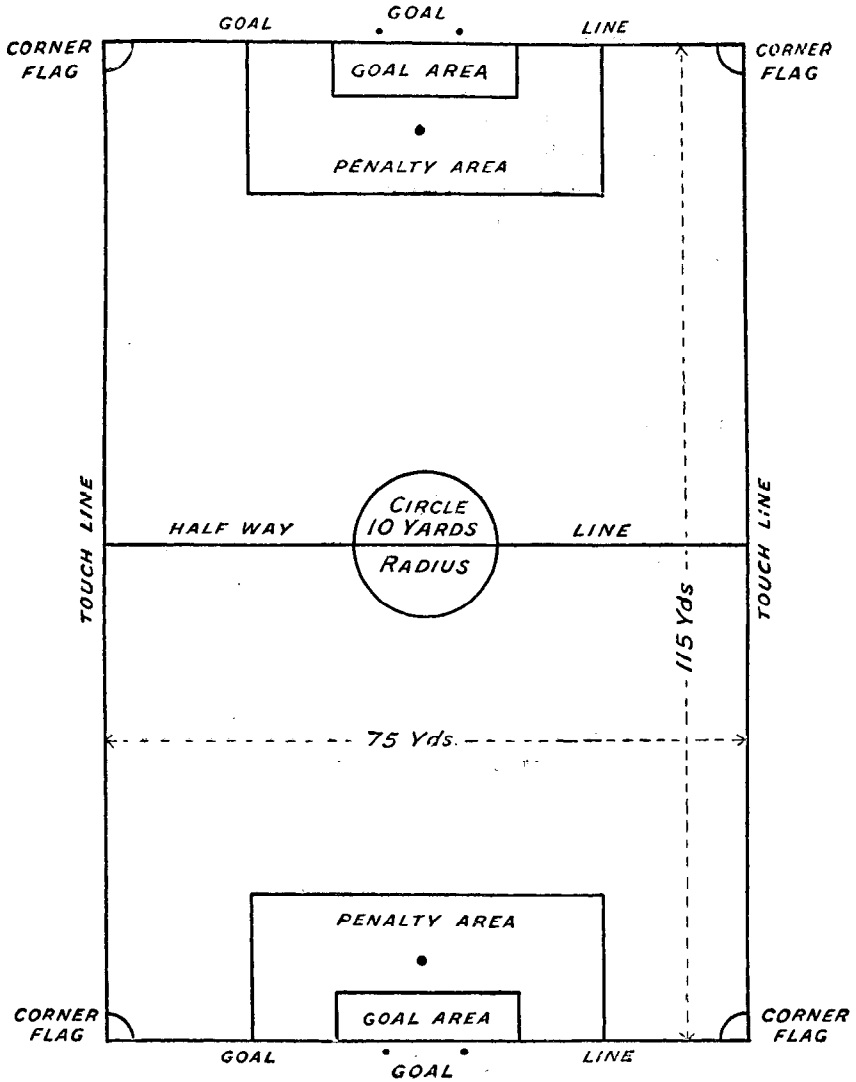

## DEFINITION OF TERMS.

---

A **Place Kick** is a kick at the ball while it is on the ground in the centre of the field of play.

A **Free Kick** is a kick at the ball, in any direction the player pleases, when it is lying on the ground.

A **Place Kick**, a **Free Kick**, or a **Penalty Kick** must not be taken until the Referee has given a signal for the same.

**Carrying** by the goal-keeper is taking more than two steps while holding the ball, or bouncing it on the hand.

**Knocking on** is when a player strikes or propels a ball with his hands or arms.

**Handling and Tripping.** Handling is intentionally playing the ball with the hand or arm, and Tripping is intentionally throwing, or attempting to throw, an opponent by the use of the legs, or by stooping in front of, or behind him.

**Holding** includes the obstruction of a player by the hand or any part of the arm extended from the body.

**Touch** is that part of the ground on either side of the field of play.

# GOLF.

## P R O G R A M M E .

				Maximum Number of Competitors from each Country.
<b>I. Individual Medal Competition</b>	...	...		<b>20</b>
<b>II. Team Competition</b>	...	...	...	<b>4 teams</b>

6 to play, 4 to count.



## GENERAL REGULATIONS FOR THE COMPETITION.

---

(a) The Competition shall be open to all Amateur Golfers, members of any Golf Club.

(b) An AMATEUR Golfer shall be a Golfer who has never made for sale golf clubs, balls, or any other article connected with the game ; who has never carried clubs for hire after attaining the age of fifteen years, and who has not carried clubs for hire at any time within six years of the date on which the Competition begins ; who has never received any consideration for playing in a match, or for giving lessons in the game, and who, for a period of five years prior to September 1, 1886, has never received a money prize in any open competition.

(c) Entries shall be made in accordance with Section 8 of the General Regulations of the Olympic Games of London 1908, "through the Olympic Committee of each country."

(d) The dates of play and the date on which the entries close shall be duly advertised by the British Olympic Council.

(e) The Competition shall be played in accordance with the rules of the Royal and Ancient Golf Club of St. Andrews, and the bye-laws of the Clubs on whose greens the Competition is held.

(f) Every Competitor shall play two rounds of each of the following greens :

1. Royal St. George's Golf Club, Sandwich.
2. Prince's Golf Club, Sandwich.
3. Cinqueports Golf Club, Deal.

(g) In the event of a tie the competitors shall play off at a date to be fixed by the British Olympic Council.

(h) The winners shall receive gold Olympic medals, the second the silver Olympic medals, and the third the bronze Olympic medals.

(i) All disputes shall be settled by the Committees of the Clubs on whose greens the Competitions are held, whose decisions shall be final.

## RULES OF GOLF.

*Authorised by the Royal and Ancient Golf Club of St. Andrews,  
23rd September, 1902, and amended 27th September, 1904,  
and 29th September, 1908.*

### I. DEFINITIONS :—

- (a) The Game of Golf is played by two sides, each playing its own ball. A side consists either of one or of two players. If one player play against another the match is called a “single.” If two play against two, it is called a “foursome.” One player may play against two playing one ball between them, when the match is called a “threesome.” Matches constituted as above shall have precedence of and be entitled to pass any other kind of match.
- (b) The game consists in each side playing a ball from a teeing-ground into a hole by successive strokes, and the hole is won by the side which holes its ball in fewer strokes than the opposite side, except as otherwise provided for in the Rules. If the sides hole out in the same number of strokes, the hole is halved.
- (c) The “teeing-ground” is the starting-point for a hole and shall be indicated by two marks placed in a line as nearly as possible at right angles to the course. The hole shall be  $4\frac{1}{4}$  inches in diameter, and at least 4 inches deep.
- (d) The “putting-green” is all ground with twenty yards of the hole, except hazards.
- (e) A “hazard” is any bunker, water (except casual water), sand, path, road, railway, whin, bush, rushes, rabbit scrape, fence or ditch. Sand blown on to the grass, or sprinkled on the course for its preservation, bare patches, sheep tracks, snow and ice are not hazards. Permanent grass within a hazard is not part of the hazard.
- (f) “Through the green” is any part of the course except hazards and the putting-green which is being played to.
- (g) “Out of bounds” is any place outside the defined or recognised boundaries of the course.
- (h) “Casual water” is any temporary accumulation of water (whether caused by rainfall or otherwise) which is not one of the ordinary and recognised hazards of the course.

- (i) A ball is "in play" as soon as the player has made a stroke at the teeing-ground in each hole, and remains in play until holed out, except when lifted in accordance with the Rules.
- (j) A ball has "moved" only if it leave its original position in the least degree, and stop in another ; but if it merely oscillate, without finally leaving its original position, it has not "moved."
- (k) A ball is "lost" if it be not found within five minutes after the search for it is begun.
- (l) A "match" consists of one round of the Links, unless it be otherwise agreed. A match is won by the side which is leading by a number of holes greater than the number of holes remaining to be played. If each side win the same number of holes, the match is halved.
- (m) A "stroke" is any movement of the ball caused by the player, except as provided for in Rule 3, or any downward movement of the club made with the intention of striking the ball.
- (n) A "penalty stroke" is a stroke added to the score of a side under certain rules, and does not affect the rotation of play.
- (o) The "honour" is the privilege of playing first from a teeing-ground.
- (p) A player has "addressed the ball" when he has taken up his position and grounded his club, or if in a hazard, when he has taken up his position preparatory to striking the ball.
- (q) The reckoning of the strokes is kept by the terms—"the odd," "two more," "three more," etc., and "one off three," "one off two," "the like." The reckoning of holes is kept by the terms—so many "holes up," or "all even," and so many "to play."

2. A match begins by each side playing a ball from the first teeing-ground. The player who shall play first on each side shall be named by his own side. The option of taking the honour at the first teeing-ground shall be decided, if necessary, by lot. A ball played from in front of, or outside of, or more than two club lengths behind the marks indicating the teeing-ground, or played by a player when his opponent should have had the honour may be at once recalled by the opposite side, and may be re-teeed without penalty. The side which wins a hole shall have the honour at the next teeing-ground. If a hole has been halved, the side which had the honour at the previous teeing-ground shall retain the honour. On beginning a new

match the winner of the long match in the previous round shall have the honour, or if the previous match was halved the side which last won a hole shall have the honour.

3. If the ball fall or be knocked off the tee in addressing it, no penalty shall be incurred, and it may be replaced, and if struck when moving no penalty shall be incurred.

4. In a threesome or foursome the partners shall strike off alternately from the teeing grounds, and shall strike alternately during the play of the hole. If a player play when his partner should have done so, his side shall lose the hole.

5. When the balls are in play, the ball further from the hole which the players are approaching shall be played first, except as otherwise provided for in the Rules. If a player play when his opponent should have done so, the opponent may at once recall the stroke. A ball so recalled shall be dropped, in the manner prescribed in Rule 15, as near as possible to the place where it lay, without penalty.

6. The ball must be fairly struck at, not pushed, scraped, nor spooned, under penalty of the loss of the hole.

7. A ball must be played wherever it lies or the hole be given up, except as otherwise provided for in the Rules.

8. Unless with the opponent's consent, a ball in play shall not be moved, nor touched, before the hole is played out, under penalty of one stroke, except as otherwise provided for in the Rules. But the player may touch his ball with his club in the act of addressing it, provided he does not move it, without penalty. If the player's ball move the opponent's ball through the green, the opponent, if he choose, may drop a ball (without penalty) as near as possible to the place where it lay, but this must be done before another stroke is played.

9. In playing through the green any loose impediment (not being in or touching a hazard) which is within a club length of the ball may be removed. If the player's ball move after any such loose impediment has been touched by the player, his partner, or either of their caddies, the penalty shall be one stroke. If any loose impediment (not being on the putting-green) which is more than a club length from the ball be removed, the penalty shall be the loss of the hole.

10. Any vessel, wheel-barrow, tool, roller, grass-cutter, box, or similar obstruction may be removed. If a ball be moved in so doing, it may be

replaced without penalty. A ball lying on or touching such obstruction, or on clothes, nets, or ground under repair or covered up or opened for the purpose of the upkeep of the Links, may be lifted and dropped without penalty as near as possible to the place where it lay, but not nearer the hole. A ball lifted in a hazard, under such circumstances, shall be dropped in the hazard. A ball lying in a golf hole or flag hole, or in a hole made by the green-keeper, may be lifted and dropped without penalty as near as possible to the place where it lay, but not nearer the hole.

11. Before striking at a ball in play, the player shall not move, bend, nor break anything fixed or growing near the ball, except in the act of placing his feet on the ground for the purpose of addressing the ball, in soling his club to address the ball, and in his upward or downward swing, under penalty of the loss of the hole, except as otherwise provided for in the Rules.

12. When a ball lies in or touches a hazard, nothing shall be done to improve its lie ; the club shall not touch the ground, nor shall anything be touched or moved before the player strikes at the ball, subject to the following exceptions :—(1) The player may place his feet firmly on the ground for the purpose of addressing the ball ; (2) in addressing the ball, or in the upward or downward swing, any grass, bent, whin, or other growing substance, or the side of a bunker, wall paling, or other immovable obstacle may be touched ; (3) steps or planks placed in a hazard by the Green Committee for access to or egress from such hazard may be removed, and if a ball be moved in so doing, it may be replaced without penalty ; (4) any loose impediments may be removed from the putting-green ; (5) the player shall be entitled to find his ball as provided by Rule 31. The penalty for a breach of this Rule shall be the loss of the hole.

13. A player or caddie shall not press down nor remove any irregularities of surface near a ball in play. Dung, worm-casts, or mole-hills may be removed (but not pressed down) without penalty. The penalty for a breach of this Rule shall be the loss of the hole.

14. (a) If a ball lie, or be lost in water, or in casual water in a hazard, a ball may be dropped in or as far behind the hazard as the player may please, under penalty of one stroke ; but if it be impossible from want of space in which to play, or from any other cause, to drop the ball behind the hazard, the player may drop a ball at the side of the hazard as

near as possible to where the ball lay, but not nearer to the hole, under penalty of one stroke.

(b) If a ball lie, or be lost, in casual water through the green, or if casual water through the green interfere with the player's stance, the player may drop a ball without penalty within two club lengths from the margin, directly behind the place where the ball lay, or from the margin nearest to the place where the ball lay, but not nearer to the hole. If the ball, when dropped, roll into the water, or rest so that the water interferes with the player's stance, it may be re-dropped without penalty as near to the margin as the nature of the ground permits, but not nearer to the hole.

(c) In dropping a ball behind the spot from which the ball was lifted, the player shall keep that spot, or in the case of water, the spot at which the ball entered, in line between himself and the hole. Whenever it is impossible to drop a ball, as prescribed in sections (a) and (b), it shall be dropped as near as possible to the place where it lay, but not nearer to the hole. The penalty for a breach of this rule shall be the loss of the hole.

(d) In casual water on a putting-green a ball may be placed by hand behind the water without penalty.

15. A ball shall be dropped in the following manner : The player himself shall drop it ; he shall face the hole, stand erect, and drop the ball behind him from his head ; if the ball when dropped touches the player, he shall incur no penalty, and if it roll into a hazard it may be redropped without penalty. The penalty for the breach of this rule shall be the loss of the hole.

16. When the balls lie within 6 inches of each other on a putting-green, or within a club length of each other through the green or in a hazard (the distance to be measured from their nearest points), the ball nearer the hole may, at the option of either the player or the opponent, be lifted until the other is played, and shall then be replaced as near as possible to the place where it lay. If the ball further from the hole be moved in so doing, or in measuring the distance, it shall be replaced without penalty. If the lie of the lifted ball be altered by the player in playing, the ball may be placed in a lie as nearly as possible similar to that from which it was lifted, but not nearer the hole.

17. Any loose impediments may be removed from the putting-green, irrespective of the position of the player's ball. The opponent's ball may not be moved except as provided for by the immediately preceding Rule.

If the player's ball move after any loose impediment lying within 6 inches of it has been touched by the player, his partner, or either of their caddies, the penalty shall be one stroke.

18. When the ball is on the putting-green the player or his caddie may remove (but not press down) sand, earth, dung, worm casts, mole-hills, snow, or ice lying around the hole or in the line of his putt. This shall be done by brushing lightly with the hand only across the putt and not along it. Dung may be removed by a club, but the club must not be laid with more than its own weight upon the ground. The line of the putt must not be touched, except with the club immediately in front of the ball, in the act of addressing it, or as above authorised. The penalty for a breach of this Rule is the loss of the hole.

19. When the ball is on the putting-green, no mark shall be placed, nor line drawn as a guide. The line of the putt may be pointed out by the player's caddie, his partner, or his partner's caddie, but the person doing so must not touch the ground. The player's caddie, his partner, or his partner's caddie, may stand at the hole, but no player nor caddie shall endeavour, by moving or otherwise, to influence the action of the wind upon the ball. The penalty for a breach of this rule is the loss of the hole.

20. When on the putting-green, a player shall not play until the opponent's ball is at rest, under penalty of one stroke.

21. Either side is entitled to have the flag-stick removed when approaching the hole, but if a player's ball strike the flag-stick which has been so removed by himself, or his partner, or either of their caddies, his side shall lose the hole. If the ball rest against the flag-stick when in the hole, the player shall be entitled to remove the stick, and if the ball fall in it shall be deemed as having been holed out at the last stroke. If the player's ball knock in the opponent's ball, the latter shall be deemed as having been holed out at the last stroke. If the player's ball move the opponent's ball, the opponent, if he choose, may replace it, but this must be done before another stroke is played. If the player's ball stop on the spot formerly occupied by the opponent's ball and the opponent declare his intention to replace, the player shall first play another stroke, after which the opponent shall replace and play his ball. If the opponent's ball lie on the edge of the hole, the player, after holing out may knock it away, claiming the hole if holing at the like, and the half if holing at the odd, provided that the player's ball does not strike the opponent's ball and set it in motion. If, after the player's ball is in the

hole, the player neglect to knock away the opponent's ball, and it fall in also, the opponent shall be deemed to have holed out at his last stroke.

22. If a ball *in motion* be stopped or deflected by any agency outside the match, or by the forecaddie, the ball must be played from where it lies, and the occurrence submitted to as a "rub of the green." If a ball lodge in anything moving, a ball shall be dropped as near as possible to the place where the object was when the ball lodged in it, without penalty. If a ball *at rest* be displaced by any agency outside the match, excepting wind, the player shall drop a ball as near as possible to the place where it lay, without penalty. On the putting-green the ball shall be replaced by hand, without penalty.

23. If the player's ball strike, or be moved by, an opponent, or an opponent's caddie or clubs, the opponent shall lose the hole.

24. When a player has holed out and his opponent has been left with a putt for the half, nothing that the player can do shall deprive him of the half which he has already gained.

25. If the player's ball strike, or be stopped by himself or his partner, or either of their caddies or clubs, his side shall lose the hole.

26. If the player, when not intending to make a stroke, or his partner, or either of their caddies, move his or their ball, or by touching anything cause it to move when it is in play, the penalty shall be one stroke. If a ball in play move, after the player has grounded his club in the act of addressing it, or when in a hazard, if he has taken up his stand to play it, he shall be deemed to have caused it to move, and the movement shall be counted as his stroke.

27. Except from the tee a player shall not play while his ball is moving under penalty of the loss of the hole. If the ball only begin to move while the player is making his upward or downward swing he shall incur no penalty for playing while it is moving, but is not exempted from the penalty stroke which he may have incurred under Rules 9, 17, or 26, and in a foursome a stroke lost under Rule 26 shall not, in these circumstances, be counted as the stroke of the player, so as to render him liable for having played when his partner should have done so.

28. If the player when making a stroke strike the ball twice the penalty shall be one stroke, and he shall incur no further penalty by reason of his having played while his ball was moving.



29. If a player play the opponent's ball his side shall lose the hole, unless (1) the opponent then play the player's ball, whereby the penalty is cancelled, and the hole must be played out with the balls thus exchanged, or (2) the mistake occur through wrong information given by the opponent or his caddie, in which case there shall be no penalty, but the mistake, if discovered before the opponent has played, must be rectified by placing a ball as near as possible to the place where the opponent's ball lay.

If a player play a stroke with the ball of a party not engaged in the match, and the mistake be discovered and intimated to his opponent before his opponent has played his next stroke, there shall be no penalty, but if the mistake be not discovered and so intimated until after the opponent has played his next stroke, the player's side shall lose the hole.

30. If a ball be lost, except as otherwise provided for in the Rules, the player's side shall lose the hole ; but if both balls be lost, the whole shall be considered halved.

31. If a ball lie in bog, bent, whins, long grass, or the like, only so much thereof shall be touched as will enable the player to find his ball, but if the ball lie in sand, the sand shall not be touched. The penalty for a breach of this Rule shall be the loss of the hole.

32. If a ball be played out of bounds, a ball shall be dropped at the spot from which the stroke was played, under penalty of loss of the distance. A ball played out of bounds need not be found. If it be doubtful whether a ball has been played out of bounds another may be dropped and played, but if it be discovered that the first ball is not out of bounds, it shall continue in play without penalty. A player may stand out of bounds to play a ball lying within bounds.

33. A player shall not ask for advice from anyone except his own caddie, his partner, or his partner's caddie, nor shall he willingly be otherwise advised in any way whatever, under penalty of the loss of the hole.

34. If a ball split into separate pieces, another ball may be put down where the largest portion lies, or if two pieces are apparently of equal size it may be put where either piece lies, at the option of the player. If a ball crack or become unfit for play, the player may change it on intimating to his opponent his intention to do so. Mud adhering to a ball shall not be considered as making it unfit for play.

35. Where no penalty for the breach of a rule is stated, the penalty shall be the loss of a hole.

36. If a dispute arise on any point, the players have right of determining the party or parties to whom it shall be referred, but should they not agree, either side may refer it to the Rules of Golf Committee, whose decision shall be final. If the point in dispute be not covered by the Rules of Golf, the arbiters must decide it by equity. (See page 467, §i.)

37. An umpire or referee, when appointed, shall take cognisance of any breach of rule that he may observe, whether he be appealed to on the point or not.

### SPECIAL RULES FOR STROKE COMPETITIONS.

1. In Stroke Competitions the competitor who holes the stipulated course in fewest strokes shall be the winner.

2. If the lowest scores be made by two or more competitors, the tie or ties shall be decided by another round to be played on the same day. But if the Green Committee determine that to be inexpedient or impossible, they shall then appoint the following day or some subsequent day whereon the tie or ties shall be decided. (See page 467, §g.)

3. New holes shall be made for Stroke Competitions, and thereafter before starting no competitor shall play any of the putting-greens, nor shall he intentionally play at any of the holes nor on to any of the putting-greens, under penalty of disqualification.

4. The scores for each hole shall be kept by a special marker, or by the competitors noting each other's scores. The scores marked ought to be called out after each hole, and on completion of the round the cards shall be signed by the marker, under penalty of disqualification, and handed in. Competitors must satisfy themselves before the cards are handed in that their scores for each hole are correctly marked, as no alteration can be made on any card after it has been returned. If it be found that a score returned is below that actually played, the competitor shall be disqualified. For the addition of the scores marked the Secretary or his deputy shall be responsible.

5. If a competitor play from outside the limits of the teeing-ground, the penalty shall be disqualification.

6. If a ball be lost (except as otherwise provided for in the Rules of Golf), the competitor shall return as near as possible to the spot from

which the last ball was struck, tee a ball and lose a penalty stroke. The lost ball shall continue in play, if it be found before the player has struck another ball. The penalty for a breach of this rule shall be disqualification.

7. If a competitor's ball strike himself, his clubs or caddie, the penalty shall be one stroke.

8. If a competitor's ball strike another competitor, or his clubs or caddie, it is a "rub of the green," and the ball shall be played from where it lies. If a competitor's ball which is at rest be moved by another competitor or his caddie, or his club, or his ball, or by any outside agency excepting wind, it shall be replaced as near as possible to the place where it lay without penalty.

9. A competitor shall hole out with his own ball at every hole, under penalty of disqualification. But if it be discovered before he has struck off from the next teeing-ground, or, if the mistake occur at the last hole, before he has handed in his card, that he has not holed out with his own ball, he shall be at liberty to return and hole out with his own ball without penalty.

10. A ball may be lifted from any place under penalty of two strokes. A ball so lifted shall be teed if possible behind the place where it lay. If it be impossible to tee the ball behind the place where it lay, it shall be teed as near as possible thereto, but not nearer the hole. The penalty for a breach of this Rule shall be disqualification.

II. All balls shall be holed out under penalty of disqualification. When a competitor's ball is within 20 yards of the hole, the competitor shall not play until the flag has been removed, under penalty of one stroke. When both balls are on the putting-green, if the player's ball strike the opponent's ball, the player shall lose a stroke. The ball nearer the hole shall, on request of the player, be either lifted or holed out at the option of the owner under penalty of his disqualification. Through the green a competitor may have any other competitor's ball lifted if he find that it interferes with his stroke.

12. A competitor, unless specially authorised by the Green Committee, shall not play with a professional, and he may not willingly receive advice from anyone but his caddie, in any way whatever, under penalty of disqualification.

A forecaddie may be employed.

13. Competitors shall not discontinue play, nor delay to start, on account of bad weather, nor for any other reason whatever, except such as is satisfactory to the Committee of the Club in charge of the competition. The penalty for a breach of this Rule is disqualification.

14. Where in the "Rules of Golf" the penalty for the breach of any rule is the loss of the hole, in Stroke Competitions the penalty shall be the loss of two strokes, except where otherwise provided for in these Special Rules.

15. Any dispute regarding the play shall be determined by the Rules of Golf Committee.

16. The Rules of Golf, so far as they are not at variance with these Special Rules, shall apply to Stroke Competitions.

## MATERIAL DIFFERENCES

BETWEEN THE

RULES OF GOLF, 1902 AND 1909.

RULE IN QUESTION.	UNDER THE OLD RULE.	UNDER THE NEW RULE.
<i>How to Drop a Ball.</i>	From the head. 15 ( <i>General</i> ).	Over the shoulder. 8 ( <i>General</i> ).
<i>Ball in Sand.</i>	Sand covering a ball was not allowed to be touched. 31 ( <i>General</i> ).	Allowed to remove sufficient sand to enable player to see the top of the ball. 22 (2) ( <i>General</i> ).
<i>Ball out of Bounds.</i>	Another ball was "dropped" whether played from a teeing-ground or "through the green." 32 ( <i>General</i> ).	Another ball may be <i>teed</i> when played from a teeing-ground. 23 ( <i>General</i> ).
<i>Ball in Casual Water on Putting-Green.</i>	Permitted only to lift and place the ball immediately behind the water without penalty. 14 ( <i>d</i> ) ( <i>General</i> ).	The ball may be lifted without penalty if lying in casual water or if casual water intervene, and placed either within two club lengths directly behind the spot from which it was lifted, or in the nearest position to that spot which is not nearer to the hole and which affords a putt to the hole without casual water intervening. 27 (3) ( <i>General</i> ).

RULE IN QUESTION.	UNDER THE OLD RULE.	UNDER THE NEW RULE.
<i>Removal of Dung, &amp;c., from Putting-Green.</i>	Earth, sand, worm-casts, snow, &c., removed by brushing lightly with the hand across the line of putt. 18 ( <i>General</i> ).	Dung, worm-casts, snow, and ice only removed by scraping them aside with a club—brushing with the hand is not permitted. 28 (2) ( <i>General</i> ).
<i>Opponent's Ball to be at rest on Putting-Green.</i>	Playing before opponent's ball was at rest incurred a penalty of one stroke. 20 ( <i>General</i> ).	The penalty is the loss of the hole. 30 ( <i>General</i> ).
<i>Additions of Scores.</i>	The Secretary was responsible. 4 ( <i>Stroke</i> ).	The Committee in charge of the competition is responsible. 5 (2) ( <i>Stroke</i> ).
<i>Playing outside limits of Teeing-Ground in Stroke Competition.</i>	The player was disqualified. 5 ( <i>Stroke</i> ).	The stroke played must be counted and the second stroke played from within the limits. 7 ( <i>Stroke</i> ).
<i>Playing two consecutive strokes with wrong Ball in Stroke Competition. (Hazards excepted.)</i>	The player was entitled to return and hole out with his own ball provided he discovered his mistake before striking off from the next teeing-ground or, in the case of the last hole, before handing in his card. 9 ( <i>Stroke</i> ).	Disqualification, but if the player plays not more than <i>one</i> stroke with a ball other than his own he shall incur no penalty provided he then play his own ball. 8 (2) ( <i>Stroke</i> ).
<i>Play in Hazards.</i>	<i>See under "New Features."</i>	
<i>Play within 20 yards of Hole in Stroke Competition.</i>	Playing before the flag-stick had been removed incurred penalty of one stroke whether ball hit the flag-stick or not. 11 ( <i>Stroke</i> ).	No penalty, unless ball hit the flag-stick or the person standing at the hole. The penalty for doing so, however, is two strokes. 13 (1) ( <i>Stroke</i> ).
<i>Disputes—How decided.</i>	By the Rules of Golf Committee. 15 ( <i>Stroke</i> ).	By the Committee in charge of the competition, but an appeal may be made to the Rules of Golf Committee. 16 ( <i>Stroke</i> ).

## IMPORTANT NEW FEATURES.

<p><i>Committee to decide doubtful penalties.</i> New Rule 5 (3) (Stroke).</p>	<p>Under this new Rule, if on the completion of the stipulated round, a player is doubtful whether he has incurred a penalty at any hole, he may enclose his scoring card with a written statement of the circumstances to the Committee, who shall decide what penalty, if any, has been incurred.</p>
<p><i>Playing wrong Ball in Hazard.</i> New Rule 8 (3) (Stroke).</p>	<p>Under this new Rule, if a competitor play more than one stroke with a ball other than his own in a hazard, and the mistake be discovered before he has played a stroke with the wrong ball from outside the limits of the hazard, he shall incur no penalty, provided he then play his own ball.</p>
<p><i>Stroke Competitions—Order of Play.</i> New Rule 1 (2) (Stroke).</p>	<p>The old Rules did not govern this point, and it was not considered compulsory for competitors to play in couples, a three ball match being allowed when necessary. The new Rule, however, expressly states that competitors must play in couples, but in the event of a single player being left it is the duty of the Committee to either provide him with a player or select a marker for him and allow him to compete alone.</p>

## GOLFING TERMS.

- Bisques.*—Are strokes conceded by one side to another under Match play, but they differ from the strokes ordinarily given in that the receiver may use them as he pleases. In other words, he may take the strokes allowed to him singly or together at any hole or holes. The side receiving bisques does not require to declare that a stroke or strokes is being taken until the hole is played out.
- Bogey.*—The number of strokes that should be taken to each hole by a scratch player after making allowance for difficulties in the course. Thus, a very difficult four-stroke hole under par play might be a bogey five.
- Dormie.*—A side is said to be “dormie” when it is as many holes up as there are holes remaining to be played.
- Eclectic Competitions.*—A stroke competition in which the competitors each play two rounds of eighteen holes and count the best score which has been made at each hole in the two rounds. The total for eighteen holes thus obtained forming the eclectic score.
- Par play.*—Perfect golf without flukes. Thus, if a green can be reached in two strokes the hole is a par four ; two putts being allowed on each green.
- Stymie.*—A player is laid a stymie if on the putting-green the opponent’s ball lies in the line of his putt to the hole, provided the balls be not within six inches of each other.

# GYMNASTICS.

## PROGRAMME.

Maximum No.  
of Competitors  
from  
each Country

### A. Individual Competitions ... .. 20

Voluntary Exercises.

1. Horizontal Bar, swinging movements.
2. Horizontal Bar, slow movements.
3. Parallel Bars, slow and swinging movements.
4. Rings, steady.
5. Rings, flying.
6. Pommel Horse, placed sideways, quick movements.
7. Rope Climbing.

Every competitor must take part in every item.

### B. Team Competitions ... .. 1 team

Voluntary Mass Exercises. The exercises may be those known as free gymnastics or exercises with hand apparatus, or any combination of both or either.

Teams of not less than 16 nor more than 40.

Time limit 30 minutes.

### C. Displays (Non-competitive). Open to women.



## RULES AND CONDITIONS OF COMPETITION.

---

### DIVISION OF COMPETITIONS.

The Gymnastic Competitions shall be divided into two sections,  
viz :—

- (i) Competitions for Individuals,
- (ii) Competitions for Teams,

and are open to Amateurs.

### GYMNASTIC AMATEUR DEFINITION.

An Amateur is any person who has never competed for a money prize, or remuneration from any source whatever, who has never competed with professionals, and never engaged in, assisted in or taught any athletic exercise as a means of pecuniary gain.

The strict repayment of out-of-pocket expenses by a responsible Association or Club does not disqualify a competitor as an Amateur.

**Nomination of Judges.** —The International Gymnastic Board shall be invited to nominate, in consultation with other Gymnastic Organizations, Judges who shall be amateurs.

---

## SECTION I.

---

### COMPETITIONS FOR INDIVIDUALS.

**Number of Competitors.** —No country may send more than twenty competitors to represent it.

**Items of Competition.**— The Individual Competitions shall comprise :—

1. Exercises on the Horizontal Bar—Swinging movements.
2. Exercises on the Horizontal Bar—Slow movements.
3. Exercises on the Parallel Bars—Slow and swinging movements ; competitors must introduce a reasonable proportion of both.
4. Exercises on the Steady Rings.
5. Exercises on the Flying Rings.
6. Exercises on the Pommel Horse. (Quick movements.)
7. Rope Climbing.

This shall be an “All round” Competition of which the highest aggregate scorer over the seven Individual Items shall be the winner. Every competitor must take part in every Item.

### APPARATUS TO BE USED.

**Horizontal Bar.** —Movable horizontal bars of “steel” and of “steel covered with leather.”

**Parallel Bars.** —Movable parallel bars; the dimensions of which can be regulated at will.

**Rings.** —Circular rings with swivels for turning. Rings to be adjusted to 6 feet from the ground.

**Pommel Horse.** —Placed sideways.

**Climbing Rope.** —Rope  $4\frac{1}{2}$ -inches in circumference, marked off every 18 inches, commencing at a height of 6 feet from the ground. Top mark 24 feet from the ground (or metric equivalents).

Generally speaking the apparatus used shall be of the standard size and measurements used at the International Continental Gymnastic Contests.

**Shifting apparatus.** —The judges shall have power if they consider it fair to cause any apparatus to be shifted or altered so as to suit any competitor.

### INFORMATION AND INSTRUCTIONS FOR JUDGES AND COMPETITORS.

**Judges.**—An official list of the judges and the pieces of apparatus they are to judge will appear in the Official programme.

The number of judges shall be three for each apparatus.

As far as possible the same three judges shall act for the same piece of apparatus throughout the entire competition, but in the event of the unavoidable absence of any judge from any unforeseen cause, the Gymnastic Sub-Committee shall appoint one of the reserve judges to act.

**Conditions of Competition.** —In each of the first six items of competition each competitor shall execute one “voluntary” combination exercise, the time occupied by each exercise not to exceed 2 minutes. In the seventh item, viz. Rope Climbing, the Rope shall be climbed hand over hand, starting from the sitting position (*i.e.* from a position as if sitting, the arms at full stretch ready for the climb), with legs together, and clear of the rope, No kicking, or swinging the legs from the hips, allowed.

**System of Scoring.** —For the Rope Climbing  $\frac{1}{2}$  mark shall be allowed for every 18 inches climbed in accordance with the foregoing rule. There shall be no maximum time. For the other apparatus the maximum number of marks shall be 24 for each voluntary. Each judge shall have this number of marks at his disposal, and the number of marks to be allotted for any exercise shall be the aggregate of the marks allotted by the 3 judges.

Marks shall be awarded for :

- (a) Difficulty and quality of the combination of movements shown
- (b) Style and sequence
- (c) Variety of movements.

**Instructions to Competitors.** —On a competitor’s name being called out he shall assume the position of attention, opposite to and about 6 to 10 ft. away from the apparatus. He shall then smartly approach the apparatus, halt at a convenient distance from it, and commence his combination without further word of command.

At the conclusion of the exercise the competitor shall, in alighting, bend the knees outward, holding the head and trunk erect, and shall assume the position of attention by straightening the legs and lowering the heels (which should be brought together), pause, then walk smartly to his seat.

Judging shall commence when the competitor begins to approach the apparatus for the purpose of doing the exercise, and will cease on his resuming the position of attention at its conclusion.

**Style.** —Attention is called to the following points of style :—

- (a) Correct carriage in approaching the apparatus.
- (b) Decision of movement in commencing the exercise.
- (c) Even speed in the execution of the exercise.
- (d) Precision of grasp or in change of grasp.
- (e) Avoidance of any touch of the apparatus except that of the needful grasp or seat.
- (f) Straightness of extended limbs or feet, with legs closed, except when otherwise necessary.
- (g) Easy and graceful carriage of the head.
- (h) Precision in alighting from the apparatus.

**Order of Rotation of Competitors.** —The order of rotation of competitors shall be determined by ballot before the commencement of the competition, and the order so determined upon shall be adhered to throughout the competition.

**Second Attempts.** —No competitor shall have the option of a second attempt at any exercise unless the judges consider that he has been interfered with in his first attempt, or that his first attempt has otherwise been rendered abortive through no fault on his part.

**Resumption after a Fall.** —A competitor who has the misfortune to fall off the apparatus during the performance of his combination may resume his position on the apparatus and continue his combination from the point at which he fell off, the fall being considered a break in sequence, and marked as such.

If the competitor decides to resume his position on the apparatus and to complete his combination, he must do so immediately, and no extra time shall be allowed for the time off the apparatus.

**Squadding of Competitors.** —The competitors shall be divided into squads of not less than 10, nor more than 12, and shall be each under the charge of a Steward, who shall conduct his squad from apparatus to apparatus in the order directed by the Gymnastic Sub-Committee.

If the number of competitors exceed 84, then for each squad in excess of that 84 additional apparatus and judges shall be provided.

It being understood that additional apparatus means a complete set of additional apparatus, and that when two or more sets of apparatus are in use the Competitors shall be so squadded as to assign, so far as possible, an equal number of competitors to each apparatus.

**Hints to Competitors and Judges.** —The judges will pay particular attention to the following points :—

- (a) Successful performance of the exercise attempted. Competitors are warned against attempting exercises that are not well within their powers. A competitor who fails in some of the movements he attempts will score less than he would have done if he had omitted these movements altogether, and merely attempted the movements he actually accomplished.
- (b) The difficulty of the movements shown and the manner in which the combinations are composed. It is desirable that the exercise as a whole should be elegant. Great attention should therefore be paid to the sequence of the movements, and it should be remembered that the employment of easy or inelegant movements as connecting links is undesirable.
- (c) The variety of movements in a combination. Endurance shown in the repetition of the same or similar movements will not be regarded as meritorious. Competitors should also avoid the performance of any inordinate number of movements easy in themselves. Variety of this kind is not desirable, and will not gain marks.

---

## SECTION II.

---

### COMPETITIONS FOR TEAMS.

#### MASS EXERCISES, OR MOVEMENTS IN UNISON.

**Nature of the Competition.**—The exercises may be those known as “Free Gymnastics” or exercises with Hand Apparatus such as Dumb Bells, Indian Clubs, Wands (Iron or Wood), etc.

Any exercises or combination of exercises, whether those known as “Free Gymnastics” or those with any kind of hand apparatus, are admissible, but exercises which require fixed apparatus are not admissible.

Each competing Team must supply its own hand apparatus for this Competition.

**Number of Teams, and Strength of Teams.** —No country shall be represented by more than one team.

Each team shall consist of not less than 16 nor more than 40 men.

**Conditions.** —The exercises in this competition are left to the choice of the competing teams.

The members of a team must all wear the same costume, provided with the distinctive badge of the team.

The time allowed for each team to take up position, execute its exercises, and march off shall be thirty minutes.

The Instructor shall bring his team into the arena and give them the necessary instructions preliminary to the commencement of the exercises. At the conclusion of the exercises he shall re-form his team and march it off the arena.

The Instructor here mentioned may be either an amateur or professional.

So far as possible the judges shall form their judgment from a consideration of the following subjects :

- (1) The physique, carriage and movements of the team in general, —the quality of the latter to be judged especially in marching and running.
- (2) The manner of performing the exercises in regard to the strength and beauty of their execution, and the homogeneity of the team-work. All the members of the team must perform every exercise.
- (3) The physiological value of the programme of exercises in regard to the character, combination, arrangement and relative quantities of the exercises : and the completeness and suitability of such a programme as a normal gymnastic practice.

The maximum number of marks to be allotted by any one judge to any team shall be 160, allocated as follows :—

Appearance and march of the competitors	... 40
Precision of movement, style, &c. ...	... 60
Physiological and rational combination of the exercises executed ...	... 60
	160

Each team will be judged by three judges and their marks shall be added together. The team securing the highest aggregate in this manner shall be adjudged the winners.

The judges, who shall be the same throughout the games, will remain on duty throughout the whole competition and can only retire in case of illness or other urgent cause, in which case a substitute will be appointed by authority of the Gymnastic Sub-Committee from the list of judges in reserve.

### DISPLAYS (Non-competitive).

By selected teams, either men or women.

Time limit, 45 minutes.

# HOCKEY.

---

---

## GENERAL REGULATIONS.

---

1. Each country competing shall be allowed to enter four teams, the definition of a "country" being that laid down by the British Olympic Council, viz. : "A country is any territory having separate representation on the International Olympic Committee, or, where no such representation exists, any territory under one and the same sovereign jurisdiction."

2. The Competition shall be confined to amateurs.

3. The special code of Laws of Hockey printed below shall be those governing this Competition.

4. The Competition shall be held under the control and management of the Hockey Association, whose decisions on all matters relating thereto, except such as may be hereinafter specified, shall be final and without appeal. They shall appoint the Umpires in all matches.

5. All entries shall be made by the Governing Associations (or where Governing Associations do not exist by Amateur Clubs), through the Olympic Committee in each country, who will be responsible to the British Olympic Council for the competence of such Associations or Clubs to guarantee that the competitors so entered are amateurs.

6. Entries shall be in writing on the authorised forms, and must reach the British Olympic Council, 108 Victoria Street, Westminster, London, S. W., on or before September 15, 1908.

7. The number of names which may be comprised in each entry, from which the team and reserves shall be finally selected, shall not exceed thirty-six, and the final nominations of each team and its reserves must be received by the British Olympic Council in London not later than October 4, 1908.



## RULES OF THE COMPETITION.

---

1. The competition shall be conducted on the knock-out principle, and a draw shall take place between the various teams that enter.

2. In any match should the two sides, within the time specified for the duration of the match, have failed to score or have scored an equal number of goals, they shall forthwith play for such extra time as the umpires may direct, changing ends after play has been continued for half the extra time. No interval may be claimed between such change of ends. In the event of the scores being then even, the umpires may consult with the captains, and shall at their own discretion either order the play to be forthwith continued for a further extra period, or direct that the match shall be replayed on such a date and time as shall be decided by the Hockey Association Council.

3. All matches shall be commenced precisely at the times to be published, unless altered by the Managing Committee; but in the event of the ground or weather being considered unfit for play by the umpires, either before the commencement of or during a match, they shall be empowered to stop the play, and in such event the Managing Committee shall decide whether the match shall be re-played or only continued for the unexpired portion on such a date and time as they shall decide.

# PLAN OF GROUND

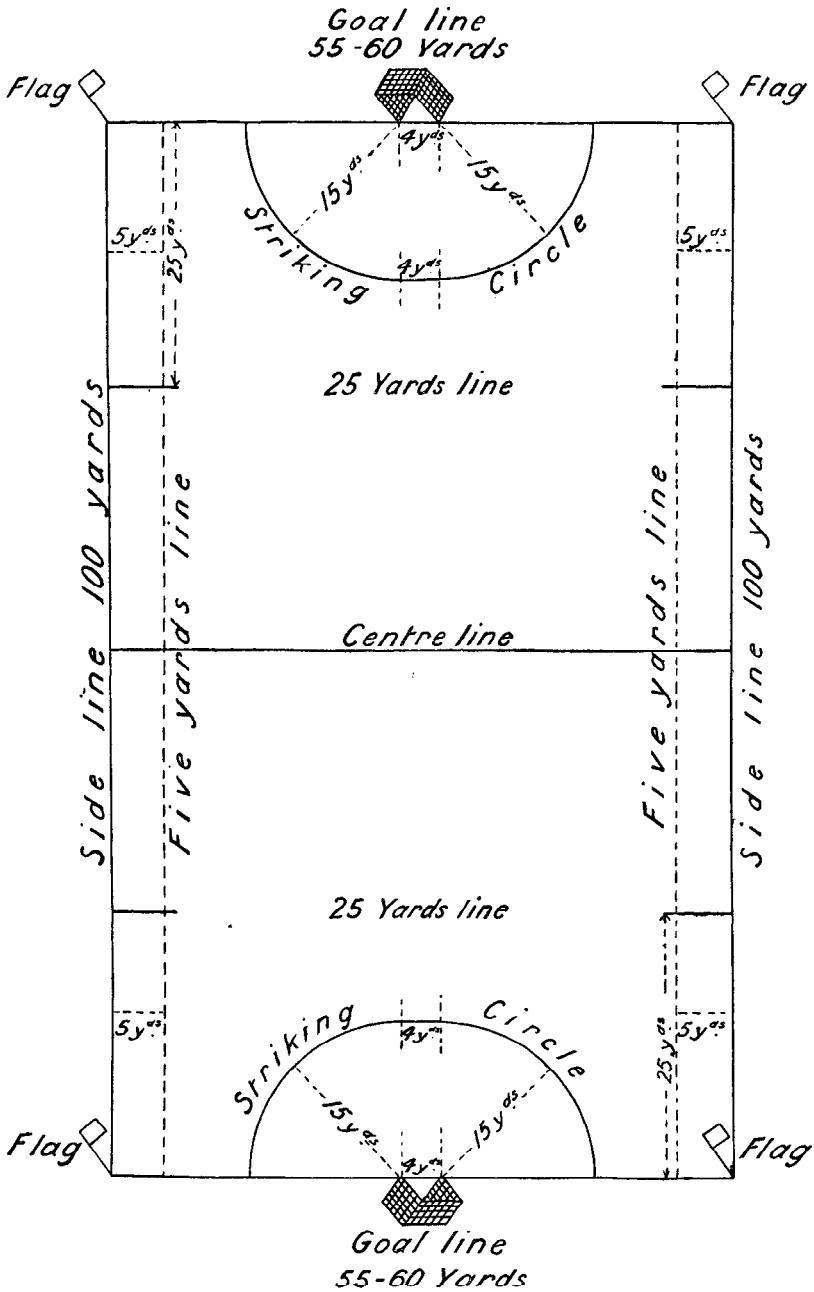

N.B.—The 25 yds. line must not be fully drawn, but only its extremities (7 yds. only to be marked at each end) as shown in above plan.

## RULES OF THE GAME OF HOCKEY.

---

### RULES.

---

1. **Teams.**—A game of hockey shall be played by two teams of eleven players. The correct constitution of a team is five forwards, three half-backs, two backs, and a goalkeeper, but this formation shall not be compulsory. The duration of the game shall be 70 minutes (unless otherwise agreed by the respective captains), half-time being called after 35 minutes' play, when the teams shall change ends.

2. **Captains.**—The Captains shall (1) toss for choice of ends ; (2) act as umpires, if there be no umpires, or delegate the duties of umpires to one member of their respective teams ; and (3) indicate the goalkeepers for their respective teams before starting play, and after any change of goalkeeper.

3. **Ground.**—The ground shall be rectangular, 100 yds. long, and not more than 60 yds. or less than 55 yds. wide. The ground shall be marked with white lines in accordance with plan on page 492 ; the longer boundary lines to be called the side lines, and the shorter boundary lines to be called the goal lines. A flag-post shall be placed for the whole game at each corner, and at the centre of each side line, one yard outside the line, and any other flag-post must be a yard outside the ground. All flag-posts shall be at least 4 ft. high.

4. **Goals, Posts, &c.**—A goal shall be in the centre of each goal line, and shall consist of two posts 4 yds. apart (inside measurement), joined together by a horizontal cross-bar 7 ft. from the ground. The goal posts shall not extend upward beyond the cross-bar, nor the cross-bar sideways beyond the goal-posts. The posts shall be 2 in. square and the cross-bars shall have rectangular edges. Nets shall be attached to the posts, cross-bars, and to the ground behind the goals.

5. **Striking Circle.** —In front of each goal shall be drawn a white line 4 yds. long, parallel to, and 15 yds. from, the goal line. This line shall be continued each way to meet the goal line by quarter-circles having the goal posts as centres. The space enclosed by these lines and the goal lines, including the lines themselves, shall be called the striking circle.

6. **Ball.** —The ball should be a leather cricket ball painted white or made of white leather.

PENALTY.—Umpires shall forbid the use of any other ball.

7. **Sticks.** —A stick shall have a flat face on its left-hand side only, and shall have no metal or other fittings or weights or sharp edges or dangerous splinters. Each stick must be of such size that it can be passed through a 2 in. ring. An indiarubber ring, 4 in. in external diameter when on the stick, may be used, but, all fittings included, the total weight must not exceed 28 ozs.

PENALTY.—Umpires shall prohibit play with a stick which does not comply with this rule.

8. **Boots, &c.** —No player shall wear any dangerous material, such as spikes or nails, &c.

9. **Bully-off.** —The game shall be started by one player of each team together bullying the ball in the centre of the ground (and after each goal and half-time). To bully the ball each player shall strike the ground on his own side of the ball and his opponent's stick over the ball three times alternately ; after which one of these two players must strike the ball before it is in general play. In all cases of bullying the two players who are bullying shall stand squarely facing the side lines. Every other player shall be nearer to his own goal line than the ball is (except in the case of a penalty bully).

PENALTY.—For any breach of this rule the "bully" shall be taken again.

10. **Goal.**—A goal is scored when the whole ball has passed entirely over the goal line under the bar, the ball, whilst within the striking circle, having been hit by or glanced off the stick of an attacker. Should the goal posts or bar become displaced, and the ball pass at a point which, in the opinion of the umpire, is between where the posts or below where the bar should have been, he shall give a goal.

11. **Off-side.** —When a player hits or rolls in the ball, any other player of the same team who is nearer his opponent's goal line than the

striker or roller in at the moment *when the ball is hit or rolled in* is off-side, unless there be at least three of his opponents nearer to their own goal line than he is. He may not be within 5 yds. of the ball, nor in any way interfere with any other player until the ball has been touched or hit by one of his opponents. No player, however, shall be off-side in his own half of the ground, nor if the ball was last touched or hit by one of his opponents (subject to the 5 yds. rule), or by one of his own team who, at the time of hitting, is nearer his opponent's goal line than himself.

*PENALTY.—Inside or outside the circles.*

For any breach the penalty shall be a free hit by one of the opposing team on the spot where the breach occurred.

12. **General Details.** —The ball may be caught (but must be immediately released to fall perpendicularly to the ground) or stopped, but may not be picked up, carried, kicked, thrown, or knocked on or back, except with the stick. No player shall gain an advantage by the use of any part of his person or apparel except such as may accrue from stopping the ball; the foot, if used for that purpose, shall be taken away immediately. There shall be no play with the rounded back of the stick, no charging, kicking, shoving, shinning, tripping, personal handling, or hooking. Hooking sticks is allowed only when the stick hooked is within striking distance of the ball. There shall be no striking at sticks. A player may not obstruct by running in between his opponent and the ball, nor cross his opponent's left, unless he touches the ball before his opponent's person or stick, nor may he in any way interpose himself as an obstruction.

The goalkeeper is allowed to kick the ball only in his own striking circle, but in the event of his taking part in a penalty bully this privilege shall not be allowed him. A ball touching an umpire or post is in play, unless it goes off the ground. No player shall in any way interfere with the game unless his stick is in his hand.

*PENALTY.—(1) Outside the circles.*

For any breach the penalty shall be a free hit for one of the opposing team on the spot where the breach occurred.

(2) *Inside the circles.*

(a) For any breach by the attacking team the penalty shall be a free hit for the defending team.

(b) For any breach by the defending team the penalty shall be a “penalty corner” or a “penalty bully” on the spot where the breach occurred. A penalty bully should only be given for a wilful breach of a rule or when a goal would most probably have been scored but for the occurrence of the breach of the rule.

(3) *Inside or outside the circles.*

In the event of two players being simultaneously at fault in obstructing each other, the umpire shall give a bully at the spot where the breach of rule occurred.

13. “Sticks.”—When a player strikes at the ball, no part of his stick must in any event rise above his shoulders at either the beginning or end of the stroke.

PENALTY.—1. *Outside the circles.*

For any breach the penalty shall be a free hit for one of the opposing team on the spot where the breach occurred.

(2) *Inside the circles.*

(a) For any breach by the attacking team the penalty shall be a free hit for the defending team.

(b) For any breach by the defending team the penalty shall be a “penalty corner” or a “penalty bully” (except in the case of “sticks” when a “penalty corner” only shall be allowed). A “penalty bully” should only be given for a wilful breach of a rule, or when a goal would most probably have been scored but for the occurrence of the breach of the rule.

14. **Undercutting.**— No player shall intentionally undercut the ball.

*Note.*—This rule is not intended to penalise the “scoop” stroke which raises the ball, nor the hitting of the ball when in the air except as provided for in Rule 15.

PENALTY.—(1) *Outside the circles.*

For any breach the penalty shall be a free hit for one of the opposing team on the spot where the breach occurred.

(2) *Inside the circles.*

(a) For any breach by the attacking team the penalty shall be a free hit for the defending team.

- (b) For any breach by the defending team the penalty shall be a "penalty corner" or a "penalty bully" (except in the case of "sticks" when a "penalty corner" only shall be allowed). A "penalty bully" should only be given for a wilful breach of a rule, or when a goal would most probably have been scored but for the occurrence of the breach of the rule.

15. **Free Hit.**— On the occasion of a free hit, no other player than the striker shall be within 5 yds. of the spot where such hit is made, and the striker must not touch the ball again until it has been touched or hit by another player. He must fairly hit the ball, "scooping up" not being allowed. If the striker hit at but miss the ball, the stroke shall be taken again by him, provided that he has not given "sticks."

PENALTY. —If any player, other than a striker, be within 5 yds. of the ball at the time of a free hit, the umpire shall order the hit to be taken again.

If the striker, after taking such hit, touches the ball again before it has been touched or hit by another player

- (1) *Inside the circles*

The umpire shall give a "penalty corner"

- (2) *Outside the circles*

The umpire shall give a free hit to one of the opposite team to the offender.

If the ball is "scooped up"

- (1) *Outside the circles*

The umpire shall give a free hit to one of the opposite side to the offender

- (2) *Inside the circles*

The umpire shall give a "penalty corner."

16. **Penalty Bully.** —A penalty bully shall be played by the offender, and by any player selected by the other team on the spot where the breach occurred. All other players shall be outside the striking circle in the field of play, and shall not enter the striking circle or take any further part in the game until the ball is driven outside the striking circle.

PENALTY.—(a) Breach of any rule by defending team (except Rule 9).

The attacking team shall be awarded a penalty goal, which shall be of the same value as an ordinary goal.

(b) Breach of any rule by attacking team (except Rule 9).

The defending team shall be allowed a free hit.

17. **Roll-in.**— When a ball passes wholly over the side line, it shall be rolled in along the ground (and not bounced) into play by hand from the point where it crossed the side line in any direction by one of the team opposite to that of the player who last touched it. Players may cross the 5 yds. line immediately the ball leaves the hand of the roller-in. The ball may be rolled in at once, but no player shall stand (himself or his stick) within the 5 yds. line; but should the umpire consider that a player is standing within the 5 yds. line to gain time, he shall not stop the game. The roller-in must have both feet and stick behind the side line, and may only play the ball again after another player.

PENALTY.—(a) Breach of the rule by the player who rolls in.

The roll-in shall be taken by a player of the other team.

(b) Breach of the rule by any other player.

The roll-in shall be taken again except as specially provided for in this rule.

18. **Behind.**— (a) If the ball is hit behind the goal line by a player of the attacking team, or glance off the stick or person of, or be unintentionally, in the umpire's opinion, hit behind the goal line by one of the defending team who is farther away from his own goal line than the 25 yds. line, it shall be brought out 25 yds. in a direction at right angles to the goal line from the point where it crossed the line and there "bullied."

(b) If the ball glances off, or is, in the umpire's opinion, unintentionally sent behind the goal line by any player of the defending team behind the 25 yds. line, he (the umpire) shall give a corner to the attacking team.

(c) If, however, the ball is intentionally, in the umpire's opinion, sent behind the goal line by any player of the defending team, the umpire shall give a penalty corner to the attacking team.



Provided that no player shall stand within 5 yds. of the striker when a corner hit is taken, and that no goal can be scored from a corner hit by the attacking team unless the ball has been stopped motionless on the ground by one of the attacking team, or has touched the person or stick of one of the defending team before the last stroke of the attacking team. A player hitting a corner hit cannot participate in the game again until the ball has been played by another player. On hitting a corner hit, if the hitter misses the ball he shall take the hit again, provided he does not contravene Rule 13.

19. **Corner.**—A player of the attacking team shall have a hit from a point on the side or goal line within 3 yds. of the nearest corner flag, and at the moment of such hit all the defending team (their sticks and feet) must be behind their own goal line, and all the attacking team must be outside the circle in the field of play.

Provided that no player shall stand within 5 yds. of a striker when a corner hit is taken, and that no goal can be scored from a corner hit by the attacking team unless the ball has been stopped motionless on the ground by one of the attacking team, or has touched the person or stick of one of the defending team before the last stroke of the attacking team. A player hitting a corner hit cannot participate in the game again until the ball has been played by another player. On hitting a corner hit, if the hitter miss the ball he shall take the hit again, provided he does not contravene Rule 13.

**PENALTY.** —If the striker after taking such hit touches the ball again before it has been touched or hit by another player, the umpire shall give a free hit to one of the opposite team to the offender.

20. **Penalty Corner.**—A player of the attacking team shall have a hit from any point on the goal line he may choose, and at the moment of such hit all the defending team (their sticks and feet) must be behind their own goal line, also all the attacking team must be outside the striking circle in the field of play.

Provided that no player shall stand within 5 yds. of the striker when a penalty corner hit is taken, and that no penalty corner hit shall be taken at a less distance than 5 yds. from the nearest goal post, and that no goal can be scored from a corner hit by the attacking team unless the ball has been stopped motionless on the ground by one of the attacking team, or has touched the person or stick of one of the defending team before the last stroke of the attacking team. A player hitting a penalty corner hit cannot participate in the game again until the ball has been

played by another player. On hitting a penalty corner hit, if the hitter miss the ball he shall take the hit again provided he does not contravene Rule 13.

**PENALTY.** —If the striker after taking such hit touches the ball again before it has been touched or hit by another player, the umpire shall give a free hit to one of the opposite team to the offender.

21. **Umpires.** —Each umpire shall take half the ground for the whole game without changing ends. He shall also take one side line and give decisions *re* the roll-in (but not the corner hit) in both halves of the ground. If an umpire is doubtful he shall decide in favour of the team appealed against. The umpire shall allow (the elements permitting) the full or agreed time, neither more nor less, deducting all wastage, and keep a record of the game. Until a decision is given the ball is in play. If there be only one umpire, there should be two linesmen to give decisions as to the ball passing over the side lines, and as to where and by which team the ball shall be rolled in.

Umpires and linesmen are debarred from coaching or claiming during a game.

The umpire shall refrain from putting the provisions of any rule into effect in cases where he is satisfied that by enforcing it he would be giving an advantage to the offending team. The umpires shall give all decisions without waiting for an appeal.

22. **Rough Play and Misconduct.** —For rough play or misconduct the umpire shall have a discretionary power to warn the offending player, or to suspend him from further participation in the game.

23. **Accidents.** —When a player is temporarily incapacitated, the umpire shall suspend the game. When it is resumed the ball shall be bullied off on a spot to be chosen by the umpire in whose half of the ground the player was hurt.

---

#### NOTE.

#### OFFICIAL RINGS FOR THE MEASUREMENT OF STICKS.

Official Rings can be obtained only from the Hon. Sec. of the Hockey Association,

P. COLLINS,

6 Bedford Row, London, W.C.

Telephones: Holborn 60.

Bromley 1058.

# LACROSSE.

---

## GENERAL REGULATIONS,

1. Each country competing shall be allowed to enter one team, the definition of a "country" being that laid down by the British Olympic Association, viz.: "A country is any territory having separate representation on the International Olympic Committee, or, where no such representation exists, any territory under one and the same sovereign jurisdiction."

2. The Competition shall be confined to amateurs.

3. The special code of Laws of Lacrosse printed below shall be those governing this Competition.

4. The Competition shall be held under the control and management of the English Lacrosse Union, whose decisions on all matters relating thereto, except such as may be hereafter specified, shall be final and without appeal. They shall appoint the Referees and Timekeepers in all matches.

5. All entries shall be made by the governing Associations [or where Governing Associations do not exist by Amateur Clubs], through the Olympic Committee in each country, who will be responsible to the British Olympic Council for the competence of such Associations or Clubs to guarantee that the competitors so entered are amateurs in accordance with the following definition :—

"An Amateur is one who has never competed for a money prize or monetary consideration, or for any declared wager, or staked bet; who has never engaged in, assisted in, or taught any athletic exercise as a means of pecuniary gain."

6. Entries shall be in writing on the authorised forms, and must reach the British Olympic Council, 108 Victoria Street, Westminster, London, S.W., on or before September 1, 1908.

7. The number of names which may be comprised in each entry, from which the team and reserves shall be finally selected, shall not exceed thirty-six, and the final nominations of each team and its reserves must be received by the British Olympic Council in London not later than October 4, 1908.

8. Every player shall wear a sleeved jersey or shirt and loose drawers to the knee, and any player shall be excluded unless properly attired.

## RULES OF THE COMPETITION.

---

---

1. Each team shall play one match with each other team, and the team which wins the most matches shall be the winner of the Competition.
2. In the event of two or more teams winning an equal number of matches, they shall play again on the ordinary tournament (knock out) system, and the winner of this shall be the winner of the Competition.
3. In any match, should the two sides, within the specified time for the duration of the match, have failed to score or have scored an equal number of goals, they shall forthwith play for such extra time as the Referee may direct, changing ends after play has been continued for half the extra time. No interval may be claimed between such change of ends. In the event of the scores being then even, the Referee may consult with the Captains, and shall at his own discretion either order the play to be forthwith continued for a further extra period, or direct that the match shall be replayed on such a date and time as shall be decided by the managing committee.
4. Each team may have six reserve players, any of whom may, prior to the commencement of a match, be substituted for members of the team in that match, except in the case of a replayed match under Rules 3 and 5, when there shall be no change in the constitution of the team replaying.
5. All matches shall be commenced precisely at the times to be published, unless altered by the managing committee, but in the event of the ground or weather being considered unfit for play by the Referee, either before the commencement of or during a match, he shall be empowered to stop the play, and in such event the managing committee shall decide whether the match shall be replayed or only continued for the unexpired portion on such a date and time as they shall decide.

## LAWS OF LACROSSE.

---

### SPECIAL CODE FOR OLYMPIC GAMES.

---

#### I.—*The Crosse.*

The crosse may be of any length. In its widest part it shall not exceed one foot. A string must be brought through a hole at the side of the tip of the turn to prevent the point of the stick catching an opponent's crosse. A leading string resting on the top of the stick may be used. No string may be fastened so as to form a pocket. The length strings shall be woven to within two inches of their termination, so that the ball cannot catch in the meshes. No metal of any kind shall be allowed upon the crosse; splices must be made either with string or gut.

#### II.—*The Ball.*

The ball shall be of indiarubber sponge, not less than seven and three quarters, nor more than eight inches in circumference. It shall weigh not less than four and a half, nor more than five ounces.

#### III.—*The Goals.*

Sec. 1. Each goal shall consist of two square poles six feet apart and six feet high out of the ground, joined above by a rigid top cross bar. Netting of not more than one and one half inch mesh shall be attached to the posts and cross bar, and to a point on the ground six feet behind the centre of the goal, and shall be firmly pegged to the ground. The goals shall be placed not less than 120, nor more than 125 yards apart. The posts may be supported by back stays within the netting.

Sec. 2. The Goal crease shall be a marked line enclosing an oblong space 18 feet by 12 feet, laid out 6 feet in front, behind, and to either side of the goal posts.

IV.— *The Boundaries.*

The Boundaries of the field of play shall be indicated by flags or marked lines. Should the ball go out of bounds, the Referee shall (unless the Captains shall have previous to the match agreed with him otherwise) call "Stand," and the ball shall then be "faced" by the two nearest players, not less than four yards within the bounds at the point where the ball went out.

*Stand.*—The ball is dead when the Referee calls "Stand," and no player shall move, unless otherwise directed by the Referee, until the Referee calls "Play."

N.B.—The blowing of a whistle may be substituted for the above calls, or such calls as may be hereinafter mentioned.

*Face.*—The ball shall be placed upon the ground between the backs of crosses of two opponents, and the defending player's crosse shall be between the ball and the goal he is defending. They shall not move till "Play" has been called by the Referee, but must then immediately draw their crosses apart (towards them), before removing them from the ground. The Referee shall not allow players to be within five yards of those "facing," and no face shall take place within ten yards of the centre of goal, when it is caused by the action of an attacking party.

N.B.—The object of "facing" is to start the play so that neither side has an advantage over the other.

V.—*The Teams.*

*Sec. 1.* Number.—Twelve players shall constitute a full team.

*Sec. 2.* Should an accident or injury occur to any player which, in the opinion of the Referee, incapacitates him from playing, the opposing side must withdraw one of their players as long as the player remains so incapacitated. If the "accident" or "injury" is due to a foul, and the Referee suspend the offending player, a player other than the suspended one shall be withdrawn.

VI.—*The Captains.*

*Sec. 1.* A Captain shall be appointed from each team previous to the commencement of a match.

*Sec. 2.* They alone shall be the representatives of their respective teams in all disputes.

*Sec. 3.* They shall "toss" for choice of goals previous to the commencement of the match.

*Sec. 4.* Nothing in this Law shall prevent any player notifying the Referee of any infringement of these Laws.

VII.—*The Referee.*

*Sec. 1.* The authority of the Referee shall commence from the time of the appointment and shall continue until the end of the match, and his duties shall be to enforce these Laws and Regulations. His decisions shall be final and without appeal.

*Sec. 2.* Before the match, he shall see that the Umpires and Time-keepers have been properly appointed, and that the goals, balls, &c., are in accordance with the Laws.

*Sec. 3.* He shall draw up the players in lines immediately before the match begins, and see that the regulations respecting the crosses and spiked shoes, &c., are adhered to.

*Sec. 4.* If he observe any infringement of the rules, or when a "foul" claimed by any player has been allowed, or in any case of injury or accident (Law V., Sec. 2), the Referee is empowered to immediately call "Stand." If the ball enter goal after "Stand" has been called by the Referee it shall not count; or if a foul be claimed by one side and their opponents score a goal immediately afterwards, the Referee shall first give a decision on the foul, which, if allowed, shall nullify the goal. If the foul, however, be claimed by the scoring party, whether the claim be allowed or not, a goal scored before the Referee has called "Stand" shall count.

*Sec. 5.* The infliction of penalties shall be at his discretion without appeal, and any side rejecting his decision or refusing to continue the match shall be declared the losers.

*Sec. 6.* He shall arbitrate in all disputes between the Captains.

VIII.—*The Umpires.*

*Sec. 1.* There must be only one Umpire at each goal. They shall stand behind the posts and shall not change ends during a match. No person shall be allowed to speak to them, or in any way to distract their attention.

*Sec. 2.* In the event of a goal being claimed the Umpire at the goal shall at once decide whether or not the ball has fairly passed through the goal space, his decision being simply "Game" or "No game" without comment of any kind. His decision shall be final.

*Sec. 3.* If the Umpire observe any infringement of Law XI., Sec. 13, he shall notify the Referee in such manner as the latter shall direct. The decision of each Umpire at his own goal shall be final in this matter,

IX.— *The Timekeepers.*

*Sec. 1.* There shall be two Timekeepers, whose duty shall be to keep an accurate account of the time of each period, deducting the times of all stoppages in the actual play. They shall immediately report to the Referee any variance in their times, and the matter shall be at once decided by him. He shall be guided by them as to the duration of the match.

*Sec. 2.* There shall be another Timekeeper, who shall keep the time of penalised players, and shall direct them when to enter the game.

X.— *The Game.*

*Sec. 1.* The playing time shall be four periods of twenty minutes each. The time of actual play only shall be counted.

*Sec. 2.* Ends shall be changed after each period, and between the second and third periods either side may claim not more than ten minutes' interval.

*Sec. 3.* Each game shall be started by the centres facing at the centre mark, and when both sides are ready the Referee shall call "Play."

*Sec. 4.* The side scoring the greater number of goals shall be the winners. A goal shall be scored by the ball passing between the goal posts and under the cross bar from in front, and not being propelled by the foot or leg of an attacking player.

*Sec. 5.* Should the ball be put through either goal space by one of the players defending it, by whatsoever means, it shall be counted a goal to the opposite side. Should it be put through by anyone not actually a player it shall not count.

*Sec. 6.* In the event of a goal post being knocked down during a match, and the ball put through what would be the goal if the posts were standing, it shall count a goal for the attacking side.

*Sec. 7.* When goal has been claimed and allowed, the ball shall be again faced at the centre mark.

*Sec. 8.* The goal-keeper, while defending goal within the goal crease, although not allowed to catch or throw with his hand, may put the ball away with his hand, or block it in any manner with his crosse or body.



Sec. 9. Any player is at liberty to propel the ball with his foot or leg.

Sec. 10. A match is ended by the Referee calling "Time."

Sec. 11. When the ball lodges in a place inaccessible to the crease, or about the clothing of a player, or becomes ensnared in the goal netting, the Referee shall call "Stand," and the player must at once remove it with the hand and "face" with his nearest opponent.

Sec. 12. Should the ball catch in the netting the crosse must be struck on the ground and the ball dislodged immediately, otherwise the Referee shall call "Stand," and the ball shall be "faced" where the player caught it.

Sec. 13. Players may exchange their crosses during a match.

## XI —Fouls.

A player shall not—

1. Deliberately charge or shoulder an opponent. This does not prevent the use of the "body check," nor pushing the opponent with the shoulder in ground scuffles.

*Charging or Shouldering* implies motion and unnecessary force, and is forbidden.

N.B.—The object of the game should be to play the ball and not the man.

*Body Check* is the placing of the body in the way of an approaching opponent so that the latter is simply impeded.

2. Hold or trip an opponent, or push with the hand or crosse.

*Holding* shall mean clutching with the hand or arm, or detaining an opponent between the two arms and the crosse, or placing the crosse against him so as to impede his movements.

*Tripping* is the use of the legs, feet, or crosse to throw an opponent.

3. Wrestle with the legs entwined so as to throw an opponent.

4. Use the "square" or "crosse" check, which consists of one player "charging into" another with both hands on the crosse, so as to make the stick meet the body of his opponent.

5. Deliberately or recklessly strike another, or threaten to do so under any circumstance.

*Striking* means the giving a blow with the crosse or otherwise.

6. Grasp an opponent's crosse with the hands, hold it with his arms or between his legs or under his feet, or kick it.

7. Interfere in any way with another player who is in pursuit of an opponent.

8. Deliberately kneel, lie down, or drop in front of an opponent when both are in pursuit of the ball, or wilfully fall and cover the ball with his body.

9. Wilfully touch the ball with his hands, save as in Law X., Secs. 8 and 11.

10. Throw his crosse under any circumstances.

11. Move from his position when "Stand" has been called.

12. If he drop his crosse, touch the ball, or impede an opponent in any way until he recovers it.

13. When attacking, go within the goal crease, nor shall he check the goal-keeper while the latter is within the bounds of the goal crease. Any goal made while an attacking player is within the goal crease, or is interfering with the goal-keeper while the latter is within the crease, shall be deemed to be a foul, and shall not be counted.

14. Wear spiked shoes (indiarubber spikes excepted), nor shall the soles be of a material other than indiarubber.

15. Check an opponent's crosse, or attempt to knock the same out of his hands in any way, unless both players are contending for the ball.

16. Persistently throw the ball out of bounds, or in any way try to delay the play of the game.

---

17. The goal-keeper, while within the crease, shall not hold the ball on his crosse longer than is necessary to step out of the crease.

18. Claiming a foul on trivial grounds when, in the opinion of the Referee, no foul was intended, cannot be tolerated. The Referee shall first caution the player so offending, and, if persisted in, the offence shall be deemed to be a foul.

XII.—*Penalties.*

The penalty for a foul shall be at the discretion of the Referee, either—

1. A “free position”; or

*Free Position.*—The players shall “stand,” except the goal-keeper, who may resume his place, and the player to whom the Referee awards the “free position”; and no player may be nearer than five yards to the last-mentioned. If anyone be within the prescribed distance, he must retire to the satisfaction of the Referee. The player awarded the “free position” shall then take the ball on his crosse in front of him, and at the word “Play” from the Referee the game shall proceed. The “free position” shall never be within ten yards of goal, and the Referee may under extreme circumstances, order any player or players, including the goal-keepers from between such “free position” and goal. The ten yards shall be measured in a straight line from the centre of the goal through the place where the foul occurred.

2. Suspension of the player for the remainder of the match, or for such lesser period as the Referee shall forthwith decide; or

3. A “face” at any point he may direct not nearer than two yards from the goal crease, in the event of a breach of Law XI., Sec. 17.

## I. LAWN TENNIS.

---

### P R O G R A M M E .

	Maximum number of Competitors from each country
<b>Men's Singles</b> ... ..	<b>12</b>
<b>Men's Doubles</b> .. ..	<b>6 pairs</b>
<b>Ladies' Singles</b> ... ..	<b>12</b>

---

## II. COVERED LAWN TENNIS.

---

### P R O G R A M M E .

<b>Men's Singles</b> ... ..	<b>12</b>
<b>Men's Doubles</b> ... ..	<b>6 pairs</b>
<b>Ladies' Singles</b> ... ..	<b>12</b>

# LAWN TENNIS AND COVERED LAWN TENNIS.

---

## LAWS OF THE GAME.

---

### THE SINGLE-HANDED GAME.

1. For the single-handed game, the Court is 27 ft. (8.23 metres) in width, and 78 ft. (23.80 metres) in length. It is divided across the middle by a net, the ends of which are attached to the tops of two posts, which stand 3 ft. (.91 metre) outside the Court on each side. The height of the net is 3 ft. 6 in. (1.06 metres) at the posts, and 3 ft. (.91 metre) at the centre. At each end of the Court, parallel with the net, and at a distance of 39 ft. (11.90 metres) from it, are drawn the *Base-lines*, the extremities of which are connected by the *Side-lines*. Half-way between the side-lines, and parallel with them, is drawn the *Half-court-line*, dividing the space on each side of the net into two equal parts, called the *Right and Left Courts*. On each side of the net, at a distance of 21 ft. (6.40 metres) from it, and parallel with it, are drawn the *Service-lines*. The marking of the part of the *Half-court-line* between the *Service-lines* and the *Base-lines* may be omitted, with the exception of a small portion at the centre of each *Base-line*, as indicated in the plans appended to these Laws.

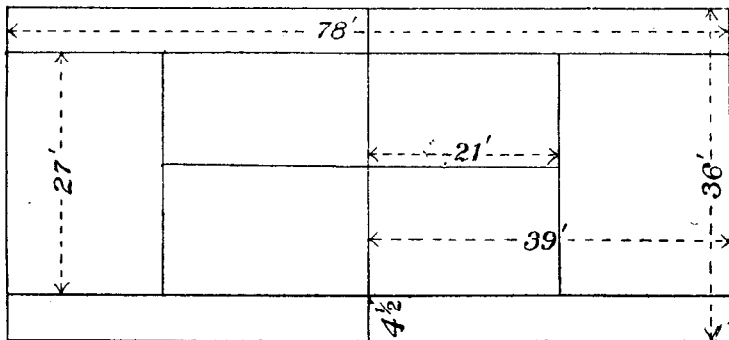

2. The balls shall not be less than  $2\frac{1}{2}$  in. (6.37 c.), nor more than  $2\frac{9}{16}$  in. (6.51 c.) in diameter; and not less than  $1\frac{7}{8}$  oz. (53 grammes), nor more than 2 oz. (57 grammes) in weight.

3. The decisions of the Umpires shall be final; but where a Referee is appointed an appeal shall lie to him from the decision of an Umpire on a question of law, and in all such cases the decision of the Referee shall be final.

4. The choice of sides and the right to be Server or Striker-out during the first games shall be decided by toss; provided that, if the winner of the toss choose the right to be Server or Striker-out, the other player shall have the choice of sides, and *vice versa*; and provided that the winner of the toss may, if he prefer it, require the other player to make the first choice.

5. The players shall stand on opposite sides of the net; the player who first delivers the ball shall be called the *Server*, the other the *Striker-out*.

6. At the end of the first game the Striker-out shall become Server, and the Server shall become Striker-out; and so on alternately in the subsequent games of the set.

7. The Server shall serve with both feet behind (*i.e.* further from the net than) the base-line and within the limits of the imaginary continuation of the centre-service and the side-lines. It is not a fault if one only of the Server's feet do not touch the ground at the moment at which the service is delivered. He shall place both feet on the ground immediately before serving, and shall not take a running nor a walking start. He shall deliver the service from the right and left Courts alternately, beginning from the right in each of his service games.

8. The ball served must drop within the service-line, half-court-line, and side-line of the Court which is diagonally opposite to that from which it was served, or upon any such line.

9. It is a *fault* if the service be delivered from the wrong Court, or if the Server do not stand as directed in Law 7, or if the ball served drop in the net or beyond the service-line, or if it drop out of Court or in the wrong Court. If the Server, in attempting to serve, miss the ball altogether, it does not count a fault; but if the ball be touched, no matter how slightly, by the racket, a service is thereby delivered, and the laws governing the service at once apply.

10. A fault may not be taken.

11. After a fault, the Server shall serve again from the same Court from which he served that fault, unless it was a fault because served from the wrong Court.

12. A fault may not be claimed after the next service has been delivered.

13. The service may not be *volleyed*, *i.e.* taken before it touches the ground, even though the ball be clearly outside the Service Court.

14. The Server shall not serve until the Striker-out is ready. If the latter attempt to return the service, but fail, he loses the stroke. If, however, the Striker-out signify that he is not ready after the service has been delivered, but before the ball touch the ground, he may not claim a fault because the ball ultimately drops outside the Service Court.

15. A ball is *in-play* from the moment at which it is delivered in service (unless a fault) until it has been volleyed by the Striker-out in his first stroke, or has dropped in the net or out of Court, or has touched either of the players or anything that he wears or carries except his racket in the act of striking, or has been struck by either of the players with his racket more than once consecutively, or has been volleyed before it has passed over the net, or has failed to pass over the net before its first bound (except as provided in Law 17), or has touched the ground twice consecutively on either side of the net, though the second time may be out of court.

16. It is a *let* if the ball served touch the net, provided the service be otherwise good; or if a service or fault be delivered when the Striker-out is not ready. In case a player is obstructed by any accident not within his control, the ball shall be considered a let; but where a permanent fixture of the Court is the cause of the accident, the point shall be counted. The benches and chairs placed around the Court and their occupants, and the umpire and linesmen, shall be considered permanent fixtures. If, however, a ball in play strike a permanent fixture of the Court (other than the net or post) before it touches the ground, the point is lost; if after it has touched the ground the point shall be counted. In case of a let, the service or stroke counts for nothing, and the server shall serve again. A let does no annul a previous fault.

17. It is a good return—

- (a) If a ball touch the net or post, provided that it passes over either and drops into the Court;
- (b) If a ball, served or returned, drop into the proper Court and screw or be blown back over the net, and the player whose turn it is to strike reach over the net and play the ball, provided that neither he nor any part of his clothes or racket touch the net, and that the stroke be otherwise good;
- (c) If a ball be returned outside the post, either above or below the level of the top of the net, even though it touch the post, provided that it drop into the proper Court;
- (d) If a player's racket pass over the net after he has returned the ball, provided the ball pass over the net before being played and be properly returned;
- (e) If a player succeed in returning a ball, served or in play, which strikes a ball lying in the Court.

18. The Server wins a stroke if the Striker-out volley the service, or fail to return the service or the ball in-play (except in the case of a let), or return the service or ball in play so that it drop outside any of the lines which bound his opponent's Court, or otherwise lose a stroke, as provided by Law 20.

19. The Striker-out wins a stroke if the Server serve two consecutive faults, or fail to return the ball in-play (except in the case of a let), or return the ball in-play so that it drop outside any of the lines which bound his opponent's Court, or otherwise lose a stroke, as provided by Law 20.

20. Either player loses a stroke if the ball in-play touch him or anything that he wears or carries, except his racket in the act of striking, or if he volley the ball (unless he thereby makes a good return) no matter whether he is standing within the precincts of the Court or outside them; or if he touch or strike the ball in-play with his racket more than once consecutively; or if he or his racket (in his hand or otherwise) touch the net or any of its supports while the ball is in-play; or if he volley the ball before it has passed the net.

21. On either player winning his first stroke, the score is called 15 for that player; on either player winning his second stroke, the score is called 30 for that player; on either player winning his third stroke, the score is



called 40 for that player; and the fourth stroke won by either player is scored game for that player; except as below :—

If both players have won three strokes, the score is called deuce; and the next stroke won by either player is scored advantage for that player. If the same player win the next stroke, he wins the game; if he lose the next stroke, the score is again called deuce; and so on until either player win the two strokes immediately following the score at deuce, when the game is scored for that player.

22. The player who first wins six games wins a set; except as below :—

If both players win five games, the score is called games-all; and the next game won by either player is scored advantage-game for that player. If the same player win the next game he wins the set; if he lose the next game, the score is again called games-all; and so on until either player win the two games immediately following the score of games-all, when he wins the set.

NOTE.—Players may agree not to play advantage-sets, but to decide the set by one game after arriving at the score of games-all.

23. The players shall change sides at the end of the first, third, and every subsequent alternate game of each set, and at the end of each set, unless the number of games in such set be even. It shall, however, be open to the players by mutual consent and notification to the umpire before the opening of the second game of the match to change sides instead at the end of every set, until the odd and concluding set, in which they shall change sides at the end of the first, third, and every subsequent alternate game of such set.

24. When a series of sets is played, the player who was Server in the last game of one set shall be Striker-out in the first game of the next.

### THE FOUR-HANDED GAME.

25. The above laws shall apply to the four-handed games, except as below.

26. For the four-handed game, the Court is 36 ft. (10.97 m.) in width. Within the side-lines, at a distance of  $4\frac{1}{2}$  ft. (1.37 m.) from them, and parallel with them, are drawn the service-side-lines. In other respects the Court is similar to that which is described in Law 1.

27. In the four-handed game, the pair who have the right to serve in the first game may decide which partner shall do so, and the opposing pair may decide similarly for the second game. The partner of the player who served in the first game shall serve in the third; and the partner of the player who served in the second game shall serve in the fourth, and so on in the same order in all the subsequent games of a set.

28. The players shall take the service alternately throughout each game; no player shall receive or return a service delivered to his partner; and the order of service and of striking out, once arranged, shall not be altered, nor shall the Striker-out change Courts to receive the service before the end of the set.

29. The ball served must drop within the service-line, half-court-line, and service-side-line of the Court, which is diagonally opposite to that from which it was served, or upon any such line.

30. It is a *fault* if the ball do not drop as provided in Law 32, or if it touch the Server's partner, or anything that he wears or carries. If, however, the ball in Service strike either the striker-out or his partner the server wins the stroke.

31. If a player serve out of his turn, the Umpire, as soon as the mistake is discovered by himself or by one of the players, shall direct the player to serve who ought to have served; but all strokes scored, and any fault served before such discovery, shall be reckoned. If a game shall have been completed before such discovery, then the service in the next alternate game shall be delivered by the partner of the player who served out of his turn; and so on in regular rotation.

---

THE OLD LAWS 7, 8, 9 ARE AMENDED AS  
FOLLOWS FOR 1909:—

7. The Server shall before commencing to serve stand with both feet at rest on the ground behind (*i.e.* further from the net than) the base-line and within the limits of the imaginary continuation of the half-court and side-lines, and thereafter the Server shall not run, walk, hop or jump before the service has been delivered, but the Server may raise one foot from (and, if desired, replace it on) the ground, provided that both feet are kept behind the base-line until the service has been delivered.

8. The service shall be delivered from the right and left Courts alternately, beginning from the right in every game, even though odds be given or owed, and the ball served shall drop within the service-line, half-court-line, and side-line of the Court which is diagonally opposite to that from which it was served or upon any such line.

9. It is a *fault* if the Server commit any breach of Law 7, or if the service be delivered from the wrong Court, or if the ball served drop in the net or beyond the service-line, or if it drop out of Court or in the wrong Court. If the Server, in attempting to serve, miss the ball altogether, it does not count a fault; but if the ball be touched, no matter how slightly, by the racket, a service is thereby delivered, and the laws governing the service at once apply.

## M O T O R   B O A T   R A C I N G .

*Under the direction of the Motor Yacht Club.*

---

1. The races will be held under the racing rules of the Marine Motor Association and in accordance with the following regulations.

2. There will be no time allowances.

3. The helmsman and every member of the crew must be an amateur member of a recognised yacht or motor boat club or of a recognised Automobile Club, and must be strictly qualified as an amateur.

An "AMATEUR" is one who has never been employed as a paid hand in the handling of a motor boat or other vessel, or in the running or construction of an internal combustion engine. The helmsman and every member of the crew must be further qualified under Nos. 7 and 8 of the General Regulations of the Olympic Games (1908), and his entry shall also be subject to No. 12 of those regulations.

4. Not more than three boats shall represent one country in each class.

5. All competing boats and their crews shall be selected and duly authenticated by the recognised club of their country. If there be any dispute as to what is the recognised club of a country, the decision of the British Olympic Council shall be final. All entries shall be made in accordance with No. 8 of the General Regulations and on forms which will be supplied on application by the Motor Yacht Club.

6. Only boats propelled by means of internal combustion engines shall be eligible to compete.

7. The helmsman and every member of the crew shall conform to the regulations as to the nationality of competitors in the Olympic Games as laid down by the B.O.C. (General Regulations 19, 20).

8. The races will be held on July 11, and all entries will close on June 28.

9. All races shall start from and finish at the "Enchantress," the flag-ship of the Motor Yacht Club lying in Southampton Water.

10. The length of the course shall be not less than 35 or more than 40 nautical miles, and the length of each round shall be not less than 5 nautical miles.

II. Races will be held for the following classes :—

(a) For motor boats of any length and power.

(b) For motor boats not exceeding sixty feet in length and with a total piston area not exceeding that represented by four cylinders each of 155 mm. bore.

(c) For motor boats exceeding  $6\frac{1}{2}$  metres, but not exceeding 8 metres in length ; not less than 800 kilos in weight in running order, but without fuel or crew on board, and with a total piston area not exceeding that represented by four cylinders each of 106 mm. bore. Boats in this class must comply with the rules of the International Sporting Club of Monaco in regard to cruisers.

[Boats entered in classes (b) and (c) shall be eligible to enter also in class (a)].

12. All boats in classes (b) and (c) must be presented at the "Enchantress" for weighing and measurement at a time to be appointed within two days of the race. All boats in classes (b) and (c) are liable to be re-weighed and re-measured, and their cylinder dimensions verified after the race.

13. All protests must be accompanied by a fee of £1.

14. As regards Great Britain the selection of representatives shall rest with the Motor Yacht Club. If in any class the qualified competitors desiring to represent Great Britain exceed three in number, the Motor Yacht Club may institute eliminating trials or races.

15. All British entries shall be made to the Secretary of the Motor Yacht Club, "Enchantress," Netley Abbey, Hants, and through them to the B.O.C.

## P O L O .

## RULES AND REGULATIONS.

---

*The matches for the Olympic Polo Cup will be held under the Hurlingham club Rules and Regulations which are as follows, with the exception that RULE I as to Measurement and Registration of Polo Ponies will be waived for the convenience of Foreign Polo Teams.*

2. No pony showing vice or not under proper control shall be allowed in the game.—(Penalty 9.)

3. The goals to be not less than 250 yards apart, and each goal to be 8 yards wide.

A full-sized ground should not exceed 300 yards in length by 200 yards in width, if unboarded ; and 300 yards in length and 160 yards in width if boarded.

4. The size of the balls shall not exceed  $3\frac{1}{4}$  inches in diameter, and the weight of the ball shall not exceed  $5\frac{1}{2}$  ounces.

5. Each side shall nominate an Umpire, and their decisions shall be final. In addition to the Umpires a Referee shall be appointed, whose decision in the event of the Umpires disagreeing shall be final.

6. The Umpire shall carry a whistle, which he shall use as required. If the Umpire blow his whistle the ball is dead, but if the other Umpire disagrees the Referee shall be called in, who, after consulting both Umpires and taking any necessary evidence, shall decide on the course to be pursued.

Any infringement of the Rules constitutes a foul. In case of an infringement of Rules 20, 21, 22, 24, 25, 27, 28, 29, and 30, the Umpire shall stop the game : and in the case of infringement of Rule 26 the Umpire shall stop the game on an appeal by anyone of the side which has been fouled.

7. An official Time-keeper and Scorer shall be employed in all games and matches.

8. The number of players contending is limited to four a side in all games and matches.

9. The game commences by both sides taking up their position in the middle of the ground, and the Umpire throwing the ball into the centre of the ground between the opposing ranks of players.

10.\* The duration of play in a match shall be one hour, divided into six periods of ten minutes each, with an interval of three minutes after each period except the third (half-time), when the interval shall be five minutes.

The first five periods of play shall terminate as soon as the ball goes out of play after the expiration of the prescribed time, or on boarded grounds, when the ball strikes the boards.

On play being resumed, the ball shall be thrown in as laid down in Rule 15.

The last period shall terminate, although the ball is still in play, at the first stroke of the final bell, wherever the ball may be.

In case of a tie the last period shall be prolonged till the ball goes out of play, and if still a tie, after an interval of five minutes, the ball shall be started from where it went out of play and the game continued in periods of ten minutes, with the usual intervals, until one side obtain a goal, which shall determine the match.

11. The bell shall be rung to signify to the players that the ten minutes has expired, and it shall be rung again when the ball next goes out of play, to indicate the time for changing ponies.

12. With the exception of the intervals allowed in Rule 10 play shall be continuous ; any change of ponies, except according to the above provision, shall be at the risk of the player.

13. If the ball be hit behind the back line by one of the opposite side, it shall be hit off without delay from where it crossed the line, but at least twelve feet from the goal post, after giving the opposing side reasonable time to get to the 30-yards line. None of the attacking side shall be within 30 yards of the back line when the ball is hit off.— (*Penalty 5.*)

N.B.—There must be no unnecessary delay.— (*Penalty 6.*)

14. If the ball be hit behind the back line by one of the defending side, penalty 4 shall be exacted, provided the ball does not glance off another player or another pony.— (*Penalty 4.*)

15. When the ball is hit out, it must be thrown into the ground by the Umpire from the exact spot where it went out, in a direction parallel to the two goal lines, and between the opposing ranks of players, no player to stand within 5 yards of the side line. There must be no delay whatsoever on any consideration for absent players.

16. The ball must go over and clear of the boundary line to be out.

---

\* Subject to local alterations, except in the United Kingdom.

17. A goal is gained when a ball passes between the goal posts and over the goal line. If a ball is hit above the top of the goal posts, but in the opinion of the Umpire, between those posts produced, it shall be deemed a goal.

18. The side that makes most goals wins the game.

19. Ends shall be changed after every goal, or if no goal have been obtained, after the 3rd period.

20. A player may ride out an antagonist, or interpose his pony before his antagonist, so as to prevent the latter reaching the ball, but he may not cross another player in possession of the ball, except at such a distance that the said player shall not be compelled to check his pony to avoid a collision.—(*Penalty 1.*)

If two players are riding from different directions to hit the ball, and a collision appears probable, then the player in possession of the ball (that is, who last hit the ball, or if neither have hit the ball, the player who is coming from the direction from which the ball was last hit) must be given way to.—(*Penalty 1.*)

(i.) Any player who follows the exact line of the ball from the direction from which it has been last hit, is in possession of the ball rather than any player coming from any other direction.

The last striker is in possession provided that no other player can, without causing the striker to check his pony to avoid a collision, get on the line of the ball in front of him. Under these circumstances the last striker may not ride into the adversary from behind, but must if necessary take the ball on the near side of his own pony.

No player shall be deemed to be in possession of the ball by reason of his being the last striker if he shall have deviated from pursuing the exact course of the ball.

(ii.) Any player who rides to meet the ball on the exact line of its course is in possession rather than any other player riding at an angle from any direction.

(iii.) Any player riding from the direction from which the ball has last been hit, at an angle to its course, has possession rather than any player riding at an angle in the opposite direction.

(iv.) If two players are riding from the same direction, that player is in possession whose course is at the smallest angle to the line of the ball.



(v.) If two players are riding from opposite directions to hit the ball, one of these being a left-handed player, the latter must give way.

N.B.—The line of the ball is the line of its course, or that line produced at the moment any question arises.

21. No player shall ride dangerously.—( *Penalty* 1.)

22. No player shall use his stick dangerously.—( *Penalty* 1.)

23. In the case of a player being disabled by a foul, penalty 8 may be exacted by the side that has been fouled, and penalty 1 shall be exacted in any case.—( *Penalties* 1 and 8.)

24. No player shall seize with the hand, strike, or push with the head, hand, arm, or elbow, but a player may push with his arm above the elbow, provided the elbow be kept close to his side.—( *Penalty* 1 or 2 or 3.)

N.B.—Penalty 1 shall only be exacted if the Umpire considers the play dangerous.

25. No player shall crook an adversary's stick, unless he is on the same side of an adversary's pony as the ball, or in a direct line behind, and his stick is neither over or under the body or across the legs of an adversary's pony. The stick may not be crooked unless an adversary is in the act of striking at the ball.—( *Penalty* 2 or 3.)

26. No player who is offside shall hit the ball, or shall in any way prevent the opposite side from reaching or hitting the ball.—( *Penalty* 2 or 3.)

A player is off-side when at the time of the ball being hit he has no one of the opposite side nearer the adversaries' goal line, or that line produced, or behind that line, and he is neither in possession of the ball nor behind one of his own side who is in possession of the ball. The goal line means the eight yard line between the goal posts. A player, if off-side, remains off-side, until the ball is hit or hit at again.

27. A player may not carry the ball. In the event of the ball lodging upon or against a player or pony, it must be immediately dropped on the ground.—( *Penalty* 2 or 3.)

28. No player shall intentionally strike his pony with the head of his polo stick.—( *Penalty* 2 or 3.)

29. Should a player's stick be broken, he must borrow one from one of his own side, or ride to the place where sticks are kept and take one. In the event of a stick being dropped he must either pick it up himself,

borrow one from one of his own side, or ride to the place where sticks are kept and take one. On no account may a stick be brought on to the ground.—( *Penalty* 2 or 3.)

30. No dismounted player is allowed to hit the ball or interfere in the game.—( *Penalty* 2 or 3.)

31. If the ball be damaged, the Umpire shall, at his discretion, stop the game, and throw in a new ball as near as possible to where the ball is when the whistle sounds towards the nearest side of the ground, in a direction parallel to the two goal lines and between the opposing ranks of players.

N.B.—It is desirable that the game shall be stopped and the ball changed when the damaged ball is in such a position that neither side is favoured thereby.

32. If a player leaves the game in order to change a pony, or to get a fresh stick, or for any other purpose, the penalty for off-side cannot be exacted against the opposing side until the return of the player into the game.

N.B.—The definition of the word “ game ” is “under the umpire’s eye.”

33. No person allowed within the arena—Players, Umpires, Referee, and Manager excepted.

34. If a pony falls, or if a player or a pony be injured, the Umpire shall stop the game.

If a player-falls off his pony, the Umpire shall not stop the game unless he is of opinion that the player is injured.

What constitutes a fall shall be left to the decision of the Umpire.

N.B.—On play being resumed, the ball shall be thrown in where it was when the game was stopped, and in the manner provided for in Rule 31.

35. No blinkers, or spurs with rowels are allowed ; no pony blind of an eye is allowed to play.

36. In the case of a penalty being incurred towards the end of a match, and there not being time to exact the penalty before the final bell rings, “one minute extra shall be allowed” from the time the ball is hit or hit at in carrying out the penalty.

See Rule 40.

38. The decision and injunctions of the Umpire must not be disregarded or questioned.—( *Penalty* 7.)

39. Should any incident or question not provided for in these Rules arise, such incident or question shall be decided by the Umpire or Umpires. If the Umpires disagree, a Referee shall be called in whose decision shall be final.

40. There is no restriction, except nationality, as regards the composition of teams ; fresh players may be introduced for any match if desired. Clubs, however, entering as Clubs can only play members of that Club.

#### PENALTIES.

*Penalty 1.* A free "hit at" the ball from a spot 50 yards from the goal line of the side fouling, opposite the centre of goal, or if preferred from where the foul occurred ; all the side fouling to be behind their back line until the ball is hit or hit at, but not between the goal posts, nor when the ball is brought into play may any of the side ride out from between the goal posts. None of the side fouled to be nearer the goal line produced than the ball is at the moment it is hit or hit at.

*Penalty 2.* A free "hit at" the ball from where it was when the foul took place, none of the side fouling to be within 20 yards of the ball. The side fouled being free to place themselves where they choose.

*Penalty 3.* The side fouling take the ball back and hit it off from behind their own goal line between the posts, none of the side fouled to be within 30 yards of the goal line produced, the side fouling being free to place themselves where they choose.

*Penalty 4.* A free "hit at" the ball, from a spot opposite where the ball was hit behind and 60 yards distant from the "goal line produced," none of the side fouling to be within 20 yards of the ball. The side fouled being free to place themselves where they choose.

*Penalty 5.* In the case of failure to correctly carry out :—

- (a) Penalties 1, 2 and 4, *by the side fouling*—a second free hit at the ball if a goal has not been scored.
- (b) Penalty 1, *by the side fouled*—a hit out from behind by the other side from the centre of goal, the defending side being free to place themselves where they please.
- (c) Penalty 3, *by the side fouled*—a second hit out from behind.
- (d) Rule 13, *by the attacking side*—a second hit out from behind.
- (e) When penalties 1, 2, 3 and 4 are not properly carried out, or Rule 13 is infringed by both sides simultaneously, the ball shall be hit or hit at, as the case may be, from the same spot as before.

*Penalty 6.* In the event of unnecessary delay in hitting out the ball, the Umpire shall call on the offending side to hit out at once; if the Umpire's request is not complied with he shall bowl in the ball underhand, at the spot where the ball crossed the back line at right angles to the goal line or "goal line produced" as hard as possible. In this case the penalty for an offside shall not be claimed against the attacking side should no one of the offending side be between them and the goal line produced, or behind that line.

*Penalty 7.* The offender warned off the ground for remainder of match, no substitute allowed to take his place.

*Penalty 8.* Designation of any of the players on the side fouling, who shall retire from the game. The game shall be continued with three players a side, and if the side fouling refuse to continue the game, it shall thereby lose the match

*Penalty 9.* The pony ordered off the ground.

---

#### NEW BYE-LAWS.

1. The County, Indian, and South African Polo Associations, the Army Polo Committee, the All Ireland Polo Club, and the Ranelagh and Roehampton Clubs shall nominate the members to represent them for the current year by January 1 of each year.

2. Alterations in the Hurlingham Polo Rules shall only be made at Meetings of the Polo Committee, held in October or November, and such alterations shall take effect from January 1 of the ensuing year.

R O W I N G .  
 RULES AND REGULATIONS  
 FOR THE INTERNATIONAL REGATTA .

---

GENERAL RULES.

1. The Regatta shall be held under the control and management of the Committee of the Amateur Rowing Association of England, whose decisions on all matters relating thereto except such as may be hereinafter specified shall be final and without appeal.

2. The Rules governing the Regatta and the Laws governing the Boat Racing shall be those set out below.

3. The following definition of a Country, being that laid down by the British Olympic Council, shall be adopted :—

A “Country” is any “territory having separate representation on the International Olympic Committee,” or, where no such representation exists “any territory under one and the same sovereign jurisdiction.”

4. The following definition of an Amateur, being that laid down by the Amateur Rowing Association, shall govern the Amateur status of each individual entering for the Regatta :—

No person shall be considered an Amateur Oarsman, Sculler, or Coxswain :

- (a) Who has ever rowed or steered in any race for a stake, money, or entrance fee.
- (b) Who has ever knowingly rowed or steered with or against a professional for any prize.
- (c) Who has ever taught, pursued, or assisted in the practice of athletic exercises of any kind for profit.
- (d) Who has ever been employed in or about boats or in manual labour for money or wages.
- (e) Who is or has been by trade or employment for wages a mechanic, artisan, or labourer, or engaged in any menial duty.
- (f) Who is disqualified as an Amateur in any other branch of sport.

5. The Regatta shall be held at Henley-on-Thames on July 28, 1908, and following days, over a course of about one and a half miles in length, which will be staked out for the purpose.

6. The events for Competition at the Regatta shall be four : namely,  
 For Eight-oars.  
 For Four-oars.  
 For Pair-oars.  
 For Sculls.

7. The number of Entries for each event to be forwarded to the British Olympic Council from each Country shall not exceed Two.

8. All entries shall be made by individual Rowing Clubs in a "Country" or by two or more Rowing Clubs in a "Country" combining for the purpose of forming a Crew from their own Members.

9. The Winners or Winner of the events will each receive the British Olympic Council's Gold Medal for the Olympic Games of 1908.

10. No competitor shall make any pecuniary gain or profit from the funds provided for expenses, which must be disbursed by a person appointed by the Club or combined Clubs, and accounted for by him to the Club or combined Clubs.

II. Any infringement of any of the Rules, Laws or Regulations governing the Regatta shall afford ground for disqualification of a crew even though the entry has been already accepted.

## RULES FOR THE REGATTA.

I. In the following Rules the Regatta Committee shall mean the Committee of the Amateur Rowing Association, and the Secretary of the Regatta, shall mean the Hon. Secretary of the Amateur Rowing Association.

2. No one shall enter twice for the same race.

3. No person may be substituted for another who has already rowed or steered in a heat.

4. The Secretary of the Regatta, after receiving the final nominations of the crews and substitutes, shall furnish a copy of the same to the Crews or Scullers competing.

5. Objections to the qualifications of a Competitor must be made in writing to the Secretary of the Regatta at the earliest moment practicable.

No protest shall be entertained unless lodged before the prizes are distributed.

6. Heats and Stations shall be drawn by lot by the Committee. It shall be open to all Competitors to be present at such draw.

7. Every Competitor must wear complete clothing from the base of the neck to within four inches of the top of the knee-cap, including a jersey with sleeves reaching to within four inches of the elbow.

8. In the event of there being but one boat entered for any event, or if more than one enter and all withdraw but one, the Crew of the remaining boat must row over the course to be entitled to be declared winner of the event.

9. If there shall be more than two competing Crews or Scullers they shall row a trial heat or heats ; but no more than two Boats shall contend in any heat for any event.

10. Every Eight-oared Boat shall carry a Coxswain ; no Coxswain shall steer for more than one Crew. The minimum weight for Coxswains shall be 7 stone 7 lbs. (48·09 kilos). Deficiencies must be made up by dead weight carried on the Coxswain's thwart.

The dead weight shall be provided by the Regatta Committee and shall be placed in the boat and removed from it by a person appointed for that purpose.

Each Coxswain shall attend to be weighed, in Rowing Costume, at the time and place appointed by the Regatta Committee ; and his weight then registered by the Secretary of the Regatta shall be considered his racing weight during the Regatta. Any Coxswain omitting to register his weight shall be disqualified.

11. All Boats shall be measured, and started with their bows level.

12. Every boat at starting shall carry a Flag showing the Colour of the Club or combined Clubs at the bow. Boats not conforming to this Rule shall be liable to be disqualified by the Umpire.

13. In the event of a Dead Heat taking place, any Competitor refusing to row again, as may be directed by the Regatta Committee, shall be adjudged to have lost.

14. The Regatta Committee shall appoint one or more Umpires and one or more Judges.

## LAWS OF BOAT RACING.

1. The boat races shall be started in the following manner :—The Starter, on being satisfied that the Competitors are ready, shall give the signal to start.

2. A boat not at its post at the time specified shall be liable to be disqualified by the Umpire.

3. The Umpire may act as Starter, or not, as he thinks fit ; when he does not so act, the Starter shall be subject to the control of the Umpire.

4. If the Starter considers the start false, he shall at once recall the boats to their stations, and any boat refusing to start again, or persistently starting before the signal, shall be liable to be disqualified by the Umpire.

5. A boat's proper course is such a course as will enable it to reach the winning post in the shortest possible time, provided that it allows ample water for the other competing boat to steer its proper course on the side on which such competing boat started, when such competing boat is in a position to enforce its right to such water. Any boat failing to keep its proper course does so at its peril in the event of a foul occurring.

6. The Umpire shall be the sole judge of a boat's proper course during a race, and shall decide all questions as to a foul.

7. The Umpire may caution any Competitor when he considers that there is a probability of a foul occurring, and may warn a Competitor of any obstruction in his course, but the Umpire shall not under any other circumstances direct the course of a Competitor.

8. It shall be considered a foul when, after a race has been started, any Competitor, by his oar, scull, boat, or person, comes into contact with the oar, scull, boat, or person of another Competitor.

9. In the event of a foul occurring, a Competitor may claim that the other Competitor be disqualified. Such claim must be made by the Competitor himself, before getting out of his boat, to the Umpire or to the Judge. The Judge, upon such claim being made to him, shall take immediate steps to communicate the same to the Umpire.

10. If the Competitor making the claim was in his proper course and the Competitor against whom the claim is made was out of his proper course, the latter shall be disqualified, unless the foul was so slight as not



to influence the race, in which case the Competitor against whom the claim is made shall be disqualified only if he has seriously encroached upon the proper course of the Competitor making the claim. In cases under this Law the Umpire may reserve his decision, but must give it within a reasonable time after the finish of the race.

11. The Umpire in either of the following cases may of his own initiative, and without a claim being made, disqualify a Competitor who is involved in a foul when out of his proper course, provided he does so immediately upon the foul occurring :—

- (a) If such Competitor has in the opinion of the Umpire wilfully encroached upon the proper course of the other Competitor.
- (b) If the foul be of such a nature as clearly to influence the race.

12. In the case of a foul the Umpire shall have power :—

- (a) To place the boats in the order in which they come in.
- (b) To order the boats to row again on the same or another day.
- (c) To re-start the boats according to his discretion.

13. Every boat shall abide by its accidents, but if during a race a boat shall be interfered with by any outside boat or person, the Umpire shall have power, if he thinks fit, to re-start the boats according to his discretion, or to order them to row again on the same or another day.

14. No boat shall be allowed to accompany or follow any race for the purpose of directing the course of any of the Competitors. Any Competitor receiving any extraneous assistance may be disqualified at the discretion of the Umpire.

15. The whole course must be completed by a Competitor before he can be held to have won a trial or final heat unless he is prevented from doing so by damage occasioned by a foul. Boats shall be held to have completed the course when their bows reach the winning post.

16. The Judge shall decide as to the order in which the boats reach the winning post, and such decision shall be final and without appeal.

17. The jurisdiction of the Umpire extends over a race and all matters connected with it, from the time the race is specified to start until its termination, and his decision in all cases shall be final and without appeal.

18. Any Competitor refusing to abide by the decision of the Umpire, or to follow his directions, shall be liable to be disqualified.

## REGULATIONS FOR CREWS FROM OUTSIDE THE UNITED KINGDOM OF GREAT BRITAIN AND IRELAND.

1. Entries shall be made by the Club or Clubs intending to compete, and shall in the first instance be sent :—

- (a) In the case of Canada to the Canadian Association of Amateur Oarsmen.
- (b) In the case of Belgium to the Fédération Belge des Sociétés d'Aviron.
- (c) In the case of Germany to the Deutscher Ruderverband.
- (d) In the case of Holland to the Verbonden Nederlandsche Roeiverenigingen.
- (e) In the case of any other country to a Committee of representative Amateur Oarsmen of that Country appointed by the Olympic Council of that Country.

2. The number of names which may be comprised in each entry, and from which the Crew will have to be finally selected shall not exceed the following :—

For Eight-oars . . . . .	27
For Four-oars . . . . .	12
For Pair-oars . . . . .	6
For Scullers . . . . .	3

3. Should the Association or Committee of any Country receive more than two entries for any one event such Association or Committee shall select the entries to be forwarded to the Olympic Council of the Country.

4. The Association or Committee receiving the entries shall investigate and be responsible for the Amateur Status of each Competitor so entered, and shall forward such entries as they approve and select, together with the declaration required by paragraph 6, to the Olympic Council of the Country, who shall, on satisfying themselves that the entries are in accordance with the requirements of the English Amateur Rowing Association, vouch for the same, and forward the entries to the British Olympic Council in London. Before accepting such entries the British Olympic Council will submit them to the Committee of the English Amateur Rowing Association for their approval, and without such approval no entries will be accepted.

5. Entries must be received by the British Olympic Council in London (108 Victoria Street, Westminster, S.W.) :—

- (a) In the case of Canada, Belgium, Germany, and Holland, not later than June 30, 1908.
- (b) In the case of other countries not later than June 1, 1908.

The final nominations of the Crews selected from the names already entered must be received by the British Olympic Council in London not later than July 15, 1908 ; and, in such final nominations, five substitutes shall be allowed for an Eight-oar, of whom one shall be a coxswain ; two for a Four-oar.

6. Entries must be accompanied by a Declaration in writing by the Secretary or a responsible Official of the Rowing Association or Committee of the Country, vouched for by the Secretary or a responsible Official of the Olympic Council of the Country, as to each person so entering to the effect that he :—

- (a) Has never rowed or steered in any race for a stake, money, or entrance fee.
- (b) Has never knowingly rowed or steered with or against a professional for a prize.
- (c) Has never taught, pursued, or assisted in the practice of Athletic exercises of any kind for profit.
- (d) Has never been employed in or about boats or in manual labour for money or wages.
- (e) Is not and never has been by trade or employment for wages a mechanic, artisan, or labourer, or engaged in any menial duty.
- (f) Is not disqualified as an Amateur in any other branch of sport.

### EXPENSES.

7. All expenses of the Crews or Scullers shall be paid by the Crews or Scullers themselves or by the Club or Combined Clubs making the original entry, but it shall be open to *bonâ-fide* members of such Clubs to contribute to the Club Funds for the above purpose. It shall also be permissible for Clubs entering Competitors for the Regatta to receive from the Governments of their respective Countries grants of money in aid of the expenses of the Crews or Scullers representing them, but such grants shall only be applicable for the Actual Journey Expenses of the men and boats and for no other purpose.

## REGULATIONS FOR CREWS FROM THE UNITED KINGDOM OF GREAT BRITAIN AND IRELAND.

### ENTRIES.

1. Entries shall be made by the Club or Clubs intending to compete and in the first instance be sent to the Amateur Rowing Association.

2. The number of names which may be comprised in each entry and from which the Crew will have to be finally selected shall not exceed the following :—

For Eight-oars . . . . .	27
For Four-oars . . . . .	12
For Pair-oars . . . . .	6
For Scullers . . . . .	3

3. Should the Amateur Rowing Association receive more than two entries for any one event they shall select the entries to be forwarded to the British Olympic Council.

4. The Amateur Rowing Association on receiving the entries shall investigate and be responsible for the Amateur status of each Competitor so entered, and shall forward such entries as they approve and select, together with, in case of entries from Clubs not affiliated to the A.R.A., the declaration required by paragraph 6 of the Regulations for Crews from outside the United Kingdom of Great Britain and Ireland, to the British Olympic Council in London.

5. Entries must be received by the Amateur Rowing Association not later than June 30, 1908. The final nominations of the Crews selected from the names already entered must be received by the British Olympic Council in London not later than July 15, 1908, and in such final nominations Five Substitutes shall be allowed for an Eight-oar, of whom one shall be a coxswain ; two for a Four-oar.

### EXPENSES.

6. All expenses of the Crews or Scullers shall be paid by the Crews or Scullers themselves or by the Club or Clubs making the entry, but it shall be open to *bonâ-fide* members of such Clubs to contribute to the Club Funds for the above purpose.

# SHOOTING.

## (RIFLE AND PISTOL.)

### P R O G R A M M E

Maximum No.  
of Competitors  
from each  
Country.

#### I. Rifle Shooting.

- |  |               |
|--|---------------|
| <i>(a)</i> Team Competition, "The International" ... ..          | <b>1 team</b> |
| <i>(b)</i> Individual Competition at 1,000 yards (914·38 metres) | <b>12</b>     |
| <i>(c)</i> Team Competition at 300 metres ... ..                 | <b>1 team</b> |
| <i>(d)</i> Individual Competition at 300 metres ... ..           | <b>12</b>     |

#### II. Miniature Rifle Shooting.

- |   |               |
|---|---------------|
| <i>(e)</i> Team Competition ... ..                            | <b>1 team</b> |
| <i>(f)</i> Individual Competition, stationary target ... ..   | <b>12</b>     |
| <i>(g)</i> Individual Competition, disappearing target ... .. | <b>12</b>     |
| <i>(h)</i> Individual Competition, moving target ... ..       | <b>12</b>     |

#### III. Revolver and Pistol Shooting.

- |  |               |
|--|---------------|
| <i>(i)</i> Team Competition ... ..       | <b>1 team</b> |
| <i>(j)</i> Individual Competition ... .. | <b>12</b>     |

#### IV. Running Deer Shooting.

- |   |               |
|---|---------------|
| <i>(k)</i> Team Competition ... ..                    | <b>1 team</b> |
| <i>(l)</i> Individual Competition, single shot ... .. | <b>12</b>     |
| <i>(m)</i> Individual Competition, double shot ... .. | <b>12</b>     |

# RULES AND CONDITIONS OF COMPETITION.

---

## GENERAL CONDITIONS.

Competitions will be held at Bisley under the management of the National Rifle Association of Great Britain and Ireland.

All Conditions not otherwise provided for to be decided by the National Rifle Association Regulations, 1908.

---

## I. RIFLE SHOOTING.

### (a) "THE INTERNATIONAL."

Open to one team from each territory having separate representation on the International Olympic Committee, or, where no such representation exists, any territory under one and the same sovereign jurisdiction.

*Rule 1.—Teams.*—Each team to consist of six men. Members of the teams participating must conform as to nationality with Articles 19 and 20 of the General Regulations.

*Rule 2.—Rifles.*—The National Military Arm of any Country. Rifles of private manufacture may be used, but they must be of a strictly regulation Military pattern ; in the case of the rifles of Countries having an official view mark, the rifle used must bear such mark.

*Rule 3.—Sights.*—Regulation sights as issued with the rifle, not being telescopic or magnifying. The only colours allowed on the sights are black or white, or black and white, but not mixed so as to produce grey. Orthoptics may be worn if desired.

*Rule 4.—Ammunition.*—Any ammunition may be used, but it must not be of a dangerous character. In all cases of accident arising from defective ammunition the user only shall be held responsible. The Captain of each team to sign a certificate testifying to the safety of the ammunition used by his team.

*Rule 5.—Distances.*—200, 500, 600, 800, 900, and 1,000 yards (182·876, 457·19, 348·628, 731·504, 822·942, and 914·38 metres).

**Rule 6.—Targets.**

Divisions	Dimensions of Targets			Scoring
	1st Class 800 to 1,000 yards	2nd Class 500 and 600 yards	3rd Class 200 yards	
Bull's-eye ...	36 ins. diam.	20 ins. diam.	6 ins. diam.	5 marks.
*Inner ...	51 " " "	32 " " "	15 " " "	4 " "
Maggie ...	72 " square	48 " " "	24 " " "	3 " "
Outer ...	Remainder of target 10 ft. × 6 ft.	Remainder of target 6 ft. diam.	Remainder of target 4 ft. diam.	2 " "

\* The inner of the 3rd class target is, up to 12 ins. diam., coloured black, and beyond that white. The inner is divided from the bull's-eye by a faint white line not visible to the firer.

(One inch equals 2.54 centimetres ; one foot equals 30.48 centimetres.)

All targets are coloured white with black bull's-eyes, unless otherwise stated.

**Rule 7.—Position.** —Any, without artificial rest.

**Rule 8.—No. of Shots.** —Two sighters and fifteen shots to be fired at each range by each competitor.

Coaching allowed by Captain, Adjutant, or any member of the team.

Ricochets will count as direct hits.

**Rule 9.—Two targets will be allotted to each team.**

**Time Limit—**

200	} yards.— 1 hour and 30 minutes at each distance.
500	
600	
800	} yards.— 1 hour and 45 minutes at each distance.
900	
1000	

The time limit is exclusive of successful challenges.

No allowance will be made for a defective cartridge, except in the case of a miss-fire.

**Rule 10.—Challenging.**—The marking may be challenged before any other shot has been fired at the same target.

**Rule 11.—The competition to occupy two days ; the 200, 500, and 600 yards being decided on the first day, and the 800, 900, and 1,000 yards on the second day.**

*Rule 12.*—The highest aggregate of the scores at all the distances shall determine the winning team.

In the event of a tie in the final totals each member to fire one sighter and seven shots at longest distance. If still a tie, each member of the team to fire one shot more, and so on.

*Rule 13.*—The National Rifle Association to appoint Umpires to supervise the shooting of the teams, and the Umpire's decision on every question shall be final.

*Rule 14.*—The Umpires shall have the power to suspend the shooting on any day should the atmospheric conditions render that course necessary, and to fix another day and hour for the resumption of the competition.

*Rule 15.*—The order of members shooting in each team to be settled by the Captain.

*Rule 16.*—Triggers to be tested with a four (4) pound (1·814 kilog.) trigger-tester immediately before firing at each distance.

*Rule 17.*—No two competitors detailed to fire at the same time may shoot with the same rifle ; nor may a competitor change his rifle or any part thereof during his firing at any single distance of the competition, unless his first rifle shall become unserviceable through an accident, which must be verified by an Umpire.

*Rule 18.*—No rifle may be cleaned or wiped out between the shots fired with it at any single distance of the competition.

*Rule 19.*—The question of sighting shots or practice targets to be decided by the Captains of the teams the day previous to the match.

### (b) INDIVIDUAL COMPETITION AT 1,000 YARDS.

Limited to twelve individual entries from each territory having separate representation on the International Olympic Committee, or, where no such representation exists, any territory under one and the same sovereign jurisdiction.

Competitors participating must conform as to nationality with Articles 19 and 20 of the General Regulations.

1. Rifle. —Any.
2. Sights. —Any, including telescopic.



3. **Ammunition.** —Any, but it must not be of a dangerous character. In all cases of accident arising from defective ammunition the user only shall be held responsible.

4. **Pull of Trigger.** —Four (4) pounds.

5. **Distance.** —1,000 yards (914·38 metres).

6. **Target.** —1st Class, as follows :—

Bull's-eye ... .. 36 inches diameter ; scoring 5 points.

Inner ... .. 54 " " " 4 "

Magpie ... .. 72 " square ; " 3 "

Outer ... .. Remainder of target,  
10 feet × 6 feet " 2 "

(One inch equals 2·54 centimetres ; one foot equals 30·48 centimetres.)

7. **Number of Shots.**—Five sighters and twenty shots. The sighting shots are optional.

8. **Ties.**—Ties to be fired off on the spot.

### (c) TEAM COMPETITION AT 300 METRES.

Open to one team from each territory having separate representation on the International Olympic Committee, or, where no such representation exists, any territory under one and the same sovereign jurisdiction.

1. **Teams.**—Each team to consist of six men. Members of the teams participating must conform as to nationality with Articles 19 and 20 of the General Regulations.

2. **Rifles.**—Any.

3. **Sights.**—Fore-sight, open ; any kind of back-sight.

4. **Ammunition.**—Any ammunition may be used, but it must not be of a dangerous character. In all cases of accident arising from defective ammunition, the user only shall be held responsible. The Captain of each team to sign a certificate testifying to the safety of the ammunition used by his team.

5. **Distance.**—300 metres.

6. **Target.**—The target to be white, 1 metre in diameter with a black centre 0m·60 diameter ; the entire target to be divided into ten zones, counting from one to ten points.

The number of targets allotted shall be at the least three per Nation, which shall be divided among the Nations by lot on the morning of the competition before shooting commences.

On the afternoon of the day before the competition at least one target per Nation shall be allotted for practice in the three positions.

The targets shall be stationary and shall be lowered and raised again after each series of ten shots. The hits shall be marked by a disc, and the points indicated, under the absolute control of the National Rifle Association.

7. **No. of Shots.**—Each competitor shall fire 120 shots (40 standing, 40 kneeling, and 40 lying down) in accordance with the positions laid down in rule 11.

Each series of ten shots must be completed without interruption. Ten sighting shots are allowed for each of the three positions.

8. The winning team will be that which has the highest aggregate number of points.

Ties will be decided :—

- (1) By the greatest number of hits on the targets.
- (2) By the greatest number of centres.
- (3) By the greatest number of 10's, 9's, 8's, &c.

9. All hits, including ricochets, to count.

10. The counting of the hits shall take place immediately after the shooting is finished, under the direction of the Committee of the National Rifle Association.

11. **Positions.**—*Standing.*—On both feet without any other support. *Kneeling.*—A cushion is allowed underneath the leg, but the knee and foot must touch the ground. *Lying.*—The competitor can place himself either in the direct line of fire or across, on the ground or on a mat or waterproof sheet, but the body must be supported on the elbows, and the fore-arms must not rest on the ground or mattress.

#### (d) INDIVIDUAL COMPETITION AT 300 METRES.

Limited to 12 individual entries from each territory having separate representation on the International Olympic Committee, or, where no such representation exists, any territory under one and the same sovereign jurisdiction.

Competitors participating must conform as to nationality with Articles 19 and 20 of the General Regulations.

1. **Rifles.** —Any.

2. **Sights.** —Fore-sight, open ; any kind of back-sight.

3. **Ammunition.** —Any, but it must not be of a dangerous character. In all cases of accident arising from defective ammunition, the user only shall be held responsible.

4. **Distance.** —300 metres.

5. **Target.** —The target to be white, 1 metre in diameter, with a black centre 0m·60 in diameter, the entire target to be divided into ten zones, counting from one to ten points. On the afternoon of the day before the competition targets will be available for practice in the three positions. The targets shall be stationary and shall be lowered and raised again after each series of ten shots. The hits shall be marked by a disc, and the points indicated, under the absolute control of the National Rifle Association.

6. **Number of Shots.** —Each competitor shall fire 120 shots (40 standing, 40 kneeling, and 40 lying down) in accordance with the positions laid down in rule 10.

Each series of ten shots must be completed without interruption. Ten sighting shots are allowed for each of the three positions.

7. The winner will be the one who has the highest aggregate number of points.

Ties will be decided :—

(1) By the greatest number of hits on the target.

(2) By the greatest number of centres.

(3) By the greatest number of 10's, 9's, 8's, &c.

8. All hits, including ricochets, to count.

9. The counting of the hits shall take place immediately after the shooting is finished, under the direction of the Committee of the National Rifle Association.

10. **Positions.** —*Standing.* —On both feet without any other support. *Kneeling.* —A cushion is allowed underneath the leg, but the knee and foot must touch the ground. *Lying.* —The competitor can place himself either in the direct line of fire or across, on the ground or on a mat or waterproof sheet, but the body must be supported on the elbows, and the fore-arms must not rest on the ground or mattress.

## II. MINIATURE RIFLE SHOOTING.

### (e) TEAM COMPETITION AT 50 AND 100 YARDS.

Open to one team from each territory having separate representation on the International Olympic Committee, or, where no such representation exists, any territory under one and the same sovereign jurisdiction.

*Rule 1.—Teams.*—Each team to consist of four men. Members of the teams participating must conform as to nationality with Articles 19 and 20 of the General Regulations.

*Rule 2.—Distances.*—50 and 100 yards (45·719 and 91·438 metres).

*Rule 3.—Targets (Stationary).—*

50 yards (45·719 metres).	Bull's-eye	1½ in. diam.	Scoring	5 points.
	Inner	3¾ „ „	„	4 „
	Magpie	6 „ „	„	3 „
	Outer	remainder of target 12 ins. diameter	„	2 „

(The inner is up to 3 ins. in diameter coloured black, and beyond that white. The inner is divided from the bull's-eye by a faint white line.)

100 yards (91·438 metres).	Bull's-eye	3 ins. diam.	Scoring	5 points.
	Inner	7½ „ „	„	4 „
	Magpie	12 „ „	„	3 „
	Outer	remainder of target 24 ins. diameter	„	2 „

(The inner is up to 6 ins. in diameter coloured black, and beyond that white. The inner is divided from the bull's-eye by a faint white line.)

(One inch equals 2·54 centimetres.)

*Rule 4.—Rifle.*—Any breech-loading rifle, shooting miniature ammunition of the class defined for the competition, except that the sights may be of any description other than magnifying or telescopic, and that they may be in any position.

*Rule 5.—Ammunition.*—The weight of the bullet must not exceed 140 grains (9,072 kilog.), and the observed velocity must not exceed 1,450 feet (442 metres) per second over 20 yards (18·288 metres) (energy equivalent 653 ft. lbs.). A hard metal base is prohibited.

*Rule 6.—No. of Shots.*—20 at 50 yards } with four sighters at each  
20 at 100 yards } distance.

*Rule 7.—*The centre of the shot-hole and not its edge will determine the value of the shot.

**(f) INDIVIDUAL COMPETITION AT 50 AND 100 YARDS.**

Limited to twelve individual entries from each territory having separate representation on the International Olympic Committee, or, where no such representation exists, any territory under one and the same sovereign jurisdiction.

Competitors participating must conform as to nationality with Articles 19 and 20 of the General Regulations.

1. **Rifle.** —Any breech-loading rifle, shooting miniature ammunition of the class defined for the competition, except that the sights may be of any description other than magnifying or telescopic, and that they may be in any position.

2. **Ammunition.** —The weight of the bullet must not exceed 140 grains (9,072 kilog.), and the observed velocity must not exceed 1,450 feet (442 metres) per second over 20 yards (18·288 metres) (energy equivalent 653 ft. lbs.). A hard metal base is prohibited.

3. **Distances.** —50 and 100 yards.

4. **Targets (Stationary).—**

50 yards.	Bull's-eye	$1\frac{1}{2}$ in. diam.	Scoring	5 points.
	Inner	$3\frac{3}{4}$ " "	"	4 "
	Magpie	6 " "	"	3 "
	Outer	remainder of target 12 ins. diameter	"	2 "

(The inner is up to 3 ins. in diameter coloured black, and beyond that white. The inner is divided from the bull's-eye by a faint white line.)

100 yards.	Bull's-eye	3 ins. diam.	Scoring	5 points.
	Inner	$7\frac{1}{2}$ " "	"	4 "
	Magpie	12 " "	"	3 "
	Outer	remainder of target 24 ins. diameter	"	2 "

(The inner is up to 6 ins. diameter coloured black, and beyond that white. The inner is divided from the bull's-eye by a faint white line.)

(One inch equals 2·54 centimetres.)

5. **No. of Shots.** —Forty at each distance, in series of ten, with four sighters at each distance.

6. The centre of the shot-hole and not its edge will determine the value of the shot.

**(g) INDIVIDUAL COMPETITION AT 25 YARDS.**

Limited to 12 individual entries from each territory having separate representation on the International Olympic Committee, or, where no such representation exists, any territory under one and the same sovereign jurisdiction.

Competitors participating must conform as to nationality with Articles 19 and 20 of the General Regulations.

1. **Rifle.**—Any breech-loading rifle, shooting miniature ammunition of the class defined for the competition, except that the sights may be of any description other than magnifying or telescopic and that they may be in any position.

2. **Ammunition.**—·22 or ·297/·230 calibre only.

3. **Distance.**—25 yards (22·86 metres).

4. **Target (Disappearing).**—Three-quarter length figure ; 4 ins. high and  $1\frac{1}{2}$  in. at widest part.

The target will appear 15 times, each time for three seconds with intervals, each of 5 seconds between the appearances.

5. **No. of Shots.**—2 sighters and 15 shots.

6. **Scoring.**—The upper two-thirds of figure will count 3 points. The lower one-third of figure will count 1 point.

7. The edge of the shot-hole will determine the value of the shot.

**(h) INDIVIDUAL COMPETITION AT 25 YARDS.**

Limited to 12 individual entries from each territory having separate representation on the International Olympic Committee, or, where no such representation exists, any territory under one and the same sovereign jurisdiction.

Competitors participating must conform as to nationality with Articles 19 and 20 of the General Regulations.

1. **Rifle.**—Any breech-loading rifle, shooting miniature ammunition of the class defined for the competition, except that the sights may be of any description other than magnifying or telescopic and that they may be in any position.

2. **Ammunition.**—·22 or ·297/·230 calibre only.

3. **Distance.**—25 yards.

4. **Target (Moving).**—Three-quarter length figure ; 4 ins. high ;  $1\frac{1}{2}$  in. at widest part.

Length of run, 10 feet ; time, 4 seconds.

5. **No. of Shots.** —Two sighters and 15 shots.

6. **Scoring.** — The upper two-thirds of figure will count 3 points. The lower one-third of figure will count 1 point.

7. The edge of the shot-hole will determine the value of the shot.

### III. REVOLVER AND PISTOL SHOOTING.

#### (i) TEAM COMPETITION.

Open to one team from each territory having separate representation on the International Olympic Committee, or, where no such representation exists, any territory under one and the same sovereign jurisdiction.

1. **Teams.**— Each team to consist of four men. Members of the teams participating must conform as to nationality with Articles 19 and 20 of the General Regulations.

2. **Weapon.**— Any Revolver or Pistol with open sights.

3. **Ammunition.**— Any with metal cartridge case.

4. **Distance.**— 50 yards.

5. **No. of Shots.**— Two sighters and 60 shots in 10 series of 6 shots each ; a fresh target will be provided for each series.

6. **Target.**— White, 0 m. 50 c. diameter; central black, 0 m. 20 c. The whole target is divided into ten equal zones counting from 1 to 10.

7. **Position.**— Standing ; right or left hand with arm extended.

8. On the afternoon of the day preceding the Match targets will be at the disposal of each Country for practice.

9. Two targets per Country to be drawn by lot the evening of the previous day.

10. The edge of the shot-hole will determine the value of the shot.

#### (j) INDIVIDUAL COMPETITION.

Limited to twelve individual entries from each territory having separate representation on the International Olympic Committee, or, where no such representation exists, any territory under one and the same sovereign jurisdiction.

Competitors participating must conform as to nationality with Articles 19 and 20 of the General Regulations.

1. **Weapon.**— Any revolver or pistol with open sights.
2. **Ammunition.**— Any with metal cartridge case.
3. **Distance.**— 50 yards.
4. **No. of Shots.**— Two sighters and sixty shots in ten series of six shots each. A fresh target will be provided for each series.
5. **Target.**— White, 0 m. 50 c. diameter ; central black, 0 m. 20 c. The whole target is divided into ten equal zones, counting from 1 to 10.
6. **Position.**— Standing; right or left hand, with arm extended.
7. On the afternoon of the day preceding the competition targets will be at the disposal of competitors for practice.
8. The edge of the shot-hole will determine the value of the shot.

## IV. RUNNING DEER SHOOTING.

### (k) TEAM COMPETITION.

Open to one team from each territory having separate representation on the International Olympic Committee, or, where no such representation exists, any territory under one and the same sovereign jurisdiction.

1. **Teams.**— Each team to consist of four men. Members of the team participating must conform as to nationality with Articles 19 and 20 of the General Regulations.

2. **Rifle.**— Any single, double, or repeating rifle (whether of Government pattern or not) complying with the following conditions :—

*Calibre.*—Any.

*Pull of Trigger.*—Minimum, 3 pounds.

*Sights.*— Open sights.

No lateral adjustment of fore- or back-sight will be permitted. The centres of both sights must be fixed over the centre of the barrel. If a platinum or other line is used on the back-sight, only one such line is permitted. Spirit levels are allowed.

3. **Ammunition.**— Any.



4. **Distance.**—110 yards=99 metres.
5. **Target.**—Running Deer Bull's-eye 6 ins. diam. Scoring 4 points,  
 Inner 12 " " " 3 "  
 Magpie 18 " " " 2 "  
 Outer rest of target,  
 except haunch " 1 point.

Length of run, 75 feet; time, about 4 seconds. The colour of the target is " Khaki."

6. **Number of Shots.**—Two sighting shots and 10 shots, one at each run.

7. **Position.**—Any.

8. The runs of the target will commence after signal from the firing point, which will be given when the competitor is ready to commence. This signal will be given by the Umpire, who shall first caution the competitor that he is about to do so.

9. The first run of the target, whether for sighting shots or competition, will be towards the Clock Tower. The intervals between the subsequent runs will only be of such duration as may be required in the butt to signal the result of the shot and to patch and turn the target.

10. The rifle must not be raised to the shoulder before the target appears from behind the screen.

11. Posts are placed near each end of the run, and no part of the target is to be outside either post when a shot is fired.

#### (l) INDIVIDUAL COMPETITION—SINGLE SHOT.

Limited to twelve individual entries from each territory having separate representation on the International Olympic Committee, or, where no such representation exists, any territory under one and the same sovereign jurisdiction.

Competitors participating must conform as to nationality with Articles 19 and 20 of the General Regulations.

1. **Rifle.**—Any single, double, or repeating rifle (whether of Government pattern or not) complying with the following conditions:—

*Calibre.*—Any.

*Pull of Trigger.*—Minimum, 3 pounds,

*Sights.*—Open sights,

No lateral adjustment of fore- or back-sight will be permitted. The centres of both sights must be fixed over the centre of the barrel. If a platinum or other line is used on the back-sight, only one such line is permitted.

Spirit levels are allowed.

2. **Ammunition.**—Any.

3. **Distance.**—110 yards=99 metres,

4. **Target.**—Running Deer.—Bull's-eye 6 ins. diam. Scoring 4 points

Inner 12 „ „ „ 3 „

Magpie 18 „ „ „ 2 „

Outer rest of target,  
except haunch „ 1 point.

Length of run, 75 feet; time, about 4 seconds. The colour of the target is "Khaki."

5. **No. of Shots.**—Two sighting shots and ten shots, one at each run.

6. **Position.**—Any.

7. The runs of the target will commence after signal from the firing point, which will be given when the competitor is ready to commence. This signal will be given by the Umpire, who shall first caution the competitor that he is about to do so.

8. The first run of the target, whether for sighting shots or competition, will be towards the Clock Tower. The intervals between the subsequent runs will only be of such duration as may be required in the butt to signal the result of the shot and to patch and turn the target.

9. The rifle must not be raised to the shoulder before the target appears from behind the screen.

10. Posts are placed near each end of the run, and no part of the target is to be outside either post when a shot is fired.

#### (m) INDIVIDUAL COMPETITION — DOUBLE SHOT.

Limited to twelve individual entries from each territory having separate representation on the International Olympic Committee, or, where no such representation exists, any territory under one and the same sovereign jurisdiction.

Competitors participating must conform as to nationality with Articles 19 and 20 of the General Regulations.

1. **Rifle.**—Any single, double, or repeating rifle (whether of Govern - ment pattern or not) complying with the following conditions :—

*Calibre*— Any.

*Pull of Trigger*— Minimum, 3 pounds.

*Sights*— Open sights.

No lateral adjustment of fore- or back-sight will be permitted. The centres of both sights must be fixed over the centre of the barrel. If a platinum or other line is used on the back-sight, only one such line is permitted.

Spirit levels are allowed.

2. **Ammunition.**— Any.

3. **Distance.**— 110 yards (100·382 metres).

4. **Target.**— Running Deer.—Bull's-eye 6 ins. diam. Scoring 4 points.

Inner 12 ,, ,, ,, 3 ,,

Magpie 18 ,, ,, ,, 2 ,,

Outer rest of target,  
except haunch,, 1 point.

Length of run 75 feet ; time, about 4 seconds. The colour of the target is “Khaki.”

5. **No. of Shots.** —Two sighting shots and twenty shots, two at each run.

6. **Position.** —Any.

7. The runs of the target will commence after signal from the firing point, which will be given when the competitor is ready to commence. Should there be any undue delay on the part of the competitor in getting ready to commence, this signal will be given by the Range Officer, who shall first caution the competitor that he is about to do so.

8. The first run of the target, whether for sighting shots or competition, will be towards the Clock Tower. The intervals between the subsequent runs will only be of such duration as may be required in the butt to signal the result of the shot and to patch and turn the target.

9. The rifle must not be raised to the shoulder before the target appears from behind the screen.

10. Posts are placed near each end of the run, and no part of the target is to be outside either post when a shot is fired.

# CLAY BIRD SHOOTING.

---

---

## P R O G R A M M E .

---

### ORDER OF SHOOTING.

---

#### FIRST STAGE.

**1. Individual Competition.** (First Stage.)

Each competitor shoots at thirty birds, in two rounds of fifteen.

**2. Team Competition.** (First Stage.)

Teams shoot at thirty birds per man, in three rounds of ten.

#### SECOND STAGE.

Fifty per cent. of the original competitors retire.

**3. Individual Competition.** (Second Stage.)

Each competitor shoots at twenty birds, in two rounds of ten.

**4. Team Competition.** (Second Stage.)

Each team shoots at twenty birds per man, in two rounds of ten.

Thereafter five birds per man are fired at from unknown traps.

#### THIRD AND FINAL STAGE.

Half the competitors in the Second Stage qualify for the Third Stage.

**5. Individual Competition** (Third Stage.)

Each competitor shoots at twenty birds in two rounds of ten birds.

Thereafter ten birds per man are fired at from unknown traps.

**6. Team Competition.** (Third Stage.)

Each team shoots at forty birds per man, in two rounds of twenty birds. Thereafter ten birds per man are fired at from unknown traps.

## PROGRAMME, RULES AND CONDITIONS OF COMPETITION.

---



---

### AMATEUR DEFINITION.

Any person who shoots or has shot in public as a means of livelihood, or who engages or has engaged in the teaching of shooting as a means of livelihood, or who has shot in any competition open only to professional shooters, shall be deemed a professional shooter.

### ELIGIBILITY CONDITIONS.

Individual competitors will be required to sign the declaration appended to entry forms vouching for their own amateur status. Captains of teams will be required in like manner to vouch for the amateur status of all the members of the teams they enter. The governing bodies of clay bird shooting will in all countries where such bodies exist satisfy themselves as to the amateur status of competitors entering under their auspices. On any question concerning amateur status, the decision of the British Olympic Council will be final.

### GENERAL REGULATIONS.

#### 1. Eligibility of Competitors.

- (a) All competitors must be amateurs.
- (b) Individual shooters of any nationality are eligible to compete, but the maximum number to represent any country is limited to twelve.
- (c) Individual members of teams shall be *bonâ fide* subjects of the country in the name of which they compete.
- (d) Two teams of six shooting members each may be entered to represent a country. Each team may have three reserves, of whom the captain may be one. Captains of teams are not necessarily required to shoot. Reserves cannot under any circumstances whatever be substituted for shooting members after the commencement of the competitions.
- (e) No individual may shoot in more than one team.

2. **Entries** will be made in accordance with the General Regulations of the IV. Olympiad, 1908.

3. **Arrangement of Traps.** — Three traps shall be arranged behind each mark, and there shall be five marks in all. The three traps behind each mark shall throw in different directions, and the shooters shall be kept in ignorance of the particular bird they are to have from any one mark.

4. **Gun.** —No gun of larger calibre than 12 gauge shall be used.

5. **Cartridges.** —Any length of case, and any powder may be used, but the charge of shot must not exceed one and one-eighth ounces by weight (soft or chilled) and no shot larger than No. 6 may be used.

6. **Disqualifying for Excess of Shot.** — The British Olympic Council reserve the right to, and will occasionally, select two cartridges from a competitor when on the line in order to test the same for proper loading, viz., not exceeding one and one-eighth ounces of shot of a size not larger than No. 6. Any competitor disqualified by reason of using an excess of shot will not be permitted to shoot again during the meeting.

7. **Disqualifying for Lateness.** — Any shooter being absent when his team is called upon to shoot shall be disqualified from the competition.

8. **Guns open at the Breech.** — All guns must be open at the breech until the referee, having satisfied himself that the shooters are in their places, calls "line ready."

9. **Unauthorised Discharge of Guns.** — A shooter who, from any cause whatever, shall discharge his gun otherwise than in accordance with the regulations shall be excluded from taking part in any further competition.

10. Competitors must make themselves acquainted with the General Regulations, and also with the Special Conditions applicable to any particular competition, as any infringement of the regulations or conditions renders the competitor liable to disqualification.

## TEAM COMPETITION.

### CONDITIONS.—TO BE SHOT IN THREE STAGES.

**First Stage.**— To be shot at thirty birds, each shooter at known traps and unknown angles on the continuous fire system, in three rounds of ten birds each shooter.

The order in which the teams shall shoot will be determined by lot.

Two teams, or if necessary three teams, will shoot together, each unit completing a round of ten shots alternately. The First Stage will thus constitute a series of matches. Ties to be shot off at ten birds each shooter.

**Second Stage.**— The teams, in the nearest proportion of half the original number, making the highest scores in the First Stage will shoot in the Second Stage.

To be shot at twenty birds, each shooter at known traps and unknown angles, on the continuous fire system, in two rounds of ten birds each, and five birds at unknown traps and unknown angles on the single fire principle. Competitors stand at No. 2 mark for five birds from Nos. 1, 2 and 3 traps, or at No. 4 mark for five birds from Nos. 3, 4 and 5 traps.

The teams will shoot in pairs, as determined by the original draw. Ties to be shot off at ten birds each shooter on the continuous fire system.

**Third and Final Stage.**— The teams, to the number of half those competing in the Second Stage, with the highest aggregate scores in the First and Second Stages will compete in the Final Stage.

To be shot at forty birds, each shooter at known traps and unknown angles on the team system, in two rounds of twenty birds each, and ten birds at unknown traps and angles on the single fire principle, the shooter standing at No. 3 mark. Ties to be shot off at ten birds each shooter on the single fire principle.

The winner of the match of the Third Stage will be the team making the highest score.

To each member of the team making the highest aggregate score in the three stages, and winning the Team Competition, a gold medal will be presented.

## INDIVIDUAL COMPETITION.

### TO BE SHOT IN THREE STAGES.

**First Stage.** — To be shot at thirty birds each shooter at known traps and unknown angles on the continuous fire system, in two rounds of fifteen birds each shooter. Ties to be shot off at ten birds each shooter if necessary.

**Second Stage.** — The competitors, in the nearest proportion of half the original number, making the highest scores in the First Stage will shoot in the Second Stage.

To be shot at twenty birds each shooter at known traps and unknown angles on the continuous fire system, in two rounds of ten birds each shooter. Ties to be shot off at ten birds each shooter if necessary.

**Third and Final Stage.** — The competitors, to the number of half those competing in the Second Stage, with the highest aggregate in the First and Second Stage will shoot in the Final Stage.

To be shot at twenty birds each shooter at known traps and unknown angles on the continuous fire system in two rounds of ten birds each, and ten birds at unknown traps and angles. Competitors stand at No. 2 mark for five birds from Nos. 1, 2, and 3 traps, and at No. 4 mark for five birds from Nos. 3, 4, and 5 traps. Ties to be shot off at ten birds each shooter at known traps and unknown angles on the continuous fire principle.

A gold medal will be awarded to the competitor making the highest aggregate score in the three stages and winning the Individual Competition.

## GENERAL SHOOTING RULES.

1. **Arrangement of Firing Marks.** — There shall be five firing marks, five yards apart, and shooters shall stand at not less than eighteen yards from the traps. The marks shall be numbered 1, 2, 3, 4 and 5, No. 1 being on the extreme left and No. 5 on the extreme right.

2. **Double Discharge of a Gun.** — If a shooter, in firing at a bird, shall let off both barrels practically at once and kill his bird, that bird shall be scored a “no-bird,” and if he misses the bird shall be scored a miss.

3. **Referee.** — A referee shall be appointed to judge all matches, and his decision shall be final.

4. **Referee’s Duties.**— The Referee shall see that the traps are properly set, and he shall also see that all due precautions are taken for the safety of the trappers, shooters and others.

5. **“No-Birds” from Fault of Throwing.** — A shooter may refuse a “no-bird ” if thrown broken from the trap, or if it be not fairly thrown ; but a shooter who takes a bird or part of a bird shall be bound by the result.

6. **“No-Birds” if extra ones accidentally thrown.**— In cases where a bird or birds are accidentally released so as to be flying in the air at the same time as the bird or birds at which the shooter is required to fire, the shooter may elect to treat it as a “no-bird.”

7. **“No-Birds” from fault of Gun, &c.** — If the shooter’s gun, being properly loaded and cocked, fails to fire from any cause whatever, excepting through the fault of the shooter, the bird shall be counted a “no-bird.” If the gun misses fire with the first barrel and the shooter fires the second and “breaks,” the shot shall be scored a “kill” ; but if



he fires the second and misses it shall be scored a "miss" ; and if he does not fire the second it shall be a "no-bird." If the gun misses fire with the second barrel the shooter shall be allowed another bird, using a cartridge primed and loaded with powder, but without a charge of shot, in the first barrel and a loaded cartridge in the second barrel : and he shall pull the trigger of the first barrel after the trap has been released. In the event of a shooter using a gun in which it is necessary to fire a fully-loaded cartridge to operate mechanism for firing the second cartridge (as in the case of a single barrel automatic gun), should the gun either jam when extracting the first cartridge or miss-fire with the second cartridge, the shooter shall be allowed two more cartridges, and shall fire the first in the air, wide of the bird, after the trap has been released, and the second at the bird. In the event of the bird being killed with the first cartridge a miss shall be scored.

8. "Kills." — A bird to be scored a "kill" must have a piece visibly broken from it whilst in the air. The referee shall be the sole judge as to whether the bird is broken, and any person impugning his decision shall be disqualified from the current competition. No bird shall under any circumstances be retrieved for examination.

### SPECIAL RULES FOR CONTINUOUS FIRE.

9. **Position of Shooters.**— There shall be six shooters for the five marks. Five shooters shall occupy the five marks, and No. 6 shooter shall stand behind No. 1, waiting his turn. No. 1 shooter shall fire first from No. 1 mark, No. 2 shooter from No. 2 mark, and so on in rotation down the line. At, or during the completion of the round, No. 1 shall take the place of No. 2, and No. 6 shall occupy No. 1 mark, No. 2 shall occupy No. 3 mark, and so on, No. 5 becoming the shooter in waiting behind No. 1 mark. No man shall leave his mark till the round is completed.

10. "No. 1" "Pull." — When the shooters are at the mark, the puller shall call No. 1, and the first shooter shall then call "pull," and the other shooters on the line shall call "pull" in the order of their turn to fire on the number of their trap being called by the puller.

11. **Firing out of Turn.** — If a shooter fires out of turn he shall be scored a miss, and the shooter due to fire shall shoot again, the bird being a no-bird notwithstanding Rule 5.

12. **Unknown Angles.** — When the traps are set to throw at unknown angles and there are two or more traps behind each screen, the puller should be informed by some suitable means which trap behind each screen he is to pull, so that the shooter shall be kept in ignorance of the angle at which his bird will be thrown.

SPECIAL RULES FOR SINGLE FIRE  
COMPETITIONS AT UNKNOWN TRAPS.

13. **Position of Shooter.**—The shooter shall stand at the centre mark and fire at his birds before leaving the line.

14. **"Ready," "Pull."**—When the shooter is at the mark, and prepared to fire, the puller shall call "ready," and the shooter shall then call "pull."

15. **Two Shooters on the Line.**—Instead of one shooter at the centre mark, two shooters may stand on the line at one time, one at No. 2 mark, for the groups of traps one, two and three; and the other at No. 4 mark, for the groups three, four and five.

16. **Order of Releasing Traps.**—All the traps shall be filled before the shooter commences to shoot. The indicator, in addition to showing the group of traps, shows which of the traps in each position to release. The indicator shall be readjusted for each competitor, and shall be capable of producing a sufficient number of combinations to render it impossible for the competitor to know beforehand which traps will be released. In the event of a no-bird being thrown, the trap throwing it shall be at once refilled, and the indicator readjusted.

17. **Regulations Generally.**—In regard to matters of detail, not specifically referred to in the foregoing paragraphs, the shooting will be conducted under the shooting rules of the Clay Bird Shooting Association.

# SKATING.

---

## P R O G R A M M E .

	Maximum No. of Competitors from each Country
<b>1. Gentlemen's Figure Skating</b> Competition	<b>3</b>
<b>2. Ladies' Figure Skating</b> Competition ...	<b>3</b>
<b>3. Pair Skating</b> Competition (Lady and Gentleman)	<b>3 pairs</b>
<b>4. Gentlemen's Special Figure Skating</b> Competition ... ..	<b>3</b>

## PROGRAMME AND REGULATIONS FOR SKATING.

*In regard to entries, prizes, etc., see the General Regulations of the  
Olympic Games.*

---

The Skating Competitions to be decided at the Olympic Games, 1908, will consist of the following events :—

### I. GENTLEMEN'S FIGURE SKATING.

1. **Compulsory Figures.**— From the Schedule to the Regulations of the International Skating Union, which is set out at the end of these Regulations :

<i>Three</i> :—	Maximum Points.
No. 8a. Rfo, Lbi ... ..	12
No. 8b. Lfo, Rbi ... ..	12
<i>One Foot Eight</i> :—	
No. 25a. Rboi ... ..	18
No. 25b. Lboi ... ..	18
<i>Rocker</i> :—	
No. 20a. Rfo ... ..	18
No. 20b. Lfo ... ..	18
<i>Counter</i> :—	
No. 23a. Rfi ... ..	18
No. 23b. Lfi ... ..	18
<i>Double Three—Change—Double Three</i> :—	
No. 36a. Rfo ... ..	18
No. 36b. Lfo ... ..	18
<i>Loop—Change—Loop</i> :—	
No. 38a. Rfo ... ..	24
No. 38b. Lfo ... ..	24
<i>Bracket—Change—Bracket</i> :—	
No. 40a. Rfo... ..	24
No. 40b. Lfo... ..	24

2. **Free Skating** of five minutes' duration.

Total highest possible points for Compulsory Figures=264 ; for Free Skating=168 (Factor 14). Total for Compulsory Figures and Free Skating=432.

## II. LADIES' FIGURE SKATING.

### 1. Compulsory Figures :—

<i>One Foot Eight</i> :—					Maximum Points.
No. 24a.	Rfoi	...	...	...	12
No. 24b.	Lfoi	...	...	...	12
<i>Bracket</i> :—					
No. 18a.	Rfo...	...	...	...	18
No. 18b.	Lfo...	...	...	...	18
<i>Change—Loop</i> :—					
No. 31a.	Rbo	...	...	...	18
No. 31b.	Lbo	...	...	...	18
<i>Double Three</i> :—					
No. 13.	Rbi ...	...	...	...	12
<i>Counter</i> :—					
No. 22a.	Rfo...	...	...	...	12
No. 22b.	Lfo...	...	...	...	12
<i>Three—Change—Three</i> :—					
No. 34a.	Rfo...	...	...	...	18
No. 34b.	Lfo...	...	...	...	18

### 2. Free Skating of four minutes' duration.

Total highest possible points for Compulsory Figures=168 ; for Free Skating=108 (Factor 9). Total for Compulsory Figures and Free Skating=276.

## III. PAIR SKATING (Lady and Gentleman).

Of five minutes' duration.

## IV. GENTLEMEN'S SPECIAL FIGURE SKATING.

Four Voluntary Figures.

1. Each country will be allowed to enter not more than three competitors for each individual event, and three pairs for event III. Any country may, however, nominate one reserve competitor in each of events I., II., and IV., and one reserve pair for event III.

2. The competitions will commence on or about October 29, 1908, at the Prince's Skating Club Rink, Knightsbridge, London. The ice area

of the rink is 200 feet by 52 feet. The rink will be open for practice of the competitors about three weeks before the commencement of the competition.

3. The entries close on September 21, 1908, but the British Olympic Committee may in its absolute discretion accept an entry after this date.

4. The Competitions will be held on the basis of the Regulations laid down by the International Skating Union, and under the management of the National Skating Association of Great Britain, which shall appoint all the officials.

5. A skater is not recognised as an Amateur if he has since January 1, 1893—

- (a) practised in his own person any sporting bodily exercise as a means of gain (gymnastic and fencing instructors excepted) ;
- (b) practised or taught skating for money (the bare repayment of hotel and travelling expenses by his own Club or Association, or by the Club or Association holding a competition and through his own Club or Association, excepted) ;
- (c) sold or pledged prizes won in sporting competitions ;
- (d) knowingly and without protest started in an open skating competition against a competitor who is not an Amateur according to these Regulations.

6. The entries must include :

- (a) the designation of the competition,
- (b) the name of the Club or Association making the entry,
- (c) the name of the competitor,
- (d) a certificate of amateur status from the Club or Association making the entry.

7. The following officials will be nominated by the National Skating Association of Great Britain :—

A Referee, an uneven number of recognised Judges of the International Skating Union, not less than five, and the necessary Course-keepers.

8. The Referee decides on all protests which may occur, and other matters of dispute ; he is empowered to decide also on any breaches of rules which may occur, without a protest having been raised, and if

necessary to exclude individuals from the competition. From his decisions there is no appeal.

9. The Referee decides whether the condition of the ice allows of the holding of a competition.

10. The competitors are bound to submit themselves in every respect to the orders of the Referee and Course-keepers.

11. A fall is no bar to a win in any branch. Personal accidents which arise through fault of the skater cannot be taken into consideration by the judges.

A skater who is interfered with, not by his own fault, may be allowed by the Referee to begin again the figure in question.

12. The British Olympic Council undertakes no sort of responsibility for risks run by the skaters.

13. Results of the competitions are to be made known at latest on the day after the conclusion of the competitions.

14. The **Individual Figure Skating** is divided into (a) the skating of prescribed exercises (compulsory figures) and (b) the skating of optional figures up to a maximum number of successive minutes (free skating). The adjudication of the prizes follows from the whole number of marks attained in both divisions. Entries are not permitted for one division only.

The compulsory figures will be skated, if possible, at some other time of day than the free figures, in any case before them ; if possible, on the same or the preceding day.

15. **Pair Skating** consists of free figures only.

16. The **Special Figure Skating** consists of individual skating of voluntary special figures of the number specified in the programme. For the purpose of enabling the judges to consider beforehand the merits of the figures, competitors must forward to the British Olympic Committee, at least one week before the date of the commencement of the competitions, a list of the figures they intend to skate with drawings showing the figures and the edges. Alternative figures not exceeding two in number may be sent in, but the actual figures selected for skating must be specified at latest the day before the competition.

17. The judges will mark independently of one another, each on a table of the character appended to these Regulations.

## COMPULSORY FIGURES.

18. Figures which begin (a) Right and (b) Left, are to be skated in both forms (a) and (b).

19. All competitors skate the same figure, after it has been announced, one after the other as his name is called, in the order of the starting numbers, as drawn by lot.

After each figure, the order is so far changed that the competitor, who before was first has the last place. An exception to this may be made when only two competitors start, but only with the consent of both. Every competitor has to begin his figure at latest two minutes after his name has been called, otherwise the figure will be marked to him as "not skated."

20. Every compulsory figure can only be begun "from rest," that is, by a single stroke off the other foot (free foot); the commencement must be made at the crossing-point of the eight. The change from one foot to the other must be made without pause by putting down the free, now tracing, foot, and a simple stroke with the lately tracing, now free, foot. Every figure must be repeated three times, both on the right and left foot ; the repetition follows without pause, as above.

21. The success of every compulsory figure is marked with the numbers 0, 1, 2, 3, 4, 5, 6 ; of which 0 = "not skated," 2 = "pass," 4 = "good," 6 = "faultless" ; 1, 3, and 5 are intermediate values. Half points are also allowed as intermediate values. In assigning a mark, there ranks, in the first place, correct tracing on the ice; in the second, carriage and movement; in the third, size of figure; in the fourth, approximately accurate covering of the traces in the triple repetition. These four points of view count as of descending importance in the foregoing order.

22. As rules for correct tracing are to be regarded :—*maintenance of the long and transverse axes* in the triple repetition (as long axis of the eight a line is to be conceived, which passes longitudinally through the middle of the eight, dividing it right and left into two equal halves; the transverse axis passes at right angles to the long axis through the middle of the eight); *approximately equal size* of the first and second halves of the eight, divided by the transverse axis; *symmetrical grouping* of the individual parts of the figure about the axis; *Curves* without sub-curves, skated out to the end, that is, returning nearly to the starting-point; *Threes* with their points in the long axis, second curve approximately of the same size as the first; *Double Threes* with the central curve cutting the



long axis at right angles, the three curves of nearly equal size; *Loops* longer than broad, without sharp angle, with their long axis lying in the long axis of the eight, second curve approximately of the same size as the first; *Changes* with an easy transition, the change falling in the (long) axis; when skated out to a full eight, the change of edge coming near the starting-point of the first curve, second curve returning to the same point, approximately of the same size as the first; *Rockers* and *Counters* without change of edge, the turn near the axis; *Brackets* without change of edge before and after the turn, turn on the axis, first and second curves approximately of equal size.

23. As rules of correct carriage and movement in skating the compulsory figures (within which rules the individuality of the skater receives free play and all possible consideration on the part of the judges) are to be regarded :—

Upright carriage, not bent at the hips, but without being stiff. Strong bending of knee or body to be only momentary; head upright. Free foot to be held only a little way from the ice, not dragging behind; toe turned downwards and outwards, knee slightly bent, generally held behind the tracing foot; otherwise swinging freely and assisting the movement, but without being held far away. Arms to hang down, easily; like the free foot, they can be used to assist by their movement, but without raising elbow or hand far away from the body; hands, when possible, never above the waist. Fingers never spread nor clenched. In general everything violent, angular, or stiff to be avoided in the movement; no effort is to be strongly expressed, but the impression that the figures are executed without trouble is to be aimed at.

## FREE SKATING.

24. In the Free skating (alike in Individual and Pair skating), the competitors follow one another in the order of starting numbers as drawn by lot. Each begins at a signal given to him by dropping a flag, from which the period of time placed at his disposal is reckoned. Every minute gone is announced to the skater by the call, One, Two, etc., and by putting up the corresponding number.

25. The free skating (including pair skating) is marked (*a*) for the contents of the programme performed (difficulty and variety); (*b*) for the manner of performance (harmonious composition, sureness, carriage and

movement, etc.); in each case with the numbers 0 to 6 with the same significance as in the compulsory figures.

In pair skating accurate timing by the skaters is specially to be considered in addition under (b).

### SPECIAL FIGURES.

26. In Special Figure skating the competitors follow one another in the order of starting numbers as drawn by lot.

Each figure will be marked (a) for difficulty and novelty, (b) for the manner of performance (sureness, carriage and movement, etc.); in each case with the numbers 0 to 6 with the same significance as in the compulsory figures.

### DETERMINATION OF THE RESULT.

27. In individual skating on each marking card, in every compulsory figure, the mark given is multiplied by the factor of value which belongs to the figure in question in proportion to its difficulty, and taken from the appended diagrams of compulsory figures. The total sum of these products on each marking card for each skater individually gives the number of points for compulsory figures which he has earned with the individual judge.

The marks given for free figures under (a) and (b) are added, and the sum multiplied by the factor stated in the programme; the product is the number of points for free figures. This factor is arranged so that the highest possible points for free figures amount to about, but not more than, two-thirds of the highest possible for compulsory figures.

The number of points for free figures plus the number of points for compulsory figures gives for each skater individually the total number of points which he has earned from the individual judge.

28. Each judge has to arrange the skaters in order, according to the total number of points given on his marking card, so that the skater with the highest number of points receives the ordinal number 1, the next the ordinal number 2, etc. If two or more skaters are equal in the total points on the marking card, the highest number of points for compulsory figures decides between them.

The winner is he who is placed first by an absolute majority of judges. If no one has an absolute majority for him, the final result is obtained by

adding the ordinal numbers assigned by the individual judges. If two or more competitors are alike in the sum of the ordinal numbers, then the sum of the total number of points on the individual cards decides between them; if this leads to no decision, then the sum of the points for compulsory figures only is to decide the question.

29. In pair skating, the marks given for free skating under (a) and (b) are added, and the place-number on each separate marking card determined by their sum.

That pair is the winner which is set in the first place by an absolute majority of the judges. If none obtain an absolute majority, the result is determined by the sum of the place-numbers. If two or more competitors are equal in the sum of place-numbers, the sum of the points received decides; if no final result then appears, the highest sum of points for the manner of performance decides.

30. In the special figure skating the marks given under (a) and (b) are added, and the place-number in each separate marking card determined by their sum. That competitor is the winner who is placed first by an absolute majority of the judges. If none obtain an absolute majority, the result is determined by the sum of the place-numbers; if two or more competitors are equal in the sum of the place-numbers, the sum of the points received decides; if no final result then appears, the highest number of points under (a) decides.

31. Of the results, there will be published at least the total number of points for compulsory figures, and for free figures and special figures, from every card, as well as the final numbers resulting from them.

32. Points for which provision is not made by the above Rules or by the General Regulations of the Olympiad of London will be settled according to the Regulations of the International Skating Union.



Figure.	No.	Description.	Value.
<b>BRACKET.</b>			
	18a.	RfoBbi—LbiBfo ... .. 3	3
	b.	LfoBbi—RbiBfo ... .. 3	3
	19a.	RfiBbo—LboBfi ... .. 3	3
	b.	LfiBbo—RboBfi ... .. 3	3
<b>ROCKER.</b>			
	20a.	RfoRKbo—LboRKfo ... .. 3	3
	b.	LfoRKbo—RboRKfo ... .. 3	3
	21a.	RfiRKbi—LbiRKfi ... .. 4	4
	b.	LfiRKbi—RbiRKfi ... .. 4	4
<b>COUNTER.</b>			
	22a.	RfoCbo—LboCfo ... .. 2	2
	b.	LfoCbo—RboCfo ... .. 2	2
	23a.	RfiCbi—LbiCfi ... .. 3	3
	b.	LfiCbi—RbiCfi ... .. 3	3
<b>ONE-FOOT EIGHT.</b>			
	24a.	Rfoi—Lfoi ... .. 2	2
	b.	Lfoi—Rfoi ... .. 2	2
	25a.	Rboi—Lboi ... .. 3	3
	b.	Lboi—Rboi ... .. 3	3
<b>CHANGE—THREE.</b>			
	26a.	RfoiTbo—LboiTfo ... .. 2	2
	b.	LfoiTbo—RboiTfo ... .. 2	2
	27a.	RfioTbi—LbioTfi ... .. 3	3
	b.	LfioTbi—RbioTfi ... .. 3	3
<b>CHANGE—DOUBLE THREE.</b>			
	28a.	RfoiTboTfi—LfioTbiTfo ... .. 1	1
	b.	LfoiTboTfi—RfioTbiTfo ... .. 1	1
	29a.	RboiTfoTbi—LbioTfiTbo ... .. 3	3
	b.	LboiTfoTbi—RbioTfiTbo ... .. 3	3

Figure.	No.	Description.	Value.
CHANGE—LOOP.			
	30a.	RfoLPfi—LfiLPfo ... .. 2	2
	b.	LfoLPfi—RfiLPfo ... .. 2	2
	31a.	RboiLPbi—LbioLPbo ... .. 3	3
	b.	LhoiLPbi—RbioLPbo ... .. 3	3
CHANGE—BRACKET.			
	32a.	RfoiBbo—LboiBfo ... .. 3	3
	b.	LfoiBbo—RboiBfo ... .. 3	3
	33a.	RfioBbi—LbioBfi ... .. 3	3
	b.	LfioBbi—RbioBfi ... .. 3	3
THREE—CHANGE—THREE.			
	34a.	RfoTbioTfi—LfiTboiTfo ... .. 3	3
	b.	LfoTbioTfi—RfiTboiTfo ... .. 3	3
	35a.	RboTfioTbi—LbiTfoiTbo ... .. 3	3
	b.	LboTfioTbi—RbiTfoiTbo ... .. 3	3
DOUBLE THREE—CHANGE—DOUBLE THREE.			
	36a.	RfoTbiTfoiTboTfi—LfiTboTfioTbiTfo ... .. 3	3
	b.	LfoTbiTfoiTboTfi—RfiTboTfioTbiTfo ... .. 3	3
	37a.	RboTfiTboiTfoTbi—LbiTfoTbioTfiTbo ... .. 4	4
	b.	LboTfiTboiTfoTbi—RbiTfoTbioTfiTbo ... .. 4	4
LOOP—CHANGE—LOOP.			
	38a.	RfoLPfoiLPfi—LfiLPfioLPfo ... .. 4	4
	b.	LfoLPfoiLPfi—RfiLPfioLPfo ... .. 4	4
	39a.	RboLPboiLPbi—LbiLPbioLPbo ... .. 5	5
	b.	LboLPboiLPbi—RbiLPbioLPbo ... .. 5	5
BRACKET—CHANGE—BRACKET.			
	40a.	RfoBbioBfi—LfiBboiBfo ... .. 4	4
	b.	LfoBbioBfi—RfiBboiBfo ... .. 4	4
	41a.	RboBfioBbi—LbiBfoiBbo ... .. 4	4
	b.	LboBfioBbi—RbiBfoiBbo ... .. 4	4

B.—MARKING CARD.

I. COMPULSORY FIGURES.				Starting Numbers and Names.									
Figure.	Number.	Description.	Value.	1		2		3		4		5	
				Mark.	Points.	Mark.	Points.	Mark.	Points.	Mark.	Points.	Mark.	Points.
Total Points for Compulsory Figs. (Highest possible points .....				x	.	x	.	x	.	x	.	x	.
II. FREE SKATING.													
(a) For the contents of the Programme - - -				.	x	.	x	.	x	.	x	.	x
(b) For the manner of its performance - - -				.	x	.	x	.	x	.	x	.	x
Sum of (a) + (b) - - -				.	x	.	x	.	x	.	x	.	x
Multiplied by the factor .....													
Total Points for Free Skating (Highest possible points.....)				x	.	x	.	x	.	x	.	x	.
Total Points for Compulsory and Free Skating - - -													
Serial Number of each Skater													

Marking by the figures 0 to 6 ; of which 0 = failed, 2 = passed, 4 = good, 6 - faultless ;  $\frac{1}{2}$ , 1,  $1\frac{1}{2}$ ,  $2\frac{1}{2}$ , 3,  $3\frac{1}{2}$ ,  $4\frac{1}{2}$ , 5,  $5\frac{1}{2}$  represent intermediate grades.

# SWIMMING, DIVING, AND WATER POLO.

---

## P R O G R A M M E .

<b>100 metres</b>	(109·3 yards)	...	...	...	...	...	<b>12</b>
<b>400 metres</b>	(437·2 yards)	...	...	...	...	...	<b>12</b>
<b>1,500 metres</b>	(1,639·5 yards)	...	...	...	...	...	<b>12</b>
<b>High Diving</b>	...	...	...	...	...	...	<b>12</b>
<b>Fancy Diving</b>	...	...	...	...	...	...	<b>12</b>
<b>200 metres Team Race (Teams of 4)</b>	(218·6						
yards)	...	...	...	...	...	...	<b>1 team</b>
<b>200 metres Breast Stroke</b>	(218·6 yards)	...	...	...	...	...	<b>12</b>
<b>100 metres Back Stroke</b>	(109·3 yards)	...	...	...	...	...	<b>12</b>
<b>Water Polo (Teams of 7)</b>	...	...	...	...	...	...	<b>1 team</b>



## PROGRAMME, RULES AND CONDITIONS OF COMPETITION.

---

1. The Swimming, Diving, and Water Polo Competitions to be decided at the Olympic Games, 1908, shall consist of :—

- (a) 100 metres, any stroke or free swimming (109·3 yards).
- (b) 400 " " " " " (437·2 yards).
- (c) 1500 " " " " " (1,639·5 yards).
- (d) Team Race, four competitors in each team, and each competitor to swim 200 metres (218·6 yards), free swimming.
- (e) 200 metres, Breast stroke (218·6 yards).
- (f) 100 metres, Back stroke (109·3 yards).
- (g) Variety High Diving from firm diving base or take-off.
- (h) Variety Diving from Spring Boards.
- (k) Water Polo (teams of 7).

Each country competing shall be allowed to enter not more than 12 competitors for events *a, b, c, e, f, g* and *h*, and one team for *d* and *k*.

2. The competitions shall be decided in the open-air bath situated in the Stadium. The bath will measure 100 metres long, not less than 15 metres wide, with a depth of 3 metres 70 centimetres in the centre, and 1 metre 20 centimetres at each end, and be filled with fresh water (not salt).

3. The competitions shall be held under the direction and in accordance with the rules and laws of the Amateur Swimming Association of England, who shall appoint all the officials and be responsible for the conduct of each competition.

“AN AMATEUR is one who has never competed for a money prize, declared wager, or staked bet; who has never taught, pursued or assisted in the practice of swimming, or any other athletic exercise, as a means of pecuniary gain; and who has not, knowingly, or without protest, taken part in any competition or exhibition with anyone who is not an amateur.”

4. A Starter shall be appointed, and all questions as to starting shall be in his absolute discretion ; also two Judges and a Referee for each race, three Judges for each of the Diving competitions, and a Referee, a Time-keeper, and two Goal Scorers for Water Polo. The Judges and Referees so appointed shall have sole control over the competitors after the start, with power to disqualify, and their decision shall be final. In cases where the Judges disagree as to the position of a competitor in a race, the Referee shall be appealed to, and his decision shall be final. The rules for the conduct of the Diving Competition and the English Amateur Swimming Association's rules of the game of Water Polo shall guide the officials appointed for Diving and for Water Polo.

5. Two or more Time-keepers shall be appointed, and the watches used by them shall be certified accurate to the satisfaction of the Association.

6. One or more Stewards shall be appointed, whose duty it shall be to observe the instructions of the Starter regarding the conduct and management of the races.

7. All competitors shall wear the regulation Amateur Swimming Association swimming costume, with swimming drawers underneath the costume. The swimming drawers and costume shall be subject to the satisfaction of the Starter or Stewards appointed for that purpose, and no competitor shall be permitted to start whose costume is objected to. All costumes must be in accordance with the following regulations :—

- (a) Only black or dark blue costumes shall be worn.
- (b) Drawers shall be worn underneath the costume. They must be of triangular pattern, with a minimum width of  $2\frac{1}{2}$  inches at the fork; they must meet on each hip, and be of not less width than 3 inches on each side when fastened.
- (c) Trimmings may be used *ad lib.*
- (d) The shoulder straps of costumes shall not be less than 2 inches wide.
- (e) All costumes shall be buttoned on the shoulder, and the arm-hole shall be cut no lower than 3 inches from the armpit.
- (f) In the front the costume shall reach not lower than 2 inches below the pit of the neck.
- (g) At the back the costume shall be cut straight from the top of shoulder to top of shoulder.
- (h) In the leg portion the costume shall extend to within 3 inches of the knee, and shall be cut in a straight line round the circumference of each leg.

8. Heats and stations in all races and the order of starting in Diving Competitions shall be drawn for by lottery. In all races stations shall count from the right, facing the course.

9. The start for all races except the Back race shall be made from the firm take-off, by the competitors diving into the water at the word "Go!" For the Back race the competitors will line up in the water and push off at the word "Go!" The Starter shall, previous to the start, describe to the competitors the course of the competition, the spot where it will terminate, and arrange the competitors in their proper positions or stations; and when all are ready the start shall be made by giving the word "Go!" Any start made before the Starter's order shall be considered a false start, and the competitor shall be required either to return to his station and start afresh or be disqualified.

10. A competitor when turning must touch the end of the bath with one or both hands ; in the Breast-stroke and Back-stroke races he must touch with both hands; and in all races when turning he may push off with his feet. Competitors do not disqualify themselves by standing on the bottom of the bath during the progress of a race.

11. Jostling, swimming across, or fouling and obstructing another so as to impede his progress shall disqualify the offender for the contest in question. The foul must be considered wilful in order to disqualify a competitor, and the Judges of the competition shall decide whether the foul has been accidental or wilful. If in the opinion of the Judges a swimmer has been fouled to a degree that endangered his chance of success, they shall have power to allow him to compete in the next round or final, and he shall be eligible to take any prize his position in the final may entitle him to. Should the foul occur in the final they may order it to be re-swum.

12. A competitor " swimming over " must complete the entire distance to qualify as the winner.

13. If a dead heat ensue in a final, the competitors shall again compete at such time as the Judges may direct. In all contests qualifying dead-heaters in preliminary heats shall be entitled to swim in the next round (or final), and shall be eligible to take any prize or prizes their positions in the final may entitle them to. The fastest loser in the preliminary heats shall qualify to compete in the next round (or final).

14. In free or speed swimming races any method of swimming may be used ; but in Back swimming the competitor must keep on the back,

and in Breast swimming both hands of the competitor must be pushed forward and brought backwards simultaneously, the shoulders must be kept perfectly in line with the surface of the water, and when touching at the turn in a Back or Breast swimming race the touch shall be made with both hands. In the Breast stroke the touch at the finish shall be made with both hands.

15. In the Team Races a team shall consist of four swimmers, and all teams shall comprise the same number of swimmers. The Team Swimming contest shall be conducted as follows: Numbers 1 of all teams competing in a race shall be started together at the word "Go;" number 2 of a team shall start as soon as number 1 of his team has finished the distance ; number 3 as soon as number 2 has finished, and so on. The team whose last man shall finish before the last man of any other team in the contest shall be the winner. In the event of a competitor of a team starting before his proper time, and not returning and re-starting, his team shall thereby be disqualified. An official Starter will be appointed for each team.

16. Any protest or objection to a competition not provided for in the foregoing and following conditions shall be made in writing by the authorised Captain or Chief of the team to which the competitor belongs, and handed to the Starter or one of the Judges. Such protest or objection shall be decided by a Committee appointed by the Amateur Swimming Association, from whose decision there shall be no appeal.

## REGULATIONS FOR DIVING COMPETITIONS.

17. For the Variety High Diving Competition *from the firm take-off* the platforms shall be 2 metres wide and 4 metres deep, and fixed, free from spring, at heights of 5 metres and 10 metres above the surface of the water.

18. For the Variety Diving Competition from a spring-board take-off, the boards shall be fixed at heights of 1 metre and 3 metres above the surface of the water. The lengths of the boards shall be 4 metres, width 50 centimetres, and of the usual elastic character.

19. The measurements, construction, and fixing of all diving boards shall be subject to the satisfaction of the Amateur Swimming Association of England.

20. The competition for Variety High Diving (Rule 17) shall consist of four compulsory Dives, and shall include : from a height of 5 metres, one "Running plain Dive" and one "Backward Somersault"; from

the 10-metre board, one “ Standing plain Dive ” and one “Running plain Dive ” : also three free or voluntary Dives selected by the competitors from the Diving Table, which shall be performed from the 10-metre platform.

21. The competition in Variety Diving from Spring Boards (Rule 18) shall comprise four compulsory Dives and shall include, from the 1-metre board, one “ Plain running Dive ” and one “ Running forward Somersault ”; and from the 3-metre board, “ One and a half Somersault ” and “ Back ward Spring and Forward Dive,” also “ three free or voluntary Dives ” selected by the competitor from the Spring Board Diving Table, which shall all be performed from the 3-metre board.

22. The competitors shall deliver at the time of entry to the Hon. Secretary of the British Olympic Association a complete statement or specification of the voluntary Dives selected by them. No competitor shall be permitted to repeat any one of the free or voluntary Dives.

23. For the Variety High Diving Competition the Judges shall observe the foregoing conditions and instructions, and in making their respective awards, each Judge shall :—

- (a) Write down his points for each Dive performed by each competitor according to the scale of points named in Rule 25.
- (b) The points awarded by him for each voluntary Dive shall, for the Variety High Diving competition, be multiplied by the degree of difficulty, and for the Variety competition from Spring Boards the points allowed for the degree of difficulty shall be added, in each case as specified against each dive named in the respective Diving Tables.
- (c) The product of each Judge, after being checked as correct, shall be added together and divided by three. The quotient (or one-third of the total awarded by three Judges to a competitor) shall be the competitor's final points.

24. In making the award of points for each Dive the Judges shall have regard to the degree of difficulty of the various Dives performed, and shall take into consideration : —

- (a) That the start is made with confidence, gracefully, and in a bold manner ; and in running Dives also the force and energy imparted.
- (b) That the bearing of the body in the air is easy, supple and graceful.

- (c) That when in the air performing plain head dives (*i.e.* dives without a turn) the head is erect, back hollowed, legs closed with feet turned back, the arms shall be stretched at right angles to the body and the fingers closed, or in advance of the head with the forefingers in contact palms downwards.

25. For each Dive each Judge shall award points according to the following scale :—

- (a) Unsuccessful attempt . . . . . 0 points.  
 (b) Bad dive . . . . . 3 „  
 (c) Good . . . . . 6 „  
 (d) Very good . . . . . 8 „  
 (e) Excellent . . . . . 10 „

The Judges may mark points and half points between those mentioned in the above scale, but 10 points shall be the highest possible that can be awarded by any Judge.

NOTE. —An unsuccessful attempt is one in which the competitor has failed to perform the dive nominated.

26. When the respective points awarded by each Judge have been settled as directed by Rule 23, Clauses (a) and (b), each Judge shall place the competitors 1, 2, 3, &c., in the order in which, in his opinion, they should finish. These placing figures of the three Judges shall be added together, and the competitor having the lowest total shall be declared the winner. In the event of a dead heat the points awarded by each Judge, and dealt with as per Rule 23, Clauses (a), (b), and (c), shall decide, but in that case the competitor having the highest aggregate shall be declared the winner of the dead heat.

## DIVING TABLE

(See pages 577-580).

### For High Variety Diving from Firm Take Off.

NAME OF DIVE	Degree of Difficult Height, 10 metre
1. Backward Spring and Forward Dive ... ..	1.2
2. Armstand Dive ... ..	1.3
3. Backward Somersault ... ..	1.5
4. Armstand and Somersault ... ..	1.5
5. Backward Head Dive ... ..	1.9
6. Mollberg's Dive, running ... ..	1.7
7. One and a half Somersault, running ... ..	1.8
8. Somersault forward, running ... ..	2.0

(Continued on page 586.

### DIVING.

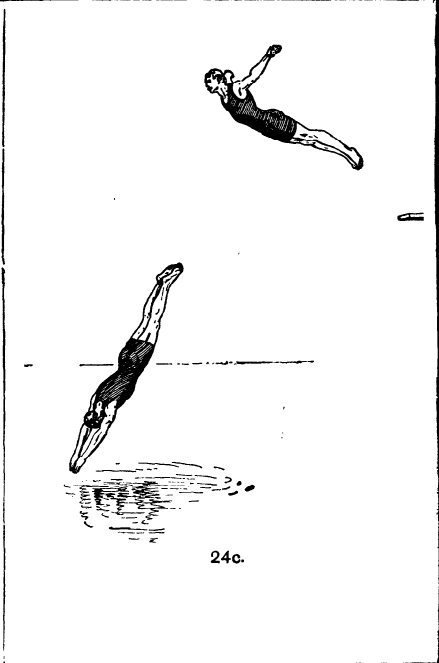
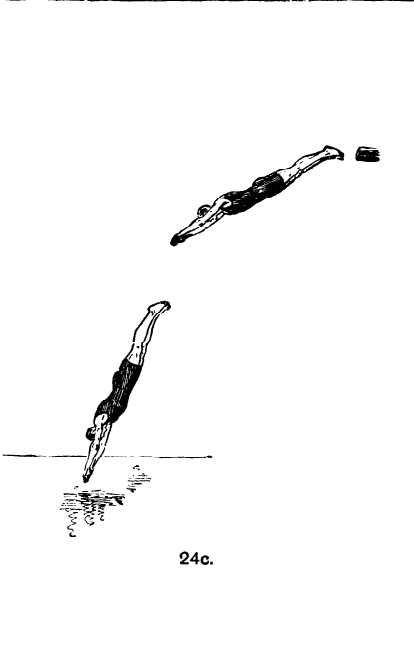

### HIGH DIVING.

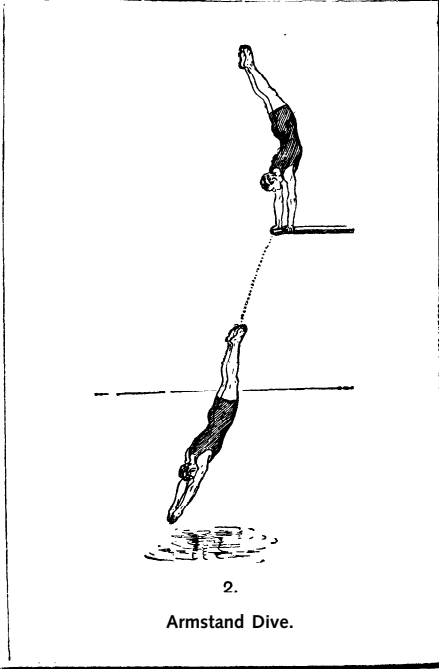
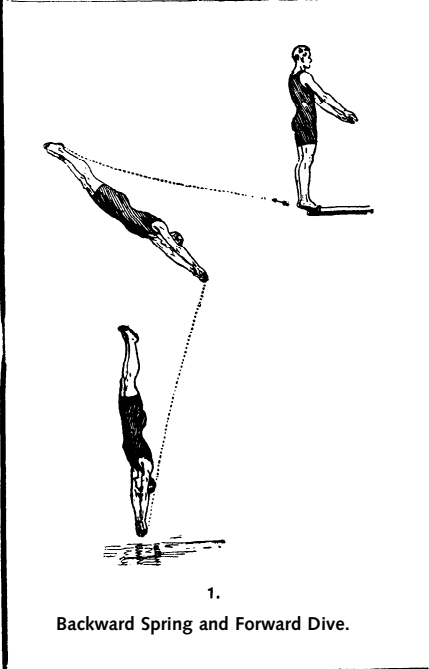

# HIGH DIVING.

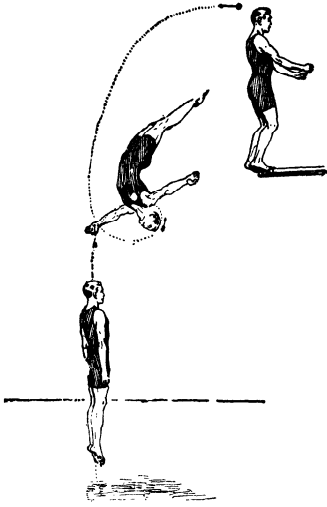

3.  
Backward Somersault.

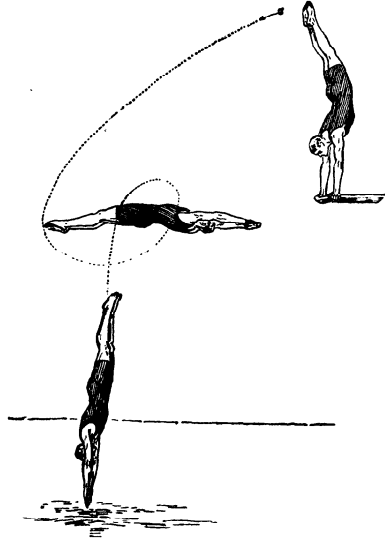

4.  
Armstand Somersault.

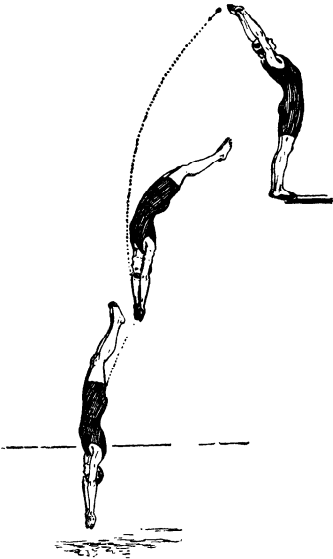

5.  
Backward Head Dive

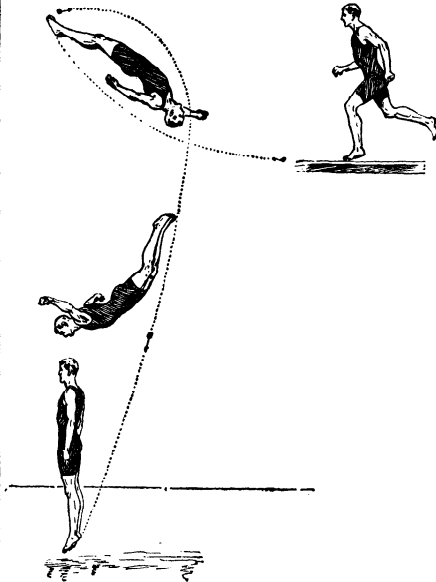

6.  
Mollberg's Dive, Running.



# HIGH DIVING.

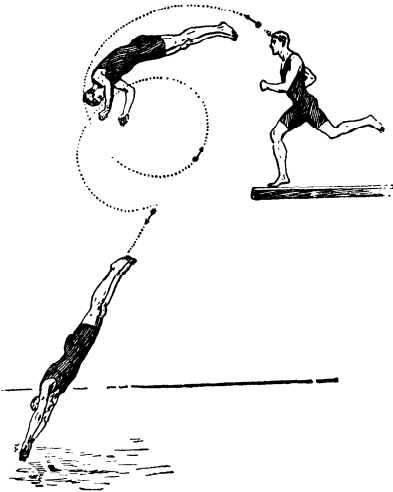

7.

One and a half Somersault Forward Running.

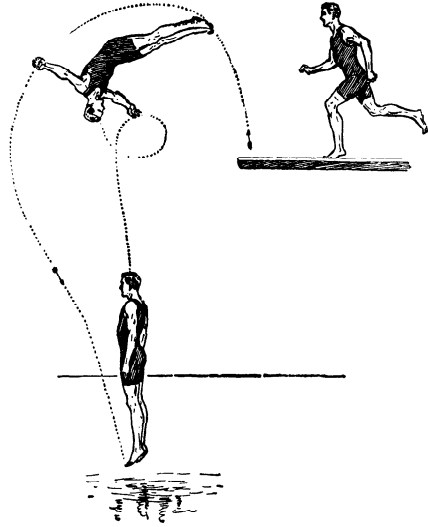

8.

Somersault Forward Running.

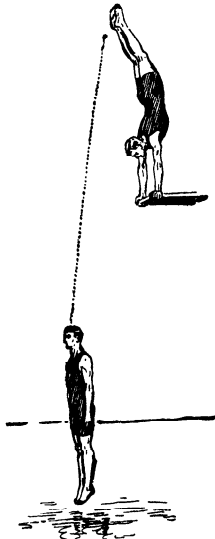

9.

Armstand Backward Fall Dive.

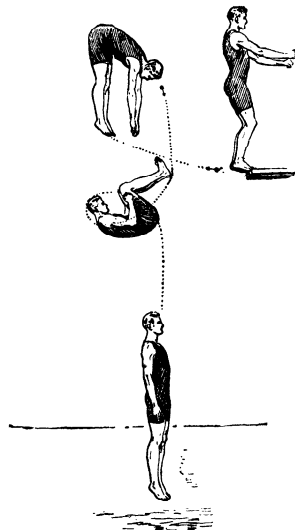

10.

Backward Spring and Forward Dive with Somersault.

# HIGH DIVING.



11.

Backward Spring and Forward Dive with one and a half Somersaults.

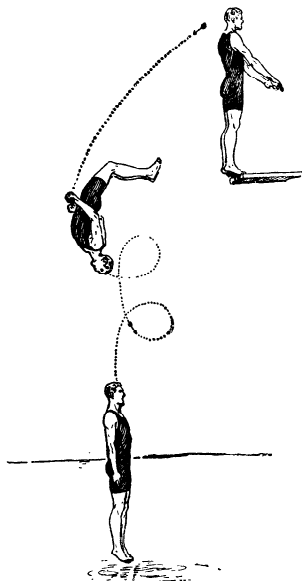

12.

Double Somersault Backwards.

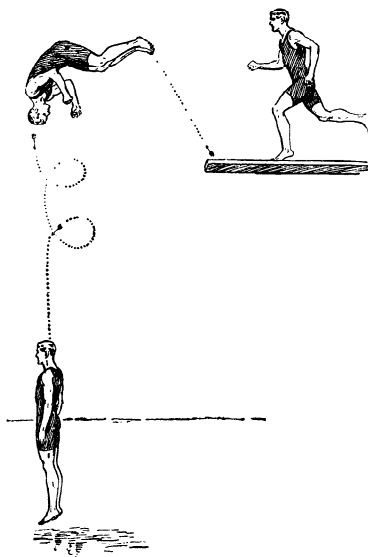

13.

Running Double Forward Somersaults.

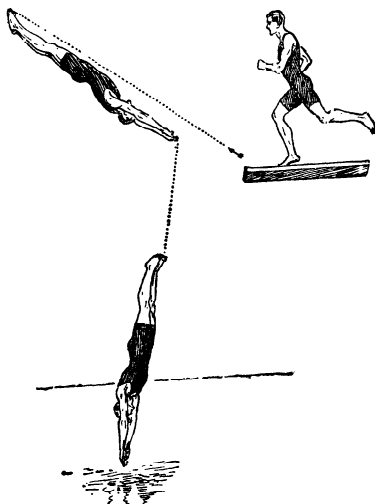

14.

Isander's Dive, Running.

### SPRING BOARD DIVING.

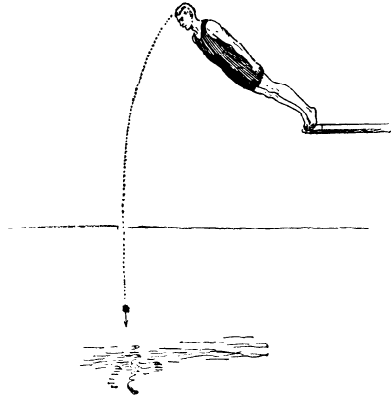

1.

Falling Dive Forwards, arms by sides.

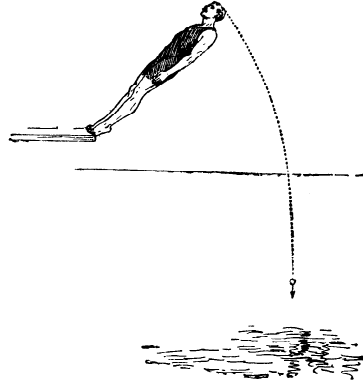

2.

Falling Dive Backwards, arms by sides.

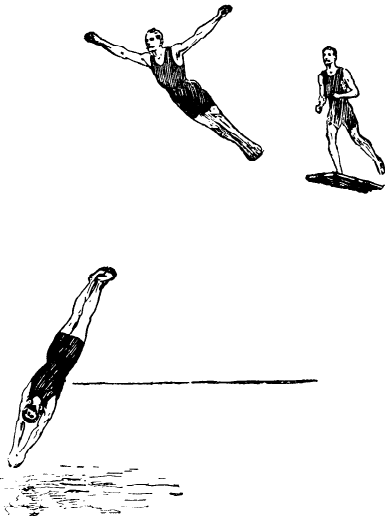

3.

Ordinary Running Header,  
take off with one foot.

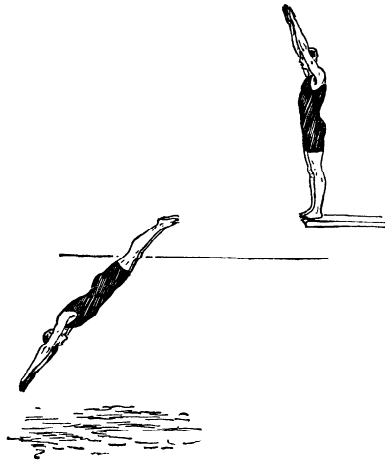

4.

Ordinary Header Forwards, arms up.

# SPRING BOARD DIVING.

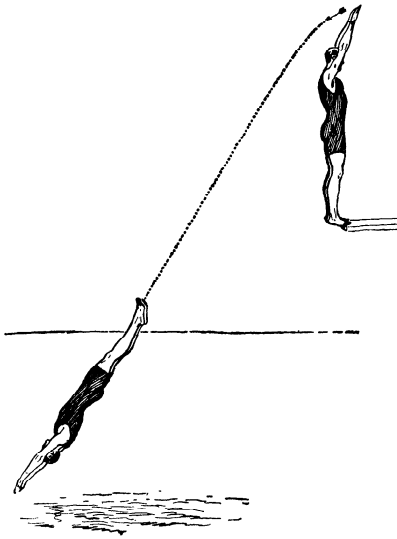

5.

Ordinary Header Backwards, arms up.

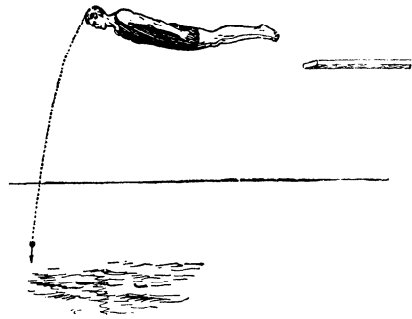

6.

Ordinary Header Forwards, arms by sides.

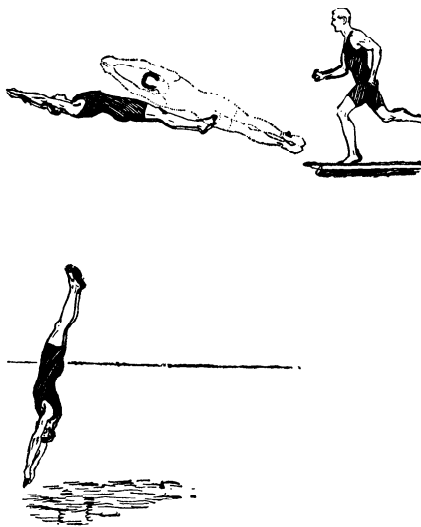

7.

Screw Dive, arms up, half turn.

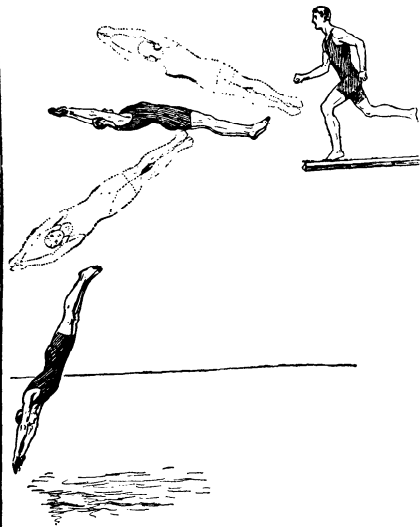

8.

Screw Dive, arms up, one turn.

# SPRING BOARD DIVING.

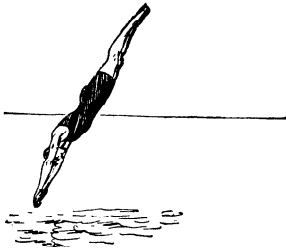

9.  
Pike Dive Forwards.

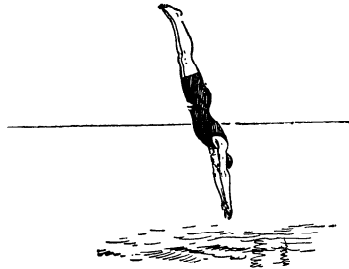

10.  
Pike Dive with Backward Spring and Forward Dive.

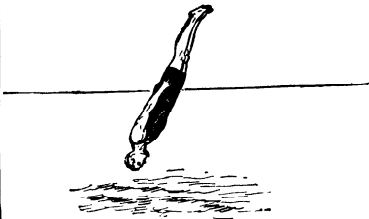

11.  
Pike Dive Forwards, arms at sides on entering the water.

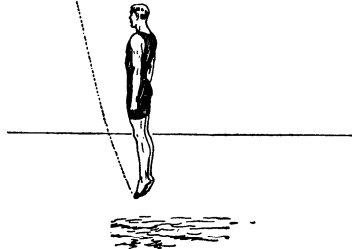
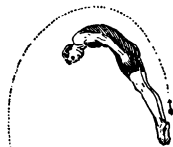

12.  
Forward Somersault.

# SPRING BOARD DIVING.

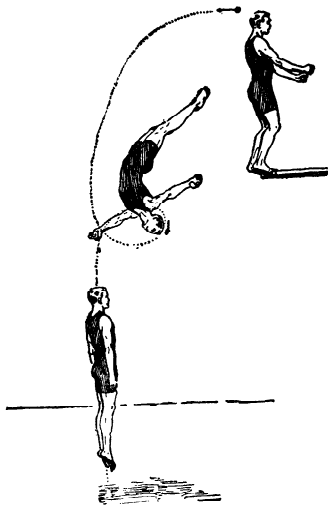

13.  
Backward Somersault.

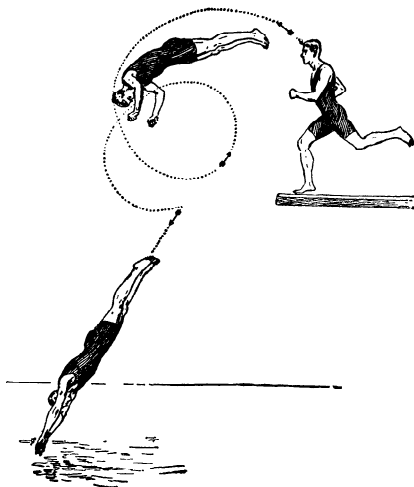

14.  
One and a half Forward Somersault.

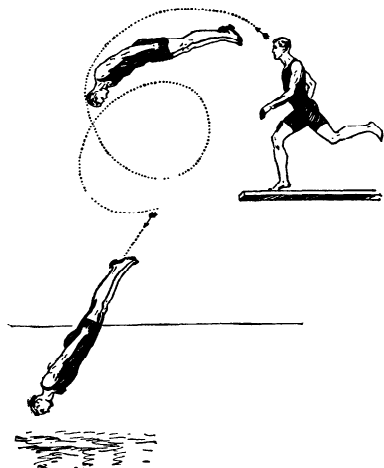

15.  
One and a half Forward Somersault,  
arms close to the body.

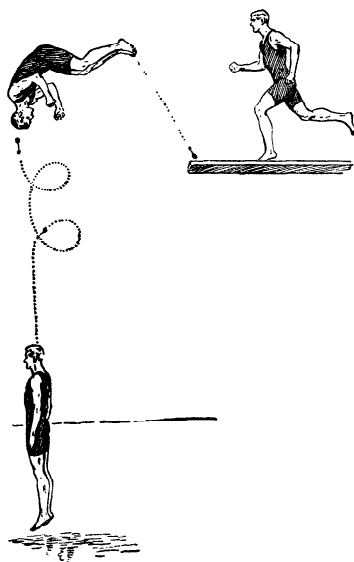

16.  
Double Forward Somersault.

# SPRING BOARD DIVING.

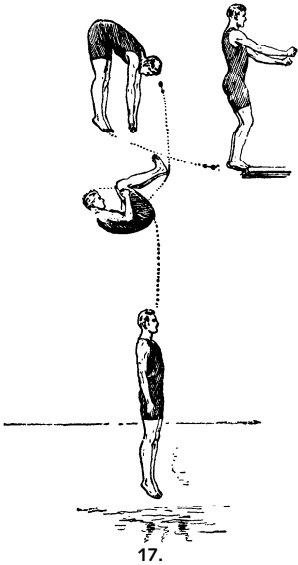

17.  
Backward Spring and Forward Somersault.

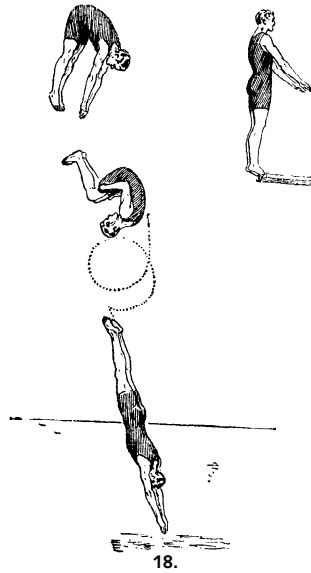

18.  
Backward Spring and Forward Dive with one and a half Somersaults.

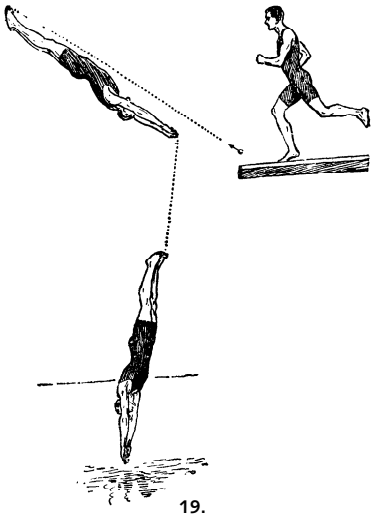

19.  
Overback, or Isander's Dive, half turn.

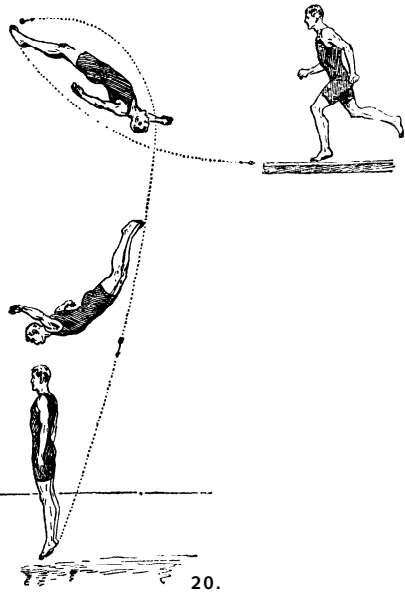

20.  
Overback, or Mollberg's Dive, one turn.

	NAME OF DIVE	Degree of Difficulty Height, 10 metres
9.	Armstand, Backward Fall Dive ... ..	1.9
10.	Backward Spring and Forward Dive with Somersault ... ..	1.6
11.	Backward Spring and Forward Dive with one- and-a-half Somersault... ..	1.8
12.	Double Somersaults, backwards ... ..	2.0
13.	Running Double Forward Somersaults... ..	2.1
14.	Isander's Dive, running ... ..	2.0

### DIVING TABLE

(See pages 581—585).

For Variety Diving from Spring Boards.

	NAME OF DIVE.	Degree of Difficulty 3-metre Board	
		Standing	Running
1.	Falling Dive Forwards, arms by sides ...	1	—
2.	Falling Dive Backwards, arms by sides ...	2	—
3.	Ordinary Running Header, take off with one foot ... ..	—	3
4.	Ordinary Header Forwards, arms up ...	3	3
5.	Ordinary Header Backwards, arms up ...	4	—
6.	Ordinary Header Forwards, arms by sides	4	5
7.	Screw Dive, arms up, half turn ... ..	5	6
8.	Screw Dive, arms up, one turn ... ..	8	8
9.	Pike Dive Forwards ... ..	4	6
10.	Pike Dive with Backward Spring and Forward Dive ... ..	6	—
11.	Pike Dive Forwards, arms at sides on entering water ... ..	5	7
12.	Forward Somersault ... ..	5	5
13.	Backward Somersault ... ..	5	—
14.	One-and-a-half-forward Somersault ...	6	6
15.	One-and-a-half-forward Somersault, arms close to body ... ..	10	9
16.	Double Forward Somersault ... ..	8	8
17.	Backward Spring and Forward Somersault	7	—
18.	Backward Spring and Forward Dive with one-and-a-half Somersault ... ..	10	—
19.	Overback or Isander's Dive, half-turn ...	8	8
20.	Overback or Mollberg's Dive, one turn ...	8	8

NOTE.—No points for the degree of difficulty will be allowed for any of the compulsory dives in either competition.

All the dives must be performed precisely in the manner indicated in the diagrams.



## REGULATIONS FOR WATER POLO.

The following International Rules for Water Polo are adopted by the A.S.A. and form part of its Laws for 1909 :—

1. **Ball.**—The ball to be round and fully inflated. It shall measure not less than 27 inches nor more than 28 inches in circumference. It shall be waterproof, with no strapped seams outside, and no grease or other objectionable substance on the surface. The ball to be furnished by the home team.

2. **Goals.**—The width of the goals to be 10 feet, the cross-bar to be 3 feet above the surface when the water is 5 feet or over in depth, and to be 8 feet from the bottom when the water is less than 5 feet in depth. The goal-posts and goal-nets to be furnished by the home team.

3. **Caps and Flags.**—One team shall wear dark blue caps and the other team white caps. Both goal-keepers shall wear red caps (*with quarterings of his own side's colours*). Each Goal Scorer shall be provided with a red flag, and the Referee with a dark blue and a white flag, and a bell.

4. **Field of Play.**—The distance between the goals shall not exceed 30 yards, nor be less than 19 yards, the width shall not be more than 20 yards, and shall be of even width throughout the field of play. The goal-posts shall be fixed at least one foot from the end of the bath, or any obstruction. In baths the half-way line and also the 4 yards penalty lines shall be marked on both sides.

5. **Depth.**—The water shall not be shallower than 3 feet.

6. **Time.**—The duration of a match shall be 14 minutes, seven minutes each way. Three minutes shall be allowed at half-time for change of ends. When the ball crosses the goal line, whether it be a goal, corner throw or goal throw, it shall be dead until the re-start of the game, or until it leaves the hand of the player taking the throw, and such time shall be deducted. Time occupied by disputes or fouls, or when the ball is thrown from the field of play, or lodges on an obstruction as per Rule 21, shall not be reckoned as in the time of play.

7. **Officials.**—The officials shall consist of a Referee, a Timekeeper, and 2 Goal Scorers.

8. **Referee.**—The Referee's duties shall be to start the game, stop all unfair play, decide all cases of dispute, declare fouls, goals, half-time, and time, and see that these rules are properly carried out. He shall decide upon all goals, whether signified or not. The Referee's decision is final.

NOTE.—A Referee may alter his decision provided such alteration be notified before the ball is again in play. A Referee has power to stop play at any period of the game if, in his opinion, the behaviour of the players or spectators, or other exceptional circumstances prevents the match from coming to a proper conclusion.

9. **Goal Scorers.**—The Goal Scorers shall stand at the side near each goal, and when they consider that the ball has passed through the goal, or over the goal-line, at their respective ends only, they shall signify their decision to the Referee by means of a red flag. They shall not change ends, and shall keep the score of goals of each team at their respective ends.

10. **Teams.**—Each side shall consist of seven players, who shall wear dark blue and white caps respectively, and drawers or costumes with drawers underneath the costumes. In baths no grease, oil, or other objectionable substance shall be rubbed on the body.

11. **Captains.**—The captains shall be playing members of the teams they represent ; they shall agree upon all preliminaries, and shall toss for choice of ends, *the loser of the toss shall have choice of colours*. If they are unable to agree upon any point, the Referee shall decide for them.

12. **Starting.**—The players shall enter the water and place themselves in a line with their respective goals. The Referee shall stand in a line with the centre of the course, and, having ascertained that the captains are ready, shall give the word "Go!" and immediately throw the ball into the water at the centre. A goal shall not be scored after starting or re-starting until the ball has been handled (viz. played with the hand below the wrist) either by two members of one team, in which case the scorer shall be within half distance of the goal attacked, or by a player of each team. The ball must be handled (viz. played with the hand below the wrist) by more than one player before a goal can be scored.

13. **Scoring.** —A goal shall be scored by the entire ball passing beyond the goal-posts and under the cross-bar. *A goal may be scored by the head or feet providing the ball has been previously handled by two Players, as per Rules 12 and 18.*

14. **Ordinary Fouls.**—It shall be a Foul :—

- (a) To touch the ball with both hands at the same time ;
- (b) To hold the rail or side during any part of the game ;
- (c) To stand on or touch the bottom during any part of the game, unless for the purpose of resting ;
- (d) To interfere with an opponent or impede him in any way unless he is holding the ball ;
- (e) To hold the ball under the water when tackled ;
- (f) To jump from the bottom or push off from the side (except at starting or re-starting) in order to play the ball or duck an opponent ;
- (g) To hold, pull back, or push off from an opponent ;
- (h) To turn on the back and kick at an opponent ;
- (i) To assist a player at the start or re-start ;
- (j) For the goal-keeper to go more than four yards from his own goal-line ;
- (k) To throw the ball at the goal-keeper from a free throw ;
- (l) To refuse to play the ball at the command of the Referee after a foul or after the ball has been out of the field of play.

NOTE.—Dribbling or striking the ball is not holding, but lifting, carrying, pressing under water, or placing the hand under or over the ball when actually touching, is holding. Dribbling the ball up and through the posts is permissible.

15. **Wilful Fouls.** —If, in the opinion of the Referee, a player commits an ordinary foul wilfully, the Referee shall at once order him out of the water until a goal has been scored.

- (a) It shall be considered a wilful foul to start before the word “Go” ;
- (b) to deliberately waste time ;

- (c) or a player to take up a position within two yards of his opponents' goal-line ;
- (d) to deliberately change position after the whistle has gone with a view to taking an advantage of an opponent ;
- (e) to deliberately splash in the face of an opponent ;
- (f) *to strike at the ball with clenched fist.*

NOTE.— In the event of a Referee ordering a player out of the water and such player refusing, the game shall be stopped, the match awarded to the other side, and the offending player reported to his Association. In the event of a Referee ordering a player out of the water for misconduct or a wilful foul, he shall not re-enter after a goal has been scored except by permission of the Referee.

**Free Throws.** —The penalty for each foul shall be a free throw to the opposing side from the place where the foul occurred. A goal cannot be scored from a free throw unless the ball has been handled (*viz.* played with the hand below the wrist) by at least one other player.

**Penalty Throw.** —A player wilfully fouled when within 4 yards of his opponents' goal-line shall be awarded a penalty throw, and the player who commits the offence must be ordered out of the water until a goal has been scored. The penalty throw shall be taken from any point on the 4-yard line. In the case of a penalty throw it shall not be necessary for the ball to be handled by any other player before a goal can be scored, but any player within the 4-yard line may intercept a penalty throw.

NOTE.—A player ordered out of the water for committing a wilful foul must remain out until a goal has been scored, notwithstanding that half-time may intervene or extra time be played, except by permission of the Referee.

**Declaring Fouls.** —The Referee shall declare a foul by blowing a whistle and exhibiting the colour of the side to which the free throw is awarded. The player nearest to where the foul occurred shall take the throw. The other players shall remain in their respective positions from the blowing of the whistle until the ball has left the hand of the player taking the throw. In the event of one or more players from each team committing a foul so nearly at the same moment as to make it impossible for the Referee to distinguish who offended first, he shall have the ball out

of the water and throw it in as nearly as possible at the place where the foul occurred, in such a manner that one member of each team may have equal chance of playing the ball. In such cases the ball must be allowed to touch the water before it is handled, and must be handled (i.e. played with the hand below the wrist) by more than one player before a goal can be scored.

19. **Goal-Keeper.**—The goal-keeper may stand to defend his goal, and must not throw the ball beyond half-distance ; the penalty for doing so shall be a free throw to the opposing side from half-distance at either side of the field of play. The goal-keeper *must wear a red cap with quarterings of his own side's colours.* He must keep within four yards of his own goal-line or concede a free throw from the 4-yard line to his nearest opponent, The goal-keeper is exempt from clauses (a), (c), and (f) in Rule 14, and Clause (f) in Rule 15, but he may be treated as any other player when in possession of the ball. Except when injury or illness compels him to leave the water (when Rule 23 shall apply), the goal-keeper can only be changed at half-time.

NOTE.—In the event of a goal-keeper being ordered out of the water, his side cannot appoint another goal-keeper except at half-time, as defined in Rule 19, and any player defending the goal in his place shall be considered an ordinary player, and not come under the special limitations and exceptions attached to a goal-keeper.

20. **Goal and Corner Throws.**—A player throwing a ball over his own goal-line shall concede a free corner throw to his opponents, and such free corner throw shall be taken by the player on the opposing side nearest the point where the ball leaves the field of play. If the attacking side throw the ball over it shall be a free goal-throw to their opponents' goal-keeper.

NOTE.—In the event of the ball having become dead by being thrown over the goal-line, it must not be considered in play until it has left the goal-keeper's hands. If the goal-keeper puts the ball in play, and, before any other player has handled it takes it again and allows it to pass fully through his goal, a corner throw shall be awarded to the opposing side.

21. **Out of Play.**—Should a player send the ball out of the field of play at either side, it shall be thrown in any direction from where it went out by one of the opposing side, and shall be considered a free throw.

The player nearest the point where the ball leaves the field of play must take the throw. Should the ball strike or lodge in an overhead obstruction it shall be considered out of play, and the Referee shall then stop the game and throw the ball into the water under the said obstruction.

22. **Declaring Goals, Time, &c.** —The Referee shall declare fouls by whistle and goals by bell. The time-keeper *shall* notify half-time and time by whistle.

23. **Leaving the Water.** —A player leaving the water, or sitting or standing on the steps, or sitting on the side of the bath in which the match is being played, except at half-time or by permission of the Referee, shall not re-enter it until a goal has been scored, or until half-time. Should a player leave the water, he can only re-enter at his own goal-line. Any player or players leaving the water during the progress of a game without permission of the Referee (except in case of illness or accident), or refusing to enter the water at the request of the Referee, shall be deemed guilty of misconduct, and be liable to suspension by the body governing the particular match in which he is competing, and the team to which such player or players belong shall be deemed to have lost the game.

P R O G R A M M E .



Maximum Number  
of Competitors from  
each Country.

TENNIS.

**Singles** ... .. **12**



RACKETS.

**Singles** ... .. **12**

**Doubles** ... .. **6 pairs**

## LAWN TENNIS COMPETITIONS.

### RULES AND CONDITIONS OF COMPETITION.

1. The Lawn Tennis Competitions to be decided in connection with the Olympic Games, 1908, shall consist of

Lawn Tennis (Covered Courts), to be held at Queen's Club, May 6, and following days.

- (a) Men's singles.
- (b) Men's doubles.
- (c) Ladies' singles.

Lawn Tennis (Grass Courts) to be held on the Grounds of the All England Club, Wimbledon, July 6, and following days.

- (a) Men's singles.
- (b) Men's doubles.
- (c) Ladies' singles.

2. The competitions shall be played in accordance with the Laws of Lawn Tennis as sanctioned by the L.T.A. and the United States National L.T.A.

3. The competitions shall be managed

(a) *For the Covered Courts Matches*

By a Joint Committee appointed by the L.T.A. and Queen's Club.

(b) *For the Grass Courts Matches*

By a Joint Committee appointed by the L.T.A. and the All England Club.

The respective committees shall have full power to make all arrangements in connection with their competitions, and shall appoint a Referee, with power to appoint a substitute to be approved by them.

The Referee, or such other member or members of the committee as may be selected for the purpose, shall have power to appoint Umpires



and the Referee shall decide any point of law which an Umpire may profess himself unable to decide, or which may be referred to him on appeal from the decision of an Umpire. The decision of the Referee shall be final.

4. The competitions shall be individual competitions.

All matches shall be the best of five advantage sets, except in the case of the ladies' singles, in which the matches shall be the best of three advantage sets.

5. All entries shall be made in accordance with the General Regulations of the British Olympic Council for the Olympic Games of London, 1908.

6. The draw shall be on the Bagnall-Wild system, and shall be conducted in the following manner :—Each competitor's name shall be written on a separate card or paper, and these shall be placed in a bowl or hat, drawn out one by one at random, and copied on a list in the order in which they have been drawn.

Competitors shall have a right by themselves or their deputies, to be present at the draw, which shall take place on the first convenient day following the date of the closing of the entries.

7. If a competitor be absent when called on to play, or shall refuse to play, or shall have given previous notice to the Referee or a member of the Committee that he cannot play in the round, his adversary shall win in that round.

8. No competitor shall be allowed to play in boots or shoes with nails or spikes other than those known as "Steel points," and "Steel points" will only be allowed if, in the opinion of the Committee of Management, the state of the ground warrants their use.

9. The competitors beaten in the semi-finals shall have the right of playing each other for the bronze medals.

The "Slazenger" ball shall be used for these competitions.

N.B.—Entries for the above competitions must be received by the British Olympic Council in London (108 Victoria Street, Westminster, S.W.)

(a) For the Covered Court competitions not later than April 28, 1908.

(b) For the Grass Court competitions not later than June 6, 1908.

## CONDITIONS OF COMPETITION.

1. The competitions to be decided in connection with the Olympic Games, 1908, will be held at Queen's Club, West Kensington.

(a) *Rackets*, singles and doubles, to commence on April 27.

(b) *Tennis*, singles only, to commence on May 18.

2. The competitions shall be played in accordance with the usual rules of these games which govern the Amateur Championships of England.

3. The competitions shall be managed by a joint committee of three, representing the Tennis, Rackets, and Fives Association, and the Queen's Club Tennis and Rackets sub-committee. The Joint Committee shall have full power to make all arrangements in connection with these competitions.

4. Each competitor shall select an umpire for himself for his particular match, if he so desires ; if not, the committee shall appoint the umpires, who shall nominate a referee, unless the players agree to dispense with the services of umpires and referee altogether for that particular match.

5. The competitions shall be individual competitions. All matches at Rackets to be the best of five games in the singles, the best of seven games in the doubles. All matches at Tennis to be the best of five sets (no advantage sets).

6. All entries shall be made in accordance with the General Regulations of the British Olympic Council for the Olympic Games, London, 1908, through the Olympic secretary of each country.

7. The draw shall be on the Bagnall-Wild system, and shall be conducted in the following manner—Each competitor's name shall be written on a separate card or paper, and these shall be placed in a bowl or hat, drawn out one by one at random and copied on a list in the order in which they have been drawn.

Competitors shall have the right to be present at the draw, which shall take place on the first convenient day after the date of the closing of the entries.

8. Every match shall be played at the appointed hour, due notice of which shall be given to all competitors.

The committee shall have powers to "scratch" any competitor who fails to present himself to play at the appointed hour.

9. The competitors in the semi-finals shall have the right to play each other for the bronze medals.

10. The entries for the above competitions must be received by the British Olympic Council in London (108 Victoria Street, Westminster, SW.) :

(a) Rackets, not later than April 13, 1908.

(b) Tennis, not later than May 4, 1908.

11. If any competitors wish to enter for the "Doubles" competition, their names as pairs must be entered as directed on the Entry Form, and no alteration in this can be made after the date of closing the entries.

## TENNIS.

---

### DEFINITIONS.

*All-the-walls.*— See *Touch-no-walls*.

*Bar-the-openings.*—A point of cramped-odds, by which the giver of the odds loses a stroke whenever a ball, returned by him, enters any opening, or touches the post of any opening.

*Bar-the-winning-openings.*— A point of cramped-odds, by which the giver of the odds loses a stroke whenever a ball returned by him, enters a winning-opening.

*Better.*— With reference to chases, describes

- (a) that part of the court which lies between a chase-line and the half-line which is next to it in the direction of the nearest end-wall; as, *e.g. better than 2*, by which is defined that part of the floor which lies between the chase-lines 2 and 1 & 2 ; or
- (b) generally, that part of the court which lies between a chase-line, or gallery, and the nearest end-wall.

NOTE. This term used to be, but is now no longer, applied to the half-yard chase-lines, as, *e.g. better than 1 and 2*, which is now marked and called, *worse than a yard* ; but of these there are two, *viz. better than half-a-yard*, and *hazard-side better than half-a-yard*, both of which are still so marked and called.

*Beyond.*— Further from the net, in the direction of the nearest end-wall.

*Bisque.*— A point of odds, which is equivalent to a stroke claimed at pleasure by the recipient, subject to the provisions of Laws 29 and 30. It wins a chase. A *bisque*, or *bisques*, may be given in augmentation or diminution of other odds ; as *e.g. 15 and a bisque, 15 for a bisque, &c.*

*Boast, to.*— To return the ball in-play by striking it against either of the side-walls, or against the end-wall on that side on which the striker is : this stroke is called *a boast*, or *boasted stroke*.

*Chase.*— A stroke in abeyance, which has been made by one player, and must be played for by the other, according to the provisions of Laws 17-24.

*Cramped-odds.*— Odds, in giving which a player agrees to renounce the liberty of playing into some usual part of the court; or plays with some unusual dress or implement ; or cramps his game in some other way, by agreement. These odds may be combined with bisques or other odds either in augmentation or diminution.

*Dedans.*—

- (a) The opening at the end of the service-side of the court ; also
- (b) the spectators present behind that opening.

*Dedans-post.*— The post which stands nearly in the middle of the dedans, and continues the half-court-line up to the edge of the pent-house.

*Defend.*— The player, who has made a chase, and who (having changed sides) plays to prevent his antagonist from winning it, is said to *defend* the chase : in three-handed or four-handed games, both partners are said to *defend* the chase which either of them has made, when they (having changed sides) play to prevent their antagonist, or antagonists, from winning it.

*Double.*— When a ball is struck after it has fallen, it is said to be *doubled* or *a double*.

*Drop.*— A ball in play is said to *drop*, when it touches the floor, or the post of an opening, or enters an opening, without having previously touched any part of the court except a wall, or a pent-house, or the net.

*Enter.*— A ball in play is said to *enter* an opening, when, having been struck into that opening, it remains in it, or touches the net, boards, or other internal fittings of that opening, or the dedans-post, or any person being, or anything lying in that opening ; notwithstanding that the ball (in *entering* a gallery) may have touched the adjacent gallery-post, without having touched the floor in the interim.

*Ball.*— A ball in-play is said to *fall* when, after having dropped, it touches the floor again, or touches the net, or enters an opening.

*Fault.*— It is a *fault*,

- (a) if the server, in delivery, fail to strike the ball with his racket; or
- (b) if he strike it more than once ; or
- (c) if the ball served go out-of-court ; or
- (d) if, before touching the service-pent-house and dropping in the service-court, or on one of the lines which bound it, the ball served touch any part of the court except the rest of the side pent-house and the service-wall (*see* Laws 4-6).

**TENNIS COURT,  
QUEEN'S CLUB,  
WEST  
KENSINGTON.**

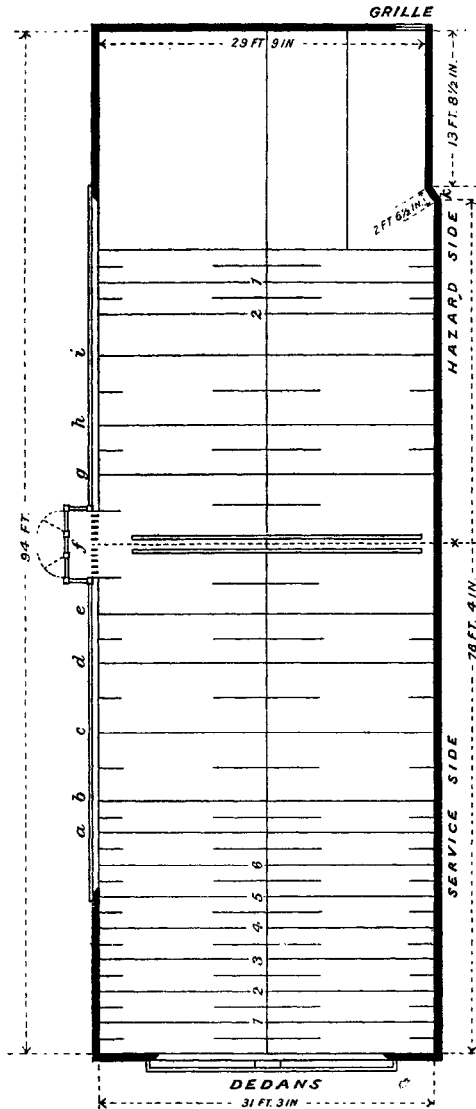

**EXPLANATION OF GROUND PLAN.**

The figures 1, 2, 3, 4, 5, 6, denote Chases.

<i>a.</i> Last Gallery	Service Side.	<i>f.</i> Marker's Box.	
<i>b.</i> Yard worse	" "	<i>g.</i> First Gallery	Hazard Side.
<i>c.</i> Second Gallery	" "	<i>h.</i> Door	" "
<i>d.</i> Door	" "	<i>i.</i> Second Gallery	" "
<i>e.</i> First Gallery	" "	<i>k.</i> Tambour.	" "

Tambour projects 18 inches from Main Wall.

*First-stroke*.— The return of the service.

*Galleries*.— The openings beneath the side-pent-house, including the first, second, and last galleries, the door, and the line opening, on each side of the net.

*Gallery-post*.— The post which separates a gallery from the gallery next beyond it.

*Good*.— A service or return, played in accordance with the provisions of the laws, is said to be *good*.

*Grille-pent-house*.— The pent-house above the wall which contains the grille.

*Grille-wall*.— The inner end-wall which contains the grille.

*Half-bisque*.— An unusual point of odds, equivalent either

(a) to a bisque in every alternate set; or

(b) to the annulling of a fault served by the recipient; or

(c) to the addition of a second fault to one already served by the giver of the odds; or

(d) to the privilege of claiming chase-off for a chase;

at the pleasure of the recipient, subject to the provisions of Laws 29 and 30.

NOTE.— Since authorities differ as to the true value of a half-bisque, it is best to settle by agreement the value to be given to it in a match, before beginning to play.

*Half-court*.— One half of the service-side, or hazard-side, as divided by the half-court-line; the openings contained in the half-court, as bounded by that line and the dedans-post, are counted in it. When a player gives the odds of *half-court* (see Law 32), that half-court, on each side of the net, into which it is agreed that he shall play, is called *his half-court*.

*Half-volley, to*.— To strike the ball in-play, as it rises from the floor, immediately after it has dropped: this stroke is called *half-volley*.

*Hazard-side*.— The part of the court which lies between the net and the end-wall beyond the grille-pent-house.

*In-play*.— A ball served or returned is said to be *in-play* until it has fallen, or has entered an opening, or has gone out-of-court, or has touched a gallery-post or a player; or unless it be a fault.

*Love-game*.— A game in which one player wins four consecutive strokes; or, in case of deuce and advantage, five consecutive strokes.

*Love-set*.— A set in which one player wins six consecutive games; or, in case of an advantage-set, seven consecutive games,

*Net-line.*—The line of the net, continued across the pent-house.

*Nick, the.*—The line of junction of the wall with the floor,

*Nick, to.*—To drop or fall on the line of junction of a wall with the floor; or, rather, to touch both wall and floor simultaneously: a ball which does this is said *to nick*, or to be *a nick*.

*Odds.*—

*Half-Fifteen.*—A point of odds, by which one stroke is given at the beginning of the second and every subsequent alternate game of a set.

*Fifteen.*—As a point of odds, one stroke given at the beginning of every game of a set.

*Half-Thirty.*—A point of odds, by which one stroke is given at the beginning of the first game, two strokes are given at the beginning of the second game, and so on, alternately, in all the subsequent games of a set.

*Thirty.*—As a point of odds, two strokes given at the beginning of every game of a set.

*Half-Forty.*—A point of odds, by which two strokes are given at the beginning of the first game, three strokes at the beginning of the second game, and so on, alternately, in all the subsequent games of a set.

*Forty.*—As a point of odds, three strokes given at the beginning of every game of a set.

NOTE.—See also *Bar-the Openings*, *Bar-the-winning-openings*, *Cramped-odds*, *Bisque*, *Half-bisque*, *Half-court*, *Touch-no-side-walls*, and *Touch-no-walls*. \*

*Openings.*—The *dedans*, *galleries*, and *grille* (see *Bar-the-openings*, *Bar-the-winning-openings*, *Galleries*, and *Winning-openings*.)

*Out-of-Court.*—

- (a) That part of the court which includes the play-line, the walls above it, the windows, and the roof; also
- (b) a ball in-play, which touches any of these, or goes behind the wing-net above the tambour (even though it touch either of the

\* The value of the ordinary cramped-odds, though varying with different players, is usually estimated as follows: Round services = 15, or nearly half-30; Half-court = half-30; Touch-no-side-walls = half-30 and, perhaps, a bisque; Touch-no-walls = about 40; Bar-the-hazard (*i.e.* the winning-openings) = about 15; Bar-the-opening = 15 and a bisque, or nearly half-p.



rods to which the wing-net is fixed), or goes over a beam or rafter (in courts which have the roof open), is said to have gone *out-of-court* (see *Play-line*).

NOTE.— In courts which are lighted by side-windows, the last, or (sometimes only) the lower half of the last, side-windows at each end of the court (as also the wing-net above the tambour, with the rods to which it is fixed), are not counted out-of-court.

*Pass*.— It is a pass,

(a) if the ball served, not being a fault, drop in the pass-court; or,

(b) if the ball served, not being a fault, go across the pass-line on the pent-house.

*Pass-court*.—That part of the floor which is contained between the service-line, the pass-line, the grille-wall, and the main wall.

*Play-line*.—A painted line, or board, at a certain height on the end-walls, and also on the side-walls except above the tambour (see *Out-of-Court*).

*Rest*.— The repeated return of the ball in-play.

*Return, to*.—To receive the ball in-play and play it (before it has fallen) back over the net : this stroke is called a *return*.

*Rough*.— The back of the racket, which shows the knots.

*Serve, to*.—To deliver the service.

*Server*.—The player who delivers the service.

*Service*.—

(a) The starting of the ball in-play, in accordance with the provisions of Laws 3-10 ; or

(b) the ball served.

*Service-court*.—That part of the floor which is contained between the service-line, the pass-line, the grille-wall, and the gallery-wall and battery.

*Service-line*.—That line on the floor which is parallel and nearest to the grille-wall.

*Service-pent-house*.—That portion of the side-pent-house which lies between the net-line and grille-pent-house.

*Service-side*.—That part of the court which lies between the net and the end-wall beyond the dedans-pent-house.

*Service-wall*.—The wall above the side-pent-house.

*Sides*.—The two portions into which the net divides the court.

*Side-walls.*— See *Touch-no-side-walls*.

*Smooth.*—The front of the racket, which shows no knots.

*Spin.*—The decision by a racket, thrown spinning up into the air by one player, while the other calls “rough” or “smooth” ; if the racket falls with that side uppermost which the caller named, the latter wins ; if not, he loses.

*Strike out, to.*—To receive the service, and so to play the first-stroke.

*Striker.*— The player who last struck the ball in-play.

*Striker-out.*— The player who receives the service, and so plays the first-stroke.

*Stroke.*—

- (a) The return of a ball ; or
- (b) a return which decides a rest ; and so
- (c) (in scoring) the fourth part of a game, except as provided by Law 25 (exception).

*Touch-no-side-walls, or Side-walls.*—A point of cramped-odds, by which the giver of the odds loses a stroke whenever a ball, returned by him, touches a side-wall or a gallery-post, or enters a gallery ; but, if the ball, returned by him, touch the pent-house only, before dropping on the floor, and do not afterwards touch a side-wall or a gallery-post, or enter a gallery, it is not counted against the giver of the odds.

*Touch-no-walls, or All-the-walls.*— A point of cramped-odds, by which the giver of the odds loses a stroke whenever a ball, returned by him, touches a wall or a gallery-post, or enters an opening, before falling on the floor ; but, if the ball, returned by him, touch the pent-house only before falling on the floor, it is not counted against the giver of the odds.

*Volley, to.*— To strike the ball in-play before it drops ; this stroke is called *a volley*.

*Winning-gallery.*— The hazard-side last gallery.

*Winning-openings.*— The dedans, winning-gallery, and grille (see *Bar-the-winning-openings*).

*Worse.*— With reference to chases, describes

- (a) that part of the court which lies between a chase-line and the chase-line which is next to it in the direction of the net, as, e.g. *worse than 2*, by which is defined that part of the floor which lies between the chase-lines 2 and 2 & 3 ; or

- (b) generally, that part of the court which lies between a gallery or a chase-line, and the net.

NOTE.—This term used to be, but is now no longer, applied to the half-yard chase-lines, as, *e.g.* worse than 1 & 2, which is now marked and called, *better than 2*.

---

## THE LAWS.

### IMPLEMENTS, AND CHOICE OF SIDES.

#### *Balls and Rackets.*

1. The balls shall be not less than  $2\frac{1}{4}$  and not more than  $2\frac{5}{8}$  in diameter; and shall not be less than  $2\frac{1}{8}$  and not more than  $2\frac{3}{4}$  oz. in weight.

NOTE.—There is no restriction as to the shape or size of the rackets.

#### *Choice of Sides.*

2. (a) The choice of sides at the beginning of the first set is determined by spin.
- (b) In subsequent sets of a series, the players shall begin each set on the sides on which they finished the set before it.

### SERVICE.

#### *Delivery.*

3. The ball served must be struck with the racket, and may be delivered from any part of the service-side.

#### *Service.*

4. The ball served must touch the service-pent-house before touching any other part of the court, except the rest of the side-pent-house and the service-wall; and it must drop in the service-court, or on one of the lines which bound it.

#### *Service, when good.*

5. The service is good,
- (a) if the ball served touch (in its descent) any part of the service-pent-house, so as to rise again from it; or
- (b) if the ball served strike the service-wall, and afterwards touch (in its descent) any part of the service-pent-house, even though it do not rise again from it; or
- (c) if the ball served drop in the winning-gallery.

*Faults, not returnable.*

6 . A fault may not be returned.

*Passes, not returnable.*

7 . A pass may not be returned; but a ball served, which has not gone across the pass-line on the pent-house, may be volleyed, although, if untouched, it might have dropped in the pass-court. If a pass touch the striker-out, or if a service (before it has dropped) touch him, when standing with both feet in the pass-court and not having attempted to strike the ball, it is still counted as a pass.

*Faults annulled.*

8 . A pass does not annul a fault.

*Service and Faults annulled.*

9 . If the striker-out declare himself not ready for a service, and have made no attempt to return it, that service is counted for nothing, though it be a fault. It annuls a previous fault. The striker-out, having been asked if he be ready, and having declared himself ready, may not similarly refuse a second service.

*Continuation of Service.*

10 . The server continues to serve until two chases be made, or one chase when the score of either player is at forty or advantage (*see* Law 25); the players then change sides, the server becomes striker-out, and the striker-out becomes server.

## RETURN.

*Return, when good.*

11 . The return is good, if the ball in-play be struck with the racket so that it passes the net without touching a gallery-post or anything fixed or lying in an opening on the side from which it is struck, and without going out-of-court.

*Return, when not good.*

12 . The return is not good,

- (a) if not in accordance with the terms of Law 11; or
- (b) if the ball be struck-more than once, or be not definitely struck; or
- (c) if the ball in-play, having passed the net, come back and drop on the-side from which it was struck, unless it should have touched a gallery-post or anything fixed or lying in an opening on that side of the court which is opposed to the striker.

*Ball, when not returnable.*

13 . A ball which is no longer in play may not be returned.

## SCORING.

*The Server, when he wins a stroke.*

14 . The server wins a stroke (except as provided in Law 9),

- (a) if a good service enter the winning-gallery or the grille; or
- (b) if the striker-out fail to return a good service (except when it makes a chase: *see* Laws 17-19); or
- (c) if the striker-out fail to return the ball in-play (except when it makes a chase: *see* Laws 17-19); or
- (d) if he himself return the ball in-play so that it enters the winning-gallery or grille, or falls on or beyond the service-line; or
- (e) if he serve or return the ball in-play so that it drops or falls upon a ball, or other object, which is on or beyond the service-line; or
- (f) if he win a chase (*see* Law 20); or
- (g) if the striker-out lose a stroke (*see* Law 16).

*The Striker-out, when he wins a stroke.*

15 . The striker-out wins a stroke (except as provided in Law 9),

- (a) if the server serve two consecutive faults [except as provided in Law 31 (b)] ; or
- (b) if the server fail to return the ball in-play (except when it makes a chase: *see* Laws 17-19); or
- (c) if he himself return the ball in-play so that it enters the dedans; or
- (d) if he win a chase; or
- (e) if the server lose a stroke (*see* Law 16).

*Either player, when he loses a stroke.*

16 . Either player loses a stroke,

- (a) if he lose a chase (*see* Law 21); or
- (b) if the ball in play (except as provided in Law 7), touch him or anything which he wears or carries (except his racket in the act of returning the ball); or
- (c) if he touch or strike the ball in-play with his racket more than once, or do not definitely strike it.

*Chases, how made and marked.*

17. When a ball in-play (on either side of the net, not being that on which the striker is standing)

(a) falls on any part of the floor, except on or beyond the service-line ;

or

(b) enters any gallery, except the winning-gallery ; or

(c) touches a gallery-post ;

it is marked a chase

(α) at that line on the floor on which it fell ; or

(β) better or worse than that line on the floor which is nearest to the point at which it fell ; or

(γ) at that gallery the post of which it touched,

except, as provided in Laws 18 and 19.

NOTE (a).—A ball in-play, which touches the net-post and drops on the side opposed to the striker, is marked a chase at the line on the side on which it drops.

NOTE (b).—A ball in-play, which enters a gallery, is marked a chase at that gallery which it enters, notwithstanding that it may have touched an adjacent gallery-post without touching the floor in the interim.

NOTE (c).—The gallery-lines on the floor correspond, and are equivalent, to the galleries of which they bear the names.

*A Ball dropping or falling in net, or bounding over net after dropping, how marked.*

18. When a ball in-play

(a) drops or falls in the net, on the side opposed to the striker ; or

(b) drops on the floor, on the side opposed to the striker, and, bounding over the net, falls on that side of it from which it was struck, whether it touches the net in its bound or not ;

it is marked a chase at the line on the side opposed to the striker.

*A ball dropping or falling upon another ball, how marked.*

19. When a ball in-play drops or falls upon a ball, or other object, which is on the floor [except when it is on or beyond the service-line : see Law 14 (e)] it is marked a chase at the point at which that ball, or other object, was when the ball in-play dropped or fell upon it.

*Chases, how won.*

20. Either player wins a chase

(a) if he serve or return the ball so that it enters a winning-opening ; or

- (b) if he serve or return the ball so that it falls better than the chase for which he played ; or enters a gallery, or touches a gallery-post, better than the gallery, or the gallery-line, at which the chase was, for which he played ; or
- (c) if he serve or return the ball so that it drops or falls upon a ball, or other object, which is at a point on the floor better than that at which, or at the gallery, corresponding to which, the chase was, for which he played ; or
- (d) if his antagonist fail to return the ball in-play, except when it falls worse than the chase in question.

*Chases, how lost.*

21. Either player loses a chase

- (a) if he fail to return the ball in-play, except when it falls worse than the chase in question ; or
- (b) if he return the ball in-play so that it falls worse than the chase, or enters a gallery, or touches a gallery-post, worse than the gallery, or the gallery-line, at which the chase was, for which he played ; or
- (c) if he return the ball in-play so that it drops or falls upon a ball, or other object, which is at a point on the floor worse than that at which the chase was, for which he played.

*Chase-off.*

22. When a ball in-play

- (a) falls at a point on the floor neither better nor worse than that at which, or at the gallery corresponding to which, the chase was, for which the striker played ; or
- (b) enters that gallery, or the gallery corresponding to that gallery-line, or touches the post of that gallery, or falls on the gallery-line corresponding to that gallery, at which the chase was, for which the striker played ; or
- (c) drops or falls upon a ball, or other object, which is at a point on the floor, neither better nor worse than that at which, or at the gallery corresponding to which, the chase was, for which the striker played ;

it is marked chase-off; it is not scored as a stroke won by either player ; the chase is annulled, and the striker has not to play for it again.

*Chases, when played for.*

23. As soon as two chases are marked, or one chase when the score of either player is at forty or advantage (*see* Law 25), the players change sides ; the player who made the first chase now defends it, while the other plays to win it ; and so with the second chase, except when only one has been marked.

*Chases marked in error, annulled.*

24. If by an error three chases have been marked, or two chases when the score of either player is at forty or advantage (*see* Law 25), the last chase in each case is annulled.

*Strokes, how scored.*

25. On either player winning his first stroke, the score is called fifteen for that player ; on either player winning his second stroke, the score is called thirty for that player ; on either player winning his third stroke, the score is called forty for that player ; and the fourth stroke won by either player is scored game for that player ; except, as below :

if both players have won three strokes, the score is called deuce, and the next stroke won by either player is scored advantage for that player ; if the same player win the following stroke, he wins the game ; if he lose the following stroke, the score is again called deuce ; and so on, until either player win the two strokes immediately following the score of deuce, when the game is scored for that player.

*Games, how scored.*

26. The player who first wins six games wins a set ; except, as below :  
if both players win five games, the score is called games-all, and the next game won by either player is scored advantage-game for that player ; if the same player win the following game, he wins the set ; if he lose the following game the score is again called games-all ; and so on, until either player win the two games immediately following the score of games-all, when he wins the set.

NOTE.—Players often agree not to play advantage-sets, but to decide the set by one game after arriving at the score of games-all.

*Doubtful and disputed cases, how decided.*

27. Every chase is marked, and every stroke scored, by the marker, who is entitled to consult the dedans, when he is in doubt. A player, who is dissatisfied with the marker's decision, is entitled to appeal to the dedans. A majority of the dedans confirms or reverses the marker's decision. An appeal must be made before a recommencement of play.

NOTE.—The dedans should not give a decision, unasked, on a question of marking a chase or stroke ; but may, and should, correct inaccurate scoring of chases, strokes, games, or sets.



*THREE-HANDED, or FOUR-HANDED GAMES (sometimes called DOUBLE GAMES).*

*Order of play.*

28. The partners serve and strike-out in alternate games ; unless it shall have been previously agreed to the contrary.

NOTE.—It is usually, but not always, agreed that the striker-out may leave to his partner such services as pass him.

The former Laws apply to these, as well as to Single, Games ; the advantages and disadvantages attaching to a single player under the former Laws here attaching to a pair of players.

*ODDS.*

*Bisques and half-bisques when taken, generally.*

29. (a) A bisque, or a half-bisque, may not be taken after the service has been delivered.
- (b) The server may not take a bisque after a fault ; but the striker-out may do so.

*Bisques and half-bisques when taken, in changing sides.*

30. A player, who wishes to take a bisque, or a half-bisque, there being a chase, or two chases marked, may take it either before or after changing sides ; but he may not, after changing sides, go back to take it.

*Round Services.*

31. (a) When the odds of round services are given, the ball served by the giver of the odds must touch the grille-pent-house after touching the service-pent-house, and before dropping in the service-court, or on one of the lines which bound it.
- (b) Neither faults, nor failure in complying with the above condition, are counted against the giver of the odds ; but the recipient of the odds may decline to return such services as do not touch both the pent-houses ; if, however, he attempt and fail to return any such service, it is counted against him.

*Half-court.*

32. The players having agreed into which half-court, on each side of the net, the giver of the odds shall play, the latter loses a stroke if the ball, returned by him, drop in either of the other half-courts ;

but a ball, returned by the giver of the odds, which

- (a) drops on the half-court-line; or

(b) drops in his half-court and touches the dedans-post before falling ;  
or

(c) drops in his half-court and falls in the dedans, even though on the  
other side of the dedans-post ; or

(d) touches the dedans-post before dropping ;

is counted for the giver of the odds :

and a return, boasted against any wall by the giver of the odds, which

(e) drops in his half-court ; or

(f) drops on the half-court-line ; or

(g) touches the dedans-post before dropping ; or

(h) touches any pent-house, battery, or wall, before dropping in his  
half-court, dropping on the half-court-line, or touching the  
dedans-post ;

is also counted for the giver of the odds.

NOTE.—It is, of course, evident that the giver of these odds may make a chase, or win a chase or a stroke, with a ball which drops in his half-court, or on the half-court-line, but falls in the other half-court.

*Nicks, when All-the-walls or Side-walls are given.*

33. When the odds of touch-no-walls or touch-no-side-walls, are given, a ball returned by the giver of the odds, which makes a nick in falling, is counted for the striker.

#### *DIRECTIONS TO THE MARKER.*

It is the duty of the marker

to call the faults, and the passes ;

to call the strokes, when won, or when he is asked to do so ;

to call the games, and sets, at the end of each, or when asked to do so ;

to mark the chases, when made;

to call the chases, when there are two, in the order in which they were made ; or the chase, when there is one with the score at forty or advantage ; and then

to direct the players to change sides ;

to call the chase or chases again, in order as above, when the players have changed sides, and each chase as a player has to play for it ;

- not to call *play* or *not play* in doubtful cases before the conclusion of the rest, unless asked to do so ;
- to decide all doubtful and disputed strokes, subject to an appeal to the dedans ;
- to warn the players of any balls lying on the floor in their way, or to their danger or disadvantage, and to remove all such balls ;
- to collect the balls into the ball-basket ; and
- to keep the ball troughs constantly replenished in the dedans and last gallery, and the latter especially in three-handed and four-handed games.

## RACKETS.

---

### DEFINITIONS AND LAWS.

*As approved and adopted by the M.C.C., Queen's Club, Prince's Club,  
Manchester Tennis and Racket Club, etc., 1891.*

### DEFINITIONS.

*Ace.*— A stroke won and scored.

*Board.*— The wooden plank or planks covering the lower part of the front wall to the height of 2 ft. 2 in. from the floor. (Queen's Club Court 2 ft. 1½ in.)

NOTE.—The height is different in some courts. The planks are usually coloured red. They do not in all courts extend downwards as far as the floor ; but they should do so, and it is assumed in these Definitions and Laws that they do.

*Box.*— See *Service-box*.

*Bully.*— See *Rally*.

*Court.*— The whole building in which the game is played : or one half of the floor, between the short-line and the back wall, as divided by the half-court-line, and called the *right* (or *fore-hand*) *court*, or the *left* (or *back-hand*) *court*.

*Cut.*— A ball served so that it strikes upon or below the *cut-line* is called a *cut*. It is a *fault* [see *Fault (c)*].

*Cut-line.*— See *Service-line*.

*Double.*— A ball struck after it has touched the floor a second time is called a *double*, or *foul*.

*Fault.*— It is a *fault*,

- (a) if the server, in serving, fail to stand as provided in Law 2 ; or
- (b) if he strike the ball, in serving, more than once ; or
- (c) if the ball served by him strike upon or below the cut-line ; or
- (d) if it fail to drop in the proper court (*see* Law 4).

*Foul.*— See *Double*.

*Good.*— A service delivered, or a return made, in conformity with the Laws, is called *good*.

*Half-court-line.*— The line on the floor, drawn from the short-line to the back wall, and dividing that portion of the floor into two equal spaces.

*Hand-in.*— The player who has the right of serving the ball.

*Hand-out.*— The player who has to receive the service.

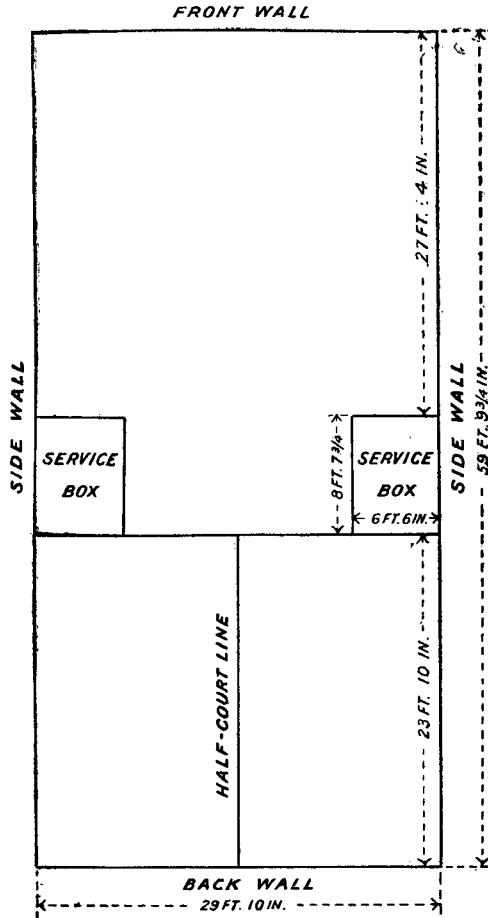

GROUND PLAN OF COURT.

*In-play.*— The ball, after being served, is said to be *in-play* until it has touched the floor twice, or a player, or the board, or has gone out-of-court.

*Let.*— A *let* is when a player is hindered by his opponent from returning a ball which he might otherwise have returned. In that case, the ace counts for nothing and the server serves again from the same box.

*Out-of-court.*—A ball served, or in play, is said to go *out-of-court* when it touches the roof, posts, or cushions, or any part of the back wall at or above the level of the gallery-sill, or is driven into the gallery.

*Rally.*—The repeated return of the ball *in-play* ; it is sometimes called a *bully*.

*Rubber.*—A set of 3, 5, 7, or any other uneven number of games. The winner of the majority of the games wins the *rubber*.

NOTE.—The usual number is five for a single, and seven for a double, match.

*Serve, to.*—To start the ball in-play by striking it with the racket.

*Service.*—The ball served.

*Service-box.*—The square (marked out on each side of the floor) from which the service must be delivered.

*Service-line.*—A line painted on the front wall, about the height of 6 ft. from the floor. It is sometimes called the *cut-line*.

NOTE.—The height is different in some courts, in proportion to their size and quickness.

*Short-line.*—The line on the floor at the distance of about 39 ft. from the front wall and parallel to it.

NOTE.—The distance is different in some courts.

*Volley.*—A ball which is struck before it has touched the floor, is said to be struck at, or on, the *volley* : the stroke is called a *volley*.

---

## LAWS.

### THE SINGLE GAME.

1. The right to serve first shall be determined by the spin of a racket. The player who wins the spin shall have the right to serve first.
2. The server, in serving, must stand with at least one foot within the service-box, and not touching any of the lines which bound it.
3. The server may begin serving from the right or from the left service-box, as he pleases ; but, after serving from the right, he must next serve from the left, or *vice versa*; and so on, alternately, as long as he remains hand-in.
4. The ball served must strike the front wall before touching any other part of the court, and must strike it above the cut-line, and must drop

within the lines \* which bound the court on the side opposite to the box from which the ball was served, and must not touch either of such lines.

5. Hand-out may declare, immediately after the delivery of a service, that he was not ready; in that case, the service shall count for nothing, and the server shall serve again from the same box. If hand-out make any attempt to take the service, he cannot claim that he was not ready.

6. Hand-out may take a fault ; but, if he do so, the rally must be played as if the service had been good.

7. Aces are scored by hand-in only.

8. Hand-in wins and scores an ace,

- (a) if hand-out fail to return the ball served or in-play to the front wall, above the board, before the ball has touched the floor twice, *except in case of a let (see Law 10)* ; or
- (b) if hand-out return the ball served or in-play so that it goes out-of-court; or
- (c) if the ball in-play touch hand-out, or anything that he wears or carries, except his racket in the act of striking.

9. Hand-in becomes hand-out,

- (a) if he serve the ball so that it touches him before touching the floor twice, as provided in Law 4 ; or
- (b) if he serve the ball on the board or out-of-court ; or
- (c) if the ball served touch any part of the court before striking the front wall ; or
- (d) if he serve two consecutive faults; or
- (e) if he fail to return the ball in-play to the front wall, above the board, *except in case of a let (see Law 10)* ; or
- (f) if he return the ball in-play so that it goes out-of-court ; or
- (g) if the ball in-play touch him, or anything that he wears or carries, except his racket in the act of striking.

Then, in any of these cases, hand-out becomes hand-in, and serves in his turn.

10. It shall be a let, and the service or rally shall count for nothing, and the server shall serve again from the same box,

- (a) if the ball in-play touch the striker's opponent on, or above, the knee, and (in the marker's opinion) is thereby prevented from reaching the front wall, above the board ; or

---

\* That is the short-line and the half-court-line.

(b) if either player (in the marker's opinion) hinder his opponent from returning the ball served or in-play.

11. The ball served or in-play may be returned by the striker's opponent at the volley, or after it has touched the floor once, but not after it has touched the floor a second time.

12. Each player must get out of his opponent's way as much as possible ; if either player claim that his opponent hindered him from returning the ball served or in-play, the marker shall decide whether it shall be a let, or not (subject to provisions of Law 15).

13. The game is 15-up ; that is, the player who first scores 15 aces wins the game, provided that,

(a) immediately on the score being called 13-all, hand-out may "set" the game to 5, or to 3 ; and

(b) immediately on the score being called 14-all, hand-out may "set" the game to 3 ; that is, in the first case,

(α) the player who first scores 5 (or 3) aces, according as the game was "set," wins the game ; and, in the second case,

(β) the player who first scores 3 aces wins the game.

NOTE.—In either case, the claim to "set" the game must be made by hand-out before the next service shall have been delivered.

14. The player who was serving at the end of any game of a rubber shall serve first in the next game.

15. In ordinary games the marker's decision shall be final; but, if he doubt which way to decide, he shall direct that the ace be played over again. In matches, when there are Umpires and Referee appointed, the marker's decision shall be final on all questions relating to the service; but he may refer any other question to the Umpires and Referee; and either player may appeal to them from: any decision of the marker, except as to any service ; and they shall decide each case by a majority of votes. If, in course of a rally, the marker call any ball "foul," the rally shall cease from that moment, and the ball shall not be returned; but, if, on appeal to the Umpires and Referee, the marker's decision be reversed, the ace shall count for nothing, and the server shall serve again from the same box. All appeals must be made before another service shall have been delivered.

NOTE.—In matches, the marker should call "play" in doubtful cases which occur in the course of rallies and should refer such cases, at the close of the rallies, to the Umpires and Referee. The players should in their own interest endeavour to return the ball in any case which may seem to them to be doubtful, since, if they omit to do so, and the previous stroke should be declared "good," the case must be decided against them.



## THE DOUBLE, OR FOUR-HANDED, GAME.

1. The Laws of the Single Game (as above) shall apply to the Double or Four-handed, Game, except as set forth in the following Laws.

2. At the beginning of a rubber, only one of the side which has won the spin shall serve at the first time of being hand-in. In all subsequent games of the same rubber, the player who was hand-in at the end of any game shall serve first in the next game, and his partner shall not serve at that time of being hand-in. At all subsequent times, the players on each side shall serve in succession, and shall continue to serve in the same order in which they began serving.

3. One player on the hand-out side may stand where he pleases to receive the service ; but his partner and the server's partner must stand behind the server until the service has been delivered.

4. If the ball served touch the server's partner before touching the floor twice, whether it was, or would have been, a fault or not, the server shall lose his right of service, and the next hand-in shall serve; except when the ball served has been played at and missed, when the ace must be scored to the server.

5. The players on the hand-out side may choose the order in which they shall receive the service, and they shall adhere to that order, and shall only change it once in any game, or at the end of any game, of a rubber.

6. If the ball in-play touch the striker's partner, it shall count against the striker and his partner; that is, if the striker was hand-out, the other side shall score an ace ; if he was hand-in, his side shall lose one hand-in :—

Except, in case the ball in-play touch the striker's partner after it has been hit at and missed by one of their opponents, when it shall be a let, if, in the opinion of the marker, subject to the usual appeal in matches (under Law 15), the other opponent might reasonably have been expected to return the said ball.

7. If a player has hit at and missed a ball in the course of a rally, his partner shall not be entitled to claim a let, though he may have been accidentally hindered by one of the opponents from returning the ball.

# WRESTLING.

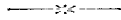

## P R O G R A M M E .

Maximum number  
of Competitors from  
each Country.

### A. Style : Catch-as-Catch-Can.

*Bouts limited to fifteen minutes. Five weights.*

(a) Bantam to 119 lbs. (54 kilos.)	.	.	.	.	12
(b) Feather „ 133 „ (60.3 kilos.)	.	.	.	.	12
(c) Light „ 147 „ (66.6 kilos.)	.	.	.	.	12
(d) Middle „ 161 „ (73 kilos.)	.	.	.	.	12
(e) Heavy over 161 „	.	.	.	.	12

### B. Style : Græco-Roman.

*Bouts limited to twenty minutes. Three weights.*

(a) Light to 147 lbs. (66.6 kilos.)	.	.	.	.	12
(b) Middle „ 161 „ (73 kilos.)	.	.	.	.	12
(c) Heavy over 161	.	.	.	.	12

## CONDITIONS OF COMPETITIONS.

---

1. The Competitions shall be held under the Laws and Rules of the National Amateur Wrestling Association of Great Britain, who shall appoint all the Officials and be responsible for the conduct of each competition.

2. The Competitions are strictly confined to Amateurs.

3. The following is the "Amateur" definition of the National Amateur Wrestling Association :

" An AMATEUR is one who has never competed for a money prize or monetary consideration, or for any declared wager or staked bet ; or who has never engaged in or taught any athletic exercise as a means of pecuniary gain ; or who has never taken part in any competition with anyone who is not an Amateur."

4. The number of Competitors shall be made up to 4, 8, 16, 32 (and so on), thereby ensuring that after the first round there can be no byes.

5. Competitors will be required to wear short sleeved vests and to be clothed at least to the knees and to wear trunks above their wrestling tights, to compete in their stockinged feet or to wear rubber-soled gymnastic shoes without heels. The wearing of sweaters will not be permitted.

6. The Judges shall see that the finger nails of all competitors are trimmed short and that they have not on their hands or body any substance likely to cause injury or distress to an opponent, or give advantage to themselves.

7. The Referee shall disqualify any wrestler using unfair means after having been once cautioned. He shall have full control of the Competitions and his decision shall be final and without appeal, and he shall have power to decide any point not provided for in these Rules.

8. The two losers in the semi-finals shall contest for the third prize.
9. The preliminary bouts shall be decided by one fall only, the final bouts the best out of three falls.
10. In all competitions the ring shall be not less than 16 feet (4·85 metres) nor more than 24 feet (7·3 metres) square.
11. Should any incident not provided for in these Rules arise, such incident or question shall be decided by the Rules of the National Amateur Wrestling Association of Great Britain.
12. A rest of not less than five minutes or more than ten shall be allowed between each fall in the finals.

---

## I.—CATCH-AS-CATCH-CAN STYLE.

---

### RULES.

13. Every contest shall be decided by not less than two nor more than four Judges and a Referee, the latter to be appealed to if the Judges disagree.

14. The wrestlers shall take hold how and where they please, subject to the following restrictions : The wrestlers are not allowed to strike or scratch.

The hair, flesh, ears, private parts, or clothes may not be seized, the twisting of fingers and thumbs is forbidden, nor may any such hold be obtained that the fear of breakage or dislocation of a limb shall induce a wrestler to give the fall. It shall be unlawful to butt or to kick, but striking with the side of the foot shall not be deemed kicking.

The following holds are barred :

The double-nelson, the arm or foot up the back with the bar on ; the hammerlock ; the strangle; the half-strangle ; the scissors ; the hang ; the flying mare with the palm uppermost ; the foot twist.

15. A fall is obtained when a wrestler's two shoulders shall be on the ground at the same time, to the satisfaction of the Judges. If no fall be obtained at the expiration of 15 minutes the Judges shall write their decisions on paper and hand same to the Referee, who in the event of the Judges not agreeing shall decide which wrestler shall be declared the winner.

## II.—GRÆCO-ROMAN STYLE.

### RULES.

16. Every contest shall be decided by not less than two nor more than four Judges and a Referee, the latter to be appealed to if the Judges disagree.

17. The wrestlers are allowed to take hold only from the head and not lower than the waist. Taking hold of the legs and tripping are forbidden. The wrestlers are not allowed to strike or scratch. The hair, flesh, ears, private parts, or clothes may not be seized, the twisting of fingers and thumbs is forbidden, nor may such a hold be obtained that the fear of breakage or dislocation of a limb shall cause the wrestler to give the fall.

The following holds are barred :

The double-nelson ; the arm up the back with the bar on ; the hammer-lock ; the strangle ; the half-strangle ; the hang ; and the flying mare with the palm uppermost.

18. A fall is obtained when a wrestler's two shoulders shall be on the ground at the same time, to the satisfaction of the Judges. A bout shall be limited to twenty minutes, and if no fall be obtained within that period, the Judges shall write their decisions on paper and hand same to the Referee, who, in the event of the Judges not agreeing, shall decide which wrestler shall be declared the winner.

# YACHT RACING.

*Under the direction of a Committee of the Council of the*  
YACHT RACING ASSOCIATION OF GREAT BRITAIN.

---



---

## GENERAL CONDITIONS.

1. The Races will be sailed under the Yacht Racing Association's Rules, as in force in 1908, and incorporating the International Rules.
2. Measurement of yachts will be in accordance with the International Rule.
3. There will be no Time Allowance.
4. The Classes for which matches will be arranged are those of 6, 7, 8, 12, and 15 metres.
5. The helmsman and every member of the crew of each yacht must be an *Amateur* member of a recognised yacht or sailing club, and must be strictly qualified as an Amateur under Nos. 7 and 8 of the General Regulations for the Olympic Games of London (1908), and his entry is subject also to No. 12 of those Regulations.  
As the Olympic Games are *exclusively* for Amateurs, and as it is practically impossible to frame an exact definition of the word, intending competitors are reminded that they may be required to justify their *Amateur status* to the satisfaction of the Committee of the Y.R.A.  
No person can be considered an Amateur who has ever been employed for wages in the handling of a sailing yacht (whether racing or otherwise), or of any fore-and-aft rigged vessel.
6. Not more than *two* yachts can represent any one Country in each Class.

7. All Competitors (yachts *and* crews) must be selected and duly authenticated Representatives \* of their respective Countries, and all entries must be made in accordance with No. 8 of the General Regulations, and in the forms which will be supplied, on application, by the Y.R.A. Committee.

8. The Races will be held on July 27, 28, and 29, 1908, and all entries will close on June 28.

9. Three Races will be sailed in each Class. In the event of three different yachts winning these Races, points will be allotted to them according to the following scale—viz. three points for a first place, two points for a second, and one for a third. Should two or more winners in any class tie under these conditions, they shall sail an extra match, on a day to be appointed, and the winner of this match shall be adjudged the absolute winner of the series. Any tie for second place will be decided in the same manner.

10. The Committee of the Yacht Racing Association will be the Sailing Committee, and the Officer of the Day will be one of its number.

11. All Races will be started from and finish at Ryde Pier, Isle of Wight.

12. All entries are to be addressed in writing to the Hon. Secretary, British Olympic Council, 108 Victoria Street, Westminster, London, S.W., from whom Entry Forms and all instructions will be obtainable.

13. For the purpose of the Olympic Games the definition of a Country entitled to enter its own Representative Yachts is that given in Section 6 of the General Regulations.

14. As regards Great Britain, the selection of Representative Yachts rests with the Committee of the Yacht Racing Association as the National Authority. If in any class the qualified competitors desiring to enter exceed two in number, the Committee may be guided in their selection by the performances of the yachts during the racing season of 1908, or may institute trial matches.

---

(\* *i.e.* "Adopted as representative." The nationality of the crew is the essential matter ; it is not necessary that the yachts should have been designed or built in the respective competing countries.

## APPENDIX A.

---



---

# PROGRAMME OF EVENTS

## IN THE STADIUM

SHOWING ARRANGEMENTS OF THE HEATS  
AND OFFICIALS IN CHARGE OF EACH EVENT.

---

### First Day.—Monday, July 13.

#### 3.0 GRAND PARADE OF ATHLETES.

*Director of Ceremony.*— ROBERT MITCHELL.  
*Chief Marshal.*—HENRY ELLIOTT.

#### 3.30 OPENING OF THE OLYMPIC GAMES BY HIS MOST GRACIOUS MAJESTY THE KING.

The International Olympic Committee, the British Olympic Council, accompanied by Members of the Comité d'Honneur, passed before His Majesty the King. At the request of Lord Desborough of Taplow, K.C.V.O., President of the British Olympic Council, His Majesty declared the Fourth Olympiad open.

### ATHLETICS.

#### OFFICIALS.

*Referee.*— G. V. A. SCHOFIELD.

*Judges.*— E. B. HOLMES and E. H. PELLING.

*Timekeepers.*— W. M. BARNARD, C. J. PRATT, and W. W. ALEXANDER.

*Starter.*— C. L. LOCKTON.

*Starter's Steward.*— I. DAVIDSON.

*Umpires.*— W. A. BROMMAGE, A. J. EGGLESTON, H. VENN, and J. T. GREEN.

*Competitors' Stewards.*— H. J. BARCLAY (Chief), F. W. BAKER, H. W. G. HASLEGRAVE, E. F. NICHOLLS, J. M. ANDREW, D. BASAN, and C. T. W. HICKMAN.

*Press Steward.*— P. W. B. TIPPETTS.

*Hon. Sec. Amateur Athletic Association.*— P. L. FISHER.

*Assistant Secretary.*— S. G. MOSS.

*Committee Room.*— Stadium, Block GG—FF, Room No. 6.

4.0 1,500 METRES. TWO HEATS. [*Winners only run again.*]



**SWIMMING.**

## OFFICIALS.

*Starter.*— A. HUDSON.

*Judges.*— H. BENJAMIN and Dr. W. J. LEIGHTON, M. B.

*Referee.*— G. W. HEARN.

*Timekeepers.* —J. C. HURD and H. H. GRIFFIN.

*Timekeeper for Second Man.* —R. F. B. CROSS.

*Turning Judges.* —A. W. CREASY and C. E. MACRAE.

*Stewards.* —H. E. FERN, W. G. EMERY, R. W. JONES, and F. O. VENNING.

*Committee Room.*— Stadium, Room No. 24.

4.0 400 METRES. THREE HEATS. [*Winners and fastest loser to compete again.*]

**CYCLING.**

## OFFICIALS.

*Judge.* —Dr. E. B. TURNER.

*Assistant Judge.* —T. LONSDALE.

*Umpires.* —S. H. ANSELL, T. W. J. BRITTEN, R. J. GEAR, R. C. HARRIS, E. P. HEWKIN, P. NIX, E. PAYNE, and J. H. STAPLEY.

*Starter.* —C. E. LILES.

*Timekeeper.* —T. H. WOOLLEN.

*Clerks of the Course.*—J. R. SMILES and J. C. P. TACAGNI.

*Members of B.O.C.*—T. W. J. BRITTEN (National Cyclists' Union), J. BLAIR (N.C.U. and Scottish Cyclists' Union), and E. J. O'REILLY (Irish Cyclists' Association).

*Olympic Committee of the N.C.U.*—R. BRADLEY (Chairman), Messrs. BLAIR, BRITTEN, ANSELL, MITSON, LONSDALE, VICKERS, SMILES, TURNER, HALLIWELL, and ORD.

*Secretary.* —S. R. NOBLE, 27 Chancery Lane, W.C.

*Committee Room.*—Stadium, Block GG—FF, Room No. 6.

4.15 2,000 METRES (1.24 MILES). TANDEM. FOUR HEATS. Time Limit, 4 minutes. [*Winners and fastest loser to compete in Second Round.*]

4.30 GYMNASTIC DISPLAY by teams representing Denmark, Norway, and Sweden.

ATHLETICS.—1,500 METRES. SIX HEATS.

5.0 DIVING DISPLAY.

5.15 CYCLING.—2,000 METRES. TANDEM. THREE HEATS.

6.0 CYCLE POLO.—Match between the Deutscher Radfahrer Bund and the Irish Bicycle Polo Association.

## Second Day.—Tuesday, July 14.

### ATHLETICS.

#### OFFICIALS.

- Referees (Racing).* —G. V. A. SCHOFIELD and E. H. PELLING. (Field).—  
E. B. HOLMES.
- Judges (Racing).* —C. VAL. HUNTER, D. BASAN, H. A. BUTLER. (Field).—  
A. J. EGGLESTON, C. T. W. HICKMAN, J. T. GREEN, M. J. BULGER, G. S.  
ROBERTSON, W. J. B. TIPPETS, J. SHEARMAN.
- Starters.* —C. L. LOCKTON, J. M. ANDREW, W. TRIPP.
- Judges (Walking).*—H. VENN, G. DUXFIELD, A. SMITH, E. ION POOL.
- Timekeepers.*—A. E. MACHIN, W. W. ALEXANDER, H. J. ROTHERY.
- Umpires.* —F. HARRISON, M. CURRY, C. OTWAY, H. W. G. HASLEGRAVE.
- Competitors' Stewards.* —A. OVENDEN (Chief), J. E. DUTTON, H. A. MEARS,  
E. O. CHESHIRE, W. P. SPARKS.

- 10.0 THROWING THE HAMMER, 16 lb., from a 7 ft. Circle. In Three Sections.

### CYCLING.

#### OFFICIALS.

- Judges.* —L. BRETON, T. W. J. BRITTEN.
- Assistant Judges.* —W. E. COPE, R. J. OWEN.
- Umpires.* —W. G. CHANDLER, R. B. FRANKLIN, M. PANARD (U.V.F.), C. E. SALT,  
J. DALTON SMITH, W. W. RIDLEY, R. H. VESSEY, S. C. WINKS.
- Starters.* —W. ROBINSON, J. BROWN.
- Timekeepers.*—E. V. EBBLEWHITE, A. J. WAKEFORD.
- Clerks of the Course.*—R. HARDING, J. R. SMILES.
- Stewards.* —E. BLAKESLEY, ELLIS [BRADSHAW, S. S. CURRA, A. DEACON,  
R. R. FLINT, R. G. GEAR, C. K. MILLS, P. NIX, H. SCOTT, J. A. WALKER.

- 10.0 20 KILOMETRES (12.427 MILES). TWO HEATS. Time Limit, 40 minutes. [*Winners and three leaders of greatest number of laps in three fastest heats to compete in Final.*]
- 11.0 ATHLETICS.—3,500 METRES WALK. [*First three in each heat to compete in Final.*]
- 12.0 CYCLING.—20 KILOMETRES. TWO HEATS.

### GYMNASTICS.

#### OFFICIALS:

#### TEAM COMPETITIONS.

JUDGES.— JOHN ADAMS, Lieut. GRENFELL, Lieut. LOCKHART LEITH, R.N.  
RESERVE JUDGE.—Major MOORE.

#### TIMEKEEPERS.

Messrs. COOKER, FAITH, FRENCH, HALL, HASKINS, HOLLOWAY, LARCHIN,  
A. J. PERRING, RENDELL, SANDON, SYERS, FATTORINI.

## STEWARDS AND WHIPS.

*Chief Steward.*—H. E. WILLIAMS (Birmingham Athletic Club).

*Deputy Chief Steward.*—F. W. STEVENS (Southern Counties A.G.A.).

English. —Messrs. BATH, BASS, BAXTER, BOOKER, DODD, ENGLISH, A. FATTORINI, T. E. MARR, MOSELEY, MORTIMER, PARTRIDGE, H. W. RENDELL, RICKARDS, RODGERS, SIMMONS, TAYLOR, W. T. WALTON, WARD, W. O. WILLIAMS, WOODMAN.

Scotch. —Messrs. CULLEN, MCGAW, MCGREGOR, SCOTT, W. F. WOOD.

Welsh. —Messrs. BAKER, COWIG, FITT, HAWKINS, SUDERMAN, WATKINS.

## SCORERS.

*Chief Scorer.*—H. J. BARCLAY.

Messrs. CHESTERTON, COLE, DUFFY, KEATH, LAMBERT, MORTIMER, MUNROE, PARKINSON, F. G. PERRING, RIDOUT, TURNER, WILSON.

## HON. MEDICAL OFFICERS.

J. A. HOWARD, Esq., M.D., London ; Surgeon BELL, R.N.

## INDIVIDUAL COMPETITIONS.

## JUDGES.

*Horizontal Bar (Swinging).* —J. DALLAS (Midland Counties A.G.A.), W. G. MILLAR (Scottish A.G.A.), E. R. ROGERS (Midland Counties A.G.A.).

*Horizontal Bar (Slow).*—F. R. B. EMMSLIE (Southern Counties A.G.A.), B. M. LLOYD (Midland Counties A.G.A.), T. WHITE (Welsh A.G.A.).

*Parallels (Mixed).*—A. BARNARD (Southern Counties A.G.A.), D. C. STUART (Scottish A.G.A.), J. H. TINDALL (Liverpool Gymnastic League).

*Rings (Steady).* —A. GROCOCK (Southern Counties A.G.A.), S. PLATT (Midland Counties A.G.A.), S. STEWART (Midland Counties A.G.A.).

*Rings (Flying).*—F. JEANS (Welsh A.G.A.), W. PATERSON (Scottish A.G.A.), Dr. R. URY (Liverpool District League).

*Horse.*—H. L. CAIN (Southern Counties A.G.A.), A. F. JENKIN (Southern Counties A.G.A.), E. RICHARDSON (Southern Counties A.G.A.).

*Rope.* —D. MAULE (Scottish A.G.A.), G. HOWELLS (Welsh A.G.A.), E. WILSON (Yorkshire A.G.A.).

## RESERVE JUDGES.

Messrs. BURFIELD, H. COOKE, DRURY, GRAF, PERROTT, H. C. POTTS, E. F. RICHARDSON, and STEWART.

2.30 INDIVIDUAL COMPETITION. HEPTATHLON. In Seven Squads for Horizontal Swinging, Horizontal Slow, Parallel Bars, Rings (Swinging), Rings (Stationary), Vaulting Horse, Rope.

2.30 GYMNASTICS.—TEAM COMPETITION. Denmark.

2.30 CYCLING.—20 KILOMETRES. TWO HEATS.

**SWIMMING.**

*Diving Judges.* —S. J. MONKS, H. J. GRIMWADE, H. STROMBERG.

*Scorers.* —W. BURTON, A. BARNES.

2.30 FANCY DIVING.—TWO HEATS.

3.30 ATHLETICS.—3,500 METRES WALK. FINAL.

- 3.55 ATHLETICS. — THREE MILE TEAM RACE. Five to run. Three to count. TWO HEATS. [*Winners only run in Final.*]  
 FIRST HEAT. United Kingdom, Italy, Holland.  
 SECOND HEAT. France, U.S.A., Sweden.
- 4.0 CYCLING. —ONE LAP (660 yards). Time Limit, 70 Seconds. 16 Heats.  
 [*Winners to compete in Second Round.*]
- 4.0 GYMNASTICS. —TEAM COMPETITION. United Kingdom.

## SWIMMING.

### OFFICIALS.

*Starter.* —R. W. JONES.  
*Judges.* —G. H. ROPE, A. ST. P. CUFFLIN.  
*Referee.* —A. MOSLEY.  
*Timekeepers.*— J. BROGDON, H. H. GRIFFIN.  
*Timekeeper for Second Man.* —H. CRAPPER.  
*Turning Judges.* —G. H. GRAY, F. CORDINGLEY.  
*Stewards.*—F. O. VENNING, G. LUDLAM, T. CLEGG, J. H. PHIPPS, A. G. CHALMERS,  
 F. B. HOWARD, G. H. LEE, H. E. FERN, A. W. CREASY.  
*Costume Stewards.*—W. G. EMERY, W. S. HANKINS, H. J. JOHNSON.  
*Press Stewards.* —H. T. BRETTON, G. F. SIMMONS.  
*Telegraph Steward.* —A. FREEDMAN.

- 4.45 400 METRES. SIX HEATS.
- 5.0 GYMNASTIC DISPLAY. Finland.
- 5.20 ATHLETICS.—1,500 METRES. FINAL.
- 5.30 CYCLING.—20 KILOMETRES. FINAL.
- 6.0 GYMNASTIC DISPLAY. Italy.
- 7.0 " " Germany.

---

## Third Day.—Wednesday, July 16.

### ATHLETICS.

#### OFFICIALS.

*Referees (Racing).* —G. V. A. SCHOFIELD, T. M. ABRAHAM. (Field)—E. B. Holmes.  
*Judges (Racing).* —C. VAL. HUNTER, R. W. GALE, H. A. BUTLER. (Field)—  
 A. J. EGGLESTON, C. T. W. HICKMAN, J. T. GREEN, M. J. BULGER, G. S.  
 ROBERTSON, W. J. B. TIPPETTS, J. SHEARMAN.

*Starters.* —C. L. LOCKTON, W. TRIPP.  
*Starters' Steward.* —I. DAVIDSON.  
*Timekeepers.* —A. J. URRY, E. H. PELLING, W. W. ALEXANDER.  
*Umpires.* —F. HARRISON, M. CURRY, C. OTWAY, F. W. BAKER.  
*Competitors' Stewards.* —A. OVENDEN (Chief), J. E. DUTTON, E. O. CHESHIRE,  
 D. PROSSER, W. P. SPARKS, H. W. G. HASLEGRAVE.  
*Press Stewards.* —P. W. B. TIPPETTS, F. W. YEXLEY.

10.0 JAVELIN. —Free Style, In Eight Sections.

**CYCLING.**

## OFFICIALS.

*Judges.* —J. BLAIR, T. LONSDALE.

*Assistant Judges.* —R. F. DAVIS, F. P. LOW.

*Umpires.* —W. R. BOND, F. CHICK, O. COLE, R. R. FLINT, T. GRANTHAM,  
A. T. HEELAS, E. PERMAN, J. TEUTON (I.C.A.), E. P. HEWKIN.

*Starters.* —J. BROWN, A. VICKERS.

*Timekeepers.* —C. P. GLAZEBROOK, T. H. WOOLLEN.

*Clerks of the Course.* —A. BARRETT, W. E. COPE.

*Stewards.* —S. H. ANSELL, E. BRADSHAW, L. DUCROCQ, H. HOLLANDS, W. R. JAMES, E. PAYNE, H. SCOTT, W. F. SUTTON, A. J. WAKEFORD, E. O. WHITE.

*Lap Scorers.* —V. WATERHOUSE (Chief), E. BLAKESLEY, W. A. BLOFIELD,  
A. DEACON, R. B. FRANKLIN, W. B. GOODWIN, H. C. HARRIS, C. K. MILLS  
W. MITSON, P. NIX, W. T. PEARSE, J. W. RIDLEY, C. E. SALT, J. H. STAPLEY.

10.0 100 KILOMETRES (62·135 MILES) RACE FOR H.R.H. THE  
PRINCE OF WALES' CHALLENGE CUP. FIRST HEAT.  
Time Limit, 3 hours 15 minutes [*First six men and two leaders of  
greatest number of laps in each heat to compete in Final.*]

**SWIMMING.**

## OFFICIALS.

## SEMI-FINAL, 400 METRES.

*Starter.* —H. J. JOHNSON.

*Judges.* —H. T. BRETTON and W. S. HANKINS.

*Referee.* —G. W. HEARN.

*Timekeepers.* —E. J. PLUMBRIDGE and W. KENDALL.

*Timekeeper for Second Man.* —E. J. TACKLEY.

*Turning Judges.* —W. H. M. MARX and A. W. CREASY.

## BREAST STROKE.

*Starter.* —H. E. FERN.

*Judges.* —J. C. HURD and W. N. BENJAMIN.

*Referee.* —G. W. HEARN.

*Timekeepers.* —M. JEFFERSON and E. J. TACKLEY.

*Timekeeper for Second Man.* —W. E. BULL

*Turning Judges.* —W. H. M. MARX and A. W. CREASY.

## FANCY DIVING.

*Judges.* —S. J. MONKS, D. F. COOKE, and H. STROMBERG.

*Scorers.* —W. BURTON and S. DICKSON.

## WATER POLO.

*Referee.* —Rev. G. W. BRODRIBB.

*Timekeeper.* —E. J. PLUMBRIDGE.

*Goal Scorers.* —G. W. EMERY and G. F. SIMMONS.

*Stewards.* —G. LUDLAM, F. O. VENNING, T. B. HOWARD, F. B. MARTIN, A. G. CHALMERS, A. FREEDMAN, G. T. LEE,  
A. JUDKINS, H. T. BUTLER, and H. E. FERN.

11.0 400 METRES. TWO SEMI-FINAL HEATS.

11.30 THIRD HEAT. FANCY DIVING.

## 11.30 ATHLETICS.—THREE MILES TEAM RACE. FINAL.

*[Five to run and three to count.]*

## 2.30 SWIMMING.—200 METRES. BREAST STROKE. SIX HEATS.

*[First in each heat and fastest loser in Second Round.]*

## 2.30 ATHLETICS.—FIVE MILES FLAT RACE. TWO HEATS.

*[First two to run in Final.]***GYMNASTICS.**

## OFFICIALS.

## TEAM COMPETITIONS.

JUDGES.—JOHN ADAMS, Lieut. GRENFELL, Lieut. LOCKART LEITH, RN.

RESERVE JUDGE.—Major MOORE.

## TIMEKEEPERS.

Messrs. COOKER, FAITH, FRENCH, HALL, HASKINS, HOLLOWAY, LARCHIN,  
A. J. PERRING, RENDELL, SANDON, SYERS, FATTORINI.

## STEWARDS AND WHIPS.

*Chief Steward.*—H. E. WILLIAMS (Birmingham Athletic Club).*Deputy Chief Steward.*—W. F. STEVENS (Southern Counties A.G.A.).*English.*—Messrs. BATH, BASS, BAXTER, BOOKER, DODD, ENGLISH, A. FATTORINI,  
T. E. MARR, MOSELEY, MORTIMER, PARTRIDGE, H. W. RENDELL, RICKARDS,  
RODGERS, SIMMONS, TAYLOR, W. T. WALTON, WARD, W. O. WILLIAMS,  
WOODMAN.*Scotch.*—Messrs. CULLEN, MCGAW, MCGREGOR, SCOTT, W. F. WOOD.*Welsh.*—Messrs. BAKER, COWIG, FITT, HAWKINS, SUDERMAN, WATKINS.

## SCORERS.

*Chief Scorer.*—H. J. BARCLAY.Messrs. CHESTERTON, COLE, DUFFY, KEATH, LAMBERT, MORTIMER, MUNROE,  
PARKINSON, F. G. PERRING, RIDOUT, TURNER, WILSON.

## HON. MEDICAL OFFICERS.

J. A. HOWARD, Esq., M.D., London ; Surgeon BELL, R.N.

## INDIVIDUAL COMPETITIONS.

## JUDGES.

*Horizontal Bar (Swinging).*—J. DALLAS (Midland Counties A.G.A.), W. G. MILLAR  
(Scottish A.G.A.), E. R. ROGERS (Midland Counties A.G.A.).*Horizontal Bar (Slow).*—F. R. B. EMSLIE (Southern Counties A.G.A.), B. M.  
LLOYD (Midland Counties A.G.A.), T. WHITE (Welsh A.G.A.).*Parallels (Mixed).*—A. BARNARD (Southern Counties A.G.A.), D. C. STUART  
(Scottish A.G.A.), J. H. TINDALL (Liverpool Gymnastic League).*Rings (Steady).*—A. GROCOCK (Southern Counties A.G.A.), S. PLATT (Midland  
Counties A.G.A.), S. STEWART (Midland Counties A.G.A.).*Rings (Flying).*—F. JEANS (Welsh A.G.A.), W. PATERSON (Scottish A.G.A.),  
Dr. R. URY (Liverpool District League).*Horse*—H. L. CAIN (Southern Counties A.G.A.), A. F. JENKIN (Southern Counties  
A.G.A.), E. RICHARDSON (Southern Counties A.G.A.).*Rope.*—D. MAULE (Scottish A.G.A.), G. HOWELLS (Welsh A.G.A.), E. WILSON  
(Yorkshire A.G.A.).

## RESERVE JUDGES.

Messrs. BURFIELD, H. COOKE, DRURY, GRAF, PERROTT, H. C. POTTS,  
E. F. RICHARDSON, and STEWART.

- 2.30 TEAM COMPETITIONS. Finland.
- 2.30 INDIVIDUAL COMPETITION. HEPTATHLON. Seven Squads, as before. [*See 2.30 on July 14.*]
- 3.15 TEAM COMPETITION. France.
- 3.30 CYCLING.—ONE LAP RACE. SECOND ROUND. FOUR HEATS.  
[*First in each heat to ride in Final.*]
- 3.45 SWIMMING.—FANCY DIVING. FOURTH HEAT.
- 3.50 ATHLETICS.—FIVE MILES FLAT RACE. THIRD HEAT.  
[*First two to run in Final.*]
- 4.0 GYMNASTICS.—TEAM COMPETITION. Sweden.
- 4.30 CYCLING.—ONE LAP (660 Yards, 603·491 Metres). FINAL.
- 4.30 ATHLETICS.—FIVE MILES FLAT RACE. FOURTH HEAT.  
[*First two to run in Final.*]
- 4.30 GYMNASTICS.—DISPLAY BY LADIES representing Denmark, Northern Polytechnic Institute, Ladies' Section of the Yorkshire Amateur Gymnastic Association.
- 5.0 CYCLING.—2,000 METRES TANDEM. SECOND ROUND. TWO HEATS. [*First in each heat and fastest loser to compete in Final.*]
- 5.0 SWIMMING.—WATER POLO. Belgium v. Holland.
- 5.15 ATHLETICS.—FIVE MILES FLAT RACE. FIFTH HEAT.  
[*First two to run in Final.*]
- 5.45 CYCLING.—2,000 METRES (1·24 Miles). TANDEM. FINAL.
- 5.55 ATHLETICS.—FIVE MILES FLAT RACE. SIXTH HEAT.  
[*First two to run in Final.*]
- 6.0 GYMNASTICS.—DISPLAY. Metropolitan and Southern Counties' Amateur Gymnastic Association.

---

## Fourth Day. —Thursday, July 16.

### CYCLING.

#### OFFICIALS.

*Judges.* —J. HILL (S.C.U.), Dr. E. B. TURNER.

*Assistant Judges.*—S. H. ANSELL, J. R. SMILES.

*Umpires.*—P. COLEMAN, J. D. DOUGLAS, E. PAYNE, FRANCIS PORTIER (Swiss Cyclists' Union), GERARD BOUSSELOT, MEYERDE STADELHOFEN (Swiss Cyclists' Union), M. YOUNG (Scottish Cyclists' Union).

*Starters.* —C. E. LILES, W. ROBINSON.

*Timekeepers.* —J. H. BURLEY, C. P. GLAZEBROOK.  
*Clerks of the Course.* —R. HARDING, J. C. P. TACAGNI.  
*Stewards.* —S. AYRES, F. CHICK, R. B. FRANKLIN, W. B. GOODWIN, W. MATSON,  
 H. PAYNE, W. W. RIDLEY, R. H. VESSEY, W. H. S. WALKER.  
*Lap Scorers.* —V. WATERHOUSE (Chief), W. A. BLOFIELD, E. BLAKESLEY,  
 E. BRADSHAW, W. E. COPE, S. S. CURRA, A. DEACON, R. R. FLINT, H. C.  
 HARRIS, D. LUCAS, P. NIX, J. W. RIDLEY, J. H. STAPLEY, A. VICKERS,  
 Z. WHEATLEY.

10.0 100 KILOMETRES (62·135 Miles) RACE. SECOND HEAT. [*First six and two leaders of greatest number of laps in each heat to compete in Final.*]

## ATHLETICS.

### OFFICIALS.

*Referees (Racing)* . —G. V. A. SCHOFIELD, T. M. ABRAHAM. (Field)—E. B. HOLMES.  
*Judges (Racing)* .—S. J. HARDY, H. A. BUTLER. (Field)—A. J. EGGLESTON,  
 C. T. W. HICKMAN, M. J. BULGER, F. W. PARKER, G. S. ROBERTSON,  
 W. J. B. TIPPETTS.  
*Starters* . —C. L. LOCKTON, J. M. ANDREW, W. TRIPP.  
*Starters' Steward.* —I. DAVIDSON.  
*Judges (Walking).* —H. VENN, G. DUXFIELD, A. SMITH.  
*Timekeepers.* —A. J. URRY, C. J. PRATT, D. MCKEOG.  
*Umpires.* —J. S. DUTTON, G. TALBOT, E. F. NICHOLLS, H. W. G. HASLEGRAVE.  
*Competitors' Stewards.*—C. OTWAY (Chief), D. PROSSER, A. OVENDEN, J. E.  
 DUTTON, E. O. CHESHIRE, W. P. SPARKS, E. GREENWOOD.

10.0 TEN MILES WALKING RACE. FIRST HEAT.  
 [*First four in each heat to compete in Final.*]

11.30 SECOND HEAT.

10.0 THROWING THE DISCUS.—Free Style. In Eight Sections

## SWIMMING.

### OFFICIALS.

#### BREAST STROKE (Second Round).

*Starter.* —H. THOMSETT.  
*Judges.* —Dr. W. J. LEIGHTON and A. ST. P. CUFFLIN.  
*Referee.* —A. MOSLEY.  
*Timekeepers.* —E. J. TACKLEY and H. CRAPPER.  
*Turning Judges.* —G. T. EVERSHERD and F. CORDINGLEY.

#### FANCY DIVING (Fifth Heat).

*Judges.* —H. J. GRIMWADE, D. F. COOKE, and H. STROMBERG.  
*Scorers.* —W. BURTON and S. DIXON.

#### 400 METRES (Final).

*Starter.*—R. W. JONES.  
*Judges.*—Dr. W. J. LEIGHTON, M. B., and G. H. ROPE.  
*Referee.* —T. J. HINCKS.  
*Timekeepers.*—H. H. GRIFFIN and E. J. TACKLEY.  
*Turning Judges.* —G. T. EVERSHERD and F. CORDINGLEY.



## BACK STROKE (Opening Heats).

*Starter.* —W. M. BULL.

*Judges.* —A. ST. P. CUFFLIN and J. C. HURD.

*Referee.*—T. J. HINCKS.

*Timekeepers.* —H. H. GRIFFIN and H. CRAPPER.

*Timekeeper for Second Man.* —E. J. TACKLEY.

*Stewards.* —J. H. BUCKLE, G. T. LEE, F. O. VENNING, H. BOLTON, H. B. MARTIN, A. FREEDMAN, H. E. FERN, A. W. CRESSY, H. J. BRETTON, G. F. SIMMONS, W. G. EMERY, H. J. JOHNSON, and W. S. HAWKINS.

*Hon. Sec. A.S.A.,* J. C. HURD, 24 Cautley Avenue, Clapham, S.W.

2.30 200 METRES BREAST STROKE. SECOND ROUND. TWO HEATS.  
[First and Second in each heat to swim in Final.]

## GYMNASTICS.

## OFFICIALS.

*Judges.* —JOHN ADAMS, Lieut. GRENFELL, Lieut. LOCKHART LEITH, R.N.

*Reserve Judge.*—Major MOORE.

*Timekeepers.*—Messrs. COOKER, FAITH, FRENCH, HALL, HASKINS, HOLLOWAY, LARCHIN, A. J. PERRING, RENDELL, SANDON, SYERS, FATTORINI.

*Stewards and Whips.* —*Chief Steward,* H. E. WILLIAMS (Birmingham Athletic Club). *Deputy Chief Stewards,* F. W. STEVENS (Southern Counties A.G.A.). *English,* Messrs. BATH, BASS, BAXTER, BOOKER, DODD, ENGLISH, A. FATTORINI, T. E. MARR, MOSELEY, MORTIMER, PARTRIDGE, H. W. RENDELL, RICKARDS, RODGERS, SIMMONS, TAYLOR, W. T. WALTON, WARD, W. O. WILLIAMS, WOODMAN. *Scotch,* Messrs. CULLEN, MCGAW, MCGREGOR, SCOTT, W. F. WOOD. *Welsh,* Messrs. BAKER, COWIG, FITT, HAWKINS, SUDERMAN, WATKINS.

*Scorers.* —*Chief Scorer,* H. J. BARCLAY. Messrs. CHESTERTON, COLE, DUFFY, KEATH, LAMBERT, MORTIMER, MUNROE, PARKINSON, F. G. PERRING, RIDOUT, TURNER, WILSON.

*Hon. Medical Officers.* —J. A. HOWARD, Esq., M.D. London ; Surgeon BELL, R.N.

2.30 TEAM COMPETITION. Holland.

2.30 ATHLETICS.—PUTTING THE WEIGHT. In Eight Sections.

3.0 SWIMMING.—FANCY DIVING. FIFTH HEAT.

3.0 CYCLING.—1,000 METRES (1,093 yds. 2 ft.). Time Limit, 1 min. 45 secs.  
SIXTEEN HEATS. [First in each heat to compete in Second Round.]

3.15 GYMNASTICS.—TEAM COMPETITION. Norway.

4.0 " " " Italy.

4.15 SWIMMING.—400 METRES. FINAL.

4.30 CYCLING.—1,000 METRES. FOUR SEMI-FINAL HEATS.

4.30 SWIMMING.—100 METRES. BACK STROKE. SEVEN HEATS.  
[First in each heat and fastest loser to compete in Second Round.]

4.45 GYMNASTICS.—DISPLAY BY HOLLAND.

5.30 CYCLING.—1,000 METRES. FINAL.

5.30 GYMNASTICS.—DISPLAY BY NORWAY.

6.0 " DISPLAY BY BATTERSEA POLYTECHNIC.

## Fifth Day.—Friday, July 17.

### ARCHERY.

#### OFFICIALS.

*Judges.* —Colonel WALROND, Mr. EYRE W. HUSSEY, Comte DE BERTIER.

*Stewards.* —General APPELYARD, C.B., G. B. S. WALROND.

10.0 GENTLEMEN.—THE YORK ROUND. FIVE TARGETS.

LADIES.—THE NATIONAL ROUND.

### FENCING.

#### OFFICIALS.\*

#### COMMITTEE.

Sir COSMO DUFF GORDON, Bart., A. VIRGOE BUCKLAND, G. H. BAILLIE, F. LEGGE, Colonel J. LESLIE, A. G. ROSS, Dr. G. H. SAVAGE, J. POLLOCK, M. SILVERSTON, Commander H. WATSON, RN., H. MONTGOMERIE (*Secretary*).

#### JUDGES.

G. R. ALEXANDER, C. H. BISCOE, F. J. BRETT, Capt. E. C. BRIERLEY, C. F. CLAY, Capt. A. E. CRESSWELL, J. B. CUNLIFFE, Capt. S. DE Joux, R. W. DOYNE, A. FELLOWS, G. C. D. GORDON, G. L. JACOBS, J. JENKINSON, E. B. MILNES, Major C. MOORE, H. POLLOCK, A. RAWLINSON, Colonel S. P. ROLT, Commander ROYDS, R.N., W. H. C. STAVELEY, Capt. A. E. SYSON, F. H. TOWNSEND, Capt. C. TRUEMAN, F. MOORE, Capt. W. C. WRIGHT.

*French.* —G. BREITMAYER, le Marquis DE CHASSELOUP-LAUBAT.

*Swedish.* —Lieut. CARL HJÖRTH.

*Bohemian.* —Dr. MAGY and another.

#### SCORERS AND TIMEKEEPERS.

A. C. AMY, R.A.M.C., W. BEAN, Rev. G. L. BLAKE, P. G. DOYNE, Capt. S. DYER, Capt. A. G. HALL, C. MONTGOMERIE, E. PLOWDEN, F. C. REYNOLDS, Major A. B. KING, H. TURNER, A. TODHUNTER.

10.30 SABRE INDIVIDUAL COMPETITION. FOUR PRELIMINARY POOLS.

### ATHLETICS.

#### OFFICIALS.

*Referees (Racing).* —G. V. A. SCHOFIELD, T. M. ABRAHAM.

*Field.* —E. B. HOLMES.

*Judges (Racing).* —J. P. ELLIS, R. W. GALE, H. A. BUTLER.

*Field.* —W. A. BROMMAGE, H. J. BARCLAY, C. T. W. HICKMAN, J. H. A. REAY,

G. S. ROBERTSON, W. J. B. TIPPETTS, WHITTON, BRYSON.

*Starters.* —C. L. LOCKTON, J. M. ANDREW, W. TRIPP.

*Starters' Steward.* —I. DAVIDSON.

*Judges (Walking).* —H. VENN, C. DUXFIELD, A. SMITH.

*Timekeepers.* —A. E. MACHIN, D. MCKEOG, A. OVENDEN.

*Umpires.* —J. S. DUTTON, G. TALBOT, E. F. NICHOLLS, H. W. G. HASLEGRAVE.

*Competitors' Stewards.* —C. OTWAY (Chief), E. O. CHESHIRE, W. P. SPARKS,

C. W. GARNHAM, H. A. MEARS (C. of C.), J. BENNETT, WHITE, F. W. BAKER.

2.30 TEN MILES WALK. FINAL.

---

\*The Fencing Officials will not be repeated here, as they are given fully for every contest recorded in Chapter IV.

- 2.30 JAVELIN. [*Held in the Middle.*] In Four Sections.
- 2.30 TUG OF WAR. Teams of Eight from Greece, United States, Germany, Sweden, and United Kingdom (three), of whom Greece and Germany scratched. FIRST ROUND. UNITED KINGDOM II. (Liverpool Police) v. U.S.A.
- 2.30 FENCING.—ÉPÉE INDIVIDUAL COMPETITION. FOUR PRELIMINARY POOLS.
- 2.30 SWIMMING.—100 METRES BACK STROKE. TWO SEMI-FINAL HEATS.  
[*First and Second to compete in Final.*]

## OFFICIALS.

## FOR SEMI-FINAL AND FINAL.

*Starter.* —A. HUDSON.

*Judges.* —A. E. BIRCH and W. J. READ.

*Referee.* —G. PRAGNELL.

*Timekeepers.*— F. BAXTER and W. KENDALL.

- 3.25 FANCY DIVING.—SECOND ROUND. TWO HEATS.  
[*First and Second to compete in Final.*]

## OFFICIALS.

*Judges.* —S. J. MONKS, H. J. GRIMWADE, and H. STROMBERG.

*Scorers.* —W. BURTON and S. DICKSON.

*Stewards.*—H. J. BUCKLE, V. O. VENNING, A. RICHARDSON, H. T. EDNEY, J. H. PHIPPS, F. B. HOWARD, G. F. SIMMONS, W. G. EMERY, R. W. JONES, W. S. HANKINS, H. J. JOHNSON, H. BOLTON, A. G. CHALMERS, A. FREEDMAN, A. JUDKINS, H. T. BRETTON, and H. C. MARTIN.

**CYCLING.**

## OFFICIALS.

*Judges.* —A. BLAKEBROUGH, W. H. HALLIWELL.

*Assistant Judges.*—T. W. CRAIG, C. GOSTA DAKE (Sweden).

*Umpires.* —A. E. LUMSDEN (U.S.A.), A. W. SAWYER, J. H. STAPLEY, R. G. SANGSTER (S.C.U.), W. F. SUTTON, E. G. WARDEN, E. O. WHITE.

*Starter.* —C. E. LILES.

*Timekeepers.*—V. WATERHOUSE, H. H. GRIFFIN.

*Clerk of the Course.*—J. C. P. TACAGNI.

*Stewards.*—S. H. ANSELL, F. CHICK, H. HOLLANDS, W. MITSON, P. NIX, R. J. OWEN, J. R. SMILES, Z. WHEATLEY.

- 4.0 5,000 METRES (3 Miles, 188 Yards). Time Limit, 9 minutes 25 seconds.  
[*First in each heat to compete in Final.*]

- 4.15 SWIMMING.—100 METRES. PRELIMINARY ROUND. NINE HEATS.  
[*First in each heat and fastest loser in Second Round.*]

- 4.30 FENCING.—ÉPÉE INDIVIDUAL COMPETITION. FOUR PRELIMINARY POOLS.

- 5.0 ATHLETICS.—3,200 METRES STEEPLECHASE. SIX HEATS.  
[*First in each heat to run in Final.*]

5.0 CYCLING.—THREE LAP TEAM PURSUIT RACE ( 1 mile 220 yards).  
FIRST ROUND.

Heat I.—Great Britain rode over. Belgium scratched.

Heat II.—Canada rode over. U.S.A. scratched.

Heat III.—Germany v. France. Holland, a bye.

*[Teams of Four started at opposite sides of the track. Time of the third man in each team was deemed time of the team. Fastest time to win.]*

5.0 SWIMMING.—100 METRES BACK STROKE. FINAL.

5.30 ATHLETICS.—TUG OF WAR. SEMI-FINALS. United Kingdom II. v. Sweden. United Kingdom I. (City Police) v. United Kingdom III. (K Division Police).

5.45 CYCLING.—THREE LAP TEAM PURSUIT RACE. SEMI-FINALS.  
Great Britain v. Canada. Germany v. Holland.

6.0 GYMNASTICS.—DISPLAYS BY THE BOROUGH POLYTECHNIC,  
THE WOOLWICH POLYTECHNIC, AND THE REGENT  
STREET POLYTECHNIC.

6.15 CYCLING.—THREE LAP TEAM PURSUIT RACE. FINAL.  
Great Britain v. Germany.

## Sixth Day.—Saturday, July 18.

### ARCHERY.

OFFICIALS.

*Judges.* —Colonel WALROND, Mr. EYRE W. HUSSEY, Comte DE BERTIER.

*Stewards.* —General APPELYARD, C.B., and G. B. S. WALROND.

10.0 LADIES.—THE NATIONAL ROUND. FIVE TARGETS.

GENTLEMEN.—THE YORK ROUND. TEN TARGETS.

### FENCING.

OFFICIALS [see Chapter IV.].

10.30 EPÉE INDIVIDUAL COMPETITION. FOUR PRELIMINARY POOLS.

### ATHLETICS.

OFFICIALS.

*Referees (Racing).*—G. V. A. SCHOFIELD, M. SHEARMAN, T. M. ABRAHAM.

*Field.* —E. B. HOLMES.

*Judges (Racing).* —S. ANSTEY, H. A. BUTLER, J. BARTLEMAN.

*Field.* —W. A. BROMMAGE, H. J. BARCLAY, C. T. W. HICKMAN, G. S. ROBERTSON, W. J. B. TIPPETTS, WHITTON, BRYSON.

*Starters.* —C. L. LOCKTON, J. M. ANDREW, W. TRIPP.

*Starters' Steward.* —I. DAVIDSON.

*Timekeepers.* —W. W. ALEXANDER, C. J. PRATT, B. R. CLAYTON, OSBORNE, A. HANNAH.

*Umpires.* —WHITE, E. F. NICHOLLS, C. OTWAY, H. W. G. HASLEGRAVE.

*Competitors' Stewards.* —A. OVENDEN (Chief), J. BENNETT, H. A. MEARS, D. PROSSER, F. W. BAKER, E. O. CHESHIRE.

2.30 3,200 METRES STEEPLECHASE. FINAL.

2.30 SWIMMING.—200 METRES BREAST STROKE. FINAL.

#### OFFICIALS.

*Starter.* —H. THOMSETT.

*Judges.* —G. A. POTTER and J. R. MELODY.

*Referee.*—H. J. FISHER.

*Timekeepers.* —R. F. B. CROSS and L. MEADEN.

*Turning Judges.* — G. H. GRAY and C. E. MACRAE.

2.30 FENCING.—EPÉE INDIVIDUAL COMPETITION. ONE PRELIMINARY POOL.

SABRE INDIVIDUAL COMPETITION. THREE PRELIMINARY POOLS.

2.40 ATHLETICS.—THROWING THE DISCUS (as at Athens). In Eight Sections.

## SWIMMING.

#### OFFICIALS.

*Referee.*— J. H. FISHER.

*Judges.* —J. R. MELODY, G. A. POTTER.

*Timekeepers.* —R. F. B. CROSS, L. MEADEN.

*Turning Judges.* —G. H. GRAY, C. E. MACRAE.

*Diving Judges.*—D. F. COOKE, H. J. GRIMWADE, H. STROMBERG.

*Diving Scorers.* —W. BARNES, S. DICKSON.

*Starter.* —H. THOMSETT.

*Water Polo Referees.* —G. MARSHALL, A. E. BIRCH.

*Water Polo Timekeeper.* —R. F. B. CROSS.

*Water Polo Goal Scorers.*—W. G. EMERY, A. JUDKINS, L. LYONS, W. M. BULL.

*Stewards.* —M. JEFFERSON, H. T. BRETTON, CONWAY G. WARNE, A. G. CHALMERS,

R. W. JONES, W. S. HANKINS, H. J. JOHNSON, A. RICHARDSON, H. T.

EDNEY, H. B. HOWARD, T. ROE, R. S. TOWN, F. HARRIS, A. FREEDMAN,

G. T. LEE, J. G. COPPOCK.

2.55 FANCY DIVING. FINAL.

## CYCLING.

#### OFFICIALS.

*Judges.* —M. DE BEUKELAER (President U.C.I.), J. WRIGHT.

*Assistant Judges.* —W. MITSON, A. C. RAWSON.

*Umpires.* —R. C. BISHOP, H. L. CLARK, T. R. HENSHER, W. F. HARTT, R. JOHNSTONE (S.C.U.), G. METCALFE (I.C.A.), R. MCLARDY, F. O'CONNOR.

*Starter.* —A. VICKERS.

*Timekeepers.* —T. H. WOOLLEN, C. H. WHEELWRIGHT.

- Clerks of the Course.* —J. R. SMILES, J. C. P. TACAGNI.  
*Stewards.*—E. BATTERSBY, T. W. CRAIG, R. F. DAVIS, W. B. GOODWIN, C. K. MILLS, E. PAYNE, C. E. SALT, E. O. WHITE, S. C. WINKS, E. G. WARDEN.  
*Lap Scorers.*—V. WATERHOUSE (Chief), W. A. BLOFIELD, A. DEACON, R. R. FLINT, R. J. GEAR, H. C. HARRIS, D. LUCAS, P. NIX, H. PAPPS, W. T. PEARSON, J. W. RIDLEY, J. H. STAPLEY, J. A. WALKER, Z. WHEATLEY, H. E. WINKS.
- 2.45 CYCLING. —5,000 METRES. FINAL.
- 3.0 ATHLETICS. —TUG OF WAR FINAL.  
 United Kingdom I. v. United Kingdom II., and Pull for Bronze Medals between United Kingdom III. and Sweden.
- 3.45 CYCLING. —100 KILOMETRES (FINAL), FOR THE PRINCE OF WALES' CHALLENGE CUP, AND DIPLOMAS OF MERIT TO THE THREE RIDERS LEADING THE GREATEST NUMBER OF LAPS.
- 4.0 FENCING. — SABRE INDIVIDUAL COMPETITION. FOUR PRELIMINARY POOLS.
- 4.30 SWIMMING —EXHIBITION OF DIVING BY MISS VALBORG FLORSTROM (Finland) AND MISS EBBA GISICO (Sweden).
- 4.40 WATER POLO. —EXHIBITION MATCH. English Reserves v. British Isles.
- 5.30 FENCING. — SABRE INDIVIDUAL COMPETITION. TWO PRELIMINARY POOLS.
- 5.30 ATHLETICS. —FIVE MILES FLAT RACE. FINAL.
- 6.0 GYMNASTICS. — DISPLAY BY THE BRISTOL SECONDARY SCHOOLS.
- 7.0 GYMNASTICS. — DISPLAY BY THE YORKSHIRE AMATEUR GYMNASTIC ASSOCIATION.

## Seventh Day. —Monday, July 20.

### ARCHERY.

#### OFFICIALS.

*Judges.* —Colonel WALROND, EYRE W. HUSSEY, Comte DE BERTIER.

*Stewards.* —General APPELYARD, C.B., G. B. S. WALROND, C. E. NESHAM.

- 10.0 FORTY ARROWS AT 50 METRES (54.6 Yards), SHOT SINGLY, CONTINENTAL STYLE.

**WRESTLING.**

## OFFICIALS.

## GRÆCO-ROMAN.

*Chairman* N.A.W.A. .. A. H. SUTHERLAND.

*Referees.*—F. KLEIN and P. LONGHURST.

*Judges* (1).—G. H. WHEELDON and E. P. GRUHN.

*Judges* (2).—C. HELGESSON and J. J. KENZI.

*Timekeeper.*—A. E. TAYLER.

*Scorekeeper.*—H. W. KEEN.

*Judges' Steward* (1).—M. E. TREDWELL.

*Judges' Steward* (2).—F. G. CRUST.

*Competitors' Steward.*— P. CAIN.

10.0 to 6.0 On No. 1 Platform, North. GRÆCO-ROMAN MIDDLE-WEIGHT,  
161 lbs. (73 Kilos.).

THREE ROUNDS. SEMI-FINAL, AND FINAL.

**WRESTLING.**

## OFFICIALS.

## CATCH-AS-CATCH-CAN.

*Chairman* N.A.W.A. .. A. H. SUTHERLAND.

*Referee.*—W. H. LEVY.

*Judges* (1).—F. EMSLIE and T. MERRY.

*Judges* (2).—C. SPITAL and H. C. POTTS.

*Timekeepers.*—Capt. BREMNER and G. DE G. GRIFFITH.

*Scorekeepers.*—J. W. WHEELDON and S. HAINES.

*Judges' Steward* (1).—J. W. BURCH.

*Judges' Stewards* (2).—S. HAINES and A. WHITE.

*Competitors' Stewards.*—T. MERRY and C. SPITAL.

*Doctors.*—Dr. J. C. MCCARROLL and Dr. H. P. POTTER.

10.0 to 6.0 On No. 2 Platform, South. CATCH-AS-CATCH-CAN.  
BANTAM WEIGHT, 119 lbs. (54 Kilos.).

TWO ROUNDS. SEMI-FINAL AND FINAL.

**FENCING.**

10.30 EPÉE INDIVIDUAL COMPETITION. SECOND ROUND. Four  
Pools of 5. [Two from each Pool to qualify.]

11.30 SABRE INDIVIDUAL COMPETITION. SECOND ROUND. Four  
Pools of 5.

**SWIMMING**

## OFFICIALS.

*Starter.*—A. HUDSON.

*Judges.*—G. H. ROPER, R. H. NICOL, J. C. HURD.

*Referee.*—G. W. HEARN.

*Timekeepers.*— H. H. GRIFFIN, R. F. B. CROSS.

*Stewards.*—G. LUDLAM, F. O. VENNING, A. RICHARDSON, S. ROE, R. S. TOWN,  
F. HARRIS, A. G. CHALMER, J. G. COPPOCK, G. T. LEE, A. W. CREASY,  
A. JUDKINS.

*Press Stewards.*—C. G. WARNE, W. E. BULL.

*Costume Stewards.*—W. G. EMERY, R. W. JONES, W. S. HANKINS, H. J. JOHNSON, A. FREEDMAN.

11.0 100 METRES. SEMI-FINALS. TWO HEATS OF FOUR.

*[First and Second from each heat in Final.]*

11.30 HIGH DIVING. PRELIMINARY HEAT.

*Judges for Preliminary Heats.*—S. J. MONKS, D. F. COOKE, H. STROMBERG.

*Scorers.*—S. DICKSON, W. BURTON.

*[First and Second to compete in Semi-Final.]*

2.30 100 METRES. FINAL.

2.55 HIGH DIVING. PRELIMINARY HEAT.

## ATHLETICS.

### OFFICIALS.

*Referees (Racing).*—G. V. A. SCHOFIELD, T. M. ABRAHAM.

*Field.*—E. B. HOLMES, A. R. BADGER.

*Judges (Racing).*—W. GARBUTT, S. ANSTEY, J. BARTLEMAN.

*Field.*—P. HARDING, A. J. EGGLESTON, H. J. BARCLAY, C. T. W. HICKMAN, F. WESSENBERG, J. YORKSTON.

*Starters.*—C. L. LOCKTON, C. H. GOBLE, W. TRIPP.

*Starters' Steward.*—I. DAVIDSON.

*Timekeepers.*—G. M. TODD, A. FATTORINI, W. W. ALEXANDER, W. M. BARNARD.

*Umpires.*—F. W. BAKER, G. F. BREWILL, F. HARRISON.

*Competitors' Stewards.*—C. OTWAY (Chief), F. T. ELBOROUGH, A. W. WILKIE, H. A. MEARS, D. PROSSER, H. W. G. HASLEGRAVE, J. ALLAN, E. O. CHESHIRE, A. B. HORNER, E. GAVIN.

2.30 STANDING BROAD JUMP. In Eight Sections.

3.0 100 METRES FLAT RACE. NINE HEATS.

*[First in each heat to run again.]*

3.30 800 METRES FLAT RACE. FOUR HEATS.

*[First in each heat to run in Final.]*

4.0 100 METRES FLAT RACE. EIGHT HEATS.

*[First in each heat to run again.]*

4.15 SWIMMING.—WATER POLO. SEMI-FINAL. Belgium v. Sweden.

*[Winner to meet United Kingdom in Final.]*

### OFFICIALS.

*Referee.*—W. BEATTIE.

*Timekeeper.*—R. F. B. CROSS.

*Goal Scorers.*—R. E. CLARIDGE, R. H. HASSELL.

4.15 FENCING.—EPÉE INDIVIDUAL COMPETITION. SECOND ROUND. FOUR POOLS. *[Two from each pool to qualify.]*

4.15 SABRE INDIVIDUAL COMPETITION. SECOND ROUND. FOUR POOLS. *[Two from each pool to qualify.]*

4.45 ATHLETICS.—400 METRES HURDLE RACE. TWELVE HEATS. *[First in each heat to run again.]*

5.20 800 METRES FLAT RACE. FOUR HEATS.

*[First in each heat to run in Final.]*

5.45 STANDING BROAD JUMP. FINAL.



## Eighth Day.—Tuesday, July 21.

### WRESTLING.

#### OFFICIALS.

#### GRÆCO-ROMAN.

*Chairman* N. A. W. A. . . A. H. SUTHERLAND.

*Referee*.—P. LONGHURST.

*Judges* (1).—G. H. WHEELDON and E. P. GRUHN.

*Judges* (2).—C. HELGESSON and A. BRULL.

*Timekeeper*.—A. E. TAYLER.

*Scorekeeper*.—H. W. KEEN.

*Judges' Stewards*.—M. E. TREDWEL and F. W. KNIGHT.

*Competitors' Stewards*.—C. SPITAL and A. WHITE.

10.0 to 6.0 On No. 1 Platform, North. GRÆCO-ROMAN. HEAVY-HEAVY.  
Over 205 lbs. (93 Kilos.). TWO PRELIMINARY ROUNDS.

### WRESTLING.

#### OFFICIALS.

#### CATCH-AS-CATCH-CAN.

*Chairman* N. A. W. A. . . A. H. SUTHERLAND.

*Referee*.—W. H. LEVY.

*Judges* (1).—H. C. POTTS and F. EMSLIE.

*Judges* (2).—T. MERRY and C. SPITAL.

*Timekeepers*.—Capt. D. BREMNER and W. LAWRENCE SMITH.

*Scorekeeper*.—B. SANSOM.

*Judges' Stewards*.—J. W. BURCH, H. C. POTTS, and F. G. CRUST.

*Competitors' Stewards*.—F. EMSLIE and P. CAIN.

*Doctors*.—Dr. J. MCNAMARA and Dr. H. P. POTTER.

10.0 to 6.30 On No. 2 Platform, South. CATCH-AS-CATCH-CAN. MIDDLE.  
To 161 lbs. (73 Kilos.).  
TWO ROUNDS. SEMI-FINAL AND FINAL.

### ATHLETICS.

*Referees (Racing)*.—G. V. A. SCHOFIELD, T. M. ABRAHAM.

*Field*.—E. B. HOLMES, A. R. BADGER.

*Judges (Racing)*.—W. GARBUTT, E. H. PELLING, J. BARTLEMAN.

*Field*.—T. S. CHEESBROUGH, W. A. BROMMAGE, H. J. BARCLAY, C. T. W. HICKMAN,  
F. WESSENBERG, J. YORKSTON.

*Starters*.—C. L. LOCKTON, C. H. GOBLE, W. TRIPP.

*Starters' Steward*.—I. DAVIDSON.

*Timekeepers*.—A. FATTORINI, LUCAS, W. M. BARNARD, A. HANNAH.

*Umpires*.—G. F. BREWILL, F. HARRISON.

*Competitors' Stewards*.—C. OTWAY (Chief), F. T. ELBOROUGH, A. W. WILKIE,  
H. A. MEARS, H. W. G. HASLEGRAVE, C. R. STAINES, E. O. CHESHIRE,  
C. W. GARNHAM, J. ALLAN, A. B. HORNER.

*Press Stewards*.—F. W. PARKER, P. W. B. TIPPETTS, W. GREENWOOD, E. O. CHESHIRE.

10.30 RUNNING HIGH JUMP. In Eight Sections.

11.0 200 METRES FLAT RACE. EIGHT PRELIMINARY HEATS.  
[First in each heat to run in Second Round.]

**SWIMMING.**

## OFFICIALS.

*Stewards.*—G. LUDLAM, F. O. VENNING, R.S. TOWN, A. G. CHALMERS, A. W. CREASY, W. M. BULL, A. RICHARDSON, S. ROE, F. HARRIS, G. T. LEE, A. JUDKINS, J. G. COPPACK.

*Costume Stewards.*—W.G. EMERY, W.S. HANKINS, R. W. JONES.

*Press Stewards.*—H. T. BRETTON, CONWAY G. WARNE, W. E. BULL.

*Telegraph Steward.*—A. FREEDMAN.

11.30 HIGH DIVING. THIRD HEAT.

*[First and Second to compete in Semi-Final.]*

## OFFICIALS.

*Judges.*—S. J. MONKS, H. J. GRIMWADE, H. STROMBERG.

*Scorers.*—W. BURTON, F. DICKSON.

12.30 ATHLETICS.—200 METRES FLAT RACE. SEVEN PRELIMINARY HEATS.

2.30 RUNNING HIGH JUMP. In Sections.

2.30 SWIMMING.—1,500 METRES. SEVEN PRELIMINARY HEATS.

*[First in each heat to swim in Final.]*

## OFFICIALS.

*Starter.*—R. W. JONES.

*Judges.*—G. MARSHALL, W. HANKINS.

*Referee.*—H. DAVENPORT.

*Timekeepers.*—H. H. GRIFFITHS, F. BAXTER (for second man), E. J. PLUMBRIDGE.

*Turning Judges.*—G. T. EVERSLED, W. BEVEN.

*Lap Scorers.*—H. J. BARCLAY, A. E. ORMONDROYD.

3.0 ATHLETICS.—400 METRES FLAT RACE. EIGHT PRELIMINARY HEATS. *[First in each heat to run in Second Round.]*

**FENCING.**

3.30 Ground No. 1. EPÉE TEAM FIGHT. Denmark v. France and Germany v. United Kingdom.

Ground No. 2. SABRE TEAM FIGHT. Belgium v. France.

3.35 ATHLETICS.—100 METRES FLAT RACE. FOUR SEMI-FINAL HEATS. *[First in each heat to run in Final.]*

4.0 400 METRES HURDLE RACE. FOUR SEMI-FINAL HEATS. *[First in each heat to run in Final.]*

4.30 400 METRES FLAT RACE. EIGHT PRELIMINARY HEATS. *[First in each heat to run in Second Round.]*

4.45 FENCING.—EPEE TEAM FIGHT. Ground No. 1. Bohemia v. Italy and Belgium v. Sweden.

SABRE TEAM FIGHT. Ground No. 2. United Kingdom v. Italy.

5.0 ATHLETICS.—800 METRES FLAT RACE. FINAL.

## Ninth Day.—Wednesday, July 22.

### WRESTLING.

#### OFFICIALS.

##### GRÆCO-ROMAN.

*Chairman N.A.W.A.* . . . A. H. SUTHERLAND.

*Referees.*—F. KLEIN and P. LONGHURST.

*Judges.*—E. P. GRUHN, C. HELGESSON, A. BRÜLL, A. R. NIELSON, J. J. KENZI,  
and G. H. WHEELDON.

*Timekeeper.*—A. E. TAYLER.

*Scorekeeper.*—H. W. KEEN.

*Judges' Stewards.*—M. E. TREDWELL and F. W. KNIGHT.

*Competitors' Steward.*—F. G. CRUST.

10.0 to 6.0 On No. 1 Platform, North. GRÆCO-ROMAN LIGHT-HEAVY  
to 205 lbs. (93 Kilos.). THREE ROUNDS, SEMI-FINAL and  
FINAL.

### WRESTLING.

#### OFFICIALS.

##### CATCH-AS-CATCH-CAN.

*Chairman N.A.W.A.* . . . A. H. SUTHERLAND.

*Referee.*—W. H. LEVY.

*Judges.*—C. SPITAL, F. EMSLIE, T. MERRY and H. C. POTTS.

*Timekeeper.*—W. LAWRENCE SMITH.

*Scorekeeper.*—B. SANSOM.

*Judges' Stewards.*—F. TURNER, J. W. BURCH and A. WHITE.

*Competitors' Stewards.*—J. W. WHEELDON and F. TURNER.

*Doctors.*—Dr. J. C. MCCARROLL and Dr. H. P. POTTER.

10.0 to 6.0 On No. 2 Platform, South. CATCH-AS-CATCH-CAN FEATHER,  
to 133 lbs. (60.3 Kilos.). TWO ROUNDS, SEMI-FINAL and  
FINAL.

### FENCING.

10.0 SABRE TEAM COMPETITION. Bohemia v. Holland, and Germany v.  
Hungary.

### ATHLETICS.

#### OFFICIALS.

*Referees (Racing).*—G. V. A. SCHOFIELD, D. S. DUNCAN.

*Field.*—E. B. HOLMES, A. R. BADGER.

*Judges (Racing).*—E. H. PELLING, E. W. PARRY, C. VAL. HUNTER, C. PENNYCOOK.

*Field.*—W. A. BROMMAGE, H. J. BARCLAY, C. T. W. HICKMAN, J. YORKSTON,  
T. S. CHEESEBROUGH.

*Starters.*—C. L. LOCKTON, C. H. GOBLE, W. TRIPP.

*Starters' Steward.*—I. DAVIDSON.

*Timekeepers.*—J. H. HARDWICK, D. LUCAS, W. M. BARNARD.

*Umpires.*—G. F. BREWILL, F. W. BAKER, W. J. MORGAN.

*Competitors' Stewards.*—C. OTWAY (Chief), D. PROSSER, H. W. G. HASLEGRAVE,  
A. B. HORNER, F. T. ELBOROUGH, A. W. WILKIE, J. ALLAN.

*Press Stewards.*—P. W. B. TIPPETTS, F. W. YEXLEY, E. O. CHESHIRE.

10.15 ATHLETICS.—200 METRES FLAT RACE. FOUR SEMI-FINAL  
HEATS. [*First in each heat to run in Final.*]

10.30 RUNNING BROAD JUMP. In Nine Sections.

## SWIMMING.

### OFFICIALS.

*High Diving Judges.*—H. J. GRIMWADE, D. F. COOKE, H. STROMBERG.

*Scorers.*—W. BURTON, S. DICKSON, A. BARNES.

*Water Polo Referee.*—F. BAXTER.

*Timekeeper.*—R. F. B. CROSS.

*Goal Scorers.*—W. G. EMERY, A. R. INGERSOLL.

*Costume Stewards.*—R. W. JONES, W. S. HANKINS.

*Press Stewards.*—CONWAY G. WARNE, W. E. BULL.

*Telegraph Steward.*—A. FREEDMAN.

*Stewards.*—G. LUDLAM, S. ROE, R. S. TOWN, F. HARRIS, A. JUDKINS, F. O.  
VENNING, J. G. COPPOCK, A. G. CHALMERS, A. W. CREASY, E. J. PLUMBRIDGE.

11.30 HIGH DIVING. FOURTH HEAT.  
[*First and Second to compete in Semi-Final.*]

2.30 SWIMMING.-HIGH DIVING. FIFTH HEAT.  
[*First and Second to compete in Final.*]

3.0 FENCING.—EPÉE TEAM. SEMI-FINALS. Italy v. Belgium, France  
v. United Kingdom.

SABRE TEAM. SEMI-FINALS. Bohemia v. France, Italy  
v. Hungary.

3.30 ATHLETICS.—400 METRES HURDLES. FINAL.  
RUNNING BROAD JUMP. In Sections.

4.0 SWIMMING.—WATER POLO. FINAL. Belgium v. United Kingdom.

4.15 ATHLETICS.—100 METRES. FINAL.

5.30 „ 400 METRES. SEMI-FINAL.  
[*First in each heat to run in Final.*]

## Tenth Day.—Thursday, July 23.

### WRESTLING.

#### OFFICIALS.

#### GRÆCO-ROMAN.

*Chairman N.A.W.A.* .. A. H. SUTHERLAND.

*Referees.*—F. KLEIN and P. LONGHURST.

*Judges.*—E. P. GRUHN, C. HELGESSON, A. BRÜLL, A. R. NIELSON, J. J. KENZI,  
and G. H. WHEELDON.

*Timekeeper.*—A. E. TAYLER.

*Scorekeeper.*—H. W. KEEN.

*Judges' Stewards.*—M. E. TREDWELL and F. W. KNIGHT.

*Competitors' Steward.*—F. G. CRUST.

10.0 to 6.0. On No. 1 Platform, North. GRÆCO-ROMAN LIGHT to 147 lbs.  
(66·6 Kilos.) THREE ROUNDS, SEMI-FINAL and FINAL.

### WRESTLING.

#### OFFICIALS.

#### CATCH-AS-CATCH-CAN.

*Chairman N.A.W.A.* .. A. H. SUTHERLAND.

*Referee.*—W. H. LEVY.

*Judges.*—F. EMSLIE, H. C. POTTS and E. P. GRUHN.

*Timekeeper.*—W. LAWRENCE SMITH.

*Scorekeeper.*—B. SANSOM.

*Judges' Stewards.*—F. TURNER, J. W. BURCH, and A. WHITE.

*Competitors' Stewards.*—J. W. WHEELDON and F. TURNER.

*Doctors.*—Dr. J. C. MCCARROLL and Dr. H. P. POTTER.

10.0 to 6.0. On No. 2 Platform, South. CATCH-AS-CATCH-CAN HEAVY,  
over 161 lbs. (73 Kilos.). TWO ROUNDS, SEMI-FINAL and  
FINAL.

### FENCING.

10.30 EPÉE INDIVIDUAL. SEMI-FINAL POOL.

SABRE INDIVIDUAL. SEMI-FINAL POOL,

### ATHLETICS.

#### OFFICIALS.

*Referees (Racing).*—D. S. DUNCAN, T. M. ABRAHAM.

*Field.*—E. B. HOLMES, E. H. PELLING, A. J. EGGLESTON.

*Judges (Racing).*—J. T. GRAHAM, E. W. PARRY, P. L. FISHER, C. PENNYCOOK.

*Field.*—P. HARDING, W. A. BROMMAGE, H. J. BARCLAY, C. T. W. HICKMAN.

*Starters.*—C. L. LOCKTON, C. H. GOBLE, W. TRIPP.

*Starters' Steward.*—I. DAVIDSON.

*Timekeepers.*—A. HANNAH, J. H. HARDWICK, W. W. ALEXANDER, W. M. BARNARD.

*Umpires.*—G. F. BREWILL, G. STRATTON.

*Competitors' Stewards.*—C. OTWAY (Chief), D. PROSSER, H. W. G. HASLEGRAVE.  
W. COLES, A. W. WILKIE, E. O. CHESHIRE, E. GREENWOOD, A. B. HORNER,  
F. HARRISON, M. J. BULGER, D. BASAN.

*Press Stewards.*—F. W. PARKER, P. W. B. TIPPETTS, W. GREENWOOD.

11.0 STANDING HIGH JUMP. In Eight Sections.

## SWIMMING.

### OFFICIALS.

*Stewards.*—G. LUDLAM, F. ROE, F. HARRIS, A. JUDKINS, F. O. VENNING, J. G. COPPACK, A. G. CHALMERS, H. T. EDNEY, H. J. PHIPPS, G. F. SIMMONS,  
G. T. LEE, E. J. PLUMBRIDGE, J. E. HOPKINSON.

*Costume Stewards.*—R. W. JONES, W. S. HANKINS, W. G. EMERY.

*Press Stewards.*—CONWAY G. WARNE, W. E. BULL, H. T. BRETTON.

*Telegraph Steward.*—A. FREEDMAN.

11.30 HIGH DIVING. TWO SEMI-FINALS.

[First and Second in each heat to compete in Final.]

### OFFICIALS.

*Judges.*—S. J. MONKS, D. F. COOKE, H. STROMBERG.

*Scorer.*—S. DICKSON, W. BURTON.

2.30 ATHLETICS.—STANDING HIGH JUMP. In Sections.

2.45 FENCING.—EPÉE TEAM. FINAL.

SABRE TEAM. FINAL.

3.30 ATHLETICS. —110 METRES HURDLE RACE. SEVEN PRELIMINARY HEATS. [First in each heat to run again.]

3.45 SWIMMING.—1,500 METRES. SECOND ROUND. TWO HEATS.  
[First and Second in each heat to compete in Final.]

### OFFICIALS.

*Starter.*—A. HUDSON.

*Judges.*—W. N. BENJAMIN and R. BEATTIE.

*Referee.*—G. PRAGNELL.

*Timekeepers.*—G. T. SNOW and J. S. WALKER.

*Lap Scorers.*—H. J. BARCLAY and T. CLEGG.

*Turning Judges.*—A. W. CREASY and C. E. MACRAE.

4.0 FENCING.—EPÉE INDIVIDUAL. SEMI-FINAL.

SABRE INDIVIDUAL. SEMI-FINAL.

4.0 ATHLETICS.—200 METRES FLAT RACE. FINAL.

4.10 110 METRES HURDLE RACE. FINAL. SEVEN PRELIMINARY HEATS. [First in each heat to run again.]

5.30 400 METRES FLAT RACE. FINAL.

## Eleventh Day.— Friday, July 24.

### WRESTLING.

#### OFFICIALS.

##### CATCH-AS-CATCH-CAN.

*Chairman* N. A. W. A. . . . A. H. SUTHERLAND.

*Referee*.—W. H. LEVY.

*Judges*.—F. EMSLIE, H. C. POTTS, and E. P. GRUHN.

*Timekeeper*.—W. LAWRENCE SMITH.

*Scorekeeper*.—B. SANSOM.

*Judges' Stewards*.—F. TURNER, J. W. BURCH, and A. WHITE.

*Competitors' Stewards*.—J. W. WHEELDON and F. TURNER.

*Doctors*.—Dr. J. C. MCCARROLL and Dr. H. P. POTTER.

10.0 to 6.0. On No. 2 Platform, South. CATCH-AS-CATCH-CAN. LIGHT to 147 lbs. (66.6 Kilos.). TWO ROUNDS. SEMI-FINAL AND FINAL.

GRÆCO-ROMAN MIDDLE-WEIGHT. SEMI-FINALS.

### WRESTLING.

#### OFFICIALS.

##### GRÆCO-ROMAN.

*Chairman* N. A. W. A. . . . A. H. SUTHERLAND.

*Referees*.—F. KLEIN and P. LONGHURST.

*Judges*.—C. HELGESSON, A. BRÜLL, A. R. NIELSON, J. J. KENSI, and G. H. WHEELDON.

*Timekeeper*.—A. E. TAYLER.

*Scorekeeper*.—H. W. KEEN.

*Judges' Stewards*.—M. E. TREDWELL and F. W. KNIGHT.

*Competitors' Steward*.—F. G. CRUST.

10.0 to 6.0. On No. 1 Platform, North. GRÆCO-ROMAN HEAVY-HEAVY. FINAL. [*The best of Three Falls.*]

### FENCING.

10.30 EPÉE TEAM COMPETITION for Second Place. Denmark v. United Kingdom.

SABRE TEAM COMPETITION for Second Place. Germany v. Italy.

### ATHLETICS.

#### OFFICIALS.

*Referee (Racing)*.—G. V. A. SCHOFIELD.

*Field*.—E. B. HOLMES, E. H. PELLING, A. HANNAH.

*Judges (Racing)*.—W. MABBETT, D. BASAN, O'CONNELL, A. ROSS SCOTT.

*Field*.—H. J. BARCLAY, C. T. W. HICKMAN.

*Starters*.—C. L. LOCKTON, C. H. GOBLE, W. TRIPP.

*Starters' Steward*.—I. DAVIDSON.

*Timekeepers*.—J. H. HARDWICK, A. OVENDEN, W. W. ALEXANDER, D. S. DUNCAN.

*Umpires.*—G. F. BREWILL, F. W. BAKER, W. J. MORGAN, E. F. NICHOLLS.  
*Competitors' Stewards.*—H. W. G. HASLEGRAVE (Chief), D. PROSSER, C. OTWAY,  
 W. COLES, A. W. WILKIE, J. ALLAN, A. B. HORNER.  
*Press Stewards.*—F. W. PARKER, P. W. B. TIPPETTS, E. O. CHESHIRE.  
*Hon. Secretary Amateur Athletic Association.*—P. L. FISHER.  
*Assistant Secretary.*—S. G. MOSS.  
*Committee Room, Stadium, Block QRS, Room No. 33.*

11.0 POLE JUMP. In Six Sections.

11.30 110 METRES HURDLE RACE. FOUR SEMI-FINALS.  
*[Winners only run again.]*

12.0 1,600 METRES RELAY RACE. FIRST HEAT. Hungary, Sweden,  
 and Greece. *[Winners run in Final.]*

Teams of Four with four Reserves, two at 200 Metres, one at 400 Metres,  
 and one at 800 Metres. The race is run as follows :—200, 200,  
 400, 800.

## SWIMMING.

### OFFICIALS.

*Stewards.*—G. LUDLAM, F. ROE, F. HARRIS, A. JUDKINS, F. O. VENNING,  
 A. G. CHALMERS, H. T. EDNEY, H. J. PHIPPS, J. C. RICHARDSON, T. CLEGG,  
 G. T. LEE, A. W. CREASY, J. S. WALKER, J. E. HOPKINSON, G. A. POTTER.  
*Costume Stewards.*—R. W. JONES, W. S. HANKINS, W. G. EMERY.  
*Press Stewards.*—CONWAY G. WARNE, H. T. BRETTON, A. SINCLAIR, G. F. SIMMONS.  
*Telegraph Stewards.*—A. FREEDMAN, E. A. JOHNS.

2.30 TEAM RACE. TWO HUNDRED METRES EACH MAN. THREE  
 HEATS.

### OFFICIALS.

*Starters.*—A. HUDSON, R. W. JONES, W. E. BULL, GRAHAM MARSHALL.  
*Judges.*—E. W. JORDAN, J. C. HURD, J. R. CHEETHAM.  
*Timekeepers.*—H. H. GRIFFIN, F. BAXTER.  
*For Second Team.*—E. J. TACKLEY.  
*Turning Judges.*—G. H. GRAY, W. BEVAN.  
*Referee.*—G. W. HEARN.

2.45 FENCING.—SABRE AND EPÉE INDIVIDUAL. FINALS.

3.15 SWIMMING.—HIGH DIVING. FINAL.

*Judges.*—S. J. MONKS, H. J. GRIMWADE, H. STROMBERG.  
*Scorers.*—C. DICKSON, W. BURTON.

.20 ATHLETICS.—1,600 METRES RELAY RACE.

SECOND HEAT. Germany, Holland, France, and Italy.

THIRD HEAT. Norway, Canada, U.S.A., and United Kingdom.

4.20 SWIMMING.—TEAM RACE. TWO HUNDRED METRES EACH MAN.  
 FINAL.



## 5.0 ATHLETICS.—MARATHON RACE.

## OFFICIALS.

*Referee and Starter.*—Lord DESBOROUGH.

*Judges.*—A. J. EGGLESTON, W. A. BROMMAGE, H. VENN, G. DUXFIELD,  
J. E. K. STUDD, J. T. GREEN.

*Timekeepers.*—W. M. BARNARD, C. J. PRATT, W. W. ALEXANDER, E. H. PELLING.

*Clerk of Course.*—J. M. ANDREW.

*Hon. Secretary Amateur Athletic Association.*—P. L. FISHER.

*Assistant Secretary.*—S. G. MOSS.

Race started at 2.30 from Windsor Castle to the Stadium.

## 5.30 POLE JUMP. FINAL.

## 5.30 FENCING.—EPÉE TEAM FIGHT for Second Place. Belgium v. United Kingdom.

---

## Twelfth Day. —Saturday, July 25.

### ATHLETICS.

## OFFICIALS.

*Referees (Racing).*—G. V. A. SCHOFIELD, T. M. ABRAHAM, M. SHEARMAN.

*Field.*—E. B. HOLMES, E. H. PELLING, H. J. BARCLAY.

*Judges (Racing).*—W. MABBETT, D. BASAN, A. ROSS SCOTT.

*Field.*—W. A. BROMMAGE, C. T. W. HICKMAN, J. T. GREEN.

*Starters.*—C. L. LOCKTON, C. H. GOBLE, W. TRIPP.

*Starters' Steward.*—I. DAVIDSON.

*Timekeepers.*—W. W. ALEXANDER, C. J. PRATT, W. M. BARNARD.

*Umpires.*—G. F. BREWILL, F. W. BAKER, G. STRATTON, A. J. EGGLESTON.

*Competitors' Stewards.*—H. W. G. HASLEGRAVE (Chief), D. PROSSER, A. W. WILKIE,

C. OTWAY, W. COLES, J. ALLAN, A. B. HORNER.

*Press Stewards.*—P. W. B. TIPPETTS, E. O. CHESHIRE.

*Hon. Secretary Amateur Athletic Association.*—P. L. FISHER.

*Assistant Secretary.*—S. G. MOSS.

*Committee Room, Stadium, Block QRS, Room No. 33.*

## 10.0 HOP, STEP, AND JUMP. In Three Sections.

## 400 METRES FLAT RACE. FINAL. RE-RUN.

### WRESTLING.

## OFFICIALS.

*Chairman N.A.W.A.* •• A. H. SUTHERLAND.

*Referees.*—P. KLEIN, P. LONGHURST.

*Judges.*—C. HELGESSON, A. BRÜLL, A. R. NIELSON, G. LISTER,  
G. H. WHEELDON.

*Timekeeper.*—A. E. TAYLER.

*Scorekeeper.*—H. W. KEEN.

*Judges' Stewards.*—M. E. TREDWELL and F. W. KNIGHT.

*Competitors' Steward.*—F. G. CRUST.

10.0 On No. 1 Platform, North.

GRÆCO-ROMAN LIGHT-WEIGHT. SEMI-FINAL AND FINAL.

GRÆCO-ROMAN MIDDLE-WEIGHT. FINAL.

## SWIMMING.

### OFFICIALS.

*Starter.*—A. HUDSON.

*Judges.*—H. BENJAMIN, Dr. W. J. LEIGHTON, M.B.

*Referee.*—G. W. HEARN.

*Timekeepers.*—F. BAXTER, J. C. HURD ; Third Man, E. J. TACKLEY.

*Turning Judges.*—A. ST. P. CUFFLIN, G. A. POTTER.

*Lap Scorers.*—H. J. BARCLAY, W. S. HANKINS.

*Stewards.*—J. C. RICHARDSON, J. H. PHIPPS, F. HARRIS, W. E. BULL, A. G.

CHALMERS, J. G. COPPOCK, A. W. CREASY, A. JUDKINS, F. O. VENNING.

*Press Stewards.*—CONWAY G. WARNE, H. I. BRESTON.

*Costume Stewards.*—W. S. HANKINS, R. W. JONES.

*Telegraph Steward.*—A. FREEDMAN.

*Hon. Sec. A.S.A.*—J. C. HURD, 24 Cautley Avenue, Clapham, S.W.

*Committee Room,* Stadium, Block GG—FF, Room No. 6.

2.30 EXHIBITION OF DIVING.

EXHIBITION OF WATER POLO.

3.0 WRESTLING.—On North Platform.

DISPLAY OF CUMBERLAND AND WESTMORELAND  
WRESTLING.

WRESTLING.—On South Platform.

DISPLAY OF ICELANDIC WRESTLING.

3.30 SWIMMING.—1,500 METRES. FINAL.

4.6 1,600 METRES RELAY RACE. FINAL.

Hungary, Germany, and U.S.A.

4.5 ATHLETICS.—110 METRES HURDLE RACE. FINAL.

## PRIZE-GIVING ON SATURDAY, JULY 25.

---

### I.—All Awards except Gold Medals.

N.B.—As the Prize-giving involves five separate Divisions of Prize-Winners, it is essential that the following instructions should be strictly observed :—

- (a) The holder of a prize ticket must walk up to receive his prize between two flags of the same colour as his ticket, or he will not obtain the award to which he is entitled.
- (b) He will only receive his prize in exchange for his ticket, which will be handed to the official instructed to ask for it.
- (c) The number on his ticket not only indicates the exact prize won by its holder, but also shows the order of the place he must take in the procession allotted to prizes of that kind.
- (d) Team Prizes will be taken by the Captain.
- (e) Challenge Cups will be given in the Red Division after the Gold Medals have been distributed.

Dark Blue Vouchers	=	Second Prize.
Yellow Vouchers	=	Third Prize.
Light Blue Vouchers	=	Diploma of Merit.
Green Vouchers	=	Commemorative Medals.

---

2.10.—All winners of second and third prizes and of diplomas of merit, and all recipients of the special green cards for commemorative medals, will assemble on the east side of the Stadium, on the cycle track, opposite Block MM, and between Rooms 11 and 12.

2.15.—The Band of the Grenadier Guards will play the National Anthems of all the foreign countries represented.

2.25.—The Drums and Fifes of the Irish Guards will play the "Advance," followed by a march.

2.30.—The prize-winners mentioned above will advance across the grass to the cinder-path at the south-west corner of the Stadium, and from there along

the cycle track to their respective prize tables, which will be arranged as follows, counting outwards from the Royal Box :—

A.—Second-prize winners, holding dark-blue tickets, will advance between the dark-blue flags to the table of the same colour, at which Her Grace the Duchess of Rutland will distribute the silver medals, assisted by Mr. Sutherland, Mr. Fisher, and Mr. Boulger, members of the British Olympic Council, as her marshals.

B.—Third-prize winners, holding yellow tickets, will advance between the yellow flags to the table of the same colour, at which Katharine Duchess of Westminster will distribute the bronze medals, assisted by Mr. Syers, Mr. Biedermann, and Mr. Hawes, members of the British Olympic Council, as her marshals.

C.—Winners of diplomas of special merit will advance between the light-blue flags to the table of the same colour, at which the Duchess of Westminster will distribute the diplomas, assisted by Mr. Henry, Mr. Benjamin, and Mr. Richardson, members of the British Olympic Council, as her marshals.

D.—Recipients of the special commemorative medals will advance between the green flags to the table of the same colour, at which the Lady Desborough will distribute the medals, assisted by Mr. Blair, member of the British Olympic Council, and Mr. Vaughton, as her marshals.

The Drums and Bugles of the Irish Guards will sound the “Advance” as each of these processions start.

The Band of the Grenadier Guards will play the National Folk Songs during the first part of the prize-giving.

---

## II.—Gold Medals. Holders of Red Vouchers for First Prizes.

4.0.—When the National Anthem announcing the arrival of the Queen has begun, the winners of all first prizes will have been drawn up along the east side of the Stadium, opposite Block MM, on the concrete cycle track, between Rooms 11 and 12.

4.15.—Immediately the 1,600 Metre Relay Race is over, the Band of the Grenadier Guards will play “See, the Conquering Hero Comes!” and the procession of first-prize winners will form up on the two tracks and cross the grass to the south-west corner of the arena, and when the Drums and Bugles of the Irish Guards have sounded the “Advance,” they will advance to the platform on the cycle track, beneath the Royal Box, where they receive the gold medals from Her Majesty the Queen, who will be attended by Lord Desborough, the members of the International Olympic Committee, the members of the British Olympic Council, and others.

On descending from the platform in front of the Royal Box, the winners receive their diplomas from Mr. George C. Drinkwater, O.U.B.C., and Mr. C. K. Philips, O.U.B.C., acting as marshals, with a sprig of oak-leaves from Windsor Forest, graciously sent by His Majesty the King, which will be handed to them by Lieutenant Norman Leith Hay Clark, Lincolnshire Regiment, acting as marshal, each sprig being tied with the Union Jack.

5.15.—Her Majesty the Queen will then present her Gold Cup to Dorando Pietri.

5.20.—Her Majesty the Queen will then present the following Challenge Cups to their winners, assisted by Mr. George Stuart Robertson and Mr. Theodore A. Cook, members of the British Olympic Council, as her marshals :—

- The Greek Trophy for the Marathon Race.
- The Prague Trophy for Gymnastics.
- The Montgomery Statuette for Discus.
- The Prince of Wales' Cup for Cycling.
- The Hurlingham Club Trophy for Polo.
- The Gold and Silversmiths' Cup for Wrestling.
- Lord Westbury's Cup for Clay Bird Shooting.
- The British Fencers' International Challenge Cup for Epée Teams.

Winners of the Challenge Cups and Captains of the winning teams, accompanied by their teams, will advance to receive their cups at the signal of three bugles from the Irish Guards.

5.30.—The Drums and Bugles of the Irish Guards will sound after the last cup has been given ; and prize-winners, having formed in line on the running-track in front of the Royal Box, will give three cheers for the Queen at a signal from Lord Desborough, after which the Band of the Grenadier Guards will play the National Anthem.

## APPENDIX B.

---

**TOTALS OF ENTRIES**  
**RECEIVED FROM EACH COUNTRY.**

---

	<i>Summer</i>	<i>Winter</i>	<i>Total</i>
ARGENTINE REPUBLIC .. ..	—	1	1
AUSTRALASIA .. .. .	17	17	34
AUSTRIA .. .. .	33	1	34
BELGIUM .. .. .	88	—	88
BOHEMIA .. .. .	31	—	31
CANADA .. .. .	67	—	67
DENMARK .. .. .	73	28	101
FINLAND .. .. .	67	—	67
FRANCE .. .. .	247	116	363
GERMANY .. .. .	92	18	110
GREECE .. .. .	20	—	20
HOLLAND .. .. .	133	32	165
HUNGARY .. .. .	153	—	153
ITALY .. .. .	115	—	115
NORWAY .. .. .	64	—	64
RUSSIA .. .. .	7	1	8
SOUTH AFRICA .. .. .	18	—	18
SWEDEN .. .. .	181	23	204
SWITZERLAND .. .. .	4	—	4
TURKEY .. .. .	1	—	1
UNITED KINGDOM .. ..	614	225	839
UNITED STATES OF AMERICA ..	159	1	160
	<hr style="width: 100%;"/>	<hr style="width: 100%;"/>	<hr style="width: 100%;"/>
	2,184	463	2,647
	<hr style="width: 100%;"/>	<hr style="width: 100%;"/>	<hr style="width: 100%;"/>

## APPENDIX C.

## ENTRIES

FOR THE OLYMPIC GAMES OF 1908  
IN LONDON.

## SUMMER.

<i>Name</i>	<i>Country</i>	<i>Sport</i>	<i>Event</i>
Accorsi, A. . . .	Italy . .	Gymnastics	Team.
Adam, J. . . .	Germany	Fencing . .	Epée, Individual.
" . . . .	"	" . .	" Team.
" . . . .	"	" . .	Sabre, Individual.
" . . . .	"	" . .	" Team.
" . . . .	"	" . .	Foils, Display.
Adams, P. . . .	U.S.A. . .	Athletics	Standing Broad Jump.
" . . . .	" . .	" . .	" High Jump.
" . . . .	" . .	" . .	Running Broad Jump.
" . . . .	" . .	" . .	Hop, Step, and Jump.
" . . . .	" . .	" . .	Discus, Free Style.
" . . . .	" . .	" . .	" Greek Style.
" . . . .	" . .	" . .	Javelin, Free Style.
" . . . .	" . .	" . .	" Held in the Middle.
Adam, S. . . .	Hungary	Swimming	100 Metres.
" . . . .	" . .	" . .	400 "
" . . . .	" . .	" . .	Team Race.
" . . . .	" . .	" . .	Back Stroke.
" . . . .	" . .	" . .	Water Polo.
Adams, S. B. . .	U.S.A. . .	Shooting . .	Revolver & Pistol, Team.
" . . . .	" . .	" . .	" Individual.
Adams, W. T. . .	U.K. . .	Wrestling	Catch-as-Catch-Can, Feather Weight.
Adlerstrahle, Mrs. M.	Sweden . .	Lawn Tennis	Covered Courts.
Adlerz, E. . . .	" . .	Swimming	High Diving.
Agger, H. . . .	Denmark	Athletics . .	Throwing the Hammer.
" . . . .	" . .	" . .	Discus, Free Style.
" . . . .	" . .	" . .	" Greek Style.
Agliorini, U. . .	Italy . .	Gymnastics	Team.
Agodi, N. . . .	" . .	" . .	"

<i>Name</i>	<i>Country</i>	<i>Sport</i>	<i>Event</i>
Ahearne, T. J. ..	U.K. ..	Athletics ..	110 Metres, Hurdles.
" ..	" ..	" ..	Standing Broad Jump.
" ..	" ..	" ..	" High Jump.
" ..	" ..	" ..	Running Broad Jump.
" ..	" ..	" ..	" High Jump.
" ..	" ..	" ..	Hop, Step, and Jump.
Aitken, W. V. ..	Australasia	" ..	5 Miles Run.
" ..	" ..	" ..	10 Miles walk.
" ..	" ..	" ..	Marathon Race.
" ..	" ..	" ..	3,500 Metres Walk.
Aldous, H. J. M. ..	U.K. ..	Swimming	High Diving.
Alibert, G. .. ..	France ..	Fencing ..	Epée, Individual
" ..	" ..	" ..	Team.
Allen, C. P. .. ..	U.S.A. ..	Athletics ..	Pole Jump.
Allessie, A. B. ..	Holland ..	Wrestling	Graeco-Roman, Light Weight.
Almqvist, A. ..	Sweden ..	Athletics ..	Tug-of-War.
Alpen, H. P. T. ..	" ..	Yachting ..	8 Metres.
Amen, A. H. .. ..	Holland	Wrestling ..	Graeco-Roman, Light Weight.
Amende, Frau N. ..	Austria ..	Lawn Tennis	Grass Courts.
Amoare, C. J. ..	U.K. ..	Shooting ..	Miniature Rifle, Team.
" ..	" ..	" ..	Individual, Stationary.
" ..	" ..	" ..	Disappearing.
" ..	" ..	" ..	Moving.
Amour, J. T. .. ..	U.S.A. ..	Athletics ..	5 Miles Run
" ..	" ..	" ..	3 Miles, Team.
Amphlett, E. M. ..	U.K. ..	Fencing ..	Epée, Individual.
" ..	" ..	" ..	Team.
Amson, G. .. ..	France ..	" ..	Individual.
Amundsen, A. M. ..	Norway	Gymnastics	Team.
Andersen, A. .. ..	Denmark	Wrestling	Graeco-Roman, Middle Weight.
Andersen, C. A. ..	Norway	Gymnastics	Individual.
" ..	" ..	" ..	Team.
Andersen, C. C. ..	Denmark	" ..	" ..
Andersen, N. .. ..	" ..	Shooting ..	Rifle, Team, International.
" ..	" ..	" ..	Individual, 1,000 Yards.
" ..	" ..	" ..	Team, 300 Metres.
" ..	" ..	" ..	Individual, 300 Metres.
" ..	" ..	" ..	Miniature Rifle, Team.
" ..	" ..	" ..	Individual, Stationary.
" ..	" ..	" ..	Disappearing.
" ..	" ..	" ..	Moving.
Anderson, C. G. ..	Sweden ..	Wrestling	Graeco-Roman, Middle Weight.
" ..	" ..	" ..	Catch-as-Catch-Can, Middle
" ..	" ..	" ..	Weight
" ..	" ..	" ..	Heavy
" ..	" ..	Athletics ..	100 Metres, Flat.
" ..	" ..	" ..	1,500 " "
Anderson, G. C. ..	U.K. ..	Cycling ..	1,660 Yards.
Anderson, W. .. ..	Canada ..	" ..	1,000 Metres.
" ..	" ..	" ..	5,000 "
" ..	" ..	" ..	20 Kilometres.
" ..	" ..	" ..	100 "
" ..	" ..	" ..	Pursuit Race.
" ..	" ..	" ..	Tandem, 2,000 Metres.



<i>Name</i>	<i>Country</i>	<i>Sport</i>	<i>Event</i>
Andersson, K. A.	Sweden ..	Athletics..	Tug-of-War.
An tal, P. .. ..	Hungary	„ ..	Discus, Free Style.
Anker, J. A. ..	Norway ..	Yachting..	8 Metres.
Abarbanell, R. ..	Hungary	Athletics..	Standing High Jump.
Avattaneo, U. ..	Italy ..	„ ..	Putting the Weight.
„ ..	„ ..	„ ..	Discus, Free Style.
„ ..	„ ..	„ ..	„ Greek „
„ ..	„ ..	„ ..	Javelin, Free Style.
„ ..	„ ..	„ ..	„ Held in the Middle.
Anza, B. A. ..	„ ..	Fencing ..	Epee, Individual.
„ ..	„ ..	„ ..	Sabre, „
Anspach, P. ..	Belgium	„ ..	Epee „
„ ..	„ ..	„ ..	„ Team.
„ ..	„ ..	„ ..	Sabre, Individual.
„ ..	„ ..	„ ..	„ Team.
Apáti, Dr. E. ..	Hungary	„ ..	„ Individual.
Appleyard, Mrs.	U.K. ..	Archery ..	National Round.
Angelini, Capt. ..	France ..	Shooting ..	Individual, 1,000 Yards.
„ ..	„ ..	„ ..	„ 300 Metres.
„ ..	„ ..	„ ..	Running Deer, Team.
„ ..	„ ..	„ ..	„ „ „ Indiv.,Single Shot.
„ ..	„ ..	„ ..	„ „ „ „ Double „
Axtell, C. S. ..	U.S.A. ..	„ ..	Revolver and Pistol, Team.
„ ..	„ ..	„ ..	„ „ „ „ Individual.
Andrews, W. ..	Canada ..	Cycling ..	660 Yards.
„ ..	„ ..	„ ..	1,000 Metres.
„ ..	„ ..	„ ..	5,000 „
„ ..	„ ..	„ ..	20 Kilometres.
„ ..	„ ..	„ ..	100 „
„ ..	„ ..	„ ..	Pursuit Race.
„ ..	„ ..	„ ..	Tandem, 2,000 Metres.
Andrews, B. ..	U.K. ..	„ ..	5,000 Metres.
Andre, R. .. ..	France ..	Swimming	100 „
Andersson, R. T,	Sweden ..	„	100 „
„ ..	„ ..	„	400 „
„ ..	„ ..	„	High Diving.
„ ..	„ ..	„	Team Race.
„ ..	„ ..	„	Water Polo.
Anderson, V. ..	„ ..	„	400 Metres.
„ ..	„ ..	„	1,500 „
„ ..	„ ..	„	Water Polo.
Andersson, C. A.	„ ..	„	Breast Stroke.
„ ..	„ ..	„	Water Polo.
Andersson, J. G.	„ ..	„	„
Andersson, M. ..	„ ..	Wrestling ..	Graeco-Roman, Middle Weight.
Andreoli, A. ..	Italy ..	„	„ Light Heavy.
Andreotti, A. ..	„ ..	Gymnastics	Individual.
Andreani, A. ..	„ ..	„	Team.
Andersson, T. ..	Sweden ..	„	„
Atlec, J. C. ..	U.S.A. ..	Athletics..	200 Metres, Flat.
„ ..	„ ..	„ ..	400 „ „
Astley, A. .. ..	U.K. ..	„	400 „ „
„ ..	„ ..	„	800 „ „
„ ..	„ ..	„	Relay Race.

<i>Name</i>	<i>Country</i>	<i>Sport</i>	<i>Event</i>
Andre, G. . . .	France . .	Athletics . .	Standing High Jump.
" " " "	" " "	" "	Running " "
Arvidsson, P. O.	Sweden . .	Shooting . .	Rifle, Team, International.
" " " "	" " "	" "	" 1,000 Yards, Individual.
" " " "	" " "	" "	" Team, 300 Metres.
" " " "	" " "	" "	" Individual, 300 Metres.
" " " "	" " "	" "	Min. Rifle, Indiv., Stationary.
" " " "	" " "	" " "	" " " Disappearing.
" " " "	" " "	" " "	" " " Moving.
Azrini, L. . . .	Italy . .	Cycling . .	1,000 Metres.
" " " "	" " "	" " "	5,000 "
" " " "	" " "	" " "	20 Kilometres.
" " " "	" " "	" " "	100 "
Avrillon, C. . . .	France . .	" " "	20 "
" " " "	" " "	" " "	100 "
" " " "	" " "	" " "	Tandem, 2,000 Metres.
Arbin, H. . . .	Sweden..	Swimming	High Diving.
" " " "	" " "	" "	Fancy "
Aspinall, E. . . .	U.K. . .	Gymnastics	Individual.
Asbrink, G. . . .	Sweden	" "	Team.
Archibald, E. . . .	Canada . .	Athletics, .	Pole Jump.
" " " "	" " "	" "	Throwing the Hammer.
" " " "	" " "	" "	Discus, Free Style.
" " " "	" " "	" "	" Greek
" " " "	" " "	" " "	Javelin, Free Style.
" " " "	" " "	" " "	" Held in the Middle.
Armitage, Mrs. S.H.	U.K. . .	Archery . .	National Round.
Astor, J. J. . . .	" " "	Racquets	Singles.
" " " "	" " "	" "	Doubles.
Apponyi, H. . . .	Hungary	Shooting, . .	Individual, 1,000 yards.
" " " "	" " "	" " "	300 Metres.
" " " "	" " "	" " "	Min. " Rifle, Individual, Stationary.
" " " "	" " "	" " "	" " Disappearing.
" " " "	" " "	" " "	" " Moving.
" " " "	" " "	" " "	Revolver and Pistol, Individual.
" " " "	" " "	" " "	Running Deer, Indiv., Single Shot.
" " " "	" " "	" " "	" " " Double "
Apor, L. . . .	" " "	Swimming	100 Metres.
" " " "	" " "	" "	400 "
Aro, T. . . .	Finland	" "	High Diving.
Antos, M. . . .	Hungary	Gymnastics	Individual.
Ashford, F. M. . . .	U.K. . .	Athletics	800 Metres, Flat.
Appleby, F. . . .	" " "	" "	Marathon Race.
Auffray, A. . . .	France . .	Cycling . .	660 Yards.
" " " "	" " "	" " "	1,000 Metres.
" " " "	" " "	" " "	5,000 "
" " " "	" " "	" " "	Pursuit Race.
" " " "	" " "	" " "	Tandem, 2,000 Metres.
Aurisch, G. . . .	Germany	Swimming	Back Stroke.
Authen, O. F. . . .	Norway..	Gymnastics	Team.
Aumant-Thieville, J.	France . .	Fencing . .	Epée, Individual.
Aubras, C. . . .	" " "	Archery . .	Continental.
Arthus, H. . . .	" " "	Yachting . .	6 Metres,

<i>Name</i>	<i>Country</i>	<i>Sport</i>	<i>Event</i>
Bartkó, J. . . .	Hungary	Athletics . .	100 Metres, Flat.
„ „ „ „	„ „	„ „	200 „ „
„ „ „ „	„ „	„ „	400 „ „
„ „ „ „	„ „	„ „	400 „ Hurdle.
„ „ „ „	„ „	„ „	Relay Race.
Baker, P. A. . .	U.K. . .	Gymnastics	Team.
Barrell, W. F. . .	„ „	„ „	„ „
Barozzi, U. . .	Italy . .	Athletics . .	100 Metres, Flat.
„ „ „ „	„ „	„ „	200 „ „
„ „ „ „	„ „	„ „	Relay Race.
Braun, H. . . .	Germany	„ „	400 Metres, Flat.
„ „ „ „	„ „	„ „	800 „ „
„ „ „ „	„ „	„ „	Relay Race. „
„ „ „ „	„ „	„ „	3 Mile Team Race.
„ „ „ „	„ „	„ „	1, 500 Metres, Flat.
Blake, G. . . .	Australasia	„ „	1,500 „ „
„ „ „ „	„ „	„ „	5 Miles Run.
„ „ „ „	„ „	„ „	Marathon Race.
Barber, G. . . .	Canada . .	„ „	110 Metres, Hurdle.
„ „ „ „	„ „	„ „	400 „ „
„ „ „ „	„ „	„ „	Standing Broad Jump.
„ „ „ „	„ „	„ „	„ High „
„ „ „ „	„ „	„ „	Running Broad Jump.
„ „ „ „	„ „	„ „	„ High Jump.
„ „ „ „	„ „	„ „	Hop., Step, and Jump.
„ „ „ „	„ „	„ „	Javelin, Free Style.
„ „ „ „	„ „	„ „	„ Held in Middle.
„ „ „ „	„ „	„ „	Relay Race.
Bacon, C. J. . .	U.S.A. . .	„ „	400 Metres, Hurdle.
Barker, H. . . .	U.K. . .	„ „	3,200 „ Steeplechase.
Barker, J. N. . .	S. Africa	„ „	Marathon Race.
Braams, W. T. . .	Holland . .	„ „	„ „
„ „ „ „	„ „	„ „	5 Miles Run. „
Blasi, Ú. . . .	Italy . .	„ „	Marathon Race.
Blankenagel, J. Č.	U.S.A. . .	„ „	1,500 Metres, Flat.
Barrett, H. F. . .	U.K. . .	„ „	Marathon Race.
Barnes, E. . . .	„ „	„ „	„ „
Blazsek, F. . . .	Hungary . .	„ „	Standing High Jump.
Banikas, G. . . .	Greece . .	„ „	Pole Jump.
„ „ „ „	„ „	„ „	Tug-of-War.
Baillard, G. . . .	France . .	„ „	Putting the Weight
„ „ „ „	„ „	„ „	Discus, Free Style.
„ „ „ „	„ „	„ „	„ Greek „
„ „ „ „	„ „	„ „	Javelin, Free „
„ „ „ „	„ „	„ „	„ Held in Middle.
Bailey, J. G. . .	U.K. . .	„ „	Tug-of-War.
Brandthwaite, A. .	„ „	„ „	„ „
Barrett, J. . . .	„ „	„ „	Discus, Greek Style.
„ „ „ „	„ „	„ „	Putting the Weight.
Branting, G. . .	Sweden . .	Fencing. . .	Épée, Individual.
„ „ „ „	„ „	„ „	„ Team.
Blake, J. P. . . .	U.K. . .	„ „	„ Individual.
Badman, R. A. B. .	„ „	„ „	Sabre, „
Baudoin, E. . . .	France . .	Archery . .	The York Round.

<i>Name</i>	<i>Country</i>	<i>Sport</i>	<i>Event</i>
Baudoin, E. ..	France ..	Archery ..	Continental.
Bagnall-Oakeley, R. H.	U.K. ..	.. ..	The York Round.
Backhouse, R. O.	.. ..	.. ..	.. .. "
Babington, Mrs.	.. ..	.. ..	National Round.
Baudrier, B. ..	France ..	Yachting ..	6 Metres.
Baddeley, J. ..	U.K. ..	Wrestling	Graeco-Roman, Middle Weight.
Berthet, A. ..	France ..	Athletics ..	Standing High Jump.
.. ..	.. ..	.. ..	Running .. "
Bellah, S. H. ..	U.S.A. ..	.. ..	.. Broad "
.. ..	.. ..	.. ..	Hop,,, Step, and Jump.
.. ..	.. ..	.. ..	Pole Jump.
Bellerby, A. C. B.	U.K. ..	.. ..	Running Broad Jump.
.. ..	.. ..	.. ..	.. High "
Becker, O. C. ..	Denmark	Fencing ..	Epée, Individual.
.. ..	.. ..	.. ..	.. Team.
Bertinetti, M. ..	Italy ..	.. ..	.. Individual.
.. ..	.. ..	.. ..	.. Team.
.. ..	.. ..	.. ..	Sabre, Individual.
.. ..	.. ..	.. ..	.. Team.
Bergeland, H. ..	Norway ..	.. ..	Epée, Individual.
.. ..	.. ..	.. ..	Foils, Display.
Beaurain, D. ..	Belgium	.. ..	Epée, Individual.
.. ..	.. ..	.. ..	.. Team.
Berger, H. ..	France ..	.. ..	.. "
Berré, M. .. ..	Belgium	.. ..	Sabre, Individual.
Beaudin, L. ..	.. ..	.. ..	.. "
Berton, H. .. ..	France ..	Archery ..	The York Round.
.. ..	.. ..	.. ..	Continental.
Barrett, H. R. ..	U.K. ..	Lawn Tennis	Covered Courts, Singles.
.. ..	.. ..	.. ..	.. .. Doubles.
Baerlein, E. M.	.. ..	Racquets ..	Singles.
Balme, E. .. ..	France ..	Shooting ..	Rifle, Team.
.. ..	.. ..	.. ..	300 Metres.
.. ..	.. ..	.. ..	Miniature Rifle, Team.
.. ..	.. ..	.. ..	Running Deer, Single Shot.
.. ..	.. ..	.. ..	.. .. Indiv., Single Shot.
.. ..	.. ..	.. ..	.. .. " Double "
Barnett, R. W.	U.K. ..	.. ..	1,000 Yards.
Barbillat .. ..	France ..	.. ..	Revolver and Pistol, Team.
.. ..	.. ..	.. ..	.. .. Individual.
.. ..	.. ..	.. ..	Running Deer, Team.
.. ..	.. ..	.. ..	.. .. Indiv., Single Shot.
.. ..	.. ..	.. ..	.. .. " Double "
Bashford, J. ..	U.K. ..	.. ..	Revolver and Pistol, Team.
.. ..	.. ..	.. ..	.. .. Individual.
.. ..	.. ..	.. ..	Running Deer, Team.
.. ..	.. ..	.. ..	.. .. Indiv., Single Shot.
.. ..	.. ..	.. ..	.. .. " Double "
Barnes, G. ..	.. ..	.. ..	Min. Rifle, Individual, Stationary.
Ball-Green, G. C.	.. ..	Lawn Tennis	Grass Courts, Men's Singles.
.. ..	.. ..	.. ..	.. .. " Doubles.
Black, A. W. ..	.. ..	Clay Bird Shooting	Team.

<i>Name</i>	<i>Country</i>	<i>Sport</i>	<i>Event</i>
Bailey, W. J.	U.K.	Cycling	660 Yards.
"	"	"	1,000 Metres.
"	"	"	5,000 "
Brambilla G.	Italy	"	1,000 "
"	"	"	5,000 "
"	"	"	20 Kilometres.
"	"	"	100 "
Baumler, M.	France	"	20 "
"	"	"	100 "
Bailey, S. F.	U.K.	"	100 "
Bartlett, C. H.	"	"	100 "
Barnard, J. L.	"	"	Tandem, 2,000 Metres.
Baker, R. L.	Australasia	Swimming	100 Metres.
"	"	"	400 "
"	"	"	1,500 "
"	"	"	Fancy Diving.
"	"	"	Team Race.
Baiardo, D.	Italy	"	100 Metres.
"	"	"	400 "
"	"	"	Team Race.
Battersby, T. S.	U.K.	"	400 Metres.
"	"	"	1,500 "
Blatherwick, S.	"	"	400 "
"	"	"	400 "
Baubiat	France	"	1,500 "
Brack, W.	Germany	"	Breast Stroke.
"	"	"	Back "
Banonyi, A.	Hungary	"	Breast "
Braglia, A.	Italy	Gymnastics	Individual.
Bradshaw, G. A.	U.K.	Wrestling	Graeco-Roman, Middle Weight.
"	"	"	Catch-as-Catch-Can, Heavy.
Bacon, S. V.	"	"	Graeco-Roman, Middle Weight.
"	"	"	Catch-as-Catch-Can, Middle.
Barrette, J.	Holland	"	Graeco-Roman, Middle Weight.
Branbrook, A.	U. K.	"	" " Light, Heavy.
Barrett, E.	"	"	" " Heavy.
"	"	"	Catch-as-Catch-Can, Heavy.
"	"	Athletics	Putting the Weight.
"	"	"	Tug-of-War.
"	"	"	Discus, Free Style.
"	"	"	Greek "
"	"	"	Javelin, Free "
Baillie, H.	"	Wrestling	Catch-as-Catch-Can, Light.
Bacon, E. H.	"	"	" " Middle.
Brambilla, E.	Italy	Gymnastics	Individual.
"	"	Athletics	100 Metres, Flat.
"	"	"	200 " "
"	"	"	110 " Hurdle.
"	"	"	Hop, Step, and Jump.
"	"	"	Javelin, Free Style.
"	"	"	Relay Race.
Bacchilli, E.	"	Gymnastics	Individual.
Bailey, G.	U.K.	"	"
Bauscher, O.	"	"	"

<i>Name</i>	<i>Country</i>	<i>Sport</i>	<i>Event</i>
Benedict, C. S. . .	U.S.A. . .	Shooting . .	Rifle, Team.
"	"	"	" Individual, 1,00 Yards.
"	"	"	" Team, 300 Metres.
"	"	"	" Individual, 300 Metres.
Béjot, E. . . .	France . .	Clay Bird Shooting . .	Individual.
"	"	"	Team.
Beattie, G. . . .	Canada . .	"	Individual.
"	"	"	Team.
Beaurepaire, F. E.	Australasia	Swimming	100 Metres.
"	"	"	400 "
"	"	"	1,500 "
"	"	"	Team Race.
Benanga, B. . .	Holland . .	"	100 Metres.
"	"	"	Team Race.
"	"	"	Water Polo.
Briard . . . .	France . .	"	High Diving
Behrens, K. . .	Germany	"	Fancy
Beckett, A. R. . .	U.K. . .	"	"
Benedicks, E. . .	Sweden.	Clay Bird Shooting	Individual.
"	"	"	Team.
Beretta, A. . . .	Italy . .	Swimming	" Race.
"	"	"	Breast Stroke.
"	"	"	Back Stroke.
Bergqvist, E. G	Sweden . .	"	Water Polo.
Bergvall, E. . .	"	"	"
Beck, F. . . .	U.K. . .	Wrestling	Graeco-Roman, Middle.
"	"	"	" " Light Heavy.
"	"	"	Catch-as-Catch-Can, Heavy.
Belmer, J. . . .	Holland . .	"	Graeco-Roman, Middle.
Bechyni, J. . . .	Bohemia	"	" " Light Heavy.
Bertinotti, R. . .	Italy . .	Gymnastics	Individual.
Becker, C. L. J.	Holland . .	"	"
"	"	"	Team.
Behme, R. . . .	Germany	"	Individual.
"	"	"	Team.
Bedmose, H. . . .	Denmark	"	"
Bersen, P. . . .	Norway . .	"	"
Bertilsson, C. . .	Sweden . .	"	"
Bergman, C. . . .	"	"	"
Belaud, D. . . .	Canada . .	Athletics	100 Metres, Flat.
Bechler, C. . . .	Germany	"	100 " "
"	"	"	200 " "
"	"	"	Running Broad Jump
"	"	"	Javelin, Held in Middle.
"	"	"	Relay Race.
Berneg, J. . . .	Hungary	"	400 Metres, Flat.
"	"	"	800 " "
"	"	"	Relay Race.
Beard, C. B. . . .	U.S.A. . .	"	800 Metres, Flat.
Breyneck, A. . .	Germany	"	800 " "
"	"	"	1,500 " "
"	"	"	3 Mile, Team.

<i>Name</i>	<i>Country</i>	<i>Sport</i>	<i>Event</i>
Breyneck, A. ..	Germany	Athletics ..	Relay Race.
Becske, K. . . .	Hungary	" ..	1,500 Metres, Flat.
" .. ..	"	" ..	5 Miles Run.
Bellars, F. G. ..	U.S.A. ..	" ..	5 " Race.
" .. ..	" ..	" ..	3 Mile, Team.
Bergval, J. T. ..	Sweden ..	" ..	Marathon Race.
Beale, J. G. ..	U.K. ..	" ..	" "
Brennan, J. J. ..	U.S.A. ..	" ..	Standing Broad Jump.
" .. ..	" ..	" ..	" High "
" .. ..	" ..	" ..	Running Broad "
" .. ..	" ..	" ..	" High "
" .. ..	" ..	" ..	Hop, Step, and Jump.
Bleaden, W. H. ..	U.K. ..	" ..	Standing Broad Jump.
" .. ..	" ..	" ..	Running High "
Bengtsson, A. ..	Sweden ..	" ..	Standing " "
Biedermann, E. A. ..	U.K. ..	Tennis ..	Singles.
Britton, H. ..	" ..	Shooting ..	Rifle, Team.
Bianchetti, P. ..	Italy ..	" ..	Revolver, Individual.
Bishop, J. H. ..	U.K. ..	Cycling ..	100 Kilometres.
" .. ..	" ..	" ..	Pursuit Race.
Bieberstein, A. ..	Germany	Swimming	Back Stroke.
Biel, M. . . .	Holland..	Gymnastics	Individual.
Bingley, S. S. N. ..	U.K. ..	Yachting..	7 Metres.
Borzani, A. ..	Italy ..	Gymnastics	Team.
Borsetti, P. ..	" ..	" ..	"
Blo, V. ..	" ..	" ..	"
Bottoni, F. ..	" ..	" ..	"
Bolme, H. . . .	Norway ..	" ..	"
Boysen, T. ..	" ..	" ..	"
Bogart, L. ..	France ..	" ..	"
Borchert, K. ..	Germany	" ..	Individual.
Bolt, J. . . .	Holland..	" ..	"
" .. ..	" ..	" ..	Team.
Blom, R. J. C. ..	" ..	" ..	Individual.
" .. ..	" ..	" ..	Team.
Brouwer, E. ..	" ..	" ..	Individual.
" .. ..	" ..	" ..	Team.
Boislevé, E. ..	France ..	" ..	Individual
Borghí, P. . . .	Italy ..	" ..	"
Brown, C. H. ..	U.K. ..	Wrestling	Graeco-Roman, Light Heavy.
" .. ..	" ..	" ..	Catch-as-Catch-Can, Heavy.
Blount, E. J. ..	" ..	" ..	Graeco-Roman, Light Weight.
" .. ..	" ..	" ..	Catch-as-Catch-can, Light.
Bórovi, J. F. ..	Hungary	Swimming	Water Polo
Bourdon, G. ..	France ..	" ..	Breast Stroke.
Bonnars, H. ..	Belgium	" ..	Team Race.
" .. ..	" ..	" ..	Water Polo.
Bornemann, F. H. ..	U.S.A. ..	" ..	High Diving.
" .. ..	" ..	" ..	Fancy "
Bonfanti, C. ..	Italy ..	" ..	High "
" .. ..	" ..	" ..	Fancy "
Bronner, V. ..	" ..	" ..	1,500 Metres.
" .. ..	" ..	" ..	Team Race.
Broogham, H. ..	U.K. ..	Racquets	Singles.

<i>Name</i>	<i>Country</i>	<i>Sport</i>	<i>Event</i>
Browning, F. H.	U.K.	Racquets	Singles.
Browning, C.	"	"	"
"	"	"	Doubles.
Bostock, J., Q.M.S.I.	"	Shooting	Rifle, Team, 300 Metres.
"	"	"	" Indiv., 300 "
Blood, M.	"	"	" " 1,000 Yards.
"	"	"	" Team, 300 Metres.
"	"	"	" Indiv., 300 "
"	"	"	Running Deer, Team.
"	"	"	" " Indiv., Single Shot .
"	"	"	" " " Double "
Bonnefoy, H.	France	"	Rifle, Indiv., 300 Metres.
"	"	"	Miniature Rifle, Team.
"	"	"	" " Indiv., Stationary,
"	"	"	" " " Disappearing.
"	"	"	" " " Moving.
Boin, V.	Belgium	Swimming	100 Metres.
"	"	"	400 "
"	"	"	Team Race.
"	"	"	Water Polo.
Boström, Wollman	Sweden	Lawn Tennis	Covered Courts, Singles.
"	"	"	" " Doubles.
Boothby, Miss D.	U.K.	"	" " Singles.
"	"	"	Grass Courts, Singles.
Brothe, J.	Norway	Shooting	Rifle, Individual, 1,000 Yards.
"	"	"	" Team, 300 Metres.
"	"	"	" Individual, 300 Metres.
"	"	"	Min. Rifle, Team.
"	"	"	" " Indiv., Stationary.
"	"	"	" " " Disappearing.
"	"	"	" " " Moving.
"	"	"	Running Deer, Team.
"	"	"	" " Indiv., Single Shot.
"	"	"	" " " Double "
Boyd, M.	U.K.	"	Rifle, Individual, 1,000 Yards.
Brosch, C.	Holland	"	" Team, 300 Metres.
"	"	"	" Individual, 300 Metres.
"	"	"	Revolver and Pistol, Team.
"	"	"	" " " Individual.
Bouwens, A. H. M.	"	"	Rifle, Team, 300 Metres.
"	"	"	" Individual, 300 Metres.
"	"	"	Revolver and Pistol, Team.
"	"	"	" " Individual.
Brown, Arm.-Sergt. R.H.	U.K.	"	Rifle Team, 300 Metres.
"	"	"	" Individual, 300 Metres.
Bonicelli, D.	Italy	"	" Team.
"	"	"	" Individual, 1,000 Yards.
"	"	"	" " 300 Metres.
"	"	"	Revolver and Pistol, Team.
"	"	"	" " Individual.
Brown, S. S.	Canada	"	Rifle, 1,000 Yards.
Bargagelli, G.	Italy	"	Revolver and Pistol, Team.
"	"	"	" Individual.



<i>Name</i>	<i>Country</i>	<i>Sport</i>	<i>Event</i>
Bocchino, V. ..	Italy ..	Cycling ..	660 Yards.
" .. ..	" ..	" ..	1,000 Metres.
Boldt, A. .. ..	Germany	" ..	660 Yards.
" .. ..	" ..	" ..	1,000 Metres.
" .. ..	" ..	" ..	5,000 "
" .. ..	" ..	" ..	20 Kilometres.
" .. ..	" ..	" ..	100 "
" .. ..	" ..	" ..	Pursuit Race.
" .. ..	" ..	" ..	Tandem, 2,000 Metres.
Bonnet, F. . . .	France ..	" ..	20 Kilometres.
" .. ..	" ..	" ..	100 "
" .. ..	" ..	" ..	Tandem, 2,000 Metres.
Bouffler, H. C. . .	U.K. ..	" ..	20 Kilometres.
Brooks, C. . . .	" ..	" ..	"
" .. ..	" ..	" ..	Tandem, 2,000 Metres.
Bury, E. W. . . .	" ..	Racquets	Singles.
" .. ..	" ..	" ..	Doubles.
Bru, J. . . . .	Norway ..	Shooting ..	Rifle, Team, International.
" .. ..	" ..	" ..	" Individual, 1,000 Yards.
" .. ..	" ..	" ..	" Team, 300 Metres.
" .. ..	" ..	" ..	" Individual, 300 Metres.
" .. ..	" ..	" ..	Min. Rifle, Team.
" .. ..	" ..	" ..	" " Indiv., Stationary.
" .. ..	" ..	" ..	" " " Disappearing.
" .. ..	" ..	" ..	" " " Moving.
" .. ..	" ..	" ..	Running Deer, Team.
" .. ..	" ..	" ..	" " Indiv., Single Shot.
" .. ..	" ..	" ..	" " " Double "
Broussard, P. J. .	Holland ..	" ..	Rifle, Team, 300 Metres.
" .. ..	" ..	" ..	" Individual, 300 Metres.
Bruggan, Cate P. .	" ..	" ..	" Team, 300 Metres.
" .. ..	" ..	" ..	" Individual, 300 Metres.
" .. ..	" ..	" ..	Revolver and Pistol, Team.
" .. ..	" ..	" ..	" " " Individual.
Buttafore, C. . .	Italy ..	" ..	" " " Team.
" .. ..	" ..	" ..	" " " Individual.
Bucquet, M. . . .	France ..	Clay Bird Shooting	Individual.
" .. ..	" ..	" "	Team.
Butt, J. H. . . .	U.K. ..	" "	Individual.
" .. ..	" ..	" "	Team.
Buck, H. D. . . .	" ..	Cycling ..	660 Yards.
" .. ..	" ..	" ..	1,000 Metres.
" .. ..	" ..	" ..	5,000 "
" .. ..	" ..	" ..	Pursuit Race.
Bruckner, A. . . .	Hungary	Swimming	100 Metres.
" .. ..	" ..	" ..	400 "
" .. ..	" ..	" ..	Team Race.
Bull, W. J. . . .	U.K. ..	" ..	Fancy Diving.
Bruseker, U. O. . .	Holland .	Wrestling	Graeco-Roman, Light Weight.
Bruce, L. . . . .	U.K. ..	" "	Catch-as-Catch-Can, Heavy.
Bouzzi, B. . . .	Italy ..	Gymnastics	Team.
Buddo, D. . . . .	Canada ..	Athletics ..	400 Metres, Flat.
" .. ..	" ..	" ..	800 " "

<i>Name</i>	<i>Country</i>	<i>Sport</i>	<i>Event</i>
Buddo, D.	.. Canada ..	Athletics..	1,500 Metres.
"	" "	" "	Relay Race.
Bye, O. W.	.. Norway	Gymnastics	Team.
Bryant, W.	.. U.S.A. ..	Archery ..	York Round.
"	" "	" "	Continental.
Biet, M.	.. Holland..	Gymnastics	Team.
Billar, J. A.	.. U.S.A. ..	Athletics..	Standing Broad Jump.
"	" "	" "	" High "
Blystad, W.	.. Holland..	" "	" " "
Bricker, C.	.. Canada ..	" "	Running Broad "
"	" "	" "	Hop, Step, and Jump.
"	" "	" "	110 Metres, Hurdle.
"	" "	" "	400 " "
Bridges, J. H.	.. U.K. ..	Archery ..	York Round.
Briard, ..	.. France ..	Swimming	High Diving.
Bonney, R.	.. U.K. ..	Gymnastics	Team.
Bodor, O.	.. Hungary	Athletics..	400 Metres, Flat.
"	" "	" "	800 " "
"	" "	" "	1,500 " "
"	" "	" "	400 " Hurdle.
"	" "	" "	Relay Race.
Bromelow, J.	.. U.S.A. ..	" "	800 Metres, Flat.
"	" "	" "	400 " "
Bouin, J.	.. France ..	" "	800 " "
"	" "	" "	1,500 " "
"	" "	" "	5 Miles Run.
Bjorn, E.	.. Sweden..	" "	800 Metres, Flat.
"	" "	" "	1,500 " "
"	" "	" "	Relay Race
Bonniot de Fleurac	France *	" "	1,500 Metres, Flat.
L. N. D.	" "	" "	3,200 " Steeplechase.
"	" "	" "	5 Miles Run.
Bonhag, G. V. ..	.. U.S.A. ..	" "	3,200 Metres, Steeplechase.
"	" "	" "	5 Miles Run.
"	" "	" "	10 " Walk.
"	" "	" "	3 " Team Race.
"	" "	" "	3,500 Metres Walk.
Blois, V.	.. France ..	" "	Pole Jump.
Bonnifant, H.	.. U.K. ..	" "	Tug-of-War.
Brown, B. C.	.. " "	" "	3,500 Metres Walk.
Bosman, F.	.. Belgium .	Fencing ..	Epée, Individual.
"	" "	" "	" Team.
"	" "	" "	Sabre, Individual.
"	" "	" "	" Team.
Brookfield, E. W. H.	.. U.K. ..	" "	" Individual.
"	" "	" "	" Team.
Bossini, E.	.. Italy ..	" "	" Individual.
"	" "	" "	" Team.
Borezée, A.	.. France ..	Gymnastics	Team.
Brooks-King, R.	.. U.K. ..	Archery ..	York Round.
Bowen, Mrs.	.. " "	" "	National Round.
Buddam-Wheathan,	" "	" "	" "
Mrs.			

<i>Name</i>	<i>Country</i>	<i>Sport</i>	<i>Event</i>
Bovini, K. A.	.. Sweden ..	Yachting..	8 Metres.
"	" "	" "	6 "
Bruger, G.	.. Hungary	Athletics..	800 Metres, Flat.
Butterfield	.. U.K. ..	" "	800 " "
"	" "	" "	1,500 " "
Burton, L. A.	.. " "	" "	400 " Hurdle.
Buckley, F. J.	.. " "	" "	3,200 " Steeplechase.
Burton, G.	.. " "	" "	400 " Hurdle.
Braams, W. T.	.. Holland ..	" "	3 Miles, Team.
Burn, A.	.. Canada ..	" "	5 " Run.
"	" "	" "	Marathon Race.
"	" "	" "	3 Miles Team Race.
Butler, J.	.. U.K. ..	" "	10 Miles Walk
"	" "	" "	3,500 Metres Walk,
Büff, G. J. M.	.. Holland ..	" "	Marathon Race.
Brustmann, M.	.. Germany	" "	Running Broad Jump.
"	" "	" "	Hop, Step, and Jump.
Burroughs, W. J.	.. U.S.A. ..	" "	Throwing the Hammer.
"	" "	" "	Putting the Weight.
"	" "	" "	Tug-of-War.
"	" "	" "	Discus, Free Style.
"	" "	" "	" Greek "
"	" "	" "	Javelin, Free "
"	" "	" "	" Held in Middle.
Butler, T.	.. U.K. ..	" "	Tug-of-War.
Cartmell, N. J.	.. U.S.A. ..	" "	100 Metres, Flat.
"	" "	" "	200 " "
"	" "	" "	400 " "
"	" "	" "	Relay Race.
Carpenter, J. C.	.. " "	" "	400 Metres, Flat.
Cartasegna, M.	.. Italy ..	" "	" " Steeplechase.
"	" "	" "	3,200 " "
"	" "	" "	3 Miles, Team.
Chavasse, N. G.	.. U.K. ..	" "	400 Metres, Flat.
Chavasse, C. M.	.. " "	" "	" " "
Charvin, C.	.. France ..	Wrestling	Graeco-Roman, Middle-Weight.
"	" "	" "	Catch-as-Catch-Can, Middle.
Cazenove	.. " "	Athletics..	110 Metres, Hurdle.
"	" "	" "	Standing High Jump.
"	" "	" "	Running " "
Choisel, E.	.. " "	" "	110 Metres, Hurdle.
"	" "	" "	400 " "
Chavey, G. A.	.. " "	" "	" " "
Carr, E. C.	.. U.S.A. ..	" "	3,200 Metres, Steeplechase.
"	" "	" "	5 Miles Run.
"	" "	" "	3 " Team.
Carr, R. G.	.. " "	" "	5 " Run.
"	" "	" "	3 " Team.
Claro, O.	.. Italy ..	" "	10 " Walk.
Carter, F. T.	.. U.K. ..	" "	" " "
"	" "	" "	3,500 Metres Walk

<i>Name</i>	<i>Country</i>	<i>Sport</i>	<i>Event</i>
Clarke, W. F. ..	U.K. ..	Athletics..	Marathon Race.
Caffery, J. P. ..	Canada ..	" "	" "
Campbell, C. S. ..	U.S.A. ..	" "	Pole Jump.
Carey, D. ..	U.K. ..	" "	Throwing the Hammer.
Clarke, J. M. ..	" ..	" "	Tug-of-War.
Chaffé, W. ..	" ..	" "	" "
Crattinguis, B. A.	Sweden ..	Fencing ..	Epée, Individual.
" "	" "	" "	" Team.
Cagiati, G. ..	Italy ..	" "	" Individual.
Chalmers, R. ..	U.K. ..	" "	" "
Castle, E. ..	" ..	" "	" Team.
" "	" "	" "	Sabre, "
Chalke, A. P. P.	" ..	" "	" Individual.
Chopins, Lt. ..	France ..	" "	" "
" "	" "	" "	" Team.
Cart ..	" ..	" "	" Individual.
Cabaret, G. ..	" ..	Archery ..	York Round,
" "	" "	" "	Continental.
Cadman, Mrs. C.	U.K. ..	" "	National Round.
Campbell, C. R. ..	" ..	Yachting..	8 Metres.
Carlsson, J. E. B.	Sweden ..	" "	" "
Casson, A. C. B.	U.K. ..	" "	7 "
Caridia, G. A. ..	" ..	Lawn Tennis	Covered Courts, Singles.
" "	" "	" "	" " " Doubles.
" "	" "	" "	Grass Courts, Men's Singles.
Chambers, Mrs. L.	" ..	" "	Covered Courts, Singles.
" "	" "	" "	Grass Courts, Ladies' Singles,
Cazalet, W. M.	" ..	Tennis ..	Singles.
Chain, H. ..	France ..	Shooting ..	Rifle, Team.
" "	" "	" "	" Individ., 300 Metres.
" "	" "	" "	Min. Rifle, Individ., Stationary.
" "	" "	" "	" " " Disappearing.
" "	" "	" "	" " " Moving.
" "	" "	" "	Revolver and Pistol, Individual.
Caldwell, T. ..	U.K. ..	" "	Rifle, Individual, 1,000 Yards.
Chaney, H. E., ..	" ..	" "	Team, 300 Metres.
C.S.M.I.	" "	" "	" Individual, 300 Metres.
Carlberg, W. ..	Sweden ..	" "	Min. Rifle, Individ., Stationary.
" "	" "	" "	" " " Disappearing.
" "	" "	" "	" " " Moving.
" "	" "	" "	Revolver and Pistol, Team.
" "	" "	" "	" " " Individual.
" "	" "	Gymnastics	Team.
Carlberg, E. ..	" ..	Fencing ..	Epée, Individual.
" "	" "	" "	" Team.
" "	" "	Shooting ..	Min. Rifle, Individ., Stationary.
" "	" "	" "	" " " Disappearing.
" "	" "	" "	" " " Moving.
" "	" "	" "	Revolver and Pistol, Team.
" "	" "	" "	" " " Individual.
Cartnell, A. A. ..	U.K. ..	" "	Min. Rifle, Team.
" "	" "	" "	" " " Individ., Stationary.
Calkins, J. R. ..	U.S.A. ..	" "	Revolver and Pistol, Team.

<i>Name</i>	<i>Country</i>	<i>Sport</i>	<i>Event</i>
Cantoni, G. G. . .	Italy . .	Shooting . .	Rifle, Team.
" "	" "	" "	" Individ., 1,000 Yards.
" "	" "	" "	" Team, 300 Metres.
" "	" "	" "	" Individ. " "
" "	" "	" "	Revolver and Pistol, Team.
" "	" "	" "	" " " Individual.
Cantoni, R. . .	" "	" "	Rifle, Team.
" "	" "	" "	" Individ., 1,000 Yards.
" "	" "	" "	" Team, 300 Metres.
" "	" "	" "	" Individ., " "
Casey, K. K. . .	U.S.A . .	" "	" Team.
" "	" "	" "	" Individ., 1,000 Yards.
" "	" "	" "	" Team, 300 Metres.
" "	" "	" "	" Individ. " "
Crawley, W. C. . .	U.K. . .	Lawn Tennis	Grass Courts, Men's Singles.
" "	" "	" "	" " " Doubles.
Czalet, C. H. L. . .	" "	" "	" " " "
Cameron, G. G. . .	U.S.A. . .	Cycling . .	660 Yards.
" "	" "	" "	100 Kilometres.
" "	" "	" "	Pursuit Race.
" "	" "	" "	Tandem, 2,000 Metres.
Clark, C. V. . .	U.K. . .	" "	5,000 Metres.
Calvert, A. E. . .	" "	" "	" "
Cane, G. F. . .	" "	Swimming	High Diving.
Clarke, H. . .	" "	" "	Fancy "
Crank, H. . .	" "	" "	" "
Carlsen, C. . .	Denmark	Wrestling	Graeco-Roman, Light Weight.
Cats, A. . .	Holland .	" "	" " " "
Craige, J. H. . .	U.S.A. . .	" "	Catch-as-Catch-Can, Middle.
Czada, J. . .	Bohemia	Gymnastics	Individual.
Castelli, A. . .	France . .	" "	" "
Charmille, R. . .	" "	" "	" "
Castiglione, J. . .	" "	" "	" "
Castille, F. . .	" "	" "	" "
Carlsrud, C. M. . .	Norway . .	" "	" "
" "	" "	" "	Team.
" "	" "	Athletics .	Javelin, Held in Middle.
Challstorp, H. . .	Sweden . .	Wrestling	Catch-as-Catch-Can, Middle.
" "	" "	" "	" " " Heavy.
Calabresci, G. . .	Italy . .	Gymnastics	Team.
Cattley, J. H. . .	U.K. . .	" "	" "
Clay, M. . .	" "	" "	" "
Chapman, M. . .	" "	Athletics .	100 Metres, Flat.
Cěrný, J. . . .	Bohemia	Lawn Tennis	Grass Courts, Men's Singles.
" "	" "	" "	" " " Doubles.
Creasey, H. P. . .	U.K. . .	Clay Bird Shooting	Individual.
" "	" "	" "	Team.
Csery, Mme. K. . .	Hungary	Lawn Tennis	Grass Courts, Ladies' Singles.
" "	" "	" "	" " " Doubles.
Cederberg, H. . .	Finland	Swimming	1,500 Metres.
" "	" "	" "	Breast Stroke.
" "	" "	" "	Back "
Chenery, H. R. . .	U. K. . .	Wrestling	Catch-as-Catch-Can, Middle.

<i>Name</i>	<i>Country</i>	<i>Sport</i>	<i>Event</i>
Celada, C.	Italy	Gymnastics	Team.
Cervin, A.	Sweden	"	"
Cedercrona, H.	"	"	"
Celis, F.	Belgium	Athletics	Marathon Race.
Celano, G.	Italy	Fencing	Epée, Individual.
"	"	"	Sabre, "
Cesarano, F.	"	"	Epée, "
"	"	"	Sabre, "
Ceccherini, S.	"	"	" "
"	"	"	" Team.
Christiansen, N.	Denmark	Shooting	Rifle, Team, International.
"	"	"	" Individual, 1,000 Yards.
"	"	"	" Team, 300 Metres.
"	"	"	" Individual, 300 Metres.
"	"	"	Min. Rifle, Indiv., Stationary.
"	"	"	" " Team.
"	"	"	" " Indiv., Disappearing.
Christensen, J. H.	"	Wrestling	Graeco-Roman, Light Heavy.
Civinini, C.	Italy	Gymnastics	Individual.
Chievitz, J.	Denmark	"	Team.
Christofori, G.	Italy	"	"
Christie, D. C.	U.K.	Athletics	400 Metres, Flat.
Crichton Thetton, G.	"	Yachting	8 Metres.
Crichton, Major	"	"	"
C. W. H.	"	"	"
Cloughan, R.	U.S.A.	Athletics	100 Metres, Flat.
"	"	"	200 " "
Clough, E.	U.K.	Gymnastics	Team.
Cotterell, J.	"	"	"
Conti, A.	Italy	Shooting	Rifle, Team.
"	"	"	" Individual, 1,000 Yards.
"	"	"	" Team, 300 Metres.
"	"	"	" Individual, 300 Metres.
"	"	"	Revolver and Pistol, Team.
"	"	"	" Individual.
Cowen, Col. J. H.	U.K.	"	Running Deer, Team.
"	"	"	" " Indiv., Single Shot.
"	"	"	" " Indiv., Double "
Coeckleberg, L.	Belgium	Cycling	660 Yards.
"	"	"	1,000 Metres.
"	"	"	5,000 "
"	"	"	20 Kilometres.
"	"	"	100 "
"	"	"	Pursuit Race.
"	"	"	2,000 Metres, Tandem.
Coeckleberg, G.	"	"	660 Yards.
"	"	"	1,000 Metres.
"	"	"	5,000 "
"	"	"	20 Kilometres.
"	"	"	100 "
"	"	"	Pursuit Race,
"	"	"	2,000 Metres, Tandem.
Couderc, R.	France	"	660 Yards.
"	"	"	1,000 Metres.

<i>Name</i>	<i>Country</i>	<i>Sport</i>	<i>Event</i>
Couderc, R.	France	Cycling	5,000 Metres.
"	"	"	Pursuit Race.
Crowther, H.	U.K.	"	1,000 Metres.
Cook, E. J. L.	Australasia	Swimming	100 "
"	"	"	400 "
"	"	"	Team Race.
"	"	"	Breast Stroke.
Conzani, A.	Italy	"	Back "
"	"	"	400 "
"	"	"	Team Race.
Collings, F. J.	U.K.	"	High Diving.
Churcher, C. W.	"	Shooting	Rifle, Team, 300 Metres.
Q.M.S.I.			
"	"	"	Rifle, Individual, 300 Metres.
Cunault, H.	France	Cycling	20 Kilometres.
"	"	"	100 "
Csüdor, B.	Hungary	Wrestling	Graeco-Roman, Middle.
Cullen, G. C.	U.K.	Gymnastics	Team.
Coulcumberdos, G.	Greece	Athletics	5 Mile Run.
"	"	"	Marathon Race.
Coutoulakis, A.	"	"	5 Mile Run.
"	"	"	Marathon Race.
Cohn, H. W.	U.S.A.	"	5 Mile Run.
"	"	"	3 " Team Race.
Coales, W.	U.K.	"	5 " Run.
"	"	"	3 " Team Race.
Cowy, W.	"	Gymnastics	Team.
Colevati, T.	Italy	"	"
Cosechini, A.	"	"	"
Courtois, A.	France	"	"
Cook, J. J.	U.K.	"	Individual.
Costa, A.	France	"	"
Coleman, A.	U.K.	Wrestling	Catch-as-Catch-Can, Middle.
Couch, R.	"	"	" Feather
Cocking, P. H.	"	"	" "
Côte, A.	Canada	"	" Bantam
Cox, W. G.	U. K.	"	" "
Cox, J. E.	"	"	" "
Collett, H. J.	"	"	Graeco-Roman, Light Weight.
"	"	"	Catch-as-Catch-Can, Light Weight.
Comet, G. T.	"	Swimming	Water Polo.
Courbet, F.	Belgium	"	"
"	"	"	Breast Stroke.
Cortlever, J. G.	Holland	"	Back "
Courtman, P.	U.K.	"	Breast "
Cross, C. A.	"	"	Fancy Diving.
Coles, Miss M.	"	Lawn Tennis	Covered Courts, Singles.
Courguin, A.	France	Shooting	Rifle, Team.
"	"	"	" 300 Metres.
"	"	"	" Individual, 300 Metres.
"	"	"	Min. Rifle, Team.
Colas P.	"	"	Rifle, Individual, 1,000 Yards.
"	"	"	" Team, 300 Metres.
"	"	"	" Indiv., " "

<i>Name</i>	<i>Country</i>	<i>Sport</i>	<i>Event</i>
Colas, P. . . .	France . .	Shooting . .	Min. Rifle, Individual, Stationary.
" . . . .	" . .	" . .	" " Team.
" . . . .	" . .	" . .	" " Indiv., Disappearing.
" . . . .	" . .	" . .	" " " Moving.
Cottely, E. . . .	Hungary	" . .	Rifle, Individual, 1,000 Yards.
" . . . .	" . .	" . .	" " " 300 Metres.
" . . . .	" . .	" . .	Min. Rifle, Indiv., Stationary.
" . . . .	" . .	" . .	" " " Disappearing.
" . . . .	" . .	" . .	" " " Moving.
" . . . .	" . .	" . .	Revolver and Pistol, Individual.
" . . . .	" . .	" . .	Running Deer, Indiv., Single Shot.
" . . . .	" . .	" . .	" " " Double Shot.
Coles, G. H. . .	U.K. . .	" . .	Revolver and Pistol, Team.
Crowe, G. R. . .	Canada . .	" . .	Rifle, Team.
" . . . .	" . .	" . .	" Individual, 1,000 Yards.
" . . . .	" . .	" . .	" Team, 300 Metres.
Csurgay, E. . .	Hungary	Athletics . .	Running Broad Jump.
Cruyssen, W. U	Belgium	Yachting . .	6 Metres.
Coe, H. L. . . .	U.S.A. . .	Athletics . .	800 Metres Flat.
" . . . .	" . .	" . .	1,500 " "
" . . . .	" . .	" . .	400 " "
Cook, E. T. . . .	" . .	" . .	110 Metres, Hurdles.
" . . . .	" . .	" . .	Running Broad Jump.
" . . . .	" . .	" . .	Hop, Step, and Jump.
" . . . .	" . .	" . .	Pole Jump.
Cotter, E. . . .	Canada . .	" . .	5 Miles Run.
" . . . .	" . .	" . .	Marathon Race.
Cocca, A. . . .	Italy . .	" . .	" " "
" . . . .	" . .	" . .	3 Mile Team Race.
Cornish, L. J. . .	U.K. . .	" . .	Standing Broad Jump.
" . . . .	" . .	" . .	Running " "
Coutouriotis, E,	Greece . .	" . .	Pole Jump.
" . . . .	" . .	" . .	Tug-of-War.
" . . . .	" . .	" . .	Relay Race.
Coe, W. W. . . .	U.S.A. . .	" . .	Putting the Weight.
" . . . .	" . .	" . .	Tug-of-War.
Collins, M. . . .	U.K. . .	" . .	Discus, Free Style.
" . . . .	" . .	" . .	" Greek "
Cserna, D. C. . .	Hungary	" . .	Javelin, Free "
" . . . .	" . .	" . .	" Held in Middle.
Collignon . . . .	France . .	Fencing . .	Epée, Individual.
" . . . .	" . .	" . .	" Team.
Constant, N . . .	" . .	Gymnastics	Team.
Cornwall, G. . .	U.K. . .	Archery . .	York Round.
Coates, C. H. . .	" . .	" . .	"
Cochrane, B. O.	" . .	Yachting . .	8 Metres.
Dharancy, E. . .	France . .	Gymnastics	Team.
Dahl, N. . . . .	Norway . .	Athletics . .	100 Metres, Flat.
" . . . .	" . .	" . .	1,500 " "
" . . . .	" . .	" . .	Relay Race.
Dahl, E. M. . . .	Sweden . .	" . .	800 Metres, Flat.



<i>Name</i>	<i>Country</i>	<i>Sport</i>	<i>Event</i>
Dahl, E. M. ..	Sweden ..	Athletics ..	1,500 Metres, Flat
„ ..	„ ..	„ ..	5 Miles Run.
„ ..	„ ..	„ ..	3 „ Team Race.
„ ..	„ ..	„ ..	Relay Race.
Danielson, F. G. ..	„ ..	„ ..	800 Metres, Flat.
„ ..	„ ..	„ ..	1,500 „ „
„ ..	„ ..	„ ..	„ Relay Race.
Daubin, R. ..	Switzerland ..	„ ..	1,500 Metres, Flat.
Daly, J. J. .. ..	U.K. ..	„ ..	3,200 „ Steeplechase.
„ .. ..	„ ..	„ ..	5 Miles Run.
„ .. ..	„ ..	„ ..	3 „ Team Race.
Dánér, B. .. ..	Hungary ..	„ ..	Running High Jump.
Dray, W. R. .. ..	U.S.A. ..	„ ..	Pole Jump.
Dávid, M. .. ..	Hungary ..	„ ..	Putting the Weight.
Daniell, C. L. .. ..	U.K. ..	Fencing ..	Epée, Individual.
„ .. ..	„ ..	„ ..	„ Team.
„ .. ..	„ ..	„ ..	„ Individual.
Davson, P. M. .. ..	„ ..	„ ..	„ „
d'Hanson .. ..	France ..	„ ..	Sabre, Individual.
Daschez, A. .. ..	„ ..	Archery ..	York Round.
„ .. ..	„ ..	„ ..	Continental.
Day, Mrs. E. H. ..	U.K. ..	„ ..	National Round.
Davies, C. S., Lt. ..	„ ..	Yachting ..	7 Metres.
Deleschux, A. .. ..	France ..	Gymnastics ..	Team.
Deleschux, L. .. ..	„ ..	„ ..	„
Degermark, R. .. ..	Sweden ..	„ ..	„
de Boer, J. .. ..	Holland ..	„ ..	„
Denby, F. .. ..	U.K. ..	„ ..	„
den Held, E. J. .. ..	Holland ..	Athletics ..	100 Metres, Flat.
„ .. ..	„ ..	„ ..	200 „ „
„ .. ..	„ ..	„ ..	400 „ „
„ .. ..	„ ..	„ ..	800 „ „
„ .. ..	„ ..	„ ..	Relay Race.
Dery, E. .. ..	Hungary ..	„ ..	100 Metres, Flat.
„ .. ..	„ ..	„ ..	200 „ „
„ .. ..	„ ..	„ ..	400 „ „
de Selding, F. M. .. ..	U.S.A. ..	„ ..	„ „ „
Delmas, G. .. ..	France ..	„ ..	800 „ „
Demettrion, S. .. ..	Greece ..	„ ..	1,500 „ „
„ .. ..	„ ..	„ ..	Tug-of-War.
„ .. ..	„ ..	„ ..	Relay Race.
„ .. ..	„ ..	„ ..	1,500 Metres, Flat.
Delloye, F. .. ..	Belgium ..	„ ..	„ „ „
De Keyser, J. .. ..	Holland ..	„ ..	5 Mile Run.
„ .. ..	„ ..	„ ..	1,500 Metres, Flat.
Deakin, J. .. ..	U.K. ..	„ ..	5 Mile Run.
„ .. ..	„ ..	„ ..	3 „ Team Race.
„ .. ..	„ ..	„ ..	400 Metres, Hurdles.
„ .. ..	„ ..	„ ..	Pole Jump.
Densham, J. B. .. ..	„ ..	„ ..	Putting the Weight.
de Petrowsky, A. .. ..	Russia ..	„ ..	Discus, Free Style.
Delfarges, A. .. ..	France ..	„ ..	Greek
„ .. ..	„ ..	„ ..	Javelin, Free.
„ .. ..	„ ..	„ ..	„ Held in Middle.

<i>Name</i>	<i>Country</i>	<i>Sport</i>	<i>Event</i>
Delfarges, A.	France	Athletics	Tug-of War.
" "	" "	" "	Discus, Free Style.
Dearborn, A. K.	U.S.A.	" "	" Greek "
" "	" "	" "	Javelin, Free "
" "	" "	" "	" Held in Middle,
De Lobsdorf, G. G.	Bohemia	Fencing	Epée, Individual.
" "	" "	" "	Team.
" "	" "	" "	Sabre, Individual.
" "	" "	" "	Team.
De Jong, A.	Holland	" "	Epée, Individual.
" "	" "	" "	Team.
" "	" "	" "	Sabre, Individual.
" "	" "	" "	Team
de Montigny, F.	Belgium	" "	Epée, Individual
" "	" "	" "	Team.
de Vreindt, I.	" "	" "	" Individual.
de Beaufort, W. H.	Holland	" "	Sabre, "
" "	" "	" "	Team.
de Falaise, Cte.	France	" "	" Individual.
" "	" "	" "	Team.
de Lesseps, Cte. I.	" "	" "	" Individual.
" "	" "	" "	Team.
de Raust, de St.	" "	" "	" "
Brisson, Marquis	" "	" "	" Individual.
" "	" "	" "	Team.
de Lesseps, Cte. B.	" "	" "	" "
de Mas-Latrie, Lt. Cte.	" "	" "	" "
de La Croix, L. S.	" "	Archery	York Round.
" "	" "	" "	Continental.
de Bertie, Cte. A.	" "	" "	" "
de La Grue, R.	" "	Yachting	6 Metres.
de Piere, P.	Belgium	" "	6 "
de Piere, L.	" "	" "	6 "
Delai, L.	Italy	Shooting	Revolver and Pistol, Team.
" "	" "	" "	" " " Individual.
Dambreville, G.	France	" "	" " " "
D'Akamande, Baron	Belgium	Clay Bird	Individual.
A. de R.	" "	Shooting	Team.
Damen, G. B.	Holland	Cycling	660 Yards.
" "	" "	" "	1,000 Metres.
" "	" "	" "	5,000 "
" "	" "	" "	20 Kilometres.
" "	" "	" "	100 "
Dannenberg, E.	Germany	" "	660 Yards.
" "	" "	" "	1,000 Metres.
" "	" "	" "	5,000 "
" "	" "	" "	20 Kilometres.
" "	" "	" "	100 "
" "	" "	" "	Pursuit Race.
" "	" "	" "	Tandem, 2,000 Metres.
Dauvergne, C.	France	" "	" " "
Daniells, C. M.	U.S.A.	Swimming	100 Metres.
" "	" "	" "	400 "

<i>Name</i>	<i>Country</i>	<i>Sport</i>	<i>Event</i>
Daniells, C. M. . .	U.S.A. . .	Swimming	Team Race.
Dam, L. . . . .	Denmark	"	" "
" " " " " "	"	"	Back Stroke.
Davies, A. . . . .	U.K. . .	"	Breast "
Davies, F. . . . .	" . .	Wrestling	Catch-as-Catch-Can, Bantam.
Dole, G. S. . . . .	U.S.A. . .	"	" " " Feather.
Danihten, Dr. E.	Hungary	Gymnastics	Individual.
Desmarchelier, C.	France . .	"	Team.
Desmarchelier, N.	" . .	"	"
Delathe, L. . . . .	" . .	"	"
Deroo, J. . . . .	" . .	"	"
De Breyle, H. . . . .	" . .	"	"
Demarbre, G. . . . .	" . .	"	"
De Buck, A. . . . .	Belgium	"	Individual.
Demine, G. . . . .	Russia . .	Wrestling	Graeco-Roman, Middle.
De Haan, C. A. . . . .	Holland . .	"	" " " "
De Relwyskow, G.	U.K. . .	"	" " " Light Weight.
" " " " " "	" . .	"	Catch-as-Catch-Can, Light.
" " " " " "	" . .	"	" " " " Middle.
De Boigne, Capt. R.	France . .	Shooting . .	Rifle, Individual, 1,000 Yards.
" " " " " "	" . .	" . .	" Team, 300 Metres.
" " " " " "	" . .	" . .	" Individual, 300 Metres.
" " " " " "	" . .	" . .	Running Deer, Indiv., Single Shot.
" " " " " "	" . .	" . .	" " " " Double "
de Gee, A. W. J.	Holland . .	" . .	Rifle Team, 300 Metres.
" " " " " "	" . .	" . .	Indiv. " "
Denghy, J. . . . .	Hungary	" . .	" " 1,000 Yards.
" " " " " "	" . .	" . .	" " 300 Metres.
" " " " " "	" . .	" . .	Miniature Rifle, Disappearing.
" " " " " "	" . .	" . .	" " " Moving.
" " " " " "	" . .	" . .	Revolver and Pistol, Individual.
" " " " " "	" . .	" . .	Running Deer, Indiv., Single Shot.
" " " " " "	" . .	" . .	" " " " Double "
de Blécourt, J. J.	Holland . .	" . .	Revolver and Pistol, Team.
" " " " " "	" . .	" . .	" " " " Individual.
Debrai, L. . . . .	France . .	" . .	" " " " Team.
" " " " " "	" . .	" . .	" " " " Individual.
Depassio, J. . . . .	" . .	" . .	" " " " Team.
" " " " " "	" . .	" . .	" " " " Individual.
de Ribaucourt, Cte. R.	Belgium	" . .	Rifle, Team, 300 Metres.
Decurgis, M. . . . .	France . .	Lawn Tennis	Grass Courts, Men's Singles.
" " " " " "	" . .	" " "	" " " " Doubles.
de Lunden, L. . . . .	Belgium	Clay Bird Shooting	Individual.
" " " " " "	" . .	" " "	Team.
De Wit, C. A. A. D.	Holland . .	" " "	Individual.
" " " " " "	" . .	" " "	Team.
de Favouge, R. . . . .	" . .	" " "	Individual.
" " " " " "	" . .	" " "	Team.
de Fontenoy, Cte.	France . .	" " "	Individual.
" " " " " "	" . .	" " "	Team.
de Rouville, Cte. S.	" . .	" " "	Individual.
" " " " " "	" . .	" " "	Team.

<i>Name</i>	<i>Country</i>	<i>Sport</i>	<i>Event</i>
de Mangel .. ..	France ..	Cycling ..	660 Yards.
.. ..	.. ..	.. ..	1,000 Metres.
.. ..	.. ..	.. ..	500
.. ..	.. ..	.. ..	Pursuit Race.
.. ..	.. ..	.. ..	2,000 Metres.
de la Plane, G. ..	.. ..	.. ..	660 Yards.
.. ..	.. ..	.. ..	1,000 Metres.
.. ..	.. ..	.. ..	5,000
.. ..	.. ..	.. ..	Pursuit Race.
Dreyfus, G. ..	.. ..	.. ..	660 Yards.
.. ..	.. ..	.. ..	1,000 Metres.
.. ..	.. ..	.. ..	5,000
.. ..	.. ..	.. ..	Pursuit Race.
.. ..	.. ..	.. ..	Tandem, 2,000 Metres.
Denny, A. J. ..	U.K. ..	.. ..	660 Yards.
.. ..	.. ..	.. ..	20 Kilometres.
Denny, C. A. ..	.. ..	.. ..	100
Duprez, A... ..	Belgium	Swimming	100 Metres.
.. ..	.. ..	.. ..	Team Race.
.. ..	.. ..	.. ..	Water Polo.
de Halmay, Z. ..	Hungary	.. ..	100 Metres.
.. ..	.. ..	.. ..	400
.. ..	.. ..	.. ..	Team Race.
Darbyshire, J. H.	U.K. ..	.. ..	100 Metres.
.. ..	.. ..	.. ..	Team Race.
de Stefanis, V. ..	Italy ..	.. ..	400 Metres.
de Coin, H. ..	France ..	.. ..	.. ..
Delahay, A. ..	Belgium	.. ..	Team Race.
Dean, W. H. ..	U.K. ..	.. ..	Water Polo.
Dietl, A. .. ..	Hungary	Shooting..	Rifle, Individual, 1,000 Yards.
.. ..	.. ..	.. ..	.. .. 300 Metres.
.. ..	.. ..	.. ..	Min. Rifle, Stationary, Individ.
.. ..	.. ..	.. ..	.. .. Disappearing, Individ.
.. ..	.. ..	.. ..	.. .. Moving, Individ.
.. ..	.. ..	.. ..	.. .. Revolver and Pistol, Individual.
.. ..	.. ..	.. ..	.. .. Running Deer, Indiv., Single Shot.
.. ..	.. ..	.. ..	.. .. Double
Dietz, J. A. ..	U.S.A. ..	.. ..	.. .. Revolver and Pistol, Team. "
.. ..	.. ..	.. ..	.. .. Individual.
Dixon, C. P. ..	U.K. ..	Lawn Tennis	Grass Courts, Men's Singles.
.. ..	.. ..	.. ..	.. .. Doubles.
Dringy, G... ..	France ..	Swimming	1,500 Metres.
Dinger, L... ..	Holland.	Wrestling	Graeco-Roman, Heavy.
Deiz, R. .. ..	France ..	Gymnastics	Individual.
Dick, T. P. ..	U.K. ..	.. ..	.. ..
Dichiara, S. ..	Italy ..	.. ..	Team.
Dreher, G... ..	France..	Athletics..	1,500 Metres, Flat.
.. ..	.. ..	.. ..	5 Miles Run.
Drubina, E. ..	Hungary	.. ..	10 Miles Walk.
.. ..	.. ..	.. ..	3,500 Metres Walk.
Dineen, M. D ..	U.K. ..	.. ..	Hop, Step, and Jump.
Dino, D. .. ..	Italy ..	Fencing..	Epée, Individual.
Dwinger, M. ..	Holland..	.. ..	.. ..
.. ..	.. ..	.. ..	.. .. Team.

<i>Name</i>	<i>Country</i>	<i>Sport</i>	<i>Event</i>
Dillon-Kavanagh, G. A.	France ..	Fencing ..	Epée Individual.
"	" ..	" ..	" Foils, Display.
Dixon, R. T. ..	U.K. ..	Yachting ..	7 Metres.
Doherty, H. L. ..	" ..	Lawn Tennis	Grass Courts, Men's Singles.
Doherty, R. F. ..	" ..	" ..	" " " Doubles.
Dockrell, G. S. ..	" ..	Swimming	100 Metres.
"	" ..	" ..	Team Race.
Domville, S. ..	" ..	Gymnastics	Individual.
Donnét, G. ..	France ..	" ..	Team.
D'Olliveira, A. ..	Holland ..	" ..	"
Downing, T. ..	U.K. ..	Athletics ..	3,200 Metres, Steeplechase.
"	" ..	" ..	5 Miles Run.
Demokas, G. ..	Hungary	" ..	Running High Jump.
Doriza, M. . . .	Greece ..	" ..	Throwing the Hammer.
"	" ..	" ..	Putting the Weight.
"	" ..	" ..	Tug-of-War.
"	" ..	" ..	Discus, Free Style.
"	" ..	" ..	" Greek "
"	" ..	" ..	Javelin, Free "
"	" ..	" ..	" Held in Middle.
Dowler, J. . . .	U.K. ..	" ..	Tug-of-War.
Doorman, J. ..	Holland ..	Fencing ..	Epée, Individual.
"	" ..	" ..	" Team.
"	" ..	" ..	Sabre, Individual.
"	" ..	" ..	" Team.
Dod, W. . . .	U.K. ..	Archery ..	York Round.
Dod, Miss L. ..	" ..	" ..	National Round.
DuPont, J. . . .	Holland ..	Wrestling	Graeco-Roman, Light Weight.
Dullin, E. . . .	Hungary	" ..	" " " "
Du Bois, M. . . .	Belgium	" ..	" " Light Heavy.
Dubois, V. . . .	France ..	Gymnastics	Individual.
Duponcheel, A. . . .	" ..	" ..	Team.
Durin, P. . . .	" ..	" ..	"
Duhamel, E. . . .	" ..	" ..	"
Drury, H. J. ..	U.K. ..	" ..	"
Duffy, E. J. ..	S. Africa	Athletics ..	100 Metres, Flat.
"	" ..	" ..	200 " "
"	" ..	" ..	400 " "
"	" ..	" ..	Relay Race.
Duncker, V. ..	" ..	" ..	100 Metres, Flat.
"	" ..	" ..	200 " "
"	" ..	" ..	400 " "
"	" ..	" ..	110 " Hurdle.
"	" ..	" ..	400 " "
"	" ..	" ..	Relay Race.
Duncan, R. C. ..	U.K. ..	" ..	100 Metres, Flat.
"	" ..	" ..	200 " "
Dubois, G. . . .	France ..	" ..	200 " "
"	" ..	" ..	400 " "
"	" ..	" ..	800 " "
"	" ..	" ..	400 " Hurdle.
"	" ..	" ..	Standing Broad Jump.
Dull, G. A. ..	U.S.A. ..	" ..	1,500 Metres, Flat.

<i>Name</i>	<i>Country</i>	<i>Sport</i>	<i>Event</i>
Dull, G. A. . . .	U.S.A. . .	Athletics . .	3,200 Metres, Steeplechase.
" " " "	" " "	" " "	5 Mile Run.
" " " "	" " "	" " "	3 " Team.
Durbec, G. . . .	France . .	" " "	110 Metres, Hurdle.
Duncan, A., Jr.	U.K. . .	" " "	5 Mile Run.
Duncan, A. . . .	" " "	" " "	Marathon Race.
" " " "	" " "	" " "	3 Mile, Team.
DuPont, L. . . .	Belgium	" " "	Standing Broad Jump.
" " " "	" " "	" " "	" High "
" " " "	" " "	" " "	Running " "
Dyson, E. . . .	U.K. . .	Gymnastics	Individual.
Durrand, P. . . .	France . .	Athletics . .	Standing Broad Jump.
" " " "	" " "	" " "	" High "
Dugmore, C. R.	U.K. . .	" " "	Running Broad "
Dugmore, C. P. R.	" " "	" " "	Hop, Step, and Jump.
Duke, H. . . .	" " "	" " "	Tug-of-War.
Dusek, F. . . .	Bohemia	Fencing . .	Epée, Individual.
" " " "	" " "	" " "	" Team.
" " " "	" " "	" " "	Sabre, Individual.
" " " "	" " "	" " "	" Team.
Dunay, B. . . .	Hungary	" " "	Epée, Individual.
" " " "	" " "	" " "	Sabre, "
Dubourdien, . .	France . .	" " "	Epée, Team.
du Bosch, A. . .	Belgium	" " "	Sabre, Individual.
" " " "	" " "	" " "	" Team.
Eaves, W. V. . .	U.K. . .	Lawn Tennis	Covered Courts, Singles.
" " " "	" " "	" " "	" " Doubles.
" " " "	" " "	" " "	Grass Courts, Men's Singles.
" " " "	" " "	" " "	" " Doubles.
Erdmann, G. . .	Norway . .	Shooting . .	Rifle, Team, International.
" " " "	" " "	" " "	Individual, 1,000 Yards.
" " " "	" " "	" " "	Team, 300 Metres.
" " " "	" " "	" " "	Individual, 300 Metres.
" " " "	" " "	" " "	Min. Rifle, Team.
" " " "	" " "	" " "	" " Indiv., Stationary.
" " " "	" " "	" " "	" " " Disappearing.
" " " "	" " "	" " "	" " " Moving.
" " " "	" " "	" " "	Revolver and Pistol, Individual.
" " " "	" " "	" " "	Running Deer, Team.
" " " "	" " "	" " "	" " Indiv., Single Shot
" " " "	" " "	" " "	" " " Double "
Eastman, I. L. . .	U.S.A. . .	" " "	Rifle, Team.
" " " "	" " "	" " "	Individual, 1,000 Yards.
" " " "	" " "	" " "	Team, 300 Metres.
" " " "	" " "	" " "	Individual, 300 Metres.
Eastcott, W. M.	Canada . .	" " "	Team.
" " " "	" " "	" " "	" " 300 Metres.
Easte, P. . . .	U.K. . .	Clay Bird	Individual.
" " " "	" " "	Shooting	Team.
Edwards, C. W.	" " "	Swimming	100 Metres.

<i>Name</i>	<i>Country</i>	<i>Sport</i>	<i>Event</i>
Edwards, F. M.	U.K.	Athletics	5 Miles Run.
"	"	"	3 " Team Race.
Ebbage, E. W.	"	"	Tug-of-War.
Erckrath de Bary, J.	Germany	Fencing	Épée, Individual.
"	"	"	" Team.
"	"	"	Sabre, Individual.
"	"	"	" Team.
"	"	"	Foils, Display.
Ekberg, O. R. B.	Sweden	Athletics	Standing Broad Jump.
Enger, O.	Norway	Shooting	Rifle, Individual, 1,000 Yards.
"	"	"	" " 300 Metres.
Englebert, R.	Belgium	"	Revolver, Individual.
Ember, S.	Hungary	Swimming	Back Stroke
"	"	"	Water Polo.
Eggremont, A.	France	Gymnastics	Team.
Evers, B.	Holland	Athletics	400 Metres, Flat.
"	"	"	800 " "
"	"	"	1,500 " "
"	"	"	Running Broad Jump.
"	"	"	Relay Race.
"	"	"	Pole Jump.
"	"	"	Standing Broad Jump.
Ellicott, W.	U.K.	Shooting	Revolver and Pistol, Team.
"	"	"	Running Deer, Team.
"	"	"	" " Indiv., Single Shot
"	"	"	" " " Double "
Elmitt, Lt. T. F.	Canada	"	Rifle, Team.
"	"	"	" Individual, 1,000 Yards.
"	"	"	" Team, 300 Metres.
Ewing, W. H.	"	Clay-Bird Shooting	Individual.
"	"	"	Team.
Errington, L. R.	U.K.	Swimming	Fancy Diving.
Eriksen, J.	Denmark	Wrestling	Graeco-Roman, Middle.
Ehrich, A.	Germany	Gymnastics	Individual.
"	"	"	Team.
"	"	Athletics	Tug-of-War.
Elliott, O.	Canada	Gymnastics	Individual.
Eriksson, G.	Sweden	"	Team.
Eicke, H.	Germany	Athletics	100 Metres, Flat.
"	"	"	Relay Race.
English, J. C.	U.K.	"	100 Metres, Flat.
"	"	"	3,200 " Steeplechase.
Eisele, J. L.	U.S.A.	"	" " "
"	"	"	5 Miles Run.
"	"	"	3 " Team.
EWry, R. C.	"	"	Standing High Jump;
"	"	"	" Broad "
Escombe, L. H.	U.K.	Lawn Tennis	Covered Courts, Singles.
Erödi, B.	Hungary	Wrestling	Graeco-Roman, Middle.
Erody, B.	"	Gymnastics	Individual.
Eyling, W. J.	Holland	Wrestling	Graeco-Roman, Heavy.

<i>Name</i>	<i>Country</i>	<i>Sport</i>	<i>Event</i>
Frasca, R. . . .	Italy . .	Shooting . .	Rifle, Team, International.
" " " "	" " "	" " "	" Individual, 1,000 Yards.
" " " "	" " "	" " "	" Team, 300 Metres.
" " " "	" " "	" " "	" Individual, 300 Metres.
" " " "	" " "	" " "	Revolver and Pistol, Team.
" " " "	" " "	" " "	" " " Individual.
Fabinyi . . . .	Hungary	Swimming	Breast Stroke.
Fjastad, P. O. S.	Sweden . .	" "	" "
Faulkner, G. A.	U.K. . .	Wrestling	Graeco-Roman, Light.
" " " "	" " "	" "	Catch-as-Catch-Can, Light.
Frank, A. R. P.	Sweden . .	" "	Graeco-Roman, Middle.
Franta, E. . . .	Bohemia	Gymnastics	Individual.
Franke, O. . . .	Germany	" "	" "
" " " "	" "	Athletics	Pole Jump.
" " " "	" "	" "	Putting the Weight.
Failliot, P. . . .	France . .	" "	100 Metres, Flat.
" " " "	" " "	" "	200 " "
" " " "	" " "	" "	400 " "
" " " "	" " "	" "	800 " "
" " " "	" " "	" "	400 " Hurdle.
" " " "	" " "	" "	Standing Broad Jump.
" " " "	" " "	" "	Javelin, Free Style.
" " " "	" " "	" "	" Held in Middle.
Fairbairn-Crawford, I. F.	U.K. . .	" "	100 Metres, Flat.
" " " "	" " "	" "	1,500 " "
Fayollat, A. . .	France . .	" "	5 Miles.
Flaxman, A. E. . .	U.K. . .	" "	Standing High Jump.
" " " "	" " "	" "	Pole Jump.
" " " "	" " "	" "	Discus, Free Style.
" " " "	" " "	" "	" Greek "
" " " "	" " "	" "	Javelin, Free "
" " " "	" " "	" "	" Held in Middle.
Flanagan, J. J. . .	U.S.A. . .	" "	Throwing the Hammer.
" " " "	" " "	" "	Putting the Weight.
" " " "	" " "	" "	Tug-of-War.
" " " "	" " "	" "	Discus, Free Style.
" " " "	" " "	" "	" Greek "
" " " "	" " "	" "	Javelin, Free "
" " " "	" " "	" "	" Held in Middle.
Fank, C. . . .	Austria . .	" "	Putting the Weight.
" " " "	" " "	" "	Discus, Free Style.
Franklin, H. . .	U.K. . .	" "	Tug-of-War.
Fast, F. O. . .	Sweden . .	" "	" "
Falchenburg, J.	Norway . .	" "	Discus, Free Style.
Fardel, G. . . .	U.K. . .	Yachting . .	8 Metres.
Fenby, R. E. . .	" " "	Shooting . .	Rifle, Team, International.
Fremantle, Lt.-Col.	" " "	" " "	" Individual, 1,000 Yards.
T. F.			
Fleming, J. F. . .	" " "	" " "	Min. Rifle, Indiv., Disappearing.
" " " "	" " "	" " "	" " " Moving.
Freeborn, J. . .	Canada . .	" " "	Rifle, International, Team.
" " " "	" " "	" " "	" Individual, 1,000 Yards.
" " " "	" " "	" " "	" Team, 300 Metres.



<i>Name</i>	<i>Country</i>	<i>Sport</i>	<i>Event</i>
Fesinger, E.	Belgium	Clay Bird Shooting	Individual.
"	"	"	Team.
Fleury, A.	France	"	Individual.
Fletcher, N. E.	Canada	"	"
Fenwick, Mme. C.	France	Lawn Tennis	Grass Courts, Ladies' Singles.
Feyaerts, F.	Belgium	Swimming	100 Metres.
"	"	"	400 "
"	"	"	1,500 "
"	"	"	Team Race
"	"	"	Water Polo.
Feret, R.	France	"	High Diving
Freund, J.	Hungary	"	Water Polo.
Fedi, A.	Italy	Gymnastics	Individual.
Flemer, J. H.	Holland	"	"
"	"	"	Team.
French, C. M.	U.S.A.	Athletics	800 Metres, Flat.
"	"	"	400 " Hurdle.,
Frère, J.	Belgium	"	110 " "
Fetense, C.	Germany	"	Tug-of-War.
Fleetwood, F.	Sweden	"	Discus, Free Style.
"	"	"	" Greek "
Feyerick, F.	Belgium	Fencing	Epée, Team.
Feilmann, F. E. B.	U.K.	"	Sabre, Individual.
"	"	"	" Team.
Flesch, F.	Austria	"	" Individual.
"	"	"	Foils, Display.
Freyschmidt, H.	Germany	Swimming	High Diving.
"	"	"	Fancy "
Frick, A.	France	"	Breast Stroke.
Friedmann, F.	Hungary	"	Water Polo.
Fritjof, O.	Norway	Gymnastics	Individual.
Fischer, P.	Germany	"	"
"	"	Athletics	100 Metres, Flat.
Fitsgerald, J.	Canada	"	800 " "
"	"	"	1,500 " "
"	"	"	3,200 " Steeplechase.
"	"	"	5 Miles Run.
"	"	"	3 " Team Race.
Fisher, F.	U.K.	"	Tug-of-War.
Fildes, L. V.	"	Fencing	Epée, Individual.
Foster, B. S.	"	Racquets	Singles.
Froitzheim, O.	Germany	Lawn Tennis	Grass Courts, Men's Singles.
"	"	"	" " " Doubles.
Foulkes, J. F.	Canada	"	" " " Singles.
"	"	"	" " " Doubles.
Foster, R. B.	U.S.A.	Swimming	100 Metres.
"	"	"	400 "
"	"	"	Team Race.
Foster, W.	U.K.	"	400 Metres.
"	"	"	1,500 "
"	"	"	Team Race.
Forsyth, C. E.	"	"	Water Polo.
Foskett, H. J.	"	Wrestling	Graeco-Roman, Light Heavy.

<i>Name</i>	<i>Country</i>	<i>Sport</i>	<i>Event</i>
Foskett, H. J. ..	U.K. ..	Wrestling	Catch-as-Catch-Can, Heavy.
Folacci, D. . . .	France ..	Gymnastics	Individual.
Forward, A. V. . .	U.K. ..	"	"
Forstrom, E. . .	Finland ..	"	Team.
Forsman, S. . . .	Sweden ..	"	"
Folscher, C. W. . .	" ..	"	"
Forshaw, J. . . .	U.S.A. ..	Athletics ..	Marathon Race.
Foden, C. . . . .	U.K. ..	" ..	Tug-of-War.
Fontaine, P. . . .	Italy ..	" ..	3,500 Metres Walk.
Földes, Dr. D. . .	Hungary	Fencing ..	Epée, Team.
" ..	" ..	" ..	" Individual.
" ..	" ..	" ..	Sabre, "
" ..	" ..	" ..	" Team.
Foule, J. . . . .	France ..	" ..	Epée Individual.
" ..	" ..	" ..	Foils, Display.
Fulton, A. G. . . .	U.K. ..	Shooting ..	Rifle, Team.
Fülsp, K. . . . .	Hungary	Swimming	Back Stroke.
Fürth, L. . . . .	Austria ..	"	Water Polo.
Fuzzi, R. . . . .	Italy ..	Gymnastics	Individual.
Füchs, Dr. E. . . .	Hungary	Fencing ..	Epée, Individual.
" ..	" ..	" ..	" Team.
" ..	" ..	" ..	Sabre, Individual.
" ..	" ..	" ..	" Team.
Frylinck, P. F. . .	S. Africa	Cycling ..	660 Yards.
" ..	" ..	" ..	1,000 Metres.
" ..	" ..	" ..	500 "
" ..	" ..	" ..	20 Kilometres.
" ..	" ..	" ..	Tandem, 2,000 Metres.
Flynn, D. . . . .	U.K. ..	" ..	660 Yards.
" ..	" ..	" ..	1,000 Metres.
" ..	" ..	" ..	5,000 "
Fryksdal, K. . . .	Sweden ..	Athletics ..	100 " Flat.
" ..	" ..	" ..	110 " Hurdle.
" ..	" ..	" ..	Standing High Jump.
" ..	" ..	" ..	Running Broad "
Fyffe, A.H. . . . .	U.K. ..	" ..	Throwing the Hammer.
" ..	" ..	" ..	Javelin, Free Style.
" ..	" ..	" ..	" Held in Middle.
Grade, E. . . . .	Belgium	Fencing ..	Epée, Individual.
" ..	" ..	" ..	Sabre, Team.
Garai, J. . . . .	Hungary	" ..	" Individual.
Godfree, D. W. . .	U.K. ..	" ..	" "
Goffin, A. . . . .	Belgium	" ..	" "
Grant-Suttie, Capt. G. D.	U.K. ..	Shooting ..	Rifle, Team, 300 Metres.
" ..	" ..	" ..	" Individual, 300 Metres.
Garzin, C. . . . .	France ..	" ..	Min. Rifle, Team.
" ..	" ..	" ..	" " Indiv., Stationary.
" ..	" ..	" ..	" " Disappearing.
" ..	" ..	" ..	" " Moving.
" ..	" ..	" ..	Revolver and Pistol, Team.
" ..	" ..	" ..	" " " Individual.

<i>Name</i>	<i>Country</i>	<i>Sport</i>	<i>Event</i>
Gauntlett, V. R.	S. Africa	Lawn Tennis	Grass Courts, Men's Singles.
"	"	"	" " " " Doubles.
Galloni, G. . . .	Italy . . . .	Cycling . . . .	1,000 Metres.
" . . . .	" . . . .	" . . . .	5,000 "
" . . . .	" . . . .	" . . . .	20 Kilometres.
" . . . .	" . . . .	" . . . .	100 "
Gaidzik, G. W. . .	U.S.A. . . .	Swimming	High Diving.
Gavora, I. . . .	Hungary	"	Water Polo.
Graaf, J. . . .	Holland . .	Wrestling	Graeco-Roman, Light.
Gräf, F. . . .	Hungary	Gymnastics	Individual.
Gautier, E. . . .	France . .	"	"
Graham, G. . . .	U.K. . . .	"	"
Granstrom, E. . .	Finland . .	"	Team.
Gasparini, G. . .	Italy . . .	"	"
Granfelt, E. . . .	Sweden . .	"	"
Graber, G. . . .	Hungary	Athletics . .	200 Metres, Flat.
" . . . .	" . . . .	" . . . .	400 " "
" . . . .	" . . . .	" . . . .	Relay Race.
Galbraith, W. . .	Canada . .	" . . . .	1,500 Metres, Flat.
" . . . .	" . . . .	" . . . .	3,200 " Steeplechase.
" . . . .	" . . . .	" . . . .	5 Miles Run.
" . . . .	" . . . .	" . . . .	3 " Team Race.
" . . . .	" . . . .	" . . . .	Relay Race.
Garrels, J. C. . .	U.S.A. . . .	" . . . .	110 Metres, Hurdle.
" . . . .	" . . . .	" . . . .	Putting the Weight.
" . . . .	" . . . .	" . . . .	Tug-of-War.
" . . . .	" . . . .	" . . . .	Discus, Free Style.
" . . . .	" . . . .	" . . . .	" Greek "
" . . . .	" . . . .	" . . . .	Javelin, Free "
" . . . .	" . . . .	" . . . .	" Held in Middle.
Garfield-Macdonald	Canada . .	" . . . .	110 Metres, Hurdle.
J.			
" . . . .	" . . . .	" . . . .	Running Broad Jump.
" . . . .	" . . . .	" . . . .	" High "
" . . . .	" . . . .	" . . . .	Hop, Step, and Jump.
Grantham, W. . .	U.K. . . .	" . . . .	3,200 Metres, Steeplechase.
Gabert, M. . . .	France . .	" . . . .	Pole Jump.
Gate, W. P. . . .	S. Africa	Fencing . .	Epée, Individual.
" . . . .	" . . . .	" . . . .	Sabre, "
" . . . .	" . . . .	" . . . .	Foils, Display.
Gaudin, L. . . .	France . .	" . . . .	Epée, Individual.
Green, Miss A. N. G.	U.K. . . .	Lawn Tennis	Covered Courts, Singles.
" . . . .	" . . . .	" . . . .	Grass Courts, "
Green, Sergt. S. A.	Australia	Shooting . .	Individual, 1,000 Yards.
" . . . .	" . . . .	" . . . .	" " " " 300 Metres.
" . . . .	" . . . .	" . . . .	Min. Rifle, Indiv., Stationary.
" . . . .	" . . . .	" . . . .	" " " " Disappearing.
" . . . .	" . . . .	" . . . .	Running Deer, Indiv., Single Shot.
" . . . .	" . . . .	" . . . .	" " " " Double Shot.
Green, E. A. . . .	U.S.A. . . .	" . . . .	International, Team.
" . . . .	" . . . .	" . . . .	Individual, 100 Yards.
" . . . .	" . . . .	" . . . .	Team, 300 Metres.
" . . . .	" . . . .	" . . . .	Individual, 300 Metres.
Geens, J. . . .	Belgium	" . . . .	Team, 300 Metres.

<i>Name</i>	<i>Country</i>	<i>Sport</i>	<i>Event</i>
Geens, J. . . .	Belgium	Shooting . .	Individual, 300 Metres.
Germot, M. . . .	France . .	Lawn Tennis	Grass Courts, Men's Singles.
" " " " . . . .	" " " "	" " " "	" " " " Doubles.
Gernaert, L. . . .	Belgium	Clay Bird Shooting	Individual.
" " " " . . . .	" " " "	" " " "	Team.
Greaves, F. . . .	U.K. . .	" " " "	" " " "
Gerrits, A. . . .	Holland . .	Cycling . .	660 Yards.
" " " " . . . .	" " " "	" " " "	1,000 Metres.
" " " " . . . .	" " " "	" " " "	5,000 "
" " " " . . . .	" " " "	" " " "	20 Kilometres.
" " " " . . . .	" " " "	" " " "	Pursuit Race.
Gentilly . . . .	France . .	Swimming	100 Metres.
Green, J. B. . . .	U.S.A. . .	" " " "	1,500 "
Gregoire, fils O. . . .	Belgium	" " " "	Team Race.
" " " " . . . .	" " " "	" " " "	Water Polo.
" " " " . . . .	" " " "	" " " "	Back Stroke.
Gelok, J. . . .	Holland . .	Wrestling	Graeco-Roman, Middle.
Gerig, H. . . .	U.S.A. . .	" " " "	Catch-as-Catch-Can, Middle.
Gerhauser, A. . . .	Hungary	Gymnastics	Individual.
Gellert, E. . . .	" " " "	" " " "	" " " "
Geidel, F. . . .	Sweden . .	" " " "	Team
Greven, E. J. C. . . .	Holland . .	Athletics . .	100 Metres, Flat.
" " " " . . . .	" " " "	" " " "	200 " "
George, J. P. . . .	U.K. . .	" " " "	100 " "
" " " " . . . .	" " " "	" " " "	200 " "
" " " " . . . .	" " " "	" " " "	Relay Race.
Georgandas, N. . . .	Greece . .	" " " "	Throwing the Hammer.
" " " " . . . .	" " " "	" " " "	Putting the Weight.
" " " " . . . .	" " " "	" " " "	Tug-of-War.
" " " " . . . .	" " " "	" " " "	Discus, Free Style.
" " " " . . . .	" " " "	" " " "	" " Greek "
" " " " . . . .	" " " "	" " " "	Javelin, Free "
Greggan, W. . . .	U.K. . .	" " " "	Tug-of-War.
Gerde, Dr. O. . . .	Hungary	Fencing . .	Sabre, Individual.
" " " " . . . .	" " " "	" " " "	" " Team.
Ginisty, G. . . .	France . .	Cycling . .	20 Kilometres.
" " " " . . . .	" " " "	" " " "	100 "
Gingell, A. . . .	U.K. . .	Wrestling	Catch-as-Catch-Can, Light.
Gill, H. . . .	" " " "	Gymnastics	Team.
Giovanoli, E. . . .	Italy . .	Athletics	5 Miles Run.
" " " " . . . .	" " " "	" " " "	3 " " Team.
Gidney, H. A. . . .	U.S.A. . .	" " " "	Running High Jump.
Gilbert, A. C. . . .	" " " "	" " " "	Pole Jump.
Gillis, S. P. . . .	" " " "	" " " "	Throwing the Hammer.
" " " " . . . .	" " " "	" " " "	Putting the Weight.
" " " " . . . .	" " " "	" " " "	Tug-of-War.
" " " " . . . .	" " " "	" " " "	Discus, Free Style.
" " " " . . . .	" " " "	" " " "	" " Greek "
" " " " . . . .	" " " "	" " " "	Javelin, Free "
" " " " . . . .	" " " "	" " " "	" " Held in Middle.
Giffin, M. H. . . .	" " " "	" " " "	Tug-of-War.
" " " " . . . .	" " " "	" " " "	Discus, Free Style.
" " " " . . . .	" " " "	" " " "	" " Greek "

Name	Country	Sport	Event
Grisot, E. .. ..	France ..	Archery ..	York Round.
" .. ..	" ..	" ..	Continental.
Grisor, A. .. ..	Belgium	Yachting ..	6 Metres.
Gravier, B. .. ..	France ..	Fencing ..	Epée Team.
Goodman, W. .. ..	U.K. ..	Athletics ..	Tug-of-War.
Goodfellow, F. W. .. ..	" ..	" ..	" ..
Gore, A. W. .. ..	" ..	Lawn Tennis	Covered Courts, Singles.
" .. ..	" ..	" ..	" ..
" .. ..	" ..	" ..	Grass Courts, Singles
" .. ..	" ..	" ..	" ..
" .. ..	" ..	" ..	" ..
Gould, J. .. ..	U.S.A. ..	Tennis ..	Singles.
Glomnes, M. .. ..	Norway ..	Shooting ..	International, Team.
" .. ..	" ..	" ..	Individual, 1,000 Yards.
" .. ..	" ..	" ..	Team, 300 Metres.
" .. ..	" ..	" ..	Individual, 300 Metres.
" .. ..	" ..	" ..	Min. Rifle, Team.
" .. ..	" ..	" ..	" ..
" .. ..	" ..	" ..	" ..
" .. ..	" ..	" ..	" ..
" .. ..	" ..	" ..	Running Deer, Team.
" .. ..	" ..	" ..	" ..
" .. ..	" ..	" ..	Indiv., Single Shot.
" .. ..	" ..	" ..	" ..
Gorman, J. E. .. ..	U.S.A. ..	" ..	Revolver and Pistol, Team.
" .. ..	" ..	" ..	" ..
" .. ..	" ..	" ..	" ..
Goetze, B. .. ..	Germany	Cycling ..	660 Yards.
" .. ..	" ..	" ..	1,000 Metres.
" .. ..	" ..	" ..	5,000 "
" .. ..	" ..	" ..	20 Kilometres.
" .. ..	" ..	" ..	100 "
" .. ..	" ..	" ..	Pursuit Race.
" .. ..	" ..	" ..	2,000 Metres, Tandem.
Goetze, M. .. ..	" ..	" ..	660 Yards.
" .. ..	" ..	" ..	1,000 Metres.
" .. ..	" ..	" ..	5,000 "
" .. ..	" ..	" ..	20 Kilometres.
" .. ..	" ..	" ..	100 "
" .. ..	" ..	" ..	Pursuit Race.
" .. ..	" ..	" ..	2,000 Metres, Tandem.
Goetze, O. .. ..	" ..	" ..	660 Yards.
" .. ..	" ..	" ..	1,000 Metres.
" .. ..	" ..	" ..	5,000 "
" .. ..	" ..	" ..	20 Kilometres.
" .. ..	" ..	" ..	100 "
" .. ..	" ..	" ..	Pursuit Race.
" .. ..	" ..	" ..	2,000 Metres, Tandem.
Goodwin, L. .. ..	U.S.A. ..	Swimming	100 Metres.
" .. ..	" ..	" ..	400 "
" .. ..	" ..	" ..	Team Race.
Goodworth, H. .. ..	U.K. ..	" ..	High Diving.
Grote, H. C. .. ..	U.S.A. ..	" ..	Fancy "
" .. ..	" ..	" ..	High "
Gooday, S. H. .. ..	U.K. ..	" ..	Breast Stroke.
Goessling, A. M. .. ..	U.S.A. ..	" ..	" ..
" .. ..	" ..	" ..	" ..

<i>Name</i>	<i>Country</i>	<i>Sport</i>	<i>Event</i>
Goessling, A. M.	U.S.A. ..	Swimming	Back Stroke
Gosnell, H. A. ..	" ..	" ..	Breast "
Goddard, A. J.	U.K. ..	Wrestling	Catch-as-Catch-Can, Feather.
Goudekct, I. ..	Holland ..	Gymnastics	Individual.
" ..	" ..	" ..	Team.
Groner, S. ..	Norway ..	" ..	" ..
Gockel, J. C. ..	Holland ..	" ..	" ..
Groenings, O. ..	U.K. ..	Athletics ..	110 Metres, Hurdle.
" ..	" ..	" ..	400 " "
" ..	" ..	" ..	Running Broad Jump.
" ..	" ..	" ..	" High "
Gordon, A. ..	" ..	" ..	110 Metres, Hurdle.
" ..	" ..	" ..	Running Broad Jump.
Gould, E. W.	" ..	" ..	400 Metres, Hurdle.
Goetzee, J. ..	Holland ..	" ..	10 Miles Walk.
" ..	" ..	" ..	3,500 Metres Walk.
Goulding, G. ..	Canada ..	" ..	10 Miles Walk.
" ..	" ..	" ..	Marathon Race.
" ..	" ..	" ..	3,500 Metres Walk.
Goldsboro, W.	" ..	" ..	Marathon Race.
Gonczy, Dr. L. ..	Hungary	" ..	Standing High Jump
" ..	" ..	" ..	Running " "
Gouvert, P. ..	France ..	" ..	Putting the Weight
Gustafsson, J. ..	Sweden ..	Shooting ..	International, Team.
" ..	" ..	" ..	Individual, 100 Yards.
" ..	" ..	" ..	Team, 300 Metres.
" ..	" ..	" ..	Individual, 300 Metres.
" ..	" ..	" ..	Min. Rifle, Team.
" ..	" ..	" ..	" " Indiv., Stationary.
" ..	" ..	" ..	" " " Disappearing.
" ..	" ..	" ..	" " " Moving.
Guyader ..	France ..	Cycling ..	2,000 Metres, Tandem.
Gumpel, M. ..	Sweden ..	Swimming	400 Metres.
" ..	" ..	" ..	Breast Stroke.
" ..	" ..	" ..	Water Polo.
Guidzick, G. W.	U.S.A. ..	" ..	Fancy Diving.
Grundemann, W.	Germany	Wrestling	Graeco-Roman, Middle.
Gundersen, J. ..	Norway ..	" ..	Catch-as-Catch-Can, Heavy.
Gualeni, C. ..	Italy ..	Gymnastics	Individual.
Gubiani, M. ..	" ..	" ..	" "
Guiot, G. ..	France ..	" ..	Team.
Guttormsen, O. ..	Norway ..	Athletics ..	100 Metres, Flat.
" ..	" ..	" ..	200 " "
" ..	" ..	" ..	400 " "
" ..	" ..	" ..	110 " Hurdle.
" ..	" ..	" ..	400 " "
" ..	" ..	" ..	Hop, Step, and Jump.
" ..	" ..	" ..	Relay Race.
Gunia, P. ..	Germany	" ..	10 Miles Walk.
Gutierrez, H. ..	France ..	" ..	Running Broad Jump.
Gustafson, E. B.	Sweden ..	Yachting ..	6 Metres.
Guiffrey, J. ..	France ..	" ..	" ..

<i>Name</i>	<i>Country</i>	<i>Sport</i>	<i>Event</i>
Hansen, I. M. ..	Denmark	Gymnastics	Team.
Halvorsen, H. ..	Norway ..	"	"
Harleman, C. ..	Sweden ..	"	"
Harley, A. S. ..	U.K. ..	"	"
Harmer, H. S. ..	" ..	Athletics ..	100 Metres, Flat.
Hamilton, W. F.	U.S.A. ..	" ..	" ..
"	" ..	" ..	200 ..
"	" ..	" ..	400 .. Hurdle.
"	" ..	" ..	Relay Race.
Hamos, R. ..	Hungary	" ..	100 Metres, Flat.
Halbart, F. ..	Belgium	" ..	200 ..
"	" ..	" ..	110 .. Hurdle.
"	" ..	" ..	400 ..
Hawkins, G. A. ..	U.K. ..	" ..	200 .. Flat.
"	" ..	" ..	Relay Race.
Halswelle, W. ..	" ..	" ..	200 Metres, Flat.
"	" ..	" ..	400 ..
"	" ..	" ..	Relay Race.
Haskins, G. ..	Australasia	" ..	800 Metres, Flat.
"	" ..	" ..	1,500 ..
"	" ..	" ..	3,200 .. Steeplechase.
"	" ..	" ..	5 Miles Run.
Halstcad, J. P. ..	U.S.A. ..	" ..	800 Metres, Flat.
"	" ..	" ..	1,500 ..
"	" ..	" ..	400 .. Hurdle.
"	" ..	" ..	3,200 .. Steeplechase.
"	" ..	" ..	Relay Race.
Hallowes, N. F.	U.K. ..	" ..	1,500 Metres, Flat.
"	" ..	" ..	3 Miles Team Race.
Hautekeet, E. ..	Belgium	" ..	110 Metres, Hurdle.
"	" ..	" ..	400 ..
Halligan, A. ..	U.S.A. ..	" ..	110 .. Hurdle.
Hall, C. L. ..	" ..	" ..	3,200 .. Steeplechase.
"	" ..	" ..	5 Miles Run.
"	" ..	" ..	3 .. Team Race.
Harmer, F. W. ..	U.K. ..	" ..	400 Metres, Hurdle.
Hansen, R. C. ..	Denmark	" ..	5 Miles Run.
"	" ..	" ..	Marathon Race.
Harrison, R. ..	U.K. ..	" ..	10 Miles Walk.
"	" ..	" ..	3,500 Metres Walk.
Hammond, T. E.	" ..	" ..	10 Miles Walk.
Hatch, S. H. ..	U.S.A. ..	" ..	Marathon Race.
Hayes, J. J. ..	" ..	" ..	"
Hartranft, J. L.	" ..	" ..	110 Metres, Hurdle.
"	" ..	" ..	400 ..
Halme, J. ..	Finland ..	" ..	Running Broad Jump.
"	" ..	" ..	Hop, Step, and Jump.
"	" ..	" ..	Putting the Weight.
"	" ..	" ..	Discus, Free Style.
"	" ..	" ..	" Greek "
"	" ..	" ..	Javelin, Free "
"	" ..	" ..	" Held in Middle.
Haluzsinszky, J.	Hungary	" ..	Running High Jump.
Hanssen, E. A.	Norway ..	" ..	Pole Jump.





<i>Name</i>	<i>Country</i>	<i>Sport</i>	<i>Event</i>
Hawkins, A. E. . .	U.K. . .	Gymnastics	Team.
Hansen, A. C. . .	Denmark	Wrestling	Graeco-Roman, Light.
Hansen, L. . . .	Belgium . .	"	" " "
Hanson, L. . . .	U.K. . .	Gymnastics	Individual.
Hatch, L. R. . .	U.S.A. . .	Shooting . .	Revolver and Pistol, Team.
"	"	"	Individual.
Harman, F. H.	U.K. . .	Wrestling	Catch-as-Catch-Can, Heavy.
Hanley, R. S. . .	"	Gymnastics	Individual.
Hansen, A. . .	Denmark	"	Team.
Hansen, C. M. . .	"	"	"
Hecht, L. . . .	France . .	Shooting	" International.
"	"	"	Individual, 1,000 Yards.
"	"	"	Team, 300 Metres.
"	"	"	Individual, 300 Metres.
Hessian, J. W. . .	U.S.A. . .	"	Team, International.
"	"	"	Individual, 1,000 Yards.
"	"	"	Team, 300 Metres.
"	"	"	Individual, 300 Metres.
Herrmann, E. . .	Belgium	Clay Bird Shooting	Individual.
"	"	"	Team.
Hegner, J. . . .	Hungary	Swimming	100 Metres.
"	"	"	400 "
"	"	"	Team Race.
"	"	"	Water Polo.
Hebner, H. J. . .	U.S.A. . .	"	100 Metres.
"	"	"	400 "
"	"	"	Team Race.
Henriksson . .	Finland . .	"	Breast Stroke.
"	"	"	Back "
Heskes, A. . . .	Holland . .	Wrestling	Graeco-Roman, Light.
Heerema, H. . .	"	"	" Heavy.
Henson, W. J. P.	U.K. . .	"	Catch-as-Catch-Can, Light.
Hermann, G. R. E.	Denmark	Gymnastics	Team.
Hennebicq, L. . .	France . .	"	"
Hellsten, N. R.	Sweden . .	"	"
Hjellen, L. E. . .	"	"	"
Henny, V. . . .	Holland	Athletics . .	100 Metres, Flat.
"	"	"	200 " "
"	"	"	400 " "
"	"	"	Relay Race.
Hervoche, C. . .	France . .	"	100 Metres, Flat.
"	"	"	200 " "
"	"	"	Running Broad Jump.
"	"	"	110 Metres, Hurdle.
Hellstrom, K. . .	Sweden . .	"	400 " Flat.
"	"	"	800 " "
"	"	"	1,500 " "
"	"	"	Relay Race.
Hefferon, C. . .	South Africa	"	1,500 Metres, Flat.
"	"	"	3,200 " Steeplechase.
"	"	"	5 Miles Run.
"	"	"	Marathon Race.
"	"	"	Relay Race.

<i>Name</i>	<i>Country</i>	<i>Sport</i>	<i>Event</i>
Hesse, A. . . .	Germany	Athletics . .	1,500 Metres, Flat.
" " "	"	" "	3 Miles, Team.
Healey, A. H. . .	U.K.	" "	110 Metres, Hurdle.
Heiner, E. . . .	France . .	" "	400 " "
Henderson, W. E. B.	U.K. . .	" "	Standing Broad Jump.
" " "	" "	" "	" High "
" " "	" "	" "	Discus, Free Style.
" " "	" "	" "	" Greek "
" " "	" "	" "	Javelin, Free "
" " "	" "	" "	" Held in Middle.
Hedenlund, J. E. A.	Sweden . .	" "	Running High Jump.
Hellstedt, F. . .	" "	" "	" " "
Hilyard, G. W.	U.K. . .	Lawn Tennis	Grass Courts, Men's Singles.
Hillyard, Mrs. B.	" "	" "	" " Ladies' Singles.
Hill, F. . . .	U.S.A. . .	Cycling . .	1,000 Metres.
" " "	" "	" "	100 Kilometres.
" " "	" "	" "	Pursuit Race.
" " "	" "	" "	2,000 Metres, Tandem.
Hilgernd, A. . .	Norway . .	Shooting . .	International, Team.
" " "	" "	" "	Individual, 1,000 Yards.
" " "	" "	" "	Team, 300 Metres.
" " "	" "	" "	Individual, 300 Metres.
" " "	" "	" "	Min. Rifle, Team.
" " "	" "	" "	" " Indiv., Stationary.
" " "	" "	" "	" " " Disappearing.
" " "	" "	" "	" " " Moving.
" " "	" "	" "	Running Deer, Team.
" " "	" "	" "	" " Indiv., Single Shot.
" " "	" "	" "	" " " Double "
Hicketick, J. . .	Belgium . .	Swimming	High Diving
" " "	" "	" "	Fancy "
" " "	" "	" "	Water Polo.
Hill, A. E. . . .	U.K. . .	" "	" "
Hillman, H. L. . .	U.S.A. . .	Athletics . .	400 Metres, Flat.
" " "	" "	" "	" " Hurdle.
Hill, W. . . .	Australasia	Shooting	Min. Rifle, Indiv., Stationary.
" " "	" "	" "	" " " Disappearing.
" " "	" "	" "	" " " Moving.
Hirons, W. . . .	U. K. . .	Athletics . .	Tug-of-War.
Hill-Lowe, Mrs. . .	" "	Archery . .	National Round.
Himloke, R. . . .	" "	Yachting	8 Metres.
Hind, Lieut. F. . .	" "	" "	7 "
Holmes, T. E. . .	" "	Athletics . .	Tug-of-War.
Hottelep, C. . .	Germany	" "	" "
Horgan, D. . . .	U.K. . .	" "	Putting the Weight.
" " "	" "	" "	Javelin, Free Style.
" " "	" "	" "	" Held in Middle.
Horr, M. F. . . .	U.S.A. . .	" "	Throwing the Hammer.
" " "	" "	" "	Putting the Weight.
" " "	" "	" "	Tug-of-War.
" " "	" "	" "	Discus, Free Style.
" " "	" "	" "	" Greek "
Holics, E. . . .	Hungary	" "	Running Broad Jump.
" " "	" "	" "	110 Metres, Hurdle.

<i>Name</i>	<i>Country</i>	<i>Sport</i>	<i>Event</i>
Hoogveld, J. ..	Holland	Athletics ..	Running Broad Jump.
" ..	" ..	" ..	Relay Race.
Horner, A. ..	Hungary	" ..	Standing Broad Jump.
" ..	" ..	" ..	" High "
Holmes, F. L. ..	U.S.A. ..	" ..	" Broad "
" ..	" ..	" ..	" High "
Hojme, A. H. S.	Denmark	" ..	10 Miles Walk.
Holdaway, C. G.	U.K. ..	" ..	3,200 Metres, Steeplechase.
Howe, L. V. ..	U.S.A. ..	" ..	110 Metres, Hurdle.
" ..	" ..	" ..	400 " "
Hoyns, G. ..	" ..	" ..	800 " Flat.
Holding, H. E. ..	U.K. ..	" ..	" " "
Holics, R. ..	Hungary	" ..	400 " "
" ..	" ..	" ..	800 " "
Hopton, Col. J. ..	U.K. ..	Shooting ..	Individual, 1,000 Yards.
Holenia, L. ..	Hungary	" ..	" " "
" ..	" ..	" ..	" 300 Metres.
" ..	" ..	" ..	Min. Rifle, Individ., Stationary.
" ..	" ..	" ..	" " " Disappearing.
" ..	" ..	" ..	" " " Moving.
" ..	" ..	" ..	Revolver and Pistol, Individual.
" ..	" ..	" ..	Running Deer, Individ., Single Shot.
" ..	" ..	" ..	" " " Double "
Hostein, P. ..	France ..	Cycling ..	20 Kilometres.
" ..	" ..	" ..	100 " "
Holin, P. ..	Denmark	Swimming	" Metres.
" ..	" ..	" ..	Team Race.
" ..	" ..	Gymnastics	Team.
Hornung, G. ..	Hungary	Swimming	100 Metres.
" ..	" ..	" ..	Team Race.
Holin, A. ..	Denmark	" ..	400 Metres.
" ..	" ..	" ..	Team Race.
Hoare, W. O. ..	U.K. ..	" ..	High Diving.
" ..	" ..	" ..	Fancy "
" ..	" ..	Gymnastics	Team.
Holman, F. ..	" ..	Swimming	Team Race.
Hochermann, S.	Austria ..	" ..	Water Polo.
Hodgson, J. ..	U.K. ..	" ..	" "
Horvath, A. ..	Hungary	Wrestling	Graeco-Roman, Middle.
Holloway, A. ..	U.K. ..	" ..	Catch-as-Catch-Can, Feather.
Hay, J. ..	" ..	" ..	" " " " Light.
Horvath, Dr. B.	Hungary	Gymnastics.	Individual.
" ..	" ..	Athletics	Standing Broad Jump.
Honzatko, B. ..	Bohemia	Gymnastics	Individual.
Hol, P. ..	Norway ..	" ..	" "
" ..	" ..	" ..	Team.
Hodgetts, S. ..	U.K. ..	" ..	Individual.
Hodges, A. R. ..	" ..	" ..	" "
Holin, K. ..	Denmark	" ..	Team.
Hornbeck, V. ..	" ..	" ..	" "
Hol, J. ..	Norway ..	" ..	" "
Holmberg, O. ..	Sweden ..	" ..	" "
Hojer, G. ..	" ..	" ..	" "
Holmberg, C. ..	" ..	" ..	" "

<i>Name</i>	<i>Country</i>	<i>Sport</i>	<i>Event</i>
Holmberg, A. ..	Sweden ..	Gymnastics	Team.
Horridge, J. A. ..	U.K. ..	" "	" "
Hoogveld, J. ..	Holland ..	Athletics ..	100 Metres, Flat.
" "	" "	" "	200 " "
" "	" "	" "	400 " "
" "	" "	" "	Standing Broad Jump.
" "	" "	" "	Running " "
" "	" "	" "	Relay Race.
Hoffman, A. ..	Germany	" "	100 Metres, Flat.
" "	" "	" "	200 " "
" "	" "	" "	Running Broad Jump.
" "	" "	" "	Hop, Step, and Jump.
" "	" "	" "	Relay Race.
Huttunen, H. ..	Finland	Shooting ..	Team, 300 Metres.
Humby, H. R. ..	U.K. ..	" "	Min. Rifle, Team.
" "	" "	" "	" Individ., Stationary.
" "	" "	" "	" " Disappearing.
Huber, R. W. ..	Finland ..	Clay Bird	Individual.
		Shooting	
Hutton, R. ..	U.K. ..	" "	" "
" "	" "	" "	Team.
Hulsuit, J. F. ..	Holland ..	Swimming	Water Polo.
Humphreys, F. H. ..	U.K. ..	Wrestling	Graeco-Roman, Heavy.
" "	" "	" "	Catch-as-Catch-Can, Heavy.
" "	" "	" "	Tug-of-War.
Husted-Nielsen, O. ..	Denmark	Gymnastics	Team.
Hubert, H. ..	France ..	" "	" "
Hudelo, D. ..	" "	" "	" "
Huskinson, H. J. ..	U.K. ..	" "	" "
Hutcheon, E. H. ..	Australasia	Athletics ..	100 Metres, Flat.
Huff, H. J. ..	U.S.A. ..	" "	" " "
" "	" "	" "	200 " "
" "	" "	" "	Relay Race.
Hussak, L. ..	Austria ..	" "	200 Metres, Flat.
Hurdsfield, S. ..	U.K. ..	" "	" " "
Hussey, E. R. J. ..	" "	" "	110 Metres, Hurdle.
Huijgen, J. ..	Holland ..	" "	10 Miles Walk.
" "	" "	" "	3,500 Metres Walk.
Hubinon, H. ..	Belgium	" "	Putting the Weight.
Hughes, A. C. . . .	U.K. ..	Yachting ..	8 Metres.
Hughes, Capt. St. J. ..	" "	" "	8 "
Huybrechts, Louis ..	Belgium ..	" "	6 "
Huybrechts, Leon ..	" "	" "	6 "
Ista, E. ..	" "	Shooting ..	Team, 300 Metres.
" "	" "	" "	Individual, 300 Metres.
Ivanka, L. . . .	Hungary	Lawn Tennis	Grass Courts, Men's Singles.
" "	" "	" "	" " Doubles.
Isaac, W. H. T. . . .	U.K. ..	Cycling ..	2,000 Metres, Tandem.
Iversen, O. ..	Norway ..	Gymnastics	Individual.
" "	" "	" "	Team.
Ingebretsen, E. . . .	" "	" "	Individual.

<i>Name</i>	<i>Country</i>	<i>Sport</i>	<i>Event</i>
Ireton, A.	U.K.	Athletics	Tug-of-War.
Innocent, G.	"	Swimming	100 Metres.
"	"	"	Team Race.
Innocenti, F.	Italy	Gymnastics	Individual.
Irons, F. C.	U.S.A.	Athletics	Standing Broad Jump.
"	"	"	" High "
"	"	"	Running Broad "
"	"	"	" High "
"	"	"	Hop, Step, and Jump.
James, H. V.	U.K.	Archery	York Round.
Jay, O.	France	"	Continental.
Jansson, A.	Sweden	Shooting	Team, International.
"	"	"	Individual, 1,000 Yards.
"	"	"	Team, 300 Metres.
"	"	"	Individual, 300 Metres.
"	"	"	Min. Rifle, Individ., Stationary.
"	"	"	" " " Disappearing.
"	"	"	" " " Moving.
Jackson, Sergt. I. A. T.	U.K.	"	Team, 300 Metres.
"	"	"	Individual, 300 Metres.
Jansky, Z.	Bohemia	Lawn Tennis	Grass Courts, Men's Singles.
"	"	"	" " " Doubles.
Jaubert, Baron.	France	Clay Bird Shooting	Individual. Team.
Jarvis, J. A.	U.K.	Swimming	1,500 Metres.
Jakonbek, J.	Bohemia	Wrestling	Graeco-Roman, Middle.
Janssen, D.	Holland	Gymnastics	Individual.
"	"	"	Team.
Jahuke, H.	Sweden	"	"
Jarling, J.	"	"	"
Jacquemin, V.	Belgium	Athletics	100 Metres, Flat.
"	"	"	400 " "
Jack, T.	U.K.	"	Marathon.
Jakobsson, J.	Finland	"	Standing Broad Jump.
"	"	"	Putting the Weight.
"	"	"	Javelin, Free Style.
"	"	"	" Held in Middle.
Jardin, H.	France	"	Standing Broad Jump.
"	"	"	" High "
"	"	"	Putting the Weight.
Jacobson, N. S.	Sweden	"	Hop, Step, and Jump.
Jackson, T. M.	U.S.A.	"	Pole Jump.
Jacobs, C. S.	"	"	" "
Jakobsson, E. B.	Finland	"	Putting the Weight.
"	"	"	Javelin, Free Style.
"	"	"	" Held in Middle.
Jarvinen, W.	"	"	Putting the Weight.
"	"	"	Discus, Greek Style.
"	"	"	Javelin, Free "

Name	Country	Sport	Event
Jarvinen, W.	Finland	Athletics	Javelin, Held in Middle.
Jack, F.	Germany	Fencing	Epée, Individual.
"	"	"	" Team.
"	"	"	Sabre, Individual.
"	"	"	" Team.
James, H. E.	U.K.	"	" Individual.
"	"	"	" Team.
Jensen, J. H.	Denmark	Shooting	Team, International.
"	"	"	Min. Rifle, Stationary.
"	"	"	" " " " Individ., Disappearing.
"	"	"	" " " " Moving.
Jensen, L. P. M.	"	"	Team, International.
"	"	"	Individual, 1,000 Yards.
"	"	"	Team, 300 Metres.
"	"	"	Individual, 300 Metres.
"	"	"	Min. Rifle, Team.
"	"	"	" " " " Individ., Stationary.
"	"	"	" " " " Disappearing.
"	"	"	" " " " Moving.
Jeffers, C. J.	U.S.A.	"	Team, International.
"	"	"	Individual, 1,000 Yards.
"	"	"	Team, 300 Metres.
"	"	"	Individual, 300 Metres.
Jensen, C. M.	Denmark	Wrestling	Graeco-Roman, Light Heavy.
"	"	"	" " " " Heavy.
Jensen, S.	"	"	" " " "
Jespersen, M. P.	Norway	Gymnastics	Individual.
"	"	"	Team.
Jensen, C. C.	Denmark	"	"
Jensen, G. D.	"	"	"
Jesina, F.	Hungary	Athletics	Discus, Free Style.
"	"	"	" Greek "
"	"	"	Javelin Free "
"	"	"	" Held in Middle.
Jenkinson, J.	U.K.	Fencing	Foils Display.
Jensen, Chris	Norway	Yachting	8 Metres.
Jirsak, J.	Bohemia	Wrestling	Graeco-Roman, Middle.
Jorgensen, F. O.	Denmark	Fencing	Epée, Individual.
"	"	"	" Team.
Jones, E.	U.K.	Athletics	Tug-of-War.
Jorgensen, O.	Sweden	Shooting	Team, International.
"	"	"	Individual, 1,000 Yards.
"	"	"	Team, 300 Metres.
"	"	"	Individual, 300 Metres.
"	"	"	Min. Rifle, Individ., Stationary.
"	"	"	" " " " Disappearing.
"	"	"	" " " " Moving.
Jonsson, G. A.	"	"	Team, International.
"	"	"	Individual, 1,000 Yards.
"	"	"	Team, 300 Metres.
"	"	"	Individual, 300 Metres.
"	"	"	Min. Rifle, Team.
"	"	"	" " " " Individ. Stationary.
"	"	"	" " " " Disappearing.

<i>Name</i>	<i>Country</i>	<i>Sport</i>	<i>Event</i>
Jonsson, G. A. ..	Sweden ..	Shooting ..	Min. Rifle, Indiv. Moving
Johnson, L. ..	France ..	" ..	Team, International.
" ..	" ..	" ..	Individual, 1,000 Yards.
" ..	" ..	" ..	Team, 300 Metres.
" ..	" ..	" ..	Individual, 300 Metres.
" ..	" ..	" ..	Min. Rifle, Indiv., Stationary.
" ..	" ..	" ..	" " " Disappearing
" ..	" ..	" ..	" " " Moving.
" ..	" ..	" ..	Running Deer, Team.
" ..	" ..	" ..	" " Indiv. Single Shot.
" ..	" ..	" ..	" " " Double "
Jones, P. H. ..	U.K. ..	" ..	Revolver and Pistol, Team.
" ..	" ..	" ..	" " " Individual.
Joynt, W. R. L. ..	" ..	" ..	" " " Team.
" ..	" ..	" ..	" " " Individual.
" ..	" ..	" ..	Running Deer, Team.
" ..	" ..	" ..	" " Indiv., Single Shot.
" ..	" ..	" ..	" " " Double "
Jones, Major J. M. ..	Canada ..	" ..	Individual, 1,000 Yards.
Johnson, V. L. ..	U.K. ..	Cycling ..	660 Yards.
" ..	" ..	" ..	1,000 Metres.
Jones, B. ..	" ..	" ..	660 Yards.
" ..	" ..	" ..	1,000 Metres.
" ..	" ..	" ..	5,000 "
" ..	" ..	" ..	20 Kilometres.
" ..	" ..	" ..	Pursuit Race.
Jolly, R. ..	" ..	" ..	100 Kilometres.
" ..	" ..	" ..	2,000 Metres, Tandem.
Johnson, H. T. ..	" ..	" ..	Tandem Race.
Jouault, H. ..	France ..	Swimming	1,000 Metres.
Johansson, H. ..	Sweden ..	" ..	High Diving.
" ..	" ..	" ..	Breast Stroke.
" ..	" ..	" ..	Water Polo.
Jonsson, H. ..	Finland ..	" ..	Breast Stroke.
" ..	" ..	" ..	Back "
Josefsson, J. ..	Denmark	Wrestling	Graeco-Roman, Middle.
Jorgensen, C. ..	" ..	" ..	" " " "
Jones, W. F. ..	U.K. ..	" ..	Catch-as-Catch-Can, " Feather.
Johansen, J. H. ..	Denmark	Gymnastics	Team.
Johansen, J. ..	Norway ..	Athletics ..	Javelin, Held in Middle.
" ..	" ..	" ..	Relay Race.
Johannsen, S. ..	" ..	Gymnastics	Team.
Jonsson, H. ..	Sweden ..	" ..	" "
Jonsson, R. ..	" ..	" ..	" "
Jones, J. W. ..	U.K. ..	" ..	" "
Jones, L. P. ..	U.S. A. ..	Athletics ..	800 Metres, Flat.
" ..	" ..	" ..	1,500 " "
" ..	" ..	" ..	3,200 " Steeplechase.
Jorgensen, J. F. ..	Denmark	" ..	5 Miles Run.
" ..	" ..	" ..	Marathon Race.
Johansson, E. ..	Sweden ..	" ..	Tug-of-War.
Johansson, K. R. ..	" ..	" ..	" "
Johansson, C. E. ..	" ..	" ..	" "
Jonsson, M. ..	" ..	Yachting ..	8 Metres.

<i>Name</i>	<i>Country</i>	<i>Sport</i>	<i>Event</i>
Julin, H. S. A. ..	Sweden ..	Swimming	100 Metres.
" ..	" ..	"	Team Race.
" ..	" ..	"	Water Polo.
Judkins, A. ..	U.K. ..	"	" "
Justice, E. ..	" ..	Gymnastics	Team.
Just, T. H. ..	" ..	Athletics..	800 Metres, Flat.
" ..	" ..	" ..	Relay Race.
Jonsson, E. J. ..	Sweden..	Yachting..	6 Metres.
Johnsson, G. ..	" ..	Gymnastics	Team.
Kram, K. .. ..	Norway..	Shooting..	Team, International.
" .. ..	" ..	" ..	Individual, 1,000 Yards.
" .. ..	" ..	" ..	Team, 300 Metres.
" .. ..	" ..	" ..	Individual, 300 Metres.
" .. ..	" ..	" ..	Min. Rifle, Team.
" .. ..	" ..	" ..	" " Individ., Stationary.
" .. ..	" ..	" ..	" " " Disappearing.
" .. ..	" ..	" ..	" " " Moving.
" .. ..	" ..	" ..	Running Deer, Team.
" .. ..	" ..	" ..	" " Individ., Single Shot.
" .. ..	" ..	" ..	" " " Double "
Karafiáth, Y. ..	Hungary	" ..	Individual, 1,000 Yards.
" .. ..	" ..	" ..	" 300 Metres.
" .. ..	" ..	" ..	Min. Rifle, Individ., Stationary.
" .. ..	" ..	" ..	" " " Disappearing.
" .. ..	" ..	" ..	" " " Moving.
" .. ..	" ..	" ..	Revolver and Pistol, Individual.
" .. ..	" ..	" ..	Running Deer, Individ., Single Shot.
" .. ..	" ..	" ..	" " " Double "
Katzer, R. . .	Germany	Cycling ..	660 Yards.
" .. ..	" ..	" ..	1,000 Metres.
" .. ..	" ..	" ..	5,000 "
" .. ..	" ..	" ..	20 Kilometres.
" .. ..	" ..	" ..	100 "
" .. ..	" ..	" ..	Pursuit Race.
" .. ..	" ..	" ..	2,000 Metres, Tandem.
Karlsen, K. C. ..	Denmark	Wrestling	Graeco-Roman, Light.
Klath, C. .. ..	Norway..	Gymnastics	Individual.
" .. ..	" ..	"	Team.
Kallmeier, R. ..	Germany	"	Individual.
" .. ..	" ..	"	Team.
" .. ..	" ..	Athletics..	Pole Jump.
" .. ..	" ..	" ..	Tug-of-War.
Karth, G. . . .	" ..	Gymnastics	Individual.
" .. ..	" ..	"	Team.
" .. ..	" ..	Athletics .	Pole Jump.
" .. ..	" ..	" ..	Tug-of-War.
Kaufmann, W. . .	" ..	Gymnastics	Individual.
" .. ..	" ..	"	Team.
Kramer, J. . . .	" ..	"	Individual.
" .. ..	" ..	"	Team.
Kantzow, N. . .	Sweden, .	"	"



<i>Name</i>	<i>Country</i>	<i>Sport</i>	<i>Event</i>
Kazar, E. . . .	Hungary	Athletics..	Pole Jump.
Kerr, H. . . .	Canada ..	Shooting ..	Team, International.
" " " "	" " "	" " "	Individual, 1,000 Yards.
" " " "	" " "	" " "	Team, 300 Metres.
Kerr, H. E. . .	Australasia	Athletics..	3,500 Metres Walk.
" " " "	" " "	" " "	10 Mile Walk.
Kempster, Sgt.-Maj.	U.K. . .	Shooting..	Running Deer, Team.
Kreuzer, O. . .	Germany	Lawn Tennis	Grass Courts, Men's Singles.
" " " "	" " "	" " "	" " " Doubles.
Klem, H. R. S. . .	Denmark	Swimming	100 Metres.
" " " "	" " "	" " "	Team Race.
" " " "	" " "	" " "	Breast Stroke.
" " " "	" " "	Gymnastics	Team.
Kell, W. . . .	U.K. . .	Swimming	" Race.
Kellner, F. . . .	Austria ..	" " "	Back Stroke.
Kleingeld, H. . .	Holland. .	Wrestling	Graeco-Roman, Heavy.
Keith, G. A. . .	Canada ..	Gymnastics	Individual
Kemp, J. . . .	Finland. .	" " "	Team.
" " " "	" " "	Athletics..	Discus, Free Style.
" " " "	" " "	" " "	" Greek "
" " " "	" " "	" " "	Javelin, Free. "
" " " "	" " "	" " "	" Held in Middle.
" " " "	" " "	" " "	Putting the Weight.
Kerr, R. . . .	Canada ..	" " "	100 Metres, Flat.
" " " "	" " "	" " "	200 " "
" " " "	" " "	" " "	400 " "
" " " "	" " "	" " "	Relay Race.
Kemendy, E. . .	Hungary	" " "	110 Metres, Hurdle.
Kelly, D. J. . .	U.S.A. . .	" " "	Running Broad Jump.
Krenckel, H. . .	Denmark	Fencing ..	Epée, Team.
" " " "	" " "	" " "	Sabre, Individual.
Keene, A. V. . .	U.K. . .	" " "	" " "
Keyworth, J. B. .	" " "	Archery ..	York Round.
" " " "	" " "	" " "	Continental.
Keene, C. J. T. . .	" " "	" " "	York Round.
Kristensen, N. K. O.	Denmark	Shooting ..	Team, International.
" " " "	" " "	" " "	Individual, 1,000 Yards.
" " " "	" " "	" " "	Team, 300 Metres.
" " " "	" " "	" " "	Individual, 300 Metres.
" " " "	" " "	" " "	Min. Rifle, Team,
" " " "	" " "	" " "	" " Individual, Stationary.
" " " "	" " "	" " "	" " " Disappearing.
" " " "	" " "	" " "	" " " Moving.
Kitson, H. A. . .	S. Africa	Lawn Tennis	Grass Courts, Men's Singles.
" " " "	" " "	" " "	" " " Doubles.
Kinzl, R. . . .	Austria ..	" " "	" " " Singles.
" " " "	" " "	" " "	" " " Doubles.
Kinan Bey . . . .	Turkey..	Wrestling	
Kiss, G. . . .	Hungary	Shooting..	Individual, 1,000 Yards.
" " " "	" " "	" " "	" " 300 Metres.
" " " "	" " "	" " "	Min. Rifle, Indiv., Stationary.
" " " "	" " "	" " "	" " " Disappearing.
" " " "	" " "	" " "	" " " Moving.
" " " "	" " "	" " "	Revolver and Pistol. Individual.

<i>Name</i>	<i>Country</i>	<i>Sport</i>	<i>Event</i>
Kiss, G. .. ..	Hungary	Shooting ..	Running Deer, Indiv., Single Shot. Double "
" " " "	"	" " "	" " "
" " " "	"	Swimming	100 "Metres." "
" " " "	"	"	400
" " " "	"	"	Team Race.
Kingsbury, C. B.	U.K. ..	Cycling ..	660 Yards.
" " " "	" " "	" " "	1,000 Metres.
" " " "	" " "	" " "	5,000
" " " "	" " "	" " "	20 Kilometres.
" " " "	" " "	" " "	Pursuit Race.
Kivimaki, J. ..	Finland..	Wrestling	Graeco-Roman, Heavy.
Knight, F. W. ..	U.K. ..	"	Catch-as-Catch-Can, Bantam.
Kiefl, J. J. ..	Holland..	Gymnastics	Individual.
" " " "	" " "	"	Team.
Kioer, N. .. ..	Norway ..	"	"
Kirksten, S. ..	Sweden..	"	"
Kiralfy, E. G. ..	U.S.A. ..	Athletics..	100 Metres, Flat.
" " " "	" " "	" " "	200 " "
Knott, F. A. ..	U.K. ..	" " "	1,500 " "
Kiss, T. .. ..	Hungary	" " "	100 " "
Kinahan, C. E. ..	" " "	" " "	110 " Hurdle.
Kiely, L. A. ..	" " "	" " "	110 " "
" " " "	" " "	" " "	400 " "
Kinchin, J. W. ..	" " "	" " "	3,200 " Steeplechase.
Kitching, F. O. ..	" " "	" " "	Standing Broad Jump.
Kivieton, F. ..	Austria ..	" " "	1,500 Metres, Flat.
" " " "	" " "	" " "	5 Miles Run.
" " " "	" " "	" " "	Marathon Race.
Kirschhoffer, R.	Hungary	" " "	Putting the Weight.
Kirkwood, T. ..	U.K. ..	" " "	" " " "
Kidd, A. .. ..	" " "	" " "	Tug-of-War.
Kolko, V. V. ..	Finland ..	Shooting ..	Team, 300 Metres.
Kolko, L. .. ..	" " "	" " "	" " "
Koopmeiners, A. H. J. ..	Holland	" " "	" " " "
" " " "	" " "	" " "	Individual, 300 Metres.
" " " "	" " "	" " "	Revolver and Pistol, Team.
" " " "	" " "	" " "	" " " Individual.
Knoppel, J. A. C.	Sweden ..	" " "	Running Deer, Team.
" " " "	" " "	" " "	" " " Indiv., Single Shot.
" " " "	" " "	" " "	" " " " Double "
" " " "	" " "	Clay Bird Shooting	Individual.
" " " "	" " "	" " "	Team.
Knoppel, A. ..	" " "	" " "	Individual.
" " " "	" " "	" " "	Team.
Kosonen, E. ..	Finland ..	Gymnastics	Individual.
Korhonen, R. ..	" " "	" " "	"
Körting, C. ..	Germany	" " "	Team.
" " " "	" " "	" " "	Individual.
Konijn, S., ..	Holland ..	" " "	Team.
Kohlmeiy, W. ..	Germany	Athletics ..	1100 Metres, Flat.
" " " "	" " "	" " "	200 " "
Krojer, G. .. ..	Austria ..	" " "	100 " "

<i>Name</i>	<i>Country</i>	<i>Sport</i>	<i>Event</i>
Krojer, G. . . .	Austria . .	Athletics . .	Running Broad Jump.
" " " "	" " "	" " "	High
" " " "	" " "	" " "	Hop, Step, and Jump.
" " " "	" " "	" " "	Javelin, Free Style.
Kovacs, N. . . .	Hungary	" " "	110 Metres, Hurdle.
" " " "	" " "	" " "	400
" " " "	" " "	" " "	Standing Broad Jump.
" " " "	" " "	" " "	Discus, Greek Style.
Koops, E. . . .	Holland . .	" " "	100 Metres, Flat.
" " " "	" " "	" " "	200 " "
" " " "	" " "	" " "	400 " "
" " " "	" " "	" " "	110 " Hurdle.
" " " "	" " "	" " "	400
" " " "	" " "	" " "	Standing Broad Jump.
" " " "	" " "	" " "	Running " "
" " " "	" " "	" " "	Relay Race.
Knyvett, W. A.	U.K. . .	" " "	100 Metres, Hurdle.
Kovacs, F. . . .	Hungary	" " "	Standing High Jump.
" " " "	" " "	" " "	Running Broad "
Kovesdy, G. . . .	" " "	" " "	" " "
Koeber, G. . . .	France . .	" " "	Pole Jump.
Koczan, M. . . .	Hungary	" " "	Putting the Weight
" " " "	" " "	" " "	Discus, Free Style.
" " " "	" " "	" " "	Greek
" " " "	" " "	" " "	Javelin, Free "
" " " "	" " "	" " "	Held in the Middle.
Kozla, A. . . .	" " "	" " "	Putting the Weight.
Krook, K. E. . . .	Sweden . .	" " "	Tug-of-War.
Kobulsky, V. . . .	Hungary	" " "	Discus, Free Style.
" " " "	" " "	" " "	Greek
Konew, M. . . .	Norway . .	Yachting . .	8 Metres.
Kumfeldt, T. . . .	Sweden . .	Swimming	Breast Stroke.
" " " "	" " "	" " "	Water Polo.
Kugler, S. . . .	Hungary	" " "	Back Stroke.
Krug, J. H. . . .	U.S.A. . .	Wrestling	Catch-as-Catch-Can, Light.
Krueger, W. A. . . .	" " "	Athletics . .	Putting the Weight.
" " " "	" " "	" " "	Tug-of-War.
Krunert, R. . . .	Germany	Fencing . .	Epée, Individual.
" " " "	" " "	" " "	Team.
" " " "	" " "	" " "	Sabre, Individual.
" " " "	" " "	" " "	Team.
Kyykoski, T. . . .	Finland . .	Gymnastics	Team.
Lampelmayer, K.	Austria . .	Athletics . .	400 Metres, Flat.
" " " "	" " "	" " "	Standing Broad Jump.
" " " "	" " "	" " "	Running " "
" " " "	" " "	" " "	Hop, Step, and Jump.
Larsen, O. . . .	Norway . .	" " "	1,500 Metres, Flat.
Lindqvist, J. . . .	Sweden . .	" " "	5 Miles Run.
" " " "	" " "	" " "	Marathon Race.
Landqvist, S. L.	" " "	" " "	5 Miles Run.
" " " "	" " "	" " "	Marathon Race.
" " " "	" " "	" " "	3 Miles, Team.

<i>Name</i>	<i>Country</i>	<i>Sport</i>	<i>Event</i>
Lapos, A. . . .	Hungary	Athletics . .	10 Miles Walk.
" " " "	" "	" "	3,500 Metres Walk.
Larner, G. E. . .	U.K. . .	" "	10 Miles Walk.
" " " "	" "	" "	3,500 Metres Walk.
Larner, E. E. . .	" "	" "	10 Miles Walk.
" " " "	" "	" "	3,500 Metres Walk.
Lawson, H. . . .	Canada . .	" "	Marathon Race.
Langkjoer, S. . .	Denmark	" "	Standing High Jump.
" " " "	" "	" "	Putting the Weight.
" " " "	" "	" "	Standing Broad Jump.
Larsen, E. . . .	Norway . .	" "	Running " "
" " " "	" "	" "	Hop, Step, and Jump.
Laszlo, G. . . .	Hungary	" "	Putting the Weight.
Lagarde, C. . . .	France . .	" "	" " " "
" " " "	" "	" "	Discus, Free Style.
" " " "	" "	" "	" " " "
" " " "	" "	" "	Javelin, Free " "
" " " "	" "	" "	" " " "
" " " "	" "	" "	Held in Middle.
Lada, V. . . .	Bohemia	Fencing . .	Epée, Individual.
" " " "	" "	" "	" " " "
" " " "	" "	" "	Team.
" " " "	" "	" "	Sabre, Individual.
" " " "	" "	" "	" " " "
" " " "	" "	" "	Team.
Lada, P. . . .	" "	" "	Epée, Individual.
" " " "	" "	" "	" " " "
" " " "	" "	" "	Team.
" " " "	" "	" "	Sabre, Individual.
" " " "	" "	" "	" " " "
" " " "	" "	" "	Team.
Lateux . . . .	France . .	" "	" " " "
" " " "	" "	" "	Individual.
Labouchere, A. J.	Holland . .	" "	Epée, " "
" " " "	" "	" "	" " " "
" " " "	" "	" "	Team.
" " " "	" "	" "	Sabre, Individual.
" " " "	" "	" "	" " " "
" " " "	" "	" "	Team.
Langevin, G. . .	France . .	" "	" " " "
" " " "	" "	" "	Individual.
Laws, G. A. . . .	U.K. . .	Yachting . .	6 Metres.
Leahy, J. P. . . .	" "	Athletics . .	Standing Broad Jump.
" " " "	" "	" "	Running High " "
Lemming, E. V. . .	Sweden . .	" "	Throwing the Hammer.
" " " "	" "	" "	Putting the Weight.
" " " "	" "	" "	Discus, Free Style.
" " " "	" "	" "	" " " "
" " " "	" "	" "	Greek " "
" " " "	" "	" "	Javelin, Free " "
" " " "	" "	" "	" " " "
" " " "	" "	" "	Held in Middle.
Leeke, H. A. . . .	U.K. . .	" "	Throwing the Hammer.
" " " "	" "	" "	Putting the Weight.
" " " "	" "	" "	Discus, Free Style.
" " " "	" "	" "	" " " "
" " " "	" "	" "	Greek " "
" " " "	" "	" "	Javelin, Free " "
" " " "	" "	" "	" " " "
" " " "	" "	" "	Held in Middle.
Levison, E. . . .	Denmark	Fencing . .	Epée, Individual.
" " " "	" "	" "	" " " "
" " " "	" "	" "	Team.
Le Blon, P. . . .	Belgium	" "	" " " "
" " " "	" "	" "	Individual.
Lesquendien, A.	France . .	Archery . .	York Round.
" " " "	" "	" "	" " " "
" " " "	" "	" "	Continental.
Leonard, Mrs. E.	U.K. . .	" "	National Round
Leete. I. . . .	" "	Yachting . .	6 Metres.

<i>Name</i>	<i>Country</i>	<i>Sport</i>	<i>Event</i>
Leuchars, J. W.	U.K. ..	Yachting ..	6 Metres.
Leuchars, W. ..	" ..	" ..	6 " "
Lindsay-Watson	" ..	Athletics ..	Throwing the Hammer.
R. H.			
Lincoln, P. . . .	" ..	" ..	Tug-of-War.
Lardin, M. ..	France ..	Shooting ..	Team, International.
" ..	" ..	" ..	Individual, 1,000 Yards.
" ..	" ..	" ..	Team, 300 Metres.
" ..	" ..	" ..	Miniature Rifle, Team.
" ..	" ..	" ..	Revolver and Pistol, Team.
" ..	" ..	" ..	" " " Individual.
" ..	" ..	" ..	Running Deer, Team.
" ..	" ..	" ..	" " " Indiv., Single Shot.
" ..	" ..	" ..	" " " Double Shot.
Laursen, N. ..	Denmark	" ..	Team, International.
" ..	" ..	" ..	Individual, 1,000 Yards.
" ..	" ..	" ..	Team, 300 Metres.
" ..	" ..	" ..	Individual, 300 Metres.
" ..	" ..	" ..	Min. Rifle, Team.
" ..	" ..	" ..	" " " Indiv. Stationary.
" ..	" ..	" ..	" " " Disappearing.
" ..	" ..	" ..	" " " Moving.
Laveni, G. . . .	Italy ..	" ..	Team, International.
" ..	" ..	" ..	Individual, 1,000 Yards.
" ..	" ..	" ..	Team, 300 Metres.
" ..	" ..	" ..	Individual, 300 Metres.
Lauber, D. . . .	Hungary	Lawn Tennis	Grass Courts, Men's Singles.
" ..	" ..	" ..	" " " Doubles.
Laan, J. ..	Holland ..	Clay-Bird Shooting	Individual.
Lavey, J. ..	U.K. ..	Cycling ..	660 Yards.
" ..	" ..	" ..	1,000 Metres.
" ..	" ..	" ..	5,000 "
" ..	" ..	" ..	Pursuit Race.
Lapize, O. . . .	France ..	" ..	20 Kilometres.
" ..	" ..	" ..	100 "
" ..	" ..	" ..	2,000 Metres, Tandem.
Lagergren, R. A.	Sweden ..	" ..	100 Metres.
Lastorres, B. ..	Hungary	Swimming	400 "
" ..	" ..	" ..	1,500 "
" ..	" ..	" ..	Team Race.
Larsson, S. D. ..	Sweden ..	" ..	400 Metres.
" ..	" ..	" ..	High Diving.
" ..	" ..	" ..	Fancy "
" ..	" ..	" ..	Team Race.
Lauterstein, I. ..	Austria ..	" ..	Water Polo.
Lagendijk, J. ..	Holland ..	Wrestling	Graeco-Roman, Light.
Larson, A. A. ..	Denmark	" ..	" " " Middle.
Larson, F. . . .	Sweden ..	" ..	" " " Light Heavy.
Lalu, M. ..	France ..	Gymnastics	Individual.
Labitte, E. . . .	" ..	" ..	Team.
Larsen, T. . . .	Norway ..	" ..	" ..
Landberg, M. ..	Sweden ..	" ..	" ..
Lanner, O. . . .	" ..	" ..	" ..

<i>Name</i>	<i>Country</i>	<i>Sport</i>	<i>Event</i>
Laycock, R.	U.K.	Gymnastics	Team.
Lamotte, G.	France	Athletics	100 Metres, Flat.
"	"	"	200 " "
"	"	"	400 " "
Laftman, S.	Sweden	"	200 " "
"	"	"	400 " "
"	"	"	Running Broad Jump.
"	"	"	Hop, Step, and Jump.
"	"	"	Relay Race.
Leaf, H. M.	U.K.	Racquets	Singles.
"	"	"	Doubles.
Lecoq, M.	France	Shooting	Team, International.
"	"	"	Individual, 1,000 Yards.
"	"	"	Team, 300 Metres.
"	"	"	Individual, 300 Metres.
Le Fevre, J. N.	U.K.	"	Revolver and Pistol, Team.
"	"	"	" " " Individual.
Le Boutillier, T.	U.S.A.	"	" " " Team.
"	"	"	" " " Individual.
Leushner, W. F.	"	"	Team, International.
"	"	"	Individual, 1,000 Yards.
"	"	"	Team, 300 Metres.
"	"	"	Individual, 300 Metres.
Leask, J.	Canada	"	Team, International.
"	"	"	Team, 300 Metres.
Lecuyer, L.	France	"	Revolver and Pistol, Individual.
"	"	"	Running Deer, Indiv. Single Shot.
"	"	"	" " " Double Shot.
Leve, P.	"	Clay Bird Shooting	Individual.
"	"	"	Team.
Lefebure, P.	"	"	Individual.
"	"	"	Team.
Lepere, A.	"	Cycling	20 Kilometres.
"	"	"	100 "
Lewis, C.	U.K.	Swimming	Back Stroke.
Lelie, A.	Holland	Wrestling	Graeco-Roman, Middle.
Lemaire, P.	France	Gymnastics	Individual.
Lekim, F.	"	"	Team.
Lem, H.	Norway	"	Individual.
"	"	"	Team.
Lehmusto, H.	Finland	"	"
Lestienne, L.	France	"	"
Lefdahl, R.	Norway	"	"
Lesca, L.	France	Athletics	100 Metres, Flat.
"	"	"	110 " Hurdle.
Lee, J. W.	U.K.	"	800 Metres, Flat.
"	"	"	1,500 " "
Lemming, O. R.	Sweden	"	110 " Hurdle.
"	"	"	Running High Jump.
"	"	"	Javelin, Held in Middle.
Leader, E. E.	U.K.	"	110 Metres, Hurdle.
"	"	"	Standing High Jump.
"	"	"	Running " "

<i>Name</i>	<i>Country</i>	<i>Sport</i>	<i>Event</i>
Lee, J. J. .. ..	U.S.A. ..	Athletics ..	Marathon Race.
Leahy, C. .. ..	U.K. ..	.. ..	Standing Broad Jump.
.. .. ..	.. ..	.. ..	.. High ..
.. .. ..	.. ..	.. ..	Running Broad ..
.. .. ..	.. ..	.. ..	.. High ..
.. .. ..	.. ..	.. ..	Hop, Step, and Jump.
Liebst, P. V. ..	Denmark	Shooting ..	Team, International.
.. .. ..	.. ..	.. ..	Individual, 1,000 Yards.
.. .. ..	.. ..	.. ..	Team, 300 Metres.
.. .. ..	.. ..	.. ..	Individual, 300 Metres.
.. .. ..	.. ..	.. ..	Min. Rifle, Team.
.. .. ..	.. ..	.. ..	.. .. Individ. Stationary.
.. .. ..	.. ..	.. ..	.. .. .. Disappearing.
.. .. ..	.. ..	.. ..	.. .. .. Moving.
Liberg, E. .. ..	Norway ..	.. ..	Team, International.
.. .. ..	.. ..	.. ..	Individual, 1,000 Yards.
.. .. ..	.. ..	.. ..	Team, 300 Metres.
.. .. ..	.. ..	.. ..	Individual 300 Metres.
.. .. ..	.. ..	.. ..	Min. Rifle, Team.
.. .. ..	.. ..	.. ..	.. .. Individ. Stationary.
.. .. ..	.. ..	.. ..	.. .. .. Disappearing.
.. .. ..	.. ..	.. ..	.. .. .. Moving.
.. .. ..	.. ..	.. ..	Running Deer, Team.
.. .. ..	.. ..	.. ..	.. .. Individ. Single Shot.
.. .. ..	.. ..	.. ..	.. .. .. Double
Litchfield, E. H.	U.S.A. ..	.. ..	Revolver and Pistol, Team.
.. .. ..	.. ..	.. ..	.. .. .. Individual.
Linden, A. .. ..	Finland ..	Wrestling	Graeco-Roman, Light.
Linna, E. .. ..	.. ..	Gymnastics	Team.
Linko, Y. .. ..	.. ..	.. ..	.. ..
Lindratn, J. .. ..	.. ..	.. ..	.. ..
Lis, R. .. ..	France ..	.. ..	.. ..
Lindberg, K. ..	Sweden ..	Athletics..	100 Metres, Flat.
.. .. ..	.. ..	.. ..	200 .. ..
.. .. ..	.. ..	.. ..	110 .. Hurdle.
.. .. ..	.. ..	.. ..	Javelin, Free Style.
.. .. ..	.. ..	.. ..	.. .. Held in Middle.
.. .. ..	.. ..	.. ..	Relay Race.
Lichtneckert, L.	Hungary	.. ..	200 Metres, Flat.
.. .. ..	.. ..	.. ..	400 .. ..
Lichtneckert, A.	.. ..	Fencing ..	Sabre, Individual.
Lightbody, J. D.	U.S.A. ..	Athletics ..	100 Metres, Flat.
.. .. ..	.. ..	.. ..	1,500 .. ..
.. .. ..	.. ..	.. ..	400 .. Hurdle.
.. .. ..	.. ..	.. ..	3,200 .. Steeplechase.
.. .. ..	.. ..	.. ..	800 .. Flat.
Lintott, J. F. ..	U.K. ..	.. ..	800 .. Flat.
Lizandier, P. ..	France ..	.. ..	5 Miles Run.
.. .. ..	.. ..	.. ..	3,200 Metres, Steeplechase.
Lister, G. .. ..	Canada ..	.. ..	5 Miles Run.
.. .. ..	.. ..	.. ..	Marathon Race.
Lind, G. .. ..	Russia ..	Athletics..	.. ..
Liesche, G. ..	Germany	.. ..	Pole Jump.
.. .. ..	.. ..	.. ..	Tug-of-War.
Lie, J. .. ..	Norway..	.. ..	Javelin, Free Style.

<i>Name</i>	<i>Country</i>	<i>Sport</i>	<i>Event</i>
Lie, J. . .	Norway . .	Athletics . .	Javelin, Held in Middle.
Lindblom, G. . .	Sweden . .	Fencing . .	Epée, Individual.
" . .	" . .	" . .	" Team.
Lichtenfels, J. . .	Germany . .	" . .	" Individual.
" . .	" . .	" . .	" Team.
" . .	" . .	" . .	Sabre, Individual.
" . .	" . .	" . .	" Team.
Lippmann, A. . .	France . .	" . .	Epée, Team.
Liles, C. E. . .	U.K. . .	Yachting . .	6 Metres.
Londen, A. F. . .	Finland . .	Clay Bird Shooting	Individual.
Lofberg, H. . .	Sweden . .	Swimming	High Diving.
Lorenz, J. . .	Holland . .	Wrestling	Graeco-Roman, Middle.
Lovas, A. . .	Hungary . .	Athletics . .	1,500 Metres, Flat.
" . .	" . .	" . .	3,200 " Steeplechase.
" . .	" . .	" . .	5 Miles Run.
Loney, E. V. . .	U.K. . .	" . .	1,500 Metres, Flat.
Longboat, T. . .	Canada . .	" . .	5 Miles Run.
" . .	" . .	" . .	3 Miles Team Race.
" . .	" . .	" . .	Marathon Race.
Lord, F. . .	U.K. . .	" . .	" "
Lorz, F. . .	U.S.A. . .	" . .	" "
Lowey, D. M. . .	" . .	" . .	Tug-of-War.
Lockhart-Leith, Lieut.	" . .	Fencing . .	Sabre, Individual.
Lord, P. F. G. . .	" . .	Yachting . .	8 Metres.
Lonnroth, H. A. . .	Sweden . .	" . .	" "
Lower, W. . .	U.K. . .	Cycling . .	20 Kilometres.
Ljungberg, A. G. E. . .	Sweden . .	Shooting . .	Running Deer, Team,
" . .	" . .	" . .	" " Indiv. Single Shot.
" . .	" . .	" . .	" " " Double Shot.
" . .	" . .	Clay Bird Shooting	Individual.
Lucassen, P. L. . .	Holland . .	" . .	" "
Lutz, G. C. . .	France . .	Cycling . .	20 Kilometres.
" . .	" . .	" . .	100 "
Lund, E. . .	Sweden . .	Wrestling	Graeco-Roman, Light.
Lux, J. . .	France . .	Gymnastics	Individual.
Ljung, A. . .	Sweden . .	" . .	Team.
" . .	" . .	Athletics . .	110 Metres, Hurdle.
Lukeman, F. . .	Canada . .	" . .	" " Flat.
" . .	" . .	" . .	200 " "
" . .	" . .	" . .	Running Broad Jump.
" . .	" . .	" . .	Hop, Step, and Jump.
" . .	" . .	" . .	Relay Race.
Lunghi, E. . .	Italy . .	" . .	200 Metres, Flat.
" . .	" . .	" . .	800 " "
" . .	" . .	" . .	1,500 " "
" . .	" . .	" . .	3,200 " Steeplechase.
" . .	" . .	" . .	3 Miles Team.
" . .	" . .	" . .	Relay Race.
Lundberg, I. . .	Sweden . .	" . .	Marathon Race.
Luntzer, G. . .	Hungary . .	" . .	Putting the Weight.
" . .	" . .	" . .	Discus, Free Style.



<i>Name</i>	<i>Country</i>	<i>Sport</i>	<i>Event</i>
Luntzer, G. ..	Hungary	Athletics ..	Discus, Greek Style
.. ..	..	.. ..	Javelin, Free ..
.. ..	..	.. ..	.. .. Held in Middle.
Lund, E. .. ..	Norway ..	Yachting ..	8 Metres.
Ljungberg, K. J.	Sweden ..	.. ..	..
Lytton, N. S. ..	U.K. ..	Tennis ..	Singles.
Lynch, J. M. ..	Australasia	Athletics ..	800 Metres, Flat.
.. ..	..	.. ..	1,500 .. ..
.. ..	..	.. ..	5 Miles Run.
.. ..	..	.. ..	Marathon Race.
Massa, M. .. ..	Italy ..	Swimming	400 Metres.
.. ..	..	..	1,500 ..
.. ..	..	..	Team Race.
Maas, A. .. ..	Belgium..	..	1,500 Metres.
Malmstrom, K. ...	Sweden ..	..	High Diving.
Mazzi, O. .. ..	Italy ..	..	Fancy ..
Mardini, R. ..	.. ..	Gymnastics	Team.
Mayer, L. .. ..	Austria ..	Swimming	Water Polo.
Mayer, V. .. ..	.. ..	..	.. ..
Manuel, R. ... ..	.. ..	..	.. ..
Maly, S. .. ..	Bohemia	Wrestling	Graeco-Roman, Light.
Mackenzie, G. ..	U.K. ..	..	.. ..
.. ..	.. ..	..	Catch-as-Catch-Can, Light.
Malmstrom, G. H	Sweden ..	..	Graeco-Roman, Light.
Marothi, F. ..	Hungary	..	.. ..
Martinsen, F. M.	Sweden ..	..	.. .. Middle.
McKie, W. ... ..	U.K. ..	..	Catch-as-Catch-Can, Feather
McKenzie, J. ..	.. ..	..	.. .. Light.
Mazzarocchi, S. ..	Italy ..	Gymnastics	Individual.
Mazzoncini, A. ..	.. ..	..	..
Markkanen, M. ..	Finland ..	..	Team.
Madsen, R. K. ..	Denmark	..	..
Madsen, V. M. ..	.. ..	..	..
Magnier, V. ..	France ..	..	..
Marchi, A. ..	Italy ..	..	..
Massari, E. ..	.. ..	..	..
Marchiaendi, C. ..	.. ..	..	..
McGaw, R. ..	U.K. ..	..	..
McPhail, J. ..	.. ..	..	..
Manning, W. ..	.. ..	..	..
McLeod, K. G. ..	.. ..	Athletics ..	100 Metres, Flat.
May, W. W. ..	U.S.A. ..	.. ..	.. ..
.. ..	.. ..	.. ..	200 .. ..
.. ..	.. ..	.. ..	100 .. ..
Majunke, E. ..	Hungary	.. ..	Running Broad Jump.
.. ..	.. ..	.. ..	.. ..
Malfait, G. ... ..	France ..	.. ..	100 Metres, Flat.
.. ..	.. ..	.. ..	200 .. ..
.. ..	.. ..	.. ..	400 .. ..
.. ..	.. ..	.. ..	800 .. ..
Manogue, L. J. ..	U.K. ..	.. ..	.. ..
McGough, J. ..	.. ..	.. ..	.. ..
.. ..	.. ..	.. ..	1,500 .. ..

<i>Name</i>	<i>Country</i>	<i>Sport</i>	<i>Event</i>
Manglitz, F. ..	Hungary	Athletics..	10 Miles Walk.
" ..	"	" ..	3,500 Metres Walk.
Mallivitz, Dr. A.	Germany	" ..	Standing Broad Jump.
" ..	"	" ..	" High "
" ..	"	" ..	Discus, Greek Style
Macmeekan, J. K.	U.K. ..	" ..	Standing High Jump.
Martens, G. ..	Belgium	" ..	" Broad "
Mahoney, J. T.	U.S.A. ..	" ..	Running " "
" ..	"	" ..	" High "
Mayberry, G. M.	U.K. ..	" ..	" " "
" ..	"	" ..	Hop, Step, and Jump.
Martin, G. . .	France ..	" ..	Running High Jump.
McGrath, M. J. .	U.S.A. ..	" ..	Throwing the Hammer.
" ..	"	" ..	Tug-of-War.
" ..	"	" ..	Discus, Free Style.
" ..	"	" ..	" Greek "
" ..	"	" ..	Javelin, Free "
" ..	"	" ..	" Held in Middle.
May, E. E. B. ..	U.K. ..	" ..	Throwing the Hammer.
" ..	"	" ..	Discus, Free Style.
" ..	"	" ..	" Greek "
" ..	"	" ..	Javelin, Free "
" ..	"	" ..	" Held in Middle.
Martin, D. . .	"	" ..	Tug-of-War.
Mangiarotti, G. .	Italy ..	Fencing ..	Epee, Individual.
" ..	"	" ..	" Team.
Martineau, S. ..	U.K. ..	" ..	" Individual.
" ..	"	" ..	" Team.
Marsh, W. W. ..	"	" ..	Sabre, Individual.
" ..	"	" ..	" Team.
Marais, J. . .	France ..	" ..	" Individual.
McMeeKin, T. D.	U.K. ..	Yachting .	6 Metres.
Martin, R. W. . .	France ..	" ..	6 Metres.
Mavrommatis, F.	Greece ..	Shooting..	Team, International.
" ..	"	" ..	Individual, 1,000 Yards.
" ..	"	" ..	Team, 300 Metres.
" ..	"	" ..	Individual, 300 Metres.
" ..	"	" ..	Min. Rifle, Team.
" ..	"	" ..	" " Indiv., Stationary.
" ..	"	" ..	" " " Disappearing.
" ..	"	" ..	" " " Moving.
" ..	"	" ..	Revolver and Pistol, Team.
" ..	"	" ..	" " " Individual.
" ..	"	" ..	Running Deer, Indiv., Single Shot.
" ..	"	" ..	" " " Double Shot.
" ..	"	Clay- Bird Shooting	Individual.
Martin, J. E. ..	U.K. ..	Shooting..	Team, International.
McHaffie, G. ..	" ..	" ..	" "
Madsen, L. J. . .	Denmark	" ..	" "
" ..	"	" ..	Individual, 1,000 Yards.
" ..	"	" ..	Team, 300 Metres.
" ..	"	" ..	Individual, 300 Metres.
" ..	"	" ..	Min. Rifle, Team.

<i>Name</i>	<i>Country</i>	<i>Sport</i>	<i>Event</i>
Madsen, L. J. . .	Denmark	Shooting . .	Min. Rifle, Indiv., Stationary.
" "	" "	" "	" " " Disappearing
" "	" "	" "	" " " Moving.
McInnes, Corpl. D.	Canada . .	" "	Team, International.
" "	" "	" "	Individual, 1,000 Yards.
" "	" "	" "	" " 300 Metres.
" "	" "	" "	Team, 300 Metres.
Matthews, M. K.	U.K. . .	" "	Min. Rifle, Team.
" "	" "	" "	" " Indiv., Stationary.
" "	" "	" "	" " " Disappearing.
" "	" "	" "	" " " Moving.
Marsden, W. B.	" "	" "	" " " "
Martin, W. B. . .	U.S.A. . .	" "	Team, International.
" "	" "	" "	Individual, 1,000 Yards.
" "	" "	" "	Team, 300 Metres.
" "	" "	" "	Individual, 300 Metres,
Martin, A. . . .	Canada . .	" "	" " 1,000 Yards.
Maunders, A. . .	U.K. . .	Clay-Bird Shooting	Individual.
" "	" "	" "	Team.
McMackon, D. . .	Canada . .	" "	Individual.
" "	" "	" "	Team.
Matuch, Frl. E. . .	Austria. . .	Lawn Tennis	Grass Courts, Ladies' Singles.
Madarasz, Mme.	Hungary	" "	" " " "
Marechal, E. . .	France . .	Cycling . .	660 Yards.
" "	" "	" "	1,000 Metres.
" "	" "	" "	5,000 "
" "	" "	" "	Pursuit Race.
" "	" "	" "	200 Metres, Tandem.
Martens, H. . . .	Germany	" "	660 Yards.
" "	" "	" "	1,000 Metres.
" "	" "	" "	5,000 "
" "	" "	" "	20 Kilometres.
" "	" "	" "	100 "
" "	" "	" "	Pursuit Race.
" "	" "	" "	Tandem.
Magee, W. F. . . .	U.K. . .	" "	660 Yards.
" "	" "	" "	1,000 Metres.
" "	" "	" "	5,000 "
" "	" "	" "	100 Kilometres.
Martinson, J. . . .	Russia . .	" "	660 Yards.
" "	" "	" "	1,000 Metres.
" "	" "	" "	100 Kilometres.
" "	" "	" "	20 "
" "	" "	" "	5,000 Metres.
Mason, R. . . . .	U.S.A. . .	Athletics .	200 " Flat.
" "	" "	" "	400 " "
McCarthy, F. . . .	Canada . .	Cycling . .	660 Yards.
" "	" "	" "	1,000 Metres.
" "	" "	" "	5,000 "
" "	" "	" "	20 Kilometres.
" "	" "	" "	1,000 "
" "	" "	" "	Pursuit Race.
" "	" "	" "	2,000 Metres, Tandem.

<i>Name</i>	<i>Country</i>	<i>Sport</i>	<i>Event</i>
Malatesta, G.	Italy	Cycling	1,000 Metres.
"	"	"	5,000 "
"	"	"	20 Kilometres.
"	"	"	100 "
Mairina, C.	"	"	1,000 Metres.
"	"	"	5,000 "
"	"	"	20 Kilometres.
"	"	"	100 "
Matthews, J.	U.K.	"	1,000 Metres.
"	"	"	Pursuit Race.
Madelaine, J.	France	"	20 Kilometres.
"	"	"	100 "
McKaig, C.	U.K.	"	2,000 Metres, Tandem.
Metaxas, A.	Greece	Shooting	Team, International.
"	"	"	Individual, 1,000 Yards.
"	"	"	Team, 300 Metres.
"	"	"	Individual, 300 Metres,
"	"	"	Min. Rifle, Team.
"	"	"	" " Individ., Stationary.
"	"	"	" " " Disappearing.
"	"	"	" " " Moving.
"	"	"	Revolver and Pistol, Team.
"	"	"	" " " Individual.
"	"	"	Running Deer, Individ., Single Shot.
"	"	"	" " " Double Shot.
Merillon, D.	France	"	Team, International.
"	"	"	Individual, 1,000 Yards.
"	"	"	Running Deer, Individ., Single Shot.
"	"	"	" " " Double Shot.
Mercie, A.	"	"	Team, International.
"	"	"	Min. Rifle, Individ., Stationary.
"	"	"	" " " Disappearing.
"	"	"	" " " Moving.
Merlin, G. E.	U.K.	Clay Bird Shooting	Individual.
"	"	"	Team.
Meredith, L.	"	Cycling	5,000 Metres.
"	"	"	20 Kilometres.
"	"	"	100 "
"	"	"	Pursuit Race.
Meyboon, H.	Belgium	Swimming	100 Metres.
"	"	"	Team Race.
"	"	"	Water Polo.
Meister, G.	France	"	100 Metres.
"	"	"	High Diving.
Meuring, F. W.	Holland	"	400 Metres.
"	"	"	1,500 "
Meyer, K.	"	"	Team Race.
"	"	"	Water Polo.
Mercej, J.	"	Wrestling	Graeco-Roman, Light.
Meessen, A.	Belgium	"	" " " Heavy.
Mehmert, G. M.	U.S.A.	"	Catch-as-Catch-Can, Bantam.
Meade, J.	U.K.	Gymnastics	Individual.
Merrifield, W. G.	"	"	Team.

<i>Name</i>	<i>Country</i>	<i>Sport</i>	<i>Event</i>
Meslot, H. . . .	France . .	Athletics . .	100 Metres, Flat.
„ . . . .	„ . .	„ . .	200 „ „
„ . . . .	„ . .	„ . .	400 „ „
„ . . . .	„ . .	„ . .	800 „ „
„ . . . .	„ . .	„ . .	110 „ Hurdle.
„ . . . .	„ . .	„ . .	400 „ „
„ . . . .	„ . .	„ . .	Standing Broad Jump.
„ . . . .	„ . .	„ . .	Running „ „
Merriam, N. A. . . .	U.S.A. . .	„ . .	400 Metres, Flat.
„ . . . .	„ . .	„ . .	„ „ Hurdle.
„ . . . .	„ . .	„ . .	Relay Race.
Meadows, F. . . .	Canada . .	„ . .	1,500 Metres, Flat.
„ . . . .	„ . .	„ . .	5 Miles Run.
„ . . . .	„ . .	„ . .	3 Miles Team Race.
Medayessy, I. . . .	Hungary	„ . .	110 Metres, Hurdle.
Merenyi, L. . . .	„	„ . .	Marathon Race.
Mercen, E. C. . . .	U.S.A. . .	„ . .	Pole Jump.
Merriman, F. . . .	U.K. . .	„ . .	Tug-of-War.
Meszaros, E. . . .	Hungary	Fencing . .	Epée, Individual.
„ . . . .	„	„ . .	„ Team.
„ . . . .	„	„ . .	Sabre, Individual.
„ . . . .	„	„ . .	„ Team.
Meran, M. . . .	France . .	Yachting . .	6 Metres.
Meyer, E. . . .	Holland . .	Swimming	1,500 Metres.
„ . . . .	„ . .	„	Team Race.
„ . . . .	„ . .	„	Water Polo.
Miles, E. . . .	U.K. . .	Tennis . .	Singles.
Milner, Col. J. K. . . .	„ . .	Shooting . .	Individual, 1,000 Yards.
„ . . . .	„ . .	„ . .	Running Deer, Indiv., Single Shot.
„ . . . .	„ . .	„ . .	„ „ „ Double Shot.
Milne, W. . . .	„ . .	„ . .	Min. Rifle, Team.
„ . . . .	„ . .	„ . .	„ „ Indiv., Stationary.
„ . . . .	„ . .	„ . .	„ „ „ Disappearing.
Milne, J. L. . . .	„ . .	„ . .	„ „ „ Stationary.
„ . . . .	„ . .	„ . .	„ „ „ Disappearing.
Miserochi, A. . . .	Italy . .	„ . .	International, Team.
„ . . . .	„ . .	„ . .	Individual, 1,000 Yards.
Micovsky, J. . . .	Bohemia	Lawn Tennis	Grass Courts, Men's Singles.
„ . . . .	„ . .	„ . .	„ „ „ Doubles.
Michant, A. . . .	Belgium	Swimming	Water Polo.
Mikkolainen, K. E. . . .	Finland . .	Gymnastics	Team.
Millerot, A. . . .	France . .	Athletics . .	5 Miles Run.
Miller, H. . . .	U.S.A. . .	„ . .	Running High Jump.
Milne, J. B. . . .	U.K. . .	„ . .	„ „ „
Mills, E. A. . . .	„ . .	„ . .	Tug-of-War.
MacIntyre, A. . . .	„ . .	„ . .	„
Mikorski . . . .	France . .	Fencing . .	Sabre, Individual.
Michels, S. A. . . .	U.K. . .	Yachting . .	6 Metres.
Morton, J. W. . . .	„ . .	Athletics . .	100 Metres, Flat.
„ . . . .	„ . .	„ . .	200 „ „
„ . . . .	„ . .	„ . .	Relay Race.
Mossberg, K. F. . . .	Sweden . .	Shooting . .	International, Team.
„ . . . .	„ . .	„ . .	Individual, 1,000 Yards.
„ . . . .	„ . .	„ . .	Team, 300 Metres.

<i>Name</i>	<i>Country</i>	<i>Sport</i>	<i>Event</i>
Mossberg, K. F.	Sweden ..	Shooting ..	Individual, 300 Metres.
Moreaux, E.	France ..	" ..	" .. 1,000 Yards.
"	" ..	" ..	Team, 300 Metres.
"	" ..	" ..	Individual, 300 Metres.
"	" ..	" ..	Min. Rifle, Indiv., Stationary.
"	" ..	" ..	" " " Disappearing.
"	" ..	" ..	" " " Moving.
"	" ..	" ..	Revolver and Pistol, Team.
"	" ..	" ..	" " " Individual.
Moricz, K. . .	Hungary	" ..	Individual, 1,000 Yards.
"	" ..	" ..	" " " 300 Metres.
"	" ..	" ..	Min. Rifle, Indiv., Stationary.
"	" ..	" ..	" " " Disappearing.
"	" ..	" ..	" " " Moving.
"	" ..	" ..	Revolver and Pistol, Individual.
"	" ..	" ..	Running Deer, Indiv., Single Shot.
"	" ..	" ..	" " " Double Shot.
Morris, Sgt. F. H.	Canada ..	" ..	Individual, 1,000 Yards.
Moltzer, C. N. J., Jr.	Holland. .	Clay Bird Shooting	Individual.
"	" ..	" ..	Team.
Moore, F. W. . .	U.K. ..	" ..	Individual.
"	" ..	" ..	Team.
Morris, W. B. . .	" ..	" ..	Individual.
"	" ..	" ..	Team.
Morton, Miss A. M.	" ..	Lawn Tennis	Grass Courts, Ladies, Singles.
Morton, W. . .	Canada ..	Cycling ..	660 Yards.
"	" ..	" ..	1,000 Metres.
"	" ..	" ..	5,000 "
"	" ..	" ..	20 Kilometres.
"	" ..	" ..	100 "
Morisetti, W. . .	Italy	" ..	1,000 Metres.
"	" ..	" ..	5,000 "
"	" ..	" ..	20 Kilometres.
"	" ..	" ..	100 "
Moist, L. . .	U.K. ..	Swimming	1,500 Metres.
Moller, A. C. . .	Denmark	Wrestling	Graeco-Roman, Light.
Mounier, G. . .	France ..	Gymnastics	Individual.
Mok, A. . . .	Holland. .	" ..	" ..
"	" ..	" ..	Team.
Moen, A. . . .	Norway. .	" ..	" ..
Moberg, O. . . .	Sweden. .	" ..	" ..
Möller, I. . . .	" ..	" ..	" ..
Montague, E. H.	U.K. ..	Athletics. .	400 Metres, Flat.
"	" ..	" ..	400 " Hurdle.
"	" ..	" ..	Relay Race.
Morphy, G. N. . .	" ..	" ..	400 Metres, Flat.
"	" ..	" ..	800 " "
"	" ..	" ..	1,500 " "
Mole, A. B. . .	S. Africa	" ..	Marathon Race.
Morrissey, T. P.	U.S.A. . .	" ..	" ..
Motte, A. . . .	France..	" ..	Standing Broad Jump.
"	" ..	" ..	" High "
Mount Pleasant, F.	U.S.A ..	" ..	Running Broad "

<i>Name</i>	<i>Country</i>	<i>Sport</i>	<i>Event</i>
Mount Pleasant, F.	U.S.A.	Athletics	Hop, Step, and Jump.
Monson, O.	Norway	"	Running High "
Moffitt, T.	U.S.A.	"	" " "
Moustey, P.	France	"	Pole Jump.
Moustey, G.	"	"	" "
Montgomerie, R. C. L.	U.K.	Fencing	Epée, Individual.
"	"	"	" Team.
"	"	"	Foils, Display.
Moldenhauer, E.	Germany	"	Epée, Individual.
"	"	"	" Team.
"	"	"	Sabre, Individual.
"	"	"	" Team.
Munk, K.	Denmark	Shooting	Team, International.
"	"	"	Individual, 1,000 Yards.
"	"	"	Team, 300 Metres.
"	"	"	Individual, 300 Metres.
"	"	"	Min. Rifle, Team.
"	"	"	" " Individ., Stationary.
"	"	"	" " " Disappearing.
"	"	"	" " " Moving.
Munier, C.	France	"	Individual. 300 Metres.
"	"	"	Min. Rifle, Individ., Stationary.
"	"	"	" " " Disappearing.
"	"	"	" " " Moving.
"	"	"	Revolver and Pistol, Individual.
Munday, Major H.	U.K.	"	" " " "
"	"	"	" " " Team.
Mussen, H.	"	Cycling	100 Kilometres.
Munk, J.	Hungary	Swimming	100 Metres.
"	"	"	Team Race.
Muzzi, O.	Italy	"	1,500 Metres.
"	"	"	Team Race.
Müller, D.	Greece	Athletics	100 Metres, Flat.
"	"	"	200 " "
"	"	"	Hop, Step, and Jump.
"	"	"	Tug-of-War.
"	"	"	Relay Race.
Murray, W.	U.K.	"	100 Metres, Flat.
"	"	"	200 " "
Murray, D.	"	"	100 " "
"	"	"	Running Broad Jump.
Murray, H. St. A.	Australasia	"	400 Metres, Flat.
"	"	"	800 " "
"	"	"	110 " Hurdles.
"	"	"	400 " "
Murphy, J.	U.K.	"	5 Miles Run.
Müller, H.	Germany	"	10 Miles Walk.
"	"	"	Marathon Race.
Muenz, S.	U.S.A.	"	Standing Broad Jump.
"	"	"	" High "
Mudin, I.	Hungary	"	" Broad "
"	"	"	" High "
"	"	"	Putting the Weight.

<i>Name</i>	<i>Country</i>	<i>Sport</i>	<i>Event</i>
Mudin, I. . . .	Hungary	Athletics..	Discus, Free Style.
" " " "	"	" "	" Greek "
" " " "	"	" "	Javelin, Free "
" " " "	"	" "	" Held in Middle.
Mudin, E. . . .	"	" "	Standing Broad Jump.
" " " "	"	" "	" High "
" " " "	"	" "	Throwing the Hammer.
" " " "	"	" "	Putting the Weight.
" " " "	"	" "	Discus, Free Style.
" " " "	"	" "	" Greek "
" " " "	"	" "	Javelin, Free "
" " " "	"	" "	" Held in Middle.
Mühl, O. . . .	Germany	" "	Running High Jump.
Murray, J.. . .	U.K.	" "	Throwing the Hammer.
" " " "	"	" "	Discus, Free Style.
" " " "	"	" "	" Greek "
Munroe, A. . . .	"	" "	Tug-of-War.
Müller, V. . . .	Hungary	" "	Discus, Free Style.
Murray, A. C. . .	U.K. . .	Fencing . .	Sabre, Individual.
" " " "	" " "	" " "	" Team.
Mudge, Miss K. G.	" . .	Archery . .	National Round.
Nassling, F. R. . .	Finland. .	Shooting . .	Team, 300 Metres.
Nassling, E. M. . .	" " "	" " "	" " "
Nagy, Z. . . .	Hungary	" "	Individual, 1,000 Yards.
" " " "	"	" "	" " 300 Metres.
" " " "	"	" "	Min. Rifle, Indiv., Stationary.
" " " "	"	" "	" " " Disappearing.
" " " "	"	" "	" " " Moving.
" " " "	"	" "	Revolver and Pistol, Individual.
" " " "	"	" "	Running Deer Indiv., Single Shot,
" " " "	"	" "	" " Double "
Naylor, F. H. . .	U.K. . .	Swimming	Breast Stroke.
Narganes, F. . .	U.S.A. . .	Wrestling	Catch-as-Catch-Can, Middle.
Nansen, H. S. . .	Norway. .	Gymnastics	Team.
Narberg, C. M. . .	Sweden. .	" "	" "
Natwick, F. J. . .	U.S.A. . .	Athletics. .	110 Metres, Hurdle.
Nagy, J. . . .	Hungary	" "	400 " Flat.
" " " "	"	" "	1,500 " "
" " " "	"	" "	400 " Hurdle.
" " " "	"	" "	Relay Race.
Naumann, A. . .	Germany	Fencing . .	Epée, Individual.
" " " "	"	" "	" Team.
" " " "	"	" "	Sabre, Individual.
" " " "	"	" "	" Team.
" " " "	"	" "	Foils, Display.
Newitt, E. J. D.	U.K. . .	Shooting . .	Min. Rifle, Indiv., Disappearing.
" " " "	" " "	" " "	" " " Moving
Newton, W. S. . .	" " "	" " "	Revolver and Pistol, Team.
" " " "	" " "	" " "	" " " Individual.
Neumer, K. . . .	Germany	Cycling . .	660 Yards.
" " " "	"	" "	1,000 Metres.





<i>Name</i>	<i>Country</i>	<i>Sport</i>	<i>Event</i>
Noel, E. B.	.. U.K. ..	Racquets ..	Doubles.
"	" "	Tennis ..	Singles.
Noon, D. R.	.. " ..	Cycling ..	100 Kilometres.
Norman, J.	.. " ..	" "	100 "
Norberg, G.	.. Sweden ..	Swimming	High Diving.
"	" "	" "	Fancy "
"	" "	Gymnastics	Team.
Norling, A.	.. " ..	" "	" "
Norling, D.	.. " ..	" "	" "
Norberg, E.	.. " ..	" "	Marathon Race.
Noseworthy, F. . .	Canada ..	Athletics ..	Marathon Race.
Nowak, R. . .	.. Italy ..	Fencing ..	Epée, Individual.
"	" "	" "	Team.
"	" "	" "	Sabre, Individual.
"	" "	" "	Team.
"	" "	" "	Foils, Display.
Notley, C. B.	.. U.K. ..	" "	Sabre, Individual.
Nyman, G. R.	.. Finland ..	Shooting ..	Team, 300 Metres.
Nyisztor, J.	.. Hungary	Gymnastics	Individual.
Nys, G.	.. France ..	" "	Team.
Orphanides, G. D.	Greece ..	Shooting ..	Team, International.
"	" "	" "	1,000 Yards.
"	" "	" "	Team, 300 Metres.
"	" "	" "	Individual, 300 Metres.
"	" "	" "	Min. Rifle, Team.
"	" "	" "	" " Indiv., Stationary.
"	" "	" "	" " " Disappearing.
"	" "	" "	" " " Moving.
"	" "	" "	Revolver and Pistol, Individual.
"	" "	" "	Team.
"	" "	" "	Running Deer, Indiv., Single Shot.
"	" "	" "	" " " Double "
"	" "	Clay Bird	Individual.
"	" "	Shooting.	
Oldacre, C. J.	.. U.K. ..	Gymnastics	Team.
Okker, S. . .	.. Holland ..	Fencing ..	Foils, Display.
"	" "	" "	Individual.
"	" "	" "	Team.
Olsen, O. . . .	Denmark	Shooting ..	" International.
"	" "	" "	Individual, 1,000 Yards.
"	" "	" "	Team, 300 Metres.
"	" "	" "	Individual, 300 Metres.
"	" "	" "	Min. Rifle, Team.
"	" "	" "	" " Indiv., Stationary.
"	" "	" "	" " " Disappearing.
"	" "	" "	" " " Moving.
Olsen, P. O.	.. Norway ..	" "	Individual, 1,000 Yards.
"	" "	" "	300 Metres.
Olsen, F. . . .	" "	Gymnastics	Team.
Olsen, Olaf	.. Denmark	" "	" "
Olsen, G. . . .	Sweden ..	" "	" "

<i>Name</i>	<i>Country</i>	<i>Sport</i>	<i>Event</i>
Olsen, H. M.	Norway	Athletics	Running Broad Jump.
"	"	"	" High "
"	"	"	Hop, Step and "
Olsen, A. L.	Sweden	Yachting	8 Metres.
O'Kelly G. C.	U.K.	Wrestling	Graeco-Roman, Heavy.
"	"	"	Catch-as-Catch-Can, Heavy.
O'Mara, W.	U.S.A.	Athletics	Marathon Race.
O'Connell, J. F.	"	"	Running Broad Jump.
"	"	"	Hop, Step, and "
Osterrieth, R.	Belgium	Yachting	6 Metres.
Orlik, S.	Austria	Swimming	Water Polo.
Olivier, A.	Italy	Fencing	Epée, Individual.
"	"	"	" Team.
"	"	"	Sabre, Individual.
"	"	"	" Team.
"	"	"	Foils, Display.
Olivier, Dr. E.	France	"	Epée Team.
"	"	"	Foils, Display.
Ohlsson, P. E. F.	Sweden	Shooting	Team, International.
"	"	"	Individual, 1,000 Yards.
"	"	"	Team, 300 Metres.
"	"	"	Individual, 300 Metres.
Olsson, R.	"	Athletics	Throwing the Hammer.
Olson, G.	"	Fencing	Epée, Individual.
"	"	"	" Team.
Onody, J.	Hungary	Swimming	400 Metres.
"	"	"	100
"	"	"	Team Race.
"	"	"	Back Stroke.
"	"	"	Water Polo.
Ooms, P. L.	Holland	"	1,500 Metres.
"	"	"	Team Race.
"	"	"	Water Polo.
Orosz, M.	Hungary	Wrestling	Graeco-Roman, Middle.
Orloff, N.	Russia	"	" Light.
O'Soorne, E.	U.K.	Athletics	Tug-of-War.
Ommundsen, H.	"	Shooting	Team, International.
Osuer, I. J.	Denmark	Fencing	Epée, Individual.
"	"	"	" Team.
Ostrup, L. C.	"	"	" Individual.
"	"	"	" Team.
"	"	"	Sabre, Individual.
Owen, E.	U.K.	Athletics	5 Miles Run.
Page, A.	U.K.	Lawn Tennis	Singles.
Palmer, A.	"	"	"
Parmentier, A.	France	Shooting	Team, International.
"	"	"	Individual, 1,000 Yards.
"	"	"	Team, 300 Metres.
Padgett, W. G.	U.K.	"	Team, International.
Parnell, E. L.	"	"	"
Plater, P.	"	"	Min. Rifle, Indiv., Stationary.

Name	Country	Sport	Event
Plater, P. . . .	U.K. . . .	Shooting . .	Min. Rifle, Individ., Disappearing.
Panza, E. . . .	Italy . . . .	„ . .	Team, International.
„ . . . .	„ . . . .	„ . .	Individual, 1,000 Yards.
„ . . . .	„ . . . .	„ . .	Team, 300 Metres.
„ . . . .	„ . . . .	„ . .	Individual, 300 Metres.
Paumier du Verger, Belgium		„ . .	Team, 300 Metres.
C.			
„ . . . .	„ . . . .	„ . .	Individual, 300 Metres.
„ . . . .	„ . . . .	„ . .	Revolver and Pistol, Individual.
„ . . . .	„ . . . .	„ . .	„ „ „ Team.
Parke, J. C. . . .	U.K. . . .	Lawn Tennis	Grass Courts, Men's Singles.
„ . . . .	„ . . . .	„ . .	„ „ „ Doubles.
Palmer, C. . . .	„ . . . .	Clay Bird Shooting	Individual.
„ . . . .	„ . . . .	„ . .	Team.
Parker, F. A. . . .	Canada . . . .	„ . .	Individual.
„ . . . .	„ . . . .	„ . .	Team.
Passmore, T. H. E.	S. Africa	Cycling . .	660 Yards.
„ . . . .	„ . . . .	„ . .	1,000 Metres.
„ . . . .	„ . . . .	„ . .	5,000 „
„ . . . .	„ . . . .	„ . .	20 Kilometres.
„ . . . .	„ . . . .	„ . .	100 „
Paton, J. . . . .	Belgium	„ . .	660 Yards.
„ . . . .	„ . . . .	„ . .	1,000 Metres.
„ . . . .	„ . . . .	„ . .	5,000 „
„ . . . .	„ . . . .	„ . .	20 Kilometres.
„ . . . .	„ . . . .	„ . .	100 „
„ . . . .	„ . . . .	„ . .	Pursuit Race.
„ . . . .	„ . . . .	„ . .	2,000 Metres, Tandem.
Payne, E. . . . .	U.K. . . . .	„ . .	660 Yards.
„ . . . .	„ . . . .	„ . .	1,000 Metres.
„ . . . .	„ . . . .	„ . .	5,000 „
„ . . . .	„ . . . .	„ . .	Pursuit Race.
Parini, B. . . . .	Italy . . . . .	„ . .	1,000 Metres.
„ . . . .	„ . . . .	„ . .	5,000 „
„ . . . .	„ . . . .	„ . .	20 Kilometres.
„ . . . .	„ . . . .	„ . .	100 „
Pasquale, S. . . .	„ . . . .	Swimming	1,500 Metres.
Patay, J. . . . .	Hungary	„	Team Race.
„ . . . .	„ . . . .	Wrestling	Graeco-Roman, Middle.
Parvin, S. . . . .	U.K. . . . .	Swimming	Back Stroke.
Payr, H. . . . .	Hungary	Wrestling	Graeco-Roman, Light Heavy.
„ . . . .	„ . . . .	„ . .	„ „ „ Heavy.
Partanen, I. . . .	Finland . .	Gymnastics	Individual.
Paasia, K. K. . . .	„ . . . .	„ . .	Team.
Parent, J. . . . .	France . . . .	„ . .	„
Pappe, L. . . . .	„ . . . .	„ . .	„
Pavani, D. . . . .	Italy . . . . .	„ . .	„
Parrott, G. . . . .	U.K. . . . .	„ . .	„
Parkin, T. . . . .	„ . . . . .	„ . .	„
Pascalides, M . . .	Greece . . .	Athletics . .	100 Metres, Flat.
„ . . . .	„ . . . .	„ . .	200 „ „
„ . . . .	„ . . . .	„ . .	400 „ „
„ . . . .	„ . . . .	„ . .	Tug-of-War.

<i>Name</i>	<i>Country</i>	<i>Sport</i>	<i>Event</i>
Pascalides, M. ..	Greece ..	Athletics ..	Relay Race.
Pankhurst, H. J.	U.K. ..	.. ..	100 Metres, Flat.
..	.. ..	.. ..	200 .. ..
..	.. ..	.. ..	Relay Race.
Patterson, A. ..	.. ..	.. ..	400 Metres, Flat.
Parkes, I. .. ..	Canada ..	.. ..	.. ..
.. .. ..	.. ..	.. ..	800 .. ..
.. .. ..	.. ..	.. ..	Relay Race.
Patterson, J. N.	U.S.A. ..	.. ..	110 Metres, Hurdle.
.. ..	.. ..	.. ..	Running High Jump.
Pangani, A. ..	Italy ..	.. ..	110 Metres, Hurdle.
Pagliani, P. ..	.. ..	.. ..	5 Miles Run.
.. ..	.. ..	.. ..	3 Miles Team.
Palmer, W. J. ..	U.K. ..	.. ..	10 Miles Walk.
.. ..	.. ..	.. ..	3,500 Metres Walk.
Pascmann, R. ..	Germany	.. ..	Standing High Jump.
.. ..	.. ..	.. ..	Running .. ..
.. ..	.. ..	.. ..	Pole Jump.
Pascarel, R. ..	France ..	.. ..	Running Broad Jump.
.. ..	.. ..	.. ..	.. High ..
.. ..	.. ..	.. ..	Pole Jump.
Parker, H. ..	U.S.A. ..	.. ..	.. ..
Pahy, G. .. ..	Hungary	.. ..	.. ..
Paoli, R. .. ..	France ..	.. ..	Putting the Weight.
.. .. ..	.. ..	.. ..	Discus, Free Style.
.. .. ..	.. ..	.. ..	.. Greek ..
.. .. ..	.. ..	.. ..	Javelin, Free ..
.. .. ..	.. ..	.. ..	.. Held in Middle.
Porlin, J. .. ..	Hungary	.. ..	.. Free Style.
.. .. ..	.. ..	.. ..	.. Held in Middle.
Pennell, V. H. ..	U.K. ..	Racquets ..	Singles.
.. .. ..	.. ..	Tennis ..	..
Pederson, P. C. ..	Denmark	Shooting ..	Team, International.
.. .. ..	.. ..	.. ..	Individual, 1,000 Yards.
.. .. ..	.. ..	.. ..	Team, 300 Metres.
.. .. ..	.. ..	.. ..	Individual, 300 Metres.
.. .. ..	.. ..	.. ..	Min. Rifle, Team.
.. .. ..	.. ..	.. ..	.. .. Indiv., Stationary.
.. .. ..	.. ..	.. ..	.. .. Disappearing.
.. .. ..	.. ..	.. ..	.. .. Moving.
Peddie, J. T. ..	U.K. ..	.. ..	Team, International.
Penati, G. .. ..	Italy ..	.. ..	.. ..
.. .. ..	.. ..	.. ..	Individual, 1,000 Yards.
.. .. ..	.. ..	.. ..	Team, 300 Metres.
.. .. ..	.. ..	.. ..	Individual, 300 Metres.
Perrin, G. .. ..	France ..	Cycling ..	660 Yards.
.. .. ..	.. ..	.. ..	1,000 Metres.
.. .. ..	.. ..	.. ..	5,000 ..
.. .. ..	.. ..	.. ..	100 Kilometres.
Pett, W. J. ..	U.K. ..	.. ..	.. ..
Persson, W. L. ..	Sweden ..	Swimming	.. Metres
.. .. ..	.. ..	.. ..	Team Race.
.. .. ..	.. ..	.. ..	Breast Stroke.
.. .. ..	.. ..	.. ..	Back ..

<i>Name</i>	<i>Country</i>	<i>Sport</i>	<i>Event</i>
Persson, W. L. . .	Sweden . .	Swimming	Water Polo.
Pletinex, J. . .	Belgium	"	Team Race.
" . .	" . .	"	Water Polo.
Petit, G. . .	France . .	"	Breast Stroke.
Persson, G. H. . .	Sweden . .	Wrestling	Graeco-Roman, Light.
Petersen, V. . .	Denmark	"	" " Middle,
Press, W. J. . .	U.K. . .	"	Catch-as-Catch-Can, Bantam.
Peake, S. J. . .	" . .	"	" Feather.
Pedersen, C. A. . .	Norway . .	Gymnastics	Team.
" . .	" . .	Athletics . .	400 Metres, Flat.
" . .	" . .	" . .	" " Hurdle.
" . .	" . .	" . .	Relay Race.
Preti, G. . .	Italy . .	Gymnastics	Team.
Petterson, L. . .	Sweden . .	"	"
Petersen, A. . .	Denmark	Athletics . .	100 Metres, Flat.
Penna, R. . .	Italy . .	" . .	400 " "
" . .	" . .	" . .	Relay Race.
Peterson, J. G. . .	Sweden . .	" . .	1,500 Metres, Flat.
" . .	" . .	" . .	5 Miles Run.
" . .	" . .	" . .	Marathon Race.
" . .	" . .	" . .	3 Miles Team.
Penninger, G. . .	Hungary	" . .	5 Miles Run.
Pesonen, A. . .	Finland . .	" . .	Running Broad Jump.
" . .	" . .	" . .	Javelin, Free Style.
" . .	" . .	" . .	" Held in Middle.
" . .	" . .	" . .	Relay Race.
Perry, W. H. . .	U.K. . .	" . .	Tug-of-War.
Petersen, N. K. . .	Denmark	Gymnastics	Team.
Peyron, H. . .	Sweden . .	Fencing . .	Epée, Individual.
" . .	" . .	" . .	" Team.
Pfeiffer, J. . .	Bohemia	" . .	" Individual.
" . .	" . .	" . .	" Team.
" . .	" . .	" . .	Sabre, Individual.
" . .	" . .	" . .	" Team.
Petri, A. . .	Germany	" . .	Epée, Individual.
" . .	" . .	" . .	" Team.
" . .	" . .	" . .	Sabre, Individual.
" . .	" . .	" . .	" Team.
Peigné, E. . .	France . .	" . .	Epée, Individual.
Perrodon, Lt. . .	" . .	" . .	Sabre, "
" . .	" . .	" . .	" Team.
Penrose, Rev. J. . .	U.K. . .	Archery . .	York Round.
Pinkney, Miss V. M. . .	" . .	Lawn Tennis	Covered Courts, Singles.
Pimm, W. E. . .	" . .	Shooting . .	Min. Rifle, Team.
" . .	" . .	" . .	" " Indiv, Stationary.
" . .	" . .	" . .	" " Disappearing.
" . .	" . .	" . .	" " Moving.
Pinchart, J. . .	Belgium	" . .	Revolver and Pistol, Individual.
Pieps, F. . .	Austria . .	Lawn Tennis	Grass Courts, Men's Singles.
" . .	" . .	"	" " Doubles.
Pike, J. F. . .	U.K. . .	Clay Bird Shooting	Individual.
" . .	" . .	"	Team.
Pinchard, G. E. . .	" . .	"	"

<i>Name</i>	<i>Country</i>	<i>Sport</i>	<i>Event</i>
Pietrzikowski, Frl.	Austria..	Lawn Tennis	Grass Courts, Ladies' Singles.
Philipsen, N. ..	Denmark	Gymnastics	Team.
Pinoy, A. .. ..	France. ..	"	"
Phillips, H. F. ..	S. Africa	Athletics ..	100 Metres, Flat.
"	"	"	200 " "
"	"	"	400 " "
"	"	"	Relay Race.
Pihkala, L. ..	Finland ..	"	400 Metres, Flat.
"	"	"	Running High Jump.
"	"	"	Pole Jump.
"	"	"	Putting the Weight.
"	"	"	Discus, Free Style.
"	"	"	Relay Race.
Pilgrim, P. H. ..	U.S.A. ..	"	400 Metres, Flat.
"	"	"	800 " "
Pittarello, A. ..	Italy ..	"	10 Miles Walk.
"	"	"	3,500 Metres Walk.
Price, J. .. ..	U.K. ..	"	Marathon Race.
Philbin, P. .. ..	"	"	Tug-of-War.
Pirzio-Biroli, A.	Italy ..	Fencing ..	Epée, Individual.
"	"	"	" Team.
"	"	"	Sabre, Individual.
"	"	"	" Team.
Pirzio-Biroli, G.	"	"	Epée, Individual.
"	"	"	" Team.
"	"	"	Sabre, Individual.
Pridohl, K. ..	Germany	"	Epée, "
"	"	"	" Team.
"	"	"	Sabre "
Priestley-Foster, Mrs.	U.K. ..	Archery..	National Round.
Piercy, E. C. ..	"	Cycling ..	2,000 Metres, Tandem.
Pietri, Dorando..	Italy ..	Athletics ..	5 Miles run
"	"	"	Marathon Race.
"	"	"	3 Miles, Team.
Pietra-Santa, F.	"	Fencing ..	Sabre, Individual.
"	"	"	" Team.
Pinelli, A. N. S.	"	"	" Individual.
"	"	"	" Team.
Pouillot, A. ..	France ..	Athletics..	800 Metres, Flat.
Pope, M. .. ..	Canada ..	Shooting..	Team International.
"	"	"	300 Metres Team.
Poty, E. .. ..	Belgium	"	300 " "
"	"	"	300 " Individual.
Powell, R. B. ..	Canada ..	Lawn Tennis	Grass Courts, Men's Singles.
"	"	"	" " " Doubles.
Prokopp, S. ..	Hungary	Shooting..	1,000 Yards, Individual.
"	"	"	300 Metres, "
"	"	"	Min. Rifle, Indiv.
"	"	"	" " " Stationary.
"	"	"	" " " Disappearing.
"	"	"	" " " Moving.
"	"	"	Revolver and Pistol, Individual.
"	"	"	Running Deer, Indiv., Single Shot.

<i>Name</i>	<i>Country</i>	<i>Sport</i>	<i>Event</i>
Prokopp, S.	.. Hungary	Shooting..	Running Deer, Indiv., Double Shot.
Powell, K.	.. U.K.	.. Lawn Tennis	Grass Courts, Men's Singles.
"	.. "	.. "	.. " Doubles.
"	.. "	.. Athletics ..	110 Metres, Hurdle.
Postens, J. M.	.. "	.. Clay Bird Shooting	Individual.
"	.. "	.. "	Team.
Poulain, A.	.. France	.. Cycling ..	660 Yards.
"	.. "	.. "	1,000 Metres.
"	.. "	.. "	5,000 "
"	.. "	.. "	Pursuit Race.
"	.. "	.. "	2,000 Metres, Tandem.
Porioli, T.	.. Italy	.. "	.. Metres.
"	.. "	.. "	5,000 "
"	.. "	.. "	20 Kilometres.
"	.. "	.. "	100 "
Pott, H. E.	.. U.K.	.. Swimming	Fancy Diving.
Porro, E.	.. Italy	.. Wrestling	Graeco-Roman, Light.
Pofinger, A. W. F.	.. Holland	.. "	.. Middle.
Posthumus, J.	.. "	.. Gymnastics	Individual.
"	.. "	.. "	Team.
Potts, E. W.	.. U.K.	.. "	Individual.
Pohjanpaa, A.	.. Finland	.. "	Team.
Pohjanen, A.	.. "	.. "	"
Pottier, G.	.. France	.. "	"
Polidori, V.	.. "	.. "	"
Potts, H. C.	.. U. K.	.. "	"
Prout, W. C.	.. U.S.A.	.. Athletics..	400 Metres, Flat.
Preiss, F.	.. Germany	.. "	10 Miles Walk.
Porter, H. F.	.. U.S.A.	.. "	Running High Jump.
Poupart, A.	.. France	.. Archery ..	York Round.
"	.. "	.. "	Continental.
Pownall, C.	.. U.K.	.. "	York Round.
Porter, C. H.	.. "	.. Yachting..	7 Metres.
Potheau, A.	.. France	.. "	6 "
Potheau, L. A.	.. "	.. "	6 "
Quenessen, R.	.. France	.. Fencing ..	Epée, Individual.
Quetiel, C.	.. "	.. Archery ..	York Round.
"	.. "	.. "	Continental.
Quersin, H. L. R.	.. Belgium	.. Clay Bird Shooting	Individual.
"	.. "	.. "	Team.
Quatfass, J. F.	.. Holland	.. Wrestling	Graeco-Roman, Heavy.
Quarg, O.	.. Germany	.. Athletics..	400 Metres, Flat.
"	.. "	.. "	800 "
"	.. "	.. "	Relay Race.
Quinn, A.	.. Canada	.. "	400 Metres, Flat.
"	.. "	.. "	800 "
"	.. "	.. "	Standing Broad Jump.
"	.. "	.. "	" High
"	.. "	.. "	Hop, Step, and



<i>Name</i>	<i>Country</i>	<i>Sport</i>	<i>Event</i>
Quilbeuf, W. ..	France ..	Athletics ..	1,500 Metres, Flat.
Quinn, R. ..	U.K. ..	" ..	3,500 " Walk.
Rand, W. M. ..	U.S.A. ..	" ..	110 Metres, Hurdle.
Rath, E. ..	Austria...	" ..	10 Miles Walk.
" ..	" ..	" ..	Marathon Race.
Rady, A. ..	Hungary	" ..	Standing Broad Jump.
Rasmussen, M. ..	Denmark	" ..	Throwing the Hammer.
" ..	" ..	" ..	Putting the Weight.
" ..	" ..	" ..	Discus, Free Style.
" ..	" ..	" ..	" Greek "
Radó, Dr. A. ..	Hungary	" ..	Javelin, Free "
" ..	" ..	" ..	" Held in Middle.
Ratsey, G. E. ..	U.K. ..	Yachting ..	8 Metres.
Ranken, T. ..	" ..	Shooting ..	1,000 Yards, Individual.
" ..	" ..	" ..	Running Deer, Team.
" ..	" ..	" ..	" " Indiv., Single Shot.
" ..	" ..	" ..	" " " Double Shot.
Raddall, T. W. ..	" ..	" ..	300 Metres, Team.
C.S.M.I.			
" ..	" ..	" ..	" " Individual.
Raven, A. J. ..	" ..	" ..	Revolver and Pistol, Team.
" ..	" ..	" ..	" " " Individual.
Raverdy, H. ..	Belgium	" ..	300 Metres, Team.
" ..	" ..	" ..	" " " Individual.
Rahe, F. W. ..	Germany	Lawn Tennis	Grass Courts, Men's Singles.
" ..	" ..	" ..	" " " Doubles.
Rázny, Z. ..	Bohemia	" ..	" " " Singles.
" ..	" ..	" ..	" " " Doubles.
Radmilovic, P. ...	U.K. ..	Swimming	100 Metres.
" ..	" ..	" ..	400 "
" ..	" ..	" ..	1,500 "
" ..	" ..	" ..	Team Race.
" ..	" ..	" ..	Water Polo.
Radvany, E. ..	Hungary	Wrestling	Graeco-Roman, Light.
Racchetta, P. ..	Italy ..	Gymnastics	Individual.
Ratelot, G. ..	France ..	" ..	" ..
Rank, M. ..	Germany	" ..	" ..
" ..	" ..	" ..	Team.
" ..	" ..	Athletics ..	Pole Jump.
" ..	" ..	" ..	Tug-of-War.
Railio, E. ..	Finland ..	Gymnastics	Team.
Rasmussen, W. ...	Denmark	" ..	" ..
Rasmussen, V. ..	" ..	" ..	" ..
Ravenna, G. ..	Italy ..	" ..	" ..
Rasanden, H. ..	Sweden ..	" ..	" ..
Railo, U. ..	Finland ..	Athletics ..	100 Metres, Flat.
" ..	" ..	" ..	200 " "
" ..	" ..	" ..	400 " "
" ..	" ..	" ..	Running Broad Jump.
" ..	" ..	" ..	Hop, Step, and "
" ..	" ..	" ..	Relay Race.

<i>Name</i>	<i>Country</i>	<i>Sport</i>	<i>Event</i>
Racz, G. . . .	Hungary	Athletics . .	100 Metres, Flat.
" " " "	"	" " "	200 " "
" " " "	"	" " "	Relay Race.
Radóczy, C. . .	"	" " "	200 Metres, Flat.
" " " "	"	" " "	400 " "
" " " "	"	" " "	Relay Race.
Raimey, H. P. . .	U.S.A. . .	" " "	400 Metres, Flat.
" " " "	" " "	" " "	800 " "
Rax, A. . . .	France . .	" " "	" " "
" " " "	" " "	" " "	400 " "
Ragueneau, A. G.	" " "	" " "	1,500 " "
" " " "	" " "	" " "	400 " Hurdle.
" " " "	" " "	" " "	3,200 " Steeplechase.
" " " "	" " "	" " "	5 Miles Run.
Rabot, P. . . .	" " "	Yachting . .	6 Metres.
Reilin, K. L. . .	Finland . .	Shooting . .	300 Metres, Team.
Rhédiades, D. . .	Greece . .	" " "	Team, International.
" " " "	" " "	" " "	1,000 Yards, Individual.
" " " "	" " "	" " "	300 Metres, Team.
" " " "	" " "	" " "	" " Individual.
" " " "	" " "	" " "	Min. Team.
" " " "	" " "	" " "	" " " Indiv., Stationary.
" " " "	" " "	" " "	" " " Disappearing.
" " " "	" " "	" " "	" " " Moving.
" " " "	" " "	" " "	Revolver and Pistol, Team.
" " " "	" " "	" " "	" " " Individual.
" " " "	" " "	" " "	Running Deer, Indiv., Single Shot.
" " " "	" " "	" " "	" " " Double Shot.
" " " "	" " "	Athletics . .	Tug-of-War.
Régaud, A. . . .	France . .	Shooting . .	1,000 Yards, Individual.
" " " "	" " "	" " "	300 Metres, Team.
" " " "	" " "	" " "	Min. Rifle, Team.
" " " "	" " "	" " "	" " " Indiv., Stationary.
" " " "	" " "	" " "	" " " Disappearing.
" " " "	" " "	" " "	" " " Moving.
" " " "	" " "	" " "	Revolver and Pistol, Team.
" " " "	" " "	" " "	" " " Individual.
" " " "	" " "	" " "	Running Deer, Team.
" " " "	" " "	" " "	" " " Indiv., Single Shot.
" " " "	" " "	" " "	" " " Double Shot.
Rey, F. . . .	Belgium . .	" " "	300 Metres, Team.
" " " "	" " "	" " "	" " " Individual.
Renard, L. . . .	Belgium	Cycling . .	660 Yards.
" " " "	" " "	" " "	1,000 Metres.
" " " "	" " "	" " "	5,000 "
" " " "	" " "	" " "	20 Kilometres.
" " " "	" " "	" " "	100 "
" " " "	" " "	" " "	Pursuit Race.
" " " "	" " "	" " "	2,000 Metres, Tandem.
Renou, E. . . .	France . .	Swimming	400 Metres.
" " " "	" " "	" " "	1,500 "
" " " "	" " "	" " "	High Diving.
Reni, K. . . .	Hungary	" " "	Water Polo.
Renn, A. . . .	U.K. . .	Wrestling	Graeco-Roman, Light.

<i>Name</i>	<i>Country</i>	<i>Sport</i>	<i>Event</i>
Rector, J. A.	U.S.A.	Athletics	100 Metres, Flat.
"	"	"	200 " "
Rehder, H.	Germany	"	100 " "
"	"	"	200 " "
"	"	"	Relay Race.
Rehder, C.	"	"	100 Metres, Flat.
"	"	"	Running High Jump.
"	"	"	Discus, Free Style.
"	"	"	" Greek "
Reed, L. J. de B.	U.K.	"	200 Metres, Flat.
Reiser, F.	Germany	"	Marathon Race.
Reid, J. J.	U.K.	"	3,500 Metres Walk.
Renard, G.	Belgium	Fencing	Epée, Individual.
Renaud, L.	France	"	Sabre, "
"	"	"	" Team.
Ritchie, M. J. G.	U.K.	Lawn Tennis	Covered Courts, Singles.
"	"	"	" " " Doubles.
"	"	"	Grass Courts, Men's Singles.
"	"	"	" " " Doubles.
Richardson, Maj. P. W.	U.K.	Shooting	Team, International.
Richardson, Rev. J.	S. Africa	Lawn-Tennis	Grass Courts, Men's Singles.
"	"	"	" " " Doubles.
Rich, L. G.	U.S.A.	Swimming	100 Metres.
"	"	"	400 " "
"	"	"	Team Race.
Rigal, G.	France	"	400 Metres.
Ritter, M.	Germany	"	Back Stroke.
Ridolfi, M.	Italy	Gymnastics	Team.
Richardson, E. F.	U.K.	"	Team.
Ringstrand, K. A.	Sweden	Athletics	400 Metres, Flat.
"	"	"	Runing Broad Jump.
"	"	"	Relay Race.
Riley, F. H.	U.S.A.	"	1,500 Metres, Flat.
Richardson, H. B.	"	Archery	York Round.
"	"	"	Continental.
Richez, E.	France	"	York Round.
Rivett-Carnac, C. J.	U.K.	Yachting	7 Metres.
Rivett-Carnac, C.	"	"	7 " "
Robertson, Mrs. N.	"	Archery	National Round.
Robinson, T.	"	"	York Round.
Rom, F.	Belgium	Fencing	Epée, Individual.
"	"	"	Team.
Robbins, W. C.	U.S.A.	Athletics	400 Metres, Flat.
Robertson, L.	"	"	100 " "
"	"	"	200 " "
"	"	"	Standing Broad Jump.
"	"	"	High
Roche, P. J.	U.K.	"	100 Metres, Flat.
"	"	"	200 " "
Rod, F.	Switzerland	"	100 " "
"	"	"	110 " Hurdle.
Ross, G. J.	U.K.	Gymnastics	Team.
Roper Barrett, H.	"	Lawn Tennis	Covered Courts, Singles.

<i>Name</i>	<i>Country</i>	<i>Sport</i>	<i>Event</i>
Roper Barrett, H.	U.K.	Lawn Tennis	Covered Courts, Doubles.
"	"	"	Grass Courts, Men's Singles.
"	"	"	" " " Doubles.
Robinson, Q.M.S.I.	"	Shooting	300 Metres, Team.
W.E.	"	"	Individual.
Robiou du Pont, M.	France	"	Min. Rifle, Individ., Stationary.
"	"	"	" " " Disappearing.
"	"	"	" " " Moving.
"	"	"	Revolver and Pistol, Team.
"	"	"	" " " Individual.
"	"	"	Running Deer, Team.
"	"	"	" " " Individ., Single Shot.
"	"	"	" " " Double Shot.
Rogers, A. E.	U.K.	"	1,000 Yards, Individual.
"	"	"	Running Deer, Team.
"	"	"	" " " Individ., Single Shot.
"	"	"	" " " Double Shot.
Rowe, G. J.	Canada	"	1,000 Yards, Individual.
Robert	Belgium	"	Revolver and Pistol, Individual.
Rosell, E. O.	Sweden	"	Running Deer, Team.
"	"	"	" " " Individ., Single Shot.
"	"	"	" " " Double Shot.
"	"	Clay Bird Shooting	Individual.
"	"	"	Team.
Roessler-Orowský, J.	Bohemia	Lawn Tennis	Grass Courts, Men's Singles.
"	"	"	" " " Doubles.
Robertson, D. C.	U.K.	Cycling	20 Kilometres.
"	"	"	100 "
Roux, F.	France	Swimming	400 Metres.
Rösler, R.	Germany	"	Breast Stroke.
Robinson, W. W.	U.K.	"	" "
Roodenburch, B. A.	Holland	"	Back "
Rose, A. E.	U.K.	Wrestling	Graeco-Roman, Light.
Rolland, J.	France	Gymnastics	Individual.
Rosen, S. A. A.	Sweden	"	Team.
Rosenqvist, G. W.	"	"	"
Robertshaw, I.	U.K.	"	"
Robb, R. C.	"	Athletics	600 Metres, Flat.
Rowe, F. A.	U.S.A.	"	1,500 " "
"	"	"	3,200 " Steeplechase.
"	"	"	5 Miles Run.
"	"	"	3 Miles Team.
Robertson, A. J.	U.K.	"	1,500 Metres, Flat.
"	"	"	3,200 " Steeplechase.
"	"	"	Miles Run.
"	"	"	3 " Team Race.
Robbins, D. R.	U.S.A.	"	110 Metres, Hurdle.
Rothman, E.	Sweden	"	10 Miles Walk.
"	"	"	3,500 Metres, Walk.
Rowland, A. E. M.	Australasia	"	10 Miles Walk.

<i>Name</i>	<i>Country</i>	<i>Sport</i>	<i>Event</i>
Rowland, A. E. M.	Australasia	Athletics ..	3,500 Metres Walk.
Rönström, G. V.	Sweden ..	.. ..	Running Broad Jump.
"	" ..	.. ..	" High "
Rökk, E. .. ..	Hungary	.. ..	" Broad "
Robin, C. .. ..	France ..	.. ..	Pole Jump.
Rose, R. .. ..	U.S.A. ..	.. ..	Throwing the Hammer.
" .. ..	" ..	.. ..	Putting the Weight.
" .. ..	" ..	.. ..	Discus, Free Style.
" .. ..	" ..	.. ..	" Greek "
" .. ..	" ..	.. ..	Javelin, Free "
" .. ..	" ..	.. ..	" Held in Middle.
" .. ..	" ..	.. ..	Tug-of-War.
Robjent, F. G. ..	U.K. ..	.. ..	"
Robinson, G. W.	" ..	.. ..	"
Ründberg, C. ..	Sweden ..	Shooting ..	Team, International.
" .. ..	" ..	.. ..	1,000 Yards, Individual.
" .. ..	" ..	.. ..	300 Metres, Team.
" .. ..	" ..	.. ..	" " Individual.
" .. ..	" ..	.. ..	Min. Rifle, Individ., Stationary.
" .. ..	" ..	.. ..	" " " Disappearing.
" .. ..	" ..	.. ..	" " " Moving.
Rodcanachi, J. A.	France ..	Fencing ..	Epée, Individual.
Rhodes, J. E. ..	U.K. ..	Yachting ..	8 Metres.
Russell-Brown, C.	Canada ..	Lawn Tennis	Grass Courts, Men's Singles.
" .. ..	" ..	.. ..	" " " Doubles.
Rushen, A. ..	U.K. ..	Cycling ..	2,000 Metres, Tandem.
Runstrom, A. W.	Sweden ..	Swimming	High Diving
" .. ..	" ..	.. ..	Water Polo.
Rühl, J. H. W.	Holland ..	.. ..	" " "
Ruff, W. .. ..	U.K. ..	Wrestling	Graeco-Roman, Light.
Rüpinen, H. ..	Finland ..	Gymnastics	Team.
Russell, A. .. ..	U.K. ..	Athletics ..	3,200 Metres, Steeplechase.
Ruimers, P. A. ..	Holland ..	.. ..	10 Miles Walk.
" .. ..	" ..	.. ..	3,500 Metres Walk.
Rushton, Mrs. ..	U.K. ..	Archery ..	National Round.
Rydin, C. .. ..	Sweden ..	Gymnastics	Team.
Ryle, E. H. ..	U.K. ..	Athletics ..	400 Metres, Flat.
Ryan, M. J. ..	U.S.A. ..	.. ..	Marathon Race.
Sanson, B. .. ..	U.K. ..	Wrestling	Catch-as-Catch-Can, Bantam.
Saunders, G. J. ..	" ..	.. ..	" " "
Szabo, C. .. ..	Hungary	Gymnastics	Individual.
" .. ..	" ..	Athletics ..	Running High Jump.
" .. ..	" ..	.. ..	Pole Jump.
Saarivuori, J. ..	Finland ..	Gymnastics	Individual.
Skrataas, J. ..	Norway ..	.. ..	"
" .. ..	" ..	.. ..	Team.
Schwarz, K. ..	Germany	.. ..	Individual.
" .. ..	" ..	.. ..	Team.
Sandelin, T. ..	Finland ..	.. ..	"
Salovaara, A. ..	" ..	.. ..	"
" .. ..	" ..	.. ..	Putting the Weight.
" .. ..	" ..	.. ..	Discus, Free Style.

<i>Name</i>	<i>Country</i>	<i>Sport</i>	<i>Event</i>
Salovaara, A.	Finland	Gymnastics	Discus, Greek Style
"	"	"	Javelin, Free "
"	"	"	" Held in Middle.
Saarinen, A.	"	"	Team.
Sahlstein, E.	"	"	"
Sandery, L.	France	"	"
Strand, A.	Norway	"	"
Salvesen, V.	"	"	"
Savonuzzi, N.	Italy	"	"
Sandberg, M.	Sweden	"	"
Stark, J. B.	U.K.	Athletics	100 Metres, Flat.
"	"	"	200 " "
Schwarz, C.	Germany	"	100 " "
Swain, C.	Australasia	"	800 " "
"	"	"	1,500 " "
Svanstrom, F.	Finland	"	800 " "
"	"	"	1,500 " "
"	"	"	Relay Race.
Shaw, A. B.	U.S.A.	"	110 Metres, Hurdle.
Savage, E. B.	Canada	"	" " "
"	"	"	Running Broad Jump.
"	"	"	Hop, Step, and "
Schofield, S. C. A.	U.K.	"	10 Miles Walk.
Svanberg, J. F.	Sweden	"	1,500 Metres, Flat.
"	"	"	5 Miles Run.
"	"	"	Marathon Race.
"	"	"	3 Miles Team.
Stafford, L. H. G.	U.K.	"	Standing Broad Jump.
"	"	"	" High "
Szathmary, C.	Hungary	"	Running Broad "
"	"	"	" High "
"	"	"	Pole Jump.
Sandr� G. E.	France	"	Running Broad Jump.
"	"	"	" High "
Sandberg, C.	Sweden	"	Throwing the Hammer.
"	"	Wrestling	Graeco-Roman, Light Heavy.
Sauli, J.	Finland	Athletics	Putting the Weight.
"	"	"	Discus, Free Style.
"	"	"	" Greek "
"	"	"	Javelin, Free "
"	"	"	" Held in Middle.
Slade, W.	U.K.	"	Tug-of-War.
Sarel, S. L.	"	"	3,500 Metres Walk.
Stranz, J.	Hungary	"	Discus, Free Style.
"	"	"	" Greek "
"	"	"	Javelin, Free "
"	"	"	" Held in Middle.
Sander, H.	Denmark	Fencing	Ep�e, Individual.
"	"	"	" Team.
Sarzano, P.	Italy	"	" Individual.
"	"	"	" Team.
Sands, C. C.	U.S.A.	Tennis	Singles.
Skatteboe, G. G.	Norway	Shooting	International, Team.
"	"	"	1,000 Yards, Individual.

<i>Name</i>	<i>Country</i>	<i>Sport</i>	<i>Event</i>
Skatteboe, G. G.	Norway ..	Shooting ..	300 Metres, Team.
"	" ..	" ..	" " Individual.
"	" ..	" ..	Min. Rifle, Team.
"	" ..	" ..	" " Indiv., Stationary.
"	" ..	" ..	" " " Disappearing.
"	" ..	" ..	" " " Moving.
"	" ..	" ..	Running Deer, Team.
"	" ..	" ..	" " Indiv., Single Shot.
"	" ..	" ..	" " " Double Shot.
Szantics, G. ..	Hungary	Athletics ..	10 Miles Walk.
"	" ..	" ..	3,500 Metres Walk.
Schartau, F. A. O.	Sweden ..	Shooting ..	Min. Rifle, Team.
"	" ..	" ..	" " Indiv., Stationary.
"	" ..	" ..	" " " Disappearing.
"	" ..	" ..	" " " Moving.
"	" ..	" ..	Revolver and Pistol, Individual.
Staunton, Capt. H. G. L.	U. K. ..	" ..	" " " Team.
Sayer, R. H. ..	U.S.A. ..	" ..	" " " "
"	" ..	" ..	" " " Individual.
Santaguiliana, A.	Italy ..	" ..	Team, International.
"	" ..	" ..	1,000 Yards, Individual.
"	" ..	" ..	300 Metres, Team.
"	" ..	" ..	" " Individual.
Salmon, G... ..	Belgium	" ..	1,000 Yards, Individual.
"	" ..	" ..	300 Metres, Team.
"	" ..	" ..	" " Individual.
Sauveur, fils, H.	" ..	" ..	" " Team.
Swahn, H. G. A.	Sweden ..	" ..	Running Deer, Team.
"	" ..	" ..	" " Indiv., Single Shot.
"	" ..	" ..	" " " Double Shot.
"	" ..	Clay Bird Shooting	Individual.
"	" ..	" "	Team.
Swahn, O. G. ..	" ..	Shooting ..	Running Deer, Team.
"	" ..	" ..	" " Indiv., Single Shot.
"	" ..	" ..	" " " Double Shot.
"	" ..	Clay-Bird Shooting	Individual.
"	" ..	" "	Team.
Slava, D. .. ..	Bohemia	Lawn Tennis	Grass Courts, Men's Singles.
"	" ..	" "	" " " Doubles.
Santorinaios, J... ..	Greece ..	Cycling ..	660 Yards.
"	" ..	" ..	1,000 Metres.
"	" ..	" ..	5,000 "
"	" ..	" ..	20 Kilometres.
"	" ..	" ..	100 "
Saxtorph, H. C.	Denmark	Swimming	100 Metres.
"	"	"	400 "
"	"	"	Team Race.
Sharp, A. T. ..	U.K. ..	"	400 Metres.
Spanberg, A. ..	Sweden..	"	High Diving.
Satzanger, O. ..	Austria ..	"	Fancy "
Strauwen, P. ..	Belguim	"	Breast Stroke.

<i>Name</i>	<i>Country</i>	<i>Sport</i>	<i>Event</i>
Strauwen, P. . .	Belgium	Swimming	Water Polo.
Schaffhauser, B.	Hungary	"	" "
Schachitz, W. . .	Austria . .	"	" "
Shaw, P. . . .	U.K. . .	" . .	" "
Svam, F. F. C. . .	Denmark	Wrestling	Graeco-Roman, Light Heavy.
Saarela, Y. . . .	Finland . .	"	" Light "
Schwann, G. H. . .	U.K. . .	"	Catch-as-Catch-Can, Bantam.
Sarens, A. . . .	Belgium	Fencing . .	Epée, Individual.
Szanty, E. . . .	Hungary	" . .	" "
" . . . .	"	" . .	" Team.
" . . . .	"	" . .	Sabre, Individual.
" . . . .	"	" . .	" Team.
Schwarz-Nielsen, E.	Denmark	" . .	Epée, "
"	"	" . .	Sabre, Individual.
Salingne, L. A. . .	France . .	Archery . .	York Round.
"	" . .	" . .	Continental.
Sandberg, E. G. . .	Sweden . .	Yachting . .	8 Metres.
Sloane-Stanley, . .	U.K. . .	" . .	7 "
Capt. R.			
Saverne, E. . .	France . .	" . .	6 "
Sederman, C. V.	U.K. . .	Gymnastics	Team.
Skeeles, W. I. . .	" . .	"	"
Speight, J. . . .	" . .	"	"
Stell, H. . . .	" . .	"	"
Sewell, H. . . .	" . .	Athletics . .	3,200 Metres, Steeplechase.
Setterwall, G. . .	Sweden . .	Lawn Tennis	Covered Courts, Singles.
"	" . .	" "	" " Doubles.
Sellars, J. C. . .	U.K. . .	Shooting . .	1,000 Yards, Individual.
Spearing, Lt.-Col.	Canada . .	" . .	Team, International.
R. J.			
"	" . .	" . .	300 Metres, "
Steele, J. A. . .	" . .	" . .	1,000 Yards, Individual.
Sterry, Mrs. C. R.	U.K. . .	Lawn Tennis	Ladies' Singles.
Séguinaud, P. . .	France . .	Cycling . .	6th Yards.
"	" . .	" . .	1,000 Metres.
"	" . .	" . .	5,000 "
"	" . .	" . .	Pursuit Race.
Scheff, O. . . .	Austria . .	Swimming	100 Metres.
"	" . .	"	400 "
"	" . .	"	1,500 "
"	" . .	"	Water Polo.
Seidel, E. . . .	Germany	"	Breast Stroke.
Seward, E. . . .	U.K. . .	"	Back "
Steens, F. . . .	Belgium	Wrestling	Graeco-Roman, Light.
Sealey, G. H. . .	U.K. . .	"	Catch-as-Catch-Can, Bantam.
Stenberg, R. . .	Finland . .	Athletics . .	100 Metres, Flat.
"	" . .	" . .	200 " "
"	" . .	" . .	400 " "
"	" . .	" . .	800 " "
"	" . .	" . .	110 " Hurdle.
"	" . .	" . .	400 " "
"	" . .	" . .	Running Broad Jump.
"	" . .	" . .	Hop, Step, and "



<i>Name</i>	<i>Country</i>	<i>Sport</i>	<i>Event</i>
Stenberg, R. . .	Finland . .	Athletics . .	Relay Race.
Sebert, L. . . .	Canada . .	„ . .	100 Metres, Flat.
„ . . . .	„ . .	„ . .	200 „ „
„ . . . .	„ . .	„ . .	400 „ „
„ . . . .	„ . .	„ . .	Relay Race.
Sherman, N. A. . .	U.S.A. . .	„ . .	100 Metres, Flat.
„ . . . .	„ . .	„ . .	Running Broad Jump.
„ . . . .	„ . .	„ . .	Hop, Step, and „
Sherman, D. R. . .	„ . .	„ . .	200 Metres, Flat.
Stevens, . . . .	„ . .	„ . .	100 „ „
Scheer, C. . . .	Hungary	„ . .	„ „ „
„ . . . .	„ . .	„ . .	200 „ „
„ . . . .	„ . .	„ . .	Relay Race.
Stenberg, K. . .	Sweden . .	„ . .	100 Metres, Flat.
„ . . . .	„ . .	„ . .	200 „ „
„ . . . .	„ . .	„ . .	400 „ „
„ . . . .	„ . .	„ . .	Running Broad Jump.
„ . . . .	„ . .	„ . .	Relay Race.
Sheean, F. P. . .	U.S.A. . .	„ . .	800 Metres, Flat.
Shepperd, M. W.	„ . .	„ . .	800 „ „
„ . . . .	„ . .	„ . .	1,500 „ „
„ . . . .	„ . .	„ . .	400 „ Hurdle.
„ . . . .	„ . .	„ . .	Relay Race.
Shee, W. A. . . .	S. Africa	„ . .	1,500 Metres, Flat.
„ . . . .	„ . .	„ . .	5 Miles Run.
Stevens, C. E. . .	„ . .	„ . .	Marathon Race.
„ . . . .	„ . .	„ . .	Javelin, Free Style.
Stevenson, S. . .	U.K. . .	„ . .	Marathon Race.
„ . . . .	„ . .	„ . .	5 Miles Run.
Sheridan, M. J. . .	U.S.A. . .	„ . .	Standing Broad Jump.
„ . . . .	„ . .	„ . .	„ High „
„ . . . .	„ . .	„ . .	Hop, Step, and „
„ . . . .	„ . .	„ . .	Putting the Weight.
„ . . . .	„ . .	„ . .	Tug-of-War.
„ . . . .	„ . .	„ . .	Discus, Free Style.
„ . . . .	„ . .	„ . .	„ Greek „
„ . . . .	„ . .	„ . .	Javelin, Free „
„ . . . .	„ . .	„ . .	„ Held in Middle.
Szande, A. . . .	Hungary	„ . .	Standing Broad Jump.
„ . . . .	„ . .	„ . .	„ High „
„ . . . .	„ . .	„ . .	Running Broad Jump.
Stephenson, B. T.	U.S.A. . .	„ . .	Running Broad Jump.
„ . . . .	„ . .	„ . .	„ High „
„ . . . .	„ . .	„ . .	Hop, Step, and „
„ . . . .	„ . .	„ . .	Putting the Weight.
„ . . . .	„ . .	„ . .	Tug-of-War.
Steiner, E. . . .	France . .	„ . .	Running Broad Jump.
„ . . . .	„ . .	„ . .	110 Metres, Hurdle.
Szegedy, G. . . .	Hungary	„ . .	Running High Jump.
Sherman, B. F. . .	U.S.A. . .	„ . .	Throwing the Hammer.
„ . . . .	„ . .	„ . .	Tug-of-War.
„ . . . .	„ . .	„ . .	Javelin, Free Style.
„ . . . .	„ . .	„ . .	„ Held in Middle.
Sjekelihidy, E. . .	Hungary	„ . .	Putting the Weight.

<i>Name</i>	<i>Country</i>	<i>Sport</i>	<i>Event</i>
Shepherd, J.	U.K.	Athletics	Tug-of-War.
Schejbal, F.	Bohemia	Fencing	Epée, Individual.
"	"	"	" Team.
"	"	"	Sabre, Individual.
"	"	"	" Team.
Spencer, C. A.	U.K.	Athletics	10 Miles Walk.
Speciale, P.	Italy	Fencing	Epée, Individual.
"	"	"	" Team.
Seligman, E.	U.K.	"	" Individual.
"	"	"	" Team.
Sénat, Capt.	France	"	" Individual.
Stern, J.	"	"	" Team.
Stewart-Savile, R.	U.K.	Yachting	7 Metres.
Sprenger, H. O.	"	Wrestling	Catch-as-Catch-Can, Bantam.
Shepherd, W. H.	"	"	" " " Light.
Specz, E.	Hungary	Gymnastics	Individual.
Segurra, L.	France	"	"
Steuernagel, A. C.	Germany	"	"
Stenberg, K.	Finland	"	Team.
Smeds, V.	"	"	"
Steffe, E.	France	"	"
Swertsen, S. J.	Norway	"	"
Smevik, H. J.	"	"	"
Svensson, K.	Sweden	"	"
Seger, A.	"	"	"
Seger, Alex.	"	"	"
Stjernstets, Y.	"	"	"
Stiffens, H.	Norway	Yachting	8 Metres.
Sipila, E. E.	Finland	Gymnastics	Team.
Sibenhaar, H.	Germany	"	Individual.
"	"	"	Tug-of-War.
Simon, W.	"	"	Individual.
"	"	"	Team.
"	"	"	Tug-of-War.
Smith, Miss G. E.	U.K.	Lawn Tennis	Covered Courts, Singles.
Simon, H.	U.S.A.	Shooting	Team, International.
"	"	"	1,000 Yards, Individual.
"	"	"	300 Metres, Team.
"	"	"	300 Individual.
Smith, W. A.	Canada	"	Team, International.
"	"	"	300 Metres, Team.
Spittal, Lt. C. D.	"	"	Team, International
"	"	"	300 Metres, Team.
Schmid, O.	Hungary	Lawn Tennis	Grass Courts, Men's Singles.
"	"	"	Doubles.
Skinner, G. H.	U.K.	Clay Bird Shooting	Team. " "
Schilles, M.	France	Cycling	660 Yards.
"	"	"	1,000 Metres.
"	"	"	5,000 Pursuit Race.
"	"	"	2,000 Metres, Tandem.
Springfield, F. W.	Australasia	Swimming	400 "
"	"	"	1,500 "

<i>Name</i>	<i>Country</i>	<i>Sport</i>	<i>Event</i>
Springfield, F. W.	Australasia	Swimming	Team Race.
Smith, C. S.	U.K.	"	Water Polo.
Slim, J. P.	"	Wrestling	Graeco-Roman, Light.
"	"	"	Catch-as-Catch-Can, Feather.
Snijdoodk, M.	Holland	"	Graeco-Roman, Light.
Sint, J.	"	"	" Middle.
Slier, J.	"	Gymnastics	Individual.
"	"	"	Team.
Stikkelman, J.	"	"	Individual.
"	"	"	Team.
Smith, C. W.	U.K.	"	Individual.
Silverstrand, C.	Sweden	"	Team.
"	"	Athletics	Running Broad Jump.
"	"	"	" High "
"	"	"	Hop, Step, and "
"	"	"	Pole Jump.
Schmitt, J.H.A.G.	Holland	Gymnastics	Team.
Smith, J. M.	U.K.	Athletics	1,500 Metres, Flat.
Spitzer, R. A.	U.S.A.	"	3,200 " Steeplechase.
Smithson, F. C.	"	"	100 " Flat.
"	"	"	110 " Hurdle.
Simon, P.	Hungary	"	100 " Flat.
"	"	"	200 " "
"	"	"	Relay Race.
Simpson, F.	Canada	"	5 Miles Run.
"	"	"	Marathon Race.
Szigiti, E.	Hungary	"	Running High Jump.
Smith, G.	U.K.	"	Tug-of-War.
Swindlehurst, T.	"	"	"
Spiegler, E.	Austria	"	3,500 Metres Walk.
"	"	"	10 Miles Walk.
Six, H.	Belgium	Fencing	Sabre, Individual.
"	"	"	" Team.
Simonson, A.	"	"	" Individual.
"	"	"	" Team.
Smith, F. R.	U.K.	Yachting	6 Metres.
Simond, G. M.	"	Lawn Tennis	Covered Courts, Doubles.
Sjeberg, G. A.	Sweden	Shooting	Team, International.
"	"	"	1,000 Yards, Individual.
"	"	"	300 Metres, Team.
"	"	"	" " Individual.
"	"	"	Min. Rifle, Team.
"	"	"	" " Indiv., Stationary.
"	"	"	" " " Disappearing.
"	"	"	" " " Moving.
Sotor, O.	Norway	"	Team, International.
"	"	"	1,000 Yards, Individual.
"	"	"	300 Metres, Team.
"	"	"	" " Individual.
"	"	"	Min. Rifle, Team.
"	"	"	" " Indiv., Stationary,
"	"	"	" " " Disappearing.
"	"	"	" " " Moving.
"	"	"	Running Deer, Team.

<i>Name</i>	<i>Country</i>	<i>Sport</i>	<i>Event</i>
Sotor, O. . . .	Norway . .	Shooting . .	Running Deer, Individ., Single Shot.
" " " "	" " "	" " "	" " " Double Shot.
Sother, O. . . .	" " "	" " "	Team, International.
" " " "	" " "	" " "	1,000 Yards, Individual.
" " " "	" " "	" " "	300 Metres, Team.
" " " "	" " "	" " "	" " Individual.
" " " "	" " "	" " "	Min. Rifle, Team.
" " " "	" " "	" " "	" " Individ., Stationary.
" " " "	" " "	" " "	" " " Disappearing.
" " " "	" " "	" " "	" " " Moving.
" " " "	" " "	" " "	Running Deer, Team.
" " " "	" " "	" " "	" " Individ., Single Shot.
" " " "	" " "	" " "	" " " Double Shot.
Storms, R. . . .	Belgium	" " "	Revolver and Pistol, Team.
" " " "	" " "	" " "	" " " Individual.
" " " "	" " "	Clay Bird	Team.
		Shooting	
Schomberg, H. . .	Germany	Lawn Tennis	Grass Courts, Men's, Singles.
" " " "	" " "	" " "	" " " Doubles.
Soupart, E. . . .	Belgium	Clay Bird	Individual.
		Shooting	
" " " "	" " "	" " "	Team.
Shore, F. . . .	S. Africa	Cycling . .	660 Yards.
" " " "	" " "	" " "	1,000 Metres.
" " " "	" " "	" " "	5,000 "
" " " "	" " "	" " "	20 Kilometres.
Schöneich, R. . .	Germany	Gymnastics	Individual.
" " " "	" " "	" " "	Team.
" " " "	" " "	Athletics .	Tug-of-War.
Soinio, K. . . .	Finland .	Gymnastics	Team.
Schmoll, E. . . .	France . .	" " "	" " "
Scjblom, A. . . .	Sweden . .	" " "	" " "
Srovik, B. . . .	" " "	" " "	" " "
Sorvik, H. . . .	" " "	" " "	" " "
Scott, D. . . .	U.K. . . .	" " "	" " "
Scoutarides, G. .	Greece . .	Athletics .	100 Metres, Flat.
" " " "	" " "	" " "	110 " Hurdle.
" " " "	" " "	" " "	Tug-of -War.
" " " "	" " "	" " "	Relay Race.
Schönecker, E. .	Austria . .	" " "	100 Metres, Flat.
" " " "	" " "	" " "	200 " "
Soudijn, P. N. . .	Holland .	" " "	10 Miles Walk.
" " " "	" " "	" " "	3,500 Metres Walk.
Schommer, J. . .	U.S.A. . .	" " "	Standing Broad Jump.
" " " "	" " "	" " "	" " High "
" " " "	" " "	" " "	Running " "
" " " "	" " "	" " "	Hop, Step, and "
" " " "	" " "	" " "	Putting the Weight.
" " " "	" " "	" " "	Javelin, Free Style.
" " " "	" " "	" " "	" " Held in Middle.
Somody, E. . . .	Hungary	" " "	Running Broad Jump.
" " " "	" " "	" " "	" " High "
Söderstrom, B. .	Sweden . .	" " "	Pole Jump.
" " " "	" " "	" " "	Javelin, Free Style.

<i>Name</i>	<i>Country</i>	<i>Sport</i>	<i>Event</i>
Söderstrom, B. . .	Sweden . .	Athletics . .	Javelin, Held in Middle.
Soneck, F. . . . .	Bohemia	„ . .	Putting the Weight.
„ . . . . .	„	„ . .	Discus, Free Style.
„ . . . . .	„	„ . .	„ Greek „
„ . . . . .	„	„ . .	Javelin, Free „
„ . . . . .	„	„ . .	„ Held in Middle.
Stöhr, G. . . . .	Germany	Fencing . .	Epée, Individual.
„ . . . . .	„	„ . .	„ Team.
„ . . . . .	„	„ . .	Sabre, Individual.
„ . . . . .	„	„ . .	„ Team.
Schön, E. . . . .	„	„ . .	Epée, Individual.
„ . . . . .	„	„ . .	„ Team.
„ . . . . .	„	„ . .	Sabre, Individual.
„ . . . . .	„	„ . .	„ Team.
„ . . . . .	„	„ . .	Foils, Display.
Schoemaker, R. L. A.	Holland . .	„ . .	Sabre, Individual.
Stopford, Rev. J. T. S.	U.K. . .	Archery . .	York Round.
Sjorgen, K. E. . .	Sweden . .	Yachting . .	6 Metres.
Stuyck, F. . . . .	Belgium	Fencing . .	Epée, Individual.
Schultz, H. . . . .	Denmark	Shooting . .	Team, International.
„ . . . . .	„	„ . .	1,000 Yards, Individual.
„ . . . . .	„	„ . .	300 Metres, Team.
„ . . . . .	„	„ . .	„ „ Individual.
„ . . . . .	„	„ . .	Min. Rifle, Team.
„ . . . . .	„	„ . .	„ „ Indiv.. Stationary.
„ . . . . .	„	„ . .	„ „ „ Disappearing.
„ . . . . .	„	„ . .	„ „ „ Moving.
Suckling, H. M. . .	Canada . .	Lawn Tennis	Grass Courts, Men's Singles.
Schulze, P. . . . .	Germany	Cycling . .	660 Yards.
„ . . . . .	„	„ . .	1,000 Metres.
„ . . . . .	„	„ . .	5,000 „
„ . . . . .	„	„ . .	20 Kilometres.
„ . . . . .	„	„ . .	100 „
„ . . . . .	„	„ . .	Pursuit Race.
„ . . . . .	„	„ . .	2,000 Metres, Tandem.
Summers, G. F. . .	U.K. . .	„ . .	660 Yards.
„ . . . . .	„ . .	„ . .	1,000 Metres.
Struby, A. . . . .	Switzerland	Wrestling	Graeco-Roman, Light.
„ . . . . .	„	„	Catch-as-Catch-Can, Light.
„ . . . . .	„	Athletics . .	Javelin, Free Style.
Sustera, M. . . . .	Bohemia	Wrestling	Graeco-Roman, Heavy.
„ . . . . .	„	Athletics . .	Putting the Weight.
„ . . . . .	„	„ . .	Discus, Free Style.
„ . . . . .	„	„ . .	„ Greek „
„ . . . . .	„	„ . .	Javelin, Free „
„ . . . . .	„	„ . .	„ Held in Middle.
Stupart, D. A. . .	S. Africa	„ . .	110 Metres, Hurdle.
„ . . . . .	„	„ . .	400 „ „
„ . . . . .	„	„ . .	Standing Broad Jump.
„ . . . . .	„	„ . .	„ High „
„ . . . . .	„	„ . .	Running Broad „
„ . . . . .	„	„ . .	„ High „

<i>Name</i>	<i>Country</i>	<i>Sport</i>	<i>Event</i>
Stupart, D. A. . .	S. Africa	Athletics..	Hop, Step, and Jump.
" "	" "	" "	Pole Jump.
" "	" "	" "	Putting the Weight.
" "	" "	" "	Discus, Free Style.
" "	" "	" "	" Greek "
" "	" "	" "	Javelin, Free "
" "	" "	" "	" Held in Middle.
Szücs, G. . . . .	Hungary	Gymnastics	Individual.
Schuberth, E. . .	" "	Athletics..	100 Metres, Flat.
" "	" "	" "	300 " "
" "	" "	" "	Relay Race.
Sutton, H. . . . .	Australasia	" "	800 Metres, Flat.
Sullivan, J. P. . .	U.S.A. . .	" "	1,500 " "
Sutton, H. C. . .	U.K. . .	Yachting . .	8 Metres.
Stuart-Little, A.	" "	" "	" "
Skymoen, O. . . .	Norway..	Shooting..	Team, International.
" "	" "	" "	1,000 Yards, Individual.
" "	" "	" "	300 Metres, Team.
" "	" "	" "	" " Individual.
" "	" "	" "	Min. Rifle, Team.
" "	" "	" "	" " Indiv., Stationary.
" "	" "	" "	" " " Disappearing.
" "	" "	" "	" " " Moving.
" "	" "	" "	Running Deer, Team.
" "	" "	" "	" " Indiv., Single Shot.
" "	" "	" "	" " " Double Shot.
Styles, W. K. . . .	U.K. . .	" "	Min. Rifle, Indiv., Disappearing.
" "	" "	" "	" " " Moving.
Smyrk, N. H. . . .	" "	Swimming	High Diving
" "	" "	" "	Fancy "
Syners, A. . . . .	Belgium	" "	Water Polo.
Syvtersen, O. . .	Norway . .	Gymnastics	Team.
Skystad, W. . . .	" "	Athletics..	110 Metres, Hurdle.
" "	" "	" "	Standing Broad Jump.
Tatham, C. E. . . .	U.K. . .	Tennis . .	Singles.
Taylor, A. E. . . .	" "	Shooting . .	Min. Rifle, Team.
" "	" "	" "	" " Indiv., Stationary.
Tayntor, C. E. . .	U.S.A. . .	" "	Revolver and Pistol, Team.
" "	" "	" "	" " " Individual.
Tavelli, L. . . . .	Italy . .	" "	" " " Team.
" "	" "	" "	" " " Individual.
Tazer, K. . . . .	Finland .	Clay Bird	Individual.
Tartakover, T. . .	" "	Shooting	" "
" "	Australasia	Swimming	100 Metres.
" "	" "	" "	400 "
" "	" "	" "	1,500 "
" "	" "	" "	Team Race.
Taylor, H. . . . .	U.K. . .	" "	400 Metres.
" "	" "	" "	1,500 "
" "	" "	" "	Team Race.
Taube, . . . . .	France . .	" "	1,500 Metres.

<i>Name</i>	<i>Country</i>	<i>Sport</i>	<i>Event</i>
Taylor, A. J. ..	U.K. ..	Swimming	Fancy Diving.
Taylor, J. R. ..	" ..	" ..	Back Stroke.
Tagg, W. ..	" ..	Wrestling	Catch-as-Catch-Can, Feather.
Talbot, L. J. ..	U.S.A. ..	" ..	" .. Heavy,
" ..	" ..	Athletics ..	Throwing the Hammer.
" ..	" ..	" ..	Putting the Weight.
" ..	" ..	" ..	Tug-of-War.
" ..	" ..	" ..	Discus, Free Style.
" ..	" ..	" ..	" Greek "
" ..	" ..	" ..	Javelin, Free "
" ..	" ..	" ..	" Held in Middle.
Taddio, G. ..	Italy ..	Gymnastics	Team.
Taylor, J. B. ..	U.S.A. ..	Athletics ..	400 Metres, Flat.
" ..	" ..	" ..	Relay Race.
Tarella, G. ..	Italy ..	" ..	400 Metres, Flat.
Tait, J. L. ..	Canada ..	" ..	1,500 "
" ..	" ..	" ..	3,200 " Steeplechase.
" ..	" ..	" ..	5 Miles Run.
" ..	" ..	" ..	Marathon Race.
" ..	" ..	" ..	3 Miles. Team.
" ..	" ..	" ..	Relay Race.
Tammas, W. B	U.K. ..	" ..	Tug-of-War.
Taylor, A. ..	" ..	" ..	"
Taylor, J. ..	" ..	" ..	"
Tape, A. L. V. ..	Belgium	Fencing ..	Epée, Individual.
" ..	" ..	" ..	" Team.
Thackwell, Miss	U.K. ..	Archery ..	National Round.
Theophilakis, A.	Greece ..	Shooting..	Team, International.
" ..	" ..	" ..	1,000 Yards, Individual.
" ..	" ..	" ..	300 Metres, Team.
" ..	" ..	" ..	" " Individual.
" ..	" ..	" ..	Min. Rifle, Team.
" ..	" ..	" ..	" " Individ., Stationary.
" ..	" ..	" ..	" " " Disappearing.
" ..	" ..	" ..	" " " Moving.
" ..	" ..	" ..	Revolver and Pistol, Team.
" ..	" ..	" ..	" " " Individual.
" ..	" ..	" ..	Running Deer, Individ., Single Shot
" ..	" ..	" ..	" " " Double
Theophilakis, J.	" ..	" ..	Team, International.
" ..	" ..	" ..	300 Metres, Team.
" ..	" ..	" ..	" " Individual.
" ..	" ..	" ..	Min. Rifle, Team.
" ..	" ..	" ..	" " Individ., Stationary.
" ..	" ..	" ..	" " " Disappearing.
" ..	" ..	" ..	" " " Moving.
" ..	" ..	" ..	Revolver and Pistol, Team.
" ..	" ..	" ..	Running Deer, Individ., Single Shot.
" ..	" ..	" ..	" " " Double
Tétart, L. E. ..	France ..	" ..	Min. Rifle, Individ., Stationary.
" ..	" ..	" ..	" " " Disappearing.
" ..	" ..	" ..	" " " Moving.
" ..	" ..	" ..	Running Deer, Individ., Single Shot.
" ..	" ..	" ..	" " " Double

<i>Name</i>	<i>Country</i>	<i>Sport</i>	<i>Event</i>
Texier, M. . . . .	France . .	Cycling . .	660 Yards.
„ . . . . .	„ . .	„ . .	1,000 Metres.
„ . . . . .	„ . .	„ . .	5,000 „
„ . . . . .	„ . .	„ . .	Pursuit Race.
„ . . . . .	„ . .	„ . .	2,000 Metres, Tandem.
Texier, P. . . . .	„ . .	„ . .	20 Kilometres.
„ . . . . .	„ . .	„ . .	100 „
„ . . . . .	„ . .	„ . .	2,000 Metres, Tandem.
Threlfall, C. H.	U.K. . .	„ . .	Pursuit Race.
Theuriet, A. . . . .	France . .	Swimming	400 Metres.
„ . . . . .	„ . .	„ . .	1,500 „
Téger, M. . . . .	Hungary	Wrestling,	Graeco-Roman, Light.
Teivonen, E. . . . .	Finland. .	Gymnastics	Individual.
Termanani, G. . . . .	Italy . .	„ . .	Team.
Tremeer, L. F. . . . .	U.K. . .	Athletics . .	400 Metres, Hurdle.
Theunissen, W. F.	Holland . .	„ . .	5 Miles Run.
„ . . . . .	„ . .	„ . .	Marathon Race.
„ . . . . .	„ . .	„ . .	3 Miles Team.
Tewanima, L. . . . .	U.S.A. . .	„ . .	Marathon Race.
Triantafyllidis, M.	Greece . .	Shooting . .	Team, International.
„ . . . . .	„ . .	„ . .	1,000 Yards, Individual.
„ . . . . .	„ . .	„ . .	300 Metres, Team.
„ . . . . .	„ . .	„ . .	„ „ Individual.
„ . . . . .	„ . .	„ . .	Min. Rifle, Team.
„ . . . . .	„ . .	„ . .	„ „ Indiv., Stationary.
„ . . . . .	„ . .	„ . .	„ „ „ Disappearing.
„ . . . . .	„ . .	„ . .	„ „ „ Moving.
„ . . . . .	„ . .	„ . .	Revolver and Pistol, Team.
„ . . . . .	„ . .	„ . .	„ „ „ Individual.
„ . . . . .	„ . .	„ . .	Running Deer, Indiv., Single Shot.
„ . . . . .	„ . .	„ . .	„ „ „ Double „
Tippins, J. . . . .	U.K. . .	„ . .	Team, International.
Ticchi, R. . . . .	Italy . .	„ . .	„ „
„ . . . . .	„ . .	„ . .	1,000 Yards, Individual.
„ . . . . .	„ . .	„ . .	300 Metres, Team.
„ . . . . .	„ . .	„ . .	„ „ Individual.
„ . . . . .	„ . .	„ . .	Revolver and Pistol, Team.
„ . . . . .	„ . .	„ . .	„ „ „ Individual.
Triebisch, M. . . . .	Germany	Cycling . .	660 Yards;
„ . . . . .	„ . .	„ . .	1,000 Metres.
„ . . . . .	„ . .	„ . .	5,000 „
„ . . . . .	„ . .	„ . .	20 Kilometres.
„ . . . . .	„ . .	„ . .	100 „
„ . . . . .	„ . .	„ . .	Pursuit Race.
„ . . . . .	„ . .	„ . .	2,000 Metres, Tandem.
Titt, W. . . . .	U.K. . .	Gymnastics	Team.
Trieloff, Dr. O. P.	Germany	Athletics . .	200 Metres, Flat.
„ . . . . .	„ . .	„ . .	400 „ „
„ . . . . .	„ . .	„ . .	Relay Race.
Thibeau, A. . . . .	U.S.A. . .	„ . .	Marathon Race.
Tsilitiras, C. . . . .	Greece . .	„ . .	Standing Broad Jump.
„ . . . . .	„ . .	„ . .	„ High „
„ . . . . .	„ . .	„ . .	Running „ „
„ . . . . .	„ . .	„ . .	Tug-of-War.



<i>Name</i>	<i>Country</i>	<i>Sport</i>	<i>Event</i>
Tison, A. . . .	France . .	Athletics . .	Putting the Weight.
" " " "	" " "	" "	Discus, Free Style.
" " " "	" " "	" "	" " Greek "
" " " "	" " "	" "	Javelin, Free "
" " " "	" " "	" "	" " Held in Middle.
Tisseux, E. . . .	" " "	Archery . .	Continental.
Thomas, R. . . .	" " "	Shooting . .	Team, International.
" " " "	" " "	" "	1,000 Yards, Individual.
" " " "	" " "	" "	300 Metres, Team.
" " " "	" " "	" "	" " Individual.
" " " "	" " "	" "	Min. Rifle, Team.
" " " "	" " "	" "	" " Indiv., Stationary.
" " " "	" " "	" "	" " " " 'Disappearing.
" " " "	" " "	" "	" " " " Moving.
" " " "	" " "	" "	Running Deer, Indiv., Single Shot.
" " " "	" " "	" "	" " " " Double "
Thorburn, R. M.	U.K. . .	" "	Individual, 1,000 Yards.
Tóth, E. . . .	Hungary	Lawn Tennis	Grass Courts, Men's Singles.
" " " "	" " "	" " "	" " " " Doubles.
Todt, C. . . .	Germany	Cycling . .	660 Yards.
" " " "	" " "	" "	1,000 Metres.
" " " "	" " "	" "	5,000 "
" " " "	" " "	" "	20 Kilometres.
" " " "	" " "	" "	100 "
Trousselier, A. . . .	France . .	" "	20 "
" " " "	" " "	" "	100 "
Tobias, Z. . . .	Hungary	Swimming	Team Race.
" " " "	" " "	" "	400 Metres.
Toldy, O. . . .	" " "	" "	Breast Stroke.
Thould, T. H. . . .	U.K. . .	" "	Water Polo.
Tol, J. E. . . .	Holland . .	Wrestling	Graeco-Roman, Heavy.
Tomkins, F. . . .	U.K. . .	" "	Catch-as-Catch-Can, Bantam.
Torstensen, T., Jr.	Norway . .	Gymnastics	Team.
Torssén, S. . . .	Sweden . .	" "	" "
Toldy, G. . . .	Hungary	Athletics . .	100 Metres, Flat.
" " " "	" " "	" "	200 " "
" " " "	" " "	" "	Relay Race.
Törnros, G. . . .	Sweden . .	" "	Marathon Race.
Thompson, F. B.	U.K. . .	" "	" "
Torretta, G. . . .	Italy . .	" "	Running Broad Jump.
" " " "	" " "	" "	" " High "
" " " "	" " "	" "	100 Metres, Flat.
Tronner, H. . . .	Austria . .	" "	Putting the Weight.
" " " "	" " "	" "	Discus, Free Style.
Toth, Dr. P. . . .	Hungary	Fencing . .	Epée, Individual.
" " " "	" " "	" "	" " Team.
" " " "	" " "	" "	Sabre, Individual.
" " " "	" " "	" "	" " Team.
" " " "	" " "	" "	Foils, Display.
Thomahlen, E. G.	Sweden . .	Yachting . .	8 Metres.
Tuijt, J. . . .	Holland . .	Wrestling	Graeco-Roman, Heavy.
Tucek, F. . . .	Bohemia	Fencing . .	Epée, Individual.
" " " "	" " "	" "	" " Team.
" " " "	" " "	" "	Sabre, Individual.

<i>Name</i>	<i>Country</i>	<i>Sport</i>	<i>Event</i>
Tucek, F. . . .	Bohemia	Fencing . .	Sabre, Team.
Tumbacz, L. . .	Hungary	Athletics . .	10 Miles Walk.
" . . . .	" . . . .	" . . . .	3,500 Metres Walk.
Trube, H. L. . .	U.S.A. . .	" . . . .	1,500 " "
" . . . .	" . . . .	" . . . .	3,200 " Flat.
" . . . .	" . . . .	" . . . .	5 Miles Run.
" . . . .	" . . . .	" . . . .	3 Miles, Team Race.
Tuiskunen, H. H.	Finland . .	Shooting . .	300 Metres, Team.
Trubenbach, C. D.	U.S.A. . .	Swimming	100 Metres.
" . . . .	" . . . .	" . . . .	400 " "
" . . . .	" . . . .	" . . . .	Team Race.
Tuijt, C. D. H. . .	Holland . .	Wrestling	Graeco-Roman, Middle.
Thurnheer, G. . .	France . .	Gymnastics	Individual.
Türi, V. E. . . .	Finland . .	" . . . .	Team.
Turi-Nielsen, N.	Denmark	" . . . .	" . . . .
Thuesen, M. . . .	" . . . .	" . . . .	" . . . .
Tyldsley, A. . . .	U.K. . . .	Swimming	100 Metres.
Tyfa, J. . . . .	Bohemia	Wrestling	Graeco-Roman, Middle.
Thysen, H. J. F.	Holland . .	Gymnastics	Individual.
" . . . .	" . . . .	" . . . .	Team.
Tysall, W. . . . .	U. K. . . .	" . . . .	Individual.
Tvrsky, W. . . . .	Bohemia	Fencing . .	Epée, Individual.
" . . . .	" . . . .	" . . . .	Team.
" . . . .	" . . . .	" . . . .	Sabre, Individual.
" . . . .	" . . . .	" . . . .	Team.
Uctviller, L. . .	Germany	Athletics . .	Standing Broad Jump.
" . . . .	" . . . .	" . . . .	High "
" . . . .	" . . . .	" . . . .	Throwing the Hammer.
" . . . .	" . . . .	" . . . .	Discus, Free Style.
" . . . .	" . . . .	" . . . .	" Greek "
" . . . .	" . . . .	" . . . .	Javelin, Free "
Unwin, F. A. . . .	U.K. . . .	Swimming	400 Metres.
" . . . .	" . . . .	" . . . .	Back Stroke.
Ulton, F. W. . . .	Canada . .	Shooting . .	Team, International.
" . . . .	" . . . .	" . . . .	1,000 Yards, Individual.
" . . . .	" . . . .	" . . . .	300 Metres, Team.
Ullstrom, A. W.	Finland . .	Swimming	High Diving.
" . . . .	" . . . .	" . . . .	Fancy "
van Altenburg, C.	Holland . .	Shooting . .	300 Metres, Team.
" . . . .	" . . . .	" . . . .	Individual.
van Asbroch, P.	Belgium	" . . . .	" " Team.
" . . . .	" . . . .	" . . . .	Individual.
" . . . .	" . . . .	" . . . .	Revolver and Pistol, Individual.
" . . . .	" . . . .	" . . . .	Team.
van Asbrock, J.	" . . . .	" . . . .	" " " Individual.
" . . . .	" . . . .	" . . . .	Team.
van den Bergh, G. A.	Holland . .	" . . . .	300 Metres, Team.
" . . . .	" . . . .	" . . . .	Individual.

<i>Name</i>	<i>Country</i>	<i>Sport</i>	<i>Event</i>
van Benthem, J.	Belgium	Cycling ..	660 Yards.
"	"	" ..	1,000 Metres.
"	"	" ..	5,000 "
"	"	" ..	20 Kilometres.
"	"	" ..	100 "
"	"	" ..	Pursuit Race.
"	"	" ..	2,000 Metres, Tandem.
van Boden, J. H.	Holland ..	Wrestling	Graeco-Roman, Heavy.
van Drakestein, J.V.	" ..	Cycling ..	660 Yards.
"	" ..	" ..	1,000 Metres.
"	" ..	" ..	5,000 "
"	" ..	" ..	20 Kilometres.
"	" ..	" ..	100 "
"	" ..	" ..	Pursuit Race.
van den Dries, W.	U.S.A. ..	" ..	660 Yards.
"	" ..	" ..	1,000 Metres.
"	" ..	" ..	5,000 "
"	" ..	" ..	20 Kilometres.
"	" ..	" ..	100 "
"	" ..	" ..	Pursuit Race.
"	" ..	" ..	2,000 Metres, Tandem.
van Dongen, P. H.	Holland ..	Wrestling	Graeco-Roman, Heavy.
van Daalen, C. ..	" ..	Gymnastics	Individual.
"	" ..	" ..	Team.
van Ederen, C. ..	" ..	Wrestling	Graeco-Roman, Middle.
van Guysee, J.C.	Belgium	Gymnastics	Individual.
van der Kop, J. ..	Holland ..	Shooting ..	300 Metres, Team.
"	" ..	" ..	" " Individual.
"	" ..	" ..	Revolver and Pistol, Team.
"	" ..	" ..	" " " Individual.
van der Kaaij, J. L.	" ..	Wrestling	Graeco-Roman, Light.
van Lennep, R. ..	" ..	Lawn Tennis	Grass Courts, Men's Singles.
"	" ..	" ..	" " " Doubles.
van Lennep, C. ..	" ..	" ..	" " " Singles.
"	" ..	" ..	" " " Doubles.
van Leeuwen, H. N.	" ..	Gymnastics	Individual.
"	" ..	" ..	Team.
"	" ..	Athletics ..	Standing High Jump.
"	" ..	" ..	Running " "
van Lobensels, M. J.	" ..	Fencing ..	Epée, Individual.
"	" ..	" ..	Sabre, "
"	" ..	" ..	" Team.
van Langenhove, M.	Belgium	" ..	Epée, Individual.
van der Meer, H. A.	Holland	Shooting ..	300 Metres, Team.
"	" ..	" ..	" " Individual.
van Moppes, J. ..	" ..	Wrestling	Graeco-Roman, Light.
van Minden, L. ..	" ..	Fencing ..	Sabre, Individual.
van Oosten, L. ..	" ..	Wrestling	Graeco-Roman, Heavy.
van Pallandt Eerde, Baron	" ..	Clay Bird Shooting	Individual.
"	" ..	" ..	Team.
van Rossen, G. ..	" ..	Fencing ..	Epée, Individual.
"	" ..	" ..	" Team.
"	" ..	" ..	Sabre, Individual.

<i>Name</i>	<i>Country</i>	<i>Sport</i>	<i>Event</i>
van Rossen, G. . .	Holland . .	Fencing . .	Sabre, Team.
van Spengen, J. J.	„ . .	Cycling . .	660 Yards.
„	„ . .	„ . .	1,000 Metres.
„	„ . .	„ . .	5,000 „
„	„ . .	„ . .	20 Kilometres.
„	„ . .	„ . .	Pursuit Race.
van Schreven, J. T. C.	„ . .	Fencing . .	Epée, Individual.
„	„ . .	„ . .	Sabre, „
van Tilt, L. . .	Belgium	Clay Bird Shooting	Individual.
„	„	„	Team.
van Tomme, A.	„	Fencing . .	Sabre, Individual.
„	„	„ . .	„ Team.
van Voorst Tot . .	Holland . .	Clay Bird Shooting	Individual.
F. Voorst, Baron	„ . .	„ . .	Team.
van Voorst Tot	„ . .	„ . .	Individual.
Voorst, Baron E.V.L.	„ . .	„ . .	Team.
van der Vliet, C. J.	Holland . .	„ . .	Individual.
„	„ . .	„ . .	Team.
van Veenhuysen, C.	„ . .	Athletics . .	Standing High Jump.
„	„ . .	„ . .	Running „ „
„	„ . .	„ . .	Pole Jump.
van der Vooedt, J.	Belgium	Fencing . .	Sabre, Individual.
„	„	„ . .	„ Team.
van Waas, P. . .	Holland . .	Shooting . .	300 Metres, Team.
„	„ . .	„ . .	„ „ Individual.
van Westerop, J.	„ . .	Wrestling	Graeco-Roman, Heavy.
van der Wal, H. J.	„ . .	Athletics . .	Relay Race.
van Hulstijn, G. A.	„ . .	Fencing . .	Sabre, Individual.
Varley, F. E. . .	U.K. . .	Shooting . .	Team, International.
Velario, C. . . .	Italy . .	„ . .	Revolver and Pistol, Team.
„ . . . .	„ . .	„ . .	„ „ „ Individual.
Vasseur, P. . . .	France . .	Swimming	100 Metres.
„ . . . .	„ . .	„	1,500 „
Vaczi, I. . . .	Hungary	„	Breast Stroke.
Vass, E. . . .	„	Wrestling	Graeco-Roman, Light.
Vaccari, G. . . .	Italy . .	Gymnastics	Team.
Vangel, J. . . .	Hungary	Athletics . .	400 Metres, Flat.
„ . . . .	„ . .	„ . .	800 „ „
Valton, J. . . .	France . .	Yachting . .	6 Metres.
Valcke, W. . . .	Belgium	„ . .	„
Vadon, G. . . .	Hungary	Athletics . .	Standing High Jump.
„ . . . .	„ . .	„ . .	Running „ „
Vallie, C. . . .	France . .	Archery . .	York Round.
„ . . . .	„ . .	„ . .	Continental.
Vance, Miss J. . .	U.K. . .	„ . .	National Round.
Vernet, L. . . .	France . .	„ . .	York Round.
„ . . . .	„ . .	„ . .	Continental.
Veres, L. . . .	Hungary	Athletics . .	Putting the Weight.
„ . . . .	„ . .	„ . .	Discus, Free Style.
„ . . . .	„ . .	„ . .	„ Greek „

<i>Name</i>	<i>Country</i>	<i>Sport</i>	<i>Event</i>
Veres, L. .. ..	Hungary	Athletics..	Javelin, Free Style
" .. ..	"	" ..	" Held in Middle.
Venter, F. D. ..	S. Africa	Cycling ..	660 Yards.
" .. ..	"	" ..	1,000 Metres.
" .. ..	"	" ..	5,000 "
" .. ..	"	" ..	20 Kilometres.
" .. ..	"	" ..	2,000 Metres, Tandem.
Vercruysee, E. ..	France ..	Gymnastics	Team.
Vergin, H. .. ..	" ..	"	"
Veres, S. .. ..	Hungary	Athletics .	200 Metres, Flat.
" .. ..	"	" ..	400 " "
Veres, I. .. ..	"	" ..	1,500 " "
" .. ..	"	" ..	5 Miles Run.
Veres, A. .. ..	"	" ..	Running Broad Jump.
Violet, A. .. ..	France ..	Shooting..	Team, International.
Vitais, C. K. ..	Bohemia	Lawn Tennis	Grass Courts, Men's Singles.
Viruly, C. M. ..	Holland..	Clay Bird Shooting	Individual.
" .. ..	" ..	" "	Team.
Vivian, G. L. ..	Canada..	" "	Individual.
" .. ..	" ..	" "	Team.
Villepontoux, P.	France ..	Cycling ..	660 Yards.
" .. ..	" ..	" ..	1,000 Metres.
" .. ..	" ..	" ..	5,000 "
" .. ..	" ..	" ..	2,000 Metres, Tandem.
Viglietti .. ..	" ..	Swimming	High Diving.
Vingqvist, G. ..	Sweden .	"	"
" .. ..	" ..	Fencing ..	Epée, Team.
Vicogne, V. ..	France ..	Gymnastics	Team.
Vigurs, C. .. ..	U.K. ..	"	"
Vigevens, T. ..	Holland .	Fencing ..	Epée, Individual.
" .. ..	" ..	" ..	Team.
" .. ..	" ..	" ..	Sabre, Individual.
" .. ..	" ..	" ..	Team.
" .. ..	" ..	" ..	Foils, Display.
von Bahr, N. ..	Sweden..	Shooting. .	Revolver and Pistol, Team.
" .. ..	" ..	" ..	" " " Individual.
von Bissing, M. F.	Germany	Lawn Tennis	Grass Courts, Men's Singles.
von Bonning- hausen, H.	"	Athletics..	100 Metres, Flat.
" .. ..	"	" ..	200 " "
" .. ..	"	" ..	Standing Broad Jump.
" .. ..	"	" ..	Running " "
von Blijburgh, H. W. P.	Holland .	Fencing ..	Epée, Individual.
" .. ..	" ..	" ..	Team.
" .. ..	" ..	" ..	Sabre, Individual.
" .. ..	" ..	" ..	Team.
von Holst, J. H.	Sweden..	Shooting..	Min. Rifle, Team.
" .. ..	" ..	" ..	" " " Indiv., Stationary.
" .. ..	" ..	" ..	" " " Disappearing.
" .. ..	" ..	" ..	" " " Moving.
" .. ..	" ..	" ..	Revolver and Pistol, Team.
" .. ..	" ..	" ..	" " " Individual.

<i>Name</i>	<i>Country</i>	<i>Sport</i>	<i>Event</i>
von Rosen, O. . .	Sweden . .	Shooting . .	Min. Rifle, Individ., Stationary.
"	"	"	" " " Disappearing.
"	"	"	" " " Moving.
"	"	"	Revolver and Pistol, Team.
"	"	"	" " " Individual.
"	"	"	Epee, Individual.
"	"	"	" Team.
von Wesseley, K. . .	Austria . .	Lawn Tennis	Grass Courts, Men's Singles.
"	"	"	" " " Doubles.
von Seigel, E. . .	Germany	Athletics . .	800 Metres, Flat.
"	"	"	3 Miles Team Race.
Vondracek, J. . .	Bohemia	Wrestling	Graeco-Roman, Light.
Vondracek, C. . .	"	Athletics . .	200 Metres, Flat.
"	"	"	400 " "
Vosbergen, A. C. H. . .	Holland . .	"	800 " "
"	"	"	1,500 " "
"	"	"	5 Miles Run.
"	"	"	Marathon Race.
"	"	"	3 Miles Team Race.
"	"	"	Relay Race.
Voigt, E. R. . .	U.K. . .	"	5 Miles Run.
"	"	"	3 Miles Team Race.
Voos, A. . .	Belgium	Yachting . .	6 Metres.
Vuurman, U. . .	Holland . .	Shooting . .	300 Metres, Team.
"	"	"	" " Individual.
Vyskocil, F. . .	Bohemia	Athletics . .	Standing Broad Jump.
"	"	"	Putting the Weight.
"	"	"	Discus, Free Style.
"	"	"	" Greek "
Wallenberg, Mrs. E. Sweden . .		Lawn Tennis	Covered Courts, Singles.
Wallingford, Sergt.- Maj. J. A. . .	U.K. . .	Shooting . .	300 Metres, Team.
"	"	"	" " Individual.
"	"	"	Revolver and Pistol, Team.
Warner, J. . .	"	"	Min. Rifle, Individ., Stationary.
Wagner-Hohenlobbese, Dr. E. . .	Germany	"	1,000 Yards, Individual.
"	"	"	Min. Rifle, Individ., Stationary.
"	"	"	" " " Moving.
Waller, P. W. . .	Holland . .	Clay Bird Shooting.	Individual.
Walz, G. . .	Germany	Swimming	Fancy Diving.
Wallis, A. E. . .	"	Wrestling	Catch-as-Catch-Can, Middle.
Watters, J. A. . .	"	Gymnastics	Individual.
Walmée, J. . .	France . .	"	Team.
Warlouzer, G. . .	"	"	"
Watters, W. . .	U.K. . .	"	Individual.
Watkins, E. L. . .	"	"	Team
Waterman, H. . .	"	"	"
Walton, E. . .	"	"	"
Walker, R. E. . .	S. Africa	Athletics . .	100 Metres, Flat.

<i>Name</i>	<i>Country</i>	<i>Sport</i>	<i>Event</i>
Walker, R. E. ..	S.Africa	Athletics ..	200 Metres, Flat.
" ..	" ..	" ..	Relay Race.
Watson, H. ..	U.K. ..	" ..	100 Metres, Flat.
" ..	" ..	" ..	200 " "
Wal, H. J. W. ..	Holland ..	" ..	" " "
" ..	" ..	" ..	400 " "
" ..	" ..	" ..	800 " "
" ..	" ..	" ..	1,500 " "
" ..	" ..	" ..	5 Miles Run.
" ..	" ..	" ..	3 Miles Team Race.
Wagner, J. ..	Switzerland	" ..	110 Metres, Hurdle.
" ..	" ..	" ..	Running Broad Jump.
" ..	" ..	" ..	Throwing the Hammer.
" ..	" ..	" ..	Discus, Free Style.
" ..	" ..	" ..	" Greek "
" ..	" ..	" ..	Javelin, Free "
" ..	" ..	" ..	" Held in Middle.
Wakker, W. W. ..	Holland ..	" ..	5 Miles Run.
" ..	" ..	" ..	Marathon Race.
" ..	" ..	" ..	3 Miles Team.
Watt, W. F. C. ..	U.K. ..	" ..	Running Broad Jump.
Wardner, Baron I.	Hungary	" ..	" High "
Walsh, C. ..	Canada ..	" ..	Throwing the Hammer.
" ..	" ..	" ..	Putting the Weight.
" ..	" ..	" ..	Discus, Free Style.
" ..	" ..	" ..	" Greek "
" ..	" ..	" ..	Javelin, Free "
" ..	" ..	" ..	" Held in Middle.
Walters, Dr. W. ..	U.K. ..	" ..	110 Metres, Hurdle.
Wall, A. E. ..	Sweden ..	" ..	Tug-of-War.
Wadworth, Miss	U.K. ..	Archery ..	National Round.
Wadworth, Mrs.			
A. H.	" ..	" ..	" "
Wallcruis, E. G.	Sweden ..	Yachting ..	8 Metres.
Wallin, J. H. ..	" ..	" ..	" "
Ward, W. D. ..	U.K. ..	" ..	" "
Weser, W. . . .	Germany	Gymnastics	Team.
Westover, A. W.	Canada ..	Clay Bird	Individual.
" ..	" ..	Shooting	Team.
Werbrouck, G. ..	Belgium	Cycling ..	660 Yards.
" ..	" ..	" ..	1,000 Metres.
" ..	" ..	" ..	5,000 "
" ..	" ..	" ..	20 Kilometres.
" ..	" ..	" ..	100 "
" ..	" ..	" ..	Pursuit Race.
" ..	" ..	" ..	2,000 Metres, Tandem.
Westerbergh, H.	Sweden ..	" ..	660 Yards.
" ..	" ..	" ..	1,000 Metres.
" ..	" ..	" ..	5,000 "
" ..	" ..	" ..	20 Kilometres.
" ..	" ..	" ..	100 "
" ..	" ..	" ..	2,000 Metres, Tandem.
Weintz, L. J. ..	U.S.A. ..	" ..	660 Yards.
" ..	" ..	" ..	1,000 Metres.

Name	Country	Sport	Event
Weintz, L. J. ..	U.S.A. ..	Cycling ..	5,000 Metres.
" ..	" ..	" ..	20 Kilometres.
" ..	" ..	" ..	100 "
" ..	" ..	" ..	Pursuit Race.
" ..	" ..	" ..	2,000 Metres, Tandem.
Wenerstrom, G. ..	Sweden ..	Swimming	400 Metres.
" ..	" ..	" ..	1,500 "
" ..	" ..	" ..	Team Race.
" ..	" ..	" ..	Water Polo.
Wretman, G. ..	" ..	" ..	1,500 Metres.
" ..	" ..	" ..	Team Race.
" ..	" ..	" ..	Back Stroke.
" ..	" ..	" ..	Water Polo.
Wetzell, O. ..	Finland ..	" ..	High Diving.
" ..	" ..	" ..	Fancy "
Webb, W. E. ..	U.K. ..	" ..	High "
Werthemer, W. ..	Austria ..	" ..	Water Polo.
West, W. .. ..	U.K. ..	Wrestling	Graeco-Roman, Light Heavy.
" .. ..	" ..	" ..	Catch-as-Catch-Can, Heavy.
" .. ..	" ..	Athletics ..	Tug-of-War.
Weckman, W. ..	Finland ..	Wrestling	Graeco-Roman, Light Heavy.
Weisz, R. .. ..	Hungary	" ..	Light.
" .. ..	" ..	" ..	Heavy.
Webster, J. A. ..	U.K. ..	" ..	Catch-as-Catch-Can, Feather.
Wesling, G. J. ..	Holland ..	Gymnastics	Individual
" .. ..	" ..	" ..	Team.
Weber, W. ... ..	Germany	" ..	" ..
" .. ..	" ..	Athletics ..	Pole Jump.
Wegelins, K. M. ..	Finland ..	Gymnastics	Team.
Westergaard, C. P. M. ..	Denmark	Athletics ..	10 Miles Walk.
" .. ..	" ..	" ..	3,500 Metres Walk.
Webb, E. J. ..	U.K. ..	" ..	10 Miles Walk.
" .. ..	" ..	" ..	3,500 Metres Walk.
Welton, A. R. ..	U.S.A. ..	" ..	Marathon Race.
Weinstein, A. ..	Germany	" ..	Running Broad Jump.
Weinstein, Dr. P. ..	" ..	" ..	" ..
" .. ..	" ..	" ..	High "
" .. ..	" ..	" ..	Hop, Step, and "
Welz, E. .. ..	" ..	" ..	Throwing the Hammer.
" .. ..	" ..	" ..	Discus, Free Style.
" .. ..	" ..	" ..	" Greek "
" .. ..	" ..	" ..	Javelin, Free "
" .. ..	" ..	" ..	" Held in Middle.
Werkner, L. ..	Hungary	Fencing ..	Sabre, Individual.
" .. ..	" ..	" ..	Team.
Weewauters, H. ..	Belgium	Yachting ..	6 Metres.
Weedon, Mrs. L. ..	U.K. ..	Archery ..	National Round.
Weisberg, A. ..	" ..	Yachting ..	6 Metres.
Whitehead, P. K. ..	" ..	Shooting ..	1,000 Yards, Individual.
Wilde, A. W. ..	" ..	" ..	Min. Rifle, Team.
" .. ..	" ..	" ..	" .. Individual, Stationary.
" .. ..	" ..	" ..	" .. Disappearing.
" .. ..	" ..	" ..	" .. Moving.



<i>Name</i>	<i>Country</i>	<i>Sport</i>	<i>Event</i>
Wirgmann, C. W.	U.K.	Shooting	Revolver and Pistol, Team.
Williams, B. M.	Canada	"	Team, International.
"	"	"	300 Metres, Team.
Whitaker, G.	U.K.	Clay Bird Shooting	Team.
"	"	"	Individual.
Williams, T. J.	"	Athletics	Tug-of-War.
Winder, C. B.	U.S.A.	"	Team, International.
"	"	"	1,000 Yards, Individual.
"	"	"	300 Metres, Team.
"	"	"	Individual.
Winans, W.	"	"	Min. Rifle, Indiv., Disappearing.
"	"	"	Moving.
"	"	"	Revolver and Pistol, Team.
"	"	"	Individual.
"	"	"	Running Deer, Indiv., Single Shot.
"	"	"	Double Shot.
Wilson, J. W.	Holland	Clay Bird Shooting	Individual.
"	"	"	Team.
Winch, Mrs.	U.K.	Lawn Tennis	Grass Courts, Ladies' Singles.
Willis, S.	"	Swimming	Back Stroke.
Wirtz, E.	Belgium	"	Water Polo.
Willner, Dr. L.	Austria	"	"
Wilkinson, G.	U.K.	"	"
Whittingstall, A. J.	"	Wrestling	Græco-Roman, Light.
Wijbrands, D.	Holland	"	Heavy
Witherall, H. P.	U.K.	"	Catch-as-Catch-Can, Bantam.
White, J. G.	"	"	Feather.
Wickman, G.	Sweden	Gymnastics	Team.
Widell, F.	"	"	"
Wiman, D.	"	"	"
Whitaker, J. T.	U.K.	"	"
Whitaker, F.	"	"	"
Witham, J. D.	U.S.A.	Athletics	108 Metres, Flat.
"	"	"	200
"	"	"	Relay Race.
Wiesner, F.	Hungary	"	100 Metres, Flat.
"	"	"	200
Wilsdn, H. A.	U.K.	"	1,500 "
"	"	"	5 Miles' Run.
"	"	"	3 Team.
Wiegandt, A. J.	A. Sweden	"	5 " Run.
"	"	"	3 " Team.
Winkelthan, W. F.	Holland	"	10 " Walk.
"	"	"	3,500 Metres Walk.
Wilhelm, R.	Germany	"	10 Miles Walk.
Withers, G. R. J.	U.K.	"	"
Wieslander, H. K.	Sweden	"	Running Broad Jump.
"	"	"	High
"	"	"	Putting the Weight.
"	"	"	Discus, Free Style.
"	"	"	Greek
"	"	"	Javelin, Free
"	"	"	"

<i>Name</i>	<i>Country</i>	<i>Sport</i>	<i>Event</i>
Williams, C. H. . .	U.K. . .	Athletics . .	Running Broad Jump.
Wilskman, L. . .	Finland . .	" . .	" High "
" . .	" . .	" . .	Putting the Weight.
" . .	" . .	" . .	Discus, Greek Style.
" . .	" . .	" . .	" Free "
Wilson, J. H. . .	U.K. . .	" . .	Running High Jump.
Wilson, C. A. . .	" . .	Fencing . .	Sabre, Individual.
" . .	" . .	" . .	" Team.
Willoughby, R.M.P.	" . .	" . .	" "
Wisbech, C. . .	Norway . .	Yachting . .	8 Metres.
Wood, W. . . .	U.K. . .	Wrestling	Graeco-Roman, Light.
" . . . .	" . .	" . .	Catch-as-Catch-Can, Light.
Wolf, F. . . .	Germany	Gymnastics	Individual.
" . . . .	" . .	" . .	Team.
Wraschtil, H. . .	Austria . .	Athletics . .	3,200 Metres, Steeplechase.
Wood, W. H. . .	Canada . .	" . .	5 Miles Run.
" . . . .	" . .	" . .	Marathon Race.
Wollgarth, A. H.	Sweden . .	" . .	Tug-of-War.
Woodget, J. . .	U.K. . .	" . .	"
Wood, Miss I. . .	" . .	Archery . .	National Round.
Wood, A. N. L. . .	" . .	Yachting . .	8 Metres.
Wyatt, A. . . .	" . .	Athletics . .	Marathon Race.
Yeumans, A. T.	U.K. . .	" . .	10 Miles Walk.
" . . . .	" . .	" . .	3,500 Metres Walk.
Young, G. . . .	Canada . .	Cycling . .	660 Yards.
" . . . .	" . .	" . .	1,000 Metres.
" . . . .	" . .	" . .	5,000 "
" . . . .	" . .	" . .	20 Kilometres.
" . . . .	" . .	" . .	100 "
" . . . .	" . .	" . .	Pursuit Race.
" . . . .	" . .	" . .	2,000 Metres, Tandem.
Young, G. W. . .	U.K. . .	Athletics . .	400 " Flat.
Young, H. C. . .	U.S.A. . .	" . .	3,200 " Steeplechase.
" . . . .	" . .	" . .	5 Miles Run.
" . . . .	" . .	" . .	3 " Team.
Yorke, R. F. C. . .	U.K. . .	" . .	3,200 Metres, Steeplechase.
Zachar, I. . . .	Hungary	Swimming	400 Metres.
" . . . .	" . .	" . .	Team Race.
Zacharias, G. . .	Germany	" . .	Breast Stroke.
Zamatine, E. . .	Russia . .	Wrestling	Graeco-Roman, Light.
" . . . .	" . .	" . .	" " Heavy.
Zemla, J. . . .	Bohemia	Lawn Tennis	Grass Courts, Men's Singles.
" . . . .	" . .	" . .	" " " Doubles.
Zesina, F. . . .	Hungary	Athletics . .	Putting the Weight.
Zsigmondy, F. . .	" . .	Lawn Tennis	Grass Courts, Men's Singles.
" . . . .	" . .	" . .	" " " Doubles.
Zimmerman, R.	Canada . .	Swimming	100 Metres.

<i>Name</i>	<i>Country</i>	<i>Sport</i>	<i>Event</i>
Zimmerman, R.	Canada ..	Swimming	Fancy Diving.
"	" ..	"	Back Stroke.
Ziliacus, B. . .	Finland ..	Athletics..	Putting the Weight.
Zborzil, A. . . .	Austria ..	Lawn Tennis	Grass Courts, Men's Singles.
" .. ..	" ..	" "	" " " Doubles.
Zöld, J. . . .	Hungary	Athletics..	Running High Jump.
Zouras, C. . . .	Greece ..	" ..	Tug-of-War.
" .. ..	" ..	" ..	Discus, Greek Style.
" .. ..	" ..	" ..	Javelin, Free "
" .. ..	" ..	" ..	" Held in Middle.
Zümer, A. . . .	Germany	Swimming	High Diving.
" .. ..	" ..	" ..	Fancy "
Zulavsky, B. . .	Hungary	Fencing ..	Epée, Individual.
" .. ..	" ..	" ..	" Team.
" .. ..	" ..	" ..	Sabre, Team.
" .. ..	" ..	" ..	" Individual.
" .. ..	" ..	" ..	Foils, Display.

## APPENDIX D.

## AUTUMN.

<i>Name</i>	<i>Country</i>	<i>Sport</i>
Albert, G. . . .	France . . . .	Football, Association.
Alexander, G. B. . . .	U.K. . . . .	Lacrosse.
Alexander, J. C. . . .	" . . . . .	"
Almqvist, S. L. . . .	Sweden . . . .	Football, Association.
Allemane, P. . . .	France . . . .	" "
Allman Smith, E. P. . . .	U.K. (Ireland) . . . .	Hockey.
Anderson, N. . . .	Sweden . . . .	Football, Association.
Andersen, P. M. . . .	Denmark . . . .	" "
Ansen, K. A. . . .	Sweden . . . .	" "
Artault, G. . . .	France . . . .	" "
Aublin, R. . . .	" . . . .	Hockey.
Aspa, G. . . .	" . . . .	Boxing, Middle Weight.
Adams, E. . . .	U.K. . . . .	" Feather "
Akkerdijk, J. J. . . .	Holland . . . .	Football, Association.
Bailey, H. P. . . .	U.K. . . . .	Football, Association
Barrett, T. . . .	" (Cornwall Co.) . . . .	" Rugby.
Bardet, D. . . .	France . . . .	Hockey.
Bardet, J. . . .	" . . . .	"
Barnett, J. T. . . .	Australasia . . . .	Football, Rugby.
Barlow, G. H. . . .	U.K. . . . .	" Association.
Bastien, J. . . .	France . . . .	" "
Baton, Z. . . .	" . . . .	" "
Battersby, W. . . .	U.K. . . . .	Lacrosse.
Batten, R. . . .	" (Cornwall Co.) . . . .	Football, Rugby.
Bayley, J. J. . . .	" . . . .	" Association.
Bayrou, G. . . .	France . . . .	" "
Beck, M. . . .	Denmark . . . .	" "
Bell, A. . . .	U.K. . . . .	" "
Bell, A. H. . . .	" . . . .	" "
Bellocq, H. . . .	France . . . .	" "
Bengtsson, C. . . .	Sweden . . . .	" "
Bennett, R. H. . . .	U.K. . . . .	Lacrosse.
Bennetts, B. . . .	" (Cornwall Co.) . . . .	Football, Rugby.
Benoist, R. . . .	France . . . .	Hockey.
Bienvenu, A. . . .	" . . . .	Football, Association.
Bergstrom, E. . . .	Sweden . . . .	" "
Bergstrom, G. . . .	" . . . .	" "

<i>Name</i>	<i>Country</i>	<i>Sport</i>
Berry, A .. .. .	U. K. .. .. .	Football, Association.
Bilot, C. .. .. .	France .. .. .	" "
Bjarnholt, O. .. .. .	Denmark .. .. .	" "
Blockley, L. E. .. .. .	U.K. .. .. .	Lacrosse.
Bohr, H. .. .. .	Denmark .. .. .	Football, Association
Bonnal, A. .. .. .	France .. .. .	Hockey.
Bon, G. .. .. .	" .. .. .	Football, Association.
Borjeson, K. .. .. .	Sweden .. .. .	" "
Brebner, R. G. .. .. .	U.K. .. .. .	" "
Bridgman, A. .. .. .	" (Cornwall Co.)	" Rugby.
Brissy, C. .. .. .	France .. .. .	Hockey.
Browett, L. .. .. .	U.K. (Cornwall Co.)	Football, Rugby.
Buckwald, C. .. .. .	Denmark .. .. .	" Association.
Buignet, R. .. .. .	France .. .. .	Hockey.
Buckland, G. F. .. .. .	U.K. .. .. .	Lacrosse.
Bruce, R. .. .. .	" (Cornwall Co.)	Football, Rugby.
Buckland, R. .. .. .	" .. .. .	Lacrosse.
Buttery, H. R. .. .. .	" .. .. .	"
Baillon, L. C. .. .. .	" (England) .. .. .	Hockey.
Baker, H. F. .. .. .	" .. .. .	"
Bell, E. T. .. .. .	" .. .. .	"
Bond, A. D. .. .. .	" .. .. .	"
Brazier, S. R. .. .. .	" .. .. .	"
Burns, J. N. .. .. .	" .. .. .	"
Butterworth, S. .. .. .	" .. .. .	"
Brehm, A. .. .. .	Germany .. .. .	"
Brown, H. J. .. .. .	U.K. (Ireland) .. .. .	"
Boudin, R. .. .. .	France .. .. .	Boxing, Feather Weight.
Bouvier, A. .. .. .	" .. .. .	" Light "
Bij, H. A. de .. .. .	Holland .. .. .	" Heavy "
Blake, G. .. .. .	Australasia .. .. .	" Light "
Baker, R. L. .. .. .	" .. .. .	" Middle "
Brockaw .. .. .	U.S.A. .. .. .	Skating, Gent's Figure.
" .. .. .	" .. .. .	" Special "
Brown, R. H. .. .. .	U.K. (Scotland) .. .. .	Hockey.
Burt, A. B. .. .. .	" .. .. .	"
Burt, J. .. .. .	" .. .. .	"
Brewer, H. .. .. .	" .. .. .	Boxing, Heavy Weight.
Burger, H. .. .. .	Germany .. .. .	Skating, Gent's Figure.
" .. .. .	" .. .. .	" Pair.
Barlow, E. .. .. .	U.K. (Wales) .. .. .	Hockey.
Bulmer, F. B. M. .. .. .	" .. .. .	"
Beatty, R. J. .. .. .	" (Ireland) .. .. .	"
Bawley, H. de B. .. .. .	" .. .. .	"
Bulloak, C. E. .. .. .	" .. .. .	"
Bullock, S. A. M. .. .. .	" .. .. .	"
Beeuwhes, R., Jr. .. .. .	Holland .. .. .	Football, Association.
Begeer, A. C. J. .. .. .	" .. .. .	" "
Bekker, C. .. .. .	" .. .. .	" "
Berg, J. J. van den .. .. .	" .. .. .	" "
Boerdam, W., Jr. .. .. .	" .. .. .	" "
Brusel dl. Riviere, J. J. .. .. .	" .. .. .	" "
Bruyn Hoyels, E. F. de .. .. .	" .. .. .	" "

<i>Name</i>	<i>Country</i>	<i>Sport</i>
Camard, R. . . .	France . . . .	Football, Association.
Canelle, F. . . .	" . . . .	" "
Carlier, J. . . .	" . . . .	" "
Carmichael, P. . .	Australasia . . . .	" Rugby.
Chapman, F. W. . .	U.K. . . . .	" Association.
Craig, R. R. . . .	Australasia . . . .	" Rugby.
Charnley, J. . . .	U.K. . . . .	" Association.
Carroll, D. B. . . .	Australasia . . . .	" Rugby.
Clegg, J. R. . . .	U. K. . . . .	Lacrosse
Crabtree, W. . . .	" . . . .	Football, Association.
Cragg, W. A. . . .	" . . . .	Lacrosse.
Corbett, W. S. . . .	" . . . .	Football, Association.
Couton, J. . . .	France . . . .	Hockey.
Cochelin . . . .	" . . . .	Football, Association.
Cypres, G. . . .	" . . . .	" "
Calsmann, E. P. . .	Germany . . . .	Hockey.
Campbell, H. I. W. .	U.K. (Ireland) . . .	"
Coulter, W. C. . . .	" " . . . .	"
Cromie, R. M. B. I. .	" (England) . . . .	"
Clément, R. . . .	France . . . .	Boxing, Bantam Weight.
Constanti, L. . . .	" . . . .	" Feather "
Condon, J. . . .	U.K. . . . .	" Bantam "
Child, W. . . .	" . . . .	" Middle "
Connah, F. A. . . .	" (Wales) . . . .	Hockey.
Connah, H. . . .	" " . . . .	"
Crawford, W. R. . .	" (Ireland) . . . .	"
Chapelle, E. H. la . .	Holland . . . .	Football, Association.
Gumming, A. . . .	U.K. . . . .	Skating, Gent's Special Figure.
Daffern, W. . . .	" . . . .	Football, Association.
Daniel, J. . . .	" (Cornwall Co.) . . .	" Rugby.
Darbonville, G. . .	France . . . .	" Association.
Dastarac, S. . . .	" . . . .	" "
Davey, J. . . .	U.K. (Cornwall Co.) . . .	" Rugby.
Davy, J. . . .	France . . . .	" Association.
Deleglise, M. . . .	" . . . .	" "
Denis, J. . . .	" . . . .	" "
Denis, V. . . .	" . . . .	" "
Dean, F. . . .	U.K. (Cornwall Co.) . . .	Football, Rugby.
Desrousseaux, F. . .	France . . . .	" Association.
Desauty, O. . . .	" . . . .	" "
Drescher, L. . . .	Denmark . . . .	" "
Dubly, A. . . .	France . . . .	" "
Dubly, J. . . .	" . . . .	" "
Du Rheart, J. . . .	" . . . .	" "
Dulton, E. C. . . .	U.K. . . . .	Lacrosse.
Danelsberg, E. . . .	Germany . . . .	Hockey.
Diederichson, F. . .	" . . . .	"
Draper, A. I. . . .	U.K. (England) . . . .	"
Doudelle, R. . . .	France . . . .	Boxing, Middle Weight.
Dorward, A. P. . . .	U.K. (Scotland) . . . .	Hockey.
Douglas, J. W. H. T. .	U.K. . . . .	Boxing, Heavy Weight.

<i>Name</i>	<i>Country</i>	<i>Sport</i>
Douglas, J. W. H. T.	U.K. . . . .	Boxing, Middle Weight.
Dees, W. J. . . . .	„ . . . . .	„ „ „
Denniston, A. G. . . . .	U.K. (Scotland) . . . . .	Hockey.
Davies, A. H. . . . .	„ (Wales) . . . . .	„
Davies, H. M. . . . .	„ „ . . . . .	„
Dagg, T. S. C. . . . .	„ (Ireland) . . . . .	„
Dalton, A. T. . . . .	„ „ . . . . .	„
Daly, H. L. . . . .	„ „ . . . . .	„
Ericson, T. . . . .	Sweden . . . . .	Football, Association.
Eucher, R. . . . .	France . . . . .	„ „
Everett, S. E. . . . .	U.K. . . . . .	Lacrosse.
Edgell, A. R. . . . .	„ (England) . . . . .	Hockey.
Edge Partington, E. F.	„ „ . . . . .	„
Ebert, C. . . . .	Germany . . . . .	„
Eustache, R. . . . .	France . . . . .	Boxing, Light Weight.
Evans, S. C. H. . . . .	U.K. . . . . .	„ Heavy „
Escott, E. R. S. . . . .	„ (Wales) . . . . .	Hockey.
Evans, L. B. . . . .	„ „ . . . . .	„
Fagrell, A. . . . .	Sweden . . . . .	Football, Association.
Fenouillere, R. . . . .	France . . . . .	„ „
Filez, A. . . . .	„ . . . . .	„
Fitzgerald, W. A. . . . .	U.K. . . . . .	Lacrosse.
Fjastad, A. H. S. . . . .	Sweden . . . . .	Football, Association.
Fontaine, E. . . . .	France . . . . .	„ „
Francois, A. . . . .	„ . . . . .	„ „
Fehr, J. W. . . . .	Germany . . . . .	Hockey.
Freeman, H. S. . . . .	U. K. (England) . . . . .	„
Foulkes, Capt. C. R.	„ (Scotland) . . . . .	„
(R.E.)		
Fearman, E. A. . . . .	„ . . . . .	Boxing, Light Weight.
Fee, P. . . . .	„ . . . . .	„ „ „
Flon, E. de . . . . .	Sweden . . . . .	Skating, Gent's Figure.
Farr, W. T. . . . .	U.K. (Wales) . . . . .	Hockey.
Fosbury, G. W. . . . .	„ „ . . . . .	„
Francis, E. H. . . . .	„ „ . . . . .	„
Fogerty, J. H. A. . . . .	„ (Ireland) . . . . .	„
Gaudil, J. . . . .	Denmark . . . . .	Football, Association.
Gautier, L. . . . .	France . . . . .	Hockey.
Gigot, L. . . . .	„ . . . . .	Football, Association.
Gilbey, V. G. . . . .	U.K. . . . . .	Lacrosse.
Gout, E. . . . .	France . . . . .	Football, Association.
Grain, A. . . . .	„ . . . . .	„ „
Gray, H. . . . .	U.K. (Cornwall Co.) . . . . .	„ Rugby
Gressilier, R. . . . .	France . . . . .	„ Association.
Griffen, T. . . . .	Australasia . . . . .	„ Rugby.

<i>Name</i>	<i>Country</i>	<i>Sport</i>
Gueguen, E. . . .	France . . . .	Football, Association.
Guerre, H. . . .	" . . . .	" "
Gustaffson, K. . . .	Sweden . . . .	" "
Gyldenstein, K. . . .	Denmark . . . .	" "
Goodwin, H. J. . . .	U.K. (England) . . . .	Hockey.
Green, E. H. . . .	" " . . . .	" "
Gerdes, F. . . .	Germany . . . .	" "
Glimmann, H. J. H. . . .	" . . . .	" "
Galvao, R. P. . . .	" . . . .	" "
Galvao, M. . . .	" . . . .	" "
Graham, W. E. . . .	U.K. (Ireland) . . . .	" "
Gregg, R. G. S. . . .	" " . . . .	" "
Goy, A. . . . .	France . . . .	Boxing, Heavy Weight.
Gunn, R. . . . .	U.K. . . . .	" Feather "
Grace, F. . . . .	" . . . .	" Light "
Greig, J. K. . . . .	" . . . .	Skating, Gent's Figure.
Greenough Smith, Mrs. . . . .	" . . . .	" Ladies' "
Gordon Phillips, F. . . . .	U.K. (Wales) . . . .	Hockey.
Goldie, A. St. L. . . . .	" (Ireland) . . . .	" "
Graham, W. E. . . . .	" " . . . .	" "
Gregg, R. G. S. . . . .	" " . . . .	" "
Gonsalves, V. A. . . . .	Holland . . . .	Football, Association.
Groskamp, W. R. . . . .	" . . . .	" "
Hanot, G. . . . .	France . . . .	" "
Hansen, H. . . . .	Denmark . . . .	" "
Hansen, K. . . . .	" . . . .	" "
Hansen, S. P. . . . .	" . . . .	" "
Hardman, H. P. . . . .	U.K. . . . .	" "
Hawkes, R. N. . . . .	" . . . .	" "
Hayden, P. . . . .	" . . . .	" "
Hayes, S. N. . . . .	" . . . .	Lacrosse.
Hicky, J. . . . .	Australasia . . . .	Football, Rugby.
Hobbins, W. A. . . . .	U.K. . . . .	Lacrosse.
Holgard, H. . . . .	France . . . .	Football, Association.
Hosken, H. . . . .	U. K. . . . .	Lacrosse.
Hunt, K. R. G. . . . .	" . . . .	Football, Association.
Hvilsted, H. M. P. . . . .	Denmark . . . .	" "
Hardy, G. . . . .	U.K. (England) . . . .	Hockey.
Hatch, B. . . . .	" " . . . .	" "
Hare, C. P. . . . .	" " . . . .	" "
Hamel, C. . . . .	France . . . .	Boxing, Feather Weight.
Halberg, . . . . .	Denmark . . . .	" Light "
Hadsen . . . . .	" . . . .	" " "
Hogarth, T. J. . . . .	U.K. (Scotland) . . . .	Hockey.
Holmes, H. . . . .	" . . . .	Boxing, Light Weight.
Hall-Say, G. N. E. . . . .	" . . . .	Skating, Gent's Special.
Hubler, Frl. A. . . . .	Germany . . . .	" Pair.
Herz, Frl., J. . . . .	Austria . . . .	" Ladies' Figure.
Holmes, E. P. C. . . . .	U.K. (Ireland) . . . .	Hockey.
Holmes, W. B. . . . .	" " . . . .	" "



<i>Name</i>	<i>Country</i>	<i>Sport</i>
Hull, F. G. . . . .	U. K. (Ireland) . . . . .	Hockey.
Haak, A. . . . .	Holland . . . . .	Football, Association.
Heyning, J. C. . . . .	„ . . . . .	„ „
Heijting, K. . . . .	„ . . . . .	„ „
Ireton, A. . . . .	U.K. . . . .	Boxing, Heavy Weight.
Jackett, E. J. . . . .	„ (Cornwall Co.)	Football, Rugby.
Jackett, R. . . . .	„ „	„ „
Jenicot, A. . . . .	France . . . . .	„ Association.
Jenkin, J. . . . .	U.K. (Cornwall Co.)	„ Rugby.
Jensen, R. . . . .	Denmark . . . . .	„ Association.
Johnson, A. S. . . . .	U.K. . . . .	Lacrosse.
Johnson, F. S. . . . .	„ . . . . .	„
Johnson, W. A. . . . .	„ . . . . .	„
Jones, E. P. . . . .	„ . . . . .	„
Jones, E. J. . . . .	„ (Cornwall, Co.)	Football, Rugby.
Jordon, W. C. . . . .	„ . . . . .	„ Association.
Jose, J. P. . . . .	„ (Cornwall, Co.)	„ Rugby.
Jouve, R. . . . .	France . . . . .	„ Association.
Julien, F. . . . .	„ . . . . .	„ „
Jordan, H. R. . . . .	U.K. (England) . . . . .	Hockey.
Jones, P. A. . . . .	„ . . . . .	Boxing, Feather Weight.
Johnson, H. H. . . . .	„ . . . . .	„ Light „
Jessop, G. . . . .	„ . . . . .	„ „ „
Johnson, J. R. . . . .	„ . . . . .	Skating, Pair.
Johnson, Mrs. P. W. . . . .	„ . . . . .	„ „
Johansson, R. . . . .	Sweden . . . . .	„ Gent's Figure.
Jones, G. T. . . . .	U.K. (Wales) . . . . .	Hockey.
Jones, G. P. . . . .	„ „ . . . . .	„
Jones, J. R. . . . .	„ „ . . . . .	„
Jones, W. E. . . . .	„ „ . . . . .	„
Jacobi, E. . . . .	Holland . . . . .	Football, Association.
Kennedy, R. L. . . . .	U. K. (Ireland) . . . . .	Hockey.
Ker, F. G. . . . .	„ (Scotland) . . . . .	„
Kok, J. A. F. . . . .	Holland . . . . .	Football, Association.
Kower, J. M. . . . .	„ . . . . .	„ „
Lang, T. . . . .	U.K. (Cornwall Co.)	Football, Rugby.
Laplace, E. . . . .	France . . . . .	„ Association.
Laplace, G. . . . .	„ . . . . .	„ „
Lawrey, A. . . . .	U.K. (Cornwall Co.)	„ Rugby.
Leigh, G. B. . . . .	„ . . . . .	Lacrosse.
Lindbom, G. T. . . . .	Sweden . . . . .	Football, Association.
Lindgreen, A. . . . .	Denmark . . . . .	„ „

<i>Name</i>	<i>Country</i>	<i>Sport</i>
Lindman, N. H. .. ..	Sweden .. .. .	Football, Association.
Louch, L. A. .. ..	U.K. .. .. .	" "
Logan, G. .. .. .	" (England) ..	Hockey.
Leighton, A. F. .. ..	" " .. .. .	" "
Lacombe, L. .. .. .	France .. .. .	Boxing, Feather Weight.
Laing, I. .. .. .	U. K. (Scotland) ..	Hockey.
Lloyd, J. .. .. .	" .. .. .	Boxing, Feather Weight.
Lycett, Miss G. .. ..	" .. .. .	Skating, Ladies' Figure.
Law, A. A. .. .. .	" (Wales) .. ..	Hockey.
Lyne, R. F. .. .. .	" " .. .. .	" "
Linthout, H. M. .. ..	Holland .. .. .	Football, Association.
Maes, E. .. .. .	France .. .. .	" "
Maillard, J. .. .. .	" .. .. .	" "
Malm, B. T. .. .. .	Sweden .. .. .	" "
Mamsfield, E. .. .. .	U.K. .. .. .	" "
Martin, T. .. .. .	" (Cornwall Co.) ..	" Rugby.
Martin, R. G. W. .. ..	" .. .. .	Lacrosse.
Marshall, H. .. .. .	" (Cornwall Co.) ..	Football, Rugby.
Mason, C. J. .. .. .	" .. .. .	Lacrosse.
Mason, G. .. .. .	" .. .. .	" "
Mathaux, P. .. .. .	France .. .. .	Football, Association.
Mellin, G. J. .. .. .	Sweden .. .. .	" "
Mesnier, L. .. .. .	France .. .. .	" "
Middelboe, E. .. .. .	Denmark .. .. .	" "
Middelboe, K. .. .. .	" .. .. .	" "
Middelboe, N. .. .. .	" .. .. .	" "
Mikkelsen, P. .. .. .	" .. .. .	" "
Mocquard, G. .. .. .	France .. .. .	Hockey.
Moigneu, H. .. .. .	" .. .. .	Football, Association.
Morillon, E. .. .. .	" .. .. .	" "
Mouton, L. .. .. .	" .. .. .	" "
Marshall, C. W. .. ..	U.K. (England) ..	Hockey.
Möding, F. .. .. .	Germany .. .. .	" "
Murphey, H. L. .. ..	U.K. (Ireland) ..	" "
Mazoir, P. .. .. .	France .. .. .	Boxing, Bantam Weight.
Morard, C. .. .. .	" .. .. .	" Middle "
Manzone, E. .. .. .	" .. .. .	" Light "
MacLean, H. .. .. .	U.K. (Scotland) ..	Hockey.
McGurk, F. .. .. .	" .. .. .	Boxing, Bantam Weight.
Morris, C. W. .. .. .	" .. .. .	" Feather "
Miner, A. J. .. .. .	" .. .. .	" Middle "
Murdoch, A. .. .. .	" .. .. .	" Middle "
March, A. .. .. .	" .. .. .	Skating, Gent's Figure.
Montgomery, Miss E.	Sweden .. .. .	" Ladies' "
McCabe, A. J. .. .. .	Australasia .. ..	Football, Rugby.
Macassey, S. E. .. ..	U.K. (Ireland) ..	Hockey.
McCue, P. .. .. .	Australasia .. ..	Football, Rugby.
McCormick, G. H. .. ..	U.K. (Ireland) ..	Hockey.
McCormick, W. G. .. ..	" .. .. .	" "
McKivett, C. C. .. ..	Australasia .. ..	Football, Rugby.
McArthur, M. .. .. .	" .. .. .	" "

<i>Name</i>	<i>Country</i>	<i>Sport</i>
McMurtrie, C. C.	Australasia	Football, Rugby.
McWilliam, H.	U.K. (Ireland)	Hockey.
Meldon, L. A.	" "	" "
Middleton, S. A.	Australasia	Football, Rugby.
Mills, J. E.	U. K. (Ireland)	Hockey.
Mundt, E. G.	Holland	Football, Association.
Myrons, I.	U.K.	Boxing, Heavy Weight.
Nicolai, E.	France	Football, Association.
Neilsen, N. C. O.	Denmark	" "
Neilsen, S. E.	" "	" "
Noble, A. H.	U.K. (England)	Hockey.
Nève, S. de	France	Boxing, Middle Weight.
Neilson, H. E. B.	U.K. (Scotland)	Hockey.
Norton, W. F.	" "	Boxing, Feather Weight.
Ohlsson, H. N.	Sweden	Football, Association.
Ohlsson, O. S.	" "	" "
Olsson, S.	" "	" "
Oldham, H. B.	U.K.	Lacrosse.
Oudin, J.	France	Boxing, Middle Weight.
Orchardson, G. Q.	U. K. (Scotland)	Hockey.
Orr, J. H.	" "	" "
Osborne, F.	" "	Boxing, Light Weight
Oldman, A. L.	" "	" Heavy "
Owen, A. K.	" (Wales)	Hockey.
O'Reilly, W. J.	" (Ireland)	" "
Otten, L.	Holland	Football, Association.
Patin, C.	France	Hockey.
Pierce, C. H.	U.K.	Football, Association.
Pedersen, C. F.	Denmark	" "
Petersen, A.	" "	" "
Porter, T. C.	U.K.	" "
Pouillet, H.	France	" "
Poupon, L.	" "	Hockey.
Prest, J. A.	U.K.	Football, Association.
Prosser, J.	" "	" "
Prouvost, G.	France	" "
Proud, E. B.	U.K.	" "
Puget, A.	France	" "
Pugh, S. O.	U.K.	Lacrosse.
Purnell, C. H.	" "	Football, Association.
Page, E. W.	" (England)	Hockey.
Peel, F. B.	" "	" "
Pridmore, R. G.	" "	" "
Peterson, W. E.	" (Ireland)	" "
Power, C. F.	" "	" "

<i>Name</i>	<i>Country</i>	<i>Sport</i>
Poillot, E. .. ..	France .. ..	Boxing, Feather Weight.
Philo, W. .. ..	U.K. .. ..	„ Middle „
Perry, H. .. ..	„ .. ..	„ Bantam „
Parks, F. G. .. ..	„ .. ..	„ Heavy „
Panin .. ..	Russia .. ..	Skating, Gent's Figure.
„ .. ..	„ .. ..	„ „ Special.
Pallot, W. J. .. ..	U.K. (Wales) .. ..	Hockey.
Parry, D. E. .. ..	„ „ .. ..	„
Pearson, T. W. .. ..	„ „ .. ..	„
Powell, J. D. .. ..	„ „ .. ..	„
Peterson, J. W. .. ..	„ (Ireland) .. ..	„
Pluim, F. G. .. ..	Holland .. ..	Football, Association.
Raine, J. E. .. ..	U.K. .. ..	„ „
Rambusch, H. A. .. ..	Denmark .. ..	„ „
Ramsey, H. W. .. ..	U.K. .. ..	Lacrosse.
Rasmussen, B. V. .. ..	Denmark .. ..	Football, Association.
Richards, T. .. ..	Australasia .. ..	„ Rugby.
Renaud, C. .. ..	France .. ..	„ Association.
Richards, H. .. ..	U.K. (Cornwall Co.) .. ..	„ Rugby.
Roux, F. .. ..	France .. ..	Hockey.
Royet, M. .. ..	„ .. ..	Football, Association.
Roze, P. .. ..	„ .. ..	„ „
Russell, S. .. ..	„ .. ..	Hockey.
Robinson, L. N. .. ..	U.K. (England) .. ..	„
Robinson, J. Y. .. ..	„ „ .. ..	„
Rudger, H. .. ..	Germany .. ..	„
Russell, C. C. .. ..	Australasia .. ..	Football, Rugby.
Rees, P. M. .. ..	U. K. (England) .. ..	Hockey.
Ringer, T. .. ..	„ .. ..	Boxing, Feather Weight.
Roddin, H. .. ..	„ .. ..	„
Rendschmidt, Fr. E. .. ..	Germany .. ..	Skating, Ladies' Figure.
Robinson, F. L. .. ..	U.K. (Ireland) .. ..	Hockey.
Richards, E. W. G. .. ..	„ (Wales) .. ..	„
Rehterghem, A. F. M. von .. ..	Holland .. ..	Football, Association.
Reeman, G. S. .. ..	„ .. ..	„ „
Saimond .. ..	France .. ..	„ „
Salarmier, R. .. ..	„ .. ..	Hockey.
Sartorius, E. .. ..	„ .. ..	Football, Association.
Saulnier, L. .. ..	„ .. ..	Hockey.
Schaff, L. .. ..	„ .. ..	Football Association.
Schalbart, .. ..	„ .. ..	„ „
Schubart, L. .. ..	„ .. ..	„ „
Scothern, A. E. .. ..	U.K. .. ..	„ „
Scott, C. H. .. ..	„ .. ..	Lacrosse.
Sergeant, B. .. ..	France .. ..	Football, Association.
Shorrocks, H. .. ..	U.K. .. ..	Lacrosse.
Signoret, J. .. ..	France .. ..	Football, Association.
Silvester, A. .. ..	U.K. .. ..	Lacrosse.

<i>Name</i>	<i>Country</i>	<i>Sport</i>
Simon, D. E. .. ..	U.K. .. ..	Lacrosse.
Six, P. .. ..	France .. ..	Football, Association.
Smith, F. B. .. ..	Australasia .. ..	„ Rugby.
Smith, H. .. ..	U.K. .. ..	„ Association.
Smith, F. .. ..	„ (Cornwall Co.)	„ Rugby.
Smith, J. P. .. ..	„ .. ..	Lacrosse
Sparks, T. M. .. ..	„ .. ..	„
Spicer, N. .. ..	„ .. ..	„
Stapley H. .. ..	„ .. ..	Football, Association.
St. Ignan, A. .. ..	France .. ..	„ „
Stafford, T. S. .. ..	U.K. (England)	Hockey.
Solomon, B. .. ..	„ (Cornwall Co.)	Football, Rugby.
Stocks, J. L. .. ..	„ (England) ..	Hockey
Stocks, A. D. .. ..	„ „ .. ..	„
Smith, A. L. F. .. ..	„ „ .. ..	„
Shoveller, S. H. .. ..	„ „ .. ..	„
Studemann, A. .. ..	Germany .. ..	„
Stevenson, N. L. .. ..	U.K. (Scotland) .. ..	„
Somers, J. M. .. ..	„ „ .. ..	„
Spiller, H. .. ..	„ .. ..	Boxing, Light Weight.
Syers, E. .. ..	„ .. ..	Skating, Pair.
Syers, Mrs. .. ..	„ .. ..	„ Ladies' Figure.
„ .. ..	„ .. ..	„ Pair.
Salchow, U. .. ..	Sweden .. ..	„ Gent's Figure.
„ .. ..	„ .. ..	„ „ Special.
Shepherd, C. W. .. ..	U.K. (Wales) .. ..	Hockey.
Stratton, M. .. ..	Holland .. ..	„
Sol, J. W. E. .. ..	„ .. ..	Football, Association.
Sneath, E. .. ..	„ .. ..	„ „
Stempes, R. .. ..	„ .. ..	„ „
Trevaskis, J. .. ..	U.K. (Cornwall Co.)	„ Rugby.
Tetar, P. .. ..	France .. ..	„ Association.
Tregurtha, N. .. ..	U. K. (Cornwall Co.)	„ Rugby.
Tilliette, M. .. ..	France .. ..	„ Association.
Thomas, A. J. .. ..	U.K. (Cornwall Co.)	„ Rugby.
Tossier, E. .. ..	France .. ..	„ Association.
Thomas, B. .. ..	U.K. (Cornwall Co.)	„ Rugby.
Twigg, F. W. .. ..	„ (England) ..	Hockey.
Twigg, W. H. .. ..	„ „ .. ..	„
Thomas, H. .. ..	„ .. ..	Boxing, Bantam Weight.
Thoren, P. .. ..	Sweden .. ..	Skating, Gent's Figure.
Torrome, H. .. ..	Argentine .. ..	„ „ „
„ .. ..	„ .. ..	„ „ Special.
Turnbull, B. .. ..	U.K. (Wales) ..	Hockey.
Turnbull, G. I. .. ..	„ „ .. ..	„
Turnbull, P. B. .. ..	„ „ .. ..	„
Thomee, J. .. ..	Holland .. ..	Football, Association.
Uren, H. J. .. ..	U.K. .. ..	„ „
Uhl, C. .. ..	Germany .. ..	Hockey.

<i>Name</i>	<i>Country</i>	<i>Sport</i>
Verbrugge, R. . . .	France . . . .	Football, Association.
Verlet, J. . . .	" . . . .	" "
Versini, F. . . .	" . . . .	Hockey.
Vialaret, J. . . .	" . . . .	Football, Association.
Vinche, A. . . .	" . . . .	" "
Vuillemot, E. . . .	" . . . .	" "
Viez, A. . . .	" . . . .	Boxing, Bantam Weight.
Veen, S. . . .	Holland . . . .	Football, Association.
Visser, H. L. . . .	" . . . .	" "
Wedge, T. G. . . .	U. K. (Cornwall Co.)	" Rugby.
Whitley, N. H. P. . . .	" . . . .	Lacrosse.
Wibaut, U. . . .	France . . . .	Football, Association.
Wilkes, C. H. . . .	" . . . .	" "
Willcocks, A. . . .	U.K. (Cornwall Co.)	" Rugby.
Williams, E. W. . . .	" . . . .	" Association.
Wilson, A. J. . . .	" (Cornwall Co.)	" Rugby.
Windin, O. S. . . .	Denmark . . . .	" Association.
Wolfhagen, W. . . .	" . . . .	" "
Woodward, V. J. . . .	U.K. . . . .	" "
Wright, E. G. D. . . .	" . . . .	" "
Wurseline, J. . . .	France . . . .	" "
Windels, E. . . .	Germany . . . .	Hockey.
Wood, H. I. . . .	U.K. (England) . . . .	" "
Walker, H. G. S. . . .	" (Scotland) . . . .	" "
Wallis, I. G. . . .	" . . . .	" "
White, T. . . .	" . . . .	" "
Warnes, R. C. . . .	U. K. . . . .	Boxing, Middle Weight.
Wells, M. . . .	" . . . .	" Light "
Wallace, C. M. . . .	" . . . .	" " "
Webb, W. . . .	" . . . .	" Bantam "
Waugh, C. S. . . .	U.K. (Ireland) . . . .	Hockey.
Whitehouse, F. J. . . .	" (Wales) . . . .	" "
Wilkins, P. G. . . .	" . . . .	" "
Williams, H. T. . . .	" . . . .	" "
Williams, J. R. . . .	" . . . .	" "
Welcker, J. H. . . .	Holland . . . .	Football, Association.
Yglesias, H. R. . . .	U.K. . . . .	Skating, Gent's Figure.
Zeiger, J. . . .	France . . . .	Football, Association.
Zimmerman, J. . . .	" . . . .	" "

## APPENDIX E

---

### DEFINITIONS OF AN AMATEUR.

---

#### INTERNATIONAL DEFINITIONS.

##### OLYMPIC GAMES, ST. LOUIS, 1904.

No person shall be eligible to compete in any athletic meeting, game, or entertainment given or sanctioned by this Union [Amateur Athletic Union of the United States] who has:

1. Received or competed for compensation or reward in any form, for the display, exercise, or example of his skill in or knowledge of any athletic exercise, or for rendering personal service of any kind to any athletic organisation, or for becoming or continuing a member of any athletic organisation; or
2. Has entered any competition under a name other than his own, or from a club of which he was not at that time a member in good standing; or
3. Has knowingly entered any competition open to any professional or professionals, or has knowingly competed with any professional for any prize or token; or
4. Has issued or allowed to be issued in his behalf any challenge to compete against any professional, or for money; or
5. Has pawned, bartered, or sold any prize won in athletic competition; or,
6. Is not a registered athlete.

##### INTERNATIONAL OLYMPIC CONGRESS, BRUSSELS.

June 1905.

1. An amateur is any person who has never taken part in a race or meeting or competition open to all comers, for a prize in money or for gate money, or with professionals, and who has not been during his lifetime a professional or hired teacher of physical exercises.
2. The Congress think that a professor or hired teacher of physical exercise should be considered an amateur for the sports that he does not teach, on condition that in the practice of these sports he has never committed an act of professionalism, and under the control of the federation to which the association belongs where he wishes to practise them as an amateur.
3. The acceptance of actually incurred travelling expenses is not considered as professionalism.

### COMMITTEE OF INTERNATIONAL GAMES AT ATHENS, 1906.

An amateur is any person who has never taken part in a contest or match for either money prize or remuneration from any source whatever, who has never competed with professionals, and never received remuneration, whether exercising by himself or teaching or training others; who has never procured money or pecuniary advantage by means of prizes won; who has never used machines or material for sports with a view to advertisement. The amateur is, however, authorised to accept expenses for travelling to and staying in a strange town, such subsidy not being considered as remuneration.

### OLYMPIC GAMES, LONDON, 1908.

The General Regulations for these Games, passed at The Hague Conference of the International Olympic Committee in 1907, contained the following references to the amateur status of competitors :—

*Art. 3* : The Olympic Games are exclusively confined to amateurs.

*Art. 4* : The definition of an amateur qualified to compete in any sport will be found in the detailed regulations under the heading of that sport.

*Art. 7* : The amateur status of every competitor must be guaranteed by the association which, in his own country, governs the sport in which he desires to enter as a competitor, or, where no such governing association or governing club exists, by a special committee of experts appointed by the Olympic Committee of that country.

*Art. 8* : All entries will be made through the governing associations, or where governing associations do not exist, by amateur clubs, through the Olympic Committee of each country, who will be responsible to the British Olympic Association for the competence of such amateur clubs to guarantee that the competitors entered by them are amateurs within the conditions laid down in the British Olympic Association's Regulations for the several sports, as set forth in the programme of the Olympiad.

### INTERNATIONAL SKATING UNION.

Amateur definition from Regulations for International Competitions settled by the Congresses of Copenhagen, 1895; Stockholm, 1897; London, 1899; Berlin, 1901; Budapest, 1903; Copenhagen, 1905; Stockholm, 1907. The regulations govern the national organisations of Austria, Canada, Denmark, Finland, France, Germany, Great Britain, Holland, Hungary, Norway, Russia, Sweden, and Switzerland.

A skater is not recognised as an amateur, if he has since Jan. 1, 1893:

(a) Practised in his own person any sporting bodily exercise as a means of gain (gymnastic and fencing instructors excepted);

(b) Practised or taught skating for money (excepted are the bare repayment of hotel and travelling expenses by his own club or association or by the club or association holding the competition; in the latter case, they may not be repaid directly to the skater, but only through the club or association which nominated him);

(c) Sold or pledged prizes won in sporting competitions;

(d) Knowingly and without protest started in an open skating competition against a competitor who is not an amateur according to these regulations.

The rehabilitation of a professional skater as amateur can only be pronounced by the Council of the I.S.U. at the request of a member of the I.S.U. The skater thus rehabilitated may take part in no open skating competition within a year of his rehabilitation.



## ENGLISH DEFINITIONS.

### AMATEUR ATHLETIC ASSOCIATION.

An amateur is one who has never competed for a money prize or monetary consideration, or for any declared wager or staked bet; who has never engaged in, assisted in, or taught any athletic exercise as a means of pecuniary gain; and who has never taken part in any competition with anyone who is not an amateur.

The following exceptions shall be made to this rule :—

(a) That amateur athletes shall not lose their amateur status by competing with or against professionals in cricket matches, or in ordinary club football matches for which no prizes are given, or in cup competitions permitted by the National Football Associations or National Rugby Unions of England, Ireland, Scotland, or Wales, providing that such competitions or matches form no part of, nor have connection with any athletic meeting.

(b) That competitions at arms between Volunteers and Regulars shall not be considered as coming within the scope of the A.A.A. Laws.

(c) That competitors in officers' races at Naval and Military athletic meetings (such races being for officers only, and for which money prizes are not given) shall be exempt from the laws of the A.A.A. disqualifying runners for competing at mixed meetings.

(d) That the championship of the Army races be exempt from the effect of this rule.

(e) That a paid handicapper is not *ipso facto* a professional.

(f) That sailors and soldiers of His Majesty's forces be exempt from the loss of their amateur status by reason of competing in team competitions at Naval and Military competitions confined to sailors and soldiers.

A competitor in athletic competitions (other than A.A.A. Championships or *bona fide* International, inter-club, inter-team, inter-college, or inter-school contests) who asks for or receives hotel, travelling, or other expenses ceases to be an amateur, and no club, society, or managing body promoting an athletic competition shall, either directly or indirectly, pay or offer a monetary consideration to, or the hotel, travelling, or other expenses of any competitor in such competition. Clubs may only pay the expenses of their first-claim members under this law.

### AMATEUR BILLIARD ASSOCIATION.

Any person who, wholly or in part, earns or has earned his living by playing or scoring games played upon a billiard table is, for the purposes of the Association, deemed a professional. An amateur is one who has not at any time earned his living, or any part of his living, by playing or scoring games played on a billiard table.

No amateur shall play in public (*i.e.*, any advertised match, or where admission is charged) without previously obtaining a permit from the committee of the Association. Violation of this rule may involve the forfeiture of his amateur status.

### AMATEUR BOXING ASSOCIATION.

An amateur is one who has never competed for a money prize, staked bet, or declared wager; who has not competed with or against a professional for any prize (except with the express sanction of the Amateur Boxing Association), and who has never taught, pursued, or assisted in the practice of athletic exercises as a means of obtaining a livelihood or pecuniary gain.

No. 15 of the Articles of Association further provides that :— ‘No amateur shall, without the permission of the Association, spar in public except at an assault-at-arms or entertainment recognised by the Amateur Boxing Association, or promoted by one of the affiliated clubs of this or other kindred association.’

#### NATIONAL CYCLISTS' UNION.

An amateur is one who has never engaged in, nor assisted in, nor taught any athletic exercise for money, or other remuneration; nor knowingly competed with or against a professional for a prize of any description, or in public, except at a meeting specially sanctioned by the Union.

No amateur shall accept from his own club, or from a club or person promoting sports at which he competes, or from any cycle manufacturer, or from any such source, any payment for his expenses. The Union, however, reserves, the right to sanction any such payment if, in the opinion of the General Committee, the very exceptional circumstances of any particular case seem to warrant such sanction being given.

A cyclist ceases to be an amateur and becomes a professional by :

(a) Engaging in cycling, or any other athletic exercise, or personally teaching, training, or coaching any other person therein, either as a means of obtaining a livelihood, or for a staked bet, a money prize, or gate money.

(b) Knowingly competing with, or pacemaking for, or having the pace made by, a professional, or persons under sentence of suspension, in public, or for a prize.

(c) Selling, realising upon, or otherwise turning into cash any prize won by him.

(d) Accepting, directly or indirectly, any remuneration, compensation, or expenses whatever from a cycle manufacturer, agent, or other person interested in the trade or sport for cycle riding.

(e) Offering, directly or indirectly, any remuneration, compensation, or expenses whatever, for cycle riding, to any amateur, as such.

(f) Having applied for and being refused an amateur licence, or by the revocation of an amateur licence.

Cycle manufacturers and agents, as such, are not to be considered as professionals, but are cautioned that to personally teach cycle riding as a means to effect the sale of a machine will be taken as an infringement of the clause (a).

#### AMATEUR FENCING ASSOCIATION.

All competitions held under A.F.A. Laws shall be confined to amateurs, and the following definition of an amateur shall obtain :—An amateur is one who has never competed for a money prize, or monetary consideration, or for any declared wager or staked bet, who has never engaged in, assisted in, or taught any athletic exercise as a means of pecuniary gain, and who has never taken part in any competition with anyone who is not an amateur, provided as follows :—

(a) Amateur fencers shall not lose their amateur status by competing with or against professional football players in cup competitions permitted by the National Football Association and Rugby Unions of England, Ireland, Scotland, and Wales, provided that such competitions or matches form no part of, nor have any connection with any fencing competitions.

(b) Competitions at arms confined to members of His Majesty's Army, Navy, and Auxiliary Forces, and competitions held out of the British Isles, shall not be deemed to be within the range of A.F.A. Laws.

(c) School masters or school teachers giving instruction in gymnastics or fencing or other forms of athletics to their school pupils as part of their school duties, and receiving no extra remuneration therefor, shall not thereby forfeit their amateur status.

(d) This article shall not apply to commissioned officers (past or present) of His Majesty's Army, Navy, or Auxiliary Forces in respect of any work done by them in their capacity as officers.

(e) A fencing club may cause the actual fare of any member of such club competing at a fencing competition to and from such competition, or any part of such fare, to be paid out of funds at the disposal of such club, without thereby causing such member to forfeit his amateur status; but, save as aforesaid, a competitor who receives expenses (except where the A.F.A. deem it desirable themselves to defray a competitor's expenses) shall forfeit his amateur status; and proof that a competitor has asked for expenses shall be *prima facie* proof that he has received expenses.

#### FOOTBALL RUGBY UNION.

1.—Professionalism is illegal.

2.—Acts of professionalism are—

(1) By an individual :—

A.—Asking, receiving, or relying on a promise, direct or implied, to receive any money consideration whatever, actual or prospective; any employment or advancement; any establishment in business; or any compensation whatever for—

(a) Playing football, or rendering any service to a football organisation.

(b) Training, or loss of time connected therewith.

(c) Time lost in playing football or in travelling in connection with football.

(d) Expenses in excess of the amount actually disbursed on account of reasonable hotel or travelling expenses.

B.—Transferring his services from one club to another in opposition to Rule 4.

C.—Playing for a club while receiving, or after having received from such club, any consideration whatever for acting as secretary, treasurer, or in any other office, or for doing or for having done any work or labour about the club's ground or in connection with the club's affairs, unless such work was done before the receiver became a football player.

D.—Remaining on tour at his club's expense longer than is reasonable.

E.—Giving or receiving any money testimonial. Or giving or receiving any other testimonial, except under the authority of this Union.

F.—Receiving any medal or other prize for any competition except under the authority of this Union.

G.—Playing on any ground where gate money is taken—

(a) During the close season.

(b) In any match or contest where it is previously agreed that less than 15 players on each side shall take part.

H.—Knowingly playing with or against any expelled or suspended player or club.

I.—Refusing to give evidence or otherwise assist in carrying out these rules when requested by this Union to do so.

J.—Being registered as, or declared a professional, or suspended by any National Rugby Union or by the Football Association.

K.—Playing within eight days of any accident for which he has claimed or received insurance compensation, if insured under these rules.

L.—Playing in any benefit match, connected directly or indirectly with football, but this shall not prevent this Union giving permission for a *bona-fide* charity match.

M.—Knowingly playing or acting as referee or touch judge on the ground of an expelled or suspended club.

N.—Receiving money or other valuable consideration from any person or persons as an inducement towards playing football.

O.—Signing any form of the Northern Union.

(2) By a club or other organisation :—

A.—Paying or promising payment, or giving, offering, or promising any inducement as to employment, advancement, or establishment in business, or any compensation whatever to any player for—

(a) Playing for that club.

(b) Training or for travelling expenses to or from any training resort, or for loss of time in connection with training.

(c) Loss of time while playing or travelling in connection with football.

(d) Hotel or travelling expenses in excess of the sum actually and reasonably disbursed.

B.—Receiving as a member a member of another club in opposition to Rule 4.

C.—Receiving or continuing as a member anyone it may pay or have paid for either regular or occasional services.

D.—Paying for any of its teams, players, officials, or members on tour longer than a reasonable time; or paying for more than a reasonable number.

E.—Giving from its funds, subscribing, or playing a match for any testimonial.

F.—Giving any medal or other prize for any competition except under the authority of this Union

G.—Taking gate money at any ground—

(a) During the close season.

(b) At any match or contest where it is previously agreed that less than 15 players on each side shall take part.

H.—Knowingly playing or allowing its members to play with or against any expelled or suspended player or club.

I.—Refusing to produce its books or documents, or to allow its officials or members to give evidence or to assist in carrying out these rules when requested by the Union to do so.

J.—Knowingly playing or admitting as a member, without the consent of the Union, any member of an expelled or suspended club, or any expelled or suspected player, or any person registered as or declared a professional or suspended by any National Rugby Union or by the Football Association.

K.—Knowingly allowing a player to play in its matches within eight days of any accident for which he has received or claimed insurance compensation, if insured under these rules.

L.—Playing or allowing its ground to be used for any benefit or charity match connected directly or indirectly with football, except permission to play which has previously been obtained from this Union.

M.—Knowingly allowing its members or teams to play on the ground of any expelled or suspended club.

N.—Refusing to pay, within any time ordered by this Union, any costs or expenses ordered by this Union for inquiries held under these rules.

3.—For offences under 2.—(1) A, H, I, L, M, N, and O, an individual shall be expelled from all English clubs playing Rugby football, and shall not be eligible for re-election or election to any club. For offences under 2.—(1) B, C, D, E, F, G, J, and K, an individual shall be suspended during the pleasure of this Union.

For offences under 2.—(2) A, D, H, I, L, M, and N, a club shall be expelled from this Union. For offences under 2.—(2) B, C, E, F, G, J, and K, a club shall be suspended during the pleasure of this Union. Any club disregarding a sentence of suspension shall be liable to expulsion.

But when this Union is fully satisfied that any offence under 2.—(2) A, D, H, I, L, M, and N, was of an accidental, trivial, or technical character, they may suspend instead of expel.

#### FOOTBALL ASSOCIATION.

Players are either amateur or professional. Any player registered with this Association as a professional, or receiving remuneration or consideration of any sort above his necessary hotel and travelling expenses actually paid, shall be considered to be a professional. Training expenses not paid by the players themselves will be considered as remuneration beyond necessary travelling and hotel expenses. Amateur players receiving any payment must give a written receipt for the same, stating particulars of expenses, and secretaries must produce such receipt to the Council of this Association at any time if required to do so. If an amateur player is engaged by a club in any capacity for which he receives remuneration, the club may be required to prove, to the satisfaction of the Association, that his services as a player do not affect the amount of remuneration paid to him. Players competing for any money prizes in football contests shall be considered professionals, (a) when a player is registered as a professional he at once loses his status as an amateur. When an amateur player is injured whilst playing football he shall, upon obtaining the consent of this Association, or the local affiliated association, be entitled to receive his doctor's fees, or the proceeds of any benefit match, subscription or collection, without losing his amateur status (b) (c). Where two affiliated associations cover the same area, the permission must be obtained from the senior association.

(a) Wages paid by an amateur club to a trainer are training expenses within the meaning of Rule 28.

(b) A player (except under provisions of Rule 28) is not entitled to take the proceeds of a benefit match until he has been registered a professional.

(c) It is misconduct for any association or club, or any player, official, or member of any association or club, to offer or attempt to offer, either directly or indirectly, any consideration whatever to another club, player, or players of any other club, with a view to influence the result of a match. It is misconduct for any club, player, or players, to accept any such consideration.

#### AMATEUR FOOTBALL ASSOCIATION.

No person shall be considered an amateur who has signed a professional football form, or, directly or indirectly, received for playing football remuneration or consideration of any kind beyond his necessary hotel and travelling expenses actually paid.

An amateur club is a club of which all the playing members are amateurs.

## GOLF.

An amateur golfer shall be a golfer who has never made for sale golf clubs, balls, or any other article connected with the game; who has never carried clubs for hire after attaining the age of fifteen years, and who has not carried clubs for hire at any time within six years of the date on which the competition begins; who has never received any consideration for playing in a match, or for giving lessons in the game, and who for a period of five years prior to Sept. 1, 1886, has never received a money prize in any competition.

**AMATEUR GYMNAS TIC ASSOCIATION AND AMATEUR GYMNAS TIC  
FEDERATION OF GREAT BRITAIN AND IRELAND.**

An amateur is one who has never competed for a money prize, or monetary consideration, or for any declared wager or staked bet; who has never engaged in, assisted in, or taught any athletic exercise as a means of pecuniary gain, and who has never taken part in any competition with anyone who is not an amateur, save and except as modified and added to by the rules of the A.G.A., 1902.

**HOCKEY ASSOCIATION.**

Membership of the association is entirely confined to amateurs. There is no definition of an amateur, but the following rules apply :—

No affiliated club, and no club belonging to an affiliated association, and no player or member of such club shall institute, or take part in any hockey challenge cup or prize competition, and any affiliated association, club, player, or member so offending shall be dealt with by the Council under Rule 16.

In the event of any affiliated association, club, player, official, or member being proved to the satisfaction of the Council to have been guilty of any misconduct or breach of rules, the Council shall have power to order the name of the offending affiliated association, club, player, official, or member to be removed from this Association, suspended for a stated period, or dealt with in such manner as the Council may think fit.

**LACROSSE.**

An amateur is one who has never competed for a money prize or monetary consideration, or for any declared wager or staked bet, who has never engaged in, assisted in, or taught any athletic exercise as means of pecuniary gain.

(Olympic Games amateur definition borrowed from the A.A.A., to which some of the lacrosse clubs are affiliated. The English Lacrosse Union has no amateur definition in its rules.)

**MOTOR BOAT RACING.**

An amateur is one who has never been employed as a paid hand in the handling of a motor-boat or any other vessel, or in the running or construction of an internal combustion engine. [In the Olympic Games, 1908, the helmsman and every member of the crew had further to qualify under Nos. 7 and 8 of the General Regulations of the Olympic Games (1908) and his entry was also subject to No. 12 of those Regulations.]

### AMATEUR ROWING ASSOCIATION.

No person shall be considered an amateur oarsman, sculler, or coxswain:

1. Who has ever rowed or steered in any race for a stake, money, or entrance fee;

[This clause is not to be construed as disqualifying any otherwise duly qualified amateur who previously to April 23, 1894, has rowed or steered for a stake, money, or entrance fee in a race confined to members of any one club, school, college, or University.]

2. Who has ever knowingly rowed or steered with or against a professional for any prize;

3. Who has ever taught, pursued, or assisted in the practice of athletic exercises of any kind for profit;

4. Who has ever been employed in or about boats, or in manual labour, for money or wages;

5. Who is or has been by trade or employment for wages a mechanic, artisan, or labourer, or engaged in any menial duty;

6. Who is disqualified as an amateur in any other branch of sport.

An amateur may not receive any contribution towards his expenses in competing in a race or a regatta except from the club which he represents, or a *bona fide* member of such club; but the committee shall have power to make special rules for any International regatta or competition.

### SHOOTING ASSOCIATION (CLAY BIRDS).

Any person who shoots or has shot in public as a means of livelihood, or who engages or has engaged in the teaching of shooting as a means of livelihood, or who has shot in any competition open only to professional shooters, shall be deemed a professional shooter.

### AMATEUR SWIMMING ASSOCIATION.

An amateur is one who has never competed for a money prize, declared wager, or staked bet; who has never taught, pursued, or assisted in the practice of swimming, or any other athletic exercise, as a means of pecuniary gain; and who has not, knowingly, or without protest, taken part in any competition or exhibition with anyone who is not an amateur.

A Professional.—That a swimmer shall cease to be an amateur, and become a professional by—

(a) Engaging in swimming or any other athletic exercise—or personally teaching, training, or coaching any other person therein—for pecuniary gain.

(b) Selling, realising upon, or otherwise turning into cash, any prize won by him or her.

(c) Asking for, offering or accepting remuneration or expenses except under the conditions set out in exception F.

(d) Accepting remuneration for swimming in public, or by being employed for money or wages in a swimming bath or elsewhere as an attendant on swimmers.

(e) Asking for, offering, or accepting any consideration by way of employment or otherwise for becoming a member of a club, except in cases where clubs or associations give scholarships or free membership of clubs to children at or leaving school, the holders of such scholarships not to exceed fifteen years of age.

No professional can make an amateur handicap or represent or hold any office in the A.S.A. or in any district thereof, and no amateur is allowed to take a fee or expenses for attending and acting as an official at any competition held under A.S.A. Laws beyond third-class railway, boat, and tram fares, or cab fares when no trams or trains are available, and reasonable out of pocket expenses or hotel expenses when necessary and away from home (limited to 7s. 6d. per man), handicappers only excepted.

#### EXCEPTIONS.

NOTE.—The following exceptions shall be made to the foregoing laws, but the A.S.A. reserves full powers to prevent any abuse of these :—

(a) Amateur swimmers shall not lose their amateur status by competing with or against professional football players in ordinary club matches, for which no prizes are given, or in cup competitions permitted by the National Football Associations or Rugby Unions of England, Ireland, Scotland, or Wales.

(b) School masters or school teachers giving instruction in swimming to their school pupils, or at evening schools organised by the Education Authority, shall not thereby endanger their amateur status.

(c) The fact of any payment being made to an instructor of life-saving shall not endanger the instructor's status as an amateur, but no such instructor can receive any fee or expenses for any meeting at which he competes for a prize of any description.

(d) A bath manager who is not a personal attendant on swimmers in a swimming bath (or otherwise ineligible to compete as an amateur under A.S.A. Laws) does not, as such, endanger his amateur status.

(e) None of the standing laws of amateurism laid down by the A.S.A., A.A.A., N.C.U., and N.A.W.A. apply to life-saving, either in the matter of learning, teaching, or exhibiting, the A.S.A. being of opinion that the life-saving land and water drills (including resuscitation) form a higher and combined development of gymnastic exercise, swimming, ability, and medical knowledge for the benefit of the race, and as such cannot be classified as 'Sport,' or be considered to come within the term 'Athletic Exercises,' specified in Laws 49 and 50 of the A.S.A.

(f) An amateur swimmer may accept his or her third-class railway, boat, or tram fare (or cab fare when no trains or trams are available), but not exceeding the actual cost of the journey; and when return on the same day is impossible hotel expenses (limited to 7s. 6d. in any period of twenty-four hours), under the following conditions :—(1) When competing in any International (controlled by the A.S.A.), National, District, or County Championship. (2) When taking part in the King's Cup or National Diving Competition. (3) When engaged as a member of a team of swimmers in any water polo, life-saving, diving, or squadron competition or exhibition, provided no prizes are offered to individual members of the team, except in any *bona fide* unlimited open handicap in which no fast time or other special prize is offered. (4) When attending an entertainment to give an exhibition, provided that no prize is offered for such attendance or exhibition, and that he or she does not compete for a prize at the same gala. In no case may any expenses be paid to any individual to secure his or her attendance at any gala (except to give an unremunerated exhibition as provided for in clause 4) or to any members of a team who take part in any events at the gala at which they attend under the provisions of this exception (other than as provided for in clause 3 above), other than those in which the team competes as a whole, and for which no prizes are offered. No amateur swimmer may ask for or receive his or her railway fare or expenses, for the whole or part of any journey from more than one individual or promoting body, and railway fares can only



be paid from the actual point of departure for attendance at the event for which the fare is accepted. Return fare can only be accepted when the return journey is made on the day of, or the day immediately following the event (week-end tickets excepted). Individuals, promoting bodies, or clubs taking advantage of this exception must satisfy themselves that any expenses paid are actually incurred. Amateur swimmers travelling abroad (outside the British Isles may receive second-class railway fare and first-class boat fare.

#### NATIONAL AMATEUR WRESTLING ASSOCIATION.

An amateur is one who has never competed for a money prize or monetary consideration, or for any declared wager or staked bet; who has never engaged in or taught any athletic exercise as a means of pecuniary gain; and who has never taken part in any competition with anyone who is not an amateur.

To this definition the only exceptions allowed are as follows :—

(a) Amateur wrestlers shall not lose their amateur status by competing with or against professionals in cricket matches or in ordinary club football matches for which no prizes are given, or in cup competitions permitted by the National Football Associations or National Rugby Unions of England, Ireland, Scotland, or Wales, providing that such competitions or matches form no part of, nor have connection with, any athletic meeting.

(b) Competitions at arms between Volunteers and Regulars shall not be considered as coming within the scope of the N.A.W.A. Laws.

(c) Competitors in officers' competitions at Naval and Military athletic meetings (such competitions being for officers only, and for which money prizes are not given) shall be exempt from the laws of the N.A.W.A. disqualifying wrestlers from competing at mixed meetings.

(d) The 'Championships of the Navy and Army' competitions shall be exempt from the effect of this rule.

### SCOTTISH DEFINITIONS.

#### SCOTTISH AMATEUR ATHLETIC ASSOCIATION.

An amateur is one who has never competed for a money prize or monetary consideration, or for any declared wager or staked bet ; who has never engaged in, assisted in, or taught any athletic exercise as a means of pecuniary gain; and who has never taken part in any competition with anyone who is not an amateur. Exceptions :—

(a) That amateur athletes shall not lose their amateur status by competing with or against professionals in cricket matches, or in ordinary club football matches for which no prizes are given, or in competitions permitted by the National Football Associations or National Rugby Unions of England, Ireland, Scotland, or Wales.

(b) That competitions at arms between Volunteers and Regulars shall not be considered as coming within the scope of the S.A.A.A.

(c) That competitors in officers' races at Naval and Military athletic meetings (such races being for officers only, and for which money prizes are not given) shall be exempt from the laws of the S.A.A.A. disqualifying runners for competing at mixed meetings.

(d) That the championship of the Army races be exempt from the effect of this rule.

(e) That a paid handicapper or timekeeper is not a professional.

The payment by clubs to competitors of travelling, hotel, or other expenses is strictly prohibited.

The following exception shall be made to this law :—That, on application to either of the divisional committees, permission be granted to clubs or other bodies to pay the third-class train fares of representatives in inter-club, inter-city, inter-county, or International contests, and, if participation in such contests entail absence from home for more than one day, to pay legitimate hotel expenses in addition.

The disposal for money of prizes is strictly prohibited, and will entail the suspension of the offender.

#### SCOTTISH CYCLISTS' UNION.

The following shall be the definition of an amateur :—

An amateur is one who has never engaged in, nor assisted in, nor taught any athletic exercise for money or other remuneration; nor knowingly competed with or against a professional for a prize of any description, or in public (except at a meeting specially sanctioned by the Union).

It is explained that an amateur becomes a professional by—

(a) Accepting or having accepted, directly or indirectly, any remuneration, compensation, or expenses whatever from a cycle or tyre manufacturer, agent, or other person for cycle riding.

(b) Competing with, or pacemaking for, a professional, except in events sanctioned by the Union.

(c) Engaging in cycling or any other athletic exercise, or personally teaching, training, or coaching any other person therein, either as a means of obtaining a livelihood or for a staked bet, money prize, or gate money.

(d) Competing with, or pacemaking for, a professional or person under suspension in public, or for a prize.

(e) Selling, realising upon, or otherwise turning into cash any prize won by him.

(f) Offering, directly or indirectly, any remuneration, compensation, or expenses whatever for cycle riding to any amateur.

#### SCOTTISH AMATEUR SWIMMING ASSOCIATION.

An amateur is one who has never competed for a money prize, declared wager, or staked bet, or knowingly with or against a professional for any prize, or who has never taught, pursued, or assisted in the practice of athletic exercises as a means of pecuniary gain.

#### EXCEPTIONS.

1. That swimming amateurs shall not lose their amateur status by exhibiting with their teacher or instructor, provided they are *bona-fide* pupils of such and no remuneration is accepted.

2. That amateurs shall not lose their amateur status by competing with or against professionals at cricket, football, or other games, provided that such competitions form no part of, nor have any connection with any athletic, swimming, gymnastic, rowing, or skating meeting.

3. School or School Board entertainments, when confined to present pupils only, and no money prizes are given. A permit shall be required when ex-pupils are competing, or for any open competition in such entertainments.

4. That amateurs shall not lose their amateur status by accepting remuneration for swimming matter supplied to journals, magazines, or the general Press.

5. A bath master, who is not a personal attendant on swimmers in a swimming bath (or otherwise ineligible to compete as an amateur under the S.A.S.A. Laws), does not, as such, endanger his amateur status.

A swimmer ceases to be an amateur and becomes a professional by—

(a) Engaging in swimming or any other athletic exercise, or personally teaching, training, or coaching any other person therein, for pecuniary gain.

(b) Selling, realising, upon or otherwise turning into cash, or altering or defacing so that its original form is unrecognisable any prize won by him.

(c) Any amateur taking part in an unregistered entertainment, gala, or competition, or other swimming event is thereby liable to lose his amateur status.

## IRISH DEFINITIONS.

### IRISH AMATEUR ATHLETIC ASSOCIATION.

An amateur is one who has never competed for a money prize or monetary consideration, or for any declared wager or staked bet; who has never engaged in, assisted in, or taught any athletic exercise as a means of pecuniary gain; and who has never taken part in any competition with anyone who is not an amateur.

#### EXCEPTIONS.

(a) Amateur athletes shall not lose their amateur status by competing with or against professionals in cricket matches, or in ordinary club football matches for which no prizes are given, or in cup competitions permitted by the National Football Associations or National Rugby Unions of England, Ireland, Scotland, and Wales, providing that such competitions or matches form no part of, nor have any connection with, any athletic meeting, except by permission.

(b) Competitions at arms between Volunteers and Regulars shall not be considered as coming within the scope of the I.A.A.A. Laws.

(c) Competitions in officers' races at Naval and Military athletic meetings (such meetings being for officers only, and for which money prizes are not given) shall be exempt from the laws of the I.A.A.A. disqualifying runners for competing at mixed meetings.

(d) The championship of the Army race at the Curragh shall be exempt from the effect of this rule.

(e) A paid handicapper is not a professional.

### GAELIC ATHLETIC ASSOCIATION (IRELAND).

An amateur is one who never competed for a money prize or monetary consideration, or for any declared wager or bet; who has never engaged in, assisted in, or taught any athletic exercise as a means of pecuniary gain, and who has never taken part in any competition with anyone who is not an amateur.

#### EXCEPTIONS.

(a) Amateur athletes shall not lose their amateur status by competing with or against professionals in cricket matches, or by ordinary football club matches for which no prizes are given, or cup competitions permitted by the National Football Associations or National Rugby Unions of England, Ireland, Scotland, and Wales, providing such competitions form no part of, nor have any connection with any athletic meeting.

(b) Competitions at arms between Volunteers and Regulars shall not be considered as coming within the scope of the G.A.A. Laws.

(c) Competitions in officers' races at Naval and Military athletic meetings, such meetings being for officers only, and for which money prizes are not given, shall be exempt from the laws of the G.A.A. disqualifying runners for competing at an unregistered meeting.

(d) The championship of an Army meeting at the Curragh shall also be exempt from this rule.

(e) A paid handicapper is not a professional.

## AMERICA.

### INTER-COLLEGIATE ASSOCIATION OF UNITED STATES OF AMERICA, 1906.

An amateur is a person who has never competed in an open competition, or for money, or under a false name or with a professional for a prize; or with a professional where gate money is charged; nor has ever at any time taught, pursued, or assisted at athletic exercises for money, or for any valuable consideration. But nothing in this definition shall be construed to prohibit the competition between amateurs for medals, cups, or other prizes than money. To prevent any misunderstanding in reading the above, the Association draws attention to the following explanations and adjudications :—

An athlete has forfeited his right to compete as an amateur, and has thereby become a professional, by—

(a) Ever having competed in an open competition—*i.e.*, a competition the entries to which are open to all, irrespective as to whether the competitors are amateurs or professionals, and whether such competition be for a prize or not, in any athletic exercises, viz. baseball, rowing, cricket, &c.

(b) Ever having competed for money in any athletic exercise.

(c) Ever having competed under a false name in any athletic exercise.

(d) Ever having knowingly competed with a professional for a prize, or where gate money is charged, in any athletic exercise.

(e) Ever having taught or pursued as a means of livelihood any athletic exercise.

(f) Ever having directly or indirectly accepted or received remuneration for engaging in any athletic exercise.

An athlete shall hereafter forfeit his right to compete as an amateur, and shall thereby become a professional, if, at any time after the foregoing definition shall take effect, he shall—

(1) Directly or indirectly receive payment for training or coaching any other person in any athletic exercise.

(2) Directly or indirectly receive payment for services personally rendered in teaching any athletic-exercise.

(3) Directly or indirectly receive payment for services rendered as referee, judge, umpire, scorer, manager, director, or in any other capacity at any professional exhibition or contest of any athletic exercise whatsoever.

NOTE.—Nothing herein shall be construed to prohibit the acceptance by any amateur of his necessary travelling expenses incurred as referee, judge, umpire, scorer, or starter, in going to and from the place of any amateur contest.

(4) Directly or indirectly run, manage, or direct, for prospective profit, any professional exhibition or contest.

An amateur shall not forfeit his right to compete as an amateur, and shall not become a professional, by—

(a) Receiving compensation for services rendered as ticket taker or ticket seller at any contest or exhibition of amateur athletics.

(b) Receiving compensation for services personally rendered as secretary, treasurer, manager, or superintendent of any amateur athletic club.

(c) Receiving compensation as editor, correspondent, or reporter of, or contributor to, any sporting, athletic, or other paper or periodical.

(d) Running, managing, or directing, for prospective profit, any sporting, athletic, or other paper or periodical.

(e) Receiving compensation for services personally rendered as official handicapper, under the direction and authority of any amateur athletic association.

(f) Receiving from a club of which he shall be a member the amount of his expenses necessarily incurred in travelling to and from the place of any amateur contest.

(g) Nothing in this rule shall be construed so as to consider a man a professional who has played in a college team against a professional team.

## AUSTRALASIA.

### AMATEUR ATHLETIC UNION OF AUSTRALASIA.

An amateur is one who has never competed for a money prize, staked bet, or declared wager, or who has not knowingly and without protest competed with or against a professional for a prize of any description or for public exhibition, or who has never taught, pursued, or assisted in the practice of any athletic exercise as a means of livelihood or for pecuniary gain.

An amateur forfeits his status and becomes a professional by—

(a) Any infringement of the above definition.

(b) Competing with or pacemaking for a professional or person under sentence of suspension, in public or for a prize.

(c) Selling, realising, bartering, or otherwise turning into cash any prize won by him, or accepting any remuneration, directly or indirectly, from any person for any competition in which he is an entrant or competitor.

(d) Wagering, or being in any way interested in a staked bet or wager made in connection with any competition in which he is an entrant or competitor.

(e) Entering for any athletic event for which a money prize is offered, or for which a money prize or trophy are offered as alternatives, or any event open to professionals.

(f) Accepting any travelling or hotel expenses from any club or sports promoters, except in the case of a championship meeting, or with the special sanction of the amateur athletic association to which he belongs, provided such association is a member of the Union.

(g) Entering for, or competing in, any athletic event under a fictitious name.

### EXCEPTIONS.

The following exceptions shall be made to this rule :—

(a) All persons who have been reinstated by the association in the State or in the Dominion of New Zealand in which they reside, and which association is a member of the Union, and have not infringed their amateur status subsequent to such reinstatement, shall be considered amateurs.

(b) Amateurs shall not lose their status by competing with or against professionals in any game (for list of “games” see jurisdiction clause) for which no money prize is offered.

(c) Competitions at arms between Volunteers or Regulars, fire brigade competitions pure and simple, the pastimes of shooting and sailing, and

all other pastimes not coming within the definition of athletic exercises (for list of "athletic exercises" see jurisdiction clause), shall not be considered as coming within the scope of these rules.

(*d*) Competitions open only to Volunteers or Regulars at Naval or Military athletic meetings (such events being for trophies only) shall be exempt from any rule disqualifying persons for competing against professionals.

(*e*) Receiving remuneration for any office connected with athletic sport, if sanctioned by the governing amateur athletic association, shall not constitute a person a professional.

(*f*) Schoolboys who have infringed their amateur status may compete at their own school sports without affecting the amateur status of their schoolfellows.

(*g*) Teaching athletic exercises at a school does not constitute a person a professional, provided his engagement includes scholastic duties at the same institution.

#### VICTORIA AMATEUR ATHLETIC ASSOCIATION.

The definition of the Victoria A.A.A. is precisely the same as that of the Amateur Athletic Union of Australasia.

#### AMATEUR SPORTING FEDERATION OF NEW SOUTH WALES.

Amateur shall mean one who has never competed for money, whether in the form of a prize, staked bet, or declared wager, or knowingly competed with or against a professional, or taught, pursued, or assisted in the practice of any athletic exercise as a means of livelihood or for pecuniary gain.

An amateur forfeits his status, and becomes a professional by—

(*a*) Any infringement of the above definition.

(*b*) Knowingly competing with or pacemaking for a professional or person under sentence of suspension in public or for a prize.

(*c*) Pawning, selling, realising, bartering, or otherwise turning into cash any prize won by him.

(*d*) Accepting any remuneration directly or indirectly from any person in any competition in which he is an entrant or competitor.

(*e*) Wagering, or being in any way interested in a money stake, bet, or wager made in connection with any competition in which he is an entrant or competitor.

(*f*) Entering for any athletic exercise for which a money prize is offered, or for which a money prize or trophy are offered as alternative, or any event open to professionals, or issuing or allowing to be issued on his behalf any challenge to compete against any professional or for money.

(*g*) Accepting any travelling or hotel expenses from any association, club, or sports promoter, except at the special sanction of the body governing the particular athletic exercise in connection with which the same is accepted. Provided always that the body governing any athletic exercise may allow persons taking part therein as the accredited representatives of that body outside New South Wales for wine and sundries allowance a sum not exceeding 5s. per diem during their absence from New South Wales.

(*h*) Accepting directly or indirectly any money payment whatsoever, whether as compensation for loss of time, salary, or otherwise, except as provided in sub-clause (*g*).

(i) Entering for or competing in any athletic exercise under a fictitious name without first obtaining the sanction of the body controlling the particular branch of athletic exercise concerned.

#### EXCEPTIONS.

The following exceptions shall be made :—

(a) Any persons who have been reinstated by each of the governing bodies by whom they have been declared professionals or whose regulations they have infringed, and who have not infringed their amateur status since the date of such reinstatement, shall be considered amateurs.

(b) Amateurs shall not lose their status by competing with or against professionals in any game (for list of “games” see interpretation clause) for which no money prize is offered for the amateur.

(c) Competitions at arms between Volunteers or Regulars, fire brigade competitions pure and simple, the pastimes of shooting and sailing, and all other pastimes, not coming within the definition of athletic exercises, shall not be considered as coming within the scope of this federation.

(d) Competitions open only to Volunteers or Regulars at Naval or Military athletic meetings, such events being for trophies only, shall be exempt from any rule disqualifying persons for competing against professionals.

(e) Receiving any remuneration for any office connected with athletic sport if sanctioned by the body governing the branch of sport in question.

(f) Teaching athletic exercises at a school will not constitute a person a professional provided his engagement *bona-fide* include scholastic duties at the same institution.

#### FEDERATION OF TASMANIAN AMATEUR SPORTS ASSOCIATIONS

The definition of the Tasmanian A.S.A. is precisely the same as that of the A.S.F. of New South Wales.

### BELGIUM.

#### UNION BELGE DE SPORTS ATHLÉTIQUES.

An amateur is one who has never participated in a public race, in a competition, or a meeting open to all comers; nor competed for a money prize, or for money obtained for admission to grounds, or competed with professionals for a prize, or for money obtained by public subscription; or who has never, at any period of his career, received payment as professor or instructor in any kind of physical exercise.

### DENMARK.

#### DANISH SPORTING FEDERATION.

##### ARTICLE 1.

Anyone practising sports is considered an amateur providing—

(a) That he does not teach for salary (or fee) any sport. It is understood, however, that anyone teaching for salary, &c., one or several sections of sports is not considered a professional as regards this or these sections providing that

he keeps intact his rights and title of amateur for all the other sections. The sections are :—

1. Gymnastics (turn).
2. Sword exercises, fencing.
3. Athletic sports.
4. Skating and other exercises practised on the ice.
5. Ski racing.
6. Swimming and other aquatic sports.
7. Boating and sculling.
8. Tennis, football, &c.
9. Cycling and motoring.
10. Riding.
11. Navigation.
12. Shooting.

(b) That he takes part in no matches or public displays, either for cash prizes or rewards, or at any sporting place where the revenue is not wholly given to benefit the sports or for a charitable object.

*Note 1.*—Nevertheless, money prizes are allowed for Sections 10, 11, and 12, as well as at sporting places which are exclusively military.

*Note 2.*—An amateur has the right to obtain repayment of travelling and living expenses at sporting “rendezvous” outside his residential locality.

(c) That he does not participate in any match in public, amateurs or non-amateurs, whether for a prize or not, without having obtained beforehand the special permit from the proper central organisation.

(d) That he does not act as judge, starter, or official at duties analogous to those meetings or exercises indicated under “b” and “c” of the present article without having obtained beforehand the permit of the proper central organisation.

(e) That he does not take advantage by selling, exchanging, giving as a bond, letting, or exhibiting the prizes won.

#### ARTICLE 2.

Will not be admitted to take part in matches or public displays—

- (a) Anyone who is the object of public censure.
- (b) Anyone who is not considered an amateur in conformity of Article 1 in the present rules.
- (c) Anyone who is considered to blame by the competent central organisation for debt or other cause, who has been excluded from a sporting society, provided that the organisation in question has been advised of the fact. Assessments (or shares) in arrear which have not been claimed for six months are not acknowledged by the amateurs’ committee.
- (d) Whoever takes part as competitor in public displays or matches with or against individuals who are declared excluded in conformity with Rules (a), (b), and (c) of the present Article, and of those of Article 3, or who in capacity as judge, starter, or whatever else, assists without the special permit of the competent central organisation in public displays or matches in which individuals of this class participate.

#### ARTICLE 3.

Anyone who has during the progress of a match or other sporting display given offence to a judge, starter, or other official during the exercise of his official duties, or who refuses to obey their legal instructions, or who presents himself indecently clothed, or conducts himself otherwise than in a proper manner, can be sent back and declared excluded from meetings and public displays for the future.



## ARTICLE 4.

Persons who have been excluded from taking part in matches or meetings can submit to the competent central organisation a written application to be reinstated in order to take part in these exercises. In the case of a second offence a request cannot be entertained until after a lapse of three years, counting from the last offence.

Whoever is convicted a second time with contravening in regard to Article 1 of the rules of amateurs cannot be again reinstated to his rights as an amateur.

The decisions of the central organisation with regard to these questions are open to no appeal.

## ARTICLE 5.

The other Scandinavian central organisations are informed of the names of individuals declared "professional."

## FRANCE.

## UNION DES SOCIÉTÉS FRANÇAISES DE SPORTS ATHLÉTIQUES.

The definition quoted below is that adopted by the following federations in France :—

(1) Union des Sociétés Françaises de Sports Athlétiques, which governs Association and Rugby football, hockey, athletics, lawn tennis and tennis (*jeu de Paume*), skating, cricket, pelota, fencing, croquet, swimming, and wrestling.

(2) Union Vélocipédique de France, which governs cycling.

(3) Fédération Française des Sociétés d'Aviron, which governs rowing.

(4) Fédération Française des Sociétés de Boxe, which governs boxing.

Minimum definition :—

"An amateur is one who has never taken part in a race, competition, or meeting open to all comers, nor competed for a money prize, nor for gate money, nor with professionals, and who has never been, at any time in his life, a paid teacher or demonstrator of physical exercises."

Each federation has qualified the above minimum definition. Thus :—

(1) The U.S.F.S.A. considers as money prizes cheques on tradesmen, orders for goods, travelling expenses, varying according to the performance of the competitor. Reasonable travelling and hotel expenses are permitted, but all such allowances must be paid to competitors through the secretary of the U.S.F.S.A. The selling of prizes or turning them into money is also forbidden. No athlete may allow his name to be used for commercial advertising purposes.

(2) The U.V.F. forbids amateurs to receive any wages or allowances from any firm manufacturing bicycles or cycling accessories, allows travelling and hotel expenses to the maximum amount of 12.50 frs. a day, and allows also a firm to supply an amateur with a machine and accessories for the purpose of any race.

(3) The F.F.S.A. considers also as professionals—professional rowers, sailors, watermen, ferrymen, fishermen, fishermen, boathouse attendants, boat-builders, paid teachers of rowing; in short, all persons deriving or having derived their means of existence from manual labour carried on regularly and continually around or upon boats. The F.F.S.A. allows payment of travelling and transport expenses to clubs, such payments to be based on the distance travelled, but never on the performance of the crew.

(4) The F.F.S.B. admits the possibility of an amateur boxer being a professional in other branches of sport.

## APPENDIX F.

**SPEECHES DELIVERED AT THE  
 FINAL BANQUET  
 GIVEN TO OLYMPIC COMPETITORS  
 AND OFFICIALS IN THE HOLBORN  
 RESTAURANT on OCTOBER 31, 1908.**

LORD DESBOROUGH: My Lords, Your Worships, Ladies and Gentlemen, I rise to propose the first toast, which is that of His Most Gracious Majesty the King, the Patron of the Olympic Games, who in person opened the Fourth Olympiad; and I should also, as this is an international dinner, ask you at the same time to drink to the health of foreign rulers, especially of those whose countries were good enough—and they were most of the civilised countries of the world—to send competitors to our Games in London in 1908. I give you the toast of His Majesty. (Cheers.)

LORD DESBOROUGH: My Lords, Ladies, and Gentlemen, I rise with some trepidation, but not without a sense of relief to propose on this last occasion the toast of the Olympic Games. Well, I think that whatever nationality we may belong to we can all say to-night that both the Summer and the Autumn Games of 1908 have been a success, ("Hear, hear," and cheers.) They have brought together from nearly every country of the world a trained body of athletes, who have striven together amicably in what was, I think, the best adapted arena which has ever been constructed for the purpose since the history of athletics began. (Hear, hear.) And I will also say this, that we were able to extend to that great body of athletes a hospitality which will at all events show them that we in England are not unmindful of the splendid manner in which we have been treated when we have gone abroad, and that we are all sportsmen at heart, and that we wish to inculcate the greatest factor in all sportsmanship, which is the true feeling of comradeship inherent in all sport when it is properly carried out. (Cheers.)

I may say that during the last Olympic Games there were some twenty different competitions and about twenty-one different countries taking part in them, and that the athletes—the picked athletes of these countries—numbered very nearly 3000. In the management of the Games something like 800 officials took part, and I should like to take this opportunity of thanking all these gentlemen—I cannot call upon them individually—for the splendid assistance which they rendered one and all to the British Olympic Council from the first to the last of the Olympic Games. The programme has been somewhat criticised at times, and I should just like to say this, that we began to draw it up nearly two years ago, and that the programme in its entirety was submitted to the International Olympic Committee, which met at the Hague, and, in

the Peace Conference Buildings, discussed that programme for the greater part of a week, and so whatever we placed before you had received the endorsement of all those distinguished gentlemen representing different countries who form that great International Council, under whose auspices was inaugurated, and has hitherto been carried out, the idea of the Olympic Games. (Cheers.)

I think that these Games have done two great things, have achieved two great objects in the sphere of athletics. In the first place they have brought foreign athletes of all countries into close comradeship with each other, and in the second place they have made the different nations realise that they must set aside their merely local rivalries and enter teams representing their country as a whole, and in that respect I think we have done something for athletics of every kind and description. In the United Kingdom, for instance, athletics are organised in their various different associations, and our International matches were games in which England competed with Scotland and Ireland and Wales; but when we came to the Stadium we had to select one team representing the British Isles to meet the rest of the world. I think I may also say that the same thing held good of the United States of America. I believe that in Chicago they very often did not think much of the athletes of New York or San Francisco, and the athletes of New York and San Francisco thought equally little of the athletes of Chicago. But when that splendid American team went on board ship and sailed for England they found they were setting aside their local jealousies, and were representing the United States as a whole for the first time. Now I think that is something to have been able to achieve. (Hear, hear.) Or take South Africa; whether the individual competitor came from Natal, or from the Orange Free State, or from the Transvaal, he came as representing not his own particular colony, but South Africa; and I think we may claim that in South Africa we have thus taken the first step towards the Federation of the States of that great country. (Cheers.)

But it would have been absolutely impossible to carry out a programme of the enormous complexity of the Olympic Games of 1908 if we had not had the hearty co-operation of the great Athletic Associations which govern the sports of this country. When we went to the Hague we told the representatives of other countries that it would be absolutely impossible to complete the programme here unless it was carried out through the great Associations governing all our various forms of sport; and I should like on behalf of the British Olympic Council to tender my most hearty thanks and gratitude to all those Associations who have done such splendid work in the Stadium, and by their assistance have made the achievement, and the successful achievement, of the Olympic Games of 1908 a possibility. (Cheers.)

Then, there are two sides to sport, one the athletic and the other the social; and it would have been impossible to have carried out the social side successfully unless we had had the great assistance of our subscribers. I am sorry to say—I do not know if it is modesty which has kept him away—but at all events something has prevented our largest subscriber, Mr. Sandow, who gave us no less than 1,500*l.* towards this fund—(cheers)—from being present on this occasion. But I must say this, that when he wrote to me he said he did not want anything said about it, but that he gave his subscription as some slight recognition of the splendid hospitality which he had always received in his journeys all over the world, and he took this unique occasion of expressing his appreciation of those kindnesses.

Even with the assistance of the subscribers and the Associations we should never have been able to carry out the Games but for the splendid arena in which they took place, and I would take advantage of this opportunity to thank the Executive of the Franco-British Exhibition and the designer of all the details

of the Stadium, Mr. Imre Kiralfy, whom I see present here to-night, for the splendid building in which these sports took place. Ladies and Gentlemen, Commissioners from foreign countries have been over here on behalf of their Governments watching all these Games, watching the gymnastics, watching the running, watching the swimming, and watching the whole management, and I heard only the other day that from Italy a Commissioner has come over to see the Stadium with the intention of erecting at the municipal expense a similar Stadium in Turin. We, on the other hand, are talking of pulling it down, and it seems to me that this reveals a curious contrast between the way in which this great movement has been looked upon here, and the way in which it is being taken up abroad. (Hear, hear.)

I will not at this moment detain you longer as I have got to appear before you on so many other occasions, but I should just like before sitting down to thank all my friends for the very hearty support which they have given to us all through these Games. They have I think, more than fully carried out the objects of those who began the great idea of the Olympic Games, for all over the world they have promoted not merely athletics and the culture of the body, but they have cultivated that excellent spirit which I am happy to think will be carried to their own countries by the 3000 athletes who were here for the Games, and who, through their delegates, will be able to return thanks for the hospitality they received, and will be able to give their opinions of the Games to their colleagues all over the world.

The Winter Games, of course, have been confined to a, much smaller number of contestants, but France is represented here, Germany is represented here, Sweden is represented here, the United States are here, and so are representatives from Australia and South Africa. Now, Ladies and Gentlemen, as regards the Winter Games, I shall speak of the countries alphabetically and not necessarily in the order of merit. With regard to France I should like to say this, that I feel a great debt of gratitude to France for their great energy in sending over two football teams and one hockey team. (Cheers.) I think that is a most splendid thing to have done, and I am happy to say that Mr. E. P. Denny, who is the delegate of the U.S.F.S.A., is here, and will be able to respond on behalf of France. To come to Germany, Mr. A. Brehm is here, the captain of their hockey team, and I should like to thank him for his great enterprise in bringing over this hockey team, and to congratulate him on the enormous strides they have made in that game of late. Germany, too, sent over a splendid team of gymnasts earlier in the Olympic Games; but unfortunately they drew by lot a very late hour, and had to perform on a rather dark afternoon in the earlier days of the Stadium, and did not receive that recognition at the hands of the public which so splendid an athletic team deserved. (Cheers.) I come to Sweden, which is represented here to-night by Mr. Salchow, who has lately won the first gold medal for skating, and I must say that of the Winter Games this certainly was not the least successful and was decidedly the most graceful. As regards the Swedes, the athletes in England feel a sense of gratitude to them for the splendid manner in which they always support us when we want anything done in the way of athletics, whether it is swimming, high diving, or any other form of sport. I am reminded too that Germany is also represented here by the German pair who won the pair-skating, and I believe a more admirable and excellent performance than theirs it would have been difficult to witness. We have another skater here from the United States of America, and I believe it is the first time they have taken part in European and Continental competitions, and I will ask him to respond for the United States of America. Australia—and I congratulate them on winning the Rugby football and going back to Australia with Olympic medals—is here represented by Mr. Muirhead Collins, whose team came to the Olympic Games as one representative of Australasia, and their boxer was one of

the finest seen at the Olympic boxing competitions. South Africa, which gained one of the most important prizes at the Olympic Games in the hundred metres race, is represented by a member of the Committee, and I ask him very kindly to say a few words on behalf of South Africa. Ladies and Gentlemen, I ask you to drink to the recent memory of the Olympic Games in 1908.

MR. E. P. DENNY: As you have a very long programme I will content myself, as the representative here of the French Federation, with thanking the British Olympic Council most heartily for the way they have received our athletes and for the way in which they have done everything they possibly could, and at the same time with thanking the English Federations for the way they have organised the sports and have conducted them to a successful finish. I have no doubt I am one of those people who like to criticise; but I came here with the idea that the main thing was to push the thing along, and it was in that spirit that we have taken part in the Games. Speaking with a certain amount of experience in organisation, I must say I am perfectly astonished with the satisfactory result, which speaks well for the care with which the enormous programme was carried out. The French teams return home with the utmost feeling of gratitude, and I also wish to thank Lord Desborough especially for his very kind reference to our two football teams. We were unfortunately unable to send over our best, on account of the hostility of employers and on account of the requirements of military service. But we preferred to send two teams rather than not come up to the scratch after promising to do so. The teams, I am sorry to say, did not give a very good performance, but that, as I have said, was because they were not our best. I am also requested by our Federation to offer excuse to the British Olympic Council for our inability to send over a Rugby football team. That was due to circumstances over which we had no control, and was owing to certain clubs refusing to send men because they would be engaged in championship matches in their own country. With regard to the hockey, we got two beatings from England, but we still feel that we were not disgraced and that we have at least done something, and therefore we go back to France perfectly content. I thank you all once more for the excellent way in which you have received us. (Cheers.)

MR. SALCHOW (of Sweden), winner of the gold medal for skating, said :

My Lord, Ladies, and Gentlemen, on behalf of the Swedish skating team I wish to be allowed to express my most sincere and warmest thanks to the British Olympic Council for the splendid hospitality and kindness shown to us during our stay in this country. We have received the greatest kindness, and the best possible arrangements that we could wish for were made for the skating competitions. I wish to point out that not only we Swedes, but also all foreigners I believe, were more than satisfied with the arrangements made, and it is quite admirable that the skating competition should have been carried out in such a splendid way in a country where for climatic reasons skating cannot be said to be a national sport. As regards your Lordship's kind words regarding our interest in sport in this country, I may say that we in Sweden like very much to come to this country. We gave proof of that about 1000 years ago when we came here, though perhaps we were not quite so welcome. We come in a different way now, and we have always appreciated the good English spirit of sport which has made your sportsmen in our country so popular. I have only again to thank the British Olympic Council, and I raise my glass to the health of this splendid body. (Cheers.)

MR. T. A. COGLAN (Agent-General for New South Wales), in replying for Australia, said :

I have been called on very suddenly to reply for Australia. It gives me extreme pleasure to do so. First of all because Australia, I believe, above all

people in the world is an athletic nation. We, I think, carry out the principles of athletics more than any country, because we, the people of Australia, are all athletes. They don't pay their shilling and their sixpence to go to see other people contend in the arena, but they contend themselves, and the result is that we produce the greatest scullers of the world. Some gentlemen, I notice, are rather sceptical, but it is at any rate a fact that we have for the last twenty-two years held the rowing championship of the world. I think we can also claim pre-eminence in the game which is England's own, I mean cricket. If we are not your superiors at all events we are your equals—(cheers)—and I do hope the success we had last year over the English team will be repeated next year in England. In football, too, we are not doing badly. Now, Gentlemen, I do not wish to be considered boastful, but we must recognise that the success of athletics the world over can only be achieved by people not merely looking on but taking part in the games themselves. Of course, we do this in Australia because we have the finest climate you can conceive of. In a gathering of this kind when you are telling simple home truths you are sometimes laughed at; but we can play cricket all the year round, and therefore we are good cricketers, and I think there must be something to be said for a people who, having no winter, can yet play football and do as well as we do. Now, Gentlemen, as you wish to get on with other speeches, I will simply thank you on behalf of the Australian athletes. We did not do much this year, but we will do better next time, and I hope that next time the Olympic Games are held, wherever they are held, you will find Australia maintaining the position of the lover of athletics and the lover of all manly sports. (Cheers.)

The CHAIRMAN then said :

Ladies and Gentlemen, I have a most pleasing duty to perform, which I shall have to do in a very much shorter space of time than its real merits deserve, and that is to ask our Honorary Secretary of the British Olympic Council to accept at our hands, his colleagues of the Council, some slight testimony to remind him of the splendid work which now for two years he has done for the Olympic Games. (Cheers.) He would, Ladies and Gentlemen, I am perfectly sure, be the first to admit that he has received very substantial help from the members of the Council, which met, I think, some fifty times, and if you take all the Committees and Sub-Committees which they attended, I think they have met continuously for the last two years. I should like to mention the work of the Art Committee, over which Mr. Theodore Cook presided; the Finance and General Purposes Committee, of which Mr. Newton Robinson was Chairman; and the Programme Committee, over which Mr. Gridley presided, to all of whom we owe a great deal for the success which attended their labours. No less than seven Olympic banquets have been held in this hall, and the success of these was due to the Housing and Entertainment Committee, presided over by Mr. Guy M. Campbell. The Press Committee, which did its work to the unanimous satisfaction of the Press, had as its Chairman Mr. Wall.

I am not quite sure about the number of letters which have been written and received, but I believe that the most important ones—and they have been put away and docketed—amount to something like 11,000. I also see that these 11,000 letters, or at any rate the greater number of them were written in four languages—English, French, German, and Italian, in all of which my friend Mr. de Courcy Laffan is a proficient.

I am going to ask him—I am afraid I cannot tell you all his excellencies—I am going to ask him to take from US with our very best wishes, the wishes of the British Olympic Council, this album which contains all their names. I may say it is the work of Mr. Herbert Grimwade, an official of the Olympic Games, who has done the work with the same whole-hearted enthusiasm which

he threw into all his other work. I shall also ask him to accept this clock, which was made nearly three hundred years ago by Thomas Wheeler, then a parishioner of Walbrook, over which Mr. Laffan now presides, so that you will see it is not a very modern clock, and if the spirit of Thomas Wheeler remains with his old parish, and if he had known what was to be the future of his clock he would I am sure long to have been here and to have seen it presented to Mr. Laffan. (Cheers.) Mr. Laffan, I will ask you to accept these souvenirs with the most hearty good wishes of the whole of the Olympic Council, and in handing them over to you I cannot do better than read the inscriptions which they bear. In the first page of the album are the following words :—

“The Rev. R. S. de Courcy Laffan, Honorary Secretary of the British Olympic Association, from the Members of the Council, 1908.”

And on the second page are the following words :—

“On the following pages are inscribed the names of your colleagues on the British Olympic Council who desire to place on record their appreciation of the kindly, tactful, and whole-hearted manner in which you have discharged the arduous duties of Honorary Secretary in connection with the Olympic Games of London, 1908.

“That health and prosperity may ever attend you is the most sincere wish of the undersigned.”

The inscription on the clock is as follows :—

“To the Rev. R. S. de Courcy Laffan, Honorary Secretary of the British Olympic Association, from his Colleagues on the Council, 1908.”

To this I should like to add my own thorough endorsement of every word which is contained in these inscriptions. Mr. Laffan, you will kindly accept these gifts from your colleagues. (Loud cheers.)

REV. R. S. DE COURCY LAFFAN, who was received with loud and prolonged cheering, replied as follows :—

My Lord Desborough, Friends and Colleagues of the British Olympic Council, Your Excellency, My Lords, Ladies, and Gentlemen, it is with feelings of the deepest and most heartfelt gratitude that I rise to thank you for this most generous appreciation which you have shown me of the little that I have been able to do for the Olympic Games of London. I thank you, Sir, for the more than kind words which you have spoken, and if it were not that I fear to encroach upon the territory of my friend, Mr. Hayes Fisher, I should like to dwell for a moment upon the fact that it has been your influence and the prestige of your name and the world-wide reputation which you have made as a sportsman, and the respect and admiration with which you are greeted in every country in the world, that has made it possible to hold this Olympiad in London at all. But as I must not trespass on a subject which will be dealt with much more ably than I could deal with it, you will allow me to pass on and to thank my colleagues and friends of the British Olympic Council for these exquisitely beautiful gifts and for that of which they will always be a symbol and memory—the kindness, the courtesy, the patience, and forbearance with which they have treated me during those two years of arduous work.

It is inevitable that in work like this many mistakes should be made, that there should have been many moments when it was impossible to satisfy the demands of everyone, and I thank my colleagues with all my heart for the kindness and patience which throughout they have shown me. These gifts of yours, Gentlemen, will always be to me the memorials of close friendships which, I trust, will only be ended by the ending of our lives. I believe, Gentlemen, that my wife has already—she was let into the secret before I was—has already selected the place in which she is going to place this beautiful clock of yours, and as she looks upon it she will, I think, be reminded very often of the many hours

during which she has anxiously watched the face of the clock to see whether I was coming back from the Olympic Offices. (Laughter.) Now, Ladies and Gentlemen, I do want to say just one word about that. I think that to the ladies of the Olympic Council for the splendid way in which they have all sympathised with us in our work, in which they have helped us to do it, and in which they have been patient under the great difficulties which we must each of us have raised in our household, our very best thanks are due. (Cheers.) I should like to tender, if I may, to all ladies connected with the Council our most hearty thanks. (Cheers.)

Then you will allow me also to say that this work could not possibly have been done unless we had met from all our correspondents in foreign countries with a very great measure of patience and forbearance and readiness to excuse all manner of shortcomings. Sometimes it was not possible to answer questions at once, sometimes letters had to be delayed. I can only say that to my correspondents in every country my heartfelt thanks are due for the kindness they have shown to me during the time of my correspondence with them. It has been because they have so nobly and disinterestedly worked with us in the organisation that these Games have attained the success which they have; and let me say to you, you gentlemen who come to us from foreign countries, let me say on behalf of all the English organisers that we hope and we intend, when your turn comes to organise Olympic Games, to try to repay you something at least of the kindness and courtesy which you have shown to us.

For, Ladies and Gentlemen, if you will bear with me for a moment longer, do not let US forget that these Olympic Games in London are only an episode in a great movement and a great life. The first revival of the Olympic Games took place at Athens in 1896. What is twelve years in the life of a movement which sets before it those great ideals, the perfect physical development of a new humanity, the spreading all over the world of that spirit of sport which is the spirit of the truest chivalry, and the drawing together of all the nations of the earth in the bonds of peace and mutual amity? You cannot expect, Ladies and Gentlemen, that an ideal such as that can be carried out in a year or in a decade or possibly even in a century. You are at the beginning of one of those great world movements which is going to develop itself long after those who are here have left this world. You have seen the beginnings of something of which no man can foresee the great and the ultimate results. I am perfectly well aware that there are those who will laugh at this ideal. I should have laughed at it myself twelve years ago. I came to the Olympic movement prepared to scoff and I remain to admire, and I hope I shall remain to work. Well, Ladies and Gentlemen, if we have achieved something, we have had our dark times, and I must warn those who organise future Olympiads that they must be prepared for difficulties, that they must be prepared for the times of trial, for of this, as of all great human endeavours, it is true :—

“With aching hands and bleeding feet  
We dig and heap, lay stone on stone;  
We bear the burden and the heat  
Of the long day and wish 'twere done,  
Not till the hours of light return,  
All we have built do we discern.”

(Cheers). If we have built something, if on the side of the organisation which has centred in my office, something has been done, you will allow me, I am sure, to-night to take one minute more to return thanks to my colleagues, through whom this work has been made possible. I want to thank first of all my friend and colleague, Captain Whitworth Jones, whose clear judgment and robust common sense has pierced to the heart of so many a difficulty, whose unquenchable optimism and whose imperturbable cheerfulness have lightened the darkest day, and



whose sympathy and whose tact have been acknowledged and admired in letter after letter which I have received from foreign nations, so that he has won in the last Italian letter I have received the title of "il simpatico Capitano F. Whitworth Jones." And then I want to thank all the members of my staff without exception. Again, from all foreign countries I have received messages of thanks for the courtesy and patience with which they have been treated by all the officials in the Offices of the British Olympic Council. And that, let me tell you, was not a very easy thing when our rooms were sometimes crowded with athletes of all nations, and five or six languages were being spoken at the same time. This is known to everybody, but what nobody but myself knows is the ungrudging, lavish work done by all my colleagues, who stayed on till the small hours of the morning in those weeks in July, sometimes more than a week at a time. To every-one of them I offer my hearty, grateful, and most enduring thanks.

For what you, My Lord, have been kind enough to say about myself I thank you very heartily. I have only to add that it is to me a privilege in itself to have been allowed to do something for what I consider one of the greatest causes on earth, the cause which has as its supreme ideal "Peace on earth and good will towards men." (Cheers.)

MR. WILLIAM HAYES FISHER : Your Excellency, Your Worships, My Lords, Ladies, and Gentlemen, we are reversing the usual order of proceedings. On almost every occasion the gold medal is given first, the silver medal is given next, and the bronze medal comes last of the three. But to-night Lord Desborough has first awarded what I think is only the bronze medal—the vote of thanks to all the competitors; the silver medal has just been awarded most deservedly to one who has proved himself to have a silver tongue—Mr. Laffan. But now, in the names of my colleagues, it is my privilege to present to Lord Desborough the gold medal for the arrangements of all these Olympic Games.

During these contests we have experienced very little division of opinion as to who ought to have either the gold or the silver medal, and to-night we shall experience no difference of opinion whatever, for by the universal consent of every judge from every country the gold medal to-night is awarded to you, Lord Desborough. (Cheers.) Let me recall to the rest of you, my own countrymen, that you took no part, or very little part in 1896 when this splendid movement was inaugurated at Athens; that you took no part, or very little part, when it was repeated for the second time in Paris four years afterwards; you took no part, or very little part, when it was repeated for the third time at St. Louis. We are a slow-going nation—slow to wake up, but when we do get into our stride we get into it pretty fast; and I think we have shown that, though we were slow to take part in the movement, we have made up for lost time on this occasion, and that we have been able to do so is due in no small measure to you, Lord Desborough, who from the earliest moment initiated Great Britain into these wonderful mysteries and into the knowledge of the possibilities and potentialities of the Olympic revival.

There was a curious situation to deal with. Here was a great movement, spreading over Europe, rousing young ambitions, lighting new fires, setting afoot new rivalries among young men, aye and even among the young women of Europe. And yet England, the home of sport—I believe everyone would acknowledge that—the national field most fertile in games, hung back, stood aloof, took no part in that movement. And why? Because, I believe it was this reason only, we had not yet found a leader with that necessary combination of qualities for popularising this noble ideal which has been so splendidly put before you in that magnificent speech of Mr. Laffan's to-night. (Hear, hear.) And not only for popularising the ideal, but for devising the complex and elaborate

machinery by which you might develop it. Well, they say : "Given a crisis, given an hour, the man will come." We had a crisis, we had our hour, and the man arrived. (Cheers.) And in 1905 the British Olympic Association was formed and Lord Desborough became the first Chairman of the British Olympic Council. To my mind he arose like a Homeric hero, much like Ajax, of whom it was said (remembering that this is a British Olympic Council I shall not quote it in Greek) :—

"Ajax, the grace of the gods has bestowed on thee vigour and stature,  
 Knowledge of arms; in the use of the spear thou art first of Achaia!  
 So let us cease for awhile from strife and the mortal encounter,  
 Cease for to-day—we shall combat again."

And I think we might paraphrase or parody that and say : "In the knowledge of games and sports, in the use not only of the spear but of the sword, in the use of your limbs for swimming, for cricket, for running—you have been the first almost in England." (Cheers.) And if Ajax should come back again, I undertake that our President would take him on! (Laughter and cheers.) Ajax was first with the spear, but Lord Desborough would, I believe, take him on with the sword. I daresay Ajax could swim, I daresay he could possibly row one of those old galleys, but I am certain he could not punt like our Chairman. (Laughter.) Well, now, we had to look for a leader, and I say a leader arose to the hour. But for what qualities had we to look? We had to look for a leader who had a knowledge of most sports and a sympathy with all, because it was necessary that his judgments and his decisions should carry weight with the world of sport. But we wanted more than that. In our very elaborate social system we wanted some one who could carry weight with the whole social structure in this country. We wanted a man who if he gave his name to any undertaking, that name would be taken as a guarantee by kings and by princes that they might attend the meeting without any loss of dignity, and that they might grace that exhibition with their presence; and we wanted a name which was equally a guarantee that every humble subject of this country who had a shilling left in his pocket on Saturday, or any day of the week, might be able to spend that shilling with the certain knowledge that he would get his money's worth of true sport. All this we found in Lord Desborough. To-night we, of the British Olympic Council as a body, are asking you to accept this token of our appreciation. We wanted some one to preside over US to whose judgment we could attach importance. We wanted somebody who knew a little bit more than we did, and we wanted somebody with zeal. But zeal is no good unless it is coupled with humour, the capacity to appreciate a little jest, to make the proceedings pass off merrily, and very often by just a little turn of phrase to settle a little quarrel. We got him in Lord Desborough. We wanted a man of untiring energy and patience and industry in dealing with all the details that led up to meetings, which, I am told, on some occasions lasted a week without a break. (Laughter.) Well, I say you must search Great Britain all over and you won't find any other man—and I know most of our public men—you won't find any other man in Great Britain with that combination of qualities except Lord Desborough. (Cheers.) In fact, I believe, he was born for the occasion. (Laughter.)

Well, I am not going to expatiate on all the merits—I could and would on other occasions—of this great Olympic movement. But I would like to associate myself with every word that has fallen from Mr. Laffan; if we have achieved this great success it is due in the main to these two gentlemen who sit the one on my right and the other on my left, who have been the great pillars upon which the whole fabric of the movement in Great Britain has been built and sustained. And, again, I will give you one more Homeric quotation. I notice that there are pessimists sometimes in the Press and sometimes outside the Press, who say that

this movement will breed bad blood and ill-feeling amongst nations. I say : "Nothing of the kind." I say, on the contrary, that this movement will build up amongst all nations a great knowledge of each other's merits and a great respect for each other's performances, and that it will make an innumerable number of international friendships scattered all over Europe, and that everybody who enters in to these contests in future will breathe that magnificent spirit which Homer puts into the mouth of Hector :—

"But let us each now grace with a notable gift his opponent;

So that a man may say, if a stranger he be or a Trojan,

Deadly enough was the strife of those chieftains heated in combat,

Yet did they part from the battle united in friendship together."

And so, Ladies and Gentlemen, I not only believe but I know that those who have met in the most intense rivalry each desiring not so much for himself as for his country the highest prize that could be awarded for the magnificent physical development which it betokened, each of them, whether victor or vanquished, has gone away with the desire to cultivate the friendship of all those who, in whatever nation or country they may live, have the same pursuits as himself and are engaged in the same arduous struggle for supremacy and for victory.

We cannot crown you with wild olives, with apples, with parsley, or with bay. These were the gifts of the old Greeks one to another. But we present you with the only token which you will receive from us. We would like to give you the Stadium if we could—(laughter and cheers)—and Mr. Imre Kiralfy is here, and I just recommend him to take a little note of it. That is the gift we should like to give you. As it is we can only give you this token of our esteem and appreciation, of your zeal, of your untiring energy and good will which you have displayed during your Presidency of the British Olympic Council, and which have contributed so largely to the successful issue of the Olympic Games of London in 1908. (*Mr. Hayes Fisher then handed to Lord Desborough an illuminated testimonial signed by all the members of the British Olympic Council. The company afterwards joined in three cheers for Lord Desborough and another for Lady Desborough.*)

LORD DESBOROUGH: My Lords, Ladies, and Gentlemen, I have listened with the greatest interest to the words which have fallen from my friend, Mr. Hayes Fisher, who compared me to a great many gentlemen of old times. I can only hope they were all respectable. (Laughter.) My classical education has been somewhat neglected of late, but I have considerable doubt about some of them. I can only say this : I return to you all, sportsmen here and ladies too, my most hearty thanks for the very kind manner in which you have received these words, which I feel I do not anything like deserve. I do not wish to detain you long to-night. I have made many speeches on the subject of the Olympic Games, but I think that subject has been well summed up by my friends on my left and right. We have here a gentleman who is the Secretary (we are all Honorary), the Honorary Secretary to the International Olympic Committee, who has been with its movement from the first, and who will respond to this toast which, I venture to think, is the toast of the evening. Now that the Fourth Olympiad is over, and we have to look forward to the Fifth, my friend, Count Brunetta d'Usseaux, who represents the Kingdom of Italy, which did so well this year on the racecourse and in other sports, will respond to the toast of "The Fifth Olympiad."

But before I propose his health, which I shall do in one or two words, I should like to return my thanks and those of the British Olympic Council to those who worked so hard in the aquatic portion of the Games. There are several Mayors here to-night—the Mayors of Oxford Reading, Henley, and

High Wycombe. All these gentlemen, under the leadership of the Mayor of Henley, combined together in the three counties to give our aquatic representatives the reception which England knows how to give to those who do well. I think there is also one other name which this meeting could not separate without acknowledging. I allude to the splendid personal efforts which Lord Northcliffe threw into the Olympic Games at a moment of the most critical import. The appeal which he made was splendidly responded to by both Houses of Parliament, by the Army, by many clubs, among others the Bath Club, and the Stock Exchange, and by innumerable gentlemen throughout the country.

We now have to turn our attention to the Fifth Olympiad. I am not going to say anything about the objects of the institution of this great movement, except to say that I believe in times past, and especially this year, it has promoted friendship and good will between nations, and I believe it is a movement which in times to come has a great future to look forward to. I associate the toast with the name of Count Brunetta d'Usseaux, and I give it with all enthusiasm, knowing well from personal knowledge and acquaintance with him the great work which he has done for it in many years past. He is representing on this occasion the founder of the Olympic movement, Baron Pierre de Coubertin, by whose genius the Games were first started in the historic Stadium at Athens. Baron de Coubertin had every intention of attending this banquet. He was here during the past week, but yesterday, unfortunately, he was summoned home by the unexpected and sudden death of his father. I am sure we all lament the occasion which has taken him from us. I ask you to drink to the health of his representative, Count Brunetta d'Usseaux. (Loud cheers.)

COUNT BRUNETTA D'USSEAU spoke as follows:—

Lord Desborough, Mylords, Mesdames et Messieurs,—

Je remercie avant tout mon cher ami lord Desborough pour les mots très gracieux qu'il vient de prononcer à mon égard.

Le président du Comité International Olympique, rappelé à Paris par un deuil inattendu, m'a chargé de le remplacer ce soir. C'est ainsi que j'ai l'honneur de prendre la parole ici au nom de tous nos collègues.

Monsieur le président et Messieurs les membres du British Olympic council,— Vous avez organisé, dirigé et conduit brillamment jusqu'à son terme cette Olympiade d'une façon digne de la haute réputation sportive que l'Angleterre possédait et que le monde entier vient en quelque sorte de confirmer à nouveau. C'est au nom de tous les pays qui ont répondu à votre appel que je me crois autorisé à vous remercier pour l'accueil à la fois cordial et grandiose et si conforme à vos traditions que tous ont trouvé près de vous. C'est aussi en leur nom et en toute conscience que je me permets de rendre hommage à l'esprit de justice et d'équité dont s'est inspirée votre ligne de conduite.

Aucun pays sans doute, hormis le votre qui possède des organisations sportives aussi puissantes que disciplinées, n'aurait pu, en moins de deux années, accomplir ce tour de force d'organiser et de mener jusqu'à leur apogée triomphale un pareil ensemble de concours. La pierre de touche de ce succès sera le compte que devront en tenir les organisateurs des Olympiades futures tant par rapport au nombre des problèmes résolus qu'à la perfection technique réalisée.

Il n'y a toutefois de belle médaille qui n'ait son revers. Avec une large moisson de compliments vous avez récolté quelques critiques. La critique courtoise, dictée par le désir de vous aider dans votre tâche, a été accueillie par vous comme elle le méritait. L'autre critique, inspirée de sentiments opposés au désintéressement absolu, ne pouvait vous atteindre et sert seulement à prouver que, non pas parmi les champions, mais parmi les officiels venus de loin, il s'en est trouvé pour ne pas comprendre encore à quel point la résurrection des antiques Olympiades repose sur le désintéressement absolu, la généreuse émulation, la

camaraderie cordiale, la discipline et enfin le respect des conditions librement acceptées.

Je salue les vaillants champions du monde entier qui ont eu l'honneur d'être couronnés par les plus belles et nobles mains de l'Angleterre et qui ont compris, eux, le but que nous poursuivons ; ils ont montré quels beaux résultats on obtient par l'entraînement rationnel et discipliné allié au véritable esprit sportif.

Je me plais à reconnaître d'autre part le mérite des jurys qui ont fonctionné ici d'une manière si satisfaisante. On peut se demander si les jurés désignés en pareil cas par chaque nation constituent vraiment un jury ou s'ils en ont seulement le nom, n'étant en fait que les avocats de leurs nationaux?... Mais, en tous les cas, et quelles que soient les décisions prises pour l'avenir, il faut admettre que les jurys de la IV<sup>e</sup> Olympiade ont fait en conscience leur devoir et y ont apporté autant de zèle et de compétence que d'impartialité.

Du jury mon hommage monte aux organisateurs qui n'ont épargné ni temps ni fatigues pour que les Jeux Olympiques de Londres fussent dignes de l'Angleterre. En nommant lord Desborough et le Révérend de Courcy Laffan, je rends hommage en même temps à tous leurs dévoués collaborateurs depuis les éminents jusqu'aux modestes employés dont l'intelligence et le tact ont paru au-dessus de toute éloge.

Et maintenant je voudrais être orateur pour trouver les paroles appropriées dignes de saluer Sa Majesté la Reine qui, dans un moment où des milliers de cœurs ont palpité d'angoisse et où le règlement d'un côté, la *vox populi vox Dei* de l'autre tenaient la foule perplexe, a eu l'inspiration la plus gracieuse et d'un geste charmant trancha le noeud gordien aux applaudissements de l'univers.

Enfin, je dirai qu'ayant eu l'honneur d'être reçu aujourd'hui même en audience, au palais de Buckingham, S. M. le Roi a daigné me manifester sa satisfaction et me charger d'en transmettre l'expression à lord Desborough et à ses collaborateurs.

La quatrième Olympiade se termine ce soir. Vive donc, comme on le disait tout à l'heure, la cinquième Olympiade! Le Comité International qui s'assemblera au mois de mai à Berlin dira à laquelle des deux nobles nations concurrentes, la Suède ou l'Allemagne, doit revenir l'honneur de convier en 1912 les champions du monde. Nos Olympiades représentent bien la fameuse "course du flambeau." Le flambeau olympique passe de mains en mains. Les nations en le tenant tour à tour tracent à travers l'humanité moderne un sillon de progrès vers la conception des forces individuelles harmonieusement développées par la culture physique.

Et maintenant, Mylords et Messieurs, de la part et au nom du Comité International Olympique, je proclame la clôture des Jeux Olympiques de Londres. Et je crois ne pouvoir le mieux faire qu'en ces termes : Hurrah for old England, the seat of the Fourth Olympiad, the land of sport and fair play!

LORD DESBOROUGH (before asking the company to join in singing Auld Lang Syne) said : It would not be proper to close these proceedings without acknowledging to the Press of England our sense of indebtedness for the splendid manner in which it has supported the movement by so adequately and fully reporting all the details in connection with the Olympic Games.

There has just been put into my hands a telegram from Baron de Laveleye, President of the Belgium Olympic Council, which I shall read :—

"To the Secretary, Olympic Council,  
"Holborn Restaurant, Londres.

"President Belgian Olympic Committee deeply regrets unable be with you. Sends best thanks for past kindnesses. All congratulations for splendid organisation and fair play of Games. Hearty wishes for future successes of British sports.  
BARON DE LAVELEYE."

## SPEECH AT THE GOVERNMENT BANQUET.

It will be an appropriate close to this record of the Olympic Games of 1908 if I print the speech delivered by Baron Pierre de Coubertin at the official banquet given by His Majesty's Government to the officials of the Olympic Games on July 24. The Right Hon. L. Harcourt and the Right Hon. Sir Edward Grey, His Majesty's Ministers, were present and spoke on this important occasion. But the words of the President of the International Olympic Committee form a statement of his views on the foundation of the Games and on the trusteeship, of the idea vested in his Committee which deserves permanent commemoration here. He spoke as follows :—

Excellences, Mylords et Messieurs,—Au nom du Comité International Olympique je vous exprime ma profonde reconnaissance pour l'hommage qui vient de nous être rendu. Nous en garderons un souvenir ému comme de cette IV<sup>e</sup> Olympiade pour laquelle, grâce au zèle et au labeur de nos collègues anglais, un effort colossal a pu être tenté dans la voie de la perfection technique. Et si satisfaisant que soit le résultat, j'espère de ne pas marquer une ambition trop grande en disant que dans l'avenir nous espérons qu'on fera mieux encore, si cela est possible. Car nous voulons toujours progresser. Qui ne progresse pas recule.

Messieurs, les progrès du Comité au nom duquel j'ai l'honneur de parler ont été jusqu'ici considérables et rapides. Et quand je songe aux attaques sans nom dont il a été l'objet, aux embûches, aux obstacles que des cabales invraisemblables et des jalousies forcenées ont dressé sur sa route depuis quatorze ans, je ne puis m'empêcher de penser que la lutte est un beau sport—même lorsque, délaissant les passes classiques, vos adversaires en viennent à pratiquer contre vous les surprises du *catch as catch can*. Tel est le régime auquel le Comité International Olympique a été soumis dès sa naissance, et il paraît y avoir gagné une solide et robuste santé.

La raison de ces combats? Oh! mon Dieu! je vous la dirai en deux mots. Nous ne sommes pas des élus ; nous nous recrutons nous-mêmes et nos mandats ne sont pas limités. En faut-il davantage pour irriter une opinion qui s'accoutume de plus en plus à voir le principe de l'élection étendre sa puissance et mettre peu à peu sous son joug toutes les institutions? Il y a, dans notre cas, une entorse à la loi commune difficilement tolérable, n'est-il pas vrai? Eh bien! nous supportons la responsabilité de cette anomalie très-volontiers et sans inquiétude.

Pour ma part j'ai appris autrefois dans ce pays-ci beaucoup de choses et celle-ci entre autres, que le meilleur moyen de sauvegarder la liberté et de servir la démocratie, ce n'est pas toujours de tout abandonner à l'élection, mais de maintenir, au contraire, au sein du grand océan électoral, des îlots où puisse être assurée, dans certaines spécialités, la continuité d'un effort indépendant et stable.

L'indépendance et la stabilité, voilà, Messieurs, ce qui nous a permis de réaliser de grandes choses ; voilà ce qui, trop souvent, il faut bien l'avouer, fait défaut aux groupements d'aujourd'hui, aux groupements sportifs en particulier.

L'idée olympique, c'est à nos yeux la conception d'une forte culture musculaire appuyée d'une part sur l'esprit chevaleresque, ce que vous appelez ici si joliment

le *fair play*, et de l'autre sur la notion esthétique, sur le culte de ce qui est beau et gracieux. Je ne dirai pas que les anciens n'aient jamais failli à cet idéal. Je lisais ce matin à propos d'un incident survenu hier et qui a causé quelque émoi, je lisais dans un de nos grands journaux une expression de désespoir à la pensée que certains traits de nos mœurs sportives actuelles nous interdisaient d'aspirer à atteindre le niveau classique. Eh! messieurs, croyez-vous donc que de pareils incidents n'ont pas émaillé la chronique des Jeux Olympiques, Pythiques, Néméens, de toutes les grandes réunions sportives de l'antiquité? Il serait bien naïf de le prétendre. L'homme a toujours été passionné et le ciel nous préserve d'une société dans laquelle il n'y aurait point d'excès et où l'expression des sentiments ardents s'enfermerait à jamais dans l'enceinte trop étroite des convenances.

Il est vrai de dire pourtant que de nos jours, oit les progrès de la civilisation matérielle—je dirais volontiers de la civilisation mécanique—ont magnifié toutes les choses, certains travers qui menacent l'idée olympique sollicitent l'inquiétude. Oui, je ne veux point le celer, le "fair play" est en danger; et il l'est surtout à cause de ce chancre auquel on a permis imprudemment de se développer: la folie du jeu, la folie du pari, du *gambling*. Eh bien! s'il faut une croisade contre le *gambling* nous sommes prêts à l'entreprendre et je suis sûr qu'en ce pays l'opinion voudra nous seconder—l'opinion de tous ceux qui aiment le sport pour lui-même, pour sa haute valeur éducative, pour le perfectionnement humain dont il peut être un des facteurs les plus puissants. Dimanche dernier, lors de la cérémonie organisée à Saint-Paul en l'honneur des athlètes, l'évêque de Pensylvanie l'a rappelé en termes heureux; l'important dans ces olympiades, c'est moins d'y gagner que d'y prendre part.

Retenons, messieurs, cette forte parole. Elle s'étend à travers tous les domaines jusqu'à former la base d'une philosophie sereine et saine. L'important dans la vie ce n'est point le triomphe mais le combat; l'essentiel ce n'est pas d'avoir vaincu mais de s'être bien battu. Répandre ces préceptes c'est préparer une humanité plus vaillante, plus forte—pourtant plus scrupuleuse et plus généreuse.

Telles sont les idées qui dominent au sein de notre groupement. Nous continuerons à nous en inspirer. Nous vous donnons rendez-vous dans quatre ans pour célébrer la V<sup>e</sup> Olympiade, sans oublier que, dans l'intervalle, se tiendront de nouveau les jeux d'Athènes et que, de nouveau, l'univers se tournera vers l'Hellade immortelle dont le culte est inséparable de toute aspiration ennobliissante.

Permettez-moi au nom de tous mes collègues de saluer ici vos patries respectives et en premier lieu la vieille Angleterre, mère de tant de vertus, inspiratrice de tant d'efforts. L'internationalisme tel que nous le comprenons est fait du respect des patries et de la noble émulation dont tressaille le cœur de l'athlète lorsqu'il voit monter au mât de victoire, comme résultat de son labeur, les couleurs de son pays.

A vos pays, Messieurs, à la gloire de vos souverains, à la grandeur de leurs règnes, à la prospérité de vos gouvernements et de vos concitoyens.

## KING EDWARD VII. AND THE OLYMPIC GAMES.

The following short account of the audience granted to the Secretary of the International Olympic Council by the King appeared in the *Revue Olympique* for November 1908 :—

Le comte Brunetta d'Usseaux s'est rendu le 31 octobre au palais de Buckingham pour porter à S. M. le roi d'Angleterre, à l'issue des Jeux Olympiques de Londres, les hommages et les remerciements du Comité International. L'accueil fait par Sa Majesté au représentant du Comité a été des plus gracieux. Après avoir excusé le baron Pierre de Coubertin, rappelé à Paris par la mort soudaine de son père, le comte Brunetta d'Usseaux a exprimé le sentiment de gratitude dont tous ses collègues étaient animés envers Leurs Majestés qui avaient daigné au cours de la IV<sup>e</sup> Olympiade, manifester si clairement l'intérêt qu'Elles y prenaient.

Le roi Edouard s'est alors informé si le Comité International était pleinement satisfait des efforts faits par le British Olympic Council et des résultats auxquels il avait atteint. Le comte Brunetta d'Usseaux n'a pu que certifier à son auguste interlocuteur combien le Comité était heureux de rendre hommage à de tels efforts et à de si beaux résultats. Sa Majesté s'est plu alors à déclarer qu'elle appréciait à un haut degré l'œuvre du Comité International Olympique et tenait à lui marquer sa bienveillance toute spéciale. Le roi n'aperçoit pas seulement en effet la valeur de cette œuvre au point de vue sportif mais encore et surtout au point de vue éducatif et social. Elle renferme le principe de relations internationales qui, débutant pendant la jeunesse par les rencontres sportives, s'étendent ensuite au cours de la vie à toutes les manifestations de l'activité humaine et répondent directement aux instincts et aux besoins du temps présent. C'est par les contacts étrangers que le jeune homme achève de se former au "self-government" et élargit le champ de son initiative. Les contacts sportifs sont les premiers et les plus naturels entre jeunes gens.

Le roi s'est encore informé de ce qui concernait la prochaine Olympiade, puis, il a chargé le comte Brunetta de transmettre à lord Desborough l'assurance de sa vive satisfaction pour le succès des Jeux Olympiques de Londres.—Le comte Brunetta après avoir remercié le roi de ses importantes déclarations lui a de nouveau présenté, ainsi qu'à Sa Majesté la Reine, les respectueux hommages du Comité International Olympique.









