



LONDON  
1948

## XIV OLYMPIAD



**HIS MAJESTY KING GEORGE VI**

THE OFFICIAL REPORT  
OF  
THE ORGANISING COMMITTEE FOR THE  
XIV OLYMPIAD



PUBLISHED BY  
THE ORGANISING COMMITTEE FOR THE XIV OLYMPIAD • LONDON • 1948



COPYRIGHT - 1951  
BY  
THE ORGANISING COMMITTEE FOR THE XIV OLYMPIAD • LONDON • 1948

" *THE spirit of the Olympic Games, which has tarried here awhile, sets forth once more. May it prosper throughout the world, safe in the keeping of all those who have felt its noble impulse in this great Festival of Sport.*"

LORD BURGHEY, *Chairman of the Organising Committee, for the scoreboard at the Closing Ceremony, August 14, 1948.*



# INTRODUCTION

*By the General Editor, The Right Hon. The Lord Burghley, K.C.M.G.*

**I**N the production and presentation of this Official Report, the Organising Committee has endeavoured to satisfy two primary objects : that the matter shall be, as far as possible, accurate, and that it shall serve not only as a record of the work leading up to the staging of the London Games of 1948, and of the competitions themselves, but also that it may be of assistance to future Organising Committees in their work.

The arrangement of the matter has been dictated, apart from the Results sections and those articles dealing with the celebration of the actual Games themselves, by the arrangement of the work of the departments of the Organising Committee which it was found necessary to create.

With their immensely varied ramifications the Games depend enormously for their successful organisation on the enthusiastic team spirit of all those engaged in the work. Although the shortage of time made the rapid assembly of an organisation necessary, yet in fact it suffered but little for this. If the success of the Games can be attributed to one factor more than any other, it is to the remarkable way in which the Olympic spirit fired all those who worked in the organisation, whether on a voluntary or a paid basis. It is the proudest boast of each and every one of them that they contributed to their uttermost to create a great and glorious landmark, not only in the saga of sport, but also in the achievement of youth to rise above the jealousies of the world and lay a cornerstone in that building of tolerance, understanding and friendship within which the world alone can truly prosper.



## **The President of the Games**

*Within a few months of the conclusion of the London Games, all those connected with them suffered a most grievous loss in the death of the President of the Games, Lord Portal. The position was planned originally as a non-executive one, but it was typical of the man that in his very busy life he yet found time, during those last eighteen months, not only to attend all the meetings of the Executive Committee, but also to preside over the General Purposes Committee in its most important work. His wisdom, experience, enthusiasm and generosity played a vital part in the success of the Games, and all connected with their organisation mourn the loss of not only a most valued colleague but a true friend.*

## ACKNOWLEDGMENTS

**I**N the preparation of a Report of this magnitude, it is not possible to pay tribute to all those persons who have given of their services. The Organising Committee, however, gratefully acknowledges the contributions of the undermentioned persons who provided the material which formed the basis of the various articles preceding the results :

H. M. Abrahams, H. S. Anderson, G. A. Bark, C. L. de Beaumont, O. van Beets, J. Beresford, W. R. Browning, J. Dudderidge, F. G. Hands, B. Joy, Cmdr. H. Lingard, Major A. A. Longden, P. Longhurst, G. Mackenzie, G. T. Matveieff, T. O'Connor, J. Scott Hughes, E. A. Simmonds, O. State, Lt.-Col. O. G. White, H. Wynmalen.

The Organising Committee also extends its thanks to the many technical representatives who have submitted articles and given their advice and time in the preparation of the technical and administrative, sections of this Report. These members of the national governing bodies of sport in Great Britain, the staffs of the various organisations with whom the Organising Committee worked and the staff of the Organising Committee itself, have all endeavoured to produce a true picture of the happenings in London in 1948. No list can be comprehensive but mention must be made of at least the following persons :

E. A. Barker, C. J. Battersby, S. G. Briault, R. A. Brown, W. R. Browning, R. F. Church, Cmdr. F. W. Collins, Capt. B. W. Cummins, C. S. Dann, E. Dennison-Cross, J. Dudderidge, Lt.-Col. D. A. Farquharson, L. V. Fildes, Miss M. Hallifax, F. G. Hands, P. W. A. Herbert, Castleton Knight, L. Litchfield, Major A. A. Longden, S. J. de Lotbiniere, J. McIntosh, Cmdr. E. Mount-Haes, I. Orr-Ewing, D. T. Pain, A. E. Porritt, E. A. Simmonds, E. J. Southcott, O. State, F. Osborne, B. J. Wainwright, Lt.-Col. O. G. White, L. D. Williams, H. Wynn-Jones.

Acknowledgment is made to the following organisations for the use of material for which they hold the copyright :

Messrs. Omega, Ltd. (Timing Report); The Race Finish Recording Co. Ltd. (Photo-Finish Report); Messrs. Shell-Mex & B.P. Ltd. (Flame Report); The Olympic Photographic Association (on behalf of the various member agencies) ; The Olympic Film Company; The B.B.C. and H.M. Postmaster-General (for photographs of the B.B.C. and Post Office arrangements); Mr. F. J. Coyne (for certain photographs taken privately by him).

Lord Burghley, together with Mr. E. J. Holt, Mr. C. L. Elliott and Mr. E. B. Christie, acknowledge with grateful thanks the assistance rendered to them by all persons, both in voluntary and paid capacities, in the production of this work. Many former members of the staff of the Organising Committee spent many hours in the checking of proofs, results sections and like matter, a task of no small magnitude. In particular, it extends its thanks to Mrs. B. F. Syer, Miss E. Brie and Mr. J. Ashenden, the representative of Messrs. M<sup>c</sup>Corquodale & Co. Ltd.



# CONTENTS

Introduction .....	7
Acknowledgments .....	9
Contents .....	11
International Olympic Committee .....	13
International and British Sporting Associations .....	14
XIV Olympiad, London, 1948 .....	16
PART I—Organisation of the Games .....	18
Organising Committee .....	18
Staff .....	23
Finance .....	26
Attaches .....	30
Technical Department .....	34
Programmes and Dates .....	37
Arenas .....	42
Equipment .....	51
Training .....	60
Entry Forms .....	66
Identity Cards .....	71
Programmes .....	79
Telecommunications .....	91
Press Department .....	105
Radio and Television .....	114
Olympic Film .....	123
Box Office .....	129
Housing Department .....	143
Transport Department .....	162
Medical Services .....	180
Reception Committee .....	189
Fine Arts Department .....	195
Opening Ceremony .....	199
Torch Relay .....	209



Part II—Events of the Games .....	215
Torch Relay .....	217
Opening Ceremony .....	221
Athletics .....	226
Basketball .....	286
Boxing .....	293
Canoeing .....	307
Cycling .....	317
Equestrian .....	336
Fencing .....	347
Football.....	382
Gymnastics .....	389
Hockey .....	406
Modern Pentathlon .....	413
Rowing .....	417
Shooting .....	433
Swimming .....	443
Weightlifting .....	476
Wrestling .....	494
Yachting .....	513
Demonstrations.....	532
Arts Competitions .....	535
Closing Ceremony .....	538
Statistics .....	541
Index of Competitors .....	549

# INTERNATIONAL OLYMPIC COMMITTEE

FOUNDER  
BARON PIERRE DE COUBERTIN

PRESIDENT  
MR. J SIGFRID EDSTROM

## MEMBERS

ARGENTINE	Mr R. C. Aldao Mr Horacio Bustos Moron	INDIA	Mr G. D. Sondhi H.H. Raja Bhalinder Singh
AUSTRALIA	Sir Harold Luxton Mr Hugh Weir	ITALY	Count Alberto Bonacossa Count Paolo Thaon de Revel General Giorgio Vaccaro
AUSTRIA	Dr Manfred von Mautner- Markhof	JAPAN	Count Michimasa Soyeshima Dr Matsuzo Nagai
BELGIUM	Baron de Trannoy Mr R. W. Seeldrayers	LATVIA	Mr J. Dikmanis
BRAZIL	Mr Arnaldo Guinle Dr J. Ferreira Santos Mr Antonio Prado	LIECHTENSTEIN	H.H. Prince Francois-Joseph de Liechtenstein
CANADA	Mr C. J. Patteson Mr A. Sidney Dawes	LUXEMBOURG	H.R.H. Prince Jean of Luxemburg
CHINA	H.E. Dr C. T. Wang Dr H. H. Kung Prof Shou-Yi Tung	MEXICO	Mr Marte R. Gomez
CUBA	Dr Miguel A. Moenck	NETHERLANDS	Colonel P. W. Scharroo Lt-Col C. F. Pahud de Mortanges
CZECHOSLOVAKI	Dr J. Gruss	NEW ZEALAND	Mr A. E. Porritt
DENMARK	H.R.H. Prince Axel of Denmark	NORWAY	Mr Thos. Fearnley
EGYPT	H.E. Mohammed Taher Pacha	PERU	H.E. Alfredo Benavides
EIRE	Mr J. J. Keane	PHILIPPINES	Hon Jorge B. Vargas
FINLAND	Mr Ernst Krogius Mr J. W. Rangell	PORTUGAL	Dr Jose Pontes
FRANCE	Marquis Melchior de Polignac Mr Armand Massard	ROUMANIA	Mr Georges A. Plagino
GERMANY	H.E. Duke Adolphe-Frederic de Mecklenburg	SOUTH AFRICA	Mr S. Dowsett Mr Reginald Honey
GREAT BRITAIN	The Rt Hon The Lord Burghley Sir Noel Curtis-Bennett	SPAIN	Baron de Guell Count de Vallellano
GREECE	Mr Angelo Bolanachi Mr J. Ketseas	SWEDEN	Mr J. Sigfrid Edstrom Count Clarence de Rosen
HUNGARY	Mr Nicolas de Horthy, jr	SWITZERLAND	Major Albert Mayer
ICELAND	Mr Ben G. Waage	TURKEY	Mr Rechid Saffet Atabinen
		UNITED STATES OF AMERICA	Mr W. M. Garland Mr Avery Brundage Mr Frederic Rene Coudert
		URUGUAY	Mr Joaquin Serratosa Cibils
		YUGOSLAVIA	General S. Djoukitch

## EXECUTIVE COMMITTEE OF THE I.O.C.

CHAIRMAN	Mr J. Sigfrid Edstrom
VICE-CHAIRMAN	Mr Avery Brundage
MEMBERS	Marquis Melchior de Polignac Count Alberto Bonacossa The Rt Hon The Lord Aberdare Colonel P. W. Scharroo
CHANCELLOR	Mr Otto Mayer
SECRETARY	Madame L. Zanchi
OFFICE ADDRESS	Mon Repos, Lausanne Switzerland

# INTERNATIONAL AND BRITISH SPORTING ASSOCIATIONS

## ATHLETICS

### **International Amateur Athletic Federation**

*President* The Rt Hon the Lord Burghley KCMG

*Hon. Secretary* Mr E. J. H. Holt OBE

*Address* 71 St. George's Square, London SW1

### **British Amateur Athletic Board**

*Hon. Secretary* Mr J. C. G. Crump

*Address* 118 Chancery Lane, London WC2

## BASKETBALL

### **Federation Internationale de Basketball Amateur**

*President* Mr Leon Bouffard

*General Secretary* Mr R. William Jones

*Address* 36 Moserstrasse, Berne, Switzerland

### **Amateur Basketball Association**

*President* Sir Noel Curtis-Bennett KCVO

*Hon. Secretary* Mr J. A. Clay

*Address* 71 Warley Road, Langley, Birmingham

## BOXING

### **Association Internationale de Boxe Amateur**

*President* Mr Emile Gremaux

*Hon. Secretary* Lt.-Col. R. H. Russell

*Address* 69 Victoria Street, London SW1

### **Amateur Boxing Association**

*President* Mr J. M. Wyatt FRCS

*Hon. Secretary* Mr J. O. McIntosh

*Address* 69 Victoria Street, London SW1

## CANOEING

### **International Canoe Federation**

*President* Mr J. Asschier

*Secretary-Treasurer* Mr O. Verner

*Address* Sturepalatset 7, Stockholm, Sweden

### **British Canoe Union**

*President* Mr H. Eustace Wells

*Hon. Secretary* Mr J. W. Dudderidge

*Address* 33 The Avenue, Radlett Herts

## CYCLING

### **Union Cycliste Internationale**

*President* Mr Achille Joinard

*General Secretary* Mr R. Chesal

*Address* 1 rue Ambroise Thomas, Paris IXe, France

### **National Cyclists' Union**

*President* Mr E. J. Southcott

*Secretary* Mr A. P. Chamberlin

*Address* 35 Doughty Street, London WC1

## EQUESTRIAN

### **Federation Equestre Internationale**

*President* General Baron de Trannoy

*General Secretary* Commandant G. Hector

*Address* 26 rue Brunel, Paris XVIIe, France

### **British Horse Society**

*President* Mr W. J. Cumber CBE

*Secretary* Mr R. A. Brown

*Address* 66 Sloane Street, London SW1

## FENCING

### **Federation Internationale d'Escrime**

*President* Mr Paul Anspach

*Secretary* Mr Charles Huybrechts

*Address* 211 Rue de la Victoire, Brussels, Belgium

### **Amateur Fencing Association**

*President* H.E. Vice-Admiral the Earl Granville KCVO CB DSO

*Hon. Secretary* Mr C. L. de Beaumont

*Address* 1a Tenterden Street, Hanover Square, London W1

## FOOTBALL

### **Federation Internationale de Football Association**

*President* Mr J. Rimet

*General-Secretary* Dr I. Schrickler

*Address* 77 Bahnhofstrasse, Zurich, Switzerland

### **The Football Association**

*President* The Rt Hon the Earl of Athlone KG

*Secretary* Mr S. F. Rous CBE

*Address* 22 Lancaster Gate, London W2

## GYMNASTICS

### **Federation Internationale de Gymnastique**

*President* Count Goblet d'Alviella

*Secretary General* Mr Charles Thoeni

*Address* Route de Lyon 88, Geneva, Switzerland

### **Amateur Gymnastic Association**

*President* Rt Hon the Earl of Gainsborough

*Hon. Secretary* Mr E. A. Simmonds

*Address* 55 Holdenhurst Avenue, London N12

## HOCKEY

### **Federation Internationale de Hockey**

*President* Mr L. J. Quarles van Ufford

*General Secretary* Mr Albert Demaurex

*Address* Chemin de Bouchet 17, Geneva, Switzerland

### **British Hockey Board**

*President* Sir Denys Stocks CB OBE

*Hon. Secretary* Mr K. H. Ingredew

*Address* Royal Chambers, Parkgate, Cardiff

# INTERNATIONAL AND BRITISH SPORTING ASSOCIATIONS

## MODERN PENTATHLON

### **Comite International du Pentathlon Moderne Olympique**

*President* Count Clarence de Rosen

*Hon. Secretary* Major Tor Wibom

*Address* Stromsborg, Stockholm, Sweden

### **The Modern Pentathlon Association of Great Britain**

*President* Brig L. F. E. Weiler CBE

*Hon. Secretary* Lt-Col O. G. W. White DSO

*Address* H.Q. Aldershot and Hants District, Aldershot, Hants

## ROWING

### **Federation Internationale des Societes d'Aviron**

*President* Mr Rico Fioroni

*General Secretary* Mr Gaston Mullegg

*Address* Territet—Montreux, Switzerland

### **Amateur Rowing Association**

*President* His Honour C. M. Pitman KC

*Hon. Secretary* Mr G. O. Nickalls

*Address* 93 Park Lane, London WI

## SHOOTING

### **Union Internationale de Tir**

*President* Mr Eric Carlsson

*General Secretary* Mr K. A. Larsson

*Address* Arsenalsgatan 4, Box 284, Stockholm, Sweden

### **The National Rifle Association**

*President* H.R.H. The Duke of Gloucester KG

*Secretary* Major-General D. P. Dickinson CB DSO OBE MC

*Address* Bisley Camp, Brookwood, Woking, Surrey

### **National Smallbore Rifle Association**

*President* Field Marshal Viscount Alanbrooke KG GCB OM DSO

*Acting Secretary* Mr A. J. Palmer

*Address* Mayleigh, Petersham Road, Richmond, Surrey

## SWIMMING

### **Federation Internationale de Natation Amateur**

*President* Alderman H. E. Fern OBE JP

*Hon. Secretary* Mr Max Ritter

*Address* 428 Vernon Road, Jenkintown, Pa., U.S.A.

### **Amateur Swimming Association**

*President* Mr R. J. Pryde

*Hon. Secretary* Alderman H. E. Fern OBE JP

*Address* Springhaven, 9 Bedford Avenue, Barnet, Herts

## WEIGHTLIFTING

### **Federation Internationale Halterophile**

*President* Mr J. Rosset

*General Secretary* Mr E. Gouleau

*Address* Av. des Gobelins 9, Paris Ve, France

### **British Amateur Weightlifters' Association**

*President* Mr Percy F. Cranmer

*Hon. Secretary* Mr Oscar State

*Address* 181 Fulwell Park Avenue, Twickenham, Middlesex

## WRESTLING

### **Federation Internationale de Lutte Amateur**

*President* Mr Viktor Smeds

*Secretary-Treasurer* Mr Roger Coulon

*Address* rue Taitbout 1, Paris VIIIe, France

### **British Amateur Wrestling Association**

*President* Mr P. Longhurst

*Secretary* Mr G. Mackenzie

*Address* 60 Calabria Road, London N5

## YACHTING

### **International Yacht Racing Union**

*President* Major Sir Ralph Gore, Bart

*Secretary* Mr F. P. Osborne

*Address* 54 Victoria Street, London SW1

### **Yacht Racing Association of Great Britain**

*President* Major Sir Ralph Gore, Bart

*Secretary* Mr F. P. Osborne

*Address* 54 Victoria Street, London SW1

*The particulars given on pages 13-15 are as at the time of the 1948 Olympic Games, and may since have changed.*



# XIV OLYMPIAD LONDON 1948

PATRON  
HIS MAJESTY THE KING

PRESIDENT OF THE GAMES  
The Rt Hon The Viscount Portal DSO MVO

CHAIRMAN OF THE ORGANISING COMMITTEE  
The Rt Hon The Lord Burghley KCMG

MEMBERS OF THE ORGANISING COMMITTEE

The Rt Hon The Lord Aberdare	Mr E. J. H. Holt OBE
Sir Noel Curtis-Bennett KCVO	Colonel Evan A. Hunter OBE
Mr Jack Beresford	Mr J. Emrys Lloyd OBE
Mr C. B. Cowley	Mr C. J. Patteson
Mr J. Eaton Griffith OBE	Mr Arthur Porritt CBE FRCS
Alderman H. E. Fern OBE JP	Mr S. F. Rous CBE
Mr R. B. Studdert	

CHAIRMAN OF THE EXECUTIVE COMMITTEE  
The Rt Hon The Lord Burghley KCMG

MEMBERS OF THE EXECUTIVE COMMITTEE

Mr C. B. Cowley	Colonel Evan A. Hunter OBE
Mr J. Eaton Griffith OBE	Mr S. F. Rous CBE
Alderman H. E. Fern OBE JP	Mr R. B. Studdert

DIRECTOR OF ORGANISATION  
Mr E. J. H. Holt OBE

GENERAL ORGANISING SECRETARY  
Lt-Col T. P. M. Bevan MC

## XIV OLYMPIAD LONDON 1948

THE Olympic Games of the modern era were created by the genius of a Frenchman, Baron de Coubertin, who, with a small band from various countries devoted to the same ideals, carried through the plan of holding the first Games in Greece in 1896. They followed at regular four-yearly intervals until the World War of 1914 caused an interruption. Although, like so many great movements, substantial difficulties and opposition were encountered in the early days, the devotion and enthusiasm of those who believed in the Olympic movement planted their roots firmly, and with the end of the war they were held once more in 1920. From that year they were celebrated in each subsequent Olympiad, or four-yearly period, until the Great World War of 1939 intervened.

With the termination of hostilities in 1945, the Olympic Movement throughout the world wondered when it would be possible to re-start the Games. The International Olympic Committee with courage and foresight decided that it would be possible, though difficult, for them to be staged in 1948. The Games of 1944 had been allocated to London, and so it was that in October, 1945, the Chairman of the British Olympic Council, Lord Burghley, went to Stockholm and saw the President of the International Olympic Committee to discuss the question of London being chosen for this great event. As a result, an investigating committee was set up by the British Olympic Council to work out in some detail the possibility of holding the Games. After several meetings they recommended to the Council that the Lord Mayor of London should be invited to apply for the allocation of the Olympic Games of 1948. The investigating committee was under no illusion as to the magnitude of the task which confronted them. The organisation of the Olympic Games under ordinary circumstances is a tremendous undertaking ; to carry through what promised to be the largest gathering ever held, in a country which had been torn and wracked by warfare, and for which the problems of housing, feeding, equipment and the like had thereby been increased a hundredfold, was indeed a herculean task. But the spirit of the people had come through the war not only unimpaired but strengthened, and the same was true of its belief in all those great ideals of amateur sport, whether followed in sport or in life, for which the Olympic movement stands. A postal vote was taken by the International Olympic Committee and early in March, 1946, the Games to celebrate the XIV Olympiad were allotted to London.

# ORGANISATION OF THE GAMES

It is the task of the National Olympic Committee of the country to whom the Games are allotted to set up a Committee, with full responsibility for their organisation. An Organising Committee was formed therefore on March 14, 1946, composed of the officers of the British Olympic Association : Lord Burghley, Chairman, Sir Noel Curtis-Bennett, Mr. E. J. H. Holt, Alderman H. E. Fern, Colonel Evan A. Hunter, Mr. J. Emrys Lloyd, together with the other British member of the International Olympic Committee, Lord Aberdare, and Mr. A. E. Porritt, the New Zealand member who is now resident in London.

The next step was to appoint an Executive Committee or Board of Directors to carry out the operative work. Lord Burghley was elected Chairman with the following as members : Mr. E. J. H. Holt, Colonel Evan A. Hunter, Mr. J. Emrys Lloyd, and shortly afterwards they co-opted Mr. R. B. Studdert, Managing Director of the Army & Navy Stores, and Mr. C. B. Cowley, of the London Press and Advertising, to the Committee. Lt.-Colonel T. P. M. Bevan was appointed as General Organising Secretary.

In July, 1946, Mr. Stanley Rous, the Secretary of the Football Association, was invited to join the Organising and Executive Committees, and the Olympic Rowing Champion, Mr. Jack Beresford, became a member of the Organising Committee. After Wembley had been chosen as the principal venue, Sir Arthur Elvin, the Managing Director of Wembley Stadium Ltd., was invited to attend the Meetings of the Organising and Executive Committees. During 1946, the Executive Committee held fifteen meetings and the Organising Committee three.

From April, 1947, Lord Portal, the President of the Games, began to attend the meetings of the Executive and Organising Committees and from then onwards took a lively interest in the organisation. On December 23, 1947, Mr. J. Eaton Griffith was nominated by the Prime Minister to join the Committee as full-time Government representative. On the incorporation of the Organising Committee in December, 1946, the firm of Messrs. Farrar & Co., of Lincoln's Inn Fields, was appointed Legal Advisors, and Mr. J. Emrys Lloyd, who was a partner in the firm, retired from the Executive Committee. He continued, however, to attend all the meetings in his capacity as Legal Advisor. In 1947, thirty Executive Committee meetings were held and one Ordinary and one Extraordinary Meeting of the Organising Committee.

In 1948, Mr. J. C. Patteson, one of the Canadian members of the International Olympic Committee, who was resident in London, joined the Organising Committee. In this year eighteen Executive Committee Meetings were held and eight Extraordinary General Meetings of the Organising Committee.

## **The Patron**

In 1946, one of the first actions of the Organising Committee was to approach His Majesty the King and humbly request him to accept the position of Patron of the Games. His Majesty was graciously pleased to accede to this request.

### **The President of the Games**

Viscount Portal of Laverstoke, President of the British Olympic Association, accepted an invitation to become President of the Games.

### **Government Help**

The Committee approached H.M. Government at an early date and stated that, whereas financial help was not sought, there were many ways in which the Government could assist the Committee. To this the Government readily agreed, and in the ensuing liaison the Committee was most fortunate in that the then Secretary of State for Air was the Rt. Hon. P. J. Noel-Baker, who had himself been second in the 1,500 metres in the Antwerp Games of 1920 and who had always been an enthusiastic supporter of the Olympic movement. He gave the greatest assistance, particularly on questions related to housing which closely affected the Government.

The Government gave considerable help in many directions, most of which is referred to in detail throughout this report. There is, however, no appropriate place elsewhere to pay tribute to the Special Committee which the War Office established to help in the work of the Organising Committee, and which gave assistance in many directions, particularly in regard to the arrangements for the modern pentathlon and equestrian events. To facilitate these arrangements, Major G. White with a small group was posted to an office in the Aldershot area.

For obvious reasons the Organising Committee decided that it was advisable to form itself into a limited liability company, and this was soon accomplished with the help of the Legal Advisor, Mr. J. Emrys Lloyd.

For the detailed organisation of the Games eight committees of voluntary members were set up, each with a secretary from the staff of the Organising Committee.

The activities of these Committees varied from an advisory capacity to full executive powers subject only to general and financial approval from the Executive Committee.

### **Assistance from Governing Bodies of Sport**

Each Governing Body in Britain of sports included in the Games was invited to nominate a representative to form the Technical Committee, under the chairmanship of Mr. E. J. H. Holt. At the first meeting each of these bodies was requested to co-operate with the Executive Committee and undertake the responsibility for the technical planning of their separate sports ; the response was universal acceptance, and in most cases the planning was carried out on a voluntary basis. These technical arrangements had to be inspected and approved by the International Federation for each sport, immediately previous to the Games. Considerable credit is due to the Governing Bodies for the fine spirit in which they entered upon their respective tasks and for the excellent manner in which they carried out their duties.



### **General Purposes Committee**

For the first twenty-one months of the preparations the Executive Committee itself was able to deal with all the general business of the Organisation. However, by the end of 1947, it was apparent that its work would increase substantially over the last six months, and the General Purposes Committee, a sub-committee of the Executive Committee, was therefore set up. Lord Portal kindly accepted the Chairmanship of this Committee, and his wide business experience and interests were of the utmost value. The General Purposes Committee was composed of : Viscount Portal, Chairman, Sir Arthur Elvin, Alderman H. E. Fern, Mr. J. Eaton Griffith, Mr. E. J. H. Holt, Mr. J. Emrys Lloyd, Mr. S. F. Rous, Mr. R. B. Studdert, Mr. E. B. Christie, Secretary.

All commercial questions concerning agreements on housing, catering and the like were passed to it. The Committee took operative decisions on certain matters, and after detailed examination made recommendations to the Executive Committee on the more important questions which fell within its purview.

In addition, whereas all financial commitments up to £1,000 were screened by the Finance Committee, those in excess of this sum came before the General Purposes Committee as did any supplementary estimates above the agreed budget laid down by the Executive Committee. Recommendations to the Executive Committee were made on any such estimates.

Before the Games took place the General Purposes Committee drafted a "Plan of Liquidation" which was put into operation after the Closing Ceremony and which the General Purposes Committee supervised. All major accounts were examined by it and approved for settlement during this period.

In addition its work included a close contact with those Government Departments which were providing facilities for the Organising Committee. It held its first meeting on January 8, 1948, and, like the Executive Committee, met once a fortnight until just before the Opening Ceremony. During the Games there were naturally many formal and informal meetings.

### **Staff**

It was decided that it would be unnecessary to build up a large paid staff immediately, but that, as the work developed, additional personnel of the manager standard should be brought in. To start with, this meant that two men carried out the work, and as the various sections grew, they were shed off among additional staff, until finally each man had only one main activity. As a result of this policy the early senior members of the staff had a wide knowledge of the problems and activities of the different sections of the organisation.

By the end of 1947, five main groups had emerged, each in charge of a manager who was also Secretary to the corresponding Committee. They were :—

Mr. E. A. Barker, *Technical*.

Mr. S. G. J. Briault, *Housing*.

Mr. R. F. Church, *Press*.

Major A. A. Longden, *Art*.

Mr. B. J. Wainwright, *Transport*.

All further necessary expansion occurred within these headings.

On the top level, in due course, it became apparent that the load on Colonel Bevan was increasing substantially and that it would be of great assistance to have the added help of a top senior executive with technical experience of sports and their government. Mr. E. J. Holt was therefore appointed Director of Organisation and on his shoulders fell much of the responsibility, including the technical organisation of the Games. This general organisation proved adequate until six months before the opening, when the following final set up for the day-to-day work was evolved. The Chairman, Lord Burghley, with Mr. Holt and Colonel Bevan, covered all the I.O.C. arrangements, technical preparations for the sports venues, foreign contacts with International Federations and National Olympic Committees, complimentary and other special seating arrangements, press problems, ceremonial, including the Opening and Closing Ceremonies, Arts Competitions and general office organisation.

Lord Portal, with Mr. Eaton Griffith (and, until illness intervened, Mr. R. B. Studdert), on the other hand, looked after the commercial angles of housing, catering and transport, all agreements over the use of the venues, such as Wembley and Empress Hall, and kept a continual watch on the budget.

This system worked smoothly and stood up to the severe test imposed by the tremendous pressure of the period immediately before and during the Games.

Messrs. Kemp Chatteris & Co. were appointed Auditors to the Organising Committee and a representative in either Mr. C. G. Moira or Mr. Gordon Johnston was in attendance at all the meetings.

### **Work of Executive Committee**

It is not proposed here to cover in full the work of the Executive Committee, for the decisions which they took will be found in greater detail in their implementation under various headings in this report. There are, however, certain points which do not appear elsewhere and which for the sake of record are now given.

### **Reports to I.O.C.**

At the meetings of the I.O.C. in Lausanne in 1946, Stockholm in 1947, and St. Moritz in 1948, detailed reports of the progress of the preparations were presented to the Committee in full Council, both in writing and orally, by the Chairman and a small delegation from the Executive Committee.

### **International Federations**

In arranging the programme close contact was kept with the International Federations governing the sports which were to be included. In certain cases protracted negotiations were necessary in order that the most satisfactory dates and arrangements could be ensured

for all concerned. The task of the Committee was, however, complicated by the fact that, in Britain, unlike most other countries, no competitions are held on Sundays. To meet this point the I.O.C. agreed to an extra day being given for the celebration of the Games. As a result of these discussions with the International Federations final integration of the various sports into the programme was concluded towards the end of 1947. An original plan, drawn up in 1947, had to be modified as the I.O.C. added events to certain sports and also decided to include women's gymnastics in the programme. A large number of other sports applied to be included, but these applications were resisted by the Organising Committee on the grounds of the enormous size of the programme, and the I.O.C. supported this view.

### **Invitations**

The official invitations to the Member Countries of the I.O.C. to take part in the Games were sent through their Embassies in London on April 17, 1947. The design for the invitation was the work of Mr. J. E. Slater, of Leicester, and a reproduction of it is shown elsewhere. The position was somewhat complicated by the fact that a considerable number of additional countries were accepted for affiliation by the I.O.C. during the next year, which necessitated the production of more of these special invitation forms.

### **Torch Relay**

The Committee decided, after careful consideration, that the Torch Relay, first held in 1936, had a great symbolic value to the Olympic Games, and that, although considerable expense would be involved, it should be included in the plans for the Games.

The route in general and the negotiations with the Countries concerned were concluded by the Committee, and the responsibility for the detailed organisation was then handed over to a small committee organised under Commander F. W. Collins, R.N. (Rtd.).

### **Ceremonial Flag**

The Ceremonial Flag, presented to the I.O.C. by the Belgian Olympic Committee in 1920, had disappeared in Berlin during the war. However, the British Army was successful in discovering it intact, and it was brought to London for the Games. The official book of guests for the 1936 Games was discovered in the ruins of Berlin at the same time, and, after being on display in the Art Exhibition at the Victoria and Albert Museum during the Games, was sent to the Olympic Museum in Lausanne.

### **Symbol**

The Committee gave lengthy consideration to the choice of an appropriate symbol for the London Games. It was felt that it should be one typically British but with a special meaning, not only to the present generation but to future ones. It was decided that it should be the clock tower of the Houses of Parliament, with the hands of the famous "Big Ben" pointing to 4 o'clock, the hour at which the Games would in due course be declared open.

## STAFF

The problem facing the Organising Committee was that of building up a satisfactory secretariat which, while allowing of the efficiency of a permanent body, was to be made up of temporary staff, the majority of whom would be employed for only the briefest period.

As has already been said the first appointments made were those of the General Organising Secretary, Lt.-Col. T. P. M. Bevan, and his secretary. This was in 1946. By the Autumn of that year the volume of work and research to be done had grown sufficiently to warrant the employment of two assistant secretaries of the executive grade, together with a consequent enlargement of the clerical and typing staff. At this early date no hard and fast rules were laid down as to responsibility and the broad principles of the organisation were known to all.

By the Spring of 1947 the Organising Committee had appointed the Director of Organisation, Mr. E. J. Holt, as its Chief Executive Officer responsible for the implementation of all policy matters and for the administration of the Games. The General Organising Secretary was responsible for the day to day administration of the offices and staff which, as the Games drew nearer, grew in size and responsibilities.

Throughout the period leading up to the Games the Organising Committee were, on the executive side, most fortunate in the very considerable help that was rendered by several Committee members in a voluntary capacity. By the constant presence of Committee members at the Offices and their availability to answer questions and guide the steps of the paid executives, not only was work made easier, but much time and money was saved to the Committee.

The Chairman of the Organising Committee, Lord Burghley, had an office from the start and was in constant attendance. Later, in January 1948, the President of the Games, Lord Portal, also had office accommodation and his deputy on the General Purposes Committee, Mr. J. Eaton-Griffith, too, was in attendance every day. The Chairmen of the Sectional Committees were in frequent attendance, and for necessary consultations, as regards their particular interests. Also the British Olympic Association had temporary offices with the Organising Committee and so it was that the Secretary of the Association, who was a member of the Executive Committee, was always present for consultation. With the comparatively short period available for the entire organisation this voluntary help by committee members was an extremely important factor.

### Staff Employment

By Autumn 1947 the departmental heads had taken up their duties and as is seen in the departmental reports, built up from that date their own internal organisations. The central administration too under the General Organising Secretary also grew, but even by the Spring of 1948 the total staff on the headquarters strength was comparatively small. As the Opening of the Games drew nearer it was necessary to expand quickly and this eventuality was met in all departments by the employment of student labour. On July 29 when the staff requirements reached their peak the total strength on the headquarters pay roll, which included all the departments whose reports are contained in this volume, other than those dealing with outside services called in, was 219.

### **Staff run-down**

The fact that the organisation was only transitory made it necessary for a scheme to be ready, directly the Games were concluded, for the run-down of staff. Such a scheme was in fact drawn up by June 1948 and came into operation during the progress of the Games themselves. All student labour was released by the middle of August and the junior executives commenced to depart at the same time.

In September 1948 the work of winding up was in full swing and as each section of each department was able to bring its work down to small proportions these were then handed over to the departmental head and the sectional chief was released. Eventually when the department's work and responsibilities themselves had dwindled sufficiently the department itself wound up and handed over the remaining problems to the small central staff remaining.

By January 1949 all departments had been merged and the organisation had gone the full cycle, for in the next three months one executive with two secretaries dealt with the work and was responsible to the Executive Committee.

As with any organisation, the final problems and matters tend to be financial and on April 1, 1949, the last member of the full-time staff was released and all matters that related to the Organisation of the London Olympic Games 1948 were transferred to the Accountants to the Committee who, from that time, were able to deal with the problems as part of their normal work.

### **Internal Administration**

Elsewhere in this volume the working of the departments is dealt with under their particular headings but these had to be woven together and certain functions carried out which did not fall within any particular sphere.

The Executive Committee which was solely responsible for policy decisions was served by the General Organising Secretary and his staff, who was responsible for passing on to the departmental heads and, consequently, the committee responsible for that department, the decisions which would have to be implemented by that section. All routine finance as well was handled by the central department and reciprocally the central department had to be informed that matters passed out to departments for action were in fact dealt with and the results reported back to the Executive Committee.

The Director of "Organisation held conferences with his staff heads from time to time at which it was possible for all departments to be kept readily in touch with the workings of others and at which, too, it was possible to find out where there might be overlap and consequent co-ordination of effort. This co-ordination was carried out through the General Secretary's department.

From the central department went out to all nations, accepting the invitation, the administration bulletins which superseded the departmental circulars which were despatched in the early months of the organisation. It was found that whereas in the initial stages departments could profitably circulate nations on their own, as the Games drew nearer, it was necessary for the information to go out and answers and queries to come

in, as far as possible through a central office which could at once see that it went to the proper department and that action was taken on it immediately if necessary.

Mail too was centralised and a special mail section was set up to handle all outgoing and incoming mail. This not only reduced the amount of clerical staff required by each department but also made the financial control of postage considerably easier.

A central information bureau was also set up under the control of the Director of Organisation which acted not only to answer queries from the visitor to the Organising Committee Offices but as a means of channelling visitors to the right department when the bureau itself could not deal with the query.

Each department was responsible for its own records and filing, as it proved that with but two and a half years in which to organise the whole Games, the setting up of a central registry was not justified by the time lag in handling the files. When the wind up of the organisation took place all files were whittled down to financial commitments and necessary information before being handed over to the central department for final sorting, clearance or retention.

### **OFFICE ACCOMMODATION**

On the formation of the Organising Committee by the British Olympic Association, the latter arranged for the General Organising Secretary and his assistant to have accommodation in their permanent offices in St. George's Square. It was apparent however that this could be but a temporary measure and further space was sought.

Due to the kindness of the Directors of the Army and Navy Stores, accommodation was found in the stores premises which allowed for expansion, and for committee meetings. Here the departments were set up and broke away from the central administration. By the Autumn of 1947 two suites of offices in the Army and Navy Stores had been occupied. Subsequently it was found to be necessary to obtain larger accommodation as the staff continued to grow. Also visitors could not come to the offices outside normal trading hours, and, as many of these were members of voluntary associations, they tended to call after business hours.

Through the help of the Ministry of Works two houses in Upper Brook Street, Mayfair, were made available to the Organising Committee which provided much larger facilities and easier access than before. Departments were able to be grouped and to some extent cater for their own proposed expansion. Had the period of the organisation not been post war it is true to state that much larger accommodation would have been advantageous, which particularly relates to the period immediately prior to and during the Games, when due to the number of visitors and the amount of time that they had to spend in the Organising Committee Offices work was difficult on account of lack of space.

The Organising Committee kept down to an absolute minimum the amount of equipment that it purchased. This was possible again due to the help of the Ministry of Works which made furniture available on hire. Had it been necessary to purchase office furniture and equipment, the amount of money spent would have been very considerable. Fortunately this was obviated. Typewriters were hired and in some cases purchased but these found a ready market after the Games and were therefore not a liability.

Duplicating machines and the smaller items of office equipment too, were bought but as far as possible central facilities were used to avoid too great a duplication of effort.

A direct telephone line was installed between the Organising Committee Offices and Wembley Stadium which more than carried its anticipated traffic. The twenty-line switch-board at Upper Brook Street was, during the months of June, July and August, 1948, taxed to the uttermost and in fact for that period direct line instruments were provided for all the senior executives.

## FINANCE

In reading the official reports of previous Olympic Games, all allude to the difficulties which had to be overcome on the financial issues. The following comment in the report of the Olympic Games held in 1908 in London was most apt—"If the question of finance has proved difficult in the past, that difficulty is not likely to diminish in the future, for Olympic balance sheets like other budgets are in the habit of proving their healthy existence by a vigorous growth." It is sufficient to state that the expenditure incurred in 1908 approximated £15,000, which figure did not allow for the construction of the new stadium at Shepherds Bush, provided by the Franco-British Exhibition at a cost in the region of £60,000. The total receipts amounted to £21,500, of which sum £15,850 was donated. In 1948, expenditure totalled approximately £732,000, which included the cost of housing, feeding and transporting the teams while in England—an item for which a charge is made to the National Olympic Committees and which did not operate in 1908 as each country made its own arrangements. The receipts approximated to £762,000.

It must be pointed out that the sponsors of the Games, the International Olympic Committee, determine the conditions under which the Games must be held. They endeavour to ensure that they are promoted not so much as a commercial venture but in the best interests of sport; For this reason many means of raising money are not permissible, such for example as the inclusion of advertisements in the brochures and programmes. It must be realised, in assessing any profit in connection with the London Games, that although substantial expenditure had to be incurred in connection with the Herne Hill cycle track and the erection of additional stand accommodation at other places, the Organising Committee had not to build any stadia or arenas and had the use of some venues given to them free of any rental charge. Many other facilities were provided without any charge being made. Therefore, it is not possible to view the Games as a coldly calculated business proposition of which the principal motive is to make a profit.

The Executive Committee gave much time and careful thought to the financial aspect, and in the early stages had to consider three principal items, so far as could be envisaged at that time—(a) to make provision for finance up to the period when money became available from advance ticket sales, (b) estimated revenue from all sources and (c) estimated total expenditure. With reference to the provision of finance, an offer by Wembley Stadium Ltd. to make advances free of interest up to an amount not exceeding £100,000 against the ticket receipts was accepted. In addition a further offer of a guarantee against loss to the extent of £100,000 made by the same company was also accepted. These offers

supported the agreement that the Organising Committee should have the full use of the Wembley properties during the games and for fourteen days previously, together with the services of the Executive staff of the Stadium Company, and the benefit of its organisation. Bound up with the agreement, the Organising Committee undertook to compensate Wembley Stadium Ltd., for loss of revenue during the time the Stadium had to be closed to their ordinary business, for the preparation and duration of the Games, as well as the period required for re-adjustment to normal working. The figure of compensation was based on the previous year's results, after taking into account external factors such as the Government decrees on the permissible number of racing days and petrol rationing. The amount advanced was £62,500, which was repaid one month before the Games commenced, and the guarantee was released at about the same time.

The estimated revenue was based on the sale of admission tickets and turnstile takings, film rights, programmes, trading concessions, equipment after the Games and salvage. Estimated expenditure covered general administration (including box office, accountancy and legal fees), torch relay, technical equipment, transport for the Organising Committee, printing and stationery, medical services, telephone installations, temporary works and replacements, and technical charges at Wembley Stadium, compensation to Wembley Stadium Ltd., staff wages and daily maintenance at arenas, insurance, reception and entertainment by the Organising Committee, equipment of the British team, contribution to the International Olympic Committee and a marginal amount for miscellaneous expenses. In addition an independent estimated budget was prepared relating to housing, feeding and transport for the competing teams.

### **Finance Committee**

A Finance Committee was appointed which consisted of :—

Ald. H. E. Fern, O.B.E., J.P., Chairman  
 Mr. E. J. Holt, O.B.E. (Director of Organisation)  
 Mr. S. F. Rous, O.B.E.  
 Col. E. A. Hunter, O.B.E.  
 Mr. R. B. Studdert  
 Mr. C. G. Moira

Lt.-Col. T. P. M. Bevan, M.C. (General Organising Secretary)

Detailed reports relating to receipts and disbursements were submitted periodically to the Committee and summaries, together with matters relating to ticket receipts and any extensive expenditure, were referred to the Executive Committee. Messrs. Kemp Chatteris & Co., who had been appointed auditors, worked closely with the organisation throughout, and undertook the accountancy work.

In preparing the first budget it was not possible to make reference to the Games held at Los Angeles in 1932 or at Berlin in 1936, as no statements of accounts had been published, and recourse had to be made to the figures related to the Olympic Games held at Amsterdam in 1928. These were helpful as a guide to expenditure items only, as it was appreciated that, owing to the rapid development at Los Angeles in 1932 and at Berlin in 1936, they bore no proportion to subsequent Games. The war factor also had brought



about a complete change in values, accentuated by shortages of materials, and rising costs of both wages and goods. Although due allowance had been made to cover these points, it was soon obvious that the original figures would have to be revised, and a fresh budget was drawn up to cover increased expenditure. Even this fell considerably short of the actual amount which was spent and supplementary estimates had to be placed before the Executive Committee from time to time.

The principal item of revenue was the sale of tickets. This came under constant review, particularly with regard to sales in advance, by which means it was possible to get an indication from time to time as to the likelihood of making ends meet. In a sporting undertaking of this magnitude, there were inevitably times when shocks were received. In particular, the number of tickets ordered from abroad which were not taken up at one time assumed alarming dimensions. Fortunately the demand during the Games enabled the organisation to dispose of the greater part of the tickets which had not been taken up.

Arrangements, which worked very satisfactorily, were made with the organisations to whom the venues belonged, in co-operation with the auditors to the Organising Committee for the receipt of monies taken at the turnstiles during the Games. Messrs. Betts, Son and Malyon were appointed agents for the sale of programmes.

The arrangements for receiving payments for the housing and feeding of competitors and officials were made on a day-to-day basis. Each day the numbers in residence were agreed between the camp cashier and the principal officer of each delegation. Where possible a settlement was effected daily, but owing to the scattered area over which the teams were lodged this could not always be done. In this connection the appointed attaches gave much help, particularly in obtaining outstanding accounts.

The agreed figures were checked regularly by the auditors and the monies banked.

Insurance was effected against the risk of the Games being postponed at any time. This was done by taking out policies at intervals as cover against accrued expenditure.

Other insurances which were taken out covered liabilities against injuries to staff, public and third party risks, loss or damage to equipment, yachts and deaths of horses.

### **Control of Expenditure**

The control of expenditure was somewhat difficult particularly in the period immediately before the Games. This was due in no small measure to the short time available in which to organise the Games, and was aggravated by the prevailing conditions of shortage of materials and labour. The difficulty lay in the fact that the organisation had of necessity to be built up rapidly and in consequence a system of routine, such as would be in existence in an old established organisation, was not possible. The ideal method would have been to have centralised the ordering of goods and services through one channel ; this, however, would have meant delays, which in the short time available would have been dangerous. The preparations at the housing centres caused some anxiety on the score of extravagance ; in the end special arrangements were made to watch the development carefully, and check unnecessary expenditure. It must be remembered that London had less than two and a half years in which to promote the Games. Los Angeles, in anticipation of being allocated the Games in 1932, began to make their plans as far ahead as 1923,

and Berlin, for the Games of 1936, had commenced their preliminary organisation in 1931. The particulars with regard to box office receipts will be found under the special chapter dealing with the subject.

In order that visiting competitors could import technical equipment free of customs duty, the Customs and Excise authorities insisted upon a guarantee of £10,000 being given. The guarantee was given jointly by Viscount Portal and Lord Burghley, who in turn were indemnified by the Organising Committee. Except for a few sales and expendable items, all equipment was taken back by the competitors and very little duty and purchase tax had to be paid.

### Receipts and Expenditure

The following statement of Receipts and Expenditure to December 31, 1949, is not completed owing to certain contingent liabilities remaining outstanding, but it is anticipated the final accounts will show an approximate profit of £29,000, subject to tax and to the publication of the Official Report.

RECEIPTS		£
GROSS REVENUE FROM THE SPORTS .....		545,628
HOUSING, FEEDING AND TRANSPORT OF COMPETITORS .....		174,097
MISCELLANEOUS INCOME (less outgoings directly chargeable thereto) .....		41,963
		£761,688
EXPENDITURE		£
TECHNICAL CHARGES AND EQUIPMENT (including Staff wages during the Games) .....		121,741
TEMPORARY WORKS AT WEMBLEY AND OTHER VENUES .....		78,120
WEMBLEY STADIUM, LTD—COMPENSATION .....		92,500
WORKS AND SERVICES PROVIDED BY GOVERNMENT DEPARTMENTS (including accommodation and telephone) .....		118,033
HOUSING, FEEDING AND TRANSPORT OF COMPETITORS .....		164,644
TRANSPORT .....		37,925
INSURANCE AGAINST CANCELLATION .....		7,821
EQUIPMENT OF BRITISH TEAM .....		10,884
ADMINISTRATIVE CHARGES (including professional fees) .....		90,557
PAYMENT TO THE INTERNATIONAL OLYMPIC COMMITTEE .....		5,000
ENTERTAINMENT .....		3,638
PERMANENT RECORD OF WINNERS AT MAIN STADIUM (Provision) .....		1,000
OFFICE FURNITURE (Amount written off) .....		405
BALANCE, BEING EXCESS OF INCOME OVER EXPENDITURE, SUBJECT TO INCOME TAX, PROFITS TAX, PUBLICATION OF THE OFFICIAL REPORT AND CERTAIN CONTINGENT LIABILITIES .....		29,420
		£761,688

When the accounts are finally completed an audited copy will be filed at Bush House in accordance with the Companies Act, where they will be available to the public.

The promotion of the Games of the XIV Olympiad has proved successful financially as well as in all other respects. In this connection, tribute must be paid to His Majesty's Government and the respective Government Departments concerned, for the full co-operation and assistance which was so willingly given to the Organising Committee and its officials at all times. It is fair to state that, without such help, it would not have been possible to stage the Games in the adequate manner in which they were presented to the visiting nations and the general public.

## ATTACHES

The Olympic Attaches are, from the point of view of an Organising Committee, an integral part of the machine. When used to full advantage, they can play a great part in the success of the work leading up to the Games, and assist, in no small measure, in the smooth running of the organisation during the Games.

The Organising Committee wrote to each nation, as soon as it had accepted the invitation to the 1948 Games, urging the necessity of appointing an attache in London. The Rules of the I.O.C. require that such appointments shall be made not later than six months prior to the commencement of the Games. Some nations complied with this, others did not, either through the difficulty, especially in the case of the smaller countries, of finding a suitable person with the time at his disposal to take on what can only be called an extremely exacting task, or through failure to appreciate the paramount need for such an official. One nation in particular brought their attache with them as a member of their team administration, and though, when he came, he was a most useful and excellent officer, there can be no doubt that his presence in London for the six months before July 29 would have helped to iron out many difficulties which were encountered.

Due to the short time at the disposal of the Organising Committee for setting up the administration of the Games, and to the fact that, in the immediate post-war period of 1946-47, world communications were not up to their peace time level, the Organising Committee used the attaches very greatly as clearing houses for information and for urgent communication work. Those attaches who were members of their country's diplomatic mission in London were much better placed than those who were in business, since this channel of communication to their own country was generally easier.

The first meeting of the attaches was held 18 May, 1948, at which the Director of Organisation outlined to those present the arduous duties that the Organising Committee would expect them to fulfil, apart from any they might have from the Chef de Mission of their team before its arrival. It was explained that they would be regarded as the first check on all information received ; that they would be expected to advise on all special matters of housing and catering, if time did not permit of communication with the National Olympic Committee ; that they would be responsible for their team if the arrival date was before the official opening of the housing centres (this, in fact, arose in only one case), and after the closing of the centres as well, if the team stayed on; they

would also have to arrange any transport that the team might require other than that for training, participation or official functions, and all transport outside certain specified dates. Officials accompanying their team but not an integral part of it and persons related thereto, would be their responsibility throughout. In addition to these duties, they would be required to attend a daily meeting at the H.Q. of the Organising Committee during the Games, to receive any vital information for immediate transmission to their Chef de Mission and to deal with demands for tickets by competitors at venues (other than the main stadium) for which the holders' identity card was not a valid entry document.

All these functions the attaches performed and several more beside and most of them seemed to spend much of their waking lives in the office of the Committee for many weeks before the Games.

To facilitate liaison with the Organising Committee the attaches formed amongst themselves an Executive Committee under the Chairmanship of Mr. Bjorn Bjornsson (Iceland), and with Hon. Secretary, Mr. C. Roberts (Argentine); Treasurer, Mr. B. McCabe (Great Britain) ; and members, Capt. Carlbom (Sweden), Dr. Y. S. Chen (China) and Mr. M. Saad El Din (Egypt).

Each time the attaches met before the Games, the procedure followed was that they met first by themselves and decided outstanding matters and then the Executive Committee of the attaches handled all details with the staff of the Organising Committee. General matters and those affecting overall policy were still subject to full meeting with the Organising Committee representatives.

As far as possible, each time such a committee meeting was held one representative of each department of the Organising Committee was present and dealt with queries that the attaches had received from their National Olympic Committees. Reciprocally, the department member could ask the attache of any particular country to follow up any point on which information was needed. In this way, it was not long before the attaches were able, by the knowledge they had of the Committee's working procedure, to deal direct either by visit or telephone call with that particular officer at H.Q. who was responsible for any section of the work.

One of the Committee's main difficulties in the Housing, Transport and Entry Form Departments was the lack of accurate information as to team strength and dates of arrival and departure. Here the attaches were of particular help and it cannot be too strongly stressed that this source of information was invaluable. Whenever possible, attaches were included in the reception parties meeting teams, when they were able to help over many difficulties such as language and also shepherd those persons who arrived unheralded with the teams and who had no official standing, and were therefore no one's official responsibility.

From Monday, July 26, until Thursday, August 12, the attaches met daily at 8.45 in the morning under the Chairmanship of the Assistant to the Director of Organisation, Mr. E. Blanchard Christie, and either with or without H.Q. department personnel, as necessary. Due to several factors, these meetings did not always fulfil their original object. The transference from H.Q. to Wembley of the Technical Department resulted

in the draws and timing of events reaching the teams direct by teleprint, telephone or special message. Housing Department was able to use the meetings, however, to get a fairly accurate preview of the departure dates and for the clearance of points on financial matters. Transport, too, found these meetings beneficial since there were many movements of personnel required which were not on the scheduled scheme and which the Organisation were able to provide either on a paid or unpaid basis. The Reception Committee was able, through the medium of the attaches' meetings, to pass on to interested teams the many invitations that were extended to competitors and officials either locally around housing centres or on a comprehensive scale by major London social and other bodies.

Inevitably, the supply of additional complimentary tickets to team members and officials caused no little heartburning and it must be said that the attaches took much of the sting out of the comments made by teams and, by their willingness to help, did secure to some great measure an equity in distribution which would have been impossible if an attempt had been made to allocate the very small ration of free seats against individual team application to H.Q.

Some reference should be made to the hospitality extended by the Olympic Attaches' Committee. An inaugural cocktail party was held before the day of the Opening Ceremony, another to say farewell after the close of the Games. At a later date still they met once more, not in any way to wind up, but to continue that spirit of international camaraderie that had been engendered during the months preceding the Games. In addition to these functions, each individual attache extended hospitality to his fellow members and to the Organising Committee in munificent manner.

The meetings of attaches, either official or social, are yet another noteworthy example of international friendliness brought about by the Olympic Games. That the representatives of over 50 nations did work together as a team in such a happy spirit with such outstanding success proves yet again that the Olympic Games are a potent force towards the drawing together of the peoples of the world.

#### **ATTACHES APPOINTED BY THE NATIONAL OLYMPIC COMMITTEES TO REPRESENT THEM IN LONDON**

C. B. ROBERTS, *Argentine*  
 NORMAN R. MIGHELL: D. T. GLYNN, *Australia*  
 Sir GEORGE FRANCKENSTEIN, GCVO, *Austria*  
 Major I. M. FLOOR, DSO, MBE, *Belgium*  
 JAMES MURRAY, *Bermuda*  
 Don RAMOS DE CARVALHO, *Brazil*  
 H. G. SEAFORD, OBE, *British Guiana*  
 U. THEIN KYAW, *Burma*  
 J. C. PATTESON, CMG: J. F. G. SWAN, *Canada*  
 A. WEERASINGHE, *Ceylon*  
 Don HORACIO SUAREZ: EDUARDO GROVE (Assistant) *Chile*  
 Dr. Y. S. CHEN and T. C. LAI (Assistant), *China*  
 JULIO A. BRODERMAN, *Cuba*

Dr. A. FELZMANN: D. VOJTA, *Czechoslovakia*  
 NILS MIDDLEBOE : E. MUNCK, *Denmark*  
 M. SAAD EL DIN, *Egypt*  
 Prof. P. F. DONOVAN, *Eire*  
 Colonel JACK HILLS: A. R. LINDSAY (Assistant), *Finland*  
 PAUL GRALL, *France*  
 BRIAN McCABE, MC, *Great Britain*  
 LEONIDES A. PAPAGOS, *Greece*  
 Lt.-Col. L. J. A. SCHOONENBERG, *Holland*  
 BELA PAL MIKLOS, *Hungary*  
 BJORN BJORNSSON, *Iceland*  
 SUNDAR KABADI, *India*  
 E. KAZEMI: H. G. KIYANI, *Iran*  
 E. R. J. HUSSEY, *Iraq*  
 RENZO CHIOVENDA, *Italy*  
 H. J. SHELLEY, *Jamaica*  
 Lt.-Col. C. HWANG: LEE WON SOON, *Korea*  
 FAWZY SHEHADI, *Lebanon*  
 PETER CASSON: P. LUBBOCK, *Liechtenstein*  
 GEORGE HEISBOURG, *Luxembourg*  
 Lt.-Col. A. V. AGIUS, MC, TD, *Malta*  
 Dr. A. MENA: Dr. FRANCISCO CUEVAS, *Mexico*  
 F. T. SANDFORD, *New Zealand*  
 Major AARDAL: K. KREFTING, *Norway*  
 GHULAM M. MUMTAZ, *Pakistan*  
 E. MORALES, *Panama*  
 J. FERNANDEZ DAVILA, *Peru*  
 Dr. FELIX HOCSON, *Philippines*  
 K. DUNIN-KEMPLICZ : S. ROLAND, *Poland*  
 Lt.-Col. LUIZ DA CAMARA PINA, *Portugal*  
 O. T. BUSSEK, *Singapore*  
 H. WELSH, *South Africa*  
 JOSE BRUGADA Y WOOD, *Spain*  
 Captain EDWARD CARLBOM, *Sweden*  
 ROY HUNZIKER: V. UMBRICH, *Switzerland*  
 M. JOSEPH-MITCHELL, *Trinidad*  
 IHSAN TUREMEN, *Turkey*  
 L. H. CLOSE, *Uruguay*  
 J. LYMAN BINGHAM, *U.S.A.*  
 JAKOV BRADANOVIC, *Yugoslavia*

# TECHNICAL DEPARTMENT

In view of the many ramifications in the work of the Technical Department, consequent upon the Committee decisions already enumerated, it was necessary to break it down into several sub-sections. In this report, the work of each sub-section is considered separately, so far as is possible. In the section dealing with the arena arrangements and the provision of equipment, however, it has been found more convenient to deal with each sport separately.

## Administration of Department

The work of the Department began in October, 1946. In a report to the International Olympic Committee in September, 1946, the Chairman of the Organising Committee had already announced that the Empire Stadium, Wembley, had been chosen as the main Olympic Stadium and that boxing and swimming would be held at the Empire Pool, Wembley. Rowing was to be at Henley-on-Thames, cycling at Herne Hill and yachting probably at Torquay.

The main work envisaged at that time for the Technical Department was to find the numerous other venues and courses which were needed, circulate the rules approved by the International Federation governing each sport; provide medals, badges and diplomas, programmes, flags ; and arrange for music and technical research.

The Technical Committee had as Chairman, Mr. E. J. Holt, O.B.E., who later became Director of Organisation, and as Deputy Chairman, Colonel E. A. Hunter, O.B.E., (the Secretary of the British Olympic Association). The members consisted of one representative from each of the National Governing Bodies in Great Britain of those sports included in the Games, and representatives from the Royal Navy, the Army and the Royal Air Force Sports Boards.

### *List of Members*

- Mr. E. J. H. Holt, O.B.E. (Chairman)
- Col. Evan A. Hunter, O.B.E. (Vice-Chairman)
- Mr. D. T. P. Pain (British Amateur Athletic Board)
- Mr. W. Browning (Amateur Basketball Association)
- Mr. J. M. Wyatt, F.R.C.S. (Amateur Boxing Association)
- Mr. H. E. Wells (British Canoe Union)
- Mr. A. P. Chamberlin (National Cyclists' Union)
- Col. V. D. S. Williams, O.B.E. (British Horse Society)
- Mr. L. V. Fildes (Amateur Fencing Association)
- Mr. C. J. Battersby (Football Association)
- Mr. E. A. Simmonds (Amateur Gymnastic Association)
- Mr. A. G. J. Hands (Hockey Association)
- Lt.-Col. O. G. W. White, D.S.O. (Modern Pentathlon Association of Great Britain)
- Mr. G. O. Nickalls (Amateur Rowing Association)
- Cdr. H. Lingard, R.N. (retd.) (National Rifle Association)
- Mr. A. J. Palmer (National Smallbore Rifle Association)

Capt. B. W. Cummins (Amateur Swimming Association)  
 Mr. O. State (British Amateur Weightlifting Association)  
 Mr. P. Scott, M.B.E., D.S.C. (Yacht Racing Association of Great Britain)  
 Lt.-Col. R. H. Russell (International Amateur Boxing Association)  
 Lt.-Cdr. R. S. Attwater, R.N. (Royal Navy and Royal Marines)  
 Wing Cdr. A. F. Ingram (Royal Air Force)  
 Brigadier L. F. E. Wieler, C.B.E. (Army)  
 Mr. E. A. Barker (Secretary to Committee and Technical Manager)

The policy of the Organising Committee was to ask the National Governing Bodies, not only to act as technical advisers on every phase in the preparations, but to provide the necessary personnel for the actual competitions, apart from those officials nominated by the various International Federations themselves.

All the National Governing Bodies responded immediately, despite the heavy burden involved, and most of them set up special Olympic sub-committees. Throughout the preparatory work and during the Games these voluntary organisers carried out their work with unflinching enthusiasm and efficiency. Without the help of the Associations, which provided over 1,000 officials during the Games, the task of the Organising Committee and of the Technical Department in particular would have proved very difficult and would have entailed the employment of a far larger paid staff. These officials devoted their leisure hours during many months to ensure the success of the technical arrangements.

In planning the work of the Department, it was considered essential to set up at least the following sections :—

Arenas	Communications
Handbooks	Results
Training	Entry Forms
Equipment	

A staff table was drawn up showing the dates on which each section would commence work and the dates of expansion of staff. In the main, this table proved an accurate forecast though naturally adjustments had to be made.

Much extra work was undertaken by the Department, including the work in connection with the special Customs arrangements, the distribution of mail, obtaining and allocating clothing coupons for uniforms for officials, and other matters.

The detailed arrangements in regard to Victory Ceremonies, flags of the nations and decorations were carried out by the Department. In November, 1947, the Executive Committee set up a special Decorations Sub-Committee which included members of the Technical Committee.

The Department undertook the preliminary negotiations in the research for a suitable fuel for the torch to be carried in the relay from Olympia and with the Olympic Committees abroad.



The Technical Department conducted discussions with the B.B.C. (radio and television) on the programme of events and the venues to be used. Each venue was surveyed in turn by the Director of Outside Broadcasts or other members of the B.B.C. staff, and all information of alterations in the programme of events was passed on as quickly as possible to the B.B.C.

In considering the work of the Technical Department, as indeed, with the organisation as a whole, the background of a country recovering from the effects of war must be appreciated. Government regulations and controls affected almost every phase of preparation. Equipment was either in short supply or was affected by orders of the Treasury, Board of Trade or other Government departments. Government licences were necessary to obtain timber for constructional work, petrol and other items.

### **Arenas and Equipment**

A provisional timetable of events was drawn up for the meeting of the International Olympic Committee in September, 1946. Subsequently, it proved necessary to amend this for every one of the 17 sports except athletics.

Previous Organising Committees have experienced the same difficulty in making firm decisions as to the dates and times of the various events at an early stage. It was not until June, 1948, that the final timetable was produced. When the International Federations were approached, early in 1947, to ascertain if they had any comments to make on the proposed dates and times, many Federations asked for alterations, usually requesting additional time for their sport. Every effort was made to assess the probable number of entries in the different sports and thus to calculate the time required.

In finding adequate accommodation, the Organising Committee had to use and adapt existing buildings. Every stadium or hall which could be used was inspected to see if it were suitable. Dressing rooms were often inadequate owing, not only to the probable number of competitors, but also to the desirability of grouping teams. Furthermore, difficulty was often experienced in adapting or adding to the existing accommodation.

In obtaining the equipment needed for the 17 sports, two principles were followed. The equipment had to be the finest available and that made in Great Britain used so long as it fulfilled the first condition.

The Technical Department ascertained the exact type, and approximate quantities of equipment required by each International Federation, and then approached British manufacturers to find out if they could produce it to Olympic standards.

It was, of course, not always possible to decide at that stage, the exact quantities required, as most International Federations had little knowledge, in 1946, of the number of competitors likely to take part.

The manufacturers of many items of equipment bought in England had to ask for priority in the supply of raw materials, and the Technical Department negotiated this with the Government department concerned. It was necessary to place orders, so far as possible, well in advance as many firms were unable to fulfil orders at short notice owing to the prevailing industrial and economic conditions.

The greatest care was taken to ensure that each item to be purchased was first approved by the appropriate International Federation or its British representative. In many cases this involved long delays, but the care exercised was justified in that no type of equipment in any sport was condemned on final inspection, and only a very small percentage of articles rejected because of faulty workmanship.

British manufacturers were able to supply all leather goods such as balls and boxing gloves. Finland and Sweden provided most of the athletic equipment for field events.

Detailed lists were prepared of all the equipment necessary for the conduct of each sport, from major items down to scoresheets, whistles, pencils and the like, and agreement was then reached on whether the Technical Department or the National Governing Body should be responsible for providing them. In addition to the equipment needed for the competitions, it was necessary to provide that for nearly 100 training centres.

## **PROGRAMMES AND DATES**

### **Athletics**

This was the only sport for which the original allocation of dates was maintained. This was mainly due to the policy of the International Amateur Athletic Federation of having a standard programme for the Games which required only slight modification.

For the Games of the XIV Olympiad, the alterations made, compared with the XI Olympiad, were the addition of the 10,000 metres track walk, and, for women, the 200 metres, long jump and weight (these events had, however, been included in the provisional programme for Helsinki, 1940).

### **Basketball**

Owing to the large number of entries expected, and the length of time required to conduct the tournament on the " pool " system as laid down by the International Federation, it appeared necessary to provide two courts in Harringay arena which was also to be used to stage the wrestling events. The International Federation throughout the negotiations was most co-operative and agreed to limit the number of days to eight and to modify their " pool " system. Eventually, however, it became clear that the physical difficulties of providing two courts on one arena, together with the problems that this would create for the box office in guaranteeing seating for any specified match, were so great that it was considered necessary to move the wrestlers to another venue, and so allow 13 full days to be devoted to basketball at Harringay, using only one court.

### **Boxing**

In the original schedule, boxing was to take place at the Empire Pool in the first week of the Games, two rings being used simultaneously. This led to a protest from the International Amateur Wrestling Association who asked that, as certain officials were common to both sports, they should not be held on the same days. It was, therefore, decided to move the wrestling to the second week. Subsequently, it proved necessary to transfer swimming to the first week and boxing to the second week, to facilitate the arena change-over at the Pool. Wrestling was therefore moved back to the first week.

Further complications arose, first owing to negotiations with F.I.N.A. who wished swimming to be held in the second week, and secondly, because the boxing authorities did not agree to the use of two rings in the same arena. It had been tried at Berlin in 1936, and found unsatisfactory. As the prospective number of entries was uncertain, the decision was left until June 16th, when the entries closed. Though the entries were not as large as had at one time been expected, it was decided to start the boxing on August 7th at the Empress Hall, using two rings. Boxing in the Empire Pool began on the afternoon of August 9th, which was the earliest time by which the Pool could be converted from use for the swimming events.

### **Canoeing**

The International Canoeing Federation made early application for an increase in the number of events and for the inclusion of women's competitions. The question of the inclusion of women was raised at the International Olympic Committee meeting in Stockholm in 1947, and it was agreed that an event for women could be included, provided that there was no increase in the number of canoeing events already fixed. The Federation decided to omit the proposed men's K.1 relay and include a K.1 women's event over 500 metres.

### **Cycling**

Discussions took place between the U.C.I., the N.C.U. and the Organising Committee on the number of events and the arrangement of the programme. The U.C.I. wished to increase the number of participants per nation to two in the sprint and tandem events. The Organising Committee was reluctant to accept this suggestion in view of the consequent increase in the number of competitors, and the U.C.I. agreed to waive it.

There was considerable difficulty in agreeing the detailed timetable of events and the hours of racing with the U.C.I. and the N.C.U., and it was not possible to settle this finally until just prior to the Games, thus causing considerable dislocation of the box office arrangements.

### **Equestrian**

The programme of events for the equestrian sports is well established and there was no intention of making any variation. The difficulties encountered were only on timing.

The time to be allowed for all the events depended directly on the number of competitors. The F.E.I. obtained a reasonable forecast of numbers in the light of the regular programme of international events in this sport. It was agreed to limit the sessional duration of the dressage in view of the strain upon the judges, and this involved allowing one-and-a-half days each for the Dressage competition, and for the Dressage section of the Three Day Event. The likely duration of the Prix des Nations had a direct bearing upon the timing of the Closing Ceremony, as it was desired to obviate the late finishing hour in Berlin (due to a jump off), and time was allowed not only for this eventuality but also for the removal of certain of the jumps.

Discussions were necessary over the starting time of some of the events. The F.E.I. wished the Dressage events to start at 8 a.m., and the cross-country section of the Three Day Event at 5.30 a.m. The latter was agreed on to avoid exposing the horses to the heat of the day, and also as no box office considerations were involved. A compromise was reached over the Dressage, which began at 9 a.m. to give spectators a reasonable chance of seeing the whole event.

### **Fencing**

The programme of events for the fencing tournament was unchanged ; it was again allocated 13 full days. Due to the fact that all the events are conducted on the " pool " system, no accurate forecast of the finishing time of any session could be given. The timing was also dependent on the number of pistes available. The estimated entries were accurate. A world championship meeting had been held in Lisbon in 1947, and the experience gained from this was most helpful in the necessary planning by the Federation and Amateur Fencing Association officials.

### **Football**

The regulations for Olympic football laid down by the F.I.F.A. admit sixteen nations only to the tournament proper. This necessitated making arrangements for preliminary matches to be held as the number of competing nations was more than sixteen. It was agreed in conjunction with the I.O.C. and F.I.F.A. that as these did not form part of the Olympic Games proper, they might be held outside London and before the Opening Ceremony. The draw for the eliminating rounds was held in Zurich on June 17th. At that date 23 teams had declared their intention of entering but only 18 actually played. This meant that matches on three of the grounds outside London that were to have been used were cancelled.

### **Gymnastics**

Two major decisions had to be reached over the gymnastic events. The inclusion of women's events, which had been queried by the Organising Committee, was agreed upon by the I.O.C. at their 1947 Congress, subject to a minimum of six nations indicating that they would be represented, and to the contest being confined to a team event.

The International Federation were most anxious that the gymnastic events should be held in the main stadium. The A.G.A. counselled that this was inadvisable, due to the uncertainty of the English climate, as the main stadium inevitably meant open-air competition. The I.O.C. supported the International Federation and the mornings and afternoons of three days of the last week of the Games were allocated to gymnastics at the Empire Stadium. The major difficulty was that the clearing of the Stadium in readiness for the hockey and football semi-finals, which were fixed for the evening sessions of those days, necessitated the closure of the gymnastic session by 4 p.m.

Due to torrential rains on the day and night preceding the start of the gymnastics, the whole programme had to be postponed at a moment's notice until the last three days of Games when it was possible to occupy the Empress Hall. The consequent strain upon

the box office administration was severe. However, as three sessions were available each day at the Empress Hall, and as the men's and women's events were run simultaneously, the competitions were concluded by mid-day on Saturday.

### **Hockey**

The increased number of countries likely to compete in the hockey tournament caused the Organising Committee to extend the number of days from four to nine, and to provide three grounds instead of two for the preliminary matches.

### **Modern Pentathlon**

There was no deviation from the order of events laid down by the International Federation, but the event was begun one day earlier than had originally been planned in order that it should be completed before the commencement of the epee event in London.

### **Rowing**

There was no change in the programme of events. F.I.S.A. objected to the original time schedule as they wished to have a rest day between the semi-finals and the finals. For box office reasons it was desirable that this should be a Sunday, particularly as by holding the semi-finals on Saturday, August 7th, there was a reasonable chance of a larger crowd attending on the final day, when both the athletics and swimming events had been concluded.

### **Shooting**

The programme of events, as to the type of arm to be used was settled early in 1947. Due to the difficulty of the conversion of English ranges to metric distances, the Organising Committee made representations with a view to altering some of the technical details of the International Federation's programme. These were finally agreed at the Congress of the International Federation in September, 1947. This Congress was held at the same time as a World Championship meeting as a result of which much valuable experience was gained.

### **Swimming**

Certain difficulties were encountered in arranging the dates for this sport. Originally it was planned to take place in the second week and an outside pool was to have been constructed at Wembley for the diving and water polo events.

In the spring of 1947, however, the Wembley authorities stated that, due to rising costs of labour and materials, the cost of building the outside pool would be prohibitive, and further that the work could not be completed in time.

It also became apparent that an extra day for swimming would be needed and in addition an outside bath for the preliminary rounds of the water polo. This was only possible if the change-over from swimming to boxing or vice versa took place at a week-end, allowing the Sunday for the necessary work. Owing to the number of days allotted to these sports, the order had to be swimming followed by boxing. In addition, F.I.N.A. were

most anxious that the pool should be available for practice before the opening of the Games. F.I.N.A. were therefore asked to approve the suggestion that swimming should take place from July 29th to August 7th.

They eventually agreed to this alteration of dates, after the I.O.C. had consented, in view of the special difficulties involved, to the holding of the F.I.N.A. Inter-Continental Relays (a non-Olympic event usually held immediately after the end of the Games) in the Empire Pool during the Olympic period. The Relays took place on the evening of Saturday, August 7th, and, in order to allow sufficient time for the change-over to boxing, the I.A.B.A. and A.B.A., with ready co-operation, altered their programme to commence in the afternoon of August 9th instead of in the morning.

### **Weightlifting**

The weightlifting programme included one extra class in comparison with the Berlin Games, that for bantamweights which had been added to the recognised international schedule of the International Federation. Early agreement was reached that six sessions would be needed, one for each weight, and if possible, spread over three days to avoid undue strain upon the officials. The chief obstacle in settling the dates was to find a suitable venue giving adequate accommodation both for spectators and competitors, and which would, if possible, meet the request of the weightlifting authorities that all the spectators should face the front of the platform on which the lifting took place. When the wrestling events were arranged for the Empress Hall, it was decided that it would be desirable to use the same venue for weightlifting after the conclusion of the wrestling events.

### **Wrestling**

The wrestling programme also was larger than it had been at Berlin, as the flyweight class had been added in both Greco-Roman and Free Styles. It was realised that more time must be allocated than previously, to avoid the competitions continuing until the early hours of the morning as had occurred at the Berlin Games. When it was intended to stage the events at Harringay where the basket ball was also to take place, it was feared that the number of competitors would be so great as to necessitate starting the competitions before the Opening Ceremony, which is contrary to Olympic practice. In making the decision to allocate Harringay exclusively to basket ball, and to move the wrestling to the Empress Hall, it was at once apparent that sufficient time could easily be allotted to this sport at this latter arena. Morning and evening sessions took place on seven days, three for the free style events and four for the Greco-Roman, and the programme was completed before midnight each evening.

The Federation conducts judging demonstrations and conferences before the competitions in each style. Normally they wish to have a free day between the styles, to allow time for the second conference, but advantage was taken in this case of Sunday, August 1st, although the free style competition did not finish until Monday night.

## **Yachting**

The number of events was increased over the Berlin figures from four to five. The 8-metre class was abandoned as so few yachts of this size were being sailed in the post-war world, and the " Dragon " and " Swallow " classes were added. For the single-handed event, the Organising Committee agreed to provide boats of the " Firefly " type, a design recognised by the Y.R.A. of Great Britain instead of the monotypes previously sailed.

Agreement was reached some 18 months before the Games with the Torquay authorities, at whose invitation the events were to be held in Torbay, and with the yacht racing authorities that the seven days of sailing should be broken into four in the week of August 2nd, and three in the last week of the Games, thus giving time for overhaul of the boats.

## **ARENAS**

### **Athletics**

The early negotiations for holding the Olympic Games in London, were linked up with the Track and Field events taking place in the Empire Stadium at Wembley.

As there was no running track or field event facilities available, it was agreed with the Stadium authorities that these would be provided in accordance with the requirements of the International Amateur Athletic Federation.

### **Basketball**

The choice of arena for staging the basketball tournament of the Olympic Games was influenced by the need for suitable flooring for the conduct of this sport, as the International Federation had asked that in London the tournament should take place under cover.

It had been intended to provide two courts, a necessity in view of the large number of matches that would have to be played under the "pool" system proposed by the International Federation.

Harringay Arena, a covered building capable of seating some 6,000-7,000 persons, was chosen since it fulfilled the requirements already stated. Much time was spent during the period when basketball had only been allocated eight days within the Games period, in endeavouring to arrange the courts on the arena floor. The decision to allow the full thirteen days simplified the use of this arena.

The wooden flooring was laid in sections, and was approved by the basketball authorities, as was the standard lighting installed at Harringay. In actual practice it was found that sectional flooring is not the ideal for a fast-moving tournament such as this, and a carpenter was in constant attendance in order to reset the flooring between sessions and even, in some cases, at shorter intervals.

An office, equipped with secretarial and telephone facilities, was arranged for the International Federation at Harringay Arena. A Press room was also set up with similar facilities. This principle, of providing an office for the International Federation controlling the sport at each arena, was followed as closely as possible in the arrangements for all sports.

## **Boxing**

The negotiations over the time table of the boxing did not affect the decision that this event should be held at the Empire Pool. The change-over from swimming to boxing was estimated to take rather more than 24 hours and the work was carried out between midnight, Saturday, August 7th, and midday, Monday, August 9th. A scaffolding bridge was erected in the water of the Pool to carry the ring.

Office accommodation for the International Federation and a weighing-in room were provided. Facilities also had to be arranged for breakfast for the competitors after they had completed their weigh-in.

It was not until a comparatively late date that the arrangements for an additional boxing venue were completed, as for some time it had been thought desirable to have the additional site close to the arena in which most of the bouts would be contested.

When this proviso was waived, the Organising Committee arranged for the preliminary bouts to be held in the Empress Hall, Earl's Court, on Saturday, August 7th. It was originally intended to use two rings in this arena, but due to the reduction in the number of actual contestants, as against entrants, only one was used. A rapid change-over of the arena from wrestling, which had concluded the night previously, was carried out during the night August 6/7th.

## **Canoeing**

The venue chosen for the canoeing event was the same as that of the rowing. Two main considerations influenced this decision : (1) that the Henley-on-Thames reach provides the only straight 1,600 metres of water within reasonable access of London; (2) for economic reasons it was desirable to stage both the aquatic sports at the same venue. The main difficulty encountered in staging the canoeing events at Henley was lengthening the course for the 10,000 metre events. The regatta rowing course was lengthened in both directions and the requisite 10,000 metres was covered by proceeding down-stream from the enclosure, round Temple Island, up-stream past the enclosures, under Henley Bridge, round Rod Eyot, down the full course again to Temple Island and back as far as the normal finishing post. The river at Henley is, unfortunately, too narrow to allow mass starts in the long-distance events if there were more than six contestants and this necessitated some of these competitions being staged against the clock. The boat tents, landing stages and rackings erected for the rowing regatta, together with all the necessary marquees of the enclosures were, of course, used for this event. The telephonic communication system installed for the rowing was extended to include Temple Island down-stream and Rod Eyot up-stream for the purpose of the control and report of the racing. This field telephone system was laid by the Royal Air Force.

## **Cycling**

*Track Events.* It was realised in 1946 that, though the Herne Hill track was the only one suitable, considerable work would have to be carried out to bring the arena, both from a competition and spectator point of view, up to the required standard for Olympic events. Minor repairs to the track were carried out, spectator accommodation was increased by the erection of permanent stands (the only major constructional work of a permanent



nature carried out at the instance of the Organising Committee), and the general approaches, gates, turnstiles, were repaired, replaced or augmented. In addition to the permanent stands, a temporary stand was erected on the back straight of the course and the total seating capacity of the ground was considerably added to. Press accommodation was increased and twelve telephone boxes were installed directly behind their seats. The B.B.C. erected a special stand (with control room below) directly behind and slightly above the Press stand. An arena telephone system was installed, in addition to the one in existence, and at the request of the U.C.I. photo-finish equipment was also provided. First aid and refreshment accommodation for competitors and officials were provided in an adjacent field in marquees.

*Road Race.* An attempt was made to secure the use of Richmond Park for the Road Race event as it can be said to lie within the Greater London area. Unfortunately, the Parliamentary Act governing this Park prohibits any such use as was contemplated. By permission of His Majesty The King, however, the Organising Committee were allowed to hold it in Windsor Great Park, and initially a track of four-mile laps was mapped out, lying entirely within the Park itself. Due to representations made to increase the length of lap, the course was re-planned to pass over a short stretch of public road between two of the Park gates, giving a lap of seven miles. Arrangements were made for accommodating spectators by the provision of stands and enclosures on the starting and finishing straight in that area of the Park known as Smith's Lawn. The rest of the course was, of course, open free for spectators, subject to police control. Two sets of pits were erected, one on the finishing straight and one half-way round the course. A special Royal Enclosure at the start and finishing point was arranged for H.R.H. The Duke of Edinburgh, who started the race. It was quite impossible to forecast accurately the probable number of spectators for this event as numbers depended directly upon the weather. Enclosure accommodation was arranged for 10,000 persons and estimates of the probable actual attendance over the entire course varied from 20,000 to 100,000. It is believed from reports received that between 10,000 and 12,000 actually watched the race in torrential rain. A feeding point for competitors was established and catering arrangements made for all officials. Catering for the public was put out to a contractor and, apart from the siting, was not the responsibility of the Organising Committee.

### **Equestrian**

In conformity with normal Olympic practice, the Prix des Nations was held in the Empire Stadium immediately preceding the Closing Ceremony.

As no suitable area within the precincts of London was available for the cross-country section of the 3-day event, all other events of the equestrian sports were held in or around the Aldershot area. The choice of Aldershot was dictated, not only by this factor but also because adequate stabling and groom accommodation was available there in the military camps.

The use of the Central Stadium of the Aldershot Military Headquarters was secured for the Dressage competitions and for the Jumping section of the 3-day event. The Cross-Country event was planned in conjunction with the British Horse Society and the

Federation Equestre Internationale, and great assistance was received from the military, who played a major part in the organisation, control and constructional work that had to be carried out.

The course of the Cross-Country test falls into five sections, arranged as follows :—

- (i) roads and paths commencing near the Command Central Stadium and stabling accommodation, through Aldershot and out to the Tweseldown racecourse;
- (ii) steeplechase over the Tweseldown racecourse ;
- (iii) roads and paths section from Tweseldown racecourse to an area north-west of Aldershot, known as Old Dean Common ;
- (iv) cross-country course specially constructed over the Old Dean Common area ;
- (v) one km. flat from the cross-country course to the finishing line.

The not inconsiderable work necessary for establishing this 33½ km. course was undertaken on behalf of the Organising Committee under the direct supervision of the British Horse Society. The design of obstacles was also controlled by the British Horse Society, and their construction, for the steeplechase course, was carried out by civilian labour, and for the cross-country course by military labour.

Training grounds for equestrian sports were readily available in Aldershot, and hockey, cricket and football pitches and disused polo grounds were allocated by the military for use by the Organising Committee.

### **Fencing**

After considerable search within the London area, part of an old exhibition building on the Wembley Empire Exhibition site was secured as the venue of the Fencing events.

Due to the anticipated number of entries, both of teams and individuals, and the " pool " system adopted by the International Federation for their competitions, sufficient floor space had to be acquired for 8 pistes (92 ft. by 6 ft.) with adequate free space surrounding them, together with stand accommodation and the necessary offices and rooms for the conduct of an Olympic event. The building, when taken over by the Organising Committee, was an empty shell and within it were constructed two main stands overlooking the piste to be used for the finals, one smaller stand on the No. 1 piste, a competitors' lounge and cafe, a restaurant, an office for the International Federation, a workshop for the repair and maintenance of weapons, a first aid room and dressing rooms.

As the roof of the Palace of Engineering is glass, daylight lighting was adequate, but as it was anticipated that the fencing events would continue late in the evening, special flood lights were installed over each piste. This necessitated the running of cables into the area allocated for the tournament.

### **Football**

The final, semi-finals and the third-place match of the Olympic football tournament were held in the Empire Stadium.

As has already been stated in the programme and dates section of this Report, only 16 teams are admitted under the rules of F.I.F.A. to the tournament proper, and it was therefore possible to estimate accurately the number of grounds that would be required

for the preliminary matches. Five football grounds belonging to professional clubs and three to amateur clubs were loaned to the Organising Committee by their owners and arrangements were made for these grounds to be available, not only for the matches of each round, but also for re-plays should these be necessary. For the preliminary matches prior to the official tournament, five clubs on the south coast of England were approached and agreed to loan their grounds for this purpose. Since, of the original 23 entries at the closing date for entries, only 18 teams arrived to take part in the Olympic tournament, only two of the offers were accepted. The actual grounds used were :—

Preliminary matches : Brighton and Hove Albion, and Portsmouth  
 Olympic tournament proper: Arsenal, Crystal Palace, Fulham, Ilford, Brentford,  
 Dulwich Hamlet, Walthamstow Avenue, and  
 Tottenham Hotspur.

The arrangement and control of the football tournament in respect of the negotiations with the various clubs was conducted on behalf of the Organising Committee by the Football Association.

### **Gymnastics**

Despite the objections on the grounds of weather put forward by the Organising Committee and the Amateur Gymnastic Association of Great Britain, the I.O.C. supported the International Federation in urging that the gymnastic events should be staged in the Empire Stadium. The torrential rain of the week-end August 7th-9th, rendered it unfit for the gymnastic events, and the whole competition was therefore transferred at very short notice to the Empress Hall, Earl's Court. As the Wrestling and Weightlifting events had already been held at the Empress Hall, telephone, Press and office facilities were all available and required little alteration.

### **Hockey**

The semi-finals, final and third-place match of the Olympic Hockey tournament were held in the Empire Stadium.

Preliminary matches for the hockey tournament were somewhat numerous due to the "pool" system adopted by the International Federation. It was, however, agreed that three grounds would be sufficient and those of the Lyons' Sports Club, Guinness Sports Club and Polytechnic were made available to the Organising Committee. Due to a draw in the third-place match, a re-play was necessary. As no time was available in the Main Stadium, the Lyons' Club ground was used. These grounds normally cater for team matches, so little additional work had to be carried out, with the exception of the installation of Press telephones and marking the grounds. This latter was undertaken by the permanent staff of the venues.

### **Modern Pentathlon**

As in the Equestrian sports, the primary consideration in the choice of a venue for the Modern Pentathlon events was finding a suitable terrain for the Riding section and, as far as possible, grouping the other four sections at places reasonably situated in the same neighbourhood. The fact that the Modern Pentathlon has developed entirely out of

military training and that the Association governing it in Great Britain is under the control of the British Army made it natural for the Organising Committee to approach the military authorities for assistance. As the Equestrian sports themselves were already centred in the Aldershot area and the Tweseldown racecourse was to form part of the Cross-Country event, it was decided that Tweseldown should also be used for the riding section of the Pentathlon. The accommodation problem, too, was solved by the British War Office placing the Royal Military Academy, Sandhurst, at the disposal of the Organising Committee for housing the competitors.

(i) *Riding*. As has already been stated, the Tweseldown racecourse was already on loan to the Organising Committee, and a suitable course was marked out in conjunction with the equestrian authorities and the necessary jumps constructed by civilian labour employed by the Organising Committee. Field telephones were laid to all jumps and connected up to a central control point. The Press facilities to be used for the equestrian events were available for this event also.

(ii) *Fencing*. Although it was originally intended to utilise the gymnasium of the Military Academy for the Fencing event, it was decided eventually that what little gate might be attracted would be better encouraged if it was held in Aldershot itself, and Aldershot Military Command kindly loaned the Central Gymnasium.

(iii) *Shooting*. A special range constructed at Bisley, the headquarters of the National Rifle Association, for the rapid-fire pistol event of the shooting proper, was adapted for use for the third section of the Modern Pentathlon. All Press and telephone facilities were, of course, available at Bisley.

(iv) *Swimming*. The municipal authorities of Aldershot placed their public bath at the disposal of the Organising Committee free of charge for the swimming section of the Modern Pentathlon event. As this bath is considerably larger than would normally be necessary, a turning board was arranged at 50 metres. No other alterations were necessary at the pool, and as the event is not conducted on competitive lines but against the clock, it was not considered necessary to have cork lanes as at the Empire Pool. This event attracted a certain number of spectators.

(v) *Running*. The Royal Military Academy is situated in very wooded and undulating country, so the cross-country course for the last section was laid out by officials of the I.A.A.F. in the immediate vicinity of the competitors' housing centre.

## **Rowing**

The Royal Regatta course at Henley-on-Thames provides the most suitable situation within reasonable distance of London for a regatta of the importance of an Olympic event, and, of course, the rowing events of the 1908 Games had been held over this course. The Stewards of Henley Regatta undertook the supervision of the necessary work to be carried out and the Secretary of the Regatta Committee was formally attached to the Organising Committee staff for this purpose. As the normal Henley Regatta preceded the Olympic event by about a month, a large amount of preparatory work was already done for the purpose of the former event. It was necessary, however, to widen

the course to allow three boats to take part together in each event. The course was not boomed, as is normal in Great Britain, but cork buoys at 50-yard intervals formed the demarcation lines.

A Press stand on the river itself was constructed to cater for the very much larger number of Pressmen that would attend the Olympic events. The judges box used for the Henley Regatta was converted into a stand for radio commentators. A field telephone system was laid to supplement the normal communications which are used for the Henley Regatta, and served the start and finish and points along the course.

Boat tents, racks and landing stages used for the Henley Regatta were left in position, and a special stand seating 4,000 persons was constructed in the general enclosure.

### **Shooting**

A decision of the I.O.C. to uphold the application of the Union Internationale de Tir for the inclusion of the 300 metre event in the 1948 Olympic Games made the National Rifle Association ranges at Bisley an obvious choice.

An entirely new range was constructed for the 25 -metre rapid-fire pistol event. Alternative cover and open firing positions were provided and a special automatic control for the targets was employed.

*50-metre Free Pistol and 50-metre Small Bore Rifle.* The range known as the "Running Deer " range at Bisley was used and special targets were erected at the requisite distances from the firing point. As the firing point of this range is a grass mound, no construction was needed here other than the erection of cover for the competitors.

*300-metre Free Rifle.* The famous " Century" range of the National Rifle Association at Bisley, which caters for distances both less and greater than that of the Olympic event, was converted for the purpose of this event. To provide the necessary firing point 300 metres from the butts, construction work had to be undertaken, and this was accomplished by taking an area equivalent to the frontage of the targets to be used (30 in number), enclosing it by boards pegged in position 9 inches in height and giving a depth from the targets of 12 feet from the front to back of the firing point. This area was filled to a depth of 7 inches with rough clinker and ash, fine ash and dust, 2 inches in depth on top, and finally rolled and raked. Despite the extremely bad weather experienced during this part of the Olympic Games, this firing point remained dry throughout.

The regulations of the U.I.T. made it necessary to construct covers both for the 300- and 50-metre events. These were erected in the form of a wooden framework, constructed of rafters supported at intervals by uprights and strengthened by cross beams front and back. Across the framework tarpaulins were stretched as tight as possible and overlapping each other by approximately 2 feet. The rafters projected 18 inches in front of the actual firing point and 6 inches to the rear. The tarpaulins folded back under at both points. The back of the construction was enclosed by hessian screens from the actual ash firing point to within 1 inch of the tarpaulin. It should be noted that the gap at the top is most necessary to allow wind to pass through the firing point. When firing in the

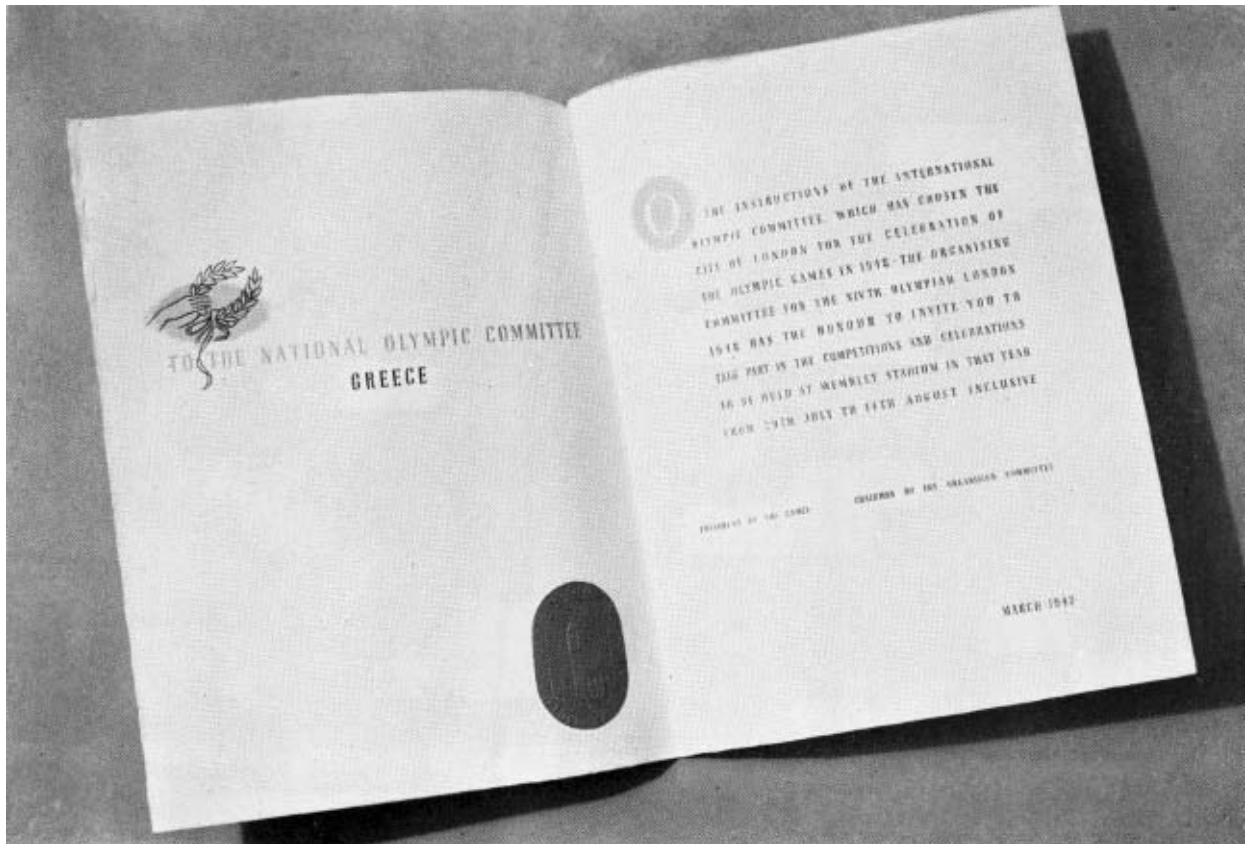

*The specially designed invitation sent by the Organising Committee to each of the National Olympic Committees recognised by the International Olympic Committee.*

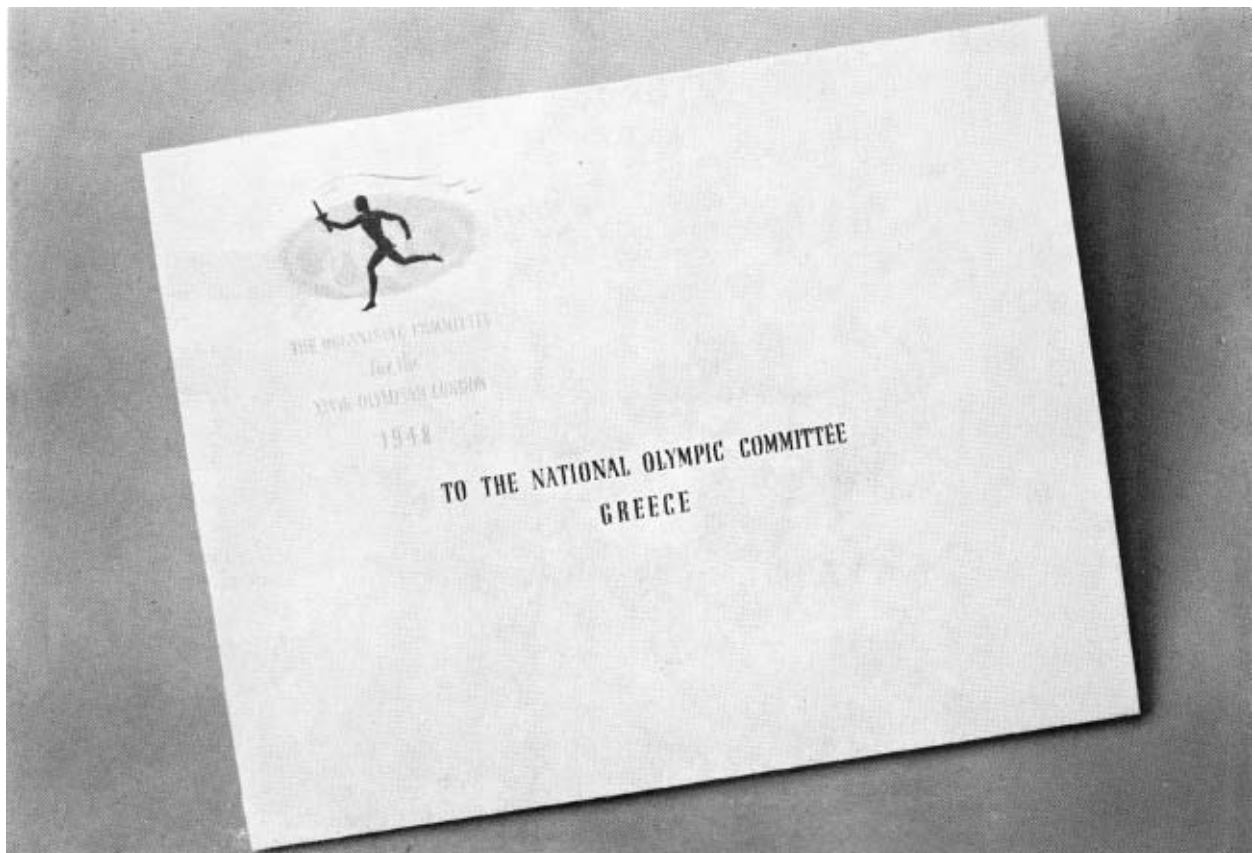

*The envelope in which the invitations were sent.*



*A general view of the work of laying the special track for the athletic events of the Games at the Empire Stadium, Wembley.*

*The special scoreboard which was erected at the Empire Stadium, Wembley, for the Games is here nearing completion.*

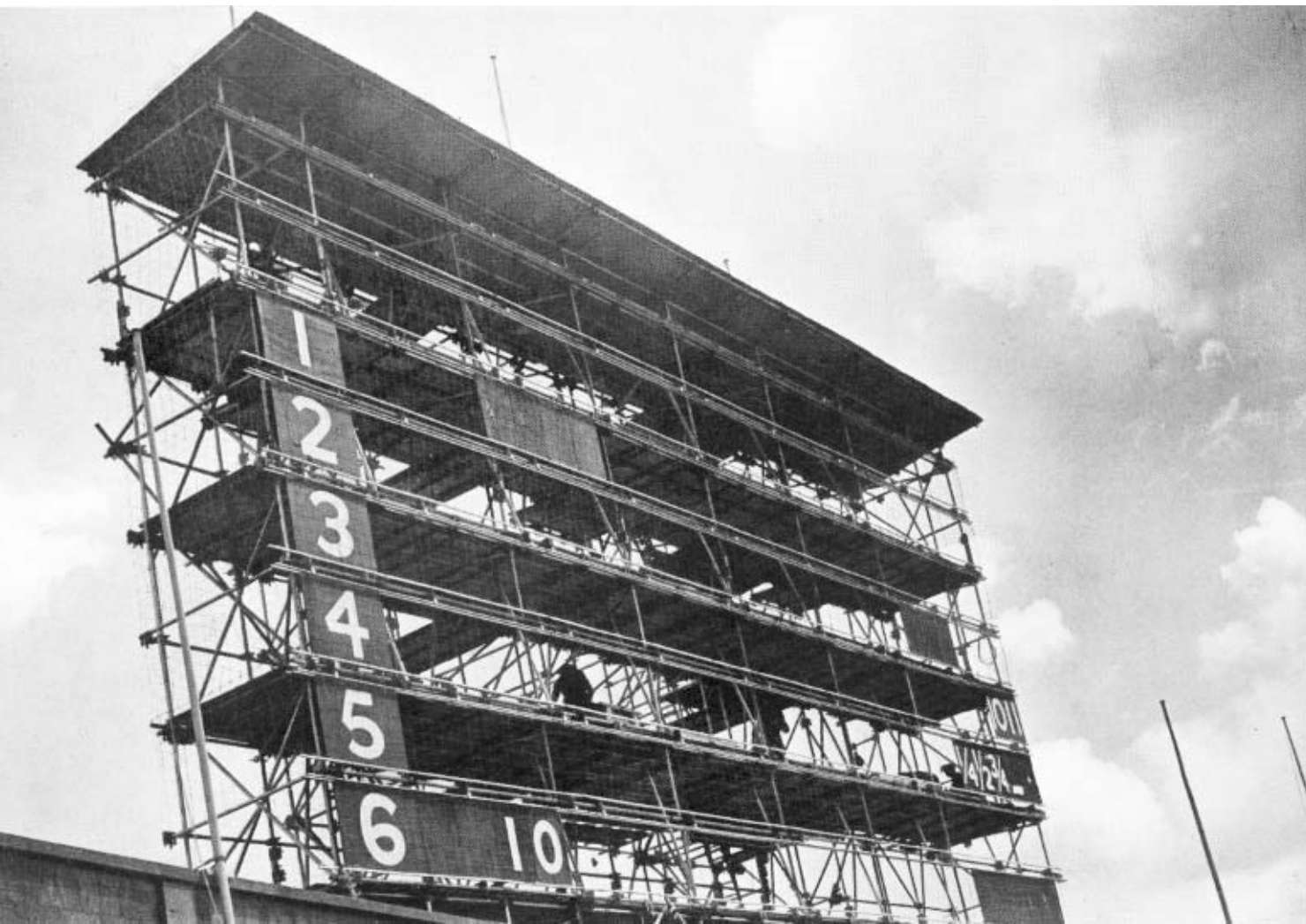





*Work in progress on the preparation of the bowl for the Olympic flame at the Empire Stadium, Wembley. In the background, the finishing touches are being given to the athletic track and arena.*





*Lord Burghley, Chairman of the Organising Committee, speaking at the official opening of the Richmond Park Olympic Housing Centre.*

*The Luxembourg flag is raised at the Uxbridge Olympic Housing Centre on the arrival of the national team, seen lined up in front of the flag.*





*Hoisting the Ceylon flag at the Richmond Park Housing Centre on the team's arrival. The hoisting is carried out by the team's Chef de Mission, Mr. Pereira.*

*One of the women's housing centres : American athletes in the lounge of Southlands College, Wimbledon, are being told of the arrangements for their hospitality by Mrs. Ada Sackett of the administrative committee.*





*A view of one of the bedrooms for Olympic competitors in the Richmond Park housing centre.*

*Competitors in the special section for their use on the terraces at the Empire Stadium. I. Schaeffer, wearing Austrian national costume, and her team colleague, U. Pilhatsch.*



*A veteran spectator at the Olympic Games : undaunted by the rain, John Miller, of Scotland, watches the start of the cycle road race in Windsor Great Park.*

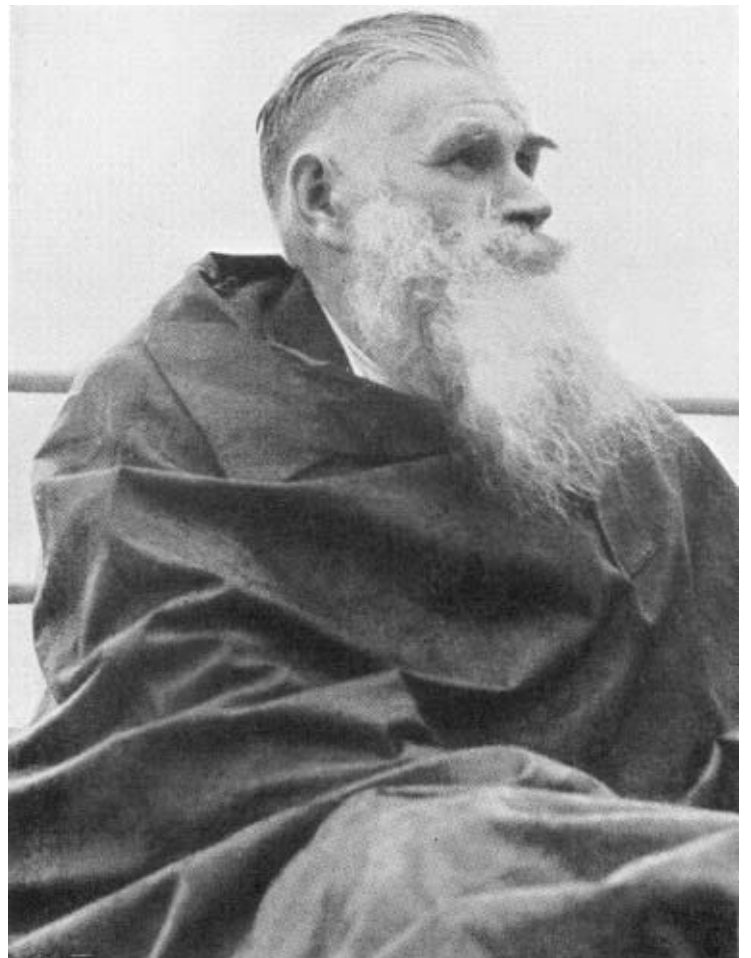



# OLYMPIC GAMES



29 JULY 1948 14 AUGUST  
L O N D O N

Designed by HELEN PALUCHY STUBBS LTD.

Printed in Great Britain by WEDGWOODS & CO. LTD. LONDON, E.C.

*The official Olympic poster.*

# THE VICTORIA AND ALBERT MUSEUM

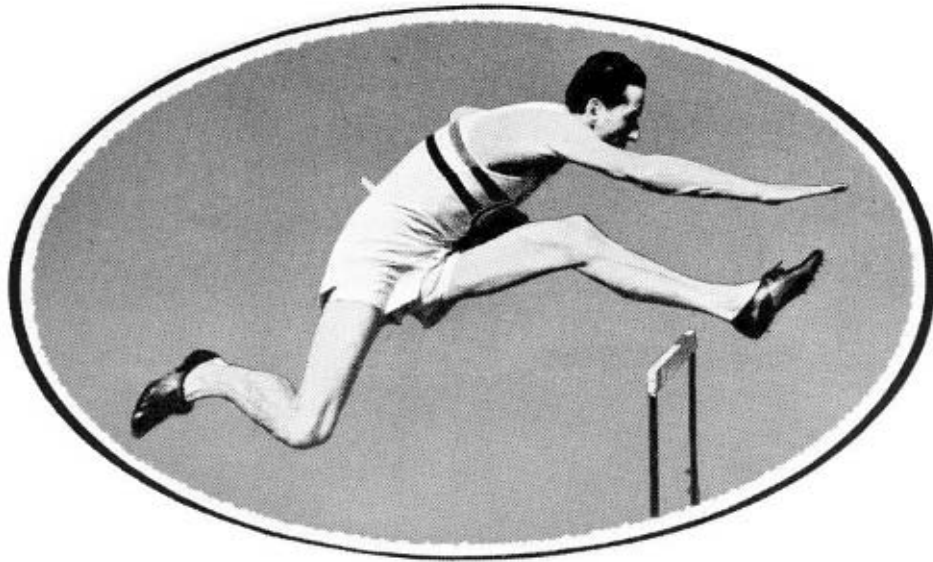

## XIV<sup>TH</sup> OLYMPIAD SPORT IN ART EXHIBITION

LONDON 1948



MONDAY, TUESDAY, THURSDAY & FRIDAY 10-6

**15 JULY-14 AUGUST**

WEDNESDAY & SATURDAY 10-10 SUNDAY 2-30-6

Printed by GRIFFIN PUBLISHING & LITHO, THROUGH THE PRESS

*The poster advertising the Olympic art exhibition.*

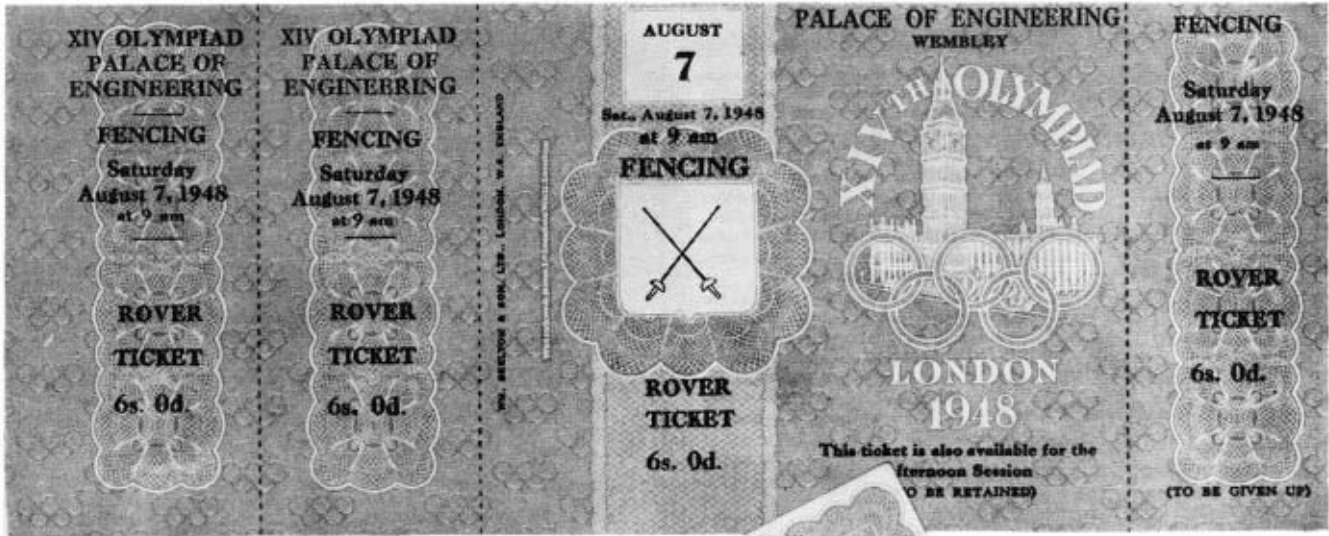

Examples of the tickets and passes issued for the Olympic Games.



*Kindling the Olympic flame at Olympia before the start of the torch relay.*



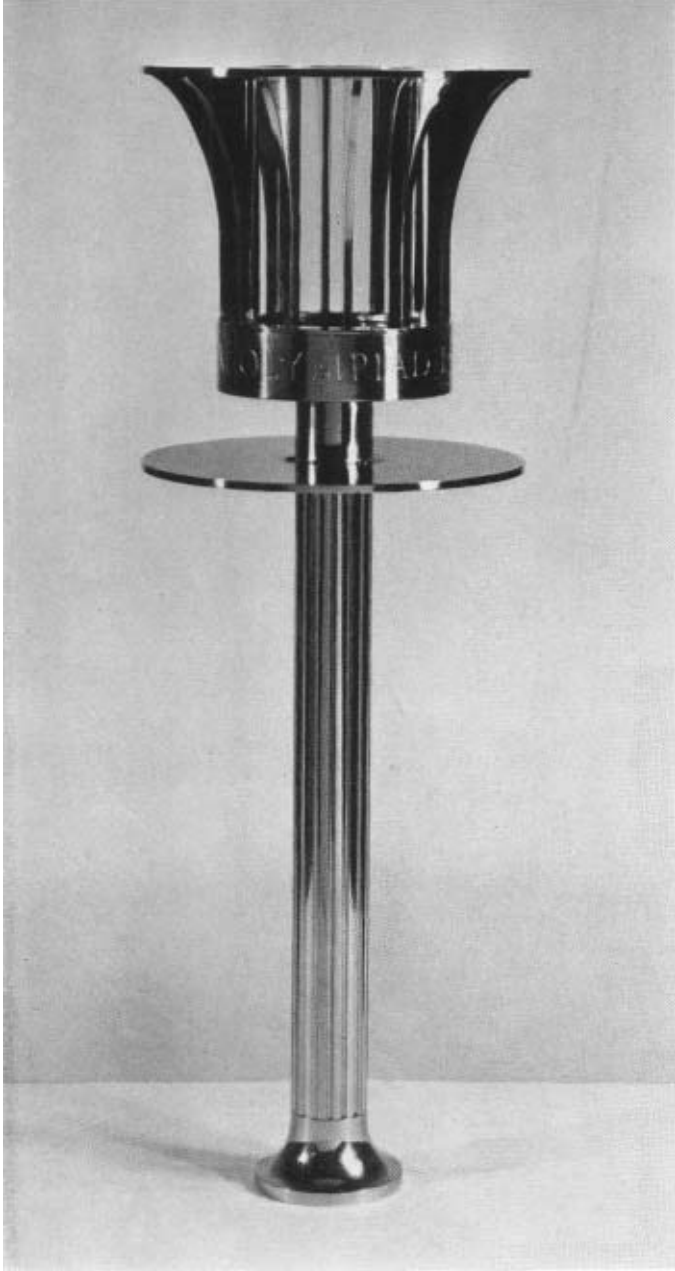

*The specially designed torch carried by the torch bearer in the Olympic arena, constructed to carry the magnesium flare.*

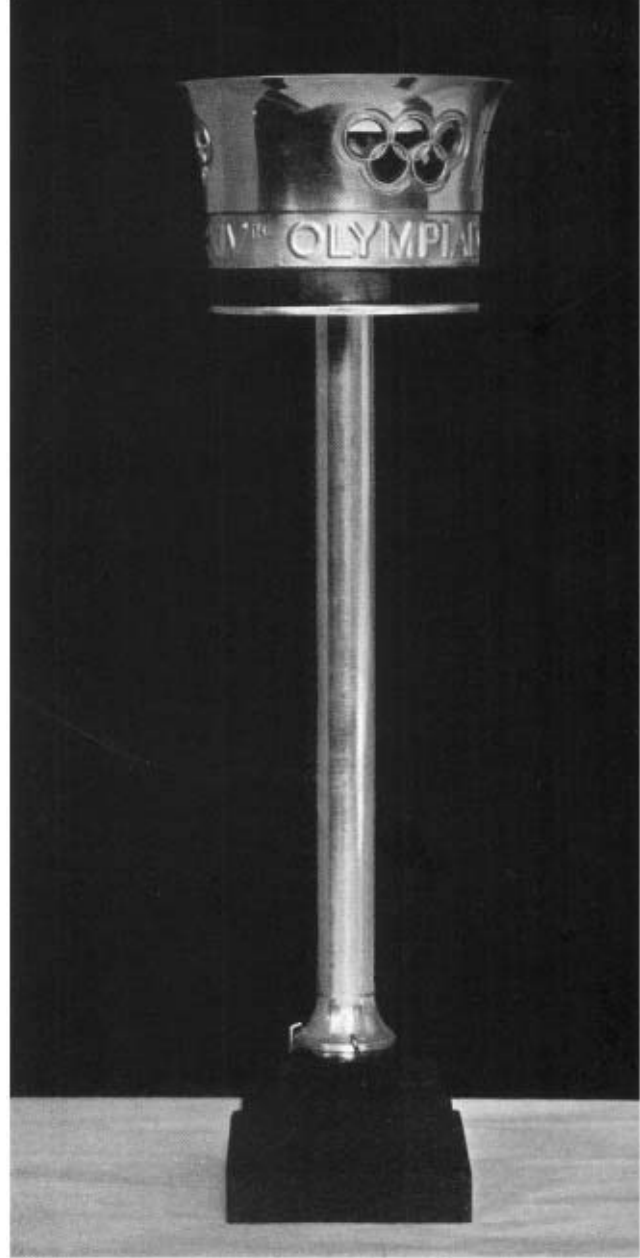

*The standard torch used by runners throughout the course of the relay from Greece to London.*

*Carrying the Olympic flame across the frontier from Switzerland to France beneath an archway of national flags.*







*The Olympic flame is borne across the River Thames, on its way to Wembley, as one of the runners in the torch relay passes over the bridge between Windsor and Eton, with Windsor Castle in the background.*

*The final runner in the torch relay enters the Empire Stadium during the Opening Ceremony and stands in salute beneath the scoreboard on which were Baron de Coubertin's words surmounted by three Olympic flags.*





*Cameras in position on the terraces of the Empire Stadium, Wembley, for filming the Olympic Games. A heat of the 400 metres hurdles is just starting. On the arena can be seen the portable towers on which other film cameras were sited.*



*The specially constructed motor trolley used by the Olympic Film Company in the course of filming the various events in the Empire Stadium.*

*While the 10,000 metres walk is in progress, the film cameraman is busy on the top of the 24 foot portable tower which could be moved to the most effective vantage point for a particular event. The pulley apparatus at the side of the tower was used for hoisting camera equipment.*







*One of the pits constructed alongside the track in the Empire Stadium for filming the Olympic events. One of the camera units is at work during the course of a race.*



*A view of the television commentator's box at the Empire Stadium during the parade at the Opening Ceremony. Michael Henderson (left) and Richard Dimbleby were the commentators. The screen on which the commentators follow the course of the transmission can be seen between them.*

*The mobile television control room which was first used at the Empire Pool for the Olympic Games.*





*A view in the television control room while events were in progress.*





*The television commentators' box at the Empire Stadium was used for interviews with leading athletes. Here Maureen Gardner (Great Britain) is being interviewed by Jack Crump after her exciting race with Fanny Blankers-Koen in the final of the 80 metres hurdles on August 4th.*

*The teleprinter network at Wembley which enabled contact to be kept between the various Olympic offices, arenas and housing centres, and by which results and official instructions and messages were transmitted.*



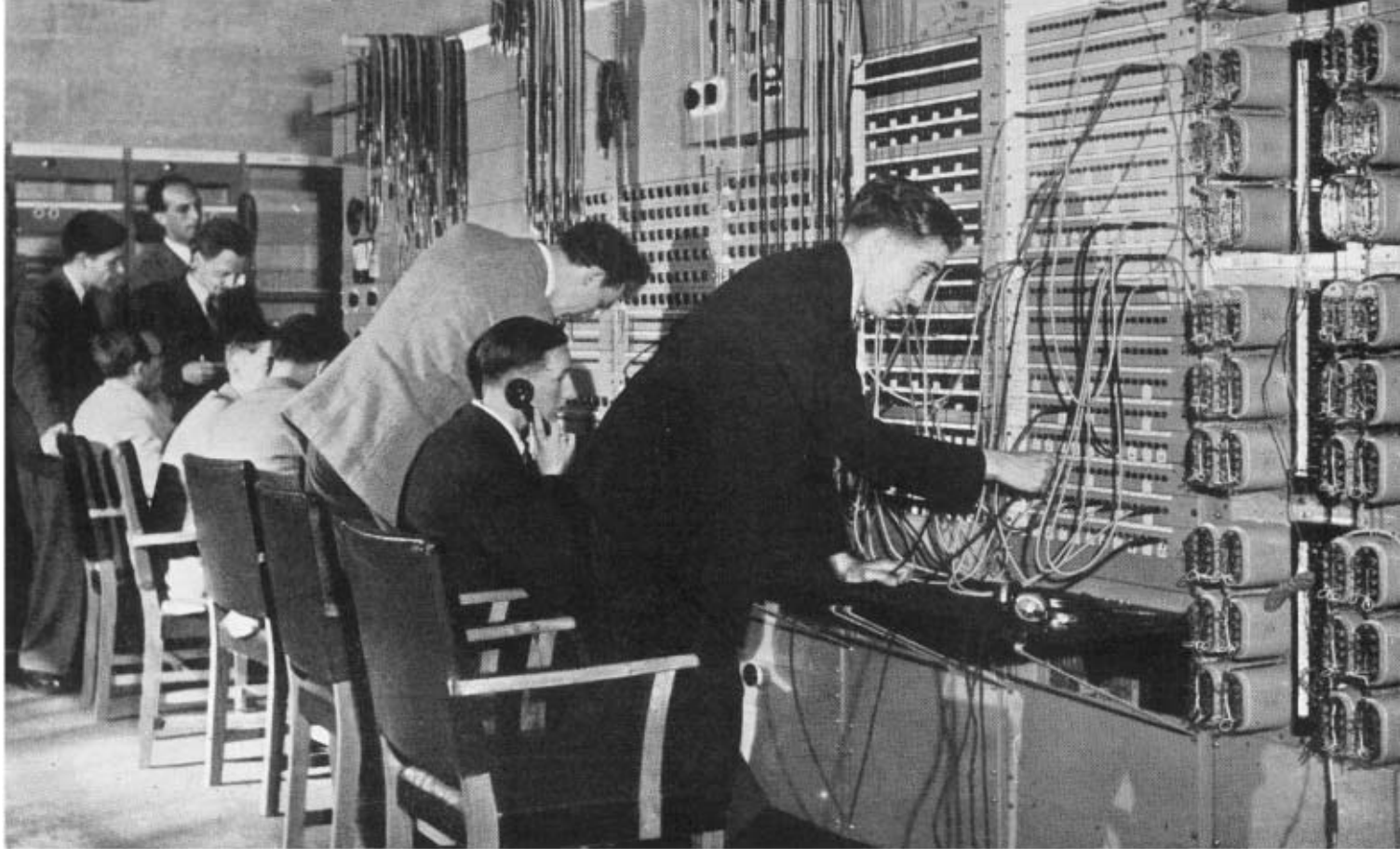

*The control room in the B.B.C.'s Broadcasting Centre at Wembley. Engineers are plugging through the outgoing lines carrying the broadcasts to the Distribution Centre at Broadcasting House.*

*The specially equipped telephone room in the Press Club at Wembley where journalists and radio correspondents made inland or international calls.*







EMPIRE STADIUM  
The Swedish  
Gymnastic Association

*A general view of the Empire Stadium during the demonstration given before the start of the marathon by the Swedish Gymnastic Association.*



*A scene during the demonstration lacrosse match at the Empire Stadium between a British team and Rensselaer (United States). A Rensselaer player gets away with the ball.*

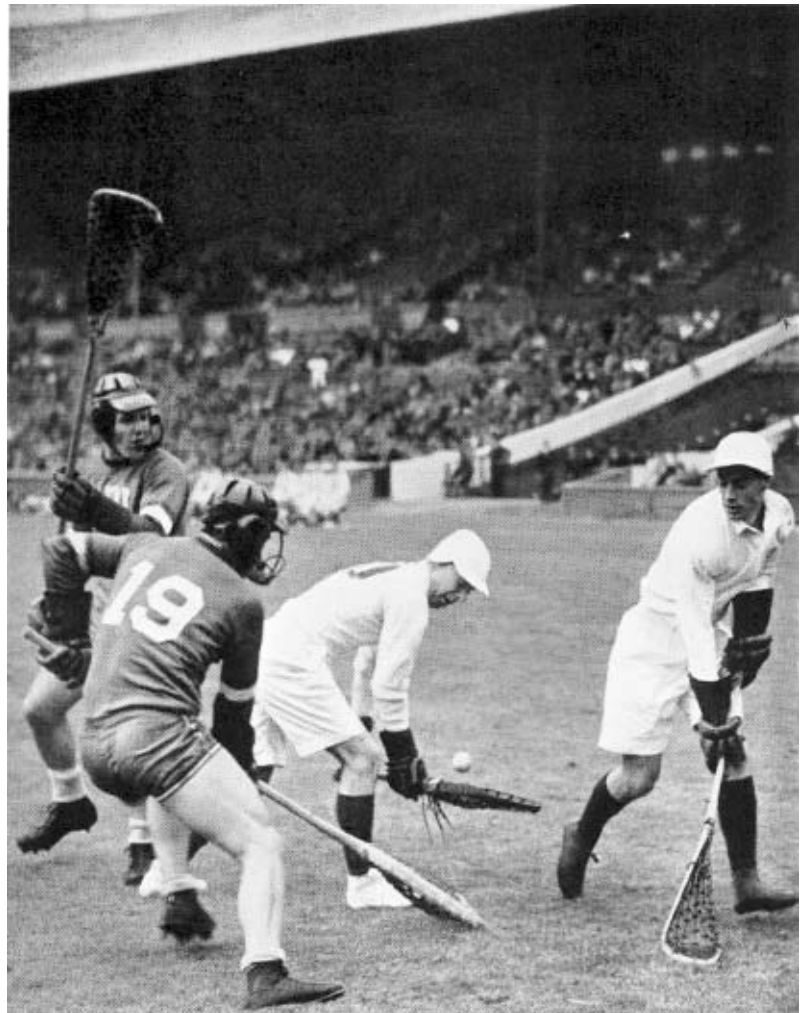

*A British player taking the ball in his crosse during the demonstration lacrosse match at the Empire Stadium.*



*Lord Burghley, Chairman of the Organising Committee, speaking at the ceremony of unveiling the Olympic Roll of Honour at the Empire Stadium, Wembley.*

*The Olympic Roll of Honour, erected on two large plaques on the walls of the Empire Stadium, Wembley, contains the names of the winners of each Olympic event.*







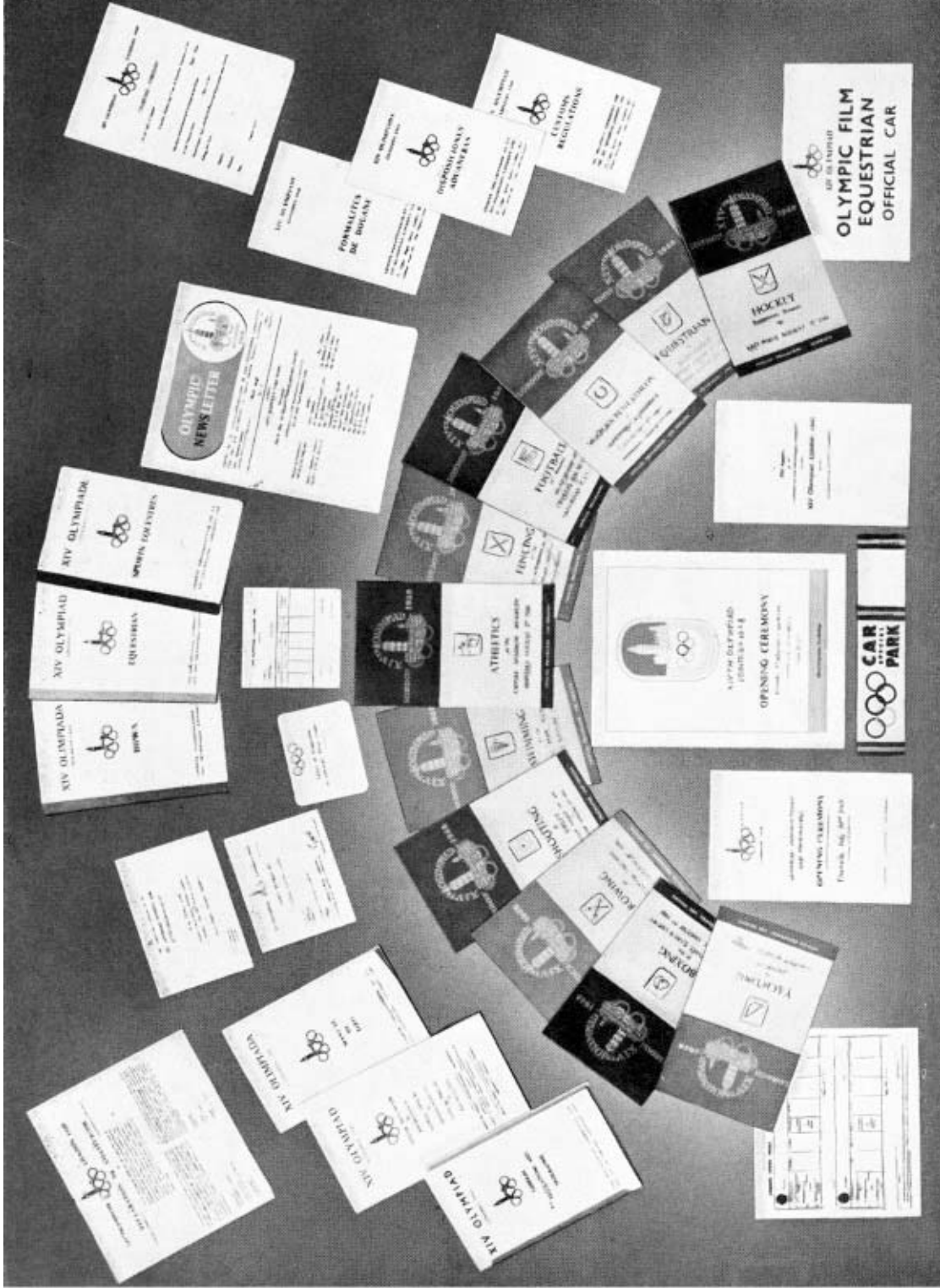

*Examples of some of the printed material produced by the Organising Committee—handbooks, entry forms, programmes, score sheets, etc.*

standing position at this range, competitors requested that this gap should be enclosed and this was done. The construction was divided into bays 12 inches wide by stretching hessian on uprights from the front to the back of the firing point. These did not join up with the back screen and thus a corridor was formed behind each competitor's position. As the " Century " range is laid out in blocks of 10 targets, the firing points were so arranged to have 12 bays, 10 opposite the targets and a spare one at each end for the range officer's staff and telephones. Tarpaulins were stretched over the actual ash firing point before shooting mats, etc., were laid for competitors. Range telephones were already installed at Bisley but pick-ups had to be arranged for the new metric firing point.

There are two bodies in Great Britain who govern these events, the National Rifle Association and the National Small-Bore Rifle Association, and a joint committee was formed by them to supervise these arrangements.

### **Swimming**

The Empire Pool, Wembley, was chosen for this sport, and although in the early stages the construction of an adjoining outside pool was planned, this was not proceeded with.

Due to the anticipated large number of entries for Water Polo, arrangements were concluded with the Finchley Borough Council for the use of their public open-air pool for five days at the commencement of the Swimming programme, for matches which could not be fitted into the Empire Pool schedule.

*Empire Pool.* As this bath is more than 50 metres long, a wooden bridge was constructed giving the requisite swimming length and acting as a platform for swimming officials, turn judges and time-keepers. Special stands were constructed on either side of the pool on the finishing line for the actual swimming judges and small transportable " sentry " boxes were provided for the diving judges in that section of the programme. Seating for Press and Radio commentators was arranged almost on bath level and this did not interfere with spectator accommodation which is considerably raised from the bath.

*Finchley Pool.* Finchley Pool was chosen for the preliminary rounds of the water polo as it had the advantage of a sufficient area and depth to conform to the International Federation regulations. Spectator accommodation was provided by the construction of stands around three sides of the entire playing area.

As several of the teams that had entered did not arrive, the actual programme staged at this venue was less full than had originally been anticipated.

### **Weightlifting**

The considerations affecting the choice of the Weightlifting venue have already been set out in full in the report affecting the programme and dates.

The special weightlifting platform constructed at the Empress Hall, Earl's Court, was placed close to one side of the arena, but centrally along the arena's length. By the provision of a back-cloth to this platform the desire of the International Weightlifting Federation to have all spectators facing the platform was met to a considerable extent. A rest room for competitors was arranged directly behind the back-cloth in addition to

the dressing rooms, which, of course, were the same as for the wrestling event. Press and Radio commentators were accommodated on the floor of the arena.

The platform itself was 24 feet square and 5 feet 1 inch in height. This considerable height from the arena floor was necessary in order to afford a good view to spectators within the actual arena which had no "rake." The judges' and officials' positions immediately surrounding the platform were raised about 15 inches from the floor in order to secure an adequate view. The normal office facilities for the International Federation were also provided.

### **Wrestling**

The transfer of the venue for Wrestling from Harringay Arena to the Empress Hall was effected after approval of the former venue had already been secured from the International Federation. This necessitated a further visit of that body's officials and a survey of the new conditions under which the Olympic tournament would be conducted. Spectator accommodation at the Empress Hall was entirely adequate and the size of the arena itself allowed for the construction of three wrestling rings. Special arc lamps were installed over each ring of a similar type to that used for boxing tournaments. The construction of the rings was of tubular scaffolding covered by timber, with sloping sides and a small sunken well on the surface to contain the mat. The measurements and specifications of this were supplied by the International Federation.

The Press and Radio commentators were accommodated in ringside seats and the normal telephone and cable facilities were installed, together with an office for the International Federation.

### **Yachting**

Once the location of the Yachting venue had been settled in Torbay, the Organising Committee requested the Yacht Racing Association of Great Britain to proceed with preliminary plans. It was of assistance that the International Yacht Racing Union has its headquarters in Great Britain and that, in fact, the Secretary of both bodies was the same individual.

Three courses were planned in Torbay ; that nearest inshore for the Firefly class, that furthest out to sea for the 6 metre and Dragon classes, and the intermediate one for the Swallow and Star classes. The marking and buoying of the courses was undertaken by the Royal Navy from the Devonport Dockyards, which also supplied the necessary patrol and "police" boats during the actual events.

In conjunction with the Corporation of Torquay, the entire harbour was reserved for Olympic competitors during the period of the Games, apart from one or two official boats which were present. The Marine Spa, a building belonging to the Torquay Corporation on the harbour side, was made available as a headquarters for the International Federation offices, with competitors' lounge, Press and telephone facilities.

A special measuring tank was constructed on the hards for the checking of boats prior to the commencement of the Games, and a mobile crane was installed together with a 10-ton crane weighing machine. Facilities, including launching trollies, were provided for accommodating the Firefly dinghies on the hards at night.

## EQUIPMENT

The provision of equipment for the 17 sports falls under two main headings : that which may be described as arena equipment, without which a venue would not be properly " furnished " for the conduct of the particular sport in question ; and that which may be called sports equipment, that is to say articles actually used by the competitors themselves during their contests.

### Arena Equipment

#### Athletics

The Empire Stadium had not been in use for an athletic contest for more than 20 years, and it was, therefore, necessary to provide everything that would be required for the conduct of the greatest athletic meeting in the world.

(i) *Track.* An entirely new athletic track had to be laid in the stadium and research was carried out with various materials to obtain the best possible surface. A small piece of ground adjacent to the Stadium was employed for testing tracks.

One consideration which could not be overlooked was the time factor in producing this track, as the stadium was in normal use until July 10, and the entire work of excavating the ground, removing the existing greyhound track, together with fencing, arc lights and the electric hare equipment, and the subsequent laying of the track itself was carried out within a period of three weeks.

(ii) *Scoreboards.* A giant scoreboard which was used for all events in this stadium was erected at the east end of the stadium directly behind the last spectator tier. This was designed by Sir Owen Williams & Partners, the architects to Wembley Stadium Ltd., and was operated by a naval party supplied by the Admiralty.

In addition to the main scoreboard, four scoreboards, one on each corner of the arena, showed the progress of field events.

(iii) *Field Event Equipment.* Both the high jump and pole vault standards incorporated accurate measuring scales so that the height of the lath could be read off on the scales by the officials. For the jumping pit a sliding arm, in the form of a triangle was lowered over the pit. A hair line was fixed from the apex to the base of the triangle. The whole of the triangle could be slid along on rails running on both sides of the pit, so that the hair line could be accurately placed on the desired spot in the pit. A scale was incorporated on one side of the triangle so that the distance jumped could be read off instantly. To detect a faulty jump through the competitor crossing the take-off board, a shallow tray of plasticine was used, and this proved most effective.

The pole vault and high jump also had an indicator so that the competitor's number and the height being attempted could be seen. This indicator was useful when other field events were proceeding at the same time.

For the shot, hammer and discus events officials were able to give measurements very quickly by measuring back to a datum line only. This datum line consisted of round steel pegs set out in the form of an arc whose centre was the centre of the throwing circle. The arc was drawn at a convenient but arbitrary distance. A special arm carrying a steel tape



could be fitted over the datum line pegs at that point on the arc where a line drawn from the point of impact to the centre of the throwing circle crossed the arc. It was possible to set the arm so that the tape was exactly at right angles to a chord drawn on the arc at the point where the line of impact crossed the arc. The reading of the tape was, of course, arranged so as to read from the outer edge of the stopboard.

For recording the throwing events, officials were provided with a metal tray which was hooked over the shoulders. The tray was covered with a perspex cover hinged so that in wet weather the result could be written on the scoresheet, which remained dry.

Competitors in the jumping events were each provided with a small metal flag with their number on. These flags were used for marking the start of a competitor's run-up. They had a metal peg for insertion in the ground, and the flag could be turned on a hinge, so that when placed in position the number was easily seen.

For all throwing events, two operating positions were arranged and in particular for the javelin the base line for the throwing could be accommodated at either end of the Stadium. A plan showing the actual lay-out of the arena appears in the Athletics Report section later.

(iv) *Track Events.* A new form of hurdle was used to give greater accuracy in adjusting the toppling correction to different heights, and although these conformed to the specification of the I.A.A.F., they were unfortunately constructed to be adjustable in the first instance in inches, a secondary adjustment having to be made for the metric equivalent. The marking of the track was carried out under the supervision of the I.A.A.F. and amongst the equipment provided for this purpose was a special Invar steel tape giving an exact measurement of 100 metres irrespective of weather conditions.

The starting points of all the track events were clearly marked by special notices showing the names of the events concerned and were so arranged that only one finishing post was used.

(v) *Warming-up Arrangements.* A track 100 metres in length, adjacent to the stadium, was laid to permit competitors to warm up, and sufficient area was allocated for hurdling competitors and long distance runners to practise as well.

The details of the timing arrangements are incorporated under the general report on Timing and Photo-Finish.

## **Basketball**

Special tubular steel constructions to carry the back board, rings and nets were designed in conjunction with the basketball authorities. Two sets were supplied at Harringay in case the set in use should become damaged.

## **Boxing**

As the Empire Pool, Wembley, is normally used for the staging of the major amateur boxing tournaments in Great Britain, their ring conformed to international requirements.

Two weighing machines, constructed to record on the metric scale, were supplied at the Empire Pool for the official competitions. Two others of an exactly similar type to those at the Pool were in use at training centres.

## Canoeing

The course markings that had been laid on the Henley Reach for the rowing events were supplemented for canoeing and their positioning extended to Temple Island and Rod Eyot at both ends of the regatta course, for the purposes of the 10,000 metre events. Three sets of overhead indicators were provided along the course for the guidance of competitors. Although a spring balance with special canoe carrying attachments was provided for the purpose of weighing canoes and kayaks, this was not used, as the platform scales used for the rowing events were found satisfactory and simpler to use.

## Cycling

The problems of arranging the necessary equipment for the cycling events were chiefly concerned with the road race at Windsor Park. Herne Hill track, being regularly used for cycling, few special arrangements were necessary (apart from the accommodation for the spectators and the photo-finish equipment, dealt with elsewhere in this report). As, however, no Scoreboard had previously been in use at the track, it was agreed to construct a small board to supplement the use of the arena amplifying equipment.

At Windsor Park special measures were taken to protect dangerous parts of the course by the removal of certain gateposts, and the padding of other posts, trees and walls at corners, especially at such points as Blacknest Gate. Reference to the erection of the pits will be found in the Arena section.

## Equestrian Sports

(i) *Dressage Competition.* The dressage arena was laid out in the Central Stadium at Aldershot by the British Horse Society and constructed by civilian labour.

### (ii) *Other Events*

(a) *Three Day Event Cross-country Course.* Two distinct sets of obstacles were constructed. One on the steeplechase course was built by civilian labour and was composed of obstacles, design and construction of which had been approved by the Federation Equestre Internationale. The other set of obstacles, 35 in number, for the cross-country course was constructed, under the direction of the B.H.S., by military labour supplied from the Aldershot Military Command. The considerable amount of material required for the jumps was obtained by the Organising Committee at an early date and stored until needed.

(b) *Three Day Event Jumping.* The jumps for this event, which took place in the Stadium at Aldershot, were lent to the Organising Committee by the British Horse Society and were of standard international pattern.

(c) *Prix des Nations.* The British Show-Jumping Association was responsible for the design and lay-out of the Prix des Nations course. The jumps were constructed by a London contractor under the supervision of Captain Webber of the B.S.J.A.

### **Fencing**

Eight wooden pistes, 92 feet by 6 feet, were constructed in sections 9 feet long. These were 6 inches high, and to guard against the risk of injury to competitors, slopes were added to all sides. Linoleum was laid the entire length of each piste and secured to it by narrow battens of wood or metal  $\frac{1}{2}$  inch in width along all sides.

At the end of each piste on the concrete floor of the Palace of Engineering, ring bolts were fixed to the floor for the tensioning of the insulated carpet which had to be laid for the epee events.

These carpets, eight in number, were supplied in fine copper mesh and fitted with metal strip ends to which the tensioning rings were attached. The special electrical judging apparatus required for the epee event was supplied on loan to the Organising Committee by the French fencing federation, and was maintained throughout the competition by a mechanic from the French manufacturing firm which had produced the apparatus.

### **Football**

All necessary equipment for the staging of the football tournament was supplied by the grounds where the competitions were held.

### **Gymnastics**

As gymnastic equipment conforming to the regulations of the international federation is not manufactured in Great Britain, the requisite four sets of equipment were constructed in Switzerland, under the supervision of an official of the international federation resident in that country. The use of new equipment was not satisfactory as many competitors complained that it was far too stiff and would have been better had it been given considerable use beforehand. In addition to the equipment supplied by the Organising Committee, a few competing nations brought their own apparatus with them.

### **Hockey**

All necessary equipment for the staging of the hockey tournament was supplied by the grounds where the competitions were held.

### **Modern Pentathlon**

(i) *Riding*. Under the rules of the Olympic Games, the Organising Committee is responsible for the provision of horses to be used by competitors in the modern pentathlon event. In December, 1947, the Organising Committee obtained from the Army Council 50 horses from the British Zone of Occupation of Germany and they were shipped over at

the Committee's expense. Owing to shortage of forage in Germany, they arrived in extremely poor condition and the very greatest credit is due to Capt. W. Townson, F.R.C.V.S., who was in charge of them, for not one died, and all looked fit and well on the day of the competition. They were out at grass for the first three months near Peterborough, and were then moved to Aldershot where their schooling and field work were carried through by Major G. Crawford and a party of officers and N.C.O.'s from the 7th Carabiniers. During this latter period the Committee borrowed an additional six horses to provide a further margin.

Saddles and bridles, together with the necessary weights and saddle cloths, were obtained from British firms. The allocation of horses to competitors was by ballot.

(ii) *Swimming*. No additional equipment was required for this event.

(iii) *Fencing*. The electrical epee apparatus, together with four of the insulated pistes that had been acquired for the main epee events at the Palace of Engineering, were used for this event.

(iv) *Shooting*. The apparatus designed for the rapid fire pistol event in the main shooting contests was adapted for the modern pentathlon, the five silhouette targets being specially added.

(v) *Cross-country*. No additional equipment was required.

### **Rowing**

The course was marked by buoys at 50-yard intervals. Three sets of overhead indicators were provided for the guidance of crews and stake boat facilities were provided at the start.

### **Shooting**

In addition to the construction carried out on the Bisley ranges, mentioned in the Arena section of this Report, certain additional equipment was required. One hundred coconut mats, 2 feet by 18 inches, were needed. All the targets were obtained from Sweden, and special target frames were constructed to meet the requirements of a metric range. They were designed by the National Rifle Association and produced by a London firm. The necessary blackboards for scoring parties at firing points were loaned to the Organising Committee by the N.R.A.

### **Swimming**

Special cork lanes, painted white with the exception of the last three metres at each end, were supplied for the Empire Pool. Starting blocks and mats were installed on the bridge and a special trap at water level at the bridge was provided for the start of the back stroke events.

*Diving*. Suitable diving boards were not obtainable in Great Britain and these, together with the necessary fulcra, were acquired from a firm in the U.S.A. They were of a laminated construction and two were erected at the Empire Pool with a further two in reserve in case of breakage. By special permission of F.I.N.A., a board of a lighter

construction was installed for the use of one competitor, a schoolboy who was not heavy enough to operate the standard Olympic springboard. The 10-metre high board was already in existence at the Empire Pool.

*Water Polo.* One set of water polo nets was already available at the Empire Pool and a further set was constructed for use at Finchley Open Air Pool. The numbered caps, of two distinct colours, for this event were provided by the Organising Committee.

### **Weightlifting**

Six competition barbells were provided, specially constructed of 90-ton tensile strength steel, and although competitors expressed satisfaction at the somewhat springy nature of this equipment, it was found that the constant dropping caused a certain amount of bending. Special light signals, the property of the British Amateur Weightlifters' Association, were installed and the circuit was so arranged that each judge had two switches, one controlling a red and one a white light. The switches were covered with a metal hood so that no one judge could see which switch the other was operating. The lights were so controlled that they could not illuminate until the switches on all three had been thrown, when all lights showed simultaneously.

Three weighing machines were used in the actual competition, one for competitors weighing in, one in the warming up enclosure and one on the main platform which was used for checking competitors and barbells.

A special scoreboard was constructed above and behind the weightlifting platform showing at the top, in English and French, which lift was being taken by the competitor ; the second line showed the exact weight in pounds and kilogrammes being attempted, and the third line showed the name and country of the competitor performing.

### **Wrestling**

Suitable wrestling mats could not be obtained in Great Britain, and though the Argentine Olympic Committee generously offered to supply three competition mats for the Olympic Games, those manufactured in their country unfortunately did not conform to the requirements of the international federation.

Three mats were therefore obtained from Sweden and laid on the three rings already referred to in the Arena report. Some difficulty was experienced in the assembly of these mats as no official with the requisite experience was available at the time. Two weighing machines, of a similar type to those used in the boxing competitions, were used for the weigh-in of competitors at the Empress Hall. These were specially constructed to conform to metric standards. Special electrical judging apparatus, similar to that described under weightlifting, was installed at each ring.

### **Yachting**

As has been stated in the Arena report, the buoys, marking and general regulation of the course and the necessary flares and signals were supplied by the Royal Navy. Three sets of large recall numbers were manufactured in Torquay for the umpire's boat.

## **Sports Equipment**

### **Athletics**

Investigations were carried out with various British firms in an endeavour to supply equipment manufactured in Great Britain for the Games. It was, however, not possible for these companies to produce, in the comparatively short time available, all the equipment conforming to the requirements of the International Amateur Athletic Federation, and eventually certain items were procured from firms in Sweden and Finland who had been manufacturing them for a considerable number of years.

Shots, javelins and disconi were obtained from these sources, but some special steel javelins and vaulting poles were provided by British manufacturers. A quantity of bamboo vaulting poles was also given to the Organising Committee by the Army.

### **Basketball**

One hundred basket balls manufactured in Great Britain were supplied, of which 50 were reserved for tournament use and 50 for training.

### **Boxing**

All gloves used by the competitors were supplied by the Organising Committee and were obtained in Great Britain. The number of each size was agreed with the technical representative of the Amateur Boxing Association.

### **Football**

Footballs manufactured in Great Britain were used, each ground being responsible for producing a match ball for any game held on its ground.

### **Hockey**

One hundred hockey balls manufactured in Great Britain were bought and arrangements were made for those not too badly damaged during play to be cleaned and repainted, and kept in reserve for later matches, should they be required.

## **TIME-KEEPING**

Early in 1947, the Organising Committee set up a sub-committee to consider the question of timing the Olympic events. An offer had been made by Messrs. Omega, of Switzerland, to supply free on loan to the Organising Committee all timing apparatus required for the Olympic Games of London. This generous offer was accepted, and the Committee then had to decide upon the type of watches, and as far as possible the numbers required for the various events.

Each sport was considered in relation to its particular requirements in respect of timing for world records, general regulations for international meetings and like considerations, and the schedule appended to this section sets out the final numbers of time-pieces actually

supplied by Messrs. Omega. The Organising Committee and the suppliers of the apparatus entered into a formal contract. One of the conditions of the contract was that the time-of-day chronograph stop watches should pass the Class A Certificate of the National Physical Laboratory at Teddington as well as the corresponding test at the Swiss Neuchatel Observatory. Other stop watches had to pass appropriate tests. The Class A test takes 56 days, and it was found that there was insufficient time for the watches to pass this and the full Swiss test as well. It was therefore agreed to concentrate on the N.P.L. test and to have only a modified test at Neuchatel.

The N.P.L. had never handled such a large number of watches for testing at one time. They nevertheless undertook the work in spite of the difficulties that had to be overcome. Thanks to their efforts and those of Omega, all the watches were eventually handed over to the Organising Committee in time for use.

Apart from the actual timepieces, electrically operated timing devices were also provided for certain venues. For example, the Prix des Nations competitors passed across an electrically controlled start and finish line using the optical eye for actuating the start and stop of the timer. At the rowing regatta, the chronographs at the finish were actuated by the starter's pistol, and timing devices were also installed for the modern pentathlon and cycling events. All this apparatus was supplied by Messrs. Omega, and a team of technicians from their factory in Switzerland attended the London Games and supervised the control, regulation and servicing of all apparatus.

### **PHOTO-FINISH**

Considerable discussions took place between the Organising Committee and various International Federations concerned as to the use of photo-finish for certain events in the Games. The final outcome was that this method of judging was used for the cycling events at Herne Hill and Windsor Great Park, but only as an aid to the judges in athletic track events when necessary.

A photo-finish camera room already existed at the Empire Stadium, but the position of this was not in line with the finishing tape for the Olympic Games. The camera was installed 60 feet above the track in the roof of the north stand and on the finishing line. The company who supplied the cameras and apparatus operated the equipment, and were able to produce prints of the finish of any race within 90 seconds of the tape being broken. A special hand-operated lift ran from the camera room to the judges' position on the finishing line. The camera room was in telephonic communication with the finishing post in order to check on each event on which the camera was operating before the finish took place. On the opposite side of the track to the camera, on the finishing line, was a revolving drum, synchronised to the camera speed. This ensured that every print showed a series of reproductions of the lettering on this drum, which carried the wording "Wembley," and the date and programme number of the event being photographed. This guaranteed identification of the photograph against the particular event. At Herne Hill and Windsor Great Park, as no camera position existed, special tubular steel scaffolding towers were built. Mobile dark rooms were provided adjacent to the camera tower. The same system of a revolving drum on the finishing line was employed.

### Types of Watches

- M.G. 1135 — 1/10th split second.  
 M.G. 1134 — 1/5th split second.  
 M.G. 1138 — 1/10th second normal.  
 M.G. 1110 — 1/5th second stop-go clock.  
 Type 7 — Stop watch marked in minutes to 45 mins. (football), 35 mins. (hockey).

	M.G. 1134	M.G. 1135 1 push button	M.G. 1110	7	M.G.1138
Athletics	12	14	—	—	—
Basketball	—	—	6	—	—
Boxing	—	—	4	—	—
Canoeing	2	—	—	—	—
Cycling	6	—	—	—	—
Equestrian	10*	—	—	—	—
Fencing	—	9	—	—	—
Football	—	—	—	8	—
Hockey	—	—	—	6	—
Pentathlon	24	6	—	—	—
Rowing	6	—	—	—	—
Shooting	—	—	—	—	40
Swimming	—	16	4	—	—
Wrestling	—	—	4	—	—
Yachting	12	—	—	—	—
	72	45	18	14	40

---

\* 10 pieces comprising 6 individual pieces and 4 provided with two sets operating the broken thread timing device.



## TRAINING ARRANGEMENTS

The Organising Committee realised the heavy demands that would be made by visiting teams for training facilities, particularly by those nations whose competitors might arrive early because of travelling difficulties, or to give their representatives time to acclimatise themselves.

Very adequate training facilities had been provided at the two previous Games, and the Organising Committee was determined that this standard must be maintained.

The representatives of the National Governing Bodies on the Technical Committee were asked to provide comprehensive lists of grounds or halls best suited for training purposes and of the amount of equipment likely to be required. Inspections were carried out where necessary and preliminary approaches made to the owners for their use as Olympic Training Centres. At many places equipment was available, but where necessary this was supplemented or provided. In nearly all instances, owners generously gave facilities free of charge in order to assist the Olympic movement.

Due to the fact that most swimming baths are publicly owned and the demand for Olympic Training came at the peak of the season, it was necessary to restrict Olympic Training to periods when the public demand was slight or outside normal opening hours. This meant that a larger number of baths had to be used than would have been necessary had the Organising Committee been able to secure exclusive use for the periods required.

When preliminary negotiations had been put in hand, and a programme of detailed allocation and control was required, a Training Manager was appointed to take complete charge of all arrangements under the supervision of the Technical Manager. He had two assistants at the Organising Committee's Office, and as each housing centre or group of sub-centres was opened, a Technical Department Representative was appointed to be responsible for liaison at that centre. This official had training as his main function, but he was also the liaison for other technical matters affecting the department.

### Method of Organisation

Four forms were drawn up to provide a basis for the machinery of training facilities:—

Chart A for issue to Chefs de Mission.

Chart B for issue to Technical Representatives, for the allocation of training facilities existing in the housing centre.

Chart C for issue to Technical Representatives, for the allocation of training centres to which transport was necessary.

Training Allocation Form for issue by Technical Representatives as a means of demanding transport and as an authority for competitors to use that transport and training centre.

On arrival in England, the Chef de Mission received Chart A from the Training Manager. This showed training "Entitlements" and it was explained that the actual

allocation would be given, on demand, by the Technical Representative at his housing centre. Difficulties were, as far as possible, resolved at this initial meeting.

The Technical Representative at the housing centre concerned dealt directly hereafter with the team managers of each sport.

Each day the team manager visited the Technical Representative. His "Entitlement" was verified and the actual allocation was made. In nearly all cases, teams received the times they wanted. If the ground was, however, already booked, or the load of an athletic ground had become too great, it was a matter for the Technical Representative to settle to the satisfaction of all concerned.

At this daily visit from the team manager the Technical Representative filled in the allocation given on Charts B or C (thus preventing duplication) and, at the same time, prepared four copies of the " Training Allocation Form."

One remained as an office copy.

One was sent to Transport as a demand.

Two were given to the team manager, one of which had to be presented to the driver as an authority to use that transport and the other presented at the training centre as the authority to use it at that particular time and date.

These Training Allocation Forms were, in all cases, made out 24 hours in advance of requirement. Thus the team manager demanded on Monday his requirements for Tuesday. This system worked well.

In order to simplify matters for visiting nations, a general map of the London area was produced which showed clearly Olympic stadia, housing and training centres. The number of the training centre was invariably referred to in Chart A.

A forecast of training was prepared for each sport. A copy of these was forwarded to each Technical Representative and to the training centre concerned. Charts C were then prepared, showing the availability of each training centre, the anticipated users and, if necessary, the divisions of the available periods amongst housing centres that had to share the same training centre. These were also forwarded to Technical Representatives and the training centre concerned. Charts C were not completed until teams were actually present and an allocation was demanded by the team manager.

### **Analysis of Training**

*Athletics*—(600 *Allocations*). Seven grounds or tracks were provided. In accordance with precedent the Empire Stadium was not allowed to be used. At the main athletic training centres of Uxbridge and Paddington a special field was reserved for field events, to prevent the danger of accidents. Each nation was allowed two hours per day. Southall Athletic Ground was reserved for women.

*Basketball*—(200 *Allocations*). Four halls were specially equipped and each team was given an hour a day of practice. In addition, each nation was allowed one hour of daylight and one hour of artificial light practice at Harringay, the venue for the basketball tournament.

*Boxing*—(400 *Allocations*). Six rings were provided as well as punchballs and other training equipment. Each individual was allowed 10 minutes in the ring. All boxing facilities were provided at the housing centre.

*Canoeing*—(*Allocations not available*). Two periods were allotted daily on the river at Henley-on-Thames. Practice was "free for all." Competitors, could, therefore, have as much as four hours practice per day if desired.

*Cycling*—(400 *Allocations*). HERNE HILL TRACK. Each man was allowed two hours per day. WINDSOR GREAT PARK. Free for all from July 15. MATCHING GREEN AERODROME. Four periods, of four hours each period, were available for competitors.

*Equestrian and Pentathlon*—(*Allocations not available*). These were held at Aldershot, where arrangements were made by the Army Liaison Officer, as all grounds and other facilities were provided by the Army.

*Fencing*—(200 *Allocations*). Three London fencing clubs, one gymnasium at Uxbridge, a hall at Kingston and school gymnasia were used, affording at least one hour of practice per team per day.

*Football*—(100 *Allocations*). Ten London football grounds were available for training purposes. Each team had an allotment of half a day on the ground. Owing to the early start of the preliminary rounds these grounds were not used as much as had been anticipated.

*Gymnastics*—(200 *Allocations*). Two halls were provided and the allocation was made not by the Technical Representatives at the housing centres, but directly by the Training Manager. One hall, Chelsea Barracks, was reserved for women. Each national team was scheduled to have about 40 minutes per day. As some nations brought their own equipment, and the competition was scheduled to be held in the open air at Wembley, many practised in the open and did not use the gymnasia provided. When, however, owing to rain, the event had to be held at an indoor venue, these gymnasia were used intensively. It is important to note, therefore, that unless training facilities resemble as closely as possible competition conditions, they will not be used.

*Hockey*—(100 *Allocations*). Seven grounds were available for training, each nation being allotted half a day. These were particularly popular.

*Rowing*—(*Allocations not available*). Two periods on the river at Henley-on-Thames were allotted daily. Practice was "free for all" and competitors could, therefore, have as much as four hours training per day.

*Shooting*—(200 *Allocations*). From July 8-July 26. BISLEY.—One 300-yd. range was open on a "free for all" basis from 11 a.m. to 6 p.m. for three days per week. This was very popular. HAM AND PETERSHAM.—One small-bore range was open from 2 p.m. to dusk daily.

From July 26 all training was carried out at Bisley on the competition ranges. Allocation figures are not included under this head.

*Swimming, Diving and Water Polo*—(700 Allocations). EMPIRE POOL. This was the competition venue and was allotted for diving and swimming from July 18, so that all nations had approximately two hours practice per day. SWIMMING BATHS. In addition to the Empire Pool, there were 23 swimming baths available, which gave each nation a further hour per day to practise swimming, diving or water polo. These baths were allocated individually.

*Weightlifting*—(400 Allocations). Ten sets of barbells, weights and platforms were provided at the housing centres. This afforded approximately 20 minutes practice per man per day.

*Wrestling*—(400 Allocations). Four mats were provided at the housing centres. London clubs were used in addition. Each individual required about 20 minutes per day.

*Yachting*—(Allocations not available). This was held at Torquay, and it was unnecessary to make any strict allocations.

The total training allocations (excluding outside London venues and private arrangements) were 4,000.

In conclusion, two lessons in particular which were learned were that as near a similarity as possible between training and competition conditions is desirable, and as many facilities as possible should exist at the housing centres.

## GENERAL REGULATIONS AND SPORTS HANDBOOKS

In view of the short time between the allocation to London and the holding of the Games, the preparation of the handbooks of regulations for the various sports was given priority in the initial stages of the Organising Committee's work.

It had been agreed that the three languages to be used for the Games should be English, French and Spanish, and it was hoped to produce the general regulations in each of these languages about 18 months before the Games (*i.e.*, in the early spring of 1947) and the complete set of sports handbooks a year before the Games. (*i.e.*, by the end of July, 1947). It proved quite impossible to keep to this time-table for two main reasons:—

(a) the fact that negotiations with certain international federations about their programme and their technical regulations were protracted until the autumn of that year.

(b) The difficulties and delays in printing in England during 1947.

In addition, the time required for translation and checking (particularly of such technical regulations as those for gymnastics and equestrian events) had been underestimated, even though the translators were French and Spanish nationals.

The Organising Committee delegated the approval of the sports handbooks to the Director of Organisation in agreement with the representatives of the national governing bodies and international federations concerned.

In October, 1946, the various governing bodies were circularised and asked to submit any necessary alterations to the text of the draft regulations which had been prepared for

the Helsinki (1940) Games. The text, as revised, was then submitted to the international federation for approval. Proofs, in all three languages, were submitted to both bodies to ensure, as far as possible, that there were no errors, particularly as so many technicalities were involved.

The decision to take the Helsinki English text as a starting point proved a failure. In view of the considerable amount of alteration involved, it would have been easier to have started entirely afresh, as ultimately had to be done for the gymnastics and shooting handbooks.

The frequent alterations in the programme of events, too, were an additional complication.

By the time the General Regulations had been printed, no fewer than two pages of amendments were necessary. Even later than this, other alterations were made and were incorporated in circular letters to all National Olympic Committees. Of the 17 sports, the only ones for which the programme particulars (dates, events, venues) were actually the same as had been envisaged in January, 1947, were athletics, rowing and yachting.

The greatest delays occurred in connection with the shooting and swimming handbooks. The shooting federation held a Congress in September, 1947, which made many changes in the regulations for the various events. The swimming handbook was delayed by the negotiations between F.I.N.A. and the Organising Committee, and it was not until late in 1947 that this was produced. The detailed programme of events was only settled in time to send it to National Olympic Committees in an administrative circular in the spring of 1948. Changes in the regulations were also made at a late date by the gymnastic federation. It is strongly recommended that federations should be urged to fix their technical regulations at least two years before the Games.

The distribution of the various handbooks to different bodies is shown in the attached tables.

### DISTRIBUTION OF HANDBOOKS

	General Regulations	Arts	Athletics	Basketball	Boxing	Canoeing	Cycling	Equestrian	Fencing	Football	Gymnastics	Hockey	Modern Pentathlon	Rowing	Shooting	Swimming	Weightlifting	Wrestling	Yachting
AFGHANISTAN .....	25	5	10	5	5	5	5	5	5	5	5	10	5	5	5	5	5	5	5
ARGENTINE .....	110	20	25	25	25	5	25	30	25	25	30	25	30	30	20	30	20	25	25
AUSTRALIA .....	100	20	15	5	15	5	20	5	5	5	5	5	5	20	5	25	10	15	5
AUSTRIA .....	50	20	20	5	20	20	20	25	15	25	30	25	10	15	15	30	15	20	20
BELGIUM .....	110	20	20	25	20	20	20	20	30	5	5	25	15	15	15	20	5	20	15
BERMUDA .....	25	5	5	5	5	5	5	5	5	5	5	5	5	5	5	15	5	5	5
*BOLIVIA .....	50	5	5	5	5	5	5	5	5	5	5	5	5	5	5	5	5	5	5
BRAZIL .....	60	10	20	5	5	5	10	5	15	5	5	5	15	25	15	25	5	5	10
BRITISH GUIANA .....	25	5	5	5	5	5	5	5	5	5	5	5	5	5	5	5	5	5	5
*BULGARIA .....	50	10	10	20	5	5	20	15	10	5	30	5	5	5	10	5	5	5	5
BURMA .....	25	5	5	5	5	5	5	5	5	5	5	5	5	5	5	5	5	5	5
CANADA .....	100	20	30	25	20	15	15	25	15	5	15	5	5	20	5	30	10	15	10
CEYLON .....	25	5	5	5	5	5	5	5	5	5	5	5	5	5	5	5	5	5	5
CHILE .....	35	10	20	25	15	5	15	5	15	5	5	5	5	5	15	15	5	5	10
Carried forward .....	790	160	195	180	155	110	175	160	160	110	155	135	120	165	130	220	105	140	130

\* Did not compete.

DISTRIBUTION OF HANDBOOKS—*continued*

	General Regulations	Arts	Athletics	Basketball	Boxing	Canoeing	Cycling	Equestrian	Fencing	Football	Gymnastics	Hockey	Modern Pentathlon	Rowing	Shooting	Swimming	Weightlifting	Wrestling	Yachting
Brought forward	790	160	195	180	155	110	175	160	160	110	155	135	120	165	130	220	105	140	130
CHINA .....	50	10	30	5	10	5	10	5	5	20	5	5	5	5	5	10	15	5	5
COLOMBIA .....	35	5	10	5	5	5	5	5	5	5	5	5	5	5	5	5	5	5	5
CUBA .....	35	5	15	25	10	5	5	5	15	5	25	5	5	5	15	10	15	15	10
CZECHOSLOVAKIA .....	60	20	30	25	25	30	25	30	20	25	30	25	10	35	20	30	20	30	15
DENMARK .....	100	20	20	5	20	25	30	25	30	25	30	25	5	35	20	35	15	20	25
EGYPT .....	50	10	5	25	20	5	15	30	25	25	30	25	5	15	20	35	20	25	5
EIRE .....	100	10	15	5	15	5	5	5	5	5	5	5	5	5	5	5	5	5	5
*EL SALVADOR .....	35	5	5	5	5	5	5	5	5	5	5	5	5	5	5	5	5	5	5
FINLAND .....	100	20	40	20	15	15	15	20	10	25	30	5	15	15	20	15	15	25	25
FRANCE .....	110	20	50	25	20	20	25	30	30	25	30	25	15	40	20	50	20	20	20
GREAT BRITAIN .....	100	20	50	20	20	20	25	30	30	25	30	25	15	35	20	50	20	20	25
GREECE .....	50	20	25	5	5	5	5	5	15	5	5	5	10	5	20	15	5	15	5
*GUATEMALA .....	25	5	5	5	5	5	5	5	5	5	5	5	5	5	5	5	5	5	5
*HAITI .....	35	5	5	5	5	5	5	5	5	5	5	5	5	5	5	5	5	5	5
HOLLAND .....	100	20	25	5	20	20	20	30	20	5	5	20	15	20	15	25	5	5	20
HUNGARY .....	50	10	30	20	20	15	20	30	25	30	25	15	30	15	35	20	20	20	25
ICELAND .....	35	5	15	5	5	5	5	5	5	5	5	5	5	5	20	5	5	5	5
INDIA .....	100	10	20	5	5	5	15	5	5	25	5	25	5	5	25	20	15	5	5
IRAN .....	25	5	5	5	5	5	5	5	5	5	5	5	5	5	5	5	5	5	5
IRAQ .....	25	5	5	5	5	5	5	5	5	5	5	5	5	5	5	5	5	5	5
ITALY .....	110	20	50	25	20	20	30	30	30	25	30	25	15	35	20	30	15	25	30
JAMAICA .....	25	5	5	5	5	5	5	5	5	5	5	5	5	5	5	5	5	5	5
KOREA .....	25	5	5	5	5	5	5	5	5	5	5	5	5	5	5	5	5	5	5
LEBANON .....	25	5	5	5	5	5	5	5	5	5	5	5	5	5	5	5	5	5	5
LIECHTENSTEIN .....	35	5	15	5	5	5	5	5	5	5	5	5	5	15	5	5	5	5	5
LUXEMBOURG .....	35	10	10	20	10	10	15	5	10	20	30	5	5	5	5	10	5	10	5
MALTA .....	25	5	10	5	5	5	5	5	5	20	5	5	5	5	20	5	5	5	5
MEXICO .....	35	10	15	20	15	5	5	15	5	5	5	10	5	15	10	5	5	5	5
MONACO .....	25	5	5	5	5	5	5	5	5	5	5	5	5	5	5	5	5	5	5
NEW ZEALAND .....	100	10	15	5	15	5	10	5	5	5	5	5	10	5	5	5	5	5	5
NORWAY .....	110	20	25	5	15	15	15	25	15	25	30	5	5	25	20	15	5	20	25
PAKISTAN .....	50	10	15	5	15	5	15	5	15	5	5	25	5	5	5	15	15	15	5
*PALESTINE .....	50	10	20	20	10	5	5	5	10	20	5	20	5	5	10	25	5	5	5
PANAMA .....	25	5	5	5	5	5	5	5	5	5	5	5	5	5	5	5	5	5	5
*PARAGUAY .....	35	5	5	5	5	5	5	5	5	5	5	5	5	5	5	5	5	5	5
PERU .....	35	10	20	20	5	5	15	5	5	20	5	5	5	5	10	15	5	5	5
PHILIPPINES .....	50	10	15	20	15	5	5	5	5	5	5	5	5	5	10	15	5	10	5
POLAND .....	50	10	25	20	15	10	15	25	20	25	30	5	5	20	15	15	5	15	15
PORTUGAL .....	60	10	10	5	5	5	20	15	5	5	5	10	5	15	5	5	5	5	15
PUERTO RICO .....	25	5	5	5	5	5	5	5	5	5	5	5	5	5	5	5	5	5	5
*ROUMANIA .....	50	10	15	5	15	5	5	25	15	5	30	5	5	5	5	5	5	15	5
SINGAPORE .....	25	5	5	5	5	5	5	5	5	5	5	5	5	5	5	5	5	5	5
SOUTH AFRICA .....	100	20	25	5	15	5	10	5	5	5	5	5	10	5	5	5	5	10	10
SPAIN .....	110	20	20	20	20	10	5	30	15	20	30	5	15	30	20	30	5	25	25
SWEDEN .....	110	20	40	5	15	20	15	30	15	25	5	5	15	15	15	20	15	25	15
SWITZERLAND .....	110	20	25	25	20	25	25	30	30	25	30	25	15	35	20	25	15	25	30
SYRIA .....	25	5	5	5	5	5	5	5	5	5	5	5	5	5	5	5	5	5	5
TRINIDAD .....	25	5	5	5	5	5	5	5	5	5	5	5	5	5	5	5	5	5	5
TURKEY .....	50	5	5	20	5	5	15	25	15	20	5	5	5	5	5	5	5	20	15
UNITED STATES .....	100	20	50	25	25	25	20	30	25	25	30	25	15	50	20	50	20	25	25
URUGUAY .....	35	10	5	20	15	5	5	5	15	5	5	5	5	15	5	15	5	5	10
VENEZUELA .....	35	5	5	5	5	5	5	5	5	5	5	5	5	5	5	5	5	5	5
YUGOSLAVIA .....	60	10	30	5	5	15	15	5	20	5	30	5	5	25	10	20	5	15	10
I.O.C. OFFICE .....	90	50	50	50	50	50	50	50	50	50	50	50	50	50	50	50	50	50	50
I.O.C. MEMBERS .....	60	60	60	60	60	60	60	60	60	60	60	60	60	60	60	60	60	60	60
INTERNATIONAL FEDERATIONS .....	90	25	25	25	25	25	25	25	25	25	25	25	25	25	25	25	25	25	25
NATIONAL GOVERNING BODIES .....	125	50	50	50	50	50	50	50	50	50	50	50	50	50	50	50	50	50	50
PRESS AND B.B.C. ....	800	500	500	400	300	250	450	500	300	450	500	400	250	350	350	500	400	350	400
ORGANISING COMMITTEE .....	300	350	350	350	350	350	350	350	350	350	350	350	350	350	350	350	350	350	350
RESERVE .....	750	495	850	305	410	620	280	645	465	255	625	415	200	285	440	940	510	370	380
TOTAL .....	6,000	2,250	3,000	2,000	2,000	2,000	2,000	2,500	2,100	2,000	2,500	2,000	1,500	2,000	2,000	3,000	2,000	2,000	2,000

\* Did not compete.

Handbooks were sent to National Olympic Committees in English and/or French, Spanish, as appropriate.

## ENTRY FORMS

The entry forms for the Olympic Games of 1948 were based upon the system evolved for the Los Angeles Games in 1932 and maintained with minor modifications for the Berlin Games in 1936. The system was designed to reduce the number of types of entry form to a minimum, to simplify the task of National Olympic Committees in completing them, and to make easier the task of handling them when received. The simplification was carried one stage further in 1948 by eliminating the forms used in 1936 for colours worn by teams in those sports in which it is necessary to wear distinctive colours. This information was to be included on the national entry form by sports and events(1). The entry forms used in 1948 were, therefore, six in number, three basic and three special. The basic forms were:—

(1) The national entry form by sports and events, on which each nation had to indicate those sports and events in which it intended to take part. (No names of competitors were required on this form.) This form had to be received by the Organising Committee by 12 midnight on June 16, 1948 (six weeks before the opening of the Games).

(2) The team entry form, one of which had to be completed for each "team" event for which a nation was entering. ("Team" events include not only team games and relays, but also such events as double sculls, pair-oars, two-seater canoes, etc.) This form had to list all the individuals entered by the nation for the event (including reserves if permitted) and had to be accompanied by an individual entry form (No. 3 below) for each member of the team and each reserve.

(3) The individual entry form, giving the full name, place and date of birth of the entrant. Where a competitor was entered for more than one event a separate individual entry form had to be completed for each event. This form carried a declaration by the National Olympic Committee and the appropriate national governing body of sport as to the amateur status of the entrant.

(4) Equestrian, the primary purpose of which was to give particulars of the horses.

(5) Yachting, the primary purpose of which was to give particulars of the vessels (and was not, therefore, needed for the dinghy class, in which boats were supplied by the Organising Committee). Forms 2-5 inclusive had to be received at least a fortnight before the beginning of the sport (not event) concerned. The closing dates varied from July 14-27.

(6) Arts. These forms were received by the Arts Department and were not the responsibility of the Technical Department.

### **Method of Completion**

All forms had to be completed in triplicate (the original for transmission to the International Federation, the duplicate for the Organising Committee, and the triplicate for retention by the National Olympic Committee making the entry) in either English, French or Spanish, and had to be countersigned by the President or Secretary of the

National Olympic Committee making the entry and the President or Secretary of the governing body in that country, of the sport concerned.

The Olympic rules allow entries of all types to be made by cable, subject to confirmation on the appropriate form, provided that the cable is received by midnight on the relevant closing date, and the subsequent confirmation gives proof of posting before midnight on that date in the country of origin.

Instruction leaflets were printed in the three languages and circulated to all National Olympic Committees in sufficient quantity for copies to be passed on to the governing bodies responsible for completing the forms.

Sufficient copies of the entry forms for nations and for teams, of the special forms for the yachting and equestrian events, and of the instruction leaflet were sent to each nation to meet their maximum possible requirements:—

	No. sent	Max. No. reqd. if every possible entry made
Entry form for nations .....	20	17
” ” teams .....	35	33
” ” yachting .....	4	4
” ” equestrian .....	10	9
Instruction leaflet .....	20*	

(\*This allowed at least one copy for each governing body making entries, with a reserve for headquarters use by the National Olympic Committee.)

The extra cost of supplying even the smaller countries with the maximum number of these forms was so small that there was no need to reduce the numbers. With the individual forms, however, such a policy would have been wasteful, requiring about 30-35,000 forms. The number sent was, therefore, based upon estimates previously received from the various National Olympic Committees as to the likely number of competitors or (where no estimate had been received), upon the number of competitors at Berlin, plus a reserve for contingencies in either case. The numbers distributed were as follows:—

Afghanistan	50	Czechoslovakia	350
Argentina	300	Denmark	300
Australia	100	Egypt	200
Austria	200	Eire	250
Belgium	250	Finland	200
Bermuda	50	France	400
Brazil	150	Great Britain	400
British Guiana	50	Greece	100
Burma	50	Holland	200
Canada	150	Hungary	300
Ceylon	50	Iceland	100
Chile	50	India	100
China	100	Iran	50
Colombia	50		



Iraq	50	Portugal	100
Italy	350	Puerto Rico	50
Jamaica	50	Singapore	50
Korea	50	South Africa	100
Lebanon	50	Spain	200
Liechtenstein	50	Sweden	200
Luxembourg	100	Switzerland	300
Malta	50	Syria	50
Mexico	150	Trinidad	50
Monaco	50	Turkey	150
New Zealand	100	Uruguay	50
Norway	200	U.S.A.	500
Pakistan	100	Venezuela	50
Panama	50	Yugoslavia	200
Peru	50	Reserve	3,700
Philippines	50	Total	12,000
Poland	100		

For various reasons the number of forms printed was too small. Some were lost in transit; the numbers sent were not always sufficient to cover spoilages and, as described later, many forms were subsequently used in the entry form department to facilitate the handling of cabled entries. This, combined with the number of requests received from National Olympic Committees for additional supplies meant that eventually reprints had to be obtained of every type of form.

A request was sent to each National Olympic Committee that they should acknowledge receipt of the entry forms. Only 23 National Olympic Committees actually did so—a proportion which was typical of other attempts to obtain acknowledgments of such things as identity cards, customs regulations and other circulars.

### **Receipt and Checking of Entries**

With the exception of the Arts forms, which were the responsibility of the Arts Department, all entry forms were received by the Technical Department. There were two stages in the process:—

- (i) June 16 was the closing date for entries from nations, indicating the sports and events in which they intended to participate.
- (ii) The closing dates for receiving individual, team and special entry forms for equestrian and yachting were between July 14 and 27, the dates varying according to the starting date of the sport concerned.

### **Stage One**

The checking of the national entry forms began at 3 p.m. on June 16 (entries being due to close at midnight) and was completed by the evening of Friday, June 18, with the exception of a few queries which had to be referred back to the National Olympic Committee concerned. This checking was done on June 16, by 19 members of the staff

of the Technical Department, who were engaged between 3 p.m. and 10 p.m. and, on the two succeeding days, between 6 and 10 persons according to availability.

The purpose of the check was:—

- (a) to ensure that the forms had been completely and correctly filled in;
- (b) to provide summaries for circulation to the international federation and national governing body concerned, and to the press, showing how many nations had entered for each event ;
- (c) to provide a chart showing at a glance which nations had entered for which events (this was a wall chart with 136 vertical divisions for the 136 events and 61 horizontal divisions for the 61 nations which had accepted the Organising Committee's invitation).

The chart also acted as an aid in checking that all forms had been dealt with and that every country that had accepted the invitation to participate in the Games had sent in its forms.

The original entry form was checked and simultaneously six proformae were filled up to show which nations had entered for a particular event. These forms were sent to the international federation and British national governing body concerned and to various Organising Committee departments.

The vast majority of No. 1 entry forms was received in adequate time for this process, but cabled reminders had to be sent to four National Olympic Committees with a request that they should cable their entries and confirm. As a result of this precaution, the number of No. 1 forms which were not received to time was extremely small, and the few late forms were subsequently accepted, on instructions. There were, however, large numbers of cabled entries, including the entire entry lists from two nations which had entered for a large majority of the events. In addition, there was quite a number of cables amending or adding to No. 1 forms already received. This complicated the task, but not so greatly as the number of queries which had to be referred back to the nations concerned. The most fruitful sources of queries on No. 1 forms were:—

- (a) wrestling, boxing and weightlifting forms which omitted to specify the weight classes and (in wrestling) the styles of the events for which entry was to be made;
- (b) omission of specification of men's or women's event in cases where the event title was the same;
- (c) omission of signature of either the National Olympic Committee representative or the sports governing body representative;
- (d) entry for an event not on the Olympic programme.

Despite the cabling of all these queries, it was some time before all could be satisfactorily resolved, and work on the second process had to begin before this was complete.

It is absolutely essential that this first process should be finished as rapidly as possible, as many of the final details of the organisation of the events depend upon the number of entries received. The international federations and the national governing bodies were clamouring for details before the closing hour, particularly in respect of such events as football and hockey, where draws were to be made at an early date, and of basketball

and water polo, where the length of the tournament depended directly upon the number of entries received. In addition, the Organising Committee officials were anxious to know whether the provision of horses for the modern pentathlon and of dinghies for the yachting was adequate, and whether dressing rooms, pits and other accessories would be available in sufficient quantities. A delay of even 48 hours was felt to be serious, particularly by the press and radio correspondents, who were likewise desperate for information.

### Stage Two

The checking of the detailed entry forms began on July 12.

The purpose of this check was:—

- (a) to ensure that the forms had been completely and correctly filled and that a national entry form had been received from that nation for the event concerned.
- (b) to compile an alphabetical card index of all competitors in the Games.
- (c) to compile for the printers a list of entries, event by event, for programme purposes, and for supply to sports officials, press and radio.
- (d) to compile a ready reference index of all entries, event by event, in alphabetical order of nations and alphabetical order of competitors from each nation.
- (e) to analyse the number of entries, nation by nation, sport by sport and event by event.

Much more difficulty in obtaining entries before the closing date was experienced in this phase than in the preceding. There were increased numbers of queries, especially as some nations sent in more individual entries in certain events than were permitted by the regulations. This should not have occurred since the instruction leaflets listed the maximum number of entries for each event in the programme.

The cumulative effect of these queries and late entries was that in no case was it possible to compile the printers' lists and pass on to the international federations their copies of the entry forms until at least 48 hours after the closing hour. In certain cases additional delays were encountered and the lists were as much as four to five days behindhand.

The use of airmail has, strangely enough, complicated the strict application of the rules. This is due to the fact that National Olympic Committees now leave the despatch of entry forms until the last possible moment so that there is insufficient time for the resolution of inaccuracies by reference back. In a number of cases, too, due to cancellations of airline flights, the entry forms were seriously delayed.

No additional staffing of the entry form section could have obviated this delay, nor were there avoidable bottlenecks within the department, the delays being primarily due to the errors or the tardiness of National Olympic Committees.

In theory, all these late incorrect entries could have been rejected and the task of the Organising Committee and the international federations would have been much easier. With entries closing fourteen days before a sport commences, it is difficult, indeed it was agreed to be impossible, to adhere too strictly to the rules when such a high percentage of entries (in many cases between 30 per cent. and 40 per cent.) is late or incorrect.

## IDENTITY CARDS

The Executive Committee decided that the precedent of the Berlin and Los Angeles Games should be followed and that Olympic Identity Cards should be issued to all competitors and those officials intimately connected with the conduct of the various sports and teams.

The design and preparation of the Card was the responsibility of the Technical Department and it was planned to fulfil two main functions. It had to be a pass to allow competitors and officials access to those stadia where they had a right to watch events and, of course, to the dressing rooms of the stadium where they themselves were competing, and also to housing centres.

In addition it had to act as a valid passport and travel document for Olympic competitors and officials, for it was felt that this would greatly assist National Olympic Committees not only in the crossing of frontiers, but also from the point of view of Customs facilities in the United Kingdom. These considerations made it necessary that the document should be easily recognised and hard to imitate.

Certain box office considerations had to be met in the design of the card to avoid abuse for gaining admission to the complimentary stands reserved for competitors and officials. Every effort was made for the scrutiny of the card by arena and stadium stewards to be as simple as possible, and yet retain reasonable control. The card was designed to show on its first page the sport with which the holder was connected and the category in that sport to which he or she belonged, together with photograph, signature and full name. How the card operated as far as spectator use is concerned is dealt with under the complimentary ticket section. The scrutiny of the card for admission to the dressing rooms was especially strict.

As regards the use of the Identity Card as a travel document, the Aliens Department of the Home Office of His Majesty's Government gave great assistance and guidance as to the lay-out of the second page giving the agreement of the holder's own government, and the third page which gave the certified details of the holder.

H.M. Government agreed to allow the Identity Card to serve as a valid passport of entry into the United Kingdom, subject to the following provisos :

- (i) That the government of the country of origin of the holder should also agree to its use as a travel document for both inward and outward journeys.
- (ii) That the card should be valid for one journey only in each direction.
- (iii) That before the team of any country using the card as a travel document started its journey to London, a complete list of those persons to whom the card had been issued by the appropriate National Olympic Committee should be submitted to the nearest British Consul or Passport Office in order that the nominal roll could be checked by the U.K. representative.

The Government also agreed to waive visa fees for persons travelling on the Olympic Identity Cards, where these were still in force.

Nº  
XIV OLYMPIAD LONDON 1948

IDENTITY CARD

PHOTOGRAPH  
OF HOLDER

N.O.C.  
STAMP

Signature

Full Name

CATEGORY

Issued by the Organising Committee for XIV Olympiad,  
London, 1948

CHAIRMAN

DIRECTOR OF  
ORGANISATION

THE NATIONAL OLYMPIC COMMITTEE OF

certifies that the information contained herein is true and  
that the photograph on page 1 is that of

M

who is travelling to London, England, as a non-immigrant  
temporary visitor to attend the Games of the XIV Olympiad  
in the capacity stated on page 1.

(SIGNATURE OF PRESIDENT OR SECRETARY)

SURNAME  
(BLOCK LETTERS)

GIVEN NAMES  
(BLOCK LETTERS)

DATE OF BIRTH

PLACE OF BIRTH

ADDRESS

Street

Town

Country

NATIONALITY

This is to certify that this Identity Card is recognised  
by the Government of

(Name of Country)

as a valid travel document permitting the person whose  
name, photograph and signature appear hereon to  
depart from this country, travel to London, England,  
and return to this country.

AUTHORITY OF GOVERNMENT

SECRETARY OF NATIONAL  
OLYMPIC COMMITTEE

Dated 1948

Where the first proviso was not met, the visiting competitors and officials had to travel on ordinary passports. National Olympic Committees were circularised as to these conditions and the onus of approaching their own governments was placed on them. Specimen cards were forwarded early in 1948, and the National Olympic Committees requested to make the necessary representations as soon as possible to their governments. Due to national regulations governing the issue of passports, some countries were unable to accept the card as a valid travel permit and, where this condition applied, the third page of the card was left blank. Even where competitors and officials travelled on normal passports, the Identity Card operated on arrival at the port of disembarkation in Great Britain as a Customs clearance certificate for the individual. As some of the teams, whose governments had been prepared to recognise the Card as a travel document, crossed in their journey to London the frontiers of certain countries who did not recognise it, they also had to be provided with normal passports, unless they came direct to London by air as, in fact, happened in one case.

Thirty nations accepted the Card as a valid travel document, which justified its use for this purpose.

A facsimile of the Card is reproduced opposite.

## **MAIL FOR COMPETITORS**

In conjunction with the Post Office authorities, special arrangements were made to handle mail for competitors and team officials. It was known that many teams would arrive early and be accommodated in temporary quarters until their Olympic housing centre was opened.

Each country with competitors in the London area was therefore allotted two Post Office box numbers, one for their men's and one for their women's team.

National Olympic Committees were informed of their box numbers before they left their countries, and also before it was known which housing centre each national team was to occupy.

As soon as a team's housing centre, whether temporary or permanent, was decided on, the postal authorities were notified of the centre to which mail addressed to the relevant box number was to be sent. Equally, when a team moved, the postal authorities were informed of the change of address.

Competitors and team officials for rowing and canoeing (High Wycombe), shooting (Bisley), equestrian and modern pentathlon (Aldershot) and yachting (Torquay) had permanent postal addresses.

The arrangements made at certain previous Olympic Games of one central address are only possible when a single Olympic village is used.

Special facilities to handle parcels which might contain articles liable to customs duty or purchase tax were arranged, but few parcels were received.

On the whole the system worked smoothly and efficiently.

## CUSTOMS FACILITIES

Reference has been made to the fact that holders of Olympic identity cards were granted special Customs facilities on entering the United Kingdom. The regulations of the Board of Customs and Excise do not permit the import of certain articles into Great Britain, and no exception could be made in this rule for the holders of Olympic identity cards. Special arrangements had to be made to permit all Olympic competitors and officials to import those items which they required for the conduct of their particular sport but which would normally involve the payment of customs duty and purchase tax. In addition to the Board of Customs and Excise, the following departments of His Majesty's Government were all approached in the negotiations leading up to the facilities arranged :

- (1) The Treasury, in respect of the financial implications.
- (2) The Board of Trade, in respect of the export and import licences.
- (3) The Home Office, in respect of fire-arms and ammunition.
- (4) Ministry of Food, in respect of fodder.
- (5) Ministry of Agriculture and Fisheries, in regard to horses.
- (6) H.M. Commissioners of Police through the medium of Scotland Yard, in regard to fire-arm permits which are compulsory in Great Britain.

Visitors to the United Kingdom who import dutiable and taxable articles can, on the payment of a deposit, bring such items into the country, recovering the deposit on re-export of the goods, and it was made clear to all National Olympic Committees that this principle would not be varied. The concession granted was that the Organising Committee, by entering into a financial bond with H.M. Government for a considerable sum of money, guaranteed to the Government that the dutiable articles would be exported by the owners on the conclusion of the Games, except in those cases where proof was given that they had been destroyed or consumed in the course of the Games.

In order to facilitate the rapid passage of all unaccompanied baggage, foodstuffs and items consigned in advance by National Olympic Committees through bonded warehouses and customs offices in the United Kingdom, the Organising Committee appointed Messrs. Beck & Pollitzer as official forwarding agents to be responsible for the receipt of such goods at the port of discharge and advised National Olympic Committees accordingly. This arrangement worked smoothly.

## CIRCULAR LETTERS

In the early days of the administration, the Technical Department undertook the circularisation of National Olympic Committees, to whom invitations to attend the London Games had been sent, requesting information such as the probable numbers of their competitors. A detailed questionnaire was drawn up covering all of the 136 events and was sent out in early 1947. Although most nations returned the questionnaire completed, there were certain gaps in the list and, despite repeated requests for information, up to a few months before the Games these returns had still not been received.

Reference is made elsewhere to the distribution by the Technical, Press and Housing Departments of the handbooks, press reports, newsletters and information circulars.

A supplementary questionnaire covering certain sports was sent out later in 1947 and, after that, information was requested piecemeal. It appears to be inevitable that any Organising Committee has to be repetitive in its demands and be prepared for nations to alter their proposed entries, or even to give no information at all, right up to the final date for the submission of national entry forms.

The Technical and Housing sections also initiated a series of circular letters to National Olympic Committees, and these were continued departmentally until February, 1948. The letters were sent out in all three official languages and an endeavour was made to keep all interested nations fully informed of developments in London. These departmental circulars were discontinued when responsibility for collating and circulating information from all departments was assumed by the Administration Department in March, 1948.

## **BADGES AND MEDALS**

The Technical Department was responsible to the Organising Committee for the detailed work in regard to the production of medals and badges and for the distribution of the diplomas.

The Executive Committee had already chosen a symbol for the 1948 Games, and had decided that this symbol should form the basis of the badge, although it should be solid and not "cut out," as had been the case at both Los Angeles and Berlin.

### **Badges**

The Executive Committee ruled at an early date that the badges to be issued to competitors and officials for the Games would be for purposes of identification and as souvenirs only and not to give admission to Olympic venues or other centres.

The general principles that have grown up with various Olympic Games were followed in that the finish of the metal of which the badge was to be made would vary according to the category of person to whom it was issued. In addition the ribbon to be attached to the badges was to be distinctive to the group to which the wearer belonged, by colour or overprinting.

Estimates of the number of badges required were drawn up by reference to those numbers issued at Berlin and Los Angeles, and by correlating these figures against the anticipated attendance at the London Games. In addition to this, national governing bodies of sport in Great Britain were asked to give some idea of the number of officials that they expected would be required for the conduct of their sports. In retrospect, the number of badges provided was, within well-defined limits, reasonably accurate although due to a misunderstanding of the regulations applying to the sports officials entitled to badges, there was a certain amount of over-issue to this class of person, which necessitated the Organising Committee having to strike a few extra during the course of and directly after the Games.



The ribbon for all the badges was supplied by the makers with the exception of the special International Olympic Committee ribbon which was supplied to the Organising Committee as a gift.

A schedule of the types of badges issued, together with the numbers and details of distribution, is included in the statistical section of this Report.

### **Medals**

(i) *Prize Medals.* The design used in the 1928, 1932 and 1936 Games for the Olympic medals, modelled by Professor Cassiole of Florence, was again used for the XIV Olympiad, with the alteration of the appropriate wording to " XIV Olympiad, London, 1948." These were struck in silver-gilt, silver and bronze and the number required based on the number of events and therefore the number of eligible victors. It must be borne in mind that, in computing these numbers, the maximum number for team sports had to be produced, since any reserve of a prize-winning team actually taking part in the Olympic competitions is entitled to a medal.

(ii) *Commemorative Medals.* The Executive Committee placed the production of the commemorative medals in the hands of Messrs. John Pinches, Ltd., and it was agreed by the Committee that the design of Sir Bertram Mackennal that was used for the 1908 Games should again be used for the obverse. The reverse bears the inscription " XIV Olympiad, London, 1948 " above the five rings of the International Olympic Committee and below a panel showing Big Ben and St. Stephen's Tower of the Palace of Westminster, a variation of the symbol of the XIV Olympiad.

As every person entitled to a badge was also held to be entitled to a commemorative award, the numbers were related. The Executive Committee instructed the Technical Department to arrange the distribution of these and, chiefly for the purposes of identification, three types of box were designed to contain the awards, the definition being for the class of person to receive the medal.

### **Distribution of Badges and Medals**

A fundamental principle, agreed by the Executive Committee, was that where a person was entitled to a badge of more than one classification, he should be issued with that badge which indicated his highest rank within the Olympic framework. That is to say, a member of a National Olympic Committee who was also a member of the I.O.C., received the I.O.C. badge. The official of an Olympic Committee who was also a president or secretary of an international federation wore the international federation badge.

(i) *International Olympic Committee.* The badges, commemorative awards and travel and stadium passes for members of the I.O.C. were distributed to these gentlemen in the folders placed before them at the Congress of the I.O.C. held immediately prior to the Games.

(ii) *International Federation Officials and Judges.* It was agreed that the technical representative of the national governing body of each sport should receive from the Organising Committee the badges and awards for the members of his international federation, together with the necessary badges and commemorative medals for the operating officials

in each sport. It was clearly laid down that no issue should be made until the arrival of the president or secretary of the international federation in Great Britain. As the badges and medals were felt to be of some value from an historic point of view, the Organising Committee urged all national governing bodies to limit the issue of these articles to those officials who played an active part in the conduct of the sport. It was felt that if all officials from the most important umpire, referee or timekeeper down to those persons of lesser stature within the framework were to receive badges and medals, the value of both articles as mementoes would be seriously impaired. As all sports place the status of their various officials differently, even those having the same titles, it was impossible to lay down any hard and fast rules, but as far as possible it was suggested to the sporting associations that the line should be drawn where the officials ceased to require international federation approval to their appointment.

(iii) *Visiting Delegations and Teams.* The issue of badges, commemorative awards and travel passes was conducted by the Technical Department through an officer who interviewed the Chef de Mission of each team on arrival, and agreed with him by reference to the nominal roll provided, the number of each class of badge to which that team was entitled. The Chef de Mission was also responsible for collecting, in the name of his National Olympic Committee, the badges and medals for the Committee members and officials accompanying the team. When he had provided the information as to his requirements, he received a requisition form which he presented to the Technical Department Stores Officer and was issued with his quota of badges and medals. An exception was made to this procedure in the case of the competitors and officials for the yachting, equestrian, modern pentathlon, shooting, canoeing and rowing events, who were housed outside the London area. In these cases each Chef de Mission supplied the necessary information as before and informed the Technical Department of the name of an appropriate officer of his team at the appropriate outlying housing centre who should receive the medals and badges. The necessary badges and medals were then despatched from the Headquarters to Aldershot, Bisley, etc., and the issue made direct at that housing centre.

In the light of experience gained in the distribution of these items in the London Games, certain conclusions can be drawn. In regard to the issue of badges and awards to officials of federations and participating officials in the sports, it would be more satisfactory if these were issued by the international federation office set up for each sport.

The success or failure of the distribution to national delegations depends upon the number of staff available in the Organising Committee offices, together with the amount of office accommodation allocated for this purpose. As many Chefs de Mission attend at the same time, a system of multiple interviewing and pre-arranged counter distribution is suggested in order that the visiting official may not be required to spend too much time at the Organising Committee offices in collecting his entitlement.

It is, of course, essential that the entitlement be properly established against certified nominal rolls submitted by the Chef de Mission. As the nominal rolls in the case of the London Games were those used for travel purposes, many names appeared of persons accompanying the delegations who were not entitled to badges, and consequently valuable time was wasted in determining which names must be removed from these lists.

## NUMBERING OF COMPETITORS

It had been intended that the numbers for each sport should be allocated in blocs in alphabetical order of nations—*i.e.*, all the athletic competitors from Afghanistan, in whatever event, would receive a number before any of the athletic competitors from the Argentine, and so on. Had this policy been carried out, certain complaints regarding the numbering, particularly in athletics, would have been obviated. As it was, owing to a misunderstanding, each event was numbered in order—the 100 metres from 1-74, the 200 metres from 75 onwards, etc. Thus, instead of being able to issue a bloc of say, 348-385 to the Italian team manager, the Italian numbers had all to be sorted out separately. The only exception to this was that, where a competitor was entered in more than one event, he retained his first allotted number in all events.

Numbers were allocated in all sports, even in those in which no numbers were worn, for convenience in announcing and to simplify the use of scoreboards.

Attempts were made to ascertain the numbers which would be worn by the players in team games—basketball, football, hockey and water polo. The numbering was made more complicated by the fact that in basketball, where substitution of players can take place during the game, the individual players are numbered; in the other games the positions are numbered, the player appearing at right back, for instance, wearing No. 2, whoever he may be.

The football, hockey and water polo teams were rarely selected until immediately before the match, so that the programmes could only show the complete list of players entered by each national team, leaving the actual selected team to be filled in by announcement on the ground. Only for the finals and third place matches of the football and hockey tournaments was an attempt made to indicate the likely team, and in all cases alterations were made and had to be announced just before the match.

Until after the tournament had begun it proved impossible to obtain the actual numbers to be worn by the basketball teams, so difficult was it to contact team managers. Eventually the majority was obtained through the arena manager and incorporated in subsequent programmes. There seems no reason why the numbers to be worn in this sport should not be incorporated on the entry forms in future. The same solution is obviously not applicable to the other team games so that, unless a ruling is made that teams should be selected 48 or 24 hours in advance, or arrangements made for direct contact with all team managers, it will still be difficult to give accurate information in the programmes for these sports.

### Instructions for Issue

The instructions regarding the issue of competitors' numbers were as follows:—

Where a competitor is entered for two or more events in the *same* sport, he will only be numbered once, but his number must be written in on the second and any subsequent entry.

Each sport will commence with Afghanistan as No. 1. Competitors entered for two or more *sports* will be given a fresh number under each sport. The cycle road race

is numbered on a separate series from the cycle track events, and each equestrian event is numbered separately.

On receipt of the printed list from the printers, the issue of numbers by the Equipment Officer must commence. The numbers for each team in sports needing numbers, viz., athletics, cycling, equestrian events, fencing, gymnastics and modern pentathlon, will be tied up in bundles and clearly labelled with the name of the team and sport and the numbers issued (which will run concurrently for each team). The complete parcels for each centre in the London and Aldershot areas will then be made up and delivered to the Technical Representative at the housing centres, or, if none, to the Camp Commandant. In parcel-ling up a team's numbers an envelope containing the issue voucher and the printed list of competitors will be included in the parcel.

On receipt of a parcel of numbers, these must be issued to the team(s) concerned. It should be explained to the chef de mission or team manager that the numbers *must be sewn on at the camp tailor's shop* as follows :—

<i>Athletics</i>	On vest—a number back and front. On tracksuit—a number on back.
<i>Cycling</i>	A number on right hip. A number on left hip. For road race only, a number attached to crossbar at handlebar end.
<i>Equestrian</i>	One saddlecloth and one armband for dressage, the jumping of the three days' event and the Prix des Nations. For the three days' event (cross-country) one saddlecloth, one armband, and a number on back and front (not sewn).
<i>Fencing</i>	One number on the back of the fencing suit.
<i>Gymnastics</i>	One number on back of vest.
<i>Modern Pentathlon</i>	For equestrian events—one saddlecloth, one armband and a number back and front (not sewn). For epee and shooting—number on the back. For cross-country athletics—number back and front (sewn on vest). For swimming—none.

## PROGRAMMES

Work on the preparation of the Olympic programmes began more than a year before the Opening Ceremony, but the nature of the task was such that, if all the preparatory work had been done as much in advance as possible, there would still have been a hectic rush in the last two weeks and during the Games. This was due to the late hour at which entry lists became available, and because certain draws had to be made and officials appointed even as late as the evening before the events.

As it transpired, it would have been helpful if the preparatory work had been further advanced. The ideal would have been the appointment about three months beforehand of an editor who would have been responsible for all contact with the programme printers and who, working in the Organising Committee's office, could also have been entirely responsible for the collection of all programme material, as well as for matters of typography, layout, etc. With this in view, at a late date, Mr. H. J. Hewson, of the Wembley Stadium staff, was appointed as Programme Editor, and carried out this task in collaboration with Mr. C. L. Elliott, who was seconded from the Organising Committee's Technical Department, and who had done all the preparatory work on programmes.

### **Preliminary**

The first estimates of programme quantities were compiled in the summer of 1947, and were based upon 80 per cent. purchasing of the estimated attendance. These quantities were subject to slight amendments. In fact, during the Games, it was found that 80 per cent. was substantially too high a figure.

It had also been agreed early in 1947 that there should be separate daily programmes for each sport and not a combined daily programme. The reason for this was fourfold :—

- (1) It was hoped to secure additional revenue and to incur fewer costs.
- (2) The various events were at more scattered venues than had been the case at Berlin.
- (3) The printers' task would have been considerably greater if they had had to produce vast quantities of a large combined programme.
- (4) It would have been difficult to justify to the Paper Control the quantities of paper which would have been necessary to produce a combined programme.

Discussions took place with the Technical Representatives for each sport as to whether they needed a programme each day, or whether a combined programme to cover all their events would suffice. It was decided that the following events should have a combined programme :—

Canoeing, Equestrian, Fencing, Gymnastics, Modern Pentathlon, Shooting, Weight-lifting.

The only event in which this decision was subject to doubt was the Fencing, which went on for 13 days and in which it was impossible to include some of the first round draws and any subsequent draws. In view, however, of the very limited sale and the disproportionate cost and printing effort involved, it was decided to produce only one combined programme for this event.

It was originally agreed that the Yachting programme should be " combined " and not " daily," as the conditions of the contest were such that the only change from day to day was the insertion of the previous day's results. In view, however, of the representations of the Torquay Corporation, who were anxious to have a new production available daily, it was later agreed to reverse this decision.

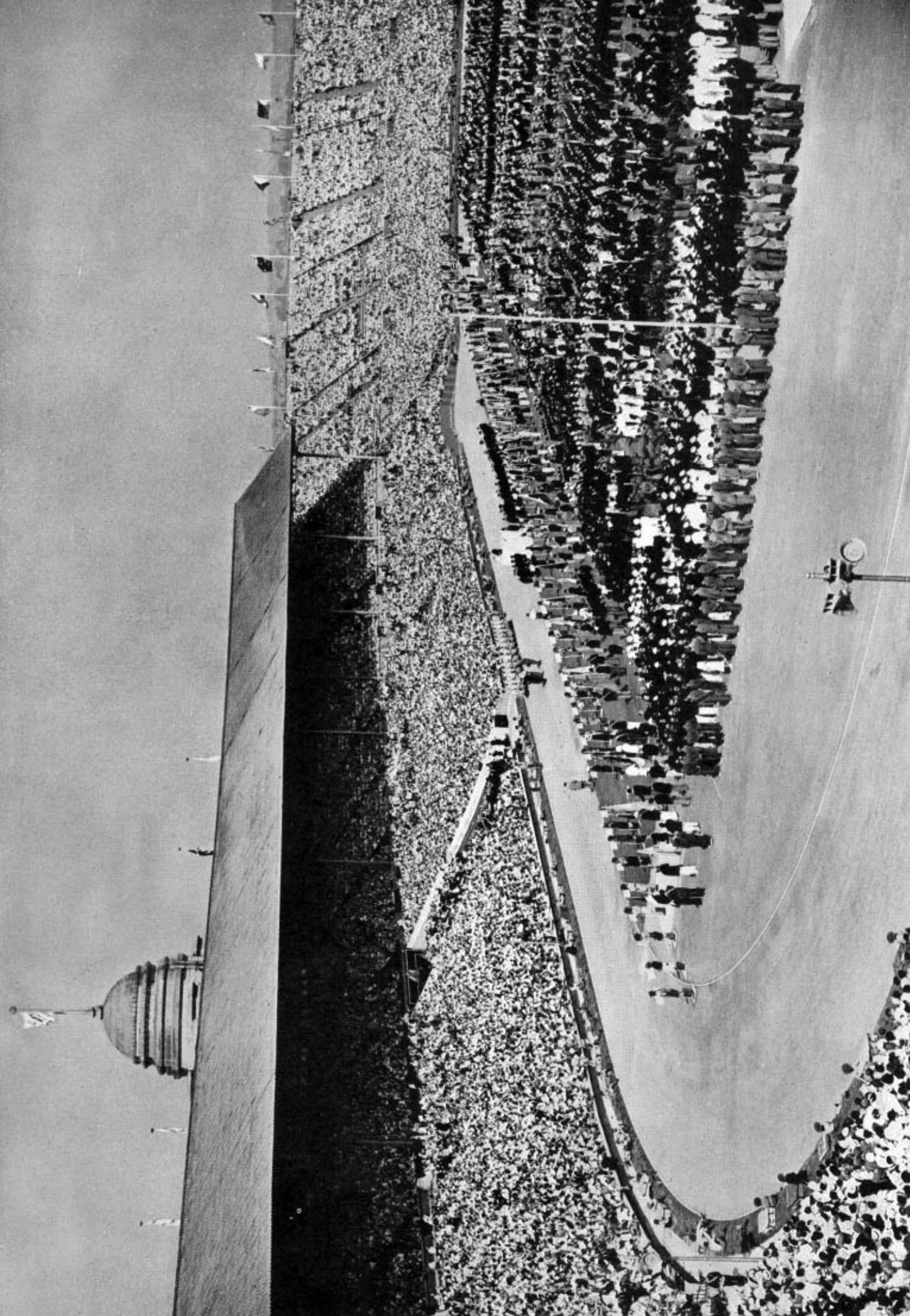

*A general view of the Stadium during the Opening Ceremony. The competing teams are all lined up in formation, and Lord Burghley, Chairman of the Organising Committee, is inviting H.M. the King to declare the Games open.*





*Viscount Portal, President of the Games, presents the President of the International Olympic Committee, Mr. J. Sigfrid Edstrom, to H.M. the King. On the right is the Chairman of the Organising Committee, Lord Burghley.*



*A salute of 21 guns is fired to mark the opening of the Games.*



*Members of the International Olympic Committee are presented to H.M. the King by the President, Mr. J. Sigfrid Edstrom.*





*A fanfare of trumpets is sounded in the arena by the Trumpeters of the Household Cavalry immediately the Games have been declared open. On the left of the Tribune of Honour are members of the International Olympic Committee, and on the right members of the Organising Committee. In the Tribune is the Chairman of the Organising Committee, Lord Burghley.*

*The scene in the arena on the release of the thousands of pigeons, symbolic of the spirit of peace which must reign during the Games.*

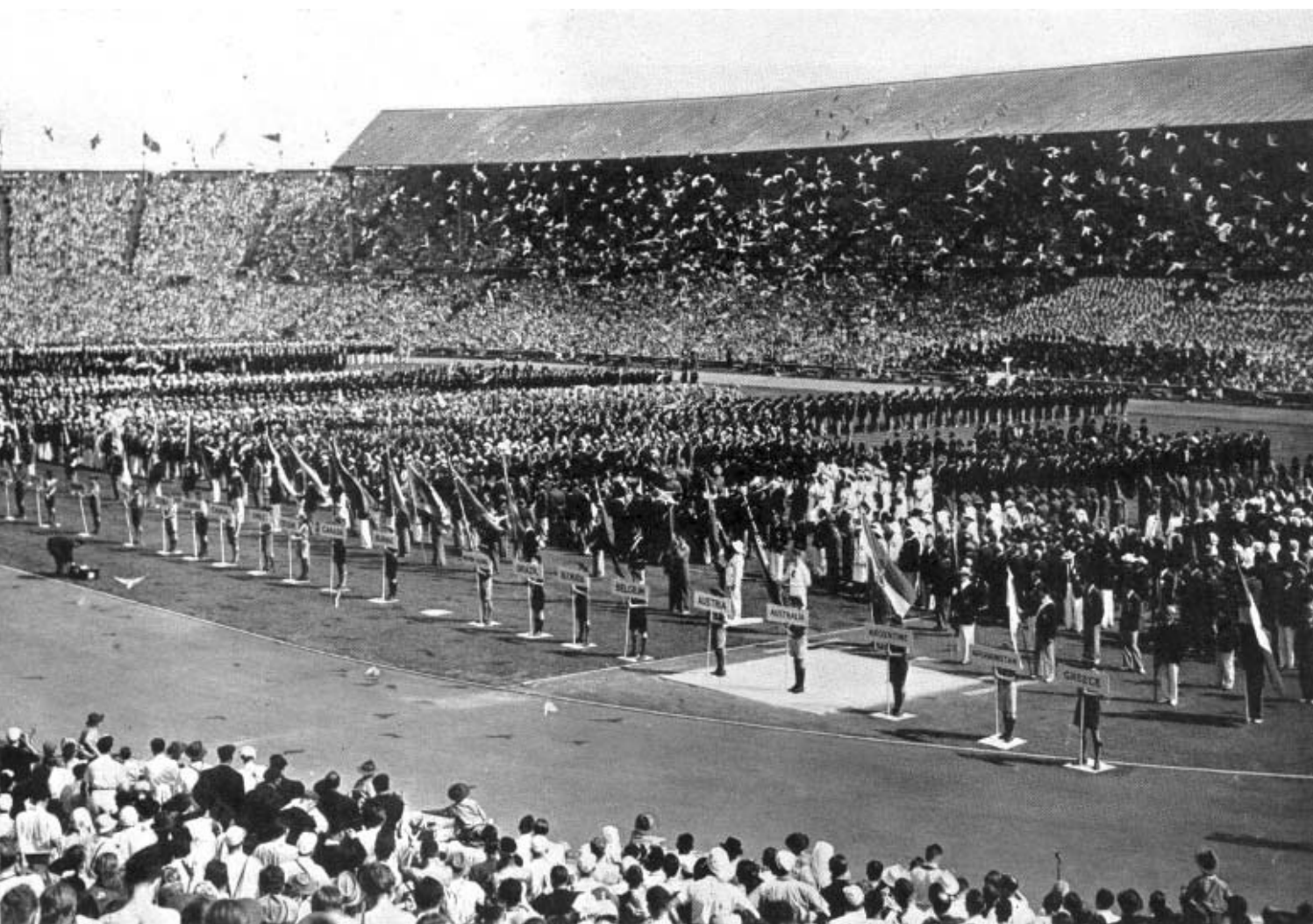

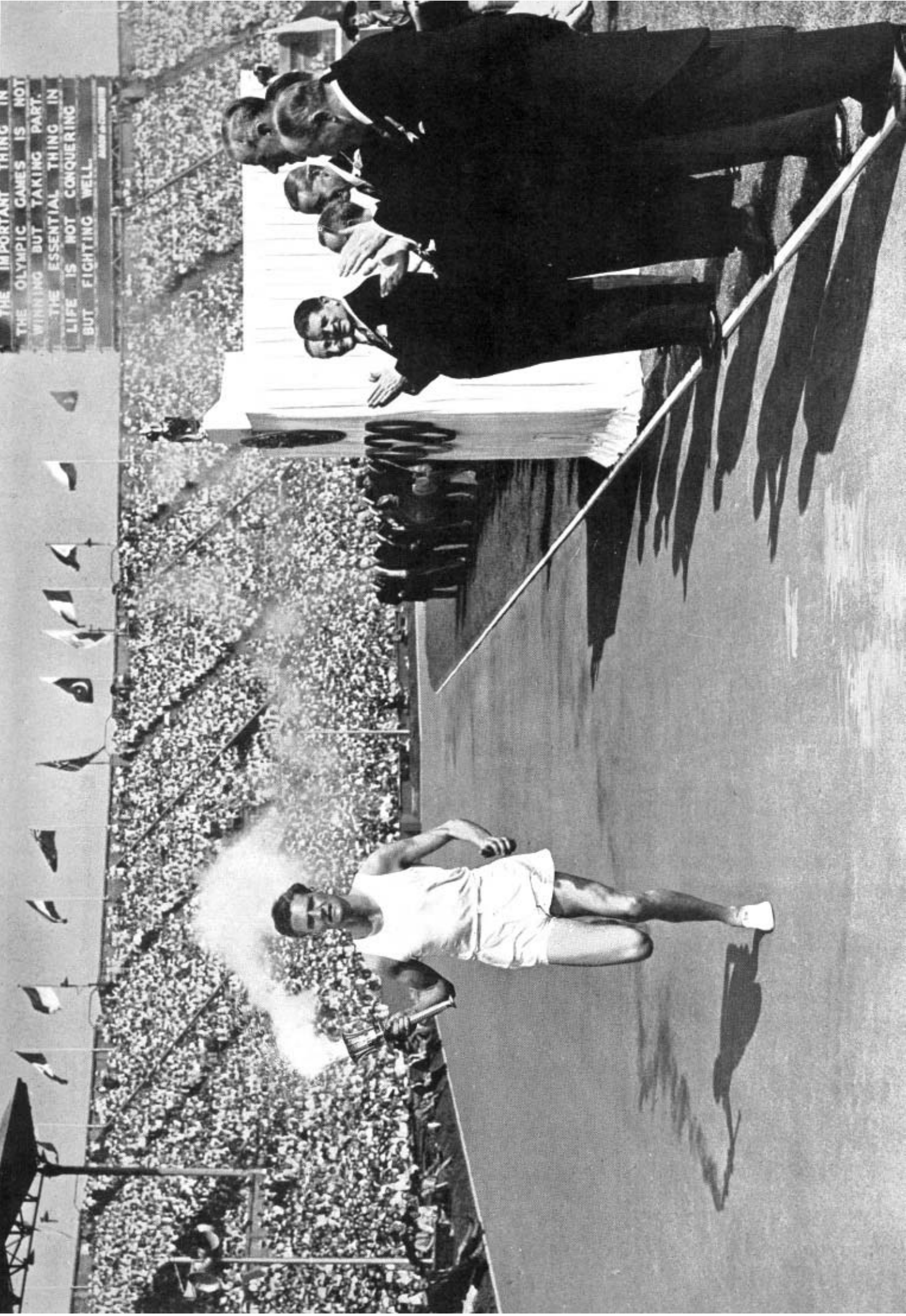

*The torch-bearer, passing the Tribune of Honour during his circuit of the Stadium, is applauded by members of the Organising Committee.*





*Bearing the flame kindled in Greece and borne across Europe, the torch-bearer is seen as he makes his circuit of the track.*



*Flags of the competing nations are dipped in salute as Donald Finley, in the Tribune of Honour, takes the oath on behalf of all the competitors. He is holding a corner of the British flag, carried by J. Emrys Lloyd, a competitor in the fencing events and a member of the Organising Committee.*



A general view of the scoreboard and a section of the Stadium as the Olympic Flame is kindled in the bowl of the peristyle by the torch-bearer. The scoreboard carried, throughout the Opening Ceremony, the famous words of Baron de Coubertin, founder of the modern Olympic Games.





*A general view of the Athletic arena. The Olympic flag is flying in the foreground; at the far end, beneath the scoreboard, is the peristyle with its bowl, in which the Olympic flame burns. At the near end of the left-hand straight is the line on which all races finished. Some of the arena scoreboards which were used to record heights and distances and to show the numbers of the competitors in action are seen, and one of the camera crews on the tower used for the official film is in action on the right.*



*Operating the wind gauge which recorded the strength and direction of the wind during sprint races. The officials are C. A. Sinfield and H. W. Harbin.*

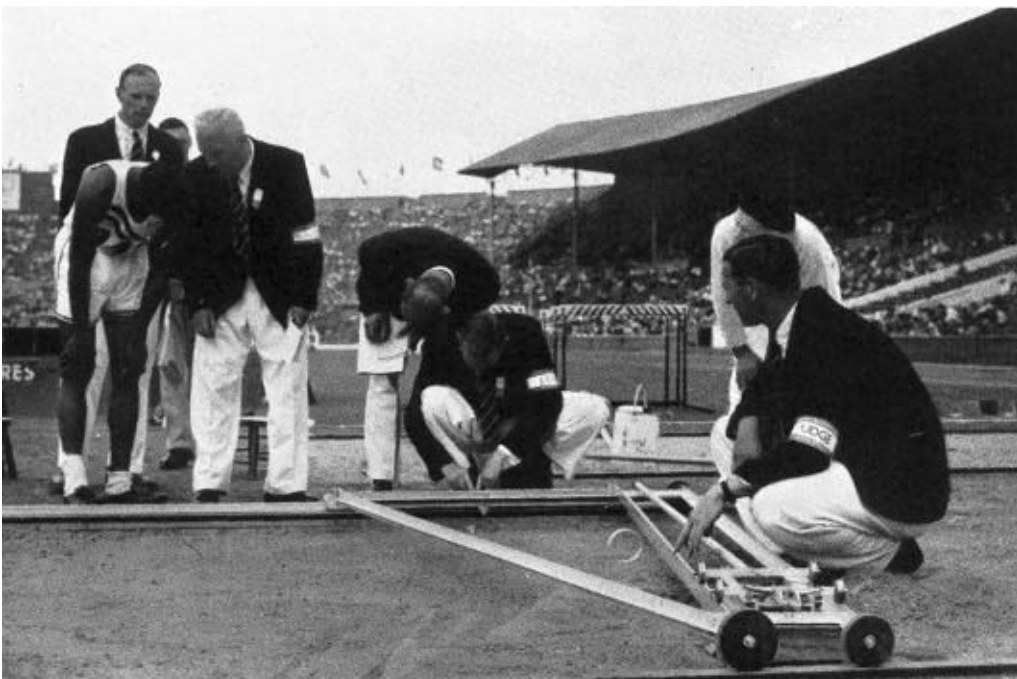

*The device for measuring jumps in the long jump and for smoothing off the sand in the pit to the correct level.*



*The start of the 100 metres final. From left to right, the competitors are H. Dillard (U.S.A.), E. Macdonald Bailey (Great Britain), A. McCorquodale (Great Britain), L. Labeach (Panama), H. Ewell (U.S.A.), and M. Patton (U.S.A.).*

*The finish of the 100 metres as seen by the photo-finish camera, with Dillard first, Ewell second, Labeach third, McCorquodale fourth, Patton fifth, and Macdonald Bailey sixth.*

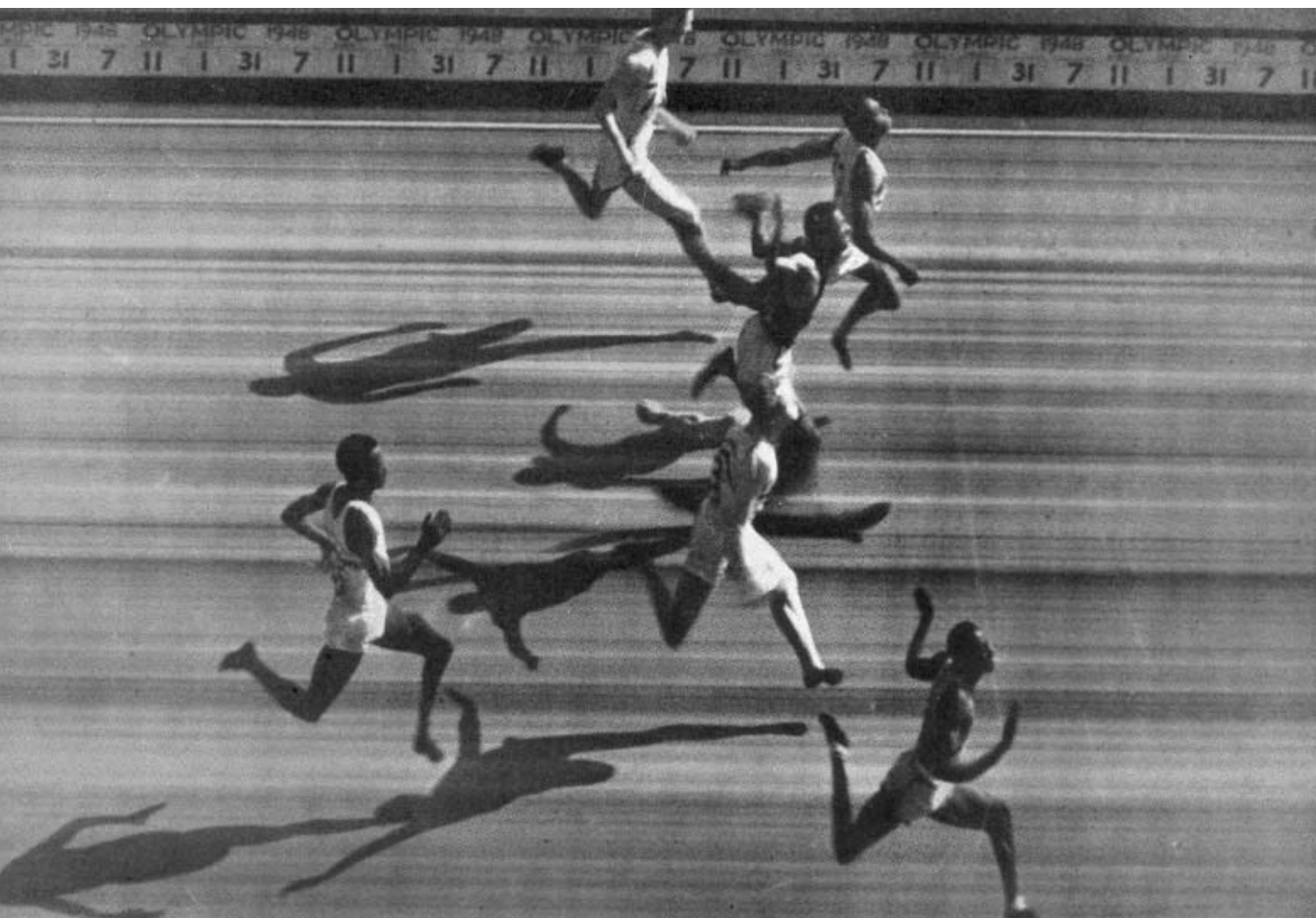





*How the finish of the 100 metres final appeared from the competitors' stand.*

*A heat in the 200 metres event as the runners pass the peristyle and the Olympic Flame, which burned throughout the Games. The competitors are, from left to right, D. Pettie (Canada), M. Fayos (Uruguay), J. Stephan (France), J. Lammers (Holland), and L. Labeach (Panama), winner of the heat and third in the final.*





*The finish of the 200 metres final. From left to right: L. Laing (Jamaica) sixth, C. Bourland (U.S.A.) fifth, H. Ewell (U.S.A.) second, L. Labeach (Panama) third, M. Patton (U.S.A.) first, and H. McKenley (Jamaica) fourth.*

*As the runners enter the last straight in the 400 metres final, H. McKenley (Jamaica) is leading A. Wint (Jamaica) by three to four yards with M. Whitfield (U.S.A.) further in the rear.*







. . . . at the finish of the 400 metres final, A. Wint (Jamaica) has caught and passed H. McKenley (Jamaica). M. Whitfield (U.S.A.) holds third place, and behind him can be seen M. Curotta (Australia), who finished fifth.

One of the field events judges marking the card supported on his tray, held firm by the shoulder straps, while a colleague telephones the distance recorded to the arena scoreboards, and competitors in the women's shot-putting event check their progress and positions. The competitors are, from left to right, I. Mello de Preiss (Argentine), A. Panhorst-Niesink (Holland), and M. Birtwistle (Great Britain).





*The start of the 800 metres final, the runners from left to right being H. Parlett (Great Britain), M. Hansenne (France), H. Barten (U.S.A.), N. Holst-Sorensen (Denmark), A. Wint (Jamaica), R. Chef d'hotel (France), I. Bengtsson (Sweden), R. Chambers (U.S.A.), and M. Whitfield (U.S.A.).*

*At the end of the first lap R. Chef d'hotel (France) leads from A. Wint (Jamaica), and M. Whitfield (U.S.A.). Barten is passing Bengtsson, and is followed by Hansenne. Parlett is behind Bengtsson.*



*At the finish of the 800 metres final, M. Whitfield (U.S.A.) wins from A. Wint (Jamaica), with M. Hansenne (France) third, H. Barten (U.S.A.) fourth, and I. Bengtsson (Sweden) fifth.*



*During the course of the 800 metres final, with M. Whitfield (U. S. A.), the winner leading from R. Chef d'hotel (France) No.152, A. Wint (Jamaica) No. 122, and H. Barten (U.S.A.), as the runners are about to enter the finishing straight.*



*The amazing finish to the second heat in the 5,000 metres when, although four in each heat qualified for the final, neither E. Zatopek (Czechoslovakia), on left, nor E. Ahlden (Sweden) would give way to the other in the last lap, Ahlden eventually winning by a yard, with the rest of the field well behind.*



*G. Reiff (Belgium) just gets home in the final of the 5,000 metres, despite a wonderful spurt by E. Zatopek (Czechoslovakia), who had been about thirty yards behind with half a lap to go.*

*Zatopek leading the field in the early stages of the 5,000 metres final from V. Makela (Finland), with Reiff lying third, followed by W. Slijkhuis (Holland), and E. Ahlden (Sweden).*







*The weather conditions during the 1,500 metres final are shown by the state of the track and the umbrellas among the spectators. The runners shown are, from left to right, H. Eriksson (Sweden), M. Hansenne (France), L. Strand (Sweden) V. Cerona (Czechoslovakia), G. Bergkvist (Sweden) W. Slijkhuis (Holland), D. Johansson (Finland), and G. Nankeville (Great Britain).*



*Left. The finish of the 1,500 metres final, with H. Eriksson (Sweden) winning from L. Strand (Sweden), and W. Slijkhuis (Holland). Centre. A general view of the competitors early in the 10,000 metres with M. Ramjohn (Trinidad) leading from S. McCooke (Great Britain) and S. Cox (Great Britain). Other runners who can be identified are 238 V. Heino (Finland), 237 E. Heinstrom (Finland), 244 J. Peters (Great Britain), 241 A. Paris (France), 250 F. Wilt (U.S.A.). Right. E. Zatopek (Czechoslovakia) comes home an easy winner of the 10,000 metres, more than three-quarters of a minute in front of any of his rivals.*

Separate programmes were scheduled for the Opening Ceremony, the Closing Ceremony, and for road sales on the marathon and the road walk courses. At first it was intended that the Opening Ceremony programme should be standard with the rest, as had been the case at Berlin, but it was later decided to have a double size with a selling price of two shillings instead of one shilling.

### **Covers**

The programme cover was approved at the Executive Committee meeting of January 6th, 1948. The design, prepared by Messrs. M<sup>c</sup>Corquodale & Co., Ltd. was standard throughout, but the colour varied from day to day to prevent confusion. All programmes for the same day, however, were of the same colour, whatever the sport. With the acceptance of the design and the provisional acceptance of the schedule of quantities, the printers were anxious to start work. It was not, however, until April, 1948, that it was possible to complete and pass the proofs of the remaining material for the cover pages. This consisted of:—

- (i) Metric conversion tables where appropriate (it was finally decided they were necessary only for weightlifting and athletics).
- (ii) An announcement (full page) of the Olympic Art Exhibition.
- (iii) A summary of how to get to the various London district Olympic venues by London Transport. This summary was prepared by London Transport officials at the request of the Transport Department, but had to be severely cut in order to fit the available space.

### **Text**

Sample pages were put into type early in 1948, and general approval of the style was given.

In the later stages there were three major difficulties :—

- (i) The slowness with which final lists of competitors and draws became available.
- (ii) Lack of information from the officials of the sport concerned.
- (iii) The impossibility of keeping a close check on printers and officials outside the London area in the last stages of production.

With regard to (i), the explanation of this delay is outlined in the report of the Entry Form Department. Unless this delay can be obviated it is clearly impossible for the work on programmes to be expedited.

With regard to (ii), it is true that all officials were hard-pressed, but even so, it was regrettable that information was not always available to the programme department at an earlier moment. Even where the sports officials were on the spot, continual contact was necessary to obtain all the information needed, and the difficulties were much increased in respect of outlying venues.

As a result, much time had to be spent in obtaining information about officials, draws, etc., and three extra members of the staff were appointed for this purpose.

By making a complete check of all results as they were received, keeping in touch with the Results Department correspondents at the various Olympic centres, and taking up all



queries, either on their own initiative or when instructed to do so from the Programmes Office, they kept a flow of all the necessary material for the programmes. Their contact with the various arenas also enabled them to get draws, names of officials, etc., much sooner than would otherwise have been the case.

With regard to (iii), this did not hinder the work of the department, but resulted in the production of a less perfect programme either from the point of view of information or appearance.

### **Opening Ceremony**

A design for a special Opening Ceremony programme was submitted by Mr. H. A. Rothholz. The cover design was approved, but it was decided that the inner pages should not be illustrated as had originally been suggested. Instead a plain make-up was adopted.

### **Printing and Distribution**

The distribution of programmes to the public was satisfactory, but the distribution to officials, press, etc., did not, on all occasions, work quite so smoothly.

As was to be expected, some results for inclusion in the following day's programme were very late in coming to hand (even as late as 11 p.m.) and the very greatest credit is due to the printers for the way in which they overcame these difficulties and provided the programmes to time.

So far as possible the complete proofs of all programmes were checked in the Programmes Office before printing went ahead. There were two major exceptions to this :—

(a) At out-of-London venues only the first day's programme could be seen in proof, and the Rowing, Canoeing and Yachting programmes were all subsequently considerably altered on the spot. The Equestrian, Shooting and Cycle Road Race programmes were, however, finally checked in the Programmes Office.

(b) Where late results and draws had to be incorporated only a skeleton page proof could be checked.

At first it had been suggested by the printers that daily proofs of each programme for such sports as Athletics, Swimming, Wrestling, Boxing and Basketball were unnecessary. The Programmes Office's insistence on seeing as much as possible was, however, fully justified both in theory and in practice. In theory the Programmes Office was the responsible authority and had to take all possible precautions against any errors appearing in the programmes. In practice, the amount of pressure in the various printing offices inevitably led to several errors creeping into the proofs.

Even with the precautions taken it was impossible to keep all errors out of the programmes. Two sources of error were the following :—

(a) The printed lists of competitors from which the programmes were compiled were produced under stress. The proofs of these lists were not checked back against the entry forms and several errors, as it subsequently appeared, were to be found in most of the lists. It was obviously impracticable to waste time by checking the proofs against the entry forms, but it would have been desirable to check the printed lists

against the entry forms and notify the printers of any necessary amendments before the programmes appeared.

(b) In order to produce larger quantities in a short time, some of the programmes were set in type more than once. For instance, each of the Athletics programmes was set six times and each of the Swimming programmes twice. Any alteration made on the corrected proof copy should have been made also in each other set of proofs. This in practice worked reasonably well, considering the speed of operation, but it did not cover the case of errors in existence in other sets of proofs, but not in the set submitted to the office. The printers had considered that they would be able to obviate any such errors, but after some had been found in two of the early Athletics programmes, all six proof copies were checked in the Programmes Office. Several of the errors which had to be explained by the announcers arose from this practice. (Some errors, however, were due to rulings by an International Federation not being conveyed to the Programmes Office, as with the reduction in the number of 5,000 metre qualifiers per heat from five to four.)

The time factor made it impossible to check every proof name by name and number by number. So far as possible, however, a check of the number of entries in each heat and each event was made to guard against omissions, and by and large few slips were made.

## THE OLYMPIC FLAME

The 1932 and 1936 Olympic Games provided guidance in some degree on the methods to be employed by the Organising Committee. The Los Angeles Stadium was situated in a country where natural gas was readily available and therefore the Technical Department here had to rely more on the experiments and research on fuel carried out by the German Olympic Committee.

Propane gas, a commercial product, largely used for industrial purposes, had been used in 1936 and, while this was the ideal fuel, it was not available in sufficient quantity for the Olympic Flame. Butane, a compound allied to propane, was therefore chosen.

The requirements of the Olympic Fire were that it should have a bright, smokeless, odourless flame ; that it should be readily lit; that the fuel should be in good supply and be transportable in a simple fashion ; and, above all, that it should be extremely difficult to extinguish the flame. Most of these requirements were met by the fuel itself, butane gas. Others were dependent upon the type of burner that was used, which had a direct bearing on the size of the flame, its height and burning area.

All these considerations had to be linked up with the position that the bowl would occupy at the Empire Stadium.

It was obviously desirable to place the Flame in a prominent position, but one in which it would not obscure the view of any spectators or cause them discomfort by their proximity to the fire. Initially it was decided to erect the bowl and its peristyle above and behind all spectator accommodation at the west end of the Stadium, and experimental work continued on these lines until a comparatively late date.

It was found, however, that to place the fire here had two major obstacles :

(1) from the seating angle a considerable number of seats would have to be lost in arranging a stairway or ramp for the last torch runner to mount to the bowl to ignite the Olympic Flame ;

(2) a far more serious obstacle, that the cylinders containing the gas would have to be mounted some 120 feet above ground level, where, if one fell during refuelling, it would have disastrous consequences to the Stadium.

### **Siting of Peristyle**

The Wembley Stadium authorities, advised by their architects, put forward an alternative plan which was adopted and which proved most workable. The pageant tunnel at the east end of the Stadium was roofed in to provide a platform some 30 feet by 25 feet at a level mid-way between the track and the back row of spectators. The bowl and peristyle were placed about 5 feet from the front of this platform and were visible from nearly every seat within the Stadium itself. A flight of steps leading up to the platform was specially constructed at the side of the tunnel to give the last torch runner easy access to the bowl. A special protective screen was erected 20 feet behind the Flame, and directly behind this wall a control room was built in the gallery of the Stadium itself, where the fuel supply was situated. In this control room an operative was in constant attendance.

Experiments were carried out in Holland and a burner was manufactured there which had a 2-foot diameter and, at maximum pressure, could give a flame 10 feet in height. In practice, it was found that a flame of about 4 feet in height, giving the impression of a lazy burning oil fire, produced the minimum amount of discomfort to anyone within the immediate vicinity of the flame and in all but the highest winds could not be extinguished. As this flame was under constant supervision of the control room, any change in the wind direction or its velocity was immediately counteracted by increasing or decreasing the rate of supply of the gas.

### **Pilot Burner**

Beside the main burner, and inside the actual casing of the bowl itself, a small pilot burner was installed. This lit automatically from the main flame when given a supply of gas. Reciprocally, if the pilot burner was alight, and the gas supply turned on to the main bowl, this ignited from the pilot burner. The object of this pilot light was to conserve fuel during the time when the Empire Stadium was empty. After the spectators had left the arena each day, the pilot light was turned on and the main flame extinguished. The actual Flame never died. The result of this provision was that during the 17 days, July 29-August 14, the time for which the Flame was actually ignited was 386 hours, the main bowl only being alight for some 70 hours of this period. It may be said in passing that the installation of the pilot burner led, on one occasion, to a false report being circulated that the Flame had gone out.

Butane gas was supplied in cylinders holding 60 lb. and two were always in parallel on the supply line. An indicator on each cylinder head showed the amount of gas expended

and, as soon as 75 per cent. had been used, the other cylinder was turned on and the partially expended one replaced by a fresh cylinder.

On the Torch Relay route from Greece to London, a burner similar to the pilot light used at Wembley was supplied to H.M.S. *Whitesand Bay* for the transport of the Flame from Greece to Italy across the Adriatic. A similar burner was installed at Torre Abbey, Torquay, where the Olympic Fire burned during the period of the Olympic yachting regatta.

## VICTORY CEREMONIES

The Executive Committee gave careful consideration to the desirability of holding all Victory Ceremonies at the Empire Stadium. Various international federations had differing points of view on this question. While some felt that the Empire Stadium, the centre of the Games, was the appropriate place, others, whose sports took place in outside arenas, felt that the Victory Ceremonies should take place directly each event was concluded and before those spectators who had witnessed the contest. The athletic authorities, who were chiefly concerned with the use of the Empire Stadium, pointed out that it was undesirable, from the point of view of their programme, to have too many Victory Ceremonies in the Stadium for sports other than athletics, as they would be disturbing both to spectators and competitors, who would be held in additional suspense before major athletic contests. Furthermore, owing to the somewhat widespread nature of the venues, considerable travelling would have to be done if all successful competitors were to be brought to the Empire Stadium. The decision which was finally reached was that Victory Ceremonies should be held in five centres, and it was only the last-minute alteration of the Gymnastics venue to the Empress Hall that brought about the inclusion of a sixth centre. These proposals for the staging of Victory Ceremonies were referred to the I.O.C. for approval.

The final arrangements were as follows :—

(1) *Empire Stadium*. The Victory Ceremonies of all athletic events were held directly each particular event was concluded. The successful competitors in the following sports were also brought to the Empire Stadium for Victory Ceremonies :—

Fencing—the day after the conclusion of the event.

Wrestling—the day after the finals of each style.

Weightlifting—the day after the conclusion of the particular weights.

Modern Pentathlon—the day after the conclusion of the event.

Shooting—the day after the conclusion of the Shooting events.

Canoeing—the day after the conclusion of the Canoeing events.

Football and Hockey—directly after the final matches.

Basketball and Cycle Road Race—immediately preceding the Prix des Nations.

Equestrian—Aldershot events immediately preceding the Prix des Nations ; Prix des Nations immediately preceding the Closing Ceremony.

(2) *Empire Pool*. At the request of the international Swimming and Boxing Federations, Victory Ceremonies of the Swimming contests were held in the Empire Pool at the completion of each event, and on the final night of the boxing tournament.

(3) *Henley-on-Thames*. The Victory Ceremonies for the Rowing events were held at the water-side after the final of each race.

(4) *Torquay*. Victory Ceremonies for the Yachting events were held immediately preceding the special Closing Ceremony staged at Torbay.

(5) *Herne Hill*. Victory Ceremonies for each Cycling track event were held immediately after the final had been concluded.

(6) *Empress Hall*. It had been intended to hold the Victory Ceremonies for the Gymnastics events in the Empire Stadium, but owing to the change of venue, they were held at Earl's Court.

Victory ceremony platforms were provided at all centres with the exception of Henley, and the flag poles to carry the flags of the countries of the winning competitors were erected wherever possible above the scoreboard in the arena.

### **Presentation of Medals**

Mr. J. Sigfrid Edstrom, the President of the International Olympic Committee, performed a very large number of the prize distributions personally, and other members of the I.O.C. also assisted in this function. At the invitation of the I.O.C. Sir Ralph Gore conducted the victory ceremonies at Torquay and the President of the London Games, Lord Portal, presented some of the medals at the Empire Pool. An officer of the Organising Committee's staff was detailed to attend with the necessary medals at each venue on any day on which victory ceremonies were to take place. His duty was to collect the successful competitors and conduct them at the appropriate moment to the victory ceremony rostrum. Where victory ceremonies were held on the day after the conclusion of an event, the officer informed the appropriate team manager that his competitors should attend at a specified time.

The victors of the Prix des Nations took part in their victory ceremony mounted.

## **NATIONAL ANTHEMS**

In 1947, when the Organising Committee was circularising national Olympic Committees who had either accepted the invitation to the London Games or were likely to do so, copies of the scores of the national anthem or hymn of each country were requested for use in the Victory Ceremony celebrations. It was particularly desired that, when the national anthem of a winning competitor's nation was played, it should be in a form that was recognisable to that competitor, as it is quite possible for the rendering of a piece of music, by variation in tempo and expression, to sound unfamiliar to the national concerned. With this in view, band parts, scored for military bands, were requested for all national anthems. Even this was not a sufficient safeguard, since the composition of a military band varies from country to country. Many nations supplied gramophone records

as well as scores and these gave a clear indication of the rendering normally used in the country of origin.

Difficulties were experienced, as certain countries had, due to a change in government after the conclusion of World War II, altered or amended their national anthem and in some cases the final form had not been decided.

In the case of many of the countries of the British Commonwealth of Nations, " God Save The King " is played in conjunction with an anthem peculiar to the member country.

As formal Victory Ceremonies and presentations of medals took place at five centres, the allocation of band parts was carried out as follows:—one complete set of all competing nations was compiled for the Empire Stadium ; one set of competing nations in swimming and boxing for the Empire Pool; one set of competing nations in cycling for Herne Hill; one set of competing nations in rowing for Henley; and one set of competing nations in yachting for Torquay.

In all cases the National Olympic Committees had been asked to indicate on their scores that part of the anthem normally used in a shortened version, and it was this shortened version that was played at Victory Ceremonies.

## DECORATIONS

The chief factor in the general scheme of decoration for the Games was the flying of national flags, surmounted by the official Olympic flag, at the various sports venues and housing centres.

Supplementary decorations at all these sites, were as follows :—

(a) The flying in a prominent position of international code signalling flags arranged to spell the Olympic motto, " Citius, Altius, Fortius."

(b) The mounting of the Olympic emblem, a shield bearing the five interlocking Olympic rings on a white background, the whole set against a background of draped flags in the five Olympic colours.

(c) The decorating of dining tables and interiors of housing centres with small national pennants. Bunting, and travel posters showing typical scenes from town and country in the British Isles were displayed on interior walls.

On the occupation of a housing centre by a team allotted to it a ceremony of welcome took place, the most important part of which was the hoisting of the flag of the nation concerned. A similar ceremony in which the flag was lowered marked the departure of the team from its centre at the close of the Games.

### Size of Flags

The flags used in the above instances were 4, 3 or 2 yards in size, depending on the function which they fulfilled. Due to the shortage of suitably sized poles it was not found possible to retain uniformity of flag sizes between all venues and centres. However, at most sports venues, the flags were either 3 or 4 yards in size and at all housing centres 2 or 3 yards.



In no instance was the Olympic flag smaller than the largest national flag flown at any housing centre or sports venue, and, in all cases, it was flown on the tallest pole and in the most prominent position.

### **Victory Ceremony Flags**

The protocol of the Olympic Games requires that flags for victory ceremonies should be of two sizes. Therefore, a 4-yard national flag for the winner, and two 2-yard flags for those in second and third places were used. A deviation from this arrangement occurred at Torquay as only one set of 3-yard national flags of those nations competing was supplied, since duplication of nations in the victory ceremony could not occur.

### **Flag Allocation**

At all venues and housing centres except Wembley only the national flags of those countries participating in sports at such venues or residing in such centres, were flown. Allocation was as follows :—

(a) *Empire Stadium.* Here in the main Olympic stadium, the site of the Opening and Closing Ceremonies, the flag of every nation participating in the Games was flown. Four-yard national flags were flown from 30-foot poles at the top of the containing wall of the stadium in such a manner as to be visible from the arena. From the twin towers surmounting the main entrance two 4-yard Olympic flags were flown, the Royal Standard being substituted for one on the occasion of the Opening of the Games by His Majesty the King or when the King was present on other days.

The great Olympic Flag which was 6 by 4 yards in size, hoisted to mark the Opening the Games of the XIV Olympiad, was the gift of a firm of flag contractors, and flew from the main mast at the west end of the arena.

Flag poles on the stadium's structure were dressed with Olympic flags alternating with St. George's Cross and the standard of the City of London, the host city.

Three flag poles, two of 25 feet and the centre one of 50 feet were erected over the main scoreboard. Towering high above the main structure these carried three Olympic flags on the opening day and subsequently flew national flags during the victory ceremonies, the centre pole flying the flag of the winning nation.

(b) *Empire Pool, Palace of Engineering, Empress Hall and Harringay Arena.* It was found impracticable to fly flags from poles indoors. In the venues referred to, use was made of interior rafters or girders, from which flags of a size dependent on the height of the roof hung bannerwise. A most effective display was that in the Palace of Engineering where pillars supporting the arched girders of the roof broke up the continuity of the floor space to form four separate fencing salles. Two-yard flags of those nations competing in the fencing were hung from short bamboo poles fixed at an angle of 45 degrees to the junction of each pillar and arch. The walls were draped with gaily coloured hangings and the general effect was that of a series of medieval manorial halls.

(c) *Henley-on-Thames.* Twenty-five-foot poles were erected outside the stewards' enclosure at intervals of 5 yards. From these were flown 4-yard flags of those nations

competing in the rowing and canoeing events. The Olympic Flag flew from the 40-foot mainmast inside the stewards' enclosure.

(b) *Camberley and Aldershot*. Two-yard flags of those nations competing at Aldershot flew at Camberley housing centre. Four-yard flags of competing nations in equestrian sports were flown at the Command Stadium at Aldershot. Olympic flags were supplied for each place.

(e) *Windsor Great Park*. Twenty-five-foot flag poles were erected behind stands on Smith's Lawn and were dressed with 4-yard national flags of the competing nations. An Olympic flag flew from the top of the photo-finish tower opposite the start and finish line. Many of the gates used by the public were decorated with emblems and bunting.

(f) *Herne Hill*. The flags (2-yard) of the nations competing in the cycling events were flown at each end of the arena, and the Olympic flag flew from the main flag staff.

(g) *Bisley*. Flags of all nations competing in the shooting events were flown here, together with an Olympic flag.

(h) *Victoria and Albert Museums*. An Olympic flag was flown.

(i) *Torquay*. The Organising Committee agreed to provide the Torquay Town Council with one set of victory ceremony flags (3-yard) of those nations competing in the yacht racing events. Three large Olympic flags and twenty 2½ by 1½ foot Olympic flags to be flown by patrol launches were also provided. Carrying flags for the Parade of Nations at Torquay were lent by the Boy Scouts Association.

(j) *Richmond Park, Uxbridge and West Drayton*. At the three main housing centres 2-yard flags of the resident nations were flown. An Olympic flag flew from the mainmast at each centre.

(k) *Middlesex and High Wycombe Schools*. Three-yard flags of resident nations flew at the former and 2-yard flags at the latter. An Olympic flag was flown at each school.

" Citius, Altius, Fortius " bunting, and at least one official emblem was displayed at each venue.

The following London boroughs and provincial towns co-operated at their own expense in the general scheme of decoration :—

The City of Westminster, Aldershot, Chelsea, Deptford, Dover, Hackney, Henley-on-Thames, High Wycombe, Islington, Royal Borough of Kensington, Southwark, Royal Borough of Windsor, Uxbridge, Wembley, West Drayton.

In most instances these boroughs decorated their public buildings with national flags and bunting. The City of Westminster and Henley decorated their main thoroughfares, Piccadilly Circus having a special display. Several of the large stores displayed the national flags of the competing nations inside and outside their buildings.

## Conclusion

The same set of flags was used to cover the decoration of more than one venue. Such an arrangement requires careful timing and stringent supervision, and even so, during the transfers, many flags, emblems and bunting were lost or taken as souvenirs.

A further difficulty was the fact that a large number of teams had to be accommodated temporarily in one housing centre and later transferred to another.

Great care was exercised in obtaining the correct design of each national flag. It was not always possible to obtain in advance from the various National Olympic Committees properly coloured and dimensional drawings. In two cases the College of Heralds was consulted for a final decision. In addition, many countries had changed the design of their flag since the war, and, in some instances, the new design was still under consideration by the Government concerned. Eventually, however, a book of coloured scale drawings of each flag was prepared, and this was passed to the manufacturer who was thus able to provide the correct flag for each of the participating nations.

On receipt of an enquiry from the Decoration Sub-Committee, 18 nations informed the Committee that they proposed to bring their own carrying flag for the Parade of Nations ; 24 replied that they wished the Organising Committee to provide the necessary flags. No answer having been obtained from the remaining 17 a month prior to the Games, it was decided to place an order with the flag contractors for those flags. A sling and flag pole were provided for each flag ordered, and a supply of spare poles and slings was on hand for an emergency. Unfortunately, at both the Opening and Closing Ceremonies, several nations who had formerly declared their intention to provide their own flags, did not do so, for one reason or another. The flags from the Scoreboard were used to meet the emergency.

# TELECOMMUNICATIONS

The magnitude of the task confronting the Organising Committee and the British Post Office in providing postal, telegraph and telephone communication facilities was realised at an early stage and preliminary discussions, designed to ensure that the needs of the home and foreign press, the British Broadcasting Corporation, competitors and visitors were fully met, took place as early as January, 1947, eighteen months before the opening of the Games. The estimate of requirements which the Organising Committee was then able to furnish to the Post Office became the basis upon which all future planning proceeded.

A special committee was set up to undertake this task, under the chairmanship of the Telephone Controller of the London Telecommunications Region, including representatives of the Postal, Telecommunications and Finance Departments of the Post Office. The Telephone Manager of the London North West Area, in whose territory Wembley is situated, was also a member. The Technical Manager and other representatives of the Organising Committee attended a number of the Committee's meetings. Certain other persons, notably journalists whose comments upon the arrangements made at the Olympic Winter Games in Switzerland had found expression in a press journal, were also invited to contribute their views upon what would be required. The opinions of the Foreign Press Association of London, the United Press Association of America, the Empire Press Union and the Newspaper Proprietors' Association were also sought, and, as a result, the Post Office was able to form some picture of the magnitude of the traffic which might be expected and how it might be divided between the different media—postal, telegraph, teleprinter and telephone.

It was necessary to cover the communications requirements of (a) the Organising Committee in London for purposes of general management; (b) the arena managers at Wembley for controlling the Games; (c) the public at all venues; (d) the press at all venues and (e) the competitors at all housing centres.

The main centre of the Games was the Empire Stadium, Wembley, and it was obvious that the Wembley Telephone Exchange, fully loaded by existing public requirements, would be unable to handle the additional traffic which the presence of the Games in the area would produce. An exchange, aptly named "Corinthian," was therefore provided to serve the Games offices at Wembley, the press and public call offices and some other subscribers. A staff of 22 operators was employed. The general layout of the switchroom is illustrated in Figure I. The exchange was equipped for 1,200 subscribers with 260 outgoing and 181 incoming junctions.

## Telephones for the Organising Committee

No special problems were presented in the provision of telephone service at the Committee's Head Office at 37, Upper Brook Street, London, W.1. The installation consisted of two 10 + 50 switchboards with 75 extensions, but traffic over the exchange lines during the two weeks preceding the opening of the Games became heavy and relief



Figure 1

had to be afforded to the switchboards by the installation of additional lines (terminating on instruments) for the use of administrative officials.

### **Teleprinter Network for the Organising Committee**

A teleprinter switchboard was installed in the Civic Hall, Wembley, to which were connected teleprinter lines within the Stadium grounds, the main housing centres and venues. It was thus possible to connect any teleprinter with any other by asking the switchboard operator to set up the connection. If necessary any one point could readily disseminate a message to a number of other points.

The " B " broadcast (see Figure II) was operated from the rear of the arena managers' control room, and transmitted simultaneously to the following points :—

- 1 Press stand.
- 2 British Broadcasting Corporation.
- 3 Main Scoreboard.
- 4 Results section (Civic Hall).
- 5 Head Office, 37, Upper Brook Street, London, W.1.

It was necessary to issue duplicated sheets of draws and results to approximately 400 press correspondents. This work was carried out efficiently by installing two teleprinters in the press stand with parallel teleprinters on both. A switch enabled either the main or parallel instrument to be used. The fitting of loaded hammers enabled stencil cutting to be undertaken, thereby greatly reducing the time factor in the distribution of the information.

From Henley and the Empress Hall, results were transmitted direct by teleprinter to Wembley, but this was considered unnecessary from the other venues as results came at long intervals and then only for limited periods. The " A " broadcast (see Figure II) connected the five points mentioned above and, in addition, Henley, the Empress Hall and the housing centres at Richmond Park, West Drayton and Uxbridge.

The machines that were equipped for stencilling were expected to give some trouble through the clogging of the type heads. Although on some days they were continuously in use, it was found that the type heads required cleaning only once every three or four hours.

### **Teleprinter Staffing**

The Post Office provided the operator for the teleprinter switchboard. All the other teleprinter points and the telephones at Richmond Park and the Empress Hall were operated by Army and Royal Air Force personnel, under the general control of Captain I. E. Gibson.

### **Arena Telephone Arrangements**

The arena managers' office at the Empire Stadium was in an elevated position near the side of the track and adjacent to the finishing post. The telephone apparatus consisted of a ten-line multiphone switchboard with extensions to key points. Over this network instructions were sent out, competitors were located, and the public address system

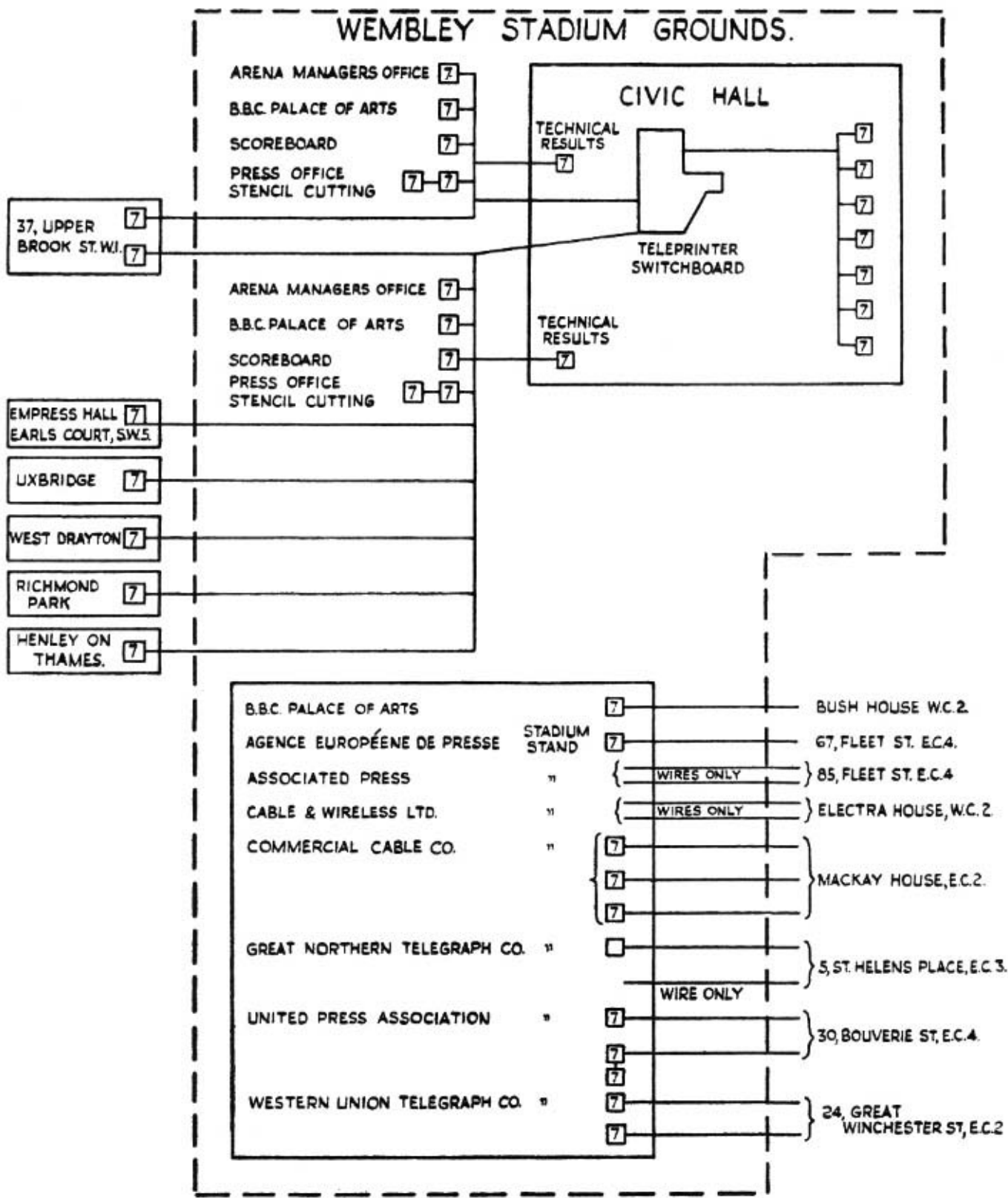

Figure II



operators advised of any special announcements. In association with this network, and immediately behind the control office, were two teleprinters which ensured the immediate transmission of all results to the B.B.C., the scoreboard and the press office. A plan of the network is shown in Figure III.

It was necessary to provide information about the progress of events and the results for the audience in the Stadium but, as track and field events were often being contested simultaneously, to use the public address system for both would have caused overloading and confusion. It was therefore decided to announce the track results by the public address system and, by means of a telephone network, to pass all information concerning field events to an operator, for visual display on the smaller scoreboards in the arena. A second ten-line multiphone switchboard was installed in the arena manager's office, with telephones to various points in the arena as shown in Figure IIIA. These telephones were fitted with breastplate transmitters and headgear receivers, and special waterproof plugs and sockets.

Stadium officials, stationed at A and B in Figure IIIA, reported times, distances, etc., to the switchboard operators, who passed the information forward for visual display on the scoreboards. Telephones at points R1-4 and C1 and C2 were used for intercommunication between camera locations on the field and the photo-finish points.

### **Special Telephone Facilities for the Marathon and Road Walk**

It was essential that the results department at Wembley should be kept informed of the positions of the runners throughout the course of the Marathon and Road Walk, and for this purpose a number of public telephone kiosks along the route were reserved to the Organising Committee. Care was taken to select telephones in situations where the presence of adjacent facilities minimised public inconvenience, and the arrangement, which was typical of many improvisations, proved most successful.

### **Public Telephone Service**

The public demand for telephones at all venues and at the main housing centres was estimated to be small and little additional provision was made. At some venues, such as the Empress Hall and Harringay, facilities already existed and no further provision was considered necessary. It was, however, essential that the public should have adequate facilities at the Empire Stadium, and 37 kiosks were provided within the Stadium grounds and 20 call offices in a room adjoining the Olympic Games Post Office.

### **Press Arrangements**

The Press were specially catered for at the following points :—

- 1 The press stand in the Empire Stadium.
- 2 The press centre in the Civic Hall, Wembley.
- 3 The Empire Pool.

Points 1 and 2 were each provided with ten lines connected direct to the London Continental Exchange, and these were terminated on lamp-signalling, cordless switchboards. Silence cabinets were installed. A suite of call offices was reserved for the exclusive use of journalists at the Empire Pool.

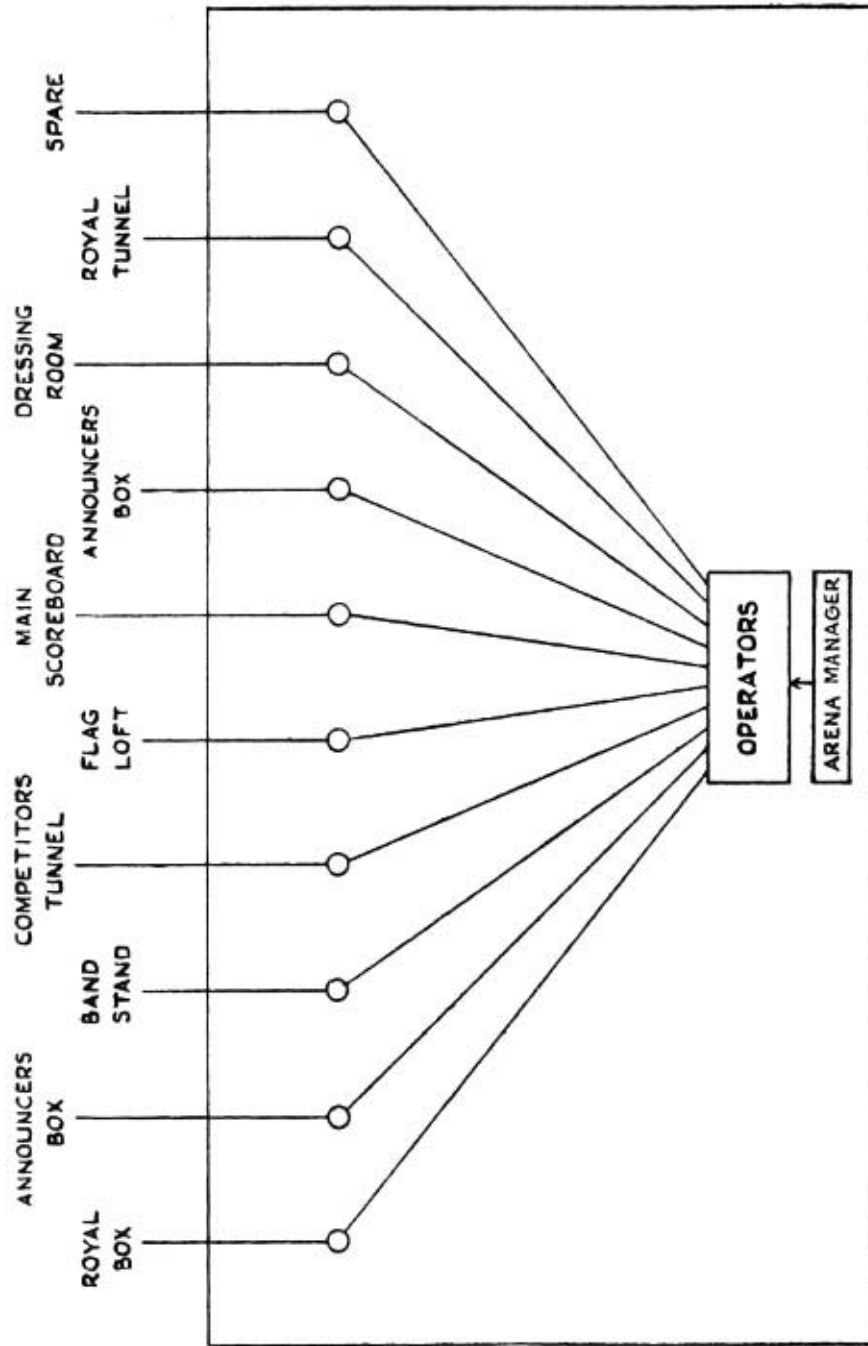

FigIII OPERATORS PROVIDED WITH BREAST PLATE TRANSMITTERS AND DOUBLE HEADGEAR RECEIVERS

A schedule of facilities provided for the press, cable companies and agencies at the 28 venues of the Games with the headings " Call Offices," " Private Wires," and " Exchange Lines " follows :—

C/O = Call Offices ; P/W = Private Wires ; E/L = Exchange Lines.

Venue	Press			Cable companies			News agencies			Competitor call offices
	C/O	P/W	E/L	C/O	P/W	E/L	C/O	P/W	E/L	
Uxbridge .....	15	—	—	—	—	2	—	1	—	19
Richmond .....	15	—	—	—	—	—	—	2	—	12
West Drayton .....	7	—	—	—	—	—	—	—	—	6
Empress Hall .....	10	—	5	—	—	—	—	1	2	—
Aldershot .....	20	—	—	—	—	—	—	—	—	—
Aldershot Baths .....	3	—	—	—	—	—	—	—	—	—
R.M.A., Camberley .....	5	—	—	—	—	—	—	—	—	—
Herne Hill .....	20	—	2	—	—	—	—	1	2	—
Guinness Sports .....	3	—	—	—	—	—	—	—	—	—
Lyons Sports .....	3	—	—	—	—	—	—	—	—	—
Harringay Arena .....	10	—	3	—	—	1	—	1	2	—
Polytechnic Sports .....	3	—	—	—	—	—	—	—	—	—
Arsenal F.C. ....	5	—	—	—	—	—	—	—	—	—
Tottenham Hotspur F.C. ....	5	—	—	—	—	—	—	—	—	—
Fulham F.C. ....	5	—	—	—	—	—	—	—	—	—
Brentford F.C. ....	5	—	—	—	—	—	—	—	—	—
Crystal Palace F.C. ....	5	—	—	—	—	—	—	—	—	—
Dulwich Hamlet F.C. ....	5	—	—	—	—	—	—	—	—	—
Ilford F.C. ....	5	—	—	—	—	—	—	—	1	—
Walthamstow Avenue F.C. ...	5	—	—	—	—	—	—	—	1	—
Brighton & Hove Albion F.C. ....	4	—	—	—	—	—	—	—	—	—
Portsmouth F.C. ....	5	—	—	—	—	—	—	—	—	—
Windsor Great Park .....	20	—	1	—	—	—	—	—	—	—
Henley .....	15	—	3	—	—	3	—	2	2	—
Bisley .....	5	—	—	—	—	1	—	—	2	—
Finchley Baths .....	5	—	—	—	—	—	—	—	—	—
Torquay ... ..	10	—	—	—	—	—	—	—	2	3
Wembley ... ..	144	38	30	—	10	4	—	14	7	5

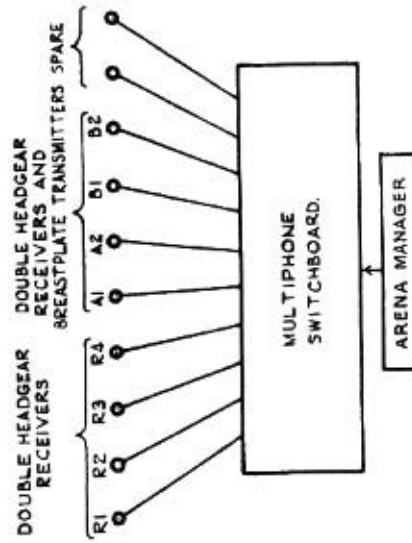
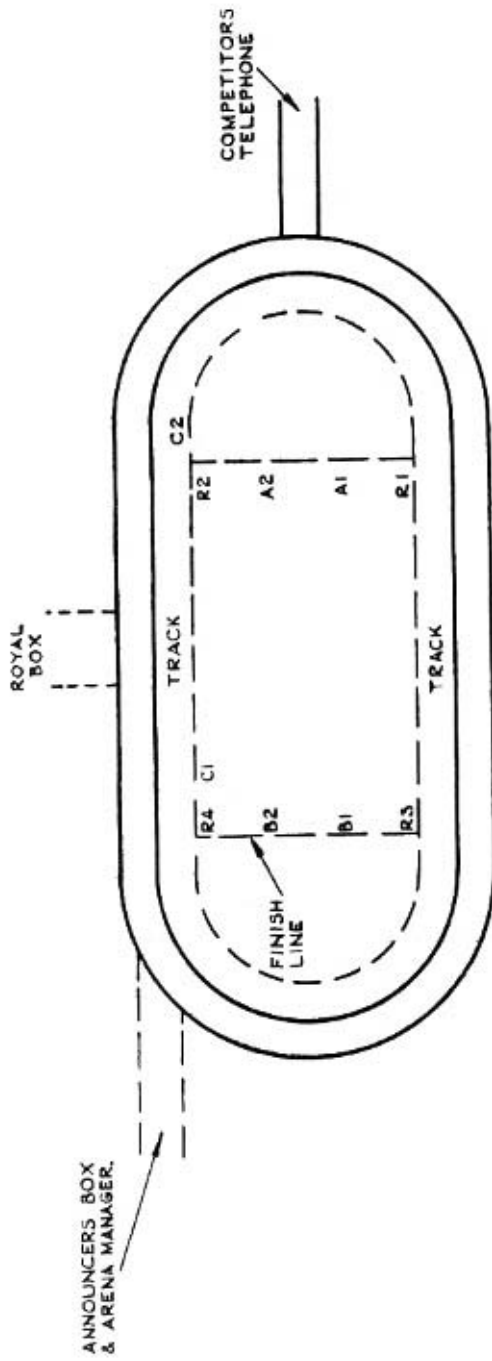

Fig. III A

Foreign-speaking telephonists were provided and their presence did much to assist the smooth running of the arrangements. A staff of eight telephonists was made responsible for the task of advising reporters in the press stand that they were required for incoming telephone calls and they rapidly overcame the anticipated difficulty of identifying individuals among the great number of international representatives. " Paging " at the Press Centre was carried out by means of loudspeaker installation provided by the Organising Committee and operated by call office attendants from the Post Office. Two methods of collecting charges for calls were employed ; by cash at the time of booking the call and by specially opened press deposit accounts.

### **Brochure for Press Representatives**

A brochure, detailing all the communication services and facilities available to accredited press representatives, was produced in English, French and Spanish and distributed by the Organising Committee.

### **Teleprinters for Cable Companies and News Agencies**

The following companies had circuits between Wembley and their head offices in London. In some cases the Post Office provided the circuit and apparatus, while in others the company rented the wires only and provided their own apparatus. Where the latter was the case, the Post Office had to ensure that interference suppressors were inserted to avoid interference with television transmissions.

Agence Europeene du Presse.  
 Associated Press, Ltd.  
 Great Northern Telegraph Company, Ltd.  
 Western Union Telegraph Company.  
 United Press Association of America.  
 Cable and Wireless, Ltd. Commercial  
 Cable Company.

### **Competitors' Facilities**

A table under " Press Arrangements " shows the number of call offices provided for competitors' use. Generally the facilities were ample to meet their needs. A reduction in the numbers at the three main housing centres, Richmond, Uxbridge and West Drayton, would not have resulted in any delays. The provision of a private wire between the Post Office and the Camp Commandant's office enabled competitors who had booked an overseas or continental call to be called to the telephone quickly.

### **Information Centre**

A suite of ten positions, known as " London Olympic Games Enquiries " was set up in Central London. This bureau aimed at the provision of information on any point connected with the Games. During the period, some 3,000 enquiries were dealt with.

### Telegraphs

Telegraph circuits were provided from the Games Post Offices to the Central Telegraph Office in London as follows :—

<i>Venue</i>	<i>Number of circuits</i>
Wembley .....	12
Richmond .....	4
Uxbridge .....	4
West Drayton .....	2
Henley .....	2

The telegraph circuits were, in the main, set up on three 12-channel voice frequency systems, two to Faraday Building and one to Whitehall, operated by a mobile voice frequency unit stationed in the vicinity of the Wembley telephone exchange. Precautions were taken against power failures, reserve equipment being held in readiness on site.

### Traffic Arising from the Games

During the fortnight of the Games the additional continental telephone traffic was estimated at 750 effective calls (150 outgoing and 600 incoming) daily. The additional inter-continental traffic was negligible. The local and short-distance traffic at some exchanges, particularly at those in the neighbourhood of the sporting venues and at those serving hotels, etc., was very heavy. The net increase in the London Region was probably of the order of 5 per cent. to 7 per cent. on local traffic and about 3 per cent. on short-distance traffic. There was no measurable effect on inland long-distance traffic.

Five hundred and twelve broadcast connections were set up to continental countries.

The traffic began to increase about three weeks before the Games and lasted for about the same period afterwards.

### Press Deposit Scheme

A press deposit scheme was arranged for foreign journalists by which a sum of money deposited in advance could be used to cover the costs of international telephone and telex calls and press telegrams. Accounts were opened for 17 journalists from the following countries :—Switzerland 5, Belgium 2, Norway 2, Sweden 4, France 2, Denmark 1, Mexico 1. The small demand for the system was undoubtedly due to the currency restrictions in force. The traffic handled at the press deposit positions was below the estimated level, and it was therefore only necessary to employ about one half of the authorised staff.

### Picture Calls

Full details of picture calls are given on page 104. During the period of the Games 1,023 calls were handled as compared with a normal average of 75 for the same period.

## Postal Facilities

1. Special Olympic Games Post Offices were opened as shown below :—

Place	Dates	Open (Weekdays only)
Wembley.....	July 27 to Aug. 14	9 a.m. to 10 p.m. (noon to 6 p.m. July 27 and 28).
Torquay.....	July 10 to Aug. 12	8 a.m. to 6.30 p.m.
Bisley .....	July 26 to Aug. 14	10 a.m. to 9 p.m.
Richmond Park housing centre .....	July 5 to Aug. 21 ...	8 a.m. to 2 p.m. 6 p.m. to 8 p.m.
Uxbridge housing centre .....	July 8 to Aug. 21 ...	8 a.m. to 2 p.m. 6 p.m. to 8 p.m.
West Drayton housing centre .....	do....	8 a.m. to noon. 1 p.m. to 2 p.m.
Mobile Post Offices attended at Henley and Aldershot.	As required...	6 p.m. to 8 p.m. As required.

2. The main Olympic Post Office at Wembley was well sited in the Stadium grounds on one of the main approaches to the Stadium. It comprised a public office of about 670 square feet, with a counter 29 feet long to accommodate six clerks, a public telephone hall of about 520 square feet, a telegraph instrument room of about 950 square feet, and several small rooms for clerical work, messengers and cloaks amounting to about 530 square feet. The busiest periods were the three hours before the afternoon session at the Stadium and the hour or so after the last event. Little business was done between 9 p.m. and 10 p.m. on most days.

Temporary Post Office facilities were provided at Torquay. A counter 18 feet long was installed and a posting box was erected near by. Poste Restante facilities were provided at all Games Post Offices and used extensively. Business started soon after 8 a.m., reaching its peak between 9 and 9.30 a.m. Business was then quiet throughout the day.

The special issues of 2½d., 3d., 6d. and 1/- commemorative stamps were on sale at all Post Offices in the country. Those affixed to letters posted in the posting boxes in the Stadium grounds at Wembley were cancelled with a special Olympic Games commemorative cancellation stamp. Consequently, the Olympic Post Office was thronged with people buying stamps and completing letters for the post and much more public office space than that provided was necessary at times, particularly on the first day. On the whole, however, the provision made for counter service was reasonably satisfactory. About 40 per cent. of persons using the Office were from abroad and the services of an interpreter provided by the Post Office in the public office were much appreciated.



ANALYSIS OF OUTGOING TRAFFIC HANDLED AT THE VARIOUS OLYMPIC CENTRES

	ALDERSHOT			BISLEY			CAMBERLEY			HENLEY			TORQUAY*		
	15.7.48—25.8.48			2.8.48—6.8.48			19.7.48—5.8.48			2.8.48—16.8.48			9.7.48—16.8.48		
	Inland Trunk Calls	Inland Tele-grams	Foreign Tele-grams	Cont. Overseas	Inland Trunk Calls	Inland Tele-grams	Inland Trunk Calls	Cont. Overseas	Inland Trunk Calls	Inland Tele-grams	Foreign Tele-grams	Cont. Overseas	Inland Trunk Calls	Inland & Foreign Tele-grams	
Total No. of O/G Calls	114	27	12	2	146	176	83	9	852	66	40	5	247	482	
Max. No. of O/G Calls connected on any one day.	23 (23.7.48)	12 (10.8.48)	6 (13.8.48)	1 (3.8.48)	49 (5.8.48)	18 (4.8.48)	10 (26.7.48)	4 (9.8.48)	162 (9.8.48)	27 (7.8.48)	15 (7.8.48)	3 (10.8.48)	32 (4.8.48)	—	
Total No. of chargeable mins. for the whole period.	379	—	—	16	763	—	413	71	4,193	—	—	20	1,283	—	

	WEMBLEY				KINGSTON				UXBRIDGE				WEST DRAYTON	
	28.7.48—14.8.48				5.7.48—23.8.48				22.7.48—12.8.48					
	Press Centre Attd. Call Offices		Press Stand Attd. Call Offices		Unattended Call Offices		Attended Call Offices		Cont.	Overseas	Foreign Telegrams	Cont.	Overseas	
	Cont.	Overseas	Cont.	Overseas	Cont.	Overseas	Cont.	Overseas						
Total No. of O/G Calls...	122	9	23	2	18	73	103	22	22	14	—	—	—	
Max. No. of O/G Calls connected on any one day.	12 (2.8.48)	2 (30.7.48)	4 (31.7.48)	1 (30.7.48)	4 (31.7.48)	—	—	11 (5.8.48)	4 (22.7.48)	2 (27.7.48)	—	—	—	
Total No. of chargeable mins....	1,200 Estimate	26	160 Estimate	3	—	—	—	354	84	—	—	—	—	

\* The majority of the Correspondents and Competitors who made or received calls abroad did so from their hotels. It is not possible to check how many such calls were made.

A small public office was also provided in the Stadium itself, alongside the positions allotted to the several cable companies. This office was primarily for the convenience of press correspondents wishing to send messages to places in Europe served by Post Office telegraphs, but little use was made of the facility. The office was open only when events were in progress and for one hour before and after.

3. The Post Offices at the three main housing centres were not available to the general public. No more than three counter serving positions were required at any of them at any time. Generally the hours of opening proved to be satisfactory.

4. As it was not possible for the Organising Committee to allocate teams to housing centres until shortly before the Games, each country's team was given a London E.C. box number. Competitors and team officials were informed that their address for mail would be, for example:

Name of Competitor (or Team Official),  
Olympic Team of \_\_\_\_\_,  
Box \_\_\_\_\_,  
London, E.C.1, England.

and for cables:

Name of Competitor (or Team Official),  
Olympic Team of \_\_\_\_\_,  
Box \_\_\_\_\_,  
London.

The Organising Committee kept the Post Office informed of the location of the various teams for the re-direction of mail and cables. About 3,000 letters per day were dealt with in this way ; there were about 150 parcels in all. Mail and telegrams were delivered to the Camp Commandant at the appropriate housing centre and he assumed responsibility for delivery to the individual competitor or team official. This arrangement worked well.

5. There is no philatelic department in the British Post Office and no special arrangements were made for the benefit of philatelists in connection with the issue of the Commemorative 2½d., 3d., 6d. and 1/- stamps and 6d. air letter forms except that posting boxes in the Wembley Stadium grounds were specially marked in French, Spanish and English to indicate that items posted therein would be stamped with a special Olympic Games postmark. Only unregistered items, which were suitable in size and make up for passing through an ordinary stamp cancelling machine and which were posted in these boxes or handed over the counter at the Olympic Games Post Office at Wembley, bore this special postmark. The Olympic Games stamps were on sale at all Post Offices in the United Kingdom from July 29, 1948 ; they were withdrawn from sale on December 31, 1948.

The numbers sold were :	2½d. ....	155,350,000
	3d. ....	32,554,000
	6d. ....	24,397,000
	1/- ....	32,187,000
	Air letter forms .....	4,060,000

6. A schedule of the business done at the Olympic Games Post Office at Wembley and at the Post Offices in the housing centres is given below :—

Olympic Post Office	Value of stamps sold	No. of parcels accepted	No. of packets registered	No. of transactions			No. of telegrams	
				Money Orders	Postal Orders	Saving Bank	For-warded	Re-ceived
	£							
Wembley	3,695	23	1,401	75	672	496	1,382	440
Richmond Park	1,679	570	962	31	283	—	716	2,550
Uxbridge	1,558	223	436	64	211	—	723	2,962
West Drayton	533	150	213	25	169	—	381	1,126
Totals .....	7,465	966	3,012	195	1,335	496	3,202	7,078

### CONTINENTAL PICTURE CALLS

#### Picture Calls To or From

Date	Stockholm	Copenhagen	Paris	Oslo	Gothenburg	Milan	Brussels	Berlin	Frankfurt	Zurich	Prague
29 July	18	18	11	4	1	6	1	2	2	2	—
30 "	31	20	17	7	4	3	1	—	—	—	2
31 "	26	25	18	1	6	1	4	—	—	—	—
1 August	17	1	1	1	—	—	—	—	—	—	—
2 "	25	18	22	4	4	1	—	—	—	—	—
3 "	25	22	15	4	3	1	1	—	—	—	—
4 "	32	22	21	3	3	1	1	—	—	—	—
5 "	36	26	24	4	4	1	1	—	—	—	—
6 "	36	25	13	3	1	1	—	—	—	—	—
7 "	26	20	8	—	1	3	3	—	—	—	—
8 "	8	—	—	4	—	2	—	—	—	—	—
9 "	17	11	8	3	3	2	—	—	—	—	—
10 "	26	14	3	3	3	—	—	2	—	—	—
11 "	17	8	3	1	3	—	—	—	—	—	—
12 "	18	12	8	3	3	—	—	—	2	—	—
13 "	28	21	17	3	1	3	1	2	—	—	—
14 "	20	14	8	—	1	2	—	—	—	—	—
Totals ...	406	277	197	48	41	27	13	6	4	2	2

## PRESS DEPARTMENT

At the start of the report of the Press Department it is of interest to review the attitude of the press itself towards the Games.

In the early days there was by no means unanimity in support of the Games; there were those few who have so far always been hostile to them, those who approved of them but doubted if 1948 was the time to hold them, and those who doubted if, as a result of the destruction by the war and the innumerable shortages, England could carry them through adequately. However, when the decision to hold the Games here was taken the great bulk of these latter two groups came in wholeheartedly behind the Organising Committee, who owe them a real debt of gratitude for their help.

The Press Committee was formed under the Chairmanship of Mr. C. B. Cowley and the Members were, Mr. Francis Williams, Mr. J. H. Brebner, Mr. Howard Marshall and Mr. H. M. Abrahams. Mr. R. F. Church, Press Officer, was Secretary.

The Committee gave much useful advice during the first year of the preparations, but it was then disbanded for, owing to the increasing necessity of immediate decisions, it was found impossible to refer the day-to-day problems to it for advice. The activities of the Department were from then carried out by the Press Officer under the Chairman of the Executive Committee and the Director of Organisation with the experienced advice of Mr. C. B. Cowley.

The Department opened in January, 1947. The Press Officer decided to tackle every individual critic and follower on his own ground and persuade him by specialist treatment, of the rightness of the course. Those with influence on the sports side of the newspapers were encouraged and those hoping to intrude with political opinions avoided or completely ignored. This policy paid dividends for although, even in the last days before the Games, many came to abuse, they stayed to praise. These Games can claim among their records the best press ever. The most glowing leading articles appeared even from the ranks of the bitterest critics and, despite the counter-attraction of a disturbed political situation, more space was given to the Games than to any other single event since the end of the war.

The Press Department had hardly started its work when one of the greatest economic interruptions that Great Britain had ever experienced took place. It is difficult, on looking back, to realise what the " fuel crisis " meant at that time. It disrupted everything ; progress was at a standstill. But, after that cloud had blown away, inroads were made upon the columns of the meagre four-page papers in Great Britain. A monthly newsletter was begun, first in stencilled form and then in printed and illustrated stapled sheets. After two issues, it was translated into French and Spanish as the two other official languages of the Games. This letter achieved a world-wide circulation in a short time and, although the papers in Great Britain and America preferred the " hard " news which appeared in announcements, or in stories which they themselves developed, distant countries and European nations used the material in the letter to a very great extent.

There was an early demand for photographs, which was very difficult to satisfy, for apart from stock pictures of the various venues, there was nothing to photograph until the later stages of the preparations. In Berlin before the 1936 Games there was always something being built, but in London the first alteration of any kind was at the housing centre at Richmond in the spring of 1948.

The newsletter was supplemented by another of a more modest kind for tourist agencies and finally, shortly before the Games, a complete programme and time table was produced.

The modern trend of publicity produced demands for news of the Olympic Games from a wide field, including government departments, radio companies, sporting organisations and schools, as well as from the Olympic Committees throughout the world.

The policy of encouraging inquirers to write personal stories rather than rely on printed material led to hundreds of interviews having to be granted, and, six months before the Games, apart from home inquiries, visits had been paid by journalists and correspondents from over fifty countries. The resultant publicity was most gratifying.

### **Facility Visits (Olympic Camps)**

Requests from journalists, photographers, newsreels and broadcasters, for access to Olympic Camps, particularly to Richmond, were heavy.

Up to the time of the appointment of Senior Press Stewards to the three main camps, facilities were organised by the Press Office. Where possible, these early visits and tours were personally conducted by members of Headquarters staff, and where this was not practicable, arrangements were made with the Camp Commandants to attend to the needs of the press.

It was clearly laid down in all cases that contact with competitors must be arranged through chefs de mission or team managers and no interviews or photographs permitted without their consent.

The official opening of each housing centre attracted large attendances of press and photographic representatives, and coverage was excellent.

Many visiting and home journalists also wished to visit the training grounds and the venues of the Games in order to note preparations and progress. For example, a party of Swedish editors visited Wembley a month before the opening of the Games, U.S.A. and Canadian journalists visited Aldershot and Camberley, and South African journalists visited West Drayton before their teams took up residence there.

Shortly after the official opening of the three main centres, Senior Stewards were appointed to attend to press facilities, and this relieved the Press Department headquarters of the bulk of the work.

### **Olympic Photo Association**

The Olympic Photo Association was set up as the body to take all the official photographs at the Games. It was composed of representatives of the leading picture agencies.

There was some heartburning about the privilege given to the Association to take, exclusively, all the photographs from the selected sites approved by the Committee and the international federations governing sports—but there is no other way of achieving reasonable control of photographers in the arenas. In return the Association had to take all their pictures from the agreed positions and had to make them available to all other agencies and to the general public. A large number of tickets were, however, made available to such other photographers as might care to take pictures from other vantage points which did not encroach upon the Association's territory nor upon the arenas. The negotiations leading up to this arrangement were long and difficult, and the work of taking the operators to every single arena, assessing the possibilities and obtaining the agreement of the governing bodies was an arduous task. That the trouble taken was worth while, may be gauged from the remarkable display of photos which appeared in newspapers all over the world.

Brassards had to be worn by the Association's photographers and the stewards were instructed to admit and allow to operate only photographers wearing such brassards, which were numbered as an additional check. The maximum number of photographers to be permitted at each venue, especially in the arena at Wembley, was laid down by the Organising Committee, in consultation with the International Sports Federations. The programme of events and coverage was worked out before the Games opened, for the whole fifteen days, but the briefing committee of the Association met each morning throughout the Games to discuss the following day's events and to give final and detailed instructions as to the exact placing of the operators, and their particular duties. Transport, which was, of course, also pooled, was arranged each day at these meetings, so that not only could photographers be conveyed to and from the various venues, but a constant service of motor-cyclist messengers bringing back exposed plates to Fleet Street was running all day. In order to co-ordinate this service, and to make sure that all material was sent back with as little delay as possible, liaison officers were appointed at the various venues, and more particularly at Wembley, to collect plates from the various operators, not only in the arena, but at the Empire Pool and at the Palace of Engineering and to dispatch the motor-cyclists as necessary. They were in constant telephonic communication with Fleet Street, and were able therefore to advise the agencies when they could expect packets to arrive, and also were able to request extra plates or apparatus or even additional photographers to be sent back to the venues. Through these same liaison officers, arrangements for securing specially commissioned photographs for various British and foreign papers were made, it being left to their discretion to make the necessary arrangements with the operators on the spot.

Eight photographers only were permitted by the Organising Committee to operate in the arena at Wembley at any one time. Two permits were allotted to the Newspaper Proprietors' Association, and the Olympic Photo Association had six operators in the arena every day throughout the period of the events. Their positions were clearly laid down, and they were allowed a minimum of movement. In addition to these six, there were usually several others with roving commissions for crowd pictures, general views and other incidentals. Three men covered the swimming every day, and some twenty-five were

employed daily on such other events as were taking place. Special facilities were granted for the marathon, the road walk and the cycle road race, to enable operators to use cars on the road. Twelve operators were employed at Windsor. As far as possible operators were moved from venue to venue to avoid the risk of staleness, while at the same time every endeavour was made to ensure that the right man was placed in each position. On the busiest days some forty photographers were employed. Twenty operators covered the Opening Ceremony.

Agencies in the Association were responsible for issuing to the British press those photographs taken by their own operators. One print of each photograph was immediately made available to every other agency who could copy it, if desired, for use in its own foreign service, for transmitting by wire, or for dispatching by air-mail.

Of the countless thousands of pictures exposed during the Games, three thousand and thirty were printed for issue to the press of the world, and put on view to the public at the Association's sales bureau and exhibition in the Palace of Engineering at Wembley. Public demand and interest was enormous and the staff on duty were constantly occupied taking orders and dealing with inquiries, from 9 a.m. when the exhibition opened until 9 p.m. when, with great difficulty, the doors were shut. As the would-be purchasers came from all parts of the world, many of the conversations were conducted in dumb-show and pantomime, with a good deal of amusement on both sides. The exhibition overflowed on to the verandah outside, and after four days it was found necessary to take over another room to cope with the great queues of people. The Association's offices were likewise besieged by numbers of people unable to get to Wembley. Nor did the interest die with the ending of the Games. It was therefore decided to transfer the exhibition to London, and it was opened in the week after the Games at the St. Bride's Institute, Fleet Street, where the public continued to show their interest for another fortnight. The Association was dealing for several months after with callers at their office and with inquiries and orders from all parts of the world. Over five thousand orders for varying numbers of prints have been dispatched to all parts of the world.

The member agencies had agreed to sink their identities in the Association so all fees were paid to the Association, and they were re-imbursed for services rendered.

### **Films**

It was clearly quite impossible to have more than a very limited number of cameras in the arena and in addition it was necessary for the makers of the official film to recoup some of their heavy expenditure. Consequently, an agreement was made with the J. Arthur Rank Organisation to give them the monopoly of taking the official film. This they did using a new colour technique. In addition many thousands of feet of black and white film were taken.

As regards the newsreels, a monopoly of taking the films was also arranged in consultation with the Newsreel Association, and the films made available to newsreel companies throughout the world. Up to the date on which the agreement with the Newsreel Association became effective, the newsreels were very busy, and all the six leading companies made picture stories at least once a week for three months before the Games.



## **Communications**

The next major problem in the preparations was the telephone, cable and wireless transmission problem. Owing to post-war conditions, the Post Office had to have the longest possible notice of press requirements and this involved a good deal of guesswork as it was quite impossible to get newspapers to indicate in advance how many telephones they would want. The greatest tribute must be paid to the Post Office for their help.

On the basis of these forecasts, telephone, cable and wireless facilities were arranged at each of the venues where contests were to take place ; some quite extensive as at Wembley and some quite modest as at the football and hockey grounds for the preliminary rounds. Not a single complaint was made by a correspondent that he could not get his copy away, or that it was seriously delayed in transmission.

## **Ticket Allocation**

The allocation of press seats was perhaps the most difficult task of all. Accommodation could not meet the demand and some system of rationing had to be devised. The Organising Committee decided to allot tickets to countries in proportion to their entry in the Games. Incidentally there was a precedent for this, for in the Berlin Games roughly one press seat for every ten competitors was allocated. The position was further complicated by the fact that some venues, such as the stadium at Wembley, would accommodate 600 pressmen whereas others could take only as few as fifty. It was therefore manifestly impossible to allow every one a season ticket which would take the holder to a seat in any arena at any time. Hence the allocation had to be made according to each country's participation in the Games generally and according to their entry in any sport in particular. It was assumed that if a country was not participating in a sport, its public would not need special detailed reports.

It must not be thought that the system was simple in application. Once the allocation was made there were, as expected, some protests from certain nations.

Even at the Empire Stadium there was an acute shortage of accommodation. Some countries asked for many more seats than those to which they would have been entitled under any system of allocation. These nations received a special letter from the Chairman suggesting that they should purchase tickets for such additional seats as they required and where they did so, they were provided with identity cards which enabled the holders to enjoy all the privileges of pressmen although not given a seat in the official press stand. The number of complimentary press tickets issued was 1,364, but over two thousand journalists actually attended the Games, the biggest assembly of journalists ever to report an event of its kind.

In every instance, however, a guaranteed seat was provided for the principal news agencies of the world and the technical journal of the sport concerned. The results proved that in every country a full report was available to the press even though all its demands for tickets could not be met.

At the Empire Stadium there was accommodation for 600 pressmen, and all had access to the cable station, post office, and the restaurant which were near at hand. At the

Empire Pool 300 were accommodated, and seating at the other venues varied according to their size and the need of the press. Considerable construction had to be carried out at the Empire Stadium, the Empire Pool and the cycling and rowing venues, but in all cases the estimates of requirements proved adequate. During the whole course of the Games, only two people made complaints of their seats being wrongfully occupied. This was partly due to strict supervision by the stewards. The seating and ticket problem would, however, have been much easier to handle if it had been possible to insist on National Olympic Committees making their returns to date.

The block allocation of tickets for the Empire Stadium and other main venues was made through National Olympic Committees for overseas and the Newspaper Proprietors' Association for home journalists.

There remained a certain limited number of tickets for daily or sessional admission, which were allocated at the discretion of the headquarters staff and senior stewards. In the case of some of the outside venues, tickets were given to the steward-in-charge and all press inquiries for admission which had not already been dealt with by the original allocation were dealt with on a basis of priorities on the spot. The system worked satisfactorily.

In the case of the Empire Stadium, a small reserve of tickets was kept at the Information Desk for distribution on a strictly controlled basis for specially deserving cases.

There was no case reported of any bona fide journalist being unable to obtain admission to any venue.

### **Press Centre**

The creature comforts of the press were provided mainly by the generosity of the newspaper proprietors of Great Britain, who between them subscribed ten thousand pounds towards the provision of a club which acted as a business headquarters as well as a restaurant. The Ministry of Works lent valuable help in providing kitchen equipment; the Wembley authorities gave the premises rent free; and the Housing Department helped with the catering plans. The club had to be manned night and day by the Press Department. This centre was opened by Lord Rothermere (Chairman of the Newspaper Proprietors' Association) and Lord Burghley on July 28.

The provision of press stewards at all venues and main camps presented a complicated problem. Duties fell into the following main categories :

1. Manning the information desk at the press centre and venues for the period of competition and maintaining liaison with headquarters at Wembley.
2. Transmitting results from outside venues by phone or teleprinter to Wembley for distribution.
3. Supervising press seating and telephone facilities.
4. Dealing with press queries as they arose.
5. Organising the collection, recording, collating, duplication and distribution to all journalists in the Stadium of all Olympic results from all sources, and supplying full sets of results to Organising Committee headquarters and the Information Centre.

To operate this service a Chief Press Steward was appointed a month before the opening of the Games, and he was assisted by 20 senior, 40 assistant and 60 junior stewards.

Senior stewards were recruited mainly from professional and service men on leave and medical students. Assistant stewards were mainly students, senior schoolboys and keen amateur sportsmen with a knowledge of the section to which they were appointed. Junior stewards were supplied by the Boy Scouts' Association and acted as messengers, and distributors of results.

As soon as competitors began to arrive from overseas, press stewards were installed with their own offices, telephone call boxes and reception rooms, at the housing centres at Richmond, Uxbridge and West Drayton. Their duties were to receive visiting press men and to arrange through the respective team managers for any facilities which might be required.

At the Information Centre installed in the Civic Hall at Wembley, visiting journalists made their inquiries, picked up their mail, collected the day's programmes and results, and had the use of a special silence room for their work.

At the Empire Stadium, during the athletics' week, at least two senior stewards and fourteen assistants were on duty to look after 600 members of the press to whom seats were allocated. One senior and one assistant were assigned to the Results Box for the purpose of checking results, as given out over the loudspeaker, for the benefit of any members of the press who might have been absent from their seats at the time. Such results were posted in the windows of the Box, as were such matters of interest as special announcements and photo-finishes. A direct telephone line to the Arena Manager was available to the Steward-in-charge.

Three senior stewards were employed in the distribution of duplicated results. These results which came in on stencil-cutting teleprinters from all venues were duplicated on electric machines and distributed to the Press in their seats, to the Information Centre, and to Organising Committee headquarters at 37, Upper Brook Street. During the athletics' week some 25,000 copies were made daily and distributed by Boy Scout Messenger Service.

During the second week of the Games, with the transfer of gymnastics to the Empress Hall, Earl's Court, it was possible to reduce the work and staff at the Empire Stadium by about two-thirds and to increase the staff at certain of the other venues.

### **Accommodation**

Accommodation was another aspect of the journalists' comfort and it became a self-imposed task of the department to help as far as possible in this particular, having regard to the acute accommodation shortage due to the war.

National Olympic Committees were advised early in 1948 to inform the press of their respective countries that every effort would be made to provide hotel accommodation for visiting journalists, provided they were duly authorised by their N.O.Cs. and carried the appropriate identity cards. The response was slow, largely owing to the uncertain number of tickets to be allocated to each nation.

It was impossible to reserve suitable accommodation by the customary method of payment of a deposit, but hotels and boarding houses in Central London, and private accommodation in the Wembley area were visited and inspected where advisable. Each visiting journalist was helped to find suitable accommodation. Altogether some 480 rooms were thus provisionally bespoken.

A further communication was sent to N.O.Cs. in June stating that if advantage was not taken of the scheme before July 1st, no guarantee of accommodation could be given.

In practice, fully authenticated journalists were still arriving up to the opening day of the Games, without having previously booked accommodation. Not one was disappointed. Some 230 were put in touch with suitable addresses. Many cancelled at the last moment, having made other arrangements, but on the whole the scheme worked well and no complaints were received.

### **Poster**

An official poster was produced in connection with the Games. As there was not time to stage a competition for the design of the poster, the choice rested between a few designs submitted to the Executive Committee.

As regards production and distribution, 100,000 copies of the official poster were printed (50,000 double crown, 25,000 crown and 25,000 double royal). Estimates were obtained for distribution, but the cost was prohibitive. It was decided to organise free distribution, and this was done by the Press Department.

The first step was to approach the governing bodies in Great Britain of the seventeen sports concerned in the Games. These bodies accepted quantities varying from 400 to 2,000, covering a total of nearly 10,000 for distribution among branches and affiliated bodies. All travel and tourist agencies with offices in London were approached, as also were all airlines with services operating to and from Britain. This accounted for a further 6,000-7,000.

A circular letter from the Director of Organisation inviting co-operation in the distribution was sent to the Town Clerks of nearly 300 towns and cities in Great Britain, and to the Directors of Education of all counties. This was followed by parcels of posters with varying numbers in proportion to the size of the towns or district concerned. The response was excellent. Only three towns failed to co-operate, and a large majority promised to display the posters on corporation vehicles, in schools and sports pavilions, and in public places in their areas. Every London Borough was covered, and each area in which sections of the Games were to take place was given special attention. In addition, every housing centre was given a generous supply.

Repeat orders were being received right up to the time of the Games, and the whole 100,000 were eventually distributed.

There were two subjects on which disappointment was expressed by visiting journalists.

It had always been the practice to give free travel in the towns holding the Games, but the authorities in London would not grant this. The other disappointment came from the

non-issue of badges to the press, who value them more as souvenirs than indications of authority or privilege.

### **Staff**

After the appointment of the press officer in January, 1947, the first assistant came in September of the same year and the third staff appointment was made in April, 1948. These three were responsible for publicity arrangements in connection with the Games. There were four secretarial assistants during the peak period and, including the voluntary corps of stewards at the Games, there were never more than sixty people engaged. It would be impossible to name all those who gave up their holidays to join the team, but none of them will ever forget the occasion. The newspapers in almost every country in the world bear ample testimony to the work performed.

In this, the greatest undertaking of its kind ever staged, it is a matter for satisfaction that there were few complaints and that afterwards many congratulatory letters were received from all over the world.

Interest in the Games reached a higher level than ever before, and their success completely confounded those critics who had pessimistically forecast dire failure and international discord.

# RADIO AND TELEVISION

The XIV Olympiad was the greatest sporting festival that had ever been staged and the progress and results of the 136 Olympic events were of interest to millions of people throughout the world. As only a small number out of those millions was able to be at the Games in person, radio had to provide the rest with the nearest equivalent to front row seats whenever and wherever anything exciting was happening. Thus, the listeners of five continents found themselves at Wembley as the competitors of 59 nations marched into the Stadium in brilliant sunshine on the opening day and, thereafter, as record after record was broken, they were able to share in the suspense of each event while it was actually taking place. In fact, they were often better off than the spectator, because he could be in only one place at once, whereas the radio listener could visit half-a-dozen venues in as many minutes and could travel from Empress Hall to Torbay at the turn of a single knob.

## **Planning the Radio Facilities**

The size of the broadcasting operation meant elaborate technical arrangements—so elaborate that plans had to be made and new equipment ordered long before it was possible to know exactly what might be wanted when the time came. Discussions about the radio coverage of the Games first took place in November, 1946, 20 months before the opening of the Games. The British Broadcasting Corporation realised, at that time, that there must be much guess work in arriving at the final plan, but it was necessary to guess accurately so as to make the best possible use of manpower and materials at a time when both were needed for post-war reconstruction.

Details of the broadcasting provisions for the Berlin Games provided a useful starting point, always bearing in mind that radio had had ten years to develop since 1936 and that in those ten years the British Broadcasting Corporation had increased the number of languages used for broadcasting from four to 43. Finland's unfulfilled plans for 1940 were also available, and useful discussions were held with Finnish broadcasters about what was contemplated for the Helsinki Games of 1952. At the same time, the radio organisations of all countries likely to send competitors to London were asked what their broadcasting requirements were likely to be : whether they would want to make recordings or broadcast " live," in which events they were likely to be most interested, and how many " reporters " they hoped to send. Helpful replies were received and by July, 1947, with twelve months still to go, the basic plan was agreed upon and put in hand.

This basic plan had to fulfil two main needs—the provision of enough commentators' microphones at positions overlooking each of the thirty Olympic venues and the construction of a Radio Centre which would link all the outside microphones and which would provide a focal point for the whole Olympic Games broadcasting operation. It was plain that this Centre must be at Wembley, within easy reach of the Stadium and Pool. It was not so easy to decide how big it should be or how elaborate. At first it was proposed to erect a temporary building alongside the Stadium. This would have been both costly and cramped, so instead the Wembley authorities offered to lend the

B.B.C. the " Palace of Arts " building which was close to the Pool and in which at one time it was planned to house the fencing events. This offer was a great boon to broadcasting, for there was plenty of floor space and the building was conveniently placed.

While the planning of this Radio Centre was still in its early stages, the outside venues were being surveyed one by one and, with the help of the Olympic Games organising staff, points of vantage were being set aside at each venue for broadcasting purposes. The ideal would have been to provide enough facilities for every reporter to broadcast " live " or to record whenever and wherever it suited him. Even if it had been known at this stage that well over 200 radio reporters would be in London for the Games, it would clearly have been impossible to reach this ideal, since not only did the Games range over so many different venues, but at some of them more than one viewpoint was required (*e.g.*, at the Palace of Engineering where the fencers used several different pistes hidden from each other by spectators' stands). The result was that there had to be a drastic rationalisation of all the possible demands, and the B.B.C.'s available resources of equipment and technical staff had to be concentrated at the points where they were most likely to be needed. To decide on such concentrations was partly a matter of common sense, but it would have been less than common sense to suppose that no more than two microphone positions would ever be required for, say, boxing just because contestants from only two countries could be simultaneously involved in any one boxing bout. More commentators' microphones might be needed for several reasons, *e.g.*, one of the countries involved might have more than one broadcasting system (like Holland or the U.S.A.) or it might have citizens who did not share a common language (like Belgium or Switzerland or Canada) or, like the B.B.C., it might have shortwave services broadcasting in many languages other than its own. In addition, some nationalities might be so enthusiastic about boxing that they might wish to broadcast or record a commentary on a bout in which they had no competitor. In the end, a detailed scheme was worked out for each venue and events were left to prove or disprove its adequacy.

This scheme involved a total of 121 commentators' microphones, an average of four for each venue. At one end of the scale this average was much exceeded, for in the Empire Stadium there were 32 commentators' positions and another 16 in the Empire Pool. The reason for this concentration is evident, since in these venues were staged such events as athletics and swimming, which involved a number of nations simultaneously, and which were run off in such a swift succession of heats that there was not always time for commentators to change places between one heat and the next. Such a situation was bound to create a demand for the largest possible number of positions. In addition, the events at the Pool and the Stadium were not only amongst the most important in the Games from a broadcasting point of view, but were generally of an appropriate length for commentary treatment. By contrast, the shooting at Bisley gave so few opportunities for " live " commentary that the facilities there could more safely be confined to a single microphone from which progress reports could be made as the event developed. In between these extremes of thirty-two microphones at the Empire Stadium and one at Bisley came six at Henley, Herne Hill and Windsor Great



Park, four at the Empress Hall, Harringay and the Palace of Engineering, and then an assortment of threes and twos for the eleven grounds where the football and hockey preliminaries were staged. At Torquay for the yachting a launch was equipped with a transmitter, and there was a second microphone on shore from which progress reports could be made at convenient intervals. It was expected that this launch would be well occupied, as the five daily races took place simultaneously and were divided between three different courses. On the other hand, Torquay was 200 miles from the other Olympic centres and it did not seem probable that many commentators would be able to spare the time to travel so far afield.

The microphone used by commentators at all these outside venues was of a special B.B.C. type (lip-ribbon) that normally made it possible to do without sound-proof boxes. Many visitors to the Games must have carried away memories of broadcasters talking excitedly in unknown languages or listening intently on headphones as they checked their watches against the Post Office time signal or waited to pick up an opening cue from some studio announcer on the other side of the world. If ever they did find the commentators uncomfortably close, the spectators never complained, for they no doubt recognised the part that radio was playing in enlarging so greatly the Olympic Games audience. Spectators had of necessity to be numbered in thousands but listeners could be numbered in millions.

Besides the actual microphone positions at each venue, extra seats had to be installed for commentators who were awaiting their turn at one of the microphones or who were watching an event in order to make a studio report later in the day. Here again, it was not easy to determine in advance how many seats would be needed. Space was valuable and it was important to strike a balance between wasting seats and having too few for an efficient use of all the radio facilities available. This meant a close study of the Olympic Games schedule. Where two events overlapped it was clear that commentators could not be in both places at once, but it was equally clear that commentators would not always divide themselves evenly between the two venues. Each place would, at some time or other, be staging an event which commanded a " peak " load of interest, and it was just at those times that it was most important not to have to turn broadcasters away. Broadcasters were allotted about two hundred seats in the Empire Stadium, one hundred in the Empire Pool and anything from ten to fifty at the other venues.

### **The Radio Centre**

Having surveyed the outside venues and gained some idea of the number of broadcasts that might have to be handled simultaneously, the final lay-out for the Radio Centre had to be determined. This lay-out needed careful planning, since here was to be the hub of the whole broadcasting operation. Not only was it to be a technical centre, through which nearly all the Olympic broadcasts would pass, but it was also to be a working centre for the reporters and an administrative centre for booking and controlling all the facilities. As finally planned, the Centre covered an area of some 35,000 square feet, of which 25,000 square feet were devoted to technical operations, *e.g.*, control room, studios, recording " channels," and playback rooms. The remainder provided ad-

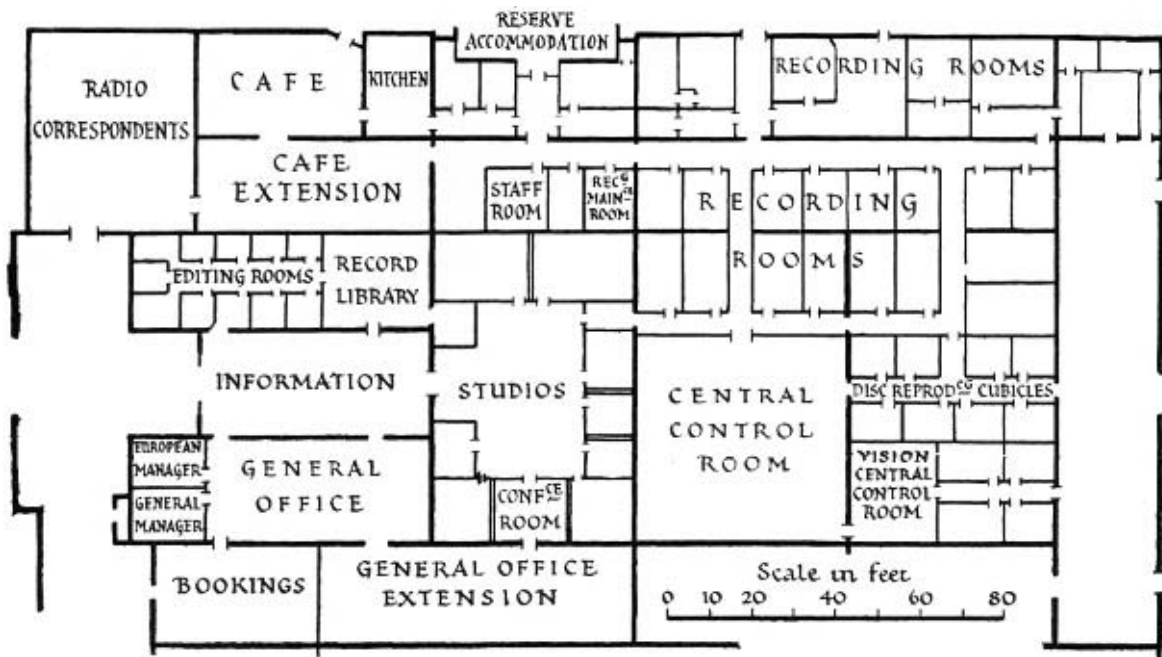

THE RADIO CENTRE

ministrative and booking offices, a radio correspondents' room, an information room and a canteen and bar. The whole had to be built inside an existing shell and took six months to construct and equip.

The show piece of the technical area was the control room. It was capable of passing 32 simultaneous broadcasts (or 36 in an emergency) and each broadcast (or recording) could combine a mixture of "sources," *e.g.*, "live" commentaries from the Empire Stadium, the Empire Pool, Torbay and Herne Hill, as well as a studio report with recordings made earlier in the day. One such broadcast, for a Dutch station, lasted over four hours. This control room also housed special turntables which played records, in the appropriate languages, for "guiding" trans-continental line transmissions to their right destinations. A broadcast for Czechoslovakia would, for instance, be heralded by "Transmission from London to Prague" repeated in English, French, German and Czech until the line was safely established all across Europe. This idea was, incidentally, suggested by the Finnish Broadcasting Authorities for their own Games in 1952.

Grouped around the control room were sixteen studios (eight of them were disc reproducing cubicles equipped for emergency studio use only), two television production suites and twenty disc recording channels, which were used for commentaries originating at any of the outside venues. This "pooling" of recording equipment at Wembley ensured its most productive use, besides making certain that all the discs would be on the spot for immediate reproduction in studio "round-ups" of the day's events. The discs, after checking, were passed to a library for filing. Here they could be collected by broadcasters and taken next door for timing and editing. There were eleven such editing cubicles and anyone lingering outside them in the early evening could get a

very good idea of what working conditions must have been like at the Tower of Babel. Apart from these twenty static recording channels there were twelve recording cars, one of which was capable of making eight different recordings at once.

Of the non-technical part of the Radio Centre, one of the most important areas accommodated the ten service organisers, whose job it was to co-ordinate broadcasting needs within a given language group or throughout a certain part of the world. These service organisers gave a provisional acceptance to requests for this or that facility and then agreed their schedule with the Bookings Room, who had the final say as to what was possible. This Bookings Room was much helped by the presence of Post Office representatives, who could deal on the spot with requests for trans-continental and transatlantic circuits. The Information Room was also of vital importance to commentators. Here were displayed, as soon as they became available, lists of competitors, the draw for heats, the timetable of each day's events and the fullest possible list of results. Most of the material was " duplicated " on the spot and made available in " hand-out " form. The Information Room also displayed Olympic Games weather forecasts, provided twice daily for the purpose by the Central Meteorological Office at Dunstable.

This then was the set-up which was ready to go into action in the last week of July, one that involved thousands of pounds' worth of B.B.C. equipment diverted from other uses, and hundreds of miles of special wiring installed by the General Post Office. The staff to man all these facilities, sufficient to cover a two-shift day, had been borrowed from other B.B.C. work and needed a few days in which to study the new parts that they had to play. Someone from the B.B.C.'s Schools Department might perhaps be organising the distribution of tickets to all the different venues, or a regional programme expert might be deciding the best way to display pentathlon results in the Information Room. Altogether, some 750 B.B.C. staff were involved in the operation as a whole (including television). Of these, 350 were engineers, 200 were reporters and other programme staff and the rest were concerned with the transport, canteen, telephone and messenger services, with on-the-spot help to broadcasters at each of the outside venues and with general office work and organisation, including a 48-hour laundry service for visiting broadcasters and a supply of Olympic Games postage stamps for those who were too busy to queue up for them.

### **The Broadcasting Machine in Action**

By the Tuesday before the opening day most of the visiting broadcasters had assembled in London. In the end there were 134 visitors ; of these 120 were directly engaged on reporting work. Between them they represented 60 different radio organisations and 28 different countries, and they came from as far afield as Korea and Peru. The B.B.C., with its services in (at that time) 41 languages, had 146 reporters of its own, so that an original estimate of 180 broadcasters had grown to a grand total of 266. It was necessary to acquaint all these broadcasters with the nature and whereabouts of the facilities, and with the procedure for securing their requirements. This information was provided in a broadcasting handbook, which also included details of the 136 events. An attempt

had been made to concentrate visiting broadcasters in one hotel and a small enquiry office had been opened nearby for their use.

There were a few broadcasts from the Radio Centre on the day before the Opening, and then on the opening day itself the machine really swung into action. Twenty-eight of the 32 Stadium " positions " were in use both for " live " and recorded commentaries on the Opening Ceremony. Over 400 discs were cut and 80 " live " broadcasts passed through the Radio Centre. Next day's " load " was a great deal heavier and was complicated by the fact that events in the Stadium were running late and it was necessary to make drastic alterations in a very tightly-packed schedule. These alterations were not carried through without some anxieties, and in particular one or two of the more precarious European line circuits failed to cope with the emergency. Thereafter things improved, though the circuits to Denmark and Scandinavia always remained a little problematical.

On the whole, the facilities proved equal to the demand. Only at Harringay and Windsor Great Park had a few extra microphones to be added. Pressure on seating was at times heavy, but the only crisis was when heavy rain twice induced spectators to leave their unprotected seats in the Stadium and crowd amongst those commentators' positions which were under cover and opposite the finishing line for the track events. However, Stadium officials intervened and the situation was saved. In the Radio Centre, too, facilities seemed equal to demand, though on several occasions the sixteen studios only just met peak load requirements, the reason being that studio reports of the day's proceedings tended to accumulate each evening around the 6 p.m. to 8 p.m. period.

Statistics show that " live " Olympic broadcasts averaged 103 per day for the fifteen days of the Games. There was, in addition, a daily average of 175 recordings, which involved each day about 400 discs (6,066 in all for the fifteen days). The heaviest " load " was on the Wednesday of the first week when there were 364 " operations," of which 114 were " live " broadcasts and 250 were recordings (478 discs). A good proportion of each day's " live " broadcasts lasted 15 minutes, and involved studio reports illustrated by recordings made earlier in the day, but many of them lasted half-an-hour or more and involved contributions from a number of different venues. In some ways the longer broadcasts were easier to handle, since they gave broadcasting and lines engineers some respite from the continuous strain of breaking down and setting up all the different circuits required in so elaborate an operation; for, at one moment, a control room position might be handling a broadcast from Henley and the Empire Stadium to Radio Globo, Brazil, and the next, a hockey commentary for India or a basketball broadcast from Harringay to the U.S.A. In fact, the destination column of the forty-page Daily Broadcasting Schedule read like the index to a child's geography book. Altogether 41 languages were used in the Olympic Games broadcasts and all but one of the 59 competing countries were able to hear Olympic Games reports in their own language direct from London.

The cost of the whole broadcasting organisation and operations was met by the British Broadcasting Corporation, apart from 100 seats in the Stadium and accommodation elsewhere provided free of charge. The load on B.B.C. staff was heavy, but all those

engaged on the Olympic Games broadcasting operation will always count it a privilege to have been at Wembley for the XIV Olympiad and to have been able to help their broadcasting colleagues from overseas.

## TELEVISION

Early in 1946, the B.B.C. started making plans for comprehensive television coverage of the 1948 Olympic Games. In view of the concentration of events around Wembley, it was decided to use two mobile units there ; one to cover the events held in the Empire Stadium ; and the second to cover those in the Empire Pool. It was planned to cover the other Olympic events, most of which were contested in places remote from Wembley, by including in Television Newsreel selected film items shot by the Olympic Games Film Company. The highlights of the Wembley events were also to be repeated in the Newsreel for the benefit of people who would be unable to see the " live " broadcasts during the afternoons.

### General Lay-out

The diagram shows the lay-out which was used. The three cameras in the Stadium fed their signals to the Engineering Control Van, which was parked almost immediately below them, whence the cable fed pictures from the various cameras back to the Radio

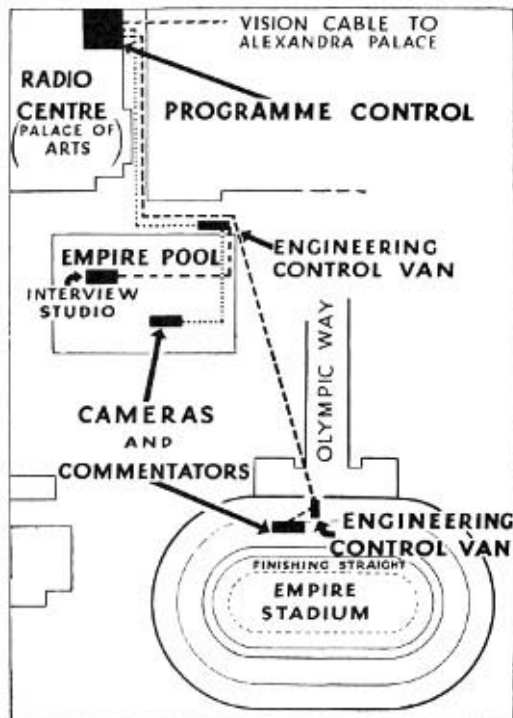

Centre. It was from here in the Production Room (Stadium) that the Producer and the Senior Engineer controlled and balanced vision and sound. The new unit was positioned just beside the Empire Pool, and in this instance engineering and programme control were both undertaken in the van. This latter arrangement, though quicker to install, did not permit the same standard of production owing to the greater noise and distraction. General programme co-ordination and the switching from the Empire Pool to the Stadium were done from the Television Control Room in the Radio Centre. Standard commercial receivers were used as monitors in this control room. It was at this control point that the decision was taken as to the comparative programme value of the events taking place in the two places.

### Lighting

When the question of the suitability of the light for the existing television cameras was considered, it became clear that the existing design of camera would be satisfactory

for all the Stadium events, since the latest event, football, was due to end by 8.30 p.m. The Empire Pool provided the greater problem as swimming and boxing sessions were to be continued long after daylight had faded. It was obviously undesirable and impracticable to provide a high intensity of light over the large area occupied by the bath, and it was accordingly decided to order a new mobile television unit, equipped with more sensitive cameras.

### **Programme Times**

It was planned to televise all the major events at Wembley but at the same time to maintain some of the ordinary studio programmes for the benefit of those viewers who were not sports enthusiasts. As a result of the public interest in the Games, however, and the resultant demands of viewers, the duration of the Olympic broadcasts considerably exceeded the plans which had been made. During the Olympic Games television outside broadcasts provided a total programme time of 64 hours 27 minutes of Olympic events.

### **Position of Cameras and Commentators**

In the Stadium three cameras were used, the main camera position being in the back row of the stand almost immediately behind the Royal Box. This position was on the finishing straight, and some twenty yards short of the tape, thus providing an almost ideal point from which to watch events. A secondary camera position was used lower down the stand in order to get a frontal view of His Majesty the King as he declared the Games open. This lower position also provided an uninterrupted view of the large scoreboard at the end of the Arena and excellent views of the crowd. The commentary box, adjacent to the main camera position was also used as an interview studio.

The newer cameras used in the Empire Pool were equipped with a three-lens turret and it was, therefore, possible to use only two cameras in the Pool and allocate the third camera for work in the Pool interview studio. It was not feasible to put the camera higher as it would have obstructed the view of large numbers of spectators.

### **Interviews**

Small studios were constructed in the Stadium and the Empire Pool as it was considered that television provided an ideal opportunity of introducing the public to athletes whom they would normally get little chance of meeting. In the Stadium a member of the television unit acted as a " chaser " and, within a few minutes of the tape being broken, he was to be seen gently jogging the winner's arm. It was a tribute to his diplomacy and the athletes' co-operation that he succeeded in inveigling nearly all the great athletes into giving a television interview. The interviews were conducted by Jack Crump, who was Team Manager for the British athletic team, and whose knowledge and tact helped to make these interviews a popular feature.

An interview studio in the Empire Pool was better equipped and more convenient for competitors to reach. Competitors, still panting and dripping, were brought before the cameras, whilst viewers also met trainers, managers and other well-known personalities who were visiting the Games.

Results achieved far exceeded expectation. The pictures, particularly during the opening week when the weather was excellent, were outstandingly good. Visitors from the U.S.A., the Dominions and Europe all confirmed that the picture quality was more than equal to any other operational television that they had seen. The pictures were sent from the Radio Centre to Alexandra Palace by a vision cable which was provided and manned by the G.P.O. There is little doubt that the vision cable contributed considerably to the high quality of the pictures, which were completely free of all types of interference as they were retransmitted from Alexandra Palace.

### **Commentaries**

A large commentary box was used in order to accommodate four commentators, provide room for interviews and still allow room for a television monitor immediately in front of the main commentary position.

A team of commentators provided the background information, which gave viewers an increased interest in the athletes taking part. In the long-distance races, when there were large fields, it was found essential for the main commentator to have a "race reader." A further assistant kept the lap times and records and made it his business to listen to the public address announcements, many of which were unsuitable for radiation as they concerned the progress of field events which were not being televised.

The various events in the Empire Pool also had their specialist commentators. One did the diving, another did the racing, whilst a third provided the essential background material and acted as "race reader." Harry Getz, a visitor from South Africa and an international water-polo referee, proved an admirable discovery and gave an outstanding commentary on the water-polo matches. During the second week of the Games, two boxing commentators took over in the Empire Pool.

### **Television Audience**

The Radio Industries Council estimate that at the time of the Olympic Games there were 80,000 television sets installed—largely, of course, in private houses. From evidence received it appears probable that the average audience for any given transmission was in excess of half-a-million. The majority of these viewers were, of course, situated within fifty miles of London, but excellent reports have been received from much further afield. The B.B.C.'s faithful viewer in the Channel Islands (180 miles), where reception is variable, was able to get pictures of excellent entertainment value.

The British Radio Industry had organised viewing-rooms in the competitors' training camps in the London area. From all accounts, these facilities were greatly appreciated and gave competitors an opportunity of following the progress of the Games and their fellow athletes without exerting themselves. The heats of certain events and the final of the 10,000 metres took place on the first day of the athletics and some team managers, therefore, thought it undesirable for these athletes to attend the Opening Ceremony on the previous day. Competitors in the sprint, therefore, had the opportunity of watching this impressive ceremony on television and, judging from their written comments, they seem to have been surprised by the outstanding results achieved.



# OLYMPIC FILM

" XIV Olympiad—The Glory of Sport," the official film of the Olympic Games, 1948, made history in two ways. It was the first colour film to be made of an Olympic Games and also the first full length feature film ever to be finished in so short a time. When the Games of the XIV Olympiad were allotted to London, the J. Arthur Rank Organisation was granted by the Organising Committee the exclusive rights of filming the Games. It had already been decided by the Committee that one company should be responsible for the whole film coverage, thereby keeping the number of cameramen in the various arenas to a minimum. For convenience the Rank Organisation set up a unit called " The Olympic Film Company."

Mr. Castleton Knight was appointed producer and was faced with a major undertaking. Not only had a full-length feature film in colour of the whole Games to be made, but also the newsreels throughout the world had to be supplied with up-to-the-minute sections for their twice-weekly issues. At the same time the B.B.C. had to be provided with material for their Television service. All known records were broken by the production of the complete colour film of 12,000 feet, normally a task of several months, in just over fourteen days. This would have been impossible without the co-operation of every person engaged on the production of the film and especially without the aid of the whole of the Technicolor Organisation which suspended much of its normal work in order to give priority to this 12-reel Technicolor film. The Olympic Film Company decided that the film to be made for public presentation should not be a technical production to be enjoyed only by athletes, but one which would be enjoyed by the cinema-going public, even those with no taste for sport.

## **Technichrome Process**

The many problems to be faced were made more difficult by the restrictions still remaining from the war. For instance, it was found that there were only three Technicolor cameras available in England, whereas twenty or more would be needed. Experiments had, however, reached an advanced stage with a new process called Technichrome by which it was possible to use a normal studio-type camera, after some adjustments and attachments had been made. These alterations, together with the supply of specially constructed camera magazines for the colour process, cost some £10,000. Sorbo-lined waterproof and dustproof carrying cases had to be made in order that the magazines would not be damaged when being lowered from a height to the ground.

Specially large changing bags were made for the units on location, and both electric and hand trucks were provided for the transport of the heavy equipment.

New sound units and other equipment were ordered and continual watch kept on delivery dates to be sure that the equipment would be ready for photographing the Games.

The next difficulty was the assembly from the studios of technicians and camera crews, most of them with little or no experience of either colour photography or the filming of

actual events. This is entirely different from their usual work when, in the event of a camera breakdown or a missed opportunity, the scene can be repeated. Furthermore, these studio technicians were not used to filming under the varying light conditions in which the Olympic Games would be held.

Mr. Guy Warrack was commissioned to compose and orchestrate the special musical accompaniment which, under the direction of Mr. Muir Mathieson, was recorded by the Royal Philharmonic Orchestra in the Watford Town Hall, one of the finest halls in the country for sound.

Supplying the black and white records of the Games for the newsreels was almost a routine matter, except that several locations had to be covered. Agreements were entered into with the member companies of the Newsreel Association for the use of some of their equipment and personnel, and for the supply of batches of material to them at the appropriate times ; and also with the Television authorities for their requirements in England and America. Arrangements were also made for the despatch of shipments to the newsreels of other countries.

The production personnel were assembled and visits paid to the various locations : to Torquay to arrange for boats and boatmen and accommodation for the cameramen filming the Yachting events ; to Aldershot and Camberley to decide on the best vantage points for cameras for the Equestrian events ; to Windsor, Henley and the many other venues. The headquarters of the Film Unit were established in the grounds of the Civic Hall at Wembley. In the pre-war years this would have been a comparatively simple matter, but improvisation was, of course, necessary, and several air-raid shelters were turned into loading and storage rooms for film and camera equipment. The ceilings, walls and floors were treated with a solution to prevent dust scratching the sensitive film during the loading and unloading operations, and in the loading rooms double light-lock doors were fitted with special ventilation and lighting arrangements.

These shelter dark-rooms also provided a safe fireproof storage for the extremely valuable camera equipment.

### **Staff Arrangements**

To house the necessary administrative staff, temporary offices were established under canvas, and dressing-rooms, cloakrooms, camera repair shops and a signwriting department were similarly accommodated. The various sections had a host of duties ranging from the obtaining of weather reports, programmes, badges and meal tickets, to the disbursement of petty cash, the distribution of petrol coupons and the maintenance of film stock supplies, which latter had to be kept at an even temperature, no easy matter in the varying weather conditions. In view of the large number of spectators, the staff could not expect to obtain their meals in the public restaurants, so a catering section was set up for this task, and three television sets were provided in the rest and dining rooms to keep all members of the Unit in touch with the progress of the Games.

With the main events taking place at Wembley, the laboratories at Harmondsworth and Denham and the cutting rooms at Shepherds Bush, a well-organised system of

transport was essential. This was controlled from a caravan parked outside the Empire Stadium. The completed negatives were sent immediately for processing, and the returning transport brought fresh negative stock. Cars were provided to convey personnel to and from their various locations. For collecting the exposed negatives inside the Stadium a small motorcycle was used, as it was able to thread its way through the ever-present crowds of spectators. The producer lived on the job, having his sleeping quarters in a caravan at the hub of all departments. Another caravan contained two telephone switchboards so that at all times contact could be kept with the outside world, as well as with every camera position at Wembley, including those of the Empire Pool.

This venue provided some particular problems. The extra lighting necessary to take colour films had to be arranged so that there were no reflections from the water to confuse or worry the competitors in the Diving events. A gang of men spent ten days on the glass roof, scraping off the paint that had been so necessary such a short time before to black out this huge building. Some unique and fascinating underwater pictures were shot through a glass porthole in a drain running beneath the Pool.

### **Distinctive Dress**

The Organising Committee had asked that a distinctive dress should be worn by the camera crews, so the men were equipped with red berets, white jackets bearing the Olympic badge on the pocket, brown trousers and white shoes. In case of wet weather oilskins were supplied. Finally, as a safeguard against pirate cameramen, a special tie and badge were designed and registered. The pains taken to obtain this uniformity resulted in one of the smartest turn-outs ever worn by cameramen.

In the arena at the Empire Stadium was placed a tower rostrum, 25 feet high. This was built of light material to enable it to be moved easily by three men, without disturbing the camera crew on top. It had to be mobile as otherwise it would have been in the way for such events as throwing the javelin.

### **Arena Control**

Similar smaller rostrums were designed for each end of the arena and their locations arranged to suit the time table of the events. Altogether 130 camera stands and rostrums were erected in connection with the Games and in all cases great care had to be taken in placing them to avoid interference with the view of the spectators. At the Empire Stadium gantry positions in the roof of the stands were adapted for use and steel-lined pits were sunk. A film control centre was established at the edge of the running track and linked by special telephone to each camera position. Instructions could be given for taking particular shots of any event and any breakdown at any position was immediately known and the Producer or the Production Manager (Mr. H. Ware Bishop) could assign another camera to cover the event then being filmed.

A large number of batteries was required for the cameras, though as a safeguard almost every camera position in the Empire Stadium had current laid on. Thousands of yards of cable were laid under the running track to supply the towers and sunken pit positions



in the centre of the arena. A charging plant was installed for re-charging the batteries and for the mobile electric camera trolleys.

Cameramen and assistants were assembled at Wembley ten days before the opening of the Games for tests of cameras, lenses and other equipment. They were an interested and enthusiastic unit and their concentration never wavered, even during the unpleasant conditions when the weather broke. On one or two occasions men in the pits were working up to their knees in water and others were drenched from head to foot in spite of efforts to provide against these contingencies.

### **Shooting Script**

A shooting script was prepared of the events. This manuscript included details of every event to be taken, its venue, time, camera positions, units, names of camera personnel engaged, lenses to be used, coverage required from each camera, the continuity of filming in correct sequence and the main requirements of coverage. Each day the camera crews received details of their assignment on files compiled from this script, altered if there were any change of circumstance. A plan (see diagram) in connection with this script indicated every camera position in the Empire Stadium, the position of the sun throughout the day, the area used for the various events, and the position of the rostrums, which were to be moved from point to point in accordance with the pre-arranged time-table. Effects were recorded by studio type sound recording equipment built into a control room at the back of the scoreboard at Wembley and an " effects " sound track made by placing microphones at some sixty points around the arena. A great deal of care was taken to retain the atmosphere of the Games by the right use of these sound tracks.

While many of these preparations were in progress another unit, specially flown to Greece, was filming a reconstruction of the ceremony of kindling the Olympic Flame, which was to be borne by relays of torch bearers across Europe to light the Olympic Flame at Wembley.

For the Marathon Race, arrangements were made to enable cars carrying camera crews to cover the entire course. Music was specially written to bring out all the drama of this great test of stamina and endurance, and its final presentation was undoubtedly the highlight of the whole film.

Filming proceeded smoothly, there being exciting moments for everybody and something of a sensation when the jury of the International Amateur Athletic Federation referred to the film to decide that the United States had indeed won the 4 x 100 Metres Relay after having been disqualified for an allegedly faulty handing on of the baton.

For the Rowing events at Henley, a stand was built in the River Thames to film the finishes, and the intermediate stages of the racing were filmed from launches.

Altogether, some 350,000 feet of film were exposed. This entailed a tremendous task for the editor (Mr. Roy Drew), especially in view of the speed at which the film had to be cut. A great deal of imagination had to be used in selecting material. The cutting started the day after the Games began and between ten and twenty thousand feet were dealt with

daily. Sequences of many events were assembled which did not appear in the film, as for various reasons some had to be discarded. This can be understood when so many thousands of feet had to be cut down to 12,000 or 12,500. The music composed by Mr. Guy Warrack had been completed and had to be adapted to the picture. The score derived its main material from a Grand March based on the Olympic Hymn, " Non Nobis Domine," and a symphonic arrangement of the themes of the National Anthems of the nations taking part in the Games.

The commentary played an important part in the film and it was spoken in many languages. Three versions were produced simultaneously, beginning three days after the first event took place at Wembley.

In order to show the film to the press on September 1st, the dubbing crews, projectionists and cutting room staff worked almost continuously, but they triumphed over all difficulties and a double premiere was held in London, one for the Organising Committee of the XIV Olympiad and the other for the film personnel. Thus " the back-room boys and girls " were able to sit back and enjoy in retrospect " XIV Olympiad—The Glory of Sport," the Olympic Games of 1948 in its natural colour, some of them seeing for the first time the events they had been at such pains to record.



*The start of the Marathon with E. Guinez (Argentine) leading the field out of the stadium, followed by C. Singh (India). R. Josset (France) is No. 262, and he is followed by T. Richards (Great Britain), who finished second.*

*On the road at an early stage of the race with Guinez and Josset leading. In the next group are J. Kurikkala (Finland), G. Ostling (Sweden), and M. Hietanen (Finland), with J. Holden (Great Britain) just behind.*

*The Marathon winner, D. Cabrera (Argentine) reaches the tape.*







*The final of the 3,000 metres steeplechase as the leading runners take the water jump. M. Chesneau (France) is leading from 349 R. Pujazon (France), 355 E. Elmsator (Sweden), who finished second, and 357 T. Sjostrand (Sweden), the winner. 348 is A. Guyodo (France), 222 C. Miranda Justo (Spain), 235 R. Everaert (Belgium), and 345 P. Sitaloppi (Finland).*

*A general view of the arena during the third lap of the 10,000 metres walk final, showing the field passing the dais used for the victory ceremonies, and the seats of the members of the Jury of Appeal. J. Mikaelsson (Sweden), the winner, is leading from F. Schwab (Switzerland), B. Johansson (Sweden), H. Churcher (Great Britain), C. Morris (Great Britain), E. Maggi (France), G. Hardmo (Sweden).*

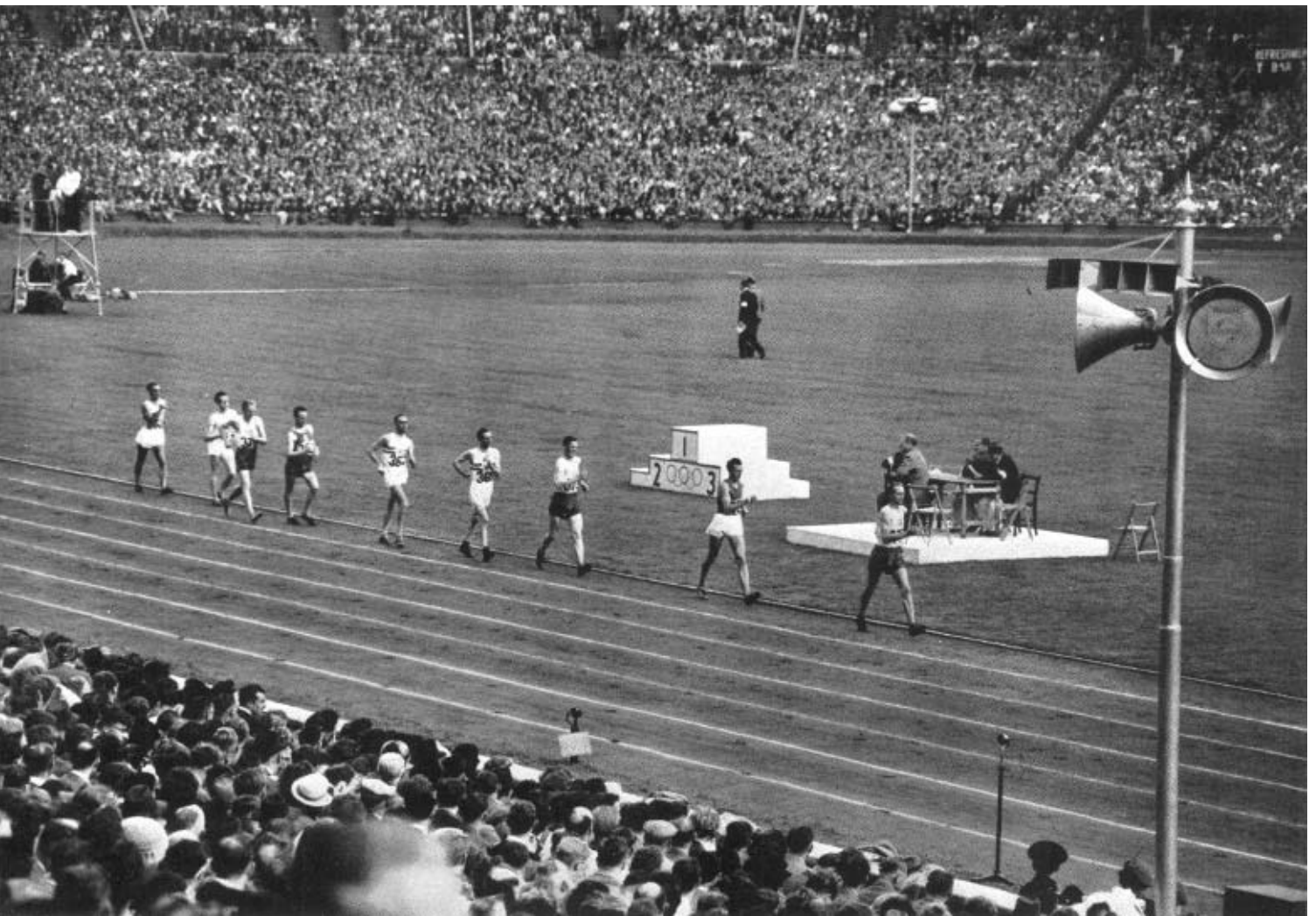



*The start of the 50,000 metres walk, showing 389 S. Laszlo (Hungary), 398 J. Ljunggren (Sweden), 385 P. Mazille (France), 384 C. Hubert (France), 390 V. Bertolini (Italy), 391 S. Cascino (Italy), 392 F. Pretti (Italy), 387 H. A. Martineau (Great Britain), 386 T. Johnson (Great Britain), 388 G. Whitlock (Great Britain), 403 A. Weinecker (U.S.A.), and 402 J. Deni (U.S.A.).*

*(Left) The winner, J. Ljunggren (Sweden), is already in front as the competitors leave the stadium grounds and was never caught. Behind him here are R. Bjurstrom (Sweden) and F. Pretti (Italy). (Right) The victory ceremony for the 50,000 metres walk with J. Ljunggren, G. Godel (Switzerland) second, and the 48-year-old T. Johnson (Great Britain) third. The President of the International Olympic Committee, Mr. J. Sigfrid Edstrom, on right, has just presented the Olympic medals and the winner's national anthem is being played.*





*The first change-over in the final of the 4 x 400 metres relay. On the left R. Cochran (U.S.A.) has just passed the baton to C. Bourland, and on the right V. Rhoden (Jamaica) is handing on to L. Laing.*



*The finish of the 4 x 100 metres relay final. The runners from left to right are E. Haggis (Canada), A. Siddi (Italy), J. Archer (Great Britain), M. Patton (U.S.A.), J. Lammers (Holland), and B. Goldovanyi (Hungary).*

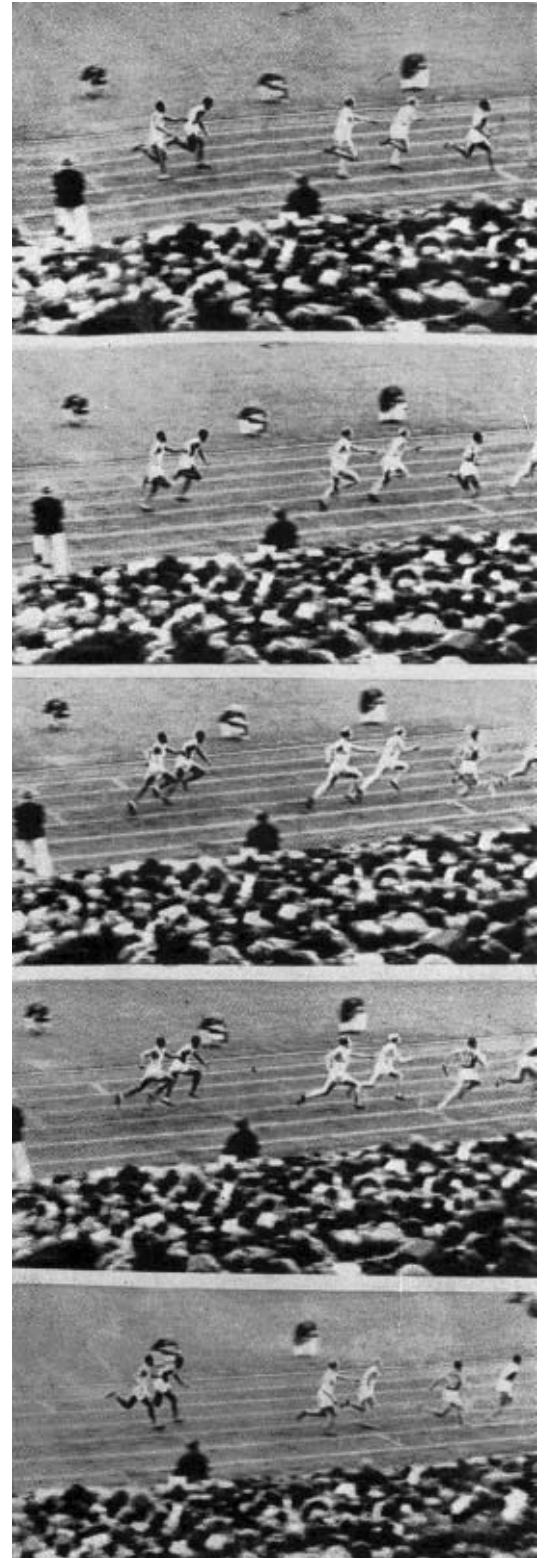

*The sequence of shots from the Olympic film of the 4 x 100 metres relay final, which were examined by the Jury of Appeal, who decided that the disqualification of the U.S.A. team should be overruled, and the race awarded to them. The U.S.A. runners, on left, are H. Ewell, handing on to L. Wright. To their right, A. McCorquodale (Great Britain) handing on to J. Gregory.*



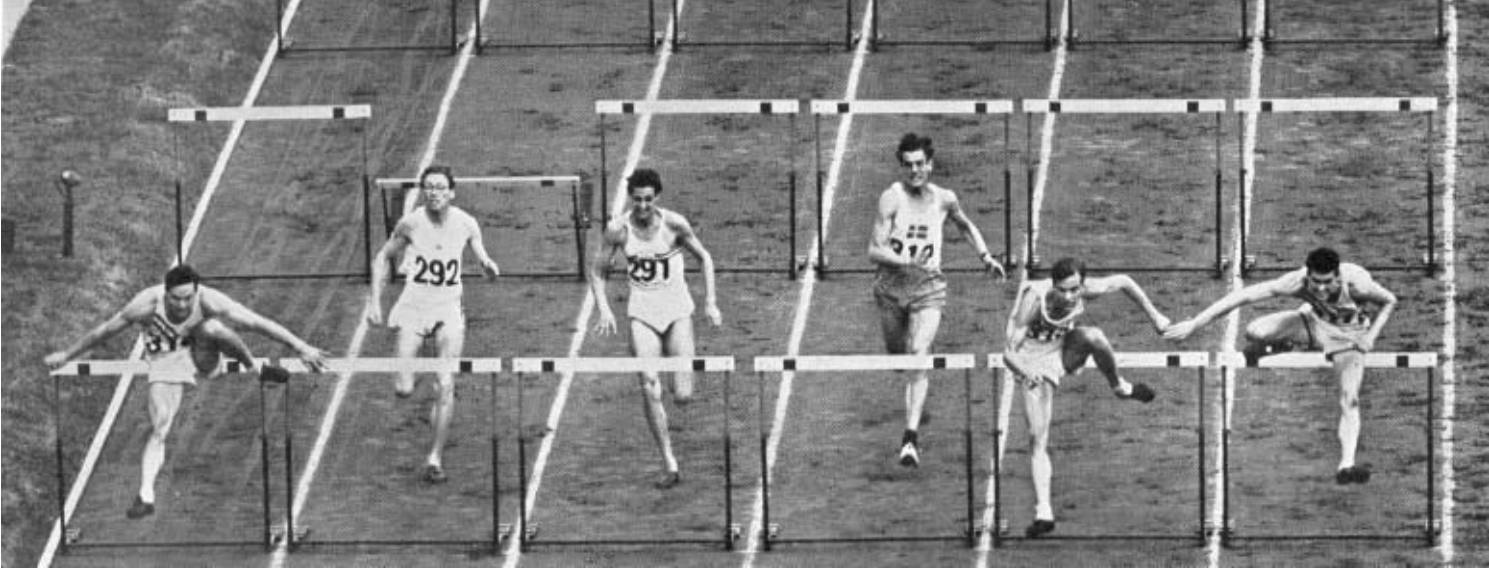

*The runners in the 110 metres hurdles final at the last obstacle. Left to right, C. L. Scott (U.S.A.) second, P. Gardner (Australia) fifth, A. Triulzi (Argentine), fourth, H. Lidman (Sweden) sixth, W. Porter (U.S.A.) first, C. Dixon (U.S.A.) third.*

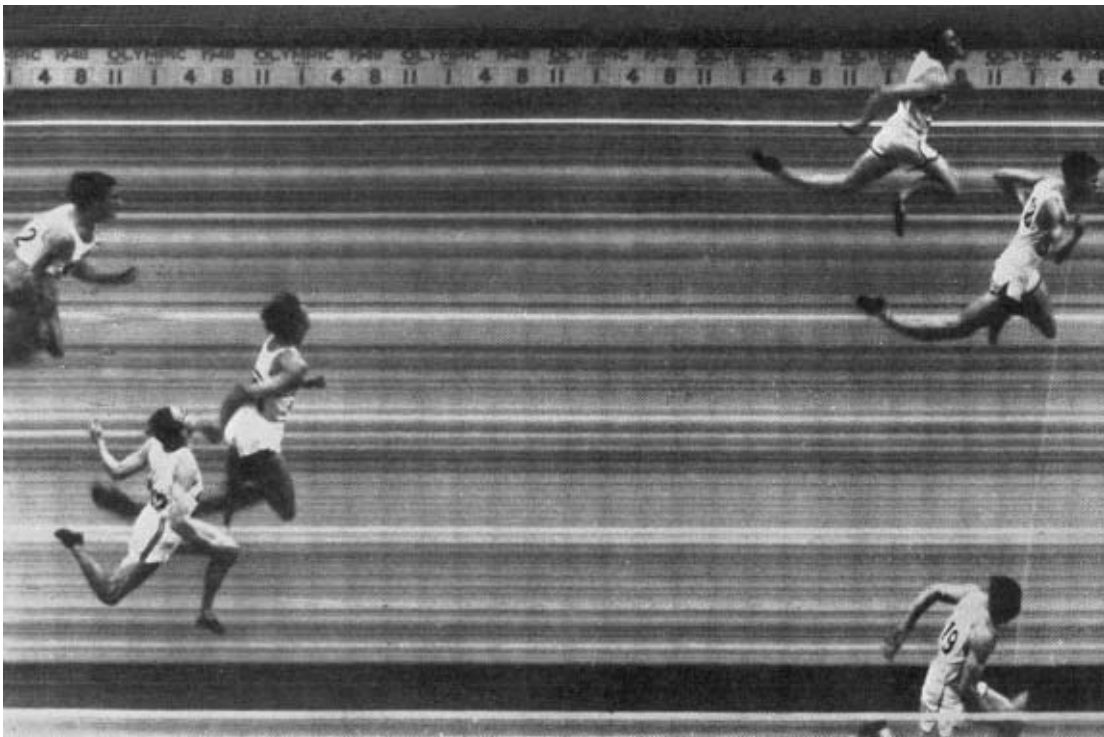

*(Above) A view of the finish of the 110 metres hurdles final and (Left) the photo-finish print, which shows how far ahead of their rivals the three U.S.A. representatives finished.*

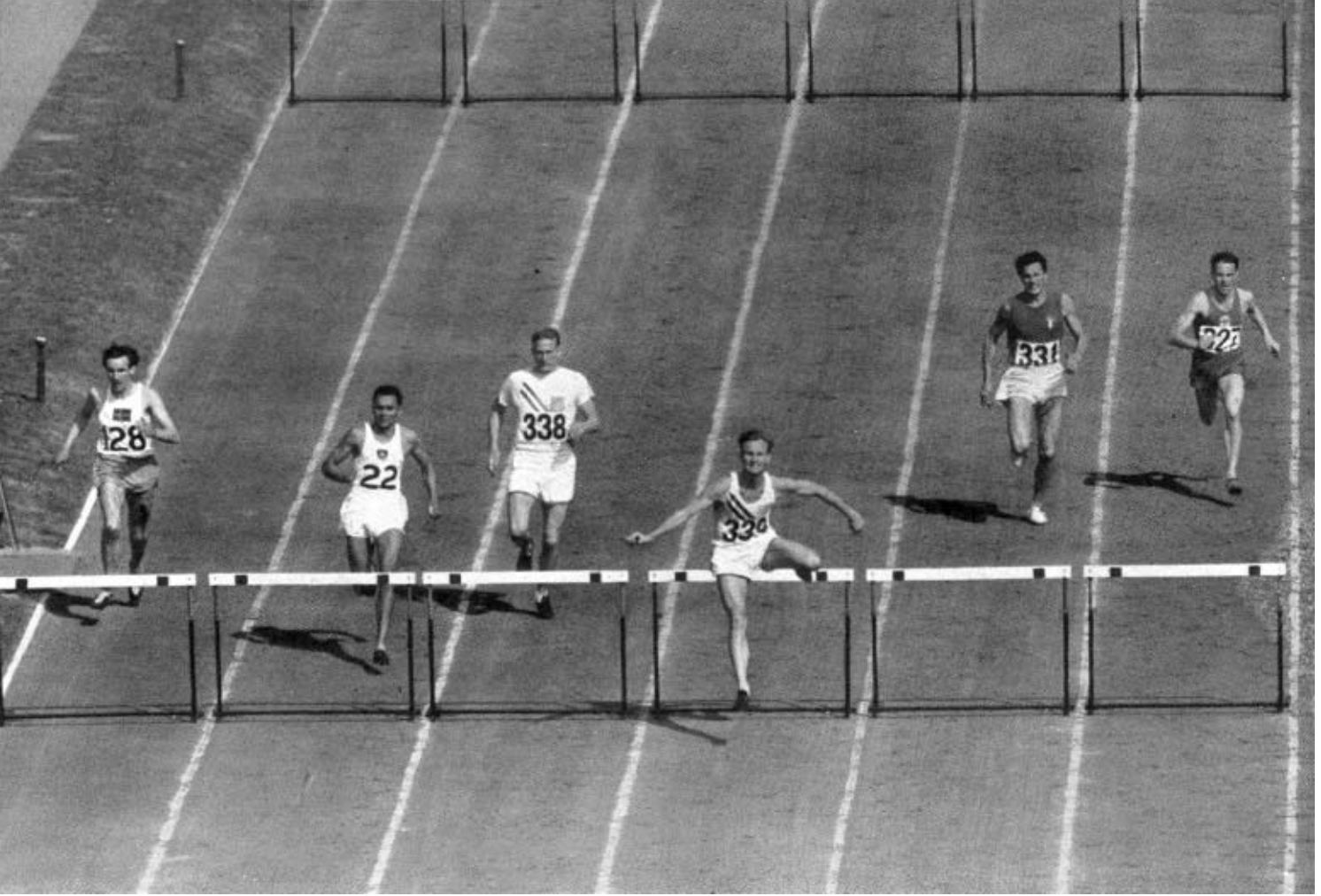

*The last hurdle in the 400 metres hurdles final. Left to right, R. Larsson (Sweden) third, D. White (Ceylon) second, R. Ault (U.S.A.) fourth, R. Cochran (U.S.A.) first, O. Missoni (Italy) sixth, and Y. Cros (France) fifth.*

*The finish of the 400 metres hurdles with Cochran well clear of his rivals.*

*A view of the tiers of seats for judges (on far side of track), and timekeepers (in foreground). Owing to the rain the officials have put on their mackintoshes. The event is a heat of the decathlon 100 metres.*



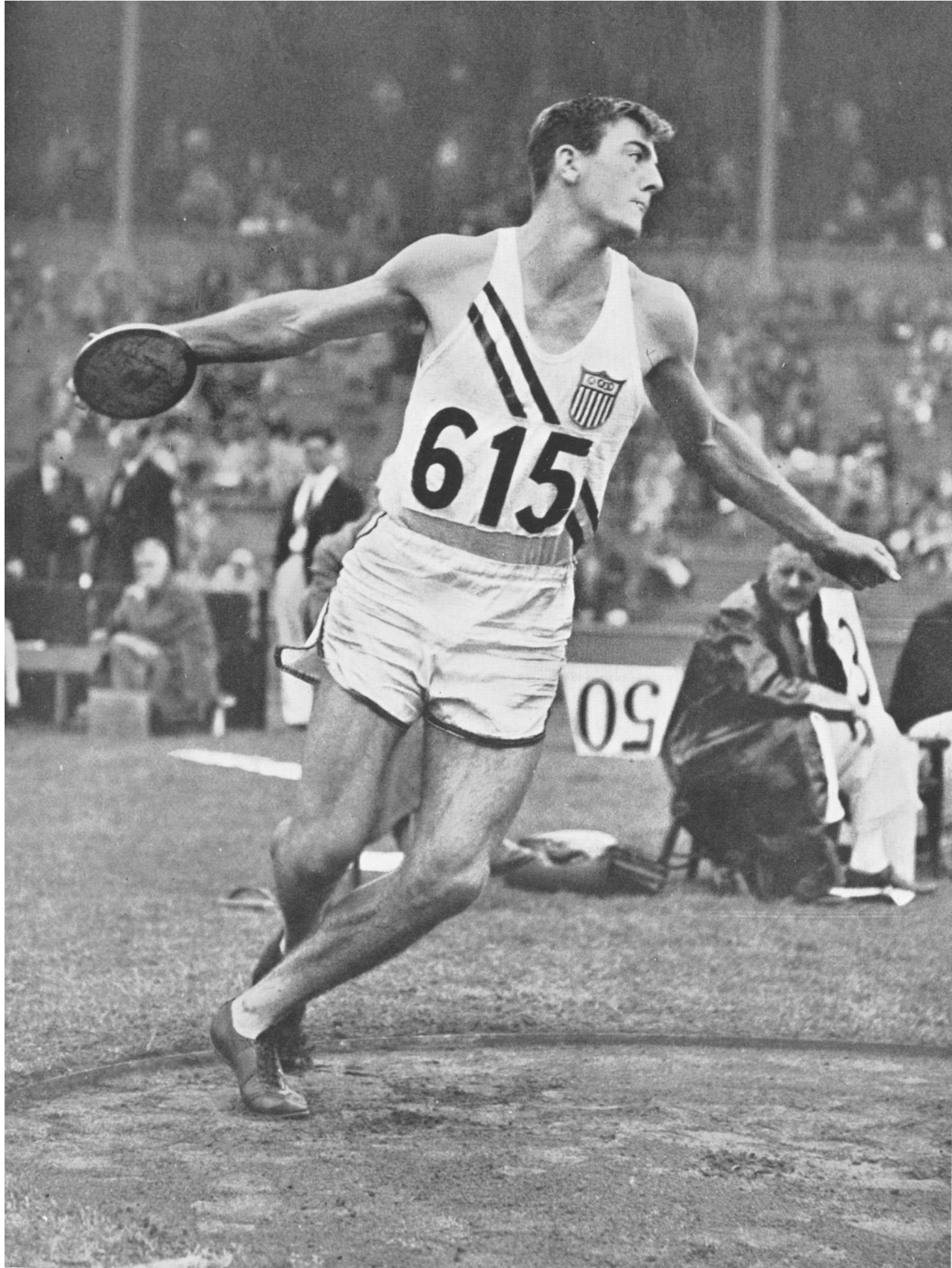

*R. Mathias (U.S.A.), the 17-year-old winner of the decathlon, throwing the discus.*





*Winner of the long jump, W. Steele (U.S.A.).*

*Darkness fell before the decathlon was finished, and here officials are checking distances by artificial light.*



*J. Winter (Australia) first in the high jump.*





*W. Thompson (U.S.A.), winner of the shot putt.*



*I. Nemeth (Hungary), first in hammer throwing.*



*O. Smith (U.S.A.), winner of the pole vault.*



*E. Kataja (Finland), second in the pole vault.*



*The finish of the women's 100 metres final. Left to right, D. Manley (Great Britain) second, P. Jones (Canada) fifth, S. Strickland (Australia) third, F. Blankers-Koen (Holland) first, C. A. Thompson (Jamaica) sixth, V. Myers (Canada) fourth.*

*The finish of the women's 200 metres final. Left to right, D. Robb (South Africa) sixth, A. Patterson (U.S.A.) third, A. Williamson (Great Britain) second, M. Walker (Great Britain) fifth, S. Strickland (Australia) fourth, F. Blankers-Koen (Holland) first.*





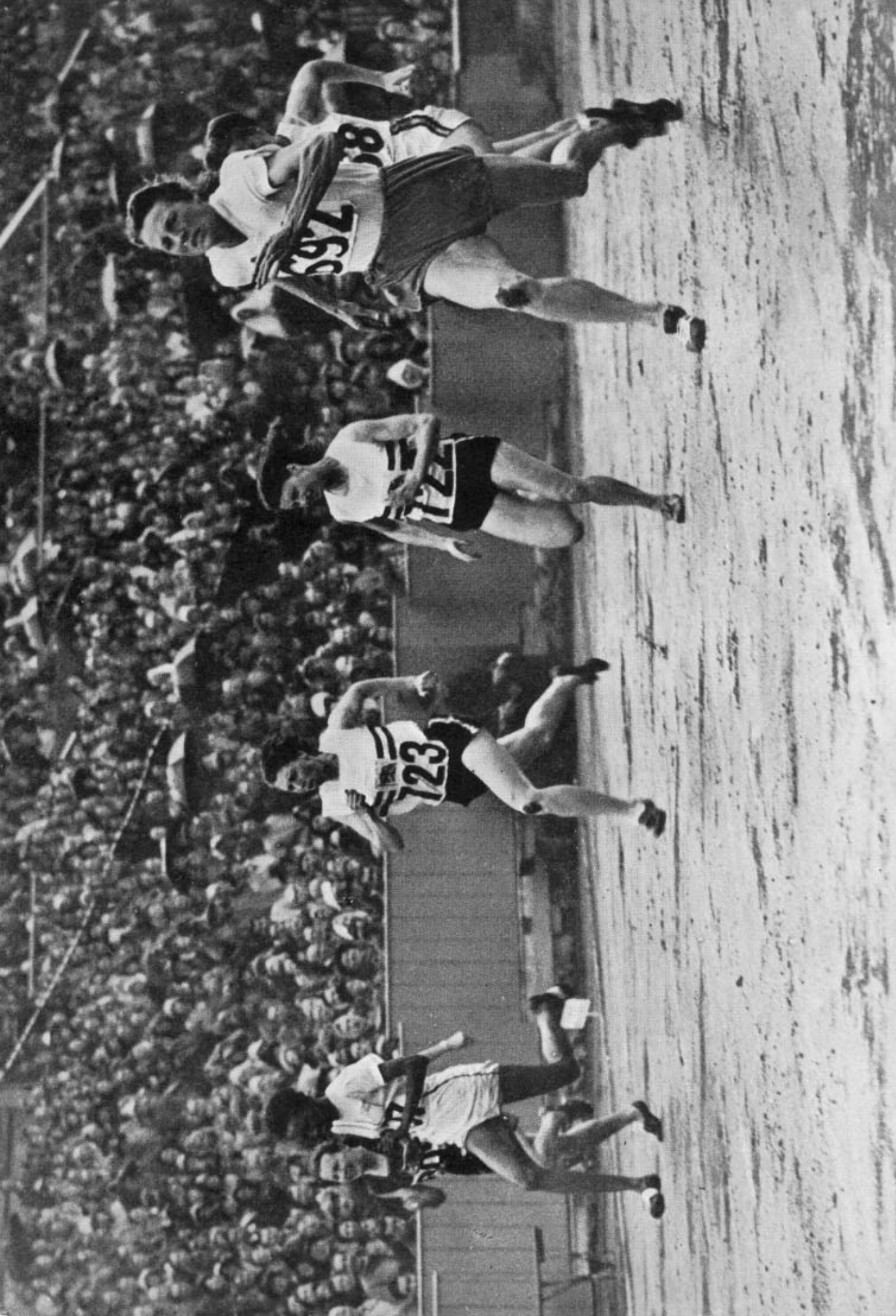

*A view of the women's 200 metres final as the runners were rounding the bend into the finishing straight. This was another final run while rain was falling.*



*The last change-over in the women's 4x100 metres relay final. Australia, in the foreground, are in the lead. A desperate effort by F. Blankers-Koen (Holland), however, overhauled J. King (Australia) as seen below, where the runners are reaching the tape. Third is the Canadian team (P. Jones), fourth Great Britain (M.Gardner), and fifth Denmark (H. Nissen).*

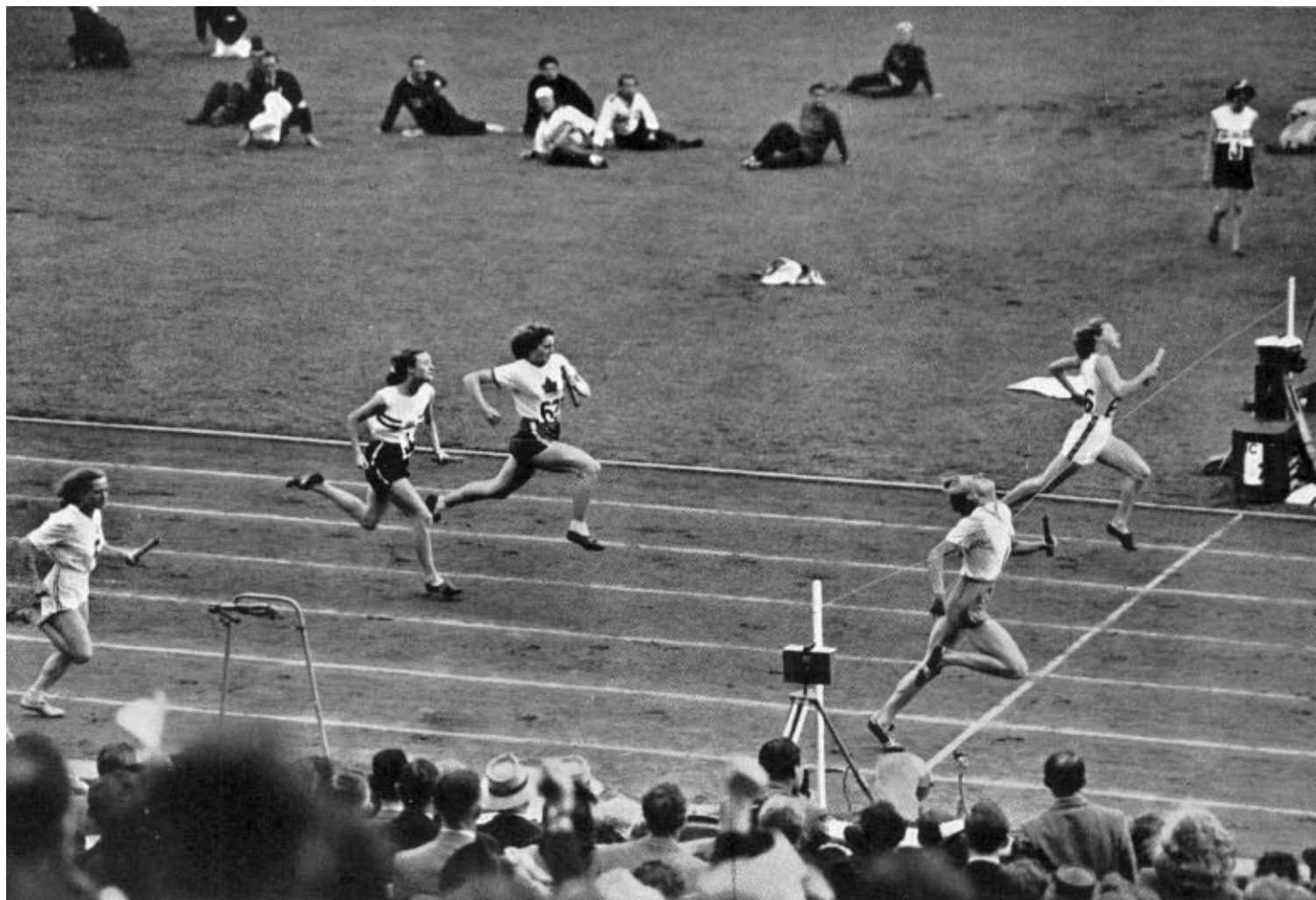





*(Above) First hurdle in the final of the women's 80 metres hurdles. Left to right, L. Lomska (Czechoslovakia) sixth, S. Strickland (Australia) third, Y. Monginon (France) fourth, M. Oberbreyer (Austria) fifth, M. Gardner (Great Britain) second and F. Blankers-Koen (Holland) first.  
 (Below) The photo-finish view of the finish.*

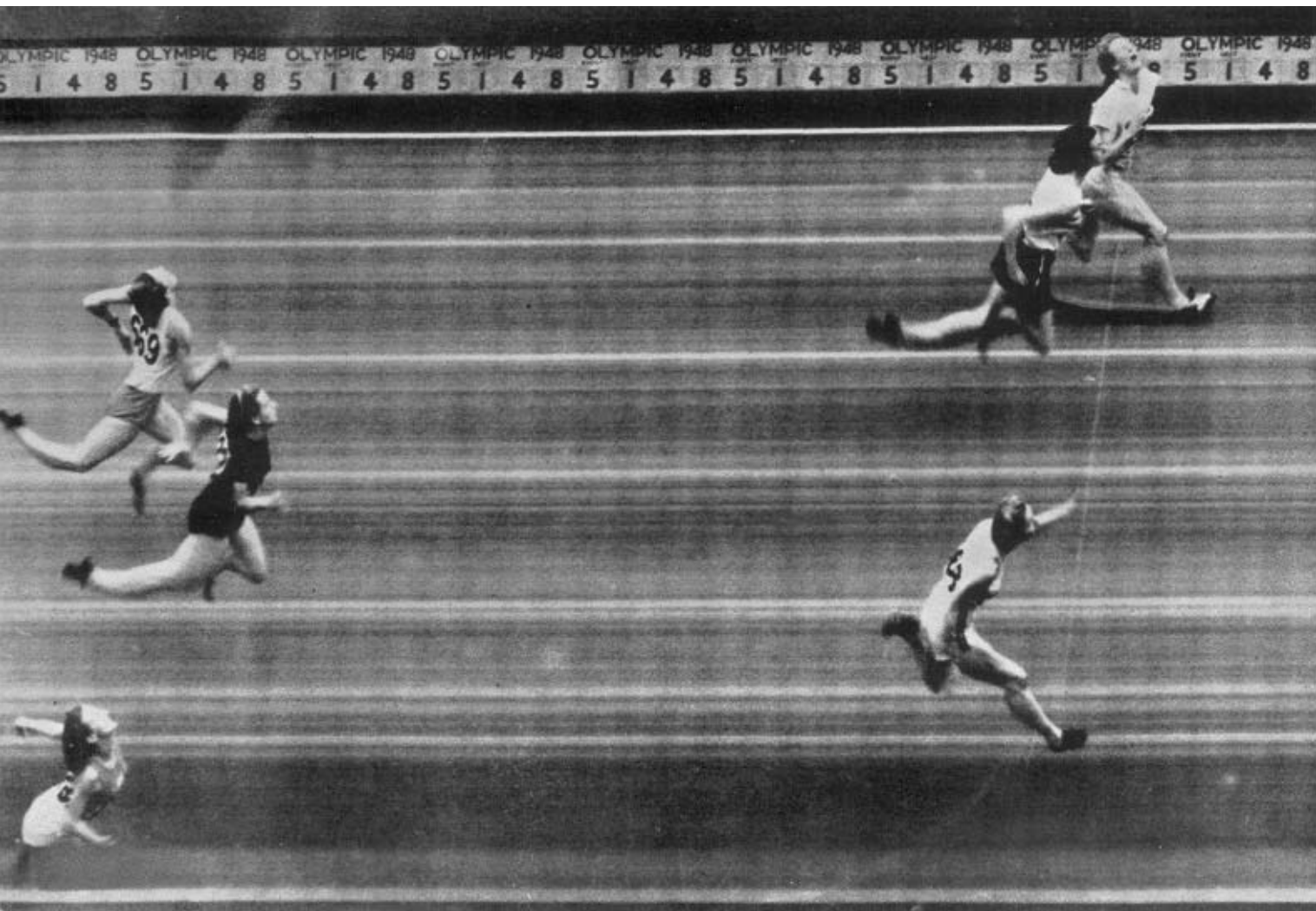



*H. Bauma (Austria), winner of the women's javelin throw.*





*Top left. A. Coachman (U.S.A.), winner of the women's high jump.*



*Top right. M. Ostermeyer (France), winner of both the women's throwing the discus and putting the weight.*



*Bottom. Victory ceremony for the women's long jump. Mr. J. Sigfrid Edstrom, President of the International Olympic Committee, is handing the winner's medal to O. Gyarmati (Hungary); second is N. S. de Portela (Argentine), third A. Leyman (Sweden).*

# BOX OFFICE

A study of the position showed that conditions had changed materially since preceding Olympiads and that a new approach to the problems of ticket sales and distribution was necessary. Five fundamental decisions from which the ticket organisation developed, were taken by the Executive Committee.

## A. Season Tickets

At previous Olympic Games, it had been possible to purchase season tickets enabling the holder to see any of the events. Such season tickets had been " transferable " but, owing to the simultaneous holding of several events, a situation had arisen whereby reserved accommodation was not used, and at the same time people were turned away. The popularity of the Games is such that this system could no longer be justified and it was decided that season tickets would not be available for London, 1948.

## B. Series Tickets

It was felt that it should be possible for persons from other countries to come to the Games with the certainty that they could see a competitor taking part in his event. It was, therefore, decided to sell books of series tickets for each sport, giving admission to every session of that sport, and to give priority to applications for these books. This system did not include the Football and Hockey preliminaries, in which matches took place simultaneously, or Water Polo, as distinct from Swimming and Diving.

In arriving at these decisions, the Committee was influenced by the fact that there is an overwhelming demand for admission to events of outstanding interest, often to the exclusion of the *bona fide* sportsman, who is also interested in the sessions in lesser demand. It was considered that those who are sufficiently interested in a sport to attend all the sessions, should have priority. The system of series books covered this point.

The series book consisted of separate tickets for the same seat for all sessions of one sport.

## C. Admission by Ticket only

Reports were received on the probable demand for tickets from both home and overseas sources and these indicated that the demand would be heavy. To set aside any specific proportion of the accommodation for payment at the turnstiles on the day, would, it was thought, create anomalies and possibly disappointments. By printing tickets for all seats and standing places, it was possible to keep the sales position in clear perspective and to provide the best and simplest box office service to all applicants for tickets.

For those sports, such as Football, Water Polo and Hockey, in which preliminary matches had to be played and for which the draw would not be made until shortly before the Games, it was decided that admission should be at the turnstiles.

#### **D. Pricing**

There had been a change of values since the previous Games, and it was difficult to arrive at a clear assessment of costs and to reconcile these with reasonable charges for admission.

It was decided that a minimum receipt from sales of £500,000 should be the aim and the box office staff was instructed to fix the prices of admission with this figure as an objective. They had, however, to keep in mind that support for different sports varies, and that, while some events would produce capacity attendances, others would not be well patronised. The final pricings approved by the Executive Committee represented a total capacity value of approximately £850,000.

#### **E. Allocation of Tickets**

It was decided to reserve half the tickets for overseas applications. These were divided between nations according to estimated requirements, based on probable team strength, travel facilities, currency problems and national interest in the Games. These reservations were entered upon the seating plans in national blocks for each session of each sport and at all prices.

The remaining 50 per cent. was divided into one third for the clubs and members of the National Governing Body of the sport concerned, and two thirds for the general public in Great Britain.

The preliminary work in connection with the organisation and administration of the admission tickets was undertaken by the Finance Committee, at whose meetings on this subject representatives from Wembley Stadium Box Office attended in an advisory capacity.

#### **The Seating Plans**

The first step was to obtain copies of the plans of the seating and standing capacities of all the venues and of the temporary stands which were to be erected. These were marked with the prices which were to be charged and formed the Key Plans.

From the Key Plans, numeral lists, known as the Seating Plans, were prepared for each venue, stating entrance number, block number, row number, seat number and price. These were carefully checked with the Key Plan and one set of copies of all seating plans for all events formed the basis of the printing order for the tickets.

Another complete set of these Seating Plans was divided into sports and then bound into books, which became the Master Seating Plans for each sport. On these Master Plans, the tickets reserved for each country were marked.

From each Master Seating Plan a copy was made for each session of each sport and these became the Session Seating Plans.

The Master Seating Plans were to be used for the work in connection with the Series Books, covering all sessions of a sport, while the separate Session Seating Plans would be used when dealing in separate sessions, and after crossing out the accommodation taken up by series books.

## OLYMPIC SYMBOLS



Opening Ceremony



Athletics



Basketball



Boxing



Canoeing



Cycling



Equestrian

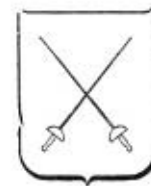

Fencing



Football



Gymnastics



Hockey



Modern Pentathlon



Rowing



Shooting



Swimming



Weightlifting



Wrestling



Yachting



Arts



Closing Ceremony

### **Means of Admission**

The tickets were printed so that each price had a distinctive colour, and each sport an appropriate symbol.

The turnstile attendants at any point of entry, had to recognise only (*a*) the symbol of the event, (*b*) the colour applicable to the price of seats and (*c*) the date and session. Stand stewards subsequently dealt with the block and seat numbers, for rapid admission and placing of the public in a manner which obviated language difficulties.

The badges worn by officials and competitors were for purposes of identification only, as all Competitors, Officials, Press, Radio correspondents and other sporting personnel had passes or identity cards.

### **Background of Tickets**

A basic design was prepared for the ticket paper, incorporating the official emblem of the XIV Olympiad and the Olympic Rings.

The colour backgrounds were printed on the special paper in a manner making it impossible to alter anything on the ticket without damaging the background. Thus, it was almost impossible to produce forgeries.

Because the preparation of these colour backgrounds was a lengthy process and the full details had to be overprinted on two and a quarter million tickets in a very short space of time, the final printing operation was divided between several firms, although the matter was one of sub-contract. The total cost of all tickets was £8,500 which included an addition of a further 250,000 tickets for emergency purposes.

On delivery each ticket was checked with the session plan, before being stacked in labelled racks. For financial control, a certificate issued by the printer and countersigned by the Box Office Manager, was lodged with the Accountancy control.

A supply of blank duplicate tickets on a neutral grey background was provided to deal with the problem of lost or stolen tickets. Attendants were instructed that duplicate took precedence over originals ; persons presenting originals when duplication took place were referred to the box office for attention and enquiry.

### **Identity Cards**

The problem of providing all competitors and officials with an Identity Card which might act as passport and also give easy admission to the holder where he was entitled to be admitted while at the same time avoiding abuses and errors, was very difficult to solve. Negotiations had to be entered into with the Foreign Office (Passport Department) and eventually the Identity Card illustrated was issued to the National Olympic Committees and their Chefs de Mission. (See Technical Department report, page 72.)

### **Passes**

Passes on stiff cardboard with coloured background were prepared for all types of operating personnel and staff.

These were all numbered and there was strict control of their issue at headquarters.

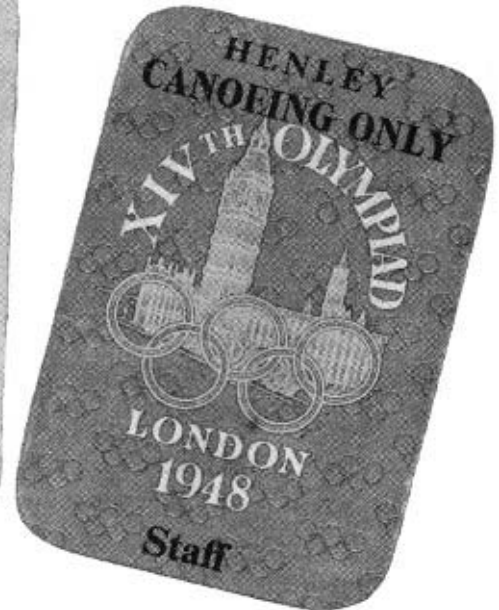
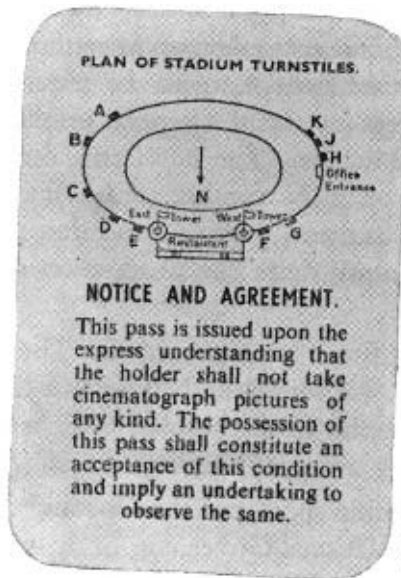

### **The Box Office in Operation**

The experience and existing organisation of Wembley Stadium Ltd. Box Office, which had been generously placed at the disposal of the Organising Committee by Sir Arthur Elvin, proved a great boon. Time was taken up in settling matters of policy, such as the pricing, the allocations to be set aside to meet the requirements of Overseas Sporting bodies, National Governing bodies and the general public, and matters connected with the design and printing of the tickets. The Box Office came into operation as a separate entity under Mr. F. A. Jackson in November, 1947, nine months prior to the Games. The system of application, allotment, payment and despatch was devised to enable all the work to proceed concurrently with the production of the printed matter and the tickets.

Three types of application form were provided. The first, consisting of schedules covering all events and prices, was sent to all National Olympic Committees abroad, with a notification stating the limitation in the number of tickets for which application could be made, and the latest date by which applications must be received at the Box Office.

The second, covering a specific sport and the Opening and Closing Ceremonies only, was issued to the appropriate National Governing Body in Great Britain, for applications from club and members, together with a circular intimating the number of tickets reserved to them and the date for the return of the application.

The third, a simple all-purpose form, was provided for issue to the general public, with a brochure giving full particulars (see opposite).

As these forms were returned to the Box Office, they were given reference numbers, and the details were entered in registers, in which were kept running totals of the number of applications for every session, for comparison with the known capacity at each price. As long as the number of applications in each class did not exceed the total set aside for that category (National Olympic Committees, Governing Bodies and general public) allotment was made in full and in strict rotation. Running totals of alterations to applications were recorded in a master register.

Allotment letters were sent out in duplicate and required that one copy should be returned with the necessary remittance.

When the allotment letters were returned with remittances, they were first dealt with by cashiers, who recorded the amount received and made daily payments into the special bank account. Letters taking up allotments in full were then passed direct to the supervisor in charge of the seating plans, but those having alterations were passed to the supervisor in charge of the master registers, for the adjustments to be entered. By this means, an accurate record of the numerical position was maintained. The seating plan clerks linked up the allotment letters with the original application forms, by means of the reference numbers, and applied them to the appropriate seating plans, by crossing out the numbers of the seats on the plan and entering the same details on the application form.

The completed form became the authority for the issue of the tickets required thereon. The forms were checked, to establish that the tickets which were issued against the remittance had been correctly entered on the seating plans. They were then passed to





# Information Sheet

containing  
Programme of Events  
and prices of admission

## OLYMPIC GAMES

Thursday, July 28th to Sunday, August 10th, 1948  
at WEMBLEY and other venues

Applications for tickets from the British Olympic Council are being accepted by post from the 1st of July 1948. The programme of events for each sport is given on the following pages. For complete details of the programme and the names of the athletes who will be given or award honours, and the names of the athletes who will be given or award honours, see the programme of events for each sport. For the names of the athletes who will be given or award honours, see the programme of events for each sport. For the names of the athletes who will be given or award honours, see the programme of events for each sport.

OLYMPIC GAMES BOX OFFICE,  
EMPIRE STADIUM, WEMBLEY  
High Wycombe, Bucks., U.K.  
Telephone: WEMBLEY 244  
Based on the programme of events as published in the Olympic Review, London, 1948.

**GYMNASTICS at the Empire Stadium, Wembley**  
Thursday, July 28th to Saturday, August 1st, 1948.  
The programme of events is as follows:  
Men's: Individual All-round, Team All-round, Pommel Horse, Vault, Bars, Rings, Floor Exercises, Parallel Bars, Horizontal Bar.  
Women's: Individual All-round, Team All-round, Pommel Horse, Vault, Bars, Rings, Floor Exercises, Parallel Bars, Horizontal Bar.

**HOCKEY at the Empire Stadium, Wembley**  
Friday, July 29th and Saturday, August 2nd, 1948.  
The programme of events is as follows:  
Men's: Hockey, Women's: Hockey.

**MODERN PENTATHLON at the Empire Stadium, Wembley**  
Friday, July 29th and Saturday, August 2nd, 1948.  
The programme of events is as follows:  
Men's: Modern Pentathlon, Women's: Modern Pentathlon.

**ROWING at Henley**  
Friday, July 29th and Saturday, August 2nd, 1948.  
The programme of events is as follows:  
Men's: Rowing, Women's: Rowing.

**SHOOTING at Bully**  
Friday, July 29th and Saturday, August 2nd, 1948.  
The programme of events is as follows:  
Men's: Shooting, Women's: Shooting.

**SWIMMING at the Empire Pool, Wembley**  
Friday, July 29th and Saturday, August 2nd, 1948.  
The programme of events is as follows:  
Men's: Swimming, Women's: Swimming.

**WRESTLING (Freestyle) at the Empire Stadium, Wembley**  
Friday, July 29th and Saturday, August 2nd, 1948.  
The programme of events is as follows:  
Men's: Wrestling, Women's: Wrestling.

**WRESTLING (Greco-Roman) at the Empire Stadium, Wembley**  
Friday, July 29th and Saturday, August 2nd, 1948.  
The programme of events is as follows:  
Men's: Wrestling, Women's: Wrestling.

**YACHTING at Cowes, Dorset**  
Friday, July 29th and Saturday, August 2nd, 1948.  
The programme of events is as follows:  
Men's: Yachting, Women's: Yachting.

**FOURTEEN at the Empire Stadium, Wembley**  
Friday, July 29th and Saturday, August 2nd, 1948.  
The programme of events is as follows:  
Men's: Fourteen, Women's: Fourteen.

**FOURTEEN at the Empire Stadium, Wembley**  
Friday, July 29th and Saturday, August 2nd, 1948.  
The programme of events is as follows:  
Men's: Fourteen, Women's: Fourteen.

**FOURTEEN at the Empire Stadium, Wembley**  
Friday, July 29th and Saturday, August 2nd, 1948.  
The programme of events is as follows:  
Men's: Fourteen, Women's: Fourteen.

**FOURTEEN at the Empire Stadium, Wembley**  
Friday, July 29th and Saturday, August 2nd, 1948.  
The programme of events is as follows:  
Men's: Fourteen, Women's: Fourteen.

OFFICIAL TICKET APPLICATION FORM

These coupons (10) Application form and return to:-

**OLYMPIC GAMES BOX OFFICE**  
The Empire Stadium,  
WEMBLEY

**OPENING CEREMONY at the Empire Stadium**  
Thursday, July 28th, 1948.  
The programme of events is as follows:  
Men's: Opening Ceremony, Women's: Opening Ceremony.

**CLOSING CEREMONY at the Empire Stadium**  
Sunday, August 10th, 1948.  
The programme of events is as follows:  
Men's: Closing Ceremony, Women's: Closing Ceremony.

**ART EXHIBITION at the Victoria & Albert Museum**  
July 28th to August 10th, 1948.  
The programme of events is as follows:  
Men's: Art Exhibition, Women's: Art Exhibition.

**ATHLETICS at the Empire Stadium, Wembley**  
Friday, July 29th to Sunday, August 1st, 1948.  
The programme of events is as follows:  
Men's: Athletics, Women's: Athletics.

**ATHLETICS at the Empire Stadium, Wembley**  
Friday, July 29th to Sunday, August 1st, 1948.  
The programme of events is as follows:  
Men's: Athletics, Women's: Athletics.

**BASKET BALL at Henley-on-Avon**  
Friday, July 29th and Saturday, August 2nd, 1948.  
The programme of events is as follows:  
Men's: Basketball, Women's: Basketball.

**BOXING at the Empire Pool, Wembley**  
Friday, July 29th and Saturday, August 2nd, 1948.  
The programme of events is as follows:  
Men's: Boxing, Women's: Boxing.

**CARROMBOL at Henley**  
Friday, July 29th and Saturday, August 2nd, 1948.  
The programme of events is as follows:  
Men's: Carrombol, Women's: Carrombol.

**CYCLING at the Victoria & Albert Museum**  
Friday, July 29th and Saturday, August 2nd, 1948.  
The programme of events is as follows:  
Men's: Cycling, Women's: Cycling.

**CYCLING at the Victoria & Albert Museum**  
Friday, July 29th and Saturday, August 2nd, 1948.  
The programme of events is as follows:  
Men's: Cycling, Women's: Cycling.

**EQUESTRIAN at Aldenham, Central Bedfordshire**  
Friday, July 29th and Saturday, August 2nd, 1948.  
The programme of events is as follows:  
Men's: Equestrian, Women's: Equestrian.

**FENCING at the Victoria & Albert Museum**  
Friday, July 29th and Saturday, August 2nd, 1948.  
The programme of events is as follows:  
Men's: Fencing, Women's: Fencing.

**FOOTBALL at the Empire Stadium, Wembley**  
Friday, July 29th and Saturday, August 2nd, 1948.  
The programme of events is as follows:  
Men's: Football, Women's: Football.

**FOOTBALL at the Empire Stadium, Wembley**  
Friday, July 29th and Saturday, August 2nd, 1948.  
The programme of events is as follows:  
Men's: Football, Women's: Football.

**FOOTBALL at the Empire Stadium, Wembley**  
Friday, July 29th and Saturday, August 2nd, 1948.  
The programme of events is as follows:  
Men's: Football, Women's: Football.

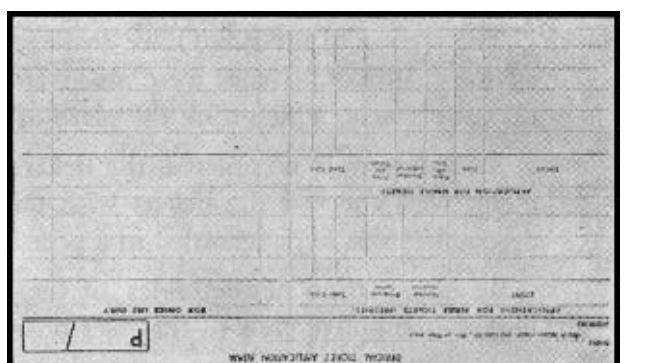

the clerks to extract the actual tickets from the racks. Series books were assembled first and then the individual tickets.

The section of the Box Office dealing with cash sales over the counter was considered as one customer. Issues were made, from time to time, from the separate seating plans on issue sheets, which took the place of application forms.

As orders were completed, the tickets and forms were passed to the despatch department, who checked the tickets with the order, prior to despatch. A running total of despatches was kept recorded in a post book.

By examination of the tables of the running figures, it was possible at all times to obtain a complete view of the sales position.

The analysis of totals revealed, under their numbered headings, (1) the demands from all sources, (2) the pace at which they were being handled, (3) the rate of payment and (4) the progress of the despatch of tickets. The official in charge was, therefore, able to have complete control of the administrative machine and to give the Committee periodic reports of the position.

### **Cancellations**

Applications for tickets from overseas sources had been very satisfactory up to the end of May. But a change quickly took place and cancellations poured in all at once from the U.S.A., involving a considerable sum of money and placing a great strain on the Box Office officials and staff. The report made to the Executive Committee revealed that the policy as regards sales needed immediate re-adjustment to meet the altered circumstances to enable the machinery of the Box Office to continue operating successfully.

The Committee settled the future policy at once. Up to this stage the large number of applications from overseas, National Governing Bodies and the general public, had given the public the impression that tickets for the principal events would be difficult to obtain. Publicity was released to eradicate this view and to recreate a demand. The Press co-operated in generous manner and the general public began to make application for tickets at an ever-increasing rate. The new development was continuously kept under close review but it was not until immediately prior to the Opening of the Games that it became probable that the new demand would overtake the overseas cancellations.

These developments added very much to the difficulties of the Box Office. Set up to deal in the main with bulk issues, it had to be expanded to deal with a vast volume of small individual applications. To assist the public and to relieve the pressure at the Box Office, special issues of tickets on " sale or return " were made to the theatre ticket and travel agencies and the public was informed by press and radio that tickets could now be obtained at these agencies. Taking everything into consideration the system and method outlined above stood up to this severest of tests.

The important lesson to be learned from the operation is that unexpected and heavy foreign cancellations can wreck a scheme, if they eventuate only seven weeks prior to the Games. Future organisers would be well advised to start operations for foreign applica-

tions at least one year prior to the Games, and the foreign cash payment position should be finalised if possible not later than six months before the Opening Ceremony, to enable unclaimed balances of tickets to be released for sale to the home market. This would ensure as even a load as possible on the Box Office organisation and a satisfactory position for the home public.

## COMPLIMENTARY TICKETS

The protocol for the celebration of the Olympic Games lays down the provisions for reserved seats for various classes of persons who attend the Games, as of right. These regulations were the subject of discussions at various International Olympic Committee Congresses and committee meetings before the 1948 Games. The regulations were as follows :—

" Apart from the big stand reserved for the Press, invitation cards must be sent out by the Organising Committee and seats reserved in the stadium as follows :

Stand A.—For members of the International Olympic Committee and their families.

Stand B.—For the Presidents of the National Olympic Committees and the Presidents of the International Federations and their families.

Stand C.—For members of the National Olympic Committees and their guests— one ticket to be allotted for every ten athletes competing with a maximum of twenty and a minimum of four.

For the official delegate of each sport in which a country is represented.

For secretaries of International Federations.

For the " Chef de Mission " of each participating country.

For members of committees of the organising country.

Stand D.—For members of the various juries.

Also 1,500 places for athletes near the winning posts.

In the other stadia : seats for the Press and occupants of Stands A and B. One Stand to which shall be admitted, as far as the places will allow, the occupants of Stands C and D. Seats for the competitors in the sport which is then taking place, but not for other competitors."

It had been thought that a revised set of rules which were being considered by the I.O.C. would have been in force before July, 1948, and with this in view, the Organising Committee drew up its plans for the allocation of complimentary tickets. These proposed changes would have made considerable reductions in the number of complimentary tickets that an Organising Committee is obliged to provide. This was particularly so in respect of Stand C, where the minimum of four for each National Olympic Committee was to be abolished and the basis of computation made one for every twenty competitors. In addition, the official delegate of any sport in which a country was represented was to receive a complimentary ticket only for the sport in which he was interested. It will readily be appreciated that the arrangements planned by the Organising Committee did

not cater for the number of reserved seats which are required under the old rules set out above.

As the new regulations had not by the end of May, 1948, received ratification by the I.O.C., the Organising Committee felt that it would be unfair to officials of visiting nations who were making arrangements based on the rules then in force, if they were informed on their arrival in London that a serious cut had been made in the number of tickets they were expecting to receive. Therefore, a complete change of seating allocation had to be made in a very short time to cater for the considerably increased number of seats to be made available.

The reservation of free seats for Press and radio correspondents is dealt with under the headings of those two sections, elsewhere in this Report.

In 1936, in Berlin, the German Organising Committee amalgamated Stands C and D, not only in the main Olympic stadium but also at all other venues. The Organising Committee for the London Games decided that if any amalgamation were to take place at all, it was more appropriate for Stand D—that catering for juries and sports officials—to be allied with the competitors' stand.

In the light of this decision, four stands were provided at all stadia, although at the smaller venues Stands A and B were normally the same, except that priority was given to I.O.C. members.

In previous Olympic Games the practice had been adopted of issuing passes to all persons entitled to accommodation in Stands A, B and C. It was felt that this causes a real wastage of seating accommodation. For example, a person with a reserved seat at the main stadium who is occupying it during an afternoon session of athletics cannot at the same time be present at the fencing or swimming tournaments, and it is undesirable at a sports celebration of the magnitude of the Olympic Games to have large numbers of unoccupied seats. This applies more particularly to venues other than the main stadium, since the Olympic rules state that occupants of Stand C shall only be admitted " as far as the places will allow."

To overcome this wastage, Stand C ticket holders were supplied with a book of tickets, one for each day of the Games, each ticket being divided into three sections for the morning, afternoon and evening sessions. On presentation at the barrier of any particular venue, the appropriate sessional section of the ticket was removed. By this means the right of Stand C ticket holders to attend any venue desired was maintained, whereas the problem of the duplication of places was overcome. A further advantage of this system is that as Stand C tickets are issued en bloc to the Secretary of each National Olympic Committee, he can issue them day by day instead of having the difficulty of recovering passes issued for the whole period from successive holders.

### **Stand A**

All members of the International Olympic Committee and their families were issued with passes admitting them to a specially constructed stand in front of the Royal Box at the Empire Stadium. These passes were contained in a special leatherette holder and

admitted the bearer not only to the Empire Stadium, but also to Stand A at all other venues.

The maximum accommodation likely to be required was reserved at the Empire Stadium (this was assessed at an early date by circularising members of the I.O.C. as to the members of their families who would be accompanying them).

At venues other than the Empire Stadium, the amount of accommodation reserved under the Stand A heading was reduced, some 60 seats being held in readiness at the Empire Pool, down to the minimum of 10 at the hockey grounds and the Finchley Open Air Pool. The Royal Box at the Aldershot Command Central Stadium was, in fact, used for I.O.C. members. The accommodation reserved was found to be adequate in all cases.

### **Stand B**

All persons entitled to Stand B accommodation were issued with special passes, and 200 seats directly behind the Royal Box were reserved at the Empire Stadium. On the same basis as the I.O.C. allocation, smaller quantities were held in readiness at other venues.

### **Stand C**

The method of admission to this Stand has already been referred to, and accommodation at the Empire Stadium for 1,500 persons was reserved, directly beside the competitors' and judges' stand on the finishing line for athletics.

At the Empire Pool, Stand C was situated for the swimming events at the end of the Pool directly behind the starting bridge, and was somewhat enlarged for the boxing tournament.

At Harringay Arena and the Empress Hall, Stands A, B and C were amalgamated into one main block, A and B pass holders at the ringside and C ticket holders behind.

### **Competitors' and Juries' Stand**

Much thought was given to the amount of accommodation that would be required for this Stand at the Empire Stadium. On the day of the Opening Ceremony, few competitors would be in the stand and therefore it was felt that the accommodation reserved would cater sufficiently for the officials not taking part in the Parade of Nations, together with those large numbers of sports officials in Great Britain who would attend the Ceremony. As far as the Closing Ceremony was concerned, the stand would be occupied by such competitors as were still in London, but it was known from previous Olympic experience that a large number would have returned to their homes.

The I.O.C. Rules lay down that this stand shall hold 1,500 persons and for the Opening Ceremony at the Empire Stadium and for all days other than that of the Closing Ceremony, this amount of accommodation was reserved. For the Closing Ceremony, an additional block of 1,000 places was added and the accommodation so provided proved to be adequate.

The basis of numbers for reservation at other venues was governed by the number of competitors in the sport concerned.

It is appropriate here to make reference to the situation which occurs at all venues other than the main stadium for the admission of competitors not taking part in the sport being held at that arena. All competitors of whatever sport have access to the main stadium and their own venue, but competitors in any sport held outside the main stadium have not the right of entry to the Competitors' Stand to watch any other sport held outside the main venue. This is an Olympic rule. None the less, there was some disappointment amongst the competitors. For example, it is only natural that a competitor who has been taking part in the swimming events but is still attending the Olympic Games during the boxing contests wishes to watch his compatriots. Provision is normally made for a few complimentary tickets to be available to teams from day to day for every venue, and to meet this necessity, the Organising Committee issued 100 competitor tickets for every venue, for the Competitors' Stand only, and these were distributed, through the attaches at their daily meetings, to competing teams. It is true to say that this number did not meet all the requests that were put forward, but it is difficult to see how this demand can ever be met successfully. The rule which was applied by the Organising Committee was that tickets should, in the first instance, be issued to nations who had competitors taking part, but even this did not entirely succeed in meeting the demand. For instance, during the wrestling competitions, large numbers of the Swedish and Turkish teams wished to be present at these events to watch their very successful teams taking part. An allocation of 20 tickets to both these nations left only 60 for distribution between some 30 other nations. The restricted space available for complimentary tickets, did not permit the Committee to grant any further concessions and the attaches were often disappointed at the number of complimentary tickets handed out to them each morning.

### **Use of Identity Cards**

For competitors and sports officials, the method of admittance to the stands to which they had a right of entry was by Identity Card, and stewards at the Empire Stadium were instructed that all Identity Cards bearing the name of a sport on the first page and any category other than those catered for in Stands A, B and C (only about six in number), would admit the bearer to the Competitors' Stand.

At other venues the stewards had only to check that the name of the sport shown on the Identity Card was that which was taking place in the arena concerned, and coupled with the provision already made for the main stadium as to category, the bearer was allowed to enter. The fact that all Identity Cards bore the holder's photograph was a safeguard against abuse of this method of admission. Since the Identity Card was a document of some value to the holder, it was thought that there would be little chance of unauthorised persons gaining admission to the Competitors' Stands.

### **Other Complimentary Tickets**

In addition to any complimentary tickets which an Organising Committee provides under International Olympic Committee rules, there are certain classes of persons to whom complimentary tickets must be issued. The Organising Committee decided that as far as the 1948 Games were concerned, these persons fell into certain definite categories :

(1) *Members of Diplomatic Missions in London.* Provision was made in the Empire Stadium for two seats to be allotted on a complimentary basis, to the Ambassador, Minister or Representative of every State, together with the High Commissioners and Agents of the various member nations of the British Commonwealth. These seats, which were in a block directly behind the Royal Box and a little to the left of it, while issued direct to the head of each Mission for the entire fortnight of the Games, were distributed as daily tickets rather than passes in order that, should the Ambassador himself not be able to attend, he was at liberty to dispose of them amongst the members of his staff.

It should perhaps be said at this point that facilities were offered at the same time for all these Missions to purchase four series tickets for the Empire Stadium on a priority basis. It was felt undesirable to reserve any one permanent block in outside venues for this class of person and they were asked by circular letter for which specific sports not being held in the Empire Stadium they would like tickets. The basis of allocation of tickets for this was the same as for the Empire Stadium.

Alongside the block of seats allocated to Diplomatic Representatives, another large stand was reserved and the tickets for this sold to the Government Hospitality Board, an organisation which caters for the entertainment and hospitality for persons of note visiting Great Britain. Priority purchase of these seats was arranged together with similar facilities for outside venues.

(2) *The Organising Committee.* The Organising Committee reserved a smaller block of seats contiguous to Stand B itself for the members of the Committee themselves and their families, and in addition complimentary tickets were provided for the members of other Committees of the Organising Committee under the Olympic rules which state : " Stand C : for the members of committees of the organising country."

(3) *Guests of the Organising Committee.* The Royal Box and the Private Box in the Empire Stadium were reserved for the exclusive use of the guests of the President of the the Games, and of the Chairman of the Organising Committee. For the Opening and Closing Ceremonies, due to the presence of His Majesty and his entourage, these seats were not available to anyone else. For other days distinguished persons from home and abroad were the guests of the President and Chairman.

For outside venues, special tickets were issued from day to day for this type of person, admitting them to a section adjacent to Stand A.

In addition to these boxes, the Organising Committee reserved a block of 100 seats on a complimentary basis which were distributed to those persons who had rendered valuable assistance to the Organising Committee in its work.

Senior members of the Service Departments, the Ministries of Supply and Works and the Board of Inland Revenue were among the guests of the Organising Committee at this level.

Again special provision was made for the issue of tickets for this class of persons into either Stands C or B at outside venues where accommodation permitted. A further 100 complimentary seats were allotted to Wembley Stadium Ltd.



(4) *Other Complimentary Facilities.* For the Opening and Closing Ceremonies, a large block was reserved on the South Stand directly facing the Royal Box for the purpose of accommodating the band and choir.

For the Opening Ceremony, standing accommodation for some 2,000 or more was given free to hospital staffs, boys' clubs and youth clubs throughout Great Britain, since the Olympic Games is above all a celebration of sport by youth.

Members of committees of the Organising Committee and Departmental Managers were asked to submit lists of persons who had rendered valuable assistance to the Organising Committee in the preparatory work and as far as possible these people were invited to attend the various venues of the Olympic Games in which they were thought to be interested.

The provision of these complimentary tickets was ruled in all cases by Box Office sales consideration, and they were offered to guests only when it appeared that on any one day (even as late as the night before) there would be a few vacant places. Particularly was this true in respect of the morning sessions of swimming and boxing and few, if any, complimentary tickets, other than the obligatory ones, were issued for the afternoon sessions of these two sports.

Camp Commandants and Departmental Managers were allocated a certain number of seats and blocks of standing positions, mainly for the Empire Stadium, for the domestic and catering staffs of the housing centres and for the somewhat large number of temporary personnel engaged by the Organising Committee.

### **Conclusion**

Apart from those reserved places falling under I.O.C. rules, it is doubtful if any Organising Committee can give guidance to its successors in the provision of complimentary tickets, as the needs of any one city will vary from those of another. The popularity of various sports from a spectator point of view alters, too, with every different country of the world, and though the Opening and Closing Ceremonies, athletics, swimming, football and boxing are universal attractions, such sports as fencing, basketball, cycling, wrestling and weightlifting have varying followings in different parts of the Olympic world.

A misunderstanding may have arisen in the minds of some of the complimentary ticket holders over the fact that the Empire Stadium is partly covered. The Los Angeles and Berlin stadia are both entirely open and the fact that Stand B and certain other important guest places were under cover at Wembley, whereas Stand A, the I.O.C. themselves, and Stand C for the National Olympic Committees were in the open may have given rise to the feeling that discrimination had been practised. This, of course, was not so. The only discrimination that ever entered into the decisions of the Organising Committee was the according of the best places from a spectator point of view to the various groups of complimentary ticket holders. The Organising Committee endeavoured to meet the requirements of all people who could justly be said to have a claim to be included in the guest list, but it is probably true to say that no Olympic Games, or other sports festival for that matter, will ever satisfy everybody from a complimentary ticket angle.

# HOUSING DEPARTMENT

Every Organising Committee faced with the task of accommodating competitors and officials for Olympic Games must view the problem confronting them from what may be termed a domestic aspect. That is to say, the difficulties to be overcome and the basic manner of approaching the problems will be peculiar to the city in which the Games are to be celebrated.

Whatever the machinery created may be, and whatever the aspects of the work carried out, there is one fundamental decision which has to be taken in regard to the accommodation side of the organisation. This decision is whether or not an Olympic Village can be provided. It is relatively immaterial whether the village is specifically constructed for the Games or whether it is created out of existing accommodation of camps, hostels and hotels. 1932 and 1936 had seen the creation of Olympic villages designed and constructed specially to meet Olympic needs. Whatever may have been the desires of Olympic competitors and officials and the Organising Committee itself, such a project for the 1948 Games was out of the question. No building programme could possibly have been entertained in a country with the immediate post-war housing and building problem of Great Britain in 1946 and 1947.

Since the Organising Committee had to rely on existing accommodation, adapted for Olympic needs, and as it was anticipated from a very early date that the number of competitors to the 1948 Games would reach a higher figure than ever before, it became equally obvious that no one existing building or set of buildings could accommodate all competitors to be housed within the London area itself.

This Report on the Housing Department covers not only accommodation, but also catering, and it would probably have been more accurate to name the department the "Accommodation Department." "Housing Department" was however the name used from the beginning and so it remained.

## **Administration and Build-up of Department**

In May, 1947, Mr. S. G. J. Briault was appointed Manager, Housing and Catering Department.

The assistance of His Majesty's Government had been sought, not to provide the accommodation, but to suggest where it might be found and, if provision was to be made, to suggest the terms under which the Organising Committee might become the user.

Negotiations were opened with the Ministry of Food in regard to the rationing question, since it was apparent that the standard British rations would not meet the needs of visiting athletes. Investigations were carried on and negotiations opened with the Ministry of Works with regard to the supply of a very great amount of equipment required in the shape of soft and hard furnishings and other items for the short term period of the competitors' stay in England.

By September, 1947, the Executive Committee felt that it must delegate its functions with regard to housing and catering to a sub-committee, and the Housing Committee was set up under the Chairmanship of Wing Commander Sinclair. He relinquished this

position after the first meeting on being posted abroad, and from that date the Committee was under the Chairmanship of Mr. H. Stuart Townend, an athlete of distinction and an officer of the British Travel Association. The members of the Committee were :—

Squadron Leader Adams, R.A.F. Sports Board.  
Mr. S. Ashburner, Ministry of Works.  
Mr. H. L. Churcher, British Olympic Association.  
Air Commodore G. Harcourt Smith, Air Ministry.  
Mr. W. H. Knight, Middlesex County Council Education Committee.  
Mr. J. H. Polfrey, Ministry of Food.  
Mr. R. B. Studdert, Executive Committee.

At a later date, owing to ill-health, Mr. Studdert was unable to continue and his place was taken by Mr. J. Eaton Griffith.

When the Housing Committee was created the Housing and Catering Manager was also appointed Secretary to the Committee, with an Assistant Housing Manager under him. By the time the Games opened in July, 1948, the organisation of the Department had been canalised into the following sections : Administration, Equipment and Supplies, Food and Transport, Accommodation, Accounts, Personnel and Catering, each with an official in charge and under the Housing and Catering Manager. The work of each of these sections is considered separately.

## ACCOMMODATION

### London

The negotiations between the Organising Committee and His Majesty's Government in 1946 and early 1947 resulted in the R.A.F. camps of Uxbridge and West Drayton, together with the ex-military camp in Richmond Park, being made available for the housing of Olympic competitors. It was estimated that the total accommodation available at these three centres was in the neighbourhood of 3,500 and, as preliminary investigations had led the Committee to put the probable numbers of officials and competitors at 6,000, the additional accommodation required had to be found outside these three main centres. However, since certain sports in the Olympic Games were to be held outside London, the competitors taking part in those sports would not in any event, except for transit purposes, be accommodated in London. It was estimated that 600 beds had to be found in the Henley district for Rowing and Canoeing officials and competitors, approximately 300 at Aldershot for the Equestrian and Pentathlon events, and 400 at Torquay for Yachting. The remaining 1,200 competitors and officials, of which 500 would probably be women, would have to be housed in the London area.

The terms under which the Government property lent to the Olympic Games for housing competitors was made available were that no rental charge should be made but that any work of a non-permanent character carried out specifically for the Olympic Games at these centres would be paid for by the Organising Committee. No small amount of constructional alteration and decoration was necessary to put the three camps in order for Olympic occupation after six years of war.

The work of conversion and redecoration at Uxbridge and West Drayton was carried out by the Air Ministry works department in conjunction with the Ministry of Works, and at Richmond Park by the Ministry of Works entirely. Equipment for all these centres was supplied by the Ministry of Works, although some issues were made through the R.A.F. stores department at Uxbridge. The accommodation at Uxbridge and West Drayton consisted of barrack blocks, while at Richmond Park camp there were hutments far more in line with a temporary Olympic Village. The overall principle of four to six competitors per room was maintained very largely in all three camps, team managers and Chefs de Mission being given private accommodation.

### **Other London Accommodation**

No other centre of the magnitude of the Government camps could be found to house either the women competitors or the remaining male teams in London, and the use of schools belonging to the Middlesex County Council Education Committee for the men, and privately owned establishments for the women was secured. The M.C.C. Education Committee kindly allowed their schools to be used rent free and most helpfully agreed to commence their normal school summer holiday one week early in 1948 in order to allow sufficient time for the necessary conversion work to be carried out to transform an educational building into an Olympic housing centre. The arrangements in the main centres were carried out in miniature in the schools, although in most cases each school housed only one national team. These schools were originally regarded as overflow accommodation for late arrivals, but this plan was abandoned when it became apparent that certain nations preferred to be alone for domestic reasons and when it was also clear that from the administrative and catering angles it was simpler to house certain nations by themselves. In all, eighteen schools under the jurisdiction of the M.C.C. were allocated to the Organising Committee. Equipment was lent by the Ministry of Works. Toilet and washing accommodation also had to be supplemented since the schools were not designed for residents. To meet the needs of the women competitors, three large private colleges in the London area were rented on special terms from their owners. As these buildings had all been designed for residential accommodation, little or no work had to be carried out other than the supply of additional equipment.

The Committee also undertook the reservation of hotel accommodation in London on behalf of certain officials and, in all, some 950 beds were reserved in various London hotels to meet the needs of the I.O.C., National Olympic Committees and those team officials who were not accommodated in the housing centres.

### **Aldershot**

The accommodation problem in the Aldershot area for the Equestrian and Pentathlon competitors was solved most successfully by the offer of the Army Council to place the Royal Military Academy at Sandhurst at the disposal of the Organising Committee. This building was ideally suited to the purpose and staff was also provided. Although Sandhurst is somewhat distant from Aldershot from the point of view of training, it was felt that it would be impossible to find better accommodation and the offer was readily accepted. Accommodation for grooms was arranged at barracks within the Aldershot

camp itself, in order that they might be near the horses for which they were responsible and which were accommodated in military stabling in the Aldershot camp.

### **Torquay**

During the early negotiations with the Torquay authorities, the Organising Committee raised the question of accommodation of the yachtsmen of the Olympic Games. To meet this need, the Torquay Corporation made representations to the hotels of their area through their Hotels Association. As a result of these representations, 350 hotel beds were reserved at Torquay, together with some 50 beds for the accompanying professional crews should these arrive. Unfortunately, large numbers of the yachting competitors and officials made their own arrangements and the anticipated demand on the Committee's accommodation was never fulfilled.

### **Bisley**

When Bisley was chosen as the site of the shooting events the question of providing the necessary accommodation for these competitors solved itself. The National Rifle Association camp, which is a semi-permanent erection, was placed at the disposal of the Organising Committee and the various chalets used by the competitors in the normal rifle contests were transformed into Olympic accommodation by the provision of the necessary beds and bedding and other items of equipment supplied by the Ministry of Works to all centres.

### **Henley**

The provision of accommodation for the Rowing and Canoeing competitors presented one of the most difficult problems. No suitable accommodation to cater, on Olympic lines, for the numbers of competitors existed in the immediate vicinity. At one time negotiations were opened with colleges at Oxford and at R.A.F. stations near to Henley, but none of the latter were found suitable and it was decided that Oxford was too far away. Bearing in mind the provisions which had been made for accommodation in the London area, the Bucks County Council Education Committee were approached and helpfully agreed to allow the Committee to have the use rent free of three schools at High Wycombe, which were equipped in the same way as the M.C.C. schools in the London area. Although High Wycombe was ten miles by road from Henley, it was felt that the use of permanent buildings was more satisfactory than the erection of a tented Olympic camp at Henley itself. As the Games drew nearer it became apparent that three schools would not provide sufficient accommodation and a private school, a school belonging to the Oxfordshire Education Committee, and a Government camp were added on similar terms to provide the requisite number of beds. The very few women competitors in the Canoeing events were accommodated at an hotel in Henley itself.

## CIRCULAR LETTERS

From the inception of the Housing Department, the practice which was general throughout the Organising Committee was followed of sending out circulars to all National Olympic Committees who had accepted the invitation to attend the London Games.

The first circular was in the form of a questionnaire requesting information as to the probable size of the team and any specific requirements that the visitors might have in the way of diet, special foods or special accommodation facilities. The answers received from the questionnaires were by no means comprehensive, and further requests for information were sent out during 1947 and the early part of 1948.

The Administration Department undertook, from March 1, 1948, the circularisation of all National Olympic Committees. Important letters to National Olympic Committees informing them of the ration scale to be allocated to competitors and the regulations in regard to the importing by visiting teams of foodstuffs and wines for their own use were included in administrative circulars. Notification of the charge to be made for accommodation was also included in one of the administrative circulars.

## EQUIPMENT

The main principles governing the equipment and furnishing of the housing centres have already been mentioned in the report of the early planning of the Housing Department. The more detailed plan provided that the Ministry of Works should furnish Richmond Park and the Middlesex schools, whilst the Air Ministry should furnish the two R.A.F. stations as far as supplies permitted, any non-available stores being provided by the M.o.W. and taken on charge by the R.A.F.

Three separate categories of stores were involved :—

- (a) furniture, linoleum, beds and bedding and soft furnishings ;
- (b) heavy catering equipment;
- (c) light catering equipment.

In the centres to be furnished by the M.o.W., little had to be done by the Equipment Section under category (a), since the M.o.W. Supplies Division, with its vast experience of furnishing hundreds of wartime hostels, was able to put into effect its general normal routine and fixed scales, which served the purpose admirably. Its draughtsmen produced plans for every room, with the proposed furniture plotted in to scale, and only in a very few cases was it thought necessary to make any alteration.

In the case of the R.A.F. Stations, the matter was not quite so simple, as here it was necessary to enumerate the pieces of furniture and equipment required and to indicate the type thought most suitable. The fullest co-operation was given by the Air Ministry and by the Equipment Officer and Barrack Wardens on the site, and the operation was carried out with the minimum of difficulty.

### **Catering Equipment and Utensils**

It was thought advisable to obtain from the official caterers lists of what, in their opinion, was considered necessary. These included, under (*b*) a certain amount of additional heavy equipment, such as grillers, hot plates, bains-marie, refrigerators, etc. (obtained through either Air Ministry Works Department, or M.o.W. Engineer Section), also the estimated requirements under (*c*) in kitchen utensils, plate, cutlery and crockery, and chefs' and waitresses' clothing. These lists were sent, for Uxbridge and West Drayton, to the Air Ministry, who earmarked all they could supply, and passed over for completion to M.o.W.

Passed direct to the M.o.W. were the lists for Richmond Park, the 17 Middlesex Schools, the three women's hostels, the six schools or other premises for the Henley-High Wycombe area, additional requirements at Bisley and Aldershot, and at Wembley Civic Hall (Competitors' Rest Room and Lounge, Press Club, Film Company Employees' Canteen, etc.). By the end of May, the M.o.W. had been able to earmark over 90 per cent. of the caterers' requirements. The remaining non-standard items were referred back to the caterers and in some cases deleted as non-essential; authority was then given to hire or purchase the balance on behalf of the Committee. Those items actually purchased by the Committee were, at the close of the Games (less losses and breakages), purchased by the caterers for their own use at an average of 85 per cent. of cost.

The greatest difficulty experienced was in connection with the Middlesex schools, since there were only a few days between the end of term when they became available to the Committee and the date of occupation by the competitors. No praise can be too great for the way in which the M.o.W. stacked away the school furniture, re-furnished the classrooms with beds, bedding, cupboards, etc., and in some cases, with curtain rails and curtains in a matter of hours.

### **Recreation Equipment**

Billiard tables and pianos were obtained on hire from R.A.F. or N.A.A.F.I.; table-tennis tables and radio sets provided by the M.o.W.; television and radio sets at larger centres lent by the manufacturers.

Complete Milk Bar equipment was hired direct from the manufacturers for inclusion in the cafeterias at Richmond Park and Uxbridge.

### **Towels**

It was decided not to provide towels, and National Olympic Committees were advised in the early days to this effect. Arrangements were, however, made at all centres to have a reserve available for hire to such competitors who failed to bring, or had lost their own towels. As was expected, these were in great demand.

### **Equipment at Venues**

Tentage was provided in considerable quantity and also a large number of chairs and tables for outside catering commitments. The majority was provided by the Ministry of Works, with small quantities from the War Office.



Apart from the equipment supplied by the two Ministries, certain other requirements were obtained from various sources, the more important items being :—

80 typewriters for staff and Chefs de Mission at centres ....	Nominal hire charges
1,300 overalls for female catering staff .....	Nominal hire charges
1,200 denim overall suits for male catering and cleaning staff	On loan
Extra refrigerators .....	On loan
Cash registers .....	On hire
Coffee-making equipment .....	On hire
Toilet rolls .....	Purchased
Staff badges .....	Purchased
Cake cartons for box lunches .....	Purchased

### **Dormitory Equipment**

A special Scandinavian vapour bath was installed at Uxbridge and at one of the schools, and two such baths were installed at Richmond Park.

The competitors' dormitories were equipped on the following scales :—

Beds and mattresses .....	1 each
Blankets .....	3 each
Sheets .....	4 each
Pillow cases .....	2 each
Pillows .....	2 each
Lockers .....	1 to 2 persons
Tables .....	1 to 4 persons
Chairs .....	1 each
Water bottles .....	1 to 2 persons
Glasses .....	1 each
Mirrors .....	1 to 2 persons

The general quantities of the main items supplied by the Ministry of Works to the Organising Committee were :—

33,000 yards of curtaining.  
 4,250 bedsteads.  
 4,250 mattresses.  
 12,750 blankets.  
 34,000 sheets.  
 4,250 bedspreads.  
 12,000 pillows.  
 17,000 pillow cases.  
 4,000 wardrobes.  
 13,000 small chairs.  
 1,300 easy chairs.  
 500 tables.  
 36,000 pieces of crockery.  
 6,500 tumblers and wine glasses.

## CATERING

The Organising Committee decided at a very early stage in its planning operations that the catering for Olympic officials and competitors should be put out to contractors and that the Housing Department should act in a supervisory capacity in regard to the fulfilment of such contracts.

It was not found possible or practicable to allocate the entire Olympic catering to one firm of contractors. It followed from the plan of having three main London centres and the balance of London competitors in Middlesex schools that a reasonable arrangement was to allocate the catering of each centre (treating the Middlesex schools as one centre) to four individual catering contractors.

A Catering sub-Committee, consisting of a representative of each firm and various members of the Housing Committee, was formed, and, after the technical aspect had been studied, the matter was referred to the General Purposes Committee to negotiate the contracts.

One of the caterers chosen to operate in the London centres undertook the catering for the camps at Henley and for the grooms at Aldershot. The catering at Bisley was placed in the hands of the official caterer to the N.R.A. who was already operating on site. No special arrangements were necessary either at Torquay or at Aldershot. The catering at the women's colleges was placed in the hands of one of the London firms. Special contracts were entered into with firms specialising in Indian and Far Eastern cooking to cater for the needs of teams from those parts of the world, and these caterers worked either as independent units if the particular nation were housed alone in a school, or alongside the main caterer where the teams were allocated to one of the main housing centres. As far as possible, it was hoped to provide kitchen accommodation at the main centres for each particular type of food to be produced and though it would have been ideal to provide a kitchen for every national team, this was obviously not necessary in cases where nations in the same centre partook of similar diets. For instance, France, Belgium and Luxembourg could all be supplied from the same kitchen. Nations were requested to inform the Organising Committee by circular whether they intended to bring their own national cook with them, or if they were prepared to rely upon the services of a chef provided by the Organising Committee. Eventually, the total number of kitchens in operation in the London area was 25.

Throughout the operation, the caterers acted as agents of the Organising Committee, which was responsible for the actual settlement of accounts and payment of staff wages, although the vouching of all bills for payment was done by the supervisory staff of the caterers.

### **Catering Staff**

The necessity of staffing over 25 large kitchens in the London area at the peak of the holiday season was a major problem. Staff were required in three main groups :—

- (1) Key personnel loaned by the official caterers and employed on the supervisory and higher grade levels.
- (2) Staff of technical, but not supervisory, grades.

(3) Non-technical staff, i.e., porters, washers-up, etc., obtained mainly from student sources.

### **Cafeterias**

In the initial planning stages it was decided to provide cafeterias at the main centres in view of the success of this idea at Berlin and Los Angeles. Here, in the main centres, competitors, their friends from other centres and non-competitor friends and officials could assemble in comfortable surroundings, and with facilities available for light refreshments. Here, too, cigarettes, fruit and the special sweet rations were on sale. In the smaller centres no separate cafeteria could be provided, but light refreshments were always available until a late hour.

### **Commandants' Messes**

It was the original intention to have a separate mess in the larger centres where Chefs de Mission and the Commandant and his Chief Executive Officers could have meals together. This idea was discontinued as it was found that Chefs de Mission preferred to eat with their teams, in some cases because they preferred their national diet, and also because Chefs de Mission found that meal times were the best opportunity to gather their teams together for announcements. Commandant's Messes were therefore established at centres for the executive staff and official visitors; team officials could use them at any time by open invitation.

### **Staff Canteens**

The large centres were also provided with staff canteens where both permanent staff and visiting employees could obtain meals and light refreshments cheaply.

### **Box Lunches**

The long distances to be covered by competitors both during training and during the Games, made it impossible for them to return to their housing centre for a midday meal. At one time it was hoped to provide hot meal facilities at the main Olympic venues, but this was found impracticable. It would also have been most difficult to provide a diet agreeable to all competitors at short notice. It was therefore decided to provide a good variety of box lunches to be prepared at the housing centres in conjunction with Team Managers, to ensure that the food supplied was suitable and satisfactory to the competitors concerned.

### **Meal Times**

It was the original intention to maintain definite meal times, but during the Games period it was found to be quite impossible. Transport difficulties, training and other matters made it necessary for an almost continuous service to be available in the kitchens.

### **Swill and Refuse**

Arrangements already in existence for the collection of swill and the disposal of refuse were continued at the centres.

### Catering at Venues

No catering arrangements had to be organised by the Committee at the Empire Stadium, Empire Pool, Harringay Arena or the Empress Hall, except that breakfasts for the wrestling and boxing competitors after their weigh-in at their venues had to be provided.

### Herne Hill

Certain catering arrangements were necessary for both public and competitors. These facilities consisted of:—

- (a) A grandstand catering bar for the public using the stands.
- (b) Refreshment tent for the Press.
- (c) Two catering bars for the remainder of the public—these consisted of wooden chalets, one on each side of the ground.

Competitors also made use of these services.

For the Games, the catering arrangements were divided into two periods:— the training period, July 8-August 11, and the competition days, August 7, 9 and 11.

During the training period, the competitors were provided with tea, coffee, minerals and light refreshments from the grandstand catering bar.

To increase facilities on competition days, permission was obtained to erect three marquees on a field behind the grandstand. Here competitors, competition officials and the Press were able to obtain tea, coffee, minerals and light refreshments. A grandstand bar was reserved for visiting officials and official guests. To supplement the service to the general public, two marquees were erected in addition to the two existing wooden chalets. The agreement with the contractors included the following points :—

- (a) They should supply all equipment, except that which the Organising Committee might agree to supply.
- (b) All catering arrangements were to be left in their hands and the scale of charges and type of food were to be fixed by them.
- (c) Responsibility for supplying staff, effecting insurance and meeting any claims for damages, etc., was to rest with the caterers.

The following equipment was supplied to the contractors by the Organising Committee :—

3 large marquees; 2 smaller marquees; 14 trestle tables; 14 forms; 500 mugs and coffee cups.

In addition, the catering contractors ordered a further marquee and additional trestle tables and forms from an independent source.

The meals served were as shown under :—

	<i>Light refreshments</i>	<i>Beverages</i>	<i>Ices</i>
August 7 .....	9,650	6,400	5,200
” 9 .....	3,300	3,800	4,000
” 11 .....	3,200	3,200	3,000
	16,150	13,400	12,200

The arrangements at this venue were satisfactory.

### Marathon and Road Walk

The International Amateur Athletic Federation rule relating to long distance races states.

" In long distance races and walking races, refreshments shall be provided after 15 km. (race) or 10 km. (walk) and refreshment stations shall be arranged at every 5 kilometres. A competitor has the right to bring his own refreshments. The organisers of the competition shall supply such refreshments as can be obtained under normal conditions."

For these events, eight feeding stations were established for the Road Walk and seven for the Marathon. Mobile canteens were used for this purpose. The personnel at each station consisted of the driver, a canteen assistant, and a number of other assistants ; three of these were placed at some distance before the station to establish the requirements of the competitors, some to assist in serving the refreshments and others beyond the station to assist in sponging down the competitors. The canteen assistants were supplied by one of the official caterers. Rations were picked up from the Olympic Catering headquarters at Willesden County School.

Two hundred Boy Scouts were used along the course as distance markers, and they were supplied with box lunches for their own use. Beverages were supplied to helpers after the competitors had passed their feeding stations.

The following rations were supplied to each station :—

<i>Marathon</i>	<i>Road Walk</i>
6 pints of warm tea	6 pints of warm tea
3 " " " " sweetened tea	3 " " " " sweetened tea
6 " " cold tea	6 " " cold tea
3 " " " " sweetened tea	3 " " " " sweetened tea
4 " " warm coffee	4 " " warm coffee
3 " " barley water	3 " " barley water
3 " " lemonade	3 " " lemonade
1 syphon of soda water	1 syphon of soda water
1 bottle of orange juice	1 bottle of orange juice
½ lb. sugar cubes	½ lb. sugar cubes
6 oranges	6 oranges
6 lemons	6 lemons
20 cubes grape sugar	20 cubes grape sugar
	1 lb. biscuits
	½ lb. boiled sweets

Beverages were served in waxed drinking containers.

A special request was made by the British Road Walking team that rice should be available in their kitchens during training.

Each station was provided with a sun umbrella.

### **Windsor Great Park, Cycle Road Race**

Arrangements were made to provide food for the 150 competitors. By agreement with the National Cyclists' Union, a cold buffet lunch was provided for the 150 officials of the race. A considerable quantity of tentage was obtained from the M.o.W. to provide for refreshment buffets at vantage points on the course as well as for the main catering arrangements near the grandstands at the finish.

### **Henley River Bank**

The catering arrangements in the enclosures on the river bank were divided into three categories :—

(a) for the officials—this consisted of a cold buffet with beverages.

(b) " A " Enclosure. The catering for this enclosure was under the direct control of the Secretary of the Henley Regatta Committee who undertook all catering and bar facilities.

(c) " B " Enclosure. This enclosure contained the grandstand and the catering was put out to contract.

No provision was made for feeding the competitors at the river bank. They had the choice of bringing their box lunches with them or of returning, as most of them preferred, to the centres for meals.

## **SUPPLIES OF FOOD**

A sub-section to the Equipment Section was set up at the end of January, 1948, to deal with supplies and transport of food. By early spring it had become apparent that Supplies could no longer be a sub-section of the Equipment Section, and it became a separate section, also responsible for the provision of chocolate, confectionery and soap for the competitors.

It was foreseen that the rations which would be available to competitors from supplies in this country would not be considered sufficient by some of the competing nations, and that additional supplies amounting to 200-300 tons of various foodstuffs would have to be obtained from other sources. It was therefore necessary to make arrangements for the reception, storage and distribution of such foodstuffs upon their arrival. A plan was prepared for the storage and distribution of:—

(a) foods supplied by individual nations for their own teams.

(b) gifts from other nations.

The Ministry of Food was asked to grant an increased ration scale and as a result a scale based on that allowed for workers in heavy industry was authorised. In April a circular was sent to all competing nations advising them of the scale of rations which would be available to their teams, and listing foods which were available free of ration. Nations were informed that the ration scale was the same as that given to heavy industrial workers in Britain and could not be increased, and that any special items of diet which they considered necessary in the training of their athletes could be brought or sent into this country free of duty, providing it was for the exclusive use of the members of their

teams. From correspondence received, it was evident that nations fully appreciated the food restrictions in force in this country and many nations intimated their intention of bringing additional foodstuffs with them.

The food supplied to competitors was drawn from the following four sources :—

1. Special Olympic scale.
2. Food brought by nations for their own consumption.
3. Gift food donated by certain nations for the consumption of all.
4. Gifts of certain foods made by trade organisations or firms in Great Britain.

For the transport of foodstuffs the official forwarding agents were approached. In view of the heavy cost of private transport, the War Office Olympic Committee was asked whether it could assist the Organising Committee by providing transport at reduced rates. The Royal Army Service Corps gave the help required.

The official forwarding agents assisted with the collection and transport of consignments of food from the docks. They also handled all negotiations with the Customs on behalf of the Committee and opened warehouses for temporary storage of non-perishable goods. The Ministry of Food placed a large depot at the Organising Committee's disposal for cold storage of perishable items.

Early in July the Food Depots were opened and staffed and at the end of the first week, as consignments began to arrive, they were transported to the depots by R.A.S.C. vehicles in convoy.

Some of the teams also arrived soon after this and began to draw upon their stores. This process continued most satisfactorily throughout the period of their stay, without the loss of any foodstuffs whatsoever. The distribution of wines and spirits also worked smoothly and no losses were sustained.

The Dutch Olympic Committee offered to supply 100 tons of fresh fruit and vegetables for the use of all competitors throughout the period of training and competitions, and sent consignments two and three times in each week. Other gifts received for general distribution were 160,000 eggs from Denmark, 5,000 eggs from Eire and 20,000 bottles of mineral waters from Czechoslovakia. A gift of supplies of fresh fish of approximately 3,000 stone was received from the British Trawlers' Federation. These supplies arrived at Billingsgate three times weekly and were distributed by the department's transport. A gift of kippers and herrings was received from the Herring Industry Board. Gifts were also received from Australia and Switzerland, for the use of the British Olympic Team, who could not import food on the same basis as other competing nations ; and some carcasses of mutton from Iceland.

Chocolates and sweets were provided at all centres and schools, being bought from the manufacturers by the Committee and sold to competitors, who were each entitled to a ration of eight ounces weekly.



Special permission was granted by the Ministry of Food for the making of different kinds of bread not then permitted in Britain. All London centres were supplied by the bakery of one of the official caterers. This bread was very popular with the majority of the competitors.

Over and above the gifts, large supplies of food arrived from 36 of the competing countries, ranging from a weight of 160 tons sent by one country to a few pounds of special commodities by another nation. The items sent were varied, but consisted mainly of meat, poultry, fats and sugar. The total tonnage of food imported by national teams for their own use was about 300 tons.

After the Games, it was found that approximately 80 tons of foodstuffs remained at the centres. By arrangement with the team managers and attaches, and with the permission of the Ministry of Food, this food was distributed amongst the London hospitals.

## PERSONNEL

Reference has already been made to the task confronting the Housing Department in finding the necessary personnel to staff the housing centres for the Olympic Games. The short term for which these persons would be required, together with the fact that the period coincided with the normal holidays in Great Britain made the problem even more complex. By December, 1947, two main principles had been evolved :—

(a) Staffing requirements should be planned so as to keep the numbers of persons employed at the minimum compatible with efficiency, thereby avoiding unnecessary expenditure.

(b) Where possible, the employees should possess sufficient knowledge of suitable languages to assist them in meeting the needs of foreign residents and should be allocated to centres according to these qualifications.

A Personnel Officer was appointed to the Housing Department and he produced figures based on the capacity of each centre to provide for :—

Domestic Staff—	Catering Staff—
Administratives	Charge Hands
Staff Superintendents	Storemen
Supervisors	Kitchen and Butcher Porters
Wardens	Counter Hands
Receptionists	Service Hands
Storemen	Cashiers
Labourers	Clerks
Cleaners	Typists
Porters	Still Room Hands
Toilet Attendants	

Subsequently, the Committee agreed that the caterers should engage their own staff, thus relieving the Personnel Officer of this responsibility. The arrangements (referred to

later) with the National Union of Students were put at their disposal and used by the caterers.

Simultaneously with the above planning, the Personnel Officer endeavoured to earmark staff to meet the administrative and domestic needs of the centres, through the machinery of the Ministry of Labour offices and other employment sources. It soon became apparent, however, that the nation-wide shortage of manpower would prevent satisfactory recruitment of sufficient numbers for temporary work by the time intakes would be required. Consequently an approach was made to the National Union of Students on the possibility of engaging student labour. It was agreed with this body that, where required, student employees would be accommodated and provided with food at the centres where they would work.

In these circumstances it was decided that:—

(a) The N.U.S. would provide the main source of staff for the requirements of the Organising Committee.

(b) Upon their appointment by the Executive Committee, the centre commandants would engage through their local Ministry of Labour offices such staff as could not be supplied by the N.U.S. by virtue of specialist requirements.

(c) The Personnel Officer would be the liaison representative between the centre commandants and the employment sources.

To give effect to the above arrangements, the National Union of Students was informed of the range of staff requirements, the effective dates of the engagements, the types of duties for which the students were required and the locations at which they were needed.

The N.U.S. thereupon circularised information regarding the project and the terms of engagements to their members at home and to affiliated organisations overseas, at the same time calling for students to apply for engagement in the various types of work. This produced some 2,000 replies which allowed the N.U.S. to make an adequate selection of suitable student employees according to their abilities and language qualifications. This figure included applications from many foreign students who wished to visit this country to see the competitions. The N.U.S. obtained the agreement of the Ministry of Labour to the employment of foreign students, subject to the provision that they were treated in the same manner as British students regarding wages and hours of work.

The intake of employees commenced on a sliding scale from July 1, 1948, for the three main centres, and from July 19, 1948, for the Middlesex schools, High Wycombe, women's centres, Bisley, Aldershot and Camberley areas. Approximately 570 and 500 students were employed for domestic and catering requirements respectively.

Early in 1948 Commandants were appointed for Richmond Park, Uxbridge and West Drayton by the Executive Committee.

The normal school and college staffs were employed as commandants, caretakers and cleaners at the small centres, supplemented by student labour under the control of area commandants.

The discharge of staff took place progressively between August 6, 1948 and September 14, 1948 ; the peak rate of discharge occurred between August 15 and 20, 1948.

The overall ratio of domestic and administrative employees to residents in centres was 1 to 8, but if catering figures are taken into account this becomes 1 to 3.

The employment of students proved extremely valuable and highly satisfactory. They were amenable and adaptable to the majority of staff requirements. The majority had language qualifications which were of considerable assistance. The general demeanour and spirit of co-operation in all spheres was admirable and worthy of recommendation in considering staffing projects for future Olympic Games.

## SERVICES

### Cinemas

Cinemas were operated at two main centres, but were not extensively patronised.

### Banking

The National Provincial Bank Limited provided banking facilities at all centres and opened branches at Uxbridge, West Drayton and Richmond Park centres.

### Other Facilities

A 72-hour laundry service was set up for the benefit of competitors and officials, and a tailor's shop at each of the three main London centres. Barbers' shops were opened at Uxbridge, West Drayton and Richmond Park, and similar facilities existed in the Aldershot and Bisley area. At the large centres, newsagents and small trading establishments were provided.

## ALLOCATION OF NATIONS

As a result of the necessity to house Olympic competitors in a number of centres, the problem of the allocation of nations presented considerable difficulty.

It was at first intended that those European and other nations who would arrive immediately prior to the Games should be accommodated in the schools which did not become available until a week before the Opening Ceremony.

This intention had to be altered in the light of catering problems, since it was found necessary that many Far Eastern nations, with their special feeding requirements, should have separate kitchens for the preparation of their food. The grouping under feeding requirements was as follows :—

- French cooking
- Scandinavian cooking
- South American and Spanish cooking
- North American cooking
- Central European cooking
- Nations requiring specialised treatment

### Early Arrivals

Due to the lack of accurate information as to the size of teams, it was virtually impossible to decide the final placings until approximately two weeks before the Games commenced. Other problems were those of language and religion or the specific requests made by certain nations who had sent special delegates to London during 1947 and early 1948. Since certain teams arrived in London at an early date (the first team arrived before the end of May), the Richmond Park centre was opened for "pre-Olympic" occupation on June 10, and certain nations were installed there. It was made clear to them that they could not necessarily expect to remain at Richmond for their entire stay. Although it was possibly regrettable to have to move teams during the periods when their athletes were in training, this was inevitable in view of the problems set out above. These accommodation problems existed only so far as London was concerned, since the Henley, Torquay, Aldershot and Bisley centres presented no difficulties. The final allocation of nations is set out in the table on page 160.

### OLYMPIC HOUSING CENTRES

Housing Centre	Dates Open	Capacity	No. of Dining Rooms and Kitchens
Uxbridge	July 8-August 21 ...	1,600	5 kitchens, 6 dining rooms
Richmond Park	June 5-September 1	1,600	5 kitchens, 5 dining rooms
West Drayton	July 8-August 21 ...	700	3 kitchens, 3 dining rooms
Pinner County School	July 18-August 20	101	1 kitchen, 1 dining room
Greenford County School	July 18-August 20	92	1 kitchen, 1 dining room
St. Helen's School, Northwood	July 24-August 20	120 women	1 kitchen, 1 dining room
National Training College of Domestic Science	July 26-August 20	120 women	1 kitchen, 1 dining room
Southlands College, Wimbledon	July 12-August 20	150 women	1 kitchen, 1 dining room
Twickenham Technical School	July 18-August 20	185 male staff	1 kitchen, 1 dining room
Ealing County Boys' School	July 18-August 20	100 female staff	1 kitchen, 1 dining room
Manor Senior School, Ruislip	July 18-August 20	100 male staff	1 kitchen, 1 dining room
Southall Technical School	July 18-August 20	80 male staff	1 kitchen, 1 dining room
Hendon Technical School	July 18-August 20	250	1 kitchen, 1 dining room
Willesden Technical School	July 18-August 20	220	1 kitchen, 1 dining room
Acton County School (in reserve)		120	1 kitchen, 1 dining room
Wembley County School	July 18-August 20	100	1 kitchen, 1 dining room
Willesden County School	July 18-August 20	90	1 kitchen, 1 dining room
Preston Manor County School	July 18-August 20	90	1 kitchen, 1 dining room
Ealing County School for Girls	July 18-August 20	100	1 kitchen, 1 dining room
Cophtham County School, Mill Hill	July 18-August 20	84	
Bisley	July 26-August 6		1 kitchen, 2 dining rooms
Kilburn Technical School	July 18-August 20	65	
Harrow Weald School	July 18-August 20	85	1 dining room
Chandos Secondary School	July 18-August 20	120	1 dining room
Kingsbury County School	July 18-August 20	91	1 dining room
Royal Grammar School, High Wycombe	July 18-August 20	} 500 to 600	
County School, Hatter's End	July 18-August 20		
County School, Mill End	July 18-August 20		

**ALLOCATION OF NATIONS**  
**London Area Housing Centres (Men)**

<b>Main Centres</b>	<b>Middlesex Schools</b>
<i>Richmond Park</i>	<i>Acton County</i>
Argentina	Iran
Chile	Iraq
Colombia	Pakistan
Cuba	
Denmark	<i>Greenford County</i>
Finland	Greece
Iceland	Lebanon
Italy	Syria
Norway	
Panama	<i>Hendon Technical</i>
Peru	Hungary
Puerto Rico	
Spain	<i>Kilburn Technical</i>
Sweden	China
Uruguay	
Venezuela	<i>Preston Manor</i>
	Mexico
<i>Uxbridge</i>	
Afghanistan	<i>Pinner County</i>
Belgium	Burma
Canada	India
France	
Great Britain	<i>Twickenham Technical</i>
Liechtenstein	Egypt
Luxembourg	
Monaco	<i>Wembley County</i>
Netherlands	Bermuda
Philippines	British Guiana
Switzerland	Ceylon
Turkey	Jamaica
U.S.A.	Malta
	Singapore
<i>West Drayton</i>	Trinidad
Austria	
Brazil	<i>Willesden County</i>
Czechoslovakia	Korea
Poland	
Portugal	<i>Willesden Technical</i>
South Africa	Australia
Yugoslavia	Eire
	New Zealand

## **ADMINISTRATION OF CENTRES**

Day-to-day responsibility for each centre was placed in the hands of a centre commandant, who was directly responsible to the Executive Committee. For the smaller centres, an area commandant, to whom the commandants of the smaller centres were responsible, was also usually appointed.

At the three large centres the commandant's staff consisted of an assistant commandant, a housing officer, a staff supervisor, a head receptionist and an equipment officer. The other sub-departments were covered by representatives appointed by the department concerned, i.e., accounts and food stores by the Housing Department, technical matters, press liaison and transport arrangements by their respective departments.

The catering was not under the direct control of the centre commandant. A catering supervisor was appointed by the catering contractor concerned. All dealings with the caterers were in principle to be conducted through the head office of the contractor. In practice, however, the domestic and catering sides worked so well together that the great majority of matters that arose were dealt with by agreement on the spot.

### **Fire Precautions**

Firemen were on duty at all times at the large centres to deal with minor outbreaks of fire, the local Fire Brigade being available if required for any serious outbreaks.

### **Sign-posting**

The centres were well sign-posted to indicate the whereabouts of all the principal buildings, each block or building bearing a notice stating its purpose.

### **Gates**

All gates were manned by police officials who scrutinised the passes of all who wished to enter the centre.

## **ACCOUNTS**

In February, 1948, an Accounts Officer was appointed to plan the various systems connected with the payment of the accounts of the Housing and Catering Department and at the appropriate time, to make arrangements for the rendering and collection of accounts for accommodation and catering charges against the visiting teams.

As regards the visiting teams, it was necessary that the Chef de Mission of each country should agree daily with the Accounts Officer, the numbers of his team and officials in residence. It was further planned that National Olympic Committees should make a daily settlement. The daily settlement was not always effective, although all accounts were settled without any real difficulties.

One cashier and one assistant paid the staff wages at Richmond Park, Uxbridge and West Drayton, and this service was carried out for other centres by Headquarters with a staff of three.

# TRANSPORT DEPARTMENT

The first body to be formed by the Executive Committee to assist in the organisation of the transport problems of the Olympic Games was the Olympic Games Transport Advisory Committee. The Chairman, Mr. F. A. A. Menzler, and the Secretary, Mr. McKenna, were both senior members of the staff of the London Passenger Transport Board. The Committee was made up of representatives of the four Main Line Railway Companies and the London Passenger Transport Board.

## Transport Committee

Mr. F. A. A. Mender, F.I.A. (Chairman),  
Mr. C. K. Bird,  
Mr. W. P. Bradbury, O.B.E.,  
Mr. Gilbert Matthews, C.B.E.,  
Mr. F. G. Maxwell,  
Mr. R. M. T. Richards, O.B.E.,  
Mr. D. McKenna and  
Mr. B. J. Wainwright (Secretaries to Committee).

This Committee held four meetings to ensure that the whole of the country's transport organisation was in complete harmony as to the general principles of dealing with the transport questions arising out of the Games.

It arranged for a Liaison Officer to be appointed by each of the Railways to deal with the many and varied requests for assistance put to them by the Transport Department of the Organising Committee in its efforts to provide a smooth and efficient service to the incoming competitors, their baggage and their equipment.

The Organising Committee had appointed Messrs. Beck and Pollitzer to be its official agent in the importation of all the equipment and heavy baggage that was expected to precede the teams. All the bulk supplies sent by National Olympic Committees, such as special food, yachts, horses, feeding stuffs and the sculptures and paintings were handled by this organisation, and those articles received in advance were stored awaiting the requirements of the competitors. They were able to make use of the assistance of the Railway Liaison Officers in dealing with all these intricate matters.

## Administration

In July, 1947, the Transport Department of the Organising Committee was formed by the appointment of Mr. Wainwright as Transport Manager. His first duty was to acquaint the Advisory Committee more fully on the detailed needs of the Organising Committee, and to inform the Shippers of the Committee's requirements. By making the Manager Co-Secretary with Mr. McKenna to the Advisory Committee, close liaison was established and, in addition, a representative of the Shippers, was appointed to work in close touch with the Transport Department.

The task of the Transport Department to advise those outside the Organising Committee staff of the special requirements of the Committee was, at this and every stage,



the subject of a great deal of conjecture, for there was no easy way to form plans. It was by examining the history of previous Games and conversations with those who had acted at them in an official capacity, and by a careful study, in co-operation with the Technical Department, of the probable requirements of the competitions, that the general picture of future operations began to take on a recognisable shape.

The main task of the Department was to formulate a plan to move the competitors and their team officials to the official housing centres when they arrived in London, and then provide adequate transport facilities during their stay.

The Executive Committee had decided that transport would be included for competitors within the daily charge of 25s. Official responsibility was to commence with the arrival of competitors in London. They were to be met at London rail termini and airports, conveyed to their living quarters, and provided with all necessary transport for official training needs and for the competitions. Special arrangements were to be made for the Opening, Closing and Religious Ceremonies, and also for the official parties being organised for the competitors. The competitors at Henley-on-Thames, Aldershot and Bisley, were given similar facilities as those in London, but those at Torquay were excluded.

The facilities were to commence operating on July 8, 1948, and were to cease on August 21, these dates being those between which the major movements would take place. The Department was instructed to keep its arrangements confined to these dates.

The plan was based on a figure of 6,000 competitors, who would stay in London for an average of 17 days each.

### **Buses and Coaches**

Early enquiries were made among private coach operators, to form an estimate of the cost of placing coaches at the service of National Olympic Committees for their sole use.

Although details of ultimate requirements were not known, it was quite obvious that under the working conditions of training and competitions, a contingent of say 60 competitors would be restricted in movement if supplied with only two 30-seater coaches, for their daily destinations would be various districts of London and the country at the same time. Allowance had therefore to be made for something in excess of 200 coaches per day. A quick check of costs showed that a bare minimum of 250 coaches of this nature would involve the Organising Committee in the expenditure of not less than £3,000 for a short working day of eight hours, with mileage limits imposed, giving a possible total of between £60,000 and £70,000 for the complete operations. It was, therefore, imperative that further explorations be made in order to discover a less expensive approach.

Through the Advisory Committee, the London Passenger Transport Board offered to provide some of their double-decker buses for the transport of the competitors who were residing in London proper, on a most reasonable hire-charge based on wages and miles travelled. This offer was accepted by the Executive Committee.

London Transport made it clear that the number of vehicles to be loaned would be small. Post-war conditions had created a situation which had caused them to hire,

from private sources, up to 400 single-decker coaches a day to augment their own fleet of more than 3,000 vehicles, in order to administer an efficient daily service to London's road passenger needs.

At no stage, therefore, was the Transport Department able to plan on anything but an austerity basis. In order to meet this situation demands on the vehicles had to be kept below a figure allocating a seat to all competitors at the same time. Eventually, a scheme for the running of a shuttle service between the main venues and living quarters was devised. This could be worked by approximately fifty vehicles, and London Transport agreed to provide the Organising Committee with a maximum of twenty double-decker vehicles of 56-seat capacity, twelve single-deck coaches of 30-seat capacity and twenty small 20-seaters. These last were an obsolete type, and were offered reluctantly as, owing to age, their condition was below standard.

Further arrangements were made to hire sufficient London Transport vehicles for the Opening Ceremony and other special occasions. It was also arranged that, to operate the fleet of buses efficiently, twelve members of the London Passenger Transport Board's own road staff, under the control of a senior official, should be loaned to the department for the days of operating, and should become, for these few weeks, paid members of the Transport Department.

A Transport Working Committee was set up under the Chairmanship of the Director of Organisation. Members consisted of senior officials of the Metropolitan Police, the London Passenger Transport Board, the Royal Automobile Club, the Automobile Association, the Secretary of the British Olympic Association and the Olympic Games Transport Manager. Through pressure of business the Director of Organisation asked Mr. Percy F. Cranmer to take over the Chairmanship of this Committee after the first meeting. From this time onwards, Mr. Cranmer took an active daily interest in all arrangements and negotiations.

The deliberations of this Committee were in the nature of a round-table conference. Members did not meet often, but as each was an expert in his own particular sphere of activity, it was only necessary for the telephone to be brought into use between individual members for plans to proceed smoothly from stage to stage.

The main concern of the Committee was to ensure that competitors' vehicles would have free and unobstructed runs. As the police required all buses to travel on set routes, the London Transport prepared a plan of such routes for their approval, and the two motoring organisations undertook to give attention to the posting of road signs.

Members of the Committee met together or went individually to each new site as its location became known. Each brought his organisation's local representative for discussions and in most cases decisions were reached on the spot.

Especially helpful at this stage was the arrangement that allowed the senior Road Official nominated by the London Passenger Transport Board to accompany the Transport Manager in investigating every housing centre and sports venue. In this way the known requirements of the Organising Committee were translated into practical working possibilities for the heavy double-decker vehicles. Journeys were measured and timed and

noted for the proposed schedule. Managers of the local bus depots, from which vehicles and staff would eventually be drawn, were brought into discussion, and much attention was given to such details as the capacity of the road surfaces in the housing centres to bear the weight of the buses, the width of the gateways, low bridges, and other matters that only informed local knowledge could supply.

### **Light Transport**

As details became available from the Technical Department about the sports venues and training grounds, and from the Housing Department about the number and location of the housing centres, it was clear that the Transport Department would have to provide a speedy and mobile form of transport which would work independently of buses. What was needed was a fleet of comparatively fast cars to carry small parties of five or six people on the innumerable cross-London journeys which had to be undertaken.

Approach was made to car manufacturers for assistance, but it was soon apparent that, because of the demands of the export programme, their co-operation was impossible. The cost of private hire cars of the capacity needed was prohibitive. Finally, approach was made to the Ministry of Supply. This Ministry has a large pool of cars in use for many Government Departments. Normally, these cars cannot be used outside government work, but the needs of the Organising Committee were placed fully before the Treasury, and permission was granted for the Organising Committee to hire up to fifty vehicles each day from the Ministry of Supply's Essential Car Services' Organisation.

The detailed final arrangements were for fifty 8-seater station wagons, driven by green-uniformed girls, to be hired for the period July 8 to August 21. The scale of charges was to be similar to that agreed with London Transport, that is, on a wages and mileage basis. Again, a senior Road Official was to be loaned to the Transport Department for the whole period of planning. He accompanied the Transport Manager and London Transport Official on their calls to the sites so that they were able fully to co-ordinate the arrangements both for buses and cars. It added a great load to the Department when this official had to be withdrawn a few days before the station wagons came into service.

### **Henley**

It was known that at least four housing centres would be established in High Wycombe, Buckinghamshire, thirteen miles from the river at Henley-on-Thames, Oxfordshire, for the competitors in the Rowing and Canoe events. A daily maximum total of 600 people was expected to require transport from about July 22 until August 12. It had been suggested that all the competitors should be conveyed to the river in the morning for training, should feed and rest nearby, and return at a set time in the evening.

It was pointed out, however, that, apart from the possible wishes of some of the competitors, this was likely to be an expensive way of undertaking the movement, especially as the hours for training had been carefully allocated between Rowing and Canoeing. Instead of using up to twenty coaches a day on one return journey, the Department suggested a shuttle scheme to use approximately ten coaches a day, each vehicle to make

as many return trips as was necessary for training and competition. This would also dispense with the trouble and expense of arranging for rest rooms by the river, the competitors being able to return to their own quarters for food and rest. This plan was accepted.

No firm could provide sufficient coaches during the summer season. The only vehicles that could be obtained were of the luxury type in use for summer pleasure trips. Petrol rationing and the lack of new vehicles gave them a scarcity value and, in addition, no coach operator was willing to hire to the Organising Committee to the total exclusion of the needs of local people.

However, eventually, five separate companies, in High Wycombe, Henley and Reading, were combined together into an unofficial association that agreed to provide, from one source or another, sufficient vehicles each day to cover the Committee's needs. Firm orders had to be placed with these operators for all requirements. It became more necessary than ever to check and re-check the daily needs and, to avoid unnecessary expense, orders were eventually placed for a varying number of vehicles for each day, according to the likely flow of traffic suggested by the timetable of events. Having ordered these coaches on a daily hire and contract mileage basis of 120 miles per day per coach, Transport Department placed the responsibility for the efficient running of the proposed service in the hands of the local association of coach operators.

The Reading organisation provided an experienced official to whom was delegated the task of running the local High Wycombe-Henley coach service which was then augmented by two Ministry of Supply station wagons.

### **Aldershot**

The Aldershot and District Traction Company, the chief bus proprietors in the area of the equestrian events, was approached to co-operate with the Organising Committee's Transport Department. This they readily agreed to do and all the vehicles necessary were made available at reasonable rates.

Both double- and single-decker buses and luxury coaches were used in the area which included Camberley, Sandhurst, Aldershot and Bisley Camp. By careful research into the requirements of the official programme, and the unofficial needs of the officers and men travelling between living quarters and the stables, it was again possible to place firm orders for vehicles, but, unlike the Henley arrangements, the resources of the Aldershot Bus Company allowed for a degree of elasticity in ordering in case of necessity.

Once again a local man, nominated by the Bus Company, was given the appointment of Olympic Transport controller, and acted in complete liaison with the Bus Company, the Organising Committee's Transport Department, and the local military and housing centre officials. Five station wagons were provided as run-about in addition to the buses.

As Bisley Camp was a combined camp and sports venue, it was not necessary to provide daily transport, and arrangements were confined to travel between London and the Camp.

The Southern Railway had a small branch line between Brookwood and Bisley Camp.

Although it was not thought possible to re-open this railway owing to fuel restrictions, it was eventually decided to run trains for the convenience of competitors, officials and members of the public for the period of the competitions, at no cost, of course, to the Organising Committee.

### **Financial**

By March, 1948, these arrangements were satisfactorily concluded and the financial commitments were reviewed. In every case orders had been placed in such a manner that the mileage travelled had a direct influence upon costs. This varied from 1s. 6d. per mile at Henley to 5½d. per mile travelled by the 8-seater station wagons. Great care, therefore, had to be taken in estimating the possible daily mileage of each of approximately 120 vehicles in use throughout the period from July 8 to August 21. A total figure of 345,960 miles was estimated, and the Executive Committee was advised that the daily cost of competitors' transport would not exceed 5/- per head.

### **Private Cars**

Two subsidiary but important side issues took up a great deal of time and attention from January, 1948. Petrol rationing had made it impossible for officials of National Governing Bodies to use their cars for the additional work being thrown upon them while assisting the Organising Committee. It was, therefore, necessary to approach the Ministry of Fuel and Power to lay the position before them. This approach was received most sympathetically.

It was necessary to take precautions against false claims for petrol allowances, and an assistant to the Transport Manager was given the task of examining all claims to establish their authenticity. Once this was done, they were passed to the local petroleum officers for their attention.

Olympic attaches and visiting officials of all kinds placed their demands through the Transport Department, so that all claims were dealt with through one channel. An official of the Ministry was nominated to deal with all Olympic business and it was through this close liaison between the two offices that everyone who had official reason to travel by road was, in fact, kept mobile.

### **Car Parks**

The other important side issue was that of car parking arrangements. When discussions on this subject were first opened, it was not known whether petrol would be available for private cars for pleasure at the time of the Games. It was decided that arrangements should go ahead upon the assumption that such use of petrol would be allowed.

At the Empire Stadium the normal arrangements for the parking of coaches and cars were in the hands of a professional organisation specialising in this work, and this firm was asked to undertake all the necessary work for the Organising Committee at Wembley and all other venues at which such services might be required.

Appropriate financial arrangements were made by the Executive Committee and the Transport Department's chief task was therefore in acting as liaison between the various Departments of the Olympic Games Organisation, the National Governing Bodies, the National Olympic Committees, and all other Bodies who would require to use the official car parking facilities.

Space was checked at all venues, and allocated for official use before the needs of the public were considered. In many cases the space available was quite inadequate, and the assistance of the police had to be sought in order to see what public roads, if any, might be used as overflow parks.

In no case could public roads be used as official car parks, but, as all cars in use on official business were to carry special identity discs, it was agreed that the police should direct the cars and coaches to conveniently quiet side roads.

At the Empire Stadium, a whole section of the forecourt was taken over as a competitors' bus station, and another large area was allocated to the official Film Unit, the Press and B.B.C. Space for another three hundred cars was set aside close to the main entrance for all other official cars. Each National Governing Body was provided with two free passes, as were the National Olympic Committees. Attaches and members of the I.O.C. were given one pass each, whilst the Press Department were furnished with 150 passes for distribution to home and visiting journalists. Members of the Organising Committee Staff also carried the passes, which consisted of a small circular disc of cardboard on which was printed a suitable inscription. These discs were affixed to the windscreens of the cars by a rubber suction pad, which permitted the holder of the pass to carry it on any car in use at the time.

### **Reduced Fares**

Soon after its inception, the Transport Advisory Committee had undertaken to discover whether reduced fares could be arranged for the convenience of competitors and officials when travelling in this country. It was able to co-ordinate arrangements between the then four main line railway companies in such a way that a reduction by one-half was made in all single fares, and return tickets were issued at the single fare. A similar reduction was obtained on baggage and certain equipment. All National Olympic committees were advised of these concessions, and the necessary vouchers sent to them, but it soon became apparent that some difficulties would have to be overcome before countries could take full advantage of the offer.

There were no international arrangements in operation that would allow through bookings to London to incorporate the reduced fare on English railways. In most cases teams would have their passages booked to Britain and would be required to exchange their voucher for reduced fare tickets on arrival. The delay so caused would have been disastrous to train connections. Messrs. Thomas Cook & Son were approached to see what might be done to clear this point and arranged for their agents abroad to discover from the secretaries of National Olympic Committees the exact numbers of the contingents crossing in each boat. They then booked the rail section of the journey in advance. Reduced train fares were available to all those entitled to the Olympic Identity card.

Other advantages of importance were gained by this arrangement. Foreign currency difficulties received some relief. Cook's advices confirmed the information received from the National Olympic Committees about the numbers of persons travelling, and sometimes gave information that had not been made available to the Transport Department through other channels. Furthermore, Cook's agents in Europe approached railway organisations in the various countries and in nearly all cases obtained considerable reductions in rail fares for Olympic teams travelling over national rail systems. To make complete the service offered, the travel company placed their own interpreters at the service of the larger parties reaching England from European ports without charge, and assisted in some cases as guides and interpreters from the South of France to London.

Messrs. Thomas Cook & Son also arranged for a senior member of their staff to be continually at the service of the Transport Department, and help and information was given on all enquiries placed before them.

### **Travel Passes**

Concessions on sea and air journeys were not obtainable, but London Transport made a notable contribution in offering free travel in the London area to all those carrying the Olympic Identity card between the dates July 15 and August 15, inclusive.

London Transport control and operate all the public transport in London outside the main line railway systems. Special passes were printed and issued in bulk to National Olympic Committees on arrival at the housing centres. The sole requirement of London Transport was that each ticket should be signed by the holder to avoid possible use by those not entitled to this concession.

### **Staff**

The engaged staff of the Transport Department was always planned to be small. The Transport Manager relied mainly upon men borrowed from the concerns from which transport was to be hired for the strength of operations. For some months the staff consisted of the manager, a secretary and one male assistant, whose duties became largely arranging car parking with the official agents. In January, 1948, the services of an additional secretary were secured. Shortly after this, another male assistant was employed to supervise the allocation of the petrol ration. Later it was arranged that five students on holiday should augment the staff during the last days of July and the first half of August.

### **Routes and Schedules—Buses and Coaches**

A list of 67 training centres to be used by competitors was provided by the Technical Department. The Housing Department had also given a provisional list of the housing centres expected to be in use in London. It therefore became necessary to complete a final survey of routes between the various stations, airports, housing centres, sports venues and training centres in order that the police and bus operators could agree the roads over which the double-decker and single-decker buses should run.



This entailed a great deal of work, the results of which were published in duplicated book form and issued to all London Transport bus drivers undertaking Olympic work. In addition to details of 750 possible routes to be followed, this book also contained instructions to drivers to assist them in the special work they were undertaking.

The importance of the use of this book can be judged by the fact that the area to be covered in London alone was in excess of 400 square miles. The road system to be used was too vast to allow of special sign-posting, which would have proved too complicated and expensive, and the bus service was to be operated by drivers strange to most of the roads over which they must travel. No special corps of men could be recruited for the work and no special training could be given. If the drivers had not been provided with some such guide, the completion of London journeys to time would have been impossible.

No rigid plan of working was designed for the training side of the competitors' activities. It was simply agreed that Team Managers, through Chefs de Missions, should tell the local Transport Officer of their requirements for the following day, and transport would be arranged accordingly. It was, therefore, not important to the Department that there were a few more or a few less training centres, the elasticity of arrangements would take care of daily fluctuations. What was of major importance was knowledge of the final arrangements for housing competitors, in order that the proposed schedule of buses could be worked out and timed.

Journeys between the centres at Uxbridge, West Drayton and Richmond Park and the venues were easy to arrange and, if this had been the sole undertaking, the schedules would have been relatively simple. There were, however, a number of schools to be brought into the picture. No school was large enough to warrant its own scheduled service with 56-seater buses and, to avoid waste of vehicle seats, certain schools had to be linked up into one service. The buses were planned to start at the most distant of three schools from Wembley, or whatever venue was in question, and would then call at the other two places *en route*. Until these schools were known, nothing could be done to advance this plan. Finally, when a start could be made on the schedules, two experienced men were loaned to the Department by London Transport, and these men, with occasional assistance, worked on the problem for six or seven weeks, studying each and every route, timing and measuring, until the whole complicated plan was complete. This work was undertaken under the direction of the Transport Department.

A most important issue, was the necessity of seeing that nothing was demanded of the bus drivers or crews that would be in excess of their normal day's work. At times this seemed impossible to accomplish, especially owing to the comparatively small supply of vehicles. Journeys were to start at 7.0 a.m., and were not planned to finish until 1.0 a.m. As the garages were not always near to the housing centres this would mean that bus crews would be moving at 5.0 a.m. and some vehicles would need three crews each day. It became clear that some relief should be sought, and London Transport agreed to provide an almost unlimited supply of double-decker vehicles if their use was restricted to hours of working outside the public peak hours. This offer eased the situation and planning continued more freely.

The bus service was under the supervision of twelve London Transport officials, who staffed the transport offices at Uxbridge, West Drayton and Richmond Park, two men each working about nine hours, staffed the office from the first to the last bus. Four men worked in the Central Control office at Wembley, again in two shifts, and two men were in charge of the main bus parks at Wembley.

No difficulty was expected in running the vehicles to strict schedule as this was done daily throughout London. The important work, in which no advance training could be given was in the ordering and controlling of the numerous journeys on the training runs. By allocating to each housing centre a quota of buses, decentralisation was achieved, so that each could have complete local control for the basis of their daily work. Extra needs were supplied by the main pool, established at Wembley. When the schedule began on July 29, it absorbed most of these buses, and the few spare ones remaining were allocated according to the needs of the still continuing training programme.

### **Station Wagons**

The fifty Ministry of Supply station wagons were driven by women, half of whom were drawn from districts outside London. To ensure an orderly operation, billets had to be found for them. Arrangements had been made for two to take their vehicles to Henley, and five to Camberley (for the Sandhurst service). Twenty were found quarters just outside Richmond Park housing centre and the rest were billeted in Eccleston Square, Victoria. The cars of those living at Victoria were garaged and serviced in the usual manner by the Ministry of Supply and for others, local arrangements were made. In the case of those vehicles under the care of the drivers at Richmond Park, the housing centre had excellent accommodation, and this was completed by the Ministry sending down a mobile servicing plant and a petrol bouser, to give the vehicles daily care and refuelling attention.

In Henley and Camberley the drivers were under the instructions of the resident transport officers. At Richmond Park the twenty vehicles were under the control of a senior woman official working mainly at the housing centre and taking instructions from the Transport Office there. The balance of the Station Wagons reported to Wembley each morning.

To fill any gaps that might appear during the period of operations, and to provide a source of extra transport which would also help the Organising Committee to provide for the International Olympic Committee and other special bodies, the department booked twelve luxury 30-seater coaches from private sources. Mr. Percy F. Cranmer, placed three cars free of charge at the disposal of the Department, and two others were loaned, also free of charge, by his business colleagues.

### **Cycle Training**

In dealing with the cycle training programme a certain amount of difficulty was experienced at first in satisfying all demands. When discussing plans the Transport Department had been assured on several occasions that as far as the track at Herne Hill was concerned, competitors would house their machines in the accommodation provided at

the track once training had commenced, and that most of those using Windsor Great Park would travel on their machines between their living quarters and the race circuit.

In fact, nothing like this happened. A certain number of station wagons had been equipped with special racks to carry two or three machines and their riders, but this was quite inadequate to meet the demand of nearly all the competitors that the cycles should be conveyed to and from the training grounds on every occasion.

Operators refused to take the machines aboard with their owners for fear of damage to the seats of the coaches, so lorries and furniture vans were brought into service. This brought complaints from some teams that they were prevented from accompanying their bicycles by this method of transport. There were actually no hold-ups, but the whole operation was the cause of a great deal of daily last-minute arrangements.

The best answer to the problem was obtained by having seats stripped from one side of a 32-seater coach. This enabled about twelve machines to be carried in the space so provided, the riders, trainers and others interested in the teams, being able to travel in comfort with the bicycles. The cost of such an arrangement was twice that of the lorries, but there is no doubt that it gave complete satisfaction to those able to make use of it.

### **Communications**

For communication between Transport officers and the Central Transport Control, it was arranged to have complete independence of telephone operations between each main housing centre and the Wembley Control, and three private lines were installed.

At the Wembley Control office, six exchange lines were installed in addition to the three private lines. London Transport have their own private telephone exchange system inter-communicating with all their garages and repair depots in London. This system was extended to include Wembley Control, so that twelve instruments were available to the Control operators. A telephone extension was placed in a small Control office on the bus park at Harringay, and the use of a line was placed at the disposal of the bus controller at Earls Court, as these two places were in continuous use during the Games up to a late hour. London Transport supplied officials to control competitors' buses at these points.

### **Transport Control**

As at Head Office, space in the Wembley administrative buildings was not available in sufficient quantity for convenient arrangements to be made for the Transport Department. In consequence the Department obtained the use of the meeting hall of a local Roman Catholic Church, and this became the Wembley Transport Control. A newly laid concrete bus park, served by the main road, had already been earmarked as a bus pool. This Church Hall was the nearest building to the parking ground, and its windows overlooked the area. In the same building there were lavatories, canteen and rest room, and a small number of sleeping quarters. The grounds outside offered parking for the whole of the Department's cars and station wagons, so that the site was in every way ideally situated for the operations planned. Occupation of this building was taken on July 8 and it

was vacated on August 21. After the first few days a night staff was employed, and the office did not close until the end of the whole operation.

### **Arrival of Teams**

The first arrivals to be met were the New Zealand contingent. Because the Executive Committee had ruled that the Official Transport Service should commence on July 8, all coaches used before this date were charged direct to the National Olympic Committee using them, but this financial arrangement did not prevent the Department from taking its full part in the arrival arrangements.

Already it was obvious, from the varied and often contradictory information reaching the Department, that great care would have to be taken to discover the actual facts of all proposed movements before transport was laid on to meet them. To be able to present a true picture of impending arrivals to each Department of the Organising Committee, it was agreed that the Transport Department should receive all information available from any source, check and re-check, and distribute the final corrected results to all Departments of the organisation.

For this purpose, a man and two women secretaries were installed in two rooms, the larger of which was equipped with a number of telephones, and three walls covered with specially prepared blackboards. One wall represented today, one tomorrow, and one the following day. The boards were ruled in lines and columns and each board had current information chalked upon it as soon as it became available. Each operation was washed from its place as soon as completed.

The distribution of information was worked in three distinct stages. A white paper containing early advices was sent by hand to each Department. News of arrivals, the method of travel, numbers travelling, and other relevant details were checked and cross-checked, until the Department was as certain as it could be of its information. All this was transposed to a pink paper and distributed 24 hours before the arrival. Finally, a red paper, sent out within a few hours of arrival, was the warning for everyone concerned to be ready.

These precautions were vitally necessary to avoid chaos in reception centres and in the detailing of transport. The Olympic Attaches were originally thought to be the reliable source of all this information, but in actual fact there were so many parties arriving from the same country at different stations and airports, with places of arrival being switched at the last moment, that nothing less than a complete organisation, continually informing itself, hour by hour, could hope to keep abreast of events.

On behalf of the Organising Committee, three people were employed to await arrival of ships at the ports, and to work alongside the Reception Committee in assisting the contingents to disembark. These officers telephoned the Department from Glasgow, Liverpool, Bristol, Harwich or Southampton or wherever they might be, and were able to confirm the numbers of men and women in the parties, and the weight and number of pieces of baggage.

At the station or airport in London, students were employed to act as Transport Stewards for each party. They were instructed by the briefing room from the last minute

information contained on the day's blackboard. For two days each man was able to trace the movement of his party, and his was the responsibility of requesting transport from Wembley Control. Separate coaches were ordered for the women, and special arrangements made for the reception and delivery of the baggage which accompanied the teams. The Steward's final duty for each operation was to telephone the reception centres as the coaches departed from the place of arrival. He would then prepare for the next assignment.

Five men were employed for this job ; four were students on holiday, and one a school-master. The biggest troubles arose over baggage. At no time in planning this section of the undertaking was there warning of the large and varied parcels, mainly of food that would accompany the teams. The London Transport buses and coaches were not fitted for the carrying of much luggage. The loads were too large for the station wagons, so that the Department was compelled to hire lorries and vans from private services to deal with the situation.

The system of sending a Steward to supervise transport arrangements was especially successful at the airports. Small parties were continually arriving by air, some without prior advices ; other parties were delayed. By installing a Transport representative at Heathrow and Northolt Aerodromes, all arrivals were covered throughout the days of the peak arrivals. In the earlier days, buses and coaches were often standing-by for hours until much overdue aircraft finally arrived. This waste of vehicles was overcome by not ordering transport for any but arrivals in B.O.A.C. aircraft, of which there was firm detailed information. For the others, transport was ordered from West Drayton or Uxbridge Camps only when the information was received that the expected aircraft was actually in the air over the airport.

The main airlines take passengers by road coaches from the airport to their various headquarters in London. The Transport Department arranged with the B.O.A.C., B.E.A., PAN-AMERICAN, K.L.M., A.O.A. and SABENA airlines, that their coaches should, instead of travelling to London with Olympic competitors, take them direct to the Olympic centres at which they were expected. The B.O.A.C. placed their duty crew officers at the disposal of the Department, and eventually their Transport officer undertook to take care of any unexpected arrivals and convey them to their centres in aircrew cars at nominal cost. In view of the Company's preoccupation with their own work, this service to the Olympic Games Transport Department was greatly appreciated.

The schools in London and High Wycombe came into use as Olympic Centres between July 21 and 23. Many of the competitors to be housed in the schools had already arrived and were housed temporarily in one of the other centres. They had to be transferred to the schools at a time when other arrivals were at their peak. Special arrangements were made to transfer them at times convenient to competitors, in order to avoid undue interference with their training programme. On July 23, over 1,000 competitors were moved to twenty-three housing centres from stations, airports, and main Olympic centres. During the whole period the mislaying of only one package was reported. This was a small suitcase placed on a wrong coach and delivered to Richmond Park instead of Uxbridge. It was retrieved and re-delivered the same day.

The centres housing women competitors were a difficulty, because many nationalities were collected together, all anxious to train either with male colleagues, or under their coach, who also had to train his men. A member of the Transport Department toured all the women's centres daily to obtain concrete instructions from the Commandants, and in this way the difficulties were overcome. A certain number of vehicles were placed on permanent service at these centres, and also at one or two of the men's housing centres where special circumstances warranted this course.

### **Opening Ceremony**

The arrangements for transport for the Opening Ceremony were not without their special difficulties. By studying the past and current movements from the stations and airports a general idea of requirements was obtained, and by checking with Camp Commandants a reasonably accurate forecast was made. Training runs were curtailed and the whole of the regular fleet and sufficient extra double-decker buses were ordered for the occasion.

No attempt was made to restrict numbers of vehicles ; a surplus was provided so that each nation should have adequate transport. The Parade Marshal had selected a site close to the Stadium for the assembly point, and requested that competitors should all be in position by 1.30 p.m. In order to avoid congestion of traffic, it was arranged that bus and coaches should leave their bases at intervals, timed to allow arrivals to be spaced over ninety minutes. In fact, all competitors were unloaded in eighty minutes. The first arrivals, from High Wycombe, were at midday, the last, from Uxbridge, at 1.20 p.m. Two hundred and twenty vehicles were used for the operation.

As soon as competitors had alighted, the vehicles moved to prearranged parking places behind the Empire Stadium. When the Ceremony was over, the parade marched straight out of the Stadium to their buses, and in less than an hour the ground was cleared.

### **Transport during the Games**

The carefully prepared schedule of buses came into operation on the Friday morning, July 30, to an inauspicious start. For weeks it had been arranged that buses should leave all centres in time to arrive for the wrestling weigh-in at Earls Court at 8 a.m. However, the weigh-in had been put forward to 7 a.m. As the bus service was run on a two shift system, no drivers were available to be acquainted with the alterations, so that search parties were sent out to find them at their homes. Fortunately, lists of private car hire firms had been compiled, and these cars were employed to fill the gaps left by drivers who could not be reached.

However, from then on things went remarkably smoothly. The schedule arranged for Uxbridge, West Drayton and Richmond Park worked well. It relieved the Transport staff from the need to plan for each individual team, and the published time-tables allowed team managers to make their necessary arrangements in good time. All buses kept a strict schedule, controlled by the experience of the London Transport inspectors. Spare buses were placed near to the normal departure points, and these were brought into use as extra demands arose.

This was not entirely the case with the School centres, as no allocation of transport staff had been made for these establishments, and in consequence no tight control could be kept of the bus movements and demands. Very often delay or confusion was caused by the residents themselves, especially where more than one nation was concerned. To assist matters, a few additional coaches were obtained, and placed at the disposal of certain contingents who proved unable to avail themselves of the scheduled services. It is clear, however, that had it been possible to have a permanent transport official, who was completely familiar with the geography of London, and well briefed in the complexity of the needs of the competitors, resident at each school, the needs of both the Transport Department and the competitors would have been better served.

During the early days of the Games, the training programme continued with unabated pressure. Extra buses could not be spared by London Transport during the critical early morning hours, and a great number of special luxury coaches had to be secured to augment the fleet. They were brought in from Aldershot, Reading, High Wycombe and Cambridge, apart from those obtained in London. August Bank Holiday saw forty of these extra vehicles in use. The first training run on this day was from Uxbridge at 7 a.m. Sixty orders for buses were dealt with by Wembley Control alone on this day for training runs or to meet competitors still arriving. The main housing centres, Transport offices and the station wagons accounted for over a hundred more runs between them. This was outside the 300 journeys of the vehicles running on schedule.

The work of those allocating the vehicles for these indents was not helped by orders being telephoned from some school centres as late as 1 a.m. in the morning. No one was refused transport even though only a few hours warning was given, but it meant continuing planning the next day's work all through the night. It was not unusual for men, whose work started at midday to continue without a break for eighteen hours at a time, only to start again six hours later for another long spell.

### **Release of Transport**

Competitors continued to arrive until August 10. The first departures were on August 2. As the departures became more frequent, there was less need to operate the full fleet of vehicles. The first to go were the specially hired coaches, for although these vehicles were mobile, they were also expensive. The double-decker and single-decker buses running on the schedules were not so easy to release. The framework of the time-table was so elaborate that no one bus could be eliminated. However, as it was imperative that vehicles should be released as early as possible, the whole time-table was scrapped after the completion of the athletic and swimming programmes, and everyone was advised that journeys would revert to an indenting basis. In this way buses and station wagons were released in almost direct proportion to the departures from the country.

This sudden change was made more necessary by the fact that all bus crews were to be changed on August 9, and new ones were to take over. In the early days of planning the Department had asked London Transport to see that the Organising Committee should have the services of the same drivers for the whole of the proceedings. This request, however, could not be granted, as it is the custom to allocate this type of special work to



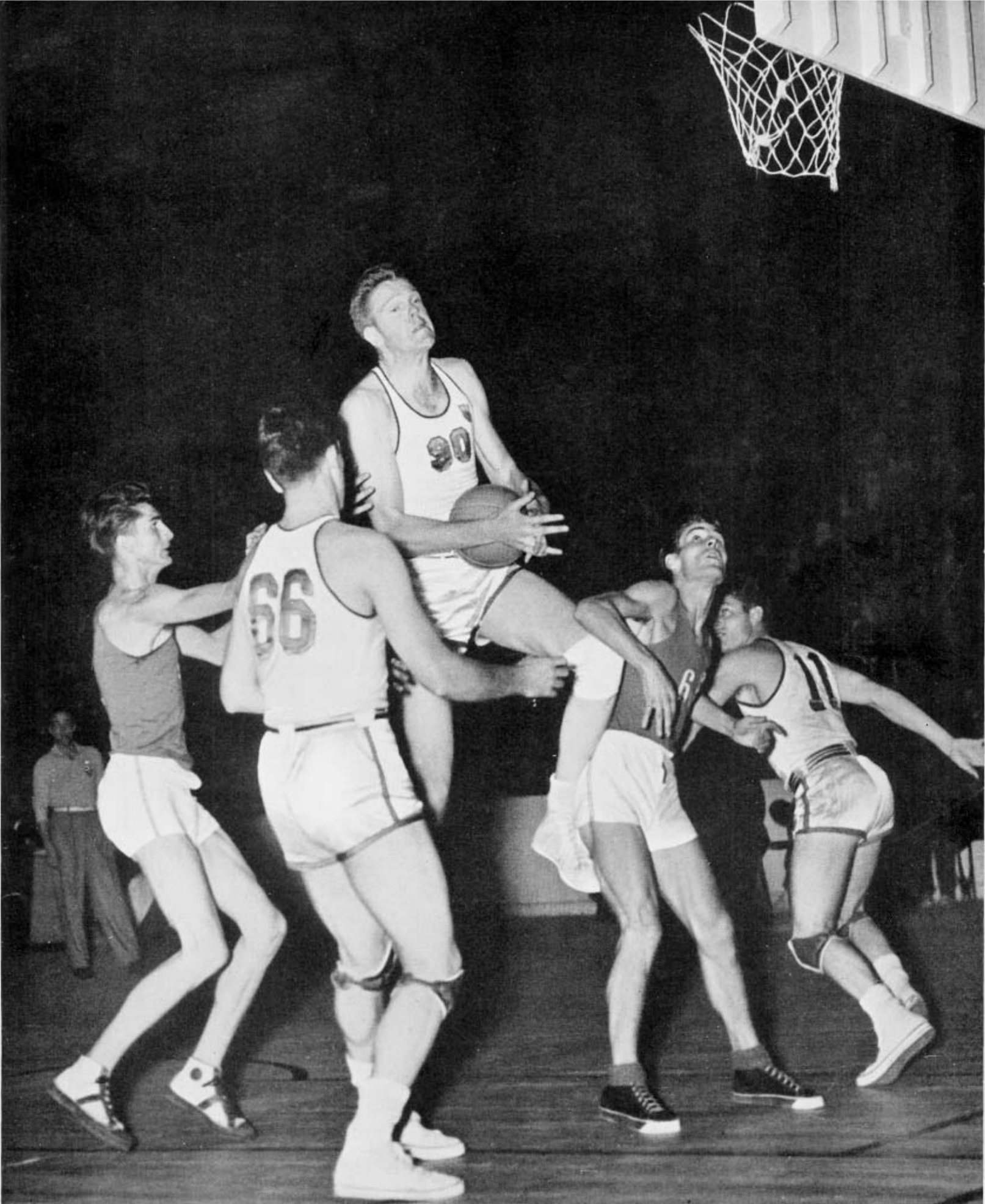

*The final game of the basketball tournament between U.S.A. and France, U.S.A. winning by 65-21. R. Kurland (U.S.A.) No. 90 is here taking the ball on the rebound. No. 66 is C. Carpenter and No. 11 L. Beck. The French No. 6 is J. Perrier.*



*The vital match in Group C of the Preliminary Round was that between U.S.A. and Czechoslovakia, which U.S.A. won 53-28. R. Kurland (U.S.A.) and J. Siegel (Czechoslovakia, in light shirt) are jumping for the ball. Nos. 11 and 66 for U.S.A. are C. Carpenter and L. Beck respectively and on the Czechoslovak side No. 7 is L. Trpkos and No. 4 J. Drvota.*

*USA against Argentine in a match in the Preliminary Round which U.S.A. won 59-57. This was the only match of the tournament in which the USA team was in danger of defeat. Here C. Carpenter (No. 66) passes to R. Robinson (No. 77). The Argentine players on the right are R. Lledo (No. 6) and L. Contarbio (No. 13).*



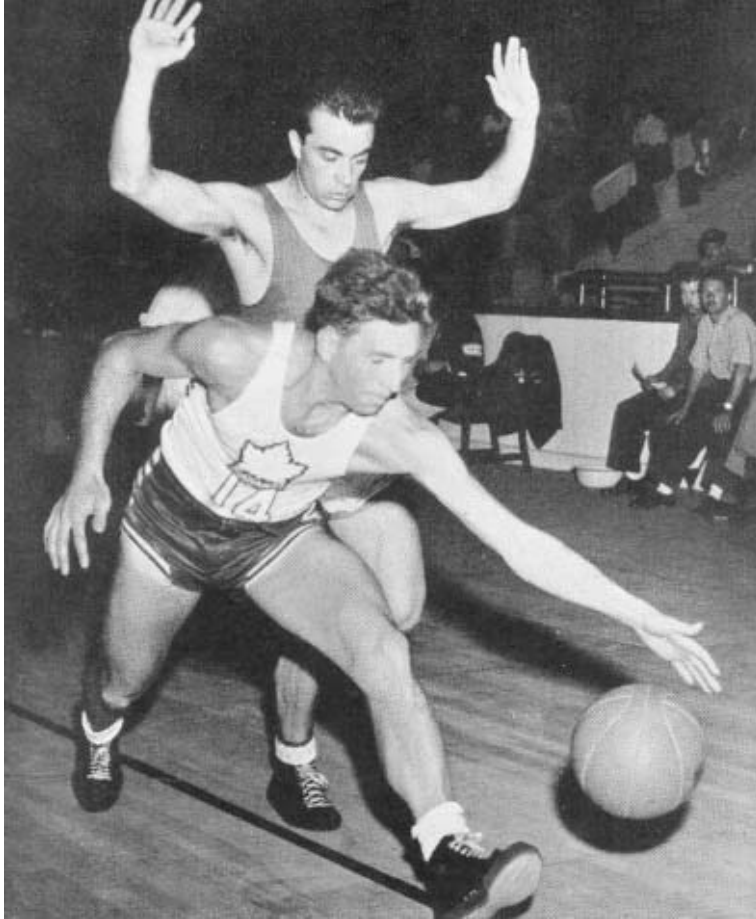

*Canada v. Italy in a Preliminary Round match on the first day of the tournament, Canada winning 55-37. D. Bloomfield (Canada) reaches for the ball and is hotly pursued by R. Ranuzzi (Italy).*

*The match between Chile and Uruguay which determined fifth and sixth placings, Uruguay winning 50-32. A. Lombardo (Uruguay) No. 84 is just making a scoring shot. His colleague on the right, No. 78, is R. Lovera. Chilean players are No. 46 E. Cordero Fernandez, No. 52 V. Mahana Badrie and No. 41 E. Parrá Rojas.*







*The highest score during the tournament was recorded by China who beat Iraq 125-25. No. 11, John Sung-Yuan Pao (China) is about to score after taking the ball from a rebound.*



*The semi-final in which U.S.A. beat Mexico 71-40. Of the players leaping for the ball only D. Barksdale (U.S.A.) No. 33 can be identified. No. 55 is J. Renick (U.S.A.) and No. 14 J. Rojas Herrera (Mexico).*

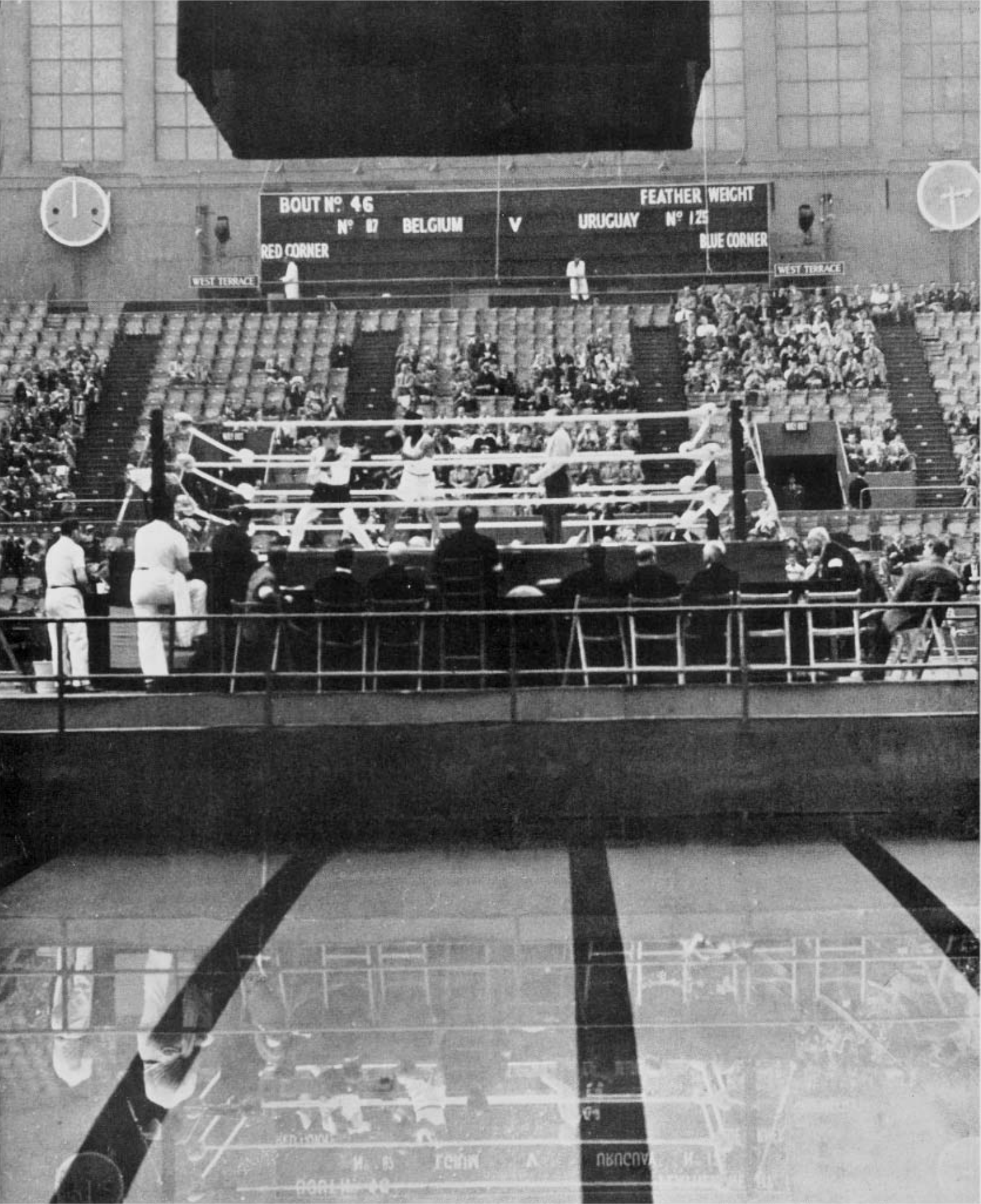

*A general view of the boxing ring erected on the "bridge" across the Empire Pool. The bout in progress is between B. Alves (Uruguay) and E. Delannoit (Belgium) in the featherweight class, Alves being the winner.*

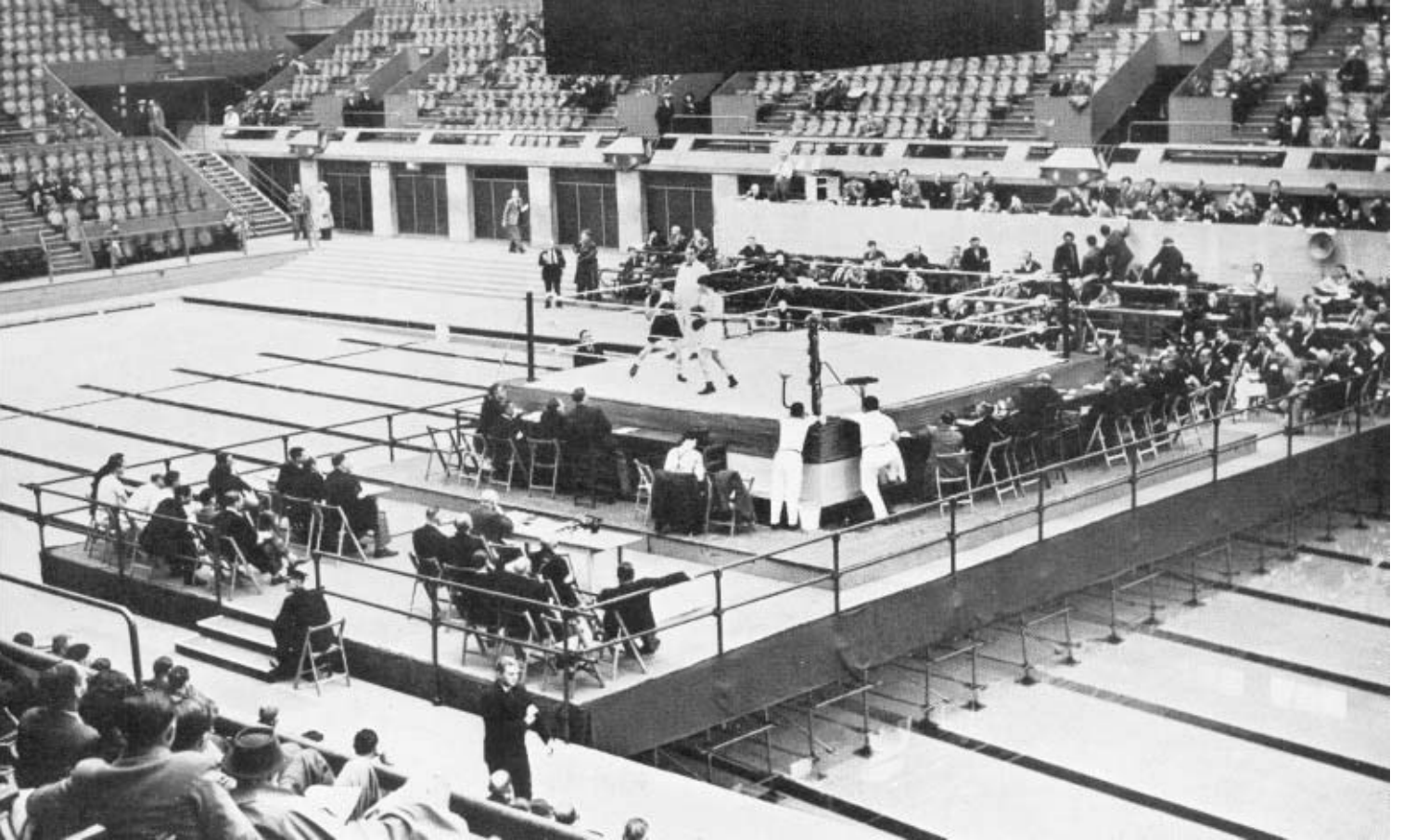

*Another general view of the ring, showing the method of construction adopted and the placing of the seats of the officials.*

*The final bout in the flyweight class between P. Perez (Argentine) the winner, on the left, and S. Bandinelli (Italy).*







*E. Formenti (Italy), left, beating D. Shepherd (South Africa) in the featherweight final.*



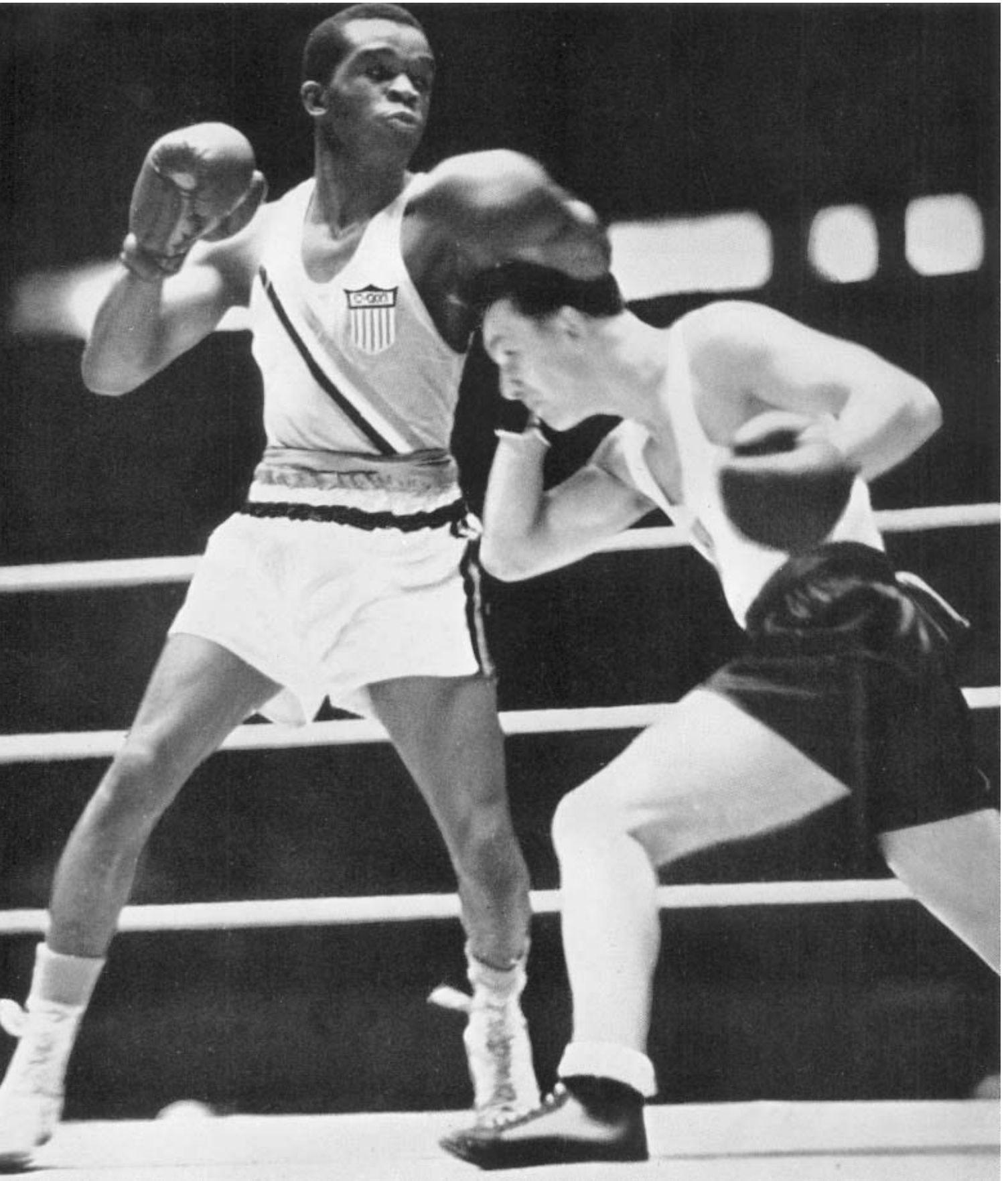

*A semi-final in the lightweight class between W. Smith (U.S.A.) on the left and J. Vissers (Belgium) the winner, and Olympic silver medallist.*



*G. Zuddas (Italy) ducks in the bantamweight final against T. Csik (Hungary) but Csik was the winner.*

*The lightweight final, G. Dreyer (South Africa) on left, the winner, against J. Vissers (Belgium)*

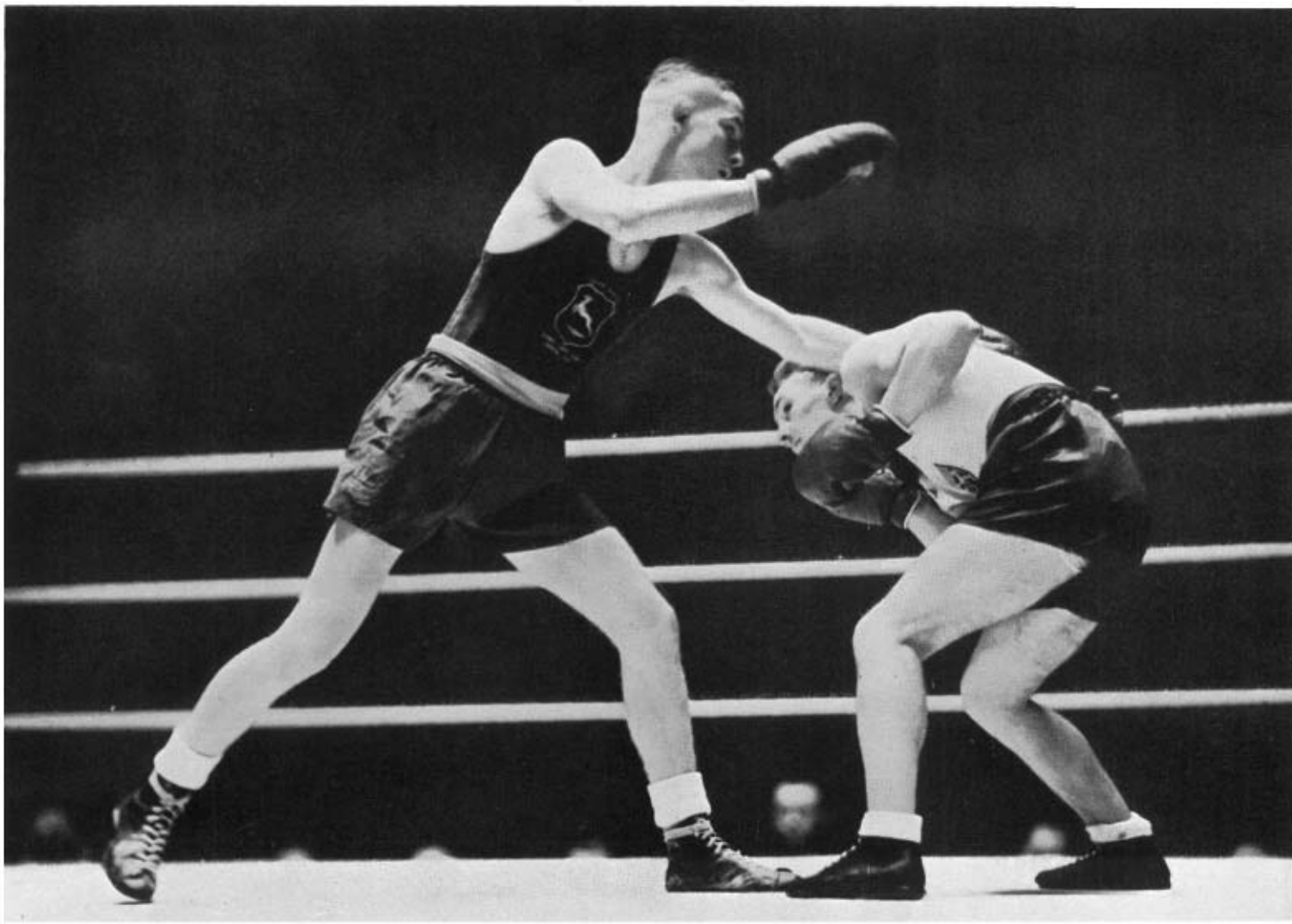

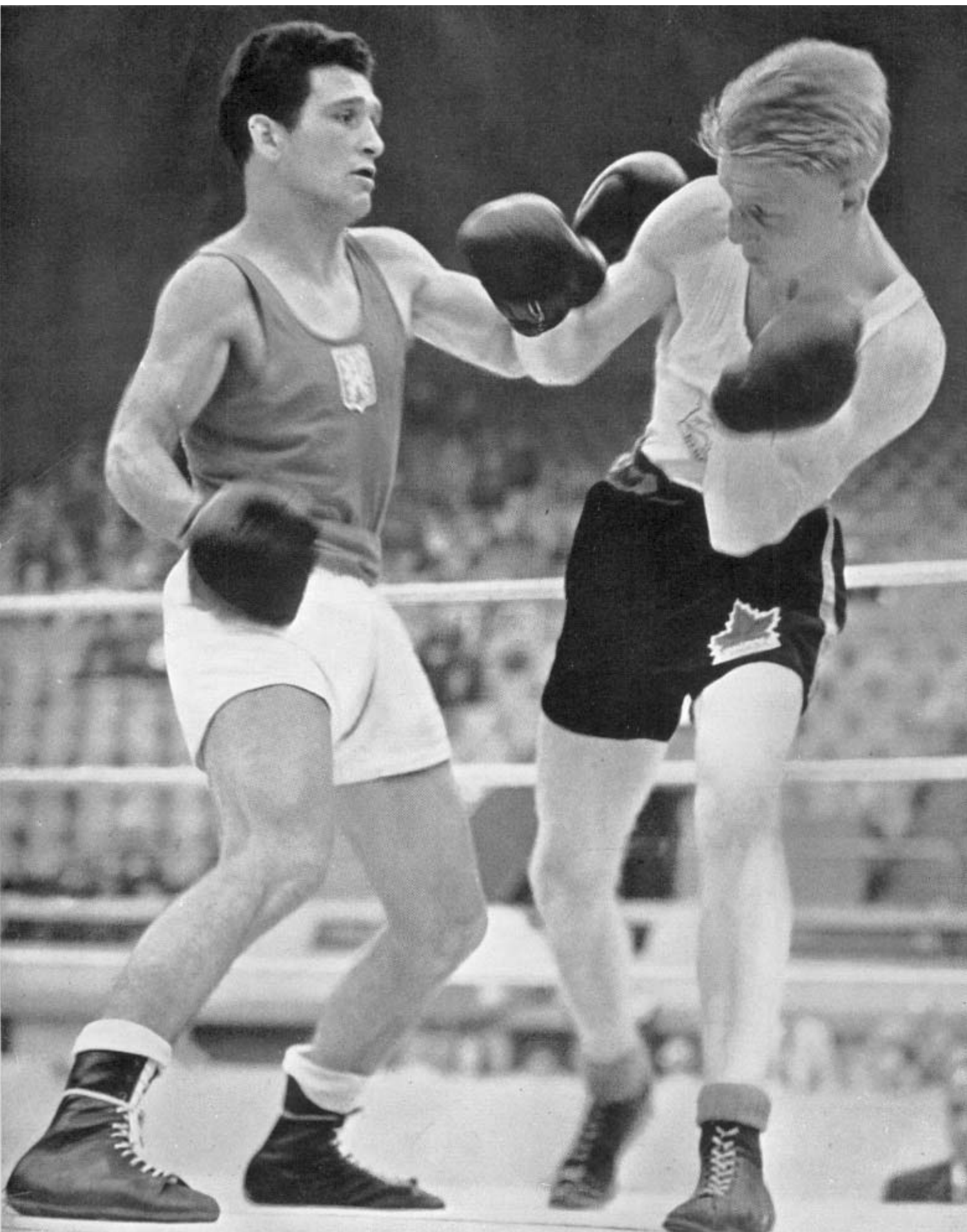

*J. Torma (Czechoslovakia) eventual winner of the welterweight class, on left, in action against G. Blackburn (Canada) in the second round.*



*J. Wright (Great Britain) is knocked down during the final of the middleweight class by the winner, L. Papp (Hungary).*

*The light-heavyweight final in which G. Hunter (South Africa) on right won the Olympic title by beating D. Scott (Great Britain).*





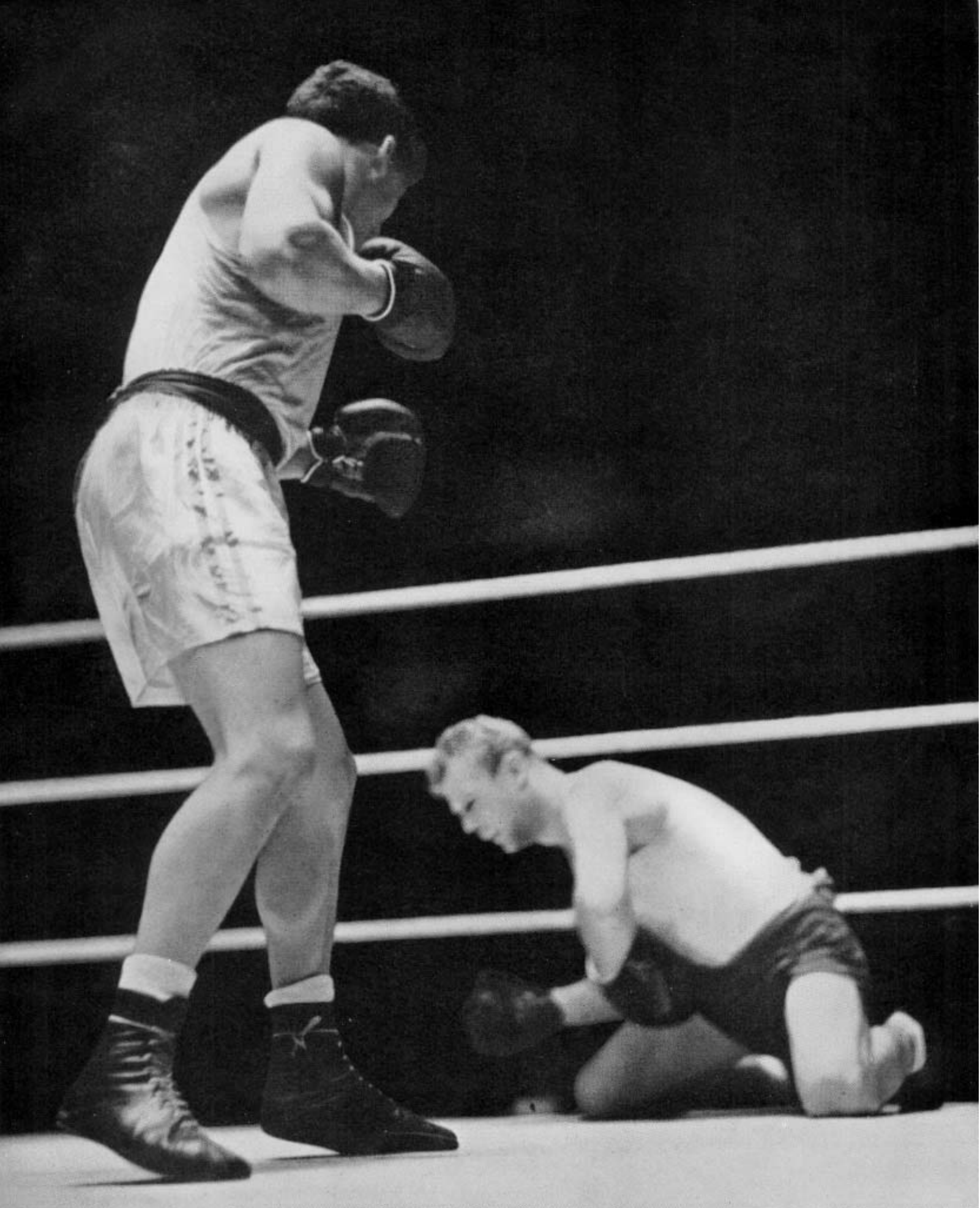

*A knock-out decides the heavyweight final, A. R. Iglesias (Argentina) putting G. Nilsson (Sweden) down in the second round.*

drivers on a rota. This meant that some drivers were delayed by driving on strange ground every day. After Mr. Cranmer had made special representations it was agreed that drivers could work a week for the Department, and then be relieved. So to avoid the delays that arose in the earlier days, a change of programme with a change of drivers seemed to be the best solution possible.

No difficulty presented itself in the final phases of the programme. In the main, local Transport Officers arranged the transport for departing competitors. Those teams from High Wycombe, Henley, Sandhurst and Bisley, who were waiting to return with their main contingent, were brought to London with their baggage and equipment.

### **Closing Ceremony**

Gradually, the transport fleet was reduced in numbers, vehicles being released to their normal activities as soon as possible. For the Closing Ceremony a number of extra vehicles were brought into service. At Uxbridge ten double-decker buses were used for 530 competitors. Five of the same type of vehicle were sent to West Drayton for 240 people. Richmond Park still contained sufficient numbers for twelve 30-seater and twelve 20-seater buses to be needed, about 605 competitors in all. One bus went to Greenford School for twenty people. Southlands, Wimbledon, had two 56-seaters for 100 women. St. Helens, Northwood, still housed seventy women for whom two double-decker buses were sent. Willesden County School and Acton School each had two buses for 80 and 108 competitors respectively. Hendon, Willesden Technical and all Wembley County Schools each housed about sixty, and one double-decker bus was sent to each. On this same day 681 competitors were taken to London stations and airports on their return journeys.

For Hurlingham, where the official party was held, a great number of buses was concentrated. No accurate idea of the numbers attending could be gained. Competitors, released from their period of training, were off sight-seeing, but there was no point in under-estimating the number to be expected at the party. Few travelled in official buses to Hurlingham, but some 100 vehicles of those assembled were used to take competitors back to their centres.

During the final period of the competitions, the Transport Department was able to release a number of their vehicles to National Olympic Committees and the Ling Association for private trips. These buses and coaches were charged at cost price.

### **Accounts**

The accounts worked out much as anticipated. The Henley operations were 5 per cent. above estimate, but coaches had been used from this area to take competitors to and from Uxbridge, and the saving in rail fares was considerably more than this. At Aldershot, a matter of £30 less was spent than had been anticipated. In London, the cost of wages of the bus crews was £3,000 more than estimate, mainly due to two shifts and overtime being worked, and the fact that the men had long journeys to and from their local garages, travelling time, of course, being paid to them. The bus mileage was less than

estimated, but this was balanced by the mileage of extra coaches, which were used during the rush period. The Ministry of Supply account for the use of fifty vehicles was slightly below the anticipated figure.

### **Total Mileage**

The total mileage of all vehicles, except the lorries, was 345,200 ; 760 miles short of the original estimate.

Such results were only obtained after a magnificent response from all sides. It had been rather a battle at times to keep on top of events, but the Transport Department was extremely fortunate in its choice of helpers. These people, strangers to each other mostly, were gathered together hurriedly, and for a few short weeks, but worked loyally and cheerfully for long hours, carrying out strange tasks in a spirit that was fully worthy of the organisation.

There were few special incidents to be recorded. One double-decker bus became mis-routed and smashed its top deck on the low bridge at West Drayton. One bus damaged a gatepost at the Indian Gymkhana. An eight-seater vehicle was badly damaged in Windsor Park when an excited cycle coach attempted to drive the vehicle away. Two buses, one in London and one in Henley, were driven away by competitors. Those responsible in London were taken home from the Wembley Police Station by Mr. Cranmer and no charge was made. The Henley joy-riders were not traced. Neither bus received any damage.

### **Emergency Arrangements**

One special item which expresses the willingness shown by the Transport Department to find a quick answer to a problem, was shown with the arrival of a contingent from Hungary at Northolt. The Steward telephoned Control to say that the aircraft was in circuit at 5 p.m. A bus was sent at once. At 7 p.m. Northolt telephoned to say that the aircraft had been re-directed to Blackbush. This Aerodrome is easily reached from Aldershot and the manager of Aldershot and District Traction Company was reached on the telephone and a special coach was sent to meet the contingent. At 10 p.m., Manston Aerodrome, in Kent, eighty miles away, telephoned to say that they had some Hungarians in the Mess. What should they do ? Transport Department at once telephoned the East Kent Road Car Company's garage at Herne Bay, and by 12.30 a.m. in the morning the coach and company were at their housing centre at Hendon School. As the Commandant had been kept advised, a meal was ready and the party sat down to eat at 1 a.m., six hours after they had sighted their Olympic centre from the air.

This then is the short history of the many and rapidly changing problems of the transporting of the 6,000 competitors and officials to their temporary homes in the many housing centres, to their training on the 67 practice grounds, to their competitions in the 27 arenas, and finally to their departure by sea and air. For the success of this incredibly complicated operation, the credit belongs to all and everyone who took part in it from the executive staff to the drivers, for the enthusiastic and wholehearted way in which they gladly carried out their tasks for this great festival of sport.



**COMPETITORS' OFFICIAL TRANSPORT  
OPERATIONAL STATISTICS**

<i>Operators</i>	<i>Vehicle Days</i>	<i>Journeys</i>	<i>Passengers</i>	<i>Miles</i>
London Transport	1,988	10,000*	117,547	127,576
Ministry of Supply	1,342	11,700	40,000	127,913
Henley area	203	1,461	28,980	23,769
Camberley and Bisley area	96	480	7,680*	8,000
London Coaches	279	1,395	22,320*	(approx.) 41,360
Private Hire Cars	241	1,792	5,000*	16,582
Totals	4,149	26,828	221,527	345,200

\* Indicates estimated figures.

The Transport Department was responsible for meeting 5,806 people on 233 occasions at five aerodromes, four docks and seven rail termini.

The highest figure of arrivals was at London Airport, 1,913 in 81 parties. Victoria Station was second highest with 1,188 in 51 parties.

# MEDICAL SERVICES

A comprehensive Medical Service, which would be available free of charge to all competitors and officials, was envisaged from the time of the earliest meetings of the Organising Committee.

## Chairman

Mr. Arthur E. Porritt, F.R.C.S., was appointed Chairman of the Medical Sub-Committee and Director of the Olympic Medical Services. Mr. Porritt, himself a former Olympic bronze medal winner and a member of the International Olympic Committee, had had wide experience of medical organisation during the war, and as a member of the surgical staff of several well-known London hospitals, an extensive knowledge of sports injuries and their treatment.

## Committee

The Medical Sub-Committee had many members well known in sport. Its personnel consisted of:—

- \*Mr. A. E. Porritt (Chairman)
- \*Brigadier H. Glyn-Hughes (Vice-Chairman)
- \*Sir Adolphe Abrahams
- \*Lord Amulree (Ministry of Health)
- \*Mr. E. H. Beasant (Wembley Stadium First-Aid Services)
- \*Captain Goulden, R.A.M.C. (Equipment)
- Dr. R. Greene
- Professor A. V. Hill
- Dr. K. N. Irvine (Rowing, Henley)
- \*Mr. Hume Kendall
- \*Professor A. Kennedy
- Dr. K. O'Flanagan
- Dr. J. M. G. Sarson (Wembley Stadium)
- Mr. H. B. Stallard
- Sir Henry Tidy
- Mr. W. E. Tucker
- Major A. C. White-Knox (St. John Ambulance)
- \*Dr. A. L. Winner
- Mr. R. S. Woods
- Lt.-Col. T. P. M. Bevan (Secretary)

Those members marked with an \* formed an executive committee, the other members being employed in an advisory capacity. (Dr. J. E. Lovelock was also a member of the Committee in its early stages, but resigned on leaving to take up permanent residence in U.S.A.). The full advisory Committee held its first meeting in October, 1946, and had four subsequent meetings before July, 1948 ; the Executive Committee met first in January, 1947, and held in all fifteen meetings before the Games.

## **Objects**

The Medical Committee set out to provide a complete and free medical service in all the various sports arenas and housing centres used by Olympic Competitors and Officials. This involved the provision at each arena and housing centre of medical officers, nurses, orderlies, physiotherapists and nursing auxiliaries ; the arranging of facilities for X-ray and bacteriological examinations as required; the provision of suitable drugs and appliances at the various centres ; the organisation of an ambulance service between arenas, housing sites and hospitals ; and the catering for special facilities required for individual events such as the Road Walk, Marathon, Cycle Road Race, Yachting and Equestrian events. Apart from these commitments, the Sub-Committee was also able to advise the Organising Committee on various general problems, such as camp hygiene (inspection of food and cooking arrangements), and physiological research on competitors.

Full liaison was made with visiting medical officers accompanying national teams and with the various medical services at the different sports arenas catering for spectators' needs. As a matter of policy the Medical Sub-Committee in general confined its activities exclusively to competitors and officials, although working in co-operation with those organisations responsible for the medical care of spectators.

The medical problem was, like many others, greatly intensified by the multiplicity of arenas to be served and even more by the large number of separate housing centres. These facts meant considerable reduplication of facilities and added materially to the expense of the service.

## **Finance**

Early in 1947, the Medical Sub-Committee made a provisional budget of £1,000 for the medical services. The fact that such a comprehensive service could be provided in so many places, at such a reasonable outlay, was largely due to the generosity of the 150-odd medical men employed—all of whom gave their services free, apart, in a few special instances, from certain travelling and out-of-pocket expenses.

## **Associated Organisations**

Generous help was given by various organisations—the Royal Army Medical Corps, the British Red Cross, the St. John Ambulance Brigade and the Chartered Society of Physiotherapists.

Several London hospitals (Wembley, St. Mary's, Middlesex, University College, Royal Free and Royal Northern) also carried out X-ray and other special investigations, and in a few cases in-patient care free of charge.

## **Drugs and Equipment**

Messrs. Boots, Chemists, of Nottingham, were responsible for the provision of drugs and appliances on a sale or return basis. This part of the service was excellently organised under the capable direction of Captain Goulden, R.A.M.C., who was responsible for the distribution of, re-collection of and accounting for all medical supplies—itsself a task of

no small magnitude. Messrs. Boots were able to dispense prescriptions, through their multiple branches, near all the various housing and sports venues, and their central branch in Piccadilly was specially equipped with a series of drugs in popular demand on the Continent and elsewhere, and staffed with a group of interpreters.

### **Medical Case Card**

The Medical Committee had printed a special Medical Card (one side for surgical conditions and the reverse for medical conditions) to enable records to be kept by medical officers with the minimum of clerical work and to allow a correlation of results after the Games. These cards were distributed to the medical officers at the various sports arenas and housing centres as soon as the arena or housing site was due to function and were returned to the Olympic office for analysis after the Games.

### **Medical Services Pamphlet**

A small 14-page pamphlet was produced, by June, 1948, summarising all the medical facilities and giving details of doctors available, chemist shops, etc., in each particular area. General information was included regarding medical supplies and special drugs, ambulance and hospital facilities, and how to procure them, and instructions for filling up medical case cards. These were distributed to all administrative departments, to commandants and medical officers of housing centres and arenas, to all allied medical bodies and to the medical officers, managers and captains of each national team on arrival. Judging by subsequent reports from many sources, this booklet served a definite and useful purpose.

### **Sports Arenas**

1. *Wembley Stadium*.—A special "Olympic Hospital" (a prefabricated hutment) was constructed outside the Pageant Tunnel of the Stadium. This hospital contained two small wards (eight beds for men and four for women), a reception room for first-aid treatment, a small operating room, a medical officers' room, a physiotherapy room, showers and lavatories. It was staffed day and night during the Games by four Medical Officers (Mr. W. E. Tucker, in charge, and Major Wheatley, R.A.M.C., Mr. Lipmann Kessel and Dr. D. S. Chapman, assistants), two trained nurses, four nursing auxiliaries, ten R.A.M.C. orderlies and a physiotherapist. Cases were brought into the hospital by the R.A.M.C. orderlies stationed in pairs, with a stretcher and first-aid equipment, at strategic points around the stadium ; cases were also received from other neighbouring arenas and, when necessary, spectators (brought in by local St. John Ambulance Brigade workers) were given treatment. After treatment, casualties returned to the Stadium to continue in the competitions, or were sent by ambulance or car to their individual housing centres. Where necessary, patients were sent to hospital for investigation (X-ray, etc.), or admission, according to the particular needs of each case.

2. *Empire Pool*.—A first-aid room was established here with a medical officer in attendance and six R.A.M.C. orderlies. After immediate preliminary treatment, cases were transferred to the nearby Olympic hospital. For the Swimming events here (and also at

2a. *Finchley Baths*), the following medical officers shared the duties of the three daily sessions :—

Drs. Behrman, Bleasdale, Caffrey, Grey, Hudson-Clifford, H. McClatchey, W. McClatchey and Stanley.

For the Boxing events, the Amateur Boxing Association provided four medical officers for each session.

3. *Palace of Engineering, Wembley*.—A first-aid room was established here for the fencing events, staffed by four R.A.M.C. orderlies, but, in view of the propinquity of this venue to the Olympic Hospital, no medical officer was permanently stationed here.

4. *Harringay*.—A dressing room was adapted as a first-aid room for the basketball events, this being staffed by a medical officer and four R.A.M.C. orderlies. Two trained nurses attached to the small Red Cross room for spectator casualties also gave assistance.

5. *Empress Hall*.—A good existing first-aid room was staffed by a medical officer (for wrestling events, not for weightlifting) and four R.A.M.C. orderlies. An ambulance was standing by.

6. *Herne Hill Cycling Track*.—A tented first-aid station was improvised and staffed by a medical officer from King's College Hospital and four St. John orderlies. Ambulance facilities were immediately available.

7. *Henley*.—Medical arrangements, both on the riverside and in the six housing centres at High Wycombe and Henley, for the rowing crews and canoeists, were in the hands of Dr. K. N. Irvine, assisted by Drs. Bristow, Hawkins and Owen. A first-aid station was established on the banks of the Thames near the finishing post, with one medical officer, St. John orderlies and a masseur in attendance during the actual events; in High Wycombe daily visits were made to the various housing centres, a separate sick-bay and a medical centre were established, and 14 beds in a local hospital were taken over and put under the care of two trained nurses and two auxiliaries. Dental facilities were also made easily available.

8. *Torquay*.—Medical arrangements for yachting competitors were organised by Dr. Dobson Smyth and included first-aid posts (with telephone) at the harbour-side in Torquay, Paignton and Brixham, with Red Cross orderlies on duty all day. Hospital facilities were made readily available, and an ambulance service organised to cover the various localities. For accidents afloat, arrangements were in the hands of the Royal Navy, which had a Medical Guard Ship moored in the harbour and several speed patrol boats to follow the actual races.

9. *Aldershot*.—For the equestrian and modern pentathlon events, all arrangements were in the hands of the Assistant Director of Medical Services at Aldershot and were carried out by R.A.M.C. personnel, both at the competitors' living quarters and at a series of field first-aid posts during the competitions.

10. *Bisley*.—A sick bay for the shooting events was established on the rifle range under the charge of Lt. Brierly, R.A.M.C. Three R.A.M.C. orderlies were on permanent duty

during the events, an ambulance was standing by and full hospital facilities were available at the nearby Cambridge Hospital in Aldershot.

11,12. *Football and Hockey*.—Preliminary Rounds in the football tournament were held on the grounds of the following clubs :—

Arsenal	Fulham
Brentford	Ilford
Crystal Palace	Tottenham Hotspur
Dulwich Hamlet	Walthamstow Avenue

In each case, the local medical officer of the club on whose ground the match was being played was in attendance. In the hockey preliminaries, played at Guinness Ground, Park Royal, Polytechnic Ground, Chiswick, and Lyons Ground, Sudbury, two St. John Ambulance Orderlies were detailed to provide first aid and obtain such medical assistance as might be required.

13. *Marathon*.—The start and finish were covered by the Olympic Hospital at the Stadium. Seven first-aid stations were established at various points on the course, each of which was manned by three St. John orderlies. Five of these stations were connected by telephone to Wembley. One ambulance was stationed at the half-way point, at which post a medical officer, Dr. Reader, was also stationed. A second ambulance followed the competitors and carried another medical officer, Dr. D. S. Chapman.

14. *Road Walk*.—Similar arrangements to those for the Marathon were organised. There were eight first-aid stations with two St. John orderlies at each, and two medical officers, Drs. Chapman and Pybus, one following the race in an ambulance and the other, with another ambulance, at the half-way point.

15. *Cycle Road Race, Windsor Great Park*.—A tented Medical Centre was established at the enclosures and seven first-aid stations en route. Each of the stations was staffed by two St. John Ambulance men; at the centre, four nursing auxiliaries were also in attendance. Two medical officers, Drs. Janson and Linzee, were in charge, one remaining at the centre, the other touring the course in one of the two ambulances which accompanied the competitors.

### **Housing Centres**

(Numbers in brackets give approximately the capacity for competitors and officials of each site.)

1. *Richmond Park* (1,600). A small hutted hospital was established here with ten beds, consulting and treatment rooms. The centre was under the charge of Surgeon Captain Digby-Bell, R.N. (Retd.), who was resident throughout the Games. He was assisted by daily visits from Dr. Hogbin. The staff included three trained nurses (resident), three auxiliaries, and three orderlies (one resident). There was at this centre a fully equipped physiotherapy department, with two trained physiotherapists in daily attendance, and a mobile dental van, lent by the Army. An ambulance stood by.

2. *Uxbridge* (1,600) and *West Drayton* (700).—These two housing centres were Royal

Air Force camps. At Uxbridge the R.A.F. hospital, with R.A.F. medical personnel, provided all the necessary facilities. Wing-Cdr. Dales and Flt.-Lt. Lumsden were in charge. Two trained physiotherapists were resident at Uxbridge and full dental facilities were available. At West Drayton, a sick bay was established and visited twice daily by a Royal Air Force medical officer. Any case requiring more than simple first-aid treatment was sent to Uxbridge in one of the several ambulances kept available.

3. *Women's Centres* (390).

(a) St. Helen's, Northwood (120).

(b) National Training College, Eccleston Square (120).

(c) Southlands Training College, Wimbledon (150).

In each of these centres a room was set aside for consultations and minor treatment; a local medical officer visited daily and as required, and a trained nurse, who was assisted daily by two nursing auxiliaries and a physiotherapist, was in residence.

4. *Middlesex Schools* (2,070).—Eighteen schools were temporarily converted into residential centres for competitors and officials. For each of these schools, a nearby medical practitioner was on constant call and paid a routine daily visit. Through him, dental facilities were made easily available, and each school was provided with detailed instructions as to methods of obtaining drugs, physiotherapy and hospital facilities in case of emergency.

5. *High Wycombe*

6. *Torquay*

7. *Aldershot*

} See Sports Arenas, 7, 8, 9 and 10.

### Activities of the Service

In general the medical services worked smoothly and, although from the above description it will be seen that ample cover was provided at all points, at no time was any real strain thrown on the organisation. To some extent this was due to the fact that a number of national teams, including some of the larger ones, brought their own medical officers, who dealt with their own cases, often assisted by the Olympic service.

One tragic fatality occurred during the Games, a Czech girl gymnast dying of meningitis. Infectious diseases were conspicuous by their absence, only one case of paratyphoid being reported. There were relatively few major accidents (three major fractures and two dislocations of the shoulder), one case of concussion and one serious burn. Amongst surgical conditions, the usual cuts, lacerations and abrasions, sprains and contusions, and minor sepsis accounted for most of the cases requiring treatment. On the medical side mild gastro-enteritis, colds, tonsillitis and fibrositis were the commonest complaints. It is of interest to note that in a country with a climate such as England's both sunburn and insect bites produced a noticeable number of patients. Various analyses of the 550 case cards are appended below.



## CLASSIFICATION BY COUNTRIES

Country	Competitors		Officials		Unclassified	
	(M.)	(F.)	(M.)	(F.)	(M.)	(F.)
1. Afghanistan (11) .....	4	—	—	—	7	—
2. Argentine (4) .....	2	—	1	—	1	—
3. Australia (13) .....	4	3	—	—	6	—
4. Austria (9) .....	2	1	—	—	—	6
5. Belgium (9) .....	8	1	—	—	—	—
6. Bermuda (3) .....	2	1	—	—	—	—
7. Brazil (7) .....	7	—	—	—	—	—
8. Br. Guiana (1) .....	—	—	—	—	1	—
9. Canada (8) .....	7	1	—	—	—	—
10. Chile (9) .....	5	—	2	—	2	—
11. Cuba (1) .....	—	—	—	—	—	1
12. Czechoslovakia (5) .....	1	2	1	—	1	—
13. Denmark (6) .....	5	—	—	—	—	1
14. Egypt (2) .....	2	—	—	—	—	—
15. Eire (7) .....	3	—	4	—	—	—
16. Finland (12) .....	6	1	3	—	1	1
17. France (13) .....	8	—	4	—	1	—
18. Great Britain (205) .....	29	2	101	37	29	7
19. Greece (16) .....	14	—	—	—	2	—
20. Holland (17) .....	4	4	4	—	—	5
21. Hungary (6) .....	4	—	1	—	—	1
22. Iceland (5) .....	1	2	1	—	1	—
23. India (7) .....	3	—	1	—	3	—
24. Iraq (5) .....	5	—	—	—	—	—
25. Italy (16) .....	9	—	—	—	7	—
26. Jamaica (2) .....	1	—	1	—	—	—
27. Korea (4) .....	3	—	1	—	—	—
28. Lebanon (4) .....	4	—	—	—	—	—
29. Lichtenstein (2) .....	2	—	—	—	—	—
30. Luxembourg (4) .....	4	—	—	—	—	—
31. Malta (1) .....	—	—	—	—	1	—
32. Mexico (3) .....	1	—	—	—	2	—
33. New Zealand (6) .....	5	1	—	—	—	—
34. Nigeria (1) .....	—	—	1	—	—	—
35. Norway (10) .....	1	—	4	2	2	1
36. Pakistan (3) .....	3	—	—	—	—	—
37. Panama (2) .....	1	—	1	—	—	—
38. Peru (5) .....	4	—	—	—	1	—

**CLASSIFICATION BY COUNTRIES**

	<i>Country</i>	<i>Competitors</i>		<i>Officials</i>		<i>Unclassified</i>	
		<i>(M.)</i>	<i>(F.)</i>	<i>(M.)</i>	<i>(F.)</i>	<i>(M.)</i>	<i>(F.)</i>
39.	Poland (6) .....	—	2	—	—	3	1
40.	Portugal (2) .....	2	—	—	—	—	—
41.	Russia (1) .....	—	—	—	—	1	—
42.	South Africa (2) .....	—	—	2	—	—	—
43.	Spain (8) .....	4	—	—	—	4	—
44.	Sweden (15) .....	2	1	8	—	4	—
45.	Switzerland (10) .....	5	—	1	—	4	—
46.	Turkey (7) .....	4	1	—	—	2	—
47.	Uruguay (13) .....	11	—	1	—	1	—
48.	U.S.A. (12) .....	7	—	3	—	2	—
49.	Yugoslavia (2) .....	—	—	2	—	—	—

**CLASSIFICATION BY SPORTS**

	<i>Male</i>	<i>Female</i>	<i>Total</i>
Athletics .....	50	10	60
Basketball .....	34	—	34
Boxing .....	11	—	11
Canoeing .....	9	—	9
Cycling .....	13	—	13
Equestrian .....	1	—	1
Fencing .....	8	1	9
Football .....	2	—	2
Gymnastics .....	8	3	11
Hockey .....	10	—	10
Rowing .....	21	—	21
Swimming .....	8	8	16
Weightlifting .....	3	—	3
Wrestling .....	22	—	22
Yachting .....	2	—	2
Non-Competitors (Officials and Staff).	146	49	195
Spectators .....	4	1	5
Unclassified .....	—	—	116
			541

## CLASSIFICATION OF DISEASES

<i>Medical</i>	<i>Male</i>	<i>Female</i>	<i>Surgical</i>	<i>Male</i>	<i>Female</i>
Asthma .....	1	—	Abrasions .....	51	15
Bronchitis .....	12	—	Appendicitis .....	2	—
Chicken-Pox .....	1		Burns, Scalds .....	9	6
Chills, Colds .....	15	2	Bursitis .....	1	—
Deafness .....	5	—	Boils .....	23	—
Dermatitis .....	13	4	Concussion .....	1	—
Exhaustion .....	2	1	Conjunctivitis .....	9	2
Faints .....	3	—	Contusions .....	28	8
Fibrositis .....	10	1	Crushes .....	1	1
Gastro-Enteritis .....	24	4	Cuts, Lacerations .....	50	10
Headache, Migraine .....	3	1	Dislocations .....	2	—
Insect Bites .....	11	10	Eye, Foreign Body ...	5	2
Meningitis .....	—	1	Finger, Foreign Body	3	—
Neuroses .....	5	—	Fractures .....	11	1
Paratyphoid .....	1	—	Otitis Media .....	3	—
Pleurisy .....	1	—	Septic Hand, etc. ....	24	6
Pneumonia .....	1	—	Sinusitis .....	1	—
Stomatitis .....	1	1	Sprains, etc. ....	37	6
Sunstroke ... ..	3	—	Tear Muscle .....	19	1
Tinnitus, Earache.....	5	1	Miscellaneous .....	1	1
Tonsillitis .....	17	10			
Toothache .....	5	1			
Vaccination .....	9	1			
Miscellaneous.....	2	1			
Not Recorded ...		12			
	150	12	39	281	59
	201			340	
Total: 541					

*Commonest Medical Conditions*

Tonsillitis and Pharyngitis

Gastro-Enteritis

Insect Bites

*Commonest Surgical Conditions*

Abrasions

Cuts and Lacerations

Sprains

# RECEPTION COMMITTEE

A Reception Committee was formed towards the end of 1947 and consisted of the following members:—

Sir Eugen Millington-Drake (Chairman)  
Sir Noel Curtis-Bennett (Vice-Chairman)  
The Viscount Acheson  
Sir John Bennett  
Mr. Arthur Deakin  
Sir Angus Gillan  
Mr. Harold Holt  
Mr. J. W. Platt  
Lt.-Col. Rudyard H. Russell  
Mr. Thomas H. Preston  
Mr. Lawrence Litchfield } Joint Secretaries  
Mr. Garry Fifer }

This Committee was responsible for the co-ordination of the entertainment both of competitors and officials, including members of the International Olympic Committee, for the engagement of interpreters and the administration of this service, and to organise the various conferences of the International Federations which are normally held during the period of the Olympic Games. One of the main functions of the Committee prior to the Games was the greeting of the teams and officials. The Chairman, or a member of the Committee, met every team, either at the London railway stations or at the airports. After delivering a message of welcome on behalf of the Organising Committee, the member travelled to the housing centre at which the team was to be accommodated, and was present at the ceremony of the raising of its national flag. As certain teams arrived in the early hours of the morning, it was not always possible to arrange the " flag-raising " ceremony on their first entering the housing centre and in some cases the address of welcome was coupled with this ceremony the following day. Certain teams did insist that no matter what the hour, their flag should be run up as soon as they arrived.

## **International Olympic Committee Official Functions and Entertainment**

Most of the members of the I.O.C. arrived some days before the Opening Ceremony and were accommodated in London hotels. Mr. J. Sigfrid Edstrom, the President of the I.O.C., arrived by air from Sweden on Thursday, July 22, and was met at the airport by Lord Burghley. The I.O.C. Office was opened on that date at the Dorchester Hotel by Mr. Otto Mayer and Madame Zanchi, Chancellor and Secretary respectively of the I.O.C. An English secretary from the Organising Committee staff was attached to the I.O.C. Office.

Mr. Edstrom, in his official capacity as President of the I.O.C., had the honour to be received, shortly after his arrival in England, by His Majesty the King. The President also paid an official call on the Lord Mayor of London.

The following members of the International Olympic Committee, many of whom were accompanied by members of their family, were present in London for the opening of the Games:—

Mr. H. BUSTOS MORON, *Argentine*  
 Dr. M. M. R. von MARKHOF, *Austria*  
 Sir HAROLD LUXTON, *Australia*  
 Baron de TRANNOY, *Belgium*  
 Mr. R. W. SEELDRAYERS, *Belgium*  
 Dr. J. FERREIRA SANTOS, *Brazil*  
 Mr. J. C. PATTESON, *Canada*  
 Mr. A. S. DAWES, *Canada*  
 Dr. C. T. WANG, *China*  
 Prof. SHOU-YI-TUNG, *China*  
 Dr. M. A. MOENCK, *Cuba*  
 Prof. J. GRUSS, *Czechoslovakia*  
 S.A.R. PRINCE AXEL, *Denmark*  
 H. E. MOHAMMED TAHER PACHA, *Egypt*  
 Mr. J. J. KEANE, *Eire*  
 Mr. E. KROGIUS, *Finland*  
 Marquis de POLIGNAC, *France*  
 M. A. MASSARD, *France*  
 LORD ABERDARE, *Great Britain*  
 LORD BURGHLEY, *Great Britain*  
 SIR NOEL CURTIS-BENNETT, *Great Britain*  
 Mr. A. BOLANACHI, *Greece*  
 Mr. J. KETSEAS, *Greece*  
 Col. P. W. SCHARROO, *Holland*  
 Lt.-Col. C. F. PAHUD de MORTANGES, *Holland*  
 Dr. F. MEZO, *Hungary*  
 Mr. B. G. WAAGE, *Iceland*  
 Mr. G. D. SONDHI, *India*  
 Count ALBERTO BONACOSSA, *Italy*  
 S.A.R. Prince JEAN, *Luxembourg*  
 Sir THOMAS FEARNLEY, *Norway*  
 Mr. DITLEV-SIMONSEN, *Norway*  
 Mr. A. E. PORRITT, *New Zealand*  
 Mr. A. BENAVIDES, *Peru*  
 Hon. J. B. VARGAS, *Philippines*  
 Prof. JERZY LOTH, *Poland*  
 Dr. J. PONTES, *Portugal*  
 Mr. S. DOWSETT, *South Africa*  
 Mr. R. HONEY, *South Africa*  
 Baron de GUELL, *Spain*  
 Mr. J. SIGFRID EDSTROM (President of I.O.C.), *Sweden*  
 Mr. Bo EKELUND, *Sweden*  
 Major ALBERT MAYER, *Switzerland*  
 Mr. JOHN JEWETT GARLAND, *United States of America*  
 Mr. AVERY BRUNDAGE (Vice-President of I.O.C.), *United States of America*  
 Mr. F. H. COUDERT, *United States of America*  
 Mr. J. SERRATOSA CIBILS, *Uruguay*  
 Mr. S. BLOUDEK, *Yugoslavia*  
 Mr. OTTO MAYER (Chancellor of the I.O.C.)

Sir Eugen Millington-Drake, Chairman of the Reception Committee, gave a luncheon party on Monday, July 26, in honour of Mr. J. Sigfrid Edstrom, President of the I.O.C., Viscount Portal, President of the London Games, and Lord Inverchapel, who had been appointed by His Majesty's Government, in connection with the XIV Olympiad, to welcome the visitors on its behalf. Later that afternoon the Twelve Great Livery Companies of the City of London gave a Reception to celebrate the XIV Olympiad at the Grocers' Hall. Some two hundred guests were present, including most members of the I.O.C. and their ladies, and presidents and secretaries of National Olympic Committees, international sporting federations, national governing bodies of sport and other Olympic officials. The guests were shown the treasures and gold plate displayed in the hall and rooms of the Grocers' Company. Members of the I.O.C. were conveyed to and from the Grocers' Hall in private buses. That evening the Empire Members of the I.O.C. gave a dinner at the Dorchester Hotel to the other members of the I.O.C. and their ladies, at which His Royal Highness the Duke of Gloucester was present, together with other former Governors-General of the Dominions. The Rt. Hon. Philip Noel-Baker, M.P., Secretary of State for Commonwealth Relations, himself an Olympic athlete in 1912, was in the chair.

### **I.O.C. Conference**

The Conference of the I.O.C. was opened at the Royal Institute of British Architects, Portland Place, on the morning of Tuesday, July 27, by the Rt. Hon. Philip Noel-Baker. Mr. Edstrom and Lord Burghley delivered addresses on this occasion, which was attended by all the members of the I.O.C. and their ladies, together with many Ambassadors and Diplomatic representatives. After the official opening, the I.O.C. Conference began in the Council Room. In the late afternoon, Lord and Lady Aberdare and the Committee of the Lansdowne Club gave a Reception for members of the I.O.C. and their ladies. After this Reception, members of the I.O.C. were entertained to dinner by Lord Portal at Claridges' Hotel. At this dinner the Prime Minister, the Rt. Hon. Clement Attlee, other members of the Cabinet and many Ambassadors and Ministers were present. While the dinner was in progress, the ladies of the I.O.C. were taken by bus from the Lansdowne Club to the Odeon Cinema, Leicester Square, where they were entertained by the Hon. Mrs. J. Arthur Rank at a showing of "Hamlet." After the film the ladies went to a supper party given by Sir Eugen and Lady Effie Millington-Drake at their house.

On Wednesday, July 28, the I.O.C. Conference continued. In the afternoon, the ladies of the I.O.C. were entertained to tea by the Rt. Hon. Philip Noel-Baker on the terrace of the House of Commons, and in the evening the Chairman and members of the Organising Committee gave a dinner for some four hundred and fifty guests at the Dorchester Hotel. Among those present at this dinner were Their Royal Highnesses the Duke of Edinburgh, the Crown Prince and the Crown Princess of Norway, Prince Bernhard of the Netherlands and Presidents and Secretaries of National Olympic Committees, Presidents of International Federations and representatives of National Governing Bodies of sport in Great Britain, together with their ladies.

The I.O.C. Conference ended on the morning of Thursday, July 29. Members of the I.O.C. with their ladies were driven from the Dorchester Hotel in a large number of Rolls Royce cars and attended a luncheon party given by Lord Portal at the Empire Stadium. In the afternoon the Opening Ceremony of the Games of the XIV Olympiad took place. In the evening, the Lord Mayor, Sir Frederick Wells, and the Lady Mayoress of London, gave an official dinner for members of the I.O.C. at the Mansion House. Speeches were made by the Lord Mayor and Mr. J. Sigfrid Edstrom.

Religious services were held in the afternoon of Sunday, August 1, at St. Paul's and Westminster Cathedrals for the Olympic competitors and officials. Most of the members of the I.O.C. were present.

During the following two weeks there were few official functions, and members of the I.O.C. went to Wembley and other Olympic stadia on most afternoons or evenings. Special buses were arranged for those who did not have their own cars with them. Receptions, to which members of the I.O.C. and other Olympic officials were invited, were given at the Embassies and Legations of countries taking part in the Games.

On Sunday, August 8, a concert in honour of the Olympic Games took place at the Royal Albert Hall. The B.B.C. Symphony Orchestra was conducted by Sir Malcolm Sargent, and the soloists were Eva Turner and Ida Haendel. After the concert, the members of the I.O.C. attended the distribution of medals for the Arts Competition at the Victoria and Albert Museum. The President of the I.O.C., Mr. Edstrom, presented the awards, and Lord Burghley proposed a vote of thanks to him.

His Majesty's Government gave an evening Reception in honour of Olympic officials at Hurlingham Club on Tuesday, August 10, at which some two thousand guests were present.

A further meeting of the I.O.C. was held on Friday, August 13, in the conference room of the Organising Committee offices. Certain presentations were made to members after the conclusion of official business. During that morning the ladies of the I.O.C. visited the Tower of London. In the evening Sir Eugen and Lady Effie Millington-Drake gave a dance at their house in honour of the members of the I.O.C.

The members of the I.O.C. were entertained to lunch by Lord Portal at the Empire Stadium, prior to the Closing Ceremony. In the evening the Organising Committee gave a farewell party for competitors at Hurlingham Club. 2,500 guests were present, including many members of the I.O.C., officials and competitors.

### **International Federation Conferences**

The Secretary of the Reception Committee circularised all International Federations in 1947 in order to ascertain their requirements for the conferences which they would hold during the course of the Olympic Games in London. Information regarding the numbers attending, the duration of the conferences and the provisions to be made for committee meetings was sought, together with details of any specific hotel accommodation which might be required in this connection. These requirements varied considerably as certain Federations held their meetings prior to their sport and others subsequently.



Some, too, held formal dinner parties to which were invited members of the I.O.C. and Organising Committee. As accommodation in London was somewhat limited and as the Organising Committee had no suitable accommodation of its own, the venues of conferences were widespread throughout the city.

The deliberations and findings of these conferences are not within the scope of the Report of the Organising Committee.

### **Contact with Attaches and Other Official Bodies**

The first contact between the Reception Committee and the Olympic Attaches was at a meeting held in February, 1948. Subsequently, the Attaches were kept informed of the proceedings of the Reception Committee by circulars.

On Tuesday, July 27, Sir Eugen and Lady Effie Millington-Drake gave a garden party at their residence to welcome all Ibero-American visitors to London on the occasion of the Olympic Games and for the benefit of the Ibero-American Benevolent Society. To this the Olympic delegates from Latin-America, Spain and Portugal were invited, as well as the heads of Diplomatic Missions concerned. The occasion was honoured by the presence of H.H. Princess Marie-Louise.

Prior to the services for the Olympic visitors at St. Paul's and Westminster Cathedrals, the Chairman of the Reception Committee and Lady Effie Millington-Drake gave a buffet lunch for the Presidents and Chefs de Mission of all Olympic Delegations, the Heads of Diplomatic Missions of countries participating in the Games, and the members of the Executive Committee of the Olympic Attaches. The occasion was honoured by the presence of His Eminence the Cardinal Archbishop of Westminster and the Archdeacon of London.

In connection with the Olympic Regatta, the Chairman of the Reception Committee arranged jointly with the Chairman of the Welcome and Entertainment Committee of Henley-on-Thames, Alderman C. Luker, a luncheon on Monday, August 9, the day of the Rowing Finals. To this were invited the members of the International Olympic Committee, the Organising Committee, Presidents of National Olympic Committees of the countries participating in the Olympic Regatta, international rowing personalities and the Stewards of the Henley Regatta.

### **Competitors**

On Tuesday, August 3, Their Majesties the King and Queen received at Buckingham Palace 300 competitors and officials, representing all countries taking part in the Games. The party was informal; with Their Majesties were H.M. Queen Mary, Their Royal Highnesses the Princess Elizabeth, Duchess of Edinburgh, the Duke of Edinburgh, and the Princess Margaret.

The Organising Committee entertained competitors to a farewell party at Hurlingham Club on Saturday, August 14. This took place after the Closing Ceremony and the guests, who numbered over 2,000 were given a buffet supper, followed by dancing and a fireworks display.

Many public and private parties were held in honour of the Olympic competitors. The Mayors of the Boroughs of Wembley, Richmond, Hammersmith, Kingston-upon-Thames, High Wycombe, Henley-on-Thames, Torquay, and the Chairmen of the Urban District Councils of Uxbridge and West Drayton gave Receptions for the competitors. At some of these places recreational facilities and entertainments were provided throughout the period of the Games. Many Societies, such as the English-Speaking Union, the Union of Maccabi Association, the International Sports Fellowship, organised large parties, and in some cases offered honorary membership of their clubs. British European Airways gave a dinner at Uxbridge for 75 competitors who were quartered near Northolt Airport. After the dinner they were taken for flights over London. In addition to these and other similar functions, the Embassies and Legations of the countries taking part in the Games offered hospitality to their competitors and officials.

### **Interpreters**

While the International Olympic Committee rules lay down the provision of an interpreter service as a necessity for all Olympic Games, the celebration of the Games in an English-speaking country curtails this need very greatly. With the exception of the Finnish team, no interpreters were allocated individually to nations. So many of the competitors were English-speaking that they fulfilled the function for their teams at their housing centres.

In addition to this, the employment of student labour for domestic and catering duties in the centres proved an added advantage since many were multi-lingual.

The interpreter service that was established was on a purely voluntary basis, the individuals being paid only travel and out-of-pocket expenses.

The languages catered for at the various housing centres were : French, German, Italian, Spanish, Dutch, Flemish, Greek, Arabic, Persian, Turkish, Hungarian, Polish and the Slavonic languages. Only at the out-lying centres of High Wycombe and Bisley was it necessary for any interpreter to live in.

The military provided the necessary facilities for the equestrian and modern pentathlon teams in the Aldershot area.

Interpreters are required for certain sports, and National Governing Bodies in England, as the representatives of the International Federation concerned, were circularised by the Reception Committee Secretary. The majority stated that as many members of the teams and officials to be appointed would have sufficient knowledge of languages, no facilities would be necessary. However, in boxing, wrestling, swimming, weight-lifting and athletics a small number of interpreters was supplied.

There can be little doubt that the need for interpreter service at Olympic Games must vary according to the country of celebration; and each Organising Committee will have its own special requirements.

# FINE ARTS DEPARTMENT

The rules and regulations, based upon those of previous Olympiads, were printed and despatched to all nations invited to participate in the Games some fourteen months before the commencement of the Games of the XIV Olympiad. Labels in different colours according to the nature of the exhibits, and entry forms, were sent to each country. Labels for work in competition differed from those to be attached to work for exhibition only. All entry forms and music and literature contributions were sent in fifteen weeks before the opening of the exhibition.

The Fine Arts form had spaces to be filled in as follows :—

- (a) Category.
- (b) Title.
- (c) Date of execution.
- (d) Measurement.
- (e) Material employed.
- (f) Size of base for sculpture and models.
- (g) Insurance.
- (h) Price.

The latest date for receiving art works was five weeks before the opening of the exhibition.

The British Fine Arts Committee was set up approximately a year before the Games. This was under the Chairmanship of General Sir Ronald Adam, Bt., G.C.B., D.S.O. The Deputy Chairman was Sir Eric de Normann, K.B.E., C.B. The Chairmen of the Sub-Committees were as follows :—

*Architecture.*—Sir Percy Thomas, O.B.E., LL.D.

*Painting.*—Mr. Norman Wilkinson, O.B.E., P.R.I.

*Graphic Art.*—Mr. Malcolm Osborne, R.A.

*Sculpture.*—Sir William Reid Dick, K.C.V.O., R.A.

*Literature.*—Sir Alan Herbert, M.P.

*Music.*—Sir Arnold Bax, Mus.D.

*Director of Art, and Secretary to the Committees.*—Major A. A. Longden, D.S.O., O.B.E.

## Judging

The Craft section was greatly strengthened by the competition instituted by the Worshipful Company of Goldsmiths, who gave prizes for the best shield, cup, or torch. Two torches of considerable excellence were forthcoming, one of which, by Mr. Lavers, was used at the Games.

The Members of the International Juries were decided by ballot. The following countries accepted the invitation to serve :—Belgium, Brazil, Czechoslovakia, Denmark, Finland, France, Holland, Italy, Sweden, Switzerland, and the U.S.A. Two foreign

representatives were included, with the British Jurors, in each of the five sections. They were :—

<i>Architecture</i>	1. JAN WILS, Holland. 2. HOWARD CRANE, U.S.A.
<i>Painting</i>	1. PAUL BRET, France. 2. PROFESSOR GIULIO CARLO ARGAN, Italy.
<i>Sculpture</i>	1. STIG BLOMBERG, Sweden. 2. PROFESSOR HENRIQUE SALVIO, Brazil
<i>Graphic Art</i>	1. VIKTOR STRETTI, Czechoslovakia. 2. SAKARI SAARIKIVI, Finland.
<i>Crafts</i>	1. BLAKE-MORE GODWIN, U.S.A.
<i>Literature</i>	1. PROFESSOR MAX WILDI, Switzerland. 2. SIGFRED PEDERSEN, Denmark.
<i>Music</i>	1. PAUL LEROI, France. 2. BRUNO ROGHI, Italy.

### Exhibition Galleries

The Minister of Education generously placed seven galleries at the disposal of the Hanging Committee in part of the front of the Victoria and Albert Museum, South Kensington. The number of running feet in which to hang work was 1,144 (352 metres).

- 3 Galleries were devoted to oil paintings.
- 1 Gallery was reserved for sculpture.
- 1 Gallery for architecture.
- 1 Gallery for water-colours and graphic arts.
- 2 Galleries for crafts.

Large sculpture was exhibited in the centre of the picture galleries and vitrines containing glass, porcelain and silver were placed in the centres of the water-colour and craft rooms. Works of art were arranged in groups according to class and not by countries. Every work was clearly described in the catalogue, giving the country of the exhibitor.

An impressive entrance to the exhibition was designed by the architects department of the Ministry of Works. This included the Olympic sign cut out of wood above the main entrance with the flags of competing nations on either side. Stands for the sale of catalogues and photographs were built at each end of the exhibition. Screens were built at right angles to the walls, at intervals along the sides of the larger galleries. This greatly increased the hanging space. Eighty-three exhibitors in the sculpture section required special pedestals, and numerous tables had to be constructed for the architectural models. The cost of constructional work was approximately £666. The cost of the Fine Arts exhibition, apart from office expenses, was approximately £3,000.

Foreign exhibits were unpacked and repacked under customs supervision in the exhibition galleries, no duty being levied thereon. The Jurors worked with the utmost accord. The work of judging in the Fine Arts took four days and in the case of every award the decision was unanimous. The question of language was extremely difficult.

Linguists and professors from the University of London, however, gave the Jurors much assistance. Readers from the British Broadcasting Corporation were of great help in going through the music compositions and reducing the entries to a reasonable size for the judges.

All exhibits were covered by insurance by the Organising Committee from the moment they were received at the exhibition galleries until they were handed over to the shippers, in the case of foreign exhibits, and until they were handed over to the owners in the case of British exhibits.

A non-illustrated catalogue was printed and sold at 1s. 6d. An illustrated souvenir, containing 97 illustrations, i.e., 32 paintings, 20 water-colours and black and whites, 25 pieces of sculpture, 10 crafts, and 10 architecture, was sold at 3s. 6d. A charge for admission of 2s. was made. This proved to be too high. A reduction was made for large parties, and art students were admitted at half price. None the less, a number of people with children abandoned the idea of entering on hearing of the 2s. charge. Photographic prints of exhibits from every nation were on sale in the exhibition, and there was a large demand for them.

### Opening of Exhibition

The Exhibition was opened by H.R.H. The Duchess of Gloucester, in the presence of approximately 1,000 guests, including Ministers, Members of the Corps Diplomatique, the President of the International Olympic Committee, the President of the Games, and numerous distinguished foreigners. The Exhibition was open from July 15 to August 14, on Monday, Tuesday, Thursday, Friday, 10 a.m. to 6 p.m.; Wednesday and Saturday, 10 a.m. to 10 p.m. Sunday, 2.30 p.m. to 6 p.m.

Twenty-seven countries participated in the competition and exhibition. The names of the prize-winners were announced during the Olympic Victory Ceremonies in the Empire Stadium, Wembley, on July 29.

On the termination of the exhibition the awards were made to the successful competitors on Sunday, August 15, in the main gallery of the Exhibition in the Victoria and Albert Museum, by the President of the International Olympic Committee, Mr. J. Sigfrid Edstrom, supported by the Chairman of the Organising Committee, Lord Burghley, K.C.M.G. One hundred and ninety-six Commemoration medals and diplomas were sent to foreign and overseas exhibitors as follows :—

Austria	44	France	29	Czechoslovakia	19	Poland	17
Italy	35	Canada	21	Switzerland	16	Eire	15

There were 36 Music and 44 Literature entries. The remainder were in the various sections of Art.

The Exhibition was advertised in four leading dailies, two leading Sunday newspapers, and three magazines, at a cost of £135. The Juries agreed that on future occasions a more intensive press campaign would result in supporters of sport becoming interested in art. Such a campaign amongst intellectuals would lead to an enrichment of the Olympic ideal, and of one of its most important missions, the balance between body and mind.

On the termination of the exhibition, the British Fine Arts Committee drew up a report containing a number of recommendations for guidance in connection with future Olympic art competitions and exhibitions. The Jurors' recommendations were :—

1. *Architecture*.—The committee were of the opinion that the conditions should be simplified. There was great difficulty in judging owing to the immense variety of subjects.

The suggestion was put forward that a set competition would be best. For example, in the Town Planning Section, a design for the lay-out of a Sports Centre; in the Architectural Section, a design either for a Stadium or a Swimming Bath. A real competition amongst the nations for a *definite project*. A separate prize should be given for the best model as such, regardless of the subject. The Dutch Juror stated that in his country it is intended to hold annual national competitions with prizes to encourage high quality at the International Competition at the Games, physical culture in general to be the main theme.

2. *Painting*.—The Jurors were unanimous in their proposal that oil painting must be in a different class to water-colours and drawings. As regards black and white, there should be separate classes for (a) original work, and (b) prints (reproduction work), such as etchings, lithographs, engravings and wood-cuts.

3. *Sculpture*.—The Jurors recommend that owing to the lengthy process of creating important work in stone or bronze, at least 15 months notice should be given to exhibitors.

4. *Crafts*.—There must be two sections, one for objects in the *round*, and one for *flat* exhibits, such as posters, stamps, banners, textiles, etc.

5. *Literature*.—For the benefit of judges, the language in which the entries are submitted should be either French or English. It is impossible to judge fairly from a *precis*. In their opinion a set subject with a direct connection with the Games would be desirable.

6. *Music*.—In this section there were 38 entries, eight countries gaining awards. There were 15 Diplomas. Italy and Poland won first places. The Jurors' recommendations were that the competitions should be devoted to a specific idea, such as an ode or a symphony to the Olympic Games. They suggested that there should be three sections

- (a) A march, hymn, or song to the Olympic Games.
- (b) A cantata on an Olympic subject limited to 20 minutes.
- (c) An overture or tone poem with Olympic Spirit.

7. *General Recommendations*.—One of the results of the Exhibition was to cause a general feeling that the exhibits could be more closely linked up with the Games themselves. For example the large sculpture could be displayed in the open air, in or near the Stadium. In the craft section the Committee were of the opinion that such exhibits as posters, stamps, seals, diplomas—even announcements and letter headings and invitation cards—should all be designed in a topical manner, judged first nationally and then internationally *well in advance of the Games*, so that the winning entries could be used for and at the Games.

# THE OPENING CEREMONY

At the very outset it was realised that if the Opening Ceremony was carried through smoothly and with traditional solemnity, a spirit would be engendered which would permeate the whole of the Games.

To this end, in January, 1947, an Opening Ceremony Committee was formed to deal with all necessary preparations. The constitution of this Committee was :—

Chairman : Lord Burghley.

Members : Brigadier L. F. E. Wieler, Captain R. C. Harry, R.N., Wing-Commander A. F. Ingram, Mr. E. J. Holt, Director of Organisation, Lt.-Col. T. P. M. Bevan, General Organising Secretary.

Previously, towards the end of 1946, the Executive Committee had already given consideration to the choice of the Olympic Hymn to be sung at the Opening Ceremony. Various possibilities were discussed. It was suggested that an established British composer might be commissioned to write the hymn, or that a competition be held. There were, however, some practical difficulties. Should a new work be written, it would require to be printed, orchestrated and, of course, rehearsed. Also, time was short. Colonel Bevan found that there existed a work written in 1936 by Roger Quilter, which was eminently suitable, a setting of Rudyard Kipling's " Non Nobis Domine." Both words and music when heard by the Committee, made a deep impression and it was agreed, with the approval of Mr. Kipling's family and Mr. Quilter, to adopt the work as the Olympic Hymn.

## NON NOBIS, DOMINE.

*Words by Rudyard Kipling.*

Non Nobis, Domine  
Not unto us, O Lord.  
The praise and glory be  
Of any deed or word  
For in thy judgment lies  
To crown or bring to nought  
All knowledge and device  
That man has reached or wrought.

*Music by Roger Quilter.*

And we confess our blame,  
How all too high we hold  
That noise which men call fame,  
That dross which men call gold.  
For these we undergo  
Our hot and godless days  
But in our souls we know  
Not unto us the praise.

O Power, by whom we live,  
Creator, Judge and Friend,  
Upholdingly forgive,  
Nor leave us at the end.  
But grant us yet to see  
In all our piteous ways,  
Non Nobis, Domine  
Not unto us the praise  
Non Nobis, Domine.

The Hallelujah Chorus was chosen as the official cantata for the Opening Ceremony.



# OPENING CEREMONY

## DIAGRAM OF PARADE ARRANGEMENTS

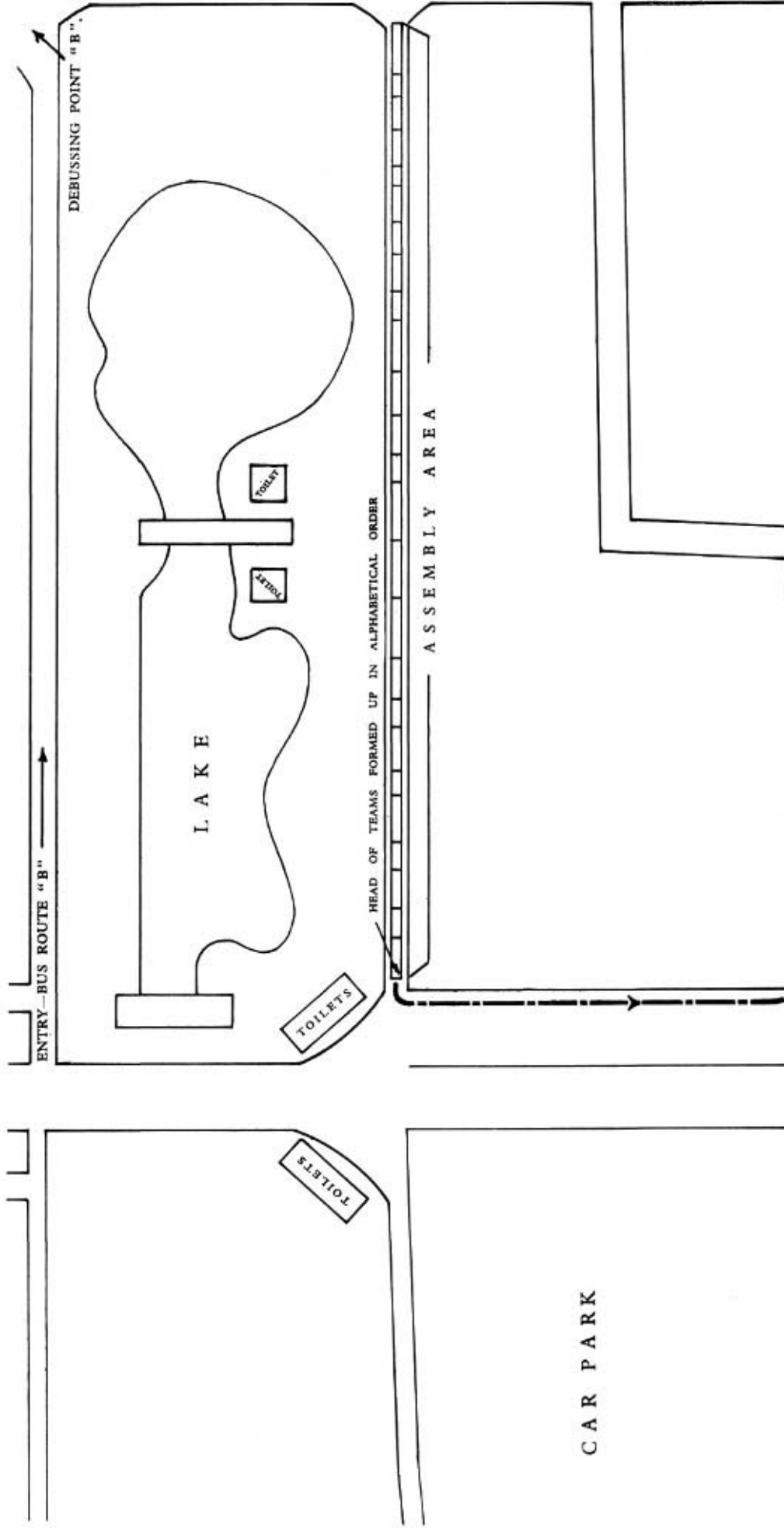

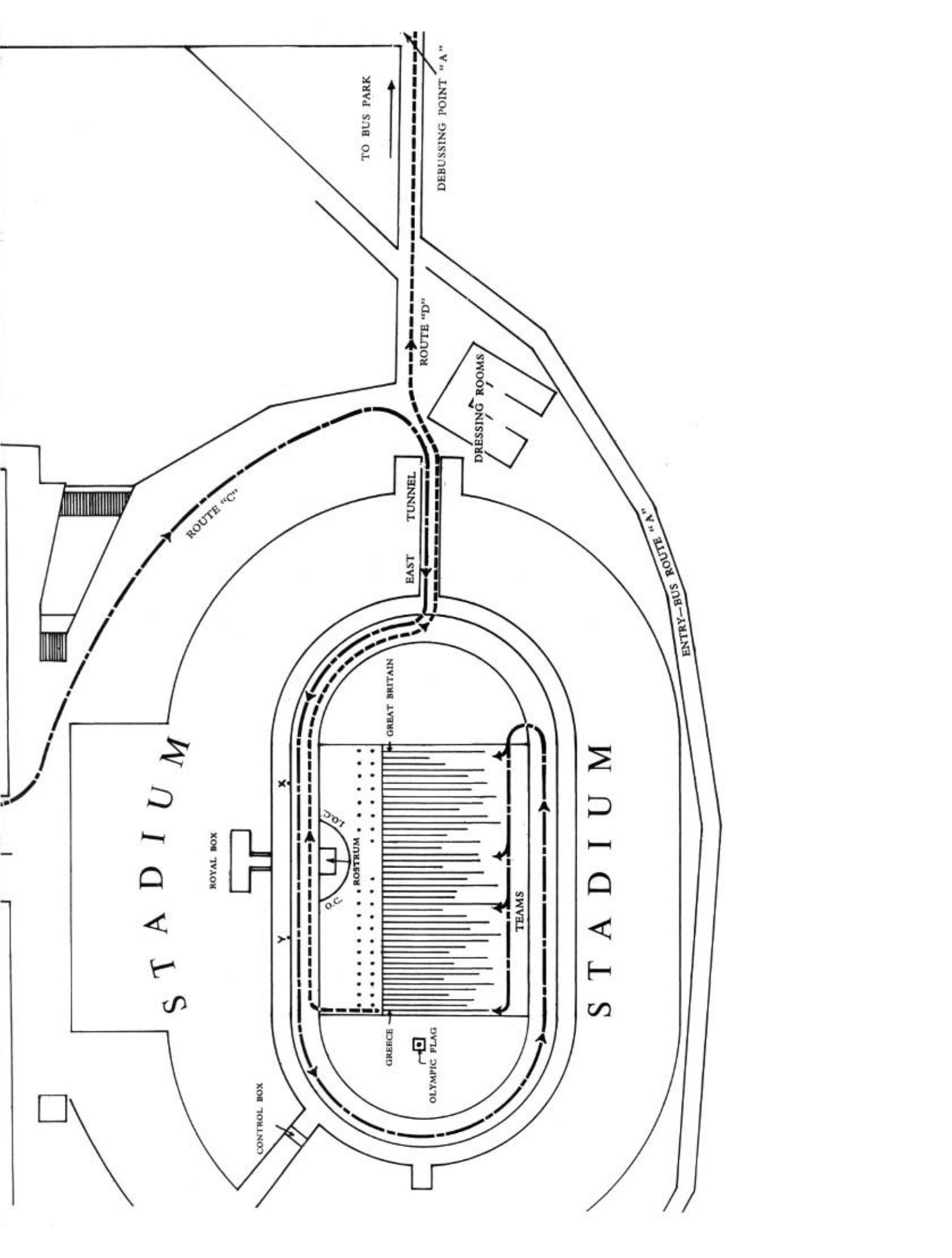

Sir Malcolm Sargent accepted the invitation to act as Director of Music and conduct the massed bands and choirs at the Opening and Closing Ceremonies. As full rehearsals would be impossible, owing to the dispersal of most Choral Societies during the summer, it was necessary to select music well known to those choirs which would be taking part.

To enlist the services of 1,200 singers, drawn from seven Choral Societies, was in itself a problem. It was necessary to acquire nominal rolls and addresses of each Society's members and then ascertain who, among them, would volunteer. The next problem was to ensure some reasonable degree of balance between parts, and this was based on 6 sopranos to 5 contraltos, 3 tenors and 4 basses. The final difficulty was the distribution of music where necessary, and of tickets, which were sent to each individual member taking part. Every precaution was taken to ensure that each of the four sections of the Choir was seated together.

The preliminary detailed work was well rewarded, for when the day came, the choirs moved into their respective places and no adjustments in seating were necessary.

The music for the March Past, to be played by the Massed Bands of the Brigade of Guards, 200 musicians under the Directorship of Major G. H. Willcocks, was carefully selected in order to make it, as far as possible, representative of the 59 competing nations. The Bands were to play continuously for 45 minutes while the 6,000 athletes and officials marched past. There was some doubt, and a very reasonable one, as to whether the bandsmen, dressed as they would be in Bearskin and Tunic Order, with no protection from the sun, would withstand the ordeal. However, in spite of the sweltering heat experienced on July 29, not a single man "fell out."

### **Parade Organisation**

Colonel the Hon. J. Hennessy, who had had much experience in ceremonial parades, was loaned by the Army to take charge of the Parade and to work out the detailed timing of the Ceremony to conform with the protocol as laid down by the International Olympic Committee.

With several thousands, the representatives of 59 nations, taking part in the Parade it was necessary to find a large assembly ground close to the arena and to provide facilities for light refreshment and conveniences for men and women. Five Guards Officers and two Drill Sergeants were employed to marshal the teams on this ground and at the turning points in the arena itself.

One of the major points confronting the Opening Ceremony Committee was the most satisfactory method of disposing of the teams in the arena after they had marched past the Royal Box. It was decided that they should proceed the full length of the back straight before making a complete left wheel on to the grass, thus ensuring that all the spectators had the opportunity of seeing each team. The first team, the Greek, on reaching the end of the back straight, therefore, counter-marched to the end of the ground, before wheeling to the right to take up its position in column facing the Royal Box. The following teams carried out the same manoeuvre, each counter-marching a little less, to take up their positions beside the preceding team. As a result, the Greek team was on the left facing

the Royal Box, and the British team, which came in last, was on the extreme right (see diagram on pages 200 and 201).

It was agreed that His Majesty should perform the actual Opening at 4 p.m. The timing of the whole Ceremony, before and after, depended, therefore, upon this hour. Consequently, it could not be decided until the last moment, when the sizes of the individual teams were known, as to how many abreast each team should march. Actually this varied from one to six. It was arranged that 250 buses would transport the competitors, and the limited number of team officials who were permitted to march, from their housing centres to the Assembly ground, to arrive at 1.30 p.m.

After discussion with the Racing Pigeon Association, it was decided that 2,500 birds would be the most suitable number for release, and these were placed around the arena in 350 baskets with one Boy Scout to every two baskets. No announcement or commentary was made over the loudspeaker system during the Ceremony.

The official Olympic Flag—which measured 18 ft. by 11 ft.—was hoisted by three corporals of the Guards. The arena was decorated by the flags of all the competing nations, with three Olympic flags over the scoreboard, which was to carry the famous words of Baron de Coubertin :—

*" The important thing in the Olympic Games is not winning, but taking part. The essential thing is not conquering, but fighting well."*

The two main towers carried the Union Jack and the Olympic Flag. The jumping pits were boarded in for the day and small white circular plates were set in the grass for positioning the name-board carriers, who were drawn from the Boy Scouts' Association. These, under Colonel Hennessy's Deputy, Colonel Johnstone, carried out a practice parade the night before the Opening. The Tribune of Honour, appropriately decorated and with microphones connected, was situated on the edge of the track opposite the Royal Box. Owing to the size of the teams, the International Olympic Committee did not form a semi-circle round the Tribune, but was drawn up in line to the right of it, facing the Royal Box in order of seniority, with the most senior members on the right. Luncheon was taken by this body as the guests of Lord Portal in the precincts of the Stadium, but before lunch they held a practice parade in order that they could, in due course, go straight to their correct positions. The Organising Committee was lined up similarly, on the left of the Tribune.

The detailed instructions and the timetable for the Opening Ceremony are reproduced in full on the next five pages.

# GENERAL INSTRUCTIONS AND PROGRAMME FOR THE OPENING CEREMONY, JULY 29

The following instructions cover all the points of which those taking part in the March at the Opening Ceremony should be informed.

In order that the ceremony should be carried out with precision and in a manner worthy of the occasion, Chefs de Missions and other officials responsible for controlling the teams of their respective nations are strongly urged to read these instructions carefully and to do all in their power to ensure that they are followed as closely as possible.

As there will be no rehearsal, IT IS IMPORTANT that an official from each nation and the athlete chosen to carry the flag of each nation should present themselves at Wembley Stadium at the EAST TUNNEL of the Stadium at 14.30 hours on Wednesday, 28th July, 1948, in order to have the instructions for the ceremony fully explained to them on the ground. Will these individuals please make every effort to be punctual at this rendezvous.

1. *Those permitted to take part in the March are :* Men and women athletes and those holding an official position with an Olympic team.

Persons NOT holding official Olympic connections with a team are NOT permitted to march, neither can any band or musical organisation be added to the team.

2. *Dress.* All taking part in the March must wear their team's parade uniform or the athletes may wear their athletic suits. All must be so dressed when they leave their living quarters as they will NOT be able to change on arrival at Wembley. Should any persons taking part in the parade bring extra clothing with them, they should leave it in the bus and NOT in the Assembly area, since after the March, teams will NOT return to the Assembly area before re-embussing.

3. *Transport.* Buses will be provided to bring teams from their camps to Wembley Stadium. They will leave the camps in time to deposit their passengers not later than 13.30 hours. Teams will de-bus at either de-bussing point "A" or "B" and should then proceed immediately to the Assembly area where they will find boards with the names of all nations taking part. When each team has found its place in the " Order of March " it should keep together as much as possible while waiting to move forward by Route " C " to the Stadium. Seating and toilet facilities will be provided in the immediate vicinity of the Assembly Area.

4. *Order of March.* Teams will form up in the Assembly Area and enter the Stadium with Greece leading and Gt. Britain last. Other nations will be in alphabetical order according to English spelling. Carriers for the " name of country " boards will be provided by the Organising committee, but each nation must provide its own flag-bearer.

A guide carrying the " name of country " board will lead each team, followed at an interval of five metres by the flag-bearer. Another interval of five metres will be maintained between the flag-bearer and the team itself which should be led by its officials followed by the women competitors and then the men competitors. There will be a gap of 20 metres between the rear of one team and the board carrier of the following team.

5. *Formation on the March and in the Stadium.* As soon as teams arrive in the Assembly Area, they will be told how many abreast they will march. It is NOT possible to circulate this information sooner owing to the strengths of teams not being known till almost the last moment. Generally speaking, the small teams will march in single file or two abreast; the medium-sized teams three or four abreast; and the largest six abreast. On arrival at their correct position in the Stadium, teams should stand " at ease " but remain in their ranks. They should come to " attention " only during the National Anthem, the formal opening of the Games by the King, and the taking of the Olympic oath.

6. *The Salute.* As each team approaches point X (see plan) all athletes should turn their heads towards the Royal Box—but NOT raise their arms—and the flag bearer should lower his flag. At point Y they will look to their front and flags will be raised again. Points X and Y will be indicated by markers with small British flags.

7. *The Olympic Oath.* As soon as the band and choir start the " Hallelujah " Chorus, the flag-bearer of each nation will move forward and form a semi-circle on the position just vacated by the O.C. and I.O.C., the British athlete chosen to take the Olympic Oath will follow his flag-bearer and will mount the Rostrum. While the chosen British athlete is reciting the Oath, he will hold the corner of the flag in his left hand and at the same time raise his right hand. At the same time, every member of every team will raise their right hands level with their faces, palm to the front, or as is customary when taking an oath in their own countries. At the end of the Oath, there will be a short pause before the National Anthem is played. All flag-bearers and the chosen athlete will remain where they are till the *end* of the National Anthem when they will rejoin their respective teams.

8. *The March Out* will start as soon as the flag-bearers rejoin their teams and the Band begins to play again. Teams will march out in the same order as they marched in, i.e., Greece leading and Gt. Britain last. There will be no further salute. Each team will march straight forward on to the track, turn right and leave the Stadium by the East tunnel, i.e., as for their entry. On emerging from the East tunnel, teams will proceed straight on by Route D (see plan) to the area where their buses will be waiting for them. ON NO ACCOUNT must teams halt or even pause during this movement or the effect will be felt right back on to the Stadium. The Guides provided for each team will be responsible for collecting the flag and name-board of each country before the teams re-enter their buses since these are required for the Closing Ceremony.



**OPENING CEREMONY TIMETABLE****JULY 29, 1948 at 14.30 hours**

From 14.00 hours to 14.25 hours there will be a display in the Stadium by the Trumpeters of the Household Cavalry and the Massed Drums, Fifes and Pipers of His Majesty's Brigade of Guards :—

Then:

Serial No.	Time	Item	Notes
1	14.35	I.O.C. and O.C. take up position on the grass opposite the Royal Box to await The King.	
2	14.45	The Royal Party arrives in the Royal Tunnel and is received by the President of the Games who will present the President of the I.O.C., The Chairman of the O.C. and the Lord Mayor of London to the King.	The remainder of the Royal Party will be conducted straight up to the Royal Box by the Lord Mayor of London.
3	14.48	National Anthem by the Massed Bands.	The Choir will NOT sing.
4	14.50	President of the I.O.C. presents the members of the I.O.C. to the King and the Chairman of the O.C. presents the members of the O.C.	When all have been presented, the King goes to the Royal Box accompanied by the two Presidents. The I.O.C. and O.C., return to their seats in the stand, <i>MUSIC during all this.</i>
5	15.00	MARCH IN starts.	Teams enter in alphabetical order, as in the English language, except that Greece leads and Gt. Britain comes in last. Details of spacing, saluting, etc., will be issued to all taking part in the March. Massed Bands play all the time.
6	15.50 (approx.)	I.O.C. and O.C. with their Presidents leave their seats and form a semi-circle on the field as soon as last Team has passed saluting Base.	See Plan.
7	15.55	Chairman of the O.C. makes an address from the Rostrum ending by asking the King to open the Games.	
8	16.00	H.M. The King opens the XIV Olympiad.	
9	16.01	Fanfare of Trumpets and Olympic Flag raised.	The Trumpeters of the Household Cavalry will have taken up position on the track in front of the Royal Tunnel while serial 6 is going on.
10	16.02	Pigeons released.	Boy Scouts and baskets already in position on the side of the track.
11	16.05	21 Gun salute.	Five sec. interval between guns.
12	16.07	Runner with torch arrives, circles track and lights Olympic flame.	Enters by East Tunnel.

XIV OLYMPIAD

Serial No.	Time	Item	Notes
13	16.10	Olympic Hymn by Band and Choir.	Conducted by Sir Malcolm Sargent.
14	16.13	Dedication address by The Archbishop of York.	From the Rostrum.
15	16.18	I.O.C. and O.C. return to their seats and the Presidents to the Royal Box.	
16	16.20	" Hallelujah " Chorus by Band and Choir.	While this is being sung, the flag bearers of all the Nations form a semi-circle on the position just vacated by the I.O.C. and O.C.
17	16.27	Olympic Oath by Athletes.	The athlete who is to take the oath mounts the Rostrum with the bearer of the British flag on his left side. He holds the corner of the flag with his left hand and reads the oath facing the Royal Box.
18	16.30	National Anthem by Band and Choir (One verse).	At the conclusion of the National Anthem, the Royal Party leaves the Royal Box. The flag-bearers of the Nations rejoin their teams.
19	16.36	MARCH OUT starts.	Teams march out in the same order as for the MARCH IN. Bands play all the time.



*The winning pair in the 10,000 metres Kayak pairs, G. Akerland and H. Wetterstrom (Sweden).*



*The 10,000 metres Kayak pairs with W. Piemann and A. Umgeher (Austria) on far side, being passed by G. Covey and H. Harper (Canada), nearer the camera.*

*During the race for the 10,000 metres Canadian pairs.*

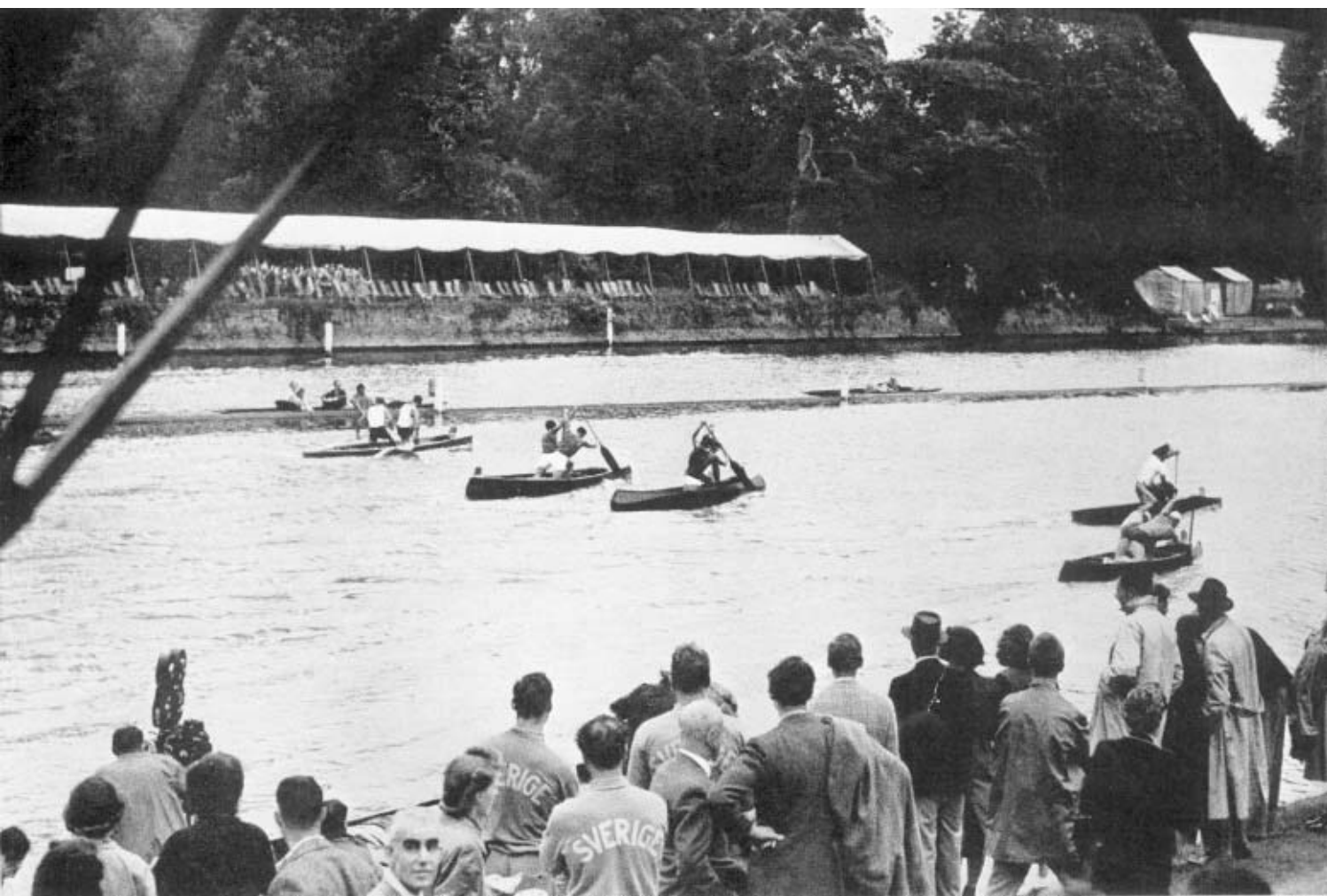

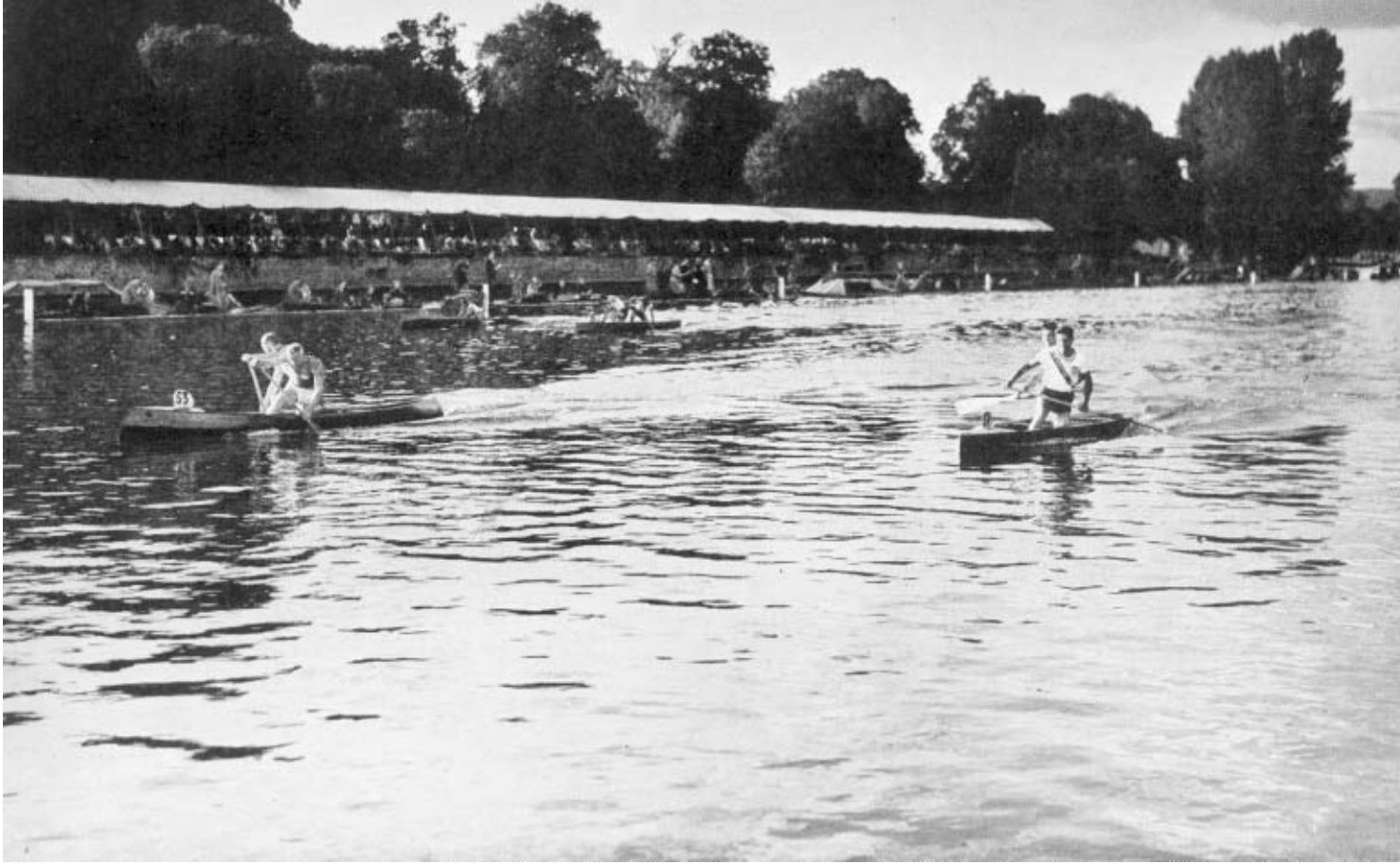

*The finish of the 1,000 metres Canadian pairs, with Czechoslovakia (J. Brzak and B. Kudrna) in boat 53 on left, beating U.S.A. (S. Lysak and S. Macknowski) in boat 57 on right, with France (G. Dransart and G. Gandil) boat 54, on left of the pair in the background, third.*

*J. Holecek (Czechoslovakia), left, winning the 1,000 metres Canadian singles from D. Bennett (Canada), further from the camera on right, and R. Boutigny (France).*







*A view of the starting arrangements for the canoeing events. The Hungarian pair (J. Toldi and G. Andrasi) are awaiting their signal in the 10,000 metres Kayak pairs.*

*G. Fredriksson (Sweden), winner of the 10,000 metres Kayak singles, leading from A. Corbiaux (Belgium) and J. Bobeldijk (Holland) during the course of the race.*



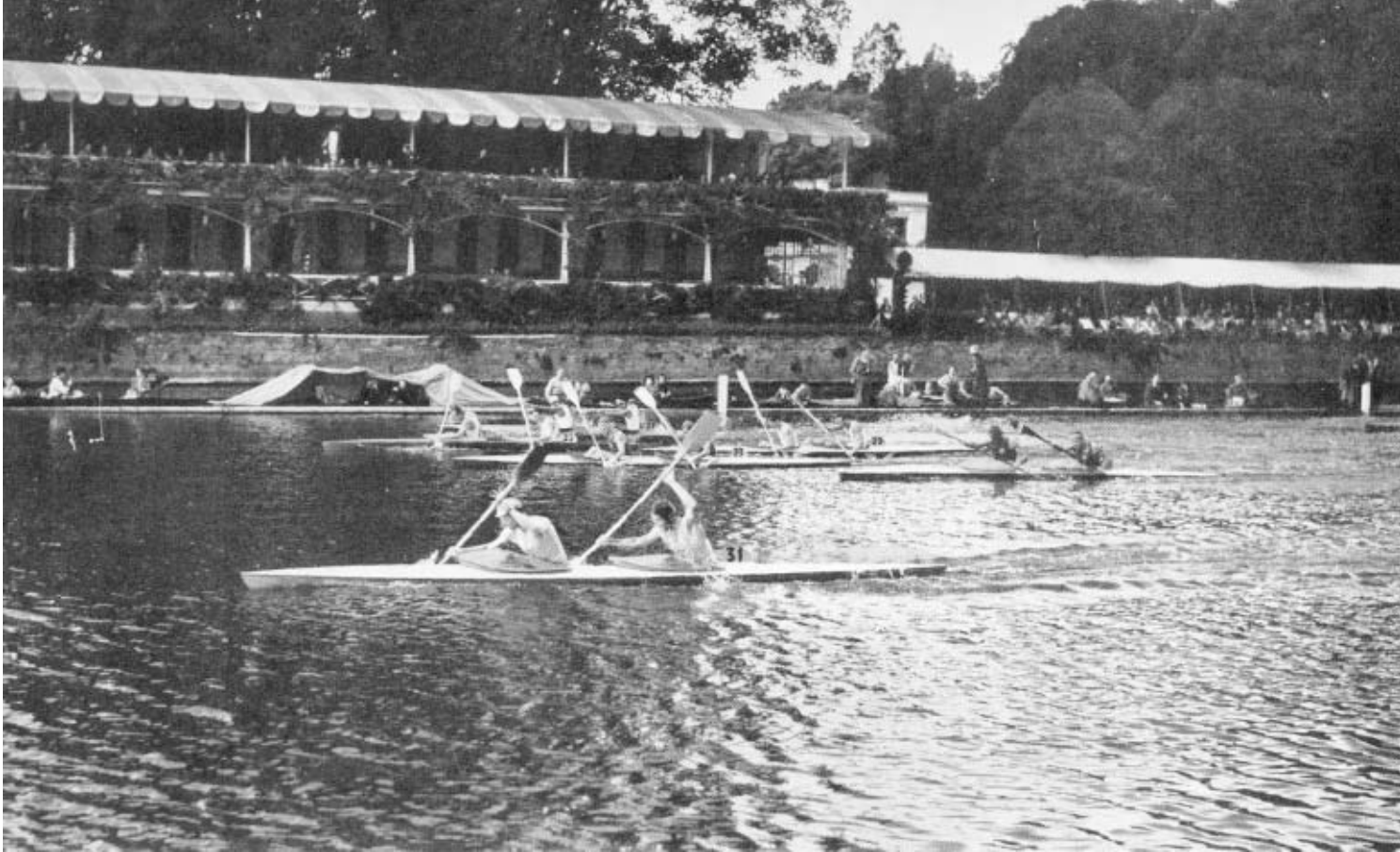

*The finish of the 1,000 metres Kayak pairs, with Sweden (H. Bergland and L. Klingstrom) in boat 31 narrowly beating Denmark (E. W. Hansen and J. B. Jensen) in boat 22 and Finland (T. Axelsson and N. Bjorklof) in boat 23.*

*Victory ceremony of the women's 500 metres Kayak singles. K. Hoff(Denmark) 1st, Van de Anker-Doedans (Holland) 2nd, F. Schwingl(Austria) 3rd.*





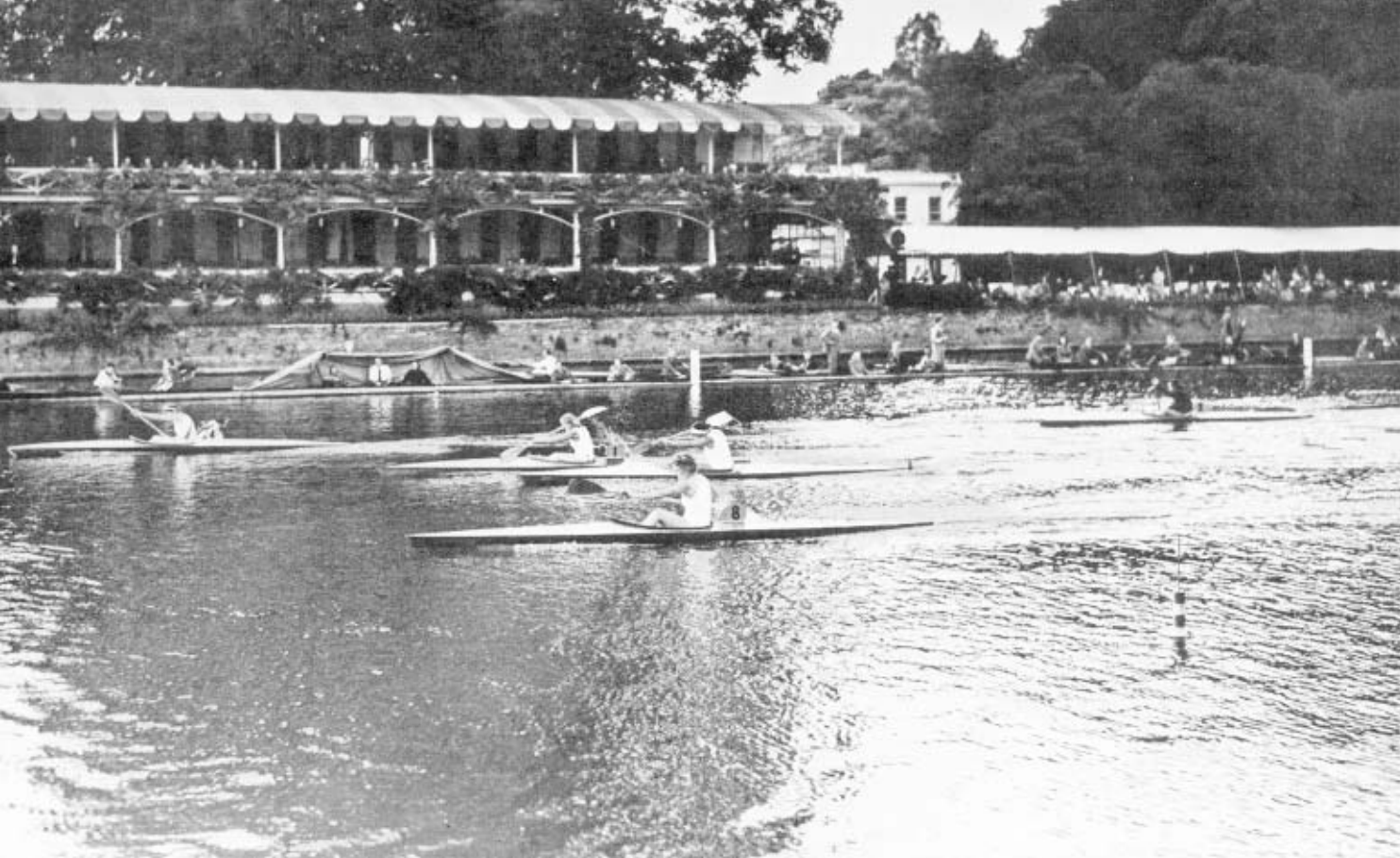

*The 500 metres women's Kayak singles; K. Hoff (Denmark), on left, beats A. G. Van de Anker-Doedans (Holland), nearest the camera, and F. Schwingl (Austria) in boat No. 1.*

*G. Fredriksson (Sweden) completes a double by taking the 1,000 metres Kayak singles by a large margin, followed home by J. Andersen (Denmark) and H. Eberhardt (France).*

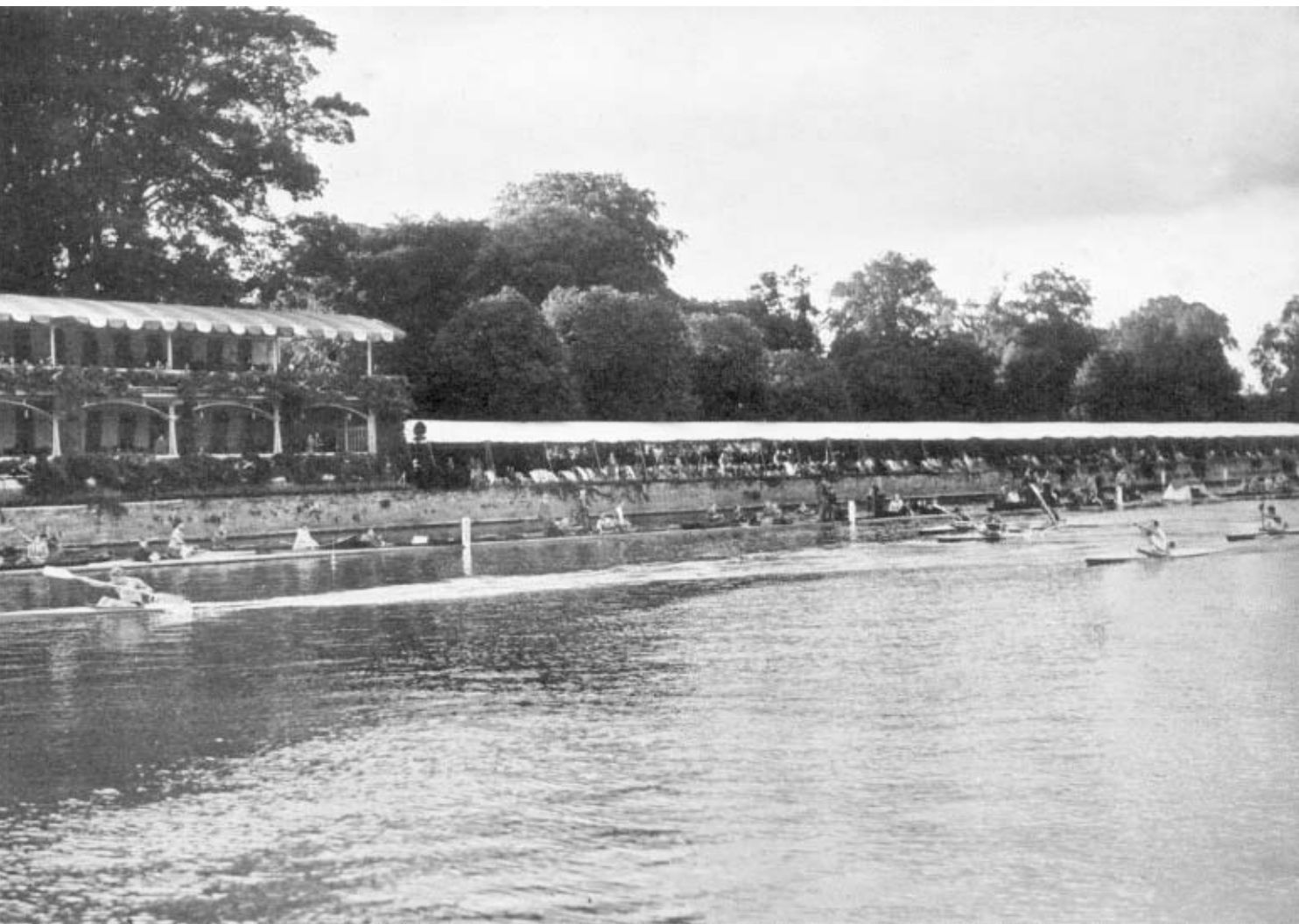

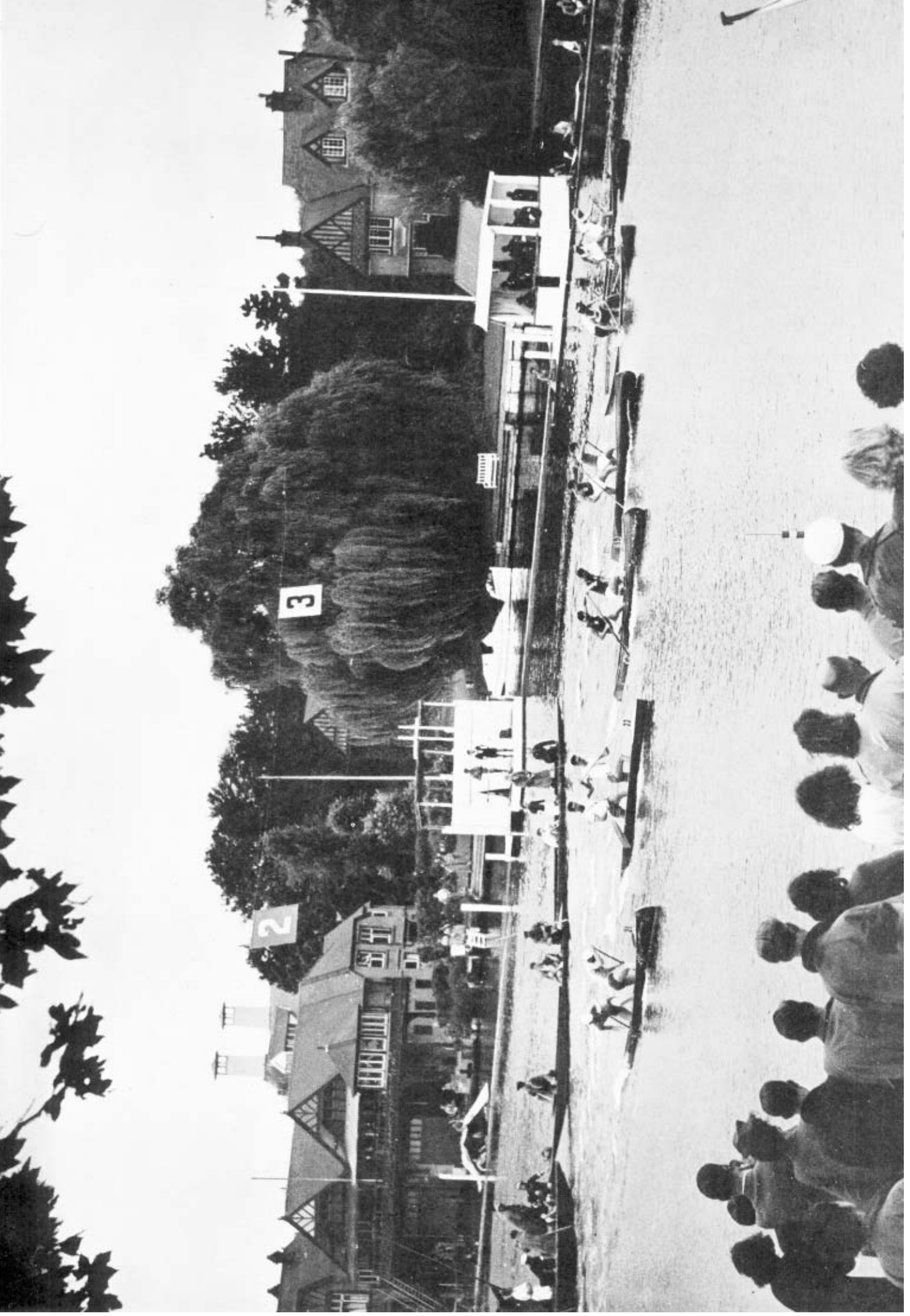

The start of the 10,000 metres Canadian pairs. From left to right: G. Johansson and V. Wettersten (Sweden), S. Lysak and S. Macknowski (U.S.A.), the winners, V. Havel and J. Pecka (Czechoslovakia), G. Dransart and G. Gandil (France), B. Oldershaw and W. Stevenson (Canada), and K. Molnar and V. Salmhofer (Austria).



*The finalists in the 1,000 metres sprint, M. Ghella (Italy), the winner, on the outside, and R. Harris (Great Britain) nearer the camera.*

*The photo-finish print of the finish of the second and deciding heat in the sprint final, showing Ghella beating Harris by one and a half lengths.*

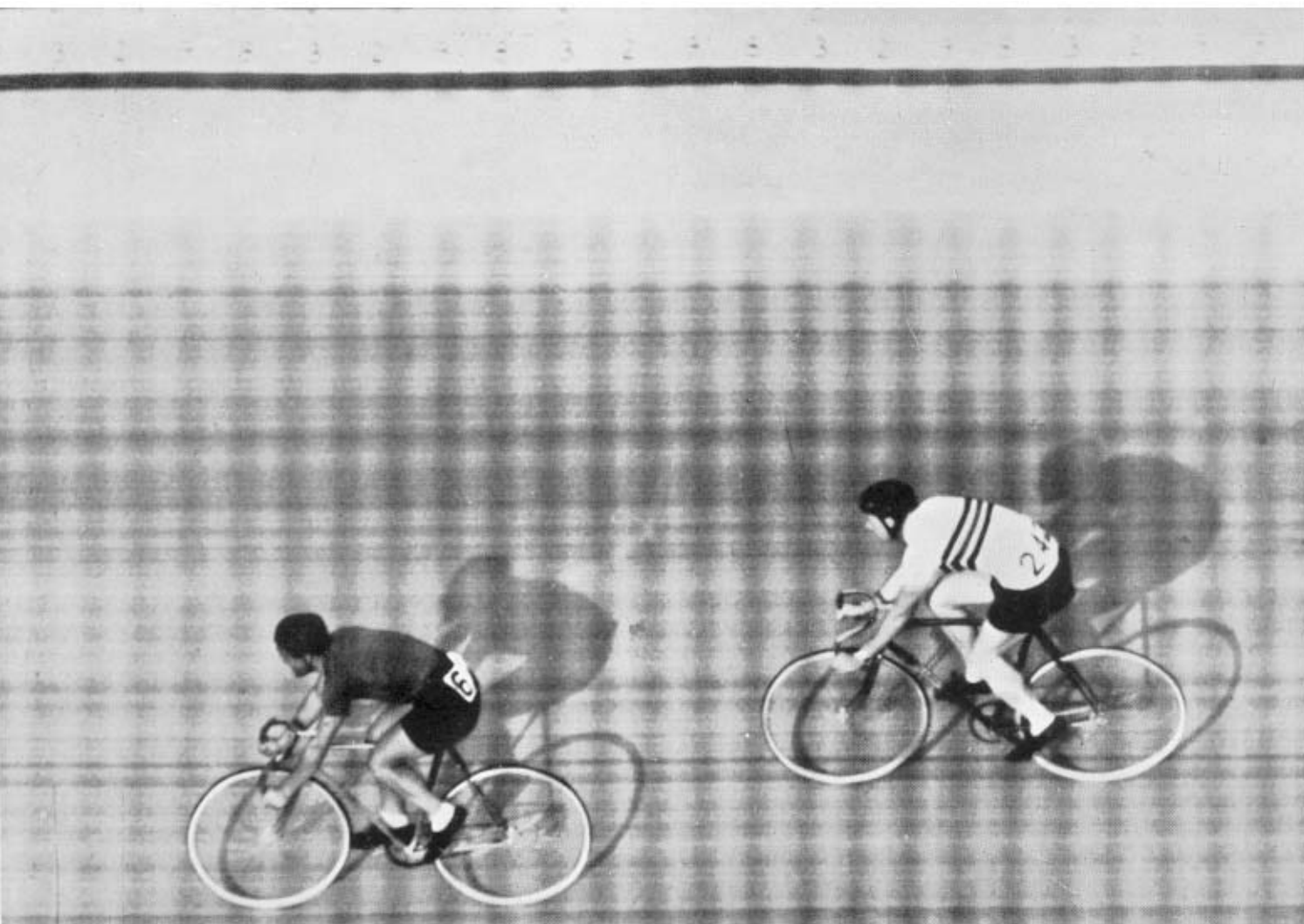





*The French team who won the 4,000 metres pursuit, C. Coste, S. Blusson, F. Decamal, and P. Adam.*



*J. Dupont (France), winner of the 1,000 metres time trial.*

*The result of the collision in the eighth finals of the 1,000 metres sprint, heat two, between J. Hijzelendoorn (Holland) and L. Rocca (Uruguay). Rocca is falling to the ground, while Hijzelendoorn is already lying on the track behind him.*

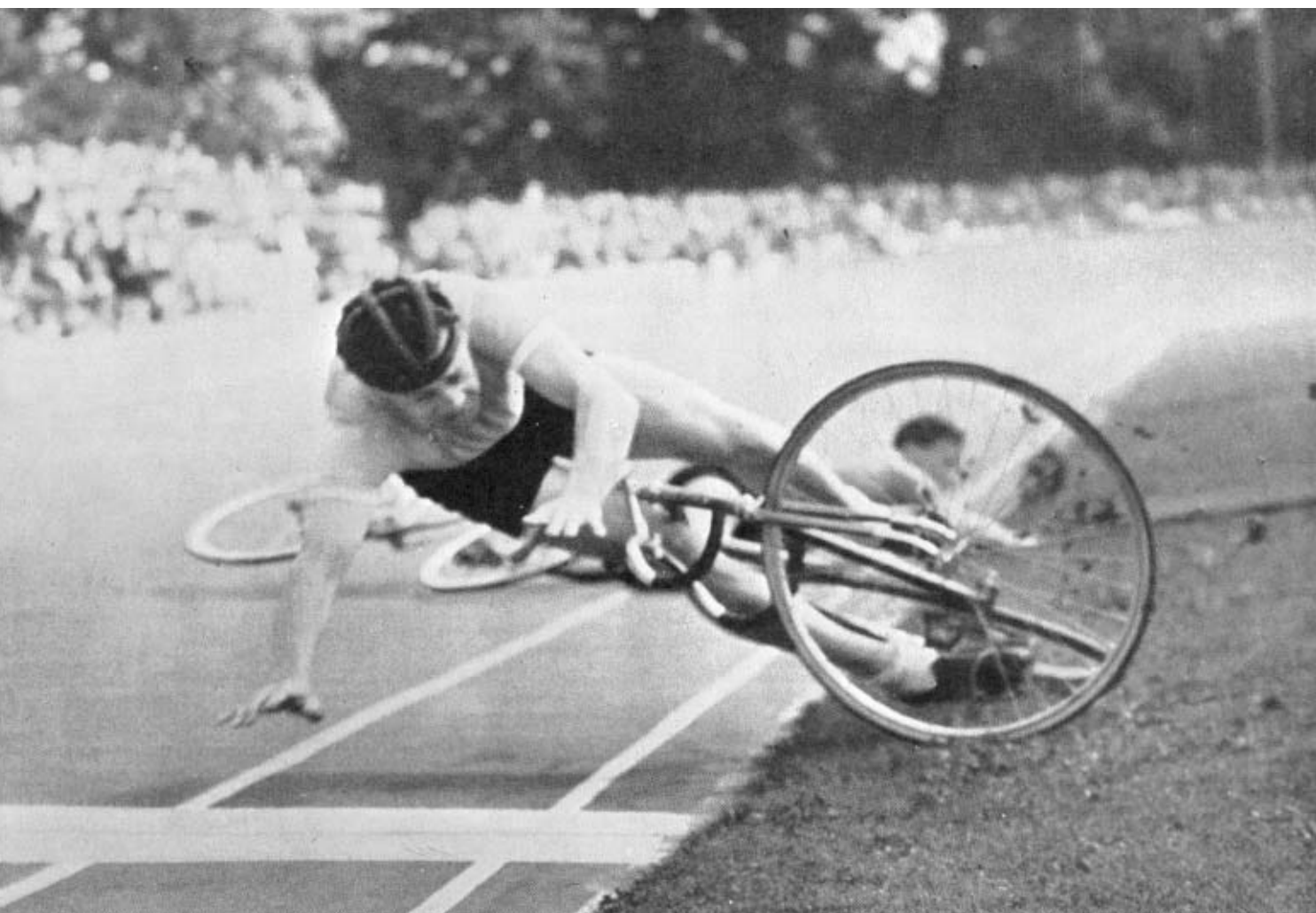



*Tandems full speed for the line in the final between F. Teruzzi and R. Perona (Italy), the winners, nearer the camera, and R. Harris and A. Bannister (Great Britain).*





*The field in the cycle road race gets away in damp and cloudy conditions. The weather conditions can be judged by the garb of the spectators, and the gaps on the stand.*

*The start of the 120 miles cycle road race.*







*The field in the cycle road race close together in one of the early laps, takes the corner at Johnson's Pond and begins the climb up Breakheart Hill.*



*A view of the corner at Blacknest Gate, with competitors swinging round on the first lap. Note the protective padding on the gatepost.*





*The sharp corner at Blacknest Gate was the scene of the only major crash during the race. Here two competitors have taken a tumble, and those following are having difficulty in avoiding trouble.*

*Climbing Breakheart Hill on the second lap of the cycle road race, the competitors are still in close formation.*





*The crucial moment of the race. Approaching the top of Breakheart Hill on the final lap, J. Beyaert (France) jumps into the lead, which he held over the last half-mile to win by 3.6 seconds. The official car follows closely behind the riders.*

*J. Beyaert winner of the cycle road race at Windsor Great Park, is congratulated by H.R.H. the Duke of Edinburgh, who acted as starter.*



# TORCH RELAY

In September, 1946, the Organising Committee decided that the lighting of the Sacred Fire should be carried out by a Torch kindled in the traditional manner at Olympia, in Greece, and carried by relays of runners across Europe to London. It was soon discovered that to repeat the arrangements of 1936 would be so costly as to be quite out of the question. It was therefore necessary so to organise the relay that while capturing the imagination of the public and the spirit of the Olympic torch, the cost would not be prohibitive.

For the XI Olympiad, the torch holder was made of stainless steel and the burner element was a magnesium candle. As this had a burning time often minutes at maximum, to ensure ample time at each take-over point, the runners covered only about one kilometre each, running for some three to four minutes. A longer burning time was decided on, to enable each runner to cover two miles (three kilometres) on the flat and thus reduce the number of torches. The Fuel Research Station of the Department of Scientific and Industrial Research was asked to design a suitable container and to recommend a fuel. A metal canister, containing a solid fuel which was already in commercial manufacture and reasonably cheap, met requirements. The holder for the fuel container had to be inexpensive and easy to make but, at the same time, it had to be of pleasing appearance and a good example of British craftsmanship. This latter requirement was particularly necessary as the torches would be on view to the people of many countries during the Relay and afterwards would become mementoes for the runners who would carry them from Olympia to Wembley.

The Fuel Research Station started their experiments early in 1947 and in May of that year the first running trials were held. As a result of these trials it was decided to use hexamine in tablet form as the fuel, housed in a perforated canister. In order to make luminous the flame from the hexamine, 6% naphthalene was incorporated in the tablets.

It had been agreed that the minimum burning time of each torch should be 15 minutes. As this requirement seemed to be the governing factor, the arrangement of air holes in the fuel canister was made so that, even in a strong wind, the fuel would last for that time.

To ensure economy of production, the size of tablets had to be similar to those in commercial production, but these were not large enough to ensure the required burning time if all in the fuel pack were lit on ignition. Eight tablets were therefore placed on a central rod, the bottom three being carried in a cup in the holder; as the top tablets burnt away, these were gradually fed up by a spring.

To keep the fuel, which readily absorbed moisture, dry under all weather conditions it had to be kept in an airtight pack which would burn completely, leaving no residue to choke the air holes in the canister. A thin nitro-cellulose casing to hold the eight tablets was specially made for the purpose.

When the final prototype torch and holder in sheet metal had been made and tested by the Fuel Research Station, Mr. Ralph Lavers, A.R.I.B.A., accepted an invitation to

design an aluminium holder without altering the basic principles of the prototype torch and to supervise manufacture so that all torches would reach the agreed standard.

The torch, to be carried by the final runner in the Stadium, had a magnesium flame in order that it would be sufficiently bright to be seen across the Stadium, even in the brightest sunlight. To carry the magnesium candle, a stainless steel holder was required. This also was designed by Mr. Lavers and made by E.M.I. Factories, Ltd. The candle, which was designed to burn for ten minutes, was supplied by Wessex Aircraft Engineering Co., Ltd. All the work on the final torch and torch holder was done without charge.

### **Organisation of Runners—Route of the Relay**

The most direct route from Greece to England was to have been used. This meant a sea passage from Greece to Italy, thence through Switzerland and France, and a sea passage to England. However, two additional countries, Luxembourg and Belgium, asked if the Flame could pass through their territory, and this was agreed.

The exact route to be followed was fixed with the Olympic Committees of the countries concerned and the final route decided upon was as follows :

*Greece.*—Owing to the unsettled state of the country the Flame went direct from Olympia to the coast at Katakolon, thence by Greek warship to the island of Corfu.

*Adriatic.*—The Admiralty willingly gave their co-operation in providing warships to make the sea passages. From Corfu, H.M.S. *Whitesand Bay*, a frigate of the Mediterranean Fleet, carried the Flame to Bari in Italy. Though this passage was planned to take only 22 hours, H.M.S. *Whitesand Bay*, had to be ready to carry the Flame for a period of up to 48 hours in case there was a last minute change of route in Greece. It was therefore decided that she should burn a gas Flame, and a special burner for this was made by Spencers (London), Ltd. It was fed with butane gas, the same fuel as was used for the Flame at Wembley and Torquay. The burner, piping and gas cylinders were sent to the Mediterranean by the Admiralty, being shipped in H.M.S. *Liverpool* in April, 1948, when she also took the torches for Greece.

*Italy.*—Bari, Foggia, Pescara, Ancona, Rimini, Bologna, Parma, Piacenza, Milan, Domodossola, the Simplon Pass.

*Switzerland.*—Brig, Martigny, Montreux, Lausanne, Geneva, Perly.

*France.*—St. Julien en Genevois, Belgarde, Nantua, Lons-le-Saulnier, Poligny, Besancon, Vesoul, Epinal, Nancy, Metz, Thionville, Evrange.

*Luxembourg.*—Frisange, Esch, Luxembourg City, Ettelbruck, Wiltz.

*Belgium.*—Bras, Bastogne, Marche, Namur, Brussels, Renaix, Tournai, Hertain.

*France.*—Lille, Armentieres, St. Omer, Calais.

*English Channel.*—H.M.S. *Bicester*, a destroyer of the Nore Command, was detailed to carry the Flame from Calais to Dover.

*England.*—The route from Dover to Wembley passed through the following towns :—Dover, Canterbury, Charing, Maidstone, Westerham, Redhill, Reigate, Dorking, Guildford, Bagshot, Ascot, Windsor, Slough, and Uxbridge.

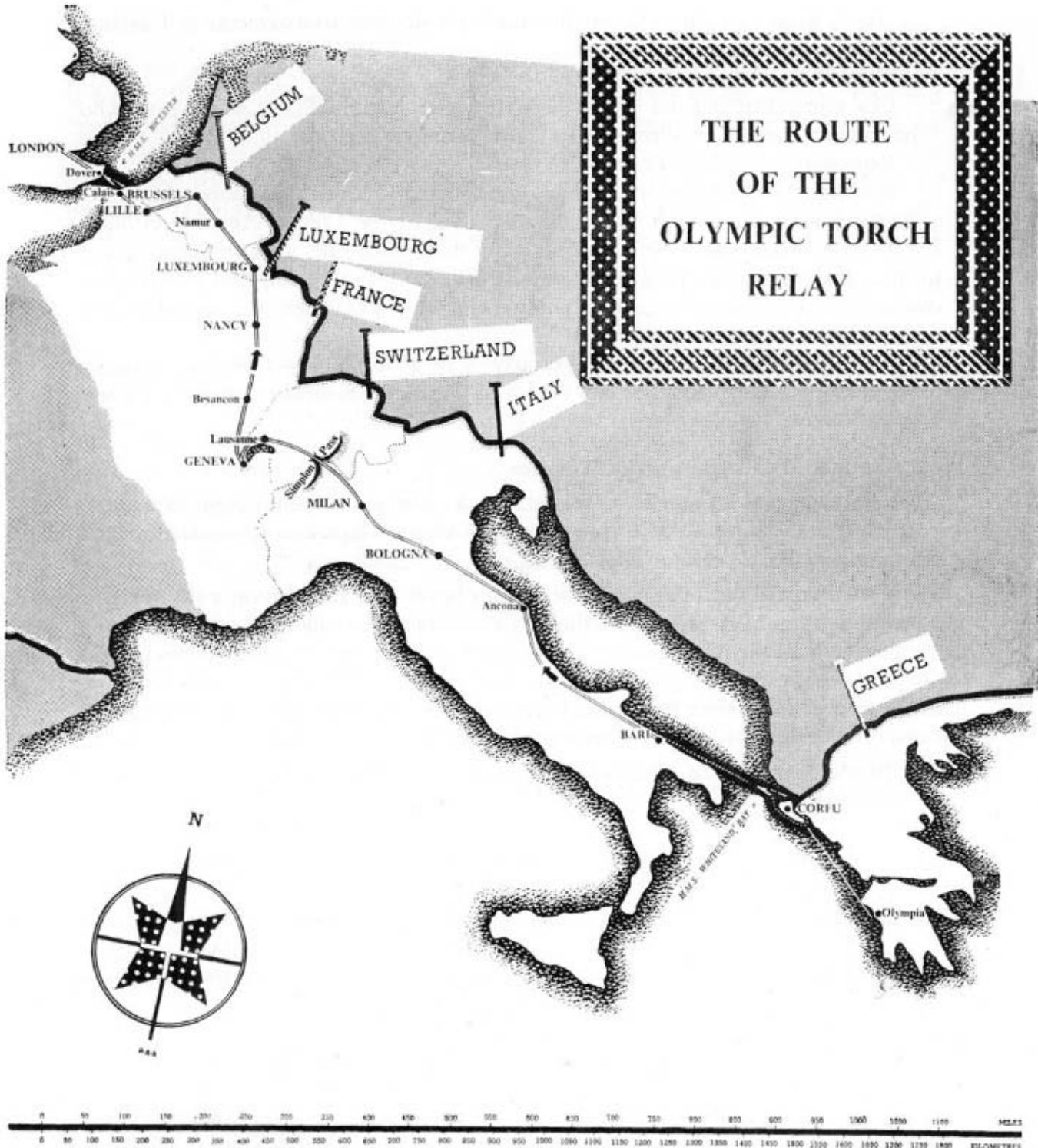



A Torch Relay (England) Committee made the detailed arrangements in England. The members were:

Torch Relay Organiser (Chairman).

One representative from each county through which the Flame would pass, who had a close connection with athletics in the county concerned.

Representatives of the Police.

Representatives of the Automobile Association and Royal Automobile Club.

The runners were chosen from clubs affiliated to the County Amateur Athletic Associations, one runner from each club being the general rule, with preference given to those clubs through whose area the route passed. Stages in England were as near two miles as possible, change-over points being at places where the runners could shelter in case of bad weather.

The route from Wembley to Torquay was as follows :—Uxbridge, Slough, Maidenhead, Reading, Basingstoke, Andover, Salisbury, Sherborne, Yeovil, Exeter, Newton Abbot.

### Final Trials and Distribution of Torches

When the route and the number of stages in each country had been completed, torches were packed and shipped. The entire work of design, experiment, production and distribution was carried out in Great Britain.

Trials were carried out in a gale of wind with heavy rain and also on a day when it was fine with a light breeze. Under the first conditions the trials were satisfactory, the torches burning for the requisite time, and under the second condition the torches burned for over half an hour when carried by a runner. As the last date for shipping the first batch of torches for Greece had by then been reached, no more trials could be carried out and production was completed with the torches as then designed.

The distance, numbers of torches supplied and the number of stages in each country were as follows :

	<i>Kms.</i>	<i>Stages</i>	<i>Torches</i>
Greece .....	750*	300	324
H.M.S. <i>Whitesand Bay</i> .....	415	—	6
Italy .....	1,072	500	540
Switzerland .....	261	135	144
France (i) .....	521	270	300
Luxembourg .....	108	38	42
Belgium .....	287	108	120
France (ii) .....	126	—	—
H.M.S. <i>Bicester</i> .....	35	—	12
England (Dover-Wembley) .....	255	73	80
(Wembley-Torquay) .....	330	107	120
Total	3,160	1,531	1,688

\* As planned.

A late request for a further 12 torches for Switzerland was met from the spares retained for such purposes and 20 other torches were used for demonstrations, trials and as spares in England. The total number manufactured was thus 1,720.

### **Extension of Route to Torquay**

In the first week of May, 1948, arrangements were agreed for an Olympic Flame at Torquay ; this was to be lit from the parent Flame at Wembley by an extension of the Torch Relay. The arrangements for the run from Wembley to Torquay were on the same basis as that from Dover to Wembley.



# EVENTS OF THE GAMES

TORCH RELAY

OPENING CEREMONY

ATHLETICS

BASKETBALL

BOXING

CANOEING

CYCLING

EQUESTRIAN

FENCING

FOOTBALL

GYMNASTICS

HOCKEY

MODERN PENTATHLON

ROWING

SHOOTING

SWIMMING

WEIGHTLIFTING

WRESTLING

YACHTING

DEMONSTRATIONS

FINE ARTS

CLOSING CEREMONY



## TORCH RELAY

At midday on Saturday, July 17, the Olympic Flame was kindled in the ancient Stadium at Olympia by a Greek girl, a Girl Guide troop-leader from the neighbouring town of Pyrgos. She had been chosen for this honour only the evening before, because the Athenian girl and her escort who had been trained for the ceremony were not allowed to make the journey to Olympia owing to the difficulties arising from the unsettled state of the country. With her escort of young men from the town of Olympia, she carried the Flame in procession from the Stadium and across the Altis to the spot where the heart of Baron de Coubertin lies buried.

A simple ceremony then took place. A message was read from Mr. Sigfrid Edstrom, the President of the International Olympic Committee, and short speeches were made by Mr. Zalacostas, the Chairman of the Greek Olympic Committee, and Mr. Cosmopoulos, the Mayor of Olympia. The first runner, Corporal Dimitrelis of the Greek Army, stepped forward, clad in uniform with his rifle in his hand. Laying down his arms and taking off his uniform, he appeared clad as an athlete and thus, having symbolised the tradition that war ceased during the period of the ancient Games, he lit his torch and set off on the first stage of the Relay. Mr. Zalacostas then handed to Commander F. W. Collins, R.N. (Retd.), the representative of the Organising Committee and Organiser of the Relay, the ancient Greek " *lychnos* " from which the first torch had been lit, asking him to carry it to H.R.H. Princess Elizabeth as a gift from the Greek Olympic Committee.

The first runner having crossed the Alpheos River, the Flame was passed on to the series of Greek runners who carried it through Pyrgos to Katacolon, the port some 22 miles from Olympia.

This short route on the Greek mainland had been decided on only a short time previously, when it was evident that lack of security on the route to Athens necessitated a much shorter journey direct to the coast.

Meanwhile, the Flame had been carried aboard the Greek destroyer *Hastings* which sailed at 7 p.m. for Corfu, arriving there early the next morning. It was taken ashore at Lefkimi and carried by runners to Corfu town, where a ceremony of welcome and a short festival of sport took place. The enthusiasm for the Flame both on the mainland and at Corfu was a forerunner of similar acts of welcome and rejoicing throughout the whole route. Wherever the Flame went it was acclaimed as a symbol of that brighter future for which all peoples are yearning, and it was noteworthy that no differences of race, creed or political persuasion damped the ardour of those who turned out to applaud its passage.

At 1.30 p.m. on July 18, H.M.S. *Whitesand Bay*, a frigate from the Mediterranean Fleet, received the Flame on board. As well as carrying a special burner for the Flame, one of her boilers was lit from a torch. She sailed for Bari where, at 12.30 p.m. on July 19, the Flame was carried ashore and welcomed in Italy at a ceremony in the main square of the town. Here, as in at least one city in every country through which the Relay passed, a message of welcome and good wishes for the progress of the Flame

from Mr. Edstrom was read aloud midst a large crowd, much impressed by the ceremony.

In Italy, the Army supplied all the runners and undertook the whole organisation of the route. As the torch bearers were not trained athletes, their distance was restricted to about 1½ kms. each, the total number of runners being 762. Directly behind the first runner came the official car, followed by a convoy of military vehicles and press cars. In every town, official welcome was accorded to the Flame by the Mayor, the Prefect and other local notables, while in the country crowds gathered at every one of the change-over points. Major receptions were held at St. Salvo, Francavilla, Roseto, Ancona, Rimini, Forli, Bologna, Modena, Milan, Galarate, Baveno and Domodossola.

At several of these places, presentations were made to the British Representative, Mr. K. S. Duncan, who travelled from Bari to Calais in the British official car, while escorts for the Flame were often provided by past Olympic champions, boys carrying fireworks, roller skaters, racing cars, motor cyclists and bicyclists. By night as well as by day the enthusiasm of the crowds was unbounded. This enthusiasm was a fitting reward to the Italian Olympic Committee and the Italian Army for their great efforts to conduct the Relay from one end of their country to the other at a time when economic conditions made such a task unduly arduous.

At 10.30 p.m. on July 23, the Flame was handed to the first Swiss runner on the Simplon road. Despite the late hour, a splendid welcome was accorded by the Swiss who asked the whole of the official Italian party across the frontier, all normal frontier regulations being waived, to a ceremony of greeting and celebration.

### **Ceremony at Lausanne**

The next day the Flame reached Lausanne, where Madame la Baronne de Coubertin was present at a ceremony held at Mon Repos, the I.O.C. headquarters. Thence the Flame was carried to the cemetery, where it was dipped in salute in front of the tomb of the founder of the modern Olympic Games. Great crowds were present at Geneva as the Flame passed through that city the same evening, and some 8,000 people were gathered at the Swiss/French frontier at St. Julien to bid farewell to the Flame. All arrangements in Switzerland were made by the Swiss Olympic Committee, and runners were provided not only by athletic clubs, but from the boxing, gymnastic, hockey, polo, basketball and rowing organisations.

Throughout July 25 and 26, the Flame was carried across south-east France, an area in which there is no strong athletic organisation. However, the arrangements planned by the Federation Francaise d'Athletisme were good and the time-table was strictly kept. Many runners from Paris helped in the Relay, each covering stages both by day and night. At Metz there was an official welcome from the civic authorities.

Monday July 26, was a great occasion in the sporting life of Luxembourg, for on that day representatives of every sporting organisation were able to play their part in furthering the ideals of the Olympic Movement by helping to carry the Flame through their country. So keen were they to honour this symbol of the Olympic ideals that the Luxembourg Olympic Committee had planned a very much longer route than could be



allowed. None the less the occasion was used by the people of this small nation for a display of the Olympic spirit, which was not excelled in any other country. Because the Flame passed through the City of Luxembourg during the night, the main ceremony was held at Wiltz after which, at 10.30 a.m. on July 27, the Flame passed on to Belgium. Once again, as on the entry into Luxembourg, frontier restrictions were relaxed and a great welcome to all concerned was given by the Belgian authorities.

In Belgium all arrangements were made by the Ligue Royale d'Athletisme and, despite the excited crowds, the schedule was followed exactly. The chief ceremony took place at the Tomb of the Unknown Warrior at Brussels on the same night, when the Burgomaster and the British Ambassador were present; other ceremonies of welcome and homage were held at many of the towns en route.

At 6.30 a.m. on July 28, the Flame re-entered France with the usual international goodwill being observed. Through Lille the route was lined with athletes and a ceremony was held at the Hotel de Ville. Other ceremonies took place at Armentieres, Nieppe, Bailleul and finally at Calais, where the last French runner took the Flame aboard H.M.S. *Bicester* at 6.15 p.m.

The reserve Flames which had been lit at Olympia and had been carried throughout in the official car were transferred to the ship, which then sailed for Dover.

### **Arrival at Dover**

Wednesday, July 28, was a fine summer's day and a vast crowd had assembled at Dover to welcome the Flame to England. By 7.30 p.m. the whole promenade and Prince of Wales' Pier were packed with people, but it was not until an hour later, at 8.25 p.m., that H.M.S. *Bicester* entered the harbour and, in the words of one of the onlookers, " You could feel the Olympic fever run through the crowd."

From then until its arrival at Wembley at 4 p.m. the next day, the English showed in no uncertain manner that they, too, wished to pay tribute to this symbol of the Olympic ideals. At Dover, the speeches of the Mayor, the Vice Lieutenant of Kent and the representative of the British Olympic Council, Sir Lionel Fletcher, could hardly be heard above the cheers, even though loudspeakers were used. At Charing, in Kent, at 1.30 a.m., 3,000 people mobbed the torch bearer ; at Guildford every available policeman was needed to control the early morning crowds, while Western Avenue, the great double highway from Uxbridge towards London, was lined on both sides for the first time in history. Further civic welcomes had been arranged at Maidstone, Guildford, Windsor and Uxbridge and, despite the great crowds that lined the route, the time-table was strictly maintained.

Up Olympic Way, with an escort of four runners and six police motor-cyclists, the pressure of the crowds was so great that the runner was reduced to a walk. However, a passage was just kept clear and the Flame arrived at the Empire Stadium only 30 seconds late at the end of its 2,000-mile journey.

An allowance had been made in the time-table in case the Flame was delayed or the Opening Ceremony programme was ahead of time. The name of the final runner had

been kept secret because he was to be the symbol of British athletic youth. The Organising Committee chose Mr. John Mark for this important role.

Some had doubted the value of the Torch Relay, others had thought it would create little interest and would be a waste of time and effort, but, at its conclusion, everyone was agreed on its astonishing success. By linking the scene of the Olympic contests of the past with the competitions of to-day, a direct connection was made between the great traditions of the ancient Games and the ideals of the modern Games which fired the imagination of the public in every land. After long years of apparently almost unending national and international strain and stress, here was a gleam of light, the light of a Flame, which crossed a continent without hindrance, which caused frontiers to disappear in its presence, which gathered unprecedented crowds to see it pass in city, town and village, and which lit the path to a brighter future for the youth of the world, whose chosen representatives were gathered to welcome it at the end of its journey.

### **The Relay to Torquay**

At 9 a.m. on Sunday, August 1, the Chairman of the Organising Committee, Lord Burghley, lit a torch from the Olympic Flame at Wembley Stadium and started the Relay to Torquay which was to light the Flame which burned there during the Olympic Regatta.

This extension of the main Relay was just as successful and, when the Flame passed through Devonshire on the morning of August 2, the crowds were everywhere the largest in living memory. One typical scene was at the small town of Chard, in Somerset, where at 3.30 a.m. a crowd of 3,000 people, headed by the Mayor and the town band turned out to welcome the runner. At Newton Abbot, the crowds almost prevented the change-over taking place, but none the less, the time-table was kept, and at 11 a.m. the final runner appeared on the balcony of Torre Abbey and lit the Torquay Olympic Flame.

# OPENING CEREMONY

July 29 was a perfect day with a blazing sun to welcome the teams and the spectators. At 2 o'clock the trumpeters of the Household Cavalry and the massed Drums, Fifes and Pipers of His Majesty's Brigade of Guards, dressed in Review Order, entertained the crowd for half an hour with their playing, marching and counter-marching. The Stadium was packed with 85,000 people. The scarlet of the Guards Band, the white of the choirs, the many coloured dresses of the ladies and the shirts of the coatless male spectators blended with the orange red of the track, the vivid green of the grass in the centre and the gaily coloured flags, to form a never-to-be-forgotten spectacle.

At 2.35 p.m. the International Olympic Committee and the Organising Committee, attired in top hats and tail coats took up their positions in the arena. Their Majesties, the King and Queen, accompanied by Queen Mary and other Members of the Royal Family, arrived at 2.45 p.m. and were met at the entrance to the arena by the President of the Games, Viscount Portal of Laverstoke, and the Lord Mayor of London, Sir Frederick Wells. The Queen and other Members of the Royal Family were conducted by the Lord Mayor to the Royal Box, where were His Imperial Majesty, the Shah of Persia, H.R.H. Prince Bernard of the Netherlands, and H.R.H. Prince Bertil of Sweden. The King entered the arena, accompanied by Lord Portal, who presented the President of the International Olympic Committee, Mr. J. Sigfrid Edstrom, and the Chairman of the Organising Committee, Lord Burghley. The National Anthem was played. The Members of the International Olympic Committee were then presented to His Majesty by Mr. Edstrom and the Members of the Organising Committee by Lord Burghley. The King was then escorted to his Box by the President of the International Olympic Committee and Lord Portal, and the International Olympic Committee and the Organising Committee resumed their seats. At 3 p.m. the " March In " started and for fifty minutes the Stadium echoed and re-echoed to the plaudits of the huge crowd as the 59 nations entered and marched around the arena. During the whole of this period, the Massed Bands continued to play.

## Lord Burghley's Speech

As soon as the last team (Great Britain) passed beyond the saluting base, the International Olympic Committee and the Organising Committee returned to their places in the arena. When the British team had taken up its position, Lord Burghley, Chairman of the Organising Committee, mounted the Tribune of Honour and, to the hushed audience in the Stadium and to the millions listening-in, in Britain and overseas, made the following speech inviting His Majesty to declare the Games open :—

" Your Majesty,

" The hour has struck. A visionary dream has to-day become a glorious reality. At the end of the world-wide struggle in 1945, many institutions and associations were found to have withered and only the strongest had survived. How, many wondered, had the great Olympic Movement prospered?

" In 1946, the clarion call went forth to the athletes of the world, inviting them to gather in London in 1948 to celebrate the XIV Modern Olympiad. Here to-day, in this vast arena, are assembled 6,000 competitors, the cream of the Youth of the world drawn from the fifty-nine nations, who have answered this call. This is the answer to that question, and here is the proof of the inherent strength and vitality of the Olympic Movement.

" For the next two weeks, these young men and young women will be engaged in keen but friendly rivalry, competing together in the highest traditions of our Olympic ideals and of Amateur Sport. The eyes of the world to-day, and for the next fourteen days, will be on London. Not only will they be turned towards this ancient City to follow the fortunes of their champions and those of other countries, but also, I believe that in the hearts of millions of men and women in every corner of the earth, that warm flame of hope, for a better understanding in the world which has burned so low, will flare up into a very beacon, pointing a way to the goal through the Fellowship of Sport.

" These Games are a living proof of this great common bond of sportsmanship that binds the youth of the world together. They take place under rules drawn up by common accord and respected by all, not only in the letter of the law but also in the spirit. These high ideals are the very life blood of the Olympic Games, and if, as I believe and pray, as a result of them, the Olympic spirit spreads yet more widely throughout the earth, then, surely, we can feel that a very real contribution has been made to the welfare and happiness of mankind.

" Your Majesty, we are deeply honoured that you have graciously consented to come here to-day to declare the Games open.

" Forty years ago, your Royal Grandfather, King Edward VII, in 1908, opened the Olympic Games of London, the Games which were carried through under the leadership and genius of that great British sportsman, Lord Desborough.

" The first Olympic Games of modern times were held in 1896, appropriately enough in Athens, and from these early beginnings they have grown and blossomed into the present gigantic Festival of Sport.

" Like all steps forward in the panorama of history, the Olympic Movement has not escaped entirely the pointed barbs of the critics, but these have but acted as a spur to increase the speed of its advance. The secret of its success, I believe, lies in the certain knowledge of its rightness bedded in the very being of its adherents. When a great cause marches hand in hand with sincerity and enthusiasm, none can stop its progress.

" This is indeed a memorable occasion, and in asking you, Sire, to carry out this task, I speak for all when I say, not only are we deeply grateful to you, but it is our firm belief that you are kindling a torch, the light from which will travel to the uttermost corners of the earth, a torch of that ageless and heartfelt prayer of mankind throughout the world for Peace and Goodwill amongst men.

" Your Majesty, I humbly ask you to declare the Olympic Games of 1948 open."

At 4 o'clock precisely, The King rose in the Royal Box and in the solemn words laid down in the Olympic Protocol declared the Games of the XIV Olympiad open :—

*" I proclaim open the Olympic Games of London celebrating the XIV Olympiad of the modern era"*

Immediately he had concluded, the cheers of the crowd were joined by a fanfare of trumpets by the Trumpeters of the Household Cavalry, who had taken up their positions in front of the Tribune of Honour while the International Olympic Committee and the Organising Committee were taking their places in the arena. At the same time three corporals of the Guards slowly raised the gigantic Olympic flag on the 35 ft. flagpole at the end of the arena where it was to remain unstruck for the next sixteen days. The 2,500 pigeons were released to add yet a further touch of colour and romance to this impressive moment. Three minutes later a twenty-one gun salute was fired outside the Stadium by the King's Troop of the Royal Horse Artillery.

### **The Flame Kindled**

The last runner in the Torch Relay appeared at the entrance to the arena with his torch aloft. Accompanied by the deafening applause of the assembled multitude, he carried out a complete circuit of the track, mounted the steps to the Bowl where the Flame was to be kindled and, after facing the Stadium with torch held high in salute, turned and dipped it into the Bowl, and the Sacred Flame sprang into life.

### **Dedicatory Address**

The Bands and Choir then burst forth into the Olympic Hymn and, as the strains died away, the Archbishop of York, who had been accompanied into the arena by his Chaplain, mounted the Tribune of Honour and delivered the following Dedicatory Address.

" After an interval of forty years, this famous International Meeting of Athletes is held once again in this country, where games and sport are of interest to all, where cricket is played on every village green, and in whose cities any available space is used for football.

" If a Greek, who had been present at the Olympic Games two thousand years ago, came here to-day, he would be amazed at much which he would see. Our cars would seem to him strangely shaped chariots, driven at great speed by unseen magic; he would suppose that the planes he saw in the sky were the flying dragons of which in his childhood he had been warned; while those who, like myself, speak through the microphone would sound to him as if they were miraculously gifted with trumpet-like voices a thousand times more powerful than the loudest of the heralds of his day. But even so, notwithstanding all these changes, he would find that the spirit of the Games is still the same as it was in ancient Greece, for now as then, their purpose is to develop and show physical fitness and skill at their best. Those who compete in them should

be strong and graceful in movement, swift of foot, skilful with their hands, keen in sight and hearing, and this, not merely for victory for themselves or for the pleasure of the spectators, but to set the highest standard of excellency for athletes in all parts of the world ; and the Greek knew, as we know, that no victory in the Games can be gained without the moral qualities of self-control and self-discipline. Hard and stern training is necessary, and when a competitor is a member of a team, he must sink all desire for individual notice and applause in the determination to play his part unselfishly with his fellows as, with one will and one purpose, they strive for victory. Honour is due not only to the victors but also to the defeated, if, in the true spirit of sportsmanship, they give at once ungrudging and generous praise to those who have surpassed them in skill and endurance. For, by so doing, though beaten in the contest, they show mastery over themselves.

" During the Greek Games, a month of peace was proclaimed so that the athletes from the small but very quarrelsome cities might attend them in safety. To-day our world is largely hag-ridden by hate and fear, and yet thousands of the youth from distant and different nations have come together by land, sea and air for the peaceable and friendly rivalry of sport. This is a very happy omen for the future. During this fortnight and more, many friendships should be formed and many foolish suspicions and unreasonable prejudices should vanish. And, when the Games are over, those who have taken part in them should return to their homes as torch bearers, not indeed bearing the visible light just carried into the arena, but with the flame of goodwill burning in their hearts and continuing to burn there long after the Olympic Flame has been extinguished.

" So, as the Games open, we wish you goodwill and we dedicate them to the promotion of peace and goodwill between the nations of the world, all called to be Members of the one great Family under the one God and Father who is over all."

### **The Olympic Oath**

At the end of the Archbishop's speech, the International Olympic Committee and the Organising Committee returned to their seats and the Choir sang the Hallelujah Chorus accompanied by the Massed Bands. While this was in progress, the standard bearers of all the nations formed a semi-circle round the Tribune of Honour and the Flag Bearer of Great Britain, Mr. J. Emrys Lloyd, and Wing Commander Donald Finlay, took up their positions on the left of the Tribune of Honour. At the conclusion of the Hallelujah Chorus, Wing Commander Finlay, Captain of the British Team and competitor in three Olympiads, mounted the Tribune of Honour facing the Royal Box, and holding the flag in his left hand, in a clear voice took the Olympic Oath on behalf of the assembled athletes :

*" We swear that we will take part in the Olympic Games in loyal competition, respecting the regulations which govern them, and desirous of participating in them in the true spirit of sportsmanship, for the honour of our country and for the glory of sport"*

To end the formal ceremony, one verse of the National Anthem was played by the Massed Bands and sung by the choir, joined by all those assembled in the Stadium.

Once again the Bands broke into continuous march rhythm ; in turn the teams, headed once more by Greece, wheeled to the right and gradually filed out of the arena ; and the vast crowd, deeply impressed by the ceremony they had witnessed, dispersed with thoughts now turning to the competitions yet to come.

Thus were launched the Olympic Games of London, under the most happy auspices. The smooth-running Ceremony, which profoundly moved not only all who saw it but also the millions who were listening-in on the radio throughout the world, and the glorious weather in which it took place, combined to give birth to a spirit which was to permeate the whole of the following two weeks of thrilling and intensive sport.



# ATHLETICS

" The important thing in the Olympic Games is not so much to have been victorious, but to have taken part." On the last occasion on which the Olympic Games were held in London, in the year 1908, these felicitous words were spoken by the Bishop of Pennsylvania in St. Paul's Cathedral. A few days later at a banquet given by the British Government, Baron Pierre de Coubertin, with due acknowledgment, incorporated them into his own speech : " L'important dans ces olympiades c'est moins d'y gagner que d'y prendre part. L'important dans la vie, ce n'est point le triomphe mais le combat; l'essential ce n'est pas d'avoir vaincu mais de s'etre bien battu."

At the Empire Stadium for the 33 track and field events 740 athletes from 53 different nations assembled. Including the winning teams in the two men's and one women's relay races, 34 men and women gained Olympic First medals, but one can feel reasonably confident that not one of the other 706 " unsuccessful" competitors failed to feel that it was thoroughly worth while taking part.

Of necessity the vast majority of competitors at the Olympic Games must fail to gain Olympic victories, just as the great majority of nations sending athletes must fail to have the honour of welcoming home an Olympic Champion. The bare facts show that at Wembley just over 200 athletes—25 per cent. of those competing—were placed in the first six, that thirteen countries only had Olympic victors, and that twenty-five placed athletes in the first six. An ideal Olympic Games would undoubtedly produce a winner from a different country for each of the 33 events, with every competing country having some athlete in the first six. This is, unfortunately, a Utopian dream.

## **The Standard at Wembley**

The standard at Wembley was higher than ever before. Fewer records were beaten than at Berlin twelve years previously, but it is obvious that as each four years passes, it is increasingly difficult to beat records. But the performances necessary to reach the various finals were in many cases appreciatively higher than on previous occasions. Details will be given in most cases where the individual events are discussed. Suffice it to say that new Olympic best performances (there are no official Olympic records) were set up in the 800, 5,000 and 10,000 metres ; in the 10,000 metres walk, 110 and 400 metres hurdles, putting the weight and throwing the discus, and equalled in the 400 metres so far as the men's events were concerned. As for the women, there were best performances in the 80 metres hurdles, high jump and javelin.

It is a little difficult to decide what is the best way to present to the reader the excitement and astonishing interest of those eight days of competition at the Empire Stadium from Friday, July 30, to Saturday, August 7. Almost every day provided the packed stands with thrills, and all would agree that the behaviour of the crowd throughout the Games was quite exemplary. Four-fifths of the spectators at Wembley were drawn from Great Britain—the home country—and not once during the Games could they applaud a victory by one of their own athletes. And it is not unreasonable to say that they set a standard of impartial generosity which may well stand as a model for all time; a

classic example of the Olympic spirit at its very best. Their first thought seemed to be " what a great performance. What a fine athlete. Let us look at the programme and see which country he comes from."

The scene at that Stadium which was perhaps the most remarkable of all was when thousands upon thousands stayed for the best part of an hour to witness an almost unbearable duel in the women's high jump. It would have been a fine piece of poetic justice if Mrs. Tyler of Great Britain had finally emerged as her country's only track and field winner, but it was not to be; yet the spectators streamed out of the Stadium convinced that the contest was more important than the result, and assuredly possessed of a memory that will be for ever green.

To stage the track and field events of a modern Olympic Games is no light task ; but to stage such a meeting with hardly a single hitch and with no serious incident is nothing short of a miracle. The thanks of the whole world of athletes should go out to the band of officials who worked so desperately for many months to achieve the high degree of quiet efficiency which was undoubtedly reached. A well-run meeting depends on a proper balance of trust and co-operation between athlete, official and spectator. Each played their part, and all may feel humbly, but genuinely, proud of the result.

### **Track Events**

The 100 metres consisted of twelve heats and four second round heats on Friday, July 30, and the two semi-finals and the final on the following day. The first two in each heat qualified for the second round, thereafter the first three proceeded to the next round. Competitors in the two semi-finals consisted of three United States athletes, three Australians, three from Great Britain, and one apiece from Cuba, Panama and Uruguay. The three U.S.A. men—Dillard, Ewell and Patton, Labeach of Panama, and McCorquodale and Macdonald Bailey of Great Britain, reached the final.

After one break, the runners were away to an almost perfect start. Dillard showed slightly in front almost at once, and it was soon plain that Patton was off colour. There was no doubt in the mind of the judges about the order in which the first two crossed the finishing line, Dillard being the best part of a yard ahead of Ewell; but the photo-finish had to be examined before the third place could be awarded. It went to Labeach, who was inches ahead of McCorquodale. The photo-finish shows that about four feet covered the first four runners, and Dillard's time was 10.3 seconds. Considering that he only just managed to get into the United States team (as world record holder in the hurdles, he failed to gain his place in that event), his achievement was all the more remarkable. The standard of sprinting, taken all round, was higher than ever before—10.3 seconds was achieved in the final; 10.4 on five occasions in the preliminary rounds, and 10.5 seconds on no less than thirteen occasions.

After the 100 metres, in which for the third Olympiad in succession the United States fielded three finalists and coloured athletes occupied the first two places, the 200 metres on the two following days was awaited with interest, chiefly to see if Patton could stage a come-back.

In the first two rounds McKenley of Jamaica and Bourland of the United States were the most impressive. Again the three United States representatives, Patton, Ewell and Bourland, reached the final, together with Labeach and two Jamaicans, McKenley and Laing—the first occasion in the history of the Olympic Games when representatives from that particular British Colony had competed. McKenley was drawn in the inside lane, then Patton, Labeach, Ewell, Bourland, and on the outside Laing. McKenley seemed quickest into his running, but Patton entered the straight running to perfection and at least a couple of yards clear of the field. Ewell made desperate efforts in the last fifty yards to get on level terms and was perhaps two feet behind at the finish. Both he and Patton were credited with the same time, 21.1 seconds.

The world record holder, McKenley (of Jamaica), was undoubtedly favourite for the 400 metres before the Games began. Many thought him unwise to run in the 200 metres, in which he reached the final. But his two most serious opponents, Wint, a fellow-countryman, and Whitfield of the United States, had already competed in three rounds of the 800 metres and finished first and second in the final. The first two rounds gave little real indication of what was to come. Wint was the only athlete to break 48 seconds, which he did in both the first and second rounds on Wednesday, August 4. In the first semi-final Wint strode home in most convincing fashion, 1/10 second outside the existing Olympic record and nearly a whole second ahead of his nearest rival, Curotta of Australia. McKenley was one second slower in the second semi-final, but he was clearly running well within himself.

### **Wint's Final Effort**

The order of starting for the final was Bolen (U.S.A.) inside, McKenley, Wint, Whitfield and Guida (U.S.A.) and on the outside Curotta. There was absolute silence before the gun went and then a continuous and ever-increasing roar throughout the whole 46 seconds. McKenley went off like a hurricane, far too fast it seemed, but then he had always run his races in this fashion. The first 200 metres he was clocked in 21.6 seconds (little slower than his time in the 200 metres final two days before). By this time he was fully six yards ahead of Wint. He was still well in the lead 100 yards from the finish, and then Wint, with that powerful stride of his, found that McKenley was definitely coming back to him. Nothing could have been better from Wint's point of view, and as he found himself effectively closing the gap, he ran on like a man inspired, caught his fellow-countryman 30 yards from the tape and won to equal the Olympic record made 16 years before in the much better climatic conditions of Los Angeles. Wint's running, and particularly the perfect timing of his final effort, was one of the most stimulating sights of the Games.

The three semi-finals of the 800 metres, run on Saturday, July 31, left little doubt that the final would be superb. All nine finalists, three from U.S.A., two from France, and one apiece from Denmark, Great Britain, Jamaica and Sweden, had to beat 1 min. 53.0 sec. to reach the final stage. Indeed, the winner's time in each of the three semi-finals was better than any Olympic final except that of 1932.

Nine runners in an Olympic 800 metres final was really too many, especially with the

start so near the first bend. The draw for positions virtually settled the fate of those on the outside. It was Chef d'hotel, of France, who went into the lead and there was a good deal of scrambling for position down the back straight. The first 400 metres run in 54.2 secs. was appreciably slower than anticipated, and Whitfield, running with beautiful ease, went into the lead immediately after the bell. He was never seriously challenged, although Bengtsson, of Sweden, was within four yards with a furlong to go. Whitfield won in a time which beat Hampson's Olympic record by  $\frac{3}{5}$  second, and Wint, of Jamaica, who ran again a very restrained and well-judged race, was three yards behind. Hansenne, of France, in third place also equalled the previous Olympic best. The fifth man, Bengtsson, of Sweden, though perhaps ten yards behind the winner, did a time good enough to win all previous Olympic 800 metre races except one.

### **The 1,500 Metres**

In many ways the 1,500 metres was the event from which most excitement was expected at the Games, particularly as the world record holder, Lennart Strand, was in the field. Strand's world record time was nearly five seconds faster than Jack Lovelock's at Berlin in 1936, and an Olympic record was confidently expected. The three Swedes, Strand, Eriksson and Bergkvist, together with Hansenne of France, all had performances better than 3 min. 48 sec. to their credit. Eleven of the twelve finalists were Europeans (including the first five in the European Championships of 1946), and, with a Swedish victory almost a certainty, one recalled that never before had a Swedish runner finished in the first three in this event.

Unfortunately a downpour in the early hours of the afternoon made an Olympic record unlikely and the race itself started in heavy rain and on a sodden track. Hansenne went into the lead, covering the first 300 metres in 42.3 sec., 400 metres in 58.3 sec., 700 in 1 min. 46.2 sec. and 800 in 2 min. 2.6 sec. With 400 metres to go (time for 1,100 metres 2 min. 49.4 sec.), Strand and Eriksson were, perhaps, 15 yards ahead of Slijkhuis, of Holland. Down the back straight Slijkhuis and Nankeville (Great Britain) closed a good deal on the leaders. Nankeville ran better than ever before to finish sixth, nearly three seconds behind the winner, but his efforts were unavailing; Slijkhuis, however, got within striking distance of Strand, to finish just behind him and their times at the finish were identical. Eriksson was a good four yards clear to win in 3 min. 49.8 sec. and under good conditions the time might well have been three seconds faster.

The most astonishing thing about the three heats of the 5,000 metres was the totally unnecessary duel between Zatopek, of Czechoslovakia, and Ahlden, of Sweden, in heat two. Though the best part of 100 yards ahead of the rest of the field, and qualifying with ease, they elected to stage a spirited battle, much to the delight of the crowd. How far this battle affected their running in the final two days later it is impossible to say.

Three Swedes, three Finns, two Belgians, and one runner each from Czechoslovakia, Holland and the United States, faced the starter before a packed Stadium on August 2. Zatopek, after his great 10,000 metres victory, started favourite, with Ahlden, Reiff (of Belgium) and Slijkhuis (Holland) looked upon as his most serious opponents. The track was sodden and covered with pools as the twelve runners started soon after five o'clock.

By half distance the race had resolved into a four-sided contest between the runners mentioned above. With four laps to go Reiff suddenly jumped his rivals, running a lap in 67.8 sec., over two seconds faster than the immediately previous one. Zatopek seemed out of the race and it was Slijkhuis, some 20 yards behind Reiff, who was in second position at the bell. With Reiff almost exhausted 300 yards from home, Zatopek started one of those now familiar rushes. With unbelievable speed, he closed the gap between himself and Slijkhuis and then, as the tape got ever nearer and nearer, he charged after Reiff. With perhaps twenty yards to go the Czech was practically on level terms and Reiff, with an agonised glance over his shoulder, produced a small amount of unexpended energy, sufficient to take him over the finishing line a bare yard ahead. Despite the adverse conditions, both men beat the previous Olympic record. Here are the lap times :

<i>Lap</i>	<i>Distance</i> <i>metres</i>	<i>Total time</i>		<i>Lap</i> <i>sec.</i>
		<i>min.</i>	<i>sec.</i>	
1 .....	200		33.0	—
2 .....	600	1	39.2	66.2
3 .....	1,000	2	48.0	68.8
4 .....	1,400	3	56.4	68.4
5 .....	1,800	5	04.0	67.6
6 .....	2,200	6	13.0	69.0
7 .....	2,600	7	23.0	70.0
8 .....	3,000	8	34.0	71.0
9 .....	3,400	9	44.2	70.2
10 .....	3,800	10	52.0	67.8
11 .....	4,200	12	00.0	68.0
12 .....	4,600	13	08.0	68.0
13 .....	5,000	14	17.6	69.6

### **Zatopek's Victory**

The 10,000 metres was the first 1948 final to be decided, on the late afternoon of the first day, July 30. Zatopek, of Czechoslovakia, who a few weeks before the Games had been within a few seconds of Heino's world record, was expected to run the race of his life against the world champion, and a great Czecho-Finnish contest was eagerly awaited. Heino went into the lead at once, and at the end of seven laps was still first, followed by Heinstrom of Finland and then the Swede, Albertsson. Zatopek was sixth. Two laps later Zatopek had sputtered to the front and at half distance the order was Zatopek, Heino, Albertsson, Heinstrom and Mimoun-o-Kacha, of France. With nine laps to go, and a good race between the Czech and the Finn still on the cards, Heino suddenly stopped running and left the track. Thereafter the only interest was to watch the incredible and forceful, if ungainly, running of Zatopek, who proceeded to lap most of his opponents. Zatopek won in 2/5 sec. inside the half hour, a time which beat the previous Olympic record by practically twelve seconds. Again the total and lap times will complete the picture. Note that the average lap time is 72 seconds and that the first and last laps were the fastest.

<i>Laps of</i> 400 metres	<i>Total</i> <i>Distance</i> <i>metres</i>	<i>Total time</i>		<i>Lap</i> <i>time</i>
		<i>min.</i>	<i>sec.</i>	<i>sec.</i>
1 .....	400	1	07.0	67.0
2 .....	800	2	18.6	71.6
3 .....	1,200	3	29.8	71.2
4 .....	1,600	4	39.8	70.0
5 .....	2,000	5	52.6	72.8
6 .....	2,400	7	03.2	70.6
7 .....	2,800	8	15.0	71.8
8 .....	3,200	9	28.4	73.4
9 .....	3,600	10	42.0	73.6
10 .....	4,000	11	54.0	72.0
11 .....	4,400	13	06.6	72.6
12 .....	4,800	14	20.8	74.2
13 .....	5,200	15	35.2	74.4
14 .....	5,600	16	49.0	73.8
15 .....	6,000	18	01.0	72.0
16 .....	6,400	19	11.8	70.8
17 .....	6,800	20	22.8	71.0
18 .....	7,200	21	34.6	71.8
19 .....	7,600	22	47.0	72.4
20 .....	8,000	24	00.0	73.0
21 .....	8,400	25	13.4	73.4
22 .....	8,800	26	25.0	71.6
23 .....	9,200	27	39.8	74.8
24 .....	9,600	28	53.0	73.2
25 .....	10,000	29	59.6	66.6

The Marathon Race on the final afternoon of the track and field events provided as dramatic a finish as could have been devised, and was curiously reminiscent of the famous Dorando race of forty years before. There were forty-one starters, and Guinez, of the Argentine, led at the end of the first two miles. From the sixth mile onwards, it was the 21-year-old Gailly, of Belgium, who dominated the scene most of the way and until almost the very last moments. At 15 km. he was 14 seconds ahead of the rest of the field and nearly 1½ minutes ahead of Cabrera (Argentine). At 20 km. he was leading by half a minute and still about the same distance in advance of Cabrera. Cabrera had closed the gap slightly by 25 km., being 1 minute 11 seconds behind the leader; Richards (Great Britain) was another 1½ minutes behind the Argentinian.

At 30 km. Gailly was 53 seconds ahead of Cabrera, and five kilometres later it was Choi (of Korea) who had snatched the lead, 28 seconds ahead of Cabrera, with Gailly another three seconds behind, and Richards fifth, 20 seconds behind Gailly. With 5,000 metres to go, Cabrera was leading, five seconds ahead of Gailly, with Richards another 11 seconds behind.

### **Gailly's Gallant Failure**

Just about half-past five Gailly entered the Stadium, well-nigh exhausted and hardly able to drag one foot after the other. Less than 500 yards away was the Olympic Crown waiting to be grasped. Only just over a lap of the track to go, but he had covered nearly 26 miles. Hardly had he taken half a dozen steps round the Wembley track, when another figure entered—Cabrera of the Argentine, and it was plain that he would have no difficulty in overhauling his gallant, but practically insensible, Belgian opponent. About ten seconds later Richards entered the Stadium and he, too, had no difficulty in passing the Belgian, who finished third just over half a minute ahead of the South African, Coleman, who was sixth in the 1936 Games. The 16-second margin between the first two men was even smaller than the distance between Zabala (Argentine) and Ferris (Great Britain) at Los Angeles in 1932, but not quite as small as the margin (12.8 seconds) by which Hannes Kohlemainen was successful at Antwerp in 1920.

The 3,000 metres steeplechase was a triumph for Sweden, who provided the first three men home—Sjostrand, Elmsater and Hagstrom. Some idea of the speed of modern steeplechasing may be gathered from the fact that the last lap of 400 metres (including four 3-foot hurdles and the water jump) was 69.6 seconds, and Sjostrand won in 9 min. 4.6 sec. Elmsater is reported to have beaten 9 minutes on one occasion.

### **The Hurdles**

The two hurdles events, the 110 and 400 metres, were in a way two of the most remarkable achievements of the Games. Both were won by athletes from the U.S.A., as was expected, and in both there was a new Olympic record.

In the second semi-final of the 110 metres, Porter, of U.S.A., had equalled Forrest Towns's previous Olympic best, and he seemed just a trifle better than his two fellow countrymen, Scott and Dixon. The final was really two races with the three U.S.A. men almost neck and neck from start to finish and the others, Triulzi (Argentine), Gardner (Australia) and Lidman (Sweden)—a finalist in the Berlin Games—fighting their own battle some five yards behind. Porter gained a clear win with Scott beating Dixon by inches for second place. The winner beat the previous Olympic best by one-fifth of a second and the second and third equalled Towns's Berlin record.

In many ways the 400 metres hurdles may have been the finest achievement of the whole Games. The semi-final winners, Larsson of Sweden and Cochran of United States, both beat the Olympic best time of 52.0 sec. made by Hardin in 1932. It will be remembered that when Tisdall won at Los Angeles in 1932 in 51.8 sec. he knocked down the last hurdle. At that time hurdlers who knocked over a hurdle could not claim a record.

In the final Cochran was in the third lane, White of Ceylon in the fifth and Larsson of Sweden on the outside. White went off at a terrific pace, but by half distance Cochran, hurdling in superb form, was ahead. He won by a huge margin in 51.1 sec., a magnificent victory. White of Ceylon, who was second, had had very little real competition before the Games and his achievement of 51.8 sec. deserves the very highest praise.



Sweden won both the walking events. In the 10,000 metres, Mikaelsson, the European champion, walking well within himself, won from his fellow Swede, Johansson. During the preliminary heats and the final, the previous Olympic record made in 1912 was beaten ten times. The event had not been included in the last three Games.

In the 50 km. Ljunggren of Sweden, European champion in 1946, was three minutes ahead after 10 km., 10 minutes ahead at 25 km. (half distance), and though Godel of Switzerland had reduced the lead to one of six minutes with 5,000 metres to go, Ljunggren won by over six minutes. T. Lloyd Johnson, almost the veteran of the athletics, and a competitor at Berlin, was third, only 14 seconds behind Godel.

### **A Relay Sensation**

Each of the relays produced its own excitement. In the 4 x 100 metres, the three U.S.A. 100 metres finalists—Dillard, Ewell and Patton—with Wright, their long jumper, passed the tape a good eight yards ahead of Great Britain. It was then announced that the United States team had failed to pass the baton within the first 20-metre change-over marks, and Great Britain was awarded the victory. The huge crowd did not relish Britain gaining her only victory in this way, and when, three days later, the Olympic Jury after carefully examining the film of the race reversed the judges' decision, everyone was delighted.

The following extract from the *New York Times* is here included, not just from the British point of view but because it typifies the spirit which permeated all teams at this mighty Festival of Sport :

" There was a far finer demonstration of sportsmanship than that in connection with the event. It was given last Saturday afternoon by the majority of the 83,000 spectators in Wembley Stadium—most of them British—just after the United States team that had won by several yards was disqualified. The judicial victory awarded the British sprinters was the first time the British crowd had had an opportunity to cheer a triumph by their countrymen. But the Britons disagreed with the judges. They did not want to win even one victory in that way. They gave their loudest cheers to the disqualified Americans, three of whom, incidentally were Negroes. That is sportsmanship at its best. That will be remembered we believe, long after many other incidents of the Olympiad are forgotten."—*New York Times*.

In the 4 x 400 metre relay the Jamaican team—Wint, McKenley, Rhoden and Laing—were expected to give the quartet from the U.S.A.—Harnden, Bourland, Cochran and Whitfield—a keen race. Over the third stretch, with the U.S.A. team well ahead, Wint left the track with an injured muscle, leaving the U.S.A. victors from France by over four seconds. Great Britain was unlucky not to survive the first round, being drawn in easily the strongest heat. They might well have finished close to the U.S.A. in the final.

### **The Field Events**

In the high jump the U.S.A. trio were much below their transatlantic form and two of them, Stanich and Edleman were placed third and fourth with 6 ft. 4¾ in. (1.95 m.).

Paulson, Norway, was second with the same height, but fewer faults. The winner, J. A. Winter of Australia, with 6 ft. 6 in. (1.98 m.), deserves praise for consistent jumping.

In the pole vault, concluded in pouring rain, O. G. Smith just managed to retain the U.S.A.'s unbeaten record in this event. At one time it looked as if Kataja of Finland would gain a most unexpected victory. 14 ft. 1¼ in. (4.30 m.) was a remarkable achievement in the prevailing conditions. Richards of U.S.A. was third.

The long jumping was much below the Berlin standard, when the first six jumpers beat 25 ft. (7.62 m.). Steele of U.S.A. was easily the best of the finalists with a leap of 25 ft. 8 in. (7.825 m.), winning with 10¾ inches (.27 m.) to spare over Bruce of Australia, who beat Douglas of U.S.A. by a quarter of an inch.

Ahman of Sweden had one and a half inches to spare over Avery of Australia in the hop, step and jump, to win with 50 ft. 6¼ in. (15.40 m.) and Sarialp, Turkey, was third. Again the standard was lower than at Berlin. Not so the performances in the weight, discus and throwing the hammer.

In the weight the first three competitors, Thompson, Delaney and Fuchs, all of the U.S.A., which was not represented by Fonville, their best putter and the world record-holder, all beat the previous Olympic best. The winner, with 56 ft. 2 in. (17.12 m.) was three feet (.92 m.) better than Woellke of Germany in Berlin.

### **An Italian Duel**

All three medallists in the discus beat the Olympic record. Consolini of Italy, whose duels with his compatriot, Tosi, were one of the features of the 1948 season, was the victor with 173 ft. 2 in. (52.78 m.), Tosi being second and Gordien (U.S.A.) third.

The all-round standard of the hammer throwing was better than that at Berlin, though Nemeth (Hungary), the eventual winner, did not improve the Olympic best. His winning distance was 183 ft. 11½ in. (56.07 m.). Gubijan of Yugoslavia was second and Bennett of the U.S.A., third.

Finland gained her only 1948 athletic victory in the javelin, although Rautavaara's performance of 228 ft. 10½ in. (69.77 m.) would not have placed him in the first three in Berlin. Seymour of the U.S.A. was second, and Varszegi of Hungary, third.

The entries for the decathlon numbered 35, with the result that it was not concluded until 11 p.m. on Friday evening, August 6. Many of the competitors had been on the track for over 12 hours, and in the circumstances the performance of Mathias, the 17-year-old boy from U.S.A., with 7,139 points, the only competitor to beat 7,000, was phenomenal. Heinrich (France) was second with 6,974, and Simmons, also of the U.S.A., third with 6,950. Kistenmacher (Argentine) who had led at the end of the first day, was only fourth, with 6,929 points, at the conclusion of the competition.

### **The Woman's Events**

It is only 20 years since women's track and field events were first introduced into the Olympic Games, and then, owing to the temporary distress of some of the com-

petitors in the 800 metres at Amsterdam, the innovation met with a very mixed reception. Though the 800 metres was abandoned after this initial venture, the other events remained, and at Wembley in 1948 three new contests were added, making nine in all. There can be no doubt that the public enjoyed the women's competitions very much, and the quadruple victory of Fanny Blankers-Koen of Holland was perhaps the most talked-of achievement in the whole Games.

Blankers-Koen, who holds world records for 100 yards, 80 metres hurdles, high jump and long jump, is joint holder of the 100 metres record and was a member of the Dutch team responsible for two relay world records, began her victorious career at Wembley by winning the 100 metres with a good three yards to spare from Dorothy Manley, of Great Britain. Next day in the first heat of the 80 metres hurdles, she beat the previous Olympic best by 3/10 second, equalling the existing world record of 11.3 sec., of which she was the joint holder. Her present world record of 11.0 sec., made before the Games, had not at that time been recognised by the International Federation. In the second heat of the hurdles Maureen Gardner of Great Britain equalled the previous Olympic Games best, and in the semi-final she just managed by great determination to squeeze her way into the final.

### **A Thrilling Final**

This final was one of the most thrilling events of the Games, with Gardner ahead at the first hurdle, clearing her fences throughout with great precision, and though behind Blankers-Koen at the final hurdle, finishing gallantly to be beaten by about one foot, with Shirley Strickland of Australia inches away, third. Both Blankers-Koen and Gardner were clocked at 11.2 seconds, a new Olympic best performance. Overshadowed by Blankers-Koen, Strickland has not had sufficient praise for her all-round achievements at Wembley; she was third in the 100 metres and 80 metres hurdles, fourth in the 200 metres and a member of the Australian relay team which finished second, 1/10 second behind the Dutch.

Blankers-Koen was even more outstanding in the 200 metres than in her other two victories, winning easily from Audrey Williamson of Great Britain in 24.4 seconds (having recorded 1/10 second faster time in the semi-finals).

### **Two Victories for Ostermeyer**

In the field events Ostermeyer of France with two victories (both Olympic bests) in the weight and the discus, and third place in the high jump, deserves the fullest recognition. In the weight she put 45 ft. 1½ in. (13.75 m.) and in the discus she threw 137 ft. 6½ in. (41.92 m.). In both events second place was gained by Italy, respectively by A. Piccinini and E. Cordiale Gentile.

Blankers-Koen did not appear in either the long jump or the high jump, although at her best she could have won both. The long jump was won by V. Gyarmati (Hungary) with 18 ft. 8¼ in. (5.695 m.).

The high jump produced one of the most thrilling duels imaginable. Both the winner, Alice Coachman, a coloured athlete from the U.S.A., and Dorothy Tyler of Great Britain, who as Dorothy Odam had been runner-up in Berlin while still a schoolgirl, cleared 5 ft.  $6\frac{1}{8}$  in. (1.68 m.) for a new Olympic best performance. The fact that Coachman cleared this height at her first attempt while Tyler required a second jump decided the tie in Coachman's favour. So close was this contest throughout that had Tyler also cleared this height at her first attempt she would have been the winner by reason of having fewer failures throughout the whole competition.

In the javelin, the winner, H. Bauma, of Austria, who was fourth in Berlin, beat the previous best with a throw of 149 ft. 6 in. (45.57 m.), although until the last throw K. Parviainen (Finland), who was second, had been leading.

So far as victories in the men's events were concerned, Belgian, Czechoslovakian and Jamaican athletes gained victories for the first time, while competitors from Ceylon, Panama and Turkey were placed in the first six for the first time.

**INTERNATIONAL AMATEUR ATHLETIC FEDERATION**  
**OFFICERS AND JURY OF APPEAL**

*President*

THE RT. HON. THE LORD BURGHLEY, KCMG, *Great Britain*

*Honorary Secretary-Treasurer*

E. J. H. HOLT, OBE, *Great Britain*

AVERY BRUNDAGE, *United States*

P. MERICAMP, *France*

L. MIETTINEN, *Finland*

A. PAULEN, *Holland*

B. KOPAL, *Czechoslovakia*

**OFFICIALS**

*Arena Manager*

D. T. P. Pain

*Assistant  
Managers*

D. G. Caswall  
K. R. Cooper  
W. J. Pepper  
A. A. Harley (*Walk*)  
H. E. Winter (*Marathon*)

*Liaison Officer (I.A.A.F.)*

J. W. Turner

*Keeper of the  
Implements*

C. O. Alexander

*Steward to  
Keeper of the  
Implements*

E. J. Reynolds

*Announcers (English)*

H. Green  
T. D. Morrison  
S. R. West  
A. C. Cook

*Announcer  
(French)*

A. Millet

*Referee*

(*Track*)  
J. Gilbert

*Judges*

(*Track*)

W. C. Jewell  
I. Allcock  
L. B. Bishop  
R. T. Cooling  
A. W. Green  
G. Jones  
J. Littleover  
A. Macfie  
A. D. Thwaites  
E. Tomlinson  
A. E. Wotton

*Judges'*

*Stewards*

A. Howard  
A. G. White

*Timekeepers*

W. C. A. Findlay  
(*Chief*)

D. McSwein  
(*Dep. Chief*)  
H. A. Hathway  
B. C. Long  
H. P. McCormack  
H. Ruddock  
J. Turner  
R. Taylor  
H. R. Walker  
S. C. Wright  
C. H. J. Ward

*Referee*

(*Throwing*)  
E. H. L. Clynes

*Judges*

(*Throwing*)

J. C. McPhail  
G. M. Adam  
J. E. Clarke  
J. Drummond  
H. W. Ellsey  
P. S. Gale  
P. T. King  
M. C. Nokes  
G. Peat  
J. C. Rice  
C. W. Starnes  
R. W. L. Thrasher  
W. E. Wilde  
E. R. Walker

*Referee*

(*Jumping*)  
S. E. J. Best

*Judges*

(*Jumping*)

A. B. Wignall  
W. Carmichael  
K. S. Duncan  
P. Fish  
R. St. G. T. Harper  
J. Higginson  
H. A. Langley  
F. E. Neal  
W. D. Stretton  
A. W. Taylor  
L. R. Truelove  
B. Shillington  
J. Porter

*Track Walking*

*Judges*

J. B. Belchamber  
H. Evans  
G. R. Goodwin  
R. C. Mawbey  
W. J. Palmer  
E. Parslow  
Grayson Stone  
G. F. McCombe

*Women*

*Field Event*

*Judges*

Mrs. Palmer  
Mrs. Hayward  
Mrs. Neal  
Mrs. Cornell  
Mrs. Taylor

*Competitors'*

*Stewards*

N. W. Easlea  
J. R. Ellick  
G. Gould  
F. Hall  
C. M. Howell  
W. H. King  
T. Matthewman  
E. Gough

*Competitors'*

*Stewards*

(*Women*)  
Mrs. Pope  
Mrs. Bashford  
Mrs. Amies  
Miss Curson

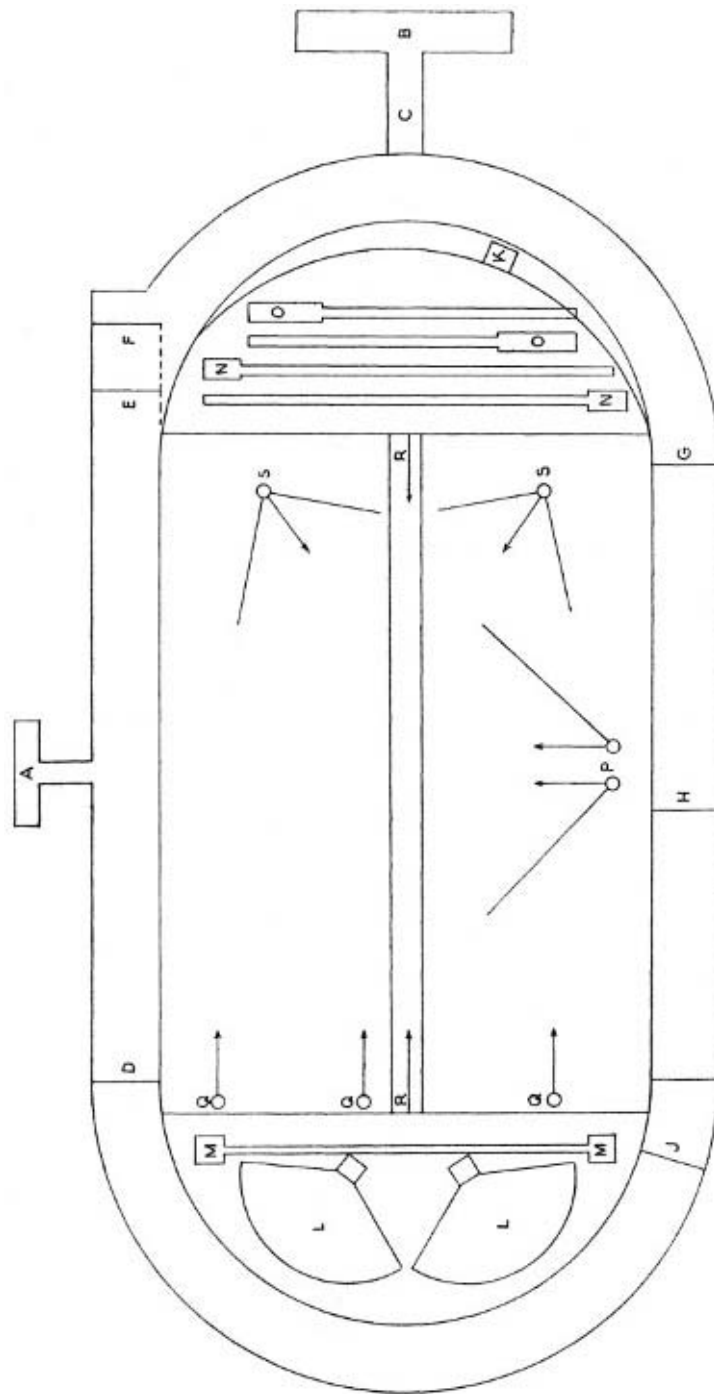

LAY-OUT OF ATHLETIC ARENA

- A Royal Box.
- B Main Score Board.
- C Competitors' Tunnel.
- D Finish of all races and start of 400 m. 800 m. and 10,000 m.
- E Start of 100 m.

- F Start of 110 m. hurdles.
- FF Start of 80 m. hurdles.
- G Start of 200 m. and 5,000 m.
- H Start of 3,000 m. steeplechase.
- J Start of 1,500 m.
- K Water Jump.
- L High Jump.

- M Pole Vault.
- N Hop, Step and Jump.
- O Long Jump.
- P Throwing the Hammer.
- Q Putting the Shot.
- R Throwing the Javelin.
- S Throwing the Discus.

OFFICIALS—*continued*

<i>Enclosure</i>	<i>Decathlon</i>	<i>Marksman</i>	H. F. Armstrong
<i>Stewards</i>	<i>Recorders</i>	E. A. Duffett	E. Trigg
H. L. S. McCarthy	J. Alvey, R.M.	G. Nicol	J. C. Simmons
H. W. Payne	F. W. Moulder	F. W. Norris	Miss A. F. O'Connor
<i>Press</i>	<i>Wind Gauge</i>	<i>Clerks</i>	Miss D. V. Crook
<i>Stewards</i>	<i>Observers</i>	<i>of the Course (Track)</i>	P. W. Malaghan
R. W. Revans	F. W. Collins	S. A. Tomlin	C. E. Musselwhite
T. Hampson	P. G. Goodeve-Docker	W. J. Wareham	T. S. Fairhurst
<i>Official</i>	A. A. Goodwin	<i>Clerk</i>	E. D. Jenner
<i>Surveyor</i>	H. W. Harbin	<i>of the Course (Field)</i>	E. W. Stockdale
From Wembley	R. F. Kerslake	E. R. Powell	T. W. Barrett
<i>Doctors</i>	C. A. Sinfield	<i>Chief Steward</i>	N. Griffiths
From Medical	B. Dagnall	A. W. H. Stringer	J. Solomons
Committee	D. B. L. Hibbert	<i>Telephone and</i>	D. Harvey
<i>Lap Scorers</i>	<i>Umpires</i>	<i>Score Board</i>	J. Sinfield
W. Pearson	H. E. Bird	<i>Operators</i>	T. Cannon
L. N. Richardson	J. T. Bridges	H. A. Johnston	J. Thorn
A. P. Turk	T. Ferguson	G. W. Tolley	F. D. Rawkins
<i>Recorders</i>	S. J. Hutchinson	G. P. Wilson	R. A. Bullworthy
G. Howell	B. Macdonald	G. H. Siers	L. F. Enfield
F. T. Summerfield	R. Taylor	K. N. Reed	C. E. Bass
W. E. Hamnett	<i>Starters</i>	F. J. Tomlin	J. Pattison
E. A. Reavell	J. J. Gillis	E. P. Manley	W. C. Foister
	H. Grindall	A. G. T. Beresford	H. F. Bradley
	F. H. Hulford	W. A. Collins	J. C. Parkinson
		Miss M. H. Ingram	J. H. W. Ayre
			J. G. Davis
			E. H. Harding-Roberts
			Miss J. M. Edwards
			Mrs. M. S. Jenner



### Athletic Timetable

The following table shows the daily programme and timing of the athletics events :

#### Friday, July 30th

- 11. 0 a.m. High Jump (qualifying trials).
- 2.30 p.m. 400 metres hurdles (first round).
- 3. 0 p.m. 100 metres (first round).
- 3.30 p.m. Throwing the Discus, women (final).
- 4. 0 p.m. 800 metres (first round).
- 4.30 p.m. High Jump (final).
- 5. 0 p.m. 400 metres hurdles (semi-finals).
- 5.30 p.m. 100 metres (second round).
- 6. 0 p.m. 10,000 metres (final).

#### Saturday, July 31st

- 10. 0 a.m. Throwing the Hammer (qualifying trials).
- 11. 0 a.m. Long Jump (qualifying trials).
- 11. 0 a.m. Pole Vault (qualifying trials).
- 1.15 p.m. 50 kilometres road walk.
- 2.30 p.m. Throwing the Javelin, women (final).
- 2.30 p.m. 100 metres (semi-finals).
- 2.45 p.m. 100 metres, women (first round).
- 3.15 p.m. 800 metres (semi-finals).
- 3.30 p.m. 400 metres hurdles (final).
- 3.30 p.m. Throwing the Hammer (final).
- 3.45 p.m. 100 metres (final).
- 4. 0 p.m. 5,000 metres (heats).
- 4.45 p.m. Long Jump (final).

#### Monday, August 2nd

- 11. 0 a.m. Throwing the Discus (qualifying trials).
- 2.30 p.m. 200 metres (first round).
- 2.30 p.m. Pole Vault (final).
- 3.30 p.m. Throwing the Discus (final).
- 3.30 p.m. 100 metres, women (semi-finals).
- 4. 0 p.m. 800 metres (final).
- 4.15 p.m. 200 metres (second round).
- 4.45 p.m. 100 metres, women (final).
- 5. 0 p.m. 5,000 metres (final).

#### Tuesday, August 3rd

- 10.30 a.m. 10,000 metres walk (heats).
- 11. 0 a.m. Hop, Step and Jump (qualifying trials).
- 11. 0 a.m. Putting the Shot (qualifying trials).
- 3. 0 p.m. 80 metres hurdles, women (first round).
- 3.30 p.m. 200 metres (semi-finals).
- 3.30 p.m. Hop, Step and Jump (final).
- 3.45 p.m. 110 metres hurdles (first round).
- 4. 0 p.m. Putting the Shot (final).
- 4.15 p.m. 3,000 metres steeplechase (heats).
- 5. 0 p.m. 80 metres hurdles, women (semi-finals).
- 5.15 p.m. 200 metres (final).

**Wednesday, August 4th**

- 11. 0 a.m. Throwing the Javelin (qualifying trials).
- 11. 0 a.m. Long Jump, women (qualifying trials).
- 11. 0 a.m. Putting the Shot, women (qualifying trials).
- 2.30 p.m. Throwing the Javelin (final).
- 3. 0 p.m. 80 metres hurdles, women (final).
- 3.15 p.m. 110 metres hurdles (semi-finals).
- 3.30 p.m. 400 metres (first round).
- 4.30 p.m. 1,500 metres (heats).
- 4.30 p.m. Long Jump, women (final).
- 5. 0 p.m. Putting the Shot, women (final).
- 5. 0 p.m. 110 metres hurdles (final).
- 5.15 p.m. 400 metres (second round).

**Thursday, August 5 th**

- 10.30 a.m. Decathlon, 100 metres.
- 11.30 a.m. Decathlon, Long Jump.
- 3. 0 p.m. 400 metres (semi-finals).
- 3. 0 p.m. Decathlon, Putting the Shot.
- 3.30 p.m. 200 metres, women (first round).
- 4. 0 p.m. Decathlon, High Jump.
- 4.15 p.m. 3,000 metres steeplechase (final).
- 4.45 p.m. 400 metres (final).
- 5. 0 p.m. 200 metres, women (semi-finals).
- 5.30 p.m. Decathlon, 400 metres.

**Friday, August 6th**

- 10.30 a.m. Decathlon, 110 metres hurdles.
- 11.30 a.m. Decathlon, Throwing the Discus.
- 2.30 p.m. Decathlon, Pole Vault.
- 4. 0 p.m. 400 metres relay (heats).
- 4.30 p.m. Decathlon, Throwing the Javelin.
- 4.30 p.m. 200 metres, women (final).
- 5. 0 p.m. 1,500 metres (final).
- 5.30 p.m. 1,600 metres relay (heats).
- 6.30 p.m. Decathlon, 1,500 metres.

**Saturday, August 7th**

- 3. 0 p.m. Marathon.
- 3.15 p.m. 400 metres relay, women (heats).
- 3.30 p.m. 400 metres relay (final).
- 3.35 p.m. High Jump, women (final).
- 3.45 p.m. 10,000 metres walk (final).
- 4.40 p.m. 400 metres relay, women (final).
- 4.50 p.m. 1,600 metres relay (final).

## 100 METRES

*Previous Olympic Winners*

1896	T. E. Burke	U.S.A.	12.0 sec.	1920	C. W. Paddock	U.S.A.	10.8 sec.
1900	F. W. Jarvis	U.S.A.	10.8 sec.	1924	H. M. Abrahams	Great Britain	10.6 sec.
1904	A. Hahn	U.S.A.	11.0 sec.	1928	P. Williams	Canada	10.8 sec.
1908	R. E. Walker	South Africa	10.8 sec.	1932	E. Tolan	U.S.A.	10.3 sec.
1912	R. C. Craig	U.S.A.	10.8 sec.	1936	J. Owens	U.S.A.	10.3 sec.
World Record:		10.2 sec.	J. Owens (U.S.A.)	Chicago, 1930			
Olympic Record:		10.2 sec.	H. Davis (U.S.A.)	California, 1941			
		10.3 sec.	J. Owens (U.S.A.)	Berlin, 1936			

---

There were 75 entries from 37 nations ; 66 participants from 34 nations

## FIRST ROUND

*The first two in each heat qualified for the Second Round*

HEAT 1			HEAT 2			HEAT 3					
		<i>secs.</i>			<i>secs.</i>			<i>secs.</i>			
1	Ewell, H.	U.S.A.	10.5	1	Patton, M.	U.S.A.	10.6	1	Labeach, L.	Panama	10.5
2	McCorquodale, A.	Great Britain	10.5	2	Zanoni Hausen, I.	Brazil	10.9	2	Goldovanyi, B.	Hungary	11.0
3	Laing, L.	Jamaica	11.0	3	O'Brien, J.	Canada	10.9	3	Mahoney, F.	Bermuda	11.8
4	Garcia Delgado, A.	Cuba	—	4	Lapuente, F.	Argentina	—	4	Rhoden, V.	Jamaica	—
5	Jacono, N.	Malta	—	5	Gosset, H.	Belgium	—	5	Salvador Paquete, T.	Portugal	—
				6	Rodrigues Silva, G.	Mexico	—	6	de Saram, J.	Ceylon	—
HEAT 4			HEAT 5			HEAT 6					
		<i>secs.</i>			<i>secs.</i>			<i>secs.</i>			
1	Lopez Testa, J.	Uruguay	10.5	1	Dillard, H.	U.S.A.	10.4	1	Macdonald Bailey, E.	Great Britain	10.5
2	Jones, K.	Great Britain	10.6	2	Pereira da Silva, H.	Brazil	10.6	2	Clausen, H.	Iceland	11.0
3	Meyer, J.	Holland	11.0	3	Bloch, P.	Norway	11.1	3	van Heerden, A.	South Africa	11.1
4	Reyes Anchante, M.	Peru	—	4	Braekman, P.	Belgium	—	4	Silva Anguita, C.	Chile	—
5	Thorvaldsson, F.	Iceland	—					5	Lovina, B.	Philippines	—
								6	Lines, S.	Bermuda	—
HEAT 7			HEAT 8			HEAT 9					
		<i>secs.</i>			<i>secs.</i>			<i>secs.</i>			
1	Treloar, J.	Australia	10.5	1	Fortun Chacon, R.	Cuba	10.7	1	Curotta, M.	Australia	10.7
2	Valmy, R.	France	10.8	2	Bartram, J.	Australia	10.8	2	Bonnhoff, G.	Argentina	10.8
3	Csanyi, G.	Hungary	11.1	3	McKenzie, B.	Jamaica	10.8	3	Mazorra Zamorra, R.	Cuba	11.1
4	Isaack, C.	Argentina	—	4	Coutinho da Silva, H.	Brazil	—	4	Clausen, O.	Iceland	—
5	Mukhtar, E.	Egypt	—	5	Zwaan, J. G.	Holland	—	5	Oztas, R.	Turkey	—
6	Salman, D.	Iraq	—					6	Johnson, P.	Bermuda	†
HEAT 10			HEAT 11			HEAT 12					
		<i>secs.</i>			<i>secs.</i>			<i>secs.</i>			
1	Lewis, G.	Trinidad	10.8	1	Van de Wiele, I.	Belgium	10.8	1	Fayos, M.	Uruguay	11.0
2	Haggis, E.	Canada	10.9	2	Rodrigues de Morais, J.	Portugal	10.9	2	Phillips, E.	India	11.0
3	Perez, W.	Uruguay	11.0	3	Labarthe Celery, A.	Chile	11.0	3	Bartha, L.	Hungary	11.1
4	Ferrando Dietz, S.	Peru	—	4	Butt, M. S.	Pakistan	—	4	Kleyn, J.	Holland	—
5	Petrakis, S.	Greece	—					5	Aksur, K.	Turkey	—
6	Stephan, J.	France	—					6	Maung Sein Pe	Burma	—
								7	Bally, E.	France	—

† Disqualified by starter.

## SECOND ROUND

The first three in each heat qualified for the Semi-finals

## HEAT 1

		<i>secs.</i>
1	Dillard, H..... U.S.A.....	10.4
2	Lopez Testa, J..... Uruguay.....	10.6
3	Jones, K..... Great Britain	10.7
4	Zanoni Hausen, I..... Brazil.....	—
5	Haggis, E..... Canada.....	—
6	Rodrigues de Morais, J..... Portugal.....	—

## HEAT 2

		<i>secs.</i>
1	Ewell, H..... U.S.A.....	10.5
2	Macdonald Bailey, E..... Great Britain	10.6
3	Curotta, M..... Australia.....	10.8
4	Lewis, G..... Trinidad.....	—
5	Goldovanyi, B..... Hungary.....	—
6	Clausen, H..... Iceland.....	—

## HEAT 3

		<i>secs.</i>
1	Patton, M..... U.S.A.....	10.4
2	McCorquodale, A..... Great Britain	10.5
3	Bartram, J..... Australia	10.6
4	Valmy, R..... France	—
5	Fayos, M..... Uruguay	—
6	Van de Wiele, I..... Belgium	—

## HEAT 4

		<i>secs.</i>
1	Labeach, L..... Panama.....	10.5
2	Treloar, J..... Australia.....	10.5
3	Fortun Chacon, R..... Cuba.....	10.6
4	Pereira da Silva, H..... Brazil.....	—
5	Bonnhoff, G..... Argentine.....	—
6	Phillips, E..... India.....	—

## SEMI-FINALS

The first three in each heat qualified for the Final

## HEAT 1

		<i>secs.</i>
1	Dillard, H..... U.S.A.....	10.5
2	Ewell, H..... U.S.A.....	10.5
3	McCorquodale, A..... Great Britain	10.7
4	Bartram, J..... Australia.....	—
5	Lopez Testa, J..... Uruguay.....	—
6	Curotta, M..... Australia.....	—

## HEAT 2

1	Patton, M..... U.S.A.....	10.4
2	Labeach, L..... Panama.....	10.5
3	Macdonald Bailey, E..... Great Britain	10.6
4	Treloar, J..... Australia.....	—
5	Fortun Chacon, R..... Cuba.....	—
6	Jones, K..... Great Britain	—

## FINAL

		<i>secs.</i>
1	<b>DILLARD, H.</b> ..... U.S.A.....	10.3
2	<b>EWELL, H.</b> ..... U.S.A.....	10.4
3	<b>LABEACH, L.</b> ..... Panama.....	10.6
4	McCorquodale, A..... Great Britain.....	—
5	Patton, M..... U.S.A.....	—
6	Macdonald Bailey, E..... Great Britain.....	—

## 200 METRES

*Previous Olympic Winners*

1900 J. W. B. Tewkesbury	<i>U.S.A.</i>	22.2 sec.	1920 A. Woodring	<i>U.S.A.</i>	22.0 sec.
1904 A. Hahn	<i>U.S.A.</i>	21.6 sec.	1924 J. V. Scholz	<i>U.S.A.</i>	21.6 sec.
1908 R. Kerr	<i>Canada</i>	22.6 sec.	1928 P. Williams	<i>Canada</i>	21.8 sec.
1912 R. C. Craig	<i>U.S.A.</i>	21.7 sec.	1932 E. Tolan	<i>U.S.A.</i>	21.2 sec.
	1936 J. Owens		<i>U.S.A.</i>	20.7 sec.	

World Record : 20.3 sec. J. Owens (U.S.A.) Michigan, 1935

Olympic Record : 20.7 sec. J. Owens (U.S.A.) Berlin, 1936

---

There were 61 entries from 33 nations ; 50 participants from 26 nations

## FIRST ROUND

*The first two in each heat qualified for the Second Round*

## HEAT 1

	<i>secs.</i>
1 McKenley, H. .... <i>Jamaica</i> .....	21.3
2 Haggis, E. .... <i>Canada</i> .....	22.2
3 Clausen, H. .... <i>Iceland</i> .....	22.2
4 Lines, S. .... <i>Bermuda</i> .....	—

## HEAT 2

	<i>secs.</i>
1 Valle, P. .... <i>Great Britain</i> .....	22.3
2 de Saram, J. .... <i>Ceylon</i> .....	23.1
3 Lovina, B. .... <i>Philippines</i> .....	23.2
4 Petrakis, S. .... <i>Greece</i> .....	—

## HEAT 3

	<i>secs.</i>
1 Fortun Chacon, R. .... <i>Cuba</i> .....	21.9
2 Shore, D. .... <i>South Africa</i> ....	22.1
3 Rodrigues de Morais, J. .... <i>Portugal</i> .....	22.6

## HEAT 4

	<i>secs.</i>
1 Ewell, H. .... <i>U.S.A.</i> .....	21.6
2 van Heerden, A. .... <i>South Africa</i> .....	21.8
3 Garcia Delgado, A. .... <i>Cuba</i> .....	22.2
4 Linssen, F. .... <i>Belgium</i> .....	—
5 Dill, H. .... <i>Bermuda</i> .....	—
6 Salman, D. .... <i>Iraq</i> .....	—

## HEAT 5

	<i>secs.</i>
1 Le Bas, J. .... <i>France</i> .....	22.0
2 Costa Ramos, R. .... <i>Brazil</i> .....	22.2
3 McKenzie, B. .... <i>Jamaica</i> .....	22.4

## HEAT 6

	<i>secs.</i>
1 Patton, M. .... <i>U.S.A.</i> .....	21.6
2 Laing, L. .... <i>Jamaica</i> .....	21.8
3 Geary, G. .... <i>Argentine</i> .....	23.0
4 White, D. .... <i>Ceylon</i> .....	—

## HEAT 7

	<i>secs.</i>
1 Bonnhoff, G. .... <i>Argentine</i> .....	22.2
2 Fairgrieve, J. .... <i>Great Britain</i> .....	22.2
3 Mazorra Zamorra, R. .... <i>Cuba</i> .....	23.0
4 Aksur, K. .... <i>Turkey</i> .....	—
5 Rodrigues Silva, G. .... <i>Mexico</i> .....	—

## HEAT 8

	<i>secs.</i>
1 Bourland, C. .... <i>U.S.A.</i> .....	21.3
2 Pereira da Silva, H. .... <i>Brazil</i> .....	21.9
3 Lewis, G. .... <i>Trinidad</i> .....	22.4
4 Perez, W. .... <i>Uruguay</i> .....	—
5 Bloch, P. .... <i>Norway</i> .....	—

## HEAT 9

	<i>secs.</i>
1 Treloar, J. .... <i>Australia</i> .....	21.7
2 Butt, M. S. .... <i>Pakistan</i> .....	22.8
3 Oztas, R. .... <i>Turkey</i> .....	23.0
4 Johnson, P. .... <i>Bermuda</i> .....	—

## HEAT 10

1 McCorquodale, A. .... <i>Great Britain</i> .....	22.3
2 Ferrando Dietz, S. .... <i>Peru</i> .....	22.5
3 Bourgaux, F. .... <i>Belgium</i> .....	22.9
4 Bally, E. .... <i>France</i> .....	—

## HEAT 11

	<i>secs.</i>
1 Lopez Testa, J. .... <i>Uruguay</i> .....	22.1
2 Zanoni Hausen, I. .... <i>Brazil</i> .....	22.2
3 Scholten, G. .... <i>Holland</i> .....	22.2

## HEAT 12

	<i>secs.</i>
1 Labeach, L. .... <i>Panama</i> .....	21.4
2 Lammers, J. .... <i>Holland</i> .....	22.0
3 Pettie, D. .... <i>Canada</i> .....	22.0
4 Fayos, M. .... <i>Uruguay</i> .....	—
5 Stephan, J. .... <i>France</i> .....	—

## SECOND ROUND

The first three in each heat qualified for the Semi-finals

## HEAT 1

1	McKenley, H.	Jamaica	21.3
2	Ewell, H.	U.S.A.	21.8
3	Valle, P.	Great Britain	22.1
4	Lammers, J.	Holland	—
5	Le Bas, J.	France	—
6	Costa Ramos, R.	Brazil	—

## HEAT 2

1	Bourland, C.	U.S.A.	21.3
2	Treloar, J.	Australia	21.5
3	Pereira da Silva, H.	Brazil	22.0
4	Bonnhoff, G.	Argentina	—
5	Shore, D.	South Africa	—
6	de Saram, J.	Ceylon	—

## HEAT 3

1	Labeach, L.	Panama	21.7
2	Laing, L.	Jamaica	21.8
3	van Heerden, A.	South Africa	22.9
4	Fairgrieve, J.	Great Britain	—
5	Ferrando Dietz, S.	Peru	—
—	Lopez Testa, J.	Uruguay	*

## HEAT 4

1	Patton, M.	U.S.A.	21.4
2	McCorquodale, A.	Great Britain	21.8
3	Fortun Chacon, R.	Cuba	22.0
4	Zanoni Hausen, I.	Brazil	—
5	Haggis, E.	Canada	—
6	Butt, M. S.	Pakistan	—

## SEMI-FINALS

The first three in each heat qualified for the Final

## HEAT 1

1	McKenley, H.	Jamaica	21.4
2	Patton, M.	U.S.A.	21.6
3	Ewell, H.	U.S.A.	21.8
4	Pereira da Silva, H.	Brazil	—
5	van Heerden, A.	South Africa	—
6	Valle, P.	Great Britain	—

## HEAT 2

1	Bourland, C.	U.S.A.	21.5
2	Labeach, L.	Panama	21.6
3	Laing, L.	Jamaica	21.6
4	Treloar, J.	Australia	—
5	McCorquodale, A.	Great Britain	—
6	Fortun Chacon, R.	Cuba	—

## FINAL

1	<b>PATTON, M.</b>	U.S.A.	21.1
2	<b>EWELL, H.</b>	U.S.A.	21.1
3	<b>LABEACH, L.</b>	Panama	21.2
4	McKenley, H.	Jamaica	—
5	Bourland, C.	U.S.A.	—
6	Laing, L.	Jamaica	—

\* Did not compete.

## 400 METRES

*Previous Olympic Winners*

1896	T. E. Burke	U.S.A.	54.2 sec.	1920	B. G. D. Rudd	South Africa	49.6 sec.
1900	M. W. Long	U.S.A.	49.4 sec.	1924	E. H. Liddell	Great Britain	47.6 sec.
1904	H. L. Hillman	U.S.A.	49.2 sec.	1928	R. Barbutti	U.S.A.	47.8 sec.
1908	W. Halswell	Great Britain	50.0 sec.	1932	W. Carr	U.S.A.	46.2 sec.
1912	C. D. Reidpath	U.S.A.	48.2 sec.	1936	A. F. Williams	U.S.A.	46.5 sec.

World Record :	{	46.0 sec.	R. Harbig (Germany)	Frankfurt, 1939
		46.0 sec.	G. Klemmer (U.S.A.)	Philadelphia, 1941
Olympic Record :		46.2 sec.	W. Carr (U.S.A.)	Los Angeles, 1932

---

There were 61 entries from 32 nations ; 53 participants from 28 nations

## FIRST ROUND

*The first two in each heat qualified for the Second Round*

## HEAT 1

		<i>secs.</i>
1	Reardon, J. ....	Eire ..... 48.4
2	Racic, M. ....	Yugoslavia .... 50.5
3	Chen, Ying-Long .....	China ..... 50.9
4	Karageorgos, G. ....	Greece..... 54.5

## HEAT 2

		<i>secs.</i>
1	McKenley, H. ....	Jamaica..... 48.4
2	Larsson, R. ....	Sweden..... 49.2
3	Banhalmi, F. ....	Hungary..... 49.6
4	Aparicio Rodewaldt, J. ....	Colombia ..... 50.8
5	Evans, G. ....	Argentina..... 51.8

## HEAT 3

1	Sabolovic, Z. ....	Yugoslavia .... 49.9
2	Lundqvist, K. ....	Sweden..... 50.0
3	Pocovi, A. ....	Argentina ..... 50.7
4	Rosas Ruiz, M. ....	Colombia ..... 51.4
5	Hasso, L. ....	Iraq..... 56.8

## HEAT 4

		<i>secs.</i>
1	Rhoden, V. ....	Jamaica..... 48.4
2	Shore, D. ....	South Africa 49.0
3	Hardmeier, O. ....	Switzerland... 49.2
4	Garcia Delgado, A. ....	Cuba..... 50.2
5	Ramsay, J. ....	Australia ..... 50.3

## HEAT 5

		<i>secs.</i>
1	Lunis, J. ....	France..... 49.3
2	Alnevik, F. ....	Sweden..... 50.2
3	Monges Caldera, C. ....	Mexico..... 50.9

## HEAT 6

1	Bolen, D. ....	U.S.A..... 50.1
2	Bartram, J. ....	Australia ..... 50.8
3	Dill, H. ....	Bermuda ..... 53.0

## HEAT 7

		<i>secs.</i>
1	Lewis, L. ....	Great Britain 48.9
2	Vade, B. ....	Norway..... 49.6
3	McCullough, E. ....	Canada..... 49.9
4	Keller, W. ....	Switzerland.... 50.3
5	Holmberg, R. ....	Finland..... 50.6

## HEAT 8

1	Whitfield, M. ....	U.S.A. .... 48.3
2	Roberts, W. ....	Great Britain 48.9
3	McFarlane, D. ....	Canada..... 49.5
4	Talja, O. ....	Finland..... 50.4
5	Trepp, M. ....	Switzerland .. 50.9

## HEAT 9

		<i>secs.</i>
1	Wint, A. ....	Jamaica ..... 47.7
2	Schewetta, F. ....	France ..... 48.9
3	de Saram, J. ....	Ceylon..... 51.2
4	Suvanto, T. ....	Finland..... 51.5
5	Acarbay, E. ....	Turkey..... 53.0

## HEAT 10

		<i>secs.</i>
1	Curotta, M. ....	Australia..... 49.1
2	Costa Ramos, R. ....	Brazil..... 49.2
3	Crapet, R. ....	France ..... 49.4
4	Horulu, K. ....	Turkey ..... 51.5

## HEAT 11

		<i>secs.</i>
1	Guida, G. ....	U.S.A. .... 49.0
2	Pugh, D. ....	Great Britain 49.3
3	Ehlers Trostel, G. ....	Chile..... 49.5
4	Petrakis, S. ....	Greece..... 54.5

## HEAT 12

		<i>secs.</i>
1	Kunnen, H. ....	Belgium..... 50.0
2	McFarlane, R. ....	Canada..... 50.6
3	Sigurdsson, R. ....	Iceland ..... 51.4
4	Hitelman Reitich, J. ....	Chile..... 51.5
5	Stratakos, S. ....	Greece..... 52.8



## SECOND ROUND

*The first three in each heat qualified for the Semi-finals*

## HEAT 1

		<i>secs.</i>
1	Whitfield, M. .... <i>U.S.A.</i> .....	48.0
2	Rhoden, V. .... <i>Jamaica</i> .....	48.6
3	Costa Ramos, R. .... <i>Brazil</i> .....	48.7
4	Lewis, L. .... <i>Great Britain</i> .....	49.2
5	Sabolovic, Z. .... <i>Yugoslavia</i> ....	49.5
6	Alnevik, F. .... <i>Sweden</i> .....	50.6

## HEAT 2

		<i>secs.</i>
1	Wint, A. .... <i>Jamaica</i> .....	47.7
2	Curotta, M. .... <i>Australia</i> .....	48.4
3	Shore, D. .... <i>South Africa</i> .....	48.5
4	Roberts, W. .... <i>Great Britain</i> .....	48.6
5	Vade, B. .... <i>Norway</i> .....	49.7
–	Kunnen, H. .... <i>Belgium</i> .....	*

## HEAT 3

		<i>secs.</i>
1	McKenley, H. .... <i>Jamaica</i> .....	48.0
2	Guida, G. .... <i>U.S.A.</i> .....	48.0
3	Larsson, R. .... <i>Sweden</i> .....	48.8
4	Bartram, J. .... <i>Australia</i> .....	49.9
5	Schewetta, F. .... <i>France</i> .....	49.9
6	Racic, M. .... <i>Yugoslavia</i> ....	52.1

## HEAT 4

		<i>secs.</i>
1	Bolen, D. .... <i>U.S.A.</i> .....	48.0
2	Reardon, J. .... <i>Eire</i> .....	48.3
3	McFarlane, R. .... <i>Canada</i> .....	48.4
4	Lundqvist, K. .... <i>Sweden</i> .....	48.4
5	Pugh, D. .... <i>Great Britain</i> .....	48.8
6	Lunis, J. .... <i>France</i> .....	48.9

## SEMI-FINALS

*The first three in each heat qualified for the Final*

## HEAT 1

		<i>secs.</i>
1	Wint, A. .... <i>Jamaica</i> .....	46.3
2	Curotta, M. .... <i>Australia</i> .....	47.2
3	Whitfield, M. .... <i>U.S.A.</i> .....	47.4
4	Rhoden, V. .... <i>Jamaica</i> .....	47.7
5	Reardon, J. .... <i>Eire</i> .....	47.8
–	Larsson, R. .... <i>Sweden</i> .....	*

## HEAT 2

		<i>secs.</i>
1	McKenley, H. .... <i>Jamaica</i> .....	47.3
2	Bolen, D. .... <i>U.S.A.</i> .....	47.9
3	Guida, G. .... <i>U.S.A.</i> .....	48.3
4	Shore, D. .... <i>South Africa</i> .....	48.8
5	Costa Ramos, R. .... <i>Brazil</i> .....	49.1
6	McFarlane, R. .... <i>Canada</i> .....	51.7

## FINAL

		<i>secs.</i>
1	<b>WINT, A.</b> .... <i>Jamaica</i> .....	46.2
2	<b>McKENLEY, H.</b> .... <i>Jamaica</i> .....	46.4
3	<b>WHITFIELD, M.</b> .... <i>U.S.A.</i> .....	46.9
4	Bolen, D. .... <i>U.S.A.</i> .....	47.2
5	Curotta, M. .... <i>Australia</i> .....	47.9
6	Guida, G. .... <i>U.S.A.</i> .....	50.2

\* Did not compete.

## 800 METRES

### Previous Olympic Winners

1896	E. H. Flack	Australia	2 m.	11	1920	A. G. Hill	Great Britain	1 m.	53.4 sec.
1900	A. E. Tysoe	Great Britain	2 m.	1.4 sec.	1924	D. G. A. Lowe	Great Britain	1 m.	52.4 sec.
1904	J. D. Lightbody	U.S.A.	1 m.	56	1928	D. G. A. Lowe	Great Britain	1 m.	51.8 sec.
1908	M. W. Sheppard	U.S.A.	1 m.	52.8	1932	T. Hampson	Great Britain	1 m.	49.8 sec.
1912	J. E. Meredith	U.S.A.	1 m.	51.9	1936	J. Woodruff	U.S.A.	1 m.	52.9 sec.
World Record :		1 m.	46.6 sec.	R. Harbig (Germany)	Milan, 1939				
Olympic Record :		1 m.	49.8 sec.	T. Hampson (Great Britain)	Los Angeles, 1932				

There were 44 entries from 26 nations ; 41 participants from 24 nations

## FIRST ROUND

The first four in each heat qualified for the Semi-finals

HEAT 1			HEAT 2			HEAT 3		
		<i>m s.</i>			<i>m s.</i>			<i>m s.</i>
1	Hansenne, M.	France	1	Barten, H.	U.S.A.	1	Holst-Sorensen, N.	Denmark
		54.6			55.6			54.2
2	Parlett, H.	Great Britain	2	Harris, D.	New Zealand	2	Vade, B.	Norway
		55.0			56.6			54.2
3	Ramsay, J.	Australia	3	White, C.	Great Britain	3	Chambers, R.	U.S.A.
		55.0			56.6			54.3
4	Volkmer, K.	Switzerland	4	Rosier, R.	Belgium	4	Brys, J.	Belgium
		55.3			56.7			55.4
5	Torres, A.	Argentina	5	Mavroidis, B.	Greece	5	Jonsson, O.	Iceland
		56.7			57.4			55.4
6	Lee, Yun Suk	Korea	6	Mongrut		6	Parnell, C.	Canada
		2 1.4						55.7
-	Khedr, R.	Egypt		Munoz, A.	Peru		- Adarraga	
		*			58.7			
				- Christensen, H.	Denmark		Elizaran, J.	Spain
					*			*
				- Onel, C.	Turkey			
					*			
HEAT 4			HEAT 5			HEAT 6		
		<i>m s.</i>			<i>m s.</i>			<i>m s.</i>
1	Wint, A.	Jamaica	1	Ljunggren, O.	Sweden	1	Whitfield, M.	U.S.A.
		53.9			56.1			52.8
2	de Ruyter, F.	Holland	2	Chef d'hotel, R.	France	2	Bengtsson, I.	Sweden
		54.4			56.2			52.9
3	Barthel, J.	Luxembourg	3	Streuli, H.	Switzerland	3	Hutchins, J.	Canada
		54.8			56.5			55.5
4	Winter, V.	Czechoslovakia	4	Taraway, H.	Great Britain	4	Mayordome, G.	France
		55.1			56.6			55.7
5	Henniger, E.	Canada	5	Avalos, A.	Argentina	5	Stratakos, S.	Greece
		55.4			56.6			2 2.2
6	Tull, W.	Trinidad	6	Ishman, R.	Turkey	6		
		55.7			2 1.1			
-	Dincturk, S.	Turkey		- Karageorgos, G.	Greece			
		*			*			

## SEMI-FINALS

The first three in each heat qualified for the Final

HEAT 1			HEAT 2			HEAT 3		
		<i>m s.</i>			<i>m s.</i>			<i>m s.</i>
1	Hansenne, M.	France	1	Bengtsson, I.	Sweden	1	Barten, H.	U.S.A.
		50.5			51.2			51.7
2	Whitfield, M.	U.S.A.	2	Wint, A.	Jamaica	2	Chef d'hotel, R.	France
		50.7			52.7			52.0
3	Parlett, H.	Great Britain	3	Chambers, R.	U.S.A.	3	Holst-Sorensen, N.	Denmark
		50.9			52.9			52.4
4	Hutchins, J.	Canada	4	Mayordome, G.	France	4	Ljunggren, O.	Sweden
		52.6			54.3			52.5
5	Brys, J.	Belgium	5	Ramsay, J.	Australia	5	White, C.	Great Britain
		53.2			54.9			53.0
6	Barthel, J.	Luxembourg	6	Winter, V.	Czechoslovakia	6	de Ruyter, F.	Holland
		54.6			57.7			54.6
-	Vade, B.	Norway		- Harris, D.	New Zealand		- Rosier, R.	Belgium
		*			*			*
-	Volkmer, K.	Switzerland		- Taraway, H.	Great Britain		- Streuli, H.	Switzerland
		*			*			*

## FINAL

1	<b>WHITFIELD, M.</b>	U.S.A.	<i>m.</i>	<i>s.</i>
			1	49.2
2	<b>WINT, A.</b>	Jamaica	1	49.5
3	<b>HANSENNE, M.</b>	France	1	49.8
4	Barten, H.	U.S.A.	1	50.1
5	Bengtsson, I.	Sweden	1	50.5
6	Chambers, R.	U.S.A.	1	52.1
-	Chef d'hotel, R.	France		*
-	Holst-Sorensen, N.	Denmark		*
-	Parlett, H.	Great Britain		*

\* Also competed.

**1500 METRES***Previous Olympic Winners*

1896	E. H. Flack	<i>Australia</i>	4 m. 33.2 sec.	1920	A. G. Hill	<i>Great Britain</i>	4 m. 1.8 sec.
1900	C. Bennett	<i>Great Britain</i>	4 m. 6.2 sec.	1924	P. Nurmi	<i>Finland</i>	3 m. 53.6 sec.
1904	J. D. Lightbody	<i>U.S.A.</i>	4 m. 5.4 sec.	1928	H. E. Larva	<i>Finland</i>	3 m. 53.2 sec.
1908	M. W. Sheppard	<i>U.S.A.</i>	4 m. 3.4 sec.	1932	L. Beccali	<i>Italy</i>	3 m. 51.2 sec.
1912	A. N. S. Jackson	<i>Great Britain</i>	3 m. 56.8 sec.	1936	J. E. Lovelock	<i>New Zealand</i>	3 m. 47.8 sec.
World Record :			3 m. 43.0 sec.	G. Hagg (Sweden)		Gothenburg, 1944	
			3 m. 43.0 sec.	L. Strand (Sweden)		Malmö, 1947	
Olympic Record :			3 m. 47.8 sec.	J. E. Lovelock (New Zealand)		Berlin, 1936.	

There were 42 entries from 24 nations ; 37 participants from 22 nations

**FIRST ROUND**

*The first three in each heat qualified for the Final*

**HEAT 1**

		<i>m</i>	<i>s.</i>
1	Strand, L. .... <i>Sweden</i> .....	3	54.2
2	Jorgensen, E. .... <i>Denmark</i> .....	3	54.2
3	Gehrmann, D. . . . . <i>U.S.A.</i> .....	3	54.8
4	de Ruyter, F. .... <i>Holland</i> .....	3	55.2
5	Luoto, T. .... <i>Finland</i> .....	3	58.0
6	Klein, H. .... <i>France</i> .....	3	59.8
-	Onel, C. .... <i>Turkey</i> .....	*	
-	Barry, J. .... <i>Eire</i> .....	*	
-	Salmond, C. .... <i>Canada</i> .....	*	
-	Mongrut		
-	Munoz, A. ... <i>Peru</i> .....		

**HEAT 2**

		<i>m</i>	<i>s.</i>
1	Slijkhuis, W. .... <i>Holland</i> .....	3	52.4
2	Cevona, V. .... <i>Czechoslovakia</i> 3	53.0	
3	Johansson, D. .... <i>Finland</i> .....	3	54.0
4	Hutchins, J. .... <i>Canada</i> .....	3	54.4
5	Wilson, D. .... <i>Great Britain</i> ..	3	54.8
6	Eischen, C. .... <i>U.S.A.</i> .....	4	0.2
-	Mavroidis, B. .... <i>Greece</i> .....	*	
-	Adarraga		
-	Elizaran, J. .... <i>Spain</i> .....	*	
-	Tull, W. .... <i>Trinidad</i> .....	*	

**HEAT 3**

		<i>m</i>	<i>s.</i>
1	Eriksson, H. .... <i>Sweden</i> .....	3	53.8
2	Nankeville, G. .... <i>Great Britain</i> ....	3	55.8
3	Barthel, J. .... <i>Luxembourg</i> ....	3	56.4
4	Vernier, J. .... <i>France</i> .....	3	57.6
5	Palmeiro, M. .... <i>Argentina</i> .....	4	1.6
6	Jonsson, O. .... <i>Iceland</i> .....	4	3.2
-	Ishman, R. .... <i>Turkey</i> .....	*	
-	Parnell, C. .... <i>Canada</i> .....	*	
-	Poyan Diaz, D. .... <i>Spain</i> .....	*	

**HEAT 4**

		<i>m</i>	<i>s.</i>
1	Bergkvist, G. .... <i>Sweden</i> .....	3	51.8
2	Hansenne, M. .... <i>France</i> .....	3	52.8
3	Garay, S. .... <i>Hungary</i> .....	3	53.0
4	Sink, R. .... <i>U.S.A.</i> .....	3	53.2
5	Vefling, K. .... <i>Norway</i> .....	3	54.6
6	Morris, R. A. .... <i>Great Britain</i> ....	3	55.8
-	Hubler, H. .... <i>Switzerland</i> .....	*	
-	Lee, Yun Suk. .... <i>Korea</i> .....	*	
-	Nielsen, I. B. B. . <i>Denmark</i> .....	*	

**FINAL**

		<i>m</i>	<i>s.</i>
1	<b>ERIKSSON, H.</b> .... <i>Sweden</i> .....	3	49.8
2	<b>STRAND, L.</b> .... <i>Sweden</i> .....	3	50.4
3	<b>SLIJKHUIS, W.</b> .... <i>Holland</i> .....	3	50.4
4	Cevona, V. .... <i>Czechoslovakia</i> .....	3	51.2
5	Bergkvist, G. .... <i>Sweden</i> .....	3	52.2
6	Nankeville, G. .... <i>Great Britain</i> .....	3	52.6
-	Jorgensen, E. .... <i>Denmark</i> .....	*	
-	Gehrmann, D. .... <i>U.S.A.</i> .....	*	
-	Johansson, D. .... <i>Finland</i> .....	*	
-	Barthel, J. .... <i>Luxembourg</i> .....	*	
-	Hansenne, M. .... <i>France</i> .....	*	
-	Garay, S. .... <i>Hungary</i> .....	*	

\* Also competed.

## 5000 METRES

*Previous Olympic Winners*

1912	H. Kolehmainen	<i>Finland</i>	14 m. 36.6 sec.	1928	V. Ritola	<i>Finland</i>	14	38.0 sec.
1920	J. Guillemot	<i>France</i>	14 m. 55.6 sec.	1932	L. Lehtinen	<i>Finland</i>	14	30.0 sec.
1924	P. Nurmi	<i>Finland</i>	14 m. 31.2 sec.	1936	G. Hockert	<i>Finland</i>	14	22.2 sec. m.

World Record : 13 m. 58.2 sec. G. Hagg (Sweden) Gothenburg, 1942

Olympic Record : 14 m. 22.2 sec. G. Hockert (Finland) Berlin, 1936

There were 37 entries from 21 nations ; 33 participants from 20 nations

## FIRST ROUND

*The first four in each heat qualified for the Final*

HEAT 1			HEAT 2			HEAT 3			
	<i>m.</i>	<i>s.</i>		<i>m.</i>	<i>s.</i>		<i>m.</i>	<i>s.</i>	
1	Nyberg, E.	<i>Sweden</i>	14	58.2	1	Ahlden, E.	<i>Sweden</i>	1	34.2
2	Koskela, V.	<i>Finland</i>	14	58.3	2	Zatopek, E.	<i>Czechoslovakia</i>	1	34.4
3	Stone, C.	<i>U.S.A.</i>	14	58.6	3	Makela, V.	<i>Finland</i>	1	45.8
4	Vande Wattyne, M.	<i>Belgium</i>	15	14.0	4	Stokken, M.	<i>Norway</i>	1	4.4
5	Vernier, J. M.	<i>France</i>	15	29.8	5	Pouzieux, M.	<i>France</i>	1	9.8
6	Nelson, W.	<i>New Zealand</i>	15	34.4	6	Rojo Sagredo, G.	<i>Spain</i>	1	19.0
-	Lataster, J.	<i>Holland</i>	*		-	Lucas, W.	<i>Great Britain</i>	*	
-	Salmond, C.	<i>Canada</i>	*		-	Lou, Wen-Ngau	<i>China</i>	*	
-	Broughton, J.	<i>Great Britain</i>	*		-	Mavrapostolos, B.	<i>Greece</i>	*	
-	Ramjohn, M.	<i>Trinidad</i>	*		-	Shim, B.	<i>Korea</i>	*	
-	Poulsen, A.	<i>Denmark</i>	‡		-	Ozcan, M.	<i>Turkey</i>	‡	
-	Barry, J.	<i>Eire</i>	‡		-	Robison, C. F.	<i>U.S.A.</i>	‡	
1	Slijkhuis, W.	<i>Holland</i>	15	6.8	6	Mimoun-o-Kacha, A.	<i>France</i>	11.2	
2	Reiff, G.	<i>Belgium</i>	15	7.0	-	Olney, H.	<i>Great Britain</i>	*	
3	Albertsson, B.	<i>Sweden</i>	15	7.8	-	Alarcon, E.	<i>Mexico</i>	*	
4	Perala, H.	<i>Finland</i>	15	7.8	-	Gunther, E.	<i>Switzerland</i>	*	
5	Thompson, J.	<i>U.S.A.</i>	15	8.4					

## FINAL

	<i>m.</i>	<i>s.</i>
1 REIFF, G.	<i>Belgium</i>	14 17.6
2 ZATOPEK, E.	<i>Czechoslovakia</i>	14 17.8
3 SLIJKHUIS, W.	<i>Holland</i>	14 26.8
4 Ahlden, E.	<i>Sweden</i>	14 28.6
5 Albertsson, B.	<i>Sweden</i>	14 39.0
6 Stone, C.	<i>U. S. A.</i>	14 39.4
- Koskela, V.	<i>Finland</i>	*
- Van de Wattyne, M.	<i>Belgium</i>	*
- Makela, V.	<i>Finland</i>	*
- Perala, H.	<i>Finland</i>	‡
- Nyberg, E.	<i>Sweden</i>	‡
- Stokken, M.	<i>Norway</i>	†

\* Also competed.

† Did not compete.

‡ Did not finish.

**10000 METRES***Previous Olympic Winners*

1912	H. Kolehmainen	<i>Finland</i>	31m. 20.8 sec.	1928	P. Nurmi	<i>Finland</i>	30 m. 18.8 sec.
1920	P. Nurmi	<i>Finland</i>	31m. 45.8 sec.	1932	J. Kusocinski	<i>Poland</i>	30 m. 11.4 sec.
1924	V. Ritola	<i>Finland</i>	30 m. 23.2 sec.	1936	I. Salminen	<i>Finland</i>	30 m. 15.4 sec.

World Record : 29 m. 35.4 sec. V. Heino (Finland) Helsinki, 1944  
 Olympic Record : 30 m. 11.4 sec. J. Kusocinski (Poland) Los Angeles, 1932

---

There were 32 entries from 18 nations ; 27 participants from 15 nations

		<i>m.</i>	<i>s.</i>
1	ZATOPEK, E. .... <i>Czechoslovakia</i> .....	29	59.6
2	MIMOUN-O-KACHA, A. .... <i>France</i> .....	30	47.4
3	ALBERTSSON, B. .... <i>Sweden</i> .....	30	53.6
4	Stokken, M. .... <i>Norway</i> .....	30	58.6
5	Dennolf, S. .... <i>Sweden</i> .....	31	5.0
6	Abdallah, B. .... <i>France</i> .....	31	7.8
-	Bralo, R. .... <i>Argentina</i> .....		*
-	Cox, S. .... <i>Great Britain</i> .....		*
-	Everaert, R. .... <i>Belgium</i> .....		*
-	Fahy, P. .... <i>Eire</i> .....		*
-	Goffberg, H. .... <i>U.S.A.</i> .....		*
-	Guinez, E. .... <i>Argentina</i> .....		*
-	Heino, V. .... <i>Finland</i> .....		*
-	Heinstrom, E. .... <i>Finland</i> .....		*
-	Kjersem, J. .... <i>Norway</i> .....		*
-	Kononen, S. .... <i>Finland</i> .....		*
-	Lataster, J. .... <i>Holland</i> .....		*
-	Lou, Wen-Ngau ..... <i>China</i> .....		*
-	McCooke, S. .... <i>Great Britain</i> .....		*
-	Miranda Justo, C. .... <i>Spain</i> .....		*
-	Nelson, W. .... <i>New Zealand</i> .....		*
-	O'Toole, E. .... <i>U.S.A.</i> .....		*
-	Paris, A. .... <i>France</i> .....		*
-	Peters, J. .... <i>Great Britain</i> .....		*
-	Ramjohn, M. .... <i>Trinidad</i> .....		*
-	Rojo Sagredo, G. .... <i>Spain</i> .....		*
-	Wilt, F. .... <i>U.S.A.</i> .....		*

\* Also competed.

## MARATHON

*Previous Olympic Winners*

1896	S. Louis	<i>Greece</i>	2 h. 58 m. 50 sec.	1920	H. Kohlemainen	<i>Finland</i>	2 h. 32 m. 35.8 sec.
1900	M. Theato	<i>France</i>	2 h. 59 m. 45 sec.	1924	A. Stenroos	<i>Finland</i>	2 h. 41 m. 22.6 sec.
1904	T. J. Hicks	<i>U.S.A.</i>	3 h. 28 m. 53 sec.	1928	El Ouafi	<i>France</i>	2 h. 32 m. 57 sec.
1908	J. J. Hayes	<i>U.S.A.</i>	2 h. 55 m. 18.4 sec.	1932	J. C. Zabala	<i>Argentina</i>	2 h. 31 m. 36 sec.
1912	K. K. McArthur	<i>South Africa</i>	2 h. 36 m. 54.8 sec.	1936	K. Son	<i>Japan</i>	2 h. 29 m. 19.2 sec.

There is no official world record for this event.

Olympic Record : 2 h. 29 m. 19.2 sec. K. Son (Japan) Berlin, 1936

There were 44 entries from 23 nations ; 41 participants from 21 nations

		<i>h.</i>	<i>m.</i>	<i>s.</i>
1	CABRERA, D. ....	2	34	51.6
2	RICHARDS, T. ....	2	35	7.6
3	GAILLY, E. ....	2	35	33.6
4	Coleman, J. ....	2	36	6.0
5	Guinez, E. ....	2	36	36.0
6	Luyt, S. ....	2	38	11.0
7	Ostling, G. ....	2	38	40.6
8	Systad, J. ....	2	38	41.0
9	Sensini, A. ....	2	39	30.0
10	Larsen, H. K. ....	2	41	22.0
11	Heino, V. ....	2	41	32.0
12	Melin, A. ....	2	42	20.0
13	Kurikkala, J. ....	2	42	46.0
14	Vogel, T. ....	2	45	27.0
15	Imostroza Arancibia, A. ....	2	47	48.0
16	Evans, L. ....	2	48	7.0
17	Cote, G. ....	2	48	31.0
18	Kyriakidis, S. ....	2	49	0.0
19	Kiss, J. ....	2	50	20.0
20	Koru, S. ....	2	51	7.0
21	Kelley, J. A. ....	2	51	56.0
22	Schiesser, K. ....	2	52	9.0
23	Fedorick, W. ....	2	52	12.0
24	Manninen, A. ....	2	56	49.0
25	Hong, Chong Oh ....	2	56	52.0
26	Mulvihill, F. ....	2	57	35.0
27	Suh, Y. ....	2	59	36.0
28	Hakansson, S. ....	3	0	9.0
29	Jutz, J. ....	3	3	55.0
30	Jones, S. ....	3	9	16.0
—	Choi, Yun Chil.....			*
—	Costantino, S. ....			*
—	Cousin, P. ....			*
—	Frischknecht, H. ....			*
—	Hietanen, M. ....			*
—	Holden, J. ....			*
—	Josset, R. ....			*
—	Lou, Wen-Ngau ....			*
—	Piesset, A. ....			*
—	Ragazos, A. ....			*
—	Singh, C. ....			*

\* Also competed.

MARATHON—*continued*

## INTERMEDIATE PLACINGS

## At 10 Kilometres

	<i>m.</i>	<i>s.</i>
1 Gailly ..... <i>Belgium</i> .....	34	34
2 Lou ..... <i>China</i> .....	34	46
3 Josset ..... <i>France</i> .....	35	5
4 Guinez ..... <i>Argentina</i> .....	35	5
5 Hietanen ..... <i>Finland</i> .....	35	9
6 Kurikkala ..... <i>Finland</i> .....	35	11
7 Ostling ..... <i>Sweden</i> .....	35	11
8 Choi ..... <i>Korea</i> .....	35	15
9 Sensini ..... <i>Argentina</i> .....	35	36
10 Cabrera ..... <i>Argentina</i> .....	35	42
11 Holden ..... <i>Great Britain</i> .....	35	42
12 Piesset ..... <i>France</i> .....	35	49
13 Luyt ..... <i>South Africa</i> .....	35	50
14 Richards ..... <i>Great Britain</i> .....	35	51
15 Melin ..... <i>Sweden</i> .....	35	54
16 Coleman ..... <i>South Africa</i> .....	35	55
17 Suh ..... <i>Korea</i> .....	35	55
18 Heino ..... <i>Finland</i> .....	35	55
19 Schiesser ..... <i>Switzerland</i> .....	35	58
20 Larsen ..... <i>Denmark</i> .....	36	5
21 Kiss ..... <i>Hungary</i> .....	36	10
22 Frischknecht ..... <i>Switzerland</i> .....	36	16
23 Kyriakidis ..... <i>Greece</i> .....	36	30
24 Koru ..... <i>Turkey</i> .....	36	35
25 Kelley ..... <i>U.S.A.</i> .....	36	40
26 Hong ..... <i>Korea</i> .....	36	44
27 Systad ..... <i>Norway</i> .....	36	49
28 Fedorick ..... <i>Canada</i> .....	36	54
29 Ragazos ..... <i>Greece</i> .....	37	1
30 Singh ..... <i>India</i> .....	37	4
31 Jones ..... <i>Great Britain</i> .....	37	7
32 Hakansson ..... <i>Sweden</i> .....	37	16
33 Jutz ..... <i>Switzerland</i> .....	37	20
34 Vogel ..... <i>U.S.A.</i> .....	37	34
35 Cote ..... <i>Canada</i> .....	37	36
36 Evans ..... <i>Canada</i> .....	37	46
37 Costantino ..... <i>Italy</i> .....	38	16
38 Imostroza Arancibia .... <i>Chile</i> .....	38	18
39 Mulvihill ..... <i>Eire</i> .....	38	50
40 Manninen ..... <i>U.S.A.</i> .....	39	14

## At 20 Kilometres

	<i>h.</i>	<i>m.</i>	<i>s.</i>
1 Gailly ..... <i>Belgium</i> .....	1	9	29
2 Lou ..... <i>China</i> .....	1	9	53
3 Guinez ..... <i>Argentina</i> .....	1	10	34
4 Josset ..... <i>France</i> .....	1	10	36
5 Ostling ..... <i>Sweden</i> .....	1	10	40
6 Cabrera ..... <i>Argentina</i> .....	1	10	51
7 Kurikkala ..... <i>Finland</i> .....	1	10	54
8 Luyt ..... <i>South Africa</i> .....	1	11	8
9 Choi ..... <i>Korea</i> .....	1	11	18
10 Holden ..... <i>Great Britain</i> .....	1	11	18
11 Sensini ..... <i>Argentina</i> .....	1	11	42
12 Coleman ..... <i>South Africa</i> .....	1	11	47
13 Heino ..... <i>Finland</i> .....	1	11	47
14 Richards ..... <i>Great Britain</i> .....	1	11	47
15 Piesset ..... <i>France</i> .....	1	12	25
16 Suh ..... <i>Korea</i> .....	1	12	51
17 Melin ..... <i>Sweden</i> .....	1	12	56
18 Larsen ..... <i>Denmark</i> .....	1	13	40
19 Schiesser ..... <i>Switzerland</i> .....	1	14	17
20 Kiss ..... <i>Hungary</i> .....	1	14	17
21 Systad ..... <i>Norway</i> .....	1	14	24
22 Kelley ..... <i>U.S.A.</i> .....	1	14	24
23 Kyriakidis ..... <i>Greece</i> .....	1	14	24
24 Frischknecht ..... <i>Switzerland</i> .....	1	14	38
25 Hong ..... <i>Korea</i> .....	1	15	11
26 Vogel ..... <i>U.S.A.</i> .....	1	15	16
27 Fedorick ..... <i>Canada</i> .....	1	15	24
28 Ragazos ..... <i>Greece</i> .....	1	15	27
29 Koru ..... <i>Turkey</i> .....	1	15	36
30 Cote ..... <i>Canada</i> .....	1	16	1
31 Hietanen ..... <i>Finland</i> .....	1	16	6
32 Singh ..... <i>India</i> .....	1	16	21
33 Evans ..... <i>Canada</i> .....	1	17	7
34 Jutz ..... <i>Switzerland</i> .....	1	17	18
35 Imostroza Arancibia .... <i>Chile</i> .....	1	17	31
36 Jones ..... <i>Great Britain</i> .....	1	17	36
37 Hakansson ..... <i>Sweden</i> .....	1	18	11
38 Manninen ..... <i>U.S.A.</i> .....	1	18	48
39 Mulvihill ..... <i>Eire</i> .....	1	19	45



MARATHON—*continued*INTERMEDIATE PLACINGS—*continued*

At 25 Kilometres			<i>h.</i>	<i>m.</i>	<i>s.</i>
1	Gailly	Belgium	1	27	27
2	Guinez	Argentina	1	28	8
3	Ostling	Sweden	1	28	26
4	Cabrera	Argentina	1	28	28
5	Luyt	South Africa	1	28	42
6	Lou	China	1	29	3
7	Heino	Finland	1	29	4
8	Choi	Korea	1	29	5
9	Kurikkala	Finland	1	29	10
10	Holden	Great Britain	1	29	28
11	Richards	Great Britain	1	29	32
12	Sensini	Argentina	1	29	34
13	Coleman	South Africa	1	30	11
14	Suh	Korea	1	31	21
15	Piesset	France	1	31	50
16	Melin	Sweden	1	32	12
17	Larsen	Denmark	1	32	38
18	Systad	Norway	1	32	49
19	Vogel	U.S.A.	1	33	8
20	Kelley	U.S.A.	1	33	16
21	Kiss	Hungary	1	33	38
22	Schiesser	Switzerland	1	33	39
23	Hong	Korea	1	33	53
24	Kyriakidis	Greece	1	33	58
25	Cote	Canada	1	35	6
26	Fedorick	Canada	1	35	10
27	Koru	Turkey	1	35	28
28	Evans	Canada	1	36	32
29	Ragazos	Greece	1	36	39
30	Imostroza				
	Arancibia	Chile	1	37	4
31	Frischknecht	Switzerland	1	37	7
32	Manninen	U.S.A.	1	38	30
33	Jutz	Switzerland	1	38	46
34	Hakansson	Sweden	1	39	6
35	Jones	Great Britain	1	39	11
36	Mulvihill	Eire	1	40	1
37	Singh	India	1	42	20

At 30 Kilometres			<i>h.</i>	<i>m.</i>	<i>s.</i>
1	Gailly	Belgium	1	47	1
2	Guinez	Argentina	1	47	33
3	Choi	Korea	1	47	53
4	Cabrera	Argentina	1	47	54
5	Ostling	Sweden	1	48	25
6	Luyt	South Africa	1	48	30
7	Richards	Great Britain	1	48	48
8	Heino	Finland	1	48	49
9	Sensini	Argentina	1	49	25
10	Kurikkala	Finland	1	49	29
11	Coleman	South Africa	1	49	50
12	Systad	Norway	1	52	26
13	Melin	Sweden	1	52	31
14	Vogel	U.S.A.	1	52	57
15	Larsen	Denmark	1	53	9
16	Suh	Korea	1	53	50
17	Piesset	France	1	53	51
18	Kellev	U.S.A.	1	54	23
19	Kiss	Hungary	1	55	15
20	Schiesser	Switzerland	1	55	25
21	Hong	Korea	1	55	37
22	Kyriakidis	Greece	1	55	44
23	Cote	Canada	1	56	30
24	Fedorick	Canada	1	57	3
25	Koru	Turkey	1	57	4
26	Imostroza				
	Arancibia	Chile	1	57	21
27	Evans	Canada	1	57	34
28	Manninen	U.S.A.	2	0	34
29	Ragazos	Greece	2	2	29
30	Mulvihill	Eire	2	2	30
31	Jutz	Switzerland	2	2	36
32	Hakansson	Sweden	2	2	49
33	Jones	Great Britain	2	3	4

## At 35 Kilometres

		<i>h.</i>	<i>m.</i>	<i>s.</i>	
1	Choi	Korea	2	6	2
2	Cabrera	Argentina	2	6	30
3	Gailly	Belgium	2	6	33
4	Guinez	Argentina	2	6	37
5	Richards	Great Britain	2	6	54
6	Luyt	South Africa	2	8	0
7	Ostling	Sweden	2	8	4
8	Coleman	South Africa	2	8	18
9	Sensini	Argentina	2	8	56
10	Kurikkala	Finland	2	9	54
11	Heino	Finland	2	9	57
12	Systad	Norway	2	11	32
13	Larsen	Denmark	2	11	53
14	Melin	Sweden	2	11	59
15	Vogel	U.S.A.	2	13	28
16	Kelley	U.S.A.	2	15	55
17	Kyriakidis	Greece	2	16	18

		<i>h.</i>	<i>m.</i>	<i>s.</i>	
18	Imostroza				
	Arancibia	Chile	2	16	18
19	Kiss	Hungary	2	16	38
20	Schiesser	Switzerland	2	16	48
21	Cote	Canada	2	17	2
22	Piesset	France	2	17	28
23	Evans	Canada	2	17	33
24	Koru	Turkey	2	17	52
25	Fedorick	Canada	2	18	20
26	Suh	Korea	2	18	38
27	Hong	Korea	2	18	47
28	Manninen	U.S.A.	2	22	27
29	Mulvihill	Eire	2	24	18
30	Jutz	Switzerland	2	26	0
31	Hakansson	Sweden	2	27	2
32	Jones	Great Britain	2	28	5

## 110 METRES HURDLES

### Previous Olympic Winners

1896	T. P. Curtis	<i>U.S.A.</i>	17.6 sec.	1920	E. Thomson	<i>Canada</i>	14.8 sec.
1900	A. C. Kraenzlein	<i>U.S.A.</i>	15.4 sec.	1924	D. Kinsey	<i>U.S.A.</i>	15.0 sec.
1904	F. W. Schule	<i>U.S.A.</i>	16.0 sec.	1928	S. J. M. Atkinson	<i>South Africa</i>	14.8 sec.
1908	F. C. Smithson	<i>U.S.A.</i>	15.0 sec.	1932	G. Saling	<i>U.S.A.</i>	14.6 sec.
1912	F. W. Kelly	<i>U.S.A.</i>	15.1 sec.	1936	F. G. Towns	<i>U.S.A.</i>	14.2 sec.
World Record :		{ 13.7 sec. F. G. Towns (U.S.A.)		Oslo, 1936			
		{ 13.7 sec. F. Wolcott (U.S.A.)		Philadelphia, 1941			
Olympic Record :		14.1 sec. F. G. Towns (U.S.A.)		Berlin, 1936			

There were 29 entries from 18 nations ; 28 participants from 18 nations  
*The event was over 10 flights of hurdles each 3 ft. 6 ins. (106 cm.) high*

## FIRST ROUND

*The first two in each heat qualified for the Semi-finals*

HEAT 1			HEAT 2			HEAT 3		
	<i>s.</i>			<i>s.</i>			<i>s.</i>	
1 Porter, W. ....	<i>U.S.A.</i> .....	14.3	1 Scott, C. L. ....	<i>U.S.A.</i> .....	14.8	1 Triulzi, A. ....	<i>Argentina</i> .....	14.6
2 Braekman, P. ....	<i>Belgium</i> .....	15.2	2 Frayer, H. ....	<i>France</i> .....	15.5	2 Gardner, P. ....	<i>Australia</i> .....	14.6
3 Recordon Burnier, M. ....	<i>Chile</i> .....	15.3	3 Rendin, B. ....	<i>Sweden</i> .....	15.5	3 Suarez Molezun, M. ....	<i>Spain</i> .....	15.9
4 Barkway, R. ....	<i>Great Britain</i> ....	—	4 Petropoulakis, L. ....	<i>Greece</i> .....	—	4 Birrell, J. ....	<i>Great Britain</i> ....	—
5 Berkay, E. ....	<i>Turkey</i> .....	—				5 Omiros- Crosfield, P. ....	<i>Greece</i> .....	—
HEAT 4			HEAT 5			HEAT 6		
	<i>s.</i>			<i>s.</i>			<i>s.</i>	
1 Vickers, J. ....	<i>India</i> .....	14.7	1 Marie, A. ....	<i>France</i> .....	14.9	1 Dixon, C. ....	<i>U.S.A.</i> .....	14.2
2 Lidman, H. ....	<i>Sweden</i> .....	14.7	2 Bernard, O. ....	<i>Switzerland</i> ....	14.9	2 Weinberg, R. ....	<i>Australia</i> .....	15.0
3 Sabater, J. ....	<i>Puerto Rico</i> .....	15.3	3 Foster, S. ....	<i>Jamaica</i> .....	15.1	3 Omnes, G. ....	<i>France</i> .....	15.2
4 Zwaan, J. M. ....	<i>Holland</i> .....	—	4 Finlay, D. ....	<i>Great Britain</i> ....	—	4 Alzamora, H. ....	<i>Peru</i> .....	—
5 Green, C. ....	<i>Australia</i> .....	—				5 Khan, Mazhar-Ul-Haq	<i>Pakistan</i> .....	—

## SEMI-FINALS

*The first three in each heat qualified for the Final*

HEAT 1			HEAT 2		
	<i>s.</i>			<i>s.</i>	
1 Dixon, C. ....	<i>U.S.A.</i> .....	14.2	1 Porter, W. ....	<i>U.S.A.</i> .....	14.1
2 Gardner, P. ....	<i>Australia</i> .....	14.5	2 Scott, C. L. ....	<i>U.S.A.</i> .....	14.2
3 Lidman, H. ....	<i>Sweden</i> .....	14.6	3 Triulzi, A. ....	<i>Argentina</i> .....	14.6
4 Braekman, P. ....	<i>Belgium</i> .....	—	4 Vickers, J. ....	<i>India</i> .....	—
5 Bernard, O. ....	<i>Switzerland</i> ....	—	5 Weinberg, R. ....	<i>Australia</i> .....	—
- Marie, A. ....	<i>France</i> .....	‡	6 Frayer, H. ....	<i>France</i> .....	—

## FINAL

	<i>s.</i>	
1 PORTER, W. ....	<i>U.S.A.</i> .....	13.9
2 SCOTT, C. L. ....	<i>U.S.A.</i> .....	14.1
3 DIXON, C. ....	<i>U.S.A.</i> .....	14.1
4 Triulzi, A. ....	<i>Argentina</i> .....	—
5 Gardner, P. ....	<i>Australia</i> .....	—
6 Lidman, H. ....	<i>Sweden</i> .....	—

‡ Did not finish.

**400 METRES HURDLES***Previous Olympic Winners*

1900	J. W. B. Tewkesbury	U.S.A.	57.6 sec.	1924	F. M. Taylor	U.S.A.	52.6 sec.
1904	H. L. Hillman	U.S.A.	53.0 sec.	1928	Lord Burghley	Great Britain	53.4 sec.
1908	C. J. Bacon	U.S.A.	55.0 sec.	1932	R. M. N. Tisdall	Eire	51.8 sec.
1920	F. F. Loomis	U.S.A.	54.0 sec.	1936	G. Hardin	U.S.A.	52.4 sec.

World Record : 50.6 sec. G. Hardin (U.S.A.) Sweden, 1934  
 Olympic Record : 52.0 sec. G. Hardin (U.S.A.) Los Angeles, 1932

There were 29 entries from 21 nations ; 25 participants from 17 nations  
*The event was over 10 flights of hurdles, each 3 feet (91.4 ms.) high*

**FIRST ROUND***The first two in each heat qualified for the Semi-finals*

HEAT 1			HEAT 2			HEAT 3		
		<i>secs.</i>			<i>secs.</i>			<i>secs.</i>
1	Cochran, R. .... U.S.A. ....	53.9	1	Whittle, H. .... Great Britain....	56.9	1	Holland, J. .... New Zealand....	54.6
2	Andre, J. .... France ....	54.5	2	Arifon, J. .... France ....	56.9	2	Storskrubb, A. .... Finland. ....	54.6
3	Alberti, H. .... Argentine ....	54.6	3	Petropoulakis, L. ... Greece .....	57.9	3	Horulu, K. .... Turkey.....	55.1
4	Aparicio Rode- waldt, J. .... Colombia.....	55.1	4	Khan, Mohsin .... Pakistan .....	59.5	4	Pope, M. .... Great Britain....	55.3
HEAT 4			HEAT 5			HEAT 6		
		<i>secs.</i>			<i>secs.</i>			<i>secs.</i>
1	Missoni, O. .... Italy .....	53.9	1	Ault, R. .... U.S.A. ....	54.7	1	White, D. .... Ceylon.....	53.6
2	Larsson, R. .... Sweden.....	54.5	2	Cros, Y. .... France .....	55.7	2	Kirk, J. .... U.S.A. ....	54.3
3	Unsworth, H. .... Great Britain....	55.1	3	Christen, W. .... Switzerland .....	56.7	3	Westman, A. .... Sweden.....	54.5
4	Guzman Lira, S. .... Chile .....	55.9	4	Ng, Liang-Chian.... China.....	57.7	4	Larochelle, W. .... Canada .....	54.9
5	Rosas Ruiz, M. .... Colombia .....	55.9						

**SEMI-FINALS***The first three in each heat qualified for the Final*

HEAT 1			HEAT 2		
		<i>secs.</i>			<i>secs.</i>
1	Larsson, R. .... Sweden.....	51.9	1	Cochran, R. .... U.S.A. ....	51.9
2	Ault, R. .... U.S.A. ....	52.1	2	Cros, Y. .... France .....	52.5
3	White, D. .... Ceylon .....	52.1	3	Missoni, O. .... Italy .....	53.4
4	Arifon, J. .... France .....	52.3	4	Whittle, H. .... Great Britain...	53.4
5	Kirk, J. .... U.S.A. ....	52.5	5	Storskrubb, A. .... Finland.....	53.5
6	Andre, J. .... France .....	56.3	6	Holland, J. .... N. Zealand .....	53.9

**FINAL**

		<i>secs.</i>
1	<b>COCHRAN, R.</b> .... U.S.A. ....	51.1
2	<b>WHITE, D.</b> .... Ceylon .....	51.8
3	<b>LARSSON, R.</b> .... Sweden .....	52.2
4	Ault, R. .... U.S.A. ....	52.4
5	Cros, Y. .... France .....	53.3
6	Missoni, O. .... Italy .....	54.0



*H. Moser (Switzerland), winner of the individual dressage contest, on Hummer, at the Command Central Stadium, Aldershot.*

*D. Pais (Portugal) riding Zuari in the roads and tracks section of the endurance test in the three-day event. The speed necessary over this section of the course was 220 metres a minute.*





*A. Blaser (Switzerland) on Mahmud, clearing the fence leading to the "slide," during the cross-country section of the three-day event.*

*L. Bolton (Great Britain), on Sylveste, coming down the "slide."*







*A. Blaser (Switzerland) on Mahmud taking the difficult double fence in the cross-country section of the three-day event.*



*Aecio Morrot Coelho (Brazil), on Guapo, takes one of the jumps in the steeplechase section of the endurance test in the three-day event.*

*B. Chevallier (France), winner of the three-day event, riding Aiglonne over the double bar in the jumping test on the third day.*





*F. Henry (U.S.A.), second in the three-day event (individual) clears the double bar on Swing Low during the final day's jumping.*

*J. Selfelt (Sweden), third in the three-day event (individual), clearing the same jump on Claque.*







*H. Mariles Cortes (Mexico), individual winner of the Prix des Nations, clearing the wall on Arete.*

*J. d'Orgeix (France), third in the Prix des Nations individual contest, clearing the wall on Sucre de Pomme.*





*R. Campos (Argentine), on Santa Fe, at the stile and ditch in the Prix des Nations.*



*F. Wing (U.S.A.), fourth in the Prix des Nations, clearing the triple bar on Democrat.*

*H. Llewellyn (Great Britain) on Foxhunter, taking the fence and ditch in the Prix des Nations.*



*E. Thomson (U.S.A.) saluting the judges on the completion of the dressage section of the three-day event. The type of fencing used to enclose the dressage arena can be clearly seen*





*F. Ahern (Eire) riding Aherlow over the six-barred gate in the Prix des Nations.*





*R. Urizac (Mexico), second in the Prix des Nations, on Hatvey, clearing the stile and ditch.*

*A general view of the Empire Stadium, Wembley, on the closing day of the Games, during the course of the Prix des Nations.*





*A general view of part of the fencing arena during the semi-final of the men's foil team event. The fencers on the nearer piste are M. Zulficar (Egypt) (No. 34), and C. d'Oriola (France) (No. 49). A women's foil contest is proceeding in the background.*

*J. Buhan (France) on the right, winner of the individual foil title, in play against G. A. Pouliot (Canada).*

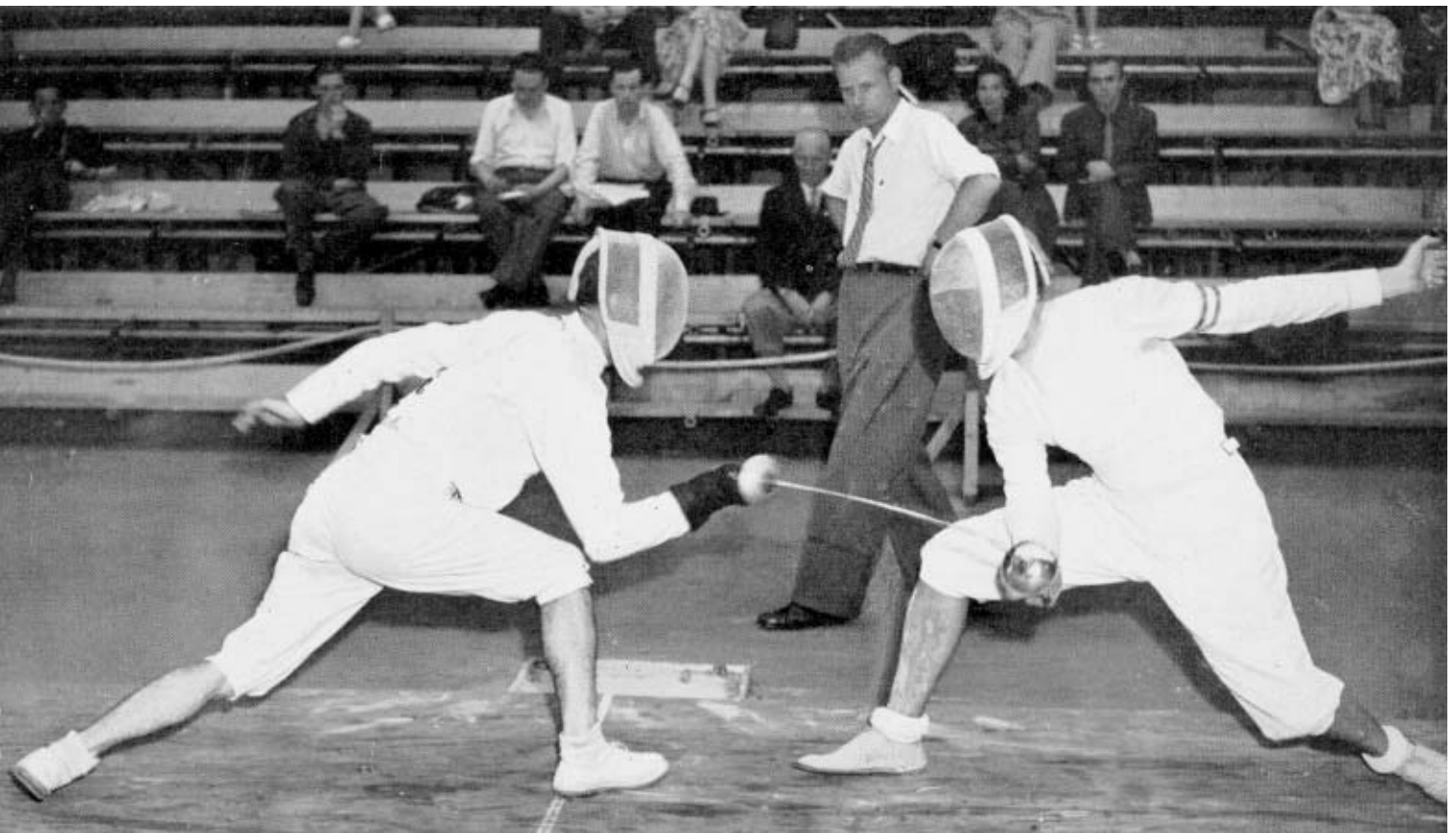

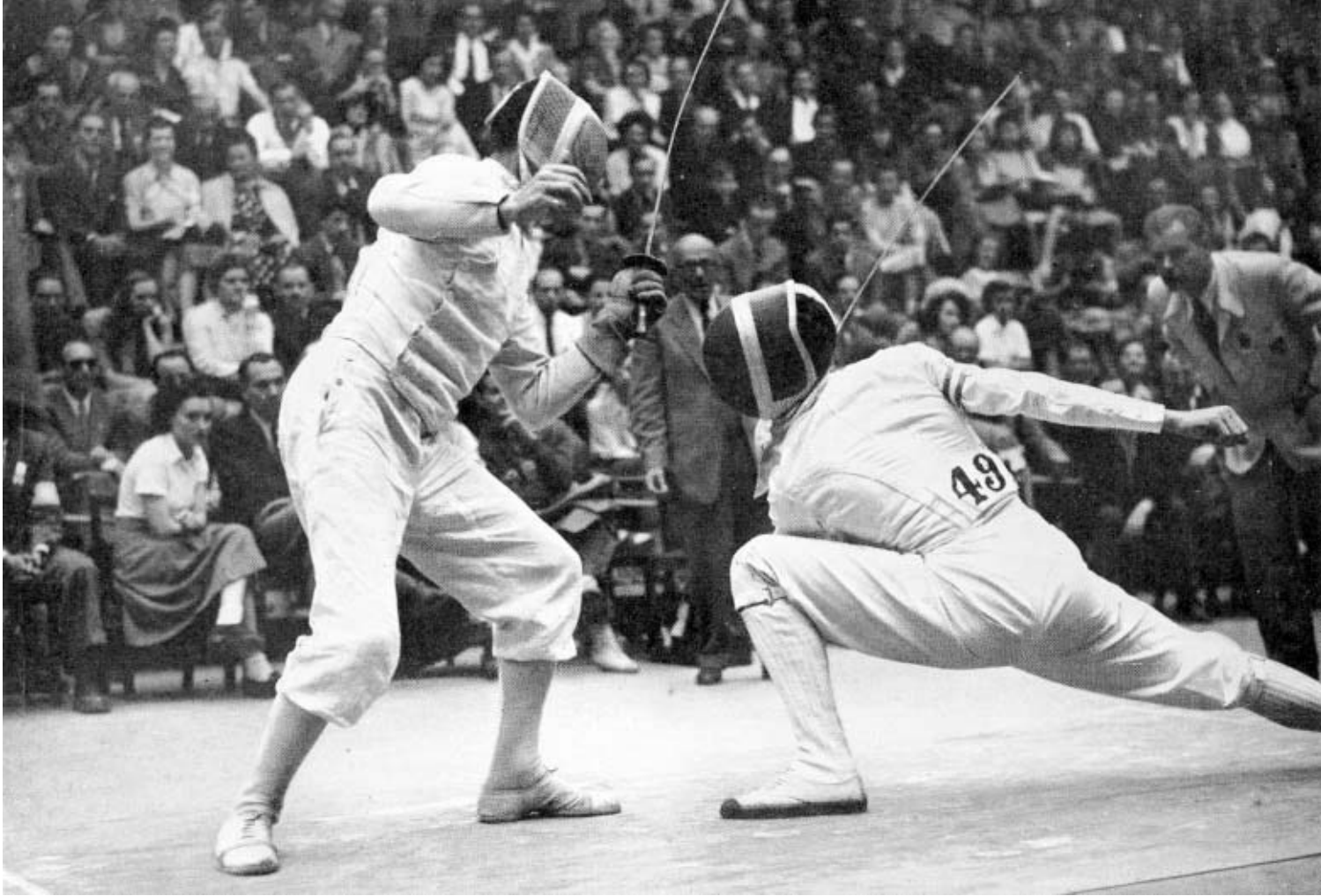

*C. d'Oriola (France) (No. 49), runner-up in the individual foil title, competing in the final pool against R. Bougnol (France), who was placed fifth.  
J. Buhan (France) on right, winner of the individual foil title, against J. Emrys Lloyd (Great Britain), who was placed fourth.*

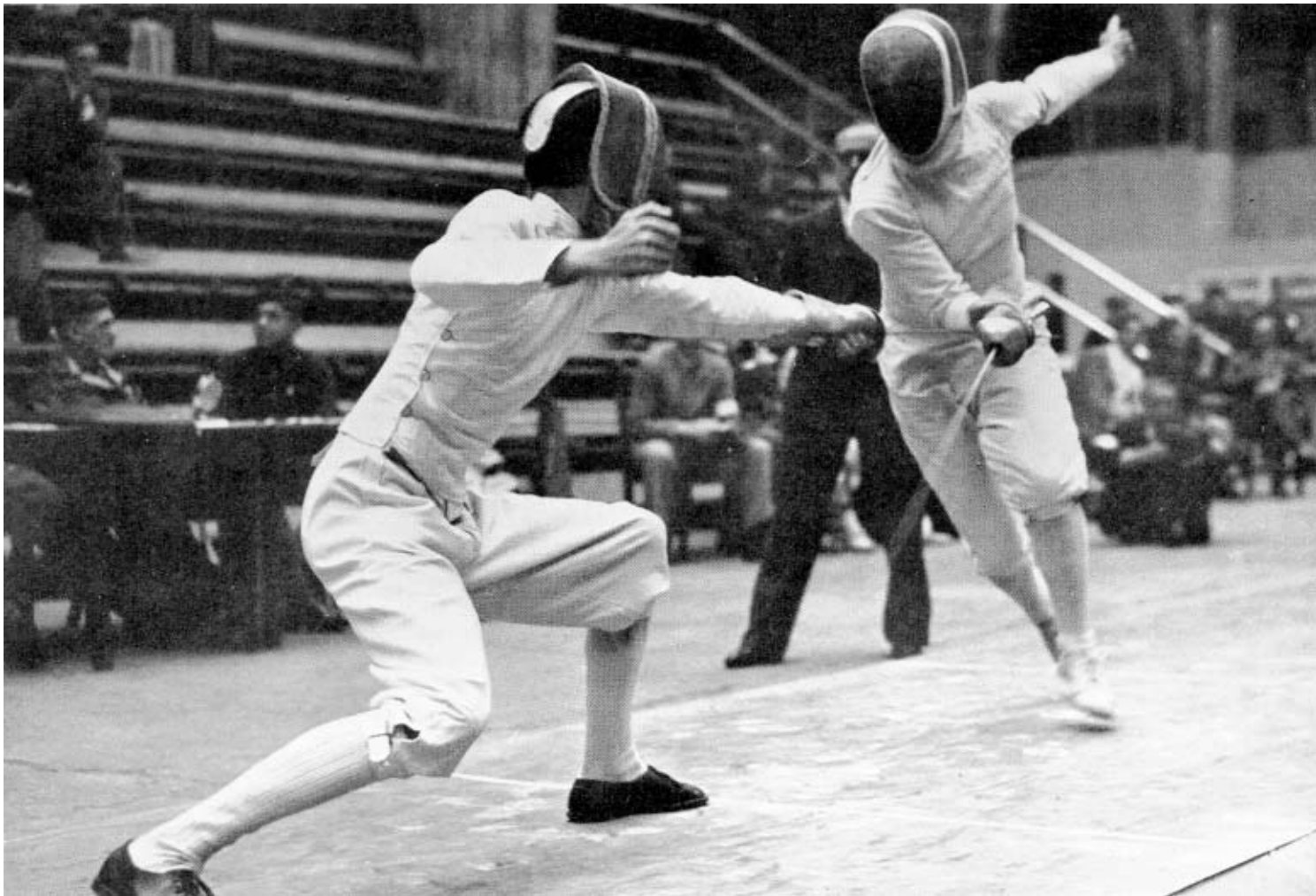





A "double Hit" in the epee contest. B. Mikla (Hungary) on the left, against S. Thofelt (Sweden).

A general view of the main piste during the semi-final of the epee team competition.

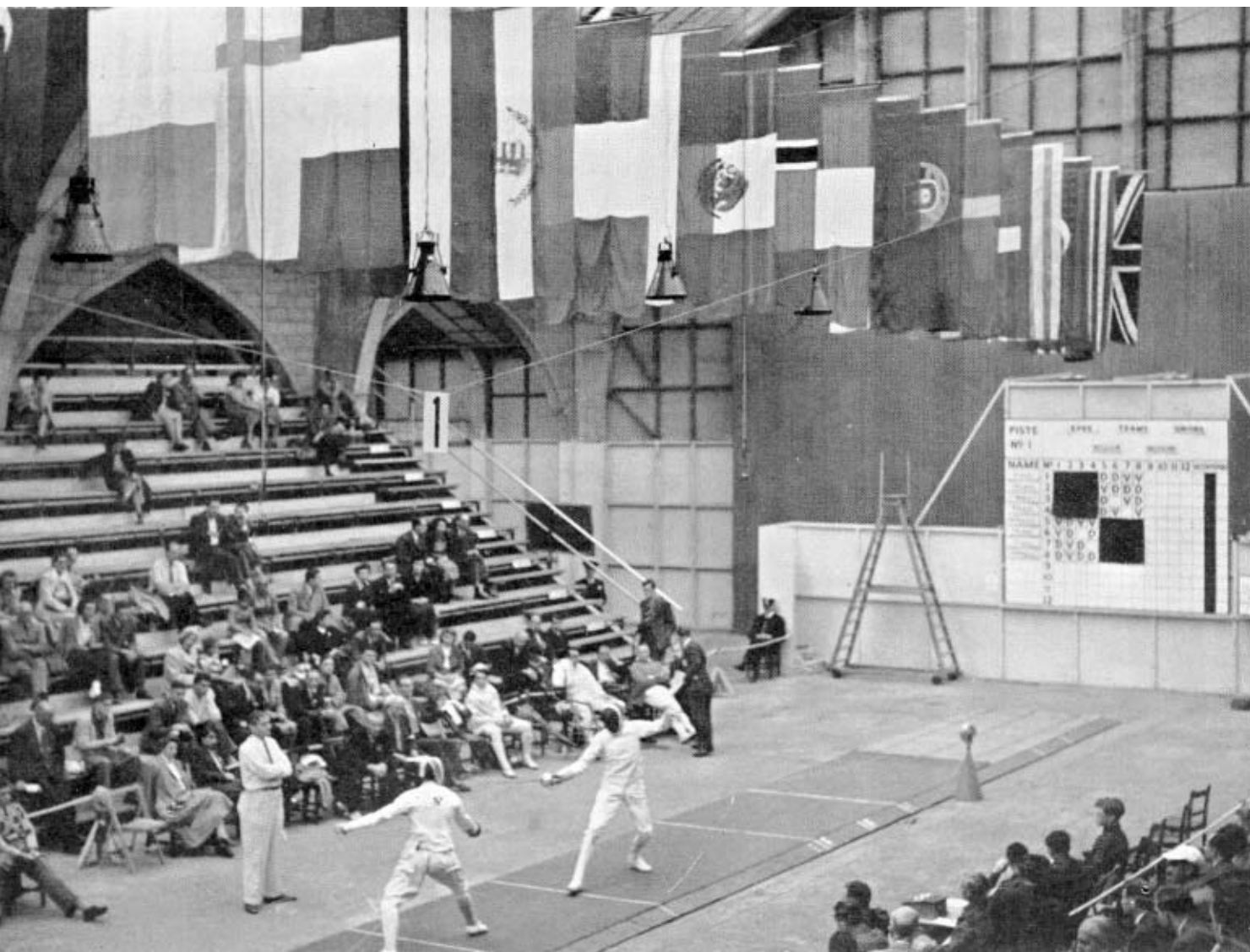





*The final pool of the individual epee. L. Cantone (Italy) is in play against H. Lepage (France), who was placed sixth.*

*A. Gerevich (Hungary) on the right, winner of the individual sabre title, taking part in the final pool against G. Dare (Italy).*





*The final pool of the individual sabre, with P. Kovacs (Hungary), who was placed third, on the left, against A. Haro Oliva (Mexico). The scoreboard shows that A. Gerevich (Hungary) is already winner of the event.*

*A. Gerevich (Hungary) on the right, winner, attacking V. Pinton (Italy), the runner-up, in the final pool of the individual sabre championship.*





*Sabre team semi-final, France v. Italy. G. Leveque (France), on the left, stop-hitting A. Montano (Italy)*





Victory ceremony for the women's foil, after the presentation of the medals by the President of the International Olympic Committee, Mr. J. Sigfrid Edstrom, on right. The winner was I. Elek (Hungary), who had also been the winner in 1936. Second was K. Lachmann (Denmark), and third E. Muller-Preis (Austria).

The scoreboard on completion of the final pool of the women's foil

PISTE Nº 1	LADIES											F
	INDIVIDUAL											
FINAL												
NAME	Nº	1	2	3	4	5	6	7	8	9	10	11
MULLER-Preis	1	■	V	V	V	V	D	D	V			
ELEK HUNGARY	2	D	■	V	D	D	D	D	D			
GLEN HAIG AUSTRALIA	3	D	D	■	V	D	D	D	D			
CESARI ITALY	4	D	V	D	■	D	D	D	D			
FILZ AUSTRIA	5	D	V	V	V	■	V	D	D			
ELEK I HUNGARY	6	V	V	V	V	D	■	V	V			
LACHMANN DENMARK	7	V	V	V	V	V	D	■	D			
CERRA U.S.A.	8	D	V	V	V	V	D	V	■			

**3000 METRES STEEPLECHASE***Previous Olympic Winners*

1920	P. Hodge	Great Britain	10 m.	0.4 sec.	1932	V. Iso-Hollo	Finland	10 m.	33.4 sec.*
1924	V. Ritola	Finland	9 m.	33.6 sec.	1936	V. Iso-Hollo	Finland	9 m.	3.8 sec.
1928	T. A. Loukola	Finland	9 m.	21.8 sec.	* An extra lap was covered by mistake				

There is no official World Record for this event

Olympic Record : 9 m. 3.8 sec. V. Iso-Hollo (Finland) Berlin, 1936

*There were four flights of hurdles each 3 ft. (91.4 cm.) high and one water jump in each lap*

There were 29 entries from 14 nations ; 26 participants from 12 nations

**FIRST ROUND**

*The first four in each heat qualified for the Final*

HEAT 1			HEAT 2			HEAT 3			
		<i>m s.</i>			<i>m s.</i>			<i>m s.</i>	
1	Elmsarar, E.	Sweden.....	9	15.0	1	Pujazon, R.	France .....	9	20.8
2	Guyodo, A.	France .....	9	17.2	2	Hagstrom, G.	Sweden .....	9	22.6
3	Siltaloppi, P.	Finland .....	9	22.4	3	Segedin, P.	Yugoslavia .....	9	25.0
4	Miranda Justo, C.	Spain.....	9	24.2	4	Ross, H.	U.S.A. ....	9	30.4
5	Stefanovic, D.	Yugoslavia .....	9	39.6	5	Olesen, A.	Denmark.....	9	33.6
6	Doms, J.	Belgium .....	9	41.8	6	Theys, L.	Belgium .....	9	37.4
-	Curry, T.	Great Britain.	*		-	Ozcan, M.	Turkey.....	*	
-	McMillen, R.	U.S.A.....	*		-	Toivari, P.	Finland.....	*	
-	Mavrapostolos, B.	Greece .....	*		-	Tudor, G.	Great Britain	*	
1	Sjostrand, T.	Sweden.....	9	21.0	2	Kainlauri, A.	Finland.....	9	25.8
2	Everaert, R.	Belgium .....	9	26.4	3	Chesneau, M.	France .....	9	27.6
3	Onel, C.	Turkey.....	9	28.4	4	Overton, W.	U.S.A. ....	1	14.4
4	Howell, R.	Great Britain.	*		5	Frieden, Paul.	Luxembourg...	*	
5	Frieden, Paul.	Luxembourg...	*		6				

**FINAL**

		<i>m s.</i>
1	SJOSTRAND, T. ....	Sweden..... 9 4.6
2	ELMSATER, E.....	Sweden..... 9 8.2
3	HAGSTROM, G.....	Sweden..... 9 11.8
4	Guyodo, A. ....	France .....
5	Siltaloppi, P. ....	Finland .....
6	Segedin, P. ....	Yugoslavia .....
-	Ross, H. ....	U.S.A. .... *
-	Kainlauri, A. ....	Finland .....
-	Everaert, R. ....	Belgium .....
-	Chesneau, M. ....	France .....
-	Miranda Justo, C. ....	Spain..... *
-	Pujazon, R. ....	France .....

\* Also competed.

‡ Did not finish.

**4 x 100 METRES RELAY***Previous Olympic Winners*

1912	Great Britain	42.4 sec.	1928	U.S.A.	41.0 sec.
1920	U.S.A.	42.2 sec.	1932	U.S.A.	40.0 sec.
1924	U.S.A.	41.0 sec.	1936	U.S.A.	39.8 sec.

World and Olympic Record : 39.8 sec. U.S.A. (J. Owens, R. H. Metcalfe, F. Draper, F. C. Wykoff) Berlin, 1936

There were 98 entries from 16 nations ; 60 participants from 15 nations

**FIRST ROUND**

*The first two teams in each heat qualified for the Final*

HEAT 1		HEAT 2		HEAT 3	
	<i>s.</i>		<i>s.</i>		<i>s.</i>
1	<i>U.S.A.</i> (Ewell, H., Wright, L.)	41.1	1	<i>Great Britain</i> (McCorquodale, A., Gregory, J., Jones, K., Archer, J.)	41.4
2	<i>Italy</i> (Tito, M., Perucconi, E., Monti, C., Siddi, A.)	41.3	2	<i>Hungary</i> (Tima, F., Bartha, L., Goldovanyi, B., Csanyi, G.)	41.4
3	<i>Brazil</i> (Costa Ramos, R., Coutinho da Silva, H., Zanoni Hausen, I., Pereira da Silva, H.)	42.4	3	<i>Australia</i> (Bruce, T., Bartram, J., Curotta, M., Treloar, J.)	41.5
-	<i>Turkey</i> (Aksur, K., Berkay, E., Oztas, R., Sarialp, R.)	*	4	<i>Uruguay</i> (Fayos, M., Lopez Testa, J., Perez, W., Ascune, H.)	42.8
			5	<i>Bermuda</i> (Dill, H., Johnson, P., Lines, S., Mahoney, F.)	45.4
			-	<i>Belgium</i> (Bourgaux, F., Braekman, P., Linssen, F., Van de Wiele,	‡
			1	<i>Holland</i> (Scholten, G., Meyer, J., Zwaan, J. G., Lammers, J.)	41.7
			2	<i>Canada</i> (Pettie, D., O'Brien, J., McFarlane, D., Haggis, E.)	42.3
			3	<i>Argentine</i> (Bonnhoff, G., Biedermann, A., Isaack, C., Lapuente, F.)	42.4
			4	<i>Iceland</i> (Bjarnasson, A., Thorvaldsson, F., Eyjolfsson, T., Clausen, H.)	42.9
			-	<i>France</i> (Porthault, A., Litaudon, M., Le Bas, J., Valmy, R.)	‡

**FINAL**

	<i>s.</i>
1	<b>U.S.A.</b> ..... 40.6
2	<b>GREAT BRITAIN</b> ..... 41.3
3	<b>ITALY</b> ..... 41.5
4	<i>Hungary</i> ..... 41.6
5	<i>Canada</i> ..... 41.9
6	<i>Holland</i> ..... 41.9

\* Disqualified.

‡ Did not finish.

**4 x 400 METRES RELAY***Previous Olympic Winners*

1912	U.S.A.	3 m. 16.6 sec.	1928	U.S.A.	3 m. 14.2 sec.
1920	Great Britain	3 m. 22.2 sec.	1932	U.S.A.	3 m. 8.2 sec.
1924	U.S.A.	3 m. 16.0 sec.	1936	Great Britain	3 m. 9.0 sec.

World and Olympic Record : 3 m. 8.2 sec. U.S.A. (I. Fuqua, E. Ablowich, K. Warner, W. Carr) Los Angeles, 1932

There were 102 entries from 17 nations ; 60 participants from 15 nations

**FIRST ROUND**

*The first two teams in each heat qualified for the Final*

HEAT 1		HEAT 2		HEAT 3							
	<i>m. s.</i>		<i>m. s.</i>		<i>m. s.</i>						
1	U.S.A. (Cochran, R., Bourland, C., Harnden, A., Whitfield, M.).....	3	12.6	1	Jamaica (Rhoden, V., Laing, L., Wint, A., McKenley, H.)....	3	14.0	1	Finland (Suvanto, T., Talja, O., Holmberg, R., Storskrubb, A.) .....	3	20.6
2	Italy (Rocca, G., Missoni, O., Paterlini, L., Siddi, A.).....	3	14.0	2	France (Kerebel, J., Schewetta, F., Chef d'hotel, R., Lunis, J.) .....	3	17.0	2	Sweden (Lundqvist, K., Wolfbrandt, L., Alnevik, F., Larsson, R.).....	3	21.0
3	Great Britain (Lewis, L., Pugh, D., Pike, M., Roberts, W.)....	3	14.2	3	Canada (McCullough, E., Larochelle, W., McFarlane, D., McFarlane, R.).....	3	19.0	3	Argentina (Pocovi, A., Alberti, H., Evans, G., Avalos, A.)....	3	21.2
4	Switzerland (Hardmeier O., Keller, W., Trepp, M., Volkmer, K.).....	3	23.0	4	Chile (Silva Anguita, C, Hitelman Reiticft, J., Guzman Lira, S., Ehlers Trostel, G.)..	3	23.8	4	Yugoslavia (Bulic, J., Racic, M., Cosic, A., Sabolovic, Z.).....	3	25.4
-	Eire (Denroche, C., Myles, R., Dolan, P., Reardon, J.).....	*		5	Turkey (Dincturk, S., Ishman, R., Acarbay, E., Horulu, K.)	3	35.0	5	Greece (Mavroidis, B., Petropoulakis, L., Petrakis, S., Stratakos, S.).....	3	33.0

**FINAL**

	<i>m. s.</i>		
1	U.S.A. ....	3	10.4
2	FRANCE.....	3	14.8
3	SWEDEN.....	3	16.0
4	Finland.....	3	24.8
-	Italy.....	‡	
-	Jamaica.....	‡	

\* Disqualified.

‡ Did not finish.



**10000 METRES WALK***Previous Olympic Winners*

1912	G. H. Goulding	<i>Canada</i>	46 m. 28.4 sec.	1920	U. Frigerio	<i>Italy</i>	48 m. 6.2 sec.
				1924	U. Frigerio	<i>Italy</i>	47 m. 49.0 sec.
	World Record :		42 m. 39.6 sec.		V. Hardmo (Sweden)		Kumla, 1945
	Olympic Record :		46 m. 28.4 sec.		G. H. Goulding (Canada)		Stockholm, 1912

## THE JUDGES OF WALKING WERE :

F. W. Blackmore (*Great Britain*) (Chief)

F. Guilleux ( <i>France</i> )	H. Evans	G. Oberweger ( <i>Italy</i> )
L. Henrichson ( <i>Norway</i> )	G. R. Goodwin	R. C. Mawbey
J. B. Belchamber	E. Linde ( <i>Sweden</i> )	W. J. Palmer
	G. F. McCombe	

There were 19 entries from 10 nations ; 19 participants from 10 nations

**FIRST ROUND***The first five in each heat qualified for the Final*

## HEAT 1

		<i>m</i>	<i>s.</i>
1	Mikaelsson, J..... <i>Sweden</i> .....	4	3.0
2	Morris, C..... <i>Great Britain</i> .....	4	10.4
3	Maggi, E..... <i>France</i> .....	4	44.2
4	Dordoni, G..... <i>Italy</i> .....	4	25.8
5	Johansson, B..... <i>Sweden</i> .....	4	44.2
6	Norregard		
	Hammer, K..... <i>Norway</i> .....	4	48.6
-	Knott, G..... <i>Australia</i> .....		*
-	Reyneke, J..... <i>South Africa</i> .....		†
-	Sharaga, F..... <i>U.S.A.</i> .....		†
-	Weber, E..... <i>U.S.A.</i> .....		†

## HEAT 2

		<i>m</i>	<i>s.</i>
1	Churcher, H..... <i>Great Britain</i> .....	4	26.4
2	Schwab, F..... <i>Switzerland</i> ..	4	38.0
3	West, R..... <i>Great Britain</i> .....	4	11.6
4	Corsaro, G..... <i>Italy</i> .....	4	26.8
5	Hardmo, G..... <i>Sweden</i> .....	4	34.8
6	Courron, L..... <i>France</i> .....	4	13.0
-	Singha, S..... <i>India</i> .....		†
-	Laskau, H..... <i>U.S.A.</i> .....		†
-	Chevalier, L..... <i>France</i> .....		†

**FINAL**

		<i>m.</i>	<i>s.</i>
1	<b>MIKAELSSON, J</b> ..... <i>Sweden</i> .....	45	13.2
2	<b>JOHANSSON, B</b> ..... <i>Sweden</i> .....	45	43.8
3	<b>SCHWAB, F</b> ..... <i>Switzerland</i> .....	46	0.2
4	Morris, C..... <i>Great Britain</i> .....	46	4.0
5	Churcher, H..... <i>Great Britain</i> .....	46	28.0
6	Maggi, E..... <i>France</i> .....	47	2.8
-	Dordoni, G..... <i>Italy</i> .....		*
-	West, R..... <i>Great Britain</i> .....		*
-	Corsaro, G..... <i>Italy</i> .....		*
-	Hardmo, G..... <i>Sweden</i> .....		†

\*Also competed.

† Disqualified.

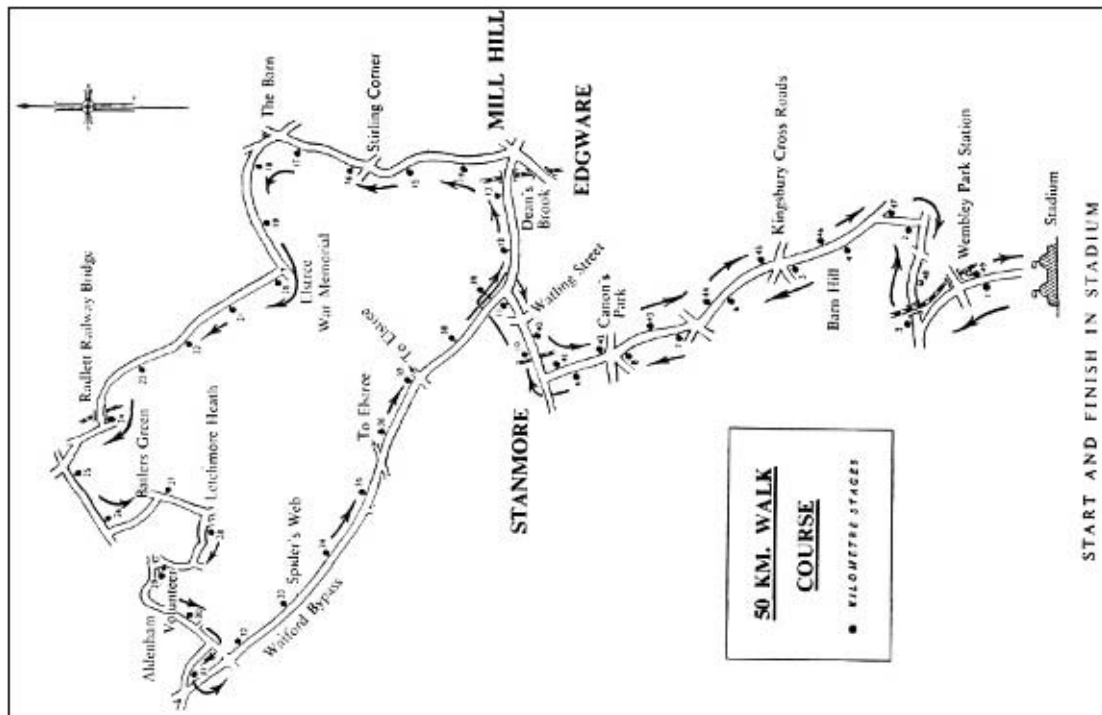
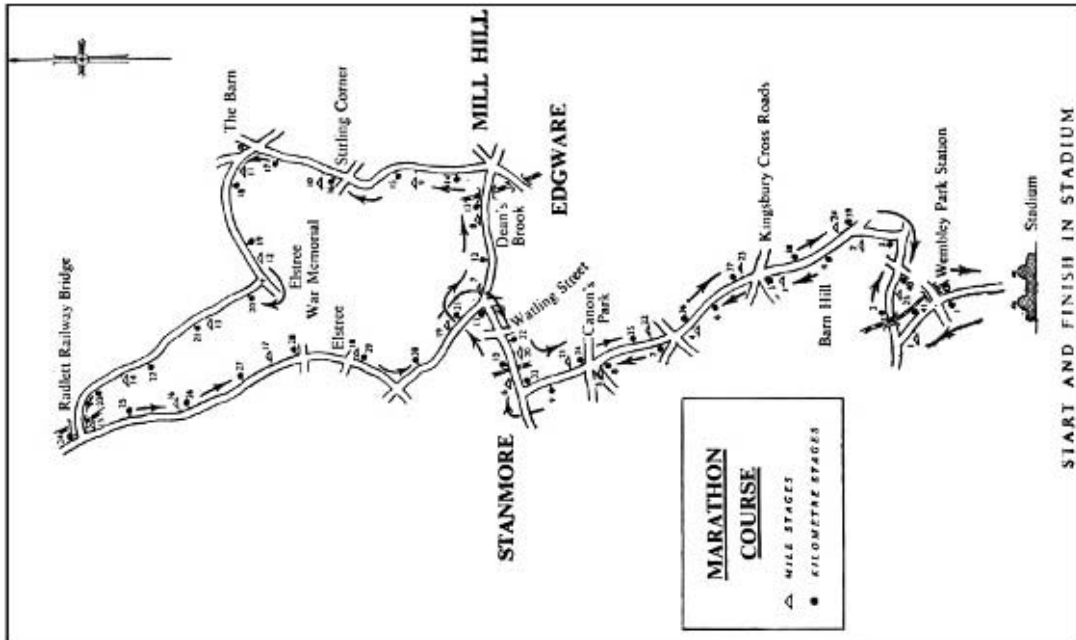

**50000 METRES ROAD WALK***Previous Olympic Winners*

1932 T. W. Green *Great Britain* 4 h. 50 m. 10 sec. 1936 H. H. Whitlock *Great Britain* 4 h. 30 m. 41.4 sec.

There is no official World Record for this event

Olympic Record : 4 h. 30 m. 41.4 sec. H. H. Whitlock (Great Britain) Berlin, 1936

There were 23 entries from 11 nations ; 23 participants from 11 nations

		<i>h. m. s.</i>
1	<b>LJUNGGREN, J.</b> <i>Sweden</i> .....	4 41 52
2	<b>GODEL, G.</b> ..... <i>Switzerland</i> .....	4 48 17
3	<b>JOHNSON, T.</b> ..... <i>Great Britain</i> .....	4 48 31
4	Bruun, E..... <i>Norway</i> .....	4 53 18
5	Martineau, H. A ..... <i>Great Britain</i> .....	4 53 58
6	Bjurstrom, R..... <i>Sweden</i> .....	4 56 43
7	Mazille, P..... <i>France</i> .....	5 1 40
8	Hubert, C..... <i>France</i> .....	5 3 12
9	Villaplana Vargas, E. <i>Spain</i> .....	5 3 31
10	Jonsson, T ..... <i>Sweden</i> .....	5 5 8
11	Caron, H..... <i>France</i> .....	5 8 15
12	Crosbie, E..... <i>U.S.A.</i> .....	5 15 16
13	Laszlo, S..... <i>Hungary</i> .....	5 16 30
14	Cascino, S ..... <i>Italy</i> .....	5 20 3
15	Deni, J ..... <i>U.S.A.</i> .....	5 28 33
16	Weinecker, A ..... <i>U.S.A.</i> .....	5 30 14
—	Barnaas, P..... <i>Norway</i> .....	‡
—	Bertolini, V ..... <i>Italy</i> .....	‡
—	Ibanez, S..... <i>Argentina</i> .....	‡
—	Pretti, F..... <i>Italy</i> .....	‡
—	Singha, S ..... <i>India</i> .....	‡
—	Whitlock, G..... <i>Great Britain</i> .....	‡
—	Winther, G ..... <i>Norway</i> .....	‡

‡ Did not finish.

## 50000 METRES ROAD WALK—continued

## INTERMEDIATE PLACINGS

## At 10 Kilometres

		<i>m.</i>	<i>s.</i>
1 Ljunggren .....	<i>Sweden</i> .....	52	36
2 Bruun .....	<i>Norway</i> .....	54	4
3 Whitlock .....	<i>Great Britain</i> .....	54	21
4 Martineau .....	<i>Great Britain</i> .....	54	21
5 Pretti .....	<i>Italy</i> .....	54	27
6 Laszlo .....	<i>Hungary</i> .....	55	1
7 Jonsson .....	<i>Sweden</i> .....	55	3
8 Bjurstrom .....	<i>Sweden</i> .....	55	12
9 Bertolini .....	<i>Italy</i> .....	56	3
10 Mazille .....	<i>France</i> .....	56	16
11 Godel .....	<i>Switzerland</i> .....	56	18
12 Hubert .....	<i>France</i> .....	56	21
13 Johnson .....	<i>Great Britain</i> .....	56	32
14 Cascino .....	<i>Italy</i> .....	56	40
15 Villaplana Vargas .....	<i>Spain</i> .....	56	47
16 Caron .....	<i>France</i> .....	56	50
17 Winther .....	<i>Norway</i> .....	57	46
18 Baarnaas .....	<i>Norway</i> .....	58	27
19 Deni .....	<i>U.S.A.</i> .....	63	7
20 Crosbie .....	<i>U.S.A.</i> .....	63	12
21 Weinecker .....	<i>U.S.A.</i> .....	64	48

## At 25 Kilometres

1 Ljunggren .....	<i>Sweden</i> .....	2	12	17
2 Whitlock .....	<i>Great Britain</i> ...	2	17	2
3 Martineau .....	<i>Great Britain</i> ...	2	19	35
4 Bruun .....	<i>Norway</i> .....	2	20	24
5 Johnson .....	<i>Great Britain</i> ...	2	21	12
6 Jonsson .....	<i>Sweden</i> .....	2	21	28
7 Bjurstrom .....	<i>Sweden</i> .....	2	22	16
8 Godel .....	<i>Switzerland</i> ..	2	22	26
9 Mazille .....	<i>France</i> .....	2	24	21
10 Hubert ..	<i>France</i> .....	2	24	21
11 Villaplana Vargas .....	<i>Spain</i> .....	2	25	16
12 Caron .....	<i>France</i> .....	2	26	38
13 Pretti .....	<i>Italy</i> .....	2	27	11
14 Laszlo .....	<i>Hungary</i> .....	2	28	26
15 Baarnaas .....	<i>Norway</i> .....	2	29	44
16 Cascino .....	<i>Italy</i> .....	2	29	55
17 Winther .....	<i>Norway</i> .....	2	29	57
18 Deni .....	<i>U.S.A.</i> .....	2	38	32
19 Crosbie .....	<i>U.S.A.</i> .....	2	38	45
20 Weinecker .....	<i>U.S.A.</i> .....	2	47	55

## At 40 Kilometres

1 Ljunggren .....	<i>Sweden</i> .....	3	42	35
2 Johnson .....	<i>Great Britain</i> ...	3	49	7
3 Godel .....	<i>Switzerland</i> ....	3	49	52
4 Martineau .....	<i>Great Britain</i> ...	3	53	4
5 Bruun .....	<i>Norway</i> .....	3	53	6
6 Bjurstrom .....	<i>Sweden</i> .....	3	56	27
7 Mazille .....	<i>France</i> .....	3	58	15
8 Jonsson .....	<i>Sweden</i> .....	3	58	28
9 Villaplana Vargas .....	<i>Spain</i> .....	3	59	29
10 Hubert .....	<i>France</i> .....	4	0	47
11 Caron .....	<i>France</i> .....	4	5	43
12 Crosbie .....	<i>U.S.A.</i> .....	4	12	15
13 Cascino .....	<i>Italy</i> .....	4	13	43
14 Laszlo .....	<i>Hungary</i> .....	4	14	8
15 Winther .....	<i>Norway</i> .....	4	21	45
16 Deni .....	<i>U.S.A.</i> .....	4	22	54
17 Weinecker .....	<i>U.S.A.</i> .....	4	28	9

## At 20 Kilometres

		<i>h.</i>	<i>m.</i>	<i>s.</i>
1 Ljunggren .....	<i>Sweden</i> .....	1	45	5
2 Whitlock .....	<i>Great Britain</i> ..	1	48	41
3 Martineau .....	<i>Great Britain</i> ..	1	50	4
4 Bruun .....	<i>Norway</i> .....	1	50	16
5 Pretti .....	<i>Italy</i> .....	1	50	35
6 Jonsson .....	<i>Sweden</i> .....	1	51	16
7 Bjurstrom .....	<i>Sweden</i> .....	1	51	16
8 Johnson .....	<i>Great Britain</i> ..	1	52	40
9 Godel .....	<i>Switzerland</i> ..	1	53	11
10 Mazille .....	<i>France</i> .....	1	53	39
11 Hubert .....	<i>France</i> .....	1	53	41
12 Villaplana Vargas .....	<i>Spain</i> .....	1	55	8
13 Laszlo .....	<i>Hungary</i> .....	1	55	25
14 Caron .....	<i>France</i> .....	1	55	25
15 Bertolini .....	<i>Italy</i> .....	1	55	41
16 Cascino .....	<i>Italy</i> .....	1	58	34
17 Winther .....	<i>Norway</i> .....	1	58	35
18 Baarnaas .....	<i>Norway</i> .....	1	59	19
19 Crosbie .....	<i>U.S.A.</i> .....	2	5	47
20 Deni .....	<i>U.S.A.</i> .....	2	5	47
21 Weinecker .....	<i>U.S.A.</i> .....	2	12	5

## At 35 Kilometres

1 Ljunggren .....	<i>Sweden</i> .....	3	10	49
2 Whitlock .....	<i>Great Britain</i> ..	3	18	56
3 Johnson .....	<i>Great Britain</i> ..	3	19	15
4 Godel .....	<i>Switzerland</i> ....	3	20	24
5 Martineau .....	<i>Great Britain</i> ..	3	20	54
6 Bruun .....	<i>Norway</i> .....	3	21	10
7 Bjurstrom .....	<i>Sweden</i> .....	3	24	57
8 Jonsson .....	<i>Sweden</i> .....	3	24	57
9 Mazille .....	<i>France</i> .....	3	25	26
10 Villaplana Vargas .....	<i>Spain</i> .....	3	27	9
11 Hubert .....	<i>France</i> .....	3	27	32
12 Caron .....	<i>France</i> .....	3	32	5
13 Laszlo .....	<i>Hungary</i> .....	3	36	53
14 Cascino .....	<i>Italy</i> .....	3	38	59
15 Winther .....	<i>Norway</i> .....	3	41	5
16 Crosbie .....	<i>U.S.A.</i> .....	3	41	31
17 Deni .....	<i>U.S.A.</i> .....	3	47	22
18 Weinecker .....	<i>U.S.A.</i> .....	3	54	35

## At 45 Kilometres

1 Ljunggren .....	<i>Sweden</i> .....	4	12	45
2 Johnson .....	<i>Great Britain</i> ...	4	17	59
3 Godel .....	<i>Switzerland</i> ....	4	18	31
4 Martineau .....	<i>Great Britain</i> ...	4	23	1
5 Bruun .....	<i>Norway</i> .....	4	23	2
6 Bjurstrom .....	<i>Sweden</i> .....	4	27	25
7 Mazille .....	<i>France</i> .....	4	30	16
8 Villaplana Vargas .....	<i>Spain</i> .....	4	30	27
9 Hubert .....	<i>France</i> .....	4	32	25
10 Jonsson .....	<i>Sweden</i> .....	4	32	27
11 Caron .....	<i>France</i> .....	4	36	29
12 Crosbie .....	<i>U.S.A.</i> .....	4	43	38
13 Laszlo .....	<i>Hungary</i> .....	4	45	26
14 Cascino .....	<i>Italy</i> .....	4	46	8
15 Deni .....	<i>U.S.A.</i> .....	4	55	39
16 Weinecker .....	<i>U.S.A.</i> .....	4	59	31

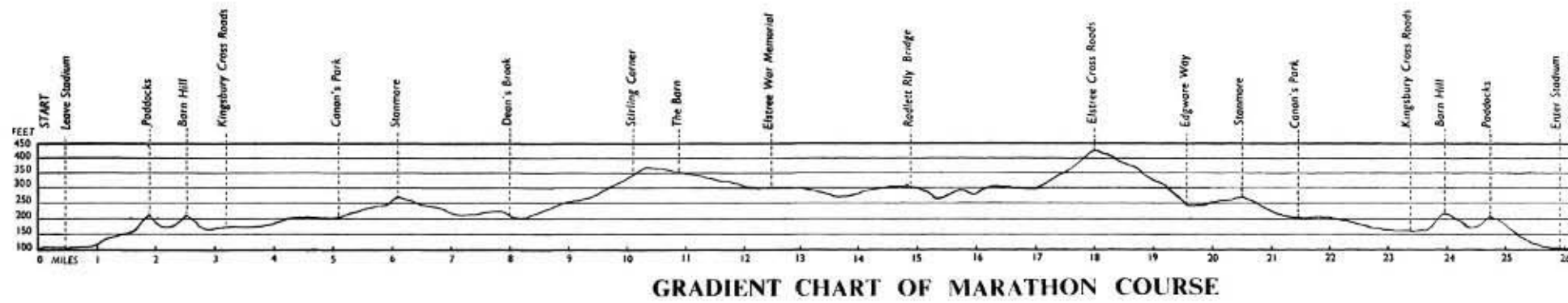

GRADIENT CHART OF MARATHON COURSE

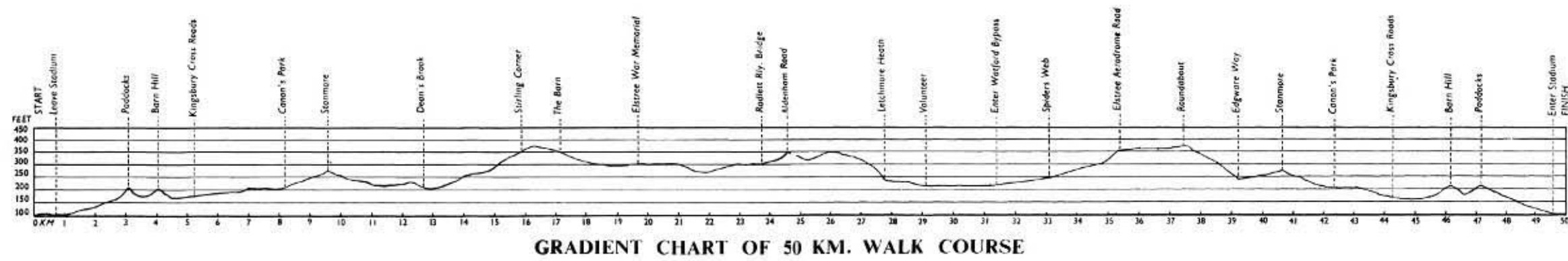

GRADIENT CHART OF 50 KM. WALK COURSE

## HIGH JUMP

### *Previous Olympic Winners*

			ft.	in.	m.			ft.	in.	m.	
1896	E. H. Clark	<i>U.S.A.</i>	5	11¼	1.81	1920	R. W. Landon	<i>U.S.A.</i>	6	4¼	1.94
1900	I. K. Baxter	<i>U.S.A.</i>	6	2¾	1.90	1924	H. M. Osborn	<i>U.S.A.</i>	6	6	1.98
1904	S. S. Jones	<i>U.S.A.</i>	5	11	1.80	1928	R. W. King	<i>U.S.A.</i>	6	4¼	1.94
1908	H. F. Porter	<i>U.S.A.</i>	6	3	1.90	1932	D. McNaughton	<i>Canada</i>	6	5 <sup>5</sup> / <sub>8</sub>	1.97
1912	A. W. Richards	<i>U.S.A.</i>	6	4	1.93	1936	C. C. Johnson	<i>U.S.A.</i>	6	8	2.03

World Record :    6 ft. 11 in. 2.11 m.    L. Steers (U.S.A.)            Los Angeles, 1941

Olympic Record :    6 ft. 8 in. 2.03 m.    C. C. Johnson (U.S.A.)        Berlin, 1936

There were 30 entries from 17 nations ; 26 participants from 16 nations

*The competition began at 1.60 m. and continued at 1.70, 1.80, 1.84 and 1.87 m. 1.87 m. was the qualifying height. All competitors who cleared this height took part in the Final*

		m.	in.
1	<b>WINTER, J.</b> ..... <i>Australia</i> .....	1.98	6 6
2	<b>PAULSON, B.</b> ..... <i>Norway</i> .....	1.95	6 4¾
3	<b>STANICH, G.</b> ..... <i>U.S.A.</i> .....	1.95	6 4¾
4	Edleman, T..... <i>U.S.A.</i> .....	1.95	6 4¾
5	Damitio, G..... <i>France</i> .....	1.95	6 4¾
6	Jackes, A..... <i>Canada</i> .....	1.90	6 2¾
7	Paterson, A..... <i>Great Britain</i> .....	1.90	6 2¾
	Wahli, H..... <i>Switzerland</i> .....	1.90	6 2¾
9	Widenfelt, G..... <i>Sweden</i> .....	1.90	6 2¾
	Jadresic Vargas, A..... <i>Chile</i> .....	1.90	6 2¾
	Lacaze, P..... <i>France</i> .....	1.90	6 2¾
12	Adedoyin, A..... <i>Great Britain</i> .....	1.90	6 2¾
13	Leirud, B..... <i>Norway</i> .....	1.90	6 2¾
14	Ascune, H..... <i>Uruguay</i> .....	1.80	5 11
	Valberg, L..... <i>Singapore</i> .....	1.80	5 11
16	McGrew, V..... <i>U.S.A.</i> .....	1.80	5 11
17	Honkonen, U..... <i>Finland</i> .....	1.80	5 11
18	Gurnam Singh, S..... <i>India</i> .....	1.80	5 11
—	Nicklen, N..... <i>Finland</i> .....	*	
—	Gundersen, B..... <i>Norway</i> .....	*	
—	Benard, C..... <i>France</i> .....	†	
—	Casado, B..... <i>Puerto Rico</i> .....	†	
—	Lambrou, J..... <i>Greece</i> .....	†	
—	Listur, P..... <i>Uruguay</i> .....	†	
—	Pavitt, R..... <i>Great Britain</i> .....	†	
—	Pilhatsch, A..... <i>Austria</i> .....	†	

\* Were not placed in the Final, as they failed to record a jump.

† Did not qualify for the Final.

## LONG JUMP

*Previous Olympic Winners*

		ft.	in.	m.			ft.	in.	m.		
1896	E. H. Clark	U.S.A.	20	10	6.35	1920	W. Pettersson	Sweden	23	5½	7.15
1900	A. C. Kraenzlein	U.S.A.	23	6¾	7.18	1924	D. H. Hubbard	U.S.A.	24	5	7.44
1904	M. Prinstein	U.S.A.	24	1	7.34	1928	E. B. Hamm	U.S.A.	25	4½	7.73
1908	F. C. Irons	U.S.A.	24	6½	7.48	1932	E. L. Gordon	U.S.A.	25	0¾	7.64
1912	A. L. Gutterson	U.S.A.	24	11¼	7.60	1936	J. Owens	U.S.A.	26	5¾	8.06

World Record : 26 ft. 8¼ in. 8.13 m. J. Owens (U.S.A.) Michigan, 1935

Olympic Record : 26 ft. 5¾ in. 8.06 m. J. Owens (U.S.A.) Berlin, 1936

---

There were 27 entries from 19 nations ; 21 participants from 17 nations

Each competitor had three attempts. The qualifying distance was 7.20 m. All competitors who attained this distance took part in the Final, but as less than 12 competitors attained 7.20 m. the 12 best competitors qualified

			m.	ft.	in.
1	<b>STEELE, W.</b>	U.S.A.	7.825	25	8
2	<b>BRUCE, T.</b>	Australia	7.555	24	9¼
3	<b>DOUGLAS, H.</b>	U.S.A.	7.545	24	9
4	Wright, L	U.S.A.	7.450	24	5¼
5	Adedoyin, A	Great Britain	7.270	23	10
6	Damitio, G	France	7.070	23	2¼
7	Whittle, H	Great Britain	7.030	23	0¾
8	Wurth, F	Austria	7.000	22	11⅝
9	Askew, H	Great Britain	6.935	22	9⅞
10	Kistenmacher, E	Argentina	6.800	22	3¼
11	Adamczyk, E	Poland	6.735	22	1¼
12	Singh, Balder	India			*
—	Aguirre Martin, J	Mexico			†
—	Fikejz, J	Czechoslovakia			†
—	Kim, Wun Kwun	Korea			†
—	Marinis, C	Greece			†
—	Peiris, G	Ceylon			†
—	Pereira Dias Cachulo, A	Portugal			†
—	Studer, J	Switzerland			†
—	Thompson, C.C.F.O.	British Guiana			†
—	Thorvaldsson, F	Iceland			†

\* Qualified for Final but withdrew.

† Did not qualify for the Final.



## POLE VAULT

*Previous Olympic Winners*

			ft.	in.	m.				ft.	in.	m.
1896	W. W. Hoyt	U.S.A.	10	9¾	3.30	1912	H. S. Babcock	U.S.A.	12	11½	3.95
1900	I. K. Baxter	U.S.A.	10	9¾	3.30	1920	F. K. Ross	U.S.A.	13	5	4.09
1904	C. E. Dvorak	U.S.A.	11	6	3.50	1924	L. S. Barnes	U.S.A.	12	11½	3.95
1908	A. C. Gilbert	U.S.A.	12	2	3.71	1928	S. W. Carr	U.S.A.	13	9½	4.20
	E. T. Cooke	U.S.A.				1932	W. W. Miller	U.S.A.	14	1⅞	4.31
			1936	E. Meadows	U.S.A.				14 ft. 3¼ in.		4.35 m..

World Record : 15 ft. 7¾ in. 4.77 m. C. Warmerdam (U.S.A.) California, 1942

Olympic Record : 14 ft. 3¾ in. 4.35 m. E. Meadows (U.S.A.) Berlin, 1936

---

There were 21 entries from 12 nations ; 19 participants from 10 nations  
*The competition began at 3.60 m. and continued at 3.80, 3.95, 4.10, 4.20 and 4.30 m.*

			m.	ft	in.
1	<b>SMITH, O.</b>	U.S.A.	4.30	14	1¼
2	<b>KATAJA, E.</b>	Finland	4.20	13	9¼
3	<b>RICHARDS, R.</b>	U.S.A.	4.20	13	9¼
4	Kaas, E	Norway	4.10	13	5½
5	Lundberg, R	Sweden	4.10	13	5½
6	Morcom, A	U.S.A.	3.95	12	11½
7	Gollors, H	Sweden	3.95	12	11½
	Olenius, V	Finland	3.95	12	11½
9	Barbosa, J	Puerto Rico	3.95	12	11½
	Sillon, V	France	3.95	12	11½
	Vicente, C	Puerto Rico	3.95	12	11½
12	Lindberg, A	Sweden	3.80	12	5½
—	Balafas, T	Greece			*
—	Bouvet, C	France			*
—	Breitman, G	France			*
—	Bryngeirsson, T	Iceland			*
—	Ganoza Rios, L	Peru			*
—	Piqueras Sanchez, J. ...	Peru			*
—	Webster, F	Great Britain			*

\* Did not qualify for the Final.

**HOP, STEP and JUMP***Previous Olympic Winners*

			ft.	in.	m.			ft.	in.	m.	
1896	J. B. Connolly	<i>U.S.A.</i>	44	11¾	13.71	1920	V. Tuulos	<i>Finland</i>	47	7	14.50
1900	M. Prinstein	<i>U.S.A.</i>	47	5½	14.47	1924	A. W. Winter	<i>Australia</i>	50	11¼	15.53
1904	M. Prinstein	<i>U.S.A.</i>	47	1	14.35	1928	M. Oda	<i>Japan</i>	49	10¾	15.21
1908	T. J. Ahearne	<i>Great Britain</i>	48	11¼	14.92	1932	C. Nambu	<i>Japan</i>	51	7	15.72
1912	G. Lindblom	<i>Sweden</i>	48	5¼	14.76	1936	N. Tajima	<i>Japan</i>	52	5 <sup>7</sup> / <sub>8</sub>	16.00

World and Olympic Record : 52 ft. 5 <sup>7</sup>/<sub>8</sub> in. 16.00 m. N. Tajima (Japan) Berlin, 1936

There were 30 entries from 19 nations ; 29 participants from 18 nations

*Each competitor had three attempts. The qualifying distance was 14.50 m. All competitors who attained this distance took part in the Final*

			m.	ft.	in.
1	<b>AHMAN, A.</b>	<i>Sweden</i>	15.40	50	6¼
2	<b>AVERY, G.</b>	<i>Australia</i>	15.365	50	4¾
3	<b>SARIALP, R.</b>	<i>Turkey</i>	15.025	49	3½
4	Larsen, P.	<i>Denmark</i>	14.83	48	7¾
5	Oliveira, G.	<i>Brazil</i>	14.825	48	7½
6	Rautio, K.	<i>Finland</i>	14.70	48	2¾
7	McKeand, L.	<i>Australia</i>	14.53	47	8
8	Pereira da Silva, A.	<i>Brazil</i>	14.49	47	6½
9	Hallgren, A.	<i>Sweden</i>	14.485	47	6¼
10	Albans, W.	<i>U.S.A.</i>	14.33	47	0¼
11	Coutinho da Silva, H.	<i>Brazil</i>	14.31	46	11½
12	Kim, Wun Kwun	<i>Korea</i>	14.25	46	7½
13	Moberg, L.	<i>Sweden</i>	14.215	46	7½
—	Rebello, H.	<i>India</i>			*
—	Aguirre Martin, J.	<i>Mexico</i>			†
—	Alcide de Nunes				
—	Garcia, L.	<i>Portugal</i>			†
—	Beckus, R.	<i>U.S.A.</i>			†
—	Bobin, R.	<i>France</i>			†
—	Cross, S.	<i>Great Britain</i>			†
—	Epalle, C.	<i>France</i>			†
—	Hawkey, R.	<i>Great Britain</i>			†
—	Koutonen, E.	<i>U.S.A.</i>			†
—	Lindsay, A.	<i>Great Britain</i>			†
—	Peiris, G.	<i>Ceylon</i>			†
—	Reyes Anchante, M.	<i>Peru</i>			†
—	Rodrigues Vieira, J.	<i>Portugal</i>			†
—	Sorensson, S.	<i>Iceland</i>			†
—	Vera Guardia, C.	<i>Chile</i>			†
—	Wurth, F.	<i>Austria</i>			†

\* Qualified for the Final, but did not record a jump.

† Did not qualify for the Final.

## PUTTING THE SHOT

### *Previous Olympic Winners*

		ft. in. m.					ft. in. m.				
1896	R. S. Garrett	U.S.A.	36	9¾	11.22	1920	V. Porhola	Finland	48	7	14.81
1900	R. Sheldon	U.S.A.	46	3	14.10	1924	C. Houser	U.S.A.	49	2¼	14.99
1904	R. W. Rose	U.S.A.	48	7	14.81	1928	J. Kuck	U.S.A.	52	0¾	15.87
1908	R. W. Rose	U.S.A.	46	7½	14.21	1932	L. Sexton	U.S.A.	52	6	16.00
1912	P. J. McDonald	U.S.A.	50	4	15.34	1936	H. Woellke	Germany	53	1¾	16.20

World Record :    57 ft. 1 in. 17.40 m.    J. Torrance (U.S.A.)    Oslo, 1934

Olympic Record :    53 ft. 1¾ in. 16.20 m.    H. Woellke (Germany)    Berlin, 1936

There were 30 entries from 17 nations ; 24 participants from 14 nations

*Each competitor had three attempts. The qualifying distance was 14.60 m. All competitors who attained this distance took part in the Final. As less than 12 competitors attained 14.60 m. the 12 best competitors qualified.*

		m.		in.	
1	<b>THOMPSON, W.</b> ... U.S.A. ....	17.12	56	2	
2	<b>DELANEY, F.</b> ..... U.S.A. ....	16.68	54	8½	
3	<b>FUCHS, J.</b> ..... U.S.A. ....	16.42	53	10½	
4	Lomowski, M ..... Poland .....	15.43	50	7½	
5	Arvidsson, G..... Sweden.....	15.37	50	5	
6	Lehtila, Y..... Finland .....	15.05	49	4½	
7	Jouppila, P..... Finland .....	14.59	47	10½	
8	Kalina, C..... Czechoslovakia.....	14.55	47	9	
9	Yataganas, C..... Greece .....	14.54	47	8½	
10	Gierutto, W ..... Poland .....	14.37	47	2	
11	Giles, J..... Great Britain .....	13.73	45	0½	
12	Sigurosson, S ..... Iceland .....	13.66	44	9½	
—	Coy, E..... Canada .....			*	
—	Guiney, D ..... Eire .....			*	
—	Kahnert, J..... Argentine .....			*	
—	Khan, Z..... Pakistan.....			*	
—	Malchiodi, E..... Argentine .....			*	
—	Malik, N..... Pakistan.....			*	
—	Moody, H..... Great Britain .....			*	
—	Nilsson, R ..... Sweden.....			*	
—	Patine, P..... Peru .....			*	
—	Senn, W ..... Switzerland .....			*	
—	Verhas, R..... Belgium .....			*	
—	Vilmundaeson, V ..... Iceland .....			*	

\* Did not qualify for the Final.

## THROWING THE DISCUS

### *Previous Olympic Winners*

		ft.	in.	m.			ft.	in.	m.		
1896	R. S. Garrett	<i>U.S.A.</i>	95	7¾	29.15	1920	E. Niklander	<i>Finland</i>	146	7¼	44.68
1900	R. Bauer	<i>Hungary</i>	118	3	36.04	1924	C. Houser	<i>U.S.A.</i>	151	5	46.15
1904	M. J. Sheridan	<i>U.S.A.</i>	128	10½	39.28	1928	C. Houser	<i>U.S.A.</i>	155	3	47.32
1908	M. J. Sheridan	<i>U.S.A.</i>	134	2	40.89	1932	J. Anderson	<i>U.S.A.</i>	162	4 <sup>7</sup> / <sub>8</sub>	49.49
1912	A. R. Taipale	<i>Finland</i>	148	4	45.21	1936	K. Carpenter	<i>U.S.A.</i>	165	7½	50.48

World Record : 180 ft. 2¾ in. 54.93 m. R. E. Fitch (U.S.A.) Minneapolis, 1946  
 Olympic Record : 165 ft. 7½ in. 50.48 m. K. Carpenter (U.S.A.) Berlin, 1936

There were 35 entries from 21 nations ; 28 participants from 18 nations

*Each competitor had three attempts. The qualifying distance was 46 m. All competitors who attained this distance took part in the Final. As less than 12 competitors attained 46 m., the 12 best competitors qualified.*

		m.	ft.	in.
1	<b>CONSOLINI, A.</b> ... <i>Italy</i> .....	52.78	173	2
2	<b>TOSI, G.</b> ..... <i>Italy</i> .....	51.78	169	10
3	<b>GORDIEN, F.</b> ..... <i>U.S.A.</i> .....	50.77	166	7
4	Ramstad, I .....	<i>Norway</i> .....	49.21	161 5½
5	Klics, F.....	<i>Hungary</i> .....	48.21	158 2
6	Nyqvist, K.....	<i>Finland</i> .....	47.33	155 3½
7	Syllas, N.....	<i>Greece</i> .....	47.25	155 0
8	Johnson, S .....	<i>Norway</i> .....	46.54	152 8
9	Huutoniemi, A.....	<i>Finland</i> .....	45.28	148 6½
10	Fransson, U .....	<i>Sweden</i> .....	45.25	148 5½
11	Tunner, H .....	<i>Austria</i> .....	44.43	145 9
12	Julve Ciriaco, E.....	<i>Peru</i> .....	44.05	144 6
—	An, Yung H.....	<i>Korea</i> .....	*	
—	Brewer, E .....	<i>Great Britain</i> .....	*	
—	Burton, W.....	<i>U.S.A.</i> .....	*	
—	Clancy, C.....	<i>Eire</i> .....	*	
—	Consiglieri, M...	<i>Peru</i> .....	*	
—	Coy, E .....	<i>Canada</i> .....	*	
—	Erauquin			
—	Erauquin, F.....	<i>Spain</i> .....	*	
—	Frank, V .....	<i>U.S.A.</i> .....	*	
—	Khan, Z .....	<i>Pakistan</i> .....	*	
—	Malchiodi, E.....	<i>Argentina</i> .....	*	
—	Malik, N .....	<i>Pakistan</i> .....	*	
—	Nesbitt, J.....	<i>Great Britain</i> .....	*	
—	Oberweger, G .....	<i>Italy</i> .....	*	
—	Reavell Carter, L. ...	<i>Great Britain</i> .....	*	
—	Verhas, R.....	<i>Belgium</i> .....	*	
—	Zerjal, D .....	<i>Yugoslavia</i> .....	*	

\* Did not qualify for the Final.

## THROWING THE JAVELIN

### *Previous Olympic Winners*

		ft.    in.    m.					ft.    in.    m.				
1908	E. V. Lemming	<i>Sweden</i>	179	10½	54.83	1928	E. H. Lundqvist	<i>Sweden</i>	218	6	66.60
1912	E. V. Lemming	<i>Sweden</i>	189	11½	60.64	1932	M. Jarvinen	<i>Finland</i>	238	7	72.71
1920	J. Myyra	<i>Finland</i>	215	9¾	65.78	1936	G. Stoeck	<i>Germany</i>	235	8¾	71.84
1924	J. Myyra	<i>Finland</i>	206	6¾	62.96						

World Record :    258 ft.   2<sup>3</sup>/<sub>8</sub> in.   78.70 m.   Y. Nikkanen (Finland)    Kotka, 1938

Olympic Record:   238 ft.   7 m.    72.71 m.   M. Jarvinen (Finland)    Los Angeles, 1932

There were 25 entries from 16 nations ; 22 participants from 15 nations

*Bach competitor had three attempts. The qualifying distance was 64 m. All competitors who attained this distance took part in the Final  
As less than 12 competitors attained 64 m., the 12 best competitors qualified.*

		m.	ft.	in.
1	<b>RAUTAVAARA, K.</b> ..... <i>Finland</i> .....	69.77	228	10
2	<b>SEYMOUR, S.</b> ..... <i>U.S.A.</i> .....	67.56	221	7½
3	<b>VARSZEGI, J.</b> ..... <i>Hungary</i> .....	67.03	219	11
4	Vesterinen, P..... <i>Finland</i> .....	65.89	216	2
5	Mahlum, O..... <i>Norway</i> .....	65.32	214	3½
6	Biles, M..... <i>U.S.A.</i> .....	65.17	213	9½
7	Vujacic, M..... <i>Yugoslavia</i> .....	64.89	212	10½
8	Likens, R..... <i>U.S.A.</i> .....	64.51	211	7¾
9	Pettersson, G..... <i>Sweden</i> .....	62.80	206	0½
10	Berglund, A..... <i>Sweden</i> .....	62.62	205	5
11	Kiesewetter, L..... <i>Czechoslovakia</i> ...	60.25	197	8
12	Nikkinen, S..... <i>Finland</i> .....	58.05	190	5
—	Apellaniz Zarraga, P. <i>Spain</i> .....		*	
—	Chote, M..... <i>Great Britain</i> .....		*	
—	Dalrymple, M..... <i>Great Britain</i> .....		*	
—	Heber, R..... <i>Argentina</i> .....		*	
—	Lutkeveld, N..... <i>Holland</i> .....		*	
—	Roininen, L..... <i>Canada</i> .....		*	
—	Sigurdsson, J..... <i>Iceland</i> .....		*	
—	Tissot, R..... <i>France</i> .....		*	
—	Vujacic, D..... <i>Yugoslavia</i> .....		*	
—	Ziraman, H..... <i>Turkey</i> .....		*	

\* Did not qualify for the Final.

## THROWING THE HAMMER

### *Previous Olympic Winners*

		ft.	in.	m.			ft.	in.	m.		
1900	J. J. Flanagan	U.S.A.	163	1¾	49.73	1920	P. Ryan	U.S.A.	173	5½	52.87
1904	J. J. Flanagan	U.S.A.	168	1	51.23	1924	F. D. Tootell	U.S.A.	174	10¼	53.29
1908	J. J. Flanagan	U.S.A.	170	4¼	51.92	1928	P. O'Callaghan	Eire	168	7¼	51.39
1912	M. J. McGrath	U.S.A.	7		54.74	1932	P. O'Callaghan	Eire	176	11⅛	53.92
			1936	K. Hein	Germany	185 ft. 4¼ in.					56.49 m.

World Record : 193 ft. 6⅞ in. 59.00 m. E. Blask (Germany) Stockholm, 1936

Olympic Record : 185 ft. 4¼ in. 56.49 m. K. Hein (Germany) Berlin, 1936

---

There were 27 entries from 17 nations ; 24 participants from 16 nations

*Each competitor had three attempts. The qualifying distance was 49 m. All competitors who attained this distance took part in the Final.*

		m.	in.
1	<b>NEMETH, I.</b> ..... <i>Hungary</i> .....	56.07	183 11½
2	<b>GUBIJAN, I.</b> ..... <i>Yugoslavia</i> .....	54.27	178 0½
3	<b>BENNETT, R.</b> ..... <i>U.S.A.</i> .....	53.73	176 3½
4	Felton, S..... <i>U.S.A.</i> .....	53.66	176 0½
5	Tamminen, L..... <i>Finland</i> .....	53.08	174 1½
6	Ericson, B..... <i>Sweden</i> .....	52.98	173 10
7	Taddia, T..... <i>Italy</i> .....	51.74	169 9
8	Soderkvist, E..... <i>Sweden</i> .....	51.48	168 10½
9	Dreyer, H..... <i>U.S.A.</i> .....	51.37	168 6
10	Frederiksen, S..... <i>Denmark</i> .....	50.07	164 3
11	Clark, D..... <i>Great Britain</i> .....	48.35	158 7½
12	Houtzager, J..... <i>Holland</i> .....	45.69	149 10½
13	In, Kang Whan..... <i>Korea</i> .....	43.93	144 1½
—	Cederquist, P..... <i>Denmark</i> .....	*	
—	Coyle, D..... <i>Eire</i> .....	*	
—	Douglas, E..... <i>Great Britain</i> .....	*	
—	Drake, N..... <i>Great Britain</i> .....	*	
—	Fuse, J..... <i>Argentina</i> .....	*	
—	Zuniga Erraz, E..... <i>Chile</i> .....	*	
—	Gonzalez Suaste, F..... <i>Mexico</i> .....	*	
—	Kuivamaki, R..... <i>Finland</i> .....	*	
—	Legrain, P..... <i>France</i> .....	*	
—	Somnath, S..... <i>India</i> .....	*	
—	Knotek, O..... <i>Czechoslovakia</i> ...	*	

\* Did not qualify for the Final.

# DECATHLON

## Previous Olympic Winners

1912 H. Weislander	Sweden	1928 P. Yrjöla	Finland
1920 H. Loevland	Norway	1932 J. Bausch	U.S.A.
1924 H. M. Osborn	U.S.A.	1936 G. E. Morris	U.S.A.

**World and Olympic Record : 7,900 points. G. E. Morris (U.S.A.) Berlin, 1936.**

The Decathlon was an all-round athletic contest of ten events, 3 running, 3 jumping, 3 throwing and 1 hurdling. Each competitor took part in all ten events and was awarded points according to the height, distance or time he achieved, the points being on a fixed scale approved by the International Amateur Athletic Federation. Three trials only were allowed to each competitor in the jumping and throwing events. In the running events and the hurdles the competitors were drawn in groups by lot. Their points were determined by the times achieved, each competitor being individually timed in his group. There were no finals. The following achievements represent an award of 1,000 points :—

100 metres .....	10.5 sec.	High Jump .....	1.97 m.
Long Jump .....	7.70 m.	400 metres .....	48.0 sec.
Shot .....	15.70 m.	110 metres hurdles .....	14.6 sec.
		1,500 metres .....	3 min. 54.0 sec.

	100 METRES		LONG JUMP		WEIGHT PUT		HIGH JUMP		400 METRES		110 METRES HURDLES		DISCUS		POLE VAULT		JAVELIN		1,500 METRES		GRAND TOTAL OF PTS.										
	Time	Pts.	metres	ft. in.	metres	ft. in.	metres	ft. in.	Time	Pts.	secs.	metres	ft. in.	metres	ft. in.	metres	ft. in.	metres	ft. in.	Time		Pts.									
1 MATHIAS, R.	11.2	787	6.615	21 8½	703	13.04	42 9¼	719	1.86	6 1¼	889	51.7	780	15.7	818	44.0	144	4	834	3.5	11 5¾	692	50.32	165	1	593	5	11 35.4	7,139	1	
2 HEINRICH, I.	11.3	760	6.895	22 7¼	775	12.85	42 2¼	701	1.86	6 1¼	889	51.6	785	15.6	833	40.94	134	3½	739	3.2	10 6	575	40.98	134	5	430	4	43.8	517	6,974	2
3 SIMMONS, F.M.	11.2	787	6.725	22 0¾	731	12.8	42 0	696	1.86	6 1¼	889	51.9	770	15.2	896	32.73	107	4½	509	3.4	11 2	652	51.99	170	7	624	4	58	426	6,950	3
4 Kistenmacher, E.	10.9	872	7.080	23 2¾	825	12.67	41 6¾	684	1.70	5 7	671	50.5	845	16.3	736	41.11	134	10¾	744	3.2	10 6	575	45.06	147	10	499	4	49.6	478	6,929	4
5 Andersson, E. P.	11.6	686	6.595	21 7½	698	12.66	41 6¼	683	1.75	5 9	727	52.0	765	15.9	790	36.07	118	6	599	3.6	11 9¾	733	51.04	167	5½	607	4	34	589	6,877	5
6 Mullins, P.	11.2	787	6.645	21 9½	711	12.75	41 9¾	691	1.83	6 0	822	53.2	706	15.2	896	33.94	111	4	541	3.4	11 2	652	51.32	168	4½	612	5	17.6	321	6,739	6
7 Eriksson, P.	11.9	618	6.80	22 3¾	751	11.96	37 2¾	617	1.80	5 11	786	52.5	740	16.2	749	34.91	114	6½	567	3.3	10 10	613	56.7	186	0½	715	4	35.8	575	6,731	7
8 Mondschein, I.	11.3	760	6.810	22 4	754	12.74	41 9¾	690	1.83	6 0¼	822	51.6	785	16.6	698	38.74	127	1½	674	3.5	11 5¾	692	36.81	120	9	363	4	49.8	477	6,715	8
9 Adamczyk, E.	11.7	662	7.08	23 1¾	739	13.20	43 3¾	735	1.75	5 9	727	52.5	740	15.8	804	39.11	128	3½	685	3.4	11 2	652	43.7	143	4½	476	5	1.4	406	6,712	9
10 Holmvang, G.	12.1	576	6.75	22 1¾	739	12.17	39 11	637	1.7	5 7	671	52.9	720	16.4	723	38.11	125	0½	656	3.4	11 2	652	53.66	176	0½	656	4	28.6	633	6,663	10
11 Stavem, P.	12.0	597	6.705	22 0	726	13.89	45 6¼	805	1.8	5 11	786	56.0	585	16.4	723	41.06	134	8½	743	3.2	10 6	575	52.79	173	2½	639	5	7.4	373	6,552	11
12 Clausen, O.	11.1	814	6.545	21 5¾	686	12.87	42 2½	703	1.8	5 11	786	54.7	639	16.0	776	36.34	119	2½	606	3.2	10 6	575	44.16	144	10½	484	5	0.7	375	6,444	12
13 Makela, Y.	11.9	618	6.20	20 4	603	13.10	42 1¼	725	1.8	5 11	786	54.3	656	17.5	597	36.12	118	6	600	3.2	10 6	575	62.55	205	2½	835	4	5.8	426	6,421	13
14 Sprecher, P.	11.9	618	6.38	20 11	646	12.22	40 1	641	1.6	5 3	563	51.8	775	16.7	686	37.02	121	5½	625	3.0	9 11	501	58.79	192	10½	757	4	3.4	589	6,401	14
15 Tannander, K.	11.6	686	6.58	21 7	695	12.5	41 0¼	668	1.86	6 1¼	859	54.5	647	16.4	723	36.5	119	9	610	3.2	10 6	575	43.65	143	2½	475	5	4.8	387	6,325	15



**DECATHLON (continued)**

	100 METRES	LONG JUMP	WEIGHT PUT	HIGH JUMP	400 METRES	110 METRES HURDLES		DISCUS	POLE VAULT	JAVELIN	1,500 METRES		GRAND TOTAL OF PTS.
						Time secs.	Pts.				metres	ft.	
16 Kuznicki, W.	120 597	6.565 21 6½ 690	12.34 40 6 652	1.7 5 7 671	54.3 656	17.6 587	38.06 124 10½ 655	3.2 10 6 575	47.34 155 4 539	4 41.8 531	6,153 16		
17 Sonek, J.	11.9 618	6.715 22 0¼ 728	11.83 38 9¾ 605	1.75 5 9 727	55.2 618	16.8 674	34.71 113 10½ 561	3.4 11 2 652	48.24 158 3 555	5 1.8 404	6,142 17		
18 Marcelja, D.	12.1 576	6.05 19 10¼ 568	12.19 39 11¾ 638	1.7 5 7 671	54.4 652	17.5 597	39.44 129 4½ 695	3.3 10 10 613	55.34 181 7 688	4 55.2 443	6,141 18		
19 Gieruto, W. . .	12.1 576	5.905 19 4½ 534	14.53 47 8 871	1.7 5 7 671	55.4 610	17.0 651	41.8 137 1½ 765	3.0 9 11 501	51.06 167 6 607	5 17.8 320	6,106 19		
20 { Ascune, H.	11.6 686	6.405 21 0 651	10.87 35 7¾ 520	1.86 6 1¼ 859	52.7 730	17.1 640	36.62 120 2 614	3.2 10 6 575	38.31 125 8½ 387	5 9 364	6,026		
{ Figueroa, H.	11.6 686	6.425 21 1 656	12.17 39 11 637	1.7 5 7 671	54.3 656	16.5 710	32.98 108 2½ 515	3.4 11 2 652	43.05 141 3 465	5 6.4 378	6,026		
22 Cretaine, J.	11.6 686	6.425 21 1 656	10.78 35 4¾ 512	1.65 5 5 616	54.8 635	17.3 618	38.9 127 7½ 679	3.4 11 2 652	43.26 141 11½ 469	5 20.8 306	5,829 22		
23 Nussbaum, F.	11.9 618	6.345 20 9¾ 637	11.02 36 1¾ 533	1.6 5 3 563	53.6 687	16.5 710	33.54 110 0½ 530	3.3 10 10 613	46.13 151 4 518	5 2.6 399	5,808 23		
24 Recordon Bumier, M.	11.8 640	6.085 19 11½ 575	11.45 37 7 571	1.7 5 7 671	53.9 674	15.8 804	33.77 110 9½ 536	2.8 9 2¼ 431	38.06 124 10½ 383	4 54.8 445	5,730 24		
25 Fournier, L.	11.6 686	6.510 21 4¾ 678	10.42 34 2¼ 482	1.65 5 5 616	54.5 647	17.4 607	32.31 106 0 498	3.2 10 6 575	42.39 139 1 454	5 12.4 347	5,590 25		
26 Dayer, A.	12.0 597	5.825 19 1¼ 516	12.45 40 10¼ 663	1.65 5 5 616	57.1 543	19.5 422	41.54 136 3½ 757	3.0 9 11 501	48.71 159 9½ 564	5 1.2 407	5,586 26		
27 Gerber, O.	11.9 618	5.96 19 6¾ 547	11.61 38 1 585	1.6 5 3 563	54.8 635	16.8 674	34.32 112 7 551	3.2 10 6 575	42.44 139 3 455	5 10.8 355	5,558 27		
28 Mukhtar, E.	11.8 640	5.51 18 0¾ 448	11.02 36 1¾ 533	1.5 4 11 462	54.8 635	17.9 557	36.54 119 10½ 612	2.35 7 8½ 285	44.59 146 3½ 491	5 8.4 368	5,031 28		

**The following retired from the competition.**

29 Singh, Baldev	11.8 640	6.63 21 9 708	10.05 32 11¼ 451	1.7 5 7 671	57.1 543	16.1 762	29.63 97 2½ 430					4,205
30 Seger, J.	12.3 536	5.945 19 6 543	9.4 30 10 398	1.65 5 5 616	55.7 597	18.7 485	28.6 93 10 404					3,579
31 Julve Ciriacco, E.	11.6 686	6.665 21 10½ 716	13.03 42 9 718	1.65 5 5 616	53.5 692							3,428
32 Rebulia, O.	11.6 686	6.53 21 5 683	11.55 37 10¾ 580	1.6 5 3 563	55.3 614							3,126
33 Kremer, R.	11.5 710	6.255 20 6¼ 615	11.67 38 ¾ 591	1.6 5 3 563	56.5 566							3,045
34 Buebel, G.	12.7 464	5.55 18 2¼ 457	10.36 33 11¾ 477	1.4 4 7 368								1,766
35 Scheurer, A.	12.5 499											499

DECATHLON—INTERMEDIATE PLACINGS TABLE

	AFTER 100 METRES	AFTER LONG JUMP	AFTER WEIGHT PUT	AFTER HIGH JUMP	AFTER 400 METRES	AFTER 110 METRES HURDLES	AFTER DISCUS	AFTER POLE VAULT	AFTER JAVELIN	CONCLUSION AFTER 1,500 METRES
1	Kistenmacher 872	Kistenmacher 1697	Kistenmacher 2381	Heinrich 3095	Kistenmacher 3897	Simmons 4739	Mathias 5500	Mathias 6192	Mathias 6785	Mathias 7139 1
2	Clausen 814	Heinrich 1535	Heinrich 2236	Simmons 3073	Heinrich 3880	Heinrich 4713	Heinrich 5452	Heinrich 6027	Simmons 6524	Heinrich 6974 2
3	Mathias } 787	Simmons 1518	Adameczyk 2222	Mathias 3068	Mathias 3848	Mathias 4666	Kistenmacher 5377	Kistenmacher 5952	Heinrich 6457	Simmons 6950 3
4	Simmons } 787	Mondschein 1514	Simmons 2214	Kistenmacher 3052	Simmons 3843	Kistenmacher 4633	Simmons 5248	Simmons 5900	Kistenmacher 6451	Kistenmacher 6929 4
5	Mullins } 760	Clausen 1500	Mathias 2209	Mondschein 3026	Mondschein 3811	Mullins 4613	Mondschein 5183	Mondschein 5875	Mullins 6418	Andersson 6877 5
6	Mondschein } 760	Mullins 1498	Mondschein 2204	Mullins 3011	Mullins 3717	Mondschein 4509	Adameczyk 5178	Adameczyk 5830	Adameczyk 6306	Mullins 6739 6
7	Heinrich } 710	Mathias 1490	Clausen 2203	Clausen 2989	Adameczyk 3689	Adameczyk 4493	Mullins 5154	Mullins 5806	Andersson 6288	Eriksson 6731 7
8	Kremer } 686	Adameczyk 1487	Mullins 2189	Adameczyk 2949	Clausen 3628	Clausen 4404	Clausen 5010	Andersson 5681	Mondschein 6238	Mondschein 6715 8
9	Tannander } 686	Julve Ciriaco 1402	Stavem 2128	Stavem 2914	Andersson 3559	Andersson 4349	Stavem 4965	Clausen 5585	Stavem 6179	Adameczyk 6712 9
10	Cretaine } 686	Andersson 1384	Julve Ciriaco 2120	Tannander 2908	Tannander 3555	Tannander 4278	Andersson 4948	Stavem 5540	Eriksson 6156	Holmvang 6663 10
11	Fournier } 686	Tannander 1381	Andersson 2067	Andersson 2794	Eriksson 3512	Eriksson 4261	Tannander 4888	Tannander 5463	Clausen 6069	Stavem 6552 11
12	Julve Ciriaco } 686	Rebula } 1369	Tannander 2049	Eriksson 2772	Stavem 3499	Stavem 4222	Eriksson 4828	Eriksson 5441	Holmvang 6030	Clausen 6444 12
13	Andersson } 686	Eriksson } 1369	Rebula 2049	Julve Ciriaco 2736	Ascune 3446	Ascune 4086	Holmvang 4722	Holmvang 5374	Makela 5995	Makela 6421 13
14	Figueroa } 662	Fournier 1364	Eriksson 1986	Julve Ciriaco 2736	Ascune 3446	Ascune 4086	Holmvang 4722	Holmvang 5374	Makela 5995	Makela 6421 13
15	Rebula } 662	Singh 1348	Gierutto 1981	Makela 2732	Julve Ciriaco 3428	Holmvang 4066	Ascune 4700	Ascune 5275	Tannander 5938	Sprecher 6401 14
16	Ascune } 662	Sonck 1346	Holmvang 1952	Sonck 2678	Holmvang 3306	Sonck 3970	Sprecher 4554	Sonck 5179	Sonck 5738	Sonck 6142 17
17	Adameczyk } 662	Cretaine } 1342	Figueroa 1979	Ascune 2716	Makela 3388	Figueroa 4016	Gierutto 4678	Figueroa 5183	Sprecher 5812	Tannander 6325 15
18	Recordon B. } 640	Figueroa } 1342	Rebula 1949	Figueroa 2650	Sonck 3296	Recordon B. 3935	Figueroa 4531	Makela 5160	Marcelja 5698	Marcelja 6141 18
19	Singh } 640	Ascune 1337	Makela 1946	Holmvang 2623	Kuzmicki 3266	Sprecher 3929	Sonck... 4531	Kuzmicki 5083	Ascune 5662	Gierutto 6106 19
20	Mukhtar } 618	Kremer 1325	Kuzmicki 1939	Kuzmicki 2610	Gierutto 3262	Gierutto 3913	Kuzmicki 4508	Sprecher 5055	Figueroa 5648	Ascune 6026 20
21	Sprecher } 618	Stavem 1323	Kremer 1916	Rebula 2512	Sprecher 3243	Kuzmicki 3853	Recordon B. 4471	Cretaine 5054	Figueroa 5622	Figueroa 6026 20
22	Nussbaum } 618	Holmvang 1315	Sprecher 1905	Kremer 2479	Recordon B. 3131	Singh 3775	Cretaine 4402	Marcelja 5010	Cretaine 5523	Cretaine 5829 22
23	Gerber } 618	Kuzmicki 1287	Ascune 1857	Singh 2470	Rebula 3126	Nussbaum 3748	Marcelja 4397	Recordon B. 4902	Nussbaum 5409	Nussbaum 5808 23
24	Eriksson } 618	Sprecher 1264	Cretaine 1854	Cretaine 2470	Fournier 3109	Cretaine 3723	Nussbaum 4278	Nussbaum 4891	Recordon B. 5285	Recordon B. 5730 24
25	Sonck } 618	Sprecher 1255	Fournier 1846	Sprecher 2468	Cretaine 3105	Fournier 3716	Fournier 4214	Fournier 4789	Fournier 5243	Fournier 5590 25
26	Makela } 597	Makela 1221	Singh 1799	Fournier 2462	Cretaine 3105	Marcelja 3013	Mukhtar 3887	Gerber 4748	Gerber 5203	Daye 5586 26
27	Daye } 597	Recordon B. 1215	Nussbaum 1788	Recordon B. 2457	Kremer 3045	Gerber 3622	Gerber 4173	Daye 4615	Daye 5179	Gerber 5558 27
28	Kuzmicki } 597	Gerber 1165	Recordon B. 1786	Marcelja 2453	Nussbaum 3038	Daye 3357	Daye 4114	Mukhtar 4172	Mukhtar 4663	Mukhtar 5031 28
29	Stavem } 576	Marcelja 1144	Marcelja 1782	Daye 2392	Singh 3013	Mukhtar 3275	Mukhtar 3887	—	—	—
30	Gierutto } 576	Daye 1113	Daye 1776	Nussbaum 2351	Gerber 2948	Sege 3175	Sege 3579	—	—	—
31	Holmvang } 576	Gierutto 1110	Gerber 1750	Gerber 2313	Daye 2935	—	—	—	—	—
32	Marcelja } 566	Mukhtar 1088	Mukhtar 1621	Sege 2093	Mukhtar 2718	—	—	—	—	—
33	Sege } 556	Sege 1079	Sege 1477	Mukhtar 2083	Sege 2690	—	—	—	—	—
34	Schauer } 499	Buchel 921	Buchel 1398	Buchel 1766	—	—	—	—	—	—
35	Buchel } 464	—	—	—	—	—	—	—	—	—

**100 METRES (Women)***Previous Olympic Winners*

1928 E. Robinson U.S.A. 12.2 sec. 1932 S. Walasiewicz Poland 11.9 sec.

1936 H. H. Stephens U.S.A. 11.5 sec.

World and Olympic Record : 11.5 sec. H. H. Stephens (U.S.A.) Berlin, 1936

There were 45 entries from 22 nations ; 38 participants from 21 nations

**FIRST ROUND***The first two in each heat qualified for the Semi-finals*

HEAT 1		HEAT 2		HEAT 3		
	<i>s.</i>		<i>s.</i>		<i>s.</i>	
1	Blankers-Koen, F. .... <i>Holland</i> .....	12.0	1	Strickland, S. .... <i>Australia</i> .....	12.4	
2	Myers, V. .... <i>Canada</i> .....	12.5	2	Nielsen, B. .... <i>Denmark</i> .....	12.9	
5	McKinnon, B. .... <i>Australia</i> .....	12.7	3	de Portela, N. S. .... <i>Argentine</i> .....	13.1	
4	Oberbreyer, M. .... <i>Austria</i> .....	—	4	Souza Oliveira, B. .... <i>Brazil</i> .....	—	
			5	Decker, M. .... <i>Luxembourg</i> .....	—	
				3	Lovso Nielsen, G. .... <i>Denmark</i> .....	12.6
				2	Jordan, W. S. .... <i>Great Britain</i> .....	12.7
				3	Patterson, A. .... <i>U.S.A.</i> .....	12.8
				4	King, J. .... <i>Australia</i> .....	—
				5	Kretschmer de Buccicardi, B. .... <i>Chile</i> .....	—
HEAT 4		HEAT 5		HEAT 6		
	<i>s.</i>		<i>s.</i>		<i>s.</i>	
1	Thompson, C. A. .... <i>Jamaica</i> .....	12.4	1	Batter, D. .... <i>Great Britain</i> .....	12.6	
2	Robb, D. .... <i>South Africa</i> .....	12.4	2	Russell, K. .... <i>Jamaica</i> .....	12.9	
3	Walker, M. E. .... <i>U.S.A.</i> .....	12.8	3	Young, L. .... <i>U.S.A.</i> .....	13.0	
4	Cheater, M. .... <i>Canada</i> .....	—	4	Clara Muller, E. .... <i>Brazil</i> .....	—	
				1	Manley, D. .... <i>Great Britain</i> .....	12.1
				2	Lightbourn, P. .... <i>Bermuda</i> .....	13.0
				3	Renard, M. .... <i>Belgium</i> .....	13.6
HEAT 7		HEAT 8		HEAT 9		
	<i>s.</i>		<i>s.</i>		<i>s.</i>	
1	Sicnerova, O. .... <i>Czechoslovakia</i> .....	12.4	1	Tagliaferri, L. .... <i>Italy</i> .....	12.8	
2	Bergendorff, B. .... <i>Denmark</i> .....	12.6	2	Stad-de Jong, X. .... <i>Holland</i> .....	12.9	
3	Cardoso de Menezes, H. .... <i>Brazil</i> .....	13.2	3	Edness, P. .... <i>Bermuda</i> .....	13.6	
4	Teoman, U. .... <i>Turkey</i> .....	—	4	Pavlousek, G. .... <i>Austria</i> .....	—	
			5	Butia, A. .... <i>Yugoslavia</i> .....	—	
				1	Jones, P. .... <i>Canada</i> .....	12.7
				2	de Jongh, G. .... <i>Holland</i> .....	12.9
				3	Moussier, J. .... <i>France</i> .....	12.9
				4	Paulsen, L. .... <i>Norway</i> .....	—

**SEMI-FINALS***The first two in each semi-final qualified for the Final*

HEAT 1		HEAT 2		HEAT 3		
	<i>s.</i>		<i>s.</i>		<i>s.</i>	
1	Blankers-Koen, F. .... <i>Holland</i> .....	12.0	1	Manley, D. .... <i>Great Britain</i> ..	12.4	
2	Strickland, S. .... <i>Australia</i> .....	12.4	2	Jones, P. .... <i>Canada</i> .....	12.6	
3	Lovso Nielsen, G. .... <i>Denmark</i> .....	12.7	3	Robb, D. .... <i>South Africa</i> ..	12.7	
4	Batter, D. .... <i>Great Britain</i> .....	—	4	Bergendorff, B. .... <i>Denmark</i> .....	—	
5	Tagliaferri, L. .... <i>Italy</i> .....	—	5	Stad-de Jong, X. .... <i>Holland</i> .....	—	
6	Lightbourn, P. .... <i>Bermuda</i> .....	—	6	Russell, K. .... <i>Jamaica</i> .....	—	
				1	Myers, V. .... <i>Canada</i> .....	12.4
				2	Thompson, C. A. .... <i>Jamaica</i> .....	12.5
				3	Sicnerova, O. .... <i>Czechoslovakia</i> ..	12.5
				4	Nielsen, B. .... <i>Denmark</i> .....	12.5
				5	Jordan, W. S. .... <i>Great Britain</i> .....	—
				6	de Jongh, G. .... <i>Holland</i> .....	—

**FINAL**

	<i>s.</i>	
1	<b>BLANKERS-KOEN, F.</b> .... <i>Holland</i> .....	11.9
2	<b>MANLEY, D.</b> .... <i>Great Britain</i> .....	12.2
3	<b>STRICKLAND, S.</b> .... <i>Australia</i> .....	12.2
4	Myers, V. .... <i>Canada</i> .....	—
5	Jones, P. .... <i>Canada</i> .....	—
6	Thompson, C. A. .... <i>Jamaica</i> .....	—

**200 METRES (Women)**

This event was included in the Olympic programme for the first time

World Record : 23.6 sec. S. Walasiewicz (Poland) 1935

There were 38 entries from 17 nations ; 33 participants from 17 nations

**FIRST ROUND***The first two in each heat qualified for the Semi-finals*

HEAT 1			HEAT 2			HEAT 3					
		<i>s.</i>			<i>s.</i>			<i>s.</i>			
1	Blankers-Koen, F.	Holland.....	25.7	1	Thompson, C. A..	Jamaica .....	25.6	1	King, J.....	Australia .....	25.9
2	Sprecher, L.....	France .....	26.0	2	Cheeseman, S.....	Great Britain..	25.7	2	Lightbourn, P.....	Bermuda.....	27.0
3	Faggs, M.....	U.S.A.....	26.0	3	Foster, D.....	Canada .....	26.1	3	Pini, L.....	Brazil.....	27.6
4	Luz, M.....	Brazil.....	—	4	Cardoso de			4	Renard, M.....	Belgium .....	—
5	Edness, P.....	Bermuda .....	—	-	Menezes, H.....	Brazil.....	—	-	Sicnerova, O.....	Czechoslovakia	*

HEAT 4			HEAT 5				
		<i>s.</i>			<i>s.</i>		
1	Robb, D.....	South Africa .....	25.3	1	Patterson, A.....	U.S.A.....	25.5
2	Strickland, S.....	Australia.....	25.8	2	Walker, M.....	Great Britain....	25.8
3	Jackson, N.....	U.S.A.....	25.8	3	Russell, K.....	Jamaica .....	26.3
4	Gilmore, D.....	Canada.....	—	4	Leyman, A.....	Sweden.....	—
5	Butia, A.....	Yugoslavia .....	—	5	Decker, M.....	Luxembourg.....	—
				6	Kretschmer de		
					Buccardi, B.	Chile.....	—

HEAT 6			HEAT 7				
		<i>s.</i>			<i>s.</i>		
1	McKinnon, B.....	Australia.....	25.9	1	Williamson, A.....	Great Britain....	25.4
2	Faugouin, R.....	France.....	25.9	2	Karelse, N.....	Holland .....	26.0
3	de Jongh, G.....	Holland .....	26.2	3	Cheater, M.....	Canada .....	26.4
4	Pavlousek, G.....	Austria.....	—	-	Weller Schneider,		
				A.....	Chile .....	†	

**SEMI-FINALS***The first three in each Semi-final qualified for the Final*

HEAT 1			HEAT 2				
		<i>s.</i>			<i>s.</i>		
1	Blankers-Koen, F.	Holland.....	24.3	1	{ Strickland, S.....	Australia.....	24.9
2	Patterson, A.....	U.S.A.....	25.0		{ Williamson, A.....	Great Britain....	24.9
3	Walker, M.....	Great Britain....	25.3	3	Robb, D.....	South Africa.....	25.1
4	Thompson, C. A.....	Jamaica .....	—	4	Cheeseman, S.....	Great Britain....	—
5	Faugouin, R.....	France.....	—	5	Karelse, N.....	Holland.....	—
6	King, J.....	Australia.....	—	6	McKinnon, B.....	Australia.....	—
7	Lightbourn, P.....	Bermuda.....	—	7	Sprecher, L.....	France .....	—

**FINAL**

		<i>s.</i>	
1	<b>BLANKERS-KOEN, F.</b> .....	Holland.....	24.4
2	<b>WILLIAMSON, A</b> .....	Great Britain.....	25.1
3	<b>PATTERSON, A</b> .....	U.S.A.....	25.2
4	Strickland, S.....	Australia.....	—
5	Walker, M.....	Great Britain.....	—
6	Robb, D.....	South Africa.....	—

\* Did not finish.

† Disqualified by the Starter.

**80 METRES HURDLES (Women)***Previous Olympic Winners*

1932	M. Didrikson	U.S.A.	11.7 sec.	1936	T. Valla	Italy	11.7 sec.
World Record :	{	11.3 sec.	C. Testoni (Italy)	Dresden, 1939			
		11.3 sec.	F. E. Blankers-Koen (Holland)	Amsterdam, 1942			
Olympic Record :		11.6 sec.	T. Valla (Italy)	Berlin, 1936			

There were 22 entries from 12 nations. 21 participants from 12 nations

*The event was over 8 flights of hurdles each 2 ft. 6 ins. (76.2 cm.) high*

**FIRST ROUND**

*The first three in each heat qualified for the Semi-finals*

**HEAT 1**

		<i>s.</i>
1	Blankers-Koen, F. .... <i>Holland</i> .....	11.3
2	Upton, J. .... <i>Great Britain</i> .....	11.8
3	Toulouse, J. .... <i>France</i> .....	12.0
4	James, M. .... <i>Finland</i> .....	—
5	Huber von Appen, M. .... <i>Chile</i> .....	—
6	Manuel, T. .... <i>U.S.A.</i> .....	—

**HEAT 2**

		<i>s.</i>
1	Gardner, M. .... <i>Great Britain</i> .....	11.6
2	Lomska, L. .... <i>Czechoslovakia</i> .....	11.8
3	de Portela, N. S. .... <i>Argentina</i> .....	11.8
4	Magnin-Lamoueche, J. .... <i>France</i> .....	—
5	Kavounidou, D. .. <i>Greece</i> .....	—

**HEAT 3**

		<i>s.</i>
1	Monginou, Y. .... <i>France</i> .....	11.7
2	Strickland, S. .... <i>Australia</i> .....	11.9
3	Oberbreyer, M. .... <i>Austria</i> .....	11.9
4	Robinson, C. .... <i>U.S.A.</i> .....	—
5	Crowther, B. .... <i>Great Britain</i> .....	—

**HEAT 4**

		<i>s.</i>
1	Steurer, E. .... <i>Austria</i> .....	12.2
2	Van der Kade-Koudijs, G. .... <i>Holland</i> .....	12.2
3	Walraven, J. .... <i>U.S.A.</i> .....	12.6
4	Naukkerinen, K. .... <i>Finland</i> .....	—
5	Beckett, V. .... <i>Jamaica</i> .....	—

**SEMI-FINALS**

*The first three in each Semi-final qualified for the Final*

**HEAT 1**

		<i>s.</i>
1	Blankers-Koen, F. .... <i>Holland</i> .....	11.4
2	Oberbreyer, M. .... <i>Austria</i> .....	11.9
3	Lomska, L. .... <i>Czechoslovakia</i> .....	12.0
4	Upton, J. .... <i>Great Britain</i> .....	—
5	Toulouse, J. .... <i>France</i> .....	—
6	Walraven, J. .... <i>U.S.A.</i> .....	—

**HEAT 2**

		<i>s.</i>
1	Strickland, S. .... <i>Australia</i> .....	11.7
2	Monginou, Y. .... <i>France</i> .....	11.8
3	Gardner, M. .... <i>Great Britain</i> .....	11.8
4	de Portela, N. S. .... <i>Argentina</i> .....	—
5	Van der Kade-Koudijs, G. .... <i>Holland</i> .....	—
6	Steurer, E. .... <i>Austria</i> .....	—

**FINAL**

		<i>s.</i>
1	<b>BLANKERS-KOEN, F.</b> .... <i>Holland</i> .....	11.2
2	<b>GARDNER, M.</b> .... <i>Great Britain</i> .....	11.2
3	<b>STRICKLAND, S.</b> .... <i>Australia</i> .....	11.4
4	Monginou, Y. .... <i>France</i> .....	—
5	Oberbreyer, M. .... <i>Austria</i> .....	—
6	Lomska, L. .... <i>Czechoslovakia</i> .....	—

**4 x 100 METRES RELAY (Women)***Previous Olympic Winners*

1908 Canada 48.4 sec.      1932 U.S.A. 47.0 sec.      1936 U.S.A. 46.9 sec.

World and Olympic Record : 46.4 sec. Germany (E. Albus, K. Krauss, M. Dollinger, I. Dorffeldt) 1936

There were 74 entries from 13 nations ; 40 participants from 10 nations

**FIRST ROUND**

*The first two teams in each heat qualified for the final.*

HEAT 1		HEAT 2		HEAT 3		
	s.		s.		s.	
1	<i>Canada</i> (Myers, V., Mackay, N., Foster, D., Jones, P.).....	47.9	1	<i>Great Britain</i> (Manley, D., Pletts, M., Walker, M., Gardner, M.).....	48.4	
2	<i>Australia</i> (Strickland, S., Maston, J., McKinnon, B., King, J.).....	48.0	2	<i>Austria</i> (Jenny, G., Steurer, E., Pavlousek, G., Oberbreyer, M.).....	50.0	
3	<i>France</i> (Toulouse, J., Faugouin, R., Sprecher, L., Moussier, J.) .....	48.1	3	<i>Chile</i> (Huber von Appen, M., Kretschmer de Buccicardi, B., Millard Pacheco, A., Weller Schneider, A.).....	51.5	
4	<i>Brazil</i> (Souza Oliveira, B., Pini, L., Luz, M., Morg, G. ....)	49.0				
				1	<i>Holland</i> (Stad-de Jong, X., Witziers-Timmer, J., Van der Kade-Koudijs, G., Blankers-Koen, F. ....)	47.6
				2	<i>Denmark</i> (Lovso Nielsen, G., Bergendorff, B., Nielsen, B., Nissen, H.).....	48.1
				3	<i>U.S.A.</i> (Jackson, N., Manuel, T., Patterson, A., Walker, M. E.).....	48.3

**FINAL**

	s.	
1	<b>HOLLAND</b> .....	47.5
2	<b>AUSTRALIA</b> .....	47.6
3	<b>CANADA</b> .....	47.8
4	<i>Great Britain</i> .....	48.0
5	<i>Denmark</i> .....	48.2
6	<i>Austria</i> .....	49.2

**HIGH JUMP (Women)***Previous Olympic Winners*

1928 E. Catherwood *Canada* 5 ft. 2½ in. 1.59 m.      1932 J. Shiley *U.S.A.* 5 ft. 5¼ in. 1.65 m.  
 1936 I. Csak *Hungary* 5 ft. 3 in. 1.60 m.

World Record: 5 ft. 7¼ in. 1.71 m. F. E. Blankers-Koen (Holland) Brentwood, 1943

Olympic Record: 5 ft. 5¼ in. 1.65 m. { J. Shiley (U.S.A.) }  
 { M. Didrikson (U.S.A.) } Los Angeles, 1932

There were 22 entries from 12 nations ; 19 participants from 10 nations

*There were no qualifying trials in this event.*

			<i>m.</i>	<i>ft.</i>	<i>in.</i>
1	<b>COACHMAN, A.</b> .....	<i>U.S.A.</i> .....	1.68	5	6 <sup>1</sup> / <sub>8</sub>
2	<b>TYLER, D.</b> .....	<i>Great Britain</i> .....	1.68	5	6 <sup>1</sup> / <sub>8</sub>
3	<b>OSTERMEYER, M.</b>	<i>France</i> .....	1.61	5	3 <sup>3</sup> / <sub>8</sub>
4	{ Beckett, V.....	<i>Jamaica</i> .....	1.58	5	2¼
	{ Dredge, D.....	<i>Canada</i> .....	1.58	5	2¼
6	Crowther, B.....	<i>Great Britain</i> .....	1.58	5	2¼
7	Steinegger, I.....	<i>Austria</i> .....	1.55	5	1
8	Gardner, D .....	<i>Great Britain</i> .....	1.55	5	1
9	{ Ruas, S .....	<i>France</i> .....	1.50	4	11
	{ Iversen, A .....	<i>Denmark</i> .....	1.50	4	11
11	{ Gordon, S .....	<i>Canada</i> .....	1.50	4	11
	{ Phipps, C .....	<i>Jamaica</i> .....	1.50	4	11
	{ Robinson, C.....	<i>U.S.A.</i> .....	1.50	4	11
14	{ Bourkel, C .....	<i>Luxembourg</i> .....	1.40	4	7 <sup>1</sup> / <sub>8</sub>
	{ Colchen, A.....	<i>France</i> .....	1.40	4	7 <sup>1</sup> / <sub>8</sub>
	{ Reed, E.....	<i>U.S.A.</i> .....	1.40	4	7 <sup>1</sup> / <sub>8</sub>
17	{ Clara Muller, E.....	<i>Brazil</i> .....	1.40	4	7 <sup>1</sup> / <sub>8</sub>
	{ Gyarmati, O.....	<i>Hungary</i> .....	1.40	4	7 <sup>1</sup> / <sub>8</sub>
19	Silburn, K.....	<i>Canada</i> .....	1.40	4	7 <sup>1</sup> / <sub>8</sub>



**LONG JUMP (Women)**

This event was included in the Olympic programme for the first time  
 World Record : 20 ft. 6 in. 6.25 m. F. E. Blankers-Koen (Holland) Leyden, 1943

---

There were 30 entries from 18 nations ; 26 participants from 17 nations

*Each competitor had three attempts. The qualifying distance was 5.30 m. All competitors who attained this distance took part in the Final. As 12 competitors did not attain 5.30 m., the 12 best competitors qualified.*

		<i>m.</i>	<i>ft.</i>	<i>in.</i>
1	<b>GYARMATI, O.</b> ..... <i>Hungary</i> .....	5.695	18	8¼
2	<b>DE PORTELA, N. S.</b> .... <i>Argentina</i> .....	5.600	18	4½
3	<b>LEYMAN, A.</b> ..... <i>Sweden</i> .....	5.575	18	3½
4	VanderKade-Koudijs, G. <i>Holland</i> .....	5.570	18	3¼
5	Karelse, N ..... <i>Holland</i> .....	5.545	18	2½
6	Russell, K..... <i>Jamaica</i> .....	5.495	18	0½
7	Canty, J..... <i>Australia</i> .....	5.380	17	7¾
8	Curtot-Chabot, Y ..... <i>France</i> .....	5.350	17	6½
9	Oberbreyer, M..... <i>Austria</i> .....	5.240	17	2½
10	Steinegger, I..... <i>Austria</i> .....	5.195	17	0½
11	Beckett, V ..... <i>Jamaica</i> .....	5.145	16	10½
12	Reed, E..... <i>U.S.A</i> .....	4.845	15	10¼
—	Erskine, M ..... <i>Great Britain</i> ....		*	
—	Morg, G ..... <i>Brazil</i> .....		*	
—	Lee, L..... <i>Great Britain</i> ....		*	
—	Ludwig, M ..... <i>Luxembourg</i> .....		*	
—	Martel, Y ..... <i>France</i> .....		*	
—	Maston, J..... <i>Australia</i> .....		*	
—	Nowakowa, H ..... <i>Poland</i> .....		*	
—	Parviainen, K..... <i>Finland</i> .....		*	
—	Pierucci, S..... <i>Italy</i> .....		*	
—	Shepherd, J..... <i>Great Britain</i> ....		*	
—	Silburn, K..... <i>Canada</i> .....		*	
—	Walraven, J ..... <i>U.S.A</i> .....		*	
—	Young, L..... <i>U.S.A</i> .....		*	
—	Lightbourn, P..... <i>Bermuda</i> .....		*	

\* Did not qualify for the Final.

**THROWING THE DISCUS (Women)***Previous Olympic Winners*

1928 H. Konopacka *Poland* 129 ft. 11¾ in. 39.62 m.      1932 L. Copeland *U.S.A.* 133 ft. 2 in. 40.58 m.  
 1936 G. Mauermeyer *Germany* 156 ft. ¾ in. 47.63 m.

World Record :      158 ft. 6 in.    48.31 m.    G. Mauermeyer    (Germany)    Dresden, 1936

Olympic Record :    156 ft. ¾ in.    47.63 m.    G. Mauermeyer    (Germany)    Berlin, 1936

There were 21 entries from 11 nations ; 21 participants from 11 nations

*There were no qualifying trials in this event. Each competitor had three attempts, and the leading six competitors three further attempts*

		<i>m.</i>	<i>ft.</i>	<i>in.</i>
1	OSTERMEYER, M.....	France .....	41.92	137 6½
2	CORDIALE GENTILE, E. ....	Italy .....	41.17	135 0½
3	MAZEAS, J.....	France .....	40.47	132 9½
4	Wajs-Marcinkiewicz, J.....	Poland .....	39.30	128 11½
5	Haidegger, L.....	Austria.....	38.81	127 4
6	Panhorst-Niesink, A. ....	Holland.....	38.74	127 1
7	Aberg, M.....	Sweden .....	38.48	126 2½
8	Mello de Preiss, I.....	Argentina .....	38.44	126 1
9	Tiltsch, F.....	Austria.....	37.19	122 0
10	Veste, P.....	France .....	36.84	120 10
11	Kaszubski, F.....	U.S.A. ....	36.50	119 9
12	Arenander, G.....	Sweden .....	36.25	118 11
13	Roos-Lodder, P.....	Holland.....	36.15	118 7
14	Reid, B.....	Great Britain .....	35.84	117 7
15	Schlager, M.....	Austria.....	34.79	114 1½
16	Dodson, D.....	U.S.A. ....	34.69	113 9½
17	Gabric Calvesi, L.....	Italy .....	34.17	111 11
18	Pak, Pong Sik.....	Korea.....	33.80	110 10½
19	Birtwistle, M.....	Great Britain .....	33.02	108 4
20	Whyte, E.....	Great Britain .....	32.46	106 5½
21	Matej, J.....	Yugoslavia.....	30.25	99 2½

**PUTTING THE SHOT (Women)**

This event was included in the Olympic programme for the first time

World Record : 47 ft. 2<sup>1</sup>/<sub>8</sub> in. 14.38 m. G. Mauermeyer (Germany) Warsaw, 1934

*Each competitor had three attempts. The qualifying distance was 12.3 m. All competitors who attained this distance took part in the Final. As 12 competitors did not attain 12.3 m., the best 12 competitors qualified.*

---

There were 20 entries from 12 nations ; 19 participants from 12 nations

		<i>m.</i>	<i>ft.</i>	<i>in.</i>
1	<b>OSTERMEYER, M.</b> ..... <i>France</i> .....	13.75	45	1½
2	<b>PICCININI, A.</b> ..... <i>Italy</i> .....	13.095	42	11½
3	<b>SCHAFFER, P.</b> ..... <i>Austria</i> .....	13.08	42	11
4	Veste, P ..... <i>France</i> .....	12.985	42	7¼
5	Komarkova, J ..... <i>Czechoslovakia</i> .....	12.92	42	4½
6	Bruk, A..... <i>Austria</i> .....	12.50	41	0
7	Radosavljevic, M ..... <i>Yugoslavia</i> .....	12.355	40	6½
8	Reid, B ..... <i>Great Britain</i> .....	12.17	39	11
9	Mello de Preiss, I ..... <i>Argentina</i> .....	12.085	39	7¾
10	Laurent, S ..... <i>France</i> .....	12.03	39	5½
11	Olsson, E ..... <i>Sweden</i> .....	11.84	38	10
12	Schlager, M ..... <i>Austria</i> .....	11.775	38	7½
—	Birtwistle, M ..... <i>Great Britain</i> .....		*	
—	Clara Muller, E..... <i>Brazil</i> .....		*	
—	Dodson, D ..... <i>U.S.A.</i> .....		*	
—	Kazubski, F..... <i>U.S.A.</i> .....		*	
—	Panhorst-Niesink, A ..... <i>Holland</i> .....		*	
—	Paulsen, L..... <i>Norway</i> .....		*	
—	Whyte, E ..... <i>Great Britain</i> .....		*	

\* Did not qualify for the Final.

**THROWING THE JAVELIN (Women)***Previous Olympic Winners*

1932 M. Didrikson *U.S.A.* 143 ft. 4 in. 43.68 m.      1936 T. Fleischer *Germany* 148 ft. 2¾ in. 45.18 m.

World Record :      154 ft. 11⅛ in. 47.24 m. A. Steinheuer (Germany)      Frankfurt, 1942

Olympic Record :      148 ft. 2¾ in. 45.18 m. T. Fleischer (Germany)      Berlin, 1936

There were 17 entries from 11 nations ; 15 participants from 10 nations

*There were no qualifying trials in this event. Each competitor had three attempts, and the leading six competitors three further attempts*

		<i>m.</i>	<i>ft.</i>	<i>in.</i>
1	<b>BAUMA, H.</b> ..... <i>Austria</i> .....	45.57	149	
2	<b>PARVIAINEN, K.</b> ..... <i>Finland</i> .....	43.79	143	8
3	<b>CARLSTEDT, L.</b> ..... <i>Denmark</i> .....	42.08	138	0½
4	Dodson, D ..... <i>U.S.A.</i> .....	41.96	137	7½
5	Teunisse-Waalboer, J..... <i>Holland</i> .....	40.92	134	3
6	Koning, J..... <i>Holland</i> .....	40.33	132	3½
7	Ingrova, D ..... <i>Czechoslovakia</i> .....	39.64	130	0½
8	Dammers, E..... <i>Holland</i> .....	38.23	125	5
9	Schilling, G ..... <i>Austria</i> .....	30.01	124	8½
10	Almqvist, I ..... <i>Sweden</i> .....	37.26	122	2½
11	Sinoracka, M..... <i>Poland</i> .....	35.74	117	3
12	Manuel, T..... <i>U.S.A.</i> .....	33.82	110	11½
13	Saeyns, N. .... <i>Belgium</i> .....	31.77	104	3
14	Long, M ..... <i>Great Britain</i> .....	30.29	99	4½
15	Clarke, G..... <i>Great Britain</i> .....	29.59	97	1

# BASKETBALL

Perhaps the most astonishing thing about the basketball tournament in the Games was the extremely close competition. For instance, Korea, who finished eighth, was beaten in the preliminary round by China, who eventually was eighteenth in the table. If the Games were played again, the order of finishing might well be different, for there was little to choose between the second and nineteenth teams. The figures speak for themselves:—in Group B, five of the six teams tied on points; out of 85 games four required extra time, four were won by one point, eleven won by two points and twelve won by three to six points.

Mr. Omar Browning, the U.S.A. coach, was astonished at the high standard of play, and expressed the view that, by 1952, his country would have to improve still further to hold the Olympic title.

It is well known that the United States is the home of basketball, and it is quite obvious that the New World is still ahead of the Old, as of the first six positions, nations from the American continent filled five.

Of the U.S.A. team, the salient features were the enormous height of their players and their speed. Normally men of 6 ft. 9 ins. to 7 ft. 0 ins. tall are not fast, but these players had all the agility of bantams! When height is combined with agility, superb ball control and intelligence there is no answer. Apart from the match with Argentine before the U.S.A. team had settled down, there was not a team who gave them a close game. As soon as these giants entered the arena, the opposing teams seemed to wilt and fade away. Though the U.S.A. won the championship, that they played the best basketball to watch may be in doubt, for some of the most scintillating ball play was that of the far eastern teams, Korea, Philippines and China. These three teams were a joy to watch. Though small of stature, their speed and ball manipulation were an education. How the crowd loved them, and how well they earned the admiration and respect of all basketball enthusiasts!

France, who finished second, was a steady team, and although not brilliant, their rock-like defence and methodical offensive earned their players this high position. Insufficient notice has perhaps been taken of the high ranking in the Games of the South American teams. What a match was the play-off for 3rd and 4th place between Brazil and Mexico! Mexico might well have been the runners up, but unfortunately for them they met the U.S.A. in the semi-finals. However, to the surprise of most, Brazil beat Mexico by 52-47. The game was a needle match, full of colour and incidents, and the two referees must have been very tired by the end of the game! It was good to see these South American teams with their colourful turn-out, and they play with a fire and determination which lower-ranking teams would do well to copy.

The Canadian team, who were second in 1936, did not on this occasion get an Olympic award.

Of the other teams there is little to say. They all played basketball of a high standard, with the exception of those countries where the game has only recently been established

on a firm footing. To reach international class, basketball players must learn the game in their early youth. This applies to all games, of course, but, because of its highly scientific tactical play, it may apply even more to basketball.

From the technical point of view, the tournament made it clear that centre pivot play had slowed the game. There was far too much bringing the ball down slowly and then setting up a play. Match after match revealed the same movement; the tremendous urge to establish a solid defence and to set up an attack around the pivot player. During the Games the Technical Committee of the International Federation amended the rules so that in future no player, whilst his team possesses the ball, may remain under his basket for more than three seconds.

All the games were played in an extraordinarily fine spirit. Managers were always on the most cordial terms and though, during a match, it sometimes appeared that the two teams were bitter enemies, after the game the true spirit of the Olympic Games was apparent. The best qualities of each and every country prevailed and the contestants recognised that although thousands of miles might separate their nations, the underlying virtues of human nature are the same everywhere and, on occasions such as this, shine like the Olympic flame.

# FEDERATION INTERNATIONALE DE BASKETBALL AMATEUR

## JURY OF APPEAL

CHAIRMAN  
CHARLES BOIZARD, *France*

### MEMBERS

WILLARD N. GREIM, *U.S.A.*                      FERENG HEPP, *Hungary*  
MENDEZ SCHIAFFINO, *Uruguay*              Comm. PAOLO MAIRANO, *Italy*

### SUBSTITUTES

Col. ABDULLA RIFAAT, *Egypt*                      CHUNG HAN PUM, *Korea*

### OLYMPIC TECHNICAL COMMITTEE

W. R. JONES, *Great Britain*                      D. H. SCHMULL, *Holland*                      J. TOBIN, *U.S.A.*

### OFFICIALS

#### REFEREES

M. A. SIENER, *France*                      M. F. VANDERPERREN, *Belgium*                      M. N. MORAN, *Turkey*  
M. M. PFEUTI, *Switzerland*                      M. J. OSUSKI, *Czechoslovakia*                      M. V. UGOLINI, *Italy*  
M. G. FOLLATI, *Italy*                      M. G. D. PETKOFF, *Bulgaria*                      M. A. A. ASHRI, *Egypt*

ARENA MANAGER  
W. BROWNING

LIAISON OFFICER  
M. BUXTON

#### CHAIRMEN

T. PEACE                      J. L. MORTENSEN                      F. VERNON DAVIES  
R. M. MACMASTER                      R. SLOLEY                      H. LITTLEWOOD

#### TIMEKEEPERS

A. J. F. AMPHLETT                      R. W. CLAYTON                      A. N. LAGOPOULOS  
P. TIMPANY                      S. W. SOUTH                      E. J. RECKLESS

#### SCORERS

A. J. MACKENZIE                      A. J. HASKINS                      R. J. ROBBINS  
A. V. DEACON                      A. D. BRENNAN                      H. J. LEWIS

#### TEAM STEWARDS

L. C. PIPER                      A. MAURINS                      H. ERRINGTON                      J. GOODMAN  
R. DAVIS                      A. P. LEGER

#### MARSHALS

A. S. KNIGHT                      J. W. GREGOLAJTYS                      K. G. KINDELAN                      L. DOMANSKI  
G. S. DALEY                      J. CUTHBERT                      C. HEPBURN                      I. D. ROBB  
T. B. BURKE                      P. R. DENNISON                      A. D. CALVERT                      K. R. WARREN  
C. COLLINS                      R. C. COLLINS                      G. R. BOWEN                      C. CROMAR  
E. B. DAVIS                      R. H. PERRY                      M. NEJMAN                      S. OSBORNE

#### SCOREBOARD OPERATORS

J. WALLIS                      R. M. HARFIELD                      R. SCOTT CAMERSON                      M. SOFIER  
M. D. COULTER                      R. ROTE                      D. M. LUSH                      M. E. C. ROBLOU  
J. F. PERREN                      J. SOFIER                      S. MORRIS                      P. LONGHURST

P. NILSSON



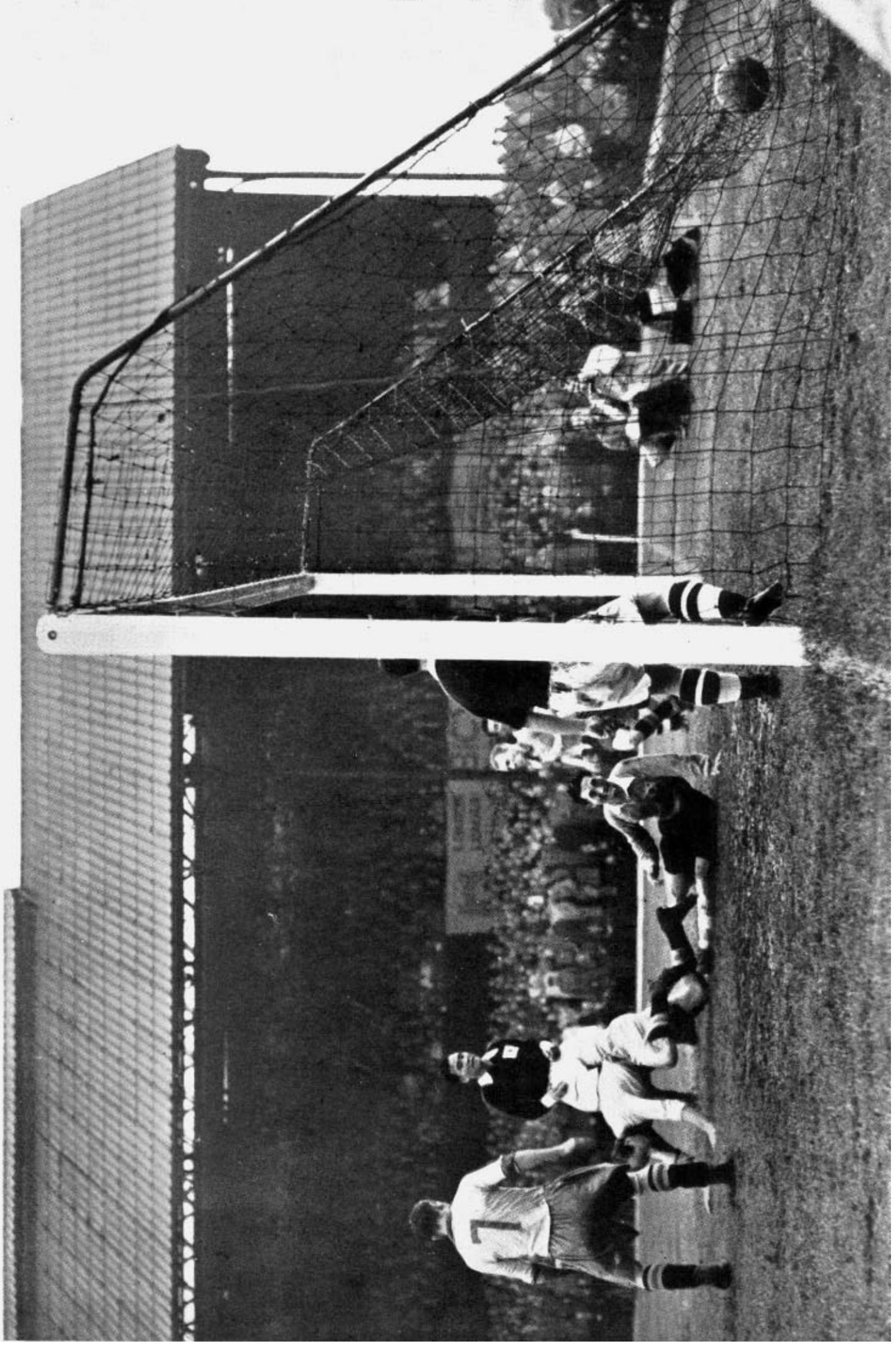

*Biggest victory in the football tournament was Sweden's over Korea in the second round match on the Crystal Palace football club's ground. This is one of Sweden's twelve goals*



*Great Britain beat Holland in the first round of the football tournament by 4 goals to 3 on the ground of the Arsenal football club. Here Britain are scoring their third goal.*

*The first round match in the football tournament in which Denmark beat Egypt on the ground of the Crystal Palace football club by 3 goals to 1. The Egyptian goalkeeper, Y. Imam, has dived to push a shot round the corner of the post.*





*A general view of the match in the first round of the football tournament between Sweden and Austria on the ground of the Tottenham Hotspur football club. Austria are attacking but Sweden won the match by three goals to nil*

*A goal for Sweden during their semi-final match at the Empire Stadium against Denmark. K. Rosen was the scorer. Sweden won by 4 goals to 2.*







*The goalkeeper, E. Nielsen, comes out to save for Denmark during the course of a Swedish attack in the semi-final match at the Empire Stadium.*

*A view taken during heavy pressure by Great Britain in the closing stages of their semi-final match with Yugoslavia at the Empire Stadium. J. Hardisty has just got his head to the ball, while H. McIlvenny (9) and D. Kelleher (10) look on.*





*Another view of the semi-final between Great Britain and Yugoslavia. F. Volfl, at centre forward for Yugoslavia, has tried a shot, but the British goalkeeper, K. McAlinden, turns it round the post for a corner.*

*Yugoslavia's equalising goal in the final. S. Bobek, the Yugoslav centre forward is tackled by a Swedish defender, but his shot is already on its way past T. Lindberg in the Swedish goal.*





*The final match in the football tournament at the Empire Stadium. The captains, B. Rosengren (Sweden) and M. Brozovic (Yugoslavia) shake hands before the start. Between them are Mr. C. J. Battersby, who was in charge of the technical arrangements for the tournament, and the referee for the final, Mr. W. Ling (Great Britain).*



*T. Lindberg, the Swedish goalkeeper, saving during the final*





*The match for third place in the football tournament at the Empire Stadium between Great Britain and Denmark. E. Neilsen, the Danish goalkeeper pushes the ball clear of the British centre forward, H. McIlvenny*



*A general view of the arena at the Empress Hall during the progress of the gymnastic events ; a women's team exercise is in progress in the left foreground.*

*The winning team, Czechoslovakia, in the women's gymnastic event.*







*Z. Mijatovic (Yugoslavia) on the balancing beam.*

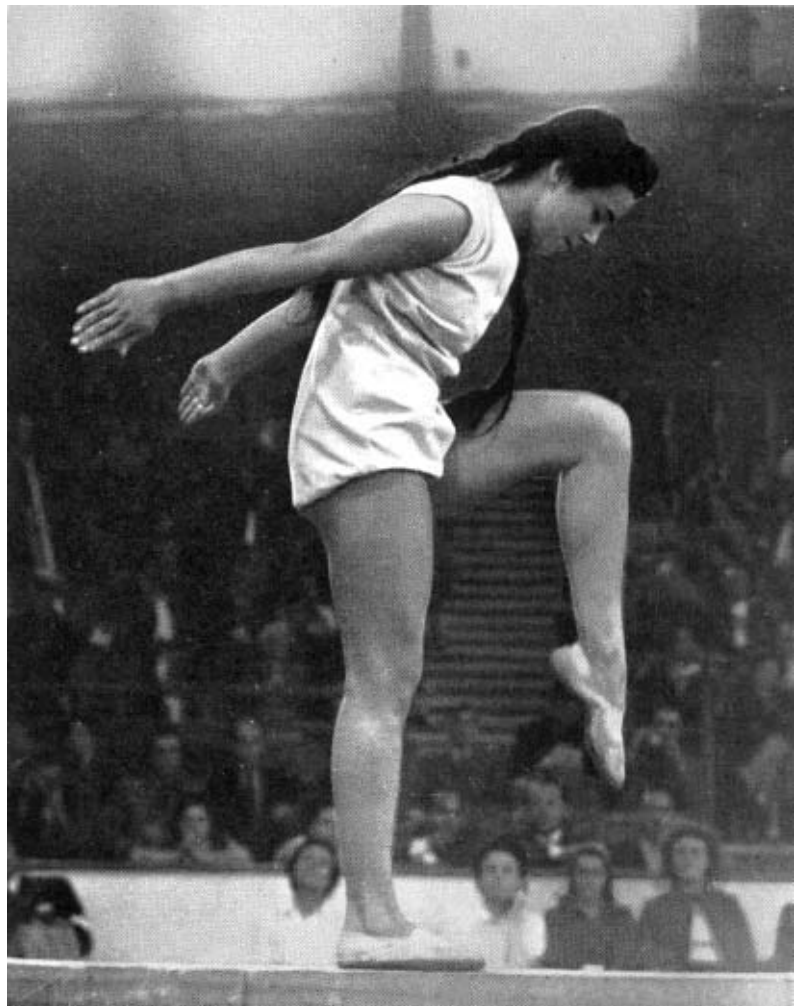

*L. Micheli (Italy), the pig-tailed youngest competitor in the gymnastics, poised on the balancing beam.*



*A. Wales (Great Britain) on the rings, with other members of the British team watching.*

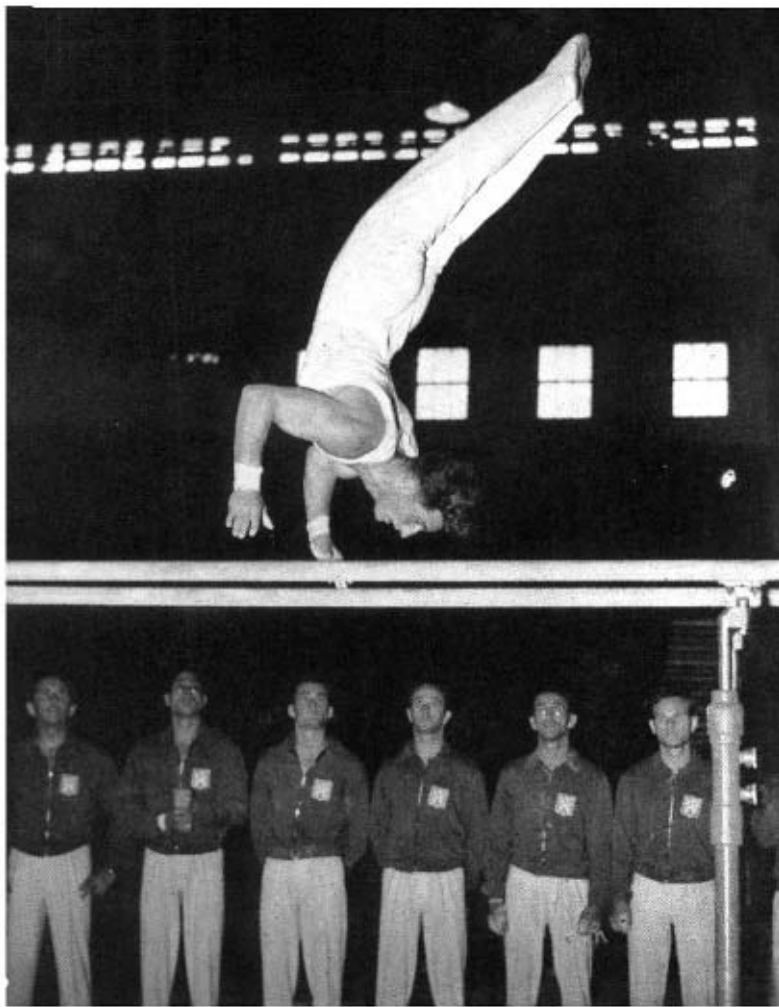

*P. Benetka (Czechoslovakia) on the parallel bars.*

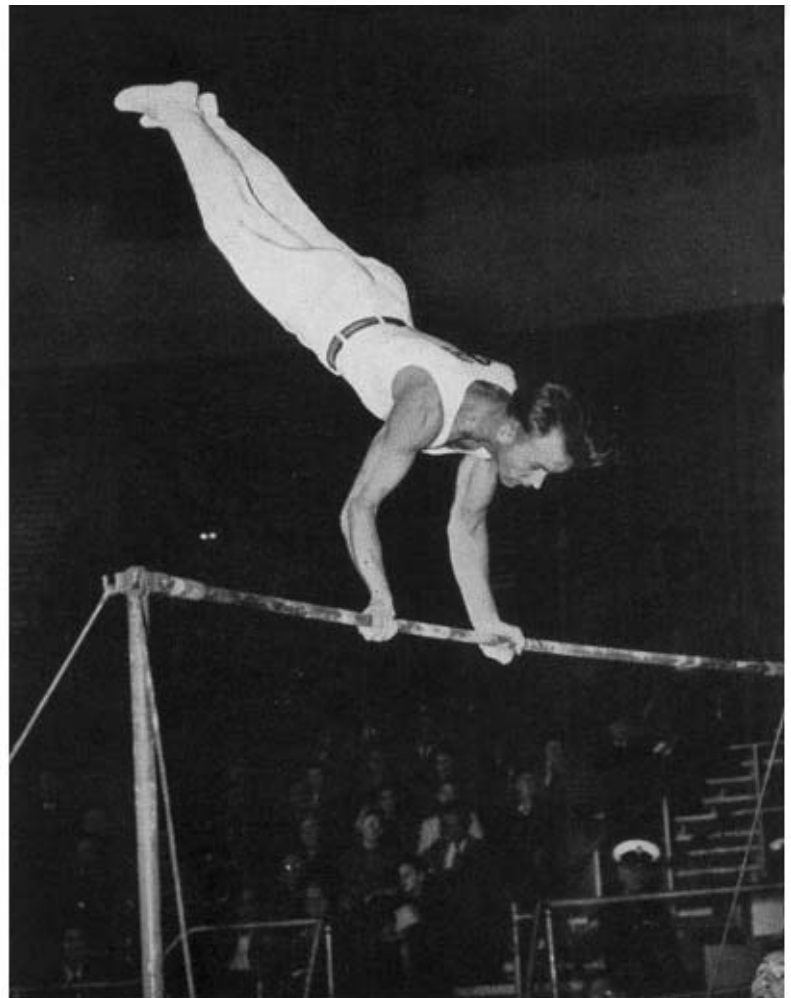

*A. Thomsen (Denmark) on the horizontal bar.*

*E. Studer (Switzerland), one of the team which was placed second in gymnastics, during the horizontal bar exercise. E. Studer finished sixth of the competing gymnasts in the twelve-exercise competition.*

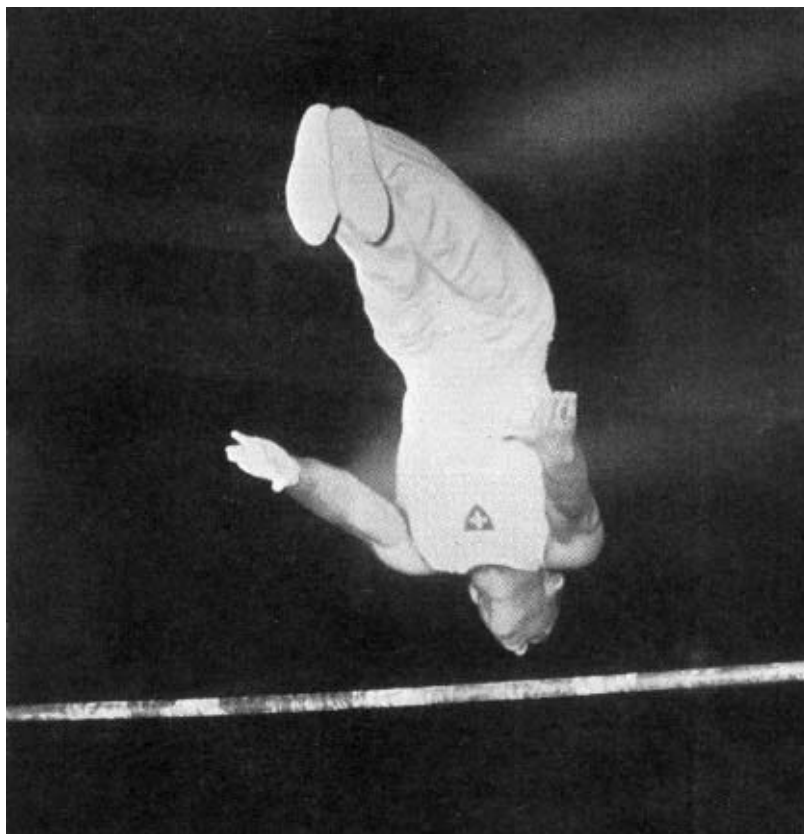

*M. Reusch (Switzerland) competes on the horizontal bar.*

**BASKETBALL**

*Previous Olympic Winner*  
1936 U.S.A.

---

There were 298 entries and participants from 23 nations

---

**CONDITIONS OF TOURNAMENT**

The competing nations were divided into four preliminary groups, the grouping being determined by the International Federation.

Each team met every other team in the same preliminary group.

Group placings were determined on match points awarded as follows :—

- 2 points for match won.
- 1 point for match lost.
- 0 point for match forfeited.

In the case of a tie on match points the proportion of points for and against was used to determine the group placings.

The two teams at the head of each preliminary group qualified for a group which played a series of eliminating matches to determine the first eight places in the competition. The third and fourth teams in each preliminary group played off a similar series of eliminating matches to determine places nine to sixteen. The fifth and sixth teams in each preliminary group played a series to determine the remaining placings.

**PRELIMINARY GROUP RESULTS AND TABLES**

<b>Group A</b>				<b>Group B</b>			
<i>Uruguay</i>	69	<i>Great Britain</i>	17	<i>Philippines</i>	102	<i>Iraq</i>	30
<i>Brazil</i>	45	<i>Hungary</i>	41	<i>Belgium</i>	27	<i>Korea</i>	29
<i>Canada</i>	55	<i>Italy</i>	37	<i>China</i>	39	<i>Chile</i>	44
<i>Uruguay</i>	32	<i>Brazil</i>	36	<i>Iraq</i>	18	<i>Chile</i>	100
<i>Canada</i>	44	<i>Great Britain</i>	24	<i>Korea</i>	33	<i>Philippines</i>	35
<i>Italy</i>	19	<i>Hungary</i>	32	<i>Belgium</i>	34	<i>China</i>	36
<i>Great Britain</i>	11	<i>Brazil</i>	76	<i>Philippines</i>	39	<i>Chile</i>	68
<i>Canada</i>	36	<i>Hungary</i>	37	<i>Iraq</i>	20	<i>Belgium</i>	98
<i>Italy</i>	34	<i>Uruguay</i>	46	<i>Korea</i>	48	<i>China</i>	49
<i>Great Britain</i>	28	<i>Italy</i>	49	<i>Chile</i>	36	<i>Belgium</i>	38
<i>Hungary</i>	31	<i>Uruguay</i>	49	<i>Korea</i>	120	<i>Iraq</i>	20
<i>Canada</i>	35	<i>Brazil</i>	57	<i>Philippines</i>	51	<i>China</i>	32
<i>Hungary</i>	60	<i>Great Britain</i>	23	<i>Philippines</i>	35	<i>Belgium</i>	37
<i>Brazil</i>	47	<i>Italy</i>	31	<i>China</i>	125	<i>Iraq</i>	25
<i>Canada</i>	52	<i>Uruguay</i>	50	<i>Chile</i>	21	<i>Korea</i>	28

<b>Group A</b>							<b>Group B</b>						
	P.	W.	L.	F.	A.	PTS.		P.	W.	L.	F.	A.	PTS.
<i>Brazil</i>	5	5	0	261	150	10	<i>Korea</i>	5	3	2	258	152	8
<i>Uruguay</i>	5	3	2	246	170	8	<i>Chile</i>	5	3	2	269	162	8
<i>Hungary</i>	5	3	2	201	172	8	<i>Belgium</i>	5	3	2	234	156	8
<i>Canada</i>	5	3	2	222	205	8	<i>Philippines</i>	5	3	2	262	200	8
<i>Italy</i>	5	1	4	170	208	6	<i>China</i>	5	3	2	281	202	8
<i>Great Britain</i>	5	0	5	103	298	5	<i>Iraq</i>	5	0	5	113	545	5

XIV OLYMPIAD

Group C				Group D			
U.S.A.	86	Switzerland	21	Iran	30	France	62
Czechoslovakia	38	Peru	30	Mexico	39	Cuba	31
Argentina	57	Egypt	38	Mexico	71	Eire	9
Peru	52	Egypt	27	Cuba	31	France	37
Switzerland	23	Argentina	49	Mexico	56	France	42
U.S.A.	53	Czechoslovakia	28	Eire	22	Iran	49
Switzerland	19	Peru	49	Mexico	68	Iran	27
U.S.A.	59	Argentina	57	Eire	25	Cuba	88
Czechoslovakia	52	Egypt	38	Iran	30	Cuba	63
U.S.A.	66	Egypt	28	France	73	Eire	14
Czechoslovakia	54	Switzerland	28				
Argentina	42	Peru	34				
Egypt	31	Switzerland	29				
U.S.A.	61	Peru	33				
Argentina	41	Czechoslovakia	45				

Group C							Group D						
	P.	W.	L.	F.	A.	PTS.		P.	W.	L.	F.	A.	PTS.
U.S.A.	5	5	0	325	167	10	Mexico	4	4	0	184	109	8
Czechoslovakia	5	4	1	217	190	9	France	4	3	1	214	131	7
Argentina	5	3	2	246	199	8	Cuba	4	2	2	213	131	6
Peru	5	2	3	198	187	7	Iran	4	1	3	136	219	5
Egypt	5	1	4	162	252	6	Eire	4	0	4	70	281	4
Switzerland	5	0	5	120	269	5							

FINAL GROUPS

Group for first eight places

U.S.A.	63	}	U.S.A.	71	}	U.S.A.	65	}	U.S.A.
Uruguay	28		Mexico	40					
Mexico	43	}	Brazil	33	}	France	21		
Korea	32		France	43					
Brazil	28	}	Brazil	52	}	Mexico	47		
Czechoslovakia	23		Czechoslovakia	36		Chile	38		
Chile	52	}	Korea	36	}	Uruguay	45		
France	53		Uruguay	50		Chile	32		
Match for 3rd and 4th place			Korea	38		Czechoslovakia	39		
Matches for 5th to 8th places									

Group for places nine to sixteen

Belgium (a bye)	}	Belgium	40	}	Canada	49	}	CANADA	
Hungary (withdrew)		Canada	45		Peru				43
Canada	81	}	Peru	40	}	Peru			43
Iran	25		Philippines	29					
Cuba	40	}	Belgium	38	}	Philippines			34
Peru	45		Cuba	35		Argentina			34
Argentina	43	}	Iran (a bye)	70	}	Hungary (withdrawn)	36		
Philippines	45		Cuba	38		Iran	36		
Match for 11th and 12th place									
Matches for 13th to 16th places									

Group for places seventeen to twenty-three

China	42	}	China	54	}	China	38	}	ITALY
Switzerland	34		Great Britain	25					
Eire	21	}	Italy	35	}	Italy	54		
Great Britain	46		Egypt	33					
Italy	77	}	Egypt	50	}	Great Britain	18		
Iraq	28		Eire	12		Switzerland	55		
Egypt (a bye)			Iraq (a bye)						
Match for 19th and 20th place			Switzerland w.o. for 21st place						
Matches for 21st to 23rd place									

## FINAL ORDER OF NATIONS

## 1. U.S.A.

Barker, C.  
Barksdale, D.  
Beard, R.  
Beck, L.

Boryla, V.  
Carpenter, C.  
Groza, A.  
Jones, W. C.

Kurland, R.  
Lumpp, R.  
Pitts, R.  
Renick, J.

Robinson, R.  
Rollins, K.

## 2. FRANCE

Barraix, A.  
Bonnevie, M.  
Buffiere, A.  
Chocat, R.

Derency, R.  
de Saymonnet, M.  
Even, A.  
Girardot, M.

Guillou, F.  
Offner, R.  
Perrier, J.  
Quenin, Y.

Robuffic, L.  
Thiolon, P.

## 3. BRAZIL

Azevedo, Z.  
Benvenuti, L.  
Braz, J.

da Motta, R.  
Dias, M.  
Evora, A.

Freitas, R.  
Gemignani, A.  
Marson, A.

Oliveira, N.  
Rodrigues, G.  
Sorcinelli, M.

## 4. MEXICO

Acuna Lizana, A.  
Alfaro Loza, I.  
Bienvenu Baraias, A.  
Cabrera Gandara, J.

Cardiel Gayton, J.  
Diaz Mercado, R.  
Galindo Chavez, F.  
Gudino Goya, J.

Guerrero Delgado, H.  
Lopez Enriquez, E.  
Romo Porchas, I.  
Rojas Herrera, J.

Rojas Herrera, F.  
Santos de Leon,

## 5. URUGUAY

Acosta y Lara, M.  
Anton, N.  
Cieslinkas, V.  
Demarco, N.

Diab, M.  
Eidlin, A.  
Folle, E.  
Garcia Otero, H.

Gordon, E.  
Lombardo, A.  
Lovera, R.  
Margarinos, G.

Rossello, C.  
Ruiz, H.

## 6. CHILE

Cordero Fernandez, E.  
Figueroa Reyes, E.  
Gallo Chinchilla, J.  
Hammer Casadio, R.

Kapstein Suckel, E.  
Ledesma Barrales, M.  
Mahana Badrie, V.  
Marmontini, G. L. E.

Mitrovic Guic, A.  
Moreno Rodillo, A.  
Parra Rojas, E.  
Raffo Abarca, H.

Sanchez Carmona, M.  
Verdugo Yanez, G.

## 7. CZECHOSLOVAKIA

Belohradsky, J.  
Benacek, C.  
Chlud. Z.  
Drvota, J.

Ezr, J.  
Kalina, J.  
Kozak, J.  
Krasa, V.

Krenicky, Z.  
Krepela, J.  
Mrazek, I.  
Siegel, J.

Toms, J.  
Trpkos, L.

## 8. KOREA

Ahn, B.  
Bang, W.  
Chang, Ri Chin

Chyo, Deuk Joon  
Kang, Bong Hyun

Kim, Chung Shin  
Lee, Choon Yung

Lee, Sang Hoon  
Oh, Soo Chul

## 9. CANADA

Bakken, O.  
Bell, W.  
Bloomfield, D.  
Campbell, D.

Kermode, H.  
Lands, B.  
McGeer, P.  
Mitchell, J. R.

Morein, M.  
Munro, G.  
Scarr, R.  
Strulovitch, S.

Tolchinsky, S.  
Waxman, M.

## 10. PERU

Ahrens Valdivia, G.  
Alegre Benavides, C.  
Descalso, D.

Drago Burga, V.  
Fernandez Calderon, A.  
Ferreiros Perez, A.

Fiestas Arce, E.  
Salas Crespo, R.  
Sanchez Maquiavelo, L.

Soracco Rios, R.  
Vizcarra Nieto, J.

## 11. BELGIUM

Baert, G.  
Bernauer, A.  
Coosemans, H.  
De Fauw, F.

Hermans, H.  
Hollanders, A.  
Hollanders, H.  
Kets, E.

Lampo, L.  
Neuris, Julien  
Poppe, G.  
Sturbaut, R.

Van de Goor, L.  
Van Wambeke, A.

## 12. PHILIPPINES

Araneta, Jr., M.  
Campos, Jr., R.  
Decena, E.

De La Cruz, A.  
Fajardo, F.  
Fajardo, G.

Fulgencio, E.  
Martinez, P.

Mumar, L.  
Vestil, F.



XIV OLYMPIAD

13. CUBA

Aguero Medrano, M.  
Alvarez, A.  
Garcia, A. C.  
Garcia, J.

Garcia Ordonez, R.  
Lavernia, H.  
Llanusa Gobel, J.  
Llaneras Rodriguez, M.

Lopez Garviso, F.  
Otero Vazquez, P. M.  
Paget, O.  
Quintero Padron, M.

Ruiz Vinajeras, F.  
Wilts Bucelo, R.

14. IRAN

Ashtari, K.  
Ehssassi, A.  
Esfendiari, F.  
Hashemi, H.

Jabbarzadegan, H.  
Karandish, H.  
Mohtadi, F.

Rafatjah, H.  
Sadeghi, F.  
Shademan, Z.

Solbi, A.  
Soroudi, H.  
Soudipour, H.

15. ARGENTINE

Calvo, R.  
Contarbio, L.  
Furlong, O.  
Gonzalez, R.

Guerrero, M.  
Lledo, R.  
Martinetti, L.  
Menini, R.

Nure, J. Perez  
Perez Cattaneo, O.  
Ruffa, A.  
Uder, J.

Varani, B.  
Vio, T.

16. HUNGARY

Bankuti, A.  
Benedek, P.  
Halasz, J.  
Kardos, G.

Kozma, J.  
Lovrics, I.  
Mezofi, T.  
Nagy, G.

Novakovszky, L.  
Timar-Geng, A.  
Timar-Geng, I.  
Vadaszi Viboch, E.

Verbenyi, J.  
Zsiros, T.

17. ITALY

Bersani, G.  
Cerioni, C.  
Ferriani, S.  
Mantelli, E.

Marietti, F.  
Marinelli, G.  
Nesti, G.  
Pellarini, V.

Primo, G.  
Ranuzzi, R.  
Rapini, L.  
Romanutti, R.

Stefanini, S.  
Tracuzzi, A.

18. CHINA

Chia, Chung-Chang  
Chua, Bon-Hua  
Kya, Is-Kyun

Lee, E.  
Lee, Tsun-Tung  
Pao, John Sung-Yuan

Wee, Tian-Siak  
Woo, Cheng-Chang

Yee, J.  
Yu, Sai-Chang

19. EGYPT

Abbas, Y.  
Abo Ouf, Y.  
Abdul Kheir, F.  
Catafago, A.

El Leissy, G.  
Fahmy, A.  
Habib M.  
Ismail, A.

Makzoume, R.  
Moawad, H.  
Mohamad, M.  
Montassir, H.

Nessin, A.

20. GREAT BRITAIN

Cole, F.  
Davies, T.  
Eke, A.  
Finlay, M.

Hunt, C.  
Legg, D.  
Legg, R.

McMeekan, Stanley  
McMeekan, Sydney  
Norris, R.

Price, L.  
Weston, H.  
Weston, S.

21. SWITZERLAND

Albrecht, P.  
Baumann, H.  
Bossy, M.  
Chevalley, C.

Chollet, M.  
Dutoit, B.  
Geiser, R.  
Gujer, H.

Landini, C.  
Pare, J.  
Piaget, G.  
Pollet, J.

Stockly, G.  
Tribolet, J.

22. IRAQ

Ahmed, H.  
Emile, Y.  
Hanna, G.

Hashim, A.  
Irfan, A.  
Kanaan, A.

Saleh, F.  
Salmain, M.

Salman, D.  
Wadoon, K.

23. EIRE

Boland, H.  
Crehan, P.  
Flynn, J.  
Jackson, W.

Keenan, T.  
McLoughlin, G.  
Malone, T.  
O'Connor, F.

O'Donovan  
McGee, J.  
Reddin, D.  
Sheriff, D.

Sheriff, P.  
Walsh, C.

# BOXING

The popularity of boxing as a universal sport can be in little doubt after the evidence of the 1948 Olympic Games, and it is a matter of pride and satisfaction that amateur boxing had its origins in England.

In all, thirty-nine nations sent 206 competitors, all the best at their weights from wherever they came, and not one who did not hope to return home victorious.

Owing to the large entry, the greatest ever, it was necessary to hold a preliminary day's boxing at the Empress Hall, Earl's Court, on Saturday, August 7. On Monday, however, the events were transferred to their intended venue, the Empire Pool at Wembley. The swimmers, who had completed their events on the Saturday before, left a legacy of a water-filled swimming pool, over which a bridge was built to hold the boxing ring. In the evening the bright lights and many coloured flags presented a kaleidoscopic reflection in the water around the ring, and without doubt enhanced the splendour of the scene.

Just as splendid was the boxing itself that took place above the pool. In the earlier series, the standard was at times indifferent but, with the approaching conclusion of the competitions, the quality of the performances increased perceptibly. No critic could have wished for a better display of boxing than was seen on the final evening. Despite some questionable verdicts at an earlier stage of the competitions, no one could question the decisions of the judges in the finals. The skill, the pluck and, above all, the sportsmanship of the competitors paid tribute to the ideals of the Olympic Games.

*Flyweights.* The first Olympic Boxing title of 1948 went to the Argentine, P. Perez winning a closely contested bout in the final against the southpaw Italian, S. Bandinelli. Perez had already beaten some first class opponents before reaching the final, among them A. Bollaert (Belgium), who had outpointed Great Britain's Henry Carpenter. In the semi-final, the Argentinian had a points win over the slim but speedy F. Majdloch, a Czechoslovakian with boundless energy and no little skill. Third place in the flyweights was taken by S. A. Han (Korea) who outboxed Majdloch. The reigning European Champion, L. Martinez Zapata of Spain, after winning his first and second bouts, was outpointed by the eventual runner-up, Bandinelli. This was a surprise to many, as Martinez Zapata had won the European Championship in 1947, and followed this by being the only successful European competitor in the match against U.S.A., shortly after.

*Bantamweights.* As a whole, the boxing in this weight was hardly up to the standard of the flyweights, with the exception of the winner, T. Csik, of Hungary, and his opponent in the final, G. Zuddas (Italy). The sturdy Zuddas's close-quarter work was nullified by Csik's speedy boxing, which enabled Csik to gain the first of Hungary's two titles. Italy, with a finalist in each of the first two weights, had to be content with a second place in each case.

*Featherweights.* E. Formenti, Italy's third finalist, made up for the defeats of his countrymen by outpointing the plucky South African, D. G. Shepherd, in the final.

Shepherd, another southpaw, had sustained a cut eye early in the series and boxed under this severe handicap. From time to time, his eye had to be stitched and re-stitched, and at the finish he certainly looked as if he had been in the wars. Formenti was a worthy champion with a good boxing style which gained its just reward. The third place winner, A. Antkiewicz (Poland), also displayed a forceful style, but met his master in Formenti at the semi-final stage.

*Lightweights.* In the lightweight class, South Africa had the first of her two winners, G. Dreyer, who was an example of the English style which paid such good dividends throughout the boxing in the Games. He had no easy passage in winning his title. The European Champion, J. Vissers of Belgium, was Dreyer's opponent in the final. Vissers is a persistent attacker and set about wearing Dreyer down, until a short left to the chin put him down for a count in the second round. Thereafter, there seemed little doubt that Dreyer would finish up the winner. Of all the competitors in the boxing, no one was more courteous and gentlemanly than S. Wad of Denmark. His exemplary conduct in the ring was matched by the skilful use of his left hand. At times, he seemed hardly strong enough to weather the storm, especially against the powerful M. McCullagh (Eire), but his apparent weakness was a mere deception. Beaten by Dreyer in the semi-final, he was eventually placed third.

*Welterweights.* The welterweight winner, J. Torma (Czechoslovakia), was probably the best defensive boxer in the competitions, and he was also a strong attacker. His defensive work was a joy to watch. Without moving his feet, he would sway out of distance or ride any punch that was close enough to be menacing. His sangfroid must have been disconcerting to his numerous opponents, and, coupled with his general ringcraft, proved too much for all of them. His opponent in the final, H. Herring (U.S.A.), certainly made Torma move around, but his snappy punches did not land often enough to give him the verdict. Herring was the only U.S.A. competitor to gain a place in the Olympic Boxing events.

*Middleweights.* In this weight, Hungary had a second winner in L. Papp, another of the many southpaws competing. Although his style was hardly ideal, his punch must be classified as lethal. His first three opponents did not last the three rounds. In the final he met J. Wright (Great Britain), who had taken some hard knocks in his earlier bouts. Against Papp, Wright showed great pluck and, after recovering from some of the Hungarian's damaging punches, went into the attack. Papp, however, was equal to the occasion and finished a clear winner. The feature of this weight was the number of gruelling contests which took place. Not the least of these was the one between two much-fancied contestants, M. McKeon (Eire) and A. Escudie (France). Both were strong boxers, who had no intention of giving way to each other, and they punched and counter-punched from start to finish of a thrilling and cleanly contested bout.

*Light-heavyweights.* Contrary to the normal run of boxing, this weight provided the most polished boxer of the entire Games. G. Hunter (South Africa), the winner, was without doubt the best all-round competitor in any weight. Nearly matching Hunter in his excellence was D. E. Scott of Great Britain. The luck of the draw kept these

two apart until the final. The copy-book boxing of each, attack and counter-attack, the variety of punches, the speed and natural ring-craft ensured a final which could not have displeased even a connoisseur of the sport. Scott, who had injured his nose prior to the Games, made light of his handicap, and was little behind the faultless Hunter in any round, but Hunter's superiority was sufficient to gain him the decision. An unusual casualty in this weight was A. F. Holmes of Australia. During his contest with G. M. Cia (Argentine) for third place, he fell to the floor and broke his ankle.

*Heavyweights.* The form of the heavyweights was not exceptional. Argentine, who had won the first event, the flyweights, capped the evening by winning the final event. A. R. Iglesias, who had won his previous three bouts on points, knocked out the Swede, G. Nilsson, in the final. The latter had hardly been expected to finish in second place, and in his bout with Iglesias, found the Argentinian a little too good for him. J. Gardner of Great Britain had shown promise in knocking out the Austrian, K. Ameisbichler, in the second round. Against H. Muller (Switzerland), however, in his next fight, he was unable to cope with the swinging blows of his opponent, after taking a heavy punch in the first round. Two other boxers who promised well in this less-polished weight, were J. Arthur (South Africa) and E. Lambert (U.S.A.). An injury to his ribs, had without doubt, affected the performance of Lambert, who lost to Arthur in the third round. Arthur, who lost to Iglesias in the semi-final, finished in third place.

It is a tribute to the birthplace of boxing to say that almost all of the winners, and many of those who reached the later stages, owed much to the fact that they boxed in the traditional English style. True, they all showed that they could meet emergencies by "fighting" when necessary, but there is little doubt that the upstanding, straight-punch style is still the basis of good boxing. The staying power of most of the competitors was also a notable feature and in many cases proved to be the deciding factor when two otherwise equal men met.

No boxer can survive a week's competition unless he is perfectly fit and it was evident that each country had ensured the fitness and stamina of its competitors. At the same time, the large number of participants in the Olympic Games boxing places a great strain on those who reach the finals. It is true that each finalist is in much the same position, but it must be realised that, at the end of a week's boxing, they are bound to feel the continuous strain of keeping to weight, surviving injury and facing a new opponent almost every day.

In the course of the boxing at the 1948 Games, there was no major failing in relation to the arrangements for the competitors or the spectators, if the refereeing and judging in the earlier rounds is excepted. That this left much to be desired was evidenced by strong action taken by the Association Internationale de Boxe Amateur in eliminating those officials who were adjudged below the required standard. The refereeing and judging in the final stages was impeccable and not one verdict in the finals was questioned by the vast audience at the Empire Pool, despite the closeness of many of the bouts. The value of the Jury d'Appel in finding the best officials on this occasion cannot be doubted.

Though the boxing events in this class of competition are not unknown for incidents, there was only one affair which could possibly be labelled as such. A competitor, who had had the verdict given against him, was encouraged to run round the Pool to demonstrate his disagreement. This incident, however, turned out to be more amusing than amazing.

Altogether the boxing events could be termed most successful. The results of the finals saw two titles go to South Africa, two to South America and four to Europe, a not uneven distribution. The progress shown by some of the lesser known boxing nations is most encouraging, and they can look forward to the next Games with a fair measure of confidence.

Keen competition and good fellowship were the order of the day. This was the spirit of the 1948 Games, and while that spirit is shown, the Olympic Games fulfil, indeed, the ideals of their inaugurator.

## ASSOCIATION INTERNATIONALE DE BOXE AMATEUR

### JURY OF APPEAL

Major-General W. R. E. MURPHY, DSO, MC, *Ireland*

VIKTOR SMEDS, *Finland*

J. ORIANI, *Argentine*

A. DVORAK, *Czechoslovakia*

A. SCHEMAN, *France*

A. FORRAY, *Hungary*

H. G. H. CHANDLEY, *Great Britain*

E. MAZZIA, *Italy A.*

PROET HOST, *Norway*

A. ZAPLATKA, *Poland*

T. ST. J. DEAN, *South Africa*

J. A. LEE, *U.S.A.*

---

### OFFICERS OF THE ASSOCIATION INTERNATIONALE DE BOXE AMATEUR

PRESIDENT OF HONOUR

J. M. WYATT, FRCS

PRESIDENT EMILE

GREMAUX, *France*

HON. SECRETARY-TREASURER Lt.-Col. R.

H. RUSSELL, *Great Britain*

VICE-PRESIDENTS

EDOARDO MAZZIA, *Italy*

JAMES A. LEE, *U.S.A.*

VIKTOR SMEDS, *Finland*

MEMBERS OF EXECUTIVE COMMITTEE

Sir EUGEN MILLINGTON DRAKE, KCMG, *Argentine*

Major-Gen. W. R. E. MURPHY, DSO, MC *Ireland*

A. PROET HOST, *Norway*

SECRETARIAT

W. J. G. LEWIS, Assistant Secretary

J. H. POOLE, i/c Draws

F. FROST, i/c Brassards, Referees and Judges

Miss P. PEYTON, Stenographer

Mlle. MICHELINE BASQUIN, Stenographer

---

**All Bouts were contested over three rounds of  
three minutes each with one minute between rounds.**

*Referees and Judges*

Oscar Garzon Funes  
 W. Hanks M. M.  
 Devos M.  
 Rayemackers  
 A. F. d'Almeida  
 Gustavo de Mattos  
 B. Kobza  
 H. A. Afifi  
 M. Haddad  
 E. Makinen  
 M. Vaisberg  
 M. Rabret  
 M. Pecquer  
 H. S. Murray  
 M. Fitzpatrick  
 G. Marjoribanks  
 J. Sanders  
 P. Loomans  
 C. Gallagher  
 J. J. Walsh  
 J. J. Healy  
 S. Loy  
 Sr. Pagani-Cesa  
 G. Pixius J.  
 Welter A. Nuss  
 D. Calvo  
 J. Casanovas J.  
 Risoto  
 F. V. Del Valle  
 M. Ritzi  
 Tage Bergman  
 Cervera  
 C. R. Thompson  
 S. Royle  
 Ivor Matthews  
 F. Rostron  
 Cdr. S. D. Cutter  
 A. Naderi  
 B. Missik

*Judges*

R. Almeida  
 E. Bustamente  
 W. Ver Eecken  
 James Sims  
 D. G. Obeyesekere  
 S. W. Dassenaike  
 C. C. Bartolome  
 Dave Stevenson  
 John Eriksson  
 O. Soderlund  
 Sven Holmberg  
 Frank Schwinger  
 J. L. Fabricio  
 A. Rondini  
 F. Gill  
 A. Harmo  
 Yussef

*Secretariat*

J. O. McIntosh  
 H. C. Brundle

*Arena Managers*

W. T. Lovett L. A.  
 Maddison R. H.  
 Charles H N.  
 Mansergh

**OFFICIALS**

*Liaison Officers*

H. W. Mallin  
 J. Titmus

*Interpreters*

W. Morrison  
 D. Schwizik  
 A. Hauptrief  
 F. H. Trevett

*Scales Managers*

C. Bloomfield  
 H. W. Adams  
 R. J. Munford  
 E. N. Mobbs  
 F. G. Parish  
 A. F. Fish  
 R. W. Kittlehales  
 E. Booth  
 W. Parker  
 L. S. Deubert  
 H. Parfitt  
 F. A. S. Hinton  
 Glyn Evans  
 W. E. Nightingale J.  
 Procter

*M.C.'s*

R. Pressney  
 S. Lock  
 H. A. Hedger  
 F. Mills  
 F. Tyler  
 J. Holland  
 P. Fox  
 E. S. Every  
 T. Bryan  
 W. B. Marchant

*M.C.'s Stewards*

J. H. Rice J. E.  
 Taylor R.  
 Bebbington P.  
 Morrison  
 D. Williams  
 J. Harding

*Timekeepers*

T. C. L. Parkinson  
 A. J. P. Martin J. S.  
 Hawkins R. C.  
 Warnes R. K. Gunn  
 R. S. Attwater A.  
 Ratcliffe A. L.  
 Cartwright J. S.  
 Williams W.  
 Nichols

*Medical Officers*

A. Kennedy  
 J. P. Reidy  
 E. B. Strauss

J. L. Blonstein  
 J. Fenton  
 J. H. Hale  
 H. M. Rashbrook  
 J. G. Golroy  
 D. R. Tipping  
 A. H. Cogman  
 C. L. Greenbury  
 J. C. Lade  
 D. Wallace  
 D. McPhail  
 I. MacKenzie  
 D. Wilkinson  
 Dr. Gilbert

*Whips*

W. C. Robins J. P.  
 Barry P. B. Swann  
 W. H. Sherwood  
 E. T. M. Austin  
 W. A. Ingham  
 D. Greenway  
 L. Copson  
 A. J. Lennox  
 C. V. Sederman  
 J. W. Turner  
 F. Verlander  
 R. F. Thomas  
 K. L. Wall

*Recorders*

E. J. Tucker  
 F. S. Dove  
 R. C. Green  
 F. J. Attwood  
 C. Allen  
 H. J. Mitchell W.  
 Carpenter J. H.  
 Miller J. H. Bryan  
 J. Gardiner  
 E. Williams  
 D. C. Keating  
 A. F. Jamieson

*Competitors' Stewards*

W. H. Stalley J.  
 Graves W. J.  
 Parmenter J. Beard

*Glovers*

J. Holmes  
 J. Dennis  
 A. C. Essex  
 W. R. H. Yexley  
 T. Wilder

*Seconds*

F. E. Perry  
 L. S. Coman  
 D. R. Wilson  
 T. Ryder



## FLYWEIGHT

(Up to 51 kg. 112 lb. 6 oz. 15 dr.)

### Previous Olympic Winners

1904 G. Finnigan	U.S.A.	1928 A. Koesis	Hungary
1920 F. de Genaro	U.S.A.	1932 St. Enekes	Hungary
1924 F. la Barba	U.S.A.	1936 W. Kaiser	Germany

There were 39 entries from 28 nations ; 26 participants from 26 nations

1st ROUND	2nd ROUND	3rd ROUND	SEMI-FINALS	FINAL
Sodano, F. U.S.A.	Sodano	} Sodano On pts.	} Majdloch On pts.	} <b>Perez</b> On pts.
Bhatta, R. India	Bhatta			
Barnes, W. Eire	Barnes	} Majdloch On pts.		
Majdloch, F. Czechoslovakia	Majdloch			
Bollaert, A. Belgium	Bollaert	} Bollaert On pts.	} <b>Perez</b> On pts.	
Carpenter, H. Great Britain (The above had byes)	Carpenter			
<b>Perez, P.</b> Argentina	} <b>Perez</b> Ref. stopped fight 3rd rd.	} <b>Perez</b> Ref. stopped fight 3rd rd.	} <b>Perez</b> On pts.	
Adolfo, R. Philippines				
Williams, D. South Africa	} Williams On pts.	} <b>Han</b> On pts.	} <b>PEREZ</b> On pts.	
Burgstrom, P. Sweden				
<b>Han, S. A.</b> Korea	} <b>Han</b> On pts.	} <b>Han</b> On pts.		
Gausterer, R. Austria				
Meneses Rodriguez, C. Peru	} Cochin On pts.	} <b>Han</b> K.O. 2nd rd.		
Cochin, M. France				
Corman, H. Hollana	} Corman On pts.	} Corman Ref. stopped fight 3rd rd.	} <b>Bandinelli</b> On pts.	
Rassaeli, G. Iran				
Maung Myo Thant Burma	} Maung Myo Thant On pts.	} <b>Bandinelli</b> On pts.		
Sandulo, O. Canada				
Martinez Zapata, L. Spain	} Martinez Zapata On pts.	} Martinez Zapata On pts.		
Bondi, M. Hungary				
Gower, R. Australia	} Gower On pts.	} <b>Bandinelli</b> On pts.		
Kasperczak, J. Poland				
Lehtinen, O. Finland	} <b>Bandinelli</b> On pts.	} <b>Bandinelli</b> On pts.		
<b>Bandinelli, S.</b> Italy				
Handunge, L. Ceylon	} Handunge On pts.	} <b>Bandinelli</b> On pts.		
Porteiro, G. Uruguay				

Third place bout **HAN** bt. Majdloch on points.

### FINAL PLACINGS

- 1 **PEREZ, P.** Argentina
- 2 **BANDINELLI, S.** Italy
- 3 **HAN, S. A.** Korea

**BANTAMWEIGHT**

(Up to 54 kg. 119 lb. 0 oz. 12 dr.)

*Previous Olympic Winners*

1904 O'Kirk	U.S.A.	1928 V. Tamagnini	Italy
1908 H. Thomas	Great Britain	1932 H. Gwyne	Canada
1920 Walker	South Africa	1936 U. Sergo	Italy
1924 W. Smith	South Africa		

There were 42 entries from 32 nations ; 30 participants from 30 nations

1st ROUND	2nd ROUND	3rd ROUND	SEMI-FINALS	FINAL
Saw, H.	Burma Saw	} Perera Ref. stopped fight 2nd rd.	} <b>Venegas</b> On pts.	} <b>Csik</b> On pts.
Perera, A. (The above had byes)	Ceylon Perera			
Callebout, L.	Belgium } <b>Venegas</b> Puerto Rico } On pts.	} <b>Venegas</b> On pts.	} <b>Venegas</b> On pts.	
<b>Venegas, J.</b>				
Lall, B.	India } Lall	} <b>Venegas</b> On pts.	} <b>Venegas</b> On pts.	
Monterio, A.	Pakistan } Ref. stopped fight 1st rd.			
Rivera Saenz, S.	Peru } Rivera Saenz	} <b>Csik</b> On pts.	} <b>Csik</b> On pts.	
Ahlin, N.	Sweden } On pts.			
<b>Csik, T.</b>	Hungary } <b>Csik</b>	} <b>Csik</b> On pts.	} <b>Csik</b> w.o.	
Nascimento, M.	Brazil } disq. 2nd rd.			
Toweel, V.	South Africa } Pares	} Carruthers On pts.	} <b>Csik</b> w.o.	
Pares, A.	Argentina } On pts.			
Daigle, F.	Canada } Carruthers	} Carruthers On pts.	} <b>Csik</b> w.o.	
Carruthers, J.	Australia } disq. 2nd rd.			
Proffitt, T.	Great Britain } Ojeda Malpica	} Vicente Demenech disq. 3rd rd.	} Vicente Demenech disq. 2nd rd.	
Ojeda Malpica, E.	Mexico } On pts.			
Vicente Demenech, A.	Spain } Vicente Demenech	} Vicente Demenech disq. 2nd rd.	} Vicente Demenech disq. 2nd rd.	
Aghassi, E.	Iran } On pts.			
Carrizo, P.	Uruguay } Carrizo	} Gonzalez Henriques On pts.	} <b>Zuddas</b> On pts.	
Mazurkiewicz, H.	Austria } On pts.			
Bazarnik, W.	Poland } Gonzalez Henriques	} Gonzalez Henriques On pts.	} <b>Zuddas</b> On pts.	
Gonzalez Henriques, C.	Chile } On pts.			
Lineham, W.	Eire } Lineham	} Lineham On pts.	} <b>Zuddas</b> On pts.	
Behm, R.	Luxembourg } On pts.			
Ouvinen, O.	Finland } Ouvinen	} Lineham On pts.	} <b>Zuddas</b> On pts.	
Thastum, E.	Denmark } On pts.			
Zarcal, B.	Philippines } <b>Zuddas</b>	} <b>Zuddas</b> K.O. 2nd rd.	} <b>Zuddas</b> Ref. stopped fight 3rd rd.	
<b>Zuddas, G.</b>	Italy } On pts.			
Bossio, W.	U.S.A. } Grenot	} <b>Zuddas</b> K.O. 2nd rd.	} <b>Zuddas</b> Ref. stopped fight 3rd rd.	
Grenot, J.	France } On pts.			

Third place bout **VENEGAS** bt. Vicente Demenech on points

**FINAL PLACINGS**

- 1 **CSIK, T.** Hungary
- 2 **ZUDDAS, G.** Italy
- 3 **VENEGAS, J.** Puerto Rico

### FEATHERWEIGHT

(Up to 58 kg. 127 lb. 13 oz. 14 dr.)

#### Previous Olympic Winners

1904 O'Kirk	U.S.A.	1928 L. van Kloveren	Holland
1908 R. Gunn	Great Britain	1932 R. Robledo	Argentina
1920 P. Fritsch	France	1936 O. Casanovas	Argentina
1924 F. Field	U.S.A.		

There were 42 entries from 31 nations ; 30 participants from 30 nations

1st ROUND	2nd ROUND	3rd ROUND	SEMI-FINALS	FINAL				
Kerschbaumer, E. <i>Austria</i>	Kerschbaumer	} Kerschbaumer On pts.	} Nunez On pts.	} <b>SHEPHERD</b> On pts.				
Verdu Belen, F. <i>Spain</i> (The above had byes)	Verdu Belen							
Bose, B. <i>India</i>	} Nunez On pts.	} Nunez On pts.	} <b>SHEPHERD</b> On pts.					
Nunez, F. <i>Argentina</i>								
Ghaoui, M. <i>Lebanon</i>	} Videla Castillo On pts.	} Johnson On pts.			} <b>FORMENTI</b> On pts.			
Videla Castillo, M. <i>Chile</i>								
Delannoit, E. <i>Belgium</i>	} Alves On pts.	} Johnson On pts.				} <b>FORMENTI</b> On pts.		
Alves, B. <i>Uruguay</i>								
Goslin, C. <i>New Zealand</i>	} Johnson Ref. stopped fight 3rd rd.	} <b>SHEPHERD</b> On pts.					} <b>FORMENTI</b> On pts.	
Johnson, E. <i>U.S.A.</i>								
<b>SHEPHERD, D.</b> <i>South Africa</i>	} <b>SHEPHERD</b> On pts.	} <b>SHEPHERD</b> On pts.		} <b>FORMENTI</b> On pts.				
Greve, S. <i>Pakistan</i>								
Ammi, M. <i>France</i>	} Ammi On pts.	} Su K.O. 2nd rd.	} <b>FORMENTI</b> On pts.					
Brander, P. <i>Great Britain</i>								
Tammelin, M. <i>Finland</i>	} Birks On pts.	} Su K.O. 2nd rd.			} <b>FORMENTI</b> On pts.			
Birks, L. <i>Australia</i>								
Hamoda, M. <i>Egypt</i>	} Su On pts.	} <b>ANTKIEWICZ</b> On pts.				} <b>FORMENTI</b> On pts.		
Su, Bung Nan <i>Korea</i>								
Garcia Arcila, P. <i>Peru</i>	} Garcia Arcila On pts.	} <b>ANTKIEWICZ</b> On pts.					} <b>FORMENTI</b> On pts.	
Sorensen, S. <i>Denmark</i>								
Trani, L. <i>Philippines</i>	} <b>ANTKIEWICZ</b> On pts.	} <b>ANTKIEWICZ</b> On pts.		} <b>FORMENTI</b> On pts.				
<b>ANTKIEWICZ, A.</b> <i>Poland</i>								
Farkas, B. <i>Hungary</i>	} <b>FORMENTI</b> On pts.	} <b>FORMENTI</b> On pts.	} <b>FORMENTI</b> On pts.					
<b>FORMENTI, E.</b> <i>Italy</i>								
Martin, K. <i>Eire</i>	} Martin On pts.	} <b>FORMENTI</b> On pts.			} <b>FORMENTI</b> On pts.			
Linneman, N. <i>Holland</i>								
Gundersen, K. <i>Norway</i>	} Colon K.O. 1st rd.	} <b>FORMENTI</b> On pts.				} <b>FORMENTI</b> On pts.		
Colon, S. <i>Puerto Rico</i>								
Fani, J. <i>Iran</i>	} Savoie On pts.	} Savoie On pts.					} <b>FORMENTI</b> On pts.	
Savoie, A. <i>Canada</i>								

Third place bout ANTKIEWICZ bt. Nunez on points

#### FINAL PLACINGS

- 1 **FORMENTI, E.** *Italy*
- 2 **SHEPHERD, D.** *South Africa*
- 3 **ANTKIEWICZ, A.** *Poland*

**LIGHTWEIGHT**

(Up to 62 kg. 136 lb. 10 oz. 15 dr.)

*Previous Olympic Winners*

1904 H. Spanger	U.S.A.	1928 C. Orlandi	Italy
1908 F. Grace	Great Britain	1932 L. Stevens	South Africa
1920 S. Mosberg	U.S.A.	1936 I. Harangi	Hungary
1924 H. Neilson	Denmark		

There were 42 entries from 32 nations ; 28 participants from 28 nations

1st ROUND	2nd ROUND	3rd ROUND	SEMI-FINALS	FINAL
<b>Dreyer, G.</b> } <i>South Africa</i>	<b>Dreyer</b>	} <b>Dreyer</b> On pts.	} <b>Dreyer</b> On pts.	} <b>DREYER</b> On pts.
Porto, E. } <i>Philippines</i>	Porto			
Breiby, I. } <i>Norway</i>	Breiby	} <b>Breiby</b> On pts.	}	
Kang, In Suk } <i>Korea</i>	Kang			
(The above had byes)				
Rinkinen, Tauno } <i>Finland</i>	McCullagh	} <b>McCullagh</b> On pts.	}	
McCullagh, M. } <i>Eire</i>	On pts.			
Remie, J. } <i>Holland</i>	Cooper	} <b>Wad</b> On pts.	}	
Cooper, R. } <i>Great Britain</i>	On pts.			
Raymond, G. } <i>India</i>	<b>Wad</b>	} <b>Wad</b> On pts.	}	
<b>Wad, S.</b> } <i>Denmark</i>	On pts.			
Boullosa, A. } <i>Uruguay</i>	Boullosa	} <b>Wad</b> On pts.	}	
Argote Marquinez, A. } <i>Spain</i>	On pts.			
Benedito Zumbano, R. } <i>Brazil</i>	Benedito Zumbano	} <b>Benedito Zumbano</b> On pts.	}	
Ehringer, N. } <i>Luxembourg</i>	K.O. 2nd rd.			
Caulet, A. } <i>France</i>	Caulet	} <b>Smith</b> K.O. 2nd rd.	}	
Minatelli, M. } <i>Italy</i>	On pts.			
Cornejo Diaz, E. } <i>Chile</i>	Smith	} <b>Smith</b> On pts.	}	
Smith, W. } <i>U.S.A.</i>	On pts.			
Rahimiha, M. } <i>Iran</i>	Lopez	} <b>Smith</b> On pts.	}	
Lopez, M. } <i>Argentina</i>	On pts.			
Haddad, E. } <i>Canada</i>	Haddad	} <b>Haddad</b> On pts.	}	
Nasir, E. } <i>Egypt</i>	On pts.			
Gray, E. } <i>Ceylon</i>	Gray	} <b>Haddad</b> On pts.	}	
Petrina, A. } <i>Czechoslovakia</i>	disq. 1st rd.			
Gutierrez Chacon, L. } <i>Peru</i>	Schmidiger	} <b>Vissers</b> On pts.	}	
Schmidiger, E. } <i>Switzerland</i>	w.o.			
Barber, W. } <i>Australia</i>	<b>Vissers</b>	} <b>Vissers</b> On pts.	}	
<b>Vissers, J.</b> } <i>Belgium</i>	On pts.			

Third place bout **WAD** w.o., Smith withdrew

**FINAL PLACINGS**

- 1 **DREYER, G.** *South Africa*
- 2 **VISSERS, J.** *Belgium*
- 3 **WAD, S.** *Denmark*

**WELTERWEIGHT**

(Up to 67 kg. 147 lb. 11 oz. 5 dr.)

*Previous Olympic Winners*

1904 A. Young	U.S.A.	1928 E. Morgan	New Zealand
1920 Schmieder	Canada	1932 E. Flynn	U.S.A.
1924 J. Delorge	Belgium	1936 S. Suvio	Finland

There were 37 entries from 27 nations ; 26 participants from 26 nations

1st ROUND	2nd ROUND	3rd ROUND	SEMI-FINALS	FINAL
Boyce, W. <i>Australia</i>	Boyce	} Boyce On pts.	} Du Preez On pts.	} <b>Herring</b> On pts.
Roller, L. <i>Luxembourg</i>	Roller			
Du Preez, D. <i>South Africa</i>	Du Preez	} Du Preez On pts.		
Rosano, A. <i>Uruguay</i>	Rosano			
Herrera, E. <i>Argentine</i>	Herrera	} Herrera On pts.	} <b>Herring</b> On pts.	
Loayza Veas, H. <i>Chile</i> (The above had byes)	Loayza Veas			
Afifi, G. <i>Egypt</i>	Foran	} <b>Herring</b> On pts.	} <b>Herring</b> On pts.	} <b>TORMA</b> On pts.
Foran, P. <i>Eire</i>	On pts.			
Bombart, E. <i>Belgium</i>	<b>Herring</b>	} <b>Herring</b> On pts.		
<b>Herring, H.</b> <i>U.S.A.</i>	On pts.			
Obeyesekere, A. <i>Ceylon</i>	Obeyesekere	} Chychla K.O. 2nd rd.	} <b>d'Ottavio</b> On pts.	
Turki, A. <i>Pakistan</i>	On pts.			
Chychla, Z. <i>Poland</i>	Chychla	} <b>d'Ottavio</b> On pts.		
Wijngaard, F. <i>Holland</i>	On pts.			
Hansen, G. <i>Norway</i>	Hernandez	} <b>d'Ottavio</b> On pts.	} <b>Torma</b> On pts.	
Hernandez, P. <i>France</i>	On pts.			
<b>d'Ottavio, A.</b> <i>Italy</i>	<b>d'Ottavio</b>	} <b>Torma</b> On pts.		
Issabeg, G. <i>Iran</i>	On pts.			
Shacklady, M. <i>Great Britain</i>	Shacklady	} Diaz Cadabeda On pts.	} <b>Torma</b> On pts.	
Christensen, C. <i>Denmark</i>	K.O. 3rd rd.			
Cranston, R. <i>India</i>	Diaz Cadabeda	} <b>Torma</b> disq. 2nd rd.		
Diaz Cadabeda, A. <i>Spain</i>	On pts.			
Bene, G. <i>Hungary</i>	<b>Torma</b>	} <b>Torma</b> Ref. stopped fight 2ndrd.		
<b>Torma, J.</b> <i>Czechoslovakia</i>	On pts.			
Blackburn, G. <i>Canada</i>	Blackburn	} <b>Torma</b> Ref. stopped fight 2ndrd.		
Velez, M., Jr. <i>Philippines</i>	On pts.			

Third place bout **D'OTTAVIO** bt. Du Preez on points

**FINAL PLACINGS**

- 1 **TORMA, J.** *Czechoslovakia*
- 2 **HERRING, H.** *U.S.A.*
- 3 **D'OTTAVIO, A.** *Italy*

## MIDDLEWEIGHT

(Up to 73 kg. 160 lb. 15 oz.)

### Previous Olympic Winners

1904 A. Mayer	U.S.A.	1928 P. Toscani	Italy
1908 I. Douglas	Great Britain	1932 G. Barth	U.S.A.
1920 H. Mallin	Great Britain	1936 J. Despeaux	France
1924 H. Mallin	Great Britain		

There were 34 entries from 25 nations ; 25 participants from 25 nations

1st ROUND	2nd ROUND	3rd ROUND	SEMI-FINALS	FINAL
Martinez, D. <i>Uruguay</i>	Martinez	} Martinez <i>On pts.</i>	} <b>Fontana</b> <i>On pts.</i>	} <b>Papp</b> <i>On pts.</i>
Kolczynski, A. <i>Poland</i>	Kolczynski			
Nuttall, J. <i>India</i>	Nuttall	} <b>Fontana</b> <i>On pts.</i>		
<b>Fontana, I.</b> <i>Italy</i>	<b>Fontana</b>			
Jones, W. <i>U.S.A.</i>	Jones	} Cavnignac <i>Disq. 2nd rd.</i>	} <b>Papp</b> <i>K.O. 1st rd.</i>	
Cavnignac, A. <i>Belgium</i>	Cavnignac			
Welter, J. <i>Luxembourg</i> <i>(Theabovehad byes)</i>	Welter	} <b>Papp</b> <i>Ref. stopped fight 1st rd.</i>	} <b>Papp</b> <i>K.O. 1st rd.</i>	
Resko, V. <i>Finland</i>	<b>Papp</b>			
<b>Papp, L.</b> <i>Hungary</i>	<b>Papp</b> <i>K.O. 2ndrd.</i>	} McKeon <i>On pts.</i>	} McKeon <i>On pts.</i>	} <b>PAPP</b> <i>On pts.</i>
Karlsson, T. <i>Sweden</i>	Toussi			
Toussi, H. <i>Iran</i>	<i>On pts.</i>	} McKeon <i>On pts.</i>		
Keenan, J. <i>Canada</i>	McKeon			
McKeon, M. <i>Eire</i>	<i>On pts.</i>	} Escudie <i>On pts.</i>	} <b>Wright</b> <i>On pts.</i>	
Hansen, M. <i>Denmark</i>	Hansen			
Johansen, E. <i>Norway</i>	<i>K.O. 1strd.</i>	} Escudie <i>On pts.</i>		
Escudie, A. <i>France</i>	Escudie			
La Grange, K. <i>S. Africa</i>	<i>On pts.</i>	} Schubart <i>On pts.</i>	} <b>Wright</b> <i>On pts.</i>	
Fahim, M. <i>Egypt</i>	Fahim			
Oliver Frontera, J. <i>Spain</i>	<i>Ref. stopped fight 2nd rd.</i>	} Schubart <i>On pts.</i>		
Prihoda, M. <i>Czechoslovakia</i>	Schubart			
Schubart, J. <i>Holland</i>	<i>On pts.</i>	} <b>Wright</b> <i>On pts.</i>		
Schneider, H. <i>Switzerland</i>	<b>Wright</b>			
<b>Wright, J.</b> <i>Great Britain</i>	<i>On pts.</i>	} <b>Wright</b> <i>Ref. stopped fight 2nd rd.</i>		
Higham, G. <i>Australia</i>	Garcia			
Garcia, H. <i>Argentine</i>	<i>On pts.</i>			

Third place bout **FONTANA** w.o. McKeon withdrew

### FINAL PLACINGS

- 1 **PAPP, L.** *Hungary*
- 2 **WRIGHT, J.** *Great Britain*
- 3 **FONTANA, I.** *Italy*

**LIGHT-HEAVYWEIGHT**

(Up to 80 kg. 176 lb. 5 oz. 14 dr.)

*Previous Olympic Winners*

1920 E. Eagan	U.S.A.	1932 D. Carstens	South Africa
1924 H. Mitchell	Great Britain	1936 R. Michelot	France
1928 V. Avendano	Argentine		

There were 33 entries from 24 nations ; 24 participants from 24 nations

1st ROUND	2nd ROUND	3rd ROUND	SEMI-FINALS	FINAL
Menabawi, M. <i>Egypt</i>	Menabawi	Holmes <i>K.O. 2nd rd.</i>	Holmes <i>On pts.</i>	} <b>HUNTER</b> <i>On pts.</i>
Holmes, A. <i>Australia</i>	Holmes			
Schwerzmann, H. <i>Switzerland</i>	Schwerzmann	O'Hagan <i>On pts.</i>	} <b>Scott</b> <i>On pts.</i>	
O'Hagan, H. <i>Eire</i>	O'Hagan			
Ossipoff, A. <i>Iran</i>	Ossipoff	Di Segni <i>On pts.</i>	} <b>Scott</b> <i>On pts.</i>	
Di Segni, G. <i>Italy</i>	Di Segni			
<b>Scott, D.</b> <i>Gt. Britain</i>	<b>Scott</b>	} <b>Scott</b> <i>Ref. stopped fight 2nd rd.</i>	} <b>Scott</b> <i>On pts.</i>	
Kapocsi, G. <i>Hungary</i>	Kapocsi			
<i>(The above had byes)</i>		} <b>Hunter</b> <i>On pts.</i>	} <b>Hunter</b> <i>On pts.</i>	
Spieser, C. <i>U.S.A.</i>	Spieser			
Jensen, E. <i>Denmark</i>	<i>On pts.</i>	} <b>Hunter</b> <i>On pts.</i>	} <b>Hunter</b> <i>On pts.</i>	
Edwards, R. <i>Jamaica</i>	<b>Hunter</b>			
<b>Hunter, G.</b> <i>South Africa</i>	<i>On pts.</i>	} <b>Hunter</b> <i>On pts.</i>	} <b>Hunter</b> <i>On pts.</i>	
Arteche Zurinaga, A. <i>Spain</i>	L'Hoste			
L'Hoste, V. <i>Belgium</i>	<i>On pts.</i>	} Siljander <i>On pts.</i>	} <b>Hunter</b> <i>On pts.</i>	
Michtits, O. <i>Austria</i>	Siljander			
Siljander, H. <i>Finland</i>	<i>On pts.</i>	} <b>Cia, G. M.</b> <i>Disq. 3rd rd.</i>	} <b>Cia</b> <i>On pts.</i>	
<b>Cia, G. M.</b> <i>Argentina</i>	<b>Cia</b>			
Quentemeyer, H. <i>Holland</i>	<i>On pts.</i>	} <b>Cia</b> <i>On pts.</i>	} <b>Cia</b> <i>On pts.</i>	
Suares, F. <i>Uruguay</i>	Suares			
Rademacher, O. <i>Czechoslovakia</i>	<i>On pts.</i>	} Szymura <i>Ref. stopped fight 3rd rd.</i>	} <b>Cia</b> <i>On pts.</i>	
Roude, J. <i>France</i>	Quitcon			
Quitcon, I. <i>Puerto Rico</i>	<i>Kef. stopped fight 1st rd.</i>	} Szymura <i>Ref. stopped fight 3rd rd.</i>	} <b>Cia</b> <i>On pts.</i>	
Szymura, F. <i>Poland</i>	Szymura			
Joachim, M. <i>India</i>	<i>On pts.</i>			

Third place bout **CIA** bt. Holmes, ref. stopped fight 3rd round

**FINAL PLACINGS**

- 1 **HUNTER, G.** *South Africa*
- 2 **SCOTT, D.** *Great Britain*
- 3 **CIA, G. M.** *Argentina*



## HEAVYWEIGHT

(Any weight)

### Previous Olympic Winners

1904 S. Berger	U.S.A.	1928 A. Jurdado	Argentine
1908 A. Oltman	Great Britain	1932 S. R. Lovell	Argentine
1920 Rawson	Great Britain	1936 H. Runge	Germany
1924 O. V. Porath	Norway		

There were 28 entries from 18 nations ; 17 participants from 17 nations

	1st ROUND	2nd ROUND	3rd ROUND	SEMI-FINALS	FINAL
Faul, A. <i>Canada</i>	Faul	Faul <i>On pts.</i>	Nilsson <i>On pts.</i>	Nilsson <i>On pts.</i>	IGLESIAS <i>K.O. 2nd rd.</i>
Bignon Guzman, V. <i>Chile</i>	Bignon Guzman				
<b>Nilsson, G.</b> <i>Sweden</i>	<b>Nilsson</b>	Nilsson <i>Disq. 2nd rd.</i>			
Djamshidabadi, M. <i>Iran</i>	Djamshidabadi				
Muniz, A. <i>Uruguay</i>	Muniz	Muller <i>K.O. 2nd rd.</i>	Muller <i>On pts.</i>		
Muller, H. <i>Switzerland</i>	Muller				
Ameisbichler, K. <i>Austria</i>	Ameisbichler	Gardner <i>K.O. 2nd rd.</i>	Iglesias <i>On pts.</i>		
Gardner, J. <i>Gt. Britain</i>	Gardner				
Baccilieri, U. <i>Italy</i>	Baccilieri	Baccilieri <i>On pts.</i>	Iglesias <i>On pts.</i>		
O'Colmain, G. <i>Eire</i>	O'Colmain				
Rubio Fernandez, J. <i>Spain</i>	Rubio Fernandez	<b>Iglesias</b> <i>On pts.</i>	<b>Iglesias</b> <i>On pts.</i>		
<b>Iglesias, A. R.</b> <i>Argentine</i>	<b>Iglesias</b>				
<b>Arthur, J.</b> <i>S. Africa</i>	<b>Arthur</b>	Arthur <i>Ref. stopped fight 1st rd.</i>	Arthur <i>On pts.</i>		
Galli, J. <i>France</i>	Galli				
Bothy, F. <i>Belgium</i>	Bothy	Lambert <i>On pts.</i>	Arthur <i>On pts.</i>		
(The above had byes)					
Lambert, E. <i>U.S.A.</i>	Lambert				
Antonio dos Santos, V. <i>Brazil</i>	Antonio dos Santos				

Third place bout **ARTHUR** w.o. Muller withdrew

### FINAL PLACINGS

- 1 **IGLESIAS, A. R.** *Argentine*
- 2 **NILSSON, G.** *Sweden*
- 3 **ARTHUR, J.** *South Africa*

# CANOEING

At Henley, the centre of British rowing, canoeing enjoyed the advantage of being brought before the wider public gathered there for that sport. The Canoeing Regatta occupied two days and on each there were races for two distinct classes of boat, the Kayaks and the Canadian Canoes.

The Kayak, a Swedish development of the older English " Rob Roy Canoe," is founded on the hunting craft used by Eskimo fishermen. It is long, narrow and decked, and is propelled from a sitting position by a man wielding a double-bladed paddle. A rudder operated by the feet may be used if desired.

The Canadian Canoe is an open craft, based on the birch bark canoe of the North-American Indian. The paddler kneels on one knee and using a single-bladed paddle he both propels and steers his craft. No rudder is permitted. This class has a very strong following in the land of its origin and in several European countries, notably Czechoslovakia, Austria and France.

Most of the teams arrived in time for the Opening Ceremony and afterwards settled down to serious practice over the course.

Many of the competitors expressed their approval of the technical arrangements and admiration for the beautiful setting provided by Henley and its surroundings. The warm welcome given by the people of Henley and the villages around was much appreciated. The provision of rest tents where competitors could relax was a happy innovation.

During the competitions, commentaries were received from some half-dozen stations along the course, and this enabled the longer races to be followed throughout.

The canoeing programme contained nine events from the World Championship list, and they had been selected to give a balanced representation. Thus, there were 1,000 metre and 10,000 metre races in kayaks and Canadian canoes for both Singles and Pairs, and one event for women, 500 metre Kayak Singles, the first time a women's event had been included.

## **The 10,000 Metre Course**

The 10,000 metre events were all held on the first day; the course used comprised four legs, two downstream and two upstream. The starting line and the finishing line were the same and the start was made downstream to Temple Island round which a left hand turn was made, the turning arc being marked by buoys. It then continued upstream past the enclosures, through the bridge and round Rod Eyot before returning over the same course back to Temple Island. Then came the final straight of 2,000 metres to the normal finishing line. Such a course provided the competitors with plenty of variety and the races could be watched not only from the enclosures, but also from the bridge, the tow path, and the roads skirting the bank above and below the bridge. When the 10,000 metre events were held in Berlin in 1936, they were along a straight course and each spectator saw but one short part of each race. In Scandinavia, it has now become the

practice to hold these races over a triangular course with the craft in view all the time, very much as sailing races are held.

During the morning of the first day of competition, rain fell heavily and continuously, and although it had cleared by the time racing was due to begin, it had discouraged many who would have attended. Sixteen nations had submitted entries for the kayak events, and this large number, combined with the narrow course, made it impossible to carry out a collective start. Since the I.C.F. Rules forbid heats for the long races, the kayaks had to be sent off at intervals of 30 seconds. This decision, although inevitable, was not popular, since it is impossible for a competitor to judge his position relative to the others, and he is forced to race to the clock, an extremely difficult technique. For similar reasons the method is unpopular with spectators, who, if they wish to follow progress, must make regular checks of time and order. However, this spacing of craft made possible a closer study of individual techniques.

In the Kayak Singles and Pairs, the spectators soon realised that the Scandinavian competitors were making good progress, and when the result of the Pairs was announced it was found that, not only had Sweden won as expected, with Akerlund and Wetterstrom but all the first four places had gone to the Northern countries.

In the Singles, the Swedish champion, Gert Fredriksson, who had not competed in the pairs, took part. During the last few years he has gained an enviable reputation in kayak racing circles in Europe. His superb technique, confidence and physique were most impressive, and he won his race by a comfortable margin. It was in this race that Wires of Finland collapsed after crossing the line and was gallantly assisted by Ditlevsen of Denmark until help arrived. It was found afterwards that Wires had gained second place and again the first four places went to Scandinavia, with Skabo (Norway) 3rd, and Ditlevsen 4th.

### **The Canadian Events**

As only some half-dozen countries had entered for the Canadian canoe events, it was possible to have normal mass starts, and this enabled spectators to see both the start and finish of two first-class races. In the Pairs, the American crew, Lysak and Macknowski, soon took the lead, and although Havel and Pecka of Czechoslovakia fought hard, and came in second, they never seriously challenged the leaders, who won by nearly two minutes. It was therefore with some surprise and consternation that a report was received from the Turning Point Control on Rod Eyot that the leading canoe had fouled one of the buoys marking the turn. The Umpire, in deciding against disqualification, presumably took account of the fact that the buoy was struck by a paddle during recovery and not by the canoe, and that the incident had in no way affected the outcome of the race. It had been a fine race, particularly interesting from the contrast in paddling styles displayed by the crews.

The Canadian Singles, the last event of the day, proved a test of endurance. It was the first time that this competition had been included in an international programme and some had considered it to be too long and severe.

When a canoe is paddled by one man, the drive of his paddle on one side has the effect of turning the bow away from the paddling side, and it is the skill involved in correcting this turning tendency, with the minimum loss of forward motion, that constitutes one of the most important factors in Single Canadian Canoe technique.

### **" Crooked " Canoes**

In this race certain teams used what came to be known as " crooked " canoes, from the lateral curve put into all or part of the keel. The effect of this curve is to give the canoe a tendency to turn in one direction, and by curving the keel in the appropriate direction, it can be made to neutralize the turning tendency caused by the paddling. Under these conditions, the canoe will run straight without the need for expenditure of effort in steering, by the paddler. Naturally, this gives a man in a " crooked " canoe an advantage over an opponent who must steer as well as drive, and protests were registered with the I.C.F. some days before the competition. These were rejected on the ground that this form of construction did not violate the existing building rule, since a curved keel is not a rudder in the accepted sense of the word. It was agreed, however, that such a development was undesirable, and the rule was amended to forbid their use in future competitions. The race was won by Capek of Czechoslovakia in one of these canoes. The removal of the need for much steering had enabled him to develop a stroke of maximum power.

### **The Second Day**

The second day's programme was composed of the heats and finals of the short-distance events, 500 metre and 1,000 metre. The large entry for kayaks made it necessary to hold eliminating races in the morning. Although in America and Britain women have never taken part in serious racing activity, in Denmark and a number of other countries the sport is very popular. It was from some of these countries, led by Denmark, that there came a strong call for the inclusion of at least one event for women. The Organising Committee and the International Olympic Committee agreed to this in substitution for the originally scheduled men's relay race. The admission of this one race proved fully justified, for ten nations sent entries and a very high standard was achieved.

Again the Canadian canoe entries were limited to the half-dozen nations who used this craft, and it was not necessary to arrange morning heats. In the Singles, Holecek of Czechoslovakia took first place, leading from Bennett of Canada by some ten seconds. Obviously, the " crooked canoe " technique could have no value outside racing, for it could not lead to advancement in the technique of running rapids.

The luck of the draw for Kayak Pairs placed three of the Scandinavian countries into one heat, but they all succeeded in reaching the final, in which Berglund and Klingstrom of Sweden won from Hansen and Jensen of Denmark by a split second. The first five kayaks crossed the line within three seconds. Toldi and Andrasi of Hungary were well placed, but were unfortunate in being disqualified for the technical fault of " hanging " in the wash of another kayak. This is forbidden by I.C.F. Rules, but over a short distance under conditions which permit only a minimum space between craft, it is possible to give the appearance of " hanging " when innocent of any such intent.

The Kayak Singles gave Fredriksson his second triumph, and he again demonstrated his amazing reserve of power and self assurance. In his heat in the morning he had allowed himself to lie fourth until within about 50 metres of the line when he increased his stroke and took first place, a split second ahead of Akerfelt of Finland. In the final, he repeated this by travelling with several others until near the finish and then spurting to cross about 6 seconds ahead of Andersen of Denmark, the winner of the other heat. Eberhardt of France, who gained third place, was a veteran of the 1936 Olympiad in which he won a Silver Medal in Singles.

The Canadian Pairs was a hard-fought race in which the Czechoslovak crew, Brzak and Kudrna, beat the Americans by three-quarters of a length.

The second Olympic Canoeing Regatta went off very smoothly and brought few surprises. The results followed known form remarkably closely, and the outstanding figure was Gert Fredriksson. His country set the seal on its reputation for kayak racing by winning all four events for men. Similarly, the Czech team, with three gold medals in Canadian canoes, demonstrated that in Europe they are pre-eminent with the single blade.

## INTERNATIONAL CANOE FEDERATION

*President*

J. ASSCHIER *Sweden*

*Vice - Presidents*

Dr. K. POPEL *Czechoslovakia* J. W. DUDDERIDGE *Great Britain*

*Honorary Secretary - Treasurer*

O. VERNER *Sweden*

---

### 10,000 METRES KAYAK SINGLES

*Previous Olympic Winners*

1936 E. Krebs *Germany* 46 m. 1.6 sec.

There were 27 entries from 16 nations ; 13 participants from 13 nations

		<i>m.</i>	<i>s.</i>
1	<b>FREDRIKSSON, G.</b> ..... <i>Sweden</i> .....	50	47.7
2	<b>WIRES, K.</b> ..... <i>Finland</i> .....	51	18.2
3	<b>SKABO, E.</b> ..... <i>Norway</i> .....	51	35.4
4	Ditlevsen, K. .... <i>Denmark</i> .....	51	54.2
5	Eberhardt, H. .... <i>France</i> .....	52	9.0
6	Bobeldijk, J. .... <i>Holland</i> .....	52	13.2
7	Sobieraj, C. .... <i>Poland</i> .....	52	15.2
8	Cobiaux, A. .... <i>Belgium</i> .....	53	23.5
9	Matocha, J. .... <i>Czechoslovakia</i> .....	53	51.0
10	Klepp, H. .... <i>Austria</i> .....	55	11.7
11	Bottlang, E. .... <i>Switzerland</i> .....	55	33.7
12	Riedal, E. .... <i>U.S.A.</i> .....	56	34.5
13	Lentz, M. .... <i>Luxembourg</i> .....	59	58.2

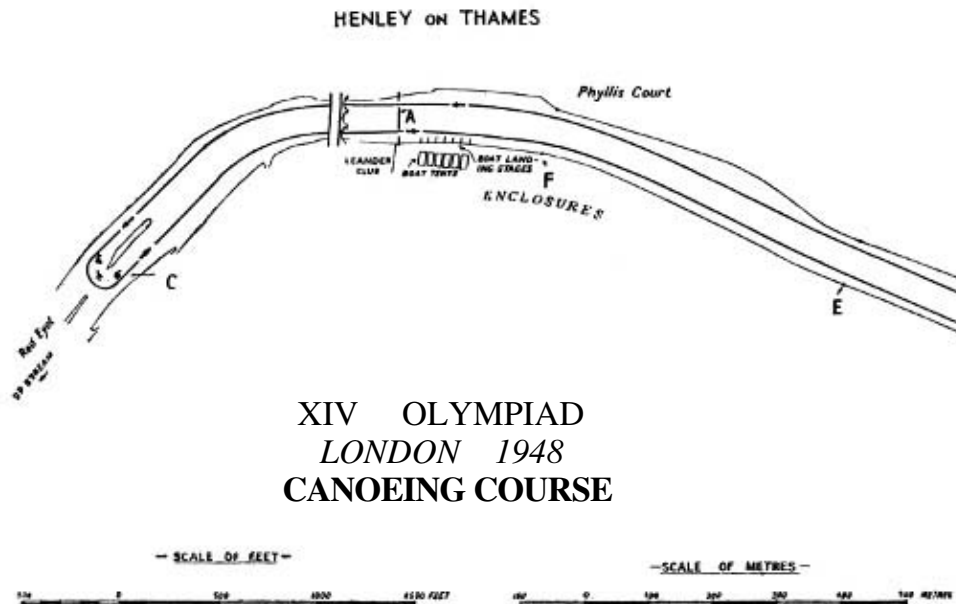

XIV OLYMPIAD  
LONDON 1948  
CANOEING COURSE

**10,000 METRES KAYAK PAIRS**

*Previous Olympic Winners*

1936 P. Wevers and L. Landen *Germany* 41 m. 45 sec.

There were 47 entries from 15 nations ; 30 participants from 15 nations

	<i>m.</i>	<i>s.</i>
1 <b>SWEDEN</b> (Akerlund, G. and Wetterstrom, H.) .....	46	9.4
2 <b>NORWAY</b> (Mathiesen, I. and Ostby, K.) .....	46	44.8
3 <b>FINLAND</b> (Axelsson, T. and Bjorklof, N.) .....	46	48.2
4 <i>Denmark</i> (Christensen, A. and Rasmussen, F.).....	47	17.5
5 <i>Hungary</i> (Andrasi, G. and Uranyi, J.) .....	47	33.1
6 <i>Holland</i> (Koch, C. and Stroo, H.) .....	47	35.6
7 <i>Czechoslovakia</i> (Klima, L. and Lomecky, K.).....	48	14.9
8 <i>Belgium</i> (Deprez, H. and Massy, J.) .....	48	23.1
9 <i>Austria</i> (Piemann, W. and Umgeher, A.) .....	48	24.5
10 <i>Poland</i> (Jezewski, A. and Matloka, M.) .....	48	25.6
11 <i>Switzerland</i> (Frey, F. and Zimmerman, W.) .....	48	33.2
12 <i>France</i> (Fleche, R. and Graffen, M.) .....	50	10.1
13 <i>U.S.A.</i> (Clark, R. and Eiseman, J.) .....	50	26.6
14 <i>Canada</i> (Covey, G. and Harper, H.) .....	53	4.2
15 <i>Luxembourg</i> (Fonck, R. and Nickels, J.).....	53	4.60



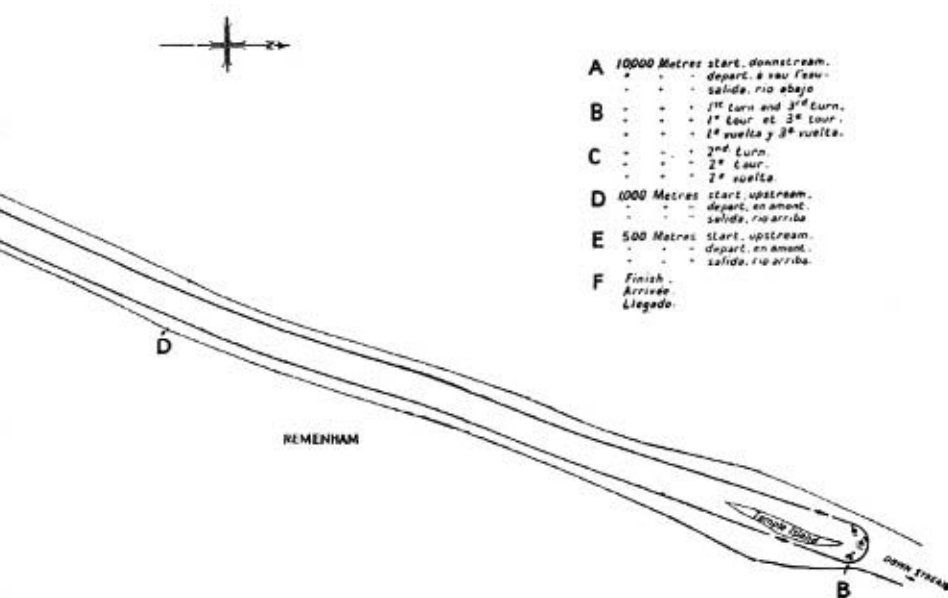

## 10,000 METRES CANADIAN SINGLES

This event was included in the Olympic programme for the first time

There were 9 entries from 6 nations ; 5 participants from 5 nations

		m.	s.
1	CAPEK, F. .... Czechoslovakia.....	62	5.2
2	HAVENS, F..... U.S.A. ....	62	40.4
3	LANE, N. D..... Canada.....	64	35.3
4	Argentin, R..... France .....	66	44.2
5	Andersson, I..... Sweden .....	67	27.1

**10,000 METRES CANADIAN PAIRS***Previous Olympic Winners*1936 V. Mottl and Z. Skrdlant *Czechoslovakia* 50 m. 33.5 sec.

There were 18 entries from 7 nations ; 12 participants from 6 nations

	<i>m.</i>	<i>s.</i>
1 <b>U.S.A.</b> (Lysak, S. and Macknowski, S.) .....	55	55.4
2 <b>CZECHOSLOVAKIA</b> (Havel, V. and Pecka, J.) .....	57	38.5
3 <b>FRANCE</b> (Dransart, G. and Gandil, G.) .....	58	0.8
4 <i>Austria</i> (Molnar, K. and Salmhofer, V.) .....	58	59.3
5 <i>Canada</i> (Oldershaw, B. and Stevenson, W.) .....	59	48.4
6 <i>Sweden</i> (Johansson, G. and Wettersten, V.) .....	63	34.4

**1,000 METRES KAYAK SINGLES***Previous Olympic Winners*1936 G. H. Hradetzky *Austria* 4 m. 22.9 sec.

There were 27 entries from 16 nations ; 15 participants from 15 nations

**FIRST ROUND***The first four in each heat qualified for the Final*

HEAT 1			HEAT 2		
	<i>m.</i>	<i>s.</i>		<i>m.</i>	<i>s.</i>
1 Fredriksson, G. .... <i>Sweden</i> .....	4	51.9	1 Andersen, J. .... <i>Denmark</i> .....	4	40.9
2 Akerfelt, H. .... <i>Finland</i> .....	4	52.0	2 Gulbrandsen, H. .... <i>Norway</i> .....	4	45.4
3 Piemann, W. .... <i>Austria</i> .....	4	52.2	3 Eberhardt, H. .... <i>France</i> .....	4	45.5
4 Vamera, L. .... <i>Czechoslovakia</i> .....	4	52.8	4 Van der Kroft, W. .... <i>Holland</i> .....	4	46.2
5 Boogaert, J. .... <i>Belgium</i> .....	5	0.1	5 Sobieraj, C. .... <i>Poland</i> .....	4	46.5
6 Straub, H. .... <i>Switzerland</i> .....	5	5.5	6 Horton, T. .... <i>U.S.A.</i> .....	4	58.0
7 Lentz, M. .... <i>Luxembourg</i> .....	5	10.8	7 Blaho, K. .... <i>Hungary</i> .....	4	59.8
			8 Dobson, N. .... <i>Great Britain</i> .....	5	0.1

**FINAL**

	<i>m.</i>	<i>s.</i>
1 <b>FREDRIKSSON, G.</b> .... <i>Sweden</i> .....	4	33.2
2 <b>ANDERSEN, J.</b> .... <i>Denmark</i> .....	4	39.9
3 <b>EBERHARDT, H.</b> .... <i>France</i> .....	4	41.4
4 Gulbrandsen, H. .... <i>Norway</i> .....	4	41.7
5 Van der Kroft, W. .... <i>Holland</i> .....	4	43.5
6 Akerfelt, H. .... <i>Finland</i> .....	4	44.2
7 Vamera, L. .... <i>Czechoslovakia</i> .....	4	44.3
8 Piemann, W. .... <i>Austria</i> .....	4	50.3

**1,000 METRES KAYAK PAIRS***Previous Olympic Winners*1936 A. Kainz and A. Dorfner *Austria* 4 m. 3.8 sec.

---

There were 52 entries from 16 nations ; 32 participants from 16 nations

**FIRST ROUND***The first four in each heat qualified for the Final*

HEAT 1			HEAT 2		
	<i>m.</i>	<i>s.</i>		<i>m.</i>	<i>s.</i>
1 <i>Finland</i> (Axelsson, T. and Bjorklof, N.) .....	4	16.7	1 <i>Denmark</i> (Hansen, E. W. and Jensen, J. B.)		
2 <i>Hungary</i> (Toldi, J. and Andradi, G.) .....	4	18.4	2 <i>Norway</i> (Mathiesen, I. and Ostby, K.)		
3 <i>Czechoslovakia</i> (Kroutil, O. and Pech, M.) .....	4	20.1	3 <i>Holland</i> (Gravesteyn, C. and Pool, W.)		
4 <i>Canada</i> (Covey, G. and Harper, H.).....	4	34.2	4 <i>Sweden</i> (Berglund, H. and Klingstrom, L.)		
5 <i>Luxembourg</i> (Fonck, R. and Nickels, J.) .....	4	41.7	5 <i>Austria</i> (Felinger, P. and Klepp, H.)		
6 <i>Switzerland</i> (Masciadri, B. and Reiner, F.) .....	4	43.9	6 <i>Belgium</i> (Van Den Berghen, R. and Van de Vliet, A.)		
7 <i>Great Britain</i> (Henderson, J. and Simmons, A.) ....	4	45.0	7 <i>France</i> (Donna, F. and Richez, R.)		
			8 <i>Poland</i> (Jezewski, A. and Matloka, M.)		
			9 <i>U.S.A.</i> (Clark, R. and Eiseman, J.)		
			(No times were taken)		

**FINAL**

	<i>m.</i>	<i>s.</i>
1 <b>SWEDEN</b> (Berglund, H. and Klingstrom, L.) ....	4	7.3
2 <b>DENMARK</b> (Hansen, E. W. and Jensen, J. B.) ..	4	7.5
3 <b>FINLAND</b> (Axelsson, T. and Bjorklof, N.) .....	4	8.7
4 <i>Norway</i> (Mathiesen, I. and Ostby, K.) .....	4	9.1
5 <i>Czechoslovakia</i> (Kroutil, O. and Pech, M.).....	4	9.8
6 <i>Holland</i> (Gravesteyn, C. and Pool, W.).....	4	15.8
7 <i>Canada</i> (Covey, G. and Harper, H.).....	4	56.8
<i>Hungary</i> (Toldi, J. and Andradi, G.)..... (Disqualified)		

**1,000 METRES CANADIAN SINGLES***Previous Olympic Winners*1936 F. Amyot *Canada* 5 m. 32.1 sec.

---

There were 11 entries from 7 nations ; 6 participants from 6 nations

	<i>m.</i>	<i>s.</i>
1 <b>HOLECEK, J</b> ..... <i>Czechoslovakia</i> .....	5	42.0
2 <b>BENNETT, D</b> ..... <i>Canada</i> .....	5	53.3
3 <b>BOUTIGNY, R</b> ..... <i>France</i> .....	5	55.9
4 Andersson, I. ......... <i>Sweden</i> .....	6	8.0
5 Havens, W..... <i>U.S.A.</i> .....	6	14.3
6 Maidment, H .....	6	37.0

**1,000 METRES CANADIAN PAIRS***Previous Olympic Winners*1936 R. V. Syrovatka and F. J. Brzak *Czechoslovakia* 4 m. 50.1 sec.

---

There were 21 entries from 8 nations ; 16 participants from 8 nations

	<i>m</i>	<i>s.</i>
1 <b>CZECHOSLOVAKIA</b> (Brzak, J. and Kudrna, B.)	5	7.1
2 <b>U.S.A.</b> (Lysak, S. and Macknowski, S.)	5	8.2
3 <b>FRANCE</b> (Dransart, G. and Gandil, G.)	5	15.2
4 <i>Canada</i> (Bennett, D. and Poulton, H.)	5	20.7
5 <i>Austria</i> (Salmhofer, V. and Molnar, K.)	5	37.3
6 <i>Sweden</i> (Johansson, G. and Wettersten, V.)	5	44.9
7 <i>Great Britain</i> (Symons, J. and Van Zwanenberg, H.)	5	50.8
<i>Belgium</i> (Coomans, H. and Dubois, J.) (Retired, man overboard).		

**500 METRES KAYAK SINGLES (Women)**

This event was included in the Olympic programme for the first time.

---

There were 13 entries from 10 nations ; 10 participants from 10 nations

**FIRST ROUND***The first four in each heat qualified for the Final*

HEAT 1				HEAT 2				
	<i>m</i>	<i>s.</i>		<i>m</i>	<i>s.</i>		<i>m</i>	<i>s.</i>
1 Kostalova, R.	2	39.6	<i>Czechoslovakia</i>	1 Hoff, K.	2	32.2	<i>Denmark</i>	
2 Saimo, S.	2	41.7	<i>Finland</i>	2 Van de Anker-Doedans, A. G.	2	35.4	<i>Holland</i>	
3 Van Marcke, A.	2	44.7	<i>Belgium</i>	3 Schwingl, F.	2	35.7	<i>Austria</i>	
4 Vautrin, C.	2	45.2	<i>France</i>	4 Banfalvi, K.	2	37.5	<i>Hungary</i>	
5 Richards, J.	3	0.1	<i>Great Britain</i>	5 Apelgren, I.	2	38.5	<i>Sweden</i>	

**FINAL**

	<i>m</i>	<i>s.</i>
1 <b>HOFF, K.</b>	2	31.9
2 <b>VAN DE ANKER-DOEDANS, A. G.</b>	2	32.8
3 <b>SCHWINGL, F.</b>	2	32.9
4 Banfalvi, K.	2	33.8
5 Kostalova, R.	2	38.2
6 Saimo, S.	2	38.4
7 Van Marcke, A.	2	43.4
8 Vautrin, C.	2	44.4

## CYCLING

Of all the Olympic programme, it was the cycling events which produced the greatest number of surprise results, not a single one of the eventual champions having been expected to win his event. As always, most attention focused upon the sprint, one event which it had been confidently expected would be won by a rider on his home track and cheered on by his own supporters—Reg Harris, already world champion among the amateur sprinters. Yet it was M. Ghella, of Italy, who was the winner in two straight heats, both won by comfortable margins.

The sprint was due to be taken to the semi-final stage on the first afternoon of the cycling events, Saturday, August 7. Actually, only three of the semi-finalists were known at the end of the day's racing, owing to the protest against the result of the race in the eighth-final between L. Rocca (Uruguay) and J. Hijzelendoorn (Holland). There had been a crash, almost on the finishing line, when this heat was first run, as a result of which the U.C.I. Controllers disqualified Rocca. A protest from Uruguay was, however, upheld by the Jury of Appeal, which decided that the race should be re-run on the following Monday. This protest caused a long delay in the racing on Saturday, already held up by the insistence of the U.C.I. Controllers on leaving the track after each round of the sprint to make the draw for the next succeeding round. The climax of this and the Uruguay appeal was that there was a period of 40 minutes during which no racing took place, a delay which the spectators bore with some impatience.

On the other hand, the large crowd fully appreciated the new results board, specially installed for the Games, and the extra seating space provided by the new stand and the temporary stand along the back straight. At the start of the afternoon there had been no real surprises in the first round of the sprint, nor in the repechage, but there was one shock in the eighth-finals (apart from the disputed heat) when J. Bellanger of France was eliminated by the Chilean rider, M. Masanes Gimeno. The eighth-finals were decided by a single race, subsequent stages being the best of three runs; and there was no repechage after the first round, so a half-wheel margin was sufficient to put Bellanger out of the competition.

All three quarter-finals which were decided on the Saturday were settled in straight races, and by convincing margins, Harris, for instance, beating Masanes Gimeno by a distance and 3 lengths; and Ghella disposing of E. Van de Velde (Belgium) by a distance and 2 lengths. The remaining quarter-final on the Monday, saw Rocca unable to cope with C. Bazzano (Australia), after winning his re-run against Hijzelendoorn. Bazzano, in turn, went down to Harris in one of the semi-finals, the other giving a foretaste of the power of Ghella's jump when he beat A. Schandorff (Denmark), in one race by as much as six lengths.

The power was immediately obvious in the first heat of the final, for at the 300-yard mark, Ghella whipped down inside Harris and was away with a two-length lead, which he not merely held but increased round the final banking and down the straight, to win by 3 lengths. Nor was the result any different in the second leg, in which Ghella was in front. When Harris challenged, coming off the banking into the back straight, Ghella

fought him off, held the inside position into the final bend and was untroubled by Harris's renewed challenge in the home straight. Like all the quarter-finals, the semi-finals and the final, the race for third place was decided in straight legs, Schandorff beating Bazzano (as he had done in the first round).

The other event to start on the Saturday afternoon was the team pursuit for which Italy were the most popular fancy, but which was eventually won by a first-rate French team. Once again there were few surprises in the preliminary stages, apart from a win by Uruguay over Holland. In the quarter-finals, competition was much keener, and Italy were inside 5 minutes for the distance in beating Belgium. The French team's time was only half a second outside 5 minutes, with Great Britain about two seconds slower. Britain, as it turned out, were unlucky in being drawn against France in the semi-final, for the French team recorded the fastest time of the whole event, 4 mins. 54.4 secs. in beating them, while the British time was faster than that of Italy, who beat Uruguay in the other semi-final. The French team's time beat the track record by five seconds.

In the final Italy went away the faster and held a lead of about two lengths for the first three laps. As in previous races, however, the French were riding strongly in the later stages and drew ahead two laps from the end, despite dropping one of their team. In their desperate efforts to draw level, the Italians dropped not one, but two of their team, and so were well beaten. Meanwhile Britain had gained third place by beating Uruguay in their fastest time, 4 mins. 55.8 secs., a time more than 3 seconds faster than the best Italian time.

### **Tandem Thrills**

The tandem event, which began on the Monday evening and concluded on the Wednesday, saw Harris in the final again, with A. Bannister as his partner; and once again he succumbed to Italy, represented by F. Teruzzi and R. Perona. In this case, however, the final went to a deciding leg, which was ridden in gathering darkness, so long had the programme taken to complete. The early stages of the event caused no surprises, and it was obvious that the Italian riders would be dangerous when they recorded a time of 11.2 seconds for the last 200 metres in their quarter-final, this being the same time as Harris and Bannister had put up in the first round. In the semi-finals Harris and Bannister were leading R. Faye and G. Dron (France) with 200 metres to go when they punctured, but wonderful control of the machine kept them upright, and they duly won the re-run by a wheel after an all-out effort by both pairs over the final lap. Teruzzi and Perona had an easier task, for they beat the Swiss pair, J. Roth and M. Aeberli, by six lengths. Nor were the latter pair a real match for the Frenchmen in the contest for third place.

The final of the tandems saw, perhaps, the most thrilling racing of the cycling events, and it was all the more to be regretted, therefore, that the darkness made it so difficult to follow. The British pair won the first race, jumping into the lead with a lap to go and trying an all-out sprint from the start of the back straight, which, despite the Italian challenge, carried them home with a length to spare, and with the fastest last 200 metres of the whole event, 11.1 secs. In the second race, however, they were caught when the

Italians dropped inside on the first banking of the last lap and went away so fast that they could not be overhauled. In the deciding race the Italians were inside at the bell, but Harris and Bannister, determined to go all the way, jumped them very early in the final lap and were nearly 2 lengths up in the back straight. But the Italians were game and determined, and had just that extra kick left in the last few yards which enabled them to draw level and to win by inches in a desperate finish.

There was some criticism of the fact that the 1,000 metres time trial was not run off as rapidly as possible. Instead of the minimum time between each separate trial, the event was 'staggered' to space out the tandem's concluding stages, with the result that the later competitors had to contend with a rising wind which had not troubled the earlier starters. However, for once, the favourite won : J. Dupont of France having a clear second's margin over P. Nihant of Belgium, with T. Godwin, the British representative, a further half second behind. G. Guerra, the Italian, who had shown promising form in training, was too fast in the early stages of his ride. His time at 500 metres, 37.8 secs., was one-fifth of a second faster than Dupont, but his final placing was only ninth. But for the damp and humid weather conditions, it is likely that the times recorded in this event would have been appreciably faster.

### **The Road Race**

The final Olympic cycling event was the road race which was held in Windsor Great Park by gracious permission of H.M. King George VI. The race was over a course of about 120 miles in 17 laps. The course included no severe gradients, but was sufficiently undulating to provide a real test of stamina, and with bends, especially that at Blacknest Gate, which needed all the skill of the contestants at the speed at which the race was run. Preparations had been made for a crowd which, it had been thought, might reach forty or fifty thousand, but this was, unfortunately, one of the wettest days of the whole Games, and it was surprising that there were as many as the 15,000 enthusiasts who, it was estimated, were on the circuit when the race was started by H.R.H. The Duke of Edinburgh.

Although attempts had been made to improve the surface of the roads within the Park, the wet weather had nullified them and unfortunately, punctures were frequent, several fancied riders being eliminated from the race.

The first competitor to break away decisively was N. Johansson (Sweden) during the second lap, at the end of which he was a minute ahead of the field. G. Voorting and H. Faanhof (both of Holland) caught him on Breakheart Hill, the chief rise on the course, on lap 3. For the next four laps these three riders not merely held their place, but increased their lead over the rest of the field until at the end of lap 7 they were 4 minutes ahead of the next group of riders. Then, however, Johansson punctured and lost nearly 3 minutes, being caught by the second group on lap 9. It was on lap 12 that the eventual pattern of the race became quite clear, the leading pair being caught by a group of nine riders which included all the eventual six placed competitors. Unlucky competitors at this stage of the race were R. Rasmussen (Denmark), who punctured, R. Rouffeteau (France), who crashed

at the pits while taking food, and Faanhof who sustained a puncture at Blacknest Gate. This left a leading group of eight with two laps to go.

G. Thomas (Great Britain), tried a breakaway on the penultimate lap, between Ascot and Blacknest Gates, and he was chased by L. Delathouwer (Belgium). The pair held a 15 second lead as they climbed Breakheart Hill and finished the lap. But with five miles still to go, the group were gaining fast, and as they caught the leaders, all the riders eased in readiness for the sprint which seemed certain to decide the race. J. Beyaert made his first real effort at Ascot gate, but, led by J. Hoobin, the group regained contact. The decisive moment was not, however, to be in the final sprint after all. A short distance before the top of Breakheart Hill, and with over half a mile still to go, Beyaert again sprinted into the lead and opened up a gap of at least eight lengths which was too much for any of his rivals, all of whom seemed more tired than the winner at the finish. Voorting won the sprint finish from the remainder of the leaders for second place, after being in the leading bunch ever since the third lap, and Belgian riders, L. Wouters and L. Delathouwer, finished third and fourth to gain the team title with the aid of E. Van Roosbroeck in twelfth place. Great Britain also had two riders among the leading group, R. Maitland and G. Thomas, and C. S. I. Scott came in sixteenth to gain the second team award.





*Hockey Preliminary Rounds—Great Britain v. Switzerland at the Guinness Sports Ground, Park Royal, Saturday, July 31st. The Swiss goalkeeper, Stuehlinger, saves a shot by W. Griffiths, the British outside left (extreme right).*

*Hockey Preliminary Rounds—India v. Spain at the Polytechnic Sports Ground, Chiswick, Friday, August 6th. An attack on the Spanish goal by GrahnanandanSingh.*





*Hockey Preliminary Rounds - Holland v. Belgium at the Guinness Sports Ground, Park Royal, Saturday, July 31st. J. Kielbaye, Belgium, shoots for goal, but his shot is blocked.*

*Hockey Preliminary Rounds - India v. Argentine at the Guinness Sports Ground, Park Royal, Wednesday, August 4th. "Sticks everywhere."*





*Hockey Semi-Final—India v. Holland at the Empire Stadium, Wembley, Monday, August 9th. An Indian forward falls in shooting at the Dutch goal.*





*Hockey Preliminary Rounds—India v. Argentina at the Guinness Sports Ground, Park Royal, Wednesday, August 4th. A general view of the game, which India won by 9 goals to 1, during an Indian attack.*



*Hockey Semi-Final—India v. Holland at the Empire Stadium, Wembley, Monday, August 9th. A Dutch player falls intercepting an Indian attack.*

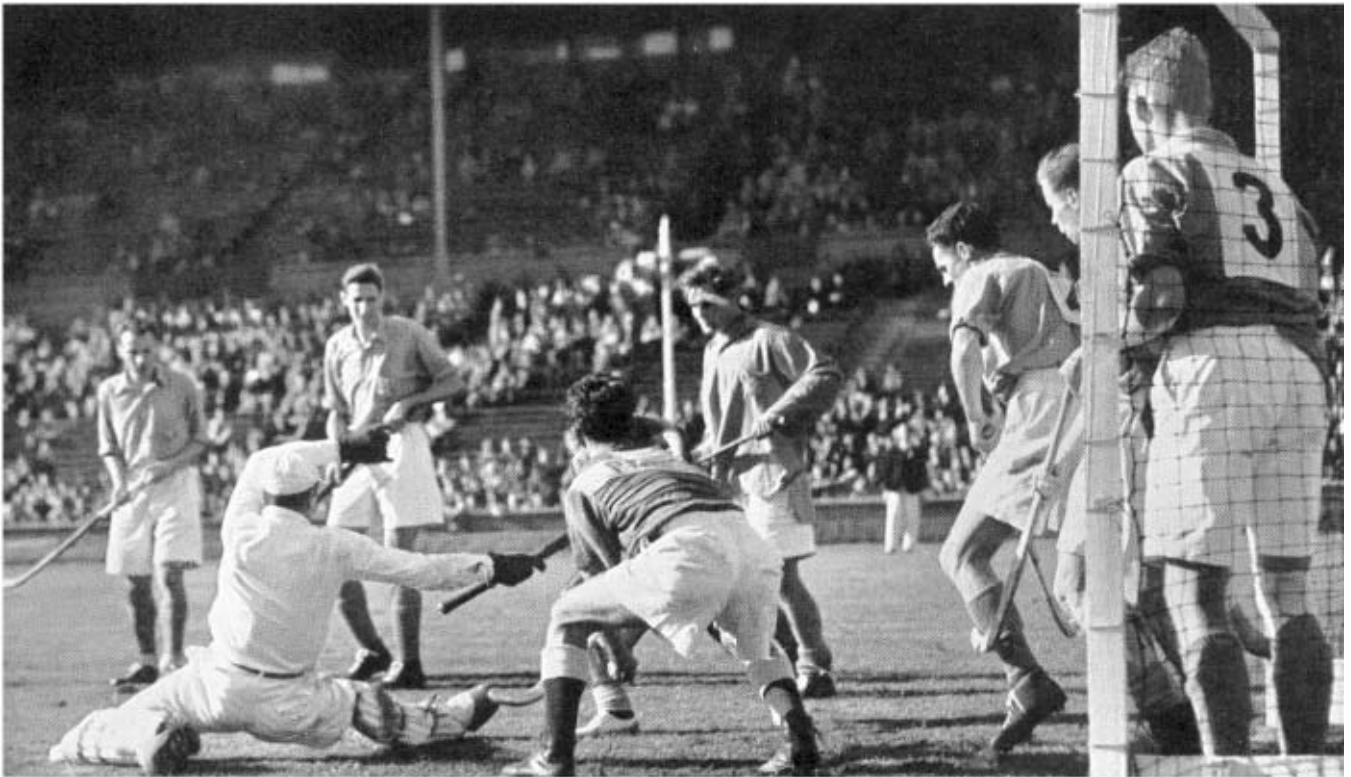

*Hockey Third Place Match—Pakistan v. Holland. An incident during an attack on the Dutch goal during the drawn match at the Empire Stadium, Wembley, on Thursday, August 12th.*



*Hockey, Third Place Match Replay—Pakistan v. Holland at Lyons Sports Ground, Sudbury Hill, Friday, August 13th. M. Moghal, the Pakistan goalkeeper, saves during a Dutch attack.*



*Hockey Semi-Final—Pakistan v. Great Britain at the Empire Stadium, Wembley, Monday, August 9th. An attack on the Pakistan goal by the British forwards.*





*Hockey Semi-Final—Pakistan v. Great Britain at the Empire Stadium, Wembley, Monday, August 9th. An attack by Pakistan is foiled by the British defence.*

*Hockey Final—India v. Great Britain at the Empire Stadium, Wembley, Thursday, August 12th. Grahnanandan Singh, the Indian centre-forward, runs through to score one of his team's goals. India won by 4 goals to nil.*





*Hockey Final—India v. Great Britain at the Empire Stadium, Wembley, Thursday, August 12th. Above, D. L. S. Brodie, the British goalkeeper, saving from Grahnanandan Singh. Below, India scoring her third goal.*





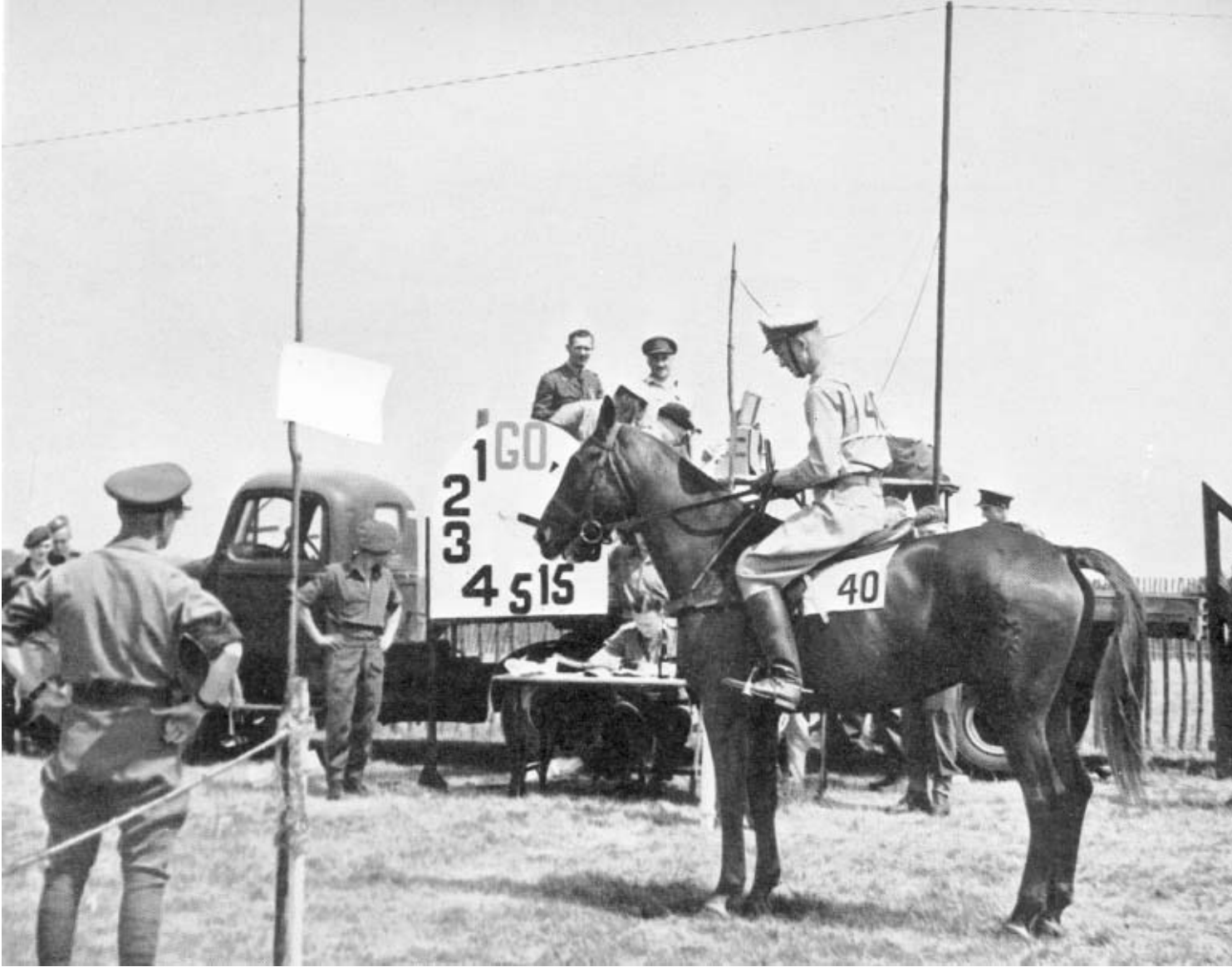

*Modern Pentathlon, Riding—Above, the starting gate, with Gruenther (U.S.A.) awaiting his signal. Note the clock on which competitors and officials could see the number of seconds still to elapse before the next man's departure. Below, Gardin (Sweden), bronze medallist, clearing a jump in the country. He was placed sixth in the riding.*





*Modern Pentathlon, Riding—Lumsden (Great Britain) who was placed third in the riding, clearing a ditch and fence.*



*Modern Pentathlon, Riding—Above, Palant (France) tackles one of the obstacles. He finished fortieth in the Riding. Below, Bernabeu Prada (Spain) climbing the bank in front of one of the jumps. Note the arrow showing the course turning away to the right.*







*Modern Pentathlon Fencing—Moore (U.S.A.), nearer the camera, "fleches" but misses Grut (Sweden). Grut was equal first in the fencing placings, and Moore equal third. They finished first and second respectively in the entire competition.*



*Modern Pentathlon, Running—Moore (U.S.A.) finishing the course in 15 min. 7.5 sec. He was fourth in this contest.*



*Modern Pentathlon, Swimming—The start of one of the heats at the Aldershot Pool. Although each competitor was timed separately, and the results determined on these timings, they swam in groups of four.*

*Modern Pentathlon, Shooting—Grut (Sweden), placed fifth in this event on a count-out after five competitors had each scored 190 points.*





*Modern Pentathlon, Riding — A general view of Tweseldown Racecourse, showing the type of country over which the event was held.*

*Modern Pentathlon, Fencing — The Army Gymnasium at Aldershot which was used for the fencing contests.*







*Modern Pentathlon, Shooting—The special range at Bisley, constructed for the Olympic Games, showing the covered firing points and the pentathlon targets in position.*



*Modern Pentathlon, Swimming—The Aldershot Council Swimming Pool which was the scene of the swimming contest.*





Modern Pentathlon—The Swedish competitors, Wehlin (seventeenth), Grut (first) and Gardin (third) at the conclusion of the competition. Note the multiple electric timer used in the swimming, riding and cross-country running events

### MODERN PENTATHLON RESULT SHOOTING BOARD

NUMBER	NATION	FLAGS	NAME	RANK	HITS POINTS	PLACING	
1	SWITZERLAND	☝☝☝	BEAN, B.	SERGEANT	20	174	
2	SWITZERLAND	☝☝☝	SCHEIDT, W.	CAPTAIN	10	173	
3	FINLAND	☝☝☝	HANSSON, F.	LIEUTENANT	20	170	
4	FINLAND	☝☝☝	VILKKO, L.T.	CAPTAIN	20	170	
5	SWEDEN	☝☝☝	GRUT, W.O.B.	LIEUTENANT	20	170	
6	CHILE	☝☝☝	PRUDENTI, BEGONER	LIEUTENANT	20	170	
7	FINLAND	☝☝☝	LANKKA, H.O.	MAJOR	20	170	
8	FRANCE	☝☝☝	BLANCH, C.L.G.	LIEUTENANT	20	170	
9	FRANCE	☝☝☝	FUCHON, L.F.M.	CAPTAIN	20	170	
10	SWEDEN	☝☝☝	GARDIN, S.	LIEUTENANT	20	169	
11	HUNGARY	☝☝☝	BEKONYI, L.	SERGEANT	20	169	
12	ITALY	☝☝☝	BRIGNETTI, D.	CAPTAIN	20	168	
13	UNITED STATES	☝☝☝	QUINCY, R.L.	LIEUTENANT	20	168	
14	ITALY	☝☝☝	CUSCIO, R.	CAPTAIN	20	168	
15	ITALY	☝☝☝	BRUNO, G.	CAPTAIN	20	167	
16	MEXICO	☝☝☝	RODRIGUEZ, A.	LIEUTENANT	20	167	
17	MEXICO	☝☝☝	ORTIZ, A.	LIEUTENANT	20	165	
18	FRANCE	☝☝☝	LACROIX, A.J.A.	DRUMMER	20	165	
19	SPAIN	☝☝☝	RODRIGUEZ, L.O.P.E.Z.	CAPTAIN	20	165	
20	CHILE	☝☝☝	FLORIO, SUXON, N.	LIEUTENANT	20	165	
21	SWEDEN	☝☝☝	WIKSTROM, W.	LIEUTENANT	20	165	
22	NETHERLANDS	☝☝☝	MARTIN, A.C.	LIEUTENANT	20	165	
23	NETHERLANDS	☝☝☝	MEGNER, E.	LIEUTENANT	20	165	
24	BELGIUM	☝☝☝	FALCONIER, L.	SERGEANT	20	177.7	
25	RUSSIAN SOVIET FEDERATION	☝☝☝	BAVLE, N.	CAPTAIN	20	177	
26	UNITED STATES	☝☝☝	BAUGH, H.	LIEUTENANT	20	177	
27	ARGENTINE	☝☝☝	WURDE, E.J.	LIEUTENANT	20	177	
28	ROMANIA	☝☝☝	JEMELIA, O.	CAPTAIN	20	173	
29	HUNGARY	☝☝☝	KARACSON, L.	CAPTAIN	19	173	
30	HUNGARY	☝☝☝	MERCADER, C.	LIEUTENANT	19	173	
31	ARGENTINE	☝☝☝	PERAZOLI, L.M.	LIEUTENANT	19	169	
32	BRAZIL	☝☝☝	JAMES, ROBERT, A.	CAPTAIN	19	167	
33	GREAT BRITAIN	☝☝☝	LUMSDEN, J.M.	LIEUTENANT	19	167	
34	BELGIUM	☝☝☝	V.V.T. C.	ADJUTANT	19	165	
35	SPAIN	☝☝☝	BERNABEU PRADA, M.	CAPTAIN	19	165	
36	BRAZIL	☝☝☝	RODRIGUEZ, SEBASTIAO, M.	CAPTAIN	18	166	
37	MEXICO	☝☝☝	GARCIA ROSAS, R.	LIEUTENANT	17	166	
38	FINLAND	☝☝☝	PLATAN, V.	CAPTAIN	17	161	
39	CUBA	☝☝☝	CADALSO PINOYER, R.	LIEUTENANT	17	161	
40	BELGIUM	☝☝☝	MOLLET, B.	LIEUTENANT	17	161	

Modern Pentathlon, Shooting—One of the result boards used to show the progress of the pentathlon competition.

Prince Bertil of Sweden congratulates the winner of the Modern Pentathlon, W. Grut (Sweden) on his victory. Grut's score of 16 points was an Olympic record for this event.



**UNION CYCLISTE INTERNATIONALE****OFFICERS**

ACHILLE JOINARD, President, *France*  
 ALBAN COLLIGNON, President of Honour, *Belgium*  
 LE JONKHEEN VAN DEN BERCH VAN HEEMSTEDE, Vice-President, *Holland*  
 E. J. SOUTHCOTT, Vice-President, *Great Britain*  
 CH. SENN, Vice-President, *Switzerland* SVEND HANSEN, Vice-President, *Denmark*  
 CH. SMULDERS, Vice-President, *Belgium*  
 ACHILLE LEGROS, Vice-President of Honour, *France*  
 ALBERT VEROUGSTRAETE, Treasurer, *Belgium*  
 RENE CHESAL, General Secretary, *France*

The events were contested under the regulations of the Union Cycliste Internationale

**OFFICIALS**

## TIMEKEEPERS

B. W. BEST                      H. CRYE                      L. F. DIXON                      A. V. GORDON                      A. LUSTY  
 R. T. MATTHEWS                      M. P. McCORMACK                      W. J. PETT                      R. TAYLOR                      J. T. WELLS

## CLERK-OF-THE-COURSE

L. C. VANNER

## ASSISTANT CLERKS-OF-COURSE

C. J. HALLERBACK                      J. H. WALLACE

## STARTERS

C. F. LAWTON                      A. C. SMYTH

## COMPETITORS' STEWARDS

C. T. KING                      T. A. MACDONALD                      F. K. MARSHALL                      M. G. SOUTHALL

## COMPETITORS' WHIPS

S. V. HARRISON                      W. L. WILSON                      E. D. WINGRAVE

## RECORDERS

T. M. BARLOW                      H. CROOKES                      E. N. CHIPPENDALE                      J. F. DITCHMAN

## ANNOUNCERS

C. R. ST. QUINTIN                      T. A. MACDONALD

## ANNOUNCERS' STEWARD

C. KING

## JUDGES' STEWARDS

E. ANDERSON                      S. SCOTT                      J. SIBBIT

## TRACK CENTRE ENCLOSURE STEWARD

H. DENISON

## LAP STEWARDS

W. GRAY                      T. H. MARTIN

## INTERPRETERS

A. GRANT                      F. J. SAUNDERS                      H. A. SMITH                      J. W. E. TERRY

## PRESS STEWARDS

H. MAYES                      W. J. MILLS                      F. J. DEVEREUX                      P. BRYAN  
 J. F. M'DERMOTT                      S. SELWYN                      G. PEARSON                      J. B. WADLEY

## LIAISON OFFICER

S. T. COZENS

## ARENA MANAGER

A. R. HAINE

## ASSISTANTS TO ARENA MANAGER

H. E. MILES                      A. STUMP

**1,000 METRES SCRATCH***Previous Olympic Winners*

1920	M. P. Peeters	<i>Holland</i>	1928	R. Beaufrand	<i>France</i>
1924	L. Michard	<i>France</i>	1932	J. J. van Egmond	<i>Holland</i>
1936	T. Merckens	<i>Germany</i>			

There were 43 entries from 26 nations ; 23 participants from 23 nations

By a decision of the commissaires of the International Cycling Union, the distance of the race was reduced from 1,000 m. (1,093 yards) to an exact two laps of the track, i.e., 920 m.

**FIRST ROUND**

*First Round winners qualified for eighth-finals, losers for the repechage heats.*

<b>HEAT 1</b>	<b>HEAT 2</b>	<b>HEAT 3</b>
Rocca, L. ( <i>Uruguay</i> ) bt. Gonsalves, C. ( <i>Trinidad</i> ) by 1½ l. 3 m.i.s. 10.9 sec., last 200 m., 12.6 secs.	Van de Velde, E. ( <i>Belgium</i> ) bt. Wing, Howard ( <i>China</i> ) by a wheel. 2 mins. 48.2 secs., last 200 m., 13.6 secs.	Roth, J. ( <i>Switzerland</i> ) bt. Masanes Gimeno, M. ( <i>Chile</i> ) by inches. 2 mins. 31.5 secs., last 200 m., 13.0 secs.
<b>HEAT 4</b>	<b>HEAT 5</b>	<b>HEAT 6</b>
Harris, R. ( <i>Great Britain</i> ) bt. Mullafiroze, R. ( <i>India</i> ) by one l. 2 mins. 17.0 secs., last 200 m., 14.4 secs.	Hijzelendoorn, J. ( <i>Holland</i> ) bt. Paseiro Rodriguez, R. ( <i>Cuba</i> ) by half l. 1 min. 42.7 secs., last 200 m., 13.3 secs.	Cortoni, C. ( <i>Argentina</i> ) bt. Leon, J. ( <i>Venezuela</i> ) by two l. 1 min. 58.0 secs., last 200 m., 12.4 secs.
<b>HEAT 7</b>	<b>HEAT 8</b>	<b>HEAT 9</b>
Schendorff, A. ( <i>Denmark</i> ) bt. Bazzano, C. ( <i>Australia</i> ) by one l. 1 min., 49.8 secs., last 200 m., 12.5 secs.	Bellanger, J. ( <i>France</i> ) bt. Lewis, L. F. ( <i>British Guiana</i> ) by two l. 2 mins. 9.1 secs., last 200 m., 12.5 secs.	Welt, E. ( <i>Austria</i> ) bt. Romero Quinones, R. ( <i>Mexico</i> ) by half l. 3 mins. 13.9 secs., last 200 m., 17.2 secs.
<b>HEAT 10</b>	<b>HEAT 11</b>	
Heid, J. ( <i>U.S.A.</i> ) bt. Mullick, N. ( <i>Pakistan</i> ) by two l. 1 min. 57.4 secs., last 200 m., 13.0 secs.	Ghella, M. ( <i>Italy</i> ) bt. Lacourse, R. ( <i>Canada</i> ) easily. 1 min. 54.4 secs., last 200 m., 12.9 secs.	

**REPECHAGE**

*Winners qualified for the eighth-finals.*

*Wing of China, having broken a collar bone after finishing in his heat, was unable to start. The commissaires then decided to allow Kaloudis, M. (Greece), who had arrived too late to compete in the preliminary rounds, to take Wing's place in the repechage.*

<b>HEAT 1</b>	<b>HEAT 2</b>	<b>HEAT 3</b>
Lacourse, R. ( <i>Canada</i> ) bt. Romero Quinones, R. ( <i>Mexico</i> ) by two l. 1 min. 48.1 secs., last 200 m., 13.7 secs.	Paseiro Rodriguez, R. ( <i>Cuba</i> ) bt. Mullafiroze, R. ( <i>India</i> ) by two l. 3 mins. 15.3 secs., last 200 m., 14.5 secs.	Bazzano, C. ( <i>Australia</i> ) bt. Mullick, N. ( <i>Pakistan</i> ) by two l. 2 mins. 31.0 secs., last 200 m., 14.1 secs.
<b>HEAT 4</b>	<b>HEAT 5</b>	
Leon, J. ( <i>Venezuela</i> ) bt. Gonsalves, C. ( <i>Trinidad</i> ) by one l. 2 mins. 4.7 secs., last 200 m., 12.6 secs.	1 Masanes Gimeno, M. ( <i>Chile</i> ); 2 Kaloudis, M. ( <i>Greece</i> ); 3 Lewis, L. ( <i>British Guiana</i> ). Won by two l. 1 min. 55.3 secs., last 200 m., 13.3 secs.	

## EIGHTH-FINALS

The winner of each heat qualified for the quarter-finals.

HEAT 1 Ghella, M. ( <i>Italy</i> ) bt. Leon, J. ( <i>Venezuela</i> ) by four l. 1 min. 59.7 secs., last 200 m., 12-0 secs.	HEAT 2 Hijzelendoorn, J. ( <i>Holland</i> ) bt. Rocca, L. ( <i>Uruguay</i> ) ( <i>disq.</i> ) 2 mins. 9.8 secs., last 200 m., 13.1 secs., <i>Both riders fell.</i>	HEAT 2 Rocca, L. ( <i>Uruguay</i> ) bt. Hijzelendoorn, J. ( <i>Holland</i> ) by two l. 1 min., 35.9 secs., last 200 m., 13.5 secs.
HEAT 3 Masanes Gimeno, M. ( <i>Chile</i> ) bt. Bellanger, J. ( <i>France</i> ) by inches. 3 mins., 4.5 secs., last 200 m., 12.8 secs.	HEAT 4 Schandorff, A. ( <i>Denmark</i> ) bt. Welt, E. ( <i>Austria</i> ) easily. 1 min., 49.6 secs., last 200 m., 12.5 secs.	HEAT 5 Van de Velde, E. ( <i>Belgium</i> ) bt. Paseiro Rodriguez, R. ( <i>Cuba</i> ) by ½ wheel. 3 mins. 46.5 secs., last 200 m., 13.0 secs.
HEAT 6 Heid, J. ( <i>U.S.A.</i> ) bt. Cortoni, C. ( <i>Argen- tine</i> ) by an inch. 2 mins. 5.7 secs., last 200 m., 12.0 secs.	HEAT 7 Bazzano, C. ( <i>Australia</i> ) bt. Roth, J. ( <i>Switzerland</i> ) by 1½ l. 3 mins. 51.6 secs., last 200 m., 14.3 secs.	HEAT 8 Harris, R. ( <i>Great Britain</i> ) bt. Lacourse, R. ( <i>Canada</i> ) by one l. 1 min. 31.7 secs., last 200 m., 15.1 secs.

\* By a later decision of the commissaires, following a protest by Uruguay, the result of Heat 2 and the disqualification of Rocca, L., were annulled, and the race re-ridden two days later.

## QUARTER-FINALS

The winner of each heat qualified for the semi-finals.

"A"	
HEAT 1 Ghella, M. ( <i>Italy</i> ) bt. Van de Velde, E. ( <i>Belgium</i> ) by a distance. 1 min. 47.7 secs., last 200 m., 12.1 secs.	HEAT 2 Ghella, M. bt. Van de Velde, E. by two l. 2 mins. 37.4 secs., last 200 m., 12.6 secs.
"B "	
HEAT 1 Schandorff, A. ( <i>Denmark</i> ) bt. Heid, J. ( <i>U.S.A.</i> ) by one l. 1 min. 49 secs., last 200 m., 12.3 secs.	HEAT 2 Schandorff, A. bt. Heid, J. by two l. 2 mins. 14.8 secs., last 200 m., 12.4 secs.
"C"	
HEAT 1 Harris, R. ( <i>Great Britain</i> ) bt. Masanes Gimeno, M. ( <i>Chile</i> ) by a distance. 2 mins. 39.8 secs., last 200 m., 12.5 secs.	HEAT 2 Harris, R. bt. Masanes Gimeno, M. by one l. 2 mins. 13.0 secs., last 200 m., 12.8 secs.
"D"	
HEAT 1 Bazzano, C. ( <i>Australia</i> ) bt. Rocca, L. ( <i>Uruguay</i> ) by a wheel. 3 mins. 9.4 secs., last 200 m., 12.8 secs.	HEAT 2 Bazzano, C. bt. Rocca, L. by 1½ l. 2 mins. 26.6 secs., last 200 m., 13.2 secs.

## SEMI-FINALS

The winner of each semi-final qualified for the final ; the loser for the third place match.

"A"	
HEAT 1 Ghella, M. ( <i>Italy</i> ) bt. Schandorff, A. ( <i>Denmark</i> ) by ¾ l. 3 mins. 53 secs., last 200 m., 12.1 secs.	HEAT 2 Ghella, M. bt. Schandorff, A. by three l. 1 min. 55.7 secs., last 200 m., 11.9 secs. (track record).
" B "	
HEAT 1 Harris, R. ( <i>Great Britain</i> ) bt. Bazzano, C. ( <i>Australia</i> ) by one l. 4 mins. 43.8 secs., last 200 m., 13.7 secs.	HEAT 2 Harris, R. bt. Bazzano, C. by ¾ l. 2 mins. 24.4 secs., last 200 m., 12.7 secs.

**1,000 METRES SCRATCH—continued.**

**FINAL**

HEAT 1

**GHELLA, M.** (*Italy*) bt. Harris, R. (*Great Britain*) by three l. 4 mins. 1.2 secs., last 200 m., 12.2 secs.

HEAT 2

**GHELLA, M.** bt. Harris, R. by 1½ l. 4 mins. 13.4 secs., last 200 m., 12.0 secs.

**RACE FOR 3RD PLACE**

HEAT 1

**SCHANDORFF, A.** (*Denmark*) bt. Bazzano, C. (*Australia*) by ¾ l. 2 mins. 10.4 secs., last 200 m., 12.9 secs.

HEAT 2

**SCHANDORFF, A.** bt. Bazzano, C. by two l. 2 mins. 26.0 secs., last 200 m., 12.0 secs.

**FINAL PLACINGS**

- 1 **GHELLA, M.** (*Italy*)
- 2 **HARRIS, R.** (*Great Britain*)
- 3 **SCHANDORFF, A.** (*Denmark*)
- 4 Bazzano, C. (*Australia*)

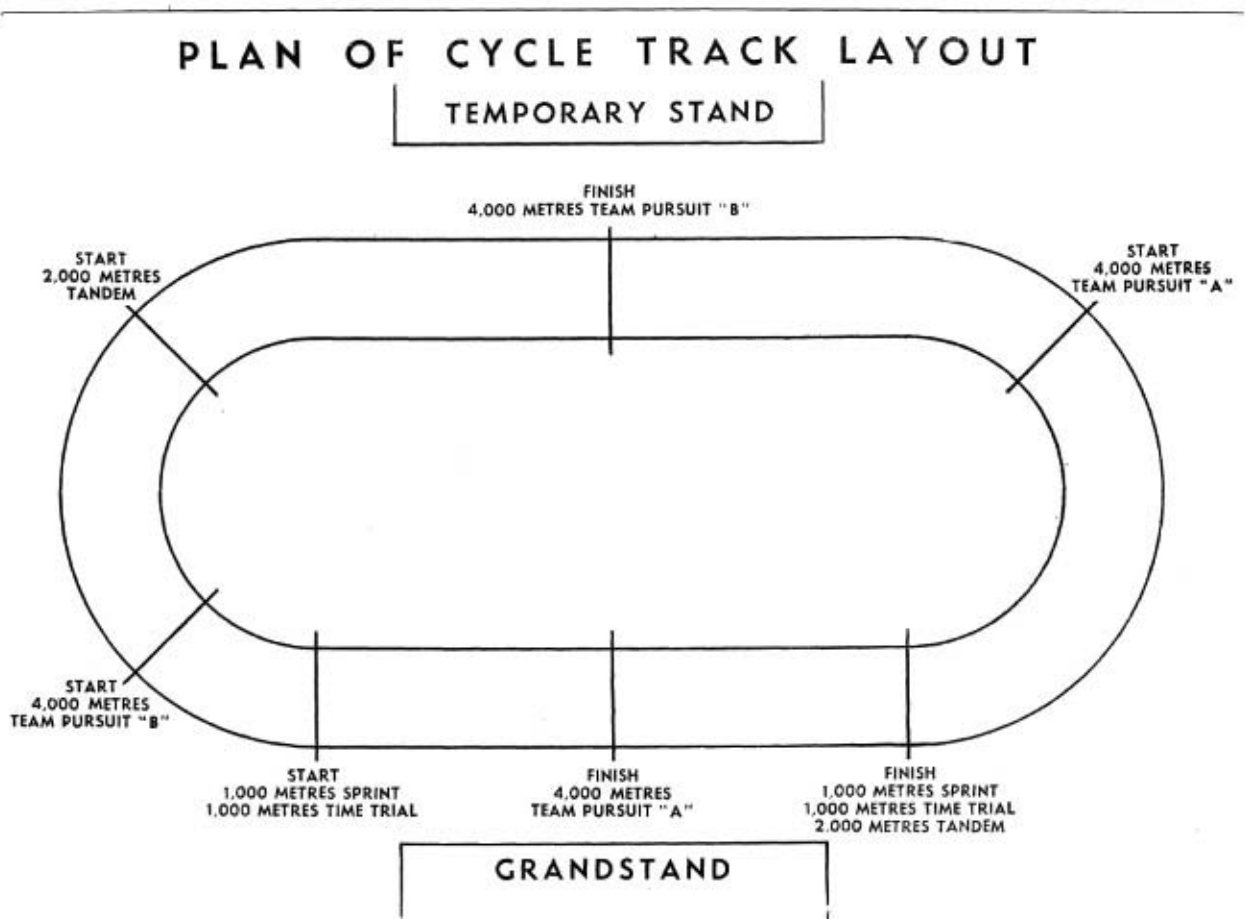

**1,000 METRES TIME TRIAL***Previous Olympic Winners*

1928	W. Falck-Hansen	<i>Denmark</i>	1	14.4 sec
1932	E. Gray	<i>Australia</i>	1	13.0 sec
1936	Van Vliet	<i>Holland</i>	1	12.0 sec
World Record* : 1 m. 10 sec. F. Battesini (Italy) Milan, 1938				
Olympic Record : 1 m. 12 sec. Van Vliet (Holland) Berlin, 1936				

(\*The U.C.I. does not differentiate between amateur and professional records.)

This event was decided entirely on time, each competitor riding 1,000 metres on his own, against the watch, from a standing start. Only one competitor from each nation could start. The order of riding was decided by the U.C.I. Commissaires.

---

There were 46 entries from 25 nations ; 21 participants from 21 nations.

		<i>m.</i>	<i>s.</i>
<b>1</b>	<b>DUPONT, J.</b> ..... <i>France</i> .....	1	13.5
<b>2</b>	<b>NIHANT, P.</b> ..... <i>Belgium</i> .....	1	14.5
<b>3</b>	<b>GODWIN, T.</b> ..... <i>Great Britain</i> .....	1	15.0
4	Fluckiger, H..... <i>Switzerland</i> .....	1	15.3
5	Schandorff, A..... <i>Denmark</i> .....	1	15.5
6	Patterson, S..... <i>Australia</i> .....	1	15.7
7	Heid, J..... <i>U.S.A.</i> .....	1	16.2
8	Freitag, W..... <i>Austria</i> .....	1	16.8
9	Guerra, G..... <i>Italy</i> .....	1	17.1
10	Kasslin, O..... <i>Finland</i> .....	1	17.4
11	Tramutolo, C..... <i>Uruguay</i> .....	1	17.5
12	Blankenauw, T..... <i>Holland</i> .....	1	17.7
13	Sobrevila, J..... <i>Argentina</i> .....	1	17.9
14	Leon, J..... <i>Venezuela</i> .....	1	18.1
15	Atkinson, L..... <i>Canada</i> .....	1	20.2
16	Gonsalves, C..... <i>Trinidad</i> .....	1	21.5
	Paseiro Rodriguez, R..... <i>Cuba</i> .....	1	21.5
18	Romero Quinones, R. .... <i>Mexico</i> .....	1	22.7
19	Noble, R..... <i>India</i> .....	1	22.9
20	Ali Wazir, A..... <i>Pakistan</i> .....	1	24.8
21	Lewis, L. F. .... <i>British Guiana</i> .....	1	25.0

**2,000 METRES TANDEM***Previous Olympic Winners*

1908	M. Schilles and A. Auffray	France	1928	Van Dyk and Leene	Holland
1920	H. E. Ryan and T. G. Lance	Great Britain	1932	M. Perin and L. Chaillot	France
1924	J. Cugnot and L. Choury	France	1936	E. Ihbe and C. Lorenz	Germany

---

There were 39 entries from 11 nations ; 20 participants from 10 nations

**FIRST ROUND**

*The heat winners qualified for the quarter-finals, the losers for the repechage.*

**HEAT 1**

Switzerland (Roth, J., Aeberli, M.) bt. Holland (Buchly, N., van Gelder, M.) 4 mins. 24.6 secs., last 200 m., 12.0 secs.

**HEAT 2**

Denmark (Andresen, H., Klamer, E.) bt. Belgium (van Schill, L., de Pauw, R.) 4 mins., 53.6 secs., last 200 m., 11.7 secs.

**HEAT 3**

Italy (Teruzzi, F., Perona, R.) bt. Argentine (Giacche, O., Passi, M.) 4 mins. 58.4 secs., last 200 m., 13.3 secs.

**HEAT 4**

France (Faye, R., Dron, G.) bt. U.S.A. (Thomson, M., Stiller, A.) 4 mins. 34.8 secs., last 200 m., 11.4 secs.

**HEAT 5**

Great Britain (Harris, R., Bannister, A.) bt. Austria (Nemetz, K., Welt, E.) 5 mins. 37.9 secs., last 200 m., 11.2 secs.

**REPECHAGE**

*The heat winners and the second in heat one qualified for the quarter-finals*

**HEAT 1**

1 Belgium (van Schill, L., de Pauw, R.) ; 2 Holland (Buchly, N., van Gelder, M.) ; 3 Argentine (Giacche, O., Passi, M.) 3 mins. 5.6 secs., last 200 m., 13.2 secs.

**HEAT 2**

1 U.S.A. (Thomson, M., Stiller, A.) ; 2 Austria (Nemetz, K., Welt, E.) 3 mins. 54.5 secs., last 200 m., 11.7 secs.

**QUARTER-FINALS**

*The winners of each heat qualified for the semi-finals*

**HEAT 1**

Great Britain (Harris, R., Bannister, A.) bt. Holland (Buchly, N., van Gelder, M.) by 1/4 l. 7 mins. 57.8 secs., last 200 m., 11.6 secs.

**HEAT 2**

France (Faye, R., Dron, G.) bt. Denmark (Andresen, H., Klamer, E.) by 1 1/2 l. 5 mins. 26.3 secs., last 200 m., 11.9 secs.

**HEAT 3**

Switzerland (Roth, J., Aeberli, M.) bt. U.S.A. (Thomson, M., Stiller, A.) by one l. 3 mins. 58.5 secs., last 200 m., 12.0 secs.

**HEAT 4**

Italy (Teruzzi, F., Perona, R.) bt. Belgium (van Schill, L., de Pauw, R.) by a distance. 4 mins. 35.6 secs., last 200 m., 11.2 secs.

**SEMI-FINALS**

*The winners of each semi-final qualified for the final; the losers for the third place match*

**HEAT 1**

Great Britain (Harris, R., Bannister, A.) bt. France (Faye, R., Dron, G.) by one l. 6 mins. 6.4 secs., last 200 m., 11.4 secs.

**HEAT 2**

Italy (Teruzzi, F., Perona, R.) bt. Switzerland (Roth, J., Aeberli, M.) by 6 l. 4 mins. 36.9 secs., last 200 m., 11.5 secs.



**FINAL**

## HEAT 1

**GREAT BRITAIN** (Harris, R., Bannister, A.) bt. **Italy** (Teruzzi, F., Perona R.) by one l. 3 mins. 56.6 secs., last 200 m., 11.1 secs.

## HEAT 2

**ITALY** bt. **Great Britain** by two l. 4 mins. 38.8 secs., last 200 m., 11.3 secs.

## HEAT 3

**ITALY** bt. **Great Britain** by 6 inches. 3 mins. 55.1 secs., last 200 m., 11.6 secs. **ITALY** won by 2 wins to 1.

**RACE FOR 3RD PLACE**

## HEAT 1

**FRANCE** (Faye, R., Dron, G.) bt. **Switzerland** (Roth, J., Aeberli, M.) by one l. 3 mins. 59.9 secs., last 200 m., 11.7 secs.

## HEAT 2

**FRANCE** bt. **Switzerland** by one l. 2 mins. 56.2 secs., last 200 m., 12.2 secs. **FRANCE** took 3rd place by 2 wins to 0.

**FINAL PLACINGS**

- 1 **ITALY** (Teruzzi, F., Perona, R.)
- 2 **GREAT BRITAIN** (Harris, R., Bannister, A.)
- 3 **FRANCE** (Faye, R., Dron, G.)
- 4 **Switzerland** (Roth, J., Aeberli, M.)

**4,000 METRES TEAM PURSUIT***Previous Olympic Winners*

1908	Great Britain	(1,809 m.)	1928	Italy	5 m. 6.2 sec.
1920	Italy	5 m. 20 sec.	1932	Italy	4 m. 53 sec.
1924	Italy	5 m. 12 sec.	1936	France	4 m. 45 sec.

Olympic Record : 4 m. 41.4 sec. France. Berlin, 1936

There were 93 entries from 16 nations ; 60 participants from 15 nations

**FIRST ROUND**

## HEAT 1

Great Britain (Geldard, R., Godwin, T., Ricketts, D., Waters, W.), 5 mins. 127 secs., bt. Canada (Atkinson, L., Hamilton, W., Pugh, L., Tessier, L.), 5 mins. 38.2 secs.

## HEAT 2

France (Coste, C., Blusson, S., Decanali F., Adam, P.), 5 mins. 3.6 secs., bt. Austria (Freitag, W., Goldschmid, H., Pohmetal, J., Schiebel, H.), 5 mins. 18.8 secs.

## HEAT 3

Switzerland, (Bucher, W., Gerosa, G., Kamber, E., Pfenninger, H.), 5 mins. 13.8 secs., bt. Argentine (Guerrero, R., Alba, J., Aimar, A., Molina, E.), 5 mins. 17.1 secs.

LAP TIMES—First lap time for  $\frac{3}{4}$  lap only, 4,000 m. being  $8\frac{3}{4}$  laps.

<i>Great Britain</i>		<i>Canada</i>		<i>France</i>		<i>Austria</i>		<i>Switzerland</i>		<i>Argentine</i>	
<i>m.</i>	<i>s.</i>	<i>m.</i>	<i>s.</i>	<i>m.</i>	<i>s.</i>	<i>m.</i>	<i>s.</i>	<i>m.</i>	<i>s.</i>	<i>m.</i>	<i>s.</i>
	29.1		29.0		28.2		29.6		29.4		27.1
1	1.0	1	2.4	1	1.2	1	2.6	1	4.6	1	7.3
1	34.4	1	38.6	1	34.1	1	38.0	1	38.0	1	54.0
2	9.2	2	16.6	2	9.1	2	13.6	2	14.0	2	10.3
2	45.4	2	54.6	2	41.4	2	43.6	2	50.2	2	47.0
3	21.2	3	33.8	3	16.2	3	27.0	3	28.2	3	24.1
5	58.1	4	13.2	3	51.4	4	4.2	4	3.8	4	1.4
4	35.2	4	55.2	4	27.4	4	41.6	4	38.4	4	39.3
5	12.7	5	38.2	5	3.6	5	18.8	5	13.8	5	17.1

XIV OLYMPIAD

HEAT 4

Italy (Benfenati, A., Bernardi, G., Citterio, A., Pucci, R.), 5 mins. 10.2 secs., bt. India (Havewalla A., Amin, J., Noble, R., Sarkari, P.), 6 mins. 0.5 sec.

<i>India</i>		<i>Italy</i>	
<i>m.</i>	<i>s.</i>	<i>m.</i>	<i>s.</i>
	30.2		27.1
1	5.8		59.2
1	43.6	1	33.4
2	24.4	2	8.4
3	6.0	2	44.2
3	46.6	3	21.0
4	33.0	3	57.1
5	17.4	4	33.3
6	0.5	5	10.2

HEAT 5

Uruguay (Francois, A., de Armas, J., De los Santos, L., Bernatsky, W.), 5 mins. 8.6 secs., bt. Holland (Voorting, G. Harmans, J., Blankenauw, T., Faanhof, H.), 5 mins. 14.7 secs.

<i>Holland</i>		<i>Urugua</i>	
<i>m.</i>	<i>s.</i>	<i>m.</i>	<i>s.</i>
	28.4		27.3
1	1.4	1	0.1
1	36.2	1	33.3
2	12.2	2	9.0
2	49.2	2	44.4
3	26.2	3	20.1
4	2.6	3	56.1
4	38.3	4	31.4
5	14.7	5	8.6

HEAT 6

Belgium (De Beukelaere, J., Blomme, M., Van Brabant, G., Glorieux, R.), 5 mins. 5.5 secs., bt. U.S.A. (Stiller, A., Montemage, T. Smith, T. R., Heid, J.), 5 mins. 22.5 secs. (Heid, J. was a non-starter.)

<i>U.S.A</i>		<i>Belgium</i>	
<i>m.</i>	<i>s.</i>	<i>m.</i>	<i>s.</i>
	28.0		28.2
1	1.2	1	4.0
1	36.9	1	34.2
2	13.8	2	9.1
2	50.6	2	43.2
3	29.0	3	18.2
4	7.6	3	54.4
4	46.8	4	31.0
5	22.5	5	5.5

HEAT 7

Denmark (Jorgensen, M., Gissel, B., Mortensen, B., Schnoor, B.), 5 mins. 4.1 secs., bt. Australia (Patterson, S. Nestor, E., Hoobin, J., Mockridge, E.), 5 mins. 6.5 secs.

<i>Australia</i>		<i>Denmark</i>	
<i>m.</i>	<i>s.</i>	<i>m.</i>	<i>s.</i>
	27.6		29.1
1	2.0	1	2.4
1	36.6	1	35.1
2	12.0	2	10.1
2	46.2	2	44.4
3	21.5	3	19.2
3	56.5	3	54.1
4	31.5	4	28.3
5	6.5	5	4.1

HEAT 8

Finland (Kasslin, O., Kuusinen, P., Koskinen, E., Hogstrom, T.), walked over, 5 mins, 17.4 secs.

<i>Finland</i>	
<i>m.</i>	<i>s.</i>
	29.3
1	3.4
1	38.0
2	14.1
2	50.3
3	27.2
4	4.1
4	41.2
5	17.4

NOTE.—As Finland had a rideover, it was ruled that her time must beat that of the fastest loser to qualify for Quarter-finals. However, fastest loser was Australia, with 5 m. 6.5 secs., against Finland's 5 m. 17.4 secs. The former, therefore, passed into Quarter-final.

QUARTER-FINALS

HEAT A

France, 5 mins. 0.5 secs., bt. Switzerland, 5 mins. 9.2 secs.

<i>France</i>		<i>Switzerland</i>	
<i>m.</i>	<i>s.</i>	<i>m.</i>	<i>s.</i>
	29.0		27.4
1	1.6	1	1.2
1	35.6	1	35.1
2	9.2	2	11.4
2	43.1	2	46.4
3	17.4	3	21.4
3	51.2	3	56.4
4	26.1	4	32.0
5	0.5	5	9.2

HEAT B

Great Britain, 5 min. 2.9 secs., bt. Denmark, 5 min. 5.6 secs.

<i>Great Britain</i>		<i>Denmark</i>	
<i>m.</i>	<i>s.</i>	<i>m.</i>	<i>s.</i>
	26.9		29.1
	59.5	1	2.2
1	33.7	1	35.3
2	8.9	2	10.0
2	43.2	2	45.1
3	18.7	3	19.4
3	53.8	3	56.2
4	28.0	4	31.1
5	2.9	5	5.6

HEAT C

Italy, 4 min. 59.0 secs., bt. Belgium, 5 min. 5.7 secs.

<i>Italy</i>		<i>Belgium</i>	
<i>m.</i>	<i>s.</i>	<i>m.</i>	<i>s.</i>
	26.9		29.3
	59.0	1	0.2
1	31.9	1	34.0
2	6.2	2	8.1
2	40.5	2	42.3
3	15.1	3	17.3
3	49.8	3	53.3
4	24.8	4	29.1
4	59.0	5	5.7

HEAT D

Uruguay, 5 min. 3.5 secs., bt. Australia, 5 min. 7.7 secs.

<i>Uruguay</i>		<i>Australia</i>	
<i>m.</i>	<i>s.</i>	<i>m.</i>	<i>s.</i>
	27.4		27.5
1	0.0	1	0.8
1	32.4	1	35.0
2	7.0	2	9.7
2	4.1	2	44.9
3	18.1	3	21.7
3	54.2	3	57.3
4	29.4	4	32.4
5	3.5	5	7.7

## SEMI-FINALS

## HEAT 1

France, 4 min., 54.4 secs., bt. Great Britain, 4 min. 59.1 secs.

<i>France</i>		<i>Great Britain</i>	
<i>m.</i>	<i>s.</i>	<i>m.</i>	<i>s.</i>
	28.2		26.8
1	0.4		56.6
1	32.0	1	31.2
2	5.1	2	14.0
2	37.4	2	38.6
3	11.7	3	12.0
3	45.6	3	47.2
4	20.4	4	22.0
4	54.4	4	59.1

## HEAT 2

Italy, 5 min. 0.5 secs., bt. Uruguay, 5 min. 6.8 secs.

<i>Italy</i>		<i>Uruguay</i>	
<i>m.</i>	<i>s.</i>	<i>m.</i>	<i>s.</i>
	26.0		27.4
	57.2		59.4
1	30.2	1	33.2
2	4.4	2	5.8
2	38.4	2	40.4
3	14.4	3	15.2
3	49.0	3	51.2
4	24.0	4	27.2
5	0.5	5	6.3

## FINAL

FRANCE, 4 min. 57.8 secs., bt. ITALY, 5 min. 36.7 secs.

<b>FRANCE</b>		<b>ITALY</b>	
<i>m.</i>	<i>s.</i>	<i>m.</i>	<i>s.</i>
	27.9		26.4
1	0.4		58.0
1	31.7	1	31.0
2	5.2	2	5.2
2	39.0	2	39.8
3	13.6	3	14.8
3	48.6	3	49.8
4	23.0	4	25.6
4	57.8	5	36.7

## RACE FOR 3rd PLACE

GREAT BRITAIN, 4 min. 55.8 secs. bt. URUGUAY, 5 min. 4.4 secs.

<b>GREAT BRITAIN</b>		<b>URUGUAY</b>	
<i>m.</i>	<i>s.</i>	<i>m.</i>	<i>s.</i>
	27.3		27.0
1	0.2		59.4
1	33.4	1	31.4
2	7.6	2	6.6
	40.6	2	40.8
3	14.7	3	15.8
3	47.4	3	50.8
4	22.0	4	27.4
4	55.8	5	4.4

## FINAL PLACINGS

- 1 FRANCE
- 2 ITALY
- 3 GREAT BRITAIN
- 4 Uruguay

**OFFICIALS FOR CYCLE ROAD RACE**

RACE CONTROLLERS

CHIEF

C. SENN, *Switzerland*

A. RODONI, *Italy*

A. STANDAERT, *Belgium*

ASSISTANT

L. DOREAU, *France*

H. ANDERSEN, *Denmark*

CHIEF JUDGE

M. DUPIN, *France*

ASSISTANT JUDGES

L. BERTOULINO, *Italy*

M. HORISBERGER, *Switzerland*

W. STAMPFLI, *Switzerland*

F. VASSEROT, *France*

PIT CONTROLLERS

Pit No. 1 : J. STOHL, *Holland*

Pit No. 2 : G. STINCHELLI, *Italy*

Feeding : M. HORISBERGER, *Switzerland*

*SMITH'S LAWN:*

*Controller in Chief*  
*Secretariat*  
*Control Room*

*Announcers*  
*Announcers' Clerk*  
*Commissaires' Stewards*  
*Competitors' Stewards.*  
*Timekeepers*  
*Timekeepers' Recorders*  
*Historical Recorders*  
*No. 1 Pits and Feeding Station*  
*No. 1 Pits Communications*  
*Interpreters*  
*Scoreboard Operator*  
*Officials' Enclosure*  
*Competitors' Dressing Tent*  
*Circuit Crossing Control*  
*Press Stewards...*

A. V. Jenner.  
S. R. Forrest, A. R. Haine, K. S. Forrest, E. R. Spencer.  
J. C. Clague, A. C. Quayle, L. C. Vanner, E. Anderson, W. H. Townsend,  
H. K. Evans, C. Cripps, F. H. Sore, S. Votier, S. Davies, D. Crease,  
E. K. Brunert (Interpreter).  
T. Macdonaldm, C. Wharrad  
R. Naris.  
H. E. Miles, J. Dupin.  
R. Flament, J. W. E. Terry.  
L. F. Dixon, J. T. Wells, A. Gordon.  
E. N. Chippendale, R. H. Grimsell.  
J. F. Ditchman, T. M. Barlow  
G. H. Fleming, C. King.  
L. S. Reader, H. Bishop.  
A. Grant, F. J. W. Saunders, H. Smith.  
W. F. Burl.  
H. F. Ryan.  
F. Wingrave.  
W. H. Gray, R. N. Miller.  
Appointed by the N.C.U. Press Committee.

*CUMBERLAND GATE*

A. Mulberry.

*CUMBERLAND LODGE TURNING*

(1) F. Robertson. (2) K. Loder.

*CHAPEL LODGE CROSS ROADS :*

*Communications*  
*Marshal*

R. T. Matthews, A. E. Dimmock.  
A. R. Drowley.

*LIME GROVE CROSSING CONTROL*

G. Shurman.

*SPRING HILL BRIDGE*

G. W. Hunton.

*LONG WALK:*

*Communications*  
*Marshal*  
*Circuit Crossing Control*  
*Announcer*  
*Announcer's Clerk*

J. Davis, H. Crye.  
B. E. Foster  
C. Spencer.  
L. E. Kent  
L. E. Ames.

<i>LEFT FORK:</i>	
<i>Communications</i>	L. A. Buttrey, H. D. Hawkins.
<i>Marshal</i>	E. Witcomb.
<i>WORKSHOPS CROSS ROADS</i>	K. J. Hill.
<i>ROYAL SCHOOLS CROSSING</i>	(1) H. Deighton.      (2) V. Slemen.
<i>WHITE FIELD GATE :</i>	
<i>Communications</i>	A. Smythe, E. Millet.
<i>Marshal</i>	E. A. Taylor.
<i>PRINCE CONSORTS GATE :</i>	
<i>Communications</i>	D. Lyons, A. E. Houghton.
<i>Marshal</i>	C. R. Uren.
<i>No. 2 Pits</i>	A. L. Pullen.
<i>ASCOT GATE :</i>	
<i>Communications</i>	J. Covill, F. S. Needle.
<i>Marshal</i>	H. Crookes.
<i>SUNNINGHILL FORK</i>	C. Lawton, H. Clapham.
<i>BLACKNEST GATE:</i>	
<i>Communications</i>	F. H. Robinson, K. H. Mosedale, F. A. Selwood.
<i>Marshals</i>	J. C. Beauchamp, R. Allen.
<i>HIGH BRIDGE</i>	M. Leventhal.
<i>KING'S LAWN</i>	D. Sweetland.
<i>BREAKHEART HILL :</i>	
<i>Communications</i>	C. G. Bowtle, F. Lloyd.
<i>Marshal</i>	M. G. Southall.
<i>Announcer</i>	S. Newport.
<i>Announcer's Clerk</i>	N. Wells.

#### EXTRACTS FROM THE REGULATIONS FOR THE CYCLE ROAD RACE

*The race was held under the Regulations of the Union Cycliste Internationale*

The distance was 17 laps of the Windsor circuit of 7 miles 202 yards (approximately 11½- kilometres), the total distance being 120 miles 1,674 yards (approximately 195 kilometres).

The circuit was closed from 10.30 a.m. to all traffic other than the riders and the motors under the control of the Race Controllers.

The race was both an individual event and a team race. In the team race each nation could enter a team of six riders of whom not more than four riders could take part in the event. The individual placings were determined by the order of finishing as returned by the Judges appointed by the U.C.I. The team placings were determined by the addition of the times of the first three riders in each team. No team could be placed if less than three of its riders finished. If two teams were equal on time the placings of these teams were determined by totalling the placings of the team members in the individual order of finish.

The Race Controllers were appointed by the Union Cycliste Internationale, and the complete control of the race was in their hands. They were empowered to exclude from the race any rider not qualified to compete or who, in their opinion, constituted a danger to other riders. They could also disqualify any rider for a breach of the Regulations of the U.C.I. or of the special regulations for the race.

Bicycles had to be fitted with two brakes in good order and carried the same number as that worn by the rider.

The order of positions at the start was determined by lot. One rider from each team took up position in the order of the draw, then a second rider from each team in the same order, and similarly for the third and finally the fourth riders.

Riders could exchange between themselves, food, drink, tyres and pumps and small tools such as spanners, but not bicycles, wheels or other parts of the bicycle. They could be handed articles only at the two official stations marked on the plan of the course (see page 332). A rider had to carry out all replacements and adjustments himself, except at the official stations.

Members of the public were forbidden to assist riders in any way whatsoever.

A rider could be supplied with a spare wheel or bicycle only if the damaged wheel or bicycle was considered unusable by the Station Controller.

Food and drink could be handed up to riders only at the Official Station near Cumberland Gate after the completion of the eighth and fourteenth laps. Food and drink could not be picked up on any other lap or at any other point on the circuit.

Riders who were lapped could be directed to withdraw from the race by the Controllers.

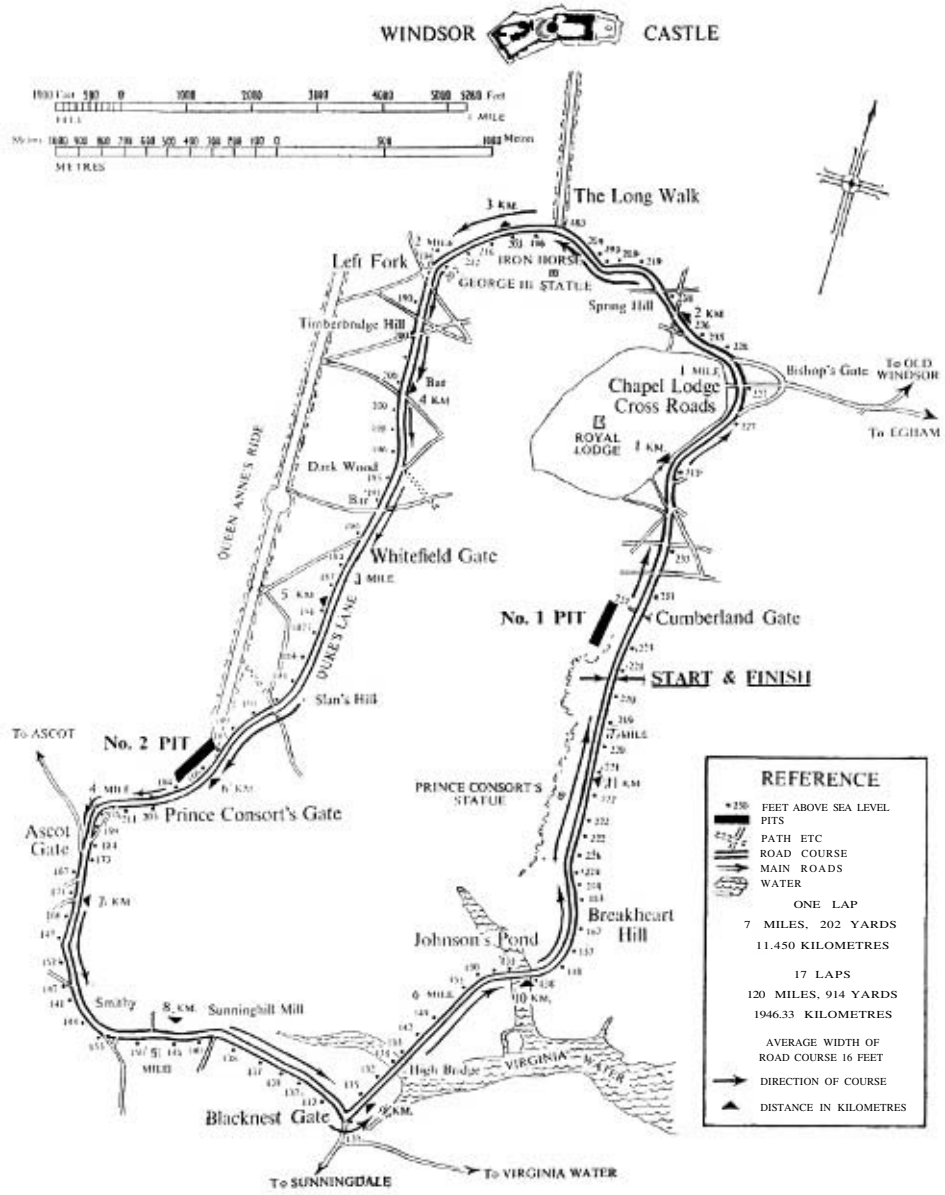

PLAN OF THE OLYMPIC ROAD COURSE,  
WINDSOR GREAT PARK

## CYCLE ROAD RACE

### Previous Olympic Winners

<i>(Individual)</i>					
1896	Constantides (87 km.)	<i>Greece</i>	1924	A. Blanchonnet	<i>France</i>
1896	Schmal (315 km.)	<i>Austria</i>	1928	H. Hansen	<i>Denmark</i>
1912	R. Lewis	<i>S. Africa</i>	1932	A. Pavesi	<i>Italy</i>
1920	E. H. Stenquist	<i>Sweden</i>	1936	R. Charpentier	<i>France</i>
<i>(Team Race)</i>					
1912	Sweden	1928	Denmark		
1920	France	1932	Italy		
1924	France	1936	France		

There were 141 entries from 31 nations ; 101 participants from 29 nations.

### INDIVIDUAL RESULTS

		<i>h m. s.</i>			<i>h m. s.</i>		
<b>1</b>	<b>BEYAERT, J</b> .....	<b>France</b> .....	5 18 12.6	15	Brun, J .....	<i>Switzerland</i> .....	5 26 54.0
<b>2</b>	<b>VOORTING, G</b> .....	<b>Holland</b> .....	5 18 16.2	16	Scott, C. S. I .....	<i>Great Britain</i> .....	5 26 57.2
<b>3</b>	<b>WOUTERS, L</b> .....	<b>Belgium</b> .....	5 18 16.2	17	Dupont, J .....	<i>France</i> .....	5 28 21.8
4	Delathouwer, L.....	<i>Belgium</i> .....	5 18 16.2	18	Snell, H.....	<i>Sweden</i> .....	5 28 22.2
5	Johansson, N .....	<i>Sweden</i> .....	5 18 16.2	19	Fanti, F .....	<i>Italy</i> .....	5 29 35.2
6	Maitland, R .....	<i>Great Britain</i> .....	5 18 16.2	20	Isotti, L .....	<i>Italy</i> .....	5 31 08.6
7	Hoobin, J .....	<i>Australia</i> .....	5 18 18.2	21	Perone, C .....	<i>Argentina</i> .....	5 33 15.4
8	Thomas, G.....	<i>Great Britain</i> .....	5 18 18.2	22	Benvenuti, D.....	<i>Argentina</i> .....	5 33 15.4
9	Ferrari, A.....	<i>Italy</i> .....	5 21 45.0	23	Sevillano, M.....	<i>Argentina</i> .....	5 33 15.4
10	Pedroni, S.....	<i>Italy</i> .....	5 21 45.0	24	Olivestedt, A.....	<i>Sweden</i> .....	5 33 48.2
11	Moineau, A .....	<i>France</i> .....	5 21 45.0	25	Reiser, W.....	<i>Switzerland</i> .....	5 34 25.2
12	Van Roosbroeck, E .....	<i>Belgium</i> .....	5 21 45.0	26	Mockridge, E.....	<i>Australia</i> .....	5 39 54.6
13	Schenk, J .....	<i>Switzerland</i> .....	5 21 45.0	27	Pedersen, K.....	<i>Denmark</i> .....	5 39 57.2
14	Valenta, R .....	<i>Austria</i> .....	5 24 48.0	28	Andersen, K.....	<i>Denmark</i> .....	5 39 57.2

### DID NOT FINISH

Mathieu, M. (*Argentina*) ; Caves, K. and Nestor, E. (*Australia*) ; Goldschmid, H., Huber, S. and Pohnetal, J. (*Austria*) ; Lerno, L. (*Belgium*) ; Lewis, L. F. (*Br. Guiana*) ; Atkinson, L., Jodoin, F., Pugh, L. and Tessier, L. (*Canada*) ; Iturrate Azocar, R., Masanes Gimeno, M., Ramirez Valero, E. and Salcedo Munoz, R. (*Chile*) ; Nielsen, B. S. and Rasmussen, R. (*Denmark*) ; Backman, P., Hogstrom, T. and Koskinen, E. (*Finland*) ; Rouffeteau, R. (*France*) ; Clements, E. (*Gt. Britain*) ; Kaloudis, M., Kouvelis, E. and Leonidis, P. (*Greece*) ; Faanhof, H., Grift, E. and Peters, P. (*Holland*) ; Havaladar, M., Mehrah, R., Mistry, E. and Pavri, H. (*India*) ; Hwang, San Ung and Kwon, Ik Hyun (*Korea*) ; Bintz, R., Ernzer, M., Kellen, H. and Scheer, P. (*Luxembourg*) ; Herrera Briones, P., Rodriguez Ledezma, F., Rodriguez Rodea, G. and Solis Archundia, M. (*Mexico*) ; Carter, T. (*New Zealand*) ; Christiansen, L., Flengsrud, L., Kristiansen, E. and Myhrvold, A. (*Norway*) ; Ali, W. (*Pakistan*) ; Llerena Valderrama, H., Mathey Hoke, P. and Poggi Cebrero, L. (*Peru*) ; Binneman, D., Estman, G. and Rivers, W. (*S. Africa*) ; Vanlund, O. (*Sweden*) ; Rossi, G. (*Switzerland*) ; Cetiner, A., Osmali, M., Suda, O. and Tuncalp, A. (*Turkey*) ; Brilando, F., Lynch, E., Nelsen, A. and Rollins, W. (*U.S.A.*) ; Bernatsky, W., De Marco, E., Figueredo, M. and Lopez, L. (*Uruguay*) ; Poredski, M., Prosenik, A., Strain, A. and Zoric, A. (*Yugoslavia*).



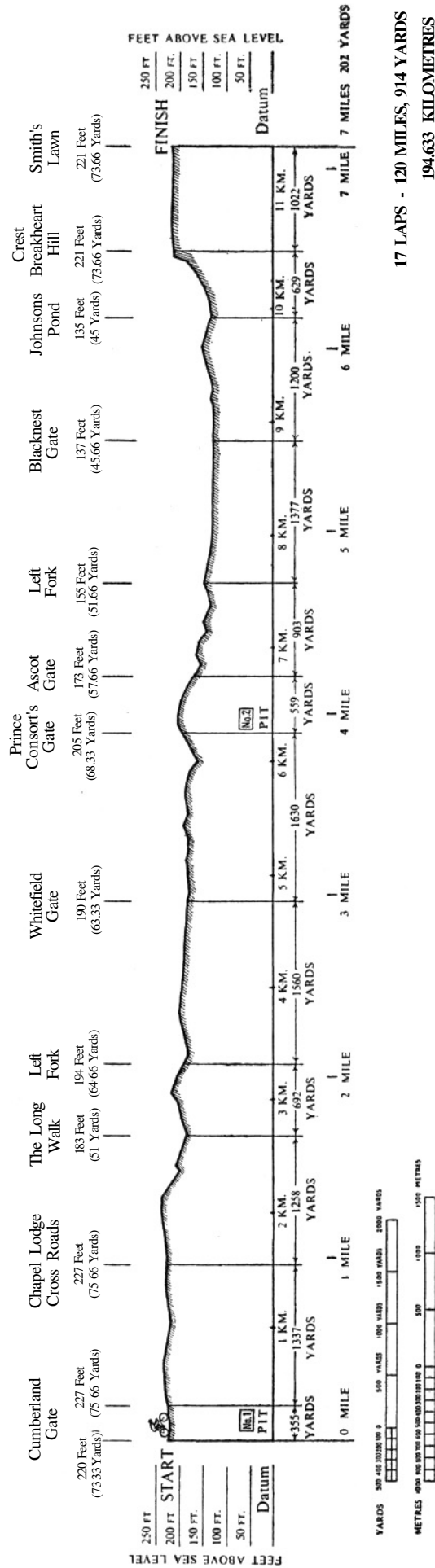

PROFILE OF THE OLYMPIC ROAD COURSE, WINDSOR GREAT PARK

## INTERMEDIATE LAP LEADERS AND TIME

Lap	1st	2nd	3rd	Time			Lap	1st	2nd	3rd	Time		
				h.	m.	s.					h.	m.	s.
1	Faanhof	Johansson	Suda	18	22		9	Faanhof	Voorting	Delathouwer	2	45	15
2	Johansson	—	—	36	56		10	Voorting	Faanhof	—	3	4	51
3	Faanhof	Johansson	Voorting	56	59		11	Beyaert	—	—	3	23	45
4	Voorting	Faanhof	Johansson	1	13	41	12	Thomas	—	—	3	42	44
5	Voorting	Faanhof	Johansson	1	31	16	13	Faanhof	Voorting	Delathouwer	4	1	14
6	Faanhof	Poggi Cebrero	Voorting	1	49	26	14	Thomas	Rouffeteau	Wouters	4	20	11
7	Voorting	Johansson	Faanhof	2	7	43	15	Beyaert	Maitland	Wouters	4	39	32
8	Faanhof	Voorting	Johansson	2	26	22	16	Delathouwer	Thomas	Johansson	4	58	58

## TEAM RESULTS

- 1 BELGIUM (L. Wouters, 3rd, L. Delathouwer, 4th, and E. Van Roosbroeck, 12th). 15 h. 58 m. 17.4 s.**
- 2 GREAT BRITAIN (R. Maitland, 6th, G. Thomas, 8th, and C. S. I. Scott, 16th). 16 h. 3 m. 31.6 s.**
- 3 FRANCE (J. Beyaert, 1st, A. Moineau, 11th and J. Dupont, 17th). 16 h. 8 m. 19.4 s.**
- 4 *Italy* (A. Ferrari, 9th, S. Pedroni, 10th, and F. Fanti, 19th). 16 h. 13 m. 5.2 s.
- 5 *Sweden* (N. Johansson, 5th, H. Snell, 18th, and A. Olivestedt, 24th). 16 h. 20 m. 26.6 s.
- 6 *Switzerland* (J. Schenk, 13th, J. Brun, 15th, and W. Reiser, 25th). 16 h. 23 m. 4.2 s.
- 7 *Argentine* (C. Perone, 21st, D. Benvenuti, 22nd, and M. Sevillano, 23rd). 16 h. 39 m. 46.2 s.

# EQUESTRIAN

In general outline the programme and conditions of the Equestrian events of 1948 conformed closely to the formula used in previous Olympic Games and were almost identical with those of the preceding Games, those of the XI Olympiad, held in 1936 in Berlin. The competitions comprised the Dressage Test, the Three Days Event and the Prix des Nations.

The Federation Equestre Internationale, as the governing body whose rules are accepted for the equestrian events and which is responsible for their application, did, however, make some slight alterations in the conditions of the Dressage Test and of the Three Days Event. They held the view that some of the nations which had suffered the consequences of the recent war might find it difficult, if not impossible, to produce for these particular Games riders and horses up to full Olympic standard. Therefore, the most advanced movements, the Passage and the Piaffe were taken out of the Dressage Test and the total length of the Endurance Test in the Three Days Event was also slightly reduced. None the less the various tests imposed remained severe and quite difficult enough to demand an exceedingly high standard of horsemanship.

Some of the competitors seemed disappointed with the character of the land over which they had to ride ; it was obviously an army exercising ground rather than the grassy velvet of a typical English hunting country of their dreams. They had not appreciated that most English meadows, so velvety in the damp of an English Autumn, turn to concrete in the heat of an English August; nor that one just cannot gallop across an English country in the height of a farming season ; nor, perhaps, that the best hunting counties are mostly far distant from the essential facilities without which a competition on such a scale cannot be run.

## **The Dressage**

However, at daybreak on Monday, August 9, the Aldershot Command Stadium was set fair for the first competition, the Dressage. The arrangements on the ground, the dressage arena specially built for the purpose, the judges' marquee, the complicated arrangements for keeping the score sheets accurately and quickly up to date, the stewards and the army teams to level out the arena after each horse, all were perfect and worked smoothly and without a hitch.

The competition itself, though a little eased by comparison with full Olympic standard, called none the less for an exceedingly high standard of horsemanship. None but a true master of the art of classical riding with a finely schooled horse, balanced, supple, light, free, bold and yet intelligently submissive, could hope to gain a place among the leaders.

Nineteen competitors, representing nine nations, faced the judges, General Decarpentry (France), Colonel Thommen (Switzerland) and Count Bonde (Sweden). The individual competition was won by H. Moser, of Switzerland, riding Hummer. Second place was taken by A. Jousseau, of France, and G. Boltstern, of Sweden, was third on Trumf. There was little to choose between these excellent performances. The

fourth competitor, R. Borg (U.S.A.) also put up a brilliant performance, right in the top class, and he may well have been unlucky in failing to win a medal.

Apart from the individual awards in this event, there are also three team prizes, awarded to the best aggregate performance by three riders of any one competing nation.

The first, second and third teams, in order were, Sweden, France and the U.S.A. Unfortunately the Swedish team was later disqualified as one of their members was not qualified to compete under the rules of the Federation Equestre Internationale. The final result was, therefore : France 1st; U.S.A. 2nd ; Argentine 3rd.

France owed her success to the outstanding performance of A. Jousseume. The U.S.A. were, on the contrary, impressive as a team, with high class performances by all three riders ; that of R. Borg has already been specially mentioned.

### **The Three Days' Event**

The three days following the judging of the Dressage Individuel had been set aside for the Three Days Event or, to give it its proper title, Le Concours Complet d'Equitation. And a complete competition of horsemanship it certainly is, requiring all round equestrian talent and ability of the highest order. It comprises, on the first day, a Dressage competition of quite sufficient difficulty to place it beyond the capacity of the vast majority of ordinarily good riders ; on the second day, a gruelling endurance test—a road section of 6 kilometres, a steeplechase course of 3,500 metres, another road section of 15 kilometres, a cross-country course of 8,000 metres over some thirty fixed and quite formidable obstacles, and a run-out—altogether 33½ kilometres to be covered inside 2 hrs. 2 mins. 18 secs., and finally, on the third day, a course over a dozen jumps, of reasonable size, to be ridden in a fast time, having regard to the twisty nature of the course.

On the first day the average performance in the Dressage was of a high standard, well above that seen at previous Olympic Games.

The second day, by far the most thrilling of all the equestrian competitions, attracted a large number of interested spectators, notwithstanding the early hour, to the cross-country course near Camberley. The building of such a course, with more than thirty fixed obstacles, all different and all sufficiently difficult, yet entirely fair, is not an easy task, especially without any reliable indication, at such a short time after a great war, of the likely form of competing horses. It was, therefore, gratifying that the course, as built, fulfilled its purpose well. There were no untoward incidents and no one fence was responsible for too large a proportion of failures. The layout was commented upon most favourably in leading organs of the world's equestrian press.

Spectators saw many bold and brilliant performances, but that of B. Chevallier, of France, was outstanding. Riding his Anglo-Arab mare, Aiglonne, he established an Olympic record by finishing the day, not only without a single fault, but with a plus score gained through the achievement of record times.

The jumping, on the third day, unfortunately caused the elimination of several teams. Some of the markers on the course had been moved, inadvertently, at the last moment and without sufficient warning to competing riders. As a result, some riders had to be

disqualified for taking a wrong course, which was hard luck both on the individual riders and on their teams.

The final Equestrian Competition, the Prix des Nations jumping contest, coincided with the Closing Ceremony of the Games, and took place in the Empire Stadium at Wembley in splendid weather, although the going was somewhat slippery from previous rain.

Forty-four riders, representing fifteen nations and fourteen teams, took part over a magnificent, but exceedingly severe course. Only three teams finished and of the forty-four individual riders, nineteen were eliminated.

The jumping of the winning Mexican team caused a sensation that will be remembered as long as these Olympic Games. The style of the Spanish riders who finished second, was of a classical perfection and a pleasure to watch, and the British riders deserve great credit in finishing as a team and in gaining third place.

The first of the riders to incur as few faults as eight was J. d'Orgeix (France) on Sucre de Pomme, and this feat was subsequently equalled by F. Wing (U.S.A.) on Democrat and R. Urizac (Mexico) on Hatvey. This was the position when the last competitor entered the arena. He was H. Mariles Cortes of Mexico on Arete, and it was already clear that his team had a splendid chance of winning the competition : he had to incur no more than 28 faults for the team to gain the first place medals. However, excitement among the spectators mounted steadily as it was soon obvious that here was one of the outstanding riders in the competition. It was not until he reached the 15 th jump that he was faulted; there was a tense hush as he faced each succeeding obstacle, and after he had landed safely over the final jump an outburst of applause, for his round with only 6¼ faults, gave him the individual victory as well as assuring his team of first place.

There was still, however, the further excitement of the jump-off to settle second and third places. For this the three competitors with eight faults each jumped the final six obstacles again, the first of the six having been raised. The Mexican rider was faultless over them to gain second place to his compatriot, while J. d'Orgeix and F. Wing each incurred four faults, the French rider being placed third by completing the course in 38.9 secs. against F. Wing's 40.1 secs.

**FEDERATION EQUESTRE INTERNATIONALE****JURY OF APPEAL**

General Baron DE TRANNOY, *Belgium*  
 Commandant G. HECTOR, *France*  
 Major-General G. V. HENRY, *U.S.A.*

**OFFICERS OF THE FEDERATION EQUESTRE INTERNATIONALE**

PRESIDENT	SEC. GENERAL
General DE TRANNOY	Commandant G. HECTOR

**JUDGES—DRESSAGE**

General DE CARPENTRY, <i>France</i>	Count CARL G. BONDE, <i>Sweden</i>
Colonel N. THOMMEN, <i>Switzerland</i>	

**JUDGES—THREE-DAY EVENT**

General DE LANDRAIN, <i>Belgium</i>	Count RANIERI DI CAMPELLO, <i>Italy</i>
Capt. E. A. SARASIN, <i>Switzerland</i>	

**JUDGES—GRAND PRIX DES NATIONS**

Duke of BEAUFORT, K.G.	Commandant X. BIZARD, <i>France</i>
Lt.-Col. ARNE E. FRANCKE, <i>Sweden</i>	Mr. J. H. A. JURGEN (Reserve), <i>Holland</i>

**TECHNICAL DELEGATES**

Colonel E. A. HACCIUS, <i>Switzerland</i>	Major R. MOEREMAN D'EMAUS, <i>Belgium</i>
---	--

**BRITISH HORSE SOCIETY**

VICE-PATRON AND VICE-PRESIDENT OF F.E.I. HIS GRACE THE DUKE OF BEAUFORT	PRESIDENT OF BRITISH HORSE SOCIETY W. J. CUMBER, OBE
--	---

**BRITISH HORSE SOCIETY'S OLYMPIC GAMES COMMITTEE**

Colonel The Hon. C. G. CUBITT, DSO, TD  
 (Chairman of British Horse Society)

Brig. P. E. BOWDEN SMITH, CBE	Lt.-Col. M. ANSELL, DSO, MC
Mr. CHARLES CORNELL	Capt. G. H. S. WEBBER
Colonel G. DE CHAIR, OBE, DSO	Colonel V. D. S. WILLIAMS, OBE
Major H. F. FAUDEL-PHILLIPS, MBE	Mr. HENRY WYNMALEN
Colonel TREVOR HORN, MC	Mr. C. N. WOODBRIDGE
Colonel G. T. H. HURRELL, OBE	Mr. E. HOLLAND-MARTIN
Mr. R. A. BROWN (Secretary)	

**PRIX DES NATIONS SUB-COMMITTEE OF THE BRITISH SHOW JUMPING ASSOCIATION**

Lt.-Col. ANSELL	Mr. J. H. SCOTT, JP
Mr. S. ALLISON	Lt.-Col. J. A. TALBOT PONSONBY
Mr. C. W. MURRAY, DSG	Mr. JOSEPH TAYLOR
Lt.-Col. C. T. WALWYN, DSO, OBE, MC	

**IN CHARGE OF ARENA AT WEMBLEY**

Mr. PHILLIP BLACKMORE

## DRESSAGE

### Individual and Team Competition

#### *Previous Olympic Winners*

##### (Individual)

1912 Count C. Bonde	<i>Sweden</i>	1928 C. F. von Langen	<i>Germany</i>
1920 Captain Lundblad	<i>Sweden</i>	1932 Cdt. F. Lesage	<i>France</i>
1924 E. de Linder	<i>Sweden</i>	1936 H. Pollay	<i>Germany</i>

##### (Team)

1924 <i>Sweden</i>	1932 <i>France</i>
1928 <i>Germany</i>	1936 <i>Germany</i>

### CONDITIONS

The prescribed test must be carried out entirely from memory. Each competitor will be allowed 13 minutes to complete it. In the event of a rider failing to complete the test within the prescribed time he will lose half a point for every second over the time limit.

Teams will be placed according to the total number of points gained by the three riders of each team.

### INDIVIDUAL PLACINGS

1 <b>MOSER, H.</b>	<b>Hummer</b>	<i>Switzerland</i>	492½
2 <b>JOUSSEAUME, A.</b>	<b>Harpagon</b>	<i>France</i>	480
3 <b>BOLTENSTERN, G.</b>	<b>Trumf</b>	<i>Sweden</i>	477½
4 Borg, R.	Klingson	<i>U.S.A.</i>	473½
5 St. Cyr, H.	Djimm	<i>Sweden</i>	444½
6 Paillard, J.	Sous les Ceps	<i>France</i>	439½
7 Podhajsky, A.	Teja	<i>Austria</i>	437½
8 Thomson, E.	Pancraft	<i>U.S.A.</i>	421
9 Pais, F.	Matamas	<i>Portugal</i>	411
10 Valadas, F.	Feitico	<i>Portugal</i>	405
11 Iturrealde, J.	Pajarito	<i>Argentine</i>	397
12 Mena e Silva, L.	Fascinante	<i>Portugal</i>	366
13 Henry, F.	Reno Overdo	<i>U.S.A.</i>	361½
14 Kirkpatrick, O'Donnell, C.	Yanta	<i>Spain</i>	353
15 Buret, M.	Saint Ouen	<i>France</i>	349½
16 Terzano, H.	Bienvenido	<i>Argentine</i>	327
17 Goulu, O.	Grillo	<i>Argentine</i>	281½
18 Gracida Jaramillo, G.	Kamcia	<i>Mexico</i>	248½

### TEAM PLACINGS

1 <b>FRANCE</b> (A. Jousseume, J. Paillard, M. Buret)	1269 marks
2 <b>U.S.A.</b> (R. Borg, E. Thomson, F. Henry)	1256 „
3 <b>PORTUGAL</b> (F. Pais, F. Valadas, L. Mena e Silva)	1182 „
4 <b>Argentine</b> (J. Iturrealde, H. Terzano, G. Gracida Jaramillo)	1005½ „



## THREE-DAY EVENT

### Individual and Team Competition

#### *Previous Olympic Winners*

(Individual)				
1912	Lieut. Norlander	<i>Sweden</i>	1928	Lieut. C. F. P. de Mortanges <i>Holland</i>
1920	de Morner	<i>Sweden</i>	1932	Lieut. C. F. P. de Mortanges <i>Holland</i>
1924	V. de V. van Zyp	<i>Holland</i>	1936	L. Stubbendorff <i>Germany</i>
(Team)				
	1912	Sweden	1928	Holland
	1920	Sweden	1932	U.S.A.
	1924	Holland	1936	Germany

### CONDITIONS

The Three-Day event is in three sections as follows :—

#### Dressage Test

The test must be carried out entirely from memory. Each competitor is allowed 12 minutes in which to complete it. In the event of a rider failing to complete the test within the prescribed time he will lose half a point for every second over the time limit. The maximum number of points obtainable is 400 ; if a competitor does not obtain at least 200 points he will be excluded from the remaining sections of the event.

#### Endurance, Speed and Cross-Country Test

This test is divided into five consecutive stages :—

A	6 km. over roads or paths	Time allowed	27 min 17 sec.
B	3½ km. steeplechase	„ „	5 min 50 sec.
C	15 km. over roads or paths	„ „	68 min 11 sec.
D	8 km. cross-country	„ „	18 min 0 sec.
E	1 km. on the flat	„ „	3 min 0 sec.

Riders exceeding the time limit are penalised 5 points for each 5 seconds or part of 5 seconds on stages A, C and E, 3 points for each 5 seconds or part of 5 seconds on stage B, and 3 points for each 10 seconds or part of 10 seconds on stage D.

No credit is given for finishing within the time limit on stages A, C or E. On stage B 3 points are awarded for each 5 seconds or part of 5 seconds gained up to a maximum of 36 points, and on stage D 3 points are awarded for each 10 seconds or part of 10 seconds gained up to a maximum of 72 points.

Faults at obstacles are penalised as follows :—

First refusal or swerve of horse	20 pts.
Second refusal or swerve of horse at the same obstacle	40 pts.
Fall of horse and rider at an obstacle, or fall of a rider only at an obstacle	60 pts.
Third refusal or swerve of horse at the same obstacle	80 pts.
Fourth refusal or swerve of horse at the same obstacle	} Disqualification
Errors of course not rectified	
Omitting an obstacle or boundary flag	

Refusal or swerving of horse at the second or third obstacle in a double or triple obstacle does not entail the retaking of the obstacle in its entirety from the first jump. The rider will extricate himself as best he can. All his attempts will be counted. At the fourth attempt he will be disqualified.

#### Jumping Test

The obstacles are 12 in number and the test must be carried out at a speed of 400 metres to the minute. Any rider failing to complete the test in the prescribed time will be penalised a quarter of a point per second or part of a second. Penalties for faults at the obstacles are as follows :—

First disobedience of horse	10 pts.
Knocking over an obstacle, feet in the water or in the ditch	} 10 pts.
Second disobedience of horse in the whole test	
Fall of horse and rider or fall of rider alone	30 pts.
Third disobedience of horse in the whole test, taking obstacle in wrong order. Wrong course not rectified	} Disqualification

A rider disqualified in any of the three tests is not entitled to a placing in the event as a whole. The rider with the least number of penalty points is the winner, and the team whose three riders have the least number of penalty points wins the team event.

## THREE-DAY EVENT

Name	Country	Horse	Dressage Points	Cross Country		Jumping		Total Points Lost	Points Gained			Total Points
				Points Lost		Points Lost			Steeple Chase	Cross Country	Total	
				Obstacles	Time	Obstacle	Time					
1 CHEVALLIER, B.	France	Aiglonne	104	—	—	—	—	104	36	72	108	+ 4
2 HENRY, F.	U.S.A.	Swing Low	117	—	—	—	—	117	36	60	96	21
3 SELFELT, J.	Sweden	Claque	109	—	—	—	—	109	24	60	84	25
4 Andersen, C.	U.S.A.	Reno Palisade	111	—	—	10	1½	122½	36	60	96	26½
5 Nogueras Marquez, J.	Spain	Epsom	128	—	—	—	—	128	36	51	87	41
6 Carlsen, E.	Denmark	Ezja	113	—	—	—	—	113	18	51	69	44
7 Morrot Coelho, Accio	Brazil	Guapo	114	—	—	10	—	124	27	45	72	52
8 Caveleiro, F.	Portugal	Satari	135	—	—	10	—	145	33	57	90	55
8 Mangilli, F.	Italy	Guerriero da Capestrano	85	20	—	20	2	127	33	39	72	55
10 Carrere, F.	Argentina	Rosarino	121	—	—	—	4	125	24	42	66	59
11 Blaser, A.	Switzerland	Mahmud	93	—	—	20	¼	113¼	18	36	54	59¼
12 Mariles Cortes, H.	Mexico	Parral	134	—	—	—	2¾	136¾	24	51	75	61¾
13 Van Loon, E.	Holland	Springsteel	129	—	—	10	1	140	18	60	78	62
14 Krarup, K.	Denmark	Rollo	114	—	—	10	4	128	27	36	63	65
15 Stahre, N.	Sweden	Komet	143	—	—	20	—	163	33	60	93	70
15 Svensson, S.	Sweden	Dust	103	—	—	—	—	103	21	12	33	70
17 Borwick, P.	Great Britain	Liberty	167	—	—	—	¼	167¼	36	51	87	80¼
18 Sagasta, J.	Argentina	Cherenda Cue	124	—	—	—	4½	128½	21	15	36	92½
19 Buhler, A.	Switzerland	Amour Amour	80	60	—	—	—	140	15	30	45	95
20 Ehrnrooth, A.	Finland	Lilia	141	20	—	—	—	161	24	27	51	110
21 Thomson, E.	U.S.A.	Reno Rhythm	105	60	—	20	1	186	30	42	72	114
22 Campero, R.	Mexico	Tarahumara	128	—	—	30	1½	159½	15	24	39	120½
23 Solano Chagoya, J.	Mexico	Malinche	149	—	—	10	—	159	24	12	36	123
24 Ten Cate, A.	Holland	Unique de Genuel	144	40	—	30	4	214½	33	36	69	145½
25 Pais, D.	Portugal	Zuari	169	—	30	—	1½	200½	33	—	33	167½
26 Gazapo De Sarraga, F.	Spain	Vivian	153	20	—	80	1¼	254¼	27	48	75	179¼
27 Bolton, L.	Great Britain	Sylveste	109	120	—	—	1	230	30	18	48	182
28 Roiha, M.	Finland	Roa	125	80	—	20	4	229	18	9	27	202
29 Martinez Larraz, S.	Spain	Fogoso	163	—	50	10	¼	223¼	21	—	21	202¼
30 D'Inzeo, R.	Italy	Regate	129	—	70	30	—	229	6	—	6	223
31 Renildo, P.	Brazil	Indio	184	80	—	40	—	304	18	36	54	250
32 Musy, P.	Switzerland	Franzoin	109	60	80	10	¼	259¼	9	—	9	250¼
33 Emmanuelli, R.	France	Tourtourelle	113	240	—	—	1¼	354¼	24	27	51	303¼
— Koc, S.	Turkey	Cesur	197	—	—	—	—	—	24	21	45	Eliminated
— Mikkelsen, N.	Denmark	St. Hans	108	—	—	—	—	—	24	54	78	Eliminated
— Silva Rocha, A.	Brazil	Carioca	185	80	—	—	—	—	21	15	36	Eliminated
— Sauer, H.	Austria	Sobri	144	Retired								Eliminated
— Serodio, A.	Portugal	Abstrato	137	—	—	—	—	—	30	57	87	Eliminated
— Yigitturk, E.	Turkey	Ozbek	122	Disqualified.								Eliminated
— Montessoro, E.	Italy	Tic Tac	144	20	—	—	—	—	24	45	69	Eliminated
— Sagasta, J. M.	Argentina	Mandinga	110	—	—	—	—	—	30	42	72	Eliminated
— Azak, Z.	Turkey	Ruzgar	172	Retired								Eliminated
— Jousseau, A.	France	Gigolo	78	180	80	—	—	—	27	—	27	Eliminated
— Haanpaa, A.	Finland	Upea	162	—	—	—	—	—	27	54	81	Eliminated
— Stewart, D.	Great Britain	Dark Seal	116	Retired								Eliminated

No riders lost any marks on stages A, B, C and E of the cross-country test, except Azak (Turkey) who lost 95 marks by time on stage A and then retired.

## TEAM PLACINGS

1	U.S.A. (F. Henry, C. Andersen, E. Thomson)	161½
2	SWEDEN (J. Selfelt, N. Stahre, S. Svensson)	165
3	MEXICO (H. Mariles Cortes, R. Campero, J. Solano Chagoya)	305¼
4	Switzerland (A. Blaser, A. Buhler, P. Musy)	404½
5	Spain (J. Nogueras Marquez, F. Gazapo De Sarraga, S. Martinez Larraz)	422½

## PRIX DES NATIONS

### Individual and Team Competition

#### *Previous Olympic Winners*

##### (Individual)

1912 Capt. J. Cariou	<i>France</i>	1928 Capt. F. Ventura	<i>Czechoslovakia</i>
1920 Lieut. T. Leguio	<i>Italy</i>	1932 Lieut. T. Nishi	<i>Japan</i>
1924 A. Gemuseus	<i>Switzerland</i>	1936 K. Hasse	<i>Germany</i>

##### (Team)

1912 Sweden	1928 Spain
1920 Sweden	1932 No complete team finished
1924 Sweden	1936 Germany

### HOW THE EVENT IS DECIDED

Each rider is allowed to enter two horses for the event, but the horse to be ridden must be nominated by 8 p.m. the previous evening. If a national team is entered, the horses nominated by the riders in that team may be any of the six entered on behalf of the three riders.

The order of starting is determined by lot, the first rider from each team starting before the second rider of any team.

Horses must carry minimum weight of 75 kg. (approx. 165 lbs.).

Officers must wear Service Dress ; civilians, hunting attire or a dark jacket, white breeches and top hat or hunting cap.

The obstacles are between 1.30 and 1.60 m. high (between 4 ft. 3 in. and 5 ft. 3 in.). The water jump is 4.50 m. wide (approx. 14 ft. 9 in.).

The competition is carried out at the gallop, the time allowed being calculated at a speed of 400 metres to the minute. No allowance is made for completing the course in less time, but any excess time will be penalised at a rate of a quarter of a point per second.

Faults are penalised as follows :—

First refusal	3 pts.
Obstacle knocked down, landing in water or ditch, or on their delimiting marks	4 pts.
Second refusal	6 pts.
Fall of horse and rider or fall of rider only	8 pts.
Third refusal	Elimination
Jumping an obstacle out of its proper course	Elimination

The rider with the least number of penalty points is the winner; the team whose three riders total the least number of penalty points wins the team event. No team can receive a placing unless all three riders complete the course.

In the event of a tie in either the individual or team competition, there will be a " jump-off " over six obstacles, the height of which may be increased to 1.80 m. (approx. 5 ft. 11 in.). There is no time limit in a " jump-off," but if the jump-off results in a tie, then the time taken will decide the placings.

## PRIX DES INDIVIDUAL

Name.	Country.	Horse.	1	2	3	4	5 Double
<b>1 MARILES CORTES, H.</b>	<i>Mexico</i>	Arete	—	—	—	—	—
<b>2 URIZAC, R.</b>	<i>Mexico</i>	Hatvey	—	—	—	—	4
<b>3 d'ORGEIX, C.</b>	<i>France</i>	Sucre de Pomme	—	—	—	—	—
4 Wing, F.	<i>U.S.A.</i>	Democrat	—	—	—	4	—
5 Garcia Cruz, J.	<i>Spain</i>	Bizarro	—	—	—	—	—
5 Sorensen, E.	<i>Sweden</i>	Blatunga	4	—	—	—	—
7 Fresson, M..	<i>France</i>	Decametre	—	4	4	—	—
7 Llewellyn, H.	<i>Great Britain</i>	Foxhunter	—	4	4	—	—
7 Nicoll, H.	<i>Great Britain</i>	Kilgeddin	—	4	4	—	—
10 Navarro Morenes, J.	<i>Spain</i>	Quorum	—	—	4	—	—
10 Franco Pontes, J.	<i>Brazil</i>	Itaguai	—	—	4	4	—
10 Valdes, R.	<i>Mexico</i>	Chihuochoc	—	4	4	4	—
13 Lewenhaupt, J.	<i>Sweden</i>	Orkan	—	4	4	—	—
14 Corry, D.	<i>Eire</i>	Tramore Bay	—	—	4	—	—
15 Campos, R.	<i>Argentina</i>	Santa Fe	—	4	4	—	4
16 Gavilan y Ponce de Leon, M.	<i>Spain</i>	Forajido	—	4	4	—	4
17 Ahern, F.	<i>Eire</i>	Aherlow	—	—	—	4	7
18 Calado, H.	<i>Portugal</i>	Xerez	—	4	4	—	—
19 Carr, A.	<i>Great Britain</i>	Monty	3	4	4	—	—
20 Gruppelaar, J.	<i>Holland</i>	Random Harvest	4	—	4	4	—
21 Russell, J.	<i>U.S.A.</i>	Air Mail	—	—	—	—	3
22 Correia Barrento, J.	<i>Portugal</i>	Alcoa	4	4	4	4	—
23 Rissanen, T.	<i>Finland</i>	Viser	4	—	4	4	4
— de Maupeou d'Ableiges, G.	<i>France</i>	Nankin	—	—	4	—	—
— Acthon, O.	<i>Denmark</i>	Please	—	4	4	—	—
— Alvarado, N.	<i>Argentina</i>	Mineral	—	—	4	—	4
— de Bruine, J.	<i>Holland</i>	Romanichel	4	—	4	—	—
— Cakir, S.	<i>Turkey</i>	Guclu	4	4	4	7	<i>Elim.</i>
— Bettoni Cazzago, A.	<i>Italy</i>	Uranio II	—	—	—	—	<i>Elim.</i>
— Conforti, G.	<i>Italy</i>	Furore	—	—	4	—	<b>9</b>
— Frierson, A.	<i>U.S.A.</i>	Rascal	—	—	—	—	<i>Elim.</i>
— Hultberg, K	<i>Sweden</i>	Ismed	—	—	4	—	7
— D'Inzeo, R.	<i>Italy</i>	Briacone	—	4	4	—	4
— Kasar, K.	<i>Turkey</i>	Siyok	—	—	4	4	—
— Lewis, J.	<i>Eire</i>	Loughneagh	—	4	4	4	—
— Martins, H.	<i>Portugal</i>	Optus	4	—	—	—	<i>Elim.</i>
— Massey Oliveira de Menezes, E.	<i>Brazil</i>	Sabu	—	—	4	4	3
— Mikkelsen, L.	<i>Denmark</i>	Atom	4	—	9	—	<i>Elim.</i>
— Oncu, E.	<i>Turkey</i>	Yildiz	4	4	4	—	<i>Elim.</i>
— Pistarini, P.	<i>Argentina</i>	Canguro	4	—	4	—	13
— Continentino Dias Ribeiro, R.	<i>Brazil</i>	Bon Soir	4	—	4	4	4
— Rijks, J.	<i>Holland</i>	Master	4	4	—	—	—
— Tryde, T.	<i>Denmark</i>	Attila	4	—	4	4	<i>Elim.</i>
— Vartiainen, V.	<i>Finland</i>	Pontus	—	4	4	12	<i>Elim.</i>

# NATIONS PLACINGS

6	7	8	9	10 Treble	11	12	13	14	15 Water	16	Points Lost at Obstacles	Time Taken	Time Faults	Total Points Lost
—	—	—	—	—	—	—	—	—	4	—	4	2.18.1	2¼	6¼
—	—	—	—	—	—	—	—	4	—	—	8	1.58	—	8
—	—	—	—	8	—	—	—	—	—	—	8	1.51.8	—	8
—	—	—	4	—	—	—	—	—	—	—	8	1.51.8	—	8
—	—	4	—	—	—	4	—	—	4	—	12	1.47	—	12
4	—	—	—	—	—	—	—	—	4	—	12	2.05	—	12
—	—	—	—	4	—	—	—	—	—	4	16	1.55.4	—	16
—	—	—	—	—	—	4	—	—	—	4	16	2.02	—	16
—	—	4	—	—	—	—	—	—	4	—	16	2.05	—	16
—	—	4	—	8	—	—	—	—	4	—	20	1.44.7	—	20
—	—	—	4	4	—	—	—	—	4	—	20	1.50.8	—	20
—	—	—	4	—	—	—	—	—	4	—	20	2.0.3	—	20
3	—	—	—	4	—	—	—	—	4	—	19	2.16.2	1¾	20¾
—	—	—	—	4	—	—	—	4	4	4	20	2.14.5	1¼	21¼
—	—	4	—	4	—	—	—	—	4	—	24	1.59.4	—	24
—	—	—	—	—	—	—	4	4	4	—	24	2.11.5	½	24½
—	—	—	—	—	—	—	—	4	4	4	23	2.19.3	2½	25½
—	—	—	—	15	—	—	—	—	—	—	23	2.22	3	26
—	—	4	—	8	—	4	—	4	4	—	35	1.51.7	—	35
—	—	—	4	12	4	—	—	—	—	4	36	1.57.6	—	36
—	—	4	—	14	—	—	—	—	4	—	25	3.2.8	13¼	38¼
—	—	—	—	—	—	—	4	8	4	—	32	2.52	10½	42½
—	—	4	4	12	—	4	4	4	4	4	56	1.55.7	—	56
—	—	4	—	—	—	—	—	Elim.	—	—	Elim.	—	—	Elim.
—	—	—	—	Elim.	—	—	—	—	—	—	Elim.	—	—	Elim.
4	—	—	4	11	6	4	Elim.	—	—	—	Elim.	—	—	Elim.
4	4	4	4	Elim.	—	—	—	—	—	—	Elim.	—	—	Elim.
—	—	—	—	—	—	—	—	—	—	—	Elim.	—	—	Elim.
—	—	—	—	—	—	—	—	—	—	—	Elim.	—	—	Elim.
—	—	4	4	Elim.	—	—	—	—	—	—	Elim.	—	—	Elim.
—	—	—	—	—	—	—	—	—	—	—	Elim.	—	—	Elim.
—	—	—	—	Elim.	—	—	—	—	—	—	Elim.	—	—	Elim.
—	—	—	—	—	—	—	—	—	—	—	Elim.	—	—	Elim.
—	—	—	—	—	—	—	—	—	—	—	Elim.	—	—	Elim.
—	—	—	—	—	—	—	—	—	—	—	Elim.	—	—	Elim.
—	—	—	—	—	—	—	—	—	—	—	Elim.	—	—	Elim.
—	—	4	Elim.	—	—	—	—	—	—	—	Elim.	—	—	Elim.
—	—	—	—	—	—	—	Elim.	—	—	—	Elim.	—	—	Elim.
—	—	—	—	Elim.	—	—	—	—	—	—	Elim.	—	—	Elim.
—	—	—	—	—	—	—	—	—	—	—	Elim.	—	—	Elim.

### INDIVIDUAL BARRAGE FOR SECOND PLACE

Name	Horse	1	2	3	4	5	6	Points lost at Obstacles	Time Taken	Time Faults	Total
2 Urizac, R.....	Hatvey	—	—	—	—	—	—	Nil	49.1	—	Nil
3 d'Orgeix, C.....	Sucre de Pomme	—	4	—	—	—	—	4	38.9	—	4
4 Wing, F. ....	Democrat	—	4	—	—	—	—	4	40.1	—	4

### TEAM PLACINGS

	Total
<b>1 MEXICO</b> (Valdes, R., Urizac, R., Mariles Cortes, H.) .....	34¼
<b>2 SPAIN</b> (Gavilan y Ponce de Leon, M., Navarro Morenes, J., Garcia Cruz, J.) .....	56½
<b>3 GREAT BRITAIN</b> (Nicoll, H., Carr, A., Llewellyn, H.) .....	67
— Eire (Ahern, F., Corry, D., Lewis, J.).....	Elim.
— Sweden (Sorensen, E., Lewenhaupt, J., Hultberg, K.) .....	Elim.
— France (de Maupeou d'Ableiges, G., d'Orgeix, C., Fresson, M.) .....	Elim.
— Holland (de Bruine, J., Gruppelaar, J., Rijks, J.) .....	Elim.
— Italy (Conforti, G., Bettoni Cazzago, A., D'Inzeo, R.) .....	Elim.
— U.S.A. (Russell, J., Wing, F., Frierson, A.) .....	Elim.
— Argentine (Campos, R., Alvarado, N., Pistarini, P.).....	Elim.
— Portugal (Martins, H., Correia Barrento, J., Calado, H.) .....	Elim.
— Finland (Vartiainen, V., Rissanen, T.).....	Elim.
— Brazil (Continentino Dias Ribeiro, R., Franco Pontes, J., Massey Oliveira de Menezes, E.) .....	Elim.
— Denmark (Mikkelsen, L., Tryde, T., Acthon, O.) .....	Elim.
— Turkey (Cakir, S., Kasar, K., Oncu, E.).....	Elim.

PLAN OF PRIX DES NATIONS COURSE

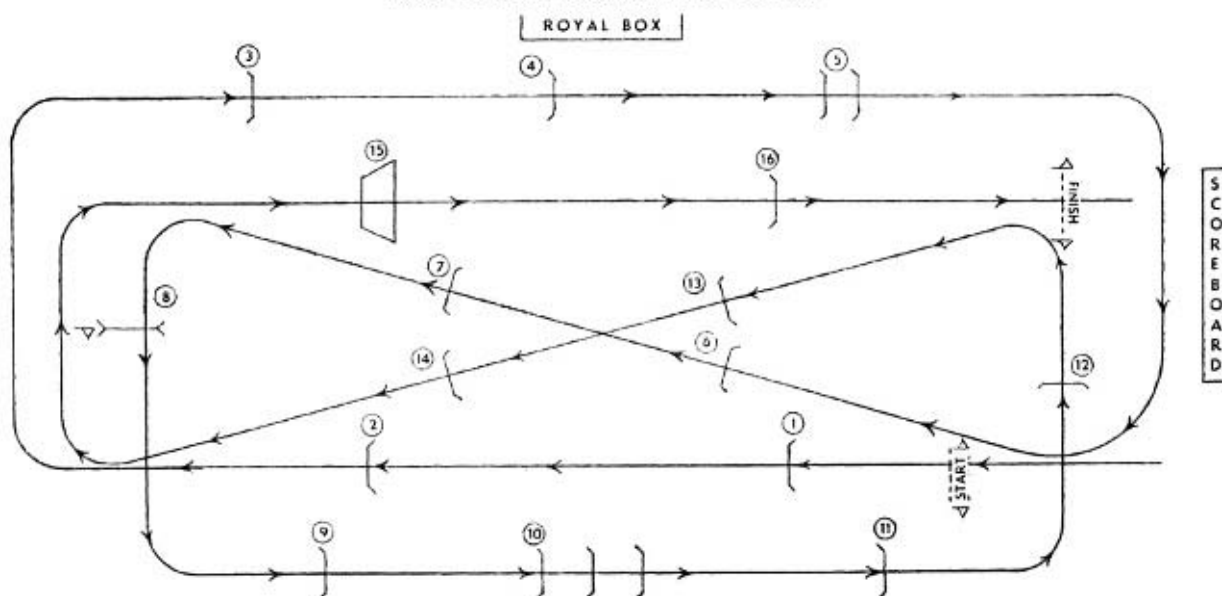

# FENCING

The number of individual entries and countries participating made the fencing events at the Games of the XIV Olympiad the greatest competition ever staged in the history of the sport.

The lay-out of the arena at the Palace of Engineering and the organisation of the heavy programme proved adequate. The central piste, on which all the finals were fought, with its steeply banked seating, giant Scoreboard and national flags overhead, was declared by visitors to be the best fencing arena yet seen.

The standard of the finals, except perhaps at sabre, was not quite up to that of fencing in the immediate pre-war years, but the general standard seemed higher than before, resulting in very close results in the preliminary rounds. It is evident that many nations have made great technical progress but France and Italy are still supreme at men's foil and epee, while the Hungarians once again swept all before them at sabre.

## **The Foil Events**

France proved to be the leading nation at men's foil, maintaining an unbeaten record from a field of twenty teams, and supplying the winner of the individual event for which there were 68 entries. The Italians, once again their chief rivals, have not yet quite regained the high standard of their pre-war teams at this weapon.

Buhan, of France, was the outstanding foilist of the Games. His brilliant fencing throughout was in the highest tradition of French foil play and, after taking a leading part in his team's victory, he dominated the final pool of the individual event which he won without losing a fight.

France, Italy, Belgium and the U.S.A. formed the final pool of the foil team event and finished in that order. The crucial match between France and Italy was an epic struggle. France established a lead of 6 victories to 3, but their opponents then staged a remarkable recovery, winning 5 of the remaining 7 bouts to end 8-8, France winning an exciting match by 2 hits.

Buhan's clear-cut victory in the men's foil individual has already been noted. The runner-up was Christian d'Oriola, the remarkable Frenchman who, at 18, won the 1947 World Championship at Lisbon. Third place went to L. Maszlay (Hungary), a somewhat unorthodox fencer, on a count of hits over J. Emrys Lloyd (Great Britain), who had been an Olympic finalist in 1932 and semi-finalist in 1936.

## **A Title Retained**

There were 42 entries for the Women's Foil and, with certain individual exceptions, the standard was not as high as in previous Games. Ilona Schacherer Elek, of Hungary, retained the title which she won in the Berlin Games, a feat never before achieved by a woman fencer. Her forcefulness and energy seem to have increased with the passing years. She was closely followed by Karen Lachmann (Denmark), who maintained her classic style throughout. Third place went to Ellen Muller-Preis (Austria), who won the Olympic title in 1932.

### Surprises in the Epee

From the 22 teams entered at epee, France and Italy again divided the first two places. Italy started well in this match with France, winning 4 of the first 5 bouts. The French team then settled down and lost only one of the remaining 11 bouts. Michel Pecheux, a former world champion, who was included in the team only at the last moment, won all his fights in the matches in the final pool. The Swedish team took third place but never struck their best form in the final. The young Danish team provided the surprise of the meeting by taking fourth place and losing to Sweden only by the odd bout. They fenced with courage, dash and tenacity throughout.

The epee individual event, with an entry of 70, proved the severest competition of all. Many well-known epeeists were eliminated in the preliminary rounds and the final pool of 10 took 5½ hours to decide. Luigi Cantone, after losing his first 2 bouts to his compatriots, went through the rest of the field undefeated and was two victories ahead of his nearest rivals at the end.

Cantone fenced in the individual event only as substitute for D. Mangiarotti who had injured his foot in the team final. He certainly proved the best epeeist on the day and maintained his orthodox style throughout the final. His attacks, mainly by *prise-de-fer* and always well covered, were remarkable for speed and assurance.

The next four fencers all scored 5 victories. Oswald Zappelli (Switzerland) and Edouardo Mangiarotti (Italy) were equal with 17 hits against and 20 hits scored. The resulting barrage was won 3-0 by Zappelli whose stop-hits were remarkable for choice of time. Henri Guerin of France took fourth place, two hits behind, and separated by a narrow margin from J. M. Radoux of Belgium.

### High Sabre Standard

The sabre events, for which there was an entry of 19 teams and 68 individuals, provided the highest standard in the three weapons. The Hungarians won both titles, as they have done in the last three Games. Hungary, Italy, Belgium and the U.S.A. reached the final pool of the team event. The crucial match between Hungary and Italy was a magnificent display of sabre fencing. The Italian team fought well to hold the score at 4-4 at the half-way stage, but the class of the Hungarian fencers then told and they proved worthy winners by 10 victories to 6. T. Berczelly, of Hungary, was the only unbeaten fencer.

There was keen competition for the remaining places. The Italy-U.S.A. match to decide second place took place at a late hour and proved a desperate encounter. In the last bout, V. Pinton (Italy) beat Dean Cetrulo 5-1 to make the score 8 victories each and to give Italy the victory by two hits.

The sabre individual final was a delightful exhibition of modern sabre play at its best. It was the outstanding event of the tournament. A. Gerevich (Hungary), who had won the World Championship in 1935 and was third in the event at Berlin, was the unbeaten winner of this strong pool. In his first fight against his compatriot, P. Kovacs, he was led 4-2, but by forceful attacks he won this bout by the odd hit. Thereafter, his speed in



attack, sureness in defence and choice of time and distance proved too much for his remaining opponents and he received only 18 hits in his 7 bouts. V. Pinton (Italy) took second place by two hits over Kovacs (Hungary), and fourth place went to J. Lefevre, the 21-year-old French champion.

The extremely keen competition throughout, and the large entry, necessitated fencing for long hours on most of the thirteen days of the meeting, but the outstanding memory of these Games remains the atmosphere of good fellowship and good sportsmanship which prevailed.

**FEDERATION INTERNATIONALE D'ESCRIME**

*President*

PAUL ANSPACH

*Secretary*

CHARLES HUYBRECHTS

**TECHNICAL DIRECTORATE**

JACQUES COUTROT, *France*

LUKE V. FILDES, *Great Britain*

RAOUL HEIDE, *Norway*

GIORGIO MACERATA, *Italy*

BRIGADIER T. H. WAND-TETLEY, C.B.E., *Great Britain*

**ADDITIONAL MEMBERS**

TRACY JAECKEL, *U.S.A.*

ROMULO GOMEZ ZAMUDIO, *Argentine*

## FOIL—TEAMS

### *Previous Olympic Winners*

1904 Cuba	1928 Italy
1920 Italy	1932 France
1924 France	1936 Italy

There were 95 entries from 19 nations ; 89 participants from 16 nations  
*The first two teams from each pool were promoted. All bouts were for the best of nine hits*

## FIRST ROUND

### POOL I

Result: FRANCE won 1 match, EGYPT 1, Eire 0

FRANCE (16 victories) beat EIRE (0)

*President: M. de CAPRILES (U.S.A.)*

	V.	D.		V.	D.
Rommel, A.	4	0	Tuohy, O.	0	4
d'Oriola, C.	4	0	Duffy, P.	0	4
Bonin, A.	4	0	Smith, T. P.	0	4
Lataste, J.	4	0	Thuillier, N.	0	4

EGYPT (9 v.) beat EIRE (0)

*President: G. JEKELFALUSSY (Hungary)*

	V.	D.		V.	D.
Abdel Hafeez, O.	2	0	Tuohy, O.	0	3
Dessouki, S.	2	0	Smith, T. P.	0	2
Younes, M.	3	0	Duffy, P.	0	2
Zulficar, M.	2	0	Thuillier, N.	0	2

### POOL II

Result: ITALY won 1 match, URUGUAY 1, Greece 0

ITALY (16 v.) beat GREECE (0)

*President: R. MERCIER (Frame)*

	V.	D.		V.	D.
Ragno, S.	4	0	Nanopoulos, A.	0	4
Nostini, R.	4	0	Zintzos, S.	0	4
Di Rosa, M.	4	0	Karamazakidis, J.	0	4
Pellini, G.	4	0	Bebis, C.	0	4

URUGUAY (9 v.) beat GREECE (2)

*President: G. GRINDA (Italy)*

	V.	D.		V.	D.
Rossi Stajano, D.	2	1	Nanopoulos, A.	0	3
Ucar Ferreiro, J.	2	1	Zintzos, S.	0	2
Gallardo, C.	3	0	Karamazakidis, J.	1	2
Iesi, S.	2	0	Bebis, C.	1	2

### POOL III

Result: ARGENTINE and FINLAND promoted. Cuba withdrew

### POOL IV

Result: HUNGARY won 1 match, U.S.A. 1, Switzerland 0

HUNGARY (11 v.) beat SWITZERLAND (5)

*President: G. HEYVAERT (Belgium)*

	V.	D.		V.	D.
Bay, B.	1	3	Von Meiss, G.	1	3
Gerevich, A.	4	0	Stirn, R.	2	2
Hatszeghy, J.	3	1	Horning, W.	0	4
Maszlay, L.	3	1	Schlaepfer, G.	2	2

U.S.A. (9 v.) beat SWITZERLAND (3)

*President: V. CUCCIA (Italy)*

	V.	D.		V.	D.
Bukantz, D.	4	0	Von Meiss, G.	0	3
Prokop, A.	2	1	Rubli, J.	0	3
Every, D.	1	1	Schlaepfer, G.	1	2
Cetrulo, D.	2	1	Stirn, R.	2	1

### POOL V

Result: BELGIUM and CANADA promoted. Brazil and Austria withdrew

XIV OLYMPIAD

POOL VI

Result: GREAT BRITAIN won 1 match, DENMARK 1, Holland 0

GREAT BRITAIN (8 v., 58 hits) beat

HOLLAND (8 v., 63 hits)

President: G. HEYVAERT (Belgium)

	V.	D.	H.		V.	D.	H.
Paul, R.....	3	1	13	Van den Berg, W.	1	3	19
Smith, A.....	1	3	16	Ter Weer, H.....	2	2	12
Cooke, H.....	0	4	20	Mosman, F.....	2	2	17
Lloyd, J. E.....	4	0	9	Kuijpers, L.....	3	1	15

DENMARK (9 v.) beat HOLLAND (5)

President: C. LION (France)

	V.	D.		V.	D.
Ruben, I.....	4	0	Van den Berg, W.....	2	2
Albrechtsen, O.....	1	2	Ter Weer, H.....	0	4
Leidersdorff, A.....	3	0	Kuijpers, L.....	1	2
Jorgensen, T.....	1	3	Mosman, F.....	2	1

SECOND ROUND

POOL I

Result: FRANCE won 1 match, U.S.A. 1, Canada 0

FRANCE (16 v.) beat CANADA (0)

President: F. del VECCHIO (Italy)

	V.	D.		V.	D.
Bonin, A.....	4	0	Desjarlais, R.....	0	4
Lataste, J.....	4	0	Pouliot, G.....	0	4
Buhan, J.....	4	0	Horn, A.....	0	4
Bougnol, R.....	4	0	Asselin, R.....	0	4

U.S.A. (9 v.) beat CANADA (0)

President: R. ANSELMINI (Italy)

	V.	D.		V.	D.
Every, D.....	3	0	Desjarlais, R.....	0	2
Prokop, A.....	2	0	Horn, A.....	0	2
Giolito, S.....	2	0	Asselin, R.....	0	3
Lubell, B.....	2	0	Pouliot, G.....	0	2

POOL II

Result: ARGENTINE won 1 match, ITALY 1, Finland 0

ARGENTINE (12 v.) beat FINLAND (4)

President: C. DELPORTE (Belgium)

	V.	D.		V.	D.
Rodriguez, J. M.....	3	1	Jalkanen, K.....	0	4
Galimi, Fulvio.....	2	2	Sjoblom, N.....	1	3
Torrente, M.....	3	1	Kerttula, E.....	2	2
Galimi, Felix.....	4	0	Raitio, H.....	1	3

ITALY (9 v.) beat FINLAND (0)

President: R. BONDOUX (France)

	V.	D.		V.	D.
Nostini, G.....	2	0	Raitio, H.....	0	3
Di Rosa, M.....	2	0	Jalkanen, K.....	0	2
Mangiarotti, E.....	3	0	Sjoblom, N.....	0	2
Pellini, G.....	2	0	Kerttula, E.....	0	2

POOL III

Result: BELGIUM won 2 matches, GREAT BRITAIN 1, Denmark 0

BELGIUM (12 v.) beat GREAT BRITAIN (4)

President: E. EMPEYTA (Switzerland)

	V.	D.		V.	D.
Van de Werve de			Cooke, H.....	1	3
Vorselaere, A.	3	1	Turquet, P.....	0	4
Valcke, P.....	3	1	Wendon, U.....	0	4
Bru, R.....	2	2	Paul, R.....	3	1
de Bourguignon, G.....	4	0			

GREAT BRITAIN (10 v.) beat DENMARK (6)

President: F. del VECCHIO (Italy)

	V.	D.		V.	D.
Paul, R.....	2	2	Ruben, I.....	3	1
Smith, A.....	3	1	Albrechtsen, O.....	0	4
Cooke, H.....	2	2	Leidersdorff, A.....	3	1
Lloyd, J. E.....	3	1	Vogg, A.....	0	4

BELGIUM (9 v.) beat DENMARK (3)

President: R. MERCIER (France)

	V.	D.		V.	D.
Paternoster, H.....	1	2	Ruben, I.....	1	2
Valcke, P.....	3	0	Osiier, I.....	1	2
Bru, R.....	2	1	Jorgensen, T.....	1	2
Yves, E.....	3	0	Leidersdorff, A.....	0	3

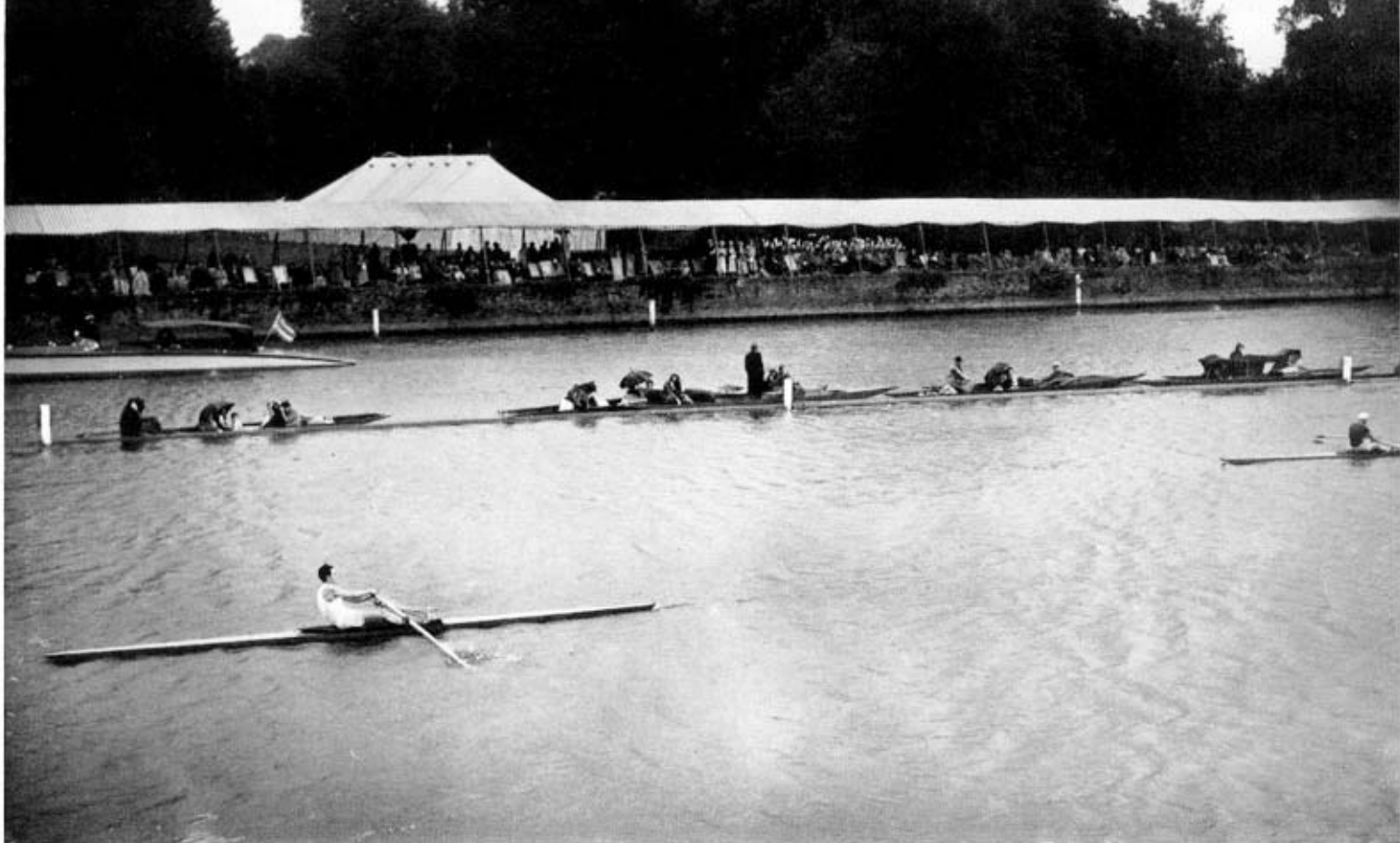

*Modern Pentathlon, Fencing — The Army Gymnasium at Aldershot which was used for the fencing contests.*

*After the final of the single sculls: M. Wood (Australia) is congratulated on his victory by E. Risso (Uruguay) on right.*





*Great Britain (J. H. T. Wilson and W. Laurie) on far side, winning the coxless pairs from Switzerland (H. Kalt and J. Kalt) in centre, and Italy (F. Fanetti and B. Boni) nearest the camera.*

*Another view of the final of the coxless pairs, with Great Britain nearest the camera.*







The whole length of the 1850 metre course, from Temple Island to the finish, and the slopes of the Chilterns behind the bend in the river, can be seen in this view of the final of the double sculls. Great Britain (R. M. Burnell and B. Bushnell) centre station, are winning from Denmark (E. Parsner and A. Larsen) in No. 1 station, and Uruguay (W. Jones and J. A. Rodriguez), No. 3 station. The indicators hung over the river at various points can be clearly seen, while in the foreground are the judges' box on the left, and the press box on the right, both specially built in the river.



*The victory ceremony for the double sculls. The Olympic medals have been presented to the winning pair by the President of the International Olympic Committee, Mr. J. Sigfrid Edstrom (on right), on the raft in front of the main stand, and the British national anthem is being played.*

*The final of the coxed pairs. Denmark, on the Bucks side (Station No. 3), winning from Italy, Berks station (No. 1), who have moved some way across the course, and Hungary in the centre station (No. 2).*

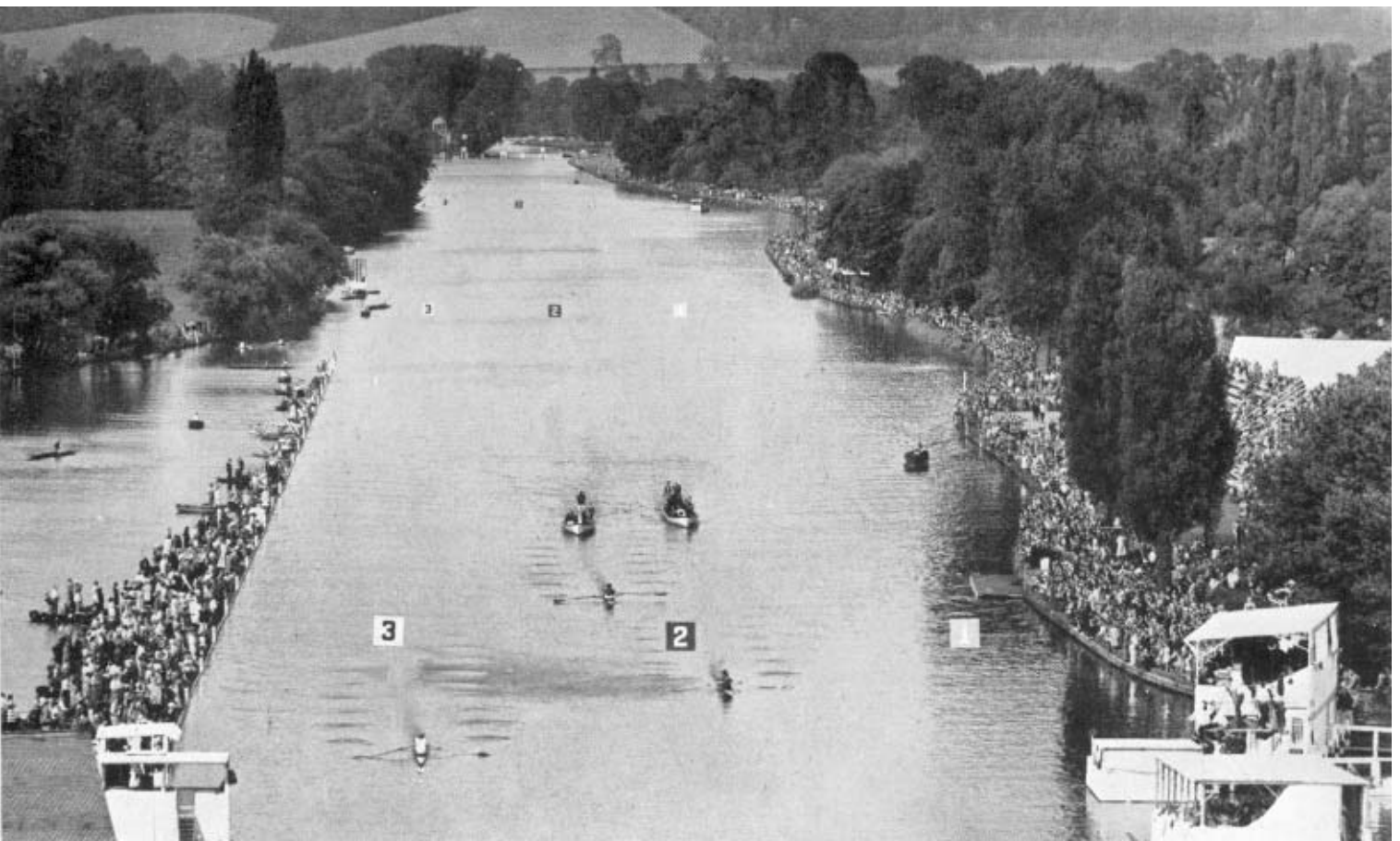





*Final of the coxed pairs: Denmark winning from Italy and Hungary.*

*The final of the coxless fours with Italy winning from Denmark and U.S.A.*





*An easy win for U.S.A. in the semi-final of the coxless fours, South Africa being a good three lengths down as the crews row past the temporary stands in the general enclosure and approach the finish.*



*Another view of the final of the coxed fours with U.S.A., on the side nearest the camera, just passing the finish.*



*The final of the coxed fours. U.S.A., on the Berks side (No. 1) winning from Switzerland, in the centre, and Denmark, on the Bucks side (No. 3).*



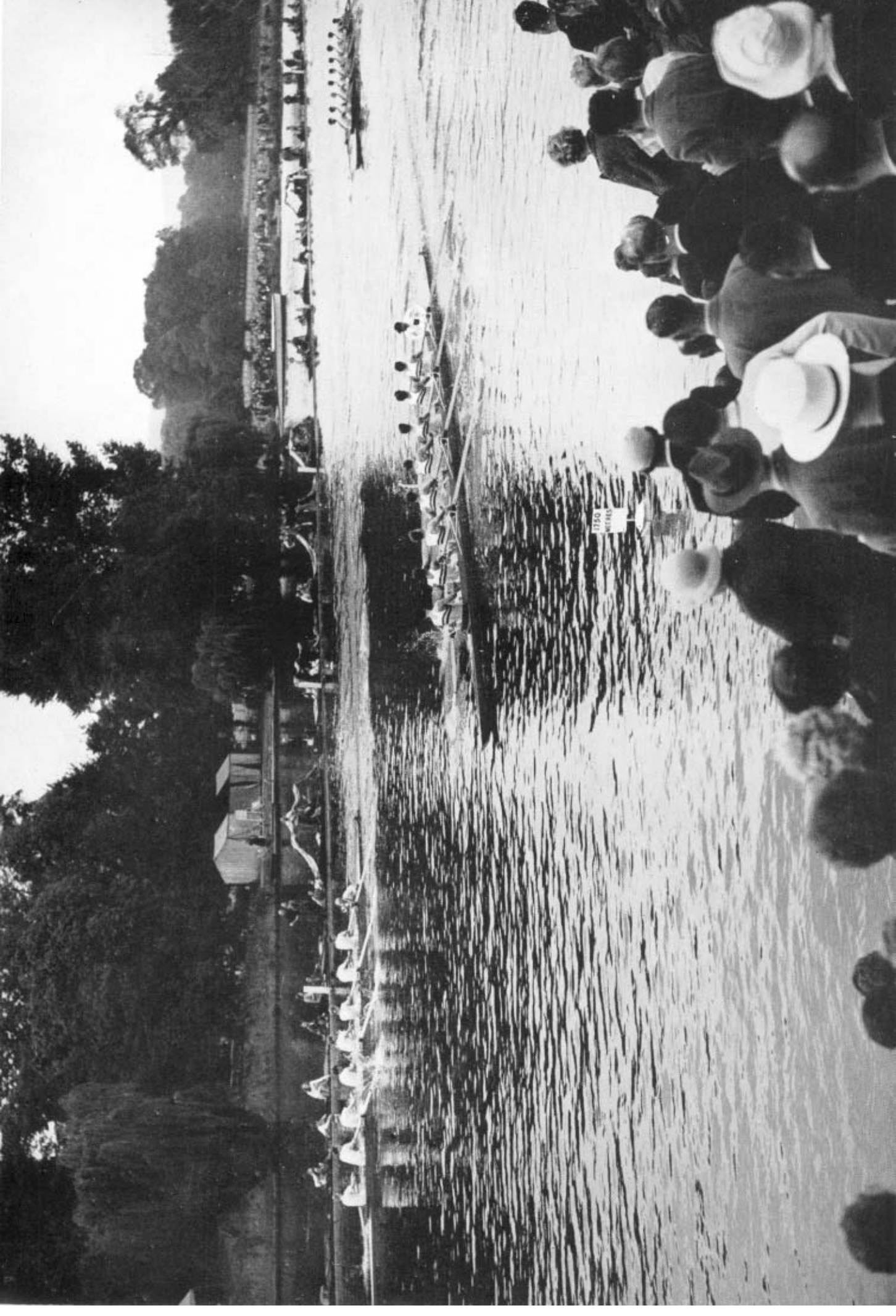

The first heat in the eights, in which Great Britain, nearest to the camera, just beat Norway, on the far side, and Denmark, centre, 100 metres from the finish. One of the distance indicators (1,750 metres) can be seen in the centre foreground.



*A first round heat in the eights, with Italy (centre) leading Switzerland (left, Bucks station), and Argentine (right, Berks station), as they pass the enclosures 100 metres before the finish.*

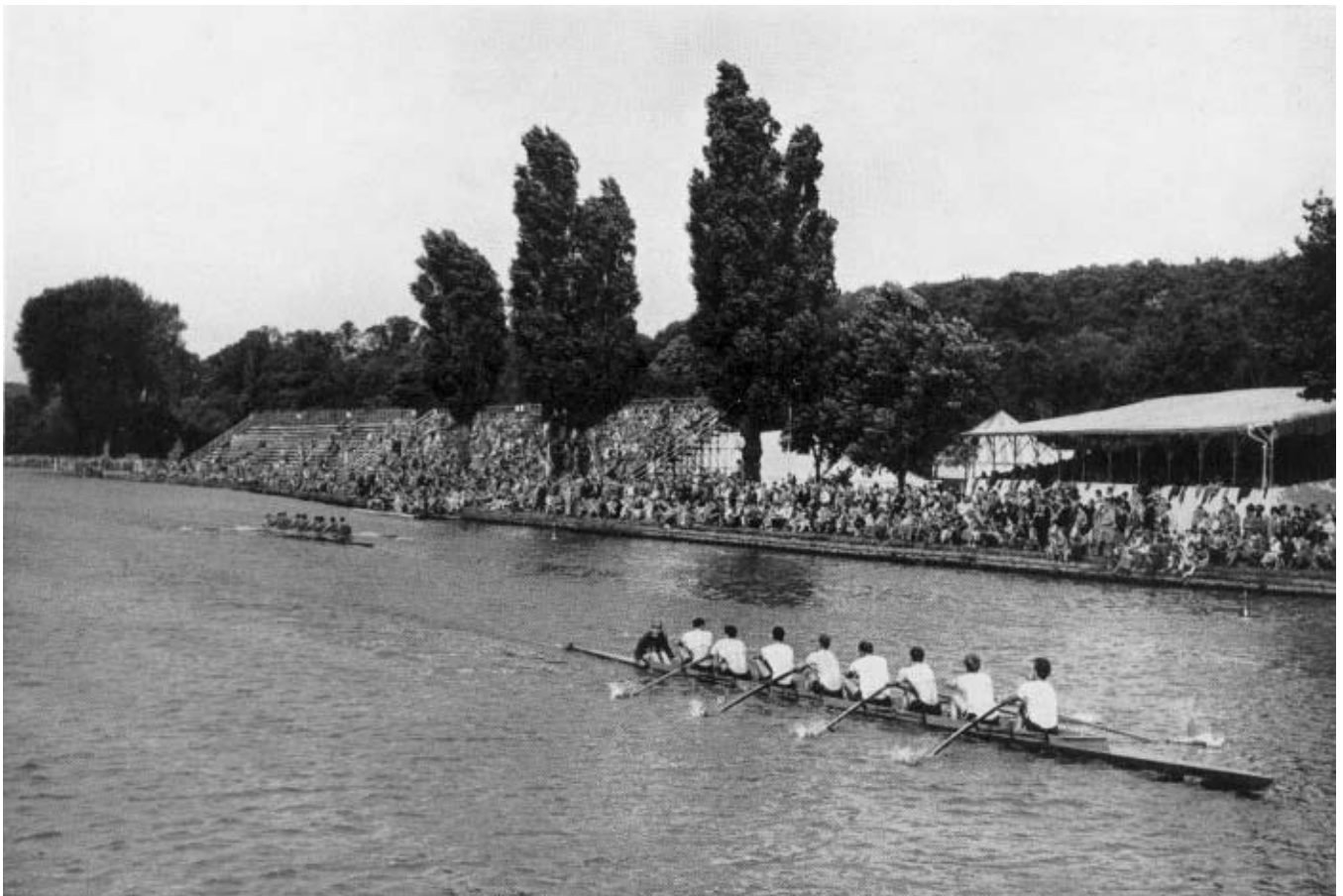

*The semi-final of the eights, in which U.S.A. beat Italy.*



*Approaching the finish in the final of the eights. U.S.A., in the centre station, are leading from Great Britain, station 1, and Norway, station 3.*

*The finish of the final in the eights. U.S.A. in the centre have reached the judges well in advance of Great Britain, nearest the camera, and Norway on the far side.*







*E. Grunig (Switzerland), winner of the 300 metres free rifle.*

*E. Vasquez Cam (Peru), winner of the 50 metres free pistol (centre), with T. Ullman (Sweden) third, and H. Benner (U.S.A.), fourth.*





*K. Takacs (Hungary), the one-armed winner of the 25 metres automatic pistol.*

*The scoreboard for the 50 metres smallbore rifle, with A. Cook (U.S.A.) and W. Tomsen (U.S.A.) checking the scores, which gave them first and second places respectively.*





## POOL IV

Result : HUNGARY won 1 match, EGYPT 1, Uruguay 0

HUNGARY (8 v., 60 hits) beat URUGUAY (8 v., 66 hits)

*President: R. ANSEMI (Italy)*

	V	D	H.		V	D	H.
Dunay, P.....	2	2	13	Rossi Stajano, D...	2	2	16
Gerevich, A.....	3	1	12	Ucar Ferreiro, J.....	1	3	16
Palocz, E.....	3	1	15	Paladino, J.....	2	2	18
Hatszegy, J.....	0	4	20	Iesi, S.....	3	1	16

EGYPT (9 v.) beat URUGUAY (1)

*President: H. DRAKENBERG (Sweden)*

	V	D.		V	D.
Abdel Hafeez, O.....	3	0	Rossi Stajano, D.....	0	3
Dessouki, S.....	3	0	Ucar Ferreiro, J.....	0	2
Younes, M.....	1	1	Iesi, S.....	1	2
Tewfik, H.....	2	0	Paladino, J.....	0	2

## SEMI-FINALS

## POOL I

Result: ITALY won 2 matches, BELGIUM 2, Hungary 0, Argentine 0

ITALY (11 v.) beat ARGENTINE (5)

*President: C. DELPORTE (Belgium)*

	V	D.		V	D.
Nostini, R.....	2	2	Rodriguez, J. M.....	2	2
Di Rosa, M.....	4	0	Galimi, Fulvio.....	2	2
Mangiarotti, E.....	3	1	Torrente, M.....	0	4
Pellini, G.....	2	2	Galimi, Felix.....	1	3

ITALY (9 v.) beat HUNGARY (2)

*President: R. MERCIER (France)*

	V	D.		V	D.
Ragno, S.....	1	2	Gerevich, A.....	1	2
Nostini, R.....	3	0	Hatszegy, J.....	1	1
Mangiarotti, E.....	3	0	Palocz, E.....	0	3
Nostini, G.....	2	0	Maszlay, L.....	0	3

BELGIUM (10 v.) beat HUNGARY (6)

*President: V. CUCCIA (Italy)*

	V	D.		V	D.
Yves, E.....	2	2	Bay, B.....	0	4
Valcke, P.....	2	2	Gerevich, A.....	2	2
Bru, R.....	3	1	Dunay, P.....	1	3
de Bourguignon, G.....	3	1	Palocz, E.....	3	1

BELGIUM (1 v.) beat ARGENTINE (0)

*President: E. EMPEYTA (Switzerland)*

	V	D.		V	D.
Yves, E.....	1	0	Rodriguez, J. M.....	0	1
Valcke, P.....	-	-	Galimi, Fulvio.....	-	-
Bru, R.....	-	-	Torrente, M.....	-	-
de Bourguignon, G.....	-	-	Galimi, Felix.....	-	-

Argentine withdrew after one bout.

## POOL II

Result : FRANCE won 2 matches, U.S.A. 2, Egypt 0, Great Britain 0

FRANCE (13 v.) beat EGYPT (3)

*President: M. de CAPRILES (U.S.A.)*

	V	D.		V	D.
Buhan, J.....	2	2	Zulficar, M.....	1	3
Rommel, A.....	4	0	Abdine, M.....	1	3
d'Oriola, C.....	4	0	Younes, M.....	0	4
Bougnol, R.....	3	1	Dessouki, S.....	1	3

FRANCE (10 v.) beat GREAT BRITAIN (6)

*President: G. ROZGONYI (Hungary)*

	V	D.		V	D.
Bonin, A.....	2	2	Paul, R.....	2	2
Lataste, J.....	2	2	Smith, A.....	1	3
Rommel, A.....	3	1	Lloyd, J. E.....	2	2
Buhan, J.....	3	1	Turquet, P.....	1	3

U.S.A. (8 v., 60 hits) beat GREAT BRITAIN (8 v., 64 hits)

*President: G. BASLETTA (Italy)*

	V	D	H.		V	D	H.
Bukantz, D.....	3	1	10	Paul, R.....	3	1	15
Lubell, B.....	0	4	20	Turquet, P.....	1	3	19
Cetrulo, D.....	2	2	15	Cooke, H. (retired).....	1	1	9
Giolito, S.....	3	1	15	Smith, A.....	1	1	7
				Lloyd, J. E.....	2	2	14

U.S.A. (9 v.) beat EGYPT (5)

*President: G. GRINDA (Italy)*

	V	D.		V	D.
Bukantz, D.....	4	0	Abdel Hafeez, O.....	1	3
Prokop, A.....	1	2	Tewfik, H.....	1	3
Cetrulo, D.....	1	2	Dessouki, S.....	1	2
Giolito, S.....	3	1	Younes, M.....	2	1

**FINAL**

1 FRANCE won 3 matches  
2 ITALY won 2 matches

3 BELGIUM won 1 match  
4 U.S.A. won 0 matches

FRANCE (11 v.) beat U.S.A. (5)  
President: G. GRINDA (Italy)

	Name	No.	1	2	3	4	5	6	7	8	Victories	Hits Against
U.S.A.	Bukantz, D.	1	■	■	■	■	■■■■	■■■■	■■	■■■■	1	
	Prokop, A	2	■	■	■	■	■■■	■■■■	■■■	■■■	3	
	Giolito, S.....	3	■	■	■	■	■■■■	■■■■	■■■	■■■■	1	
	Every, D.....	4	■	■	■	■	■■■■	■■■■	■■■■	■■■■	0	
FRANCE	Bonin, A .....	5	■■	■■■■	■■		■	■	■	■	3	
	Buhan, J .....	6	■■■	■	■■■	■■■	■	■	■	■	4	
	Bougnol, R.....	7	■■■■	■■■■	■■■■	■■■	■	■	■	■	1	
	Lataste, J.....	8	■■■	■■■■	■■	■	■	■	■	■	3	

ITALY (11 v.) beat BELGIUM (5)  
President: R. MERCIER (France)

	Name	No.	1	2	3	4	5	6	7	8	Victories	Hits Against
BELGIUM	de Bourguignon, G.....	1	■	■	■	■	■■■■	■	■■■■	■■■	2	
	Van de Werve de Vorsseleare, A.	2	■	■	■	■	■■■■	■■■■	■■■	■■■■	1	
	Valcke, P.....	3	■	■	■	■	■■■■	■■■■	■■■■	■■■	1	
	Bru, R.....	4	■	■	■	■	■■■■	■■■■	■■■■	■■■	1	
ITALY	Nostini, R.....	5	■■■	■■	■	■■■	■	■	■	■	4	
	Mangiarotti, E .....	6	■■■■	■■	■■■	■■■	■	■	■	■	3	
	Nostini, G.....	7	■	■■■■	■■■	■■	■	■	■	■	3	
	Di Rosa, M.....	8	■■■■	■■	■■■■	■■■■	■	■	■	■	1	

## FRANCE (9 v.) beat BELGIUM (5)

President: C. de BEAUMONT (Great Britain)

	Name	No.	1	2	3	4	5	6	7	8	Victories	Hits Against		
BELGIUM	de Bourguignon, G.....	1	■	■	■	■	1111	1111	1111	11	1			
							D	D	D	V				
	Paternoster, H.....	2	■	■	■	■	1111	1111	11	11			2	
							D	D	V	V				
Yves, E.....	3	■	■	■	■	1111		1111	1111	0				
						D		D	D					
	Bru, R.....	4	■	■	■	■	11	1111		1111	2			
							V	V		D				
FRANCE	Bonin, A.....	5	111	11	111	1111	■	■	■	■	3			
			V	V	V	D								
	d'Oriola, C.....	6	1111	111		1111	■	■	■	■	2			
			V	V		D								
Bougnol, R.....	7	1	1111	111		■	■	■	■	2				
		V	D	V										
Buhan, J.....	8	1111	1111	111	111	■	■	■	■	2				
		D	D	V	V									

## ITALY (9 v.) beat U.S.A. (2)

President: C. LION (France)

	Name	No.	1	2	3	4	5	6	7	8	Victories	Hits Against
U.S.A.	Bukantz, D.....	1	■	■	■	■	1111	1111	1111		0	
							D	D	D			
	Lubell, B.....	2	■	■	■	■		1111	1111	1111	0	
								D	D	D		
	Giolito, S.....	3	■	■	■	■	1111		1111	1111	0	
							D		D	D		
	Cetrulo, D.....	4	■	■	■	■	11			11	2	
							V			V		
ITALY	Di Rosa, M.....	5	1111		1	1111	■	■	■	■	2	
			V		V	D						
	Mangiarotti, E.....	6	1111	1			■	■	■	■	2	
			V	V								
Nostini, G.....	7	11	111	11		■	■	■	■	3		
		V	V	V								
Nostini, R.....	8		1111	11	1111	■	■	■	■	2		
			V	V	D							

XIV OLYMPIAD

BELGIUM (9 v.) beat U.S.A. (7)

President: F. del VECCHIO (Italy)

	Name	No.	1	2	3	4	5	6	7	8	Victories	Against
U.S.A.	Lubell, B.....	1					iii	iiiiii	i	iiii	3	
							V	D	V	V		
	Prokop, A.....	2					iiiiii	iiiiii	iiiiii	iiiiii	0	
							D	D	D	D		
	Giolito, S.....	3					iiii	iiiiii	iiii	iiiiii	2	
							V	D	V	D		
	Cetrulo, D.....	4					ii	iiiiii	i	iiiiii	2	
							V	D	V	D		
BELGIUM	Yves, E.....	5	iiiiii	ii	iiiiii	iiiiii					1	
			D	V	D	D						
	Valcke, P.....	6	ii	ii		iiiiii					4	
			V	V	V	V						
	Van de Werve de Vorsslaere, A.....	7	iiiiii	iiii	iiiiii	iiiiii					1	
			D	V	D	D						
	de Bourguignon, G.....	8	iiiiii	iiii	ii	i					3	
			D	V	V	V						

FRANCE (8 v., 60 hits) beat ITALY (8 v., 62 hits)

President: J. E. LLOYD (Great Britain)

	Name	No.	1	2	3	4	5	6	7	8	Victories	Hits Against
ITALY	Nostini, R.....	1					iii	iiiiii	iiiiii	iiiiii	1	18
							V	D	D	D		
	Di Rosa, M.....	2					iiiiii	iiiiii	iiiiii	ii	1	17
								D	D	D		
	Mangiarotti, E.....	3					iii	iiii	iiiiii	iii	3	15
							V	V	D	V		
	Nostini, G.....	4					iiiiii	iii	iii	i	3	12
							D	V	V	V		
FRANCE	Lataste, J.....	5	iiiiii	iiii	iiiiii	iiii					2	18
			D	V	D	V						
	d'Oriola, C.....	6	i	ii	iiiiii	iiiiii					2	13
			V	V	D	D						
	Buhan, J.....	7	iii	ii	iiii	iiiiii					3	14
			V	V	V	D						
	Rommel, A.....	8		iiiiii	iiiiii	iiiiii					1	15
			V	D	D	D						

**FOIL—INDIVIDUAL***Previous Olympic Winners*

1896	M. Gravelotte	France	1924	R. Ducret	France
1900	Coste	France	1928	L. Gaudin	France
1904	R. Post	Cuba	1932	G. Marzi	Italy
1912	N. Nadi	Italy	1936	G. Gaudini	Italy
1920	N. Nadi	Italy			

There were 68 entries from 24 nations ; 63 participants from 25 nations

*The first four competitors from each pool were promoted. All bouts were for the best of nine hits. Barrages for promotion were fought off.*

**FIRST ROUND****POOL I**

President: W. DOW (U.S.A.)

	V.	D.	H.A.	H.F.
1 Di Rosa, M..... Italy	6	1	16	— †
2 Galimi, Fulvio..... Argentine	6	1	18	— †
3 Leidersdorff, A..... Denmark	6	2	24	—
4 Horning, W..... Switzerland	5	3	—	— *
5 Gretsche, E..... Luxembourg	5	3	—	— *
6 de la Pena Lopez Trigo, L..... Cuba	3	4	—	— †
7 Higuera Ureta, H..... Peru	2	5	—	— †
8 Scianamea, S. O..... Brazil	0	7	—	— †
{ Smith, T. P..... Eire	0	7	—	— †

**POOL II**

President: B. SCHMETZ (France)

	V.	D.	H.A.	H.F.
1 Nostini, G..... France	7	0	—	—
2 Van de Werve de Vorselaere, A..... Belgium	5	1	—	— †
3 Younes, M..... Egypt	4	3	—	— *
4 Rydstrom, N..... Sweden	4	3	—	— *
5 Barrientos, A..... Cuba	4	3	—	— *
6 Karamazakidis, J..... Greece	2	5	—	—
7 Ucar Ferreiro, J..... Uruguay	1	5	—	— †
8 Pouliot, G..... Canada	0	7	—	—

**POOL III**

President: C. LION (France)

	V.	D.	H.A.	H.F.
1 Lloyd, J. E..... Great Britain	5	1	—	—
2 Paternoster, H..... Belgium	4	2	18	—
3 Nostini, R..... Italy	4	2	20	—
4 Palocz, E..... Hungary	3	3	—	— *
5 Albrechtsen, O..... Denmark	3	3	—	— *
6 Raitio, H..... Finland	2	4	—	—
7 Accorsi Teuthorn, E..... Chile	0	6	—	—

**POOL IV**

President: F. del VECCHIO (Italy)

	V.	D.	H.A.	H.F.
1 d'Oriola, C..... France	7	0	—	—
2 Maszlay, L..... Hungary	5	2	19	—
3 Alessandri, L..... Brazil	5	2	22	—
4 Ter Weer, H..... Holland	4	3	—	—
5 Buck, L..... Luxembourg	3	4	27	—
6 Bebis, C..... Greece	3	4	30	—
7 Thuillier, N..... Eire	1	6	—	—
8 Asselin, R..... Canada	0	7	—	—

**POOL V**

President: G. GRINDA (Italy)

	V.	D.	H.A.	H.F.
1 Buhan, J..... France	6	0	—	— †
2 Eriksson, B..... Sweden	5	2	20	—
3 Rossi Stajano, D..... Uruguay	5	2	22	—
4 Tewfik, H..... Egypt	4	3	—	—
5 Lubell, B..... U.S.A.	3	4	—	—
6 Zoet, J..... Holland	2	5	31	—
7 Agostini, J..... Cuba	2	4	27	— †
8 Tuohy, O..... Eire	0	7	—	—

**POOL VI**

President: F. SOILLE (France)

	V.	D.	H.A.	H.F.
1 Cetrulo, D..... U.S.A.	7	0	—	—
2 Bougnol, R..... France	6	1	—	—
3 Torrente, M..... Argentine	5	2	—	—
4 Smith, A..... Great Britain	4	3	—	—
5 Jalkanen, K..... Finland	2	5	30	—
6 Camargo, R..... Colombia	2	5	32	—
7 Rubli, J..... Switzerland	1	5	29	— †
{ Kuijpers, L..... Holland	1	6	34	—

**POOL VII**

President: R. ANSELMINI (Italy)

	V.	D.	H.A.	H.F.
1 Paul, R..... Great Britain	5	1	17	—
2 Galimi, Felix..... Argentine	5	1	20	—
3 Giolito, S..... U.S.A.	4	2	—	—
4 Abdel Hafeez, O..... Egypt	3	3	—	— *
5 Lamesch, G..... Luxembourg	3	3	—	— *
6 { Balkan, N..... Turkey	0	5	—	— †
{ Grisi Solorzano,..... Mexico	0	5	—	— †

**POOL VIII**

President: V. CUCCIA (Italy)

	V.	D.	H.A.	H.F.
1 Iesi, S..... Uruguay	6	1	16	—
2 Valcke, P..... Belgium	6	1	18	—
3 Ruben, I..... Denmark	5	2	—	—
4 Schlaepfer, G..... Switzerland	4	3	—	— *
5 Hatszeghy, J..... Hungary	4	3	—	— *
6 Zintzos, S..... Greece	2	5	—	—
7 Horn, A..... Canada	1	6	—	—
8 Tulgar, H..... Turkey	0	7	—	—

\* After Barrage.

† One bout unfought.

## SECOND ROUND

## POOL I

President: G. GRINDA (Italy)

		V.	D.	H.A.	H.F.
1	Nostini, G..... Italy .....	6	0	—	— †
2	Bougnol, R..... France .....	5	1	—	— †
3	Ruben, I..... Denmark .....	4	3	23	—
4	Cetrulo, D..... U.S.A.....	4	3	26	—
5	Van de Werve de Vorsseleere, A..... Belgium.....	3	4	—	—
6	Tewfik, H..... Egypt .....	2	5	—	—
7	Palocz, E..... Hungary.....	1	5	27	— †
8	Rossi Stajano, D..... Uruguay.....	1	5	28	— †

## POOL II

President: R. MERCIER (France)

		V.	D.	H.A.	H.F.
1	Di Rosa, M..... Italy .....	6	0	—	— †
2	Buhan, J..... France .....	5	1	—	— †
3	Giolito, S..... U.S.A.....	4	2	22	— †
4	Eriksson, B..... Sweden .....	4	2	23	— †
5	Leidersdorff, A..... Denmark.....	2	4	22	— †
6	Smith, A..... Great Britain .....	2	4	27	— †
7	Galimi, Fulvio..... Argentine .....	1	5	—	— †
8	Horning, W..... Switzerland.....	0	6	—	— †

## POOL III

President: H. van NEROM (Belgium)

		V.	D.	H.A.	H.F.
1	d'Oriola, C..... France .....	6	1	18	33
	Galimi, Felix..... Argentine .....	6	1	18	33
3	Paternoster, H..... Belgium.....	4	3	21	—
4	Abdel Hafeez, O..... Egypt.....	4	2	22	— †
5	Paul, R..... Great Britain .....	3	4	—	—
6	Ter Weer, H..... Holland.....	2	4	—	— †
7	Schlaepfer, G..... Switzerland.....	1	5	—	— †
8	Alessandri, L..... Brazil .....	0	6	—	— †

## POOL IV

President: G. ROSGONYI (Hungary)

		V.	D.	H.A.	H.F.
1	Nostini, R..... Italy .....	5	1	12	— †
2	Lloyd, J. E..... Great Britain .....	5	1	16	28 †
3	Maszlay, L..... Hungary.....	5	1	16	27 †
4	Valcke, P..... Belgium.....	5	2	20	—
5	Iesi, S..... Uruguay.....	3	4	—	—
6	Torrente, M..... Argentine .....	1	5	26	— †
7	Younes, M..... Egypt .....	1	5	27	— †
8	Rydstrom, N..... Sweden .....	0	6	—	— †

## SEMI-FINALS

## POOL I

President: F. del VECCHIO (Italy)

		V.	D.	H.A.	H.F.
1	Buhan, J..... France .....	6	0	—	— †
2	d'Oriola, C..... France .....	5	1	—	— †
3	Ruben, I..... Denmark.....	4	2	18	— †
4	Lloyd, J. E..... Great Britain .....	4	2	22	— †
5	Nostini, R..... Italy .....	2	4	—	— †
6	Paternoster, H..... Belgium.....	1	5	28	— †
7	Abdel Hafeez, O..... Egypt .....	1	5	29	18 †
8	Giolito, S..... U.S.A.....	1	5	29	17 †

## POOL II

President: B. SCHMETZ (France)

		V.	D.	H.A.	H.F.
	Maszlay, L..... Hungary.....	5	1	18	— †
1	Bougnol, R..... France .....	5	2	22	—
	Valcke, P..... Belgium.....	5	2	23	—
4	Di Rosa, M..... Italy .....	4	3	—	— *
5	Cetrulo, D..... U.S.A.....	4	3	—	— *
6	Nostini, G..... Italy .....	2	4	—	— †
7	Galimi, Felix..... Argentine .....	1	5	—	— †
8	Eriksson, B..... Sweden .....	0	6	—	— †

\* After barrage.

† One bout unfought.

## FINAL

President (first half): G. ROSGONYI (Hungary)

(second half) G. HEYVAERT (Belgium)

No.	Name	Country	1	2	3	4	5	6	7	8	Victories	Hits Against	Hits For	Place
1	BUHAN, J.....	France	■	V	V	V	V	V	V	V	7	14		1
2	Ruben, I.....	Denmark	■■■■	■	■	■■■	■■■	■■■	■■■	■■■	1	33		8
3	Valcke, P.....	Belgium	■■■■	■■■	■	■■■	■■■	■■■	■■■	■	1	31		7
4	d'ORIOLA, C.....	France	■■■■	■	■	■	■	■	■	■	5	18		2
5	Bougnol, R.....	France	■■■■	■	■	■■■	■	■	■■■	■■■	3	26		5
6	MASZLAY, L.....	Hungary	■■■■	■	■	■■■	■■■	■	■	■	4	22		3
7	Lloyd, J. E.....	Great Britain	■■■■	■■■	■■■	■	■■■	■■■	■	■■■	4	29		4
8	Di Rosa, M.....	Italy	■■■■	■	■■■	■■■	■■■	■■■	■	■	3	27		6

1 **BUHAN, J.**..... France2 **d'ORIOLA, C.**..... France3 **MASZLAY, L.**..... Hungary



**EPEE—TEAMS***Previous Olympic Winners*

1908 France	1924 France	1936 Italy
1912 Belgium	1928 Italy	
1920 Italy	1932 France	

There were 128 entries from 22 nations ; 122 participants from 21 nations

*The first two teams from each pool were promoted. All bouts were for the best of five hits*

**FIRST ROUND****POOL I**

Result: ARGENTINE won 2 matches, POLAND 1, Cuba 0

ARGENTINE (10 victories) beat POLAND (6)

*President: C. DELPORTE (Belgium)*

	V	D.		V	D.
Simonetti, V .....	3	1	Sobik, A.....	3	1
Villamil, A.....	4	0	Karwicki, R .....	0	4
Saucedo, R.....	1	3	Nawrocki, J.....	2	2
Diaz Arnesto, F.....	2	2	Zaczyk, T.....	1	3

POLAND (8 v.) beat CUBA (6)

*President: F. SOILLE (France)*

	V	D.		V	D.
Sobik, A.....	4	0	Manalich, R.....	2	2
Karwicki, R.....	0	4	Lamar Schwyer, C...	3	1
Nawrocki, J.....	2	2	Barrientos, A .....	0	4
Zaczyk, T.....	2	2	Martinez Valdes		
			Cantero, J.	1	3

ARGENTINE (9 v.) beat CUBA (5)

*President: M. YOUNES (Egypt)*

	V.	D.		V.	D.
Balza, J.....	3	1	Manalich, R.....	3	1
Diaz Arnesto, F. ....	1	2	Lamar Schwyer, C.....	0	4
Simonetti, V .....	2	1	Barrientos, A .....	0	3
Saucedo, R.....	3	1	Martinez Valdes		
			Cantero, J.	2	1

**POOL II**

Result : BELGIUM won 2 matches, DENMARK 2, Mexico 0, Canada 0

BELGIUM (10 v.) beat MEXICO (6)

*President: V. CUCCIA (Italy)*

	V	D.		V	D.
Stasse, R.....	3	1	Meraz Segura, E.....	1	3
Hauben, L.....	2	2	Valero Recio, F.....	1	3
Bru, R.....	2	2	Ramos Ramos, B.....	2	2
Radoux, J.....	3	1	Haro Oliva, A.....	2	2

BELGIUM (12 v.) beat CANADA (1)

*President: F. PAREDES (Portugal)*

	V	D.		V	D.
Henkart, R.....	2	1	Desjarlais, R. ....	0	4
Stasse, R.....	3	0	Horn, A.....	0	3
Radoux, J.....	3	0	Asselin, R.....	1	2
de Beur, C.....	4	0	Pouliot, G.....	0	3

DENMARK (13 v.) beat CANADA (2)

*President: R. ANSELMINI (Italy)*

	V	D.		V	D.
Luchow, M.....	3	1	Horn, A.....	1	3
Andersen, E.....	3	1	Pouliot, G.....	0	4
Nielsen, I. B.....	3	1	Desjarlais, R.....	1	3
Dybkaer, R.....	4	0	Asselin, R.....	0	4

DENMARK (9 v.) beat MEXICO (2)

*President: G. JEKELFALUSSY (Hungary)*

	V	D.		V	D.
Luchow, M.....	3	0	Meraz Segura, E.....	0	3
Andersen, E.....	2	1	Valero Recio, F.....	0	2
Dybkaer, R.....	2	1	Haro Oliva, A.....	1	2
Nielsen, I. B.....	2	0	Ramos Ramos, B.....	1	2

## POOL III

Result: U.S.A. won 1 match, LUXEMBOURG 1, Finland 0

U.S.A. (9 v.) beat FINLAND (5)

*President: G. BRICUSSE (Belgium)*

	V	D.		V	D.
Lewis, N.....	1	3	Sjoblom, N.....	2	2
Boyd, A.....	3	1	Larkas, H.....	0	4
de Capriles, J.....	2	2	Kerttula, E.....	2	2
Thompson, D.....	3	1	Vartia, A.....	1	3

LUXEMBOURG (8 v.) beat FINLAND (6)

*President: J. de A. MACHADO (Portugal)*

	V	D.		V	D.
Leischen, J-F.....	1	3	Sjoblom, N.....	0	4
Anen, P.....	4	0	Jalkanen, K.....	3	1
Gretsch, E.....	1	3	Kerttula, E.....	1	3
Lamesch, G.....	2	2	Vartia, A.....	2	2

## POOL IV

Result: FRANCE and NORWAY promoted. Chile withdrew

## POOL V

Result: ITALY won 1 match, GREAT BRITAIN 1, Brazil 0

ITALY (14 v.) beat BRAZIL (2)

*President: L. CORDING (Great Britain)*

	V.	D.		V	D.
Cantone, L.....	4	0	Biancalana, M.....	1	3
Mandruzzato, A.....	4	0	Camargo, B.....	0	4
Agostoni, C.....	4	0	Vallim, A.....	1	3
Mangiarotti, E.....	2	2	de Paula, A.....	0	4

GREAT BRITAIN (8 v.) beat BRAZIL (6)

*President: E. EMPEYTA (Switzerland)*

	V.	D.		V	D.
de Beaumont, C.....	3	1	Biancalana, M.....	1	3
Beddard, T.....	2	2	Camargo, B.....	1	3
Parfitt, R.....	2	1	Vallim, H.....	2	2
Pelling, A.....	1	3	Scianamea, S. O.....	2	1

## POOL VI

Result: EGYPT won 1 match, SWITZERLAND 1, Portugal 0

EGYPT (10 v.) beat PORTUGAL (5)

*President: P. FERRI (France)*

	V.	D.		V	D.
Dessouki, S.....	4	0	Pinheiro Chagas, M.....	1	3
Asfar, J.....	2	2	Melo e Castro, J.....	1	3
Younes, M.....	2	2	Gomes Lino, E.....	1	3
Abdel Rahman, M.....	2	2	Pinto, A. da C.....	2	2

SWITZERLAND (8 v.) beat PORTUGAL (6)

*President: T. JAECKEL (U.S.A.)*

	V.	D.		V	D.
Thiebaud, F.....	1	3	Penha e Costa.....	2	2
Lips, R.....	3	1	Gomes Lino, E.....	1	3
Hauert, J.....	2	2	Pereira Dias, C.....	2	1
Zappelli, O.....	2	1	Pinto, A. da C.....	1	3

## POOL VII

Result: SWEDEN won 1 match, HUNGARY 1, Greece 0

SWEDEN (16 v.) beat GREECE (0)

*President: M. DUTERQUE (France)*

	V.	D.		V	D.
Cervell, F.....	4	0	Nanopoulos, A.....	0	4
Forsell, C.....	4	0	Skotidas, A.....	0	4
Ljungquist, B.....	4	0	Zintzos, S.....	0	4
Thofelt, S.....	4	0	Bebis, C.....	0	4

HUNGARY (9 v.) beat GREECE (1)

*President: M. DUTERQUE (France)*

	V.	D.		V	D.
Henneyi, I.....	3	0	Nanopoulos, A.....	1	1
Dunay, P.....	3	0	Skotidas, A.....	0	2
Rerrich, B.....	2	0	Karamazakidis, J.....	0	3
Mikla, B.....	1	1	Bebis, C.....	0	3

## SECOND ROUND

## POOL I

Result : ITALY won 2 matches, HUNGARY 2, Norway 0, Poland 0

ITALY (14 v.) beat POLAND (1)

*President: F. SOILLE (France)*

	V.	D.		V.	D.
Marini, F.....	3	1	Sobik, A.....	0	4
Mangiarotti, D.....	4	0	Karwicki, R.....	1	3
Mangiarotti, E.....	4	0	Nawrocki, J.....	0	4
Mandrzzato, A.....	3	1	Banas, B.....	0	4

ITALY (12 v.) beat NORWAY (2)

*President: M. de CAPRILES (U.S.A.)*

	V.	D.		V.	D.
Cantone, L.....	2	2	Von Koss, J.....	0	4
Agostoni, C.....	3	1	Knutzen, E.....	2	2
Mangiarotti, D.....	3	1	Eriksen, A.....	0	4
Mangiarotti, E.....	4	0	Morch, C.....	0	4

HUNGARY (7 v., 34 hits) beat NORWAY (7 v., 35 hits)

*President: E. EMPEYTA (Switzerland)*

	V.	D.	H.		V.	D.	H.
Hennyei, I.....	2	2	6	Knutzen, E.....	2	2	9
Dunay, P.....	3	1	6	Von Koss, J.....	2	2	7
Rerrich, B.....	2	2	10	Eriksen, A.....	3	1	7
Mikla, B.....	0	4	12	Gillebo, S.....	0	4	12

HUNGARY (10 v.) beat POLAND (6)

*President: A. ROMMEL (France)*

	V.	D.		V.	D.
Hennyei, I.....	3	1	Sobik, A.....	2	2
Balthazar, E.....	1	3	Karwicki, R.....	2	2
Rerrich, B.....	2	2	Nawrocki, J.....	0	4
Dunay, P.....	4	0	Zaczyk, T.....	2	2

## POOL II

Result: FRANCE won 3 matches, DENMARK 2, Egypt 1, Great Britain 0

FRANCE (12 v.) beat DENMARK (4)

*President: F. del VECCHIO (Italy)*

	V.	D.		V.	D.
Huet, M.....	4	0	Lyng, J.....	1	3
Pechoux, M.....	4	0	Luchow, M.....	1	3
Desprets, M.....	3	1	Flindt, K.....	1	3
Artigas, E.....	1	3	Nielsen, I. B.....	1	3

DENMARK (8 v.) beat EGYPT (6)

*President: J. TILLE (Czechoslovakia)*

	V.	D.		V.	D.
Nielsen, I. B.....	1	3	Abdel Hafeez, O.....	2	2
Andersen, E.....	3	1	Younes, M.....	2	2
Flindt, K.....	1	3	Asfar, J.....	0	4
Dybkaer, R.....	3	1	Abdel Rahman, M.....	2	2

EGYPT (11 v.) beat GREAT BRITAIN (5)

*President: J. de A. MACHEDO (Portugal)*

	V.	D.		V.	D.
Dessouki, S.....	2	2	de Beaumont, C.....	1	3
Asfar, J.....	4	0	Beddard, T.....	1	3
Younes, M.....	2	2	Craig, A.....	2	2
Abdel Rahman, M.....	3	1	Parfitt, R.....	1	3

FRANCE (8 v.) beat EGYPT (5)

*President: G. JEKELFALUSSY (Hungary)*

	V.	D.		V.	D.
Huet, M.....	1	3	Abdel Hafeez, O.....	0	4
Guerin, H.....	3	1	Younes, M.....	2	1
Lepage, H.....	3	0	Asfar, J.....	1	2
Artigas, E.....	1	2	Abdel Rahman, M.....	2	2

FRANCE (12 v.) beat GREAT BRITAIN (3)

*President: C. FILOGAMO (Italy)*

	V.	D.		V.	D.
Huet, M.....	2	2	de Beaumont, C.....	0	4
Guerin, H.....	4	0	Craig, A.....	0	4
Pechoux, M.....	3	1	Parfitt, R.....	1	3
Lepage, H.....	3	1	McCready, M.....	2	2

DENMARK (8 v.) beat GREAT BRITAIN (4)

*President: G. BASLETTA (Italy)*

	V.	D.		V.	D.
Luchow, M.....	2	2	de Beaumont, C.....	1	2
Lyng, J.....	2	1	Craig, A.....	1	2
Dybkaer, R.....	1	2	Parfitt, R.....	1	2
Andersen, E.....	3	0	McCready, M.....	1	3

## POOL III

Result : SWITZERLAND won 1 match, SWEDEN 1, Argentine 0

SWITZERLAND (11 v.) beat ARGENTINE (3)

*President: V. CUCCIA (Italy)*

	V.	D.		V.	D.
Rufenacht, O.....	3	1	Guido Lavallo, A.....	0	4
Lips, R.....	3	1	Simonetti, V.....	1	3
Zappelli, O.....	2	2	Villamil, A.....	1	3
Chamay, M.....	3	1	Saucedo, R.....	1	3

SWEDEN (9 v.) beat ARGENTINE (3)

*President: M. DUTERQUE (France)*

	V.	D.		V.	D.
Cervell, F.....	1	2	Simonetti, V.....	1	2
Forsell, C.....	3	0	Villamil, A.....	0	3
Ljungquist, B.....	3	0	Diaz Arnesto, F.....	1	2
Thofelt, S.....	2	1	Balza, J.....	1	2

## POOL IV

Result: BELGIUM won 1 match, LUXEMBOURG 1, U.S.A. 0

LUXEMBOURG (8 v.) beat U.S.A. (6)

*President: G. BASLETTA (Italy)*

V.	D.	V.	D.
Leischen, J-F .....	1 3	Boyd, A .....	1 3
Anen, P .....	1 3	Wolff, A .....	3 1
Lamesch, G .....	3 1	de Capriles, J .....	1 3
Gretsch, E .....	3 1	Goldstein, R .....	1 3

BELGIUM (9 v.) beat U.S.A. (5)

*President: G. GRINDA (Italy)*

V.	D.	V.	D.
Henkart, R .....	3 1	Lewis, N .....	2 2
Bru, R .....	0 3	Wolff, A .....	2 2
Radoux, J .....	2 1	Thompson, D .....	0 3
de Beur, C .....	4 0	de Capriles, J .....	1 2

## SEMI-FINALS

## POOL I

Result: FRANCE won 2 matches, DENMARK 2, Belgium 1, Switzerland 1

DENMARK (7 v.) beat BELGIUM (6)

*President: M. DUTERQUE (France)*

V.	D.	V.	D.
Nielsen, I. B .....	3 1	de Beur, C .....	3 1
Luchow, M .....	1 3	Henkart, R .....	0 4
Andersen, E .....	1 3	Stasse, R .....	0 4
Dybkaer, R .....	2 2	Radoux, J .....	3 1

DENMARK (12 v.) beat SWITZERLAND (3)

*President: B. FORSSELL (Sweden)*

V.	D.	V.	D.
Nielsen, I. B .....	3 1	Hauert, J .....	0 4
Luchow, M .....	4 0	Lips, R .....	1 3
Andersen, E .....	2 2	Chamay, M .....	2 2
Dybkaer, R .....	3 1	Rufenacht, O .....	0 4

FRANCE (12 v.) beat SWITZERLAND (3)

*President: G. GRINDA (Italy)*

V.	D.	V.	D.
Guerin, H .....	3 1	Thiebaud, F .....	0 4
Artigas, E .....	3 1	Hauert, J .....	1 3
Desprets, M .....	2 2	Zappelli, O .....	1 3
Pecheux, M .....	4 0	Lips, R .....	1 3

SWITZERLAND (7 v., 33 hits) beat BELGIUM (7 v., 39 hits)

*President: H. DRAKENBERG (Sweden)*

V.	D.	H.	V.	D.	H.
Rufenacht, O .....	3 1	6	de Beur, C .....	2 2	9
Hauert, J .....	1 3	9	Hauben, L .....	1 3	11
Chamay, M .....	2 2	8	Bru, R .....	2 2	10
Zappelli, O .....	1 3	10	Radoux, J .....	2 2	9

BELGIUM (10 v.) beat FRANCE (5)

*President: F. del VECCHIO (Italy)*

V.	D.	V.	D.
Hauben, L .....	3 1	Lepage, H .....	0 4
Bru, R .....	3 1	Huet, M .....	3 1
Radoux, J .....	2 2	Desprets, M .....	0 4
de Beur, C .....	2 2	Pecheux, M .....	2 2

FRANCE (7 v.) beat DENMARK (5)

*President: F. SOILLE (France)*

V.	D.	V.	D.
Guerin, H .....	4 0	Luchow, M .....	1 2
Huet, M .....	1 2	Nielsen, I. B .....	2 1
Desprets, M .....	1 2	Andersen, E .....	2 1
Pecheux, M .....	1 2	Dybkaer, R .....	0 4

## POOL II

Result: SWEDEN won 2 matches, ITALY 2, Luxembourg 0, Hungary 0

SWEDEN (15 v.) beat HUNGARY (0)

*President: F. SOILLE (France)*

V.	D.	V.	D.
Cervell, F .....	3 1	Mikla, B .....	0 4
Ljungquist, B .....	4 0	Hennyei, I .....	0 4
Thofelt, S .....	4 0	Rerrich, B .....	0 4
Forssell, C .....	4 0	Dunay, P .....	0 4

SWEDEN (11 v.) beat LUXEMBOURG (3)

*President: P. FERRI (France)*

V.	D.	V.	D.
Forssell, C .....	2 2	Lamesch, G .....	1 3
Carleson, P .....	3 1	Leischen, J-F .....	1 3
Ljungquist, B .....	2 2	Putz, E .....	1 3
Thofelt, S .....	4 0	Gretsch, E .....	0 4

ITALY (11 v.) beat LUXEMBOURG (4)

*President: P. FERRI (France)*

V.	D.	V.	D.
Marini, F .....	2 2	Putz, E .....	0 4
Agostoni, C .....	3 1	Leischen, J-F .....	1 3
Mangiarotti, E .....	3 1	Lamesch, G .....	1 3
Mandrizzato, A .....	3 1	Gretsch, E .....	2 2

ITALY (8 v.) beat HUNGARY (1)

*President: R. STIRN (Switzerland)*

V.	D.	V.	D.
Cantone, L .....	2 1	Hennyei, I .....	0 3
Mandrizzato, A .....	2 1	Bay, B .....	0 2
Marini, F .....	2 1	Mikla, B .....	1 2
Mangiarotti, D .....	2 0	Rerrich, B .....	0 3

## FINAL

1 FRANCE won 3 matches  
2 ITALY won 2 matches

3 SWEDEN won 1 match  
4 Denmark won 0 matches

FRANCE (11 v.) beat SWEDEN (4)

President: C. de BEUR (Belgium)

	Name	No.	1	2	3	4	5	6	7	8	Victories	Hits Against
SWEDEN	Cervell, F.....	1					X	111	111	1X1	1	
							V	D	D	D		
	Forssell, C.....	2					1	1X1	1X1	11X	1	
							V	D	D	D		
Ljungquist, B.....	3						11X	X11	111	1		
						V	D	D	D			
Thofelt, S.....	4					11X	X1	11X	111	1		
						D	V	D	D			
FRANCE	Guerin, H.....	5	11X	111	111	1X					1	
			D	D	D	V						
	Lepage, H.....	6	1	1	X	X11					3	
			V	V	V	D						
Pecheux, M.....	7	1	1X	1X	1X					4		
		V	V	V	V							
Desprets, M.....	8	1X	11X							3		
		V	D	V	V							

ITALY (12 v.) beat DENMARK (4)

President: R. MERCIER (France)

	Name	No.	1	2	3	4	5	6	7	8	Victories	Hits Against
ITALY	Cantone, L.....	1					1X1	1	1X1	XX	2	
							D	V	D	V		
	Mandrizzato, A.....	2					111	1X1		XX	2	
							D	D	V	V		
Mangiarotti, D.....	3					X	11	X	11	4		
						V	V	V	V			
Mangiarotti, E.....	4					11		1	1	4		
						V	V	V	V			
DENMARK	Luchow, M.....	5	1X	11	1X1	111					2	
			V	V	D	D						
	Andersen, E.....	6	111	1X	111	111					1	
			D	V	D	D						
Nielsen, I. B.....	7	1X	111	X11	111					1		
		V	D	D	D							
Dybkaer, R.....	8	X1X	XX1	111	111					0		
		D	D	D	D							

FRANCE (9 v.) beat DENMARK (1)

President: F. SOILLE (France)

	Name	No.	1	2	3	4	5	6	7	8	Victories	Hits Against
DENMARK	Luchow, M .....	1	■	■	■	■	X11	X11	1X1		0	
							D	D	D			
	Lyng, J.....	2	■	■	■	■		11X	X1X	111	0	
									D	D		
	Flindt, K.....	3	■	■	■	■			11X	X	1	
									D	V		
	Andersen, E .....	4	■	■	■	■	X11			11X	0	
							D			D		
FRANCE	Guerin, H .....	5	X			1X	■	■	■	■	2	
			V			V						
	Lepage, H .....	6	X1	X			■	■	■	■	2	
			V	V								
	Pecheux, M.....	7	1X	XX	X		■	■	■	■	3	
			V	V	V							
	Desprets, M .....	8			1X1	X	■	■	■	■	2	
				V	D	V						

ITALY (8 v.) beat SWEDEN (6)

President: P. FERRI (France)

	Name	No.	1	2	3	4	5	6	7	8	Victories	Hits Against
ITALY	Agostoni, C.....	1	■	■	■	■	X11	111	X1	1X	2	
							D	D	V	V		
	Mandrizzato, A .....	2	■	■	■	■	X11	11X	X11		1	
									D	V		
	Mangiarotti, E.....	3	■	■	■	■	111	1	1X	1	3	
							D	V	V	V		
	Marini, F.....	4	■	■	■	■	11	1		1XX	2	
							V	V		D		
SWEDEN	Cervell, F.....	5	X	X1	11	111	■	■	■	■	3	
			V	V	V	D						
	Ljungquist, B.....	6		1X	111	111	■	■	■	■	2	
			V	V	D	D						
	Thofelt, S.....	7	1X1	X1	11X		■	■	■	■	1	
			D	V	D							
	Forssell, C.....	8	11X	111	111	X1X	■	■	■	■	0	
			D	D	D	D						

XIV OLYMPIAD

SWEDEN (8 v.) beat DENMARK (7)

President: M. DUTERQUE (France)

	Name	No.	1	2	3	4	5	6	7	8	Victories	Hits Against
SWEDEN	Forssell, C.....	1					XI	XX	I	XI	4	
							V	V	V	V		
	Tollbom, H.....	2					XX	II X	I X	IX I	2	
							V	D	V	D		
Ljungquist, B.....	3					II X	IX I		IX	2		
						D	D	V	V			
Thofelt, S.....	4					II X	XIX	III	III	0		
						D	D	D	D			
DENMARK	Nielsen, I. B.....	5	XII	XIX	IX	IX					2	
			D	D	V	V						
	Luchow, M.....	6	IX X	IX	XI	IX X					2	
			D	V	V	D						
Flindt, K.....	7	III	IX I	III	II					1		
		D	D	D	V							
Andersen, E.....	8	IX I	X	II X	II					2		
		D	V	D	V							

FRANCE (11 v.) beat ITALY (5)

President: H. DRAKENBERG (Sweden)

	Name	No.	1	2	3	4	5	6	7	8	Victories	Hits Against
FRANCE	Guerin, H.....	1					XII	III	IX	X	2	
							D	D	V	V		
	Lepage, H.....	2						III	I		3	
							V	D	V	V		
Desprets, M.....	3					XX I	II	XIX	IX	2		
						D	V	D	V			
Pechoux, M.....	4					X	IX	II	II	4		
						V	V	V	V			
ITALY	Mangiarotti, D.....	5	X	III	XX	II X					2	
			V	D	V	D						
	Mangiarotti, E.....	6		I	III	IX I					2	
			V	V	D	D						
Agostoni, C.....	7	IX I	III	XX	III					1		
		D	D	V	D							
Marini, F.....	8	IX I	III	XII	III					0		
		D	D	D	D							



**EPEE—INDIVIDUAL***Previous Olympic Winners*

1900	R. Fonst	<i>Cuba</i>	1924	C. Delporte	<i>Belgium</i>
1904	R. Fonst	<i>Cuba</i>	1928	L. Gaudin	<i>France</i>
1908	Alibert	<i>France</i>	1932	G. Comaggia-Medici	<i>Italy</i>
1912	P. Anspach	<i>Belgium</i>	1936	F. Riccardi	<i>Italy</i>
1920	A. Massard	<i>France</i>			

There were 70 entries from 25 nations ; 66 participants from 25 nations

*All bouts were for the best of five hits. Barrages for promotion were fought off.*

**FIRST ROUND**

*The first four competitors from each pool were promoted.*

**POOL I**

*President: L. CORDING (Great Britain)*

		V.	D.	H.A.	H.F.
1	Lips, R..... <i>Switzerland</i> .....	4	2	9	—
2	Abdel Rahman, M..... <i>Egypt</i> .....	4	2	12	—
3	Saucedo, R..... <i>Argentina</i> .....	3	3	11	—
4	Anen, P..... <i>Luxembourg</i> .....	3	3	12	—
5	Pinto, A. da C..... <i>Portugal</i> .....	2	4	16	14
6	Accorsi Teuthorn, E. <i>Chile</i> .....	2	4	16	12
7	Vartia, A..... <i>Finland</i> .....	1	5	—	—

**POOL II**

*President: G. GRINDA (Italy)*

		V.	D.	H.A.	H.F.
1	Villamil, A..... <i>Argentina</i> .....	6	1	—	—
2	Gretsch, E..... <i>Luxembourg</i> .....	4	3	11	18
3	Sjoblom, N..... <i>Finland</i> .....	4	3	11	16
4	Biancalana, M..... <i>Brazil</i> .....	3	4	—	— *
5	Morch, C..... <i>Norway</i> .....	3	4	—	— *
6	Wolff, A..... <i>U.S.A.</i> .....	3	4	—	— *
7	Pinheiro Chagas, M... <i>Portugal</i> .....	2	5	—	—
8	Ahumada Ruiz, A..... <i>Colombia</i> .....	0	7	—	—

**POOL III**

*President: J. HEYMANN (France)*

		V.	D.	H.A.	H.F.
1	Pelling, A..... <i>Great Britain</i> .....	5	0	—	— †
2	Spillmann, R..... <i>Switzerland</i> .....	5	1	—	—
3	de Beur, C..... <i>Belgium</i> .....	3	2	—	— †
4	Simonetti, V..... <i>Argentina</i> .....	2	4	—	— *
5	Meraz Segura, E..... <i>Mexico</i> .....	2	4	—	— *
6	Pouliot, G..... <i>Canada</i> .....	2	4	—	— *
7	Goldstein, D..... <i>Chile</i> .....	0	6	—	—

**POOL IV**

*President: B. FORSELL (Sweden)*

		V.	D.	H.A.	H.F.
1	Dunay, P..... <i>Hungary</i> .....	6	1	9	—
2	Horn, A..... <i>Canada</i> .....	6	1	13	—
3	de Beaumont, C..... <i>Great Britain</i> .....	5	2	—	—
4	Radoux, J..... <i>Belgium</i> .....	3	4	—	— *
5	Camargo, B..... <i>Brazil</i> .....	3	4	—	— *
6	Nawrocki, J..... <i>Poland</i> .....	3	4	—	— *
7	Karamazakidis, J..... <i>Greece</i> .....	1	6	—	—
8	Valero Recio, F..... <i>Mexico</i> .....	0	7	—	—

**POOL V**

*President: M. DUTERQUE (France)*

		V.	D.	H.A.	H.F.
1	Zappelli, O..... <i>Switzerland</i> .....	5	1	—	—
2	{ Haro Oliva, A..... <i>Mexico</i> .....	3	3	12	—
	{ Parfitt, R..... <i>Great Britain</i> .....	3	3	12	—
4	Skotidas, A..... <i>Greece</i> .....	3	3	13	—
5	Henkart, R..... <i>Belgium</i> .....	2	4	13	—
6	Mikla, B..... <i>Hungary</i> .....	2	4	15	—
7	Karwicki, R..... <i>Poland</i> .....	1	5	—	—

**POOL VI**

*President: J. de A. MACHADO (Portugal)*

		V.	D.	H.A.	H.F.
1	Knutzen, E..... <i>Norway</i> .....	5	1	4	— †
2	Asselin, R..... <i>Canada</i> .....	5	2	13	—
3	Henyei, I..... <i>Hungary</i> .....	4	3	13	—
4	Camargo, R..... <i>Colombia</i> .....	4	3	15	—
5	Kerttula, E..... <i>Finland</i> .....	3	4	15	—
6	Vallim, A..... <i>Brazil</i> .....	3	4	18	—
7	Nanopoulos, A..... <i>Greece</i> .....	2	5	—	—
8	Leischen, J-F..... <i>Luxembourg</i> .....	0	6	—	— †

**POOL VII**

*President: C. FILOGAMO (Italy)*

		V.	D.	H.A.	H.F.
1	de Capriles, J..... <i>U.S.A.</i> .....	4	0	—	—
2	Eriksen, A..... <i>Norway</i> .....	2	2	8	—
3	Lamar Schweyer, C. <i>Cuba</i> .....	2	2	9	—
4	Younes, M..... <i>Egypt</i> .....	1	3	—	— *
5	Ituuri Quevedo, C..... <i>Peru</i> .....	1	3	—	— *

**POOL VIII**

*President: R. WINTON (Great Britain)*

		V.	D.	H.A.	H.F.
1	Lewis, N..... <i>U.S.A.</i> .....	4	0	—	—
2	Hordijk, R..... <i>Holland</i> .....	1	2	7	— †
3	Manalich, R..... <i>Cuba</i> .....	1	2	8	— †
4	Asfar, J..... <i>Egypt</i> .....	1	3	9	—
5	Gomes Lino, E..... <i>Portugal</i> .....	0	4	—	—

## SECOND ROUND

The first three competitors from each pool were promoted. The three competitors from those nations in the final of the team event were given byes into this round

## POOL I

President: R. MERCIER (France)

	V	D.	H.A.	H.F.
1 Zappelli, O..... Switzerland.....	6	0	—	—
2 Cantone, L..... Italy.....	4	2	—	*
3 Camargo, R..... Colombia.....	3	3	—	*
4 de Capriles, J..... U.S.A.....	3	3	—	*
5 Horn, A..... Canada.....	3	3	—	—
6 Sjoblom, N..... Finland.....	1	5	—	—
7 Skotidas, A..... Greece.....	0	0	—	—

## POOL II

President: F. SOILLE (France)

	V	D.	H.A.	H.F.
1 Agostoni, C..... Italy.....	5	2	—	—
2 Biancalana, M..... Brazil.....	4	3	—	*
3 Saucedo, R..... Argentine.....	4	3	—	*
4 de Beaumont, C..... Great Britain.....	4	3	—	*
5 Cervell, F..... Sweden.....	3	4	15	—
6 Abdel Rahman, M..... Egypt.....	3	4	17	†
7 Hordijk, R..... Holland.....	2	4	—	†
8 Lamar Schweyer, C..... Cuba.....	1	5	—	†

## POOL III

President: A. GOMBOS (Hungary)

	V	D	H.A.	H.F.
1 Gretschi, E..... Luxembourg.....	5	1	—	—
2 Mangiarotti, E..... Italy.....	4	2	9	—
3 Ljungquist, B..... Sweden.....	4	2	13	—
4 Villamil, A..... Argentine.....	3	3	—	—
5 Pelling, A..... Great Britain.....	2	4	13	—
6 Eriksen, A..... Norway.....	2	4	14	—
7 Haro Oliva, A..... Mexico.....	1	5	—	—

## POOL IV

President: L. CORDING (Great Britain)

	V	D	H.A.	H.F.
1 Lewis, N..... U.S.A.....	4	1	9	†
2 Desprets, M..... France.....	4	2	11	—
3 de Beur, C..... Belgium.....	4	2	13	—
4 Luchow, M..... Denmark.....	2	3	—	†
5 Lips, R..... Switzerland.....	1	2	—	§
6 Simonetti, V..... Argentine.....	1	3	—	‡
7 Henyey, I..... Hungary.....	0	5	—	†

## POOL VI

President: F. THIEBAUD (Switzerland)

	V	D.	H.A.	H.F.
1 Younes, M..... Egypt.....	4	2	10	—
2 Radoux, J..... Belgium.....	4	2	14	*
3 Lepage, H..... France.....	3	3	—	*
4 Anen, P..... Luxembourg.....	3	3	—	*
5 Nielsen, I. B..... Denmark.....	3	3	—	—
6 Spillmann, R..... Switzerland.....	1	5	17	—
7 Dunay, P..... Hungary.....	1	5	17	—

	V	D	H.A.	H.F.
1 Guerin, H..... France.....	4	1	8	14 †
2 Parfitt, R..... Great Britain.....	4	1	8	13 †
3 Knutzen, E..... Norway.....	4	2	11	—
4 Manalich, R..... Cuba.....	3	3	—	—
5 Asfar, J..... Egypt.....	2	3	11	— †
6 Forssell, C..... Sweden.....	2	4	14	—
7 Asselin, R..... Canada.....	0	5	—	— †

## SEMI-FINALS

The first five competitors from each pool were promoted

## POOL I

President: F. SOILLE (France)

	V	D.	H.A.	H.F.
1 Lewis, N..... U.S.A.....	6	1	—	— †
2 Radoux, J..... Belgium.....	5	3	—	—
3 Cantone, L..... Italy.....	4	2	8	— †
4 Lepage, H..... France.....	4	2	9	— †
5 Agostoni, C..... Italy.....	3	4	—	*
6 Ljungquist, B..... Sweden.....	3	4	—	*
7 Knutzen, E..... Norway.....	1	5	—	— †
8 Saucedo, R..... Argentine.....	1	6	—	—
9 Camargo, R..... Colombia.....	0	2	retired hurt	—

## POOL II

President: G. ROZGONYI (Hungary)

	V	D.	H.	H.F.
1 Parfitt, R..... Great Britain.....	6	2	—	—
2 Guerin, H..... France.....	5	3	—	—
3 Gretschi, E..... Luxembourg.....	4	3	—	— †
4 Mangiarotti, E..... Italy.....	4	3	—	— †
5 Zappelli, O..... Switzerland.....	4	4	—	—
6 Desprets, M..... France.....	3	5	18	—
7 Biancalana, M..... Brazil.....	3	5	19	—
8 de Beur, C..... Belgium.....	3	5	21	—
9 Younes, M..... Egypt.....	1	7	—	—

\* After barrage.

† One unfought.

‡ Two unfought.

§ Three unfought.

## FINAL

President: R. MERCIER (Frame)

No.	Name	Country	1	2	3	4	5	6	7	8	9	10	Victories	Hits Against	Hits For	Place
1	Agostoni, C. ....	Italy .....		XIX	XI	IXI	IIIX	XI	X	IXI	X	IXX	4	21		7
			D	V	D	D	V	V	D	V	D					
2	Lepage, H. ....	France .....	XX		X	III	I	III	XII	I	III	III	4	20		6
			V		V	D	V	D	D	V	D	D				
3	Parfitt, R. ....	Great Britain	IXI	XII			III	XII	III	III	II	IIIX	2	23		10
			D	D		V	D	D	D	D	V	D				
4	Gretsch, E. ....	Luxembourg	IX	I	III		XII	IXI	IIIX	IXI	III	X	3	22		8
			V	V	D		D	D	D	D	D	V				
5	Radoux, J. ....	Belgium ...	IX	III	II	XI		III	IXI	X	III	I	5	20		5
			V	D	V	V		D	D	V	D	V				
6	CANTONE, L. ....	Italy .....	XII	II	IX	X			XX	X	III	I	7	15		1
			D	V	V	V	V		V	V	D	V				
7	Guerin, H. ....	France .....	IXI	X	I	IX	X	XIX		IIIX	III	II	5	19		4
			D	V	V	V	V	D		D	D	V				
8	ZAPPELLI, O. ....	Switzerland	X	III	I	X	IIIX	XII	IX			XII	5	17	20	2
			V	D	V	V	D	D	V		V	D				
9	MANGIAROTTI, E.	Italy .....	IXI	I	III	I	II	I		III		III	5	17	20	3
			D	V	D	V	V	V	V	D		D				
10	Lewis, N. ....	U.S.A. ....	IXX	II	IIIX	IIIX	III	III	III	XI	II		3	24		9
			D	V	D	D	D	D	D	V	V					

In the barrage for second place O. ZAPPELLI, Switzerland, defeated E. MANGIAROTTI, Italy, 3—0

- 1 CANTONE, L.**                      *Italy*  
**2 ZAPPELLI, O.**                      *Switzerland*  
**3 MANGIAROTTI, E.**                  *Italy*

**SABRE—TEAMS***Previous Olympic Winners*

1908 Hungary	1924 Italy	1936 Hungary
1912 Hungary	1928 Hungary	
1920 Italy	1932 Hungary	

There were 108 entries from 19 nations ; 95 participants from 17 nations

*The first two teams from each pool were promoted. All bouts were for the best of nine hits*

**FIRST ROUND****POOL I**

Result: CZECHOSLOVAKIA won 1 match, EGYPT 1, Mexico 0

EGYPT (13 victories) beat MEXICO (3)

*President: G. JEKELFALUSSY (Hungary)*

	V.	D.		V.	D.
Dessouki, S.....	4	0	Ramos Ramos, B.....	0	4
Zulficar, M.....	4	0	Valero Recio, F.....	0	4
Younes, M.....	2	2	Haro Oliva, A.....	2	2
Abu Shadi, A.....	3	1	Luna Herrera, F.....	1	3

CZECHOSLOVAKIA (9 v.) beat MEXICO (2)

*President: G. JEKELFALUSSY (Hungary)*

	V.	D.		V.	D.
Kakos, J.....	1	2	Ramos Ramos, B.....	0	3
Skyva.....	3	0	Valero Recio, F.....	1	1
Sary.....	3	0	Haro Oliva, A.....	1	2
Sokol, A.....	2	0	Luna Herrera, F.....	0	3

**POOL II**

Result: AUSTRIA won 1 match, FRANCE 1, Switzerland 0

AUSTRIA (14 v.) beat SWITZERLAND (2)

*President: M. KLIKA (Czechoslovakia)*

	V.	D.		V.	D.
Plattner, W.....	4	0	Turian, R.....	0	4
Putzl, H.....	3	1	Ruckstuhl, A.....	0	4
Lechner, H.....	4	0	Greter, O.....	0	4
Loisel, H.....	3	1	Widemann, W.....	2	2

FRANCE (9 v.) beat SWITZERLAND (1)

*President: M. KLIKA (Czechoslovakia)*

	V.	D.		V.	D.
Tournon, J-F.....	3	0	Ruckstuhl, A.....	0	2
Parent, J.....	2	1	Greter, O.....	0	2
Gramain, M.....	2	0	Widemann, W.....	1	2
Lefevre, J.....	2	0	Turian, R.....	0	3

**POOL III**

Result: POLAND won 1 match, BELGIUM 1, Turkey 0

POLAND (11 v.) beat TURKEY (5)

*President: G. GRINDA (Italy)*

	V.	D.		V.	D.
Sobik, A.....	3	1	Sezen, M.....	1	3
Banas, B.....	3	1	Balkan, N.....	1	3
Zaczyk, T.....	2	2	Arseven, R.....	2	2
Wojcik, J.....	3	1	Tezcan, S.....	1	3

BELGIUM (9 v.) beat TURKEY (2)

*President: R. ANSELMI (Italy)*

	V.	D.		V.	D.
Yves, E.....	3	0	Balkan, N.....	0	3
Bayot, R.....	1	1	Sezen, M.....	1	2
Nys, M.....	3	0	Arseven, R.....	1	2
Laermans, E.....	2	1	Bakanay, V.....	0	2

**POOL IV**

Result : HOLLAND won 1 match, ITALY 1, Canada 0

HOLLAND (13 v.) beat CANADA (3)

*President: A. GOMBOS (Hungary)*

	V.	D.		V.	D.
Ter Weer, H.....	4	0	Desjarlais, R.....	1	3
Hoeyers, A.....	2	2	Horn, A.....	1	3
Van den Berg, W.....	4	0	Asselin, R.....	1	3
Mosman, F.....	3	1	Pouliot, G.....	0	4

ITALY (9 v.) beat CANADA (1)

*President: A. GOMBOS (Hungary)*

	V.	D.		V.	D.
Turcato, C.....	3	0	Desjarlais, R.....	0	2
Dare, G.....	2	1	Horn, A.....	0	2
Pinton, V.....	2	0	Asselin, R.....	1	2
Racca, M.....	2	0	Pouliot, G.....	0	3

## POOL V

Result: U.S.A. won 1 match, ARGENTINE 1, Greece 0

U.S.A. (14 v.) beat GREECE (2)

*President: G. ROZGONYI (Hungary)*

	V	D.		V	D.
de Capriles, M.....	4	0	Christogianno-		
Armitage, N.....	4	0	poulos, L.	1	3
Worth, G.....	4	0	Nanopoulos, A.....	0	4
Cetrulo, D.....	2	2	Karamazakidis, J.....	1	3
			Skotidas, A.....	0	4

ARGENTINE (9 v.) beat GREECE (1)

*President: G. ROZGONYI (Hungary)*

	V	D.		V	D.
Aguero, M.....	2	0	Nanopoulos, A.....	0	3
D'Andrea Mohr, J.....	1	1	Christogianno-		
Pomini, E.....	3	0	poulos, L.	1	2
Cermesoni, J.....	3	0	Karamazakidis, J.....	0	2
			Skotidas, A.....	0	2

## POOL VI

Result: GREAT BRITAIN and HUNGARY promoted. Denmark withdrew

## SECOND ROUND

## POOL I

Result: BELGIUM won 1 match, HUNGARY 1, Egypt 0

BELGIUM (13 v.) beat EGYPT (3)

*President: R. MERCIER (France)*

	V.	D.		V	D
Laermans, E.....	3	1	Dessouki, S.....	1	3
Yves, E.....	4	0	Zulficar, M.....	0	4
Jassogne, F.....	2	2	Younes, M.....	1	3
de Bourguignon, G.....	4	0	Abu Shadi, A.....	1	3

HUNGARY (9 v.) beat EGYPT (3)

*President: R. ANSELMINI (Italy)*

	V	D.		V.	D.
Rajcsanyi, L.....	3	0	Dessouki, S.....	1	2
Papp, B.....	1	2	Zulficar, M.....	1	2
Gerevich, A.....	3	0	Younes, M.....	0	3
Berczelly, T.....	2	1	Abu Shadi, A.....	1	2

## POOL II

Result: U.S.A. won 1 match, ITALY 1, Great Britain 0

U.S.A. (11 v.) beat GREAT BRITAIN (5)

*President: M. KLIKA (Czechoslovakia)*

	V.	D.		V	D.
de Capriles, M.....	3	1	Pilbrow, A.....	1	3
Armitage, N.....	3	1	Moore, G.....	1	3
Cetrulo, D.....	2	2	Lloyd, J. E.....	2	2
Worth, G.....	3	1	Tredgold, R.....	1	3

ITALY (9 v.) beat GREAT BRITAIN (4)

*President: L. MASZLAY (Hungary)*

	V	D.		V	D.
Nostini, R.....	2	2	Pilbrow, A.....	1	2
Montano, A.....	1	2	Moore, G.....	0	3
Dare, G.....	3	0	Tredgold, R.....	2	1
Turcato, C.....	3	0	Brook, R.....	1	3

## POOL III

Result: ARGENTINE won 2 matches, HOLLAND 1, Czechoslovakia 0

ARGENTINE (9 v.) beat HOLLAND (7)

*President: G. JEKELFALUSSY (Hungary)*

	V.	D.		V.	D.
Aguero, M.....	3	1	Ter Weer, H.....	2	2
Pomini, E.....	2	2	Kuijpers, L.....	3	1
Cermesoni, J.....	1	3	Mosman, F.....	0	4
Huergo, F.....	3	1	Van den Berg, W.....	2	2

HOLLAND (10 v.) beat CZECHOSLOVAKIA (6)

*President: F. del VECCHIO (Italy)*

	V.	D.		V	D.
Ter Weer, H.....	3	1	Skyva.....	1	3
Kuijpers, L.....	4	0	Stary.....	1	3
Van den Berg, W.....	2	2	Sokol, A.....	2	2
Mosman, F.....	1	3	Chmela.....	2	2

ARGENTINE (9 v.) beat CZECHOSLOVAKIA (7)

*President: B. BAY (Hungary)*

	V	D.		V.	D.
Aguero, M.....	2	2	Stary.....	0	4
Pomini, E.....	2	2	Chmela.....	2	2
Huergo, F.....	3	1	Kakos, J.....	2	2
Cermesoni, J.....	2	2	Sokol, A.....	3	1

XIV OLYMPIAD

POOL IV

Result: FRANCE won 1 match, POLAND 1, Austria 0

FRANCE (10 v.) beat AUSTRIA (6)

President: R. ANSELMINI (Italy)

	V.	D.		V.	D.
Levavasseur, J.....	2	2	Plattner, W.....	1	3
Gramain, M.....	2	2	Putzl, H.....	1	3
Lefevre, J.....	4	0	Lechner, H.....	2	2
Tournon, J-F.....	2	2	Loisel, H.....	2	2

POLAND (8 v., 55 hits) beat AUSTRIA (8 v., 59 hits)

President: G. JEKELFALUSSY (Hungary)

	V.	D.	H.		V.	D.	H.
Zaczyk, T.....	0	4	20	Plattner, W.....	1	3	16
Banas, B.....	1	3	17	Putzl, H.....	2	2	14
Sobik, A.....	3	1	9	Lechner, H.....	3	1	15
Wojcik, J.....	4	0	9	Loisel, H.....	2	2	14

SEMI-FINALS

POOL I

Result: HUNGARY won 2 matches, BELGIUM 2, Argentine 0, Poland 0

HUNGARY (15 v.) beat ARGENTINE (1)

President: V. CUCCIA (Italy)

	V.	D.		V.	D.
Berczelly, T.....	4	0	Sande, D.....	0	4
Karpati, R.....	4	0	Pomini, E.....	0	4
Rajcsanyi, L.....	3	1	Huergo, F.....	1	3
Kovacs, P.....	4	0	D'Andrea Mohr, J.....	0	4

BELGIUM (9 v.) beat ARGENTINE (4)

President: V. CUCCIA (Italy)

	V.	D.		V.	D.
Laermans, E.....	2	1	Aguero, M.....	1	3
Yves, E.....	3	0	Cermesoni, J.....	0	3
Jassogne, F.....	1	2	Pomini, E.....	3	0
de Bourguignon, G.....	3	1	Huergo, F.....	0	3

BELGIUM (9 v.) beat POLAND (7)

President: C. FILOGAMO (Italy)

	V.	D.		V.	D.
Laermans, E.....	3	1	Wojcik, J.....	1	3
Yves, E.....	3	1	Zaczyk, T.....	2	2
Nys, M.....	2	2	Banas, B.....	2	2
de Bourguignon, G.....	1	3	Sobik, A.....	2	2

HUNGARY (12 v.) beat POLAND (3)

President: R. ANSELMINI (Italy)

	V.	D.		V.	D.
Berczelly, T.....	3	1	Wojcik, J.....	0	4
Papp, B.....	3	1	Nawrocki, J.....	1	3
Gerevich, A.....	4	0	Sobik, A.....	0	3
Karpati, R.....	2	1	Banas, B.....	2	2

POOL II

Result : ITALY won 2 matches, U.S.A. 2, France 0, Holland 0

ITALY (13 v.) beat HOLLAND (3)

President: G. ROZGONYI (Hungary)

	V.	D.		V.	D.
Nostini, R.....	3	1	Ter Weer, H.....	0	4
Racca, M.....	3	1	Kuijpers, L.....	2	2
Turcato, C.....	4	0	Mosman, F.....	1	3
Dare, G.....	3	1	Van den Berg, W.....	0	4

U.S.A. (9 v.) beat HOLLAND (2)

President: G. JEKELFALUSSY (Hungary)

	V.	D.		V.	D.
Armitage, N.....	3	0	Ter Weer, H.....	0	3
Worth, G.....	1	2	Kuijpers, L.....	1	1
Nyilas, T.....	3	0	Mosman, F.....	1	2
Cetrulo, D.....	2	0	Van den Berg, W.....	0	3

U.S.A. (11 v.) beat FRANCE (5)

President: G. JEKELFALUSSY (Hungary)

	V.	D.		V.	D.
de Capriles, M.....	2	2	Levavasseur, J.....	1	3
Armitage, N.....	3	1	Tournon, J-F.....	2	2
Cetrulo, D.....	3	1	Gramain, M.....	0	4
Nyilas, T.....	3	1	Lefevre, J.....	2	2

ITALY (9 v.) beat FRANCE (5)

President: A. GOMBOS (Hungary)

	V.	D.		V.	D.
Montano, A.....	2	2	Levavasseur, J.....	0	4
Racca, M.....	3	1	Tournon, J-F.....	1	2
Dare, G.....	2	1	Lefevre, J.....	3	0
Pinton, V.....	2	1	Leveque, G.....	1	3

## FINAL

1 HUNGARY won 3 matches  
2 ITALY won 2 matches

3 U.S.A. won 1 match  
4 Belgium won 0 matches

ITALY (10 v.) beat BELGIUM (6)

President: G. ROZGONYI (Hungary)

	Name	No.	1	2	3	4	5	6	7	8	Victories	Hits Against
ITALY	Racca, M.....	1	■	■	■	■	III	I	I	IIII	4	
							V	V	V	V		
	Nostini, R.....	2	■	■	■	■	IIIII	II	IIII	IIIII	2	
							D	V	V	D		
Turcato, C.....	3	■	■	■	■	I	IIIII	IIIII	IIIII	1		
						V	D	D	D			
Pinton, V.....	4	■	■	■	■		IIII	I	IIIII	3		
						V	V	V	D			
BELGIUM	Laermans, E.....	5	IIIII	I	IIIII	IIIII	■	■	■	■	1	
			D	V	D	D						
	Yves, E.....	6	IIIII	IIIII	IIII	IIIII	■	■	■	■	1	
			D	D	V	D						
Bayot, R.....	7	IIIII	IIIII	IIII	IIIII	■	■	■	■	1		
		D	D	V	D							
de Bourguignon, G.....	8	IIIII	II	IIII	III	■	■	■	■	3		
		D	V	V	V							

HUNGARY (10 v.) beat U.S.A. (6)

President: V. CUCCIA (Italy)

	Name	No.	1	2	3	4	5	6	7	8	Victories	Hits Against
U.S.A.	de Capriles, M.....	1	■	■	■	■	IIIII	IIIII	IIIII	IIIII	0	
							D	D	D	D		
	Flynn, J.....	2	■	■	■	■	IIII	IIIII	IIIII	IIII	2	
							V	D	D	V		
Worth, G.....	3	■	■	■	■	IIIII	IIIII	II	IIII	2		
						D	D	V	V			
Cetrulo, D.....	4	■	■	■	■	IIIII	III		IIIII	2		
						D	V	V	D			
HUNGARY	Kovacs, P.....	5	III	IIIII		III	■	■	■	■	3	
			V	D	V	V						
	Karpati, R.....	6	I	III	IIII	IIIII	■	■	■	■	3	
			V	V	V	D						
Gerevich, A.....	7	I	III	IIII	IIIII	■	■	■	■	2		
		V	V	D	D							
Rajcsanyi, L.....	8	I	IIIII	IIIII	III	■	■	■	■	2		
		V	D	D	V							



XIV OLYMPIAD

HUNGARY (9 v.) beat BELGIUM (1)

President: A. MONTANO (Italy)

	Name	No.	1	2	3	4	5	6	7	8	Victories	Hits Against
BELGIUM	Nys, M.....	1	■	■	■	■	■■■■	■■■■	■■■■		0	
	Jassogne, F.....	2	■	■	■	■		■■■	■■■■	■■■■		
	Bayot, R.....	3	■	■	■	■			■■■■	■■■■		
	Yves, E.....	4	■	■	■	■	■■■■			■■■■		
HUNGARY	Berczelly, T.....	5	■			■	■	■	■	■	2	
	Karpati, R.....	6	■■■	■■■■			■	■	■	■		
	Rajcsanyi, L.....	7	■	■			■	■	■	■		
	Kovacs, P.....	8		■	■	■	■	■	■	■		

ITALY (8 v., 59 hits) beat U.S.A. (8 v., 61 hits)

President: B. BAY (Hungary)

	Name	No.	1	2	3	4	5	6	7	8	Victories	Against
U.S.A.	Armitage, N.....	1	■	■	■	■	■■■	■■■■	■■■■	■	2	17
	Worth, G.....	2	■	■	■	■	■■■	■■■■	■■■■	■		
	Nyilas, T.....	3	■	■	■	■		■■■	■■■	■■■■		
	Cetrulo, D.....	4	■	■	■	■	■■■■	■	■■■■	■■■■		
ITALY	Dare, G.....	5	■■■■	■■■■	■■■■	■■■	■	■	■	■	1	19
	Turcato, C.....	6	■■■■	■■■	■■■■	■■■■	■	■	■	■		
	Pinton, V.....	7	■	■	■■■■	■	■	■	■	■		
	Racca, M.....	8	■■■	■■■■	■■■	■	■	■	■	■		

U.S.A. (10 v.) beat BELGIUM (5)

President: G. JEKELFALUSSY (Hungary)

	Name	No.	1	2	3	4	5	6	7	8	Victories	Against
U.S.A.	Armitage, N. ....	1	■	■	■	■	III V	II V	II V	III V	4	
	Worth, G. ....	2	■	■	■	■	II V	IIIIII D	III V	IIIIII D	2	
	Nyilas, T. ....	3	■	■	■	■	II V	II V	III V	IIIIII D	3	
	Cetrulo, D. ....	4	■	■	■	■	V	IIIIII D		IIIIII D	1	
BELGIUM	Laermans, E. ....	5	IIIIII D	IIIIII D	IIIIII D	IIIIII D	■	■	■	■	0	
	Yves, E. ....	6	IIIIII D	IIIIII V	IIIIII D	IIIIII V	■	■	■	■	2	
	Bayot, R. ....	7	IIIIII D	IIIIII D	IIIIII D		■	■	■	■	0	
	de Bourguignon, G. ....	8	IIIIII D		IIIIII V	IIIIII V	■	■	■	■	3	

HUNGARY (10 v.) beat ITALY (6)

President: J. LACROIX (France)

	Name	No.	1	2	3	4	5	6	7	8	Victories	Hits Against	
HUNGARY	Berczelly, T. ....	1	■	■	■	■	II V	II V	III V	II V	4		
	Karpati, R. ....	2	■	■	■	■	IIIIII D	IIIIII D	IIIIII D		V	1	
	Gerevich, A. ....	3	■	■	■	■		II V	IIIIII V	IIIIII D	IIIIII V	3	
	Kovacs, P. ....	4	■	■	■	■	IIIIII D	IIIIII V	IIIIII D	IIIIII V	IIIIII V	2	
ITALY	Dare, G. ....	5	IIIIII D	IIIIII V	IIIIII D	IIIIII V	■	■	■	■	2		
	Turcato, C. ....	6	IIIIII D	IIIIII V	IIIIII D	IIIIII D	■	■	■	■	1		
	Pinton, V. ....	7	IIIIII D	IIIIII V	IIIIII V	IIIIII V	■	■	■	■	3		
	Racca, M. ....	8	IIIIII D	IIIIII D	IIIIII D	IIIIII D	■	■	■	■	0		

**SABRE—INDIVIDUAL***Previous Olympic Winners*

198 G. Georgiades	<i>Greece</i>	192 N. Nadi	<i>Italy</i>
190 De La Falaise	<i>France</i>	192 A. Posta	<i>Hungary</i>
190 M. Diaz	<i>Cuba</i>	192 E. Tertzyszanszky	<i>Hungary</i>
190 J. Fuchs	<i>Hungary</i>	193 G. Piller	<i>Hungary</i>
191 J. Fuchs	<i>Hungary</i>	193 E. Kabos	<i>Hungary</i>

There were 68 entries from 26 nations ; 60 participants from 24 nations.

All bouts were for the best of NINE hits. Barrages for promotion were fought off.

**FIRST ROUND**

(The first three competitors from each pool were promoted)

**POOL I**

President: M. KLIKA (Czechoslovakia)

	V.	D.	H.A.	H.F.
1 Dessouki, S..... <i>Egypt</i> .....	4	1	16	— †
2 Haro Oliva, A..... <i>Mexico</i> .....	4	2	20	28
3 Skyva..... <i>Czechoslovakia</i> .....	4	1	20	20 †
4 Manalich, R..... <i>Cuba</i> .....	3	3	20	—
5 Pilbrow, A..... <i>Great Britain</i> .....	3	3	23	—
6 Arseven, R..... <i>Turkey</i> .....	1	4	—	— †
7 Jalkanen, K..... <i>Finland</i> .....	0	5	—	— †

**POOL II**

President: C. BEBIS (Greece)

	V.	D.	H.A.	H.F.
1 Lefevre, J..... <i>France</i> .....	4	0	—	— †
2 Van den Berg, W..... <i>Holland</i> .....	3	0	5	— ‡
3 Brook, R..... <i>Great Britain</i> .....	3	2	17	—
4 Ramos Ramos, B..... <i>Mexico</i> .....	1	3	17	11 †
5 Tezcan, S..... <i>Turkey</i> .....	1	3	17	10 †
6 Kerttula, E..... <i>Finland</i> .....	0	4	—	— †

**POOL III**

President: C. FILOGAMO (Italy)

	V.	D.	H.A.	H.F.
1 Loisel, H..... <i>Austria</i> .....	5	0	—	— †
2 Levavasseur, J..... <i>France</i> .....	4	2	18	—
3 Abu Shadi, A..... <i>Egypt</i> .....	4	2	19	—
4 Sary, J..... <i>Czechoslovakia</i> .....	3	3	—	—
5 Osiier, I..... <i>Denmark</i> .....	2	3	—	— †
6 Sjoblom, N..... <i>Finland</i> .....	1	5	—	—
7 Luna Herrera, F..... <i>Mexico</i> .....	0	4	—	— ‡

**POOL IV**

President: J. F. TOURNON (France)

	V.	D.	H.A.	H.F.
1 Sokol..... <i>Czechoslovakia</i> .....	6	0	—	—
2 Putzl, H..... <i>Austria</i> .....	4	2	21	25
3 Paladino, J..... <i>Uruguay</i> .....	4	2	23	28
4 Ruben, I..... <i>Denmark</i> .....	2	3	20	— †
5 Neubauer Rosenberg, A..... <i>Chile</i> .....	2	4	23	—
6 Sezen, M..... <i>Turkey</i> .....	1	4	24	— †
7 Karamazakidis, J..... <i>Greece</i> .....	1	5	28	—

**POOL V**

President: R. MERCIER (France)

	V.	D.	H.A.	H.F.
1 Kuijpers, L..... <i>Holland</i> .....	4	1	—	—
2 Huergo, F..... <i>Argentina</i> .....	3	2	16	—
3 Leidersdorff, A..... <i>Denmark</i> .....	3	2	18	—
4 Plattner, W..... <i>Austria</i> .....	2	3	18	—
5 Greter, O..... <i>Switzerland</i> .....	2	3	23	—
6 Christogiannopoulos, L..... <i>Greece</i> .....	1	4	—	—

**POOL VI**

President: T. FRIEDRICH (Poland)

	V.	D.	H.A.	H.F.
1 Pomini, E..... <i>Argentina</i> .....	5	0	—	—
2 Sobik, A..... <i>Poland</i> .....	4	1	—	—
3 Mosman, F..... <i>Holland</i> .....	3	2	—	—
4 Widemann, W..... <i>Switzerland</i> .....	2	3	—	—
5 Asselin, R..... <i>Canada</i> .....	1	4	—	—
6 Martinez Valdes Cantero, J..... <i>Cuba</i> .....	0	5	—	—

**POOL VII**

President: C. BEBIS (Greece)

	V.	D.	H.A.	H.F.
1 Cermesoni, J..... <i>Argentina</i> .....	4	1	—	—
2 Gramain, M..... <i>France</i> .....	3	2	—	— *
3 Zulficar, M..... <i>Egypt</i> .....	3	2	—	— *
4 Zaczky, T..... <i>Poland</i> .....	3	2	—	— *
5 Goldstein, D..... <i>Chile</i> .....	2	3	—	—
6 Nanopoulos, A..... <i>Greece</i> .....	0	5	—	—

**POOL VIII**

President: C. FILOGAMO (Italy)

	V.	D.	H.A.	H.F.
1 Tredgold, R..... <i>Great Britain</i> .....	4	1	10	—
2 Molnar, E..... <i>Brazil</i> .....	4	1	15	—
3 Sarria Goicochea, J..... <i>Peru</i> .....	3	2	—	— *
4 Eriksson, B..... <i>Sweden</i> .....	3	2	—	— *
5 Banas, B..... <i>Poland</i> .....	1	4	—	—
6 Ruckstuhl, A..... <i>Switzerland</i> .....	0	5	—	—

\* After Barrage.

† 1 unfought.

‡ 2 unfought.

## SECOND ROUND

The first four competitors from each pool were promoted. The three competitors from nations in the final of the team event were given byes into this round

## POOL I

President: V. CUCCIA (Italy)

	V	D.	H.A	H.F.
1 Levavasseur, J..... France .....	6	0	—	— †
2 Berczelly, T..... Hungary.....	5	1	—	— †
3 Cetrulo, D..... U.S.A.....	4	3	21	—
4 Loisel, H..... Austria .....	4	2	22	— †
5 Mosman, F..... Holland.....	2	4	23	— †
6 Abu Shadi, A..... Egypt .....	2	4	24	— †
7 Sarria Goicochea, J..... Peru .....	1	5	29	— †
8 Cermesoni, J..... Argentine .....	1	6	31	—

## POOL II

President: G. ROZGONYI (Hungary)

	V.	D.	H.A	H.F.
1 Dare, G..... Italy .....	5	1	14	— †
2 Lefevre, J..... France .....	5	1	16	— †
3 Worth, G..... U.S.A.....	4	2	24	— †
4 Sobik, A..... Poland .....	4	3	26	—
5 Van den Berg, W..... Holland.....	3	4	—	—
6 Huergo, F..... Argentine .....	2	4	23	— †
7 Molnar, E..... Brazil .....	2	5	32	—
8 Putzl, H..... Austria .....	0	5	—	— ‡

## POOL III

President: R. MERCIER (France)

	V.	D.	H.A	H.F.
1 Gerevich, A..... Hungary.....	7	0	—	—
2 Piriton, V..... Italy .....	5	2	—	—
3 Dessouki, S..... Egypt .....	4	3	—	—
4 Haro Oliva, A..... Mexico .....	3	4	—	— *
5 Tredgold, R..... Great Britain .....	3	4	—	— *
6 Kuijpers, L..... Holland.....	3	4	—	— *
7 Paladino, J..... Uruguay.....	2	5	—	—
8 Skiva..... Czechoslovakia .....	1	6	—	—

## POOL IV

President: M. KLIKA (Czechoslovakia)

	V.	D.	H.A	H.F.
1 Kovacs, P..... Hungary.....	6	0	—	— ‡
2 Nyilas, T..... U.S.A.....	5	1	16	— ‡
3 Leidersdorff, A..... Denmark.....	5	2	23	— †
4 Turcato, C..... Italy .....	5	3	27	—
5 { Brook, R..... Great Britain .....	3	4	28	— †
{ Pomini, E..... Argentine .....	3	4	28	— †
{ Sokol..... Czechoslovakia .....	3	5	34	—
8 Gramain, M..... France .....	2	5	—	— †
9 Zulficar, M..... Egypt .....	0	8	—	—

## SEMI-FINALS

The first four competitors from each pool were promoted

## POOL I

President: G. ROZGONYI (Hungary)

	V.	D.	H.A	H.F.
1 Kovacs, P..... Hungary.....	6	0	—	— †
2 Worth, G..... U.S.A.....	5	1	18	— †
3 Pinton, V..... Italy .....	5	2	24	—
4 Nyilas, T..... U.S.A.....	4	3	—	—
5 Levavasseur, J..... France .....	3	4	—	—
6 Turcato, C..... Italy .....	2	4	—	— †
7 Dessouki, S..... Egypt .....	1	5	—	— †
8 Leidersdorff, A..... Denmark.....	0	7	—	—

## POOL II

President: R. ANSELMINI (Italy)

	V.	D.	H.A	H.F.
1 Lefevre, J..... France .....	6	1	—	—
2 { Gerevich, A..... Hungary.....	5	1	16	— †
{ Dare, G..... Italy .....	5	1	16	— †
4 Haro Oliva, A..... Mexico .....	4	3	—	— *
5 Berczelly, T..... Hungary.....	4	3	—	— *
6 { Cetrulo, D..... U.S.A.....	1	5	27	— †
{ Sobik, A..... Poland .....	1	5	27	— †
8 Loisel, H..... Austria .....	0	7	—	—

\* After barrage.

† 1 unfought.

‡ 2 unfought.

**FINAL**

President (first half) : M. KLIKA (Czechoslovakia)

(second half): J. LACROIX (France)

No.	Name	Country	1	2	3	4	5	6	7	8	Victories	Hits Against	Hits For	Place
1	GEREVICH, A....	Hungary...	■	11	11	111	1111	1	1111	11	7	18		1
				V	V	V	V	V	V	V				
2	Worth, G.....	U.S.A. ....	1111	■	1111	1111	1111	1	1111	1	2	27		5
			D		D	D	D	V	D	V				
3	Dare, G.....	Italy .....	1111	111	■	1111	1111	1111	1111	11	2	30		6
			D	V		D	D	D	D	V				
4	Lefevre, J.....	France .....	1111	1111	1	■	1111	111	1111	111	4	26		4
			D	V	V		D	V	D	V				
5	KOVACS, P.....	Hungary...	1111	1111	1111	11	■	1	111	1111	5	24		3
			D	V	V	V		V	V	D				
6	Nyilas, T. ....	U.S.A. ....	1111	1111	1111	1111	1111	■	1111	11	2	31		7
			D	D	V	D	D		D	V				
7	PINTON, V.....	Italy .....	1111	111	1111	11	1111	1111	■		5	23		2
			D	V	V	V	D	V		V				
8	Haro Oliva, A.....	Mexico.....	1111	1111	1111	1111	1111	1111	1111	■	1	34		8
			D	D	D	D	V	D	D					

**1 GEREVICH, A.**..... Hungary

**2 PINTON, V.**..... Italy

**3 KOVACS, P.**..... Hungary

**FOIL—INDIVIDUAL (WOMEN)***Previous Olympic Winners*

192	E. Osier	<i>Hungary</i>	1932	E. Preis	<i>Austria</i>
192	H. Mayer	<i>Germany</i>	1936	I. Elek-Schacherer	<i>Hungary</i>

There were 42 entries from 16 nations ; 39 participants from 15 nations

All bouts were for the best of seven hits. Barrages for promotion were fought off.

**FIRST ROUND**

The first four competitors from each pool were promoted

**POOL I**

President: G. JEKELFALUSSY (*Hungary*)

		V.	D.	H.A	H.F.
1	Cerra, M..... <i>U.S.A</i>	5	1	—	—
2	Klupfel, A..... <i>Switzerland</i>	4	2	14	16
3	Kun, E..... <i>Hungary</i>	4	2	14	21
4	Olsen, G..... <i>Denmark</i>	3	2	—	†
5	Meyer v. d. Sluis, M... <i>Holland</i>	2	4	17	—
6	Nawrocka, T..... <i>Poland</i>	2	4	20	—
7	Dermody, D..... <i>Eire</i>	0	6	—	—

**POOL II**

President: R. ANSELMINI (*Italy*)

		V.	D.	H.A	H.F.
1	Lachmann, K..... <i>Denmark</i>	6	0	—	—
2	Garilhe, R..... <i>France</i>	5	1	—	—
3	Camber, I..... <i>Italy</i>	3	3	15	—
4	Filz, F..... <i>Austria</i>	3	3	17	—
5	Secreve, A..... <i>Holland</i>	2	4	16	—
6	Boudezoque de Haro, N..... <i>Mexico</i>	2	4	21	—
7	Schwindt, E..... <i>Belgium</i>	0	6	—	—

**POOL III**

President: J. EGGERMONT (*Belgium*)

		V.	D.	H.A	H.F.
1	Elek, S..... <i>Hungary</i>	5	0	—	—
2	York, J..... <i>U.S.A</i>	4	1	—	—
3	Addams, J..... <i>Belgium</i>	3	2	—	—
4	Minton, G..... <i>Great Britain</i>	1	4	—	*
5	Martin, R. E..... <i>Canada</i>	1	4	—	*
6	Fullone, N..... <i>Argentina</i>	1	4	—	*

**POOL IV**

President: G. JEKELFALUSSY (*Hungary*)

		V.	D.	H.A	H.F.
1	Zeilinger, G..... <i>Austria</i>	4	1	—	—
2	Gouny, F..... <i>France</i>	3	2	10	—
3	Mahaut, K..... <i>Denmark</i>	3	2	12	—
4	Cesari, V..... <i>Italy</i>	3	2	13	—
5	Mayora Duenas, E..... <i>Mexico</i>	2	3	—	—
6	Hamilton, E..... <i>Canada</i>	0	5	—	—

**POOL V**

President: R. ANSELMINI (*Italy*)

		V.	D.	H.A	H.F.
1	Elek, B..... <i>Hungary</i>	4	1	—	—
2	Malherbaud, L..... <i>France</i>	3	1	7	†
3	Libera, E..... <i>Italy</i>	3	1	13	†
4	Irigoyen, E..... <i>Argentina</i>	2	3	—	—
5	Carnegy Arbutnott, E..... <i>Great Britain</i>	1	4	17	—
6	Hagemann, V..... <i>Switzerland</i>	1	4	18	—

**POOL VI**

President: J. EGGERMONT (*Belgium*)

		V.	D.	H.A	H.F.
1	Muller-Preis, E..... <i>Austria</i>	5	1	9	—
2	Glen Haig, M..... <i>Great Britain</i>	5	1	15	—
3	de Antequeda, I..... <i>Argentina</i>	4	2	—	—
4	Dow, H..... <i>U.S.A</i>	3	3	—	*
5	Rieder, H..... <i>Switzerland</i>	3	3	—	*
6	Christiaens, A..... <i>Belgium</i>	1	5	—	—
7	Ruiz Velasquez, E..... <i>Mexico</i>	0	6	—	—

\* After barrage.

† One unfought.

XIV OLYMPIAD

SECOND ROUND

*The first three competitors from each pool were promoted*

POOL I

*President: I. OSIER (Denmark)*

		V.	D.	H.A.	H.F.
1	Cerra, M..... U.S.A.....	4	1	10	—
2	Addams, J..... Belgium.....	4	1	13	—
3	Minton, G..... Great Britain.....	3	2	—	—
4	de Antequeda, I..... Argentine.....	2	3	15	—
5	Malherbaud, L..... France.....	2	3	17	—
6	Zeilinger, G..... Austria.....	0	5	—	—

POOL II

*President: J. EGGERMONT (Belgium)*

		V.	D.	H.A.	H.F.
1	Glen Haig, M..... Great Britain.....	5	0	—	—
2	Elek, S..... Hungary.....	3	2	—	— *
3	Filz, F..... Austria.....	3	2	—	— *
4	Garilhe, R..... France.....	3	2	—	— *
5	Libera, E..... Italy.....	0	4	—	— †
6	Mahaut, K..... Denmark.....	0	4	—	— †

POOL III

*President: C. FILOGAMO (Italy)*

		V.	D.	H.A.	H.F.
1	Muller-Preis, E..... Austria.....	4	1	10	19
2	Elek, B..... Hungary.....	4	1	10	18
3	Camber, I..... Italy.....	3	2	—	—
4	Olsen, G..... Denmark.....	2	3	—	—
5	Gouny, F..... France.....	1	4	18	—
6	Dow, H..... U.S.A.....	1	4	19	—

POOL IV

*President: J. HATSZEGHY (Hungary)*

		V.	D.	H.A.	H.F.
1	Lachmann, K..... Denmark.....	4	1	7	—
2	Kun, E..... Hungary.....	4	1	12	—
3	Cesari, V..... Italy.....	3	2	—	— *
4	York, J..... U.S.A.....	3	2	—	— *
5	Irigoyen, E..... Argentine.....	1	4	—	—
6	Klupfel, A..... Switzerland.....	0	5	—	—

SEMI-FINALS

*The first four competitors from each pool were promoted*

POOL I

*President: G. ROSGONYI (Hungary)*

		V.	D.	H.A.	H.F.
1	Elek, S..... Hungary.....	5	0	—	—
2	Lachmann, K..... Denmark.....	3	2	12	—
3	Glen Haig, M..... Great Britain.....	3	2	13	—
4	Filz, F..... Austria.....	2	3	—	— *
5	Camber, I..... Italy.....	2	3	—	— *
6	Kun, E..... Hungary.....	0	5	—	—

POOL II

*President: C. FILOGAMO (Italy)*

		V.	D.	H.A.	H.F.
1	Muller-Preis, E..... Austria.....	4	1	—	—
2	{ Cerra, M..... U.S.A.....	3	2	13	15
	{ Cesari, V..... Italy.....	3	2	13	15
4	Elek, B..... Hungary.....	3	2	14	—
5	Addams, J..... Belgium.....	2	3	—	—
6	Minton, G..... Great Britain.....	0	5	—	—

\* After barrage.

† One unfought.



## FINAL

President: G. HEYVAERT (Belgium)

No.	Name	Country		2	3	4	5	6	7	8	Victories	Hits Against	Hits For	Place
1	MULLER- PREIS, E.	Austria ....		11	1	111	1	1111	1111	1	5	16	24	3
				V	V	V	V	D	D	V				
2	Elek, B .....	Hungary...	1111		11	1111	1111	1111	1111	1111	1	26		6
			D		V	D	D	D	D	D				
3	Glen Haig, M.....	Great Britain	1111	1111		111	1111	1111	1111	1111	1	27	10	8
			D	D		V	D	D	D	D				
4	Cesari, V .....	Italy.....	1111	111	1111		1111	1111	1111	1111	1	27	15	7
			D	V	D		D	D	D	D				
5	Filz, F.....	Austria .....	1111	111	11	1		111	1111	1111	4	21		5
			D	V	V	V		V	D	D				
6	ELEK, S.....	Hungary...	11	111		11	1111		11	11	6	15		1
			V	V	V	V	D		V	V				
7	LACHMANN, K.	Denmark..	11	1				1111		1111	5	11	24	2
			V	V	V	V	V	D		D				
8	Cerra, M .....	U.S.A. ....	1111		1	11	111	1111	11		5	16	23	4
			D	V	V	V	V	D	V					

1 ELEK, S. .... Hungary

2 LACHMANN, K. .... Denmark

3 MULLER-PREIS, E. .... Austria

# FOOTBALL

The power and control of polished teamwork made Sweden worthy winners of the Football Tournament of the XIV Olympiad at Wembley in 1948. Three teams, Yugoslavia, Denmark and Italy, approached Sweden's standard and the other fourteen helped to make the competition the most varied and colourful ever staged in England, the home of the game.

There were tactical formations and styles of play to delight the eye of the technically minded. The Swedish play was modelled on that of the best modern English professional teams. While Denmark had the fast open style of English football, they retained the looser marking and carefree shooting so typical of the amateur. The old-fashioned attacking centre-half was demonstrated by Austria, Yugoslavia presented a slower version of the Moscow Dynamo's slick game and Italy had the too close marking of their "W M" formation. Added spice came from the barefooted Indians, the deceptively lazy Mexicans, the close passing of the Chinese and Koreans and the ball jugglery of the Egyptians.

With varied temperaments, the keenness to win and different ideas on body checking, occasional incidents were inevitable. What few there were, were easily outweighed by the sporting way in which the eighteen matches were played.

## **Sweden's Determination**

It was Sweden's relentless determination as much as her brilliant football which won the title. She was established as favourite by a fine second-half exhibition at the Arsenal Stadium against the pick of the English professionals in November, 1947. After that game, nothing could shake her resolve to carry off the title.

An intensive training and coaching programme during the summer welded the individuals into a team and brought the players to peak fitness by July. The whole country was scoured for talent to fill the notable weaknesses on the wings. When no wingers of international standing could be found, the bold course was taken of converting Rosen, a right-half, into outside-right, and Liedholm—one of the finest inside forwards on the Continent—into outside-left.

Their determination showed itself on the field. In the first round, they decided to upset Austria, whom they feared as much as any other competitor, by a bustling start, contrary to their usual practice. They were two goals up in ten minutes, both being scored by Gunnar Nordahl. In the semi-final Denmark followed up an early goal by Seebach with twenty minutes of storming football, which would have broken a side of lesser calibre. The Swedes, however, refused to be flustered, rode the storm, fought back to equalise, and had a commanding 4—1 lead by half time.

The Swedes were not put out of their stride in the Final by the intricate and often bewildering pattern-weaving of the Yugoslavs. They continued to play football according to their plans. They were the first to recover after one or two players on both sides had been carried away by the excitement of the moment.

In Gunnar Nordahl Sweden had the best centre-forward in the Games. Big, strong and fast, he was not merely the spearhead of the attack, but also held his line together. On either side were first class inside men—Gunnar Gren, an accurate shot and untiring worker, and elusive "Garvis" Carlsson. At right-back was polished Knut Nordahl, while the third Nordahl brother, Bertil, at centre-half, never knew when he was beaten. No man allowed his individuality to shine at the expense of teamwork.

Although the Yugoslavs had the easier half of the draw, they amply justified their right to be in the final by the fine display against Sweden. Their style reminded one of the Moscow Dynamos playing at a slower tempo. They pushed the ball first time along the ground into the open space, and then ran into position for the return. Unfortunately, however, two or even three passes were used where one would have done the work, and progress was across the field rather than towards goal.

The hard drive with which Bobek scored in the final must have surprised his colleagues as much as his opponents. Usually the Yugoslavs appeared to be trying to walk the ball into the net. Right-back Brozovic was perhaps the outstanding player with right-half Z. Cajkovski, a Zagreb student, not far behind.

The Danes obviously enjoyed their football. And so did their opponents, because they gave and took a knock and accepted defeat or victory in the best spirit. It was lack of ruthlessness which probably lost them the semi-final against Sweden after twenty minutes of superb football had put them well on top. Adopting the English open and direct game, the Danes threw everything into attack, and in consequence left holes in the defence. Hence the forwards shone, particularly Praest, who was at home anywhere in the line, and the captain, Karl Aage Hansen. The defence, on the other hand, was often drawn out of position by the gaps in front, and looked by no means reliable.

Perhaps the best single game of the eighteen was that between Denmark and Italy in the second round at Highbury. Denmark won a tremendous see-saw match by 5—3. The Italians, too, concentrated on attack and were weak in defensive covering.

The Egyptians were another fancied side to fall victims to Denmark. Accustomed to hard, dry grounds, they met the Danes on a wet evening, and even then took the match to extra time before losing 1—3. Their ball control was of a high order, but they kept play too close. The Egyptians would be very hard to beat on their own grounds.

### **Team Spirit and Enthusiasm**

Few, even in England, expected Great Britain to reach the last four. That she did so was due largely to coach Matt Busby. The two Erics, Lee at centre-half and Fright at left-half, were the backbone of the team, while Kelleher was a quick, clever inside forward. The side's lack of technical ability was made up by team spirit and enthusiasm, as Holland found to her cost. Holland met Great Britain at Highbury in the first round, and although ahead in the finer points of the game, she had to yield to the fighting qualities of her opponents.

China and Korea, both small players, overdid the close passing, and lacked stamina because they were accustomed to matches of shorter duration than ninety minutes.

The lack of cohesion of the United States players was undoubtedly due to some extent to their having had no serious match practice since the previous May. Mexico needed some of Sweden's determination to improve their finishing. The Turks were finely built and had a good knowledge of the game, but were slow-moving, and found the grassy turf difficult.

Playing without boots, as did nine of the Indian team, gave them speed off the mark and lightness on their feet. This advantage they often threw away by hesitation in front of goal. Several had their feet bound in bandages to make up for lack of footwear, but not one shirked even the heaviest tackle.

The Austrians had their centre-half, Ocwirk, upfield just behind his forwards, but the backs did not cover the middle as they should have done. There are indications that Austria is changing to the third-back game, and perhaps the Olympic side was caught in the transitional period.

France and Eire are handicapped by the fact that professional football takes the cream of talent in both countries ; Afghanistan came to learn ; and Luxemburg played attractive football without the stamina or punch to trouble the better opposition.

Because the English season did not open until a week after the Games had finished, the Olympic teams were fortunate to find the practice grounds and the arenas used for earlier rounds in perfect condition. Nations used to dry, bare pitches may not have found this an advantage. Several teams suffered from lack of serious match practice, Korea who had a long journey without games *en route*, the United States and Egypt, where an epidemic had prevented visits of foreign sides earlier in the summer to tune up the Olympic XI. As it was the English close season there were no strong club sides, amateur or professional, apart from the Metropolitan Police, able to fill the gap. As a result, the competitors played friendly matches among themselves to provide practice.



*Men's 100 m. Free Style, Heat 2. Swimmers in lane order: M. Guerra Perez (Spain), P. Kendall (Great Britain), Z. Szilard (Hungary), A. Canton (Argentine), N. Silverio Ferrer (Cuba), out of picture, P. Olsson (Sweden) 6th in the final, D. Mitra (India), out of picture, K. Carter (U.S.A.), heat winner and 4th in final. Note the judges' rostrum on the far side of the bath, a similar stand existed on the other side. The F.I.N.A. judges and timekeepers' enclosure in top right hand corner of picture. The construction of the bridge can be seen in this picture.*

*The Start of the men's 100 m. Free Style Final. Left to right—T. El Gamal (Egypt) 8th, P. Olsson (Sweden) 6th, A. Jany (France) 5th, K. Carter (U.S.A.) 4th, W. Ris (U.S.A.) Olympic Champion, A. Ford (U.S.A.) 2nd, G. Kadas (Hungary) 3rd, Z. Szilard (Hungary) 7th.*

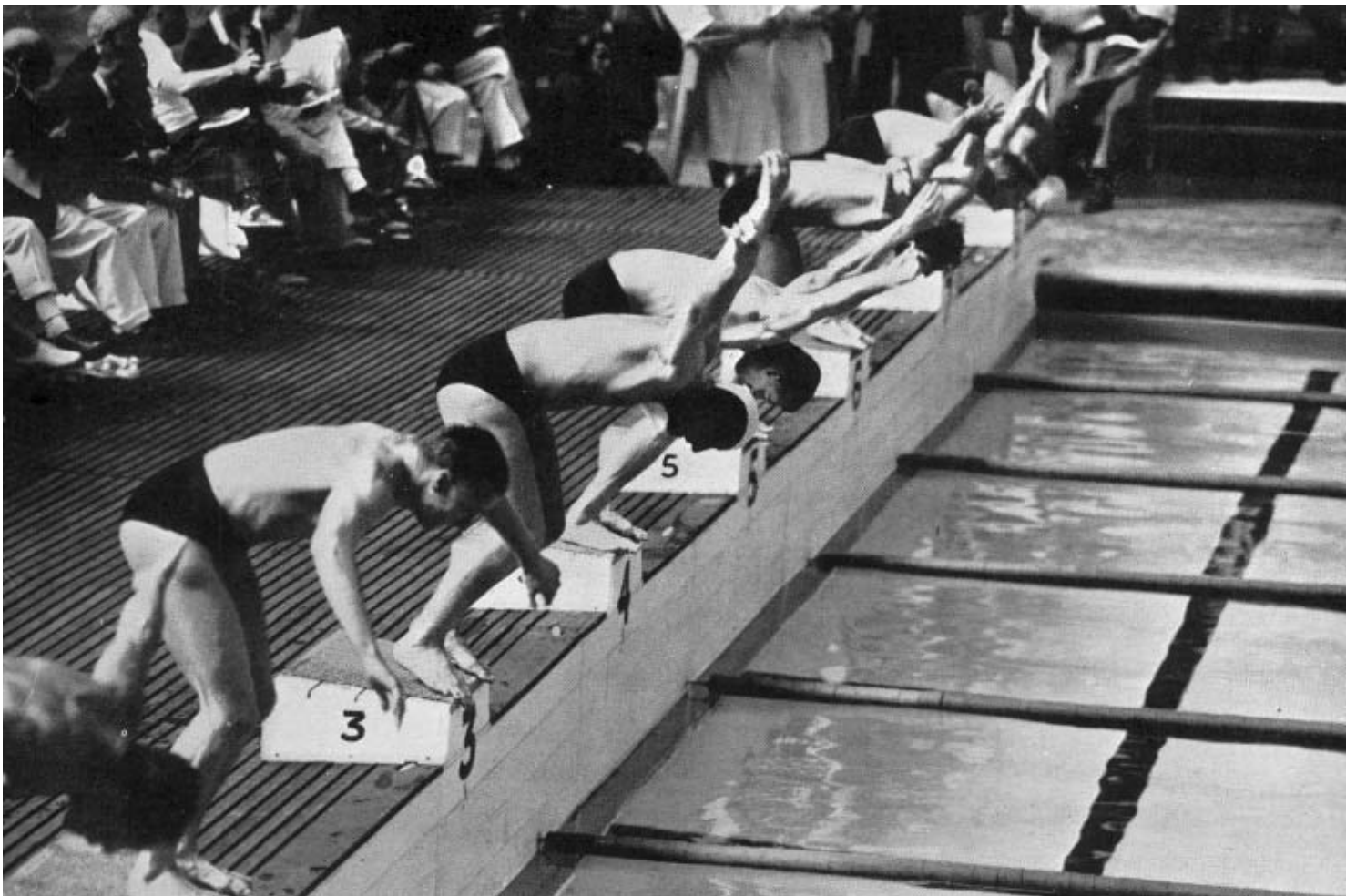



*Men's 400 m. Free Style - Heat 1. The finish J.F.McLane, the winner is in lane 5. Note the special sloping starting blocks. Three timekeepers on each lane except for lanes 1 and 2 where the swimmers had not come to within striking distance. They can be seen in the background.*



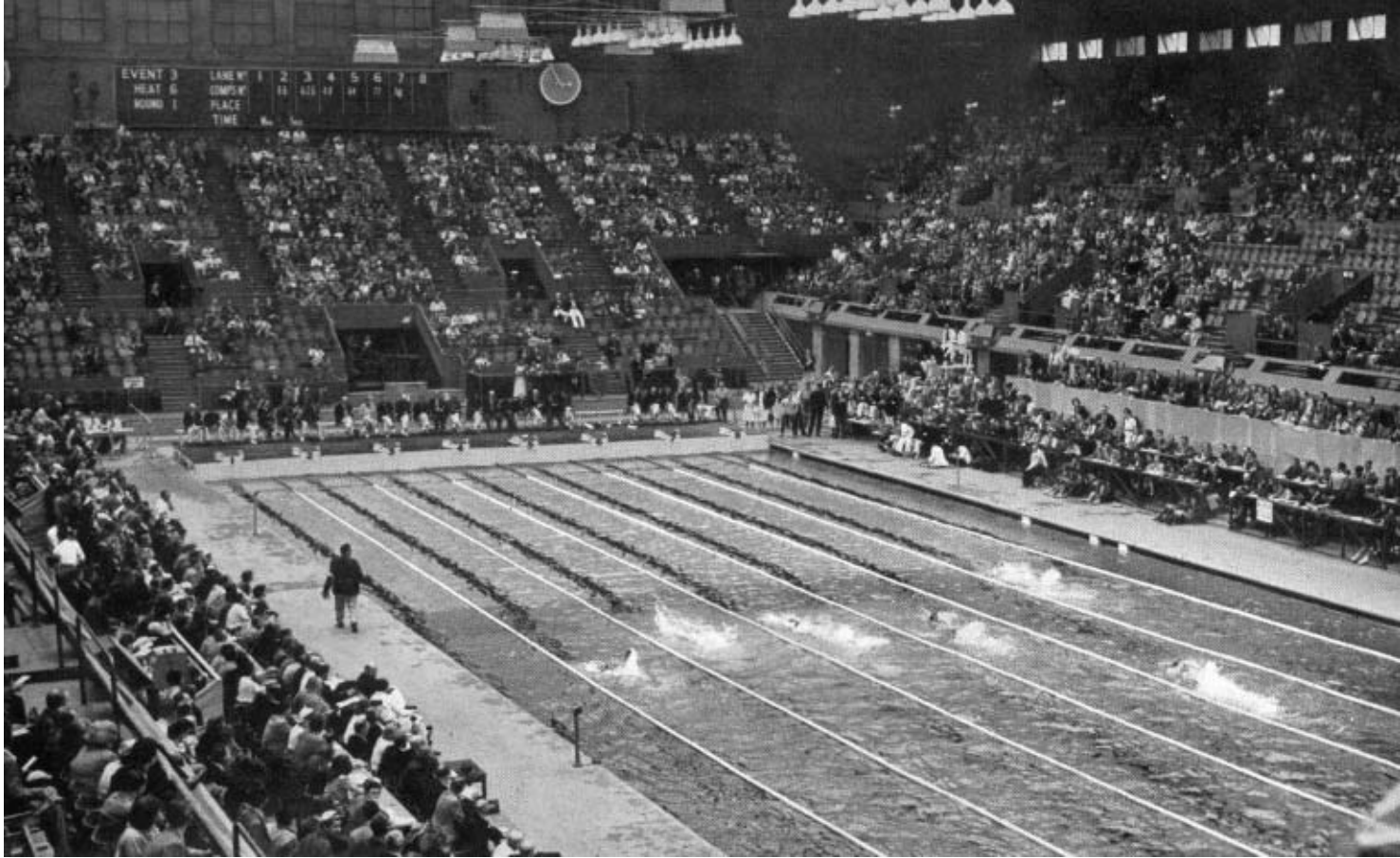

*General view of the Empire Pool during heat 6 of the men's 100 m. Backstroke. The winner, G. Vallerey (France) who was the bronze medallist is in lane 7. Note the recall rope on its stanchion ; the referee, R. de Reeve, Vice-President F.I.N.A. (Belgium) on the bath side ; the scoreboard upon which results were immediately recorded and the television cameras in the enclosures on the left of the picture.*

*Men's 400 m. Free Style—Semi-final No. 1. Competitors on the third lap. From the camera—M. Stipetic (Yugoslavia), M. Bartusek (Czechoslovakia) J. B. Marshall (Australia), the bronze medallist, J. P. McLane (U.S.A.) silver medallist and semi-final winner, J. I. Hale (Great Britain) G. Mitro (Hungary), B. Vidovic (Yugoslavia), P. Ostrand (Sweden) did not start (Lane 3).*

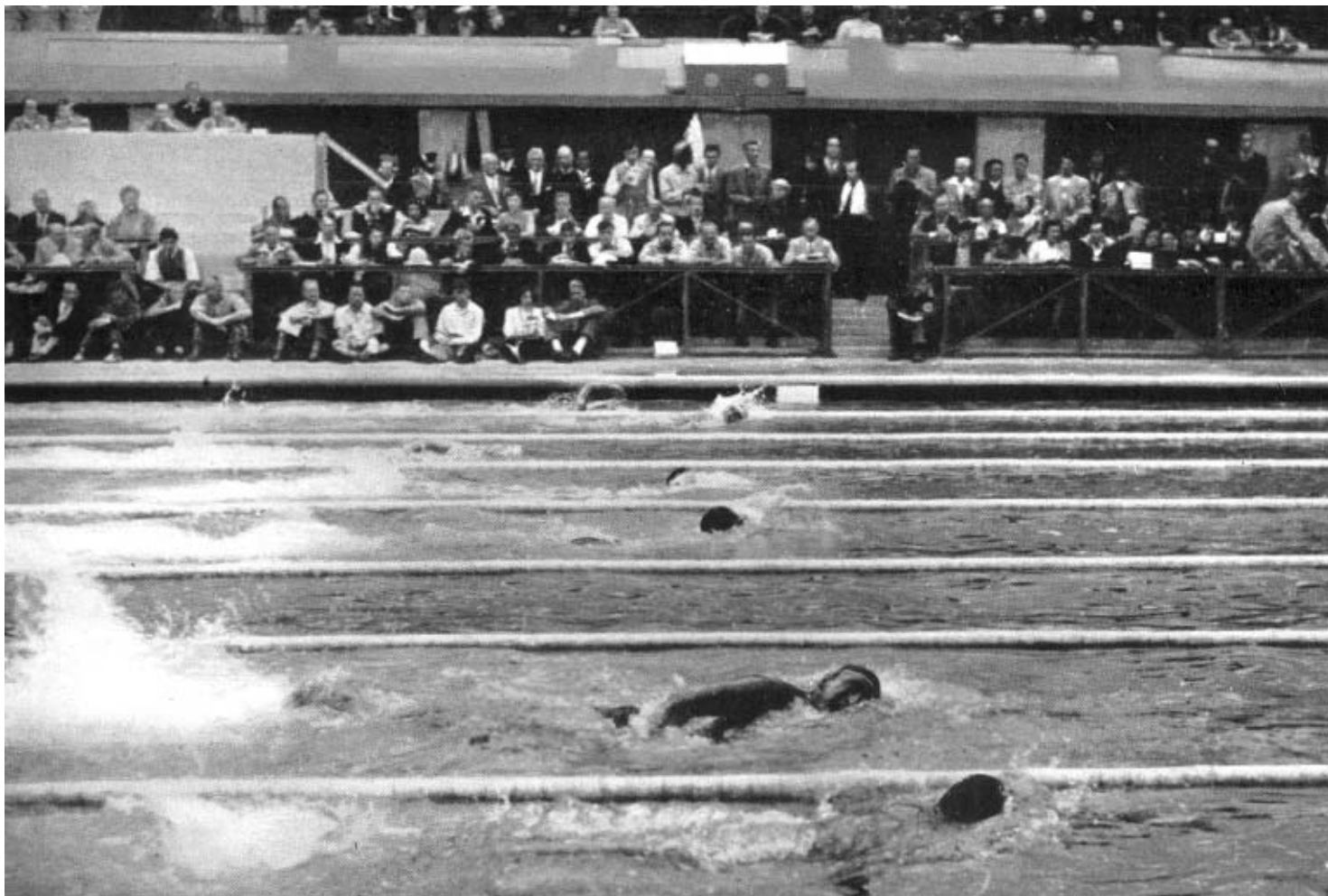





*Men's 400 m Free Style Final The finish. W. Smith (U.S.A.), lane 5, the Olympic Champion in the Olympic record time of 4.41.0. J. P. McLane (U.S.A.), lane 6, the silver medallist, 4.43.4. J. Marshall (Australia), lane 3, bronze medallist. Note where the colour of the cork lanes changes to indicate the last 4 metres of the course.*

*The start of the men's 1 500 m. Free Style Final. Left to right—W. Heusner (U.S.A.) 8th, M. Stipetic (Yugoslavia) 5th, G. Csordas (Hungary) 4th, J. Marshall (Australia) 2nd, J. P. McLane (U.S.A.) Olympic Champion, G. Mitro (Hungary) 3rd, F. Norris (U.S.A.) 6th, D. Bland (Great Britain) 7th. Note the lap numbers in piles in front of the timekeepers.*

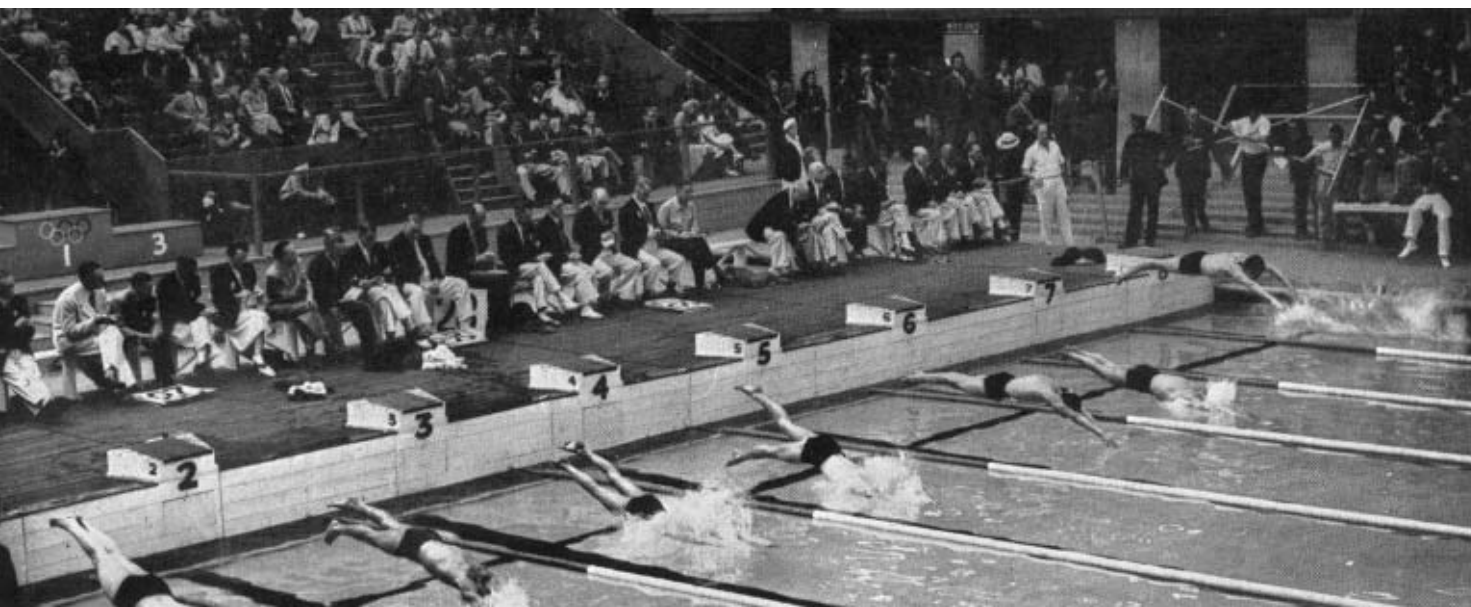

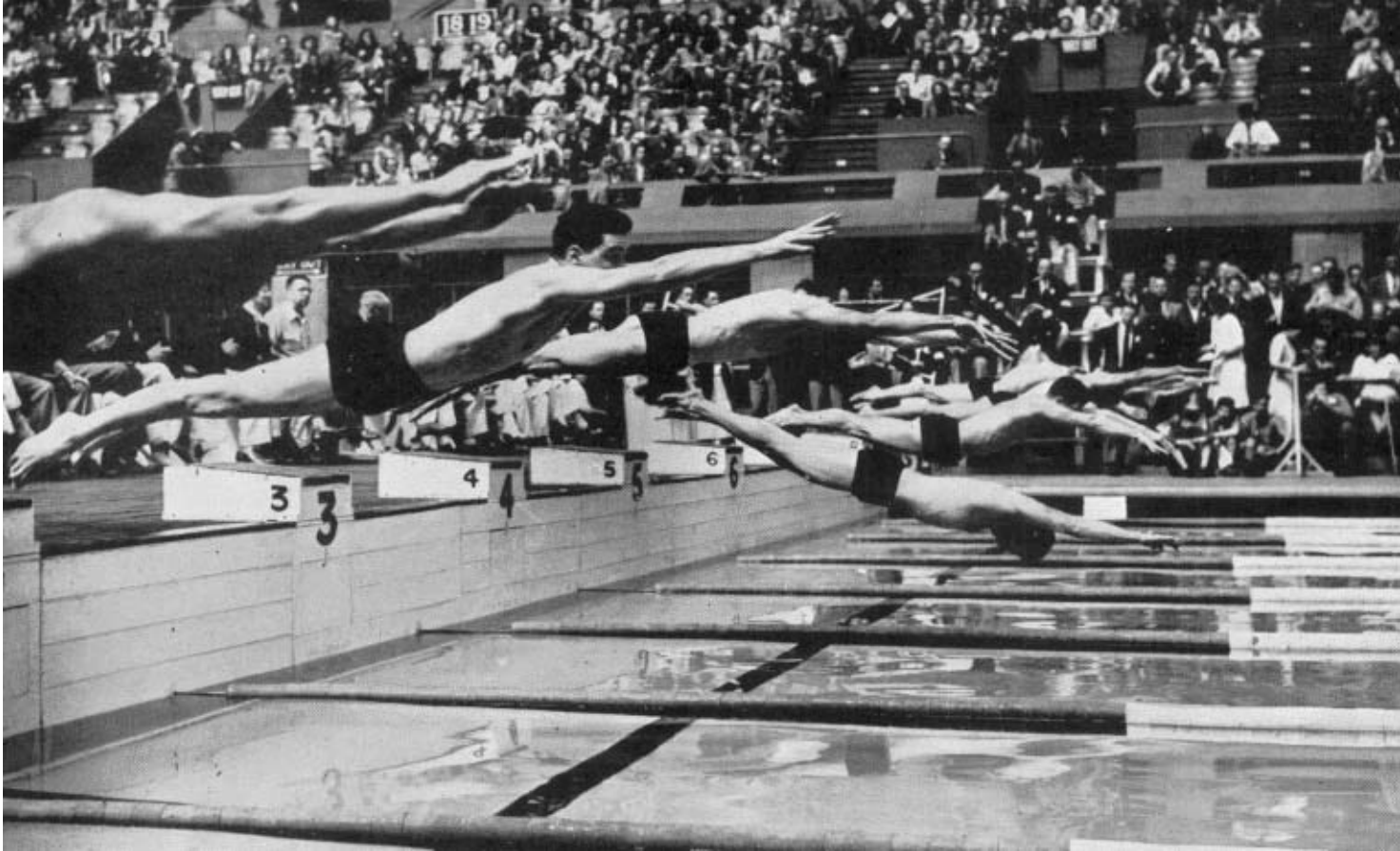

*The start of the Men's 200m. Breast Stroke Final. Left to Right—T.Cerer(Yugoslavia) 5th(hands only showing), J. Griffith Davies (Australia) 4th, W. O. Jordan (Brazil) 6th, K. E. Carter (U.S.A.) 2nd, J. Verdeur (U.S.A.) Olympic Champion in Olympic record time of 2.39.3 A. Kandil (Egypt) 7th, R. Sohl (U.S.A.) 3rd, B. Bonte (Holland) 8th.*

*Men's 100 m. Back Stroke—Heat 1. Note the special traps for the start of the back-stroke races in the bridge, which were closed immediately after the swimmers had passed the recall rope which can be seen in the foreground. In the picture above, the traps can be seen in the closed position.*



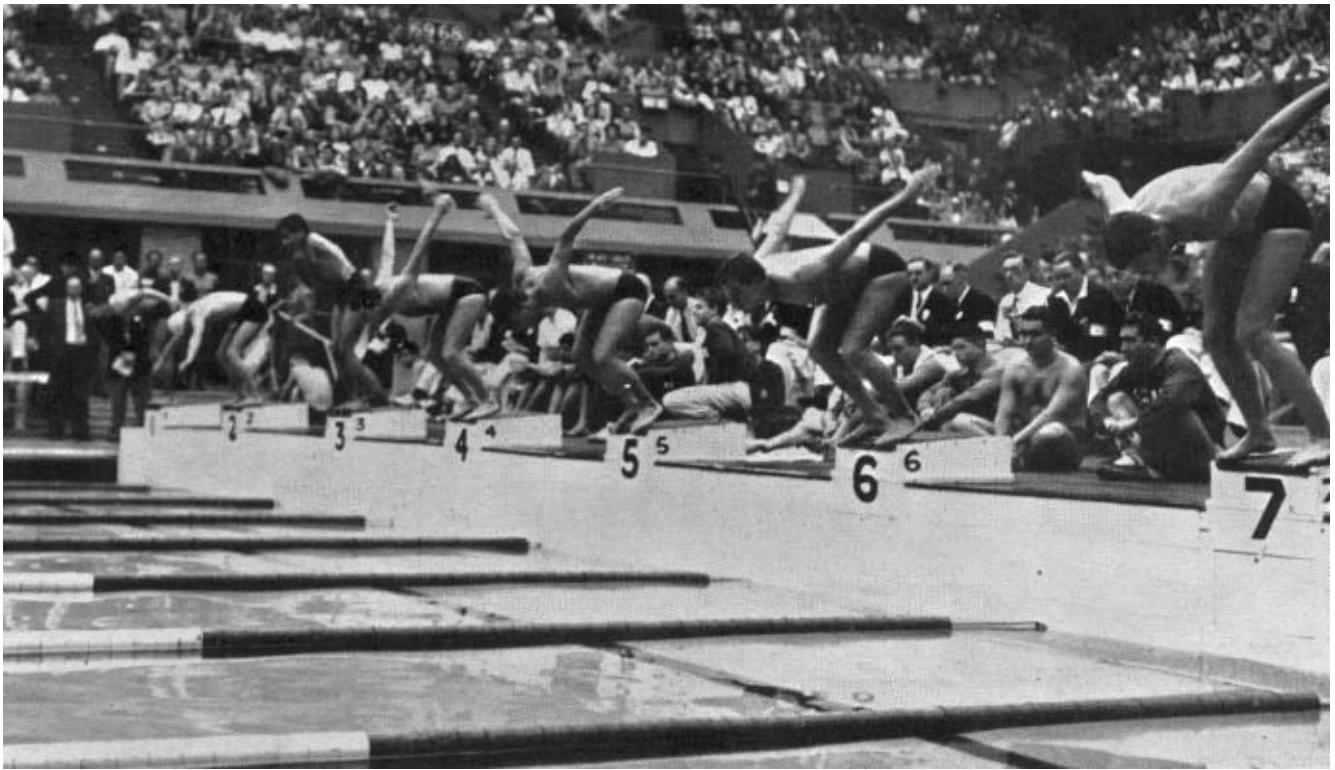

*Men's 800 m. (4 X 200 m.) Relay. Start of heat 1. Left to right—U.S.A. (Olympic Champions), Hungary (heat winners and silver medallists), Pakistan, Argentine, Brazil, Spain, Bermuda.*



*Victory Ceremony of women's 400 m. (4 X 100 m.) Relay. The President of the Games, Viscount Portal, presents medals to the U.S.A. team, Olympic Champions, Olympic Record time 4.29.2 (A Curtis M. Corridon, T. Kalama, B. Helsler), Denmark (E. Riise, K. Harup, G. Andersen, F. Carstensen) 2nd, Holland (I. Schumacher, M. Marsman, M. Vaessen, J. Termeulen) 3rd.*



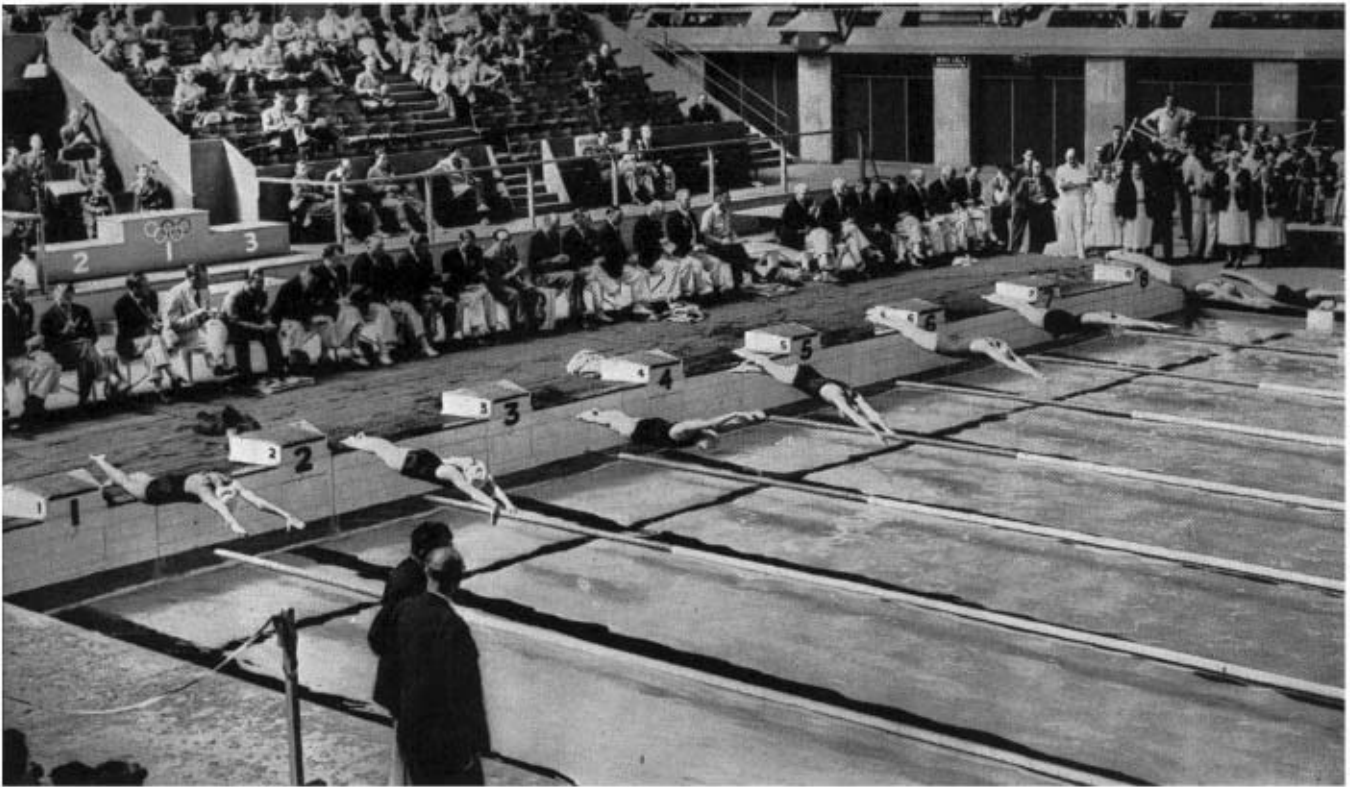

*The start of the women's 400m. Free Style Final. The first four competitors were within the previous Olympic Record time. Left to right—N.Lees (U.S.A.) 8th, C.Gibson (Great Britain) 3rd, B. Helser (U.S.A.) 5th, F. Caroen (Belgium) 4th, K.M. Harup (Denmark) 2nd, A.Curtis (U.S.A.) Olympic Champion, F. Cartensen (Denmark) 7th, P.Silva Tavaras (Brazil) 6th.*



*Prince Axel of Denmark congratulates K.Harup (Denmark) on winning the women's 100m. Back Stroke in the new Olympic Record time of 1.14.4.*



*Men's Highboard Diving. J. Capilla Perez (Mexico) 3rd. Header Forward Running Straight, 10 metres at the point of take-off.*



*Men's Highboard Diving. Bruce Harlan (U.S.A.) 2nd, seen leaving the 10 metre platform in a Reverse Somersault Running Straight.*



*Men's Highboard Diving. Sammy Lee (U.S.A.) Olympic Champion, at the start of a three-and-a-half Somersault Forward Running with Tuck, his last and winning voluntary dive from the 10-metre board.*

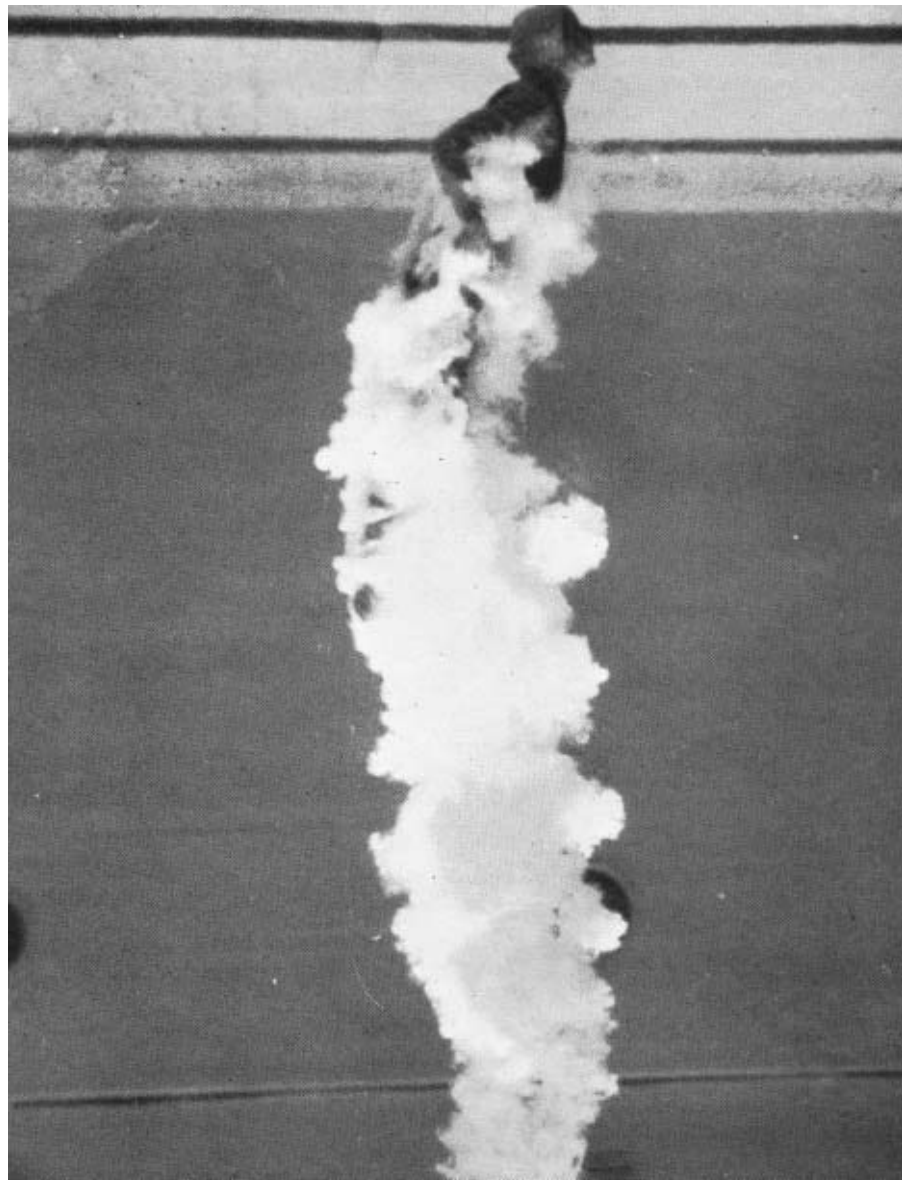

*A shot taken from the underwater porthole used at the Empire Pool for the Olympic Film.*



*Men's Springboard Diving. Miller Anderson (U.S.A.) silver medallist, backward spring forward dive with pike, 3 metres. Note three of the judges in the specially-prepared cubicles. Four similar cubicles were on the other side of the bath. On the right of the picture may be seen the 2 secretaries responsible for calculating the marks, seated next to the referee in charge of the contest.*





*Men's Springboard Diving. Bruce Harlan (U.S.A.) the Olympic Champion. 1 1/2 Somersault Backward Straight, 3 metres.*



*Men's Springboard Diving. Sammy Lee (U.S.A.), bronze medallist. Header Backward with Pike, 3 metres. Lee is opening out from his pike preparatory to entry.*

*Victory Ceremony of the women's Springboard Diving. Victoria M. Draves (U.S.A.) Olympic Champion, Zoe Ann Olsen (U.S.A.) 2nd, Patricia Elsener (U.S.A.) 3rd.*





*Women's Springboard Diving. Victoria Draves (U.S.A.) Olympic Champion. The take-off for a Header Backward Straight from 3 metres.*



*Women's Springboard Diving. Patricia Elsener (U.S.A.) bronze medallist, Reverse Dive Running Straight.*

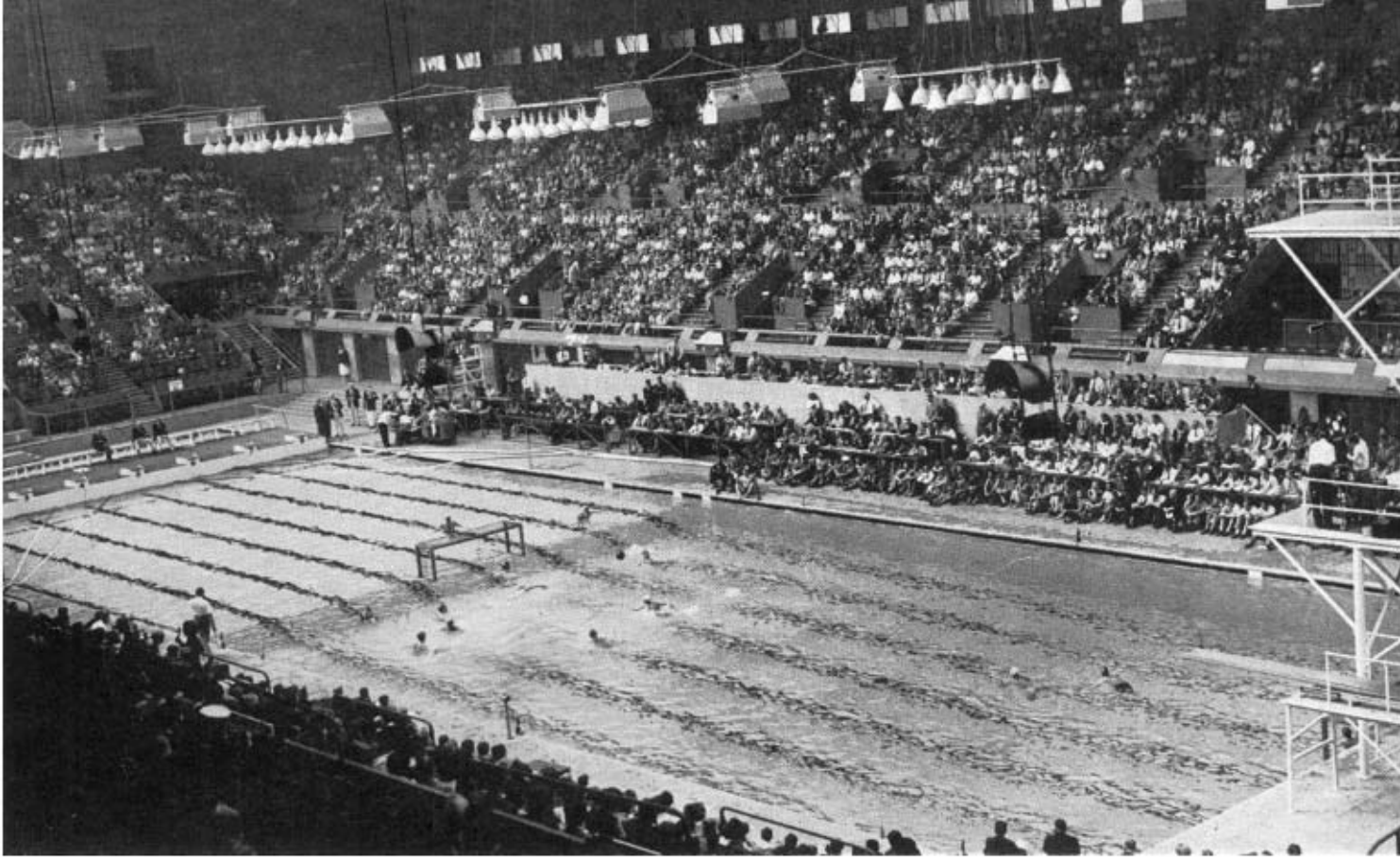

*General view of the Empire Pool with a water polo match in progress. The two swimmers behind the goal at the shallow end of the bath were there to return the ball when it went out of play. The persons sweated on the bath side at the far side of the picture are officials and competitors, while those in the raised stand immediately in front of the spectators are Press officers at the special positions provided with world telephone communication.*

*A general view of the open air pool at Finchley during a match between Holland and Spain. The playing area is marked out by cork lanes on either side of the bath. The special numbered caps provided by the Organising Committee can be clearly seen in this photograph.*





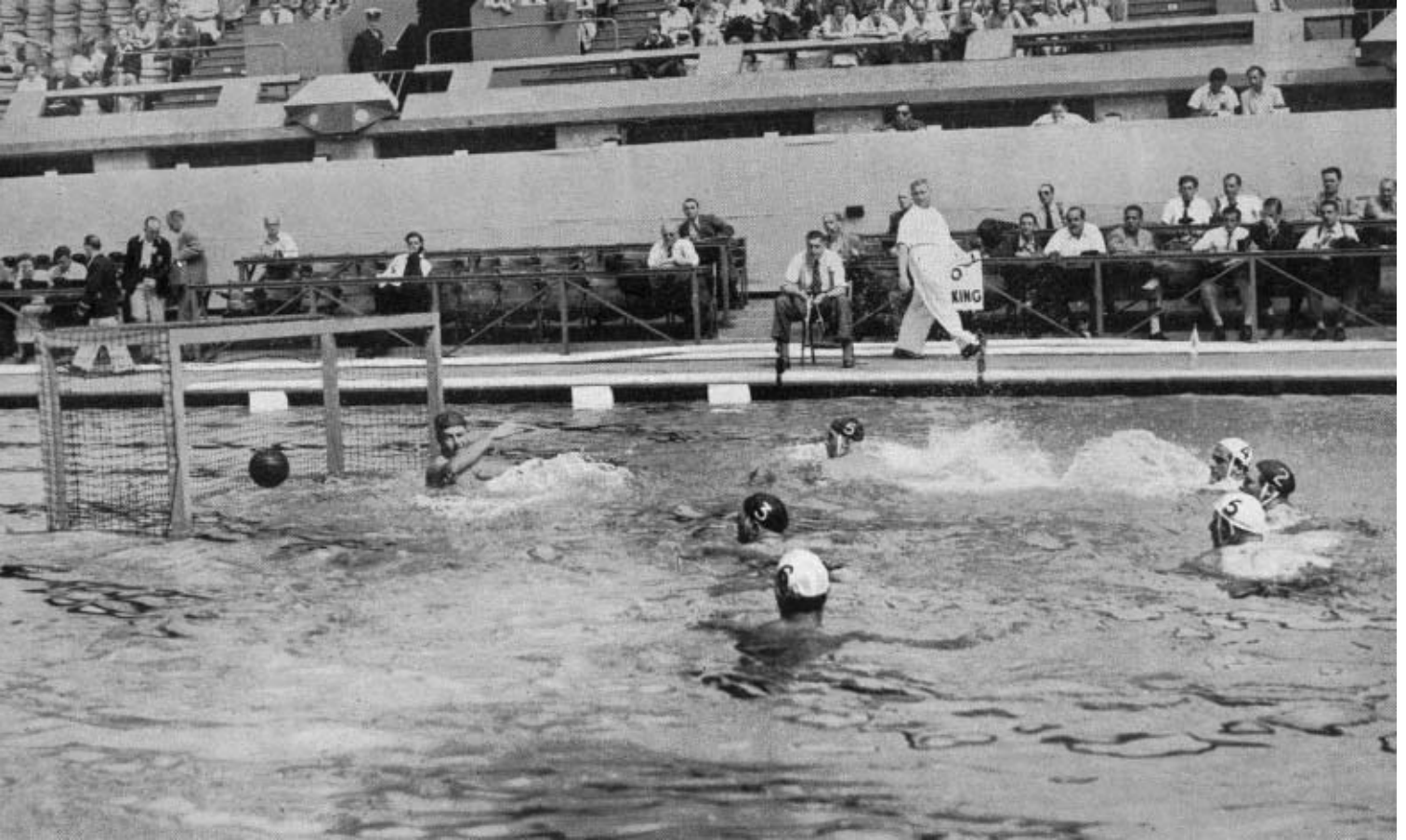

*Greece scoring their second goal against the Argentine in the match at the Empire Pool which they lost 6-2.*

*Hungary scoring against Great Britain in the match at the Empire Pool which they won 11-2.*

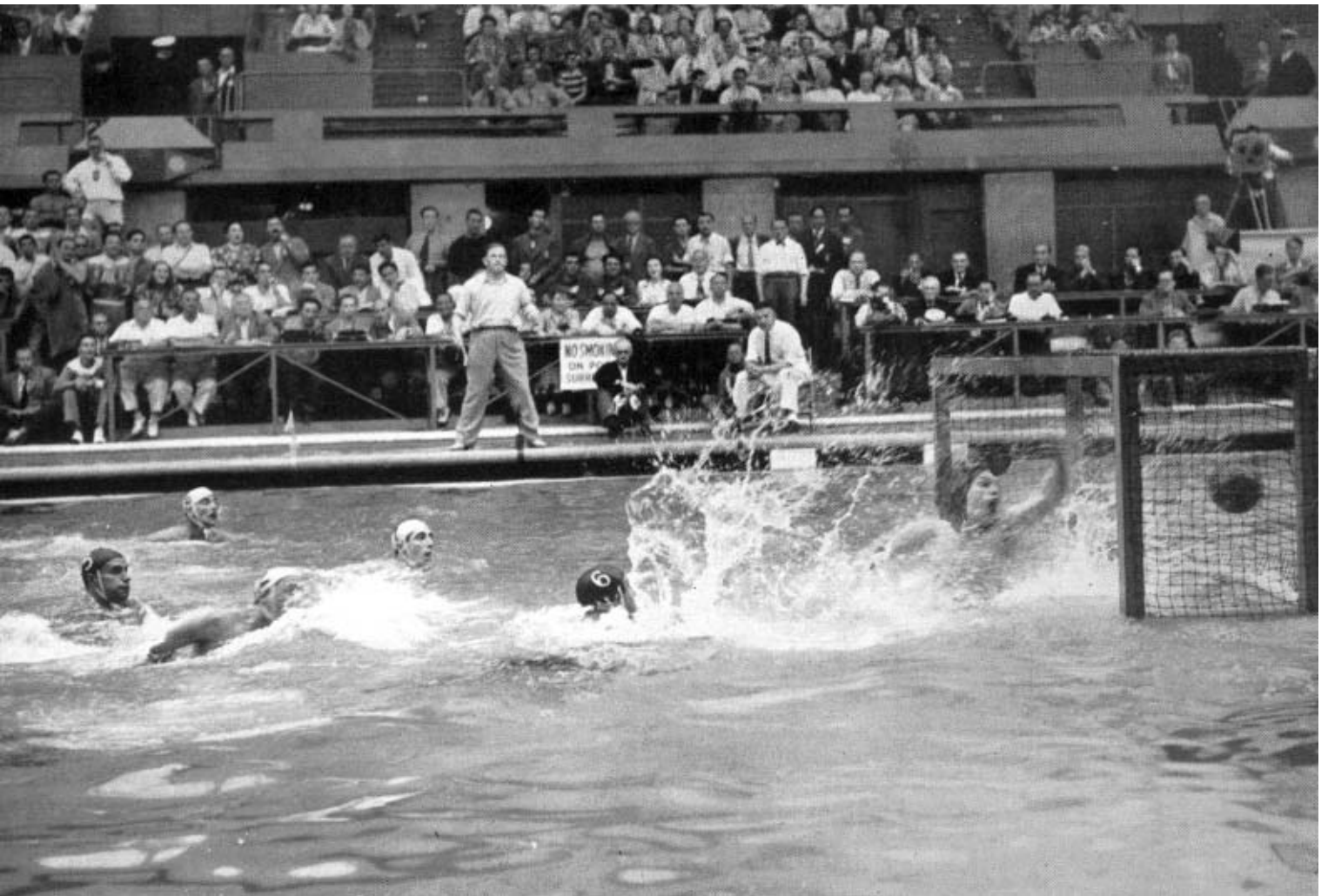

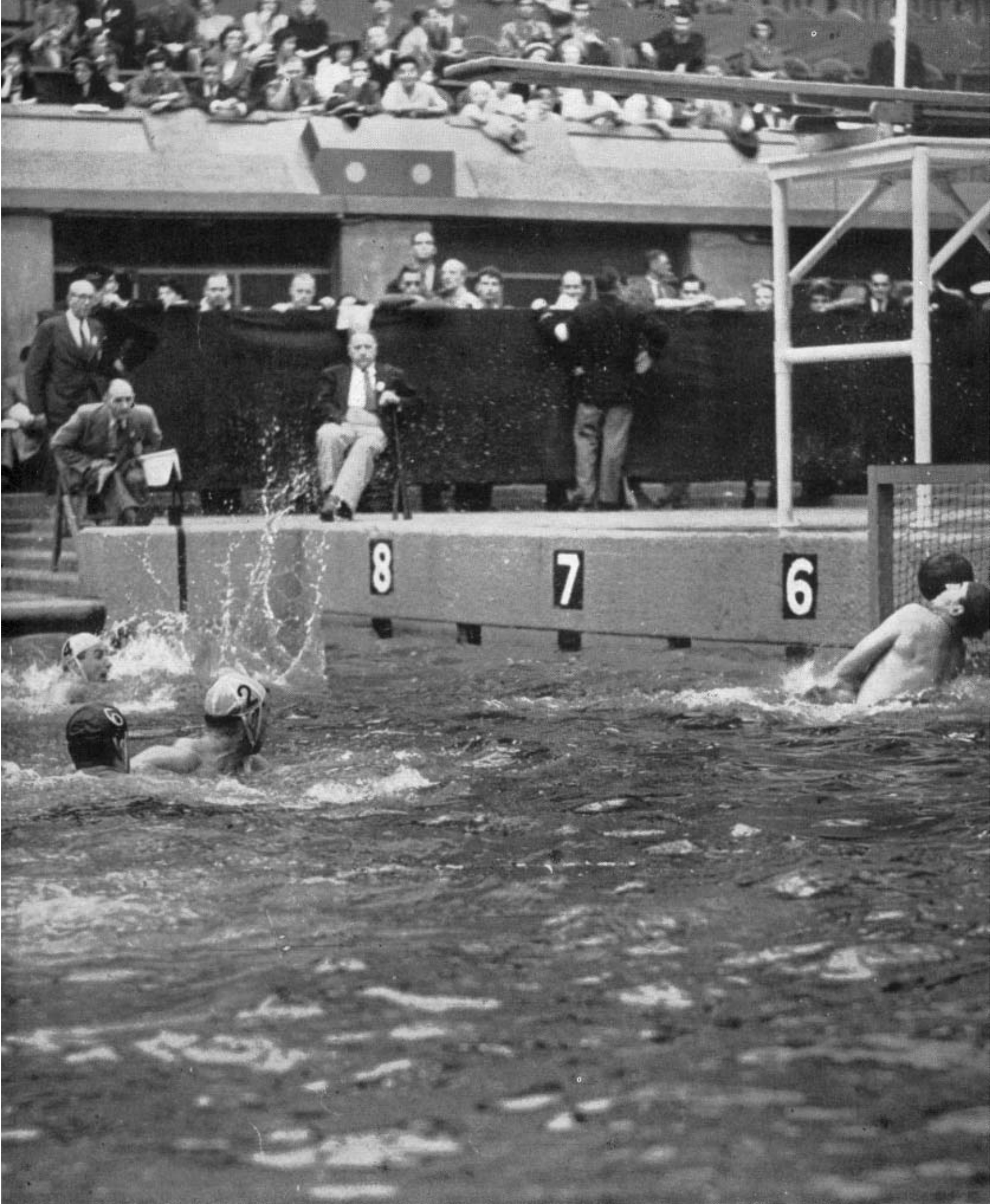

*Hungary against Belgium at the Empire Pool. Hungary, silver medallists, scoring their third goal in the match which they won 3-0.*

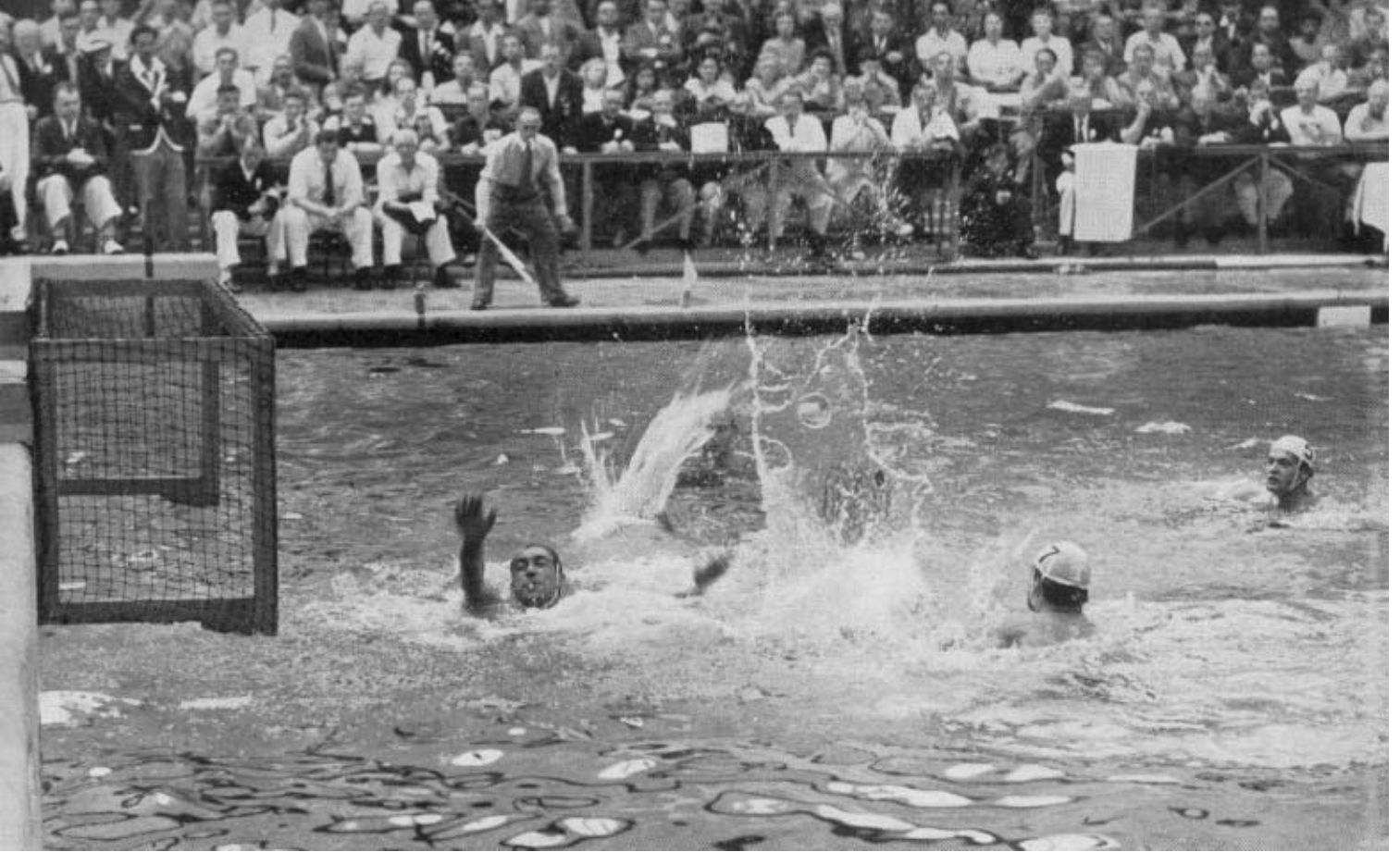

*Hungary against Italy, the all-important match of the water polo tournament, won 4-3 by Italy. An attack on the Italian goal by the Hungarians (white caps).*

*Italy scoring their second goal against Holland on the last day of the Olympic tournament. By winning this match 4-2, Italy became Olympic Champions.*



## FEDERATION INTERNATIONALE DE FOOTBALL ASSOCIATION

### JURY OF APPEAL

J. RIMET	HIS EXCELLENCY M. BIANCHI
A. DREWRY	R. KIRKWOOD
L. ARANHA	J. KREBS
L. FREDERIKSEN	K. J. J. LOTSY
R. W. SELLDRAYERS	V. VALOUSEK
W. GRANATKIN	Dr. I. SCHRICKER
Dr. M. ANDRE JEVIC	H. RIJNINK

### GROUND COMMITTEE

A. DREWRY, <i>President</i>	L. FREDERIKSEN
Dr. M. ANDRE JEVIC	S. F. ROUS, <i>Secretary</i>

### *Previous Olympic Winners*

1908 Great Britain	1924 Uruguay
1912 Great Britain	1928 Uruguay
1920 Belgium	1936 Italy

---

### THE TOURNAMENT IN BRIEF

Prelim. Round	1st Round	2nd Round	Semi-Finals	Final
	Sweden : } 3 Austria : } 0	Sweden : } 12		
	Korea : } 5 Mexico : } 3	Korea : } 0	Sweden : } 4	
	Italy : } 9 U.S.A. : } 0	Italy : } 3		Sweden : } 3
	Denmark : } 3 Egypt : } 1	Denmark : } 5	Denmark : } 2	
Luxembourg : } 6 Afghanistan : } 0	Luxembourg : } 1 Yugoslavia : } 6	Yugoslavia : } 3	Yugoslavia : } 3	} SWEDEN
	China : } 0 Turkey : } 4	Turkey : } 1		
Holland : } 3 Eire : } 1	Gt. Britain : } 4 Holland : } 3	Gt. Britain : } 1	Gt. Britain : } 1	
	India : } 1	France : } 0		Yugoslavia : } 1

Play-off for third place : **Denmark 5**, Gt. Britain 3.

### FINAL PLACINGS

- 1 SWEDEN
- 2 YUGOSLAVIA
- 3 DENMARK
- 4 Great Britain



### PRELIMINARY MATCHES

Luxembourg beat Afghanistan by 6 goals to 0 at Brighton. (Half-time score, 3-0.)

LUXEMBOURG : Michaux, B.; Pauly, N., Feller, J.; Wagner, R., Feller, V., May, N.; Gales, J., Kremer, J., Kettel, N., Paulus, M., Schammel, F.

AFGHANISTAN : Assar, A. Ghafoor; Gharzai, M., Yusufzai, A.; Azimi, A., Barakzai, Y., Kharot, A.; Kharot, M., Afzal, A., Assar, A. Ghani, Tajik, A. H., Yusufzai, M.

*Referee:* A. C. Williams (Great Britain). *Linesmen:* A. W. Smith and W. E. Dellow (Great Britain).

---

Holland beat Eire by 3 goals to 1 at Portsmouth. (Half-time score, 2-0.)

HOLLAND : Kraak, P.; Van Bun, J., Schijvenaer, H.; Krijgh, C, Terlouw, M., de Vroet, A.; Van der Tuyn, C. Rijvers, C, Roosenburg, A., Wilkes, S., Lenstra, A.

EIRE : Lawler, D.; Glennon, F., Richardson, W. Barry, W., Kavanagh, P., O'Grady, W.; McDonald, P., McLoughlin, E, Cleary, D., O'Kelly, B., Smith, Robert.

*Referee:* Mr. G. Reader (Great Britain). *Linesmen:* Mr. S. T. Stevens and Mr. P. G. Drewry (Great Britain).

---

### FIRST ROUND MATCHES

Sweden beat Austria by 3 goals to 0 at Tottenham. (Half-time score, 2-0.)

SWEDEN : Lindberg, T.; Nordahl, K., Nilsson, E.; Rosengren, B., Nordahl, B., Andersson, S.; Rosen, K., Gren, G., Nordahl, G., Carlsson, N., Liedholm, N.

AUSTRIA : Pelikan, F.; Kowanz, K., Happel, E. Mikolasch, L., Ocwirk, E., Joksch, S.; Melchior, E., Habitzl, E. Epp, J., Hahnemann, W., Koereer, A.

*Referee:* Mr. W. Ling (Great Britain). *Linesmen:* Mr. El Sayed (Egypt) and Mr. A. Gamba (Italy).

---

Korea beat Mexico by 5 goals to 3 at Dulwich. (Half-time score, 2-1.)

KOREA : Hong, Duk Yung ; Pak, Kyoo Chung, Pak, Dai Chong ; Choi, Song Gon, Kim, Kyoo Whan, Min, B. D. ; Chung, Kook Chin, Woo, Zung Whan, Bai, C., Chung, Nam Sik, Kim, Yong Sik.

MEXICO : Quintero Nava, F.; Rodriguez Peralta, J. L., Rodriguez Novarro, J.; Thompson Durand, C, Figueroa, Rodriguez, F., Cordoba Alcaia, A.; Garduno Gomez, E., Mercado Luna, J., Cardenas de la Vega, R., Sanchez, Huerta M., Ruiz Aguilar, J.

*Referee:* Mr. Leo Lemesic (Yugoslavia). *Linesmen:* Mr. M. Matanic (Yugoslavia) and Mr. D. Carpani (Italy).

---

Italy beat U.S.A. by 9 goals to 0 at Brentford. (Half-time score, 2-0.)

ITALY : Casari, G.; Giovannini, G., Stellin, A.; Presca, C., Neri, M., Mari, G.; Cavigioli, E., Turconi, A., Pernigo, F., Cassani, V., Caprile, E.

U.S.A. : Strimel, A.; Costa, J., Martin, M.; Colombo, C., Ferreira, J., Bahr, W.; Beckman, R., Souza, J., Bertani, W., McLaughlin, B., Souza, E.

*Referee:* Mr. Delasalle (France). *Linesmen:* Mr. A. Amussen (Denmark) and Mr. R. Dez (France).

---

Denmark beat Egypt by 3 goals to 1 at Crystal Palace after extra time. (Half-time score, 0-0.)

DENMARK : Nielsen, E.; Jensen, H. V., Overgaard, K.; Pilmark, P., Ornvold, D., Jensen, T.; Ploger, J., Hansen, K., Lundberg, K., Hansen, J. A. V. O., Praest, C.

EGYPT : Imam, Y.; Hammami, A., Sedki, F.; Maati, H., Abuhabaga, M., Bastan, H.; Dezwi, El S.; El Gindi, M., El Mekkawi, A., Sakr, A., Madkour, H.

*Referee:* Mr. S. Boardman (Great Britain). *Linesmen:* Mr. J. Beck (Austria) and Mr. I. Ekland (Sweden).

---

Yugoslavia beat Luxembourg by 6 goals to 1 at Fulham. (Half-time score, 1-1.)

LUXEMBOURG : Michaux, B.; Feller, J., Pauly, N.; Wagner, R., Feller, V., May, N.; Gales, J., Konter, L., Kettel, N., Paulus, M., Schammel, F.

YUGOSLAVIA : Sostaric, F.; Brozovic, M., Stankovic, B.; Cajkovski, Zlatko, Jovanovic, M., Atanackovic, A.; Mihajlovic, P., Mitic, R., Volf, F., Bobek, S., Cajkovski, Zeljko.

*Referee:* Mr. K. L. Van de Meer (Holland). *Linesmen:* Mr. J. Best (U.S.A.) and Mr. K. Schippel (Holland).

**FIRST ROUND MATCHES**—*continued*

Turkey beat China by 4 goals to 0 at Walthamstow. (Half-time score, 1-0.)

TURKEY : Arman, C. ; Alyuz, M., Tosuncuk, V., Torkal, S., Eken, B., Saygin, H. ; Kircan, F., Keskin, E., Kilic, G., Andonyadis, K., Gulesin, S.

CHINA : Chang, Pang-Rum ; Hau, Yung-Sang, Nien, Sze-Shing ; Chau, Man-Chi, Sung, Ling-Sing, Lau Chung-Sang ; Ho, Ying-Fun, Chang, King Hai, Chu, Wing-Keung, Chia, Boon-Leong, Li Tei-Fei.

*Referee*: Mr. Joh Beck (Austria). *Linesmen*: Mr. N. Awny (Egypt) and Mr. S. Boardman (Great Britain).

Great Britain beat Holland by 4 goals to 3, after extra time, at Arsenal. (Half-time score, 1-1.)

GREAT BRITAIN : Simpson, R. ; Neale, C, Manning, G. ; McBain, D., Lee, E., Fright, E. ; Hopper, A., Hardisty, J., McIlvenny, H., Kelleher, D., Kippax, F.

HOLLAND : Kraak, P. ; Van Bun, J., Schijvenaer, H. ; Krijgh, C, Terlouw, M., de Vroet, A. Van der Tuyn, C., Rijvers, C., Appel, A., Wilkes, S., Lenstra, A.

*Referee*: Mr. Vald Laursen (Denmark). *Linesmen*: Mr. G. Carpani (Italy) and Mr. V. Sdez (France).

France beat India by 2 goals to 1 at Ilford. (Half-time score 1-0.)

FRANCE : Rouxel, G. ; Rouelle, C., Bienvenu, B.; Krug, R., Colau, M., Robert, G. ; Heckel, J., Persillon, R., Paluch, J., Strappe, A., Courbin, R.

INDIA : Varadaraj, K. ; Mahomed, T., Manna, S. ; Basheer, A., Aao, T., Prasad, M.; Das, R., Parab, R., Mcwalall, S., Khan, M., Raman, S.

*Referee*: Mr. Gunnar Dahlner (Sweden). *Linesmen*: Mr. V. Rae (Great Britain) and Mr. A. Gamba (Italy).

**SECOND ROUND MATCHES**

Sweden beat Korea by 12 goals to 0 at Crystal Palace. (Half-time score, 4-0.)

SWEDEN : Lindberg, T. ; Leander, O. B., Nilsson, E. ; Rosengren, B., Nordahl, B., Andersson, S.; Rosen, K., Gren, G., Nordahl, G., Carlsson, N., Liedholm, N.

KOREA : Hong, Duk Yung; Pak, Kyoo Chung, Pak, Dai Chong ; Choi, Song Gon, Kim, Kyoo Whan, Min, B. D.; Woo, Zung Whan, Bai, C, Chung, Nam Sik, Kim, Yong Sik, Chung, Kook Chin.

*Referee*: Mr. G. Caparni (Italy). *Linesmen*: Mr. R. J. Leafe (Great Britain) and Mr. K. Schiffell (Holland).

Denmark beat Italy by 5 goals to 3 at Arsenal. (Half-time score, 1-0.)

DENMARK : Nielsen, E. ; Jensen, H. V., Overgaard, K.; Pilmark, P., Ornvold, D., Jensen, T. ; Ploger, J., Hansen, K., Praest, C, Hansen, J. P. E., Seebach, H.

ITALY : Casari, G. ; Giovannini, G., Stellin, A. ; Maestrelli, T., Neri, M., Mari, G. ; Caviglioli, E., Turconi, A., Pernigo, F., Cassani, V., Caprile, E.

*Referee*: Mr. W. Ling (Great Britain). *Linesmen*: Mr. J. Beck (Austria) and Mr. V. Rae (Great Britain).

Yugoslavia beat Turkey by 3 goals to 1 at Ilford. (Half-time score, 1—1.)

YUGOSLAVIA : Sostaric, F.; Brozovic, M., Stankovic, B.; Cajkovski, Zlatko, Jovanovic, M., Atanackovic, A.; Tomasevic, K., Mitic, R., Volfl, F., Bobek, S., Cajkovski, Zeljko.

TURKEY : Arman, C.; Alyuz, M., Tosuncuk, V.; Ozkaya, N., Eken, B., Saygin, H.; Kircan, F., Keskin, E., Kilic, G., Andonyadis, K., Gulesin, S.

*Referee* : Mr. V. Sdez (France). *Linesmen* : Mr. A. Asmussen (Denmark) and Mr. G. Dahlner (Sweden).

Great Britain beat France by 1 goal to 0 at Fulham. (Half-time score, 1—0.)

GREAT BRITAIN : McAlinden, K.; Neale, C, McColl, J.; McBain, D., Lee, E., Fright, E.; Donovan, F., Hardistry J., McIlvenny, H., Kelleher, D., Kippax, F.

FRANCE : Rouxel, G.; Krug, R., Bienvenu, B.; Persillon, R., Colau, M., Robert, G.; Heckel, J., Strappe, A., Hebinge, R., Paluch, J., Courbin, R.

*Referee*: Mr. K. L. Van de Meer (Holland). *Linesmen*: Mr. Vald Laursen (Denmark) and Mr. Leo Lemesic (Yugoslavia).

**SEMI-FINAL**

Sweden beat Denmark by 4 goals to 2 at the Empire Stadium, Wembley. (Half-time score, 4-1.)

SWEDEN : Lindberg, T. ; Leander, O. B., Nilsson, E. ; Rosengren, B., Nordahl, B., Andersson, S. ; Rosen, K., Gren, G., Nordahl, G., Carlsson, N., Liedholm, N.

DENMARK : Nielsen, E. ; Jensen, H. V., Overgaard, K.; Pilmark, P., Ornvold, D., Jensen, T. ; Ploger, J., Hansen, K., Praest, C., Hansen, J. P. E., Seebach, H.

Referee: Mr. S. Boardman (Great Britain). Linesmen: Mr. R. J. Leafe (Great Britain) and Mr. M. Matanic (Yugoslavia).

---

Yugoslavia beat Great Britain by 3 goals to 1 at the Empire Stadium, Wembley. (Half-time score, 2—1.)

YUGOSLAVIA : Sostaric, F. ; Brozovic, M., Stankovic, B. ; Cajkovski Zlatko, Jovanovic, M., Atanackovic, A.; Mihajlovic, P., Mitic, R., Volfl, F., Bobek, S., Cajkovski, Zeljko.

GREAT BRITAIN : McAlinden, K. ; Neale, C., McColl, J. ; McBain, D., Lee, E., Fright, E. ; Donovan, F., Hardisty, J., McIlvenny, H., Kelleher, D., Kippax, F.

Referee: Mr. K. L. Van der Meer (Holland). Linesmen: Mr. J. Best (U.S.A.) and Mr. I. Eklind (Sweden).

**FINAL**

Sweden beat Yugoslavia by 3 goals to 1 at the Empire Stadium, Wembley. (Half-time score, 1-1.)

SWEDEN: Lindberg, T.; Nordahl, K. E., Nilsson, E.; Rosengren, B., Nordahl, B., Andersson, S.; Rosen, K., Gren, G., Nordahl, G., Carlsson, N., Liedholm, N.

YUGOSLAVIA: Lovric, L.; Brozovic, M., Stankovic, B.; Cajkovski, Zlatko, Jovanovic, M., Atanackovic, A.; Cimermanic, Z., Mitic, R., Bobek, S., Cajkovski, Zeljko, Vukas, B.

Referee: Mr. W. Ling (Great Britain). Linesmen: Mr. M. de la Salle (France) and Mr. A. Gamba (Italy).

**THIRD PLACE MATCH**

Denmark beat Great Britain by 5 goals to 3 at the Empire Stadium, Wembley. (Half-time score, 3-2.)

DENMARK: Nielsen, E.; Jensen, H. V., Overgaard, K.; Pilmark, P., Ornvold, D., Jensen, T.; Ploger, J., Lundberg, K., Praest, C., Hansen, J. P. E., Sorensen, J. L.

GREAT BRITAIN : Simpson, R.; Neale, C., Carmichael, A.; Hardisty, J., Lee, E., Fright, E.; Boyd, J., Aitken, A., McIlvenny, H., Rawlings, J., Amor, W.

Referee : Mr. K. L. Van der Meer (Holland). Linesmen: Mr. J. Best (U.S.A.) and Mr. D. Carpani (Italy).

# GYMNASTICS

An outstanding fact which soon revealed itself in the Gymnastic events was that, in spite of the ravages of war in nearly every country of the world, Gymnastics has been maintained at the high level seen in previous Olympic Games. Not only was the standard of the sport high, but the physique of the men's teams coming from the devastated areas of Europe was little short of marvellous.

There is no doubt that champions of any sport require experience as well as skill to perform at the high standard of the Olympic Games, and it was noticeable that this was present in several of the teams. This was sometimes reflected in the age of the team. For instance, Finland's average age was 33.7, whilst that of Great Britain was 27-5.

The main evidence of the experience of the Finnish team, however, was in their controlled movements, their perfect timing and all the other qualities which, combined, enabled them as a team to come out on top. These same comments apply to a great extent also to the Swiss team, the runners-up.

There was an occasion when one of the Finnish team missed his grasp on the horizontal bar—during a " long swing "—and swung round the bar on one arm. His beautiful recovery into a different movement without a break in rhythm drew a roar of applause from the knowledgeable people nearby, and the judges showed their appreciation of the clever recovery by only a small penalisation in the marking.

With sixteen men's teams competing, the countries had to be divided into two groups of eight teams each, as it was only possible to work six pieces of apparatus at one time. As it happened, both the Finnish and Swiss teams were in the same section, and it soon became apparent that the closeness of competition between these two nations would not end until the final results were announced. They were both well-balanced teams, for each of the eight men was an all-round gymnast.

The final score was obtained by deducting the scores of the two lowest gymnasts in each team, and when it was realised that Finland suffered a deduction of 439.55 marks for these two men compared with other nations' deductions of 278, 134, and like figures, then it will be appreciated what is meant by a well-balanced team.

## **Vaulting Decides**

An analysis of the marks shows that Switzerland lost the championship by the difference in their marks for Vaulting, compared with those obtained by Finland. On the set vaults they were 6.6 points behind, and on the voluntary vaults 2.3 points, making a total loss of 8.9 points. The final difference, however, between the two teams was only 1.6 points.

The rivalry between the teams was also present in the individual competition, for when V. Huhtanen of Finland was announced as the all-round individual champion, it was found that the runner-up, W. Lehmann of Switzerland, was only 7 of a point behind out of a maximum of 240 points. The third man was P. Aaltonen, also of Finland. He was only .2 of a point behind Lehmann ; surely one of the closest finishes of any contest in Gymnastics.

It was fortunate in a way that the rain storms of the weekend compelled the holding of the Gymnastic events indoors. As Wembley was more or less under water, it was impossible to work there, and so the suggestion to transfer the whole competition to the Empress Hall was eagerly accepted, at least by the organisers, who knew the vagaries of the English climate. In spite of the complications caused by the change of venue, there is no doubt whatever that it redounded to the benefit of the spectators, as the distance between them and the competitors was lessened. They were able to follow more closely the beautiful work done by the teams, which provided such a feast of "poetry in motion" that the audience found it difficult to decide what to watch.

The fact that the people stayed in their seats throughout the day demonstrated the fact that they were deeply interested in the events. The visual method of judging did much to stimulate this interest. By this method, when the competitor has finished his exercise, the four judges show the marks given by raising cards. This is done simultaneously by the judges so that they will not be influenced by the marks given by any of the other judges. The scorers then eliminate the highest and lowest marks, the remaining two counting. Not only did this add to the interest of the spectators, but it was an easy method of allowing the competitor to know how many marks he had obtained, and so of deciding whether or not he would exercise his right to repeat the set exercise if he thought he could do better. This method of judging had been used in the women's event in the 1936 Games, but had not been the practice with the men.

### **The Judging**

Judging in Gymnastic competitions is always a difficult matter, calling for a complete knowledge of the sport, of the exercise, and of the right approach. Continued concentration on points during the performance of the exercise is also very tiring, and all honour is due to the judges who worked much longer hours than the competitors. It was natural that there were differences of opinion on the value to be placed on any particular movement, for from the different positions one judge could see a small fault, whilst another one differently placed would not see it, and varying marks would reflect these differences. Each country had to give a declaration as to the competence and integrity of their judges but, so that every aspect of the judging might be considered in retrospect, it was decided at the meeting of the Federation that all judges' marks would be published throughout the world. In this way it would be established if any were excessively severe, too easy or of unreliable judgment, and in such cases they would not be allowed to judge in future. It is of interest that, whereas the rules allow each nation to nominate an observer at the scoring table, none were in fact so appointed.

The hurried rearrangement of the event from Wembley to Empress Hall made it impossible to provide for a Scoreboard on which to record the progress of events, and recourse had to be made to the loudspeaker. This proved to be a drawback in many ways ; firstly, the announcements tended to interfere with the competitors ; secondly, it distracted the spectators when they wanted to watch something especially interesting ; and thirdly, it was found that people did not really listen after a time, and consequently announcements which needed action did not get the attention required.

### The Women's Events

The women's events took place at the same time as the men's but before commenting on these, it is necessary to record the deep sympathy felt for the members and friends of the Czech women's team. On arriving in England, one of the team was taken ill and, although everything possible was done, the patient died in hospital just before the team was due in the arena. Under these depressing circumstances it is all the more credit to the team, which included the sister of the dead girl, that they should have come out on top in one of the most severe tests of steady nerves in the world.

The Czech women's team finished with a lead of 4.95 points over Hungary, the runners-up, and once again vaulting made all the difference in the final result. The set vault, although difficult to perform perfectly, could in fact be done with several faults, and there is no doubt that the lady judges had to watch this most carefully. It was on the balancing beam, however, that the most charming women's work was seen. The feats of balance and movement shown in this work held the spectators breathless.

As the women's work had to take place at the same time as the men's it was considered in the Federation meeting that the music used for the women's team exercises would interfere with the men's concentration. It was therefore decided that the men should cease work for the few minutes taken by the music. As it happened, however, many of the men took no notice of the music, which in any case was never very loud, and in fact the only interference to the competitors by noise came from the reverse direction. The Finnish men's team were on the horizontal bar, whilst the British women were on the swinging rings. One of the men had just finished a beautiful voluntary exercise, and such a roar of applause went up from the spectators, that the girl on the rings was startled and put " off her stroke " just as she was preparing for the finish. The finish was called a " saut perilleux," so it was with great relief that she was seen to land safely, although she undoubtedly lost some marks through this incident.

Although there was no individual championship for the women, certain outstanding competitors must be mentioned. Z. Honsova, of Czechoslovakia, scored the highest number of marks on all the apparatus combined, including first place on both beam and rings. This was a very fine performance, achieved with all the certitude of the practised and experienced gymnast. Pigtailed L. Micheli of Italy, a serious little girl of 17, was placed third in total marks. What an achievement at that age against so much experience ! On one occasion, when she had just finished an exercise perfectly, she forgot all her seriousness and ran back to the team with kisses all round !

## FEDERATION INTERNATIONALE DE GYMNASTIQUE

### JURY OF APPEAL

#### Men

M. LE COMTE GOBLET D'ALVIELLA, *Belgium*  
DR. M. KLINGER, *Czechoslovakia*  
M. C. LAPALU, *France*  
P. HENTGES, *Luxembourg*

#### Women

MME. M. PROVAZNIKOVA, *Czechoslovakia*  
MISS W. M. TAYLOR, *Great Britain*

### OFFICIALS FOR GYMNASTIC EVENTS

*Arena Manager* : E. A. SIMMONDS

*Assistant Arena Manager* : P. H. SEYMOUR

*Chief Steward* : J. K. COCHRANE

*Chief Scorer* : G. A. BELLAMY

*Announcer* : W. L. LATTO

*Liaison Officer* : L. NORRIS

*Television Commentators* : B. E. WOODIN, F. H. RODEN, H. LITTLEWOOD

#### *Stewards and Scorers :*

Miss G. V. CUTLER, MISS E. HUNTLEY, R. WALSHAW, W. BUFFIN,  
L. QUARTLY, W. PILKINGSTON, J. DRURY, C. E. MAATHEWS,  
G. WALSHAW, F. EDWARDS, L. GROSS, E. KINSELLEY, J. DOYLE,  
C. FRANKLIN, C. LORD, W. WILLIAMS, R. NICKSON, H. STELL,  
W. WALSH, G. MARTIN, F. SILLS, L. WEBB, R. SAMUELS, R. SMALE,  
J. J. COOK, E. HULME, J. BRITTON, B. E. IVESON, A. BACH,  
T. PARKINSON, A. REYNOLDS, H. BOLT, H. WANTZEN, G. A. WHITE,  
K. CHURCH, A. PONTON, I. VICE, Mrs. E. GROSS, Mrs. M. BARROW,  
MISS I. STIMPSON, MISS W. DAVIS, Mrs. W. O. CHAPPELL,  
Mrs. M. M. COOK, MISS M. G. SANT, Mrs. E. G. WILKINSON,  
Mrs. J. M. DRURY, Mrs. E. R. BARBOR, MISS V. PETER, Mrs. E.  
PADGETT, Mrs. F. OFFER, Mrs. C. GOODSALL, MISS T. ROWLANDS,  
Miss M. MORGAN, MISS L. WALSHAW, Mrs. M. PRINCE, MISS W.  
KILGOUR, MISS S. TAYLOR, MISS M. TAYLOR, Mrs. I. JUDD

### CONDITIONS

The following Gymnastics events are decided during the three days :—

#### **MEN**

A. Team Competition.

B. Individual Competitions—

- (i) 12 exercises combined.    (ii) Parallel Bars.    (iii) Horizontal Bars.    (iv) Rings  
(v) Pommel Horse.    (vi) Long Horse.    (vii) Free Exercises.

**WOMEN** Team Competition only.

For the Men's events teams of not less than six nor more than eight competitors take part from the original entry of ten. Each competitor must take part in each of the six compulsory exercises and in six voluntary exercises, one on each piece of apparatus and one free exercise (without apparatus). The scores are totalled and the best six individual totals constitute the team total, which decides the team competition. The Men's individual awards are made on the points scored during the progress of the team competition.

In the Men's events, a gymnast may repeat a compulsory exercise. If he does so only the repetition will be taken into account. This does not apply to the compulsory free standing exercise. Each competitor is allowed two attempts at the vaults, compulsory and optional, the better to count. The other optional exercises may not be repeated.



Competing teams are allowed to instal their own apparatus, providing it conforms with the regulations. If they do so, other competitors may use it if they desire.

For the Men's events, points from 0—10 are awarded for each exercise. The award may be made in tenths of a point. The highest and lowest awards of the four judges are cancelled, the score being the addition of the two middle awards. If these differ by more than one point (or by more than half a point if each is nine or more), the judges confer and, unless they reach agreement, a decision is given by the president.

The Women's team contest is carried out on similar lines to the team contest for Men. There are, however, no individual awards for Women.

The exercises in the Women's event comprise :—

1. Team exercises without hand apparatus.
2. Team exercises with hand apparatus.
3. Compulsory exercise on swinging rings.
4. Compulsory balancing exercise on the beam.
5. Voluntary balancing exercise on the beam.
6. Compulsory vault on the pommel horse, sideways, with spring board.
7. Voluntary vault on the pommel horse, sideways, with spring board.

In the women's vaults, competitors are allowed a trial vault, after which two vaults may be made, the better to count.

In the judging of the women's team exercises, the jury is divided into three groups, one to judge the difficulty and the physiological value of the exercise, one the beauty and composition, and one the correctness of execution and the performance as a whole.

### *Previous Olympic Winners*

<b>Teams</b>			
1896 <i>Germany</i>		1912 <i>Italy</i>	1928 <i>Switzerland</i>
1904 <i>U.S.A.</i>		1920 <i>Italy</i>	1932 <i>Italy</i>
1908 <i>Sweden</i>		1924 <i>Italy</i>	1936 <i>Germany</i>
<b>Individual</b>			
1896 A. Flatow	<i>Germany</i>	1920 G. Zampori	<i>Italy</i>
1900 S. Saudras	<i>France</i>	1924 L. Stukely	<i>Yugoslavia</i>
1904 W. Weber	<i>Germany</i>	1928 G. Miez	<i>Switzerland</i>
1908 A. Braglia	<i>Italy</i>	1932 R. Neri	<i>Italy</i>
1912 A. Braglia	<i>Italy</i>	1936 A. Schwarzmann	<i>Germany</i>
<b>Apparatus Exercises (Individual)</b>			
<b>Parallel Bars</b>			
1896 A. Flatow	<i>Germany</i>	1932 R. Neri	<i>Italy</i>
1924 G. Guttinger	<i>Switzerland</i>	1936 K. Frey	<i>Germany</i>
1928 L. Vacha	<i>Czechoslovakia</i>		
<b>Long Horse</b>			
1896 K. Schumann	<i>Germany</i>	1932 S. Guglielmetti	<i>Italy</i>
1924 A. Kriz	<i>U.S.A.</i>	1936 A. Schwarzmann	<i>Germany</i>
1928 E. Mack	<i>Switzerland</i>		
<b>Pommel Horse</b>			
1896 E. Zutter	<i>Switzerland</i>	1932 St. Pelle	<i>Hungary</i>
1924 G. Wilhelm	<i>Switzerland</i>	1936 K. Frey	<i>Germany</i>
1928 P. Hanggi	<i>Switzerland</i>		
<b>Rings</b>			
1896 M. Mitropoulos	<i>Greece</i>	1932 M. Gulack	<i>U.S.A.</i>
1924 L. Martino	<i>Italy</i>	1936 A. Hudec	<i>Czechoslovakia</i>
1928 L. Stukely	<i>Yugoslavia</i>		
<b>Free Exercises</b>			
1932 St. Pelle	<i>Hungary</i>	1936 G. Miez	<i>Switzerland</i>
<b>Horizontal Bar</b>			
1896 P. Weingartner	<i>Germany</i>	1932 L. Bixler	<i>U.S.A.</i>
1924 A. Stukely	<i>Yugoslavia</i>	1936 A. Saarvala	<i>Finland</i>
1928 G. Miez	<i>Switzerland</i>		
<b>Women's Team</b>			
1928 <i>Holland</i>		1936 <i>Germany</i>	

XIV OLYMPIAD

**1 FINLAND**

Name	Free Exercises				Pommelled Horse				Rings			
	Compulsory	Voluntary	Total	Place	Compulsory	Voluntary	Total	Place	Compulsory	Voluntary	Total	Place
1 Huhtanen, V. ....	17.8	18.5	36.3	= 34	19.2	19.5	38.7	= 1	18.7	19.1	37.8	= 11
2 Aaltonen, P. ....	18.5	18.0	36.5	= 29	19.2	19.5	38.7	= 1	18.7	18.6	37.3	= 17
3 Laitinen, K. ....	18.75	18.4	37.15	13	17.5	19.4	36.9	= 19	18.6	18.8	37.4	16
4 Rove, O. ....	17.9	17.9	35.8	= 47	17.9	18.6	36.5	= 23	18.8	19.1	37.9	= 9
5 Teraesvirta, E. ....	17.6	18.2	35.8	= 47	18.2	18.8	37.0	18	18.4	18.4	36.8	= 27
6 Savolainen, H. ....	17.55	17.1	34.65	58	19.3	19.4	38.7	= 1	19.0	19.1	38.1	8
7 Saarvala, A. ....	17.9	16.0	33.9	= 67	19.2	18.5	37.7	= 5	18.5	18.8	37.3	= 17
8 Salmi, S. ....	17.05	15.0	32.05	79	16.9	18.3	35.2	= 45	18.7	18.6	37.3	= 17
<b>TOTAL</b> .....	<b>143.05</b>	<b>139.1</b>	<b>282.15</b>		<b>147.4</b>	<b>152.0</b>	<b>299.4</b>		<b>149.4</b>	<b>150.5</b>	<b>299.9</b>	

**2 SWITZERLAND**

Name	Free Exercises				Pommelled Horse				Rings			
	Compulsory	Voluntary	Total	Place	Compulsory	Voluntary	Total	Place	Compulsory	Voluntary	Total	Place
1 Lehmann, W. ....	18.3	18.2	36.5	= 29	18.4	19.2	37.6	11	19.2	19.2	38.4	4
2 Stalder, J. ....	18.6	18.4	37.0	= 16	19.3	18.4	37.7	= 8	18.8	19.5	38.3	= 5
3 Kipfer, C. ....	18.4	18.1	36.5	= 29	18.3	18.9	37.2	= 14	18.8	19.0	37.8	= 11
4 Studer, E. ....	18.8	17.2	36.0	= 41	18.7	19.0	37.7	= 8	18.9	19.4	38.3	= 5
5 Lucy, R. ....	18.3	17.7	36.0	= 41	18.8	18.3	37.1	= 16	18.3	18.7	37.0	24
6 Reusch, M. ....	16.2	17.7	33.9	= 67	18.6	19.2	37.8	7	19.5	19.6	39.1	2
7 Thalmann, M. ....	18.5	18.1	36.6	= 25	18.3	18.2	36.5	= 23	17.8	18.7	36.5	31
8 Frei, K. ....	17.0	18.0	35.0	56	18.5	17.9	36.4	= 26	19.8	19.8	39.6	1
<b>TOTAL</b> .....	<b>144.1</b>	<b>143.4</b>	<b>287.5</b>		<b>148.9</b>	<b>149.1</b>	<b>298.0</b>		<b>151.1</b>	<b>153.9</b>	<b>305.0</b>	

**3 HUNGARY**

Name	Free Exercises				Pommelled Horse				Rings			
	Compulsory	Voluntary	Total	Place	Compulsory	Voluntary	Total	Place	Compulsory	Voluntary	Total	Place
1 Toth, L. ....	18.7	18.1	36.8	= 21	18.1	18.2	36.3	= 30	18.4	18.9	37.3	= 17
2 Santha, L. ....	18.9	18.4	37.3	9	18.3	18.8	37.1	= 16	18.6	18.2	36.8	= 27
3 Baranyai, L. ....	18.3	17.7	36.0	= 41	17.3	19.0	36.3	= 30	18.7	19.2	37.9	= 9
4 Pataki, F. ....	19.3	19.4	38.7	1	17.6	17.6	35.2	= 45	18.9	18.9	37.8	= 11
5 Mogyorossy Klencs, J. ....	19.5	18.9	38.4	2	17.8	16.5	34.3	= 53	17.65	18.2	35.85	43
6 Varkoi, F. ....	18.8	17.5	36.3	= 34	18.4	18.0	36.4	= 26	18.9	17.8	36.7	= 29
7 Fekete, J. ....	18.2	18.4	36.6	= 25	18.4	18.5	36.9	= 19	17.8	18.6	36.4	= 32
8 Mogyorossy, G. ....	17.9	17.8	35.7	= 50	17.8	17.0	34.8	= 50	17.6	18.7	36.3	37
<b>TOTAL</b> .....	<b>149.6</b>	<b>146.2</b>	<b>295.8</b>		<b>143.7</b>	<b>143.6</b>	<b>287.3</b>		<b>146.55</b>	<b>148.5</b>	<b>295.05</b>	

**4 FRANCE**

Name	Free Exercises				Pommelled Horse				Rings			
	Compulsory	Voluntary	Total	Place	Compulsory	Voluntary	Total	Place	Compulsory	Voluntary	Total	Place
1 Dot, R. ....	18.8	19.0	37.8	4	18.2	14.2	32.4	69	18.4	18.0	36.4	= 32
2 Mathiot, M. ....	18.5	18.7	37.2	= 10	18.0	18.0	36.0	= 36	17.5	17.9	35.4	47
3 Masset, L. ...	18.1	18.8	36.9	20	19.1	18.1	37.2	= 14	17.6	18.6	36.2	38
4 Weingand, A. ....	18.3	18.2	36.5	= 29	18.4	17.3	35.7	40	18.7	18.9	37.6	14
5 Schlindwein, A. ....	18.2	18.5	36.7	24	16.8	18.0	34.8	= 50	18.5	18.7	37.2	23
6 Anger, A. ....	17.8	18.2	36.0	= 41	17.6	17.3	34.9	= 48	18.4	18.3	36.7	= 29
7 Dewolf, M. ....	17.9	18.1	36.0	= 41	18.0	18.2	36.2	35	17.6	18.8	36.4	= 32
8 Sirot, A. ....	17.5	17.9	35.4	= 53	18.0	18.3	36.3	= 30	17.8	15.9	33.7	66
<b>TOTAL</b> .....	<b>145.1</b>	<b>147.4</b>	<b>292.5</b>		<b>144.1</b>	<b>139.4</b>	<b>283.5</b>		<b>144.5</b>	<b>145.1</b>	<b>289.6</b>	

GYMNASTICS

Parallel Bars				Horizontal Bar				Long Horse				Total Points			Position in 12 Exercises			
Com-pulsory	Volun-tary	Total	Place	Com-pulsory	Volun-tary	Total	Place	Com-pulsory	Volun-tary	Total	Place	Com-pulsory	Volun-tary	Total				
1	19.7	19.6	39.3	2	19.6	19.6	39.2	3	19.5	18.9	38.4	6	114.5	115.2	229.7	1		
2	19.0	19.8	38.8	= 7	18.8	19.6	38.4	= 12	19.6	19.5	39.1	1	113.8	115.0	228.8	3		
3	19.5	18.6	38.1	= 16	19.1	19.0	38.1	14	19.3	18.7	38.0	= 10	112.75	112.9	225.65	8		
4	19.5	19.1	38.6	10	18.5	18.9	37.4	24	19.6	19.4	39.0	2	112.2	113.0	225.2	10		
5	19.5	18.9	38.4	12	19.5	19.2	38.7	8	19.3	19.0	38.3	7	112.5	112.5	225.0	12		
6	19.2	19.7	38.9	6	19.5	17.6	37.1	29	18.5	18.0	36.5	= 48	113.05	110.9	223.95	14		
7	18.2	19.4	37.6	24	19.0	19.8	38.8	= 4	18.7	18.1	36.8	= 40	111.5	110.6	222.1	17		
8	18.1	18.7	36.8	= 31	19.1	18.9	38.0	= 15	19.2	18.9	38.1	= 8	109.05	108.4	217.45	31		
				152.7	153.8	306.5		153.1	152.6	305.7		153.7	150.5	304.2		899.35	898.5	1,797.85
														Subtract points scored by 7th and 8th Competitors		439.55		
														<b>Final Team Total</b>		<b>1,358.3</b>		

Parallel Bars				Horizontal Bar				Long Horse				Total Points			Position in 12 Exercises			
Com-pulsory	Volun-tary	Total	Place	Com-pulsory	Volun-tary	Total	Place	Com-pulsory	Volun-tary	Total	Place	Com-pulsory	Volun-tary	Total				
1	19.5	19.5	39.0	5	19.7	19.7	39.4	2	19.0	19.1	38.1	= 8	114.1	114.9	229.0	2		
2	19.3	19.8	39.1	= 3	19.8	19.9	39.7	1	18.7	18.2	36.9	= 38	114.5	114.2	228.7	4		
3	19.7	19.4	39.1	= 3	19.2	19.4	38.6	= 9	19.0	18.9	37.9	= 14	113.4	113.7	227.1	5		
4	18.5	19.3	37.8	= 21	19.5	19.3	38.8	= 4	19.2	18.8	38.0	= 10	113.6	113.0	226.6	6		
5	18.9	18.9	37.8	= 21	18.6	18.9	37.5	23	19.0	18.9	37.9	= 14	111.9	111.4	223.3	15		
6	19.8	19.7	39.5	1	19.6	18.8	38.4	= 12	16.1	17.2	33.3	= 84	109.8	112.2	222.0	18		
7	19.1	18.8	37.9	20	17.6	17.9	35.5	= 46	19.0	18.6	37.6	= 20	110.3	110.3	220.6	21		
8	18.3	18.6	36.9	30	15.0	18.7	33.7	= 65	17.1	18.5	35.6	= 64	105.7	111.5	217.2	= 32		
				153.1	154.0	307.1		149.0	152.6	301.6		147.1	148.2	295.3		983.3	901.2	1,794.5
														Subtract points scored by 7th and 8th Competitors		437.8		
														<b>Final Team Total</b>		<b>1,356.7</b>		

Parallel Bars				Horizontal Bar				Long Horse				Total Points			Position in 12 Exercises			
Com-pulsory	Volun-tary	Total	Place	Com-pulsory	Volun-tary	Total	Place	Com-pulsory	Volun-tary	Total	Place	Com-pulsory	Volun-tary	Total				
1	19.1	19.1	38.2	= 14	19.0	19.6	38.6	= 9	18.9	19.1	38.0	= 10	112.2	113.0	225.2	10		
2	19.4	19.3	38.7	9	19.4	19.4	38.8	= 4	18.3	17.3	35.6	= 64	112.9	111.4	224.3	13		
3	19.3	18.8	38.1	= 16	17.7	18.8	36.5	= 38	18.7	18.9	37.6	= 20	110.0	112.4	222.4	16		
4	19.1	18.9	38.0	= 18	14.0	19.1	33.1	= 68	19.0	19.5	38.5	= 3	107.9	113.4	221.3	19		
5	17.4	18.5	35.9	= 39	18.0	18.0	36.0	= 42	18.9	19.6	38.5	= 3	109.25	109.7	218.95	27		
6	17.8	18.8	36.6	34	16.6	18.1	34.7	55	18.6	19.4	38.0	= 10	109.1	109.6	218.7	29		
7	18.5	18.6	37.1	28	17.4	16.3	33.7	= 65	18.7	19.2	37.9	= 14	109.0	109.6	218.6	30		
8	18.1	18.3	36.4	= 35	18.0	18.8	36.8	31	18.2	16.1	34.3	= 77	107.6	106.7	214.3	= 38		
				148.7	150.3	299.0		140.1	148.1	288.2		149.3	149.1	298.4		877.95	885.8	1,763.75
														Subtract points scored by 7th and 8th Competitors		432.9		
														<b>Final Team Total</b>		<b>1,330.85</b>		

Parallel Bars				Horizontal Bar				Long Horse				Total Points			Position in 12 Exercises			
Com-pulsory	Volun-tary	Total	Place	Com-pulsory	Volun-tary	Total	Place	Com-pulsory	Volun-tary	Total	Place	Com-pulsory	Volun-tary	Total				
1	19.1	18.9	38.0	= 18	19.3	19.5	38.8	= 4	19.1	18.3	37.4	= 26	112.9	107.9	220.8	20		
2	18.9	19.3	38.2	= 14	18.5	19.3	37.8	19	18.2	17.6	35.8	= 60	109.6	110.8	220.4	22		
3	18.6	15.75	34.35	61	19.3	19.2	38.5	11	18.8	18.0	36.8	= 40	111.5	108.45	219.95	24		
4	18.2	18.8	37.0	29	18.9	18.7	37.6	= 20	17.7	17.7	35.4	67	110.2	109.6	219.8	25		
5	18.0	17.4	35.4	= 49	16.8	19.2	36.0	= 42	18.3	18.1	36.4	= 50	106.6	109.9	216.5	34		
6	18.6	18.2	36.8	= 31	19.0	18.6	37.6	= 20	16.0	18.4	34.4	= 75	107.4	109.0	216.4	35		
7	18.2	17.5	35.7	= 44	16.2	18.6	34.8	= 53	18.0	17.3	35.3	= 68	105.9	108.5	214.4	= 36		
8	17.6	18.0	35.6	48	18.6	19.3	37.9	= 17	17.1	18.1	35.2	70	106.6	107.5	214.1	= 40		
				147.2	143.85	291.05		146.6	152.4	299.0		143.2	143.5	286.7		870.7	871.65	1,742.35
														Subtract points scored by 7th and 8th Competitors		428.5		
														<b>Final Team Total</b>		<b>1,313.85</b>		

XIV OLYMPIAD

**5 ITALY**

Name	Free Exercises				Pommel Horse				Rings			
	Compulsory	Voluntary	Total	Place	Compulsory	Voluntary	Total	Place	Compulsory	Voluntary	Total	Place
1 Figone, G. ....	18.9	18.1	37.0	= 16	19.0	19.2	38.2	5	18.3	17.8	36.1	39
2 Zanetti, L. ....	18.6	18.6	37.2	= 10	18.9	19.4	38.3	4	16.2	17.9	34.1	62
3 Guglielmetti, A. ....	15.0	17.3	32.3	= 76	18.2	18.7	36.9	= 19	17.7	18.3	36.0	= 40
4 Grosso, D. ....	17.7	16.9	34.6	59	18.5	18.1	36.6	22	17.0	17.2	34.2	= 60
5 Vadi, Quinto ....	17.1	17.0	34.1	= 65	18.4	19.0	37.4	13	17.6	16.8	34.4	= 57
6 Fioravanti, D. ....	17.9	18.4	36.3	= 34	18.1	16.3	34.4	52	17.3	16.2	33.5	= 67
7 Perego, E. ....	18.3	17.0	35.3	54	18.9	18.6	37.5	12	13.8	14.7	28.5	101
8 Armelloni, E. ....	15.9	16.7	32.6	75	18.4	17.5	35.9	38	15.75	17.3	33.05	72
<b>TOTAL</b> .....	<b>139.4</b>	<b>140.0</b>	<b>279.4</b>		<b>148.4</b>	<b>146.8</b>	<b>295.2</b>		<b>133.65</b>	<b>136.2</b>	<b>269.85</b>	

**6 CZECHOSLOVAKIA**

Name	Free Exercises				Pommel Horse				Rings			
	Compulsory	Voluntary	Total	Place	Compulsory	Voluntary	Total	Place	Compulsory	Voluntary	Total	Place
1 Ruzicka, Z. ....	19.1	19.0	38.1	<b>3</b>	18.8	17.5	36.3	= 30	18.8	19.7	38.5	3
2 Benetka, P. ....	18.9	18.7	37.6	= 6	18.1	15.5	33.6	= 59	18.0	18.9	36.9	= 27
3 Malek, M. ....	17.5	17.6	35.1	55	17.0	16.1	33.1	63	17.4	19.0	36.4	= 32
4 Karas, V. ....	18.8	18.6	37.4	8	17.2	16.4	33.6	= 59	18.9	19.3	38.2	7
5 Sotornik, L. ....	18.8	18.8	37.6	= 6	17.0	14.4	31.4	76	18.8	18.5	37.3	= 17
6 Wirth, F. ....	17.8	17.35	34.55	60	18.3	15.6	33.9	57	16.6	16.4	33.0	73
7 Petracek, V. ....	16.0	18.2	34.2	64	15.6	16.7	32.3	70	18.4	18.5	36.9	= 25
8 Hruby, G. ....	18.1	18.0	36.1	= 38	18.7	16.9	35.6	= 41	17.0	18.5	35.5	= 46
<b>TOTAL</b> .....	<b>144.4</b>	<b>146.25</b>	<b>290.65</b>		<b>140.7</b>	<b>129.1</b>	<b>269.8</b>		<b>143.9</b>	<b>148.8</b>	<b>292.7</b>	

**7 U.S.A.**

Name	Free Exercises				Pommel Horse				Rings			
	Compulsory	Voluntary	Total	Place	Compulsory	Voluntary	Total	Place	Compulsory	Voluntary	Total	Place
1 Scrobe, E. ....	17.9	16.4	34.3	63	17.4	18.2	35.6	= 41	17.8	16.8	34.6	= 54
2 D'Autorio, V. ....	18.1	18.7	36.8	= 21	18.7	16.5	35.2	= 45	16.3	16.6	32.9	75
3 Roetzheim, W. ....	18.55	17.75	36.3	= 34	18.5	17.9	36.4	= 26	14.5	13.4	27.9	102
4 Kotys, J. ....	16.3	18.5	34.8	57	17.9	18.6	36.5	= 23	15.2	14.2	29.4	99
5 Cumiskey, F. ....	17.4	13.75	31.15	84	18.8	19.1	37.9	6	15.5	14.8	30.3	96
6 Sorensen, R. ....	16.75	16.7	33.45	72	17.8	17.8	35.6	= 41	16.8	14.2	31.0	= 19
7 Bonsall, W. ....	17.95	15.25	33.2	73	16.1	17.1	33.2	62	16.05	15.7	31.75	87
8 Bordo, L. ....	17.6	—	17.6	116	12.0	—	12.0	= 117	16.75	—	16.75	115
<b>TOTAL</b> .....	<b>140.55</b>	<b>117.05</b>	<b>257.6</b>		<b>137.2</b>	<b>125.2</b>	<b>262.4</b>		<b>128.9</b>	<b>105.7</b>	<b>234.6</b>	

**8 DENMARK**

Name	Free Exercises				Pommel Horse				Rings			
	Compulsory	Voluntary	Total	Place	Compulsory	Voluntary	Total	Place	Compulsory	Voluntary	Total	Place
1 Jessen, P. ....	17.9	18.7	36.6	= 25	17.7	16.1	33.8	58	17.8	18.2	36.0	= 40
2 Gronne, T. ....	18.45	19.2	37.65	5	18.0	14.25	32.25	71	18.6	18.9	37.5	15
3 Jensen, F. ....	18.7	18.3	37.0	= 16	18.1	16.2	34.3	= 53	17.5	17.8	35.3	48
4 Thomsen, A. ....	18.3	18.3	36.6	= 25	15.25	16.4	31.65	73	17.7	17.4	35.1	49
5 Moller, V. ....	18.7	18.3	37.0	= 16	14.75	13.95	28.7	82	17.3	17.4	34.7	53
6 Jensen, P. ....	18.0	17.7	35.7	= 50	16.3	13.0	29.3	80	16.4	17.8	34.2	= 60
7 Olesen, G. ....	18.4	18.4	36.8	= 21	14.3	13.0	27.3	85	16.7	17.9	34.6	= 54
8 Minerth, B. ....	19.0	—	19.0	115	16.0	—	16.0	109	17.8	—	17.8	114
<b>TOTAL</b> .....	<b>147.45</b>	<b>128.9</b>	<b>276.35</b>		<b>130.4</b>	<b>102.9</b>	<b>233.3</b>		<b>139.8</b>	<b>125.4</b>	<b>265.2</b>	

GYMNASTICS

Parallel Bars				Horizontal Bar				Long Horse				Total Points			Position in 12 Exercises	
Com-pulsory	Volun-tary	Total	Place	Com-pulsory	Volun-tary	Total	Place	Com-pulsory	Volun-tary	Total	Place	Com-pulsory	Volun-tary	Total		
1	19.3	19.0	38.3	= 13	19.2	18.8	38.0	= 15	19.1	18.6	37.7	= 18	113.8	111.5	225.3	9
2	18.9	18.4	37.3	= 26	19.0	18.3	37.3	= 25	16.8	18.0	34.8	= 73	108.4	110.6	219.0	26
3	19.1	19.4	38.5	= 11	18.9	18.3	37.2	= 27	18.0	18.3	36.3	= 55	106.9	110.3	217.2	= 32
4	17.7	17.7	35.4	= 49	18.5	18.1	36.6	= 33	18.5	18.2	36.7	= 44	107.9	106.2	214.1	= 40
5	17.5	18.2	35.7	= 44	18.4	18.2	36.6	= 33	18.0	17.8	35.8	= 60	107.0	107.0	214.0	= 42
6	17.4	18.5	35.9	= 39	18.1	18.5	36.6	= 33	16.0	18.0	34.0	= 79	104.8	105.9	210.7	51
7	15.6	17.8	33.4	= 71	18.4	17.0	35.4	= 49	18.2	18.0	36.2	= 56	103.2	103.1	206.3	57
8	17.6	17.4	35.0	= 52	18.3	16.5	34.8	= 53	6.0	17.7	23.7	= 110	91.95	103.1	195.05	72
143.1	146.4	289.5		148.8	143.7	292.5		130.6	144.6	275.2		843.95	857.7	1,701.65		
Subtract points scored by 7th and 8th Competitors														401.35		
<b>Final Team Total</b>														<b>1,300.3</b>		

Parallel Bars				Horizontal Bar				Long Horse				Total Points			Position in 12 Exercises	
Com-pulsory	Volun-tary	Total	Place	Com-pulsory	Volun-tary	Total	Place	Com-pulsory	Volun-tary	Total	Place	Com-pulsory	Volun-tary	Total		
1	19.6	19.2	38.8	= 7	19.5	18.4	37.9	= 17	17.9	18.7	36.6	= 46	113.7	112.5	226.2	7
2	18.8	18.5	37.3	= 26	18.7	18.9	37.6	= 20	18.2	19.1	37.3	= 28	110.7	109.6	220.3	23
3	17.4	17.1	34.5	= 56	18.3	18.3	36.6	= 33	18.6	18.6	37.2	= 30	106.2	106.7	212.9	47
4	18.8	17.9	36.7	= 33	17.3	16.6	33.9	= 61	14.4	18.0	32.4	= 89	105.4	106.8	212.2	48
5	18.6	16.2	34.8	= 53	14.0	17.2	31.2	= 79	19.1	19.4	38.5	= 3	106.3	104.5	210.8	50
6	18.7	15.45	34.15	= 64	18.6	18.6	37.2	= 27	18.4	18.5	36.9	= 38	107.8	101.9	209.7	52
7	17.6	17.7	35.3	= 51	16.0	15.3	31.3	= 77	15.8	17.5	33.3	= 84	99.4	103.9	203.3	65
8	16.8	10.0	26.8	= 102	15.3	6.0	21.3	= 103	18.7	19.1	37.8	= 17	104.6	88.5	193.1	74
146.3	132.05	278.35		137.7	129.3	267.0		141.1	148.9	290.0		854.1	834.4	1,688.5		
Subtract points scored by 7th and 8th Competitors														396.4		
<b>Final Team Total</b>														<b>1,292.1</b>		

Parallel Bars				Horizontal Bar				Long Horse				Total Points			Position in 12 Exercises	
Com-pulsory	Volun-tary	Total	Place	Com-pulsory	Volun-tary	Total	Place	Com-pulsory	Volun-tary	Total	Place	Com-pulsory	Volun-tary	Total		
1	18.8	19.0	37.8	= 21	18.8	17.8	36.6	= 33	16.7	18.3	35.0	= 71	107.4	106.5	213.9	44
2	16.6	17.9	34.5	= 56	18.0	17.4	35.4	= 49	18.6	17.9	36.5	= 48	106.3	105.0	211.3	49
3	18.3	17.7	36.0	= 38	17.8	18.6	36.4	= 40	18.3	17.8	36.1	= 58	105.95	103.15	209.1	53
4	18.9	18.5	37.4	= 25	17.2	16.8	34.0	= 59	18.7	17.7	36.4	= 50	104.2	104.3	208.5	55
5	16.2	17.8	34.0	= 66	18.6	18.7	37.3	= 25	18.5	16.0	34.5	= 74	105.0	100.15	205.15	62
6	15.6	17.5	33.1	= 72	17.2	18.3	35.5	= 46	18.6	17.3	35.9	= 59	102.75	101.8	204.55	63
7	15.8	17.3	33.1	= 72	15.25	17.7	32.95	= 71	18.5	19.0	37.5	= 23	99.65	102.05	201.7	69
8	14.9	—	14.9	= 117	15.75	—	15.75	= 114	—	—	—	= —	77.0	—	77.0	119
135.1	125.7	260.8		138.6	125.3	263.9		127.9	124.0	251.9		808.25	722.95	1,531.2		
Subtract points scored by 7th and 8th Competitors														278.7		
<b>Final Team Total</b>														<b>1,252.5</b>		

Parallel Bars				Horizontal Bar				Long Horse				Total Points			Position in 12 Exercises	
Com-pulsory	Volun-tary	Total	Place	Com-pulsory	Volun-tary	Total	Place	Com-pulsory	Volun-tary	Total	Place	Com-pulsory	Volun-tary	Total		
1	18.0	17.8	35.8	= 41	17.2	17.8	35.0	= 52	18.6	18.5	37.1	= 32	107.1	107.1	214.3	= 38
2	17.9	17.9	35.8	= 41	16.2	16.9	33.1	= 68	18.4	18.8	37.2	= 30	107.55	105.95	213.5	45
3	17.6	16.5	34.1	= 65	15.75	18.2	33.95	= 60	15.6	18.1	33.7	= 82	103.25	105.1	208.35	56
4	17.6	14.5	32.1	= 77	15.5	17.8	33.3	= 67	18.6	18.9	37.5	= 23	102.95	103.3	206.25	58
5	15.0	16.9	31.9	= 78	14.75	17.1	31.85	= 75	19.3	18.3	37.6	= 20	99.8	101.95	201.75	68
6	17.8	15.75	33.55	= 70	16.4	16.4	32.8	= 72	18.7	17.0	35.7	= 63	103.6	97.65	201.25	70
7	17.8	16.5	34.3	= 62	6.0	16.9	22.9	= 100	18.9	18.5	37.4	= 26	92.1	101.2	193.3	73
8	19.0	15.5	34.5	= 56	16.8	15.1	31.9	= 74	18.4	18.7	37.1	= 32	107.0	49.3	156.3	100
140.7	131.35	272.05		118.6	136.2	254.8		146.5	146.8	293.3		823.45	771.55	1,595.0		
Subtract points scored by 7th and 8th Competitors														349.6		
<b>Final Team Total</b>														<b>1,245.4</b>		

**9 AUSTRIA**

Name	Free Exercises				Pommel Horse				Rings			
	Com-pulsory	Volun-tary	Total	Place	Com-pulsory	Volun-tary	Total	Place	Com-pulsory	Volun-tary	Total	Place
1 Wister, E. ....	17.9	19.3	37.2	= 10	18.0	18.4	36.4	= 26	17.8	17.9	35.7	= 44
2 Bohusch, K. ....	18.6	18.5	37.1	= 14	17.9	18.4	36.3	= 30	16.4	17.5	33.9	= 63
3 Friedrich, H. ....	17.9	18.6	36.5	= 29	18.1	15.4	33.5	61	14.0	17.3	31.3	89
4 Schreyer, W. ....	17.8	18.3	36.1	= 38	16.9	18.0	34.9	= 48	16.5	15.7	32.2	= 83
5 Sauter, J. ....	17.0	16.75	33.75	70	18.1	17.9	36.0	= 36	16.2	15.6	31.8	86
6 Pranz, R. ....	13.0	15.75	28.75	95	13.5	18.1	31.6	= 74	15.5	14.3	29.8	98
7 Hermann, G. ....	15.5	—	15.5	118	16.4	—	16.4	108	14.25	—	14.25	117
8 Welt, W. ....	—	—	—	—	—	—	—	—	—	—	—	—
TOTAL.....	117.7	107.2	224.9		118.9	106.2	225.1		110.65	98.3	208.95	

**10 YUGOSLAVIA**

Name	Free Exercises				Pommel Horse				Rings			
	Com-pulsory	Volun-tary	Total	Place	Com-pulsory	Volun-tary	Total	Place	Com-pulsory	Volun-tary	Total	Place
1 Grilec, K. ....	16.25	18.1	34.35	= 61	17.7	17.9	35.6	= 41	17.7	17.1	34.8	52
2 Kujundzic, J. ....	18.5	18.6	37.1	= 14	15.4	16.6	32.0	72	14.5	18.0	32.5	= 78
3 Longika, B. ....	17.5	18.2	35.7	= 50	14.1	15.5	29.6	78	16.0	16.6	32.6	77
4 Jelic, D. ....	13.0	16.9	29.9	91	17.0	15.75	32.75	= 66	15.0	17.4	32.4	80
5 Jelic, I. ....	16.0	15.75	31.75	81	16.2	16.7	32.9	64	16.0	18.3	34.3	59
6 Boltizar, S. ....	17.0	16.8	33.8	69	15.8	17.0	32.8	65	16.9	16.6	33.5	= 67
7 Subelj, J. ....	15.95	17.2	33.15	74	14.5	14.75	29.25	81	12.0	15.8	27.8	103
8 Janez, K. ....	14.0	15.85	29.85	92	13.6	10.0	23.6	95	9.5	12.3	21.8	111
TOTAL.....	128.2	137.4	265.6		124.3	124.2	248.5		117.6	132.1	249.7	

**11 LUXEMBOURG**

Name	Free Exercises				Pommel Horse				Rings			
	Com-pulsory	Volun-tary	Total	Place	Com-pulsory	Volun-tary	Total	Place	Com-pulsory	Volun-tary	Total	Place
1 Kugeler, J. ....	17.7	18.4	36.1	= 38	16.7	17.5	34.2	56	18.7	18.6	37.3	= 17
2 Stoffel, J. ....	17.4	18.4	35.8	= 47	16.0	16.5	32.5	68	17.8	18.2	36.0	= 40
3 Welfring, P. ....	15.4	18.1	33.5	71	10.0	15.0	25.0	91	17.1	15.2	32.3	= 81
4 Schroeder, R. ....	17.75	18.2	35.95	46	10.5	11.0	21.5	= 100	17.2	18.5	35.7	= 44
5 Krecke, J. ....	14.75	17.4	32.15	78	11.2	14.0	25.2	90	16.8	14.6	31.4	88
6 Schmitz, P. ....	9.0	16.8	25.8	102	9.8	12.75	22.55	99	17.0	15.7	32.7	76
7 Bernard, J. ....	13.75	16.5	30.25	88	7.0	12.75	19.75	104	16.6	15.9	32.5	= 78
8 Wengler, G. ....	12.75	14.9	27.65	98	15.25	13.0	28.25	83	16.9	15.4	32.3	= 81
TOTAL.....	118.5	138.7	257.2		96.45	112.5	208.95		138.1	132.1	270.2	

**12 GREAT BRITAIN**

Name	Free Exercises				Pommel Horse				Rings			
	Com-pulsory	Volun-tary	Total	Place	Com-pulsory	Volun-tary	Total	Place	Com-pulsory	Volun-tary	Total	Place
1 Weedon, G. ....	16.0	18.1	34.1	= 65	15.5	16.1	31.6	= 74	16.8	14.4	31.2	90
2 Turner, F. ....	17.55	16.8	34.35	= 61	17.0	15.75	32.75	= 66	17.6	16.8	34.4	= 57
3 Buffin, K. ....	16.05	15.5	31.55	82	14.95	12.25	27.2	86	14.5	14.8	29.3	100
4 Wales, A. ....	15.0	15.5	30.5	87	17.6	18.2	35.8	39	16.95	16.2	33.15	71
5 May, P. ....	15.5	14.5	30.0	= 89	14.0	12.75	26.75	87	14.5	16.3	30.8	93
6 Flaherty, J. ....	9.5	13.75	23.25	111	12.0	14.5	26.5	88	17.4	16.5	33.9	= 63
7 Hopkins, G. ....	13.5	12.25	25.75	= 103	11.45	12.5	23.95	94	12.0	11.0	23.0	108
8 Vice, I. ....	13.5	15.0	28.5	96	11.0	12.5	23.5	96	11.5	12.1	23.6	107
TOTAL.....	116.6	121.4	238.0		113.5	114.55	228.05		121.25	118.1	239.35	

GYMNASTICS

Parallel Bars				Horizontal Bar				Long Horse				Total Points			Position in 12 Exercises				
Com-pulsory	Volun-tary	Total	Place	Com-pulsory	Volun-tary	Total	Place	Com-pulsory	Volun-tary	Total	Place	Com-pulsory	Volun-tary	Total					
1	18.1	18.0	36.1	37	19.3	16.5	35.8	45	18.7	19.0	37.7	= 18	109.8	109.1	218.9	28 = 36 59 61 66 99 114 123			
2	17.2	16.6	33.8	68	18.9	17.8	36.7	32	18.4	18.2	36.6	= 46	107.4	107.0	214.4				
3	18.3	18.1	36.4	= 35	18.0	13.3	31.3	= 77	18.6	18.2	36.8	= 40	104.9	100.9	205.8				
4	16.1	16.9	33.0	74	18.8	17.3	36.1	41	14.2	18.9	33.1	87	100.3	105.1	205.4				
5	18.3	15.95	34.25	63	17.5	16.9	34.4	= 57	14.4	18.5	32.9	88	101.5	101.6	203.1				
6	10.5	13.5	24.0	107	13.0	16.4	29.4	87	5.0	16.0	21.0	112	70.5	94.05	164.55				
7	17.8	14.5	32.3	76	18.0	17.1	35.1	51	6.0	12.75	18.75	115	87.95	44.35	132.3				
8	2.0	—	2.0	122	—	—	—	—	—	—	—	—	2.0	—	2.0				
118.3					123.5					121.55					684.35			662.1	1,346.45
Subtract points scored by 7th and 8th Competitors															134.3				
<b>Final Team Total</b>															<b>1,212.15</b>				

Parallel Bars				Horizontal Bar				Long Horse				Total Points			Position in 12 Exercises				
Com-pulsory	Volun-tary	Total	Place	Com-pulsory	Volun-tary	Total	Place	Com-pulsory	Volun-tary	Total	Place	Com-pulsory	Volun-tary	Total					
1	18.9	16.8	35.7	= 44	18.4	17.5	35.9	44	17.5	19.2	36.7	= 44	106.45	106.6	213.05	46 54 71 75 76 78 85 103			
2	17.4	17.1	34.5	= 56	17.5	18.0	35.5	= 46	18.1	19.2	37.3	= 28	101.4	107.5	208.9				
3	18.1	13.0	31.1	86	17.4	16.5	33.9	= 61	18.3	19.2	37.5	= 23	101.4	99.0	200.4				
4	14.4	14.05	28.45	= 96	17.4	16.5	33.9	= 61	17.2	87.2	34.4	= 75	94.0	97.8	191.8				
5	14.5	14.5	29.0	= 92	14.0	13.0	27.0	92	18.0	16.8	36.8	= 40	94.7	97.05	191.75				
6	14.9	15.8	30.7	= 87	10.5	15.6	26.1	95	15.3	11.7	32.0	91	90.4	98.5	188.9				
7	13.8	11.0	24.8	105	10.0	16.4	26.4	93	18.2	18.9	37.1	= 32	84.45	94.05	178.5				
8	14.5	14.5	29.0	= 92	8.0	8.0	16.0	113	13.8	18.4	32.2	90	73.4	79.05	152.45				
126.5					113.2					147.6					746.2			779.55	1,525.75
Subtract points scored by 7th and 8th Competitors															330.95				
<b>Final Team Total</b>															<b>1,194.8</b>				

Parallel Bars				Horizontal Bar				Long Horse				Total Points			Position in 12 Exercises				
Com-pulsory	Volun-tary	Total	Place	Com-pulsory	Volun-tary	Total	Place	Com-pulsory	Volun-tary	Total	Place	Com-pulsory	Volun-tary	Total					
1	17.6	17.2	34.8	= 53	16.0	18.6	34.6	56	18.3	18.7	37.0	= 36	105.0	109.0	214.0	= 42 64 77 80 84 90 91 96			
2	17.7	13.5	31.2	= 84	14.75	16.7	31.45	76	18.2	18.2	36.4	= 50	101.85	101.5	203.35				
3	16.2	11.25	27.45	= 99	16.2	17.7	33.9	= 61	18.3	18.8	37.1	= 32	93.2	96.05	189.25				
4	14.0	15.25	29.25	91	15.5	14.8	30.3	82	16.8	18.5	35.3	= 68	91.75	96.25	188.0				
5	14.7	14.25	28.95	94	11.75	15.6	27.35	91	17.6	17.9	35.5	66	86.8	93.75	180.55				
6	14.0	13.25	27.25	101	15.0	16.2	31.2	= 79	17.7	18.1	35.8	= 60	82.5	92.8	175.3				
7	13.2	13.5	26.7	103	15.0	17.0	32.0	73	15.3	15.9	31.2	94	80.85	91.55	172.4				
8	10.5	13.25	23.75	108	9.25	13.9	23.15	99	15.6	16.0	31.6	92	80.25	86.45	166.7				
117.9					113.45					142.1					722.2			767.35	1,489.55
Subtract points scored by 7th and 8th Competitors															339.1				
<b>Final Team Total</b>															<b>1,150.45</b>				

Parallel Bars				Horizontal Bar				Long Horse				Total Points			Position in 12 Exercises				
Com-pulsory	Volun-tary	Total	Place	Com-pulsory	Volun-tary	Total	Place	Com-pulsory	Volun-tary	Total	Place	Com-pulsory	Volun-tary	Total					
1	18.0	17.8	35.8	= 41	18.1	18.4	36.5	= 38	18.2	18.2	36.4	= 50	102.6	103.0	205.6	60 67 79 83 92 98 111 112			
2	17.7	18.0	35.7	= 44	13.0	16.2	29.2	88	18.1	18.1	36.2	= 56	100.95	101.65	202.6				
3	16.3	15.0	31.3	82	17.4	17.0	34.4	= 57	17.7	17.2	34.9	72	96.9	91.75	188.65				
4	16.5	17.4	33.9	67	12.25	17.2	29.45	86	5.0	13.0	18.0	116	83.3	97.5	180.8				
5	15.0	16.2	31.2	= 84	6.0	13.5	19.5	105	16.0	17.2	33.2	86	81.0	90.45	171.45				
6	16.0	12.75	28.75	95	18.0	18.9	36.9	30	6.0	10.0	16.0	117	78.9	86.4	165.3				
7	7.5	13.75	21.25	111	5.25	8.5	13.75	117	14.1	13.0	27.1	106	63.8	71.0	134.8				
8	1.0	15.25	16.25	116	4.5	8.5	13.0	118	13.65	16.0	29.65	99	55.15	79.35	134.5				
108.0					94.5					122.7					662.6			721.1	1,383.7
Subtract points scored by 7th and 8th Competitors															269.3				
<b>Final Team Total</b>															<b>1,114.4</b>				



XIV OLYMPIAD

**13 EGYPT**

Name	Free Exercises				Pommelled Horse				Rings			
	Com-pulsory	Volun-tary	Total	Place	Com-pulsory	Volun-tary	Total	Place	Com-pulsory	Volun-tary	Total	Place
1 Attia, A .....	15.5	14.5	30.0	= 89	6.3	11.75	18.05	106	17.7	18.7	36.4	= 32
2 Abd El Al, Moustafa .....	14.25	12.75	27.0	100	12.0	13.75	25.75	89	17.0	17.5	34.5	56
3 Roushdi, M. ....	10.0	13.75	23.75	109	10.6	12.75	23.35	= 97	16.9	18.1	35.0	50
4 Khalaf Ala, A. ....	13.25	13.0	26.25	101	11.6	13.25	24.85	92	15.0	15.7	30.7	94
5 El Hefnawi, A. ....	17.0	15.0	32.0	80	5.3	9.75	15.05	110	15.0	15.5	30.5	95
6 Aly, M. ....	16.1	15.0	31.1	85	3.5	9.0	12.5	116	17.3	13.7	31.0	= 91
7 Abd El Al, Mahmoud .....	14.75	13.25	28.0	97	4.8	9.25	14.05	112	16.0	17.2	33.2	= 69
8 Giddawi, A. ....	13.0	11.75	24.75	106	5.5	9.0	14.5	111	12.0	14.4	26.4	104
TOTAL .....	113.85	109.0	222.85		59.6	88.5	148.1		126.9	130.8	257.7	

**14 CUBA**

Name	Free Exercises				Pommelled Horse				Rings			
	Com-pulsory	Volun-tary	Total	Place	Com-pulsory	Volun-tary	Total	Place	Com-pulsory	Volun-tary	Total	Place
1 Lecuona Asencio, R. ....	14.75	14.5	29.25	93	18.0	16.3	34.3	= 53	16.8	15.2	32.0	85
2 Lecuona Asencio, F. ....	11.0	14.3	25.3	105	16.5	13.0	29.5	79	17.1	16.8	33.9	= 63
3 Aguiar Garcia, A. ....	16.25	14.75	31.0	86	10.2	10.0	20.2	103	16.8	18.1	34.9	51
4 Rey Carcano, R. ....	16.3	15.0	31.3	83	15.1	14.75	29.85	77	9.75	10.5	20.25	112
5 Rubiera Fernandez, B. ....	11.5	12.3	23.8	108	10.5	11.0	21.5	= 100	16.05	16.9	32.95	74
6 Villacian Alemany, R. ....	12.75	14.5	27.25	99	14.4	10.0	24.4	93	17.2	16.0	33.2	= 69
7 Dias Corpion, A. ....	14.25	14.8	29.05	94	14.5	13.25	27.75	84	13.0	13.2	26.2	105
TOTAL .....	96.8	100.15	196.95		99.2	88.3	187.5		106.7	106.7	213.4	

**15 ARGENTINE**

Name	Free Exercises				Pommelled Horse				Rings			
	Com-pulsory	Volun-tary	Total	Place	Com-pulsory	Volun-tary	Total	Place	Com-pulsory	Volun-tary	Total	Place
1 Amos, A .....	16.0	16.3	32.3	= 76	9.1	14.25	23.35	= 97	14.0	12.1	26.1	106
2 Lonchibucco, P. ....	12.25	13.5	25.75	= 103	6.0	12.5	18.5	105	16.2	16.0	32.2	= 83
3 Rapesta, E. ....	11.5	13.0	24.5	107	10.0	11.5	21.5	= 100	15.75	14.5	30.25	97
4 Bonoris, C. ....	10.0	13.0	23.0	112	4.0	10.0	14.0	= 113	10.5	12.0	22.5	110
5 Soler, J. ....	12.0	11.3	23.3	110	6.0	11.0	17.0	107	10.0	12.8	22.8	109
6 Nunez, R. ....	10.5	11.25	21.75	113	4.0	8.0	12.0	= 117	7.5	11.5	19.0	113
7 Vidal, J. ....	—	—	—	—	11.8	—	11.8	119	8.0	—	8.0	121
TOTAL .....	72.25	78.35	150.6		50.9	67.25	118.15		81.95	78.9	160.85	

**16 MEXICO**

Name	Free Exercises				Pommelled Horse				Rings			
	Com-pulsory	Volun-tary	Total	Place	Com-pulsory	Volun-tary	Total	Place	Com-pulsory	Volun-tary	Total	Place
1 Castro Valdes, J. ....	11.0	9.0	20.0	114	3.0	8.0	11.0	120	6.5	8.0	14.5	116
2 Lira Aviles, R. ....	9.5	7.5	17.0	117	7.5	6.5	14.0	= 113	7.0	6.2	13.2	118
3 Aguilar Gonzalez, D. ....	4.0	7.0	11.0	120	4.0	10.0	14.0	= 113	6.0	5.4	11.4	119
4 Rios Pena, E. ....	12.0	—	12.0	119	4.7	—	4.7	121	11.0	—	11.0	120
5 Villarreal Sanchez, N. ....	4.0	—	4.0	121	—	—	—	—	—	—	—	—
TOTAL .....	40.5	23.5	64.0		19.2	24.5	43.7		30.5	19.6	50.1	

GYMNASTICS

Parallel Bars				Horizontal Bar				Long Horse				Total Points			Position in 12 Exercises	
Compulsory	Voluntary	Total	Place	Compulsory	Voluntary	Total	Place	Compulsory	Voluntary	Total	Place	Compulsory	Voluntary	Total		
1	15.7	18.0	33.7	69	17.6	15.4	33.0	70	18.4	18.0	36.4	= 50	91.2	96.35	187.55	82
2	14.0	16.0	30.0	89	13.75	16.7	30.45	81	13.1	16.9	30.0	97	84.1	93.6	177.7	86
3	16.7	17.9	34.6	55	14.0	16.2	30.2	83	15.25	15.2	30.45	95	83.45	93.9	177.35	87
4	14.9	16.9	31.8	= 79	13.75	16.3	30.05	84	17.0	16.5	33.5	83	85.5	91.65	177.15	88
5	16.7	14.0	30.7	= 87	10.5	13.8	24.3	98	18.1	18.9	37.0	= 36	82.6	86.95	169.55	93
6	17.0	14.175	31.75	81	10.6	17.9	28.5	89	15.8	18.0	33.8	81	80.3	88.35	168.65	94
7	17.5	17.0	34.5	= 56	16.0	12.0	28.0	90	13.95	15.8	29.75	98	83.0	84.5	167.5	95
8	16.2	13.5	29.7	90	9.5	16.0	25.5	96	11.5	16.5	28.0	104	67.7	81.15	148.85	107
128.7	128.05	256.75			105.7	124.3	230.0		123.1	135.8	258.9		657.85	716.45	1,374.3	
Subtract points scored by 7th and 8th Competitors														316.35		
<b>Final Team Total</b>														<b>1,057.95</b>		

Parallel Bars				Horizontal Bar				Long Horse				Total Points			Position in 12 Exercises	
Compulsory	Voluntary	Total	Place	Compulsory	Voluntary	Total	Place	Compulsory	Voluntary	Total	Place	Compulsory	Voluntary	Total		
1	17.3	14.5	31.8	= 79	10.75	15.6	26.35	94	18.0	16.0	34.0	= 79	95.6	92.1	187.7	81
2	17.7	15.25	32.95	75	5.5	11.8	17.3	107	15.4	12.0	27.4	105	83.2	83.15	166.35	97
3	15.7	11.75	27.45	= 99	5.5	9.0	14.5	115	11.8	16.3	28.1	103	76.25	79.9	156.15	101
4	12.8	11.5	24.3	106	6.25	10.0	16.25	112	15.6	14.5	30.1	96	75.8	76.25	152.05	104
5	13.5	9.0	22.5	110	4.5	14.5	19.0	106	15.6	15.8	31.4	93	71.65	79.5	151.15	105
6	14.4	8.25	22.65	109	5.5	11.0	16.5	= 110	13.3	—	13.3	118	77.55	59.75	137.3	109
7	6.0	11.25	17.25	114	5.5	11.0	16.5	= 110	6.0	14.0	20.0	114	59.25	77.5	136.75	110
97.4	81.5	178.9			43.5	82.9	126.4		95.7	88.6	184.3		539.3	548.15	1,087.45	
Subtract points scored by 7th Competitor														136.75		
<b>Final Team Total</b>														<b>950.7</b>		

Parallel Bars				Horizontal Bar				Long Horse				Total Points			Position in 12 Exercises	
Compulsory	Voluntary	Total	Place	Compulsory	Voluntary	Total	Place	Compulsory	Voluntary	Total	Place	Compulsory	Voluntary	Total		
1	17.0	14.25	31.25	83	15.75	13.8	29.55	85	16.0	18.3	34.3	= 77	87.85	89.0	176.85	89
2	13.3	15.0	28.3	98	6.0	14.5	20.5	104	13.75	15.2	28.95	102	67.5	86.7	154.2	102
3	11.0	14.0	25.0	104	10.25	14.8	25.05	97	11.0	11.6	22.6	111	69.5	79.4	148.9	106
4	14.2	14.25	28.45	= 96	8.0	14.2	22.2	101	16.1	13.4	29.5	100	62.8	76.85	139.65	108
5	7.0	13.5	20.5	112	8.5	12.9	21.4	102	12.0	17.3	29.3	101	55.5	78.8	134.3	113
6	6.5	12.0	18.5	113	5.0	9.4	14.4	116	13.0	11.3	24.3	109	46.5	63.45	109.95	115
7	6.5	—	6.5	121	6.0	—	6.0	= 120	5.0	—	5.0	120	37.3	—	37.3	121
75.5	83.0	158.5			59.5	79.6	139.1		86.85	87.1	173.95		426.95	474.2	901.15	
Subtract points scored by 7th Competitor														37.3		
<b>Final Team Total</b>														<b>863.85</b>		

Parallel Bars				Horizontal Bar				Long Horse				Total Points			Position in 12 Exercises	
Compulsory	Voluntary	Total	Place	Compulsory	Voluntary	Total	Place	Compulsory	Voluntary	Total	Place	Compulsory	Voluntary	Total		
1	7.0	7.5	14.5	118	6.0	11.0	17.0	= 108	16.9	10.0	26.9	107	50.4	53.5	103.9	116
2	4.0	8.25	12.25	119	3.0	14.0	17.0	= 108	11.5	14.0	25.5	108	42.5	56.45	98.95	117
3	6.0	11.0	17.0	115	2.0	6.0	8.0	119	4.0	16.4	20.4	113	26.0	55.8	81.8	118
4	9.5	—	9.5	120	6.0	—	6.0	= 120	12.0	—	12.0	119	55.2	—	55.2	120
5	—	—	—	—	—	—	—	—	—	—	—	—	4.0	—	4.0	122
26.5	26.75	53.25			17.0	31.0	48.0		44.4	40.4	84.8		178.1	165.75	343.85	
<b>Final Team Total</b>														<b>343.85</b>		

**GYMNASTICS (Women)****1 CZECHOSLOVAKIA**

Name	Beam			Pommel Horse			Rings	Total Points			
	Compulsory	Voluntary	Total	Compulsory	Voluntary	Total	Compulsory	Compulsory	Voluntary	Total	
Honsova, Z. ....	9.15	14.25	23.4	8.4	13.45	21.85	9.6	27.15	27.7	54.85	
Misakova, M. ....	9.05	14.1	23.15	7.95	13.0	20.95	9.3	26.3	27.1	53.4	
Ruzickova, V. ....	8.9	13.5	22.4	8.2	13.5	21.7	8.9	26.0	27.0	53.0	
Srnцова, B. ....	9.2	13.75	22.95	7.55	13.15	20.7	9.3	26.05	26.9	52.95	
Mullerova, M. ....	8.3	13.75	22.05	7.75	13.5	21.25	9.2	25.25	27.25	52.5	
Vermirovska, Z. ....	6.8	14.6	21.4	7.9	12.7	20.6	8.0	22.7	27.3	50.0	
Silhanova, O. ....	6.6	13.9	20.5	7.85	12.7	20.55	8.9	23.35	26.6	49.95	
Kovarova, M. ....	5.9	12.95	18.85	7.75	13.85	21.6	9.15	22.8	26.8	49.6	
<b>Total</b> .....	<b>63.9</b>	<b>110.8</b>	<b>174.7</b>	<b>63.35</b>	<b>105.85</b>	<b>169.2</b>	<b>72.35</b>	<b>199.6</b>	<b>216.65</b>	<b>416.25</b>	
Team Exercises .....										62.8	
Team Exercises with hand apparatus .....										65.95	
Total .....										545.0	
Subtract points scored by 7th and 8th Competitors .....										99.55	
<b>Final Team Total</b>										<b>445.45</b>	

**2 HUNGARY**

Name	Beam			Pommel Horse			Rings	Total Points			
	Compulsory	Voluntary	Total	Compulsory	Voluntary	Total	Compulsory	Compulsory	Voluntary	Total	
Vasarhelyi Weckinger, E. ....	8.4	14.5	22.9	7.95	14.05	22.0	9.35	25.7	28.55	54.25	
Kovi, M. ....	8.0	14.35	22.35	7.8	14.35	22.15	8.9	24.7	28.7	53.4	
Karpati Karsics, I. ....	8.7	14.45	23.15	7.3	14.1	21.4	8.7	24.7	28.55	53.25	
Gulyas, E. ....	8.0	14.3	22.3	7.35	14.15	21.5	8.45	23.8	28.45	52.25	
Sarkany, A. ....	8.0	14.2	22.2	7.35	14.05	21.4	8.5	23.85	28.25	52.1	
Tass Todembier, O. ....	8.5	14.0	22.5	7.4	12.9	20.3	8.65	24.55	26.9	51.45	
Feher, A. ....	8.1	13.95	22.05	6.45	12.9	19.35	7.75	22.3	26.85	49.15	
Sandor, M. ....	8.45	14.15	22.6	7.45	—	7.45	9.05	24.95	14.15	39.1	
<b>Total</b> .....	<b>66.15</b>	<b>113.9</b>	<b>180.05</b>	<b>59.05</b>	<b>96.5</b>	<b>155.55</b>	<b>69.35</b>	<b>194.55</b>	<b>210.4</b>	<b>404.95</b>	
Team Exercises .....										63.75	
Team Exercises with hand apparatus .....										60.1	
Total .....										528.8	
Subtract points scored by 7th and 8th Competitors .....										88.25	
<b>Final Team Total</b>										<b>440.55</b>	

**3 U.S.A.**

Name	Beam			Pommel Horse			Rings	Total Points			
	Compulsory	Voluntary	Total	Compulsory	Voluntary	Total	Compulsory	Compulsory	Voluntary	Total	
Schifano, H. ....	8.7	14.0	22.7	8.2	13.15	21.35	7.65	24.55	27.15	51.7	
Schroth, C. ....	6.7	13.7	20.4	8.0	14.3	22.3	8.35	23.05	28.0	51.05	
Elste, M. ....	8.15	14.25	22.4	6.9	13.2	20.1	8.4	23.45	27.45	50.9	
Barone, M. ....	7.75	12.75	20.5	7.85	13.3	21.15	8.65	24.25	26.05	50.3	
Bakanic, L. ....	8.7	12.75	21.45	7.3	12.9	20.2	8.45	24.45	25.65	50.1	
Lenz, C. ....	7.6	13.0	20.6	7.75	13.15	20.9	7.6	22.95	26.15	49.1	
Simonis, A. ....	6.4	13.35	19.75	7.65	12.6	20.25	7.8	21.85	25.95	47.8	
Dalton, D. ....	7.9	13.1	21.0	7.2	12.35	19.55	7.1	22.2	25.45	47.65	
<b>Total</b> .....	<b>61.9</b>	<b>106.9</b>	<b>168.8</b>	<b>60.85</b>	<b>104.95</b>	<b>165.8</b>	<b>64.0</b>	<b>186.75</b>	<b>211.85</b>	<b>398.6</b>	
Team Exercises .....										63.2	
Team Exercises with hand apparatus .....										56.25	
Total .....										518.05	
Subtract points scored by 7th and 8th Competitors .....										95.45	
<b>Final Team Total</b>										<b>422.6</b>	

## 4 SWEDEN

Name	Beam			Pommel Horse			Rings	Total Points			
	Compulsory	Voluntary	Total	Compulsory	Voluntary	Total	Compulsory	Compulsory	Voluntary	Total	
Lindberg, K .....	8.2	12.9	21.1	8.75	14.45	23.2	8.4	25.35	27.35	52.7	
Bohman, K. ....	8.05	12.8	20.85	8.35	13.8	22.15	8.4	24.8	26.6	51.4	
Sandahl, I. ....	7.6	13.0	20.6	8.15	14.0	22.15	8.25	24.0	27.0	51.0	
Pettersson, G. ....	7.1	13.1	20.2	7.8	13.35	21.15	8.75	23.65	26.45	50.1	
Johansson, G. ....	8.15	12.35	20.5	8.2	13.8	22.0	6.6	22.95	26.15	49.1	
Andersson, M. ....	7.35	12.7	20.05	7.0	14.0	21.0	8.0	22.35	26.7	49.05	
Andersson, E. I. ....	7.2	12.1	19.3	7.0	13.75	20.75	7.05	21.25	25.85	47.1	
Haage, U. ....	5.35	11.95	17.5	—	14.1	14.1	7.7	13.05	26.05	39.1	
<b>Total</b> .....	<b>59.0</b>	<b>100.9</b>	<b>159.9</b>	<b>55.25</b>	<b>111.25</b>	<b>166.5</b>	<b>63.15</b>	<b>177.4</b>	<b>212.15</b>	<b>389.55</b>	
Team Exercises .....										63.9	
Team Exercises with hand apparatus .....										50.7	
Total .....										504.15	
Subtract points scored by 7th and 8th Competitors .....										86.2	
<b>Final Team Total</b>										<b>417.95</b>	

## 5 HOLLAND

Name	Beam			Pommel Horse			Rings	Total Points			
	Compulsory	Voluntary	Total	Compulsory	Voluntary	Total	Compulsory	Compulsory	Voluntary	Total	
Tonneman, J. ....	8.1	13.7	21.8	7.8	13.9	21.7	9.0	24.9	27.6	52.5	
Gerrietsen, H. ....	7.85	13.0	20.85	8.05	13.3	21.35	7.3	23.2	26.3	49.5	
Wijnands, J. ....	7.1	12.0	19.1	7.35	12.85	20.2	7.95	22.4	24.85	47.25	
Ros, J. ....	7.1	11.25	18.35	7.3	11.9	19.2	8.2	22.6	23.15	45.75	
Van Geene, A. ....	7.9	9.0	16.9	8.0	12.35	20.35	8.2	24.1	21.35	45.45	
Post, K. ....	7.55	9.5	17.05	7.35	12.2	19.55	8.2	23.1	21.7	44.8	
Heil-Bonnet, G. ....	—	11.95	11.95	8.4	13.25	21.65	8.95	17.35	25.2	42.55	
Meyer-Haantjes, B. ....	7.55	11.25	18.8	—	11.6	11.6	7.9	15.45	22.85	38.3	
<b>Total</b> .....	<b>53.15</b>	<b>91.65</b>	<b>144.8</b>	<b>54.25</b>	<b>101.35</b>	<b>155.6</b>	<b>65.7</b>	<b>173.1</b>	<b>193.0</b>	<b>366.1</b>	
Team Exercises .....										61.55	
Team Exercises with hand apparatus .....										61.55	
Total .....										489.2	
Subtract points scored by 7th and 8th Competitors .....										80.85	
<b>Final Team Total</b>										<b>408.35</b>	

## 6 AUSTRIA

Name	Beam			Pommel Horse			Rings	Total Points			
	Compulsory	Voluntary	Total	Compulsory	Voluntary	Total	Compulsory	Compulsory	Voluntary	Total	
Fesl, G. ....	7.8	12.95	20.75	7.8	13.7	21.5	8.8	24.4	26.65	51.05	
Hehenberger, G. ....	7.6	12.6	20.2	8.4	13.3	21.7	8.1	24.1	25.9	50.0	
Kolar, G. ....	5.75	13.4	19.15	7.4	14.05	21.45	8.05	21.2	27.45	48.65	
Ruckser, I. ....	7.15	12.5	19.65	7.8	13.4	21.2	7.5	22.45	25.9	48.35	
Gries, G. ....	7.4	12.5	19.9	7.5	12.9	20.4	7.7	22.6	25.4	48.0	
Winnige, G. ....	7.6	12.65	20.25	6.85	11.2	18.05	7.3	21.75	23.85	45.6	
Schramm, E. ....	4.75	13.65	18.4	8.05	13.4	21.45	5.25	18.05	27.05	45.1	
Enzenhofer, E. ....	0.25	12.75	13.0	7.75	13.1	20.85	5.1	13.1	25.85	38.95	
<b>TOTAL</b> .....	<b>48.3</b>	<b>103.0</b>	<b>151.3</b>	<b>61.55</b>	<b>105.05</b>	<b>166.6</b>	<b>57.8</b>	<b>167.42</b>	<b>208.05</b>	<b>375.7</b>	
Team Exercises...										60.2	
Team Exercises with hand apparatus .....										53.6	
Total ...										489.5	
Subtract points scored by 7th and 8th Competitors .....										84.05	
<b>Final Team Total</b>										<b>405.45</b>	

## 7 YUGOSLAVIA

Name	Beam			Pommel Horse			Rings	Total Points			
	Compulsory	Voluntary	Total	Compulsory	Voluntary	Total	Compulsory	Compulsory	Voluntary	Total	
Gerbec, V .....	7.25	13.45	20.7	7.15	12.85	20.0	8.3	22.7	26.3	49.0	
Djordjevic, D .....	7.35	12.15	19.5	7.55	12.9	20.45	7.65	22.55	25.05	47.6	
Vojsk, R .....	6.6	13.05	19.65	7.45	12.6	20.05	7.5	21.55	25.65	47.2	
Djipalovic, D .....	7.55	12.9	20.45	7.65	12.35	20.0	6.7	21.9	25.25	47.15	
Zutic, T .....	6.85	7.75	14.6	8.45	13.6	22.05	8.6	23.9	21.35	45.25	
Basletic, D .....	5.15	11.6	16.75	6.8	11.5	18.3	7.65	19.6	23.1	42.7	
Mijatovic, Z .....	5.5	13.85	19.35	—	13.0	13.0	8.0	13.5	26.85	40.35	
Cerne, N. ....	5.95	11.0	16.95	—	—	—	7.75	13.7	11.0	24.7	
<b>Total</b> .....	<b>52.2</b>	<b>95.75</b>	<b>147.95</b>	<b>45.05</b>	<b>88.8</b>	<b>133.85</b>	<b>62.15</b>	<b>159.4</b>	<b>184.55</b>	<b>343.95</b>	
Team Exercises .....										61.3	
Team Exercises with hand apparatus .....										57.7	
<b>Total</b> .....										<b>462.95</b>	
Subtract points scored by 7th and 8th Competitors .....										65.05	
<b>Final Team Total</b>										<b>397.9</b>	

## 8 ITALY

Name	Beam			Pommel Horse			Rings	Total Points			
	Compulsory	Voluntary	Total	Compulsory	Voluntary	Total	Compulsory	Compulsory	Voluntary	Total	
Micheli, L .....	8.65	14.05	22.7	7.8	13.8	21.6	9.35	25.8	27.85	53.65	
Santoni, E .....	7.1	12.6	19.7	7.7	13.4	21.1	6.75	21.55	26.0	47.55	
Macchini, L .....	5.75	13.85	19.6	6.95	12.05	19.0	7.7	20.4	25.9	46.3	
Nuti, V .....	5.65	12.3	17.95	7.25	12.4	19.65	8.15	21.05	24.7	45.75	
Torriani, L .....	5.0	13.4	18.4	6.8	12.2	19.0	7.7	19.5	25.6	45.1	
Bianchi, R .....	6.55	13.15	19.7	6.05	11.7	17.75	5.8	18.4	24.85	43.25	
Jcardi, N .....	7.65	12.8	20.45	—	13.1	13.1	7.15	14.8	25.9	40.7	
Pezzoni, L .....	7.5	13.3	20.8	—	—	—	7.4	14.9	13.3	28.2	
<b>Total</b> .....	<b>53.85</b>	<b>105.45</b>	<b>159.3</b>	<b>42.55</b>	<b>88.65</b>	<b>131.2</b>	<b>60.0</b>	<b>156.4</b>	<b>194.1</b>	<b>350.5</b>	
Team Exercises .....										61.4	
Team Exercises with hand apparatus .....										51.2	
<b>Total</b> .....										<b>463.1</b>	
Subtract points scored by 7th and 8th Competitors .....										68.9	
<b>Final Team Total</b>										<b>394.2</b>	

## 9 GREAT BRITAIN

Name	Beam			Pommel Horse			Rings	Total Points			
	Compulsory	Voluntary	Total	Compulsory	Voluntary	Total	Compulsory	Compulsory	Voluntary	Total	
Davies, C .....	8.25	13.35	21.6	8.05	12.65	20.7	7.6	23.9	26.0	49.9	
Airey, J .....	7.75	13.8	21.55	8.4	13.9	22.3	5.15	21.3	27.7	49.0	
Hirst, M .....	6.9	12.2	19.1	8.7	12.9	21.6	8.0	23.6	25.1	48.7	
Evans, P .....	7.25	12.6	19.85	7.35	12.0	19.35	7.75	22.35	24.6	46.95	
Hey, D .....	7.75	12.15	19.9	6.5	12.5	19.0	7.25	21.5	24.65	46.15	
Rennard, A .....	5.8	10.75	16.55	7.9	12.7	20.6	8.05	21.75	23.45	45.2	
Hirst, I .....	3.4	11.4	14.8	7.9	12.4	20.3	8.5	19.8	23.8	43.6	
Smith, D .....	0.45	11.6	12.05	—	7.5	7.5	6.8	7.25	19.1	26.35	
<b>Total</b> .....	<b>47.55</b>	<b>97.85</b>	<b>145.4</b>	<b>54.8</b>	<b>96.55</b>	<b>151.35</b>	<b>59.1</b>	<b>161.45</b>	<b>194.4</b>	<b>355.85</b>	
Team Exercises .....										60.1	
Team Exercises with hand apparatus .....										46.95	
<b>Total</b> .....										<b>462.9</b>	
Subtract points scored by 7th and 8th Competitors .....										69.95	
<b>Final Team Total</b>										<b>392.95</b>	

## 10 FRANCE

Name	Beam			Pommel Horse			Rings	Total Points		
	Com-pulsory	Volun-tary	Total	Com-pulsory	Volun-tary	Total	Com-pulsory	Com-pulsory	Volun-tary	Total
Vailee, F.....	7.3	13.25	20.55	7.65	13.2	20.85	7.4	22.35	26.45	48.8
Touchard, J.....	6.3	13.7	20.0	7.65	12.95	20.6	7.1	21.05	26.65	47.7
Palau, C. ....	6.3	12.0	18.3	8.1	13.2	21.3	7.1	21.5	25.2	46.7
Guibert, G.....	6.5	12.25	18.75	7.55	13.1	20.65	7.25	21.3	25.35	46.65
Hue, C.....	5.9	12.7	18.6	7.9	13.95	21.85	6.0	19.8	26.65	46.45
Yvinou, M. ....	3.65	13.6	17.25	7.9	13.25	21.15	5.45	17.0	26.85	43.85
Pitteloen, I.....	4.65	13.4	18.05	5.65	13.4	19.05	5.0	15.3	26.8	42.1
Vogelbacher, J. ....	1.1	13.05	14.15	7.6	13.1	20.7	6.55	15.25	26.15	41.4
Total .....	41.7	103.95	145.65	60.0	106.15	166.15	51.85	153.55	210.1	363.65
Team Exercises .....										56.3
Team Exercises with hand apparatus .....										48.2
									Total.....	468.15
Subtract points scored by 7th and 8th Competitors .....										83.5
									<b>Final Team Total</b>	<b>384.65</b>

## 11 BELGIUM

Name	Beam			Pommel Horse			Rings	Total Points		
	Com-pulsory	Volun-tary	Total	Com-pulsory	Volun-tary	Total	Com-pulsory	Com-pulsory	Volun-tary	Total
Van Roy, A.....	6.4	13.6	20.0	7.2	13.8	21.0	7.75	21.35	27.4	48.75
Parmentier, D. ....	3.6	11.25	14.85	6.55	11.75	18.3	7.4	17.55	23.0	40.55
Van Bets, Y.....	3.8	10.1	13.9	7.3	12.35	19.65	6.15	17.25	22.45	39.7
Schumacher, J. ....	5.55	13.3	18.85	—	12.45	12.45	7.15	12.7	25.75	38.45
Verbraecken, C. ....	5.8	12.65	18.45	—	12.55	12.55	7.2	13.0	25.2	38.2
de Grijze, T.....	1.35	9.1	10.45	6.5	12.3	18.8	6.95	14.8	21.4	36.2
Jordaens, A. ....	5.95	—	5.95	5.85	11.5	17.35	6.4	18.2	11.5	29.7
Boudewijns, J. ....	0.25	10.25	10.5	—	10.35	10.35	7.05	7.3	20.6	27.9
Total .....	32.7	80.25	112.95	33.4	97.05	130.45	56.05	122.15	177.3	299.45
Team Exercises .....										57.45
Team Exercises with hand apparatus .....										54.3
									Total.....	411.2
Subtract points scored by 7th and 8th Competitors .....										57.6
									<b>Final Team Total</b>	<b>353.6</b>

# HOCKEY

India won their fourth successive Olympic hockey title after displaying convincing form from start to finish of the tournament, winning all their five games in the course of which they scored 25 goals and conceded only two. Nor could it be said that the conditions were in their favour, for they had none of the hard, dry, almost bare grounds to which they are accustomed. On the contrary, there was quite a lot of rain during the Olympic fortnight, and the semi-final and the final at Wembley were played on heavy ground with a good covering of grass.

The regulations of the International Federation decree that, with competing teams from thirteen nations (an increase of two on the 1936 figure), there shall be three preliminary groups, two of four teams each, with the leading team going into the semi-finals, and one of five teams, with the two leading teams qualifying. The first group was easily won by India, the only surprise being that a Spanish team, which concentrated on packing in defence, held them to two goals. In their other preliminary games the Indians scored eight and nine goals respectively.

## **A Surprise Draw**

The second group was considered likely to provide Great Britain with three easy victories, but they were surprisingly held to a goalless draw by Switzerland in their first game. Like the Spaniards, the Swiss concentrated on a packed defence and, although Great Britain attacked almost continuously, they did not show quite enough imagination in pressing home their advantage. However, the British team made no mistake against the U.S.A. and Argentine, scoring 11 and 8 goals respectively, and, as Switzerland were again held to a draw by Argentine, Britain duly headed their preliminary group.

Pakistan went unbeaten through the third group, and it was not Holland who gave them most trouble. Belgium and France held Pakistan to scores of 2-1 and 3-1 respectively, whereas Holland were beaten 6-1. The Dutch team, however, qualified for the semi-finals by winning their remaining games.

Holland showed much better form against India in the semi-final than they had done against Pakistan, and many spectators thought they deserved to draw instead of being beaten 2-1 after being two goals down at half-time. In the other match, Britain beat Pakistan 2-0, after a desperately hard game. Both goals were scored by Adlard during the second half.

## **The Final**

In the final, however, Britain proved no match for the skilful play of the Indians, who scored two goals in each half without reply, before a record crowd of about 25,000 spectators. The scorers were G. Singh (2), T. Singh and Jansen. The Indian defence was sound, and their constructive play in mid-field too fast and too clever for their opponents, and gave the wing forwards ample opportunity to make scoring openings. The Indians lasted the game well, with their young team—the average age was only about twenty, which augurs well for the future of Indian hockey.



Although they had been so convincingly beaten when the teams met in the preliminary groups, Holland first held Pakistan to a draw of 1-1 in the match for third place, and then won the replay by 4-1. They might well have won the match at the first attempt for, after being a goal down at half-time, they were so much on top in the second half that it was surprising they could score only once. On the form they displayed at their best, Holland might well have proved more than a match for Britain had the draw worked out differently.

### **An Increasing Entry**

It was gratifying to find that the number of nations competing in the Olympic hockey tournament continues to rise, the figures for recent Games being 9 at Amsterdam in 1928 ; 3 at Los Angeles in 1932 ; and 11 at Berlin in 1936. The London total of 13 competing nations might easily have been higher, for 16 nations originally sent in entries, but 3 of them did not turn up for the tournament. Of those that did compete, the general standard was higher than before, several of the teams which did not qualify for the semi-finals being good enough to hold or extend the medal winners.

There was, however, no doubt that the Indian team is still the best in the world. There had been many regrets that Great Britain had not competed in recent Olympic tournaments, and some thought that they would be strong enough, on their welcome return to the tournament, to extend the holders more than proved the case. Pakistan were a welcome addition to the competitors and might well have finished among the medal winners on their first appearance instead of being relegated to fourth place after a replay.

**FEDERATION INTERNATIONALE DE HOCKEY****JURY de TERRAIN**Mr. ALBERT DEMAUREX, President, *Switzerland*Mr. H. E. A. MOLHUYSEN, Secretary, *Holland*Mr. HENNING HOLST, *Denmark*Mr. RENE FRANK, *Belgium*Mr. MARCEL FURGEOT, *France*Mr. C. E. NEWHAM, *Great Britain*Mr. A. C. CHATTERJI, *India***OFFICIALS**A. J. G. HANDS (*Arena Manager*)W. COMBEN LONGSTAFF (*Arena Manager*)D. O. LIGHT (*Arena Manager*)W. E. SIEMS (*Liaison Officer*)*Previous Olympic Winners*

1908	Great Britain	1932	India
1920	Great Britain	1936	India
1928	India		

**SUMMARY OF RESULTS****SATURDAY, JULY 31st**

## GUINNESS GROUND

Holland	4	Belgium	1
Great Britain	0	Switzerland	0

## LYONS' GROUND

India	8	Austria	0
France	2	Denmark	2

**MONDAY, AUGUST 2nd**

## GUINNESS GROUND

Holland	4	Denmark	1
---------	---	---------	---

## POLYTECHNIC

Spain	2	Argentina	3
Pakistan	2	Belgium	1

**TUESDAY, AUGUST 3rd**

## LYONS' GROUND

Holland	2	France	0
Afghanistan	2	U.S.A.	0

## POLYTECHNIC

Pakistan	9	Denmark	0
----------	---	---------	---

**WEDNESDAY, AUGUST 4th**

## GUINNESS GROUND

India	9	Argentina	1
Spain	1	Austria	1

**THURSDAY, AUGUST 5th**

## LYONS' GROUND

Pakistan	3	France	1
Afghanistan	1	Switzerland	1

## POLYTECHNIC

Belgium	2	Denmark	1
Great Britain	11	U.S.A.	0

**FRIDAY, AUGUST 6th**

## POLYTECHNIC

Austria	1	Argentina	1
India	2	Spain	0

**SATURDAY, AUGUST 7th**

## LYONS' GROUND

Holland	1	Pakistan	6
Great Britain	8	Afghanistan	0

## GUINNESS GROUND

Switzerland	3	U.S.A.	1
France	1	Belgium	2

**MONDAY, AUGUST 9th****SEMI-FINALS**

## EMPIRE STADIUM, WEMBLEY

Gt. Britain	2	Pakistan	0
India	2	Holland	1

**THURSDAY, AUGUST 12th****FINAL**

## EMPIRE STADIUM, WEMBLEY

India	4	Gt. Britain	0
-------	---	-------------	---

**THURSDAY, AUGUST 12th****THIRD PLACE MATCH**

## EMPIRE STADIUM, WEMBLEY

Holland	1	Pakistan	1
---------	---	----------	---

**FRIDAY, AUGUST 13th****REPLAY OF THIRD PLACE MATCH**

## LYONS' GROUND

Holland	4	Pakistan	1
---------	---	----------	---

## PRELIMINARY GROUPS

Group A								Group B							
	P.	W.	L.	D.	F.	A.	Pts.		P.	W.	L.	D.	F.	A.	Pts.
INDIA .....	3	3	0	0	19	1	6	GREAT BRITAIN .....	3	2	0	1	19	0	5
ARGENTINE .....	3	1	1	1	5	12	3	SWITZERLAND .....	3	1	0	2	4	2	4
AUSTRIA .....	3	0	1	2	2	10	2	AFGHANISTAN .....	3	1	1	1	3	6	5
SPAIN .....	3	0	2	1	3	6	1	U.S.A. ....	3	0	3	0	1	19	0

Group C							
	P.	W.	L.	D.	F.	A.	Pts.
PAKISTAN .....	4	4	0	0	20	3	8
HOLLAND .....	4	3	1	0	11	8	6
BELGIUM .....	4	2	2	0	6	8	4
FRANCE .....	4	0	3	1	4	9	1
DENMARK .....	4	0	3	1	4	17	1

The leading team in GROUPS A and B and the two leading teams in GROUP C qualified for the SEMI-FINALS.

## PRELIMINARY ROUNDS

Holland beat Belgium by 4 goals to 1 at Park Royal. (Half-time score, 1-1.)

HOLLAND : Richter, A.; Derckx, H., Drijver, J.; Langhout, J., Loggere, H., Tiel, H.; Van Heel, W., Boerstra, A., Bromberg, P., Kruize, J., Esser, R.

BELGIUM : Boekmans, L.; Dubois, J. M. J., Cayman, R., Mechelynck, H., Enderle, J., Van Weydeveld, L.; Delaval, H., Waterkeyn, A., Delaval, J., Niemegeerts, H., Kielbaye, J.

*Umpires:* Messrs. Cowlishaw (Great Britain) and Allen (Great Britain).

Great Britain drew with Switzerland 0-0 at Park Royal.

GREAT BRITAIN : Brodie, D.; Sime, G., Lindsay, W.; Walford, M., Reynolds, F., Lindsay, F., Peake, J., Davies, R., Adlard, R., Borrett, N., Griffiths, W.

SWITZERLAND : Stuhlinger, F.; Kurmann, F., Vogt, K.; Eger, R., Roche, J., Gruner, J.; Grolimund, O., Rippstein, J., Siegrist, E., Pasche, P., Kehrer, F.

*Umpires:* Messrs. Domselaar (Holland) and Rogge (Holland).

India beat Austria by 8 goals to 0 at Sudbury. (Half-time score, 2-0.)

INDIA : Rangandham, F.; Singh, T., Husain, A.; Claudius, L., Datt, K., Rajput, J.; Lal Kishan, Singh, K., Rodrigues, R., Jansen, P., Rehman, L.

AUSTRIA : Raule, F.; Holzapfel, K., Bischof, A.; Ruckert, F., Schala, E., Strachota, F.; Niederle, W., Koller, J., Nowak, O., Brandl, K., Lovato, F.

*Umpires:* Messrs. Husted (Denmark) and Lombaert (Belgium).

Denmark drew with France 2-2 at Sudbury. (Half-time score, Denmark 2-0.)

DENMARK : Nielsen, J.; Hansen, J. R. V., Venge, M.; Thomsen, H., Hansen, E. A., Johansen, N. E.; Jorgensen, S., Nielsen, A., Blach, P., Sorensen, P., Jensen, J. R.

FRANCE : Butin, J.; Chevalier, G., Meyer, A.; Dubessay, J., Reynaud, P., Manoukian, D.; Hauet, J., Vandame, P., Lacroix, M., Thieffry, J., Hauet, C.

*Umpire:* Messrs. Weymann (Switzerland) and Gyles (Great Britain).

Holland beat Denmark by 4 goals to 1 at Park Royal. (Half-time score, 3-1.)

HOLLAND : Richter, A.; Derckx, H., Drijver, J.; Langhout, J., Loggere, H., Tiel, H.; Van Heel, W., Boerstra, A., Bromberg, P., Kruize, J., Esser, R.

DENMARK : Nielsen, J.; Hansen, J. R. V., Venge, M.; Sorensen, P., Hansen, E. A., Johansen, N.; Busch, J., Loft, V., Blach, P., Nielsen, A., Jensen, J. R.

*Umpires:* Messrs. Gupta (India) and Whitelaw (Great Britain).

**PRELIMINARY ROUNDS—continued**

Argentine beat Spain by 3 goals to 2 at Chiswick. (Half-time score, 3-0.)

SPAIN : Ruiz Gijon, R. ; Cabot Boix, R., Sainz, Ortueta, E. ; Jardon, Ron Fernando, Jardon, Ron Francisco, Agusti Peypoch, M. ; Pratmarso, Parera L., Farreras Valenti, P., Gasset Parrilla, P., Jardon, Ron E., Allende Maiz, J.

ARGENTINE : Mercali, C. ; Brigo, J., Zucchi, A. ; Wade, T., Scally, L., Sanchez, V. ; Quinn, T., Bianchi, L., Marquez, R., Scally, T., Anderson, R.

*Umpires:* Messrs. Chanu (France) and Ali Shaikh (Pakistan).

Pakistan beat Belgium by 2 goals to 1 at Chiswick. (Half-time score, Belgium 1-0.)

PAKISTAN : Moghal, M.; Khan, M. N., Khurram, S.; Burki, H., Khan, A. G., Shahzada, S.; Masud, A., Shaikh, M., Dara, A., Aziz, A., Khan, A. Q.

BELGIUM: Boeckmans, L.; Dubois, J. M. J., Cayman, R.; Mechelynck, H., Enderle, J., Van Weydeveld, L. ; Delaval, H., Goossens, R., Delaval, J., Niemegeerts, H., Kielbaye, J.

*Umpires:* Messrs. Gomez (Spain) and Allen (Great Britain).

Holland beat France by 2 goals to 0 at Sudbury. (Half-time score, 2-0.)

HOLLAND : Richter, A.; Derckx, H., Drijver, J.; Langhout, J., Loggere, H., Tiel, H.; Van Heel, W., Boerstra, A., Bromberg, P. Kruize, J., Esser, R.

FRANCE : Butin, J. ; Meyer, A., Manoukian, D. ; Dubessay, J., Reynaud, P., Boone, B., Hauet, C. ; Vandame, P., Lacroix, M., Thieffry, J., Hauet, J.

*Umpires:* Messrs. Weymann (Switzerland) and Whitelaw (Great Britain).

Afghanistan beat U.S.A. by 2 goals to 0 at Sudbury. (Half-time score, 0-0.)

AFGHANISTAN : Nuristani, A. J.; Nuristani, A. Q., Jagi, G.; Khogaini, M., Nuristani, D., Nuristani, M. K.; Nuristani, J., Totakhail, N., Mangal, B., Nuristani, M. A., Attai, M.

U.S.A.: Slade, J. ; Stude, W., Renwick, Jr., J.; Buck, D., Lubbers, H., Kurtz, W. ; Hewitt, F., Ucko, F., Marcoplos, H., Orban, K., Gerson, C.

*Umpires:* Messrs. Lombaert (Belgium) and Klee (Austria).

Pakistan beat Denmark by 9 goals to 0 at Chiswick. (Half-time score, 5-0.)

PAKISTAN : Saleem, S. ; Khan, M. N., Razzak, M. ; Khawaja, M., Bhatti, M., Shahzada, S. ; Khan, A., Hamidi, A., Dara A. Aziz, A., Shaikh, R.

DENMARK : Nielsen, J. ; Hansen, J. R. V., Venge, M. ; Thomsen, H., Hansen, E. A., Johansen, N. E. ; Jorgensen, S., Nielsen, A. E., Blach, P., Bohr, E., Jensen, J. R.

*Umpires:* Messrs. Cowlshaw (Great Britain) and Gyles (Great Britain).

India beat Argentine by 9 goals to 1 at Park Royal. (Half-time score, 3-0.)

INDIA : Pinto, L.; Singh, T., Gentle, R.; Datt, K., Kumar, A., Vaz, M.; Lal Kishan, Singh, K., Dosanjh, B., Jansen, P., Fernandes, L.

ARGENTINE : Mercali, C.; Brigo, J., Zucchi, A.; Wade T., Scally, L., Wilson, J.; Quinn, T., Bianchi, L., Marquez, R., Scally, T., Anderson, R.

*Umpires:* Messrs. Domselaar (Holland) and Chanu (France).

Spain drew with Austria 1-1 at Park Royal. (Half-time score, 1-1.)

SPAIN : Ruiz Gijon, R. ; Sainz Ortueta, E., Royes Bohigas, M. ; Jardon Ron, Fernando, Jardon Ron, Francisco, Agusti Peypoch, M. ; Pratmarso, Parera, L., Farreras Valenti, P., Gasset Parilla, P., Allende Maiz, J., Campo Esteban, J.

AUSTRIA: Raule, F. ; Holzapfel, K., Bischof, A.; Ruckert, F., Schala, E., Strachota, F. ; Niederle, W., Nowak, O., Brandl, K., Lovato, F., Ordogh, K.

*Umpires:* Messrs. Rogge (Holland) and Nazareth (Pakistan).

Pakistan beat France by 3 goals to 1 at Sudbury. (Half-time score, 1-1.)

PAKISTAN : Moghal, M. ; Khan, M. N., Razzak, M.; Burki, H., Khan, A. G., D'Mello, M.; Masud, A., Shaikh, M., Dara, A., Aziz, A., Rahmet.

FRANCE : Butin, J. ; Chevalier, G., Manoukian, D.; Dubessay, J., Reynaud, P., Boone, B. ; Hauet, J., Vandame, P., Lacroix, M., Thieffry, J., Hauet, C.

*Umpires:* Messrs. Cowlshaw (Great Britain) and Allen (Great Britain).

Afghanistan drew with Switzerland 1-1 at Sudbury. (Half-time score, Afghanistan led 1-0.)

AFGHANISTAN : Nuristani, A. J. ; Nuristani, A. Q., Tajik, A. ; Nuristani, J.; Totakhail, N., Mangal, B., Nuristani, M. A., Attai, M.

SWITZERLAND : Stuhlinger, F. ; Kurmann, F., Vogt, K. ; Eger, R., Roche, J., Gruner, J. ; Grolimund, O., Rippstein, J., Siegrist, E., Jenzer, R., Kehrer, F.

*Umpires:* Messrs. Ali Shaikh (Pakistan) and Husted (Denmark).

PRELIMINARY ROUNDS—*continued*

Belgium beat Denmark by 2 goals to 1 at Chiswick. (Half-time score, 2-0.)

BELGIUM : Boekmans, L. ; Dubois, J. M. J., Cayman, R. ; Mechelynck, H., Enderle, J., Van Weydeveld, L. ; Delaval, H., Goossens, R., Delaval, J., Niemegeerts, H., Kielbaye, J.

DENMARK : Nielsen, J. ; Hansen, J. R. V., Bohr, E.; Hovard, V., Hansen, E. A. Johansen, N. E. ; Jorgensen, S., Loft, V., Blach, P., Nielsen, K., Jensen, J. R.

*Umpires:* Messrs. Gyles (Great Britain) and Weymann (Switzerland).

---

Great Britain beat U.S.A. by 11 goals to 0 at Chiswick. (Half-time score, 4-0.)

GREAT BRITAIN : Brodie, D. ; Sime, G., Lindsay, W. ; Walford, M., Reynolds, F., Lindsay, F. ; Peake, J., White, W., Adlard, R., Borrett, N., Griffiths, W.

U.S.A. : Slade, J. ; Stude, W., Renwick, J., Junr. ; Ucko, F., Lubbers, H., Kurtz, W. ; Gerson, C., Wilson, W., Orban, K., Marcoplos, H., Goode, H.

*Umpires:* Messrs. Lombaert (Belgium) and Gupta (India).

---

Austria drew with Argentine 1-1 at Chiswick. (Half-time score, Argentine led 1-0.)

AUSTRIA: Raule, F. ; Holzapfel, K., Bischof, A. ; Ruckert, F., Schala, E., Ordogh, K. ; Niederle, W., Koller, J., Nowak, O., Brandl, K., Lovato, F.

ARGENTINE : Mercali, C.; Brigo, J., Zucchi, A. ; Wade, T., Scally, L., Wilson, J. ; Quinn, T., Bianchi, L., Marquez, R., Scally, T., Anderson, R.

*Umpires:* Messrs. Molhuysen (Holland) and Rogge (Holland).

---

India beat Spain by 2 goals to 0 at Chiswick. (Half-time score, 2-0.)

INDIA : Rangandham, F.; Singh, T., de Souza, W. ; Datt, K., Kumar, A., Vaz, M.; Lal Kishan, Singh, K., Singh, G., Jansen, P., Fernandes, L.

SPAIN : Ruiz Gijon, R. ; Sainz Ortueta, E., Royes Bohigas, M. ; Jardon Ron, Fernando, Jardon Ron, Francisco, Agusti Peypoch, M. ; Farreras Valenti, P., Estebanez Vela, E., Gassett Parilla, P., Allende Maiz, J., Campo Esteban, J.

*Umpires:* Messrs. Domselaar (Holland) and Whitelaw (Great Britain).

---

Pakistan beat Holland by 6 goals to 1 at Sudbury. (Half-time score, 3-0.)

PAKISTAN : Moghal, M.; Khan, M. N., Razzak, M.; Burki, H., Bhatti, M., Shahzada, S.; Masud, A., Hamidi, A., Dara, A., Aziz, A., Shaikh, R.

HOLLAND : Richter, A. ; Derckx, H., Drijver, J. ; Langhout, J., Loggere, H., Tiel, H. ; Van Heel, W., Boerstra, A., Bromberg, P., Kruize, J., Esser, R.

*Umpires:* Messrs. Husted (Denmark) and Lombaert (Belgium).

---

Great Britain beat Afghanistan by 8 goals to 0 at Sudbury. (Half-time score, 2-0.)

GREAT BRITAIN : Brodie, D.; Sime, G., Lindsay, W.; Walford, M., Reynolds, F., Lindsay, F.; Peake, J., White, W., Adlard, R., Borrett, N., Griffiths, W.

AFGHANISATAN : Nuristani, A. J. ; Nuristani, A. Q., Jagi, G. ; Nuristani, M. J., Nuristani, D., Nuristani, M. K. ; Khogaini, M., Yusufzai, A. G., Mangal, B., Totakhail, N., Attai, M.

*Umpires:* Messrs. Basir Ali Shaikh (Pakistan) and Rogge (Holland).

---

Switzerland beat U.S.A. by 3 goals to 1 at Park Royal. (Half-time score, 1-1.)

SWITZERLAND : Walser, H.; Kurmann, F., Vogt, K.; Eger, R., Grub, E., Schlee, A.; Jenzer, R., Gruner, J., Siegrist, E., Pasche, P., Kehrer, F.

U.S.A.: Ucko, F. ; Stude, W., Renwick, Jr. J.;; Buck, D., Lubbers, H., Sims, S. ; Hewitt, F., Wilson, W., Marcoplos, H., Orban, K., Gerson, C.

*Umpires:* Messrs. Nazareth (Pakistan) and Chanu (France).

---

Belgium beat France by 2 goals to 1 at Park Royal. (Half-time score, 0-0.)

BELGIUM: Boekmans, L. ; Dubois, J. M. J., Cayman, R.; Mechelynck, H., Enderle, J., Van Weydeveld, L.; Van Muylders, J., Goossens, R., Delaval, J., Niemegeerts, H., Kielbaye, J.

FRANCE : Butin, J.; Meyer, A., Manoukian, D.; Lucas, R., Reynaud, P., Boone, B. ; Hauet, J., Rouget, J., Lacroix, M., Thieffry, J., Hauet, C.

*Umpires:* Messrs. Gomez (Spain) and Gupta (India).

### SEMI-FINALS

Great Britain beat Pakistan by 2 goals to 0 at the Empire Stadium, Wembley. (Half-time score, 0-0.)

GREAT BRITAIN : Brodie, D.; Sime, G., Lindsay, W.; Walford, M., Reynolds, F., Lindsay, F.; Peake, J., White, W., Adlard, R., Borrett, N., Griffiths, W.

PAKISTAN: Moghal, M.; Razzak, M., Khan, A. G.; Burki, H., Bhatti, M., Shazada, S.; Masud, A., Hamidi, A., Dara, A., Aziz, A., Shaikh, R.

*Umpires:* Messrs. Weymann (Switzerland) and Husted (Denmark).

---

India beat Holland by 2 goals to 1 at the Empire Stadium, Wembley. (Half-time score, 2-0.)

INDIA : Pinto, L.; Singh, T., Gentle, R.; Datt, K., Kumar, A., Vaz, M.; Lal Kishan, Singh, K., Glacken, G., Jansen, P., Fernandes, L.

HOLLAND: Richter, A.; Derckx, H., Drijver, J.; Langhout, J., Loggere, H., Tiel, H.; Van Heel, W., Boerstra, A., Bromberg, P., Bouwman, H., Esser, R.

*Umpires:* Messrs. Allen and Gyles (Great Britain).

### FINAL

India beat Great Britain by 4 goals to 0 at the Empire Stadium, Wembley. (Half-time score, 2-0.)

INDIA : Pinto, L.; Singh, T., Gentle, R.; Datt, K., Kumar, A., Vaz, M.; Lal Kishan, Singh, K., Singh, G., Jansen, P., Fernandes, L.

GREAT BRITAIN : Brodie, D.; Sime, G., Lindsay, W.; Walford, M., Reynolds, F., Lindsay, F.; Peake, J., White, W., Adlard, R., Borrett, N., Griffiths, W.

*Umpires:* Messrs. Rogge (Holland) and Lombaert (Belgium).

### THIRD PLACE MATCH

Holland drew with Pakistan 1-1 at the Empire Stadium, Wembley. (Half-time score, Pakistan led by 1-0.)

HOLLAND : Richter, A.; Derckx, H., Drijver, J.; Langhout, J., Loggere, H., Tiel, H.; Van Heel, W., Boerstra, A., Bromberg, P., Kruize, J., Esser, R.

PAKISTAN: Moghal, M. ; Khan, M., Razzak, M.; Burki, H., Khan, A. G., Shahzada, S.; Masud, A., Shaikh, M., Dara, A., Aziz, Shaikh, R.

*Umpires:* Messrs. Cowlshaw and Allen (Great Britain).

### REPLAY OF THIRD PLACE MATCH

Holland beat Pakistan by 4 goals to 1 at Sudbury. (Half-time score, 1-1.)

HOLLAND: Richter, A.; Derckx, H., Drijver, J.; Langhout, J., Loggere, H., Tiel, H.; Van Heel, W., Boerstra, A., Bromberg, P., Kruize, J., Esser, R.

PAKISTAN : Moghal, M.; Khan, M., Razzak, M.; Khawaja, M., Burki, H., Shahzada, S.; Masud, A., Shaikh, M., Dara, A., Aziz, A., Khan, A.

*Umpires:* Messrs. Cowlshaw and Allen (Great Britain).

### FINAL PLACINGS

- 1 INDIA
- 2 GREAT BRITAIN
- 3 HOLLAND
- 4 Pakistan

# MODERN PENTATHLON

## Riding

It is difficult to compare times and performances in an event where courses and conditions are liable to vary considerably, and in which the horse provides yet another variable factor.

In this competition only nine riders completed the course in the new time limit of ten minutes. At Berlin the pace was set at 450 metres a minute and twenty-five riders completed the course within the time limit. On the easier course this year, another nine riders completed the course without suffering obstacle faults, though losing points on time. A further five completed the course in under ten minutes, but lost points at various obstacles on the way.

Captain W. O. G. Grut, the eventual winner of the competition, scored the first of his three victories by beating the American, Major Moore, with four-and-a-half seconds to spare, in 9 min. 18.2 sec. Lt. J. M. G. Lumsden made a good start for Great Britain by finishing third, six seconds behind Moore. The other six riders who completed the course in under ten minutes and with no obstacle faults were the two Argentine subalterns, Lts. Premoli and Wirth, Captain Platan of Finland, Lts. Garcia Rojas of Mexico, Gardin of Sweden and Hegner of Switzerland. Lt. Mollet of Belgium, a veteran of the 1936 Games, completed the course, but in doing so cracked a rib and subsequently withdrew from the competition. Captain Karacson of Hungary was unfortunate enough to break a collar bone and was the first competitor to test the efficacy of the medical services arranged for the Pentathlon. Lt. Hegedus of Hungary overrode his horse and thereby failed to complete the course.

## Fencing

In the opinion of those who had been at Berlin in 1936, the standard of fencing had definitely improved in the last twelve years.

Grut scored his second event win in the competition by tying for first place with Lt. Morrot Coelho of Brazil with 28 wins each. The results were very close, Major Moore retaining second place in the whole competition by tying for third place in the Fencing with Major Larkas of Finland—26 wins each. Another eight competitors scored more than twenty victories. Fifth was Captain Pichon of France (25), Lt. Hegner of Switzerland was sixth with 24 victories ; this put him third in the competition aggregate after two events. Lt. Floody Buxton of Chile and Captain Curcio of Italy tied for seventh place with 23 wins and 2/Lt. Riem of Switzerland and Lt. Baugh of the U.S.A. each scored 22.

A remarkable performance was that of Captain Karacson, who, after a night in the Cambridge Hospital, fenced throughout this long and gruelling day so successfully that despite his broken collar bone and his right arm being bound to his side, he shared eleventh place with Lt. Premoli of the Argentine with 21 wins to their credit.



## Shooting

An analysis of the results shows that the winner, 2/Lt. Riem of Switzerland, with the score of 194 failed to reach the standard of 200 set by the American, Leonard, in Berlin, or that reached by other winners since 1924.

However, whereas the entry for the Shooting event at Berlin had dwindled to 41, 44 competed at Bisley. This is a close enough figure to make the following table of comparisons interesting:

	1936	1948
Competitors scoring 20 shots.....	26	31
„ „ 19 „ .....	9	8
„ „ 18 „ .....	4	2
„ „ 19 „ .....	2	3

The following analysis of the competitors with 20 shots on the target gives some comparison of the standard of shooting :

	1936	1948
Scores over 190 .....	6	8
Scores between 180-189 .....	18	17
Scores between 170-179 .....	2	9

In this year's shoot Riem was closely followed by his compatriot, Captain Schmid, with a score of 193, a score also made by Hegedus of Hungary, who was counted out to third place. Five competitors, among whom was Grut, all scored 190 points, and in the count out Grut was awarded fifth place, which enabled him to maintain his lead comfortably after the completion of three events. A feature of the pistol competition was the performance of Karacson, who, had he not broken his collar bone, would have started as hot favourite for this event. Although a left-handed fencer, he was a right-handed pistol shot, and found that having to shoot with his left hand was too great a handicap. Even so, this redoubtable marksman managed to head the list of those with nineteen shots on the target and his score of 173 with " one away " was by no means discreditable under the circumstances.

## Swimming

After the completion of three events the competition was reaching a very interesting stage. Grut and Moore still retained their respective positions of first and second in the whole competition but Hegner had dropped to sixth place, the third position being filled for twenty-four hours by that other Swiss officer, Riem, on the strength of his winning the Shooting event. Gardin of Sweden was lying fourth and Larkas of Finland, fifth.

No records were broken in the Swimming event and the time of four minutes for the 300 metres, although reported to have been broken at least twice in Pentathlon competitions in Sweden, has still to be beaten in an Olympic event. Despite this, the performances showed a very definite improvement on Berlin. In 1936 only two swimmers could beat the hitherto best time of 4 min. 32.6 sec. set up by Thofelt of Sweden at Los Angeles, but this year the first five swimmers all beat 4½ minutes and Brignetti of Italy swam only

three seconds slower to secure sixth place. A further improvement can be recorded when it is appreciated that this year fifteen out of forty-three swimmers beat five minutes as opposed to only ten in Berlin.

Grut, who had represented Sweden in the main Swimming events in 1936, started as favourite and won deservedly in 4 min. 17 sec., a good four seconds faster than the runner-up. This was Grut's third event win in this Pentathlon, and in achieving it he set up a new Olympic record, beating the performances of Dyrssen in 1920 and Lindman in 1924. Szondy of Hungary was second with a swim of 4 min. 21.1 sec., followed by Vilkkko of Finland, 2.9 seconds slower. Two of the Spanish team, Lts. Riera Caballer and Moreiras Lopez, followed in 4 min. 25.7 sec. and 4 min. 29 sec. respectively.

### **Running**

The main interest of the race lay not in whether Grut would win the entire Pentathlon (he was in such a good position at the end of four events that he would have had to run very slowly indeed to fail to win an Olympic Gold medal) but whether he would finish in the first nine and thereby beat another Olympic record by scoring less than 18 points in the entire competition. This record was established by Dyrssen in 1920 and equalled by Lindman four years later. Grut broke this by covering the 4,000 metres in 15 min. 28.9 sec. to gain eighth place.

The favourite, as a result of his previous performance in Switzerland, was 2/Lt. Wehlin of Sweden, with his easy long striding style of running, but nobody knew what the Finns would pull out of the bag. As it happened, Wehlin won comfortably in 14 min. 09.9 sec., twelve seconds faster than Vilkkko of Finland, who completed the course in 14 min. 21.9 sec., less than three seconds faster than Captain Platan, his team mate, who completed the course in 14 min. 24.6 sec.

These were the only runners to finish in under 15 minutes. Moore broke the Scandinavian *bloc* by running fourth in 15 min. 07.5 sec., thereby assuring himself of an Olympic silver medal, and Gardin of Sweden followed him closely with a time of 15 min. 08.7 sec. One other non-Scandinavian runner, the Frenchman, Lacroix, distinguished himself by running into sixth place, five seconds slower than Gardin.

### **Summary**

Although Grut's record-breaking performances were the most outstanding features of the seventh Olympic Modern Pentathlon, there was keen competition between Moore (U.S.A.) and Gardin of Sweden for the silver medal. Whatever part luck may play in this long competition of five events, and it plays a very big part, Moore certainly took advantage of his good riding performance to maintain his position of runner-up throughout the competition, whilst Gardin's performance was even more remarkable in that he had only been included in the Swedish team as a last minute substitute.

Lt. Vilkkko and Major Larkas of Finland both more than made up for their weak start in the Riding by finishing fourth and fifth respectively in the whole competition. Together with Captain Platan, who was beaten by one point into tenth place by Floody Buxton of Chile, the Finns produced a strong team, auguring well for that country in the future.

## MODERN PENTATHLON

## Previous Olympic Winners

1912	G. M. Lillienhook	Sweden	27 points	1928	S. A. Thofelt	Sweden	47 points
1920	G. P. W. Dyrssen	Sweden	18 ..	1932	J. G. Oxenstierna	Sweden	32 ..
1924	B. S. G. Lindman	Sweden	18 ..	1936	G. Hardrick	Germany	31.5 ..

## OLYMPIC RECORD

Captain W. O. G. Grut      Sweden      16 pts.      1948

Scoring is by addition of points gained by the placing in each event, the competitor with the *least* number of points at the end of all five events being the victor.

NAME	NATION	Riding					Fencing		PLACING AFTER TWO EVENTS	Shooting			Swimming		PLACING AFTER FOUR EVENTS	Running		Total		
		TIME	TIME FAULTS	OBSTACLE FAULTS	POINTS	PLACE	WINS	PLACE		HITS	POINTS	PLACE	PLACING AFTER THREE EVENTS	TIME		PLACE	TIME	PLACE	PLACE	POINTS
W. Grut	Sweden	9 18.2	Nil	Nil	100	1	28	1	1	20	190	5	1	4 17	1	1	15 28.9	8	16	1
G. Moore	U.S.A.	9 22.7	Nil	Nil	100	2	26	3	2	20	183	21	2	5 9.2	17	2	15 07.5	4	47	2
G. Gardin	Sweden	9 42.6	Nil	Nil	100	6	19	17	8	20	188	10	4	4 43.1	11	3	15 08.7	5	49	3
L. Vilikko	Finland	9 55.2	Nil	8	92	17	13	38	28	20	190	4	16	4 24	3	7	14 21.9	2	64	4
H. Larkas	Finland	10 31.7	16	3	81	26	26	3	11	20	190	7	5	5 11.7	19	5	15 48.7	16	71	5
B. Riem	Switz.	10 16.1	8.5	Nil	91.5	19	22	9	10	20	194	1	3	6 24.2	36	9	15 34.9	9	74	6
F. Hegner	Switz.	9 46.4	Nil	Nil	100	7	24	6	3	20	181	24	6	4 53.4	13	4	16 32.5	29	79	7
R. Gruenther	U.S.A.	10 25	12.5	Nil	87.5	24	20	13	14	20	183	13	11	445.2	12	7	16 04.7	19	81	8
N. Floody Buxton	Chile	9 54.9	Nil	3	97	11	23	7	6	20	183	20	7	531	30	10	15 55	17	85	9
V. Platan	Finland	9 32.2	Nil	Nil	100	4	16	28	13	17	141	44	28	4 38.9	7	16	14 24.6	3	86	10
E. Wirth	Argentina	9 54.9	Nil	Nil	100	9	19	17	9	20	177	29	14	5 22.2	25	14	15 46.6	13	93	11
F. Hegedus	Hungary	D	—	—	—	45	20	13	32	20	193	3	17	5 20.2	24	18	15 39.2	10	95	12
H. Baugh	U.S.A.	9 52	Nil	3	97	0	22	9	7	20	178	28	9	4 41	9	6	18 25.4	40	96	13
A. Lacroix	France	10 26.8	13.5	9	77.5	27	19	17	22	20	185	18	19	5 28.8	29	27	15 13.7	6	97	14
G. Palmonella	Italy	10 09.6	5	Nil	95	14	17	26	16	20	187	15	14	5 12.5	21	12	16 11.2	22	98	15
L. Pichon	France	12 13	66.5	8	25.5	36	25	5	17	20	188	9	11	5 40	32	15	15 57	18	100	16
K. Wehlin	Sweden	11 09.9	35	14	51	31	14	34	39	20	183	22	35	4 53.5	14	29	14 09.9	1	102	17
I. Szondy	Hungary	10 59	29.5	Nil	70.5	28	6	44	41	20	188	11	32	421.1	2	18	16 10.7	20	105	18
R. Curcio	Italy	10 21.5	11	Nil	89	22	23	7	11	20	188	14	8	5 23.5	26	11	17 09	36	105	19
A. Martín	Gt. Brit.	10 07.3	4	Nil	96	12	15	31	21	20	182	23	21	5 33.4	31	28	15 40.7	11	108	20
L. Premoli	Argentina	9 42.3	Nil	Nil	100	5	21	11	4	19	169	35	13	541.8	33	17	16 23.1	25	109	21
A. Moreiras Lopez	Spain	10 23.5	12	Nil	88	23	15	31	27	20	183	19	24	4 29	5	13	16 58.9	34	112	22
J. Riera Caballer	Spain	10 03.3	2	6	92	18	18	24	19	17	149	42	33	4 25.7	4	21	16 27.4	26	114	23
H. Fuentes Besoain	Chile	16 13.2	187	312	—399	43	20	13	30	20	190	6	19	5 19.8	23	18	16 49.8	32	117	24
D. Brignetti	Italy	13 28.1	104.5	25	—29.5	38	14	34	41	20	183	12	33	4 33	6	26	16 32.2	28	118	25
A. Ortiz	Uruguay	10 13	6.5	3	90.5	20	11	41	37	20	186	17	30	5 43.9	34	34	15 22.5	7	119	26
W. Schmid	Switz.	14 57.4	149	103	—152	42	19	17	34	20	193	2	17	5 27	28	24	16 42	30	119	27
C. Palant	France	13 16	98	61	—59	40	18	24	38	20	190	8	23	5 08.6	16	21	16 48.6	31	119	28
K. Bartu	Czecho.	11 35.3	48	Nil	52	30	13	38	40	20	179	27	40	4 58.5	15	33	15 47.8	14	124	29
Acelio Morrot Coelho	Brazil	9 26.1	Nil	6	94	15	28	1	4	19	172	33	10	6 47.4	39	21	17 34.1	37	125	30
C. Mercader	Uruguay	9 44.4	Nil	8	92	16	16	28	22	19	171	34	30	5 56.8	35	36	15 44	12	125	31
H. Siburu	Argentina	10 03.9	2	3	95	13	16	28	17	20	177	30	22	5 10.4	18	24	17 39	38	127	32
A. Quiroz Galvez	Mexico	11 18.3	39.5	Nil	60.5	29	15	31	36	20	186	16	28	5 26.2	27	31	16 31.7	27	130	33
J. Lumsden	Gt. Brit.	9 29	Nil	Nil	100	3	14	34	14	19	167	37	26	6 31.3	38	34	16 10.7	20	132	34
R. Garcia Rojas	Mexico	9 49.8	Nil	Nil	100	8	12	40	24	17	148	43	37	442.4	10	29	16 50.7	33	134	35
M. Bernabeu Prada	Spain	14 00	121.5	106	—127.5	41	19	17	32	19	162	39	42	5 12.3	20	39	16 21.7	24	141	36
G. Brooke	Gt. Brit.	13 42.8	111.5	32	—43.5	39	20	13	26	18	153	41	38	6 29.6	37	41	15 48.4	15	145	37
A. Alves Borges	Brazil	11 15.4	38	17	45	33	17	26	34	19	167	36	40	440.3	8	31	D	43	146	38
O. Jemelka	Czecho.	10 10.5	5.5	9	85.5	25	19	17	19	20	173	31	24	7 18.2	42	37	17 03.3	35	150	39
L. Fauconnier	Belgium	11 35.2	48	6	46	32	19	17	25	20	179	26	27	7 11.1	41	38	18 03.3	39	155	40
C. Vyt	Belgium	10 03.9	2	8	90	21	14	34	28	19	165	38	38	7 05.8	40	42	16 17.2	23	156	41
R. Orozco	Uruguay	12 9.6	65	6	29	35	11	41	43	20	181	25	43	5 15.8	22	40	19 49.9	41	164	42
H. Soares Berford	Brazil	12 33.4	77	8	15	37	8	43	44	18	166	40	44	7 27.7	43	43	19 51.7	42	205	43
R. Mollet	Belgium	11 42.7	51.5	8	40.5	34	N S	—	—	N S	—	—	—	N S	—	—	N S	—	—	44
L. Karacson	Hungary	D	—	—	—	45	21	11	30	19	173	32	36	N S	—	—	N S	—	—	45

TIME: 9 42.3 = 9 min. 42.3 sec.

N S = Non-starter

D = Disqualified



*Weight lifting : the introduction of the competitors in the featherweight class.*

*Officials supervise the weighing of the barbell on the special scales.*





*J. Bonnet (Argentine) competing in the middleweight class.*

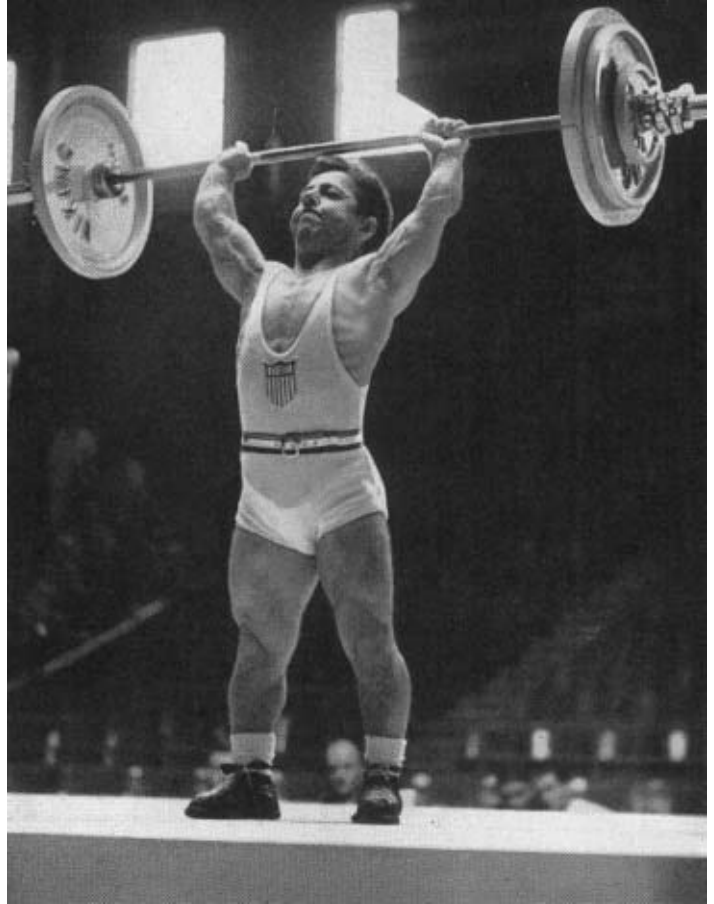

*J. de Pietro (U.S.A.) set up world records in winning the bantamweight class, held for the first time in the Olympic Games.*

*J. Creus (Great Britain) was second in the bantamweight.*

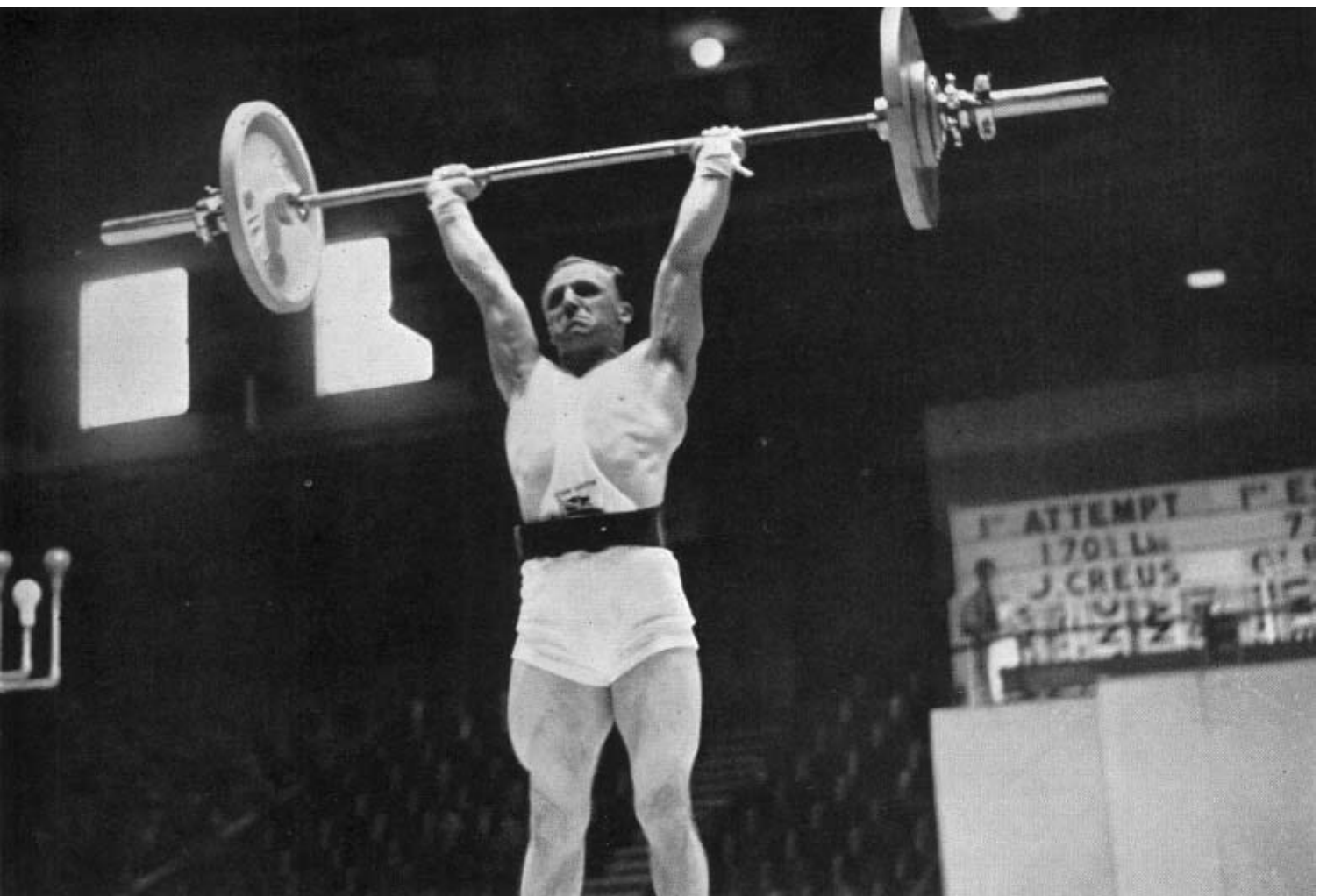

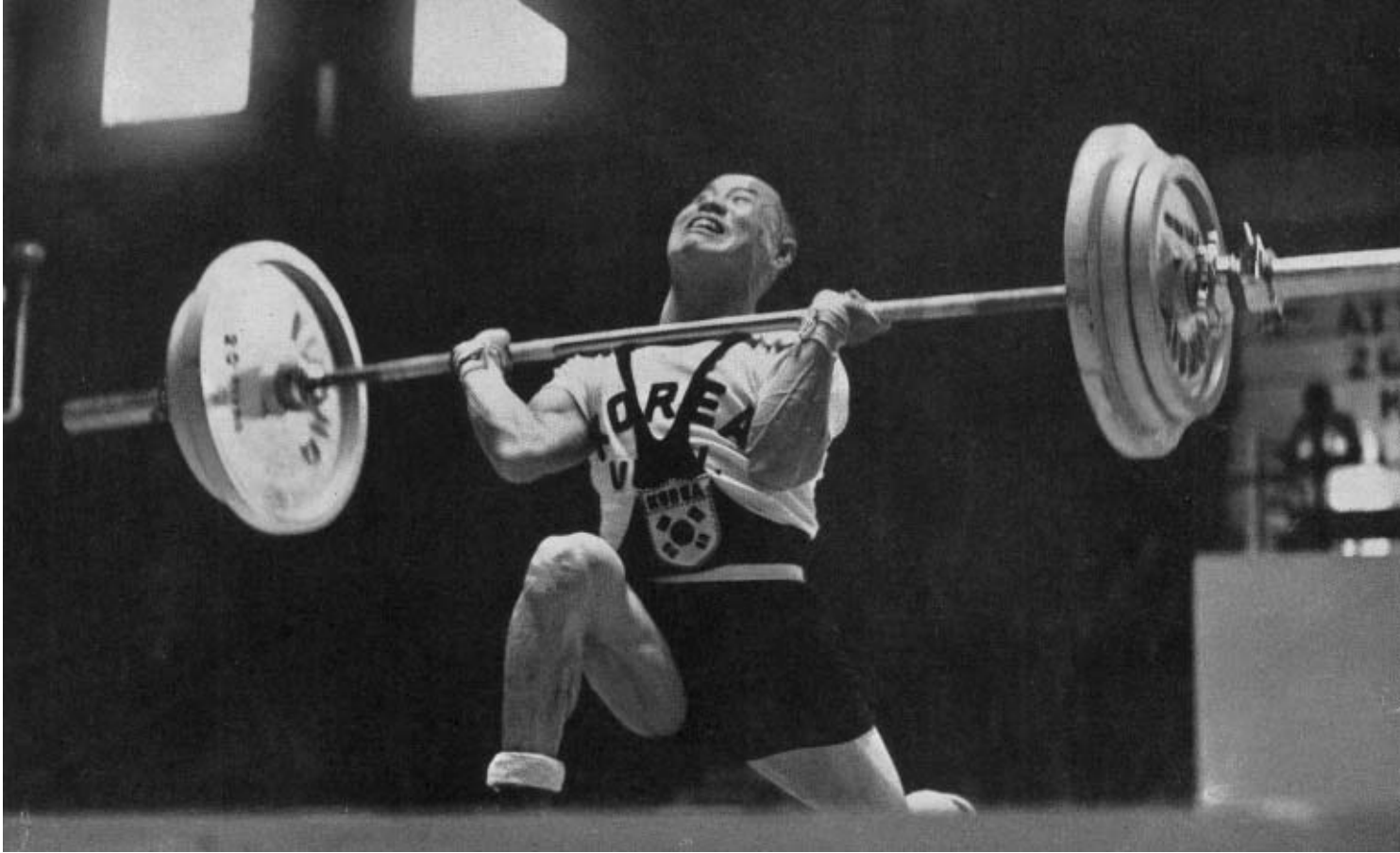

*Hang Kee Choi (Korea) in the featherweight.*

*A. Kinnunen (Sweden) a competitor in the lightweight.*

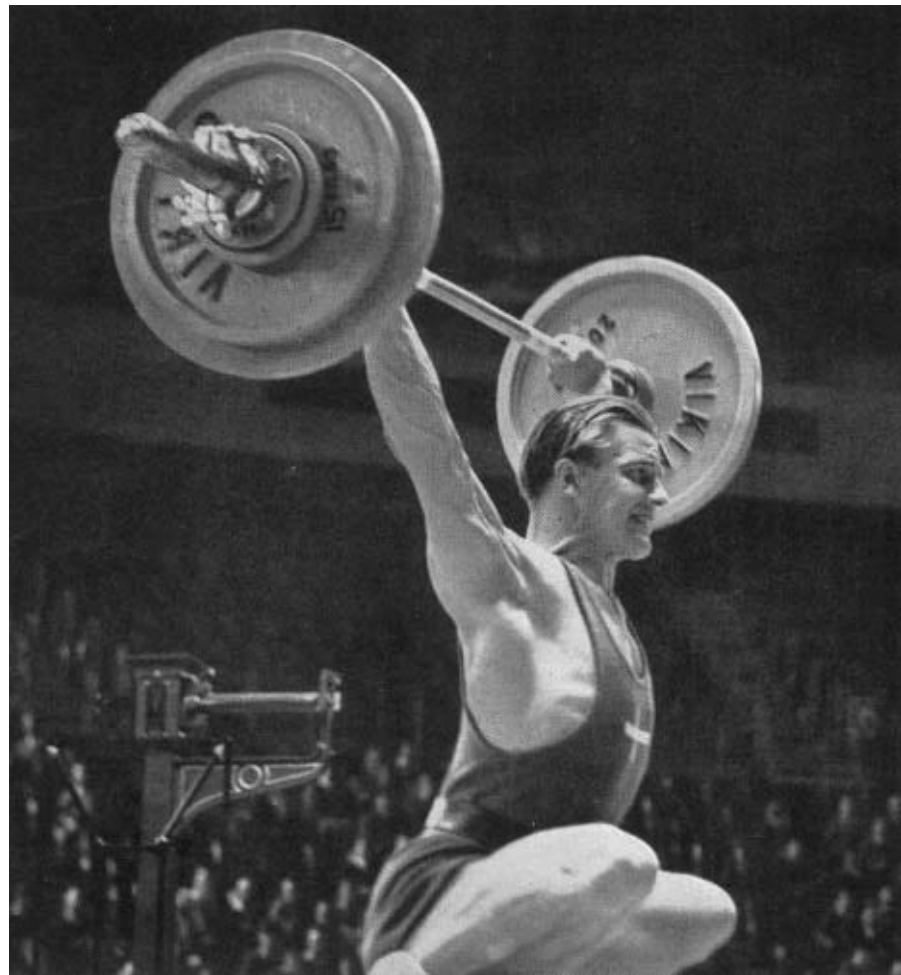



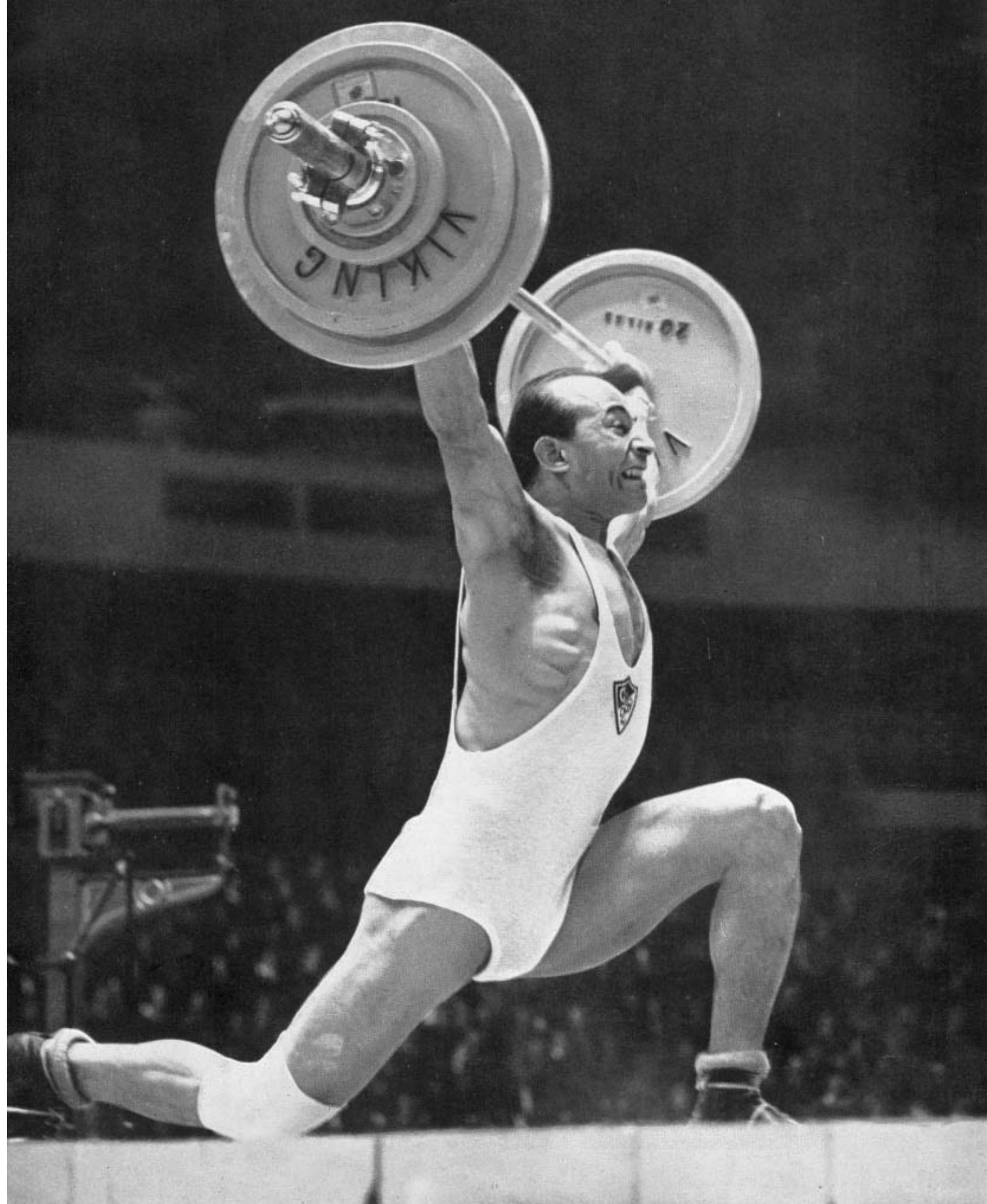

*I. Shams (Egypt) winner of the lightweight class.*



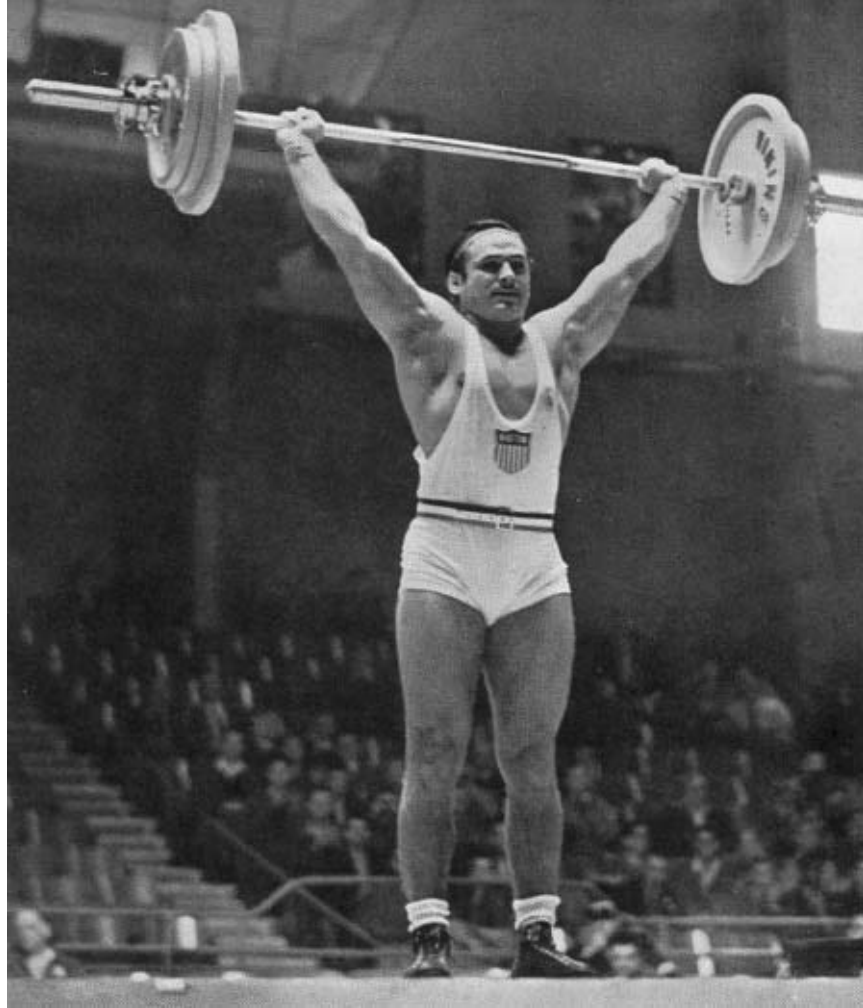

*S. Stanczyk (U.S.A.) was the light-heavyweight winner.*

*H. Sakata (U.S.A.) second in the light-heavyweight class.*

*P. George (U.S.A.) second in the middleweight class.*

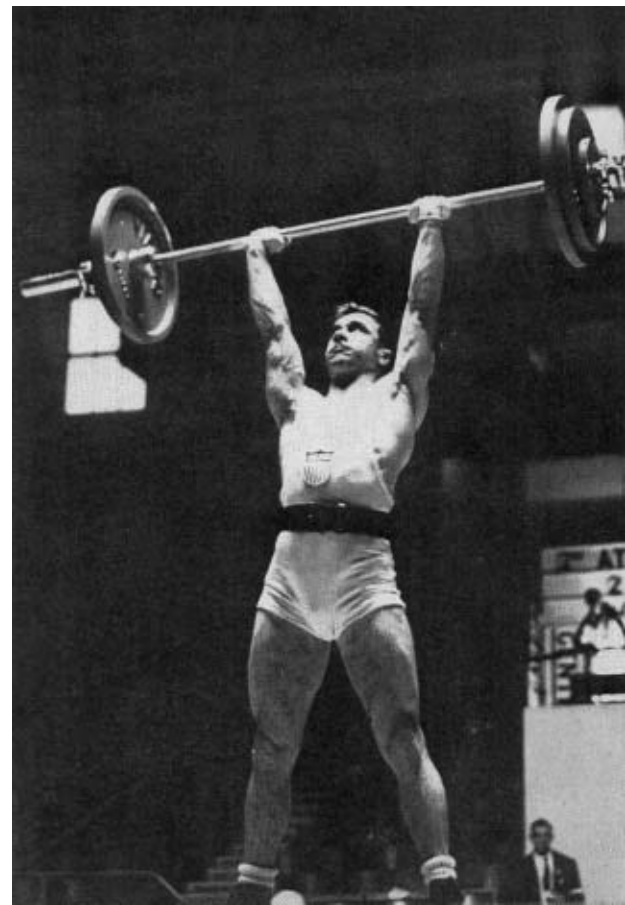
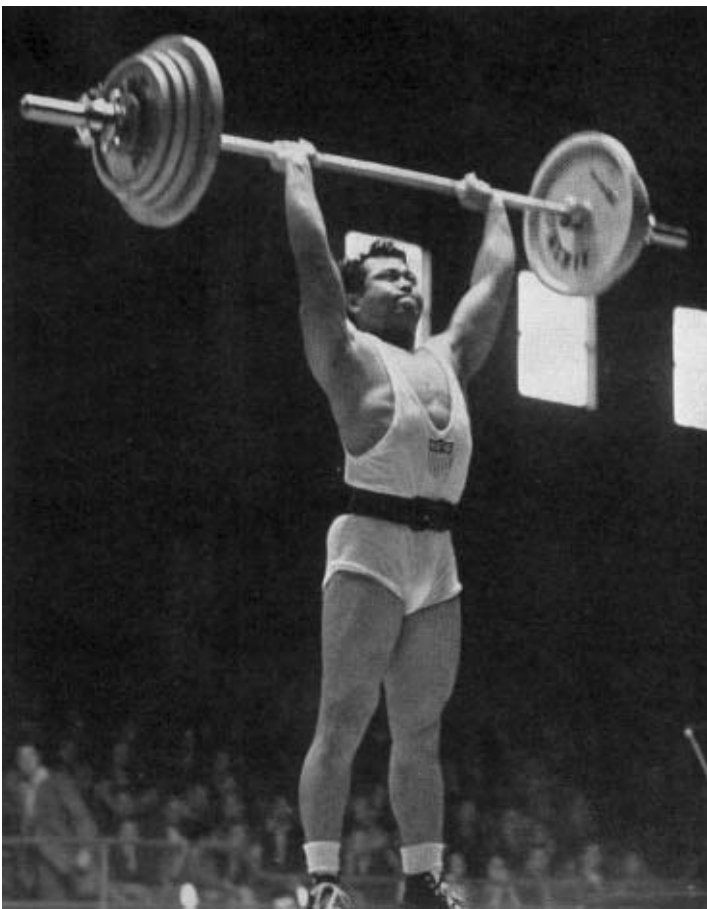

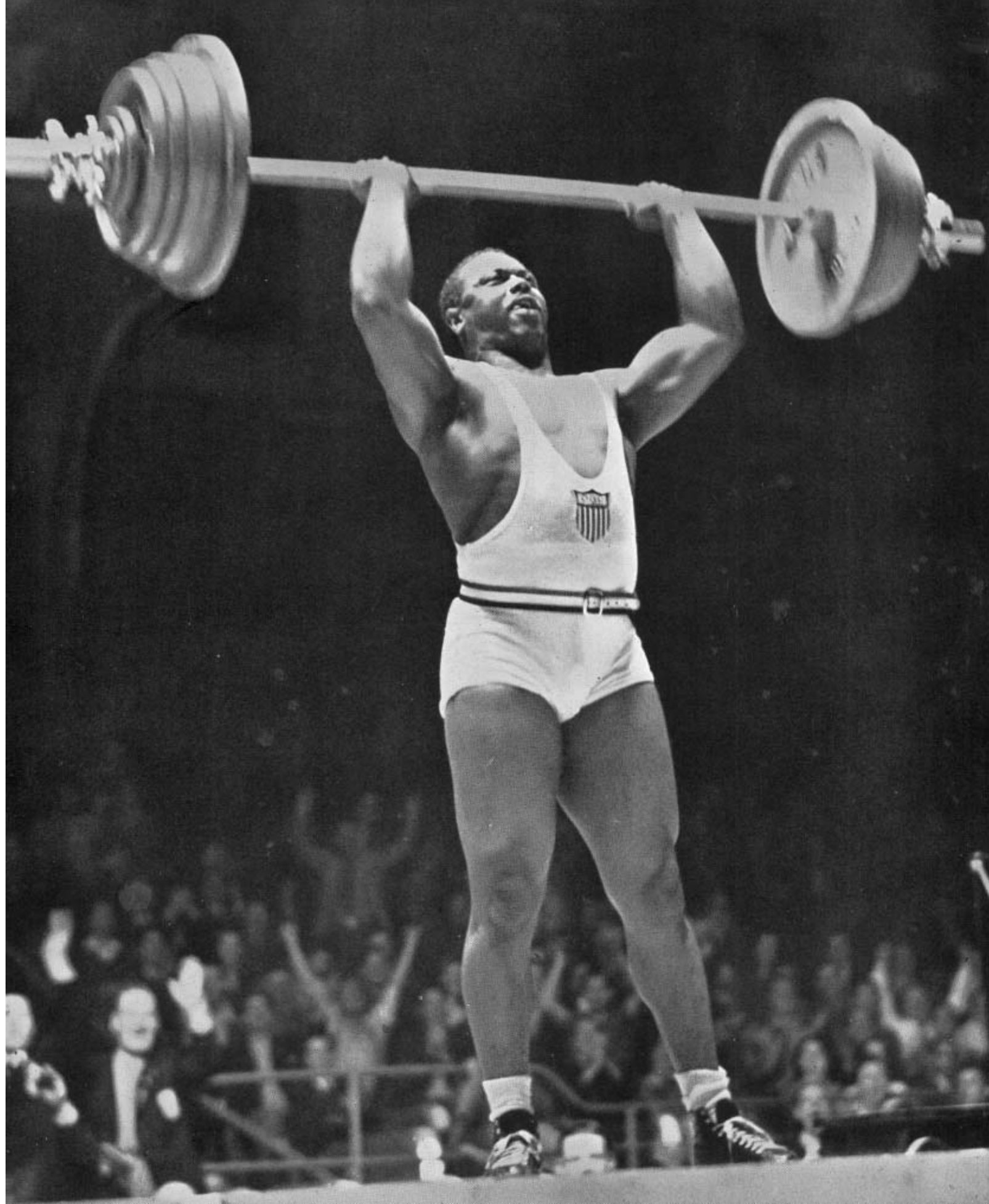

*J. Davis (U.S.A.) heavyweight victor.*

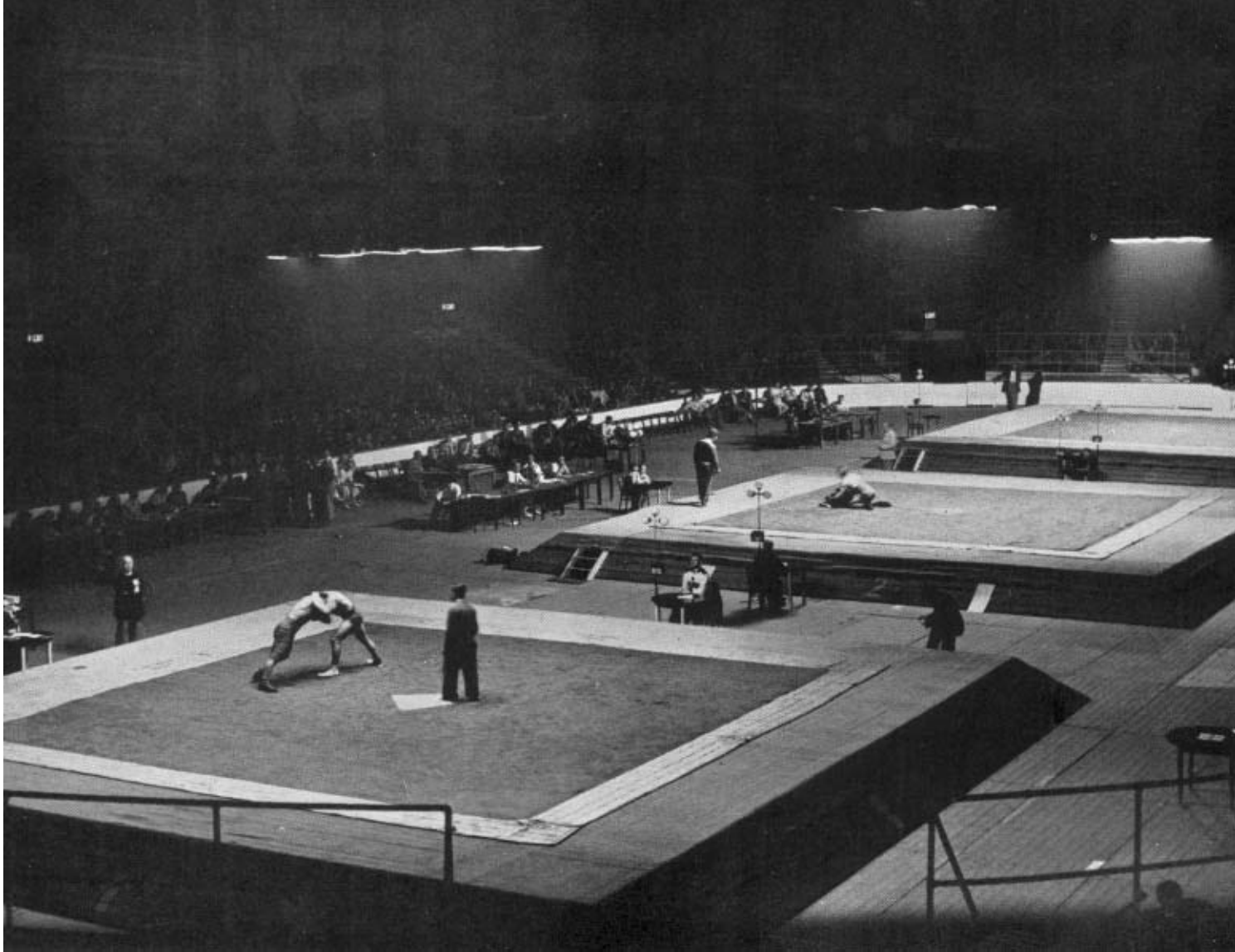

*A general view during the Greco-Roman classes of the three platforms which were erected in the arena of the Empress Hall, Earls Court, for the wrestling events.*

*A first round contest in the Greco-Roman flyweight class with P. Lombardi (Italy) winner of the class on top of S. Thomsen (Denmark).*

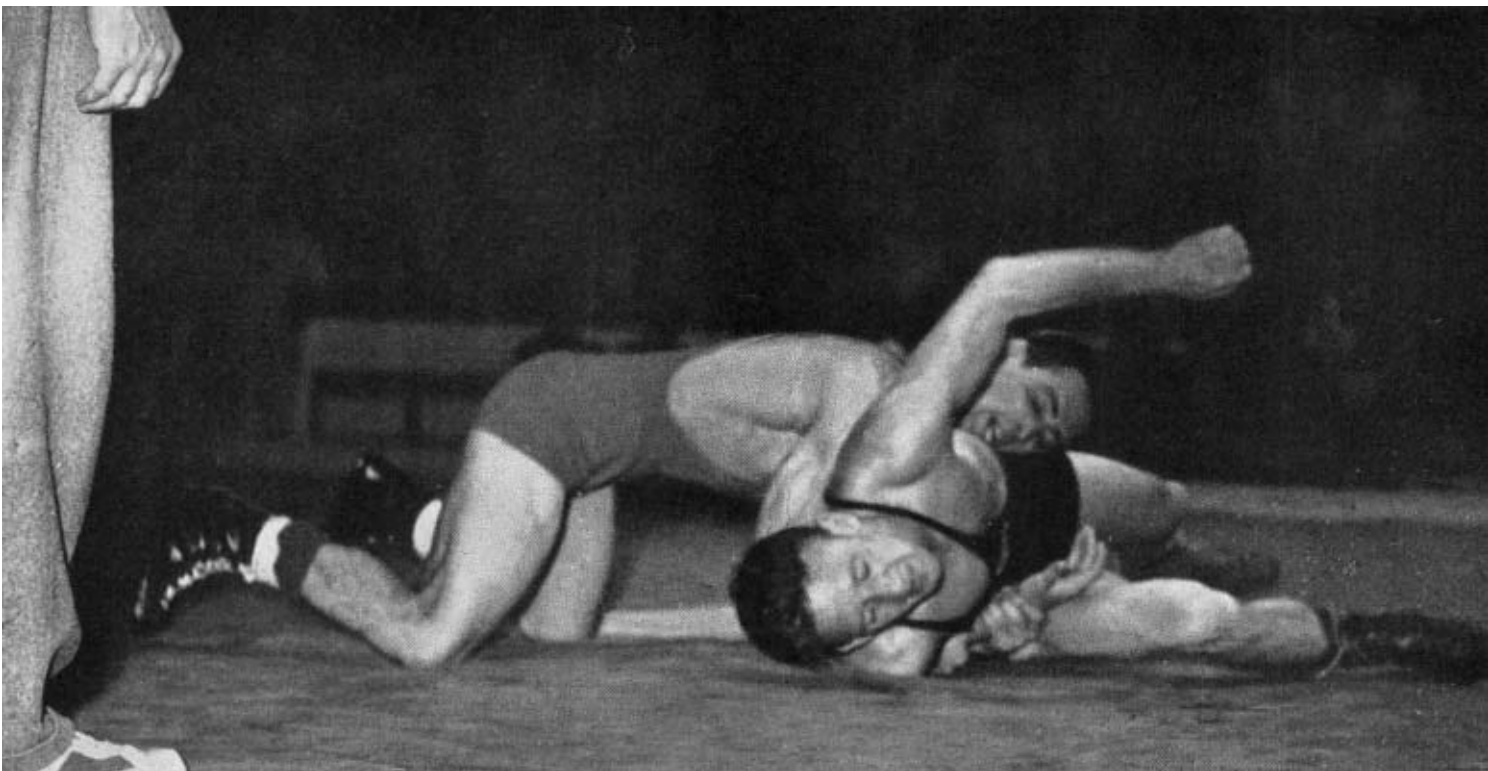

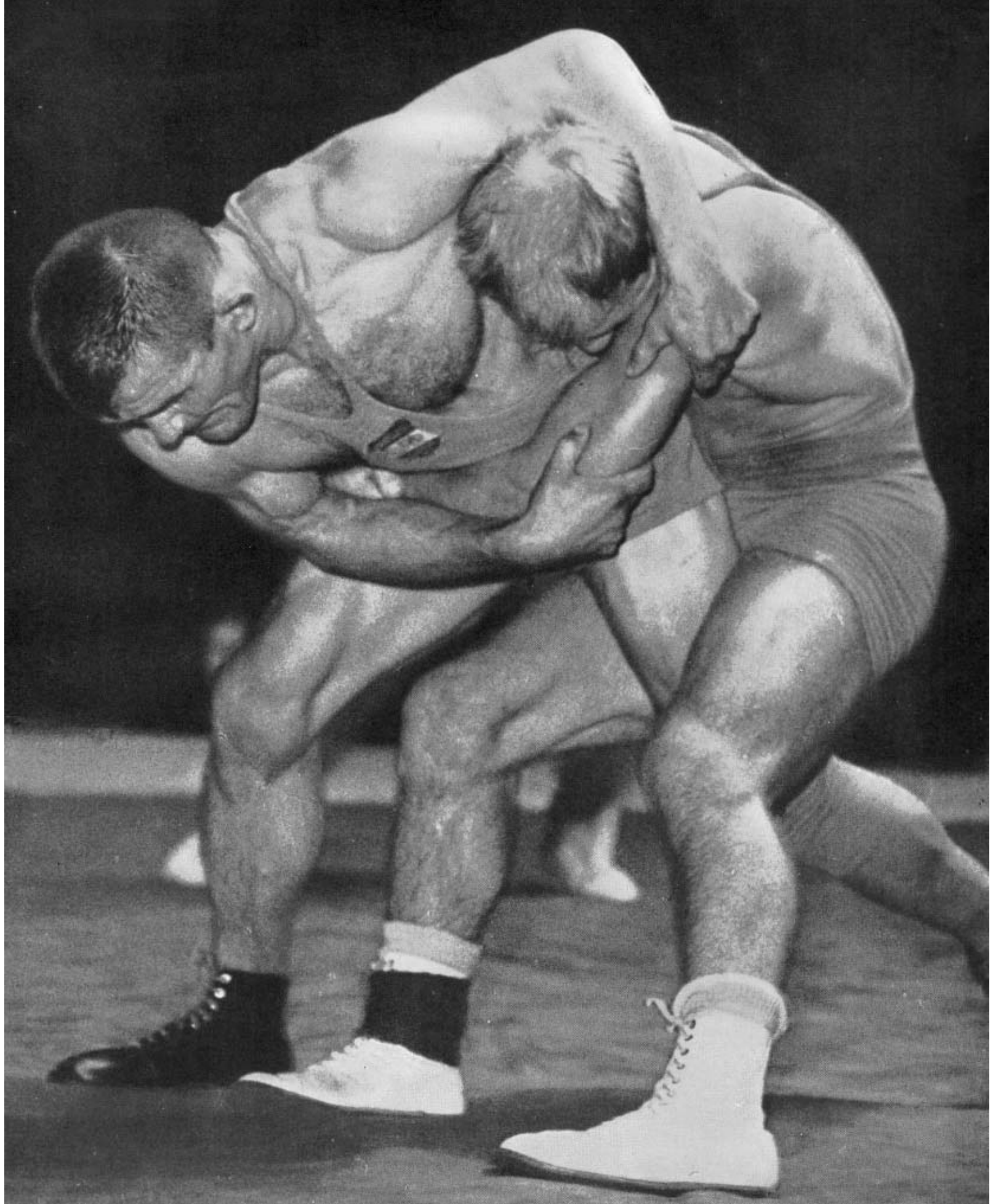

*The last contest in the featherweight class (Greco-Roman). By losing to O. Anderberg (Sweden) on left, F. Toth (Hungary) lost his chance of first place, which went to M. Oktav (Turkey), Anderberg being placed second and Toth third.*





*In the fifth round of the Greco-Roman bantamweight class M. Aly (Egypt) is seen on top of H. Kaya (Turkey). Aly, winner of the bout, was placed second in the class with Kaya third.*

*The winner of the Greco-Roman lightweight class, K. Freij (Sweden) on top of R. Myland (Great Britain) in a first round contest.*

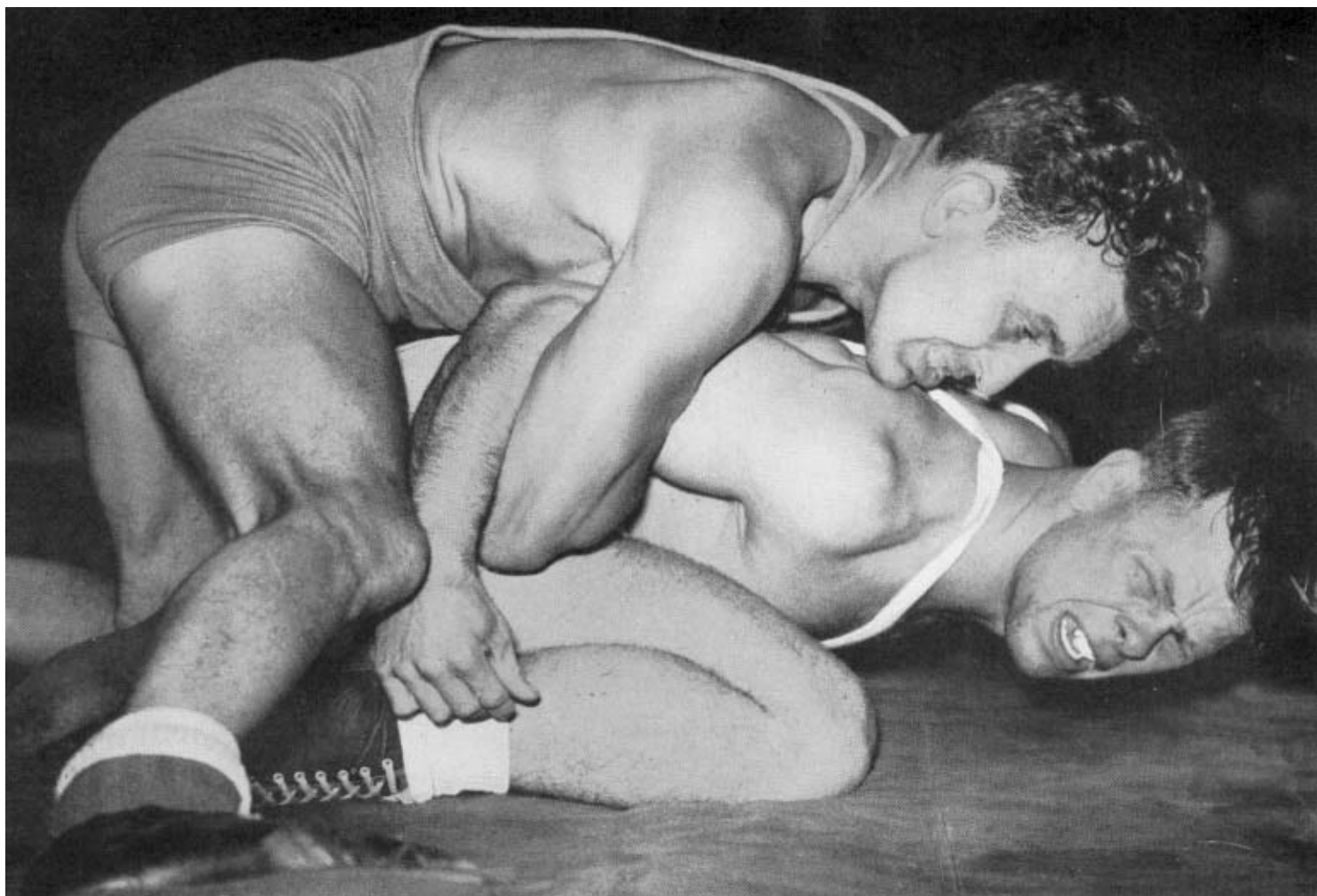

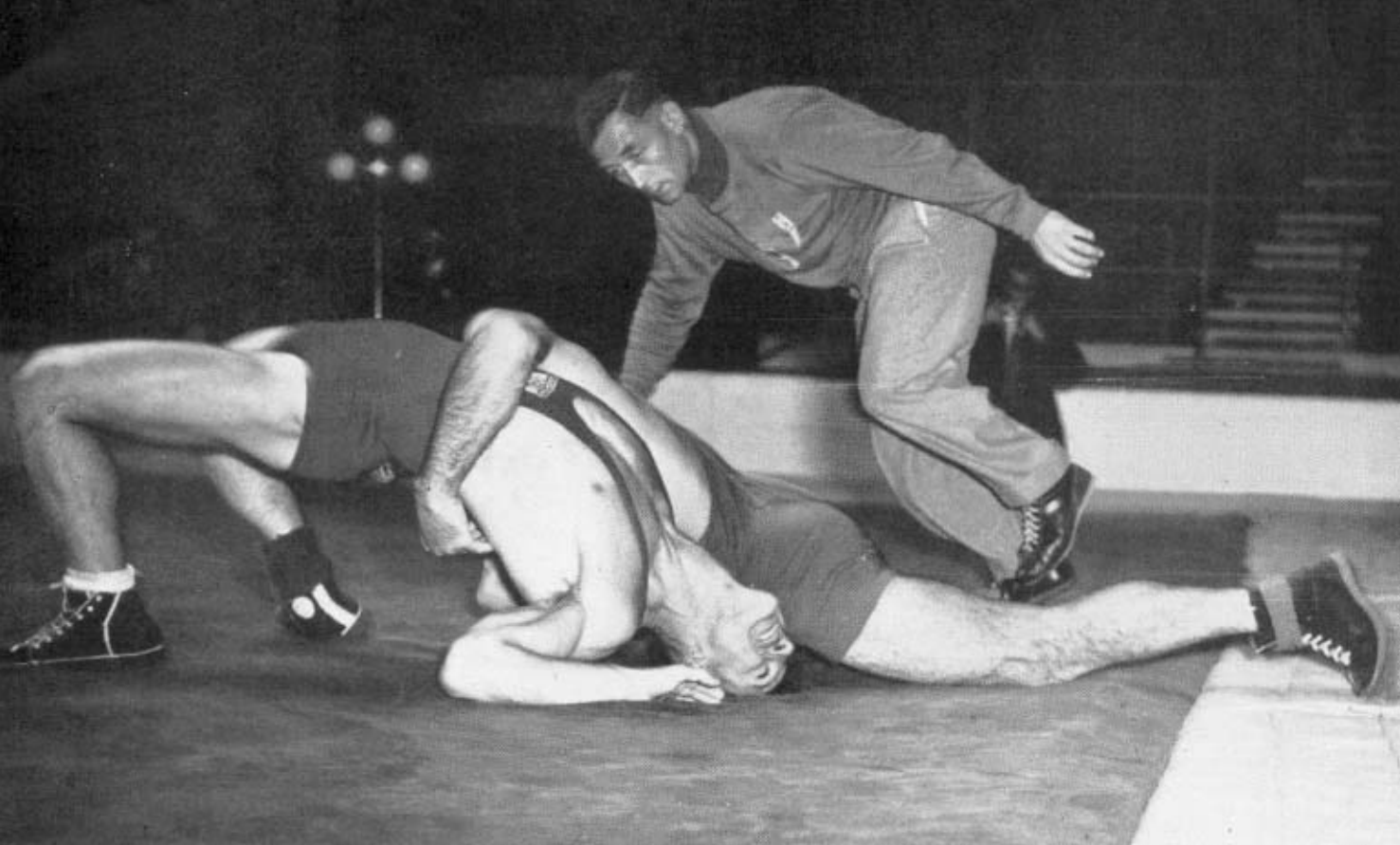

*A second round contest in the Greco-Roman middleweight class with M. Tayfur (Turkey) getting a grip on A. Bolzi (Argentine). Tayfur was eventually placed second in his class.*

*The achievement of Turkey who had four winners in the free style wrestling was exceeded by Sweden who provided five winners in the eight Greco-Roman classes, two seconds and one fourth. Here are their five gold medallists, left to right, K. Pettersen (bantamweight) and K. Freij (lightweight) behind, and K. Nilsson (light-heavyweight), E. G. Andersson (welterweight) and R. Gronberg (middleweight) in front.*



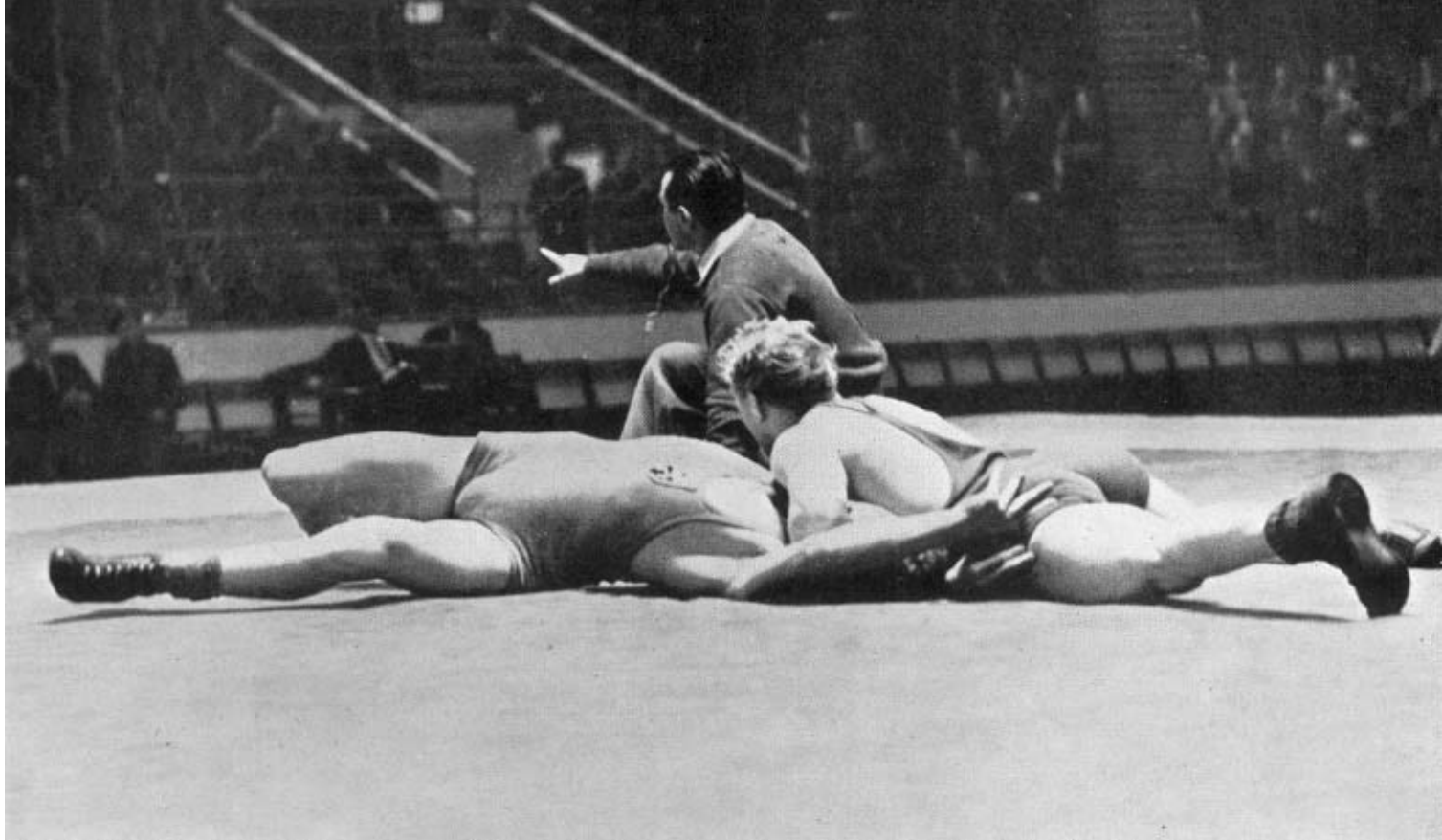

*The fifth round contest in the Greco-Roman middleweight class in which R. Gronberg (Sweden), on top, eventual winner of the class, defeated J. Benoy (Belgium).*

*After the final contest in the Greco-Roman light-heavyweight class, K. Grondahl (Finland) on right, congratulates the winner K. Nilsson (Sweden).*



*Chairing the winner of the heavyweight class (Greco-Roman), A. Kirecci (Turkey).*

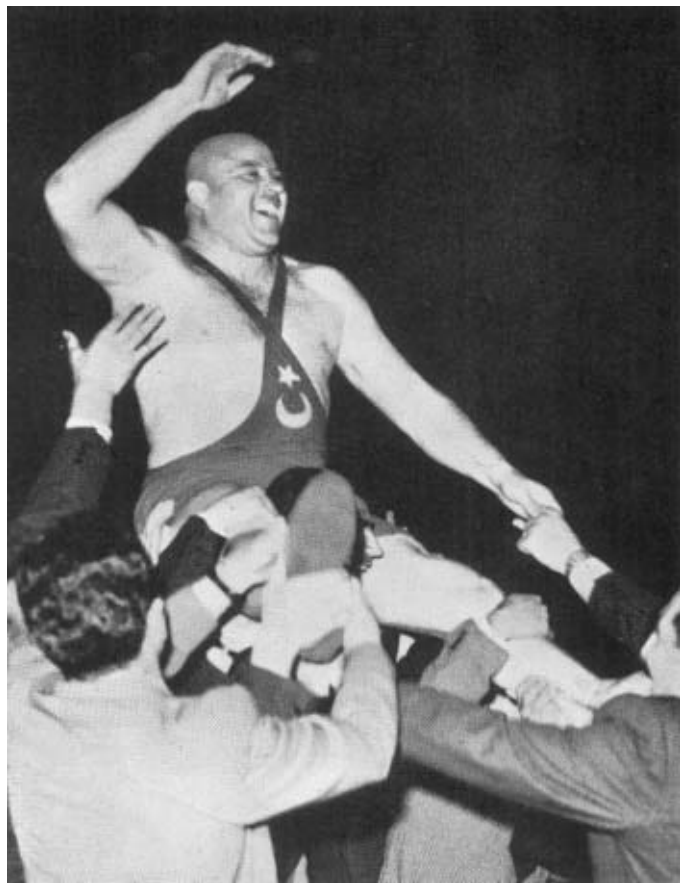





*The final contest in the Greco-Roman welterweight class in which E. G. Andersson (Sweden) on left beat M. Szilvassy (Hungary).*

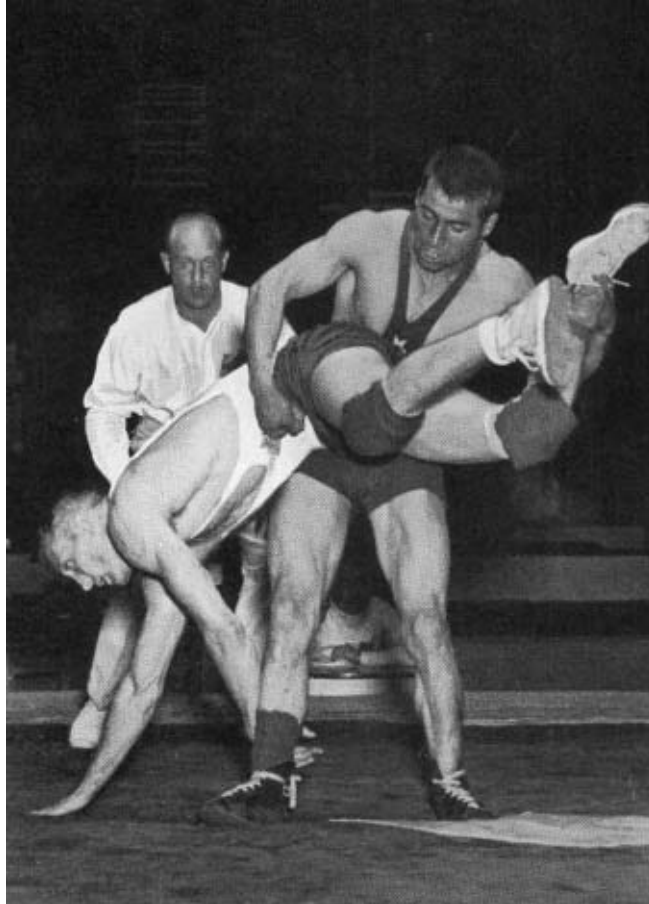

*The decisive bout in the free style bantamweight wrestling with N. Akar (Turkey) the winner throwing G. Leeman (U.S.A) who gained second place.*

*A second round contest in the Greco-Roman lightweight class. A. Eriksen (Norway), silver medallist in the class, is in difficulties against G. Gesino (Italy), but eventually beat him.*

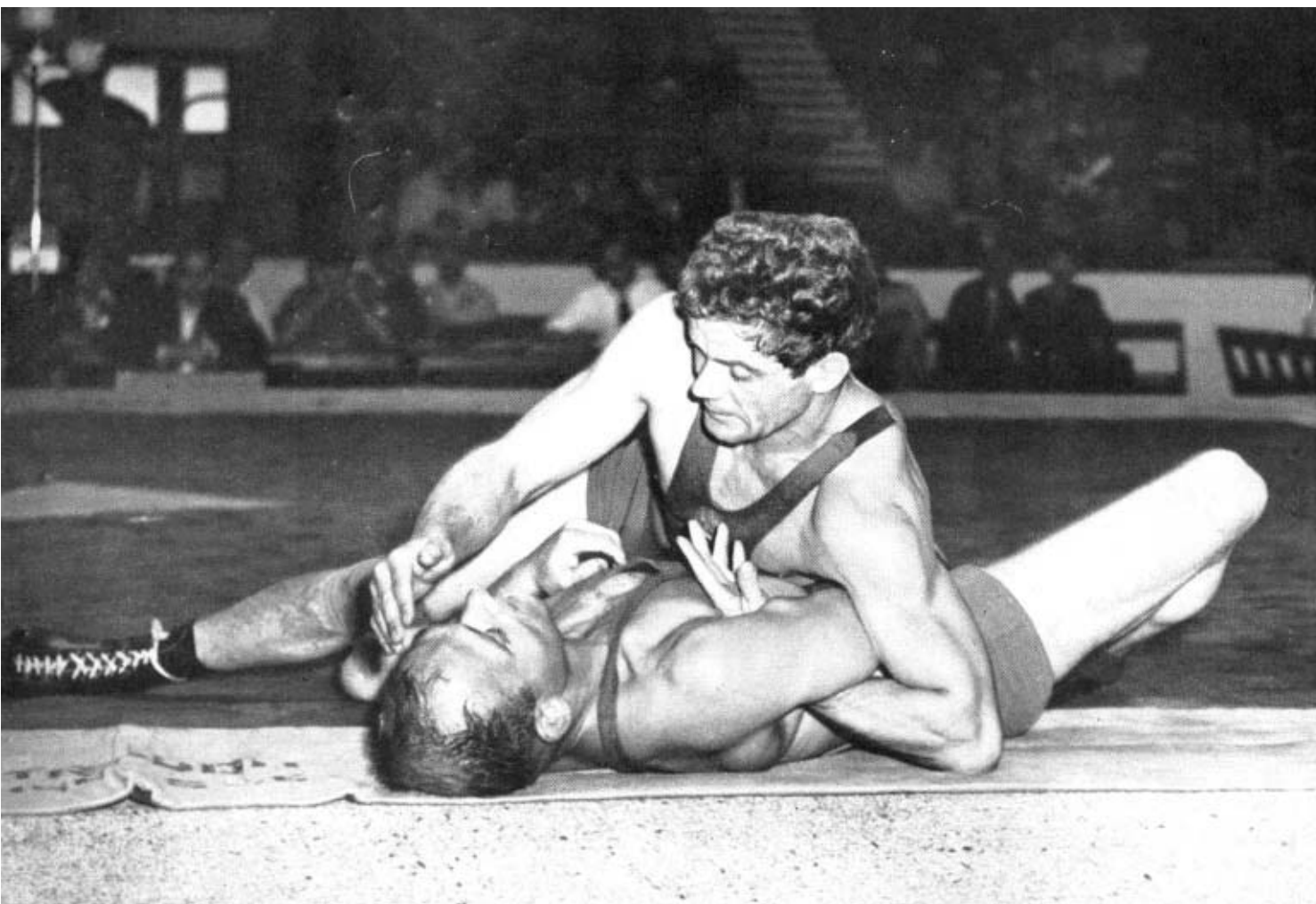

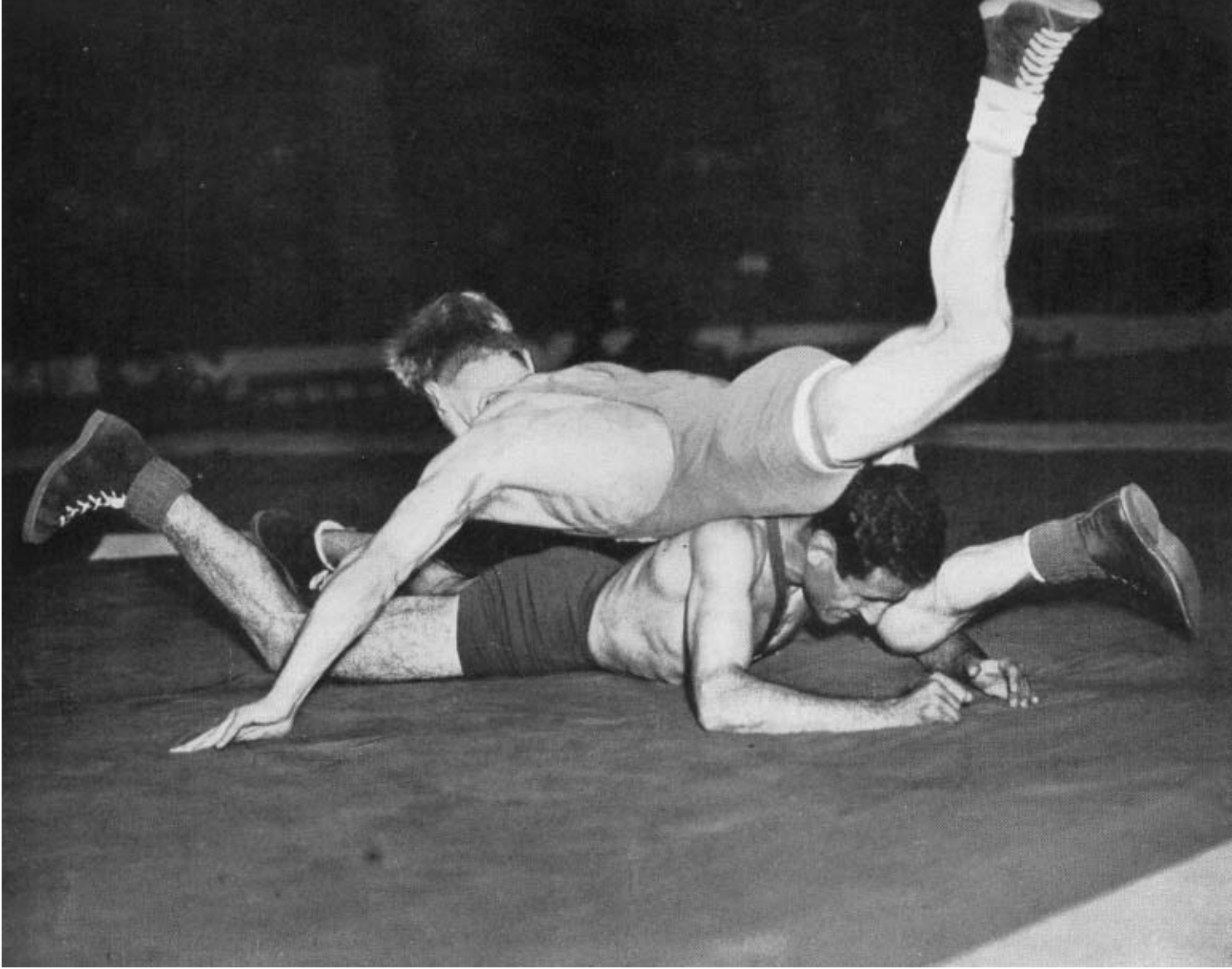

*The vital match in the free style flyweight class came in the first round when V. Viitala (Finland) gained a majority verdict over H. Balamir (Turkey). Here Viitala is above his rival. The final placings in the class were Viitala first and Balamir second.*

*The winner of the free style wrestling, flyweight class, V. Viitala (Finland) gets an arm hold on A. Lamot (Belgium) in his second round contest.*

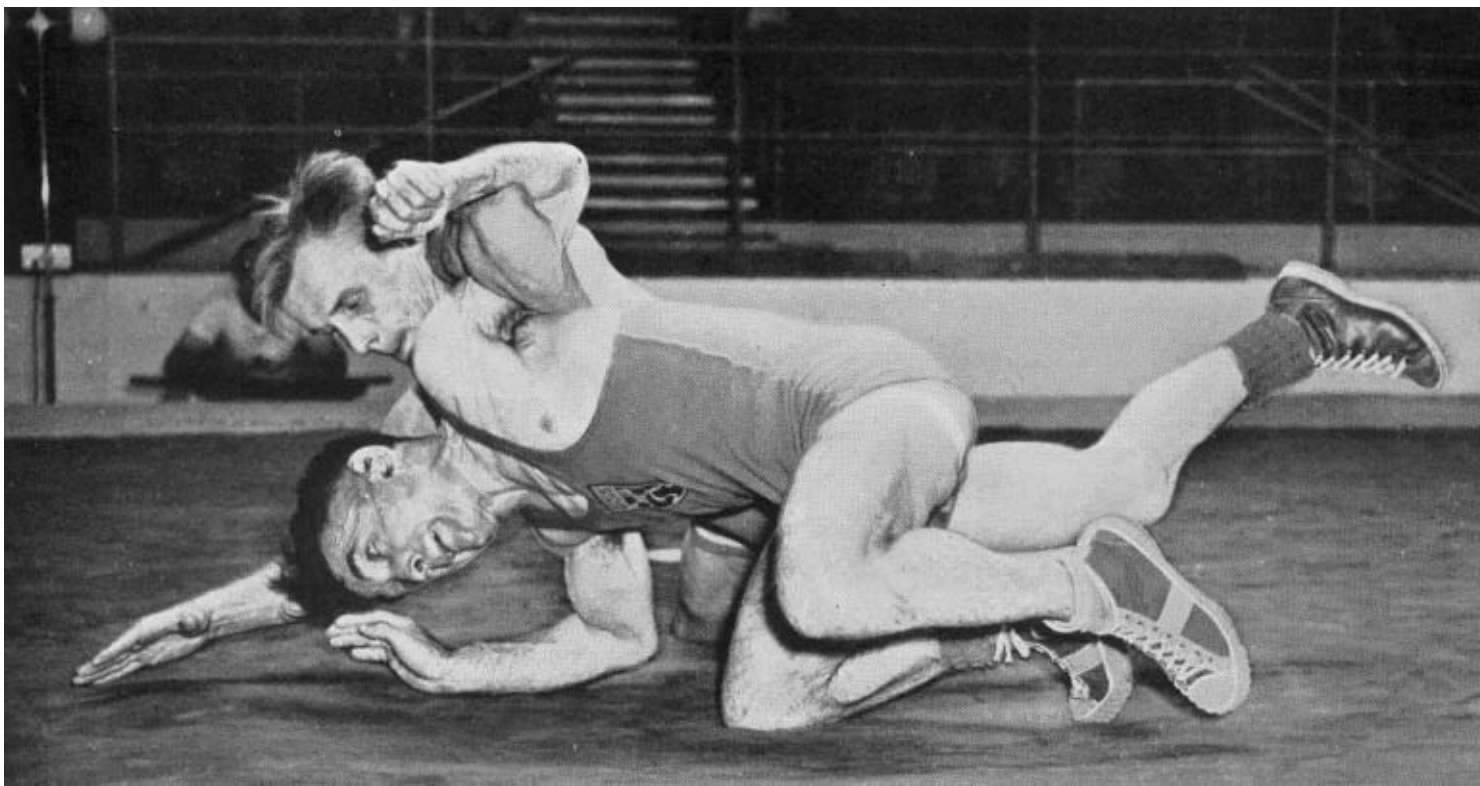

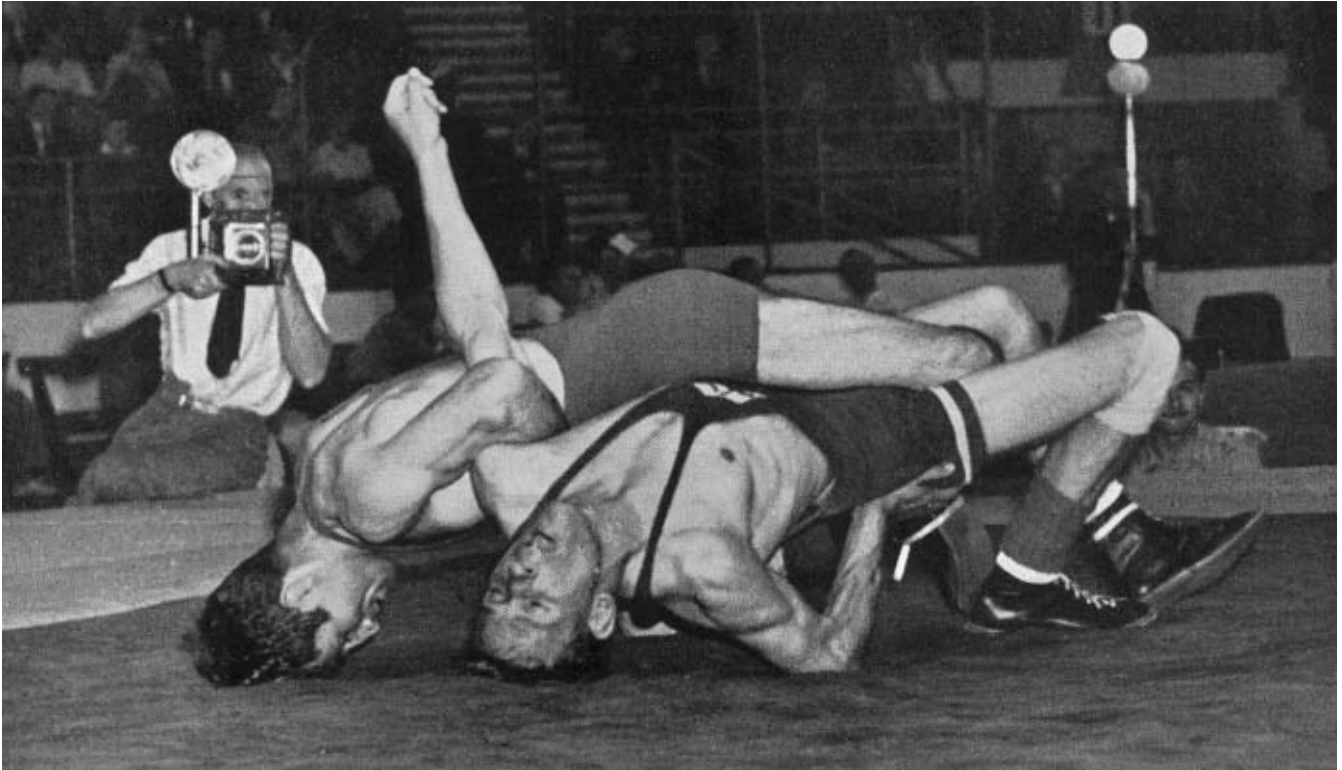

*A fifth round contest in the featherweight class, free style, between G. Bilge (Turkey) eventual Olympic winner, and P. Hietala (Finland), who is here in danger of receiving a fall.*

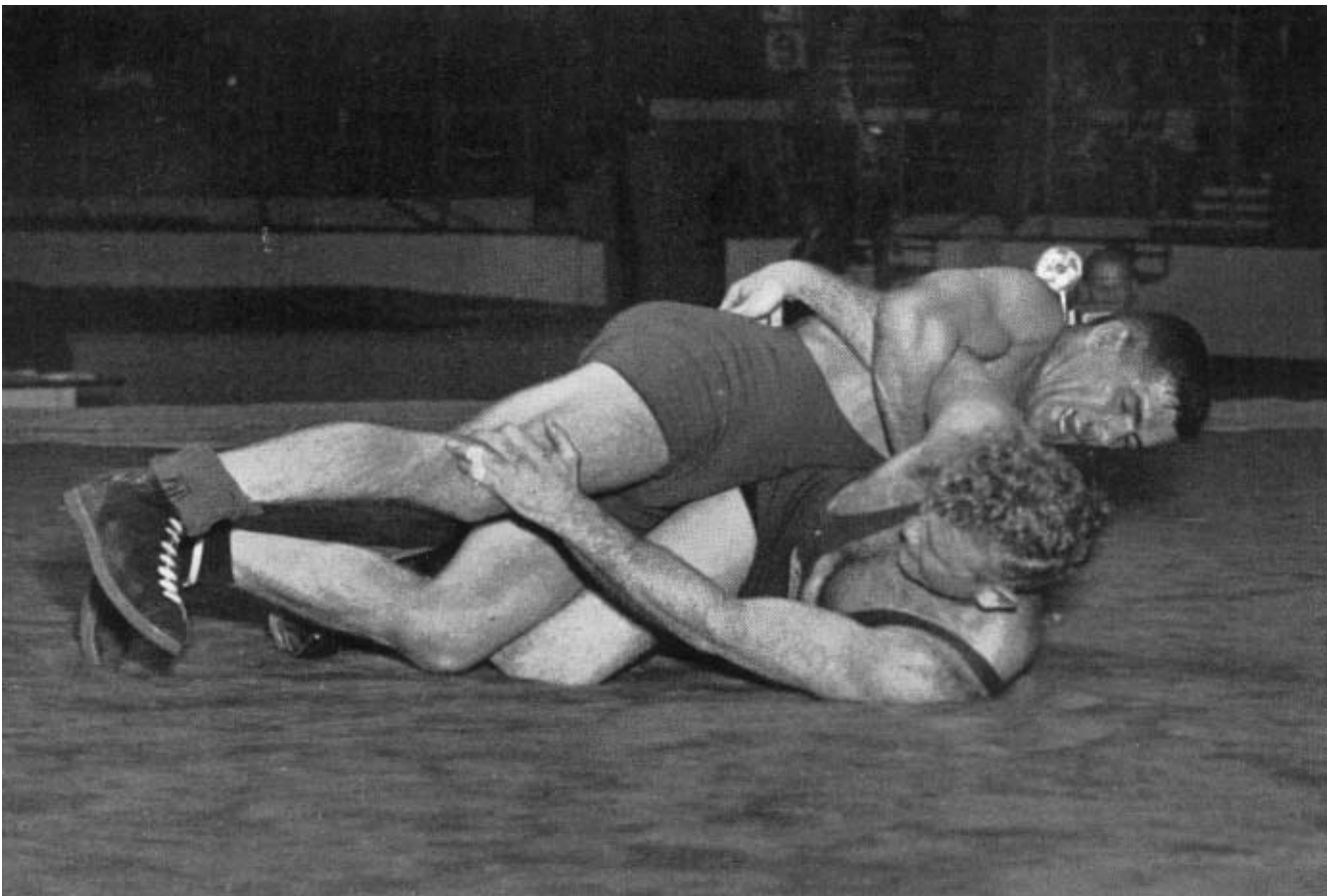

*The final bout in the welterweight class, free style, with Y. Dogu (Turkey) the winner, on top of R. Garrard (Australia).*

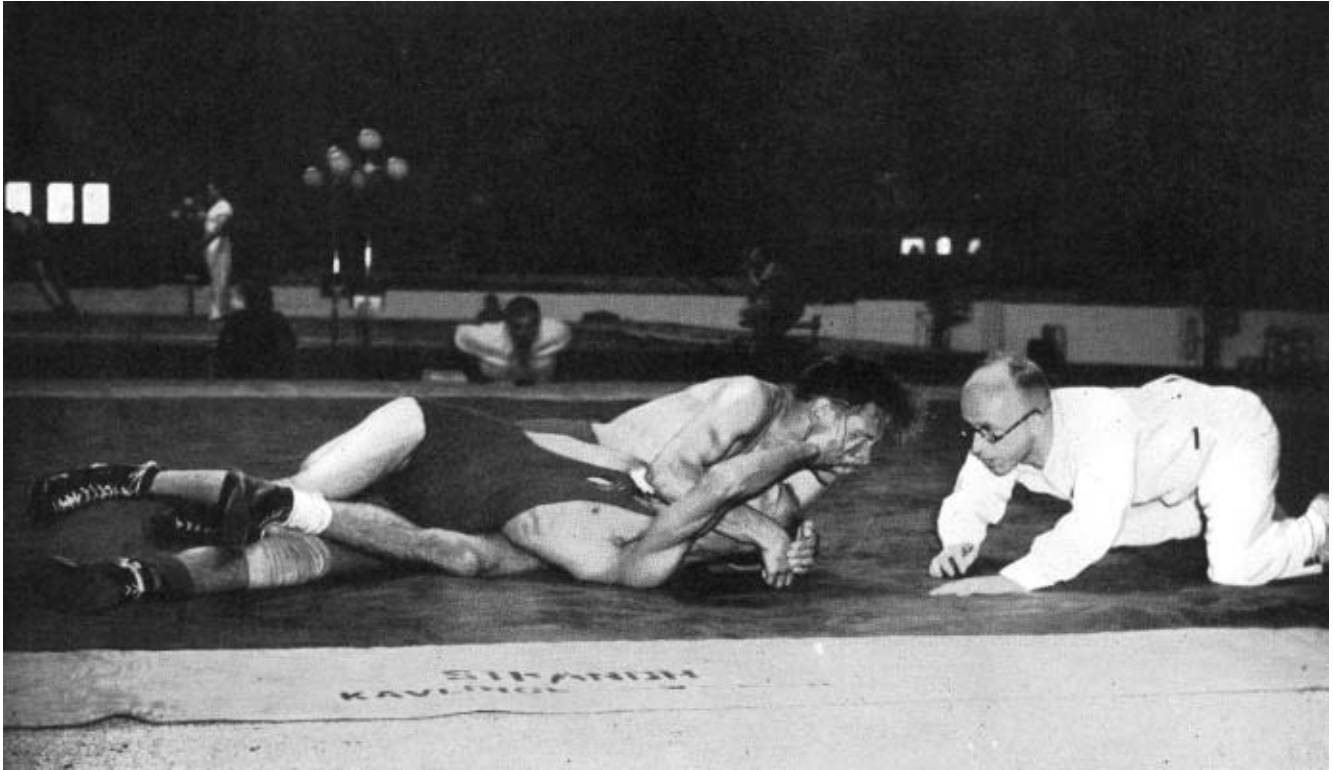

*The referee watches closely as P. Hietala (Finland) scores a fall against M. Gavelli (Italy) after 8 min. 2 sec. of their second round contest in the free style featherweight class.*



*The Turkish wrestlers were exceptionally successful in the free style contests with four winners and two seconds in the eight classes. Here are their four gold medallists with their trainer. From left to right, G. Bilge (featherweight), Y. Dogu (welterweight), Boytorun (trainer), C. Atik (lightweight) and N. Akar (bantamweight).*



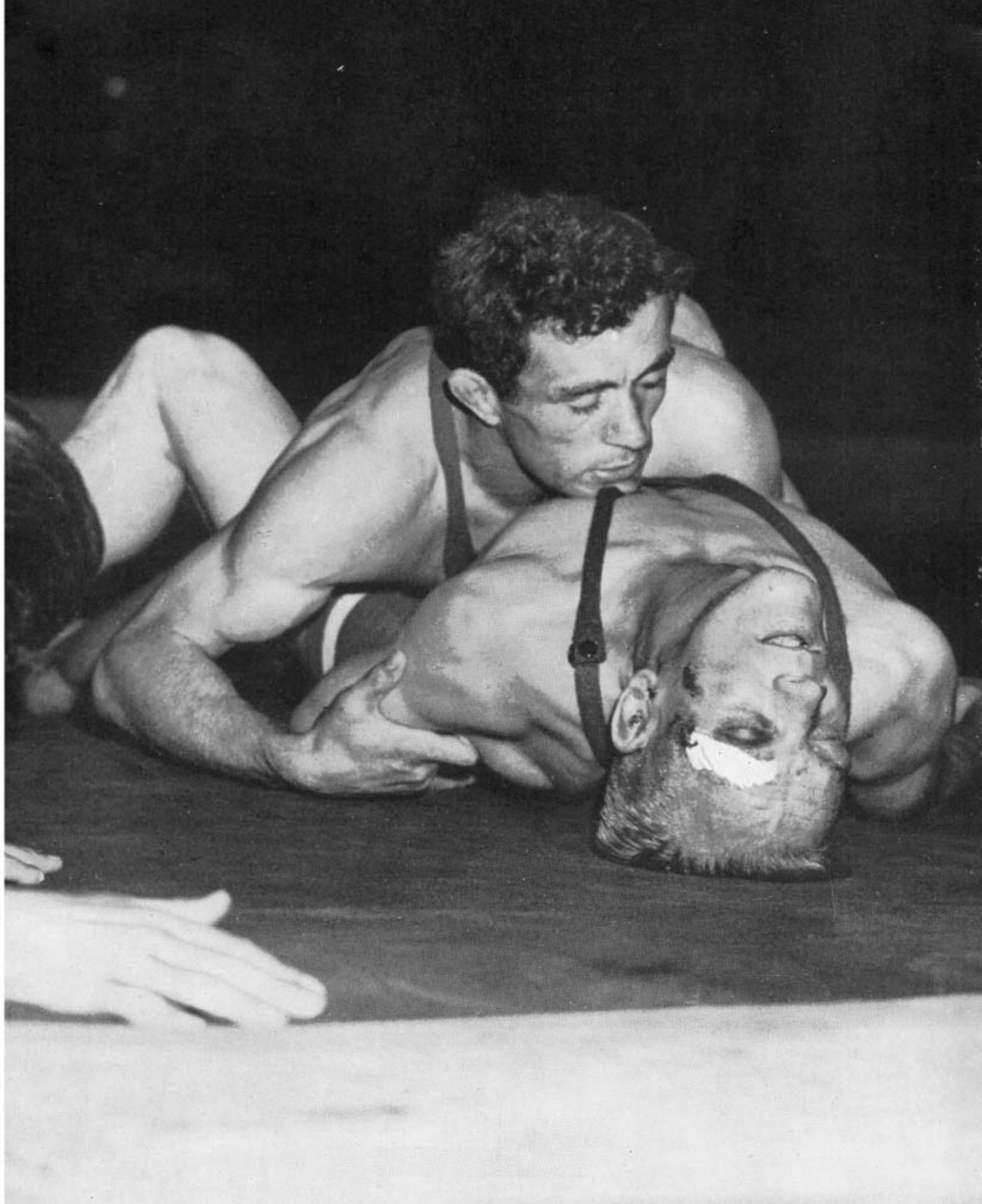

*A tense moment in the fourth round lightweight contest, free style, between C. Atik, winner and eventual gold medallist, on top, and S. Leppanen (Finland).*

# ROWING

The Committee of the Amateur Rowing Association at the request of the Organising Committee undertook the general management of the Olympic Regatta. This work was thereupon deputed to the Stewards of Henley Royal Regatta under the chairmanship of Mr. Harcourt Gold, O.B.E. Mr. David Williams was then appointed secretary of the Regatta by the Organising Committee.

The Stewards placed the whole of their equipment and land at the disposal of the Organising Committee. The six boat tents, landing stages and changing tents for competitors were left standing after Henley Royal Regatta. Booms and piles, however, had to be removed in order that the course could be widened.

The layout of enclosures was broadly as at Henley Regatta, but an additional stand to seat 4,000 people was erected.

A special Press box to seat 150 was built on piles in the river and positioned just behind the finishing line, and this gave a view of the whole course.

Broadcasting arrangements, under the supervision of the B.B.C., were made available to all countries, part of the Stewards barge (moored opposite the Judges box) being set aside for this purpose.

The rowing events were governed by the rules of the Federation Internationale de Societes d'Aviron, and all matters affecting the layout of the course, times of races, starting, umpiring and the draw for heats and stations were its sole responsibility.

As at other Olympic regattas the system of repechage was used which re-admits to competition crews which had been defeated once. After each day's racing a meeting of F.I.S.A. officials took place and a representative from each competing country attended. The results of the day's racing were announced, the draw for the following day took place and officials for the duties of starters and umpire were detailed.

## **Competing Nations a Record**

A record number of countries assembled at Henley-on-Thames to compete for the seven Olympic titles.

The 27 nations taking part in this historic regatta on the most famous and one of the loveliest courses in the world were from Argentine, Australia, Austria, Belgium, Brazil, Canada, Cuba, Czechoslovakia, Denmark, Egypt, Eire, Finland, France, Great Britain, Greece, Holland, Hungary, Italy, Norway, Portugal, Spain, South Africa, Sweden, Switzerland, United States, Uruguay and Yugoslavia. The only country not to put in an appearance was Poland, who was sadly missed.

The most popular event proved to be the Four with Coxswain, in which 16 countries competed—a record. The Single Sculls came next with 14 entrants. The Eights, Double Sculls and Coxswainless Pairs each had 12 crews competing and the Fours without Cox and the Coxless Pairs had 10 starters in each event.

Never previously in the history of the Olympic Games had 86 crews taken part, a welcome sign of the popularity of rowing the world over.

In 1908, when the Olympic Games were last held in England, the course was over one-and-a-half miles, and only nine countries took part.

In 1948, the distance was 1,929 metres (some 200 yards short of the regular Royal Regatta course). The course had been widened from 24 metres to 36 metres to take three crews abreast instead of two. The familiar piles and booms had been dispensed with and their place taken by underwater cables, moored six feet below the surface, and to which were attached marking buoys at each 50 metres mark. These, painted yellow with a red and white ringed base to the flag poles, marked the course very effectively. Overhead, at each 500 metre mark, hung, respectively, pale blue, red and yellow indicators marking stations or lanes 1, 2 and 3 to aid boats in keeping their correct positions over the course.

The umpire lost his time-honoured duty of having to start the race. In his place a starter, in a tower built on piles in the river bed above the centre stake boat, undertook this task and, as he shouted the word "Partez," a button was pressed which was connected by cable to the three stop watches at the finishing box, which were thus electrically set in motion. As each boat crossed the line, the electric circuit to each watch was broken and the time returned to a tenth of a second. The photographic finish apparatus which was installed to be called into service to confirm the result should a verdict be questioned, was happily never called into use. All decisions were given in seconds and tenths of a second.

The weather during the practice week before the Regatta commenced was wonderful, with a cloudless sky and a blazing sun all day and every day, but, as the week's racing approached, the weather deteriorated, and Thursday, August 5, was cold and rainy with a light following wind.

The day's racing opened with eight heats of the Fours with Cox, all with two in a heat, the United States, Italy and Denmark, returned the fastest times. Then came the Coxswainless Pairs, and here the British pair Laurie and Wilson only got home by a bare half length from Italy. In the Single Sculls three Diamond Sculls winners were competing in different heats, Kelly of U.S.A., Sepheriades of France and Mervyn Wood from Australia. All won convincingly. The Coxed Pairs heats were rowed off too, and here Denmark were beaten by Italy, but the Danes went through the repechage heat and then won the final. This also happened to Great Britain in the Double Sculls, when they were beaten by France, only to come through by the repechage and win the final. Repechage heats occupied the whole of the second day.

### **Wind and Rain**

On Saturday, the third day, weather conditions were at their worst, with a strong head wind blowing and almost tropical rainstorms occurring at intervals. Under such conditions the most dramatic race of the day took place, a Single Sculls heat between Kelly (U.S.A.), Rowe (Great Britain) and Risso (Uruguay). The American went off at a tremendous pace, with Rowe hanging on to him, leaving Risso well in the rear. These two virtually cracked each other, and Risso sculling his best pace over the course came up with Rowe at 1,500 metres, went through, got a view of Kelly and, in a tremendous



spurt, caught him and won by half a length. Wood of Australia was much too powerful for Sepheriades and won comfortably.

In the Coxless Fours, Denmark beat Great Britain by 3 seconds after a hard race. Great Britain beat U.S.A. fairly comfortably, with Belgium well behind, in the semi-final of the Double Sculls.

U.S.A., Denmark and Switzerland all won their semi-finals convincingly in the Coxed Fours.

In the Eights, U.S.A. overwhelmed Italy, winning by 16 seconds, Switzerland were third some 10 seconds behind Italy, Great Britain beat Canada by 6 seconds, and Norway beat Portugal by 6 seconds.

### **The Finals**

The finals were rowed on Monday and on this day the weather was sunny with a cross wind blowing.

The first final was for Fours with Cox between U.S.A., Switzerland and Denmark. Switzerland led, with U.S.A. and Denmark level; Denmark then challenged and at 750 metres were only a few feet behind, with the Americans a quarter length astern. At 1,200 metres the Americans were second only a canvas behind Switzerland. At 1,400 metres U.S.A. were just in the lead, and then a tremendous struggle ensued, America crossing the line 3 seconds ahead of Switzerland, with Denmark a length astern. After the presentation of the medals, the American tradition was observed by the throwing of the cox of the winning boat into the river, which was repeated when California University won the Eights for U.S.A.

In the final of the Coxless Pairs, Switzerland led, with Italy and Great Britain racing level. At 1,000 metres Switzerland held an advantage of a third of a length. Then the British pair challenged the leaders and gradually forged ahead to win by a bare length from the Swiss. The Italians tired perceptibly over the second half and finished two lengths astern of the Swiss.

The Single Sculls final was an anti-climax. Wood of Australia was held by the Italian for a minute or so. Then his power and stride overwhelmed his opponents and he finished easily, many lengths ahead of Risso of Uruguay, who came second, with Catasta of Italy a distance astern.

In the Coxed Pairs Italy led for the first 1,200 metres. At 1,300 metres the Danes just got their nose in front and then they steadily drew away, finally winning by three lengths with Hungary well in the rear.

The Italian Coxless Four went away like a shot from a gun and led the Danes by two lengths at 750 metres. The Danes were now out of their water, having moved over to the Bucks station instead of the centre. With a lead of one and three-quarter lengths over the Americans, they began to press the Italians. In the final burst the crew from Italy had the measure of the Danes and won by a length and a half, with U.S.A. a length astern of Denmark.

In the Double Sculls final, Burnell and Bushnell, representing Great Britain, went out for the lead from the start. At 250 metres the Danes were second, followed closely by Uruguay. Then the Danish crew hit the buoys and Uruguay came up into second place some two lengths behind the British. At 1,200 metres, the Danes, sculling strongly, had overhauled the Uruguayans and were only one and a quarter lengths behind the leaders. The British, sculling with great power and determination, staved off the Danish challenge and won convincingly by 4 seconds. Uruguay were 7 seconds behind the Danes.

### **U.S.A. Again Win Eights**

The last race of the day, the final of the Eights, proved conclusively the great superiority of the American crew from California University. At six successive Games, the Eights have been won by U.S.A. This final was far and away the easiest win, for in Berlin in 1936, and in California in 1932, the verdict each time was " 1 foot" and each time Italy was second. Great Britain (the Cambridge Boat Race crew) went out for the lead at once and went away fast, obtaining a lead of a bare length at 500 metres, but at half-way the Americans were ahead. They went off the mark in a steady rhythm, never hurrying, just rowing like a machine, entirely ignoring the opposition. Racing against the watch the whole way, their final " row in " was a joy to watch. The beat went up quite gradually and a perfectly balanced tremendously strong eight fairly swept home to win by 10 seconds from Great Britain. The British crew fought the whole way and never faltered, but even so they were gallantly hunted home by Norway who were only 3½ seconds behind.

And so ended a wonderful Olympic Regatta, the greatest ever, a wonderful exhibition of oarsmanship and, even more important, of international friendship and good fellowship at its best.

### **The Victory Ceremony**

The Victory Ceremonies for the rowing events took place at Henley after each final. The excitement and cheering of the contest died away as the victorious crew turned their boat and paddled slowly back down the course to the special raft built out from the enclosures. They climbed out and stood erect to receive the Olympic Medals, while once more the spectators cheered their victory. Once again came the hush, the national flag was raised, and the strains of the victor's National Anthem floated across the water.

Weary shoulders were braced, tired legs straightened as those lithe figures stood to attention in honour of their country. For weeks and months these young oarsmen had trained, had dedicated every moment of their lives that they might, at Henley, give of their best to strive to win the greatest rowing honours of the world.

The poignant simplicity of the brief ceremony was enhanced by the colour which surrounded it. The brilliant green of the grass, the white flagstuffs, the blazers of the men and the frocks of the women, the white canvas of the grandstand, and the scarlet, blue, green, yellow and white of the ensigns of the nations, outlined against the green of the hillside, made an unforgettable picture.

The music ceased, the tension eased and the winners climbed back into their boat to give place to the crews who had taken second and third places. They too, received their medals, silver and bronze, and the cheers of the crowd. They too, had striven and, even if they had not won, they could recall as consolation the words of Baron Pierre de Coubertin, founder of the Modern Olympic Games : " The important thing in the Olympic Games is not winning but taking part. The essential thing in life is not conquering, but fighting well." Words that every man, woman and child in the world would do well to carry in their hearts, aflame like the Olympic Torch.

# HENLEY ON THAMES

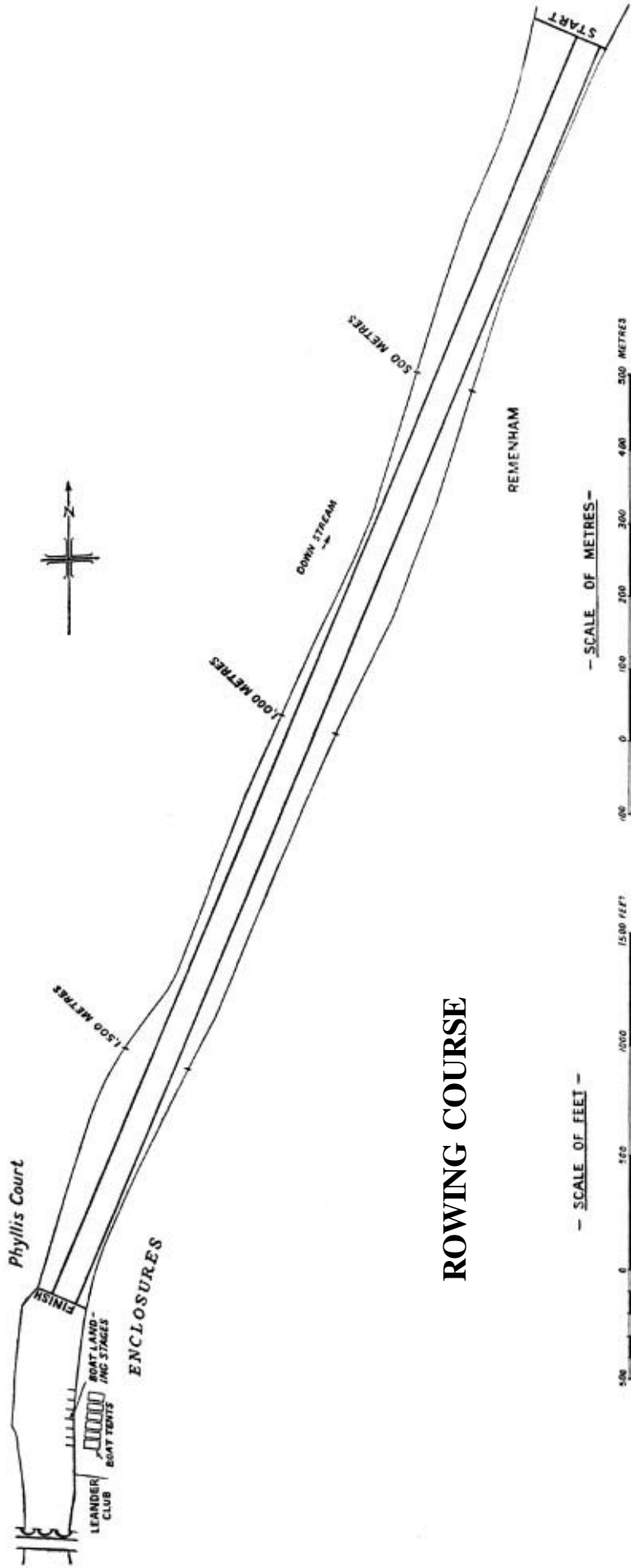

# ROWING COURSE

— SCALE OF FEET —



— SCALE OF METRES —



**FEDERATION INTERNATIONALE DES SOCIETES D'AVIRON**

*President*

RICO FIORONI, *Switzerland*

*Vice-President*

HARCOURT G. GOLD, O.B.E., *Great Britain*

*Hon. Sec. and Treasurer*

GASTON MULLEGG, *Switzerland*

**OFFICIALS FOR ROWING**

STARTERS

P. BEDENEL, *France*

V. de BISSCHOP, *Belgium*

Dr. H. BRUYN, *Holland*

H. HOTTINGER, *Switzerland*

Dr. H. MARRES, *Holland*

JUDGES AND TIMEKEEPERS

F. DUARTE, *Portugal*

M. GIOVANNETTI, *Italy*

G. HAAG, *Italy*

L. SPECK, *Switzerland*

: J. SPREUX, *Belgium*

UMPIRES

P. ANNONI, *Italy*

J. BERESFORD, *Great Britain*

C. GOES, *U.S.A.*

H. GOLD, *Great Britain*

K. N. HEINZ, *U.S.A.*

Dr. HENDRIX, *Holland*

M. MADERO, *Argentine*

G. O. NICKALLS, *Great Britain*

H. RICKETT, *Great Britain*

M. SEVERI, *Italy*

U. von SURY, *Switzerland*

W. TODD, *Australia*

Dr. H. WALTER, *Switzerland*

Dr. F. WIDIMSKY, *Czechoslovakia*

A. HOLTZ, *Greece*

## SINGLE SCULLS

### Previous Olympic Winners

1908	H. T. Blackstaffe	Great Britain	1928	H. R. Pearce	Australia
1912	W. D. Kinnear	Great Britain	1932	H. R. Pearce	Australia
1920	J. B. Kelly	U.S.A.	1936	G. Schafer	Germany
1924	J. Beresford	Great Britain			

There were 20 entries from 15 nations; 14 participants from 14 nations

## FIRST ROUND

The winner of each heat qualified for the Semi-finals. The remaining scullers competed in the Repechage

HEAT 1			HEAT 2			HEAT 3					
	<i>m.</i>	<i>s.</i>		<i>m.</i>	<i>s.</i>		<i>m.</i>	<i>s.</i>			
1 Wood, M.....	Australia	7	25.9	1 Rowe, A.....	Great Britain	7	30.5	1 Kelly, J. B., Jr. ....	U.S.A.....	7	39.7
2 Risso, E.....	Uruguay	7	36.3	2 Keller, H.....	Switzerland	7	34.2	2 Brunnqvist, C.....	Sweden.....	7	47.2
3 Stephen, I.....	South Africa	7	38.3	3 Petroveck, D.....	Yugoslavia	8	17.3	3 Omedes Calonja, J. ....	Spain.....	7	52.1
HEAT 4			HEAT 5								
	<i>m.</i>	<i>s.</i>		<i>m.</i>	<i>s.</i>		<i>m.</i>	<i>s.</i>			
1 Sepheriade, I.....	France	7	34.3	1 Catasta, R.....	Italy			*			
2 Cappozzi, T.....	Argentina	7	38.9	2 Matheou, F.....	Greece			*			
3 El Said, M.....	Egypt	8	1.4								

\* No official time given.

## REPECHAGE

The winner of each heat of the Repechage qualified for the Semi-finals

HEAT 1			HEAT 2			HEAT 3					
	<i>m.</i>	<i>s.</i>		<i>m.</i>	<i>s.</i>		<i>m.</i>	<i>s.</i>			
1 Cappozzi, T.....	Argentina	7	45	1 Risso, E.....	Uruguay	7	24.4	1 Stephen, I.....	South Africa	7	35.6
2 Omedes Calonja, J. ....	Spain	7	57.3	2 Keller, H.....	Switzerland	7	25.1	2 El Said, M.....	Egypt	7	44.8
3 Matheou, F.....	Greece	8	13.9	3 Brunnqvist, C.....	Sweden	7	27	3 Petroveck, D.....	Yugoslavia	8	17.3

## SEMI-FINALS

The winner of each Semi-final qualified for the Final

HEAT 1			HEAT 2			HEAT 3					
	<i>m.</i>	<i>s.</i>		<i>m.</i>	<i>s.</i>		<i>m.</i>	<i>s.</i>			
1 Catasta, R.....	Italy	8	5.4	1 Risso, E.....	Uruguay	8	9.3	1 Wood, M.....	Australia	8	8.5
2 Cappozzi, T.....	Argentina	8	12.6	2 Kelly, J. B., Jr. ....	U.S.A	8	9.7	2 Sepheriades, J.....	France	8	17.1
				3 Rowe, A.....	Great Britain	8	22.8				

## FINAL

		<i>m.</i>	<i>s.</i>
<b>1</b>	<b>WOOD, M.</b>	Australia	7 24.4
<b>2</b>	<b>RISSO, E.</b>	Uruguay	7 38.2
<b>3</b>	<b>CATASTA, R.</b>	Italy	7 51.4

## DOUBLE SCULLS

### *Previous Olympic Winners*

1920	J. B. Kelly and P. Costello	U.S.A.	1932	K. Myers and W. E. G. Gilmore	U.S.A.
1924	J. B. Kelly and P. Costello	U.S.A.	1936	J. Beresford and L. F. Southwood	Great Britain
1928	P. Costello and C. McIlvaine	U.S.A.			

There were 27 entries from 12 nations ; 24 participants from 12 nations

## FIRST ROUND

*The winner of each heat qualified for the Semi-finals. The remaining scullers competed in the Repechage.*

HEAT 1		HEAT 2	
	<i>m s.</i>		<i>m s.</i>
1	France (Maillet, J., str. ; Guilbert, C.) .....	1	Denmark (Parsner, E., str. ; Larsen, A.) .....
	6 47.8		6 50.1
2	Great Britain (Burnell, R., str. ; Bushnell, B.) .....	2	Switzerland (Gueissaz, M., str. ; Mathev, M.) .....
	6 56.9		6 58.7
3	Italy (Ustolin, M., str. ; Dapiran, F.) .....	3	Canada (Beaudry, J., str. ; Graves, F.) .....
	6 59.2		7 9.3
HEAT 3		HEAT 4	
	<i>m s.</i>		<i>m s.</i>
1	Belgium (Piessens, B., str. ; Collet, W.) .....	1	U.S.A. (Angyal, J., str. ; Gallagher, A.) .....
	6 50.9		7 1.3
2	Holland (Neumeier, C., str. ; Van der Meer, H.) .....	2	Argentine (Malvicino, A., str. ; Simo, J.) .....
	6 56.1		7 12.1
3	Uruguay (Jones, W., str. ; Rodriguez, J. A.) .....		
	7 14		

## REPECHAGE

*The winner of each heat of the Repechage qualified for the Semi-finals*

HEAT 1		HEAT 2		HEAT 3	
	<i>m s.</i>		<i>m s.</i>		<i>m s.</i>
1	Great Britain (Burnell, R., str. ; Van der Meer, H.) .....	1	Italy (Ustolin, M., str. ; Dapiran, F.) .....	1	Uruguay (Jones, W., str. ; Rodriguez, J. A.) .....
	7 0.2		6 53.9		7 2.1
2	Holland (Neumeier, C., str. ; Noelting, T.) .....	2	Switzerland (Gueissaz, M., str. ; Matthey, M.) .....	2	Canada (Beaudry, J., str. ; Graves, F.) .....
	7 7.1		7 0.2		7 8.7
3	Argentine (Malvicino, A., str. ; Noelting, T.) .....	3	Hungary (Ormandi, S., str. ; Simo, J.) .....		
	7 7.1		7 12.5		

## SEMI-FINALS

*The winner of each Semi-final qualified for the Final*

HEAT 1		HEAT 2		HEAT 3	
	<i>m s.</i>		<i>m s.</i>		<i>m s.</i>
1	Great Britain (Burnell, R., str. ; Bushnell, B.) .....	1	Denmark (Parsner, E., str. ; Larsen, A.) .....	1	Uruguay (Jones, W., str. ; Rodriguez, J. A.) .....
	7 55.1		7 48.3		8 3.2
2	U.S.A. (Angyal, J., str. ; Gallagher, A.) .....	2	Italy (Ustolin, M., str. ; Dapiran, F.) .....	2	France (Maillet, J., str. ; Guilbert, C.) .....
	8 7.3		7 58.2		8 33.2
3	Belgium (Piessens, B., str. ; Collet, W.) .....				
	8 17.2				

## FINAL

<b>1 GREAT BRITAIN</b> (Burnell, R., str. ; Bushnell, B.) .....	6 51.3
<b>2 DENMARK</b> (Parsner, E., str. ; Larsen, A.) .....	6 55.3
<b>3 URUGUAY</b> (Jones, W., str. ; Rodriguez, J. A.) .....	7 12.4



## PAIRS WITHOUT COX

### Previous Olympic Winners

1908	J. R. K. Fleming and G. L. Thomson	Great Britain	1932	L. Clive and H. R. A. Edwards	Great Britain
1924	A. Benyon and W. Rossingh	Holland	1936	W. Eichhorn and H. Strauss	Germany
1928	K. Moeschter and B. Muller	Germany			

There were 30 entries from 13 nations ; 24 participants from 12 nations

## FIRST ROUND

The winner of each heat qualified for the Semi-finals. The remaining pairs competed in the Repechage

HEAT 1		HEAT 2	
	<i>m s.</i>		<i>m s.</i>
1	Switzerland (Kalt, H., str. ; Kalt, J.)	1	Great Britain (Wilson, J. H. T., str. ; Laurie, W.)
	7 20.4		7 20.3
2	Australia (Grace, F., str. ; Bromley, E.)	2	Italy (Fanetti, F., str. ; Boni, B.)
	7 26.8		7 22.2
3	Denmark (Snogdahl, J., str. ; Jensen O. S.)	3	Argentina (Moreno, O., str. ; Sambuceti, C.)
	7 28.3		7 54.2
HEAT 3		HEAT 4	
	<i>m s.</i>		<i>m s.</i>
1	Austria (Watzke, G., str. ; Watzke, K.)	1	Brazil (Zancani, P., str. ; Diebold, P.)
	7 19.3		7 33.1
2	U.S.A. (Wade, F., str. ; Stephan, R. W.)	2	Belgium (Van Antwerpen, C., str. ; Rosa, J.)
	7 20.3		7 35.0
3	Sweden (Gunnarsson, E., str. ; Torberntsson, B.)	3	France (Rothley, P., str. ; Heitz, P.)
	7 36.3		7 36.2

## REPECHAGE

The winner of each heat of the Repechage qualified for the Semi-finals

HEAT 1		HEAT 2		HEAT 3	
	<i>m s.</i>		<i>m s.</i>		<i>m s.</i>
1	Italy (Fanetti, F., str. ; Boni, B.)	1	Denmark (Snogdahl, J., str. ; Jensen, O. S.)	1	Australia (Grace, F., str. ; Bromley, E.)
	7 24.6		7 26.4		7 28.4
2	U.S.A. (Wade, F., str. ; Stephan, R. W.)	2	Belgium (Van Antwerpen, C., str. ; Rosa, J.)	2	Sweden (Gunnarsson, E., str. ; Torberntsson, B.)
	7 30.5		7 34.4		7 34.9
3	France (Rothley, P., str. ; Heitz, P.)	3	Argentina (Moreno, O., str. ; Sambuceti, C.)		
	7 42.3		7 45.7		

## SEMI-FINALS

The winner of each Semi-final qualified for the Final

HEAT 1		HEAT 2		HEAT 3	
	<i>m s.</i>		<i>m s.</i>		<i>m s.</i>
1	Switzerland (Kalt, H., str. ; Kalt, J.)	1	Italy (Fanetti, F., str. ; Boni, B.)	1	Great Britain (Wilson, J. H. T., str. ; Laurie, W.)
	7 47.3		7 52.8		8 5.9
2	Australia (Grace, F., str. ; Bromley, E.)	2	Denmark (Snogdahl, J., str. ; Jensen, O. S.)	2	Brazil (Zancani, P., str. ; Diebold, P.)
	7 54.5		7 54.3		8 18.6
3	Austria (Watzke, G., str. ; Watzke, K.)				
	8 3.1				

## FINAL

	<i>m s.</i>
1 GREAT BRITAIN (Wilson, J. H. T., str. ; Laurie, W.)	7 21.1
2 SWITZERLAND (Kalt, H., str. ; Kalt, J.)	7 23.9
3 ITALY (Fanetti, F., str. ; Boni, B.)	7 31.5

## PAIRS WITH COX

### *Previous Olympic Winners*

1920 Italy	1932 U.S.A.
1924 Switzerland	1936 Germany
1928 Switzerland	

There were 38 entries from 10 nations : 27 participants from 9 nations

## FIRST ROUND

*The winner of each heat qualified for the Semi-finals. The remaining pairs competed in the Repechage*

HEAT 1		HEAT 2	
	<i>m s.</i>		<i>m s.</i>
1 <i>Yugoslavia</i> (Ristic, V., str. ; Horvatin, M., Saric, P., cox) ..	7 59.0	1 <i>Italy</i> (Steffe, G., str. ; Tarlao, A., Radi, A., cox).....	7 47.6
2 <i>Great Britain</i> (Scott, M., str. ; James, H., Walker, D., cox) ..	8 6.8	2 <i>Denmark</i> (Pedersen, F., str. ; Henriksen, T., Andersen, C. E., cox).....	7 51.7
3 <i>U.S.A.</i> (Deeney, J., str. ; Toland, J., McIntyre, J., cox) .	8 13.3	3 <i>Hungary</i> (Szendei, A., str. Zsitnik, B., Zimonyi, R., cox).....	8 19.7
HEAT 3		HEAT 4	
	<i>m s.</i>		<i>m s.</i>
1 <i>France</i> (Sartor, Ampelio, str. ; Sartor, Aristide, Crezen, R., cox) ..	8 1.7	<i>Argentina</i> (Towers, P., str. ; de Peralta, R., Parker, J., cox) rowed over.	
2 <i>Greece</i> (Diakoumakos, I., str. ; Venieris, G., Emmanouil, G., cox) ..	8 21.9	<i>Brazil</i> withdrew.	

## REPECHAGE

*The winner of each heat of the Repechage qualified for the Semi-finals*

HEAT 1		HEAT 2	
	<i>m. s.</i>		<i>m s.</i>
1 <i>Hungary</i> (Szendei, A., str. ; Zsitnik, B., Zimonyi, R., cox) ..	7 56.4	1 <i>Denmark</i> (Pedersen, F., str. ; Henriksen, T., Andersen, C. E., cox).....	7 51.2
2 <i>U.S.A.</i> (Deeney, J., str. ; Toland, J., McIntyre, J., cox) .	8 9.2	2 <i>Great Britain</i> (Scott, M., str. ; James, H., Walker, D., cox) ..	8 1.7
3 <i>Greece</i> (Diakoumakos, I., str. ; Venieris, G., Emmanouil, G., cox) ..	8 17.3		

## SEMI-FINALS

*The winner of each Semi-final qualified for the Final*

HEAT 1		HEAT 2		HEAT 3	
	<i>m s.</i>		<i>m s.</i>		<i>m s.</i>
1 <i>Denmark</i> (Pedersen, F., str. ; Henriksen, T., Andersen, C. E., cox).....	8 12.1	1 <i>Hungary</i> (Szendei, A., str. ; Zsitnik, B., Zimonyi, R., cox)	8 15.7	1 <i>Italy</i> (Steffe, G., str. ; Tarlao, A., Radi, A., cox).....	8 4.2
2 <i>France</i> (Sartor, Ampelio, str. ; Sartor, Aristide, Crezen, R., cox).....	8 14.9	2 <i>Argentina</i> (Towers, P., str. ; Porcel de Peralta, R., Parker, J., cox).....	8 27.7	2 <i>Yugoslavia</i> (Ristic, V., str. ; Horvatin, M., Djordjevic, D., cox).....	8 7.9

## FINAL

	<i>m. s.</i>
1 <b>DENMARK</b> (Pedersen, F., str. ; Henriksen, T., Andersen, C. E., cox).....	8 0.5
2 <b>ITALY</b> (Steffe, G. str.; Tarlao, A. Radi, A., cox).....	8 12.2
3 <b>HUNGARY</b> (Szendei, A., str. ; Zsitnik, B., Zimonyi, R., cox).....	8 25.2

## FOURS WITHOUT COX

*Previous Olympic Winners*

1908	Great Britain	1932	Great Britain
1924	Great Britain	1936	Germany
1928	Great Britain		

There were 56 entries from 11 nations ; 40 participants from 10 nations

## FIRST ROUND

*The winner of each heat qualified for the Semi-finals. The remaining fours competed in the Repechage*

HEAT 1		HEAT 2	
	<i>m s.</i>		<i>m s.</i>
1 <i>Italy</i> (Moioli, G., str. ; Morille, E., Invernizzi, G., Faggi, F.).....	6 34.8	1 <i>U.S.A.</i> (Kingsbury, F., str. ; Griffing, S., Gates, G., Perew, R.).....	6 43.8
2 <i>Denmark</i> (Halkjaer, H., str. ; Hansen, A., Schroder, H., Larsen, J.) .....	6 40.5	2 <i>Argentine</i> (Curatella, J., str. ; Madero, A., Zolezzi, O., Almiron, O.).....	6 51.0
3 <i>South Africa</i> (Ramsay, E., str. ; Ikin, A., Mayberry, D., Kietzman, C.).....	6 58.6	3 <i>Hungary</i> (Zagon, M., str. ; Nagy, L., Nyilasi, B., Nadas, T.).....	7 36.7
HEAT 3		HEAT 4	
	<i>m s.</i>		<i>m s.</i>
1 <i>Great Britain</i> (Kirkpatrick, P., str. ; Rushmere, H., Christie, T., Butcher, A.).....	6 37.0	1 <i>Holland</i> (Van Suylekom, H., str. ; Haarsma, S., Dekker, J., Van den Berg, J.).....	6 47.1
2 <i>Czechoslovakia</i> (Roubik, V., str. Kalas, J., Schejbal, J., Vanek, K.).....	6 44.9	2 <i>Yugoslavia</i> (Ozretic, P., str. ; Lipanovik, I., Mojtic, M., Alujevic, K.).....	6 57.1

## REPECHAGE

*The winner of each heat of the Repechage qualified for the Semi-finals*

HEAT 1		HEAT 2	
	<i>m s.</i>		<i>m s.</i>
1 <i>South Africa</i> (Ramsay, E., str. ; Ikin, A., Mayberry, D., Kietzman, C.).....	6 49.7	1 <i>Denmark</i> (Halkjaer, H., str. ; Hansen, A., Schroder, H., Larsen, J.) .....	6 35.1
2 <i>Argentine</i> (Curatella, J., str. ; Madero, A., Zolezzi, O., Almiron, O.).....	6 50.9	2 <i>Czechoslovakia</i> (Roubik, V., str. ; Kalas, J., Schejbal, J., Vanek, K.).....	6 41.7
3 <i>Yugoslavia</i> (Ozretic, P., str. ; Lipanovik, I., Mojtic, M., Alujevic, K.).....	6 59.4	<i>Hungary</i> withdrew.	

## SEMI-FINALS

*The winner of each Semi-final qualified for the Final*

HEAT 1		HEAT 2		HEAT 3	
	<i>m s.</i>		<i>m s.</i>		<i>m s.</i>
1 <i>Italy</i> (Moioli, G., str. ; Morille, E., Invernizzi, G., Faggi, F.).....	7 15.0	1 <i>Denmark</i> (Halkjaer, H., str. ; Hansen, A., Schroder, H., Larsen, J.) .....	7 13.8	1 <i>U.S.A.</i> (Kingsbury, F., str. ; Griffing, S., Gates, G., Perew, R.).....	7 42.2
2 <i>Holland</i> (Van Suylekom, H., str. ; Haarsma, S., Dekker, J., Van den Berg, J.) .....	7 23.0	2 <i>Great Britain</i> (Kirkpatrick, P., str. ; Rushmere, H., Christie, T., Butcher, A.) .....	7 16.3	2 <i>South Africa</i> (Ramsay, E., str. ; Ikin, A., Mayberry, D., Kietzman, C.).....	7 57.2

## FINAL

	<i>m s.</i>
1 <b>ITALY</b> (Moioli, G., str. ; Morille, E., Invernizzi, G., Faggi, F.) .....	6 39.0
2 <b>DENMARK</b> (Halkjaer, H., str. ; Hansen, A., Schroder, H., Larsen, J.) .....	6 43.5
3 <b>U.S.A.</b> (Kingsbury, F., str. ; Griffing, S., Gates, G., Perew, R.).....	6 47.7

## FOURS WITH COX

*Previous Olympic Winners*

1912	Germany	1928	Italy
1920	Switzerland	1932	Germany
1924	Switzerland	1936	Germany

There were 102 entries from 16 nations ; 80 participants from 16 nations

## FIRST ROUND

*The winner of each heat qualified for the Second Round. The remaining fours competed in the Repechage*

HEAT 1		HEAT 2		HEAT 3							
	<i>m. s.</i>		<i>m. s.</i>		<i>m. s.</i>						
1	<i>Portugal</i> (Goncalves Torres, A., str. ; Jose da Silva, D., Joaquim Cancela, J., Seixo, J., Goncalves Rego, L., cox) .....	6	51.4	1	<i>Hungary</i> (Zagon, M., str. ; Nagy, L., Nyilasi, B., Nadas, T., Zimonyi, R., cox) .....	6	58.8	1	<i>Italy</i> (Polloni, R., str. ; Gotti, F., Macario, R., Cerutti, R., Cambieri, D., cox) .....	6	49.1
2	<i>Greece</i> (Paraskevaidis, F., str. ; Filippidis, N., Klaggas, H., Nikolaou, N., Emmanouil, G., cox) .....	7	7.2	2	<i>Yugoslavia</i> (Bujas, S., str. Krncevic, S., Labura, J., Krncevic, D., Djordjevic, D., cox) .....	7	8.0	2	<i>Australia</i> (Lambert, W., str. ; Lambie, H., Smith, C., Webster, J., Darcey, T., cox) .....	7	4.3
HEAT 4		HEAT 5		HEAT 6							
	<i>m. s.</i>		<i>m. s.</i>		<i>m. s.</i>						
1	<i>U.S.A.</i> (Westlund, W., str. ; Martin, R. D., Will, R., Giovanelli, G., Morgan, A., cox) .....	6	48.8	1	<i>Austria</i> (Bittman, E., str. ; Sitter, K., Frauneder, F., Obrietan, T., Riedel, K., cox) .....	7	2.2	1	<i>Denmark</i> (Larsen, E., str. ; Neilsen, B., Larsen, H., Knudsen, H., Olsen, I., cox) .....	6	52.5
2	<i>Great Britain</i> (Pursell, A., str. ; Collins, R., Woodward, W., Leckie, W., Healey, J., cox) .....	7	1.9	2	<i>Cuba</i> (Cora Johnson, R., str. ; Godoy Solis, J., Puig Miyar, M., Puig Miyar, R., Junco Mesa, T., cox) .....	7	8.7	2	<i>Norway</i> (Serck-Hansen, A., str. ; Sandborg, G., Gronli, S., Evensen, W., Sandaker, T., cox) .....	6	58.9
HEAT 7		HEAT 8									
	<i>m. s.</i>		<i>m. s.</i>								
1	<i>Switzerland</i> (Reichling, R., str. ; Schriever, E., Knecht, E., Stebler, P., Moccand, A., cox) .....	6	57.3	1	<i>France</i> (Pieddeloup, J., str. ; Lotti, R., Maquat, G., Souche, J., Boige grain, M., cox) .....	6	57.7				
2	<i>Argentina</i> (Semino, C., str. ; Crosta Noceti, C., Yedro, A., Sartori, I., Boneo, R., cox) ..	7	7.9	2	<i>Finland</i> (Lommi, V., str. ; Forsberg, H., Lommi, O., Forsberg, O., Autio, V., cox) ....	7	0.6				

## REPECHAGE

*The winner of each heat of the Repechage qualified for the Second Round*

HEAT 1		HEAT 2					
	<i>m. s.</i>		<i>m. s.</i>				
1	<i>Finland</i> (Lommi, V., str. ; Forsberg, H., Lommi, O., Forsberg, O., Autio, V., cox) .....	7	1.6	1	<i>Norway</i> (Serck-Hansen, A., str. ; Sandborg, G., Gronli, S., Evensen, W., Sandaker, T., cox) .....	7	4.4
2	<i>Australia</i> (Lambert, W., str. ; Lambie, H., Smith, C., Webster, J., Darcey, T., cox) .....	7	7.1	2	<i>Yugoslavia</i> (Bujas, S., str. ; Krncevic, S., Labura, J., Krncevic, D., Djordjevic, D., cox) .....	7	13.5
HEAT 3		HEAT 4					
	<i>m. s.</i>		<i>m. s.</i>				
1	<i>Cuba</i> (Cora Johnson, R., str. ; Godoy Solis, J., Puig Miyar, M., Puig Miyar, R., Junco Mesa, T., cox) .....	7	12.0	1	<i>Great Britain</i> (Pursell, A., str. ; Collins, R., Woodward, W., Leckie, W., Healey, J., cox) ..	6	58.4
2	<i>Greece</i> (Paraskevaidis, F., str. ; Filippidis, N., Klaggas, H., Nikolaou, N., Emmanouil, G., cox) .....	7	17.1	2	<i>Argentina</i> (Semino, C., str. ; Crosta Noceti, C., Yedro, A., Sartori, I., Boneo, R., cox) ..	7	0.1

## SECOND ROUND

*The winner of each heat of the Second Round qualified for the Semi-finals*

HEAT 1		HEAT 2		HEAT 3	
	<i>m s.</i>		<i>m s.</i>		<i>m s.</i>
1 <i>Italy</i> (Polloni, R., str. ; Gotti, F., Macario, R., Cerutti, R., Cambieri, D., cox).....	7 30.5	1 <i>Switzerland</i> (Reichling, R., str. ; Schriever, E., Knecht, E., Stebler, P., Moccand,A.,cox)	7 21.8	1 <i>U.S.A.</i> (Westlund, W., str. ; Martin, R., Will, R. D., Giovanelli, G., Morgan, A., cox)	7 21.4
2 <i>Norway</i> (Serck-Hansen, A., str. ; Sandborg, G., Gronli, S., Evensen, W., Sandaker, T., cox).....	7 34.0	2 <i>Austria</i> (Bittman, E., str. ; Sitter, K., Frauneder, F., Obrietan, T., Riedel, K., cox)	7 35.9	2 <i>Finland</i> (Lommi, V., str. ; Forsberg, H., Lommi, O., Forsberg, O., Autio, V., cox)	7 36.5
HEAT 4		HEAT 5		HEAT 6	
	<i>m s.</i>		<i>m s.</i>		<i>m s.</i>
1 <i>Denmark</i> (Larsen, E., str. ; Nielsen, B. R., Larsen, H., Knudsen, H., Olsen, I., cox)	7 21.3	1 <i>France</i> (Pieddeloup, J., str. ; Lotti, R., Maquat, G., Souche, J., Boiegrain, M., cox).....	7 28.7	1 <i>Hungary</i> (Zagon, M., str. ; Nagy, L., Nyilasi, B., Nadas, T., Zimonyi, R., cox).....	7 31.6
2 <i>Portugal</i> (Goncalves Torres, A., str.; Jose da Silva, D., joaquim Cancela, J., Seixo, J., Goncalves Rego, L., cox)	7 28.5	2 <i>Cuba</i> (Cora Johnson, R., str. ; Godoy Solis, J., Puig Miyar, M., Puig Miyar, R., Junco Mesa, T., cox).....	7 37.2	2 <i>Great Britain</i> (Pursell, A., str. ; Collins, R., Woodward, W., Leckie, W., Healey, J., cox) ..	7 37.6

## SEMI-FINALS

*The winner of each Semi-final qualified for the Final*

HEAT 1		HEAT 2		HEAT 3	
	<i>m s.</i>		<i>m s.</i>		<i>m s.</i>
1 <i>U.S.A.</i> (Westlund, W., str. ; Martin, R. D., Will, R., Giovanelli, G., Morgan, A., cox).....	7 22.1	1 <i>Denmark</i> (Larsen, E., str. ; Nielsen, B. R., Larsen, H., Knudsen, H., Olsen, I., cox) ...	7 31.3	1 <i>Switzerland</i> (Reichling, R., str. ; Schriever, E., Knecht, E., Stebler, P., Moccand,A.,cox)	7 22.0
2 <i>France</i> (Pieddeloup, J., str. ; Lotti, R., Maquat, G., Souche, J., Boiegrain, M., cox).....	7 28.9	2 <i>Hungary</i> (Zagon, M., str. ; Nagy, L., Nyilasi, B., Nadas, T., Zimonyi, R., cox).....	7 46.1	2 <i>Italy</i> (Polloni, R., str. ; Gotti, F., Macario, R., Cerutti, R., Cambieri, D., cox).....	7 32.8

## FINAL

	<i>m s.</i>
1 <i>U.S.A.</i> (Westlund, W., str. ; Martin, R. D., Will, R., Giovanelli, G., Morgan, A., cox).....	6 50.3
2 <i>SWITZERLAND</i> (Reichling, R., str. ; Schriever, E., Knecht, E., Stebler, P., Moccand, A., cox).....	6 53.3
3 <i>DENMARK</i> (Larsen, E., str.; Nielsen, B. R., Larsen, H., Knudsen, H., Olsen, I., cox).....	6 58.6

## EIGHTS

*Previous Olympic Winners*

1908 Great Britain	1928 U.S.A.
1912 Great Britain	1932 U.S.A.
1920 U.S.A.	1936 U.S.A.
1924 U.S.A.	

There were 137 entries from 12 nations ; 108 participants from 12 nations

## FIRST ROUND

*The winner of each heat qualified for the Semi-finals. The remaining eights competed in the Repechage*

HEAT 1		HEAT 2	
	<i>m s.</i>		<i>m s.</i>
1 <i>Great Britain</i> (Barton, C., str. ; Lapage, M., Richardson, G., Bircher, E., Massey, P., Lloyd, C. B., Meyrick, D., Mellows, A., Dearlove, J., cox).....	6 5.3	1 <i>Italy</i> . (Fioretti, A., str. ; Acchini, M., Maninetti, F., de Bortoli, B., Ruberti, E., Sessa, P., Acchini, E., Gandini, L., Bardelli, A., cox).....	6 3.8
2 <i>Norway</i> (Lepsoe, K., str. ; Krakenes, T., Hansen, H., Gran Olsen, H., Krakenes, H., Naess, L., Pedersen, T., Monssen, C., Monssen, S., cox).....	6 8.2	2 <i>Switzerland</i> (Burri, O., str. ; Schultheiss, F., Starkl, F., Schultheiss, H., Amstutz, A., Grand, M., Gubeli, P., Vollmar, E., Vonlaufen, O., cox).....	6 6.9
3 <i>Denmark</i> (Willumsen, H., str. ; Nielsen, I., Rasmussen, N., Sorensen, J. G., Emcken, J., Korup, P., Petersen, B., Larsen, K. H., Wamberg, N., cox).....	6 17.6	3 <i>Argentine</i> (Pecchenino, L., str. ; Aichino, J., Cabral, R., Bove, C., Lingenfelder, E., Amado Kohli, C., Batista, P., Guerci, M., Fernandez, M., cox).....	6 10.5
HEAT 3		HEAT 4	
	<i>m s.</i>		<i>m s.</i>
1 <i>Canada</i> (Green, P., str. ; Christmas, R., Griffiths, H., A., Hammond, M., Zwiere-wich, J., McConnell, W., Cameron, R., Robertson, W., cox).....	6 7.2	1 <i>U.S.A.</i> (Turner, I., str. ; Turner, D., Hardy, J., Ahlgren, G., Butler, L., Brown, D., Smith, J. K., Stack, J., Purchase, R., cox).....	5 59.1
2 <i>Portugal</i> (Goncalves de Sousa Naia Fortes, F., str. ; Simoes Nato, A., Roque, C., Dias de Sousa, J., Naia Lemos, J., Roque da Benta, C., Naia Machado, J., Santos da Benta, R., Naia Machado, L., cox).....	6 10.5	2 <i>Yugoslavia</i> (Petrovic, M., str. ; Novicic, S., Drenovac, S., Becic, B., Telismanic, I., Pavlenc, K., Jovanovic, S., Sirotanovic, B., Saric, P., cox).....	6 16.2
3 <i>Eire</i> (Dooley, P., str. ; Tamplin, R., Harrold, P., McDonnell, B., Taylor, D., Hanly, S., McElligott, E., Dowdall, T., Lambert-Sugrue, D., cox).....	6 30.6	3 <i>France</i> (Fauveau, P., str. ; Sauvestre, P., Bouton, A., Aschehoug, E., Bocahut, J., Boucher, R., Clergerie, P., Lebranchu, R., Leon, R., cox).....	6 18.1

## REPECHAGE

*The winner of each heat of the Repechage qualified for the Semi-finals*

HEAT 1		HEAT 2		HEAT 3	
	<i>m s.</i>		<i>m s.</i>		<i>m s.</i>
1 <i>Portugal</i> (Goncalves de Sousa Naia Fortes, F., str. ; Simoes Nato, A., Roque, C., Dias de Sousa, J., Naia Lemos, J., Roque da Benta, C., Naia Machado, J., Santos da Benta, R., Naia Machado, L., cox) .....	6 11.3	1 <i>Switzerland</i> (Burri, O., str. ; Schultheiss, F., Starkl, F., Schultheiss, H., Amstutz., A., Grand, M., Gubeli, P., Vollmar, E., Vonlaufen, O., cox).....	6 7.3	1 <i>Norway</i> (Lepsoe, K., str. ; Krakenes, T., Hansen, H., Gran Olsen, H., Krakenes, H., Naess, L., Pedersen, T., Monssen, C., Monssen, S., cox).....	6 12.5
2 <i>Argentina</i> (Pecchenino, L., str. ; Aichino, J., Cabral, R., Bove, C., Lingenfelder, E., Amado Kohli, C., Batista, P., Guerci, M., Fernandez, M., cox) .....	6 12.6	2 <i>Denmark</i> (Willumsen, H., str. ; Nielsen, I., Rasmussen, N., Sorensen, J. G., Emcken, J., Korup, P., Petersen, B., Larsen, K. H., Wamberg, N., cox).....	6 9.4	2 <i>Eire</i> (Dooley, P., str. ; Tamp- lin, R., Harrold, P., Mc- Donnell, B., Taylor, D., Hanly, S., McElligott, E., Dowdall, T., Lambert-Sugrue, D., cox).....	6 32.5
3 <i>Yugoslavia</i> (Petrovic, M., str. ; Novicic, S., Drenovac, S., Becic, B., Telismanic, I., Pavlenc, K., Jovanovic, S., Sirotanovic, B., Saric, P., cox).....	6 19.1				

## SEMI-FINALS

*The winner of each Semi-final qualified for the Final*

HEAT 1		HEAT 2		HEAT 3	
	<i>m s.</i>		<i>m s.</i>		<i>m s.</i>
1 <i>U.S.A.</i> (Turner, I., str. ; Turner, D., Hardy, J., Ahlgren, G., Butler, L., Brown, D., Smith, J. K., Stack, J., Purchase, R., cox).....	6 36.5	1 <i>Great Britain</i> (Barton, C., str. ; Lapage, M., Richardson, G., Bircher, E., Massey, P., Lloyd, C. B., Meyrick, D., Mellows, A., Dearlove, J., cox).....	6 38.1	1 <i>Norway</i> (Lepsoe, K., str. ; Krakenes, T., Hansen, H., Gran Olsen, H., Krakenes, H., Naess, L., Pedersen, T., Monssen, C., Monssen, S., cox).....	6 43.9
2 <i>Italy</i> (Fioretti, A., str. ; Acchini, M., Maninetti, F., de Bortoli, B., Ruberti, E., Sessa, P., Acchini, E., Gandini, L., Bardelli, A., cox).....	6 52.1	2 <i>Canada</i> (Green, P., str. ; Christ- mas, R., Griffiths, H., Stefani, A., Hammond, M., Zwiere- wick, J., McConnell, W., Cameron, R., Robertson, W., cox).....	6 44.1	2 <i>Portugal</i> (Goncalves de Sousa Naia Fortes, F., str. ; Simoes Nato, A., Roque, C., Dias de Sousa, J., Naia Lemos, J., Roque da Benta, C., Naia Machado, J., Santos da Benta, R., Naia Machado, L., cox).....	6 49.9
3 <i>Switzerland</i> (Burri, O., str. ; Schultheiss, F., Starkl, F., Schultheiss, H., Amstutz, A., Grand, M., Gubeli, P., Voll- mar, E., Vonlaufen, O., cox) .....	7 3.0				

## FINAL

	<i>m s.</i>
1 <b>U.S.A.</b> (Turner, I., str. ; Turner, D., Hardy, J., Ahlgren, G., Butler, L., Brown, D., Smith, J. K., Stack, J., Purchase, R., cox) ..	5 56.7
2 <b>GREAT BRITAIN</b> (Barton, C., str. ; Lapage, M., Richardson, G., Bircher, E., Massey, P., Lloyd, C. B., Meyrick, D., Mellows, A., Dearlove, J., cox) .....	6 6.9
3 <b>NORWAY</b> (Lepsoe, K., str. ; Krakenes, T., Hansen, H., Gran Olsen, H., Krakenes, H., Naess, L., Pedersen, T., Monssen, C., Monssen, S., cox).....	6 10.3



# SHOOTING

The stage for the shooting events of the Olympic Games was set at Bisley Camp, the home of the National Rifle Association. As the competitors began to arrive, so the face of Bisley underwent a change, the gaily coloured shooting attire of the various nations providing a startling contrast to the sombre and somewhat odd garb associated with the Bisley regular. In design and colour some of these outfits were most attractive, often adorned with badges of truly impressive proportions, and leaving no doubt as to which nationality the wearer belonged.

An Englishman was speaking French to Brazilians, a Swede speaking Spanish to an Italian, and, judging from the gestures and expressions of mutual understanding, here was truly a meeting of united nations ! To walk into the dining hall, too, was to find oneself in a veritable tower of Babel, but with the comforting thought that, somewhere among the staff of interpreters, there were people who understood it all.

International shooting is generally different from that usually seen and understood in the British Empire, and it was necessary, therefore, to make many special arrangements. For instance, covers were erected over the firing points for it is held that in these events, outside factors, introduced by the vagaries of the weather, must be eliminated or neutralised as far as possible. The weapons for the competitions are also of a different type from those normally used in Great Britain. The Full-Bore Rifle, for instance, is more than twice as heavy as the British Service Rifle, and has a set or hair trigger. These rifles are considerably more accurate, as they will shoot with certainty into a group of one minute of angle. The Pistols and self-loading Pistols have the butts shaped to fit the hand, to make them more comfortable to hold, and great care is taken to balance these weapons. The same remarks apply in general to the Small-Bore Rifles. In each case it will be noted, therefore, that the competitor is permitted to provide himself with a weapon which is shaped to give him the utmost comfort and assistance in its use, and of the greatest possible accuracy.

## **Endurance and Marksmanship**

Another point is, that in international competitions, a large number of rounds have to be fired in each class. They are, therefore, as well as being a test of marksmanship, also a test of physical endurance, for which prolonged training is necessary.

The necessity to build covers over the firing points made it impossible, in the 300 metre and 50 metre competitions, for any spectator to see the contestants in action. Arrangements were made, however, to provide large blackboards to show the scores of the competitors from each country, and recorders filled in the points scored after each series often rounds. In this way, it was possible for spectators to see how any competitor was faring, and to ascertain, by comparing the boards, who were the leaders.

If the scores are studied, it will be seen that a very high standard of accuracy was obtained. A man had to be most expert in the art of marksmanship to achieve Olympic Honours.

In the 300 metre Free Rifle, many competitors were able to make a score of more than

90 out of 100 in ten shots, with a four-inch circle as the ten-point ring, firing in the standing position. E. Grunig (Switzerland), the winner, took the lead after the " prone " position had been completed with 390 out of a possible 400. The eventual runner-up, P. Janhonen (Finland), was 1 point better than Grunig for the " kneeling " position with 376 points. Another Finn, K. Elo, tied with W. Roegeberg (Norway), the bronze medallist, with 357 points as best at the " standing " position, but Grunig with a score of 355, was third in this position and so won with a grand total of 1,120.

In the 50 metre Small Bore Rifle event, two competitors scored 59 out of 60 hits on a  $\frac{3}{4}$ -inch circle. Of these 59, more than 40 were inside the inner carton, which is only  $\frac{3}{8}$ -inch in diameter. A. Cook (U.S.A.), the winner, who dropped only one point, and that in his last series, scored 43 shots in the inner carton, while his compatriot, W. Tomsen, who dropped his one point in his third series, had 42 shots in the  $\frac{3}{8}$ -inch diameter.

J. Jonsson (Sweden), who was third, actually had 44 shots in this inner circle, but had three series of 99 points each, for a total of 597.

The 50 metre Free Pistol, a 60-round competition, produced leaders who averaged 90 out of 100 on a target the centre ring of which was only two inches in diameter, but the scores in this event did not compare with those of the Small Bore Rifle in producing excitement or a close finish for the winner. E. Vasquez Cam (Peru), with a total of 545, was 6 points ahead of his nearest rivals, and it was his consistent shooting which gained him the gold medal. His highest score for any series was 93, but his lowest 89, as against B. Rhyner (Switzerland) who in the third series scored 96 (the highest total for any one series), but obtained only fifth place as he dropped to 85 and 83 in later series. R. Schnyder (Switzerland), T. Ullman (Sweden) and H. Benner (U.S.A.) who finished second, third and fourth, respectively, all totalled 539 points, the first two with 60 hits on the aiming mark as against 58 by Benner, while Schnyder had 21 tens as against Ullman's 16.

### **The Rapid Fire Contest**

The fourth event, the Rapid Fire Pistol at 25 metres, unlike the other competitions, was fired for the most part in the open; thus the spectators could see the contestants and how each was faring. Moreover the event was of a highly practical nature. Each competitor had 5 man-sized targets, coloured black and with no aiming mark, and which had 10 scoring areas inscribed on them. The competition consisted of a 30-shot course, subsequently repeated, making 60 shots in all. In each course, there were six series, two necessitated the competitor firing his 5 shots in 8 seconds, two in 6 seconds and two in 4 seconds. Each series necessitated a shoot of five rounds, one shot to be fired at each of the 5 targets ; only one hit on each target counted. The targets were operated by an electric timing device, which swung them automatically in and out of view, giving appearances of exactly 8, 6 or 4 seconds. The placing of the competitors was decided first by the number of hits on the target, and secondly by the value of these hits if the number were equal. The standard can be appreciated when it is noted that no less than 22 competitors scored the highest possible number of hits, 60, and 15 more scored 59 hits.

The range of the Rapid Fire Pistol event was the scene of perhaps the most exciting moments of the shooting competitions. It appeared for some time that C. Diaz Saenz Valiente (Argentine) might be the winner with 571 points, but K. Takacs (Hungary) with a second series of 294, for a grand total of 580, was the eventual victor. The winner had competed in World Championship class before the second World War. Unfortunately, he had the misfortune to lose his pistol hand during the war, but he overcame this handicap by teaching himself, with conspicuous success, to shoot with his left hand.

**UNION INTERNATIONALE DE TIR**

**JURY OF APPEAL**

Mr. E. CARLSSON (*President, Union Internationale du Tir*)

LT.-COL. SIR LIONEL FLETCHER, CBE (*Great Britain*)

GENERAL H. V. OSTERMAN (*Finland*)

**300 METRE FREE RIFLE***Previous Olympic Winners*

1908 Col. J. K. Millner	<i>Great Britain</i>	1920 Fisher	<i>U.S.A.</i>
1912 P. R. Colas	<i>France</i>	1924 Fisher	<i>U.S.A.</i>

---

There were 47 entries from 17 nations ; 36 participants from 13 nations

---

**CONDITIONS**

The event is contested in 120 shots, 40 shots (4 series of 10 shots each) in each of the following positions : prone, kneeling, standing. The time allowed is 2 hours each in the prone and kneeling positions and 2 ½ hours in the standing position.

The target has a diameter of 1 metre with a black bullseye of 60 cm., the whole target being divided into 10 zones with values varying from 1 to 10 points.

All rifles are allowed once they have been passed as safe, subject to the following reservations : Optical glasses placed on the rifles are forbidden; the calibre shall in no case exceed 9 mm. or the weight, all accessories inclusive, be more than 9 kilos, and every competitor must fire with the same calibre rifle from each of the three positions.

No.	Name	Country	Prone	Kneeling	Standing	Total
1	<b>GRUNIG, E.</b> .....	<i>Switzerland</i>	390	375	355	1120
2	<b>JANHONEN, P.</b> .....	<i>Finland</i>	387	376	351	1114
3	<b>ROEGERBERG, W.</b> .....	<i>Norway</i>	382	373	357	1112
4	Johansson, K. I. B. ....	<i>Sweden</i>	383	374	347	1104
5	Leskinen, V. ....	<i>Finland</i>	389	368	346	1103
6	Elo, K. ....	<i>Finland</i>	379	359	357	1095
7	Kongsjorden, H. ....	<i>Norway</i>	384	373	336	1093
8	Erben, I. ....	<i>Sweden</i>	380	367	344	1091
9	Horber, O. ....	<i>Switzerland</i>	381	366	333	1080
10	Swanson, E. ....	<i>U.S.A.</i>	380	355	344	1079
11	Ciocco, M. ....	<i>Switzerland</i>	384	364	330	1078
12	Cagnasso, P. ....	<i>Argentina</i>	370	358	347	1075
13	Grimau, R. ....	<i>Argentina</i>	378	352	344	1074
14	Ortiz, A. ....	<i>Argentina</i>	379	357	336	1072
15	Sannes, O. ....	<i>Norway</i>	377	371	322	1070
16	Jackson, A. (120 Hits) .....	<i>U.S.A.</i>	369	356	342	1067
17	Frostell, W. (119 Hits) .....	<i>Sweden</i>	376	366	325	1067
18	Parsons, F. (Jnr.) (13 Centrals) .....	<i>U.S.A.</i>	376	348	333	1057
19	Nielsen, G. (12 Centrals) .....	<i>Denmark</i>	379	353	325	1057
20	Baldwin Ponte, E. ....	<i>Peru</i>	380	351	321	1052
21	Larsen, U. ....	<i>Denmark</i>	378	342	327	1047
22	Nozari Espinosa, J. ....	<i>Mexico</i>	372	337	304	1013
23	Fournier, J. ....	<i>France</i>	347	346	308	1001
24	Rouland, E. ....	<i>France</i>	348	320	323	991
25	Maslen-Jones, R. ....	<i>Great Britain</i>	362	323	296	981
26	Knott, J. ....	<i>Great Britain</i>	372	322	272	966
27	Lesceux, S. ....	<i>France</i>	349	331	272	952
28	Barlow, J. A. ....	<i>Great Britain</i>	367	308	274	949
29	Rodriguez Mireles, J. ....	<i>Mexico</i>	324	312	308	944
30	Parker, R. ....	<i>Australia</i>	359	281	286	926
31	Martinez Fuentes, G. ....	<i>Mexico</i>	329	298	288	915
32	Menghini, M. ....	<i>Australia</i>	362	292	202	856
33	Wise, J. ....	<i>Australia</i>	358	301	193	852
34	Mollazal, S. ....	<i>Iran</i>	284	234	142	660
35	Sakhai, M. ....	<i>Iran</i>	232	217	138	587
36	Khosropanah, F. ....	<i>Iran</i>	180	186	106	472

## 50 METRE SMALL BORE RIFLE

*Previous Olympic Winners*

1908	A. Carnell .....	Great Britain	1924	P. Coq de Lisle .....	France
1912	F. S. Hird .....	U.S.A.	1932	B. Ronnmark .....	Sweden
1920	L. M. Nuesslein .....	U.S.A.	1936	W. Røgeberg .....	Norway

There were 74 entries from 27 nations ; 71 participants from 26 nations

## CONDITIONS

The event is contested in 60 shots in the prone position (6 series of 10 shots each, each ten shots consisting of 2 shots on each bull of a five-bull target). The time allowed for each series of 10 shots is 15 minutes.

The target consists of five bulls, each 20 cm. in diameter, with a black bullseye 12 cm. in diameter, the whole target being divided into 10 zones with values varying from 1 to 10 points.

All rifles of calibre .22 are allowed, once they have been passed as safe. Cartridges of any make .22 short, long, or long rifle are allowed; the bullet must be of uncovered lead, weighing not more than 40 grains.

Place	Name	Country	Series						Total Scores	"X" Ring Hits
			I	II	III	IV	V	VI		
1	COOK, A. ....	U.S.A.	100	100	100	100	100	99	599	(43)
2	TOMSEN, W. ....	U.S.A.	100	100	99	100	100	100	599	(42)
3	JONSSON, J. ....	Sweden	99	100	99	100	99	100	597	(44)
4	Kongsjorden, H. ....	Norway	100	98	100	100	100	99	597	(39)
5	Skredegaard, T. ....	Norway	99	98	100	100	100	100	597	(39)
6	Baldwin Ponte, E. ....	Peru	99	100	98	100	99	100	596	(39)
7	Ravila, J. ....	Finland	99	98	100	100	99	100	596	(37)
8	Roegeberg, W. ....	Norway	99	100	100	99	98	100	596	(37)
9	Cail, H. ....	U.S.A.	99	100	100	99	99	99	596	(30)
10	Berg, U. ....	Sweden	98	100	100	100	98	99	595	(38)
11	Nielsen, G. ....	Denmark	100	99	100	100	97	99	595	(36)
12	Horber, O. ....	Switzerland	100	100	100	98	99	98	595	(35)
13	Guimaraes, A. ....	Brazil	100	98	98	99	99	100	594	(34)
14	Kaakinen, V. ....	Finland	98	99	100	99	100	98	594	(32)
15	Chandler, J. ....	Great Britain	98	100	99	99	98	99	593	(39)
16	Hynninen, O. ....	Finland	98	99	100	99	99	98	593	(37)
17	Jayme, C. ....	Philippines	99	98	100	99	99	98	593	(27)
18	Jones, G. ....	Great Britain	97	100	98	100	100	97	592	(40)
19	Koch, E. ....	Sweden	100	98	100	98	97	9	592	(37)
20	Gauthier Lafond, R. ....	France	99	99	98	99	98	99	592	(26)
21	Gilbert, V. ....	Great Britain	100	99	99	98	97	98	591	(36)
22	Von Einsiedel, A. ....	Philippines	98	97	97	100	100	99	591	(33)
23	Lafortune, F. ....	Belgium	97	99	99	100	98	98	591	(28)
24	Genot, L. ....	France	99	99	97	98	99	99	591	(27)
25	Jhonson, G. ....	Puerto Rico	100	99	96	98	98	99	590	(34)
26	Lozano Soto, O. ....	Mexico	98	100	98	96	98	100	590	(27)
27	Bouchez, M. ....	France	97	96	100	100	98	98	589	(29)
28	Braga, A. ....	Brazil	98	99	99	99	99	95	589	(27)
29	Brussaard, J. ....	Holland	99	98	96	98	98	99	588	(30)
30	Huet Bobadilla, G. ....	Mexico	97	98	98	99	98	98	588	(28)
31	Santa Maria Vives, O. ....	Cuba	99	98	96	100	97	98	588	(27)
32	Saetter-Lassen, E. ....	Denmark	97	98	98	98	100	97	588	(26)
33	Delval, J. ....	Belgium	96	99	95	98	99	100	587	(23)
34	Grunig, E. ....	Switzerland	98	99	99	96	98	97	587	(21)
35	Larrabure Salas, A. ....	Peru	97	97	96	98	98	100	586	(30)
36	Ravarino, M. ....	Monaco	97	96	100	97	97	99	586	(30)

**50 METRE SMALL BORE RIFLE—continued**

Place	Name	Country	Series						Total Scores	"X" Ring Hits
			I	II	III	IV	V	VI		
37	Coto Gonzalez, W. ....	<i>Cuba</i>	95	98	95	99	100	99	586	(28)
38	Valatas, E. ....	<i>Greece</i>	96	98	98	97	99	98	586	(27)
39	Lafortune, M. ....	<i>Belgium</i>	95	99	97	99	99	97	586	(25)
40	Vichos, G. ....	<i>Greece</i>	97	99	98	98	99	95	586	(25)
41	Mantilla Fernandini, L. ....	<i>Peru</i>	97	96	98	98	100	97	586	(25)
42	Christensen, B. ....	<i>Denmark</i>	96	98	99	96	100	96	585	(27)
43	Gison, M. ....	<i>Philippines</i>	99	97	96	96	99	98	585	(27)
44	Silva, J. ....	<i>Argentina</i>	100	96	97	96	97	99	585	(18)
45	Pinto de Faria, J. ....	<i>Brazil</i>	100	97	97	98	97	95	584	(30)
46	Platt, C. ....	<i>Australia</i>	94	99	99	97	97	98	584	(29)
47	Holt, N. ....	<i>Australia</i>	98	97	95	97	98	99	584	(23)
48	Ando, A. ....	<i>Argentina</i>	94	96	99	99	99	97	584	(20)
49	Schiaffino, D. ....	<i>Argentina</i>	96	98	98	100	96	95	583	(26)
50	Krapf, A. ....	<i>Austria</i>	98	95	96	97	98	97	581	(23)
51	Schoonman, G. ....	<i>Holland</i>	98	92	96	100	97	97	580	(34)
52	Marsan, P. ....	<i>Monaco</i>	97	96	96	93	99	99	580	(28)
53	de la Torre Gonzalez, J. ....	<i>Mexico</i>	98	95	97	96	96	98	580	(21)
54	Capuzzi, R. ....	<i>Italy</i>	96	97	95	96	97	98	579	(21)
55	Dove, L. ....	<i>Australia</i>	98	99	94	95	95	97	578	(20)
56	Ciocco, M. ....	<i>Switzerland</i>	96	96	94	95	98	97	576	(24)
57	Brandao Goncalves, A. ....	<i>Portugal</i>	94	99	92	96	97	98	576	(18)
58	Bohslavski, R. ....	<i>Austria</i>	95	96	96	94	96	98	575	(19)
59	Adami, L. ....	<i>Italy</i>	94	96	94	94	98	97	573	(19)
60	Woll, E. ....	<i>Austria</i>	95	99	100	97	86	96	573	(20)
61	Both, C. ....	<i>Holland</i>	95	96	95	95	96	95	572	(18)
62	Tauler Alos, C. ....	<i>Spain</i>	95	95	94	93	97	98	572	(16)
63	Botelho Machado Queiroz, C. ....	<i>Portugal</i>	93	96	97	93	96	97	572	(13)
64	Andoin Torralvo, J. ....	<i>Spain</i>	98	95	96	92	95	95	571	(13)
65	Aravossitas, A. ....	<i>Greece</i>	91	96	97	95	94	97	570	(20)
66	Rodrigues Silva, J. ....	<i>Portugal</i>	98	92	96	96	93	95	570	(10)
67	Sakhai, M. ....	<i>Iran</i>	91	94	91	90	96	90	552	(15)
68	Abel, R. ....	<i>Monaco</i>	91	93	96	87	96	88	551	(16)
69	Khosropanah, F. ....	<i>Iran</i>	88	90	88	94	92	93	545	(13)
70	Salam, S. ....	<i>Lebanon</i>	94	93	89	87	87	94	544	(10)
71	Mollazal, S. ....	<i>Iran</i>	85	87	83	89	85	82	511	(6)



**50 METRE PISTOL***Previous Olympic Winners*

1896	S. Paine .....	U.S.A. (30 m.)	1912	A. P. Lane .....	U.S.A.
1900	A. Roedern .....	Switzerland	1920	K. T. Frederick .....	U.S.A.
	1936	T. Ullman .....		Sweden	

There were 55 entries from 23 nations ; 50 participants from 22 nations

**CONDITIONS**

The event is contested in 60 shots (6 series of 10 shots each), with a break of 30 minutes after 3 series. The time allowed for each series of 10 shots is 20 minutes.

The target has a diameter of 50 cm. with a black bullseye of 20 cm., the whole target being divided into 10 zones with values varying from 1 to 10 points.

Place	Name	Country	Series						Total Scores
			I	II	III	IV	V	VI	
1	VASQUEZ CAM, E. ....	Peru	93	89	89	91	90	93	545
2	SCHNYDER, R. ....	Switzerland	88	94	89	86	93	89	539
	<i>(First tie rule: Highest number of hits on aiming mark—60. Second tie rule: Greatest number of 10's—21)</i>								
3	ULLMAN, T. ....	Sweden	90	87	92	87	90	93	539
	<i>(First tie rule : 60. Second tie rule: 16)</i>								
4	Benner, H. ....	U.S.A.	88	84	90	93	94	90	539
	<i>( First tie rule: 58)</i>								
5	Rhyner, B. ....	Switzerland	90	91	96	85	91	83	536
6	Leon Gozalo, A. de .....	Spai	85	93	87	92	87	90	534
7	Balogh, A. ....	Hungary	86	87	93	86	88	92	532
8	Lafortune, M. ....	Belgium	86	89	91	92	86	86	530
9	Gruben, F. ....	Argentine	86	89	89	87	83	93	527
10	Saarnikko, E. ....	Finland	86	91	84	92	86	88	527
11	Nordlund, S. ....	Sweden	87	84	85	91	93	87	527
12	Walsh, W. ....	U.S.A.	89	88	90	87	84	87	525
13	Borzsonyi, L. ....	Hungary	89	85	87	90	89	85	525
14	Tolgyessy, S. ....	Hungary	90	87	87	94	82	85	525
15	Ambuhl, H. ....	Switzerland	86	93	87	84	88	86	524
16	Bidegain, O. ....	Argentine	81	84	91	86	92	89	523
17	Brooks, Q. ....	U.S.A.	83	86	86	89	90	89	523
18	Cruzat Santa Maria, I. ....	Chile	86	87	86	90	87	86	522
19	Lahti, K. ....	Finland	81	91	82	92	91	85	522
20	Skarp, V. ....	Finland	86	86	89	86	93	80	520
21	Granet, G. ....	Great Britain	87	88	87	84	87	86	519
22	Berg, L. ....	Sweden	89	91	86	82	82	87	517
23	Gallie, J. ....	Great Britain	86	89	89	83	90	80	517
24	Mazoyer, J. ....	France	86	88	86	84	84	88	516
25	Gison, M. ....	Philippines	87	91	87	80	87	82	514
26	Von Einsiedel, A. ....	Philippines	79	89	85	85	84	90	512
27	Salgado Gandara, W. ....	Peru	78	91	85	90	84	84	512
28	Ferreira, S. ....	Brazil	83	81	85	86	90	86	511
29	Bonin, M. ....	France	84	86	87	86	84	84	511
30	Svendsen, G. ....	Norway	83	84	87	80	88	88	510
31	Santos, A. J. dos .....	Brazil	81	90	82	80	86	90	509
32	Chryssafis, E. ....	Greece	83	86	83	79	88	90	509
33	Tzovlas, N. ....	Greece	83	88	82	85	82	88	508
34	Injoque Hurst, C. ....	Peru	81	85	80	85	87	89	507
35	Rostagno, J. ....	Argentine	86	82	89	84	80	86	507
36	Margottí, S. ....	Italy	83	85	89	70	87	89	503
37	Ruiz Tagle Vicuna, L. ....	Chile	84	84	82	88	81	83	502
38	Palomo Puyol, L. ....	Spain	86	76	83	84	87	85	501
39	Barasorda, M. ....	Puerto Rico	83	81	73	89	88	87	501
40	Muller Hess, R. ....	Chile	81	81	83	85	85	82	497
41	Schultz, H. ....	Monaco	84	78	80	83	81	89	495
42	Cardoso, M. ....	Portugal	78	86	86	76	76	83	485
43	Marchant, P. ....	Great Britain	76	82	85	81	80	80	484
44	Stathis, G. ....	Greece	85	75	80	89	75	80	484
45	Amundsen, M. ....	Norway	84	79	83	78	83	76	483
46	Botelho Machado Queiroz, C. ....	Portugal	80	75	84	82	77	84	482
47	Basso Zerquers, G. ....	Cuba	82	77	82	82	82	72	477
48	Stephan, R. ....	France	72	70	85	79	87	84	477
49	Tejeda Canete, E. ....	Cuba	71	88	77	77	76	81	470
50	Helme, K. ....	Lebanon	56	56	61	58	47	53	331

**25 METRE RAPID FIRE PISTOL***Previous Olympic Winners*

1896	J. Phrangudis	<i>Greece</i>	1920	N. Paraines (30 m.)	<i>Brazil</i>
1900	J. Larouy	<i>France</i>	1924	H. N. Bailey	<i>U.S.A.</i>
1908	P. van Asbrock (50 yds.)	<i>Belgium</i>	1932	R. Morigi	<i>Italy</i>
1912	A. P. Lane (30 m.)	<i>U.S.A.</i>	1936	C. van Oyen	<i>German</i>

There were 69 entries from 26 nations; 59 participants from 22 nations

**CONDITIONS**

The event is contested in the standing position in 60 shots consisting of two 30-shot courses. Each course of 30 shots is made up as follows :—

Two series of 5 shots in 8 seconds each.

Two series of 5 shots in 6 seconds each.

Two series of 5 shots in 4 seconds each.

The target consists of five silhouette figures (man targets), each figure 160 cm. in height and 45 cm. wide, with 75 cm. between the centre of each figure. The figures are black on a white background and are divided into 10 rings with values from 1 to 10.

All pistols or revolvers of calibre .22 are allowed, once they have been passed as safe, provided that no telescope sights are fitted. Cartridges of any make .22 short, long, or long rifle are allowed; the bullet must be of uncovered lead, weighing not more than 40 grains.

No.	Name	Country	Target Control		No. of Hits	Total
			1st Series	2nd Series		
1	TAKACS, K. ....	<i>Hungary</i>	286	294	60	580
2	DIAZ SAENZ VALIENTE, C. ....	<i>Argentina</i>	285	286	60	571
3	LUNDQVIST, S. ....	<i>Sweden</i>	282	287	60	569
4	Ullman, T. ....	<i>Sweden</i>	286	278	60	564
5	Ravilo, L. ....	<i>Finland</i>	280	283	60	563(36x 10's)
6	Heusala, V. ....	<i>Finland</i>	283	280	60	563 (34X 10's)
7	Borzsonyi, L. ....	<i>Hungary</i>	280	282	60	562
8	Andersen, B. ....	<i>Norway</i>	276	283	60	559
9	Borriello, M. ....	<i>Italy</i>	275	282	60	557
10	Des Jamonieres, C. ....	<i>France</i>	280	275	60	555
11	Mylonas, C. ....	<i>Greece</i>	279	275	60	554(28X 10's)
12	Willott, C. ....	<i>Great Britain</i>	273	281	60	554(26x 10's)
13	Chow, F. ....	<i>U.S.A.</i>	277	276	60	553
14	Montemayor Rodriguez, E. ....	<i>Mexico</i>	278	272	60	550
15	Boninsegni, W. ....	<i>Italy</i>	274	275	60	549
16	Nielsen, O. ....	<i>Norway</i>	270	276	60	546 (23X 10's)
17	Palomo Puyol, L. ....	<i>Spain</i>	272	274	60	546 (20X 10's)
18	Bustamente Cruz, F. ....	<i>Mexico</i>	267	272	60	539
19	Hernandez, H. ....	<i>Cuba</i>	273	259	60	532
20	Schnyder, R. ....	<i>Switzerland</i>	262	269	60	531
21	Muller Hess, R. ....	<i>Chile</i>	261	267	60	528
22	Andrea Ferreira, J. ....	<i>Portugal</i>	253	271	60	524
23	Roettinger, P. ....	<i>U.S.A.</i>	267	287	59	554
24	Egnell, C. ....	<i>Sweden</i>	276	272	59	548 (35 X 10's)
25	Layton, J. ....	<i>U.S.A.</i>	280	268	59	548 (26X 10's)
26	Cadalso Fernandez, R. ....	<i>Cuba</i>	273	275	59	548 (25 X 10's)
27	Steele, H. ....	<i>Great Britain</i>	268	277	59	545
28	Aasnaes, H. ....	<i>Norway</i>	274	270	59	544
29	Rintanen, J. ....	<i>Finland</i>	263	280	59	543
30	Simao, R. ....	<i>Brazil</i>	264	276	59	540 (23 X 10's)
31	Lerche, A. ....	<i>Denmark</i>	273	267	59	540 (21X 10's)
32	Bouillet, R. ....	<i>France</i>	260	274	59	534
33	Hesse, D. ....	<i>France</i>	260	273	59	533
34	Santos, A. J. dos ....	<i>Brazil</i>	250	277	59	527
35	Tantalean Zorrilla, F. ....	<i>Peru</i>	263	257	59	520

**25 METRE RAPID FIRE PISTOL— *continued***

No.	Name	Country	Target Control		No. of Hits	Total
			1st Series	2nd Series		
36	Vichos, G. ....	<i>Greece</i>	269	249	59	518
37	Valderrama Peralta, R. ....	<i>Peru</i>	257	249	59	506
38	Balogh, A. ....	<i>Hungary</i>	268	287	58	555
39	Swire, H. ....	<i>Great Britain</i>	267	271	58	538
40	Gison, M. ....	<i>Philippines</i>	259	271	58	530
41	Vilholth, C. ....	<i>Denmark</i>	265	258	58	523
42	Cruzat Santa Maria, I. ....	<i>Chile</i>	236	260	58	496
43	Rodriguez Feo, C. ....	<i>Cuba</i>	278	255	57	533
44	Alanis Tamez, J. ....	<i>Mexico</i>	268	261	57	529
45	Roger, J. ....	<i>Argentina</i>	243	270	57	513
46	Alonso Sillero, J. ....	<i>Spain</i>	268	232	57	500
47	Pena y Lillo Nino de Zepeda, P. ....	<i>Chile</i>	258	238	57	496
48	Mendizabal Raing, E. ....	<i>Peru</i>	230	250	57	480
49	Bernini, F. ....	<i>Italy</i>	281	247	56	528
50	Fernandez, D. ....	<i>Argentina</i>	236	275	56	511
51	Munter, C. ....	<i>Denmark</i>	270	228	56	498
52	Kessels, P. ....	<i>Holland</i>	252	227	56	479
53	Chryssafis, E. ....	<i>Greece</i>	271	240	55	511
54	Botelho Machado Queiroz, C. ....	<i>Portugal</i>	235	254	55	489
55	Cardoso, M. ....	<i>Portugal</i>	226	238	55	464
56	Sobocinsky, A. ....	<i>Brazil</i>	262	228	54	490
57	Helme, K. ....	<i>Lebanon</i>	228	195	53	423
58	Esteve Magnet, P. ....	<i>Spain</i>	238	209	52	447
59	Lienhard, W. ....	<i>Switzerland</i>	213	203	50	416

# SWIMMING

On great occasions such as the Olympic Games it is usually some simple action which captures the imagination and surpasses the record-breaking feats of champions. So it was during the swimming events at the Empire Pool, Wembley.

The most poignant moment came not during the battle for supremacy in the water, but when the three fastest women swimmers in the world mounted the victory rostrum. They were Greta Andersen of Denmark, who had just beaten Ann Curtis (U.S.A.), by a finger touch in the 100 metres free-style, and Marie Vaessen, from Holland who was third.

As the first woman to win an Olympic swimming medal for 12 years, young Greta was not unnaturally thrilled, but, had it not been for a simple gesture by Miss Curtis, she might have failed to appreciate fully one of the greatest moments in her life. As the Danish national anthem was played a hush fell over the arena. Behind the swimmers, the winner's flag, with its white cross on a red background was unfurled and slowly hoisted. Ann noticed it and tapped the Danish girl on the shoulder. She turned, and watching the flag rise, her face filled with happiness and pride at the honour she had brought to her country. Although deprived of a victory she had been considered certain to gain, Ann Curtis captured the true spirit of sportmanship of the Olympic ideals.

So in this vein the Olympic swimming was conducted. There was a wonderful harmony throughout and disputes were rare. Of course, there were occasional disagreements, but no major incident disturbed the peaceful waters.

London was fortunate to have available, in the Empire Pool, one of the greatest indoor swimming pools in the world. Seating as it does 8,000 under cover, and with the roof bedecked with the flags of the competing nations, it provided a never-to-be-forgotten spectacle. An added zest was provided by the fact that, as no Olympic Games had been held since 1936, many of the competitors had spent a large part of their lives training for this great moment.

## **Placings and Timings**

One of the few controversial sections of the technical organisation was the repeated disagreement between the placing of swimmers and the times recorded by the time-keepers. One striking example occurred in the third heat of the women's 100 metres free-style when three girls returned faster times than the winner. The official result reads : 1. Elizabeth Ahlgren (Sweden) 68.7 secs.; 2. Karen Harup (Denmark) 68.4 secs.; 3. Marjorie McQuade (Australia) 68.5 secs.; 4. Piedaed Silva Tavaras (Argentine) 68.6 secs. Admittedly there were only three-tenths of a second separating the competitors, but it is hoped that this difficulty will be overcome in future by the use of a mechanical device or photo-finish like that used so successfully in the athletics.

The absence of the Japanese, who in 1932 and 1936 had dominated the swimming events, left the way open for another country to be pre-eminent. Everything indicated that the U.S.A. would claim that position. This expectation proved correct, but in a more decisive manner than was anticipated.

Their men swept aside all opposition, winning every swimming title, claiming four Olympic records and establishing a new world time for the 4 x 200 metres relay. The only Olympic record for men to stand in the name of any country other than the U.S.A. was established by a Japanese, K. Kitamura in 1932, when he swam the 1,500 metres in 19 min. 12.2 secs. The present Olympic title holder for this event is Jimmy McLane (U.S.A.), who was more than six seconds behind Kitamura's time.

On the women's side the five titles went to three countries—Denmark, U.S.A. and Holland. The Danish and U.S.A. girls took two each and the Dutch one. Between them they established four new Olympic records, leaving unbroken only H. Mastenbroek's (Holland) 1936 time of 1 min. 5.9 secs. for the 100 metres free-style, which was, however, equalled by Greta Andersen.

Progress in training and improvement of style is still on the up-grade. Since the start of the Olympic Games, records have been established only to be broken. One striking difference in the swimming, compared with Berlin, was the almost complete absence of the orthodox breast-stroke in the men's events. Of the eight finalists, the first seven used the butterfly stroke, while B. Bonte of Holland with the orthodox stroke finished last. Although the butterfly stroke has made some headway with the ladies, it has not yet taken so firm a hold.

### **The Men's Swimming Events**

Seven sprinters, from France, Australia, Hungary, Spain, Sweden, Brazil and India, lined up on the bathside for the first heat of the men's 100 metres free-style. However tense they felt, they kept their bodies relaxed, remembering the years of training which had led to this moment, and at the sharp crack of the starter's pistol they were off. At last the Olympic Games swimming had started ! The giant 19-year-old Frenchman, Alex Jany, who had already pocketed a number of world records, was favourite for this title, and was drawn in the first heat. To him fell the honour of winning the first swimming race of the XIV Olympiad. But, as the next eight days disclosed, it proved a false omen for the French champion.

There had been 48 entries for the 100 metres and, although five entrants failed to start, competition was of the highest order and ten men in the six heats clocked less than a minute. The three representatives of the U.S.A. won their initial heats. Jany, Horatio White (Argentine) and Geza Kadas (Hungary), who was to prove the "dark horse," were also victorious. Apart from the U.S.A., Hungary was the only other nation to have three men in the semi-finals. In the first of these the outstanding competitors brought their times down to the 57 secs. mark and Jany lost by .3 sec. to Keith Carter (U.S.A.).

When the last eight lined up for the final, the U.S.A. still had three representatives, Hungary two, and France, Sweden and Egypt one each. Jany took the lead from the start, with Carter in lane 4 keeping right beside him. The Frenchman turned first and there was little to separate the other seven. Jany dropped away and Alan Ford moved to the front. Twenty metres from the end it was anyone's race. With a beautifully-timed burst, Walter Ris (U.S.A.), swimming with perfect grace and power, touched half a second in front of his team-mate, Ford, and Kadas forced his way into third place. The

Hungarian might have achieved a better placing had he not crashed into the cork lane three yards from the finishing post. To the dismay of the French section of the crowd, the "certainty" Jany was beaten into fifth place. Even the frantic cheers of his sister, who ran along the bathside, could not help the French ace to win the most coveted of the Olympic swimming titles. The winner, Walter Ris, who swam to a set plan and refused to be thrown out of his stride like Jany, reduced the Olympic record by one fifth of a second.

### **The 400 Metres**

One of the most exciting races of the 400 metres heats also concerned Alex Jany, the holder of the world record for the distance. Producing his best style, Jany gained such a lead that he appeared certain to win. Holding second place was Britain's Jack Hale, a small, stocky Yorkshireman. Turning for the last length, Hale noticed Jany, moving with a long, easy stroke, within striking distance. Until then he had been content to qualify but, seeing his opportunity, increased his speed. Slowly the gap narrowed. The Frenchman was oblivious to the danger until the last few yards, when he found Hale level and saw the Yorkshireman win by a touch to achieve a win, hailed with tremendous cheers by the large British crowd.

Jimmy McLane, the tall 17-year-old U.S.A. schoolboy, won his heat with amazing ease in 4 min. 42.2 secs. (2.3 secs, inside the Olympic record) to make himself favourite for the event. Other heat winners were Geza Kadas, the Hungarian who had jumped into the spotlight with his 100 metres performance, and burly Bill Smith (U.S.A.), with his powerful stroke, who with courteous sportsmanship never left the water until the last man had finished. The first semi-final afforded the opportunity of watching the two young swimmers from different continents, Marshall and McLane, swimming against each other. Both these boys are young enough to compete in the Helsinki Games. Neither appeared to be trying to break records and both were content simply to qualify.

In the final it was Bill Smith who took the lead. McLane was at the rear, with Kadas, Mitro, Marshall, Hale and Jany. Then McLane moved up at the half-way mark and challenged Smith, but was held off; Marshall slipped into third place, with the two Hungarians not far behind. Smith remained master of the race and finished in perfect style to claim the title in the new Olympic time of 4 min. 41 secs. It had been a great victory for the U.S. swimmer as he had been considered a hopeless case of typhoid at the age of six. His father, a Hawaiian policeman, sent him to a Japanese swimming coach to build up his withered body and legs. Part of his treatment was swimming in narrow rice lanes. By the age of 14 Bill had made a remarkable recovery and developed into a swimming champion with many records to his credit. Alex Jany had once more been outclassed, gaining only sixth position in 4 min. 51.4 secs., more than 16 seconds slower than his best. His eclipse was the biggest surprise of the swimming, as he had come to Wembley with bright prospects of winning three titles, 100, 400 and 1,500 metres.

Jany withdrew from the 1,500 metres, and from the heats of this event it was evident that Australia's Marshall, McLane (U.S.A.) and the Hungarians, Csordas and Mitro,

would be the stars. They all won their heats easily and the first two won the semi-finals. In the final of this swimming " Marathon," McLane immediately went into the lead and never lost that position. Marshall, content to swim his own race, waited until the 1,000 metres mark before making his bid. For nearly 100 metres the Australian and McLane swam stroke for stroke. Then the American, using his lovely, long stroke, pulled away and kept in front to the end. Marshall was an easy second and Mitro and Csordas followed him. Great Britain, unfortunate in that its champion, Jack Hale, had to withdraw with a pulled muscle, had the consolation of being represented in the final by Donald Bland.

The men's 200 metres breast-stroke went to the favourite, tall, well-built Joe Verdeur of the United States. He beat the old Olympic record in all his three races. Europe's main challenge in this event rested on the broad shoulders of its champion six-foot-six Roy Romain who, however, failed to qualify for the final. Verdeur had completely mastered the butterfly stroke and flared through the water, his massive arms sweeping him to victory. Keith Carter, the American sprinter, caused a mild sensation when he put on a terrific burst in the last 10 metres of the final and nearly overtook his team-mate. He took second place and the other American, Robert Sohl, was third.

The 100 metres back-stroke attracted 42 entries, 10 of whom clocked under 70 seconds, another indication of the vast improvement in swimming times. Even so, world-record-holder Allen Stack (U.S.A.) failed to break the 1936 Olympic time of 1 min. 5.9 secs. set up by A. Kiefer of the U.S.A. Tall and lithe, Stack had no serious opposition in his heat and semi-final, but managed to scrape home only by 0.1 sec. in the final when his colleague, R. Cowell, made a desperate last minute bid for honours. The European champion, Georges Vallerey, was an easy third, and M. Chaves (Argentine) and C. Mejia Avila (Mexico) tied for fourth place. Britain's John Brockway and Albert Kinnear could take only the seventh and eighth places respectively, behind Wiid (S. Africa).

### **A Relay Record**

The U.S.A. put four reserves into their 4 x 200 metres relay team for their heat. After an exciting race, in which they held the lead for threequarters of the way, they were beaten by Hungary on the last leg. The Hungarians' time of 8 min. 53.6 secs. was only 0.1 sec. outside the Olympic record. In the other heat, Alex Jany (France) swam his best race of the Games. Starting number four, he was some yards behind the Yugoslav and Swedish men. Moving with great speed, he overhauled his opponents and won a great victory for his country.

The U.S.A. played safe in the final and with a team of stars, three men who had won Olympic titles, Walter Ris (100 metres), Bill Smith (400 metres) and Jimmy McLane (1,500 metres), and W. Wolf, set up a world and Olympic record of 8 min. 46 secs. The Hungarians, with the same team which had won the heat, fought the U.S.A. team every inch of the way, finishing well inside the former record, with a time of 8 min. 48.4 secs. The issue was settled only on the last lap, when Smith drew away from Geza Kadas. France, after a close struggle with Sweden, just managed to claim third place.



### **The Women's Events**

Most of the girls who entered for the 100 metres free-style were well matched and the majority returned times under 70 seconds. The hopes of the continent of Australia in this event fell on the tiny shoulders of Marjorie McQuade, a 14-year-old schoolgirl who recorded the remarkable time of 68.5 secs., as if to stake her claim for the title four years hence. Holland and Denmark, who had not succeeded in producing men swimming champions, came into their own in the women's events. The best race in the heats came when the tall American, Ann Curtis, with 39 titles to her credit, beat the European favourite, Greta Andersen, with one tenth of a second to spare. These two girls went on to win their respective semi-finals.

Everything was set for a great final. Denmark provided three of the swimmers, Holland and Sweden two each, and the U.S.A. one. From the start it became a battle between Ann Curtis and Greta Andersen. There was little to choose between these two girls in either perfection of style or speed, and only one-fifth of a second separated them when the Danish girl touched first in 66.3 secs. Third was Marie Vaessen (Holland) in 67.6 secs.; the remaining five finished within a second of each other.

The greatest racing among the women's events was provided by the 400 metres. It included tragedy, thrills and a terrific final with the first five girls smashing the previous Olympic record. In the first heat, Ann Curtis and Karen Harup (Denmark) were content to qualify. The British hope, Cathie Gibson, came through from behind to win her heat in just half-a-second outside the Olympic record. In the third heat, Greta Andersen collapsed in the water during the fifth length and was rescued by competitors from the bathside, who dived in to her assistance. The semi-finals saw the surprising eclipse of Cathie Gibson, who managed to qualify for the final only as a fastest loser. As sometimes happens, the British girl failed to find her stroke and fought the water nearly all the way.

### **A Well-timed Spurt**

In the final, Ann Curtis proved she possessed a racing brain up to the best American traditions. She allowed the others to set the pace, keeping within comfortable striking distance until the last 100 metres, when she forged ahead to take the lead. At the same time Cathie Gibson, who was lying seventh, found her stroke and started to cut through the water at tremendous speed. At the last turn she was fourth, but soon overtook Fernande Caroen of Belgium and almost succeeded in overhauling Karen Harup, who took second place. Ann Curtis, who accelerated without so much splash as Cathie Gibson, was a clear winner in 5 min. 17.8 secs. Behind these three girls came Fernande Caroen (Belgium) and Brenda Helser (U.S.A.) all five being within the 1936 Olympic record time of 5 mins. 26.4 secs. set up by H. Mastenbroek (Holland). This race gave especial pleasure to the crowd, who were happy to see the Union Jack flutter for the first time above the victory ceremony rostrum.

The women's breast-stroke event was not dominated by butterfly swimmers, although the first record to fall went to Eva Szekely (Hungary), an exponent of this stroke. She clipped 0.7 sec. off the record of 3 min. 1.9 secs. set up by M. Maehata (Japan). This

new record, however, stood only a few minutes as, in the next heat, the powerfully-built Dutch girl, Nel Van Vliet, holder of six world records, using the orthodox stroke, pulled her way to victory in 2 min. 57.4 secs. In the first semi-final, the 18-year-old Australian schoolgirl, Nancy Lyons, undefeated since the age of 11, kept her record intact. In the other, Nel Van Vliet once again reduced the Olympic best with a time of 2 min. 57.0 secs. Only a second behind her was the Hungarian, Eva Novak.

These two girls had a battle royal in the final and seemed to have the race well under control until the last length, when the Australian champion, who had gone up from fifth to third place, increasing her speed with every stroke, forced her way past Eva Novak, but just failed to catch the world champion, Nel Van Vliet, by a fifth of a second. Her determination and fighting spirit were typical of all the Australian swimmers seen in action at Wembley. This was the one event where the three U.S. girls were overshadowed. In all the others, for both men and women, they had a representative in the first three finalists, but their women breast-stroke competitors did not qualify for the semi-finals.

The central figure in the 100 metres back-stroke was Karen Harup, the smiling Dane, who established a new Olympic record in her heat and had broken it twice by the time she climbed to the victory rostrum for her gold medal. Her final time of 1 min. 14.4 secs. was 2.2 secs, inside the previous best set up by the Dutch girl N. Senff, in 1936. Karen Harup was never worried in the final and led all the way just as she had in her other races. The curly-haired Susan Zimmerman (U.S.A.), swimming in beautiful style, took second place, closely followed by Australia's Judy Joy Davies.

### **A Sensational Finish**

The women's 4 x 100 metres relay final provided brilliant swimming, magnificent team-work, and a sensational finish. The 1936 record, 4 min. 36 secs. set by the Dutch, was shattered in the first heat by both Denmark and the U.S.A. and Great Britain's team was only 0.1 second outside. The Dutch team soon dispelled any notions that they were to be deprived of the record easily and reduced the new Danish time of 4 min. 33.5 secs. by 2.2 secs. in the next heat. Sweden clocked 4 min. 38.5 secs., putting themselves well in the picture for the final, the most eagerly awaited race of the session.

In the final, Denmark took the lead immediately, fighting their Dutch rivals all the way. Greta Andersen had made a gallant recovery from her mishap and came back to swim the third leg, giving the last girl, Mrs. Fritze Carstensen a valuable two-yard lead in the last 100 metres. Off went Fritze Carstensen with Hanny Termeulin, the Dutch girl, pounding behind her heels. The British and U.S. girls had fought every inch of the way for third place and Cathie Gibson and Ann Curtis were almost level when they flung themselves in for the final leg, four yards behind Fritze Carstensen. When the four girls turned, Ann Curtis had made considerable headway. Fifteen metres from the end she overhauled the Dutch girl and the crowd suddenly realised that she might bring off what had seemed an impossible victory. Slowly she drew nearer to Fritze Carstensen and the 8,000 spectators leapt to their feet in a frenzy of excitement, their cheers rising to a crescendo during those electrifying last seconds as the narrow gap separating the two girls

closed. With a final powerful lunge Ann Curtis pulled herself to the finishing line to win by inches in a new record time of 4 min. 29.2 secs., 0.4 second ahead of Carstensen.

This magnificent 100 metres by Ann Curtis had unofficially broken the world record, for her time was returned by three time-keepers as 64.4 secs., a fifth of a second under the world best set up 12 years previously by Willy den Ouden (Holland). The U.S.A. team had good reason to duck each other after this thrilling race ! Officially the first four countries, U.S.A., Denmark, Holland and Great Britain, broke the Olympic record.

## DIVING

The diving events at the 1948 Games showed a great advance in the standard of performance over any previous Games. This was most noticeable in the springboard diving events, where not only was there an improvement in the technique of using the board, but the increase in the difficulty of the movements performed marked a further stage in the development of the sport.

The U.S.A. team continued to show a substantial lead over all other countries, and indeed the nearest individual rival, Capilla, of Mexico, had received much of his training in the U.S.A. The steady improvement in the standard of other countries was, however, a most encouraging feature. No sport can be really healthy without active competition, and it is clear from the results that the U.S.A. divers can no longer afford to make any mistakes.

### **More Open Contests**

In the high diving events, both for men and women, the contest was much more open, and although four out of the six Olympic medals were won by U.S.A. divers, there was nothing like the difference in standard shown on the springboard. A number of countries are producing divers who are treading right on the heels of the exponents from the United States of America, notably Mexico with Joaquin Perez Capilla, Sweden with Lennart Brunnhage, Denmark with Birte Christoffersen and Thomas Christiansen, Austria with Alma Staudinger and Great Britain with Peter Heatly.

High stages are not numerous in the United States and, taking into account the vast distances involved in travelling, it is probably true that, as a whole, the divers in that country are not much better off than those in other countries in obtaining practice in this branch of sport. In any case, the closeness of the competition made these events attractive.

Diving is still young, compared with many other branches of sport, and it is strange to reflect that the credit for introducing it to the world belongs not to some sunlit land where bathing can be indulged in all the year round, but to the northern land of Sweden. Even as recently as 1912, high diving remained almost a monopoly of the Swedes, although Germany introduced new methods in springboard diving and was pre-eminent in that branch of the sport.

### **Improvement in Women's Events**

In the women's events there was, relatively, a much greater improvement since 1936 than in the men's. For the first time women were required to perform voluntary dives from the 10-metre stage, and the standard of execution was high. The progress of the women was also marked by the appointment, for the first time, of two women as judges: Miss B. White, of Great Britain, and Miss G. Klapwyk, of Holland, both of whom have been divers of distinction.

One aspect of the swimming events as a whole must be mentioned, as it affects the divers closely and, possibly, unfairly. This arises from the late date at which countries are required to specify the names of their competitors, or even the number of their competitors, in each event. As a result, the organisers must arrange the programme to allow for the largest possible number of competitors and frequently the sessions, as staged, hardly provide a full programme.

The first resort of the organisers, perhaps the only resort, is a diving display, and the demands made on the competitors to pad out the programmes can be burdensome and even harmful to athletes, at the peak of their training, immediately before their contests are due to take place.

### **Men's Springboard Diving**

The U.S.A. maintained their pre-eminence in this contest and secured the first three places. The consistency of B. Harlan, the winner, was remarkable, and only in one dive, the 1 Twist Forward, did any judge award less than eight points. M. Anderson secured second place and, if he had not spoilt his third dive, the Reverse Dive, the result might have been different. His last dive, the Double Twisting 1½ Somersault Forward, was the best dive of the whole Games, and was awarded the only two 10's to be shown. S. Lee dived well to secure third place, and the height he obtained from the springboard in some of his dives was remarkable. He also spoilt his 1 Twist Forward, however, and he had not much in hand over J. Perez Capilla, of Mexico, who displayed great promise. These four divers were in a class by themselves and a margin of fifteen points divided them from the next competitor, R. Mulinghausen, of France.

### **Men's High Diving**

This contest was a triumph for S. Lee, of U.S.A., who displayed remarkable control to register a win by a margin of 8 points. His last dive, a 3½ Somersault Forward, was one of the best dives performed, and scored 9½ from four judges. B. Harlan, of U.S.A., dived consistently to obtain second place, well in front of J. Perez Capilla, of Mexico, who started rather uncertainly. At the end of the compulsory dives both L. Brunnhage (Sweden) and P. Heatly (Great Britain) were ahead of Capilla, and treading closely on the heels of Harlan, but the higher scoring values of the voluntary dives selected by the leaders decided the issue in the second half of the contest. Brunnhage finished fourth, with Heatly fifth, closely followed by T. Christiansen, of Denmark, Champion of Europe, who had spoilt his first dive, but made up a lot of ground in the later stages.

### **Women's Springboard Diving**

With the last dive of the contest, V. Draves, of U.S.A., gained a victory over her compatriot, Z. A. Olsen, who had given the impression of being the better diver, particularly on the voluntary dives. A most exciting finish. Third place was taken by the other U.S.A. competitor, P. Elsener who, however, failed to perform her 1½ Somersault Backward satisfactorily, and managed to defeat N. Pellissard, of France, only by the narrow margin of .92 points. G. Groemmer, of Austria, and E. Child, of Great Britain, both dived consistently to reverse the placings in the European Championships over M. Moreau,

of France, who secured only seventh place. The challenge of the French women, who took fourth, seventh and tenth places, was of interest as they have never before been serious rivals.

### **Women's High Diving**

V. Draves, of U.S.A., was third at the end of the compulsory dives, but secured first place from her compatriot, P. Elsener, by performing two magnificent voluntary dives. B. Christoffersen, of Denmark, who finished third, had been second after the compulsory dives, during which she performed a magnificent Running Swallow Dive. A. Staudinger, of Austria, displayed fine technique and was always a danger in spite of slightly spoiling her third dive. In taking fourth place, she defeated the third U.S.A. competitor, J. Stover, who made mistakes in both the Somersault Backward and the Reverse Dive. N. Pellissard, the present European champion, dived consistently to secure sixth place. The contest showed an interesting contrast in styles between those who favoured the cautious, weak take-off, and the bold courageous divers who obtained good height and flight. It is perhaps unfortunate that the principal exponents of the bold take-off, such as B. Christoffersen and J. Stover, did not reap the reward of their courage, as they were a pleasure to watch in action.

## **WATER - POLO**

The conditions of the Olympic water-polo tournament are such that what proved to be its decisive game was actually played in one of the second round groups. If teams both of which qualify for later rounds have already met in a previous group, they do not play again, the original result standing. So that, although Italy and Hungary both fought their way through to the finals, to be placed first and second, the match which decided their position was Italy's 4-3 victory in the second round group.

As winners of the European championship in 1947, Italy were firm favourites for the Olympic title, but nearly met with a surprise in their first group, when Yugoslavia held them to a 4-4 draw. Yugoslavia subsequently were unfortunate to find themselves in the same second round group as both Italy and Hungary, and a 4-2 defeat from the latter eliminated the Yugoslav team. Had they been in any other group, they might well have finished in the first six. Italy had no difficulty in winning all the games in their semi-final and final groups, and so taking the title.

There were fewer runaway victories than in some previous tournaments, and the standard of play of at any rate all the semi-finalists was reasonably close. Some criticism was expressed of the uneven standard of the refereeing, and certainly not all the fouls went unchecked. But in many of the games the fouling was so persistent and continuous that referees were given a well-nigh impossible task.

**FEDERATION INTERNATIONALE DE NATATION AMATEUR**

**JURY OF APPEAL  
and  
COMMITTEE OF MANAGEMENT**

H. E. FERN, O.B.E., J.P., President F.I.N.A., *Great Britain*  
E. G. DRIGNY, Vice-President F.I.N.A., *France*  
R. de RAEVE, Vice-President F.I.N.A., *Belgium*  
R. M. RITTER, Hon. Secretary and Treasurer, F.I.N.A., *U.S.A.*  
H. A. BENNETT, Bureau Member, *Australia*  
L. HAUPTMAN, Bureau Member, *Czechoslovakia*  
M. NEGRI, Bureau Member, *Argentina*  
J. de VRIES, Bureau Member, *Holland*  
L. J. JOHNSON, *U.S.A.*  
Sir HAROLD PARKER, K.B.E., M.C., *Great Britain*  
W. B. PHILLIPS, *Australia*

**OFFICIALS**

H. E. FERN, <i>Great Britain</i>	REFEREES (SWIMMING) E. G. DRIGNY, <i>France</i>	R. de RAEVE, <i>Belgium</i>
R. M. RITTER, <i>U.S.A.</i>	CHIEF JUDGES	W. B. PHILLIPS, <i>U.S.A.</i>
L. J. JOHNSON, <i>U.S.A.</i>	CHIEF TIMEKEEPERS	S. T. HIRST, <i>Great Britain</i>
M. NEGRI, <i>Argentina</i>	CHIEF INSPECTORS	Sir HAROLD PARKER, <i>Great Britain</i>
	CHIEF REFEREE (DIVING) L. HAUPTMAN, <i>Czechoslovakia</i>	
G. MELVILLE CLARK, <i>Great Britain</i>	REFEREES (DIVING) G. MATVEIEFF, <i>Great Britain</i>	
	CHIEF REFEREE (WATER POLO) JAN de VRIES, <i>Holland</i>	
	REFEREE (WATER POLO) E. J. SCOTT, M.C., <i>Great Britain</i>	
E. W. KEIGHLEY, <i>Great Britain</i>	STARTERS	J. de LANCEY, <i>Great Britain</i>
	ARENA MANAGER Capt. B. W. CUMMINS, <i>Great Britain</i>	

OFFICIALS—*continued.*

A. Abdulla  
P. L. Ahir  
Capt. C. E. Altman  
Lt.-Col. W. Atherton  
Mrs. A. M. Austin

C. G. Bailey  
J. Balas  
E. H. Barton  
Dr. I. Barany  
W. J. Basher  
T. Batalle  
R. Bauwens  
Sir. F. Beaurepaire  
A. van Beets  
O. Berges  
E. Bergvall  
H. V. Binns  
A. Biswas  
F. Borre  
J. Boyd  
G. Brody  
E. H. Buckley  
T. H. Bugbee

A.. Cazomajou  
C. F. Clark  
L. Claxton  
J. A. T. Clinton  
T. E. Cogswell  
F. Collier  
R. A. Colwill  
P. G. Condon  
R. Y. Coutts  
F. J. Coyne  
F. Cre  
F. Csont  
Miss D. F. Curnow  
J. J. Curran

W. H. Dalby  
H. Daly  
H. J. de Kok  
A. Delahaye  
Mrs. A. Derbyshire  
H. Dixon  
C. Doerr  
Mme. Domon  
L. L. Draves  
S. R. Drinkwater  
P. Dujardin  
V. Dunk

G. R. Eddowes  
W. R. Edgar  
W. G. Emery  
E. Everaerts  
Y. Ezzel Din  
T. J. Fenn  
T. Fletcher  
F. Fligelstone  
W. Foulds  
A. Foulon  
Miss. L. Frampton  
R. G. E. Franks  
Miss E. Frederick

D. F. Gardner  
E. P. Gaul  
H. Getz  
Mrs. H. Gibbons  
H. Gibbons  
J. Glendinning  
E. Grandjean

D. F. Gray  
R. P. Green  
S. Greller  
J. A. Grossart

L. Hanafi  
J. A. N. Hanby  
P. H. Hardidge  
W. Hardin  
R. P. Haston  
H. Hartrich  
W. F. Hayward  
G. R. Hemsing  
S. H. Henley  
H. E. Herschorn  
C. Herzog  
J. Heyninck  
A. W. Highet  
R. Hodgson  
H. Holm  
R. Honikman  
Mrs. B. Hooper  
J. Houwaert  
I. Hunyadfi

N. D. Irving

R. H. Jansen  
W. G. Jude

C. Kemp  
Dr. E. Kendall  
Col. F. Kurtz  
Miss G. Klapwyk  
J. Kolozs

E. J. Larkin  
R. Le Gall  
M. Lehmann  
A. Ljungqvist

D. D. Magee  
H. Machiels  
G. F. Makepeace  
A. Mariscal  
C. Marchetti  
Mrs. M. G. Matveieff  
T. Mayo  
Dr. H. McClatchey  
W. McCreedy  
K. W. McCullough  
E. T. McNeill  
D. J. Merrifield  
L. Miller  
F. G. M. Milton  
H. Minto  
A. Moffat  
Dr. J. E. Montes  
R. J. Monteverde  
B. J. Moolenaar  
J. Morera  
W. E. Morley  
R. Mouy  
R. Muirhead  
C. Murray  
R. Murrey

J. Nemeth

E. H. Oldfield  
A. Olsen  
J. Ostos

J. Papadakis  
C. P. Parkin  
A. J. Perring  
W. J. Phillips  
B. Picornell  
C. E. Pinkston  
N. Politis  
I. Popper  
C. A. Potts  
A. C. Price  
Mrs. A. C. Price  
J. F. Price  
R. J. Pryde  
E. Poussard  
A. H. Pycock

B. Rajki  
V. H. Rands  
P. Ravasz  
Lt.-Col. E. M. Read  
D. F. Roby  
G. Rigal  
C. O. Roeser  
F. Roggione  
R. C. Ross  
G. de Rossi  
W. S. Rowe

B. Sallfors  
E. Sanches  
I. Sarosi  
N. W. Sarsfield  
Dr. O. Scheff  
W. Scheidegger  
A. Schlenker  
J. Schotte  
E. D. Sebborn  
R. Serina  
B. Ali Shaikh  
Air Com. Smylie  
H. Speelmans  
H. Stoelen  
G. Strachen  
C. Sufriti  
Mrs. F. H. Sutton  
C. Svolopoulos  
Lt.-Col. Swarbrick

A. G. Taylor  
W. F. Thomson  
W. G. Todd  
A. D. Touni

F. Uebersax  
E. Ugarte  
U. Ushiani  
E. Uttley

L. Valerio  
L. Van Deven  
M. A. Velarde  
A. H. Verhoeff, Jr.

H. R. Walker  
Brig. G. Welchman  
Miss B. White  
Mrs. L. Whiting  
H. C. Windebank  
R. Wolf  
D. T. Woodfield  
C. Wooton  
E. Wright

S. Zuckermann

## 100 METRES FREE STYLE

*Previous Olympic Winners*

1896	A. Hoyos	Hungary	1 m. 22.2 sec.	1920	D. Kahanamoku	U.S.A.	1 m. 0.4 sec.
1900	P. Lane (200m.)	Australia	2 m. 25.2 sec.	1924	J. Weissmuller	U.S.A.	59.0 sec.
1904	Z. de Halmay (91m.)	Hungary	1 m. 2.8 sec.	1928	J. Weissmuller	U.S.A.	58.6 sec.
1908	C. M. Daniels	U.S.A.	1 m. 5.6 sec.	1932	Y. Mivazaki	Japan	58.2 sec.
1912	D. Kahanamoku	U.S.A.	1 m. 3.4 sec.	1936	F. Csik	Hungary	57.6 sec.
World Record :		50.4 sec.	A. R. Ford (U.S.A.)	New Haven,		1948	
Olympic Record :		57.5 sec.	M. Taguchi (Japan)	Berlin, 1936			

There were 46 entrants from 22 nations; 41 participants from 20 nations

## FIRST ROUND

*The first two in each heat and the four fastest losers qualified for the Semi-finals*

HEAT 1			HEAT 2			HEAT 3					
	<i>m</i>	<i>s.</i>		<i>m</i>	<i>s.</i>		<i>m</i>	<i>s.</i>			
1	Jany, A.	France	58.1	1	Carter, K.	U.S.A.	58.7	1	Kadas, G.	Hungary	58.2
2	Bourke, B.	Australia	59.1	2	Olsson, P.-O.	Sweden	59.0	2	IsaacAhumada, A.	Mexico	1 0.1
3	Szatmari, E.	Hungary	59.7	3	Szilard, Z.	Hungary	59.8	3	Boyd, W.	Australia	1 0.4
4	Johansson, O.	Sweden	1 1.0	4	Guerra Perez, M.	Spain	1 0.7	4	Bagdadi, A.	Egypt	1 2.4
5	Barros Guimares, P.	Brazil	1 3.7	5	Canton, A.	Argentina	1 1.8	5	Jubb, E.	Canada	1 2.8
6	Perez Gonzalez, I.	Spain	1 4.0	6	SilverioFerrer, N.	Cuba	1 2.0	6	Nag, S.	India	1 3.8
7	Mansoor, I.	India	1 6.4	7	Kendall, P.	Great Britain	1 2.1				
				8	Mitra, D.	India	1 6.9				
HEAT 4			HEAT 5			HEAT 6					
	<i>m</i>	<i>s.</i>		<i>m</i>	<i>s.</i>		<i>m.</i>	<i>s.</i>			
1	White, H.	Argentina	1 0.2	1	Ris, W.	U.S.A.	58.1	1	Ford, A.	U.S.A.	59.2
2	Boghossian, A.	Brazil	1 0.9	2	Stedman, R.	Great Britain	1 1.3	2	El Gamal, T.	Egypt	59.7
3	Dominguez Garcia, J.	Spain	1 1.3	3	Padou, H.	France	1 1.5	3	Lunden, M.	Sweden	1 0.2
4	El Sayed, D.	Egypt	1 2.5	4	Alencar Rodrigues, S.	Brazil	1 1.6	4	Salmon, P.	Canada	1 1.0
5	Martinaux, F.	France	1 4.2	5	Go, Tjoan-Giok	China	1 3.5	5	Gudmundsson, A.	Iceland	1 1.6
6	Hadjikyriakakis, P.	Greece	1 7.4	6	Oatway, D.	Bermuda	1 8.6	6	Harrop, J.	Great Britain	1 2.3
								7	Garcia Vidal, R.	Cuba	1 2.5
								8	Schneider, W.	Switzerland	1 5.1

## SEMI-FINALS

*The first three in each Semi-final and the two fastest losers qualified for the Final*

HEAT 1			HEAT 2				
	<i>m</i>	<i>s.</i>		<i>m</i>	<i>s.</i>		
1	Carter, K.	U.S.A.	57.6	1	Ris, W.	U.S.A.	57.5
2	Jany, A.	France	57.9	2	Ford, A.	U.S.A.	57.8
3	Szilard, Z.	Hungary	59.6	3	Kadas, G.	Hungary	58.0
4	El Gamal, T.	Egypt	59.9	4	Olsson, P.-O.	Sweden	59.1
5	Bourke, B.	Australia	1 0.0	5	White, H.	Argentina	1 0.4
6	Lunden, M.	Sweden	1 0.2	6	Szatmari, E.	Hungary	1 0.5
7	IsaacAhumada, A.	Mexico	1 0.1	7	Stedman, R.	Great Britain	1 1.0
8	Boghossian, A.	Brazil	1 1.0	8	Boyd, W.	Australia	1 1.1

## FINAL

	<i>m</i>	<i>s.</i>	
1	<b>RIS, W.</b>	U.S.A.	57.3
2	<b>FORD, A.</b>	U.S.A.	57.8
3	<b>KADAS, G.</b>	Hungary	58.1
4	Carter, K.	U.S.A.	58.3
5	Jany, A.	France	58.3
6	Olsson, P.-O.	Sweden	59.3
7	Szilard, Z.	Hungary	59.6
8	El Gamal, T.	Egypt	1 0.5



## 400 METRES FREE STYLE

### Previous Olympic Winners

1896	P. Neumann (500m.)	<i>Austria</i>	8 m.	12.6 sec.	1924	J. Weissmuller	<i>U.S.A.</i>	5 m.	4.2 sec.
1904	C. M. Daniels (402m.)	<i>U.S.A.</i>	6 m.	16.2 sec.	1928	U. A. Zorilla	<i>Argentina</i>	5 m.	1.6 sec.
1908	H. Taylor	<i>Gt. Britain</i>	5 m.	36.8 sec.	1932	C. L. Crabbe	<i>U.S.A.</i>	4 m.	48.8 sec.
1912	G. R. Hodgson	<i>Canada</i>	5 m.	24.4 sec.	1936	J. Medica	<i>U.S.A.</i>	4 m.	44.5 sec.
1920	N. Ross	<i>U.S.A.</i>	5 m.	26.8 sec.					

World Record : 4 m. 35.2 sec. A. Jany (France) Monte Carlo, 1947  
 Olympic Record : 4 m. 44.5 sec. J. Medica (U.S.A.) Berlin, 1936

There were 46 entrants from 23 nations; 41 participants from 21 nations

## FIRST ROUND

The first two in each heat and the four fastest losers qualified for the Semi-finals

HEAT 1			HEAT 2			HEAT 3			
	<i>m</i>	<i>s.</i>		<i>m</i>	<i>s.</i>		<i>m</i>	<i>s.</i>	
1	McLane, J	<i>U.S.A.</i>	4	42.2	1	Yantorno, A	<i>Argentina</i>	4	53.8
2	Nyeki, I	<i>Hungary</i>	5	1.8	2	Johnston, D	<i>South Africa</i>	4	57.4
	Botham, F	<i>Great Britain</i>	5	3.4	3	Bartusek, M	<i>Czechoslovakia</i>	4	57.9
4	Duranona, J	<i>Argentina</i>	5	5.8	4	Bernardo, J	<i>France</i>	5	3.8
5	Febero				5	Gibson, F	<i>Canada</i>	5	13.4
	Lorenzo, A	<i>Spain</i>	5	16.9	6	Schneider, W	<i>Switzerland</i>	5	25.5
6	Cook, R.	<i>Bermuda</i>	5	37.9	7	Bardgett, W	<i>Bermuda</i>	5	37.2
7	Hakim, J	<i>Egypt</i>	5	40.3					
HEAT 4			HEAT 5			HEAT 6			
	<i>m</i>	<i>s.</i>		<i>m</i>	<i>s.</i>		<i>m</i>	<i>s.</i>	
1	Mitro, G	<i>Hungary</i>	4	56.0	1	Kadas, G	<i>Hungary</i>	4	52.8
2	Heusner, W	<i>U.S.A.</i>	4	58.3	2	Ostrand, P.-O	<i>Sweden</i>	4	53.5
3	Vidovic, B	<i>Yugoslavia</i>	4	58.7	3	Perez, F	<i>Uruguay</i>	5	4.7
4	Martinez Ferry, I	<i>Spain</i>	5	10.0	4	Cornu, R	<i>France</i>	5	5.2
5	Garay, J	<i>Argentina</i>	5	10.4	5	Perez Gonzalez, I	<i>Spain</i>	5	16.1
6	Oatway, D	<i>Bermuda</i>	5	20.9	6	Basanung, S	<i>Philippines</i>	5	21.5
7	Chundra, B	<i>India</i>	5	38.6					
1	Smith, W	<i>U.S.A.</i>	4	45.3	2	Marshall, J	<i>Australia</i>	4	51.4
2	Jany, A	<i>France</i>	4	53.3	3	Puhar, I	<i>Yugoslavia</i>	5	0.8
3	Stipetic, M	<i>Yugoslavia</i>	5	1.4	4	Gonzales, L	<i>Colombia</i>	5	2.1
4	Agnew, D	<i>Australia</i>	5	6.1	5	Gudmundsson A.	<i>Iceland</i>	5	16.2
5	Child Velez, L	<i>Colombia</i>	5	8.5	6	Holt, T	<i>Great Britain</i>	5	20.7
6	Gilchrist, A	<i>Canada</i>	5	21.5	7	Karamally, S	<i>Pakistan</i>	7	16.9
7	Chaudhry, A	<i>Pakistan</i>	6	17.4					

## SEMI-FINALS

The first two in each Semi-final and the four fastest losers qualified for the Final

HEAT 1			HEAT 2						
	<i>m</i>	<i>s.</i>		<i>m</i>	<i>s.</i>				
1	McLane, J	<i>U.S.A.</i>	4	49.5	1	Kadas, G	<i>Hungary</i>	4	47.8
2	Marshall, J	<i>Australia</i>	4	50.0	2	Smith, W	<i>U.S.A.</i>	4	48.4
3	Mitro, G	<i>Hungary</i>	4	50.8	3	Jany, A	<i>France</i>	4	51.3
4	Hale, J	<i>Great Britain</i>	4	51.4	4	Yantorno, A	<i>Argentina</i>	4	57.3
5	Stipetic, M	<i>Yugoslavia</i>	4	58.6	5	Heusner, W	<i>U.S.A.</i>	4	57.4
6	Bartusek, M	<i>Czechoslovakia</i>	4	58.7	6	Puhar, I	<i>Yugoslavia</i>	4	58.7
7	Vidovic, B	<i>Yugoslavia</i>	4	59.4	7	Johnston, D	<i>South Africa</i>	4	59.5
–	Ostrand, P.-O	<i>Sweden</i>		*	–	Nyeki, I	<i>Hungary</i>		*

## FINAL

	<i>m.</i>	<i>s.</i>
1 <b>SMITH, W.</b>	<i>U.S.A.</i>	† 4 41.0
2 <b>McLANE, J.</b>	<i>U.S.A.</i>	4 43.4
3 <b>MARSHALL, J.</b>	<i>Australia</i>	4 47.7
4 Kadas, G	<i>Hungary</i>	4 49.4
5 Mitro, G	<i>Hungary</i>	4 49.9
6 Jany, A	<i>France</i>	4 51.4
7 Hale, J	<i>Great Britain</i>	4 55.9
8 Yantorno, A	<i>Argentina</i>	4 58.7

\* Non-Starter † New Olympic Record

## 1,500 METRES FREE STYLE

*Previous Olympic Winners*

1896	A. Hoyos (1,200m.)	<i>Hungary</i>	18 m. 22.2 sec.	1920	N. Ross	<i>U.S.A.</i>	22 m. 23.2 sec.
1900	C. Jarvis (1,000m.)	<i>Gt. Britain</i>	13 m. 40.0 sec.	1924	A. Charlton	<i>Australia</i>	20 m. 6.6 sec.
1904	E. Rausch (1,609m.)	<i>Germany</i>	27 m. 18.2 sec.	1928	A. Borg	<i>Sweden</i>	19 m. 51.8 sec.
1908	H. Taylor	<i>Gt. Britain</i>	22 m. 48.4 sec.	1932	K. Kitamum	<i>Japan</i>	19 m. 12.4 sec.
1912	G. R. Hodgson	<i>Canada</i>	22 m. 0 sec.	1936	N. Terada	<i>Japan</i>	19 m. 13.7 sec.

World Record : 18 m. 58.8 sec. F. Amano (Japan) Tokio, 1938  
Olympic Record : 19 m. 12.4 sec. K. Kitamura (Japan) Los Angeles, 1932

There were 41 entrants from 21 nations: 39 participants from 21 nations

## FIRST ROUND

*The first two in each heat and the four fastest losers qualified for the Semi-finals*

HEAT 1			HEAT 2			HEAT 3		
1	Heusner, W	<i>U.S.A.</i> 20 29.6	1	McLane, J	<i>U.S.A.</i> 20 17.7	1	Stipetic, M	<i>Yugoslavia</i> 20 10.1
2	Voeroes, F	<i>Hungary</i> 20 31.9	2	Hale, J	<i>Great Britain</i> 20 31.9	2	Bland, D	<i>Great Britain</i> 20 13.9
3	Wardrop, J	<i>Great Britain</i> 20 43.0	3	Egon Kestener, R	<i>Brazil</i> 20 36.3	3	Basanung, S	<i>Philippines</i> 21 5.9
4	Maldonado Campos, A	<i>Mexico</i> 20 47.2	4	Reynders, J	<i>Belgium</i> 21 23.1	4	Febrero Lorenzo, A	<i>Spain</i> 21 15.9
5	Mancuso, A	<i>Argentina</i> 21 16.7	5	Puhar, I	<i>Yugoslavia</i> 21 45.1	5	Gibson, F	<i>Canada</i> 21 25.6
6	Ilic, V	<i>Yugoslavia</i> 21 17.0				6	Chundra, B	<i>India</i> 22 52.9
7	Chaudhry, A	<i>Pakistan</i> 25 37.4				7	Tribley, P	<i>Bermuda</i> 22 56.6

HEAT 4			HEAT 5			HEAT 6		
1	Csordas, G	<i>Hungary</i> 20 6.8	1	Marshall, J	<i>Australia</i> 20 1.1	1	Mitro, G	<i>Hungary</i> 20 15.0
2	Ostrand, P.-O.	<i>Sweden</i> 20 19.8	2	Norris, F	<i>U.S.A.</i> 20 21.0	2	Bartusek, M	<i>Czechoslovakia</i> 20 19.4
3	Gonzalez, L	<i>Colombia</i> 20 40.6	3	Bernardo, J	<i>France</i> 20 34.8	3	Perez, F	<i>Uruguay</i> 20 20.2
4	Martinez Ferry I	<i>Spain</i> 21 13.7	4	Child Velez, L	<i>Colombia</i> 20 47.0	4	Johnston, D	<i>South Africa</i> 20 41.8
5	Pineda Borja, C	<i>Mexico</i> 21 15.8	5	Garay, J	<i>Argentina</i> 21 33.2	5	Bravo Prieto, R	<i>Mexico</i> 20 45.5
6	Agnew, D	<i>Australia</i> 21 40.1	6	Dominguez Garcia, J	<i>Spain</i> 21 33.5	6	Cornu, R	<i>France</i> 21 1.6
7	Gilchrist, A	<i>Canada</i> 23 0.6	7	Oatway, D	<i>Bermuda</i> 21 55.1			

## SEMI-FINALS

*The first three in each Semi-final and the two fastest losers qualified for the Final*

HEAT 1			HEAT 2		
1	Marshall, J	<i>Australia</i> 19 53.8	1	McLane, J	<i>U.S.A.</i> 19 52.2
2	Mitro, G	<i>Hungary</i> 20 6.5	2	Csordas, G	<i>Hungary</i> 20 6.6
3	Stipetic, M	<i>Yugoslavia</i> 20 12.9	3	Norris, F	<i>U.S.A.</i> 20 9.3
4	Heusner, W	<i>U.S.A.</i> 20 23.9	4	Bland, D	<i>Great Britain</i> 20 19.8
5	Perez, F	<i>Uruguay</i> 20 32.6	5	Bernardo, J	<i>France</i> 20 25.5
6	Bartusek, M	<i>Czechoslovakia</i> 20 32.9	6	Voeroes, F	<i>Hungary</i> 20 31.4
7	Egon Kestener, R	<i>Brazil</i> 20 44.6	7	Gonzales, L	<i>Colombia</i> 20 41.6
-	Hale, J	<i>Great Britain</i> *	-	Ostrand, P.-O.	<i>Sweden</i> *

## FINAL

1	McLANE, J	<i>U.S.A.</i> 19 18.5
2	MARSHALL, J	<i>Australia</i> 19 31.3
3	MITRO, G	<i>Hungary</i> 19 43.2
4	Csordas, G	<i>Hungary</i> 19 54.2
5	Stipetic, M	<i>Yugoslavia</i> 20 10.7
6	Norris, F	<i>U.S.A.</i> 20 18.8
7	Bland, D	<i>Great Britain</i> 20 19.8
8	Heusner, W	<i>U.S.A.</i> 20 45.4

\* Non-Starter

**200 METRES BREAST-STROKE***Previous Olympic Winners*

1904 G. Zacharias (402m.)	Germany	7 m.	27.0 sec.	1924 R. Skelton	U.S.A.	2 m.	56.6 sec.
1908 F. Holman	Gt. Britain	3 m.	9.2 sec.	1928 Y. Tsurata	Japan	2 m.	48.8 sec.
1912 W. Bathe	Germany	3 m.	1.8 sec.	1932 Y. Tsurata	Japan	2 m.	45.4 sec.
1920 H. Malmroth	Sweden	3 m.	4.4 sec.	1936 T. Hamuro	Japan	2 m.	42.5 sec.
World Record :		2 m.	30.0 sec.	J. T. Verdeur (U.S.A.)			New Haven, 1948
Olympic Record :		2 m.	42.5 sec.	T. Hamuro (Japan)			Berlin, 1936

There were 38 entrants from 20 nations; 32 participants from 20 nations

**FIRST ROUND**

*The first two in each heat and the six fastest losers qualified for the Semi-finals*

HEAT 1			HEAT 2			HEAT 3					
	<i>m.</i>	<i>s.</i>		<i>m.</i>	<i>s.</i>		<i>m.</i>	<i>s.</i>			
1 Sohl, R.....	U.S.A.	2	44.9	1 Verdeur, J.....	U.S.A.	2	40.0	1 Jordan, W.....	Brazil	2	46.4
2 Nakache, A.....	France	2	50.4	2 Bonte, B.....	Holland	2	48.7	2 Nemeth, S.....	Hungary	2	48.2
3 Castillo Diaz, A.....	Mexico	2	50.7	3 Espejo Perez, C.....	Argentina	2	55.0	3 Romain, R.....	Great Britain	2	49.4
4 Amabuyok, R.....	Philippines	2	52.6	4 Jonsson, S.....	Iceland	2	56.4	4 Kunz, W.....	Switzerland	2	57.6
5 Service, J.....	Great Britain	3	0.4	5 Widmer, H.....	Switzerland	2	56.7	5 Benetti Aprosio,			
				6 Davies, J. Goldup.....	Great Britain	2	56.6	C.....	Argentina	3	0.6
				7 Salmon, P.....	Canada	3	1.5	6 Steinarsson, A.....	Iceland	3	2.3
								7 Cohen, D.....	South Africa	3	3.3
								8 Shah, I.....	Pakistan	3	28.1

HEAT 4			HEAT 5				
	<i>m.</i>	<i>s.</i>		<i>m.</i>	<i>s.</i>		
1 Carter, K.....	U.S.A.	2	46.3	1 Kandil, A.....	Egypt	2	45.5
2 Davies, J. Griffith.....	Australia	2	48.3	2 Cerer, T.....	Yugoslavia	2	46.3
3 Pavlicek, W.....	Austria	2	50.6	3 Lusien, M.....	France	2	49.5
4 Wildhaber, N.....	Switzerland	2	59.2	4 Jonsson, S. T.....	Iceland	2	50.6
				5 Linhart, J.....	Czechoslovakia	2	53.8
				6 Cayco, J.....	Philippines	2	54.0
				7 Hallett, K.....	Australia	3	2.0
				8 Mullick, P.....	India	3	14.9

**SEMI-FINALS**

*The first three in each Semi-final and the two fastest losers qualified for the Final*

HEAT 1			HEAT 2				
	<i>m.</i>	<i>s.</i>		<i>m.</i>	<i>s.</i>		
1 Kandil, A.....	Egypt	2	43.7	1 Verdeur, J.....	U.S.A.	†2	40.7
2 Jordan, W.....	Brazil	2	43.9	2 Carter, K.....	U.S.A.	2	43.0
3 Sohl, R.....	U.S.A.	2	44.4	3 Bonte, B.....	Holland	2	47.0
4 Davies, J. Griffith.....	Australia	2	44.8	4 Cerer, T.....	Yugoslavia	2	47.3
5 Romain, R.....	Great Britain	2	49.6	5 Nemeth, S.....	Hungary	2	48.1
6 Amabuyok R.....	Philippines	2	51.8	6 Pavlicek, W.....	Austria	2	50.1
7 Jonsson, S. T.....	Iceland	2	52.4	7 Lusien, M.....	France	2	51.4
8 Nakache, A.....	France	2	59.1	8 Castillo Diaz, A.....	Mexico	2	53.5

**FINAL**

1 <b>VERDEUR, J.</b> .....	U.S.A.	†2	39.3
2 <b>CARTER, K.</b> .....	U.S.A.	2	40.2
3 <b>SOHL, R.</b> .....	U.S.A.	2	43.9
4 Davies, J. Griffith.....	Australia	2	43.7
5 Cerer, T.....	Yugoslavia	2	46.1
6 Jordan, W.....	Brazil	2	46.4
7 Kandil, A.....	Egypt	2	47.5
8 Bonte, B.....	Holland	2	47.6

† New Olympic Record

# 100 METRES BACK STROKE

## Previous Olympic Winners

1900	E. Hoppenberg	<i>Germany</i>	2 m. 47.0 sec.	1920	W. Kealoha	<i>U.S.A.</i>	1 m. 15.2 sec.
	(200m.)			1924	W. Kealoha	<i>U.S.A.</i>	1 m. 13.2 sec.
1904	K. Brack (91m.)	<i>Germany</i>	1 m. 16.8 sec.	1928	G. H. Kojac	<i>U.S.A.</i>	1 m. 8.2 sec.
1908	A. Bieberstein	<i>Germany</i>	1 m. 24.6 sec.	1932	Y. Kiyokawa	<i>Japan</i>	1 m. 8.6 sec.
1912	H. Hebner	<i>U.S.A.</i>	1 m. 21.2 sec.	1936	A. Kiefer	<i>U.S.A.</i>	1 m. 5.9 sec.
	World Record :		1 m. 4-0 sec.	A. M. Stack (U.S.A.)		New Haven, 1948	
	Olympic Record :		1 m. 5-9 sec.	A. Kiefer (U.S.A.)		Berlin, 1936	

There were 42 entrants from 24 nations: 39 participants from 24 nations

## FIRST ROUND

The first two in each heat and the four fastest losers qualified for the Semi-finals

HEAT 1			HEAT 2			HEAT 3						
	<i>m</i>	<i>s.</i>		<i>m</i>	<i>s.</i>		<i>m</i>	<i>s.</i>				
1	Wiid, J.....	<i>South Africa</i>	1	Bourke, B.....	<i>Australia</i>	1	1	Brockway, J.....	<i>Great Britain</i>	1	9.2	
2	Kievit C.....	<i>Holland</i>	1	Monteiro da			2	Chaves, M.....	<i>Argentina</i>	1	9.7	
3	Vegazzi, J.....	<i>Argentina</i>	1	Fonseca, I.....	<i>Brazil</i>	1	3	Mejia Avila, C. ....	<i>Mexico</i>	1	9.5	
4	Calamita			3	Kovar, J. ....	<i>Czechoslovakia</i>	1	4	Zins, L.....	<i>France</i>	1	10.9
	Gonzales, F.....	<i>Spain</i>	1	4	Noreiga Pons, C. ....	<i>Uruguay</i>	1	5	Alua Simas, M.....	<i>Portugal</i>	1	12.8
5	Jubb, E.....	<i>Canada</i>	1	5	Lunden, M. ....	<i>Sweden</i>	1	6	Zwazi, F.....	<i>Austria</i>	1	13.5
6	Olsson, P.-O.....	<i>Sweden</i>	1	6	Gutierrez			7	Melanofidis, N. ....	<i>Greece</i>	1	22.0
7	Shah, K.....	<i>India</i>	1	7	Olguin, T. ....	<i>Mexico</i>	1					
				8	Shah, J.....	<i>Pakistan</i>	1					
HEAT 4			HEAT 5			HEAT 6						
	<i>m</i>	<i>s.</i>		<i>m</i>	<i>s.</i>		<i>m</i>	<i>s.</i>				
1	Stack, A.....	<i>U.S.A.</i>	1	1	Cowell, R.....	<i>U.S.A.</i>	1	1	Vallerey, G.....	<i>France</i>	1	7.4
2	Kinnear, A.....	<i>Great Britain</i>	1	2	Pirolley, R.....	<i>France</i>	1	2	Patterson, H.....	<i>U.S.A.</i>	1	9.3
3	da Fonseca e			3	Shanks, D.....	<i>Bermuda</i>	1	3	Oliveira e			
	Silva, P. W. ....	<i>Brazil</i>	1	4	El Sayed, D.....	<i>Egypt</i>	1		Silva, H. ....	<i>Brazil</i>	1	10.5
4	Summers, T.....	<i>Great Britain</i>	1	5	Ingolfsson, G.....	<i>Iceland</i>	1	4	Neumayer, F.....	<i>Argentina</i>	1	11.8
5	Valent, G.....	<i>Hungary</i>	1					5	Mingie, P.....	<i>Canada</i>	1	13.2
6	Guerra Perez, M. ....	<i>Spain</i>	1					6	Blumer, H.....	<i>Switzerland</i>	1	18.5
7	Mitra, P.....	<i>India</i>	1									

## SEMI-FINALS

The first three in each Semi-final and the two fastest losers qualified for the Final

HEAT 1			HEAT 2					
	<i>m</i>	<i>s.</i>		<i>m</i>	<i>s.</i>			
1	Stack, A.....	<i>U.S.A.</i>	1	1	Cowell, R.....	<i>U.S.A.</i>	1	8.5
2	Vallerey, G.....	<i>France</i>	1	2	Kinnear, A.....	<i>Great Britain</i>	1	9.2
3	Brockway, J.....	<i>Great Britain</i>	1	3	Wiid, J.....	<i>South Africa</i>	1	9.2
4	Mejia Avila, C. ....	<i>Mexico</i>	1	4	Patterson, H.....	<i>U.S.A.</i>	1	9.9
5	Chaves, M.....	<i>Argentina</i>	1	5	Oliveira e			
6	da Fonseca e				Silva, H. ....	<i>Brazil</i>	1	10.1
	Silva, P. W. ....	<i>Brazil</i>	1	6	Zins, L.....	<i>France</i>	1	11.5
7	Kievit, C.....	<i>Holland</i>	1	7	Monteiro da			
8	Bourke, B.....	<i>Australia</i>	1		Fonseca, I.....	<i>Brazil</i>	1	11.6
				8	Pirolley, R.....	<i>France</i>	1	12.9

## FINAL

	<i>m</i>	<i>s.</i>
1	STACK, A. ....	<i>U.S.A.</i> ..... 1 6.4
2	COWELL, R. ....	<i>U.S.A.</i> ..... 1 6.5
3	VALLEREY, G.....	<i>France</i> ..... 1 7.8
4	{	Chaves, M..... <i>Argentina</i> ..... 1 9.0
	{	Mejia Avila, C..... <i>Mexico</i> ..... 1 9.0
		}Tie
6	Wiid, J.....	<i>South Africa</i> ..... 1 9.1
7	Brockway, J.....	<i>Great Britain</i> ..... 1 9.2
8	Kinnear, A. ....	<i>Great Britain</i> ..... 1 9.6

**4x200 METRES RELAY***Previous Olympic Winners*

1900	Germany (5 x 40)	Time not recorded	1920	U.S.A.	10 m. 4.4 sec.
1904	U.S.A. (4 x 50)	2 m. 4.6 sec.	1924	U.S.A.	9 m. 53.4 sec.
1908	Gt. Britain	10 m. 55.6 sec.	1928	U.S.A.	9 m. 36.2 sec.
1912	Australia	10 m. 11.2 sec.	1932	Japan	8 m. 58.4 sec.
			1936	Japan	8 m. 51.5 sec.

World and Olympic Record : 8 m. 51.5 sec., Japan (C. M. Yusa, S. H. Sugufira, Th. Arai, M. Taguchi), Berlin, 1936

There were 87 entrants from 15 nations: 61 participants from 14 nations

*The first three teams in each heat and the two fastest losers qualified for the Final*

HEAT 1				HEAT 2							
			<i>m. s.</i>				<i>m. s.</i>				
1	<i>Hungary</i> .....	Kadas, G. Nyeki, I.	Mitro, G. Szatmari, E.	8	53.6	1	<i>France</i> .....	Cornu, R. Bernardo, J.	Jany, A. Padou, H.	9	8.8
2	<i>U.S.A.</i> .....	Gibe, R. Gilbert, E.	Dudley, W. Rogers, E.	8	55.9	2	<i>Yugoslavia</i> .....	Ilic, V. Puhar, I.	Pelhan, C. Vidovic, B.	9	12.4
3	<i>Argentine</i> .....	Canton, A. Garay, J.	Duranona, J. Yantorno, A.	9	16.9	3	<i>Sweden</i> .....	Johansson, O. Olsson, P.-O.	Lunden, M. Ostrand, P.-O.	9	12.9
4	<i>Brazil</i> .....	Alencar Rod- rigues, S. Boghossian, A.	Jordan, W. O. Egon Kestener, R.	9	19.9	4	<i>Mexico</i> .....	Bravo Prieto, R. Isaac Ahumada, A.	Castillo Diaz, A. Maldonado Cam- pos, A.	9	23.4
5	<i>Spain</i> .....	Domingues Garcia, J. Martinez Ferry, I.	Guerra Perez, M. Perez Gonzalez, I.	9	28.3	5	<i>Great Britain</i> .....	Botham, F. Wainwright, N.	Hale, J. Holt, J.	9	26.6
6	<i>Pakistan</i> .....	Chaudhry, A. Karamally, S.	Shah, I. Shah, J.	12	25.8	6	<i>Canada</i> .....	Gibson, F. Gilchrist, A.	Jubb, E. Salmon, P.	9	43.2
-	<i>Bermuda</i> .....	Bardgett, W. Oatway, D.	Cook, R. Tribley, P.		Disqf'd.	7	<i>Egypt</i> .....	Bagdadi, A. El Gamal, T.	Kandil, A. Khalifa, M.	10	25.0

**FINAL**

			<i>m. s.</i>		
1	<b>U.S.A.</b> .....	Ris, W. Wolf, W.	McLane, J. Smith, W.	†8	46.0
2	<b>HUNGARY</b> .....	Szatmari, E. Nyeki, I.	Mitro, G. Kadas, G.	8	48.4
3	<b>FRANCE</b> .....	Bernardo, J. Padou, H.	Cornu, R. Jany, A.	9	8.0
4	<i>Sweden</i> .....	Lunden, M. Johansson, O.	Ostrand, P.-O. Olsson, P.-O.	9	9.1
5	<i>Yugoslavia</i> .....	Ilic, V. Puhar, I.	Pelhan, C. Vidovic, B.	9	14.0
6	<i>Argentine</i> .....	White, H. Garay, J.	Duranona, J. Yantorno, A.	9	19.2
7	<i>Mexico</i> .....	Bravo Prieto, R. Castillo Diaz, A.	Maldonado Cam- pos, A. Isaac, Ahumada A.	9	20.2
8	<i>Brazil</i> .....	Alencar Rod- rigues, S. Egon Kestener, R.	Jordan, W. O. Boghossian, A.	9	31.0

† New World and Olympic Record.

**100 METRES FREE STYLE (Women)***Previous Olympic Winners*

1912 Miss F. Durack	<i>Australia</i>	1 m. 22.2 sec.	1928 Miss A. Osipowitch	<i>U.S.A.</i>	1 m. 11.0 sec.
1920 Miss E. Bliebtray	<i>U.S.A.</i>	1 m. 13.6 sec.	1932 Miss H. Madison	<i>U.S.A.</i>	1 m. 6.8 sec.
1924 Miss E. Lackie	<i>U.S.A.</i>	1 m. 12.4 sec.	1936 Miss H. Mastenbroek	<i>Holland</i>	1 m. 5.9 sec.
World Record :	1 m. 4.6 sec.	Miss W. den Ouden (Holland)	Amsterdam, 1936		
Olympic Record :	1 m. 5.9 sec.	Miss H. Mastenbroek (Holland)	Berlin, 1936		

---

There were 35 entrants from 14 nations; 34 participants from 14 nations

---

**FIRST ROUND***The first two in each heat and the six fastest losers qualified for the Semi-finals*

HEAT 1			HEAT 2			HEAT 3		
	<i>m</i>	<i>s.</i>					<i>m</i>	<i>s.</i>
1 Schumacher, I.....	<i>Holland</i>	1 7.9	1 Carstensen, F.....	<i>Denmark</i>	1 6.5	1 Ahlgren, E.....	<i>Sweden</i>	1 8.7
2 Temes, T.....	<i>Hungary</i>	1 8.3	2 Vaessen, M.....	<i>Holland</i>	1 7.5	2 Harup, K.....	<i>Denmark</i>	1 8.4
3 Helser, B.....	<i>U.S.A.</i>	1 9.0	3 Spencer, D.....	<i>Australia</i>	1 10.0	3 McQuade, M.....	<i>Australia</i>	1 8.5
4 Arene, J.....	<i>France</i>	1 9.7	4 Schmitt, E. M. J.....	<i>Brazil</i>	1 10.8	4 Silva Tavares, P.....	<i>Brazil</i>	1 8.6
5 Holt, E.....	<i>Argentina</i>	1 12.0	5 Littomeritzky, M.....	<i>Hungary</i>	1 13.0	5 Nielsen, P.....	<i>Great Britain</i>	1 9.4
6 Bruggemann			6 Camelli, A.....	<i>Argentina</i>	1 16.5	6 Jany, G.....	<i>France</i>	1 12.1
Schmith, M.....	<i>Mexico</i>	1 12.5				7 Duarte, E.....	<i>Argentina</i>	1 14.9
7 Erisman, M.....	<i>Switzerland</i>	1 19.9						

HEAT 4			HEAT 5		
	<i>m</i>	<i>s.</i>		<i>m</i>	<i>s.</i>
1 Curtis, A.....	<i>U.S.A.</i>	1 6.9	1 Fredin, I.....	<i>Sweden</i>	1 8.1
2 Andersen, G.....	<i>Denmark</i>	1 7.0	2 Corridon, M.....	<i>U.S.A.</i>	1 8.4
3 Lundquist, M.....	<i>Sweden</i>	1 9.0	3 Preece, L.....	<i>Great Britain</i>	1 9.0
4 Wellington, M.....	<i>Great Britain</i>	1 9.8	4 Termeulen, J.....	<i>Holland</i>	1 9.8
5 McNamee, K.....	<i>Canada</i>	1 13.3	5 Caroen, F.....	<i>Belgium</i>	1 12.1
6 Nador, Z.....	<i>Hungary</i>	1 15.8	6 Strong, I.....	<i>Canada</i>	1 13.5
7 Leao da Costa, M.....	<i>Brazil</i>	1 16.0	7 Vallerey, G.....	<i>France</i>	1 14.0

**SEMI-FINALS***The first two in each Semi-final and the four fastest losers qualified for the Final*

HEAT 1			HEAT 2		
	<i>m</i>	<i>s.</i>		<i>m</i>	<i>s.</i>
1 Andersen, G.....	<i>Denmark</i>	1 5.9	1 Curtis, A.....	<i>U.S.A.</i>	1 7.6
2 Carstensen, F.....	<i>Denmark</i>	1 7.5	2 Vaessen, M.....	<i>Holland</i>	1 8.4
3 Schumacher, I.....	<i>Holland</i>	1 7.7	3 Fredin, I.....	<i>Sweden</i>	1 8.4
4 Corridon, M.....	<i>U.S.A.</i>	1 8.9	4 Ahlgren, E.....	<i>Sweden</i>	1 8.6
5 Lundquist, M.....	<i>Sweden</i>	1 9.5	5 Harup, K.....	<i>Denmark</i>	1 8.7
6 McQuade, M.....	<i>Australia</i>	1 9.3	6 Preece, L.....	<i>Great Britain</i>	1 9.3
7 Nielsen, P.....	<i>Great Britain</i>	1 9.6	7 Silva Tavares, P.....	<i>Brazil</i>	1 9.5
8 Temes, T.....	<i>Hungary</i>	1 9.7	8 Helser, B.....	<i>U.S.A.</i>	1 10.0

**FINAL**

	<i>m</i>	<i>s.</i>
1 ANDERSEN, G.....	<i>Denmark</i>	1 6.3
2 CURTIS, A.....	<i>U.S.A.</i>	1 6.5
3 VAESSEN, M.....	<i>Holland</i>	1 7.6
4 Harup, K.....	<i>Denmark</i>	1 8.1
5 Fredin, I.....	<i>Sweden</i>	1 8.4
6 Schumacher, I.....	<i>Holland</i>	1 8.4
7 Ahlgren, E.....	<i>Sweden</i>	1 8.8
8 Carstensen, F.....	<i>Denmark</i>	1 9.1

**400 METRES FREE STYLE (Women)***Previous Olympic Winners*

1924	Miss M. Norelius	U.S.A.	6 m.	2.2 sec.	1932	Miss H. Madison	U.S.A.	5	28.5 sec.
1928	Miss M. Norelius	U.S.A.	5 m.	42.8 sec.	1936	Miss H. Mastenbroek	Holland	5	26.4 sec.
	World Record :	5 m.	0.1 sec.		Miss R. Hveger (Denmark)				Copenhagen, 1940
	Olympic Record :	5 m.	26.4 sec.		Miss H. Mastenbroek (Holland)				Berlin, 1936

---

There were 23 entrants from 13 nations; 19 participants from 11 nations

---

**FIRST ROUND**

*The first four in each heat and the four fastest losers qualified for the Semi-finals*

HEAT 1			HEAT 2			HEAT 3					
	<i>m</i>	<i>s.</i>		<i>m</i>	<i>s.</i>		<i>m</i>	<i>s.</i>			
1 Harup, K. ....	Denmark	5	31.7	1 Gibson, C. ....	Great Britain	5	26.9	1 Helser, B. ....	U.S.A.	5	30.0
2 Curtis, A. ....	U.S.A.	5	32.0	2 Caroen, F. ....	Belgium	5	29.2	1 Silva Tavares, P. ....	Brazil	5	30.2
3 Thomas, C. ....	France	5	32.9	3 Carstensen, F. ....	Denmark	5	29.4	3 Nielsen, P. ....	Great Britain	5	40.4
4 Thidholm, G. ....	Sweden	5	34.5	4 Lees, N. ....	U.S.A.	5	29.6	4 Spencer, D. ....	Australia	5	40.9
5 Wellington, M. ....	Great Britain	5	40.0	5 King, V. ....	Canada	5	54.8	5 Bruggemann,			
6 McNamee, K. ....	Canada	5	58.7					Schmith M. ....	Mexico	5	43.8
7 Duarte, E. ....	Argentina	6	14.4					6 Holt, E. ....	Argentina	5	44.9
								– Andersen, G. ....	Denmark		‡

**SEMI-FINALS**

*The first three in each Semi-final and the two fastest losers qualified for the Final*

HEAT 1			HEAT 2				
	<i>m.</i>	<i>s.</i>		<i>m.</i>	<i>s.</i>		
1 Harup, K. ....	Denmark	†5	25.7	1 Curtis, A. ....	U.S.A.	5	26.4
2 Caroen, F. ....	Belgium	5	26.1	2 Helser, B. ....	U.S.A.	5	28.1
3 Silva Tavares, P. ....	Brazil	5	31.1	3 Carstensen, F. ....	Denmark	5	29.5
4 Lees, N. ....	U.S.A.	5	31.9	4 Gibson, C. ....	Great Britain	5	31.0
5 Nielsen, P. ....	Great Britain	5	39.5	5 Thomas, C. ....	France	5	35.3
6 Bruggemann				6 Spencer, D. ....	Australia	5	35.6
Schmith, M. ....	Mexico	5	42.4	7 Wellington, M. ....	Great Britain	5	38.2
7 King, V. ....	Canada	5	52.7	8 Holt, E. ....	Argentina	5	52.4
– Thidholm, G. ....	Sweden		*				

**FINAL**

	<i>m.</i>	<i>s.</i>
1 <b>CURTIS, A.</b> ....	U.S.A.	†5 17.8
2 <b>HARUP, K.</b> ....	Denmark	5 21.2
3 <b>GIBSON, C.</b> ....	Great Britain	5 22.5
4 Caroen, F. ....	Belgium	5 25.3
5 Helser, B. ....	U.S.A.	5 26.0
6 Silva Tavares, P. ....	Brazil	5 29.4
7 Carstensen, F. ....	Denmark	5 29.4
8 Lees, N. ....	U.S.A.	5 32.9

\* Non-Starter      † New Olympic Record      ‡ Did not finish.

**200 METRES BREAST STROKE (Women)***Previous Olympic Winners*

1924 Miss L. Morton	<i>Gt. Britain</i>	3 m. 33.2 sec.	1932 Miss C. Dennis	<i>Australia</i>	3 m. 6.3 sec.
1928 Miss H. Schrader	<i>Germany</i>	3 m. 12.6 sec.	1936 Miss H. Maehata	<i>Japan</i>	3 m. 3.6 sec.
World Record :	2 m. 49.2 sec.	Miss P. van Vliet (Holland)	Hilversum, 1948		
Olympic Record :	3 m. 1.9 sec.	Miss H. Maehata (Japan)	Berlin, 1936		

---

There were 22 entrants from 14 nations; 22 participants from 14 nations

---

**FIRST ROUND***The first four in each heat and the four fastest losers qualified for the Semi-finals*

HEAT 1			HEAT 2			HEAT 3		
	<i>m</i>	<i>s.</i>		<i>m.</i>	<i>s.</i>		<i>m</i>	<i>s.</i>
1 Lyons, B.....	<i>Australia</i>	3 2.9	1 Szekely, E.....	<i>Hungary</i>	†3 1.2	1 van Vliet, P.....	<i>Holland</i>	†2 57.4
2 Novak, E.....	<i>Hungary</i>	3 2.9	2 Hom, A.....	<i>Holland</i>	3 6.0	2 Hansen, J. S. ....	<i>Denmark</i>	3 9.1
3 de Groot, A. ....	<i>Holland</i>	3 4.4	3 van de Kerckhove, Y. ....	<i>Belgium</i>	3 9.0	3 Leskinen, M.....	<i>Finland</i>	3 11.4
4 Church, E.....	<i>Great Britain</i>	3 7.4	4 Bertrand, J.....	<i>France</i>	3 10.7	4 Gordon, H.....	<i>Great Britain</i>	3 13.3
5 Turnbull, D.....	<i>Argentina</i>	3 12.2	5 Caplin, J.....	<i>Great Britain</i>	3 17.0	5 Strong, I.....	<i>Canada</i>	3 14.2
6 Kobi, L.....	<i>Switzerland</i>	3 16.2	6 Diederichsen			6 Lamore, C.....	<i>U.S.A</i>	3 23.6
7 Wilson, J. E.....	<i>U.S.A</i>	3 18.3	6 Schonbude, H. ....	<i>Mexico</i>	3 27.8	7 Arnadottir, T.....	<i>Iceland</i>	3 26.1
8 Olafsdottir, A.....	<i>Iceland</i>	3 19.9	7 Pence, C.....	<i>U.S.A</i>	3 28.1			

**SEMI-FINALS***The first three in each Semi-final and the two fastest losers qualified for the Final*

HEAT 1			HEAT 2		
	<i>m</i>	<i>s.</i>		<i>m</i>	<i>s.</i>
1 Lyons, B.....	<i>Australia</i>	3 0.9	1 van Vliet, P.....	<i>Holland</i>	†2 57.0
2 de Groot, A.....	<i>Holland</i>	3 1.4	2 Novak, I.....	<i>Hungary</i>	2 58.0
3 Szekely, E.....	<i>Hungary</i>	3 2.8	3 Hansen, J.....	<i>Denmark</i>	3 5.5
4 van de Kerckhove, Y. ....	<i>Belgium</i>	3 9.7	4 Hom, A.....	<i>Holland</i>	3 5.7
5 Bertrand, J.....	<i>France</i>	3 13.1	5 Church, E.....	<i>Great Britain</i>	3 7.1
6 Caplin, J.....	<i>Great Britain</i>	3 14.4	6 Leskinen, M.....	<i>Finland</i>	3 10.0
7 Turnbull, D.....	<i>Argentina</i>	3 14.4	7 Kobi, L.....	<i>Switzerland</i>	3 13.9
8 Strong, I.....	<i>Canada</i>	3 16.9	8 Gordon, H.....	<i>Great Britain</i>	3 15.8

**FINAL**

	<i>m.</i>	<i>s.</i>
1 <b>VAN VLIET, P.</b> .....	<i>Holland</i>	2 57.2
2 <b>LYONS, B.</b> .....	<i>Australia</i>	2 57.7
3 <b>NOVAK, E.</b> .....	<i>Hungary</i>	3 0.2
4 Szekely, E.....	<i>Hungary</i>	3 2.5
5 de Groot, A.....	<i>Holland</i>	3 6.2
6 Church, E.....	<i>Great Britain</i>	3 6.1
7 Horn, A.....	<i>Holland</i>	3 7.5
8 Hansen, J. ....	<i>Denmark</i>	3 8.1

† New Olympic Record.



**100 METRES BACK STROKE (Women)***Previous Olympic Winners*

1924 Miss S. Bauer	<i>U.S.A.</i>	1 m. 23.2 sec.	1932 Miss E. Holm	<i>U.S.A.</i>	1 m. 19.4 sec.
1928 Miss M. Braun	<i>Holland</i>	1 m. 22.0 sec.	1936 Miss N. Senff	<i>Holland</i>	1 m. 18.9 sec.
World Record :	1 m. 10.9 sec.	Miss C. Kint (Holland)	Rotterdam, 1939		
Olympic Record :	1 m. 16.6 sec.	Miss N. Senff (Holland)	Berlin, 1936		

---

There were 26 entrants from 16 nations; 24 participants from 16 nations

---

**FIRST ROUND**

*The first three in each heat and the four fastest losers qualified for the Semi-finals*

HEAT 1			HEAT 2			HEAT 3		
	<i>m.</i>	<i>s.</i>		<i>m.</i>	<i>s.</i>		<i>m.</i>	<i>s.</i>
1 van der Horst, H. ....	<i>Holland</i>	1 18.7	1 Harup, K .....	<i>Denmark</i>	1 15.6	1 Davies, J. J. ....	<i>Australia</i>	1 16.4
2 Lane, N .....	<i>New Zealand</i>	1 18.8	2 Zimmerman, S. ....	<i>U.S.A.</i>	1 16.8	2 Novak, I. ....	<i>Hungary</i>	1 17.3
3 Libotte Berlioux, M. ....	<i>France</i>	1 18.8	3 Yate, H. ....	<i>Great Britain</i>	1 18.3	3 Jensen, B. ....	<i>U.S.A.</i>	1 18.8
4 Fredin, I. ....	<i>Sweden</i>	1 21.2	4 Marshall, B .....	<i>Argentina</i>	1 20.9	4 van Ekris, D. ....	<i>Holland</i>	1 19.3
5 Olafsdottir, K. ....	<i>Iceland</i>	1 25.6	5 Gontersweiler, D. ....	<i>Switzerland</i>	1 26.2	5 Ellery, V. ....	<i>Great Britain</i>	1 20.9
			6 Court, J. ....	<i>Canada</i>	1 26.8	6 Gonzalias, L. ....	<i>Argentina</i>	1 26.9
			HEAT 4					
				<i>m.</i>	<i>s.</i>			
			1 Galliard, M .....	<i>Holland</i>	1 18.2			
			2 Mellon, M. ....	<i>U.S.A.</i>	1 18.7			
			3 Gibson, C. ....	<i>Great Britain</i>	1 19.7			
			4 Bruggeman Schmith, M. ....	<i>Mexico</i>	1 21.4			
			5 Ballintyn, B. ....	<i>Norway</i>	1 22.1			
			6 Nogueira da Gama Groba, E. ....	<i>Brazil</i>	1 22.5			
			7 Jany, G. ....	<i>France</i>	1 22.7			

**SEMI-FINALS**

*The first three in each Semi-final and the two fastest losers qualified for the Final*

HEAT 1			HEAT 2		
	<i>m.</i>	<i>s.</i>		<i>m.</i>	<i>s.</i>
1 Harup, K .....	<i>Denmark</i>	†1 15.5	1 Zimmerman, S. ....	<i>U.S.A.</i>	1 16.8
2 Novak, I. ....	<i>Hungary</i>	1 17.6	2 Davies, J. J. ....	<i>Australia</i>	1 17.8
3 Mellon, M. ....	<i>U.S.A.</i>	1 18.2	3 van der Horst, H. ....	<i>Holland</i>	1 18.7
4 van Ekris, D. ....	<i>Holland</i>	1 18.1	4 Yate, H. ....	<i>Great Britain</i>	1 18.6
5 Galliard, M. ....	<i>Holland</i>	1 18.4	5 Jensen, B. ....	<i>U.S.A.</i>	1 19.1
6 Gibson, C. ....	<i>Great Britain</i>	1 18.6	6 Libotte Berlioux, M. ....	<i>France</i>	1 20.2
7 Lane, N .....	<i>New Zealand</i>	1 19.0	7 Ellery, V. ....	<i>Great Britain</i>	1 20.8
8 Marshall, B .....	<i>Argentina</i>	1 20.7	Fredin, I. ....	<i>Sweden</i>	*

**FINAL**

	<i>m.</i>	<i>s.</i>
1 <b>HARUP, K.</b> .....	<i>Denmark</i>	†1 14.4
2 <b>ZIMMERMAN, S.</b> .....	<i>U.S.A.</i>	1 16.0
3 <b>DAVIES, J.J.</b> .....	<i>Australia</i>	1 16.7
4 Novak, I. ....	<i>Hungary</i>	1 18.4
5 van der Horst, H. ....	<i>Holland</i>	1 18.8
6 van Ekris, D. ....	<i>Holland</i>	1 18.9
7 Mellon, M. ....	<i>U.S.A.</i>	1 19.0
8 Galliard, M. ....	<i>Holland</i>	1 19.1

\* Non-Starter

† New Olympic Record

**4x100 METRES RELAY (Women)***Previous Olympic Winners*

1912	Gt. Britain	5 m. 52.8 sec.	1928	U.S.A.	4 m. 47.6 sec.
1920	U.S.A.	5 m. 11.6 sec.	1932	U.S.A.	4 m. 38.0 sec.
1924	U.S.A.	4 m. 58.8 sec.	1936	Holland	4 m. 36.0 sec.
World Record :	4 m. 27.6 sec.	Denmark (E. Arndt, G. Kraft, B. O. Petersen, R. H. Hveger),			Copenhagen, 1938
Olympic Record :	4 m. 36 sec.	Holland (T. Selbach, T. Wagner, W. den Ouden, H. Mastenbroek),			Berlin, 1936

---

There were 59 entrants from 11 nations ; 46 participants from 11 nations

---

*The first three teams in each heat and the two fastest losers qualified for the Final*

**HEAT 1**

			<i>m.</i>	<i>s.</i>
1	<i>Denmark</i> .....	Riise, E. Carstensen, F.	Carlsen, E. Andersen, G.	†4 33.5
2	<i>U.S.A</i> .....	Corridon, M. Helser, B.	Kalama, T. Curtis, A.	4 34.1
3	<i>Great Britain</i> ...	Wellington, M. Preece, L.	Neilsen, P. Gibson, C.	4 36.1
4	<i>France</i> .....	Arene, J. Foucher-Cretau, M.	Thomas, C. Jany, G.	4 50.0
5	<i>Argentina</i> .....	Duarte, E. Camelli, A.	Gonzalias, L. Holt, E.	4 59.5
6	<i>Canada</i> .....	McNamee, K. King, V.	Court, J. Strong, I.	5 4.5

**HEAT 2**

			<i>m.</i>	<i>s.</i>
1	<i>Holland</i> .....	Schumacher, I. Vaessen, M.	Marsman, M. Termeulen, J.	†4 31.3
2	<i>Sweden</i> .....	Lundquist, M. Ahlgren, E.	Thidholm, G. Fredin, I.	4 38.5
3	<i>Hungary</i> .....	Littomeritzky, M. Szekely, E.	Temes, T. Novak, E.	4 47.5
4	<i>Brazil</i> .....	Schmitt, M. J. Rodrigues, T.	Leao da Costa, M. Silva Tavares P.	4 51.4
5	<i>Belgium</i> .....	Huybrechts, M. Van Den Brende, R.	Oven, M. Caroen, F.	4 54.9

**FINAL**

			<i>m.</i>	<i>s.</i>
1	<b>U.S.A.</b> .....	Corridon, M. Helser, B.	Kalama, T. Curtis, A.	†4 29.2
2	<b>DENMARK</b> ....	Riise, E. Anderson, G.	Harup, T. Carstensen, F.	4 29.6
3	<b>HOLLAND</b> .....	Schumacher, I. Vaessen, M.	Marsman, M. Termeulen, J.	4 31.6
4	<i>Great Britain</i> ....	Nielsen, P. Preece, L.	Wellington, M. Gibson, C.	4 34.7
5	<i>Hungary</i> .....	Littomeritzky, M. Temes, T.	Novak, I. Szekely, E.	4 44.8
6	<i>Brazil</i> .....	Schmitt, E. M. J. Rodrigues, T.	Leao da Costa, M. Silva Tavares, P.	4 49.1
7	<i>France</i> .....	Arene, J. Thomas, C.	Vallerey, G. Jany, G.	4 49.8
–	<i>Sweden</i> .....	Thidholm, G. Lundquist, M.	Ahlgren, E. Fredin, I.	Disqld.

† New Olympic Record.

## DIVING

### RULES GOVERNING OLYMPIC CONTESTS

For MEN the Spring Board Diving Contests shall consist of five compulsory and five voluntary dives. The voluntary dives must be selected out of five different groups.

For WOMEN it shall consist of four compulsory dives and four voluntary dives in accordance with the preceding rules governing the men's contest.

The High Diving for MEN shall consist of four compulsory and four voluntary dives ; the voluntary dives must be selected from 4 different groups ; for WOMEN it shall consist of four compulsory and two voluntary dives.

The compulsory dives have been fixed for the current Olympic Period by the Diving Committee of the Federation Internationale de Natation Amateur as follows :—(a)—Straight; (b)—Pike position

	<i>Degree of Difficulty</i>
<b>MEN Spring Board Diving—3 metres.</b>	
(a) Header forward running	1.3
(b) Backward header	1.7
(a) Isander (half Gainer) reverse dive (running)	1.9
(b) Backward spring, forward dive	1.2
(a) 1 Twist forward running	2.0
 <b>WOMEN Spring Board Diving—3 metres.</b>	
(b) Header forward running	1.2
(a) Backward header	1.6
(a) Isander (half Gainer) reverse dive (running)	1.9
(b) Backward spring, forward dive	1.2
 <b>MEN High Board Diving—10 metres.</b>	
(a) Header forward running	1.2
(a) Somersault backward	1.8
(a) Mollberg (full Gainer) reverse somersault (running) Armstand with forward cut through	1.9 1.6
 <b>WOMEN High Diving—5 and 10 metres.</b>	
(b) 1½ somersault forward running	(5 m.) 1.4
(a) Somersault backward	(5 m.) 1.4
(a) Header forward standing	(10 m.) 1.1
(a) Header forward running	(10 m.) 1.2

The diving scores are obtained by cancelling the highest and lowest awards of the seven judges and multiplying the average of the remaining awards by the degree of difficulty of the dive executed. Each judge awards marks from 1 to 10.

**SPRINGBOARD DIVING***Previous Olympic Winners*

1904 R. Sheldon	<i>U.S.A.</i>	1924 A. White	<i>U.S.A.</i>
1908 A. Zurner	<i>Germany</i>	1928 P. Desjardins	<i>U.S.A.</i>
1912 P. Gunther	<i>Germany</i>	1932 M. Galitzer	<i>U.S.A.</i>
1920 L. Kuehn	<i>U.S.A.</i>	1936 R. Degener	<i>U.S.A.</i>

There were 31 entrants from 18 nations ; 26 participants from 15 nations

1 <b>HARLAN, B.</b> .....	<i>U.S.A.</i> .....	163.64	14 Heinkele, R. ....	<i>France</i> .....	110.78
2 <b>ANDERSON, M.</b> .....	<i>U.S.A.</i> .....	157.29	15 Ramzy, I.....	<i>Egypt</i> .....	110.18
3 <b>LEE, S.</b> .....	<i>U.S.A.</i> .....	145.52	16 Norris, D.....	<i>Australia</i> .....	109.67
4 Capilla Perez, J.....	<i>Mexico</i> .....	141.79	17 Mariscal Abascal, D. ....	<i>Mexico</i> .....	107.78
5 Mulinghausen, R.....	<i>France</i> .....	126.55	18 Johnson, C.....	<i>Great Britain</i> .....	105.32
6 Johansson, S.....	<i>Sweden</i> .....	120.20	19 Lippa, W.....	<i>Austria</i> .....	103.18
7 Hassan, K.....	<i>Egypt</i> .....	119.90	20 Hernandez, G.....	<i>France</i> .....	102.89
8 Christiansen, T.....	<i>Denmark</i> .....	114.59	21 Kemnits, G.....	<i>Brazil</i> .....	102.22
9 Athans, G.....	<i>Canada</i> .....	114.13	22 Ibrahim, M.....	<i>Egypt</i> .....	97.52
10 Gosling, F.....	<i>Bermuda</i> .....	113.98	23 Elliott, P.....	<i>Great Britain</i> .....	91.23
11 Buzin, M.....	<i>Brazil</i> .....	113.86	24 Castillo, J.....	<i>Cuba</i> .....	84.81
12 Worisch, F.....	<i>Austria</i> .....	112.15	25 Strupler, E.....	<i>Switzerland</i> .....	80.09
13 Heatly, P.....	<i>Great Britain</i> .....	111.73	26 Mund Borgs, G.....	<i>Chile</i> .....	68.08

**HIGHBOARD DIVING***Previous Olympic Winners*

1904 G. E. Sheldon	<i>U.S.A.</i>	1924 A. White	<i>U.S.A.</i>
1908 A. Zurner	<i>Germany</i>	1928 P. Desjardins	<i>U.S.A.</i>
1912 A. Adlerz	<i>Sweden</i>	1932 H. Smith	<i>U.S.A.</i>
1920 C. Pinkston	<i>U.S.A.</i>	1936 M. Wayne	<i>U.S.A.</i>

There were 30 entrants from 18 nations; 25 participants from 15 nations

		<i>points</i>			<i>points</i>
1 <b>LEE, S.</b> .....	<i>U.S.A.</i> .....	130.05	14 Somohano Winfield, G.....	<i>Mexico</i> .....	91.98
2 <b>HARLAN, B.</b> .....	<i>U.S.A.</i> .....	122.30	15 Worisch, F.....	<i>Austria</i> .....	90.05
3 <b>CAPILLA PEREZ, J.</b> .....	<i>Mexico</i> .....	113.52	16 Mariano, H.....	<i>Brazil</i> .....	90.00
4 Brunnhage, L.....	<i>Sweden</i> .....	108.62	17 Lippa, W.....	<i>Austria</i> .....	89.04
5 Heatly, P.....	<i>Great Britain</i> .....	105.29	18 Ward, G.....	<i>Great Britain</i> .....	88.96
6 Christiansen, T.....	<i>Denmark</i> .....	105.22	19 Niemelainen, H.....	<i>Finland</i> .....	87.82
7 Mulinghausen, R.....	<i>France</i> .....	103.01	20 Hernandez, G.....	<i>France</i> .....	87.46
8 Athans, G.....	<i>Canada</i> .....	100.91	21 Mandy, G.....	<i>South Africa</i> .....	86.00
9 Stigersand, R.....	<i>Norway</i> .....	97.93	22 Aboul Seoud, R.....	<i>Egypt</i> .....	85.85
10 Shourbagi, Z.....	<i>Syria</i> .....	97.81	23 Rist, W.....	<i>Switzerland</i> .....	81.78
11 Marchant, L.....	<i>Great Britain</i> .....	96.11	24 Allam, M.....	<i>Egypt</i> .....	77.92
12 Hassan, K.....	<i>Egypt</i> .....	95.33	25 Strupler, E.....	<i>Switzerland</i> .....	77.67
13 Mariscal Abascal, D.....	<i>Mexico</i> .....	95.14			

**SPRINGBOARD DIVING (Women)***Previous Olympic Winners*

1912	Miss G. Johansson	Sweden	1928	Miss H. Meany	U.S.A.
1920	Miss S. Fryland	Denmark	1932	Miss G. V. Coleman	U.S.A.
1924	Miss E. Becker	U.S.A.	1936	Miss M. Gestring	U.S.A.

---

There were 17 entrants from 9 nations ; 16 participants from 8 nations

---

		<i>points</i>			<i>points</i>		
1	<b>DRAVES, V.</b>	U.S.A.	108.74	9	Christoffersen, B	Denmark	87.12
2	<b>OLSEN, Z.</b>	U.S.A.	108.23	10	Aubert, J	France	86.96
3	<b>ELSENER, P.</b>	U.S.A.	101.30	11	Staudinger, A	Austria	86.93
4	Peliissard, N	France	100.38	12	Floor, J	Holland	83.14
5	Groemer, G	Austria	93.30	13	Harris, E	Great Britain	74.10
6	Child, E	Great Britain	91.63	14	Cuthbert, K	Great Britain	72.40
7	Moreau, M	France	89.43	15	Nordbo, I	Norway	70.86
8	Heck, J	Holland	87.61	16	de Belaustegigoitia, I	Mexico	58.18

**HIGHBOARD DIVING (Women)***Previous Olympic Winners*

1920	Miss A. Riffin	U.S.A.	1932	Miss D. Poynton	U.S.A.
1924	Miss C. Smith	U.S.A.	1936	Mrs. D. Poynton-Hill	U.S.A.
1928	Miss E. Pinkston	U.S.A.			

---

There were 15 entrants from 9 nations ; 15 participants from 9 nations

---

		<i>points</i>			<i>points</i>		
1	<b>DRAVES, V.</b>	U.S.A.	68.87	9	Zsagot, I	Hungary	56.62
2	<b>ELSENER, P.</b>	U.S.A.	66.28	10	Bisbrown, L	Great Britain	53.95
3	<b>CHRISTOFFERSEN, B.</b>	Denmark	66.04	11	Newman, D	Great Britain	53.50
4	Staudinger, A	Austria	64.59	12	Hider, M	Great Britain	52.31
5	Stover, J	U.S.A.	62.63	13	Nordbo, I	Norway	51.55
6	Pellissard, N	France	61.07	14	Gutierrez de Pardo, R	Mexico	41.88
7	Petersen, E	Sweden	59.86		- Groemer, G	Austria	39.65
8	Becken-Gregersen, I	Denmark	59.54				

## WATER POLO TOURNAMENT

In the First Round each team in a group met each other team in that group. The placings in the group were determined on points. If teams were equal on points, then the better goal average decided. The first two teams in each group qualified for the Second Round.

From the Second Round onwards each team in a group met each other team in that group unless they had met in a previous round, in which case the previous result stood and was carried forward to the new group placings. The first two teams in each group qualified for the next round.

### FIRST ROUND PLACINGS

Group A	P.	W.	D.	L.	F.	A.	Pts.	Group D	P.	W.	D.	L.	F.	A.	Pts.
BELGIUM	2	1	1	0	14	5	3	ITALY	2	1	1	0	13	4	3
U.S.A.	2	1	1	0	11	4	3	YUGOSLAVIA	2	1	1	0	16	7	3
URUGUAY	2	0	0	2	1	17	0	AUSTRALIA	2	0	0	2	3	21	0
Group B	P.	W.	D.	L.	F.	A.	Pts.	Group E	P.	W.	D.	L.	F.	A.	Pts.
SWEDEN	2	2	0	0	10	2	4	HUNGARY	2	2	0	0	16	4	4
SPAIN	2	1	0	1	6	5	2	EGYPT.	2	0	1	1	5	8	1
SWITZERLAND	2	0	0	2	2	11	0	GREAT BRITAIN	2	0	1	1	5	14	1
Group C	P.	W.	D.	L.	F.	A.	Pts.	Group F	P.	W.	D.	L.	F.	A.	Pts.
HOLLAND	2	2	0	0	26	1	4	FRANCE	2	2	0	0	11	2	4
INDIA	2	1	0	1	8	16	2	ARGENTINE	2	1	0	1	7	6	2
CHILE	2	0	0	2	4	21	0	GREECE	2	0	0	2	3	13	0

### SECOND ROUND PLACINGS

Group G	P.	W.	D.	L.	F.	A.	Pts.	Group I	P.	W.	D.	L.	F.	A.	Pts.
SWEDEN	2	1	1	0	8	1	3	ITALY	2	1	1	0	8	7	3
BELGIUM	2	0	2	0	5	5	2	HUNGARY	2	1	0	1	6	5	2
U.S.A.	2	0	1	1	4	11	1	YUGOSLAVIA	2	0	1	1	5	7	1
Group H	P.	W.	D.	L.	F.	A.	Pts.	Group J	P.	W.	D.	L.	F.	A.	Pts.
HOLLAND	2	2	0	0	17	3	4	FRANCE	2	1	1	0	7	4	3
SPAIN	2	1	0	1	13	6	2	EGYPT	2	0	2	0	7	7	2
INDIA	2	0	0	2	2	23	0	ARGENTINE	2	0	1	1	5	8	1

### SEMI FINAL PLACINGS

Group K	P.	W.	D.	L.	F.	A.	Pts.	Group L	P.	W.	D.	L.	F.	A.	Pts.
HOLLAND	3	2	1	0	13	8	5	ITALY	3	3	0	0	14	6	6
BELGIUM	3	1	2	0	8	5	4	HUNGARY	3	2	0	1	13	10	4
SWEDEN	3	1	1	1	8	7	3	FRANCE	3	0	1	2	9	13	1
SPAIN	3	0	0	3	4	13	0	EGYPT	3	0	1	2	6	13	1

### FINAL GROUP

	P.	W.	D.	L.	F.	A.	Pts.
1 ITALY	3	3	0	0	12	7	6
2 HUNGARY	3	1	1	1	10	8	3
3 HOLLAND	3	0	2	1	9	11	2
4 BELGIUM	3	0	1	2	5	10	1

### GROUP FOR 5th TO 8th PLACES

	P.	W.	D.	L.	F.	A.	Pts.
5 SWEDEN	3	2	1	0	8	4	5
6 FRANCE	3	1	2	0	6	5	4
7 EGYPT	3	1	1	1	8	7	3
8 SPAIN	3	0	0	3	3	9	0

## SUMMARY OF MATCH RESULTS

## GROUP A

## ROUND ONE

	Goals		Goals		Timekeeper	Goal Judges		Placings	Pts
Belgium	10	Uruguay	1	A. Foulon	T. Mayo	A. Touny	O. Berges	1. <i>Belgium</i>	3
Belgium	4	U.S.A.	4	E. J. Scott	R. P. Green	J. Nemeth	G. Rigal	2. <i>U.S.A.</i>	3
Uruguay	0	U.S.A.	7	T. Batalle	P. Haston	H. J. de Kok	R. Honikman	3. <i>Uruguay</i>	0
GROUP B									
Sweden	6	Switzerland	1	R. Honikman	H. Gibbons	R. Hodgson	H. J. de Kok	1. <i>Sweden</i>	4
Sweden	4	Spain	1	J. Houwaert	R. Touny	A. Foulon	C. Marchetti	2. <i>Spain</i>	2
Switzerland	1	Spain	5	R. Hodgson	Ali Shaikh	J. Ezzeldin	H. Getz	3. <i>Switzerland</i>	0
GROUP C									
Holland	14	Chile	0	C. Marchetti	S. Zuckerman	A. G. Taylor	R. Roggione	1. <i>Holland</i>	4
Holland	12	India	1	S. Zuckerman	R. P. Green	J. Houwaert	A. Schlenker	2. <i>India</i>	2
Chile	4	India	7	H. Getz	A. G. Taylor	R. P. Green	S. Zuckerman	3. <i>Chile</i>	0
GROUP D									
Italy	4	Yugoslavia	4	T. Batalle	R. P. Green	A. G. Taylor	R. Hodgson	1. <i>Italy</i>	3
Italy	9	Australia	0	H. R. Walker	J. Ezzeldin	R. Honikman	A. G. Taylor	2. <i>Yugoslavia</i>	3
Yugoslavia	12	Australia	3	H. J. de Kok	A. Biswas	A. H. Verhoeff	W. McCreedy	3. <i>Australia</i>	0
GROUP E									
Hungary	5	Egypt	2	R. Bauwens	H. R. Walker	A. G. Taylor	A. Foulon	1. <i>Hungary</i>	4
Hungary	11	Gt. Britain	2	A. H. Verhoeff	A. Foulon	F. Roggione	J. Houwaert	2. <i>Egypt</i>	1
Egypt	3	Gt. Britain	3	O. Berges	W. F. Hayward	G. Rigal	F. Roggione	3. <i>Gt. Britain</i>	1
GROUP F									
France	7	Greece	1	J. De Vries	A. G. Taylor	A. Biswas	A. H. Verhoeff	1. <i>France</i>	4
France	4	Argentina	1	B. Raiki	A. Schlenker	F. Roggione	J. Houwaert	2. <i>Argentina</i>	2
Greece	2	Argentina	6	A. Biswas	H. V. Binns	C. P. Parkin	E. D. Sebborn	3. <i>Greece</i>	0

## ROUND TWO

## GROUP G

Belgium	1	Sweden	1	G. Rigal	W. McCreedy	A. Verhoeff	H. V. Binns	1. <i>Sweden</i>	3
U.S.A.	0	Sweden	7	C. Marchetti	F. Roggione	C. Svolopoulos	P. Haston	2. <i>Belgium</i>	2
Belgium	4	U.S.A.	4		(Round One Result)			3. <i>U.S.A.</i>	1
GROUP H									
Spain	2	Holland	5	R. Hodgson	A. G. Taylor	J. Papadakis	W. Martv	1. <i>Holland</i>	4
Spain	11	India	1	J. Curren	W. G. Emery	R. Hodgson	H. V. Binns	2. <i>Spain</i>	2
Holland	12	India	1		(Round One Result)			3. <i>India</i>	0
GROUP I									
Italy	4	Hungary	3	A. Delahaye	R. P. Green	Ali Shaikh	R. Honikman	1. <i>Italy</i>	3
Yugoslavia	1	Hungary	3	J. Houwaert	A. Biswas	R. Bauwens	A. G. Taylor	2. <i>Hungary</i>	2
Yugoslavia	4	Italy	4		(Round One Result)			3. <i>Yugoslavia</i>	1
GROUP J									
Egypt	3	France	3	T. Batalle	P. Haston	A. Biswas	A. Schlenker	1. <i>France</i>	3
Egypt	4	Argentina	4	A. H. Verhoeff	J. Curren	W. McCreedy	H. J. de Kok	2. <i>Egypt</i>	2
France	4	Argentina	1		(Round One Result)			3. <i>Argentina</i>	1

## GROUP K

## SEMI-FINALS

Sweden	1	Belgium	1		(Round Two Result)				1. <i>Holland</i>	5
Sweden	4	Spain	1		(Round One Result)				2. <i>Belgium</i>	4
Holland	5	Spain	2		(Round Two Result)				3. <i>Sweden</i>	3
Sweden	3	Holland	5	B. Rajki	R. Honikman	H. V. Binns	P. Haston		4. <i>Spain</i>	0
Belgium	3	Holland	3	E. J. Scott	R. Honikman	H. V. Binns	R. P. Green			
Belgium	4	Spain	1	C. Marchetti	R. Hodgson	A. G. Taylor	F. Roggione			
GROUP L										
Italy	4	Hungary	3		(Round Two Result)				1. <i>Italy</i>	6
Hungary	5	Egypt	2		(Round One Result)				2. <i>Hungary</i>	4
Egypt	3	France	3		(Round Two Result)				3. <i>France</i>	1
Hungary	5	France	4	H. J. de Kok	R. Hodgson	J. Papadakis	A. H. Verhoeff		4. <i>Egypt</i>	1
Italy	5	Egypt	1	A. Delahaye	A. Biswas	Ali Shaikh	R. Honikman			
Italy	5	France	2	R. Hodgson	A. W. Highet	A. van Beets	A. G. Taylor			

## GROUP FOR 5TH TO 8th POSITION

## FINAL ROUNDS

Sweden	4	Spain	1		(Round One Result)				1. <i>Sweden</i>	5
Sweden	1	France	1	J. Houwaert	F. Roggione	A. Schlenker	J. Nemeth		2. <i>France</i>	4
Sweden	3	Egypt	2	A. H. Verhoeff	T. E. Mayo	A. Delahaye	G. Brody		3. <i>Egypt</i>	3
Spain	1	France	2	G. Marchetti	A. G. Taylor	A. Schlenker	H. J. de Kok		4. <i>Spain</i>	0
Spain	1	Egypt	3	B. Rajki	W. G. Emery	P. Haston	H. Getz			
France	3	Egypt	3		(Round Two Result)					
FINAL GROUP										
Holland	3	Belgium	3		(Semi-Final Result)				1. <i>Italy</i>	6
Holland	2	Italy	4	S. Zuckerman	P. Haston	W. McCreedy	J. Papadakis		2. <i>Hungary</i>	3
Holland	4	Hungary	4	E. J. Scott	R. P. Green	J. Curren	R. Honikman		3. <i>Holland</i>	2
Belgium	2	Italy	4	T. Batalle	R. Biswas	P. Haston	A. G. Taylor		4. <i>Belgium</i>	1
Belgium	0	Hungary	3	G. Rigal	H. V. Binns	A. Foulon	W. McCreedy			
Italy	4	Hungary	3		(Round Two Result)					

## ROUND 1, GROUP A

July 30th

Belgium beat Uruguay by 10 goals to 1 at the Empire Pool, Wembley.

*Belgium:* de Smet, L.; Leenheere, G.; d'Hooge, E.; Rigauomodt, P.; Simons, W.; Issele, F.; de Pauw, H.*Uruguay:* Periera Kliche, E.; Lopez, J.; Costemalle, J.; Gabriel, L. Bucetta, J.; Marino, O.; Abella, N.*Goal Judges:* A. Touny (*Egypt*); O. Beeches (*Argentina*). *Referee:* A. Foulon (*France*). *Timekeeper:* T. Mayo (*Great Britain*).

July 30th

U.S.A. beat Uruguay by 7 goals to 0 at the Empire Pool, Wembley.

*U.S.A.:* Budelman, R.; Case, L.; Beck, K.; Christensen, D.; Dash, H.; Fiske, D.; Bray, R.*Uruguay:* Pereira Kliche, E.; Lopez, J.; Marino, O.; Gabriel, L.; Castro, R.; Bucetta, J.; Abella, N.*Goal Judges:* H. J. de Kok (*Holland*); R. Honikman (*South Africa*). *Referee:* T. Batalle (*Spain*). *Timekeeper:* P. Haston (*Great Britain*).

July 31st

Belgium drew with U.S.A. by 4 goals to 4 at the Empire Pool, Wembley.

*Belgium:* de Smet, L.; Leenheere, G.; d'Hooge, E.; Rigauomodt, P.; Simons, W.; Issele, F.; de Pauw, H.*U.S.A.:* Budelman, R.; Case, L.; Beck, K.; Christensen, D.; Knox, E.; Fiske, D.; Bray, R.*Goal Judges:* J. Nemeth (*Hungary*); G. Rigal (*France*). *Referee:* E. J. Scott (*Great Britain*). *Timekeeper:* R. Green (*Great Britain*).

## ROUND 1, GROUP B

July 29th

Sweden beat Switzerland by 6 goals to 1 at the Empire Pool, Wembley.

*Sweden:* Oberg, R.; Holm, E.; Julin, R.; Spangberg, R.; Julin, A.; Olsson, O.; Jutner, A.*Switzerland:* Grosjean, A.; Klumpp, E.; Hauser, E.; Hauser, G.; Sauer, T.; Weibel, R.; Keller, H.*Goal Judges:* R. Hodgson (*Great Britain*); H. J. de Kok (*Holland*). *Referee:* R. Honikman (*South Africa*). *Timekeeper:* H. Gibbons (*Great Britain*).



**July 30th**

Sweden beat Spain by 4 goals to 1 at Finchley.

*Sweden:* Oberg, R.; Holm, E.; Julin, R.; Spangberg, R.; Julin, A.; Olsson, O.; Jutner, E.

*Spain:* Serra Liobet, J.; Pujol Coma, J.; Falp Mont, C.; Marti Arenas, C.; Castillo Caupana, F.; Mestres Rivas, A.; Sabate Mas, V.

*Goal Judges:* A. Foulon (*France*); C. Maechetti (*Italy*). *Referee:* J. Houwgiert (*Belgium*). *Timekeeper:* A. D. Touny (*Egypt*).

**July 31st**

Spain beat Switzerland by 5 goals to 1 at the Empire Pool, Wembley.

*Spain:* Serra Liobet, J.; Pujol Coma, J.; Falp Mont, C.; Marti Arenas, C.; Sabata Figa, A.; Mestres Rivas, A.; Castillo Caupana, F.

*Switzerland:* Grosjean, A.; Klumpp, E.; Hauser, E.; Hauser, G.; Sauer, T.; Weibel, R.; Keller, H.

*Goal Judges:* Y. Ezzelain (*Egypt*); H. Getz (*South Africa*). *Referee:* E. Hodgson (*Great Britain*). *Timekeeper:* Basir Ali Shaikh (*Pakistan*).

**ROUND 1, GROUP C****July 30th**

Holland beat India by 12 goals to 1 at the Empire Pool, Wembley.

*Holland:* Rohner, J.; Braasem, C.; Korevaar, C.; Keetelaar, H.; Ruimschotel, A.; Van Feggelen, R.; Smol, F.

*India:* Seal, G.; Chatterjee, S. N.; Murarji, D.; Das, D.; Chatterjee, S.; Nag, S.; Mansoor, I.

*Goal Judges:* J. Houwaert (*Belgium*); A. Schlenker (*Hungary*). *Referee:* S. Zuckerman (*Sweden*). *Timekeeper:* R. P. Green (*Great Britain*).

**July 30th**

India beat Chile by 7 goals to 4 at Finchley.

*India:* Seal, G.; Das, D.; Chatterjee, S.; Dass, J.; Nag, S.; Ahir, J.; Mansoor, I.

*Chile:* Salah Jaque, T.; Aguirrebena Gabiola, L.; Froimovich Schejter, I.; Aguirrebena Gabiola, P.; Hurtado Vargas, A.; Salah Jaque, J.; Tornvall, S.

*Goal Judges:* R. P. Green (*Great Britain*); S. Zuckerman (*Sweden*). *Referee:* H. Getz (*South Africa*). *Timekeeper:* A. G. Taylor (*Great Britain*).

**July 31st**

Holland beat Chile by 14 goals to 0 at Finchley.

*Holland:* Salomons, P.; Korevaar, C.; Braasem, C.; Stam, H.; Smol, F.; Van Feggelen, R.; Ruimschotel, A.

*Chile:* Salah Jaque, T.; Aguirrebena Gabiola, L.; Froimovich Schejter, I.; Salah Jaque, J.; Tornvall, S.; Martinez Jara, O.; Hurtado Vargas, A.

*Goal Judges:* A. G. Taylor (*Great Britain*); D. Roggione (*Italy*). *Referee:* C. Marchetti (*Italy*). *Timekeeper:* S. Zuckerman (*Sweden*).

**ROUND 1, GROUP D****July 30th**

Italy beat Australia by 9 goals to 0 at Finchley.

*Italy:* Buonocore, P.; Bulgarelli, E.; Maioni, M.; Ognio, G.; Pandolfini, G.; Ghira, A.; Rubini, C.

*Australia:* Dalley, B.; King, J.; Johnston, P.; Ferguson, L.; Burge, A.; Doerner, H.; Ferguson, J.

*Goal Judges:* R. Honikman (*South Africa*); A. G. Taylor (*Great Britain*). *Referee:* H. R. Walker (*Great Britain*). *Timekeeper:* Y. Ezzeldin (*Egypt*).

**July 30th**

Yugoslavia beat Australia by 12 goals to 3 at the Empire Pool, Wembley.

*Yugoslavia:* Kovacic, Z.; Bakasun, V.; Giovanelli, I.; Kurtini, I.; Brainovic, M.; Ciganovic, L.; Grkinic, B.

*Australia:* Dalley, B.; Johnston, P.; McKay, J.; French, C.; Cornforth, R.; Doerner, H.; Burge, A.

*Goal Judges:* A. H. Verhoeff (*Holland*); W. McCreedy (*Eire*). *Referee:* H. J. de Kok (*Holland*). *Timekeeper:* A. Biswas (*India*).

**August 1st**

Italy drew with Yugoslavia by 4 goals to 4 at the Empire Pool, Wembley.

*Italy:* Buonocore, P.; Bulgarelli, E.; Rubini, C.; Ognio, G.; Pandolfini, G.; Ghira, A.; Arena, E.

*Yugoslavia:* Amsel, J.; Bakasun, V.; Grkinic, B.; Kurtini, I.; Stakula, I.; Ciganovic, L.; Giovanelli, I.

*Goal Judges:* A. G. Taylor and R. Hodgson (*Great Britain*). *Referee:* T. Batalle (*Spain*). *Timekeeper:* R. P. Green (*Great Britain*).

**ROUND 1, GROUP E**

**July 31st**

Hungary beat Great Britain by 11 goals to 2 at the Empire Pool, Wembley.

*Hungary:* Gyorffy, E.; Holop, M.; Fabian, D.; Szitty, K.; Csuvik, O.; Szivos, I.; Gyarmati, D.

*Great Britain:* Johnson, J.; Potter, R.; Murray, D.; Hardie, P.; Brand, C.; Garforth, R.; Gentleman, R.

*Goal Judges:* F. Roggionne (*Italy*); J. Houwaert (*Holland*). *Referee:* A. H. Verhoeff (*Holland*). *Timekeeper:* A. Foulon (*France*).

**July 31st**

Egypt drew with Great Britain by 3 goals to 3 at Finchley.

*Egypt:* Nessim, A.; Garbo, S.; Kadry, M.; Hemmat, M.; Haraga, M.; Said, H.; Khalifa, M.

*Great Britain:* Johnson, J.; Potter, R.; Murray, D.; Lewis, T.; Brand, C.; Garforth, R.; Gentleman, R.

*Goal Judges:* F. Roggione (*Italy*); C. Rigal (*France*). *Referee:* O. Berges (*Argentina*). *Timekeeper:* W. F. Hayward (*Bermuda*).

**August 1st**

Hungary beat Egypt by 5 goals to 2 at the Empire Pool, Wembley.

*Hungary:* Jeney, L.; Holop, M.; Gyarmati, D.; Szitty, K.; Lemhenyi, D.; Szivos, I.; Brandi, J.

*Egypt:* Nessim, A.; Kadry, M.; El Gamal, T.; Garbo, S.; Hemmat, M.; Khalifa, M.; Said, H.

*Goal Judges:* A. G. Taylor (*Great Britain*); A. Foulon (*France*). *Referee:* R. Bauwens (*Belgium*). *Timekeeper:* H. R. Walker (*Great Britain*).

**ROUND 1, GROUP F**

**July 30th**

France beat Argentina by 4 goals to 1 at Finchley.

*France:* Debonnet, F.; Viaene, J.; Lefebvre, M.; Bermyn, E.; Diener, M.; Dewasch, R.; Spilliaert, M.

*Argentina:* Maidana, R.; Szabo, L.; Prono, H.; Codaro, O.; Filiberti, A.; Visentin, M.; Visentin, C.

*Goal Judges:* F. Roggionne (*Italy*); J. Houwaert (*Belgium*). *Referee:* B. Rajki (*Hungary*). *Timekeeper:* A. Schlenker (*Switzerland*).

**July 30th**

Argentina beat Greece by 6 goals to 2 at the Empire Pool, Wembley.

*Argentina:* Maidana, R.; Szabo, L.; Prono, H.; Codaro, O.; Visentin, C.; Visentin, M.; Filiberti, A.

*Greece:* Monastiriotes, A.; Papastephanou, J.; Zografos, D.; Provatopoulos, D.; Stambolis, D.; Papadopoulos, E.; Melanofidis, N.

*Goal Judges:* C. P. Parkin and E. D. Sebborn (*Great Britain*). *Referee:* A. Biskwas (*India*). *Timekeeper:* H. V. Binns (*Great Britain*).

**July 31st**

France beat Greece by 7 goals to 1 at Finchley.

*France:* Massol, R.; Le Bras, R.; Lefebvre, M.; Bermyn, E.; Diener, M.; Himgi, R.; Berthe, J.

*Greece:* Monastiriotes, A.; Papastephanou, J.; Provatopoulos, D.; Melanofidis, N.; Stambolis, D.; Papadopoulos, E.; Broussalis, R.

*Goal Judges:* A. Biswas (*India*); A. H. Verhoeff (*Holland*). *Referee:* J. de Vries (*Holland*). *Timekeeper:* A. G. Taylor (*Great Britain*).

**ROUND 2, GROUP G**

**August 2nd**

Belgium drew with Sweden by 1 goal to 1 at the Empire Pool, Wembley.

*Belgium:* de Smet, L.; Martin, A.; Leenheere, G.; Rigamont, P.; de Pauw, H.; Issele, F.; Simons, W.

*Sweden:* Oberg, R.; Holm, E.; Julin, R.; Spangberg, R.; Jutner, A.; Olsson, O.; Julin, A.

*Goal Judges:* A. Verhoeff (*Holland*); H.V. Binns (*Great Britain*). *Referee:* G. Rigal (*France*). *Timekeeper:* W. McCreedy (*Eire*).

**August 3rd**

Sweden beat U.S.A. by 7 goals to 0 at the Empire Pool, Wembley.

*Sweden:* Oberg, R.; Holm, E.; Julin, R.; Spangberg, R.; Jutner, A.; Olsson, O.; Julin, A.

*U.S.A.:* Budelman, R.; Beck, K.; Case, L.; Christensen, D.; Knox, E.; Fiske, D.; Bray, R.

*Goal Judges:* C. S. Volopoulos (*Greece*); P. Haston (*Great Britain*). *Referee:* C. Marchetti (*Italy*). *Timekeeper:* F. Roggione (*Italy*).

**ROUND 2, GROUP H****August 2nd**

Holland beat Spain by 5 goals to 2 at Finchley.

*Holland:* Salomons, P.; Korevaar, C.; Braasem, C.; Keetelaar, H.; Smol, F.; Van Feggelen, R.; Ruimchotel, A.

*Spain:* Serra Liobet, J.; Falp Mont, C.; Pujol Coma, J.; Marti Arenas, C.; Sabate Figa, A.; Mestres Rivas, A.; Castillo Caupana, F.

*Goal Judges:* J. Papadakis (*Greece*); W. Marty (*Switzerland*). *Referee:* R. Hodgson (*Great Britain*). *Timekeeper:* A. G. Taylor (*Great Britain*).

**August 3rd**

Spain beat India by 11 goals to 1 at the Empire Pool, Wembley.

*Spain:* Serra Liobet, J.; Pujol Coma, J.; Falp Mont, C.; Marti Arenas, C.; Sabata Figa, A.; Mestres Rivas, A.; Castillo Caupana, F.

*India:* Seal, G.; Chatterjee, S.; Das, D.; Nag, S.; Mansoor, I.; Ahir, J.

*Goal Judges:* J. Hodgson and H. Binns (*Great Britain*). *Referee:* J. Curren (*U.S.A.*). *Timekeeper:* W. G. Emery (*Great Britain*).

**ROUND 2, GROUP I****August 2nd**

Italy beat Hungary by 4 goals to 3 at the Empire Pool, Wembley.

*Italy:* Buonocore, P.; Bulgarelli, E.; Rubini, C.; Ognio, G.; Pandolfini, T.; Ghira, A.; Arena, E.

*Hungary:* Gyorffy, E.; Holop, M.; Fabian, D.; Szitty, K.; Csuvik, O.; Szivos, I.; Gyarmati, D.

*Goal Judges:* Basir Ali Sheik (*Pakistan*); R. B. Honikman (*South Africa*). *Referee:* A. Delahaye (*Belgium*). *Timekeeper:* R. P. Green (*Great Britain*).

**August 2nd**

Hungary beat Yugoslavia by 3 goals to 1 at the Empire Pool, Wembley.

*Hungary:* Gyorffy, E.; Gyarmati, D.; Holop, M.; Szitty, K.; Csuvik, O.; Czivos, I.; Brandi, J.

*Yugoslavia:* Amsel, J.; Bakasun, V.; Giovanelli, I.; Grkinic, B.; Brainovic, M.; Kurtini, I.; Stakula, I.

*Goal Judges:* R. Bauwens (*Belgium*); A. G. Taylor (*Great Britain*). *Referee:* J. Houwaert (*Belgium*). *Timekeeper:* A. Biswas (*India*).

**ROUND 2, GROUP J****August 2nd**

Egypt drew with France by 3 goals to 3 at the Empire Pool, Wembley.

*Egypt:* Nessim, A.; Garbo, S.; Khadry, M.; Hemmat, M.; El Gamal, T.; Said, H.; Khalifa, M.

*France:* Debonnet, F.; Viaene, J.; Lefebvre, M.; Bermyn, E.; Dewasch, R.; Berthe, J.; Diener, M.

*Goal Judges:* A. Biswas (*India*); A. Schlenker (*Hungary*). *Referee:* T. Batalle (*Spain*). *Timekeeper:* R. Haston (*Great Britain*).

**August 2nd**

Egypt drew with Argentina by 4 goals to 4 at the Empire Pool, Wembley.

*Egypt:* Nessim, A.; Kadry, M.; Garbo, S.; Hemmat, M.; Haraga, M.; Said, H.; Khalifa, M.

*Argentina:* Maidana, R.; Szabo, L.; Prono, H.; Codaro, O.; Vizentin, C.; Vizentin, M.; Filiberti, A.

*Goal Judges:* W. McCreedy (*Eire*); and H. J. de Kok (*Holland*). *Referee:* A. H. Verhoeff (*Holland*). *Timekeeper:* J. Curren (*U.S.A.*).

**ROUND 3, GROUP K****August 4th**

Belgium drew with Holland by 3 goals to 3 at the Empire Pool, Wembley.

*Belgium:* de Smet, L.; Leenheere, G.; d'Hooge, E.; Martin, A.; Rigauumont, P.; Issele, F.; Simons, W.

*Holland:* Rohner, J.; Korevaar, C.; Braasem, C.; Stam, H.; Smol, F.; Van Feggelen, R.; Ruimschotel, A.

*Goal Judges:* H. V. Binns and R. P. Green (*Great Britain*). *Referee:* E. J. Scott (*Great Britain*). *Timekeeper:* R. Honikman (*South Africa*).

**August 5th**

Holland beat Sweden by 5 goals to 3 at the Empire Pool, Wembley.

*Holland:* Rohner, J.; Korevaar, C.; Braasem, C.; Stam, H.; Ruimschotel, A.; Van Feggelen, R.; Smol, F.

*Sweden:* Oberg, R.; Holm, E.; Julin, R.; Spangberg, R.; Jutner, A.; Olsson O.; Julin A.

*Goal Judges:* H. V. Binns and R. P. Haston (*Great Britain*). *Referee:* B. Rajki (*Hungary*). *Timekeeper:* R. Honikman (*South Africa*).

## XIV OLYMPIAD

### August 5th

Belgium beat Spain by 4 goals to 1 at Finchley.

*Belgium:* de Smet, L.; Leenheere, G.; d'Hooge, E.; Rigamont, P.; Simons, W.; Issele, F.; de Pauw, H.

*Spain:* Serra Liobet, J.; Pujol Coma, J.; Falp Mont, C.; Marti Arenas, C.; Castillo Caupana, F.; Mestres Rivas, A.; Sabata Figa, A.

*Goal Judges:* A. G. Taylor (*Great Britain*) and A. Roggionne (*Italy*). *Referee:* C. Machetti (*Italy*). *Timekeeper:* R. Hodgson (*Great Britain*).

### ROUND 3, GROUP L

#### August 4th

Italy beat Egypt by 5 goals to 1 at the Empire Pool, Wembley.

*Italy:* Buonocore, P.; Bulgarelli, E.; Maioni, M.; Pandolfini, G.; Arena, E.; Ghira, A.; Ognio, G.

*Egypt:* Nessim, A.; Kadry, M.; Garbo, S.; Hemmat, M.; El Gamal, T.; Said, H.; Khalifa, M.

*Goal Judges:* B. Ali Shaikh (*Pakistan*) and R. Honikman (*South Africa*). *Referee:* A. Delahaye (*Belgium*). *Timekeeper:* A. Biswas (*India*).

#### August 4th

Hungary beat France by 5 goals to 4 at the Empire Pool, Wembley.

*Hungary:* Jeney, L.; Holop, M.; Gyarmati, D.; Lemhenyi, D.; Brandi, F.; Szivos, I.; Fabian, D.

*France:* Debonnet, F.; Viaene, J.; Lefebvre, M.; Bermyn, E.; Dewasch, R.; Spilliaert, M.; Diener, M.

*Goal Judges:* J. Papadakis (*Greece*) and A. H. Verhoeff (*Holland*). *Referee:* H. J. de Kok (*Holland*). *Timekeeper:* R. Hodgson (*Great Britain*).

#### August 5th

Italy beat France by 5 goals to 2 at Finchley.

*Italy:* Buonocore, P.; Bulgarelli, E.; Maioni, M.; Rubini, C.; Arena, E.; Ghira, A.; Pandolfini, T.

*France:* Debonnet, F.; Viaene, J.; Lefebvre, M.; Himgi, R.; Diener, M.; Dewasch, R.; Spilliaert, M.

*Goal Judges:* A. G. Taylor and V. Beets (*Great Britain*). *Referee:* R. Hodgson (*Great Britain*). *Timekeeper:* A. W. Hight (*Great Britain*).

### FINAL, GROUP 1—4

#### August 6th

Holland drew with Hungary by 4 goals to 4 at the Empire Pool, Wembley.

*Holland:* Rohner, J.; Koorevaar, C.; Braasem, C.; Stam, H.; Ruimschotel, A.; Van Feggelen, R.; Smol, F.

*Hungary:* Gyorffy, E.; Holop, M.; Gyarmati, D.; Szitty, K.; Csuvi, O.; Szivos, I.; Lemhenyi, D.

*Goal Judges:* J. Curren (*U.S.A.*) and R. Honikman (*South Africa*). *Referee:* E. J. Scott (*Great Britain*). *Timekeeper:* R. P. Green (*Great Britain*).

#### August 6th

Italy beat Belgium by 4 goals to 2 at the Empire Pool, Wembley.

*Italy:* Buonocore, P.; Bulgarelli, E.; Rubini, C.; Ognio, G.; Arena, E.; Ghira, A.; Pandolfini, G.

*Belgium:* de Smet, L.; Leenheere, G.; d'Hooge, E.; Rigamont, P.; Issele, F.; Simons, W.; De Pauw, H.

*Goal Judges:* R. P. Haston and A. G. Taylor (*Great Britain*). *Referee:* T. Batalle (*Spain*). *Timekeeper:* A. Biswas (*India*).

#### August 7th

Hungary beat Belgium by 3 goals to 0 at the Empire Pool, Wembley.

*Hungary:* Gyorffy, E.; Holop, M.; Gyarmati, D.; Szitty, K.; Csuvi, O.; Szivos, I.; Lemhenyi, D.

*Belgium:* de Smet, L.; Leenheere, G.; d'Hooge, E.; Rigamont, P.; Issele, F.; Simons, W.; De Pauw, H.

*Goal Judges:* A. Foulon (*France*) and W. McCreedy (*Eire*). *Referee:* G. Rigal (*France*). *Timekeeper:* H. V. Binns (*Great Britain*).

#### August 7th

Italy beat Holland by 4 goals to 2 at the Empire Pool, Wembley.

*Italy:* Buonocore, P.; Bulgarelli, E.; Rubini, C.; Ognio, G.; Arena, E.; Ghira, A.; Pandolfini, G.

*Holland:* Rohner, J.; Koorevaar, C.; Braasem, C.; Stam, H.; Ruimschotel, A.; Van Feggelen, R.; Smol, F.

*Goal Judges:* W. McCreedy (*Eire*) and J. Papadakis (*Greece*). *Referee:* S. Zuckerman (*Sweden*). *Timekeeper:* R. P. Haston (*Great Britain*).

**FINAL, GROUP 5—8****August 6th**

Sweden beat Egypt by 3 goals to 2 at the Empire Pool, Wembley.

*Sweden:* Oberg, R.; Holm, E.; Julin, R.; Spangberg, R.; Jutner, A.; Johansson, O.; Julin, A.

*Egypt:* Nessim, A.; El Gamal, T.; Kadry, M.; Garbo, S.; Khalifa, M.; Said, H.; Hemmat, M.

*Goal Judges :* A. Delahaye (*Belgium*) and G. Brody (*Hungary*). *Referee:* A. H. Verhoeff (*Holland*). *Timekeeper:* T. Mayo (*Great Britain*).

**August 6th**

France beat Spain by 2 goals to 1 at the Empire Pool, Wembley.

*France:* Debonnet, F.; Lefebvre, M.; Le Bras, R.; Diener, M.; Himgi, R.; Dewasch, R.; Berthe, J.

*Spain:* Serra Liobet, J.; Pujol Coma, J.; Falp Mont, C.; Marti Arenas, C.; Castillo Caupana, F.; Mestres Rivas, A.; Sabate Mas, V.

*Goal Judges :* A. Schlenker (*Hungary*) and H. J. de Kok (*Holland*). *Referee :* G. Marchetti (*Italy*). *Timekeeper:* A. G. Taylor (*Great Britain*).

**August 7th**

Egypt beat Spain by 3 goals to 1 at the Empire Pool, Wembley.

*Egypt:* Nessim, A.; El Gamal, T.; Kadry, M.; Hemmat, M.; Haraga, M.; Said, H.; Khalifa, M.

*Spain:* Serra Liobet, J.; Pujol Coma, J.; Falp Mont, C.; Marti Arenas, C.; Castillo Caupana, F.; Mestres Rivas, A.; Sabate Mas, V.

*Goal Judges:* R. P. Haston (*Great Britain*) and H. Getz (*South Africa*). *Referee:* B. Rajki (*Hungary*). *Timekeeper:* W. G. Emery (*Great Britain*).

**August 7th**

Sweden drew with France by 1 goal to 1 at the Empire Pool, Wembley.

*Sweden:* Eriksson, F.; Holm, E.; Gadd, K.; Spangberg, R.; Jutner, A.; Johansson, O.; Julin, A.

*France:* Debonnet, F.; LeBras, R.; Viaene, J.; Lefebvre, M.; Dewasch, R.; Spillaert, M.; Diener, M.

*Goal Judges :* A. Schlenker and J. Nemeth (*Hungary*). *Referee :* J. Houwaert (*Belgium*). *Timekeeper:* F. Roggione (*Italy*).

# WEIGHTLIFTING

The impressive Empress Hall arena was a most suitable venue for the thrilling contests that lasted for the three days, August 9 to 11. Altogether 120 competitors from 30 different countries were present, which made it the most representative weightlifting competition ever held. The standards also proved higher than ever before, for not only were all the existing Olympic records broken, some by a considerable margin, but five new world bests were established.

Inside the well-appointed arena, the seating arrangements gave rise to the only complaint against the organisation. The seats being somewhat distant from the actual platform, it was difficult to perceive the finer details of technique. However, the high lifting platform gave a clear view from all parts of the arena, unobscured by the normal masses of officials or team attendants. The light signals on the corner of the platform gave immediate indication of the result of each lift, and these, together with the loud-speaker announcements in French and English and the giant score-board behind the platform, kept all spectators fully informed as to the progress of the competition.

Owing to the large number of competitors in each class, the competitions were somewhat protracted in spite of efficient stewarding and non-stop work by the M.C. It is to be hoped that a preliminary round will be adopted at future competitions of this size.

## A New Class

The bantamweight class was new to the Olympic Games, but the little men soon showed that they were as stylish as the bigger fellows, and set a standard that will be difficult to emulate in 1952. Indeed, the bantamweight winner achieved a better performance than twenty of the featherweight contestants. Mighty little Joe de Pietro of U.S.A. was truly a miniature Hercules, for he stood only 4 ft. 8 in. and his unusually short arms barely enabled him to raise the bar above the top of his head. However, this peculiarity gave him a tremendous leverage advantage in the Two Hands Clean and Press. He took his first attempt after everybody else had finished, and narrowly failed to set up a new world record with his last. His best effort, 231¼ lbs. (105 kg.), stands as a new Olympic record. The next highest Press was achieved by Abe Greenhalgh of Great Britain, a success that is all the more remarkable when it is realised that this man spent eleven years lying flat on his back in an invalid bed. To recover from such an infirmity is an achievement in itself, but then to go on to become a member of an Olympic team, and to register such a performance, merits the highest praise for his pluck.

In the Two Hands Snatch, de Pietro's build was a disadvantage. Three of his rivals, Creus (Great Britain), Tom (U.S.A.) and Lee (Korea) began to overhaul the tiny American. Creus went on to exceed the world record with a lift of 209¼ lbs. (95 kg.), but did not claim it officially because he was overweight at the time. Incidentally, he was the only British male competitor, in any sport, to exceed a world record during the Games.

In the Two Hands Clean and Jerk, Creus and Tom tried gallantly to overcome de Pietro's tremendous lead, but the latter succeeded with the best Jerk he has ever performed

in competition, and thus assured himself of first place, followed by Creus and Tom. As a final gesture, Mahmoud Namdjou, a powerfully built lifter from Iran, who had been tipped as a probable winner, showed a flash of his real form by registering the highest Jerk of 270 lbs. (122½ kg.). Again it was excess body-weight that prevented this from being a new world record.

The featherweight class was a triumph for the young Egyptian, Fayad, whose total was 44 lbs. (20 kg.) higher than that of the winner in 1936. In addition to the world record total of 732¼ lbs. (332½ kg.) he also set up new world and Olympic records in the Snatch, 231¼ lbs. (105 kg.), and the Jerk, 297½ lbs. (135 kg.). His display in the fast lifts

drew thunderous applause from the connoisseurs of stylish lifting. The only keen competition in this class was for the second place. Saimassi (Iran) seemed to be well set when he claimed a new Olympic record with a Press of 220¼ lbs. (100 kg.) but Rodney Wilkes (Trinidad), who was well placed, performed a beautiful Jerk of 270 lbs. (122½ kg.) to wrest second place from the Iranian.

### **Lightweight Record**

There was no outstanding favourite for the lightweight title and it was not expected that any records would be broken, but this class gave rise to some of the most thrilling lifting of the whole meeting and once again every Olympic record was broken. John Stuart of Canada took the first record with a Press in perfect military style of 236¾ lbs. (107½ kg.). During the Snatch, Hamouda (Egypt) went into the lead after exceeding the Olympic record. Terpak (U.S.A.), Stuart (Canada) and Halliday (Great Britain) were all close behind, the latter having also exceeded the previous Olympic Snatch record. Then Shams (Egypt) caused his first sensation. On his second attempt he bettered the new record just set up by Hamouda and Halliday, and then, with his third attempt, a perfect lift, raised the record to 253½ lbs. (115 kg.). This brought him up among the leaders and the struggle for places during the Jerk kept the large audience tense with excitement.

Stuart lost his chance when he failed twice with 286½ lbs. (130 kg.). Terpak failed with 303 lbs. (137½ kg.). This gave Halliday his opportunity, and the British lifter and team captain succeeded brilliantly and determinedly with 308½ lbs. (140 kg.), thus wresting third place from the veteran Terpak. Halliday's effort was all the more praiseworthy because he had fought back from a seemingly hopeless position after the Press which had left him in 16th place.

Now the struggle for first place lay between the two Egyptians. Lifting with great determination and in faultless style, Hamouda went through to 319½ lbs. (145 kg.) which equalled the previous record. Shams was left with one attempt in hand and in order to win he had to lift 325 lbs. (147½ kg.) which was in excess of the Olympic record. The big arena was deadly quiet as he approached the barbell. He crouched over it in his own peculiar style and summoned his nerves for the great effort. Suddenly he turned away and a great sigh came from the pent-up spectators. He turned back and again crouched to lift. He stooped and then as soon as he grasped the bar, he dropped it again

and once more drew back. For a third time he concentrated, then swooped on the bar and with a terrific effort pulled it to his shoulders ; another fierce movement from this tigerish lifter and there was the weight triumphantly overhead. It was a superb effort and deservedly earned him the premier position. Both he and Hamouda set up the same record total, 793 ¼ lbs. (360 kg.), but Shams took first place as he was the lighter man.

The middleweight class was expected to bring another victory to Egypt, for their great El Touni was lifting. He had far surpassed all rivals in Berlin in 1936, and had recently been shattering more world records. However, the first shock came during the Press, for it was the Korean, Kim, who led with a new Olympic record of 270 lbs. (122½ kg.). The next shock came in the Snatch, when Frank Spellman and Pete George, both of the U.S.A., outlifted Touni. Pete George was probably the youngest lifter in the whole meeting. This 19-year-old lad had just left high school, and in his first Olympic competition won fame with a new Olympic Snatch record of 270 lbs. (122½ kg.), using a perfect

Squat style. The third lift, the Jerk, became a battle of nerves between Touni and the two from the U.S.A. The weight on the bar was steadily increased ; all the other lifters except Kim had taken all their attempts, but still these three had not yet declared their first attempt. At last the Americans succeeded in driving out Touni to make his first Jerk, fearful lest another increase in the weight of the bar would be too much for him. Unnerved, he failed ! Spellman immediately mounted the platform and with no difficulty hoisted the same weight. Touni rallied himself and made good with his second attempt, but, to the consternation of his many supporters, failed with his third lift and thus lost his chance of being placed as Kim out-jerked him to gain the bronze medal.

### **A Tense Finish**

Spellman and George were left to fight it out for first place. Spellman, lifting calmly and confidently, went on to 336 lbs. (152½ kg.) and an aggregate of 859½ lbs. (390 kg.) which was a new Olympic record total. He was the only competitor so far to lift without a single failure (a feat only equalled by Charite, the Dutchman, who was third in the heavy-weight class). George succeeded with 341½ lbs. (155 kg.) which was a new Olympic Jerk record, and then suddenly decided to go flat out for first place. To get this he had to lift 363¾ lbs. (165 kg.) an increase of 22 lbs. (10 kg.) over his own new Olympic record and 11¼ lbs. (5 kg.) more than the world record. It was a tremendous task he had set himself, and the great crowd of spectators hushed in sympathetic silence as he mounted the platform. Beside the platform, urging George on, was Spellman—unselfishly ignoring his own chance for victory as he rallied to his team-mate's support. For minutes on end George paced up and down the platform, trying to nerve himself for a supreme effort, and all the while, the atmosphere became more and more electric with suspense. As he strode he rubbed his hands mechanically with a block of chalk. Suddenly he crushed it to powder, turned abruptly and faced the barbell. Still he made no move to approach it. Around him the thousands of spectators waited in taut expectancy, not daring to move or speak, for fear of disturbing his intense concentration. He moved forward and stood over the bar. The atmosphere grew tenser and tenser. He stooped and gripped the bar with agonising deliberation. His knees bent as he set himself, then straightened with



a tremendous heave. The bar came to his shoulders and he squatted deep under it. Could he come up with this tremendous weight ? Slowly, but surely, he did and a tremendous roar burst out to greet this partial success. Abruptly, the roar died away as George set himself for the final effort of jerking the bar to arms' length. A short dip and the bar was sent overhead ! He'd done it! But no, even as he started to recover from his Split to the erect position, he slipped. Down crashed the bar to the platform and a groan of disappointment echoed round the hall while he stood gazing sadly down on the great weight that had so narrowly beaten him. The most exciting moments of the competitions were over.

The light-heavyweight class was a personal triumph for smiling Stan Stanczyk (U.S.A.). He broke every Olympic record in his class with consummate ease. In the Press, he began after everyone else had finished and went up to 286½ lbs. (130 kg.). It was the same in the Snatch, in which he successfully took 270 lbs. (122½ kg.) and 286½ lbs. (130 kg.). For his third attempt he asked for 292 lbs. (132½ kg.) which was in excess of the world record. Still as nonchalant as ever, he hurled the bar to arms' length and then arose from his very deep Split. The crowd rose to acclaim him as two of the judges signalled a pass. But Stanczyk signalled the Master of Ceremonies. He could not accept the lift for he knew that his rear knee had touched the platform, although so slightly that the two judges had failed to notice it. He did not want credit for a lift that he knew should have been rejected because of this technical fault. The roar that greeted this wonderful sporting gesture was louder than any that he had received for his former successes. Stanczyk must have been disappointed at so narrowly failing to achieve a world record, as he succeeded with only his first Jerk, 347 lbs. (157½ kg.) which was, however, yet another Olympic record, as was his final total of 920 lbs. (417½ kg.).

Mention must be made in this class of another great sportsman, Y. W. Lee (Korea). This lifter, with the massive thigh development, created a tremendous impression by his bearing in the face of overwhelming disappointment. Three times he tried to jerk 319½ lbs. (145 kg.). Success would have enabled him to register a meritorious total, but three times he failed, by the narrowest of margins. Yet, in spite of the great disappointment he must have felt, with great dignity he carefully replaced the bar, straightened himself and bowed with punctilious courtesy, the grave polite bow that all the Koreans made to the referee and the audience before and after every lift. This charming display endeared both him and the other Koreans to the sport-loving audience, who gave him a special ovation in spite of his failure to register a total.

### **The Heavyweights**

Finally, another U.S.A. lifter, John Davis, garnered yet another outstanding Olympic honour for his country, placing him beside Harrison Dillard, " the fastest human," for in winning the heavyweight class, he became known as " the strongest man in the world." His victory was almost as clear cut as Stanczyk's. Ultra-strict refereeing made Davis over-cautious in the Press. He started with 303 lbs. (137½ kg.) for a new Olympic record, but after getting his second attempt rejected, declined to take his third. It seemed that there was to be no outstanding performance from this phenomenal lifter, but

he began to show more life when his team-mate, Norbert Schemansky, beat the Olympic record in the Snatch. This roused Davis to emulation and he set the record higher with a smooth effort of 303 lbs. (137½ kg.). Yielding to the plea of his team coach, world-famous Bob Hoffman, doyen of all American lifters, Davis took an extra attempt in the Snatch and, outside the competition, put up a new world record of 314 lbs. (142½ kg.). With Schemansky again "prodding" him in the Jerk, Davis brought this wonderful cavalcade of strength to a fitting end by jerking the greatest weight ever raised by an amateur, 391¼ lbs. (177½ kg.). His total 997¼ lbs. (452½ kg.) was nearly 100 lbs. (45 kg.) more than that achieved by the German, Manger, at Berlin in 1936.



*The Opening Ceremony for the yachting programme at Torbay.*

*The six-metre boats racing on the fifth day of the yachting contests. "Llanoria" (U.S.A.), helmsman H. Whiton, (US83) and "Apache" (Norway) helmsman M. Conow, (N70) are rounding the buoy. "Llanoria" was the eventual winner in the six-metre class.*





*The start of one of the races in the six-metre class. A12 is "Djinn" (Argentine), second in the class, I-64 "Crocia II" (Italy), K65 "Johan" (Great Britain). Further from the camera are B8 "Lalage" (Belgium) and S61 "Ali Baba II" (Sweden), third in the class.*

*A picture taken from the air of the six-metre class boats rounding a buoy in their opening race on August 3rd.*







Shortly after the start of the first race for the Dragon class. In front is "Slaghoken" (Sweden), second in the class, F1 is "Allegro" (France)  
Al "Pampero" (Argentina), H50 "Joy" (Holland), and II "Ansonia" (Italy).



*Yachts in the Dragon Class rounding a buoy.*

*Yachts in the Swallow class during the final day's racing. They are US1 "Margaret" (U.S.A.), third in the class, S2 "Chance" (Sweden), H4 "St. Magriet" (Holland) behind, K10 "The Cloud" (Eire), K7 "Swift" (Great Britain), the class winner, N1 "Nora" (Norway), and BL9 "Andorinha" (Brazil).*





*The start of a Swallow class race. The yachts shown are 11 "Enotria" (Italy), K10 "The Cloud" (Eire), A1 "Antares" (Argentine), BL9 "Andorinha" (Brazil), P12 "Symphony" (Portugal), second in the class, K7 "Swift" (Great Britain), S2 "Chance" (Sweden), U1 "Nortazo" (Uruguay), N1 "Nora" (Norway), and US1 "Margaret" (U.S.A.).*

*Another view of the Swallow class as they jockey for position, with spinakers flapping. KCI is "Scamp" (Canada), and D1 "No Name" (Denmark).*







*The start of a Firefly class event. The boats are manned by 489 J. de-Jong (Holland), 500 J. Tito (Portugal), 494 (in distance) A.Oswald (Switzerland), 493 A. J. Mooney (Eire), 492 M. Skaugen (Norway), 501 R. L. Evans (U.S.A.), 503 A. W. B. Macdonald (Great Britain), 495 E. R. Sarby (Sweden) 497 L. Spanghero (Italy), 496 Y. Brauer (Argentina), 485 P. van der Haeghen (Belgium), 490 R. French (Australia), 484 J. Alonso Allende (Spain), 499 H. Musil (Austria).*

*A view of the harbour at Torquay on the first day of the yachting events, with some of the Firefly boats in the foreground.*

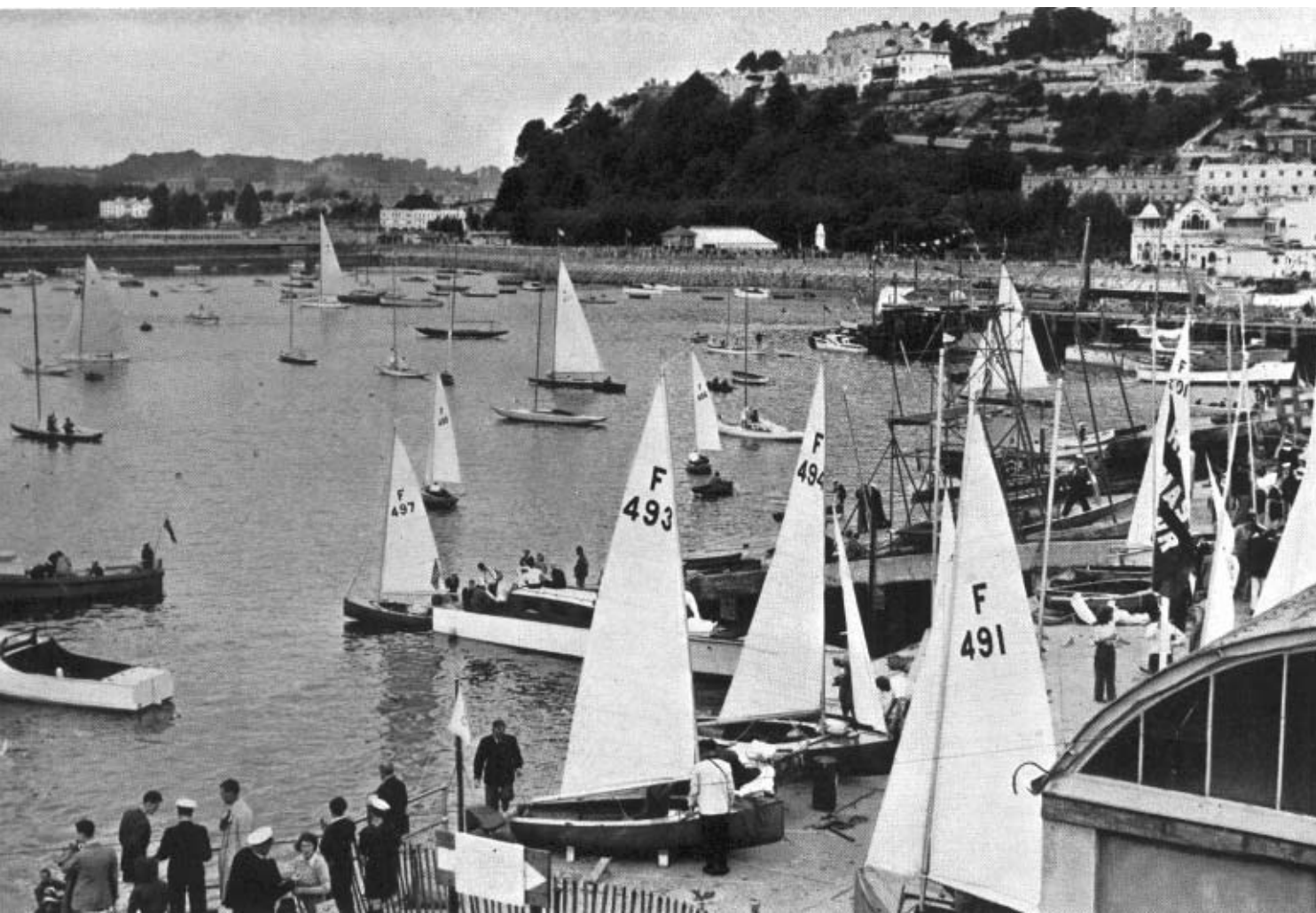





*Crown Prince Olaf of Norway, Special Delegate  
of the International Yacht Racing Union.*

*"Hilarious" (U.S.A.), winning boat in the Star  
class.*



*A general view of one of the Firefly class yachts,  
which were specially built for the Olympic regatta.  
This is being raced by J. J. M. Herbulot (France).*





*A Star class race in progress, the yachts identifiable being 2613 "Buscape II" (Brazil), 1722 "Moorina" (Australia), 2570 "Hilarious" (U.S.A.), class winner, 2376 "Kurush III" (Cuba) second, 2704 "Donar III" (Austria), 1343 "Ariel" (Canada), 1976 "Gem II" (Great Britain), 2564 "Ali Baba II" (Switzerland), and 2554 "Espardarte" (Portugal).*

*A close-up view of a Firefly class yacht, manned by E. R. Sarby (Sweden).*



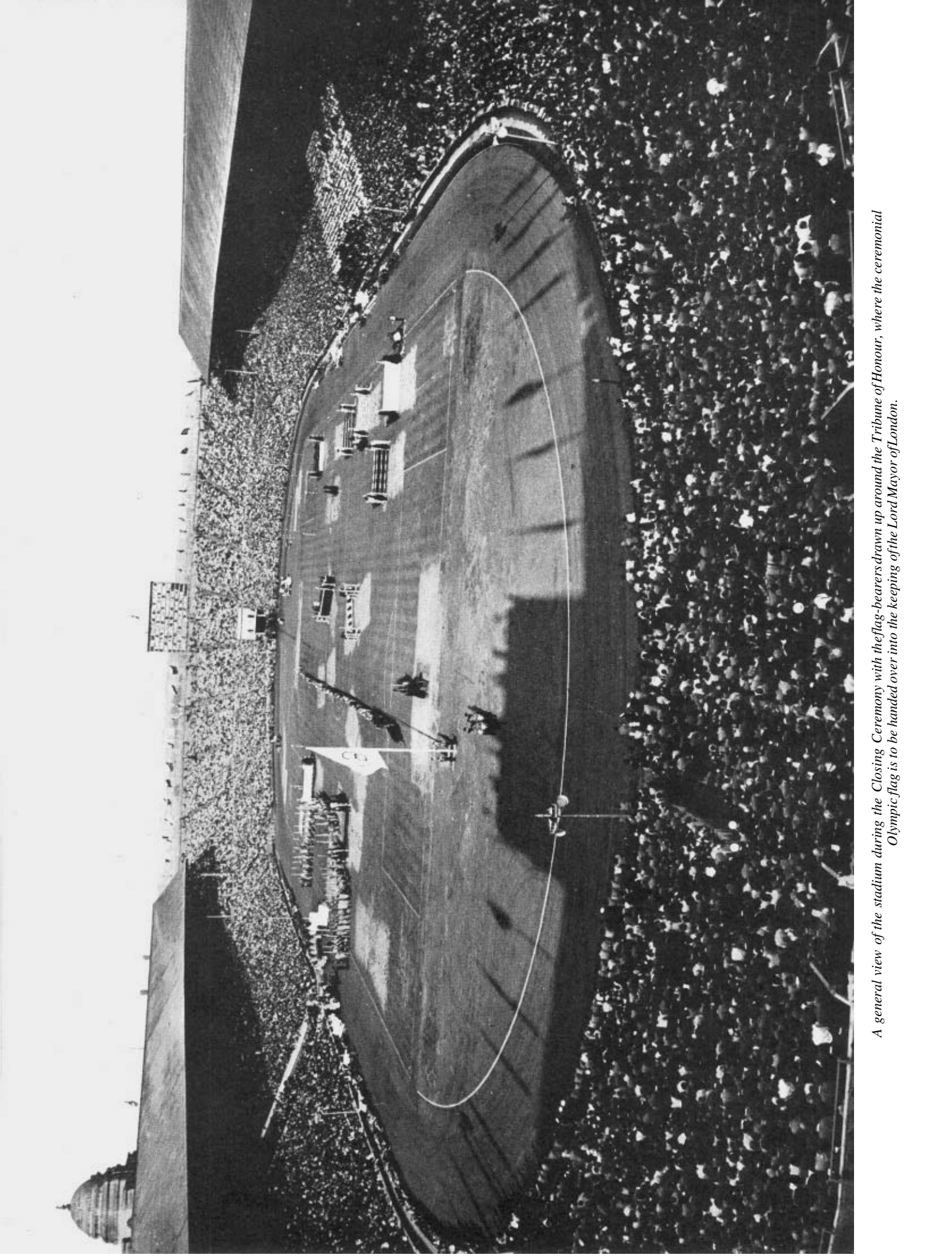

*A general view of the stadium during the Closing Ceremony with the flag-bearers drawn up around the Tribune of Honour, where the ceremonial Olympic flag is to be handed over into the keeping of the Lord Mayor of London.*



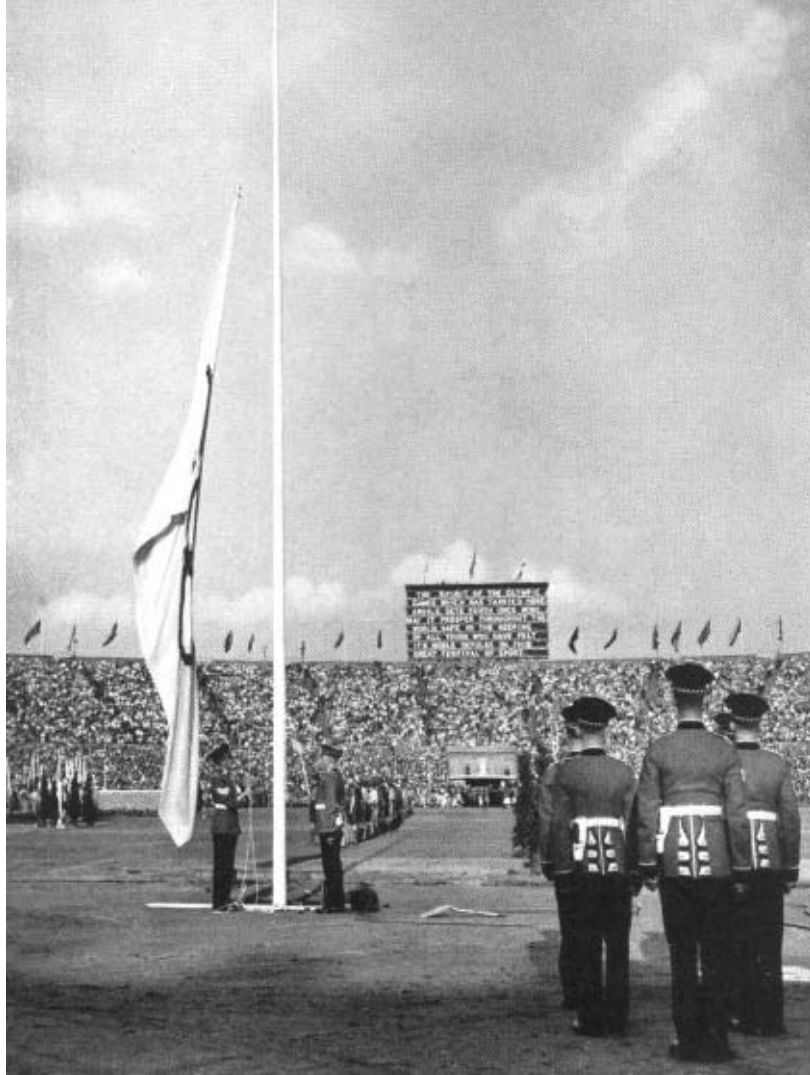

*The Olympic flag, which has flown throughout the Games, is slowly lowered . . .*

*While a fanfare of trumpets is sounded, The Lord Mayor of London, the Rt. Hon. Sir Frederick Michael Wells, holds the ceremonial Olympic flag, which will be kept in London until it is taken to Helsinki in 1952 . . . .*

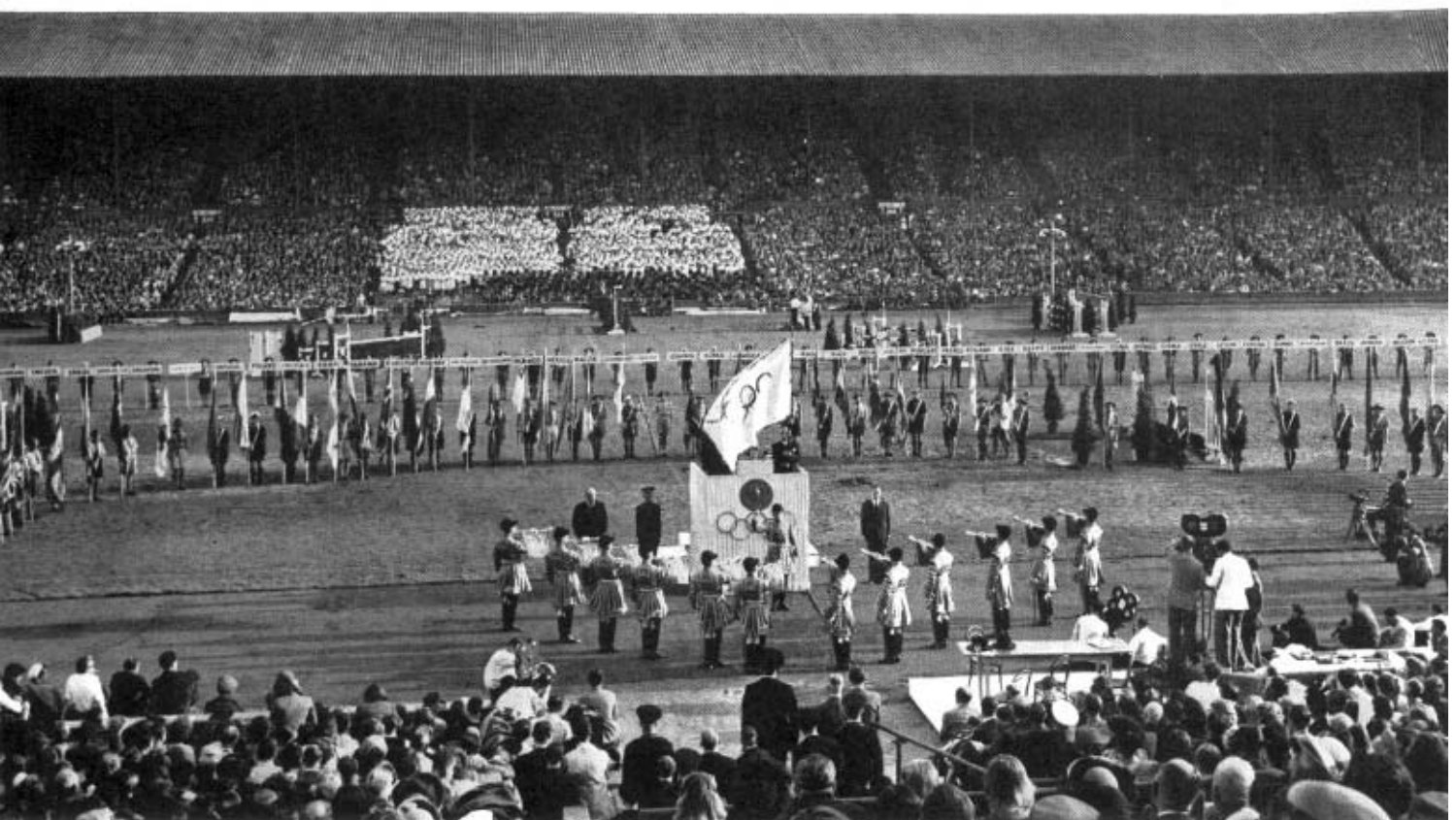



....The Olympic flame slowly dies away, while the choir sings the Olympic Hymn....



....and the Olympic flag is borne out of the arena in the wake of the flags of all the competing nations. The Games of London, 1948, the Games of the XIV Olympiad, are at an end.



**FEDERATION INTERNATIONALE HALTEROPHILE****JURY OF APPEAL**

J. ROSSET (President F.I.H.) *France*  
 E. GOULEAU (Secretary F.I.H.) *France*  
 O. BJORKLUND, *Sweden*  
 D. WORTMANN, *U.S.A.*  
 K. MAIRINGER, *Austria*  
 M. MASSIF, *Egypt*  
 W. J. LOWRY, *Gt. Britain*

**OFFICIALS:**

<i>Organiser and Master of Ceremonies</i>	OSCAR STATE
<i>Arena Stage Managers</i>	R. L. WELHAM, W. N. HANNEY
<i>Clerks of Scales</i>	H. BAKER, H. HARTNALL
<i>Recorders</i>	D. T. SHELL, G. CHRISTALL
<i>Scorers</i>	M. H. JONES, R. A. WATKINS
<i>Marksmen</i>	W. E. JONES, G. W. KIRKLEY
<i>Assistant Announcer</i>	R. WOOLGER
<i>Liaison Officer</i>	W. E. HANCOCK
<i>Competitors' Stewards</i>	J. BYRAM, J. G. SLOAN, J. HAYES, D. AYLEN, S. H. WILLEY
<i>Marshals</i>	R. H. BROWN, G. GREENWOOD, J. COLE
<i>Loaders</i>	R. GOMERSALL, J. BOYD, R. R. K. MILLS, F. GRIVVELL, J. F. FORD, R. W. F. CHIFNEY, S. BASS, J. H. GASTON

**REGULATIONS FOR WEIGHTLIFTING**

There are three lifts in the Olympic weightlifting events :— (1) Two hands Clean and Press ;  
 (2) Two hands Snatch ; (3) Two hands Clean and Jerk.

Each competitor must take part in each of the three lifts and his placing is determined by the total of his best lift in each style. He is allowed three attempts only in each style. The weight of the bar must be a multiple of 2½ kg. and if the competitor wishes to try for an increased weight at a subsequent lift in that style, the increase must be not less than 5 kg. between the first and second lift and 2½ kg. between the second and third. A competitor may never make an attempt with a weight less than that employed in a preceding attempt in that style.

The order of lifting is determined according to the weight with which the competitors wish to make their attempts, the lowest scheduled weight commencing. If two competitors wish to start at the same weight the order is determined by lot. Three judges are appointed to determine whether each lift has been made in accordance with the regulations for the style concerned. Their decision is shown by the coloured lights on the platform, a white light signifying " Good " and a red light " No lift." If the judges disagree the majority verdict determines. In the case of a tie the lighter competitor is declared the winner.

**THE LIFTS****Two HANDS CLEAN AND PRESS**

The Barbell is brought to shoulder level in a single clean movement and, when the referee gives the signal, is raised steadily to arms' length above the head and held there for two seconds. During the press to arms' length the lifter must retain an erect position without moving legs or trunk.

**Two HANDS SNATCH**

The Barbell is taken from the ground to arms' length above the head in a single movement. The lifter may move his body or legs in any manner he desires, but must recover to the erect position as soon as possible and hold the bar at arms' length for two seconds.

**Two HANDS CLEAN AND JERK**

The Barbell is brought to shoulder level in a single clean movement, during which he may move his body or legs, but must return to the erect position. In his own time he then jerks the bar to arms' length above the head and holds it there for two seconds. During the jerk, he may move his body and legs, but must return his feet to their original position.

## BANTAMWEIGHT

*Up to 56 kg. (123½ lb.)*

This event was included in the Olympic Programme for the first time.

**World Records:** Press—**106½ kg.**, de Pietro, U.S.A., 1948 ; Snatch—**91 kg.**, Creus, *Great Britain*, 1948 ; Jerk—**122½ kg.**, Namjdu, *Iran*, 1948.

**Best total in World Championships :** **300 kg.**, de Pietro, U.S.A., Philadelphia, 1947

*There were 20 entries from 15 nations; 19 participants from 14 nations.*

*Referee:* Merlin (*Italy*). *Judges:* Morin (*France*); Rizzo (*Argentine*).

The first line of figures against each competitor gives the weight in kilos; the second line, the corresponding figure in pounds. The figures in italics represent unsuccessful attempts.

Place	Name	Country	Body-weight in Kilos.	Press			Snatch			Jerk			Total		
				1	2	3	Best	1	2	3	Best	1		2	3
1	<b>J. DE PIETRO</b> .....	U.S.A.	55.900	100	105	107.5	<b>105*</b>	85	90	90	105	110	112.5	<b>112.5</b>	<b>307.5†</b>
2	<b>J. CREUS</b> .....	Great Britain	55.850	220¼	231¼	236¾	<b>231¼*</b>	187¼	198¼	198¼	231¼	242½	248	<b>248</b>	<b>677½†</b>
3	<b>R. TOM</b> .....	U.S.A.	55.250	170¾	181¾	187¼	<b>181¾</b>	198¼	209¼	214¾	253½	264½	270	<b>264½</b>	<b>655½</b>
4	Kyu Hyuk Lee .....	Korea	55.780	181¾	192¾	192¾	<b>192¾</b>	187¼	198¼	203¾	248	259	259	<b>259</b>	<b>650</b>
5	M. Namdjou .....	Iran	55.750	77.5	77.5	82.5	<b>77.5</b>	87.5	92.5	95	115	120	125	<b>120</b>	<b>290</b>
6	M. Thevenet .....	France	55.920	170¾	170¾	181¾	<b>170¾</b>	192¾	203¾	209¼	253½	264½	275½	<b>264½</b>	<b>639</b>
7	R. Smith .....	Canada	55.870	82.5	82.5	85	<b>82.5</b>	82.5	87.5	87.5	112.5	117.5	122.5	<b>122.5*</b>	<b>287.5</b>
8	M. Crow .....	New Zealand	55.100	181¾	181¾	187¼	<b>181¾</b>	181¾	192¾	192¾	248	259	270	<b>270*</b>	<b>633½</b>
9	K. Caple .....	Australia	55.160	85	90	92.5	<b>90</b>	75	80	82.5	100	105	110	<b>110</b>	<b>280</b>
10	Dong Wook Pak.....	Korea	55.800	187¼	198¼	203¾	<b>198¼</b>	165¼	176¼	181¾	220¼	231¼	242½	<b>242½</b>	<b>617</b>
11	A. Yacout .....	Egypt	55.950	77.5	82.5	85	<b>82.5</b>	80	85	87.5	85	85	115	<b>110</b>	<b>277.5</b>
				77.5	82.5	82.5	<b>77.5</b>	176¼	187¼	192¾	187¼	242½	253½	<b>242½</b>	<b>611½</b>
				77.5	82.5	82.5	<b>77.5</b>	170¾	181¾	187¼	102.5	107.5	110	<b>110</b>	<b>272.5</b>
				77.5	82.5	82.5	<b>77.5</b>	170¾	181¾	187¼	225¾	236¾	242½	<b>242½</b>	<b>600½</b>
				77.5	82.5	82.5	<b>77.5</b>	170¾	181¾	187¼	100	110	112.5	<b>110</b>	<b>272.5</b>
				77.5	82.5	82.5	<b>77.5</b>	170¾	181¾	187¼	220¼	242½	248	<b>242½</b>	<b>600½</b>
				77.5	82.5	82.5	<b>77.5</b>	170¾	181¾	187¼	107.5	107.5	112.5	<b>107.5</b>	<b>272.5</b>
				77.5	82.5	82.5	<b>77.5</b>	170¾	181¾	187¼	236¾	248	248	<b>236¾</b>	<b>600¼</b>
				77.5	82.5	82.5	<b>77.5</b>	170¾	181¾	187¼	105	110	112.5	<b>112.5</b>	<b>272.5</b>
				165¼	176¼	176¼	<b>165¼</b>	176¼	187¼	192¾	231¼	242½	248	<b>248</b>	<b>600½</b>

\* Olympic record.

† World and Olympic record.



**BANTAMWEIGHT—continued**

Place	Name	Country	Body-weight in Kilos	Press			Snatch			Jerk			Total			
				1	2	3	Best	1	2	3	Best	1		2	3	Best
12	E. Porubszky .....	Hungary	56.000	67.5	72.5	75	72.5	80	85	87.5	87.5	102.5	107.5	110	110	270
13	A. Greenhalgh .....	Great Britain	55.900	148¾	159¾	165¼	159¾	176¼	187¼	192¾	192¾	225¾	236¾	242½	242½	595
14	E. Sundstrom .....	Finland.	56.000	85	90	92.5	92.5	75	75	77.5	75	209¼	220¼	231¼	231¼	267.5
15	Maung Win Maung .....	Burma	55.910	187¼	198¼	203¾	203¾	165¼	165¼	170¾	165¼	209¼	220¼	231¼	231¼	589¼
16	E. Watier .....	France	55.970	70	75	77.5	77.5	80	85	87.5	85	105	110	110	105	267.5
17	J. Vojtech .....	Austria	55.640	154¼	165¼	170¾	170¾	176¼	187¼	192¾	187¼	231¾	242½	242½	231¼	589¼
18	P. Kotvio .....	Finland	55.850	77.5	82.5	—	82.5	77.5	82.5	85	82.5	100	105	105	100	265
19	M. Salas Maravilla .....	Mexico	55.380	170¾	181¾	—	181¾	170¾	181¾	187¼	181¾	220¼	231¼	231¼	220¼	583¾
				75	80	82.5	80	75	80	80	80	100	105	105	100	260
				165¼	176¼	181¾	176¼	165¼	176¼	176¼	176¼	220¼	231¼	231¼	220¼	572¾
				75	80	82.5	80	75	75	80	80	100	105	105	100	255
				165¼	176¼	181¾	176¼	165¼	165¼	176¼	176¼	220¼	231¼	231¼	220¼	561¾
				65	70	70	65	75	80	80	80	95	102.5	105	102.5	247.5
				143¼	154¼	154¼	143¼	165¼	176¼	176¼	176¼	209¼	225¾	231¼	225¾	545¼
				60	65	65	60	70	75	75	70	95	100	102.5	100	230
				132¼	143¼	143¼	132¼	154¼	165¼	165¼	154¼	209¼	220¼	225¾	220¼	506¾

### FEATHERWEIGHT

*Up to 60 kg. (132¼ lbs.).*

#### Previous Olympic Winners

1920 L. de Haes  
1924 P. Gabetti

Belgium 1928 F. Andrysek  
Italy 1932 R. Suvigny  
U.S.A. 1936 A. Terlazzo

Austria  
France

**World Records :** Press—**105 kg.**, Juitsu Nan, *Japan*, 1939; Snatch—**102½ kg.**, Juitsu Nan, *Japan*, 1939; Jerk—**131 kg.**, Fayad, *Egypt*, 1946.  
**Best total in World Championships :** **320 kg.**, Anderson, *Sweden*, Paris, 1946.  
**Olympic Record :** **312½ kg.**, A. Terlazzo, *U.S.A.*, Berlin, 1936.

*There were 24 entries from 19 nations; 23 participants from 18 nations.*

*Referee:* Cayeux (*France*). *Judges:* Mader (*Switzerland*); Kabasi (*India*).

The first line of figures against each competitor gives the weight in kilos.; the second line, the corresponding figure in pounds. The figures in italics represent unsuccessful attempts.

Place	Name	Country	Body-weight in Kilos.	Press			Snatch			Jerk			Total		
				1	2	3	Best	1	2	3	Best	1		2	3
1	<b>M. FAYAD</b> .....	Egypt	59.710	85	90	92.5	<b>92.5</b>	97.5	102.5	105	105†	130	135	135	<b>332.5†</b>
2	<b>R. WILKES</b> .....	Trinidad	60.000	187¼	198¼	203¾	<b>203¾</b>	214¾	225¾	231¼	<b>231¼†</b>	286½	297½	297½	<b>732½†</b>
3	<b>J. SAIMASSI</b> .....	Iran	59.990	198¼	214¾	220¾	<b>214¾</b>	198¼	209¼	214¾	<b>214¾</b>	253½	270	281	<b>317.5</b>
4	Su Il Nam .....	Korea	59.800	209¼	220¼	225¼	<b>220¼*</b>	198¼	209¼	214¾	<b>214¾</b>	253½	264½	264½	<b>699½</b>
5	R. Rosario .....	Philippines	59.920	198¼	198¼	203¾	<b>203¾</b>	192¾	203¾	209¼	<b>203¾</b>	259	259	270	<b>312.5</b>
6	K. Ishikawa .....	U.S.A.	60.000	214¾	231¼	231¼	<b>214¾</b>	192¾	203¾	203¾	<b>203¾</b>	117.5	125	125	<b>688½</b>
7	J. Runge .....	Denmark	60.000	192¾	203¾	203¾	<b>203¾</b>	198¼	209¼	214¾	<b>209¼</b>	264½	281	281	<b>307.5</b>
8	M. Heral .....	France	59.680	198¼	209¼	214¾	<b>209¼</b>	198¼	209¼	209¼	<b>198¼</b>	253½	264½	264½	<b>677½</b>
9	K. Tomita .....	U.S.A.	59.850	176¼	187¼	192¾	<b>187¼</b>	198¼	209¼	209¼	<b>209¼</b>	253½	264½	275½	<b>300</b>
				85	90	90	<b>85</b>	87.5	92.5	95	<b>92.5</b>	117.5	122.5	122.5	<b>300</b>
				187¼	198¼	198¼	<b>187¼</b>	192¾	203¾	203¾	<b>203¾</b>	259	270	270	<b>661</b>
				187¼	198¼	198¼	<b>187¼</b>	192¾	203¾	209¼	<b>203¾</b>	259	270	275½	<b>300</b>

\* Olympic record. † World and Olympic record.

**FEATHERWEIGHT—continued**

Place	Name	Country	Body-weight in Kilos	Press				Snatch				Jerk				Total
				1	2	3	Best	1	2	3	Best	1	2	3	Best	
10	A. Le Guillerm .....	France	59.860	80	85	87.5	<b>87.5</b>	85	90	92.5	<b>92.5</b>	115	120	120	<b>120</b>	<b>300</b>
11	A. Richter .....	Austria	59.650	75	80	82.5	<b>80</b>	87.5	92.5	95	<b>92.5</b>	112.5	120	120	<b>120</b>	<b>661</b>
12	I. El Dessouki .....	Egypt	59.740	80	85	87.5	<b>87.5</b>	82.5	87.5	90	<b>90</b>	115	115	264½	<b>264½</b>	<b>644½</b>
13	O. Andersson .....	Sweden	59.770	85	90	—	<b>85</b>	92.5	92.5	92.5	<b>92.5</b>	115	115	253½	<b>253½</b>	<b>292.5</b>
14	D. Hallett .....	Great Britain	59.900	82.5	87.5	87.5	<b>87.5</b>	82.5	87.5	87.5	<b>87.5</b>	110	115	117.5	<b>117.5</b>	<b>292.5</b>
15	B. Nagy .....	Hungary	59.500	82.5	87.5	87.5	<b>82.5</b>	90	90	95	<b>90</b>	110	115	259	<b>259</b>	<b>644½</b>
16	P.M.Daniel .....	India	58.450	85	90	90	<b>85</b>	80	85	87.5	<b>85</b>	110	115	259	<b>259</b>	<b>290</b>
17	S. Williams .....	Jamaica	59.750	82.5	87.5	90	<b>87.5</b>	80	80	80	<b>80</b>	105	110	242½	<b>242½</b>	<b>639</b>
18	A. Correia .....	British Guiana	59.460	75	80	80	<b>75</b>	85	85	95	<b>85</b>	115	125	242½	<b>242½</b>	<b>280</b>
19	H. Colans .....	Belgium	59.600	75	80	80	<b>75</b>	85	90	90	<b>85</b>	110	120	242½	<b>242½</b>	<b>617</b>
20	S. Kemble .....	Great Britain	59.500	87.5	87.5	92.5	<b>87.5</b>	80	85	85	<b>80</b>	105	110	275½	<b>275½</b>	<b>277.5</b>
21	A. Fiorentino .....	Argentina	59.450	70	75	80	<b>75</b>	75	80	85	<b>80</b>	100	105	242½	<b>242½</b>	<b>611½</b>
22	R. Rieder .....	Switzerland	59.900	75	80	82.5	<b>80</b>	75	80	82.5	<b>75</b>	95	100	242½	<b>242½</b>	<b>275</b>
23	Hang Kee Choi .....	Korea	59.450	95	95	95	<b>0</b>	85	90	90	<b>85</b>	—	—	—	<b>—</b>	<b>85</b>
				209¼	209¼	209¼	<b>0</b>	187¼	198¼	198¼	<b>187¼</b>	—	—	—	<b>—</b>	<b>187¼</b>

## LIGHTWEIGHT

Up to 67½ kg. (148¾ lbs.).

### Previous Olympic Winners

1920	A. Neyland	<i>Estonia</i>	1932	R. Duvzger	<i>France</i>
1924	E. Decottignies	<i>France</i>	1936	I. Mohamed Ahmed Mesbah	<i>Egypt</i>
1928	{ H. Haas K. Helbig	{ <i>Austria</i> <i>Germany</i>			<i>Austria</i>

*There were 24 entries from 19 nations; 22 participants from 17 nations.*

**World Records: Press—109 kg., Jeno (Hungary), 1948; Snatch—116.5 kg., Shams (Egypt), 1939; Jerk—153.5 kg., Shams (Egypt), 1939.**  
**Best total in World Championships : 367.5 kg., Stanczyk (U.S.A.), Paris, 1946. :**

**Olympic Record : 342.5 kg., Mesbah (Egypt) and Fein (Austria).**

*Referee: Jones (Great Britain). Judges: Fattorini (Italy), Matejcek (Czechoslovakia).*

The first line of figures against each competitor gives the weight in kilos.; the second line, the corresponding figure in pounds. The figures in italics represent unsuccessful attempts.

Place	Name	Country	Body-weight in Kilos.	Press					Snatch			Jerk			Total	
				1	2	5	Best	1	2	3	Best	1	2	3		Best
1	I. SHAMS	Egypt	65.740	92.5	97.5	97.5	97.5	107.5	112.5	115	115*	140	145	147.5	147.5*	360*
2	A. HAMOUDA	Egypt	67.100	203¾	214¾	214¾	214¾	236¾	248	253½	253½*	308½	319½	325	325*	793¼*
3	J. HALLIDAY	Great Britain	67.130	220¼	231¼	231¼	231¼	225¾	236¾	242½	242½	297½	308½	319½	319½	360*
4	J. Terpak	U.S.A.	67.170	90	95	105	105	105	110	110	110	130	135	140	140	340
5	J. Stuart	Canada	67.460	198¼	209¼	209¼	198¼	231¼	242½	242½	242½	286½	297½	308½	308½	749¼
6	Suk Young Kim	Korea	66.420	97.5	102.5	105	102.5	107.5	107.5	107.5	102.5	130	135	137.5	135	340
7	See Yun La	Korea	66.470	214¾	225¾	231¼	225¾	225¾	236¾	236¾	225¾	286½	297½	303	297½	749
8	J. Pitman	U.S.A.	66.620	102.5	107.5	110	107.5*	100	105	105	100	125	130	130	125	332.5
9	M. Espeut	Jamaica	66.910	225¾	236¾	242½	236¾*	220¼	231¼	231¼	220¼	275½	286½	286½	275½	732½
				90	95	97.5	95	95	100	102.5	100	130	135	140	135	330
				198¼	209¼	214¾	209¼	209¼	220¼	225¾	220¼	286½	297½	308½	297½	727
				90	95	95	90	95	100	100	100	130	135	140	140	330
				198¼	209¼	209¼	198¼	209¼	220¼	220¼	220¼	286½	297½	308½	308½	727
				95	100	102.5	100	95	100	100	95	127.5	132.5	132.5	127.5	322.5
				209¼	220¼	225¾	220¼	209¼	220¼	220¼	209¼	281	292	292	281	710½
				95	95	100	100	95	100	100	95	127.5	132.5	132.5	127.5	322.5
				209¼	209¼	220¼	220¼	209¼	220¼	220¼	209¼	281	292	292	281	710½

\* Olympic record.

**LIGHTWEIGHT—continued**

Place	Name	Country	Body-weight in Kilos	Press				Snatch				Jerk				Total
				1	2	3	Best	1	2	3	Best	1	2	3	Best	
10	J. Petersen .....	Denmark	66.940	85	90	92.5	90	92.5	100	97.5	120	125	127.5	127.5	315	
11	R. Aleman .....	France	67.220	187½	198¼	203¾	198¼	203¾	220¼	214¾	264½	275½	281	281	694	
12	G. Colantuono .....	Italy	66.880	198¼	209¼	214¾	209¼	214¾	220¼	209¼	270	281	281	270	315	
13	R. Eland .....	Great Britain	65.520	192¾	203¾	209¼	203¾	209¼	220¼	198¼	264½	275½	281	275½	688½	
14	A. Kinnunen .....	Sweden	67.380	198¼	209¼	209¼	209¼	209¼	209¼	90	115	120	—	—	310	
15	F. Teraskari .....	Finland	67.450	85	90	90	85	100	102.5	95	120	120	125	120	683	
16	G. Alvarado Cornejo .....	Peru	66.950	187¼	181¾	192¾	187¼	181¾	220¼	209¼	264½	264½	275½	264½	307.5	
17	T. Huyge .....	Belgium	66.900	187¼	209¼	209¼	198¼	209¼	214¾	187¼	253½	264½	275½	264½	677½	
18	S. Lo Presti .....	Argentina	67.160	85	90	90	85	87.5	92.5	90	115	120	125	120	300	
19	A. Mahini .....	Iran	66.210	187¼	198¼	198¼	187¼	198¼	203¾	192¾	253½	264½	270	270	661	
20	H. D'Atri .....	Argentina	67.500	80	85	90	85	85	90	92.5	110	115	120	120	295	
21	H. Banda Bernal .....	Mexico	63.790	176¼	187¼	198¼	187¼	198¼	203¾	187¼	242½	253½	264½	264½	650	
22	F. Louro Sierra .....	Cuba	66.580	176¼	187¼	192¾	187¼	187¼	176¼	70	102.5	107.5	112.5	107.5	275	
				92.5	97.5	97.5	92.5	92.5	176¼	154¼	225¾	236¾	248	236¾	600¼	
				203¾	214¾	214¾	203¾	203¾	—	92.5	117.5	117.5	—	—	185	
										203¾	259	259	—	—	407½	

## MIDDLEWEIGHT

Up to 75 kg. (165 3/8 lbs.)

### Previous Olympic Winners

1920 Gance	France	1928 R. François	France
1924 C. Galimberti	Italy	1932 R. Ismayr	Germany
193 Khadr-el Touni	...	1932 R. Ismayr	Egypt

There were 25 entries from 18 nations; 24 participants from 18 nations.

**World Records :Press—127.5 kg., Touni (Egypt), 1948; Snatch—127 kg., Stanczyk (U.S.A.), 1947; Jerk—160 kg., Stanczyk (U.S.A.), 1947.**

**Best total in World Championships : 405 kg., Stanczyk (U.S.A.), Philadelphia, 1947.**

**Olympic Record : 387.5 kg., Touni (Egypt), Berlin, 1936.**

Referee: Mensik (Czechoslovakia). Judges: Fahmy (Egypt); Bergeron (U.S.A.).

The first line of figures against each competitor gives the weight in kilos.; the second line, the corresponding figure in pounds. The figures in italics represent unsuccessful attempts.

Place	Name	Country	Body-weight in Kilos.	Press			Snatch			Jerk			Total			
				1	2	3	Best	1	2	3	Best	1		2	3	Best
1	F. SPELLMAN	U.S.A.	73.080	110	115	117.5	117.5	112.5	117.5	120	120	142.5	150	152.5	152.5	390*
2	P. GEORGE	U.S.A.	73.250	100	105	105	105	112.5	105	105	112.5	122.5*	122.5	155*	155*	336
3	SUNG JIP KIM	Korea	72.920	220/4	231/4	231/4	231/4	248	231/4	231/4	248	270*	270	363/4	341/2*	382.5
4	K. El Touni	Egypt	74.900	253/2	264/2	270	270	105	122.5*	112.5	112.5	140	145	147.5	145	380
5	G. Gratton	Canada	74.950	107.5	112.5	115	115	107.5	120	120	140	140	142.5	147.5	142.5	380
6	P. Bouladou	France	74.270	236/4	248	253/2	248	236/4	264/2	264/2	259	264/2	314	325	314	837/2
7	O. Garrido Luloaga	Cuba	75.000	209/4	220/4	225/4	225/4	231/4	225/4	242/2	242/2	297/2	308/2	314	314	782/4
8	G. Watson	Great Britain	74.130	236/4	248	253/2	248	220/4	248	220/4	275/2	275/2	297/2	297/2	297/2	355
9	G. Firmin	France	75.000	209/4	220/4	220/4	220/4	231/4	220/4	242/2	242/2	297/2	308/2	308/2	308/2	771/4
				92.5	97.5	100	100	102.5	102.5	102.5	107.5	107.5	135	140	140	347.5
				203/4	214/4	220/4	220/4	225/4	225/4	236/4	236/4	297/2	297/2	308/2	308/2	765/2

\* Olympic record.

**MIDDLEWEIGHT—continued**

Place	Name	Country	Body-weight in Kilos	Press			Snatch			Jerk			Total					
				1	2	3	Best	1	2	3	Best	1		2	3	Best		
10	J. Sklar .....	Canada	73.900	100	105	107.5	105	100	107.5	107.5	107.5	132.5	140	140	140	132.5	345	
11	L. Nelson .....	Sweden	74.880	220¼	231¼	236¾	231¼	220¼	236¾	236¾	236¾	292	308½	308½	292	292	292	760
12	J. G. Smeekens .....	Holland	74.950	209¼	220¼	220¼	209¼	231¼	209¼	248	248	275½	275½	297½	297½	297½	738	
13	N. Mirghavami .....	Iran	74.310	209¼	220¼	220¼	209¼	225¾	236¾	236¾	225¾	275½	292	292	292	292	727	
14	I. Bloomberg .....	South Africa	74.800	225¾	225¾	225¾	225¾	198¼	209¼	220¼	209¼	120	125	130	130	130	327.5	
15	E. Peppiatt .....	Great Britain	74.850	220¼	231¼	236¾	231¼	214¾	225¾	225¾	214¾	264½	275½	286½	286½	275½	721½	
16	K. Schuh .....	Austria	73.200	209¼	220¼	220¼	220¼	214¾	225¾	231¼	225¾	275½	286½	286½	275½	275½	721½	
17	R. Rueda Garcia .....	Mexico	73.840	209¼	220¼	220¼	220¼	209¼	220¼	220¼	209¼	125	125	130	125	125	327.5	
18	J. Bonnet .....	Argentina	72.000	209¼	220¼	225¾	220¼	198¼	220¼	220¼	220¼	264½	275½	275½	264½	264½	694	
19	F. Mast .....	Switzerland	74.650	187¼	198¼	203¾	198¼	209¼	203¾	231¼	231¼	253½	270	270	270	270	688½	
20	J. Russo .....	Argentina	74.800	198¼	198¼	209¼	198¼	209¼	209¼	231¼	220¼	264½	264½	275½	264½	264½	683	
21	O. Buttery (Chaves) .....	British Guiana	70.250	85	90	92.5	90	90	90	100	95	115	120	125	125	125	310	
22	M. I. Butt .....	Pakistan	74.830	181¼	181¼	192¾	181¼	203¾	214¾	220¼	220¼	264½	275½	281	275½	275½	677½	
23	R. Rubini .....	Switzerland	68.600	181¾	192¾	203¾	187¼	187¼	198¼	198¼	198¼	259	270	281	270	270	672	
24	J. Moritzen .....	Denmark	72.850	75	80	82.5	82.5	85	90	95	90	115	120	127.5	120	120	292.5	
				165¼	176¼	181¾	187¼	187¼	198¼	209¼	198¼	253½	264½	281	264½	264½	644½	
				87.5	92.5	92.5	92.5	87.5	87.5	92.5	95	100	100	100	100	100	182.5	
				192¾	203¾	203¾	203¾	192¾	203¾	203¾	192¾	209¼	220¼	220¼	220¼	220¼	402	

# LIGHT-HEAVYWEIGHT

Up to 82½ kg. (1817/8 lbs.).

## Previous Olympic Winners

1920	E. Cadine	France	1928	E. Nousseir	Egypt
1924	C. Rigoulot	France	1932	L. Hostin	France
1936	L. Hostin	France	...		

**World Records : Press—141.5 kg., Novack (U.S.S.R.), 1947; Snatch—131.5 kg., Novack (U.S.S.R.), 1947; Jerk—169 kg., Ferrari (France), 1945.**

**Best total in World Championships : 425 kg., Novack (U.S.S.R.), Paris, 1946.**

**Olympic Record : 372.5 kg., Hostin (France), Berlin, 1936.**

*There were 20 entries from 16 nations; 16 participants from 13 nations.*

*Referee: Hoffman (U.S.A.). Judges: Kirkley (Great Britain); Sletsjoi (Norway).*

The first line of figures against each competitor gives the weight in kilos.; the second line, the corresponding figure in pounds. The figures in italics represent unsuccessful attempts.

Place	Name	Country	Body-weight in Kilos.	Press			Snatch			Jerk				Total		
				1	2	3	Best	1	2	3	Best	1	2		3	Best
1	S. STANCZYK .....	U.S.A.	80.660	122.5	127.5	130	130*	122.5	130	132.5	130*	157.5	165	165	157.5*	417.5*
2	H. SAKATA .....	U.S.A.	80.850	270	281	286½	286½*	270	286½	292	286½*	347	363	363	347*	920*
3	K. MAGNUSSON .....	Sweden	82.490	231¼	242½	242½	242½	248	259	259	259	314	330½	336	152.5	380
4	J. Debuf .....	France	82.200	231¼	242½	248	242½	115	120	120	120	145	150	150	145	375
5	O. Forte .....	Argentina	81.420	220¼	231¼	236¾	236¾	107.5	112.5	115	112.5	142.5	147.5	150	319½	826½
6	J. Varaleau .....	Canada	80.840	220¼	231¼	236¾	231¼	105	110	110	110	135	142.5	147.5	147.5	367.5
7	J. Vellamo .....	Finland	80.980	231¼	242½	248	248	231¼	242½	248	248	297½	314	325	325	809¾
8	S. Raissi .....	Iran	81.150	209¼	220¼	225¾	220¼	110	115	117.5	115	140	145	145	140	355
9	E. Roe .....	Great Britain	82.240	225¾	236¾	242½	242½	100	105	110	110	130	135	140	135	782¼
				105	110	115	110	105	110	110	105	286½	297½	308½	297½	782½
				231¼	242½	253½	242½	231¼	242½	242½	231¼	297½	308½	308½	308½	355
																782¼

\* Olympic record.



**LIGHT-HEAVYWEIGHT—continued**

Place	Name	Country	Body-weight in Kilos	Press				Snatch				Jerk				Total
				1	2	3	Best	1	2	3	Best	1	2	3	Best	
10	L. Buronyi .....	Hungary	82.400	95	100	102.5	<b>102.5</b>	105	110	112.5	<b>112.5</b>	135	140	142.5	<b>140</b>	<b>355</b>
11	M. Saleh .....	Egypt	82.500	209¼	220¼	225¾	<b>225¾</b>	231¼	242½	248	<b>248</b>	297½	308½	314	<b>308½</b>	<b>782¼</b>
	R. Herbaux .....	France	82.500	214¾	225¾	225¾	<b>214¾</b>	236¾	248	112.5	<b>112.5</b>	140	150	150	<b>140</b>	<b>350</b>
13	W. Pankl .....	Austria	79.920	214¾	225¾	231¼	<b>102.5</b>	100	105	107.5	<b>107.5</b>	132.5	137.5	140	<b>140</b>	<b>350</b>
14	F. Haller .....	Austria	82.090	90	95	95	<b>95</b>	102.5	107.5	107.5	<b>107.5</b>	137.5	145	145	<b>145</b>	<b>347.5</b>
15	C. Bisiak .....	Peru	80.750	198½	209¼	209¼	<b>209¼</b>	225¾	236¾	236¾	<b>236¾</b>	303	319½	319½	<b>319½</b>	<b>765½</b>
16	Young Whan Lee .....	Korea	81.390	95	100	100	<b>100</b>	107.5	112.5	112.5	<b>107.5</b>	135	140	140	<b>135</b>	<b>342.5</b>
				209¼	220¼	220¼	<b>220¼</b>	236¾	248	248	248	248	<b>236¾</b>	297½	308½	308½
				97.5	97.5	102.5	<b>97.5</b>	97.5	102.5	102.5	<b>102.5</b>	127.5	132.5	135	<b>132.5</b>	<b>332.5</b>
				214¾	214¾	225¾	<b>214¾</b>	214¾	225¾	225¾	<b>225¾</b>	281	292	297½	<b>292</b>	<b>732½</b>
				100	105	105	<b>100</b>	105	105	110	<b>105</b>	145	145	145	<b>0</b>	<b>205</b>
				220¼	231¼	231¼	<b>220¼</b>	231¼	231¼	242½	<b>231¼</b>	319½	319½	319½	<b>0</b>	<b>451½</b>

# HEAVYWEIGHT

Over 82½ kg. (1817/8 lbs.)

## Previous Olympic Winners

1896	Eliot (one hand lift)	<i>Italy</i>
1896	Jensen (two hands lift)	<i>Germany</i>
1904	P. Kakousis	<i>Czechoslovakia</i>
1920	F. Bottini	<i>Germany</i>
		<i>Italy</i>
		<i>Germany</i>
		<i>Czechoslovakia</i>
		<i>Germany</i>

*There were 18 entries from 14 nations; 16 participants from 14 nations.*

**World Records : Press—151 kg.,** Davis (U.S.A.), 1948; **Snatch—139.5 kg.,** Davis (U.S.A.), 1947; **Jerk—174.5 kg.,** Davis (U.S.A.) 1947.

**Best total in World Championships : 455 kg.,** Davis (U.S.A.), Philadelphia, 1947.

**Olympic Record : 410 kg.,** Manger (Germany), Berlin, 1936.

*Referee: Dame (France). Judges: Smith (U.S.A.); Ganguly (India).*

The first line of figures against each competitor gives the weight in kilos.; the second line, the corresponding figure in pounds. The figures in italics represent unsuccessful attempts.

Place	Name	Country	Body-weight in Kilos.	Press			Snatch			Jerk			Total				
				1	2	3	Best	1	2	3	Best	1		2	3	Best	
1	<b>J. DAVIS</b> .....	U.S.A.	98.640	137.5	147.5	—	<b>137.5*</b>	127.5	137.5	142.5	165	177.5	177.5	177.5	177.5	177.5	452.5*
2	<b>N. SCHEMANSKY</b> .....	U.S.A.	92.610	303	325	—	<b>303*</b>	281	303	314	363¾	391¼	391¼	391¼	391¼	391¼	997¼*
3	<b>A. CHARITE</b> .....	Holland	102.500	259	270	275½	<b>270</b>	281	292	303	352½	374¾	374¾	374¾	374¾	374¾	425
4	<b>A. Knight</b> .....	Great Britain	99.200	264½	195	127.5	<b>127.5</b>	117.5	122.5	125	125	150	155	160	160	160	412.5
5	<b>H. Moustafa</b> .....	Egypt	102.600	112.5	117.5	122.5	<b>117.5</b>	112.5	117.5	120	275½	330½	341½	352½	352½	352½	909
6	<b>N. Petersen</b> .....	Denmark	98.280	248	259	270	<b>259</b>	248	259	264½	319½	341½	341½	341½	341½	341½	390
7	<b>R. Allart</b> .....	Belgium	101.040	112.5	117.5	120	<b>120</b>	110	115	115	145	150	155	155	155	155	859½
8	<b>P. Taljaard</b> .....	South Africa	105.250	248	259	264½	<b>264½</b>	242½	253½	253½	319½	330½	341½	341½	341½	341½	385
9	<b>A. Parera</b> .....	Cuba	96.870	105	110	110	<b>105</b>	105	112.5	112.5	115	115	115	115	115	115	382.5
				231¼	242½	242½	<b>231¼</b>	231¼	248	248	248	248	248	248	248	248	848½
				231¼	242½	242½	<b>231¼</b>	231¼	248	248	248	248	248	248	248	248	843
				231¼	242½	242½	<b>231¼</b>	231¼	248	248	248	248	248	248	248	248	377.5
				231¼	242½	242½	<b>231¼</b>	231¼	248	248	248	248	248	248	248	248	832
				231¼	242½	242½	<b>231¼</b>	231¼	248	248	248	248	248	248	248	248	375
				231¼	242½	242½	<b>231¼</b>	231¼	248	248	248	248	248	248	248	248	826½
				231¼	242½	242½	<b>231¼</b>	231¼	248	248	248	248	248	248	248	248	372.5
				231¼	242½	242½	<b>231¼</b>	231¼	248	248	248	248	248	248	248	248	820¾

\* Olympic record. † World and Olympic record.

## HEAVYWEIGHT—continued

Place	Name	Country	Body-weight in Kilos	Press				Snatch			Jerk			Total		
				1	2	3	Best	1	2	3	Best	1	2		3	Best
10	C. Dominguez Mavila .....	Peru	97.000	112.5	117.5	117.5	117.5	105	110	110	105	135	140	142.5	140	362.5
11	H. Valiarino .....	Argentina	101.080	100	105	105	100	107.5	112.5	112.5	107.5	145	152.5	152.5	145	798¾
12	R. Magee .....	Australia	115.700	220¼	231¼	231¼	220¼	236¾	248	248	248	319½	336	336	319½	787¾
13	L. Briola .....	Argentina	95.340	242½	253½	253½	242½	231¼	244	248	242½	286½	303	319½	303	788
14	F. Eibler .....	Austria	84.350	242½	253½	253½	242½	214¾	225¾	236¾	225¾	286½	297½	308½	297½	765¾
15	M. N. Butt .....	Pakistan	86.150	209¼	225¾	231¼	225¾	220¼	236¾	236¾	220¼	125	130	130	125	327.5
16	R. Dandamudi .....	India	91.700	187¼	203¾	209¼	203¾	198¼	209¼	241¾	214¾	264½	275½	281	275½	705
				187¼	203¾	209¼	203¾	187¼	198¼	203¾	198¼	248	259	270	270	672

# WRESTLING

In 1908, when the fourth celebration of the modern Olympic Games took place in London, at the White City, eleven countries entered representatives for the wrestling events. The number of contestants was 133.

In the 1948 Games, decided at the Empress Hall, Earls Court, 27 nations entered 266 competitors, of whom 229 actually competed.

One reason for these numerical increases over the 1908 figures, is the addition made in the number of weight classes. By 1948, these had been increased to 8 in each style.

Undoubtedly the growth of the Olympic Games accounts for much of the development in wrestling during the last forty years. During this period, Olympic Associations have been established in countries which, forty years ago, had little knowledge of the Olympic movement and less interest in the encouragement of national athletic recreations. In 1908, there was no international body controlling amateur wrestling, and there were no generally accepted definitions, rules and regulations governing the sport.

The I.A.W.F. was not founded until the year after the Games at Antwerp in 1920, when the proposal to form an international federation for Free-style wrestling, emanating from Great Britain, was received with acclamation by representatives of several European nations, the U.S.A. and Canada. To it was added Sweden's suggestion that the federation should control both Free and Greco-Roman styles.

## **Turkish Victories**

The most striking result of the 1948 wrestling was the strong challenge offered by the Turks to the Swedish wrestlers who, in past Olympiads, had proved so formidable. Four first and two second places were gained in Free-style by the Turks, the Swedes gaining three second places.

The Turkish victories in the Greco-Roman style were somewhat unexpected for it is Free-style wrestling in Turkey which has always been highly popular and, if its exponents were not greatly skilled, the deficiency was well made up by their great strength. " Strong as a Turk " is an almost proverbial expression, and the Turkish wrestlers at the Empress Hall proved themselves worthy of the saying. Not only were they strong, but their technique evidenced the advantage taken of the skilled instructors whose services had been employed during the preceding two or three years. The condition of the men was magnificent. Never has a better trained team of wrestlers taken part in Olympic contests.

If, however, Turkish victories in the Free-style occasioned no great surprise, the 2 first and 2 second places won in the Greco-Roman style most certainly did. The featherweight and heavyweight gold medals went to Turkey.

The reverses suffered by the Swedes in the Free-style were more than counter-balanced by their successes in the Greco-Roman contests, in which they gained no fewer than 5 first and 2 second places. The eighth gold medal went to a clever Italian wrestler in the flyweight class, P. Lombardi, who won the final bout on points against Olcay, a Turk, the judges not being unanimous in their verdict.

In neither style did Finland, the historic wrestling rival of Sweden, meet with her successes of previous Games. Nonetheless, V. Viitala succeeded in winning the flyweight (Free-style) gold medal, defeating both the Turkish and Swedish champions, and they also gained a second place in the light-heavy class (Greco-Roman).

The Greco-Roman style of wrestling has little following in America, but at Free-style the U.S.A. wrestlers again proved themselves among the best in the world. Their gold medal winners were G. Brand, middleweight, and H. Wittenberg, light-heavy. Their entry for the bantam class, G. Leeman, took second place, beaten in the final by N. Akar (Turkey).

Brand had the distinction of securing a fall from A. Candemir (Turkey), who had been expected to have the weight at his mercy. For his final bout with Linden (Sweden) the American's forthright methods against a clever and stubborn opponent gave him a well-deserved points victory.

### **A Battle of Styles**

The final contest in the light-heavy class, between H. Wittenberg and F. Stoeckli (Switzerland), went the full 20 minutes, the former obtaining the verdict, though there was disagreement among the judges. Each man had secured a verdict in earlier rounds over the much-fancied Swede, B. Fahlkvist, and an interesting contest was expected. Hopes were not disappointed. It was a battle of styles, of differing systems of technique. The Swiss, like so many of his countrymen, showed a preference for "doing his wrestling on his feet," (the Swiss national style, Schwingen, is practically all upstanding wrestling) whereas the American showed to greater advantage in the ground work. Stoeckli, having secured the requisite hold, attempted a cross-buttock and only the American's great strength prevented his being brought down. Stoeckli persisted and by a great effort brought down his opponent, but in a sidelong position, and strive as he might the Swiss could not bring the two shoulders nearer to the mat. The bout ended with the American in the uppermost position, but if ever a wrestler deserved to win it was Stoeckli.

The Free-style heavyweight event attracted only 9 contestants. Hungary supplied the gold medallist in G. Bobis, an old hand at the game, whose craft and skill enabled him to defeat not only the gigantic Czechoslovakian, Ruzicka, but won him a points victory (the judges disagreed) over the Swede, B. Antonsson, the champion of Europe.

Armstrong, the Australian victor on points over the British champion, F. A. Oberlander, and over Esen (Turkey) by a fall, lost by a fall to Antonsson in the contest for second place.

Y. Dogu (Turkey) had been considered the probable Olympic Free-style welterweight champion, and fulfilled this expectation in his usual forceful manner. The longer he wrestled the stronger he seemed to become. After defeating four opponents, each by a fall, in less than 25 minutes of actual wrestling and beating Merrill (U.S.A.), a very clever wrestler, on points, he met the Australian, R. Garrard, in the last bout. Garrard, who has a fine record, proved himself almost as tough as the Turk, and quite as willing as Dogu to spare neither himself nor his opponent, but the Turk beat him in just under 7 minutes.

**FEDERATION INTERNATIONALE DE LUTTE AMATEUR**

**JURY OF APPEAL**

- J. PEREL *Holland*  
 H. OTOPALIK *U.S.A.*  
 F. PILLITZ *Hungary*  
 PER TAMM *Sweden*  
 V. EMRE *Turkey*  
 P. LONGHURST *Great Britain*  
 J. COMBES *Luxembourg*

**CONDITIONS**

The Olympic wrestling tournaments are run on the basis that a man must receive five bad points before being eliminated from the competition. Bad points are scored as follows :—

A win by a fall .....	0 bad points.
A win by judges' decision, whether unanimous or not .....	1 bad point.
A loss by judges' decision, if judges not unanimous .....	2 bad points.
A loss by judges' decision, if judges unanimous .....	3 bad points.
A loss by a fall .....	3 bad points.

When the draw is made, competitors are paired in the order of the draw for the first round. In subsequent rounds competitors who have not been eliminated meet the next competitor on the list with whom they have not yet wrestled.

The maximum length of a bout is 20 minutes in Greco-Roman contests and 15 minutes in Free Style contests. Unless a fall has been secured by either competitor before this time, a decision is then given by the judges. A fall is secured when both shoulders of a wrestler are simultaneously in contact with the mat for however short a length of time.

If no fall has been secured in the first 10 minutes of a Greco-Roman contest or in the first 6 minutes of a Free Style contest the judges decide whether either competitor has shown a definite superiority. If neither has done so, 6 minutes ground wrestling is ordered, each competitor taking the underneath position for 3 minutes. The order of taking the underneath position is decided by lot.

If one of the competitors has shown a definite superiority he is allowed the choice of continuing the bout in the normal way or of having the six minutes of ground wrestling as described above.

If there is still no fall during the six minutes of ground wrestling, the remainder of the contest (3 minutes in Free Style or 4 minutes in Greco-Roman) is wrestled in the normal manner.

## GRECO-ROMAN STYLE

### FLYWEIGHT

Up to 52 kg. (114½ lbs.)

This event was included in the Olympic programme for the first time

There were 18 entries from 14 nations ; 13 participants from 13 nations

#### ROUND 1

Moller, M. ( <i>Sweden</i> ) beat Lamot, A. ( <i>Belgium</i> ) (Retired) .....	3 m. 34 s.
Saure, G. ( <i>France</i> ) beat Sidani, A. ( <i>Lebanon</i> ) (Judges disagreed) .....	Points
Szilagyi, G. ( <i>Hungary</i> ) beat Varela, M. ( <i>Argentine</i> ) (Fall) .....	12 m. 3 s.
Abd El Al, M. ( <i>Egypt</i> ) beat MacGuffie, W. ( <i>Great Britain</i> ) (Fall) .....	7 m. 9 s.
Olcay, K. ( <i>Turkey</i> ) beat Clausen, F. ( <i>Norway</i> ).....	Points
Lombardi, P. ( <i>Italy</i> ) beat Thomsen, S. ( <i>Denmark</i> ) .....	Points
Kangasmaki, R. ( <i>Finland</i> ) a Bye.	

#### ROUND 2

Kangasmaki, R. ( <i>Finland</i> ) beat Moller, M. ( <i>Sweden</i> ) (Judges disagreed) .....	Points
Szilagyi, G. ( <i>Hungary</i> ) beat Saure, C. ( <i>France</i> ) .....	Points
Varela, M. ( <i>Argentine</i> ) beat Sidani, A. ( <i>Lebanon</i> ) (Fall) .....	9 m. 47 s.
Clausen, F. ( <i>Norway</i> ) beat MacGuffie, W. ( <i>Great Britain</i> ) (Fall) .....	4 m. 17 s.
Lombardi, P. ( <i>Italy</i> ) beat Abd El Al, M. ( <i>Egypt</i> ) (Fall) .....	10 m. 45 s.
Olcay, K. ( <i>Turkey</i> ) beat Thomsen, S. ( <i>Denmark</i> ) .....	Points
Lamot, A. ( <i>Belgium</i> ) (Retired).	

#### ROUND 3

Kangasmaki, R. ( <i>Finland</i> ) beat Saure, C. ( <i>France</i> ) (Fall) .....	6 m. 9 s.
Moller, M. ( <i>Sweden</i> ) beat Szilagyi, G. ( <i>Hungary</i> ) (Judges disagreed) .....	Points
Clausen, F. ( <i>Norway</i> ) beat Varela, M. ( <i>Argentine</i> ) .....	Points
Olcay, K. ( <i>Turkey</i> ) beat Abd El Al, M. ( <i>Egypt</i> ) (Fall) .....	4 m. 45 s.
Lombardi, P. ( <i>Italy</i> ) a Bye.	

#### ROUND 4

Lombardi, P. ( <i>Italy</i> ) beat Kangasmaki, R. ( <i>Finland</i> ) .....	Points
Moller, M. ( <i>Sweden</i> ) beat Clausen, F. ( <i>Norway</i> ) (Fall) .....	11 m. 19 s.
Szilagyi, G. ( <i>Hungary</i> ) beat Olcay, K. ( <i>Turkey</i> ) (Judges disagreed) .....	Points

#### ROUND 5

Lombardi, P. ( <i>Italy</i> ) beat Moller, M. ( <i>Sweden</i> ) .....	Points
Szilagyi, G. ( <i>Hungary</i> ) beat Kangasmaki, R. ( <i>Finland</i> ) (Judges disagreed).....	Points
Olcay, K. ( <i>Turkey</i> ) a Bye.	

#### ROUND 6

Lombardi, P. ( <i>Italy</i> ) beat Olcay, K. ( <i>Turkey</i> ) (Judges disagreed) .....	Points
---	--------

#### FINAL PLACINGS

1 <b>LOMBARDI, P.</b> ( <i>Italy</i> ).	4 Moller, M. ( <i>Sweden</i> ).
2 <b>OLCAY, K.</b> ( <i>Turkey</i> ).	5 Szilagyi, G. ( <i>Hungary</i> ).
3 <b>KANGASMAKI, R.</b> ( <i>Finland</i> ).	6 Clausen, F. ( <i>Norway</i> ).

**BANTAMWEIGHT**

Up to 57 kg. (125½ lbs.)

*Previous Olympic Winners*

1924	E. Putsep	<i>Estonia</i>	1932	J. Brendel	<i>Germany</i>
1928	K. Leucht	<i>Germany</i>	1936	M. Lorincz	<i>Hungary</i>

---

There were 22 entries from 17 nations ; 13 participants from 13 nations

---

## ROUND 1

Maerlie, R. ( <i>Norway</i> ) beat Elias, K. ( <i>Austria</i> ) .....	Points
Aly, M. ( <i>Egypt</i> ) beat Lejserowitz, I. ( <i>Denmark</i> ) (Judges disagreed) .....	Points
Pettersen, K. ( <i>Sweden</i> ) beat Suppo, F. ( <i>Italy</i> ) (Fall) .....	11 m. 54 s.
Benzce Biringer, L. ( <i>Hungary</i> ) beat Lempinen, T. ( <i>Finland</i> ) (Judges disagreed) .....	Points
Kaya, H. ( <i>Turkey</i> ) beat Arenzana, J. ( <i>France</i> ) (Fall) .....	12 m. 1 s.
Bids, N. ( <i>Greece</i> ) beat Irvine, K. ( <i>Great Britain</i> ) (Fall) .....	5 m. 46 s.
Flamini, E. ( <i>Argentina</i> ) a Bye.	

## ROUND 2

Elias, K. ( <i>Austria</i> ) beat Flamini, E. ( <i>Argentina</i> ) .....	Points
Aly, M. ( <i>Egypt</i> ) beat Suppo, F. ( <i>Italy</i> ) (Fall) .....	5 m. 49 s.
Maerlie, R. ( <i>Norway</i> ) and Lejserowitz, I. ( <i>Denmark</i> ) both declared Losers. ....	
Pettersen, K. ( <i>Sweden</i> ) beat Benzce Biringer, L. ( <i>Hungary</i> ) .....	Points
Lempinen, T. ( <i>Finland</i> ) beat Arenzana, J. ( <i>France</i> ) (Fall) .....	8 m. 16 s.
Kaya, H. ( <i>Turkey</i> ) beat Biris, B. ( <i>Greece</i> ) .....	13 m. 55 s.
Irvine, K. ( <i>Great Britain</i> ) a Bye.	

## ROUND 3

Flamini, E. ( <i>Argentina</i> ) beat Irvine, K. ( <i>Great Britain</i> ) (Fall) .....	12 m. 43 s.
Aly, M. ( <i>Egypt</i> ) beat Elias, K. ( <i>Austria</i> ) (Fall) .....	8 m. 14 s.
Maerlie, R. ( <i>Norway</i> ) beat Pettersen, K. ( <i>Sweden</i> ) .....	Points
Benzce Biringer, L. ( <i>Hungary</i> ) beat Kaya, H. ( <i>Turkey</i> ) .....	Points
Lempinen, T. ( <i>Finland</i> ) beat Biris, M. ( <i>Greece</i> ) (Fall) .....	3 m. 53 s.

## ROUND 4

Aly, M. ( <i>Egypt</i> ) beat Flamini, E. ( <i>Argentina</i> ) (Fall) .....	19 m. 53 s.
Pettersen, K. ( <i>Sweden</i> ) beat Lempinen, T. ( <i>Finland</i> ) (Fall) .....	14 m. 17 s.
Kaya, H. ( <i>Turkey</i> ) a Bye.	

## ROUND 5

Aly, M. ( <i>Egypt</i> ) beat Kaya, H. ( <i>Turkey</i> ) .....	Points
Pettersen, K. ( <i>Sweden</i> ) a Bye.	

## ROUND 6

Pettersen, K. ( <i>Sweden</i> ) beat Aly, M. ( <i>Egypt</i> ) .....	Points
---	--------

## FINAL PLACINGS

1	<b>PETTERSEN, K.</b> ( <i>Sweden</i> ).	4	Lempinen, T. ( <i>Finland</i> ).
2	<b>ALY, M.</b> ( <i>Egypt</i> ).	5	Flamini, E. ( <i>Argentina</i> ).
3	<b>KAYA, H.</b> ( <i>Turkey</i> )	6	{ Maerlie, R. ( <i>Norway</i> ).
			{ Benzce Biringer, L. ( <i>Hungary</i> ).



**FEATHERWEIGHT**

Up to 62 kg. (136½ lbs.)

*Previous Olympic Winners*

1912	K. Koskela	<i>Finland</i>	1928	W. Vali	<i>Estonia</i>
1920	O. Friman	<i>Finland</i>	1932	G. Gozzi	<i>Italy</i>
1924	K. Antila	<i>Finland</i>	1936	Y. Erkan	<i>Turkey</i>

---

There were 24 entries from 19 nations ; 17 participants from 17 nations

---

## ROUND 1

Talosela, E. ( <i>Finland</i> ) beat Kandil, S. ( <i>Egypt</i> ) .....	Points
Dijk, H. ( <i>Holland</i> ) beat Blebel, O. ( <i>Argentina</i> ) .....	Points
Campanella, L. ( <i>Italy</i> ) beat Gryllos, A. ( <i>Greece</i> ) (Fall) .....	10 m. 0 s.
Solsvik, E. ( <i>Norway</i> ) beat Muller, A. ( <i>Switzerland</i> ) .....	Points
Taha, S. ( <i>Lebanon</i> ) beat Strasser, R. ( <i>Luxembourg</i> ) (Fall) .....	1 m. 46 s.
Toth, F. ( <i>Hungary</i> ) beat Stehlik, J. ( <i>Czechoslovakia</i> ) (Judges disagreed) .....	Points
Merle, A. ( <i>France</i> ) beat Mortimer, J. ( <i>Great Britain</i> ) (Fall) .....	1 m. 51 s.
Anderberg, O. ( <i>Sweden</i> ) beat Weidner, G. ( <i>Austria</i> ) (Fall) .....	14 m. 29 s.
Oktav, M. ( <i>Turkey</i> ) a Bye.	

## ROUND 2

Oktav, M. ( <i>Turkey</i> ) beat Talosela, E. ( <i>Finland</i> ) .....	Points
Kandil, S. ( <i>Egypt</i> ) beat Dijk, H. ( <i>Holland</i> ) .....	Points
Gryllos, A. ( <i>Greece</i> ) beat Blebel, O. ( <i>Argentina</i> ) (Judges disagreed) .....	Points
Campanella, L. ( <i>Italy</i> ) beat Solsvik, E. ( <i>Norway</i> ) (Judges disagreed) .....	Points
Toth, F. ( <i>Hungary</i> ) beat Mortimer, J. ( <i>Great Britain</i> ) (Fall) .....	5 m. 1 s.
Weidner, G. ( <i>Austria</i> ) beat Strasser, R. ( <i>Luxembourg</i> ) (Fall) .....	1 m. 51 s.
Taha, S. ( <i>Lebanon</i> ) beat Merle, A. ( <i>France</i> ) .....	Points
Anderberg, O. ( <i>Sweden</i> ) a Bye.	
Muller, A. ( <i>Switzerland</i> ) (over weight), Stehlik, J. ( <i>Czechoslovakia</i> ) (Retired).	

## ROUND 3

Oktav, M. ( <i>Turkey</i> ) beat Anderberg, O. ( <i>Sweden</i> ) (Fall) .....	2 m. 48 s.
Talosela, E. ( <i>Finland</i> ) beat Dijk, H. ( <i>Holland</i> ) (Fall) .....	7 m. 21 s.
Kandil, S. ( <i>Egypt</i> ) beat Gryllos, A. ( <i>Greece</i> ) (Fall) .....	3 m. 31 s.
Campanella, L. ( <i>Italy</i> ) beat Toth, F. ( <i>Hungary</i> ) (Judges disagreed) .....	Points
Solsvik, E. ( <i>Norway</i> ) beat Merle, A. ( <i>France</i> ) .....	Points
Weidner, G. ( <i>Austria</i> ) beat Taha, S. ( <i>Lebanon</i> ) (Fall) .....	11 m. 21 s.

## ROUND 4

Anderberg, O. ( <i>Sweden</i> ) beat Talosela, E. ( <i>Finland</i> ) (Fall) .....	13 m. 2 s.
Oktav, M. ( <i>Turkey</i> ) beat Kandil, S. ( <i>Egypt</i> ) .....	Points
Campanella, L. ( <i>Italy</i> ) beat Taha, S. ( <i>Lebanon</i> ) .....	Points
Toth, F. ( <i>Hungary</i> ) beat Solsvik, E. ( <i>Norway</i> ) (Fall) .....	16 m. 36 s.
Weidner, G. ( <i>Austria</i> ) a Bye.	

## ROUND 5

Oktav, M. ( <i>Turkey</i> ) beat Weidner, G. ( <i>Austria</i> ) (Judges disagreed) .....	Points
Anderberg, O. ( <i>Sweden</i> ) beat Campanella, L. ( <i>Italy</i> ) (Fall) .....	13 m. 2 s.
Toth, F. ( <i>Hungary</i> ) a Bye.	

## ROUND 6

Anderberg, O. ( <i>Sweden</i> ) beat Toth, F. ( <i>Hungary</i> ) (Fall) .....	15 m. 30 s.
---	-------------

## FINAL PLACINGS

1	<b>OKTAV, M.</b> ( <i>Turkey</i> ).	5	Campanella, L. ( <i>Italy</i> ).
2	<b>ANDERBERG, O.</b> ( <i>Sweden</i> ).	}	Talosela, E. ( <i>Finland</i> ).
3	<b>TOTH, F.</b> ( <i>Hungary</i> ).		Kandil, S. ( <i>Egypt</i> ).
4	Weidner, G. ( <i>Austria</i> ).	6	Taha, S. ( <i>Lebanon</i> ).
			Solsvik, E. ( <i>Norway</i> ).

**LIGHTWEIGHT**

Up to 67 kg. (147½ lbs.)

*Previous Olympic Winners*

1908	E. Porto	<i>Italy</i>	1928	L. Keresztes	<i>Hungary</i>
1912	E. Ware	<i>Finland</i>	1932	E. Malmberg	<i>Sweden</i>
1920	E. Ware	<i>Finland</i>	1936	L. Koskila	<i>Finland</i>
1924	O. Friman	<i>Finland</i>			

---

There were 22 entries from 18 nations ; 17 participants from 17 nations

---

**ROUND 1**

Gesino, G. ( <i>Italy</i> ) beat Rombaut, F. ( <i>Belgium</i> ) .....	Points
Ferencz, K. ( <i>Hungary</i> ) beat Eriksen, A. ( <i>Norway</i> ) .....	Points
Petmezas, G. ( <i>Greece</i> ) beat Osman, M. ( <i>Egypt</i> ) .....	Points
Damage, C. ( <i>Lebanon</i> ) beat Rosado, L. ( <i>Argentina</i> ) (Fall).....	11 m. 17 s.
Kurland, A. ( <i>Denmark</i> ) beat Jauch, A. ( <i>Switzerland</i> ) (Retired) .....	9 m. 53 s.
Senol, A. ( <i>Turkey</i> ) beat Falaux, A. ( <i>France</i> ) (Judges disagreed).....	Points
Freij, K. ( <i>Sweden</i> ) beat Myland, R. ( <i>Great Britain</i> ) (Fall) .....	9 m. 27 s.
Tuhý, V. ( <i>Czechoslovakia</i> ) beat Virtanen, E. ( <i>Finland</i> ) .....	Points
Munnikes, J. ( <i>Holland</i> ) a Bye. ....	

**ROUND 2**

Munnikes, J. ( <i>Holland</i> ) beat Rombaut, F. ( <i>Belgium</i> ) (Fall) .....	7 m. 35 s.
Eriksen, A. ( <i>Norway</i> ) beat Gesino, G. ( <i>Italy</i> ) (Judges disagreed).....	Points
Ferencz, K. ( <i>Hungary</i> ) beat Osman, M. ( <i>Egypt</i> ) (Judges disagreed).....	Points
Petmezas, G. ( <i>Greece</i> ) beat Rosado, L. ( <i>Argentina</i> ) (Fall).....	19 m. 52 s.
Damage, C. ( <i>Lebanon</i> ) beat Kurland, A. ( <i>Denmark</i> ) .....	Points
Freij, K. ( <i>Sweden</i> ) beat Falaux, A. ( <i>France</i> ) (Fall) .....	3 m. 57 s.
Senol, A. ( <i>Turkey</i> ) beat Myland, R. ( <i>Great Britain</i> ) (Fall) .....	2 m. 21 s.
Virtanen, E. ( <i>Finland</i> ) a Bye. ....	

**ROUND 3**

Virtanen, E. ( <i>Finland</i> ) beat Munnikes, J. ( <i>Holland</i> ) .....	Points
Ferencz, K. ( <i>Hungary</i> ) beat Gesino, G. ( <i>Italy</i> ) (Judges disagreed).....	Points
Eriksen, A. ( <i>Norway</i> ) beat Petmezas, G. ( <i>Greece</i> ) (Declared Loser) .....	17 m. 41 s.
Damage, C. ( <i>Lebanon</i> ) beat Senol, A. ( <i>Turkey</i> ).....	Points
Freij, K. ( <i>Sweden</i> ) beat Kurland, A. ( <i>Denmark</i> ) (Judges disagreed) .....	Points

**ROUND 4**

Eriksen, A. ( <i>Norway</i> ) beat Virtanen, E. ( <i>Finland</i> ) (Retired) .....	16 m. 39 s.
Ferencz, K. ( <i>Hungary</i> ) beat Munnikes, J. ( <i>Holland</i> ) (Fall) .....	1 m. 48 s.
Damage, C. ( <i>Lebanon</i> ) beat Petmezas, G. ( <i>Greece</i> ) .....	Points
Freij, K. ( <i>Sweden</i> ) beat Senol, A. ( <i>Turkey</i> ) (Fall) .....	2 m. 14 s.

**ROUND 5**

Freij, K. ( <i>Sweden</i> ) beat Ferencz, K. ( <i>Hungary</i> ) .....	Points
Eriksen, A. ( <i>Norway</i> ) beat Damage, C. ( <i>Lebanon</i> ) .....	Points

**ROUND 6**

Ferencz, K. ( <i>Hungary</i> ) beat Damage, C. ( <i>Lebanon</i> ) (Judges disagreed) .....	Points
--	--------

**FINAL PLACINGS**

1 <b>FREIJ, K.</b> ( <i>Sweden</i> ).	5 Munnikes, J. ( <i>Holland</i> ).
2 <b>ERIKSEN, A.</b> ( <i>Norway</i> ).	6 } Petmezas, G. ( <i>Greece</i> ).
3 <b>FERENCZ, K.</b> ( <i>Hungary</i> ).	6 } Senol, A. ( <i>Turkey</i> )
4 Damage, C. ( <i>Lebanon</i> ).	6 } Virtanen, E. ( <i>Finland</i> ).

**WELTERWEIGHT**

Up to 73 kg. (160½ lbs.)

*Previous Olympic Winners*1932 I. Johansson *Sweden*1936 R. Svedberg *Sweden*

---

There were 23 entries from 17 nations ; 16 participants from 16 nations

---

**ROUND 1**

Szilvassy, M. ( <i>Hungary</i> ) beat Dobbelaere, J. ( <i>Belgium</i> ) .....	Points
Schmidt, J. ( <i>Austria</i> ) beat Wilson, J. A. ( <i>Great Britain</i> ) (Fall) .....	6 m. 13 s.
Chesneau, R. ( <i>France</i> ) beat Felgen, N. ( <i>Luxembourg</i> ) (Fall) .....	17 m. 37 s.
Longarela, A. ( <i>Argentine</i> ) beat Digglemann, R. ( <i>Switzerland</i> ) (Judges disagreed) .....	Points
Mannikko, V. ( <i>Finland</i> ) beat Ozdemir, A. ( <i>Turkey</i> ) .....	Points
Cook, B. ( <i>Norway</i> ) beat Rigamonti, L. ( <i>Italy</i> ) .....	Points
Hansen, H. ( <i>Denmark</i> ) beat Munir, K. ( <i>Egypt</i> ) (Fall) .....	8 m. 14 s.
Andersson, E. G. ( <i>Sweden</i> ) beat Schouten, J. ( <i>Holland</i> ) (Fall) .....	14 m. 49 s.

**ROUND 2**

Dobbelaere, J. ( <i>Belgium</i> ) beat Wilson J. A. ( <i>Great Britain</i> ) (Fall) .....	2 m. 38 s.
Szilvassy, M. ( <i>Hungary</i> ) beat Schmidt, J. ( <i>Austria</i> ) .....	Points
Felgen, N. ( <i>Luxembourg</i> ) beat Digglemann, R. ( <i>Switzerland</i> ) (Fall).....	14 m. 18 s.
Cook, B. ( <i>Norway</i> ) beat Mannikko, V. ( <i>Finland</i> ) .....	Points
Chesneau, R. ( <i>France</i> ) beat Longarella, A. ( <i>Argentine</i> ) .....	Points
Rigamonti, L. ( <i>Italy</i> ) beat Munir, K. ( <i>Egypt</i> ) (Fall) .....	12 m.48 s.
Andersson, E. G. ( <i>Sweden</i> ) beat Hansen, H. ( <i>Denmark</i> ) .....	Points
Schouten, J. ( <i>Holland</i> ) a Bye.	

**ROUND 3**

Szilvassy, M. ( <i>Hungary</i> ) beat Chesneau, R. ( <i>France</i> ) (Fall) .....	19 m. 1 s.
Schmidt, J. ( <i>Austria</i> ) beat Felgen, N. ( <i>Luxembourg</i> ) .....	Points
Mannikko, V. ( <i>Finland</i> ) beat Longarella, A. ( <i>Argentine</i> ) (Fall) .....	3 m. 48 s.
Hansen, H. ( <i>Denmark</i> ) beat Cook, B. ( <i>Norway</i> ) .....	Points
Andersson, E. G. ( <i>Sweden</i> ) beat Rigamonti, L. ( <i>Italy</i> ) .....	Points

**ROUND 4**

Szilvassy, M. ( <i>Hungary</i> ) beat Mannikko, V. ( <i>Finland</i> ) .....	Points
Hansen, H. ( <i>Denmark</i> ) beat Schmidt, J. ( <i>Austria</i> ) (Fall) .....	12 m. 10 s.
Andersson, E. G. ( <i>Sweden</i> ) beat Chesneau, R. ( <i>France</i> ) .....	Points

**ROUND 5**

Szilvassy, M. ( <i>Hungary</i> ) beat Hansen, H. ( <i>Denmark</i> ) (Fall) .....	8 m. 36 s.
Andersson, E. G. ( <i>Sweden</i> ) a Bye.	

**ROUND 6**

Andersson, E. G. ( <i>Sweden</i> ) beat Szilvassy, M. ( <i>Hungary</i> ) .....	Points
--	--------

**FINAL PLACINGS**

1 <b>ANDERSSON, E. G.</b> ( <i>Sweden</i> ).	4 {	Schmidt, J. ( <i>Austria</i> ).
2 <b>SZILVASSY, M.</b> ( <i>Hungary</i> ).		Chesneau, R. ( <i>France</i> ).
3 <b>HANSEN, H.</b> ( <i>Denmark</i> ).		Mannikko, V. ( <i>Finland</i> ).

**MIDDLEWEIGHT**

Up to 79 kg. (174 lbs.)

*Previous Olympic Winners*

1908 F. Martensson	<i>Sweden</i>	1928 V. A. Kokkinen	<i>Finland</i>
1912 C. Johansson	<i>Sweden</i>	1932 V. A. Kokkinen	<i>Finland</i>
1920 C. Westergren	<i>Sweden</i>	1936 I. Johnansson	<i>Sweden</i>
1924 E. Westerlund	<i>Finland</i>		

---

There were 20 entries from 15 nations ; 13 participants from 13 nations

---

## ROUND 1

Gronberg, R. ( <i>Sweden</i> ) beat Ahmad, A. ( <i>Egypt</i> ) (Fall) .....	17 m. 36 s.
Kinnunen, J. ( <i>Finland</i> ) beat Nemeti-Steinhardt, G. ( <i>Hungary</i> ) (Judges disagreed) .....	Points
Tayfur, M. ( <i>Turkey</i> ) beat de Groot, K. ( <i>Holland</i> ) .....	Points
Gallegati, E. ( <i>Italy</i> ) beat Bolzi, A. ( <i>Argentine</i> ) (Fall) .....	3 m. 18 s.
Vogel, A. ( <i>Austria</i> ) beat Bissell, S. ( <i>Great Britain</i> ) (Fall) .....	11 m. 55 s.
Benoy, J. ( <i>Belgium</i> ) beat Kolb, E. ( <i>Switzerland</i> ) (Fall) .....	2 m. 42 s.
Larsen, K. ( <i>Norway</i> ) a Bye.	

## ROUND 2

Gronberg, R. ( <i>Sweden</i> ) beat Larsen, K. ( <i>Norway</i> ) .....	Points
Kinnunen, J. ( <i>Finland</i> ) beat Ahmad, A. ( <i>Egypt</i> ) (Fall) .....	10 m. 59 s.
Nemeti-Steinhardt, G. ( <i>Hungary</i> ) beat de Groot, K. ( <i>Holland</i> ) (Fall) .....	1 m. 43 s.
Tayfur, M. ( <i>Turkey</i> ) beat Bolzi, A. ( <i>Argentine</i> ) (Fall) .....	2 m. 44 s.
Gallegati, E. ( <i>Italy</i> ) beat Vogel, A. ( <i>Austria</i> ) .....	Points
Benoy, J. ( <i>Belgium</i> ) beat Bissell, S. ( <i>Great Britain</i> ) (Fall) .....	9 m. 0 s.
Kolb, E. ( <i>Switzerland</i> ) a Bye.	

## ROUND 3

Larsen, K. ( <i>Norway</i> ) beat Kolb, E. ( <i>Switzerland</i> ) (Fall) .....	3 m. 29 s.
Gronberg, R. ( <i>Sweden</i> ) beat Kinnunen, J. ( <i>Finland</i> ) (Fall) .....	4 m. 29 s.
Nemeti-Steinhardt, G. ( <i>Hungary</i> ) beat Gallegati, E. ( <i>Italy</i> ) (Fall) .....	19 m. 51 s.
Tayfur, M. ( <i>Turkey</i> ) beat Vogel, A. ( <i>Austria</i> ) (Fall) .....	52 s.
Benoy, J. ( <i>Belgium</i> ) a Bye.	

## ROUND 4

Larsen, K. ( <i>Norway</i> ) beat Benoy, J. ( <i>Belgium</i> ).....	Points
Gronberg, R. ( <i>Sweden</i> ) beat Nemeti-Steinhardt, G. ( <i>Hungary</i> ).....	Points
Kinnunen, J. ( <i>Finland</i> ) beat Tayfur, M. ( <i>Turkey</i> ) .....	Points
Gallegati, E. ( <i>Italy</i> ) a Bye.	

## ROUND 5

Gronberg, R. ( <i>Sweden</i> ) beat Benoy, J. ( <i>Belgium</i> ) (Fall) .....	7 m. 8 s.
Gallegati, E. ( <i>Italy</i> ) beat Larsen, K. ( <i>Norway</i> ) .....	Points
Tayfur, M. ( <i>Turkey</i> ) a Bye.	

## ROUND 6

Gronberg, R. ( <i>Sweden</i> ) beat Tayfur, M. ( <i>Turkey</i> ) .....	Points
--	--------

## FINAL PLACINGS

1 <b>GRONBERG, R.</b> ( <i>Sweden</i> ).	4 Benoy, J. ( <i>Belgium</i> ).
2 <b>TAYFUR, M.</b> ( <i>Turkey</i> ).	5 Larsen, K. ( <i>Norway</i> ).
3 <b>GALLEGATI, E.</b> ( <i>Italy</i> ).	6 Kinnunen, J. ( <i>Finland</i> ).

**LIGHT-HEAVYWEIGHT**

Up to 87 kg. (191 lbs.)

*Previous Olympic Winners*

1908	W. Weckman	<i>Finland</i>	1924	C. O. Westergren	<i>Sweden</i>
1912	{	A. Ahlgren	<i>Sweden</i>	1928	I. Moustafa
		J. Bohling	<i>Finland</i>	1932	R. Svensson
1920		C. Johansson	<i>Sweden</i>	1936	A. Cadier
					<i>Sweden</i>

---

There were 18 entries from 14 nations ; 14 participants from 14 nations

---

**ROUND 1**

Cakmak, M. ( <i>Turkey</i> ) beat Ramirez, A. ( <i>Argentina</i> ) .....	Points
Nilsson, K. ( <i>Sweden</i> ) beat Kovacs, G. ( <i>Hungary</i> ) (Fall) .....	16 m. 18 s.
Silvestri, U. ( <i>Italy</i> ) beat Kabafli, A. ( <i>Greece</i> ) .....	Points
Grondahl, K. ( <i>Finland</i> ) beat Istaz, K. ( <i>Belgium</i> ) (Fall) .....	3 m. 54 s.
Lauridsen, E. ( <i>Denmark</i> ) beat Mahjoub, I. ( <i>Lebanon</i> ) .....	Points
Enzinger, P. ( <i>Austria</i> ) beat Dannacher, A. ( <i>Switzerland</i> ) (Fall) .....	1 m. 41 s.
Orabi, I. ( <i>Egypt</i> ) beat Richmond, K. ( <i>Great Britain</i> ) (Fall) .....	1 m. 4 s.

**ROUND 2**

Kovacs, G. ( <i>Hungary</i> ) beat Ramirez, A. ( <i>Argentina</i> ) .....	Points
Nilsson, K. ( <i>Sweden</i> ) beat Cakmak, M. ( <i>Turkey</i> ) .....	Points
Istaz, K. ( <i>Belgium</i> ) beat Kabafli, A. ( <i>Greece</i> ) .....	Points
Grondahl, K. ( <i>Finland</i> ) beat Silvestri, V. ( <i>Italy</i> ) (Retired) .....	13 m. 34 s.
Lauridsen, E. ( <i>Denmark</i> ) beat Enzinger, P. ( <i>Austria</i> ) (Fall) .....	12 m. 51 s.
Orabi, I. ( <i>Egypt</i> ) beat Dannacher, A. ( <i>Switzerland</i> ) (Fall) .....	2 m. 18 s.
Richmond, K. ( <i>Great Britain</i> ) a Bye.	
Mahjoub, I. ( <i>Lebanon</i> ) failed to weigh in.	

**ROUND 3**

Richmond, K. ( <i>Great Britain</i> ) beat Cakmak, M. ( <i>Turkey</i> ) (Fall) .....	6 m. 26 s.
Kovacs, G. ( <i>Hungary</i> ) beat Istaz, K. ( <i>Belgium</i> ) (Fall) .....	4 m. 1 s.
Nilsson, K. ( <i>Sweden</i> ) beat Lauridsen, E. ( <i>Denmark</i> ) .....	Points
Grondahl, K. ( <i>Finland</i> ) beat Enzinger, P. ( <i>Austria</i> ) .....	Points
Orabi, I. ( <i>Egypt</i> ) a Bye.	

**ROUND 4**

Kovacs, G. ( <i>Hungary</i> ) beat Orabi, I. ( <i>Egypt</i> ) .....	Points
Nilsson, K. ( <i>Sweden</i> ) beat Richmond, K. ( <i>Great Britain</i> ) (Fall) .....	9 m. 5 s.
Grondahl, K. ( <i>Finland</i> ) beat Lauridsen, E. ( <i>Denmark</i> ) (Fall) .....	14 m. 14 s.

**ROUND 5**

Nilsson, K. ( <i>Sweden</i> ) beat Orabi, I. ( <i>Egypt</i> ) (Fall) .....	15 m. 36 s.
Grondahl, K. ( <i>Finland</i> ) a Bye.	

**ROUND 6**

Nilsson, K. ( <i>Sweden</i> ) beat Grondahl, K. ( <i>Finland</i> ) .....	Points
--	--------

**FINAL PLACINGS**

1 <b>NILSSON, K.</b> ( <i>Sweden</i> ).	4 Kovacs, G. ( <i>Hungary</i> ).
2 <b>GRONDAHL, K.</b> ( <i>Finland</i> ).	5 Richmond, K. ( <i>Great Britain</i> ).
3 <b>ORABI, I.</b> ( <i>Egypt</i> ).	6 Lauridsen, E. ( <i>Denmark</i> ).

**HEAVYWEIGHT**

Over 87 kg. (191 lbs.)

*Previous Olympic Winners*

1896	K. Schumann	<i>Germany</i>	1924	H. Deglane	<i>France</i>
1908	R. Weiss	<i>Hungary</i>	1928	J. R. Svensson	<i>Sweden</i>
1912	Y. Saarela	<i>Finland</i>	1932	C. Westergren	<i>Sweden</i>
1920	A. Lindfors	<i>Finland</i>	1936	K. Palusalu	<i>Estonia</i>

---

There were 13 entries from 10 nations ; 9 participants from 9 nations

---

## ROUND 1

Ruzicka, J. ( <i>Czechoslovakia</i> ) beat Toragris, J. ( <i>Hungary</i> ) (Fall) .....	13 m. 27 s.
Kangasniemi, T. ( <i>Finland</i> ) beat Noya, E. ( <i>Argentine</i> ) (Fall).....	4 m. 59 s.
Nilsson, T. ( <i>Sweden</i> ) beat Pidduck, L. ( <i>Great Britain</i> ) (Fall).....	4 m. 41 s.
Kirecci, A. ( <i>Turkey</i> ) beat Inderbitzin, M. ( <i>Switzerland</i> ) (Fall) .....	13 m. 51 s.
Fantoni, G. ( <i>Italy</i> ) a Bye.	

## ROUND 2

Fantoni, G. ( <i>Italy</i> ) beat Kangasniemi, T. ( <i>Finland</i> ) (Judges disagreed) .....	Points
Toragris, J. ( <i>Hungary</i> ) beat Noya, E. ( <i>Argentine</i> ) (Fall) .....	4 m. 49 s.
Inderbitzin, M. ( <i>Switzerland</i> ) beat Pidduck, L. ( <i>Great Britain</i> ) .....	Points
Kirecci, A. ( <i>Turkey</i> ) beat Nilsson, T. ( <i>Sweden</i> ) (Fall) .....	15 m. 48 s.
Ruzicka, J. ( <i>Czechoslovakia</i> ) (Retired).	

## ROUND 3

Fantoni, G. ( <i>Italy</i> ) beat Toragris, J. ( <i>Hungary</i> ) (Fall) .....	6 m. 6 s.
Kirecci, A. ( <i>Turkey</i> ) beat Kangasniemi, T. ( <i>Finland</i> ) .....	Points
Nilsson, T. ( <i>Sweden</i> ) beat Inderbitzin, M. ( <i>Switzerland</i> ) (Fall) .....	2 m. 54 s.

## ROUND 4

Nilsson, T. ( <i>Sweden</i> ) beat Fantoni, G. ( <i>Italy</i> ) (Fall) .....	13 m. 12 s.
Kirecci, A. ( <i>Turkey</i> ) a Bye.	

## ROUND 5

Kirecci, A. ( <i>Turkey</i> ) beat Fantoni, G. ( <i>Italy</i> )	Points
---	--------

## FINAL PLACINGS

1 <b>KIRECCI, A.</b> ( <i>Turkey</i> ).	4 Kangasniemi, T. ( <i>Finland</i> ).
2 <b>NILSSON, T.</b> ( <i>Sweden</i> ).	5 Toragris, J. ( <i>Hungary</i> ).
3 <b>FANTONI, G.</b> ( <i>Italy</i> ).	6 Inderbitzin, M. ( <i>Switzerland</i> ).

**FREE STYLE****FLYWEIGHT**

Up to 52 kg. (114½ lbs.)

This event was included in the Olympic programme for the first time

---

There were 16 entries from 12 nations ; 11 participants from 11 nations

---

**ROUND 1**

Johansson, K. R. ( <i>Sweden</i> ) beat El Ward, M. ( <i>Egypt</i> ) .....	Points
Viitala, V. ( <i>Finland</i> ) beat Balamir, H. ( <i>Turkey</i> ) (Judges disagreed) .....	Points
Jernigan, B. ( <i>U.S.A.</i> ) beat Raissi, M. ( <i>Iran</i> ) .....	Points
Baudric, R. ( <i>France</i> ) beat Lamot, A. ( <i>Belgium</i> ) (Judges disagreed) .....	Points
Jadav, K. ( <i>India</i> ) beat Harris, B. ( <i>Australia</i> ) .....	Points
Parker, H. ( <i>Great Britain</i> ) a Bye.	

**ROUND 2**

Johansson, K. R. ( <i>Sweden</i> ) beat Parker, H. ( <i>Great Britain</i> ) (Fall) .....	7 m. 18 s.
Balamir, H. ( <i>Turkey</i> ) beat Baudric, R. ( <i>France</i> ) .....	Points
Viitala, V. ( <i>Finland</i> ) beat Lamot, A. ( <i>Belgium</i> ) (Fall) .....	14 m. 11 s.
Raissi, M. ( <i>Iran</i> ) beat Harris, B. ( <i>Australia</i> ) (Fall) .....	3 m. 18 s.
Jadav, K. ( <i>India</i> ) beat Jernigan, B. ( <i>U.S.A.</i> ) .....	Points
El Ward, M. ( <i>Egypt</i> ) over weight at second weighing .....	

**ROUND 3**

Baudric, R. ( <i>France</i> ) beat Parker, H. ( <i>Great Britain</i> ) (Retired)	
Balamir, H. ( <i>Turkey</i> ) beat Johansson, K. R. ( <i>Sweden</i> ) (Fall) .....	13 m. 27 s.
Viitala, V. ( <i>Finland</i> ) beat Jernigan, B. ( <i>U.S.A.</i> ) .....	Points
Raissi, M. ( <i>Iran</i> ) beat Jadav, K. ( <i>India</i> ) (Fall) .....	5 m. 31 s.

**ROUND 4**

Johansson, K. R. ( <i>Sweden</i> ) beat Baudric, R. ( <i>France</i> ) (Fall) .....	5 m. 22 s.
Balamir, H. ( <i>Turkey</i> ) beat Raissi, M. ( <i>Iran</i> ) .....	Points
Viitala, V. ( <i>Finland</i> ) a Bye.	

**ROUND 5**

Viitala, V. ( <i>Finland</i> ) beat Johansson, K. R. ( <i>Sweden</i> ) .....	Points
--	--------

**FINAL PLACINGS**

1 <b>VIITALA, V.</b> ( <i>Finland</i> ).	4 Raissi, M. ( <i>Iran</i> ).
2 <b>BALAMIR, H.</b> ( <i>Turkey</i> ).	5 Baudric, R. ( <i>France</i> ).
3 <b>JOHANSSON, K. R.</b> ( <i>Sweden</i> ).	6 Jadav, K. ( <i>India</i> ).

## BANTAMWEIGHT

Up to 57 kg. (125½ lbs.)

### Previous Olympic Winners

1908 G. Mehnert	<i>U.S.A.</i>	1932 R. E. Pearce	<i>U.S.A.</i>
1924 K. Pihlajanaki	<i>Finland</i>	1936 O. Zombori	<i>Hungar</i>
1928 K. Makinen	<i>Finland</i>		

There were 24 entries from 19 nations ; 15 participants from 15 nations

### ROUND 1

Benzce Biring, L. ( <i>Hungary</i> ) beat Johnsson, E. ( <i>Finland</i> ) (Judges disagreed) .....	Points
Persson, E. ( <i>Sweden</i> ) beat Wenger, W. ( <i>Switzerland</i> ) .....	Points
Kouyos, C. ( <i>France</i> ) beat Hafez, S. ( <i>Egypt</i> ) .....	Points
Trimpont, J. ( <i>Belgium</i> ) beat Santamaria Sotomayor, S. ( <i>Cuba</i> ) (Fall) .....	1 m. 37 s.
Akar, N. ( <i>Turkey</i> ) beat May, N. E. ( <i>Canada</i> ) (Fall) .....	2 m. 57 s.
Cazaux, R. ( <i>Great Britain</i> ) beat Vicera, F. ( <i>Philippines</i> ) .....	Points
Leeman, G. ( <i>U.S.A.</i> ) beat Bose, N. ( <i>India</i> ) (Fall) .....	7 m. 35 s.
Han, S. Y. ( <i>Korea</i> ) a Bye.	

### ROUND 2

Persson, E. ( <i>Sweden</i> ) beat Han, S. Y. ( <i>Korea</i> ) .....	Points
Akar, N. ( <i>Turkey</i> ) beat Wenger, W. ( <i>Switzerland</i> ) .....	Points
Benzce Biring, L. ( <i>Hungary</i> ) beat May, N. E. ( <i>Canada</i> ) .....	Points
Johnson, E. ( <i>Finland</i> ) beat Bose, N. ( <i>India</i> ) (Judges disagreed) .....	Points
Leeman, G. ( <i>U.S.A.</i> ) beat Cazaux, R. ( <i>Great Britain</i> ) (Fall) .....	4 m. 13 s.
Kouyos, C. ( <i>France</i> ) beat Vicera, F. ( <i>Philippines</i> ) (Fall) .....	28 s.
Hafez, S. ( <i>Egypt</i> ) beat Santamaria Sotomayor, S. ( <i>Cuba</i> ) (Fall) .....	2 m. 30 s.
Trimpont, J. ( <i>Belgium</i> ) a Bye.	

### ROUND 3

Trimpont, J. ( <i>Belgium</i> ) beat Han, S. Y. ( <i>Korea</i> ) .....	Points
Akar, N. ( <i>Turkey</i> ) beat Persson, E. ( <i>Sweden</i> ) .....	Points
Leeman, G. ( <i>U.S.A.</i> ) beat Benzce Biring, L. ( <i>Hungary</i> ) .....	Points
Kouyos, C. ( <i>France</i> ) beat Johnsson, E. ( <i>Finland</i> ) (Fall) .....	10 m. 38 s.
Cazaux, R. ( <i>Great Britain</i> ) beat Hafez, S. ( <i>Egypt</i> ) .....	Points

### ROUND 4

Akar, N. ( <i>Turkey</i> ) beat Trimpont, J. ( <i>Belgium</i> ) (Fall) .....	11 m. 19 s.
Leeman, G. ( <i>U.S.A.</i> ) beat Kouyos, C. ( <i>France</i> ) .....	Points

### ROUND 5

Leeman, G. ( <i>U.S.A.</i> ) beat Trimpont, J. ( <i>Belgium</i> ) .....	Points
Akar, N. ( <i>Turkey</i> ) beat Kouyos, C. ( <i>France</i> ) (Fall) .....	13 m. 54 s.

### ROUND 6

Akar, N. ( <i>Turkey</i> ) beat Leeman, G. ( <i>U.S.A.</i> ) (Fall) .....	8 m. 52 s.
---	------------

### FINAL PLACINGS

1 <b>AKAR, N.</b> ( <i>Turkey</i> ).	}	Persson, E. ( <i>Sweden</i> ).
2 <b>LEEMAN, G.</b> ( <i>U.S.A.</i> ).		Benzce Biring, L. ( <i>Hungary</i> )
3 <b>KOUYOS, C.</b> ( <i>France</i> ).		Hafez, S. ( <i>Egypt</i> ).
4 Trimpont, J. ( <i>Belgium</i> ).		Cazaux, R. ( <i>Great Britain</i> ).



**FEATHERWEIGHT**

Up to 62 kg. (136½ lbs.)

*Previous Olympic Winners*

1908	G. Dole	U.S.A.	1932	H. Pihlajamaki	Finland
1924	R. Reed	U.S.A.	1936	K. Pihlajamaki	Finland
1928	A. R. Morrison	U.S.A.			

---

There were 26 entries from 21 nations ; 17 participants from 17 nations

---

**ROUND 1**

Bilge, G. (Turkey) beat Sadian, H. (Iran) (Fall) .....	9 m. 13 s.
Toth, F. (Hungary) beat Crete, M. (Canada) (Fall) .....	13 m. 38 s.
Raymackers, A. (Belgium) beat Jouaville, A. (France) (Fall) .....	11 m. 56 s.
Parsons, A. (Great Britain) beat Suryavanshi, S. (India) (Judges disagreed) .....	Points
Muller, A. (Switzerland) beat Lopez Alvarez, J. (Cuba) (Judges disagreed) .....	Points
Gavelli, M. (Italy) beat Kim, Kuk Fan (Korea) (Judges disagreed) .....	Points
Sjolin, I. (Sweden) beat Hietala, P. (Finland) .....	Points
Abdel Hamid, I. (Egypt) beat Bernal Contreras, D. (Mexico) .....	Points
Moore, H. (U.S.A.) a Bye.	

**ROUND 2**

Sadian, H. (Iran) beat Moore, H. (U.S.A.) (Judges disagreed) .....	Points
Bilge, G. (Turkey) beat Toth, F. (Hungary) (Fall) .....	4 m. 1 s.
Jouaville, A. (France) beat Crete, M. (Canada) .....	Points
Raymackers, A. (Belgium) beat Parsons, A. (Great Britain) .....	Points
Muller, A. (Switzerland) beat Suryavanshi, S. (India) (Fall) .....	6 m. 32 s.
Lopez Alvarez, J. (Cuba) beat Kim, Kuk Fan (Korea) .....	Points
Hietala, P. (Finland) beat Gavelli, M. (Italy) (Fall) .....	8 m. 2 s.
Sjolin, I. (Sweden) beat Bernal Contreras, D. (Mexico) (Fall) .....	8 m. 40 s.
Abdel Hamid, I. (Egypt) a Bye.	

**ROUND 3**

Moore, H. (U.S.A.) beat Abdel Hamid, I. (Egypt) (Fall) .....	13 m. 51 s.
Toth, F. (Hungary) beat Sadian, H. (Iran) .....	Points
Bilge, G. (Turkey) beat Jouaville, A. (France) (Fall) .....	2 m. 49 s.
Muller, A. (Switzerland) beat Raymackers, A. (Belgium) (Judges disagreed) .....	Points
Parsons, A. (Great Britain) beat Gavelli, M. (Italy) (Fall) .....	11 m. 59 s.
Hietala, P. (Finland) beat Lopez Alvarez, J. (Cuba) (Fall) .....	2 m. 5 s.
Sjolin, I. (Sweden) a Bye.	

**ROUND 4**

Toth, F. (Hungary) beat Raymackers, A. (Belgium) (Fall) .....	7m. 31 s.
Bilge, G. (Turkey) beat Moore, H. (U.S.A.) (Fall) .....	14 m. 28 s.
Sjolin, I. (Sweden) beat Abdel Hamid, I. (Egypt) (Fall) .....	9 m. 7 s.
Muller, A. (Switzerland) beat Parsons, A. (Great Britain) (Fall) .....	9 m. 15 s.
Hietala, P. (Finland) a Bye.	

**ROUND 5**

Bilge, G. (Turkey) beat Hietala, P. (Finland) (Fall) .....	11 m. 10 s.
Sjolin, I. (Sweden) beat Toth, F. (Hungary) (Judges disagreed) .....	Points
Muller, A. (Switzerland) a Bye.	

**ROUND 6**

Sjolin, I. (Sweden) beat Muller, A. (Switzerland) .....	Points
Bilge, G. (Turkey) a Bye.	

**ROUND 7**

Bilge, G. (Turkey) beat Sjolin, I. (Sweden) .....	Points
---	--------

**FINAL PLACINGS**

1 <b>BILGE, G.</b> (Turkey).	4 { Toth, F. (Hungary). Hietala, P. (Finland).
2 <b>SJOLIN, I.</b> (Sweden).	
3 <b>MULLER, A.</b> (Switzerland).	6 Moore, H. (U.S.A.).

**LIGHTWEIGHT**

Up to 67 kg. (147½ lbs.)

*Previous Olympic Winners*

190	G. de Relwyskow	Great Britain	1928	O. Kapp	Estonia
192	K. Anttila	Finland	1932	C. Pacome	France
192	R. Vis	U.S.A.	1936	K. Karpati	Hungary

---

There were 25 entries from 19 nations ; 18 participants from 18 nations

---

## ROUND 1

Atik, C. (Turkey) beat Koll, W. (U.S.A.) (Fall)	7 m. 42 s.
Hassan, M. (Egypt) beat Singh, Banta (India)	Points
Ries, A. (South Africa) beat Ghaffari, A. (Iran)	Points
Kim, Suk Young (Korea) beat Abourejaile, B. (Lebanon) (Retired)	4 m. 49 s.
Cools, J. (Belgium) beat Sanchez Avila, I. (Cuba)	Points
Nizzola, G. (Italy) beat Leppanen, S. (Finland) (Judges disagreed)	Points
Plumb, G. (Canada) beat Luck, P. (Great Britain)	Points
Baumann, H. (Switzerland) beat Perez Valencia, J. (Mexico) (Fall)	5 m. 4s.
Frandsfors, G. (Sweden) beat Brazsil Bakos, L. (Hungary)	Points

## ROUND 2

Koll, W. (U.S.A.) beat Hassan, M. (Egypt)	Points
Atik, C. (Turkey) beat Singh, Banta (India) (Fall)	5 m. 8 s.
Ghaffari, A. (Iran) beat Kim, Suk Young (Korea) (Fall)	3 m. 52 s.
Leppanen, S. (Finland) beat Cools, J. (Belgium)	Points
Nizzola, G. (Italy) beat Sanchez Avila, I. (Cuba)	Points
Baumann, H. (Switzerland) beat Plumb, G. (Canada)	Points
Brazsil Bakos, L. (Hungary) beat Luck, P. (Great Britain)	Points
Frandsfors, G. (Sweden) beat Reis, A. (South Africa) (Fall)	6 m. 48 s.
Abourejaile, B. (Lebanon) and Perez Valencia, V. (Mexico) did not appear.	

## ROUND 3

Nizzola, G. (Italy) beat Cools, J. (Belgium)	Points
Leppanen, S. (Finland) beat Plumb, G. (Canada)	Points
Brazsil Bakos, L. (Hungary) beat Baumann, H. (Switzerland)	Points
Koll, W. (U.S.A.) beat Ghaffari, A. (Iran) (Fall)	9 m. 12 s.
Atik, C. (Turkey) beat Ries, A. (South Africa) (Fall)	4 m. 20 s.
Kim, Suk Young (Korea) beat Hassan, M. (Egypt)	Points
Frandsfors, G. (Sweden) a Bye.	

## ROUND 4

Frandsfors, G. (Sweden) beat Koll, W. (U.S.A.) (Judges disagreed)	Points
Atik, C. (Turkey) beat Leppanen, S. (Finland)	Points
Nizzola, G. (Italy) beat Kim, Suk Young (Korea)	Points
Baumann, H. (Switzerland) a Bye.	

## ROUND 5

Frandsfors, G. (Sweden) beat Baumann, H. (Switzerland)	Points
Atik, C. (Turkey) beat Nizzola, G. (Italy) (Fall)	5 m. 15 s.

## ROUND 6

Baumann, H. (Switzerland) beat Nizzola, G. (Italy)	Points
Atik, C. (Turkey) beat Frandsfors, G. (Sweden) (Fall)	4 m. 3 s.

## FINAL PLACINGS

1	<b>ATIK, C.</b> (Turkey).	4	Nizzola, G. (Italy).
2	<b>FRANDFORS, G.</b> (Sweden).	5	Koll, W. (U.S.A.).
3	<b>BAUMANN, H.</b> (Switzerland).	6	Leppanen, S. (Finland). Kim, Suk Young (Korea).

**WELTERWEIGHT**

Up to 73 kg. (160½ lbs.)

*Previous Olympic Winners*

1924	H. Gehri	Switzerland	1932	F. van Bebber	U.S.A.
1928	A. Haavisto	Finland	1936	F. W. Lewis	U.S.A.

---

There were 23 entries from 18 nations ; 16 participants from 16 nations

---

## ROUND 1

Sovari, K. ( <i>Hungary</i> ) beat Keisala, A. ( <i>Finland</i> ) .....	Points
Garrard, R. ( <i>Australia</i> ) beat Angst, W. ( <i>Switzerland</i> ) .....	Points
Dogu, Y. ( <i>Turkey</i> ) beat Bhargava, A. ( <i>India</i> ) (Fall) .....	2 m. 58 s.
Zandi, A. ( <i>Iran</i> ) beat Estrada Ojeda, E. ( <i>Mexico</i> ) (Fall) .....	4 m. 55 s.
Leclere, J. ( <i>France</i> ) beat Moustafa, A. ( <i>Egypt</i> ) .....	Points
Whang, Byung Kwan ( <i>Korea</i> ) beat Culot, L. ( <i>Belgium</i> ) .....	Points
Merrill, L. ( <i>U.S.A.</i> ) beat Peace, H. ( <i>Canada</i> ) .....	Points
Westergren, F. ( <i>Sweden</i> ) beat Irvine, D. ( <i>Great Britain</i> ) (Judges disagreed)	Points

## ROUND 2

Garrard, R. ( <i>Australia</i> ) beat Sovari, K. ( <i>Hungary</i> ) (Judges disagreed) .....	Points
Angst, W. ( <i>Switzerland</i> ) beat Keisala, A. ( <i>Finland</i> ) .....	Points
Bhargava, A. ( <i>India</i> ) beat Estrada Ojeda, E. ( <i>Mexico</i> ) (Judges disagreed) .....	Points
Dogu, Y. ( <i>Turkey</i> ) beat Zandi, A. ( <i>Iran</i> ) (Fall) .....	4 m. 5 s.
Moustafa, A. ( <i>Egypt</i> ) beat Whang, Byung Kwan ( <i>Korea</i> ) (Judges disagreed) .....	Points
Leclere, J. ( <i>France</i> ) beat Culot, L. ( <i>Belgium</i> ) .....	Points
Merrill, L. ( <i>U.S.A.</i> ) beat Westergren, F. ( <i>Sweden</i> ) .....	Points
Peace, H. ( <i>Canada</i> ) beat Irvine, D. ( <i>Great Britain</i> ) (Fall) .....	14 m. 31 s.

## ROUND 3

Sovari, K. ( <i>Hungary</i> ) beat Angst, W. ( <i>Switzerland</i> ) (Judges disagreed) .....	Points
Garrard, R. ( <i>Australia</i> ) beat Bhargava, A. ( <i>India</i> ) (Fall) .....	2 m. 20 s.
Dogu, Y. ( <i>Turkey</i> ) beat Moustafa, A. ( <i>Egypt</i> ) (Fall) .....	7 m. 39 s.
Westergren, F. ( <i>Sweden</i> ) beat Peace, H. ( <i>Canada</i> ) .....	Points
Leclere, J. ( <i>France</i> ) beat Zandi, A. ( <i>Iran</i> ) .....	Points
Merrill, L. ( <i>U.S.A.</i> ) beat Whang, Byung Kwan ( <i>Korea</i> ) .....	Points

## ROUND 4

Dogu, Y. ( <i>Turkey</i> ) beat Sovari, K. ( <i>Hungary</i> ) (Fall) .....	7 m. 4 s.
Garrard, R. ( <i>Australia</i> ) beat Leclere, J. ( <i>France</i> ) (Fall) .....	7 m. 1 s.
Merrill, L. ( <i>U.S.A.</i> ) a Bye.	

## ROUND 5

Merrill, L. ( <i>U.S.A.</i> ) beat Garrard, R. ( <i>Australia</i> ) (Judges disagreed) .....	Points
Dogu, Y. ( <i>Turkey</i> ) a Bye.	

## ROUND 6

Dogu, Y. ( <i>Turkey</i> ) beat Merrill, L. ( <i>U.S.A.</i> ) .....	Points
Garrard, R. ( <i>Australia</i> ) a Bye.	

## ROUND 7

Dogu, Y. ( <i>Turkey</i> ) beat Garrard, R. ( <i>Australia</i> ) (Fall) .....	6 m. 45 s.
---	------------

## FINAL PLACINGS

1 <b>DOGU, Y.</b> ( <i>Turkey</i> ).	4 Leclere, J. ( <i>France</i> ).
2 <b>GARRARD, R.</b> ( <i>Australia</i> ).	5 Sovari, K. ( <i>Hungary</i> ).
3 <b>MERRILL, L.</b> ( <i>U.S.A.</i> ).	6 Westergren, F. ( <i>Sweden</i> ).

**MIDDLEWEIGHT**

Up to 79 kg. (174 lbs.)

*Previous Olympic Winners*

1908	S. V. Bacon	Great Britain	1928	E. Kyburg	Switzerland
1920	Leino	Finland	1932	I. Johansson	Sweden
1924	F. Haggmann	Switzerland	1936	E. Pailve	France

---

There were 22 entries from 17 nations ; 16 participants from 16 nations

---

## ROUND 1

Candemir, A. (Turkey) beat Arthur, R. (Australia) (Fall) .....	7 m. 26 s.
Vachon, M. (Canada) beat Roy, K. (India) (Fall) .....	54 s.
Bowey, E. (Great Britain) beat Assam Rabay, E. (Mexico) .....	Points
Sepponen, P. (Finland) beat Brunaud, A. (France) .....	Points
Daetwyler, P. (Switzerland) beat Vogel, A. (Austria) (Fall) .....	1 m. 53 s.
Reitz, C. (South Africa) beat Ahmad, A. (Egypt) (Judges disagreed) .....	Points
Linden, K. (Sweden) beat Benoy, J. (Belgium) (Fall) .....	10 m. 35 s.
Brand, G. (U.S.A.) beat Hariri, A. (Iran) (Judges disagreed) .....	Points

## ROUND 2

Arthur, R. (Australia) beat Roy, K. (India) (Fall) .....	4 m. 15 s.
Candemir, A. (Turkey) beat Vachon, M. (Canada) (Judges disagreed) .....	Points
Sepponen, P. (Finland) beat Assam Rabay, E. (Mexico) (Fall) .....	4 m. 54 s.
Brunaud, A. (France) beat Bowey, E. (Great Britain) .....	Points
Reitz, C. (South Africa) beat Vogel, A. (Austria) (Fall) .....	5 m. 48 s.
Daetwyler, P. (Switzerland) beat Benoy, J. (Belgium) (Judges disagreed) .....	Points
Linden, K. (Sweden) beat Ahmad, A. (Egypt) (Fall) .....	5 m. 4 s.
Hariri, A. (Iran) did not appear ; Brand, G. (U.S.A.) a Bye.	

## ROUND 3

Brand, G. (U.S.A.) beat Arthur, R. (Australia) (Fall) .....	4 m. 21 s.
Sepponen, P. (Finland) beat Vachon, M. (Canada) .....	Points
Brunaud, A. (France) beat Daetwyler, P. (Switzerland) (Abandoned).	
Linden, K. (Sweden) beat Reitz, C. (South Africa) .....	Points
Candemir, A. (Turkey) beat Bowey, E. (Great Britain) (Fall) .....	11 m. 57 s.

## ROUND 4

Brand, G. (U.S.A.) beat Candemir, A. (Turkey) (Fall) .....	13 m. 24 s.
Reitz, C. (South Africa) beat Sepponen, P. (Finland) .....	Points
Linden, K. (Sweden) beat Brunaud, A. (France) .....	Points

## ROUND 5

Brand, G. (U.S.A.) beat Linden, E. (Sweden) .....	Points
---	--------

## FINAL PLACINGS

1 <b>BRAND, G.</b> (U.S.A.).	4 Reitz, C. (South Africa).
2 <b>CANDEMIR, A.</b> (Turkey).	5 Sepponen, P. (Finland).
3 <b>LINDEN, K.</b> (Sweden).	6 Brunaud, A. (France).

**LIGHT-HEAVYWEIGHT**

Up to 87 kg. (191 lbs.)

*Previous Olympic Winners*

1924	J. Spellman	U.S.A.	1932	P. J. Mehringer	U.S.A.
1928	T. Sjosteat	Sweden	1936	K. Fredell	Sweden

---

There were 20 entries from 15 nations ; 15 participants from 15 nations

---

## ROUND 1

Payette, F. ( <i>Canada</i> ) beat Landesmann, R. ( <i>France</i> ) (Fall)	8 m. 40 s.
Defteraios, S. ( <i>Greece</i> ) beat El Zaim, M. ( <i>Egypt</i> ) (Fall)	6 m. 4 s.
Fahlkvist, B. ( <i>Sweden</i> ) beat Verona, O. ( <i>Italy</i> )	Points
Morton, P. ( <i>South Africa</i> ) beat Mirghavami, N. ( <i>Iran</i> )	Points
Candash, M. ( <i>Turkey</i> ) beat Istaz, K. ( <i>Belgium</i> )	Points
Sullivan, J. ( <i>Great Britain</i> ) beat Taranyi, J. ( <i>Hungary</i> )	Points
Wittenberg, H. ( <i>U.S.A.</i> ) beat Mellavuo, P. ( <i>Finland</i> )	Points
Stoekli, F. ( <i>Switzerland</i> ) a Bye.	

## ROUND 2

Stoekli, F. ( <i>Switzerland</i> ) beat Landesmann, R. ( <i>France</i> ) (Fall)	1 m. 6 s.
Payette, F. ( <i>Canada</i> ) beat Defteraios, S. ( <i>Greece</i> ) (Fall)	2 m. 7 s.
Verona, O. ( <i>Italy</i> ) beat El Zaim, M. ( <i>Egypt</i> ) (Fall)	8 m. 51 s.
Fahlkvist, B. ( <i>Sweden</i> ) beat Morton, P. ( <i>South Africa</i> )	Points
Taranyi, J. ( <i>Hungary</i> ) beat Mirghavami, N. ( <i>Iran</i> )	Points
Wittenberg, H. ( <i>U.S.A.</i> ) beat Sullivan, J. ( <i>Great Britain</i> ) (Fall)	47 s.
Candash, M. ( <i>Turkey</i> ) beat Mellavuo, P. ( <i>Finland</i> )	Points
Istaz, K. ( <i>Belgium</i> ) a Bye.	

## ROUND 3

Stoekli, F. ( <i>Switzerland</i> ) beat Istaz, K. ( <i>Belgium</i> ) (Fall)	1 m. 20 s.
Payette, F. ( <i>Canada</i> ) beat Verona, O. ( <i>Italy</i> )	Points
Fahlkvist, B. ( <i>Sweden</i> ) beat Defteraios, S. ( <i>Greece</i> ) (Fall)	38 s.
Morton, P. ( <i>South Africa</i> ) beat Sullivan, J. ( <i>Great Britain</i> ) (Judges disagreed)	Points
Wittenberg, H. ( <i>U.S.A.</i> ) beat Taranyi, J. ( <i>Hungary</i> ) (Fall)	2 m. 20 s.
Candash, M. ( <i>Turkey</i> ) a Bye.	

## ROUND 4

Stoekli, F. ( <i>Switzerland</i> ) beat Candash, M. ( <i>Turkey</i> ) (Judges disagreed)	Points
Fahlkvist, B. ( <i>Sweden</i> ) beat Payette, F. ( <i>Canada</i> ) (Fall)	7 m. 21 s.
Wittenberg, H. ( <i>U.S.A.</i> ) a Bye.	

## ROUND 5

Wittenberg, H. ( <i>U.S.A.</i> ) beat Candash, M. ( <i>Turkey</i> ) (Fall)	7 m. 38 s.
Stoekli, F. ( <i>Switzerland</i> ) beat Payette, F. ( <i>Canada</i> ) (Fall)	2 m. 26 s.
Fahlkvist, B. ( <i>Sweden</i> ) a Bye.	

## ROUND 6

Wittenberg, H. ( <i>U.S.A.</i> ) beat Fahlkvist, B. ( <i>Sweden</i> ) (Judges disagreed)	Points
Stoekli, F. ( <i>Switzerland</i> ) a Bye.	

## ROUND 7

Stoekli, F. ( <i>Switzerland</i> ) beat Fahlkvist, B. ( <i>Sweden</i> ) (Judges disagreed)	Points
--	--------

## ROUND 8

Wittenberg, H. ( <i>U.S.A.</i> ) beat Stoekli, F. ( <i>Switzerland</i> ) (Judges disagreed)	Points
---	--------

## FINAL PLACINGS

1	<b>WITTENBERG, H.</b> ( <i>U.S.A.</i> )	
2	<b>STOECKLI, F.</b> ( <i>Switzerland</i> )	
3	<b>FAHLKVIST, B.</b> ( <i>Sweden</i> )	
4	{ Payette, F. ( <i>Canada</i> ). Candash, M. ( <i>Turkey</i> ).	
6	Morton, P. ( <i>South Africa</i> ).	

**HEAVYWEIGHT****Over 87 kg. (191 lbs.)***Previous Olympic Winners*

1908	G. C. O'Kelly	<i>Great Britain</i>	1928	J. Richtoff	<i>Sweden</i>
1920	Roth	<i>Switzerland</i>	1932	J. Richtoff	<i>Sweden</i>
1924	H. Steele	<i>U.S.A.</i>	1936	K. Palusalu	<i>Estonia</i>

---

There were 15 entries from 11 nations ; 9 participants from 9 nations

---

## ROUND 1

Ruzicka, J. ( <i>Czechoslovakia</i> ) beat Hutton, R. ( <i>U.S.A.</i> ) (Judges disagreed).....	Points
Armstrong, J. ( <i>Australia</i> ) beat Oberlander, F. ( <i>Great Britain</i> ).....	Points
Bobis, G. ( <i>Hungary</i> ) beat Lardon, W. ( <i>Switzerland</i> ).....	Points
Antonsson, B. ( <i>Sweden</i> ) beat Esen, S. ( <i>Turkey</i> ) .....	Points
Sakhdari, A. ( <i>Iran</i> ) a Bye.	

## ROUND 2

Ruzicka, J. ( <i>Czechoslovakia</i> ) beat Oberlander, F. ( <i>Great Britain</i> ) (Judges disagreed) .....	Points
Hutton, R. ( <i>U.S.A.</i> ) beat Sakhdari, A. ( <i>Iran</i> ) (Judges disagreed) .....	Points
Bobis, G. ( <i>Hungary</i> ) beat Armstrong, J. ( <i>Australia</i> ) (Fall) .....	6 m. 14 s.
Esen, S. ( <i>Turkey</i> ) beat Lardon, W. ( <i>Switzerland</i> ) .....	Points
Antonsson, B. ( <i>Sweden</i> ) a Bye.	

## ROUND 3

Antonsson, B. ( <i>Sweden</i> ) beat Sakhdari, A. ( <i>Iran</i> ) (Fall) .....	8 m. 41 s.
Armstrong, J. ( <i>Australia</i> ) beat Hutton, R. ( <i>U.S.A.</i> ) (Retired) .....	2 m. 36 s.
Bobis, G. ( <i>Hungary</i> ) beat Ruzicka, J. ( <i>Czechoslovakia</i> ) (Fall) .....	9 m. 6 s.
Esen, S. ( <i>Turkey</i> ) a Bye.	

## ROUND 4

Armstrong, J. ( <i>Australia</i> ) beat Esen, S. ( <i>Turkey</i> ) (Fall) .....	12 m. 30 s.
Bobis, G. ( <i>Hungary</i> ) beat Antonsson, B. ( <i>Sweden</i> ) (Judges disagreed) .....	Points

## ROUND 5

Antonsson, B. ( <i>Sweden</i> ) beat Armstrong, J. ( <i>Australia</i> ) (Fall)	9 m. 49 s.
--	------------

## FINAL PLACINGS

1 <b>BOBIS, G.</b> ( <i>Hungary</i> ).	4 Esen, S. ( <i>Turkey</i> ).
2 <b>ANTONSSON, B.</b> ( <i>Sweden</i> ).	5 { Ruzicka, J. ( <i>Czechoslovakia</i> ).
3 <b>ARMSTRONG, J.</b> ( <i>Australia</i> ).	{ Sakhdari, A. ( <i>Iran</i> ).

# YACHTING

An amateur seaman of long experience and ripe years said of the sailing events in the XIV Olympiad: "I have been a-yachting, man and boy, these forty years. Now, having seen ' Torbay, 1948,' I could cheerfully prepare to chant my *Nunc dimittis*, not presuming to hope to see again an occasion to match it in completeness and perfection."

It is hard to imagine a more beautiful setting than wide Torbay in shadow and sunshine, whose waters were foam-flecked and sparkling with all the shades of blue and green. Then, too, there was the prolonged intensity of the racing, which held all in suspense, increasingly unbearable the longer it was prolonged. Up to the last race of the seven days' racing there was no certain winner in any class ; in some classes the issue remained in doubt up to the last second of the last minute.

Truly there has been nothing like it. For what has just been said is not all. Because it must be added that this was the biggest international event in all the 175 years of yacht racing history.

Twenty-five nations competed. They were :—Argentine, Australia, Austria, Belgium, Brazil, Canada, Cuba, Czechoslovakia, Denmark, Eire, Finland, France, Great Britain, Greece, Holland, Hungary, Italy, Norway, Portugal, South Africa, Spain, Sweden, Switzerland, U.S.A., Uruguay.

Five classes of boats were used :—International 6-metre, International Dragon, International Star, National Swallow and National Firefly classes. The Firefly was sailed single-handed, and replaced the Olympic Monotype, formerly used for the single-handed event.

Eleven nations competed in the 6-metre racing, twelve nations in the Dragon, seventeen in the Star, fourteen in the Swallow, and twenty-one in the Firefly. Thus, seventy-five vessels were engaged daily in the racing, which began on August 3rd and ended on August 12th.

## **The Yachting Opening Ceremony**

Before these long struggles began, however, there was an Opening Ceremony which was both impressive and beautiful. The scene was the meadows in which stand the grey ruins of Torre Abbey, founded by an order of White Canons in 1196 A.D. Here entered the last of the 107 runners bearing the Olympic torch from Wembley, to kindle the Olympic flame which was to burn until the yachting events ended. Then followed the singing of the Olympic hymn, *Non Nobis Domine*, the hoisting of the national flags of the competing nations, and the release of 1,000 pigeons carrying messages to yachting centres throughout Great Britain.

The President of the International Olympic Committee, Mr. J. Sigfrid Edstrom, in a moving speech, spoke of the symbolism of the Olympic Torch, " a lovely token of our efforts to increase the health and physical culture of the nations."

Torquay, the President graciously added, had organised the yachting in a manner that became the wonderful country of England.

# CHART OF TOR BAY

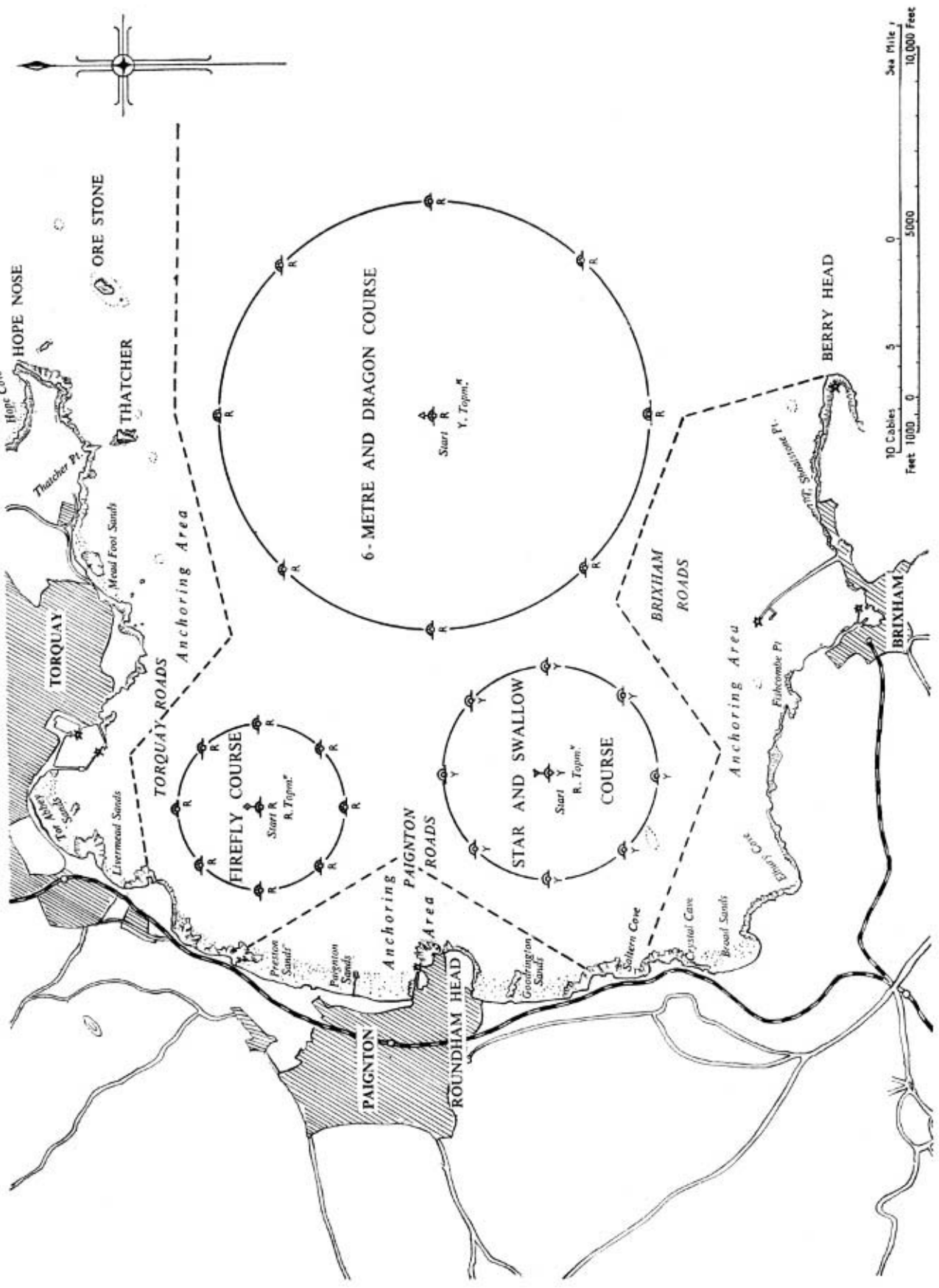



Torquay was, perhaps, an inevitable choice as the venue. It is exposed only to easterly winds, which are rare in summer. Moreover, it is remarkably free from strong tides and currents and other navigational hazards, and thus there is nothing or next to nothing to be gained from the "local knowledge" which is so profitable in difficult waters.

Torbay, as this area is properly named, is an expanse of water large enough to make it practicable for all the events to occur at the same time. At the seaward end, in the more open water, was the 6-metre course, in mid-Torbay the Dragon course, farther inshore were the courses for the Stars and the Swallows. Right inshore, close enough for the race to be followed easily by those on land, the single-handers raced the Fireflies, enjoying smooth water except when there was much weight in the wind.

It is a feature of Olympic courses that they are varied from day to day according to the direction of the wind. The marks are laid to give the maximum amount of windward work, with the first leg of all the courses so arranged as to give a beat to windward at the start of each race.

One of the most successful features of the Olympic regatta was the system of scoring. This method, the invention of an Austrian scientist and yachtsman, is that the maximum points are awarded to the winner of a race. The number of points awarded to each other competitor diminishes under a given formula, according to the placing of his boat at the finish. Any boat not completing the course, fails to score any points for that race. This process is repeated for each of the seven days' racing. The six highest marks are then totalled for each boat to determine the final order.

Therefore, what is rewarded is a record of a consistently good performance over the whole series. It is of interest that visiting yachtsmen were so impressed with the fairness of this system that some of them have decided to use it for important events in their home waters.

### **The Events**

The surprise on the first day was when D. Knowles, Great Britain, world champion in the Star class, finished second to A. D. Straulino of Italy. In the 6-metre class, however, the Belgian *Lalage* (Olympic Champion in 1936, when she was British-owned) as expected, won a most spirited race. In the Firefly event, J. Herbulot won for France by 20 secs.

The U.S.A. men and boats began to show their splendid quality as early as the second day, when *Llanoria* won in the 6-metre race and *Hilarius* (H. H. Smart) won the Star event. Great Britain (S. H. Morris) won the Swallow race, and E. R. Sarby the Firefly race for Sweden.

On the third day the winners were :—6-metre, U.S.A. ; Dragon, Great Britain ; Star, Portugal; Swallow, Denmark ; Firefly, Switzerland. The fourth day's racing proved a good day for Sweden. She won the 6-metre, and also the Firefly again. Norway won the Dragon, Britain the Swallow, and U.S.A. the Star event.

Competitors now had a three-day respite. The 200-odd yachtsmen, from the 25 countries, were able to overhaul their boats, gear and rigging.

When racing was resumed for the fifth day on August 10th, it was as exciting as any in the series. The wind was of excellent sailing strength, though not always reliable in direction. The consequence, needless to say, was a great fluctuation of fortunes. For example, in the 6-metre race, the U.S.A. boat was badly served for wind, running into a streak of calm, and finding a breeze again only in time to finish eighth, the winner being Argentine. The British boat, *Ceres*, won a superb match in the Dragon class. Italy won the Star, and Portugal the Swallow Race.

On August 11, the last day but one in the series, the wind was south-easterly and moderate in strength, but towards the end of the racing it veered south-west and blew more strongly, with squalls of rain. Indeed, there was later enough wind to dismast Sweden and Argentine in the Star class ; while, in the Firefly event, Spain's helmsman shipped so much water that, though he kept baling, he presently capsized ; nor for all his efforts could he right his boat.

At the end of the day the U.S.A. had a promising lead in the 6-metre, Italy was slightly ahead in both the Dragon and Star classes, as were Portugal in the Swallow, and Denmark in the Firefly classes respectively. Still, none could be sure of final victory.

On the concluding day a thrilling struggle was fought in the 6-metre class, between Argentine's *Djinn*, the U.S.A.'s *Llanoria*, and Norway's *Apache*. Reaching, running, or on a wind, for half the day it was impossible to tell which was the leading boat, so close together were these three. Finally, *Djinn* won by 19 seconds from *Llanoria*, with *Apache* only another 21 seconds astern. And this after 14 miles of racing in a roughish sea and rising wind.

Like the story of the 6-metre event, the sagas of the Dragon, Star, Swallow and Firefly classes will long be told.

Norway had to gain third place to win in the Dragon Class, which she achieved, though only by 3 seconds. In the Swallows, Morris had to gain at least fourth place to win the championship for Great Britain. Finish fourth he did, but with his next astern only 10 seconds behind. In the Stars, the Smarts of U.S.A., father and son, finished first; three boats in this class were dismasted and in the Fireflies five boats capsized.

This day of scarcely bearable excitement came to an end at last. The points were counted, and the results made known. The U.S.A. had won the 6-metre and the Star classes, Norway the Dragon, Great Britain the Swallow and Denmark the Firefly events.

The bare record, though, can give no notion of how close were the results. For example, neither Sweden, Italy, Portugal nor Holland won a Gold Medal, though all these countries had a consistently high performance throughout the series.

### **Closing Ceremony—Torquay**

In the evening, in the grounds of Torre Abbey, before a crowd of 10,000 spectators, was held the Closing Ceremony. Representatives of all the competing nations bore in procession their countries' flags. These flags were lowered simultaneously, and were wreathed with laurel by young girls, all dressed alike in white. The flags were then raised again in honour of the Olympic Champions.

A band of the Royal Marines played the National Anthems of the U.S.A., Norway, Denmark and Great Britain ; the winners stepped forward to receive the gold, silver or bronze medals from Sir Ralph Gore, President of the International Yacht Racing Union. He then called on the youth of all lands to assemble at Helsinki in 1952 ; trumpets sounded, a salute of guns was fired, and the Olympic Flame, which had burned steadily since August 2, flared momentarily higher, then slowly died away.

Then quite spontaneously, hundreds of men and women from over a score of countries linked hands to sing " Auld Lang Syne " accompanied by the Band of the Royal Marines.

The battleships *Anson* and *George V*, the carrier *Victorious*, the visiting Belgian, French and American destroyers, and the Royal Yacht *Norge* which had all lain at anchor in Torbay throughout the ten days of the yachting, steamed slowly from the Bay. The Yacht Regatta of the 1948 Olympic Games was over.

**INTERNATIONAL YACHT RACING UNION**

SPECIAL DELEGATE OF THE I.Y.R.U.

H.R.H. THE CROWN PRINCE OF NORWAY

PRESIDENT

Major Sir RALPH GORE, BT.

SECRETARY

F. P. USBORNE

**JURY OF APPEAL**

Sir ARTHUR YOUNG, BT, MP, Chairman, *Great Britain*

Commodore NIELS BENZON, *Denmark*

THEODORE M. DUNLAP, *U.S.A.*

JAN LOEFF, *Holland*

RENE L. ODIER, *Switzerland*

KENNETH PRESTON, *Great Britain*

PHILIP WHITECHURCH, *France*

F. P. USBORNE, Secretary

**YACHT RACING ASSOCIATION OF GREAT BRITAIN OLYMPIC COMMITTEE**

CHAIRMAN

PETER SCOTT, MBE, DSC

SECRETARY

QUINTIN RILEY

**RACE COMMITTEES**

"SIX METRE" AND "DRAGON"

W. F. BALL

M. E. BEHAR

D. R. ADAMS

E. F. WILTON

"STAR" AND "SWALLOW"

E. T. VACHELL

H. COUCH

C. J. H. WOLLEN

H. GRANT

" FIREFLY "

C. N. E. CURREY

P. PERRING

W. L. PRICHARD

L. W. DRAKE

G. A. ELLIS

**COURSES**

There were three courses in the bay each consisting of a circle of 8 buoys, with a ninth in the centre. This ninth buoy was one end of the starting and finishing lines and the race started towards whichever buoy was most directly to windward. Thereafter the course was as indicated on the diagram below; only 3 buoys were used, these being identified in the first round by smoke signals. The reason for the 8 buoys was, of course, to allow for different wind directions.

The 6 Metres and Dragons raced over the outer course—a distance of about 14 miles. The Stars and Swallows raced over the southerly course near Brixham—a distance of approximately 10 miles. The Fireflies raced over the course nearest to Torquay—a distance of approximately 6 miles.

These courses were laid and patrolled by vessels of the Royal Navy.

A race was void if the fastest yacht over the course failed to attain a minimum speed of 2 knots without allowance for tacking.

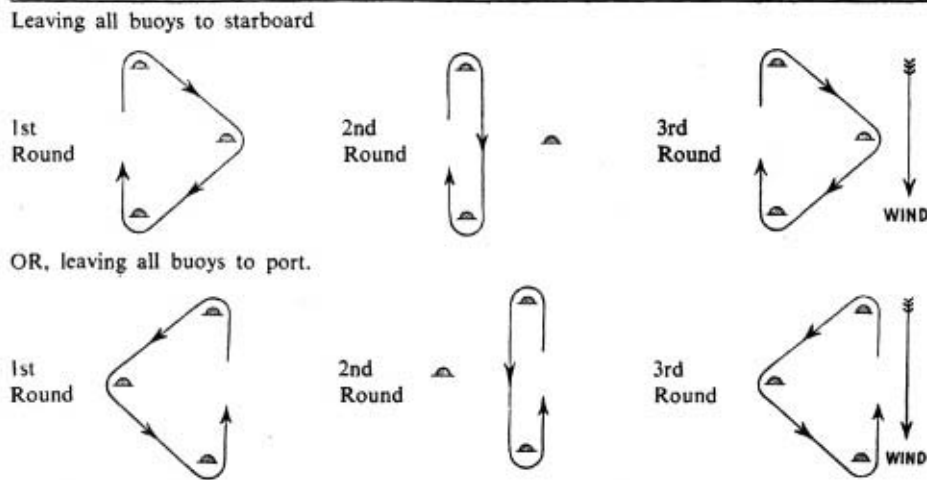

**BUOYS AND TOPMARKS**

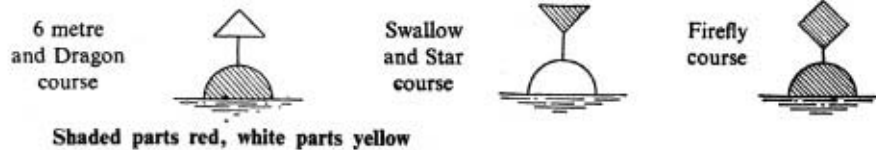

**SCORING**

Each yacht scored points in accordance with the following formula :— $101 + 1000 \log A - 1000 \log N$ , where A = Total number of yachts entered in her class, and N = the yachts finishing position.

Of the seven races, a yacht counted only the points for her best six races.

## 6-METRE CLASS

### *Previous Olympic Winners*

1900	Switzerland	1924	Norway
1908	Great Britain	1928	Norway
1912	France	1932	Sweden
1920	Norway	1936	Great Britain

There were 86 entries from 11 nations, 55 participants from 11 nations

## FINAL PLACINGS

Final Place	Nationality	AUGUST 3		AUGUST 4		AUGUST 5			AUGUST 6			AUGUST 10			AUGUST 11			AUGUST 12				
		Finishing Position	Points	Finishing Position	Points	Score to Date	Finishing Position	Points	Score to Date	Finishing Position	Points	Score to Date	Finishing Position	Points	Score to Date	Finishing Position	Points	Score to Date	Finishing Position	Points	Score to Date	Points for Best Six Races
1	U.S.A.	4	540	1	1142	1682	1	1142	2824	3	665	3489	8	239	3728	1	1142	4870	2	841	5711	5472
2	ARGENTINE	3	665	3	665	1330	3	665	1995	2	841	2836	1	1142	3978	4	540	4518	1	1142	5660	5120
3	SWEDEN	5	443	2	841	1284	2	841	2125	1	1142	3267	3	665	3932	—	—	3932	11	101	4033	4033
4	NORWAY	8	239	—	—	239	9	188	427	5	443	870	2	841	1711	2	841	2552	3	665	3217	3217
5	GT. BRITAIN	7	297	4	540	837	8	239	1076	7	297	1373	4	540	1913	3	665	2578	4	540	3018	2879
6	BELGIUM	1	1142	8	239	1381	11	101	1482	9	188	1670	5	443	2113	7	297	2410	5	443	2853	2752
7	SWITZERLAND	2	841	6	364	1205	7	297	1502	4	540	2042	9	188	2230	6	364	2594	10	142	2736	2594
8	ITALY	6	364	—	—	364	5	443	807	6	364	1171	7	297	1468	5	443	1911	9	188	2099	2099
9	FINLAND	9	188	7	297	485	10	142	627	8	239	866	6	364	1230	8	239	1469	6	364	1833	1691
10	DENMARK	10	142	5	443	585	4	540	1125	11	101	1226	10	142	1368	10	142	1510	8	239	1749	1648
11	FRANCE	11	101	9	183	289	6	364	653	10	142	795	11	101	896	9	188	1084	7	297	1381	1280

### POINTS SCORED

**6-METRES.** 1st= 1142 ; 2nd=841 ; 3rd=665 ; 4th=540 ; 5th=443 ; 6th=364 ; 7th=297 ; 8th=239 ; 9th=188 ; 10th=142 ; 11th=101.

Argentina .....	" DJINN " .....	Helmsman : E. Sieburger. Crew selected from : E. Homps, R. Rodriguez de la Torre, R. Rivademar, E. A. Sieburger, J. Sieburger.
Belgium .....	" LALAGE " .....	Helmsman : L. Franck. Crew selected from : E. Hayoit, W. Huybrechts, H. van Riel, W. van Rompaey.
Denmark .....	" MORENA " .....	Helmsman : T. La Cour. Crew selected from : B. Clausen, A. Eiermann, S. Iversen, R. La Cour, E. Schiottz, H. Sorensen.
Finland .....	" RAILI " .....	Helmsman: E. Westerlund. Crew selected from: R. Hellstroem, A. Hirvisalo, R. Jansson, J. Konto, N. Orama, R. Packalen, A. Turkkka, V. Urho.
France .....	" LA BANDERA " .....	Helmsman : A. Cadot. Crew selected from : J. Castel, C. Desouches, R. Lacarriere, F. Laverne.
Gt. Britain.....	"JOHAN " .....	Helmsman : J. H. Hume. Crew selected from : J. D. H. Hume, B. G. Hardie, H. G. Hardie, H. Hunter.
Italy.....	" CIOCCA II " .....	Helmsman : G. Reggio. Crew selected from : G. Audizio, R. Costentino, A. Croce, G. de Luca, L. M. Poggi, E. M. Poggi.
Norway .....	"APACHE" .....	Helmsman: M. Konow. Crew selected from : A. Evensen, L. Musaeus, H. Solem, R. Hargreaves.
Sweden.....	" ALI BABA II " .....	Helmsman: T. Holm. Crew selected from: T. Lord, M. Hindorff, K. Ameln, G. Salen.
Switzerland.....	" YLLIAM VII " .....	Helmsman : H. Copponex. Crew selected from : P. Bonnet, R. Fehlmann, A. Firmenich, E. Lachapelle, L. Noverraz, C. Stern, M. Stern.
U.S.A. ....	"LLANORIA " .....	Helmsman : H. Whiton. Crew selected from: A. Loomis, Jr., J. Weekes, J. Smith, Jr., M. Mooney.

## DAILY RESULTS

## First Day

Country	Boat	Time			Points
		h	m	s	
1 Belgium	Lalage	1	45	27	1,142
2 Switzerland	Ylliam VII	1	49	24	841
3 Argentine	Djinn	1	50	26	665
4 U.S.A.	Llanoria	1	50	40	540
5 Sweden	Ali Baba II	1	50	58	443
6 Italy	Ciocca II	1	55	12	364
7 Great Britain	Johan	1	55	43	297
8 Norway	Apache	1	55	54	239
9 Finland	Raili	1	58	46	188
10 Denmark	Morena	2	01	55	142
11 France	La Bandera	2	05	24	101

## Second Day

1 U.S.A.	Llanoria	1	35	51	1,142
2 Sweden	Ali Baba II	1	36	17	841
3 Argentine	Djinn	1	36	35	665
4 Great Britain	Johan	1	38	51	540
5 Denmark	Morina	1	40	46	443
6 Switzerland	Ylliam VII	1	42	07	364
7 Finland	Raili	1	43	08	297
8 Belgium	Lalage	1	43	43	239
9 France	La Bandera	1	44	06	188

## Third Day

1 U.S.A.	Llanoria	15	10	50	1,142
2 Sweden	Ali Baba II	15	11	07	841
3 Argentine	Djinn	15	14	22	665
4 Denmark	Morena	15	16	27	540
5 Italy	Ciocca II	15	17	35	443
6 France	La Bandera	15	18	18	364
7 Switzerland	Ylliam VII	15	20	42	297
8 Great Britain	Johan	15	21	49	239
9 Norway	Apache	15	23	00	188
10 Finland	Raili	15	23	31	142
11 Belgium	Lalage	15	26	04	101

## Fourth Day

Country	Boat	Time			Points
		h	m	s	
1 Sweden	Ali Baba II	13	13	13	1,142
2 Argentine	Djinn	13	18	34	841
3 U.S.A.	Llanoria	13	23	42	665
4 Switzerland	Ylliam VII	13	25	20	540
5 Norway	Apache	13	26	21	443
6 Italy	Ciocca II	13	26	40	364
7 Great Britain	Johan	13	27	09	297
8 Finland	Raili	13	28	50	239
9 Belgium	Lalage	13	29	05	188
10 France	La Bandera	13	33	16	142
11 Denmark	Morena	13	33	46	101

## Fifth Day

1 Argentine	Djinn	14	03	48	1,142
2 Norway	Apache	14	04	04	841
3 Sweden	Ali Baba II	14	04	28	665
4 Great Britain	Johan	14	04	44	540
5 Belgium	Lalage	14	05	15	443
6 Finland	Raili	14	05	17	364
7 Italy	Ciocca II	14	05	24	297
8 U.S.A.	Llanoria	14	05	33	239
9 Switzerland	Ylliam VII	14	05	36	188
10 Denmark	Morena	14	06	19	142
11 France	La Bandera	14	07	30	101

## Sixth Day

1 U.S.A.	Llanoria	14	05	06	1,142
2 Norway	Apache	14	07	33	841
3 Great Britain	Johan	14	08	18	665
- Sweden	Ali Baba II	14	08	58	—
4 Argentine	Djinn	14	09	17	540
5 Italy	Ciocca II	14	09	39	443
6 Switzerland	Ylliam VII	14	10	52	364
7 Belgium	Lalage	14	13	34	297
8 Finland	Raili	14	15	25	239
9 France	La Bandera	14	16	49	188
10 Denmark	Morena	14	17	43	142

Sweden disqualified.

## Seventh Day

Country	Boat	Time			Points
		h	m	s	
1 Argentine	Djinn	13	26	01	1,142
2 U.S.A.	Llanoria	13	26	20	841
3 Norway	Apache	13	26	41	665
4 Great Britain	Johan	13	29	36	540
5 Belgium	Lalage	13	32	08	443
6 Finland	Raili	13	34	41	364
7 France	La Bandera	13	35	01	297
8 Denmark	Morena	13	35	19	234
9 Italy	Ciocca II	13	35	27	188
10 Switzerland	Ylliam VII	13	35	30	142
11 Sweden	Ali Baba II	13	45	30	101

**DRAGON CLASS**

This event was included in the Olympic programme for the first time.

There were 61 entries from 12 nations ; 36 participants from 12 nations

**FINAL PLACINGS**

Final Place	Nationality	AUGUST 3		AUGUST 4		AUGUST 5		AUGUST 6		AUGUST 10		AUGUST 11		AUGUST 12		Points for Best Six Races						
		Finishing Position	Points	Finishing Position	Points	Score to Date	Finishing Position	Points	Score to Date	Finishing Position	Points	Score to Date	Finishing Position	Points	Score to Date		Finishing Position	Points				
1	NORWAY	1	1180	2	879	2059	12	101	2160	1	1180	3340	—	—	3340	3	703	4043	3	703	4746	4746
2	SWEDEN	2	879	3	703	1582	2	879	2461	2	879	3340	—	—	3340	12	101	3441	1	1180	4621	4621
3	DENMARK	3	703	4	578	1281	3	703	1984	5	481	2465	2	879	3344	5	481	3825	2	879	4704	4223
4	GT. BRITAIN	7	335	7	335	670	1	1180	1850	7	335	2185	1	1180	3365	9	226	3591	4	578	4169	3943
5	ITALY	9	226	8	277	503	4	578	1081	3	703	1784	6	402	2186	1	1180	3366	—	—	3366	3366
6	FINLAND	4	578	1	1180	1758	11	139	1897	6	402	2299	4	578	2877	11	139	3016	10	180	3196	3057
7	ARGENTINE	6	402	5	481	883	8	277	1160	4	578	1738	9	226	1964	2	879	2843	—	—	2843	2843
8	HOLLAND	5	481	6	402	883	7	335	1218	11	139	1357	8	277	1634	4	578	2212	7	335	2547	2508
9	PORTUGAL	11	139	9	226	365	6	402	767	8	277	1044	7	335	1379	6	402	1781	5	481	2262	2123
10	FRANCE	10	180	11	139	319	10	180	499	9	226	725	3	703	1428	8	277	1705	8	277	1982	1743
11	U.S.A.	8	277	10	180	457	5	481	938	12	101	1039	—	—	1039	10	180	1219	6	402	1621	1621
12	BELGIUM ...	12	101	—	—	101	9	226	327	10	180	507	5	481	988	7	335	1323	9	226	1549	1549

**POINTS SCORED**

**DRAGONS.** 1st=1180; 2nd=879 ; 3rd=703 ; 4th=578 ; 5th=481; 6th=402 ; 7th=335 ; 8th=277 ; 9th=226 ; 10th=180 ; 11th=139; 12th=101.

*Argentine* ..... " PAMPERO " ..... *Helmsman:* R. Sieburger. *Crew selected from :* E. Gomez, J. de Rio Salas, J. Salas Chaves, A. Suner.

*Belgium* ..... " DOLFIJN " ..... *Helmsman :* A. Huybrechts. *Crew selected from :* R. Anciaux, C. Delfosse, G. Hellebuyck, J. Lauwerys, J. Lippens.

*Denmark* ..... " SNAP " ..... *Helmsman :* W. E. Berntsen. *Crew selected from :* O. V. H. Berntsen, K. Baess.

*Finland* ..... " VINHA " ..... *Helmsman :* R. Packalen. *Crew selected from :* M. Orama, A. M. Hirvisalo.

*France* ..... " ALLEGRO " ..... *Helmsman:* M. de Kerviler. *Crew selected from:* J. Frain de la Gaulayrie, G. Bertin, P. Chancerel.

*Gt. Britain* ..... " CERES II " ..... *Helmsman :* W. Strain. *Crew selected from :* G. Brown, J. Wallace.

*Holland* ..... " JOY " ..... *Helmsman :* C. Jonker. *Crew selected from :* A. Dudok Van Heel, G. Nijbakker, J. Van den Berg, W. P. Van Duyl.

*Italy* ..... " AUSONIA " ..... *Helmsman :* G. Canessa. *Crew selected from :* B. Bianchi, L. de Manincor.

*Norway* ..... " PAN " ..... *Helmsman :* T. Thorvaldsen. *Crew selected from :* S. Lie, H. Barfod.

*Portugal* ..... " ARGUS " ..... *Helmsman :* J. Felix da Silva Capucho. *Crew selected from :* A. Guedes de Heredia, H. Reis Goncho Sallaty, C. Rogenmoser Lourenco.

*Sweden* ..... " SLAGHOKEN " ..... *Helmsman :* F. Bohlin. *Crew selected from :* V. Johnson, F. Brodin. Brodin.

*U.S.A.* ..... " RHYTHM " ..... *Helmsman:* H. Duys. *Crew selected from :* R. Craig, F. Jackson, Jr., R. Jessup, C. Lee, J. Roosevelt.



## DAILY RESULTS

First Day				Fourth Day			
Country	Boat	Time	Points	Country	Boat	Time	Points
		<i>h m s</i>				<i>h m s</i>	
1 Norway	<i>Pan</i>	2 26 03	1,180	1 Norway	<i>Pan</i>	15 29 40	1,180
2 Sweden	<i>Slaghoken</i>	2 26 57	879	2 Sweden	<i>Slaghoken</i>	15 31 45	878
3 Denmark	<i>Snap</i>	2 26 58	703	3 Italy	<i>Ausonia</i>	15 36 55	703
4 Finland	<i>Vinha</i>	2 27 07	578	4 Argentine	<i>Pampero</i>	15 39 24	578
5 Holland	<i>Joy</i>	2 27 43	481	5 Denmark	<i>Snap</i>	15 40 21	481
6 Argentine	<i>Pampero</i>	2 27 45	402	6 Finland	<i>Vinha</i>	15 41 27	407
7 Great Britain	<i>Ceres II</i>	2 28 50	335	7 Great Britain	<i>Ceres II</i>	15 42 35	335
8 U.S.A.	<i>Rhythm</i>	2 28 57	277	8 Portugal	<i>Argus</i>	15 43 17	277
9 Italy	<i>Ausonia</i>	2 30 14	226	9 France	<i>Allegro</i>	15 48 23	228
10 France	<i>Allegro</i>	2 32 09	180	10 Belgium	<i>Dolfijn</i>	15 50 11	180
11 Portugal	<i>Argus</i>	2 35 35	139	11 Holland	<i>Joy</i>	15 52 47	139
12 Belgium	<i>Dolfijn</i>	2 36 14	101	12 U.S.A.	<i>Rhythm</i>	15 59 47	101
Second Day				Fifth Day			
1 Finland	<i>Vinha</i>	2 0 35	1,180	1 Great Britain	<i>Ceres II</i>	14 52 10	1,180
2 Norway	<i>Pan</i>	2 1 13	879	- Norway	<i>Pan</i>	14 52 36	—
3 Sweden	<i>Slaghoken</i>	2 1 39	703	- Sweden	<i>Slaghoken</i>	14 52 56	—
4 Denmark	<i>Snap</i>	2 1 50	578	2 Denmark	<i>Snap</i>	14 53 03	879
5 Argentine	<i>Pampero</i>	2 1 36	481	3 France	<i>Allegro</i>	14 54 06	703
6 Holland	<i>Joy</i>	2 1 33	402	4 Finland	<i>Vinha</i>	14 54 09	578
7 Great Britain	<i>Ceres II</i>	2 1 16	335	5 Belgium	<i>Dolfijn</i>	14 55 11	481
8 Italy	<i>Ausonia</i>	2 1 23	277	6 Italy	<i>Ausonia</i>	14 57 33	402
9 Portugal	<i>Argus</i>	2 1 19	226	7 U.S.A.	<i>Rhythm</i>	15 03 17	335
10 U.S.A.	<i>Rhythm</i>	2 1 28	180	8 Portugal	<i>Argus</i>	15 04 00	277
11 France	<i>Allegro</i>	2 1 20	139	9 Holland	<i>Joy</i>	15 04 09	226
Belgium gave up.				10 Argentine	<i>Pampero</i>	15 13 10	180
				Norway and Sweden disqualified.			
Third Day				Sixth Day			
1 Great Britain	<i>Ceres II</i>	15 40 01	1,180	1 Italy	<i>Ausonia</i>	14 34 04	1,180
2 Sweden	<i>Slaghoken</i>	15 40 11	879	2 Argentine	<i>Pampero</i>	14 34 50	879
3 Denmark	<i>Snap</i>	15 40 39	703	3 Norway	<i>Pan</i>	14 35 07	703
4 Italy	<i>Ausonia</i>	15 41 00	578	4 Holland	<i>Joy</i>	14 35 38	578
5 U.S.A.	<i>Rhythm</i>	15 42 30	481	5 Denmark	<i>Snap</i>	14 36 00	481
6 Portugal	<i>Argus</i>	15 46 56	402	6 Portugal	<i>Argus</i>	14 38 02	402
7 Holland	<i>Joy</i>	16 00 30	335	7 Belgium	<i>Dolfijn</i>	14 39 00	335
8 Argentine	<i>Pampero</i>	16 04 45	277	8 France	<i>Allegro</i>	14 39 57	277
9 Belgium	<i>Dolfijn</i>	16 07 27	226	9 Great Britain	<i>Ceres II</i>	14 40 12	226
10 France	<i>Allegro</i>	16 07 55	180	10 U.S.A.	<i>Rhythm</i>	14 48 48	180
11 Finland	<i>Vinha</i>	16 08 03	139	11 Finland	<i>Vinha</i>	14 49 32	139
12 Norway	<i>Pan</i>	16 08 08	101	12 Sweden	<i>Slaghoken</i>	14 51 51	101
Seventh Day							
		<i>h m s</i>				<i>h m s</i>	
1 Sweden	<i>Slaghoken</i>	13 56 25	1,180				
2 Denmark	<i>Snap</i>	13 58 59	879				
3 Norway	<i>Pan</i>	13 59 02	703				
4 Great Britain	<i>Ceres II</i>	13 59 27	578				
5 Portugal	<i>Argus</i>	13 59 32	481				
6 U.S.A.	<i>Rhythm</i>	14 01 51	402				
7 Holland	<i>Joy</i>	14 02 16	335				
8 France	<i>Allegro</i>	14 07 55	277				
9 Belgium	<i>Dolfijn</i>	14 13 44	226				
10 Finland	<i>Vinha</i>	14 13 56	180				
Italy and Argentine gave up.							

## STAR CLASS

## Previous Olympic Winners

1932 U.S.A. 1936 Germany

There were 56 entries from 16 nations ; 34 participants from 17 nations

## FINAL PLACINGS

Final Place	Nationality	AUGUST 3		AUGUST 4		AUGUST 5		AUGUST 6		AUGUST 10		AUGUST 11		AUGUST 12		Points for Best Six Races						
		Finishing Position	Points	Finishing Position	Points	Score to Date	Finishing Position	Points	Score to Date	Finishing Position	Points	Score to Date	Finishing Position	Points	Score to Date		Finishing Position	Points				
1	U.S.A.	4	729	1	1331	2060	2	1030	3090	1	1331	4421	3	854	5275	—	—	5275	6	553	5828	5828
2	CUBA	7	486	—	—	486	7	486	972	2	1030	2002	7	486	2488	1	1331	3819	2	1030	4849	4949
3	HOLLAND	3	854	5	632	1486	5	632	2118	3	854	2972	4	729	3701	2	1030	4731	7	486	5217	4731
4	GT. BRITAIN	2	103	2	1030	2060	6	553	2613	4	729	3342	2	1030	4372	—	—	4372	—	—	4372	4372
5	ITALY	1	133	3	854	2185	3	854	3039	—	—	3039	1	1331	4370	—	—	4370	—	—	4370	4370
6	PORTUGAL	11	290	6	553	843	1	1331	2174	5	632	2806	12	252	3058	5	632	3690	3	854	4544	4292
7	AUSTRALIA	—	—	4	729	729	15	155	884	6	553	1437	10	331	1768	4	729	2497	1	1331	3828	3828
8	CANADA	9	377	14	185	562	4	729	1291	13	217	1508	8	428	1936	6	553	2489	10	331	2820	2635
9	SPAIN	15	155	7	486	641	16	127	768	9	377	1145	5	632	1777	7	486	2263	8	428	2691	2564
10	GREECE	8	428	12	252	680	9	377	1057	11	290	1347	10	331	1678	9	377	2055	4	729	2784	2532
II	FRANCE	12	252	8	428	680	8	428	1108	—	—	1108	6	553	1661	3	854	2515	—	—	2515	2515
12	FINLAND	13	217	—	290	507	13	217	724	12	252	976	9	377	1353	11	290	1643	5	632	2275	2058
13	AUSTRIA	10	331	15	155	486	14	185	671	14	185	856	15	155	1011	8	428	1439	9	377	1816	1661
14	BRAZIL	16	127	13	27	344	11	290	634	10	331	965	14	185	1150	10	331	1481	11	290	1771	1644
15	SWITZERLAND	6	553	9	377	930	12	252	1182	8	428	1610	—	—	1610	—	—	1610	—	—	1610	1610
16	ARGENTINE	14	185	10	331	516	10	331	847	7	486	1333	13	217	1550	—	—	1550	—	—	1550	1550
17	SWEDEN	5	632	—	—	632	17	101	733	15	155	888	—	—	888	—	—	888	—	—	888	888

## POINTS SCORED

**STARS.** 1st=1331; 2nd=1030; 3rd=854; 4th=729; 5th=632; 6th=553; 7th=486; 8th=428; 9th=377; 10th=331; 11th=290; 12th=252; 13th=217; 14th=185; 15th=155; 16th=127; 17th=101.

Argentina ..... "ACTURUS" ..... Helmsman : J. Piacentini. Crew selected from : A. Carrasco, H. Gil  
Australia ..... "MOORINA" ..... Elizalde.  
Austria ..... "DONAR III" ..... Helmsman : G. Obermuller. Crew selected from : H. Schachinger, G. Werner, H. Obermuller.  
Brazil ..... "BUSCAPE II" ..... Helmsman : J. Bracony. Crew selected from : C. Melo Bittencourt Filho, E. Rocco de Paula Simoes, M. Rocco de Paula Simoes.  
Canada ..... "ARIEL" ..... Helmsman : N. Gooderham. Crew : A. Fairhead.  
Cuba ..... "KURUSH III" ..... Helmsman : Dr. Carlos de Cardenas. Crew : Carlos de Cardenas Jnr.  
Finland ..... "LUCKY STAR" ..... Helmsman : R. Nyman. Crew selected from : B. Ilmoni, E. Palmgreen, V. Urho.  
France ..... "ALOHA II" ..... Helmsman : Y. Lorion. Crew selected from : A. Chatord, J. Laverne, J. Peytel.  
Gt. Britain ..... "GEM II" ..... Helmsman : D. Knowles. Crew : S. Farrington.  
Greece ..... "NEPHOS I" ..... Helmsman : G. Calambokidis. Crew selected from : C. Carolou, C. Potamianos, N. Vlangalis.  
Holland ..... "STARITA" ..... Helmsman : A. Maas. Crew : E. Stutterheim.  
Italy ..... "LEGIONARIO" ..... Helmsman : A. Straulino. Crew : N. Rode.  
Portugal ..... "ESPADARTE" ..... Helmsman : J. Mascarenhas Fiuza. Crew : J. de Sousa Leite Gourinho.  
Spain ..... "GALERNA" ..... Helmsman : J. Alonso Allende. Crew selected from : J. Allende Y Garcia Baxter, E. Aznar Y Coste.  
Sweden ..... "LOTTA IV" ..... Helmsman : B. Melin. Crew selected from : C. Edding, J. Engkvist, S. K. F. Rinman.  
Switzerland ..... "ALI BABA II" ..... Helmsman : H. Bryner. Crew selected from : A. L. Albrecht, K. A. Bryner, R. A. Rhyner.  
U.S.A. ..... "HILARIUS" ..... Helmsman : H. H. Smart. Crew : P. H. Smart.

## DAILY RESULTS

## First Day

Country	Boat	Time			Points
		h	m	s	
1 Italy	Legionario	12	56	52	1,331
2 Great Britain	Gem II	12	57	51	1,030
3 Holland	Starita	12	58	14	845
4 U.S.A.	Hilarius	12	58	52	729
5 Sweden	Lotta IV	12	58	54	632
6 Switzerland	Ali Baba II	13	00	23	553
7 Cuba	Kurush III	13	00	55	486
8 Greece	Naphos I	13	01	12	428
9 Canada	Ariel	13	01	52	377
10 Austria	Donar III	13	02	01	331
11 Portugal	Espadarte	13	02	17	290
12 France	Aloha II	13	03	17	252
13 Finland	Lucky Star	13	03	58	217
14 Argentina	Acturus	13	04	14	185
15 Spain	Galerna	13	04	31	155
16 Brazil	Buscape II	13	05	14	127

Australia (*Moorina*) retired, having hit a mark.

## Second Day

1 U.S.A.	Hilarius	12	52	12	1,331
2 Great Britain	Gem II	12	54	42	1,030
3 Italy	Legionario	12	54	46	845
4 Australia	Moorina	12	54	58	729
5 Holland	Starita	12	55	23	632
6 Portugal	Espadarte	12	57	55	553
7 Cuba	Kurush III	12	58	04	486
8 Spain	Galerna	12	58	08	428
9 France	Aloha II	12	58	38	377
10 Switzerland	Ali Baba II	12	58	43	331
11 Argentina	Acturus	12	58	58	290
12 Finland	Lucky Star	12	59	29	252
13 Greece	Nephos I	13	00	20	217
14 Brazil	Buscape II	13	00	38	185
15 Canada	Ariel	13	01	52	155
16 Austria	Donar III	13	02	48	127

Sweden did not start.

## Third Day

1 Portugal	Espadarte	14	33	11	1,331
2 U.S.A.	Hilarius	14	33	19	1,030
3 Italy	Legionario	14	33	59	854
4 Canada	Ariel	14	37	02	729
5 Holland	Starita	14	37	37	632
6 Great Britain	Gem II	14	45	35	553
7 Cuba	Kurush III	14	45	36	486
8 France	Aloha II	14	45	43	428
9 Greece	Nephos I	14	45	57	377
10 Argentina	Acturus	14	46	43	331
11 Brazil	Buscape II	14	46	55	290
12 Switzerland	Ali Baba II	14	47	10	252
13 Finland	Lucky Star	14	47	16	217
14 Austria	Donar III	14	47	58	185
15 Australia	Moorina	14	49	11	155
16 Spain	Galerna	14	50	30	127
17 Sweden	Lotta IV	14	51	57	101

## Fourth Day

Country	Boat	Time			Points
		h	m	s	
1 U.S.A.	Hilarius	13	00	53	1,331
2 Cuba	Kurush III	13	01	07	1,030
3 Holland	Starita	13	02	31	854
4 Great Britain	Gem II	13	02	37	729
5 Portugal	Espadarte	13	03	14	632
6 Australia	Moorina	13	04	49	553
7 Argentine	Acturus	13	05	08	486
8 France	Aloha II	13	06	11	428
9 Switzerland	Ali Baba II	13	06	17	377
10 Spain	Galerna	13	07	11	331
11 Brazil	Buscape II	13	07	32	290
12 Greece	Nephos I	13	07	49	252
13 Finland	Lucky Star	13	07	52	217
14 Canada	Ariel	13	07	53	185
15 Austria	Donar III	13	09	09	155
16 Sweden	Lotta IV	13	09	23	127

Italy disqualified.

## Fifth Day

1 Italy	Legionario	12	51	53	1,331
2 Great Britain	Gem II	12	52	36	1,030
3 U.S.A.	Hilarius	12	53	04	854
4 Holland	Starita	12	53	21	729
5 Spain	Galerna	12	54	32	632
6 France	Aloha II	12	55	05	553
- Switzerland	Ali Baba II	12	56	27	—
- Sweden	Lotta IV	12	58	35	—
7 Cuba	Kurush III	12	58	45	486
8 Canada	Ariel	12	58	48	428
9 Finland	Lucky Star	13	01	35	377
10 Australia	Moorina	13	02	29	331
11 Greece	Nephos I	13	02	29	331
12 Portugal	Espadarte	13	05	23	252
13 Argentina	Acturus	13	05	30	217
14 Brazil	Buscape II	13	06	36	185
15 Austria	Donar III	13	18	09	155

Switzerland and Sweden disqualified.

## Sixth Day

- Italy	Legionario	13	03	33	—
1 Cuba	Kurush III	13	05	09	1,331
- Great Britain	Gem II	13	05	38	—
2 Holland	Starita	13	06	08	1,030
3 France	Aloha II	13	06	35	854
4 Australia	Moorina	13	06	55	729
- U.S.A.	Hilarius	13	07	09	—
5 Portugal	Espadarte	13	08	08	632
6 Canada	Ariel	13	08	09	553
7 Spain	Galerna	13	08	50	486
8 Austria	Donar III	13	09	19	428
9 Greece	Nephos I	13	10	33	377
10 Brazil	Buscape II	13	11	49	331
11 Finland	Lucky Star	13	14	04	290

Argentina and Switzerland dished. Sweden did not cross finishing line. U.S.A., Great Britain and Italy disqualified.

## Seventh Day

Country	Boat	Time			Points
		h	m	s	
1 Australia	Moorina	12	52	25	1,331
2 Cuba	Kurush III	12	54	30	1,030
3 Portugal	Espadarte	12	55	45	854
4 Greece	Nephos I	12	57	33	729
5 Finland	Lucky Star	12	58	05	632
6 U.S.A.	Hilarius	12	59	34	553
7 Holland	Starita	12	59	42	486
8 Spain	Galerna	13	01	20	428
9 Austria	Donar III	13	02	23	377
10 Canada	Ariel	13	08	17	331
11 Brazil	Buscape II	13	27	46	290

France, Italy and Great Britain dished. Argentina, Sweden and Switzerland did not start.

## SWALLOW CLASS

This event was included in the Olympic programme for the first time.

There were 50 entries from 14 nations ; 28 participants from 14 nations

### FINAL PLACINGS

Final Place	Nationality	AUGUST 3			AUGUST 4			AUGUST 5			AUGUST 6			AUGUST 10			AUGUST 11			AUGUST 12			
		Finishing Position	Points	Score to Date	Finishing Position	Points	Score to Date	Finishing Position	Points	Score to Date	Finishing Position	Points	Score to Date	Finishing Position	Points	Score to Date	Finishing Position	Points	Score to Date	Finishing Position	Points	Score to Date	Points for Best Six Races
1	GT. BRITAIN	3	770		1	1247	2017	3	770	2787	1	1247	4034	2	946	4980	—	—	4980	4	645	5625	5625
2	PORTUGAL	1	1247		4	645	1892	4	645	2537	5	548	3085	1	1247	4332	5	548	4880	1	1247	6129	5579
3	U.S.A.	5	548		9	293	841	5	548	1389	3	770	2159	11	206	2365	1	1247	3612	2	946	4558	4352
4	SWEDEN	2	946		3	770	1716	14	101	1817	8	344	2161	4	645	2806	12	168	2974	6	469	3443	3342
5	DENMARK	8	344		7	402	746	1	1247	1993	9	293	2286	10	247	2533	7	402	2935	12	168	3103	2935
6	ITALY	12	168		6	469	637	10	247	884	2	946	1830	9	293	2123	4	645	2768	9	293	3061	2893
7	CANADA	7	402		2	946	1348	2	946	2294	11	206	2500	14	101	2601	—	—	2601	11	206	2807	2807
8	NORWAY	4	645		10	247	892	12	168	1060	6	469	1529	6	469	1998	3	770	2768	13	133	2901	2768
9	FRANCE	6	469		5	548	1017	11	206	1223	10	247	1470	3	770	2240	9	293	2533	7	402	2935	2729
10	BRAZIL	9	293		11	206	499	9	293	792	12	168	960	8	344	1304	2	946	2250	5	548	2798	2630
11	HOLLAND	—	—		13	133	133	6	469	602	4	645	1247	13	133	1380	8	344	1724	3	770	2494	2494
12	URUGUAY	10	247		8	344	591	7	402	993	7	402	1395	12	168	1563	6	469	2032	8	344	2376	2208
13	EIRE	—	—		12	168	168	8	344	512	13	133	645	5	548	1193	11	206	1399	14	101	1500	1500
14	ARGENTINE	11	206		14	101	307	13	133	440	—	—	440	7	402	842	10	247	1089	10	247	1336	1336

### POINTS SCORED

**SWALLOWS.** 1st= 1247 ; 2nd=946 ; 3rd=770 ; 4th=645 ; 5th=548 ; 6th=469 ; 7th=402 ; 8th=344 ; 9th=293 ; 10th=247  
11th=206; 12th=168; 13th=133; 14th=101

*Argentine* ..... " ANTARES " ..... Helmsman : J. Cibert. Crew selected from : M. Lawrence, S. Merlo, F. Monti.

*Brazil* ..... " ANDORINHA " ..... Helmsman : V. Reis Ferraz. Crew : C. Borchers.

*Canada* ..... "SCAUP" ..... Helmsman : J. Robertson. Crew : R. Townsend.

*Denmark* ..... No Name ..... Helmsman : J. Rathje. Crew : N. Petersen.

*Eire* ..... " THE CLOUD " ..... Helmsman : A. Delany. Crew selected from : R. Allen, E. Macnally, D. Sullivan.

*France* ..... "RED INDIAN" ..... Helmsman : J. Lebrun. Crew selected from : H. Perrissol, J. Peytel.

*Gt. Britain* ..... " SWIFT " ..... Helmsman : S. Morris. Crew : D. Bond.

*Holland* ..... " ST. MARGRITE " ..... Helmsman: W. de Vries Lentsch. Crew selected from: J. Bier, P. Keegstra, C. Vink.

*Italy* ..... " ENOTRIA " ..... Helmsman : D. Salata. Crew : A. Roncoroni.

*Norway* ..... "NORA " ..... Helmsman : O. Christensen. Crew selected from : K. Bengtson, K. Heje, O. Thommessen.

*Portugal* ..... "SYMPHONY" ..... Helmsman : D. de Almeida Bello. Crew : F. Pinto Coelho Bello.

*Sweden* ..... "CHANCE" ..... Helmsman : S. Hedberg. Crew : L. Matton.

*U.S.A.* ..... " MARGARET " ..... Helmsman : L. Pirie. Crew : O. Torry, Jnr.

*Uruguay* ..... "NORTAZO" ..... Helmsman : C. A. Saez. Crew selected from : J. B. Bidegaray, J. Gamenara, F. Sierra Castellanos.

## DAILY RESULTS

First Day				Fourth Day			
Country	Boat	Time	Points	Country	Boat	Time	Points
		<i>h m s</i>				<i>h m s</i>	
1 Portugal	<i>Symphony</i>	13 17 41	1,247	1 Great Britain	<i>Swift</i>	13 33 03	1,247
2 Sweden	<i>Chance</i>	13 18 52	946	2 Italy	<i>Enotria</i>	13 41 49	946
3 Great Britain	<i>Swift</i>	13 19 09	770	3 U.S.A.	<i>Margaret</i>	13 42 32	770
4 Norway	<i>Nora</i>	13 20 24	645	4 Holland	<i>St. Margriet</i>	13 43 07	645
5 U.S.A.	<i>Margaret</i>	13 23 04	548	5 Portugal	<i>Symphony</i>	13 43 47	548
6 France	<i>Red Indian</i>	13 23 14	469	6 Norway	<i>Nora</i>	13 44 27	469
7 Canada	<i>Scaup</i>	13 24 10	402	7 Uruguay	<i>Nortazo</i>	13 44 40	402
8 Denmark	No Name	13 25 23	344	8 Sweden	<i>Chance</i>	13 45 26	344
9 Brazil	<i>Andorinha</i>	13 25 59	293	9 Denmark	No Name	13 45 56	297
10 Uruguay	<i>Nortazo</i>	13 26 27	247	10 France	<i>Red Indian</i>	13 45 58	247
11 Argentine	<i>Antares</i>	13 29 14	204	11 Canada	<i>Scaup</i>	13 46 26	206
12 Italy	<i>Enotria</i>	13 33 13	168	12 Brazil	<i>Andorinha</i>	13 46 38	168
<i>Eire (The Cloud)</i> and <i>Holland (St. Margriet)</i> did not finish.				13 <i>Eire (The Cloud)</i>		13 47 33	133
				Argentine did not finish.			

Second Day			
1 Great Britain	<i>Swift</i>	13 11 54	1,247
2 Canada	<i>Scaup</i>	13 13 10	946
3 Sweden	<i>Chance</i>	13 13 38	770
4 Portugal	<i>Symphony</i>	13 13 55	645
5 France	<i>Red Indian</i>	13 16 18	548
6 Italy	<i>Enotria</i>	13 16 28	469
7 Denmark	No Name	13 16 31	402
8 Uruguay	<i>Nortazo</i>	13 16 58	344
9 U.S.A.	<i>Margaret</i>	13 17 17	293
10 Norway	<i>Nora</i>	13 17 29	247
11 Brazil	<i>Andorinha</i>	13 18 06	204
12 <i>Eire (The Cloud)</i>		13 18 24	168
13 Holland	<i>St. Margriet</i>	13 19 18	133
14 Argentine	<i>Antares</i>	13 21 06	101

Third Day			
1 Denmark	No Name	15 9 36	1,247
2 Canada	<i>Scaup</i>	15 11 07	946
3 Great Britain	<i>Swift</i>	15 12 52	770
4 Portugal	<i>Symphony</i>	15 13 10	645
5 U.S.A.	<i>Margaret</i>	15 13 25	548
6 Holland	<i>St. Margriet</i>	15 14 25	469
7 Uruguay	<i>Nortazo</i>	15 16 07	402
8 <i>Eire (The Cloud)</i>		15 16 49	344
9 Brazil	<i>Andorinha</i>	15 17 27	293
10 Italy	<i>Enotria</i>	15 17 35	247
11 France	<i>Red Indian</i>	15 18 46	204
12 Norway	<i>Nora</i>	15 19 44	168
13 Argentine	<i>Antares</i>	15 20 08	133
14 Sweden	<i>Chance</i>	15 21 26	101

Fifth Day			
1 Portugal	<i>Symphony</i>	13 23 03	1,247
2 Great Britain	<i>Swift</i>	13 23 10	946
3 France	<i>Red Indian</i>	13 24 12	770
4 Sweden	<i>Chance</i>	13 24 14	645
5 <i>Eire (The Cloud)</i>		13 24 50	548
6 Norway	<i>Nora</i>	13 25 03	469
7 Argentine	<i>Antares</i>	13 25 17	402
8 Brazil	<i>Andorinha</i>	13 25 29	344
9 Italy	<i>Enotria</i>	13 24 42	293
10 Denmark	No Name	13 25 57	247
11 U.S.A.	<i>Margaret</i>	13 26 13	206
12 Uruguay	<i>Nortazo</i>	13 26 27	168
13 Holland	<i>St. Margriet</i>	13 26 46	133
14 Canada	<i>Scaup</i>	13 27 38	101

Sixth Day			
1 U.S.A.	<i>Margaret</i>	13 22 48	1,247
2 Brazil	<i>Andorinha</i>	13 23 08	946
3 Norway	<i>Nora</i>	13 23 48	770
4 Italy	<i>Enotria</i>	13 23 56	645
5 Portugal	<i>Symphony</i>	13 24 24	548
– Great Britain	<i>Swift</i>	13 24 50	—
– Canada	<i>Scaup</i>	13 25 27	—
6 Uruguay	<i>Nortazo</i>	13 25 27 <sup>1/4</sup>	469
7 Denmark	No Name	13 26 22	402
8 Holland	<i>St. Margriet</i>	13 26 31	344
9 France	<i>Red Indian</i>	13 27 20	293
10 Argentine	<i>Antares</i>	13 27 37	247
11 <i>Eire (The Cloud)</i>		13 28 54	206
12 Sweden	<i>Chance</i>	14 04 06	168
Great Britain and Canada disqualified.			

Seventh Day			
Country	Boat	Time	Points
		<i>h m s</i>	
1 Portugal	<i>Symphony</i>	13 05 42	1,247
2 U.S.A.	<i>Margaret</i>	13 07 23	946
3 Holland	<i>St. Margriet</i>	13 07 36	770
4 Great Britain	<i>Swift</i>	13 08 55	645
5 Brazil	<i>Andorinha</i>	13 09 09	548
6 Sweden	<i>Chance</i>	13 10 40	464
7 France	<i>Red Indian</i>	13 12 50	402
8 Uruguay	<i>Nortazo</i>	13 14 32	344
9 Italy	<i>Enotria</i>	13 15 06	243
10 Argentine	<i>Antares</i>	13 15 08	247
11 Canada	<i>Scaup</i>	13 15 10	206
12 Denmark	No Name	13 15 19	168
13 Norway	<i>Nora</i>	13 15 23	133
14 <i>Eire (The Cloud)</i>		13 18 21	101

**FIREFLY CLASS***Previous Olympic Winners***SINGLE-HANDED CLASS**

1924	L. Huybrechts	<i>Belgium</i>
1928	S. G. Thorell	<i>Sweden</i>
1932	J. Lebrun	<i>France</i>
1936	D. M. J. Kagchelland	<i>Holland</i>

There were 36 entries from 21 nations ; 21 participants from 21 nations

**FINAL PLACINGS**

Final Place	Nationality	AUGUST 3		AUGUST 4		AUGUST 5		AUGUST 6		AUGUST 10		AUGUST 11		AUGUST 12		Points for Best Six Races						
		Finishing Position	Points	Finishing Position	Points	Score to Date	Finishing Position	Points	Score to Date	Finishing Position	Points	Score to Date	Finishing Position	Points	Score to Date		Finishing Position	Points				
1	DENMARK	—	—	6	645	645	3	946	1591	11	382	1973	5	724	2697	1	1423	4120	1	1423	5543	5543
2	U.S.A.	2	1122	3	946	2068	13	309	2377	9	469	2846	1	1423	4269	5	724	4993	5	724	5717	5408
3	HOLLAND	6	645	5	724	1369	17	193	1562	4	821	2383	3	946	3329	3	946	4275	2	1122	5397	5204
4	SWEDEN	8	520	1	1423	1943	7	578	2521	1	1423	3944	—	—	3944	11	382	4326	14	277	4603	4603
5	CANADA	5	724	9	469	1193	8	520	1713	2	1122	2835	2	1122	3957	—	—	3957	7	578	4535	4535
6	URUGUAY	13	309	2	1122	1431	5	724	2155	8	520	2675	10	423	3098	9	469	3567	4	821	4388	4079
7	FRANCE	1	1423	7	578	2001	11	382	2383	—	—	2383	12	344	2627	2	1122	3749	16	219	4068	4068
8	BELGIUM	3	946	14	277	1173	15	247	1470	5	724	2194	6	645	2839	4	821	3660	15	247	3907	3660
9	GT. BRITAIN	10	423	4	821	1244	18	168	1412	3	946	2358	7	578	2936	8	520	3456	—	—	3456	3456
10	SWITZERLAND	14	277	17	193	470	1	1423	1893	17	193	2086	18	168	2254	—	309	2563	8	520	3083	2915
11	BRAZIL	7	578	—	—	578	6	645	1223	19	144	1367	4	821	2188	15	247	2435	9	469	2904	2904
12	NORWAY	19	144	13	309	453	9	469	922	13	309	1231	14	277	1508	7	578	2086	3	946	3032	2888
13	PORTUGAL	15	247	10	423	670	10	423	1093	7	578	1671	8	520	2191	14	277	2468	11	382	2850	2603
14	ITALY	17	193	15	247	440	4	821	1261	10	423	1684	11	382	2066	17	193	2259	12	344	2603	2410
15	FINLAND	II	382I	—	—	382	2	1122	1504	—	—	1504	15	247	1751	6	645	2396	—	—	2396	2396
16	EIRE	4	821	8	520	1341	14	277	1618	15	247	1865	13	309	2174	18	168	2342	—	—	2342	2342
17	ARGENTINE	16	219	—	—	219	12	344	563	6	645	1208	—	—	1208	10	423	1631	6	645	2276	2276
18	AUSTRALIA	18	168	11	382	550	19	144	694	16	219	913	9	469	1382	12	344	1726	10	423	2149	2005
19	SPAIN	9	469	12	344	813	16	219	1032	12	344	1376	19	144	1520	—	—	1520	13	309	1829	1829
20	SOUTH AFRICA	12	344	16	219	563	—	—	563	14	277	840	16	219	1059	16	219	1278	—	—	1278	1278
21	AUSTRIA	20	122	—	—	122	—	—	122	18	168	290	17	193	483	19	144	627	—	—	627	627

**POINTS SCORED**

**FIREFLIES.** 1st=1423 ; 2nd=1122 ; 3rd=946 ; 4th=821 ; 5th=724 ; 6th=645 ; 7th=578 ; 8th=520 ; 9th=469 ; 10th=423 ;  
11th=382 ; 12th=344 ; 13th=309 ; 14th=277 ; 15th=247 ; 16th=219 ; 17th=193 ; 18th=168 ; 19th=144 ; 20th=122 ;  
21st=101

<i>Nation</i>	<i>Yacht's Number</i>	<i>Helmsman</i>	<i>Nation</i>	<i>Yacht's Number</i>	<i>Helmsman</i>
<i>Finland</i>	481	E. Palmgreen	<i>Switzerland</i>	494	A. Oswald
<i>Canada</i>	483	P. McLaughlin	<i>Sweden</i>	495	E. Sarby
<i>Spain</i>	484	J. Alonso Allende	<i>Argentine</i>	496	Y. Brauer
<i>Belgium</i>	485	P. Van der Haeghen	<i>Italy</i>	497	L. Spanghero
<i>Denmark</i>	486	P. Elvstrom	<i>Brazil</i>	498	W. Richter
<i>South Africa</i>	487	H. McWilliams	<i>Austria</i>	499	H. Musil
<i>Holland</i>	489	J. de Jong	<i>Portugal</i>	500	J. Miguez Tito
<i>Australia</i>	490	R. French	<i>U.S.A.</i>	501	R. Evans
<i>France</i>	491	J. Herbulot	<i>Uruguay</i>	502	F. Sienna Castellanos
<i>Norway</i>	492	M. Skaugen	<i>Gt. Britain</i>	503	A. McDonald
<i>Eire</i>	493	A. Mooney			

## DAILY RESULTS

First Day				Fourth Day			
Country	Helmsman	Time	Points	Country	Helmsman	Time	Points
		<i>h m s</i>				<i>h m s</i>	
1 France	<i>J. Herbulot</i>	12 3 49	1,423	1 Sweden	<i>E. Sarby</i>	12 39 28	1,423
2 U.S.A	<i>R. Evans</i>	12 3 09	1,122	2 Canada	<i>P. McLaughlin</i>	12 39 40	1,122
3 Belgium	<i>R. Van der Haeghen</i>	12 3 16	946	3 Great Britain	<i>A. Mcdonald</i>	12 40 37	946
4 Eire	<i>A. Mooney</i>	12 3 58	821	4 Holland	<i>J. de Jong</i>	12 40 37	821
5 Canada	<i>P. McLaughlin</i>	12 3 10	724	5 France	<i>J. Herbulot</i>	12 41 11	724
6 Holland	<i>J. de Jong</i>	12 3 15	645	6 Belgium	<i>R. Van der Haegben</i>	12 42 36	645
7 Brazil	<i>W. Richter</i>	12 3 20	578	7 Argentine	<i>J. Brauer</i>	12 43 04	578
8 Sweden	<i>E. Sarby</i>	12 3 26	520	8 Portugal	<i>J. Miguez Tito</i>	12 43 13	520
9 Spain	<i>J. Alonso Allende</i>	12 3 33	469	9 Uruguay	<i>F. Sienra Caste llanos</i>	12 43 20	469
10 Great Britain	<i>A. Mcdonald</i>	12 3 49	423	10 U.S.A	<i>R. Evans</i>	12 44 14	423
11 Finland	<i>E. Palmgreen</i>	12 3 04	382	11 Italy	<i>L. Spanghero</i>	12 44 33	352
12 South Africa	<i>H. McWilliams</i>	12 3 15	344	12 Denmark	<i>P. Elvstrom</i>	12 44 35	344
13 Uruguay	<i>F. Sienra Castellanos</i>	12 3 18	309	13 Spain	<i>J. Alonso Allende</i>	12 44 37	309
14 Switzerland	<i>A. Oswald</i>	12 3 24	277	14 Norway	<i>M. Skaugen</i>	12 45 09	277
15 Portugal	<i>J. Miguez Tito</i>	12 3 41	247	15 South Africa	<i>H. McWilliams</i>	12 45 22	247
16 Argentine	<i>J. Brauer</i>	12 3 44	219	16 Eire	<i>A. Mooney</i>	12 46 01	219
17 Italy	<i>L. Spanghero</i>	12 3 27	193	17 Australia	<i>R. French</i>	12 47 09	193
18 Australia	<i>R. French</i>	12 3 30	168	18 Switzerland	<i>A. Oswald</i>	12 47 13	168
19 Norway	<i>M. Skaugen</i>	12 3 06	144	19 Austria	<i>H. Musil</i>	12 47 40	144
20 Austria	<i>H. Musil</i>	12 3 19	124	20 Brazil	<i>W. Richter</i>	12 47 54	122
Denmark retired.				Finland retired.			
Second Day				Fifth Day			
Country	Helmsman	Time	Points	Country	Helmsman	Time	Points
		<i>h m s</i>				<i>h m s</i>	
1 Sweden	<i>E. Sarby</i>	12 28 00	1,423	1 U.S.A	<i>R. Evans</i>	13 36 14	1,423
2 Uruguay	<i>F. Sienra Castellanos</i>	12 58 55	1,122	2 Canada	<i>P. McLaughlin</i>	13 36 37	1,122
3 U.S.A	<i>R. Evans</i>	12 30 27	946	3 Holland	<i>J. de Jong</i>	13 36 53	946
4 Great Britain	<i>A. Mcdonald</i>	12 30 31	821	4 Brazil	<i>W. Richter</i>	13 36 54	821
5 Holland	<i>J. de Jong</i>	12 30 37	724	Sweden	<i>E. Sarby</i>	13 36 57	—
6 Denmark	<i>P. Elvstrom</i>	12 30 49	645	5 Denmark	<i>P. Elvstrom</i>	13 37 07	724
7 France	<i>J. Herbulot</i>	12 30 53	578	6 Belgium	<i>R. Van der Haeghen</i>	13 37 19	645
8 Eire	<i>A. Mooney</i>	12 31 55	520	7 Great Britain	<i>A. Mcdonald</i>	13 37 29	578
9 Canada	<i>P. McLaughlin</i>	12 32 26	469	8 Portugal	<i>J. Miguez Tito</i>	13 38 07	520
10 Portugal	<i>J. Miguez Tito</i>	12 32 45	423	9 Australia	<i>R. French</i>	13 38 08	469
11 Australia	<i>R. French</i>	12 33 04	352	10 Uruguay	<i>F. Sienra Castellanos</i>	13 38 13	423
12 Spain	<i>J. Alonso Allende</i>	12 33 08	344	11 Italy	<i>L. Spanghero</i>	13 38 15	382
13 Norway	<i>M. Skaugen</i>	12 33 09	309	12 France	<i>J. Herbulot</i>	13 38 23	344
14 Belgium	<i>R. Van der Haeghen</i>	12 33 11	277	13 Eire	<i>A. Mooney</i>	13 38 24	309
15 Italy	<i>L. Spanghero</i>	12 33 43	247	14 Norway	<i>M. Skaugen</i>	13 38 35	277
16 South Africa	<i>H. McWilliams</i>	12 34 11	219	15 Finland	<i>E. Palmgreen</i>	13 39 15	247
17 Switzerland	<i>A. Oswald</i>	12 34 12	193	16 South Africa	<i>H. McWilliams</i>	13 39 19	219
Finland, Argentine, Brazil and Austria retired.				17 Austria	<i>H. Musil</i>	13 39 41	193
				18 Switzerland	<i>A. Oswald</i>	13 39 54	188
				19 Spain	<i>J. Alonso Allende</i>	13 39 54	144
				Argentine ( <i>J. Brauer</i> ) retired. Sweden disqualified.			
Third Day				Sixth Day			
Country	Helmsman	Time	Points	Country	Helmsman	Time	Points
		<i>h m s</i>				<i>h m s</i>	
1 Switzerland	<i>A. Oswald</i>	13 03 40	1,423	1 Denmark	<i>P. Elvstrom</i>	13 34 44	1,423
2 Finland	<i>E. Palmgreen</i>	13 08 21	1,122	2 France	<i>J. Herbulot</i>	13 35 07	1,122
3 Denmark	<i>P. Elvstrom</i>	13 08 22	946	3 Holland	<i>J. de Jong</i>	13 35 03	946
4 Italy	<i>L. Spanghero</i>	13 08 54	821	4 Belgium	<i>R. Van der Haeghen</i>	13 36 22	821
5 Uruguay	<i>F. Sienra Castellanos</i>	13 08 59	724	5 U.S.A	<i>R. Evans</i>	13 37 07	724
6 Brazil	<i>W. Richter</i>	13 09 03	645	6 Finland	<i>E. Palmgreen</i>	13 38 02	645
7 Sweden	<i>E. Sarby</i>	13 09 04	578	7 Norway	<i>M. Skaugen</i>	13 38 16	578
8 Canada	<i>P. McLaughlin</i>	13 12 03	520	8 Great Britain	<i>A. Macdonald</i>	13 38 28	520
9 Norway	<i>M. Skaugen</i>	13 12 09	469	9 Uruguay	<i>F. Sienra Castellanos</i>	13 39 03	469
10 Portugal	<i>J. Miguez Tito</i>	13 13 14	423	10 Argentine	<i>J. Brauer</i>	13 39 39	423
11 France	<i>J. Herbulot</i>	13 13 33	392	11 Sweden	<i>E. Sarby</i>	13 40 24	382
12 Argentine	<i>J. Brauer</i>	13 14 41	344	12 Australia	<i>R. French</i>	13 41 00	344
13 U.S.A	<i>R. Evans</i>	13 14 53	309	13 Switzerland	<i>A. Oswald</i>	13 41 25	309
14 Eire	<i>A. Mooney</i>	13 15 00	277	14 Portugal	<i>J. Miguez Tito</i>	13 41 56	277
15 Belgium	<i>R. Van der Haeghen</i>	13 15 08	247	15 Brazil	<i>W. Richter</i>	13 42 50	247
16 Spain	<i>J. Alonso Allende</i>	13 16 16	219	16 South Africa	<i>H. McWilliams</i>	13 43 36	219
17 Holland	<i>J. de Jong</i>	13 16 24	193	17 Italy	<i>L. Spanghero</i>	13 43 55	193
18 Great Britain	<i>A. Mcdonald</i>	13 17 10	168	18 Eire	<i>A. Mooney</i>	13 43 57	168
19 Australia	<i>R. French</i>	13 18 14	144	19 Austria	<i>H. Musil</i>	13 44 34	144
South Africa and Austria retired.				Spain retired. Canada disqualified.			

**DAILY RESULTS—" FIREFLY " CLASS—continued.**

		Seventh Day			
Country	Helmsman	Time		Points	
		<i>h</i>	<i>m</i>	<i>s</i>	
1 Denmark .....	<i>P. Elvstrom</i> .....	13	35	37	1,423
2 Holland .....	<i>J. de Jong</i> .....	13	38	44	1,122
3 Norway .....	<i>M. Skaugen</i> .....	13	39	29	946
4 Uruguay .....	<i>F. SienraCastellanos</i> ...	13	41	32	821
5 U.S.A.....	<i>R. Evans</i> .....	13	42	22	724
6 Argentine .....	<i>J. Brauer</i> .....	13	43	16	645
7 Canada .....	<i>P. McLaughlin</i> .....	13	44	35	578
8 Switzerland .....	<i>A. Oswald</i> .....	13	44	59	520
9 Brazil.....	<i>W. Richter</i> .....	13	49	07	469
10 Australia .....	<i>R. French</i> .....	13	52	38	423
11 Portugal .....	<i>J. Miguez Tito</i> .....	13	55	57	382
12 Italy .....	<i>L. Spanghero</i> .....	13	59	40	344
13 Spain .....	<i>J. Alonso Allende</i> .....	14	05	02	309
14 Sweden .....	<i>E. Sarby</i> .....	14	10	19	277
15 Belgium .....	<i>R. Van der Haeghen</i> ....	14	13	01	247
16 France.....	<i>J. Herbulot</i> .....	14	25	13	219
Austria, Eire, Finland, South Africa and Great Britain retired.					

**Y.R.A. NATIONAL 12' FT DINGHY**

**"FIREFLY"**

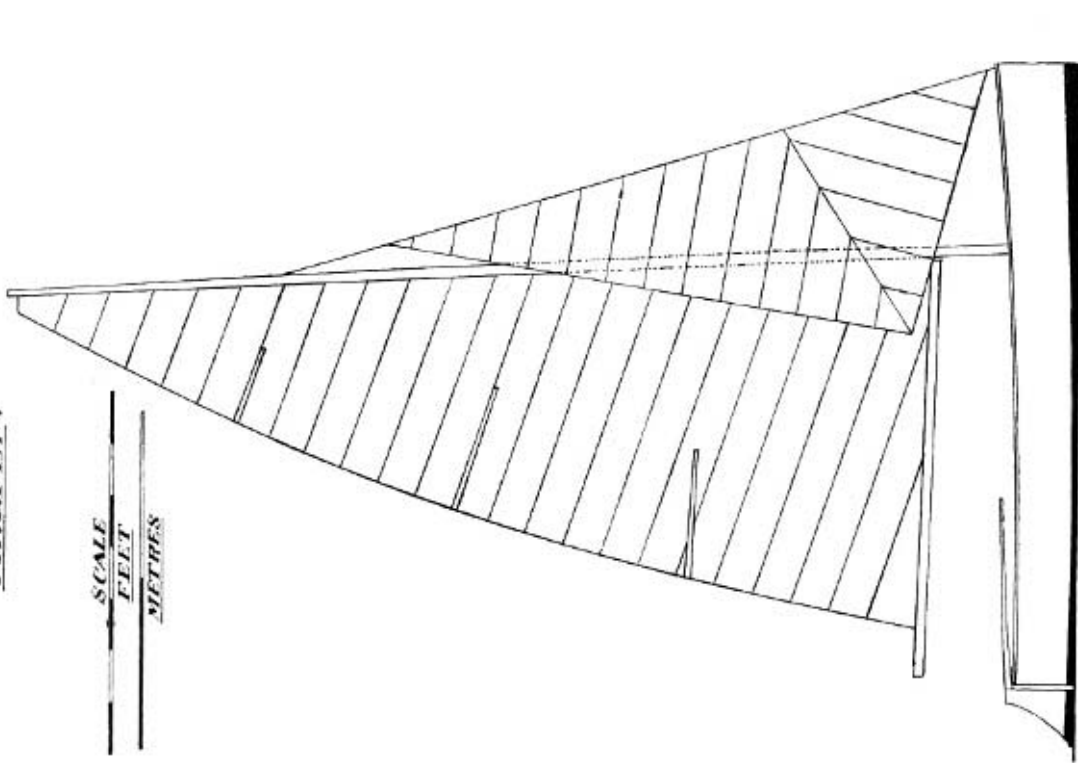



*Y.R.A. NATIONAL 12' DINGHY "FIREFLY."*

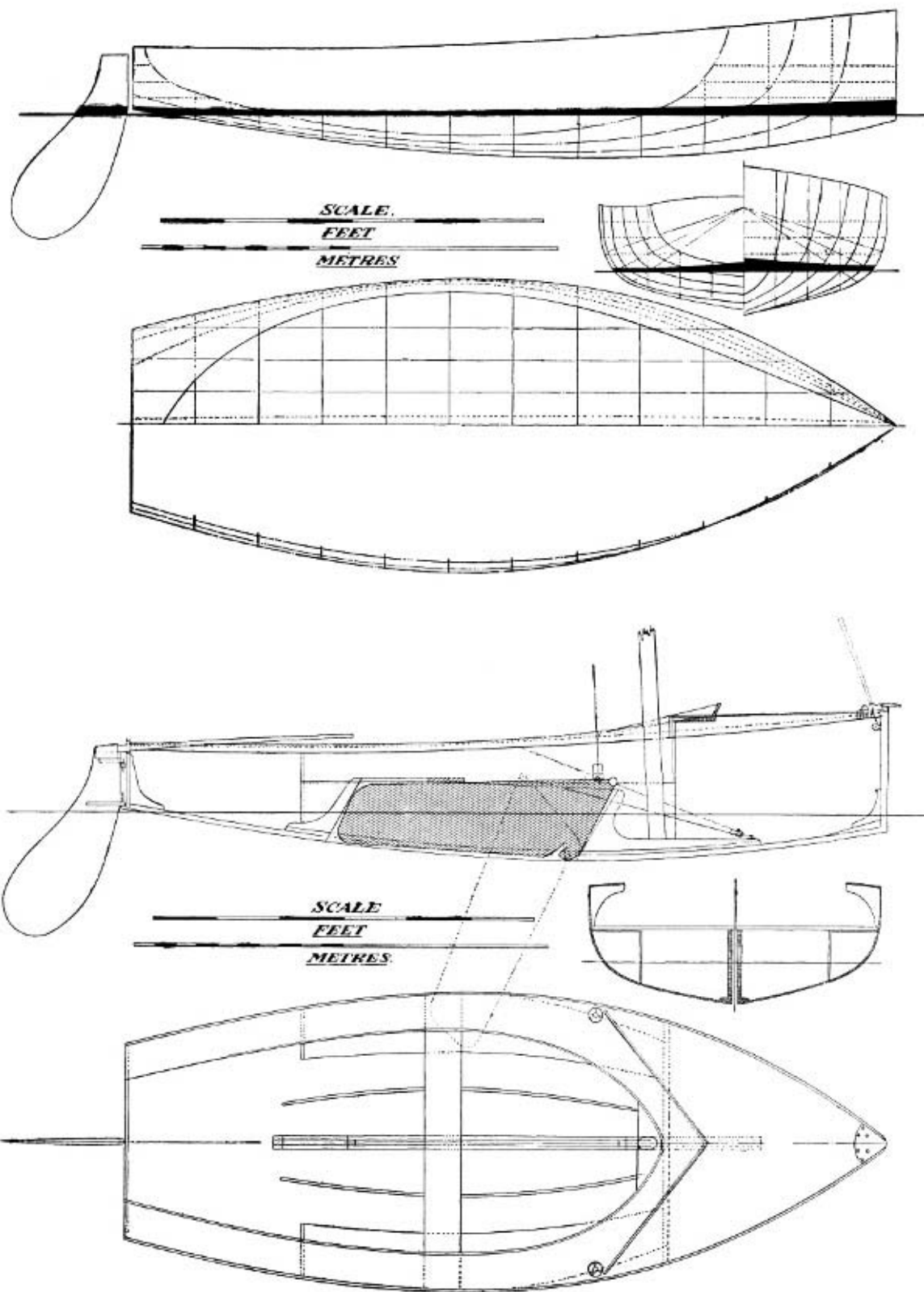

# DEMONSTRATIONS

THE regulations for the celebration of the Olympic Games lay down that " The Organising Committee can organise Demonstrations of two sports not included in the programme : (1) a National Sport; (2) a Sport foreign to the organising country."

Consideration of which sports should be included in the celebration of the London Games was given careful attention by the Executive Committee.

A considerable number of Sporting Federations who did not form part of the Olympic Games applied for their sport to be included in the London Games and the Organising Committee decided in July, 1947, to stage demonstrations of Lacrosse and of Swedish Ling.

## LACROSSE

The organisation of the Lacrosse Demonstration was carried out by the English Lacrosse Union and this body invited a team from the United States of America to play a match at the Empire Stadium against an All-England Lacrosse side. The visiting team was the Rensselaer Polytechnic of Troy, New York State. The U.S.A. team had carried out a tour in Great Britain, and concluded this with the fitting finale of the match at Wembley.

The modern game of lacrosse is believed to have originated from a tribal game known as " ball game " of the North American Indians and was brought to England by the settlers in Canada in the 18th or 19th Century. It is played not only in Great Britain, but also in Australia and Canada and, most prominently of all, in the United States of America.

The teams at Wembley proved to be excellently matched, and the resulting game was both close and exciting, in addition to being one of the best exhibitions of lacrosse ever seen in England.

During the first quarter (the game consists of four 20-minute periods), Whittaker opened the scoring for the English side, but the Americans soon asserted themselves and went away to a 4-1 lead with goals by Coleman, Myers (2) and Wood. Before the end of the period, however, Little had reduced the margin.

### **An Exciting Finish**

There was no such goal-scoring rush in the second and third periods, a single goal by Wilson, which reduced the margin to one goal, in the second period, being the only score. The English team, however, turned on full pressure at the start of the final twenty minutes and first Whittaker equalised with a brilliant goal, and then Dennis put them ahead. It seemed likely that they would hold their lead, for the defence was now closely knit, but, in a most exciting finish, Myers put the Americans on level terms with only three minutes left for play.

The teams and officials were :—

**TEAMS***Rensselaer Polytechnic (U.S.A.)**All-England*

	<i>Position</i>	
R. Campbell	Goal	H. Wyatt
S. W. Spaulding	Point	J. P. Foy
R. E. Koch	Cover Point	J. Fletcher
R. M. Wood	Third Man	J. I. Whitehead (Capt.)
A. D. Beard	Left Defence	B. C. Makin
C. J. McCann	Right Defence	A. L. Dennis
M. T. Davies	Centre	H. Prime
R. Coons	Left Attack	R. N. Whittaker
J. A. Myers	Right Attack	J. Buckland
W. L. Coleman	Third Home	R. T. Renshaw
R. E. Powell	Second Home	J. H. Little
D. E. Jordan (Capt.)	First Home	R. V. Wilson
D. R. Sutton	Substitutes	J. Swindells
R. J. Sneedon		N. R. Coe
R. F. Ball		H. J. Ginn
R. Frick		J. Griffiths
R. Hutcheon		R. F. Zimmern
O. Cook		

*Goal Umpires*

D. Pollock  
A. J. Beinschroth

F. D. Ewen

*Referee*

A. Howarth

**SWEDISH GYMNASTICS**

The Svenska Gymnastikförbundet of Stockholm staged a demonstration of Swedish gymnastics by 200 female and 200 male gymnasts. The object was to illustrate how the voluntary gymnastics of Sweden during the last decades has developed into a great national movement for the promotion of health, beauty, strength and happiness. This style of gymnastics was developed by P. H. Ling about 150 years ago and has a following all over the world.

As the number of persons to carry out the demonstration was so large, the Organising Committee came to a special arrangement with the Svenska Gymnastikförbundet, who agreed to undertake all the catering and domestic arrangements for their gymnasts, the Organising Committee providing accommodation and necessary furnishings. A nominal rate was charged to the Swedes for their food. The Swedish party included their own domestic staff and so enthusiastic were they over this demonstration that the gymnasts themselves not only gave of their services, but defrayed the cost of the journey to London out of their own pockets. They were treated as competitors, being issued with identity cards, commemorative medals, etc.

Two displays were given, one on Saturday, August 7, immediately preceding the start of the Marathon race and one on Friday, August 13, preceding the Football Final.

No words can express adequately the beauty and poetry of the motion of these gymnasts and probably the only regret that any spectator had was when the demonstration ended. The rhythm and precision with which the free exercises were carried out in the Empire Stadium, with only one rehearsal there, is adequate proof, not only of the training and ability of the gymnasts under their manager, Mr. Agne Holmstrom, but that this form of physical exercise binds together those who perform it into a cohesive whole.

# ARTS COMPETITIONS

## ARCHITECTURE

### Town Planning

#### FIRST PRIZE

Yrjo Lindegren, Finland—*The Centre of Athletics in Varkaus, Finland.*

#### SECOND PRIZE

Werner Schindler and Dr Edy Knupfer, Switzerland—*Swiss Federal Sports and Gymnastics Training Centre,*

#### THIRD PRIZE

Ilmari Niemelainen, Finland—*The Athletic Centre in Kemi, Finland.*

#### Honourable Mention

J. Neel and E. Vago, France—*Centre Social de la Jeunesse et des Sports de la Commune de Levallois.*

### Architectural Designs

#### FIRST PRIZE

Adolf Hoch, Austria—*Skisprungschanze auf dem Kobenzl.*

#### SECOND PRIZE

Alfred L. Rinesch, Austria—*Watersports Centre in Carinthia.*

#### THIRD PRIZE

Nils Olsson, Sweden—*Baths and Sporting Hall for Gothenburg.*

#### Honourable Mention

Marani and Morris, Canada—*Stadium for the Canadian National Exhibition, Toronto.*

Frantisek Marek, Czechoslovakia—*Gymnasium of Sokols, Prague.*

Patrick B. Horsbrugh, Great Britain—*Sailing Club.*

Orjan Luning, Sweden—*Civic and Sporting Hall for Rydboholm.*

Vladimir Turnia and Franjo Neidhardt, Yugoslavia—*Stadium for Zagreb.*

Vladimir Turnia, Franjo Neidhardt and Dragan Boltar, Yugoslavia—*The Great Stadium for Belgrade.*

Dagoberto Ortensi, Italy—*Olympic Centre for 1956 Olympic Games.*

## PAINTING AND GRAPHIC ART

### Oils, Water Colours, etc.

#### FIRST PRIZE

A. R. Thomson, RA, Great Britain—*London Amateur Championships.*

#### SECOND PRIZE

Giovanni Stradone, Italy—*Le Pistard.*

#### THIRD PRIZE

Letitia M. Hamilton, RHA, Eire—*Meath Hunt Point-to-Point Races.*

#### Honourable Mention

Lucien Fontanarosa, France—*Cavaliers.*

Aime Thevenet, France—*Coueurs Cyclistes dans la cote de "Coeur-Volant."*

Cosmo Clark, Great Britain—*Scullers and Crews Practising on the Thames.*

Walter Battiss, South Africa—*The Quagga Race.*

F. Brandtner, Canada—*Breaking Away.*

A. M. Luyt, Holland—*Polospel.*

### Engravings, Etchings, etc.

#### FIRST PRIZE

Albert Decaris, France—*Swimming Pool.*

#### SECOND PRIZE

John Copley, PRBA, RE, Great Britain—*Polo Players.*

#### THIRD PRIZE

Walter Battiss, South Africa—*Seaside Sport.*

#### Honourable Mention

Laura Knight, DBE, RA, Great Britain—*Boxing Sketch.*

Adam Marczynski, Poland—*Eight Studies of Athletes.*

John Skeaping, Great Britain—*Saddling Up.*

Gino de Finetti, Italy—*Spada.*

Hsiao-Nan Chen, China—*Riding.*

## Applied Art and Crafts

### SECOND PRIZE

Alex Walter Diggelmann, Switzerland—*World Championship for Cycling Poster.*

### THIRD PRIZE

Alex Walter Diggelmann, Switzerland—*World Championship for Ice Hockey Poster.*

### Honourable Mention

Designed by Bernard Cuzner, made by him and Stanley Morris and exhibited by the Worshipful Company of Goldsmiths, Great Britain—*Silver Symbolic Torch.*

## SCULPTURE

### In the Round

#### FIRST PRIZE

Gustaf Nordahl, Sweden—*Homage to Ling.*

#### SECOND PRIZE

C. Kar, ARBS, Great Britain—*The Stag.*

#### THIRD PRIZE

Hubert Yencesse, France—*Nageuse.*

#### Honourable Mention

Joseph Riviere, France—*Athlete Marchant.*

Filippo Sgarlata, Italy—*La Pesca.*

Emilio Greco, Italy—*Lottatore in riposo.*

Jerzy Bandura, Poland—*Crawl.*

Franciszek Strynkiewicz, Poland—*At the Finishing Line.*

Knud Nellemose, Denmark—*Young Man with Discus.*

Knud Nellemose, Denmark—*Head of a Boxer.*

### Reliefs

#### THIRD PRIZE

Rosamund Fletcher, M.B., Great Britain—*The End of the Covert.*

## Medals and Plaques

#### SECOND PRIZE

Oskar Thiede, Austria—*Eight Sports Plaques.*

#### THIRD PRIZE

Edwin Grienuer, Austria—*Prize Rowing Trophy.*

#### Honourable Mention

Alex Walter Diggelmann, Switzerland—*Swiss Roller-skating Championship Medal.*

Filippo Sgarlata, Italy—*La Caccia and Il Disco.*

## LITERATURE

### Lyrics

#### FIRST PRIZE

Aale Tynni, Finland—*Laurel of Hellas.*

#### SECOND PRIZE

E. Van Heerden, South Africa—*Six Poems.*

#### THIRD PRIZE

Gilbert Prouteau, France—*Rythme du Stade.*

#### Honourable Mention

J. Iwaszkiewicz, Poland—*Olympic Odes.*

Heikki Asunta, Finland—*Endure and Win.*

Walter Roberts, Great Britain—*Greetings to the Olympians.*

### Dramatic Works

#### Honourable Mention

Clotilde Luisi and J. Maria Podesta, Uruguay—*El Desafio*

## Epic Works

### FIRST PRIZE

Giani Stuparich, Italy—*La Grotta*.

### SECOND PRIZE

Josef Petersen, Denmark—*The Olympic Champion*.

### THIRD PRIZE

Eve Foldes, Hungary—*The Well of Youth*.

### Honourable Mention

H. Breidbach-Bernau, Austria—*Sensenschmied*.

Stanislaus Lynch, Eire—*Echoes of the Hunting Horn*.

## MUSIC

### Vocal

### THIRD PRIZE

Gabriele Bianchi, Italy—*Inno Olimpionico*.

### Honourable Mention

Ina Boyle, Eire—*Lament for Bion*.

### Instrumental and Chamber

### SECOND PRIZE

Jean Weinzeig, Canada—*Divertimenti for Solo Flute and Strings*.

### THIRD PRIZE

Sergio Lauricella, Italy—*Toccata per Pianoforte*.

### Honourable Mention

Jean Coulthard Adams, Canada—*Sonata for Oboe and Piano*.

Mario Panunzi, Italy—*Quartetto in Re*.

### Choral and Orchestral

### FIRST PRIZE

Zbigniew Turski, Poland—*Olympic Symphony*.

### SECOND PRIZE

Kalervo Tuukanen, Finland—*Karhunpyynti*.

### THIRD PRIZE

Erling Brene, Denmark—*Viguer*.

### Honourable Mention

Einar Englund, Finland—*Epinikia*.

Yves Baudrier, France—*Le Grand Voilier*.

Jan Kapr, Czechoslovakia—*Marathon Scherzo*.

Stanislaw Wiechowicz, Poland—*Olympic Harvest Cantate*.

Grazyna Bacewicz, Poland—*Olympic Cantate*.

Maurice Thiriet, France—*Le Serment de l'Athlete*.

The judges in the Arts Competitions need not award a first, or any, prize if they consider that the standard of the entries does not justify such an award.

# CLOSING CEREMONY

The preliminary preparations for the Closing Ceremony were made some months before the Opening of the Games. It was decided to follow the Los Angeles precedent and provide bearers for the name-boards and flags, instead of having representatives of the teams to carry them. So many of the competitors would have left for home that this was the only certain method of guaranteeing a full Parade. It was decided, therefore, to invite senior members of the Boy Scouts' Association to carry out this important function

As under the Olympic Protocol two cantatas are to be sung, the Olympic Hymn was once more included. After a great deal of serious thought and discussion, Sir Alan Herbert, Chairman of the Literature Committee, was approached and agreed to compose a lyric specially for the occasion to be sung to the tune of the " Londonderry Air " :—

*" The Race is run. The winner wears the Laurels,  
But you and I not empty go away ;  
For we have seen the least unkind of quarrels,  
The young men glowing in the friendly fray.*

*Let us be glad—but not because of winning :  
Let us go home one family today.  
God make our Games a glorious beginning.  
And, hand in hand, together guide us on our way.*

*If all the lands could run with all the others,  
And work as sweetly as the young men play,  
Lose with a laugh, and battle but as brothers,  
Loving to win—but not in every way.*

*Let us be glad—but not because of winning :  
Let us go home one family today.  
God make our Games a glorious beginning.  
And, hand in hand, together guide us on our way. "*

The music was played by the Massed Bands of the Brigade of Guards in Review Order of scarlet tunics and bearskins, under the direction of Major S. Rhodes, Mus.Bac., A.R.C.M. The members of the Choir, who had taken part in the Opening Ceremony, were again present. Colonel Johnstone was in charge of the Parade.

The Scoreboard carried the following words written by the Chairman of the Organising Committee, Lord Burghley :

*" The Spirit of the Olympic Games which has tarried here awhile, sets forth once more. May it prosper throughout the world, safe in the keeping of all those who have felt its noble impulse in this great Festival of Sport."*

The Ceremony had been provisionally timed for 5.30 p.m. as it was considered that, by then, it would have been possible to remove the jumps after the finish of the Prix des Nations. Owing to a tie for second place, which necessitated a jump off, the Ceremony



could not commence until 6 p.m. This was fortunate, as the enthusiasm of souvenir hunters had resulted in the disappearance, at the last moment, of the parade flags of eight countries. Those raised above the Scoreboard for second and third places during victory ceremonies were of the same dimensions ; some more flag poles were discovered, and all was well by zero hour.

### **A Perfect Summer Evening**

The hundred and eighteen name-board carriers and flag bearers formed up, with Greece leading and the other nations in alphabetical order according to the English language, apart from Great Britain, who brought up the rear. Once again the weather was kind, and, on a perfect summer evening, they entered the arena to the accompaniment of suitable music and marched up the centre at five-metre intervals. On reaching their marks they wheeled to the right and halted, facing the Royal Box, name-board carriers in front, flag bearers to the rear. The flag bearers passed through the ranks of the name-board carriers and formed a semi-circle around the Tribune of Honour. The President of the International Olympic Committee, Mr. J. Sigfrid Edstrom, and the President of the Games, Viscount Portal of Laverstoke, took up their positions on the right of the Tribune, and the Chairman of the Organising Committee, Lord Burghley, and the Lord Mayor of London, Sir Frederick Michael Wells, took up similar positions on the left. The Greek flag was hoisted on the right flag pole above the Scoreboard to the music of the Greek National Anthem ; this was followed by the flag of Great Britain on the centre flag pole (as the host nation) to the notes of " God Save the King " ; and finally, the Finnish flag (as the country to stage the next Games) on the third flag pole, accompanied by their National Anthem.

### **The President's Address**

The President of the International Olympic Committee then mounted the Tribune of Honour and proclaimed the Closing of the Games in the following words :

" Dear friends in England and in countries over the seas, the Olympic Games of London, 1948, are now coming to an end. I extend thanks to all those who have participated. Fifty-nine nations were here. At the last Olympic Games, 50 nations took part; thus nine new nations have been added. Both great and small nations have received Olympic honours. Six thousand athletes met here and in accordance with their Olympic oath they fought nobly and with honour. They competed with the highest efforts they could muster, but in spite of the fight they remained friends. Ties of brotherhood and friendship have been formed, not only on the field of competition, but also in the various Olympic villages. These ties will always remain.

" The Olympic Games cannot enforce peace, to which all humanity aspires, but it gives the opportunity to all the youth of the world to find out that all men on earth are brothers. Thus the Games help to obtain peace, particularly if you consider that the young men who have competed here today, will one day become leaders of their nations.

" In the Olympic Games one is striving for the highest result in each sport; one does it of one's own free will, not in order to obtain monetary advantages. We exercise our sport not only for the joy we obtain and for the physical advantages it gives us, but also to improve the physical health of our nation. To attain this goal all the youth of the world must unite.

"In the name of the International Olympic Committee, I offer to the King and to the people of Great Britain, to the authorities of the City of London, and to the organisers of the Games our deepest gratitude. I proclaim the closing of the Games of the XIV Olympiad and in accordance with tradition I call upon the youth of every country to assemble in four years at Helsinki there to celebrate with us the Games of the XV Olympiad. May they display cheerfulness and concord, so that the Olympic torch may be carried on with ever-greater eagerness, courage and honour for the good of humanity throughout the ages."

At the conclusion of the President's speech, the Lord Mayor mounted the Tribune. An officer of the Scots Guards stepped forward and handed to the President the historic ceremonial flag presented to the International Olympic Committee in 1920 by the Belgian Olympic Committee. The President, allowing the flag to float for a moment before the Tribune, then entrusted it to the Lord Mayor of London for safe keeping until 1952.

Immediately, a fanfare was sounded by the Trumpeters of the Household Cavalry, in ceremonial dress, from their position in front of the Tribune. A salute of five guns, fired by the King's Troop of the Royal Horse Artillery, thundered forth in the Stadium grounds. While the Olympic flame dwindled and died and the Olympic flag was slowly lowered, the Olympic Hymn was sung by the Choir for the last time.

As the President, Lord Portal, Lord Burghley and the Lord Mayor of London left the Arena, the flag bearers returned to their positions behind the name-board carriers for the final march out. Headed by Greece, the whole column advanced to the end of the arena, where, on reaching the track, they wheeled to the right. Parading past the Royal Box, the column left the Stadium through the same entrance by which the flags had been carried in sixteen days before.

As this final parade took place, seven guardsmen in scarlet and blue, bearing outstretched between them the Olympic flag which had flown throughout the Games, marched in slow time the length of the arena towards the peristyle of the flame. The Choir broke out into the lovely melody of the Londonderry Air and the entire audience, taking up this haunting refrain, joined in singing the final cantata. Thus, the vast and deeply-moved gathering saw the Flag depart as the music and singing faded into silence.

The London Olympic Games of 1948 were over. But, with this sad farewell, there was also combined a spirit of peaceful contentment, and indeed exaltation, that, in spite of the trials and tribulations of a troubled world, and in spite of all the dismal prophecies as to the likely failure of the Games, they had risen, and triumphantly risen, to greater heights than they had ever reached before, and had stirred a real hope in the hearts of millions of men and women throughout the earth in the possibility of mankind living together in happiness and peace.

# STATISTICS

## ANALYSIS OF OLYMPIC BADGES ISSUED

	Team Managers	Team Assistants	Competitors	
Athletics .....	74	94	783	
Basketball .....	28	42	293	
Boxing .....	42	55	273	
Canoeing .....	18	17	131	
Cycling .....	27	47	222	
Equestrian .....	29	102	114	
Fencing .....	34	48	323	
Football .....	26	32	317	
Gymnastics .....	30	50	250	
Hockey .....	14	15	226	
Modern Pentathlon .....	14	10	48	
Rowing .....	34	43	365	
Shooting .....	32	26	193	
Swimming .....	56	81	528	
Weightlifting .....	23	26	130	
Wrestling .....	33	42	257	
Yachting .....	21	26	236	
	535	756	4,689	5,980
National Olympic Committee Presidents			31	
National Olympic Committee Officials ...			348	
Chefs de Mission			60	
Miscellaneous			153	592
			<i>Grand Total</i>	6,572

## COMMEMORATIVE MEDALS ISSUED

National teams taking part in sports held in London .....	5,236
National teams taking part in sports held outside London .....	1,301
Sports Officials (British) .....	1,275
Additional issues (including Attaches, Demonstrations, Staff, etc.) .....	866
<i>Total</i> .....	8,678

ANALYSIS OF OLYMPIC BADGES ISSUED

Countries	N.O.C. Presidents	N.O.C. Officers	Chefs de Mission	Team Managers	Team Assistants	Competitors	Miscellaneous	Total
AFGHANISTAN	—	—	1	2	—	31	1	35
ARGENTINE	1	8	1	14	43	242	7	316
AUSTRALIA	—	5	1	4	5	75	1	91
AUSTRIA	—	15	1	15	9	136	—	176
BELGIUM	1	6	1	35	26	184	3	256
BERMUDA	1	4	1	2	1	12	1	22
BRAZIL	1	5	1	13	26	82	6	134
BRITISH GUIANA	—	—	1	1	—	4	—	6
BURMA	1	4	1	3	3	9	1	22
CANADA	1	4	1	10	7	106	4	133
CEYLON	—	1	1	2	2	7	—	13
CHILE	1	9	1	8	4	59	1	83
CHINA	—	10	1	4	5	33	3	56
COLOMBIA	1	4	1	4	—	11	—	21
CUBA	1	4	1	10	2	56	1	75
CZECHOSLOVAKIA	—	8	1	23	4	92	—	128
DENMARK	1	8	1	15	37	183	6	251
EGYPT	1	4	1	9	20	112	5	152
EIRE	1	10	2	9	15	78	14	129
FINLAND	1	8	1	14	32	130	—	186
FRANCE	—	4	1	20	39	317	9	390
GREAT BRITAIN	1	19	1	33	63	368	—	485
GREECE	1	4	1	8	2	59	1	76
HOLLAND	—	5	1	21	34	173	6	240
HUNGARY	1	13	1	13	22	135	5	190
ICELAND	1	6	1	2	2	22	2	36
INDIA	—	19	1	18	10	86	4	138
IRAN	1	3	1	5	4	38	2	54
IRAQ	1	2	1	2	1	11	—	18

ITALY	1	8	1	23	43	222	2	300
JAMAICA	—	2	1	2	4	14	1	24
KOREA	1	7	1	7	7	52	—	75
LEBANON	1	4	1	1	—	8	—	15
LIECHTENSTEIN	—	—	1	—	—	2	—	3
LUXEMBOURG	1	6	1	9	5	54	4	80
MALTA	—	—	1	1	1	1	—	4
MEXICO	—	2	1	17	18	107	5	150
MONACO	—	—	1	—	—	6	1	8
NEW ZEALAND	—	1	1	—	3	7	1	13
NORWAY	1	9	1	23	10	90	2	136
PAKISTAN	1	4	1	3	3	42	—	54
PANAMA	—	—	1	1	2	1	—	5
PERU	1	4	1	7	7	43	4	67
PHILIPPINES	—	2	1	7	3	24	1	38
POLAND	—	4	1	6	5	24	—	40
PORTUGAL	—	6	1	14	5	57	1	84
PUERTO RICO	—	—	1	1	2	9	—	13
SINGAPORE	—	—	1	—	—	1	—	2
SOUTH AFRICA	1	3	1	3	4	33	1	46
SPAIN	—	10	1	14	16	68	1	110
SWEDEN	1	10	1	17	41	194	1	265
SWITZERLAND	—	16	1	17	69	200	4	307
SYRIA	—	—	1	—	—	1	—	2
TRINIDAD	—	6	1	1	—	5	—	13
TURKEY	1	4	1	4	10	64	2	86
UNITED STATES	1	26	1	16	58	342	22	476
URUGUAY	—	17	1	3	13	64	9	107
VENEZUELA	—	—	1	—	1	1	1	4
YUGOSLAVIA	1	5	1	9	8	102	7	133
Total	31	348	60	535	756	4,689	153	6,572

**TYPES AND NUMBERS OF OLYMPIC BADGES ORDERED**

Category	Type	Bar if any	Inscription on Bar	Ribbon	Double Ribbon if any	Imprint on Ribbon	Number
International Olympic Committee	Gilt	Yes	I.O.C.	White	Olympic	—	80
Presidents National Olympic Committees	Gilt	Yes	OFFICIAL	Oxford Blue	Olympic	National Olympic Committee	60
Presidents, International Federations	Gilt	Yes	OFFICIAL	Colour of Sport	Olympic	International Federation	18
Secretaries and members of National Olympic Committees	Silver	Yes	OFFICIAL	Light Blue	Olympic	National Olympic Committee	400
Secretaries, International Federations	Silver	Yes	OFFICIAL	Bottle Green	Olympic	International Federation	18
Organising Committee and Grand Council (non-executive)	Gilt	Yes	OFFICIAL	Light Blue	Olympic	Organising Committee	20
Attaches	Silver	Yes	OFFICIAL	Bottle Green	Olympic	Attache	60
Chefs de Mission	Silver	Yes	OFFICIAL	Dark Blue	Olympic	Chef de Mission	60
Organising Committee Executives	Silver	Yes	XIV O.C.	Dark Green	Olympic		50
Arena Managers	Silver	—	—	Colour of Sport	—	Arena Manager	18
Housing Manager and Staff	Bronze	—	—	Olive Green	—	Housing	60
Team Managers	Bronze	—	—	Blue	—	Team Manager	40
Team Assistants	Bronze	—	—	Oxford Blue	—		500
<i>Sports Officials:</i>							
Athletics				(short ribbons)			175
Basket Ball				Orange			65
Boxing				Lilac			70
Canoeing				Red			50
Cycling				Light Green			70
Equestrian				Brown			70
Fencing				Purple			75
Football				Lavender			70
				Magenta			

Gymnastics	Silver	—	—	Pink	—	(Name of sport)	80
Hockey	—	—	—	Maroon	—	}	50
Modern Pentathlon	—	—	Light Blue	—	45		
Rowing	—	—	Violet	—	75		
Shooting	—	—	Grey	—	25		
Swimming	—	—	Orange	—	140		
Weightlifting	—	—	Dark Blue	—	45		
Wrestling	—	—	Coffee	—	70		
Yachting	—	—	Yellow	—	50		
Demonstrations	—	—	Salmon	—	25		
							1,250
<i>Competitors :</i>							
Athletics				(short ribbons)			750
Basket Ball				Orange			350
Boxing				Lilac			250
Canoeing				Red			200
Cycling				Green			200
Equestrian				Brown			120
Fencing				Purple			300
Football				Lavender			300
Gymnastics				Magenta			200
Hockey	Bronze	—	—	Pink	—	(Name of Sport)	200
Modern Pentathlon				Maroon	—		50
Rowing				Light Blue			300
Shooting				Violet			150
Swimming				Grey			450
Weightlifting				Orange			120
Wrestling				Dark Blue			250
Yachting				Coffee			200
Demonstrations				Yellow			400
				Salmon			4,790
Spare (for emergency)	Silver	—	—	Blue & white	—		76
							7,500

ANALYSIS OF COMPETITORS

Names of Countries	Athletics		Basketball	Boxing		Canoeing		Cycling	Equestrian	Fencing		Football		Gymnastics		Hockey	Modern Pentathlon	Rowing	Shooting	Swimming		Weightlifting	Wrestling	Yachting	Total	
	M	W		M	W	M	W			M	W	M	W	M	W											
Afghanistan												14				15									29	
Argentina	22	2	14	8				12	9	16	3			7			11	3	25	12	18	5	8	8	19	202
Australia	12	5		6				6											9	6	18	5	2	4	3	76
Austria	3	11		5	6	1	8	2	4	3	11	8	8	8	8	12			7	3	4	2	6	5	5	114
Belgium	15	2	12	8	8	1	13		15	3						13	3	4	3	12	4	3	10	12	149	
Bermuda	4	2																			5					11
Brazil	6	6	11	3					5	7							3	2	7	11	6			7	74	
British Guiana	1							1																		4
Burma	1			2																						4
Canada	18	8		7	7		6			4	2							11		6	5	5	6	5	104	
Ceylon	3			4																						7
Chile	11	4	13	5			4		3										4	9						55
China	3		10				1					11								1						26
Colombia	2									2																5
Cuba	3		12				1			6				7					1	5	3		3	3	2	53
Czechoslovakia	6	4		5	12	1				4			8	8					3	4						75
Denmark	10	6		6	6	1	11		6	12	3	14	8	8		16		26	7	1	8	4	5	13	163	
Egypt	2		14	5						9		12	8							17						87
Eire	10		14	8					3	4	1	11						9								65
Finland	33	3		6	3	1	5		5	6			8					3	5	12	1	1	4	15	12	123
France	51	15	14	8	9	1	11		8	18	2	12	8	8	8	14	3	23	12	24	10	9	10	15	285	
Great Britain	59	20	13	8	6	1	10		6	18	1	19	8	8	8	12	3	26	11	30	15	10	16	13	313	
Greece	14	1					3			6								7	7	9				5	4	56
Holland	11	10		6	6	1	9		6	7	2	12		8	8	12		6	4	12	11	2	4	12	141	
Hungary	11	3	14	6	4	1				15	3		8	8				3	9	4	19	6	3	11		128
Iceland	12																				5	3				20
India	8			7			9					11				20										77
Iran			13	8															3							36
Iraq	2		10																							12



Italy	17	5	14	7					12	5	16	3		3	25	6	9		1	11	15	177	
Jamaica	6	4		1															2			13	
Korea	8	1	9	3				2				11							6	5		45	
Lebanon				1												2				5		8	
Liechtenstein	2																					2	
Luxembourg	3	2		4	3			4			6	12	8							2		44	
Malta	1																					1	
Mexico	4		13	2				5	6	6	3	11	5	2		9	11	4	3	4		88	
Monaco																4						4	
New Zealand	3			1				1										1	1			7	
Norway	19	1		4	4			3		5					14	9	1	2		6	13	81	
Pakistan	5			3				3					19				4		2			36	
Panama	1																					1	
Peru	9		10	5				3			3					9			3			42	
Philippines	1		10	5												3	3		1	1		24	
Poland	5	3		6	3					6	1											24	
Portugal	4									8	6					14	5	1			9	47	
Puerto Rico	4			3												2						9	
Singapore	1																					1	
South Africa	5	1		8					3										2	3	1	32	
Spain	8			8						7					4	1	6	15			3	66	
Sweden	45	5		4	8	1		4		7	8	12	8	2	3	11	14	5	4	16	16	173	
Switzerland	20		14	4	6			10	4	16	3		8	15	3	19	7	14	3	13	12	174	
Syria																		1				1	
Trinidad	3								1										1			5	
Turkey	12	1			1			3	6	6		12								16		57	
United States	64	12	13	8	8			9	7	17	3	11	8	14	3	26	12	28	15	12	8	302	
Uruguay	5	1	14	8				9		5				3	3		10				4	62	
Venezuela								1														1	
Yugoslavia	12	2						4				15	8		21		15					85	
Total	600	140	289	206	100	10	187	100	256	36	223	123	88	187	47	309	187	353	111	118	220	216	4,106



# INDEX OF COMPETITORS

## A

- Aaltonen, P.** *Finland* Gymnastics  
**Aao, T.** *India* Football  
**Aasnaes, H.** *Norway* Shooting—25 m. Rapid Pistol  
**Abbas, Y.** *Egypt* Basketball  
**Abdallah, B.** *France* Athletics—10,000 m.  
**Abd El Al, M.** *Egypt* Wrestling—Greco-Roman Style, Flyweight  
**Abd El Al, Mahmoud.** *Egypt* Gymnastics  
**Abd El Al, Moustafa.** *Egypt* Gymnastics  
**Abdel Hafeez, O.** *Egypt* Fencing—Foil Team, Foil Individual, Epee Team  
**Abdel Hamid, I.** *Egypt* Wrestling—Free Style, Featherweight  
**Abdel Rahman, M.** *Egypt* Fencing—Epee Team, Epee Individual  
**Abdine, M.** *Egypt* Fencing—Foil Team  
**Abel, R.** *Monaco* Shooting—50 m. Small Bore Rifle  
**Abella, N.** *Uruguay* Swimming—Water Polo  
**Aberg, M.** (F) *Sweden* Athletics—Discus  
**Abo Ouf, Y.** *Egypt* Basketball  
**Aboul Seoud, R.** *Egypt* Swimming—High Diving  
**Abourejaile, B.** *Lebanon* Wrestling—Free Style, Lightweight  
**Abu Shadi, A.** *Egypt* Fencing—Sabre Team, Sabre Individual  
**Abuhabaga, M.** *Egypt* Football  
**Abul Kheir, F.** *Egypt* Basketball  
**Acarbay, E.** *Turkey* Athletics—400 m., 4 X 400 Relay  
**Acchini, E.** *Italy* Rowing—Eights  
**Acchini, M.** *Italy* Rowing—Eights  
**Accorsi Teuthorn, E.** *Chile* Fencing—Foil Individual, Epee Individual  
**Acosta y Lara, M.** *Uruguay* Basketball  
**Acthon, O.** *Denmark* Equestrian—Prix des Nations Team, Prix des Nations Individual  
**Acuna Lizana, A.** *Mexico* Basketball  
**Adam, P.** *France* Cycling—4,000 m. Pursuit  
**Adamczyk, E.** *Poland* Athletics—Decathlon, Long Jump  
**Adami, L.** *Italy* Shooting—50 m. Small Bore Rifle  
**Adarraga Elizaran, J.** *Spain* Athletics—800 m., 1,500 m.  
**Addams, J.** (F) *Belgium* Fencing—Foil Individual  
**Adedoyin, A.** *Great Britain* Athletics—Long Jump, High Jump  
**Adlard, R.** *Great Britain* Hockey  
**Adolfo, R.** *Philippines* Boxing—Flyweight  
**Aeberli, M.** *Switzerland* Cycling—4,000 m. Pursuit, 2,000 m. Tandem  
**Affi G.** *Egypt* Boxing—Welterweight  
**Afzal, A.** *Afghanistan* Football  
**Aghassi, E.** *Iran* Boxing—Bantamweight  
**Agnew, D.** *Australia* Swimming—1,500 m. Free Style, 400 m. Free Style  
**Agostini, J.** *Cuba* Fencing—Foil Individual  
**Agostoni, C.** *Italy* Fencing—Epee Team, Epee Individual  
**Aguero M.** *Argentina* Fencing—Sabre Team  
**Aguero Medrano, M.** *Cuba.* Basketball  
**Aguiar Garcia, A.** *Cuba* Gymnastics  
**Aguilar Gonzalez, D.** *Mexico.* Gymnastics  
**Aguirre Martin, J.** *Mexico* Athletics—High Jump, Long Jump, Hop, Step and Jump  
**Aguirrebena Gabiola, P.** *Chile.* Swimming—Water Polo  
**Aguirrebena Gabiola, L.** *Chile* Swimming—Water Polo  
**Agusti Peypoch, M.** *Spain* Hockey  
**Ahern, F.** *Eire* Equestrian—Prix des Nations Individual, Prix des Nations Team  
**Ahir, J.** *India* Swimming—Water Polo  
**Ahlden, E.** *Sweden* Athletics—5,000 m.  
**Ahlgren, E.** (F) *Sweden* Swimming—100 m. Free Style, 4 X 100 m. Relay  
**Ahlgren, G.** *U.S.A.* Rowing—Eights  
**Ahlin, N.** *Sweden* Boxing—Bantamweight  
**Ahmad, A.** *Egypt* Wrestling—Greco-Roman Style, Free Style, Middleweight  
**Ahman, A.** *Sweden* Athletics—Hop, Step and Jump, High Jump  
**Ahmed, H.** *Iraq* Basketball  
**Ahn, B.** *Korea* Basketball  
**Ahrens Valdivia, G.** *Peru* Basketball  
**Ahumada Ruiz, A.** *Colombia* Fencing—Epee Individual  
**Aichino, J.** *Argentina* Rowing—Eights  
**Aimar, A.** *Argentina* Cycling—4,000 m. Pursuit  
**Airey, J.** (F) *Great Britain* Gymnastics  
**Aitken, A.** *Great Britain* Football  
**Akar, N.** *Turkey* Wrestling—Free Style, Bantamweight  
**Akerfelt, H.** *Finland* Canoeing—1,000 m. Ki  
**Akerlund, G.** *Sweden* Canoeing—10,000 m. K2  
**Aksur, K.** *Turkey* Athletics—200 m., 4 x 100 m. Relay, 100 m.  
**Alanis Tamez, J.** *Mexico* Shooting—25 m. Rapid Pistol  
**Alarcon, E.** *Mexico* Athletics—5,000 m.  
**Alba, J.** *Argentina* Cycling—4,000 m. Pursuit  
**Albans, W.** *U.S.A.* Athletics—Hop, Step and Jump  
**Alberti, H.** *Argentina* Athletics—4 x 400 m. Relay, 400 m. Hurdles  
**Albertsson, B.** *Sweden* Athletics—5,000 m., 10,000 m.  
**Albrecht, A.** *Switzerland* Yachting—Star Class  
**Albrecht, P.** *Switzerland* Basketball  
**Albrechtsen, O.** *Denmark* Fencing—Foil Team, Foil Individual  
**Alcide de Nunes Garcia, L.** *Portugal* Athletics—Hop, Step and Jump  
**Alegre Benavides, C.** *Peru* Basketball  
**Aleman, R.** *France* Weightlifting—Lightweight  
**Alencar Rodrigues, S.** *Brazil* Swimming—100 m. Free Style, 4 x 200 m. Relay Free Style  
**Alessandri, L.** *Brazil* Fencing—Foil Individual  
**Alfaro Loza, I.** *Mexico* Basketball  
**Ali, W.** *Pakistan* Cycling—1,000 m. Time Trial, Road Race  
**Allam, M.** *Egypt* Swimming—High Diving  
**Allart, R.** *Belgium* Weightlifting—Heavyweight  
**Allen, R.** *Eire* Yachting—Swallow Class  
**Allende Maiz, J.** *Spain* Hockey  
**Allende y Garcia Baxter, J.** *Spain* Yachting—Star Class  
**Almiron, O.** *Argentina* Rowing—Fours Without Cox  
**Almqvist, I.** (F) *Sweden* Athletics—Javelin  
**Alnevik, F.** *Sweden* Athletics—400 m., 4 x 400 m. Relay  
**Alonso Allende, J.** *Spain* Yachting—Firefly dinghy, Star Class  
**Alonso Sillero, J.** *Spain* Shooting—25 m. Rapid Pistol  
**Alua Simas, M.** *Portugal* Swimming—100 m. Back-stroke  
**Alujevic, K.** *Yugoslavia* Rowing—Fours without Cox  
**Alvarado Cornejo, G.** *Peru* Weightlifting—Lightweight  
**Alvarado, N.** *Argentina* Equestrian—Prix des Nations Team, Prix des Nations Individual  
**Alvarez, A.** *Cuba* Basketball  
**Alves, B.** *Uruguay* Boxing—Featherweight  
**Alves Borges, A.** *Brazil.* Modern Pentathlon  
**Aly, M.** *Egypt* Gymnastics  
**Aly, M.** *Egypt* Wrestling—Greco-Roman Style, Bantamweight  
**Alyuz, M.** *Turkey* Football  
**Alzamora, H.** *Peru* Athletics—no m. Hurdles  
**Amabuyok, R.** *Philippines* Swimming—200 m. Breast-stroke  
**Amado Kohli, C.** *Argentina* Rowing—Eights  
**Ambuhl, H.** *Switzerland* Shooting—50 m. Pistol  
**Ameisbichler, K.** *Austria* Boxing—Heavyweight  
**Ameln, K.** *Sweden* Yachting—6 m. Class  
**Amin, J.** *India* Cycling—4,000 III. Pursuit  
**Ammi, M.** *France* Boxing—Featherweight  
**Amor, W.** *Great Britain* Football  
**Amos, A.** *Argentina* Gymnastics  
**Amsel, J.** *Yugoslavia* Swimming—Water Polo  
**Amstutz, A.** *Switzerland* Rowing—Eights  
**Amundsen, M.** *Norway* Shooting—50 m. Pistol  
**An, Yung H.** *Korea* Athletics—Discus  
**Anclaux, R.** *Belgium* Yachting—Dragon Class  
**Anderberg, O.** *Sweden* Wrestling—Greco-Roman Style, Featherweight  
**Andersen, B.** *Norway* Shooting—25 m. Rapid Pistol  
**Andersen, C. E.** *Denmark* Rowing—Pairs with Cox

- Andersen, C. H.** *U.S.A.* Equestrian—3 Day Individual, 3 Day Team  
**Andersen, E.** *Denmark* Fencing—Epee Team  
**Andersen, G.** (F) *Denmark* Swimming—100 m. Free Style, 400 m. Free Style, 4 x 100 m. Relay  
**Andersen, J.** *Denmark* Canoeing—1,000 m. K1  
**Andersen, K.** *Denmark* Cycling—Road Race  
**Anderson, M.** *U.S.A.* Swimming—Springboard Diving  
**Anderson, R.** *Argentine* Hockey  
**Andersson, E. G.** *Sweden* Wrestling—Greco-Roman Style, Welterweight  
**Andersson, E. I.** (F) *Sweden* Gymnastics  
**Andersson, E. P.** *Sweden* Athletics—Decathlon  
**Andersson, I.** *Sweden* Canoeing—1,000 m. C1, 10,000 m. C1  
**Andersson, M.** (F) *Sweden* Gymnastics  
**Andersson, O.** *Sweden* Weightlifting—Featherweight  
**Andersson, S.** *Sweden* Football  
**Ando, A.** *Argentine* Shooting—50 m. Small Bore Rifle  
**Andoin Torralvo, J.** *Spain* Shooting—50 m. Small Bore Rifle  
**Andonyadis, K.** *Turkey* Football  
**Andrasi, G.** *Hungary* Canoeing—1,000 m. K2, 10,000 m. K2  
**Andre, J.** *France* Athletics—400 m. Hurdles  
**Andrea Ferreira, J.** *Portugal* Shooting—25 m. Rapid Pistol  
**Andresen, H.** *Denmark* Cycling—2,000 m. Tandem  
**Anen, P.** *Luxembourg* Fencing—Epee Team, Epee Individual  
**Anger, A.** *France* Gymnastics  
**Angst, W.** *Switzerland* Wrestling—Free Style, Welterweight  
**Angyal, J.** *U.S.A.* Rowing—Double Sculls  
**Antkiewicz, A.** *Poland* Boxing—Featherweight  
**Anton, N.** *Uruguay* Basketball  
**Antonio dos Santos, V.** *Brazil* Boxing—Heavyweight  
**Antonsson, H.** *Sweden* Wrestling—Free Style, Heavyweight  
**Aparicio Rodewaldt, J.** *Colombia* Athletics—400 m., 400 m. Hurdles  
**Apelgren, I.** (F) *Sweden* Canoeing—500 m. K1  
**Apellaniz Zarraga, P.** *Spain* Athletics—Javelin  
**Appel, A.** *Holland* Football  
**Araneta, Jr., M.** *Philippines* Basketball  
**Aravossitas, A.** *Greece* Shooting—50 m. Small Bore Rifle  
**Archer, J.** *Great Britain* Athletics—4 x 100 m. Relay  
**Arena, E.** *Italy* Swimming—Water Polo  
**Arenander, G.** (F) *Sweden* Athletics—Discus  
**Arene, J.** (F) *France* Swimming—100 m. Free Style, 4 x 100 m. Relay  
**Arenzana, J.** *France* Wrestling—Greco-Roman Style, Bantamweight  
**Argentin, R.** *France* Canoeing—10,000 m. C1  
**Argote Marquinez, A.** *Spain* Boxing—Lightweight  
**Arifon, J.** *France* Athletics—400 m. Hurdles  
**Arman, C.** *Turkey* Football  
**Armelloni, E.** *Italy* Gymnastics  
**Armitage, N.** *U.S.A.* Fencing—Sabre Team  
**Armstrong, J.** *Australia* Wrestling—Free Style, Heavyweight  
**Arnadottir, T.** (F) *Iceland* Swimming—200 m. Breast-stroke  
**Arseven, R.** *Turkey* Fencing—Sabre Individual, Sabre Team  
**Arteche Zurinaga, A.** *Spain* Boxing—Light-heavyweight  
**Arthur, J.** *South Africa* Boxing—Heavyweight  
**Arthur, R.** *Australia* Wrestling—Free Style, Middleweight  
**Artigas, E.** *France* Fencing—Epee Team  
**Arvidsson, G.** *Sweden* Athletics—Putting the Shot  
**Aschehoug, E.** *France* Rowing—Eights  
**Ascune, H.** *Uruguay* Athletics—4 x 100 m. Relay, High Jump, Decathlon  
**Asfar, J.** *Egypt* Fencing—Epee Individual, Epee Team  
**Ashtari, K.** *Iran* Basketball  
**Askew, H.** *Great Britain* Athletics—Long Jump  
**Assam Rabay, E.** *Mexico* Wrestling—Free Style, Middleweight  
**Assar, A. Ghafoor.** *Afghanistan* Football  
**Assar, A. Ghani.** *Afghanistan* Football  
**Asselin, R.** *Canada* Fencing—Epee Individual, Epee Team, Foil Individual, Foil Team, Sabre Individual, Sabre Team  
**Atanackovic, A.** *Yugoslavia* Football  
**Athans, G.** *Canada* Swimming—Springboard Diving, High Diving  
**Atik, C.** *Turkey* Wrestling—Free Style, Lightweight  
**Atkinson, L.** *Canada* Cycling—1,000 m. Time Trial, 4,000 m. Pursuit, Road Race  
**Attai, M.** *Afghanistan* Hockey  
**Attia, A.** *Egypt* Gymnastics  
**Aubert, J.** (F) *France* Swimming—Springboard Diving  
**Audizio, G.** *Italy* Yachting—6 m. Class  
**Ault, R.** *U.S.A.* Athletics—400 m. Hurdles  
**Autio, V.** *Finland* Rowing—Fours with Cox  
**Avalos, A.** *Argentine* Athletics—800 m., 4 x 400 m. Relay  
**Avery, G.** *Australia* Athletics—Hop, Step and Jump  
**Axelsson, T.** *Finland* Canoeing—1,000 m. K2, 10,000 m. K2  
**Azak, Z.** *Turkey* Equestrian—3 Day Team, 3 Day Individual  
**Azevedo, Z.** *Brazil* Basketball  
**Azimi, A.** *Afghanistan* Football  
**Azimi, M.** *Afghanistan* Football  
**Aziz, A.** *Pakistan* Hockey  
**Aznar Y Coste, E.** *Spain* Yachting—Star Class
- B**
- Baarnaas, P.** *Norway* Athletics—50,000 m. Walk  
**Baccilieri, U.** *Italy* Boxing—Heavyweight  
**Backman, P.** *Finland* Cycling—Road Race  
**Baert, G.** *Belgium* Basketball  
**Baess, K.** *Denmark* Yachting—Dragon Class  
**Bagdadi, A.** *Egypt* Swimming—4 x 200 m. Relay, 100 m. Free Style  
**Bahr, W.** *U.S.A.* Football  
**Bai, C.** *Korea* Football  
**Bakanay, V.** *Turkey* Fencing—Sabre Team  
**Bakanic, L.** (F) *U.S.A.* Gymnastics  
**Bakasun, V.** *Yugoslavia* Swimming—Water Polo  
**Bakken, O.** *Canada* Basketball  
**Balafas, T.** *Greece* Athletics—Pole Vault  
**Balamir, H.** *Turkey* Wrestling—Free Style, Flyweight  
**Baldwin Ponte, E.** *Peru* Shooting—50 m. Small Bore Rifle, 300 m. Free Rifle  
**Balkan, N.** *Turkey* Fencing—Sabre Team, Foil Individual  
**Ballintyn, B.** (F) *Norway* Swimming—100 m. Back-stroke  
**Bally, E.** *France* Athletics—100 m., 200 m.  
**Balogh, A.** *Hungary* Shooting—50 m. Pistol, 25 m. Rapid Pistol  
**Balthazar, E.** *Hungary* Fencing—Epee Team  
**Balza, J.** *Argentine* Fencing—Epee Team  
**Banas, B.** *Poland* Fencing—Sabre Team, Sabre Individual, Epee Team  
**Banda Bernal, H.** *Mexico* Weightlifting—Lightweight  
**Bandinelli, S.** *Italy* Boxing—Flyweight  
**Banfalvi, K.** (F) *Hungary* Canoeing—500 m. K1  
**Bang, W.** *Korea* Basketball  
**Banhalmi, F.** *Hungary* Athletics—400 m.  
**Bankuti, A.** *Hungary* Basketball  
**Bannister, A.** *Great Britain* Cycling—2,000 m. Tandem  
**Barakzai, Y.** *Afghanistan* Football  
**Baranyai, L.** *Hungary* Gymnastics  
**Barasorda, M.** *Puerto Rico* Shooting—50 m. Pistol  
**Barber, W.** *Australia* Boxing—Lightweight  
**Barbosa, J.** *Puerto Rico* Athletics—Pole Vault  
**Bardelli, A.** *Italy* Rowing—Eights  
**Bardgett, W.** *Bermuda* Swimming—400 m. Free Style, 4 x 200 m. Relay  
**Barfod, H.** *Norway* Yachting—Dragon Class  
**Barker, C.** *U.S.A.* Basketball  
**Barksdale, D.** *U.S.A.* Basketball  
**Barkway, R.** *Great Britain* Athletics—110 m. Hurdles  
**Barlow, J.** *Great Britain* Shooting—300 m. Free Rifle  
**Barnes, W.** *Eire* Boxing—Flyweight  
**Barone, M.** (F) *U.S.A.* Gymnastics  
**Barrais, A.** *France* Basketball  
**Barrientos, A.** *Cuba* Fencing—Epee Team, Foil Individual  
**Barros Guimaraes, P.** *Brazil* Swimming—100 m. Free Style  
**Barry, J.** *Eire* Athletics—1,500 m., 5,000 m.  
**Barry, W.** *Eire* Football  
**Barten, H.** *U.S.A.* Athletics—800 m.  
**Bartha, L.** *Hungary* Athletics—4 x 100 m. Relay, 100 m.

- Barthel, J.** *Luxembourg* Athletics—1,500 m., 800 m.
- Barton, C.** *Great Britain* Rowing—Eights
- Bartram, J.** *Australia* Athletics—400 m., 100 m., 4 x 100 m. Relay
- Bartu, K.** *Czechoslovakia* Modern Pentathlon
- Bartusek, M.** *Czechoslovakia* Swimming—400 m. Free Style, 1,500 m. Free Style
- Basanung, S.** *Philippines* Swimming—1,500 m. Free Style, 400 m. Free Style
- Basheer, A.** *India* Football
- Basletic, D.** (F) *Yugoslavia* Gymnastics
- Basso Zerquers, G.** *Cuba* Shooting—50 m. Pistol
- Bastan, H.** *Egypt* Football
- Batista, P.** *Argentina* Rowing—Eights
- Batter, D.** (F) *Great Britain* Athletics—100 m.
- Baudric, R.** *France* Wrestling—Free Style, Flyweight
- Baugh, H.** *U.S.A.* Modern Pentathlon
- Bauma, H.** (F) *Austria* Athletics—Javelin
- Baumann, H.** *Switzerland* Basketball
- Baumann, H.** *Switzerland* Wrestling—Free Style, Lightweight
- Bay, B.** *Hungary* Fencing—Epee Team, Foil Team
- Bayot, R.** *Belgium* Fencing—Sabre Team
- Bazarnik, W.** *Poland* Boxing—Bantamweight
- Bazzano, C.** *Australia* Cycling—1,000 m. Scratch
- Beard, R.** *U.S.A.* Basketball
- Beaudry, J.** *Canada* Rowing—Double Sculls
- Bebis, C.** *Greece* Fencing—Foil Team, Epee Team, Foil Individual
- Becic, B.** *Yugoslavia* Rowing—Eights
- Beck, K.** *U.S.A.* Swimming—Water Polo
- Beck, L.** *U.S.A.* Basketball
- Beckett, V.** (F) *Jamaica* Athletics—80 m. Hurdles, High Jump, Long Jump
- Beckman, R.** *U.S.A.* Football
- Beckus, R.** *U.S.A.* Athletics—Hop, Step and Jump
- Beddard, T.** *Great Britain* Fencing—Epee Team
- Beeken-Gregerson, I.** (F) *Denmark* Swimming—High Diving
- Behm, R.** *Luxembourg* Boxing—Bantamweight
- Bell, W.** *Canada* Basketball
- Bellanger, J.** *France* Cycling—1,000 m. Scratch
- Belohradsky, J.** *Czechoslovakia* Basketball
- Benacek, C.** *Czechoslovakia* Basketball
- Benard, C.** *France* Athletics—High Jump
- Bene, G.** *Hungary* Boxing—Welterweight
- Benedek, P.** *Hungary* Basketball
- Benedito Zumbano, R.** *Brazil* Boxing—Lightweight
- Benetka, P.** *Czechoslovakia* Gymnastics
- Benetti Aprosio, C.** *Argentina* Swimming—200 m. Breast-stroke
- Benfenati, A.** *Italy* Cycling—4,000 m. Pursuit
- Bengtson, K.** *Norway* Yachting—Swallow Class
- Bengtsson, I.** *Sweden* Athletics—800 m.
- Benner, H.** *U.S.A.* Shooting—50 m. Pistol
- Bennett, D.** *Canada* Canoeing—1,000 m. C2, 1,000 m. C1
- Bennett, R.** *U.S.A.* Athletics—Hammer
- Benoy, J.** *Belgium* Wrestling—Greco-Roman Style, Free Style, Middleweight
- Benvenuti, D.** *Argentina* Cycling—Road Race
- Benvenuti, L.** *Brazil* Basketball
- Benze Biringier, L.** *Hungary* Wrestling—Free Style, Greco-Roman Style, Bantamweight
- Berczelly, T.** *Hungary* Fencing—Sabre Team, Sabre Individual
- Berg, L.** *Sweden* Shooting—50 m. Pistol
- Berg, U.** *Sweden* Shooting—50 m. Small Bore Rifle
- Bergendorff, B.** (F) *Denmark* Athletics—100 m., 4 x 100 m. Relay
- Bergkvist, G.** *Sweden* Athletics—1,500 m.
- Berglund, A.** *Sweden* Athletics—Javelin
- Berglund, H.** *Sweden* Canoeing—1,000 m. K2
- Berkay, E.** *Turkey* Athletics—110 m. Hurdles, 4 x 100 m. Relay
- Bermyn, E.** *France* Swimming—Water Polo
- Bernabeu Prada, M.** *Spain* Modern Pentathlon
- Bernaer, A.** *Belgium* Basketball
- Bernal Contreras, D.** *Mexico* Wrestling—Free Style, Featherweight
- Bernard, J.** *Luxembourg* Gymnastics
- Bernard, O.** *Switzerland* Athletics—110 m. Hurdles
- Bernardi, G.** *Italy* Cycling—4,000 m. Pursuit
- Bernardo, J.** *France* Swimming—400 m. Free Style, 1,500 m. Free Style, 4 x 200 m. Relay
- Bernatsky, W.** *Uruguay* Cycling—Road Race Team, 4,000 m. Pursuit
- Bernini, F.** *Italy* Shooting—25 m. Rapid Pistol
- Berntsen, O.** *Denmark* Yachting—Dragon Class
- Berntsen, W.** *Denmark* Yachting—Dragon Class
- Bersani, G.** *Italy* Basketball
- Bertani, W.** *U.S.A.* Football
- Berthe, J.** *France* Swimming—Water Polo
- Bertin, G.** *France* Yachting—Dragon Class
- Bertolini, V.** *Italy* Athletics—50,000 m. Walk
- Bertrand, J.** (F) *France* Swimming—200 m. Breast-stroke
- Bettoni Cazzago, A.** *Italy* Equestrian—Prix des Nations Individual, Prix des Nations Team
- Beyaert, J.** *France* Cycling—Road Race
- Bhargava, A.** *India* Wrestling—Free Style, Welterweight
- Bhatta, R.** *India* Boxing—Flyweight
- Bhatti, M.** *Pakistan* Hockey
- Biancalana, M.** *Brazil* Fencing—Epee Individual, Epee Team
- Bianchi, B.** *Italy* Yachting—Dragon Class
- Bianchi, L.** *Argentina* Hockey
- Bianchi, R.** (F) *Italy* Gymnastics
- Bidegain, O.** *Argentina* Shooting—50 m. Pistol
- Bidegaray, J.** *Uruguay* Yachting—Swallow Class
- Biedermann, A.** *Argentina* Athletics—4 x 100 m. Relay
- Bienvenu, B.** *France* Football
- Bienvenu Barajas, A.** *Mexico* Basketball
- Bier, J.** *Holland* Yachting—Swallow Class
- Bignon Guzman, V.** *Chile* Boxing—Heavyweight
- Biles, M.** *U.S.A.* Athletics—Javelin
- Bilge, G.** *Turkey* Wrestling—Free Style, Featherweight
- Binneman, D.** *South Africa* Cycling—Road Race
- Bintz, R.** *Luxembourg* Cycling—Road Race
- Bircher, E.** *Great Britain* Rowing—Eights
- Biris, N.** *Greece* Wrestling—Greco-Roman, Bantamweight
- Birks, L.** *Australia* Boxing—Featherweight
- Birrell, J.** *Great Britain* Athletics—110 m. Hurdles
- Birtwistle, M.** (F) *Great Britain* Athletics—Discus, Putting the Shot
- Bisbrown, L.** (F) *Great Britain* Swimming—High Diving
- Bischof, A.** *Austria* Hockey
- Bisiak, C.** *Peru* Weightlifting—Light-heavyweight
- Bissell, S.** *Great Britain* Wrestling—Greco-Roman Style, Middleweight
- Bittman, E.** *Austria* Rowing—Fours with Cox
- Bjarnasson, A.** *Iceland* Athletics—4 x 100 m. Relay
- Bjorklof, N.** *Finland* Canoeing—1,000 m. K2, 10,000 m. K2
- Bjurstrom, R.** *Sweden* Athletics—50,000 m. Walk
- Blach, P.** *Denmark* Hockey
- Blackburn, G.** *Canada* Boxing—Welterweight
- Blaho, K.** *Hungary* Canoeing—1,000 m. K1
- Bland, D.** *Great Britain* Swimming—1,500 m. Free Style
- Blankenauw, T.** *Holland* Cycling—1,000 m. Time Trial, 4,000 m. Pursuit
- Blankers-Koen, F.** (F) *Holland* Athletics—4 x 100 m. Relay, 200 m., 100 m., 80 m. Hurdles
- Blaser, A.** *Switzerland* Equestrian—3 Day Individual, 3 Day Team
- Blebel, O.** *Argentina* Wrestling—Greco-Roman Style, Featherweight
- Bloch, P.** *Norway* Athletics—200 m., 100 m.
- Blomme, M.** *Belgium* Cycling—4,000 m. Pursuit
- Bloomberg, I.** *South Africa* Weightlifting—Middleweight
- Bloomfield, D.** *Canada* Basketball
- Blumer, H.** *Switzerland* Swimming—100 m. Back-stroke
- Blusson, S.** *France* Cycling—4,000 m. Pursuit
- Bobek, S.** *Yugoslavia* Football
- Bobeldijk, J.** *Holland* Canoeing—10,000 m. K1
- Bobin, R.** *France* Athletics—Hop, Step and Jump
- Bobis, G.** *Hungary* Wrestling—Free Style, Heavyweight
- Bocahut, J.** *France* Rowing—Eights
- Boekmans, L.** *Belgium* Hockey
- Boerstra, A.** *Holland* Hockey
- Boghossian, A.** *Brazil* Swimming—4 x 200 m. Relay, 100 m. Free Style

- Bohlin, F.** *Sweden* Yachting—Dragon Class
- Bohman, K.** (F) *Sweden* Gymnastics
- Bohr, E.** *Denmark* Hockey
- Bohslavski, R.** *Austria* Shooting—50 m. Small Bore Rifle
- Bohusch, K.** *Austria* Gymnastics
- Boigegrain, M.** *France* Rowing—Fours with Cox
- Boland, H.** *Eire* Basketball
- Bolen, D.** *U.S.A.* Athletics—400 m.
- Bollaert, A.** *Belgium* Boxing—Fly-weight
- Boltenstern, G.** *Sweden* Equestrian—Dressage Team, Dressage Individual
- Boltizar, S.** *Yugoslavia* Gymnastics
- Bolton, L.** *Great Britain* Equestrian—3 Day Team, 3 Day Individual
- Bolzi, A.** *Argentina* Wrestling—Greco-Roman Style, Middleweight
- Bombart, E.** *Belgium* Boxing—Welter-weight
- Bond, D.** *Great Britain* Yachting—Swallow Class
- Bondi, M.** *Hungary* Boxing—Fly-weight
- Boneo, R.** *Argentina* Rowing—Fours With Cox
- Boni, B.** *Italy* Rowing—Pairs without Cox
- Bonin, A.** *France* Fencing—Foil Team
- Bonin, M.** *France* Shooting—50 m. Pistol
- Boninsegni, W.** *Italy* Shooting—25 m. Rapid Pistol
- Bonnet, R.** *Argentina* Weightlifting—Middleweight
- Bonnet, P.** *Switzerland* Yachting—6 m. Class
- Bonnevie, M.** *France* Basketball
- Bonnhoff, G.** *Argentina* Athletics—100 m., 200 m., 4 X 100 m. Relay
- Bonoris, C.** *Argentina* Gymnastics
- Bonsall, W.** *U.S.A.* Gymnastics
- Bonte, B.** *Holland* Swimming—200 m. Breast-stroke
- Boogaert, J.** *Belgium* Canoeing—1,000 m. K1
- Boone, B.** *France* Hockey
- Borchers, C.** *Brazil* Yachting—Swallow Class
- Bordo, L.** *U.S.A.* Gymnastics
- Borg, R.** *U.S.A.* Equestrian—Dressage Individual, Dressage Team
- Borrett, N.** *Great Britain* Hockey
- Borriello, M.** *Italy* Shooting—25 m. Rapid Pistol
- Borwick, P.** *Great Britain* Equestrian—3 Day Team, 3 Day Individual
- Boryla, V.** *U.S.A.* Basketball
- Borzsonyi, L.** *Hungary* Shooting—25 m. Rapid Pistol, 50 m. Pistol
- Bose, B.** *India* Boxing—Featherweight
- Bose, N.** *India* Wrestling—Free Style, Bantamweight
- Bossio, W.** *U.S.A.* Boxing—Bantam-weight
- Bossy, M.** *Switzerland* Basketball
- Botelho Machado Queiroz, C.** *Portugal* Shooting—50 m. Small Bore Rifle, 25 m. Rapid Pistol, 50 m. Pistol
- Both, C.** *Holland* Shooting—50 m. Small Bore Rifle
- Botham, F.** *Great Britain* Swimming—4 x 200 m. Relay, 400 m. Free Style
- Bothy, F.** *Belgium* Boxing—Heavy-weight
- Bottlang, E.** *Switzerland* Canoeing—10,000 m. K1
- Boucher, R.** *France* Rowing—Eights
- Bouchez, M.** *France* Shooting—50 m. Small Bore Rifle
- Boudeoque de Haro, N.** (F) *Mexico* Fencing—Foil Individual
- Boudewijns, J.** (F) *Belgium* Gymnastics
- Bougnol, R.** *France* Fencing—Foil Individual, Foil Team
- Bouillet, R.** *France* Shooting—25 m. Rapid Pistol
- Bouladou, P.** *France* Weightlifting—Middleweight
- Boulosa, A.** *Uruguay* Boxing—Light-weight
- Bourgau, F.** *Belgium* Athletics—4 x 100 m. Relay, 200 m.
- Bourke, B.** *Australia* Swimming—100 m. Free Style, 100 m. Back-stroke
- Bourland, C.** *U.S.A.* Athletics—4 x 400 m. Relay, 200 m.
- Boutigny, R.** *France* Canoeing—1,000 m. C1
- Bouton, A.** *France* Rowing—Eights
- Bouvet, C.** *France* Athletics—Pole Vault
- Bouwman, H.** *Holland* Hockey
- Bove, C.** *Argentina* Rowing—Eights
- Bowey, E.** *Great Britain* Wrestling—Free Style, Middleweight
- Boyce, W.** *Australia* Boxing—Welter-weight
- Boyd, A.** *U.S.A.* Fencing—Epee Team
- Boyd, J.** *Great Britain* Football
- Boyd, W.** *Australia* Swimming—100 m. Free Style
- Braasem, C.** *Holland* Swimming—Water Polo
- Bracony, J.** *Brazil* Yachting—Star Class
- Braekman, P.** *Belgium* Athletics—4 x 100 m. Relay, 100 m., 110 m. Hurdles
- Braga, A.** *Brazil* Shooting—50 m. Small Bore Rifle
- Brainovic, M.** *Yugoslavia* Swimming—Water Polo
- Bralo, R.** *Argentina* Athletics—10,000 m.
- Brand, C.** *Great Britain* Swimming—Water Polo
- Brand, G.** *U.S.A.* Wrestling—Free Style, Middleweight
- Brandao Goncalves, A.** *Portugal* Shooting—50 m. Small Bore Rifle
- Brander, P.** *Great Britain* Boxing—Featherweight
- Brandi, J.** *Hungary* Swimming—Water Polo
- Brandi, K.** *Austria* Hockey
- Brauer, Y.** *Argentina* Yachting—Fire-fly Dinghy
- Broughton, J.** *Great Britain* Athletics—5,000 m.
- Bravo Prieto, R.** *Mexico* Swimming—1,500 m., 4 x 200 m. Relay
- Bray, R.** *U.S.A.* Swimming—Water Polo
- Braz, J.** *Brazil* Basketball
- Brazil Bakos, L.** *Hungary* Wrestling—Free Style, Lightweight
- Breiby, I.** *Norway* Boxing—Light-weight
- Breitman, G.** *France* Athletics—Pole Vault
- Brewer, E.** *Great Britain* Athletics—Discus
- Brignetti, D.** *Italy* Modern Pentathlon
- Brigo, J.** *Argentina* Hockey
- Brilando, F.** *U.S.A.* Cycling—Road Race
- Briola, L.** *Argentina* Weightlifting—Heavyweight
- Brockway, J.** *Great Britain* Swimming—100 m. Back-stroke
- Brodie, D.** *Great Britain* Hockey
- Brodin, F.** *Sweden* Yachting—Dragon Class
- Bromberg, P.** *Holland* Hockey
- Bromley, E.** *Australia* Rowing—Pairs Without Cox
- Brook, R.** *Great Britain* Fencing—Sabre Team, Sabre Individual
- Brooke, G.** *Great Britain* Modern Pentathlon
- Brooks, Q.** *U.S.A.* Shooting—50 m. Pistol
- Broussalis, R.** *Greece* Swimming—Water Polo
- Brown, D.** *U.S.A.* Rowing—Eights
- Brown, G.** *Great Britain* Yachting—Dragon Class
- Brozovic, M.** *Yugoslavia* Football
- Bru, R.** *Belgium* Fencing—Epee Team, Foil Team
- Bruce, T.** *Australia* Athletics—4 x 100 m. Relay, Long Jump
- Bruggemann Schmith, M.** (F) *Mexico* Swimming—100 m. Back-stroke, 400 m. Free Style, 100 m. Free Style
- Bruk, A.** (F) *Austria* Athletics—Putting the Shot
- Brun, J.** *Switzerland* Cycling—Road Race
- Brunaud, A.** *France* Wrestling—Free Style Middleweight
- Brunnhage, L.** *Sweden* Swimming—High Board Diving
- Brunnqvist, C.** *Sweden* Rowing—Single Sculls
- Brussaard, J.** *Holland* Shooting—50 m. Small Bore Rifle
- Bruun, E.** *Norway* Athletics—50,000 m. Road Walk
- Bryner, H.** *Switzerland* Yachting—Star Class
- Bryner, K.** *Switzerland* Yachting—Star Class
- Bryngeirsson, T.** *Iceland* Athletics—Pole Vault
- Brys, J.** *Belgium* Athletics—800 m.
- Brzak, J.** *Czechoslovakia* Canoeing—1,000 m. C2,
- Bucetta, J.** *Uruguay* Swimming—Water Polo
- Buchel, G.** *Liechtenstein* Athletics—Decathlon
- Bucher, W.** *Switzerland* Cycling—4,000 m. Pursuit
- Buchly, N.** *Holland* Cycling—2,000 m. Tandem
- Buck, D.** *U.S.A.* Hockey
- Buck, L.** *Luxembourg* Fencing—Foil Individual
- Budelman, R.** *U.S.A.* Swimming—Water Polo
- Buffiere, A.** *France* Basketball
- Buffin, K.** *Great Britain* Gymnastics
- Buhan, J.** *France* Fencing—Foil Team, Foil Individual
- Buhler, A.** *Switzerland* Equestrian—3 Day Individual, 3 Day Team
- Bujas, S.** *Yugoslavia* Rowing—Fours with Cox

- Bukantz, D.** *U.S.A.* Fencing—Foil Team
- Bulgarelli, E.** *Italy* Swimming—Water Polo
- Bulic, J.** *Yugoslavia* Athletics—4 x 400 m. Relay
- Buonocore, P.** *Italy* Swimming—Water Polo
- Buret, M.** *France* Equestrian—Dressage Individual, Dressage Team
- Burge, A.** *Australia* Swimming—Water Polo
- Burgstrom, P.** *Sweden* Boxing—Flyweight
- Burki, H.** *Pakistan* Hockey
- Burnell, R.** *Great Britain* Rowing—Double Sculls
- Buronyi, L.** *Hungary* Weightlifting—Light-heavyweight
- Burri, O.** *Switzerland* Rowing—Eights
- Burton, W.** *U.S.A.* Athletics—Discus
- Busch, J.** *Denmark* Hockey
- Bushnell, B.** *Great Britain* Rowing—Double Sculls
- Busin, M.** *Brazil* Swimming—Springboard Diving
- Bustamente Cruz, F.** *Mexico* Shooting—25 m. Pistol
- Butcher, A.** *Great Britain* Rowing—Fours Without Cox
- Butia, A. (F)** *Yugoslavia* Athletics—200 m., 100 m.
- Butin, J.** *France* Hockey
- Butler, L.** *U.S.A.* Rowing—Eights
- Butt, M. I.** *Pakistan* Weightlifting—Middleweight
- Butt, M. N.** *Pakistan* Weightlifting—Heavyweight
- Butt, M. S.** *Pakistan* Athletics—100 m., 200 m.
- Buttery (Chaves) O.** *British Guiana* Weightlifting—Middleweight
- C**
- Cabot Boix, R.** *Spain* Hockey
- Cabral, R.** *Argentina* Rowing—Eights
- Cabrera, D.** *Argentina* Athletics—Marathon
- Cabrera Gandara, J.** *Mexico* Basketball
- Cadalso Fernandez, R.** *Cuba* Shooting—25 m. Rapid Pistol ; Modern Pentathlon
- Cadot, A.** *France* Yachting—6-metre Class
- Cagnasso, P.** *Argentina* Shooting—300 m. Free Rifle
- Cail, H.** *U.S.A.* Shooting—50 m. Small Bore Rifle
- Cajkovski, Zeljko.** *Yugoslavia* Football
- Cajkovski, Zlatko** *Yugoslavia* Football
- Cakir, S.** *Turkey* Equestrian—Prix des Nations Team, Prix des Nations Individual
- Cakmak, M.** *Turkey* Wrestling—Greco-Roman Style, Light-heavyweight
- Calado, H.** *Portugal* Equestrian—Prix des Nations Individual, Prix des Nations Team
- Calambokidis, G.** *Greece* Yachting—Star Class
- Calamita Gonzales, F.** *Spain* Swimming—100 m. Back-stroke
- Callebout, L.** *Belgium* Boxing—Bantamweight
- Calvo, R.** *Argentina* Basketball
- Camargo, B.** *Brazil* Fencing—Epee Individual, Epee Team
- Camargo, R.** *Colombia* Fencing—Epee Individual, Foil Individual
- Camber, I. (F)** *Italy* Fencing—Foil Individual
- Cambieri, D.** *Italy* Rowing—Fours with Cox
- Camelli, A. (F)** *Argentina* Swimming—4 x 100 m. Relay, 100 m. Free Style
- Cameron, R.** *Canada* Rowing—Eights
- Campanella, L.** *Italy* Wrestling—Greco-Roman Style, Featherweight
- Campbell, D.** *Canada* Basketball
- Campero, R.** *Mexico* Equestrian—3 Day team, 3 Day Individual
- Campo Esteban, J.** *Spain* Hockey
- Campos, R.** *Argentina* Equestrian—Prix des Nations Team, Prix des Nations Individual
- Campos, R., Jr.** *Philippines* Basketball
- Candash, M.** *Turkey* Wrestling—Free Style Light-Heavyweight
- Candemir, A.** *Turkey* Wrestling—Free Style Middleweight
- Canessa, G.** *Italy* Yachting—Dragon Class
- Canton, A.** *Argentina* Swimming—4 x 200 m. Relay, 100 m. Free Style
- Cantone, L.** *Italy* Fencing—Epee Team, Epee Individual
- Canty, J. (F)** *Australia* Athletics—Long Jump
- Capek, F.** *Czechoslovakia* Canoeing—10,000 m.C1
- Capilla Perez, J.** *Mexico* Swimming—High Diving, Spring Board Diving
- Caple, K.** *Australia* Weightlifting—Bantamweight
- Caplin, J. (F)** *Great Britain* Swimming—200 m. Breast-stroke
- Cappozzi, T.** *Argentina* Rowing—Single Sculls
- Caprile, E.** *Italy* Football
- Capuzzi, R.** *Italy* Shooting—50 m. Small Bore Rifle
- Cardenas, C.** *Cuba* Yachting—Star Class
- Cardenas, C., Jr.** *Cuba* Yachting—Star Class
- Cardenas de la Vega, R.** *Mexico* Football
- Cardiel Gayton, J.** *Mexico* Basketball
- Cardoso de Menezes, H. (F)** *Brazil* Athletics—100 m., 200 m.
- Cardoso, M.** *Portugal* Shooting—50 m. Pistol, 25 m. Rapid Pistol
- Carleson, P.** *Sweden* Fencing—Epee Team
- Carlsen, E. (F)** *Denmark* Swimming—4 x 100 m. Relay
- Carlsen, E.** *Denmark* Equestrian—3 Day Individual, 3 Day Team
- Carlsson, N.** *Sweden* Football
- Carlstedt, L. (F)** *Denmark* Athletics—Javelin
- Carmichael, A.** *Great Britain* Football
- Carnegy Arbuthnott, E. (F)** *Great Britain* Fencing—Foil Individual
- Caroen, F. (F)** *Belgium* Swimming—400 m. Free Style, 100 m. Free Style, 4 x 100 m. Relay
- Carolou, C.** *Greece* Yachting—Star Class
- Caron, H.** *France* Athletics—50,000 m. Walk
- Carpenter, C.** *U.S.A.* Basketball
- Carpenter, H.** *Great Britain* Boxing—Flyweight
- Carr, A.** *Great Britain* Equestrian—Prix des Nations Team, Prix des Nations Individual
- Carrasco, A.** *Argentina* Yachting—Star Class
- Carrere, F.** *Argentina* Equestrian—3 Day Individual, 3 Day Team
- Carrizo, P.** *Uruguay* Boxing—Bantamweight
- Carruthers, J.** *Australia* Boxing—Bantamweight
- Carstensen, F. (F)** *Denmark* Swimming—100 m. Free Style, 400 m. Free Style, 4 x 100 m. Relay
- Carter, K.** *U.S.A.* Swimming—100 m. Free Style, 200 m. Breast-stroke
- Carter, T.** *New Zealand* Cycling—Road Race
- Casado, B.** *Puerto Rico* Athletics—High Jump
- Casari, G.** *Italy* Football
- Cascino, S.** *Italy* Athletics—50,000 m. Walk
- Case, L.** *U.S.A.* Swimming—Water Polo
- Cassani, V.** *Italy* Football
- Castel, J.** *France* Yachting—6-metre Class
- Castillo Caupana, F.** *Spain* Swimming—Water Polo
- Castillo Diaz, A.** *Mexico* Swimming—4 x 200 m. Relay, 200 m. Breast-stroke
- Castillo, J.** *Cuba* Swimming—Spring Board Diving
- Castro, R.** *Uruguay* Swimming—Water Polo
- Castro Valdes, J.** *Mexico* Gymnastics
- Catafago, A.** *Egypt* Basketball
- Catasta, R.** *Italy* Rowing—Single Sculls
- Caulet, A.** *France* Boxing—Lightweight
- Cauria, L. (F)** *France* Athletics—100 m.
- Cavaleiro, F.** *Portugal* Equestrian—3 Day Individual, 3 Day Team
- Caves, K.** *Australia* Cycling—Road Race
- Caviglioli, E.** *Italy* Football
- Cavignac, A.** *Belgium* Boxing—Middleweight
- Cayco, J.** *Philippines* Swimming—200 m. Breast-stroke
- Cayman, R.** *Belgium* Hockey
- Cazaux, R.** *Great Britain* Wrestling—Free Style, Bantamweight
- Cederquist, P.** *Denmark* Athletics—Hammer
- Cerer, T.** *Yugoslavia* Swimming—200 m. Breast-stroke
- Cerioni, C.** *Italy* Basketball
- Cermesoni, J.** *Argentina* Fencing—Sabre Team, Sabre Individual
- Cerne, N. (F)** *Yugoslavia* Gymnastics
- Cerra, M. (F)** *U.S.A.* Fencing—Foil Individual
- Cerutti, R.** *Italy* Rowing—Fours with Cox
- Cervell, F.** *Sweden* Fencing—Epee Individual, Epee Team
- Cesari, V. (F)** *Italy* Fencing—Foil Individual
- Cetiner, A.** *Turkey* Cycling—Road Race
- Cetrulo, D.** *U.S.A.* Fencing—Foil Individual, Foil Team, Sabre Individual Sabre Team
- Cevona, V.** *Czechoslovakia* Athletics—1,500 m.
- Chamay, M.** *Switzerland* Fencing—Epee Team

- Chambers, R.** *U.S.A.* Athletics—800 m  
**Chancerel, P.** *France* Yachting—Firefly Dinghy, Dragon Class  
**Chandler, J.** *Great Britain* Shooting—50 m. Small Bore Rifle  
**Chang, King Hai** *China* Football  
**Chang, Pang-Rum** *China* Football  
**Chang, Ri Chin** *Korea* Basketball  
**Charite, A.** *Holland* Weightlifting—Heavyweight  
**Chaterjee, S.** *India* Swimming—Water Polo  
**Chatord, A.** *France* Yachting—Star Class  
**Chatterjee, S. N.** *India* Swimming—Water Polo  
**Chau, Man-Chi** *China* Football  
**Chaudhry, A.** *Pakistan* Swimming—400 m. Free Style, 1,500 m. Free Style, 4 X 200 m. Relay  
**Chaves, M.** *Argentina* Swimming—100 m. Back-stroke  
**Chaves, see Buttery** *British Guiana* Weightlifting  
**Cheater, M.** (F) *Canada* Athletics—100 m., 200 m.  
**Cheeseman, S.** (F) *Great Britain* Athletics—200 m.  
**Chef d'hotel, R.** *France* Athletics—800 m., 4 x 400 m. Relay  
**Chen, Ying-Long** *China* Athletics—400 m.  
**Chesneau, M.** *France* Athletics—3,000 m. Steeplechase  
**Chesneau, R.** *France* Wrestling—Greco-Roman, Welterweight  
**Chevalier, G.** *France* Hockey  
**Chevalier, L.** *France* Athletics—10,000 m. Walk  
**Chevalley, C.** *Switzerland* Basketball  
**Chevallier, B.** *France* Equestrian—3 Day Individual, 3 Day Team  
**Chia, Boon-Leong** *China* Football  
**Chia, Chung-Chang** *China* Basketball  
**Child, E.** (F) *Great Britain* Swimming—Spring Board Diving  
**Child Velez, L.** *Colombia* Swimming—1,500 m. Free Style, 400 m. Free Style  
**Chlup, Z.** *Czechoslovakia* Basketball  
**Chmela, Z.** *Czechoslovakia* Fencing—Sabre Team  
**Chocat, R.** *France* Basketball  
**Choi, Hang Kee** *Korea* Weightlifting—Featherweight  
**Choi, Song Gon** *Korea* Football  
**Choi, Yun Chil** *Korea* Athletics—Marathon  
**Chollet, M.** *Switzerland* Basketball  
**Chote, M.** *Great Britain* Athletics—Javelin  
**Chow, F.** *U.S.A.* Shooting—25 m. Rapid Pistol  
**Christen, W.** *Switzerland* Athletics—400 m. Hurdles  
**Christensen, A.** *Denmark* Canoeing—10,000 m. K2  
**Christensen, B.** *Denmark* Shooting—50 m. Small Bore Rifle  
**Christensen, C.** *Denmark* Boxing—Welterweight  
**Christensen, D.** *U.S.A.* Swimming—Water Polo  
**Christensen, H.** *Denmark* Athletics—800 m.  
**Christensen, O.** *Norway* Yachting—Swallow Class  
**Christiaens, A.** (F) *Belgium* Fencing—Foil Individual  
**Christiansen, L.** *Norway* Cycling—Road Race  
**Christiansen, T.** *Denmark* Swimming—High Diving, Spring Board Diving  
**Christie, T.** *Great Britain* Rowing—Fours Without Cox  
**Christmas, R.** *Canada* Rowing—Eights  
**Christoffersen, B.** (F) *Denmark* Swimming—Springboard Diving, High Diving  
**Christogiannopoulos, L.** *Greece* Fencing—Sabre Team, Sabre Individual  
**Chryssafis, E.** *Greece* Shooting—25 m. Rapid Pistol, 50 m. Pistol  
**Chu, Wing-Keung** *China* Football  
**Chua, Bon-Hua** *China* Basketball  
**Chundra, B.** *India* Swimming—400 m. Free Style, 1,500 m. Free Style  
**Chung, Kook Chin** *Korea* Football  
**Chung, Nam Sik** *Korea* Football  
**Church, E.** (F) *Great Britain* Swimming—200 m. Breast-stroke  
**Churcher, H.** *Great Britain* Athletics—10,000 m. Walk  
**Chychla, Z.** *Poland* Boxing—Welterweight  
**Chyo, Deuk Joon** *Korea* Basketball  
**Cia, G. M.** *Argentina* Boxing—Light-heavyweight  
**Cibert, J.** *Argentina* Yachting—Swallow Class  
**Cieslinkas, V.** *Uruguay* Basketball  
**Ciganovic, L.** *Yugoslavia* Swimming—Water Polo  
**Cimermancic, Z.** *Yugoslavia* Football  
**Ciocco, M.** *Switzerland* Shooting—300 m. Free Rifle, 50 m. Small Bore Rifle  
**Citterio, A.** *Italy* Cycling—4,000 m. Pursuit  
**Clancy, C.** *Eire* Athletics—Discus  
**Clara Muller, E.** (F) *Brazil* Athletics—100 m., Putting the Shot, High Jump  
**Clark, D.** *Great Britain* Athletics—Hammer  
**Clark, R.** *U.S.A.* Canoeing—1,000 m. K2, 10,000 m. K2  
**Clarke, G.** (F) *Great Britain* Athletics—Javelin  
**Claudius, L.** *India* Hockey  
**Clausen, B.** *Denmark* Yachting—6 m. Class  
**Clausen, F.** *Norway* Wrestling—Greco-Roman Style, Flyweight  
**Clausen, H.** *Iceland* Athletics—4 x 100 m. Relay, 100 m., 200 m.  
**Clausen, O.** *Iceland* Athletics—Decathlon, 100 m.  
**Cleary, D.** *Eire* Football  
**Clements, E.** *Great Britain* Cycling—Road Race  
**Clergerie, P.** *France* Rowing—Eights  
**Coachman, A.** (F) *U.S.A.* Athletics—High Jump  
**Cobiaux, A.** *Belgium* Canoeing—10,000 m. K1  
**Cochin, M.** *France* Boxing—Flyweight  
**Cochran, R.** *U.S.A.* Athletics—400 m. Hurdles, 4 X 400 m. Relay  
**Codaro, O.** *Argentina* Swimming—Water Polo  
**Cohen, D.** *South Africa* Swimming—200 m. Back-stroke  
**Colans, H.** *Belgium* Weightlifting—Featherweight  
**Colantuono, G.** *Italy* Weightlifting—Lightweight  
**Colau, M.** *France* Football  
**Colchen, A.** (F) *France* Athletics—High Jump  
**Cole, F.** *Great Britain* Basketball  
**Coleman, J.** *South Africa* Athletics—Marathon  
**Collet, W.** *Belgium* Rowing—Double Sculls  
**Collins, R.** *Great Britain* Rowing—Fours With Cox  
**Colombo, C.** *U.S.A.* Football  
**Colon, S.** *Puerto Rico* Boxing—Featherweight  
**Conforti, G.** *Italy* Equestrian—Prix des Nations Individual, Prix des Nations Team  
**Consiglieri, M.** *Peru* Athletics—Discus  
**Consolini, A.** *Italy* Athletics—Discus  
**Contarbio, L.** *Argentina* Basketball  
**Continentino Dias Ribeiro, R.** *Brazil* Equestrian—Prix des Nations Team, Prix des Nations Individual  
**Cook, A.** *U.S.A.* Shooting—50 m. Small Bore Rifle  
**Cook, B.** *Norway* Wrestling—Greco-Roman Style, Welterweight  
**Cook, R.** *Bermuda* Swimming—400 m. Free Style, 4 X 200 m. Relay  
**Cooke, H.** *Great Britain* Fencing—Foil Team  
**Cools, J.** *Belgium* Wrestling—Free Style, Lightweight  
**Coomans, H.** *Belgium* Canoeing—1,000 m. C2  
**Cooper, R.** *Great Britain* Boxing—Lightweight  
**Coosemans, H.** *Belgium* Basketball  
**Coppone, H.** *Switzerland* Yachting—6 m. Class  
**Cora Johnson, R.** *Cuba* Rowing—Fours With Cox  
**Cordero Fernandez, E.** *Chile* Basketball  
**Cordiale Gentile, E.** (F) *Italy* Athletics—Discus  
**Cordoba Alcalá, A.** *Mexico* Football  
**Corman, H.** *Holland* Boxing—Flyweight  
**Cornejo Diaz, E.** *Chile* Boxing—Lightweight  
**Cornforth, R.** *Australia* Swimming—Water Polo  
**Cornu, R.** *France* Swimming—4 x 200 m. Relay, 1,500 m. Free Style, 400 m. Free Style  
**Correia, A.** *see Long* *British Guiana* Weightlifting—Featherweight  
**Correia Barrento, J.** *Portugal* Equestrian—Prix des Nations Individual, Prix des Nations Team  
**Corridon, M.** (F) *U.S.A.* Swimming—100 m. Free Style, 4 X 100 m. Relay  
**Corry, D.** *Eire* Equestrian—Prix des Nations Individual, Prix des Nations Team  
**Corsaro, G.** *Italy* Athletics—10,000 m. Walk  
**Cortoni, C.** *Argentina* Cycling—1,000 m. Scratch  
**Cosentino, R.** *Italy* Yachting—6 m. Class  
**Cosic, A.** *Yugoslavia* Athletics—4 X 400 m. Relay  
**Costa, J.** *U.S.A.* Football  
**Costa, M.** (F) *Brazil* Swimming—4 x 100 m. Relay



- Costa Ramos, R.** *Brazil* Athletics—400 m., 200 m., 4 x 100 m. Relay  
**Costantino, S.** *Italy* Athletics—Marathon  
**Coste, C.** *France* Cycling—4,000 m. Pursuit  
**Costemalle, J.** *Uruguay* Swimming—Water Polo  
**Cote, G.** *Canada* Athletics—Marathon  
**Coto Gonzalez, W.** *Cuba* Shooting—50 m. Small Bore Rifle  
**Courbin, R.** *France* Football  
**Courron, L.** *France* Athletics—10,000 m. Walk  
**Court, J.** (F) *Canada* Swimming—4 x 100 m. Relay, 100 m. Back-stroke  
**Cousin, P.** *France* Athletics—Marathon  
**Coutinho da Silva, H.** *Brazil* Athletics—Hop, Step and Jump, 100 m., 4 x 100 m. Relay  
**Covey, G.** *Canada* Canoeing—10,000 m. K2, 1,000 m. K2  
**Cowell, R.** *U.S.A.* Swimming—100 m. Back-stroke  
**Cox, S.** *Great Britain* Athletics—30,000 m.  
**Coy, E.** *Canada* Athletics—Discus, Putting the Shot  
**Coyle, D.** *Eire* Athletics—Hammer  
**Craig, A.** *Great Britain* Fencing—Epee Team  
**Craig, R.** *U.S.A.* Yachting—Dragon Class  
**Cranston, R.** *India* Boxing—Welterweight  
**Crapet, R.** *France* Athletics—400 m.  
**Crehan, P.** *Eire* Basketball  
**Cretaine, J.** *France* Athletics—Decathlon  
**Crete, M.** *Canada* Wrestling—Free Style, Featherweight  
**Creus, J.** *Great Britain* Weightlifting—Bantamweight  
**Crezen, R.** *France* Rowing—Pairs With Cox  
**Croce, A.** *Italy* Yachting—6 m. Class  
**Cros, Y.** *France* Athletics—400 m. Hurdles  
**Crosbie, E.** *U.S.A.* Athletics—50,000 m. Walk  
**Cross, S.** *Great Britain* Athletics—Hop, Step and Jump  
**Crosta Noceti, C.** *Argentina* Rowing—Fours With Cox  
**Crow, M.** *New Zealand* Weightlifting—Bantamweight  
**Crowther, B.** (F) *Great Britain* Athletics—High Jump, 80 m. Hurdles  
**Cruzat Santa Maria, I.** *Chile* Shooting—25 m. Rapid Pistol, 50 m. Pistol  
**Csanyi, G.** *Hungary* Athletics—100 m., 4 x 100 m. Relay  
**Csik, T.** *Hungary* Boxing—Bantamweight  
**Csordas, G.** *Hungary* Swimming—1,500 m. Free Style  
**Csvik, O.** *Hungary* Swimming—Water Polo  
**Culot, L.** *Belgium* Wrestling—Free Style, Welterweight  
**Cumiskey, F.** *U.S.A.* Gymnastics  
**Curatella, J.** *Argentina* Rowing—Fours Without Cox  
**Curcio, R.** *Italy* Modern Pentathlon  
**Curotta, M.** *Australia* Athletics—200 m., 100 m., 400 m., 4 x 100 m. Relay  
**Curry, T.** *Great Britain* Athletics—3,000 m. Steeplechase  
**Curtis, A.** (F) *U.S.A.* Swimming—400 m. Free Style, 100 m. Free Style, 4 x 100 m. Relay  
**Curtot-Chabot, Y.** (F) *France* Athletics—Long Jump  
**Cuthbert, K.** (F) *Great Britain* Swimming—Springboard Diving
- D**
- Daetwyler, P.** *Switzerland* Wrestling—Free Style, Middleweight  
**da Fonseca e Silva, P. W.** *Brazil* Swimming—100 m. Back-stroke  
**Daigle, F.** *Canada* Boxing—Bantamweight  
**Dalley, B.** *Australia* Swimming—Water Polo  
**Dalrymple, M.** *Great Britain* Athletics—Javelin  
**Dalton, D.** (F) *U.S.A.* Gymnastics  
**Damage, C.** *Lebanon* Wrestling—Greco-Roman Style, Lightweight.  
**Damitio, G.** *France* Athletics—Long Jump, High Jump  
**Dammers, E.** (F) *Holland* Athletics—Javelin  
**da Motta, R.** *Brazil* Basketball  
**Dandamudi, R.** *India* Weightlifting—Heavyweight  
**D'Andrea Mohr, J.** *Argentina* Fencing—Sabre Team  
**Daniel, P. M.** *India* Weightlifting—Featherweight  
**Dannacher, A.** *Switzerland* Wrestling—Greco-Roman Style, Light-heavyweight  
**Dapiran, F.** *Italy* Rowing—Double Sculls  
**Dara, A.** *Pakistan* Hockey  
**Darcey, T.** *Australia* Rowing—Fours with Cox  
**Dare, G.** *Italy* Fencing—Sabre Team, Sabre Individual  
**Das, D.** *India* Swimming—Water Polo  
**Das, R.** *India* Football  
**Dash, H.** *U.S.A.* Swimming—Water Polo  
**Dass, J.** *India* Swimming—Water Polo  
**D'Atri, H.** *Argentina* Weightlifting—Lightweight  
**Datt, K.** *India* Hockey  
**D'Autorio, V.** *U.S.A.* Gymnastics  
**Davies, C.** (F) *Great Britain* Gymnastics  
**Davies, J. Goldup** *Great Britain* Swimming—200 m. Breast-stroke  
**Davies, J. Griffith** *Australia* Swimming—200 m. Breast-stroke  
**Davies, J. J.** (F) *Australia* Swimming—100 m. Back-stroke  
**Davies, R.** *Great Britain* Hockey  
**Davies, T.** *Great Britain* Basketball  
**Davis, J.** *U.S.A.* Weightlifting—Heavyweight  
**Dayer, A.** *Belgium* Athletics—Decathlon  
**De Almeida Bello, D.** *Portugal.* Yachting—Swallow Class  
**de Antequeda, I.** (F) *Argentina* Fencing—Foil Individual  
**Dearlove, J.** *Great Britain* Rowing—Eights  
**de Armas, J.** *Uruguay* Cycling—4,000 m. Pursuit  
**de Beaumont, C.** *Great Britain* Fencing—Epee Team, Epee Individual  
**de Belaustegigoitia Arozwna, I.** (F) *Mexico* Swimming—Springboard Diving  
**de Beukelaere, J.** *Belgium* Cycling—4,000 m. Pursuit  
**de Beur, C.** *Belgium* Fencing—Epee Team, Epee Individual  
**Debonnet, F.** *France* Swimming—Water Polo  
**de Bortoli, B.** *Italy* Rowing—Eights  
**de Bourguignon, G.** *Belgium* Fencing—Sabre Team, Foil Team  
**de Bruine, J.** *Holland* Equestrian—Prix des Nations Team, Prix des Nations Individual  
**Debuf, J.** *France* Weightlifting—Light-heavyweight  
**Decanali, F.** *France* Cycling—4,000 m. Pursuit  
**de Capriles, J.** *U.S.A.* Fencing—Epee Individual, Epee Team  
**de Capriles, M.** *U.S.A.* Fencing—Sabre Team  
**Decena, E.** *Philippines* Basketball  
**Decker, M.** (F) *Luxembourg* Athletics—100 m., 200 m.  
**Deeney, J.** *U.S.A.* Rowing—Pairs with Cox  
**Defteraios, S.** *Greece* Wrestling—Free Style, Light-heavyweight  
**de Grijze, T.** (F) *Belgium* Gymnastics  
**de Groot, A.** (F) *Holland* Swimming—200 m. Breast-stroke  
**de Groot, K.** *Holland* Wrestling—Greco-Roman Style, Middleweight  
**de Jong, J.** *Holland* Yachting—Firefly Class  
**de Jongh, G.** (F) *Holland* Athletics—100 m., 200 m.  
**de Kerviler, M.** *France* Yachting—Dragon Class  
**Dekker, J.** *Holland* Rowing—Fours without Cox  
**de la Cruz, A.** *Philippines* Basketball  
**Delaney, F.** *U.S.A.* Athletics—Putting the Shot  
**Delannoit, E.** *Belgium* Boxing—Featherweight  
**Delany, A.** *Eire* Yachting—Swallow Class  
**de la Pena Lopez Trigo, L.** *Cuba* Fencing—Foil Individual  
**Delathouwer, L.** *Belgium* Cycling—Road Race  
**de la Torre Gonzalez, J.** *Mexico* Shooting—50 m. Small Bore Rifle  
**Delaval, H.** *Belgium* Hockey  
**Delaval, J.** *Belgium* Hockey  
**Delfosse, C.** *Belgium* Yachting—Dragon Class  
**de los Santos, L.** *Uruguay* Cycling—4,000 m. Pursuit  
**de Luca, G.** *Italy* Yachting—6 m. Class  
**Delval, J.** *Belgium* Shooting—50 m. Small Bore Rifle  
**de Manincor, L.** *Italy* Yachting—Dragon Class  
**De Marco, E.** *Uruguay* Cycling—Road Race  
**Demarco, N.** *Uruguay* Basketball  
**de Maupeou d'Ableiges, G.** *France* Equestrian—Prix des Nations Team, Prix des Nations Individual  
**Deni, J.** *U.S.A.* Athletics—50,000 m. Walk  
**Dennolf, S.** *Sweden* Athletics—10,000 m.  
**Denroche, C.** *Eire* Athletics—4 x 400 m. Relay  
**de Paula, A.** *Brazil* Fencing—Epee Team

- de Pauw, F.** *Belgium* Basketball  
**de Pauw, H.** *Belgium* Swimming—Water Polo  
**de Pauw, R.** *Belgium* Cycling—2,000 m. Tandem  
**de Pietro, J.** *U.S.A.* Weightlifting—Bantamweight  
**de Portela, N. S.** (F) *Argentine* Athletics—Long Jump, 80 m. Hurdles, 100 m.  
**Deprez, H.** *Belgium* Canoeing—10,000 m. K2  
**Derckx, H.** *Holland* Hockey  
**Derency, R.** *France* Basketball  
**de Rio Salas, J.** *Argentine* Yachting—Dragon Class  
**Dermody, D.** (F) *Eire* Fencing—Foil Individual  
**de Ruyter, F.** *Holland* Athletics—800 m., 1,500 m.  
**de Saram, J.** *Ceylon* Athletics—200 m., 100 m., 400 m.  
**de Saymonnet, M.** *France* Basketball  
**Descalco, D.** *Peru* Basketball  
**Des Jamonieres, C.** *France* Shooting—25 m. Rapid Pistol  
**Desjarlais, R.** *Canada* Fencing—Foil Team, Epee Team, Sabre Team  
**de Smet, L.** *Belgium* Swimming—Water Polo  
**Desouches, C.** *France* Yachting—6 m. Class  
**de Sousa Leite Gourinho, J.** *Portugal* Yachting—Star Class  
**de Souza, W.** *India* Hockey  
**Desprets, M.** *France* Fencing—Epee Team, Epee Individual  
**Dessouki, S.** *Egypt* Fencing—Epee Team, Foil Team, Sabre Team, Sabre Individual  
**de Vries Lentsch, W.** *Holland* Yachting—Swallow Class  
**de Vroet, A.** *Holland* Football  
**Dewasch, R.** *France* Swimming—Water Polo  
**Dewolf, M.** *France* Gymnastics  
**Dezwi, El S.** *Egypt* Football  
**D'Hooge, E.** *Belgium* Swimming—Water Polo  
**Diab, M.** *Uruguay* Basketball  
**Diakoumakos, I.** *Greece* Rowing—Pairs With Cox  
**Dias, M.** *Brazil* Basketball  
**Dias de Sousa, J.** *Portugal* Rowing—Eights  
**Diaz Arnesto, F.** *Argentine* Fencing—Epee Team  
**Diaz Cadabeda, A.** *Spain* Boxing—Welterweight  
**Diaz Corpon, A.** *Cuba* Gymnastics  
**Diaz Mercado, R.** *Mexico* Basketball  
**Diaz Saenz Valiente, C.** *Argentine* Shooting—25 m. Rapid Pistol  
**Diebold, P.** *Brazil* Rowing—Pairs without Cox  
**Diederichtsen Schonbude, H.** (F) *Mexico* Swimming—200 m. Breast-stroke  
**Diener, M.** *France* Swimming—Water Polo  
**Diggelmann, R.** *Switzerland* Wrestling—Greco-Roman Style, Welterweight  
**Dijk, H.** *Holland* Wrestling—Greco-Roman Style, Featherweight  
**Dill, H.** *Bermuda* Athletics—400 m., 200 m., 4 x 100 m. Relay  
**Dillard, H.** *U.S.A.* Athletics—4 x 100 m. Relay, 100 m.  
**Dincturk, S.** *Turkey* Athletics—4 X 400 m. Relay, 800 m.  
**D'Inzeo, R.** *Italy* Equestrian—Prix des Nations Individual, 3 Day Individual, Prix des Nations Team, 3 Day Team  
**Di Rosa, M.** *Italy* Fencing—Foil Team, Foil Individual  
**Di Segni, G.** *Italy* Boxing—Light-heavyweight  
**Ditlevsen, K.** *Denmark* Canoeing—10,000 m. K1  
**Dixon, C.** *U.S.A.* Athletics—110 m. Hurdles  
**Djamshidabadi, M.** *Iran* Boxing—Heavyweight  
**Djipalovic, D.** (F) *Yugoslavia* Gymnastics  
**Djordjevic, D.** (F) *Yugoslavia* Gymnastics  
**Djordjevic, D.** *Yugoslavia* Rowing—Fours with Cox, Pairs with Cox  
**D'Mello, M.** *Pakistan* Hockey  
**Dobbelaere, J.** *Belgium* Wrestling—Greco-Roman Style, Welterweight  
**Dobson, N.** *Great Britain* Canoeing—1,000 m. K1  
**Dodson, D.** (F) *U.S.A.* Athletics—Javelin, Putting the Shot, Discus  
**Doerner, H.** *Australia* Swimming—Water Polo  
**Dogu, Y.** *Turkey* Wrestling—Free Style, Welterweight  
**Dolan, P.** *Eire* Athletics—4 x 400 m. Relay  
**Dominguez Garcia, J.** *Spain* Swimming—4 x 200 m. Relay, 100 m. Free Style, 1,500 m. Free Style  
**Dominguez Mavila, C.** *Peru* Weightlifting—Heavyweight  
**Doms, J.** *Belgium* Athletics—3,000 m. Steeplechase  
**Donna, F.** *France* Canoeing—1,000 m. K2  
**Donovan, F.** *Great Britain* Football  
**Dooley, P.** *Eire* Rowing—Eights  
**Dordoni, G.** *Italy* Athletics—10,000 m. Walk  
**d'Orgeix, J.** *France* Equestrian—Prix des Nations Team, Prix des Nations Individual  
**d'Oriola, C.** *France* Fencing—Foil Individual, Foil Team  
**Dosanjh, B.** *India* Hockey  
**Dot, R.** *France* Gymnastics  
**d'Ottavio, A.** *Italy* Boxing—Welterweight  
**Douglas, E.** *Great Britain* Athletics—Hammer  
**Douglas, H.** *U.S.A.* Athletics—Long Jump  
**Dove, L.** *Australia* Shooting—50 m. Small Bore Rifle  
**Dow, H.** (F) *U.S.A.* Fencing—Foil Individual  
**Dowdall, T.** *Eire* Rowing—Eights  
**Drake, N.** *Great Britain* Athletics—Hammer  
**Dransart, G.** *France* Canoeing—10,000 m. C2, 1,000 m. C2  
**Draves, V.** (F) *U.S.A.* Swimming—High Diving, Springboard Diving  
**Dredge, D.** (F) *Canada* Athletics—High Jump  
**Drenovac, S.** *Yugoslavia* Rowing—Eights  
**Dreyer, G.** *South Africa* Boxing—Lightweight  
**Dreyer, H.** *U.S.A.* Athletics—Hammer  
**Drijver, J.** *Holland* Hockey  
**Dron, G.** *France* Cycling—2,000 m. Tandem  
**Drvota, J.** *Czechoslovakia* Basketball  
**Duarte, E.** (F) *Argentine* Swimming—4 x 100 m. Relay, 400 m. Free Style, 100 m. Free Style  
**Dubessay, J.** *France* Hockey  
**Dubois, J.** *Belgium* Canoeing—1,000 m. C2  
**Dubois, J. M. J.** *Belgium* Hockey  
**Dudley, W.** *U.S.A.* Swimming—4 x 200 m. Relay  
**Dudok Van Heel, A.** *Holland* Yachting—Dragon Class  
**Duffy, P.** *Eire* Fencing—Foil Team  
**Dunay, P.** *Hungary* Fencing—Epee Team, Epee Individual, Foil Team  
**Dupont, J.** *France* Cycling—Road Race, 1,000 m. Time Trial  
**Du Preez, D.** *South Africa* Boxing—Welterweight  
**Duranona, J.** *Argentine* Swimming—400 m. Free Style, 4 x 200 m. Relay  
**Dutoit, B.** *Switzerland* Basketball  
**Duys, Jr., H.** *U.S.A.* Yachting—Dragon Class  
**Dybkaer, R.** *Denmark* Fencing—Epee Team

## E

- Eberhardt, H.** *France* Canoeing—1,000 m. K1, 10,000 m. K1  
**Edding, C.** *Sweden* Yachting—Star Class  
**Edleman, T.** *U.S.A.* Athletics—High Jump  
**Edness, P.** (F) *Bermuda* Athletics—200 m., 100 m.  
**Edwards, R.** *Jamaica* Boxing—Light-heavyweight  
**Eger, R.** *Switzerland* Hockey  
**Egnell, C.** *Sweden* Shooting—25 m. Rapid Pistol  
**Egon Kestener, R.** *Brazil* Swimming—1,500 m. Free Style, 4 x 200 m. Relay  
**Ehlers Trostel, G.** *Chile* Athletics—400 m., 4 x 400 m. Relay  
**Ehringer, N.** *Luxembourg* Boxing—Lightweight  
**Ehrnrooth, A.** *Finland* Equestrian—3 Day Team, 3 Day Individual  
**Ehssassi, A.** *Iran* Basketball  
**Eibler, F.** *Austria* Weightlifting—Heavyweight  
**Eidlin, A.** *Uruguay* Basketball  
**Eiermann, A.** *Denmark* Yachting—6 m. Class  
**Eischen, C.** *U.S.A.* Athletics—1,500 m.  
**Eiseman, J.** *U.S.A.* Canoeing—10,000 m. K2, 1,000 m. K2  
**Eke, A.** *Great Britain* Basketball  
**Eken, B.** *Turkey* Football  
**Eland, R.** *Great Britain* Weightlifting—Lightweight  
**El Dessouki, I.** *Egypt* Weightlifting—Featherweight  
**Elek, B.** (F) *Hungary* Fencing—Foil Individual  
**Elek, I.** (F) *Hungary* Fencing—Foil Individual  
**El Gamal, T.** *Egypt* Swimming—100 m. Free Style, 4 x 200 m. Relay, Water Polo  
**El Gindi, M.** *Egypt* Football  
**El Hefnawi, A.** *Egypt* Gymnastics  
**Elias, K.** *Austria* Wrestling—Greco-Roman Style, Bantamweight  
**El Leissy, G.** *Egypt* Basketball

- Ellery, V. (F)** *Great Britain* Swimming—100 m. Back-stroke
- Elliott, P.** *Great Britain* Swimming—Spring Board Diving
- El Mekawi, A.** *Egypt* Football
- Elmsater, E.** *Sweden* Athletics—3,000 m. Steeplechase
- Elo, K.** *Finland* Shooting—300 m. Free Rifle
- El Said, M.** *Egypt* Rowing—Single Sculls
- El Sayed, D.** *Egypt* Swimming—100 m. Free Style, 100 m. Back-stroke
- Elsener, P. (F)** *U.S.A.* Swimming—High Diving, Spring Board Diving
- Elste, M. (F)** *U.S.A.* Gymnastics
- El Touni, K.** *Egypt* Weightlifting—Middleweight
- Elvstrom, P.** *Denmark* Yachting—Firefly Class
- El Ward, M.** *Egypt* Wrestling—Greco-Roman, Free Style, Flyweight.
- El Zaim, M.** *Egypt* Wrestling—Free Style, Light-heavyweight
- Emanuelli, R.** *France* Equestrian—3 Day Team, 3 Day Individual
- Emcken, J.** *Denmark* Rowing—Eights
- Emile, Y.** *Iraq* Basketball
- Emmanouil, G.** *Greece* Rowing—Fours With Cox, Pairs With Cox
- Enderle, J.** *Belgium* Hockey
- Engkvist, J. Y.** *Sweden* Yachting—Star Class
- Enzenhofer, E. (F)** *Austria* Gymnastics
- Enzinger, P.** *Austria* Wrestling—Greco-Roman, Light-heavyweight
- Epalle, C.** *France* Athletics—Hop, Step and Jump
- Epp, J.** *Austria* Football
- Erauzquin Erauzquin, F.** *Spain* Athletics—Discus
- Erben, I.** *Sweden* Shooting—300 m. Free Rifle
- Ericson, B.** *Sweden* Athletics—Hammer
- Eriksen, A.** *Norway* Wrestling—Greco-Roman Style, Lightweight
- Eriksen, A.** *Norway* Fencing—Epee Individual, Epee Team
- Eriksson, B.** *Sweden* Fencing—Sabre Individual, Foil Individual
- Eriksson, F.** *Sweden* Swimming—Water Polo
- Eriksson, H.** *Sweden* Athletics—1,500 m.
- Eriksson, P.** *Sweden* Athletics—Decathlon
- Erismann, M. (F)** *Switzerland* Swimming—100 m. Free Style
- Ernzer, M.** *Luxembourg* Cycling—Road Race
- Erskine, M. (F)** *Great Britain* Athletics—Long Jump
- Escudie, A.** *France* Boxing—Middleweight
- Esen, S.** *Turkey* Wrestling—Free Style, Heavyweight
- Esfendiari, F.** *Iran* Basketball
- Espejo Perez, C.** *Argentina* Swimming—200 m. Breast-stroke
- Espeut, M.** *Jamaica* Weightlifting—Lightweight
- Esser, R.** *Holland* Hockey
- Estebanez Vela, E.** *Spain* Hockey
- Esteve Magnet, P.** *Spain* Shooting—25 m. Rapid Pistol
- Estman, G.** *South Africa* Cycling—Road Race
- Estrada Ojeda, E.** *Mexico* Wrestling—Free Style, Welterweight
- Evans, G.** *Argentina* Athletics—400 m., 4 x 400 m. Relay
- Evans, L.** *Canada* Athletics—Marathon
- Evans, P. (F)** *Great Britain* Gymnastics
- Evans, R.** *U.S.A.* Yachting—Firefly Class
- Even, A.** *France* Basketball
- Evensen, A.** *Norway* Yachting—6 m. Class
- Evensen, W.** *Norway* Rowing—Fours With Cox
- Everaert, R.** *Belgium* Athletics—3,000 m. Steeplechase, 10,000 m.
- Every, D.** *U.S.A.* Fencing—Foil Team
- Evora, A.** *Brazil* Basketball
- Ewell, H.** *U.S.A.* Athletics—4 x 100 m. Relay, 200 m., 100 m.
- Eyjolfsson, T.** *Iceland* Athletics—4 x 100 m. Relay
- Ezr, J.** *Czechoslovakia* Basketball

## F

- Faanhof, H.** *Holland* Cycling—4,000 m. Pursuit, Road Race
- Fabian, D.** *Hungary* Swimming—Water Polo
- Faggi, F.** *Italy* Rowing—Fours without Cox
- Faggs, M. (F)** *U.S.A.* Athletics 200 m.
- Fahim, M.** *Egypt* Boxing—Middleweight
- Fahlkvist, B.** *Sweden* Wrestling—Free Style, Light-Heavyweight
- Fahmy, A.** *Egypt* Basketball
- Fahy, P.** *Eire* Athletics—10,000 m.
- Fairgrieve, J.** *Great Britain* Athletics—200 m.
- Fairhead, A.** *Canada* Yachting—Star Class
- Fajardo, F.** *Philippines* Basketball
- Fajardo, G.** *Philippines* Basketball
- Faloux, A.** *France* Wrestling—Greco-Roman Style, Lightweight
- Falp Mont, C.** *Spain* Swimming—Water Polo
- Fanetti, F.** *Italy* Rowing—Pairs without Cox
- Fani, J.** *Iran* Boxing—Featherweight
- Fanti, F.** *Italy* Cycling—Road Race
- Fantoni, G.** *Italy* Wrestling—Greco-Roman Style, Heavyweight
- Farkas, B.** *Hungary* Boxing—Featherweight
- Farreras Valenti, P.** *Spain* Hockey
- Farrington, S.** *Great Britain* Yachting—Star Class
- Fauconnier, L.** *Belgium* Modern Pentathlon
- Faugouin, R. (F)** *France* Athletics—4 x 100 m. Relay, 200 m.
- Faul, A.** *Canada* Boxing—Heavyweight
- Fauveau, P.** *France* Rowing—Eights
- Fayad, M.** *Egypt* Weightlifting—Featherweight
- Faye, R.** *France* Cycling—2,000 m. Tandem
- Fayos M.** *Uruguay* Athletics—100 m., 200 m., 400 m., 4 x 100 m. Relay
- Febrero Lorenzo, A.** *Spain* Swimming—400 m. Free Style, 1,500 m. Free Style
- Fedorick, W.** *Canada* Athletics—Marathon
- Feher, A. (F)** *Hungary* Gymnastics
- Fehlmann, R.** *Switzerland* Yachting—6 m. Class
- Fekete, J.** *Hungary* Gymnastics
- Felgen, N.** *Luxembourg* Wrestling—Greco-Roman Style, Welterweight
- Felinger, P.** *Austria* Canoeing—1,000 m. K2
- Felix da Silva Capucho, J.** *Portugal* Yachting—Dragon Class
- Feller, J.** *Luxembourg* Football
- Feller, V.** *Luxembourg* Football
- Felton, S.** *U.S.A.* Athletics—Hammer
- Fenton, L.** *Australia* Yachting—Star Class
- Ferencz, K.** *Hungary* Wrestling—Greco-Roman Style, Lightweight
- Ferguson, J.** *Australia* Swimming—Water Polo
- Ferguson, L.** *Australia* Swimming—Water Polo
- Fernandes, L.** *India* Hockey
- Fernandez Calderon, A.** *Peru* Basketball
- Fernandez, D.** *Argentina* Shooting—25 m. Rapid Pistol
- Fernandez, M.** *Argentina* Rowing—Eights
- Ferrando Dietz, S.** *Peru* Athletics—200 m., 100 m.
- Ferrari, A.** *Italy* Cycling—Road Race
- Ferreira, J.** *U.S.A.* Football
- Ferreira, S.** *Brazil* Shooting—50 m. Pistol
- Ferreyros Perez, A.** *Peru* Basketball
- Ferriani, S.** *Italy* Basketball
- Fesl, G. (F)** *Austria* Gymnastics
- Fiestas Arce, E.** *Peru* Basketball
- Figone, G.** *Italy* Gymnastics
- Figueredo, M.** *Uruguay* Cycling—Road Race
- Figueroa, H.** *Chile* Athletic—Decathlon
- Figueroa Reyes, E.** *Chile* Basketball
- Figueroa Rodriguez, F.** *Mexico* Football
- Fikejz, J.** *Czechoslovakia* Athletics—Long Jump
- Filiberti, A.** *Argentina* Swimming—Water Polo
- Filippidis, N.** *Greece* Rowing—Fours with Cox
- Filz, F. (F)** *Austria* Fencing—Foil Individual
- Finlay, D.** *Great Britain* Athletics—110 m. Hurdles
- Finlay, M.** *Great Britain* Basketball
- Fioravanti, D.** *Italy* Gymnastics
- Fiorentino, A.** *Argentina* Weightlifting—Featherweight
- Fioretti, A.** *Italy* Rowing—Eights
- Firmenich, A.** *Switzerland* Yachting—6 m. Class
- Firmin, G.** *France* Weightlifting—Middleweight
- Fiske, D.** *U.S.A.* Swimming—Water Polo
- Flaherty, J.** *Great Britain* Gymnastics
- Flamini, E.** *Argentina* Wrestling—Greco-Roman Style, Bantamweight
- Fleche, R.** *France* Canoeing—10,000 m. K2
- Flengsrud, L.** *Norway* Cycling—Road Race
- Flindt, K.** *Denmark* Fencing—Epee Team
- Floody Buxton, N.** *Chile* Modern Pentathlon
- Floor, J. (F)** *Holland* Swimming—Springboard Diving
- Fluckiger, H.** *Switzerland* Cycling—1,000 m. Time Trial
- Flynn, J.** *Eire* Basketball
- Flynn, J.** *U.S.A.* Fencing—Sabre Team
- Folle, E.** *Uruguay* Basketball

- Fonck, R.** *Luxembourg* Canoeing—10,000 m. K2, 1,000 m. K2
- Fontana, I.** *Italy* Boxing—Middleweight
- Foran, P.** *Eire* Boxing—Welterweight
- Ford, A.** *U.S.A.* Swimming—100 m. Free Style
- Formenti, E.** *Italy* Boxing—Featherweight
- Forsberg, H.** *Finland* Rowing—Fours with Cox
- Forsberg, O.** *Finland* Rowing—Fours with Cox
- Forssell, C.** *Sweden* Fencing—Epee Team, Epee Individual
- Forte, O.** *Argentina* Weightlifting—Light-heavyweight
- Fortun Chacon, R.** *Cuba* Athletics—200 m., 100 m.
- Foster, D. (F)** *Canada* Athletics—200 m., 4 X 100 m. Relay
- Foster, S.** *Jamaica* Athletics—110 m. Hurdles
- Foucher-Creteau, M. (F)** *France* Swimming—4 x 100 m. Relay
- Fournier, J.** *France* Shooting—300 m. Free Rifle
- Fournier, L.** *Canada* Athletics—Decathlon
- Frain de la Gaulayrie, J.** *France* Yachting—Dragon Class
- Franck, L.** *Belgium* Yachting—6 m. Class
- Franco Pontes, J.** *Brazil* Equestrian—Prix des Nations Team, Prix des Nations Individual
- Francois, A.** *Uruguay* Cycling—4,000 m. Pursuit
- Frandsfors, G.** *Sweden* Wrestling—Free Style, Lightweight
- Frank, V.** *U.S.A.* Athletics—Discus
- Fransson, U.** *Sweden* Athletics—Discus
- Frauneder, F.** *Austria* Rowing—Fours With Cox
- Frayer, H.** *France* Athletics—110 m. Hurdles
- Frederiksen, S.** *Denmark* Athletics—Hammer
- Fredin, I. (F)** *Sweden* Swimming—4 x 100 m. Relay, 100 m. Free Style, 100 m. Back-stroke
- Fredriksson, G.** *Sweden* Canoeing—1,000 m. K1, 10,000 m. K1
- Frei, K.** *Switzerland* Gymnastics
- Freij, K.** *Sweden* Wrestling—Greco-Roman Style, Lightweight
- Freitag, W.** *Austria* Cycling—4,000 m. Pursuit, 1,000 m. Time Trial
- Freitas, R.** *Brazil* Basketball
- French, C.** *Australia* Swimming—Water Polo
- French, R.** *Australia* Yachting—Firefly Class
- Fresson, M.** *France* Equestrian—Prix des Nations Team, Prix des Nations Individual
- Frey, F.** *Switzerland* Canoeing—10,000 m. K2
- Frieden, Paul** *Luxembourg* Athletics—3,000 m. Steeplechase
- Friedrich, H.** *Austria* Gymnastics
- Frierson, A.** *U.S.A.* Equestrian—Prix des Nations Team, Prix des Nations Individual
- Fright, E.** *Great Britain* Football
- Frischknecht, H.** *Switzerland* Athletics—Marathon
- Froimovich Schejter, I.** *Chile* Swimming—Water Polo
- Frostell, W.** *Sweden* Shooting—300 m. Free Rifle
- Fuchs, J.** *U.S.A.* Athletics—Putting the Shot
- Fuentes Besoain, H.** *Chile* Modern Pentathlon
- Fulgencio, E.** *Philippines* Basketball
- Fullone, N. (F)** *Argentina* Fencing—Foil Individual
- Furlong, O.** *Argentina* Basketball
- Fuse, J.** *Argentina* Athletics—Hammer

## G

- Gabric Calvesi, L. (F)** *Italy* Athletics—Discus
- Gabriel, L.** *Uruguay* Swimming—Water Polo
- Gadd, K.** *Sweden* Swimming—Water Polo
- Gailly, E.** *Belgium* Athletics—Marathon
- Gales, J.** *Luxembourg* Football
- Galimi, Felix** *Argentina* Fencing—Foil Individual, Foil Team
- Galimi, Fulvio** *Argentina* Fencing—Foil Individual, Foil Team
- Galindo Chavez, F.** *Mexico* Basketball
- Gallagher, A.** *U.S.A.* Rowing—Double Sculls
- Gallardo, C.** *Uruguay* Fencing—Foil Team
- Gallegati, E.** *Italy* Wrestling—Greco-Roman Style, Middleweight
- Galli, J.** *France* Boxing—Heavyweight
- Galliard, M. (F)** *Holland* Swimming—100 m. Back-stroke
- Gallie, J.** *Great Britain* Shooting—50 m. Pistol
- Gallo Chinchilla, J.** *Chile* Basketball
- Gamenara, J.** *Uruguay* Yachting—Swallow Class
- Gandil, G.** *France* Canoeing—1,000 m. C2, 10,000 m. C2
- Gandini, L.** *Italy* Rowing—Eights
- Ganoza Rios, L.** *Peru* Athletics—Pole Vault
- Garay, J.** *Argentina* Swimming—400 m. Free Style, 4 x 200 m. Relay, 1,500 m. Free Style
- Garay, S.** *Hungary* Athletics—1,500 m.
- Garbo, S.** *Egypt* Swimming—Water Polo
- Garcia, A. C.** *Cuba* Basketball
- Garcia Arcila, P.** *Peru* Boxing—Featherweight
- Garcia Artime, C.** *Cuba* Basketball
- Garcia Cruz, J.** *Spain* Equestrian—Prix des Nations Team, Prix des Nations Individual
- Garcia Delgado, A.** *Cuba* Athletics—100 m., 200 m., 400 m.
- Garcia, H.** *Argentina* Boxing—Middleweight
- Garcia Ordonez, R.** *Cuba* Basketball
- Garcia Otero, H.** *Uruguay* Basketball
- Garcia Rojas, R.** *Mexico* Modern Pentathlon
- Garcia Vidal, R.** *Cuba* Swimming—100 m. Free Style
- Gardin, G.** *Sweden* Modern Pentathlon
- Gardner, D. (F)** *Great Britain* Athletics—High Jump
- Gardner, J.** *Great Britain* Boxing—Heavyweight
- Gardner, M. (F)** *Great Britain* Athletics—80 m. Hurdles, 4 X 100 m. Relay
- Gardner, P.** *Australia* Athletics—110 m. Hurdles
- Garduno Gomez, E.** *Mexico* Football
- Garforth, R.** *Great Britain* Swimming—Water Polo
- Garilhe, R. (F)** *France* Fencing—Foil Individual
- Garrard, R.** *Australia* Wrestling—Free Style, Welterweight
- Garrido Luloaga, O.** *Cuba* Weightlifting—Middleweight
- Gasset Parrilla, P.** *Spain* Hockey
- Gates, G.** *U.S.A.* Rowing—Fours without Cox
- Gausterer, R.** *Austria* Boxing—Flyweight
- Gauthier-Lafond, R.** *France* Shooting—50 m. Small Bore Rifle
- Gavelli, M.** *Italy* Wrestling—Free Style, Featherweight
- Gavilan Y Ponce De Leon, M.** *Spain* Equestrian—Prix des Nations Team, Prix des Nations Individual
- Gazapo De Sarraga, F.** *Spain* Equestrian—3 Day Team, 3 Day Individual
- Geary, G.** *Argentina* Athletics—200 m.
- Gehrmann, D.** *U.S.A.* Athletics—1,500 m.
- Geiser, R.** *Switzerland* Basketball
- Geldard, R.** *Great Britain* Cycling—4,000 m. Pursuit
- Genot, L.** *France* Shooting—50 m. Small Bore Rifle
- Gentle, R.** *India* Hockey
- Gentleman, R.** *Great Britain* Swimming—Water Polo
- George, P.** *U.S.A.* Weightlifting—Middleweight
- Gerbac, V. (F)** *Yugoslavia* Gymnastics
- Gerber, O.** *Switzerland* Athletics—Decathlon
- Gerevich, A.** *Hungary* Fencing—Sabre Individual, Foil Team, Sabre Team
- Gerosa, G.** *Switzerland* Cycling—4,000 m. Pursuit
- Gerrietsen, H. (F)** *Holland* Gymnastics
- Gerson, C.** *U.S.A.* Hockey
- Gesino, G.** *Italy* Wrestling—Greco-Roman Style, Lightweight
- Ghaffari, A.** *Iran* Wrestling—Free Style, Lightweight
- Ghaoui, M.** *Lebanon* Boxing—Featherweight
- Gharzai, M.** *Afghanistan* Football
- Ghella, M.** *Italy* Cycling—1,000 m. Scratch
- Ghira, A.** *Italy* Swimming—Water Polo
- Giacche, O.** *Argentina* Cycling—2,000 m. Tandem
- Gibe, R.** *U.S.A.* Swimming—4 x 200 m. Relay
- Gibson, C. (F)** *Great Britain* Swimming—100 m. Back-stroke, 4 x 100 m. Relay, 400 m. Free Style
- Gibson, F.** *Canada* Swimming—1,500 m. Free Style, 4 x 200 m. Relay, 400 m. Free Style
- Giddawi, A.** *Egypt* Gymnastics
- Gierutto, W.** *Poland* Athletics—Decathlon, Putting the Shot
- Gil Elizalde, H.** *Argentina* Yachting—Star Class
- Gilbert, E.** *U.S.A.* Swimming—4 x 200 m. Relay
- Gilbert, V.** *Great Britain* Shooting—50 m. Small Bore Rifle
- Gilchrist, A.** *Canada* Swimming—1,500 m. Free Style, 400 m. Free Style, 4 x 200 m. Relay

- Giles, J.** *Great Britain* Athletics—Putting the Shot  
**Gillebo, S.** *Norway* Fencing—Epee Team  
**Gilmore, D.** (F) *Canada* Athletics—200 m.  
**Giolito, S.** *U.S.A.* Fencing—Foil Individual, Foil Team  
**Giovanelli, G.** *U.S.A.* Rowing—Fours with Cox  
**Giovanelli, I.** *Yugoslavia* Swimming—Water Polo  
**Giovannini, G.** *Italy* Football  
**Girardot, M.** *France* Basketball  
**Gison, M.** *Philippines* Shooting—25 m. Rapid Pistol, 50 m. Pistol, 50 m. Small Bore Rifle  
**Gissel, B.** *Denmark* Cycling—4,000 m. Pursuit  
**Glacken, G.** *India* Hockey  
**Glen Haig, M.** (F) *Great Britain* Fencing—Foil Individual  
**Glennon, F.** *Eire* Football  
**Glorieux, G.** *Belgium* Cycling—4,000 m. Pursuit  
**Glorieux, R.** *Belgium* Cycling—4,000 m. Pursuit  
**Go, Tjoan-Giok** *China* Swimming—100 m. Free Style  
**Godel, G.** *Switzerland* Athletics—50,000 m. Walk  
**Godoy Solis, J.** *Cuba* Rowing—Fours with Cox  
**Godwin, T.** *Great Britain* Cycling—4,000 m. Pursuit, 1,000 m. Time Trial  
**Goffberg, H.** *U.S.A.* Athletics—10,000 m.  
**Goldovanyi, B.** *Hungary* Athletics—100 m., 4 X 100 m. Relay  
**Goldschmid, H.** *Austria* Cycling—4,000 m. Pursuit, Road Race  
**Goldstein Dulitzky, I.** *Chile* Fencing—Epee Individual, Sabre Individual  
**Goldstein, R.** *U.S.A.* Fencing—Epee Team  
**Gollors, H.** *Sweden* Athletics—Pole Vault  
**Gomes Lino, E.** *Portugal* Fencing—Epee Individual, Epee Team  
**Gomez, E.** *Argentina* Yachting—Dragon Class  
**Goncalves de Sousa Naia Fortes, F.** *Portugal* Rowing—Eights  
**Goncalves Rego, L.** *Portugal* Rowing—Fours with Cox  
**Goncalves Torres, A.** *Portugal* Rowing—Fours with Cox  
**Gonsalves, C.** *Trinidad* Cycling—1,000 m. Scratch, 1,000 m. Time Trial  
**Gontersweiler, D.** (F) *Switzerland* Swimming—100 m. Back-stroke  
**Gonzalez Henriques, C.** *Chile* Boxing—Bantamweight  
**Gonzalez, L.** *Colombia* Swimming—1,500 m. Free Style, 400 m. Free Style  
**Gonzalez, R.** *Argentina* Basketball  
**Gonzalez Suaste, F.** *Mexico* Athletics—Hammer  
**Gonzalias, L.** (F) *Argentina* Swimming—100 m. Back-stroke, 4 x 100 m. Relay  
**Goode, H.** *U.S.A.* Hockey  
**Gooderham, N.** *Canada* Yachting—Star Class  
**Goossens, R.** *Belgium* Hockey  
**Gordien, F.** *U.S.A.* Athletics—Discus  
**Gordon, E.** *Uruguay* Basketball  
**Gordon, H.** (F) *Great Britain* Swimming—200 m. Breast-stroke  
**Gordon, S.** (F) *Canada* Athletics—High Jump  
**Goslin, C.** *New Zealand* Boxing—Featherweight  
**Gosling, F.** *Bermuda* Swimming—Springboard Diving  
**Gosset, H.** *Belgium* Athletics—100 m.  
**Gotti, F.** *Italy* Rowing—Fours with Cox  
**Goulu, O.** *Argentina* Equestrian—Dressage Team, Dressage Individual  
**Gouny, F.** (F) *France* Fencing—Foil Individual  
**Gower, R.** *Australia* Boxing—Flyweight  
**Grace, F.** *Australia* Rowing—Pairs without Cox  
**Gracida Jaramillo, G.** *Mexico* Equestrian—Dressage Individual, Dressage Team  
**Graffen, M.** *France* Canoeing—10,000 m. K2  
**Gramain, M.** *France* Fencing—Sabre Individual, Sabre Team  
**Gran Olsen, H.** *Norway* Rowing—Eights  
**Grand, M.** *Switzerland* Rowing—Eights  
**Granet, G.** *Great Britain* Shooting—50 m. Pistol  
**Gratton, G.** *Canada* Weightlifting—Middleweight  
**Graves, F.** *Canada* Rowing—Double Sculls  
**Gravesteyn, C.** *Holland* Canoeing—1,000 m. K2  
**Gray, E.** *Ceylon* Boxing—Lightweight  
**Green, C.** *Australia* Athletics—110 m. Hurdles  
**Green, P.** *Canada* Rowing—Eights  
**Greenhalgh, A.** *Great Britain* Weightlifting—Bantamweight  
**Gregory, J.** *Great Britain* Athletics—4 x 100 m. Relay  
**Gren, G.** *Sweden* Football  
**Grenot, J.** *France* Boxing—Bantamweight  
**Greter, O.** *Switzerland* Fencing—Sabre Individual, Sabre Team  
**Gretsch, E.** *Luxembourg* Fencing—Foil Individual, Epee Individual, Epee Team  
**Greve, S.** *Pakistan* Boxing—Featherweight  
**Gries, G.** (F) *Austria* Gymnastics  
**Griffing, S.** *U.S.A.* Rowing—Fours without Cox  
**Griffiths, H.** *Canada* Rowing—Eights  
**Griffiths, W.** *Great Britain* Hockey  
**Grift, E.** *Holland* Cycling—Road Race  
**Grilec, K.** *Yugoslavia* Gymnastics  
**Grimau, R.** *Argentina* Shooting—300 m. Free Rifle  
**Grisi Solorzano, A.** *Mexico* Fencing—Foil Individual  
**Grkinic, B.** *Yugoslavia* Swimming—Water Polo  
**Groemer, G.** (F) *Austria* Swimming—High Diving, Springboard Diving  
**Grolimund, O.** *Switzerland* Hockey  
**Gronberg, R.** *Sweden* Wrestling—Greco-Roman Style, Middleweight  
**Gron Dahl, K.** *Finland* Wrestling—Greco-Roman Style, Light-heavyweight  
**Gronli, S.** *Norway* Rowing—Fours with Cox  
**Gronne, T.** *Denmark* Gymnastics  
**Grosjean, A.** *Switzerland* Swimming—Water Polo  
**Grosso, D.** *Italy* Gymnastics  
**Groza, A.** *U.S.A.* Basketball  
**Grub, E.** *Switzerland* Hockey  
**Gruben, F.** *Argentina* Shooting—50 m. Pistol  
**Gruenther, R.** *U.S.A.* Modern Pentathlon  
**Gruner, J.** *Switzerland* Hockey  
**Grunig, E.** *Switzerland* Shooting—50 m. Small Bore Rifle, 300 m. Free Rifle  
**Gruppelaar, J.** *Holland* Equestrian—Prix des Nations Team, Prix des Nations Individual  
**Grut, W.** *Sweden* Modern Pentathlon  
**Gryllos, A.** *Greece* Wrestling—Greco-Roman Style, Featherweight  
**Gubeli, P.** *Switzerland* Rowing—Eights  
**Gubijan, I.** *Yugoslavia* Athletics—Hammer  
**Gudino Goya, J.** *Mexico* Basketball  
**Gudmundsson, A.** *Iceland* Swimming—100 m. Free Style, 400 m. Free Style  
**Guedes de Heredia, A.** *Portugal* Yachting—Dragon Class  
**Gueissaz, M.** *Switzerland* Rowing—Double Sculls  
**Guerci, M.** *Argentina* Rowing—Eights  
**Guerin, H.** *France* Fencing—Epee Team, Epee Individual  
**Guerra, G.** *Italy* Cycling—1,000 m. Time Trial  
**Guerra Perez, M.** *Spain* Swimming—4 x 200 m. Relay, 100 m. Free Style, 100 m. Back-stroke  
**Guerrero Delgado, H.** *Mexico* Basketball  
**Guerrero, M.** *Argentina* Basketball  
**Guerrero, R.** *Argentina* Cycling—4,000 m. Pursuit  
**Guglielmetti, S.** *Italy* Gymnastics  
**Guibert, G.** (F) *France* Gymnastics  
**Guida, G.** *U.S.A.* Athletics—400 m.  
**Guido Lavalle, A.** *Argentina* Fencing—Epee Team  
**Guilbert, C.** *France* Rowing—Double Sculls  
**Guillou, F.** *France* Basketball  
**Guimaraes, A.** *Brazil* Shooting—50 m. Small Bore Rifle  
**Guiney, D.** *Eire* Athletics—Putting the Shot  
**Guinez, E.** *Argentina* Athletics—Marathon, 10,000 m.  
**Gujer, H.** *Switzerland* Basketball  
**Gulbrandsen, H.** *Norway* Canoeing—1,000 m. K1  
**Gulesin, S.** *Turkey* Football  
**Gulyas, E.** (F) *Hungary* Gymnastics  
**Gundersen, B.** *Norway* Athletics—High Jump  
**Gundersen, K.** *Norway* Boxing—Featherweight  
**Gunnarsson, E.** *Sweden* Rowing—Pairs Without Cox  
**Gunther, E.** *Switzerland* Athletics—5,000 m.  
**Gurnam Singh, S.** *India* Athletics—High Jump  
**Gutierrez Chacon, L.** *Peru* Boxing—Lightweight  
**Gutierrez de Pardo, R.** (F) *Mexico* Swimming—High Diving  
**Gutierrez Olguin, T.** *Mexico* Swimming—100 m. Back-stroke  
**Guyodo, A.** *France* Athletics—3,000 m. Steeplechase  
**Guzman Lira, S.** *Chile* Athletics—4 x 400 m. Relay, 400 m. Hurdles

- Gyarmati, D.** *Hungary* Swimming—Water Polo  
**Gyarmati, O.** (F) *Hungary* Athletics—Long Jump, High Jump  
**Gyorffy, E.** *Hungary* Swimming—Water Polo
- H**
- Haage, U.** (F) *Sweden* Gymnastics  
**Haanpaa, A.** *Finland* Equestrian—3 Day Individual, 3 Day Team  
**Haarsma, S.** *Holland* Rowing—Fours without Cox  
**Habib, M.** *Egypt* Basketball  
**Habitzl, E.** *Austria* Football  
**Haddad, E.** *Canada* Boxing—Lightweight  
**Hadjikyriakakis, P.** *Greece* Swimming—100 m. Free Style  
**Hafez, S.** *Egypt* Wrestling—Free Style, Bantamweight  
**Hagemann, V.** (F) *Switzerland* Fencing—Foil Individual  
**Haggis, E.** *Canada* Athletics—200 m., 100 m., 4 x 100 m. Relay  
**Hagstrom, G.** *Sweden* Athletics—3,000 m. Steeplechase  
**Hahnemann, W.** *Austria* Football  
**Haidegger, L.** (F) *Austria* Athletics—Discus  
**Hakansson, S.** *Sweden* Athletics—Marathon  
**Hakim, J.** *Egypt* Swimming—400 m. Free Style  
**Halasz, J.** *Hungary* Basketball  
**Hale, J.** *Great Britain* Swimming—1,500 m. Free Style, 4 X 200 m. Relay, 400 m. Free Style  
**Halkjaer, H.** *Denmark* Rowing—Fours without Cox  
**Haller, F.** *Austria* Weightlifting—Light-heavyweight  
**Hallett, D.** *Great Britain* Weightlifting—Featherweight  
**Hallett, K.** *Australia* Swimming—200 m. Breast-stroke  
**Hallgren, A.** *Sweden* Athletics—Hop, Step and Jump  
**Halliday, J.** *Great Britain* Weightlifting—Lightweight  
**Hamidi, A.** *Pakistan* Hockey  
**Hamilton, E.** (F) *Canada* Fencing—Foil Individual  
**Hamilton, W.** *Canada* Cycling—4,000 m. Pursuit  
**Hammani, A.** *Egypt* Football  
**Hammer Casadio, R.** *Chile* Basketball  
**Hammond, M.** *Canada* Rowing—Eights  
**Hamoda, M.** *Egypt* Boxing—Featherweight  
**Hamouda, A.** *Egypt* Weightlifting—Lightweight  
**Han, S. Y.** *Korea* Wrestling—Free Style, Bantamweight  
**Han, S. A.** *Korea* Boxing—Flyweight  
**Handunge, L.** *Ceylon* Boxing—Flyweight  
**Hanly, S.** *Eire* Rowing—Eights  
**Hanna, G.** *Iraq* Basketball  
**Hansen, A.** *Denmark* Rowing—Fours without Cox  
**Hansen, E. A.** *Denmark* Hockey  
**Hansen, E. W.** *Denmark* Canoeing—1,000 m. K2  
**Hansen, G.** *Norway* Boxing—Welterweight  
**Hansen, H.** *Denmark* Wrestling—Greco-Roman Style, Welterweight  
**Hansen, H.** *Norway* Rowing—Eights  
**Hansen, J. A. V. O.** *Denmark* Football  
**Hansen, J. P. E.** *Denmark* Football  
**Hansen, J. R. V.** *Denmark* Hockey  
**Hansen, J. S.** (F) *Denmark* Swimming—200 m. Breast-stroke  
**Hansen, K.** *Denmark* Football  
**Hansen, M.** *Denmark* Boxing—Middleweight  
**Hansenne, M.** *France* Athletics—1,500 m., 800 m.  
**Happel, E.** *Austria* Football  
**Haraga, M.** *Egypt* Swimming—Water Polo  
**Hardie, B.** *Great Britain* Yachting—6 m. Class  
**Hardie, H.** *Great Britain* Yachting—6 m. Class  
**Hardie, P.** *Great Britain* Swimming—Water Polo  
**Hardisty, J.** *Great Britain* Football  
**Hardmeier, O.** *Switzerland* Athletics—4 x 400 m. Relay, 400 m.  
**Hardmo, G.** *Sweden* Athletics—10,000 m. Walk  
**Hardy, J.** *U.S.A.* Rowing—Eights  
**Hargreaves, R.** *Norway* Yachting—6 m. Class  
**Hariri, A.** *Iran* Wrestling—Free Style, Middleweight  
**Harlan, B.** *U.S.A.* Swimming—Springboard Diving, High Diving  
**Harmans, J.** *Holland* Cycling—4,000 m. Pursuit  
**Harnden, A.** *U.S.A.* Athletics—4 x 400 m. Relay  
**Haro Oliva, A.** *Mexico* Fencing—Epee Team, Sabre Team, Epee Individual, Sabre Individual  
**Harper, H.** *Canada* Canoeing—10,000 m. K2, 1,000 K2.  
**Harris, B.** *Australia* Wrestling—Free Style, Flyweight  
**Harris, D.** *New Zealand* Athletics—800 m.  
**Harris, E.** (F) *Great Britain* Swimming—Springboard Diving  
**Harris, R.** *Great Britain* Cycling—2,000 m. Tandem, 1,000 m. Scratch  
**Harrold, P.** *Eire* Rowing—Eights  
**Harrop, T.** *Great Britain* Swimming—100 m. Free Style  
**Harup, K.** (F) *Denmark* Swimming—400 m. Free Style, 100 m. Back-stroke, 100 m. Free Style  
**Hashemi, H.** *Iran* Basketball  
**Hashim, A.** *Iraq* Basketball  
**Hassan, K.** *Egypt* Swimming—High Diving, Springboard Diving  
**Hassan, M.** *Egypt* Wrestling—Free Style, Lightweight  
**Hasso, L.** *Iraq* Athletics—400 m.  
**Hatszegy, J.** *Hungary* Fencing—Foil Team, Foil Individual  
**Hau, Yung-Sang** *China* Football  
**Hauben, L.** *Belgium* Fencing—Epee Team  
**Hauert, J.** *Switzerland* Fencing—Epee Team  
**Hauet, C.** *France* Hockey  
**Hauet, J.** *France* Hockey  
**Hauser, E.** *Switzerland* Swimming—Water Polo  
**Hauser, G.** *Switzerland* Swimming—Water Polo  
**Havalдар, M.** *India* Cycling—Road Race  
**Havel, V.** *Czechoslovakia* Canoeing—10,000 m. C2  
**Havens, F.** *U.S.A.* Canoeing—10,000 m. C1  
**Havens, W., Jr.** *U.S.A.* Canoeing—1,000 m. C1  
**Havewalla, A.** *India* Cycling—4,000 m. Pursuit  
**Hawkey, R.** *Great Britain* Athletics—Hop, Step and Jump  
**Hayoit, E.** *Belgium* Yachting—6 m. Class  
**Healey, J.** *Great Britain* Rowing—Fours With Cox  
**Heatly, P.** *Great Britain* Swimming—Springboard Diving, High Diving  
**Heber, R.** *Argentine* Athletics—Javelin  
**Hebinger, R.** *France* Football  
**Heck, J.** (F) *Holland* Swimming—Springboard Diving  
**Heckel, J.** *France* Football  
**Hedberg, S.** *Sweden* Yachting—Swallow Class  
**Hegedus, F.** *Hungary* Modern Pentathlon  
**Hegstr, F.** *Switzerland* Modern Pentathlon  
**Hehenberger, G.** (F) *Austria* Gymnastics  
**Heid, J.** *U.S.A.* Cycling—1,000 m. Time Trial, 1,000 m. Scratch, 4,000 m. Pursuit  
**Heil-Bonnet, G.** (F) *Holland* Gymnastics  
**Heinkele, R.** *France* Swimming—Springboard Diving  
**Heino, V.** *Finland* Athletics—Marathon, 10,000 m.  
**Heinrich, I.** *France* Athletics—Decathlon  
**Heinstrom, E.** *Finland* Athletics—10,000 m.  
**Heitz, P.** *France* Rowing—Pairs without Cox  
**Heje, K.** *Norway* Yachting—Swallow Class  
**Hellebuyck, G.** *Belgium* Yachting—Dragon Class  
**Hellstrom, R.** *Finland* Yachting—6 m. Class  
**Helme, K.** *Lebanon* Shooting—25 m. Rapid Pistol, 50 m. Pistol  
**Helser, B.** (F) *U.S.A.* Swimming—100 m. Free Style, 4 x 100 m. Relay, 400 m. Free Style  
**Hemmat, M.** *Egypt* Swimming—Water Polo  
**Henderson, J.** *Great Britain* Canoeing—1,000 m. K2  
**Henkart, R.** *Belgium* Fencing—Epee Individual, Epee Team  
**Henniger, E.** *Canada* Athletics—800 m.  
**Hennyei, I.** *Hungary* Fencing—Epee Team, Epee Individual  
**Henriksen, T.** *Denmark* Rowing—Pairs With Cox  
**Henry, F.** *U.S.A.* Equestrian—Dressage Team, Dressage Individual, 3 Day Team, 3 Day Individual  
**Heral, M.** *France* Weightlifting—Featherweight  
**Herbaux, R.** *France* Weightlifting—Light-heavyweight  
**Herbulot, J.** *France* Yachting—Firefly Class  
**Hermann, G.** *Austria* Gymnastics  
**Hermans, H.** *Belgium* Basketball  
**Hernandez, P.** *France* Boxing—Welterweight

- Hernandez, G.** *France* Swimming—Springboard Diving, High Diving  
**Hernandez, H.** *Cuba* Shooting—25 m. Rapid Pistol  
**Herrera, E.** *Argentina* Boxing—Welterweight  
**Herrera Briones, P.** *Mexico* Cycling—Road Race  
**Herring, H.** *U.S.A.* Boxing—Welterweight  
**Hesse, D.** *France* Shooting—25 m. Rapid Pistol  
**Heusala, V.** *Finland* Shooting—25 m. Rapid Pistol  
**Heusner, W.** *U.S.A.* Swimming—400 m. Free Style, 1,500 m. Free Style  
**Hewitt, F.** *U.S.A.* Hockey  
**Hey, D.** (F) *Great Britain* Gymnastics  
**Hider, M.** (F) *Great Britain* Swimming—High Diving  
**Hietala, P.** *Finland* Wrestling—Free Style, Featherweight  
**Hietanen, M.** *Finland* Athletics—Marathon  
**Higham, G.** *Australia* Boxing—Middleweight  
**Higueras Ureta, H.** *Peru* Fencing—Foil Individual  
**Hijzendoorn, J.** *Holland* Cycling—1,000 m. Scratch  
**Himgi, R.** *France* Swimming—Water Polo  
**Hindorff, M.** *Sweden* Yachting—6 m. Class  
**Hirst, I.** (F) *Great Britain* Gymnastics  
**Hirst, M.** (F) *Great Britain* Gymnastics  
**Hirvisalo, A.** *Finland* Yachting—6 m. Class, Dragon Class  
**Hitelman Reitch, J.** *Chile* Athletics—400 m., 4 x 400 m. Relay  
**Ho, Ying-Fun** *China* Football Team  
**Hoevers, A.** *Holland* Fencing—Sabre  
**Hoff, K.** (F) *Denmark* Canoeing—500 m. K1  
**Hogstrom, T.** *Finland* Cycling—Road Race, 4,000 m. Pursuit  
**Holden, J.** *Great Britain* Athletics—Marathon  
**Holecek, J.** *Czechoslovakia* Canoeing—1,000 m. C1  
**Holland, J.** *New Zealand* Athletics—400 m. Hurdles  
**Hollanders, A.** *Belgium* Basketball  
**Hollanders, H.** *Belgium* Basketball  
**Holm, E.** *Sweden* Swimming—Water Polo  
**Holm, T.** *Sweden* Yachting—6 m. Class  
**Holmberg, R.** *Finland* Athletics—4 x 400 m. Relay, 400 m.  
**Holmes, A.** *Australia* Boxing—Light-heavyweight  
**Holmvang, G.** *Norway* Athletics—Decathlon  
**Holop, M.** *Hungary* Swimming—Water Polo  
**Hoist-Sorensen, N.** *Denmark* Athletics—800 m.  
**Holt, E.** (F) *Argentina* Swimming—400 m. Free Style, 4 x 100 m. Relay, 100 m. Free Style  
**Holt, J.** *Great Britain* Swimming—4 x 200 m. Relay  
**Holt, N.** *Australia* Shooting—50 m. Small Bore Rifle  
**Holt, T.** *Great Britain* Swimming—400 m. Free Style  
**Holzappel, K.** *Austria* Hockey  
**Horn, A.** (F) *Holland* Swimming—200 m. Breast-stroke  
**Homps, E.** *Argentina* Yachting—6 m. Class  
**Hong, Chong Oh** *Korea* Athletics—Marathon  
**Hong, Duk Yung** *Korea* Football  
**Honkonen, U.** *Finland* Athletics—High Jump  
**Honsova, Z.** (F) *Czechoslovakia* Gymnastics  
**Hoobin, J.** *Australia* Cycling—4,000 m. Pursuit, Road Race  
**Hopkins, G.** *Great Britain* Gymnastics  
**Hopper, A.** *Great Britain* Football  
**Horber, O.** *Switzerland* Shooting—50 m. Small Bore Rifle, 300 m. Free Rifle  
**Hordijk, R.** *Holland* Fencing—Epee Individual  
**Horn, A.** *Canada* Fencing—Epee Individual, Foil Individual, Sabre Team, Foil Team, Epee Team  
**Horning, W.** *Switzerland* Fencing—Foil Individual, Foil Team  
**Horton, T.** *U.S.A.* Canoeing—1,000 m. K1  
**Horulu, K.** *Turkey* Athletics—400 m. Hurdles, 4 x 400 m. Relay, 400 m.  
**Horvatin, M.** *Yugoslavia* Rowing—Pairs With Cox  
**Houtzager, J.** *Holland* Athletics—Hammer  
**Hovard, V.** *Denmark* Hockey  
**Howell, R.** *Great Britain* Athletics—3,000 m. Steeplechase  
**Hruby, G.** *Czechoslovakia* Gymnastics  
**Huber, S.** *Austria* Cycling—Road Race  
**Huber von Appen, M.** (F) *Chile* Athletics—80 m. Hurdles, 4 x 100 m. Relay  
**Hubert, C.** *France* Athletics—50,000 m. Walk  
**Hubler, H.** *Switzerland* Athletics—1,500 m.  
**Hue, C.** (F) *France* Gymnastics  
**Huergo, F.** *Argentina* Fencing—Sabre Individual, Sabre Team  
**Huet Bobadilla, G.** *Mexico* Shooting—50 m. Small Bore Rifle  
**Huet, M.** *France* Fencing—Epee Team  
**Huhtanen, V.** *Finland* Gymnastics  
**Hultberg, K.** *Sweden* Equestrian—Prix des Nations Individual, Prix des Nations Team  
**Hume, J. D. H.** *Great Britain* Yachting—6 m. Class  
**Hume, J. H.** *Great Britain* Yachting—6 m. Class  
**Hunt, C.** *Great Britain* Basketball  
**Hunter, G.** *South Africa* Boxing—Light-heavyweight  
**Hunter, H.** *Great Britain* Yachting—6 m. Class  
**Hurtado Vargas, A.** *Chile* Swimming—Water Polo  
**Husain, A.** *India* Hockey  
**Hutchins, J.** *Canada* Athletics—800 m., 1,500 m.  
**Hutton, R.** *U.S.A.* Wrestling—Free Style, Heavyweight  
**Huutoniemi, A.** *Finland* Athletics—Discus  
**Huybrechts, A.** *Belgium* Yachting—Dragon Class  
**Huybrechts, M.** (F) *Belgium* Swimming—4 x 100 m. Relay  
**Huybrechts, W.** *Belgium* Yachting—6 m. Class  
**Huyge, T.** *Belgium* Weightlifting—Lightweight  
**Hwang, San Ung** *Korea* Cycling—Road Race  
**Hynninen, O.** *Finland* Shooting—50 m. Small Bore Rifle

## I

- Ibanez, S.** *Argentina* Athletics—50,000 m. Walk  
**Ibrahim, M.** *Egypt* Swimming—Springboard Diving  
**Iesi, S.** *Uruguay* Fencing—Foil Individual, Foil Team  
**Iglesias, A. R.** *Argentina* Boxing—Heavyweight  
**Ikin, A.** *South Africa* Rowing—Fours without Cox  
**Ilic, V.** *Yugoslavia* Swimming—4 x 200 m. Relay, 1,500 m. Free Style  
**Ilmoni, B.** *Finland* Yachting—Star Class  
**Imam, Y.** *Egypt* Football  
**Imostroza Arancibia, E.** *Chile* Athletics—Marathon  
**In, Kang Whan** *Korea* Athletics—Hammer  
**Ingolfsson, G.** *Iceland* Swimming—100 m. Breast-stroke  
**Ingrova, D.** (F) *Czechoslovakia* Athletics—Javelin  
**Injoque Hurst, C.** *Peru* Shooting—50 m. Pistol  
**Invernizzi, G.** *Italy* Rowing—Fours without Cox  
**Irfan, A.** *Iraq* Basketball  
**Irigoyen, E.** (F) *Argentina* Fencing—Foil Individual  
**Irvine, D.** *Great Britain* Wrestling—Free Style, Welterweight  
**Irvine, K.** *Great Britain* Wrestling—Greco-Roman Style, Bantamweight  
**Isaac Ahumada, A.** *Mexico* Swimming—4 x 200 m. Relay, 100 m. Free Style  
**Isaack, C.** *Argentina* Athletics—100 m., 4 x 100 m. Relay  
**Ishikawa, K.** *U.S.A.* Weightlifting—Featherweight  
**Ishman, R.** *Turkey* Athletics—800 m., 4 x 400 m. Relay, 1,500 m.  
**Ismail, A.** *Egypt* Basketball  
**Isotti, L.** *Italy* Cycling—Road Race  
**Issabeg, G.** *Iran* Boxing—Welterweight  
**Issele, F.** *Belgium* Swimming—Water Polo  
**Istaz, K.** *Belgium* Wrestling—Greco-Roman Style, Free Style, Light-heavyweight  
**Iturrealde, J.** *Argentina* Equestrian—Dressage Team, Dressage Individual  
**Iturrate Azocar, R.** *Chile* Cycling—Road Race  
**Iturri Quevedo, C.** *Peru* Fencing—Epee, Individual  
**Iversen, A.** (F) *Denmark* Athletics—High Jump  
**Iversen, S.** *Denmark* Yachting—6 m. Class

## J

- Jabbarzadegan, H.** *Iran* Basketball  
**Jacks, A.** *Canada* Athletics—High Jump  
**Jackson, A.** *U.S.A.* Shooting—300 m. Free Rifle

- Jackson, F., Jr.**, *U.S.A.* Yachting—Dragon Class
- Jackson, N. (F)** *U.S.A.* Athletics—200 m., 4 X 100 m. Relay
- Jackson, W.** *Eire* Basketball
- Jacono, N.** *Malta* Athletics—100 m.
- Jadav, K.** *India* Wrestling—Free Style, Flyweight
- Jadresic Vargas, A.** *Chile* Athletics—High Jump
- Jagi, G.** *Afghanistan* Hockey
- Jalkanen, K.** *Finland* Fencing—Foil Individual, Sabre Individual, Foil Team, Epee Team
- James, H.** *Great Britain* Rowing—Pairs with Cox
- James, M. (F)** *Finland* Athletics—80 m. Hurdles
- Janez, K.** *Yugoslavia* Gymnastics
- Janhonen, P.** *Finland* Shooting—300 m. Free Rifle
- Jansen, P.** *India* Hockey
- Jansson, R.** *Finland* Yachting—6 m. Class
- Jany, A.** *France* Swimming—100 m. Free Style, 4 X 200 m. Relay, 400 m. Free Style
- Jany, G. (F)** *France* Swimming—4 x 100 m. Relay, 100 m. Back-stroke, 100 m. Free Style
- Jardon Ron, E.** *Spain* Hockey
- Jardon Ron, Fernando.** *Spain* Hockey
- Jardon Ron, Francisco.** *Spain* Hockey
- Jassogne, F.** *Belgium* Fencing—Sabre Team
- Jauch, A.** *Switzerland* Wrestling—Greco-Roman Style, Lightweight
- Jayne, C.** *Philippines* Shooting—50 m. Small Bore Rifle
- Jcardi, N. (F)** *Italy* Gymnastics
- Jelic, D.** *Yugoslavia* Gymnastics
- Jelic, I.** *Yugoslavia* Gymnastics
- Jemelka, O.** *Czechoslovakia* Modern Pentathlon
- Jeney, L.** *Hungary* Swimming—Water Polo
- Jenny, G. (F)** *Austria* Athletics—4 x 100 m. Relay
- Jensen, B. (F)** *U.S.A.* Swimming—100 m. Back-stroke
- Jensen, E.** *Denmark* Boxing—Light-heavyweight
- Jensen, F.** *Denmark* Gymnastics
- Jensen, H. V.** *Denmark* Football
- Jensen, J. B.** *Denmark* Canoeing—1,000 m. K2
- Jensen, J. R.** *Denmark* Hockey
- Jensen, O. S.** *Denmark* Rowing—Pairs Without Cox
- Jensen, P.** *Denmark* Gymnastics
- Jensen, T.** *Denmark* Football
- Jenzer, R.** *Switzerland* Hockey
- Jernigan, B.** *U.S.A.* Wrestling—Free Style, Flyweight
- Jessen, P.** *Denmark* Gymnastics
- Jessup, R.** *U.S.A.* Yachting—Dragon Class
- Jezewski, A.** *Poland* Canoeing—1,000 m. K2, 10,000 m. K2
- Jhonson, G.** *Puerto Rico* Shooting—50 m. Small Bore Rifle
- Jnderbitzin, M.** *Switzerland* Wrestling—Greco-Roman Style, Heavyweight
- Joachim, M.** *India* Boxing—Light-heavyweight
- Joaquim Cancela, J.** *Portugal* Rowing—Fours with Cox
- Jodoin, F.** *Canada* Cycling—Road Race
- Johansen, E.** *Norway* Boxing—Middleweight
- Johansen, N. E.** *Denmark* Hockey
- Johansson, B.** *Sweden* Athletics—10,000 m. Walk
- Johansson, D.** *Finland* Athletics—1,500 m.
- Johansson, G. (F)** *Sweden* Gymnastics
- Johansson, G.** *Sweden* Canoeing—10,000 m. C2, 1,000 m. C2
- Johansson, K. I. B.** *Sweden* Shooting—300 m. Free Rifle
- Johansson, K. R.** *Sweden* Wrestling—Free Style, Featherweight
- Johansson, N.** *Sweden* Cycling—Road Race
- Johansson, O.** *Sweden* Swimming—Water Polo, 100 m. Free Style, 4 X 200 m. Relay
- Johansson, S.** *Sweden* Swimming—Spring Board Diving
- Johnson, C.** *Great Britain* Swimming—Spring Board Diving
- Johnson, E.** *U.S.A.* Boxing—Featherweight
- Johnson, J.** *Great Britain* Swimming—Water Polo
- Johnson, P.** *Bermuda* Athletics—100 m., 200 m., 4 x 100 m. Relay
- Johnson, S.** *Norway* Athletics—Discus
- Johnson, T.** *Great Britain* Athletics—50,000 m. Walk
- Johnson, V.** *Sweden* Yachting—Dragon Class
- Johansson, E.** *Finland* Wrestling—Free Style, Bantamweight
- Johnston, D.** *South Africa* Swimming—400 m. Free Style, 1,500 m. Free Style
- Johnston, P.** *Australia* Swimming—Water Polo
- Joksch, S.** *Austria* Football
- Jones, G.** *Great Britain* Shooting—50 m. Small Bore Rifle
- Jones, K.** *Great Britain* Athletics—4 x 100 m. Relay, 100 m.
- Jones, P. (F)** *Canada* Athletics—4 x 100 m. Relay, 100 m.
- Jones, S.** *Great Britain* Athletics—Marathon
- Jones, W.** *U.S.A.* Boxing—Middleweight
- Jones, W.** *Uruguay* Rowing—Double Sculls
- Jones, W. C.** *U.S.A.* Basketball
- Jonker, C.** *Holland* Yachting—Dragon Class
- Jonsson, J.** *Sweden* Shooting—50 m. Small Bore Rifle
- Jonsson, O.** *Iceland* Athletics—800 m., 1,500 m.
- Jonsson, S.** *Iceland* Swimming—200 m. Breast-stroke
- Jonsson, S. T.** *Iceland* Swimming—200 m. Breast-stroke
- Jonsson, T.** *Sweden* Athletics—50,000 m. Walk
- Jordaens, A. (F)** *Belgium* Gymnastics
- Jordan, W. O.** *Brazil* Swimming—200 m. Breast-stroke, 4 x 200 m. Relay
- Jordan, W. S. (F)** *Great Britain* Athletics—100 m.
- Jorgensen, E.** *Denmark* Athletics—1,500 m.
- Jorgensen, M.** *Denmark* Cycling—4,000 m. Pursuit
- Jorgensen, S.** *Denmark* Hockey
- Jorgensen, T.** *Denmark* Fencing—Foil Team
- Jose da Silva, D.** *Portugal* Rowing—Fours With Cox
- Josset, R.** *France* Athletics—Marathon
- Jouaville, A.** *France* Wrestling—Free Style, Featherweight
- Jouppila, P.** *Finland* Athletics—Putting the Shot
- Jousseau, A.** *France* Equestrian—Dressage Team, 3 Day Individual, 3 Day Team, Dressage Individual
- Jovanovic, M.** *Yugoslavia* Football
- Jovanovic, S.** *Yugoslavia* Rowing—Eights
- Jubb, E.** *Canada* Swimming—100 m. Free Style, 4 x 200 m. Relay, 100 m. Back-stroke
- Julin, A.** *Sweden* Swimming—Water Polo
- Julin, R.** *Sweden* Swimming—Water Polo
- Julve Ciriaco, E.** *Peru* Athletics—Decathlon, Discus
- Junco Mesa, T.** *Cuba* Rowing—Fours with Cox
- Jutner, A.** *Sweden* Swimming—Water Polo
- Jutz, J.** *Switzerland* Athletics—Marathon

## K

- Kaakinen, V.** *Finland* Shooting—50 m. Small Bore Rifle
- Kaas, E.** *Norway* Athletics—Pole Vault
- Kabafis, A.** *Greece* Wrestling—Greco-Roman Style, Light-heavyweight
- Kadas, G.** *Hungary* Swimming—100 m. Free Style, 400 m. Free Style, 4 x 200 m. Relay
- Kadry, M.** *Egypt* Swimming—Water Polo
- Kahnert, J.** *Argentina* Athletics—Putting the Shot
- Kainlauri, A.** *Finland* Athletics—3,000 m. Steeplechase
- Kakos, J.** *Czechoslovakia* Fencing—Sabre Team
- Kalama, T. (F)** *U.S.A.* Swimming—4 x 100 m. Relay
- Kalas, J.** *Czechoslovakia* Rowing—Fours without Cox
- Kalina, C.** *Czechoslovakia* Athletics—Putting the Shot
- Kalina, J.** *Czechoslovakia* Basketball
- Kaloudis, M.** *Greece* Cycling—Road Race, 1,000 m. Scratch
- Kalt, H.** *Switzerland* Rowing—Pairs without Cox
- Kalt, J.** *Switzerland* Rowing—Pairs without Cox
- Kamber, E.** *Switzerland* Cycling—4,000 m. Pursuit
- Kanaan, A.** *Iraq* Basketball
- Kandil, A.** *Egypt* Swimming—4 x 200 m. Relay, 200 m. Breast-stroke
- Kandil, S.** *Egypt* Wrestling—Greco-Roman Style, Featherweight
- Kang, Bong Hyun** *Korea* Basketball
- Kang, In Suk** *Korea* Boxing—Lightweight
- Kangasmaki, R.** *Finland* Wrestling—Greco-Roman Style, Flyweight
- Kangasniemi, T.** *Finland* Wrestling—Greco-Roman Style, Heavyweight
- Kapocsi, G.** *Hungary* Boxing—Light-heavyweight
- Karacson, L.** *Hungary* Modern Pentathlon



- Karageorgos, G.** *Greece* Athletics—400 m., 800 m.
- Karamally, S.** *Pakistan* Swimming—400 m. Free Style, 4 x 200 m. Relay
- Karamazakidis, J.** *Greece* Fencing—Foil Team, Epee Team, Sabre Team, Sabre Individual, Foil Individual, Epee Individual
- Karandish, H.** *Iran* Basketball
- Karas, V.** *Czechoslovakia* Gymnastics
- Kardos, G.** *Hungary* Basketball
- Karelse, N.** (F) *Holland* Athletics—200 m., Long Jump
- Karlsson, T.** *Sweden* Boxing—Middleweight
- Karpati, R.** *Hungary* Fencing—Sabre Team
- Karpati Karsics, I.** (F) *Hungary* Gymnastics
- Karwicki, R.** *Poland* Fencing—Epee Individual, Epee Team
- Kasar, K.** *Turkey* Equestrian—Prix des Nations Team, Prix des Nations Individual
- Kasperczak, J.** *Poland* Boxing—Flyweight
- Kasslin, O.** *Finland* Cycling—1,000 m. Time Trial, 4,000 m. Pursuit
- Kaszubski, F.** (F) *U.S.A.* Athletics—Putting the Shot, Discus
- Kataja, E.** *Finland* Athletics—Pole Vault
- Kavanagh, P.** *Eire* Football
- Kavounidou, D.** (F) *Greece* Athletics—80 m. Hurdles
- Kaya, H.** *Turkey* Wrestling—Greco-Roman Style, Bantamweight
- Keegstra, P.** *Holland* Yachting—Swallow Class
- Keenan, J.** *Canada* Boxing—Middleweight
- Keenan, T.** *Eire* Basketball
- Keetelaar, H.** *Holland* Swimming—Water Polo
- Kehrer, F.** *Switzerland* Hockey
- Keisala, A.** *Finland* Wrestling—Free Style—Welterweight
- Kelleher, D.** *Great Britain* Football
- Kellen, H.** *Luxembourg* Cycling—Road Race
- Keller, H.** *Switzerland* Swimming—Water Polo
- Keller, H.** *Switzerland* Rowing—Single Sculls
- Keller, W.** *Switzerland* Athletics—4 x 400 m. Relay, 400 m.
- Kelley, J. A.** *U.S.A.* Athletics—Marathon
- Kelly, J. B., Jr.** *U.S.A.* Rowing—Single Sculls
- Kemble, S.** *Great Britain* Weightlifting—Featherweight
- Kemnits, G.** *Brazil* Swimming—Springboard Diving
- Kendall, P.** *Great Britain* Swimming—100 m. Free Style
- Kerebel, J.** *France* Athletics—4 x 400 m. Relay
- Kermode, H.** *Canada* Basketball
- Kerschbaumer, E.** *Austria* Boxing—Featherweight
- Kerttula, E.** *Finland* Fencing—Epee Individual, Sabre Individual, Foil Team, Epee Team
- Keskin, E.** *Turkey* Football
- Kessels, P.** *Holland* Shooting—25 m. Rapid Pistol
- Kets, E.** *Belgium* Basketball
- Kettel, N.** *Luxembourg* Football
- Khalaf Ala, A.** *Egypt* Gymnastics
- Khalifa, M.** *Egypt* Swimming—4 x 200 m. Relay, Water Polo
- Khan, A.** *Pakistan* Hockey
- Khan, A. G.** *Pakistan* Hockey
- Khan, A. Q.** *Pakistan* Hockey
- Khan, M.** *India* Football
- Khan, Mazhar-Ul-Haq** *Pakistan* Athletics—110m. Hurdles
- Khan, M. N.** *Pakistan* Hockey
- Khan, Mohsin** *Pakistan* Athletics—400 m. Hurdles
- Khan, Z.** *Pakistan* Athletics—Discus, Putting the Shot
- Kharot, A.** *Afghanistan* Football
- Kharot, M.** *Afghanistan* Football
- Khawaja, M.** *Pakistan* Hockey
- Khedr, R.** *Egypt* Athletics—800 m.
- Khogaini, M.** *Afghanistan* Hockey
- Khosropanah, F.** *Iran* Shooting—300m. Free Rifle, 50m. Small Bore Rifle
- Khurram, S.** *Pakistan* Hockey
- Kielbaye, J.** *Belgium* Hockey
- Kiesewetter, L.** *Czechoslovakia* Athletics—Javelin
- Kietzman, C.** *South Africa* Rowing—Fours Without Cox
- Kievit, C.** *Holland* Swimming—100 m. Back-stroke
- Kilic, G.** *Turkey* Football
- Kim, Chung Shin** *Korea* Basketball
- Kim, Kuk Fan** *Korea* Wrestling—Free Style, Featherweight
- Kim, Kyoo Whan** *Korea* Football
- Kim, Suk Young** *Korea* Wrestling—Free Style, Lightweight
- Kim, Sung Jip** *Korea* Weightlifting—Middleweight
- Kim, Wun Kwun** *Korea* Athletics—Long Jump, Hop, Step and Jump
- Kim, Yong Sik** *Korea* Football
- King, J.** (F) *Australia* Athletics—100 m., 4 x 100 m. Relay, 200 m.
- King, J.** *Australia* Swimming—Water Polo
- King, V.** (F) *Canada* Swimming—4 x 100 m. Relay, 400 m. Free Style
- Kingsbury, F.** *U.S.A.* Rowing—Fours Without Cox
- Kinnear, A.** *Great Britain* Swimming—100 m. Back-stroke
- Kinnunen, A.** *Sweden* Weightlifting—Lightweight
- Kinnunen, J.** *Finland* Wrestling—Greco-Roman Style, Middleweight
- Kipfer, C.** *Switzerland* Gymnastics
- Kippax, F.** *Great Britain* Football
- Kircan, F.** *Turkey* Football
- Kirecci, A.** *Turkey* Wrestling—Greco-Roman Style, Heavyweight
- Kirk, J.** *U.S.A.* Athletics—400 m. Hurdles
- Kirkpatrick O'Donnell, C.** *Spain* Equestrian—Dressage Individual
- Kirkpatrick, P.** *Great Britain* Rowing—Fours without Cox
- Kiss, J.** *Hungary* Athletics—Marathon
- Kistenmacher, E.** *Argentina* Athletics—Decathlon, Long Jump
- Kjersem, J.** *Norway* Athletics—10,000 m.
- Klamer, E.** *Denmark* Cycling—2,000 m. Tandem
- Klein, H.** *France* Athletics—1,500 m.
- Klepp, H.** *Austria* Canoeing—1,000 m. K2, 10,000 m. K1
- Kleyn, J.** *Holland* Athletics—100 m.
- Klics, F.** *Hungary* Athletics—Discus
- Klima, L.** *Czechoslovakia* Canoeing—10,000 m. K2
- Klingstrom, L.** *Sweden* Canoeing—1,000 m. K2
- Klumpp, E.** *Switzerland* Swimming—Water Polo
- Klupfel, A.** (F) *Switzerland* Fencing—Foil Individual
- Knecht, E.** *Switzerland* Rowing—Fours with Cox
- Knight, A.** *Great Britain* Weightlifting—Heavyweight
- Knotek.** *Czechoslovakia* Athletics—Hammer
- Knott, G.** *Australia* Athletics—10,000 m. Walk
- Knott, J.** *Great Britain* Shooting—300 m. Free Rifle
- Knowles, D.** *Great Britain* Yachting—Star Class
- Knox, E.** *U.S.A.* Swimming—Water Polo
- Knudsen, H.** *Denmark* Rowing—Fours with Cox
- Knutzen, E.** *Norway* Fencing—Epee Individual, Epee Team
- Kobi, L.** (F) *Switzerland* Swimming—200 m. Breast-stroke
- Koc, S.** *Turkey* Equestrian—3 Day Team, 3 Day Individual
- Koch, C.** *Holland* Canoeing—1,000 m. K2
- Koch, E.** *Sweden* Shooting—50 m. Small Bore Rifle
- Koerner, A.** *Austria* Football
- Kolar, G.** (F) *Austria* Gymnastics
- Kolb, E.** *Switzerland* Wrestling—Greco-Roman Style, Middleweight
- Kolczynski, A.** *Poland* Boxing—Middleweight
- Koll, W.** *U.S.A.* Wrestling—Free Style, Lightweight
- Roller, J.** *Austria* Hockey
- Komarkova, J.** (F) *Czechoslovakia* Athletics—Putting the Shot
- Kongsjorden, H.** *Norway* Shooting—50 m. Small Bore Rifle, 300 m. Free Rifle
- Koning, J.** (F) *Holland* Athletics—Javelin
- Kononen, S.** *Finland* Athletics—10,000 m.
- Konow, M.** *Norway* Yachting—6 m. Class
- Konter, L.** *Luxembourg* Football
- Konto, J.** *Finland* Yachting—6 m. Class
- Korevaar, C.** *Holland* Swimming—Water Polo
- Koru, S.** *Turkey* Athletics—Marathon
- Korup, P.** *Denmark* Rowing—Eights
- Koskela, V.** *Finland* Athletics—5,000 m.
- Koskinen, E.** *Finland* Cycling—Road Race, 4,000 m. Pursuit
- Kostalova, R.** (F) *Czechoslovakia* Canoeing—500 m. K1
- Kotvio, P.** *Finland* Weightlifting—Bantamweight
- Kotys, J.** *U.S.A.* Gymnastics
- Koutonen, E.** *U.S.A.* Athletics—Hop, Step and Jump
- Kouvelis, E.** *Greece* Cycling—Road Race
- Kouyos, C.** *France* Wrestling—Free Style, Bantamweight
- Kovacic, Z.** *Yugoslavia* Swimming—Water Polo

- Kovacs, G.** *Hungary* Wrestling—Greco-Roman Style, Light-heavyweight
- Kovacs, P.** *Hungary* Fencing—Sabre Individual, Sabre Team
- Kovar, J.** *Czechoslovakia* Swimming—100 m. Back-stroke
- Kovarova, M. (F)** *Czechoslovakia* Gymnastics
- Kowanz, K.** *Austria* Football
- Kozak, J.** *Czechoslovakia* Basketball
- Kozma, J.** *Hungary* Basketball
- Kraak, P.** *Holland* Football
- Krakenes, H.** *Norway* Rowing—Eights
- Krakenes, T.** *Norway* Rowing—Eights
- Krapf, A.** *Austria* Shooting—50 m. Small Bore Rifle
- Krarup, K.** *Denmark* Equestrian—3 Day Team, 3 Day Individual
- Krasa, V.** *Czechoslovakia* Basketball
- Krecke, J.** *Luxembourg* Gymnastics
- Kremer, J.** *Luxembourg* Football
- Kremer, R.** *Luxembourg* Athletics—Decathlon
- Krenicky, Z.** *Czechoslovakia* Basketball
- Krepela, J.** *Czechoslovakia* Basketball
- Kretschmer-de Buccicardi, B. (F)** *Chile* Athletics—200 m., 100 m.
- Krijgh, C.** *Holland* Football
- Kristiansen, E.** *Norway* Cycling—Road Race
- Krnecvic, D.** *Yugoslavia* Rowing—Fours with Cox
- Krnecvic, S.** *Yugoslavia* Rowing—Fours with Cox
- Kroutil, O.** *Czechoslovakia* Canoeing—1,000 m. K2
- Krug, R.** *France* Football
- Kruize, J.** *Holland* Hockey
- Kudrna, B.** *Czechoslovakia* Canoeing—1,000 m. C2
- Kugeler, J.** *Luxembourg* Gymnastics
- Kuijpers, L.** *Holland* Fencing—Sabre Individual, Foil Team, Sabre Team, Foil Individual
- Kuivamaki, R.** *Finland* Athletics—Hammer
- Kujundzic, J.** *Yugoslavia* Gymnastics
- Kumar, A.** *India* Hockey
- Kun, E. (F)** *Hungary* Fencing—Foil Individual
- Kunnen, H.** *Belgium* Athletics—400 m.
- Kunz, W.** *Switzerland* Swimming—200 m. Breast-stroke
- Kurikkala, J.** *Finland* Athletics—Marathon
- Kurland, A.** *Denmark* Wrestling—Greco-Roman Style, Lightweight
- Kurland, R.** *U.S.A.* Basketball
- Kurmann, F.** *Switzerland* Hockey
- Kurtini, I.** *Yugoslavia* Swimming—Water Polo
- Kurtz, W.** *U.S.A.* Hockey
- Kuusinen, P.** *Finland* Cycling—4,000 m. Pursuit
- Kuzmicki, W.** *Poland* Athletics—Decathlon
- Kwon, Ik Hyun** *Korea* Cycling—Road Race
- Kya, Is-Kyun** *China* Basketball
- Kyriakidis, S.** *Greece* Athletics—Marathon
- L**
- La, See Yun** *Korea* Weightlifting—Lightweight
- Labarthe Celery, A.** *Chile* Athletics—100 m.
- Labeach, L.** *Panama* Athletics—100 m., 200 m.
- Labura, J.** *Yugoslavia* Rowing—Fours with Cox
- Lacarrière, R.** *France* Yachting—6 m. Class
- Lacaze, P.** *France* Athletics—High Jump
- Lachapelle, E.** *Switzerland* Yachting—6 m. Class
- Lachmann, K. (F)** *Denmark* Fencing—Foil Individual
- La Cour, R.** *Denmark* Yachting—6 m. Class
- La Cour, T.** *Denmark* Yachting—6 m. Class
- Lacourse, R.** *Canada* Cycling—1,000 m. Scratch
- Lacroix, A.** *France* Modern Pentathlon
- Lacroix, M.** *France* Hockey
- Laermans, E.** *Belgium* Fencing—Sabre Individual, Sabre Team
- Lafortune, F.** *Belgium* Shooting—50 m. Small Bore Rifle
- Lafortune, M.** *Belgium* Shooting—50 m. Pistol, 50 m. Small Bore Rifle
- La Grange, K.** *South Africa* Boxing—Middleweight
- Lahti, K.** *Finland* Shooting—50 m. Pistol
- Laing, L.** *Jamaica* Athletics—100 m., 200 m., 4 x 100 m. Relay
- Laitinen, K.** *Finland* Gymnastics
- Lal Kishan** *India* Hockey
- Lall, B.** *India* Boxing—Bantamweight
- Lamar Schwyer, C.** *Cuba* Fencing—Epee Team, Epee Individual
- Lambert, E.** *U.S.A.* Boxing—Heavyweight
- Lambert-Sugrue, D.** *Eire* Rowing—Eights
- Lambert, W.** *Australia* Rowing—Fours with Cox
- Lambie, H.** *Australia* Rowing—Fours with Cox
- Lambrou, J.** *Greece* Athletics—High Jump
- Lamesch, G.** *Luxembourg* Fencing—Epee Team, Foil Individual
- Lammers, J.** *Holland* Athletics—200 m., 4 X 100 m. Relay
- Lamore, C. (F)** *U.S.A.* Swimming—200 m. Breast-stroke
- Lamot, A.** *Belgium* Wrestling—Greco-Roman Style, Free Style, Flyweight
- Landesmann, R.** *France* Wrestling—Free Style, Light-heavyweight
- Landini, C.** *Switzerland* Basketball
- Lands, B.** *Canada* Basketball
- Lane, N. (F)** *New Zealand* Swimming—100 m. Back-stroke
- Lane, N. D.** *Canada* Canoeing—10,000 m. C1
- Langhout, J.** *Holland* Hockey
- Lapage, M.** *Great Britain* Rowing—Eights
- Lapuente, F.** *Argentina* Athletics—100 m., 4 x 100 m. Relay
- Lardon, W.** *Switzerland* Wrestling—Free Style, Heavyweight
- Larkas, H.** *Finland* Modern Pentathlon, Fencing—Epee Team
- Larochelle, W.** *Canada* Athletics—400 m. Hurdles, 4 x 400 m. Relay
- Larrabure Salas, A.** *Peru* Shooting—50 m. Small Bore Rifle
- Larsen, A.** *Denmark* Rowing—Double Sculls
- Larsen, E.** *Denmark* Rowing—Fours with Cox
- Larsen, H.** *Denmark* Rowing—Fours with Cox
- Larsen, H. K.** *Denmark* Athletics—Marathon
- Larsen, J.** *Denmark* Rowing—Fours without Cox
- Larsen, K.** *Norway* Wrestling—Greco-Roman Style, Middleweight
- Larsen, K. H.** *Denmark* Rowing—Eights
- Larsen, P.** *Denmark* Athletics—Hop, Step and Jump
- Larsen, U.** *Denmark* Shooting—300 m. Free Rifle
- Larsson, R.** *Sweden* Athletics—400 m., 4 x 400 m. Relay, 400 m. Hurdles
- Laskau, H.** *U.S.A.* Athletics—10,000 m. Walk
- Laszlo, S.** *Hungary* Athletics—50,000 m. Walk
- Lataste, J.** *France* Fencing—Foil Team
- Lataster, J.** *Holland* Athletics—10,000 m., 5,000 m.
- Lau Chung-Sang** *China* Football
- Laurent, S. (F)** *France* Athletics—Putting the Shot
- Lauridsen, E.** *Denmark* Wrestling—Greco-Roman Style, Light-heavyweight
- Laurie, W.** *Great Britain* Rowing—Pairs without Cox
- Lauwerys, J.** *Belgium* Yachting—Dragon Class
- Laverne, F.** *France* Yachting—6 m. Class, Star Class
- Lawler, D.** *Eire* Football
- Lawrence, M.** *Argentina* Yachting—Swallow Class
- Layton, J.** *U.S.A.* Shooting—25 m. Rapid Pistol
- Leander, O. B.** *Sweden* Football
- Leao da Costa, M. (F)** *Brazil* Swimming—100 m. Free Style, 4 x 100 m. Relay
- Le Bas, J.** *France* Athletics—200 m., 4 x 100 m. Relay
- Lebranchu, R.** *France* Rowing—Eights
- Le Bras, R.** *France* Swimming—Water Polo
- Lebrun, J.** *France* Yachting—Swallow Class
- Lechner, H.** *Austria* Fencing—Sabre Team
- Leckie, W.** *Great Britain* Rowing—Fours with Cox
- Leclere, J.** *France* Wrestling—Free Style, Welterweight
- Lecuona Asencio, F.** *Cuba* Gymnastics
- Lecuona Asencio, R.** *Cuba* Gymnastics
- Ledesma Barrales, M.** *Chile* Basketball
- Lee, C.** *U.S.A.* Yachting—Dragon Class
- Lee, Choon Yung** *Korea* Basketball
- Lee, E.** *China* Basketball
- Lee, E.** *Great Britain* Football
- Lee, Kyu Hyuk** *Korea* Weightlifting—Bantamweight
- Lee, L. (F)** *Great Britain* Athletics—Long Jump
- Lee, S.** *U.S.A.* Swimming—Springboard Diving, High Diving
- Lee, Sang Hoon** *Korea* Basketball
- Lee, Tsun-Tung** *China* Basketball
- Lee, Young Whan** *Korea* Weightlifting—Light-heavyweight
- Lee, Yun Suk** *Korea* Athletics—1,500 m., 800 m.

- Leeman, G.** *U.S.A.* Wrestling—Free Style, Bantamweight
- Leenheere, G.** *Belgium* Swimming—Water Polo
- Lees, N. (F)** *U.S.A.* Swimming—400 m. Free Style
- Lefebvre, M.** *France* Swimming—Water Polo
- Lefevre, J.** *France* Fencing—Sabre Team, Sabre Individual
- Legg, D.** *Great Britain* Basketball
- Legg, R.** *Great Britain* Basketball
- Legrain, P.** *France* Athletics—Hammer
- Le Guillerm, A.** *France* Weightlifting—Featherweight
- Lehmann, W.** *Switzerland* Gymnastics
- Lehtila, Y.** *Finland* Athletics—Putting the Shot
- Lehtinen, O.** *Finland* Boxing—Flyweight
- Leidersdorff, A.** *Denmark* Fencing—Foil Individual, Foil Team, Sabre Individual
- Leirud, B.** *Norway* Athletics—High Jump
- Leischner, J-F.** *Luxembourg* Fencing—Epee Team, Epee Individual
- Lejserowitz, I.** *Denmark* Wrestling—Greco-Roman Style, Bantamweight
- Lemhenyi, D.** *Hungary* Swimming—Water Polo
- Lempinen, T.** *Finland* Wrestling—Greco-Roman Style, Bantamweight
- Lenstra, A.** *Holland* Football
- Lentz, M.** *Luxembourg* Canoeing—10,000 m. K1, 1,000 m. K1
- Lenz, C. (F)** *U.S.A.* Gymnastics
- Leon Gozalo, A. de** *Spain* Shooting—50 m. Pistol
- Leon, J.** *Venezuela* Cycling—1,000 m. Scratch, 1,000 m. Time Trial
- Leon, R.** *France* Rowing—Eights
- Leonidis, P.** *Greece* Cycling—Road Race
- Lepage, H.** *France* Fencing—Epee Team, Epee Individual
- Leppanen, S.** *Finland* Wrestling—Free Style, Lightweight
- Lepsoe, K.** *Norway* Rowing—Eights
- Lerche, A.** *Denmark* Shooting—25 m. Rapid Pistol
- Lerno, L.** *Belgium* Cycling—Road Race
- Lescoux, S.** *France* Shooting—300 m. Free Rifle
- Leskinen, M. (F)** *Finland* Swimming—200 m. Breast-stroke
- Leskinen, V.** *Finland* Shooting—300 m. Free Rifle
- Levavasseur, J.** *France* Fencing—Sabre Team, Sabre Individual
- Leveque, G.** *France* Fencing—Sabre Team
- Lewenhaupt, J.** *Sweden* Equestrian—Prix des Nations Individual, Prix des Nations Team
- Lewis, G.** *Trinidad* Athletics—200 m., 100 m.
- Lewis, J.** *Eire* Equestrian—Prix des Nations Individual, Prix des Nations Team
- Lewis, L.** *Great Britain* Athletics—400 m., 4 X 400 m. Relay
- Lewis, L. F.** *British Guiana* Cycling—Road Race, 1,000 m. Scratch, 1,000 m. Time Trial
- Lewis, N.** *U.S.A.* Fencing—Epee Individual, Epee Team
- Lewis, T.** *Great Britain* Swimming—Water Polo
- Leyman, A. (F)** *Sweden* Athletics—Long Jump, 200 m.
- L'Hoste, V.** *Belgium* Boxing—Light-heavyweight
- Li Tei-Fei** *China* Football
- Libera, E. (F)** *Italy* Fencing—Foil Individual
- Libotte Berlioux, M. (F)** *France* Swimming—100 m. Back-stroke
- Lidman, H.** *Sweden* Athletics—110 m. Hurdles
- Lie, S.** *Norway* Yachting—Dragon Class
- Liedholm, N.** *Sweden* Football
- Lienhard, W.** *Switzerland* Shooting—25 m. Rapid Pistol
- Lightbourn, P. (F)** *Bermuda* Athletics—Long Jump, 100 m., 200 m.
- Likens, R.** *U.S.A.* Athletics—Javelin
- Lindberg, A.** *Sweden* Athletics—Pole Vault
- Lindberg, K. (F)** *Sweden* Gymnastics
- Lindberg, T.** *Sweden* Football
- Linden, K.** *Sweden* Wrestling—Free Style, Middleweight
- Lindsay, A.** *Great Britain* Athletics—Hop, Step and Jump
- Lindsay, F.** *Great Britain* Hockey
- Lindsay, W.** *Great Britain* Hockey
- Lineham, W.** *Eire* Boxing—Bantamweight
- Lines, S.** *Bermuda* Athletics—200 m., 100 m., 4 X 100 m. Relay
- Lingenfelder, E.** *Argentine* Rowing—Eights
- Linhart, J.** *Czechoslovakia* Swimming—200 m. Breast-stroke
- Linneman, N.** *Holland* Boxing—Featherweight
- Linszen, F.** *Belgium* Athletics—200 m., 4 x 100 m. Relay
- Lipanovic, I.** *Yugoslavia* Rowing—Fours without Cox
- Lippa, W.** *Austria* Swimming—High Diving, Springboard Diving
- Lippens, J.** *Belgium* Yachting—Dragon Class
- Lips, R.** *Switzerland* Fencing—Epee Team, Epee Individual
- Lira Aviles, R.** *Mexico* Gymnastics
- Listur, P.** *Uruguay* Athletics—High Jump
- Litaudon, M.** *France* Athletics—4 x 100 m. Relay
- Littomeritzky, M. (F)** *Hungary* Swimming—4 X 100 m. Relay, 100 m. Free Style
- Ljunggren, J.** *Sweden* Athletics—50,000 m. Walk
- Ljunggren, O.** *Sweden* Athletics—800 m.
- Ljungquist, B.** *Sweden* Fencing—Epee Individual, Epee Team
- Llaneras Rodriguez, M.** *Cuba* Basketball
- Llanusa Gobel, J.** *Cuba* Basketball
- Lledo, R.** *Argentine* Basketball
- Llerena Valderrama, H.** *Peru* Cycling—Road Race
- Llewellyn, H.** *Great Britain* Equestrian—Prix des Nations Individual, Prix des Nations Team
- Lloyd, C. B.** *Great Britain* Rowing—Eights
- Lloyd, J. E.** *Great Britain* Fencing—Foil Individual, Foil Team, Sabre Team
- Loayza Veas, H.** *Chile* Boxing—Welterweight
- Loft, V.** *Denmark* Hockey
- Loggere, H.** *Holland* Hockey
- Loisel, H.** *Austria* Fencing—Sabre Individual, Sabre Team
- Lombardi, P.** *Italy* Wrestling—Greco-Roman Style, Flyweight
- Lombardo, A.** *Uruguay* Basketball
- Lomecky, K.** *Czechoslovakia* Canoeing—10,000 m. K2
- Lommi, O.** *Finland* Rowing—Fours with Cox
- Lommi, V.** *Finland* Rowing—Fours with Cox
- Lomowski, M.** *Poland* Athletics—Putting the Shot
- Lomska, L. (F)** *Czechoslovakia* Athletics—80 m. Hurdles
- Lonchibucco, P.** *Argentine* Gymnastics
- Long (Correia), A.** *British Guiana* Weightlifting—Featherweight
- Long, M. (F)** *Great Britain* Athletics—Javelin
- Longarela, A.** *Argentine* Wrestling—Greco-Roman Style, Welterweight
- Longika, B.** *Yugoslavia* Gymnastics
- Loomis, A., Jr.** *U.S.A.* Yachting—6 m. Class
- Lopez Alvarez, J.** *Cuba* Wrestling—Free Style, Featherweight
- Lopez Enriquez, E.** *Mexico* Basketball
- Lopez Garviso, F.** *Cuba* Basketball
- Lopez, J.** *Uruguay* Swimming—Water Polo
- Lopez, L.** *Uruguay* Cycling—Road Race
- Lopez, M.** *Argentine* Boxing—Lightweight
- Lopez Testa, J.** *Uruguay* Athletics—100 m., 200 m., 4 x 100 m. Relay
- Lo Presti, S.** *Argentine* Weightlifting—Lightweight
- Lord, T.** *Sweden* Yachting—6 m. Class
- Lorion, Y.** *France* Yachting—Star Class
- Lotti, R.** *France* Rowing—Fours with Cox
- Lou, Wen-Ngau** *China* Athletics—5,000 m., 10,000 m., Marathon
- Louro Sierra, F.** *Cuba* Weightlifting—Lightweight
- Lovato, F.** *Austria* Hockey
- Lovera, R.** *Uruguay* Basketball
- Lovina, B.** *Philippines* Athletics—200 m., 100 m.
- Lovric, L.** *Yugoslavia* Football
- Lovrics, I.** *Hungary* Basketball
- Lovso Nielsen, G. (F)** *Denmark* Athletics—100 m., 4 X 100 m. Relay
- Lozano Soto, O.** *Mexico* Shooting—50 m. Small Bore Rifle
- Lubbers, H.** *U.S.A.* Hockey
- Lubell, B.** *U.S.A.* Fencing—Foil Individual, Foil Team
- Lucas, R.** *France* Hockey
- Lucas, W.** *Great Britain* Athletics—5,000 m.
- Luchow, M.** *Denmark* Fencing—Epee Team, Epee Individual
- Luck, P.** *Great Britain* Wrestling—Free Style, Lightweight
- Lucy, R.** *Switzerland* Gymnastics
- Ludwig, M. (F)** *Luxembourg* Athletics—Long Jump

- Lumsden, J.** *Great Britain* Modern Pentathlon
- Luna Herrera, F.** *Mexico* Fencing—Sabre Team, Sabre Individual
- Lundberg, K.** *Denmark* Football
- Lundberg, R.** *Sweden* Athletics—Pole Vault
- Lunden, M.** *Sweden* Swimming—4 x 200 m. Relay, 100 m. Back-stroke, 100 m. Free Style
- Lundquist, M.** (F) *Sweden* Swimming—4 x 100 m. Relay, 100 m. Free Style
- Lundqvist, K.** *Sweden* Athletics—400 m., 4 X 400 m. Relay
- Lundqvist, S.** *Sweden* Shooting—25 m. Rapid Pistol
- Lunis, J.** *France* Athletics—400 m., 4 x 400 m. Relay
- Luoto, T.** *Finland* Athletics—1,500 m.
- Lusien, M.** *France* Swimming—200 m. Breast-stroke
- Lutkeveld, N.** *Holland* Athletics—Javelin
- Luyt, S.** *South Africa* Athletics—Marathon
- Luz, M.** (F) *Brazil* Athletics—200 m., 4 x 100 m. Relay
- Lynch, E.** *U.S.A.* Cycling—Road Race
- Lyng, J.** *Denmark* Fencing—Epee Team
- Lyons, B.** (F) *Australia* Swimming—200 m. Breast-stroke
- Lysak, S.** *U.S.A.* Canoeing—10,000 m. C2, 1,000 m. C2
- M**
- Maas, A.** *Holland* Yachting—Star Class
- Maati, H.** *Egypt* Football
- Macario, R.** *Italy* Rowing—Fours with Cox
- Macchini, L.** (F) *Italy* Gymnastics
- Macknowski, S.** *U.S.A.* Canoeing—10,000 m. C2, 1,000 m. C2
- Madero, A.** *Argentina* Rowing—Eights, Fours without Cox
- Madkour, H.** *Egypt* Football
- Maerlie, R.** *Norway* Wrestling—Greco-Roman Style, Bantamweight
- Maestrelli, T.** *Italy* Football
- Magee, R.** *Australia* Weightlifting—Heavyweight
- Maggi, E.** *France* Athletics—10,000 m. Walk
- Magnin-Lamouche, J.** (F) *France* Athletics—80 m. Hurdles
- Magnusson, K.** *Sweden* Weightlifting—Light-heavyweight
- Mahana Badrie, V.** *Chile* Basketball
- Mahaut, K.** (F) *Denmark* Fencing—Foil Individual
- Mahini, A.** *Iran* Weightlifting—Lightweight
- Mahjoub, I.** *Lebanon* Wrestling—Greco-Roman Style, Light-heavyweight
- Mahlum, O.** *Norway* Athletics—Javelin
- Mahomed, T.** *India* Football
- Mahoney, F.** *Bermuda* Athletics—100 m., 4 X 100 m. Relay
- Makela, Y.** *Finland* Athletics—Decathlon
- Maidana, R.** *Argentina* Swimming—Water Polo
- Maidment, H.** *Great Britain* Canoeing—1,000 m. C1
- Maillet, J.** *France* Rowing—Double Sculls
- Maioni, M.** *Italy* Swimming—Water Polo
- Maitland, R.** *Great Britain* Cycling—Road Race
- Majdloch, F.** *Czechoslovakia* Boxing—Flyweight
- Makela, V.** *Finland* Athletics—5,000 m.
- Makzoume, R.** *Egypt* Basketball
- Malchioldi, E.** *Argentina* Athletics—Putting the Shot, Discus
- Maldonado Campos, A.** *Mexico* Swimming—400 m. Free Style, 1,500 m. Free Style, 4 x 200 m. Relay
- Malek, M.** *Czechoslovakia* Gymnastics
- Malherbaud, L.** (F) *France* Fencing—Foil Individual
- Malik, N.** *Pakistan* Athletics—Discus, Putting the Shot
- Malone, T.** *Eire* Basketball
- Malvicino, A.** *Argentina* Rowing—Double Sculls
- Manalich, R.** *Cuba* Fencing—Epee Team, Sabre Individual, Epee Individual
- Mancuso, A.** *Argentina* Swimming—1,500 m. Free Style
- Mandrizzato, A.** *Italy* Fencing—Epee Team
- Mandy, G.** *South Africa* Swimming—High Diving
- Mangal, B.** *Afghanistan* Hockey
- Mangiarotti, D.** *Italy* Fencing—Epee Team
- Mangiarotti, E.** *Italy* Fencing—Epee Team, Foil Team, Epee Individual
- Mangilli, F.** *Italy* Equestrian—3 Day Individual, 3 Day Team
- Maninetti, F.** *Italy* Rowing—Eights
- Manley, D.** (F) *Great Britain* Athletics—100 m., 4 x 100 m. Relay
- Manna, S.** *India* Football
- Mannikko, V.** *Finland* Wrestling—Greco-Roman Style, Welterweight
- Manninen, A.** *U.S.A.* Athletics—Marathon
- Manning, G.** *Great Britain* Football
- Manoukian, D.** *France* Hockey
- Mansoor, I.** *India* Swimming—Water Polo, 100 m. Free Style
- Mantelli, E.** *Italy* Basketball
- Mantilla Fernandini, L.** *Peru* Shooting—50 m. Small Bore Rifle
- Manuel, T.** (F) *U.S.A.* Athletics—80 m. Hurdles, Javelin, 4 x 100 m. Relay
- Maquat, G.** *France* Rowing—Fours with Cox
- Mara, J.** *Czechoslovakia* Modern Pentathlon
- Marcelja, D.** *Yugoslavia* Athletics—Decathlon
- Marchant, L.** *Great Britain* Swimming—High Diving
- Marchant, P.** *Great Britain* Shooting—50 m. Pistol
- Marcoplos, H.** *U.S.A.* Hockey
- Margarinos, G.** *Uruguay* Basketball
- Margotti, S.** *Italy* Shooting—50 m. Pistol
- Mari, G.** *Italy* Football
- Mariano, H.** *Brazil* Swimming—High Diving
- Marie, A.** *France* Athletics—no m. Hurdles
- Marietti, F.** *Italy* Basketball
- Mariles Cortes, H.** *Mexico* Equestrian—Prix des Nations Individual, 3 Day Team, 3 Day Individual, Prix des Nations Team
- Marinelli, G.** *Italy* Basketball
- Marini, F.** *Italy* Fencing—Epee Team
- Marinis, C.** *Greece* Athletics—Long Jump
- Marino, O.** *Uruguay* Swimming—Water Polo
- Mariscal Abascal, D.** *Mexico* Swimming—High Diving, Springboard Diving
- Marmentini Gil, E.** *Chile* Basketball
- Marquez, R.** *Argentina* Hockey
- Marsan, P.** *Monaco* Shooting—50 m. Small Bore Rifle
- Marshall, B.** (F) *Argentina* Swimming—100 m. Back-stroke
- Marshall, J.** *Australia* Swimming—1,500 m. Free Style, 400 m. Free Style
- Marsman, M.** (F) *Holland* Swimming—4 x 100 m. Relay
- Marson, A.** *Brazil* Basketball
- Martel, Y.** (F) *France* Athletics—Long Jump
- Marti Arenas, C.** *Spain* Swimming—Water Polo
- Martin, A.** *Belgium* Swimming—Water Polo
- Martin, A.** *Great Britain* Modern Pentathlon
- Martin, K.** *Eire* Boxing—Featherweight
- Martin, M.** *U.S.A.* Football
- Martin, R. D.** *U.S.A.* Rowing—Fours With Cox
- Martin, R. E.** (F) *Canada* Fencing—Foil Individual
- Martinaux, F.** *France* Swimming—100 m. Free Style
- Martineau, H. A.** *Great Britain* Athletics—50,000 m. Walk
- Martinez, D.** *Uruguay* Boxing—Middleweight
- Martinez Fuentes, G.** *Mexico* Shooting—300 m. Free Rifle
- Martinez Larraz, S.** *Spain* Equestrian—3 Day Individual, 3 Day Team
- Martinetti, L.** *Argentina* Basketball
- Martinez Ferry, I.** *Spain* Swimming—4 x 200 m. Relay, 1,500 m. Free Style, 400 m. Free Style
- Martinez Valdes Cantero, J.** *Cuba* Fencing—Epee Team, Sabre Individual
- Martinez Jara, O.** *Chile* Swimming—Water Polo
- Martinez, P.** *Philippines* Basketball
- Martinez Zapata, L.** *Spain* Boxing—Flyweight
- Martins, H.** *Portugal* Equestrian—Prix des Nations Individual, Prix des Nations Team
- Masanes Gimeno, M.** *Chile* Cycling—Road Race, 1,000 m. Scratch
- Mascarenhas Fiuza, J.** *Portugal* Yachting—Star Class
- Masciadri, B.** *Switzerland* Canoeing—1,000 m. K2
- Maslen-Jones, R.** *Great Britain* Shooting—300 m. Free Rifle
- Masset, L.** *France* Gymnastics
- Massey, P.** *Great Britain* Rowing—Eights
- Massey Oliveira de Menezes, E.** *Brazil* Equestrian—Prix des Nations Team, Prix des Nations Individual
- Massol, R.** *France* Swimming—Water Polo
- Massy, J.** *Belgium* Canoeing—10,000 m. K2
- Mast, F.** *Switzerland* Weightlifting—Middleweight

- Maston, J.** (F) *Australia* Athletics—4 x 100 m. Relay, Long Jump
- Masud, A.** *Pakistan* Hockey
- Maszlay, L.** *Hungary* Fencing—Foil Individual, Foil Team
- Matej, J.** (F) *Yugoslavia* Athletics—Discus
- Matheou, F.** *Greece* Rowing—Single Sculls
- Mathey Hoke, P.** *Peru* Cycling—Road Race
- Mathias, R.** *U.S.A.* Athletics—Decathlon
- Mathiesen, I.** *Norway* Canoeing—1,000 m. K2, 10,000 m. K2
- Mathieu, M.** *Argentina* Cycling—Road Race
- Mathiot, M.** *France* Gymnastics
- Matloka, M.** *Poland* Canoeing—1,000 m. K2, 10,000 m. K2
- Matocha, J.** *Czechoslovakia* Canoeing—10,000 m. K1
- Matthey, M.** *Switzerland* Rowing—Double Sculls
- Matton, L.** *Sweden* Yachting—Swallow Class
- Maung Myo Thant** *Burma* Boxing—Flyweight
- Maung Sein Pe** *Burma* Athletics—100 m.
- Maung Win Maung** *Burma* Weightlifting—Bantamweight
- Mavrapostolos, B.** *Greece* Athletics—5,000 m., 3,000 m. Steeplechase
- Mavroidis, B.** *Greece* Athletics—800 m., 1,500 m., 4 x 400 m Relay
- May, N.** *Luxembourg* Football
- May, N. E.** *Canada* Wrestling—Free Style, Bantamweight
- May, P.** *Great Britain* Gymnastics
- Mayberry, D.** *South Africa* Rowing—Fours without Cox
- Mayora Duenas, E.** (F) *Mexico* Fencing—Foil Individual
- Mayordome, G.** *France* Athletics—800 m.
- Mazeas, J.** (F) *France* Athletics—Discus
- Mazille, P.** *France* Athletics—50,000 m. Walk
- Mazorra Zamorra, R.** *Cuba* Athletics—100 m., 200 m.
- Mazoyer, J.** *France* Shooting—50 m. Pistol
- Mazurkiewicz, H.** *Austria* Boxing—Bantamweight
- McAlinden, K.** *Great Britain* Football
- McBain, D.** *Great Britain* Football
- McCull, J.** *Great Britain* Football
- McConnell, W.** *Canada* Rowing—Eights
- McCooke, S.** *Great Britain* Athletics—10,000 m.
- McCorquodale, A.** *Great Britain* Athletics—4 X 100 m. Relay, 200 m., 100 m.
- McCready, M.** *Great Britain* Fencing—Epee Team
- McCullagh, M.** *Eire* Boxing—Lightweight
- McCullough, E.** *Canada* Athletics—400 m., 4 x 400 m. Relay
- McDonald, A.** *Great Britain* Yachting—Firefly Class
- Macdonald Bailey, E.** *Great Britain* Athletics—100 m.
- McDonald, P.** *Eire* Football
- McDonnell, B.** *Eire* Rowing—Eights
- McElligott, E.** *Eire* Rowing—Eights
- McFarlane, D.** *Canada* Athletics—400 m., 4 x 400 m. Relay, 4 x 100 m. Relay
- McFarlane, R.** *Canada* Athletics—400 m., 4 x 400 m. Relay
- McGee, J.** *Eire* Basketball
- McGeer, P.** *Canada* Basketball
- McGrew, V.** *U.S.A.* Athletics—High Jump
- MacGuffie, W.** *Great Britain* Wrestling—Greco-Roman Style, Flyweight
- McIlvenny, H.** *Great Britain* Football
- McIntyre, J.** *U.S.A.* Rowing—Pairs with Cox
- McKay, J.** *Australia* Swimming—Water Polo
- Mackay, N.** (F) *Canada* Athletics—4 x 100 m. Relay
- McKeand, L.** *Australia* Athletics—Hop, Step and Jump
- McKenley, H.** *Jamaica* Athletics—200 m., 400 m., 4 x 400 m. Relay
- McKenzie, B.** *Jamaica* Athletics—100 m., 200 m., 4 X 100 m. Relay, 4 X 400 m. Relay
- McKeon, M.** *Eire* Boxing—Middleweight
- McKinnon, B.** (F) *Australia* Athletics—200 m., 100 m., 4 X 100 m. Relay
- McLane, J.** *U.S.A.* Swimming—400 m. Free Style, 1,500 m. Free Style, 4 x 200 m. Relay
- McLaughlin, B.** *U.S.A.* Football
- McLaughlin, P.** *Canada* Yachting—Firefly Class
- McLoughlin, E.** *Eire* Football
- McLoughlin, G.** *Eire* Basketball
- McMeekan, Stanley** *Great Britain* Basketball
- McMeekan, Sydney** *Great Britain* Basketball
- McMillen, R.** *U.S.A.* Athletics—3,000 m. Steeplechase
- Macnally, E.** *Eire* Yachting—Swallow Class
- McNamee, K.** (F) *Canada* Swimming—100 m. Free Style, 4 x 100 m. Relay, 400 m. Free Style
- McQuade, M.** (F) *Australia* Swimming—100 m. Free Style
- McWilliams, H.** *South Africa* Yachting—Firefly Class
- Mechelynyck, H.** *Belgium* Hockey
- Mehrah, R.** *India* Cycling—Road Race
- Mejia Avila, C.** *Mexico* Swimming—4 x 200 m. Relay, 100 m. Back-stroke
- Melanofidis, N.** *Greece* Swimming—Water Polo, 100 m. Back-stroke
- Melchior, E.** *Austria* Football
- Melin, A.** *Sweden* Athletics—Marathon
- Melin, B.** *Sweden* Yachting—Star Class
- Mellavuo, P.** *Finland* Wrestling—Free Style, Light-heavyweight
- Mello de Preiss, I.** (F) *Argentina* Athletics—Discus, Putting the Shot
- Mellon, M.** (F) *U.S.A.* Swimming—100 m. Back-stroke
- Mellows, A.** *Great Britain* Rowing—Eights
- Melo Bittencourt Filho, C.** *Brazil* Yachting—Star Class
- Melo e Castro, J.** *Portugal* Fencing—Epee Team
- Mena e Silva, L.** *Portugal* Equestrian—Dressage Individual, Dressage Team
- Menabawi, M.** *Egypt* Boxing—Light-heavyweight
- Mendizabal Raing, E.** *Peru* Shooting—25 m. Rapid Pistol
- Meneses Rodriguez, C.** *Peru* Boxing—Flyweight
- Menghini, M.** *Australia* Shooting—300 m. Free Rifle
- Menini, R.** *Argentina* Basketball
- Meraz Segura, E.** *Mexico* Fencing—Epee Team, Epee Individual
- Mercader, C.** *Uruguay* Modern Pentathlon
- Mercado Luna, J.** *Mexico* Football
- Mercali, C.** *Argentina* Hockey
- Merle, A.** *France* Wrestling—Greco-Roman Style, Featherweight
- Merlo, S.** *Argentina* Yachting—Swallow Class
- Merrill, L.** *U.S.A.* Wrestling—Free Style, Welterweight
- Mertin, J.** (F) *Hungary* Athletics—100 m.
- Mestres Rivas, A.** *Spain* Swimming—Water Polo
- Mewalall, S.** *India* Football
- Meyer, A.** *France* Hockey
- Meyer-Haantjes, B.** (F) *Holland* Gymnastics
- Meyer, J.** *Holland* Athletics—100 m., 4 X 100 m. Relay
- Meyer v. d. Sluis, M.** (F) *Holland* Fencing—Foil Individual
- Meyrick, D.** *Great Britain* Rowing—Eights
- Mezofi, T.** *Hungary* Basketball
- Michaux, B.** *Luxembourg* Football
- Micheli, L.** (F) *Italy* Gymnastics
- Michtits, O.** *Austria* Boxing—Light-heavyweight
- Miguez Tito, J.** *Portugal* Yachting—Firefly Class
- Mihajlovic, P.** *Yugoslavia* Football
- Mijatovic, Z.** (F) *Yugoslavia* Gymnastics
- Mikaellsson, J.** *Sweden* Athletics—10,000 m. Walk
- Mikkelsen, L.** *Denmark* Equestrian—Prix des Nations Team, Prix des Nations Individual
- Mikkelsen, N.** *Denmark* Equestrian—3 Day Team, 3 Day Individual
- Mikla, B.** *Hungary* Fencing—Epee Team, Epee Individual
- Mikolasch, L.** *Austria* Football
- Millard Pacheco, A.** (F) *Chile* Athletics—4 x 100 m. Relay
- Mimoun-o-Kacha, A.** *France* Athletics—10,000 m., 5,000 m.
- Minatelli, M.** *Italy* Boxing—Lightweight
- Min, B. D.** *Korea* Football
- Minerth, B.** *Denmark* Gymnastics
- Mingie, P.** *Canada* Swimming—100 m. Back-stroke
- Minton, G.** (F) *Great Britain* Fencing—Foil Individual
- Miranda Justo, C.** *Spain* Athletics—3,000 m. Steeplechase, 10,000 m.
- Mirghavami, M.** *Iran* Wrestling—Free Style, Light-heavyweight
- Mirghavami, N.** *Iran* Weightlifting, Middleweight
- Misakova, M.** (F) *Czechoslovakia* Gymnastics
- Missoni, O.** *Italy* Athletics—400 m. Hurdles, 4 X 400 m. Relay
- Mistry, E.** *India* Cycling—Road Race
- Mitchell, J. R.** *Canada* Basketball
- Mitic, R.** *Yugoslavia* Football
- Mitra, D.** *India* Swimming—100 m. Free Style

XIV OLYMPIAD

- Mitra, P.** *India* Swimming—100 m. Back-stroke
- Mitro, G.** *Hungary* Swimming—1,500 m. Free Style, 4 x 200 m. Relay, 400 m. Free Style
- Mitrovic Guic, A.** *Chile* Basketball
- Moawad, H.** *Egypt* Basketball
- Moberg, L.** *Sweden* Athletics—Hop, Step and Jump
- Moccand, A.** *Switzerland* Rowing—Fours with Cox
- Mockridge, E.** *Australia* Cycling—4,000 m. Pursuit, Road Race
- Moghal, M.** *Pakistan* Hockey
- Mogyorossy, G.** *Hungary* Gymnastics
- Mogyorossy Klencs, J.** *Hungary* Gymnastics
- Mohamad, M.** *Egypt* Basketball
- Mohamedzai, A.** *Afghanistan* Football
- Mohjadi, F.** *Iran* Basketball
- Moineau, A.** *France* Cycling—Road Race
- Moioli, G.** *Italy* Rowing—Fours without Cox
- Mojtic, M.** *Yugoslavia* Rowing—Fours Without Cox
- Molina, E.** *Argentina* Cycling—4,000 m. Pursuit
- Mollazal, S.** *Iran* Shooting—50 m. Small Bore Rifle, 300 m. Free Rifle
- Moller, M.** *Sweden* Wrestling—Free Style, Greco-Roman Style, Flyweight
- Moller, V.** *Denmark* Gymnastics
- Mollet, R.** *Belgium* Modern Pentathlon
- Molnar, E.** *Brazil* Fencing—Sabre Individual
- Molnar, K.** *Austria* Canoeing—10,000 m. C2, 1,000 m. C2
- Monastiriotis, A.** *Greece* Swimming—Water Polo
- Mondschein, I.** *U.S.A.* Athletics—Decathlon
- Monges Caldera, C.** *Mexico* Athletics—400 m.
- Monginou, Y. (F)** *France* Athletics—80 m. Hurdles
- Mongrut Munoz, A.** *Peru* Athletics—800 m., 1,500 m.
- Monsen, C.** *Norway* Rowing—Eights
- Monsen, S.** *Norway* Rowing—Eights
- Montano, A.** *Italy* Fencing—Sabre Team
- Montassir, H.** *Egypt* Basketball
- Monteiro da Fonseca, I.** *Brazil* Swimming—100 m. Back-stroke
- Montemage, T.** *U.S.A.* Cycling—4,000 m. Pursuit
- Montemayor Rodriguez, E.** *Mexico* Shooting—25 m. Rapid Pistol
- Monterio, A.** *Pakistan* Boxing—Bantamweight
- Montessoro, E.** *Italy* Equestrian—3 Day Team, 3 Day Individual
- Monti, C.** *Italy* Athletics—4 x 100 m. Relay
- Monti, F.** *Argentina* Yachting—Swallow Class
- Moody, H.** *Great Britain* Athletics—Putting the Shot
- Mooney, A.** *Eire* Yachting—Firefly Class
- Mooney, M.** *U.S.A.* Yachting—6 m. Class
- Moore, G.** *Great Britain* Fencing—Sabre Team
- Moore, G.** *U.S.A.* Modern Pentathlon
- Moore, H.** *U.S.A.* Wrestling—Free Style, Featherweight
- Morch, C.** *Norway* Fencing—Epee Individual, Epee Team
- Morcom, A.** *U.S.A.* Athletics—Pole Vault
- Moreau, M. (F)** *France* Swimming—Springboard Diving
- Morein, M.** *Canada* Basketball
- Moreiras Lopez, A.** *Spain* Modern Pentathlon
- Moreno, O.** *Argentina* Rowing—Pairs without Cox
- Moreno Rodillo, A.** *Chile* Basketball
- Morg, G. (F)** *Brazil* Athletics—4 x 100 m. Relay, Long Jump
- Morgan, A.** *U.S.A.* Rowing—Fours with Cox
- Morille, E.** *Italy* Rowing—Fours without Cox
- Moritzen, J.** *Denmark* Weightlifting—Middleweight
- Morris, C.** *Great Britain* Athletics—10,000 m. Walk
- Morris, R. A.** *Great Britain* Athletics—1,500 m.
- Morris, S.** *Great Britain* Yachting—Swallow Class
- Morrot Coelho, Aecio.** *Brazil* Equestrian—3 Day Team, 3 Day Individual
- Morrot Coelho, Acelio.** *Brazil* Modern Pentathlon
- Mortensen, B.** *Denmark* Cycling—4,000 m. Pursuit
- Mortimer, J.** *Great Britain* Wrestling—Greco-Roman Style, Featherweight
- Morton, P.** *South Africa* Wrestling—Free Style, Light-heavyweight
- Moser, H.** *Switzerland* Equestrian—Dressage Individual
- Mosman, F.** *Holland* Fencing—Sabre Individual, Foil Team, Sabre Team
- Moussier, J. (F)** *France* Athletics—4 x 100 m. Relay, 100 m.
- Moustafa, A.** *Egypt* Wrestling—Free Style, Welterweight
- Moustafa, H.** *Egypt* Weightlifting—Heavyweight
- Mrazek, I.** *Czechoslovakia* Basketball
- Mukhtar, E.** *Egypt* Athletics—Decathlon, 100 m.
- Mullinghausen, R.** *France* Swimming—High Diving, Springboard Diving
- Mullafiroze, R.** *India* Cycling—1,000 m. Scratch
- Muller, A.** *Switzerland* Wrestling—Free Style, Featherweight, Greco-Roman Style, Featherweight
- Muller, H.** *Switzerland* Boxing—Heavyweight
- Muller Hess, R.** *Chile* Shooting—50 m. Pistol, 25 m. Rapid Pistol
- Muller-Preis, E. (F)** *Austria* Fencing—Foil Individual
- Mullerova, M. (F)** *Czechoslovakia* Gymnastics
- Mullick, N.** *Pakistan* Cycling—1,000 m. Scratch
- Mullick, P.** *India* Swimming—200 m. Breast-stroke
- Mullins, P.** *Australia* Athletics—Decathlon
- Mulvihill, F.** *Eire* Athletics—Marathon
- Mumar, L.** *Philippines* Basketball
- Mund Borgs, G.** *Chile* Swimming—Springboard Diving
- Munir, K.** *Egypt* Wrestling—Greco-Roman Style, Welterweight
- Muniz, A.** *Uruguay* Boxing—Heavyweight
- Munnikes, J.** *Holland* Wrestling—Greco-Roman Style, Lightweight
- Munro, G.** *Canada* Basketball
- Munter, C.** *Denmark* Shooting—25 m. Rapid Pistol
- Murarij, D.** *India* Swimming—Water Polo
- Murray, D.** *Great Britain* Swimming—Water Polo
- Musaeus, L.** *Norway* Yachting—6 m. Class
- Musil, H.** *Austria* Yachting—Firefly Class
- Musy, P.** *Switzerland* Equestrian—3 Day Individual, 3 Day Team
- Myers, V. (F)** *Canada* Athletics—100 m., 4 X 100 m. Relay
- Myhrvold, A.** *Norway* Cycling—Road Race
- Myland, R.** *Great Britain* Wrestling—Greco-Roman Style, Lightweight
- Myles, R.** *Eire* Athletics—4 x 400 m. Relay
- Mylonas, C.** *Greece* Shooting—25 m. Rapid Pistol

N

- Nadas, T.** *Hungary* Rowing—Fours without Cox, Fours with Cox
- Nador, Z. (F)** *Hungary* Swimming—100 m. Free Style
- Naess, L.** *Norway* Rowing—Eights
- Nag, S.** *India* Swimming—Water Polo, 100 m. Free Style
- Nagy, B.** *Hungary* Weightlifting—Featherweight
- Nagy, G.** *Hungary* Basketball
- Nagy, L.** *Hungary* Rowing—Fours without Cox, Fours with Cox
- Naia Lemos, J.** *Portugal* Rowing—Eights
- Naia Machado, J.** *Portugal* Rowing—Eights
- Naia Machado, L.** *Portugal* Rowing—Eights
- Nakache, A.** *France* Swimming—200 m. Breast-stroke
- Nam, Su Il** *Korea* Weightlifting—Featherweight
- Namdjou, M.** *Iran* Weightlifting—Bantamweight
- Nankeville, G.** *Great Britain* Athletics—1,500 m.
- Nanopoulos, A.** *Greece* Fencing—Epee Individual, Sabre Team, Sabre Individual, Foil Team, Epee Team
- Nascimento, M.** *Brazil* Boxing—Bantamweight
- Nasir, E.** *Egypt* Boxing—Lightweight
- Naukkerinen, K. (F)** *Finland* Athletics—80 m. Hurdles
- Navarro Morenes, J.** *Spain* Equestrian—Prix des Nations Individual, Prix des Nations Team
- Nawrocka, I. (F)** *Poland* Fencing—Foil Individual
- Nawrocki, J.** *Poland* Fencing—Sabre Team, Epee Individual, Epee Team
- Neale, C.** *Great Britain* Football
- Nelsen, A.** *U.S.A.* Cycling—Road Race
- Nelson, L.** *Sweden* Weightlifting—Middleweight
- Nelson, W.** *New Zealand* Athletics—5,000 m., 10,000 m.
- Nemeth, I.** *Hungary* Athletics—Hammer

- Nemeth, S.** *Hungary* Swimming—200 m. Breast-stroke
- Nemeti-Steinhardt, G.** *Hungary* Wrestling—Greco-Roman Style, Middleweight
- Nemetz, K.** *Austria* Cycling—2,000 m. Tandem
- Neri, M.** *Italy* Football
- Nesbitt, J.** *Great Britain* Athletics—Discus
- Nessim, A.** *Egypt* Swimming—Water Polo
- Nessin, A.** *Egypt* Basketball
- Nesti, G.** *Italy* Basketball
- Nestor, E.** *Australia* Cycling—4,000 m. Pursuit, Road Race
- Neubauer Rosenberg, A.** *Chile* Fencing—Sabre Individual
- Neumayer, F.** *Argentina* Swimming—100 m. Back-stroke
- Neumeier, C.** *Holland* Rowing—Double Sculls
- Newman, D.** (F) *Great Britain* Swimming—High Diving -
- Ng, Liang-Chian** *China* Athletics—400 m. Hurdles
- Nickels, J.** *Luxembourg* Canoeing—10,000 m. K2, 1,000 m. K2
- Nicklen, N.** *Finland* Athletics—High Jump
- Nicoll, H.** *Great Britain* Equestrian—Individual
- Niederle, W.** *Austria* Hockey
- Nielsen, A.** *Denmark* Hockey
- Nielsen, B.** (F) *Denmark* Athletics—4 x 100 m. Relay, 100 m.
- Nielsen, B. R.** *Denmark* Rowing—Fours with Cox
- Nielsen, B. S.** *Denmark* Cycling—Road Race
- Nielsen, E.** *Denmark* Football
- Nielsen, G.** *Denmark* Shooting—300 m. Free Rifle, 50 m. Small Bore Rifle
- Nielsen, I.** *Denmark* Rowing—Eights
- Nielsen, I. B.** *Denmark* Fencing—Epee Individual, Epee Team
- Nielsen, I. B. B.** *Denmark* Athletics—1,500 m.
- Nielsen, J.** *Denmark* Hockey
- Nielsen, K.** *Denmark* Hockey
- Nielsen, O.** *Norway* Shooting—25 m. Rapid Pistol
- Nielsen, P.** (F) *Great Britain* Swimming—4 x 100 m. Relay, 100 m. Free Style, 400 m. Free Style
- Niemegeerts, H.** *Belgium* Hockey
- Niemelainen, H.** *Finland* Swimming—High Diving
- Nien Sze-Shing** *China* Football
- Nihant, P.** *Belgium* Cycling—1,000 m. Time Trial
- Nijbakker, G.** *Holland* Yachting—Dragon Class
- Nikkinen, S.** *Finland* Athletics—Javelin
- Nikolaou, N.** *Greece* Rowing—Fours with Cox
- Nilsson, E.** *Sweden* Football
- Nilsson, G.** *Sweden* Boxing—Heavyweight
- Nilsson, K.** *Sweden* Wrestling—Greco-Roman Style, Light-heavyweight
- Nilsson, R.** *Sweden* Athletics—Putting the Shot
- Nilsson, T.** *Sweden* Wrestling—Greco-Roman Style, Heavyweight
- Nissen, H.** (F) *Denmark* Athletics—4 x 100 m. Relay
- Nizzola, G.** *Italy* Wrestling—Free Style, Lightweight
- Noble, R.** *India* Cycling—1,000 m. Time Trial, 4,000 m. Pursuit
- Noelting, T.** *Argentina* Rowing—Double Sculls
- Nogueira da Gama Groba, E.** (F) *Brazil* Swimming—100 m. Back-stroke
- Nogueras Marquez, J.** *Spain* Equestrian—3 Day Individual, 3 Day Team
- Nordahl, B.** *Sweden* Football
- Nordahl, G.** *Sweden* Football
- Nordahl, K.** *Sweden* Football
- Nordbo, I.** (F) *Norway* Swimming—Springboard Diving, High Diving
- Nordlund, S.** *Sweden* Shooting—50 m. Pistol
- Noriega Pons, C.** *Uruguay* Swimming—100 m. Back-stroke
- Norregard Hammer, K.** *Norway*—Athletics—10,000 m. Walk
- Norris, D.** *Australia* Swimming—Springboard Diving
- Norris, F.** *U.S.A.* Swimming—1,500 m. Free Style
- Norris, R.** *Great Britain* Basketball
- Nostini, G.** *Italy* Fencing—Foil Individual, Foil Team
- Nostini, R.** *Italy* Fencing—Foil Team, Sabre Team, Foil Individual
- Novak, E.** (F) *Hungary* Swimming—200 m. Breast-stroke, 4 x 100 m. Relay
- Novak, I.** (F) *Hungary* Swimming—100 m. Back-stroke, 4 x 100 m. Relay
- Novakovszky, L.** *Hungary* Basketball
- Noverraz, L.** *Switzerland* Yachting—6 m. Class
- Novicic, S.** *Yugoslavia* Rowing—Eights
- Nowak, O.** *Austria* Hockey
- Nowakowa, H.** (F) *Poland* Athletics—Long Jump
- Noya, E.** *Argentina* Wrestling—Greco-Roman Style, Heavyweight
- Nozari Espinosa, J.** *Mexico* Shooting—300 m. Free Rifle
- Nanez, F.** *Argentina* Boxing—Featherweight
- Nunez, R.** *Argentina* Gymnastics
- Nure, J.** *Argentina* Basketball
- Nuristani, A. J.** *Afghanistan* Hockey
- Nuristani, A. Q.** *Afghanistan* Hockey
- Nuristani, D.** *Afghanistan* Hockey
- Nuristani, J.** *Afghanistan* Hockey
- Nuristani, M. A.** *Afghanistan* Hockey
- Nuristani, M. J.** *Afghanistan* Hockey
- Nuristani, M. K.** *Afghanistan* Hockey
- Nussbaum, F.** *Switzerland* Athletics—Decathlon
- Nuti, V.** (F) *Italy* Gymnastics
- Nuttall, J.** *India* Boxing—Middleweight
- Nyberg, E.** *Sweden* Athletics—5,000 m.
- Nyeki, I.** *Hungary* Swimming—4 x 200 m. Relay, 400 m. Free Style
- Nys, M.** *Belgium* Fencing—Sabre Team
- Nyilas, T.** *U.S.A.* Fencing—Sabre Individual, Sabre Team
- Nyilasi, B.** *Hungary* Rowing—Fours with Cox, Fours without Cox
- Nyman, R.** *Finland* Yachting—Star Class
- Nyqvist, K.** *Finland* Athletics—Discus
- Oatway, D.** *Bermuda* Swimming—100 m. Free Style, 400 m. Free Style, 1,500 m. Free Style, 4 x 200 m. Relay
- Oberbreyer, M.** (F) *Austria* Athletics—100 m., 80 m. Hurdles, Long Jump, 4 x 100 m. Relay
- Oberg, R.** *Sweden* Swimming—Water Polo
- Oberlander, F.** *Great Britain* Wrestling—Free Style, Heavyweight
- Obermuller, G.** *Austria* Yachting—Star Class
- Obermuller, H.** *Austria* Yachting—Star Class
- Oberweger, G.** *Italy* Athletics—Discus
- Obeyesekere, A.** *Ceylon* Boxing—Welterweight
- O'Brien, J.** *Canada* Athletics—100 m., 4 x 100 m. Relay
- Obrietan, T.** *Austria* Rowing—Fours with Cox
- O'Colmain, G.** *Eire* Boxing—Heavyweight
- O'Connor, F.** *Eire* Basketball
- Ocwirk, E.** *Austria* Football
- O'Donovan, D.** *Eire* Basketball
- Offner, R.** *France* Basketball
- Ognio, G.** *Italy* Swimming—Water Polo
- O'Grady, W.** *Eire* Football
- O'Hagan, H.** *Eire* Boxing—Light-heavyweight
- Oh, Soo Chul** *Korea* Basketball
- Ojeda Malpica, E.** *Mexico* Boxing—Bantamweight
- O'Kelly, B.** *Eire* Football
- Oktav, M.** *Turkey* Wrestling—Greco-Roman Style, Featherweight
- Olafsdottir, A.** (F) *Iceland* Swimming—200 m. Breast-stroke
- Olafsdottir, K.** (F) *Iceland* Swimming—100 m. Back-stroke
- Olcay, K.** *Turkey* Wrestling—Greco-Roman Style, Flyweight
- Oldershaw, B.** *Canada* Canoeing—10,000 m. C.2
- Olenius, V.** *Finland* Athletics—Pole Vault
- Olesen, A.** *Denmark* Athletics—3,000 m. Steeplechase
- Olesen, G.** *Denmark* Gymnastics
- Oliveira e Silva, H.** *Brazil* Swimming—100 m. Back-stroke
- Oliveira, G.** *Brazil* Athletics—Hop, Step and Jump
- Oliveira, N.** *Brazil* Basketball
- Oliver Frontera, J.** *Spain* Boxing—Middleweight
- Olivestedt, A.** *Sweden* Cycling—Road Race
- Olney, H.** *Great Britain* Athletics—5,000 m.
- Olsen, G.** (F) *Denmark* Fencing—Foil Individual
- Olsen, I.** *Denmark* Rowing—Fours with Cox
- Olsen, Z.** (F) *U.S.A.* Swimming—Springboard Diving
- Oisson, E.** (F) *Sweden* Athletics—Putting the Shot
- Olsson, O.** *Sweden* Swimming—Water Polo
- Olsson, P—O.** *Sweden* Swimming—100 m. Back-stroke, 100 m. Free Style, 4 x 200 m. Relay
- Omedes Calonja, J.** *Spain* Rowing—Single Sculls
- Omiros-Crosfield, P.** *Greece* Athletics—1 10m. Hurdles
- Omnes, G.** *France* Athletics—110 m. Hurdles

## O

XIV OLYMPIAD

- Oncu, E.** *Turkey* Equestrian—Prix des Nations Team, Prix des Nations Individual
- Onel, C.** *Turkey* Athletics—800 m., 3,000 m. Steeplechase, 1,500 m.
- Orabi, I.** *Egypt* Wrestling—Greco-Roman Style, Light-heavyweight
- Orama, N.** *Finland* Yachting—Dragon Class, 6 m. Class
- Orban, K.** *U.S.A.* Hockey
- Ordogh, K.** *Austria* Hockey
- Ormandi, S.** *Hungary* Rowing—Double Sculls
- Ornvoid, D.** *Denmark* Football
- Orozcó, R.** *Uruguay* Modern Pentathlon
- Ortiz, A.** *Uruguay* Modern Pentathlon
- Ortiz, A.** *Argentina* Shooting—300 m. Free Rifle
- Osiier, I.** *Denmark* Fencing—Foil Team, Sabre Individual
- Osmali, M.** *Turkey* Cycling—Road Race
- Osman, A.** *Egypt* Football
- Osman, M.** *Egypt* Wrestling—Greco-Roman Style, Lightweight
- Ossipoff, A.** *Iran* Boxing—Light-heavyweight
- Ostby, K.** *Norway* Canoeing—1,000 m. K.2, 10,000 m. K.2
- Ostermeyer, M.** (F) *France* Athletics—High Jump, Putting the Shot, Discus,
- Ostling, G.** *Sweden* Athletics—Marathon
- Ostrand, P.—O.** *Sweden* Swimming—1,500 m. Free Style, 400 m. Free Style, 4 x 200 m. Relay
- Oswald, A.** *Switzerland* Yachting—Firefly Class
- Otero Vazquez, P. M.** *Cuba* Basketball
- O'Toole, E.** *U.S.A.* Athletics—10,000m.
- Ouvinen, O.** *Finland* Boxing—Bantamweight
- Overgaard, K.** *Denmark* Football
- Overton, W.** *U.S.A.* Athletics—3,000 m. Steeplechase
- Oyen, M.** (F) *Belgium* Swimming—4 X 100 m. Relay
- Ozcan, M.** *Turkey* Athletics—3,000 m. Steeplechase, 5,000 m.
- Ozdemir, A.** *Turkey* Wrestling—Greco-Roman Style, Welterweight
- Ozkaya, N.** *Turkey* Football
- Ozretic, P.** *Yugoslavia* Rowing—Fours without Cox
- Oztas, R.** *Turkey* Athletics—4 x 100 m. Relay, 100 m., 200 m.
- P**
- Packalen, R.** *Finland* Yachting—6 m Class, Dragon Class
- Padou, H.** *France* Swimming—4 x 200 m. Relay, 100 m. Free Style
- Paillard, J.** *France* Equestrian—Dressage Individual, Dressage Team
- Pais, F.** *Portugal* Equestrian—Dressage Individual, Dressage Team, 3 Day Team, 3 Day Individual
- Pak, Dai Chong** *Korea* Football
- Pak, Dong Wook** *Korea* Weightlifting—Bantamweight
- Pak, Kyoo Chung** *Korea* Football
- Pak, Pong Sik** (F) *Korea* Athletics—Discus
- Paladino, J.** *Uruguay* Fencing—Foil Team, Sabre Individual
- Palant, C.** *France* Modern Pentathlon
- Palau, C.** (F) *France* Gymnastics
- Palmeiro, M.** *Argentina* Athletics—1,500 m.
- Palmgren, E.** *Finland* Yachting—Star Class, Firefly Class
- Palmonella, G.** *Italy* Modern Pentathlon
- Palocz, E.** *Hungary* Fencing—Foil Individual, Foil Team
- Palomo Puyol, L.** *Spain* Shooting—25 m. Rapid Pistol, 50 m. Pistol
- Paluch, J.** *France* Football
- Pandolfini, G.** *Italy* Swimming—Water Polo
- Pandolfini, T.** *Italy* Swimming—Water Polo
- Panhorst-Niesink, A.** (F) *Holland* Athletics—Discus, Putting the Shot
- Pankl, W.** *Austria* Weightlifting—Light-heavyweight
- Pao, John Sung-Yuan** *China* Basketball
- Papadopoulos, E.** *Greece* Swimming—Water Polo
- Papastephanou, J.** *Greece* Swimming—Water Polo
- Papp, B.** *Hungary* Fencing—Sabre Team
- Papp, L.** *Hungary* Boxing—Middleweight
- Parab, R.** *India* Football
- Paraskevaidis, F.** *Greece* Rowing—Fours with Cox
- Pare, J.** *Switzerland* Basketball
- Parent, J.** *France* Fencing—Sabre Team
- Parera, A.** *Cuba* Weightlifting—Heavyweight
- Pares, A.** *Argentina* Boxing—Bantamweight
- Parfitt, R.** *Great Britain* Fencing—Epee Individual, Epee Team
- Paris, A.** *France* Athletics—10,000 m.
- Parker, H.** *Great Britain* Wrestling—Free Style, Flyweight
- Parker, J.** *Argentina* Rowing—Pairs with Cox
- Parker, R.** *Australia* Shooting—300 m. Free Rifle
- Parlett, H.** *Great Britain* Athletics—800 m.
- Parmentier, D.** (F) *Belgium* Gymnastics
- Parnell, C.** *Canada* Athletics—800 m., 1,500 m.
- Parra Rojas, E.** *Chile* Basketball
- Parsner, E.** *Denmark* Rowing—Double Sculls
- Parsons, A.** *Great Britain* Wrestling—Free Style, Featherweight
- Parsons, F.** *U.S.A.* Shooting—300 m. Free Rifle
- Parviainen, K.** (F) *Finland* Athletics—Long Jump, Javelin
- Pasche, P.** *Switzerland* Hockey
- Paseiro Rodriguez, R.** *Cuba* Cycling—1,000 m. Time Trial, 1,000 m. Scratch
- Passi, M.** *Argentina* Cycling—2,000 m. Tandem
- Pataki, F.** *Hungary* Gymnastics
- Paterlini, L.** *Italy* Athletics—4 x 400 m. Relay
- Paternoster, H.** *Belgium* Fencing—Foil Individual, Foil Team
- Paterson, A.** *Great Britain* Athletics—High Jump
- Patine, P.** *Peru* Athletics—Putting the Shot
- Patterson, A.** (F) *U.S.A.* Athletics—100 m., 200 m., 4X 100 m. Relay
- Patterson, H.** *U.S.A.* Swimming—100 m. Back-stroke
- Patterson, S.** *Australia* Cycling—4,000 m. Pursuit, 1,000 m. Time Trial
- Patton, M.** *U.S.A.* Athletics—100 m., 200 m., 4x100 m. Relay
- Paul, R.** *Great Britain* Fencing—Foil Individual, Foil Team
- Paulsen, L.** (F) *Norway* Athletics—100 m., Putting the Shot
- Paulson, B.** *Norway* Athletics—High Jump
- Paulus, M.** *Luxembourg* Football
- Pauly, N.** *Luxembourg* Football
- Pavitt, R.** *Great Britain* Athletics—High Jump
- Pavlenec, K.** *Yugoslavia* Rowing—Eights
- Pavlicek, W.** *Austria* Swimming—200 m. Breast-stroke
- Pavlousek, G.** (F) *Austria* Athletics—100 m., 4 x 100 m. Relay, 200 m.
- Pavri, H.** *India* Cycling—Road Race
- Payette, F.** *Canada* Wrestling—Free Style, Light-heavyweight
- Peace, H.** *Canada* Wrestling—Free Style, Welterweight
- Peake, J.** *Great Britain* Hockey
- Pecchenino, L.** *Argentina* Rowing—Eights
- Pech, M.** *Czechoslovakia* Canoeing—1,000 m. K2
- Pechoux, M.** *France* Fencing—Epee Team
- Pecka, J.** *Czechoslovakia* Canoeing—10,000 m. C2
- Pedersen, F.** *Denmark* Rowing—Pairs with Cox
- Pedersen, K.** *Denmark* Cycling—Road Race
- Pedersen, T.** *Norway* Rowing—Eights
- Pedroni, S.** *Italy* Cycling—Road Race
- Peiris, G.** *Ceylon* Athletics—Hop, Step and Jump, Long Jump
- Pelhan, C.** *Yugoslavia* Swimming—4 x 200 m. Relay
- Pelikan, F.** *Austria* Football
- Pellarini, V.** *Italy* Basketball
- Pelling, A.** *Great Britain* Fencing—Epee Individual, Epee Team
- Pellini, G.** *Italy* Fencing—Foil Team
- Pellissard, N.** (F) *France* Swimming—Springboard Diving, High Diving
- Pena y Lillo Nino de Zepeda, P.** *Chile* Shooting—25 m. Rapid Pistol
- Pence, C.** (F) *U.S.A.* Swimming—200 m. Breast-stroke
- Penha e Costa** *Portugal* Fencing—Epee Team
- Peppiatt, E.** *Great Britain* Weightlifting—Middleweight
- Perala, H.** *Finland* Athletics—5,000 m.
- Perego, E.** *Italy* Gymnastics
- Pereira da Silva, A.** *Brazil* Athletics—Hop, Step and Jump
- Pereira da Silva, H.** *Brazil* Athletics—200 m., 100 m., 4 x 100 m. Relay
- Pereira Dias, C.** *Portugal* Fencing—Epee Team
- Pereira Dias Cachulo, A.** *Portugal* Athletics—Long Jump



- Pereira Kliche, E.** *Uruguay* Swimming—Water Polo
- Perera, A.** *Ceylon* Boxing—Bantamweight
- Perew, R.** *U.S.A.* Rowing—Fours without Cox
- Perez Cattaneo, O.** *Argentine* Basketball
- Perez, F.** *Uruguay* Swimming—1,500 m. Free Style, 400 m. Free Style
- Perez Gonzalez, I.** *Spain* Swimming—100 m. Free Style, 400 m. Free Style, 4 x 200 m. Relay
- Perez, P.** *Argentine* Boxing—Flyweight
- Perez Valencia, J.** *Mexico* Wrestling—Free Style, Lightweight
- Perez, W.** *Uruguay* Athletics—100 m., 200 m., 4 x 100 m. Relay
- Pernigo, F.** *Italy* Football
- Perona, R.** *Italy* Cycling—2,000 m. Tandem
- Perone, C.** *Argentine* Cycling—Road Race
- Perrier, J.** *France* Basketball
- Perrissol, H.** *France* Yachting—Swallow Class
- Persillon, R.** *France* Football
- Persson, E.** *Sweden* Wrestling—Free Style, Bantamweight
- Perucconi, E.** *Italy* Athletics—4 x 100 m. Relay
- Peters, J.** *Great Britain* Athletics—10,000 m.
- Peters, P.** *Holland* Cycling—Road Race
- Petersen, B.** *Denmark* Rowing—Eights
- Petersen, E.** (F) *Sweden* Swimming—High Diving
- Petersen, J.** *Denmark* Weightlifting—Lightweight
- Petersen, N.** *Denmark* Weightlifting—Heavyweight
- Petersen, N.** *Denmark* Yachting—Swallow Class
- Petmezias, G.** *Greece* Wrestling—Greco-Roman, Lightweight
- Petracek, V.** *Czechoslovakia* Gymnastics
- Petrakis, S.** *Greece* Athletics—100 m., 200 m., 400 m., 4 X 400 m. Relay
- Petrina, A.** *Czechoslovakia* Boxing—Lightweight
- Petropoulakis, L.** *Greece* Athletics—110 m. Hurdles, 400 m. Hurdles, 4 x 400 m. Relay
- Petrovecki, D.** *Yugoslavia* Rowing—Single Sculls
- Petrovic, M.** *Yugoslavia* Rowing—Eights
- Pettersen, K.** *Sweden* Wrestling—Greco-Roman Style, Bantamweight
- Pettersson, G.** (F) *Sweden* Gymnastics
- Pettersson, G.** *Sweden* Athletics—Javelin
- Pettie, D.** *Canada* Athletics—200 m., 4 x 100 m. Relay
- Peytel, J.** *France* Yachting—Swallow Class, Star Class
- Pezzoni, L.** (F) *Italy* Gymnastics
- Pfenninger, H.** *Switzerland* Cycling—4,000 m. Pursuit
- Phillips, E.** *India* Athletics—100 m.
- Phipps, C.** (F) *Jamaica* Athletics—High Jump
- Piacentini, J.** *Argentine* Yachting—Star Class
- Piaget, G.** *Switzerland* Basketball
- Piccinini, A.** (F) *Italy* Athletics—Putting the Shot
- Pichon, L.** *France* Modern Pentathlon
- Pidduck, L.** *Great Britain* Wrestling—Greco-Roman Style, Heavyweight
- Pieddeloup, J.** *France* Rowing—Fours with Cox
- Piemann, W.** *Austria* Canoeing—1,000 m. K1, 10,000 m. K2
- Pierucci, S.** (F) *Italy* Athletics—Long Jump
- Piessens, B.** *Belgium* Rowing—Double Sculls, Single Sculls
- Piesset, A.** *France* Athletics—Marathon
- Pike, M.** *Great Britain* Athletics—4 x 400 m. Relay
- Pilbrow, A.** *Great Britain* Fencing—Sabre Individual, Sabre Team
- Pilhatsch, A.** *Austria* Athletics—High Jump
- Pilmark, P.** *Denmark* Football
- Pineda Borja, C.** *Mexico* Swimming—1,500 m. Free Style
- Pinheiro Chagas, M.** *Portugal* Fencing—Epee Individual, Epee Team
- Pini, L.** (F) *Brazil* Athletics—200 m., 4 x 100 m. Relay
- Pinto, A. da C.** *Portugal* Fencing—Epee Team, Epee Individual
- Pinto Coelho Bello, F.** *Portugal* Yachting—Swallow Class
- Pinto de Faria, J.** *Brazil* Shooting—50 m. Small Bore Rifle
- Pinto, L.** *India* Hockey
- Pinton, V.** *Italy* Fencing—Sabre Team, Sabre Individual
- Piqueras Sanchez, J.** *Peru* Athletics—Pole Vault
- Pirie, L.** *U.S.A.* Yachting—Swallow Class
- Pirrolley, R.** *France* Swimming—100 m. Back-stroke
- Pistarini, P.** *Argentina* Equestrian—Prix des Nations Team, Prix des Nations Individual
- Pitman, J.** *U.S.A.* Weightlifting—Lightweight
- Pitteloien, I.** (F) *France* Gymnastics
- Pitts, R.** *U.S.A.* Basketball
- Platan, V.** *Finland* Modern Pentathlon
- Platt, C.** *Australia* Shooting—50 m. Small Bore Rifle
- Plattner, W.** *Austria* Fencing—Sabre Team, Sabre Individual
- Pletts, M.** (F) *Great Britain* Athletics—4 x 100 m. Relay
- Ploger, J.** *Denmark* Football
- Plumb, G.** *Canada* Wrestling—Free Style, Lightweight
- Pocovi, A.** *Argentina* Athletics—400 m., 4 x 400 m. Relay,
- Podhajsky, A.** *Austria* Equestrian—Dressage Individual
- Poggi Cebrero, L.** *Peru* Cycling—Road Race
- Poggi, E.** *Italy* Yachting—6 m. Class
- Poggi, L.** *Italy* Yachting—6 m. Class
- Pohnetal, J.** *Austria* Cycling—Road Race, 4,000 m. Pursuit Team
- Pollet, J.** *Switzerland* Basketball
- Polloni, R.** *Italy* Rowing—Fours with Cox
- Pomini, E.** *Argentina* Fencing—Sabre Individual, Sabre Team
- Pool, W.** *Holland* Canoeing—1,000 m. K2
- Pope, M.** *Great Britain* Athletics—400 m. Hurdles
- Poppe, G.** *Belgium* Basketball
- Porcel de Peralta, R.** *Argentina* Rowing—Pairs with Cox
- Poredski, M.** *Yugoslavia* Cycling—Road Race
- Porteiro, G.** *Uruguay* Boxing—Flyweight
- Porter, W.** *U.S.A.* Athletics—110 m. Hurdles
- Porthault, A.** *France* Athletics—4 x 100 m. Relay
- Porto, E.** *Philippines* Boxing—Lightweight
- Porubszky, E.** *Hungary* Weightlifting—Bantamweight
- Post, K.** (F) *Holland* Gymnastics
- Potamianos, C.** *Greece* Yachting—Star Class
- Potter, R.** *Great Britain* Swimming—Water Polo
- Pouliot, G.** *Canada* Fencing—Epee Individual, Foil Individual, Epee Team, Foil Team, Sabre Team
- Poulsen, A.** *Denmark* Athletics—5,000 m.
- Poulton, H.** *Canada* Canoeing—1,000 m. C2
- Pouzieux, M.** *France* Athletics—5,000 m.
- Poyan Diaz, D.** *Spain* Athletics—1,500 m.
- Praest, C.** *Denmark* Football
- Pranz, R.** *Austria* Gymnastics
- Prasad, M.** *India* Football
- Pratmarso Parera, L.** *Spain* Hockey
- Preece, L.** (F) *Great Britain* Swimming—100 m. Free Style, 4 X 100 m. Relay
- Premoli, L.** *Argentina* Modern Pentathlon
- Presca, C.** *Italy* Football
- Pretti, F.** *Italy* Athletics—50,000 m. Walk
- Price, L.** *Great Britain* Basketball
- Prihoda, M.** *Czechoslovakia* Boxing—Middleweight
- Primo, G.** *Italy* Basketball
- Proffitt, T.** *Great Britain* Boxing—Bantamweight
- Prokop, A.** *U.S.A.* Fencing—Foil Team
- Prono, H.** *Argentina* Swimming—Water Polo
- Prosenik, A.** *Yugoslavia* Cycling—Road Race
- Provtopoulos, D.** *Greece* Swimming—Water Polo
- Pucci, R.** *Italy* Cycling—4,000 m. Pursuit
- Pugh, D.** *Great Britain* Athletics—400 m., 4x400 m. Relay
- Pugh, L.** *Canada* Cycling—Road Race, 4,000 m. Pursuit Team
- Puhar, I.** *Yugoslavia* Swimming—400 m. Free Style, 1,500 m. Free Style, 4 x 200 m. Relay
- Puig Miyar, M.** *Cuba* Rowing—Fours with Cox
- Puig Miyar, R.** *Cuba* Rowing—Fours with Cox
- Pujazon, R.** *France* Athletics—3,000 m. Steeplechase
- Pujol Coma, J.** *Spain* Swimming—Water Polo
- Purchase, R.** *U.S.A.* Rowing—Eights
- Purrsell, A.** *Great Britain* Rowing—Fours with Cox
- Putz, E.** *Luxembourg* Fencing—Epee Team
- Putzl, H.** *Austria* Fencing—Sabre Team, Sabre Individual

## Q

- Quenin, Y.** *France* Basketball
- Quentemeyer, H.** *Holland* Boxing—Light-heavyweight

**Quinn, T.** *Argentina* Hockey  
**Quintero Nava, F.** *Mexico* Football  
**Quintero Padron, M.** *Cuba* Basketball  
**Quiroz Galvez, A.** *Mexico* Modern Pentathlon  
**Quitcon, I.** *Puerto Rico* Boxing—Light-heavyweight

## R

**Racca, M.** *Italy* Fencing—Sabre Team  
**Racic, M.** *Yugoslavia* Athletics—400 m., 4 x 400 m. Relay  
**Rademacher, O.** *Czechoslovakia* Boxing—Light-heavyweight  
**Radi, A.** *Italy* Rowing—Pairs with Cox  
**Radosavljevic, M.** (F) *Yugoslavia* Athletics—Putting the Shot  
**Radoux, J.** *Belgium* Fencing—Epee Team, Epee Individual  
**Rafatjah, H.** *Iran* Basketball  
**Raffo Abarca, H.** *Chile* Basketball  
**Ragazos, A.** *Greece* Athletics—Marathon  
**Ragno, S.** *Italy* Fencing—Foil Team  
**Rahimiha, M.** *Iran* Boxing—Lightweight  
**Raissi, M.** *Iran* Wrestling—Free Style, Flyweight  
**Raissi, S.** *Iran* Weightlifting—Light-heavyweight  
**Raitio, H.** *Finland* Fencing—Foil Individual, Foil Team  
**Rajcsanyi, L.** *Hungary* Fencing—Sabre Team  
**Rajput, J.** *India* Hockey  
**Raman, S.** *India* Football  
**Ramirez, A.** *Argentina* Wrestling—Greco-Roman Style, Light-heavyweight  
**Ramirez Valero, E.** *Chile* Cycling—Road Race  
**Ramjohn, M.** *Trinidad* Athletics—5,000 m., 10,000 m.  
**Ramos Ramos, B.** *Mexico* Fencing—Epee Team, Sabre Team, Sabre Individual  
**Ramsay, E.** *South Africa* Rowing—Fours without Cox  
**Ramsay, J.** *Australia* Athletics—400 m., 800 m.  
**Ramstad, I.** *Norway* Athletics—Discus  
**Ramzy, I.** *Egypt* Swimming—Springboard Diving  
**Rangandham, F.** *India* Hockey  
**Ranuzzi, R.** *Italy* Basketball  
**Rapesta, E.** *Argentina* Gymnastics  
**Rapini, L.** *Italy* Basketball  
**Rasmussen, F.** *Denmark* Canoeing—10,000 m. K2  
**Rasmussen, N.** *Denmark* Rowing—Eights  
**Rasmussen, R.** *Denmark* Cycling—Road Race  
**Rassaeli, G.** *Iran* Boxing—Flyweight  
**Rathje, J.** *Denmark* Yachting—Swallow Class  
**Raule, F.** *Austria* Hockey  
**Rautavaara, K.** *Finland* Athletics—Javelin  
**Rautio, K.** *Finland* Athletics—Hop, Step and Jump  
**Ravarino, M.** *Monaco* Shooting—50 m. Small Bore Rifle  
**Ravila, J.** *Finland* Shooting—50 m. Small Bore Rifle  
**Ravilo, L.** *Finland* Shooting—25 m. Rapid Pistol  
**Rawlings, J.** *Great Britain* Football  
**Raymackers, A.** *Belgium* Wrestling—Free Style Featherweight  
**Raymond, G.** *India* Boxing—Featherweight, Lightweight  
**Razzak, M.** *Pakistan* Hockey  
**Reardon, J.** *Eire* Athletics—4 x 400 m. Relay, 400 m.  
**Reavell Carter, L.** *Great Britain* Athletics—Discus  
**Rebello, H.** *India* Athletics—Hop, Step and Jump  
**Rebula, O.** *Yugoslavia* Athletics—Decathlon  
**Recordon Burnier, M.** *Chile* Athletics—Decathlon, 110 m. Hurdles  
**Reddin, D.** *Eire* Basketball  
**Reed, E.** (F) *U.S.A.* Athletics—High Jump, Long Jump  
**Reggio, G.** *Italy* Yachting—6 m. Class  
**Rehman, L.** *India* Hockey  
**Reichling, R.** *Switzerland* Rowing—Fours with Cox  
**Reid, B.** (F) *Great Britain* Athletics—Discus, Putting the Shot  
**Reiff, G.** *Belgium* Athletics—5,000 m.  
**Reiner, F.** *Switzerland* Canoeing—1,000 m. K2  
**Reiser, W.** *Switzerland* Cycling—Road Race  
**Reis Ferraz, V.** *Brazil* Yachting—Swallow Class  
**Reis Goncho Sallaty, H.** *Portugal* Yachting—Dragon Class  
**Reitz, C.** *South Africa* Wrestling—Free Style, Middleweight  
**Remie, J.** *Holland* Boxing—Lightweight  
**Renard, M.** (F) *Belgium* Athletics—100 m., 200 m.  
**Rendin, B.** *Sweden* Athletics—110 m. Hurdles  
**Renick, J.** *U.S.A.* Basketball  
**Rennard, A.** (F) *Great Britain* Gymnastics  
**Renwick, Jr., J.** *U.S.A.* Hockey  
**Rerrich, B.** *Hungary* Fencing—Epee Team  
**Resko, V.** *Finland* Boxing—Middleweight  
**Reusch, M.** *Switzerland* Gymnastics  
**Rey Carcano, R.** *Cuba* Gymnastics  
**Reyes Anchante, M.** *Peru* Athletics—100 m., Hop, Step and Jump  
**Reynaud, P.** *France* Hockey  
**Reynders, J.** *Belgium* Swimming—1,500 m. Free Style  
**Reyneke, J.** *South Africa* Athletics—10,000 m. Walk  
**Reynolds, F.** *Great Britain* Hockey  
**Rhoden, V.** *Jamaica* Athletics—100 m., 400 m., 4 x 400 m. Relay  
**Rhyner, B.** *Switzerland* Shooting—50 m. Pistol  
**Rhyner, R.** *Switzerland* Yachting—Star Class  
**Richards, J.** (F) *Great Britain* Canoeing—500 m. K1  
**Richards, R.** *U.S.A.* Athletics—Pole Vault  
**Richards, T.** *Great Britain* Athletics—Marathon  
**Richardson, G.** *Great Britain* Rowing—Eights  
**Richardson, W.** *Eire* Football  
**Richez, R.** *France* Canoeing—1,000 m. K2  
**Richmond, K.** *Great Britain* Wrestling—Greco-Roman Style, Light-heavyweight  
**Richter, A.** *Austria* Weightlifting—Featherweight  
**Richter, A.** *Holland* Hockey  
**Richter, W.** *Brazil* Yachting—Firefly Class  
**Ricketts, D.** *Great Britain* Cycling—4,000 m. Pursuit Team  
**Riedal, E.** *U.S.A.* Canoeing—10,000 m. K1  
**Riedel, K.** *Austria* Rowing—Fours with Cox  
**Rieder, H.** (F) *Switzerland* Fencing—Foil Individual  
**Rieder, R.** *Switzerland* Weightlifting—Featherweight  
**Riem, B.** *Switzerland* Modern Pentathlon  
**Riera Caballer, J.** *Spain* Modern Pentathlon  
**Ries, A.** *South Africa* Wrestling—Free Style, Lightweight  
**Rigamonti, L.** *Italy* Wrestling—Greco-Roman Style, Welterweight  
**Rigaumont, P.** *Belgium* Swimming—Water Polo  
**Riise, E.** (F) *Denmark* Swimming—4 x 100 m. Relay  
**Rijks, J.** *Holland* Equestrian—Prix des Nations Team, Prix des Nations Individual  
**Rijvers, C.** *Holland* Football  
**Rinkinen, Tauno** *Finland* Boxing—Lightweight  
**Rinman, S. K.** *Sweden* Yachting—Star Class  
**Rintanen, J.** *Finland* Shooting—25 m. Rapid Pistol  
**Rios Pena, E.** *Mexico* Gymnastics  
**Rippstein, J.** *Switzerland* Hockey  
**Ris, W.** *U.S.A.* Swimming—100 m. Free Style, 4 X 200 m. Relay  
**Rissanen, T.** *Finland* Equestrian—Prix des Nations Team, Prix des Nations Individual  
**Risso, E.** *Uruguay* Rowing—Single Sculls  
**Rist, W.** *Switzerland* Swimming—High Diving  
**Ristic, V.** *Yugoslavia* Rowing—Pairs with Cox  
**Rivademar, R.** *Argentina* Yachting—6 m. Class  
**Rivera Saenz, S.** *Peru* Boxing—Bantamweight  
**Rivers, W.** *South Africa* Cycling—Road Race  
**Robb, D.** (F) *South Africa* Athletics—100 m., 200 m.  
**Robert, G.** *France* Football  
**Roberts, W.** *Great Britain* Athletics—400 m., 4 X 400 m. Relay  
**Robertson, J.** *Canada* Yachting—Swallow Class  
**Robertson, W.** *Canada* Rowing—Eights  
**Robinson, C.** (F) *U.S.A.* Athletics—80 m. Hurdles, High Jump  
**Robinson, R.** *U.S.A.* Basketball  
**Robison, C. F.** *U.S.A.* Athletics—5,000 m.  
**Robuffic, L.** *France* Basketball  
**Rocca, G.** *Italy* Athletics—4 x 400 m. Relay  
**Rocca, L.** *Uruguay* Cycling—1,000 m. Scratch  
**Rocco de Paula Simoes, E.** *Brazil* Yachting—Star Class  
**Rocco de Paula Simoes, M.** *Brazil* Yachting—Star Class

- Roche, J.** *Switzerland* Hockey  
**Rode, N.** *Italy* Yachting—Star Class  
**Rodrigues de Morais, J.** *Portugal* Athletics—200 m., 100 m.  
**Rodrigues, G.** *Brazil* Basketball  
**Rodrigues, R.** *India* Hockey  
**Rodrigues Silva, G.** *Mexico* Athletics—100 m., 200 m.  
**Rodrigues Silva, J.** *Portugal* Shooting—50 m. Small Bore Rifle  
**Rodrigues, T. (F)** *Brazil* Swimming—4 x 100 m. Relay  
**Rodrigues Vieira, J.** *Portugal* Athletics—Hop, Step and Jump  
**Rodriguez de la Torre, R.** *Argentina* Yachting—6 m. Class  
**Rodriguez Feo, C.** *Cuba* Shooting—25 m. Rapid Pistol  
**Rodriguez, J. A.** *Uruguay* Rowing—Double Sculls  
**Rodriguez, J. M.** *Argentina* Fencing—Foil Team  
**Rodriguez Ledezma, F.** *Mexico* Cycling—Road Race  
**Rodriguez Mireles, J.** *Mexico* Shooting—300 m. Free Rifle  
**Rodriguez Novarro, J.** *Mexico* Football  
**Rodriguez Peralta, J. L.** *Mexico* Football  
**Rodriguez Rodea, G.** *Mexico* Cycling—Road Race  
**Roe, E.** *Great Britain* Weightlifting—Light-heavyweight  
**Roeberg, W.** *Norway* Shooting—50 m. Small Bore Rifle, 300 m. Free Rifle  
**Roettinger, P.** *U.S.A.* Shooting—25 m. Rapid Pistol  
**Roetzhelm, W.** *U.S.A.* Gymnastics  
**Rogenmoser Lourenco, C.** *Portugal* Yachting—Dragon Class  
**Roger, J.** *Argentina* Shooting—25 m. Rapid Pistol  
**Rogers, E.** *U.S.A.* Swimming—4 x 200 m. Relay  
**Rohner, J.** *Holland* Swimming—Water Polo  
**Roiha, M.** *Finland* Equestrian—3 Day Team, 3 Day Individual  
**Roininen, L.** *Canada* Athletics—Javelin  
**Rojas Herrera, F.** *Mexico* Basketball  
**Rojas Herrera, J.** *Mexico* Basketball  
**Rojo Sagredo, G.** *Spain* Athletics—10,000 m., 5,000 m.  
**Roller, L.** *Luxembourg* Boxing—Welterweight  
**Rollins, K.** *U.S.A.* Basketball  
**Rollins, W.** *U.S.A.* Cycling—Road Race  
**Romain, R.** *Great Britain* Swimming—200 m. Breast-stroke  
**Romanutti, R.** *Italy* Basketball  
**Rombaut, F.** *Belgium* Wrestling—Greco-Roman Style, Lightweight  
**Romero Quinones, R.** *Mexico* Cycling—1,000 m. Scratch, 1,000 m. Time Trial  
**Rommel, A.** *France* Fencing—Foil Team  
**Romo Porchas, I.** *Mexico* Basketball  
**Roncoroni, A.** *Italy* Yachting—Swallow Class  
**Roosenburg, A.** *Holland* Football  
**Roosevelt, J.** *U.S.A.* Yachting—Dragon Class  
**Roos-Lodder, P. (F)** *Holland* Athletics—Discus  
**Roque, C.** *Portugal* Rowing—Eights  
**Roque da Benta, C.** *Portugal* Rowing—Eights  
**Ros, J. (F)** *Holland* Gymnastics  
**Rosa, J.** *Belgium* Rowing—Pairs without Cox  
**Rosado, L.** *Argentina* Wrestling—Greco-Roman Style, Lightweight  
**Rosano, A.** *Uruguay* Boxing—Welterweight  
**Rosario, R.** *Philippines* Weightlifting—Featherweight  
**Rosas Ruiz, M.** *Colombia* Athletics—400 m., 400 m. Hurdles  
**Rosen, K.** *Sweden* Football  
**Rosengren, B.** *Sweden* Football  
**Rosier, R.** *Belgium* Athletics—800 m.  
**Ross, H.** *U.S.A.* Athletics—3,000 m. Steeplechase  
**Rossello, C.** *Uruguay* Basketball  
**Rossi, G.** *Switzerland* Cycling—Road Race  
**Rossi Stajano, D.** *Uruguay* Fencing—Foil Individual, Foil Team  
**Rostagno, J.** *Argentina* Shooting—50 m. Pistol  
**Roth, J.** *Switzerland* Cycling—1,000 m. Time Trial, 1,000 m. Scratch, 2,000 m. Tandem  
**Rothley, P.** *France* Rowing—Pairs without Cox  
**Roubik, V.** *Czechoslovakia* Rowing—Fours without Cox  
**Roude, J.** *France* Boxing—Light-heavyweight  
**Rouelle, C.** *France* Football  
**Rouffeteau, R.** *France* Cycling—Road Race  
**Rouget, J.** *France* Hockey  
**Rouland, E.** *France* Shooting—300 m. Free Rifle  
**Roushdi, M.** *Egypt* Gymnastics  
**Rouxel, G.** *France* Football  
**Rove, O.** *Finland* Gymnastics  
**Rowe, A.** *Great Britain* Rowing—Single Sculls  
**Roy, K.** *India* Wrestling—Free Style, Middleweight  
**Royes Bohigas, M.** *Spain* Hockey  
**Ruas, S. (F)** *France* Athletics—High Jump  
**Ruben, I.** *Denmark* Fencing—Foil Team, Sabre Individual, Foil Individual  
**Ruberti, E.** *Italy* Rowing—Eights  
**Rubiera Fernandez, B.** *Cuba* Gymnastics  
**Rubini, C.** *Italy* Swimming—Water Polo  
**Rubini, R.** *Switzerland* Weightlifting—Middleweight  
**Rubio Fernandez, J.** *Spain* Boxing—Heavyweight  
**Rubli, J.** *Switzerland* Fencing—Foil Team, Foil Individual  
**Ruckert, F.** *Austria* Hockey  
**Ruckser, I. (F)** *Austria* Gymnastics  
**Ruckstuhl, A.** *Switzerland* Fencing—Sabre Individual, Sabre Team  
**Rueda Garcia, R.** *Mexico* Weightlifting—Middleweight  
**Rufenacht, O.** *Switzerland* Fencing—Epee Team  
**Ruffa, A.** *Argentina* Basketball  
**Ruimschotel, A.** *Holland* Swimming—Water Polo  
**Ruiz Aguilar, J.** *Mexico* Football  
**Ruiz Gijon, R.** *Spain* Hockey  
**Ruiz, H.** *Uruguay* Basketball  
**Ruiz Tagle Vicuna, L.** *Chile* Shooting—50 m. Pistol  
**Ruiz Velasquez, E. (F)** *Mexico* Fencing—Foil Individual  
**Ruiz Vinajeras, F.** *Cuba* Basketball  
**Runge, J.** *Denmark* Weightlifting—Featherweight  
**Rushmere, H.** *Great Britain* Rowing—Fours Without Cox  
**Russell, J.** *U.S.A.* Equestrian—Prix des Nations Team, Prix des Nations Individual  
**Russell, K. (F)** *Jamaica* Athletics—100 m., 200 m., Long Jump  
**Russo, J.** *Argentina* Weightlifting—Middleweight  
**Ruzicka, J.** *Czechoslovakia* Wrestling—Free Style, Greco-Roman Style, Heavyweight  
**Ruzicka, Z.** *Czechoslovakia* Gymnastics  
**Ruzickova, V. (F)** *Czechoslovakia* Gymnastics  
**Rydstrom, N.** *Sweden* Fencing—Foil Individual

## S

- Saarnikko, E.** *Finland* Shooting—50 m. Pistol  
**Saarvala, A.** *Finland* Gymnastics  
**Sabata Figa, A.** *Spain* Swimming—Water Polo  
**Sabate Mas, V.** *Spain* Swimming—Water Polo  
**Sabater, J.** *Puerto Rico* Athletics—110 m. Hurdles  
**Sabolovic, Z.** *Yugoslavia* Athletics—400 m., 4 x 400 m. Relay  
**Sadat, M.** *Afghanistan* Football  
**Sadeghi, F.** *Iran* Basketball  
**Sadian, H.** *Iran* Wrestling—Free Style, Featherweight  
**Saetter-Lassen, E.** *Denmark* Shooting—50 m. Small Bore Rifle  
**Saeyns, N. (F)** *Belgium* Athletics—Javelin  
**Saez, C.** *Uruguay* Yachting—Swallow Class  
**Sagasta, J.** *Argentina* Equestrian—3 Day Team, 3 Day Individual  
**Sagasta, J. M.** *Argentina* Equestrian—3 Days Team, 3 Days Individual  
**Said, H.** *Egypt* Swimming—Water Polo  
**Saimassi, J.** *Iran* Weightlifting—Featherweight  
**Saimo, S. (F)** *Finland* Canoeing—500 m. K.1  
**Sainz Ortueta, E.** *Spain* Hockey  
**Sakata, H.** *U.S.A.* Weightlifting—Light-heavyweight  
**Sakhal, M.** *Iran* Shooting—50 m. Small Bore Rifle, 300 m. Free Rifle  
**Sakhdari, A.** *Iran* Wrestling—Free Style, Heavyweight  
**Sakr, A.** *Egypt* Football  
**Salah Jaque, J.** *Chile* Swimming—Water Polo  
**Salah Jaque, T.** *Chile* Swimming—Water Polo  
**Salam, S.** *Lebanon* Shooting—50 m. Small Bore Rifle  
**Salas Chaves, J.** *Argentina* Yachting—Dragon Class  
**Salas Crespo, R.** *Peru* Basketball  
**Salas Maravilla, M.** *Mexico* Weightlifting—Bantamweight  
**Salata, D.** *Italy* Yachting—Swallow Class  
**Salcedo Munoz, R.** *Chile* Cycling—Road Race

- Saleem, S.** *Pakistan* Hockey  
**Saleh, F.** *Iraq* Basketball  
**Saleh, M.** *Egypt* Weightlifting—Light-heavyweight  
**Salen, G.** *Sweden* Yachting—6 m. Class  
**Salgado Gandara, W.** *Peru* Shooting—50 m. Pistol  
**Salmain, M.** *Iraq* Basketball  
**Salman, D.** *Iraq* Basketball, Athletics—100 m., 200 m.  
**Salmhofer, V.** *Austria* Canoeing—10,000 m. C.2, 1,000 m. C.2  
**Salmi, S.** *Finland* Gymnastics  
**Salmon, P.** *Canada* Swimming—100 m. Free Style, 200 m. Breast-stroke, 4 x 200 m. Relay  
**Salmond, C.** *Canada* Athletics—5,000 m., 1,500 m.  
**Salomons, P.** *Holland* Swimming—Water Polo  
**Salvador Paquete, T.** *Portugal* Athletics—100 m., 200 m.  
**Sambuceti, C.** *Argentina* Rowing—Pairs without Cox  
**Sanchez Avila, I.** *Cuba* Wrestling—Free Style, Lightweight  
**Sanchez Carmona, M.** *Chile* Basketball  
**Sanchez Huerta, M.** *Mexico* Football  
**Sanchez Maquiavelo, L.** *Peru* Basketball  
**Sanchez, V.** *Argentina* Hockey  
**Sandahl, I. (F)** *Sweden* Gymnastics  
**Sandaker, T.** *Norway* Rowing—Fours with Cox  
**Sandborg, G.** *Norway* Rowing—Fours with Cox  
**Sande, D.** *Argentina* Fencing—Sabre Team  
**Sandor, M. (F)** *Hungary* Gymnastics  
**Sandulo, O.** *Canada* Boxing—Flyweight  
**Sannes, O.** *Norway* Shooting—300 m. Free Rifle  
**Santamaria Sotomayer, P.** *Cuba* Wrestling—Free Style, Bantamweight  
**Santa Maria Vives, O.** *Cuba* Shooting—50 m. Small Bore Rifle  
**Santha, L.** *Hungary* Gymnastics  
**Santoni, E. (F)** *Italy* Gymnastics  
**Santos, A. J. dos.** *Brazil* Shooting—50 m. Pistol, 25 m. Rapid Pistol  
**Santos da Benta, R.** *Portugal* Rowing—Eights  
**Santos de Leon, J.** *Mexico* Basketball  
**Sarby, E.** *Sweden* Yachting—Firefly Class  
**Sarialp, R.** *Turkey* Athletics—Hop, Step and Jump, 4 X 100 m. Relay  
**Saric, P.** *Yugoslavia* Rowing—Pairs with Cox, Eights  
**Sarkany, A. (F)** *Hungary* Gymnastics  
**Sarkari, P.** *India* Cycling—4,000 m. Pursuit  
**Sarría Goicochea, J.** *Peru* Fencing—Sabre Individual  
**Sartor, Ampelio** *France* Rowing—Pairs with Cox  
**Sartor, Aristide** *France* Rowing—Pairs with Cox  
**Sartori, I.** *Argentina* Rowing—Pairs with Cox, Fours with Cox  
**Saucedo, R.** *Argentina* Fencing—Epee Team, Epee Individual  
**Sauer, H.** *Austria* Equestrian—3 Day Individual  
**Sauer, T.** *Switzerland* Swimming—Water Polo  
**Sauter, J.** *Austria* Gymnastics  
**Sauvestre, P.** *France* Rowing—Eights  
**Savoie, A.** *Canada* Boxing—Featherweight  
**Savolainen, H.** *Finland* Gymnastics  
**Saw, H.** *Burma* Boxing—Bantamweight  
**Saygin, H.** *Turkey* Football  
**Scally, L.** *Argentina* Hockey  
**Scally, T.** *Argentina* Hockey  
**Scarr, R.** *Canada* Basketball  
**Schachinger, H.** *Austria* Yachting—Star Class  
**Schaffer, P. (F)** *Austria* Athletics—Putting the Shot  
**Schala, E.** *Austria* Hockey  
**Schammel, F.** *Luxembourg* Football  
**Schandorff, A.** *Denmark* Cycling—1,000 m. Time Trial, 1,000 m. Scratch  
**Scheer, P.** *Luxembourg* Cycling—Road Race  
**Schejbal, J.** *Czechoslovakia* Rowing—Fours without Cox  
**Schemansky, N.** *U.S.A.* Weightlifting—Heavyweight  
**Schenk, J.** *Switzerland* Cycling—Road Race  
**Scheurer, A.** *Switzerland* Athletics—Decathlon  
**Schewetta, F.** *France* Athletics—400 m., 4 x 400 m. Relay  
**Schiaffino, D.** *Argentina* Shooting—50 m. Small Bore Rifle  
**Schiebel, H.** *Austria* Cycling—4,000 m. Pursuit Team.  
**Schiesser, K.** *Switzerland* Athletics—Marathon  
**Schifano, H. (F)** *U.S.A.* Gymnastics  
**Schijvenaer, H.** *Holland* Football  
**Schilling, G. (F)** *Austria* Athletics—Javelin  
**Schiottz, E.** *Denmark* Yachting—6 m. Class  
**Schlaepfer, G.** *Switzerland* Fencing—Foil Individual, Foil Team  
**Schlager, M. (F)** *Austria* Athletics—Putting the Shot, Discus  
**Schlee, A.** *Switzerland* Hockey  
**Sch lindwein, A.** *France* Gymnastics  
**Schmid, W.** *Switzerland* Modern Pentathlon  
**Schmidiger, E.** *Switzerland* Boxing—Lightweight  
**Schmidt, J.** *Austria* Wrestling—Greco-Roman Style, Welterweight  
**Schmitt, E. M. J. (F)** *Brazil* Swimming—100 m. Free Style, 4 x 100 m. Relay  
**Schmitz, P.** *Luxembourg* Gymnastics  
**Schneider, H.** *Switzerland* Boxing—Middleweight  
**Schneider, W.** *Switzerland* Swimming—100 m. Free Style, 400 m. Free Style  
**Schnoor, B.** *Denmark* Cycling—4,000 m. Pursuit  
**Schnyder, R.** *Switzerland* Shooting—25 m. Rapid Pistol, 50 m. Pistol  
**Scholten, G.** *Holland* Athletics—200 m., 4 x 100 m. Relay  
**Schoonman, G.** *Holland* Shooting—50 m. Small Bore Rifle  
**Schouten, J.** *Holland* Wrestling—Greco-Roman Style, Welterweight  
**Schramm, E. (F)** *Austria* Gymnastics  
**Schreyer, W.** *Austria* Gymnastics  
**Schriever, E.** *Switzerland* Rowing—Fours with Cox  
**Schroder, H.** *Denmark* Rowing—Fours without Cox  
**Schroeder, R.** *Luxembourg* Gymnastics  
**Schroth, C. (F)** *U.S.A.* Gymnastics  
**Schubart, J.** *Holland* Boxing—Middleweight  
**Schuh, K.** *Austria* Weightlifting—Middleweight  
**Schultheiss, F.** *Switzerland* Rowing—Eights  
**Schultheiss, H.** *Switzerland* Rowing—Eights  
**Schultz, H.** *Monaco* Shooting—50 m. Pistol  
**Schumacher, I. (F)** *Holland* Swimming—100 m. Free Style, 4 x 100 m. Relay  
**Schumacher, J. (F)** *Belgium* Gymnastics  
**Schwab, F.** *Switzerland* Athletics—10,000 m. Walk  
**Schwerzmann, H.** *Switzerland* Boxing—Light-heavyweight  
**Schwindt, E. (F)** *Belgium* Fencing—Foil Individual  
**Schwingl, F. (F)** *Austria* Canoeing—500 m. K1  
**Scianamea, S. O.** *Brazil* Fencing—Foil Individual, Epee Team  
**Scott, C. L.** *U.S.A.* Athletics—110 m. Hurdles  
**Scott, C. S. I.** *Great Britain* Cycling—Road Race  
**Scott, D.** *Great Britain* Boxing—Light-heavyweight  
**Scott, M.** *Great Britain* Rowing—Pairs with Cox  
**Scrobe, E.** *U.S.A.* Gymnastics  
**Seal, G.** *India* Swimming—Water Polo  
**Secreve, A. (F)** *Holland* Fencing—Foil Individual  
**Sedki, F.** *Egypt* Football  
**Seebach, H.** *Denmark* Football  
**Segedin, P.** *Yugoslavia* Athletics—3,000 m. Steeplechase  
**Seger, J.** *Liechtenstein* Athletics—Decathlon  
**Seixo, J.** *Portugal* Rowing—Fours with Cox  
**Selfelt, J.** *Sweden* Equestrian—3 Day Individual, 3 Day Team  
**Semino, C.** *Argentina* Rowing—Fours with Cox  
**Senn, W.** *Switzerland* Athletics—Putting the Shot  
**Senol, A.** *Turkey* Wrestling—Greco-Roman Style, Lightweight  
**Sensini, A.** *Argentina* Athletics—Marathon  
**Sepheriades, J.** *France* Rowing—Single Sculls  
**Sepponen, P.** *Finland* Wrestling—Free Style Middleweight  
**Serck-Hansen, A.** *Norway* Rowing—Fours with Cox  
**Serodio, A.** *Portugal* Equestrian—3 Day Individual, 3 Day Team  
**Serra Liobet, J.** *Spain* Swimming—Water Polo  
**Service, J.** *Great Britain* Swimming—200 m. Breast-stroke  
**Sessa, P.** *Italy* Rowing—Eights  
**Sevillano, M.** *Argentina* Cycling—Road Race  
**Seymour, S.** *U.S.A.* Athletics—Javelin  
**Sezen, M.** *Turkey* Fencing—Sabre Team, Sabre Individual  
**Shacklady, M.** *Great Britain* Boxing—Welterweight  
**Shademan, Z.** *Iran* Basketball  
**Shah, I.** *Pakistan* Swimming—200 m. Breast-stroke, 4 X 200 m. Relay

- Shah, J.** *Pakistan* Swimming—100 m. Back-stroke, 4 x 200 m. Relay
- Shah, K.** *India* Swimming—100 m. Back-stroke
- Shahzada, S.** *Pakistan* Hockey
- Shaikh, M.** *Pakistan* Hockey
- Shaikh, R.** *Pakistan* Hockey
- Shams, I.** *Egypt* Weightlifting—Lightweight
- Shanks, D.** *Bermuda* Swimming—100 m. Back-stroke
- Sharaga, F.** *U.S.A.* Athletics—10,000 m. Walk
- Shepherd, D.** *South Africa* Boxing—Featherweight
- Shepherd, J. (F)** *Great Britain* Athletics—Long Jump
- Sheriff, D.** *Eire* Basketball
- Sheriff, P.** *Eire* Basketball
- Shim, B.** *Korea* Athletics—5,000 m.
- Shore, D.** *South Africa* Athletics—200 m., 400 m.
- Shourbagi, Z.** *Syria* Swimming—High Diving
- Siburu, H.** *Argentina* Modern Pentathlon
- Sicnerova, O. (F)** *Czechoslovakia* Athletics—100 m., 200 m.
- Sidani, A.** *Lebanon* Wrestling—Greco-Roman Style, Flyweight
- Siddi, A.** *Italy* Athletics—4 x 400 m. Relay
- Sieburger, E.** *Argentina* Yachting—6 m. Class
- Sieburger, E. A.** *Argentina* Yachting—6 m. Class
- Sieburger, J.** *Argentina* Yachting—6 m. Class
- Sieburger, R.** *Argentina* Yachting—Dragon Class
- Siegel, J.** *Czechoslovakia* Basketball
- Siegrist, E.** *Switzerland* Hockey
- Sienra Castellanos, F.** *Uruguay* Yachting—Swallow Class, Firefly Class
- Sigurdsson, J.** *Iceland* Athletics—Javelin
- Sigurdsson, R.** *Iceland* Athletics—400 m.
- Sigurosson, S.** *Iceland* Athletics—Putting the Shot
- Silburn, K. (F)** *Canada* Athletics—Long Jump, High Jump
- Silhanova, O. (F)** *Czechoslovakia* Gymnastics
- Siljander, H.** *Finland* Boxing—Light-heavyweight
- Sillon, V.** *France* Athletics—Pole Vault
- Siltaloppi, P.** *Finland* Athletics—3,000 m. Steeplechase
- Silva Anguita, C.** *Chile* Athletics—100 m., 4 x 400 m. Relay
- Silva, J.** *Argentina* Shooting—50 m. Small Bore Rifle
- Silva Rocha, A.** *Brazil* Equestrian—3 Day Team, 3 Day Individual
- Silva Tavares, P. (F)** *Brazil* Swimming—4 x 100 m. Relay, 100 m. Free Style, 400 m. Free Style
- Silverio Ferrer, N.** *Cuba* Swimming—100 m. Free Style
- Silvestri, U.** *Italy* Wrestling—Greco-Roman Style, Light-heavyweight
- Simao, R.** *Brazil* Shooting—25 m. Rapid Pistol
- Sime, G.** *Great Britain* Hockey
- Simmons, A.** *Great Britain* Canoeing—1,000 m. K2
- Simmons, F. M.** *U.S.A.* Athletics—Decathlon
- Simo, J.** *Hungary* Rowing—Double Sculls
- Simoes Nato, A.** *Portugal* Rowing—Eights
- Simonetti, V.** *Argentina* Fencing—Epee Team, Epee Individual
- Simonis, A. (F)** *U.S.A.* Gymnastics
- Simons, W.** *Belgium* Swimming—Water Polo
- Simpson, R.** *Great Britain* Football
- Sims, S.** *U.S.A.* Hockey
- Singh, Baldev.** *India* Athletics—Long Jump, Decathlon
- Singh, Banta.** *India* Wrestling—Free Style, Lightweight
- Singh, C.** *India* Athletics—Marathon
- Singh, G.** *India* Hockey
- Singh, K.** *India* Hockey
- Singh, T.** *India* Hockey
- Singha, S.** *India* Athletics—10,000 m. Walk, 50,000 m. Walk
- Sink, R.** *U.S.A.* Athletics—1,500 m.
- Sinoracka, M. (F)** *Poland* Athletics—Javelin
- Sirota, A.** *France* Gymnastics
- Sirotanovic, B.** *Yugoslavia* Rowing—Eights
- Sitter, K.** *Austria* Rowing—Fours With Cox
- Sjoblom, N.** *Finland* Fencing—Foil Team, Epee Team, Epee Individual, Sabre Individual
- Sjolin, I.** *Sweden* Wrestling—Greco-Roman Style, Featherweight
- Sjostrand, T.** *Sweden* Athletics—3,000 m. Steeplechase
- Skabo, E.** *Norway* Canoeing—10,000 m. K1
- Skarp, V.** *Finland* Shooting—50 m. Pistol
- Skaugen, M.** *Norway* Yachting—Firefly Class.
- Sklar, J.** *Canada* Weightlifting—Middleweight
- Skotidas, A.** *Greece* Fencing—Epee Team, Epee Individual, Sabre Team
- Skredegaard, T.** *Norway* Shooting—50 m. Small Bore Rifle
- Skyva.** *Czechoslovakia* Fencing—Sabre Team, Sabre Individual
- Slade, J.** *U.S.A.* Hockey
- Slijkhuis, W.** *Holland* Athletics—5,000 m. 1,500 m.
- Smart, H.** *U.S.A.* Yachting—Star Class
- Smart, P.** *U.S.A.* Yachting—Star Class
- Smeekens, J. G.** *Holland* Weightlifting—Middleweight
- Smith, A.** *Great Britain* Fencing—Foil Team, Foil Individual
- Smith, C.** *Australia* Rowing—Fours with Cox
- Smith, D. (F)** *Great Britain* Gymnastics
- Smith, Jr., J. H.** *U.S.A.* Yachting—6 m. Class
- Smith, J. K.** *U.S.A.* Rowing—Eights
- Smith, O.** *U.S.A.* Athletics—Pole Vault
- Smith, Robert.** *Eire* Football
- Smith, R.** *Canada* Weightlifting—Bantamweight
- Smith, T. P.** *Eire* Fencing—Foil Team, Foil Individual
- Smith, T. R.** *U.S.A.* Cycling—4,000 m. Pursuit
- Smith, W.** *U.S.A.* Boxing—Lightweight
- Smith, W.** *U.S.A.* Swimming—400 m. Free Style, 4 x 200 m. Relay
- Smol, F.** *Holland* Swimming—Water Polo
- Snell, H.** *Sweden* Cycling—Road Race
- Snogdahl, J.** *Denmark* Rowing—Pairs without Cox
- Soares Berford, H.** *Brazil* Modern Pentathlon
- Sobieraj, C.** *Poland* Canoeing—1,000 m. K1, 10,000 m. K1
- Sobik, A.** *Poland* Fencing—Epee Team, Sabre Team, Sabre Individual
- Sobocinsky, A.** *Brazil* Shooting—25 m. Rapid Pistol
- Sobrevila, J.** *Argentina* Cycling—1,000 m. Time Trial
- Sodano, F.** *U.S.A.* Boxing—Flyweight
- Soderkvist, E.** *Sweden* Athletics—Hammer
- Sohl, R.** *U.S.A.* Swimming—200 m. Breast-stroke
- Sokol, A.** *Czechoslovakia.* Fencing—Sabre Team, Sabre Individual
- Solano Chagoya, J.** *Mexico* Equestrian—3 Day Team, 3 Day Individual
- Solbi, A.** *Iran* Basketball
- Solem, H.** *Norway* Yachting—6 m. Class
- Soler, J.** *Argentina* Gymnastics
- Soliman, M.** *Egypt* Basketball
- Solis Archundia, M.** *Mexico* Cycling—Road Race
- Solsvik, E.** *Norway* Wrestling—Greco-Roman Style, Featherweight
- Somnath, S.** *India* Athletics—Hammer
- Somohano Winfield, G.** *Mexico* Swimming—High Diving
- Sonck, J.** *Finland* Athletics—Decathlon
- Soracco Rios, R.** *Peru* Basketball
- Sorcinelli, M.** *Brazil* Basketball
- Sorensen, E.** *Sweden* Equestrian—Prix des Nations Individual, Prix des Nations Team
- Sorensen, H.** *Denmark* Yachting—6 m. Class
- Sorensen, J. G.** *Denmark* Rowing—Eights
- Sorensen, J. L.** *Denmark* Football
- Sorensen, P.** *Denmark* Hockey
- Sorensen, R.** *U.S.A.* Gymnastics
- Sorensen, S.** *Denmark* Boxing—Featherweight
- Sorensen, S.** *Iceland* Athletics—Hop, Step and Jump
- Soroudi, H.** *Iran* Basketball
- Sostaric, F.** *Yugoslavia* Football
- Sotornik, L.** *Czechoslovakia* Gymnastics
- Souche, J.** *France* Rowing—Fours with Cox
- Soudipour, H.** *Iran* Basketball
- Souza, E.** *U.S.A.* Football
- Souza, J.** *U.S.A.* Football
- Souza Oliveira, B. (F)** *Brazil* Athletics—100 m., 4 X 100 m. Relay
- Sovari, K.** *Hungary* Wrestling—Free Style, Welterweight
- Spangberg, R.** *Sweden* Swimming—Water Polo
- Spanghero, L.** *Italy* Yachting—Firefly Class
- Spellman, F.** *U.S.A.* Weightlifting—Middleweight
- Spencer, D. (F)** *Australia* Swimming—400 m. Free Style, 100 m. Free Style
- Spieser, C.** *U.S.A.* Boxing—Light-heavyweight
- Spilliaert, M.** *France* Swimming—Water Polo

- Spillmann, R.** *Switzerland* Fencing—Epee Individual
- Sprecher, L. (F)** *France* Athletics—200 m., 4 X 100 m. Relay
- Sprecher, P.** *France* Athletics—Decathlon
- Srncova, B. (F)** *Czechoslovakia* Gymnastics
- Stack, A.** *U.S.A.* Swimming—100 m. Back-stroke
- Stack, J.** *U.S.A.* Rowing—Eights
- Stad-de Jong, X. (F)** *Holland* Athletics—100 m., 4 x 100 m. Relay
- Stahre, N.** *Sweden* Equestrian—3 Day Team, 3 Day Individual
- Stakula, I.** *Yugoslavia* Swimming—Water Polo
- Stalder, J.** *Switzerland* Gymnastics
- Stam, H.** *Holland* Swimming—Water Polo
- Stambolis, D.** *Greece* Swimming—Water Polo
- Stanczyk, S.** *U.S.A.* Weightlifting—Light-heavyweight
- Stanich, G.** *U.S.A.* Athletics—High Jump
- Stankovic, B.** *Yugoslavia* Football
- Starkl, F.** *Switzerland* Rowing—Eights
- Stary, J.** *Czechoslovakia* Fencing—Sabre Team, Sabre Individual
- Stasse, R.** *Belgium* Fencing—Epee Team
- Stathis, G.** *Greece* Shooting—50 m. Pistol
- Staudinger, A. (F)** *Austria* Swimming—High Diving, Springboard Diving
- Stavem, P.** *Norway* Athletics—Decathlon
- Stebler, P.** *Switzerland* Rowing—Fours with Cox
- Stedman, R.** *Great Britain* Swimming—100 m. Free Style.
- Steele, H.** *Great Britain* Shooting—25 m. Rapid Pistol
- Steele, W.** *U.S.A.* Athletics—Long Jump
- Stefani, A.** *Canada* Rowing—Eights
- Stefanini, S.** *Italy* Basketball
- Stefanovic, D.** *Yugoslavia* Athletics—3,000 m. Steeplechase
- Steffe, G.** *Italy* Rowing—Pairs with Cox
- Stehlik, J.** *Czechoslovakia* Wrestling—Greco-Roman Style, Featherweight
- Steinarsson, A.** *Iceland* Swimming—200 m. Breast-stroke
- Steinegger, I. (F)** *Austria* Athletics—Long Jump, High Jump
- Stellin, A.** *Italy* Football
- Stephan, J.** *France* Athletics—100 m., 200 m.
- Stephan, R.** *France* Shooting—50 m. Pistol
- Stephan, R. W.** *U.S.A.* Rowing—Pairs without Cox
- Stephen, I.** *South Africa* Rowing—Single Sculls
- Stern, C.** *Switzerland* Yachting—6 m. Class
- Stern, M.** *Switzerland* Yachting—6 m. Class
- Steurbaut, R.** *Belgium* Basketball
- Steurer, E. (F)** *Austria* Athletics—80 m. Hurdles, 4 X 100 m. Relay
- Stevenson, W.** *Canada* Canoeing—10,000 m. C2
- Stewart, D.** *Great Britain* Equestrian—3 Day Team, 3 Day Individual
- Stigersand, R.** *Norway* Swimming—High Diving
- Stiller, A.** *U.S.A.* Cycling—2,000 m. Tandem, 4,000 m. Pursuit
- Stipetic, M.** *Yugoslavia* Swimming—400 m. Free Style, 1,500 m. Free Style
- Stirn, R.** *Switzerland* Fencing—Foil Team
- Stockly, G.** *Switzerland* Basketball
- Stoekli, F.** *Switzerland* Wrestling—Free Style, Light-heavyweight
- Stoffel, J.** *Luxembourg* Gymnastics
- Stokken, M.** *Norway* Athletics—5,000 m. 10,000 m.
- Stone, C.** *U.S.A.* Athletics—5,000 m.
- Storskrubb, A.** *Finland* Athletics—4 X 400 m. Relay, 400 m. Hurdles
- Stover, J. (F)** *U.S.A.* Swimming—High Diving
- Strachota, F.** *Austria* Hockey
- Strain, A.** *Yugoslavia* Cycling—Road Race
- Strain, W.** *Great Britain* Yachting—Dragon Class
- Strand, L.** *Sweden* Athletics—1,500 m.
- Strappe, A.** *France* Football
- Strasser, R.** *Luxembourg* Wrestling—Greco-Roman Style, Featherweight
- Stratakos, S.** *Greece* Athletics—400 m., 800 m., 4 x 400 m. Relay
- Straub, H.** *Switzerland* Canoeing—1,000 m. K1
- Straulino, A.** *Italy* Yachting—Star Class
- Streuli, H.** *Switzerland* Athletics—800 m.
- Strickland, S. (F)** *Australia* Athletics—80 m. Hurdles, 100 m., 200 m. 4 X 100 m. Relay
- Strimel, A.** *U.S.A.* Football
- Stroo, H.** *Holland* Canoeing—1,000 m. K2
- Strong, I. (F)** *Canada* Swimming—100 m. Free Style, 200 m. Breast-stroke, 4 x 100 m. Relay
- Strulovitch, S.** *Canada* Basketball
- Strupler, E.** *Switzerland* Swimming—Springboard Diving, High Diving
- Stuart, J.** *Canada* Weightlifting—Lightweight
- Stude, W.** *U.S.A.* Hockey
- Studer, E.** *Switzerland* Gymnastics
- Studer, J.** *Switzerland* Athletics—Long Jump
- Stuhlinger, F.** *Switzerland* Hockey
- Sturrock, A.** *Australia* Yachting—Star Class
- Stutterheim, E.** *Holland* Yachting—Star Class
- Subelj, J.** *Yugoslavia* Gymnastics
- Su, Bung Nan** *Korea* Boxing—Featherweight
- Suares, F.** *Uruguay* Boxing—Light-heavyweight
- Suarez Molezun, M.** *Spain* Athletics—110 m. Hurdles
- Suda, O.** *Turkey* Cycling—Road Race
- Suh, Y.** *Korea* Athletics—Marathon
- Sullivan, D.** *Eire* Yachting—Firefly Class, Swallow Class
- Sullivan, J.** *Great Britain* Wrestling—Free Style, Light-heavyweight
- Summers, T.** *Great Britain* Swimming—100 m. Back-stroke
- Sundstrom, E.** *Finland* Weightlifting—Bantamweight
- Suner A.** *Argentina* Yachting—Dragon Class
- Sung, Ling-Sing** *China* Football
- Suppo, F.** *Italy* Wrestling—Greco-Roman Style, Bantamweight
- Suryavanshi, S.** *India* Wrestling—Free Style, Featherweight
- Suvanto, T.** *Finland* Athletics—400 m., 4 x 400 m. Relay
- Svensden, G.** *Norway* Shooting—50 m. Pistol
- Svensson, S.** *Sweden* Equestrian—3 Day Team, 3 Day Individual
- Swanson, E.** *U.S.A.* Shooting—300 m. Free Rifle
- Swire, H.** *Great Britain* Shooting—25 m. Rapid Pistol
- Syllas, N.** *Greece* Athletics—Discus
- Symons, J.** *Great Britain* Canoeing—1,000 m. C2
- Systad, J.** *Norway* Athletics—Marathon
- Szabo, L.** *Argentina* Swimming—Water Polo
- Szatmari, E.** *Hungary* Swimming—100 m. Free Style, 4 x 200 m. Relay
- Szekely, E. (F)** *Hungary* Swimming—4 x 100 m. Relay, 200 m. Breast-stroke
- Szendei, A.** *Hungary* Rowing—Pairs with Cox
- Szilagyi, G.** *Hungary* Wrestling—Greco-Roman Style, Flyweight
- Szilard, Z.** *Hungary* Swimming—100 m. Free Style
- Szilvassy, M.** *Hungary* Wrestling—Greco-Roman Style, Welterweight
- Szitty, K.** *Hungary* Swimming—Water Polo
- Szivos, I.** *Hungary* Swimming—Water Polo
- Szondy, I.** *Hungary* Modern Pentathlon
- Szymura, F.** *Poland* Boxing—Light-heavyweight

## T

- Taddia, T.** *Italy* Athletics—Hammer
- Tagliaferri, L. (F)** *Italy* Athletics—100 m.
- Taha, S.** *Lebanon* Wrestling—Greco-Roman Style, Featherweight
- Tajik, A.** *Afghanistan* Hockey
- Tajik, A. H.** *Afghanistan* Football
- Takacs, K.** *Hungary* Shooting—25 m. Rapid Pistol
- Talja, O.** *Finland* Athletics—4 x 400 m. Relay, 400 m.
- Taljaard, P.** *South Africa* Weightlifting—Heavyweight
- Talosela, E.** *Finland* Wrestling—Greco-Roman Style, Featherweight
- Tammelin, M.** *Finland* Boxing—Featherweight
- Tamminen, L.** *Finland* Athletics—Hammer
- Tamplin, R.** *Eire* Rowing—Eights
- Tannander, K.** *Sweden* Athletics—Decathlon
- Tantalean Zorrilla, F.** *Peru* Shooting—25 m. Rapid Pistol
- Taranyi, J.** *Hungary* Wrestling—Free Style, Light-heavyweight
- Tarlao, A.** *Italy* Rowing—Pairs with Cox
- Tarroway, H.** *Great Britain* Athletics—800 m.
- Tass Todenbier, O. (F)** *Hungary* Gymnastics
- Tauler Alos, C.** *Spain* Shooting—50 m. Small Bore Rifle
- Tayfur, M.** *Turkey* Wrestling—Greco-Roman Style, Middleweight

- Taylor, D.** *Eire* Rowing—Eights  
**Tejeda Canete, E.** *Cuba* Shooting—50 m. Pistol  
**Telismanic, I.** *Yugoslavia* Rowing—Eights  
**Temes, T.** (F) *Hungary* Swimming—4 X 100 m. Relay, 100 m. Free Style  
**Ten Cate, A.** *Holland* Equestrian—3 Day Individual, 3 Day Team  
**Teoman, U.** (F) *Turkey* Athletics—100 m.  
**Teraesvirta, E.** *Finland* Gymnastics  
**Teraskari, F.** *Finland* Weightlifting—Lightweight  
**Terlouw, M.** *Holland* Football  
**Termeuken, J.** (F) *Holland* Swimming—100 m. Free Style, 4 X 100 m. Relay  
**Terpak, J.** *U.S.A.* Weightlifting—Lightweight  
**Teruzzi, F.** *Italy* Cycling—2,000 m. Tandem  
**Ter Weer, H.** *Holland* Fencing—Foil Team, Foil Individual, Sabre Team  
**Terzano, H.** *Argentina* Equestrian—Dressage Team, Dressage Individual  
**Tessier, L.** *Canada* Cycling—Road Race, 4,000 m. Pursuit  
**Teunissen-Waalboer, J.** (F) *Holland* Athletics—Javelin  
**Tewfik, H.** *Egypt* Fencing—Foil Team, Foil Individual  
**Tezcan, S.** *Turkey* Fencing—Sabre Team, Sabre Individual  
**Thalmann, M.** *Switzerland* Gymnastics  
**Thastum, E.** *Denmark* Boxing—Bantamweight  
**Thevenet, M.** *France* Weightlifting—Bantamweight  
**Theys, L.** *Belgium* Athletics—3,000 m. Steeplechase  
**Thidholm, G.** (F) *Sweden* Swimming—400 m. Free Style, 4 x 100 m. Relay  
**Thiebaud, F.** *Switzerland* Fencing—Epee Team  
**Thieffry, J.** *France* Hockey  
**Thiolon, P.** *France* Basketball  
**Thofelt, S.** *Sweden* Fencing—Epee Team  
**Thomas, C.** (F) *France* Swimming—4 x 100 m. Relay, 400 m. Free Style  
**Thomas, G.** *Great Britain* Cycling—Road Race  
**Thommesson, O.** *Norway* Yachting—Swallow Class  
**Thompson, C. A.** (F) *Jamaica* Athletics—200 m., 100 m.  
**Thompson, C. C. F. O.** *British Guiana* Athletics—Long Jump  
**Thompson, D.** *U.S.A.* Fencing—Epee Team  
**Thompson Durand, C.** *Mexico* Football  
**Thompson, J.** *U.S.A.* Athletics—5,000 m.  
**Thompson, W.** *U.S.A.* Athletics—Putting the Shot  
**Thomsen, A.** *Denmark* Gymnastics  
**Thomsen, H.** *Denmark* Hockey  
**Thomsen, S.** *Denmark* Wrestling—Greco-Roman Style, Flyweight  
**Thomson, E.** *U.S.A.* Equestrian—Dressage Individual, 3 Day Individual, Dressage Team, 3 Day Team  
**Thomson, M.** *U.S.A.* Cycling—2,000 m. Tandem  
**Thorvaldsen, T.** *Norway* Yachting—Dragon Class  
**Thorvaldsson, F.** *Iceland* Athletics—4 X 100 m. Relay, 100 m., Long Jump  
**Thuillier, N.** *Eire* Fencing—Foil Team  
**Tiel, H.** *Holland* Hockey  
**Tiltsch, F.** (F) *Austria* Athletics—Discus  
**Tima, F.** *Hungary* Athletics—4 x 100 m. Relay  
**Timar Geng, A.** *Hungary* Basketball  
**Timar Geng, I.** *Hungary* Basketball  
**Tissot, R.** *France* Athletics—Javelin  
**Tito, M.** *Italy* Athletics—4 x 100 m. Relay  
**Toivari, P.** *Finland* Athletics—3,000 m. Steeplechase  
**Toland, J.** *U.S.A.* Rowing—Pairs with Cox  
**Tolchinsky, S.** *Canada* Basketball  
**Toldi, J.** *Hungary* Canoeing—1,000 m. K2  
**Tolgyessy, S.** *Hungary* Shooting—50 m. Pistol  
**Tollbom, H.** *Sweden* Fencing—Epee Team  
**Tomasevic, K.** *Yugoslavia* Football  
**Tom, R.** *U.S.A.* Weightlifting—Bantamweight  
**Tomita, K.** *U.S.A.* Weightlifting—Featherweight  
**Toms, J.** *Czechoslovakia* Basketball  
**Tomsen, W.** *U.S.A.* Shooting—50 m. Small Bore Rifle  
**Tonneman, J.** (F) *Holland* Gymnastics  
**Torberntsson, B.** *Sweden* Rowing—Pairs without Cox  
**Torkal, S.** *Turkey* Football  
**Torma, J.** *Czechoslovakia* Boxing—Welterweight  
**Tornvall, S.** *Chile* Swimming—Water Polo  
**Torrente, M.** *Argentina* Fencing—Foil Team, Foil Individual  
**Torres, A.** *Argentina* Athletics—800 m.  
**Torriani, L.** (F) *Italy* Gymnastics  
**Torry, O., Jr.** *U.S.A.* Yachting—Swallow Class  
**Tosi, G.** *Italy* Athletics—Discus  
**Tosuncuk, V.** *Turkey* Football  
**Totakhall, N.** *Afghanistan* Hockey  
**Toth, F.** *Hungary* Wrestling—Free Style, Greco-Roman Style, Featherweight  
**Toth, L.** *Hungary* Gymnastics  
**Touchard, J.** (F) *France* Gymnastics  
**Toulouse, J.** (F) *France* Athletics—80 m. Hurdles, 4 X 100 m. Relay  
**Tournon, J-F.** *France* Fencing—Sabre Team  
**Toussi, H.** *Iran* Boxing—Middleweight  
**Toweel, V.** *South Africa* Boxing—Bantamweight  
**Towers, P.** *Argentina* Rowing—Pairs with Cox  
**Townsend, R.** *Canada* Yachting—Swallow Class  
**Tracuzzi, V.** *Italy* Basketball  
**Tramutolo, C.** *Uruguay* Cycling—1,000 m. Time Trial  
**Trani, L.** *Philippines* Boxing—Featherweight  
**Tredgold, R.** *Great Britain* Fencing—Sabre Individual, Sabre Team  
**Treloar, J.** *Australia* Athletics—200 m., 100 m., 4 x 100 m. Relay  
**Trepp, M.** *Switzerland* Athletics—4 x 400 m. Relay, 400 m.  
**Tribley, P.** *Bermuda* Swimming—4 x 200 m. Relay, 1,500 m. Free Style  
**Tribolet, J.** *Switzerland* Basketball  
**Trimpont, J.** *Belgium* Wrestling—Free Style, Bantamweight  
**Triulzi, A.** *Argentina* Athletics—110 m. Hurdles  
**Trpkos, L.** *Czechoslovakia* Basketball  
**Tryde, T.** *Denmark* Equestrian—Prix des Nations Individual, Prix des Nations Team  
**Tudor, G.** *Great Britain* Athletics—3,000 m. Steeplechase  
**Tuhy, V.** *Czechoslovakia* Wrestling—Greco-Roman Style, Lightweight  
**Tulgar, H.** *Turkey* Fencing—Foil Individual  
**Tull, W.** *Trinidad* Athletics—1,500 m., 800 m.  
**Tuncalp, A.** *Turkey* Cycling—Road Race  
**Tunner, H.** *Austria* Athletics—Discus  
**Tuohy, O.** *Eire* Fencing—Foil Individual, Foil Team  
**Turcato, C.** *Italy* Fencing—Sabre Team, Sabre Individual  
**Turconi, A.** *Italy* Football  
**Turian, R.** *Switzerland* Fencing—Sabre Team  
**Turki, A.** *Pakistan* Boxing—Welterweight  
**Turkka, A.** *Finland* Yachting—6 m. Class  
**Turnbull, D.** (F) *Argentina* Swimming—200 m. Breast-stroke  
**Turner, D.** *U.S.A.* Rowing—Eights  
**Turner, F.** *Great Britain* Gymnastics  
**Turner, I.** *U.S.A.* Rowing—Eights  
**Turquet, P.** *Great Britain* Fencing—Foil Team  
**Tyler, D.** (F) *Great Britain* Athletics—High Jump  
**Tzovlas, N.** *Greece* Shooting—50 m. Pistol

## U

- Ucar Ferreiro, J.** *Uruguay* Fencing—Foil Individual, Foil Team  
**Ucko, F.** *U.S.A.* Hockey  
**Uder, J.** *Argentina* Basketball  
**Ullman, T.** *Sweden* Shooting—25 m. Rapid Pistol, 50 m. Pistol  
**Umgeher, A.** *Austria* Canoeing—10,000 m. K2  
**Unsworth, H.** *Great Britain* Athletics—400 m. Hurdles  
**Upton, J.** (F) *Great Britain* Athletics—80 m. Hurdles  
**Uranyi, J.** *Hungary* Canoeing—10,000 m. K2  
**Urho, V.** *Finland* Yachting—Dragon Class, 6 m. Class, Star Class  
**Urizac, R.** *Mexico* Equestrian—Prix des Nations Team, Prix des Nations Individual  
**Ustolin, M.** *Italy* Rowing—Double Sculls

## V

- Vachon, M.** *Canada* Wrestling—Free Style, Middleweight  
**Vadaszi Viboch, E.** *Hungary* Basketball  
**Vade, B.** *Norway* Athletics—400 m., 800 m.  
**Vadi, Quinto** *Italy* Gymnastics  
**Vaessen, M.** (F) *Holland* Swimming—100 m. Free Style, 4 x 100 m. Relay  
**Vailee, F.** (F) *France* Gymnastics

XIV OLYMPIAD

- Valadas, F.** *Portugal* Equestrian—Dressage Individual, Dressage Team  
**Valatas, E.** *Greece* Shooting—50 m. Small Bore Rifle  
**Valberg, L.** *Singapore* Athletics—High Jump  
**Valcke, P.** *Belgium* Fencing—Foil Individual, Foil Team  
**Valderrama Peralta, R.** *Peru* Shooting—25 m. Rapid Pistol  
**Valdes, R.** *Mexico* Equestrian—Prix des Nations Team, Prix des Nations Individual  
**Valent, G.** *Hungary* Swimming—100 m. Back-stroke  
**Valenta, R.** *Austria* Cycling—Road Race  
**Valero Recio, F.** *Mexico* Fencing—Epee Team, Epee Individual  
**Valiarino, H.** *Argentina* Weightlifting—Heavyweight  
**Valle, P.** *Great Britain* Athletics—200 m.  
**Vallerey, G.** *France* Swimming—100 m. Back-stroke  
**Vallerey, G. (F)** *France* Swimming—100 m. Free Style, 4 x 100 m. Relay  
**Vallim, A.** *Brazil* Fencing—Epee Individual, Epee Team  
**Valmy, R.** *France* Athletics—4 x 100 m. Relay, 100 m.  
**Vambara, L.** *Czechoslovakia* Canoeing—1,000 m. K1  
**Van Antwerpen, C.** *Belgium* Rowing—Pairs without Cox  
**Van Bets, Y. (F)** *Belgium* Gymnastics  
**Van Brabant, G.** *Belgium* Cycling—4,000 m. Pursuit  
**Van Bun, J.** *Holland* Football  
**Vandame, P.** *France* Hockey  
**Van de Anker-Doedans (F)** *Holland* Canoeing—500 m. K1  
**Van de Goor, L.** *Belgium* Basketball  
**Van De Kerckhove, Y. (F)** *Belgium* Swimming—200 m. Breast-stroke  
**Van de Velde, E.** *Belgium* Cycling—1,000 m. Scratch  
**Van de Vliet, A.** *Belgium* Canoeing—1,000 m. K2  
**Van de Wattyne, M.** *Belgium* Athletics—5,000 m.  
**Van de Werve de Vorselaere, A.** *Belgium* Fencing—Foil individual, Foil Team  
**Van de Wiele, I.** *Belgium* Athletics—100 m., 4 x 100 m. Relay  
**Van den Berg, J.** *Holland* Rowing—Fours without Cox  
**Van den Berg, J. B.** *Holland* Yachting—Dragon Class  
**Van den Berg, W.** *Holland* Fencing—Sabre Individual, Foil Team, Sabre Team  
**Van Den Berghen, R.** *Belgium* Canoeing—1,000 m. K2  
**Van Den Brende, M. (F)** *Belgium* Swimming—4 X 100 m. Relay  
**Van der Haeghen, P.** *Belgium* Yachting—Firefly Class  
**Van der Horst, H. (F)** *Holland* Swimming—100 m. Back-stroke  
**Van der Kade-Koudijs, G. (F)** *Holland* Athletics—4 X 100 m. Relay, 80 m. Hurdles, Long Jump  
**Van der Kroft, W.** *Holland* Canoeing—1,000 m. K1  
**Van der Meer, H.** *Holland* Rowing—Double Sculls  
**Van der Tuyn, C.** *Holland* Football  
**Van Duyl, W.** *Holland* Yachting—Dragon Class  
**Vanek, K.** *Czechoslovakia* Rowing—Fours without Cox  
**Van Ekris, D. (F)** *Holland* Swimming—100 m. Back-stroke  
**Van Feggelen, R.** *Holland* Swimming—Water Polo  
**Van Geene, A. (F)** *Holland* Gymnastics  
**Van Gelder, M.** *Holland* Cycling—2,000 m. Tandem  
**Van Heel, W.** *Holland* Hockey  
**Van Heerden, A.** *South Africa* Athletics—200 m., 100 m.  
**Van Loon, E.** *Holland* Equestrian—3 Day Individual, 3 Day Team  
**Vanlund, O.** *Sweden* Cycling—Road Race  
**Van Mareke, A. (F)** *Belgium* Canoeing—500 m. K1  
**Van Muylers, J.** *Belgium* Hockey  
**Van Riel, H.** *Belgium* Yachting—6 m. Class  
**Van Rompaey, W.** *Belgium* Yachting—6 m. Class  
**Van Roosbroeck, E.** *Belgium* Cycling—Road Race  
**Van Roy, A. (F)** *Belgium* Gymnastics  
**Van Schil, L.** *Belgium* Cycling—2,000 m. Tandem  
**Van Suylekom, H.** *Holland* Rowing—Fours without Cox  
**Van Vliet, P. (F)** *Holland* Swimming—200 m. Breast-stroke  
**Van Wambeke, A.** *Belgium* Basketball  
**Van Weydeveld, L.** *Belgium* Hockey  
**Van Zwanenberg, H.** *Great Britain* Canoeing—1,000 m. C2  
**Varadaraj, K.** *India* Football  
**Varaleau, J.** *Canada* Weightlifting—Light-heavyweight  
**Varani, B.** *Argentina* Basketball  
**Varela, M.** *Argentina* Wrestling—Greco-Roman Style, Flyweight  
**Varkoi, F.** *Hungary* Gymnastics  
**Varszegi, J.** *Hungary* Athletics—Javelin  
**Vartia, A.** *Finland* Fencing—Epee Individual, Epee Team  
**Vartiainen, V.** *Finland* Equestrian—Prix des Nations Individual, Prix des Nations Team  
**Vasarhelyi Weckinger, E. (F)** *Hungary* Gymnastics  
**Vasquez Cam, E.** *Peru* Shooting—50 m. Pistol  
**Vautrin, C. (F)** *France* Canoeing—500 m. K1  
**Vaz, M.** *India* Hockey  
**Vefling, K.** *Norway* Athletics—1,500 m.  
**Vegazzi, J.** *Argentina* Swimming—100 m. Back-stroke  
**Velez, M., Jr.** *Philippines* Boxing—Welterweight  
**Vellamo, J.** *Finland* Weightlifting—Light-heavyweight  
**Venegas, J.** *Puerto Rico* Boxing—Bantamweight  
**Venge, M.** *Denmark* Hockey  
**Venieris, G.** *Greece* Rowing—Pairs with Cox  
**Vera Guardia, C.** *Chile* Athletics—Hop, Step and Jump  
**Verbenyi, J.** *Hungary* Basketball  
**Verbraecken, C. (F)** *Belgium* Gymnastics  
**Verdeur, J.** *U.S.A.* Swimming—200 m. Breast-stroke  
**Verdu Belen, F.** *Spain* Boxing—Featherweight  
**Verdugo Yanez, G.** *Chile* Basketball  
**Verhas, R.** *Belgium* Athletics—Discus, Putting the Shot  
**Vermirovska, Z. (F)** *Czechoslovakia* Gymnastics  
**Vernier, J.** *France* Athletics—1,500 m.  
**Vernier, J. M.** *France* Athletics—5,000 m.  
**Verona, O.** *Italy* Wrestling—Free Style, Light-heavyweight  
**Veste, P. (F)** *France* Athletics—Putting the Shot, Discus  
**Vesterinen, P.** *Finland* Athletics—Javelin  
**Vestil, F.** *Philippines* Basketball  
**Viaene, J.** *France* Swimming—Water Polo  
**Vice, I.** *Great Britain* Gymnastics  
**Vicente, C.** *Puerto Rico* Athletics—Pole Vault  
**Vicente Demenech, A.** *Spain* Boxing—Bantamweight  
**Vicera, F.** *Philippines* Wrestling—Free Style, Bantamweight  
**Vichos, G.** *Greece* Shooting—50 m. Small Bore Rifle, 25 m. Rapid Pistol  
**Vickers, J.** *India* Athletics—110 m. Hurdles  
**Vidal, J.** *Argentina* Gymnastics  
**Videla Castillo, M.** *Chile* Boxing—Featherweight  
**Vidovic, B.** *Yugoslavia* Swimming—4 X 200 m. Relay, 400 m. Free Style  
**Viitala, V.** *Finland* Wrestling—Free Style, Flyweight  
**Vilholth, C.** *Denmark* Shooting—25 m. Rapid Pistol  
**Vilkko, L.** *Finland* Modern Pentathlon  
**Villacian Alemany, R.** *Cuba* Gymnastics  
**Villamil, A.** *Argentina* Fencing—Epee Individual, Epee Team  
**Villaplana Vargas, E.** *Spain* Athletics—50,000 m. Walk  
**Villarreal Sanchez, N.** *Mexico* Gymnastics  
**Vilmundaeson, V.** *Iceland* Athletics—Putting the Shot  
**Vink, C.** *Holland* Yachting—Swallow Class  
**Vio, T.** *Argentina* Basketball  
**Virtanen, E.** *Finland* Wrestling—Greco-Roman Style, Lightweight  
**Visentin, C.** *Argentina* Swimming—Water Polo  
**Visentin, M.** *Argentina* Swimming—Water Polo  
**Vissers, J.** *Belgium* Boxing—Lightweight  
**Vizcarra Nieto, J.** *Peru* Basketball  
**Vlangalis, N.** *Greece* Yachting—Star Class  
**Voeroes, F.** *Hungary* Swimming—1,500 m. Free Style  
**Vogel, A.** *Austria* Wrestling—Greco-Roman Style, Free Style, Middleweight  
**Vogel, T.** *U.S.A.* Athletics—Marathon  
**Vogelbacher, J. (F)** *France* Gymnastics  
**Vogg, A.** *Denmark* Fencing—Foil Team  
**Vogt, K.** *Switzerland* Hockey  
**Vojsk, R. (F)** *Yugoslavia* Gymnastics  
**Vojtech, J.** *Austria* Weightlifting—Bantamweight  
**Volfl, F.** *Yugoslavia* Football



- Volkmer, K.** *Switzerland* Athletics—4 x 400 m. Relay, 800 m.
- Vollmar, E.** *Switzerland* Rowing—Eights
- Von Einsiedel, A.** *Philippines* Shooting—25 m. Rapid Pistol, 50 m. Small Bore Rifle, 50 m. Pistol
- Von Koss, J.** *Norway* Fencing—Epee Team
- Vonlaufen, O.** *Switzerland* Rowing—Eights
- Von Meiss, G.** *Switzerland* Fencing—Foil Team
- Voorling, G.** *Holland* Cycling—Road Race, 4,000 m. Pursuit
- Vujacic, D.** *Yugoslavia* Athletics—Javelin
- Vujacic, M.** *Yugoslavia* Athletics—Javelin
- Vukas, B.** *Yugoslavia* Football
- Vyt, C.** *Belgium* Modern Pentathlon
- W**
- Wad, S.** *Denmark* Boxing—Lightweight
- Wade, F.** *U.S.A.* Rowing—Pairs without Cox
- Wade, T.** *Argentina* Hockey
- Wadoon, K.** *Iraq* Basketball
- Wagner, R.** *Luxembourg* Football
- Wahli, H.** *Switzerland* Athletics—High Jump
- Wainwright, N.** *Great Britain* Swimming—4 x 200 m. Relay
- Wajs-Marcinkiewicz, J.** (F) *Poland* Athletics—Discus
- Wales, A.** *Great Britain* Gymnastics
- Walford, M.** *Great Britain* Hockey
- Walker, D.** *Great Britain* Rowing—Pairs with Cox
- Walker, M.** (F) *Great Britain* Athletics—200 m., 4 x 100 m. Relay
- Walker, M. E.** (F) *U.S.A.* Athletics—100 m., 4 X 100 m. Relay
- Wallace, J.** *Great Britain* Yachting—Dragon Class
- Walraven, J.** (F) *U.S.A.* Athletics—80 m. Hurdles, Long Jump
- Walser, H.** *Switzerland* Hockey
- Walsh, C.** *Eire* Basketball
- Walsh, W.** *U.S.A.* Shooting—50 m. Pistol
- Wamberg, N.** *Denmark* Rowing—Eights
- Ward, G.** *Great Britain* Swimming—High Diving
- Wardrop, J.** *Great Britain* Swimming—1,500 m. Free Style
- Waterkeyn, A.** *Belgium* Hockey
- Waters, W.** *Great Britain* Cycling—4,000 m. Pursuit
- Watier, E.** *France* Weightlifting—Bantamweight
- Watson, G.** *Great Britain* Weightlifting—Middleweight
- Watzke, G.** *Austria* Rowing—Pairs without Cox
- Watzke, K.** *Austria* Rowing—Pairs without Cox
- Waxman, M.** *Canada* Basketball
- Weber, E.** *U.S.A.* Athletics—10,000 m. Walk
- Webster, F.** *Great Britain* Athletics—Pole Vault
- Webster, J.** *Australia* Rowing—Fours with Cox
- Wee, Tian-Siak** *China* Basketball
- Weedon, G.** *Great Britain* Gymnastics
- Weekes, J.** *U.S.A.* Yachting—6 m. Class
- Wehlin, K.** *Sweden* Modern Pentathlon
- Weibel, R.** *Switzerland* Swimming—Water Polo
- Weidner, G.** *Austria* Wrestling—Greco-Roman Style, Featherweight
- Weinberg, R.** *Australia* Athletics—110 m. Hurdles
- Weinecker, A.** *U.S.A.* Athletics—50,000 m. Walk
- Weingand, A.** *France* Gymnastics
- Welfring, P.** *Luxembourg* Gymnastics
- Weller Schneider, A. N.** (F) *Chile* Athletics—4 x 100 m. Relay, 200 m.
- Wellington, M.** (F) *Great Britain* Swimming—400 m. Free Style, 100 m. Free Style, 4 x 100 m. Relay
- Welt, E.** *Austria* Cycling—2,000 m. Tandem, 1,000 m. Scratch
- Welt, W.** *Austria* Gymnastics
- Welter, J.** *Luxembourg* Boxing—Middleweight
- Wendon, U.** *Great Britain* Fencing—Foil Team
- Wenger, W.** *Switzerland* Wrestling—Free Style, Bantamweight
- Wengler, G.** *Luxembourg* Gymnastics
- Werner, G.** *Austria* Yachting—Star Class
- West, R.** *Great Britain* Athletics—10,000 m. Walk
- Westergren, F.** *Sweden* Wrestling—Free Style, Welterweight
- Westerlund, E.** *Finland* Yachting—6 m. Class
- Westlund, W.** *U.S.A.* Rowing—Fours with Cox
- Westman, A.** *Sweden* Athletics—400 m. Hurdles
- Weston, H.** *Great Britain* Basketball
- Weston, S.** *Great Britain* Basketball
- Wettersten, V.** *Sweden* Canoeing—10,000 m. C2, 1,000 m. C2
- Wetterstrom, H.** *Sweden* Canoeing—10,000 m. K2
- Whang, Byung Kwan** *Korea* Wrestling—Free Style, Welterweight
- White, C.** *Great Britain* Athletics—800 m.
- White, D.** *Ceylon* Athletics—200 m., 400 m. Hurdles
- White, H.** *Argentina* Swimming—100 m. Free Style, 4 x 200 m. Relay
- White, W.** *Great Britain* Hockey
- Whitfield, M.** *U.S.A.* Athletics—4 x 400 m. Relay, 800 m., 400 m.
- Whitlock, G.** *Great Britain* Athletics—50,000 m. Walk
- Whiton, H.** *U.S.A.* Yachting—6 m. Class
- Whittle, H.** *Great Britain* Athletics—Long Jump, 400 m. Hurdles
- Whyte, E.** (F) *Great Britain* Athletics—Discus, Putting the Shot
- Widemann, W.** *Switzerland* Fencing—Sabre Individual, Sabre Team
- Widenfelt, G.** *Sweden* Athletics—High Jump
- Widmer, H.** *Switzerland* Swimming—200 m. Breast-stroke
- Wiid, J.** *South Africa* Swimming—100 m. Back-stroke
- Wijnands, J.** (F) *Holland* Gymnastics
- Wijngaard, F.** *Holland* Boxing—Welterweight
- Wildhaber, N.** *Switzerland* Swimming—200 m. Breast-stroke
- Wilkes, R.** *Trinidad* Weightlifting—Featherweight
- Wilkes, S.** *Holland* Football
- Will, R.** *U.S.A.* Rowing—Fours with Cox
- Williams, D.** *South Africa* Boxing—Flyweight
- Williams, S.** *Jamaica* Weightlifting—Featherweight
- Williamson, A.** (F) *Great Britain* Athletics—200 m.
- Willott, C.** *Great Britain* Shooting—25 m. Rapid Pistol
- Willumsen, H.** *Denmark* Rowing—Eights
- Wilson, D.** *Great Britain* Athletics—1,500 m.
- Wilson, J.** *Argentina* Hockey
- Wilson, J. A.** *Great Britain* Wrestling—Greco-Roman Style, Welterweight
- Wilson, J. E.** (F) *U.S.A.* Swimming—200 m. Breast-stroke
- Wilson, J. H. T.** *Great Britain* Rowing—Pairs without Cox
- Wilson, W.** *U.S.A.* Hockey
- Wat, F.** *U.S.A.* Athletics—10,000 m.
- Wiltz Bucelo, R.** *Cuba* Basketball
- Wing, F.** *U.S.A.* Equestrian—Prix des Nations Team, Prix des Nation Individual
- Wing, H.** *China* Cycling—1,000 m. Scratch
- Winnige, G.** (F) *Austria* Gymnastics
- Wint, A.** *Jamaica* Athletics—800 m., 4 x 400 m. Relay, 400 m.
- Winter, J.** *Australia* Athletics—High Jump
- Winter, V.** *Czechoslovakia* Athletics—800 m.
- Winther, G.** *Norway* Athletics—50,000 m. Walk
- Wires, K.** *Finland* Canoeing—10,000 m. K1
- Wirth, E.** *Argentina* Modern Pentathlon
- Wirth, F.** *Czechoslovakia* Gymnastics
- Wise, J.** *Australia* Shooting—300 m. Free Rifle
- Wister, E.** *Austria* Gymnastics
- Wittenberg, H.** *U.S.A.* Wrestling—Free Style, Light-heavyweight
- Witziers-Timmer, J.** (F) *Holland* Athletics—4 X 100 m. Relay
- Wojcik, J.** *Poland* Fencing—Sabre Team
- Wolf, W.** *U.S.A.* Swimming—4 x 200 m. Relay
- Wolfbrandt, L.** *Sweden* Athletics—4 x 400 m. Relay
- Wolff, A.** *U.S.A.* Fencing—Epee Individual, Epee Team
- Woll, E.** *Austria* Shooting—50 m. Small Bore Rifle
- Woo, Cheng-Chang** *China* Basketball
- Woo, Zung Whan** *Korea* Football
- Wood, M.** *Australia* Rowing—Single Sculls
- Woodward, W.** *Great Britain* Rowing—Fours with Cox
- Worisch, F.** *Austria* Swimming—High Diving, Springboard Diving
- Worth, G.** *U.S.A.* Fencing—Sabre Individual, Sabre Team
- Wouters, L.** *Belgium* Cycling—Road Race
- Wright, J.** *Great Britain* Boxing—Middleweight

XIV OLYMPIAD

**Wright, L.** *U.S.A.* Athletics—Long Jump, 4 X 100 m. Relay

**Wurth, F.** *Austria* Athletics—Long Jump, Hop, Step and Jump

**Y**

**Yacout, A.** *Egypt* Weightlifting—Bantamweight

**Yantorno, A.** *Argentina* Swimming—400 m. Free Style, 4 x 200 m. Relay

**Yataganas, C.** *Greece* Athletics—Putting the Shot

**Yate, H.** (F) *Great Britain* Swimming—100 m. Back-stroke

**Yedro, A.** *Argentina* Rowing—Fours with Cox

**Yee, J.** *China* Basketball \*

**Yigitturk, E.** *Turkey* Equestrian—3 Day Team, 3 Day Individual

**York, J.** (F) *U.S.A.* Fencing—Foil Individual

**Younes, M.** *Egypt* Fencing—Foil Team, Epee Individual, Epee Team, Sabre Team, Foil Individual

**Young, L.** (F) *U.S.A.* Athletics—Long Jump, 100 m.

**Yu, Sai-Chang** *China* Basketball

**Yusufzai, A.** *Afghanistan* Football

**Yusufzai, A. G.** *Afghanistan* Hockey

**Yusufzai, M.** *Afghanistan* Football

**Yves, E.** *Belgium* Fencing—Sabre Individual, Sabre Team, Foil Team

**Yvinou, M.** (F) *France* Gymnastics

**Z**

**Zaczyk, T.** *Poland* Fencing—Sabre Individual, Sabre Team, Epee Team

**Zagon, M.** *Hungary* Rowing—Fours with Cox

**Zalai Kovi, M.** (F) *Hungary* Gymnastics

**Zancani, P.** *Brazil* Rowing—Pairs without Cox

**Zandi, A.** *Iran* Wrestling—Free Style, Welterweight

**Zanetti, L.** *Italy* Gymnastics

**Zanoni Hausen, I.** *Brazil* Athletics—200 m., 100 m., 4 x 100 m. Relay

**Zappelli, O.** *Switzerland* Fencing—Epee Team, Epee Individual

**Zarcal, B.** *Philippines* Boxing—Bantamweight

**Zatopek, E.** *Czechoslovakia* Athletics—5,000 m., 10,000 m.

**Zeilinger, G.** (F) *Austria* Fencing—Foil Individual

**Zerjal, D.** *Yugoslavia* Athletics—Discus

**Zimmerman S.** (F) *U.S.A.* Swimming—100 m. Back-stroke

**Zimmerman, W.** *Switzerland* Canoeing—10,000 m. K2

**Zimonyi, R.** *Hungary* Rowing—Pairs with Cox, Fours with Cox

**Zins, L.** *France* Swimming—100 m. Back-stroke

**Zintzos, S.** *Greece* Fencing—Foil Team, Epee Individual, Epee Team, Foil Individual

**Ziraman, H.** *Turkey* Athletics—Javelin

**Zoet, J.** *Holland* Fencing—Foil Individual

**Zografos, D.** *Greece* Swimming—Water Polo

**Zolezzi, O.** *Argentina* Rowing—Fours without Cox

**Zoric, A.** *Yugoslavia* Cycling—Road Race

**Zsagot, I.** (F) *Hungary* Swimming—High Diving

**Zsiros, T.** *Hungary* Basketball

**Zsitnik, B.** *Hungary* Rowing—Pairs with Cox

**Zucchi, A.** *Argentina* Hockey

**Zuddas, G.** *Italy* Boxing—Bantamweight

**Zulf icar, M.** *Egypt* Fencing—Foil Team, Sabre Team, Sabre Individual

**Zuniga Erraz, E.** *Chile* Athletics—Hammer

**Zutic, T.** (F) *Yugoslavia* Gymnastics

**Zwaan, J. G.** *Holland* Athletics—100 m., 4 x 100 m. Relay

**Zwaan, J. M.** *Holland* Athletics—110 m. Hurdles

**Zwazl, F.** *Austria* Swimming—100 m. Back-stroke

**Zwierewich, J.** *Canada* Rowing—Eights

The above index is a record of the competitors who actually took part in the 1948 Olympic Games. It does not include those who were entered but who did not, in fact, participate. The names have in all cases been checked against the official entry forms supplied by the National Olympic Committees. Details of entrants in the Arts Competitions are included in the Official catalogue of the Arts Exhibition, a copy of which accompanies this volume.



Copyright © 2004, Amateur Athletic Foundation of Los Angeles

## **Notes on the digitized version of the Official Report of the Organising Committee for the XIV Olympiad London 1948**

The digital version of the Official Report of the Games of the XIV Olympiad was created with the intention of producing the closest possible replica of the original printed document. These technical notes describe the differences between the digital and printed documents and the technical details of the digital document.

### The original document

The original paper version of the 1948 Official Report has dimensions of 8.4 x 11.1” (21.3cm x 28.2cm).

The volume’s spine is dark green. The text “XIV OLYMPIAD LONDON 1948” appears in gold on the spine.

The book has 766 pages.

The fonts used in the digital version book for text, photograph captions and chapter headings are Times and such system fonts as best approximate the original fonts.

Special features of the digital version:

- The spine is not included in the digital version.
- Blank pages have been retained in the digital version to maintain correct pagination.
- The digital version includes a bookmark list that functions as a hyper linked table of contents. Selecting a topic heading will take you to the corresponding section in the document.

Profile of the digital version:

File name: OR1948.pdf

File size: 32,048 KB

Format: Portable Document Format (PDF) 1.4 (Adobe Acrobat 5.0)

Source document: The Official Report of the Organising Committee for the XIV Olympiad London 1948

Printed by McCorquodale & Co. Ltd., St.Thomas Street, London, S.E.1

Creation Platform: Windows XP

Creation Date: February 2004

Conversion Software: Adobe Acrobat, FineReader, VistaScan, FahrenEX

Image Resolution: 100 dpi for color and grayscale images

Digital Fonts: Times-Roman

Conversion Service: Exgenis Technologies, India

[www.digitization.info](http://www.digitization.info)