

C  
10.5"  
267

# Ordering & Accessory Guide

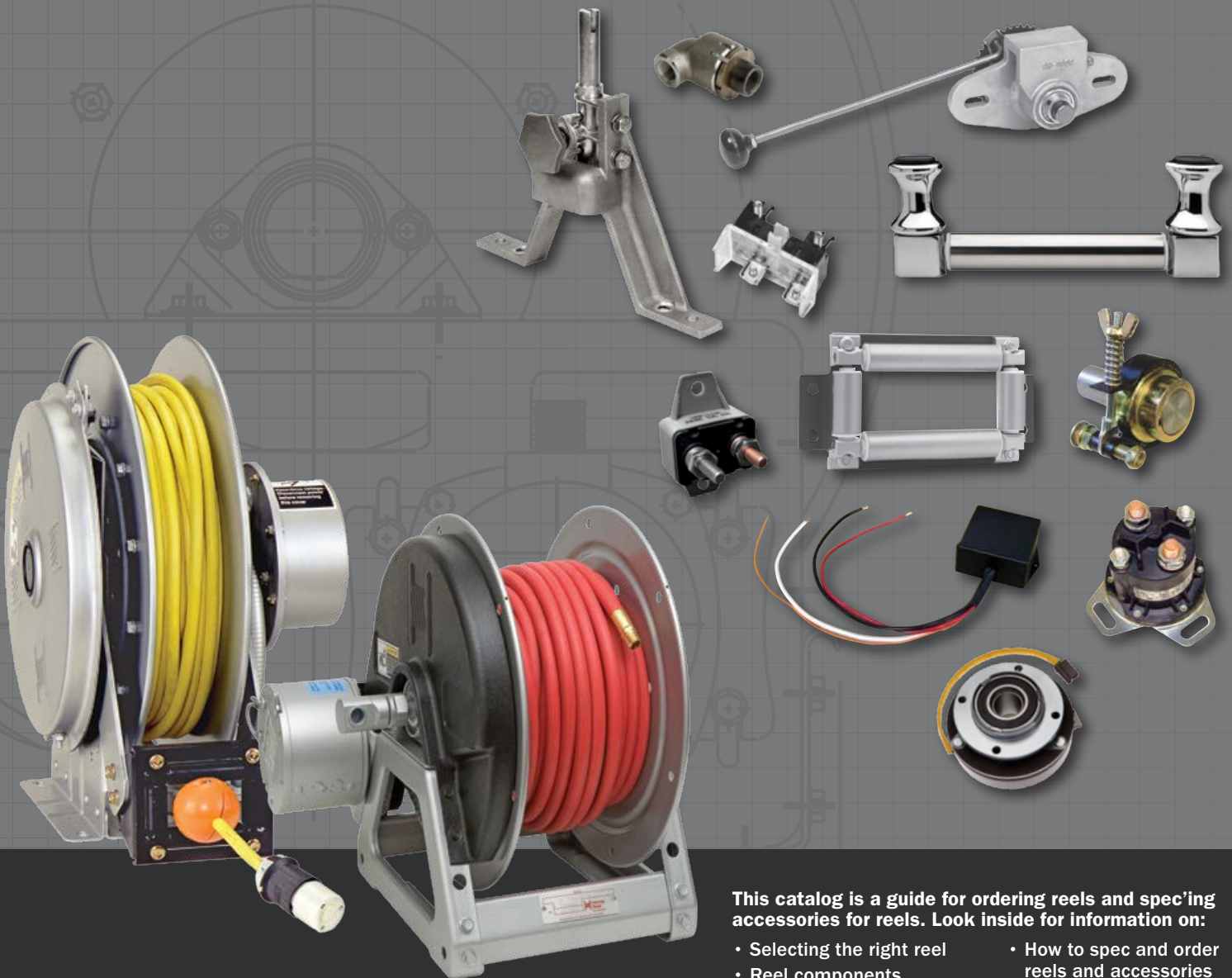

This catalog is a guide for ordering reels and spec'ing accessories for reels. Look inside for information on:

- Selecting the right reel
- Reel components
- Available accessories
- How to spec and order reels and accessories
- Ordering options
- Hannay Reels policies

# CONTENTS

<b>Part I: Reel Ordering Guide</b>	<b>Page</b>
Selecting the Reel	3
Reel Components	4-5
The Anatomy of a Hannay Hose Reel	4
General Specifications of Hannay Hose Reels	4
The Anatomy of a Hannay Cable Reel	5
General Specifications of Hannay Cable Reels	5
Ordering Options	6
How to Specify Hannay Reels	7-9
General Ordering Information	7
Specifying Location of Components	8
Specifying Spring Rewind Reels	9
Hose and Cable Roller Positions	9
Hannay Reels Spec Worksheet	10
<b>Part II: Accessory Ordering Guide</b>	<b>Page</b>
Brakes and Locks	11
RCB Kits and Switches	12
Operating Switches and Speed Controls for Electric Rewind Reels	12-13
Circuit Breakers	14
Rewind Motors	14
Rewind Assemblies for Gear-Driven Crank Rewind Reels	14
Clutch and Reduction Assemblies	15
Hose and Cable Stops	15
Hose Assemblies	15
Roller Assemblies for Spring Rewind Reels	16
Utility Hose Rollers	16
Hose Guide	16
Swivel Mounting Bracket	17
GM-700 Guidemaster	17
FH-3 Roller and Spool Assembly	17
<b>How to Order / Sales Policies</b>	<b>Page</b>
Hannay Reels Accessory Order Form	18
Hannay Reels Sales Policies	19



**Superior products. Superior service.**

We are committed to the needs of our customers and respond by developing high-quality products that perform safely, efficiently, and economically. Our friendly, helpful sales team has a thorough knowledge of our reels and accessories – from how they are made to how they can improve productivity for your business.

For reels that outlast and outperform all the others, you can depend on Hannay, the leader in OEM, industrial, and commercial reel applications.



# Selecting the Reel

## Start with the Hose or Cable

Start with the hose/cable: the size, length, and type of hose/cable to be handled are primary factors in selecting the proper reel for your job. The following points should be considered:

Be sure to use good quality hose rated for the service and operating pressures required. Poor quality hose tends to expand and contract under pressure surges. When this happens, hose remaining on the reel may bind and become difficult to handle. In extreme cases, poor quality hose may expand under pressure to the extent that the reel becomes distorted and is put out of operation.

It is important to use good quality cable, properly sized, with the correct number of conductors to carry the proper amperage and voltage. Consideration should be made for length of cable versus size of conductors, as well as local electrical codes.

We have been manufacturing reels since 1933, and the reels listed in all of our catalogs are those found most in demand to handle hose/cable. Because our reels are assembled from a stock of standard components, we can produce many more sizes than are shown.

**If the exact reel you need is not shown in any of the catalogs, please contact us with your specific requirements. In most cases, we can produce your reel from standard components, at no extra cost to you.**

The drawing shows 2 reels with identical capacity although the **A** and **G** reel dimensions are quite different. In most cases, more than one reel model will handle a particular size and length of hose or cable. Once you determine the size and length of hose or cable you need, you can specify a reel with the dimensions best suited to the available space.

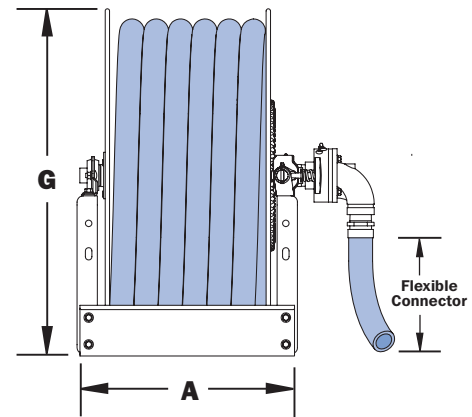
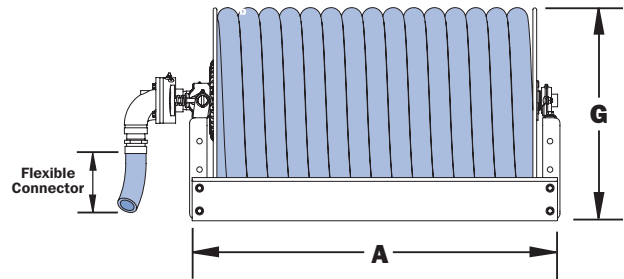

**INSTALLATION NOTE:** For the Hannay Warranty to be valid A FLEXIBLE CONNECTOR MUST BE USED BETWEEN THE SWIVEL AND THE INLET PIPING.

### Sample Model Number Configuration EF32-23-24 RT H5M

EF	32-23-24	RT	H5M
Prefix	Model Number	Suffix	Pressure Rating
Type of Reel/Rewind	Reel Size	Component Orientation	(5000 psi) Pressure

#### Common Prefix Options

<b>E</b> = Non-Explosion Proof Motor	<b>A</b> = Air	<b>C</b> = Cable Storage
<b>EF</b> = Non-Explosion Proof Motor (Fire)	<b>AG</b> = Air Governor	<b>MX</b> = Gear and Sprocket Crank Rewind
<b>EP</b> = Explosion Proof Motor	<b>HD</b> = Hydraulic	<b>T</b> = Twin Spool
<b>EPJ</b> = Explosion Proof Motor with Explosion Proof Switch and Junction Box	<b>HDD</b> = Direct Drive Hydraulic	<b>V</b> = Aviation

# Hose Reel **Components**

## The Anatomy of a Hannay Hose Reel

**1 Bearings**

Weight of spool and hose is supported by bearings.

**1a Back bearing**    **1b Front bearing**

**2 Disc**

Rolled edges prevent hose damage and add rigidity to disc. Additional strength is provided by a concentric rib.

**3 Drum**

Roll formed steel with full-length weld.

**4 Tie rods**

Join discs and drum to form spool. Reinforced with pipe spacers for rigidity and strength.

**5 Chain and sprocket drive**

Provides smooth positive rewinding on powered reels.

**6 Rewind motor**

Electric rewind motor is shown. Compressed air or hydraulic motors can be used.

**6a Electric junction box**

**7 Hub assembly**

Includes the fluid hub, the outlet riser, and the reel axle. Fluid passes from the swivel joint inlet through the hub assembly, to the hose.

**7a Outlet riser**

Contoured to match the curve of the reel drum so hose will wrap smoothly.

**7b Fluid hub**

**8 Swivel joint inlet**

Permits reel to rotate freely while connected to the fluid source. Joint is not used as a bearing. Straight or 90° swivel joints are available for most models. (Flexible connector must be used between swivel joint and inlet piping or warranty will be void.)

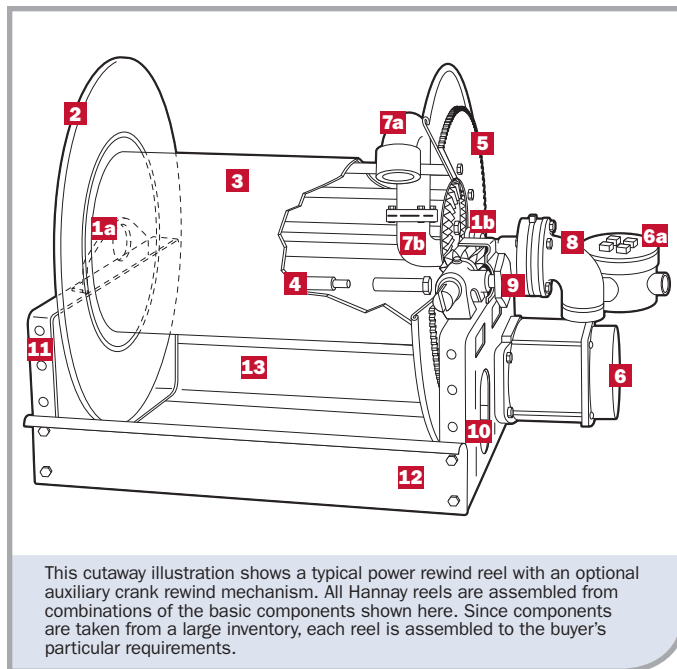

This cutaway illustration shows a typical power rewind reel with an optional auxiliary crank rewind mechanism. All Hannay reels are assembled from combinations of the basic components shown here. Since components are taken from a large inventory, each reel is assembled to the buyer's particular requirements.

**9 Brake/rewind assembly**

Bevel gear rewind has an adjustable tension brake.

Rewind and braking devices vary with different models.

**10 Front frame**

**11 Back frame**

**12 Front foot**

**13 Back foot**

### General Specifications of Hannay Hose Reels

**Construction:**

Frames, discs, and drum are fabricated of heavy-gauge steel. Bearings are self-aligning. Malleable iron and steel are used for hose reel hub assembly, outlet riser, and swivel joints.

Stainless steel, aluminum, and special swivel joint packing can be supplied to meet special requirements.

**Finish:**

Standard finish is oven-cured enamel. Finishes other than standard, such as special primers, may be specified at extra cost.

**Temperatures and Pressures:**

Standard reel construction will handle most liquids or gases at temperatures ranging from -20° to +400° F (-29° to +204° C). Operating pressures available up to 10,000 psi (690 bar) depending on the specific reel series. These operating pressures and temperatures are shown on descriptive pages in each product catalog.

Reels to operate at pressures and temperatures other than standard are available at extra cost.

**Shipping:**

Reels are shipped completely assembled, ready to install. Installation instructions are supplied with each reel.



# Cable Reel Components

## The Anatomy of a Hannay Cable Reel

### 1 Bearings

Weight of spool and cable is supported by bearings.

**1a Back bearing**    **1b Front bearing**

### 2 Disc

Rolled edges prevent cable damage and add rigidity to disc. Additional strength is provided by a concentric rib.

### 3 Drum

Roll formed steel with full-length weld.

### 4 Tie rods

Join discs and drum to form spool, reinforced with pipe spacers for rigidity and strength.

### 5 Chain and sprocket drive

Provides smooth positive rewinding on powered reels.

### 6 Hub assembly

Provides wiring access to the slip ring assembly and serves as the reel axle. Cable is connected to the slip ring assembly, passes through hub and exits drum through a grommeted hole.

### 7 Collector ring

Provides electrical continuity through reel as cable is payed out or retrieved.

### 8 Collector ring cover

Provides protection from current carried through collector ring assembly as well as keeping out contamination.

### 9 Wiring junction box

Provides connection of reel to incoming power source.

### 10 Brake/rewind assembly

Bevel gear rewind has an adjustable tension brake. Rewind and brake devices vary with different models.

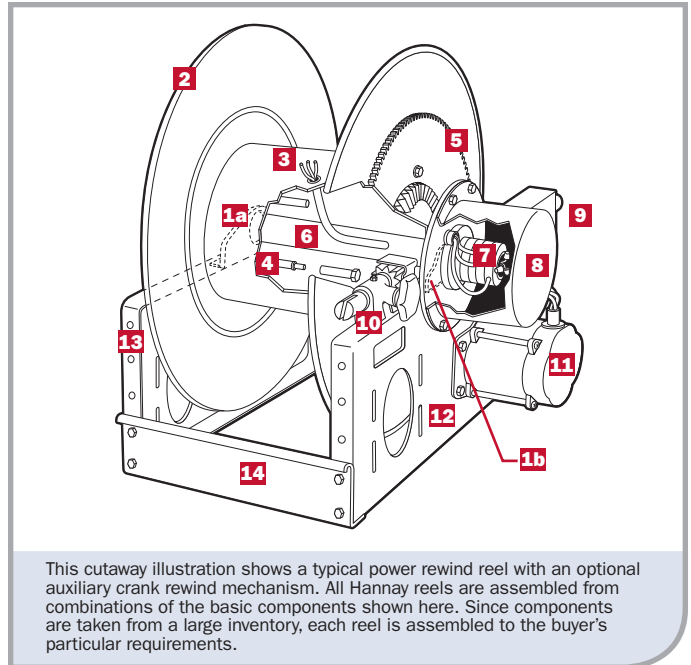

This cutaway illustration shows a typical power rewind reel with an optional auxiliary crank rewind mechanism. All Hannay reels are assembled from combinations of the basic components shown here. Since components are taken from a large inventory, each reel is assembled to the buyer's particular requirements.

### 11 Rewind motor

Electric rewind motor is shown. Compressed air or hydraulic motors can be used.

### 12 Front frame

### 13 Back frame

### 14 Front foot

### 15 Back foot (not shown)

## General Specifications of Hannay Cable Reels

### Construction:

Frames, discs, and drum are fabricated of heavy-gauge steel. Bearings are self-aligning. Collector ring housings are ABS plastic or insulated steel, depending on model.

### Electrical Connections:

A pull wire is provided for installing cable through drum and hub. Connection from the electrical source to the reel is through a junction box or a preconnected wire lead, depending on the reel model.

### Collector Ring Assembly:

Reels to handle live electric cable are normally equipped with a 3-conductor collector ring assembly. Assemblies with additional conductors and for higher amperage are available at extra cost on most models. Be sure to specify your application.

### Standard:

45A 600V standard. Up to 300A available at additional cost.

### Finish:

Standard finish is oven-cured enamel. Finishes other than our standard, such as special primers, may be specified at extra cost.

### Shipping:

Reels are shipped completely assembled, ready to install. Installation instructions are supplied with each reel.

# Ordering Options

## Hub Assembly Options

The hub assembly is the heart of the hose reel. It includes the outlet riser, the reel axle, and the threaded inlet to which the swivel joint is attached. The swivel joint permits the reel to rotate freely while connected to the fluid source.

The outlet riser is engineered to conform to the contour of the drum so the hose lies smoothly against the drum without kinking. Smooth interior surfaces are flow-contoured for unrestricted flow and minimal pressure loss through the reel.

A 2-way flow hub assembly is available on certain models as an option. On this assembly, the reel axle is threaded on both ends so the swivel joint can be attached at either end to match piping. A pipe cap is supplied to seal the opposite end.

### Standard Hub Assembly

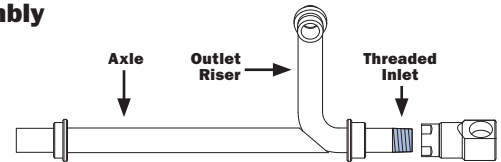

### Standard Hub Assembly with Optional Flanged Riser

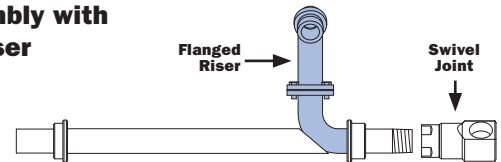

### Optional 2-Way Hub Assembly

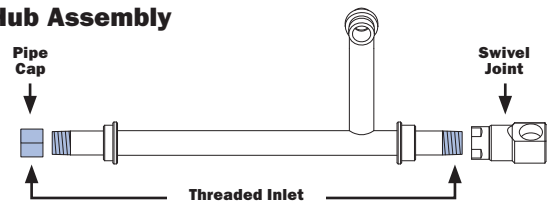

## Rewind Options

### Manual Rewind Reels

1. Gear-driven manual rewind reels are equipped with a crank operated ring gear mechanism. This mechanism can be used to provide an auxiliary rewind capability on certain power rewind reels.
2. Disc rewind reels are rewound by manually turning the reel discs (not shown).
3. Direct manual rewind reels are equipped with either a permanently attached or removable crank (depending on model) which attaches to the reel axle to rewind the reel.
4. Chain-driven manual rewind reels are equipped with a crank operated chain and sprocket mechanism parallel to the reel axle (not shown).

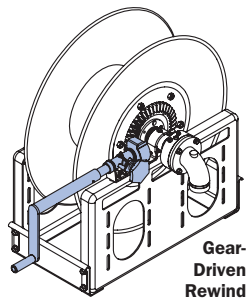

**Gear-Driven Manual Rewind**

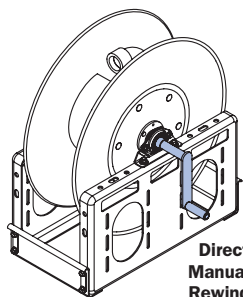

**Direct Manual Rewind**

### Spring Rewind Reels

1. Spring motor module – Tamper-proof spring housing protects the spring and eliminates risk of injury to the operator. Powerful spring delivers positive rewind power through thousands of cycles without power loss.
2. Ratchet assembly – Locks the reel at any point when hose/cable payout stops. A pull on the hose/cable disengages the lock for instant rewinding. This assembly is deleted for automatic payout and rewind for constant tension applications.
3. Declutching arbor – Disengages the spring to prevent damage from reverse winding.

Because they utilize self-contained rewind power, spring rewind reels are extremely versatile. No power connections are required and the reels can be installed in virtually any position and on all types of equipment.

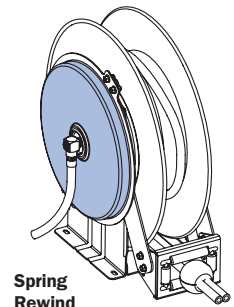

**Spring Rewind**

### Power Rewind Reels

A chain and sprocket mechanism is used on reels with power rewind; the chain drive assures smooth, positive power transmission and minimum maintenance.

A choice of electric, compressed air or hydraulic motors is offered for power rewind reels. Specific information on motors and operating controls is listed on pages 12, 13, and 14.

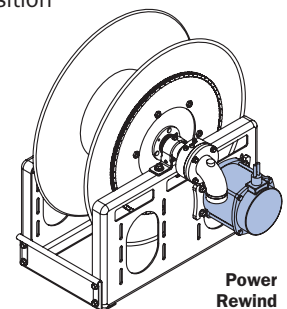

**Power Rewind**

# How to Specify Hannay Reels

## General Ordering Information

A precise and complete purchase order is your best assurance of prompt delivery of the exact reel you need. Your order should include all information listed. It is better to overspecify than to omit important information.

When space permits, select a reel with greater capacity than you actually need. This allows you to rewind the hose/cable with less care and keeps the hose/cable well protected within the disc dimension even if it is not wound in uniform coils. In most cases, the larger reel, in the same series, costs no more.

## Continuous-Flow Hose Reels

Orders for all continuous-flow hose reels should specify:

- Complete model number
- Type of rewind
- Length, I.D. and O.D. of hose(s)
- Maximum working pressures
- Size and thread of outlets
- Minimum bend radius
- 90-degree (standard) or straight swivel joint
- Liquid, gas or other product to be handled
- Oxygen/acetylene use
- Product temperature range
- Finish, if other than standard
- How reel will be installed and used
- Accessory items required

## Live Electric Cable Reels

Orders for live electric cable reels should specify:

- Complete model number
- Type of rewind
- Gauge, length, O.D. and weight of cable
- Cable voltage and amperage
- Minimum bend radius
- Number of conductors required
- Finish, if other than standard
- How reel will be installed and used
- Accessory items required

## Dry Storage Reels

Orders for dry storage reels should specify:

- Complete model number
- Length, O.D., and weight of hose, cable, rope or other material to be handled
- Bending radius, if material is not easily coiled
- Type of rewind
- Divider disc spacing, if required
- Finish, if other than standard
- How reel will be installed and used
- Accessory items required

## Power Rewind Reels

Orders for power rewind reels must also specify:

- Voltage and phase for electric motor
- Air or hydraulic rewind
- With or without auxiliary crank rewind

## Spring Rewind Reels

Orders for spring rewind reels must also specify:

- Roller position SR, VR or TR (see page 9)
- Hose stop, if required [specify O.D. of hose(s) or cable(s)]
- Ratchet locking (standard) or without ratchet for automatic operation
- Height of lift, if reel is to lift hose/cable and weight of hose/cable with or without load
- Describe installation in terms of lift, stretch, drag or recovery (see page 9)

**INSTALLATION NOTE:** For the Hannay Warranty to be valid:

1. A FLEXIBLE CONNECTOR MUST BE USED BETWEEN THE SWIVEL AND THE INLET PIPING, (see illustration on page 3 of this catalog).
2. On DC electric rewind reels, a circuit breaker must be installed between the battery and the rewind motor.

# How to Specify Hannay Reels

## Specifying Location of Components

### Optional Location of Components

Location of the inlet, outlet riser, and rewind mechanism can be varied to meet your requirements and **must be specified on your order**. The drawings below show the component locations. Unless otherwise specified, most reels will be shipped as **Right Top Rewind** with the inlet, outlet riser, and rewind mechanism on the operator's right.

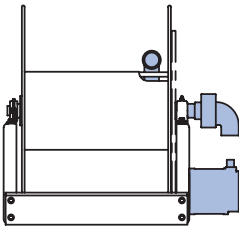

#### RT – Right Top Rewind

Reels have the inlet, outlet riser, and rewind mechanism on the operator's right. Hose unwinds from the top of the reel.

**Standard** – Always look at your reel from this position to determine right hand or left hand.

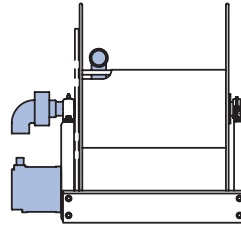

#### LT – Left Top Rewind

Reels have the inlet, outlet riser, and rewind mechanism on the operator's left. Hose unwinds from the top of the reel.

Standard for 1500, 1800, 2000 and 4000 Series reels.

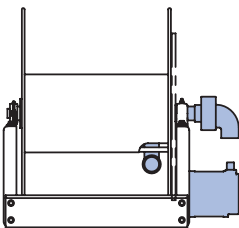

#### RB – Right Bottom Rewind

Reels have the inlet, outlet riser, and rewind mechanism on the operator's right. Hose unwinds from the bottom of the reel.

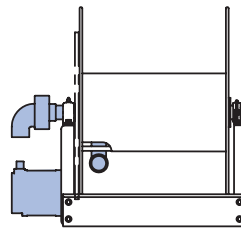

#### LB – Left Bottom Rewind

Reels have the inlet, outlet riser, and rewind mechanism on the operator's left. Hose unwinds from the bottom of the reel.

**Note:** Use component location initials as suffix **after** model number (ie: EF32-23-24 **RT**)

### Optional Motor Locations

Electric rewind motors can be installed in any of the positions shown in these drawings. The Bottom Rear position is standard. The motor is installed inside the frame on Model ESF reels (see Firefighting catalog), which are designed for installation in restricted space.

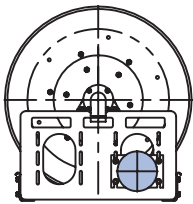

Bottom rear  
(Standard)

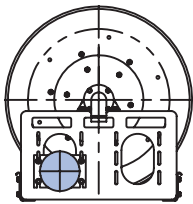

Bottom front

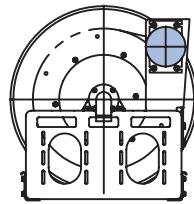

Elevated  
2 o'clock

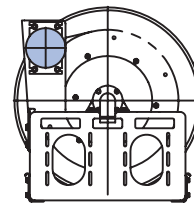

Elevated  
10 o'clock

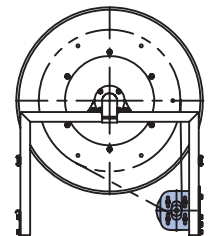

Inboard  
(ESF Reels)

### Optional Auxiliary Rewind Positions

Horizontal ring and pinion gear crank rewind mechanism is the standard configuration.

Optional positions include vertical and 30° above centerline, as shown in these drawings. Both are available at extra cost and **must be specified**.

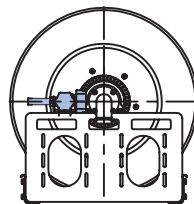

Horizontal (Standard)

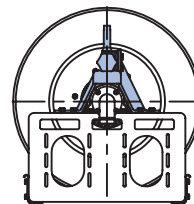

Vertical

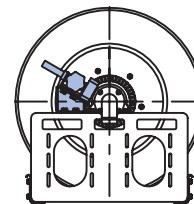

30° Angle



# How to Specify Hannay Reels

## Specifying Spring Rewind Reels

### Important Installation Guide

For proper reel operation, rewind springs must be precisely matched to the job. Your order should include a detailed description of how the reel will be installed and used. This will also help to determine the best roller position.

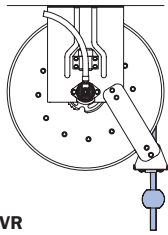

LIFT  
Roller VR

### Vertical Lift

Reel is installed overhead, on wall or ceiling, to lift hose/cable and product being handled. Spring must have power to lift total weight of hose/cable **plus any weight which will be attached to the hose/cable** such as a power tool. Reel can be manually operated or pay out and rewind **automatically**. Specify height of lift and weight of hose/cable and attachments when you order.

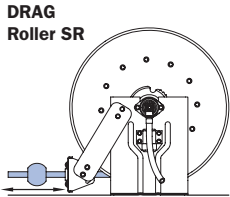

DRAG  
Roller SR

### Drag

Reel is stationary and retracts hose/cable across floor or other surface. Spring must have power to compensate for friction. Reel can be manually operated or pay out and rewind **automatically**.

Note: A rough drawing of your specific installation plans will be extremely helpful.

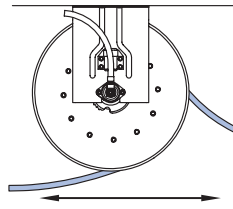

STRETCH  
2-way payout  
No roller

### Stretch

Reel is stationary and retracts suspended hose/cable attached to moving equipment. Reel pays out and rewinds **automatically**. Spring must have power to compensate for weight of unsupported hose/cable. Specify maximum hose sag allowable.

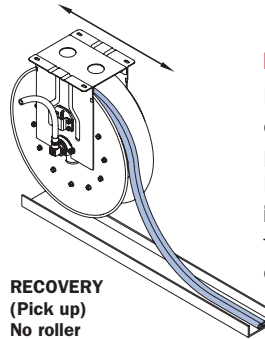

RECOVERY  
(Pick up)  
No roller

### Recovery

Reel is installed on moving equipment or at a fixed center point to retract and pay out hose/cable in 2 directions. Reel pays out and rewinds **automatically**. If reel travels, specify speed of travel, acceleration rate, and height of reel above recovery surface.

### Reverse Spring Location

A reverse spring location option is available if your installation requires it.

**For SR and VR roller positions:** swivel joint will be standard on the left, with spring on the right.

**For TR roller position:** swivel joint will be standard on the right, with spring on the left.

Must specify REV in model number when ordering.

## Hose and Cable Roller Positions

On standard spring rewind reels, the hose/cable pays out from the bottom of the reel and to the left when reel is viewed from the swivel joint or collector ring side. **Hose/cable rollers are supplied with all spring rewind models and you must specify the roller position when you order.** (If roller position is not specified, reels will be shipped with rollers in POSITION SR.)

**Pricing Note:** When reels are ordered for constant tension applications, the ratchet assembly and, in some cases, hose rollers are not required. See Price List for deductions.

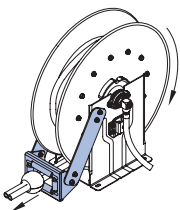

POSITION SR  
(is standard)  
Swivel joint right

### Specify roller position SR when:

- Reel will be installed in the upright position at any point from floor to eye level.
- Reel will be installed on a wall with hose/cable to be retracted close to the wall.
- Reel will be installed on ceiling and hose/cable will pay out parallel to and close to the ceiling.

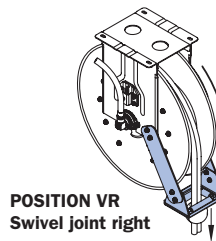

POSITION VR  
Swivel joint right

### Specify roller position VR when:

- Reel will be installed in the upright position and hose/cable will be pulled upright from the reel.
- Reel will be installed on ceiling to lift hose/cable.
- Reel will be installed on a wall with hose/cable to be pulled straight out.

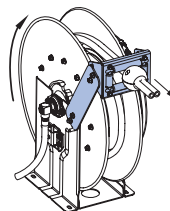

POSITION TR  
Swivel joint left

### Specify roller position TR when:

- Reel will be installed on floor.
- Reel will be installed on ceiling with hose/cable to pay out parallel to the ceiling.

**BE SURE TO SPECIFY ROLLER POSITION WHEN ORDERING.**

Arrows show direction of reel rotation and direction in which hose/cable unwinds.

# Hannay Reels **Spec Worksheet**

To specify Hannay reels, fill out this simple form and mail or fax it to your dealer.  
Photocopy this page or download and print from hannay.com

1. Who is the reel for?			
Contact		Date / /	
Company		Division	
Street Address			
City		State	Country
Telephone ( )		Fax ( )	

2. What is the reel for?			
<input type="checkbox"/> <b>HOSE</b> (check one): <input type="radio"/> Storage only <input type="radio"/> Live Single hose <input type="radio"/> Live Dual hose			
Inside diameter:	Hose length:	Bend radius:	Flat hose dimensions:
Outside diameter:	Hose weight:	Coupling spacing:	
<b>Type of product handled live application:</b> (check one):			
<input type="radio"/> Liquid (specify):	<input type="radio"/> Temperature:	<input type="radio"/> Oxygen/Acetylene:	<input type="radio"/> Other (specify):
<input type="radio"/> Gases (specify):	<input type="radio"/> Pressure:	<input type="radio"/> Hydraulic fluid (specify):	
<b>Fluid path type:</b> (check one): <input type="radio"/> Steel (standard) <input type="radio"/> Aluminum <input type="radio"/> Stainless Steel <input type="radio"/> Other			
<b>Reel inlet type:</b> (check one): <input type="radio"/> Swivel joint 90° (standard) <input type="radio"/> Straight			
<b>Reel outlet type (riser):</b> Size:			
Thread (check one):	<input type="radio"/> National Pipe Thread (NPT)	<input type="radio"/> Joint Industry Committee (JIC)	<input type="radio"/> Other
	<input type="radio"/> National Standard Thread (NST)	<input type="radio"/> British Standard Pipe (BSP)	

Indicate your custom specifications

<input type="checkbox"/> <b>CABLE</b> (check one): <input type="radio"/> Live* <input type="radio"/> Storage only		Indicate your custom specifications
*Number of conductors, or wire gauge, required:		
*Number of connectors:	Cable weight:	Cable length:
*Voltage:	Outside diameter:	
*Amperage (live application only):	Bend radius:	

### 4. Specifying Location of Components

**Optional Location of Components:**  
Location of the inlet, outlet riser, and rewind mechanism can be varied to meet your requirements and **must be specified on your order**. Unless otherwise specified, most reels will be shipped as **Right Top Rewind** with the inlet, outlet riser, and rewind mechanism on the operator's right.

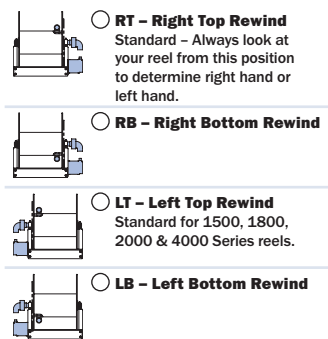

**Note:** Use component location initials as suffix after model number (ie: EF32-23-24 RT)

3. What features does the reel need? Check type of rewind:			
<input type="checkbox"/> <b>MANUAL REWIND</b>			
<input type="radio"/> Disc rewind (hand over hand)	<input type="radio"/> Gear-driven crank	<input type="radio"/> Direct crank (permanent or removable)	<input type="radio"/> Chain-driven crank
<input type="checkbox"/> <b>POWER REWIND</b>			
<input type="radio"/> Spring	<input type="radio"/> Air	<input type="radio"/> Electric (voltage):	<input type="radio"/> Hydraulic
<b>Type of installation</b> (check one): <input type="radio"/> Floor <input type="radio"/> Wall <input type="radio"/> Overhead <input type="radio"/> Vehicle			
Temperature Range:		Environment:	
Accessories (if any):		Hose/Cable Stop: <input type="radio"/> Yes <input type="radio"/> No	
Roller Assemblies:			
<b>Finish:</b> <input type="radio"/> Painted steel (standard) <input type="radio"/> Aluminum <input type="checkbox"/> Polished <input type="checkbox"/> Unpolished <input type="radio"/> Stainless steel <input type="checkbox"/> Polished <input type="checkbox"/> Unpolished			

### 5. Please note size and/or weight limitations for your installation

**SPECIFICATIONS**

Depth: \_\_\_\_\_

Height: \_\_\_\_\_

Width: \_\_\_\_\_

Weight: \_\_\_\_\_

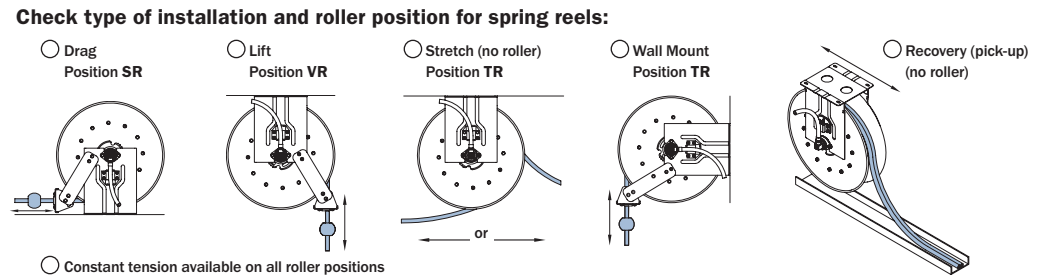

**For custom applications not found in our catalogs, call the Inside Sales Group at 518-797-3791.**

# Accessories

• Brakes and Locks

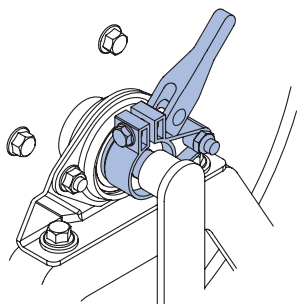

## Cam-Lock Drag Brake

Molded plastic drag brake with cam-lock lever designed for 1/2" and 1" manual reels. Corrosion proof and does not harm the hub. Infinitely adjustable for the desired drag tension to prevent cable or hose overrun. Instantly releases with the flip of a lever for drag-free rewind.

**To Order:** Specify part number (see Price List H-0415-OAL).

**For factory installation:** Specify Cam-Lock Drag Brake with reel order.

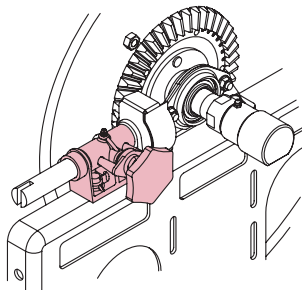

## Pinion Brake

Adjustable spring tension applies braking pressure to pinion shaft on reels equipped with ring gear rewind mechanism.

**To Order:** Specify part number (see Price List H-0415-OAL).

**For factory installation:** Specify Pinion Brake with reel order.

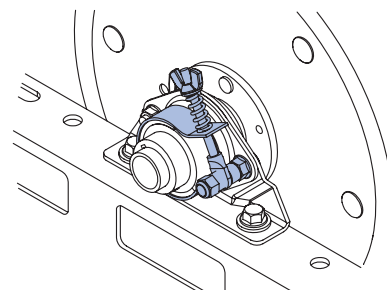

## Strap (Comet) Brake

Adjustable steel strap lined with brake pad material applies drag pressure to reel axle to control payout speed of the reel.

**To Order:** Specify part number (see Price List H-0415-OAL).

**For factory installation:** Specify Strap (Comet) Brake with reel order.

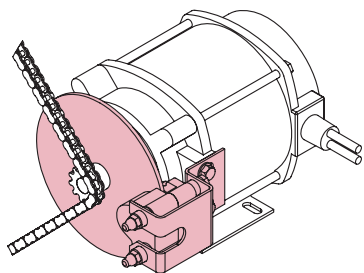

## Caliper Brake

Clamps a disc on the motor shaft for positive locking of reels with power rewind. Can be operated manually, hydraulically or by compressed air.

**To Order:** Specify part number (see Price List H-0415-OAL).

**For factory installation:** Specify Caliper Brake with reel order.

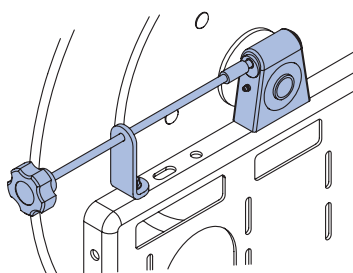

## EH-820 Bearing/Brake Assembly

This assembly provides an alternate method of braking control on certain model reels. Assembly is installed in the back bearing position. Brake applies pressure to the reel axle to slow or lock the reel.

Can be factory installed when specified with reel order, or supplied in kit form for field installation.

**To Order:** Specify part number (see Price List H-0415-OAL.)

**For factory installation:** Specify Bearing Brake/Assembly with reel order.

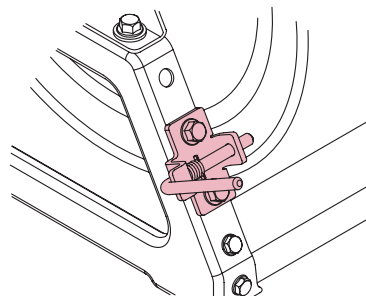

## PL-1 Pin Lock

A positive, spring-actuated pin lock to prevent free-wheeling or recoil from pressure surges. May be factory installed when specified with your reel order.

**To Order:** Specify part number (see Price List H-0415-OAL).

**For factory installation:** Specify Pin Lock with reel order.

# Accessories

- RCB Kits and Switches
- Operating Switches and Speed Controls for Electric Rewind Reels

## RCB Kits (12V DC)

### Reel-Mounted Relay and Circuit Breaker

RCB kits are factory installed, eliminating the need to fabricate and install a circuit breaker and solenoid/relay.

**RCB-12** (12 amp breaker)

**RCB-25** (25 amp breaker)

**RCB-40** (40 amp breaker)



Model RCB-25 shown

## SCB Switches (12V DC)

### Panel-Mounted Switch and Circuit Breaker

SCB switches combine a push-button rewind switch with a circuit breaker, integrated on a brushed aluminum mounting panel. These switches eliminate the need to separately mount and wire individual electrical components.

**SCB-25** (25 amp breaker)

**SCB-40** (40 amp breaker)



Model SCB-25 shown

## SCBW Switches (12V or 24V DC)

### Frame-Mounted Switch and Circuit Breaker

Weather-resistant enclosure, heavy duty push-button rewind switch, 25 amp or 40 amp manual reset circuit breaker. Includes 24 inches of 12 AWG wire (pair) for simple wiring connections – one to motor wire and one to power. Universal mounting bracket also available for mounting to trapezoidal frame.

**SCBW-25** (25 amp breaker)

**SCBW-40** (40 amp breaker)



Model SCBW-25 shown

## Switches and Speed Controls

### 12 or 24 Volt DC Switches

#### 90030 Series Switch

Sealed push-button switch with rubber cap.

Good for 12 or 24V DC service.



#### EXPB-2A Switch

Explosion-proof, push-button switch.

Good for 12 or 24V DC service.



### 115 or 230 Volt AC Switches

#### EXPBC-2B Switch

Explosion-proof, push-button switch.

Good for 115 or 230V AC service.

(Hannay motors only)



#### PB-1 Switch

Weather-resistant (non-explosion proof), push-button switch.

Good for 115 or 230V AC service.

(Hannay motors only)



### 115 or 230 Volt AC Reversing Switches

#### SB-115SR Reversing Switch

Reversing switch with rocker button and fuse.

Good for 115 or 230V AC service.

(Hannay motors only)



# Accessories

## • Operating Switches and Speed Controls for Electric Rewind Reels

### Switches and Speed Controls

#### 12 or 24 Volt AC Speed Controls and Combination Switches

##### SR-50 Speed Control

Fixed (approximate 50% reduction) speed control.

Good for 12 or 24V DC service; limited to 1/3 HP or smaller motors.



##### MD-70 Speed Control

Variable speed control.

Good for 12 or 24V DC service; limited to 1/2 HP or smaller motors.



##### MD-1225S Switch and Speed Control

Push-button rewind switch, variable speed control, and 25 amp manual reset breaker.

Good for 12V DC service; limited to 1/5 HP or smaller motors.

##### MD-1240S Switch and Speed Control

Push-button rewind switch, variable speed control, and 40 amp manual reset breaker.

Good for 12V DC service; limited to 1/3 HP or smaller motors.



##### MD-2425S Switch and Speed Control

Push-button rewind switch, variable speed control, and 25 amp manual reset breaker.

Good for 24V DC service; limited to 1/3 HP or smaller motors.

##### MD-12HDSR Heavy-Duty Reversing Switch and Speed Control

Reversing rewind switch with rocker button, variable speed control, and internal circuit protection.

Good for use on all Hannay 12V DC motors.

##### MD-24HDSR Heavy-Duty Reversing Switch and Speed Control

Reversing rewind switch with rocker button, variable speed control, and internal circuit protection.

Good for use on all Hannay 24V DC motors.



#### 115 or 230 Volt AC Speed Controls and Combination Switches

##### SR-115 Speed Control

Fixed (approximate 50% reduction) speed control.

Good for 115 or 230V AC service. (Hannay motors only)



##### MD-115 Speed Control

Variable speed control.

Good for 115 or 230V AC service. (Hannay motors only)



##### MD-115S Switch and Speed Control

Push-button rewind switch and variable speed control.

Good for 115 or 230V AC service. (Hannay motors only)



##### MD-115SR Reversing Switch and Speed Control

Reversing rewind switch with rocker button and variable speed control.

Good for 115 or 230V AC service. (Hannay motors only)



##### MD-115HDSR Heavy-Duty Reversing Switch and Speed Control

Reversing rewind switch with rocker button, variable speed control, and internal circuit protection.

Good for 115 or 230V AC service. (Hannay motors only)





# Accessories

- **Circuit Breakers** • **Rewind Motors**
- **Rewind Assemblies for Gear-Driven Crank Rewind Reels**

## Circuit Breakers

Circuit breakers must be used with all electric rewind motors. Failure to use properly sized circuit breaker will void motor warranty.

### Compact Series Circuit Breaker

Manual, push-button reset. 5, 10, 15, 25, and 40 amperage ratings available. Built-in mounting bracket.



Compact Series Circuit Breaker

### SDLM Series Circuit Breaker

Manual, push-button reset. 50 and 70 amperage ratings available.



SDLM Series Circuit Breaker

### CB-2 Mounting Bracket for SDLM Breaker

To Order: Specify amperage and give model number of reel motor. Specify CB-2 bracket, if required.



CB-2 Mounting Bracket

## Reversible Rewind Motors

### Electric Motors

For AC or DC operation.

Circuit breakers must be used with all DC electric motors.

Failure to use properly sized circuit breaker will void motor warranty.

See TSB 2013.08.006 for installation instructions.



Face-Mount, Non-E.P. DC Motor (Shown with optional mounting plate, Part No. 9923.0008)

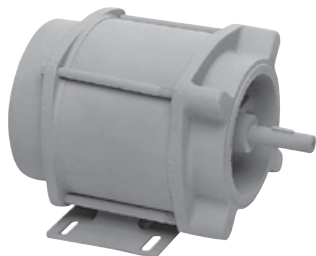

Base-Mount E.P. Electric Motor



Face-Mount E.P. Electric Motor

## Rewind Assemblies for Gear-Driven Crank Rewind Reels

These assemblies are used to change the pinion shaft position on gear-driven crank rewind reels to meet space restrictions or for greater operator convenience. Units can be factory installed, when specified with reel order, or supplied in kit form for field installation.

Assemblies are complete with drag-brake assembly, pinion, gear guard, brake handle, and fasteners. Fits standard mounting holes on reel frame.

To Order: Specify rewind position for parts order or factory installation.



Horizontal Rewind Unit



30° Rewind Unit



Vertical Rewind Unit

## Hydraulic Motors

No other hydraulic components are furnished with the reel. A 4-way, 3-position control valve with motor spool is recommended but is **not supplied**.

See TSB 2013.07.002 for installation instructions.



## Compressed Air Motors

Supplied with a fingertip control valve with integral back pressure relief, and with flexible air line from control valve to rewind motor. We recommend using a lubricator and filter with air rewind motors, which are **not supplied**.

See TSB 2013.08.003 for installation instructions.



Note: All accessories for the above motors are available, but must be ordered separately.

Note: Standard motor voltages available. 12V and 24V DC, 115V AC, 230V AC single-phase and three-phase motors available on special order.

# Accessories

- Clutch and Reduction Assemblies
- Hose and Cable Stops
- Hose Assemblies

## Clutch and Reduction Assemblies

Hannay reduction units are used to increase the torque (by 50 to 400%, depending on the ratio chosen) and decrease the rewind speed on power-driven reels. The clutch allows the motor and reduction unit to be disengaged from the reel, eliminating drag in the unwinding mode. The manual clutch is disengaged by means of a user-operated pull rod. The electric clutch requires no user intervention. It automatically engages when the motor is running, and disengages when the motor stops.

Hannay reduction units and clutches are available as a kit for field installations, or can be factory installed when specified with the reel order.

Reduction unit kits include reduction unit, length of chain, connector links, and fasteners. Clutch/reduction kits include the clutch and reduction unit, length of chain, connector links, and fasteners.

**You must specify the reel model on which the assembly is to be installed.**

Available Ratios	
Reduction Unit Only	Clutch and Reduction Unit
12/18	12/40
12/25	12/48
12/36	12/60
12/48	—
12/60	—

**Electric Clutch and Reduction Unit**

**Manual Clutch and Reduction Unit Kit**

## Hose and Cable Stops

**Recommended with spring rewind reels and 4-way roller assemblies.**

- All stops are quickly installed with included plated fasteners.
- The HS-35 is our standard stop, used for most applications up to and including 1" I.D. hose.
- HS-35 two-piece stops are molded from EPDM rubber for durability and maximum grip.
- HS-3 and HS-45 two-piece stops are molded from polypropylene, and are custom drilled to the size you specify.

**To Order:** Use Hannay part number from chart below (specify single or twin hose). Specify the outside diameter (O.D.) of your hose or cable. Please note that for the plastic stops, the drilled hole size will be 1/16" (single hose) or 1/32" (twin hose) **smaller** than the O.D. of the hose you specify to ensure a good grip.



Part Number	Spherical O.D.	Min. Hose or Cable O.D.	Max. Hose or Cable O.D.	Material	Best Used
HS-35	3.5"	0.44"	1.53"	EPDM Rubber	1/4" – 1" I.D. hose; Most multi-gauge cable
HS-35 Twin	3.5"	0.47"	0.91"	EPDM Rubber	1/4" – 1/2" Twin I.D. hose
HS-45	4.5"	None (drilled)	2.69"	Plastic	1-1/4" – 2" hose
HS-45 Twin	4.5"	None (drilled)	1.28"	Plastic	3/4" Twin I.D. hose
HS-3	3.0"	None (drilled)	1.81"	Plastic	Hose/cable O.D. less than 0.44"
HS-3 Twin	3.0"	None (drilled)	0.91"	Plastic	Twin hose O.D. less than 0.47"

## Hose Assemblies

Various hose assemblies are available for a wide variety of applications. See Industrial Hose Reel catalog (Form H-0308-H).

# Accessories

- **Roller Assemblies for Spring Rewind Reels**
- **Utility Hose Rollers • Hose Guide**

## Roller Assemblies for Spring Rewind Reels

These 4-way roller assemblies are for use on the reel, on cabinet door openings, and for similar locations where sharp metal edges may cut or damage the hose/cable. Four-way design protects hose even when payout or rewind is at an angle.

The N200 and R200 roller assemblies have Delrin rollers mounted in stamped steel housings for flush panel mounting, reel mounting (R200) or right-angle mounting (N200).

The R300 roller assemblies have stainless steel rollers, Delrin bearing inserts, and zinc die-cast corner mounting blocks assembled on a steel mounting frame.

**To Order:** Specify part numbers: N Models for N Series reels, R Models for Channel Frame reels.

**Note:** A hose stop should be used with 4-way rollers to prevent damage to rollers and nozzles. See description on page 15.

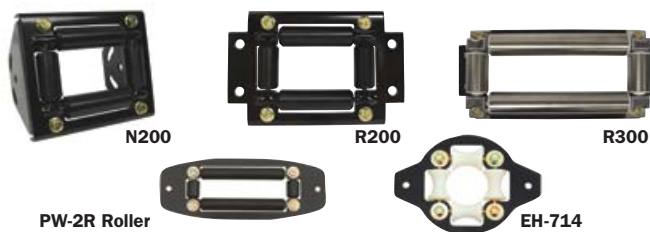

Part Number	Overall Dimensions		Roller Opening	
	Inches	mm	Inches	mm
R203	8.0 x 5.5	203.2 x 139.7	2.5 x 2.0	63.5 x 50.8
R204	9.0 x 5.5	228.6 x 139.7	3.5 x 2.0	88.9 x 50.8
R205	10.0 x 5.5	254.0 x 139.7	4.5 x 2.0	114.3 x 50.8
R206	11.0 x 5.5	279.4 x 139.7	5.5 x 2.0	139.7 x 50.8
N203	5.5 x 5.5	139.7 x 139.7	2.5 x 2.0	63.5 x 50.8
N204	6.5 x 5.5	165.1 x 139.7	3.5 x 2.0	88.9 x 50.8
N205	7.5 x 5.5	190.5 x 139.7	4.5 x 2.0	114.3 x 50.8
N206	8.5 x 5.5	215.9 x 139.7	5.5 x 2.0	139.7 x 50.8
R306	11.25 x 7.0	285.8 x 177.8	5.5 x 2.38	139.7 x 60.45
R308	13.25 x 7.0	336.6 x 177.8	7.5 x 2.38	190.5 x 60.45
R310	15.25 x 7.0	387.4 x 177.8	9.5 x 2.38	241.3 x 60.45
PW-2R	9.75 x 3.75	247.7 x 95.3	5.13 x 1.13	130.3 x 28.7
EH-714	9 x 5.625	228.6 x 142.9	2.5 x 2.5	63.5 x 63.5

## Utility Hose Rollers

Stainless steel rollers and cast alloy brackets for use on the reel, on cabinet door openings, truck platforms, and similar locations where sharp edges may cut or damage hose/cable.

**Specifications:** 1-1/2" diameter stainless steel roller, stainless steel rod, Delrin bearings, alloy brackets, and required fasteners.

**To Order:** Specify Assembly A, B or C, and give distance between **each pair** of mounting holes (Dimensions X and Y) and length of **each roller** (Dimensions W and Z). W=Vertical Roller Length, Z=Horizontal Roller Length.

**Also available factory installed on the reel.**

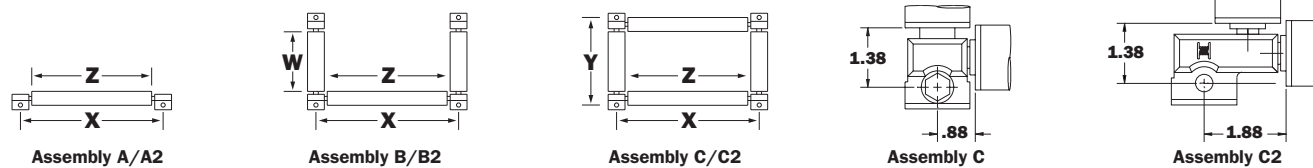

## HG-15 Hose Guide for Small Frame Models

- Available for our 1500, 1600, and 1800 Series reels.
- Simple design to rewind hose evenly and neatly every time.
- No need to handle dirty or contaminated hose.
- Powder coated bracket, stainless steel guide rods, and nylon rollers assure long service life.
- Designed for aftermarket installation.

### Hose Guide Kit – HGK-15 Hannay Part Number 9956.2200

Kit includes HG-15 Hose Guide, handle grip, 2 stainless steel guide rods, 4 mounting blocks, steel mounting bracket set, and all mounting hardware.

### Hose Guide – HG-15 Hannay Part Number 9956.2000

Assembled black powder coated hose guide and handle grip. You must specify reel model when ordering.

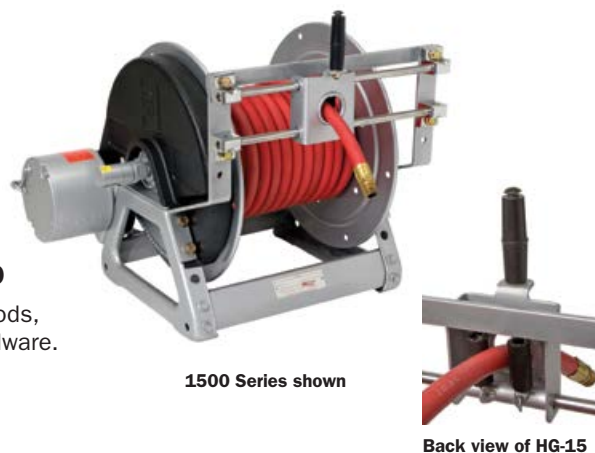



# Accessories

- Swivel Mounting Bracket • GM-700 Guidemaster
- FH-3 Roller and Spool Assembly

## Swivel Mounting Bracket

**Part No. 9908.9990** Swivel mounting bracket for N Series spring retractable reels (with 3" or 4" B dimension) has 160° rotation, designed for easy mounting on wall, post or column. Available as a kit, consult factory.



## GM-700 Guidemaster

### Multiposition hose guide with explosion-proof rewind control

Both models help unwind and rewind hose faster, easier, and with less damage to the hose. Five positive locking positions let the operator pull the hose out and away from sharp corners of cabinet or deck. An explosion-proof, push-button switch in the Guidemaster handle lets the operator control the rewind motor as he guides the hose on the reel in neat, uniform coils.

Construction: Cast aluminum alloy housing, stamped steel pivot plate. Polished aluminum alloy rollers turn on ball bearings. Stainless steel spring, components, and fasteners are used in the pivot release mechanism. Six feet of wire is supplied to connect operating switch to the solenoid. Switch has Class 1 (Groups A, B, C, D) and NEMA 4X ratings.

### The Guidemaster can be ordered in 3 ways:

1. Guidemaster only, supplied with 4 mounting bolts and ready to be attached to your mounting brackets.
2. Guidemaster and brackets, includes steel mounting bracket, beveled spacers, and fasteners designed for your reel. Ready to install. Specify top- or bottom-wind.
3. Guidemaster mounting brackets factory installed. Specify top- or bottom-wind.

**To Order:** For factory installation of mounting bracket, Guidemaster should be ordered when you order the reel.

When purchasing Guidemaster for installation on your present reel, give the complete model number and serial number of your reel and the complete part number of the Guidemaster.

### Circuit breaker must be used with all DC electric motors.

**Note:** This Guidemaster can be used with reels up to a maximum drum width (or B dimension) of 22". Operates with up to a 2.16" O.D. hose.

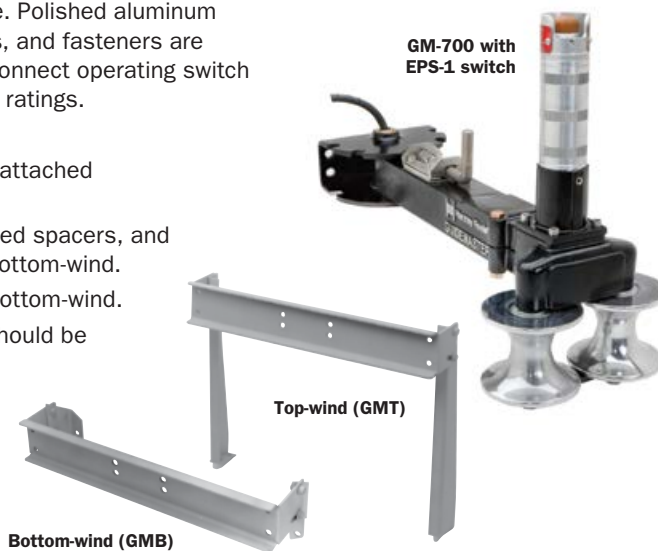

## FH-3 Roller and Spool Assembly

### Not recommended for hoses larger than 1-1/2" I.D.

Speeds handling and reduces hose wear. Buffed stainless steel rollers resist corrosion, pitting, and abrasion. Polished, chrome-plated spools and blocks add lasting beauty to your equipment. Delrin bearing surfaces assure quiet operation and minimum wear.

Assembly can be factory installed, when specified, or ordered for field installation on reels or other equipment.

**To Order:** For factory installation, specify FH-3 Assembly and indicate position on reel. As an accessory, specify FH-3 Assembly and give length of roller (Dimension Z), and distance between mounting holes (Dimension X). Mounting brackets are available.

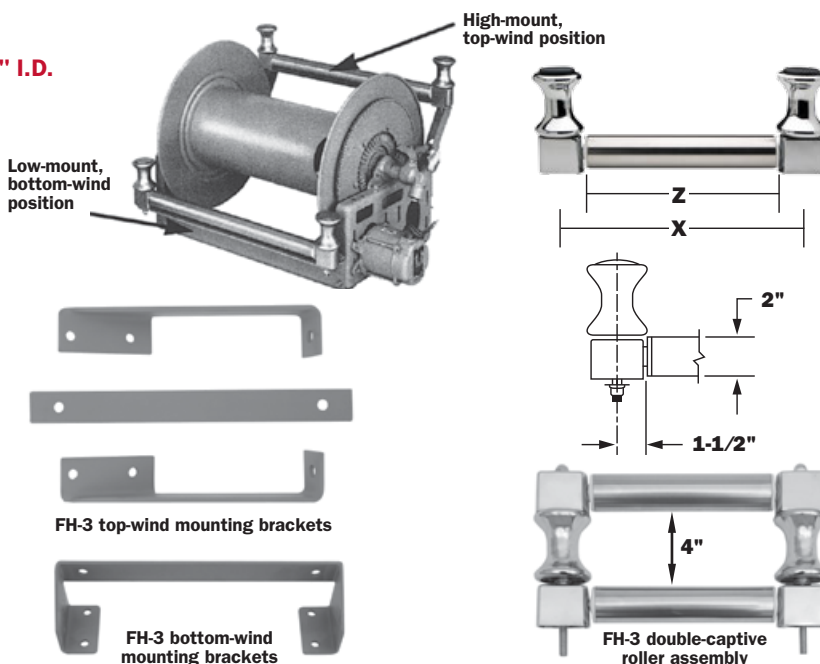





# Hannay Reels **Sales Policies**

## **Our Guarantee and Service Policy: 2-Year Warranty**

Equipment manufactured by Hannay Reels, Inc. is guaranteed for **2 years** from date of shipment when installed according to our instructions, given proper care, and used for the purpose for which it is designed.

Equipment which proves to be defective upon our inspection will be replaced free of charge, including freight to the customer. Our responsibility ceases upon delivery to any common carrier and we do not, unless previously instructed, insure shipments beyond point of delivery to such carrier. No material will be accepted for return without a return goods authorization. No allowance will be made for labor charges incurred in making exchanges, replacements or repairs.

**Components (including hose and cable) which are manufactured by other vendors will be subject to the warranty terms of their own manufacturers.**

**Also excluded from the general guarantee are normal wear items (including seals, motor brushes, and paint finish).**

We reserve the right to modify or alter materials, dimensions, design, and construction when necessary to improve the performance of the reel and/or accessories, or to meet delivery requirements.

**Failure to use a properly sized circuit breaker with any electric rewind motor will void warranty on motor.**

**Failure to use a flexible connector with any live hose reel will void warranty on swivel joint.**

We expressly disclaim any liability for damage or injuries resulting from the use, operation, service, maintenance or failure of equipment.

## **Notice on Reel Finish**

Standard finish on Hannay reels is a high performance modified acrylic enamel paint. Standard color is metallic graphite. Other colors available at no additional cost include red, white, black, and primer.

Most of the major components on standard reels are e-coated prior to receiving final topcoat paint finish. This combination of e-coat and enamel topcoat will meet the finish requirements of most customer applications and environments.

In cases where requirements cannot be met with the standard finish, Hannay Reels can coat any model reel with an automotive primer, allowing application of final coating at your facility. Alternatively, Hannay Reels can provide a quote for matching a customer-provided paint specification. For further information, please contact your Hannay Reels sales engineer and a special paint request form will be sent to you.

For environments where no paint finish is suitable, we offer both aluminum and stainless steel (304 grade) construction on most reel models.

## **Return Goods Policy**

All Hannay reels are built to order. The parts and components are ordered or placed into production as soon as the order is written.

In order to keep the number of returned goods at a minimum, we ask that you use the Hannay Reels Spec Worksheet and/or Accessory Order Form when specifying reels with us.

**Be sure to include any size and/or weight limitations for your installation.**

In the event that an item does need to be returned for credit, repair or replacement, prior approval **must** be obtained from Hannay Reels, Inc. Upon your request, we will fax a Return Goods Authorization form. A signed copy of this form must accompany the material when returned to us.

All material must be returned prepaid, unless otherwise noted on our Return Goods Authorization. **No** return will be accepted that has been damaged due to improper return packaging, tampered with or altered from its original condition. **Equipment specially built to customer specifications and requirements is not subject to cancellation or returnable for credit under any conditions.**

Our restocking and handling fee is a MINIMUM of 25% for standard catalog reels and parts.

No material will be accepted for credit when returned without permission. Orders for equipment incorporating variations from catalog listed items are special and are not subject to return.

No allowance will be made for labor or mileage charges incurred in making exchanges, replacements or repairs.

# You Can't Buy A Better Reel.

Contact our sales department at **1-877-467-3357** or online at **[hannay.com](http://hannay.com)**

## Find reels for every need.

Learn more about all of our reels, including specs, drawings, and even how to select the right reels and accessories for your industry.



View all our reel catalogs online at **[hannay.com](http://hannay.com)**



Family owned and operated since 1933, Hannay Reels is the world leader in both OEM and aftermarket applications. Hannay offers thousands of standard hose reel and cable reel models, as well as unmatched custom capabilities. We can easily and affordably customize a reel to meet your exact specifications – built to last, delivered fast. Additional catalogs are available through your local Hannay Reels dealer or online at **[hannay.com](http://hannay.com)**.



553 State Route 143 | Westerlo, New York 12193  
Email: [reels@hannay.com](mailto:reels@hannay.com) | [hannay.com](http://hannay.com)

All Hannay reels are constructed of quality heavy gauge steel (optional aluminum or stainless steel also available on most models).

Phone: **518-797-3791**  
Toll Free: **1-877-467-3357**

Domestic FAX: **1-800-733-5464**  
International FAX: **518-797-3259**

Form H-0415-OA REV 5 BMP 5M 6-15

