

COUNTRY: TUVALU	PROJECT: JICA/ JPACE	L. D. P.: 1
ATOLL: FUNAFUTI	ORGANISATION: SOPAC	POINT No.: FUN 8
ISLET: FONGAFALE	SURVEYOR: ANDRICK LAL	DATE: 2004

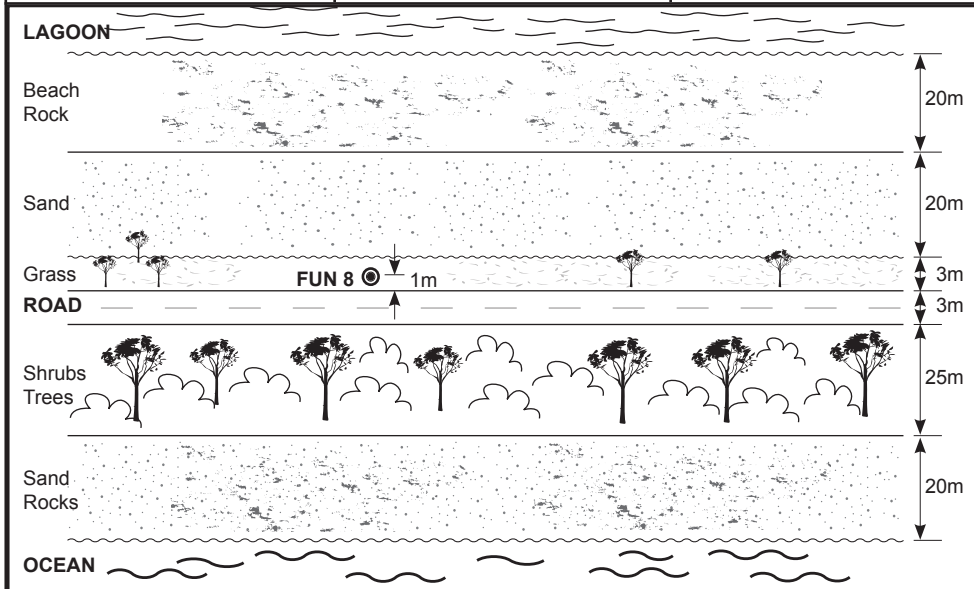

COUNTRY: TUVALU	PROJECT: JICA/ JPACE	L. D. P.: 2
ATOLL: FUNAFUTI	ORGANISATION: SOPAC	POINT No.: FUN114
ISLET: FONGAFALE	SURVEYOR: ANDRICK LAL	DATE: 31/10/2009

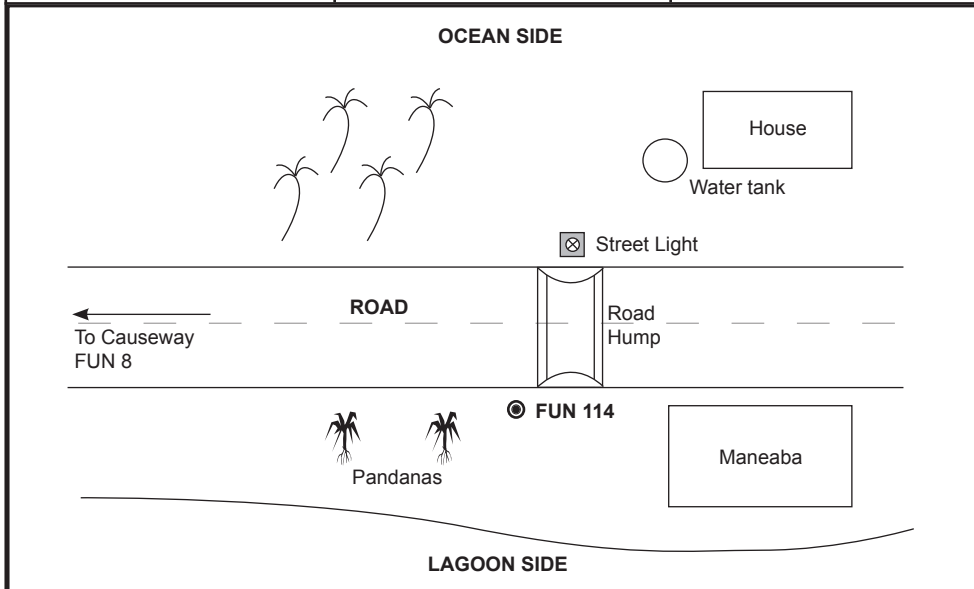

COUNTRY: TUVALU	PROJECT: JICA/ JPACE	L. D. P.: 3
ATOLL: FUNAFUTI	ORGANISATION: SOPAC	POINT No.: FUN 115
ISLET: FONGAFALE	SURVEYOR: ANDRICK LAL	DATE: 31/10/2009

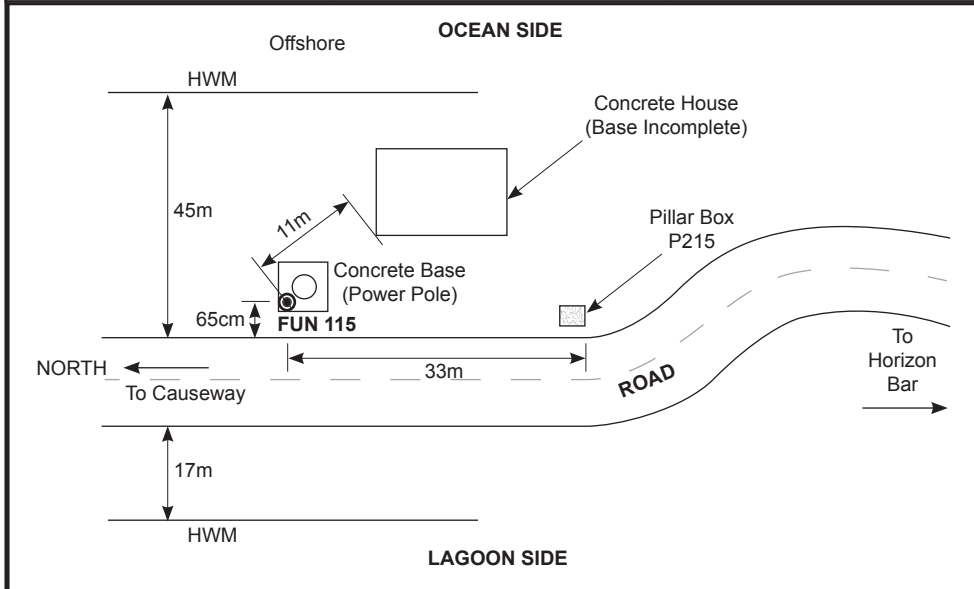

COUNTRY: TUVALU	PROJECT: JICA/ JPACE	L. D. P.: 4
ATOLL: FUNAFUTI	ORGANISATION: SOPAC	POINT No.: FUN 116
ISLET: FONGAFALE	SURVEYOR: ANDRICK LAL	DATE: 31/10/2009

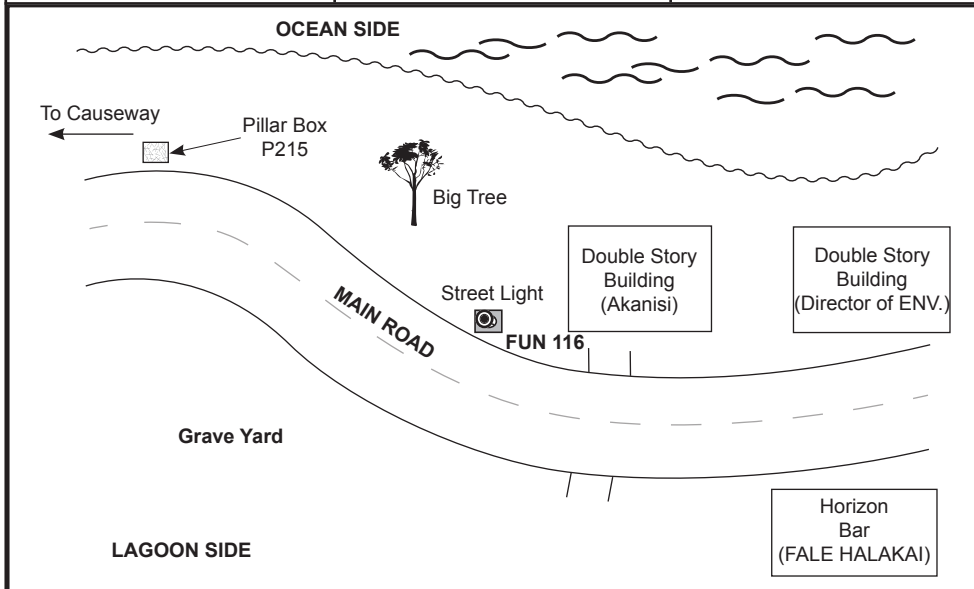

COUNTRY: TUVALU	PROJECT: JICA/ JPACE	L. D. P.: 5
ATOLL: FUNAFUTI	ORGANISATION: SOPAC	POINT No.: FUN 117
ISLET: FONGAFALE	SURVEYOR: ANDRICK LAL	DATE: 31/10/2009

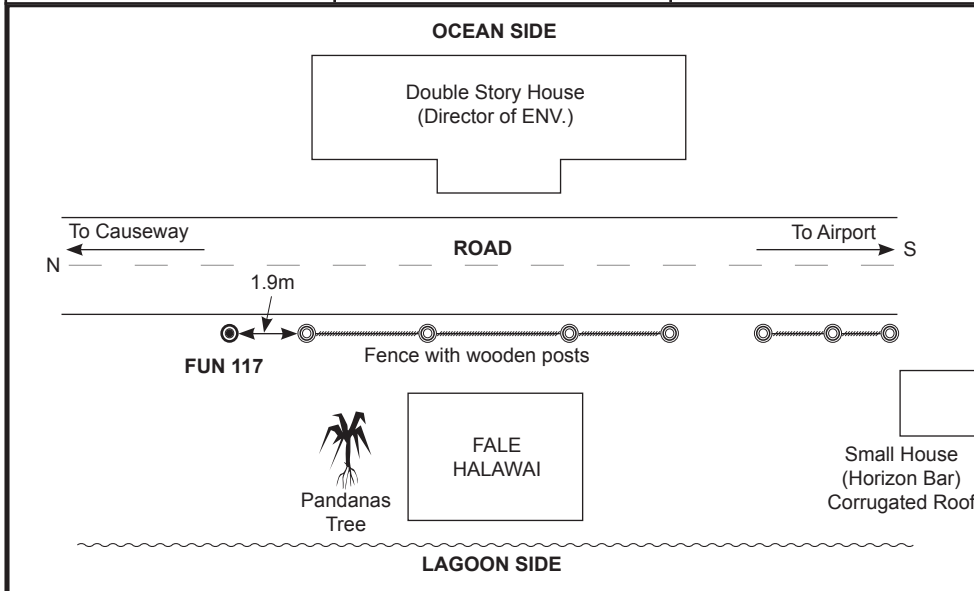

COUNTRY: TUVALU	PROJECT: JICA/ JPACE	L. D. P.: 6
ATOLL: FUNAFUTI	ORGANISATION: SOPAC	POINT No.: FUN 118
ISLET: FONGAFALE	SURVEYOR: ANDRICK LAL	DATE: 31/10/2009

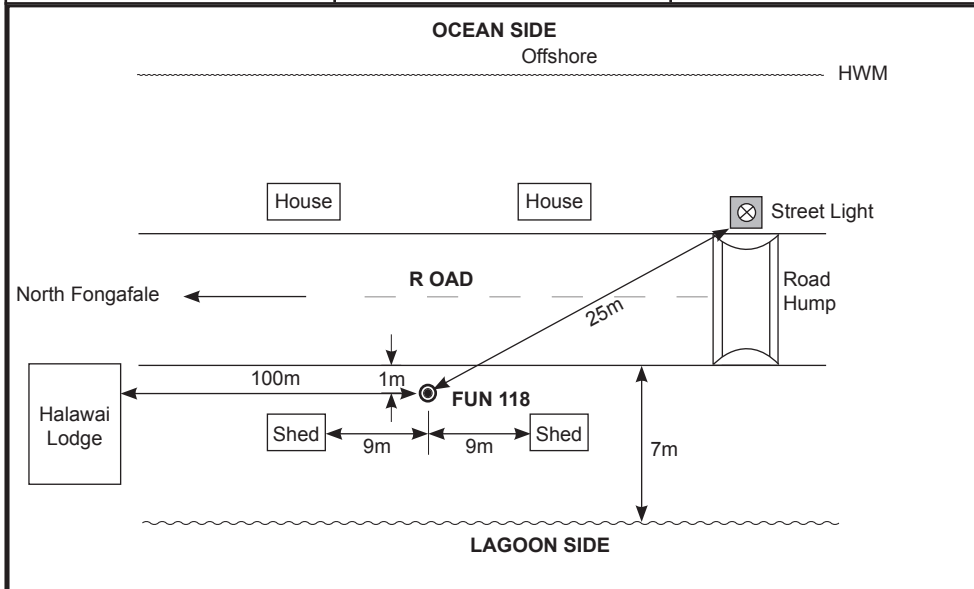

COUNTRY: TUVALU	PROJECT: JICA/ JPACE	L. D. P.: 7
ATOLL: FUNAFUTI	ORGANISATION: SOPAC	POINT No.: FUN11
ISLET: FONGAFALE	SURVEYOR: ANDRICK LAL	DATE: 2004

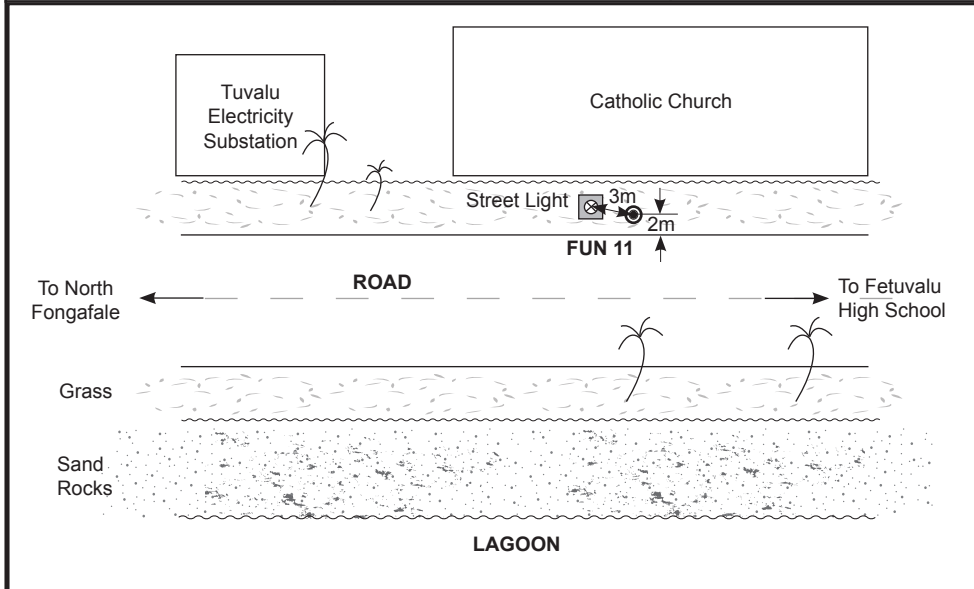

COUNTRY: TUVALU	PROJECT: JICA/ JPACE	L. D. P.: 8
ATOLL: FUNAFUTI	ORGANISATION: SOPAC	POINT No.: FUN 119
ISLET: FONGAFALE	SURVEYOR: ANDRICK LAL	DATE: 31/10/2009

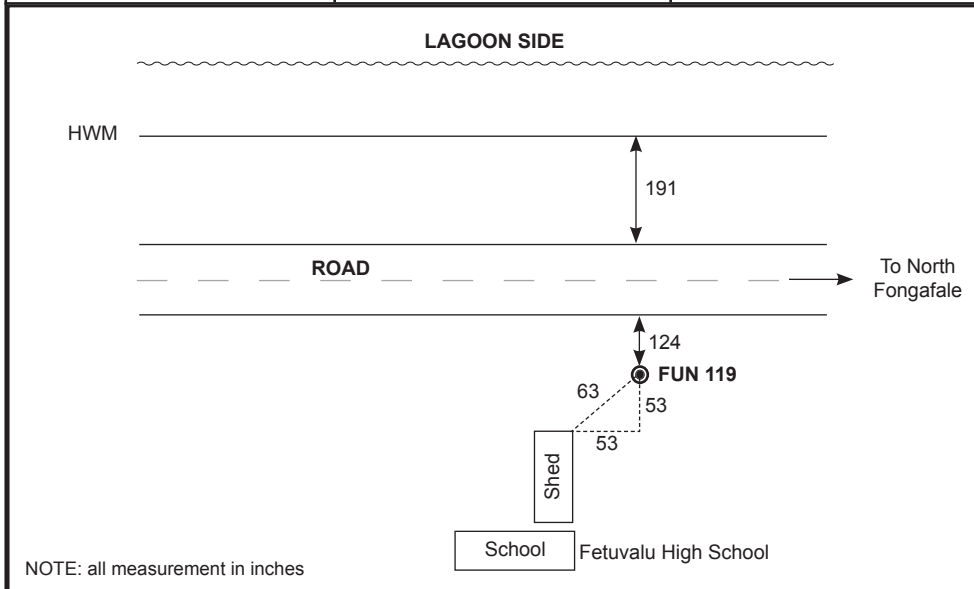

COUNTRY: TUVALU	PROJECT: JICA/ JPACE	L. D. P.: 9
ATOLL: FUNAFUTI	ORGANISATION: SOPAC	POINT No.: FUN 120
ISLET: FONGAFALE	SURVEYOR: ANDRICK LAL	DATE: 31/10/2009

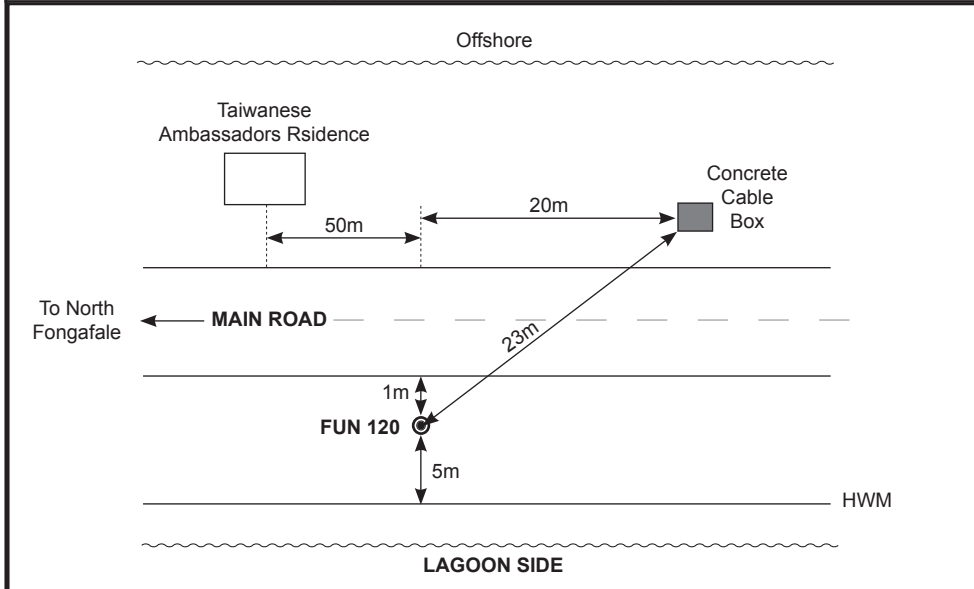

COUNTRY: TUVALU	PROJECT: JICA/ JPACE	L. D. P.: 10
ATOLL: FUNAFUTI	ORGANISATION: SOPAC	POINT No.: FUN 121
ISLET: FONGAFALE	SURVEYOR: ANDRICK LAL	DATE: 31/10/2009

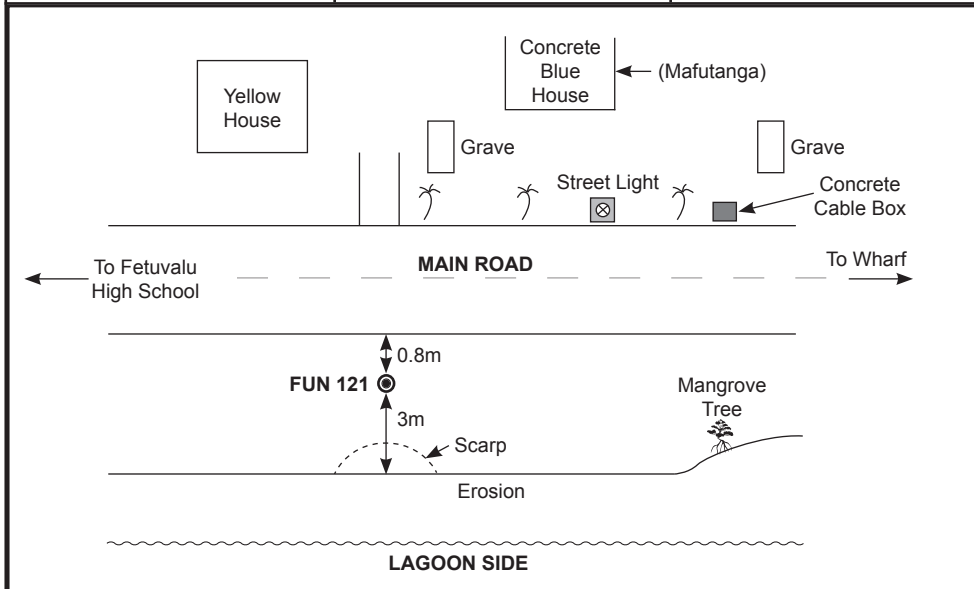

COUNTRY: TUVALU	PROJECT: JICA/ JPACE	L. D. P.: 11
ATOLL: FUNAFUTI	ORGANISATION: SOPAC	POINT No.: FUN 13
ISLET: FONGAFALE	SURVEYOR: ANDRICK LAL	DATE: 2004

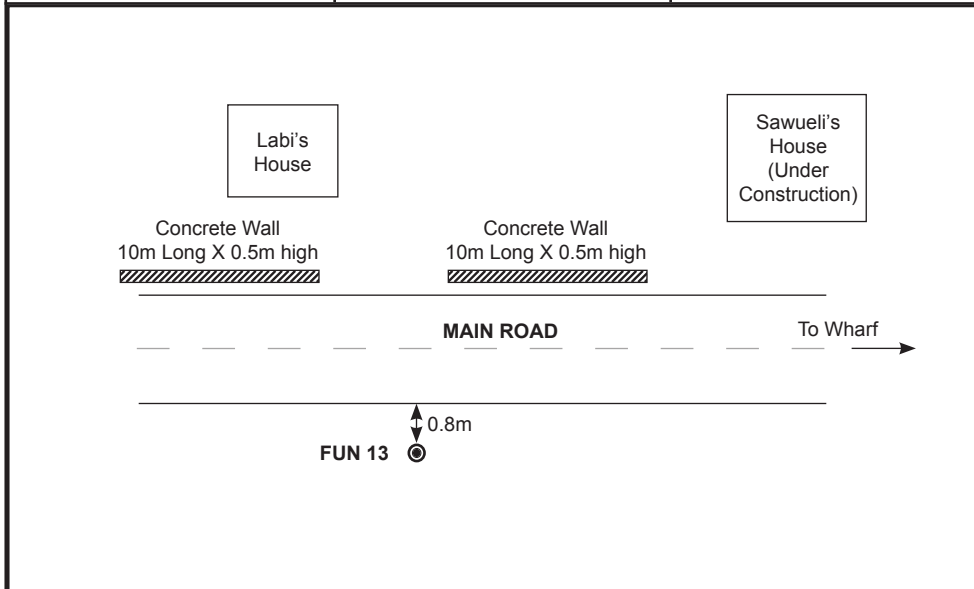

COUNTRY: TUVALU	PROJECT: JICA/ JPACE	L. D. P.: 12
ATOLL: FUNAFUTI	ORGANISATION: SOPAC	POINT No.: FUN 122
ISLET: FONGAFALE	SURVEYOR: ANDRICK LAL	DATE: 31/10/2009

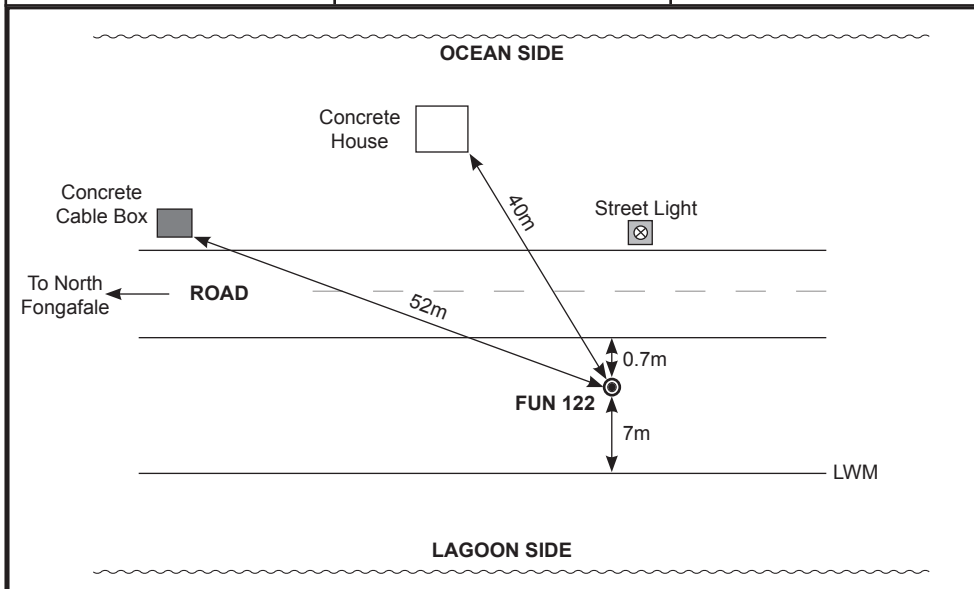

COUNTRY: TUVALU	PROJECT: JICA/ JPACE	L. D. P.: 13
ATOLL: FUNAFUTI	ORGANISATION: SOPAC	POINT No.: FUN 123
ISLET: FONGAFALE	SURVEYOR: ANDRICK LAL	DATE: 31/10/2009

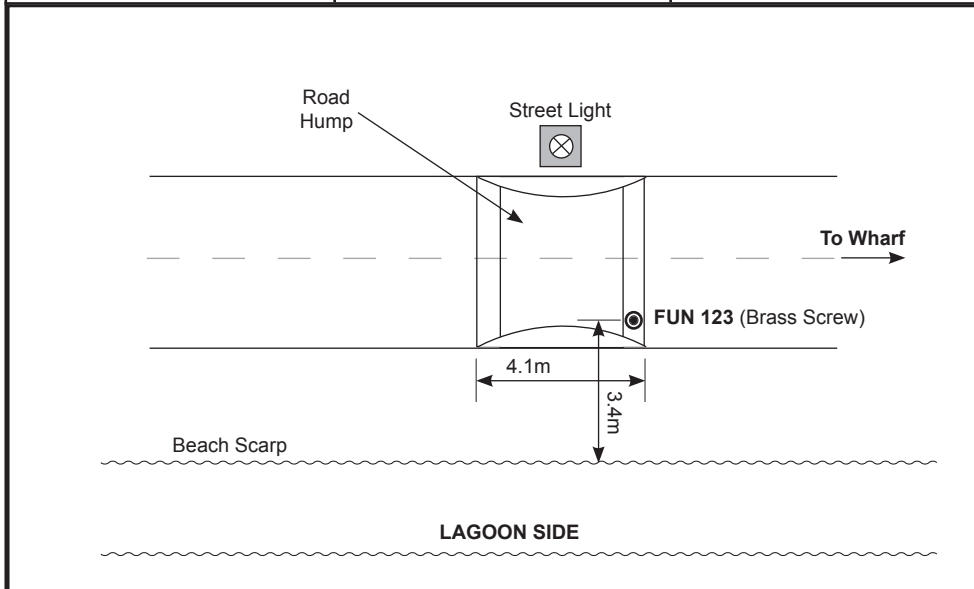

COUNTRY: TUVALU	PROJECT: JICA/ JPACE	L. D. P.: 14
ATOLL: FUNAFUTI	ORGANISATION: SOPAC	POINT No.: FUN 124
ISLET: FONGAFALE	SURVEYOR: ANDRICK LAL	DATE: 31/10/2009

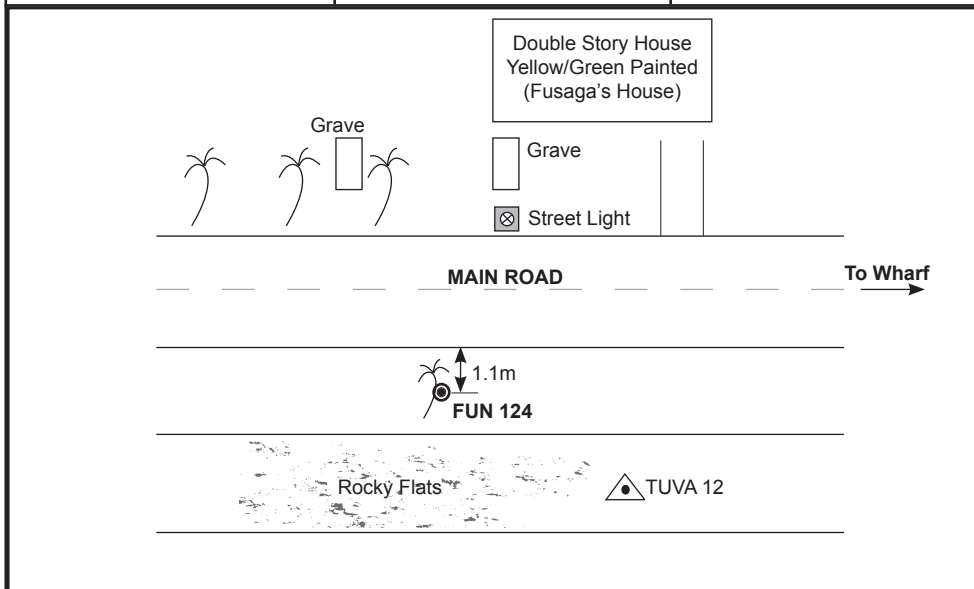

COUNTRY: TUVALU	PROJECT: JICA/ JPACE	L. D. P.: 15
ATOLL: FUNAFUTI	ORGANISATION: SOPAC	POINT No.: FUN 100
ISLET: FONGAFALE	SURVEYOR: ANDRICK LAL	DATE: 30/10/2009

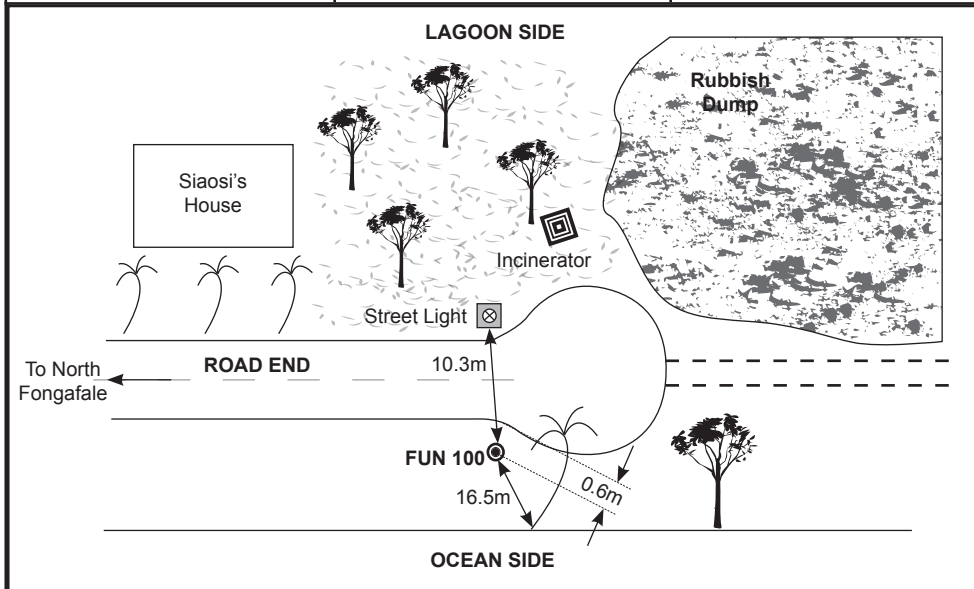

COUNTRY: TUVALU	PROJECT: JICA/ JPACE	L. D. P.: 16
ATOLL: FUNAFUTI	ORGANISATION: SOPAC	POINT No.: FUN 101
ISLET: FONGAFALE	SURVEYOR: ANDRICK LAL	DATE: 30/10/2009

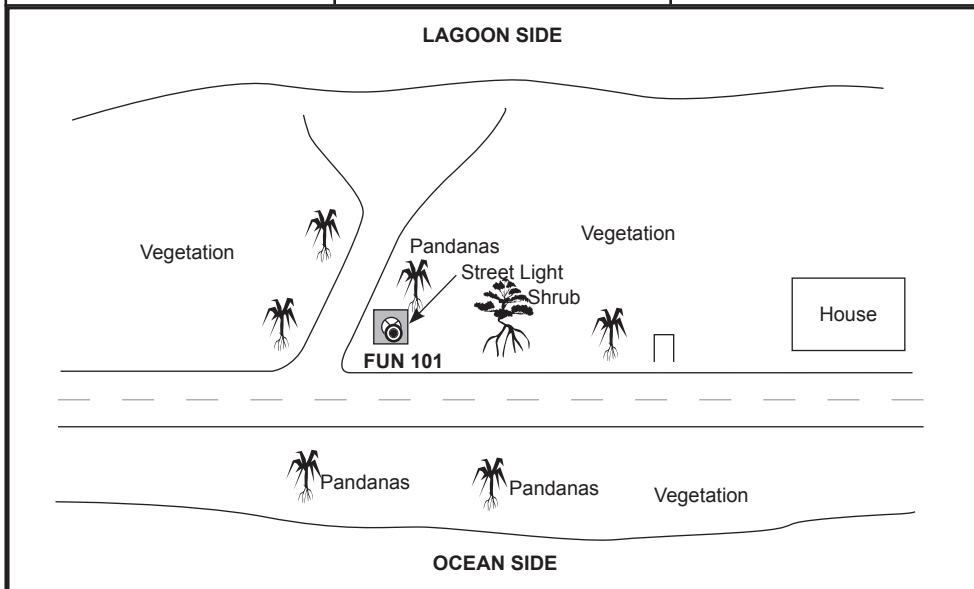

COUNTRY: TUVALU	PROJECT: JICA/ JPACE	L. D. P.: 17
ATOLL: FUNAFUTI	ORGANISATION: SOPAC	POINT No.: FUN 102
ISLET: FONGAFALE	SURVEYOR: ANDRICK LAL	DATE: 30/10/2009

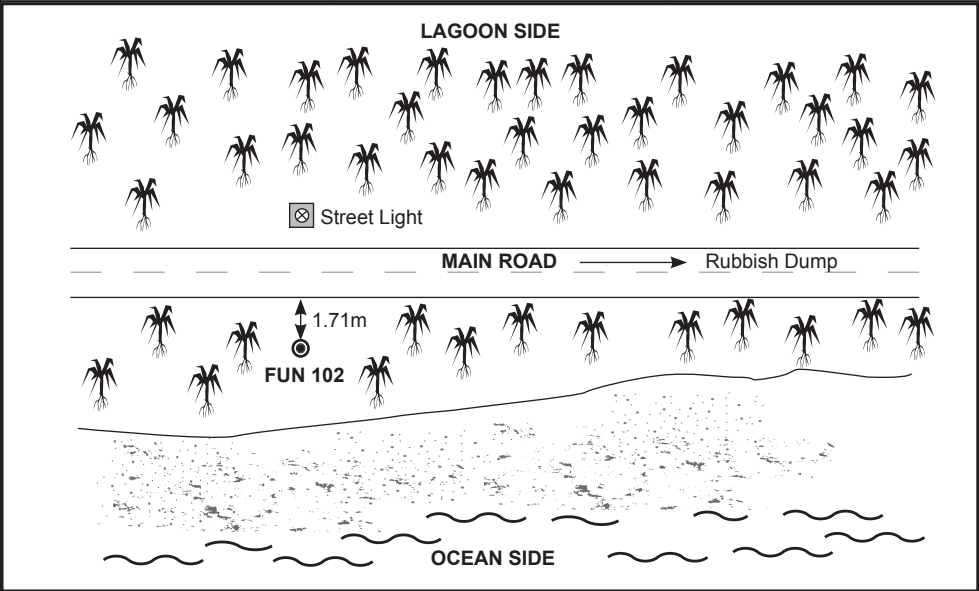

COUNTRY: TUVALU	PROJECT: JICA/ JPACE	L. D. P.: 18
ATOLL: FUNAFUTI	ORGANISATION: SOPAC	POINT No.: FUN 103
ISLET: FONGAFALE	SURVEYOR: ANDRICK LAL	DATE: 30/10/2009

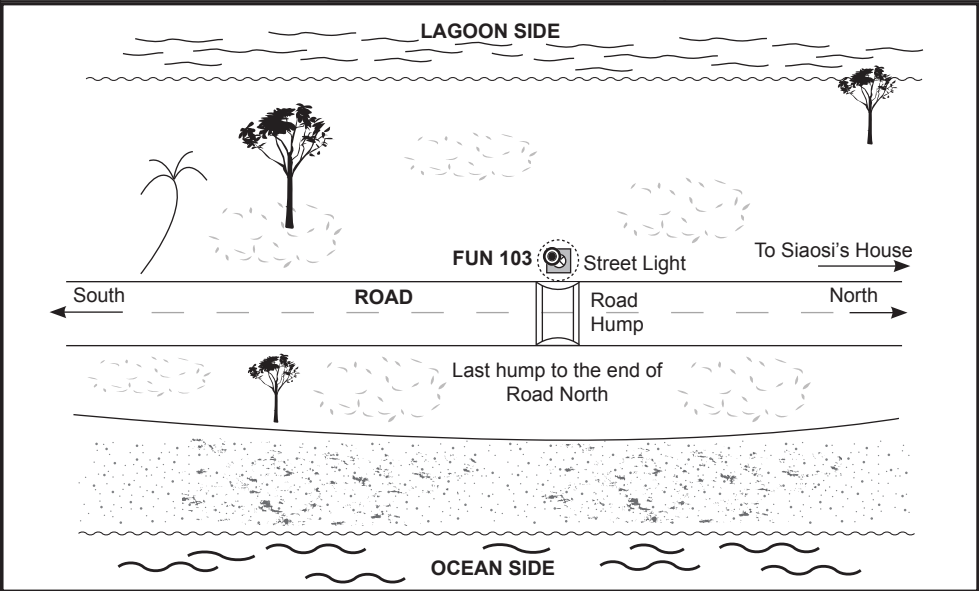

COUNTRY: TUVALU	PROJECT: JICA/ JPACE	L. D. P.: 19
ATOLL: FUNAFUTI	ORGANISATION: SOPAC	POINT No.: FUN 104
ISLET: FONGAFALE	SURVEYOR: ANDRICK LAL	DATE: 30/10/2009

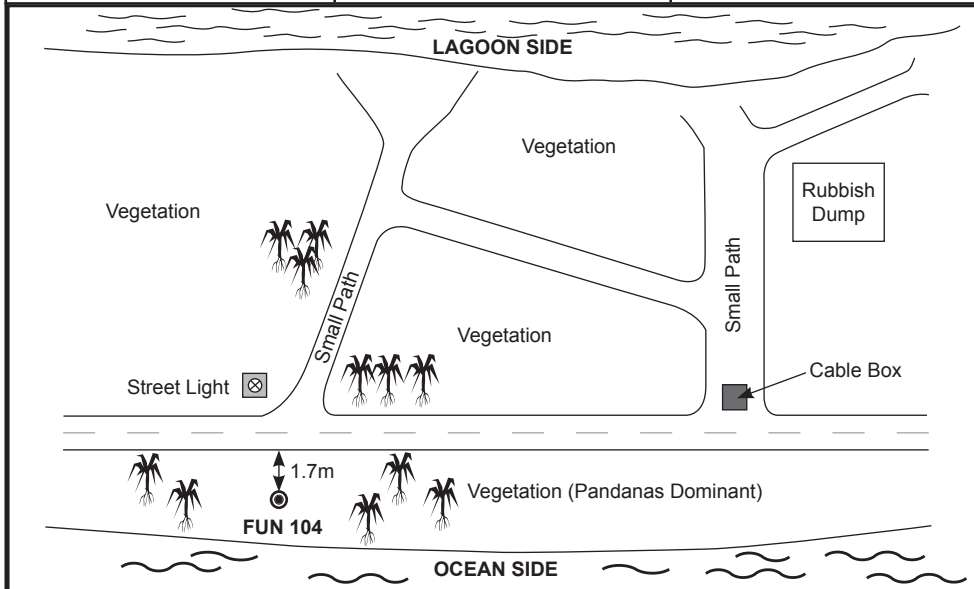

COUNTRY: TUVALU	PROJECT: JICA/ JPACE	L. D. P.: 20
ATOLL: FUNAFUTI	ORGANISATION: SOPAC	POINT No.: FUN 105
ISLET: FONGAFALE	SURVEYOR: ANDRICK LAL	DATE: 30/10/2009

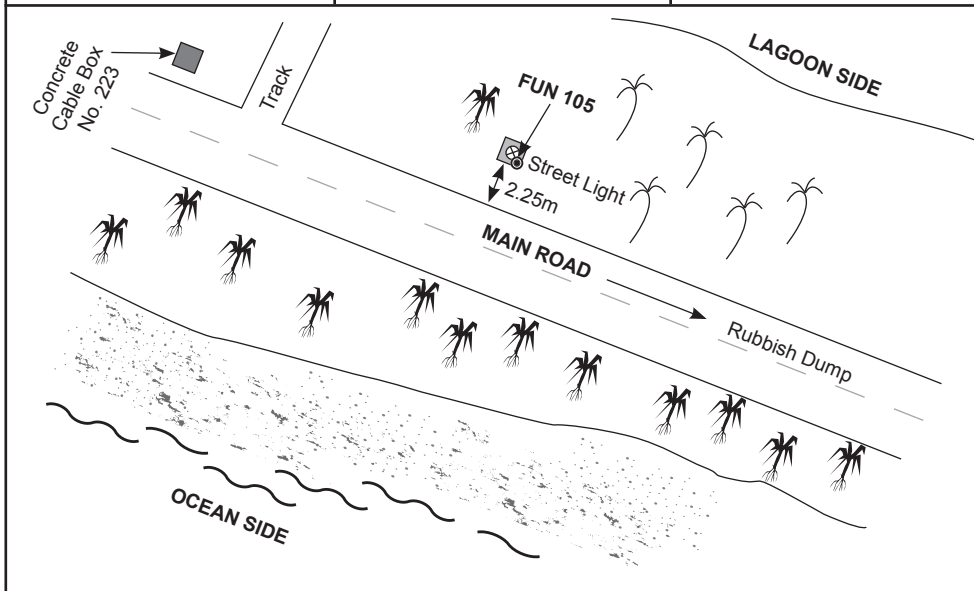

COUNTRY: TUVALU	PROJECT: JICA/ JPACE	L. D. P.: 21
ATOLL: FUNAFUTI	ORGANISATION: SOPAC	POINT No.: FUN 106
ISLET: FONGAFALE	SURVEYOR: ANDRICK LAL	DATE: 30/10/2009

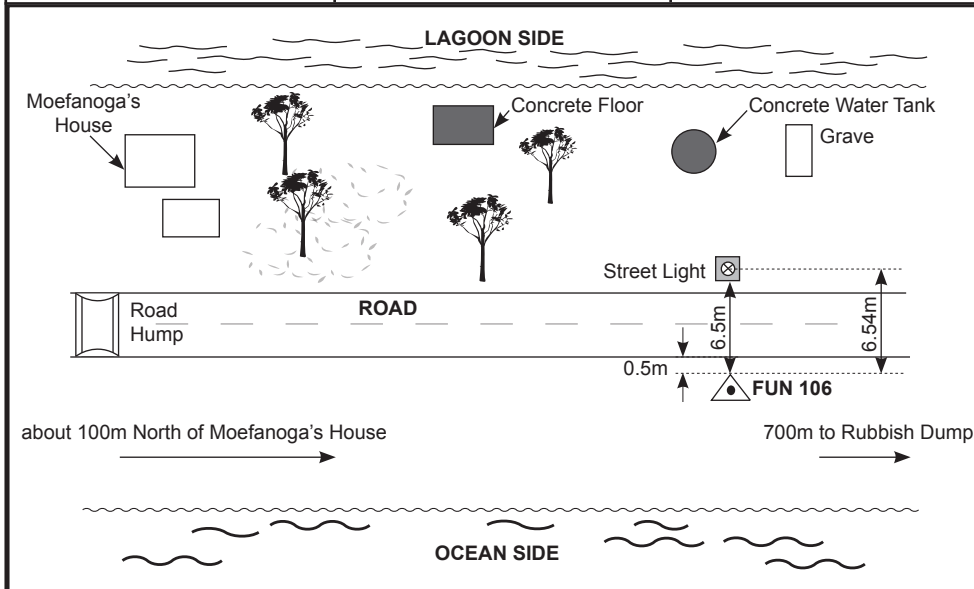

COUNTRY: TUVALU	PROJECT: JICA/ JPACE	L. D. P.: 22
ATOLL: FUNAFUTI	ORGANISATION: SOPAC	POINT No.: FUN 3
ISLET: FONGAFALE	SURVEYOR: ANDRICK LAL	DATE: 2004

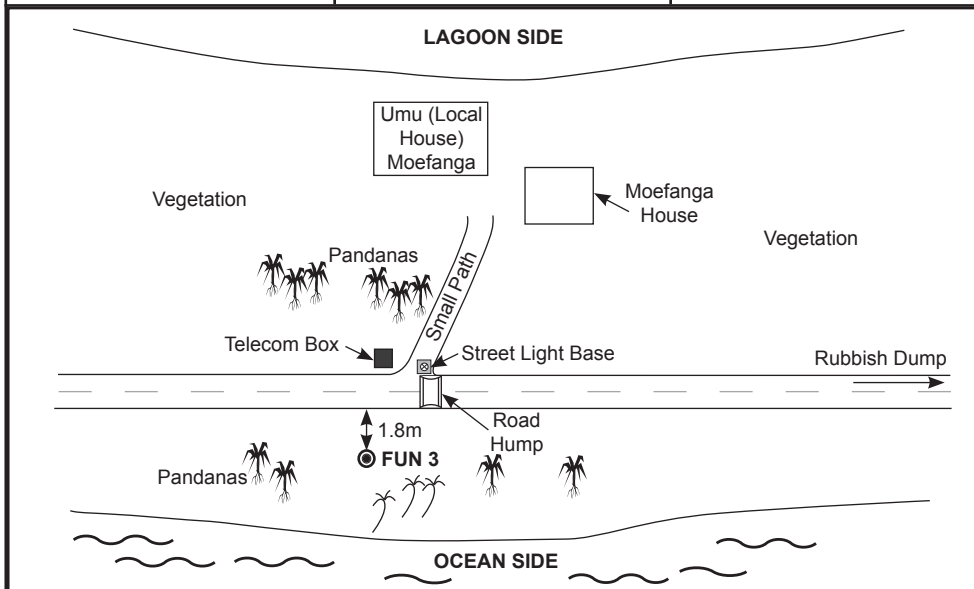

COUNTRY: TUVALU	PROJECT: JICA/ JPACE	L. D. P.: 23
ATOLL: FUNAFUTI	ORGANISATION: SOPAC	POINT No.: FUN 107
ISLET: FONGAFALE	SURVEYOR: ANDRICK LAL	DATE: 30/10/2009

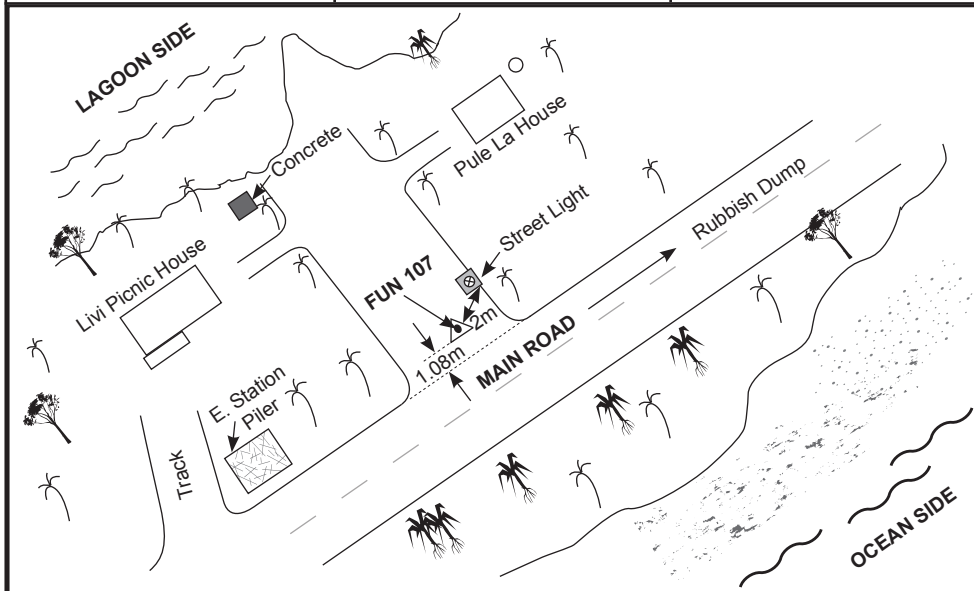

COUNTRY: TUVALU	PROJECT: JICA/ JPACE	L. D. P.: 24
ATOLL: FUNAFUTI	ORGANISATION: SOPAC	POINT No.: FUN 4
ISLET: FONGAFALE	SURVEYOR: ANDRICK LAL	DATE: 2004

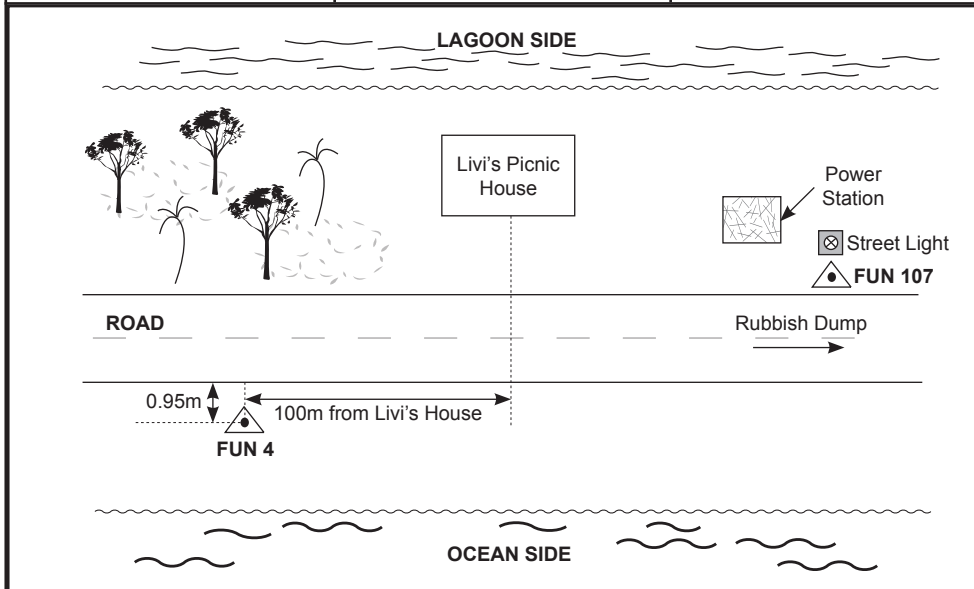

COUNTRY: TUVALU	PROJECT: JICA/ JPACE	L. D. P.: 25
ATOLL: FUNAFUTI	ORGANISATION: SOPAC	POINT No.: FUN 108
ISLET: FONGAFALE	SURVEYOR: ANDRICK LAL	DATE: 30/10/2009

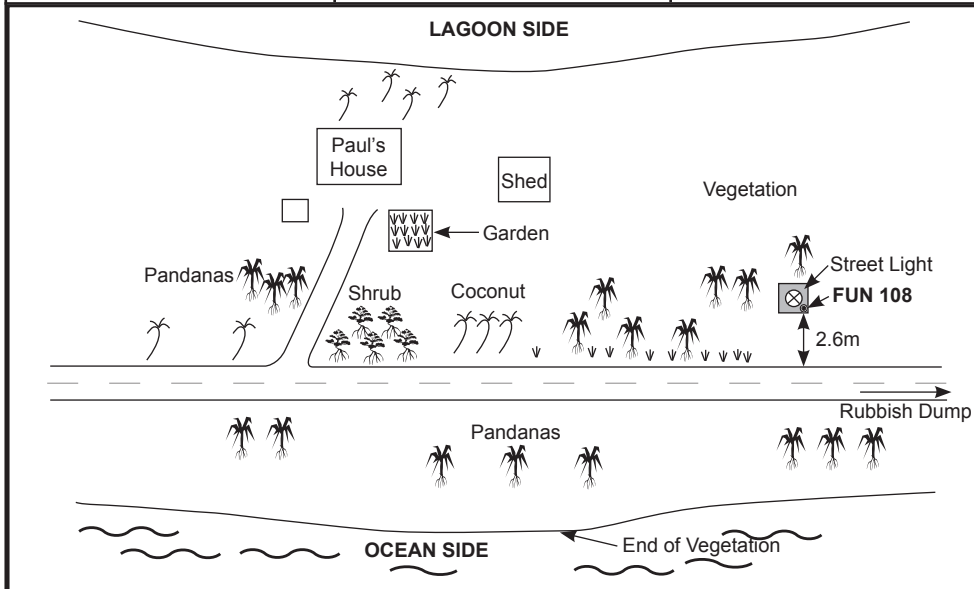

COUNTRY: TUVALU	PROJECT: JICA/ JPACE	L. D. P.: 26
ATOLL: FUNAFUTI	ORGANISATION: SOPAC	POINT No.: FUN 5
ISLET: FONGAFALE	SURVEYOR: ANDRICK LAL	DATE: 2004

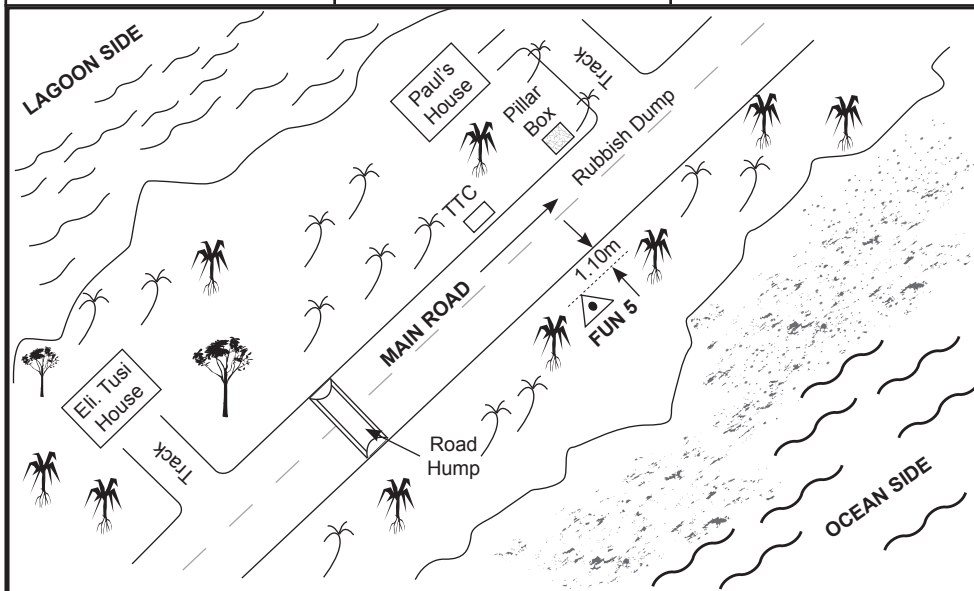

COUNTRY: TUVALU	PROJECT: JICA/ JPACE	L. D. P.: 27
ATOLL: FUNAFUTI	ORGANISATION: SOPAC	POINT No.: FUN 109
ISLET: FONGAFALE	SURVEYOR: ANDRICK LAL	DATE: 30/10/2009

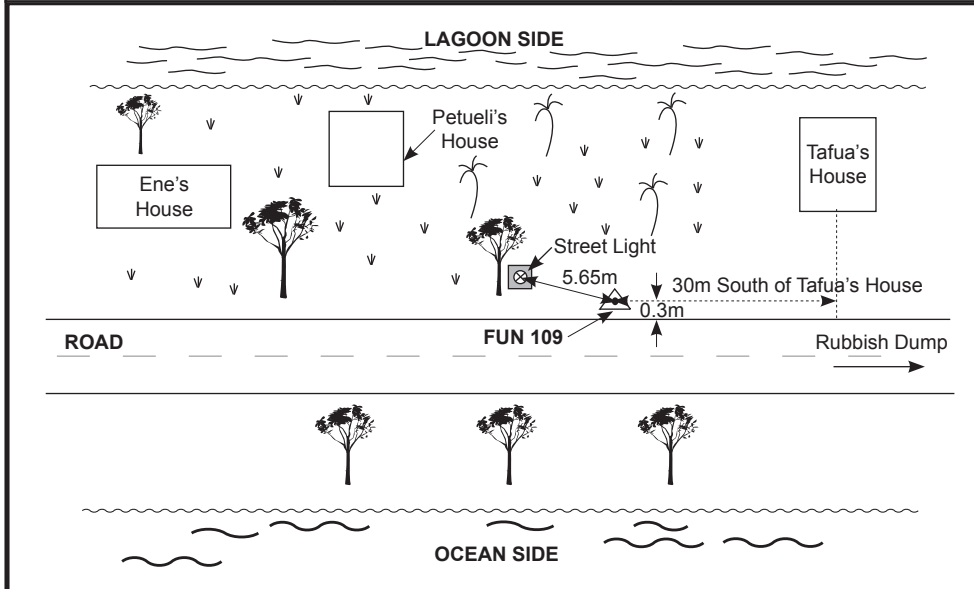

COUNTRY: TUVALU	PROJECT: JICA/ JPACE	L. D. P.: 28
ATOLL: FUNAFUTI	ORGANISATION: SOPAC	POINT No.: FUN 110
ISLET: FONGAFALE	SURVEYOR: ANDRICK LAL	DATE: 30/10/2009

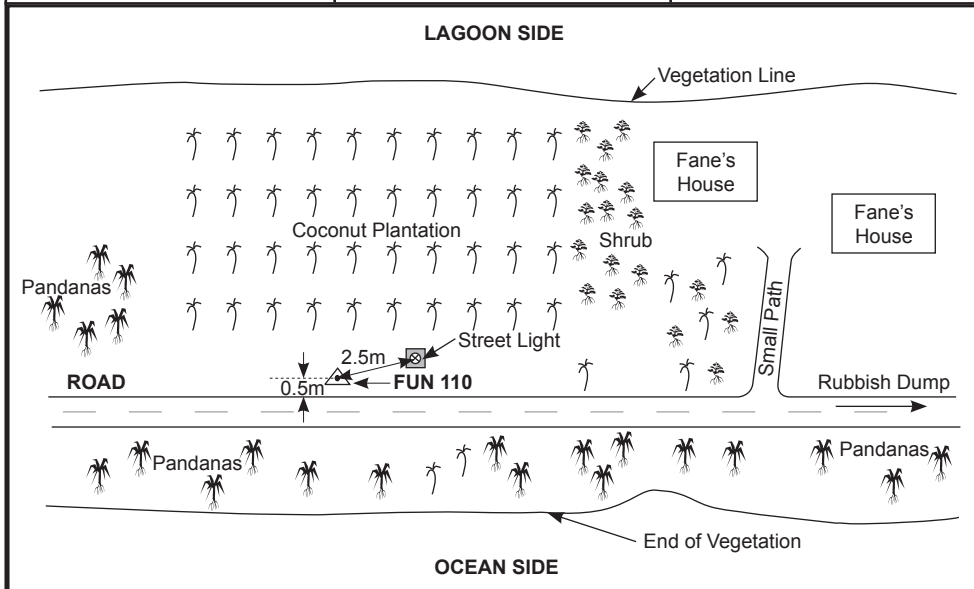

COUNTRY: TUVALU	PROJECT: JICA/ JPACE	L. D. P.: 29
ATOLL: FUNAFUTI	ORGANISATION: SOPAC	POINT No.: FUN 111
ISLET: FONGAFALE	SURVEYOR: ANDRICK LAL	DATE: 30/10/2009

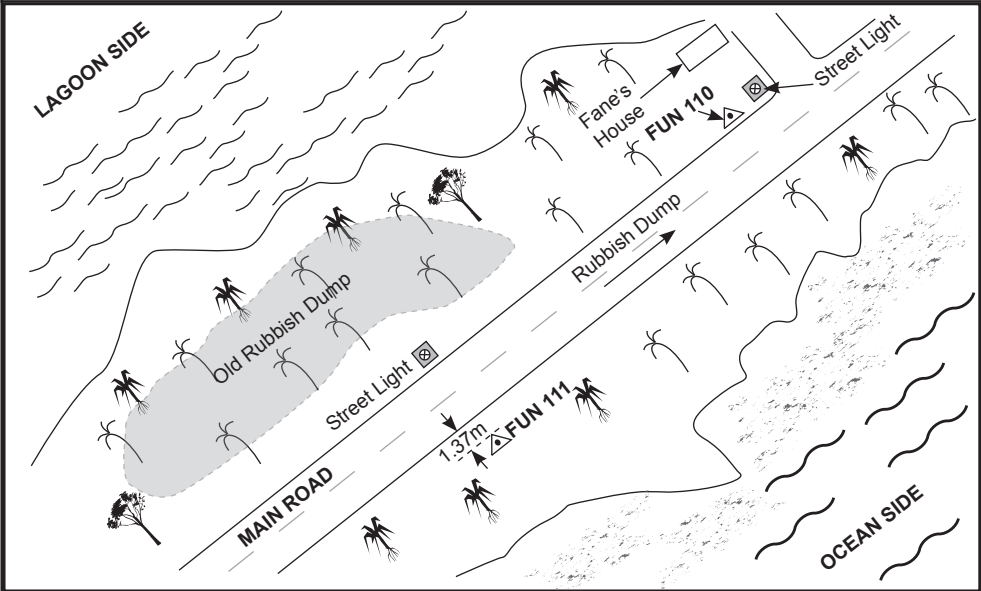

COUNTRY: TUVALU	PROJECT: JICA/ JPACE	L. D. P.: 30
ATOLL: FUNAFUTI	ORGANISATION: SOPAC	POINT No.: FUN 7
ISLET: FONGAFALE	SURVEYOR: ANDRICK LAL	DATE: 2004

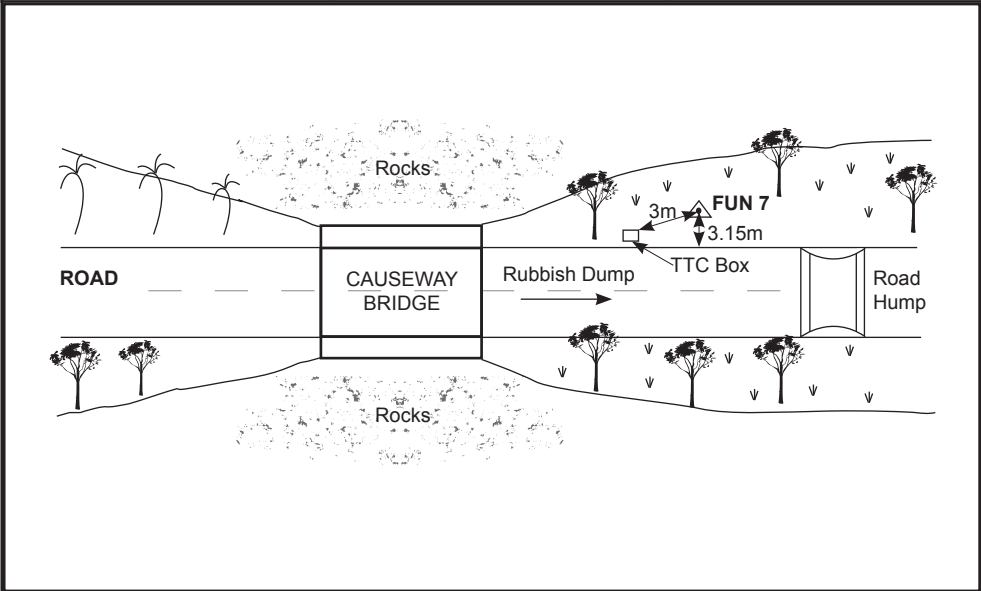

COUNTRY: TUVALU	PROJECT: JICA/ JPACE	L. D. P.: 31
ATOLL: FUNAFUTI	ORGANISATION: SOPAC	POINT No.: FUN 112
ISLET: FONGAFALE	SURVEYOR: ANDRICK LAL	DATE: 30/10/2009

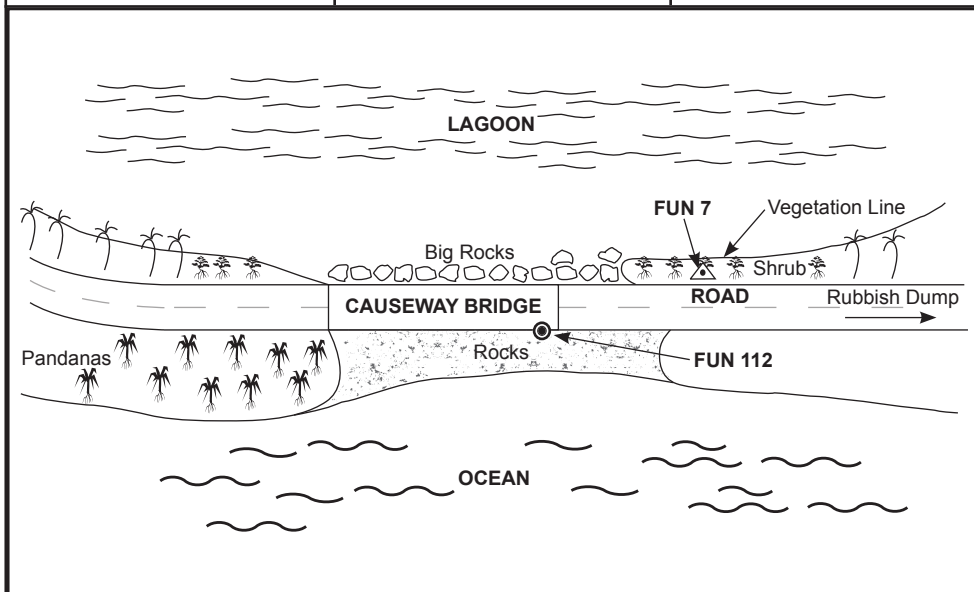

COUNTRY: TUVALU	PROJECT: JICA/ JPACE	L. D. P.: 32
ATOLL: FUNAFUTI	ORGANISATION: SOPAC	POINT No.: FUN 113
ISLET: FONGAFALE	SURVEYOR: ANDRICK LAL	DATE: 30/10/2009

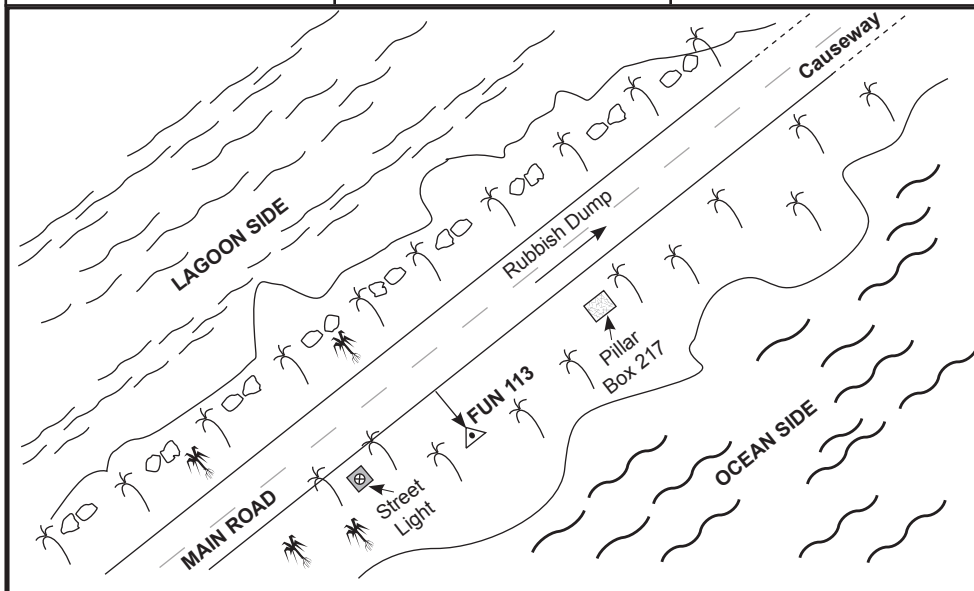

COUNTRY: TUVALU	PROJECT: JICA/ JPACE	L. D. P.: 33
ATOLL: FUNAFUTI	ORGANISATION: SOPAC	POINT No.: FUN 149
ISLET: FONGAFALE	SURVEYOR: ANDRICK LAL	DATE: 03/11/2009

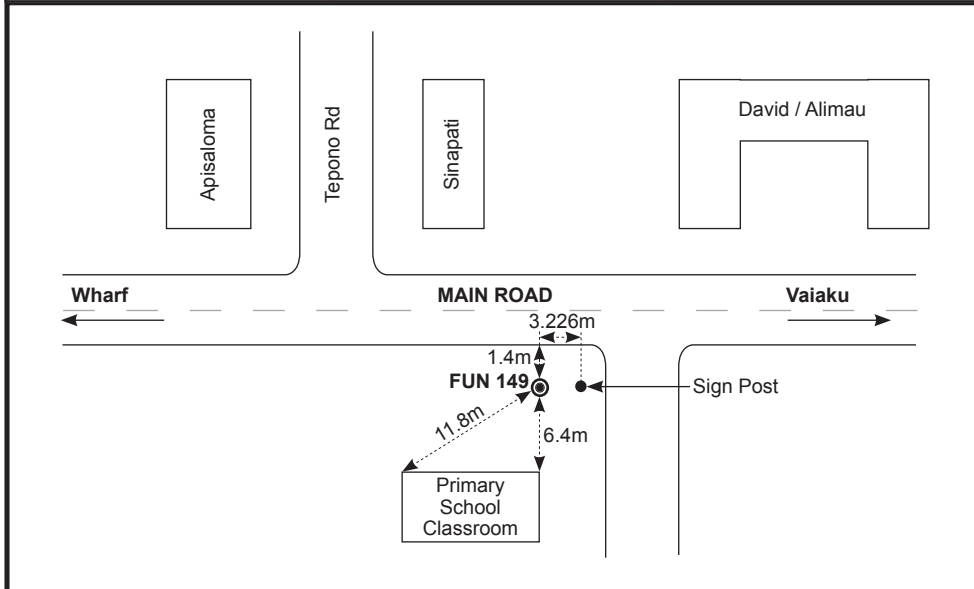

COUNTRY: TUVALU	PROJECT: JICA/ JPACE	L. D. P.: 34
ATOLL: FUNAFUTI	ORGANISATION: SOPAC	POINT No.: FUN 150
ISLET: FONGAFALE	SURVEYOR: ANDRICK LAL	DATE: 03/11/2009

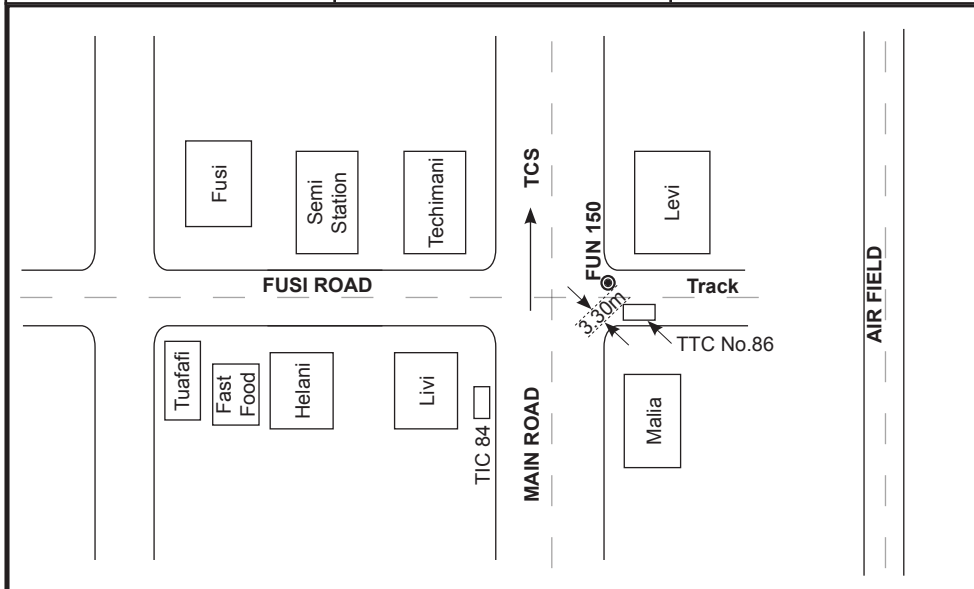

COUNTRY: TUVALU	PROJECT: JICA/ JPACE	L. D. P.: 35
ATOLL: FUNAFUTI	ORGANISATION: SOPAC	POINT No.: 62b
ISLET: FONGAFALE	SURVEYOR: ANDRICK LAL	DATE: 2004

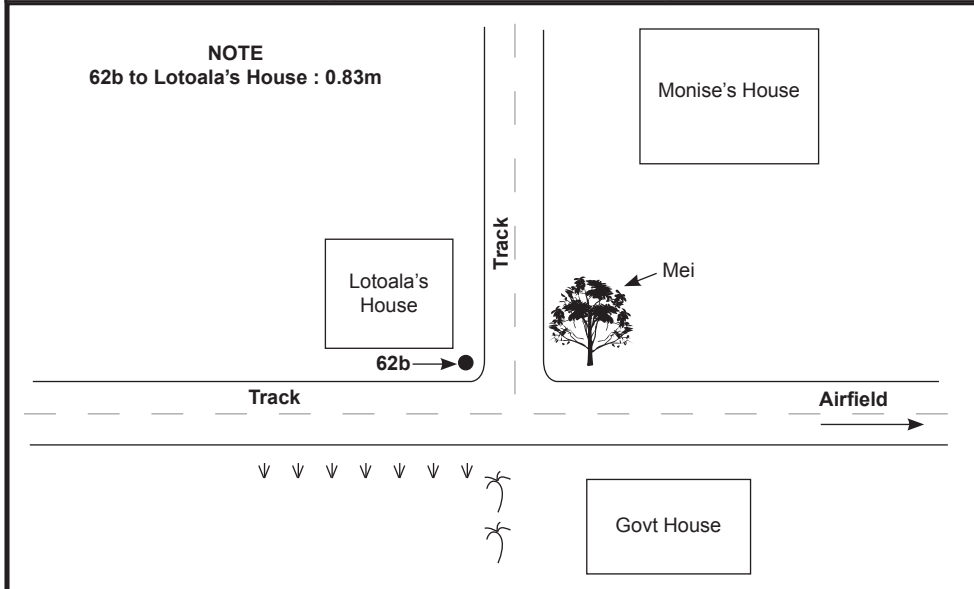

COUNTRY: TUVALU	PROJECT: JICA/ JPACE	L. D. P.: 36
ATOLL: FUNAFUTI	ORGANISATION: SOPAC	POINT No.: FUN 151
ISLET: FONGAFALE	SURVEYOR: ANDRICK LAL	DATE: 03/11/2009

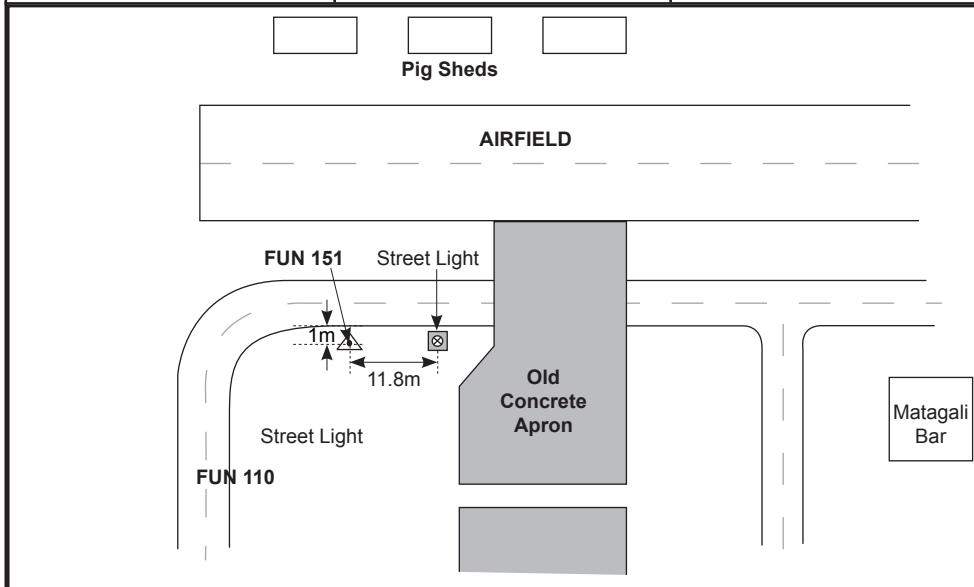

COUNTRY: TUVALU	PROJECT: JICA/ JPACE	L. D. P.: 37
ATOLL: FUNAFUTI	ORGANISATION: SOPAC	POINT No.: FUN 152
ISLET: FONGAFALE	SURVEYOR: ANDRICK LAL	DATE: 03/11/2009

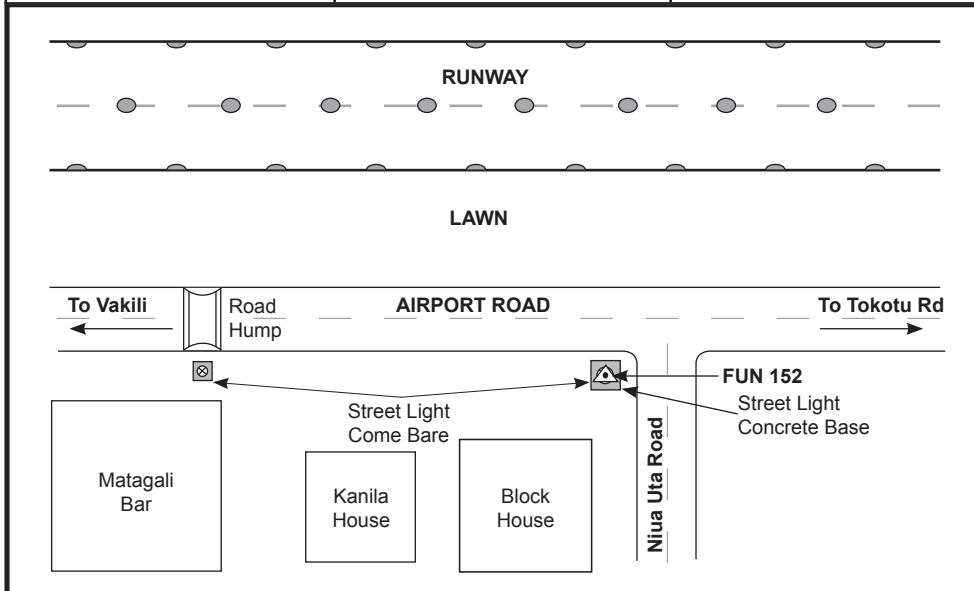

COUNTRY: TUVALU	PROJECT: JICA/ JPACE	L. D. P.: 38
ATOLL: FUNAFUTI	ORGANISATION: SOPAC	POINT No.: TUV 72
ISLET: FONGAFALE	SURVEYOR: ANDRICK LAL	DATE: 2001

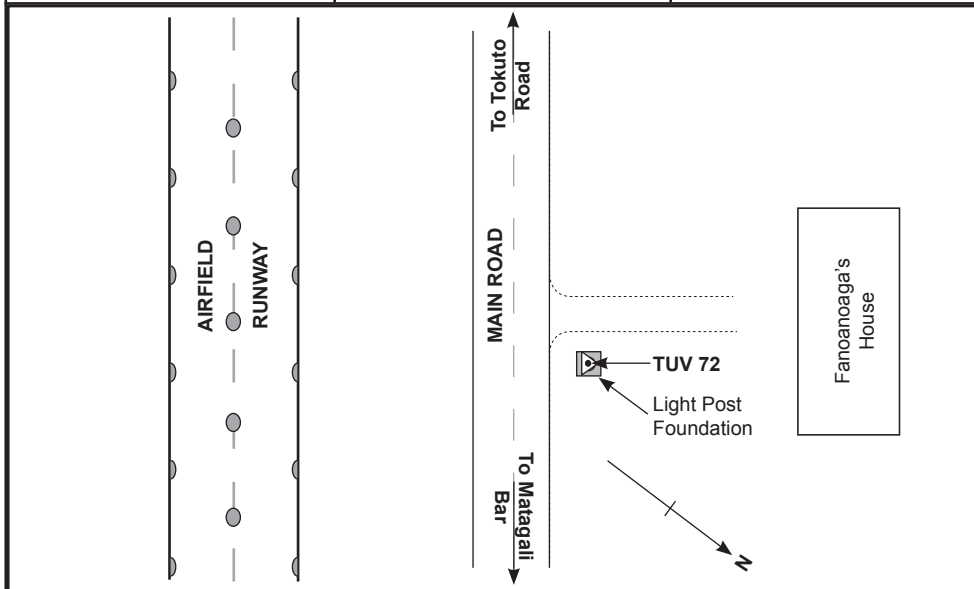

COUNTRY: TUVALU	PROJECT: JICA/ JPACE	L. D. P.: 41
ATOLL: FUNAFUTI	ORGANISATION: SOPAC	POINT No.: FUN 155
ISLET: FONGAFALE	SURVEYOR: ANDRICK LAL	DATE: 04/11/2009

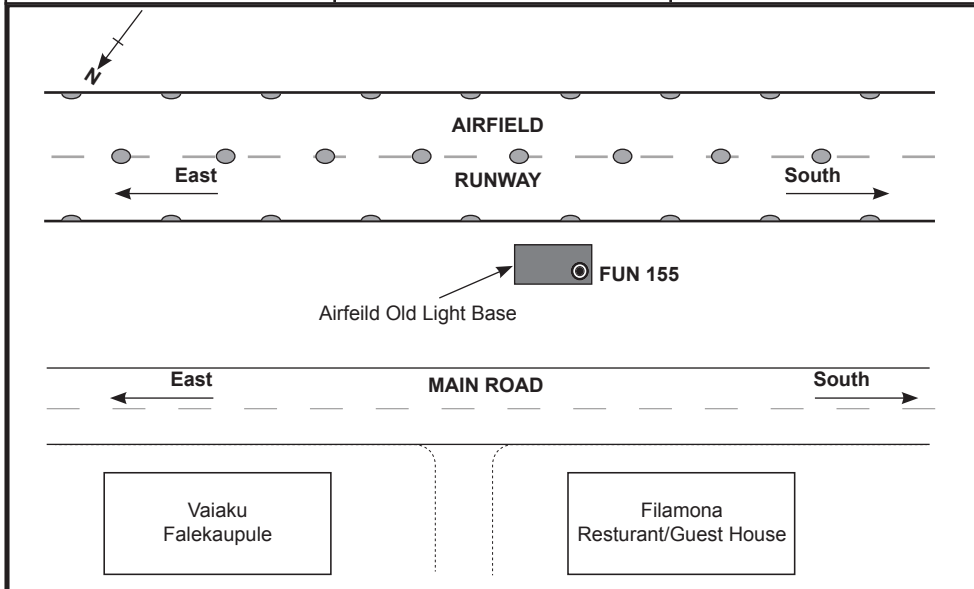

COUNTRY: TUVALU	PROJECT: JICA/ JPACE	L. D. P.: 42
ATOLL: FUNAFUTI	ORGANISATION: SOPAC	POINT No.: FUN 156
ISLET: FONGAFALE	SURVEYOR: ANDRICK LAL	DATE: 04/11/2009

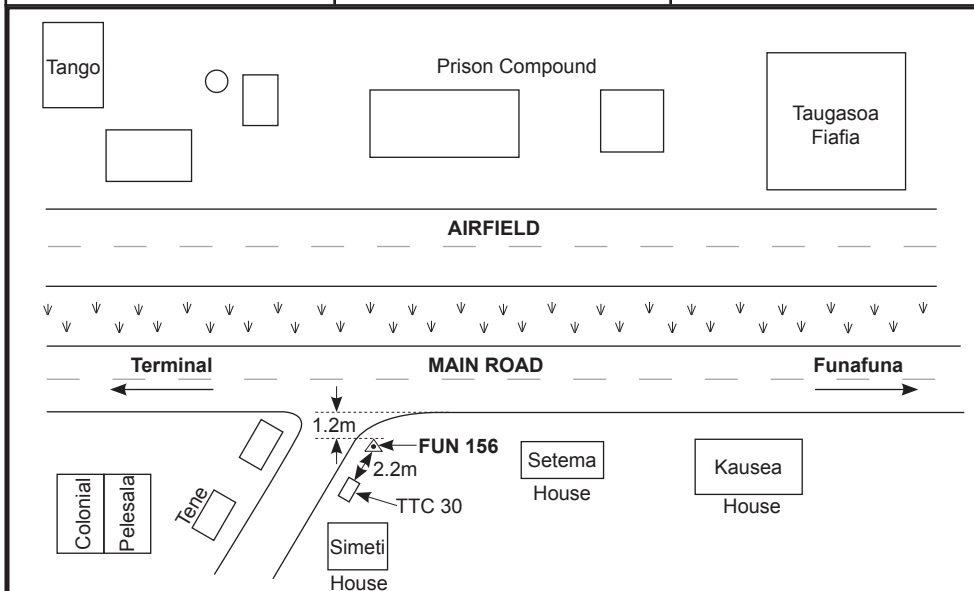

COUNTRY: TUVALU	PROJECT: JICA/ JPACE	L. D. P.: 43
ATOLL: FUNAFUTI	ORGANISATION: SOPAC	POINT No.: UF7
ISLET: FONGAFALE	SURVEYOR: ANDRICK LAL	DATE: UNKNOWN

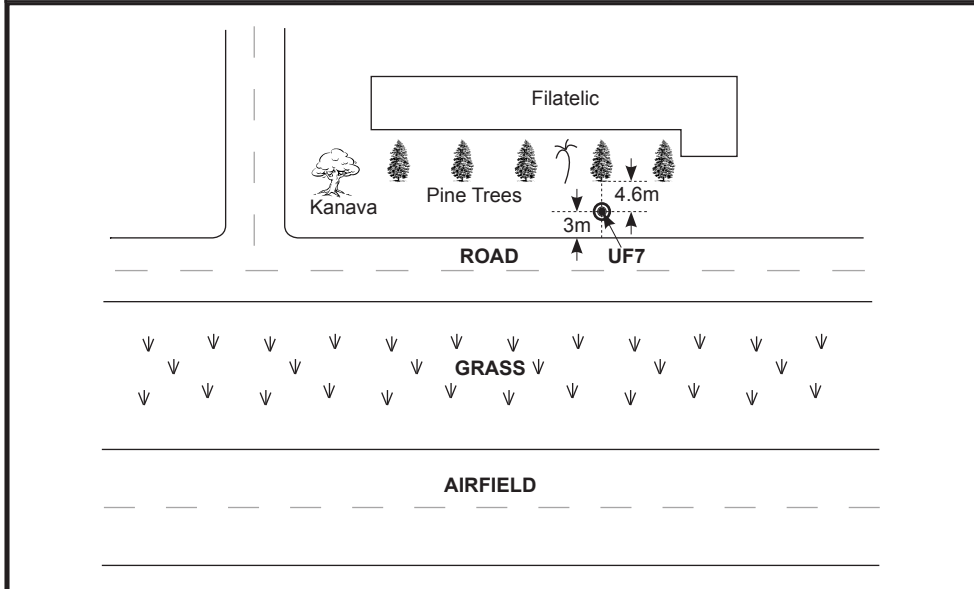

COUNTRY: TUVALU	PROJECT: JICA/ JPACE	L. D. P.: 44
ATOLL: FUNAFUTI	ORGANISATION: SOPAC	POINT No.: TUVA 1
ISLET: FONGAFALE	SURVEYOR: ANDRICK LAL	DATE: UNKNOWN

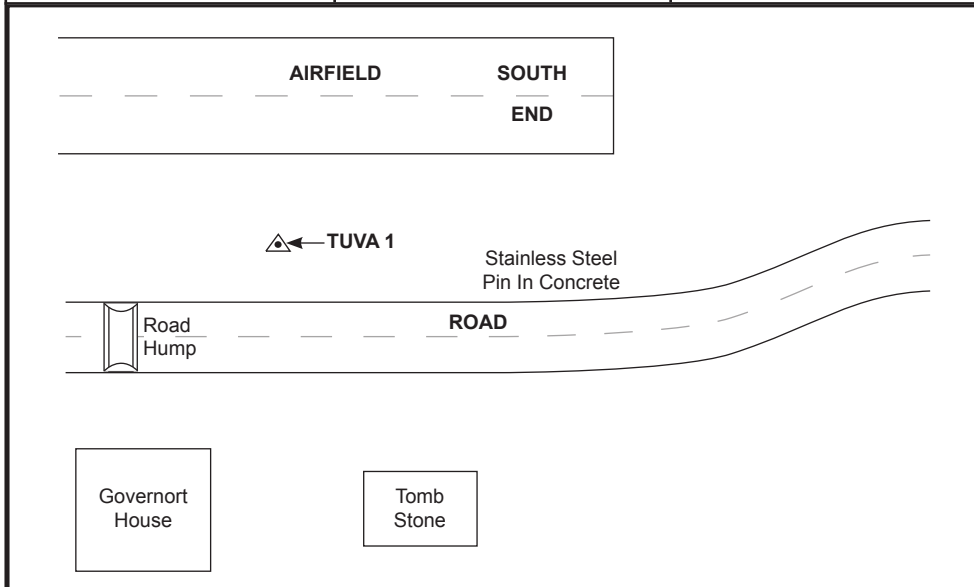

COUNTRY: TUVALU	PROJECT: JICA/ JPACE	L. D. P.: 45
ATOLL: FUNAFUTI	ORGANISATION: SOPAC	POINT No.: FUN 157
ISLET: FONGAFALE	SURVEYOR: ANDRICK LAL	DATE: 04/11/2009

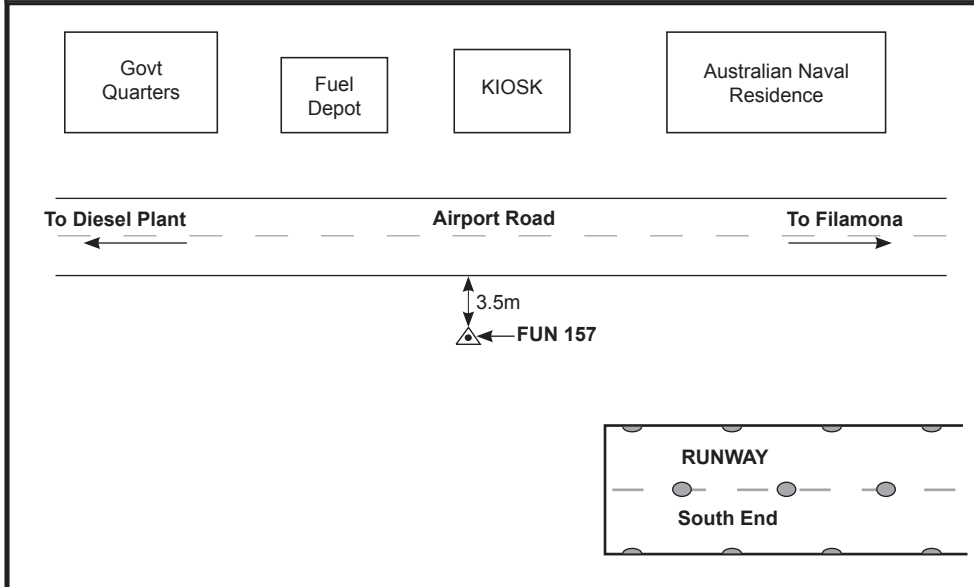

COUNTRY: TUVALU	PROJECT: JICA/ JPACE	L. D. P.: 46
ATOLL: FUNAFUTI	ORGANISATION: SOPAC	POINT No.: FUN 48
ISLET: FONGAFALE	SURVEYOR: ANDRICK LAL	DATE: 2004

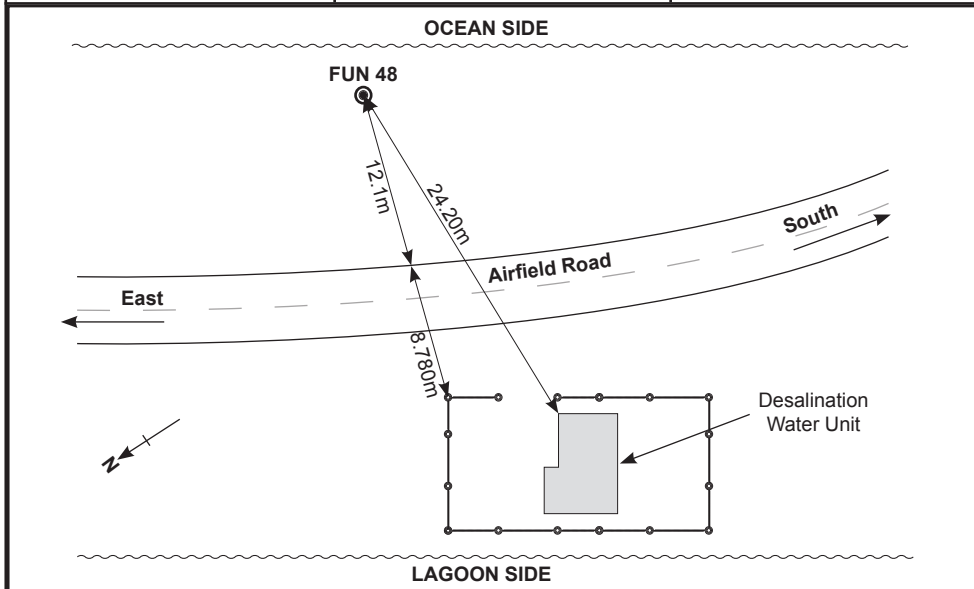

COUNTRY: TUVALU	PROJECT: JICA/ JPACE	L. D. P.: 47
ATOLL: FUNAFUTI	ORGANISATION: SOPAC	POINT No.: FUN 158
ISLET: FONGAFALE	SURVEYOR: ANDRICK LAL	DATE: 04/11/2009

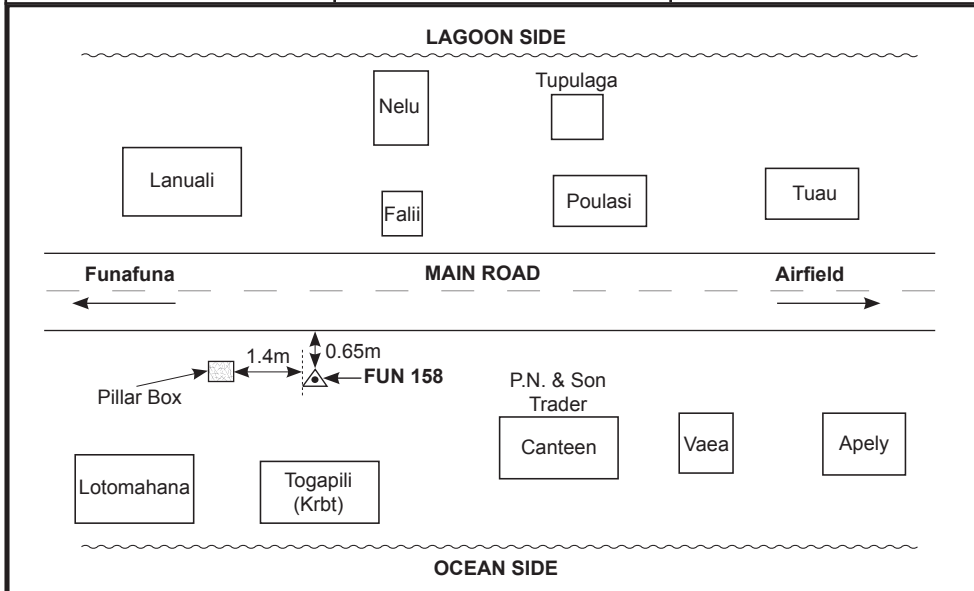

COUNTRY: TUVALU	PROJECT: JICA/ JPACE	L. D. P.: 48
ATOLL: FUNAFUTI	ORGANISATION: SOPAC	POINT No.: FUN 159
ISLET: FONGAFALE	SURVEYOR: ANDRICK LAL	DATE: 04/11/2009

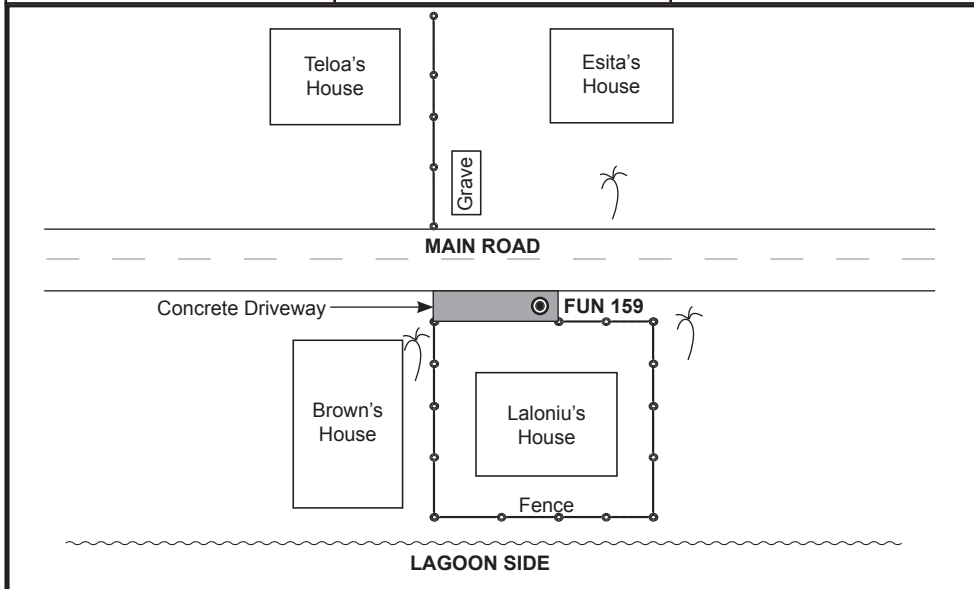

COUNTRY: TUVALU	PROJECT: JICA/ JPACE	L. D. P.: 49
ATOLL: FUNAFUTI	ORGANISATION: SOPAC	POINT No.: FUN 160
ISLET: FONGAFALE	SURVEYOR: ANDRICK LAL	DATE: 04/11/2009

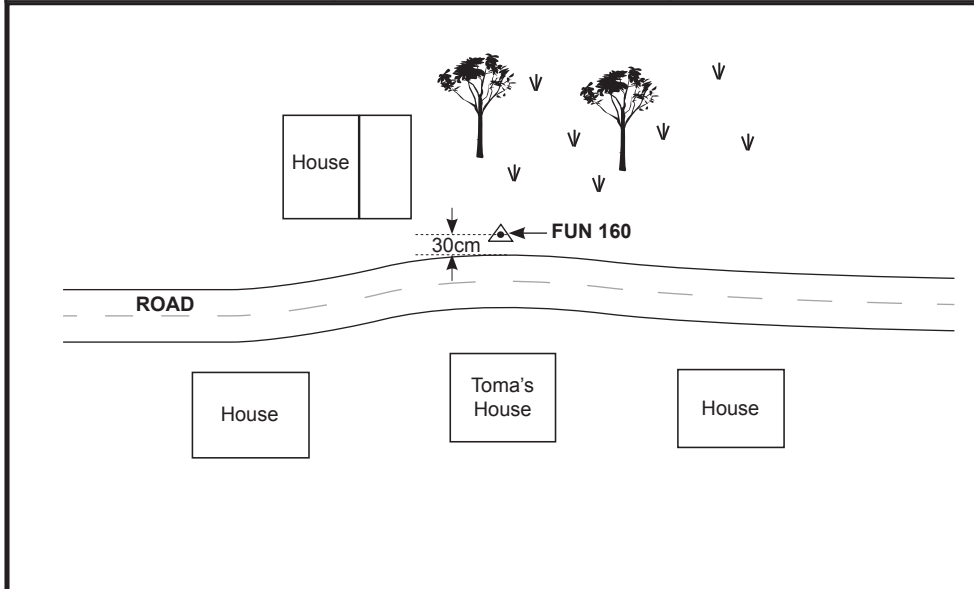

COUNTRY: TUVALU	PROJECT: JICA/ JPACE	L. D. P.: 50
ATOLL: FUNAFUTI	ORGANISATION: SOPAC	POINT No.: FUN 161
ISLET: FONGAFALE	SURVEYOR: ANDRICK LAL	DATE: 04/11/2009

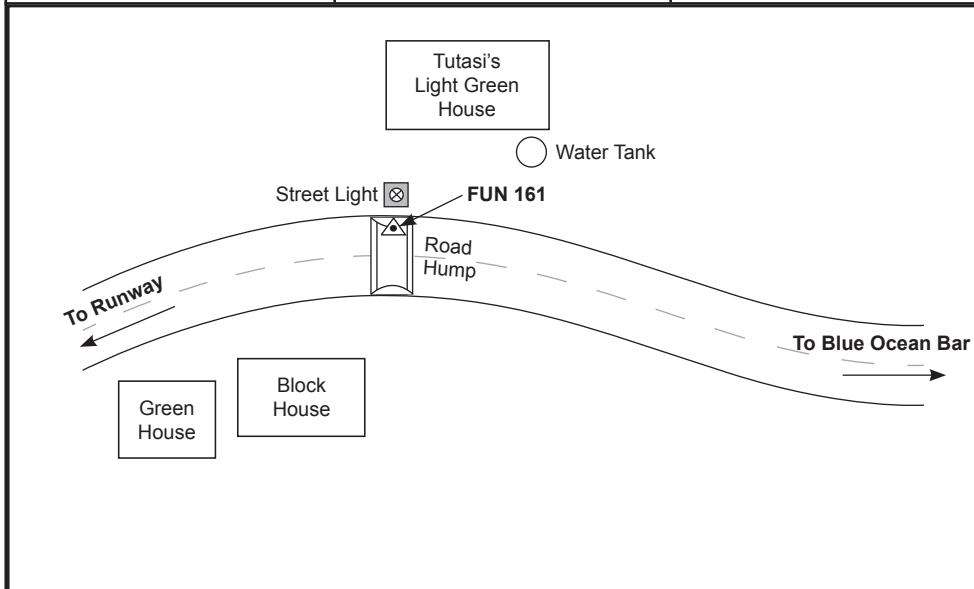

COUNTRY: TUVALU	PROJECT: JICA/ JPACE	L. D. P.: 51
ATOLL: FUNAFUTI	ORGANISATION: SOPAC	POINT No.: FUN 50
ISLET: FONGAFALE	SURVEYOR: ANDRICK LAL	DATE: 2004

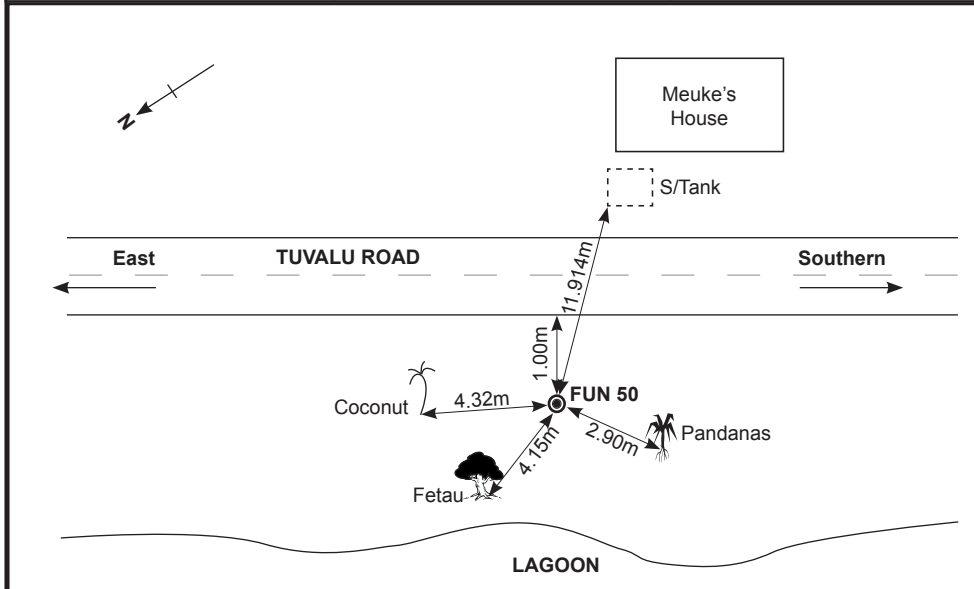

COUNTRY: TUVALU	PROJECT: JICA/ JPACE	L. D. P.: 52
ATOLL: FUNAFUTI	ORGANISATION: SOPAC	POINT No.: FUN 162
ISLET: FONGAFALE	SURVEYOR: ANDRICK LAL	DATE: 04/11/2009

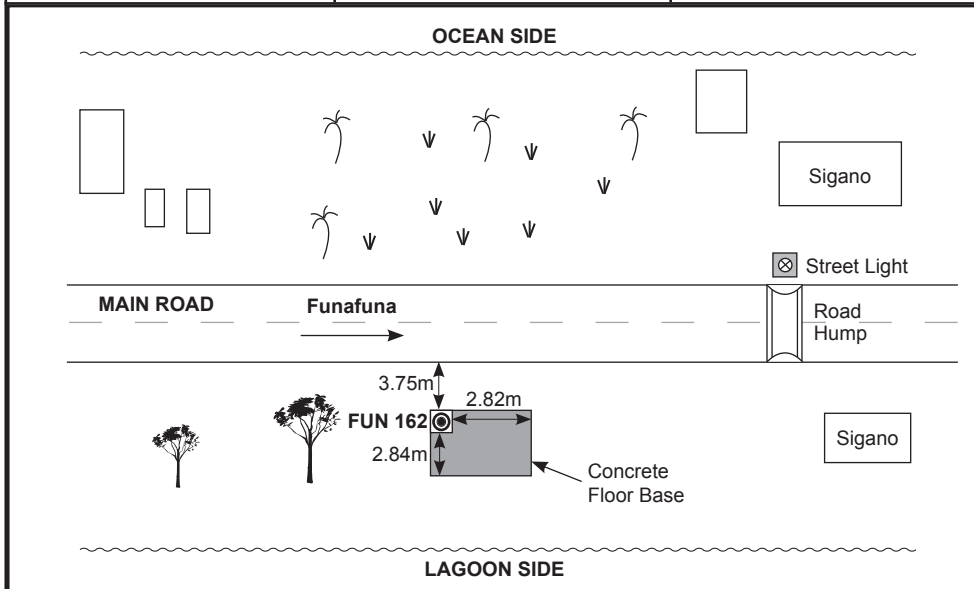

COUNTRY: TUVALU	PROJECT: JICA/ JPACE	L. D. P.: 53
ATOLL: FUNAFUTI	ORGANISATION: SOPAC	POINT No.: FUN 163
ISLET: FONGAFALE	SURVEYOR: ANDRICK LAL	DATE: 04/11/2009

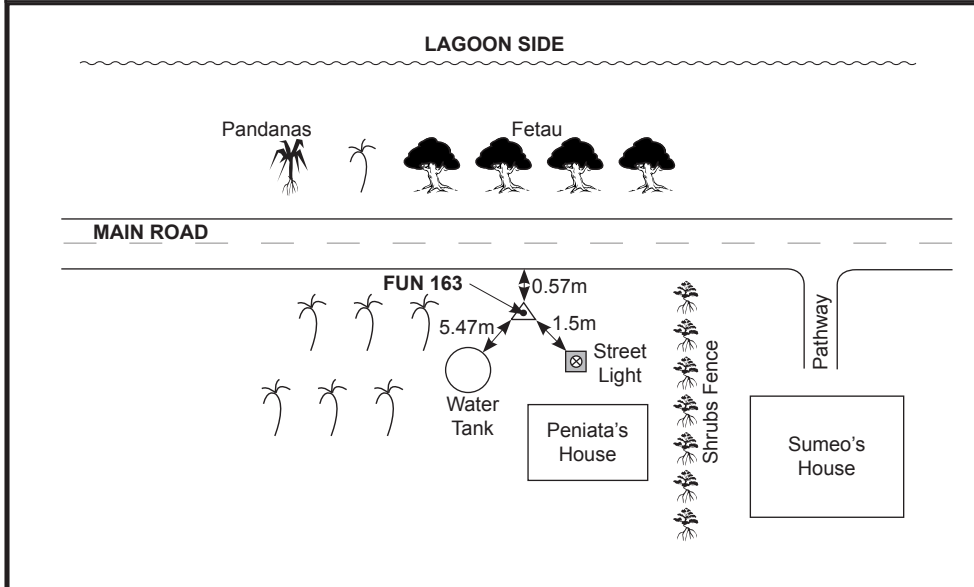

COUNTRY: TUVALU	PROJECT: JICA/ JPACE	L. D. P.: 54
ATOLL: FUNAFUTI	ORGANISATION: SOPAC	POINT No.: FUN 164
ISLET: FONGAFALE	SURVEYOR: ANDRICK LAL	DATE: 04/11/2009

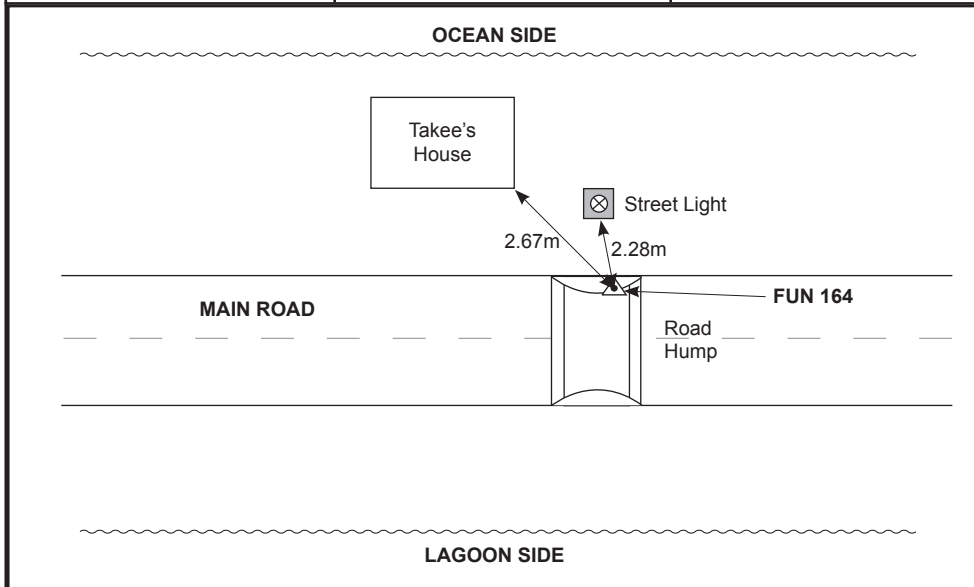

COUNTRY: TUVALU	PROJECT: JICA/ JPACE	L. D. P.: 57
ATOLL: FUNAFUTI	ORGANISATION: SOPAC	POINT No.: FUN 166
ISLET: FONGAFALE	SURVEYOR: ANDRICK LAL	DATE: 04/11/2009

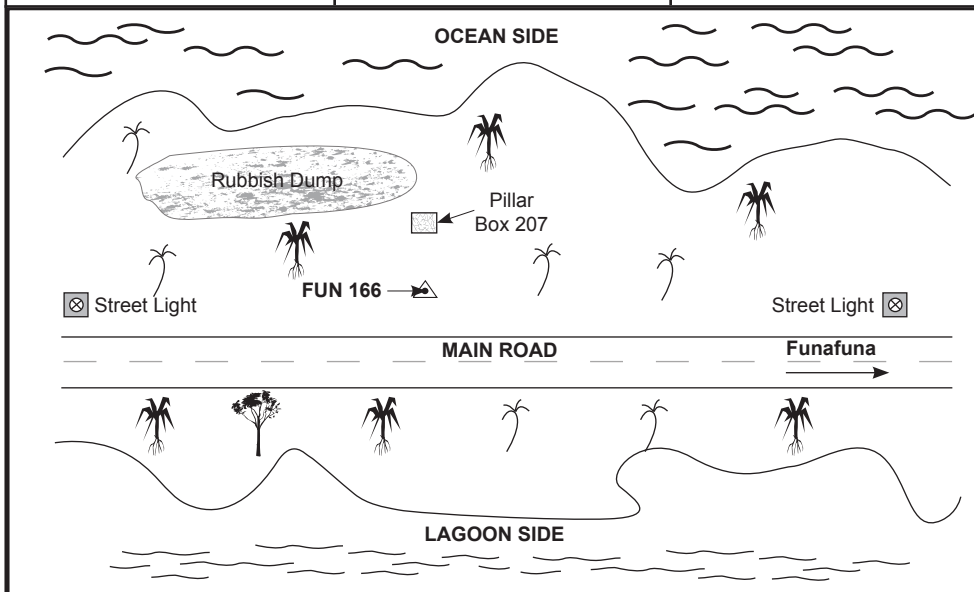

COUNTRY: TUVALU	PROJECT: JICA/ JPACE	L. D. P.: 58
ATOLL: FUNAFUTI	ORGANISATION: SOPAC	POINT No.: FUN 167
ISLET: FONGAFALE	SURVEYOR: ANDRICK LAL	DATE: 04/11/2009

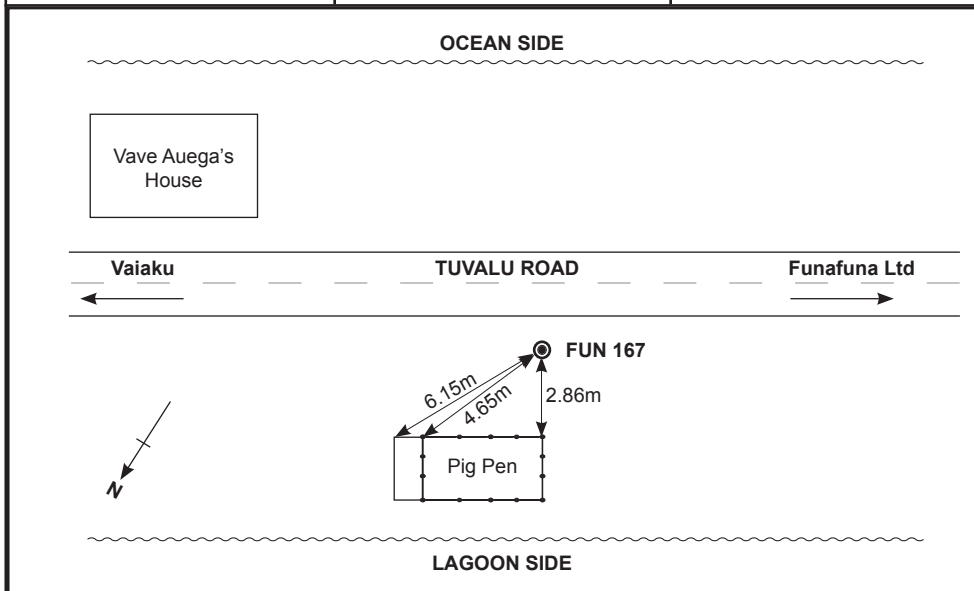

COUNTRY: TUVALU	PROJECT: JICA/ JPACE	L. D. P.: 59
ATOLL: FUNAFUTI	ORGANISATION: SOPAC	POINT No.: FUN 168
ISLET: FONGAFALE	SURVEYOR: ANDRICK LAL	DATE: 04/11/2009

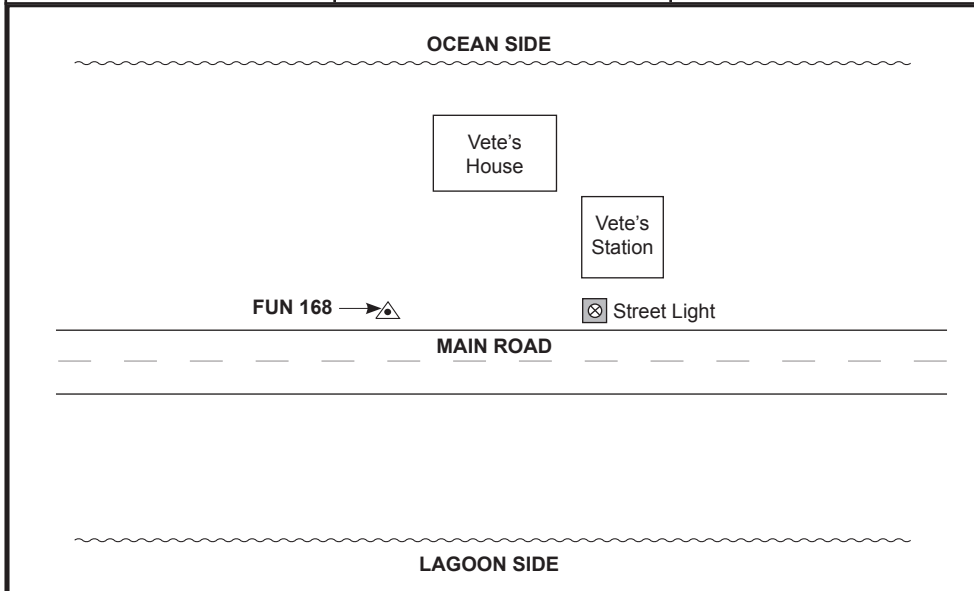

COUNTRY: TUVALU	PROJECT: JICA/ JPACE	L. D. P.: 60
ATOLL: FUNAFUTI	ORGANISATION: SOPAC	POINT No.: FUN 169
ISLET: FONGAFALE	SURVEYOR: ANDRICK LAL	DATE: 04/11/2009

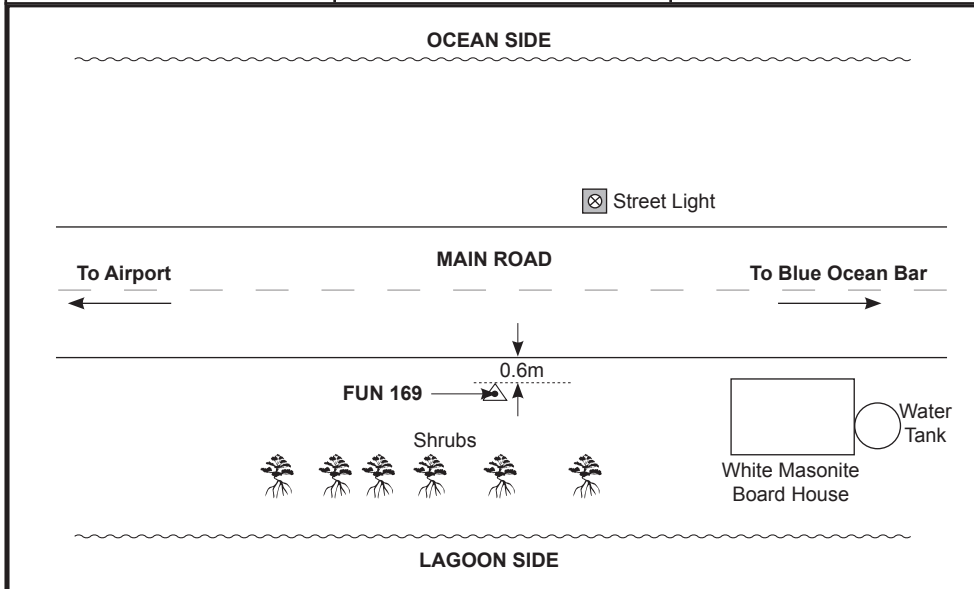

COUNTRY: TUVALU	PROJECT: JICA/ JPACE	L. D. P.: 61
ATOLL: FUNAFUTI	ORGANISATION: SOPAC	POINT No.: FUN 26
ISLET: FONGAFALE	SURVEYOR: ANDRICK LAL	DATE: 2004

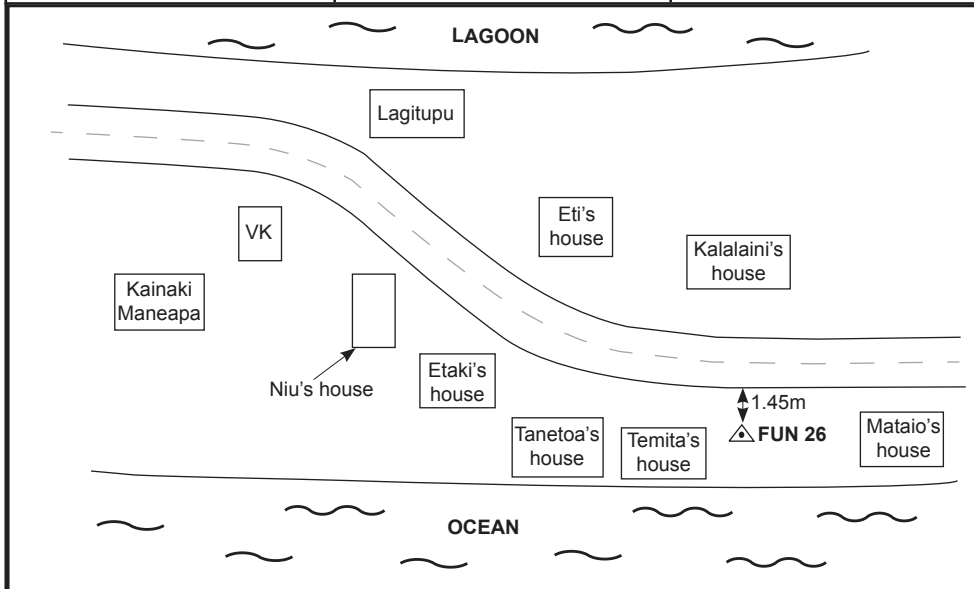

COUNTRY: TUVALU	PROJECT: JICA/ JPACE	L. D. P.: 62
ATOLL: FUNAFUTI	ORGANISATION: SOPAC	POINT No.: FUN 27
ISLET: FONGAFALE	SURVEYOR: ANDRICK LAL	DATE: 2004

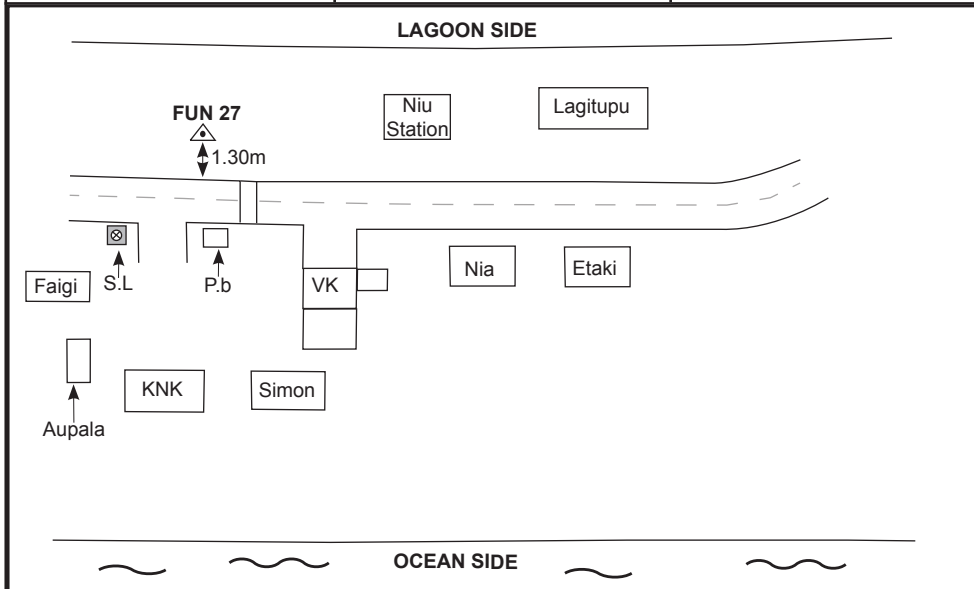

COUNTRY: TUVALU	PROJECT: JICA/ JPACE	L. D. P.: 63
ATOLL: FUNAFUTI	ORGANISATION: SOPAC	POINT No.: FUN 144
ISLET: FONGAFALE	SURVEYOR: ANDRICK LAL	DATE: 03/11/09

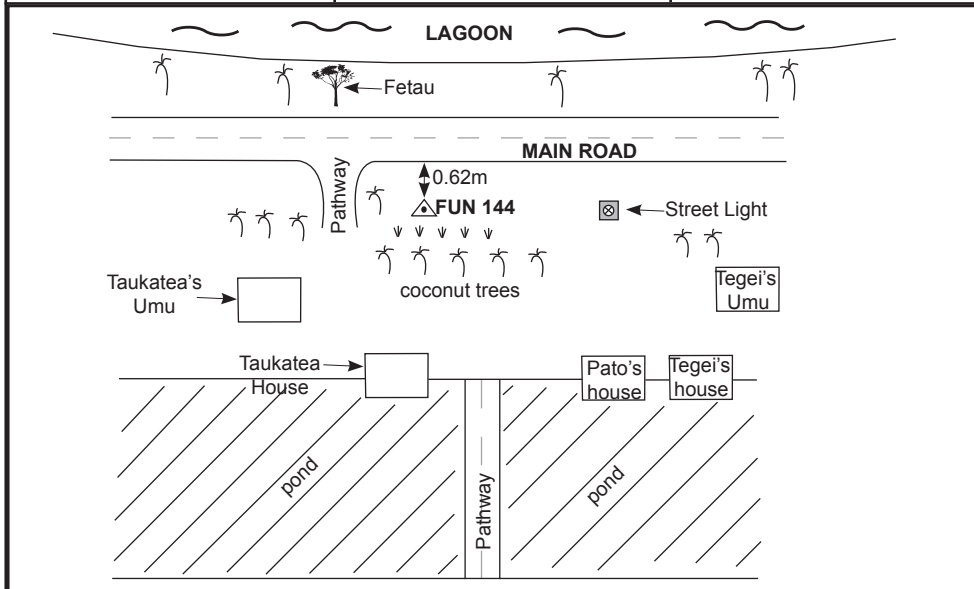

COUNTRY: TUVALU	PROJECT: JICA/ JPACE	L. D. P.: 64
ATOLL: FUNAFUTI	ORGANISATION: SOPAC	POINT No.: FUN 145
ISLET: FONGAFALE	SURVEYOR: ANDRICK LAL	DATE: 03/11/09

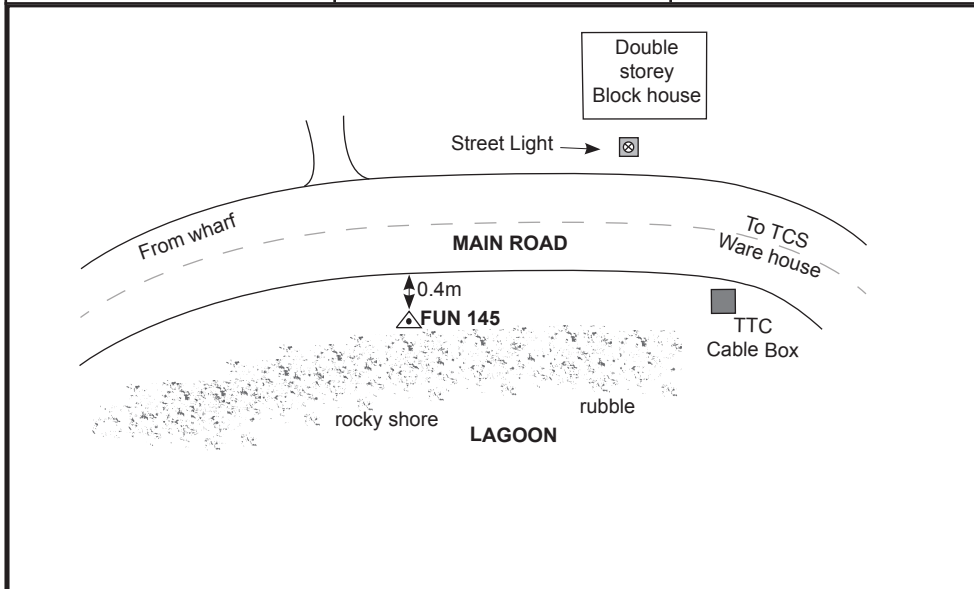

COUNTRY: TUVALU	PROJECT: JICA/ JPACE	L. D. P.: 65
ATOLL: FUNAFUTI	ORGANISATION: SOPAC	POINT No.: TUV 46
ISLET: FONGAFALE	SURVEYOR: ANDRICK LAL	DATE: AUG 2001

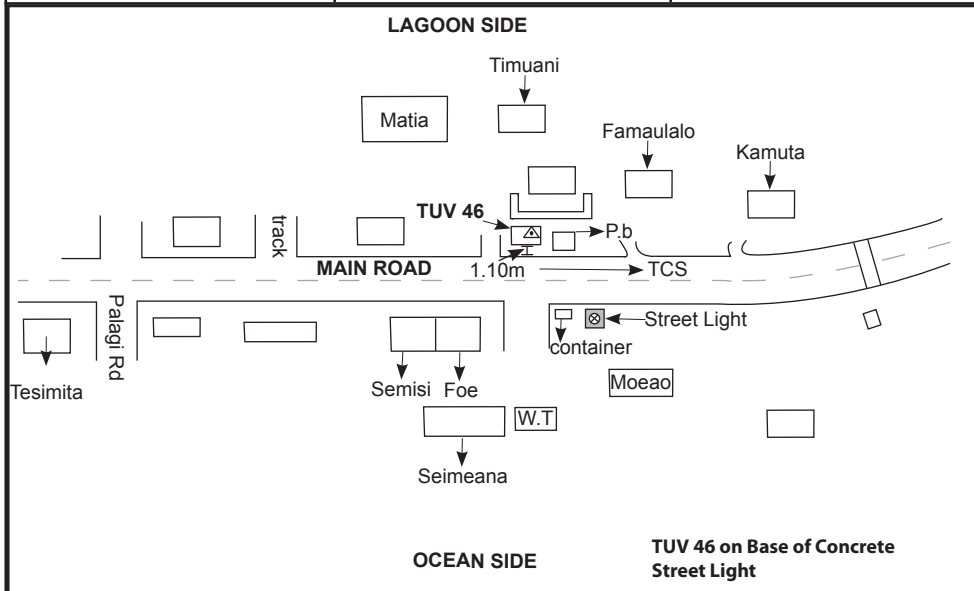

COUNTRY: TUVALU	PROJECT: JICA/ JPACE	L. D. P.: 66
ATOLL: FUNAFUTI	ORGANISATION: SOPAC	POINT No.: FUN 146
ISLET: FONGAFALE	SURVEYOR: ANDRICK LAL	DATE: 03/11/09

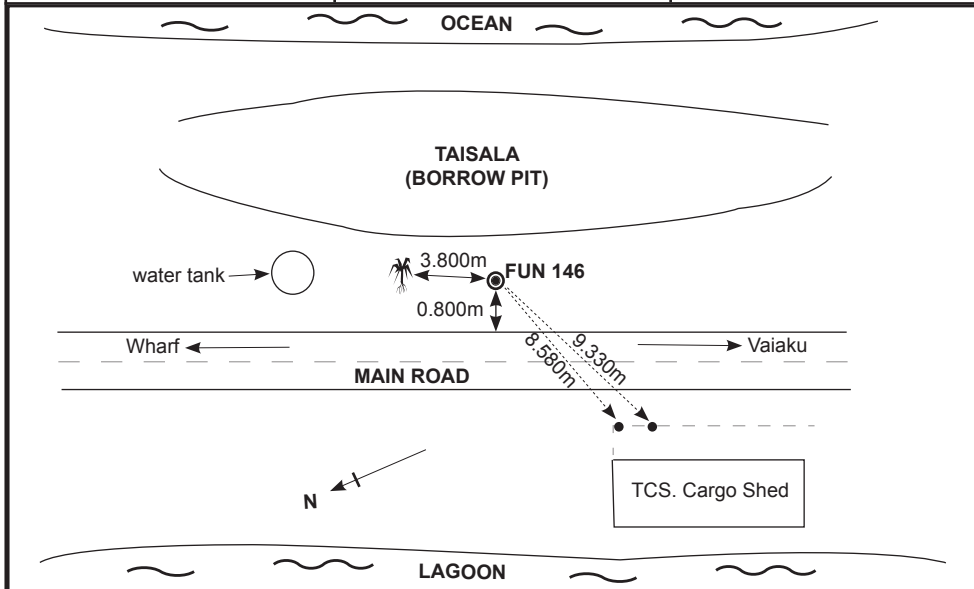

COUNTRY: TUVALU	PROJECT: JICA/ JPACE	L. D. P.: 67
ATOLL: FUNAFUTI	ORGANISATION: SOPAC	POINT No.: FUN 147
ISLET: FONGAFALE	SURVEYOR: ANDRICK LAL	DATE: 03/11/09

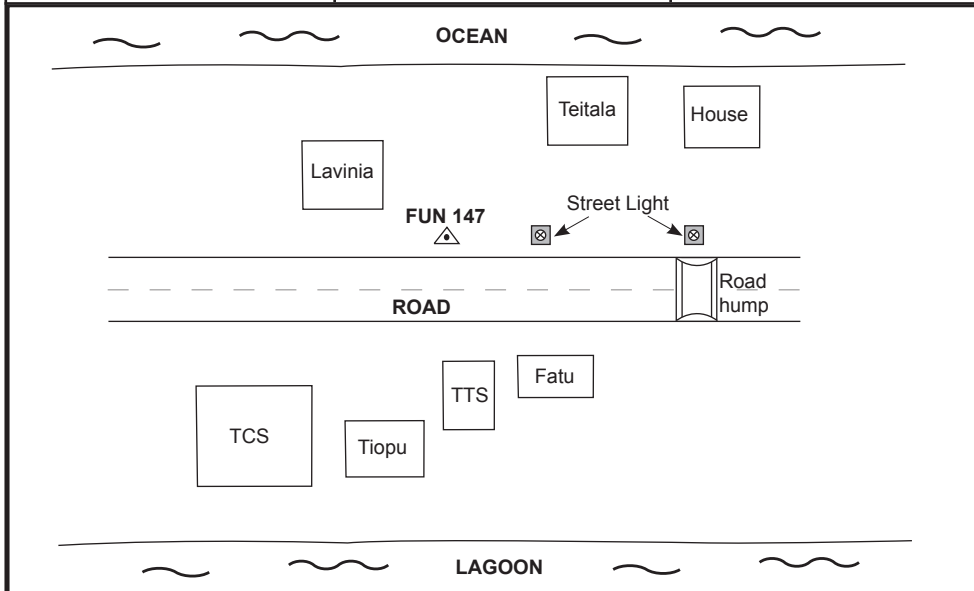

COUNTRY: TUVALU	PROJECT: JICA/ JPACE	L. D. P.: 68
ATOLL: FUNAFUTI	ORGANISATION: SOPAC	POINT No.: FUN 30
ISLET: FONGAFALE	SURVEYOR: ANDRICK LAL	DATE: 2004

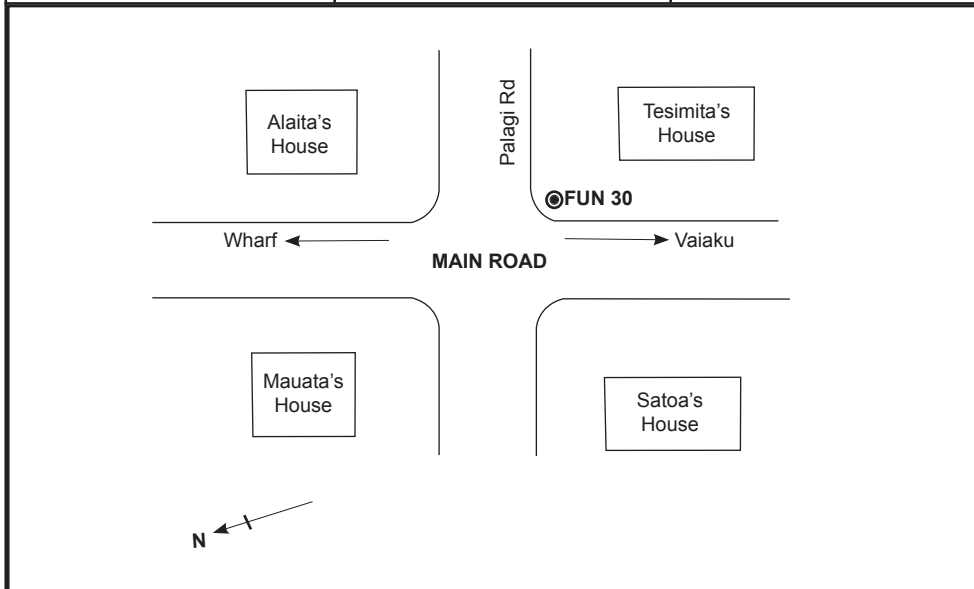

COUNTRY: TUVALU	PROJECT: JICA/ JPACE	L. D. P.: 69
ATOLL: FUNAFUTI	ORGANISATION: SOPAC	POINT No.: FUN 148
ISLET: FONGAFALE	SURVEYOR: ANDRICK LAL	DATE: 03/11/09

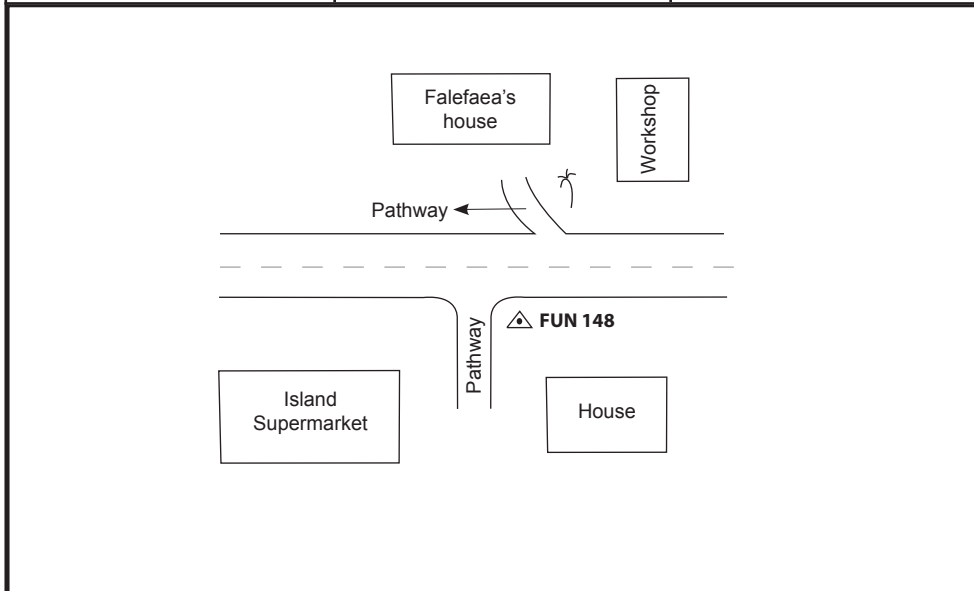

COUNTRY: TUVALU	PROJECT: JICA/ JPACE	L. D. P.: 70
ATOLL: FUNAFUTI	ORGANISATION: SOPAC	POINT No.: FUN 30A
ISLET: FONGAFALE	SURVEYOR: ANDRICK LAL	DATE: 2004

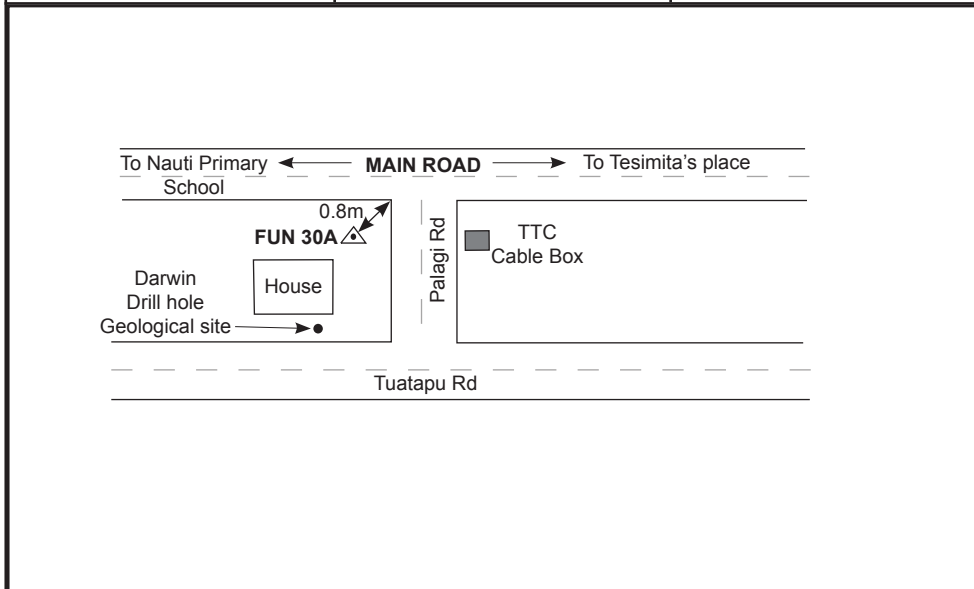

COUNTRY: TUVALU	PROJECT: JICA/ JPACE	L. D. P.: 71
ATOLL: FUNAFUTI	ORGANISATION: SOPAC	POINT No.: FUN 170
ISLET: FONGAFALE	SURVEYOR: ANDRICK LAL	DATE: 05/11/09

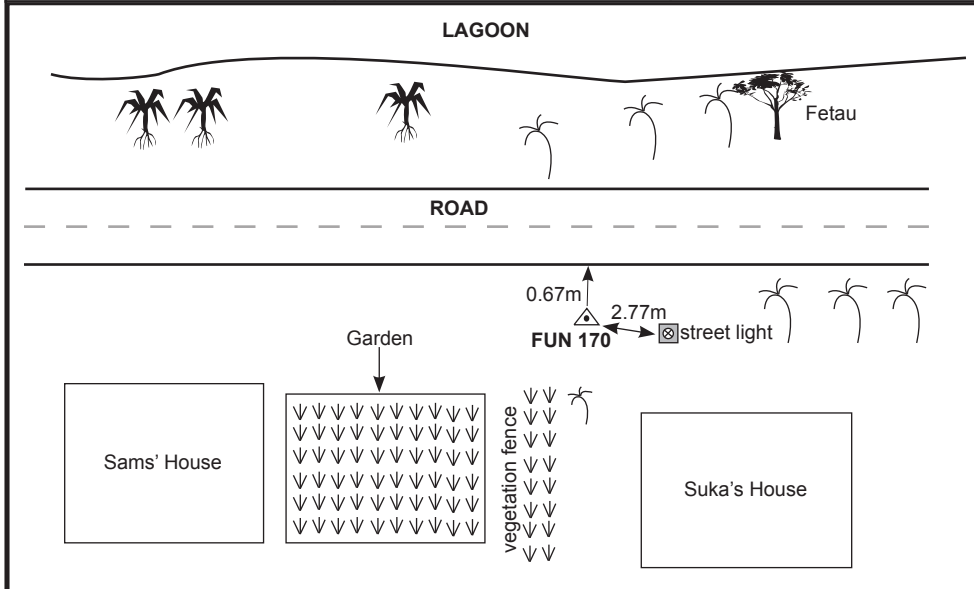

COUNTRY: TUVALU	PROJECT: JICA/ JPACE	L. D. P.: 72
ATOLL: FUNAFUTI	ORGANISATION: SOPAC	POINT No.: FUN 171
ISLET: FONGAFALE	SURVEYOR: ANDRICK LAL	DATE: 05/11/09

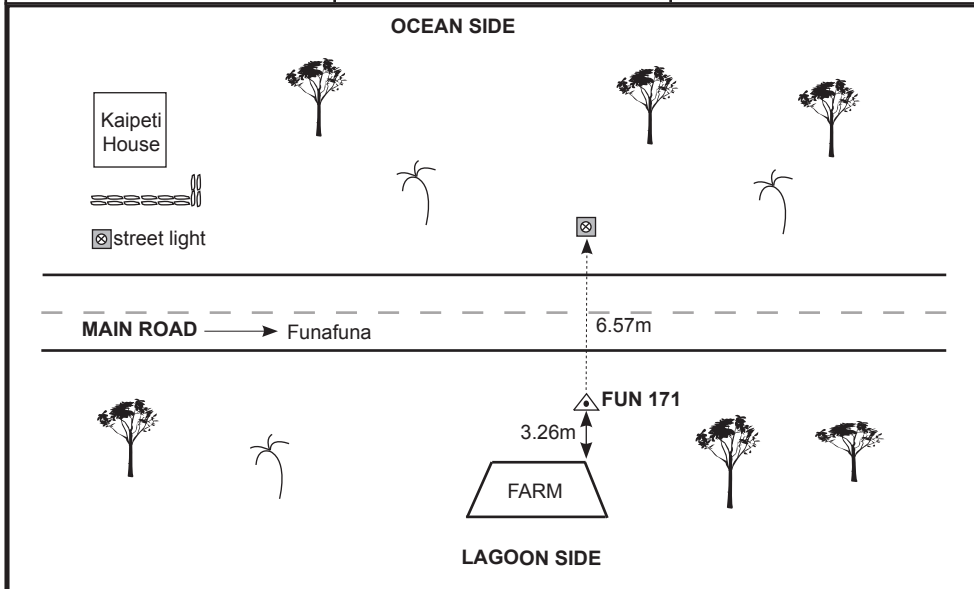

COUNTRY: TUVALU	PROJECT: JICA/ JPACE	L. D. P.: 73
ATOLL: FUNAFUTI	ORGANISATION: SOPAC	POINT No.: FUN 172
ISLET: FONGAFALE	SURVEYOR: ANDRICK LAL	DATE: 05/11/09

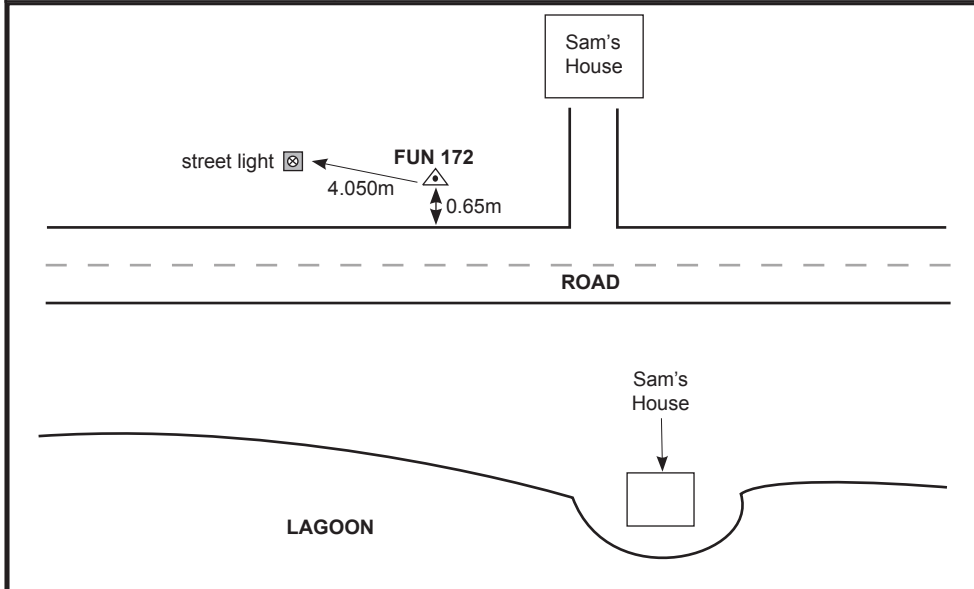

COUNTRY: TUVALU	PROJECT: JICA/ JPACE	L. D. P.: 74
ATOLL: FUNAFUTI	ORGANISATION: SOPAC	POINT No.: FUN 173
ISLET: FONGAFALE	SURVEYOR: ANDRICK LAL	DATE: 05/11/09

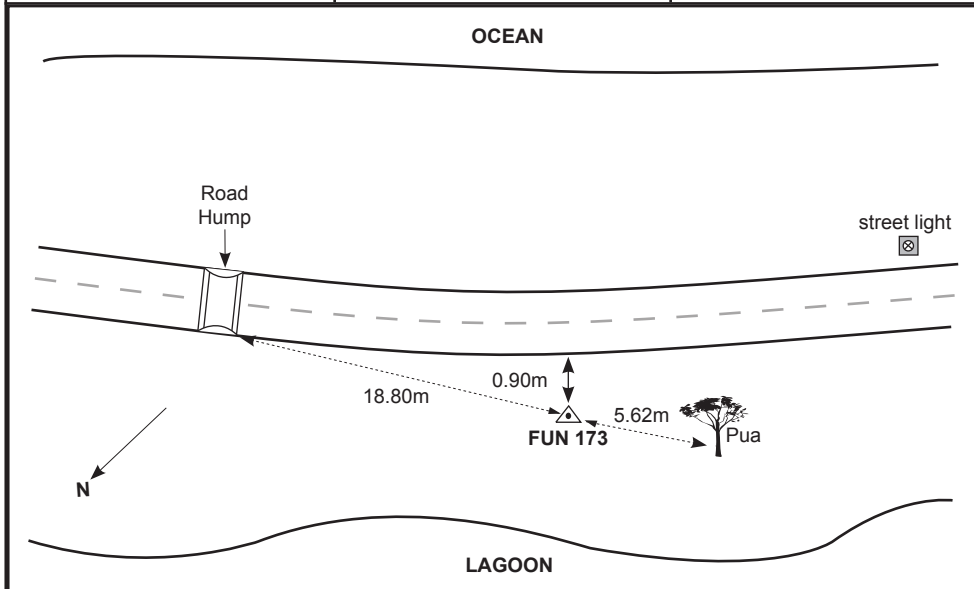

COUNTRY: TUVALU	PROJECT: JICA/ JPACE	L. D. P.: 75
ATOLL: FUNAFUTI	ORGANISATION: SOPAC	POINT No.: FUN 174
ISLET: FONGAFALE	SURVEYOR: ANDRICK LAL	DATE: 05/11/09

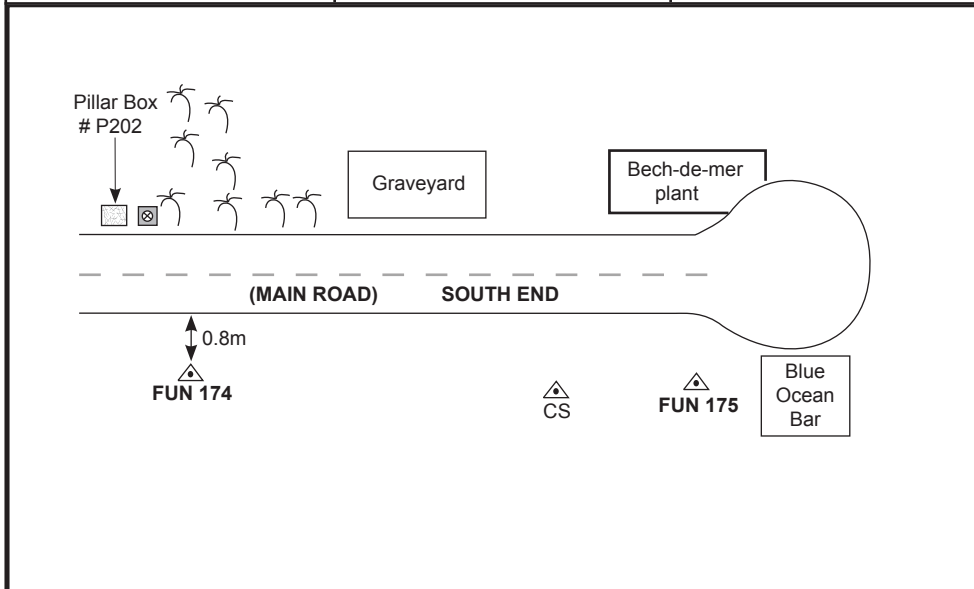

COUNTRY: TUVALU	PROJECT: JICA/ JPACE	L. D. P.: 76
ATOLL: FUNAFUTI	ORGANISATION: SOPAC	POINT No.: FUN 175
ISLET: FONGAFALE	SURVEYOR: ANDRICK LAL	DATE: 05/11/09

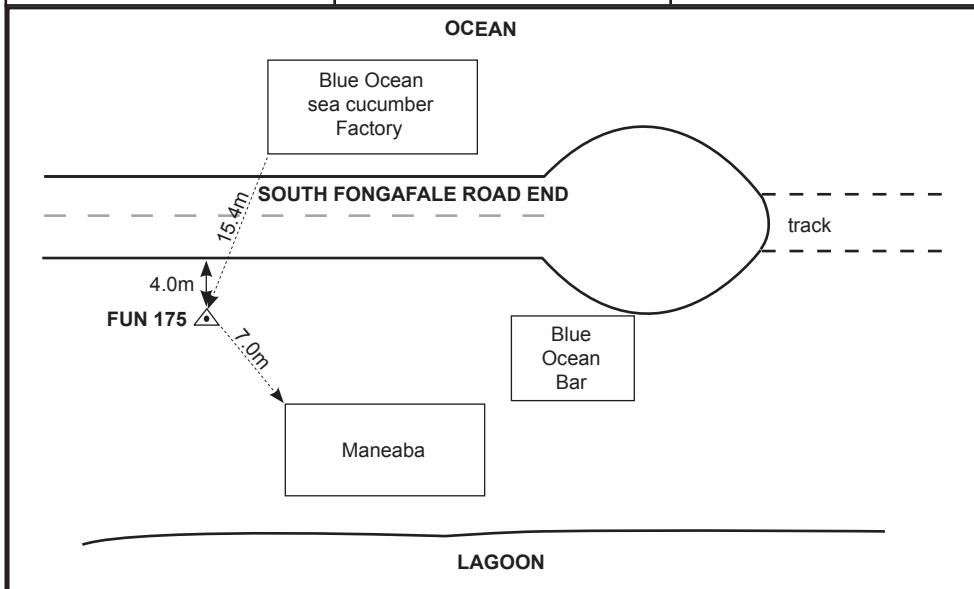

COUNTRY: TUVALU	PROJECT: JICA/ JPACE	L. D. P.: 77
ATOLL: FUNAFUTI	ORGANISATION: SOPAC	POINT No.: TUVA 16
ISLET: FONGAFALE	SURVEYOR: ANDRICK LAL	DATE: 2004

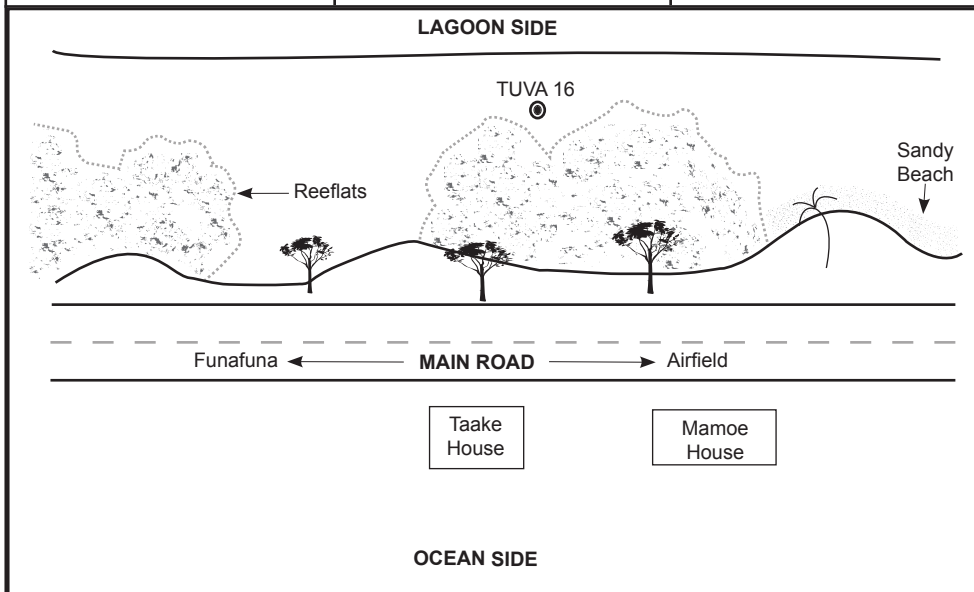

COUNTRY: TUVALU	PROJECT: JICA/ JPACE	L. D. P.: 78
ATOLL: FUNAFUTI	ORGANISATION: SOPAC	POINT No.: BM_UoH1
ISLET: FONGAFALE	SURVEYOR: ANDRICK LAL	DATE: 2004

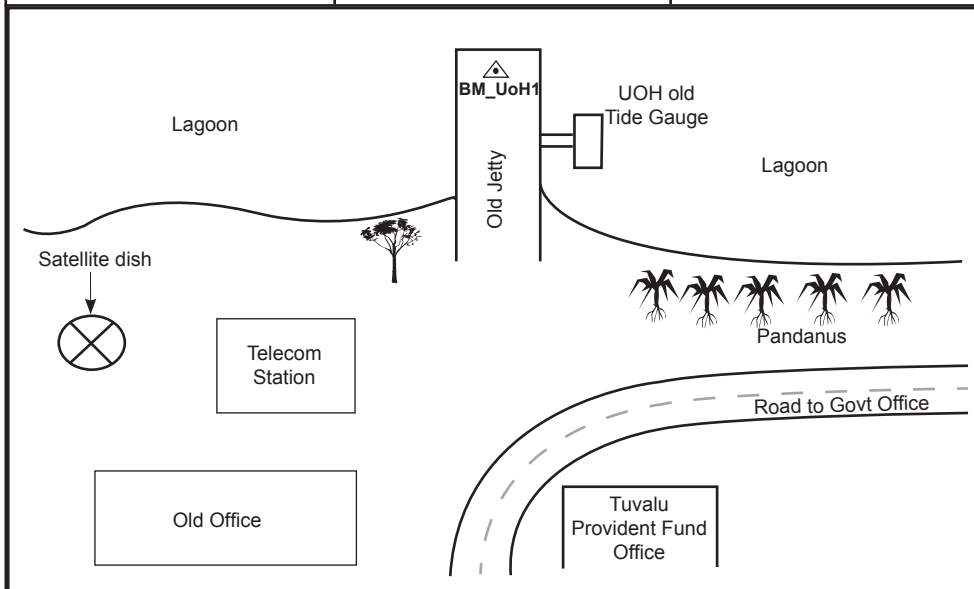

COUNTRY: TUVALU	PROJECT: JICA/ JPACE	L. D. P.: 79
ATOLL: FUNAFUTI	ORGANISATION: SOPAC	POINT No.: DS 1
ISLET: FONGAFALE	SURVEYOR: ANDRICK LAL	DATE: 06/11/09

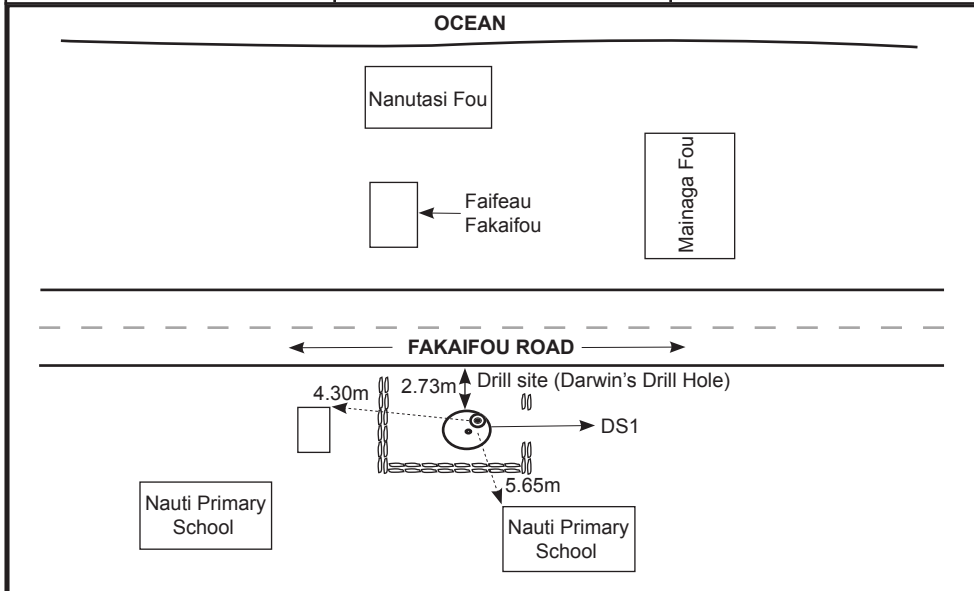

COUNTRY: TUVALU	PROJECT: JICA/ JPACE	L. D. P.: 80
ATOLL: FUNAFUTI	ORGANISATION: SOPAC	POINT No.: TUVA 14
ISLET: FONGAFALE	SURVEYOR: ANDRICK LAL	DATE: 2004

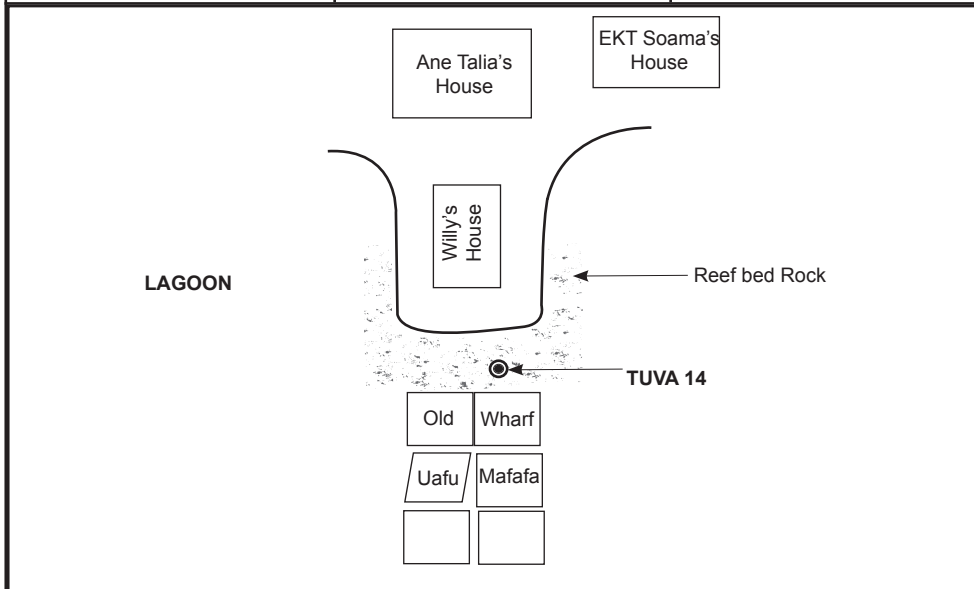

COUNTRY: TUVALU	PROJECT: JICA/ JPACE	L. D. P.: 81
ATOLL: FUNAFUTI	ORGANISATION: SOPAC	POINT No.: FUN 42
ISLET: FONGAFALE	SURVEYOR: ANDRICK LAL	DATE: 2004

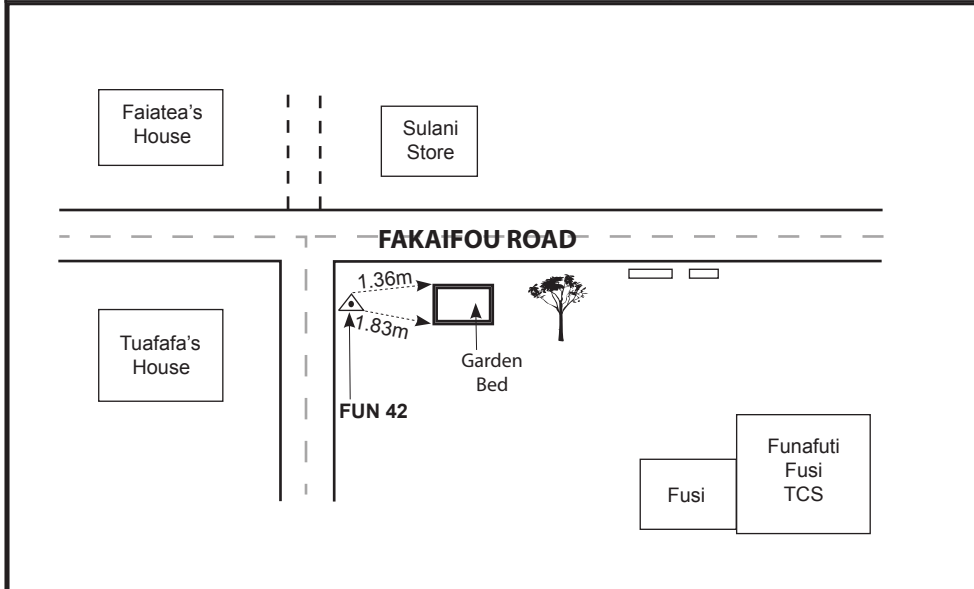

COUNTRY: TUVALU	PROJECT: JICA/ JPACE	L. D. P.: 82
ATOLL: FUNAFUTI	ORGANISATION: SOPAC	POINT No.: FUN 43
ISLET: FONGAFALE	SURVEYOR: ANDRICK LAL	DATE: 2004

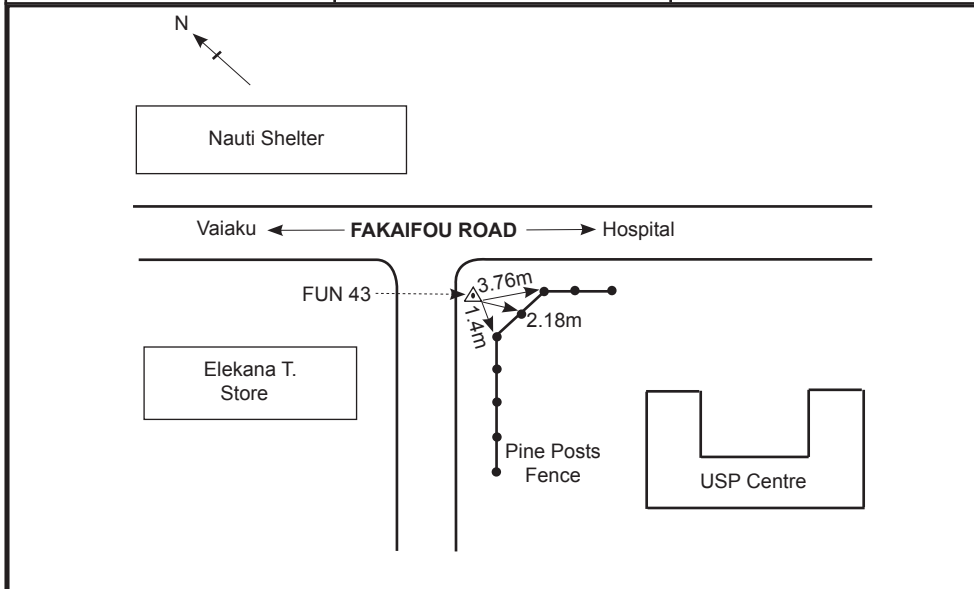

COUNTRY: TUVALU	PROJECT: JICA/ JPACE	L. D. P.: 83
ATOLL: FUNAFUTI	ORGANISATION: SOPAC	POINT No.: FUN 40
ISLET: FONGAFALE	SURVEYOR: ANDRICK LAL	DATE: 2004

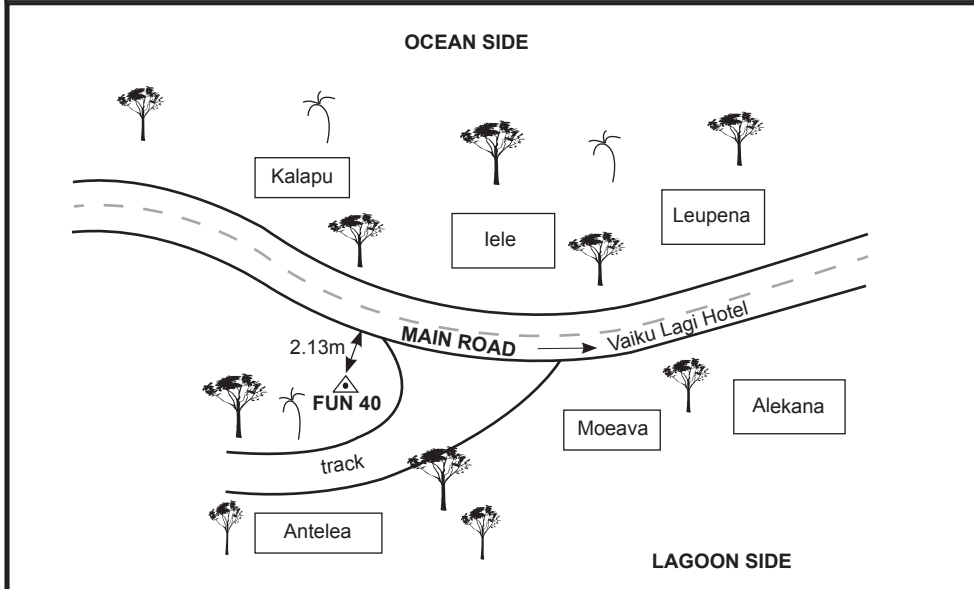

COUNTRY: TUVALU	PROJECT: JICA/ JPACE	L. D. P.: 84
ATOLL: FUNAFUTI	ORGANISATION: SOPAC	POINT No.: UF 12
ISLET: FONGAFALE	SURVEYOR: ANDRICK LAL	DATE: UNKNOWN

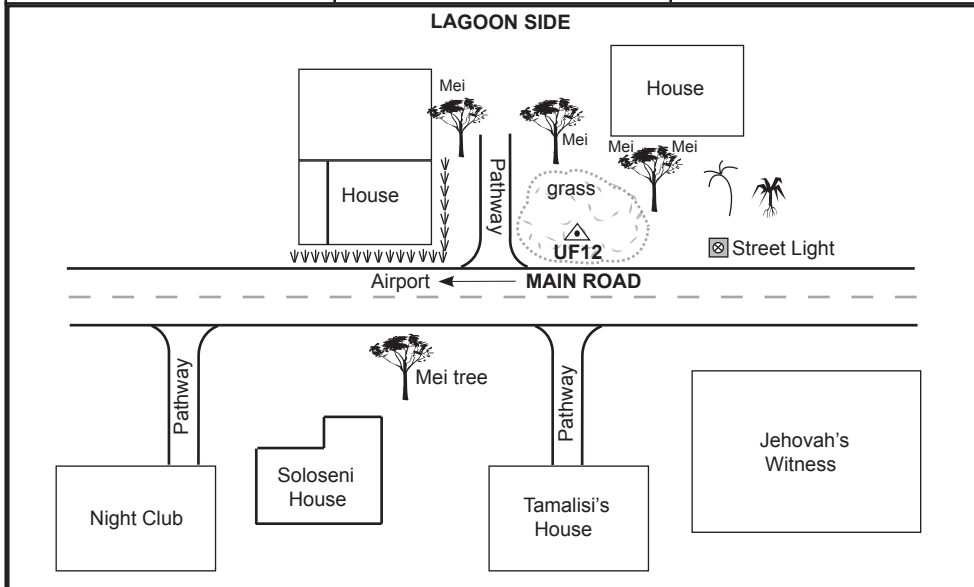

COUNTRY: TUVALU	PROJECT: JICA/ JPACE	L. D. P.: 85
ATOLL: FUNAFUTI	ORGANISATION: SOPAC	POINT No.: FUN 125
ISLET: FONGAFALE	SURVEYOR: ANDRICK LAL	DATE: 31/10/09

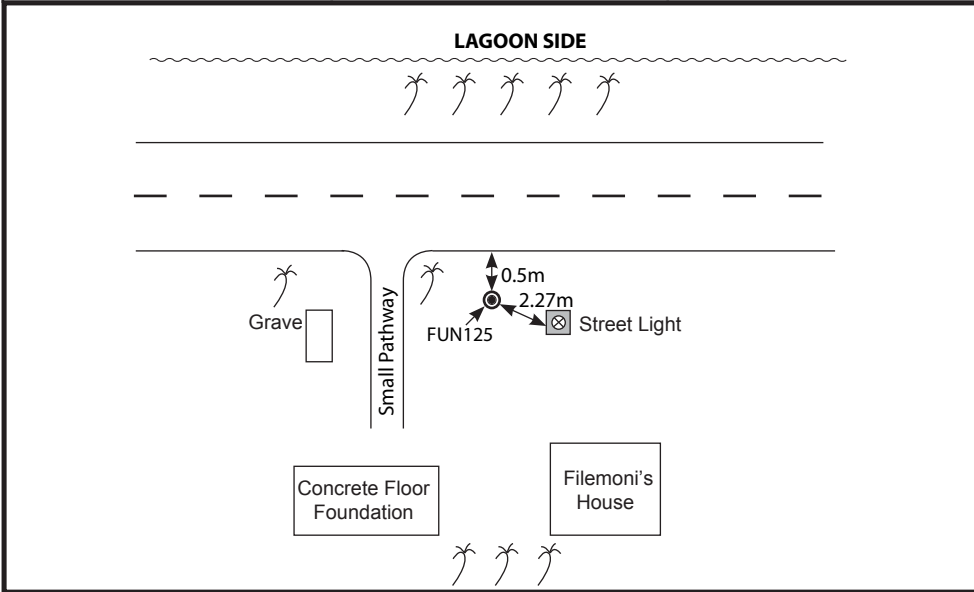

COUNTRY: TUVALU	PROJECT: JICA/ JPACE	L. D. P.: 86
ATOLL: FUNAFUTI	ORGANISATION: SOPAC	POINT No.: FUN 16
ISLET: FONGAFALE	SURVEYOR: ANDRICK LAL	DATE: 2004

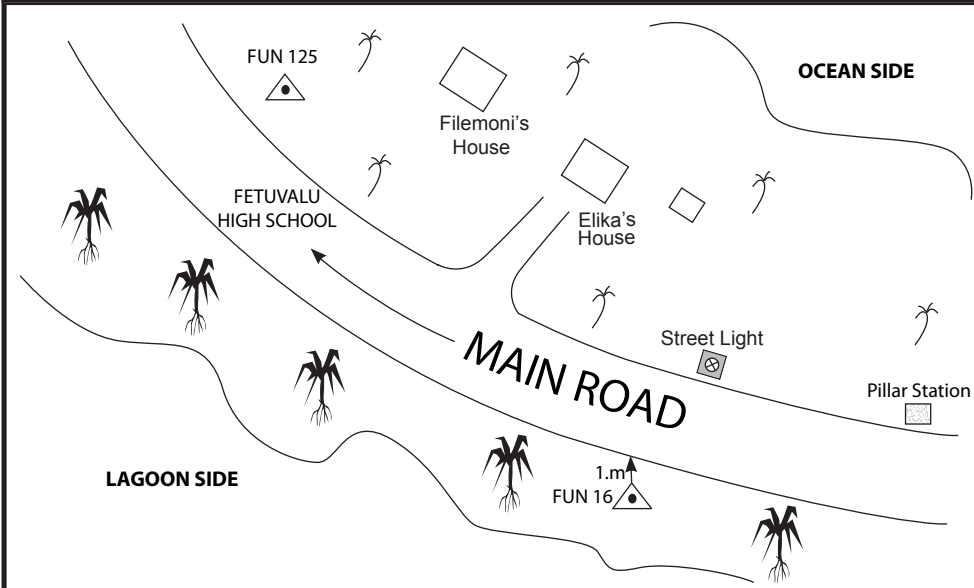

COUNTRY: TUVALU	PROJECT: JICA/ JPACE	L. D. P.: 87
ATOLL: FUNAFUTI	ORGANISATION: SOPAC	POINT No.: FUN 126
ISLET: FONGAFALE	SURVEYOR: ANDRICK LAL	DATE: 31/10/09

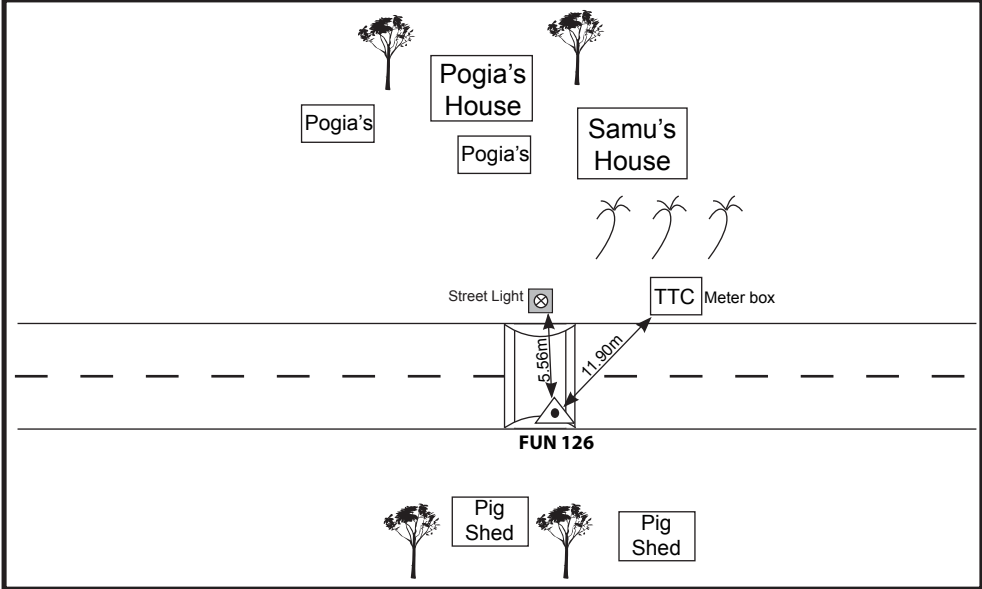

COUNTRY: TUVALU	PROJECT: JICA/ JPACE	L. D. P.: 88
ATOLL: FUNAFUTI	ORGANISATION: SOPAC	POINT No.: FUN 17
ISLET: FONGAFALE	SURVEYOR: ANDRICK LAL	DATE: 2004

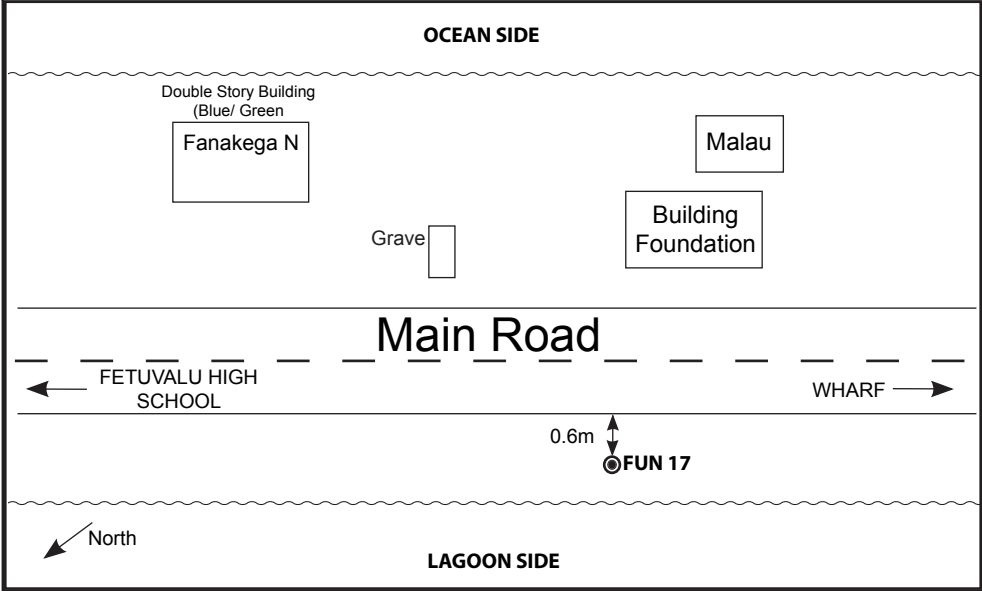

COUNTRY: TUVALU	PROJECT: JICA/ JPACE	L. D. P.: 89
ATOLL: FUNAFUTI	ORGANISATION: SOPAC	POINT No.: FUN 127
ISLET: FONGAFALE	SURVEYOR: ANDRICK LAL	DATE: 31/10/09

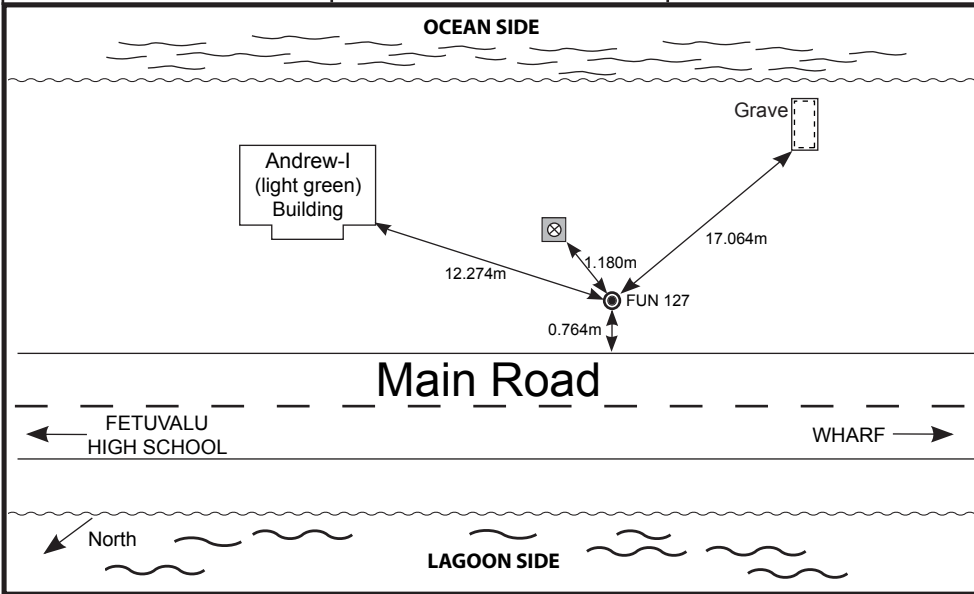

COUNTRY: TUVALU	PROJECT: JICA/ JPACE	L. D. P.: 90
ATOLL: FUNAFUTI	ORGANISATION: SOPAC	POINT No.: FUN 128
ISLET: FONGAFALE	SURVEYOR: ANDRICK LAL	DATE: 31/10/09

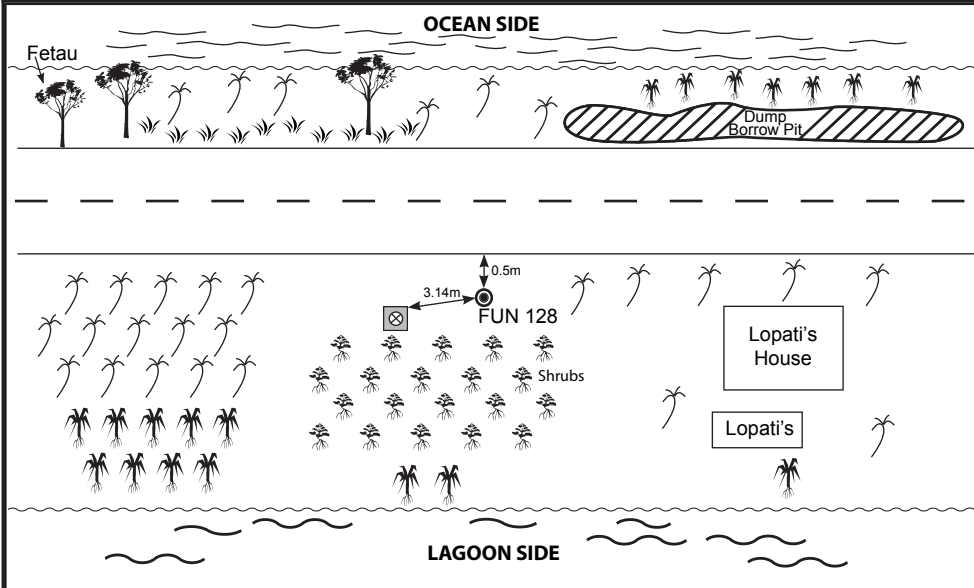

COUNTRY: TUVALU	PROJECT: JICA/ JPACE	L. D. P.: 91
ATOLL: FUNAFUTI	ORGANISATION: SOPAC	POINT No.: FUN 129
ISLET: FONGAFALE	SURVEYOR: ANDRICK LAL	DATE: 31/10/09

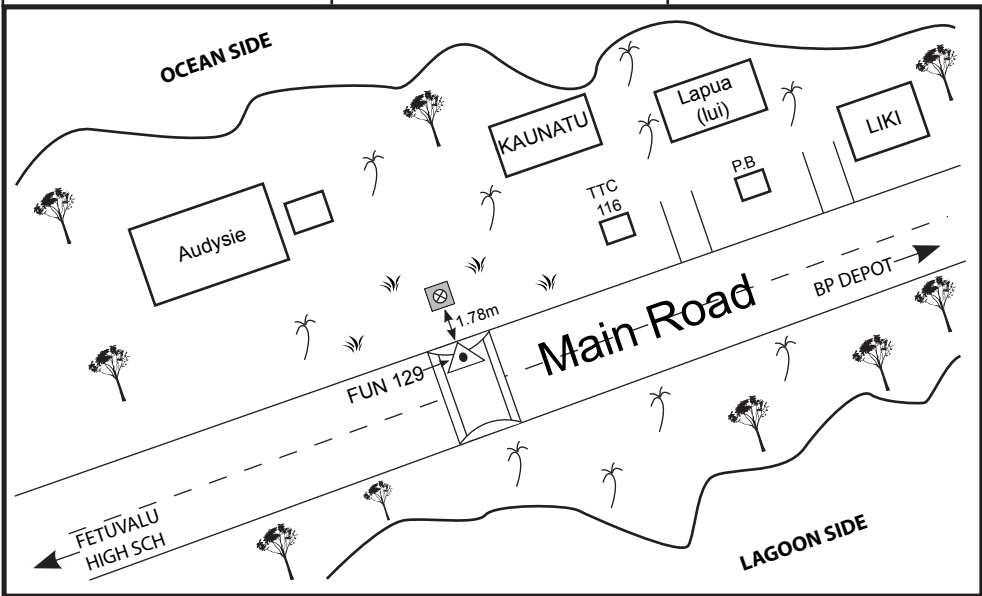

COUNTRY: TUVALU	PROJECT: JICA/ JPACE	L. D. P.: 92
ATOLL: FUNAFUTI	ORGANISATION: SOPAC	POINT No.: FUN 130
ISLET: FONGAFALE	SURVEYOR: ANDRICK LAL	DATE: 02/11/09

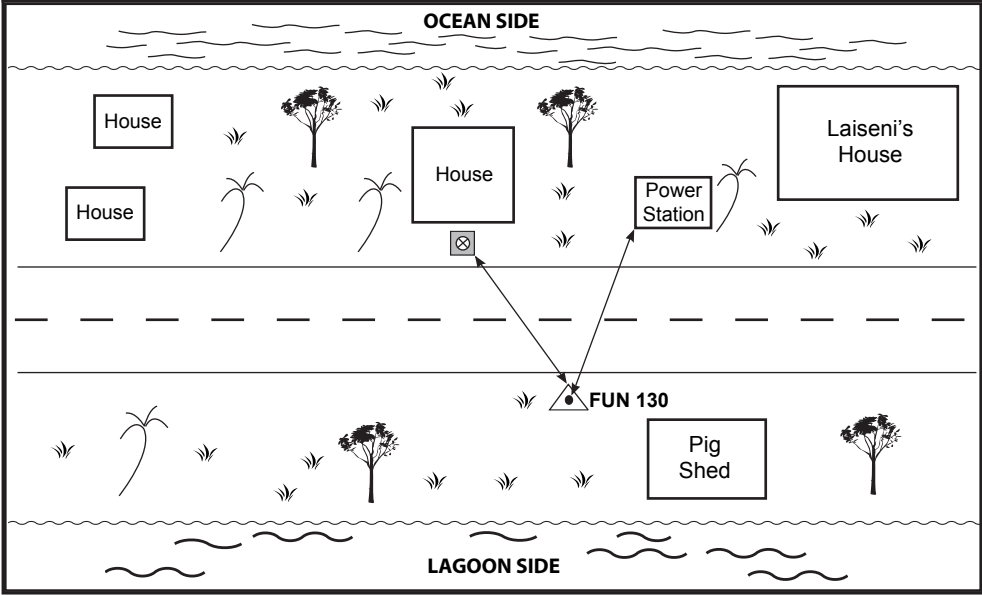

COUNTRY: TUVALU	PROJECT: JICA/ JPACE	L. D. P.: 93
ATOLL: FUNAFUTI	ORGANISATION: SOPAC	POINT No.: FUN 131
ISLET: FONGAFALE	SURVEYOR: ANDRICK LAL	DATE: 02/11/09

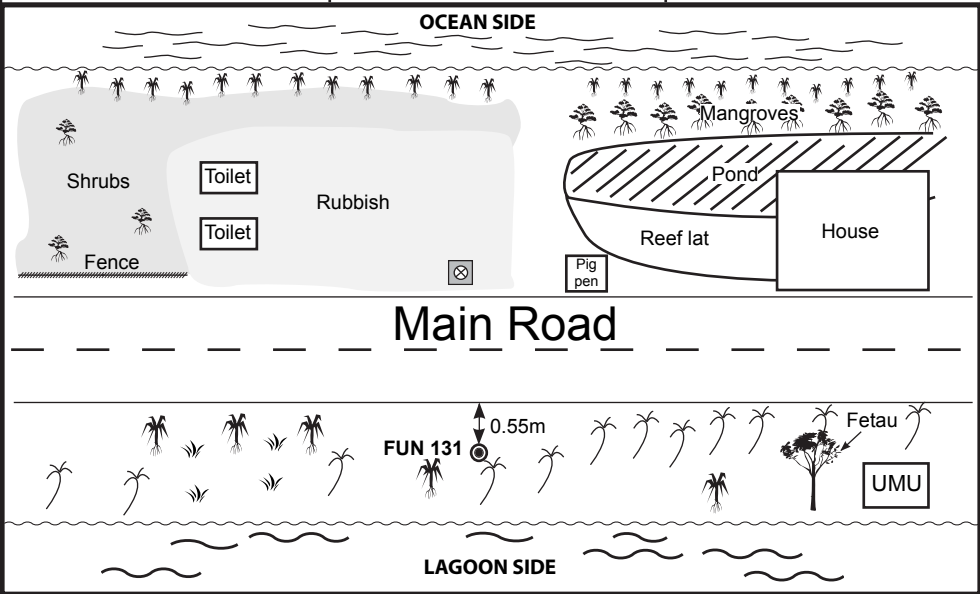

COUNTRY: TUVALU	PROJECT: JICA/ JPACE	L. D. P.: 94
ATOLL: FUNAFUTI	ORGANISATION: SOPAC	POINT No.: FUN 19
ISLET: FONGAFALE	SURVEYOR: ANDRICK LAL	DATE: 2004

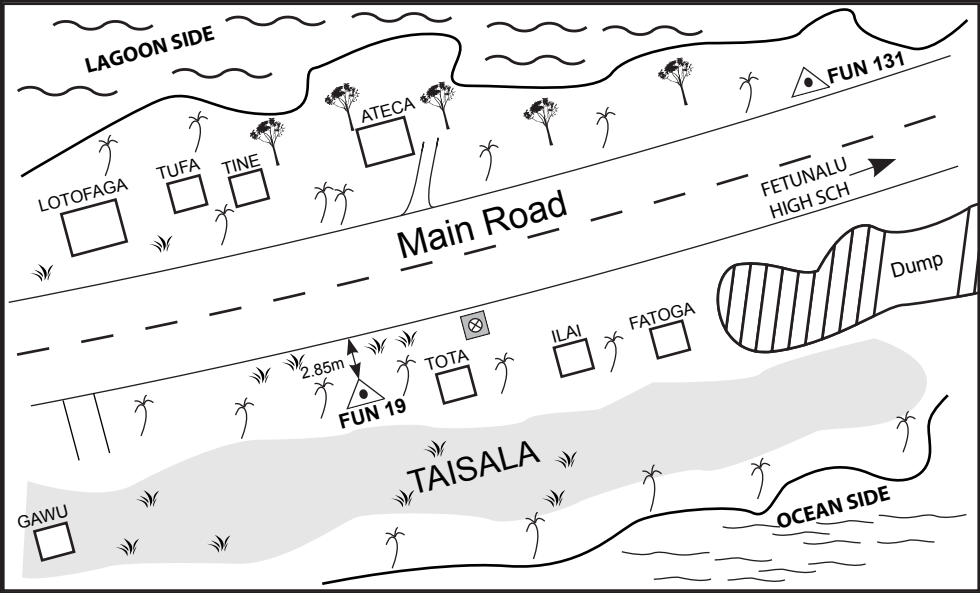

COUNTRY: TUVALU	PROJECT: JICA/ JPACE	L. D. P.: 95
ATOLL: FUNAFUTI	ORGANISATION: SOPAC	POINT No.: FUN 132
ISLET: FONGAFALE	SURVEYOR: ANDRICK LAL	DATE: 02/11/09

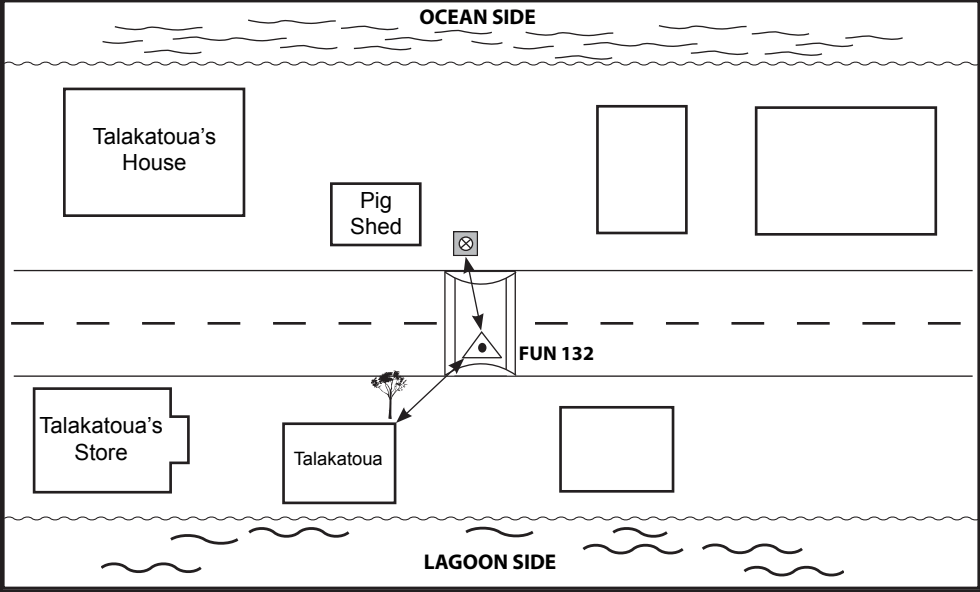

COUNTRY: TUVALU	PROJECT: JICA/ JPACE	L. D. P.: 96
ATOLL: FUNAFUTI	ORGANISATION: SOPAC	POINT No.: FUN 133
ISLET: FONGAFALE	SURVEYOR: ANDRICK LAL	DATE: 02/11/09

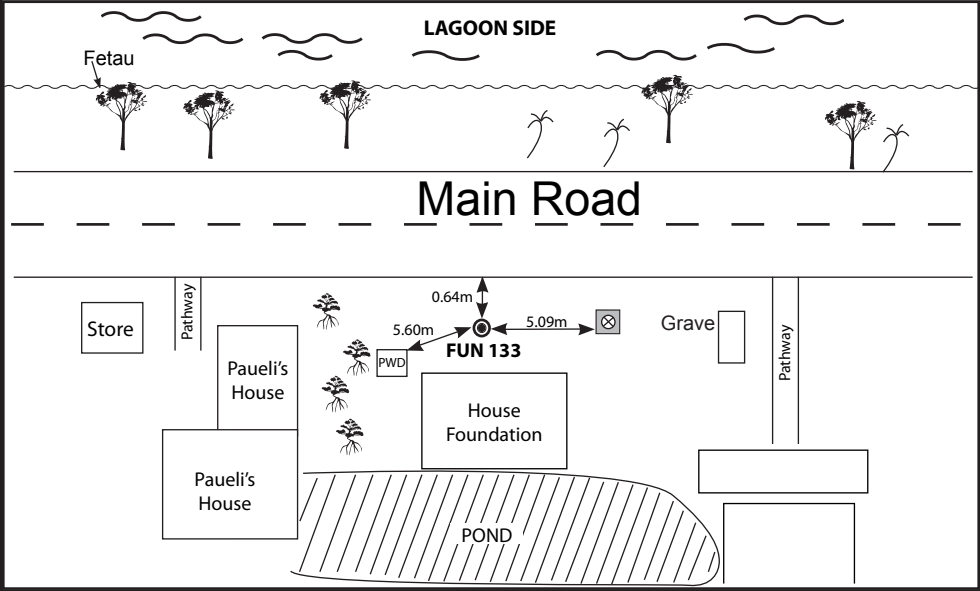

COUNTRY: TUVALU	PROJECT: JICA/ JPACE	L. D. P.: 97
ATOLL: FUNAFUTI	ORGANISATION: SOPAC	POINT No.: FUN 134
ISLET: FONGAFALE	SURVEYOR: ANDRICK LAL	DATE: 02/11/09

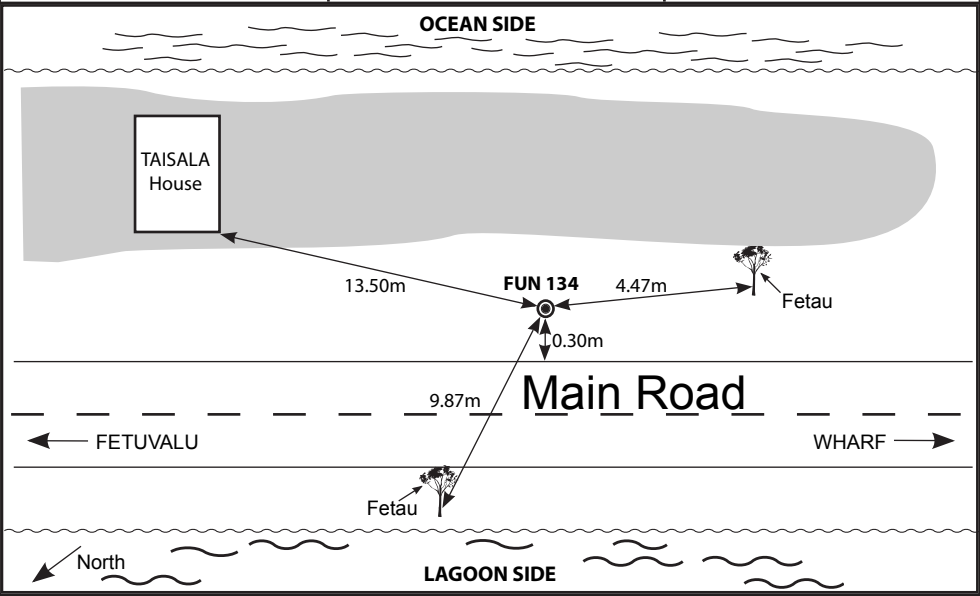

COUNTRY: TUVALU	PROJECT: JICA/ JPACE	L. D. P.: 98
ATOLL: FUNAFUTI	ORGANISATION: SOPAC	POINT No.: FUN 135
ISLET: FONGAFALE	SURVEYOR: ANDRICK LAL	DATE: 02/11/09

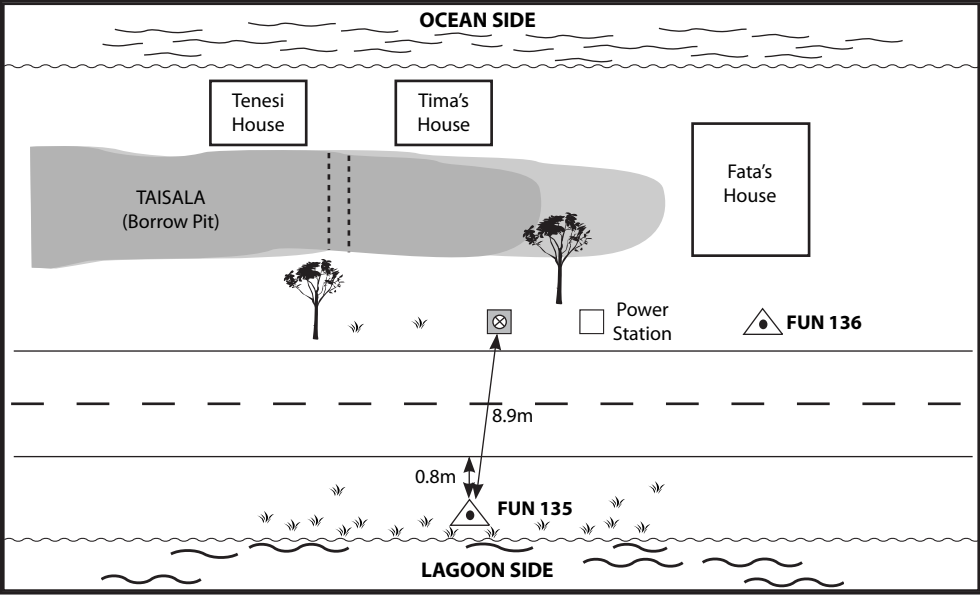

COUNTRY: TUVALU	PROJECT: JICA/ JPACE	L. D. P.: 99
ATOLL: FUNAFUTI	ORGANISATION: SOPAC	POINT No.: FUN 136
ISLET: FONGAFALE	SURVEYOR: ANDRICK LAL	DATE: 02/11/09

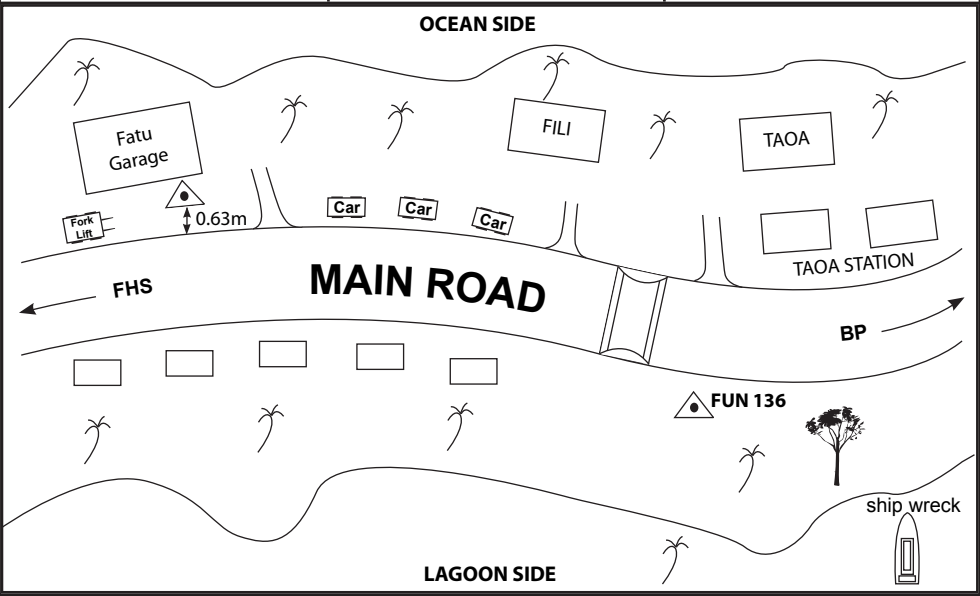

COUNTRY: TUVALU	PROJECT: JICA/ JPACE	L. D. P.: 100
ATOLL: FUNAFUTI	ORGANISATION: SOPAC	POINT No.: FUN 137
ISLET: FONGAFALE	SURVEYOR: ANDRICK LAL	DATE: 02/11/09

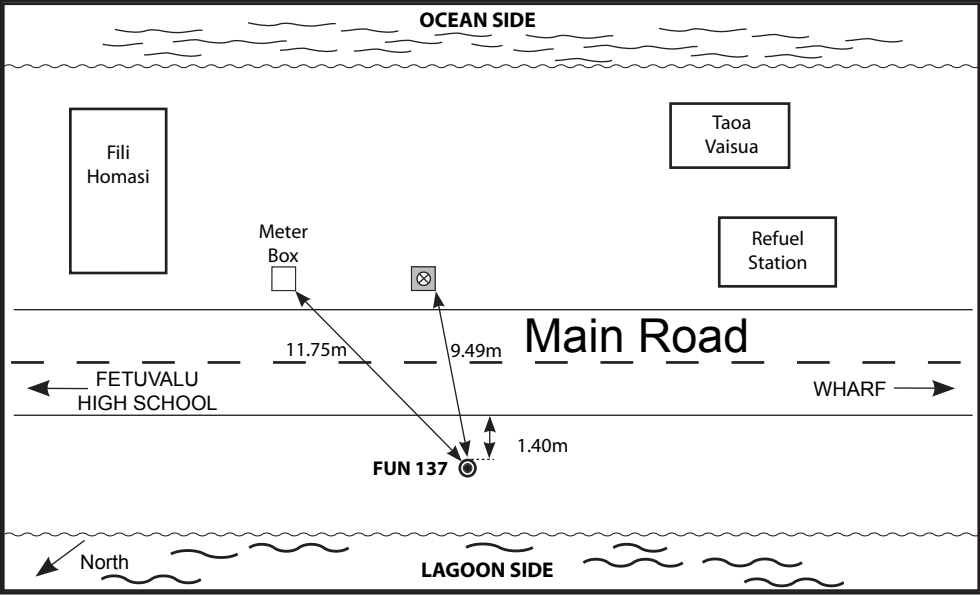

COUNTRY: TUVALU	PROJECT: JICA/ JPACE	L. D. P.: 101
ATOLL: FUNAFUTI	ORGANISATION: SOPAC	POINT No.: FUN 138
ISLET: FONGAFALE	SURVEYOR: ANDRICK LAL	DATE: 02/11/09

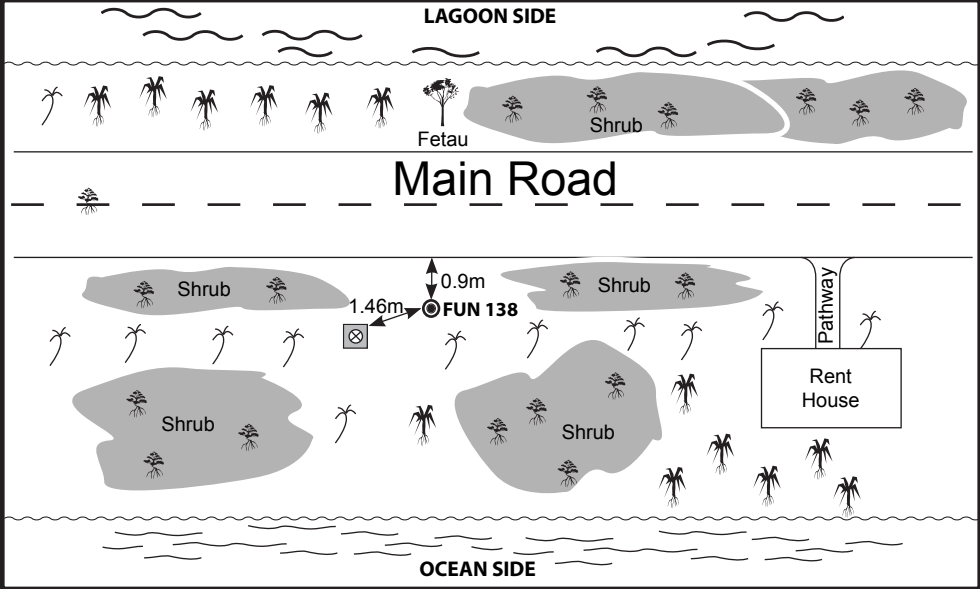

COUNTRY: TUVALU	PROJECT: JICA/ JPACE	L. D. P.: 102
ATOLL: FUNAFUTI	ORGANISATION: SOPAC	POINT No.: FUN 139
ISLET: FONGAFALE	SURVEYOR: ANDRICK LAL	DATE: 02/11/09

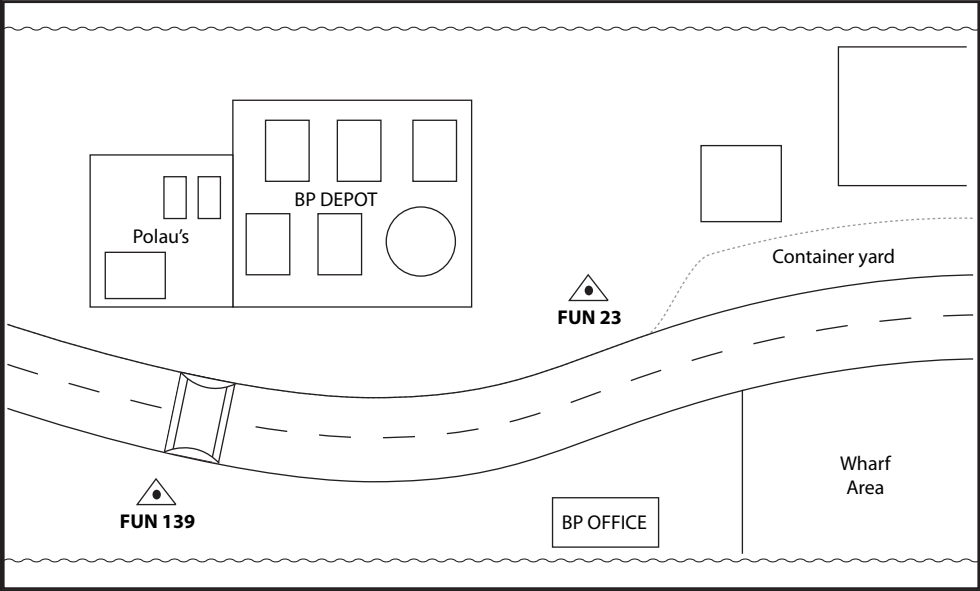

COUNTRY: TUVALU	PROJECT: JICA/ JPACE	L. D. P.: 103
ATOLL: FUNAFUTI	ORGANISATION: SOPAC	POINT No.: FUN 23
ISLET: FONGAFALE	SURVEYOR: ANDRICK LAL	DATE: 2004

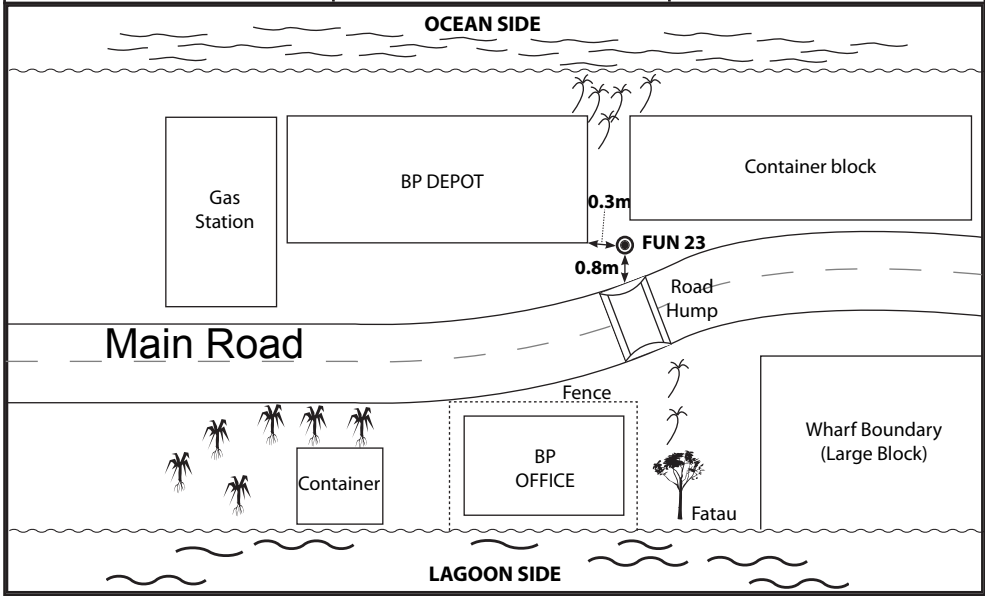

COUNTRY: TUVALU	PROJECT: JICA/ JPACE	L. D. P.: 104
ATOLL: FUNAFUTI	ORGANISATION: SOPAC	POINT No.: FUN 140
ISLET: FONGAFALE	SURVEYOR: ANDRICK LAL	DATE: 02/11/09

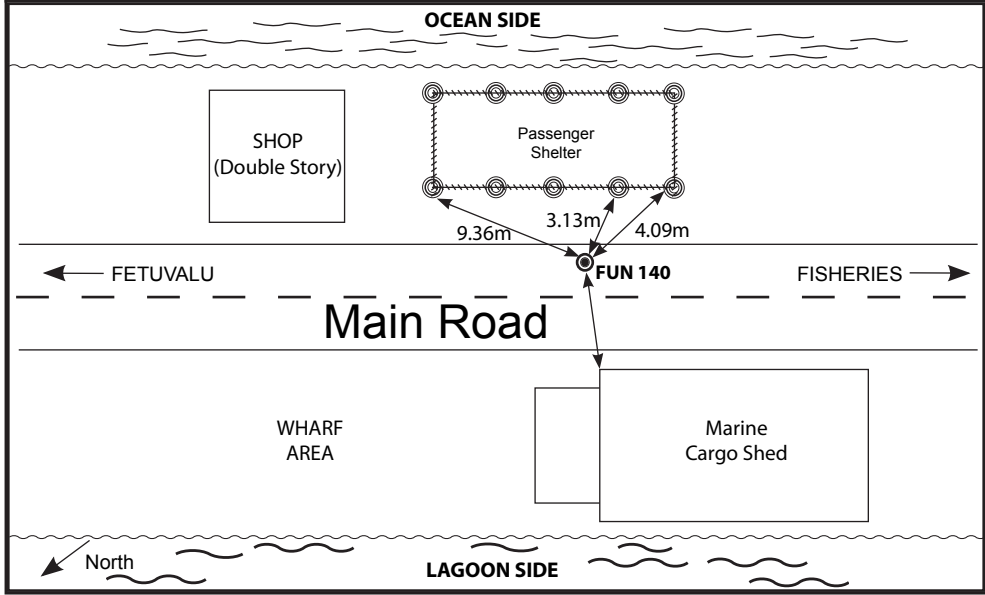

COUNTRY: TUVALU	PROJECT: JICA/ JPACE	L. D. P.: 105
ATOLL: FUNAFUTI	ORGANISATION: SOPAC	POINT No.: TUV 42
ISLET: FONGAFALE	SURVEYOR: ANDRICK LAL	DATE: AUG 2001

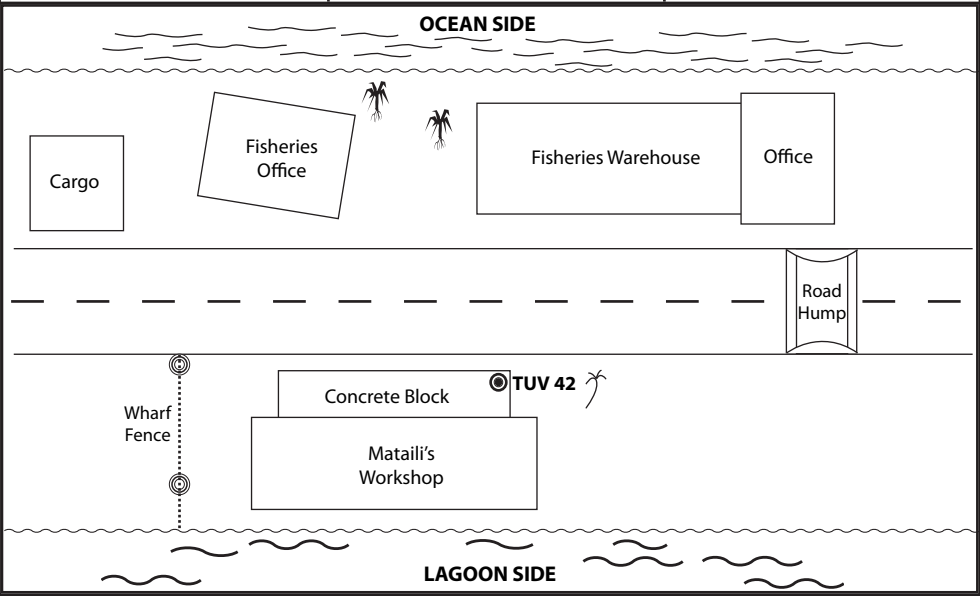

COUNTRY: TUVALU	PROJECT: JICA/ JPACE	L. D. P.: 106
ATOLL: FUNAFUTI	ORGANISATION: SOPAC	POINT No.: FUN 141
ISLET: FONGAFALE	SURVEYOR: ANDRICK LAL	DATE: 03/11/09

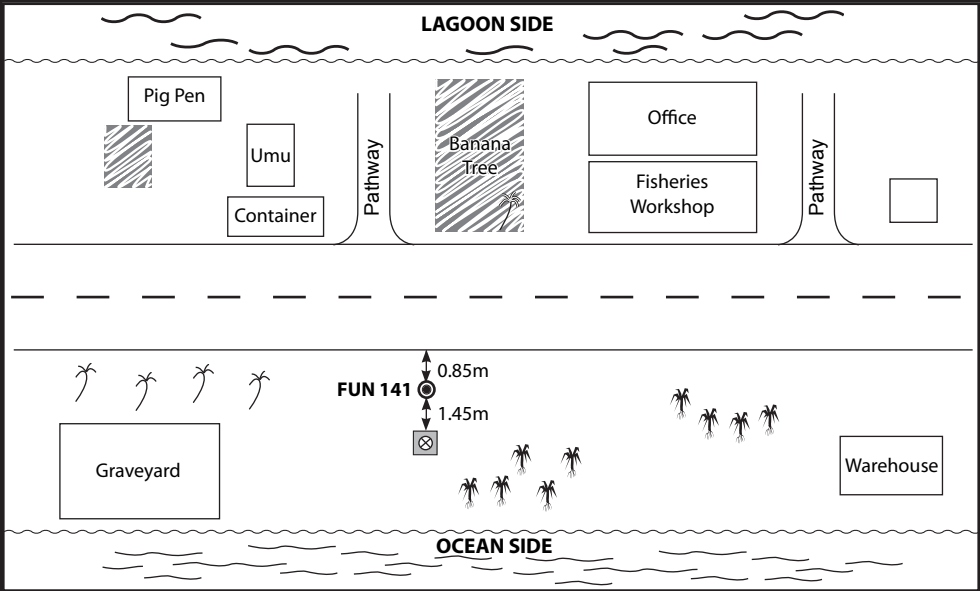

COUNTRY: TUVALU	PROJECT: JICA/ JPACE	L. D. P.: 107
ATOLL: FUNAFUTI	ORGANISATION: SOPAC	POINT No.: FUN 142
ISLET: FONGAFALE	SURVEYOR: ANDRICK LAL	DATE: 03/11/09

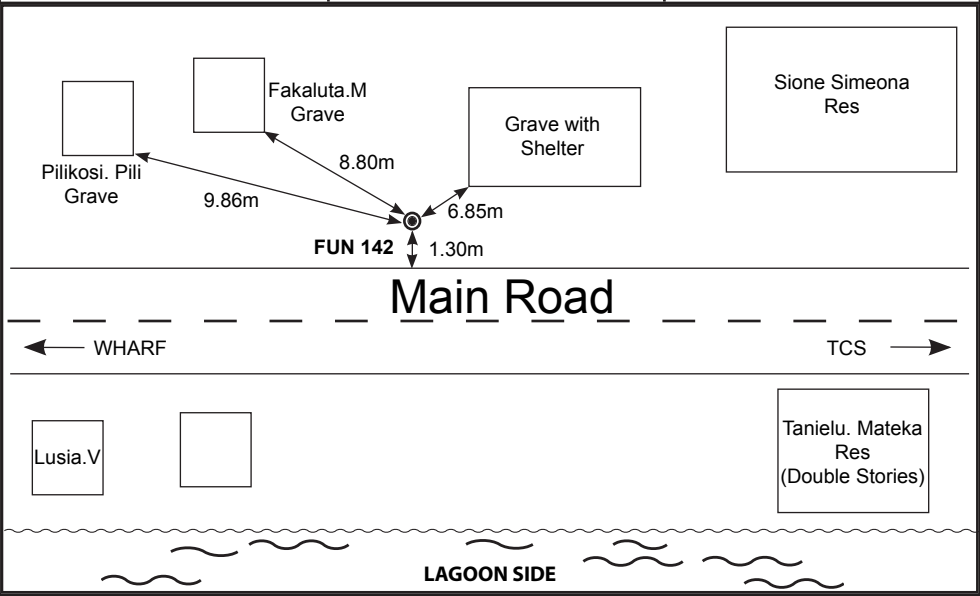

COUNTRY: TUVALU	PROJECT: JICA/ JPACE	L. D. P.: 108
ATOLL: FUNAFUTI	ORGANISATION: SOPAC	POINT No.: FUN 143
ISLET: FONGAFALE	SURVEYOR: ANDRICK LAL	DATE: 03/11/09

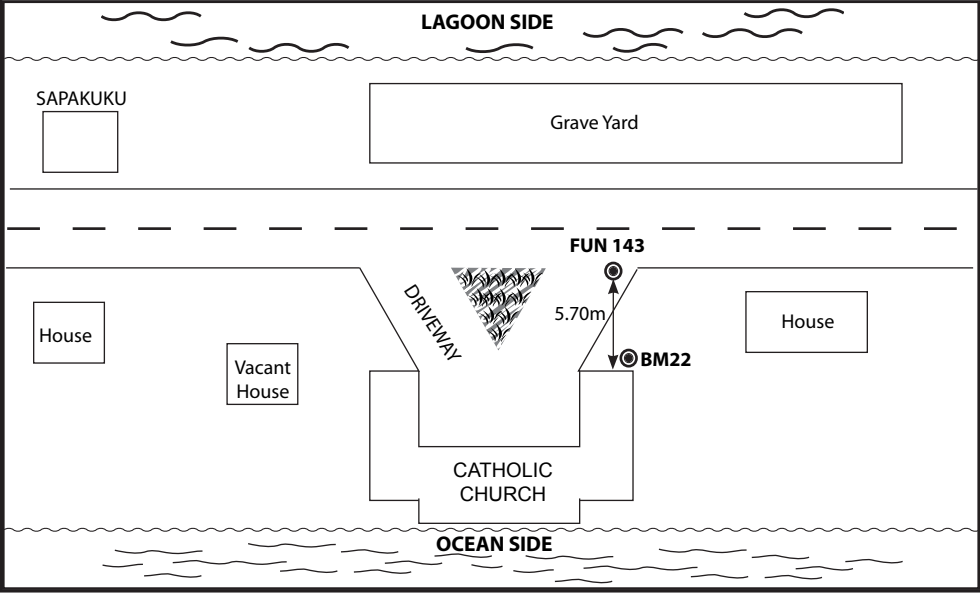

COUNTRY: TUVALU	PROJECT: JICA/ JPACE	L. D. P.: 109
ATOLL: FUNAFUTI	ORGANISATION: SOPAC	POINT No.: FUF01
ISLET: FONGAFALE	SURVEYOR: ANDRICK LAL	DATE: 24/10/09

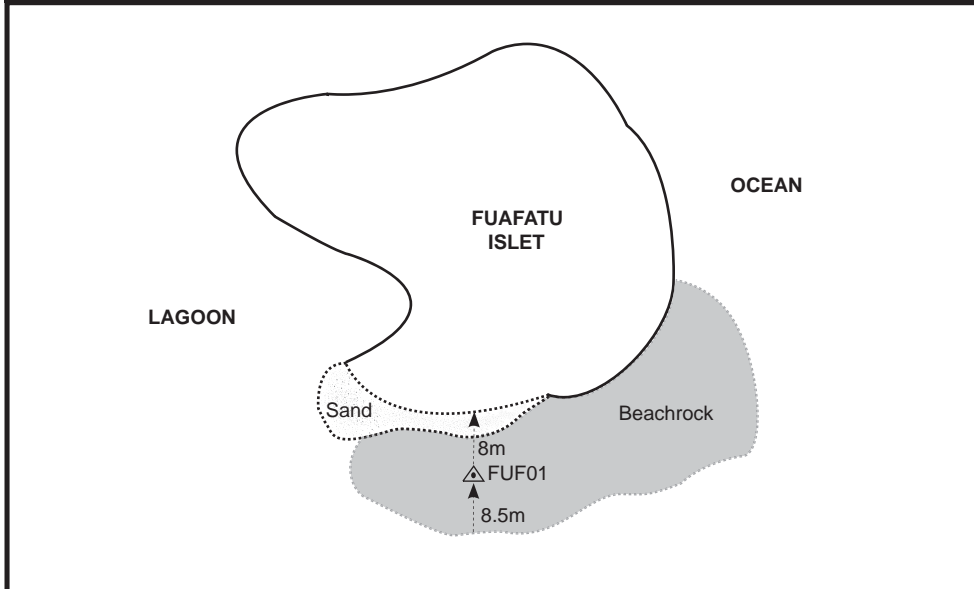

COUNTRY: TUVALU	PROJECT: JICA/ JPACE	L. D. P.: 110
ATOLL: FUNAFUTI	ORGANISATION: SOPAC	POINT No.: FAR01
ISLET: FONGAFALE	SURVEYOR: ANDRICK LAL	DATE: 24/10/09

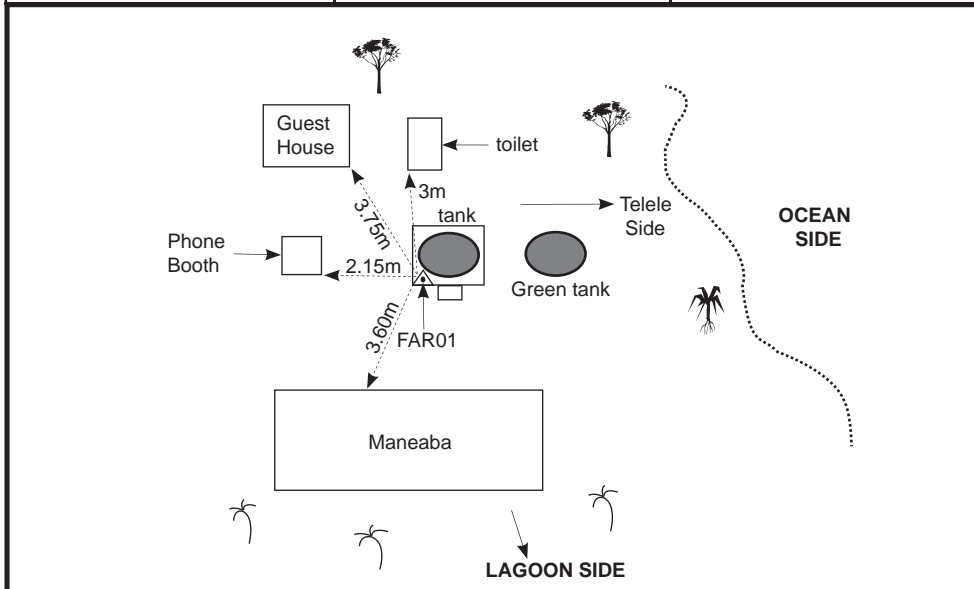

COUNTRY: TUVALU	PROJECT: JICA/ JPACE	L. D. P.: 111
ATOLL: FUNAFUTI	ORGANISATION: SOPAC	POINT No.: BS20
ISLET: FONGAFALE	SURVEYOR: ANDRICK LAL	DATE: May 1998

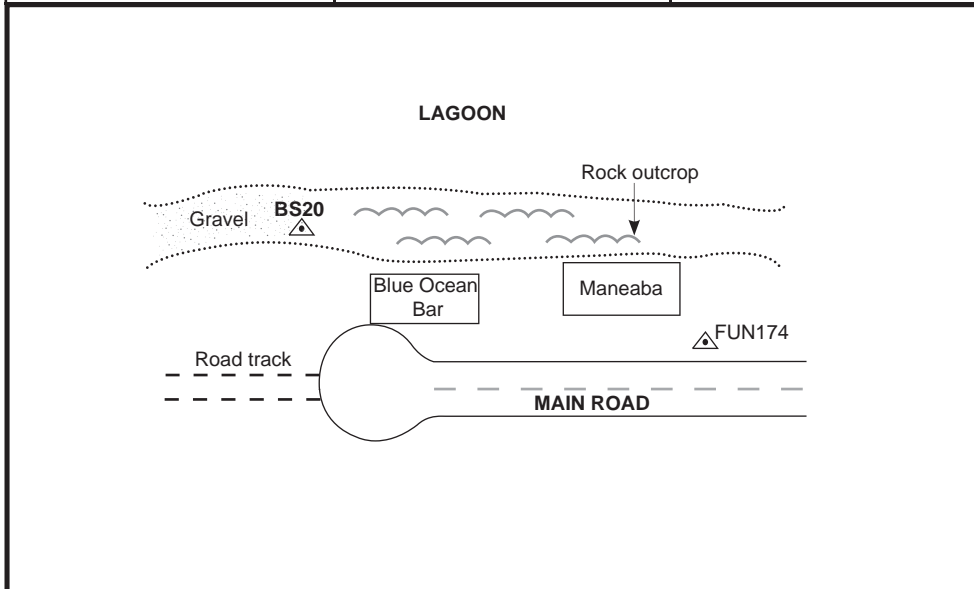

COUNTRY: TUVALU	PROJECT: JICA/ JPACE	L. D. P.: 112
ATOLL: FUNAFUTI	ORGANISATION: SOPAC	POINT No.: FFZ8A
ISLET: FONGAFALE	SURVEYOR: ANDRICK LAL	DATE: 24/10/09

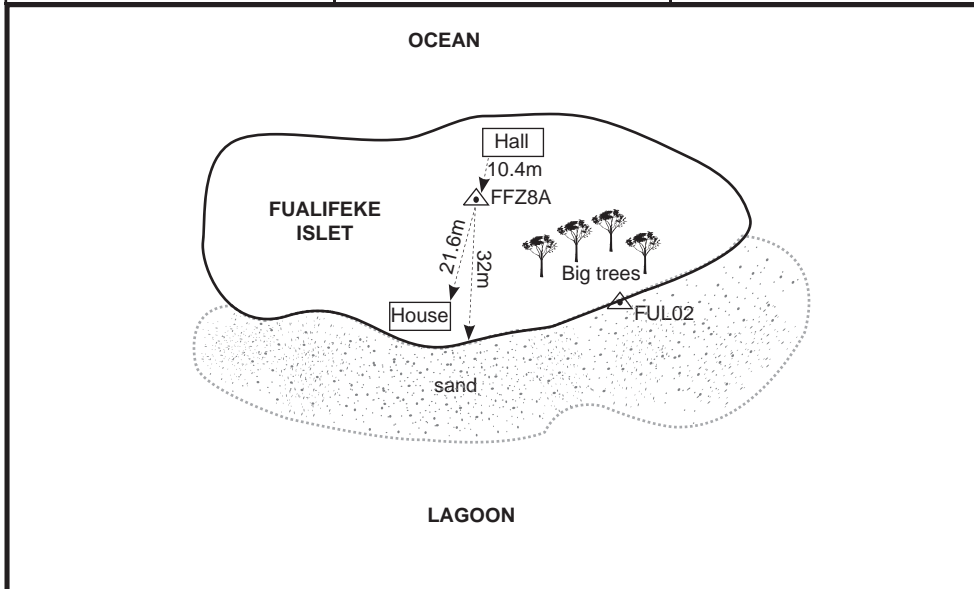

COUNTRY: TUVALU	PROJECT: JICA/ JPACE	L. D. P.: 113
ATOLL: FUNAFUTI	ORGANISATION: SOPAC	POINT No.: TEP01
ISLET: FONGAFALE	SURVEYOR: ANDRICK LAL	DATE: 24/10/09

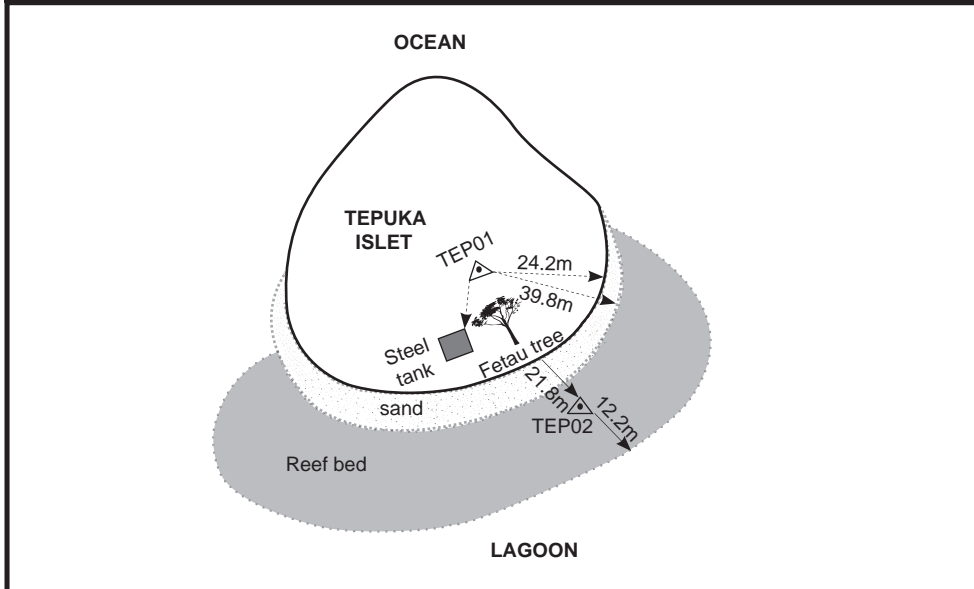

COUNTRY: TUVALU	PROJECT: JICA/ JPACE	L. D. P.: 114
ATOLL: FUNAFUTI	ORGANISATION: SOPAC	POINT No.: FAN01
ISLET: FONGAFALE	SURVEYOR: ANDRICK LAL	DATE: 24/10/09

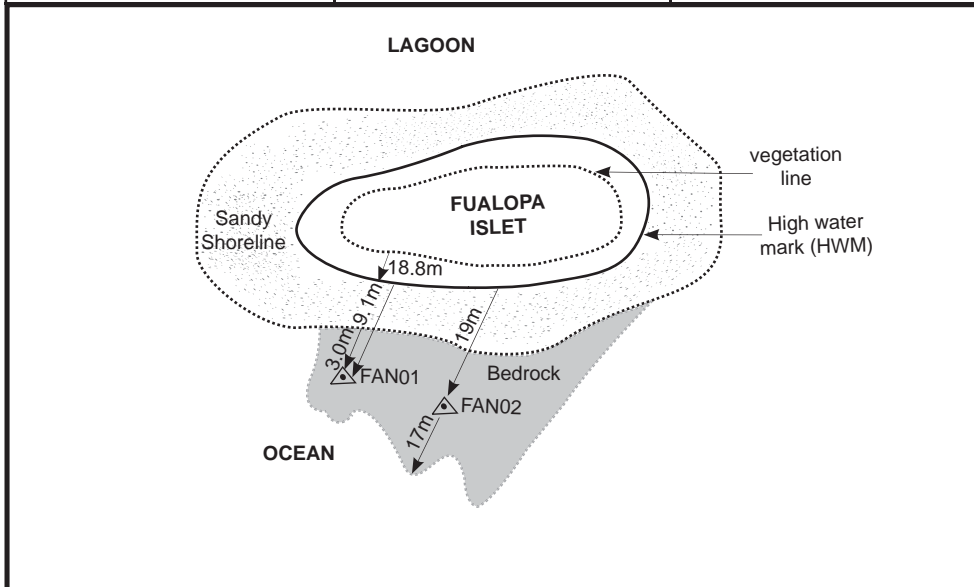

COUNTRY: TUVALU	PROJECT: JICA/ JPACE	L. D. P.: 115
ATOLL: FUNAFUTI	ORGANISATION: SOPAC	POINT No.: TAF01
ISLET: FONGAFALE	SURVEYOR: ANDRICK LAL	DATE: 24/10/09

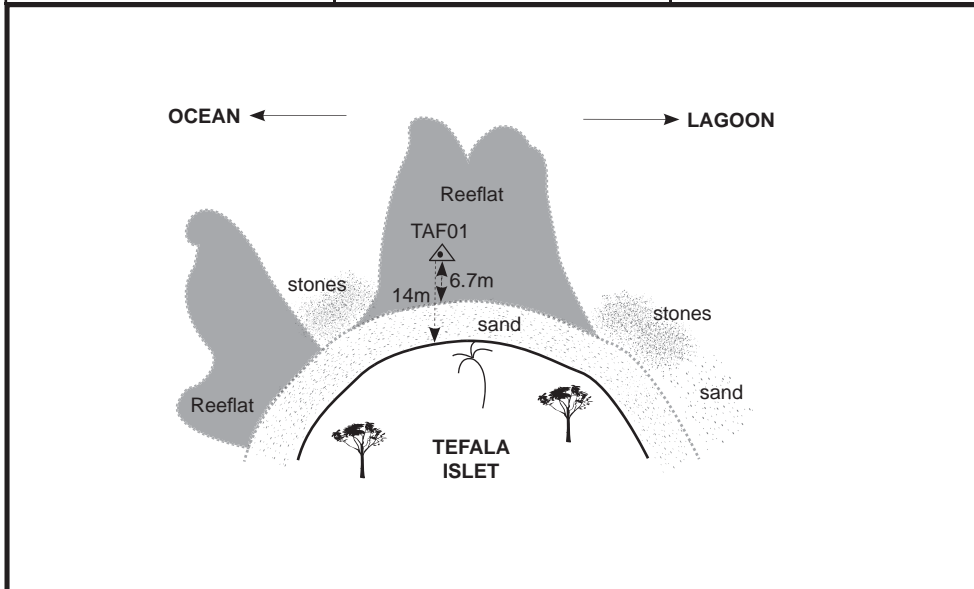

COUNTRY: TUVALU	PROJECT: JICA/ JPACE	L. D. P.: 116
ATOLL: FUNAFUTI	ORGANISATION: SOPAC	POINT No.: CSF33
ISLET: FONGAFALE	SURVEYOR: ANDRICK LAL	DATE: Unknown

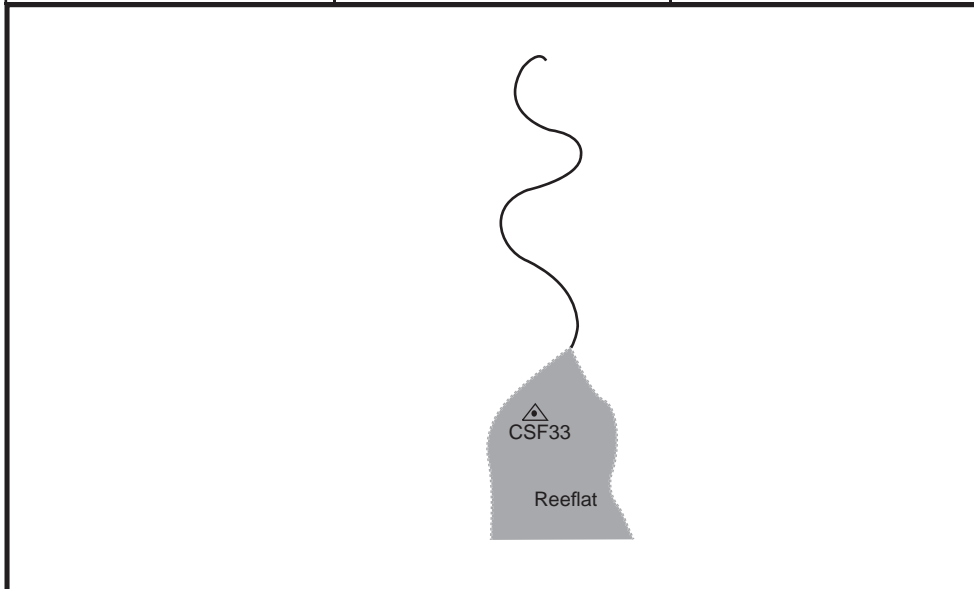

COUNTRY: TUVALU	PROJECT: JICA/ JPACE	L. D. P.: 117
ATOLL: FUNAFUTI	ORGANISATION: SOPAC	POINT No.: FUN209
ISLET: FONGAFALE	SURVEYOR: ANDRICK LAL	DATE: 08/03/10

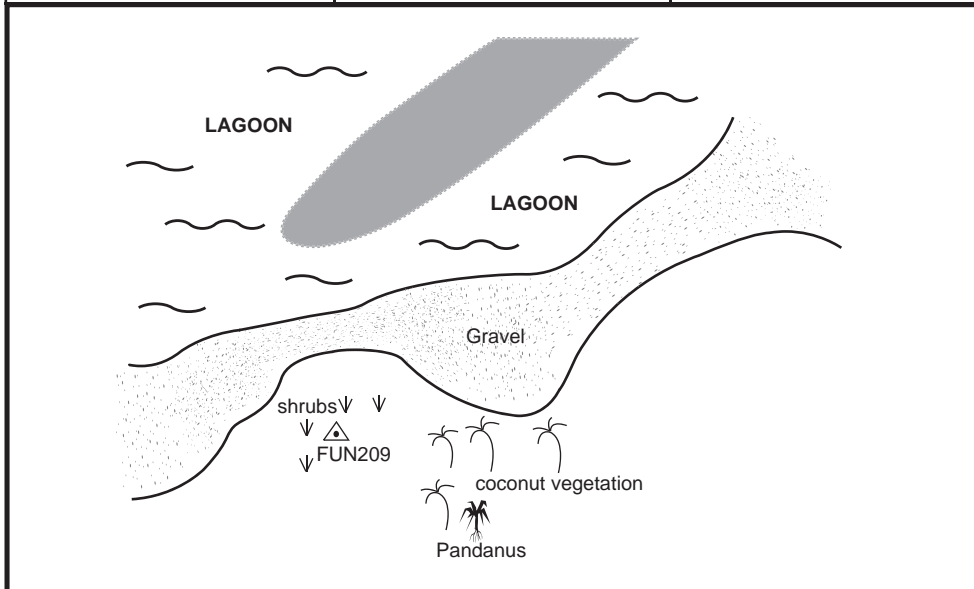

COUNTRY: TUVALU	PROJECT: JICA/ JPACE	L. D. P.: 118
ATOLL: FUNAFUTI	ORGANISATION: SOPAC	POINT No.: FUN206
ISLET: FONGAFALE	SURVEYOR: ANDRICK LAL	DATE: 08/03/10

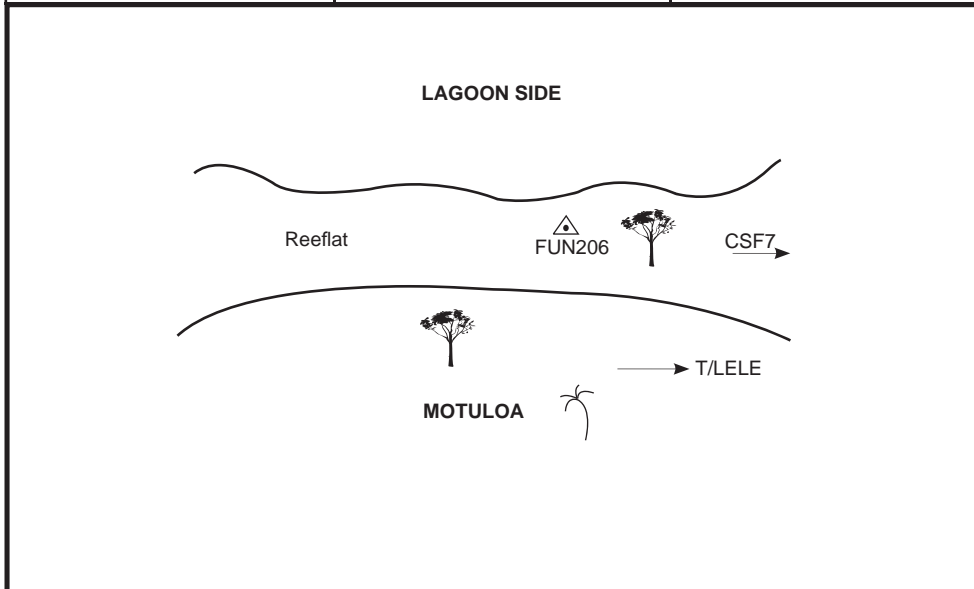

COUNTRY: TUVALU	PROJECT: JICA/ JPACE	L. D. P.: 119
ATOLL: FUNAFUTI	ORGANISATION: SOPAC	POINT No.: FUN212
ISLET: FONGAFALE	SURVEYOR: ANDRICK LAL	DATE: 08/03/10

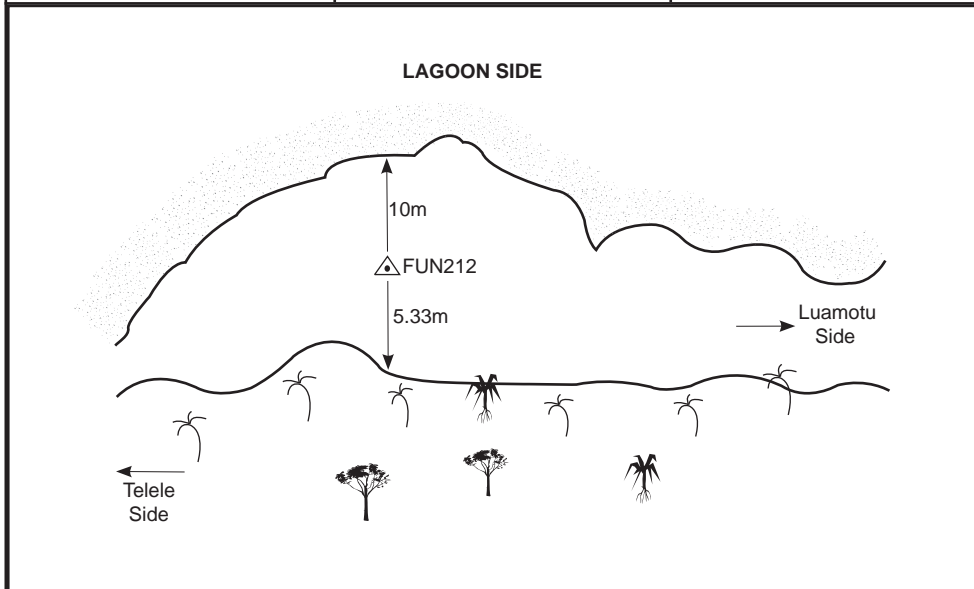

COUNTRY: TUVALU	PROJECT: JICA/ JPACE	L. D. P.: 120
ATOLL: FUNAFUTI	ORGANISATION: SOPAC	POINT No.: CSF24
ISLET: FONGAFALE	SURVEYOR: ANDRICK LAL	DATE: Unknown

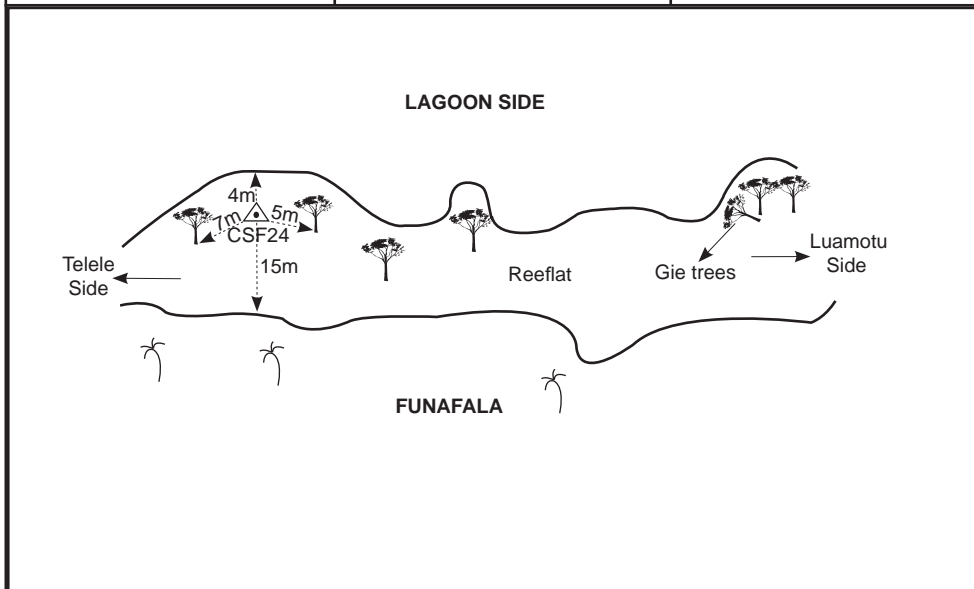

COUNTRY: TUVALU	PROJECT: JICA/ JPACE	L. D. P.: 121
ATOLL: FUNAFUTI	ORGANISATION: SOPAC	POINT No.: CSF19
ISLET: FONGAFALE	SURVEYOR: ANDRICK LAL	DATE: Unknown

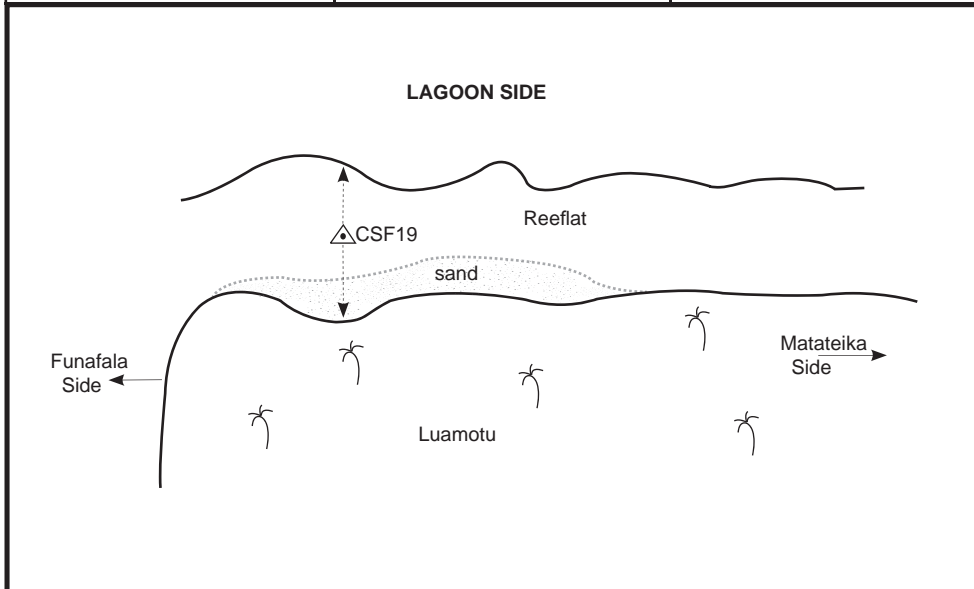

COUNTRY: TUVALU	PROJECT: JICA/ JPACE	L. D. P.: 122
ATOLL: FUNAFUTI	ORGANISATION: SOPAC	POINT No.: FUN216
ISLET: FONGAFALE	SURVEYOR: ANDRICK LAL	DATE: 08/03/10

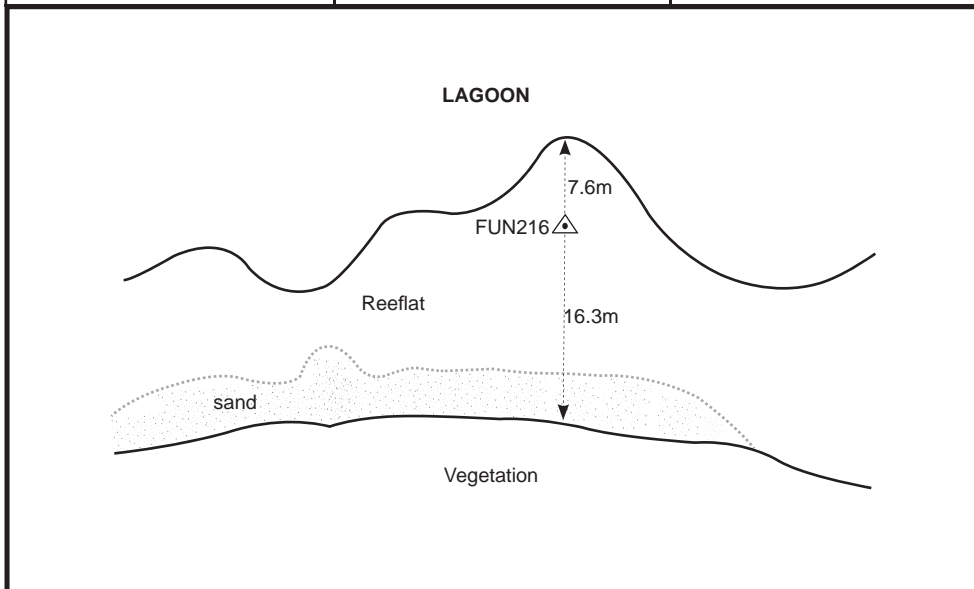

COUNTRY: TUVALU	PROJECT: JICA/ JPACE	L. D. P.: 123
ATOLL: FUNAFUTI	ORGANISATION: SOPAC	POINT No.: CSF14
ISLET: FONGAFALE	SURVEYOR: ANDRICK LAL	DATE: Unknown

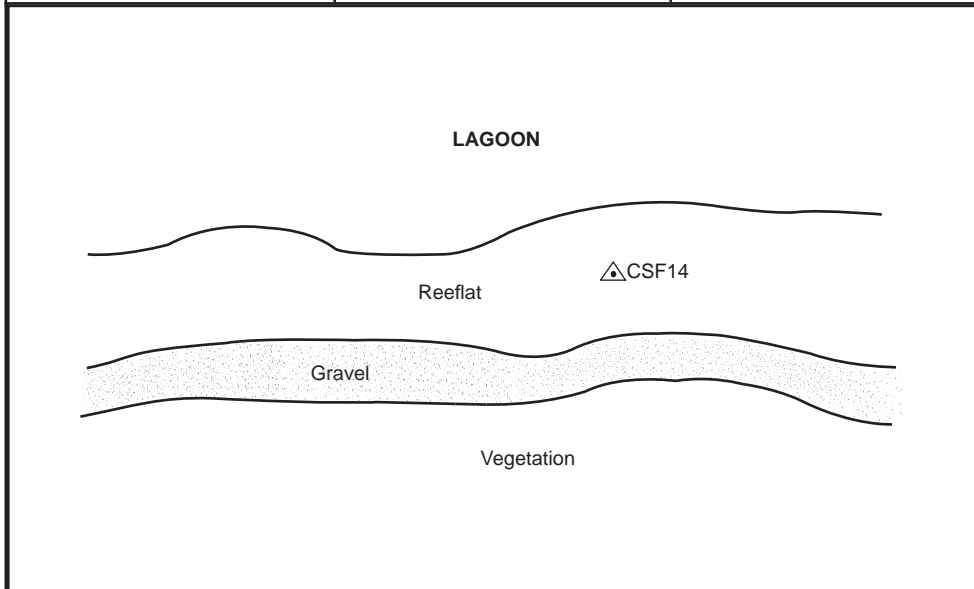

COUNTRY: TUVALU	PROJECT: JICA/ JPACE	L. D. P.: 124
ATOLL: FUNAFUTI	ORGANISATION: SOPAC	POINT No.: FUN201
ISLET: FONGAFALE	SURVEYOR: ANDRICK LAL	DATE: 08/03/10

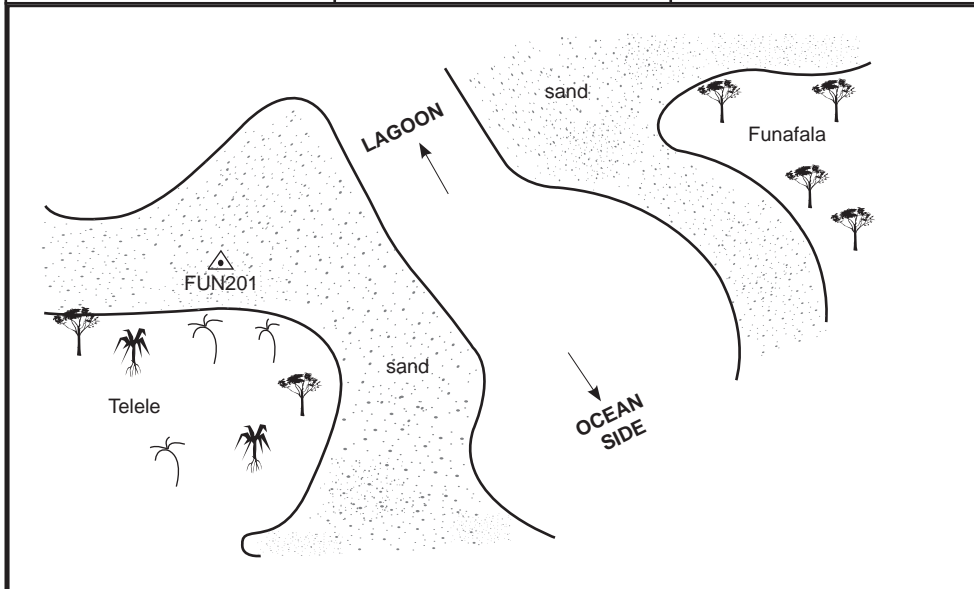

COUNTRY: TUVALU	PROJECT: JICA/ JPACE	L. D. P.: 125
ATOLL: FUNAFUTI	ORGANISATION: SOPAC	POINT No.: FUN204
ISLET: FONGAFALE	SURVEYOR: ANDRICK LAL	DATE: 08/03/10

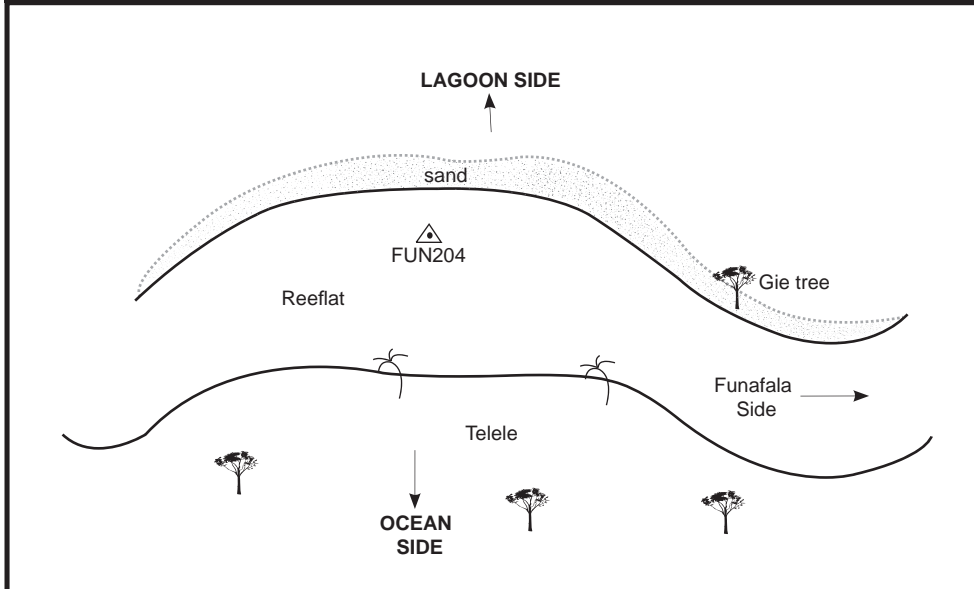

COUNTRY: TUVALU	PROJECT: JICA/ JPACE	L. D. P.: 126
ATOLL: FUNAFUTI	ORGANISATION: SOPAC	POINT No.: FUN207
ISLET: FONGAFALE	SURVEYOR: ANDRICK LAL	DATE: 08/03/10

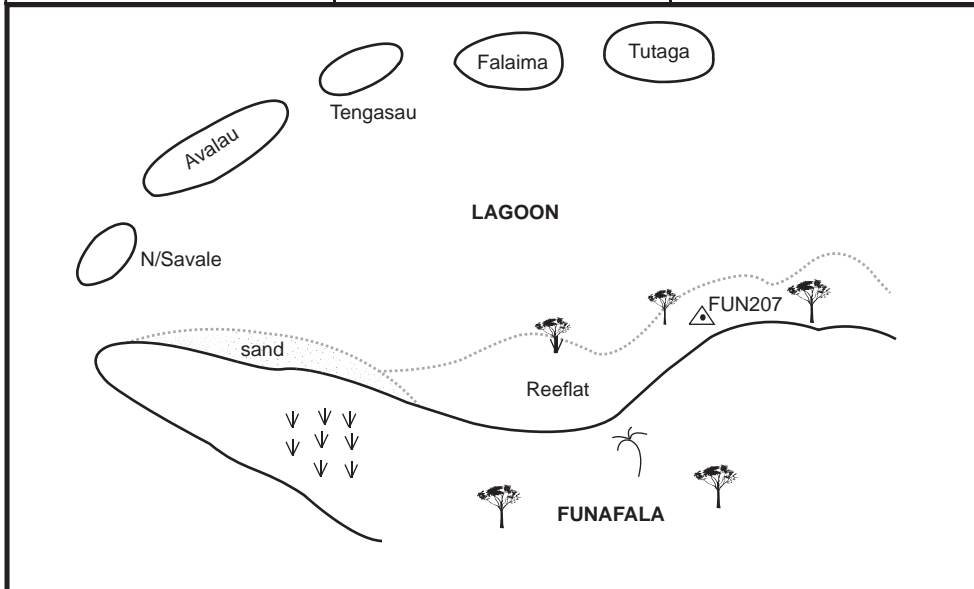

COUNTRY: TUVALU	PROJECT: JICA/ JPACE	L. D. P.: 127
ATOLL: FUNAFUTI	ORGANISATION: SOPAC	POINT No.: FUN210
ISLET: FONGAFALE	SURVEYOR: ANDRICK LAL	DATE: 08/03/10

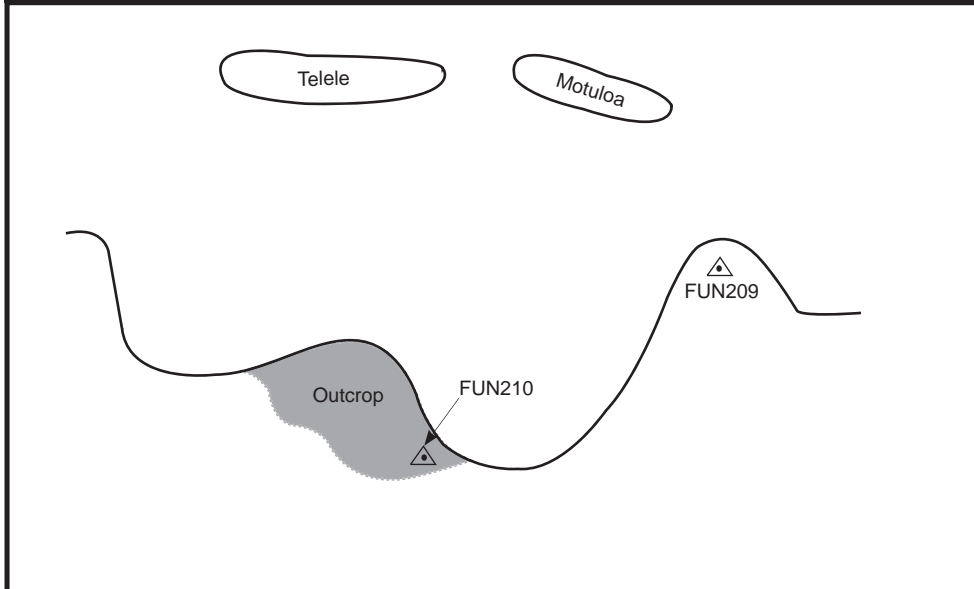

COUNTRY: TUVALU	PROJECT: JICA/ JPACE	L. D. P.: 128
ATOLL: FUNAFUTI	ORGANISATION: SOPAC	POINT No.: MAT01
ISLET: FONGAFALE	SURVEYOR: ANDRICK LAL	DATE: 25/10/09

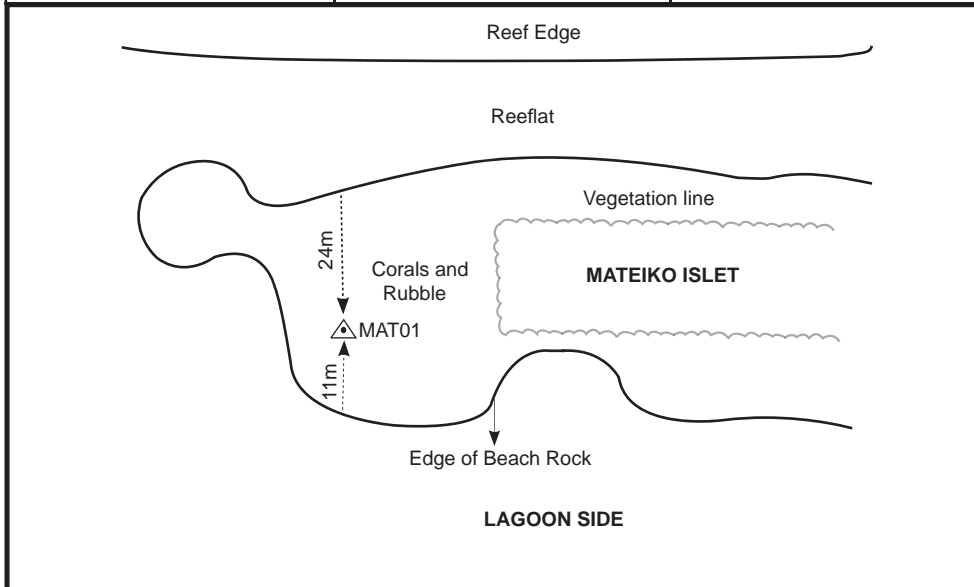

COUNTRY: TUVALU	PROJECT: JICA/ JPACE	L. D. P.: 129
ATOLL: FUNAFUTI	ORGANISATION: SOPAC	POINT No.: TAF02
ISLET: FONGAFALE	SURVEYOR: ANDRICK LAL	DATE: 25/10/09

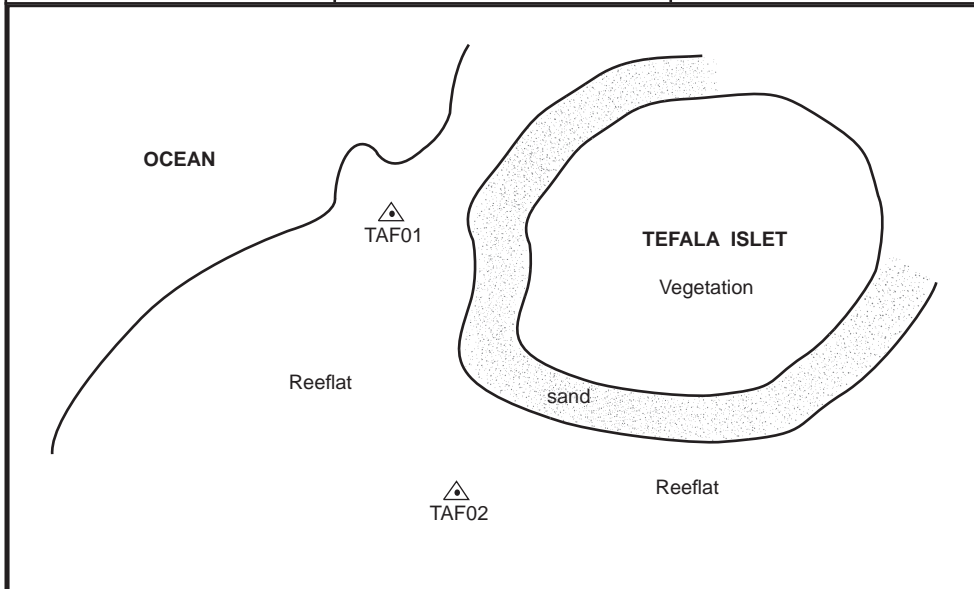

COUNTRY: TUVALU	PROJECT: JICA/ JPACE	L. D. P.: 130
ATOLL: FUNAFUTI	ORGANISATION: SOPAC	POINT No.: CSF25
ISLET: FONGAFALE	SURVEYOR: ANDRICK LAL	DATE: Unknown

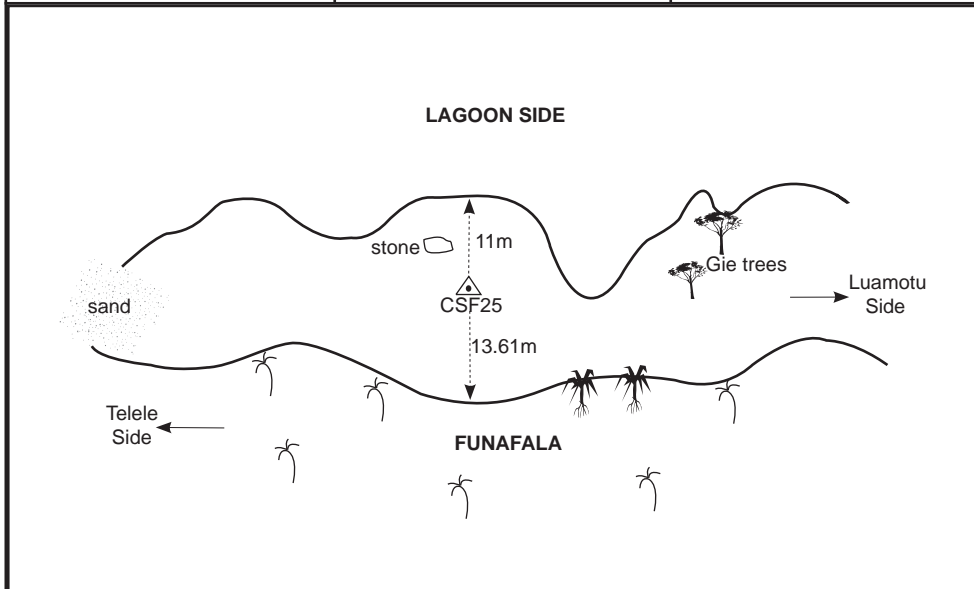

COUNTRY: TUVALU	PROJECT: JICA/ JPACE	L. D. P.: 131
ATOLL: FUNAFUTI	ORGANISATION: SOPAC	POINT No.: CSF22
ISLET: FONGAFALE	SURVEYOR: ANDRICK LAL	DATE: Unknown

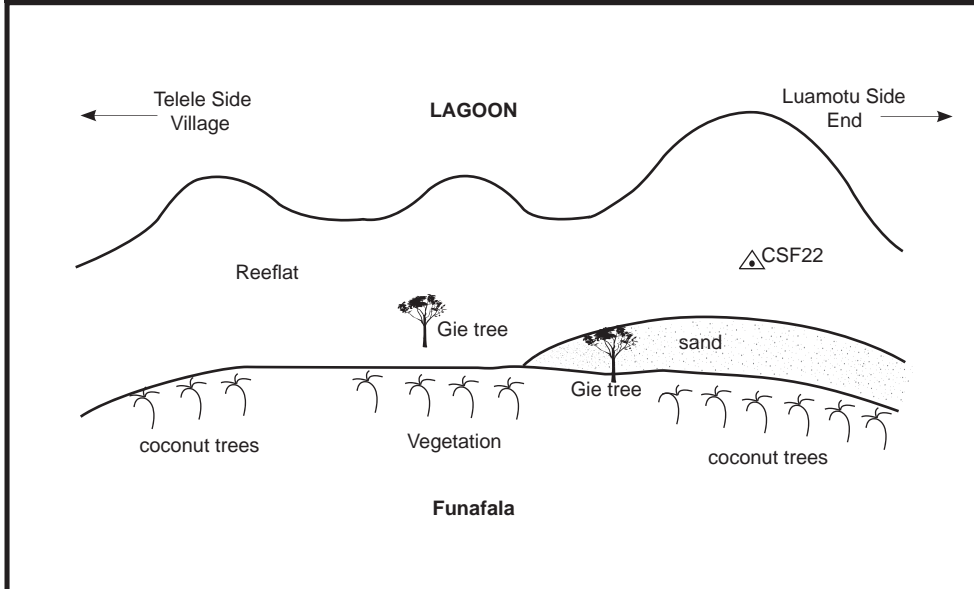

COUNTRY: TUVALU	PROJECT: JICA/ JPACE	L. D. P.: 132
ATOLL: FUNAFUTI	ORGANISATION: SOPAC	POINT No.: FUN214
ISLET: FONGAFALE	SURVEYOR: ANDRICK LAL	DATE: 08/03/10

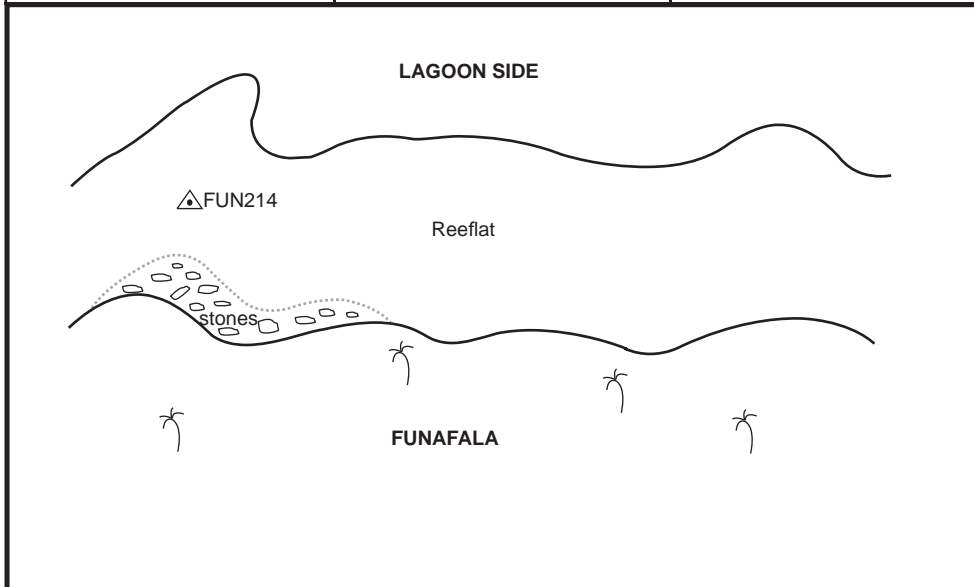

COUNTRY: TUVALU	PROJECT: JICA/ JPACE	L. D. P.: 133
ATOLL: FUNAFUTI	ORGANISATION: SOPAC	POINT No.: FUN217
ISLET: FONGAFALE	SURVEYOR: ANDRICK LAL	DATE: 08/03/10

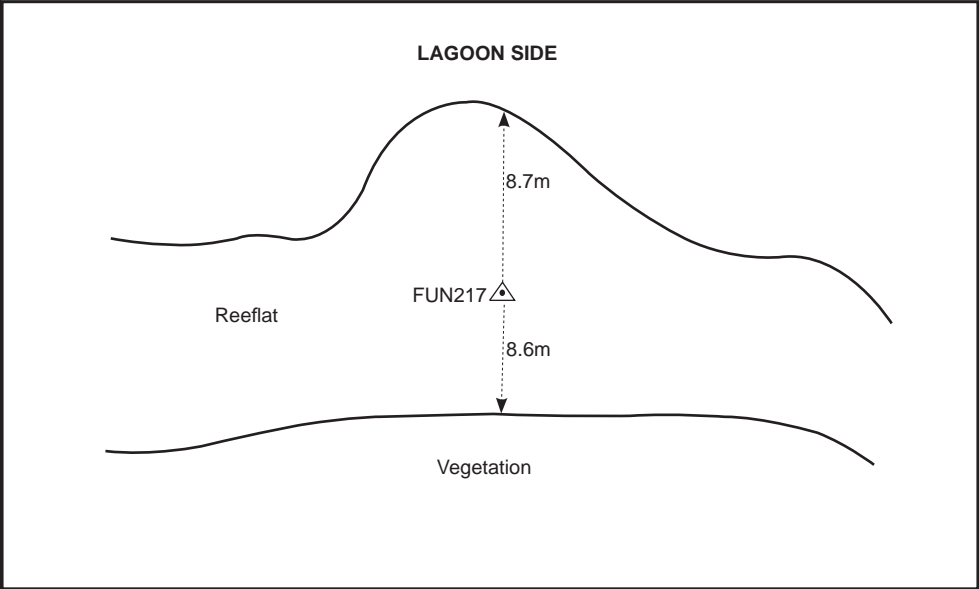

COUNTRY: TUVALU	PROJECT: JICA/ JPACE	L. D. P.: 134
ATOLL: FUNAFUTI	ORGANISATION: SOPAC	POINT No.: FUN218
ISLET: FONGAFALE	SURVEYOR: ANDRICK LAL	DATE: 08/03/10

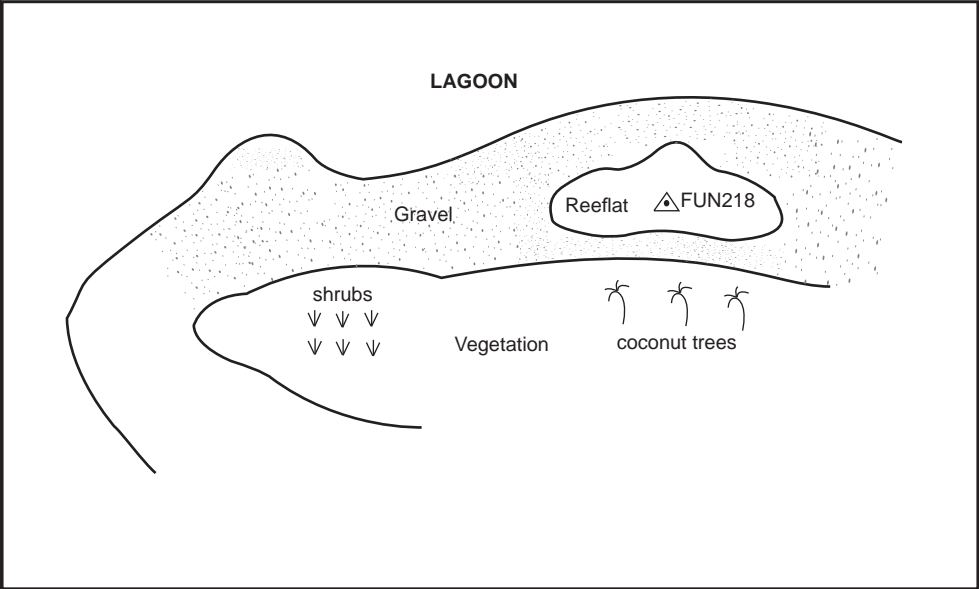

COUNTRY: TUVALU	PROJECT: JICA/ JPACE	L. D. P.: 135
ATOLL: FUNAFUTI	ORGANISATION: SOPAC	POINT No.: FUN202
ISLET: FONGAFALE	SURVEYOR: ANDRICK LAL	DATE: 08/03/10

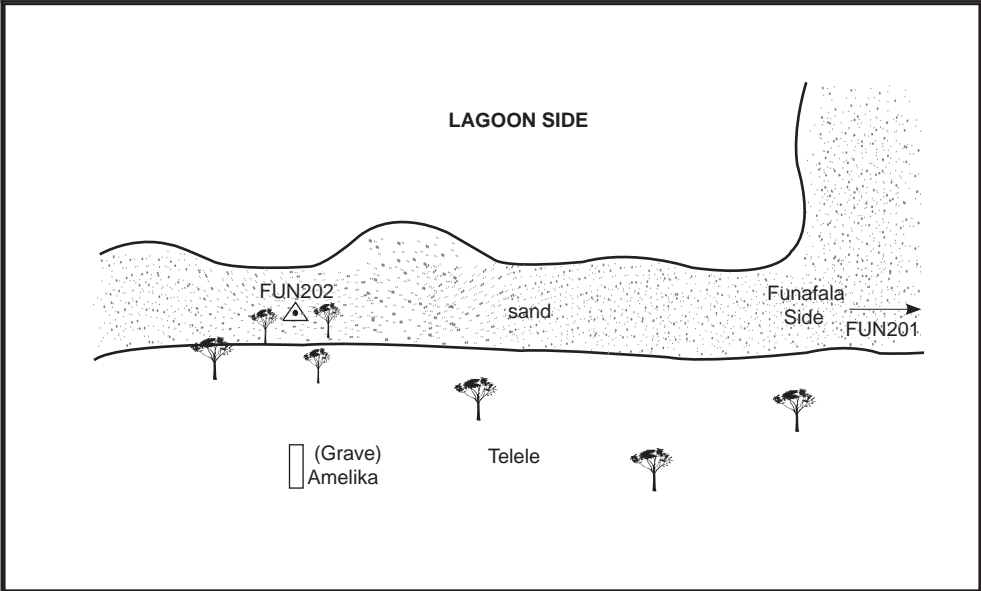

COUNTRY: TUVALU	PROJECT: JICA/ JPACE	L. D. P.: 136
ATOLL: FUNAFUTI	ORGANISATION: SOPAC	POINT No.: FUN205
ISLET: FONGAFALE	SURVEYOR: ANDRICK LAL	DATE: 08/03/10

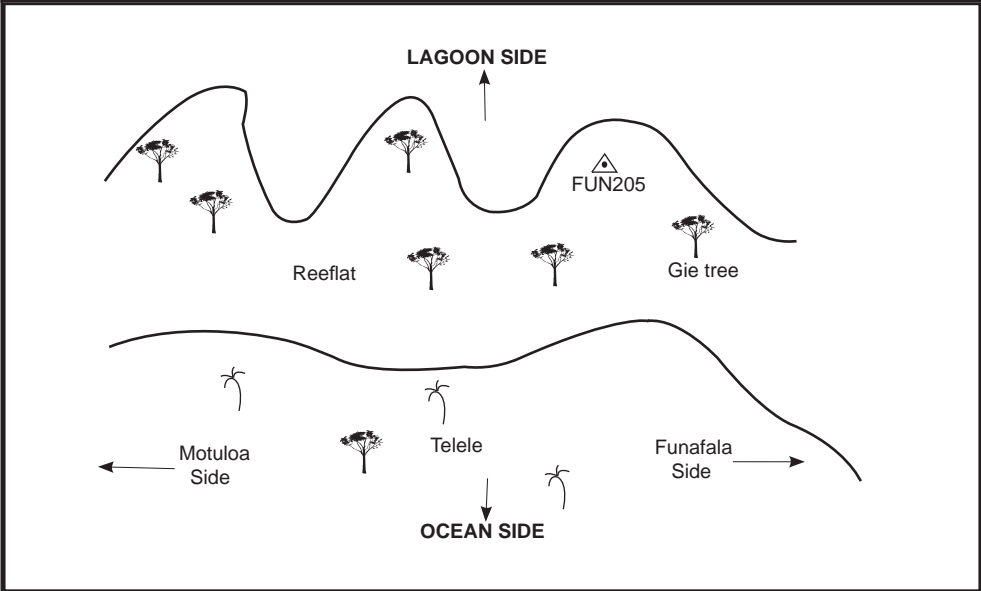

COUNTRY: TUVALU	PROJECT: JICA/ JPACE	L. D. P.: 137
ATOLL: FUNAFUTI	ORGANISATION: SOPAC	POINT No.: FUN208
ISLET: FONGAFALE	SURVEYOR: ANDRICK LAL	DATE: 08/03/10

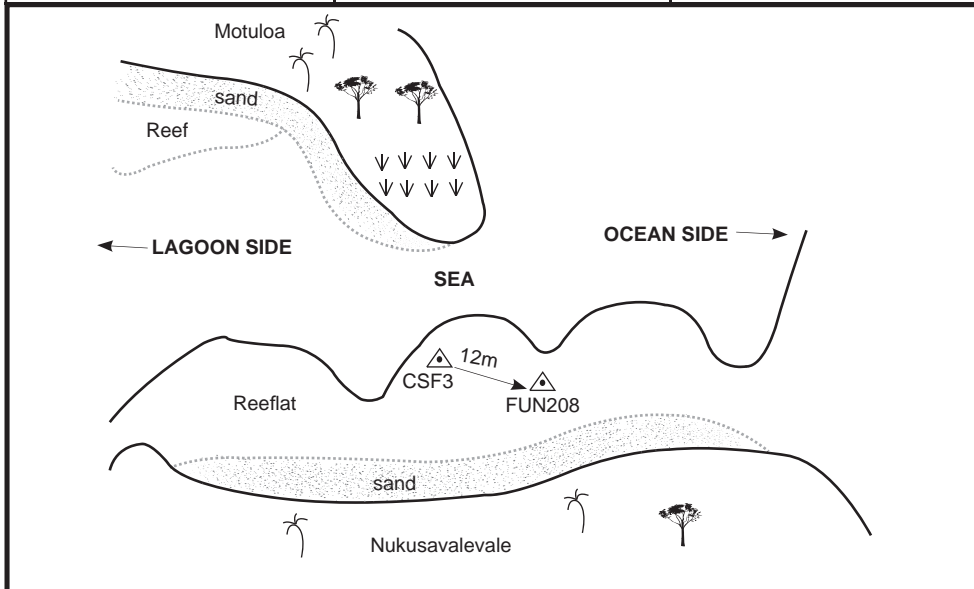

COUNTRY: TUVALU	PROJECT: JICA/ JPACE	L. D. P.: 138
ATOLL: FUNAFUTI	ORGANISATION: SOPAC	POINT No.: FUN211
ISLET: FONGAFALE	SURVEYOR: ANDRICK LAL	DATE: 08/03/10

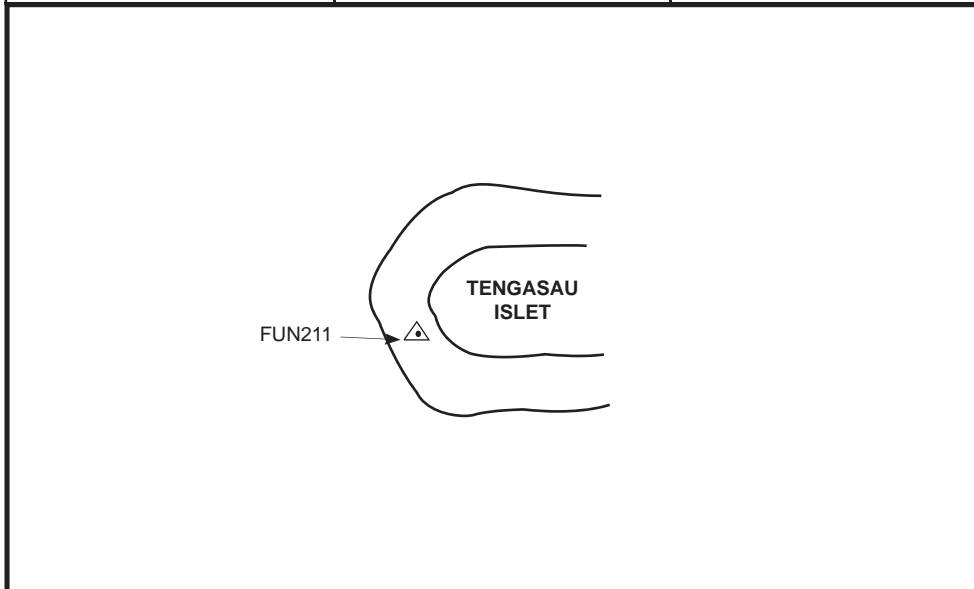

COUNTRY: TUVALU	PROJECT: JICA/ JPACE	L. D. P.: 139
ATOLL: FUNAFUTI	ORGANISATION: SOPAC	POINT No.: FUK01
ISLET: FONGAFALE	SURVEYOR: ANDRICK LAL	DATE: 25/10/03

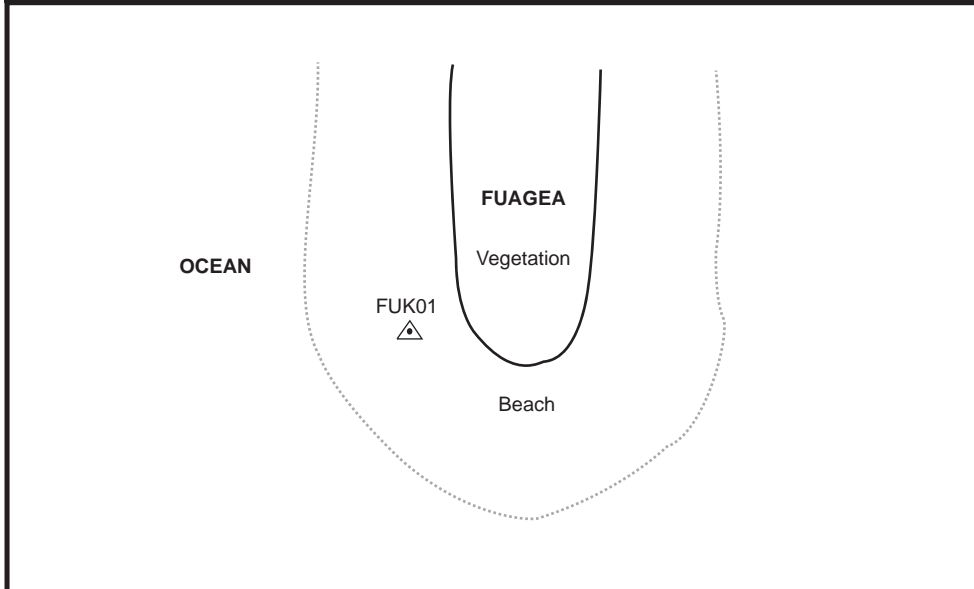

COUNTRY: TUVALU	PROJECT: JICA/ JPACE	L. D. P.: 140
ATOLL: FUNAFUTI	ORGANISATION: SOPAC	POINT No.: FUK02
ISLET: FONGAFALE	SURVEYOR: ANDRICK LAL	DATE: 17/03/10

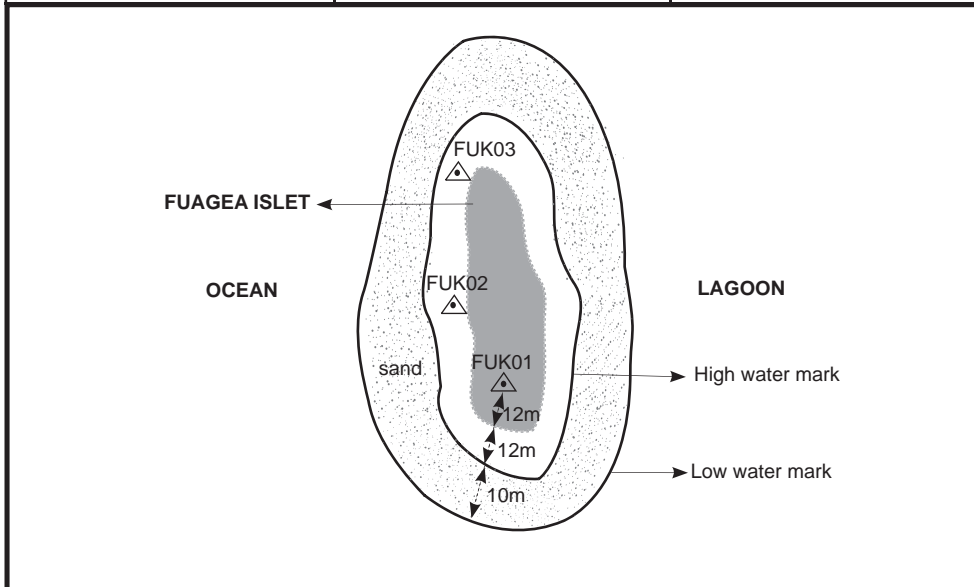

COUNTRY: TUVALU	PROJECT: JICA/ JPACE	L. D. P.: 141
ATOLL: FUNAFUTI	ORGANISATION: SOPAC	POINT No.: VAS01
ISLET: FONGAFALE	SURVEYOR: ANDRICK LAL	DATE: 25/10/09

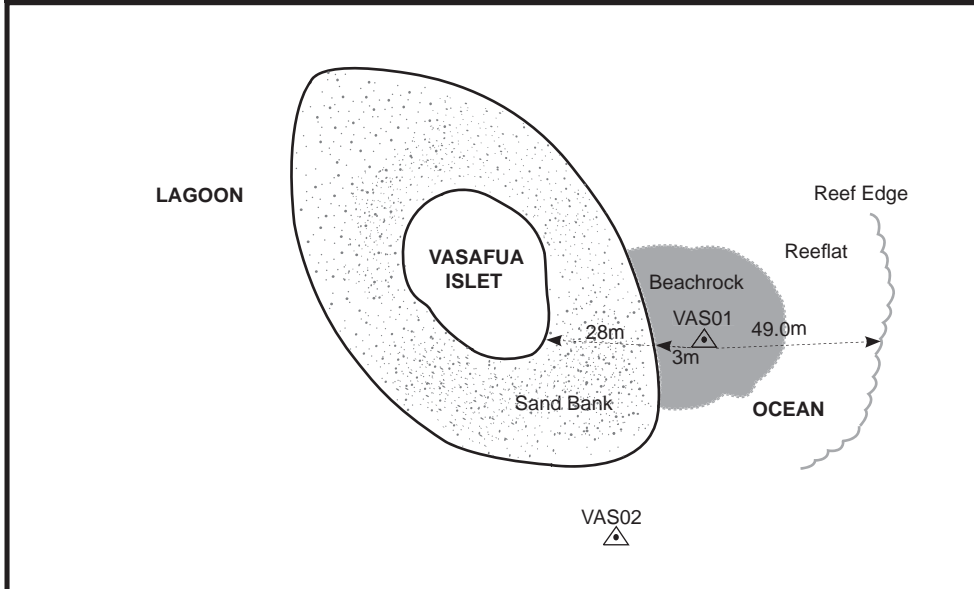

COUNTRY: TUVALU	PROJECT: JICA/ JPACE	L. D. P.: 142
ATOLL: FUNAFUTI	ORGANISATION: SOPAC	POINT No.: FUN203
ISLET: FONGAFALE	SURVEYOR: ANDRICK LAL	DATE: 08/03/10

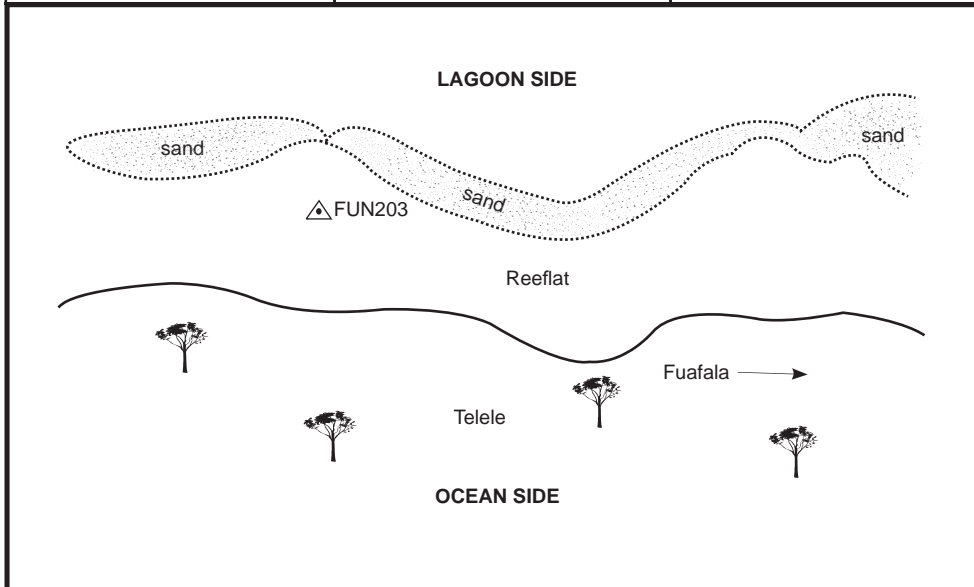

COUNTRY: TUVALU	PROJECT: JICA/ JPACE	L. D. P.: 143
ATOLL: FUNAFUTI	ORGANISATION: SOPAC	POINT No.: FUA02
ISLET: FONGAFALE	SURVEYOR: ANDRICK LAL	DATE: Unknown

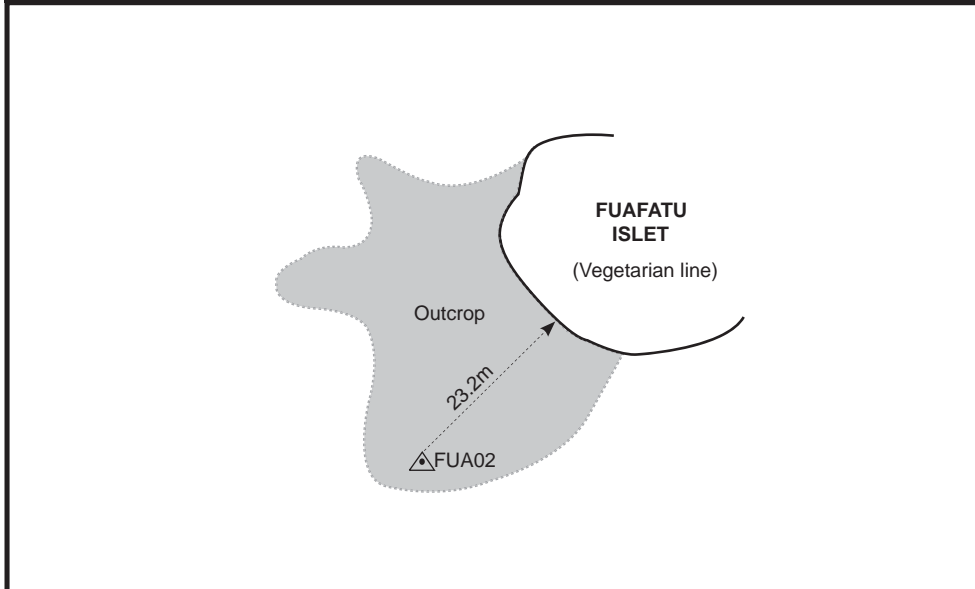

COUNTRY: TUVALU	PROJECT: JICA/ JPACE	L. D. P.: 144
ATOLL: FUNAFUTI	ORGANISATION: SOPAC	POINT No.: FAN02
ISLET: FONGAFALE	SURVEYOR: ANDRICK LAL	DATE: Unknown

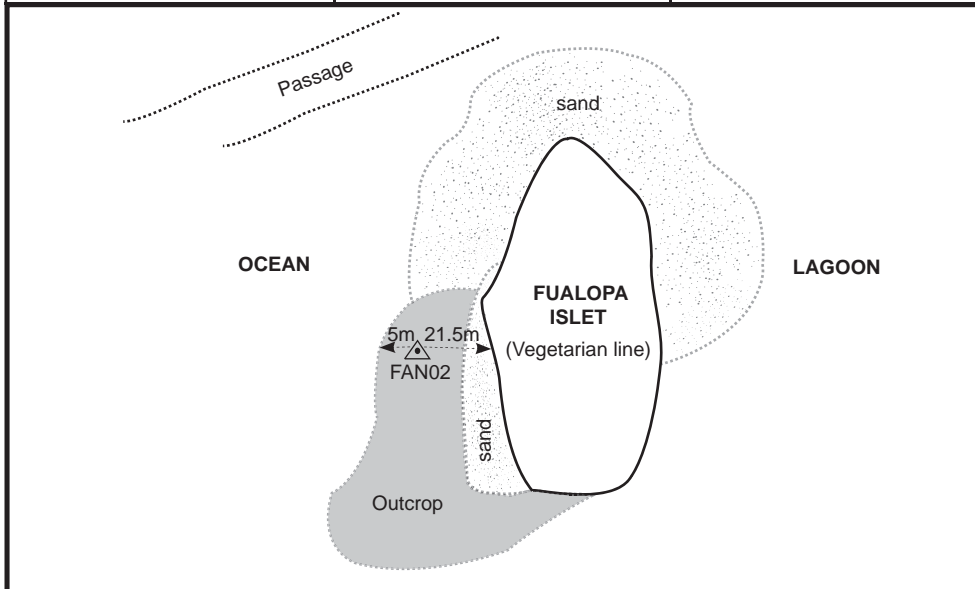

COUNTRY: TUVALU	PROJECT: JICA/ JPACE	L. D. P.: 145
ATOLL: FUNAFUTI	ORGANISATION: SOPAC	POINT No.: AMU01
ISLET: FONGAFALE	SURVEYOR: ANDRICK LAL	DATE: 25/10/09

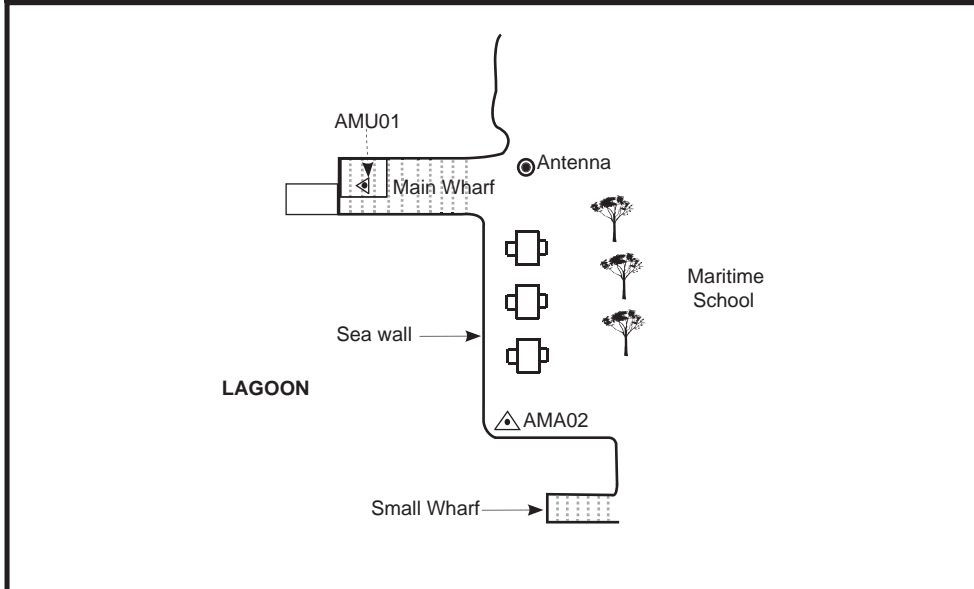

COUNTRY: TUVALU	PROJECT: JICA/ JPACE	L. D. P.: 146
ATOLL: FUNAFUTI	ORGANISATION: SOPAC	POINT No.: FUN200
ISLET: FONGAFALE	SURVEYOR: ANDRICK LAL	DATE: 04/03/10

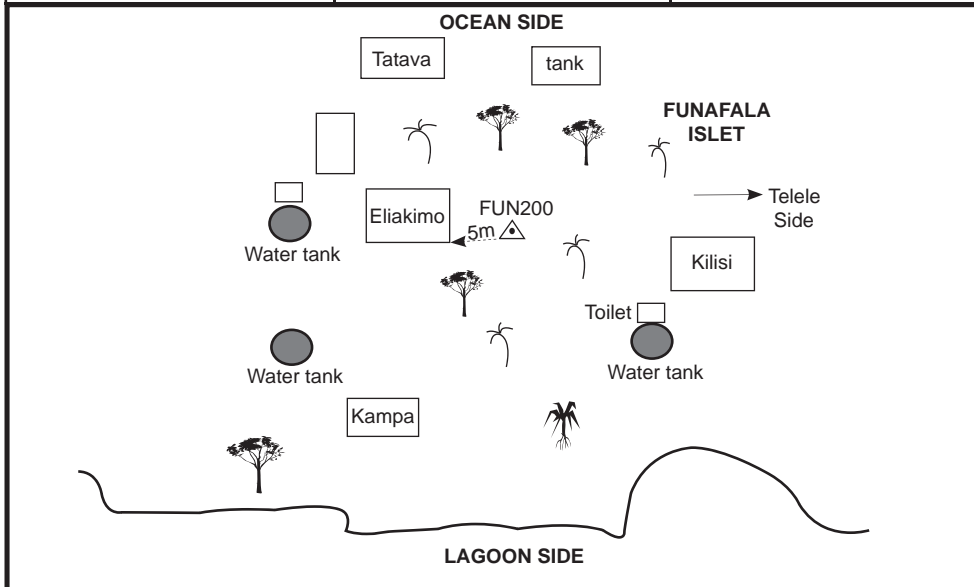

COUNTRY: TUVALU	PROJECT: JICA/ JPACE	L. D. P.: 147
ATOLL: FUNAFUTI	ORGANISATION: SOPAC	POINT No.: FUN213
ISLET: FONGAFALE	SURVEYOR: ANDRICK LAL	DATE: 04/03/10

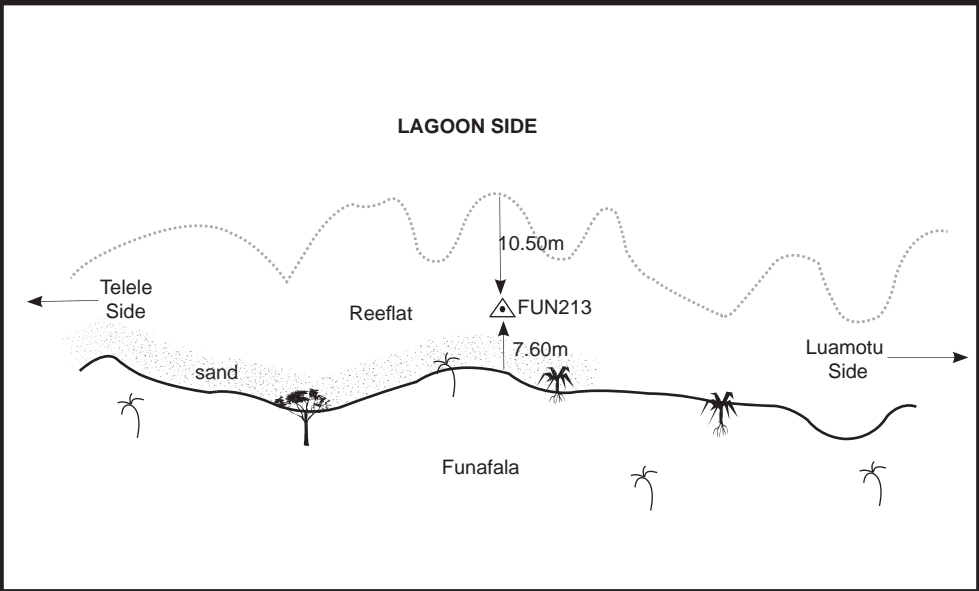

COUNTRY: TUVALU	PROJECT: JICA/ JPACE	L. D. P.: 148
ATOLL: FUNAFUTI	ORGANISATION: SOPAC	POINT No.: CSF23
ISLET: FONGAFALE	SURVEYOR: ANDRICK LAL	DATE: Unknown

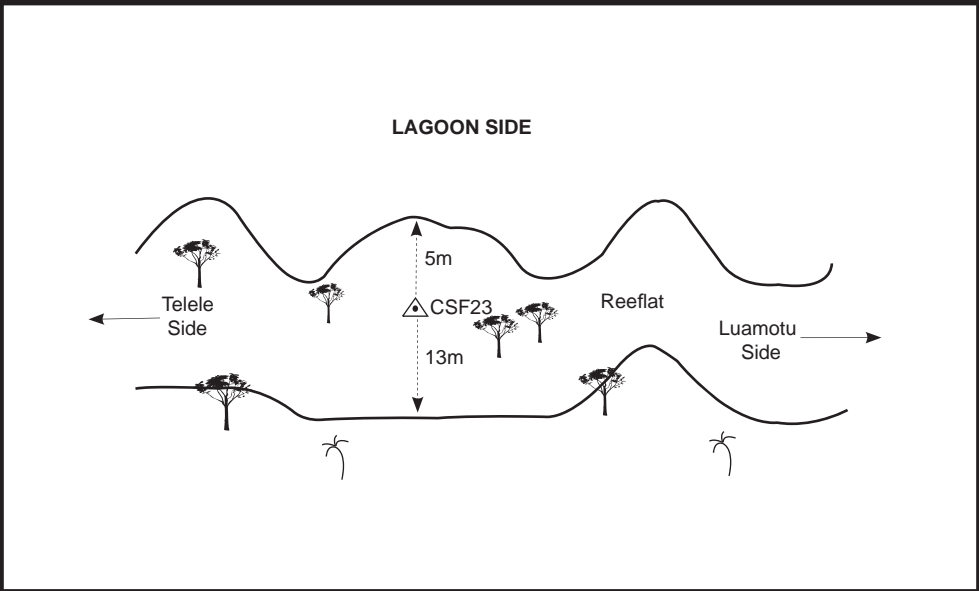

COUNTRY: TUVALU	PROJECT: JICA/ JPACE	L. D. P.: 149
ATOLL: FUNAFUTI	ORGANISATION: SOPAC	POINT No.: FUN215
ISLET: FONGAFALE	SURVEYOR: ANDRICK LAL	DATE: 08/03/10

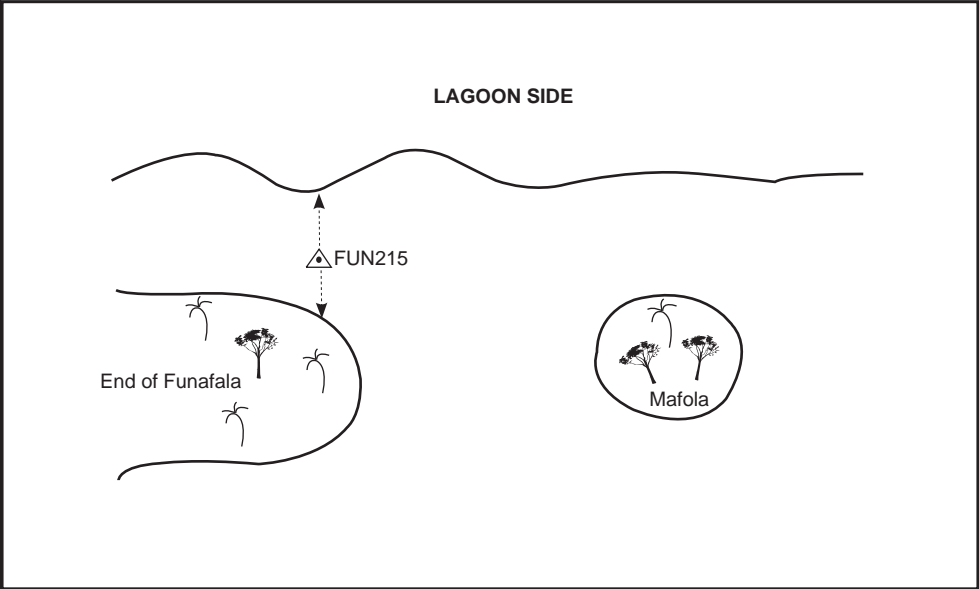

COUNTRY: TUVALU	PROJECT: JICA/ JPACE	L. D. P.: 150
ATOLL: FUNAFUTI	ORGANISATION: SOPAC	POINT No.: FUN219
ISLET: FONGAFALE	SURVEYOR: ANDRICK LAL	DATE: 08/03/10

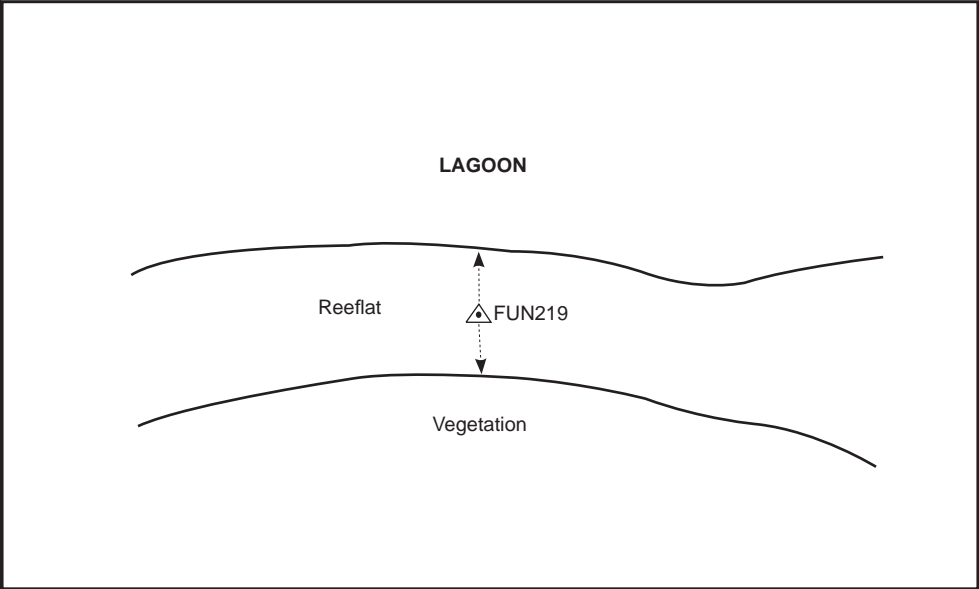

COUNTRY: TUVALU	PROJECT: JICA/ JPACE	L. D. P.: 151
ATOLL: FUNAFUTI	ORGANISATION: SOPAC	POINT No.: CS81
ISLET: FONGAFALE	SURVEYOR: ANDRICK LAL	DATE: Unknown

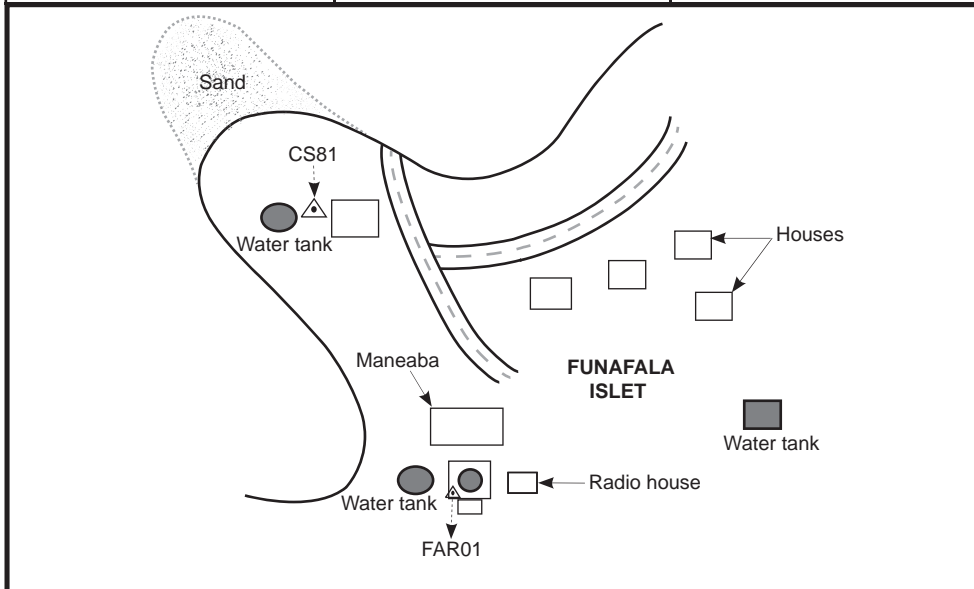

COUNTRY: TUVALU	PROJECT: JICA/ JPACE	L. D. P.: 152
ATOLL: FUNAFUTI	ORGANISATION: SOPAC	POINT No.: FFZ16
ISLET: FONGAFALE	SURVEYOR: ANDRICK LAL	DATE: 1981

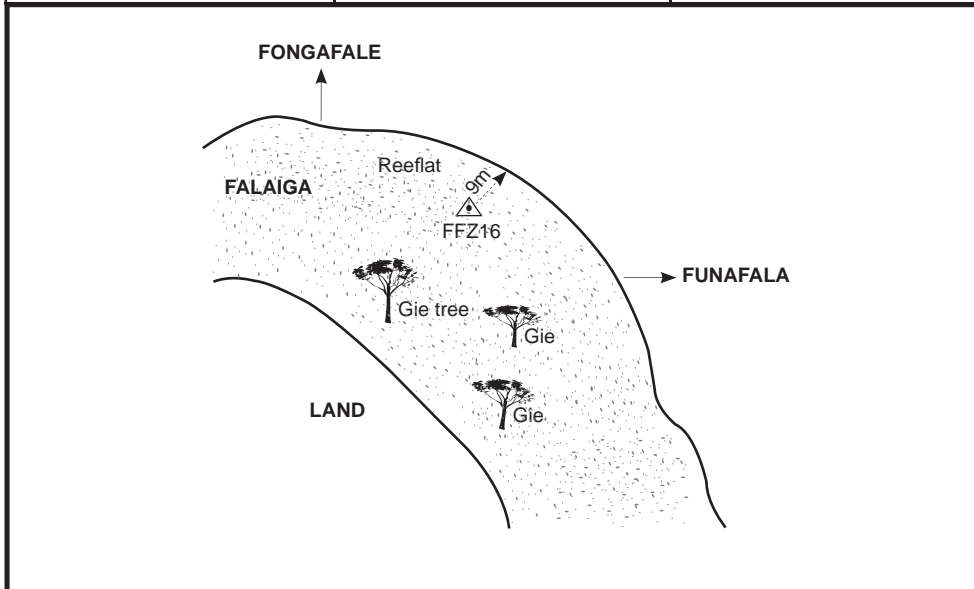

COUNTRY: TUVALU	PROJECT: JICA/ JPACE	L. D. P.: 153
ATOLL: FUNAFUTI	ORGANISATION: SOPAC	POINT No.: CS21
ISLET: FONGAFALE	SURVEYOR: ANDRICK LAL	DATE: Unknown

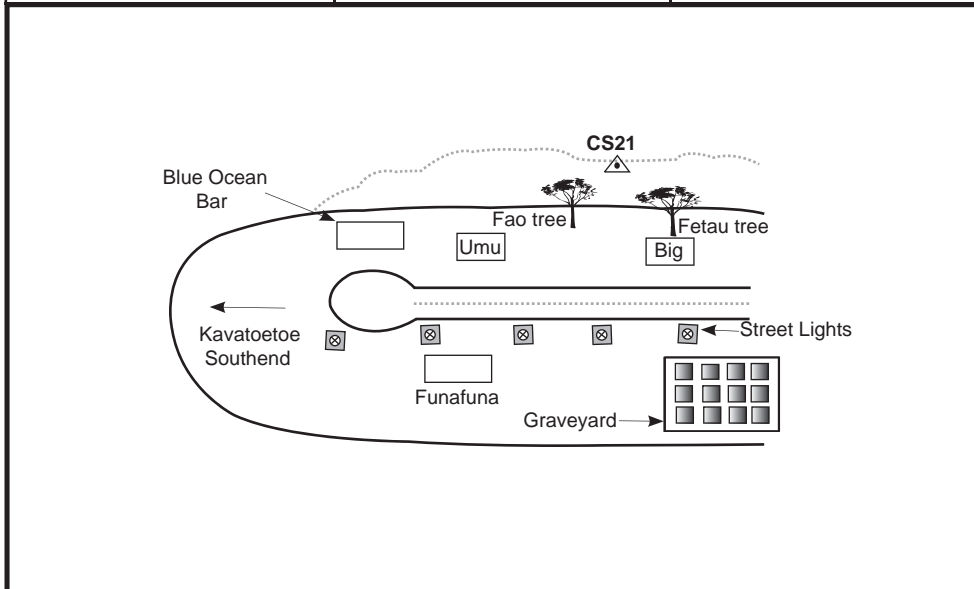

COUNTRY: TUVALU	PROJECT: JICA/ JPACE	L. D. P.: 154
ATOLL: FUNAFUTI	ORGANISATION: SOPAC	POINT No.: FFZ4
ISLET: FONGAFALE	SURVEYOR: ANDRICK LAL	DATE: 1981

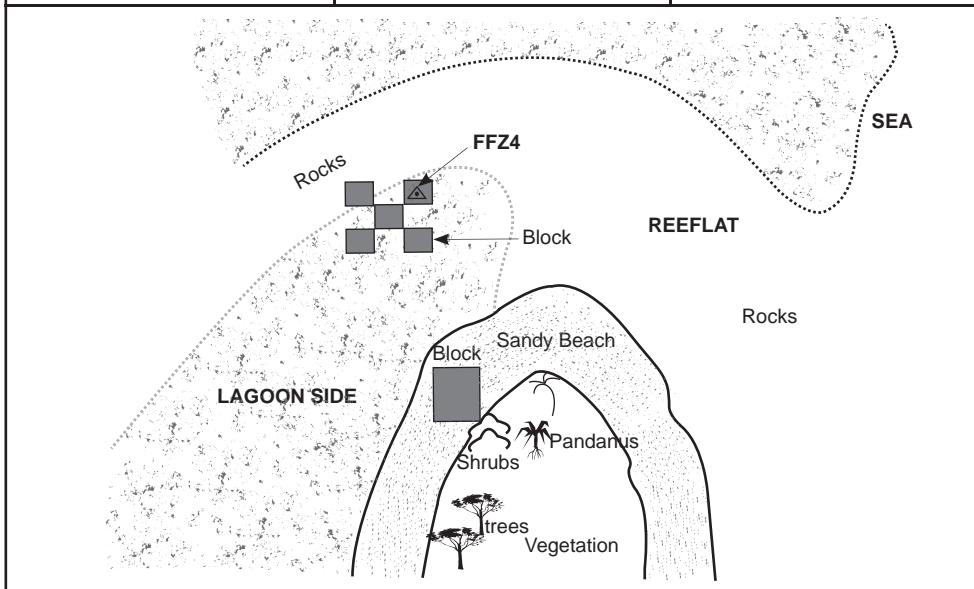

COUNTRY: TUVALU	PROJECT: JICA/ JPACE	L. D. P.: 155
ATOLL: FUNAFUTI	ORGANISATION: SOPAC	POINT No.: TR(s)
ISLET: FONGAFALE	SURVEYOR: ANDRICK LAL	DATE: 26/01/10

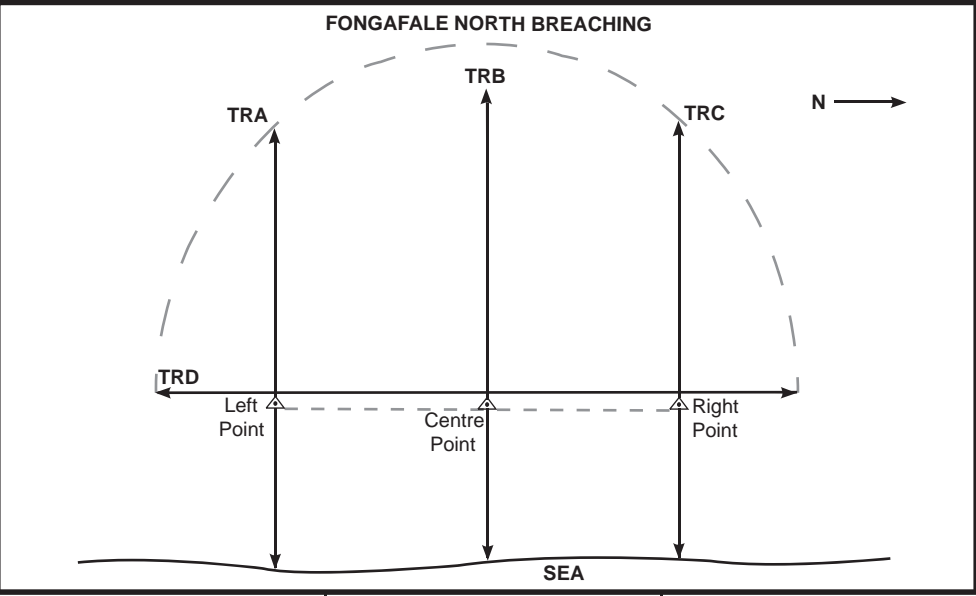

COUNTRY: Tuvalu	ISLAND: Funafuti CITY: Fongafale	L. D. P. 156 POINT NO. TUV 19A
PROJECT: SPSLCMP	SURVEYOR: A Lal	DATE: 29-03-07

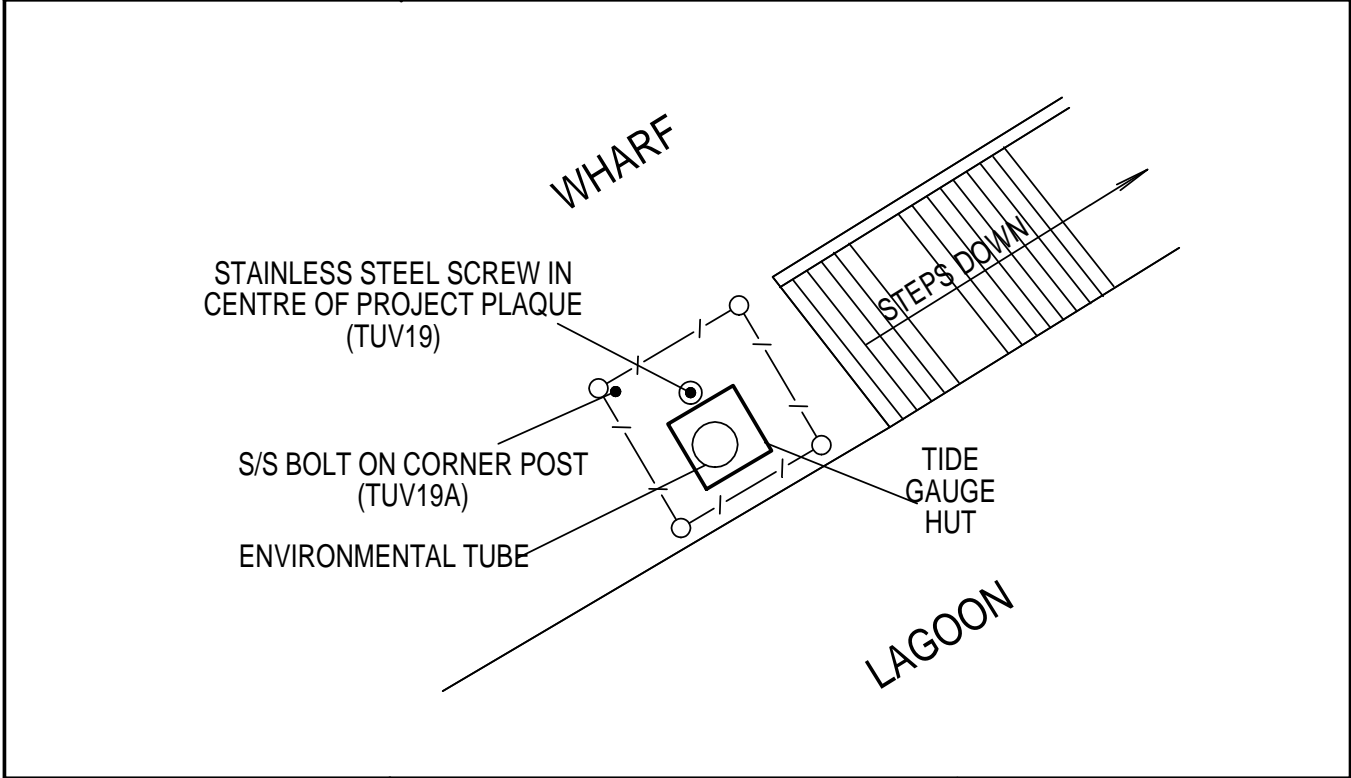

COUNTRY: Tuvalu	ISLAND: Funafuti CITY: Fongafale	L. D. P. 157 POINT NO. TUV 42
PROJECT: SPSLCMP	SURVEYOR: S. Yates & A Lal	DATE: 18-01-07

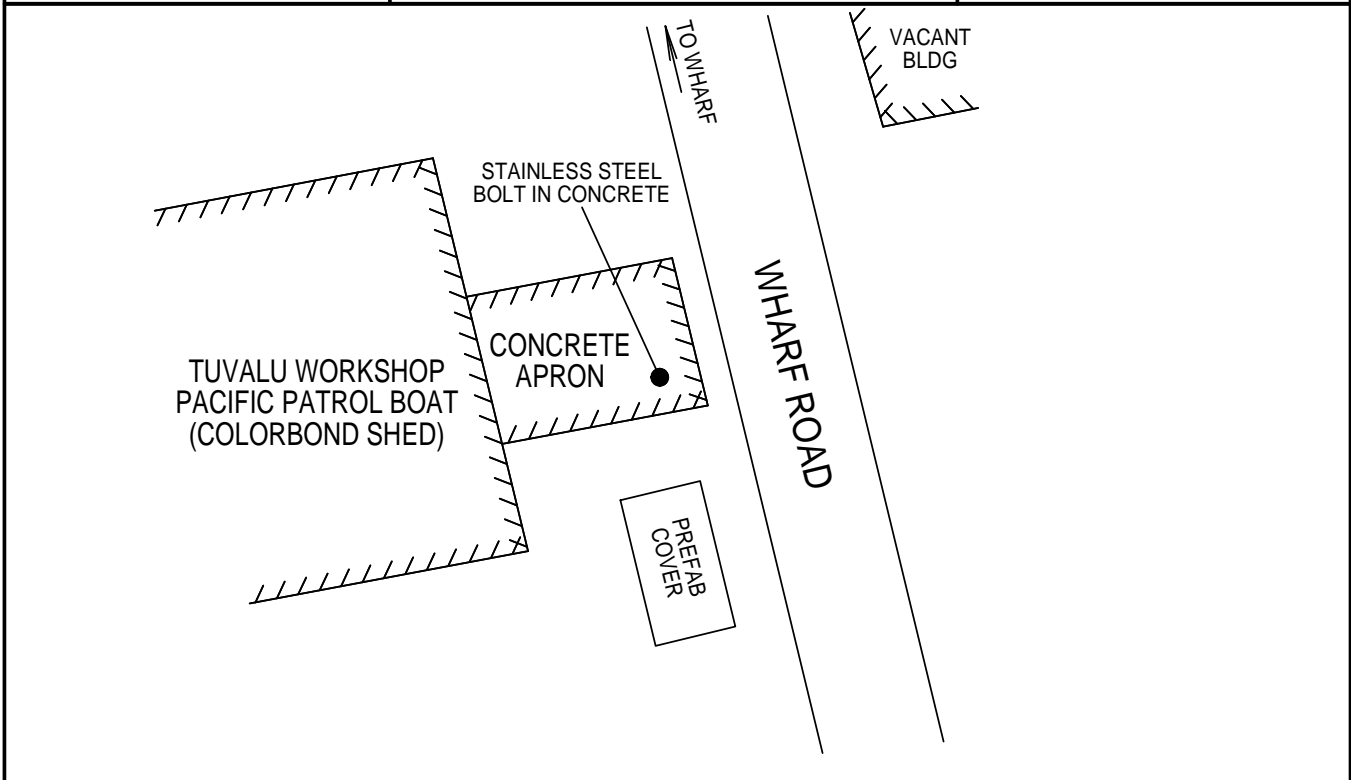

COUNTRY: Tuvalu	ISLAND: Funafuti CITY: Fongafale	L. D. P. 158 POINT NO. TUV 69
PROJECT: SPSLCMP	SURVEYOR: S. Turner	DATE: 18-05-03

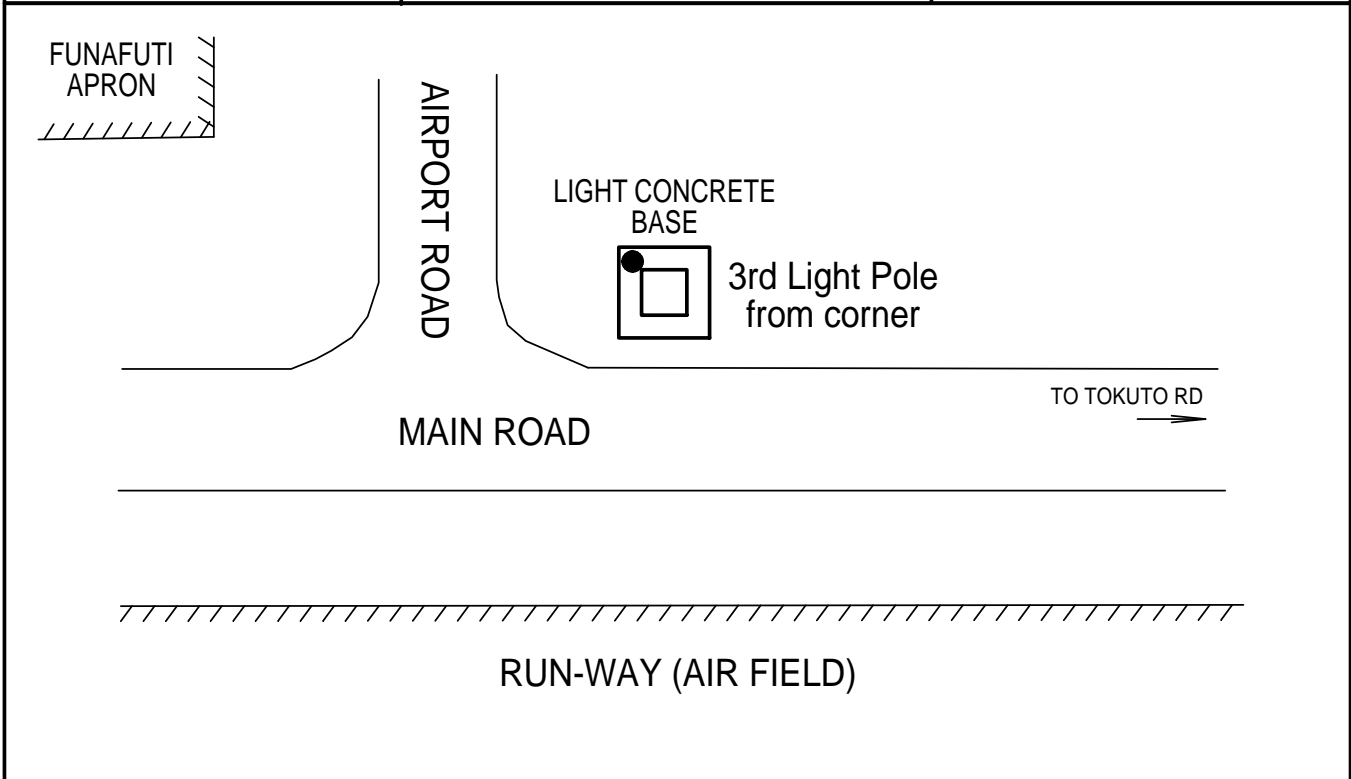

COUNTRY: Tuvalu	ISLAND: Funafuti CITY: Fongafale	L. D. P. 159 POINT NO. TUV 70
PROJECT: SPSLCMP	SURVEYOR: S. Turner	DATE: 18-05-03

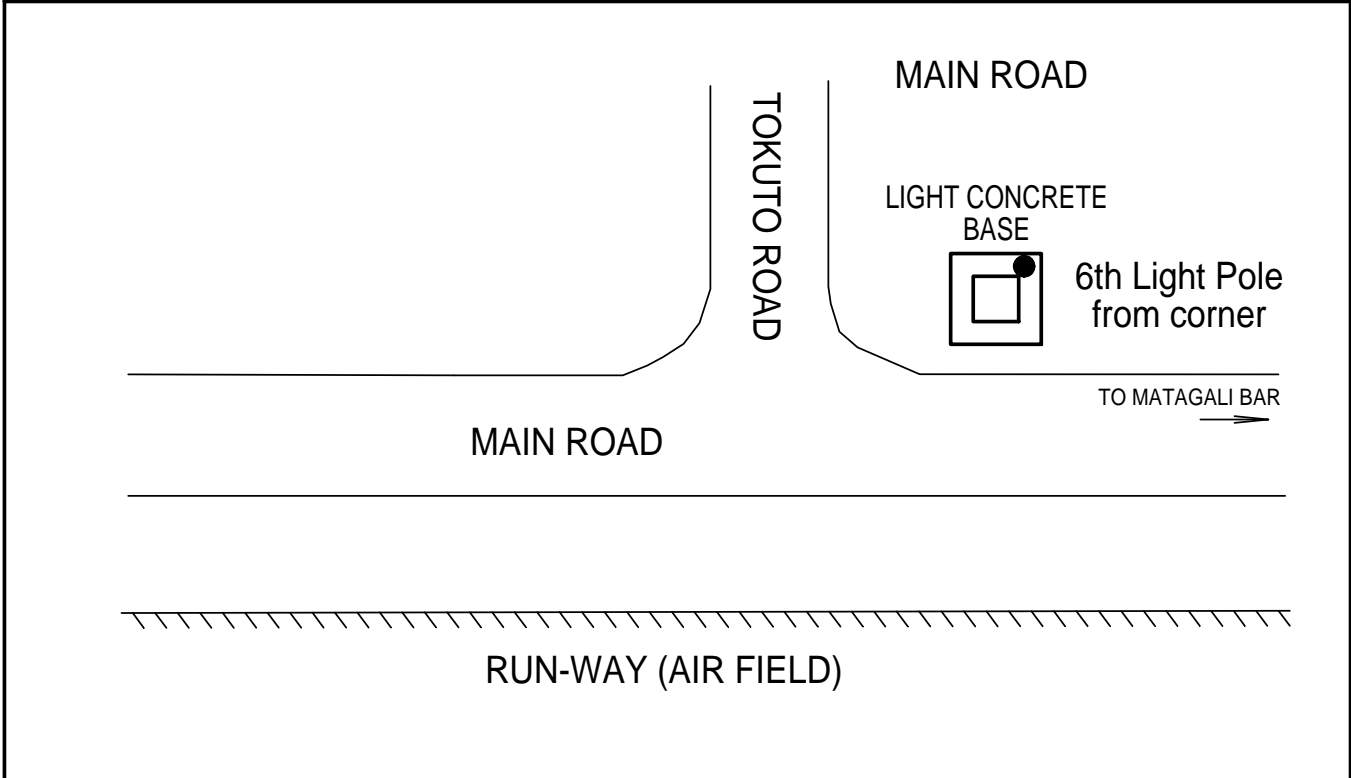

COUNTRY: Tuvalu	ISLAND: Funafuti CITY: Fongafale	L. D. P. 160 POINT NO. TUV 73
PROJECT: SPSLCMP	SURVEYOR: S. Yates & A Lal	DATE: 29-03-07

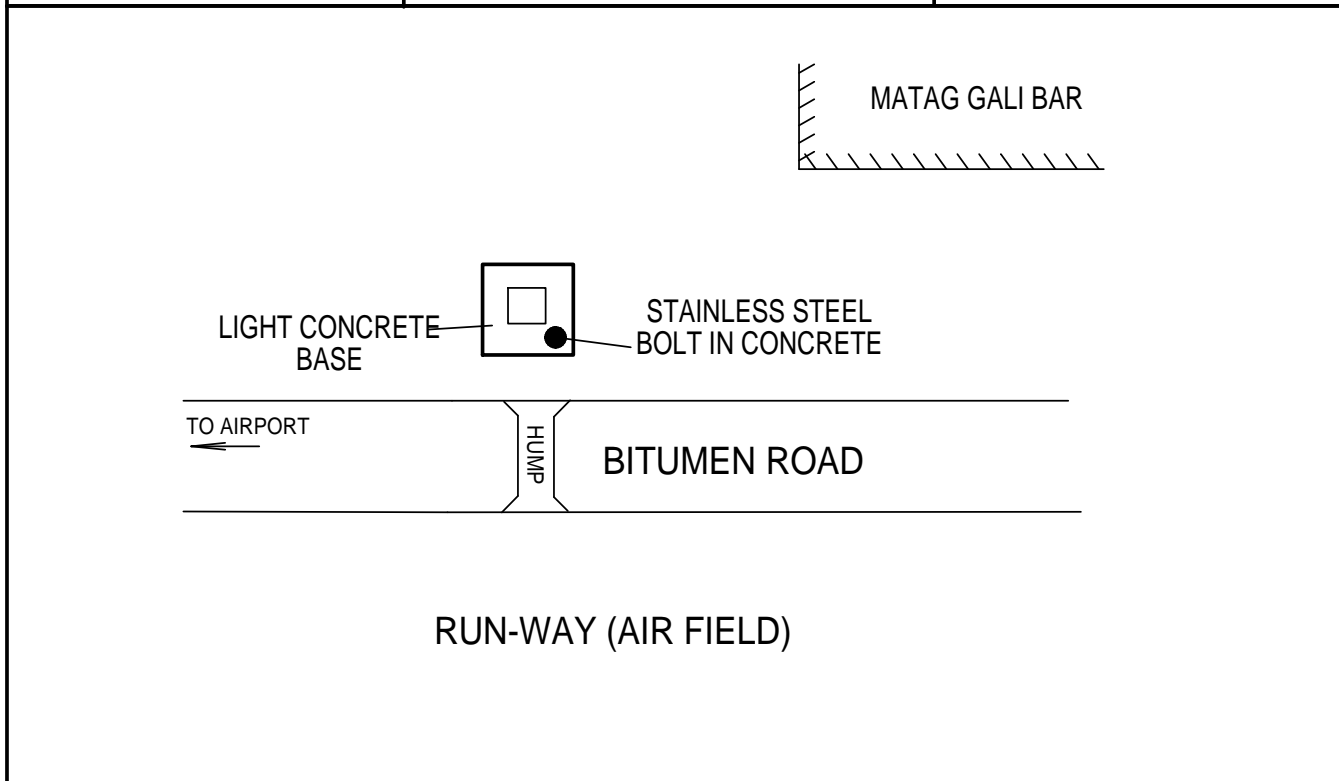

COUNTRY: Tuvalu	ISLAND: Funafuti CITY: Fongafale	L. D. P. 161 POINT NO. TUV 100
PROJECT: SPSLCMP	SURVEYOR: S. Yates & A Lal	DATE: 29-03-07

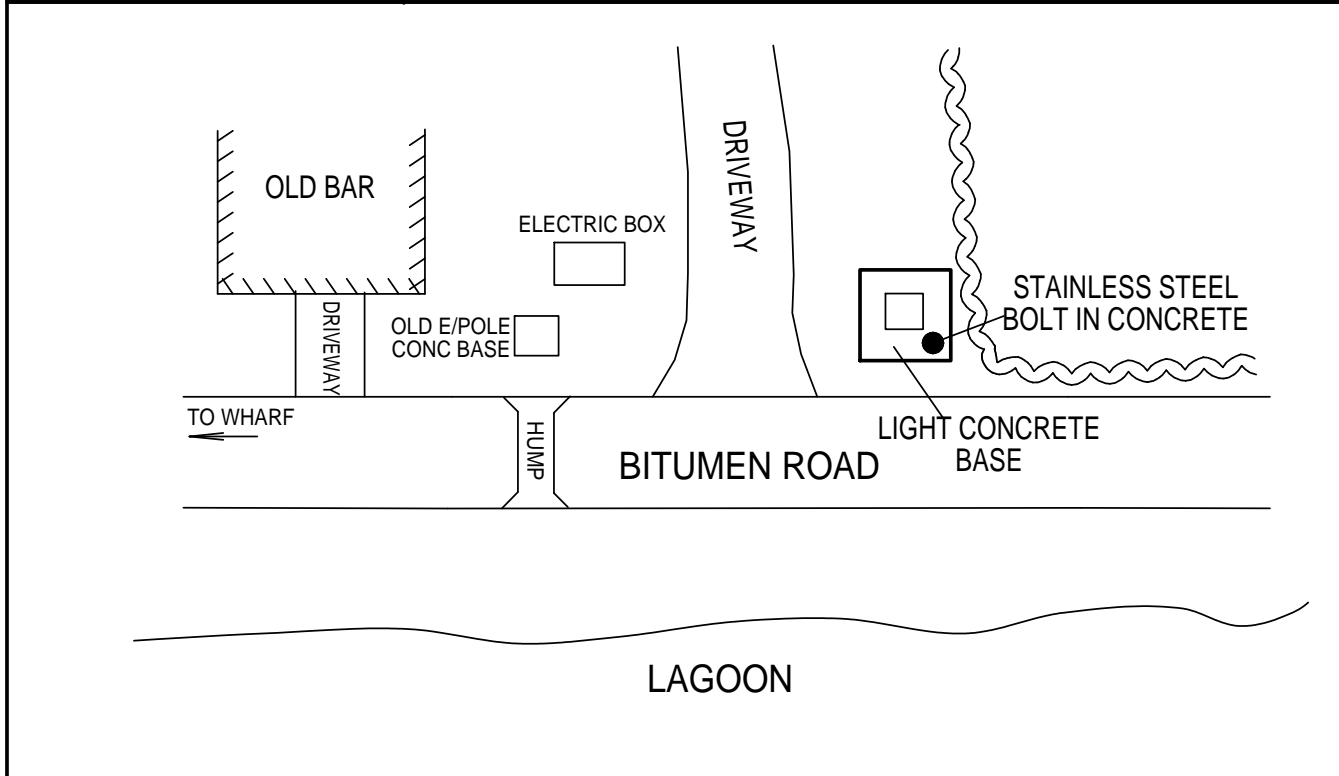



**SOUTH PACIFIC SEA LEVEL
&
CLIMATE MONITORING PROJECT**



Survey Bench Mark Record

Bench Mark Number: BM22

<i>Original Bench Mark Established by:</i> National Tidal Centre Australia, Oceanographic Services, Bureau of Meteorology, 25 College Rd, Kent Town, SA.	<i>Date:</i> 04-02-92
<i>Existing Bench Mark Established by:</i>	<i>Date:</i>
<i>Notes / References:</i> Deep Survey Benchmark This survey mark is not in a good locality for GPS occupation.	
<i>Country:</i> Tuvalu <i>Island:</i> Funafuti	<i>Atoll:</i> Fongafale

Marking and locality sketch

Bench Mark: 2.2m of 19mm diameter stainless steel capped rod driven to refusal.
Rod sheathed with 50mm diameter PVC pipe, filled with bentonite, for 0.6m. Top of mark 0.25m below ground level.

Locality sketch: Mark approximately 500m from the tide gauge station.

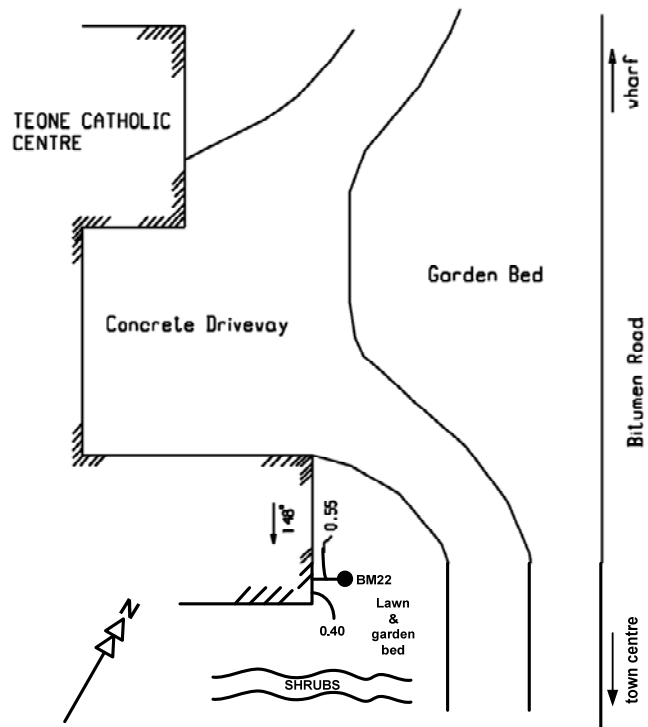

Not to scale

Distances in Metres

Magnetic bearings

Approved by: Geoscience Australia / SOPAC

Date: November 2006

c:\users\landrick\spscmp\localitydiagrams\tuavlu



**SOUTH PACIFIC SEA LEVEL
&
CLIMATE MONITORING PROJECT**



Survey Bench Mark Record

Bench Mark Number: BM23

<i>Original Bench Mark Established by:</i> National Tidal Centre Australia, Oceanographic Services, Bureau of Meteorology, 25 College Rd, Kent Town, SA.	<i>Date:</i> 03-02-92
<i>Existing Bench Mark Established by:</i>	<i>Date:</i>
<i>Notes / References:</i> Deep Survey Benchmark This survey mark is in a good locality for GPS occupation.	
<i>Country:</i> Tuvalu <i>Island:</i> Funafuti	<i>Atoll:</i> Fongafale

Marking and locality sketch

Bench Mark: 1.0m of 19mm diameter stainless steel capped rod driven to refusal.
Rod sheathed with 50mm diameter PVC pipe, filled with bentonite, for 0.6m. Top of mark 0.2m below ground level.

Locality sketch: Mark approximately 500m from the tide gauge station.

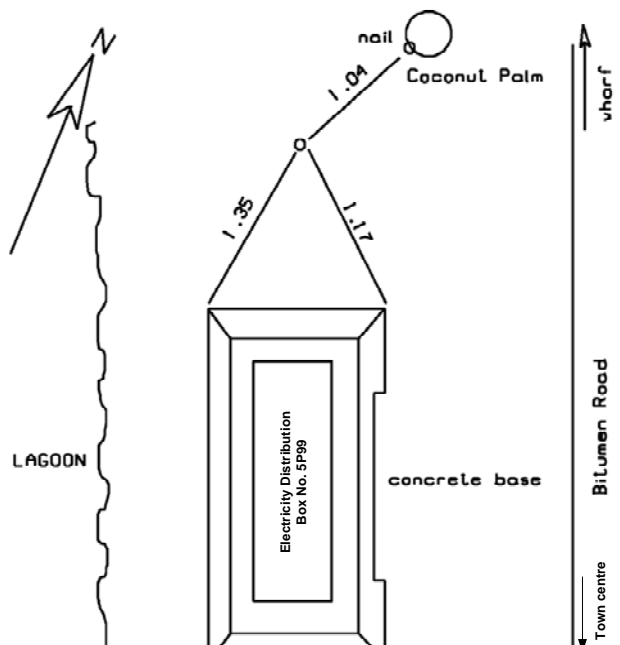

Not to scale

Distances in Metres

Magnetic bearings

Approved by: Geoscience Australia / SOPAC

Date: November 2006

c:\users\landrick\spslcmp\localitydiagrams\tuavlu



**SOUTH PACIFIC SEA LEVEL
&
CLIMATE MONITORING PROJECT**



Survey Bench Mark Record

Bench Mark Number: BM24

<i>Original Bench Mark Established by:</i> National Tidal Centre Australia, Oceanographic Services, Bureau of Meteorology, 25 College Rd, Kent Town, SA.	<i>Date:</i> 03-02-92
<i>Existing Bench Mark Established by:</i>	<i>Date:</i>
<i>Notes / References:</i> Deep Survey Benchmark This survey mark is in a good locality for GPS occupation.	
<i>Country:</i> Tuvalu <i>Island:</i> Funafuti	<i>Atoll:</i> Fongafale

Marking and locality sketch

Bench Mark: 3.8m of 19mm diameter stainless steel capped rod driven to refusal.
Rod sheathed with 50mm diameter PVC pipe, filled with bentonite, for 0.8m. Top of mark 0.15m below ground level.

Locality sketch: Mark approximately 2000m from the tide gauge station.

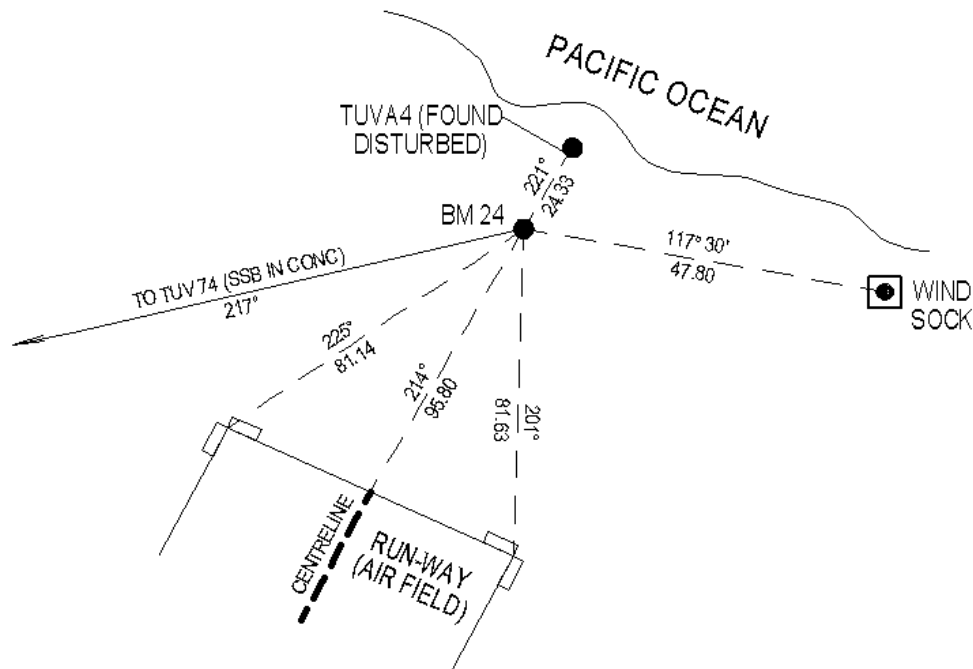

Not to scale

Distances in Metres

Magnetic bearings

Approved by: Geoscience Australia / SOPAC

Date: November 2006

c:\users\landrick\spslcmp\localitydiagrams\tuavlu



**SOUTH PACIFIC SEA LEVEL
&
CLIMATE MONITORING PROJECT**



Survey Bench Mark Record

Bench Mark Number: BM25

<i>Original Bench Mark Established by:</i> National Tidal Centre Australia, Oceanographic Services, Bureau of Meteorology, 25 College Rd, Kent Town, SA.	<i>Date:</i> 15-05-03
<i>Existing Bench Mark Established by:</i>	<i>Date:</i>
<i>Notes / References:</i> Deep Survey Benchmark This survey mark is not in a good locality for GPS occupation.	
<i>Country:</i> Tuvalu <i>Island:</i> Funafuti	<i>Atoll:</i> Fongafale

Marking and locality sketch

Bench Mark: 3.3m of 19mm diameter stainless steel capped rod driven to refusal.
Rod sheathed with 50mm diameter PVC pipe, filled with bentonite, for 0.5m. Top of mark 0.1m below ground level.

Locality sketch: Mark approximately 2300m from the tide gauge station.

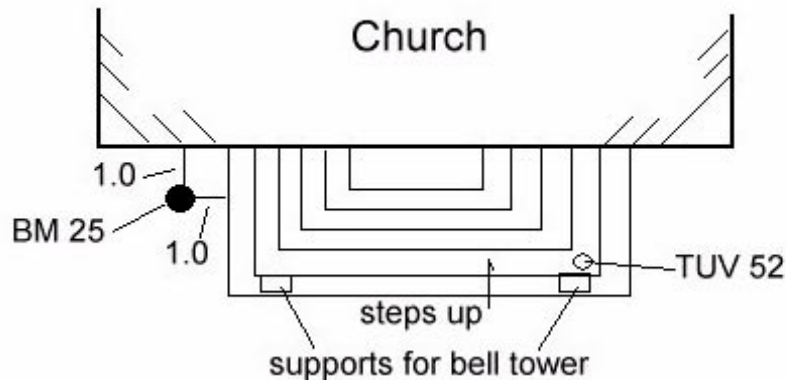

Not to scale

Distances in Metres

Magnetic bearings

Approved by: Geoscience Australia / SOPAC

Date: November 2006

c:\users\andrick\spslcmp\localitydiagrams\tuavlu



**SOUTH PACIFIC SEA LEVEL
&
CLIMATE MONITORING PROJECT**



Survey Bench Mark Record

Bench Mark Number: BM26

<i>Original Bench Mark Established by:</i> National Tidal Centre Australia, Oceanographic Services, Bureau of Meteorology, 25 College Rd, Kent Town, SA.	<i>Date:</i> 15-05-03
<i>Existing Bench Mark Established by:</i>	<i>Date:</i>
<i>Notes / References:</i> Deep Survey Benchmark This survey mark is not in a good locality for GPS occupation.	
<i>Country:</i> Tuvalu <i>Island:</i> Funafuti	<i>Atoll:</i> Fongafale

Marking and locality sketch

Bench Mark: 3.3m of 19mm diameter stainless steel capped rod driven to refusal.
Rod sheathed with 50mm diameter PVC pipe, filled with bentonite, for 0.5m. Top of mark 0.1m below ground level.

Locality sketch: Mark approximately 3100m from the tide gauge station.

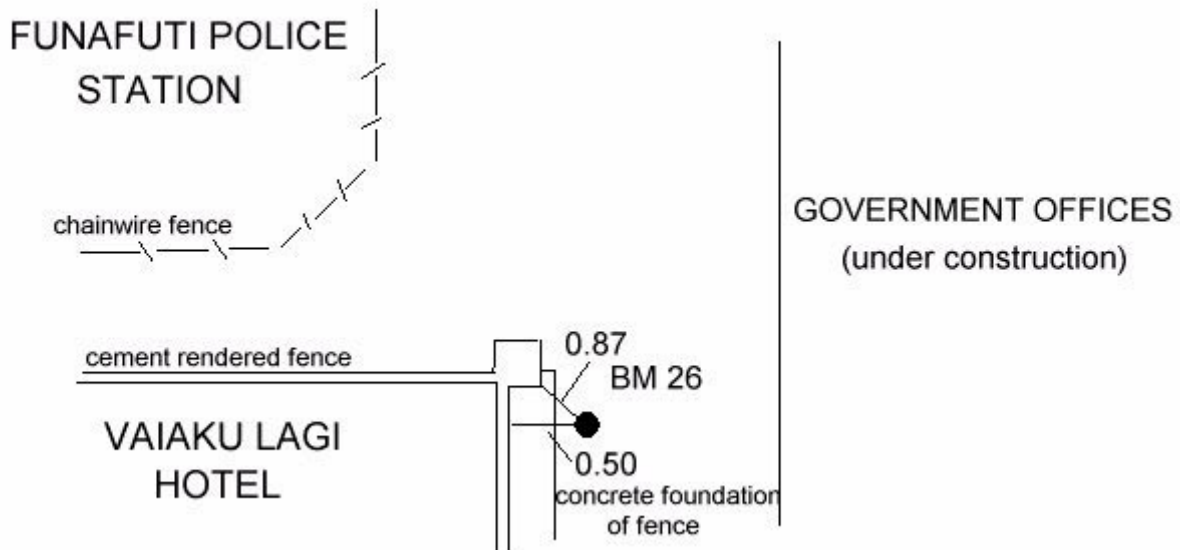

Not to scale

Distances in Metres

Magnetic bearings

Approved by: Geoscience Australia / SOPAC

Date: November 2006

c:\users\landrick\spslcmp\localitydiagrams\tuvalu



**SOUTH PACIFIC SEA LEVEL
&
CLIMATE MONITORING PROJECT**



Survey Bench Mark Record

Bench Mark Number: BM27

<i>Original Bench Mark Established by:</i> National Tidal Centre Australia, Oceanographic Services, Bureau of Meteorology, 25 College Rd, Kent Town, SA.	<i>Date:</i> 15-05-03
<i>Existing Bench Mark Established by:</i>	<i>Date:</i>
<i>Notes / References:</i> Deep Survey Benchmark This survey mark is in a good locality for GPS occupation.	
<i>Country:</i> Tuvalu <i>Island:</i> Funafuti	<i>Atoll:</i> Fongafale

Marking and locality sketch

Bench Mark: 2.4m of 19mm diameter stainless steel capped rod driven to refusal.
Rod sheathed with 50mm diameter PVC pipe, filled with bentonite, for 0.5m. Top of mark 0.1m below ground level.

Locality sketch: Mark approximately 3200m from the tide gauge station.

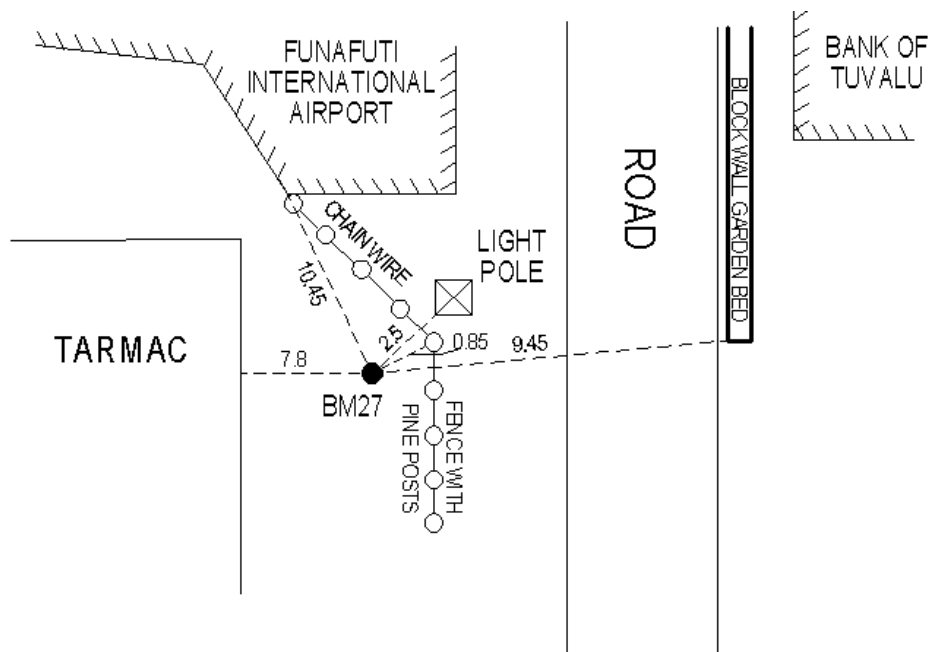

Not to scale

Distances in Metres

Magnetic bearings

Approved by: Geoscience Australia / SOPAC

Date: November 2006

c:\users\landrick\spslcmp\localitydiagrams\tuavlu



**SOUTH PACIFIC SEA LEVEL
&
CLIMATE MONITORING PROJECT**



Survey Bench Mark Record

Bench Mark Number: BM28

Original Bench Mark Established by: Geoscience Earth Monitoring Geodetic Operations
Geoscience Australia, Cnr Jerrabomberra Ave & Hindmarsh Drive, Australia
Date: 17-01-09

Existing Bench Mark Established by: _____ *Date:* _____

Notes / References: Deep Survey Benchmark
This survey mark is in a good locality for GPS occupation.

Country: Tuvalu
Island: Funafuti
Atoll: Fongafale

Marking and locality sketch

Bench Mark: 2.14m of 13mm diameter stainless steel capped rod driven to refusal.
Rod sheathed with 200mm diameter PVC pipe,. Top of mark 0.1m below ground level.

Locality sketch: Mark approximately 600m from the CGPS station.

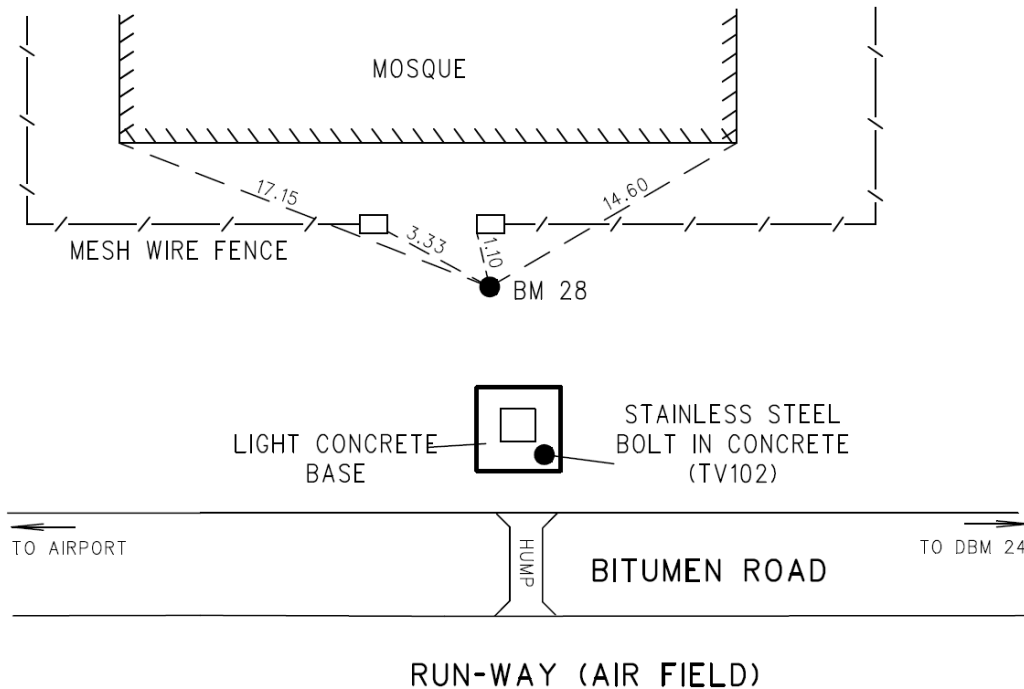

Not to scale Distances in Metres Magnetic bearings

Approved by: Geoscience Australia / SOPAC Date: January 2009

