

**(Pneumatic Systems )**

**Basics, Components, Circuits and  
Cascade Design**

**Outlines**

- Basics of Pneumatics
- Pneumatic Components
- Basic Pneumatic Circuits
- Cascade Design

# Basic of Pneumatics

## Air

The earth is surrounded by an envelope of air known as atmosphere. The composition of this 12 mile thick envelope is shown in the figure. Due to the compressibility of air, increasing the pressure causes decrease in the volume of air.

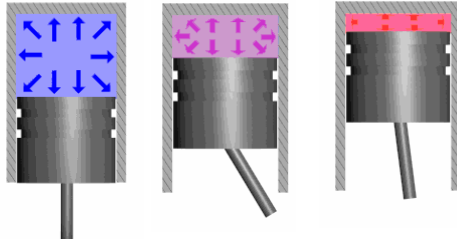
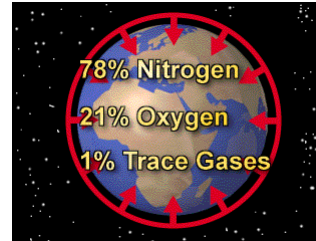

## The Perfect Gas Laws

### Boyle/Marriot's law

Boyle discovered that the pressure and the volume of a particular quantity of gas was constant provided that the temperature did not vary.

$$PV = C$$

### Charles's law

Charles found that the volume of a gas increased in equal amounts for equal increase increments of Temperature, if pressure is constant.

$$\frac{V_1}{V_2} = \frac{T_1}{T_2}$$

### Lussac's law

This law indicates that if the volume of a given gas is held constant, the pressure exerted by the gas is directly proportional to its absolute temperature.

$$\frac{p_1}{p_2} = \frac{T_1}{T_2}$$

### General Gas law

Combination of the mentioned laws results in general law as

$$\frac{p_1 V_1}{T_1} = \frac{p_2 V_2}{T_2}$$

The usefulness of using compressed air as a power source is as:

1. Cleanness
2. Pressure is transmitted undiminished in all directions throughout the system
3. Low cost
4. The best solution for the jig and fixture systems, automation lines, pick and place in electronics industry.

However, a typical maximum pressure for the pneumatic systems is 7 to 10 bars. This indicates that the pneumatic systems aren't suitable for the heavy duty in terms of load.

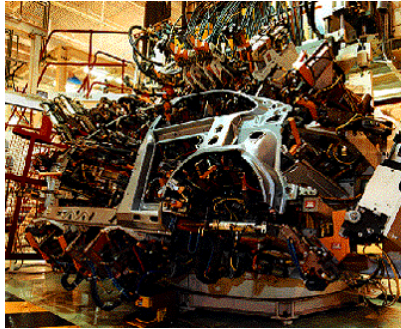

## Pneumatics Components

### Compressors

A compressor is a machine that compresses air or another type of gas from a low inlet pressure (usually atmospheric) to a higher desired pressure level. This is accomplished by reducing the volume of the gas. Air compressors are generally positive displacement units and are either of the reciprocating piston type or the rotary screw or rotary vane types.

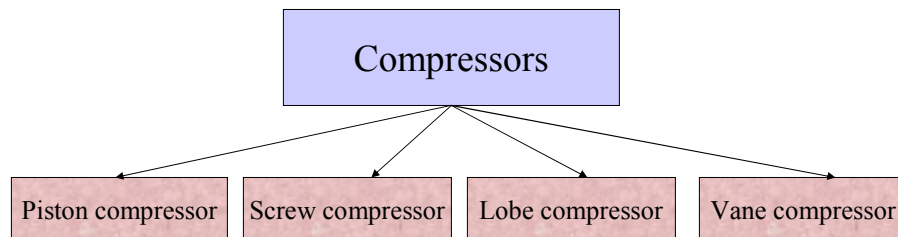

## Piston compressor

In this type of compressor a cylinder bore encloses a moving piston. As the crankshaft of the compressor rotate, the piston moves within the cylinder, similar to the piston in a car engine. As the piston is pulled down, the volume increases, creating a lower atmospheric pressure in the piston chamber. This difference in pressure causes air to enter via the inlet valve. As the piston is forced upwards the volume of air reduces. The air pressure therefore increases. Eventually the pressure forces the outlet valve to open.

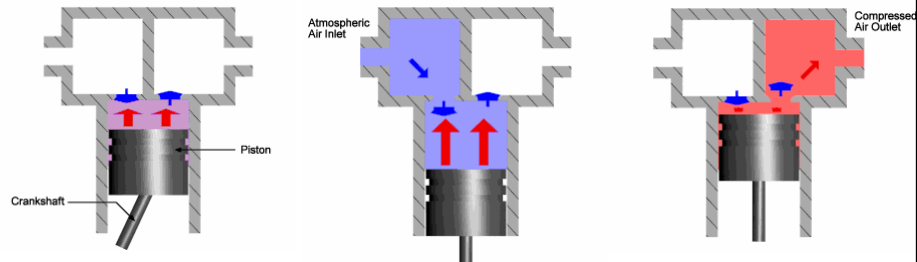

To avoid an excessive rise in temperature. Multi-stage compressors with INTERCOOLERS have been developed. These compressors can generate higher pressures than single stage compressors. The most common type is the Two-Stage compressor. The following figures show how this compressor works.

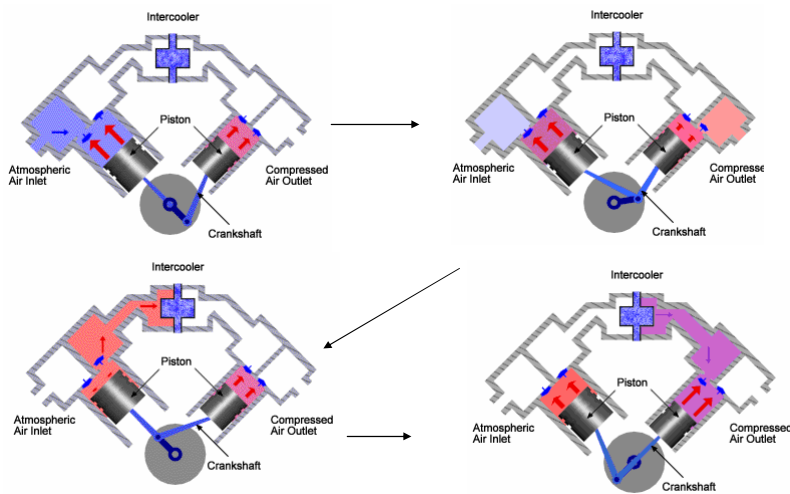

## Vane compressor

The following figure shows a cutaway view of the sliding-vane-type rotary compressor. The air inlet is placed where the volume of the compression chamber is greatest, the outlet where the volume is smallest. Consequently, as the vanes turn, the space between them is reduced. This reduction in volume compresses the air as it travels from the inlet to the outlet.

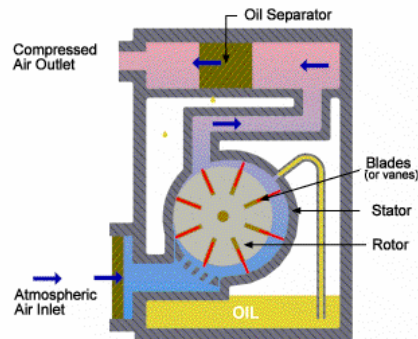

## Screw compressor

There is a current toward increased use of the rotary-type compressor due to technological advances, which have produced stronger materials and better manufacturing process. The following figure shows a cutaway view of a single-stage screw type compressor. Precise positioning of the screw is essential for its performance. Oil provides a seal between the rotating screws as well as lubricating the parts and cooling the air. The oil is then separated from the air before it enters the system.

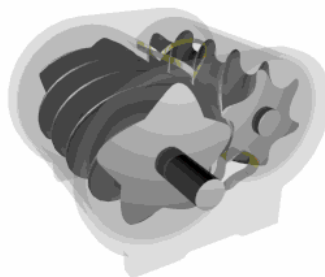

## Lobe compressor

In this type of compressor the rotors do not touch and certain amount of slip exists. This slip increases as the output pressure increases. It is therefore operated at maximum speed for the highest efficiency. 17.3 bar is obtainable with this type of constant displacement compressor.

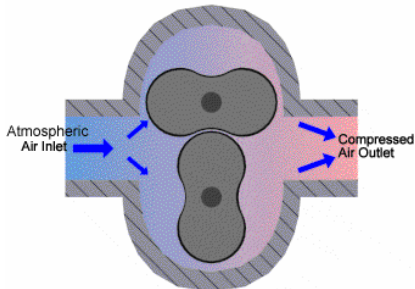

## Selection of Compressor

It is vital for the effective and efficient running of a compressed air plant that the appropriate compressor is selected to meet the system needs. Large compressor installation can be expensive and complex. However, the following points should be considered:

**SYSTEM FLOWRATE DEMAND:** This should include both the estimated initial loading and near term loading.

**STANDBY CAPACITY FOR EMERGENSIS:** This could be a second compressor that is connected to the main line.

**FUTURE AIR REQUIREMENT:** This issue should be considered in the selection of the compressor due to the cost of replacement of the compressor.

## Air capacity rating of compressors

Air compressors are generally rated in terms of SCFM of free air, defined as air at actual atmospheric conditions. The equation that allows for this calculation is

$$V_1 = V_2 \left( \frac{p_2}{p_1} \right) \left( \frac{T_1}{T_2} \right)$$

In the last equation, subscript 1 represents compressor inlet atmospheric conditions (standard or actual) and subscript 2 represents compressor discharge conditions. Dividing both sides of this equation by time (t) will give us:

$$Q_1 = Q_2 \left( \frac{p_2}{p_1} \right) \left( \frac{T_1}{T_2} \right)$$

### Sizing of Air Compressor

The sizing of air reservoirs requires taking into account parameters such as system pressure and flow-rate requirements, compressor output capability, and the type of duty of operation. It also serves to dampen pressure pulses either coming from the compressor or the pneumatic system during valve shifting and component operation. The reservoirs are equipped with a safety relief valve in order to prevent the explosion of tank.

safety relief valve

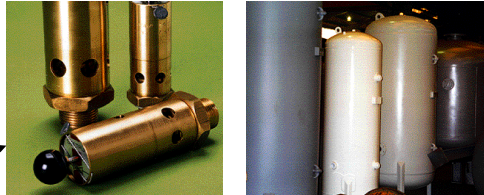

The last equation can be used to determine the proper size of the reservoir in English units and ,metrics as

$$V_r = \frac{14.7t(Q_r - Q_c)}{p_{\max} - p_{\min}} \quad \text{English units}$$

$$V_r = \frac{101t(Q_r - Q_c)}{p_{\max} - p_{\min}} \quad \text{Metric units}$$

Where  $t$  = time that reservoir can supply required amount of air (min)

$Q_r$  = consumption rate of pneumatic system (SCFM, m3/min)

$Q_c$  = output flow-rate of compressor (SCFM, m3/min)

$p_{\max}$  = maximum pressure level in reservoir (psi, kPa)

$p_{\min}$  = minimum pressure level in reservoir (psi, kPa)

$V_r$  = reservoir size (ft3, m3)

## Power required to drive compressors

The following equation can be used to determine the theoretical power required to drive an air compressor.

$$\text{Theoretical horsepower(HP)} = \frac{P_{in} Q}{65.4} \left[ \left( \frac{P_{out}}{P_{in}} \right)^{0.286} - 1 \right]$$

$$\text{Theoretical horsepower(kW)} = \frac{P_{in} Q}{17.1} \left[ \left( \frac{P_{out}}{P_{in}} \right)^{0.286} - 1 \right]$$

$P_{in}$  = inlet atmospheric pressure (psia, kPa abs)

$P_{out}$  = outlet atmospheric pressure (psia, kPa abs)

$Q$  = flow-rate (SCFM, standard m<sup>3</sup>/min)

## Air Conditioners

### Air Filters

The air needs to be filtered to be free of moisture and contamination. Air filter is used to do this job. The filter elements remove the particles and moisture as small as 5 microns.

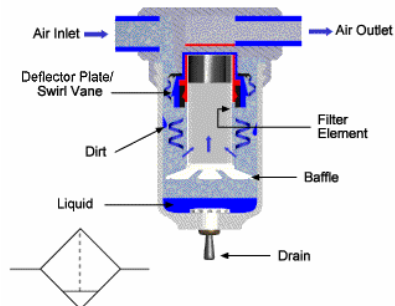

Symbols



### Air pressure regulator

The pressure regulator is used to adjust the desired pressure for the pneumatic system. This use a piston to sense downstream pressure fluctuations. The piston, in turn, works against a set spring pressure. As the pressure downstream drops it is sensed by the diaphragm and the popper valve opens. This adjusts the position of the poppet valve, which limits the downstream pressure to the pre-set valve.

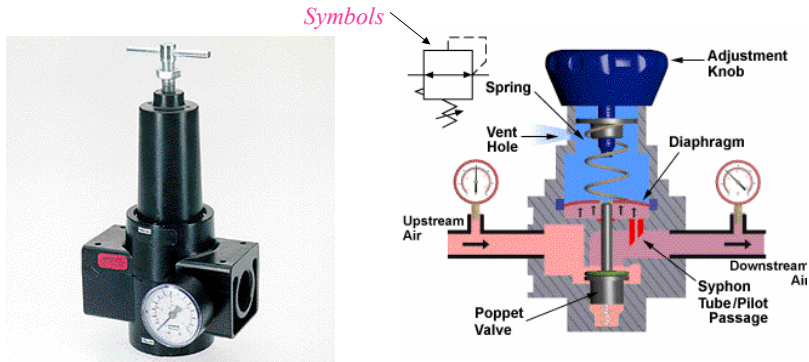

### Air lubricator

A lubricator ensures proper lubrication of internal moving parts pneumatics components. The proportional increase in oil mist by an increase of air flow is achieved by the spring loaded poppet assembly. As the flow increases and the valve opens, the area is increased and a pressure differential created.

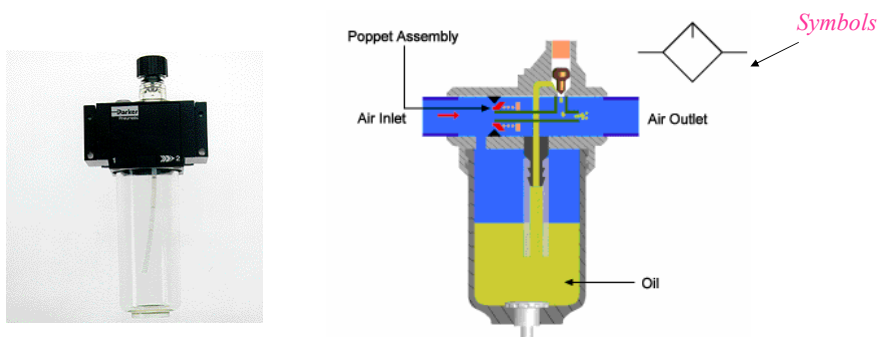

### Air service unit

Filters, regulators and lubricators can be combined to ensure optimum compressed air preparation for a specific pneumatic system.

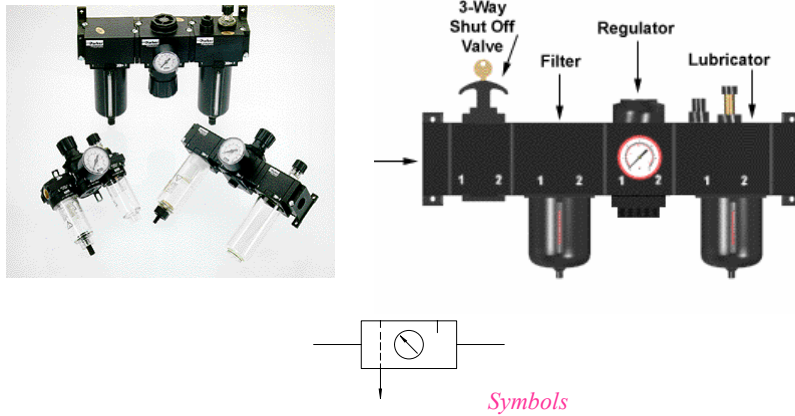

### Pneumatic Silencer

To decrease the noise of air in the outlet of valves, a silencer can be used. They are made from the porous plastic or bronze. Some of them are equipped with a control flow valve to control velocity of flow in the outlet of valves as well.

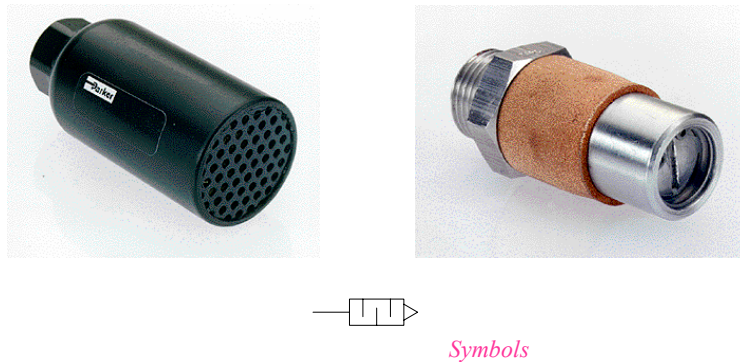

## Pneumatic Actuators

### Pneumatic Cylinders

The cylinders converts the energy of the compressed air into linear motion which extend or retract the piston rod.

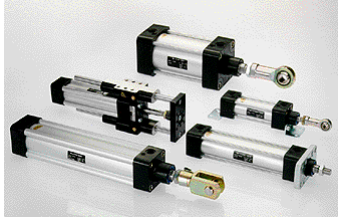

Double-acting



Single-acting  
Spring return

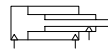

Telescopic

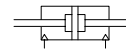

Double-ended

*Symbols*

### Pneumatic Rotary Actuators

The rotary actuators converts the energy into a rotary motion. Most of them is Vane air motor.

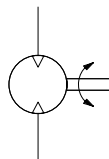
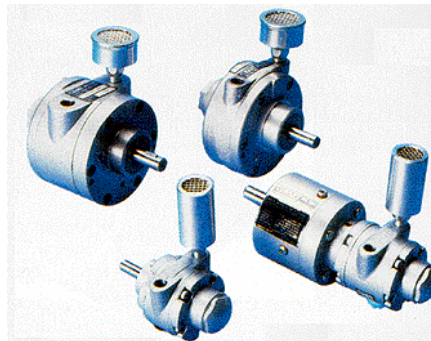

*Symbols*

### Pneumatic Semi-Rotary Actuators

Limited rotary motion can be achieved by incorporating a rack and pinion into a linear actuator or as seen opposite by a Vane Mechanism within the body of the cylinder.

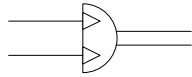
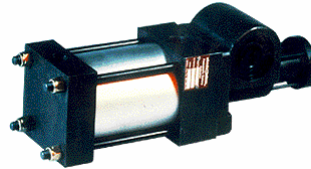

*Symbols*

### Pneumatic Valves

The pneumatic valves are similar to hydraulic valves in terms of physical concepts. They are categorized into three classes:

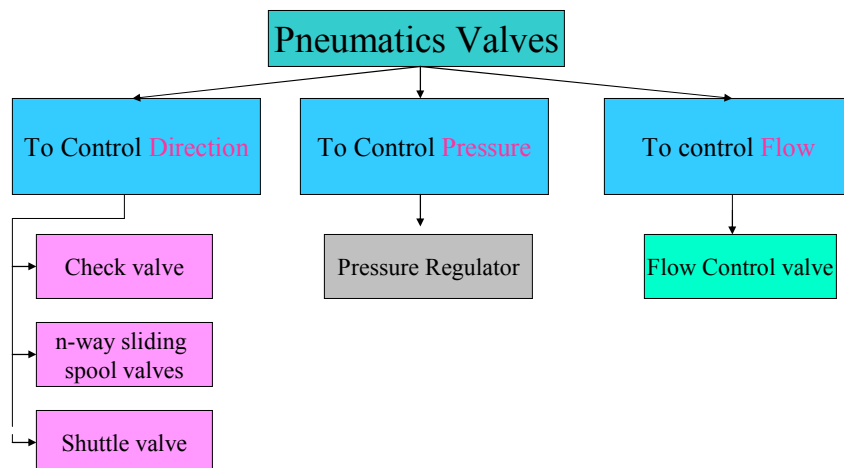

The same symbols as Hydraulic components are used for the pneumatic components. However, it is necessary to use an unfilled arrow marker. In the following, we only study the pneumatic directional control valves.

### Directional Control Valves (n-way sliding spool valve)

This control is provided by various valves in pneumatic systems. For example the following figure shows a cutaway of a 5/2 valves.

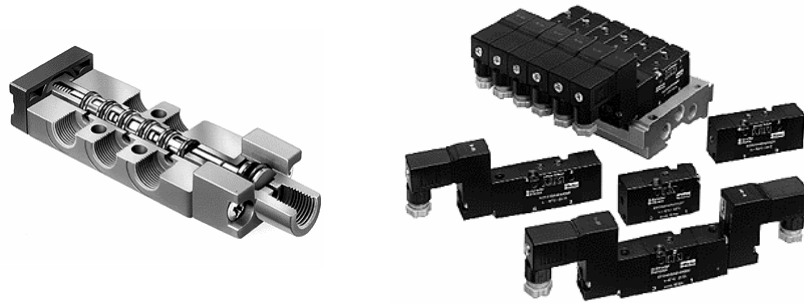

### 2/2 Pneumatic Valve

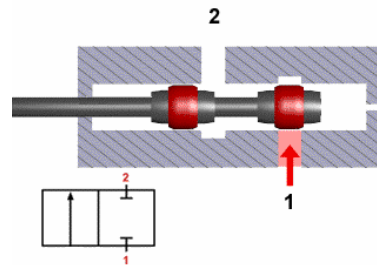

### 3/2 Pneumatic Valve

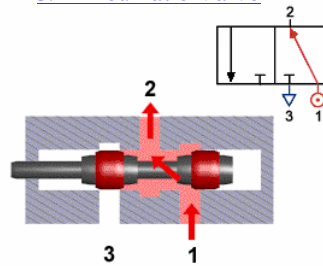

### 4/2 Pneumatic Valve

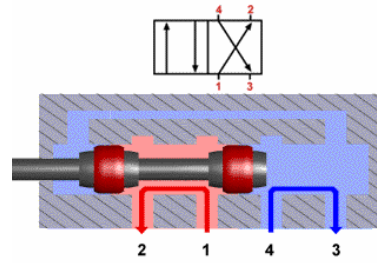

### 5/2 Pneumatic Valve

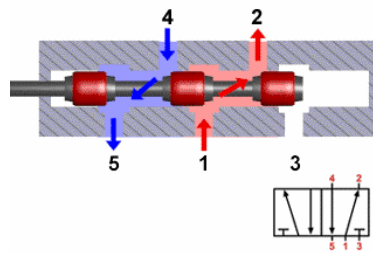

### 5/3 Pneumatic Valve

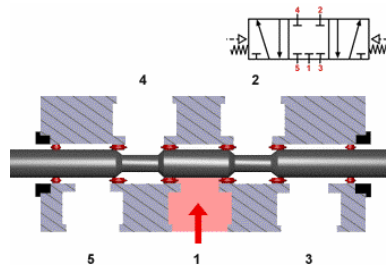

### Actuating systems

In the pneumatic valves, the same mechanism are used to activate the DCV's. The most common actuating system are Solenoid and Manual control.

# Pneumatics Circuits and Applications

## Pneumatic circuit design consideration

When analyzing or designing a pneumatic circuits, the following four important considerations must be taken into account:

- Safety of operation
- Performance of desired functions
- Efficiency of operation
- Costs

The typical cost for the compressing air to 100 psig is about \$0.35 per 1000 ft<sup>3</sup> of standard air.

## Air pressure losses in pipelines

As in the case for liquids, when air flows through a pipe, it losses energy due to friction. The energy shows up as a pressure loss, which can be calculated using the Harris formula:

$$P_f = \frac{cLQ^2}{3600(CR)d^5}$$

$P_f$ = pressure loss (psi)

$c$ = experimentally determined coefficient

$L$ = length of pipe (ft)

$Q$ = flow-rate (SCFM)

$CR$ = compression ratio= pressure in pipe/atmospheric pressure

$d$ = inside diameter of pipe (in)

For schedule 40 commercial pipe, the experimentally determined coefficient can be represented as a function of the pipe inside diameter:

$$c = \frac{0.1205}{d^{0.31}}$$

## Basics Pneumatic circuits

A pneumatic circuit is usually designed to implement the desired logics. However, there are several basics circuits, which can be integrated into the final circuit.

### Air pilot control of double-acting cylinder

*Purpose:* To operate a double-acting cylinder remotely through the use of an air pilot-actuated DCV.

*How:* Using a low pressure (10 psi) for supplying two push-button valves and activating them manually causes the main DCV to activate for cylinder retraction or extension.

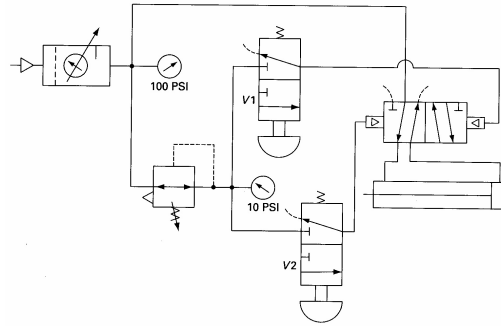

## Cylinder Cycle Timing System

*Purpose:* To provide a timed cylinder extend and retract cycle.

*How:* When push-button valve V3 is momentarily actuated, valve V2 shifts to extend the cylinder. When the piston rod cam actuates limit valve V4, it shifts V2 into its opposite mode to retract the cylinder. Flow control valve V1 controls the flow-rate and thus cylinder speed.

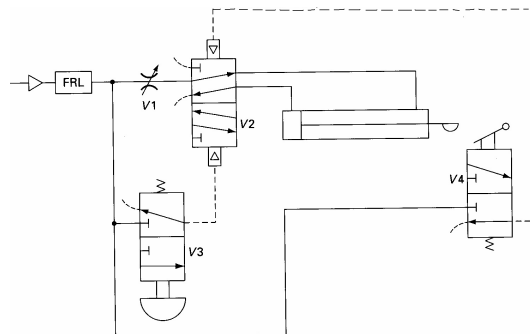



## Two-step Speed Control System

*Purpose:* To provide a timed cylinder extend and retract cycle.

*How:* Assuming that flow control valve V3 is adjusted to allow a greater flow-rate than valve V4. Initially the cylinder is fully retracted. When push-button valve V1 is actuated, air goes through valves V2 and V3 and the shuttle valve V5 to extend the cylinder a high speed. When the piston rod cam actuates valve V6, valve V2 shifts. The flow is therefore diverted to valve V4 and through the shuttle valve.

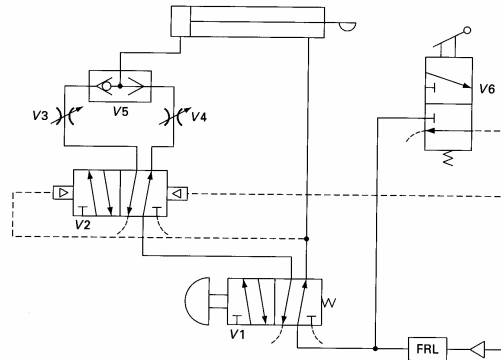

## Control of air Motor

*Purpose:* To control an air motor

*How:* When the START push-button valve is actuated momentarily, the air pilot valve shifts to supply air to motor. When the STOP push-button valve is actuated momentarily, the air pilot valve shifts into its opposite mode to shut off the supply of air to the motor.

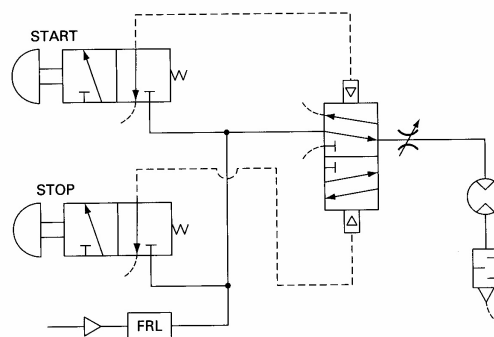

## Deceleration Air Cushion of Cylinder

*Purpose:* To provide an adjustable deceleration air cushion at both ends of the stroke of a cylinder when it drives a load of large weight.

*How:* Valve V1 supplies air to the rod end of the cylinder and to the pilot of valve V5 through flow control valve V3. Free air exhausting from the blank end of the cylinder permits a fast cylinder-retraction stroke until valve V5 operates due to exhaust is restricted by valve V7. The resulting pressure buildup in the blank end of the cylinder acts as an air cushion to gradually slow down the large weight load.

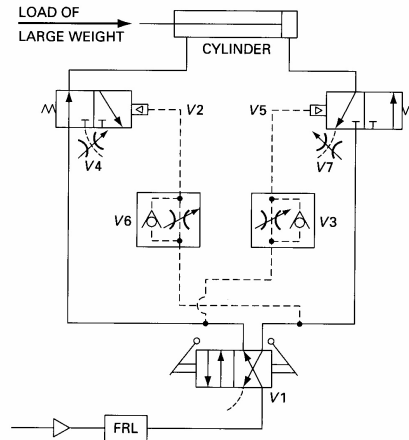

## Cascade Pneumatic Circuit Design

Implementation of a sequence of actions by a full pneumatic circuit is widely used in industries. Many industries like automotive, food, chemical and so on need to use a full pneumatic system due to the hazardous area in the site and limitation of use of the electricity in the system.

### **Procedure**

1. Code the cylinders with letters. Use positive and negative signs to show the cylinders' positions: positive sign to indicate the cylinder is completely extended, and negative sign to indicate the cylinder is completely retracted:  

$$A^+B^+B^-C^+A^-C^-$$
2. Split the motion sequence into groups in a way that any letter regardless of its sign appears only once in each group:  

$$A^+B^+ / B^-C^+A^- / C^-$$
3. Number the groups:  

$$A^+B^+ / B^-C^+A^- / C^-$$

I
II
III
4. For each cylinder, consider two limit valves to signal for the start and end of its motion and one 4/2 or 5/2 power valve to operate the cylinder.

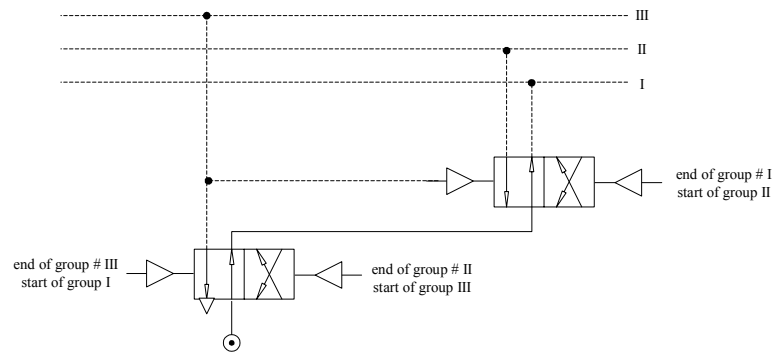

5. For the number of groups minus one consider 4/2 directional control valves and connect them in series or cascade as:
  - a) Connect the pilot line and air port of the first power and limit valve of each group to its associated control line (I, II, III).
  - b) Follow the sequence of each group and connect the limit valves to appropriate pilot lines of the power valves.
  - c) Connect the output of the last limit valve of each group to the pilot line of the group selector valve.
  - d) Add any extra valves for safety, emergency and resetting purposes.

Vahabzade@yahoo.com