

Smoke Characterization Project

Technical report

Prepared by:

Thomas Z. Fabian, Ph.D.
Pravinray D. Gandhi, Ph.D., P.E.

Underwriters Laboratories Inc.



THE
FIRE PROTECTION
RESEARCH FOUNDATION

FIRE RESEARCH

THE FIRE PROTECTION
RESEARCH FOUNDATION

ONE BATTERYMARCH PARK
QUINCY, MASSACHUSETTS, U.S.A. 02169
E-MAIL: Foundation@NFPA.org
WEB: www.nfpa.org/Foundation

FOREWORD

Residential smoke alarms provide an important notification to individuals within a residential setting that there is a presence of smoke and/or fire. Over the last four decades, several studies have been conducted to determine the response of smoke alarms and to assist in establishing performance criteria for their use in residential settings.

With the advent of new smoke particulate and the gas effluent measurement technologies becoming commercially available, UL, with support from FPRF initiated this research project to more fully characterize the products of flaming and non-flaming combustion. The materials investigated included a range of products and chemistries commonly found in today's residential settings.

The objectives of the investigation were as follows:

- Develop smoke characterization analytical test protocols using non-flaming and flaming modes of combustion on selected materials found in residential settings.
- Using materials from the analytical smoke program, develop smoke particle size distribution data and smoke profiles in the UL 217/UL 268 Fire Test Room for both nonflaming and flaming modes of combustion.
- Provide data and analysis to the fire community for several possible initiatives:
 - a. Develop recommendations to the current residential smoke alarm standard (UL 217).
 - b. Development of new smoke sensing technology.
 - c. Provide data to the materials and additives industries to facilitate new smoke suppression technologies and improved end products.

The Research Foundation expresses gratitude to the report authors Thomas Fabian and Pravinray Gandhi of Underwriters Laboratories Inc; and to the Project Technical Panelists and sponsors listed on the following page.

The content, opinions and conclusions contained in this report are solely those of the authors.

Smoke Characterization Project

Technical Panel

David Albert, InnovAlarm

Thomas Cleary, National Institute of Standards and Technology

Kenneth Dungan, PLC Foundation

Jackie Gibbs, Marietta Fire and Emergency Services

Daniel Gottuk, Hughes Associates, Inc.

Morgan Hurley, Society of Fire Protection Engineers

Arthur Lee, U.S. Consumer Product Safety Commission

James Milke, University of Maryland

Robert Polk, National Association of State Fire Marshals

Lee Richardson, NFPA

Sponsors

Underwriters Laboratories Inc.

BRK Brands/First Alert

Centers for Disease Control

GE Security

Honeywell Life Safety

Invensys Climate Controls

InnovAlarm

Kidde Safety

National Electrical Manufacturers Association

PLC Foundation

SFPE Foundation

Siemens Building Technologies

SimplexGrinnell

Smoke Characterization Project

Final Report

Project Number: 06CA08584

File Number: NC 5756

Underwriters Laboratories Inc.
333 Pfingsten Road, Northbrook, IL 60062

April 24, 2007

Prepared by



Thomas Z. Fabian, Ph.D.
Research Engineer
Fire, Signaling and Security Division



Pravinray D. Gandhi, Ph.D., P.E.
Global Director, Business Development
Fire, Signaling and Security Division

Reviewed by

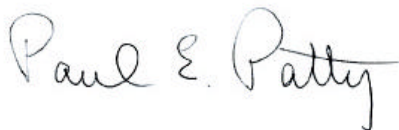

Paul E. Patty, P.E.
Senior Research Engineer
UL Corporate Research

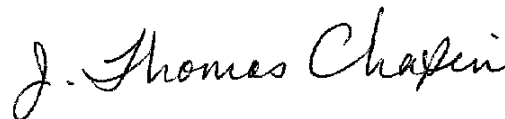

J. Thomas Chapin, Ph.D.
Director, Research & Development
UL Corporate Research

Underwriters Laboratories Inc. (UL) its trustees, employees, sponsors, and contractors, make no warranties, express or implied, nor assume and expressly disclaim any legal liability or responsibility to any person for any loss or damage arising out of or in connection with the interpretation, application, or use of or inability to use, any information, data, apparatus, product, or processes disclosed in this Report. This Report cannot be modified or reproduced, in part, without the prior written permission of Underwriters Laboratories Inc.

Copyright © 2007 Underwriters Laboratories Inc.



EXECUTIVE SUMMARY

INTRODUCTION

5 Residential smoke alarms provide an important notification to individuals within a residential setting that there is a presence of smoke and/or fire. Over the last four decades, several studies have been conducted to determine the response of smoke alarms and to assist in establishing performance criteria for their use in residential settings. These studies have led to the development and subsequent revisions of UL Standard 217 *Single and Multiple Station Smoke Alarms*, as well as a National Fire Alarm Code (NFPA 72) that addresses smoke alarm
10 installation requirements. A study completed by NIST in 2004 reflected that smoke alarms were working but there was a reduction in the margin between available and safe egress times from an earlier study in 1975.

15 Fires in either a flaming or a smoldering phase provide several cues for smoke alarms. These include smoke particulates, heat, and gas effluents (e.g., CO, CO₂). Current smoke alarms primarily utilize two types of detection technologies: photoelectric or ionization. The photoelectric type has a light source and detects the scattering or obscuration caused by smoke particulates. The ionization type detects changes in local ionization field within the detection chamber resulting from the presence of smoke. Both types of alarms activate when a set
20 threshold is reached. While current technology smoke alarms were found in the NIST study to operate within the established performance criteria, there was a difference in activation times for the different technologies depending upon the combustion mode (flaming vs. non-flaming).

25 One of the conclusions drawn from the NIST study was that performance of smoke alarms could be studied with greater precision, accuracy and confidence if there were better data available on combustibility and smoke characteristics for a wider range of products used in today's residential settings.

30 With the advent of new smoke particulate and the gas effluent measurement technologies becoming commercially available, UL initiated this UL/FPRF research project to more fully characterize the products of flaming and non-flaming combustion. The materials investigated included a range of products and chemistries commonly found in today's residential settings. The objectives of the investigation were as follows:

- 35
- Develop smoke characterization analytical test protocols using non-flaming and flaming modes of combustion on selected materials found in residential settings.
 - Using materials from the analytical smoke program, develop smoke particle size distribution data and smoke profiles in the UL 217/UL 268 Fire Test Room for both non-flaming and flaming modes of combustion.
 - Provide data and analysis to the fire community for several possible initiatives:
40
 - a. Develop recommendations to the current residential smoke alarm standard (UL 217).
 - b. Development of new smoke sensing technology.
 - c. Provide data to the materials and additives industries to facilitate new smoke suppression technologies and improved end products.
- 45

METHODOLOGY

5 A survey was conducted of residential settings for products and materials commonly found in settings there. Materials, contemporary to today’s residential settings, in addition to the prescribed UL 217 fire test materials were selected for this investigation based on product chemistry and occurrence.

10 ASTM E1354 cone calorimeter was selected as it can simulate well-ventilated, early stage fires under well-controlled radiant heating conditions. In these tests, material based combustion properties were developed that included weight loss rate, heat and smoke release rates, smoke particle size and count distribution, and effluent gas composition were characterized for a variety of natural, synthetic, and multi-component materials in both the flaming and non-flaming mode. The results from the cone calorimeter tests were used to identify materials for subsequent larger scale investigations.

15 Intermediate scale calorimeters were used to develop test parameters (*e.g.* sample size, ignition method) on the selected materials for subsequent evaluation in a UL 217/UL 268 Fire Test Room. Evaluation of the UL 217 fire test protocols, and the developed fire scenarios in intermediate calorimeters, also permitted characterization of heat and smoke release rates as well as smoke and gas effluents closer to the combustion source. This enabled collection of smoke data prior to
20 aging that would be expected in the vicinity of smoke alarms in the UL 217/UL 268 Fire Test Room. This methodology allows for the comparison of smoke particle sizes near the source of the fire, as well as at the detector location.

25 Finally, the developed scenarios were evaluated along with the prescribed UL 217 fire tests in a UL 217/UL 268 Fire Test Room. Smoke particle size and count distribution and gas effluent composition were monitored along with ceiling air velocity and temperature and analog alarm responses in the vicinity of standard UL 217 obscuration and Measuring Ionization Chamber (MIC) equipment.

30 In this study smoke particle size and count distribution and effluent gas composition were characterized using a particle size spectrometer and a gas-phase FTIR respectively.

KEY FINDINGS

35 The key findings of the research were as follows:

Gas Analysis and Smoke Characterization Measurement

- 40 1. Physical Smoke Particle Characterization - The particle spectrometer provides data on smoke particle size and count distribution that is unavailable by traditional obscuration and ionization techniques used to quantify smoke.
2. Relationship of Smoke Particle Characterization to Traditional Methods - Linear relationships between the smoke particle data and the traditional techniques were demonstrated such that:
 - 45 a. Particle size and number count are linearly related to MIC signal change:
$$\Delta\text{MIC} \sim d_m \cdot n_m$$

b. Number count is linearly related to scattering while particle size exhibits a second order relationship: $s \propto \sum n_i \cdot d_i^2$

c. Number count is linearly related to obscuration while particle size exhibits a third order relationship: $\frac{OD}{\ell} \propto \sum n_i \cdot d_i^3$

- 5 3. Smoke Particle Aggregation - Tests conducted in the UL 217 Sensitivity Test smoke box and the UL 217/UL 268 Fire Test Room indicate an aggregation of smaller smoke particles to form larger particles as evidenced by the increase in smoke particle concentrations in conjunction with increasing fractions of larger smoke particles. This was more evident for non-flaming fires than flaming fires. While the settling of smoke was observed in the Indiana Dunes study, this effect was measured and more pronounced in this study.
- 10 4. Smoke Gas Effluent Composition - Gas effluent analysis showed the dominant gas components were water vapor, carbon dioxide and carbon monoxide.

15 **Influence of Material Chemistry**

1. Combustion Behavior: Synthetic and Natural Materials - Cone calorimeter tests indicate synthetic materials (e.g. polyethylene, polyester, nylon, polyurethane) generate higher heat and smoke release rates than the natural materials (e.g. wood, cotton batting). This is anticipated to be primarily due to the modes of degradation and chemical structure of synthetic versus natural materials.
- 20 2. Charring Effects - Materials exhibiting charring behavior such as wood alter the size and amount of smoke particles generated as the combustion process progresses.
3. Influence on Smoke Particle Size - In general, the synthetic materials tested generated larger mean smoke particle sizes than natural materials in flaming mode.
- 25

Mode of Combustion

1. Flaming Combustion - Flaming combustion tends to create smaller mean particle sizes than non-flaming combustion. This is primarily due to the more efficient conversion of high molecular weight polymers to low molecular weight combustion products and ultimately CO, CO₂ and H₂O instead of organic by-products and soot.
- 30 2. Non-Flaming Combustion - Non-flaming combustion tends to generate greater volumes of smoke particles for a given consumed mass than flaming combustion.

Small-Scale and Intermediate Scale Test

- 35 1. Cone Calorimeter Test - The cone calorimeter provided combustibility, smoke characteristics and gas effluent data in flaming and non-flaming modes for a range of materials studied. The smoke characterization data revealed the influences of material chemistry, physical sample structure, and the mode of combustion. The data were found to be repeatable. In the non-flaming mode, the heat and smoke release rates were lower than the resolution of the cone calorimeter measurement system for several materials investigated. However, the smoke particle spectrometer provided repeatable data on smoke size and count distribution for both flaming and non-flaming modes.
- 40 2. Intermediate-Scale Test - The intermediate scale test provided a platform to scope combustion scenarios, and provided data on the heat and smoke release rates as well as

5 smoke size and count distribution for test samples subsequently used in the UL 217/UL 268 Fire Test Room. The tests also identified test samples with heat and smoke characteristics that varied from UL 217 fire test samples such as Douglas fir, newspaper, heptane/toluene mixture, and Ponderosa pine. In the non-flaming mode, the method used for heating the test sample was observed to influence the smoke characteristics. The heating by a hot plate provided larger particle size as compared to radiant heating.

UL 217/UL 268 Fire Test Room Tests

- 10 1. Smoke Particle Size and Count Distribution - The tests provided smoke particle size and count distribution data in conjunction with traditional obscuration and Measuring Ionization Chamber data. PU foams in the flaming mode produced the smallest particle sizes of all materials tested.
- 15 2. Combustion Mode Effects - Changes in the combustion mode (flaming versus non-flaming) resulted in different smoke particle size and count distributions that influenced the response of photoelectric and ionization smoke alarms. The particle size distribution for the non-flaming fires yielded larger mean smoke particle diameter than the flaming mode fires. The ionization alarm responded quicker to flaming fires; the photoelectric responded quicker to non-flaming fires.
- 20 3. Smoke Alarm Response to Flaming Fires - In all but one flaming test the ionization alarm activated first. Both alarm types activated within the 4 minute time limit specified in UL 217 for the three UL 217 flaming test targets (Douglas fir, heptane/toluene mixture, and newspaper). In one of two flaming tests involving PU foam with cotton/poly fabric the photoelectric smoke alarm did not activate, however the ionization alarm did activate in both tests. In a flaming PU foam with cotton/poly fabric test using a smaller sample size
25 neither alarm type activated. It should be noted that the maximum obscuration in these PU foam tests was less than for Douglas fir, heptane/toluene mixture, and newspaper test samples.
- 30 4. Smoke Alarm Response to Non-Flaming Fires - The photoelectric alarm activated first in the non-flaming tests with the exception of the higher energy bread/toaster test in which the ion alarm activated first. The UL 217 smoldering Ponderosa pine test triggered both the ionization and photoelectric smoke alarms. For many of the other materials, the ionization smoke alarm did not trigger. In each of these cases, the obscuration value was less than the 10 %/ft limit specified in UL 217. It was also found that there was settling of the smoke particles in the test room over time. Measurements from several non-flaming
35 tests showed that the obscuration values at the ceiling dropped over time, and the maximum obscuration values were observed at the 2 feet measurement location below the ceiling.
- 40 5. Smoke Stratification - Non-flaming fires result in changes in the smoke build up over time, such that stratification of smoke below the ceiling occurs. This time-dependent phenomenon results in less obscuration at the ceiling than below the ceiling. This caused both detection technologies to drift out of alarm.

Future Considerations

45 Based upon the results of this Smoke Characterization Project, the following items were identified for further consideration:

Smoke Characterization Project – Final Report

1. The addition of other test materials such as polyurethane foam in the flaming and non-flaming combustion modes in UL 217.
2. Whether a smoke alarm, once triggered, should remain activated unless deactivated manually.
- 5 3. Requiring the use of combination ionization and photoelectric alarms for residential use in order to maximize responsiveness to a broad range of fires.
4. Characterize materials described in UL 217 using cone calorimeter, smoke particle spectrometer and analytical testing.

10

KEY WORDS

Smoke, smoke alarm, smoke detector, alarm response, UL 217, optical density, smoke composition, fire tests, smoke particle size and count distribution, gas effluent, ASTM E1354 cone calorimeter, natural products, synthetic materials, polymer combustion.

TABLE OF CONTENTS

	EXECUTIVE SUMMARY	ii
	INTRODUCTION	ii
5	METHODOLOGY	iii
	KEY FINDINGS	iii
	Small-Scale and Intermediate Scale Test	iv
	UL 217/UL 268 Fire Test Room Tests	v
	KEY WORDS	vii
10	SMOKE CHARACTERIZATION PROJECT: FINAL REPORT	16
	INTRODUCTION	16
	OBJECTIVES	18
	TECHNICAL PLAN	19
	TASK 1 – SELECTION OF TEST SAMPLES	20
15	Task Objectives	20
	review, Selection and Procurement of Materials and Products in Residential Setting	20
	Experimental	24
	Results	24
20	TASK 2 – DEVELOP SMOKE CHARACTERIZATION ANALYTICAL TEST PROTOCOL USING FLAMING AND NON-FLAMING MODES OF COMBUSTION	25
	Task Objectives	25
	Smoke Characterization	25
	Characterization of Smoke in UL 217 Sensitivity Test	29
25	Small-Scale Tests	34
	Intermediate-Scale Tests	55
	Intermediate-Scale Tests	55
30	TASK 3 – DEVELOP SMOKE PROFILES AND PARTICLE SIZE AND COUNT DISTRIBUTIONS IN THE UL 217/UL 268 FIRE TEST ROOM	82
	Introduction	82
	Task Objectives	82
	Test Samples	83
	Experimental	83
	Test Procedure	88
35	Test Results	88
	TASK 4 – CORRELATE ANALYTICAL DATA AND PERFORMANCE IN THE FIRE TEST ROOM	129
	Introduction	129
	Smoke Particle Distribution Measurements	129
40	Influence of Materials and Combustion Mode: Cone Calorimeter	129
	Influence of Materials and Combustion Mode: Fire Test Room	131
	Influence OF Testing Method	137
	TASK 5 - IDENTIFY FUTURE CONSIDERATIONS	146
	SUMMARY OF FINDINGS	147
45	Gas Analysis and Smoke Characterization Measurement	147
	Influence of Material Chemistry	147

Smoke Characterization Project – Final Report

	Mode of Combustion	147
	Small-Scale and Intermediate-Scale Test	148
	UL 217/UL 268 Fire Test Room Tests	148
	APPENDIX A: Material Chemistry	150
5	APPENDIX B: Test Sample Documentation and Characterization	156
	Note: Appendices C through I are provided only in electronic format.	
	APPENDIX C: Small-Scale Flaming Combustion Test Results	
	APPENDIX D: Small-Scale Non-Flaming Combustion Test Results	
10	APPENDIX E: Intermediate-Scale Flaming Combustion Test Results	
	APPENDIX F: Intermediate-Scale Non-Flaming Combustion Test Results	
	APPENDIX G: UL 217/UL 268 Fire Test Room Flaming Combustion Test Results	
	APPENDIX H: UL 217/UL 268 Fire Test Room Non-Flaming Combustion Test Results	
	APPENDIX I: UL 217/UL 268 Fire Test Room Smoke Color	
15		

TABLE OF FIGURES

	Figure 1 – Schematic of the sampling method	26
	Figure 2 – UL 217 Smoke Box	29
5	Figure 3 – WPS Spectrometer connected to the UL 217 Smoke Box	30
	Figure 4 – UL 217 Smoke Box mean smoke particle size diameter for non-flaming cotton wick	31
	Figure 5 – UL 217 Smoke Box relative smoke particle count for non-flaming cotton wick	31
10	Figure 6 – Relationship between smoke particle size and optical density (UL 217 Sensitivity Test) for non-flaming cotton wick	32
	Figure 7 – Relationship between the MIC signal and particle density in the UL 217 Smoke Box for non-flaming cotton wick	33
	Figure 8 – Cone Calorimeter sample holder	35
	Figure 9 – Schematic of ASTM E 1354 cone calorimeter	35
15	Figure 10 – Schematic of the gas effluent and smoke measurement system for the cone calorimeter	37
	Figure 11 – Effective HOC (top) and peak HRR (bottom) for flaming combustion	45
	Figure 12 – Smoke production for flaming combustion	46
	Figure 13 – Mean particle diameter for flaming combustion	47
20	Figure 14 – Mean specific particle count for flaming combustion	48
	Figure 15 – Heat release rate per unit area and smoke particle size for flaming Douglas fir wood	48
	Figure 16 – Heat release rate per unit area and smoke particle size for flaming heptane/toluene mixture	49
25	Figure 17 – Heat release rate per unit area and smoke particle size for flaming HDPE	49
	Figure 18 – Carbon dioxide yield for flaming combustion	50
	Figure 19 – Carbon monoxide yield for flaming combustion	50
	Figure 20 – Smoke production for non-flaming combustion	51
	Figure 21 – Mean particle diameter for non-flaming combustion	52
30	Figure 22 – Mean specific particle count for non-flaming combustion	53
	Figure 23 – Carbon dioxide yield for non-flaming combustion	54
	Figure 24 – Carbon monoxide yield for non-flaming combustion	54
	Figure 25 – Schematic of NEBS calorimeter	57
	Figure 26 – Schematic of the IMO calorimeter	58
35	Figure 27 – Intermediate calorimeter evolved smoke and gas sampling cone and tube	58
	Figure 28 – Intermediate calorimeter flaming mode sampling arrangement	59
	Figure 29 – Intermediate calorimeter non-flaming mode sampling arrangement	60
	Figure 30 – Photograph of test set-up for UL 217 smoldering test	62
	Figure 31 – Schematic of smoke sampling for smoldering Ponderosa pine test	62
40	Figure 32 – Heat (top) and smoke (bottom) release rates for heptane/toluene mixture	64
	Figure 33 – Heat (top) and smoke (bottom) release rate for Douglas fir	65
	Figure 34 – Heat (top) and smoke (bottom) release rate for newspaper	66
	Figure 35 – Heat (top) and smoke (bottom) release for coffee maker	67
	Figure 36 – Heat (top) and smoke (bottom) release for nylon carpet	68
45	Figure 37 – Heat (top) and smoke (bottom) release for cotton/poly sheet wrapped PU foam	69

Smoke Characterization Project – Final Report

	Figure 38 – Smoke release rate for bread in non-flaming combustion	70
	Figure 39 – Smoke release rate for PU foam in non-flaming combustion	70
	Figure 40 – Smoke release for cotton/poly sheet wrapped PU foam in non-flaming combustion	71
5	Figure 41 – Smoke particle data from the UL 217 smoldering Ponderosa pine test	74
	Figure 42 – UL 217 smoldering Ponderosa pine particle size distribution	75
	Figure 43 – Peak HRR for flaming combustion tests	76
	Figure 44 – Peak SRR for flaming combustion tests	76
	Figure 45 – Particle size distribution for flaming combustion of natural and synthetic materials	77
10	Figure 46 – Particle size distribution for non-flaming combustion of natural and synthetic materials	78
	Figure 47 – Average smoke particle diameters for flaming combustion tests	79
	Figure 48 – Average smoke particle density for flaming combustion tests	79
15	Figure 49 – Mean smoke particle diameter for non-flaming tests	80
	Figure 50 – Average particle count for non-flaming combustion tests	81
	Figure 51 – Fire Test Room. Drawing not to scale.	87
	Figure 52 – Smoke OBS for heptane/toluene mixture in flaming combustion	90
	Figure 53 – Smoke OBS for newspaper in flaming combustion	91
20	Figure 54 – Smoke OBS for Douglas fir in flaming combustion	91
	Figure 55 – Smoke OBS for coffee maker in flaming combustion	92
	Figure 56 – Smoke OBS for PU foam in flaming combustion (35 kW/m ² radiant heating)	92
	Figure 57 – Smoke OBS for PU foam (100×100 mm) with cotton-poly sheet in flaming combustion	93
25	Figure 58 – Smoke OBS for PU foam (150×150 mm) with cotton-poly sheet in flaming combustion	93
	Figure 59 – Smoke OBS for nylon carpet in flaming combustion	94
	Figure 60 – Photo and ionization alarm analog signals for flaming PU foam tests	96
	Figure 61 – Photo and ionization alarm analog signals for flaming nylon carpet tests	97
30	Figure 62 – Photo and ionization alarm analog signals for flaming Douglas fir test	97
	Figure 63 – Comparison of smoke particle size data for selected flaming test	98
	Figure 64 – Mean smoke particle diameter and count for flaming Douglas fir tests	100
	Figure 65 – Mean smoke particle diameter and count for flaming newspaper tests	100
	Figure 66 – Mean smoke particle diameter and count for flaming heptane/toluene tests	100
35	Figure 67 – Mean smoke particle diameter and count for flaming coffee maker tests	100
	Figure 68 – Mean smoke particle diameter and count for flaming PU foam (100×100 mm) tests	101
	Figure 69 – Mean smoke particle diameter and count for flaming PU foam (100×100×100 mm) tests	101
40	Figure 70 – Mean smoke particle diameter and count for flaming PU foam (150×150×150 mm) tests	101
	Figure 71 – Mean smoke particle diameter and count for flaming nylon carpet tests	101
	Figure 72 – OBS for Ponderosa pine in non-flaming tests	105
	Figure 73 – OBS for bread in non-flaming tests	105
45	Figure 74 – OBS for polyisocyanurate foam in non-flaming tests	106
	Figure 75 – OBS for PU foam in non-flaming tests	106

Smoke Characterization Project – Final Report

	Figure 76 – OBS for cotton sheet wrapped PU foam in non-flaming tests	107
	Figure 77 – OBS for polyester microfiber wrapped PU foam non-flaming tests	107
	Figure 78 – OBS for nylon carpet in non-flaming tests	108
	Figure 79 – OBS for polystyrene in non-flaming tests	108
5	Figure 80 – Beam vs. MIC response: Ponderosa pine	110
	Figure 81 – Beam vs. MIC response for PU foam in non-flaming combustion	111
	Figure 82 – Beam vs. MIC response for cotton sheet wrapped PU foam	112
	Figure 83 – Beam vs MIC response for polyester microfiber wrapped PU foam	112
	Figure 84 – Beam vs MIC response for Polystyrene in non-flaming combustion	113
10	Figure 85 – OBS changes in the test room for heptane/toluene mixture	114
	Figure 86 – OBS changes in the test room for bread	114
	Figure 87 – OBS changes in the test room for polyester microfiber wrapped PU foam	115
	Figure 88 – OBS changes in the test room for cotton fabric wrapped PU foam	115
	Figure 89 – Mean smoke particle diameter and count for Ponderosa pine in non-flaming tests	118
15	Figure 90 – Mean smoke particle diameter and count for bread in non-flaming tests	119
	Figure 91 – Mean smoke particle diameter and count for polyisocyanurate foam in non-flaming tests	120
	Figure 92 – Mean smoke particle diameter and count for PU foam in non-flaming tests	121
20	Figure 93 – Mean smoke particle diameter and count for PU foam in non-flaming tests (Data from Test 12261 were found to be suspicious and were not plotted)	122
	Figure 94 – Mean smoke particle diameter and count for cotton fabric wrapped PU foam in non-flaming tests	123
	Figure 95 – Mean smoke particle diameter and count for cotton-poly wrapped PU foam in non-flaming tests	124
25	Figure 96 – Mean smoke particle diameter and count for polyester microfiber wrapped PU foam in non-flaming tests	125
	Figure 97 – Mean smoke particle diameter and count for nylon carpet in non-flaming tests	126
30	Figure 98 – Mean smoke particle diameter and count for polystyrene in non-flaming tests	127
	Figure 99 – Specific extinction area for small-scale flaming and non-flaming combustion	130
	Figure 100 – Mean particle diameter for small-scale flaming and non-flaming combustion	130
	Figure 101 – Specific particle count for small-scale flaming and non-flaming combustion	131
	Figure 102 – Mean particle diameters at an obscuration of 0.5 %/ft in the Fire Test Room	132
35	Figure 103 – MIC signal versus particle size data for Fire Test Room flaming tests	133
	Figure 104 – MIC signal versus particle size data for Fire Test Room non-flaming tests	133
	Figure 105 – Analog ion signal versus particle size data for Fire Test Room flaming tests	134
	Figure 106 – Analog ion signal versus particle size data for Fire Test Room non-flaming tests	134
40	Figure 107 – Obscuration versus particle size data for Fire Test Room flaming tests	135
	Figure 108 – Obscuration versus particle size data for Fire Test Room non-flaming tests	135
	Figure 109 – Analog photo (scattering) signal versus particle size data for Fire Test Room flaming tests	136
45	Figure 110 – Analog photo (scattering) signal versus particle size data for Fire Test Room non-flaming tests	136

Smoke Characterization Project – Final Report

	Figure 111 – Small-scale smoke release rate versus Fire Test Room obscuration for flaming PU foam tests	139
	Figure 112 – Intermediate-scale smoke release rate versus Fire Test Room obscuration for flaming heptane/toluene mixture tests	139
5	Figure 113 – Intermediate-scale smoke release rate versus Fire Test Room obscuration for flaming nylon carpet tests	140
	Figure 114 – Intermediate-scale smoke release rate versus Fire Test Room obscuration for flaming coffee maker tests	140
10	Figure 115 – IMO and Fire Test Room smoke particle mean diameter for flaming heptane/toluene mixture tests	141
	Figure 116 – IMO and Fire Test Room smoke particle mean diameter for flaming Douglas fir tests	142
	Figure 117 – IMO and Fire Test Room smoke particle mean diameter for flaming newspaper tests	142
15	Figure 118 – IMO and Fire Test Room smoke particle mean diameter for flaming PU foam tests	143
	Figure 119 – IMO and Fire Test Room smoke particle mean diameter for flaming coffee maker tests	143
20	Figure 120 – Intermediate-scale and Fire Test Room smoke particle mean diameter for non-flaming Ponderosa pine tests	144
	Figure 121 – IMO and Fire Test Room smoke particle mean diameter for non-flaming bread tests	145
25	Figure 122 – IMO and Fire Test Room smoke particle mean diameter for flaming nylon carpet tests	145

TABLE OF TABLES

	Table 1 – Items commonly found in residential settings	20
	Table 2 – Project test samples	21
5	Table 3 – Sample description and material chemistry	22
	Table 4 – Cone calorimeter test samples	34
	Table 5 – Test parameters for cone calorimeter flaming mode tests	39
	Table 6 – Test parameters for cone calorimeter non-flaming mode tests	39
	Table 7 – Cone calorimeter combustibility data for small-scale flaming mode tests	41
10	Table 8 – Cone calorimeter combustibility data for small-scale non-flaming mode tests	42
	Table 9 – Smoke particle and gas effluent data for small-scale flaming mode tests	43
	Table 10 – Smoke particle and gas effluent data for small-scale non-flaming mode tests	44
	Table 11 – Intermediate calorimeter test samples	56
	Table 12 – Intermediate calorimeter sample exposure scenario	61
15	Table 13 – Intermediate calorimeter combustibility results	63
	Table 14 – Intermediate calorimeter smoke particle data	72
	Table 15 – Maximum observed carbon monoxide and carbon dioxide concentrations	73
	Table 16 – Test samples for UL 217 Fire Test Room Test tests	83
	Table 17 – Fire Test Room Tests	84
20	Table 18 – Data acquisition sampling intervals	88
	Table 19 – Summary of obscuration for flaming tests	89
	Table 20 – Flaming mode alarm response times	95
	Table 21 – Smoke particle data at 0.5 %/ft and 10 %/ft OBS: flaming tests	99
	Table 22 – Observed Fire Test Room test signals for flaming mode at 240 seconds	102
25	Table 23 – Fire Test Room ceiling test signatures for flaming combustion tests	103
	Table 24 – Summary of smoke obscuration for non-flaming tests	104
	Table 25 – Non-flaming mode alarm response times	109
	Table 26 – Observed UL 217 room test signals at ceiling location for non-flaming mode tests at 0.5 % /ft	116
30	Table 27 – Observed UL 217 room test signals at ceiling location for non-flaming mode tests at 10 % Obs/ft	117
	Table 28 – UL 217 Fire Test Room ceiling test signatures for non-flaming combustion tests	128
35	Table 29 – Theoretical smoke particle dependency for traditional smoke sensor technologies	129
	Table 30 – Fire Test Room alarm trigger times	137
	Table 31 – Influence of scale on mean smoke diameter	138
	Table 32 – Influence of heating mode on smoke characteristics: non-flaming	138
40		

NOMENCLATURE

Acronyms	Description	
<i>Organizations</i>		
ASTM	American Standards for Materials and Testing	
FPRF	Fire Protection Research Foundation	
NFPA	National Fire Protection Association	
NIST	National Institute of Standards and Technology	
UL	Underwriters Laboratories Inc.	
 <i>Equipment</i>		
DMA	Dynamic Mobility Analyzer (part of WPS spectrometer)	
FTIR	Fourier Transform Infrared Spectrometer	
LPS	Light Particle Spectrometer (part of WPS spectrometer)	
MIC	Measuring Ionization Chamber	
TGA	Thermogrametric Analyzer	
Notation	Description	Units
α	Ionization chamber physical characteristics (constant)	s
β	Attachment coefficient of air-molecule ions to the soot particles	s ⁻¹
CO	Carbon monoxide	---
CO ₂	Carbon dioxide	---
C _s	Smoke concentration	kg/m ³
D	Ion diffusion coefficient	cm ² /s
d _m	Mean smoke particle diameter for one WPS Spectrometer scan	10 ⁻⁶ m
D _m	Average smoke particulate diameter over the duration of the test	10 ⁻⁶ m
HOC	Heat of combustion	kJ/g
HDPE	High density polyethylene	---
HRR	Heat release rate	kW or kW/m ²
ℓ	Path length	m or ft
n _m	Mean smoke particle count density for one WPS Spectrometer scan	cc ⁻¹
N _m	Average particle count density over the duration of the test	cc ⁻¹
OBS	Smoke obscuration (UL 217 definition)	---
OD	Optical density	---
Peak HRR	Maximum heat release rate for the duration of the test	kW or kW/m ²
Peak SRR	Maximum smoke release rate for the duration of the test	m ² /s
ppm	parts per million	---
PU	Polyurethane	---
SRR	Smoke release rate	m ² /s
T	Ceiling temperature in Fire Test Room	°C
Vel.	Velocity measured in Fire Test Room	m/s

SMOKE CHARACTERIZATION PROJECT: FINAL REPORT

INTRODUCTION

5 Residential smoke alarms provide an important notification to individuals within a residential setting that there is a presence of smoke and/or fire. Fires and incipient fires (non-flaming phase) provide several cues for detection equipment. These include smoke particulates, heat, and gas effluents (*e.g.* CO, CO₂). Current smoke alarms primarily utilize two types of detection technologies: photoelectric or ionization. The photoelectric type has a light source and detects the scattering or obscuration of light caused by smoke particulates. The ionization type detects
10 changes in local ionization field within the detection chamber resulting from the presence of burning materials. Both types of alarms activate when a set threshold is reached.

Over three decades ago following a seminal research study to develop data on smoke alarm performance and location requirements for the alarms^{1,2} known as the Indiana Dunes investigation. The use of smoke alarms began to increase. In the Indiana Dunes study, tests were conducted in actual homes with representative sizes and floor plans, utilized simulated furniture component mock-ups, actual furnishings and household items for fire sources, and tested actual smoke alarms sold in retail stores. That report concluded that smoke alarms of either
15 photoelectric or ionization type generally provided the necessary escape time for different fire types and locations. However, materials used in this investigation were not characterized for their physical and chemical properties. There were several findings worth noting: (i) smoke particulates from flaming and non-flaming fire provide different smoke signatures; (ii) detection technologies (ionization vs. photoelectric) respond differently to flaming and non-flaming smoke particulates; and (iii) the location of the alarms had a significant influence on the safe egress time.
20

The Indiana Dunes investigation contributed to the ongoing development of a smoke alarm performance standard (UL 217³) by Underwriters Laboratories Inc. (UL). The development of this standard accelerated the use of smoke alarms in residential setting such that smoke alarms are now found in more than 90 % of residential structures in the USA. In the UL certification
25 program smoke alarm models are evaluated for response to three flaming fire tests (wood, paper, and heptane/toluene) and one smoldering smoke test (Ponderosa pine). The materials used for these tests are intended to represent fuels commonly found in buildings in the USA, and produce gray and black smoke during either flaming or smoldering conditions. The non-flaming test represents the basic smoke profile that occurs during a typical slow non-flaming cushion fire.
30 Thus, the UL performance tests assess the ability of an alarm to respond to several different fire sources. The UL standard and the Indiana Dunes test also led to the development of a new national code (NFPA 72⁴).

Statistics⁵ developed by National Fire Incident Reporting System (NFIRS) provide evidence that
35 smoke alarms have a significantly beneficial impact towards preventing fatalities from fires. It has been estimated that installation of smoke alarms achieves a 40-50% reduction in the fire death rate relative to number of fires. However, over a period from 1996 to 1998, data⁶ show that smoke alarms did not operate in 22% of the residential structure fires involving one and two-family homes and apartments. In general, the fire data shows that the number of fatalities
40 increases when smoke alarms are either absent or fail to operate. Poor maintenance, disabling of
45

alarms (*e.g.*, due to nuisance alarms), and inability for the working alarms to trigger in sufficient time (*i.e.*, respond to smoke particulate) are some of the reasons for the inability of smoke alarms to provide sufficient time to execute an evacuation plan.

- 5 Substantial changes have occurred in the typical household since the Indiana Dunes study. Residential settings are now larger, with more synthetics, and contain a wide variety of manufactured products that are driven by consumer demand. Synthetic materials are now the norm with regards to textiles, thermoplastic enclosures and engineered materials. This has been accelerated by the global petrochemical and polymer industry that has exponentially advanced since the mid 1940s. With the advent of global manufacturing and shipping, these products are now manufactured and distributed throughout the world. In contrast, materials derived from natural processes, such as photosynthesis and metabolism, are less common on a percentage basis.
- 10
- 15 It is thought that synthetic materials currently found in the home tend to ignite and burn faster than materials used in the original study and this may be explained by analyzing the chemical structures of the synthetic and natural materials and investigating their modes of decomposition in a fire scenario. Accelerated decomposition is expected to result in faster growing fires and therefore an overall reduction of safe egress time. At the same time there have also been advances in fire retardant additives and compounding technology thereby improving material fire resistance. This would result in longer period of non-flaming decomposition of materials, especially with smaller ignition sources. These changes in materials are expected to alter the chemistry and the nature of smoke particulates, heat and gas component signatures. It has been suggested that non-flaming material decomposition also generate more carbon monoxide and other gases that can lead to incapacitation before occupants can respond to the smoke alarm.
- 20
- 25

The influence on smoke alarm response to changes in available materials was investigated in a recent study by NIST⁷. This work followed a design similar to that of the Indiana Dunes investigation. Tests were conducted in actual homes with representative sizes and floor plans, utilized actual furnishings and household items for fire sources, and tested commercially available smoke alarms. However, as in the Indiana Dunes investigation, the materials of these furnishings were not physically or chemically characterized.

30

NIST concluded that smoke alarms, of either photoelectric or ionization type, installed on every building level generally provided the necessary escape time for different fire types and locations though significant differences were measured between the response times of photoelectric and ionization alarms to flaming and non-flaming fires. Adding smoke alarms in bedrooms lengthened the escape time, especially for non-flaming fires. The main difference with the NIST study and the previous Indiana Dunes investigation is that the calculated safe egress time was consistently shorter and the fire growth rates were faster. In addition to developing smoke alarm performance data, the NIST study also measured smoke particle size distribution and components of gas effluents from the fire tests but did not characterize the materials.

35

40

The influence of material chemistry on smoke production is significant. Except for noncombustible materials (for example metals, minerals, glasses, ceramics), the vast majority of materials found in residential settings are carbonaceous and thus, susceptible to decomposition

45

and burning. The combustion behavior of carbonaceous materials (ignition, heat release, smoke release) with attendant softening, melting and liquefaction, and charring is dictated by chemistry. Polymeric materials (either natural or synthetic) have chemical structures and morphology that affect degradation, heat release and smoke production. In general, synthetic materials are chemically less complex than natural materials as they are derived from monomers from crude oil (ethylene, propylene, acetylene, styrene, vinyl chloride, acrylic acid, acrylonitrile and so on). Natural materials have polymeric structures that are highly complex linear and crosslinked structures (carbohydrates, proteins, glycerides, etc.) and tend to char rather than soften and liquefy.

Despite significant advances in the knowledge of alarm performance with typical products found in residential settings gained from the NIST study, it was determined that further study was needed to develop combustibility and smoke characteristics for a wider range of synthetic materials and natural products found in residential settings. These materials also need to be fully characterized for their physical and chemical composition as well their combustibility behavior.

Thus, the current research project was initiated to fully characterize the products of combustion for both the flaming and non-flaming modes on a variety of materials and products commonly found in residential settings. The study would also take advantage of advances in the smoke particle and gas effluent characterization technology that was not previously conducted.

OBJECTIVES

The objectives of this research investigation were as follows:

1. Develop smoke characterization analytical test protocols using flaming and non-flaming modes of combustion on selected materials found in residential settings;
2. Using materials from the analytical smoke program, develop smoke particle size and count distribution data and smoke profiles in the UL 217/UL 268 Fire Test Room for both flaming and non-flaming modes of combustion.
3. Provide data and analysis to the fire community for several possible initiatives:
 - Develop recommendations to change the current residential smoke alarm standard (UL 217).
 - Development of new smoke sensing technology.
 - Provide data to the materials and additives industries to facilitate new smoke suppression technologies and improved end products.

TECHNICAL PLAN

A technical plan was developed to meet the project objectives as following:

- 5 Task 1 – Selection of test samples
- Task 2 – Develop smoke characterization analytical test protocol using non-flaming and flaming modes of combustion
- 10 Task 3 – Develop smoke profiles and particle size and count distributions in the UL 217/UL 268 Fire Test Room
- Task 4 – Correlate analytical data and performance in the UL 217/UL 268 Fire Test Room
- 15 Task 5 – Identify future considerations
- Task 6 – Develop Final Report

The results of this investigation (Task 6) are described herein.

20

TASK 1 – SELECTION OF TEST SAMPLES

TASK OBJECTIVES

The objectives of this task were as follows:

- 5 • Survey materials and products in contemporary residential settings
- Select materials for the research investigation
- Procure samples
- Document and characterize the samples

10

REVIEW, SELECTION AND PROCUREMENT OF MATERIALS AND PRODUCTS IN RESIDENTIAL SETTING

An informal review of typical products and materials found in contemporary residential settings was performed to assist in the selection of test samples for investigation in this study. A list of
 15 typical items and their corresponding combustible base materials is presented in Table 1.

Table 1 – Items commonly found in residential settings

Residential Area	Common Items	Common Base Materials
Bedroom and Living Room	Appliance wiring Bed clothing Candles Carpeting Drapes and blinds Mattress Paper products Plastic enclosures for electrical products Upholstered furniture Wallpaper Wood furniture	Flexible PVC (plasticized) Cotton, Polyester, Acrylic, Blends Hydrocarbon wax, Cotton wick Polyolefin, Nylon, Polyester Cotton, Linen, Wood, PVC Polyurethane foam, Cotton, Polyester Paper Polyolefin, ABS, Nylon Polyurethane foam, Polyester, Cotton, Wood Paper, PVC plastisol, Polyacrylates coatings Wood, Polyurethane, Cotton, Polyester, Adhesives
Kitchen	Appliance enclosures Appliance wiring Cabinets Counter tops Food containers Foods Wallpaper	Polyolefins, ABS, Polycarbonate Flexible PVC (plasticized) Wood, MDF, Adhesives Laminates, Acrylics, Wood Polyolefins, PVDC Fats, Oils, Carbohydrates, etc. Paper, PVC plastisol, Polyacrylates coatings
Storage Areas	Paints Fuels Packaging materials	Acrylic latex, Oil, Polyurethane, Thinner Hydrocarbons Paper, Polystyrene, Starch

Representative test samples were selected based upon the prevalence of items in residential settings, the chemistry of their base material components, and their role in residential fires.

5 All of the selected materials were procured from commercial sources. Where the selected material was a composite item such as a mattress, individual components of the final item were also investigated to provide a connection between the components and the end product. The selected materials and UL 217 test samples are listed in Table 2 along with their corresponding base material description.

Table 2 – Project test samples

Residential Item	Samples	Material Description
Appliance wiring	Electrical wire (duplex lamp cord)	Duplex wire (16 gauge, stranded copper), brown PVC insulation
Appliance	Coffee maker	12 cup capacity; atactic polypropylene housing, PVC wire
Mattress	Mattress	Twin size, no fire barrier
Mattress components (from mattress)	Cotton batting	7 mm thick; 0.7 kg/m ²
	Polyurethane foam	25 mm thick; 1.2 kg/m ²
Bed/Upholstered furniture cover	Pillow	Queen size; white Cover: 70% polyester/30% cotton Fill: 100% polyester with silicone finish
	Cotton sheeting	White; plain weave; 102 g/m ² (CA TB 117 sheeting)
	Cotton/Poly sheeting	White; plain weave; 50:50 blend; 763 g/m ² (CA TB 117 sheeting)
	Polyester sheeting	White, plain weave; 790 g/m ² microfiber
Fabric	Rayon	White, Plain weave, 763 g/m ²
Carpeting	Nylon	Nylon 6 yarns; Polypropylene backing; 3.0 kg/m ² finished product
	Polyester	Polyester yarns; 2.7 kg/m ² finished product
Cooking material and fuels	Bread	Wonder [®] white
	Cooking oil	Wesson Vegetable oil (polyunsaturated oil)
	Lard	Natural; Saturated fat
	Heptane	Flammable liquid (represents aliphatic chemistry)
Insulation	Polyisocyanurate	½ inch thick; 43 kg/m ³
Plastic enclosures	HDPE sheet	6 mm thick; 930 kg/m ³
UL 217 Test sample	Cotton wick	Diameter: 4.3 mm; Weight: 7.2 g/m
	Douglas fir	6 × 6 × 2-1/2 inch; Weight: 450 g
	Ponderosa pine	3 × 1 × ¾ inch stick, 10 sticks weighin g 160g
	Newspaper	Black print only, 42.6 g. of ¼ inch wide strips
	Heptane/Toluene	30 mL Heptane and 10 mL Toluene (ACS reagent grade)

10

Table 3 describes the material chemistry of the test samples⁸. A cross-reference code assigned to natural (N) and synthetic (S) materials is included for reference to additional technical descriptions found in Appendix A.

15

Table 3 – Sample description and material chemistry

Sample Description	Reference Code	Material Chemistry
Lamp wire – compounded PVC	S20	Flexible PVC is produced by the incorporation of 20-60% by weight aromatic or aliphatic ester plasticizers in the PVC powder. This “plasticization” produces compounds with exceptional flexibility, toughness and weatherability. Typical aromatic plasticizers are based upon terephthalic acid (di-carboxylic acid) or trimellitic acid (tri-carboxylic acid). Alcohols used in these plasticizers usually contain from 8 to 16 carbon atoms. Elemental composition – C, H, O; structure – aromatic or aliphatic depending upon type of acid used.
Coffee maker – Polypropylene	S14	Polymers based on the polymerization of propylene ($\text{CH}_2=\text{CHCH}_3$), or copolymers with other unsaturated monomers. PP polymers and copolymers have a range of properties due to factors, such as cross-link density, molecular weight, degree of branching, incorporation of co-monomers, etc. Elemental composition – essentially C, H depending upon type and percentage of co-monomers; structure – aliphatic.
Mattress – Combination of cotton, polyester batting, and polyurethane foam	N4 S10 S16	<p><u>Cotton</u> - Staple fiber consisting primarily of cellulose (88-96%) with other natural-derived aliphatic organic compounds (C, H, O). Cellulose is a natural carbohydrate polymer (polysaccharide) consisting of anhydroglucose units joined by an oxygen linkage to form essentially linear high molecular weight chains.</p> <p><u>Polyester</u> - A generic term for commercially available textile and thermoplastic products based upon ester polymers with the characteristic linkage ($\text{R}'\text{-COO-R}''$) where R or R'' can be various hydrocarbon groups. Ester polymers are produced by either the condensation reaction of dicarboxylic acids with dihydroxy alcohols or the reaction of lactones (cyclic esters) or hydroxy-carboxylic acids. Polyester textiles are usually composed of PET – polyethylene terephthalate. PET is formed by the reaction of terephthalic acid (aromatic compound) and ethylene glycol (aliphatic compound). Elemental composition – C, H, O; structure – aliphatic and aromatic.</p> <p>For Polyurethane (S15) see Polyisocyanurate rigid foam (S16)</p>
Mattress – Cotton batting	N4	See Cotton (N4)
Mattress – Polyurethane foam	S16	See Polyisocyanurate rigid foam (S16)
Pillow - Cover: cotton/ polyester blend - Fill: polyester	N4, S10	See Cotton (N4) See Polyester (S9)
Cotton sheeting	N4	See Cotton (N4)
Cotton/Polyester sheeting	N4, S10	See Cotton (N4) See Polyester (S9)
Polyester microfiber sheeting	S10	See Polyester (S9)

Sample Description	Reference Code	Material Chemistry
Rayon fabric	S23	Generic name for a manufactured fiber composed of regenerated cellulose in which >15% of hydroxyl substituents have been replaced by chemical modification (for example by acetate groups). The fiber ignites and burns readily. Chemical composition – C, H, O; structure – aliphatic
Carpeting – Nylon 6	S7	Generic name for a family of polyamide polymers characterized by the presence of an amide group (R'-CONH-R'') where R and R'' are various hydrocarbon groups. As with polyesters, nylons are used in various applications, such as textiles and structural housings. The nylon properties are dictated by the various monomers used in the polymerization and subsequent compounded fillers that may be incorporated into the structure in post processing steps. Nylon 6 is formed from the homopolymerization of caprolactam. Chemical composition – C, H, O, N; structure – aliphatic
Carpeting – Polyester	S10	See Polyester (S9)
Bread	N1	Composed primarily of starch, sugar, fats and oils.
Cooking oil	N13	Edible oils extracted from the seeds, fruit or leaves of plants. Generally considered to be mixtures of glycerides (safflower, sunflower, peanut, walnut, etc.).
Polyisocyanurate rigid foam	S17	Rigid polyurethane or polyisocyanurate foams have a high cross-link density. Crosslinking is achieved by the ratio of co-monomers and reactive group functionality. One example of rigid foam is produced by MDI (diphenyl methane diisocyanate), water, catalyst and blowing agents. Water readily reacts with isocyanates to form amine groups, which further react to form urea linkages (R-NH-CO-NH-R) in the polymer structure. Rigid foams typically have a close-cell structure and more resistant to degradation (liquefaction) due to the high cross-link density. Elemental structure – C, H, O, N; structure - aromatic
Plastic enclosure – HDPE sheet	S11	Polyethylene (PE) is based on the polymerization of ethylene (CH ₂ =CH ₂). PE polymers can have a range of properties due to factors, such as cross-link density, molecular weight, degree of branching, incorporation of co-monomers, etc. High density polyethylene is characterized by a linear structure and high molecular weight. Elemental composition – essentially C, H depending upon type and percentage of co-monomers; structure – aliphatic.
Cotton wick	N4	See Cotton (N4)
Douglas fir	N15	Wood is typically composed of 40-60% cellulose and 20-40% lignin, together with gums, resins, variable amounts of water and inorganic matter.
Ponderosa pine	N15	See Wood (N16)
Newspaper	N8	A processed product of cellulosic fibers primarily made from softwoods. Carbon black is used in the printing ink.
Heptane/Toluene	S5 S24	Heptane is a 7-carbon, hydrocarbon liquid with the formula C ₇ H ₁₆ Toluene (methyl benzene) is a 7-carbon aromatic hydrocarbon liquid composed of a 6-membered aromatic ring (benzene – C ₆ H ₆) with an attached methyl (-CH ₃) group.

EXPERIMENTAL

The selected plastics materials were characterized for their chemistry by FTIR, and the TGA for their thermal decomposition profile.

- 5 **FTIR** - Infrared spectral response of the materials was characterized in the solid-state using a Nicolet Nexus 470 FTIR with a Golden Gate KRS-5 diamond ATR accessory. Samples were scanned from 400 to 4000 cm^{-1} wavenumber at a 4 cm^{-1} resolution; 32 scans were averaged per recorded spectra.
- 10 **TGA** - Thermal decomposition of the materials were characterized using a TA Instruments model Q500 TGA with an evolved gas analysis (EGA) furnace. Samples weighing between 10 to 50 milligrams were heated from 40 to 825 °C at 20 °C/min under a 90 mL/min dry air flow rate.

RESULTS

The material characterization results are provided along with photographs in Appendix B.

TASK 2 – DEVELOP SMOKE CHARACTERIZATION ANALYTICAL TEST PROTOCOL USING FLAMING AND NON-FLAMING MODES OF COMBUSTION

5 TASK OBJECTIVES

The objectives of this task were as follows:

- Develop sampling method for smoke particle size and gas effluent analysis
- Develop smoke particle size and count distribution data from UL 217 *Sensitivity Test* (Smoke Box)
- 10 • Develop combustibility, smoke particle size and gas effluent data using small and intermediate scale tests
- Develop flaming and non-flaming scenarios for potential use in Task 3 – UL 217/UL 268 Fire Test Room tests

15

SMOKE CHARACTERIZATION

Equipment

A smoke particle analyzer and a gas FTIR analyzer were used to characterize the smoke particle size and gas effluents.

20

Smoke Particle - Smoke particle size and count distribution was characterized using a Model WPS 1000XP wide range particle size spectrometer from MSP Corporation (WPS spectrometer). The WPS spectrometer combines laser light scattering, electrical mobility and condensation particle counting technologies in a unique, single instrument with the capability of measuring the concentration and size distribution of aerosol particles ranging from 10 nm to 10,000 nm (0.01 μm to 10 μm) in diameter. The instrument divides a 1 Liter/min sample flow between the dynamic mobility analyzer (DMA) and the light particle spectrometer (LPS) modules to develop the particle size distribution. The LPS module is sensitive to particle sizes greater than 200 nm (0.2 μm) whereas the DMA module is sensitive to particle sizes ranging from 10 nm to 500 nm (0.01 μm to 0.50 μm). The instrumentation measurement sensitivity is limited to a particle concentration not exceeding 2×10^7 particles/cc.

25

30

Effluent Gas Composition - Gas effluent composition was characterized using a MIDAC #1 1100 Fourier Transform Infrared (FTIR) Spectrometer equipped with a 10 meter path length optical cell. The UL FTIR equipment has gas calibration library to calculate the concentration of the key gas components detected. The instrument has a measurement range of 600 to 4000 cm^{-1} wavenumber and a resolution of 0.5 cm^{-1} .

35

Measurement Method

40 Smoke samples were extracted from the respective test apparatus for particle size distribution and effluent gas composition analyses as depicted in Figure 1. The smoke samples were diluted with nitrogen gas (UHP grade, 99.999%) as necessary to prevent saturation of the detection instrument. The sample flow and the nitrogen gas flows were controlled using rotameters.

Extracted smoke sample

Figure 1 – Schematic of the sampling method

5 **Smoke Particle** - Particle sizes were measured by the DMA module at a rate of 2 seconds per size interval (bin). For the data reported herein, the DMA analyzer was set to obtain data for 24 size intervals resulting in an ensemble measurement time of 48 seconds. Particle size measurements by the LPS module are instantaneous, however the recorded count is an average over the 48 second ensemble measurement time. The analyzer was purged between successive
 10 ensemble measurements resulting in subsequent measurements being collected at 67 second intervals.

Effluent Gas Composition - Infrared spectra of the effluent gas were continuously collected at 15 second intervals. Each spectrum was based on the signal average of 8 individual scans at a resolution of 0.5 cm⁻¹. Prior to testing, a background reference spectrum was collected. The background reference spectrum was based on the signal average of 32 individual scans at a resolution of 0.5 cm⁻¹.

Smoke Particle Analysis

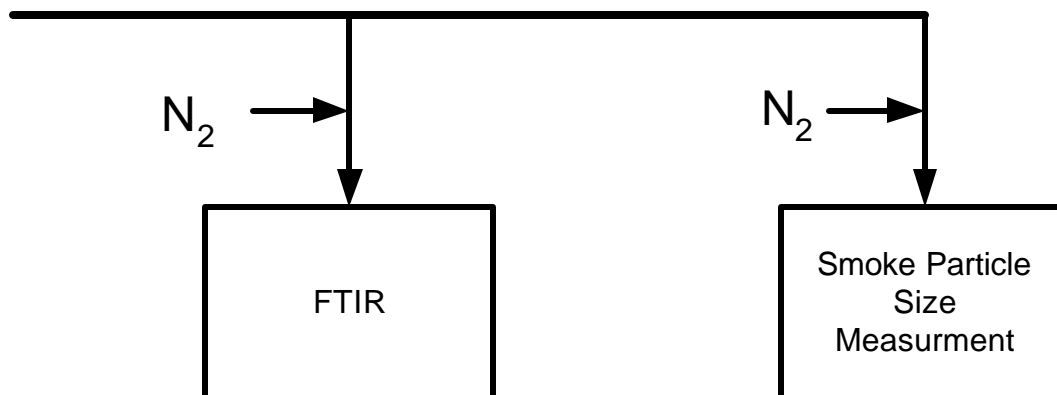
20 In order to interpret collected smoke particle data, a correlation based on Beer's Law was developed for smoke obscuration and smoke particle size and count. Beer's Law as applied to smoke relates optical density per unit path length to smoke concentration as shown in Eq. 1.

$$\frac{OD}{\ell} \propto C_s \quad \text{Eq. 1}$$

Where OD is the optical density, ℓ is path length, and C_s is the smoke concentration at a given time. The smoke concentration is related to the smoke number density as shown in Eq. 2.

$$C_s \propto \sum n_i \cdot d_i^3 \quad \text{Eq. 2}$$

25 Where n_i and d_i are the number count (density) and particle diameter for a given particle size i . Thus a relationship between optical density per path length and the number count at a given time may be established as described in Eq. 3.

$$\frac{OD}{\ell} \propto \sum n_i \cdot d_i^3 \quad \text{Eq. 3}$$

The following notation is used in the remaining body of this report to distinguish the three levels of particle data collected on the WPS spectrometer:

- 5 n_i, d_i individual bin size data
- n_m, d_m mean ensemble data (the arithmetic mean of the 24 bins of data measured per ensemble) such that:

$$n_m = \frac{\sum_{i=1}^{24} n_i}{24} \quad \text{Eq. 4}$$

$$d_m = \frac{\sum_{i=1}^{24} n_i \cdot d_i}{\sum_{i=1}^{24} n_i} \quad \text{Eq. 5}$$

- 10 N_m, D_m time averaged mean ensemble data (the arithmetic mean of all measured ensembles) such that:

$$N_m = \frac{\sum_{t=0}^{\text{finish}} n_m}{\text{number of scans}} \quad \text{Eq. 6}$$

$$D_m = \frac{\sum_{t=0}^{\text{finish}} d_m \cdot n_m}{\sum_{t=0}^{\text{finish}} n_m} \quad \text{Eq. 7}$$

15 Effluent Gas Analysis

A simple mixing model was used to deconvolute the effects of the FTIR gas cell retention time on the measured effluent gas concentrations. The relevant quantities are the fixed volumetric flow rate, $\dot{v}_{in} = \dot{v}_{out} = \dot{v}$, of the effluent gas sample through a well-mixed controlled volume V_o (the FTIR cell) at atmospheric pressure and a temperature of 120 °C. The mass flow rate for a given effluent gas component i leaving the control volume at constant air density ? is:

$$\dot{m}_{i,out} = \frac{d(\rho V[i])}{dt} = \rho[i] \frac{dV}{dt} + \rho V \frac{d[i]}{dt} = \rho[i]_{out} \dot{v} + \rho V \frac{d[i]}{dt} \quad \text{Eq. 8}$$

The mass flow rate for the given component i entering the control volume is:

$$\dot{m}_{i,int} = \frac{d(\rho V[i])}{dt} = \rho[i] \frac{dV}{dt} + \rho V \frac{d[i]}{dt} = \rho \dot{v}[i]_{in} \quad \text{Eq. 9}$$

since $d[i]/dt = 0$ for the incoming gas species at $[i]_{in}$. The mass balance for the gas is:

$$\dot{m}_{i,in} - \dot{m}_{i,out} = 0 \quad \text{Eq. 10}$$

Combining Eq. 8, Eq. 9, and Eq. 10 results in the deconvoluted incoming gas concentration:

$$[i]_{in} = \tau \frac{d[i]}{dt} + [i]_{out} \quad \text{Eq. 11}$$

such that the FTIR gas cell retention time τ is defined as \dot{v} / V_o .

5

The following values were used for the calculations:

\dot{v} = measured FTIR sample flow rate

V_o = FTIR cell volume = 2 liters

10

CHARACTERIZATION OF SMOKE IN UL 217 SENSITIVITY TEST

Introduction

- 5 The UL 217 *Sensitivity Test* (Section 37) is used to determine the relative sensitivity of smoke alarms to smoke/aerosol buildup. In this test a smoke alarm is enclosed in a sealed case with a constant re-circulating airflow and subjected to a prescribed rate of smoke/aerosol buildup. The smoke alarm must operate within specified visible smoke obscuration value between 0.5 and 4.0 %/ft, and MIC signal 93 to 37.5 pA.
- 10 Analysis of smoke generated during UL 217 Sensitivity Tests was used to (i) develop smoke particle size data for the reference smoke alarm test; (ii) compare smoke particle size to obscuration data; and (iii) develop understanding of smoke aggregation as a function of test time.

Experimental

- 15 UL 217 Sensitivity Tests were conducted in accordance with Section 37 of UL 217 *Single and Multiple Station Smoke Alarms* using Underwriters Laboratories' UL 217 Sensitivity Test case (smoke box). Aerosol buildup, by smoke generated by a non-flaming cotton wick, followed the relationship between the MIC (Elektronikcentralen Type EC 23095) output and the percent light transmission remains within the Beam and MIC curves illustrated in UL 217 (Figures 37.1, and
- 20 37.2). The air velocity in the test compartment was maintained at 32 +/-2 fpm (0.16 +/-0.001 m/s). A photograph of the UL 217 Smoke Box is shown in Figure 2; detailed descriptions of the smoke box assembly are available in the UL 217.



Figure 2 – UL 217 Smoke Box

- 25 Smoke particle size and count density was characterized using the WPS spectrometer. The sampling was accomplished by inserting a 6.25 mm O.D. conductive silicone tube 90 mm into the Smoke Box from the top. Thus, the sample point was located in the center of the flow path.

The other end of the conductive tubing was connected directly to the WPS Spectrometer. The collected smoke sample was not diluted with nitrogen as relatively low concentrations of smoke were anticipated. The schematic of the WPS connected to the Smoke Box is presented in Figure 3.

5



Figure 3 – WPS Spectrometer connected to the UL 217 Smoke Box

10 Prior to testing, the Smoke Box was exhausted and a background check was conducted with the WPS spectrometer to ensure low particle count density (less than 10^3 particle/cc). The test was initiated after igniting the cotton wick, placing it in the sample holder (Figure 2), and closing the lid. The data acquisition for both the smoke box and the WPS spectrometer were then initiated simultaneously.

15 A total of two tests were conducted and both were terminated after approximately 15 minutes.

Results

20 The mean smoke particle diameter (d_m) and mean smoke particle count (n_m) for the non-flaming cotton wick are plotted as a function of test time in Figure 4 for both of the test runs. The results from the two tests show repeatability of particle measurements over the duration of the tests.

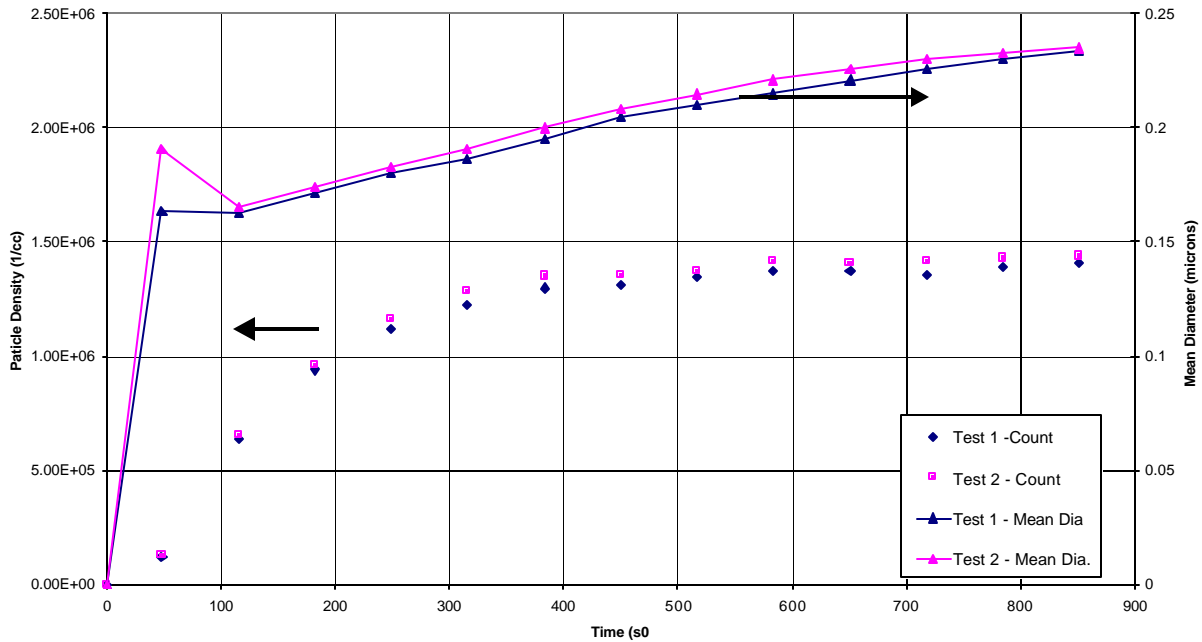

Figure 4 – UL 217 Smoke Box mean smoke particle size diameter for non-flaming cotton wick

Smoke particle count was separated into three relative size groups to differentiate the population of small, medium, and large particles. The 0.03 to 0.109 μm range characterizes small particles, 0.109 to 0.500 μm range for medium particles, and 0.500 to 10 μm range for large particles. Relative particle size counts plotted in Figure 5 indicate that over time there is a gradual increase in the number of large particles and a gradual decrease in small particles. Aggregation of smaller particles into fewer larger particles is a potential explanation for the observed phenomenon.

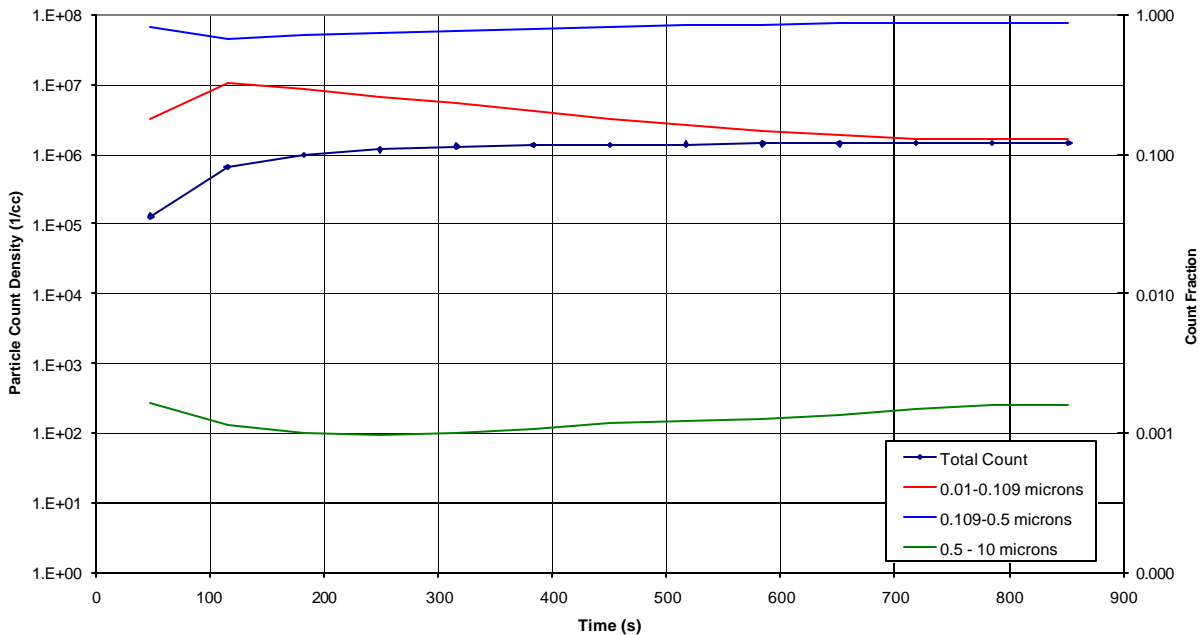

Figure 5 – UL 217 Smoke Box relative smoke particle count for non-flaming cotton wick

Particle size density, $\sum n_i \cdot d_i^3$, was calculated for each WPS spectrometer measured particle ensemble data. This calculated data was plotted against optical density per path length calculated from the measured smoke obscuration data and averaged over the same time period as the smoke particle ensemble data. The results, depicted in Figure 6, show agreement with the expected relationship described in Eq. 3.

5

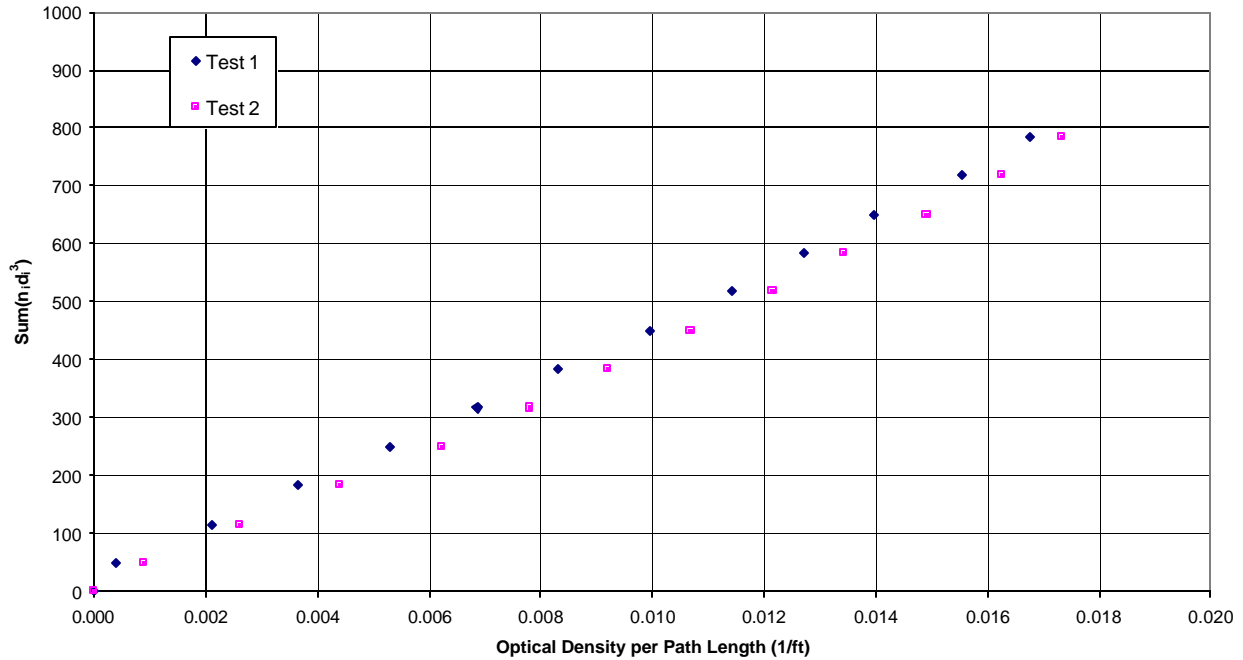

Figure 6 – Relationship between smoke particle size and optical density (UL 217 Sensitivity Test) for non-flaming cotton wick

10 The MIC response is related to the physical characteristics of the ionization chamber α and the attachment coefficient of air-molecule ions to the soot particles β such that $\beta = 2\pi D \cdot d_m$, where D is the ion diffusion coefficient.⁹ Thus MIC response is related to the product of particles count and diameter as shown in Eq. 12.

$$\Delta MIC \sim d_m \cdot n_m \tag{Eq. 12}$$

15

The MIC data were averaged over the sampling time of the particle analyzer and the number density and diameter product was plotted on the y-axis as shown in Figure 7. The data shows the linear relationship between the particle density and the MIC signal as expected from Eq. 12.

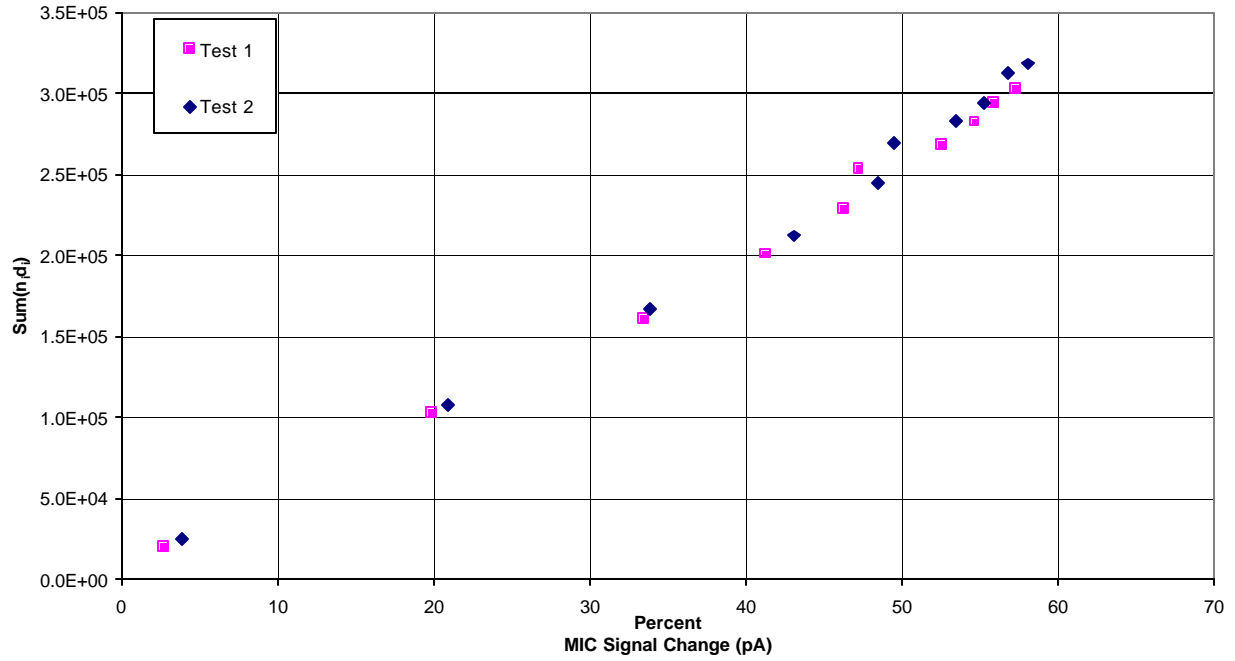

Figure 7 – Relationship between the MIC signal and particle density in the UL 217 Smoke Box for non-flaming cotton wick

SMALL-SCALE TESTS

Introduction

5 The ASTM E1354 cone calorimeter was selected to investigate the combustion of various materials on a small-scale because it can simulate well-ventilated, early stage fires and allows control of the heating conditions leading to thermal decomposition and ignition of the test sample.

In this portion of the investigation, solid and liquid test samples were evaluated under flaming and non-flaming combustion conditions.

10

Test Samples

Test samples were selected from the list in Table 2 and included both natural and synthetic materials with different chemical structures. The selected samples are presented in Table 4.

Table 4 – Cone calorimeter test samples

Test Sample	Comment
3:1 Heptane/Toluene mixture	UL 217 test material – mixture of short straight chain and simple aromatic hydrocarbon molecules
Douglas fir	UL 217 test material
Newspaper	UL 217 test material
Ponderosa pine	UL 217 test material
Heptane	Hydrocarbon liquid – short straight chain hydrocarbon
HDPE	Polyolefin plastic – long straight chain hydrocarbon
Bread	Potential nuisance source
Lard	Used in cooking; Potential nuisance source
Cooking oil	Hydrocarbon liquid – “intermediate” length hydrocarbon
Mattress composite	Natural and synthetic materials; Commonly found in home furnishings
Mattress PU foam	Synthetic; Flexible, open cell structure; Commonly found in home furnishings
Cotton batting	Natural material; Commonly found in home furnishings
Polyester pillow stuffing	Aromatic; Commonly found in home furnishings
CA TB 117 50:50 Cotton/ Polyester blend fabric	Natural and synthetic materials blend; Commonly found in bed clothing and apparel
Rayon fabric	Synthetic; Commonly found in apparel
Nylon carpet	Synthetic; Commonly found as a flooring product
PET carpet	Synthetic; Commonly found as a flooring product
Polyisocyanurate insulation foam	Synthetic; Rigid, closed cell structure; Commonly found as insulation
PVC wire	Common electrical wiring

15

Solid test specimen measuring 100×100 mm square were cut and tested in a horizontal orientation using an edge frame sample holder with a restraining grid (HEG) such that the intended outer surface of the material was exposed to the applied radiant heat flux. Liquid samples were tested in 50 mL quantities using a glass Petri dish with a surface area of 0.0061 m^2 .

20

Examples of a solid and liquid sample are presented in Figure 8.

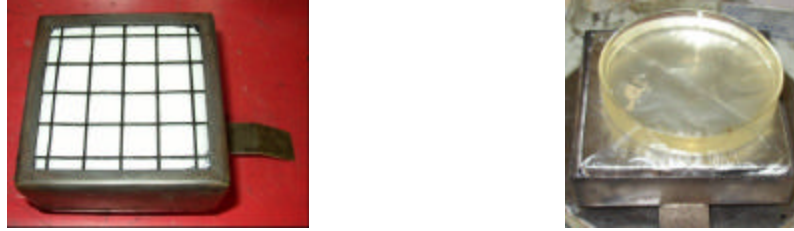
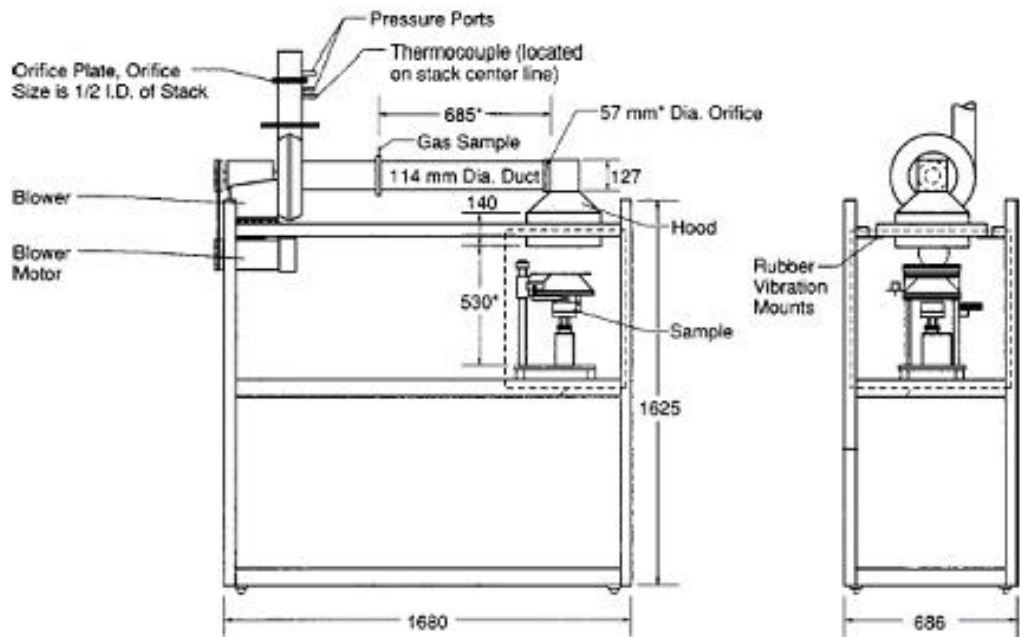

Figure 8 – Cone Calorimeter sample holder

Experimental

- 5 **Cone Calorimeter** - Cone calorimeter tests were conducted in accordance with test method ASTM E1354 *Standard Test Method for Heat and Visible Smoke Release Rates for Materials and Products Using an Oxygen Consumption Calorimeter*. The apparatus consists of a conical shaped electrical heater capable of heating a test sample with radiant heat flux of up to 100 kW/m², a load cell, a laser smoke obscuration system, and gas analysis equipment. A schematic of the Cone Calorimeter is shown in Figure 9.
- 10



Note 1—All dimensions are in millimetres.
 Note 2—* Indicates a critical dimension.

Figure 9 – Schematic of ASTM E 1354 cone calorimeter

- 15 Flaming mode tests were performed at 35 kW/m² radiant heat flux setting on the conical heater and using an electric spark igniter to ignite the thermal decomposition gases. Non-flaming mode tests were conducted at a radiant heat flux of 15 kW/m² but the combustion products were not

ignited using the electric spark igniter. Since heptane is a flammable liquid, it was tested without the application of external radiant heating, but a spark was used to ignite the vapors.

5 For the flaming mode, data was collected until flaming or other signs of combustion ceased. For the non-flaming mode, the test duration was ten minutes in order to collect sufficient data for this investigation. Observations regarding ignition time and physical changes to the sample (*i.e.* melting, swelling, or cracking) were also noted.

10 The heat and smoke release rates, effective heat of combustion, and specific extinction area were calculated using the procedures described in ASTM E1354 and are summarized in the following equations.

Heat release relations:

$$\text{HRR} = \frac{\text{Measured heat}}{\text{Sample area}} \quad [=] \text{ kW/m}^2 \quad \text{Eq. 14}$$

$$\text{Total Heat} = \frac{\int_{\text{ignition}}^{\text{completion}} \text{HRR} \cdot dt}{1000 \text{ MJ/kJ}} \quad [=] \text{ MJ/m}^2 \quad \text{Eq. 15}$$

$$\text{Effective Heat of Combustion} = \frac{\text{Total Heat} \cdot \text{Sample area}}{\text{Total weight loss} \cdot 1000 \text{ kJ/MJ}} \quad [=] \text{ kJ/g} \quad \text{Eq. 16}$$

Smoke release relations:

$$\begin{aligned} \text{SRR} &= \text{Volumetric flow rate} \times \frac{\text{Optical density}}{\text{Sample path length}} \quad [=] \text{ m}^2/\text{s} \\ &= \text{Extinction Coefficient } (\epsilon) \times \text{Mass flow rate} \end{aligned} \quad \text{Eq. 17}$$

$$\text{Total Smoke} = \int_{\text{ignition}}^{\text{completion}} \text{SRR} \cdot dt \quad [=] \text{ m}^2 \quad \text{Eq. 18}$$

$$\text{Specific extinction area} = \frac{\text{Total Smoke}}{\text{Total weight loss}} \quad [=] \text{ m}^2/\text{g} \quad \text{Eq. 19}$$

20 Combining Eq. 17 through Eq. 19, it may be observed that the Smoke Yield is proportional to the Extinction Coefficient (ϵ) and Specific Extinction Area (σ) as:

$$\text{Smoke Yield} = \frac{\epsilon}{\sigma} \quad [=] \text{ dimensionless} \quad \text{Eq. 20}$$

25 Babrauskas and Mulholland^{10,11} have been found that the Extinction Coefficient is relatively constant at 8,500 m²/kg for well-ventilated combustion of a wide variety of fuels.

Smoke Particle and Gas Effluent Sampling - A custom gas effluent and smoke sampling system for the Cone Calorimeter was designed and constructed to condition the evolved smoke for analyses in the WPS spectrometer and the gas FTIR spectrometer. A schematic of the sampling system is shown in Figure 10. The sampling port was located 0.6 m away from the cone hood in the exhaust duct and the sample line was divided to the two spectrometers. Smoke and gas samples lines were diluted with nitrogen gas (UHP grade, 99.999%) to prevent saturation of the respective detection instrument. The dilution ratio for the FTIR spectrometer was 2 and the dilution ratio for the WPS spectrometer ranged from 8 to 21. The actual dilution flow rates were documented for each test and used in the calculation of the smoke particle counts and gas effluent concentration.

Sample lines to the spectrometers were 3 m long with a 3.2 mm I.D. The sample line to the FTIR was maintained at 120 °C to prevent condensation of generated water vapor in the effluent gas stream.

Because the sampling port was facing downstream, it is anticipated that the data obtained will be biased towards the smaller particles. In addition, some particulates are anticipated to be lost due to adhesion to the sampling tube. The sampling tubes were cleaned prior to each test.

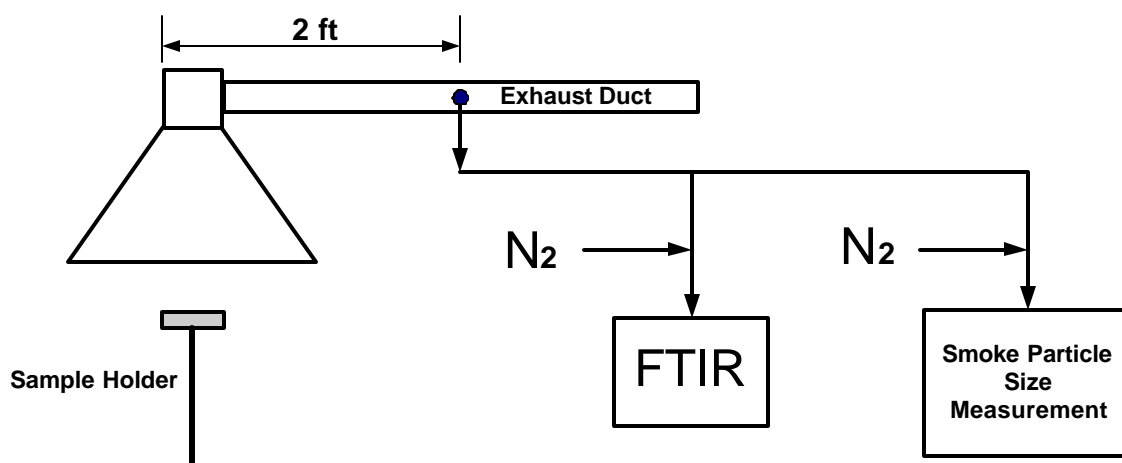

Figure 10 – Schematic of the gas effluent and smoke measurement system for the cone calorimeter

Prior to each test, the FTIR gas spectrometer and the WPS spectrometer were purged with ambient air. Both the analyzers were checked to ensure that the background signal was insignificant prior to initiating a test.

Smoke Particle Characterization - Smoke particle size and count was characterized using the WPS spectrometer previously described in the Smoke Characterization section.

Effluent Gas Composition Characterization - Gas effluent composition was characterized using the FTIR spectrometer and deconvoluted as previously described in the Smoke Characterization section (Eq. 8 through Eq. 11).

In order to determine the mass of the generated effluent gases, the deconvoluted FTIR concentrations $[i]_{in}$ must be corrected for temperature differences between the FTIR cell and the

cone calorimeter sampling port, the cone calorimeter mass flow rate, and respective gas molecular weight:

$$\text{Mass}_{\text{gas}} = \int \left([i]_{\text{in}} \cdot \frac{T_{\text{FTIR}}}{T_{\text{cone}}} \right) \cdot (\text{Cone Flow Rate}) \cdot \left(\rho_{\text{air}} \cdot \frac{\text{MW}_{\text{gas}}}{\text{MW}_{\text{air}}} \right) \cdot dt [=] \text{ g} \quad \text{Eq. 21}$$

such that the density of air is $353.22/T_{\text{cone}}$.

- 5 The following values were used for the calculations:

T_{FTIR} = FTIR cell temperature = 393 K

T_{cone} = Cone effluent gas temperature measured at photocell

MW_{air} = Molecular weight of air = 28.97 g/mol

- 10 **Exposure Scenario** - The exposure scenario used to conduct the flaming and non-flaming tests are summarized in Table 5 and Table 6 respectively.

Table 5 – Test parameters for cone calorimeter flaming mode tests

Test Sample	Heat Flux (kW/m ²)	Sample Area (m ²)	Initial Weight (g)		Dilution Rate	
			Test 1	Test 2	FTIR	WPS
UL 217 Heptane/Toluene mixture	0	0.0061	32.8	--	2	16
Heptane	0	0.0061	32.7	33.3	2	16
UL 217 Douglas fir	35	0.0088	98.8	94.3	2	16
UL 217 Newspaper	35	0.0088	7.0	7.0	2	16
UL 217 Ponderosa pine	35	0.0088	91.9	93.4	2	16
HDPE	35	0.0088	61.8	61.9	2	13
Bread	35	0.0088	22.8	22.1	2	21
Cooking oil	35	0.0061	40.0	40.2	2	16
Mattress composite	35	0.0088	9.0	9.1	2	16
Mattress PU foam	35	0.0088	7.2	7.2	2	16
Cotton batting	35	0.0088	5.9	6.0	2	16
Polyester pillow stuffing	35	0.0088	4.0	4.0	2	16
CA TB 117 50:50 Cotton/ Polyester blend fabric	35	0.0088	10.1	10.2	2	16
Rayon fabric	35	0.0088	9.9	9.8	2	8.5
Nylon carpet	35	0.0088	29.2	30.0	2	18
PET carpet	35	0.0088	29.5	29.0	2	16
Polyisocyanurate insulation foam	35	0.0088	6.0	5.6	2	16
PVC wire	35	0.0088	78.5	78.5	2	16

Table 6 – Test parameters for cone calorimeter non-flaming mode tests

Test Sample	Heat Flux (kW/m ²)	Sample Area (m ²)	Initial Weight (g)		Dilution Rate	
			Test 1	Test 2	FTIR	WPS
UL 217 Douglas fir	15	0.0088	100.9	99.0	2	21
UL 217 Newspaper	15	0.0088	7.0	7.0	2	16
UL 217 Ponderosa pine	15	0.0088	91.1	90.9	2	16
HDPE	15	0.0088	60.6	61.6	2	21
Bread	15	0.0088	20.7	24.0	2	16
Lard	15	0.0061	63.5	--	2	16
Cooking oil	15	0.0061	40.0	40.0	2	16
Mattress composite	15	0.0088	9.3	9.3	2	16
Mattress PU foam	15	0.0088	7.2	7.3	2	16
Cotton batting	15	0.0088	7.0	7.8	2	16
Polyester pillow stuffing	15	0.0088	4.0	4.1	2	16
CA TB 117 50:50 Cotton/ Polyester blend fabric	15	0.0088	9.9	10.0	2	16
Rayon fabric	15	0.0088	9.9	10.0	2	16
Nylon carpet	15	0.0088	30.0	28.9	2	21
PET carpet	15	0.0088	29.5	27.6	2	16
Polyisocyanurate insulation foam	15	0.0088	5.8	5.7	2	16
PVC wire	15	0.0088	78.5	78.5	2	16

Test Results

The cone calorimeter combustibility results from the tests included ignition time, sample weight, heat and smoke release rates, effective heat of combustion, and specific extinction area.

- 5 Sample ignition occurred in all flaming mode tests. Sample ignition was not observed in any of the non-flaming tests, however thermal degradation was observed in some of the tests. Combustibility data for flaming and non-flaming tests are summarized in Table 7 and Table 8 respectively.
- 10 The smoke particle size distribution data measured on the WPS spectrometer were analyzed to calculate the mean particle diameter D_m and count N_m for each test as described by Eq. 6 and Eq. 7. Mean particle count was further corrected to compensate for weight loss differences between the evaluated materials as described in Eq. 22.
- $$\text{Specific } N_m = N_m / \text{weight loss [=} \text{]} \text{ cm}^{-3} \cdot \text{g}^{-1} \quad \text{Eq. 22}$$
- 15 Similarly the gas concentrations were also normalized by weight loss to determine the yield.
- Mean smoke particle size, specific mean particle counts, maximum specific carbon monoxide and carbon dioxide concentrations, and carbon monoxide and carbon dioxide yields for flaming and non-flaming tests are summarized in Table 9 and Table 10 respectively.
- 20 Individual results for flaming and non-flaming combustion tests are plotted in Appendix C and D respectively.

25

Table 7 – Cone calorimeter combustibility data for small-scale flaming mode tests

Sample Description	Ignition Time (s)	Total Weight Loss (g)	Weight Loss Fraction (%)	Effective HOC (kJ/g)	Peak HRR (kW/m ²)	Peak SRR (m ² /s)	Specific Ext. Area (m ² /g)
UL 217 Heptane/Toluene mix	42	32.80	100.0	40.7	715	0.066	0.492
Heptane	6	32.70	100.0	43.0	543	0.010	0.117
	10	33.25	100.0	44.1	577	0.010	0.111
UL 217 Douglas fir	87	85.76	86.8	12.5	155	0.010	0.048
	86	84.13	89.2	11.4	133	0.008	0.016
UL 217 Newspaper	15	7.00	100.0	15.1	89	0.010	0.010
	7	7.00	100.0	13.8	109	0.004	0.007
UL 217 Pond. pine	58	77.50	84.3	11.3	142	0.005	0.004
	90	76.05	81.4	12.2	154	0.011	0.010
HDPE	144	29.97	48.5	30.0	467	0.051	0.285
	140	47.88	77.4	22.2	629	0.060	0.215
Bread	17	20.11	88.5	6.8	83	0.021	0.117
	63	19.65	89.1	6.3	67	0.016	0.084
Cooking oil	130	39.97	100.0	32.7	549	0.069	0.743
	138	40.15	100.0	33.5	584	0.069	0.736
Mattress composite	16	8.99	100.0	20.6	193	0.021	0.142
	14	9.08	100.0	21.2	196	0.020	0.158
Mattress PU foam	3	7.22	100.0	23.7	250	0.014	0.077
	6	7.22	100.0	23.3	240	0.014	0.083
Cotton batting	13	5.13	86.9	14.2	164	0.040	0.239
	12	5.29	88.2	15.4	175	0.040	0.242
Polyester pillow stuffing	73	4.04	100.0	15.9	176	0.050	0.323
	144	4.00	100.0	16.5	204	0.057	0.414
Cotton/Polyester blend fabric	24	9.89	97.5	15.1	338	0.066	0.271
	37	10.16	100.0	16.9	318	0.072	0.295
Rayon fabric	68	9.85	100.0	14.1	222	0.010	0.052
	38	9.77	100.0	16.0	213	0.008	0.078
Nylon carpet	105	21.27	72.9	29.1	410	0.084	0.467
	125	21.40	71.3	31.9	453	0.094	0.458
PET carpet	114	19.11	64.9	18.3	259	0.080	0.545
	94	18.32	63.2	19.4	260	0.076	0.521
Polyisocyanurate foam	9	2.66	44.6	7.9	67	0.005	0.117
	16	2.84	51.1	9.1	94	0.008	0.078
PVC wire	43	26.47	33.7	16.2	197	0.100	0.739
	39	27.30	34.8	14.9	182	0.094	0.733

Table 8 – Cone calorimeter combustibility data for small-scale non-flaming mode tests

Sample Description	Total Weight Loss (g)	Weight Loss Fraction (%)	Peak HRR (kW/m²)	Peak SRR (m²/s)	Total Smoke (m²)	Specific Ext. Area (m²/g)
UL 217 Douglas fir	4.22	4.2	trace ^[1]	trace	trace	---
	4.32	4.4	trace	trace	trace	---
UL 217 Newspaper	6.71	95.9	22	0.012	2.1	0.315
	5.78	82.6	14	0.012	2.2	0.371
UL 217 Ponderosa pine	9.04	9.9	trace	trace	trace	---
	9.49	10.4	trace	trace	trace	---
HDPE	3.29	5.4	trace	trace	trace	---
	0.33	0.5	trace	trace	trace	---
Bread	11.79	57.0	trace	0.008	2.1	0.176
	18.13	75.7	trace	0.009	4.4	0.244
Lard	0.24	0.4	trace	trace	trace	---
Cooking Oil	0.51	1.3	trace	trace	trace	---
	0.61	1.5	trace	trace	trace	---
Mattress composite	4.89	52.5	trace	0.014	4.2	0.849
	5.00	53.8	trace	0.016	3.3	0.668
Mattress PU Foam	3.43	47.4	trace	0.009	2.7	0.786
	4.56	62.6	trace	0.009	4.8	1.042
Cotton Batting	2.34	33.4	trace	0.004	1.4	0.604
	3.25	41.6	trace	0.005	2.3	0.714
Polyester pillow stuffing	0.41	10.4	trace	trace	trace	---
	0.42	10.2	trace	trace	trace	---
Cotton/Polyester blend fabric	5.35	54.1	trace	0.007	2.8	0.530
	5.28	53.0	trace	0.007	3.0	0.560
Rayon fabric	9.90	100.0	19	0.012	2.7	0.273
	9.99	100.0	19	0.014	3.0	0.297
Nylon Carpet	1.22	4.1	trace	trace	trace	---
	1.20	4.2	trace	trace	trace	---
PET Carpet	1.26	4.3	trace	trace	trace	---
Polyisocyanurate foam	1.44	24.9	trace	trace	trace	---
	1.62	28.4	trace	trace	trace	---
PVC wire	18.34	23.2	trace	0.005	2.3	0.127
	12.21	15.6	trace	0.006	2.2	0.177

Note to Table 8:

^[1] A value of 'trace' indicates that the measured values were less than the resolution of the instrument.

Table 9 – Smoke particle and gas effluent data for small-scale flaming mode tests

Sample Description	Smoke Particles		Effluent CO		Effluent CO ₂	
	D _m (mm)	Specific N _m (1/cc/g)	Max (ppm)	Yield (g/g)	Max (ppm)	Yield (g/g)
UL 217 Heptane/Toluene mix	0.264	9.60E+04	318	0.069	69	2.143
Heptane	0.199	1.10E+05	63	0.020	20	2.471
	0.195	1.28E+05	68	0.022	22	2.413
UL 217 Douglas fir	0.073	4.36E+04	297	0.087	87	0.998
	0.040	9.09E+04	291	0.093	93	0.928
UL 217 Newspaper	0.041	9.63E+05	434	0.259	259	1.194
	0.046	1.25E+06	429	0.264	264	1.203
UL 217 Ponderosa pine	0.037	5.14E+04	386	0.092	92	1.468
	0.034	8.02E+04	344	0.071	71	1.147
HDPE	0.167	8.48E+04	229	0.039	39	1.199
	0.158	3.40E+04	369	0.043	43	1.439
Bread	0.059	4.96E+05	161	0.099	99	0.488
	0.071	6.31E+05	190	0.113	113	0.474
Cooking oil	0.226	4.20E+04	341	0.097	97	2.162
	0.293	1.40E+05	372	0.101	101	2.276
Mattress composite	0.045	2.04E+06	158	0.140	140	0.881
	0.048	6.13E+05	190	0.146	146	1.812
Mattress PU foam	0.050	2.13E+06	64	0.029	29	1.060
	0.048	1.83E+06	79	0.044	44	1.455
Cotton batting	0.095	9.92E+05	326	0.310	310	1.360
	0.092	8.03E+05	301	0.278	278	1.179
Polyester pillow stuffing	0.091	1.29E+06	229	0.187	187	1.362
	0.093	1.01E+06	242	0.137	137	1.516
Cotton/Polyester blend fabric	0.083	2.62E+05	414	0.217	217	1.593
	0.085	5.68E+05	393	0.227	227	1.426
Rayon fabric	0.054	1.69E+05	226	0.113	113	1.559
	0.067	1.44E+05	164	0.092	92	1.034
Nylon carpet	0.134	3.11E+05	347	0.066	66	1.725
	0.112	5.28E+05	431	0.069	69	1.800
PET carpet	0.128	1.91E+05	385	0.141	141	1.211
Polyisocyanurate foam	0.070	2.42E+05	133	0.041	41	0.204
	0.063	3.11E+06	104	0.164	164	0.562
PVC wire	0.135	2.90E+06	88	0.132	132	0.430
	0.138	3.15E+05	492	0.115	115	0.859

Table 10 – Smoke particle and gas effluent data for small-scale non-flaming mode tests

Sample Description	Smoke Particles		Effluent CO		Effluent CO ₂	
	D _m (mm)	Specific N _m (1/cc/g)	Max (ppm)	Yield (g/g)	Max (ppm)	Yield (g/g)
UL 217 Douglas fir	0.136	1.05E+05	10	0.017	17	0.000
	0.141	1.05E+05	12	0.023	23	0.000
UL 217 Newspaper	0.101	4.41E+05	319	0.673	673	0.549
	0.103	4.91E+05	275	0.901	901	0.687
UL 217 Ponderosa pine	0.132	7.28E+04	59	0.129	129	0.141
	0.156	8.08E+04	63	0.129	129	0.054
HDPE	0.076	1.64E+05	10	0.019	19	0.246
	0.076	1.65E+06	12	0.218	218	0.019
Bread	0.095	2.15E+05	84	0.043	43	0.164
	0.104	2.28E+05	94	0.106	106	0.210
Lard	0.075	5.13E+06	3	0.085	-- ^[1]	-- ^[1]
Cooking Oil	0.079	1.94E+06	2	0.093	93	0.612
	0.077	1.89E+06	2	0.055	55	1.299
Mattress composite	0.061	5.66E+05	194	0.255	255	0.112
	0.072	5.32E+05	203	0.266	266	0.273
Mattress PU Foam	0.085	1.86E+06	14	0.044	44	0.699
	0.076	2.89E+06	14	0.047	47	0.152
Cotton Batting	0.086	7.09E+05	42	0.262	262	0.745
	0.105	5.94E+05	107	0.318	318	0.298
Polyester pillow stuffing	0.041	1.33E+06	2	0.033	-- ^[1]	-- ^[1]
	0.047	6.95E+05	2	0.036	-- ^[1]	-- ^[1]
Cotton/Polyester blend fabric	0.136	1.18E+05	138	0.388	388	0.391
	0.116	3.01E+05	60	0.311	311	0.884
Rayon fabric	0.088	2.64E+05	502	0.738	738	0.340
	0.093	2.21E+05	503	0.686	686	0.311
Nylon Carpet	0.072	1.86E+06	12	0.095	95	0.138
	0.079	1.66E+06	13	0.104	104	0.002
PET Carpet	0.133	5.71E+05	25	0.215	215	0.243
	0.120	3.41E+04	28	0.011	11	0.009
Polyisocyanurate foam	0.082	7.71E+05	7	0.065	65	1.230
	0.073	1.01E+06	6	0.063	63	0.179
PVC Wire	0.132	3.70E+04	16	0.008	8	0.145
	0.100	3.19E+05	103	0.085	85	0.258

Note to Table 10:

^[1] Observed carbon dioxide levels are suspect.

5 **Discussion of small-scale flaming combustion results**

Comparison of heat release rates and an effective inherent heat of combustion in the flaming mode (note that heptane and the heptane-toluene mixture were ignited without any incident heat flux), plotted in Figure 11, indicate that natural cellulosic materials generally have the lowest heat release whereas hydrocarbon and synthetic materials have the highest heat release. The heat releases exhibited by the natural cellulosic materials and synthetic materials prescribed by UL

217 are in the same range as the other evaluated materials. Materials with higher effective heat of combustion exhibit greater peak heat release rates.

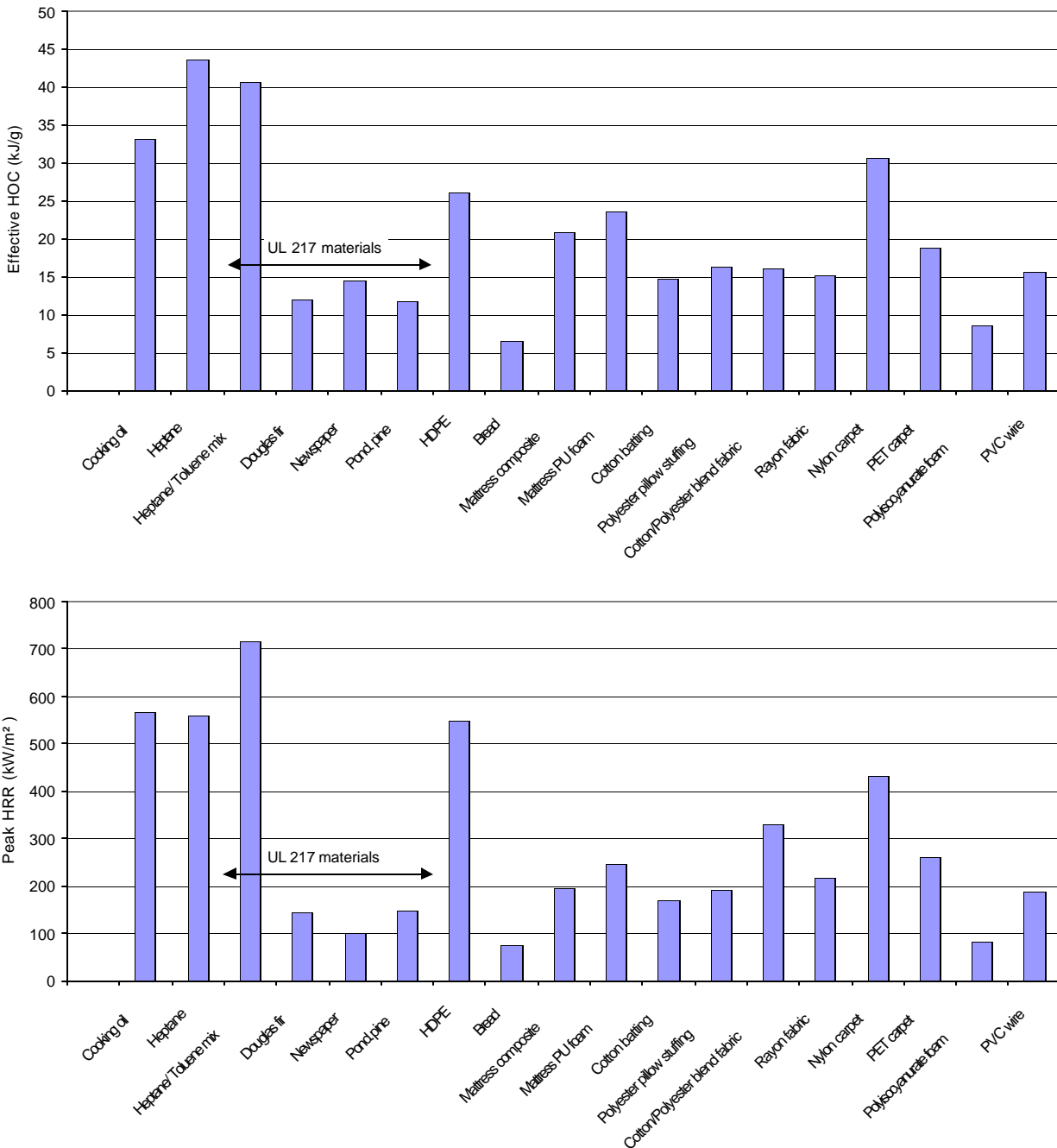

5

Figure 11 – Effective HOC (top) and peak HRR (bottom) for flaming combustion

Similarly, smoke production during flaming combustion is greater for synthetic materials than that for natural cellulosic products, plotted in Figure 12. Material chemistry plays a significant role in the amount of smoke produced such that:

10

5

1. Introduction of aromatic groups to simple straight chain hydrocarbons increases smoke production (heptane-toluene mixture versus heptane alone).
2. Materials with aromatic molecular groups exhibited the highest smoke production – polyester products (carpet, pillow stuffing, sheet), PVC wire, and heptane-toluene mixture.
3. Unsaturated cooking oil very likely decomposes to soot.
4. Substitution of nitrogen and chlorine atoms into the base polymer molecule as well as aromatic additives (nylon carpet, PVC) also increases smoke production.

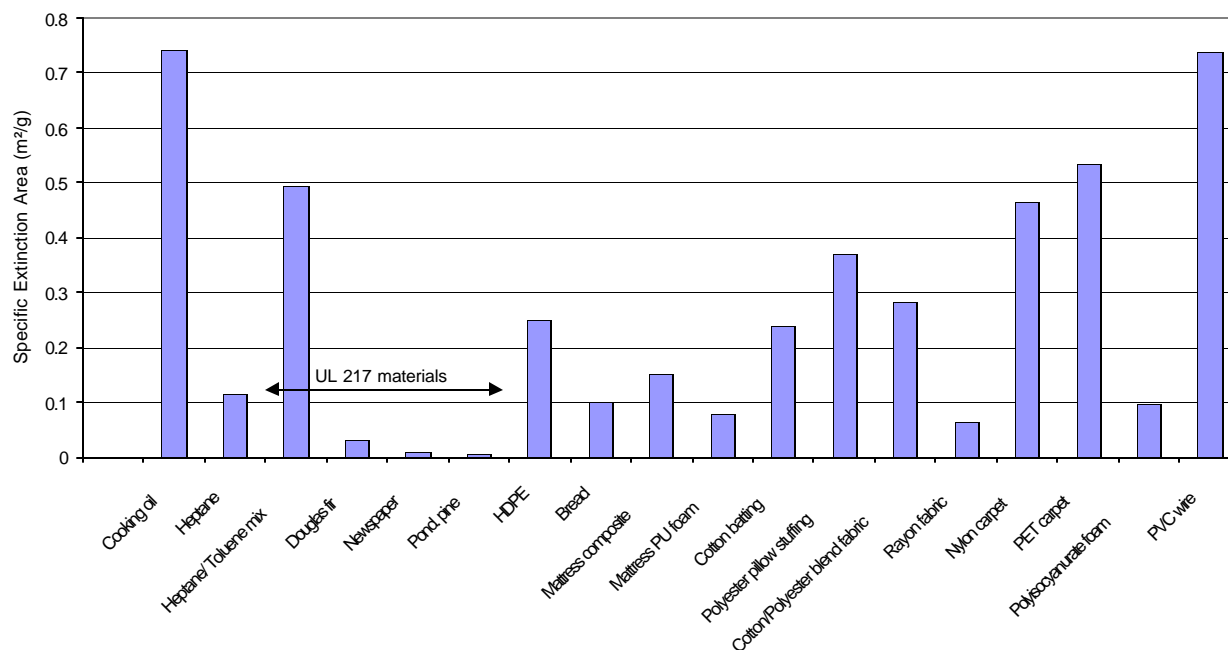

10

Figure 12 – Smoke production for flaming combustion

The mean particle sizes and specific counts for the evaluated materials are plotted in Figure 13 and Figure 14. Smokes generated by materials such as heptane, toluene, cooking oil, and HDPE have the largest mean sizes whereas the natural cellulosic materials and PU foam based materials have the smallest. The natural cellulosic materials and synthetic materials used in UL 217 are in the same range as the other evaluated materials. It was observed that materials generating larger smoke particles, *e.g.* cooking oil, heptane-toluene mixture, also have larger specific extinction areas, Figure 12. The cooking oil contains unsaturated, long-chain hydrocarbon components that resemble the behavior of the heptane-toluene mixture.

It may be observed that the mean smoke particle sizes generated by the different samples trends with the energy required to vaporize the respective material for subsequent combustion such that materials requiring the least amount of energy generate the largest mean particle sizes. The liquid samples (heptane, heptane-toluene mixture, cooking oil) that generate the largest mean particle sizes require the least amount of energy for vaporization as they do not need to be first liquefied like solid samples. HDPE, a long chain analog of heptane that is a solid at room temperature, is easily liquefied prior to vaporization and has the next largest particles, followed by the PVC wire which incorporates an easily liquefiable plasticizer in the PVC compound. The smallest particles

are from the cross-linked materials (PU and polyisocyanurate foams) and the two wood samples which form a cross-linked char structure during combustion.

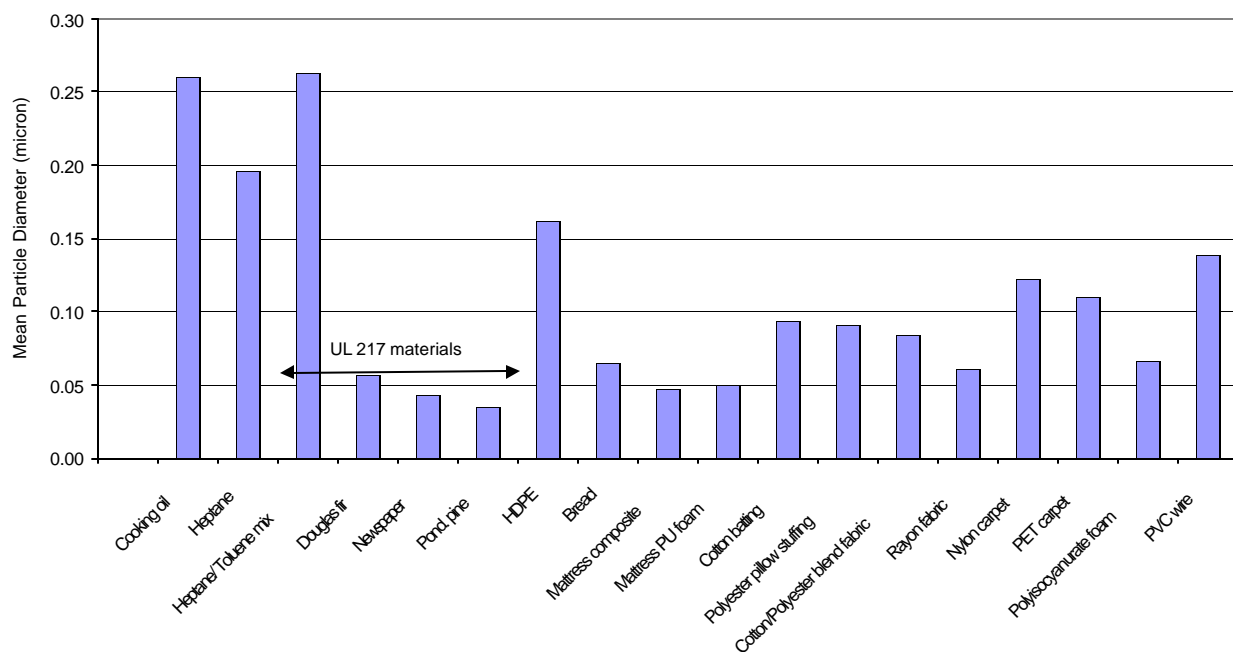

5

Figure 13 – Mean particle diameter for flaming combustion

Specific smoke particle counts indicate that the materials with the highest surface area to sample volume ratios (the two foam materials, newspaper, cotton batting, and polyester fill) generate more particles per consumed mass than the other evaluated materials. It is also worth noting that the two most prolific particle producers, the two foam materials, contain nitrogen atoms in the polymer backbone. The higher particle production from PVC versus HDPE is in part due to the high percentage of easily liquefiable aromatic plasticizers in the PVC wire insulation compound.

10

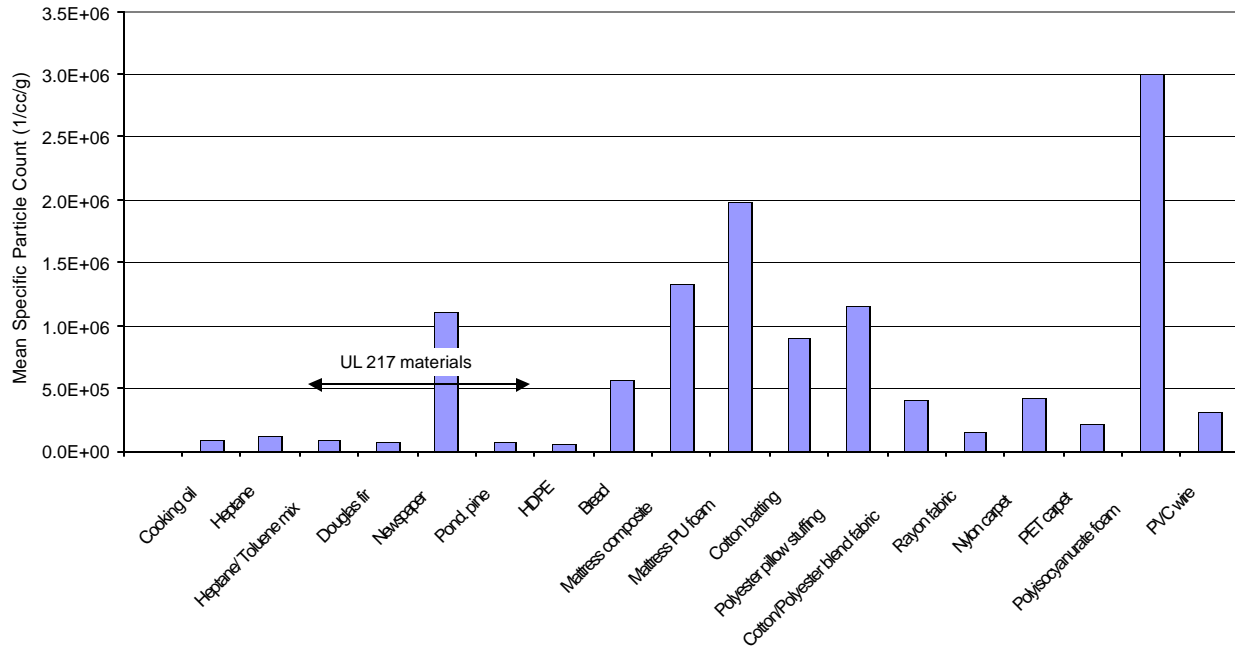

Figure 14 – Mean specific particle count for flaming combustion

5 The smoke particle characteristics also depend upon the specific combustion reaction mechanism as a function of time. For example the particle size and count change significantly for Douglas fir wood during the combustion process. After initial ignition of this material a char layer develops that reduces the heat release rate per unit area. The smoke particle size also changes and the smoke particle size reduces. The particle size then increases in conjunction with the heat release rate per unit area as depicted in Figure 15.

10

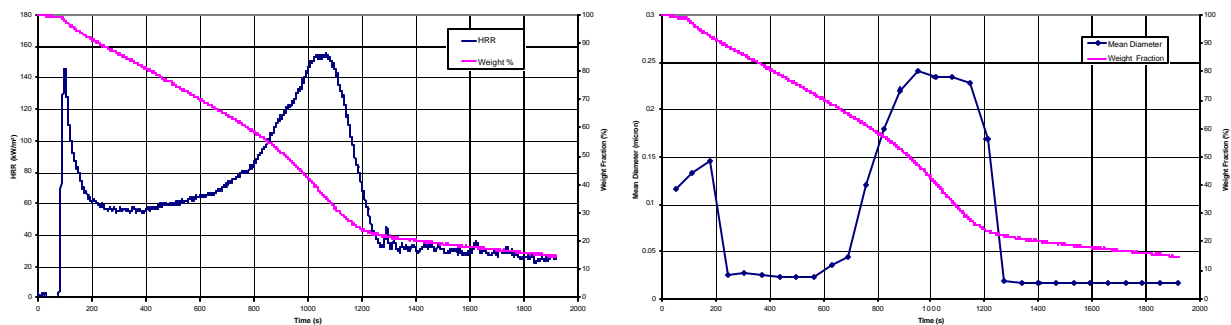

Figure 15 – Heat release rate per unit area and smoke particle size for flaming Douglas fir wood

15 In contrast to such charring materials, liquid samples such as the heptane/toluene mixture and liquefied materials such as the HDPE after 200 s exposure result in consistent particle sizes throughout the test, Figure 16 and Figure 17 respectively.

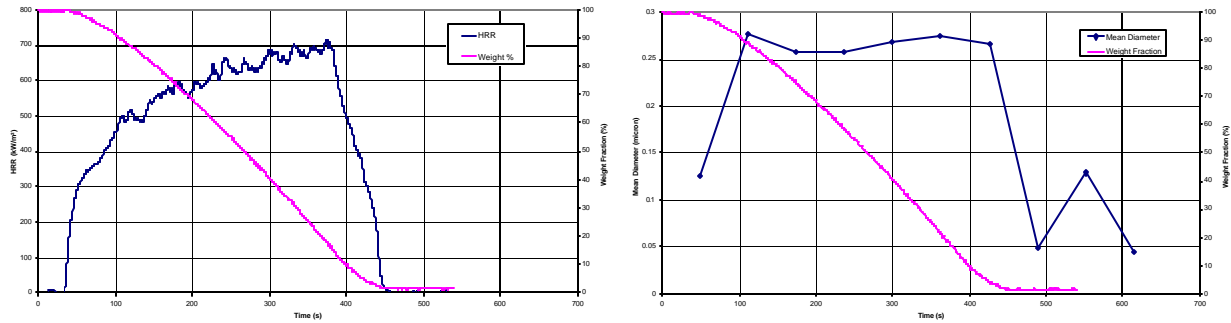
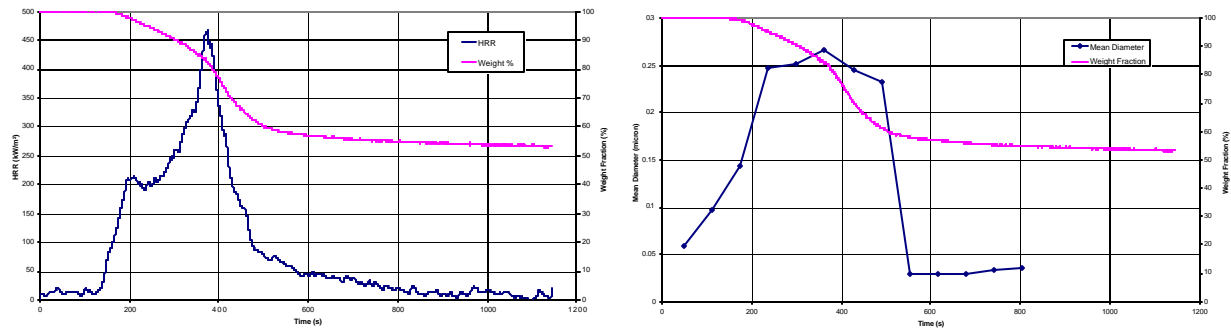

Figure 16 – Heat release rate per unit area and smoke particle size for flaming heptane/toluene mixture



5 Figure 17 – Heat release rate per unit area and smoke particle size for flaming HDPE

Effluent gas analysis indicates water and carbon dioxide are the predominant species, and carbon monoxide to a lesser extent. This is consistent with the chemical reaction for hydrocarbon combustion. Average carbon dioxide and carbon monoxide yields for the different materials are plotted in Figure 18 and Figure 19 respectively. In general carbon dioxide yield ranged between 1 to 1.5 g/g for the various materials; liquid materials exhibited the highest CO₂ yields ranging between 2 to 2.5 g/g. Carbon monoxide yield was less than 0.16 g/g with the exception of the higher unmodified cellulose content materials (newspaper, cotton batting, and cotton/poly sheet) which ranged between 0.2 to 0.3 g/g.

15

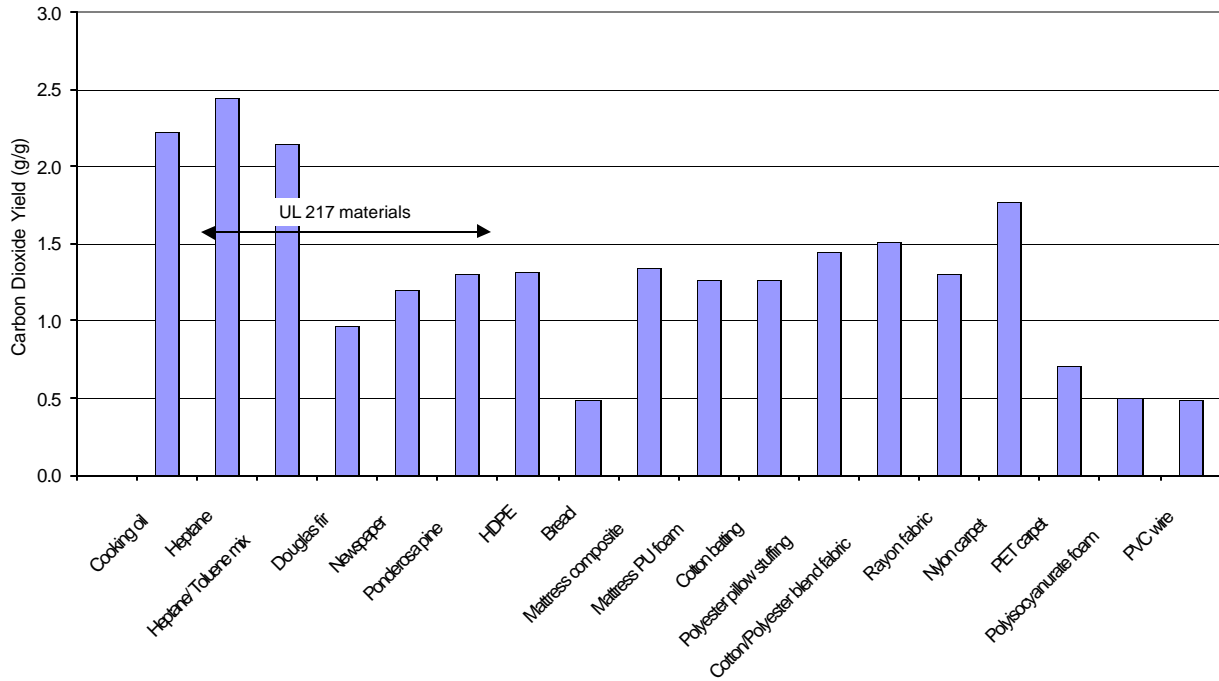

Figure 18 – Carbon dioxide yield for flaming combustion

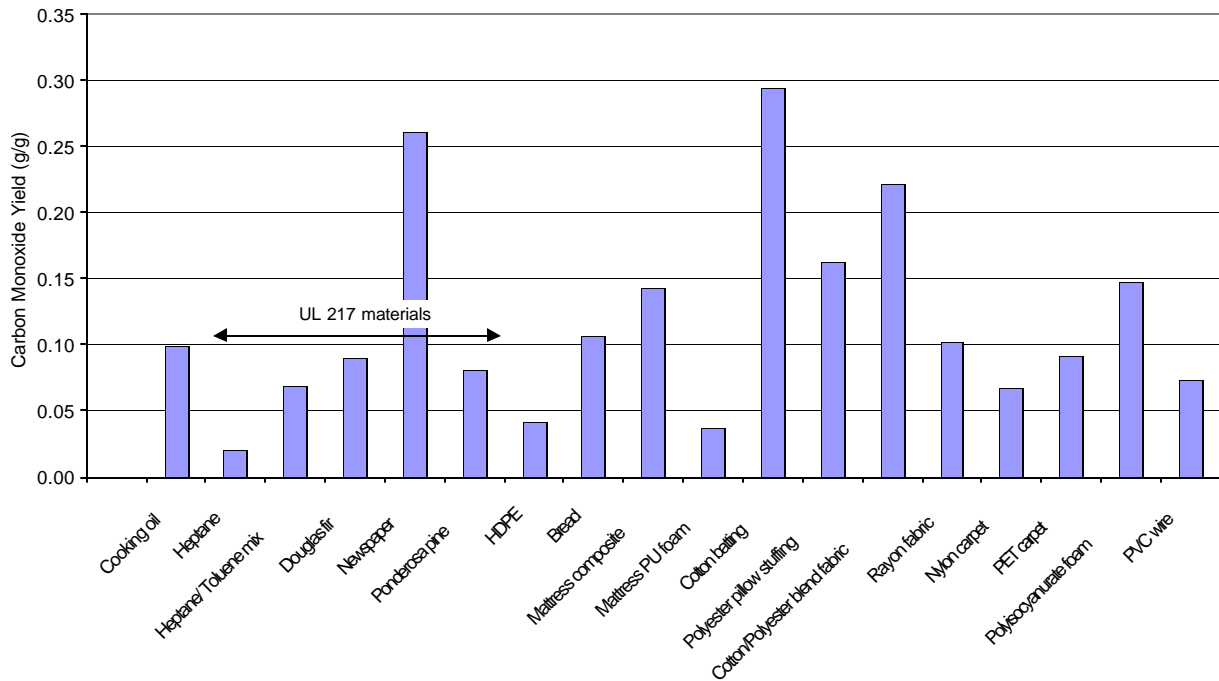

Figure 19 – Carbon monoxide yield for flaming combustion

5

Discussion of small-scale non-flaming combustion results

Heat release rate per unit area for non-flaming combustion of most materials were below the cone calorimeter resolution limit (less than 6 kW/m^2). The three materials that generated measurable amounts of heat had peak heat release rate per unit area of less than 20 kW/m^2 , which is an order of magnitude less than observed for flaming combustion.

Similar to the heat release rate measurements on the non-flaming combustion tests, smoke release rates for some of the materials evaluated under non-flaming combustion were also below the cone calorimeter resolution limit (less than $0.004 \text{ m}^2/\text{s}$). These materials are attributed as having a smoke extinction area of zero for smoke production plotted in Figure 20. It may be noted that the materials with measurable smoke release rates are the same materials identified as having either a high surface area to volume ratio or loaded with easily liberated aromatic plasticizers (PVC wire). In comparison to flaming combustion, most of the materials generate more smoke per unit of consumed mass under non-flaming conditions. The most significant effect of the combustion mode on smoke production is for the polyurethane and polyisocyanurate foams, possibly due to the high surface area to volume ratio resulting from their unique physical structure.

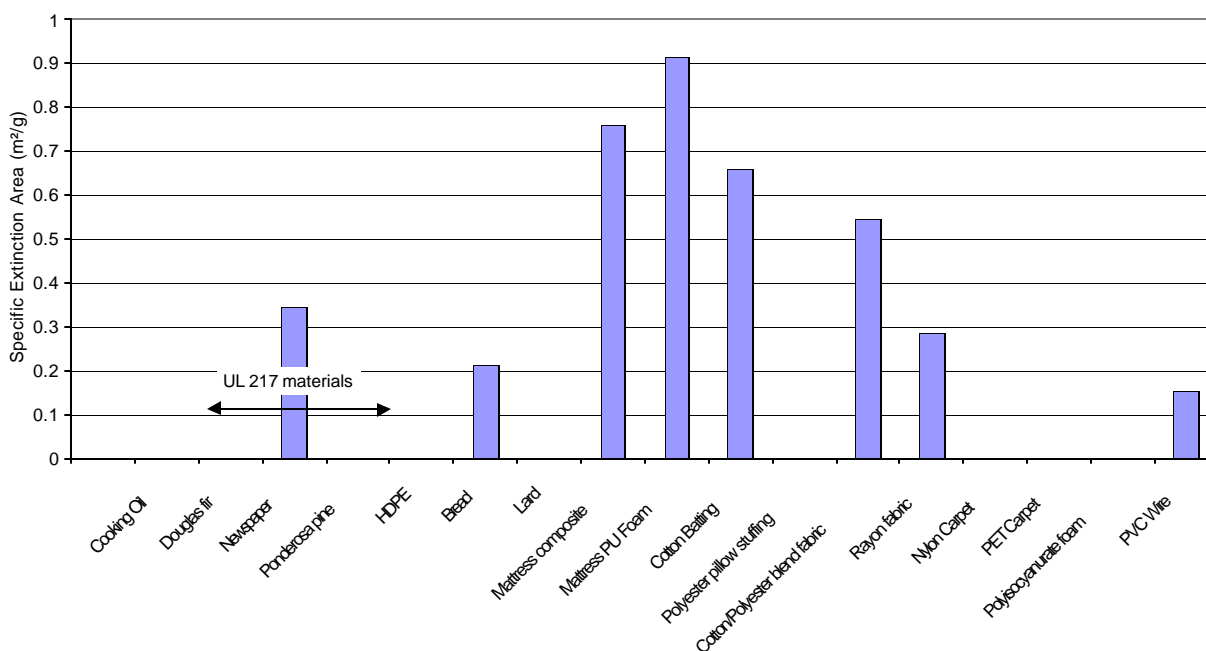

20 **Figure 20 – Smoke production for non-flaming combustion**

The mean particle sizes and mean specific particle size counts for the evaluated materials are plotted in Figure 21 and Figure 22 respectively. Smoke particles generated by the polyester materials, Douglas fir, and Ponderosa pine are amongst the largest observed whereas the PU and polyisocyanurate foams are amongst the smallest. Specific mean smoke particle counts indicate that Douglas fir and Ponderosa pine are amongst the least prolific particle producers on a per consumed mass basis whereas the lard, cooking oil, PU foam and nylon carpet are amongst the next most prolific materials.

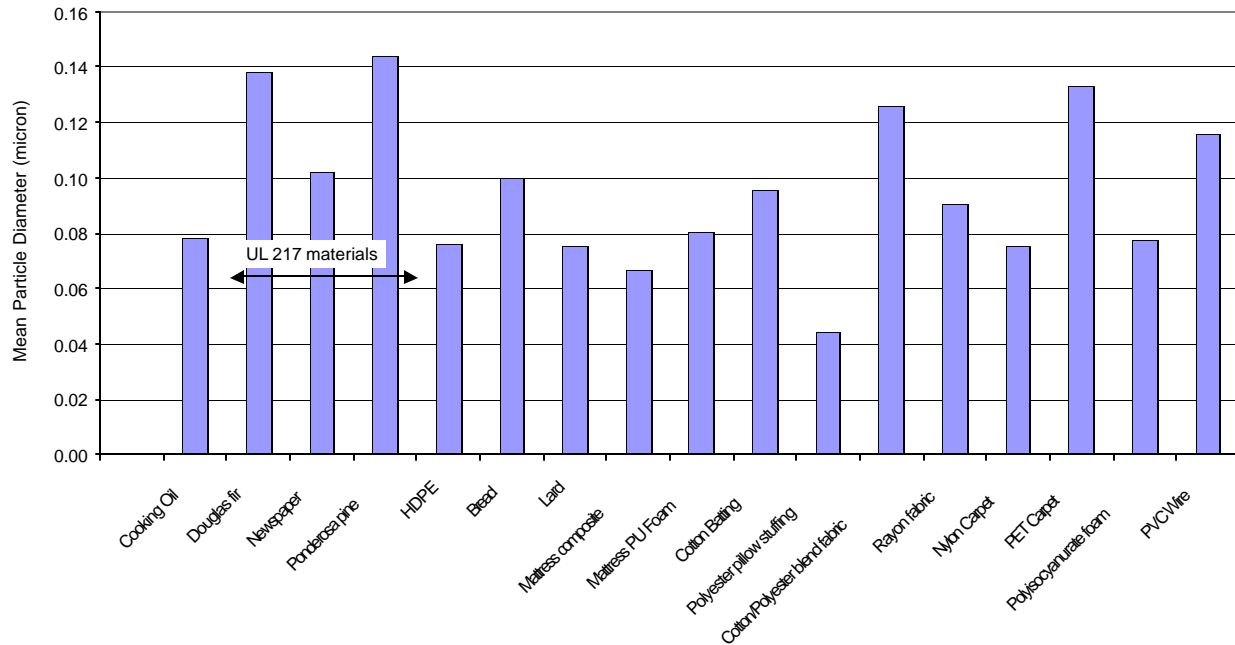

Figure 21 – Mean particle diameter for non-flaming combustion

5 Larger mean particle size observed for cooking oil versus lard may be explained by its higher unsaturated fat content. The carbon-carbon double bonds in unsaturated fats (referred to as “unsaturated” bonds by chemists) can undergo an endothermic chemical reaction during thermal degradation to form a cross-linked polymer network of saturated fats. This polymerization reaction would retard particle formation. Smaller particle formation from higher molecular weight materials is also observed for HDPE, despite being a saturated hydrocarbon. It was also observed that for some materials (cooking oil, HDPE, PE/pillow stuffing and nylon carpet) the mean particle size was smaller in the non-flaming mode than in the flaming mode.

10

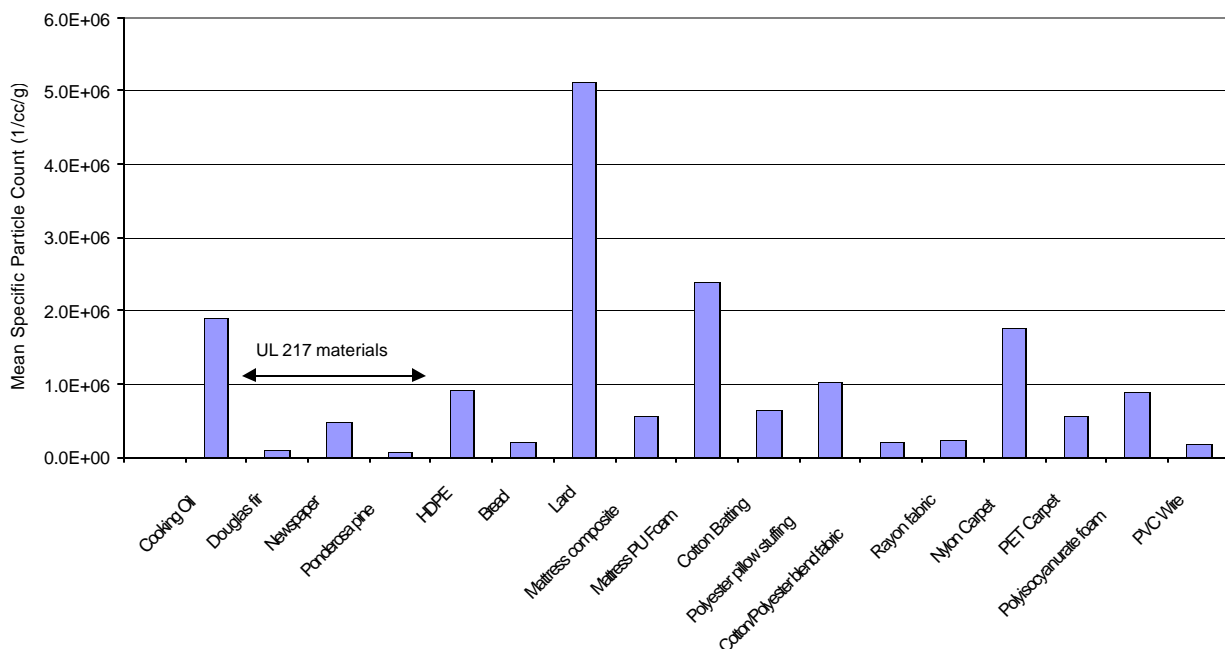

Figure 22 – Mean specific particle count for non-flaming combustion

Comparison of the mean smoke particle sizes and mean specific particle counts measured for non-flaming combustion to those measured for flaming combustion indicate that particle sizes are generally larger for non-flaming combustion. This is particularly true for the two wood species where the particle sizes are approximately three times larger. The specific particle counts were up to an order of magnitude lower for non-flaming combustion. It may be noted that under non-flaming combustion HDPE generated more, but smaller smoke particles than PVC wire whereas under flaming combustion the HDPE generated less, but larger smoke particles.

Effluent gas analysis indicates water, carbon dioxide, and carbon monoxide are the predominant species. This is consistent with the chemical reaction for incomplete hydrocarbon combustion. Average carbon dioxide and carbon monoxide yields for the different materials are plotted in Figure 23 and Figure 24 respectively. Carbon dioxide yield was less than 1 g/g for all of the various materials; the only liquid material evaluated under non-flaming conditions, cooking oil, exhibited the highest CO₂ yield. Carbon monoxide yield was less than 0.15 g/g with the exception of the higher unmodified cellulose content materials (newspaper, cotton batting, cotton/poly sheet, cotton batting topped PU foam mattress composite), Rayon (which is acetate modified cellulose), and PET carpet.

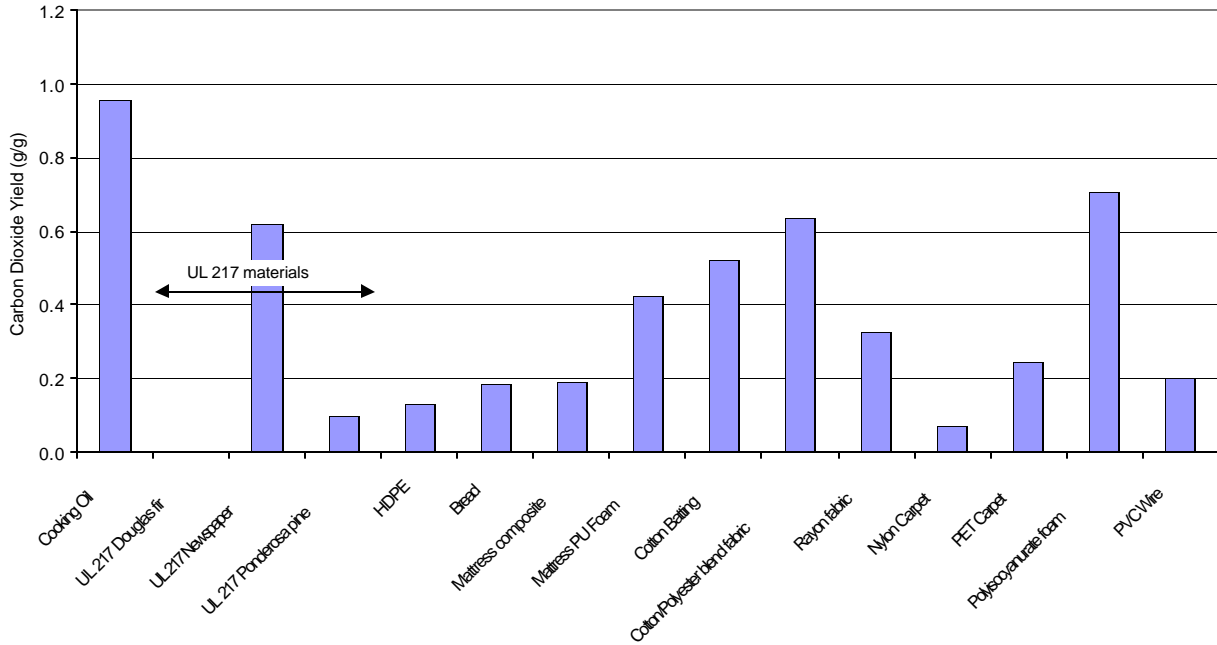

Figure 23 – Carbon dioxide yield for non-flaming combustion

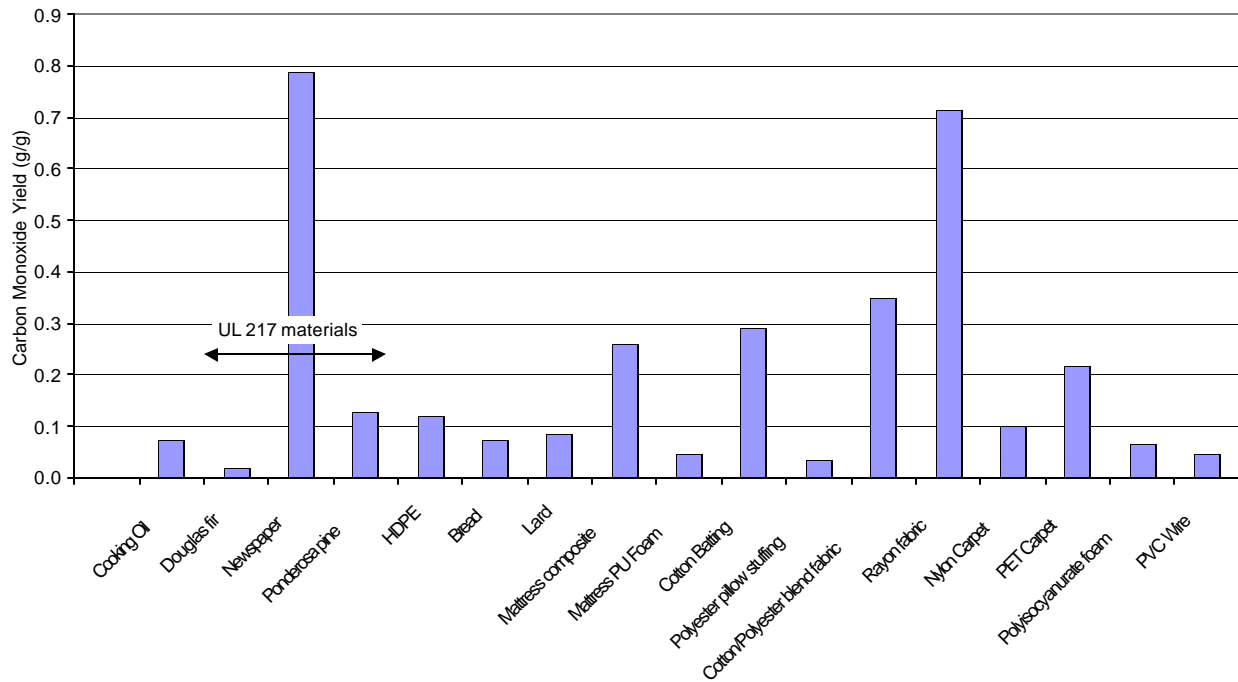

Figure 24 – Carbon monoxide yield for non-flaming combustion

5

It is also worth noting that the textile and newspaper materials that exhibit the highest carbon monoxide release rates are commonly found in residential settings.

INTERMEDIATE-SCALE TESTS

Introduction

5 Potential flaming and non-flaming scenarios for subsequent evaluation to UL 217 Fire Test
Room alarm response parameters in Task 3 were developed using intermediate-scale tests.
Evaluation of the UL 217 fire test protocols and the developed fire scenarios in intermediate
calorimeters also permitted characterization of heat and smoke release rates as well as smoke and
10 gas effluents closer to the combustion source. This enabled characterization of the smoke
particles prior to transport and aging that would be expected in the vicinity of smoke alarms in
the Fire Test Room. Two sizes of intermediate calorimeters were used depending upon the
sample size. These are identified as the NEBS calorimeter and the IMO calorimeter.

15 Smoke characteristics of smoldering Ponderosa pine were measured in UL's Fire Test Room
because the hot plate and controller could not be readily re-located to either of the two
calorimeter areas. Thus heat and smoke release rates were not measured.

20 Evolved heat and smoke were measured by the same principles as used in the ASTM E1354 cone
calorimeter; smoke particle size and gas-phase effluent components were measured using the
same WPS spectrometer and gas FTIR analyzer equipment previously described.

25 Initial testing using the NEBS calorimeter showed that the calorimeter could not be configured to
resolve combustibility data for fires less than 10 kW. Thus, a smaller calorimeter, IMO
calorimeter, was employed. Data for the UL 217 test samples were repeated in this calorimeter
and additional tests on other materials and scenarios were performed.

Test Samples

30 Test samples were selected from the materials listed in Table 2. The selected samples, other than
the UL 217 test samples, were selected on the basis of their chemistry (synthetic, natural), and
their performance in the Cone Calorimeter tests. The selected materials are presented in Table 11.

Table 11 – Intermediate calorimeter test samples

Test Sample	Comment	Test Area(s)
3:1 Heptane/Toluene	UL 217 test material	NEBS, IMO
Heptane	Provides chemistry difference from heptane/toluene mixture. Relatively large particle size in small-scale tests.	NEBS
Douglas fir	UL 217 test material	NEBS, IMO
Newspaper	UL 217 test material	NEBS, IMO
Ponderosa pine	UL 217 test material	Fire Test Room
Pillow	Composite material; Co-combustion expected	NEBS
Mattress	Composite material; Co-combustion expected	NEBS
Cotton batting	Mattress component. Particle distribution was in the middle of the range for other materials in small-scale tests.	NEBS
PU foam	Mattress component. Relatively high particle count and small size in small-scale tests.	NEBS, IMO
Cigarette	Potential nuisance source	NEBS
Coffee maker	Composite; Co-combustion expected; Synthetic base material had high heat release and relatively large particle size in small-scale tests	NEBS, IMO
Bread	Potential nuisance source	NEBS, IMO
Nylon carpet	Relatively high particle count and size in small-scale tests	IMO

Experimental

- 5 **NEBS Calorimeter** - The NEBS product calorimeter test room is 15.2 m × 4.9 m × 4.9 m (l×w×h) with a square shaped collection hood located centrally in the room 2.2 m above the floor. The dimensions of the extended hood are 3.9 m on the side and a height of 1.5 m. Collected combustion products are exhausted by way of a 0.6 × 0.6 m plenum into a 0.45 m diameter exhaust duct for the heat and smoke measurements. An exhaust flow rate of 8 m/s (bi-directional probe measured) was used for the tests. A schematic of the NEBS Calorimeter hood arrangement
- 10 is shown in Figure 25.

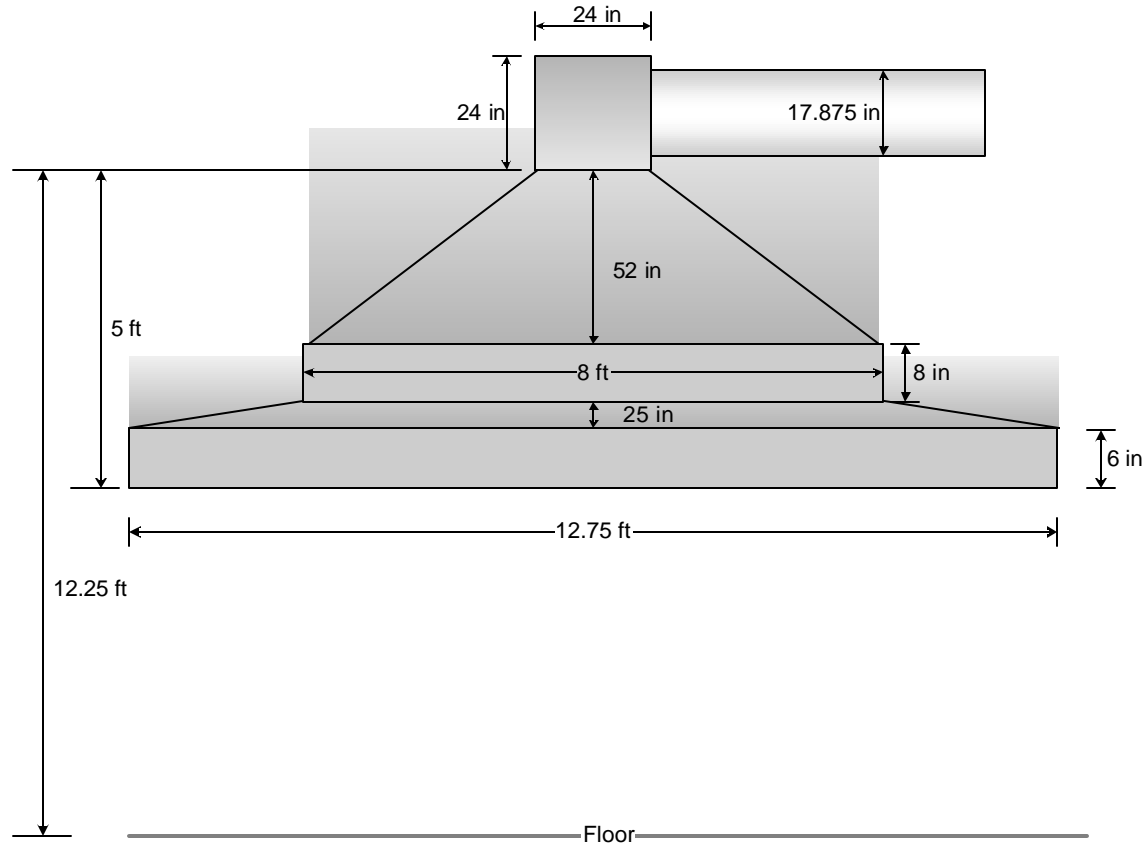

Figure 25 – Schematic of NEBS calorimeter

5 For flaming mode, data was collected until either the heat release rate exceeded 100 kW or flaming and/or other signs of combustion ceased. For non-flaming mode, the test duration ranged between 10 and 12 minutes.

10 **IMO Calorimeter** - The IMO calorimeter consists of a rectangular collection hood measuring 1.3×1.3 m. The hood is connected with a 0.18 m exhaust duct. An instrumented section is located in the exhaust duct connected to enable the measurements of heat and smoke release rates.

A schematic of the IMO calorimeter is depicted in Figure 26.

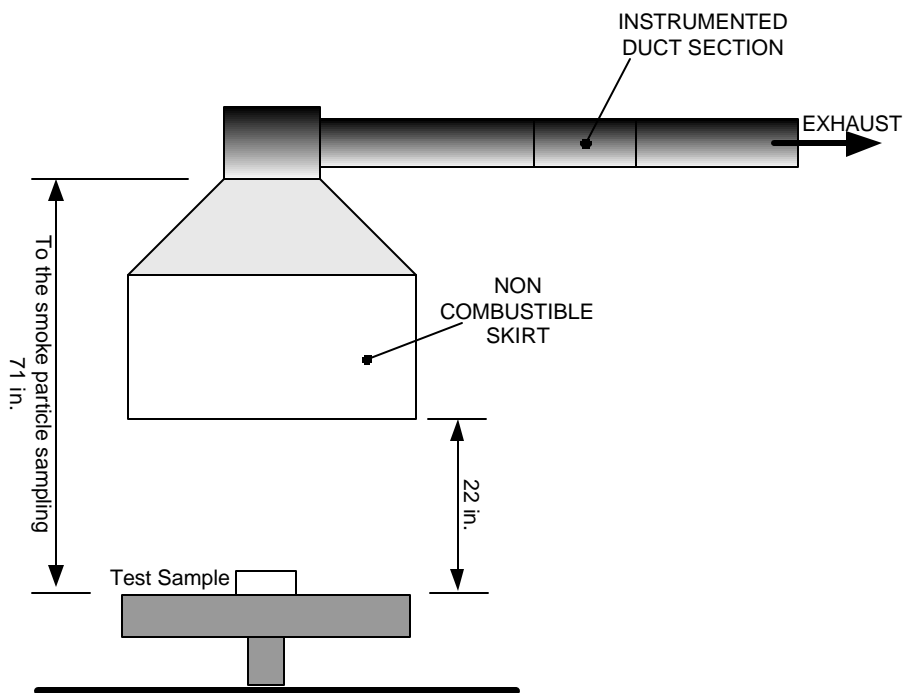

Figure 26 – Schematic of the IMO calorimeter

5 **Smoke Particle and Gas Effluent Sampling** - A custom gas effluent and smoke sampling system for the intermediate calorimeter was designed and constructed to condition the evolved smoke for analyses in the WPS spectrometer and the gas FTIR spectrometer. The evolved smoke and gas was sampled using 6.4 mm O.D. steel sampling tube mounted facing downstream along the centerline of a 0.18 m diameter steel collection cone, Figure 27. The sample flow was divided into two separate sample streams for dilution with nitrogen and subsequent smoke particle size and gas component characterization. Smoke and gas samples lines were diluted with nitrogen gas (UHP grade, 99.999%) to prevent saturation of the respective detection instrument. The dilution ratio for the FTIR spectrometer ranged from 1.5 to 2 and the dilution ratio for the WPS spectrometer ranged from 6 to 16. The actual dilution flow rates were documented for each test and used in the calculation of the smoke particle counts and gas effluent concentration.

10

15

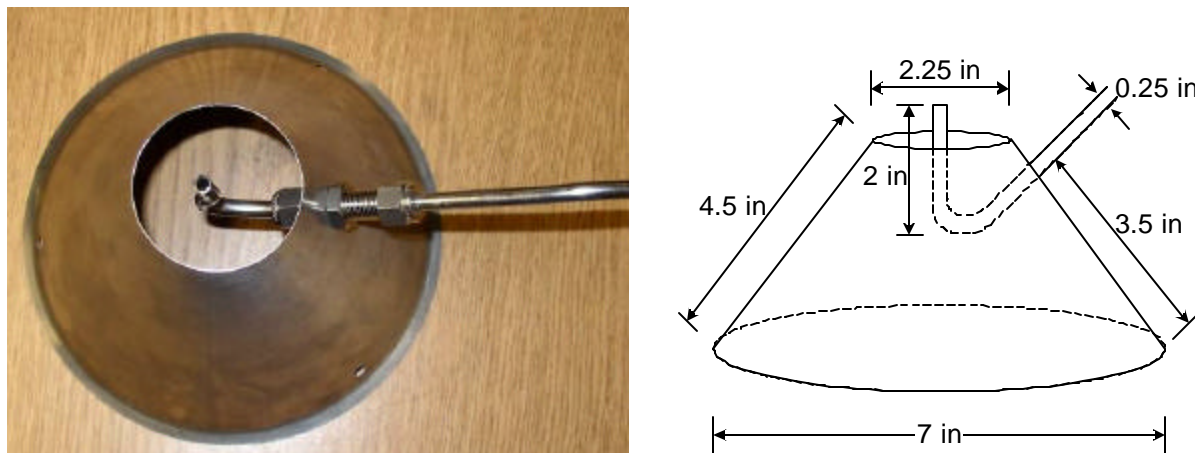
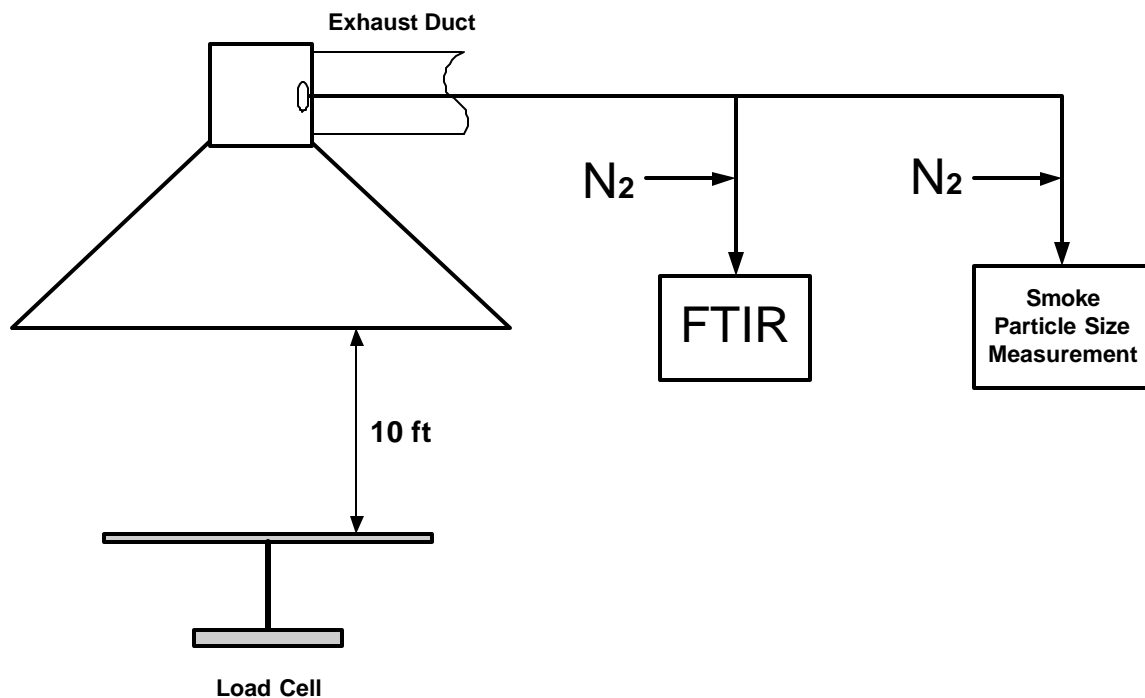

Figure 27 – Intermediate calorimeter evolved smoke and gas sampling cone and tube

Sample lines to the spectrometers were 3 m long with a 3.2 mm I.D. The sample line to the FTIR was maintained at 120 °C to prevent condensation of generated water vapor in the effluent gas stream.

- 5 Because the sampling port was facing downstream, it is anticipated that the data obtained will be biased towards the smaller particles. In addition, some particulates are anticipated to be lost due to adhesion to the sampling tube. The sampling tubes were cleaned prior to each test.

- 10 For tests conducted in the flaming mode the sampling cone and tube arrangement was located at the interface between the plenum and the exhaust duct as depicted in Figure 28. For tests conducted in the non-flaming mode the sampling cone and tube arrangement was located 0.27 m above the load cell as depicted in Figure 29.



15

Figure 28 – Intermediate calorimeter flaming mode sampling arrangement

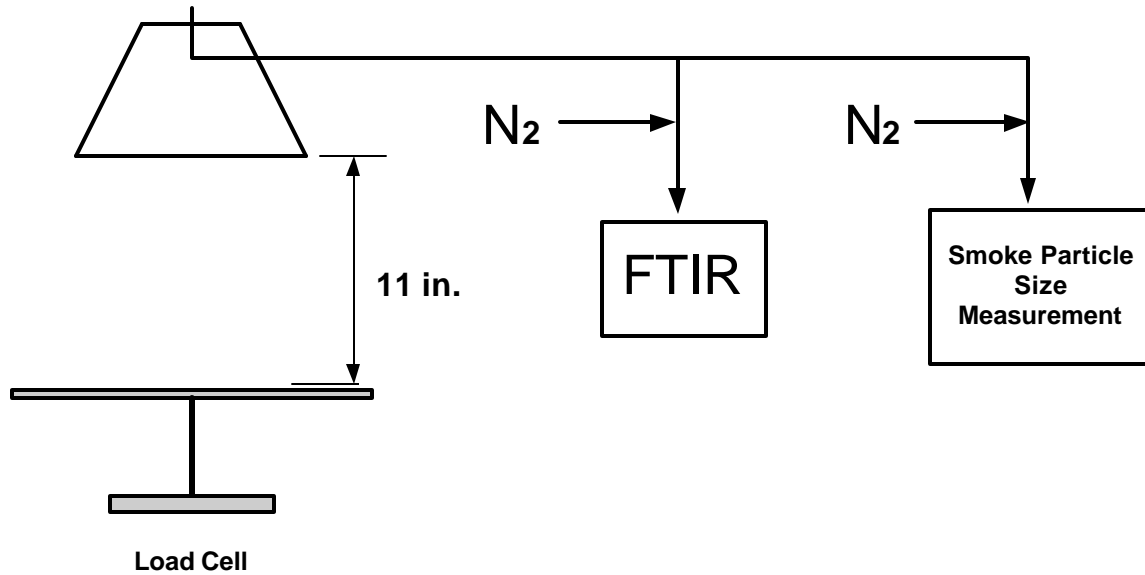

Figure 29 – Intermediate calorimeter non-flaming mode sampling arrangement

5 **Smoke Particle Characterization** - Smoke particle size and count was characterized using the WPS spectrometer previously described in the Smoke Characterization section

10 **Effluent Gas Composition Characterization** - Gas effluent composition was characterized using the FTIR spectrometer and deconvoluted as previously described in the Smoke Characterization section (Eq. 8 through Eq. 11).

Ignition Scenario - Samples were evaluated for heat and smoke release, particle size and gas effluent concentration under flaming and/or non-flaming exposure conditions as summarized in Table 12.

Table 12 – Intermediate calorimeter sample exposure scenario

Test Sample	Size/Quantity	Mode	Heat/Ignition Source	Test Area(s)	Test Duration
UL 217 Heptane/ Toluene mixture	45 mL	Flaming	UL 217 assembly	NEBS IMO	250 s 200 s
UL 217 Douglas fir	1 crib	Flaming	UL 217 assembly	NEBS IMO	365 s 340 s
UL 217 Newspaper	42.5 g	Flaming	UL 217 assembly	NEBS IMO	190 s 270 s
Heptane	500 mL	Flaming	Open-Flame	NEBS	500 s
Pillow	1 unit	Flaming	TB 604 burner	NEBS	400 s
Mattress	1 unit	Flaming	CPSC 1633 burner	NEBS	205 s
Cotton batting	300 × 300 × 6 mm	Flaming	TB 604 burner	NEBS	535 s
PU Foam	300 × 300 × 25 mm thick	Flaming	TB 604 burner	NEBS	500 s
PU Foam wrapped in cotton/poly sheet	100 × 100 × 100 mm	Flaming	TB 604 burner	IMO	480 s
Coffee maker	12 cup, no carafe	Flaming	TB 604 burner	NEBS IMO	1600 s 950 s
Nylon carpet	100 × 100 mm	Flaming	Cone heater at 35 kW/m ²	IMO	360 s
Ponderosa pine	8 sticks, 75 long × 25 × 20 mm	Non Flaming	UL 217 - Temperature controlled hot plate	Fire Test Room	3400 s
Bread	4 slices	Non- Flaming	Toaster	NEBS IMO	1035 s 600 s
Cigarettes	2	Non- Flaming	Lighter	NEBS	320 s
Mattress	Quarter section	Non- Flaming	3 Cigarettes	NEBS	1940 s
Cotton batting	100 × 100 × 6 mm	Non- Flaming	Hot Plate	NEBS	450 s
PU foam	100 × 100 × 25 mm	Non- Flaming	Hot Plate	NEBS	710 s
PU foam	3- 50 × 100 × 25 mm thick	Non- Flaming	Cone heater at 15 kW/m ²	IMO	600 s
PU foam with cotton/poly sheet	100 × 100 × 25 mm thick foam, 1 sheet cotton-poly sheet	Non- Flaming	One smoldering cigarette	IMO	620 s

UL 217 Smoldering Ponderosa Pine Test

The test sample for this test was eight Ponderosa pine sticks placed on a temperature controlled hotplate. Each stick measured $75 \times 25 \times 19$ mm with the 19×75 mm inch face in contact with the hotplate. The space between sticks was 15 mm. The temperature of the hotplate was controlled in accordance with Section 45 *Smoldering Smoke Test* of UL 217. A photograph of the test set-up is shown in Figure 30.



Figure 30 – Photograph of test set-up for UL 217 smoldering test

10

The smoke sampling collector is shown in Figure 27. The bottom of the smoke sampling collector was held 11.5 inches above the hotplate to catch the decomposition products from the test sample. The opening of sampling tube was pointing to the downstream flow to prevent clogging. A schematic of the smoke sampling is depicted in Figure 31.

15

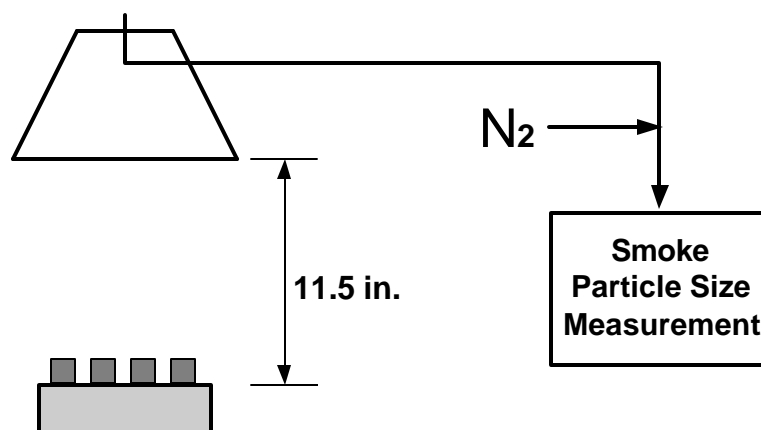

Figure 31 – Schematic of smoke sampling for smoldering Ponderosa pine test

The test was conducted in accordance with protocol specified in the UL 217. The dilution for the WPS spectrometer was documented. The gas sampling was initiated simultaneously with the hot plate. The test was terminated at 60 minutes.

20

Intermediate Calorimeter Test Results

5 The data from the combustibility tests were analyzed to calculate the heat and smoke release rates, specific extinction area, smoke particle size and count distribution, and gas effluent composition for flaming and non-flaming modes of combustion. Heat and smoke release rates were calculated using the procedures described in ASTM E1354.

The combustibility results for the tests performed in the NEBS calorimeter are presented in Table 13.

Table 13 – Intermediate calorimeter combustibility results

Test Sample (Heat source)	Area	Test Series	Mode	Peak HRR (kW)	Peak SRR (m²/s)	Total Smoke (m²)
3:1 Heptane/Toluene mixture (UL 217)	NEBS	Test 1	Flaming	19	0.24	16
	IMO	Test 1	Flaming	14	0.34	30
	IMO	Test 2	Flaming	12	0.34	29
UL 217 Douglas fir (UL 217)	NEBS	Test 1	Flaming	< 10	0.08	2
	IMO	Test 1	Flaming	12	0.26	11
	IMO	Test 2	Flaming	10	0.24	11
UL 217 Newspaper (UL 217)	NEBS	Test 1	Flaming	< 10	0.53	12
	IMO	Test 1	Flaming	6	0.99	25
	IMO	Test 2	Flaming	6	1.04	39
Heptane (lighter)	NEBS	Test 1	Flaming	51	0.09	25
Pillow (TB 604 burner)	NEBS	Test 1	Flaming	62	1.10	141
Mattress (TB 604 burner)	NEBS	Test 1	Flaming	108	1.15	60
Cotton batting (TB 604 burner)	NEBS	Test 1	Flaming	< 10	0.01	0.5
PU foam (TB 604 burner)	NEBS	Test 1	Flaming	< 10	--	0.3
PU foam in cotton/poly sheet (TB 604 burner)	IMO	Test 1	Flaming	4	0.04	4.8
	IMO	Test 2	Flaming	5	0.08	6.0
Coffee maker (TB 604 burner)	NEBS	Test 1	Flaming	87	1.27	461
	IMO	Test 1	Flaming	113	6.23	1346
	IMO	Test 2	Flaming	113	4.79	1033
Nylon carpet (cone heater at 35 kW/m ²)	IMO	Test 1	Flaming	4	0.15	20
	IMO	Test 2	Flaming	4	0.14	17
Bread (electric toaster)	NEBS	Test 1	Non-Flaming ^[1]	< 10	0.28	32
	IMO	Test 1	Non-Flaming	DNI	0.72	74
	IMO	Test 2	Non-Flaming	DNI	0.32	45
3 Smoldering cigarettes	NEBS	Test 1	Non-Flaming	DNI	--	--
Quarter mattress (3 smoldering cigarettes)	NEBS	Test 1	Non-Flaming	DNI	--	--
Cotton batting (hot plate)	NEBS	Test 1	Non-Flaming	DNI	0.01	0.6
PU foam (hot plate)	NEBS	Test 1	Non-Flaming	DNI	0.04	5.0
PU foam (cone heater at 15 kW/m ²)	IMO	Test 1	Non-Flaming	DNI	6.1	6.1
	IMO	Test 2	Non-Flaming	DNI	5.8	5.8
PU foam with Poly-cotton sheet (smoldering cigarette)	IMO	Test 1	Non-Flaming	DNI	0.00	0.1

10 Notes to Table 13:

^[1] Bread ignited 8:36 minutes into the test

DNI = Sample did not ignite

The heat and smoke release rates for the flaming IMO calorimeter tests are presented Figure 32 through Figure 37.

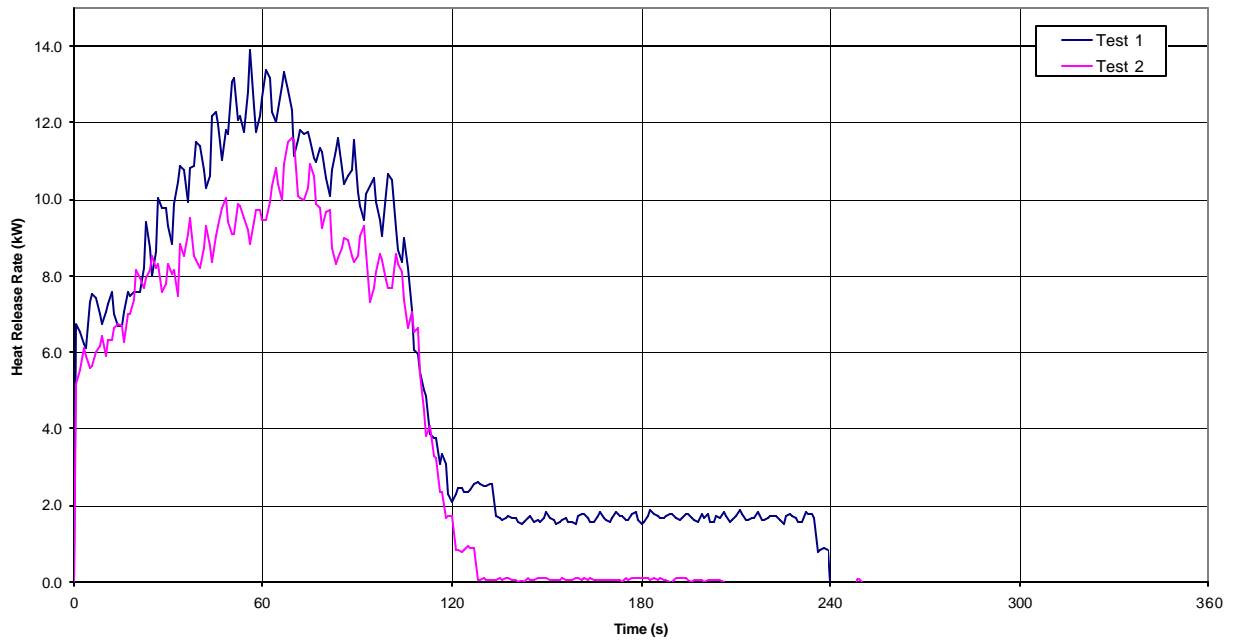

5

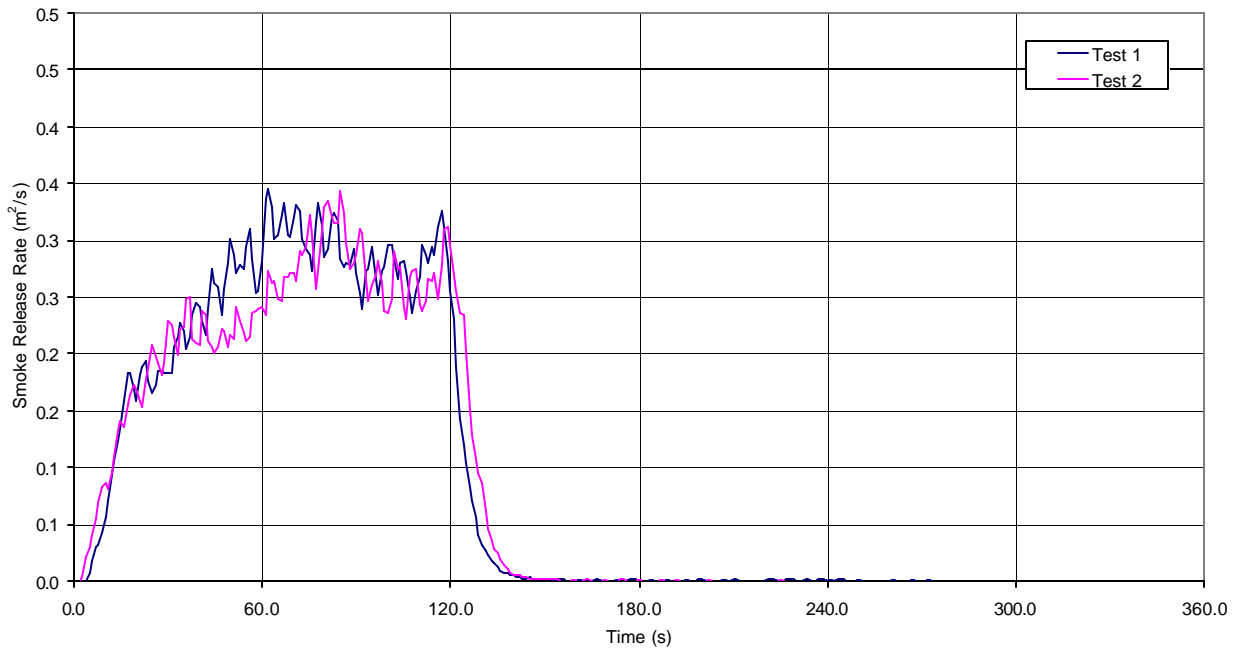
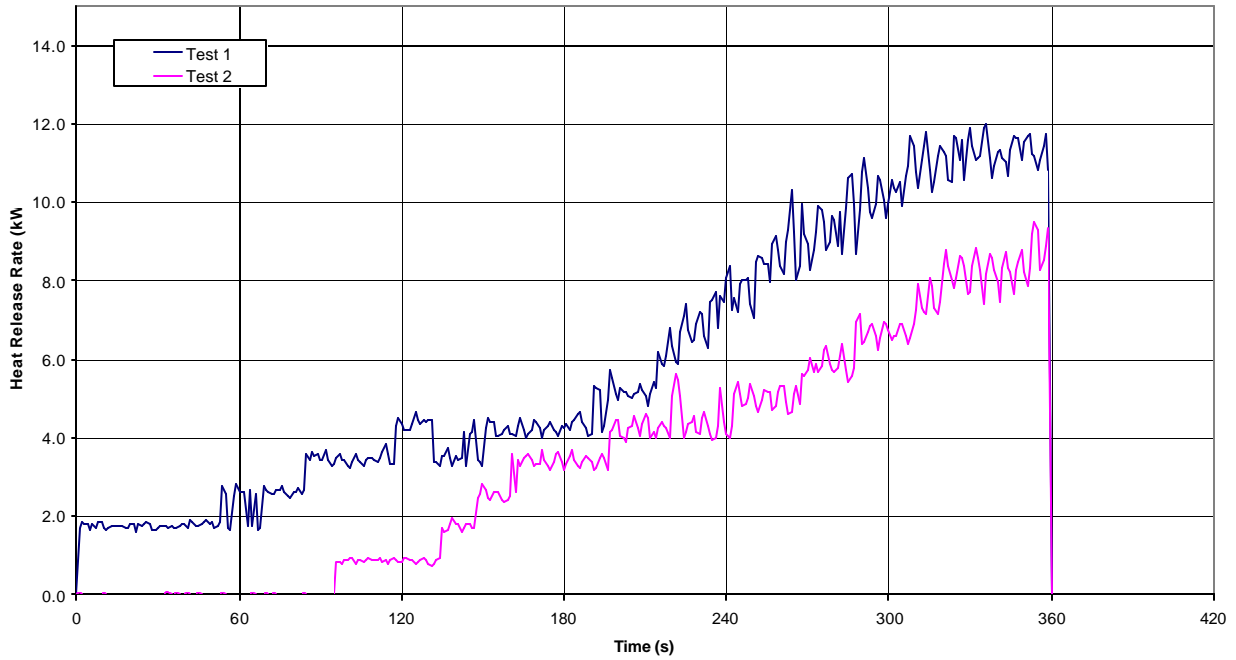

Figure 32 – Heat (top) and smoke (bottom) release rates for heptane/toluene mixture



5

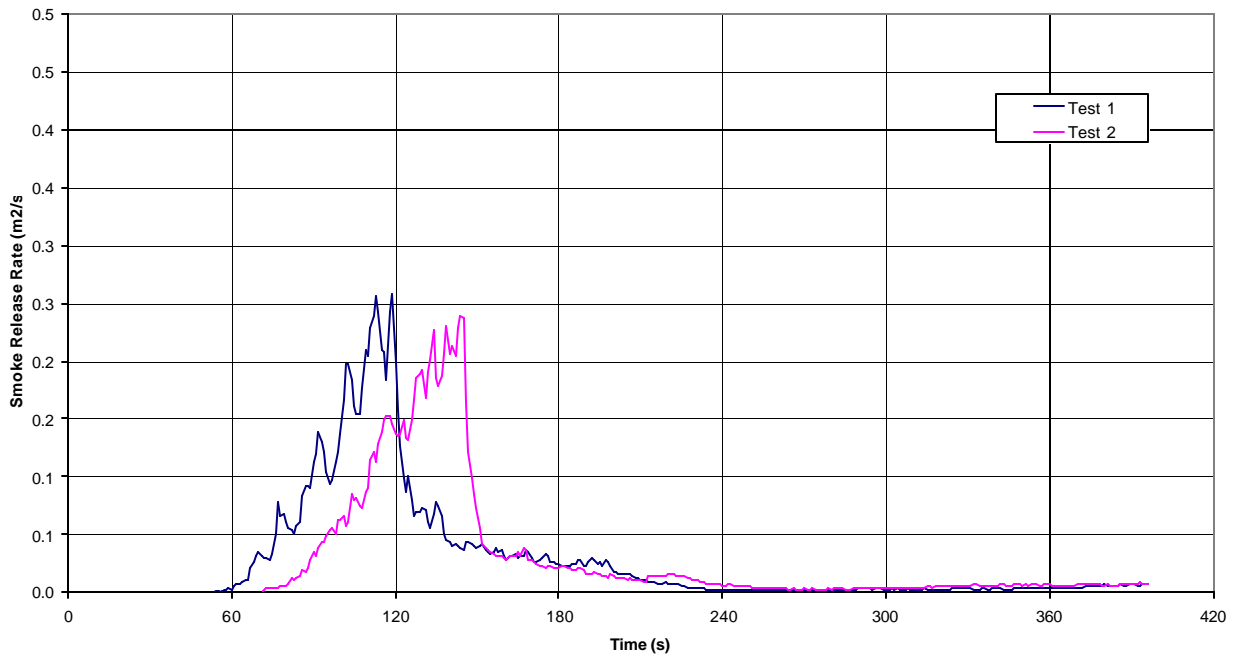
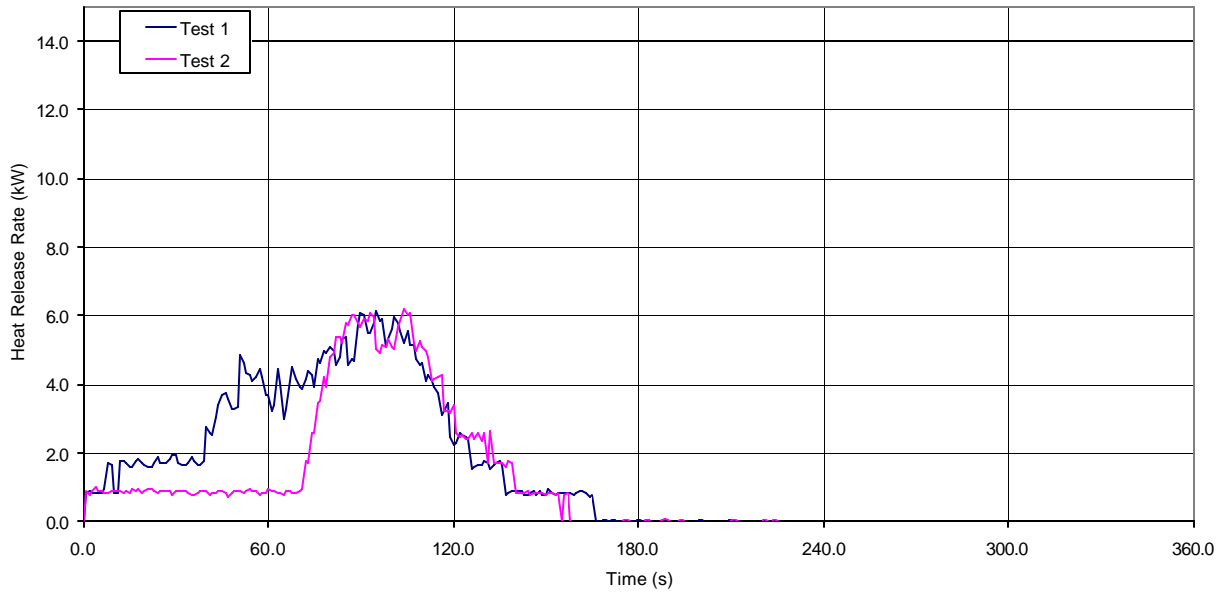

Figure 33 – Heat (top) and smoke (bottom) release rate for Douglas fir



5

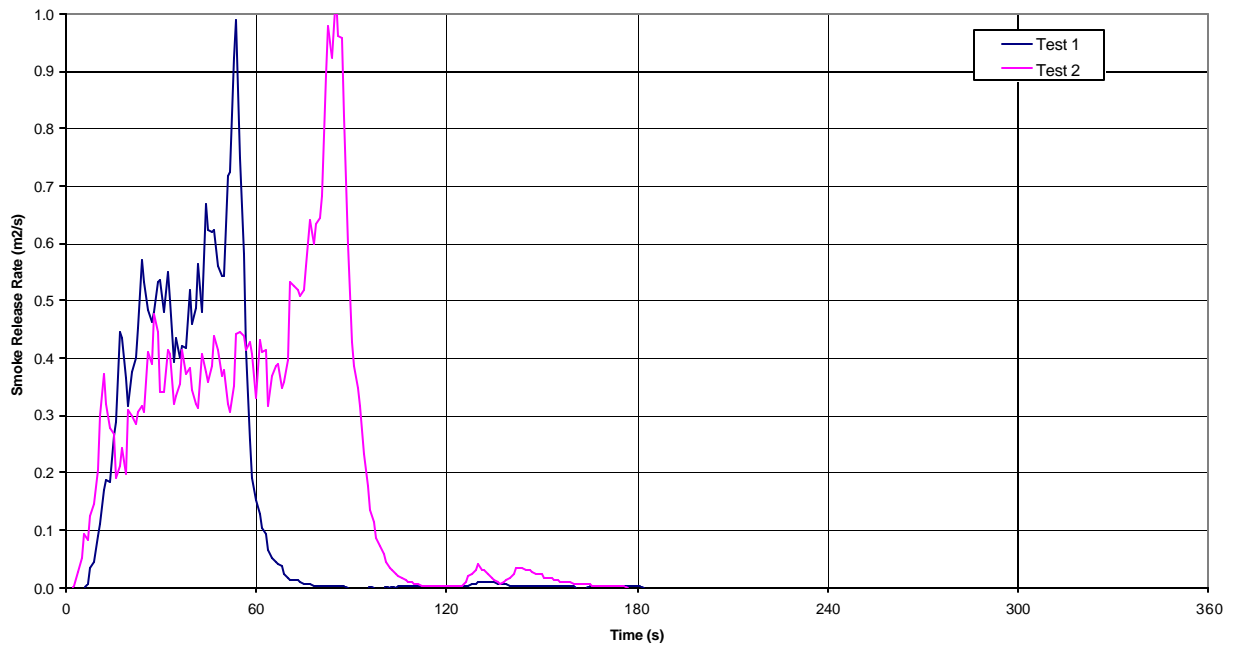
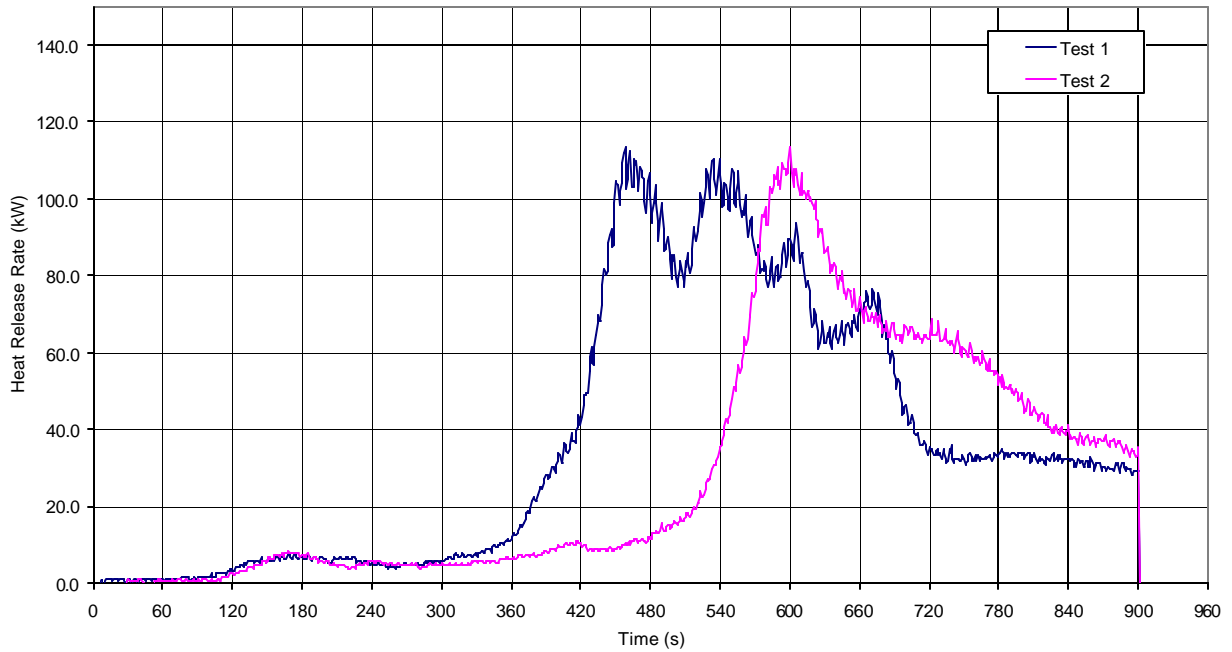

Figure 34 – Heat (top) and smoke (bottom) release rate for newspaper



5

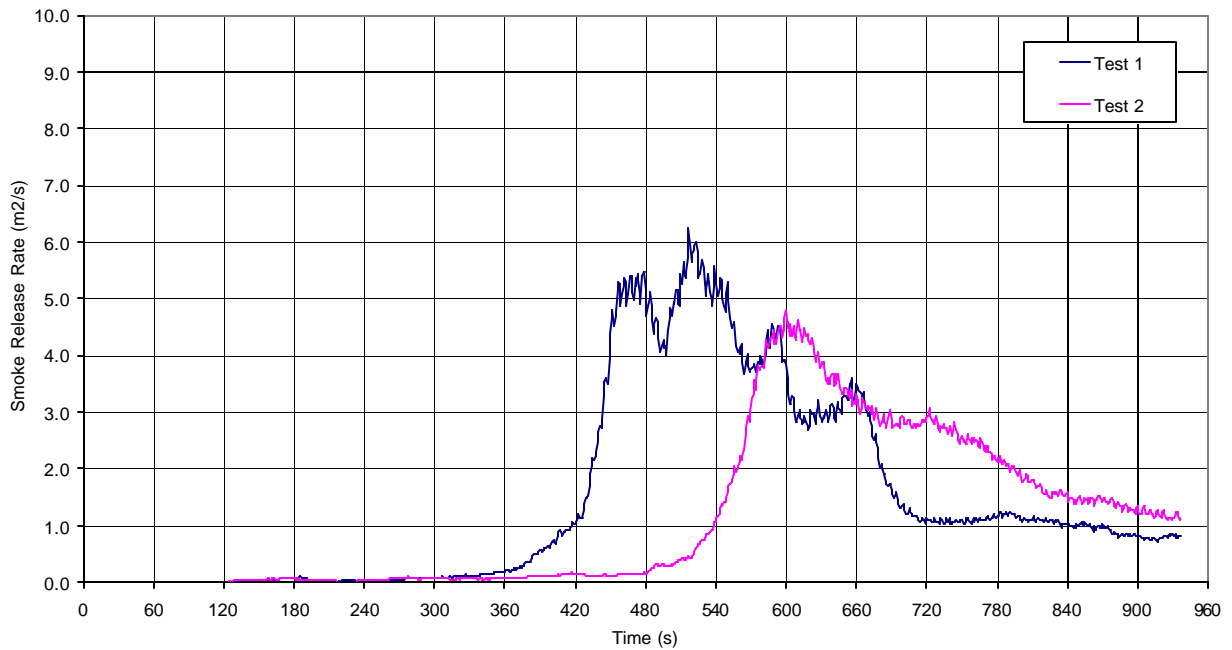
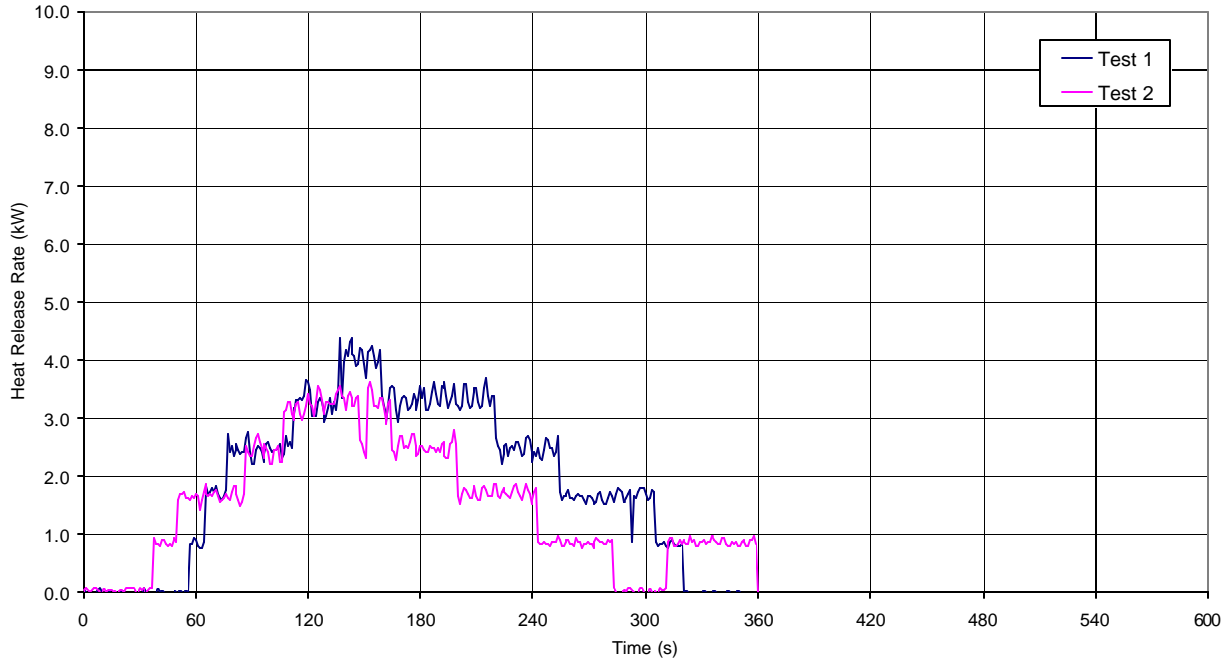

Figure 35 – Heat (top) and smoke (bottom) release for coffee maker



5

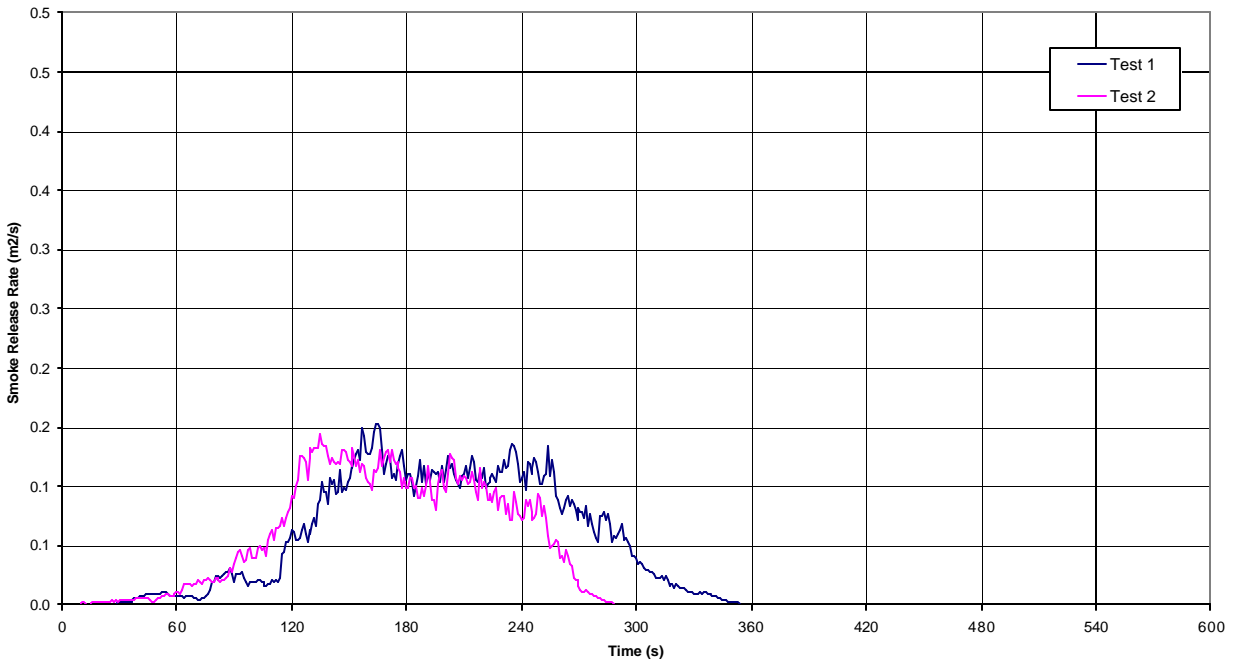
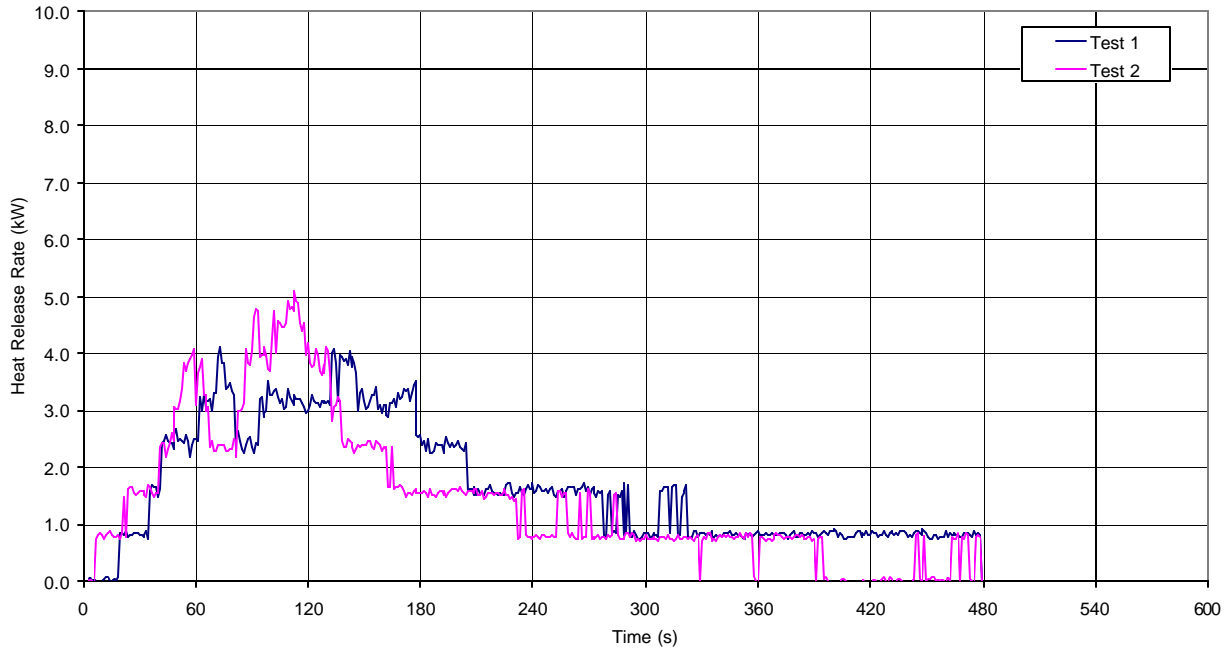

Figure 36 – Heat (top) and smoke (bottom) release for nylon carpet



5

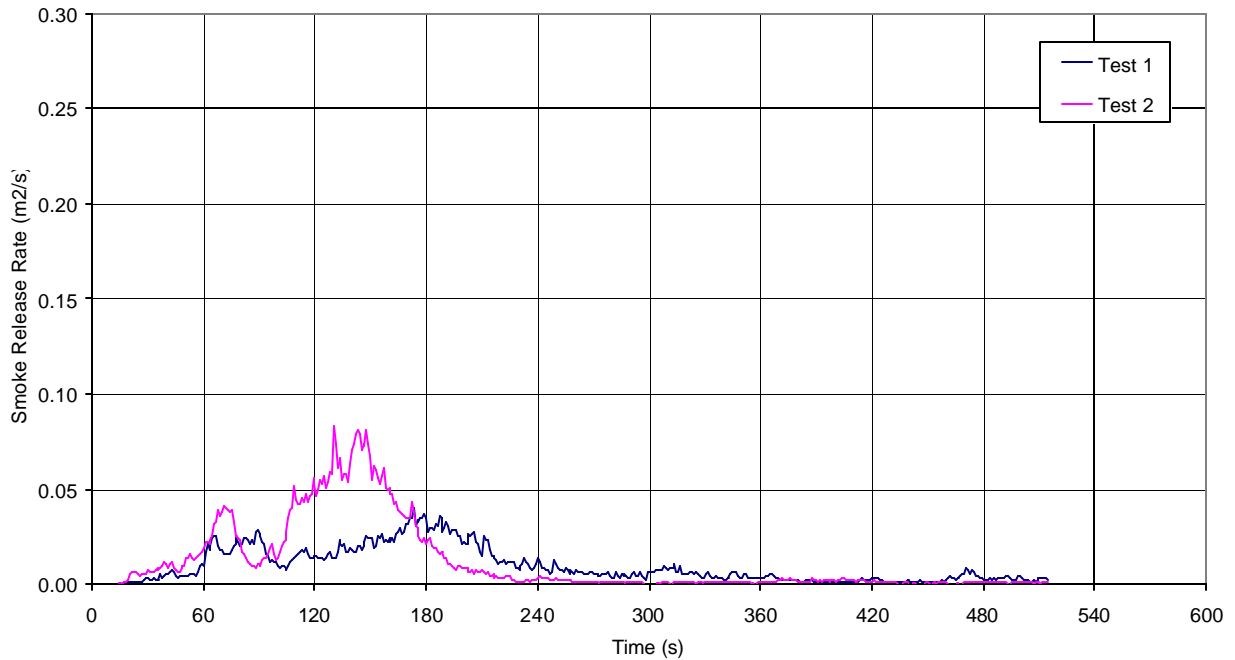
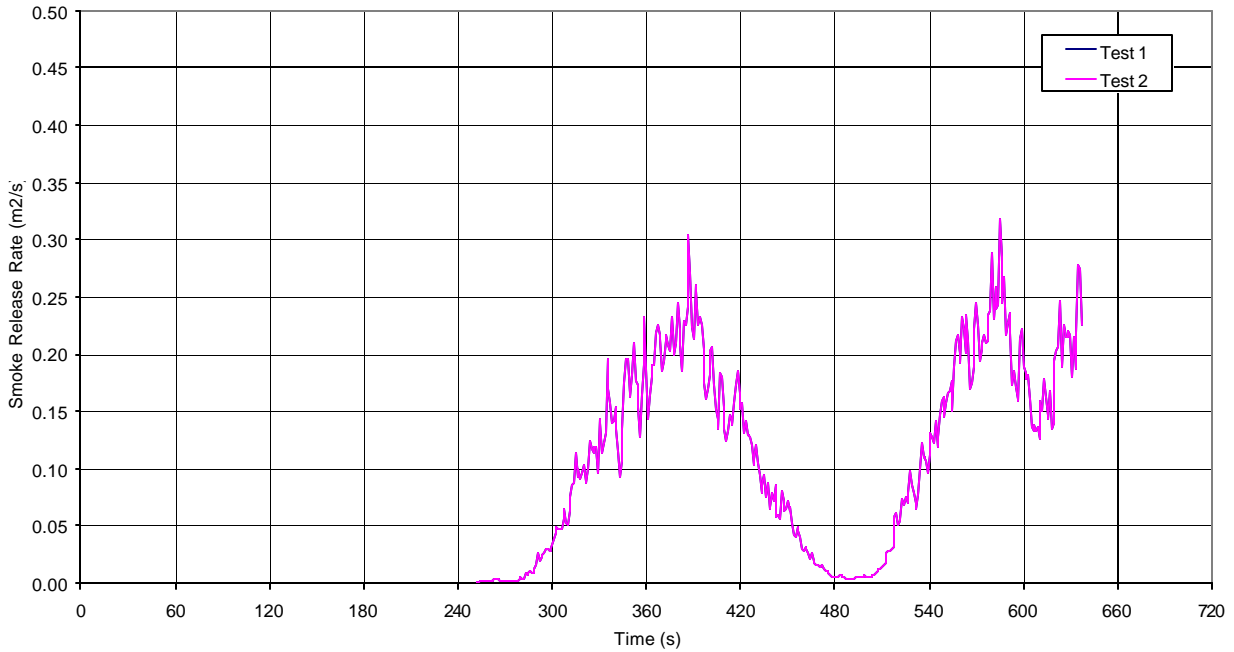

Figure 37 – Heat (top) and smoke (bottom) release for cotton/poly sheet wrapped PU foam

The smoke release data for the non-flaming tests conducted in the IMO calorimeter are presented in Figure 38 through Figure 40.



5

Figure 38 – Smoke release rate for bread in non-flaming combustion

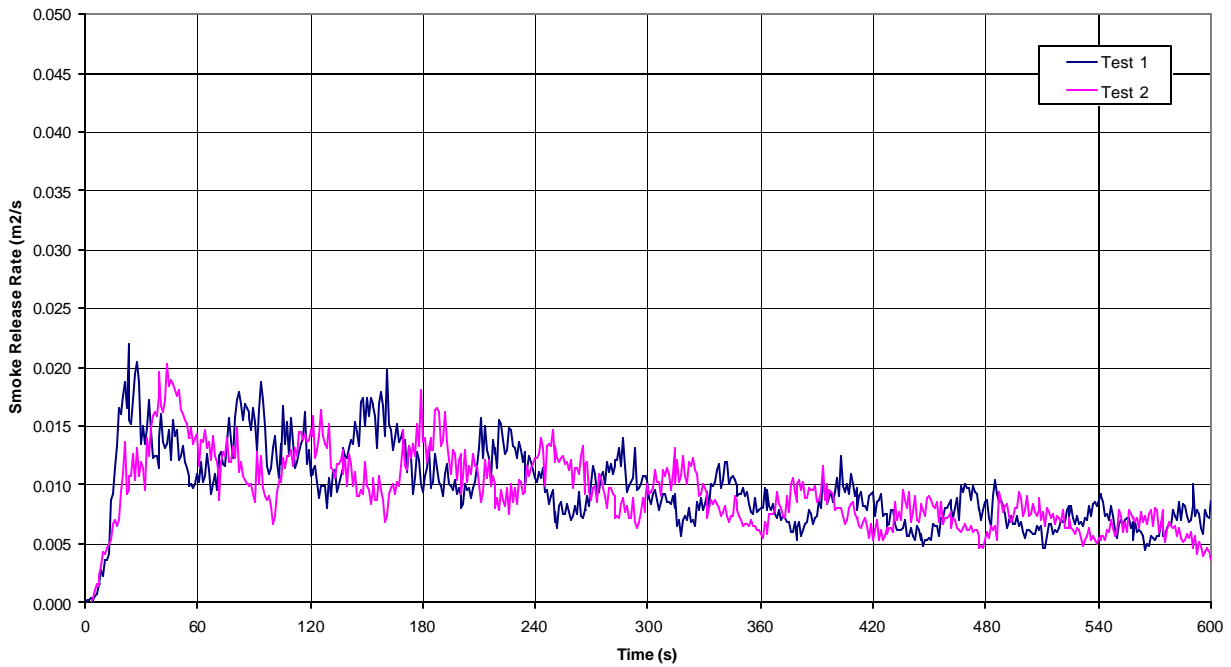

10

Figure 39 – Smoke release rate for PU foam in non-flaming combustion

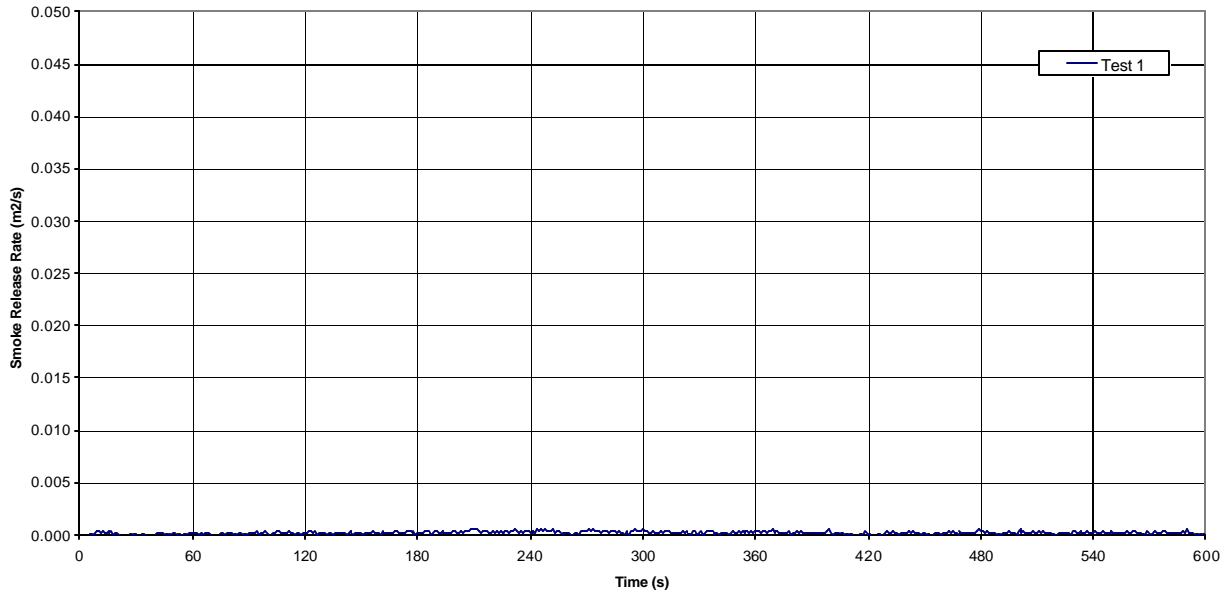

Figure 40 – Smoke release for cotton/poly sheet wrapped PU foam in non-flaming combustion

5 It was observed that only a trace amount of smoke was observed for the PU foam wrapped in the cotton/poly sheet.

The smoke particle size distribution data measured on the WPS spectrometer were analyzed to calculate the mean particle diameter D_m and count N_m for each test as described by Eq. 6 and Eq. 7. Mean smoke particle diameter and count from the intermediate calorimeter tests are summarized in Table 14.

5

Table 14 – Intermediate calorimeter smoke particle data

Sample	Calorimeter	Test Series	Mode	D_m (mm)	N_m (cc ⁻¹)
3:1 Heptane/Toluene mixture (UL 217)	NEBS	Test 1	Flaming	0.276	1.20E+06
	IMO	Test 1	Flaming	0.268	1.72E+05
	IMO	Test 2	Flaming	0.271	1.83E+05
Douglas fir (UL 217)	NEBS	Test 1	Flaming	0.066	6.94E+06
	IMO	Test 1	Flaming	0.072	1.35E+06
	IMO	Test 2	Flaming	0.061	7.87E+05
Newspaper (UL 217)	NEBS	Test 1	Flaming	0.086	6.22E+06
	IMO	Test 1	Flaming	0.073	2.98E+05
	IMO	Test 2	Flaming	0.115	7.56E+04
Heptane (lighter)	NEBS	Test 1	Flaming	0.233	1.03E+06
Pillow (TB 604 burner)	NEBS	Test 1	Flaming	0.221	1.83E+06
Mattress (TB 604 burner)	NEBS	Test 1	Flaming	0.126	6.40E+06
Cotton batting (TB 604 burner)	NEBS	Test 1	Flaming	0.053	1.90E+05
PU foam (TB 604 burner)	NEBS	Test 1	Flaming	0.038	1.95E+06
PU foam in cotton/poly sheet (TB 604 burner)	IMO	Test 1	Flaming	0.054	1.73E+06
	IMO	Test 2	Flaming	0.058	1.27E+06
Coffee maker (TB 604 burner)	NEBS	Test 1	Flaming	0.183	1.92E+06
	IMO	Test 1	Flaming	0.101	2.76E+06
	IMO	Test 2	Flaming	0.097	5.99E+06
Nylon carpet (cone Heater at 35 kW/m ²)	IMO	Test 1	Flaming	0.123	1.27E+06
	IMO	Test 2	Flaming	0.176	7.87E+05
Bread (Electric Toaster)	NEBS	Test 1	Non-Flaming	0.110	1.53E+07
	IMO	Test 1	Non-Flaming	0.146	3.17E+06
	IMO	Test 2	Non-Flaming	0.123	2.70E+06
2 Smoldering cigarettes	NEBS	Test 1	Non-Flaming	0.119	5.44E+05
Quarter mattress (3 smoldering cigarettes)	NEBS	Test 1	Non-Flaming	0.175	2.11E+05
Cotton batting (Hot plate)	NEBS	Test 1	Non-Flaming	0.106	3.98E+06
PU foam (Hot plate)	NEBS	Test 1	Non-Flaming	0.118	7.50E+06
PU foam (Cone heater at 15 kW/m ²)	IMO	Test 1	Non-Flaming	0.081	7.69E+05
	IMO	Test 2	Non-Flaming	0.085	9.98E+05
PU foam with cotton/poly sheet (Smoldering cigarette)	IMO	Test 1	Non-Flaming	0.186	3.37E+05

The results show that while mean particle diameters are similar in the two calorimeter test series, the particle density was observed to be generally lower in the IMO calorimeter. This is expected to be due to differences in air entrained prior to smoke extraction for the two test set-ups.

10

Gas effluent data were obtained only for the IMO test series. The data for the maximum concentration of carbon monoxide and carbon dioxide are presented in Table 15.

Table 15 – Maximum observed carbon monoxide and carbon dioxide concentrations

Test Sample	Test Series	Mode	Max CO (ppm)	Max CO ₂ (ppm)
Douglas fir (UL 217)	Test 1	Flaming	78	994
	Test 2	Flaming	69	317
Heptane + Toluene (UL 217)	Test 1	Flaming	13	121
	Test 2	Flaming	55	1000
Newspaper (UL 217)	Test 1	Flaming	145	179
	Test 2	Flaming	79	25
Nylon carpet (Cone heater at 35 kW/m ²)	Test 1	Flaming	160	2552
	Test 2	Flaming	170	2767
PU foam in cotton/poly sheet (TB 604 burner)	Test 1	Flaming	43	717
	Test 2	Flaming	18	349
Coffee maker (TB 604 burner)	Test 1	Flaming	686	9610
	Test 2	Flaming	612	10546
Bread (Electric Toaster)	Test 1	Non-Flaming	203	162
	Test 2	Non-Flaming	50	27
PU foam (Cone heater at 15 kW/m ²)	Test 1	Non-Flaming	3	17
	Test 2	Non-Flaming	9	34
PU foam in cotton/poly sheet (Smoldering cigarette)	Test 1	Non-Flaming	310	629

The charts depicting the heat and smoke release rates, smoke particle size and count data, and gas effluent for each of the flaming and non-flaming tests are presented in Appendix E and F respectively.

5

UL 217 Smoldering Ponderosa pine Test Results

The smoke particle data were analyzed to calculate the mean diameter and count for each scan. The data are plotted in Figure 41. The increase in smoke particle size after approximately 2,700 seconds (45 minutes) may have occurred due to the lowering of the smoke layer below the sampling point.

10

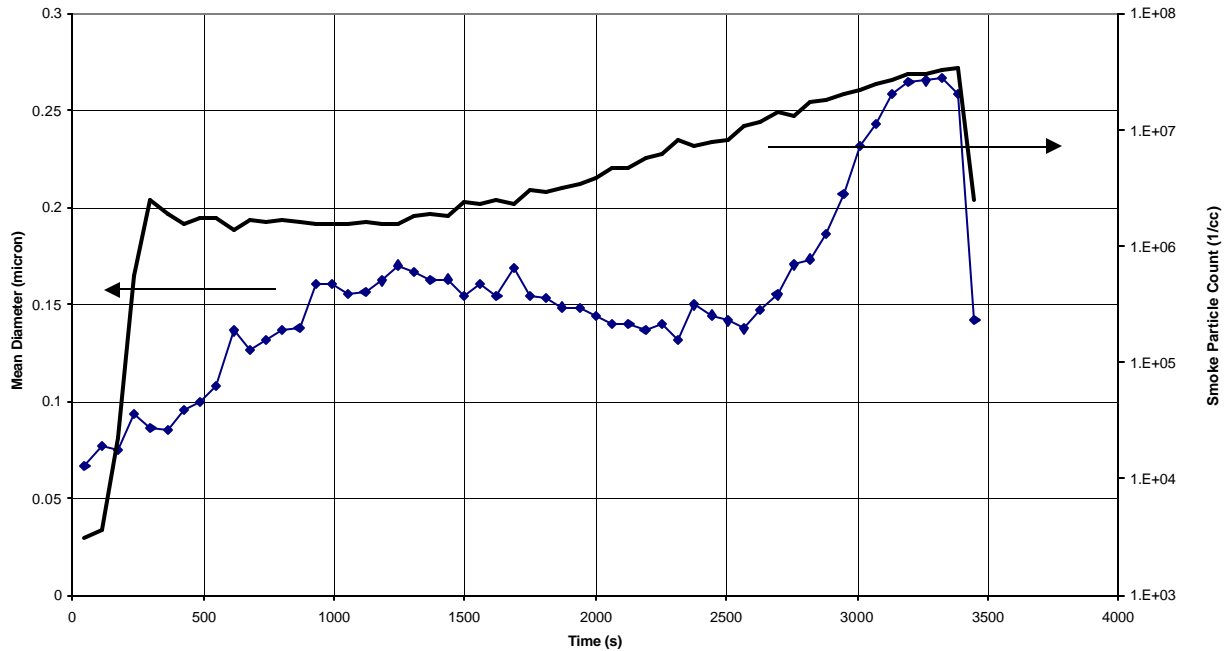

Figure 41 – Smoke particle data from the UL 217 smoldering Ponderosa pine test

5 The count distribution of the three relative particle sizes is shown in Figure 42. It was observed that after approximately 3,000 seconds (50 minutes) into the test, the number of particles in the 0.109 to 0.500 micron range increase rapidly. This increase may be related to the settling of the smoke observed during the test and/or aggregation of smoke particles as observed in the UL 217 smoke box test. The mean smoke particle diameter for the time period prior to this change (up to than 2,000 s) was 0.142 microns versus 0.204 microns for the entire test.

10

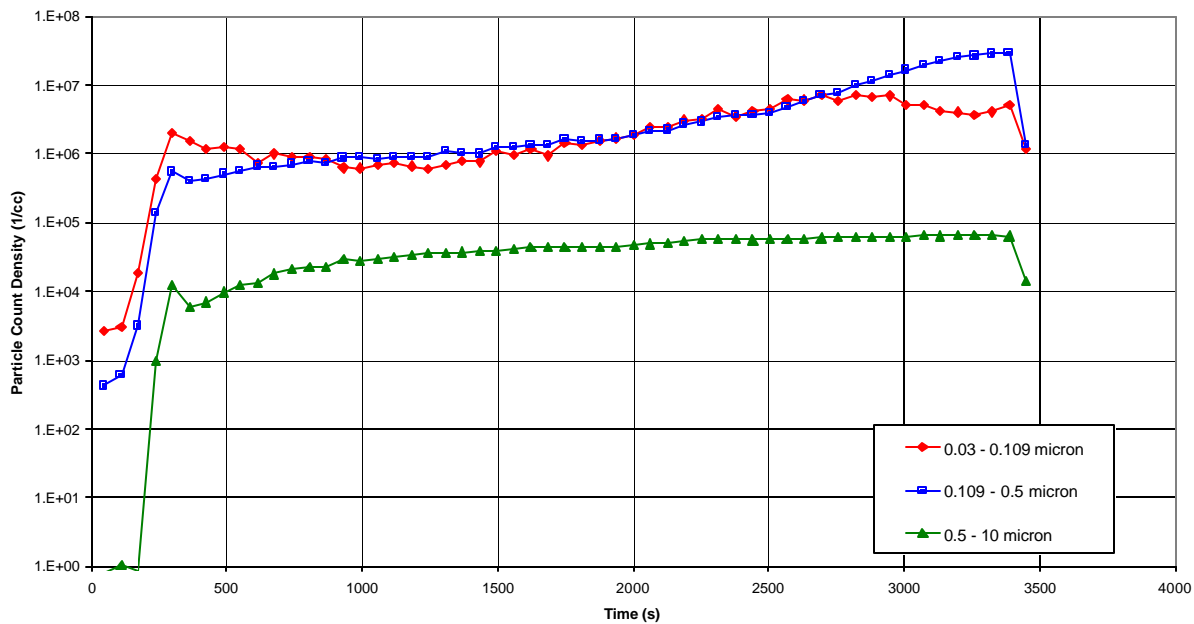

Figure 42 – UL 217 smoldering Ponderosa pine particle size distribution

Discussion of Intermediate Scale Test Results

- 5 The data were further analyzed to develop a comparison of the samples tested with the UL 217 materials with respect to their smoke characteristics.

Combustibility Results

- 10 Heat and smoke release data for the flaming tests are presented in Figure 43 and Figure 44. In order to compare heat and smoke release measurements for the coffee maker test during the same experiment time frames to the other tests, maximum plotted values for the coffee maker are through the first six minutes.

- 15 It was observed that the nylon carpet and PU foam yield smaller peak heat release rates than the Douglas fir, heptane/toluene mixture and the newspaper test samples. The peak heat release rate from the coffee maker for the duration of the test was approximately 100 kW, which was significantly higher than the other investigated scenarios.

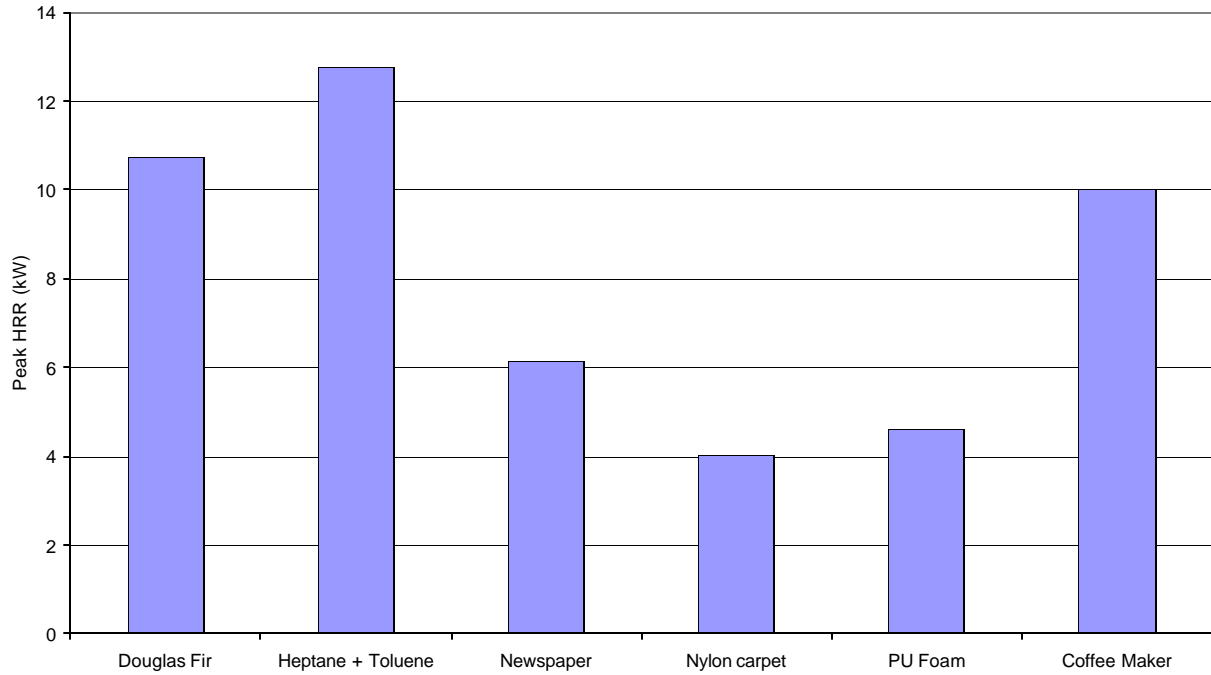

Figure 43 – Peak HRR for flaming combustion tests

5

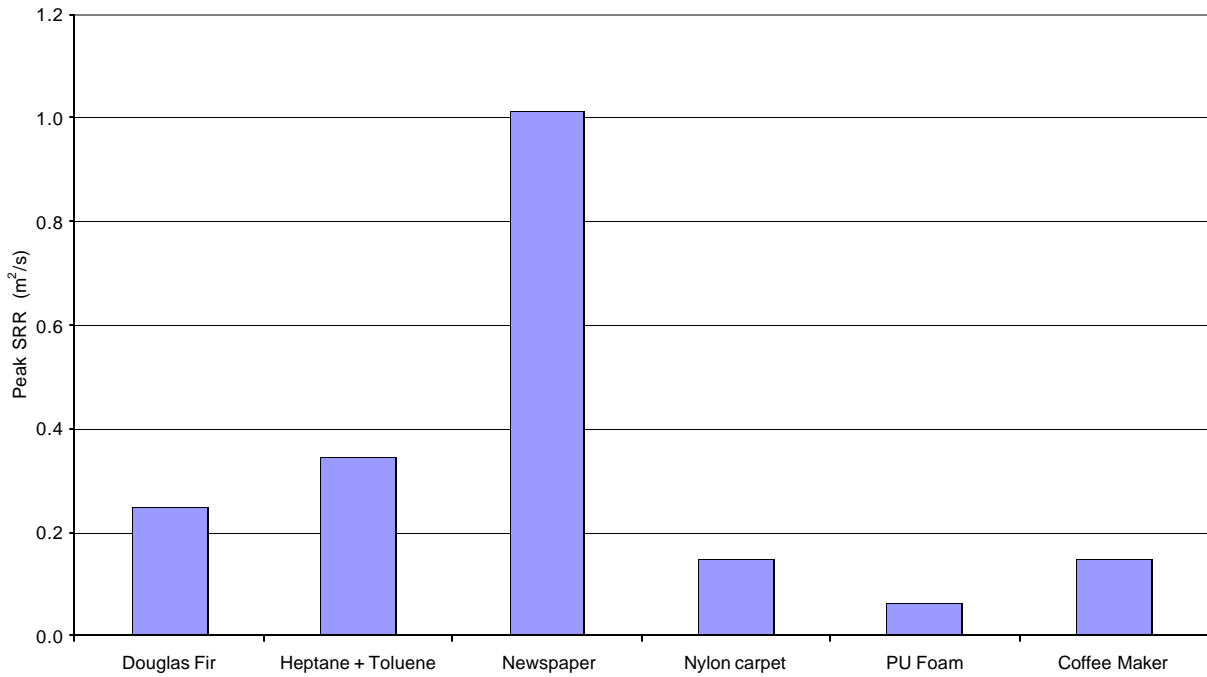

Figure 44 – Peak SRR for flaming combustion tests

Influence of Material Chemistry on Smoke Characteristics

The intermediate scale tests demonstrated the influence of material chemistry on smoke characteristics. For example, the mean smoke particle diameters were larger when aromatic hydrocarbon molecules (toluene) were mixed with the straight chain hydrocarbon molecules (heptane). Natural materials such as wood, newspaper, cotton batting had relatively smaller average particle diameter as compared to synthetic materials (coffee maker, nylon carpet). An exception was the PU foam that had a smaller average particle diameter in the flaming mode. This may be due to the unique chemistry and physical cell structure of polyurethane foam. These results are similar to those obtained in the cone calorimeter tests.

The influence of material chemistry on the particle size distribution is depicted in Figure 45 (vertical axis are identically scaled for the four plots).

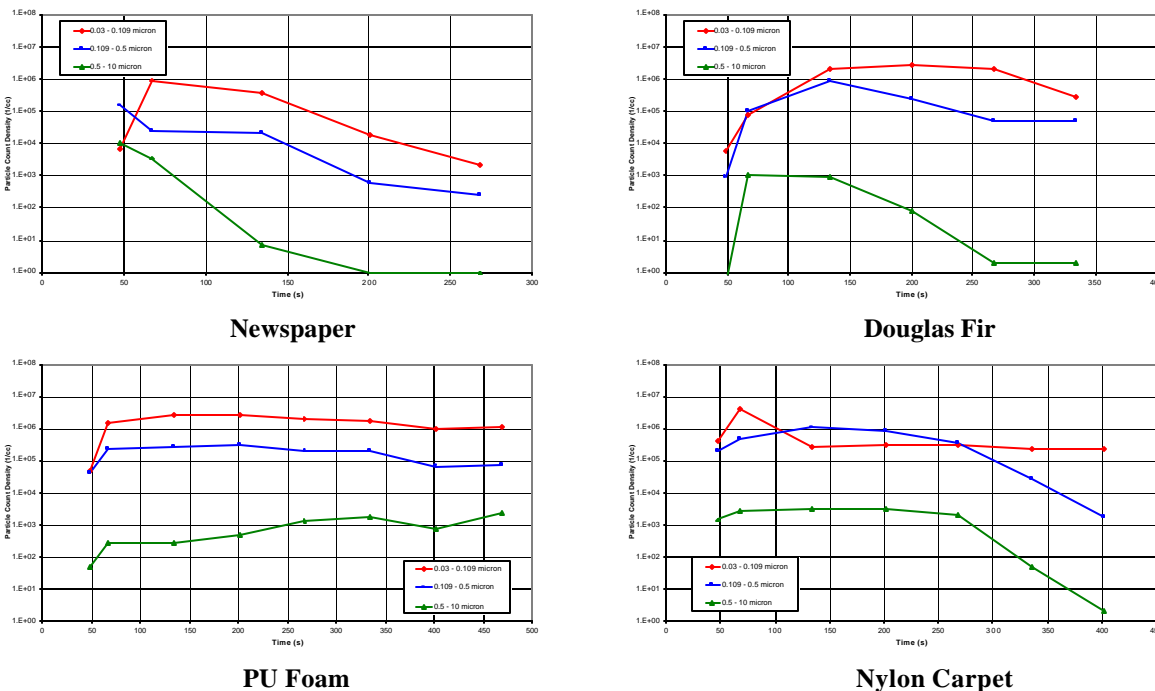
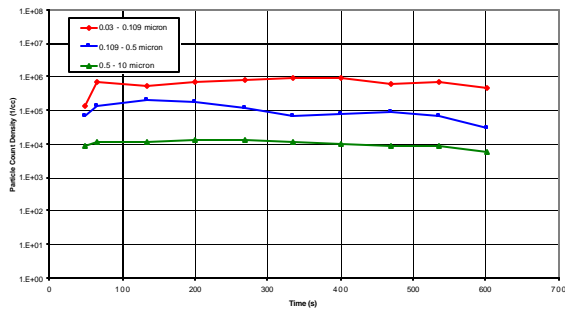

Figure 45 – Particle size distribution for flaming combustion of natural and synthetic materials

For the Douglas fir it was observed that there is significant reduction in the largest particle (0.500 to 10 microns) due to charring (also observed in small-scale tests). The change in the particle size distribution exhibited by newspaper using the UL 217 newspaper fire test protocol can be explained by formation of more large particles prior to flame-through when smoldering predominates and then smaller particles during the open flame portion of the test after flame-through occurs. This phenomenon is also in agreement with the flaming and non-flaming results observed in small-scale tests. Particle sizes are relatively stable for the PU foam and nylon carpet samples.

The particle size distribution trends for non-flaming tests on Ponderosa pine, PU foam, and PU foam wrapped in a cotton-poly sheet are shown in Figure 46.



PU Foam with radiant heating

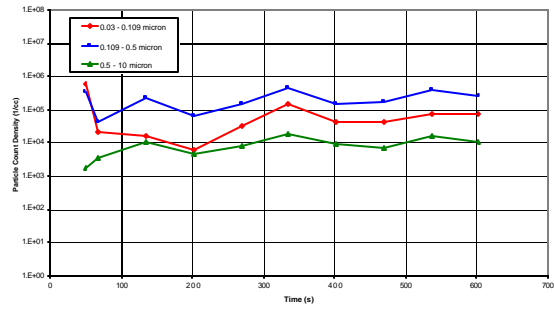

PU Foam wrapped cotton/poly fabric

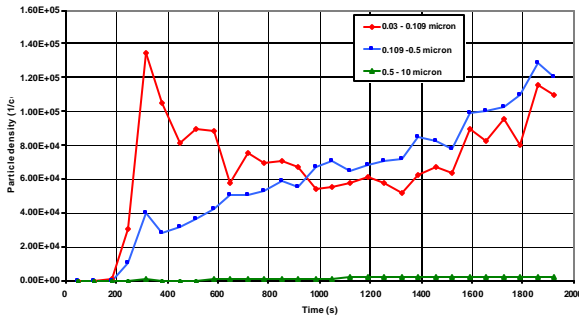

Ponderosa Pine

Figure 46 – Particle size distribution for non-flaming combustion of natural and synthetic materials

The distribution of small and large particles for the PU foam is relatively constant throughout the test. In contrast the PU foam wrapped with the cotton-poly sheet has a relatively higher count of the particles in the 0.109 to 0.500 micron range and a lower count of the smaller particles. For Ponderosa pine, there are very few particles in the range 0.500 to 10 microns as compared to either of the two PU foam tests.

Comparison of Particle Size and Count

10 The average particle sizes (D_m) for the test were calculated for each test sample using data from both the NEBS and IMO calorimeter.

A bar chart is presented in Figure 47 displaying the comparison between the evaluated samples.

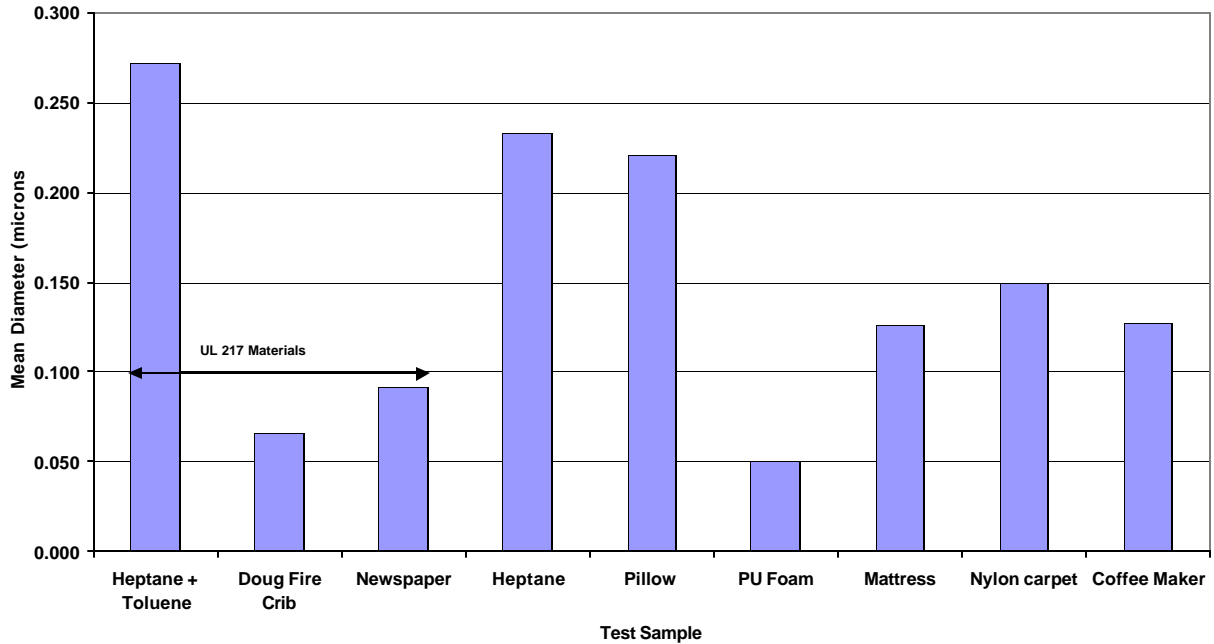

Figure 47 – Average smoke particle diameters for flaming combustion tests

The average particle densities from the flaming tests performed in the IMO calorimeter are presented in Figure 48. The three non-UL 217 materials generated larger particle densities of smoke.

5

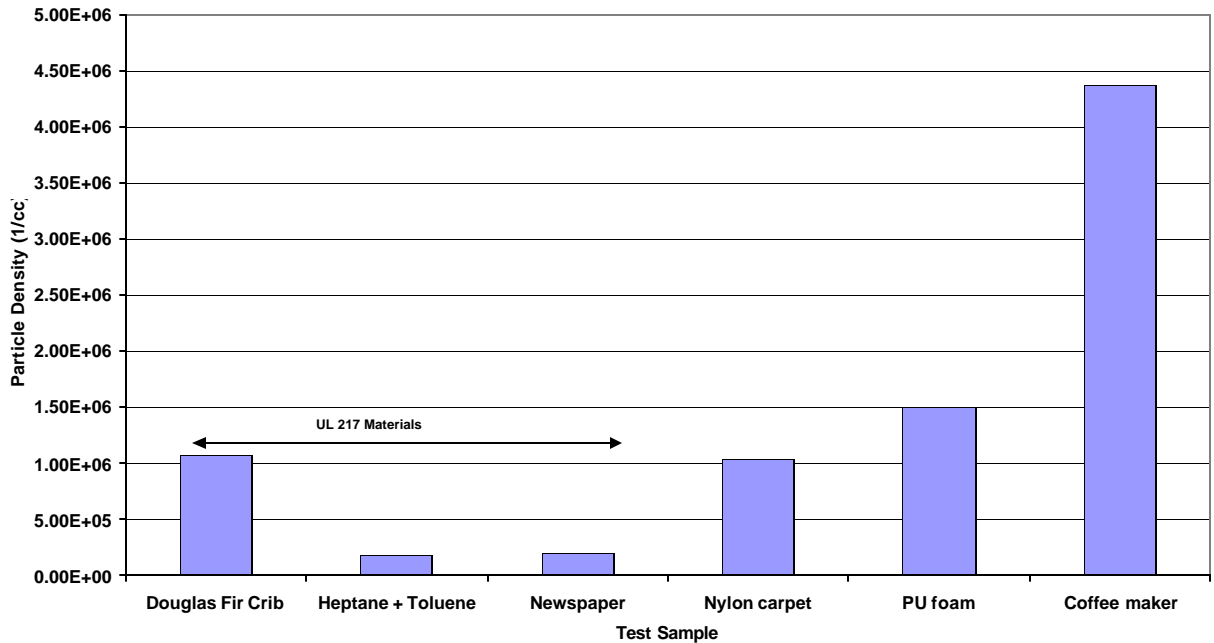

Figure 48 – Average smoke particle density for flaming combustion tests

10

The data shows that for flaming mode, the average particle sizes from UL 217 materials are in the same range as particle sizes observed for several products typically found in residential occupancy areas.

- 5 The mean particle size for non-flaming tests are presented in Figure 49.

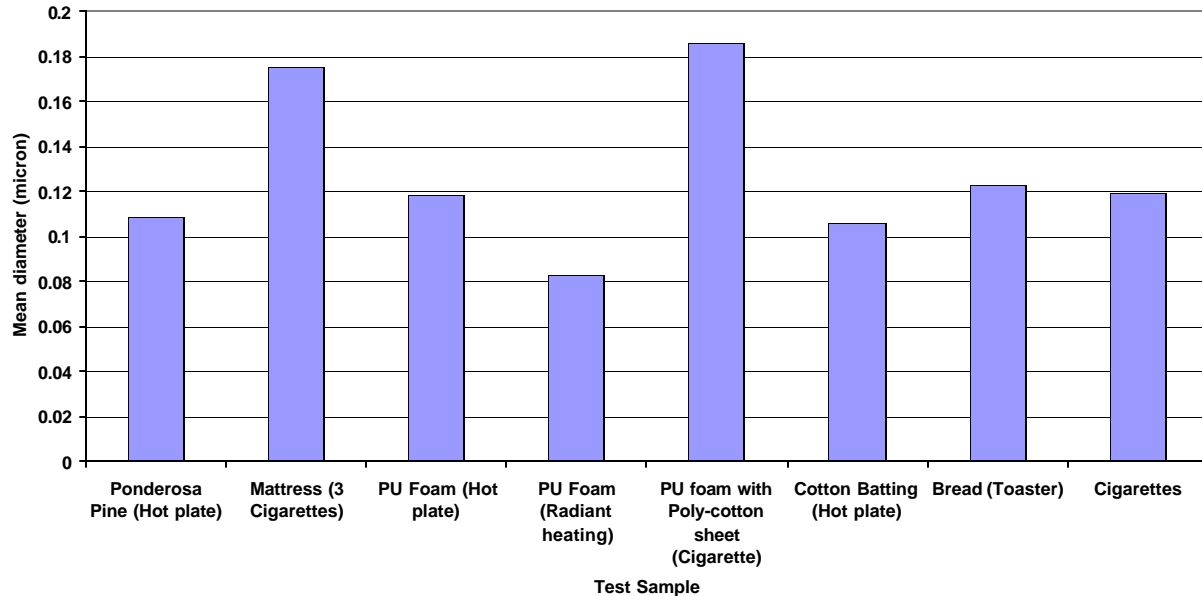

Figure 49 – Mean smoke particle diameter for non-flaming tests

- 10 The average smoke particle diameter was highest for PU foam covered with poly-cotton blend sheet, and was almost 72 % higher than the average particle size generated by Ponderosa pine. Average particle diameters from other materials were in the same range as Ponderosa pine. It may also be observed that the particle count from the PU foam covered with poly-cotton sheet was significantly lower than other materials. This is anticipated to be due to cover sheet obstructing the smoke flow away from the underlying polyurethane foam.

15

In these tests involving smoldering cigarette as a heat source, there was not a sustained involvement of the target material once the cigarette extinguished or the target material around the cigarette hot tip had gasified. Thus, this heat source scenario was not pursued.

- 20 The average particle densities for non-flaming tests are presented in Figure 50.

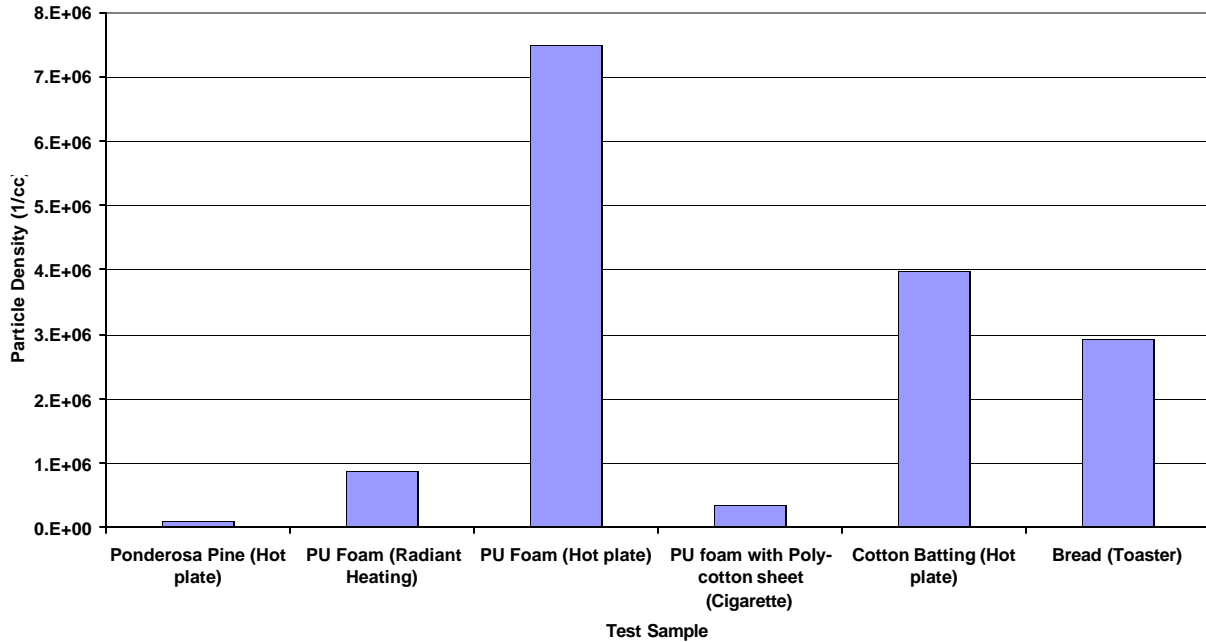

Figure 50 – Average particle count for non-flaming combustion tests

- 5 A significant difference in the PU foam particle density was observed with the two heating methods (radiant versus hot plate). Furthermore, wrapping the PU foam with poly-cotton fabric decreased the particle density count. It was also observed that bread in a toaster generated significant particle density of smoke.

TASK 3 – DEVELOP SMOKE PROFILES AND PARTICLE SIZE AND COUNT DISTRIBUTIONS IN THE UL 217/UL 268 FIRE TEST ROOM

INTRODUCTION

5 Activation response of smoke alarms to different smoke scenarios is evaluated in UL 217 through a series of four flaming and non-flaming fire tests:

1. Paper Fire (Section 44 *Fire Tests* – Test A)
2. Wood Fire (Section 44 *Fire Tests* – Test B)
3. Flammable Liquid Fire (Section 44 *Fire Tests* – Test C)
- 10 4. Wood Non-flaming Fire (Section 45 *Smoldering Smoke Test*)

The first three fire tests are open flame tests in which the alarm unit must activate within a specified maximum time limit of 240 seconds; while the fourth test is a non-flaming fire test in which the unit must activate within a specified obscuration range (0.5 to 10.0 percent per foot).

15 In this task the atmosphere in the vicinity of the alarm units during the course of the UL 217 fire and non-flaming smoke tests was characterized for MIC and obscuration signals, smoke particle size and distribution, effluent gas composition, ceiling air flow velocity, and ceiling temperature. Atmospheres generated by flaming and non-flaming combustion of other materials were also evaluated at the same prescribed 5.4 m sampling distance.

20

TASK OBJECTIVES

The objectives of this task were to characterize the following for UL 217 Section 44 fire test samples and the additional test samples and fire scenarios developed in Task 2:

- 25 (i) smoke particle size and count distribution
- (ii) gas effluent composition
- (iii) analog addressable smoke alarm signals
- (iv) standard light obscuration beam and MIC signals
- (v) standard photoelectric and ionization alarm signals
- 30 (vi) ceiling air velocity
- (vii) ceiling air temperature

TEST SAMPLES

In addition to the standard UL 217 test samples, other samples were selected from Task 2 that had unique combustibility or smoke characteristics as presented in Table 16.

5

Table 16 – Test samples for UL 217 Fire Test Room Test tests

Test Sample	Comments
Flaming Tests	
Heptane/Toluene mixture	Standard UL 217 sample
Douglas fir	Standard UL 217 sample
Shredded newspaper	Standard UL 217 sample
Coffee maker	Higher energy fire. Relatively more and larger particles in intermediate scale tests
Mattress PU foam insulation	Common in residential settings. Relatively more and smaller particles in small and intermediate scale tests
Mattress PU foam with CA TB 117 50:50 cotton/poly sheet	Common in residential settings. Relatively more and larger particles than Ponderosa pine in intermediate scale test
Nylon carpet	Common in residential settings. Relatively more particles in 0.109-0.500 micron range in small and intermediate scale tests
Non-Flaming Tests	
Ponderosa pine	Standard UL 217 sample
Mattress PU foam with CA TB 117 cotton sheet	Larger average particle diameter than Ponderosa pine in intermediate scale test
Mattress PU foam with polyester microfiber sheet	A more common current fabric in furnishings. Not tested in the small-scale and intermediate scale tests.
Polyisocyanurate foam	Relatively more and smaller particles in small-scale tests
Nylon carpet	Relatively more and smaller particles in small-scale tests
Polystyrene pellets	Anticipate more, dark colored smoke than for UL 217 Ponderosa pine
Bread	Common nuisance alarm. Relatively larger particles and count in intermediate scale tests

EXPERIMENTAL

10 All combustion tests were conducted in Underwriters Laboratories' Fire Test Room. Tests were conducted at the respective UL 217 prescribed height of 0.91 m (for flaming tests) and 0.2 m (for non-flaming tests) above the floor. Test samples were preconditioned in accordance with UL 217 at a temperature of 23 ± 2 °C (73.4 ± 3 °F) and a relative humidity of 50 ± 5 % for at least 48 hours prior to testing. The evaluated test materials and ignition scenarios are listed in Table 17.

Table 17 – Fire Test Room Tests

Mode	Target Sample Description	Heat/Ignition Source	Test No.
F L A M I N G	UL 217 Heptane/Toluene mixture (3:1)	UL 217 prescribed ignition	12112, 12131, 12181, 12182, 01221
	UL 217 Douglas fir	UL 217 prescribed ignition	12123, 12124, 12127, 12146, 12183
	UL 217 Shredded newspaper	UL 217 prescribed ignition	12113, 12122, 12125, 12141, 12144, 12145
	Coffee maker – 12 cup, no carafe	CA TB 604 burner flame (50 mm height) applied under filter holder for 35 s	12134, 12186
	Mattress PU foam – 100 × 100 × 100 mm (w × l × h) sample	ASTM E1354 cone heater at 35 kW/m ²	12154
	Mattress PU foam wrapped in CA TB 117 50:50 cotton/poly sheet – 100 × 100 × 100 mm foam	CA TB 604 burner flame (35 mm height) applied to base for 20 s	12135
	Mattress PU foam wrapped in CA TB 117 50:50 cotton/poly sheet – 150 × 150 × 150 mm foam	CA TB 604 burner flame (35 mm height) applied to base for 20 s	12142, 12156, 12191
	Nylon carpet – 100 × 100 mm sample	ASTM E1354 cone heater at 35 kW/m ²	12151, 12152, 12153
N O N - F L A M I N G	UL 217 Ponderosa pine	UL 217 prescribed hot plate and temperature profile	12126, 12132, 12143, 12184, 12185
	Bread – 4 slices	Commercial toaster – 3 cycles on dark setting	12133, 12155, 01244
	Polyisocyanurate insulation – 150 × 150 × 200 mm pieces	UL 217 Ponderosa pine hot plate and temperature profile	12271
	Mattress PU foam – 150 × 150 × 50 mm foam	UL 217 Ponderosa pine hot plate and temperature profile	12192, 12193
	Mattress PU foam – 100 × 125 × 100 mm foam with a 25 × 150 × 150 mm piece on two opposing sides	UL 217 Ponderosa pine hot plate and temperature profile	12202, 12261
	Mattress PU foam wrapped in CA TB 117 cotton sheet – 100 × 150 × 200 mm foam	UL 217 Ponderosa pine hot plate and temperature profile	01232
	Mattress PU foam wrapped in CA TB 117 cotton sheet – 125 × 125 × 300 mm foam	UL 217 Ponderosa pine hot plate and temperature profile	01241
	Mattress PU foam wrapped in polyester microfiber sheet – 125 × 125 × 300 mm foam	UL 217 Ponderosa pine hot plate and temperature profile	01233, 01245
	Nylon carpet – 150 × 150 mm sample	UL 217 Ponderosa pine hot plate and temperature profile	12262
Polystyrene pellets – 69.8 g	UL 217 Ponderosa pine hot plate and temperature profile	12272	

5 **Test Facility** - The Fire Test Room consists of 11.0 × 6.7 × 3.1 m (l×w×h) room with a smooth ceiling with no physical obstructions. The test room is constructed to maintain a temperature of 23 ±3 °C and a humidity of 50 ±10 % while ensuring minimal air movement during the test. The room is provided with exhaust system to clear the room of smoke after each test.

Measurements and Instrumentation - The test room was equipped with the following devices for evaluation of air quality:

- Measuring Ionization Chamber (MIC) – ceiling and two side walls equidistant from the test target
- 5 • Obscuration – ceiling and two side walls equidistant from the test target
- Analog addressable smoke alarms – one ionization and one photoelectric unit on the ceiling and wall
- Smoke alarms – one ionization and one photoelectric unit on the ceiling
- Air flow velocity – ceiling
- 10 • Temperature – ceiling
- Sampling port for smoke particle characterization – ceiling between commercial alarms
- Sampling port for room gas composition characterization – ceiling between commercial alarms
- Light obscuration tree – located in the vicinity of the MIC. Added for the last series of tests.

15

Measuring Ionization Chamber (MIC) - An Elektronikcentralen Type EC 23095 MIC was used to measure the relative buildup of particles of combustion during the test. The MIC utilizes the ionization principle with air drawn through the chamber at a rate of 30 ± 3 Lpm by a regulated vacuum pump. The ceiling mounted monitoring head was located 6 m from the fire source and 0.1 m below the ceiling, along the centerline of the test room; side-wall mounted monitoring heads were located 0.4 m below the ceiling, 6 m from the fire source and 0.1 m from the respective wall. The MIC was not utilized during flaming mode tests.

20

Obscuration - A white light obscuration system consisting of a lamp and photocell assembly spaced 1.52 m apart was used to measure the relative buildup of particles of combustion during the test. The ceiling mounted obscuration system was located 5.4 m from the fire source along the centerline of the room and 0.1 m below the ceiling; the side wall mounted systems were located 0.4 m below the ceiling, 5.4 m from the fire source and 0.18 m from the respective wall. Complete descriptions of the lamp and photocell assemblies are available in the UL 217.

25

30

Analog Addressable Smoke Alarms – Commercially available residential ionization and photoelectric type smoke alarm units were mounted on the ceiling and walls 5.4 m from the fire source. The alarms were equipped to provide an analog output (electrical measurement) of the alarm sensitivity during the course of the test trials.

35

Smoke Alarms - Residential ionization and photoelectric type smoke alarms were mounted on the ceiling 5.4 m from the fire source. The automated data acquisition equipment recorded the alarm trigger time.

40

Smoke Particle Characterization - Smoke for particle characterization was sampled along the centerline of the room 5.4 m from the fire source and 0.01 m below the ceiling. Smoke particle size and count were characterized using WPS Spectrometer previously described in the Smoke Characterization section of Task 2. The sample line to the spectrometer was 10.5 m long with a 3.2 mm I.D.

45

Effluent Gas Composition Characterization - Gas effluent for composition characterization was sampled along the centerline of the room 5.4 m from the fire source and 0.01 m below the ceiling. Gas effluent composition was characterized using the MIDAC #I 1100 Fourier

5 Transform Infrared (FTIR) Spectrometer and deconvoluted as previously described in the Smoke Characterization section of Task 2 (Eq. 8 through Eq. 11). The sample line to the spectrometer was 8.5 m long with a 3.2 mm I.D. The utilized sample line was not heated because water vapor condensation was not expected within the sample line as the ceiling temperatures were not anticipated to be significantly higher than ambient conditions.

10

Air Velocity - Two-component air velocities was measured 5.4 m from the fire source and 0.1 m below the ceiling using a CATI sonic anemometer (Applied Technologies Inc.) supplied by NIST. The anemometer was arranged such that the two measured air velocity components are in the radial direction away from the combustion source and in the transverse direction.

15

This device uses piezoelectric crystals to form ultrasonic transducers that can send and receive ultrasonic pulses. The forward and backward travel time of these pulses are used to compute the component velocity between two opposing transducers. The anemometer records the mean velocity over a 150 mm sonic path length (which equals the distance separating opposing

20

transducers) at a frequency of up to 10 Hz. The measurement resolution is 10 mm/s with a stated uncertainty of 10 mm/s.

Temperature - Air temperature was measured on the airflow velocity support structure 5.4 m from the fire source and 0.15 m below the ceiling using a 0.0625 mm diameter Inconel sheathed Type K thermocouple.

25

Light Obscuration Tree - The light obscuration tree was used in the final smoldering fire tests to determine the obscuration in the room at three different heights during these tests. Each of the light obscuration instruments consisted of a 12 volt DC, 20 watt, Halogen lamp (Model MR 16) and a Huygen photocell (Weston Model 856-9901033-BB). The lamp and photocell were spaced 300 mm apart. The three light and photocell assemblies were mounted on an adjustable pole such that they were located 600, 900, and 1500 mm below the ceiling.

30

Smoke Color - The filter paper used with the gas FTIR instrument were observed after each test for the color of the smoke deposited during the test.

35

A schematic of the test room with the sampling instrumentation is shown in Figure 51.

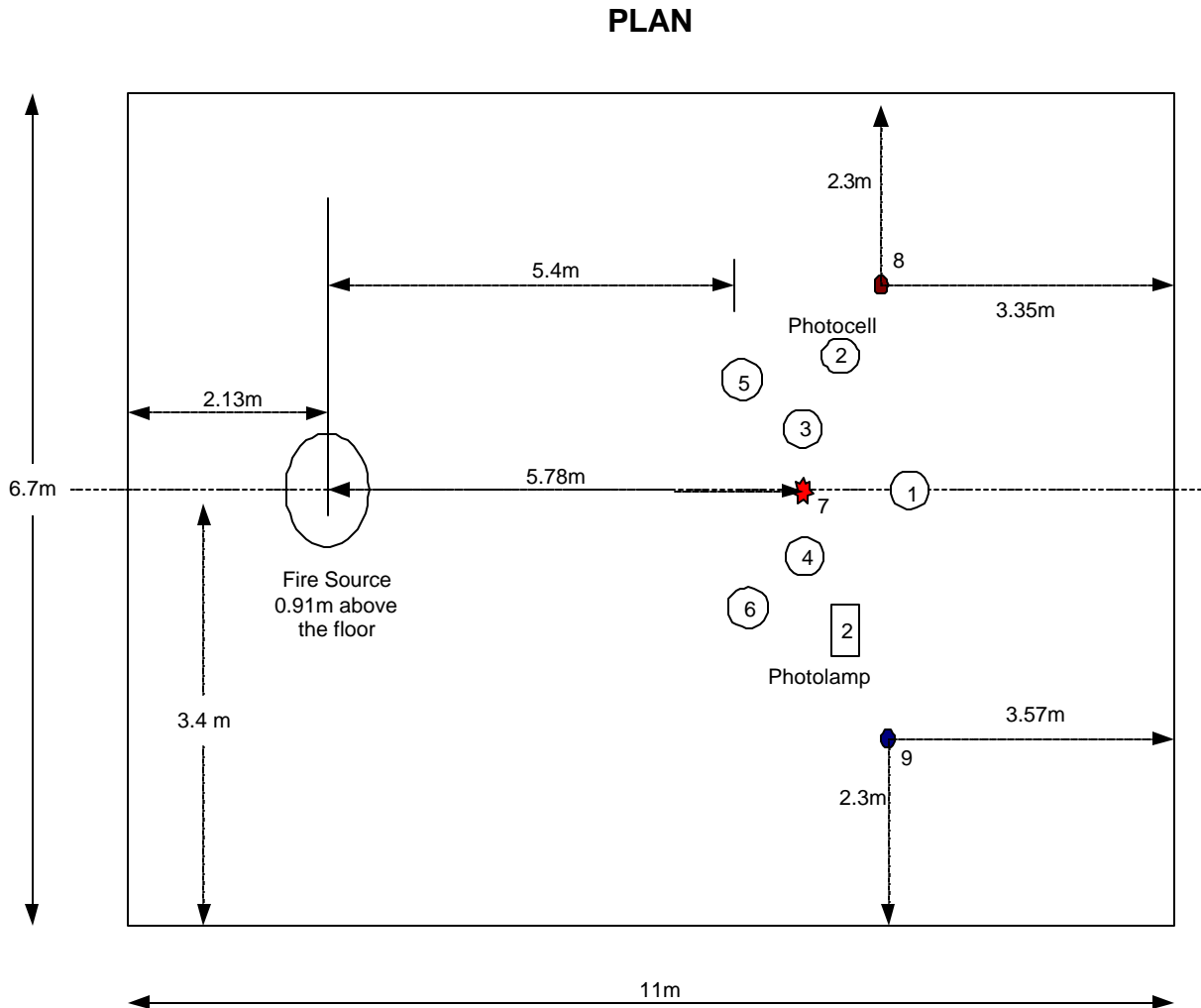

- 1 - MIC (Measuring Ionization Chamber)
- 2 - Photocell Assembly (5ft from lamp to photocell. Centerline 4in below ceiling)
- 3 - Photoelectric Smoke Detector
- 4 - Ionization Smoke Detector
- 5 - Analog Addressable Ionization Smoke Alarm
- 6 - Analog Addressable Photoelectric Smoke Alarm
- 7 - Smoke Particle Size and Gas FTIR Sampling port (3-3/8in below ceiling)
- 8 - Sonic anemometer, Thermocouple
- 9 - Obscuration Tree

Figure 51 – Fire Test Room. Drawing not to scale.

TEST PROCEDURE

The flaming tests for UL 217 test samples were conducted using the procedures described in the UL 217. For samples ignited with TB 604 ignition source, the test samples were ignited as described in Table 17. For samples heated with the ASTM E1354 conical heater, the samples were ignited with the aid of an electric spark. The data acquisition systems for all the instruments were manually initiated upon ignition of the sample. The sampling intervals for the data acquisition systems used are provided in Table 18.

Table 18 – Data acquisition sampling intervals

Data Acquisition	Sampling Interval (s)
Test room Beam, MIC, and smoke alarm triggers	1
Analog smoke alarms	8
Gas effluent FTIR	15
WPS spectrometer	67 ^[1]

Note to Table 18:

^[1] The first data was sampled at 48 s, followed by 67 s intervals between subsequent measurements

For non-flaming tests, the temperature controlled hot plate described in UL 217 was used for all the samples except for bread, where a four slice electric toaster was used.

TEST RESULTS

The results from these tests included:

- Obscuration over the test duration
- Smoke alarm trigger time
- Smoke particle size and count distribution data
- MIC and Beam signals
- Gas effluent component data
- Ceiling air velocity and temperature
- Smoke color

Individual results for flaming and non-flaming combustion tests are plotted in Appendix G and H respectively. Post-test photographs of the FTIR particulate filters for smoke particulate color comparison are presented in Appendix I.

Flaming Test Results

In Table 19, is presented the obscuration measured in the room. The obscuration (OBS) was calculated from the ceiling light beam signal data as follows:

$$\text{OBS} = 100 \left[1 - \left(\frac{T_s}{T_c} \right)^{\frac{1}{d}} \right] [=] \%/\text{ft} \quad \text{Eq. 23}$$

Where T_s is the light beam signal during the test
 T_c is the clear light beam signal

d is path length = 5 ft

The table shows the obscuration calculated at (i) UL 217 specified time for the alarm to operate (e.g., 240 seconds for the Douglas fir); (ii) maximum obscuration; and (iii) the time to attain maximum obscuration.

5

Table 19 – Summary of obscuration for flaming tests

Target Sample Description	Test No.	Flame Through Time (s)	UL 217 Time		Max. OBS	
			Time (s)	OBS (%/ft)	Time (s)	(%/ft)
UL 217 Heptane/Toluene mixture	12112	--	240	13.0	143	14.6
	12131	--	240	11.9	138	12.8
	12181	--	240	11.9	153	13.2
	12182	--	240	12.9	133	13.9
	01221	--	240	13.5	135	14.9
UL 217 Douglas fir	12123	189.7	240	5.0	217	20.2
	12124 ^[1]	142.4	240	2.3	161	14.1
	12127 ^[1]	127.6	240	1.3	189	13.2
	12146	166.3	240	5.0	150	13.1
	12183 ^[1]	102.6	240	0.6	125	9.4
UL 217 Shredded newspaper	12113 ^[1]	36.1	240	1.4	56	14.8
	12122	100.3	240	6.5	125	33.3
	12125	141.0	240	20.1	165	28.4
	12141	60.2	240	3.4	91	21.7
	12144	118.4	240	9.9	144	29.0
	12145	83.1	240	2.8	110	23.7
Coffee maker – 12 cup, no carafe	12134	--	240	0.8	605	47.4
	12186	--	240	0.7	510	44.2
Mattress PU foam – 100 × 100 mm sample	12154	--	240	[2]	64	5.5
Mattress PU foam wrapped in CA TB 117 50:50 cotton/poly sheet – 100 × 100 × 100 mm foam	12135	--	240	0.4	600	0.6
Mattress PU foam wrapped in CA TB 117 50:50 cotton/poly sheet – 150 × 150 × 150 mm foam	12142	--	240	3.9	234	3.9
	12156	--	240	3.0	167	4.7
Nylon carpet – 100 × 100 mm sample	12151	--	240	5.1	279	6.1
	12152	--	240	4.8	343	6.2
	12153	--	240	4.0	323	6.8

Notes to Table 19:

^[1] Flame through time is shorter than allowed in UL 217.

^[2] Test duration was less than 240 s.

10

The OBS data for the flaming tests are shown in Figure 52 through Figure 59. There was more variation in the newspaper tests than the others. It is believed that this was due to the influence of the packing of the shredded material.

- Repeat tests were not performed for the 4×4-in sample of PU foam wrapped in poly-cotton fabric as this sample target arrangement resulted in a very low level of obscuration in the room. Testing was repeated for this sample arrangement using a larger PU foam sample (6×6-in.). Also, repeat tests for the PU foam exposed to radiant heating were not conducted as this test resulted in a short duration fire of less than 240 s. In this test, there was rapid burn time resulting in a relatively sharp smoke obscuration peak similar to that observed for the newspaper tests. It was observed that most of the smoke remained on the ceiling. Good visibility was present throughout the rest of the room.
- 10 It was observed that there is a good repeatability between tests, except for the shredded newspaper tests. There was substantial variation observed in the shredded newspaper test with respect to the progression of the flame out of the test specimen holder. This also resulted in relatively larger variation in maximum OBS values.

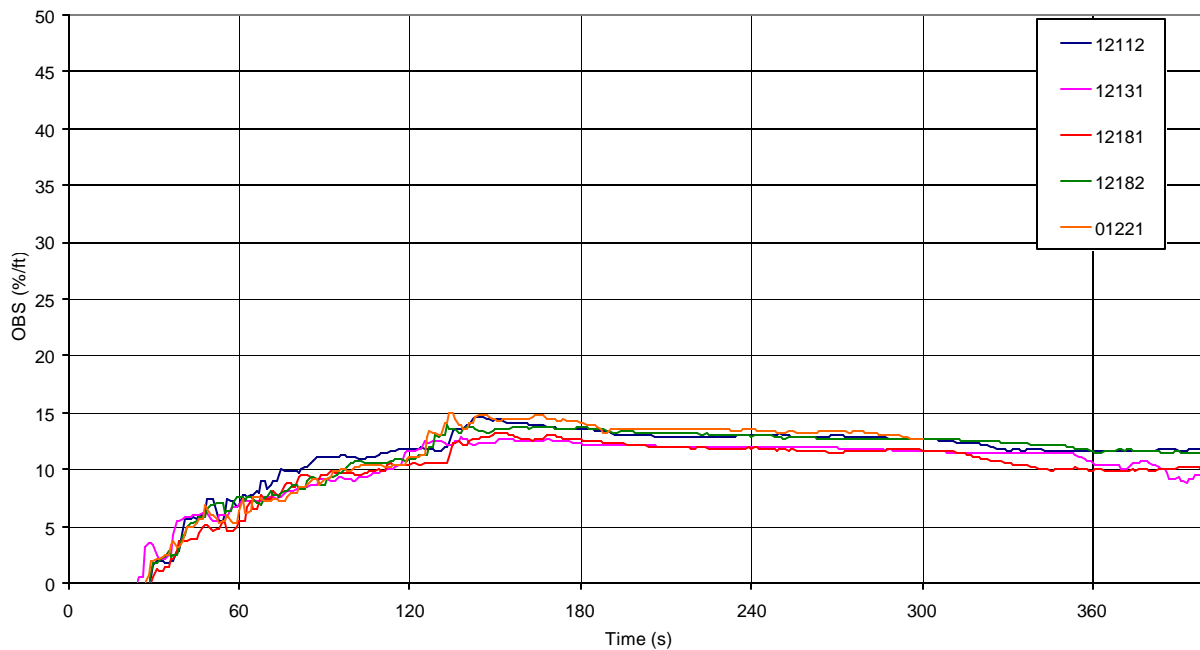

15 **Figure 52 – Smoke OBS for heptane/toluene mixture in flaming combustion**

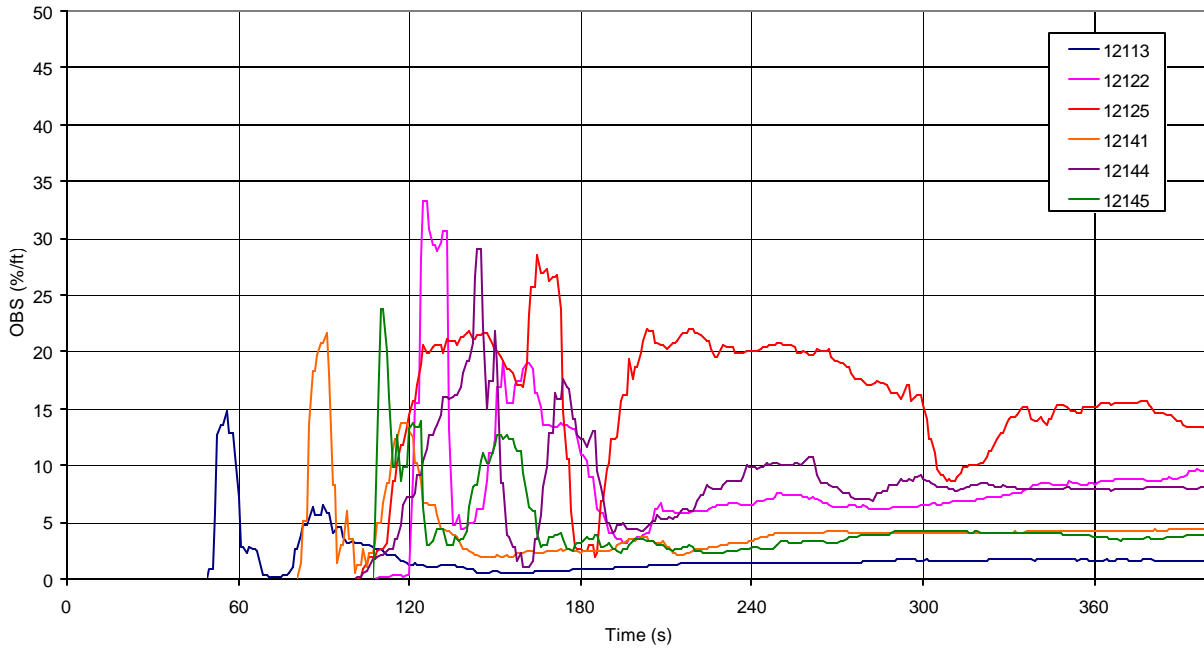

Figure 53 – Smoke OBS for newspaper in flaming combustion

5

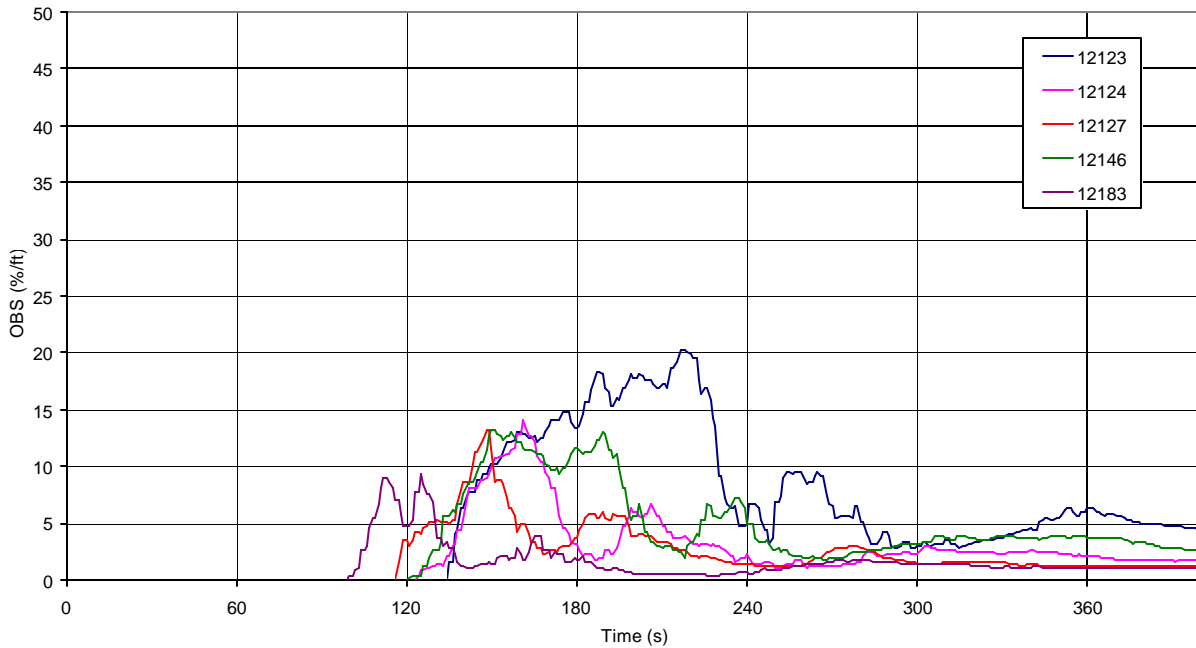

Figure 54 – Smoke OBS for Douglas fir in flaming combustion

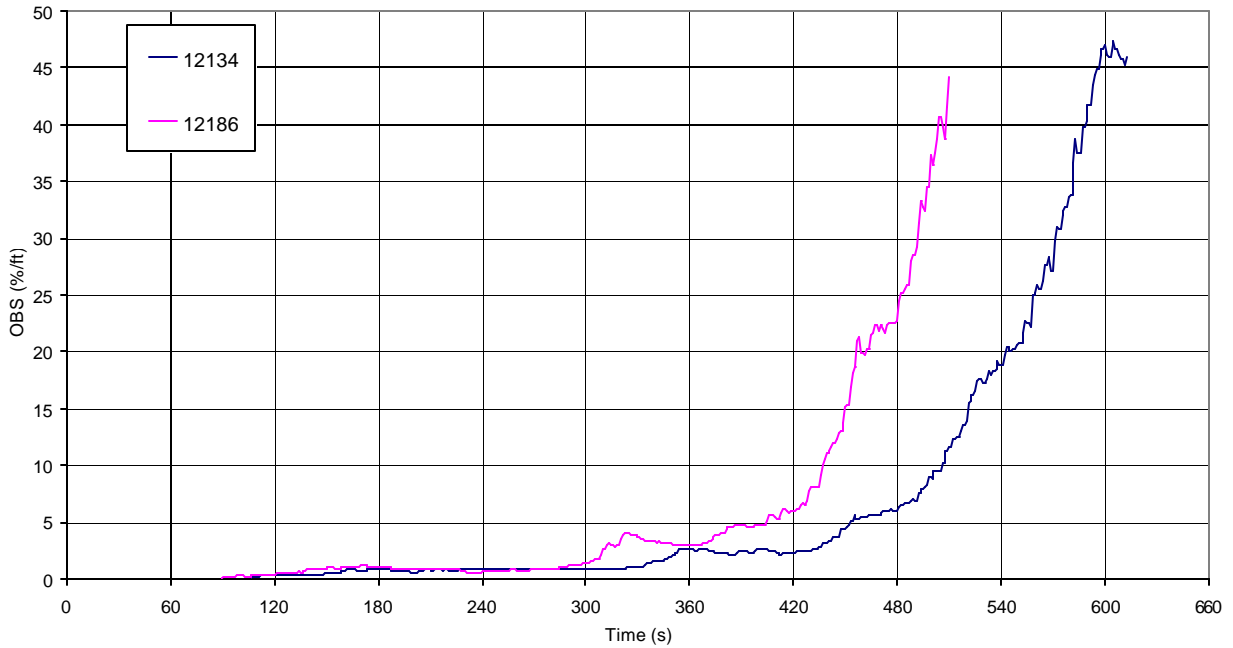

Figure 55 – Smoke OBS for coffee maker in flaming combustion

5

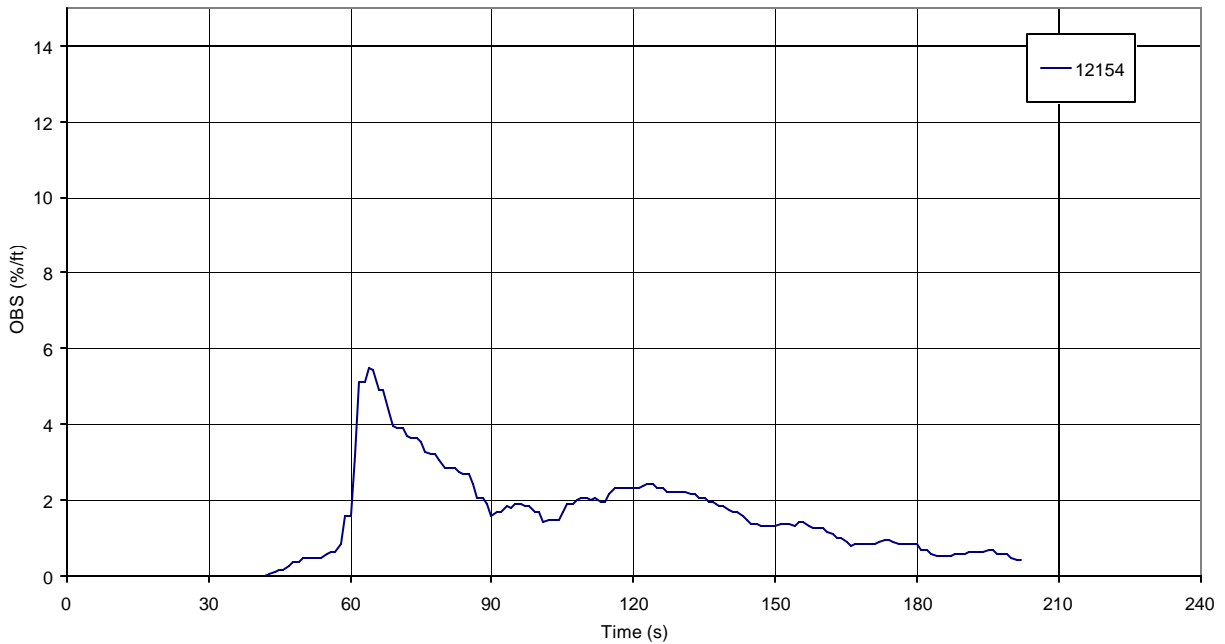

Figure 56 – Smoke OBS for PU foam in flaming combustion (35 kW/m² radiant heating)

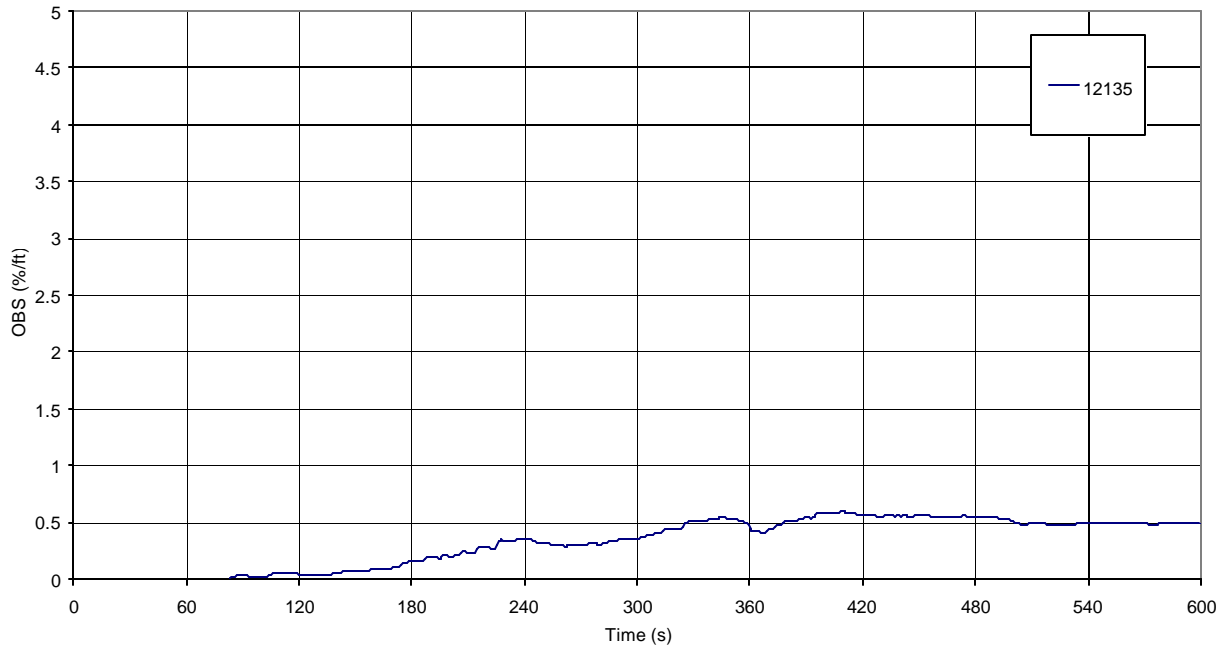

Figure 57 – Smoke OBS for PU foam (100×100 mm) with cotton-poly sheet in flaming combustion

5

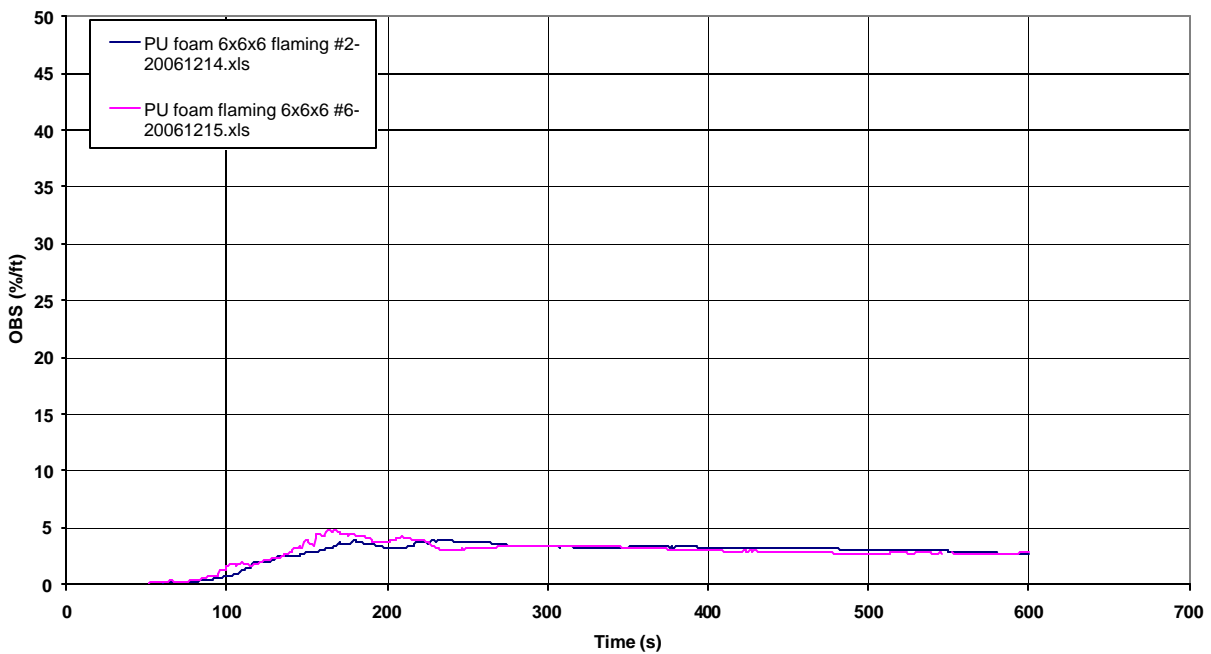

Figure 58 – Smoke OBS for PU foam (150×150 mm) with cotton-poly sheet in flaming combustion

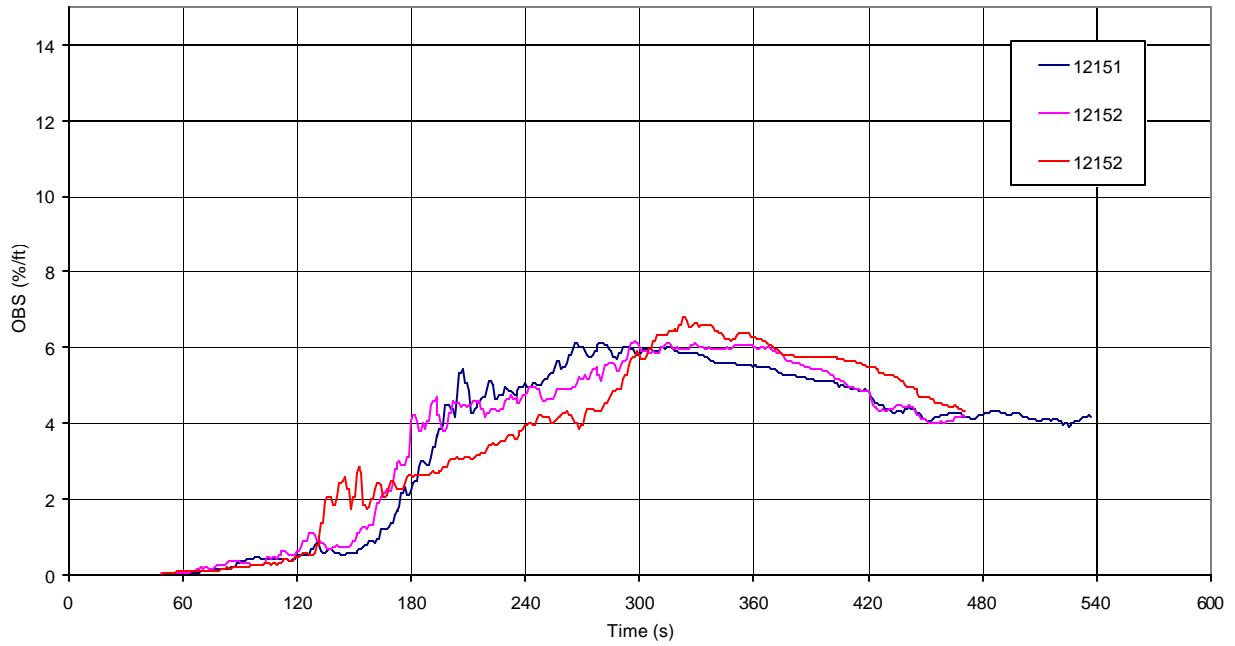

Figure 59 – Smoke OBS for nylon carpet in flaming combustion

The alarm trigger times for the flaming tests are presented in Table 20. The MIC was not used for tests on the prescribed UL 217 materials.

Table 20 – Flaming mode alarm response times

Target Sample Description	Test No.	Ion Alarm Trigger Time (s)	Analog Signal Value		Photo Alarm Trigger Time (s)	Analog Signal Value	
			MIC (pA)	Photo (mV)		MIC (pA)	Photo (mV)
UL 217 Douglas fir	12123	NAP	--	--	NAP	--	--
	12124	NAP	--	--	NAP	--	--
	12127	164	--	84.3	157	--	72.1
	12146	145	--	60.5	185	--	54.7
	12183	117	--	69.2	173	--	88.9
UL 217 Shredded newspaper	12113	NAP	--	--	NAP	--	--
	12122	NAP	--	--	NAP	--	--
	12125	176	--	57.1	179	--	87.8
	12141	87	--	36.5	134	--	80.4
	12144	143	--	21.4	160	--	94.7
	12145	126	--	85.6	126	--	85.6
UL 217 3:1 Heptane/Toluene mixture	12112	NAP	--	--	NAP	--	--
	12131	--	--	--	66	--	69.0
	12181	36	--	89.5	70	--	68.0
	12182	34	--	89.0	71	--	65.8
	01221	34	--	88.4	72	--	68.2
Coffee maker – 12 cup, no carafe	12134	210	61.5	96.0	438	36.1	85.4
	12186	151	69.8	95.2	334	33.2	84.0
Mattress PU foam – 100 × 100 mm sample	12154	68	84.8	77.6	NA	--	--
Mattress PU foam wrapped in CA TB 117 50:50 cotton/poly sheet – 100 × 100 × 100 mm foam	12135 ^[1]	DNT	--	--	DNT	--	--
Mattress PU foam wrapped in CA TB 117 50:50 cotton/poly sheet – 150 × 150 × 150 mm foam	12142 ^[2]	112	72.9	93.0	DNT	--	--
	12156 ^[3]	96	74.2	94.1	171	35.6	79.7
Nylon carpet – 100 × 100 mm sample	12151	173	67.7	92.0	221	40.7	76.8
	12152	162	72.3	90.8	DNT	--	--
	12153	137	79.0	90.0	323	37.7	70.2

5 Notes to Table 20:

NAP = Alarm not present

NA = Alarm data not recorded

DNT = Smoke alarm did not trigger

^[1] Maximum measured OBS value was 0.59 %/ft

10 ^[2] Maximum observed OBS value was 3.9 %/ft;

^[3] Maximum observed OBS value was 4.7 %/ft

It was observed that for flaming fires, the ionization smoke alarm typically triggered prior to the photoelectric smoke alarm. The difference in ionization and photoelectric smoke alarm trigger times was the highest for the coffee maker where the ionization smoke alarm on average triggered almost 2-1/2 minutes faster than the photoelectric one. It may be noted that the coffee maker had the highest heat release rate in the intermediate scale test of the selected test samples.

5 During the first test for the PU foam (6×6-in.) the photoelectric smoke alarm did not trigger while in the second one, it did trigger. This may be attributed to the higher smoke obscuration created in the second test. The reason for the photoelectric alarm not to trigger for the second nylon carpet test is not clear, as the OBS values for all the three tests were in the range of 6.1 to

10 6.8 %. Visual inspection of soot deposits on the filter paper for the PU foam and nylon carpet revealed dark gray to black in color.

The analog smoke alarm signals for these tests were examined to determine the difference in the ionization and photo alarm signals. Flaming PU foam test results are presented in Figure 60. It

15 was observed that the photo signal for the first test is smaller than the second one, though both of these signals are relatively weak as compared to the ionization signals. This may be related to low smoke obscuration in the room for these tests.

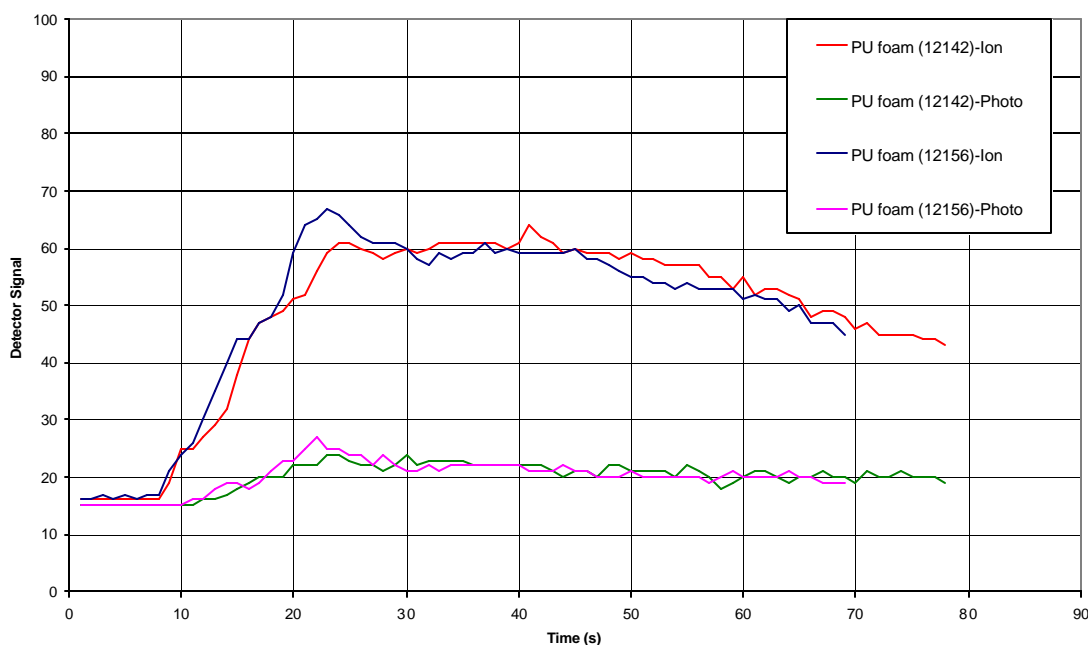

20

Figure 60 – Photo and ionization alarm analog signals for flaming PU foam tests

The analog smoke alarm signals for the nylon carpet were also examined as shown in Figure 61. The photoelectric signals for both these tests (12151, 12152) are relatively low as compared to the ionization smoke alarm signals.

25

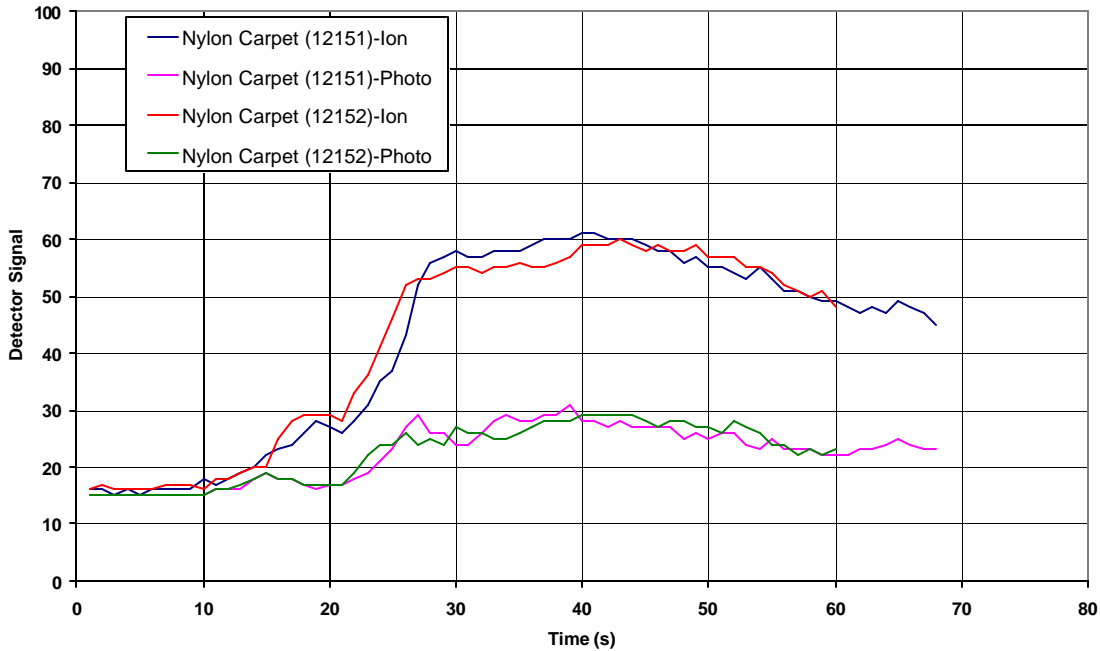

Figure 61 – Photo and ionization alarm analog signals for flaming nylon carpet tests

5 These signals may be compared with results from the Douglas fir test (12123) as depicted in Figure 62 where both the ionization and photoelectric reach saturation level between 3 and 4 minutes.

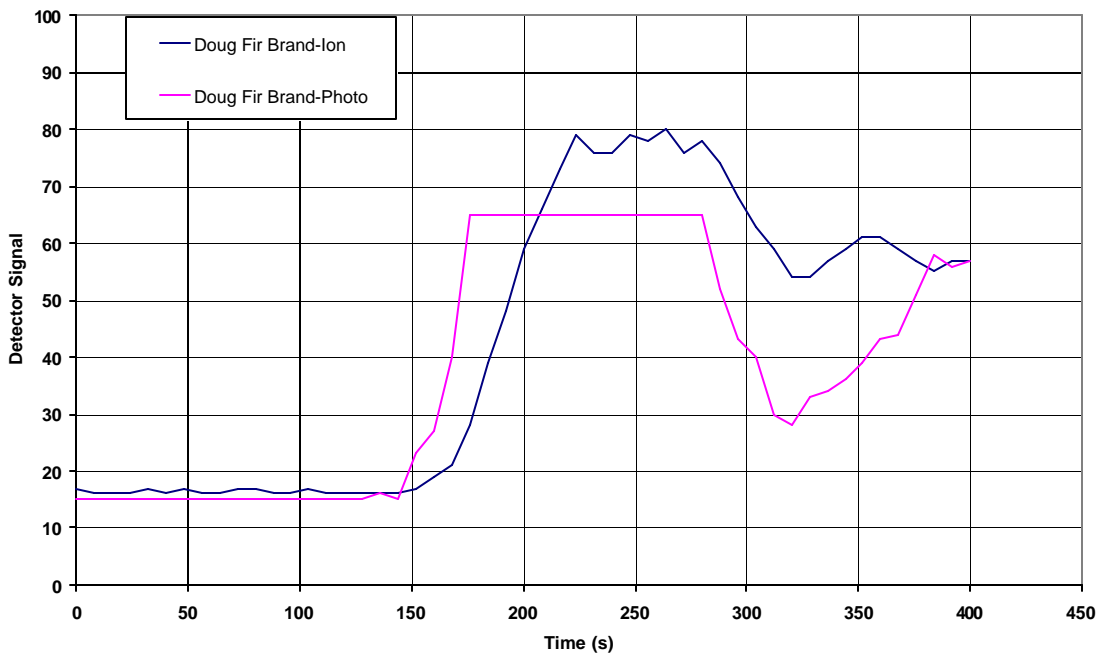

Figure 62 – Photo and ionization alarm analog signals for flaming Douglas fir test

The role of smoke particle size in these tests was investigated. Because the optical density per path length was shown to be correlated to $\sum n_i \cdot d_i^3$ (see Eq. 3), this factor was compared for the some of the flaming tests including those that did not activate the photoelectric alarm. The UL 217 Douglas fir flaming test and the 3:1 heptane/toluene mixture test were also included for comparative purposes. The data are presented in Figure 63.

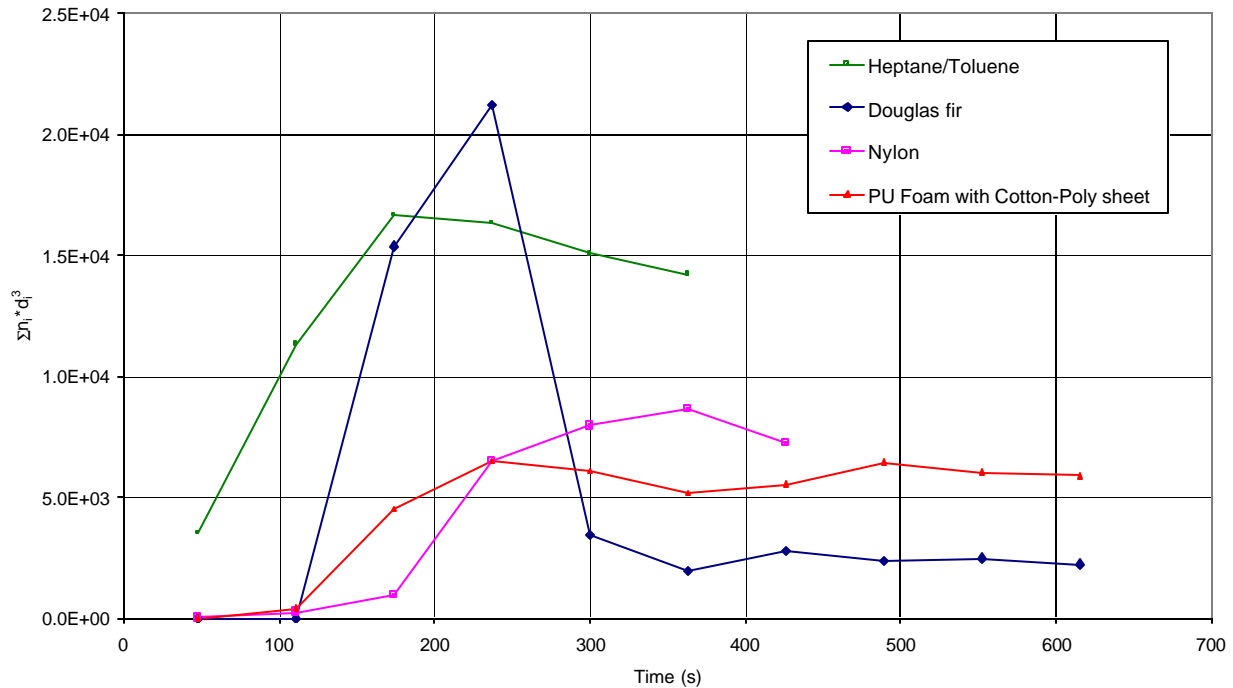

Figure 63 – Comparison of smoke particle size data for selected flaming test

10 It was observed that this factor is significantly higher for heptane/toluene mixture and Douglas fir than the other tests in which the photoelectric alarm did not trigger.

15 Smoke mean diameters and number counts at OBS values of 0.5 and 10 %/ft are summarized in Table 21. The results show that the mean particle sizes increase with time. The increase in particle count is anticipated, as there is more accumulated smoke particles in the room as the smoke obscuration increases. The increase in the mean diameter during the test is smallest for the newspaper test. This may be due to fast moving nature of this particular fire test (note the shorter time difference between 0.5 and 10 %/ft OBS).

Table 21 – Smoke particle data at 0.5 %/ft and 10 %/ft OBS: flaming tests

Target Sample Description	Test No.	0.5 %/ft OBS			10.0 %/ft OBS		
		Time (s)	d _m (mm)	n _m (cc ⁻¹)	Time (s)	d _m (mm)	n _m (cc ⁻¹)
UL 217 Douglas fir	12123	135	0.14	3.17E+05	150	0.19	5.15E+05
	12124	125	0.11	3.93E+05	151	0.17	1.12E+06
	12127	117	0.08	1.16E+05	143	0.14	6.00E+05
	12146	126	0.09	4.27E+05	146	0.16	9.85E+05
	12183	102	0.23	5.06E+03	NA	NA	NA
UL 217 Shredded newspaper	12113	50	0.06	2.37E+04	53	0.06	5.55E+04
	12122	121	0.23	2.60E+05	122	0.22	2.85E+05
	12125	104	0.33	7.57E+03	116	0.35	6.71E+04
	12141	82	0.19	9.87E+04	85	0.20	1.07E+05
	12144	104	0.05	6.28E+03	125	0.09	4.12E+04
	12145	108	0.15	6.33E+03	109	0.15	6.33E+03
UL 217 3:1 Heptane/Toluene mixture	12112	29	0.21	7.01E+03	75	0.32	1.59E+05
	12131	25	0.19	3.94E+04	112	0.30	4.34E+05
	12181	30	0.21	5.36E+03	112	0.30	4.94E+05
	12182	29	0.22	1.70E+04	97	0.31	5.58E+05
	01221	28	0.19	5.62E+03	96	0.27	2.25E+05
Coffee maker – 12 cup, no carafe	12134	154	0.11	4.53E+05	506	0.17	7.83E+05
	12186	122	0.23	1.92E+05	437	0.18	1.06E+06
Mattress PU foam – 100 × 100 mm sample	12154	55	0.08	4.52E+04	NA	NA	NA
Mattress PU foam wrapped in CA TB 117 50:50 cotton/poly sheet – 100 × 100 × 100 mm foam	12135	327	0.08	8.68E+05	NA	NA	NA
Mattress PU foam wrapped in CA TB 117 50:50 cotton/poly sheet – 150 × 150 × 150 mm foam	12142	93	0.09	3.60E+05	NA	NA	NA
	12156	84	0.09	2.80E+05	NA	NA	NA
Nylon carpet – 100 × 100 mm sample	12151	120	0.10	3.01E+05	NA	NA	NA
	12152	110	0.10	2.73E+05	NA	NA	NA
	12153	122	0.11	2.80E+05	NA	NA	NA

Note to Table 21:

NA = Did not attain 10 %/ft OBS

- 5 The particle size and count data trends for the flaming tests are shown in Figure 64 through Figure 71.

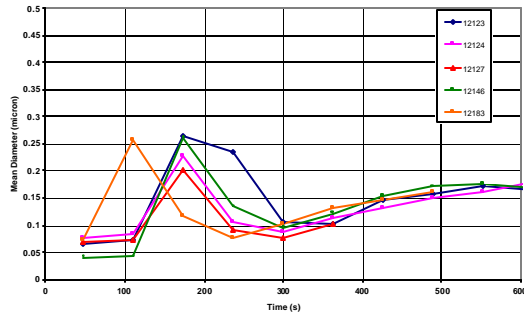

Figure 64 – Mean smoke particle diameter and count for flaming Douglas fir tests

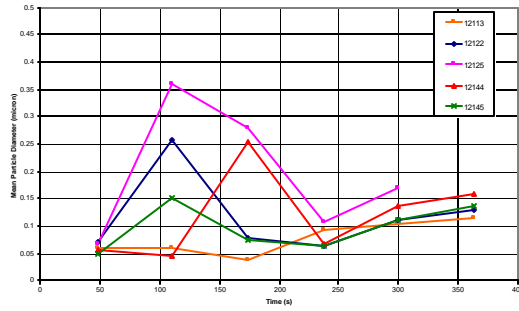
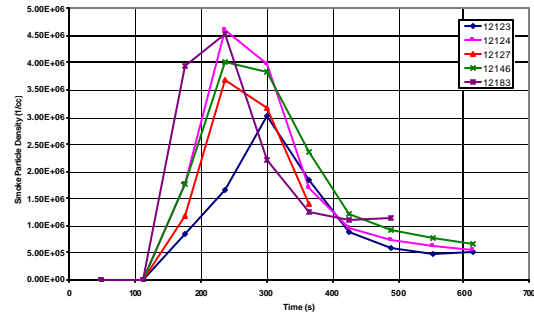

Figure 65 – Mean smoke particle diameter and count for flaming newspaper tests

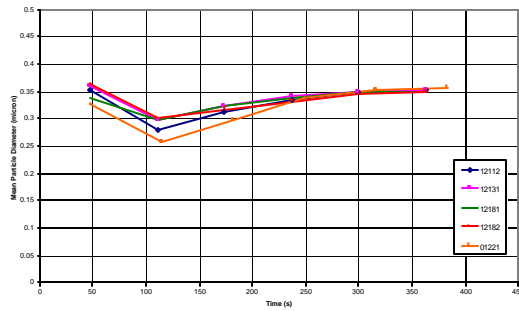
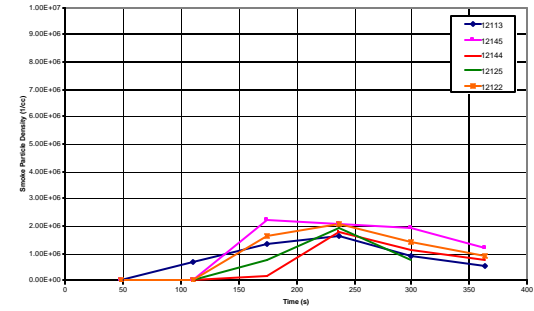
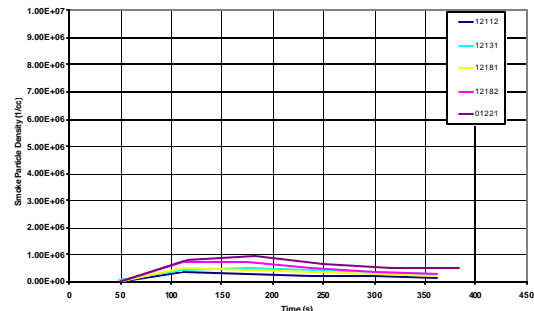

Figure 66 – Mean smoke particle diameter and count for flaming heptane/toluene tests



5

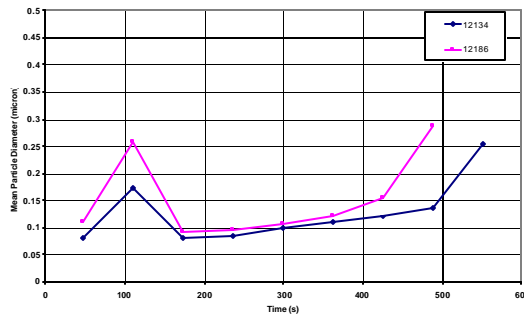
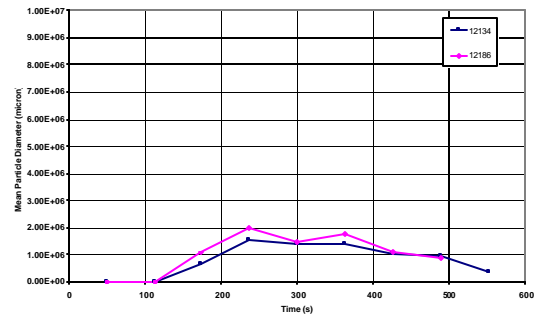

Figure 67 – Mean smoke particle diameter and count for flaming coffee maker tests



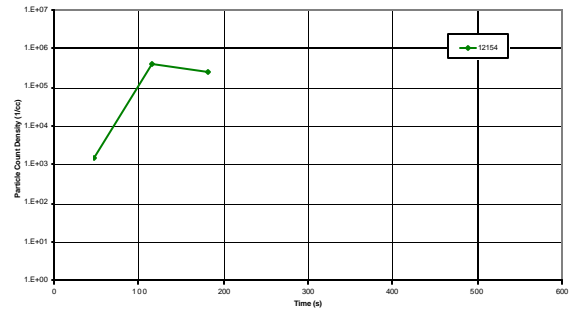
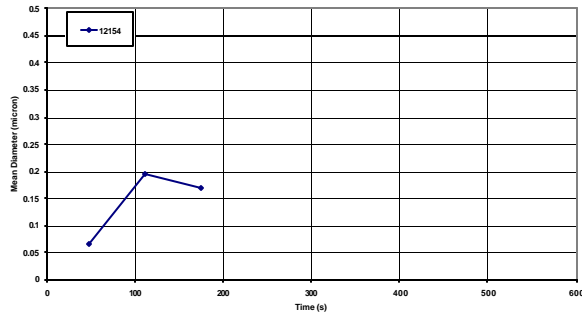

Figure 68 – Mean smoke particle diameter and count for flaming PU foam (100×100 mm) tests

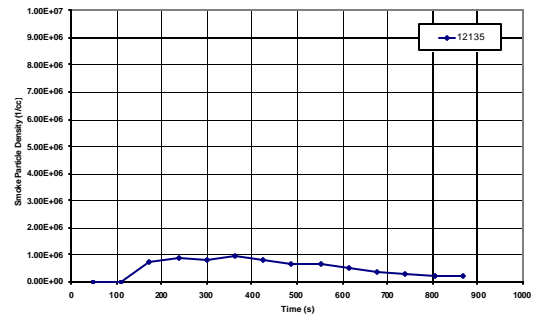
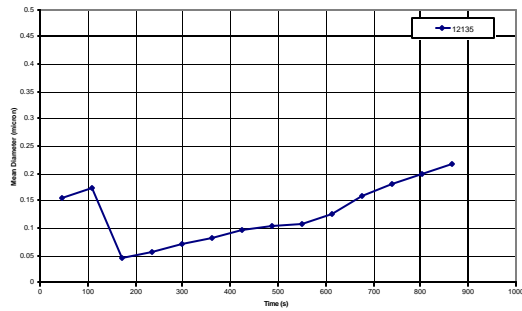

Figure 69 – Mean smoke particle diameter and count for flaming PU foam (100×100×100 mm) tests

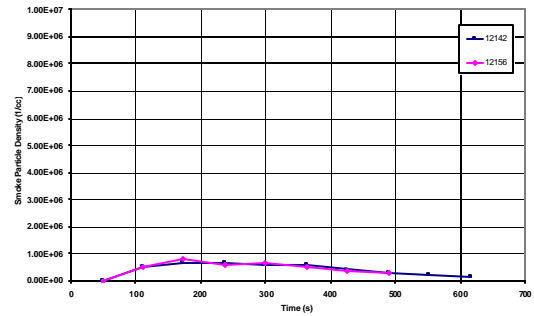
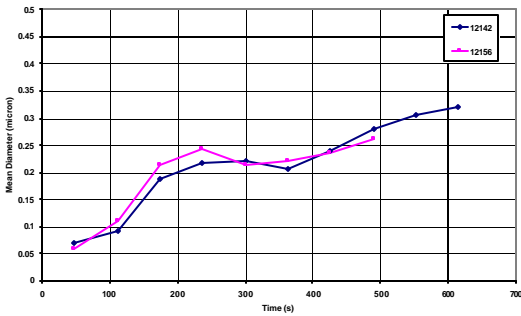

Figure 70 – Mean smoke particle diameter and count for flaming PU foam (150×150×150 mm) tests

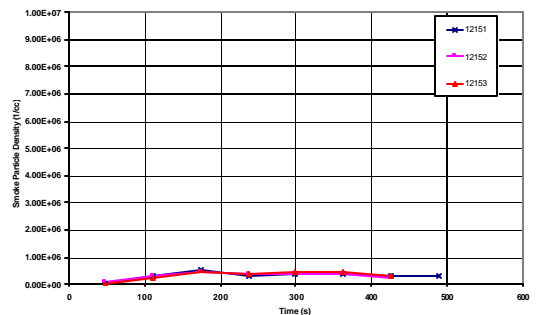
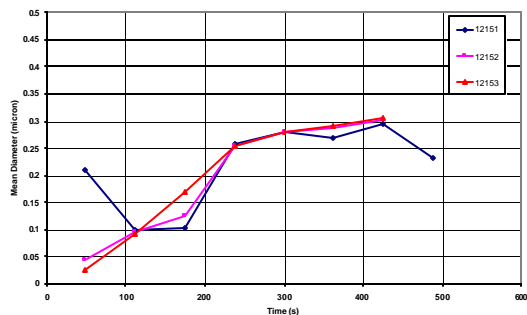

Figure 71 – Mean smoke particle diameter and count for flaming nylon carpet tests

5

A summary of test signals for the flaming tests at 240 s are presented in Table 22.

Table 22 – Observed Fire Test Room test signals for flaming mode at 240 seconds

Target Sample Description	Test No.	OBS (%/ft)	d _m (mm)	n _m (cc ⁻¹)	CO (ppm)	CO ₂ (ppm)	T (°C)	Vel. (m/s)
UL 217 Douglas fir	12123	5.0	0.23	1.73E+06	708	1120	25.7	0.18
	12124	2.3	0.10	4.57E+06	401	1662	27.3	0.16
	12127	1.3	0.09	3.66E+06	413	1733	27.7	0.14
	12146	5.0	0.15	4.00E+06	468	1312	25.5	0.14
	12183	0.6	0.08	4.42E+06	189	1891	28.1	0.16
UL 217 Shredded newspaper	12113	1.4	0.09	1.57E+06	403	1951	25.3	0.05
	12122	6.5	0.07	2.02E+06	304	1643	25.0	0.08
	12125	20.1	0.11	1.86E+06	661	1426	26.0	0.01
	12141	3.4	0.08	1.80E+06	254	1548	26.1	0.09
	12144	9.9	0.07	1.76E+06	311	1781	26.5	0.06
	12145	2.8	0.06	2.11E+06	249	1740	27.1	0.07
UL 217 3:1 Heptane/Toluene mixture	12112	13.0	0.34	2.27E+05	195	2165	25.1	-0.01
	12131	11.9	0.34	4.03E+05	183	2125	26.5	-0.02
	12181	11.9	0.34	3.37E+05	178	1973	25.7	-0.05
	12182	12.9	0.33	4.84E+05	188	1950	25.5	-0.01
	01221	13.5	0.34	2.48E+05	188	2143	21.4	-0.02
Coffee maker – 12 cup, no carafe	12134	0.8	0.09	1.52E+06	223	1218	27.0	0.13
	12186	0.7	0.10	1.94E+06	159	969	25.8	0.15
Mattress PU foam – 100 × 100 mm sample	12154	NA	NA	NA	NA	NA	NA	NA
Mattress PU foam wrapped in CA TB 117 50:50 cotton/poly sheet – 100 × 100 × 100 mm foam	12135	0.4	0.06	8.47E+05	26	1059	25.3	0.12
Mattress PU foam wrapped in CA TB 117 50:50 cotton/poly sheet – 150 × 150 × 150 mm foam	12142	3.9	0.22	6.41E+05	80	2846	30.5	0.18
	12156	3.0	0.24	5.85E+05	78	2623	31.7	0.16
Nylon carpet – 100 × 100 mm sample	12151	5.1	0.26	3.35E+05	64	2387	28.4	0.12
	12152	4.8	0.26	3.89E+05	52	952	27.6	0.16
	12153	4.0	0.25	4.05E+05	40	893	27.4	0.11

Notes to Table 22:

5 NA = Not attained

^[1] Bad data

The ceiling test signatures are summarized in Table 23.

Table 23 – Fire Test Room ceiling test signatures for flaming combustion tests

Target Sample Description	Test No.	Alarm Trigger Time (s)		Ceiling Analog Ionization Alarm Signals		Ceiling Analog Photo Alarm Signals		Max Radial Velocity (m/s)	Max Temp. (°C)
		Ion	Photo	Min	Max	Min	Max		
UL 217 Douglas fir	12123	NAP	NAP	16	80	15	65	0.26	40.0
	12124	NAP	NAP	16	78	15	65	0.30	40.5
	12127	164	157	16	74	15	61	0.26	38.0
	12146	145	185	16	78	15	65	0.26	39.4
	12183	117	173	16	70	15	40	0.28	39.3
UL 217 Newspaper	12113	NAP	NAP	15	38	15	63	0.31	28.0
	12122	NAP	NAP	15	55	15	65	0.24	27.1
	12125	176	179	16	54	15	65	0.28	28.9
	12141	87	134	16	45	15	65	0.28	28.4
	12144	143	160	16	51	15	65	0.25	29.3
	12145	126	126	16	47	15	65	0.22	27.4
UL 217 3:1 Heptane/Toluene mixture	12112	NAP	NAP	17	79	16	59	0.34	30.1
	12131	--	66	16	79	15	49	0.38	31.3
	12181	36	70	16	80	15	48	0.33	30.5
	12182	34	71	16	80	15	46	0.37	31.4
	01221	34	72	15	27	15	65	0.31	27.1
Coffee maker – 12 cup, no carafe	12134	210	438	16	78	15	65	0.58	68.3
	12186	151	334	17	78	15	65	0.53	65.7
Mattress PU foam – 100 × 100 mm sample	12154	68	ND	15	38	15	39	0.16	26.7
Mattress PU foam wrapped in CA TB 117 50:50 cotton/poly sheet – 100 × 100 × 100 mm foam	12135	DNT	DNT	17	36	15	16	0.19	28.6
Mattress PU foam wrapped in CA TB 117 50:50 cotton/poly sheet – 150 × 150 × 150 mm foam	12142	112	DNT	16	64	15	24	0.30	34.57
	12156	96	171	16	67	15	27	0.33	34.32
Nylon carpet – 100 × 100 mm sample	12151	173	221	16	61	15	31	0.20	29.6
	12152	162	DNT	16	60	15	29	0.18	28.3
	12153	137	323	16	61	15	32	0.21	28.0

Notes to Table 23:

- 5 NAP = Alarm not present
 ND = Data not recorded
 DNT = Smoke alarm did not trigger

10 The maximum radial ceiling velocity measured in the flaming test trends with the fire size measured in the intermediate scale tests. The coffee maker with the peak heat release rate of

approximately 100 kW had maximum radial ceiling velocity of approximately 0.5 m/s. The mattress PU foam and nylon carpet had peak heat release rates of approximately 4 kW in the intermediate scale tests, and developed maximum ceiling velocity of approximately 0.2 m/s in the room tests.

5

Non-Flaming Test Results

In Table 24, are presented the obscuration summary for the non-flaming tests using the alarm activation limits of 0.5 %/ft and 10 %/ft OBS. In this test series, repeat tests were conducted for PU foam samples.

10

Table 24 – Summary of smoke obscuration for non-flaming tests

Target Sample Description	Test No.	Time @ UL 217 OBS Limits (s)		Max. OBS	
		0.5 %/ft	10.0 %/ft	Time (s)	(%/ft)
UL 217 Ponderosa pine	12126	1794	3522	3676	11.42
	12132	1767	3770	4128	12.54
	12143	2409	NA	4184	8.88
	12184	1596	3776	4010	12.17
	12185	1002	3268	3710	14.94
Bread – 4 slices	12133	323	355	440	35.39
	12155	323	368	446	33.38
	01244	359	405	464	30.56
Polyisocyanurate insulation – 150 × 150 × 200 mm pieces	12271	5464	NA	6609	0.67
Mattress PU foam – 150 × 150 × 50 mm foam	12192	2190	NA	3953	1.82
	12193	2337	NA	5267	1.98
Mattress PU foam – 100 × 125 × 100 mm foam with a 25 × 150 × 150 mm piece on two opposing sides	12202	2017	NA	3799	8.54
	12261	1723	5520	5524	10.57
Mattress PU foam wrapped in CA TB 117 cotton sheet – 100 × 150 × 200 mm foam	01232	2180	NA	4085	7.03
Mattress PU foam wrapped in CA TB 117 cotton sheet – 125 × 125 × 300 mm foam	01241	2758	NA	5984	9.33
Mattress PU foam wrapped in polyester microfiber sheet – 125 × 125 × 300 mm foam	01233	2885	NA	4225	4.88
	01245	3076	NA	4569	8.63
Nylon carpet – 150 × 150 mm sample	12262	2404	NA	6404	4.27
Polystyrene pellets – 69.8 g	12272	3956	NA	5587	5.93

Note to Table 24:

NA = Not attained

15 Other than bread, only one of the non-UL 217 sample tests resulted in OBS value of 10 %/ft, even though not all of the sample mass was consumed during the tests. For the PU foam tests, the sample exposed to the hot plate was charred, and this charring reduced the smoke generation over time. A larger obscuration level was attained when the mass of the PU foam was increased (see test series 12202, 12261 versus 12192, 12193, and also 01232 versus 01241). This is also
20 depicted in Figure 75, and Figure 76 respectively.

The OBS charts for these tests are presented in Figure 72 through Figure 79.

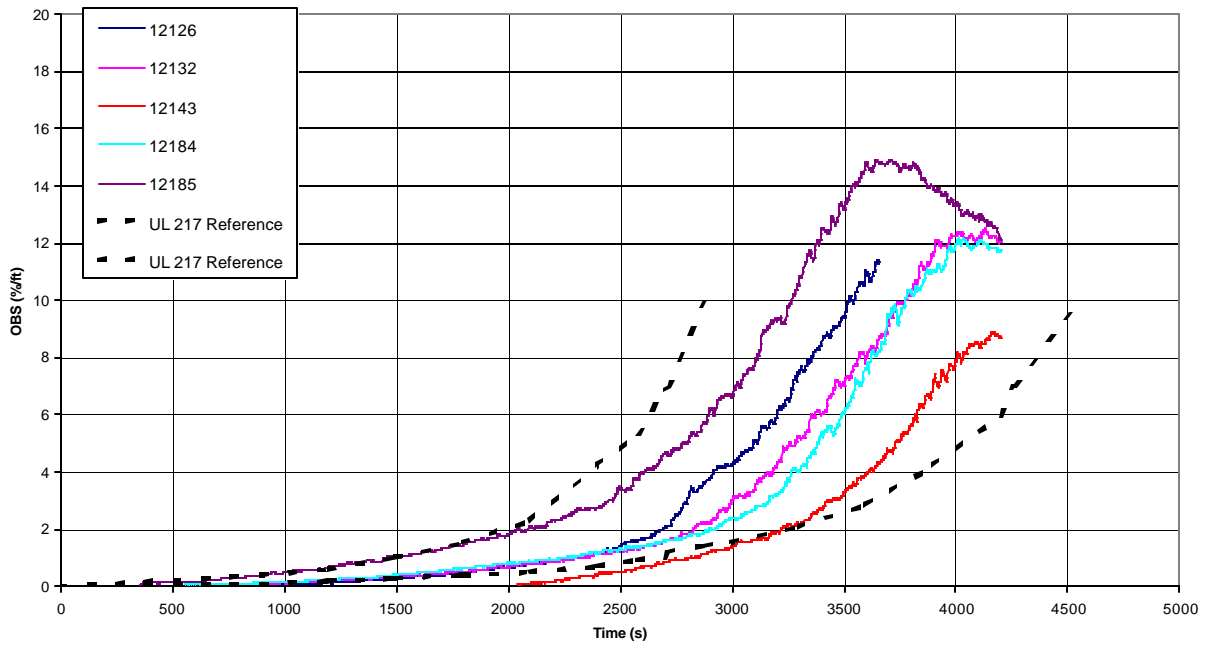

Figure 72 – OBS for Ponderosa pine in non-flaming tests

5

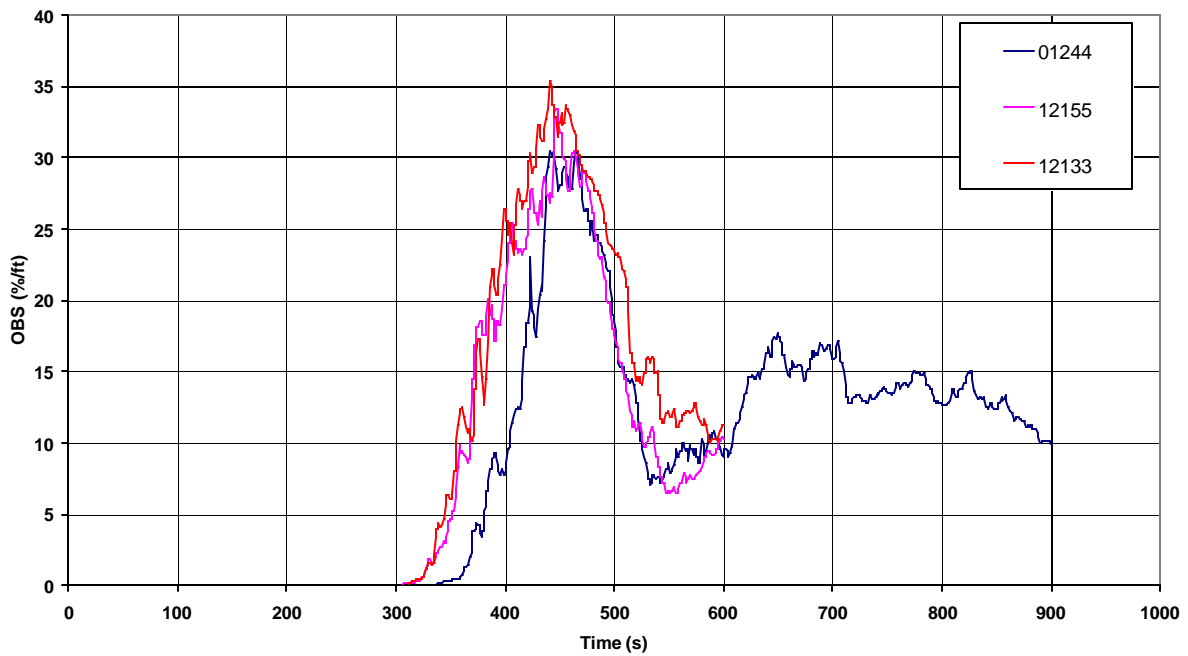

Figure 73 – OBS for bread in non-flaming tests

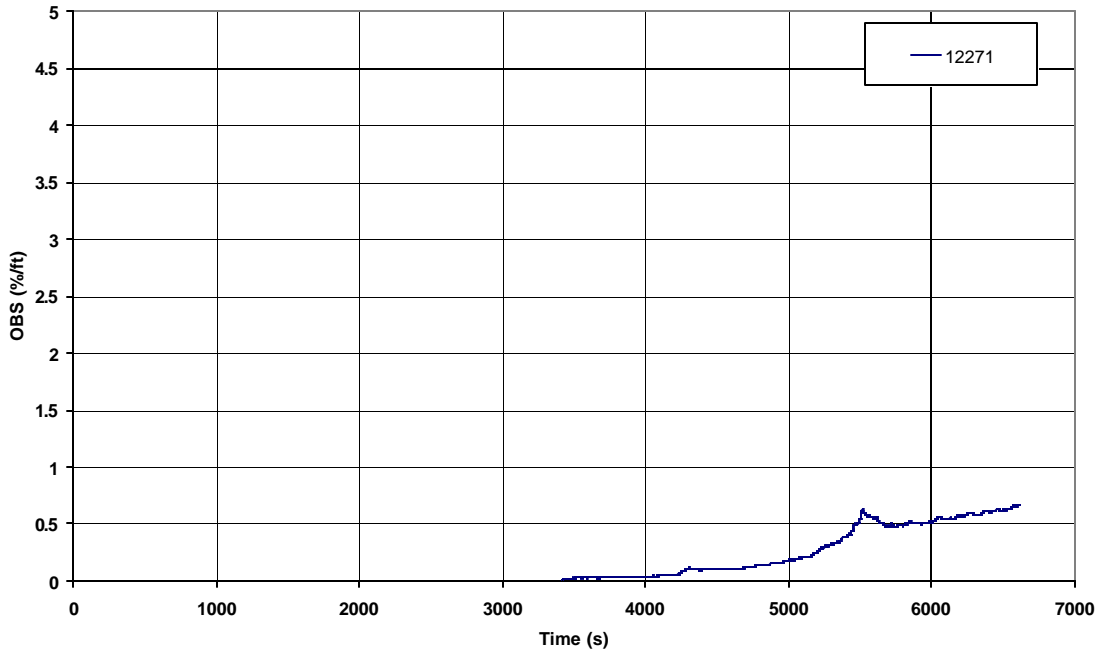

Figure 74 – OBS for polyisocyanurate foam in non-flaming tests

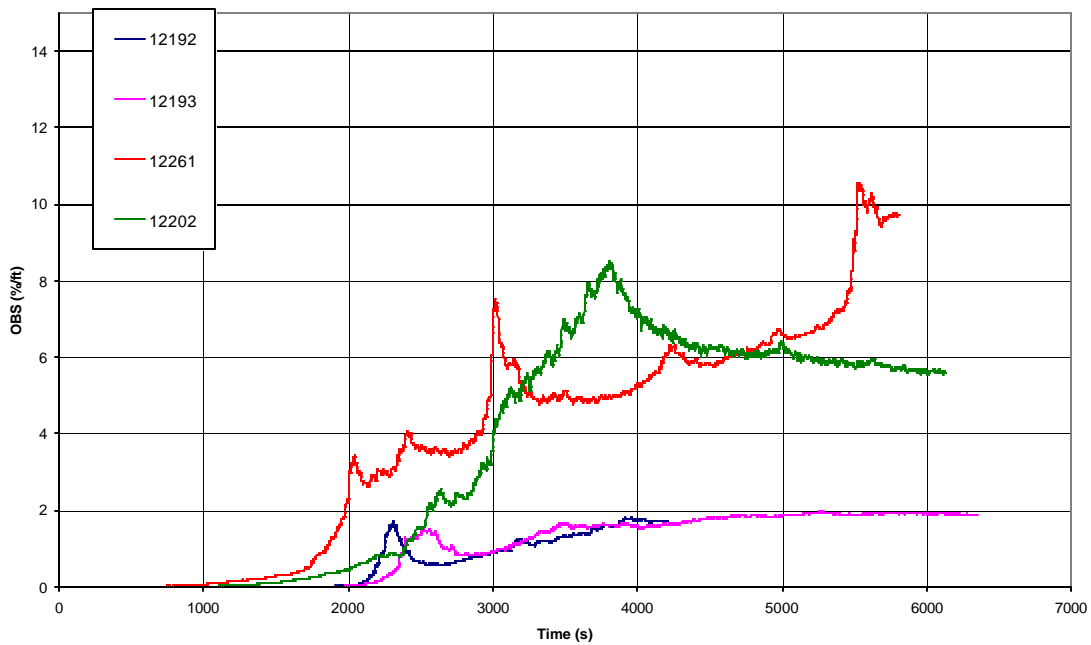

Figure 75 – OBS for PU foam in non-flaming tests

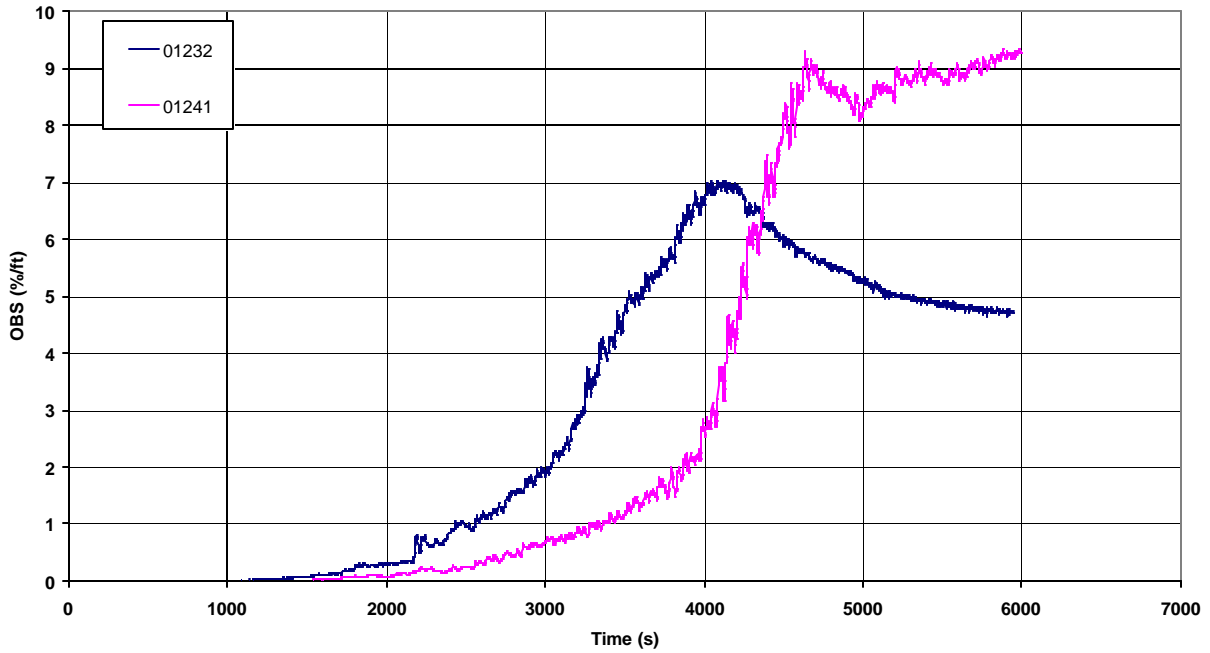

Figure 76 – OBS for cotton sheet wrapped PU foam in non-flaming tests

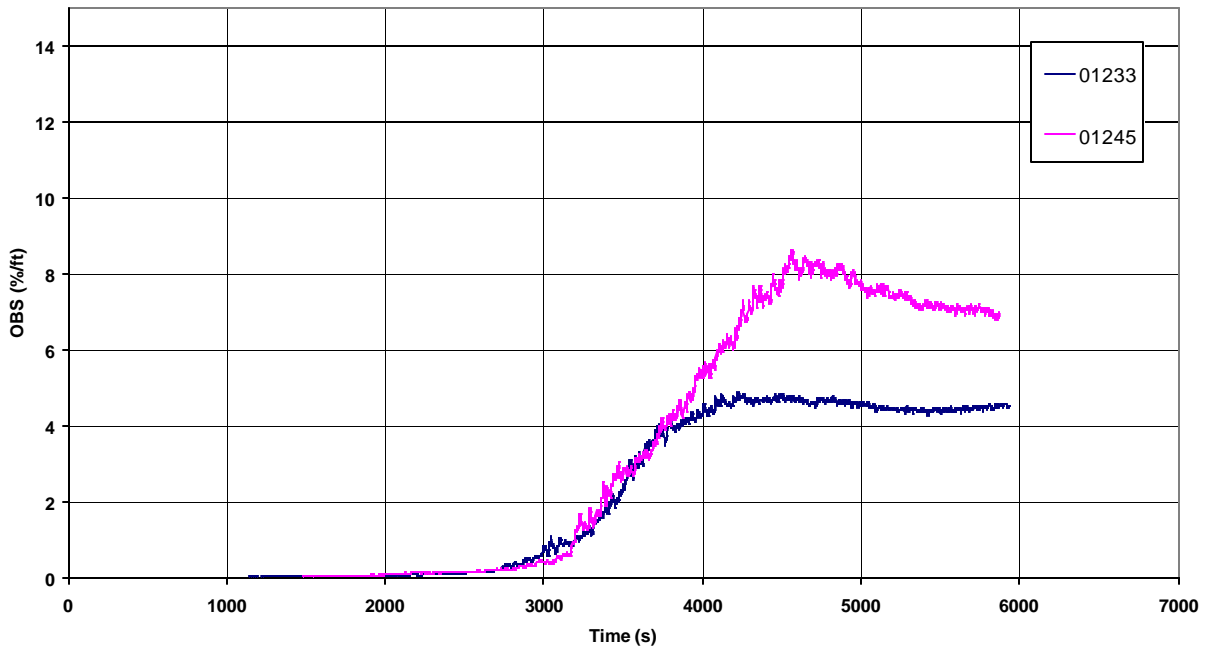

Figure 77 – OBS for polyester microfiber wrapped PU foam non-flaming tests

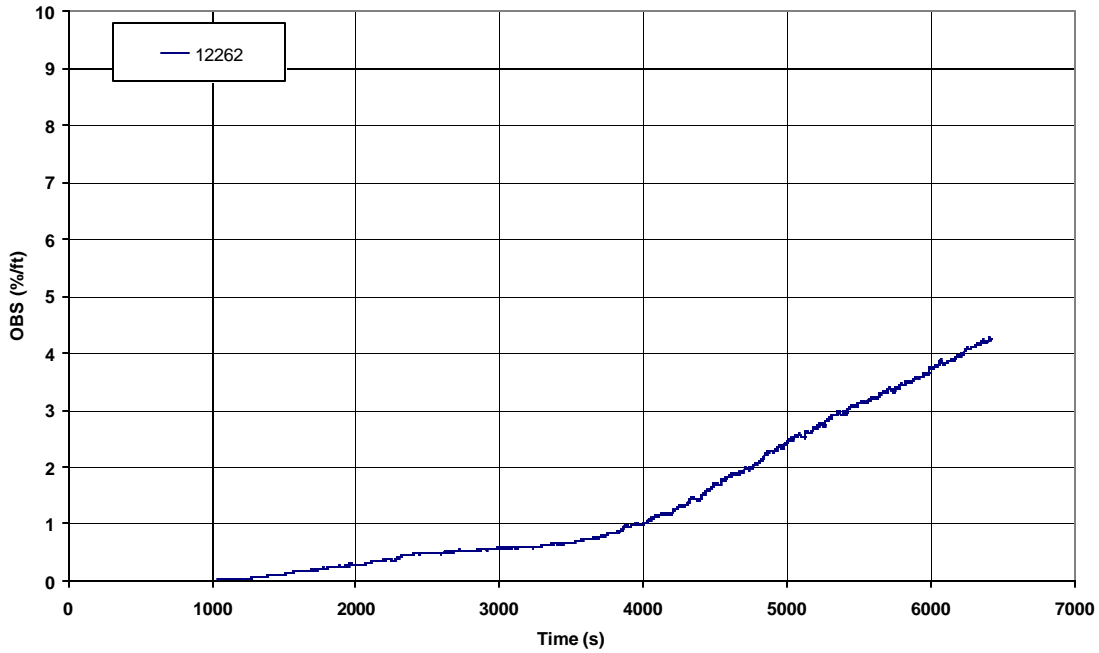

Figure 78 – OBS for nylon carpet in non-flaming tests

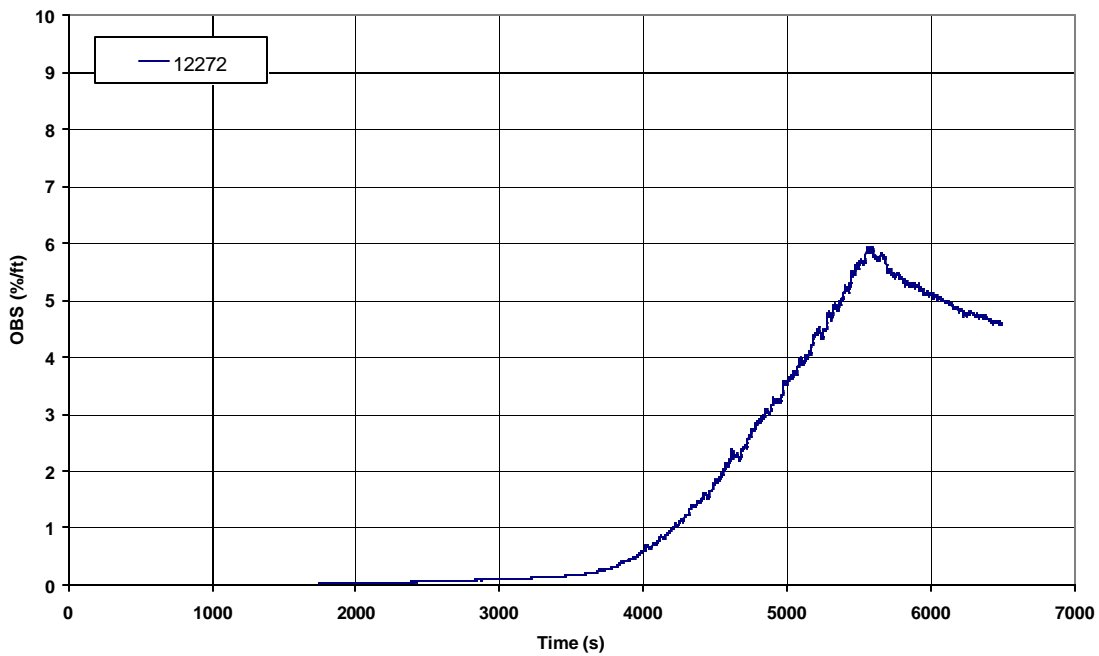

Figure 79 – OBS for polystyrene in non-flaming tests

The ionization and photoelectric smoke alarm trigger times are summarized in Table 25.

Table 25 – Non-flaming mode alarm response times

Target Sample Description	Test No.	Ion Alarm Trigger Time (s)	Analog Signal Value		Photo Alarm Trigger Time (s)	Analog Signal Value	
			MIC (pA)	Photo (mV)		MIC (pA)	Photo (mV)
UL 217 Ponderosa pine	12126	3244	63.9	71.1	3226	63.9	72.0
	12132	DNT	--	--	3318	73.4	76.4
	12143	3826	66.0	74.3	3805	68.2	75.0
	12184	3547	66.0	70.1	3451	71.6	75.9
	12185	2894	64.6	73.6	2722	72.3	79.1
Bread – 4 slices	12133	319	66.1	98.0	364	45.9	55.5
	12155	306	71.5	99.4	371	41.5	45.8
	01244	343	75.8	98.5	448	28.4	19.4
Polyisocyanurate insulation – 150 × 150 × 200 mm pieces	12271	DNT	--	--	DNT	--	--
Mattress PU foam – 150 × 150 × 50 mm foam	12192	DNT	--	--	DNT	--	--
	12193	DNT	--	--	DNT	--	--
Mattress PU foam – 100 × 125 × 100 mm foam with a 25 × 150 × 150 mm piece on two opposing sides	12202	DNT	--	--	3149	85.3	77.2
	12261	5610	63.2	58.5	3032	81.4	68.8
Mattress PU foam wrapped in CA TB 117 cotton sheet – 100 × 150 × 200 mm foam	01232	DNT	--	--	3530	83.2	77.5
Mattress PU foam wrapped in CA TB 117 cotton sheet – 125 × 125 × 300 mm foam	01241	DNT	--	--	4207	88.5	80.5
Mattress PU foam wrapped in polyester microfiber sheet – 125 × 125 × 300 mm foam	01233	DNT	--	--	5353	83.5	79.8
	01245	DNT	--	--	4128	90.2	73.6
Nylon carpet – 150 × 150 mm sample	12262	DNT	--	--	5727	84.4	84.3
Polystyrene pellets – 69.8 g	12272	DNT	--	--	5546	82.6	74.5

Note to Table 25:

5 DNT = Did not trigger

For the Ponderosa pine test sample, the photoelectric smoke alarm on an average triggered 2.3 % faster than the ionization smoke alarm. For bread the ionization smoke alarm was 22 % faster than the photoelectric smoke alarm. For most of the other test samples the ionization smoke alarm did not trigger. In each of these cases an OBS of 10%/ft had not been reached. For the one case where the ionization alarm did trigger (PU foam test series 12261), an OBS of 10 %/ft was attained. In the case of the two tests (polyisocyanurate foam, PU foam) for which neither the ionization nor the photoelectric alarm triggered, this may be due to the smaller test sample mass. For the polyisocyanurate foam test the maximum OBS value was calculated to be 0.67 %/ft and for the two PU foam tests the maximum obscurations were 1.82 and 1.98 %/ft respectively. The PU foam tests were repeated with a larger sample mass (Test series: 12202, 12261).

5 The MIC and Beam response to the PU foam were investigated by comparing the Beam and MIC signals during these tests with a Ponderosa pine test (Test Series 12132). The Beam vs. MIC signatures for the other Ponderosa pine tests were similar.

In Figure 80 is depicted the Beam vs. MIC response time for the Ponderosa pine sample. The UL 217 limits have been superimposed on the figure with dashed black lines.

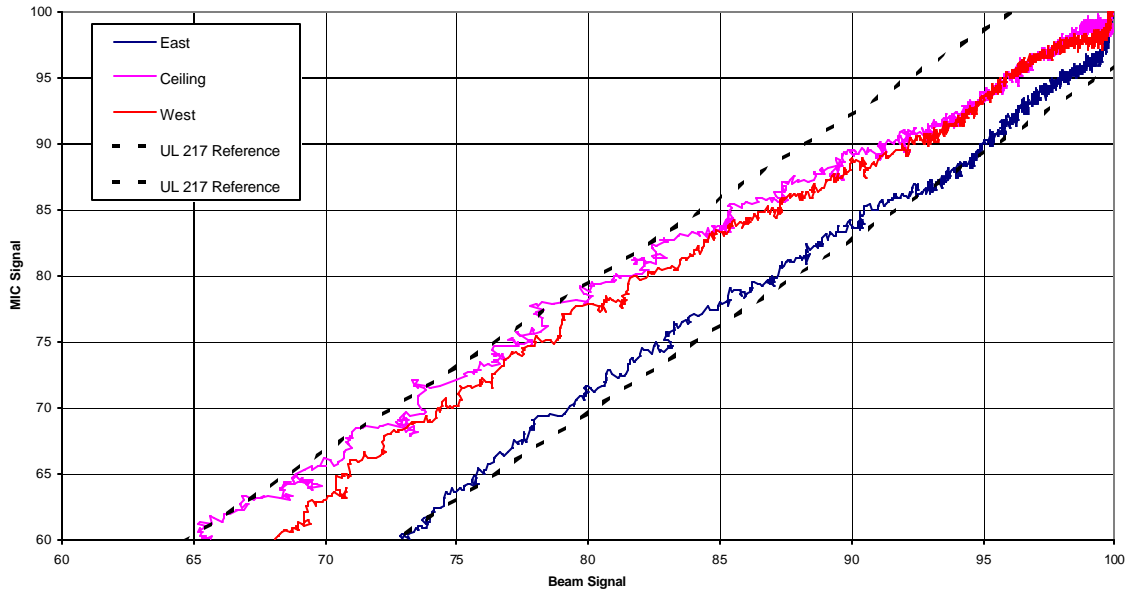

10 **Figure 80 – Beam vs. MIC response: Ponderosa pine**

15

It was observed that smoldering PU foam by itself has a Beam vs MIC response that also fits between the UL 217 limits for the Ponderosa pine as shown in Figure 81. In this test (Test Series 12022), the ionization smoke alarm did not trigger.

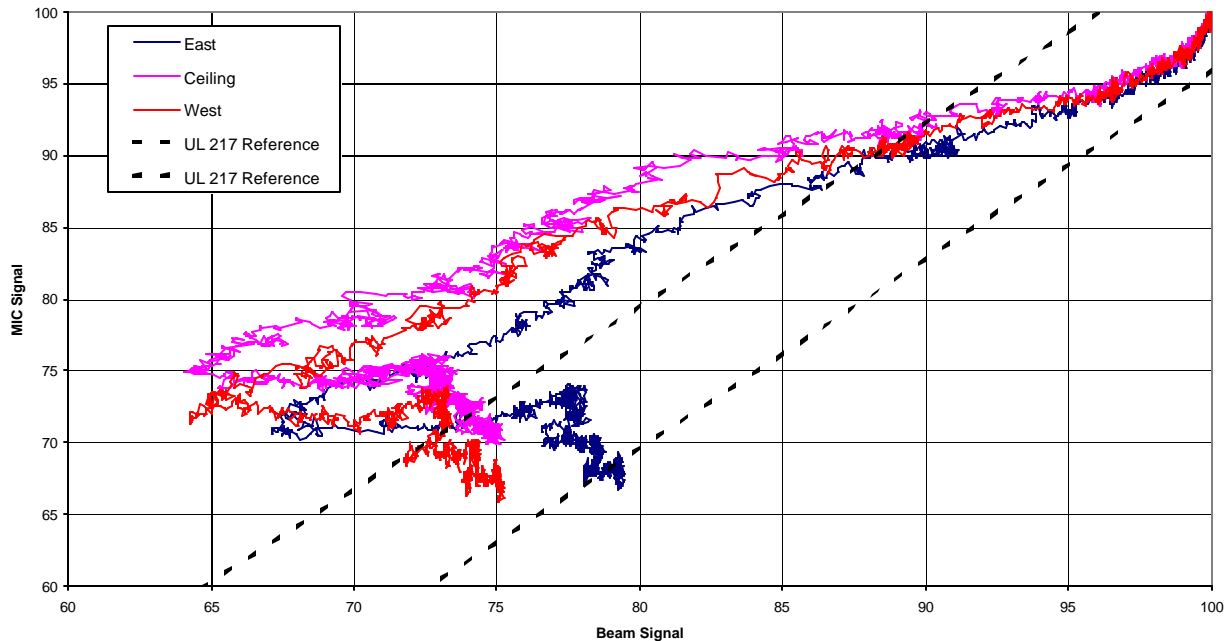

Figure 81 – Beam vs. MIC response for PU foam in non-flaming combustion

5

The data shows that for PU foam heated using the UL 217 hot plate, the Beam vs. MIC response results in the data falling above the upper limits established for Ponderosa pine. This implies that there are larger particles in the PU foam smoke than from the smoke generated by Ponderosa pine.

10

The Beam vs MIC response for PU foam wrapped with cotton fabric is shown Figure 82. It was observed that the effect of the cotton fabric on the Beam vs MIC response is similar to that observed for PU foam alone.

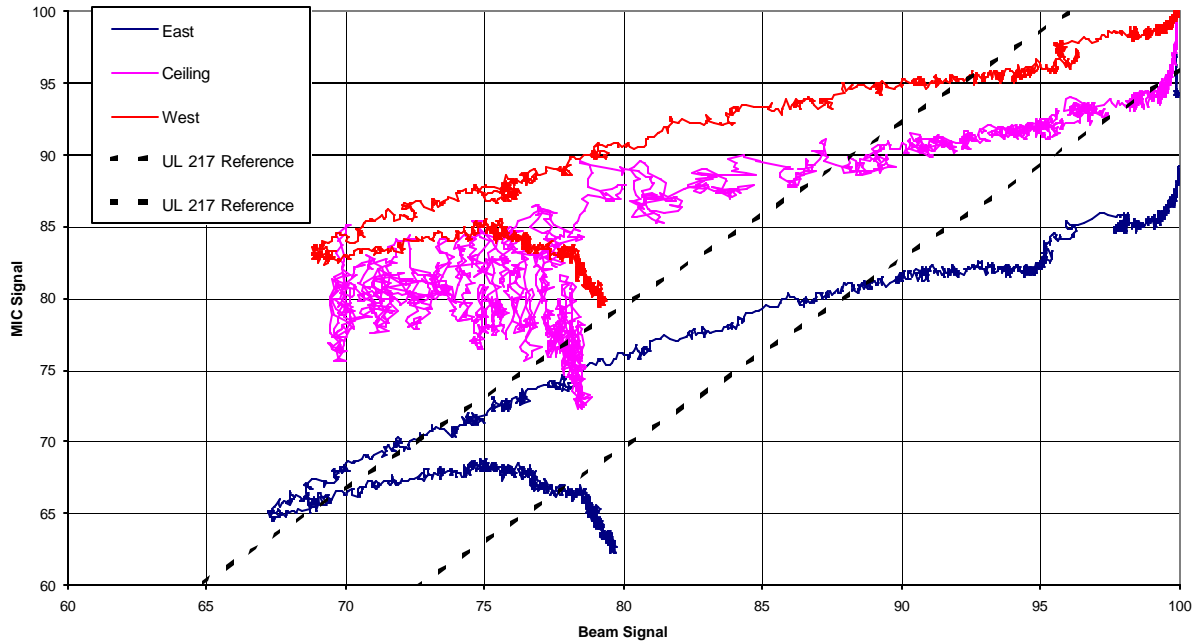

Figure 82 – Beam vs. MIC response for cotton sheet wrapped PU foam

5 The Beam vs MIC response for PU foam wrapped in polyester microfiber fabric (Test Series: 01245) is shown in Figure 83. The figure shows that the polyester microfiber fabric has a greater influence on the Beam v. MIC response than PU foam alone.

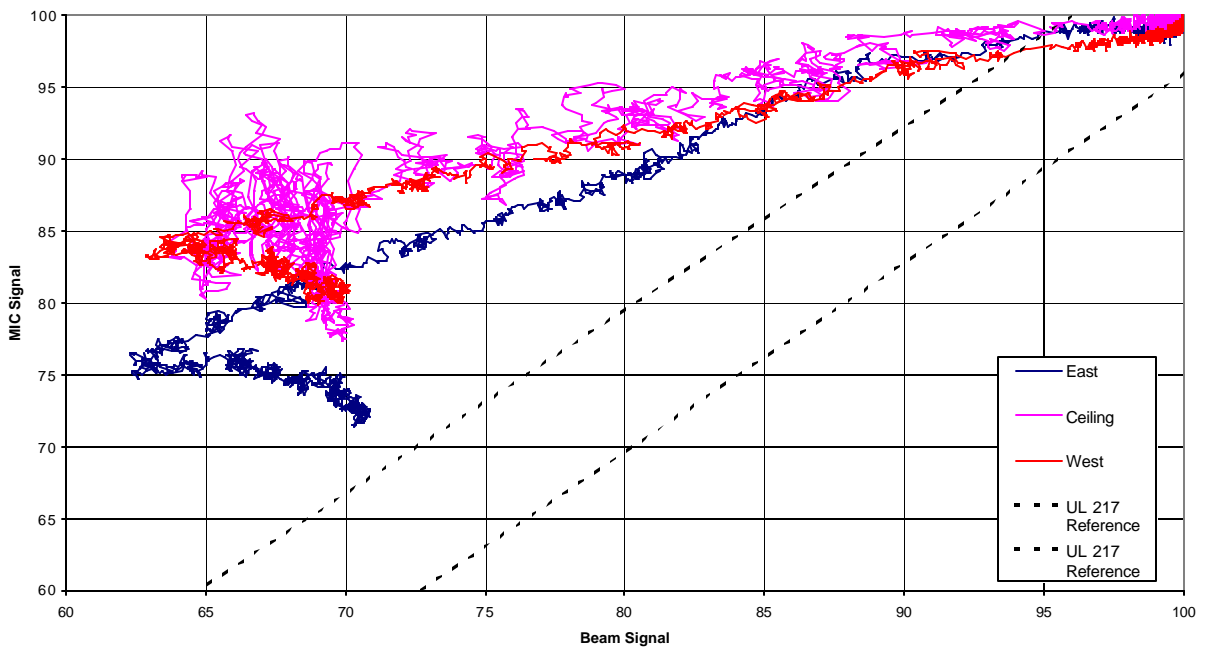

Figure 83 – Beam vs MIC response for polyester microfiber wrapped PU foam

The Beam and MIC response for the polystyrene test is shown in Figure 84.

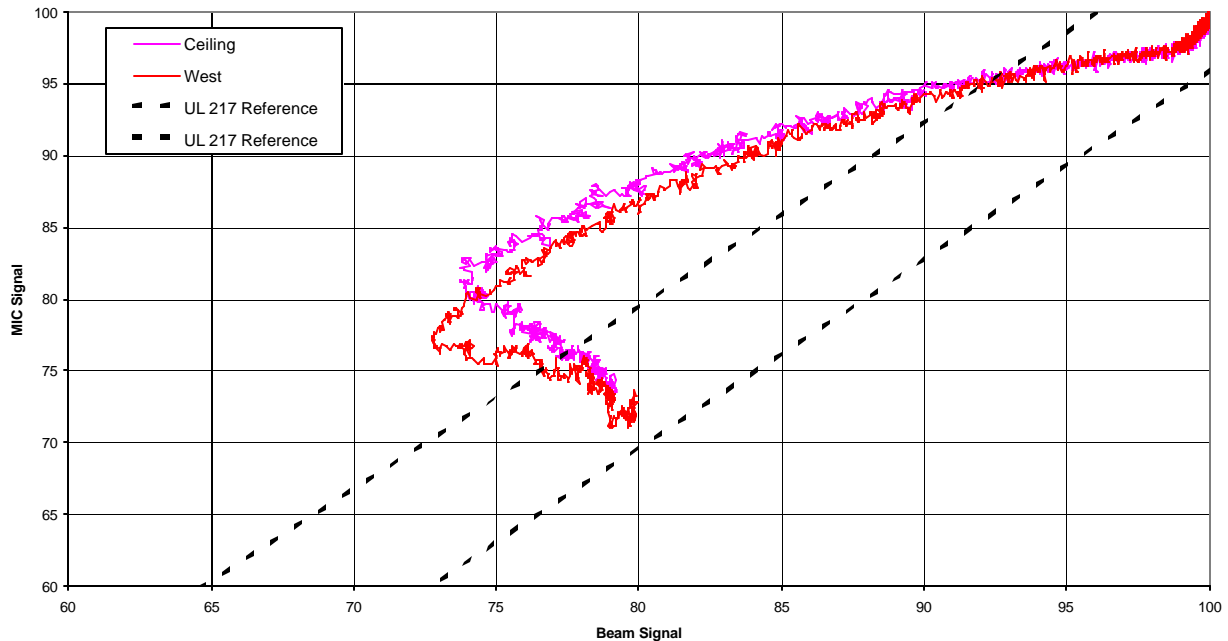

Figure 84 – Beam vs MIC response for Polystyrene in non-flaming combustion

- 5 It was observed that similar to the PU foam results, there are relatively more larger smoke particles for polystyrene than UL 217 reference of Ponderosa pine.

10 From Figure 80 through Figure 84, it may also be observed that, near the end of the test, the beam signal reduces indicating smaller smoke particle sizes and/or count. This was confirmed by observations during these tests that over time, there was settling of smoke in the room. In order to further investigate this phenomenon, an obscuration tree consisting light beams and photo-detectors located at 600, 900, and 1500 mm below the ceiling was used. These obscuration data complemented the light beam located at the ceiling, and thus provided data on change in smoke obscuration over the height of the room during the tests. As a comparative reference to flaming

15 fire, a test with heptane/toluene was also performed.

These obscuration data over the height of the room for heptane/toluene mixture is provided in Figure 85.

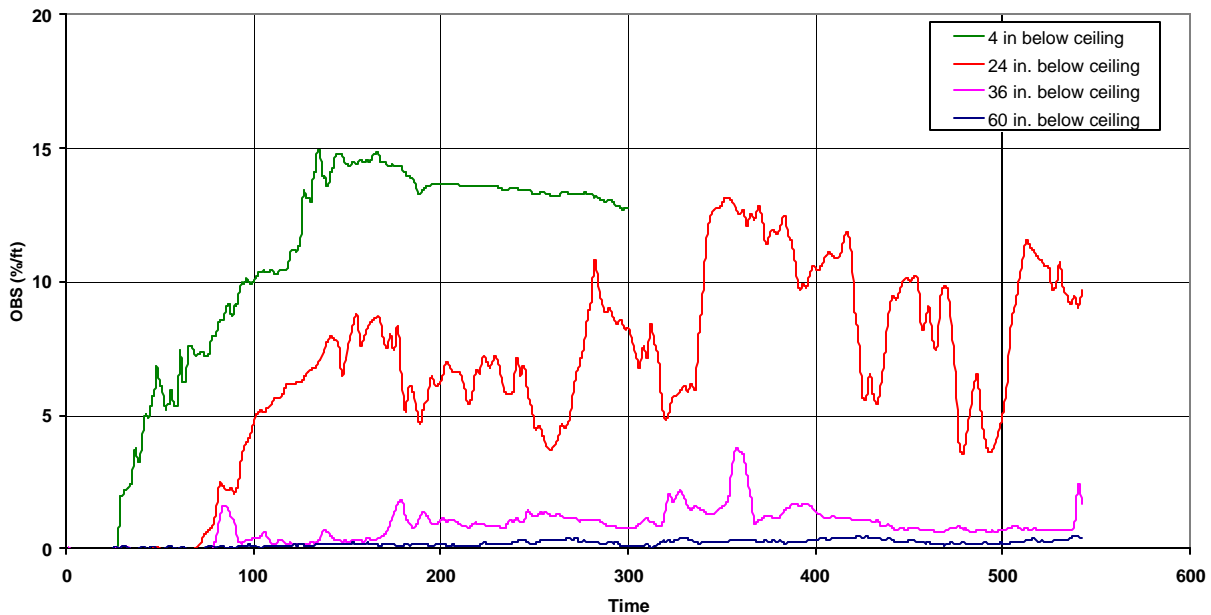

Figure 85 – OBS changes in the test room for heptane/toluene mixture

It was observed that for this flaming fire, there was not a significant effect of smoke settling. This may be due to the higher energy of the smoke, as well as the short duration of the test.

5

The smoke obscuration change over time in the test room for bread is shown in Figure 86. After peaking at the ceiling the OBS value drops below the 24 inch value at approximately 520 seconds.

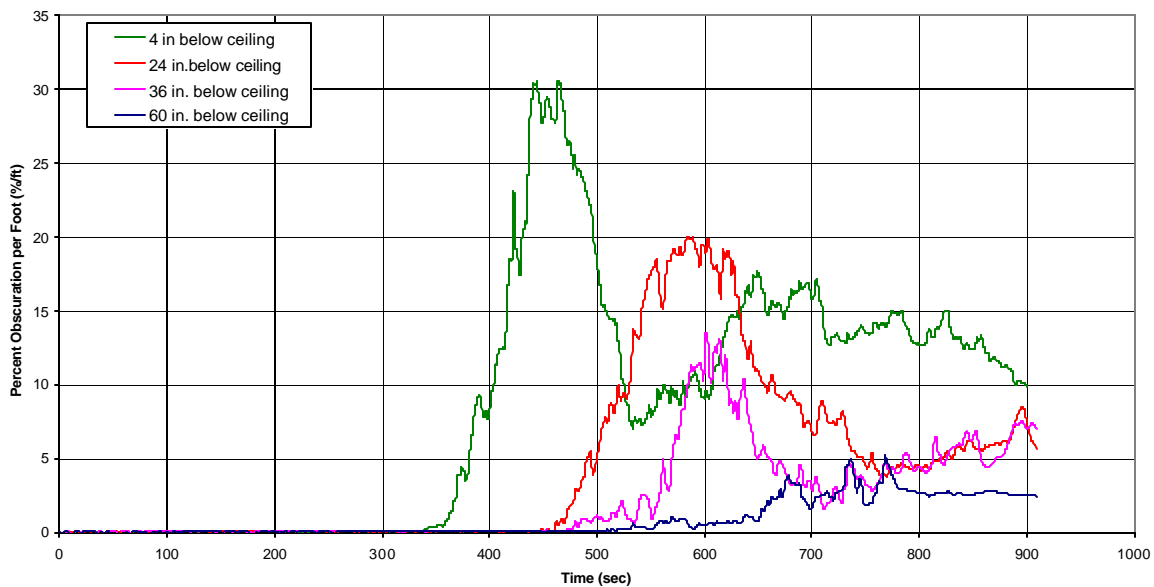

Figure 86 – OBS changes in the test room for bread

10

The OBS change over time in the test room for PU foam wrapped with polyester microfiber (Test series: 01245) is shown in Figure 87. The OBS value peaks at approximately 4500 s, and then the OBS at 24 and 36 in. below the ceiling exceed the ceiling values. It may also be observed that at approximately 5200 s, the OBS 60 in. below the ceiling is greater than at the ceiling.

5

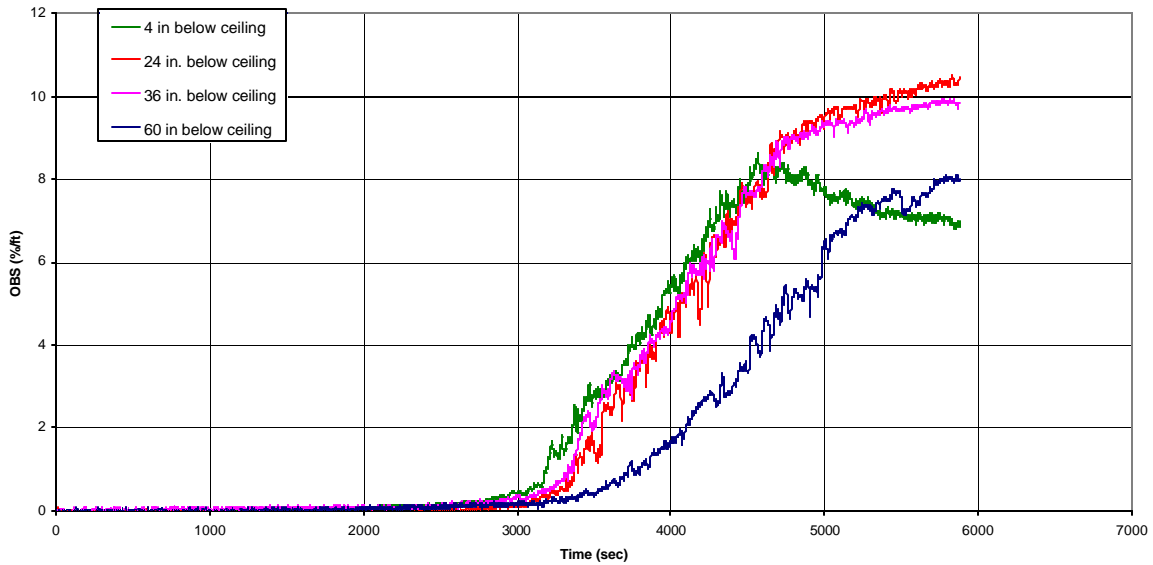

Figure 87 – OBS changes in the test room for polyester microfiber wrapped PU foam

The OBS changes in the room for cotton fabric wrapped PU foam (Test Series: 01241) is depicted in Figure 88.

10

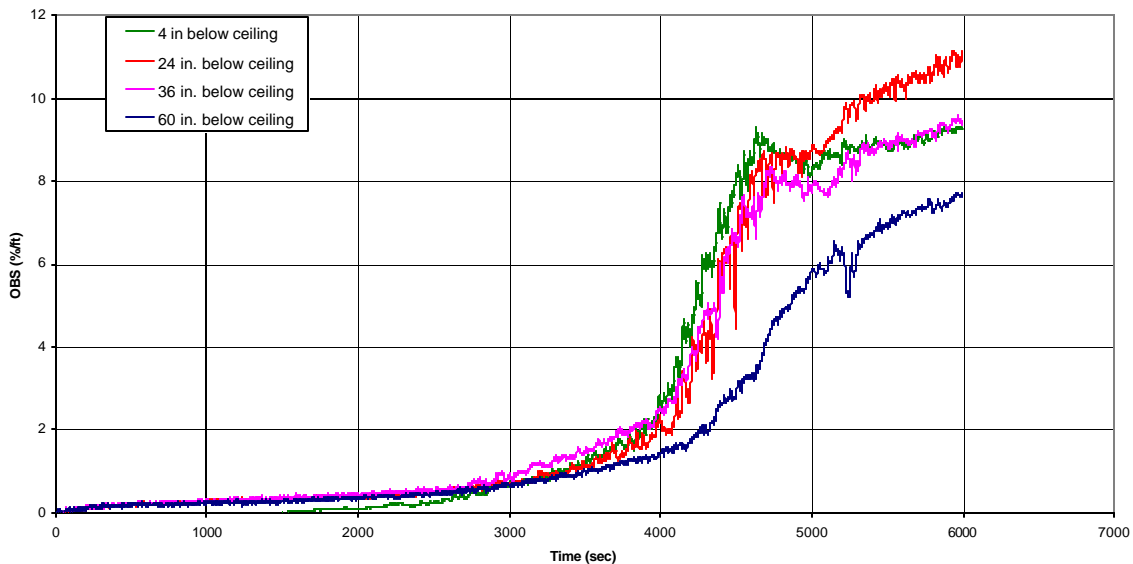

Figure 88 – OBS changes in the test room for cotton fabric wrapped PU foam

In this test, the OBS value 600 mm below the ceiling exceeds 10 %/ft, while the OBS at the ceiling appears to level off.

- 5 The reduction in the smoke obscuration at the ceiling may be due to a number of factors such as energy loss of the smoke layer at the ceiling, as well gravitational effect on the smoke particles. Because these fires are relatively long in duration, this phenomenon is more pronounced than for shorter, more intense flaming fires.

10 A summary of room test signals at an OBS value of 0.5 %/ft is presented in Table 26.

Table 26 – Observed UL 217 room test signals at ceiling location for non-flaming mode tests at 0.5 % /ft

Target Sample Description	Test No.	Time (s)	D _m (mm)	N _m (cc ⁻¹)	CO (ppm)	CO ₂ (ppm)	T (°C)	Vel. (m/s)
UL 217 Ponderosa pine	12126	1794	0.15	1.58E+05	72	45	23.8	0.05
	12132	1767	0.16	1.17E+05	47	13	23.4	0.04
	12143	2409	0.16	1.98E+05	124	12	23.6	0.05
	12184	1596	0.15	1.18E+05	35	0	22.4	0.03
	12185	1002	0.17	1.09E+05	19	11	22.2	0.03
Bread – 4 slices	12136	323	0.11	1.70E+06	33	49	24.3	0.11
	12155	323	0.11	1.66E+06	8	20	25.1	0.08
	01244	359	0.10	1.96E+06	6	70	17.8	0.07
Polyisocyanurate insulation – 150 × 150 × 200 mm pieces	12271	5464	0.10	9.82E+05	14	6	23.5	0.05
Mattress PU foam – 150 × 150 × 50 mm foam	12192	2190	0.16	1.14E+05	16	4	NA	NA
	12193	2337	0.20	8.94E+04	14	18	NA	NA
Mattress PU foam – 100 × 125 × 100 mm foam with a 25 × 150 × 150 mm piece on two opposing sides	12202	2017	0.17	1.82E+05	8	4	22.8	0.01
	12261	1723	0.27	2.76E+04	6	23	22.8	0.03
Mattress PU foam wrapped in CA TB 117 cotton sheet – 100 × 150 × 200 mm foam	01232	2180	0.28	1.12E+04	15	0	17.8	0.06
Mattress PU foam wrapped in CA TB 117 cotton sheet – 125 × 125 × 300 mm foam	01241	2758	0.16	2.68E+04	10	3	16.5	0.05
Mattress PU foam wrapped in polyester microfiber sheet – 125 × 125 × 300 mm foam	01233	2885	0.16	1.26E+04	6	22	17.8	0.06
	01245	3076	0.24	1.01E+04	8	11	16.28	0.02
Nylon carpet – 150 × 150 mm sample	12262	2404	0.21	4.00E+04	23	17	23.1	0.04
Polystyrene pellets – 69.8 g	12272	3956	0.22	1.48E+05	1	11	23.3	0.05

Note to Table 26:

NA = Not available

A summary of room test signals at OBS value of 10 %/ft is presented in Table 27.

Table 27 – Observed UL 217 room test signals at ceiling location for non-flaming mode tests at 10 % Obs/ft

Target Sample Description	Test No.	Time (s)	D _m (mm)	N _m (cc ⁻¹)	CO (ppm)	CO ₂ (ppm)	T (°C)	Vel. (m/s)
UL 217 Ponderosa pine	12126	3522	0.24	6.10E+05	ND	ND	24.3	0.05
	12132	3770	0.26	7.30E+05	480	140	23.9	0.07
	12143	NA	NA	NA	NA	NA	NA	NA
	12184	3776	0.25	8.78E+05	429	94	23.3	0.07
	12185	3268	0.27	7.72E+05	395	102	22.9	0.06
Bread – 4 slices	12136	355	0.15	1.81E+06	106	92	24.7	0.11
	12155	368	0.17	1.77E+06	42	37	25.1	0.10
	01244	405	0.20	2.05E+06	39	90	20.0	0.08
Polyisocyanurate insulation – 150 × 150 × 200 mm pieces	12271	NA	NA	NA	NA	NA	NA	NA
Mattress PU foam – 150 × 150 × 50 mm foam	12192	NA	NA	NA	NA	NA	NA	NA
	12193	NA	NA	NA	NA	NA	NA	NA
Mattress PU foam – 100 × 125 × 100 mm foam with a 25 × 150 × 150 mm piece on two opposing sides	12202	NA	NA	NA	NA	NA	NA	NA
	12261	5609	0.23	5.27E+05	104	60	23.7	0.09
Mattress PU foam wrapped in CA TB 117 cotton sheet – 100 × 150 × 200 mm foam	01232	NA	NA	NA	NA	NA	NA	NA
Mattress PU foam wrapped in CA TB 117 cotton sheet – 125 × 125 × 300 mm foam	01241	NA	NA	NA	NA	NA	NA	NA
Mattress PU foam wrapped in polyester microfiber sheet – 125 × 125 × 300 mm foam	01233	NA	NA	NA	NA	NA	NA	NA
	01245	NA	NA	NA	NA	NA	NA	NA
Nylon carpet – 150 × 150 mm sample	12262	NA	NA	NA	NA	NA	NA	NA
Polystyrene pellets – 69.8 g	12272	NA	NA	NA	NA	NA	NA	NA

Notes to Table 27:

- 5 NA = Not attained
 ND = Data not recorded

The mean particle diameter and count for the non-flaming tests are depicted in Figure 89 through Figure 98.

10

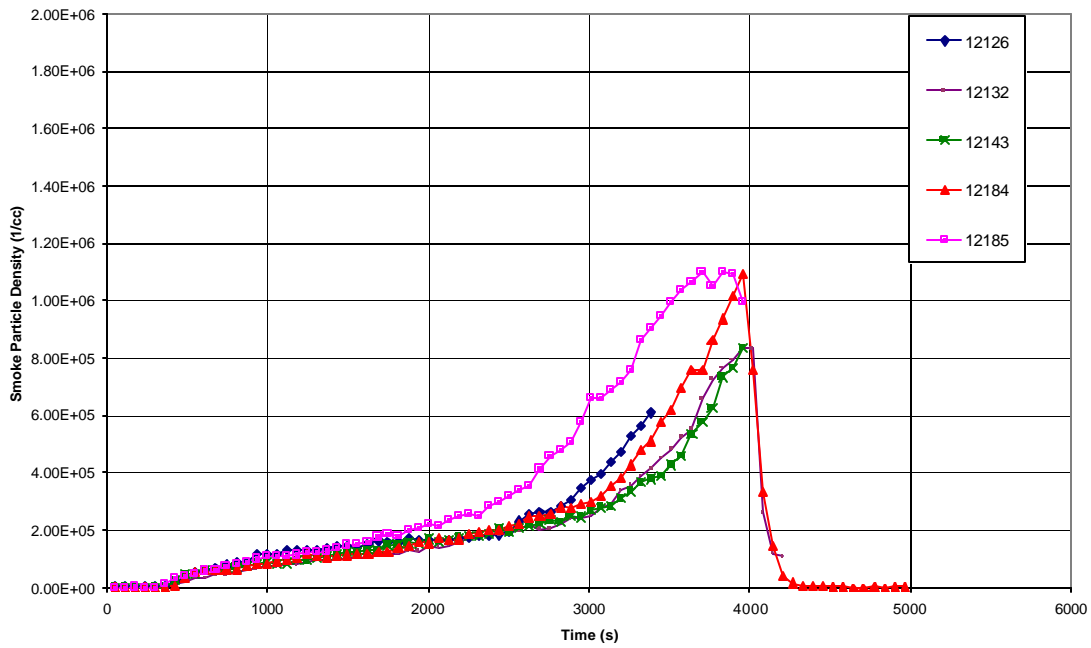
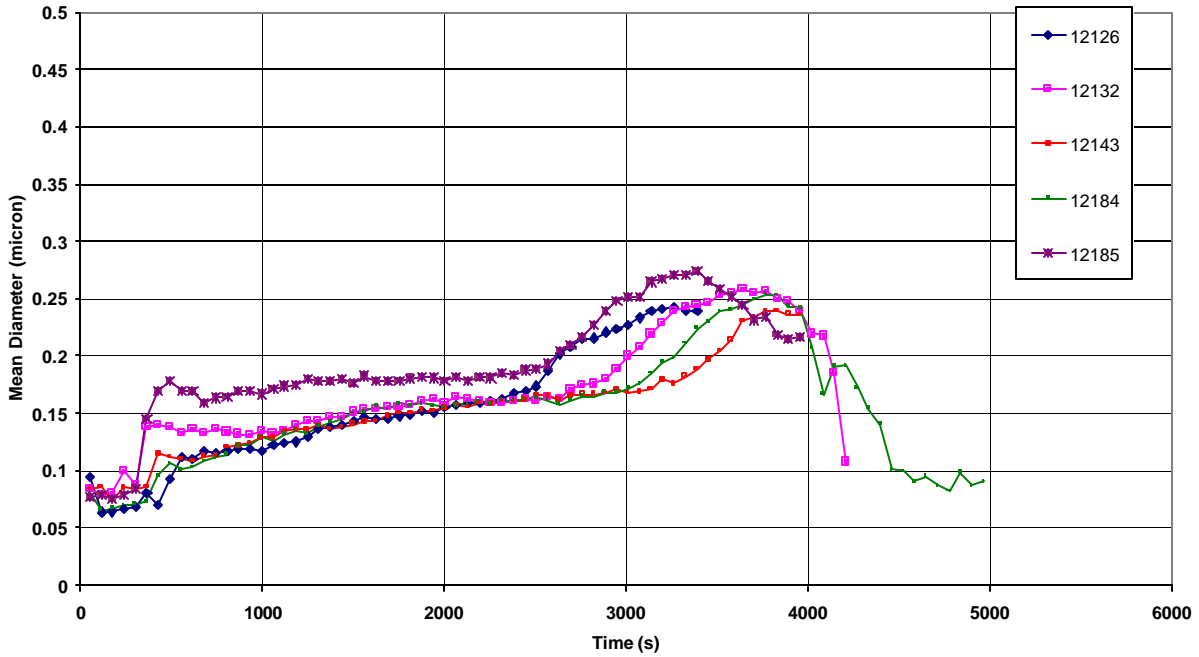

5

Figure 89 – Mean smoke particle diameter and count for Ponderosa pine in non-flaming tests

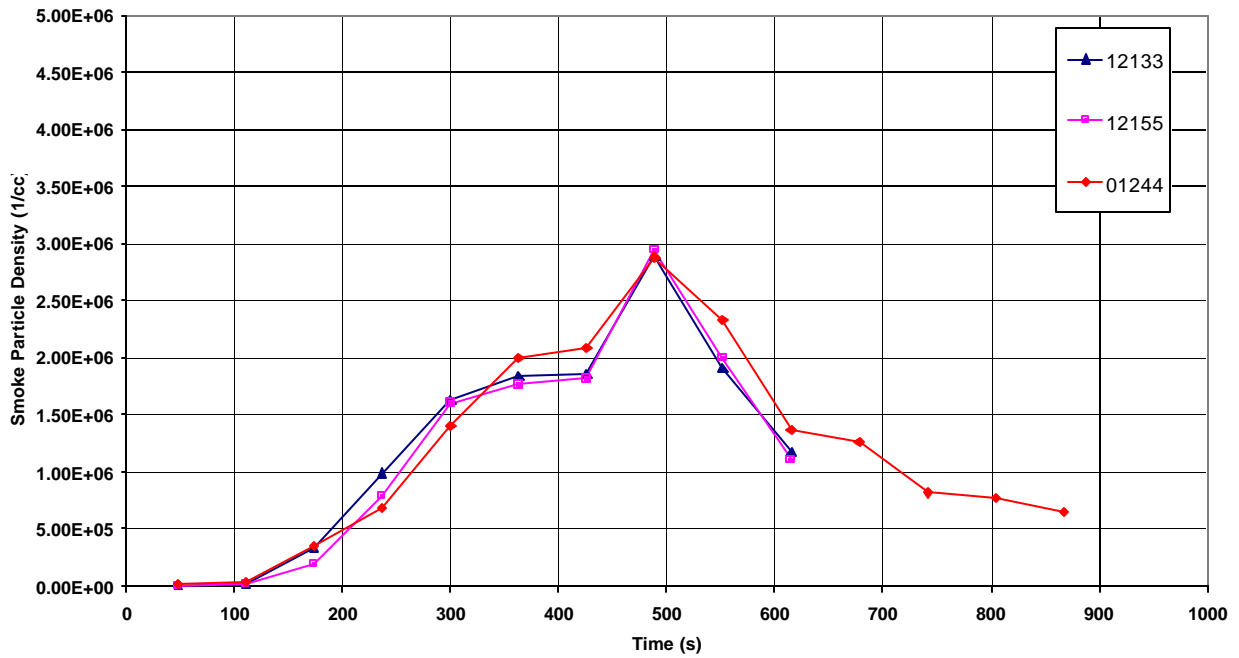
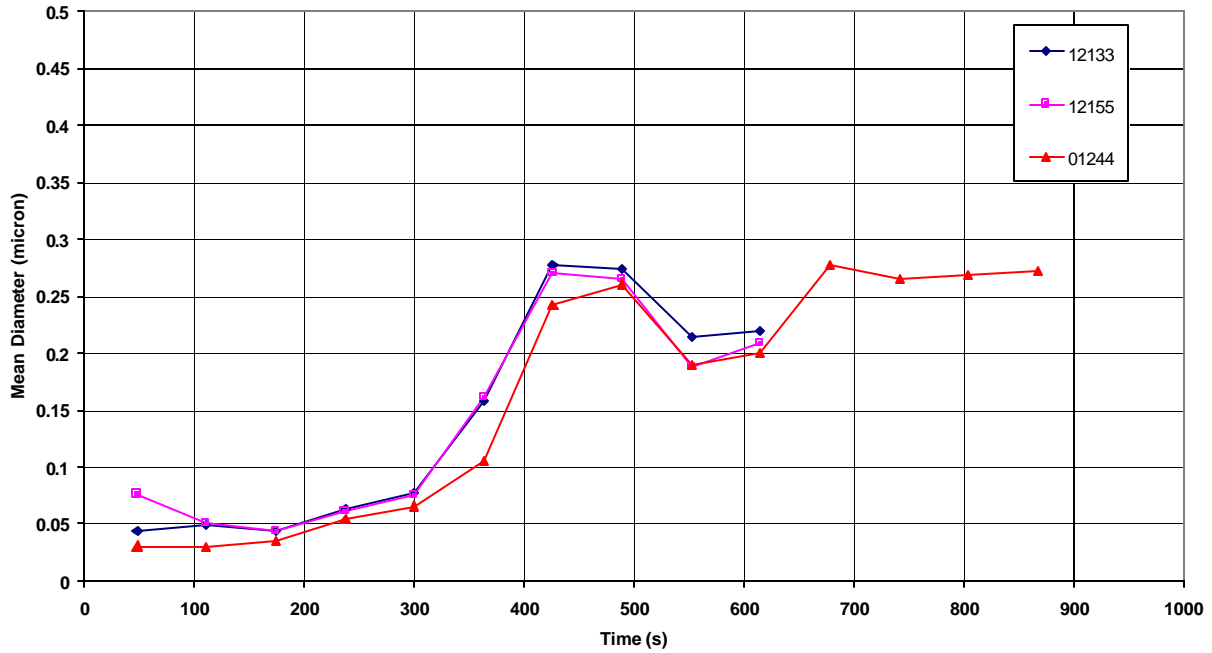

5

Figure 90 – Mean smoke particle diameter and count for bread in non-flaming tests

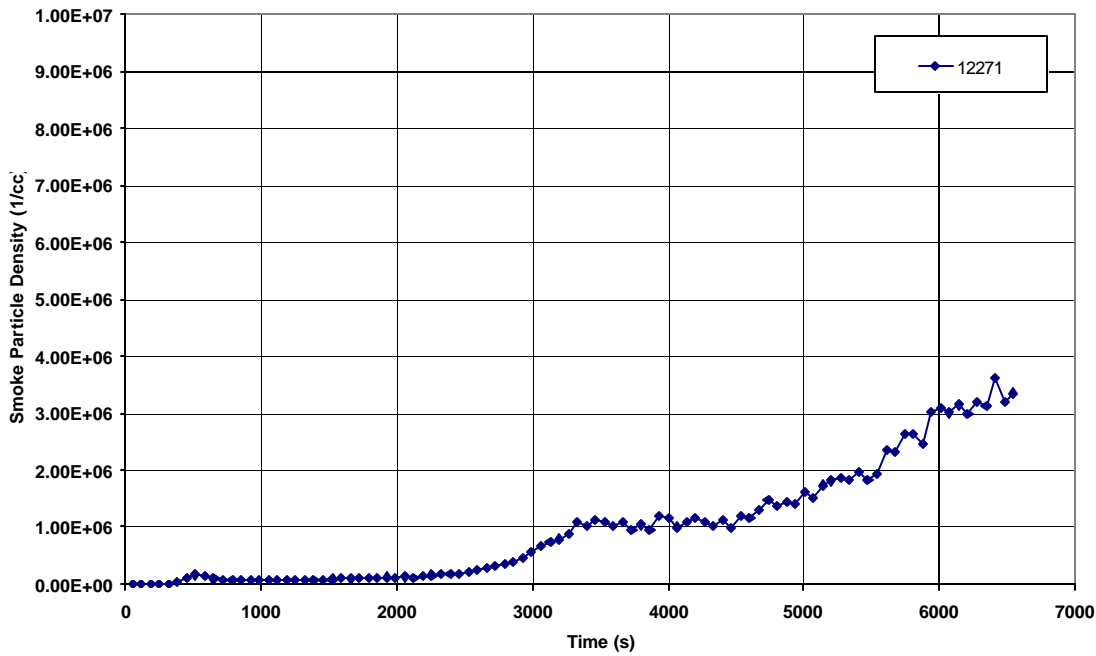
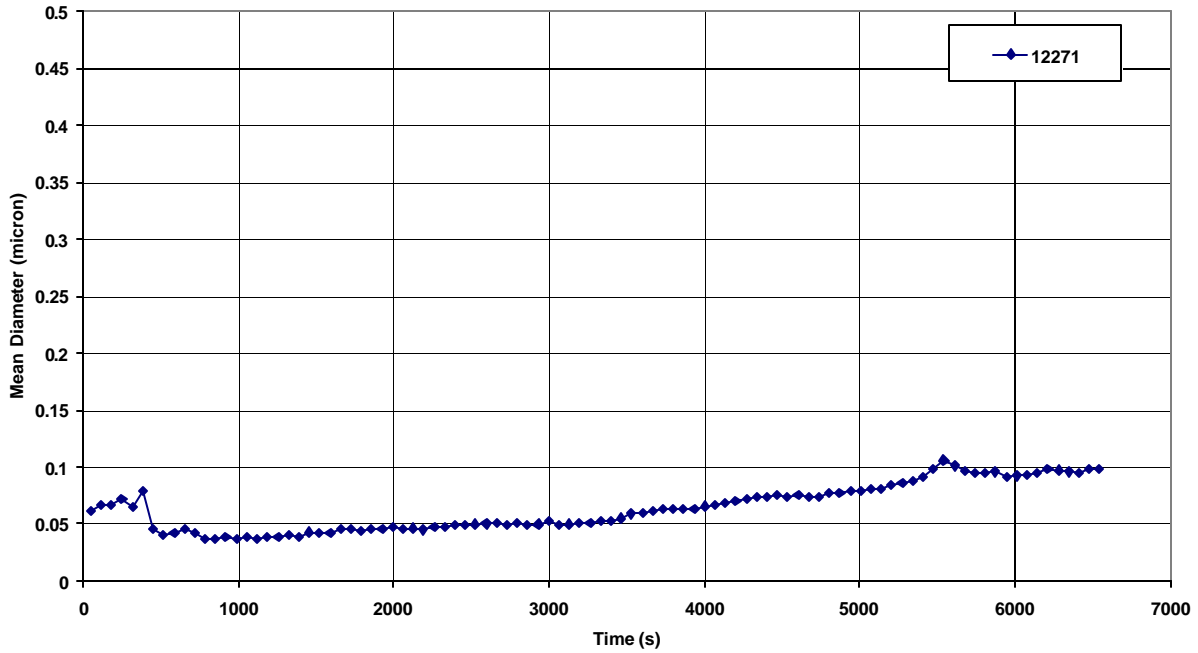

5

Figure 91 – Mean smoke particle diameter and count for polyisocyanurate foam in non-flaming tests

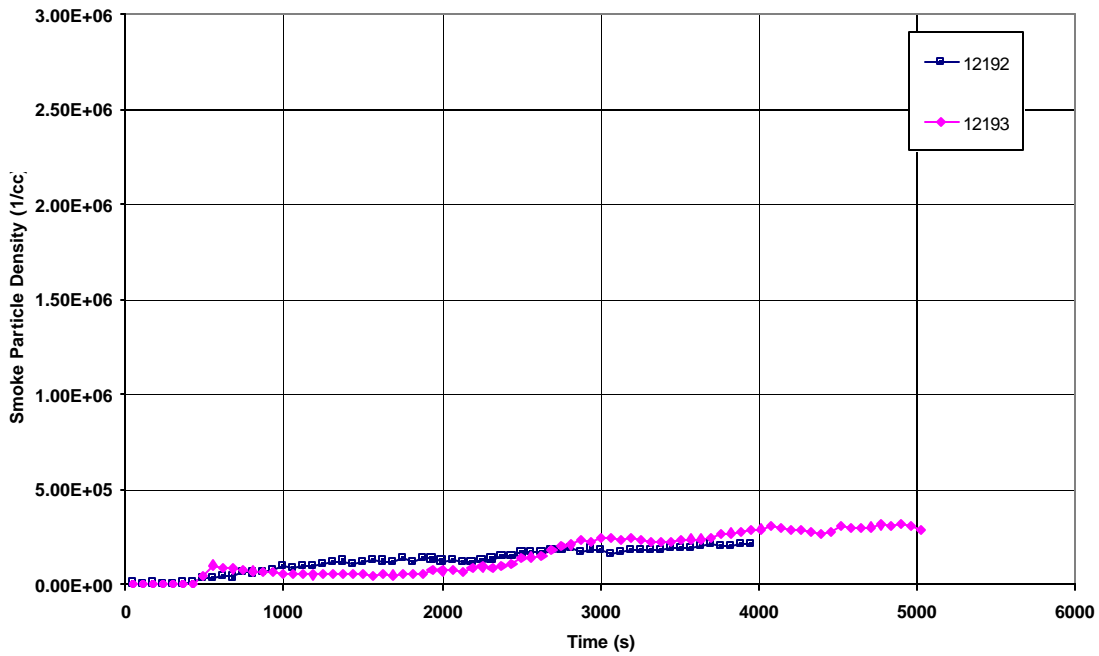
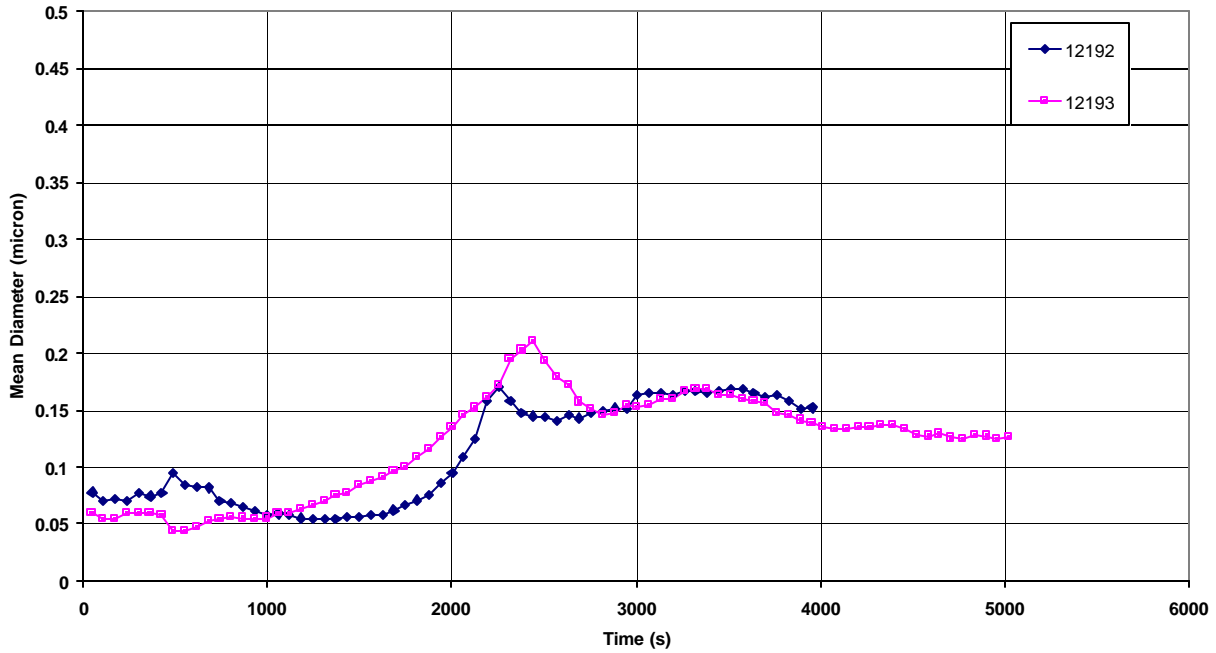

5

Figure 92 – Mean smoke particle diameter and count for PU foam in non-flaming tests

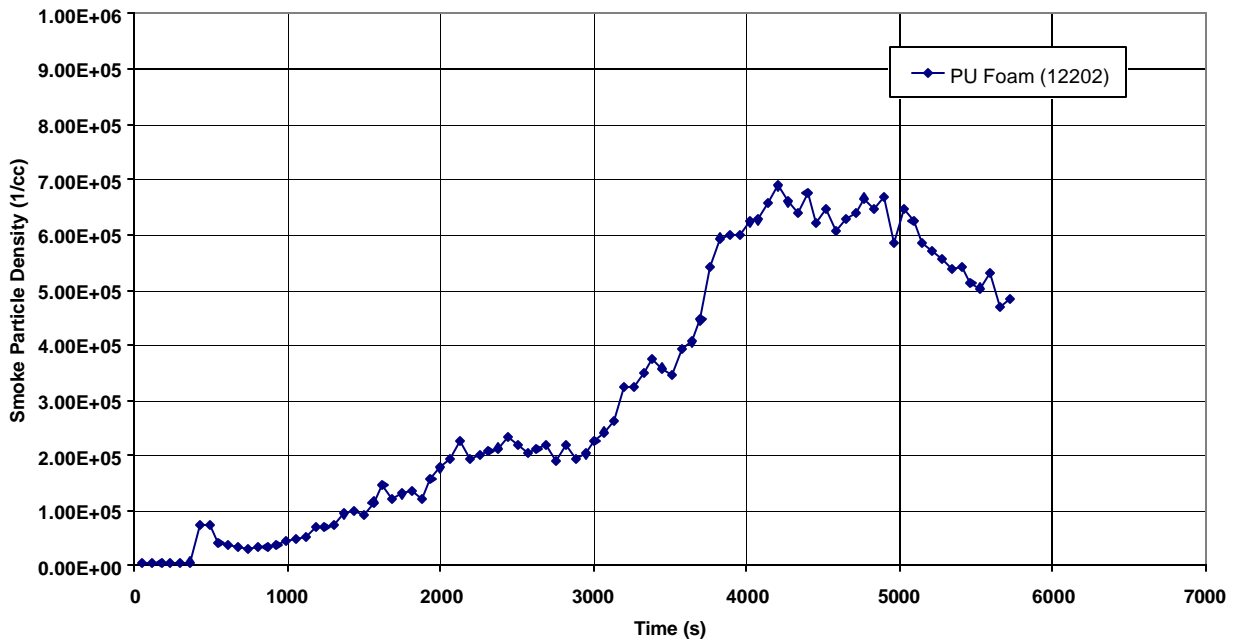
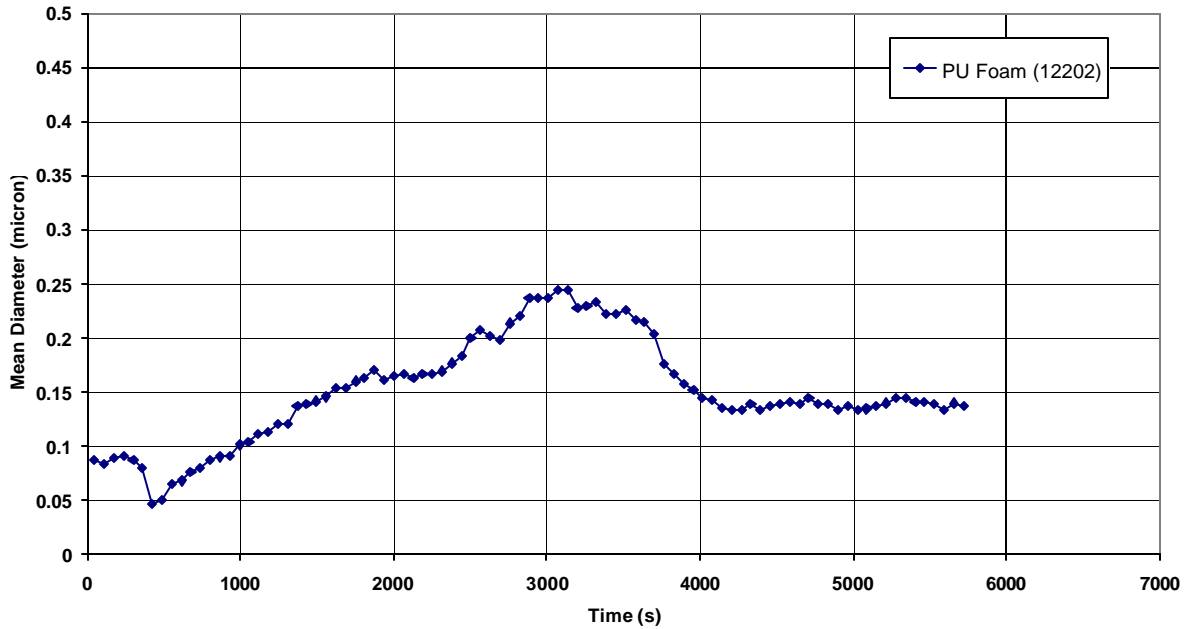

5

**Figure 93 – Mean smoke particle diameter and count for PU foam in non-flaming tests
(Data from Test 12261 were found to be suspicious and were not plotted)**

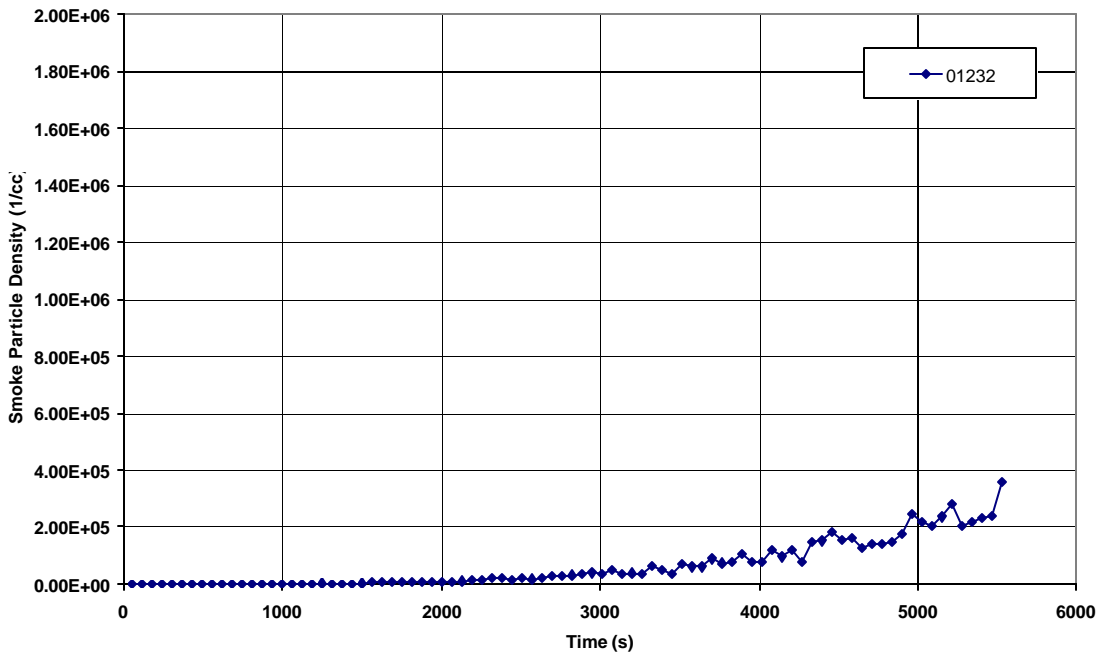
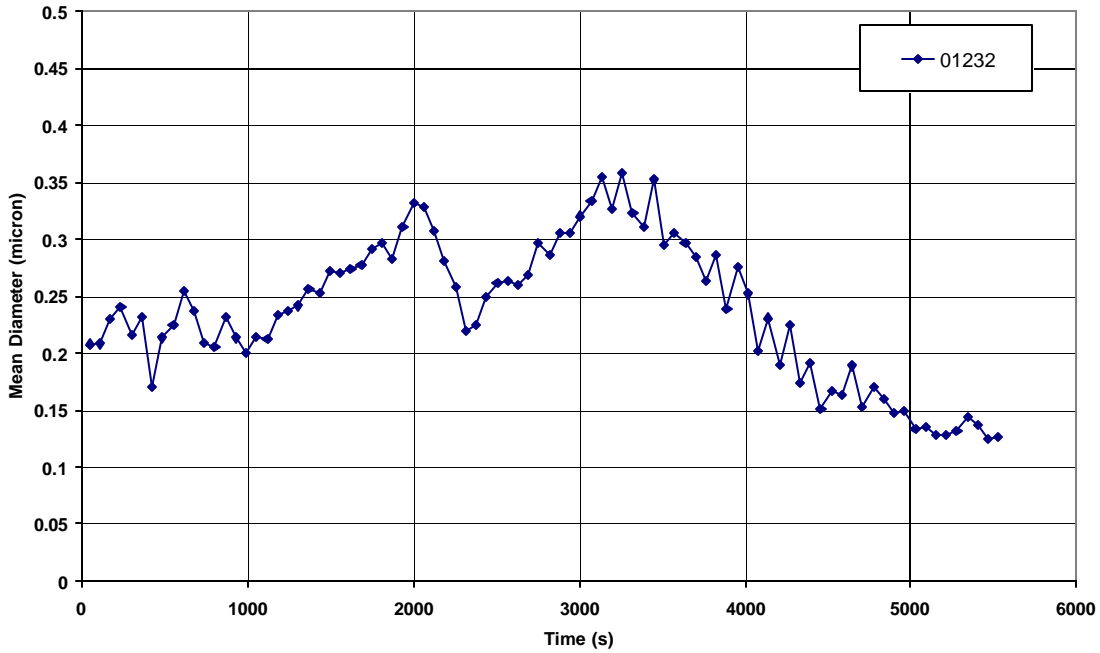

5

Figure 94 – Mean smoke particle diameter and count for cotton fabric wrapped PU foam in non-flaming tests

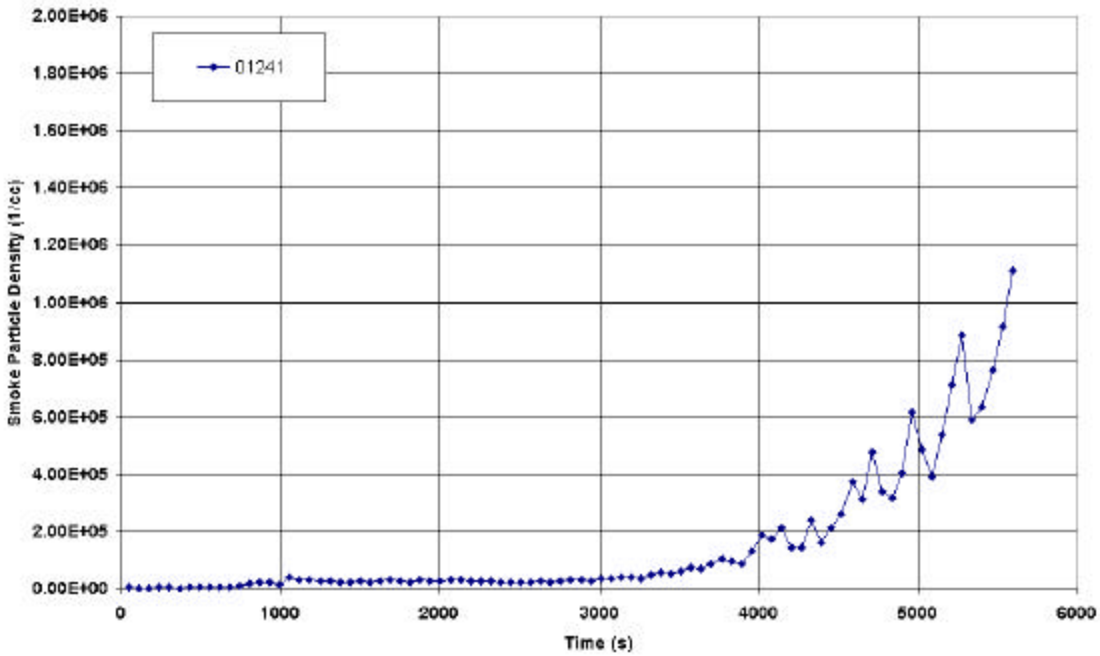
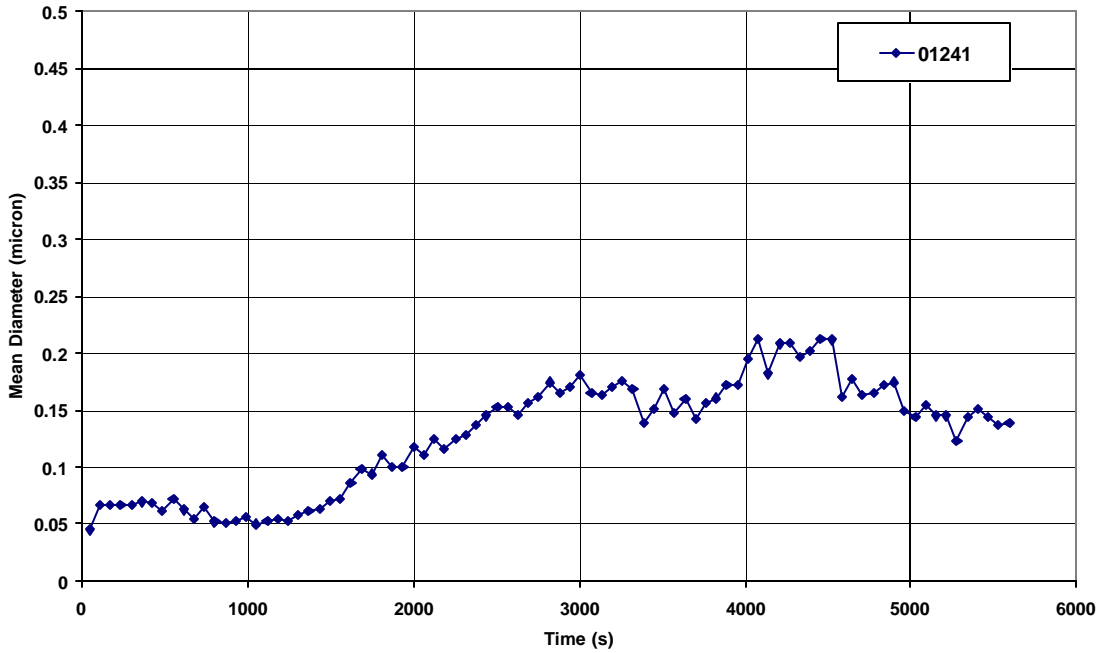

5

Figure 95 – Mean smoke particle diameter and count for cotton-poly wrapped PU foam in non-flaming tests

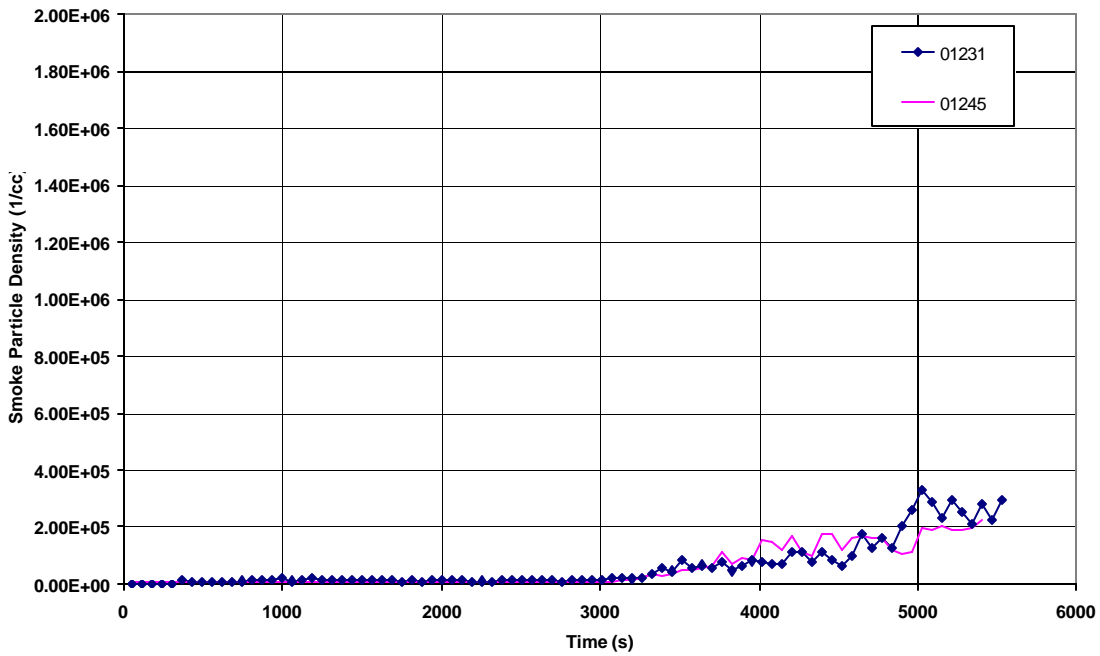
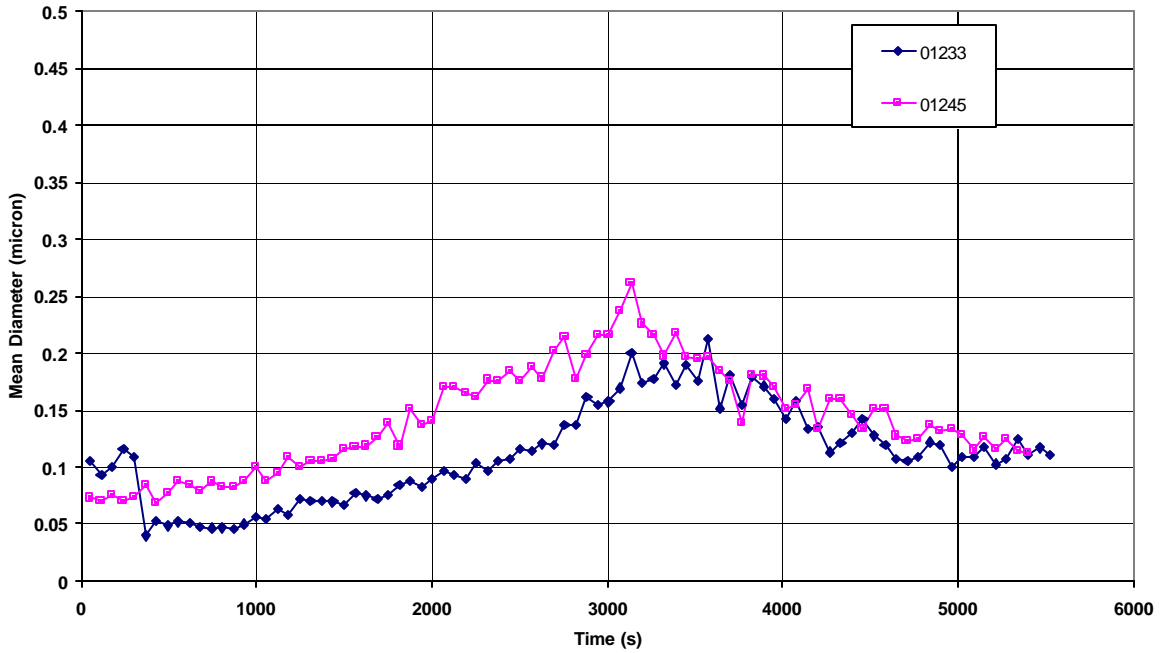

5

Figure 96 – Mean smoke particle diameter and count for polyester microfiber wrapped PU foam in non-flaming tests

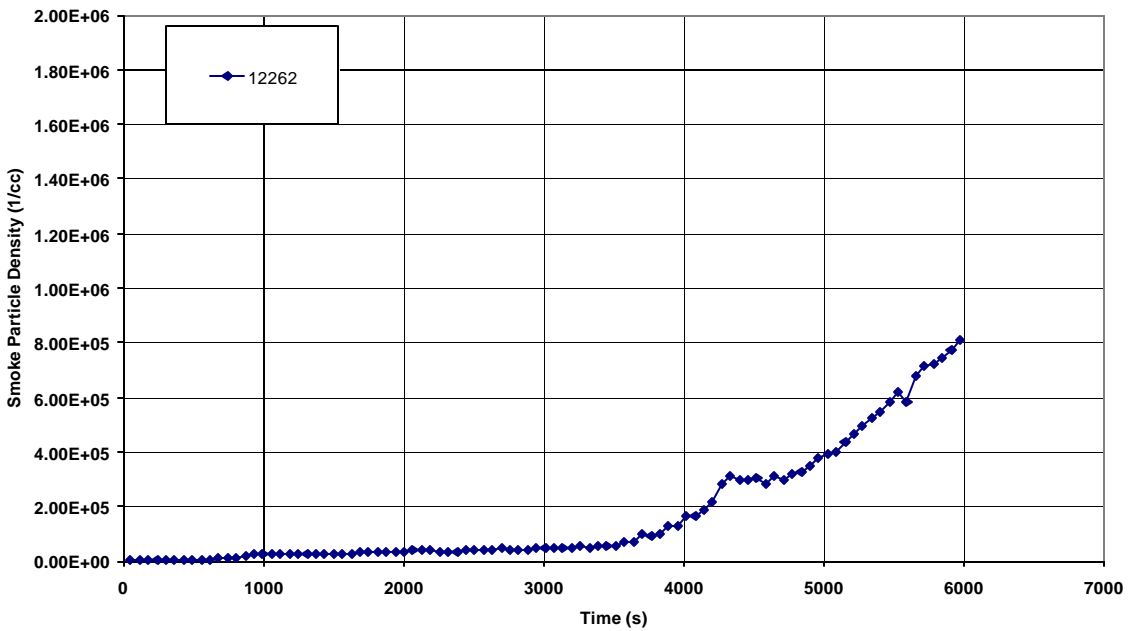
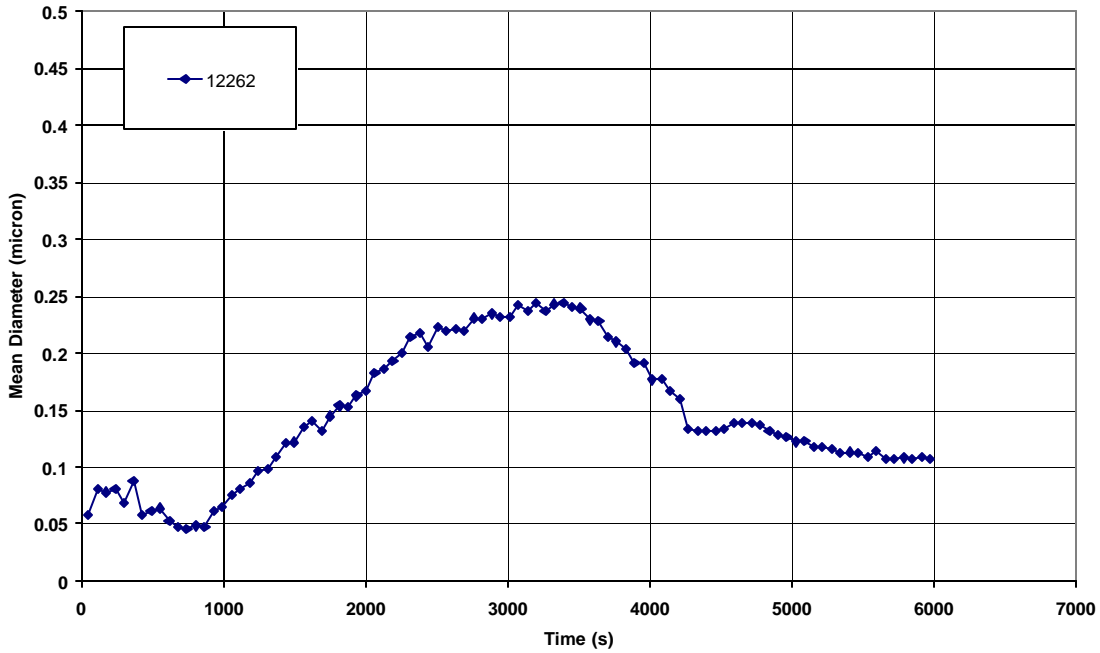

5

Figure 97 – Mean smoke particle diameter and count for nylon carpet in non-flaming tests

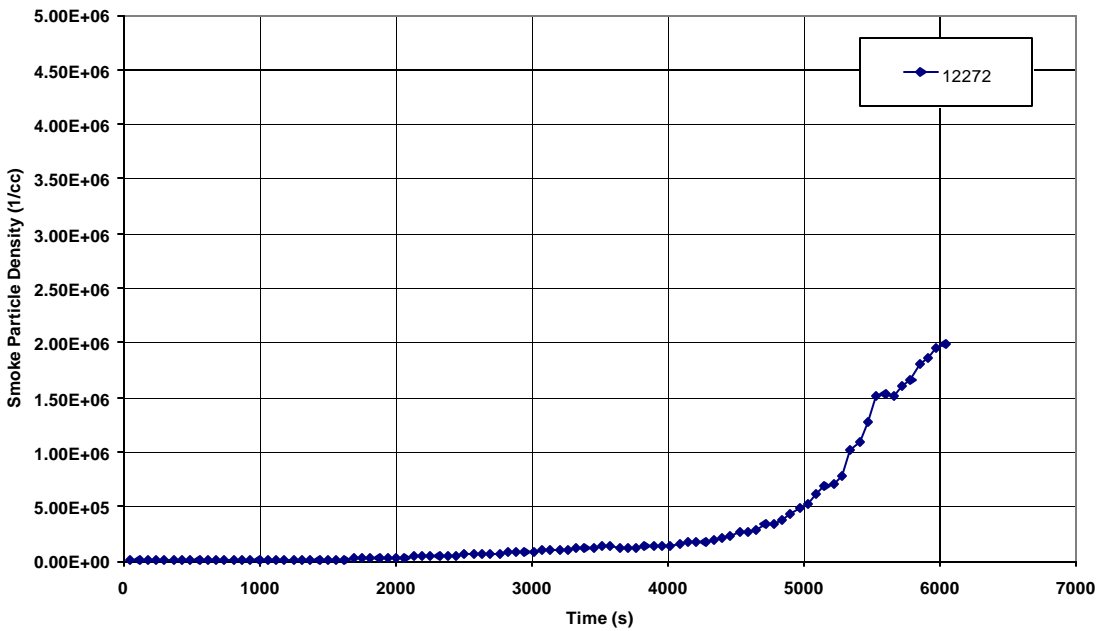
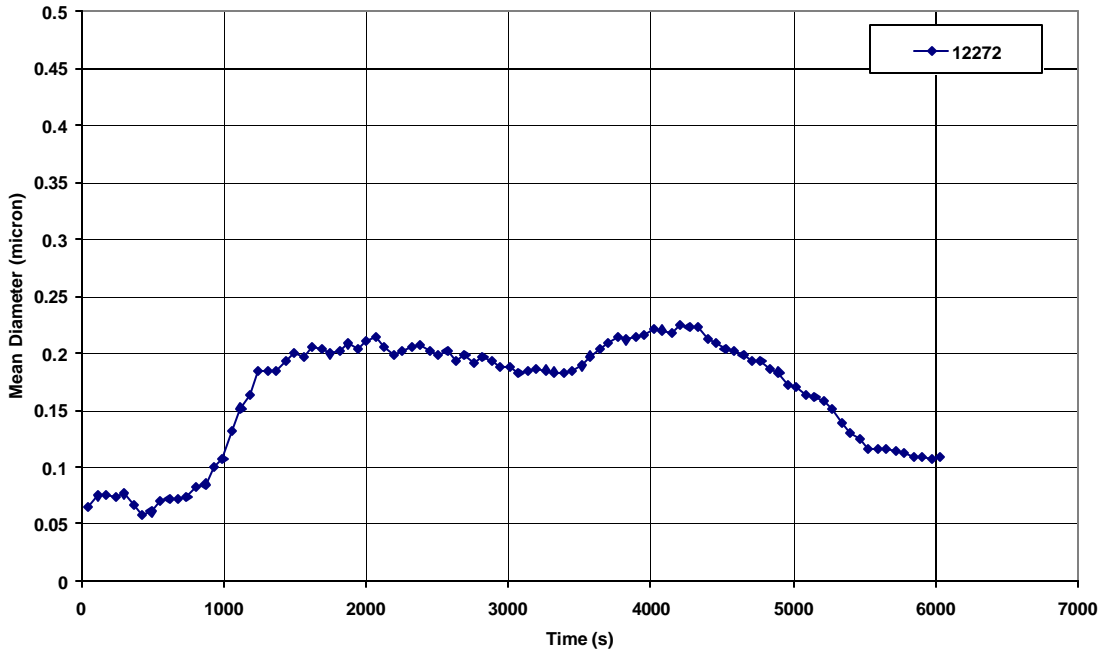

5

Figure 98 – Mean smoke particle diameter and count for polystyrene in non-flaming tests

The ceiling test signatures are summarized in Table 28.

Table 28 – UL 217 Fire Test Room ceiling test signatures for non-flaming combustion tests

Target Sample Description	Test No.	Alarm Trigger Time (s)		Ceiling Analog Ionization Alarm Signal		Ceiling Analog Photo Alarm Signal		Max Radial Velocity (m/s)	Max Temp. (°C)
		Ion	Photo	Min	Max	Min	Max		
UL 217 Ponderosa pine	12126	3244	3226	23	57	36	65	0.09	24.5
	12132	NAP	3318	15	61	15	65	0.11	24.7
	12143	3826	3805	15	46	15	65	0.10	24.4
	12184	3547	3451	16	57	15	65	0.09	23.8
	12185	2894	2722	17	67	15	65	0.11	24.0
Bread – 4 slices	12133	319	364	17	79	15	65	0.14	26.0
	12155	306	371	16	78	15	65	0.15	26.4
	01244	343	448	16	80	15	65	0.14	18.8
Polyisocyanurate insulation – 150 × 150 × 200 mm pieces	12271	DNT	DNT	15	25	15	17	0.11	24
Mattress PU foam – 150 × 150 × 50 mm foam	12192	DNT	DNT	16	24	15	32	--- ^[1]	--- ^[1]
	12193	DNT	DNT	16	29	15	34	--- ^[1]	--- ^[1]
Mattress PU foam – 100 × 125 × 100 mm foam with a 25 × 150 × 150 mm piece on two opposing sides	12202	DNT	DNT	16	33	15	65	0.10	23.8
	12261	5610	3032	15	40	15	65	0.11	23.9
Mattress PU foam wrapped in CA TB 117 cotton sheet – 100 × 150 × 200 mm foam	01232	DNT	3530	15	28	15	65	0.10	18.6
Mattress PU foam wrapped in CA TB 117 cotton sheet – 125 × 125 × 300 mm foam	01241	DNT	4207	16	34	15	65	0.11	17.4
Mattress PU foam wrapped in polyester microfiber sheet – 125 × 125 × 300 mm foam	01233	DNT	5353	16	29	15	65	0.10	17.1
	01245	DNT	4128	15	27	15	65	0.12	18.1
Nylon carpet – 150 × 150 mm sample	12262	DNT	5727	15	27	15	62	0.10	24.1
Polystyrene pellets – 69.8 g	12272	DNT	5546	15	30	15	65	0.11	24.3

Notes to Table 28:

5 NAP = Alarm not present

DNT = Did not trigger

^[1] Bad velocity and temperature data

10 It was observed that the maximum radial velocities in the non-flaming tests are on the order of 0.10 m/s. In comparison, the velocity in the UL 217 Sensitivity smoke box test is 0.16 m/s.

TASK 4 – CORRELATE ANALYTICAL DATA AND PERFORMANCE IN THE FIRE TEST ROOM

INTRODUCTION

5 A range of natural, synthetic, and multi-component materials representing the variety of products found in residential settings was evaluated for this investigation.

10 In this section, the results from the small, intermediate and Fire Test Room tests were analyzed for specific trends related to the influence of (i) materials and combustion mode, and (ii) mode of testing on the smoke generated.

SMOKE PARTICLE DISTRIBUTION MEASUREMENTS

15 Light based obscuration systems used in UL 217 operate on a principle of light extinction which is related to the volume fraction occupied by the scattering particles. Photoelectric alarms are based on light scattering which depends on the amount of particle surface area along with the particle reflectivity. Ionization field based systems (*e.g.*, MIC, ionization alarms) used in UL 217 however rely equally on the number of particles within the sample chamber as the size of the particles; hence the specific particle counts are more relevant. These sensor technologies and
20 particle size and count dependencies are summarized in Table 29. Tests using the WPS spectrometer in the UL 217 Sensitivity Test smoke box confirmed the obscuration and ionization principles.

Table 29 – Theoretical smoke particle dependency for traditional smoke sensor technologies

Sensor Type(s)	Principle	Smoke Particle Relation
MIC, Ion Alarms	Ionization	$\sum n_i \cdot d_i$
Photoelectric Alarms	Light scattering	$\sum n_i \cdot d_i^2$
Obscuration Systems	Light obscuration	$\sum n_i \cdot d_i^3$

25

INFLUENCE OF MATERIALS AND COMBUSTION MODE: CONE CALORIMETER

30 The ASTM E1354 cone calorimeter provided a consistent, well-regulated means for evaluating the smoke generated by different materials under flaming and non-flaming conditions. The specific extinction area under the two modes of combustion, Figure 99, indicates that most of the materials generate more smoke per unit of consumed mass under non-flaming conditions. The most significant effect of the combustion mode on smoke production is for the polyurethane and polyisocyanurate foams, possibly due to the high surface area to volume ratio resulting from their unique physical structure.

35

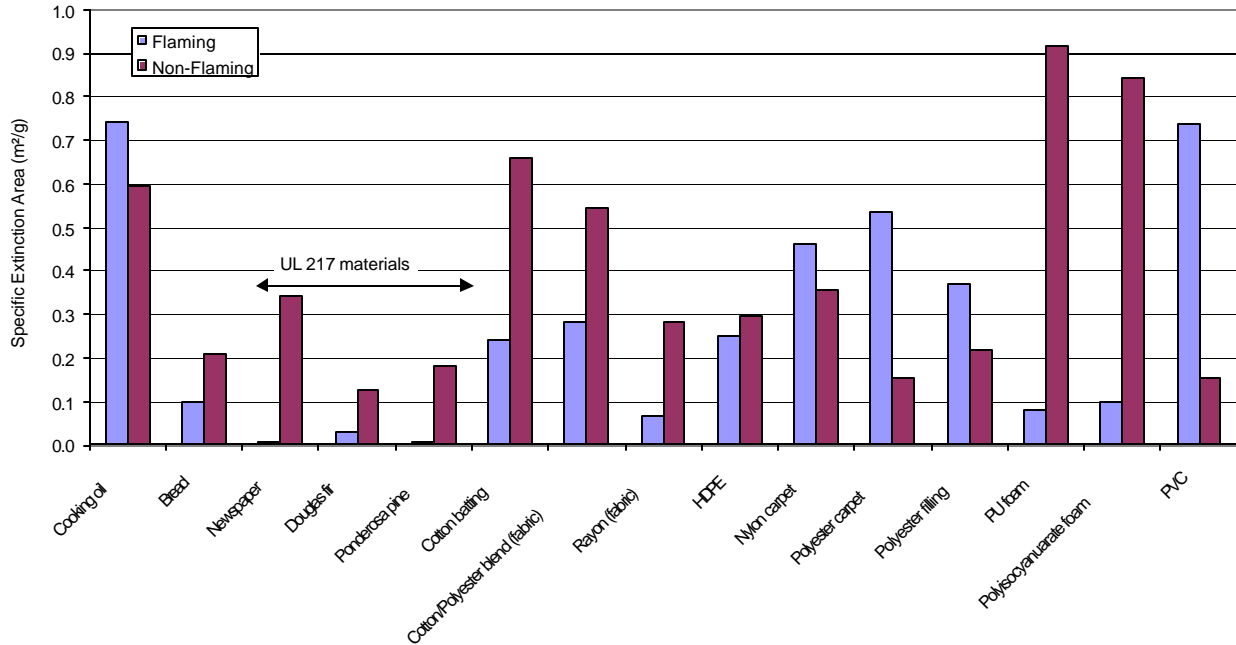

Figure 99 – Specific extinction area for small-scale flaming and non-flaming combustion

5 The mode of combustion appears to have different effects on the mean size of the generated smoke particles depending on the material chemistry, Figure 100. Non-flaming combustion generates smaller particles than flaming combustion on natural cellulosic materials but for synthetic materials the particle sizes were larger in the non-flaming conditions.

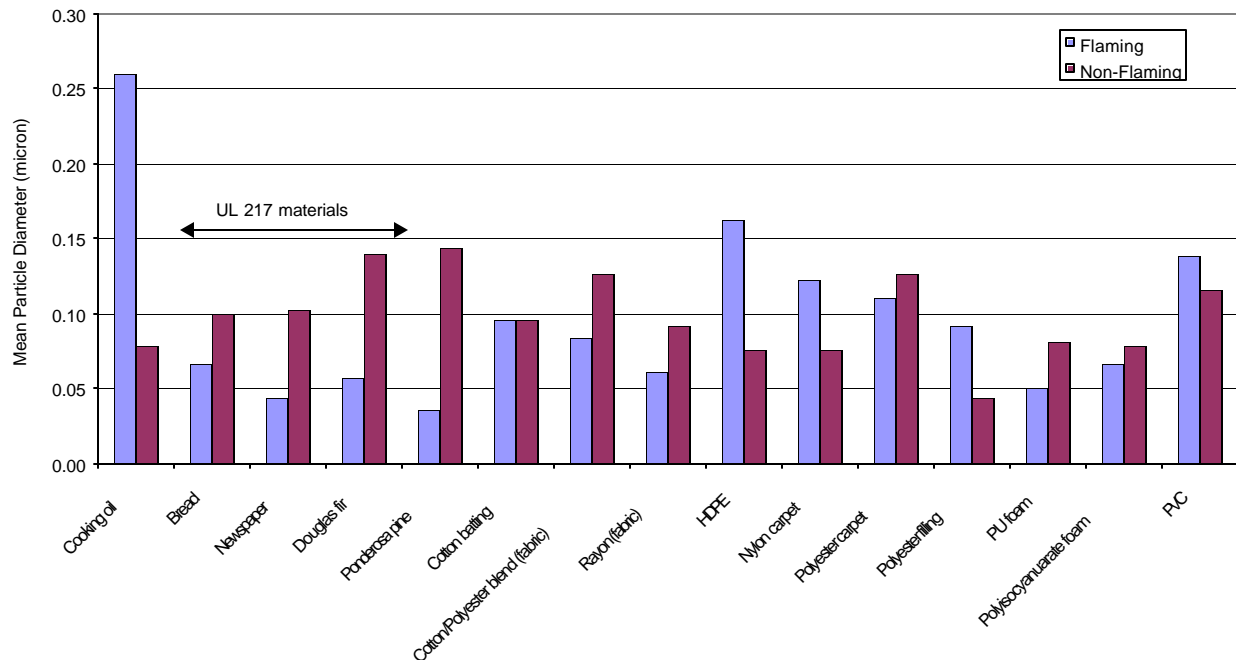
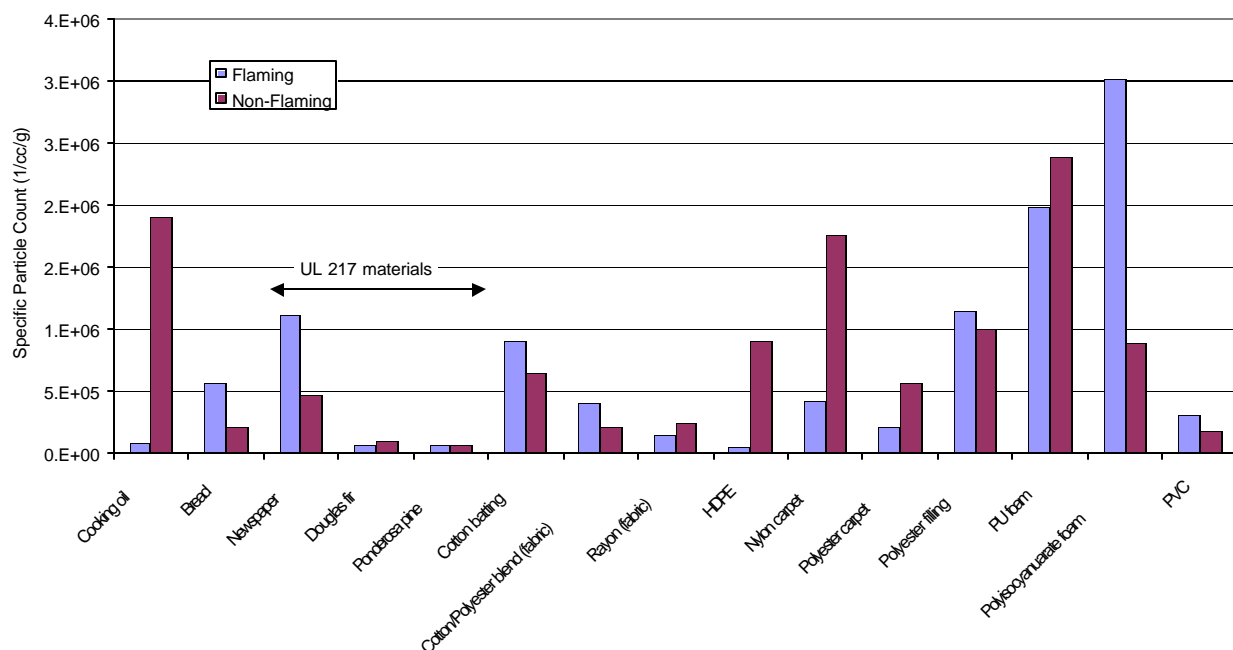

Figure 100 – Mean particle diameter for small-scale flaming and non-flaming combustion

Measured specific particle counts plotted in Figure 101 does not indicate any material independent trends for the effects of combustion mode on the number of particles generated per unit consumed mass.



5

Figure 101 – Specific particle count for small-scale flaming and non-flaming combustion

INFLUENCE OF MATERIALS AND COMBUSTION MODE: FIRE TEST ROOM

The cone calorimeter was used to characterize the inherent material products of combustion (*e.g.* heat, smoke and effluent gases generated) under consistent, well-regulated conditions. The continuous removal of smoke and other combustion products via the cone calorimeter exhaust flow prohibits smoke concentration build-up and potential smoke particle aggregation that would be expected in relatively stagnant air spaces such as a residential settings. Smoke build-up in a given air space depends on the volume of the air space, the inherent smoke particulate rate formation and consequently the size and geometry of the involved burning material, and the mode of combustion. Therefore comparison of combustion products generated by the more complex test targets evaluated in the stagnant air Fire Test Room is more appropriate at a set obscuration level as opposed to a set time. As seen in Figure 102, larger smoke particles were generally observed for non-flaming combustion than for flaming combustion. These results parallel results obtained on the cone calorimeter.

20

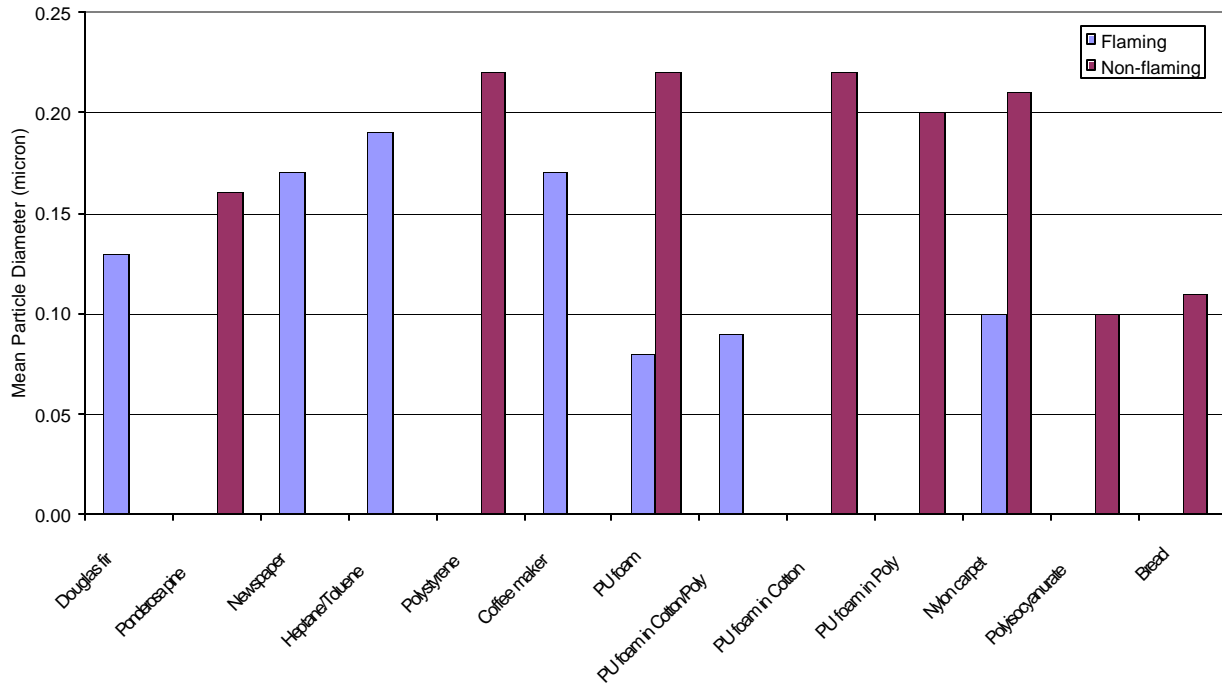

Figure 102 – Mean particle diameters at an obscuration of 0.5 %/ft in the Fire Test Room

5 Measured MIC, analog ionization alarm, obscuration, and analog photo alarm signals are plotted against respective particle size and count data in Figure 103 through Figure 110. Individual test results support the predicted relationships described in Table 29. Comparison of tests for different materials, however, indicate that there is a material effect on the respective signal in addition to the predicted particle size and count relationship. This material dependency effect is more evident for ionization and scattering sensor technologies than light obscuration because the

10 smoke particulate size and count does account for either the propensity of the particulate to ionize or its reflectivity.

15 Categorical evaluation of the data for combustion mode response indicates that the scattering sensor technology is more sensitive to combustion mode than either obscuration or ionization technologies.

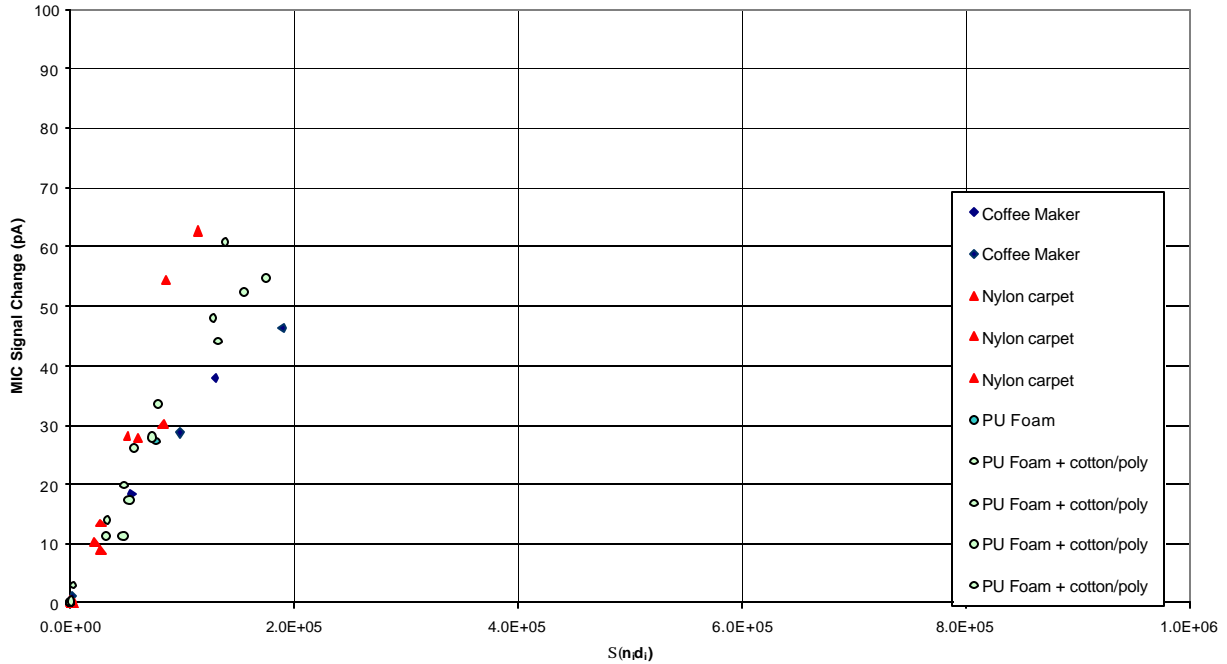

Figure 103 – MIC signal versus particle size data for Fire Test Room flaming tests

5 MIC signal response for flaming (Figure 103) and non-flaming (Figure 104) tests demonstrate the linear relationship predicted for particle size and count. Variation in signal responsiveness between materials however, indicates a material-soot chemistry dependency that is not addressed by the model such as soot-air ionization potential (β) and ion diffusivity (D). The flaming and non-flaming combustion data suggests that ionization technology is sensitive to the mode of combustion.

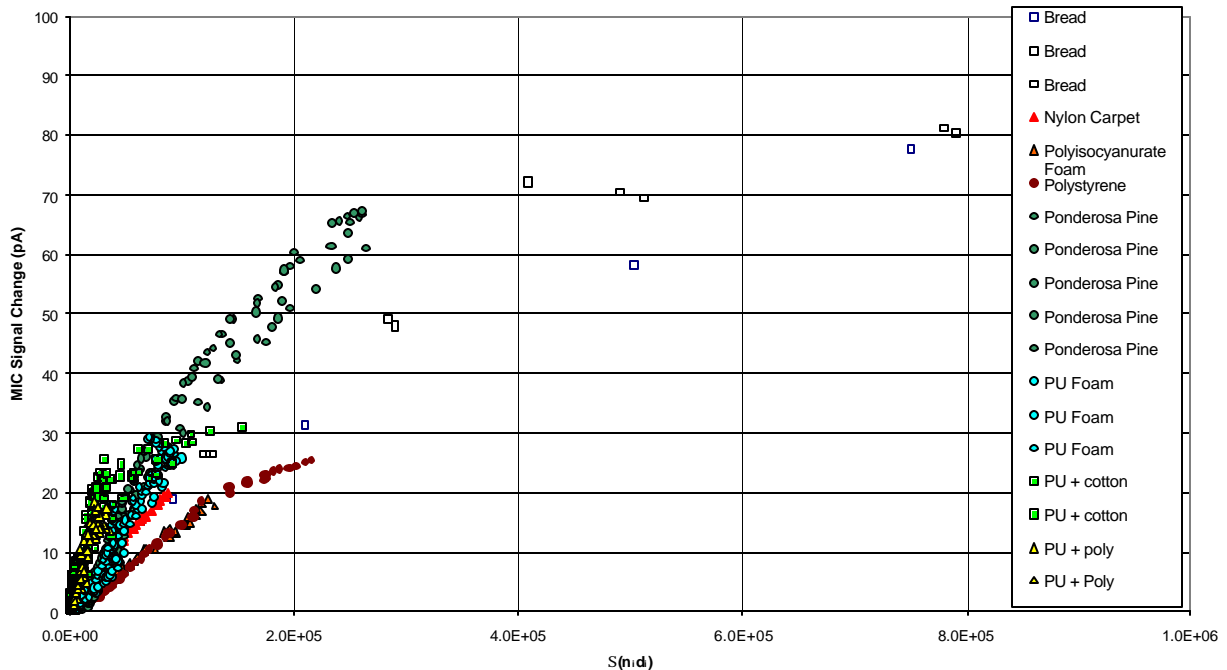

Figure 104 – MIC signal versus particle size data for Fire Test Room non-flaming tests

10

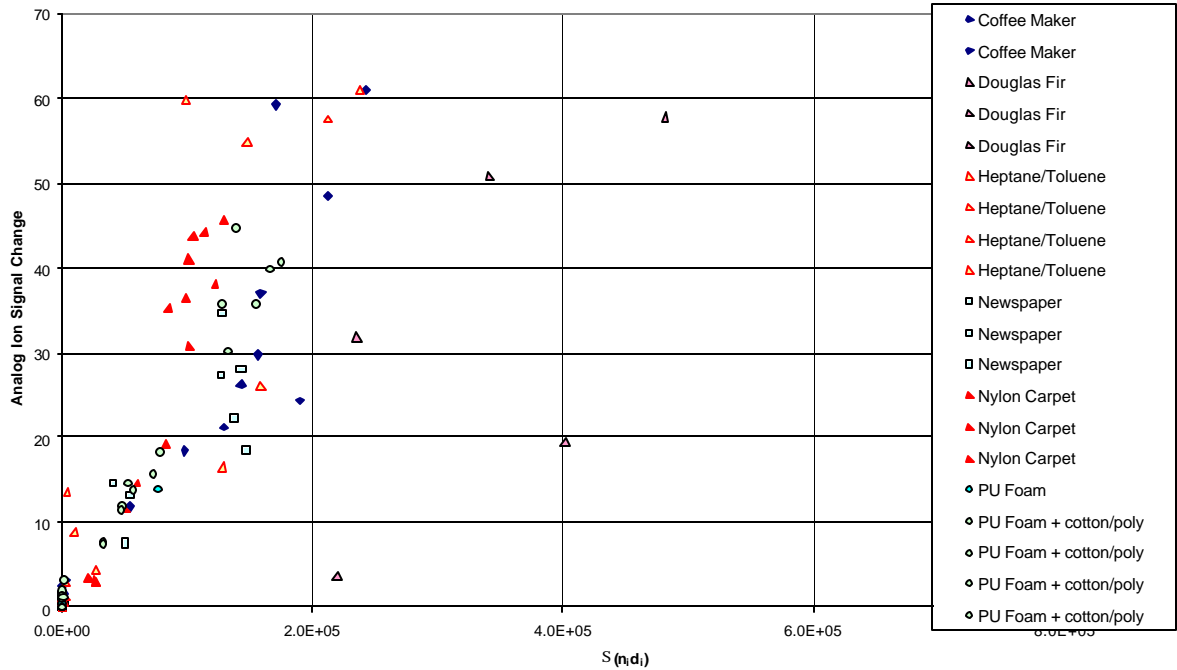

Figure 105 – Analog ion signal versus particle size data for Fire Test Room flaming tests

Analog ion signal responses for flaming (Figure 105) and non-flaming (Figure 106) tests parallel the observed MIC signal response: linear relationship with particle size and count, material/soot chemistry dependency, and sensitivity to the mode of combustion.

5

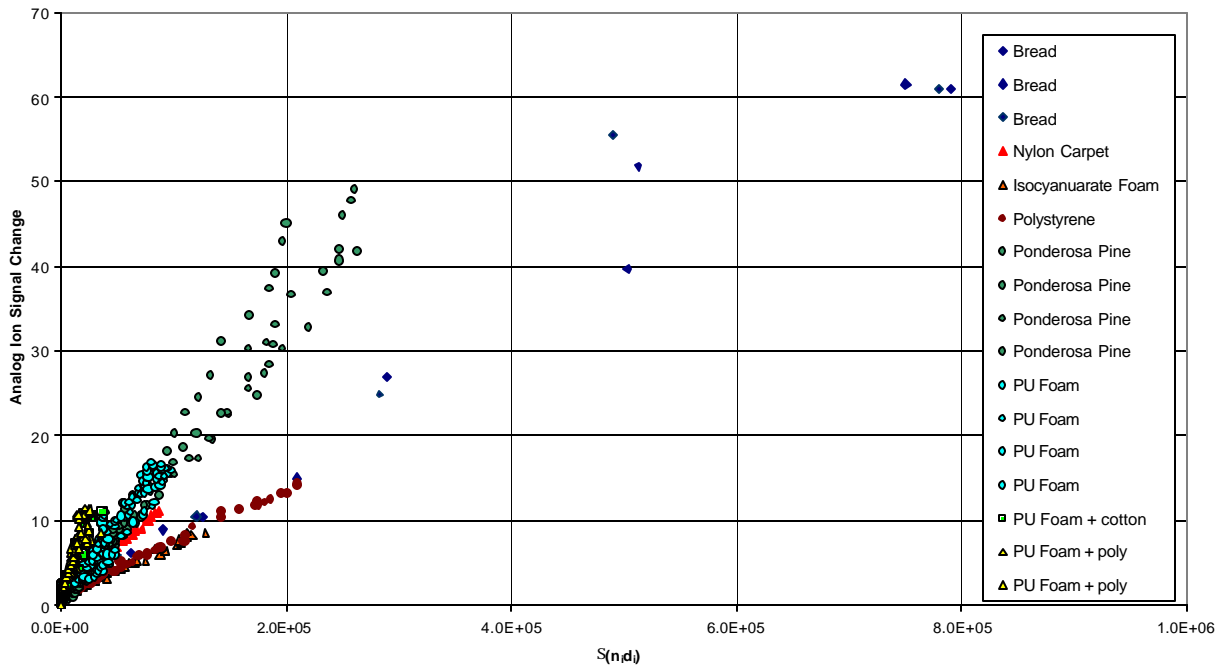

Figure 106 – Analog ion signal versus particle size data for Fire Test Room non-flaming tests

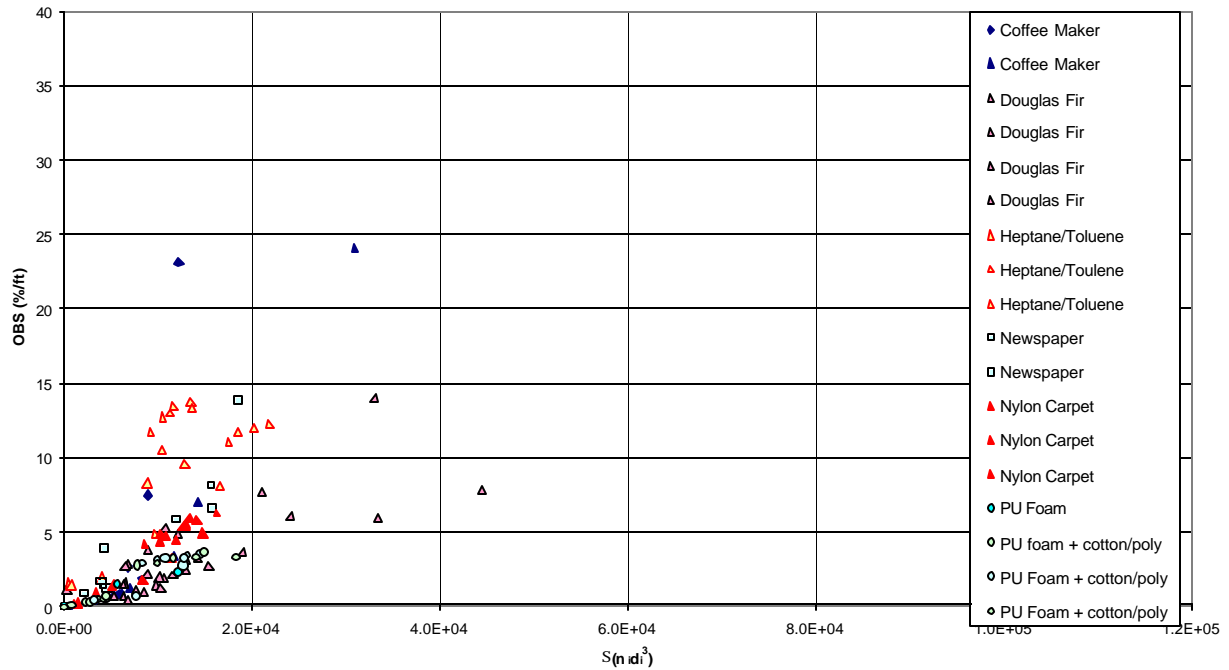
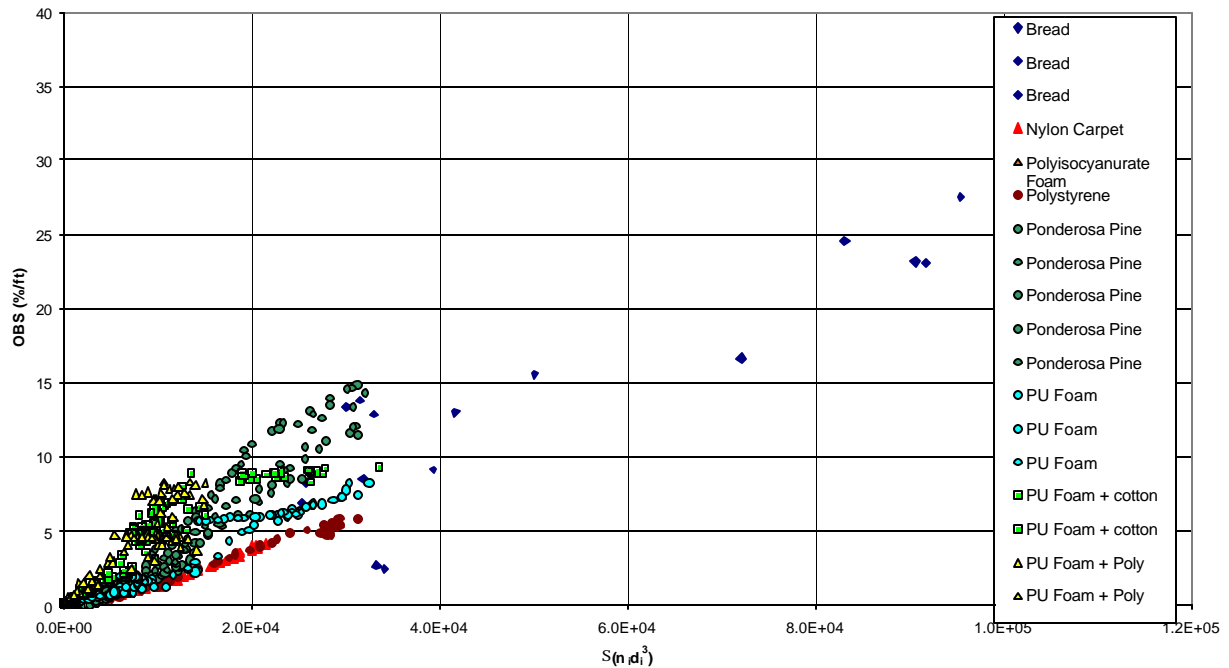

Figure 107 – Obscuration versus particle size data for Fire Test Room flaming tests

5

Obscuration responses for flaming (Figure 107) and non-flaming (Figure 108) tests demonstrate the predicted linear relationship with particle count and third order relationship with particle size. Variation in signal responsiveness between materials indicates a material/soot chemistry dependency that is not addressed by the model such as refractive index and soot particle density. The flaming and non-flaming combustion data suggests that obscuration technology is relatively insensitive to the mode of combustion.



10

Figure 108 – Obscuration versus particle size data for Fire Test Room non-flaming tests

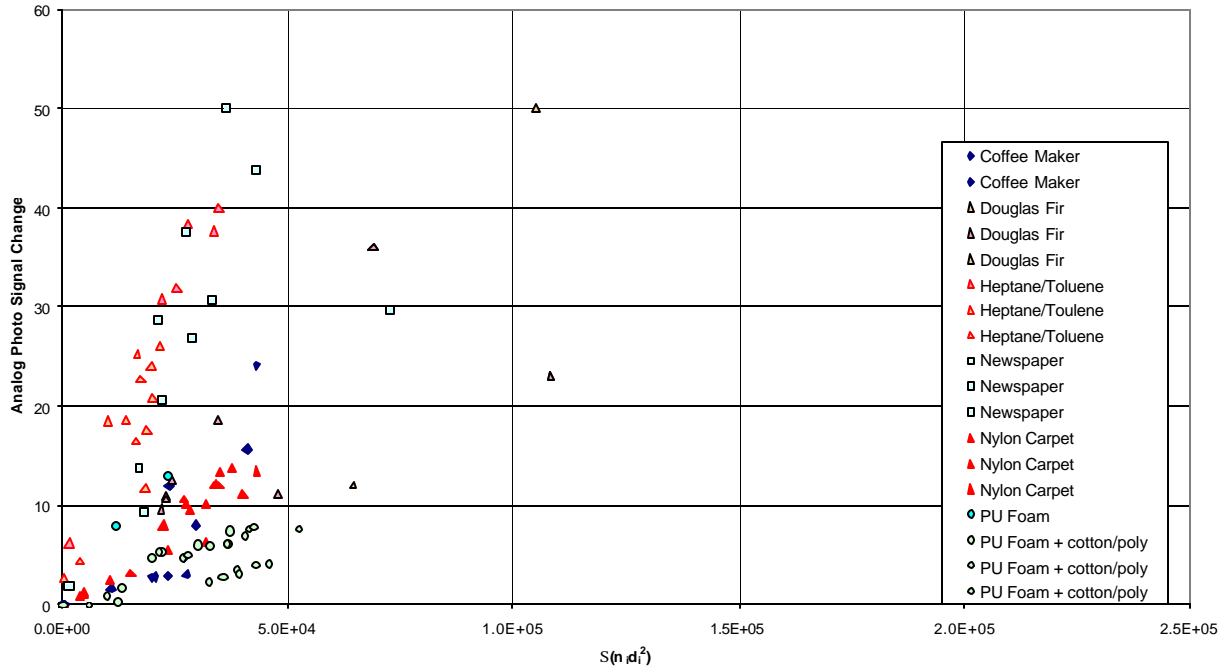
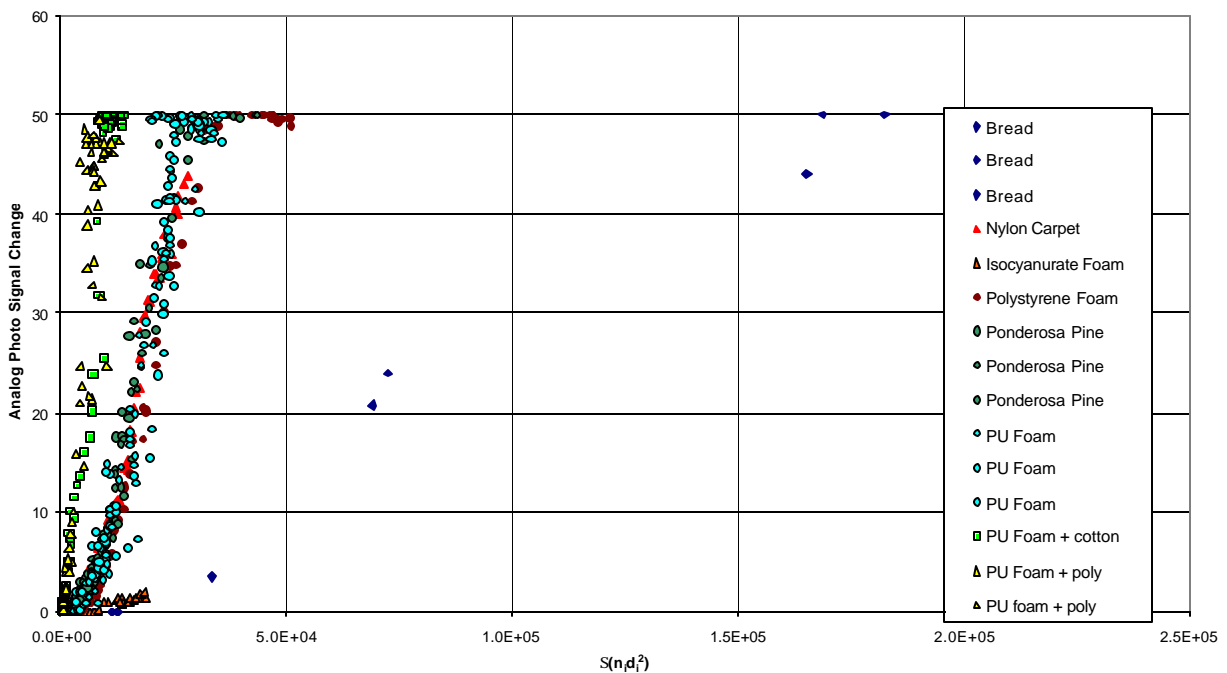

Figure 109 – Analog photo (scattering) signal versus particle size data for Fire Test Room flaming tests

5

Scattering responses for flaming (Figure 109) and non-flaming (Figure 110) tests demonstrate the predicted linear relationship with particle count and second order relationship with particle size. Variation in signal responsiveness between materials indicates a material/soot chemistry dependency that is not addressed by the model such as particle reflectivity and refractive index. The flaming and non-flaming combustion data suggests that scattering technology is more sensitive to the mode of combustion than obscuration. This difference may be attributed to variations in smoke color, *i.e.* reflectivity.



10

Figure 110 – Analog photo (scattering) signal versus particle size data for Fire Test Room non-flaming tests

Comparison of ionization and photoelectric alarm trigger times for the materials under different modes of combustion indicated that ionization alarms responded faster for flaming combustion tests whereas photoelectric alarms responded faster for the less energetic, non-flaming tests, Table 30.

5

Table 30 – Fire Test Room alarm trigger times

Flaming Tests	Alarm Trigger Time (s)		Non-Flaming Tests	Alarm Trigger Time (s)	
	Ion	Photo		Ion	Photo
Douglas fir	142	172	Ponderosa pine	3378	3304
Newspaper	133	150	Polyisocyanurate	DNT	DNT
Heptane/Toluene	35	70	PU foam	5610	3032
Coffee maker	181	386	PU foam in Cotton	DNT	3870
PU foam	68	DNT	PU foam in Poly	DNT	4741
PU foam in Cotton/Poly	104	171	Nylon carpet	DNT	5727
Nylon carpet	157	272	Polystyrene	DNT	5546
			Bread	323	394

Notes to Table 30:

DNT = Did not trigger

- 10 It was observed that both PU foam and cotton/polyester blend fabric have relatively low particle size but have relatively high particle density. This may explain why the photoelectric smoke alarm did not trigger in the room tests (more receptive to larger particles), where as the ionization smoke alarm triggered (more receptive to larger particle counts).
- 15 The non-flaming decomposition was observed to be dependant on the mode of heat provided to the sample.

INFLUENCE OF TESTING METHOD

- 20 In this investigation, testing was performed on the small-scale using the cone calorimeter, on the intermediate-scale using UL's product calorimeters, and in UL's Fire Test Room.

The mean smoke diameter data obtained during the cone calorimeter and intermediate calorimeter tests are presented in Table 31.

25

Table 31 – Influence of scale on mean smoke diameter

Test Sample	Mean Diameter D_m (mm)	
	Small-Scale Cone Calorimeter	Intermediate Calorimeter
3:1 Heptane/Toluene ^[1]	0.26	0.28
Heptane ^[2]	0.19	0.23
Newspaper ^[1]	0.04	0.09
Douglas fir ^[1]	0.06	0.07
Cotton Batting ^[3]	0.09	0.05
PU Foam ^[3]	0.05	---
Nylon Carpet	0.12	0.15

Notes to Table 31:

^[1] Sample tested using UL 217 assembly in intermediate scale^[2] Sample ignited using a lighter^[3] Sample tested using a TB 604 burner for ignition

5

It was observed that the mean smoke particle sizes for the flaming mode were similar between the cone calorimeter and the intermediate-scale test even the ignition methods were different. The small increase in the diameter observed in the intermediate calorimeter tests may be due to higher aggregation of smoke in the intermediate scale tests prior to sampling. A larger increase in intermediate scale test was observed for the newspaper sample. This is anticipated as there were different packing conditions between the two tests and that would have resulted in different combustion conditions for burning. The initial diameter data from the room tests are in good agreement with the data mean diameter data from the cone calorimeter.

15

A limited amount of testing was conducted on how the mode of heating influences the smoke characteristics. However, the results in Table 32 show a significant difference in particle size and count for the PU foam. This has also been documented by T.J. Ohlemiller ¹².

20

Table 32 – Influence of heating mode on smoke characteristics: non-flaming

Test sample	Heating Mode	Mean particle size, D_m (mm)	Average Count Density (1/cc)
PU Foam	Radiant heating (15 kW/m ²)	0.083	8.82E+05
	Hot plate (UL 217 controller)	0.118	7.50E+06
Bread	Radiant Heating (15 kW/m ²)	0.100	3.30E+06
	Electric Toaster	0.135	2.94E+06

The PU foam non-flaming tests in Fire Test Room tests were conducted with the hot plate with the temperature controlled according to UL 217 Smoldering Test protocol. The larger mean particle size observed in the intermediate-scale tests may explain why the photoelectric alarm triggered sooner than the ionization smoke alarm for Test 12261 (3032 versus 5610 s respectively).

25

Comparisons of smoke release rates measured on the small- and intermediate-scale calorimeters to obscuration values measured in the Fire Test Room for flaming PU foam, heptane/toluene mixture, nylon carpet, and the coffee maker are presented in Figure 111 through Figure 114.

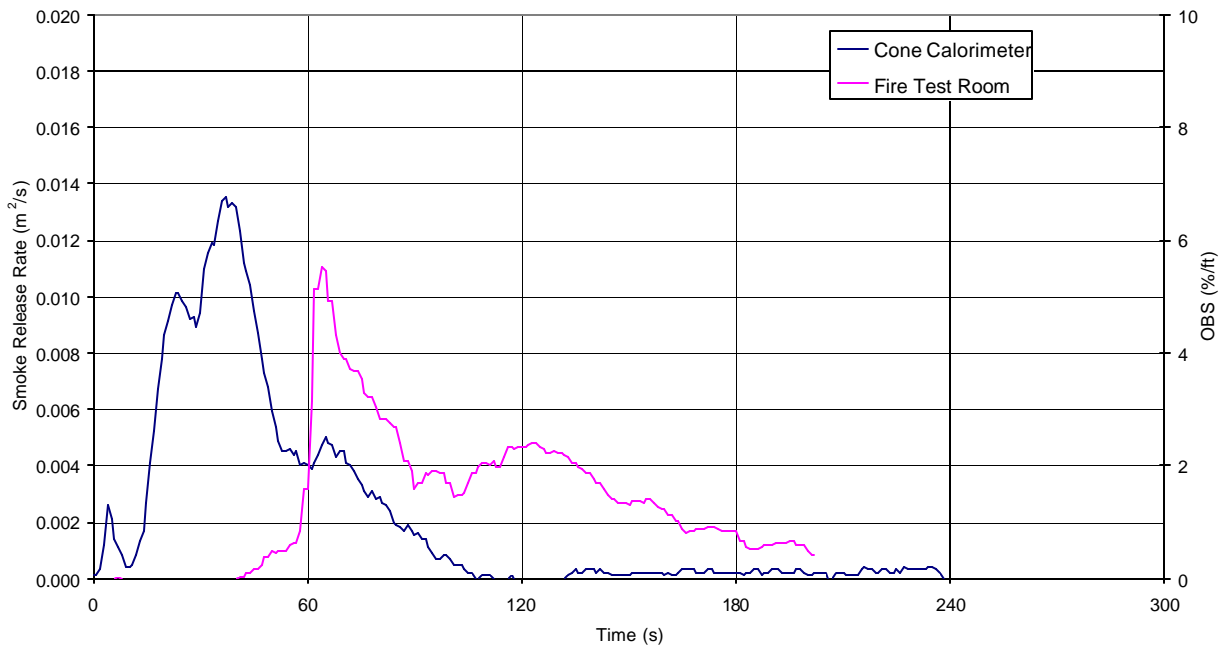

5

Figure 111 – Small-scale smoke release rate versus Fire Test Room obscuration for flaming PU foam tests

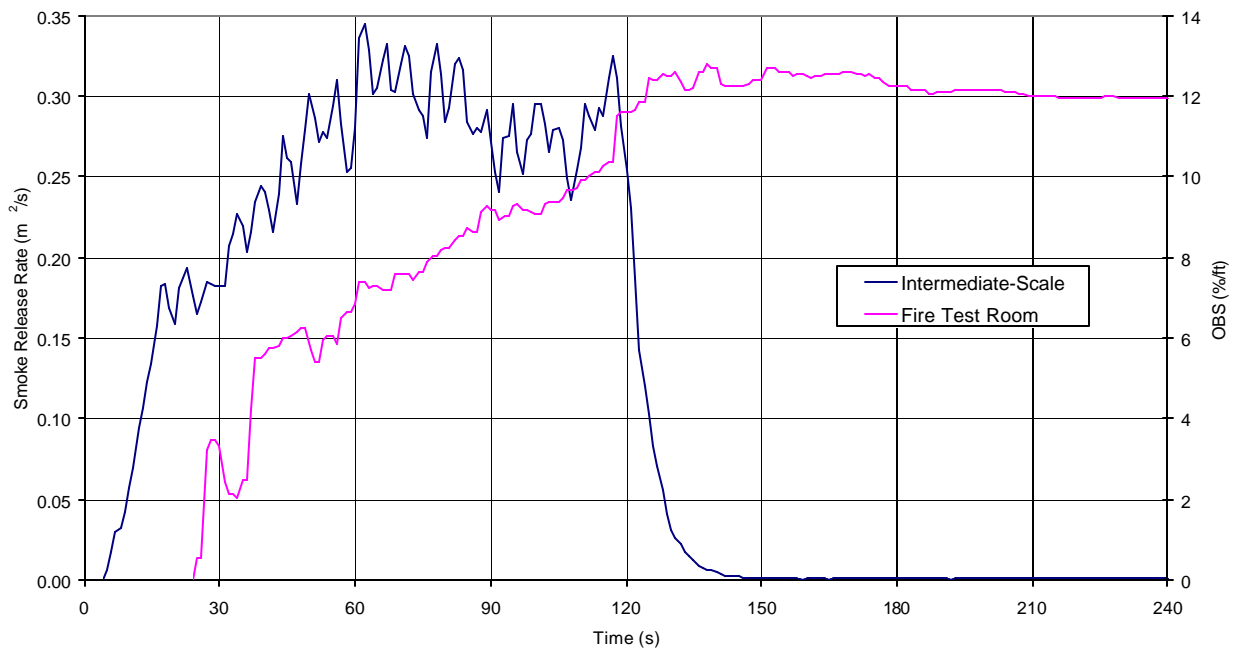

10

Figure 112 – Intermediate-scale smoke release rate versus Fire Test Room obscuration for flaming heptane/toluene mixture tests

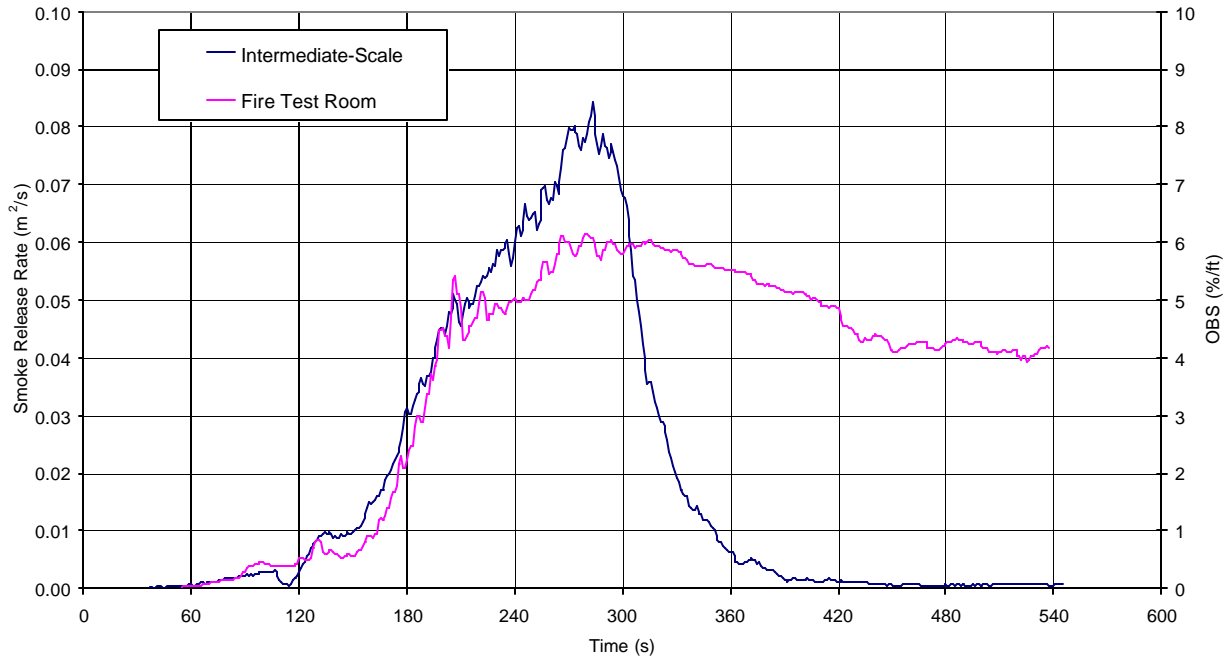

Figure 113 – Intermediate-scale smoke release rate versus Fire Test Room obscuration for flaming nylon carpet tests

5

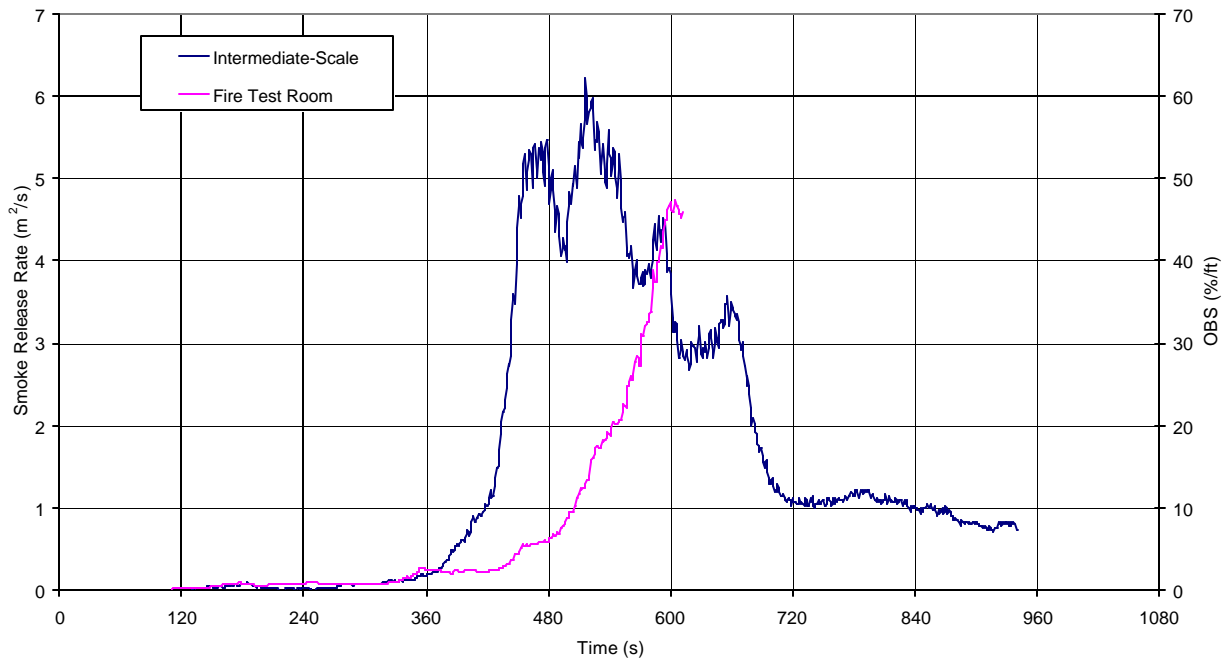

Figure 114 – Intermediate-scale smoke release rate versus Fire Test Room obscuration for flaming coffee maker tests

10 These plots illustrate how obscuration behavior measured in the Fire Test Room reflects smoke release rate. This relationship is more evident during the early stages of the experiments than the

latter stages because smoke accumulates throughout the Fire Test Room tests but not the smoke release rate measurements.

5 Particle size data from the IMO and Fire Test Room tests were compared to study the influence of particulate aggregation in the test room and are presented in Figure 115 through Figure 119. For each material data set compared, the trends appear to be similar but the Fire Test Room results indicate a time lag. Presumably this time lag is associated with the time for particles to be transported from the source to the sampling location and the propensity of the material to produce smoke particulate matter.

10

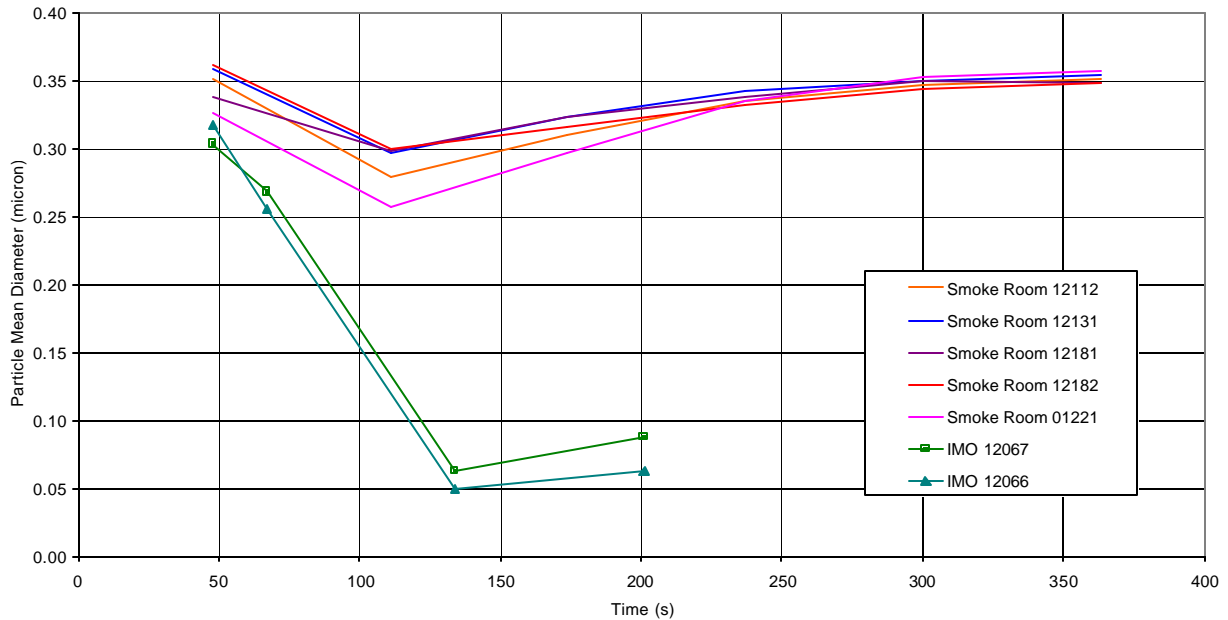

Figure 115 – IMO and Fire Test Room smoke particle mean diameter for flaming heptane/toluene mixture tests

15 Even though the initial mean diameters are similar for heptane/toluene, the particle sizes at the sampling point in the room remain higher due to accumulation and smoke aggregation.

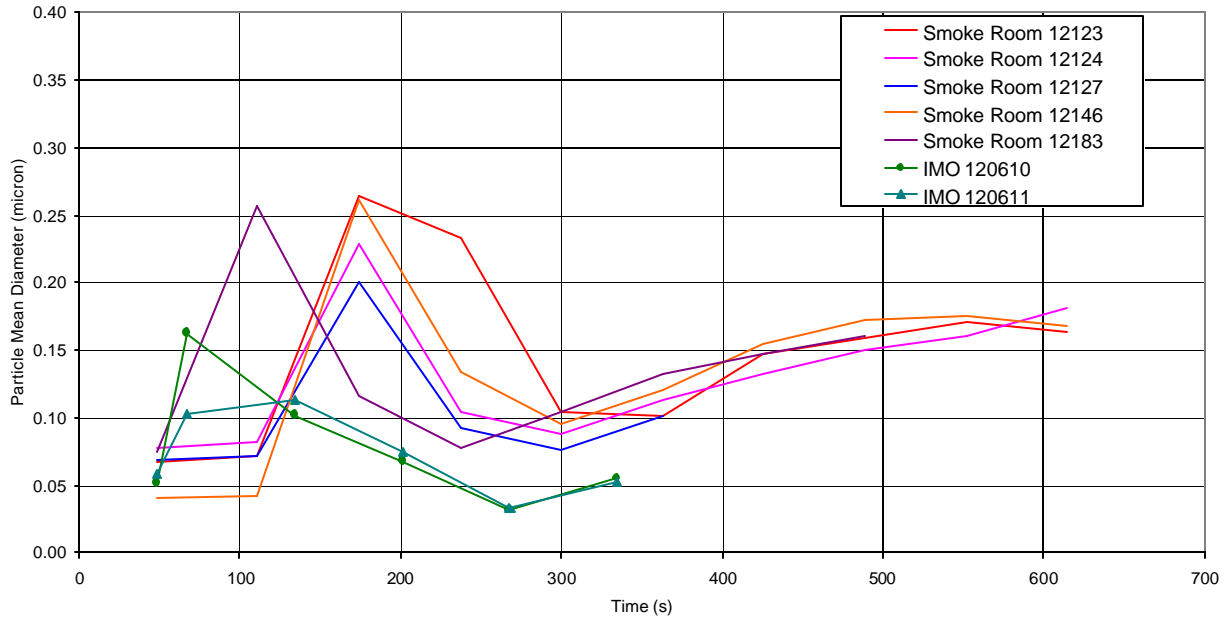
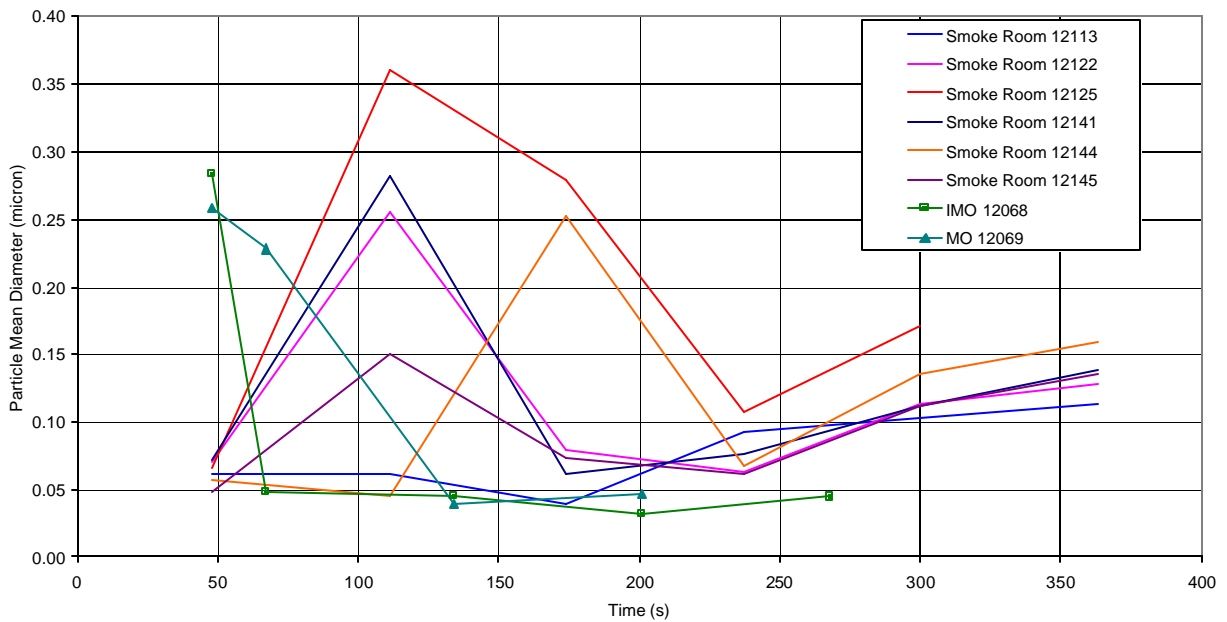

Figure 116 – IMO and Fire Test Room smoke particle mean diameter for flaming Douglas fir tests

5 The mean particle diameter data for Douglas fir in the Fir Tests Room tests are similar to the IMO data except they appear to be shifted in time. The reduction in mean diameter in both the room and the IMO tests are from the charring of wood. A reduction in mean particle diameter was observed in the cone calorimeter tests.



10 **Figure 117 – IMO and Fire Test Room smoke particle mean diameter for flaming newspaper tests**

There is a greater variation in the mean particle diameter for the newspaper both in the IMO and Fire Test Room tests. This variation is from the specific combustion conditions developed based upon the packing of the newspaper in test sample assembly.

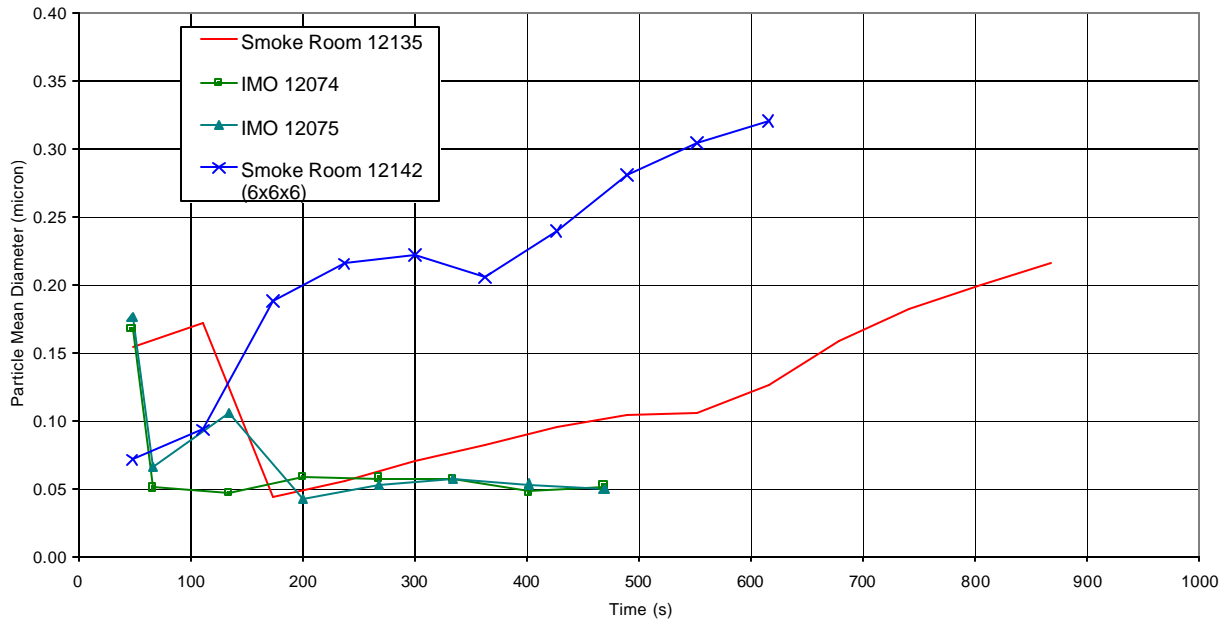

5

Figure 118 – IMO and Fire Test Room smoke particle mean diameter for flaming PU foam tests

There appear to be significant influence of smoke aggregation for the PU foam test sample in the Fire Test Room tests.

10

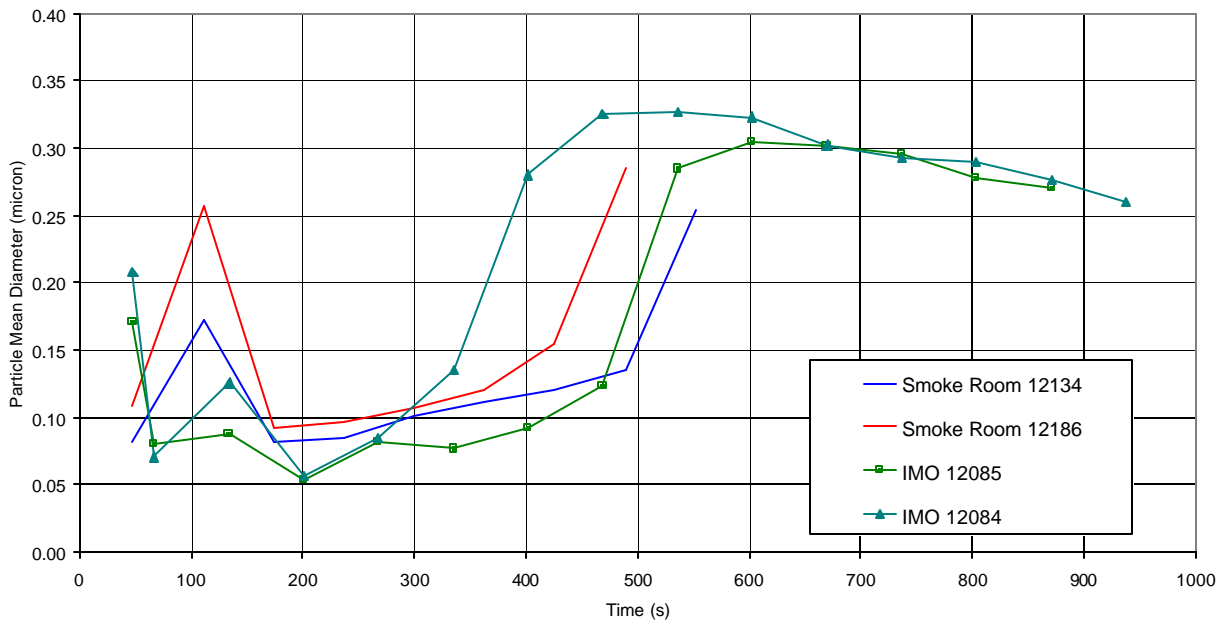

Figure 119 – IMO and Fire Test Room smoke particle mean diameter for flaming coffee maker tests

The mean particle diameter history appears to trend very well with data from the IMO tests. It may be due to heat release profile (the coffee maker had a peak heat release rate of approximately 100 kW in the IMO tests). The higher energy fire would result in faster ceiling jets. This would tend to replenish smoke particles at the smoke sampling location more quickly than other fires. The higher mean diameter size later into the test is from accumulation and aggregation of smoke at the ceiling.

5

10

15

Both the intermediate scale and Fire Test Room non-flaming Ponderosa pine test (UL 217 smoldering Ponderosa pine) were conducted in the same room using the same heat source (UL 217 hot plate). In the intermediate scale test, the smoke was sampled approximately 0.4 m above the hot plate, whereas in the Fire Test Room tests, the smoke was sampled 5.4 m away at the ceiling in vicinity of the MIC instrument. Despite the longer transport times expected for the tests in which the smoke was sampled at the ceiling, the mean smoke particle diameters remain similar, Figure 120. There is insignificant smoke aggregation as evidenced by the relatively constant particle diameter in the Fire Test Room tests until approximately 2400 seconds (40 minutes).

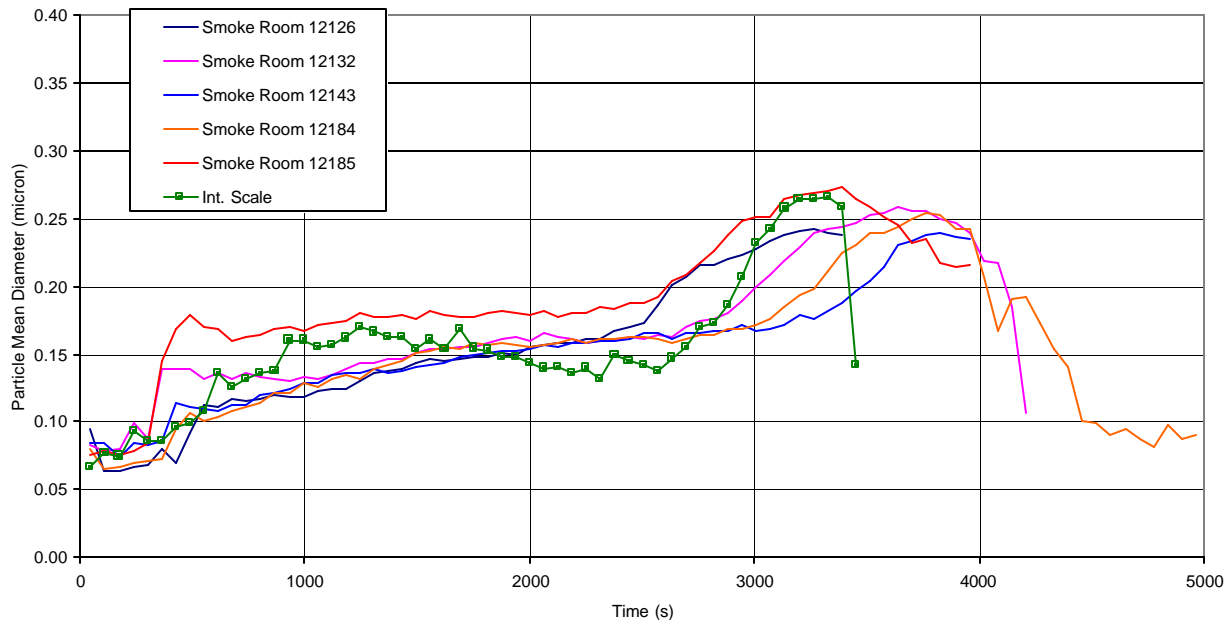

Figure 120 – Intermediate-scale and Fire Test Room smoke particle mean diameter for non-flaming Ponderosa pine tests

20

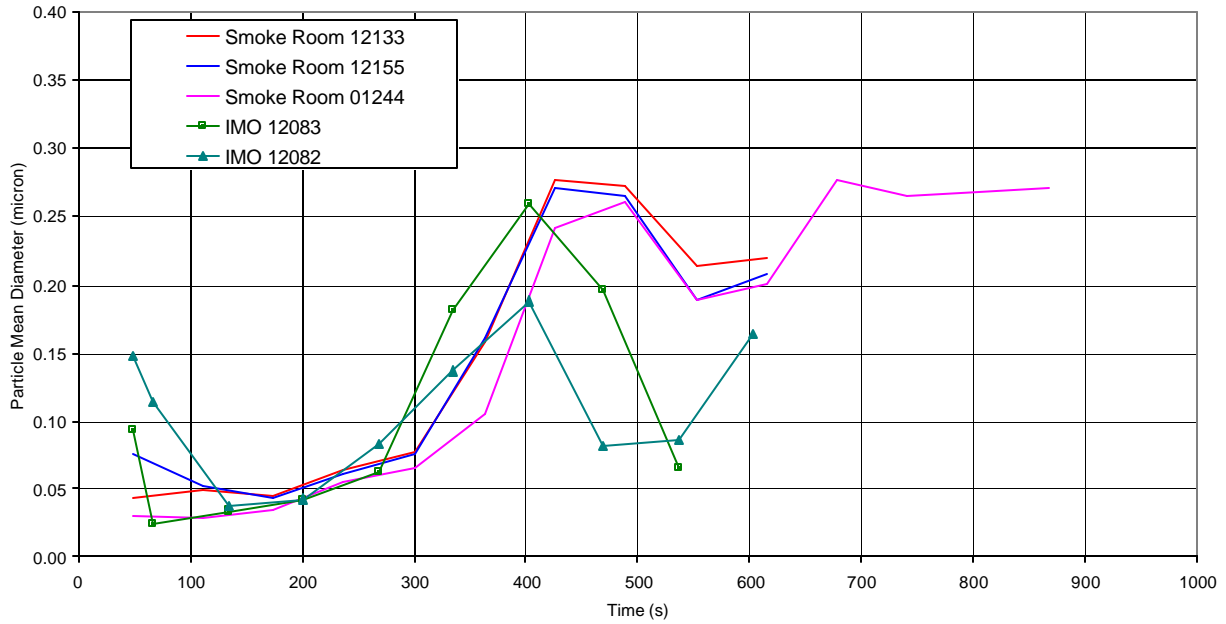

Figure 121 – IMO and Fire Test Room smoke particle mean diameter for non-flaming bread tests

The mean particle diameters for bread appear to be in good agreement between the IMO and the Fire Test Room tests. This indicates that there is not a significant effect of particle aggregation.

5

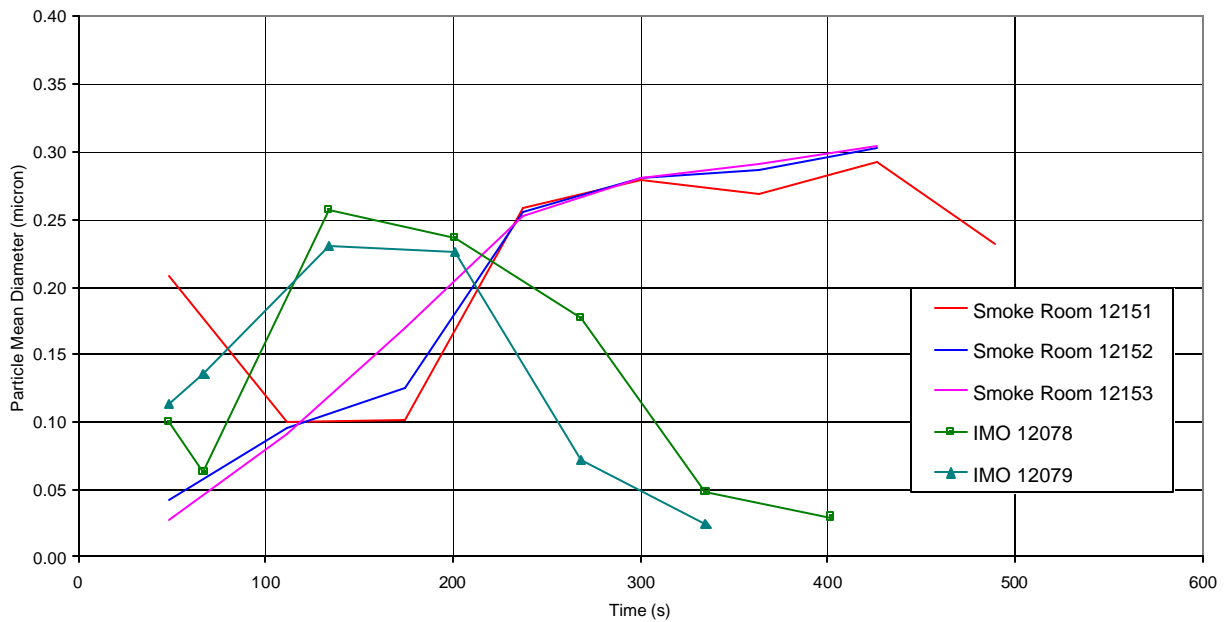

Figure 122 – IMO and Fire Test Room smoke particle mean diameter for flaming nylon carpet tests

The mean smoke diameter results from the Fire Test Room tests appear to trend with the data from IMO tests. There is a time shift that may result from the transport time for the smoke to travel from the source to the sampling location.

10

TASK 5 - IDENTIFY FUTURE CONSIDERATIONS

In this section, future considerations derived from the results of this Smoke Characterization Project are identified as follows:

- 5 1. The addition of other test materials such as polyurethane foam in the flaming and non-flaming combustion modes in UL 217.

Rationale

- 10 - Currently PU foam is prevalent in residential furniture and bedding products.
 - Tests in the small-scale and intermediate-scale showed that PU foam generated smoke that is different in particle size and count than the UL 217 test materials.
 - Some of the evaluated flaming and non-flaming test scenarios triggered one but not both the photoelectric and ionization smoke alarms within the alarm response criteria specified in UL 217.

15

2. Whether a smoke alarm, once triggered, should remain activated unless deactivated manually.

Rationale

- 20 - In the non-flaming tests, it was found that there was stratification of the smoke over time. This led to a smoke alarm that had triggered to deactivate once the smoke at the ceiling had cleared below the activation level.

20

- 25 3. Requiring the use of combination ionization and photoelectric alarms for residential use in order to maximize responsiveness to a broad range of fires.

25

Rationale

- 30 - Some of the evaluated flaming and non-flaming test scenarios triggered one but not both the photoelectric and ionization smoke alarms within the alarm response criteria specified in UL 217. Thus, a combination unit may maximize responsiveness of each technology to a non-specific fire.

30

- 35 4. Characterize materials described in UL 217 using cone calorimeter, smoke particle spectrometer and analytical testing.

35

Rationale

- 40 - The results from this research showed that the cone calorimeter augmented by the WPS particle spectrometer provided useful data on the combustibility and smoke characteristics of materials. This in conjunction with FTIR for material chemistry, and the TGA may be used to characterize the materials used in UL 217.

40

SUMMARY OF FINDINGS

The findings from this research investigation are presented herein.

Gas Analysis and Smoke Characterization Measurement

- 5 1. Physical Smoke Particle Characterization - The particle spectrometer provides data on smoke particle size and count distribution over a size range of 0.01 to 10 microns whereas traditional techniques to quantify smoke such as obscuration and ionization are limited to 0.05 to 1 micron and 0.1 to 10 microns respectively.
- 10 2. Relationship of Smoke Particle Characterization to Traditional Methods - Linear relationships between the smoke particle data and the traditional techniques were demonstrated such that:
 - a. Particle size and number count are linearly related to MIC signal change:
 $\Delta\text{MIC} \sim d_m \cdot n_m$ (Eq. 12, Figure 7)
 - 15 b. Number count is linearly related to scattering while particle size exhibits a second order relationship: $s \propto \sum n_i \cdot d_i^2$ (Figure 110)
 - c. Number count is linearly related to obscuration while particle size exhibits a third order relationship: $\frac{\text{OD}}{\ell} \propto \sum n_i \cdot d_i^3$ (Eq. 3, Figure 6).
- 20 3. Smoke Particle Aggregation - Tests conducted in the UL 217 Sensitivity Test smoke box and the UL 217/UL 268 Fire Test Room indicate an aggregation of smaller smoke particles to form larger particles as evidenced by the increase in smoke particle concentrations in conjunction with increasing fractions of larger smoke particles (Figure 5, Figure 115 – Figure 120). This was more evident for non-flaming fires than flaming fires.
- 25 4. Smoke Gas Effluent Composition - Gas effluent analysis showed the dominant gas components were water vapor, carbon dioxide and carbon monoxide (Appendices C through H).

Influence of Material Chemistry

- 30 1. Combustion Behavior: Synthetic and Natural Materials - Cone calorimeter tests indicate synthetic materials (*e.g.* polyethylene, polyester, nylon, polyurethane) generate higher heat (Figure 11) and smoke release rates (Figure 12) than the natural materials (*e.g.* wood, cotton batting). This is anticipated to be primarily due to the modes of degradation and chemical structure of synthetic versus natural materials.
- 35 2. Charring Effects - Materials exhibiting charring behavior such as wood alter the size and amount of smoke particles generated as the combustion process progresses (Figure 15).
3. Influence on Smoke Particle Size - In general, the synthetic materials tested generated larger mean smoke particle sizes than natural materials in flaming mode (Figure 13).

Mode of Combustion

- 40 1. Flaming Combustion - Flaming combustion tends to create smaller mean particle sizes than non-flaming combustion (Figure 100). This is primarily due to the more efficient conversion of high molecular weight polymers to low molecular weight combustion products and ultimately CO, CO₂ and H₂O instead of organic by-products and soot.

2. Non-Flaming Combustion - Non-flaming combustion tends to generate more smoke for a given consumed mass than flaming combustion (Figure 99).

Small-Scale and Intermediate-Scale Test

- 5 1. Cone Calorimeter Test - The cone calorimeter provided combustibility, smoke characteristics and gas effluent data in flaming and non-flaming modes for a range of materials studied. The smoke characterization data revealed the influences of material chemistry, physical sample structure, and the mode of combustion. The data were found to be repeatable. In the non-flaming mode, the heat and smoke release rates were lower than the resolution of the cone calorimeter measurement system for several materials investigated. However, the smoke particle spectrometer provided repeatable data on smoke size and count distribution for both flaming and non-flaming modes.
- 10 2. Intermediate-Scale Test - The intermediate scale test provided a platform to scope combustion scenarios, and provided data on the heat and smoke release rates as well as smoke size and count distribution for test samples subsequently used in the UL 217/UL 268 Fire Test Room. The tests also identified test samples with heat and smoke characteristics that varied from UL 217 fire test samples such as Douglas fir, newspaper, heptane/toluene mixture, and Ponderosa pine. In the non-flaming mode, the method used for heating the test sample was observed to influence the smoke characteristics. The heating by a hot plate provided larger particle size as compared to radiant heating.
- 15
- 20

UL 217/UL 268 Fire Test Room Tests

- 25 1. Smoke Particle Size and Count Distribution - The tests provided smoke particle size and count distribution data in conjunction with traditional obscuration and Measuring Ionization Chamber data. PU foams in the flaming mode produced the smallest particle sizes of all materials tested (Table 21).
- 30 2. Combustion Mode Effects - Changes in the combustion mode (flaming versus non-flaming) resulted in different smoke particle size and count distributions that influenced the response of photoelectric and ionization smoke alarms. The particle size distribution for the non-flaming fires yielded larger mean smoke particle diameter than the flaming mode fires. The ionization alarm responded quicker to flaming fires; the photoelectric responded quicker to non-flaming fires (Table 30).
- 35 3. Smoke Alarm Response to Flaming Fires - In all but one flaming test the ion alarm activated first (Table 20, Table 30). Both alarm types activated within the 4 minute time limit specified in UL 217 for the three UL 217 flaming test targets (Douglas fir, heptane/toluene mixture, and newspaper). In one of two flaming tests involving PU foam with cotton/poly fabric the photoelectric smoke alarm did not activate, however the ionization alarm did activate in both tests. In a flaming PU foam with cotton/poly fabric test using a smaller sample size neither alarm type activated. It should be noted that the maximum obscuration in these PU foam tests was less than for Douglas fir, heptane/toluene mixture, and newspaper test samples.
- 40 4. Smoke Alarm Response to Non-Flaming Fires - The photoelectric alarm activated first in the non-flaming tests with the exception of the higher energy bread/toaster test in which the ion alarm activated first (Table 25, Table 30). The UL 217 smoldering Ponderosa pine test triggered both the ionization and photoelectric smoke alarms. For many of the other materials, the ionization smoke alarm did not trigger. In each of these cases, the
- 45

5 obscuration value was less than the 10 %/ft limit specified in UL 217. It was also found that there was settling of the smoke particles in the test room over time. Measurements from several non-flaming tests showed that the obscuration values at the ceiling dropped over time, and the maximum obscuration values were observed at the 2 feet measurement location below the ceiling.

- 10 5. Smoke Stratification - Non-flaming fires result in changes in the smoke build up over time, such that stratification of smoke below the ceiling occurs. This time-dependent phenomenon results in less obscuration at the ceiling than below the ceiling (Figure 85 to Figure 88). This caused both detection technologies to drift out of alarm.

APPENDIX A: Material Chemistry

Table A1 – Chemistry of Natural Materials

Material or Substance Type	Reference Code	Chemistry
Bread	N1	Composed primarily of starch, sugar, fats and oils.
Butter	N2	Composed largely of glycerides of oleic (C ₁₈ unsaturated), stearic (C ₁₈ saturated) and palmitic (C ₁₆ saturated) acids. Elemental composition – C, H, O.
Carbohydrates	N3	A compound of carbon, hydrogen and oxygen that contains the saccharose group (R'-CHOH-CO-R"). It is the building block for essentially all natural products.
Cotton	N4	Staple fiber consisting primarily of cellulose (88-96%) with other natural-derived aliphatic organic compounds (C, H, O). Cellulose is a natural carbohydrate polymer (polysaccharide) consisting of anhydroglucose units joined by an oxygen linkage to form essentially linear high molecular weight chains.
Cellulose	N5	A natural carbohydrate consisting of anhydroglucose units joined by oxygen linkages to form long, high molecular chains that are essentially linear. Elemental composition – C, H, O; polymer structure – aliphatic
Glycerides	N6	An ester of glycerol and fatty acids in which one or more of the hydroxyl groups of the glycerol have been replaced with acid radicals. Mono and triglycerides are commonly found in food and cosmetic products and other compounded products.
Linen	N7	Thread and fabric made from the fibers of the flax plant.
Paper	N8	A processed product of cellulosic fibers primarily made from softwoods.
Silk	N9	A natural fiber secreted as a continuous filament by the silkworm. Silk consists essentially of a the protein fibroin and, in the raw state, is coated with a gum, which is usually removed before spinning.
Starch	N10	Anhydroglucose – C ₆ H ₁₀ O ₅ . This aliphatic ring compound with hydroxyl groups (and its' derivatives) is the common building block for many of the products produced by natural processes (photosynthesis).
Sugar	N11	Carbohydrate product of photosynthesis and comprised by one, two or more saccharose groups. Chief among the monosaccharides are glucose (dextrose) and fructose (general formula C ₆ H ₁₀ O ₅).
Triglyceride	N12	Any naturally occurring ester of a normal fatty acid and glycerol. Fatty acids are composed of a chain of alkyl groups (R'-CH ₂ -R") containing 4 to 22 carbon atoms with a terminal carboxylic acid (R-COOH)

Material or Substance Type	Reference Code	Chemistry
Vegetable Oil	N13	Edible oils extracted from the seeds, fruit or leaves of plants. Generally considered to be mixtures of glycerides (safflower, sunflower, peanut, walnut, etc.).
Wool	N14	Staple fibers from the fleece of sheep. Chemically, wool consists essentially of protein chains (keratin) bound together by disulfide cross-linkages. Elemental composition – C, H, O, N, S; polymer structure – essentially aliphatic.
Wood	N15	Wood is typically composed of 40-60% cellulose and 20-40% lignin, together with gums, resins, variable amounts of water and inorganic matter.

Table A2 – Chemistry of Synthetic Materials

Material or Polymer Type	Reference Code	Chemistry, Structure and Related Information
ABS	S1	An engineering thermoplastic copolymer composed of acrylonitrile, butadiene and styrene monomers. ABS is often used in appliance and enclosure housings. Elemental composition - C, H, N; structure – aliphatic and aromatic. See Acrylonitrile, Butadiene, Polystyrene.
Acrylic	S2	Generic term used for materials composed of acrylic acid (R-CH ₂ CHCOOH-R) or acrylic acid esters (R-CH ₂ CHCOOR-R). Acrylic fibers however, are prepared from acrylonitrile (see Acrylonitrile). Acrylic resins are thermoplastic polymers or copolymers of acrylic acid, methacrylic acid (R-C(CH ₃)-CHCOOH-R), esters of these acids or acrylonitrile. Elemental composition - C, H, O, and N (when acrylonitrile present), polymer structure – typically aliphatic.
Acrylonitrile	S3	Commonly referred to as vinyl cyanide or propenenitrile (CH ₂ =CHCN). As a monomer, acrylonitrile is often used to modify other plastics such as: ABS, acrylic or modacrylic fibers, nitrile rubbers or cotton fibers. Elemental composition – C, N; polymer structure - aliphatic
Butadiene	S4	As with acrylonitrile, butadiene (CH ₂ =CHCH=CH ₂) is a monomer that can be polymerized into polybutadiene or modify other polymers through copolymerization, such as ABS and nitrile elastomers. Elemental composition – C, H; polymer structure – typically aliphatic
Heptane	S5	Linear hydrocarbon chain of 7 carbons - aliphatic
Noryl®	S6	Engineering thermoplastic sold by of General Electric. Noryl is an engineering thermoplastic copolymer alloy of polyphenylene oxide (PPO) and polystyrene (PS). Elemental composition – C, H, O; structure – aromatic.

Material or Polymer Type	Reference Code	Chemistry, Structure and Related Information
Nylon	S7	Generic name for a family of polyamide polymers characterized by the presence of an amide group (R-CONH-R) where R can be various hydrocarbon groups. As with polyesters, nylons are used in various applications, such as textiles and structural housings. The nylon properties are dictated by the various monomers used in the polymerization and subsequent compounded fillers that may be incorporated into the structure in post processing steps. Typical aliphatic nylons for textile applications include Nylon 6 (formed from the homopolymerization of caprolactam and Nylon 6,6 with the copolymerization of adipic acid and hexamethylene diamine. Aromatic nylons are often found in high strength and high temperature fibers (Kevlar™, or Nomex™), or engineering thermoplastic housings.
Polyacrylates	S8	Polymers produced by the homopolymerization or copolymerization of acrylic acid or methacrylic acid on their esters. Elemental composition – C, H, O; polymer structure – aliphatic.
Polycarbonate (PC)	S9	Engineering thermoplastic with unique impact and high temperature properties. PC is often used in appliance and enclosure housings and injection molded articles. PC is produced by various companies; particularly one sold by General Electric under the trade name Lexan®. Polycarbonate is produced by the polymerization of bisphenol A and phosgene. Elemental composition – C, H, O; structure – aromatic.
Polyester	S10	A generic term for commercially available textile and thermoplastic products based upon ester polymers with the characteristic linkage (R-COO-R) where R can be various hydrocarbon groups. Ester polymers are produced by either the condensation reaction of dicarboxylic acids with dihydroxy alcohols or the reaction of lactones or hydroxyl-carboxylic acids. Polyester textiles are usually composed of PET – polyethylene terephthalate. PET is formed by the reaction of terephthalic acid (aromatic compound) and ethylene glycol (aliphatic compound). Another common polyester in this class is PBT, where ethylene glycol is replaced with butane diol. Thermoplastic polyesters are also found in appliance housings. These polymers use modified acids and alcohols with fillers incorporated and possible crosslinking agents for specific property modification (modulus, impact, temperature resistance, etc.). Elemental composition – C, H, O; structure – either aliphatic or aromatic.

Material or Polymer Type	Reference Code	Chemistry, Structure and Related Information
Polyethylene and copolymers (PE)	S11	Polymers based on the polymerization of ethylene ($\text{CH}_2=\text{CH}_2$) and other unsaturated monomers. PE polymers and copolymers can take many forms due to factors, such as cross-link density, molecular weight, degree of branching, incorporation of co-monomers, etc. Elemental composition – essentially C, H depending upon type and percentage of co-monomers; structure – aliphatic.
Polyolefin	S12	A class or group of thermoplastic polymers (or copolymers) derived from simple olefins; such as ethylene, propylene, butane, and isoprene. Essentially these polymers only contain hydrocarbon monomers (C, H) without any oxygen in the polymer structure.
Polyphenylene oxide (PPO)	S13	Engineering thermoplastic polymer with exceptional dielectric and high temperature properties. Produced by the oxidative polymerization of 2, 6-dimethyl phenol. Elemental composition – C, H, O; structure – aromatic.
Polypropylene and copolymers (PP)	S14	Polymers based on the polymerization of propylene ($\text{CH}_2=\text{CHCH}_3$) and other unsaturated monomers. PP polymers and copolymers can take many forms due to factors, such as cross-link density, molecular weight, degree of branching, incorporation of co-monomers, etc. Elemental composition – essentially C, H depending upon type and percentage of co-monomers; structure – aliphatic.
Polyurethane (PU)	S15	A broad class of thermoplastic or thermosetting polymers based upon the urethane linkage (R-NH-COOR-R). Polyurethanes are produced by the condensation reaction of a polyisocyanates and hydroxyl-containing materials. The range of properties and physical appearance (morphology) is dictated by the isocyanate and hydroxyl precursors. Depending upon the reactive materials used, polyurethanes can be flexible foams, coatings, elastomers and/or moldable resins (see below). Elemental composition – C, H, O, N; structure – primarily aromatic.
Polyurethane, flexible	S16	Flexible PU foams are produced by the reaction of toluene diisocyanate and polyhydroxy materials in the presence of blowing agents and catalyst. The polyhydroxy compounds are often referred to as “polyols”, which are low molecular weight aliphatic compounds with “ether (R'-C-O-R'’)” or “ester (R'-COOR-R'’)” linkages. Polyurethane foams (unless flame retarded) are lightly cross-linked and readily decomposed by heat or open flame resulting in liquefaction, polymer chain scission and release of low molecular weight fragments. The sensitivity of flexible PU foams to degradation is dictated by the physical structure (thin-wall, open cells) and chemical structure (aromatic, “ether” and/or “ester” content).

Material or Polymer Type	Reference Code	Chemistry, Structure and Related Information
Polyurethane, rigid	S17	In contrast to flexible PU foams, rigid PU foams have a high cross-link density. Crosslinking is achieved by the ratio of comonomers and reactive group functionality. One example of rigid foam is produced by MDI (diphenyl methane diisocyanate), water, catalyst and blowing agents. Water readily reacts with isocyanates to form amine groups, which further react to form urea linkages (R-NH-CO-NH-R) in the polymer structure. Rigid foams typically have a close-cell structure and more resistant to degradation (liquefaction) due to the high cross-link density.
Polystyrene (PS)	S18	PS is formed by the free radical reaction of styrene monomer (vinyl benzene) in the presence of catalysts. Depending upon the reaction conditions, PS can take the form of a transparent, hard solid or cellular expanded foam structure. PS is sensitive to UV degradation and solvents and is combustible and non self-extinguishing. Elemental composition – C, H; structure – aromatic.
Polyvinyl chloride (PVC)	S19	PVC is produced by the polymerization of vinyl chloride (CH ₂ =CHCl). Once polymerized, PVC has the appearance of a white powder or granular salt. PVC has a huge range of properties due to its' ability to incorporate plasticizers, fillers and ability to be expanded with blowing agents (see below). PVC has excellent resistance to UV degradation, is combustible, but self-extinguishing. Elemental composition – C, Cl; structure – aliphatic or aromatic depending upon modification.
PVC, flexible	S20	Flexible PVC is produced by the incorporation of 20-60% w/w aromatic or aliphatic ester plasticizers in the PVC powder. This “plasticization” produces materials with exceptional elastomeric properties, toughness and weatherability. Typical aromatic plasticizers are based upon terephthalic acid (di-carboxylic acid) or trimellitic acid (tri-carboxylic acid). Alcohols used in these plasticizers usually contain from 8 to 16 carbon atoms. Elemental composition – C, H, O; structure – aromatic or aliphatic depending upon modification. Typical applications are for electrical insulation, tubing, coatings, gaskets, etc.
PVC, rigid	S21	Rigid PVC differs from flexible PVC products by the ingredients compounded into the PVC resin. Rigid PVC has high percentages of inorganic fillers and additives and can be expanded with the use of blowing agents. Rigid PVC is widely used as pipe, gutters, siding and in many structural applications.
Polyvinylidene chloride (PVDC)	S22	Polyvinylidene chloride is produced by the polymerization of vinylidene chloride (CH=CCl ₂) or with or lesser amounts of unsaturated compounds. PVDC is used in numerous packaging film products and commonly known under the trade name Saran™.

Material or Polymer Type	Reference Code	Chemistry, Structure and Related Information
Rayon	S23	Generic name for a manufactured fiber composed of regenerated cellulose in which >15% of hydroxyl substituents have been replaced by chemical modification (for example by acetate groups). The fiber ignites and burns readily. Chemical composition – C, H, O; structure - aliphatic
Toluene	S24	Toluene (methyl benzene) is a 7-carbon aromatic hydrocarbon liquid composed of a 6-membered aromatic ring (benzene – C ₆ H ₆) with an attached methyl (-CH ₃) group. Toluene is a main ingredient in paint thinner.
Wax (candle)	S25	A low melting organic mixture or compound composed of hydrocarbons, esters or fatty acids or alcohols. Candle waxes typically contain aliphatic hydrocarbons that readily melt and burn when ignited.

APPENDIX B: Test Sample Documentation and Characterization

PU Foam: FTIR (top) and TGA (bottom)

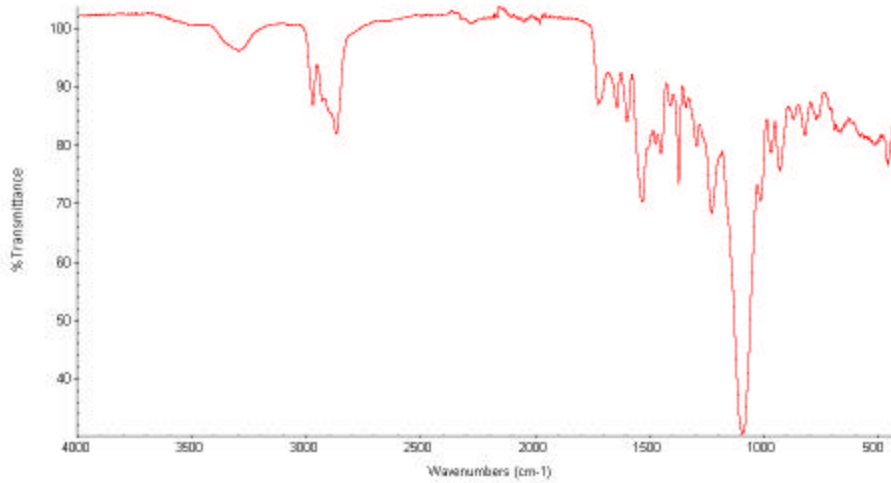

SAMPLE 2,WT, RUN AS RECEIVED
 06CA08584 DATA:NC5756_060206_GG.SPA
 UL SMOKE RESEARCH

Underwriters Laboratories, 3018DFPD
 Operator: MW Collection time: Tue Aug 01 16:22:47 2006 (GMT-05:00)

Detector: DTGS KBr
 Beamsplitter: KBr
 Source: IR

Number of sample scans: 32
 Number of background scans: 32
 Resolution: 4.000
 Sample gain: 8.0
 Mirror velocity: 0.6329
 Aperture: 100.00

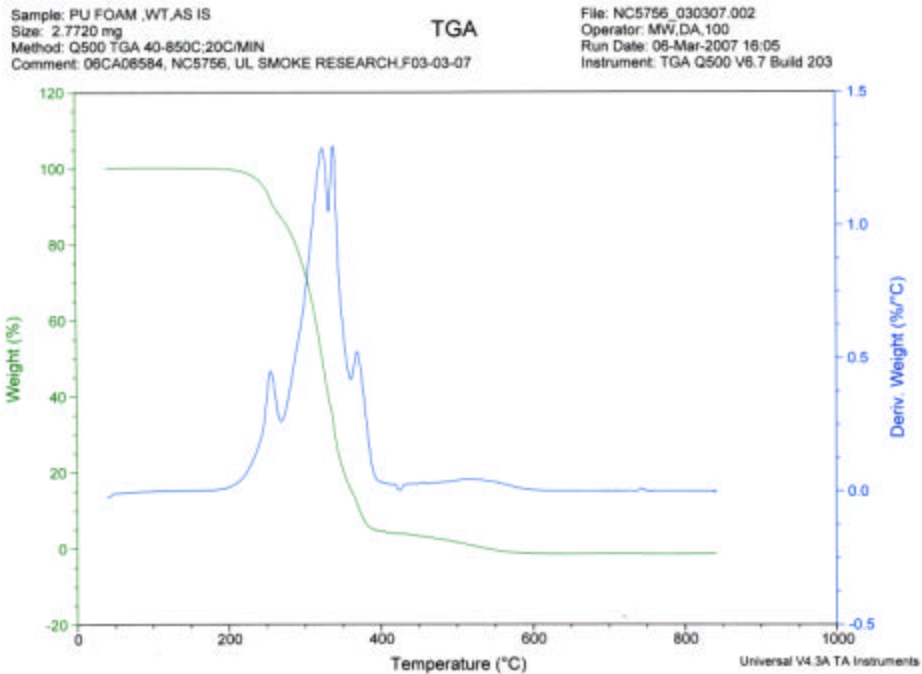

Cotton Batting: FTIR (top) and TGA (bottom)

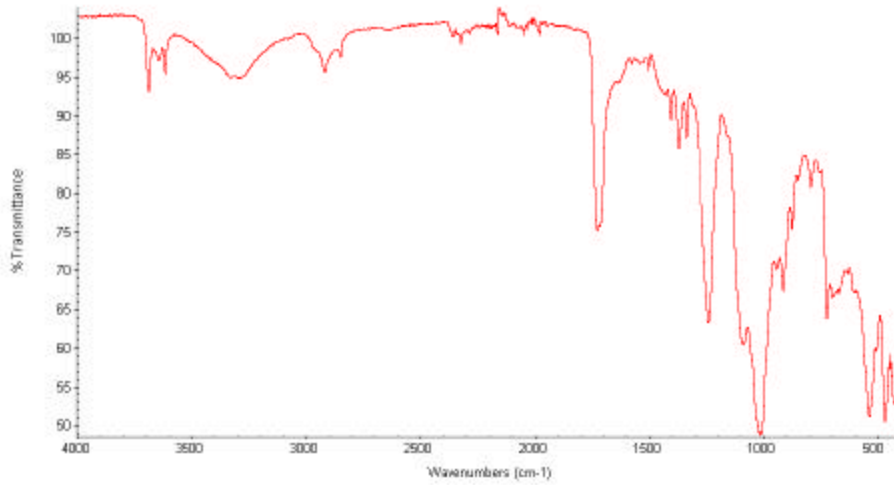

COTTON BATTING.GY.SOLID.RUN AS IS
 06CA08584 DATA.NC5756_080406_GG.SPA
 UL SMOKE RESEARCH

Underwriters Laboratories, 3019JFPD

Operator: MW

Collection time: Wed Aug 02 09:49:19 2006 (GMT-05:00)

Detector: DTGS KBr
 Beamsplitter: KBr
 Source: IR

Number of sample scans: 32
 Number of background scans: 32
 Resolution: 4.000
 Sample gain: 8.0
 Mirror velocity: 0.6329
 Aperture: 100.00

Sample: COTTON BATTING.GY.AS IS
 Size: 20.4250 mg
 Method: Q500 TGA 40-850C.20C/MIN
 Comment: 06CA08584, NC5756, UL SMOKE RESEARCH,F03-04-07

TGA

File: NC5756_030407.001
 Operator: MW,DA,100
 Run Date: 01-Mar-2007 16:17
 Instrument: TGA Q500 V6.7 Build 203

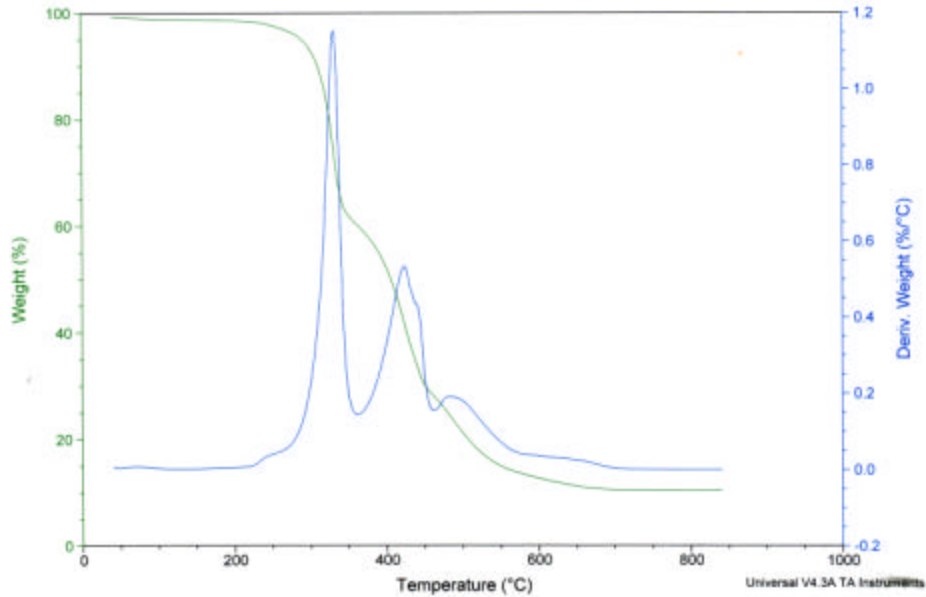

Cotton Sheet: FTIR (top) and TGA (bottom)

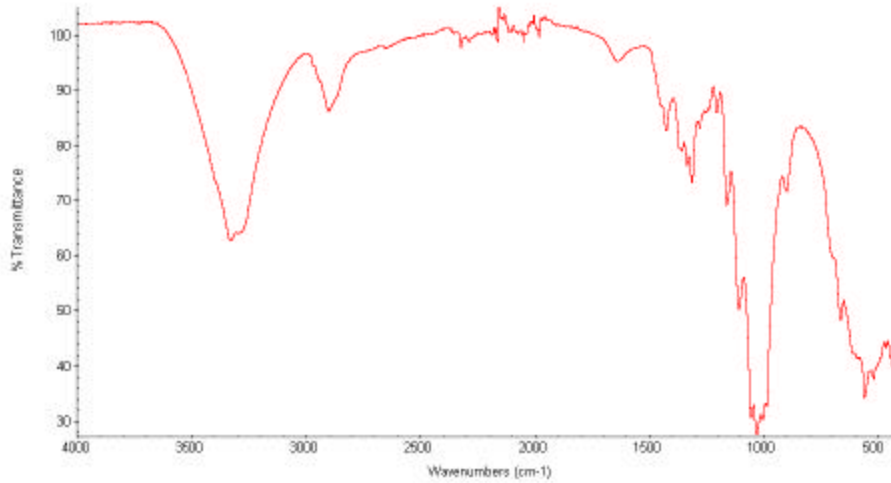

COTTON SHEET, WT FABRIC, RUN AS RECEIVED
 06CA08584 DATA:NC5756_030907-GG.SPA.F03-09-07
 UL SMOKE RESEARCH

Underwriters Laboratories, 3019JFPD

Operator: MW

Collection time: Mon Mar 26 09:14:36 2007 (GMT-06:00)

Detector: DTGS KBr
 Beamsplitter: KBr
 Source: IR

Number of sample scans: 32
 Number of background scans: 32
 Resolution: 4.000
 Sample gain: 6.0
 Mirror velocity: 0.6329
 Aperture: 100.00

Sample: COTTON SHEET, WT, AS IS
 Size: 9.1560 mg
 Method: Q500 TGA 40-850C, 20C/MIN
 Comment: 06CA08584, NC5756, UL SMOKE RESEARCH, F03-09-07

TGA

File: NC5756_030907.001
 Operator: MW, DA, 100
 Run Date: 01-Mar-2007 23:57
 Instrument: TGA Q500 V6.7 Build 203

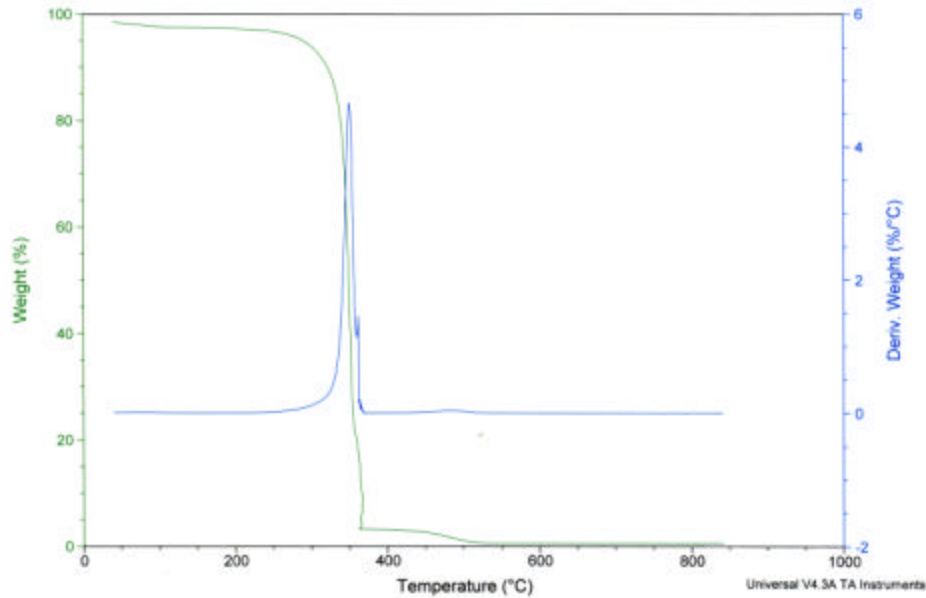

Cotton/Polyester Sheet: FTIR (top) and TGA (bottom)

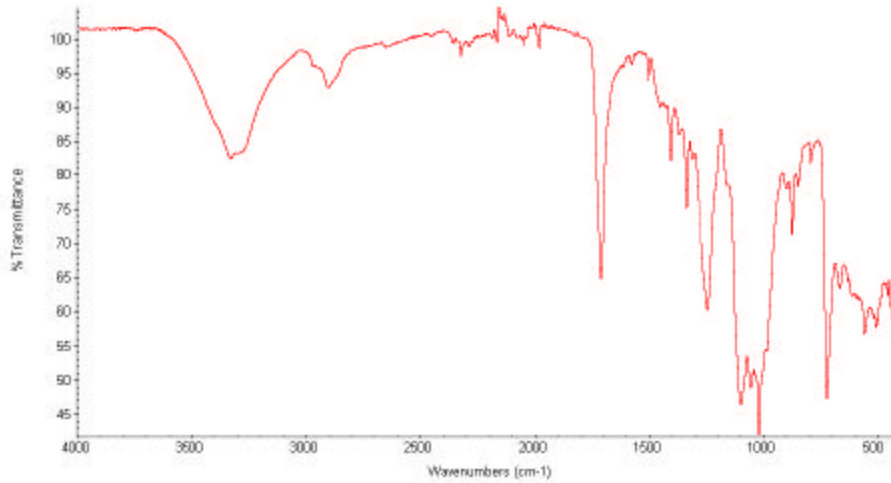

COTTON/POLYESTER SHEET, WT, SOLID, AS RECEIVED
 06CA08584 DATA: NC5756_030607_GG.SPA REF DATE: F03-06-07
 UL SMOKE RESEARCH

Underwriters Laboratories, 3019JFPD

Operator: MW

Collection time: Fri Mar 23 13:39:22 2007 (GMT-06:00)

Detector: DTGS KBr
 Beamsplitter: KBr
 Source: IR

Number of sample scans: 32
 Number of background scans: 32
 Resolution: 4.000
 Sample gain: 6.0
 Mirror velocity: 0.6329
 Aperture: 100.00

Sample: COTTON/POLYESTER SHEET, WT, AS IS
 Size: 10.8870 mg
 Method: Q500 TGA 40-850C, 20C/MIN
 Comment: 06CA08584, NC5756, UL SMOKE RESEARCH, F03-06-07

TGA

File: NC5756_030607.001
 Operator: MW, DA, 100
 Run Date: 01-Mar-2007 19:21
 Instrument: TGA Q500 V6.7 Build 203

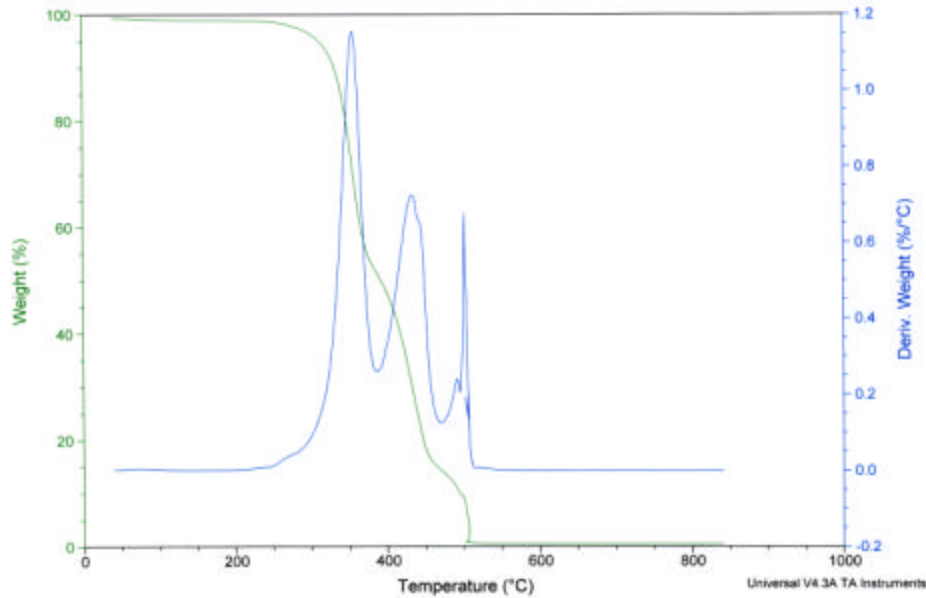

Polyester Microfiber Sheet: FTIR (top) and TGA (bottom)

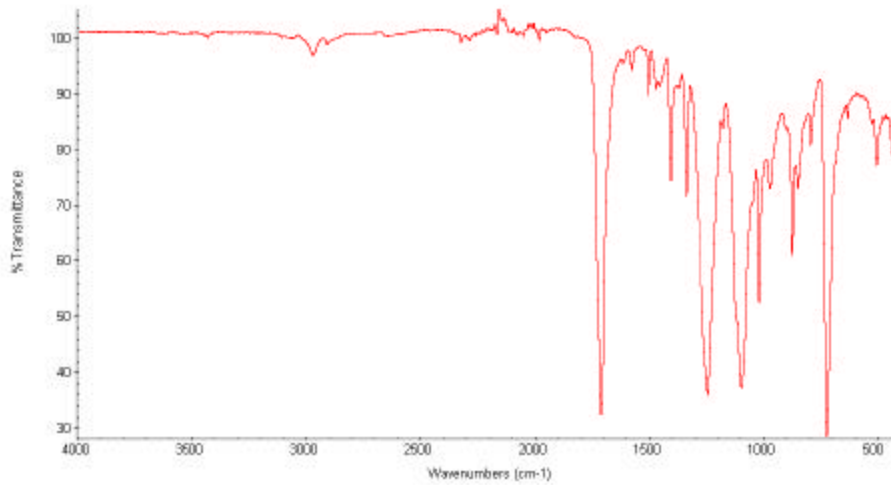

POLYESTER MICROFIBER SHEET
06CA08584 DATA:NC5756_030807_GG.SPA REF DATE:F03-08-07
UL SMOKE RESEARCH

Underwriters Laboratories, 301&JFPD

Operator: MW Collection time: Fri Mar 23 16:09:53 2007 (GMT-06:00)

Detector: DTGS KBr
Beamsplitter: KBr
Source: IR

Number of sample scans: 32
Number of background scans: 32
Resolution: 4.000
Sample gain: 6.0
Mirror velocity: 0.6329
Aperture: 100.00

Sample: POLYESTER/MICROFIBER SHEET.WT
Size: 11.2080 mg
Method: Q500 TGA 40-850C;20C/MIN
Comment: 06CA08584, NC5756, UL SMOKE RESEARCH,F03-08-07

TGA

File: NC5756_030807.001
Operator: MW,DA,100
Run Date: 01-Mar-2007 22:25
Instrument: TGA Q500 V6.7 Build 203

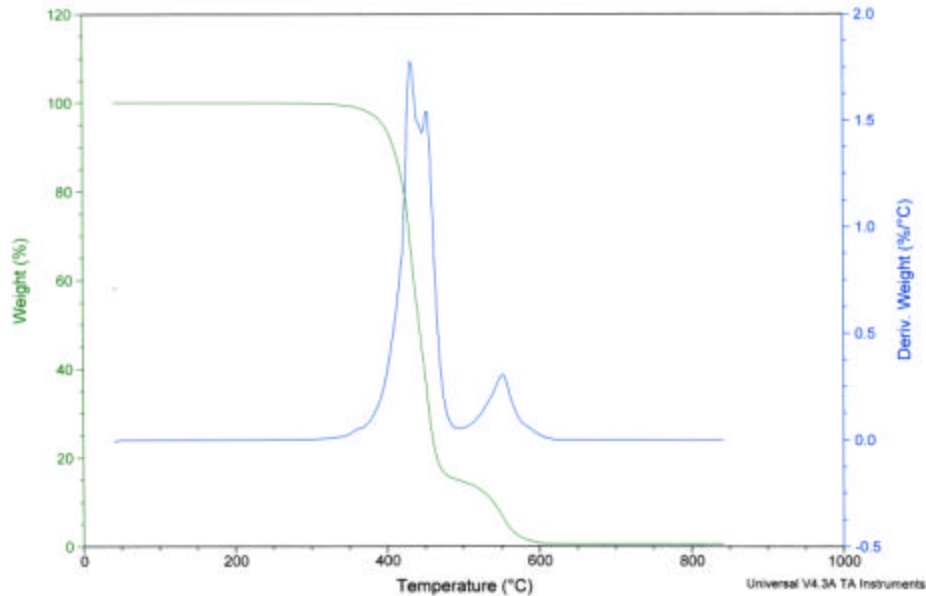

Pillow Stuffing: FTIR (top) and TGA (bottom)

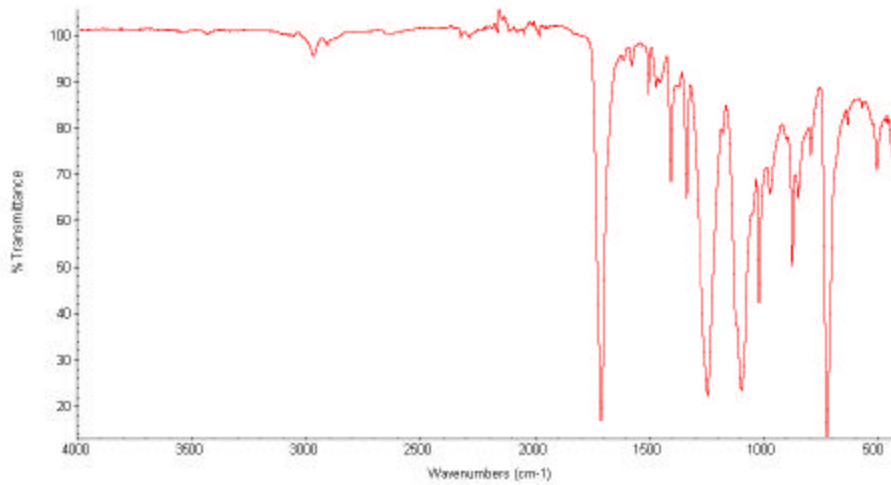

PILLOW STUFFING.WT.RUN AS RECEIVED
 06CA08584 DATA:NC5756_031007_GG.SPA.F03-10-07
 UL SMOKE RESEARCH

Underwriters Laboratories, 3019JFPD
 Operator: MWV Collection time: Fri Mar 23 09:51:32 2007 (GMT-06:00)

Detector: DTGS KBr
 Beamsplitter: KBr
 Source: IR

Number of sample scans: 32
 Number of background scans: 32
 Resolution: 4.000
 Sample gain: 6.0
 Mirror velocity: 0.6329
 Aperture: 100.00

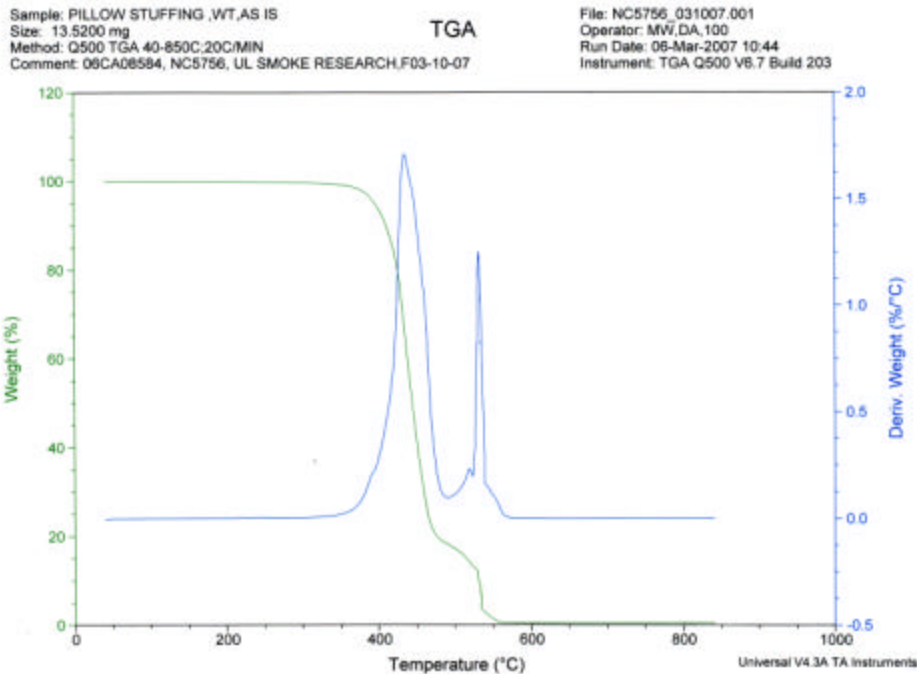

Rayon Sheet: FTIR (top) and TGA (bottom)

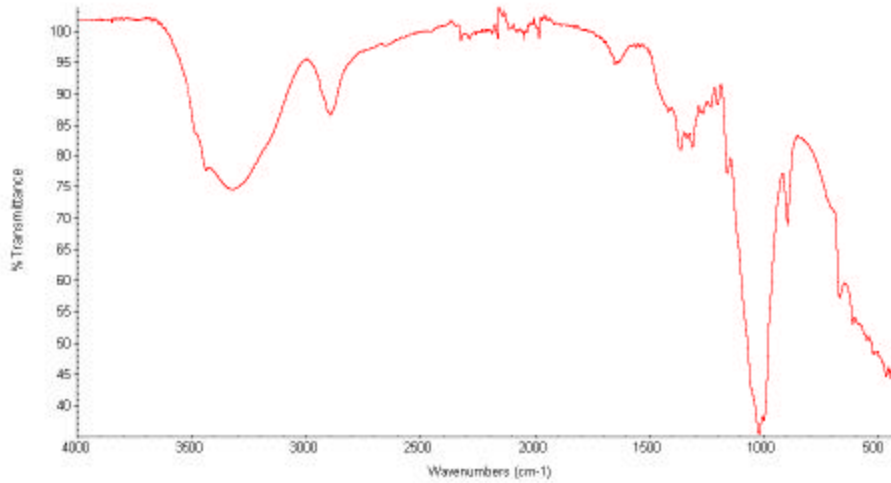

RAYON SHEET,FABRIC,WTRUN AS RECEIVED
06CA08584 DATA:NC5756_030707_GG.SPA REF DATE :F03-07-07
UL SMOKE RESEARCH
Underwriters Laboratories, 3019JFPD
Operator: ME Collection time: Fri Mar 23 14:47:58 2007 (GMT-06:00)

Number of sample scans: 32
Number of background scans: 32
Resolution: 4.000
Sample gain: 6.0
Mirror velocity: 0.6329
Aperture: 100.00
Detector: DTGS KBr
Beamsplitter: KBr
Source: IR

Sample: RAYON SHEET ,WT,AS IS
Size: 3.9940 mg
Method: Q500 TGA 40-850C,20C/MIN
Comment: 06CA08584, NC5756, UL SMOKE RESEARCH,F03-07-07

TGA

File: NC5756_030707.002
Operator: MW,DA,100
Run Date: 08-Mar-2007 10:47
Instrument: TGA Q500 V6.7 Build 203

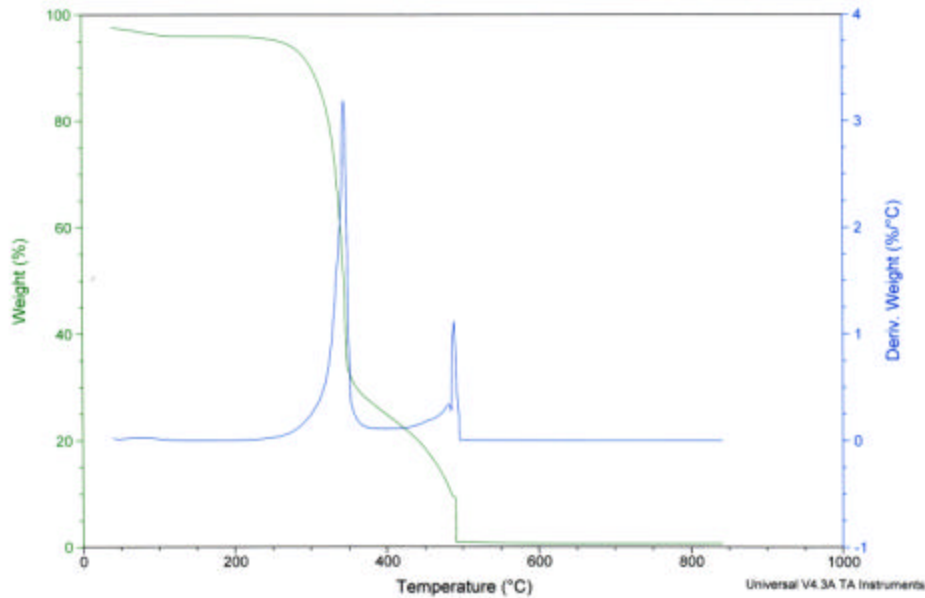

Nylon Carpet: FTIR (top) and TGA (bottom)

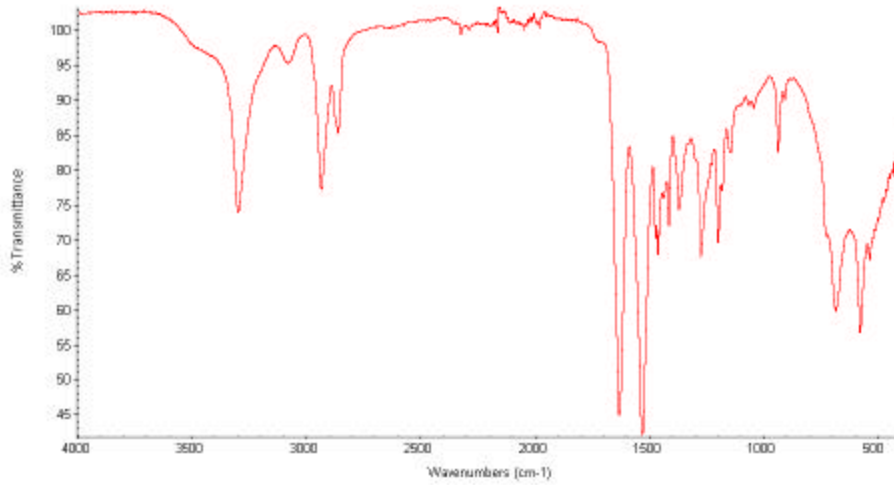

NYLON CARPET YARN, BN, RUN AS RECEIVED
 06CA08584 DATA.NC5756_062906_GG.SPA
 UL SMOKE RESEARCH

Underwriters Laboratories, 3019JFPD

Operator: MW

Collection time: Tue Aug 29 10:35:13 2006 (GMT-05:00)

Detector: DTGS KBr
 Beamsplitter: KBr
 Source: IR

Number of sample scans: 32
 Number of background scans: 32
 Resolution: 4.000
 Sample gain: 8.0
 Mirror velocity: 0.6329
 Aperture: 100.00

Sample: NYLON CARPET_BN,AS IS
 Size: 3.7240 mg
 Method: Q500 TGA 40-850C,20C/MIN
 Comment: 06CA08584, NC5756, UL SMOKE RESEARCH,F03-01-07

TGA

File: NC5756_030107.001
 Operator: MW,DA,100
 Run Date: 08-Mar-2007 09:15
 Instrument: TGA Q500 V6.7 Build 203

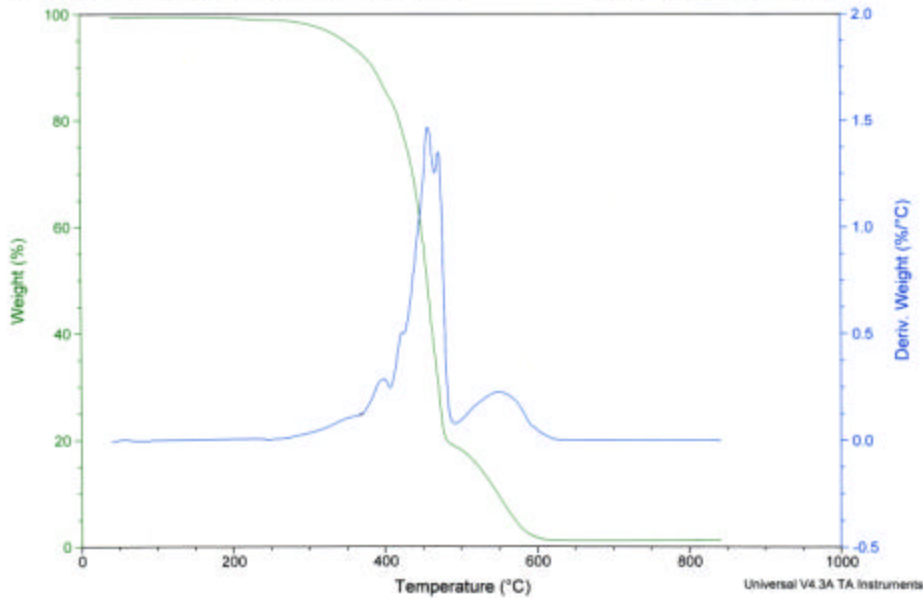

Polyester Carpet: FTIR (top) and TGA (bottom)

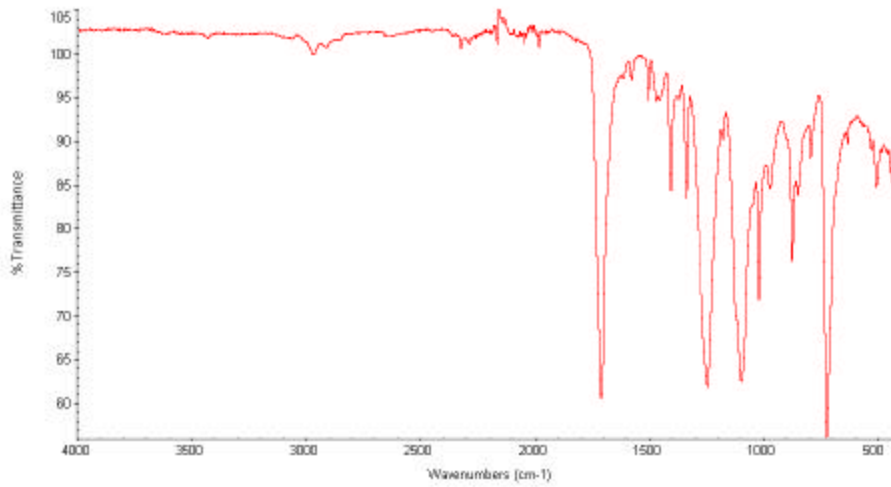

PET CARPET YARN,TAN,SOLID, RUN AS RECEIVED
 06CA08584 DATA.NC5756_063006_GG.SPA
 UL SMOKE RESEARCH

Underwriters Laboratories, 3019JFPD

Operator: MW

Collection time: Tue Aug 29 10:47:18 2006 (GMT-05:00)

Detector: DTGS KBr
 Beamsplitter: KBr
 Source: IR

Number of sample scans: 32
 Number of background scans: 32
 Resolution: 4.000
 Sample gain: 8.0
 Mirror velocity: 0.6329
 Aperture: 100.00

Sample: POLYESTER CARPET ,TN,AS IS
 Size: 23.2710 mg
 Method: Q500 TGA 40-850C:20C/MIN
 Comment: 06CA08584, NC5756, UL SMOKE RESEARCH,F03-02-07

TGA

File: NC5756_030207.001
 Operator: MW,DA,100
 Run Date: 01-Mar-2007 13:12
 Instrument: TGA Q500 V6.7 Build 203

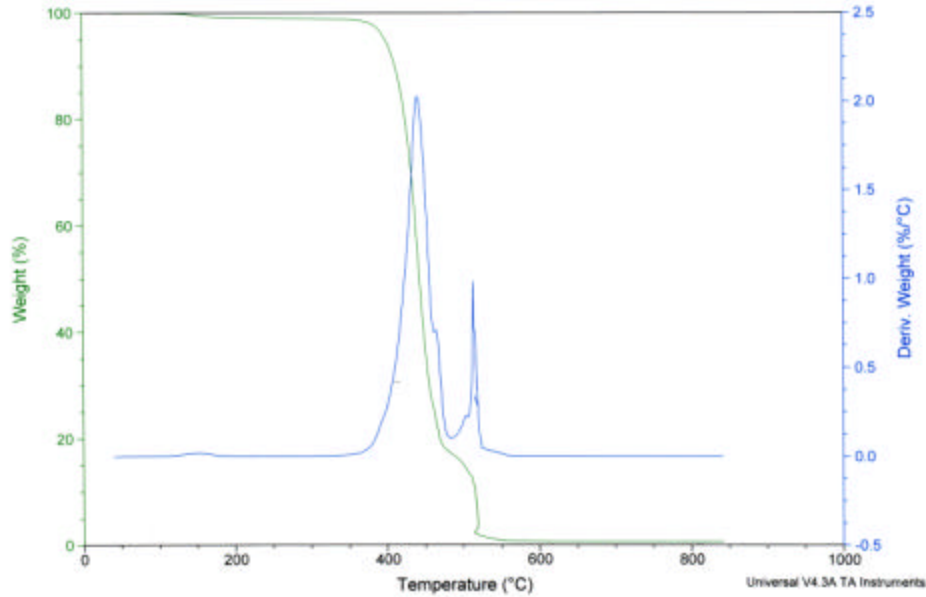

Polyisocyanurate Foam: FTIR (top) and TGA (bottom)

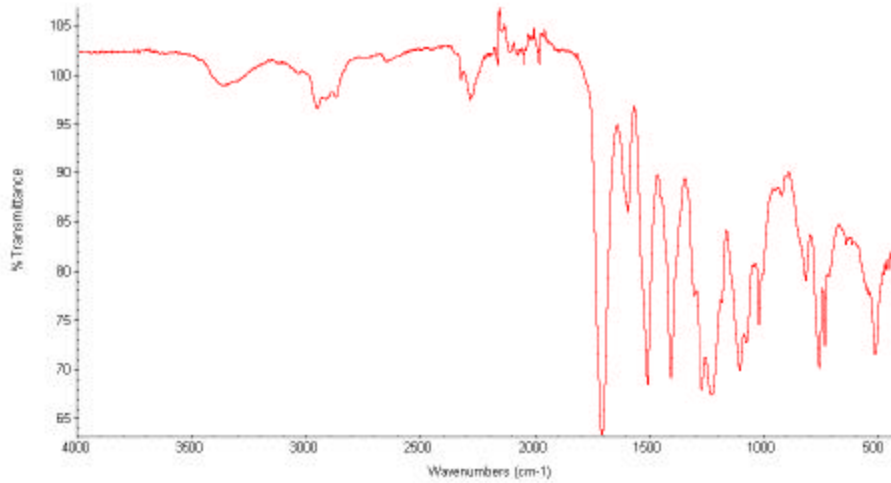

POLYSOCYANURATE FOAM,YL,SOLID,RUN AS RECEIVED
06CA08584 DATA:NC5756_030507_GG REF DATE:F03-05-07
UL SMOKE RESEARCH
Underwriters Laboratories, 301&JFPD
Operator: MW Collection time: Fri Mar 23 10:59:21 2007 (GMT-06:00)

Number of sample scans: 32
Number of background scans: 32
Resolution: 4.000
Sample gain: 6.0
Mirror velocity: 0.6329
Aperture: 100.00
Detector: DTGS KBr
Beamsplitter: KBr
Source: IR

Sample: POLYSOCYANURATE FOAM ,CLAS IS
Size: 5.3990 mg
Method: Q500 TGA 40-850C,20C/MIN
Comment: 06CA08584, NC5756, UL SMOKE RESEARCH,F03-05-07

TGA

File: NC5756_030507.001
Operator: MW,DA,100
Run Date: 01-Mar-2007 17:49
Instrument: TGA Q500 V6.7 Build 203

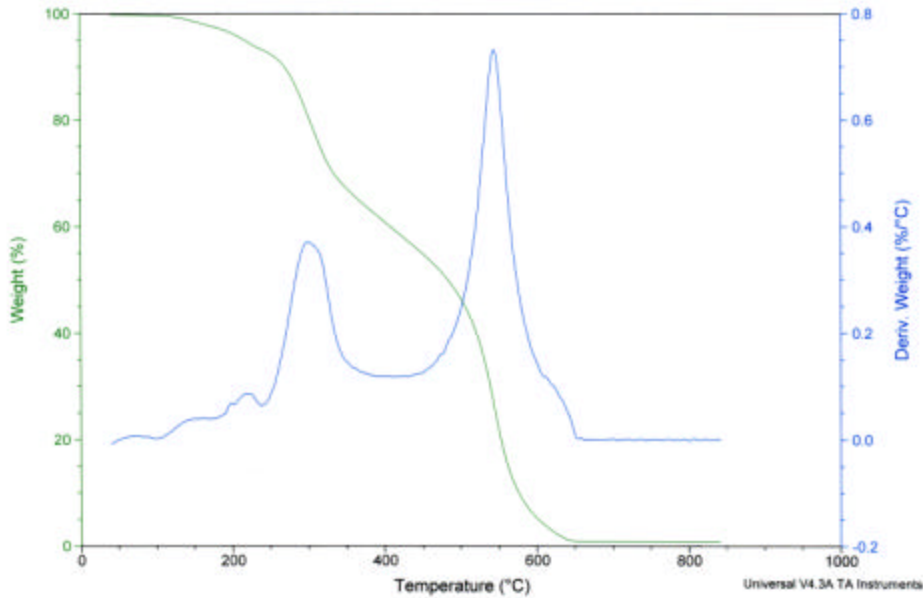

HDPE: FTIR (top) and TGA (bottom)

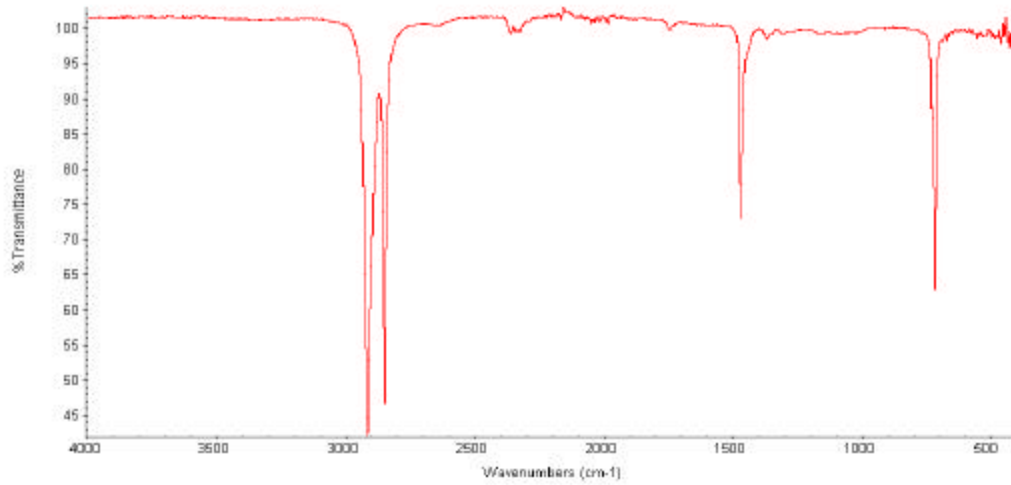

HDPE SHEETS.SAMPLE 373652421294.WT.RUN AS RECEIVED
HDPE_032806_GG.SPA REF DATE F03-28-06

Underwriters Laboratories, 3019DFPD

Operator: MW

Collection time: Wed Mar 29 10:45:15 2006 (GMT-06:00)

Detector: DTGS KBr
Beamsplitter: KBr
Source: IR

Number of sample scans: 32
Number of background scans: 32
Resolution: 4.000
Sample gain: 8.0
Mirror velocity: 0.6329
Aperture: 100.00

Sample: HDPE
Size: 5.2090 mg
Method: Q500 TGA 40-850C:20C/MIN
Comment: Smoke detector project - HDPE

TGA

File: HDPE.001
Operator: TF,DA,100
Run Date: 2006-03-29 12:40
Instrument: TGA Q500 V6.3 Build 189

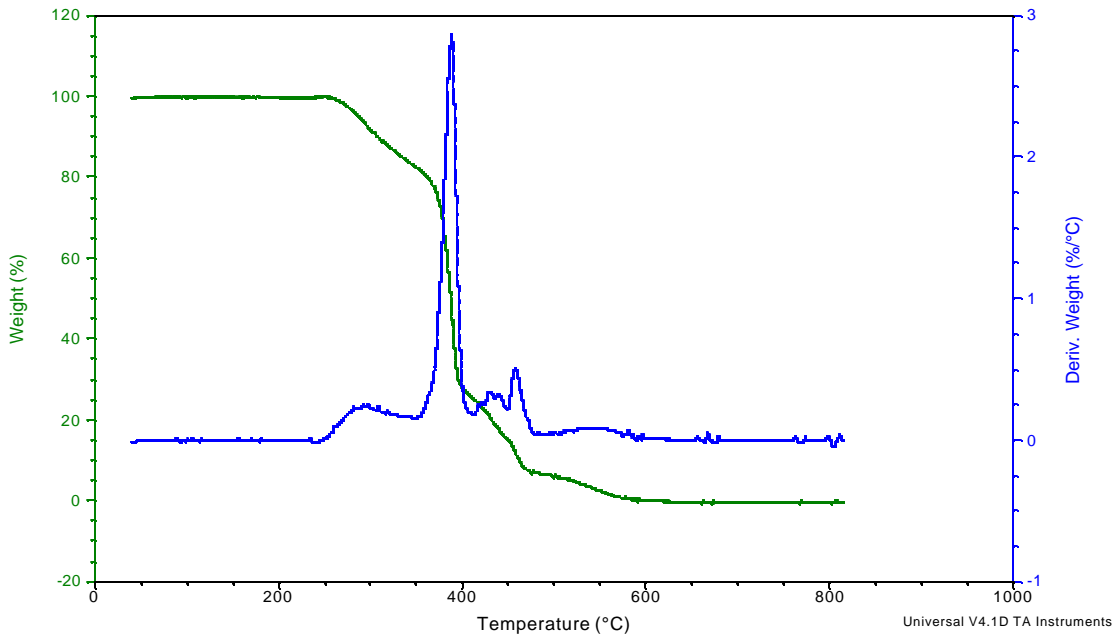

Polypropylene : FTIR (top) and TGA (bottom)

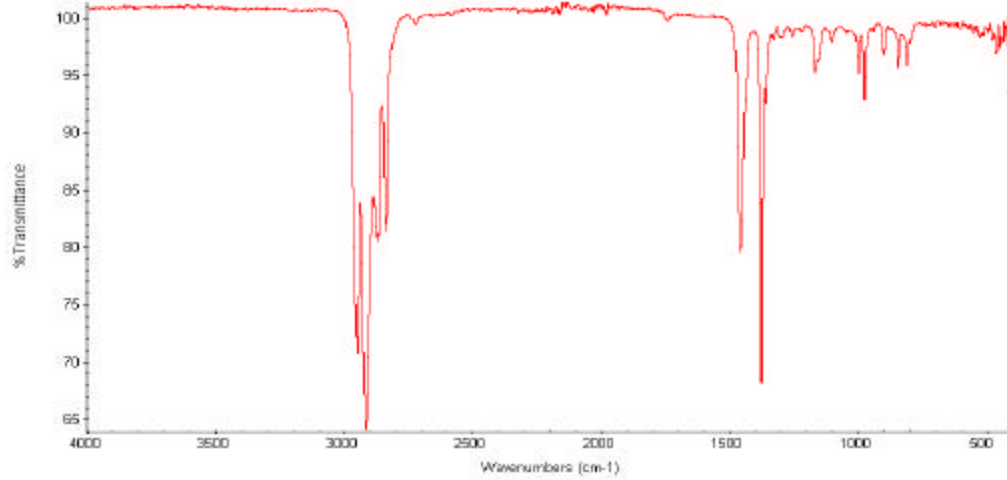

POLYPROTRANS ,WT.SHEET,RUN AS RECEIVED
POLYPRO_032906_GG SPA

Underwriters Laboratories, 3019DFPD

Operator: MW

Collection time: Wed Mar 29 11:00:42 2006 (GMT-05:00)

Detector: DTGS KBr
Beamsplitter: KBr
Source: IR

Number of sample scans: 32
Number of background scans: 32
Resolution: 4.000
Sample gain: 8.0
Mirror velocity: 0.6329
Aperture: 100.00

Sample: Polypro
Size: 5.2000 mg
Method: Q500 TGA 40-850C;20C/MIN
Comment: Smoke detector project - polypro

TGA

File: polypro.001
Operator: TF,DA,,100
Run Date: 2006-03-29 11:24
Instrument: TGA Q500 V6.3 Build 189

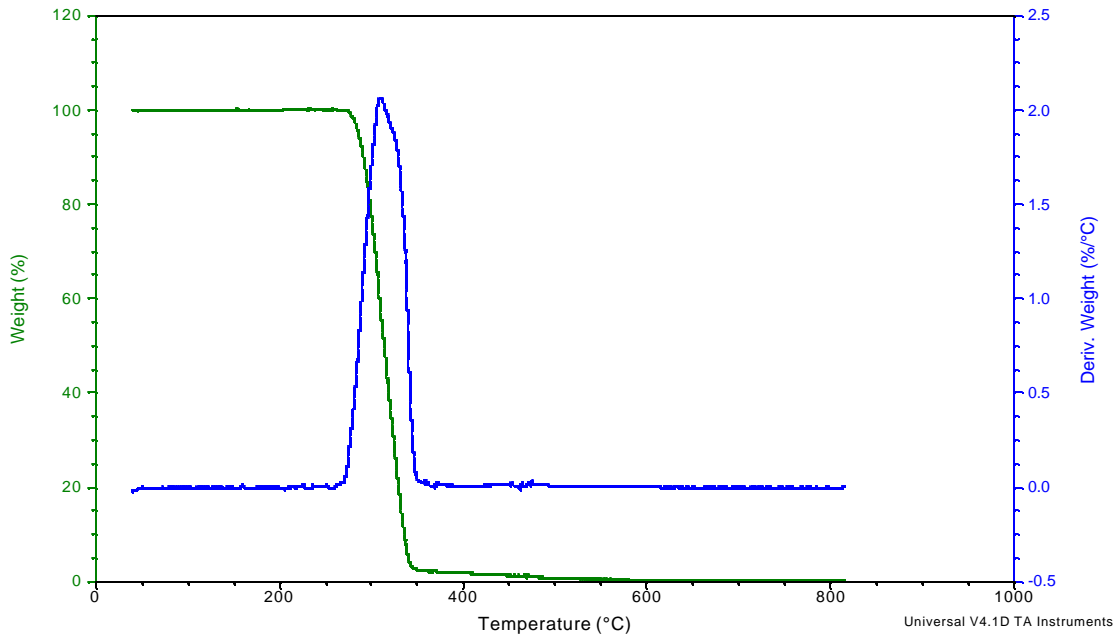

Coffee Maker: FTIR

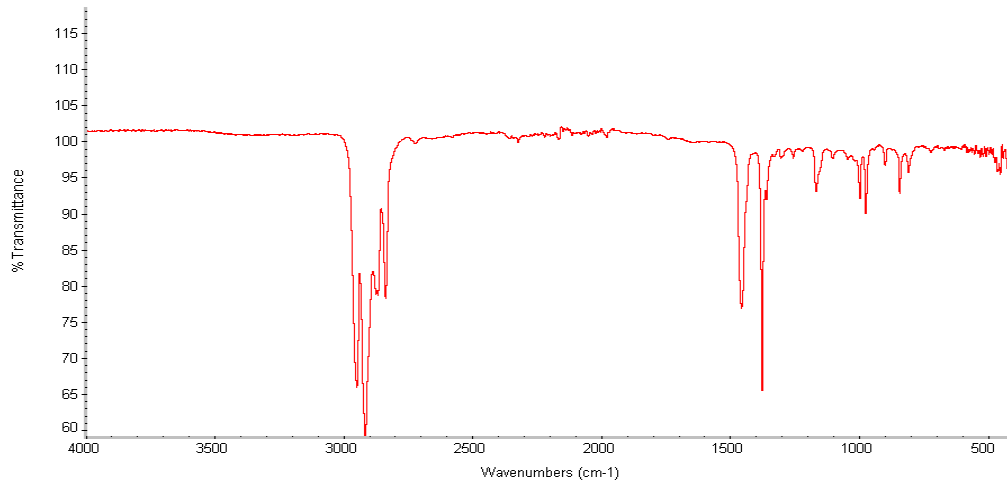

COFFEMAKER,BK,SOLID, RUN AS RECEIVED

Underwriters Laboratories, 3019DFPD

Operator: MW

Collection time: Fri Mar 31 10:19:35 2006 (GMT-06:00)

Detector: DTGS KBr
Beamsplitter: KBr
Source: IR

Number of sample scans: 32
Number of background scans: 32
Resolution: 4.000
Sample gain: 8.0
Mirror velocity: 0.6329
Aperture: 100.00

REFERENCES

- ¹ R. W. Bukowski, W. J. Christian, and T.E. Waterman, Detector Sensitivity and Siting Requirements for Dwellings. Final Technical Report, IITRI Project J6340, Underwriters Laboratories Inc. File USNC-62, Project 74NK6752 (August 1975). Prepared for US Bureau of Standards, Center for Fire Research.
- ² S. W. Harpe, T.E. Waterman, and W. J. Christian, Detector Sensitivity and Siting Requirements for Dwellings - Phase 2. Final Report, IITRI Project J6340, Underwriters Laboratories Inc File USNC-62, Project 75NK7701 (July 1976). Prepared for US Bureau of Standards, Center for Fire Research, Washington, D.C.
- ³ UL 217 - Single and Multiple Station Smoke Alarms, Underwriters Laboratories Inc., 333 Pfingsten Road, Northbrook, IL, 60062.
- ⁴ NFPA 72 – National Fire Alarm Code, National Fire Protection Association, One Batterymarch Park, Quincy, MA, 02169.
- ⁵ M. Ahrens, “U.S. Experience with Smoke Alarms”, NFPA Fire Analysis & Research Division, One Batterymarch Park, Quincy, MA, (November 2004).
- ⁶ Smoke Alarm Performance in Residential Structure Fires, U. S. Fire Administration Topical Fire Research Series, Vol. 1, Issue 15, (March 2001).
- ⁷ R.W. Bukowski, *et. al.*,” Performance of Home Smoke Alarms. Analysis of Response of Several Available Technologies in Residential Fires”, NIST Technical Note 1455, National Institute of Standards and Technology, Technology Administration, U.S. Department of Commerce, Washington DC, 20402 (2004).
- ⁸ G.G. Hawley, The Condensed Chemical Dictionary, 8th Edition, Van Nostrand Reinhold Company (1971).
G. Odian, Principles of Polymerization, McGraw Hill Company (1970).
F. Billmeyer, Jr., Textbook of Polymer Science, Wiley-Interscience (1970).
J.B. Hendricks, D.J. Cram and G.S. Hammond, Organic Chemistry, McGraw-Hill Book Company (1970).
- ⁹ C.D. Litton, K.R. Smith, R. Edwards, T. Allen, “Combined Optical and Ionization Techniques for Inexpensive Characterization of Micrometer and Submicrometer Aerosols”, *J. Sci. and Tech.*, 38 *1054* (2004).
- ¹⁰ V. Babrauskas and G. Mulholland, Smoke and Soot Determinations in the Cone Calorimeter, Mathematical Modeling of Fires, American Society for Testing and Materials (1987).
- ¹¹ G. Mulholland, ICFRE Conference, Chicago, IL (October 1999).
- ¹² T.J. Ohlemiller, “Smoldering Combustion”, SFPE Handbook of Fire Protection Engineering, 2nd Edition, pp. 2-171, Society of Fire, Boston, Massachusetts (1995).

The Fire Protection Research Foundation plans, manages and communicates consortium-funded research on a broad range of fire safety issues in collaboration with scientists and laboratories around the world. The Foundation is an affiliate of National Fire Protection Association.



THE FIRE PROTECTION
RESEARCH FOUNDATION

ONE BATTERYMARCH PARK
QUINCY, MASSACHUSETTS, U.S.A. 02169
E-MAIL: Foundation@NFPA.org
WEB: www.nfpa.org/Foundation