



Alienware 15 Service Manual

Computer Model: Alienware 15
Regulatory Model: P42F
Regulatory Type: P42F001

ALIENWARE 

Notes, Cautions, and Warnings

-  **NOTE:** A NOTE indicates important information that helps you make better use of your computer.
 -  **CAUTION:** A CAUTION indicates either potential damage to hardware or loss of data and tells you how to avoid the problem.
 -  **WARNING:** A WARNING indicates a potential for property damage, personal injury, or death.
-

Copyright © 2015 Dell Inc. All rights reserved. This product is protected by U.S. and international copyright and intellectual property laws. Dell™ and the Dell logo are trademarks of Dell Inc. in the United States and/or other jurisdictions. All other marks and names mentioned herein may be trademarks of their respective companies.

2015 - 01

Rev. A00

Contents

Before working inside your computer	12
Before you begin	12
Safety instructions.....	12
Recommended tools.....	14
After working inside your computer	15
Removing the base panel	16
Procedure.....	16
Replacing the base panel	19
Procedure.....	19
Removing the memory modules	20
Prerequisites.....	20
Procedure.....	20
Replacing the memory modules	22
Procedure.....	22
Post-requisites.....	23
Removing the solid-state drives	24
Prerequisites.....	24
Procedure.....	24
Replacing the solid-state drives	26
Procedure.....	26
Post-requisites.....	26

Removing the hard drive.....	27
Prerequisites.....	27
Procedure.....	28
Replacing the hard drive.....	32
Procedure.....	32
Post-requisites.....	32
Removing the wireless card.....	33
Prerequisites.....	33
Procedure.....	33
Replacing the wireless card.....	35
Procedure.....	35
Post-requisites.....	35
Removing the palm rest.....	36
Prerequisites.....	36
Procedure.....	36
Replacing the palm rest.....	43
Procedure.....	43
Post-requisites.....	43
Removing the touch pad.....	44
Prerequisites.....	44
Procedure.....	44
Replacing the touch pad.....	48
Procedure.....	48
Post-requisites.....	48

Removing the keyboard.....	49
Prerequisites.....	49
Procedure.....	49
Replacing the keyboard.....	55
Procedure.....	55
Post-requisites.....	55
Removing the power-button board.....	56
Prerequisites.....	56
Procedure.....	56
Replacing the power-button board.....	59
Procedure.....	59
Post-requisites.....	59
Removing the status-light board.....	60
Prerequisites.....	60
Procedure.....	61
Replacing the status-light board.....	63
Procedure.....	63
Post-requisites.....	63
Removing the I/O board.....	64
Prerequisites.....	64
Procedure.....	64
Replacing the I/O board.....	66
Procedure.....	66
Post-requisites.....	66

Removing the speakers.....	67
Prerequisites.....	67
Procedure.....	67
Replacing the speakers.....	70
Procedure.....	70
Post-requisites.....	70
Removing the front AlienFX LED boards.....	71
Prerequisites.....	71
Procedure.....	71
Replacing the front AlienFX LED board.....	73
Procedure.....	73
Post-requisites.....	73
Removing the hinge covers.....	74
Prerequisites.....	74
Procedure.....	74
Replacing the hinge covers.....	76
Procedure.....	76
Post-requisites.....	76
Removing the display assembly.....	77
Prerequisites.....	77
Procedure.....	77
Replacing the display assembly.....	81
Procedure.....	81
Post-requisites.....	81

Removing the display bezel.....	83
Prerequisites.....	83
Procedure.....	83
Replacing the display bezel.....	87
Procedure.....	87
Post-requisites.....	87
Removing the display panel.....	88
Prerequisites.....	88
Procedure.....	88
Replacing the display panel.....	91
Procedure.....	91
Post-requisites.....	91
Removing the display hinges.....	92
Prerequisites.....	92
Procedure.....	92
Replacing the display hinges.....	94
Procedure.....	94
Post-requisites.....	94
Removing the display back-cover.....	95
Prerequisites.....	95
Procedure.....	95
Replacing the display back-cover.....	98
Procedure.....	98
Post-requisites.....	98

Removing the camera.....	99
Prerequisites.....	99
Procedure.....	100
Replacing the camera.....	102
Procedure.....	102
Post-requisites.....	102
Removing the Alienware AlienHead LED board..	103
Prerequisites.....	103
Procedure.....	103
Replacing the Alienware AlienHead LED board..	106
Procedure.....	106
Post-requisites.....	106
Removing the display-panel AlienFX LEDs.....	107
Prerequisites.....	107
Procedure.....	108
Replacing the display-panel AlienFX LEDs.....	110
Procedure.....	110
Post-requisites.....	110
Removing the logo board.....	111
Prerequisites.....	111
Procedure.....	111
Replacing the logo board.....	113
Procedure.....	113
Post-requisites.....	113

Removing the system board.....	114
Prerequisites.....	114
Procedure.....	114
Replacing the system board.....	118
Procedure.....	118
Post-requisites.....	119
Removing the heat-sink assembly.....	120
Prerequisites.....	120
Procedure.....	120
Replacing the heat-sink assembly.....	122
Procedure.....	122
Post-requisites.....	122
Removing the fans.....	123
Prerequisites.....	123
Procedure.....	123
Replacing the fans.....	125
Procedure.....	125
Post-requisites.....	125
Removing the power-adapter port.....	126
Prerequisites.....	126
Procedure.....	126
Replacing the power-adapter port.....	128
Procedure.....	128
Post-requisites.....	128

Removing the coin-cell battery.....	129
Prerequisites.....	129
Procedure.....	129
Replacing the coin-cell battery.....	131
Procedure.....	131
Post-requisites.....	131
Removing the battery.....	132
Prerequisites.....	132
Procedure.....	132
Replacing the battery.....	135
Procedure.....	135
Post-requisites.....	135
Removing the computer base.....	136
Prerequisites.....	136
Procedure.....	136
Replacing the computer base.....	138
Procedure.....	138
Post-requisites.....	138
BIOS setup program.....	139
Overview.....	139
Entering BIOS setup program.....	139
BIOS setup program options.....	139
Boot sequence.....	145
Boot options.....	145
Changing boot sequence for the current boot.....	146
Changing boot sequence for future boots.....	146
Flashing the BIOS.....	148



Getting help and contacting Alienware.....	149
Self-help resources.....	149
Contacting Alienware.....	149

Before working inside your computer

 **CAUTION:** To avoid damaging the components and cards, handle them by their edges and avoid touching pins and contacts.

 **NOTE:** The images in this document may differ from your computer depending on the configuration you ordered.









Before you begin

- 1 Save and close all open files and exit all open applications.
 - 2 Shut down your computer.
 - Windows 8.1: On the **Start** screen, click or tap the power icon  → **Shut down**.
 - Windows 7: Click or tap **Start** → **Shut down**.
-  **NOTE:** If you are using a different operating system, see the documentation of your operating system for shut-down instructions.
- 3 Disconnect your computer and all attached devices from their electrical outlets.
 - 4 Disconnect all cables such as telephone cables, network cables and so on, from your computer.
 - 5 Disconnect all attached devices and peripherals, such as keyboard, mouse, monitor, and so on, from your computer.
 - 6 Remove any media card and optical disc from your computer, if applicable.

Safety instructions

Use the following safety guidelines to protect your computer from potential damage and ensure your personal safety.

 **WARNING:** Before working inside your computer, read the safety information that shipped with your computer. For more safety best practices, see the Regulatory Compliance home page at dell.com/regulatory_compliance.

-  **WARNING:** Disconnect all power sources before opening the computer cover or panels. After you finish working inside the computer, replace all covers, panels, and screws before connecting to the power source.
-  **CAUTION:** To avoid damaging the computer, make sure that the work surface is flat and clean.
-  **CAUTION:** To avoid damaging the components and cards, handle them by their edges and avoid touching pins and contacts.
-  **CAUTION:** You should only perform troubleshooting and repairs as authorized or directed by the Dell technical assistance team. Damage due to servicing that is not authorized by Dell is not covered by your warranty. See the safety instructions that shipped with the product or at dell.com/regulatory_compliance.
-  **CAUTION:** Before touching anything inside your computer, ground yourself by touching an unpainted metal surface, such as the metal at the back of the computer. While you work, periodically touch an unpainted metal surface to dissipate static electricity, which could harm internal components.
-  **CAUTION:** When you disconnect a cable, pull on its connector or on its pull-tab, not on the cable itself. Some cables have connectors with locking tabs or thumb-screws that you must disengage before disconnecting the cable. When disconnecting cables, keep them evenly aligned to avoid bending any connector pins. When connecting cables, make sure that the ports and connectors are correctly oriented and aligned.
-  **CAUTION:** To disconnect a network cable, first unplug the cable from your computer and then unplug the cable from the network device.
-  **CAUTION:** Press and eject any installed card from the media-card reader.

Recommended tools

The procedures in this document may require the following tools:

- Philips screwdriver
- Plastic scribe

After working inside your computer



CAUTION: Leaving stray or loose screws inside your computer may severely damage your computer.

- 1** Replace all screws and make sure that no stray screws remain inside your computer.
- 2** Connect any external devices, peripherals, and cables you removed before working on your computer.
- 3** Replace any media cards, discs, and any other parts that you removed before working on your computer.
- 4** Connect your computer and all attached devices to their electrical outlets.
- 5** Turn on your computer.

Removing the base panel



WARNING: Before working inside your computer, read the safety information that shipped with your computer and follow the steps in [Before working inside your computer](#). After working inside your computer, follow the instructions in [After working inside your computer](#). For more safety best practices, see the Regulatory Compliance home page at dell.com/regulatory_compliance.

Procedure

- 1 Close the display and turn the computer over.
- 2 Loosen the captive screws that secure the base panel to the computer base.
- 3 Using a plastic scribe, gently release the tabs that secure the base panel to the computer base.

4 Slide and remove the base panel from the computer base.

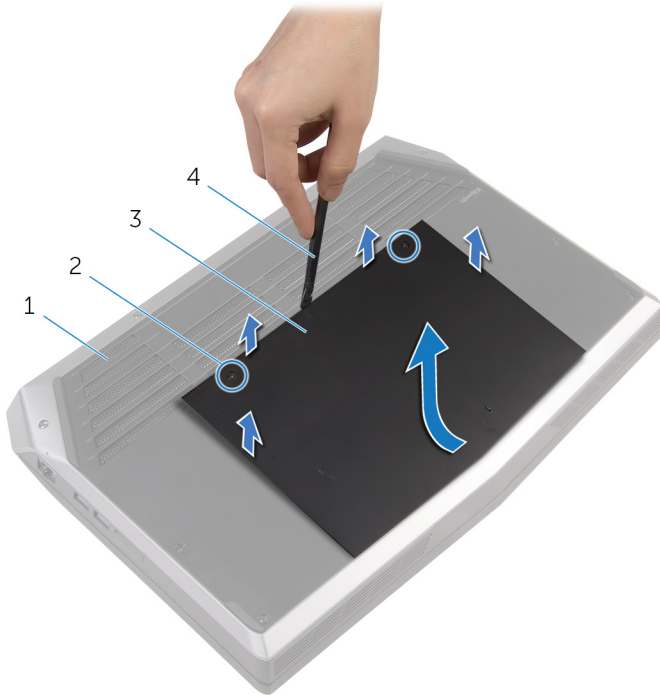

1 computer base

2 captive screws (2)

3 base panel

4 plastic scribe

- 5 Disconnect the battery cable from the system board.

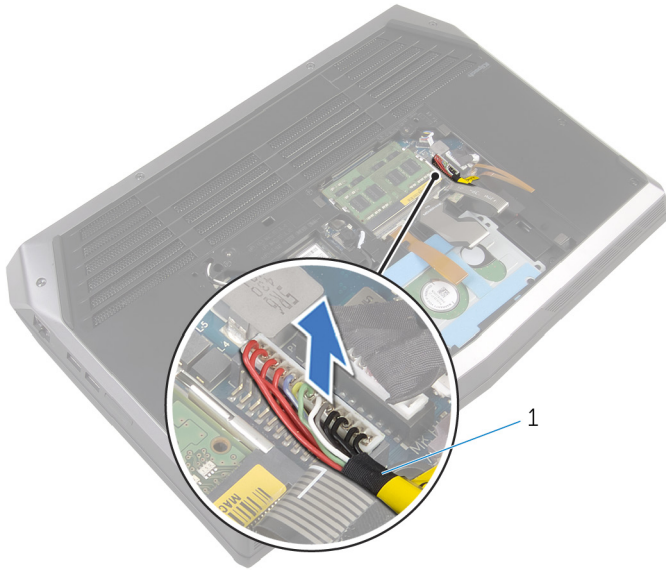

1 battery cable

- 6 Turn the computer over and open the display as far as possible.
- 7 Press and hold the power button for 4 seconds to ground the system board.

Replacing the base panel



WARNING: Before working inside your computer, read the safety information that shipped with your computer and follow the steps in [Before working inside your computer](#). After working inside your computer, follow the instructions in [After working inside your computer](#). For more safety best practices, see the Regulatory Compliance home page at dell.com/regulatory_compliance.

Procedure

- 1 Close the display and turn the computer over.
- 2 Connect the battery cable to the system board.
- 3 Slide the tabs on the base panel into the slots on the computer base and snap the base panel into place.
- 4 Tighten the captive screws that secure the base panel to the computer base.

Removing the memory modules



WARNING: Before working inside your computer, read the safety information that shipped with your computer and follow the steps in [Before working inside your computer](#). After working inside your computer, follow the instructions in [After working inside your computer](#). For more safety best practices, see the Regulatory Compliance home page at dell.com/regulatory_compliance.

Prerequisites

Remove the [base panel](#).

Procedure

- 1 Using your fingertips, carefully spread apart the securing clips on each end of the memory-module slot until the memory module pops up.

2 Slide and remove the memory module from the memory-module slot.

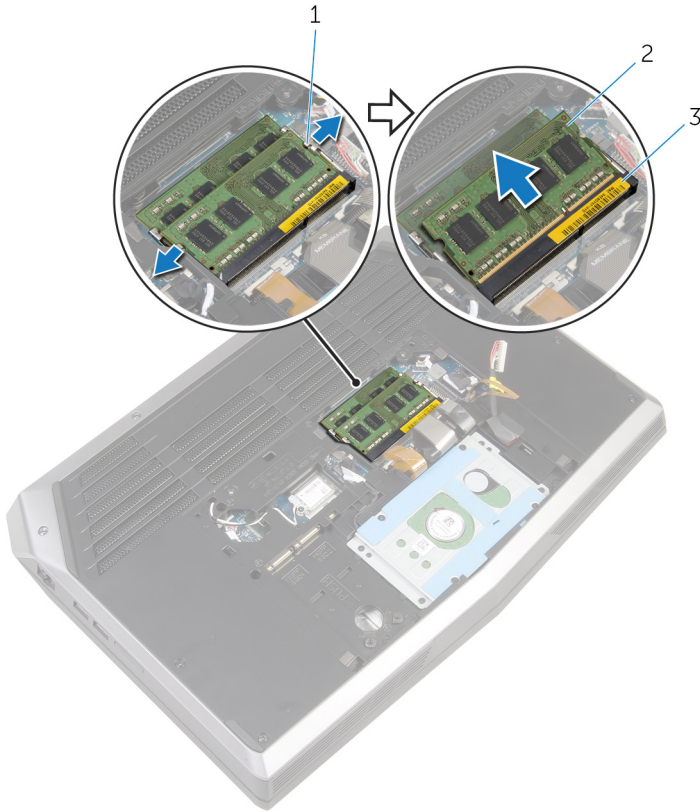

1 securing clips (2)

2 memory modules (2)

3 memory-module slot

Replacing the memory modules



WARNING: Before working inside your computer, read the safety information that shipped with your computer and follow the steps in [Before working inside your computer](#). After working inside your computer, follow the instructions in [After working inside your computer](#). For more safety best practices, see the Regulatory Compliance home page at dell.com/regulatory_compliance.

Procedure

- 1 Align the notch on the memory module with the tab on the memory-module slot.

- 2 Slide the memory module firmly into the slot at an angle and press the memory module down until it clicks into place.

 **NOTE:** If you do not hear the click, remove the memory module and reinstall it.

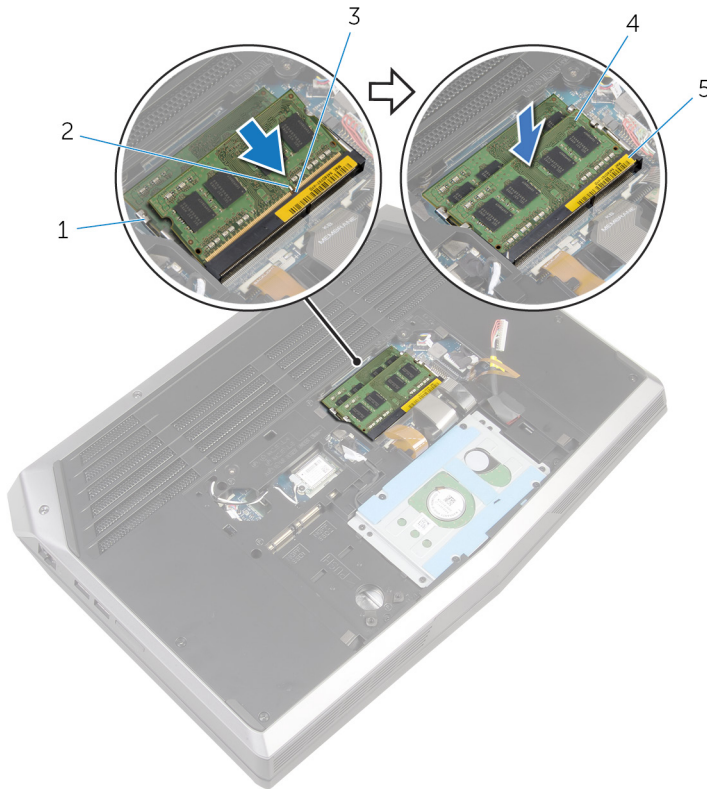

1 securing clips (2)

3 tab

5 memory-module slot



2 notch

4 memory modules (2)

Post-requisites

Replace the [base panel](#).

Removing the solid-state drives

-  **WARNING:** Before working inside your computer, read the safety information that shipped with your computer and follow the steps in [Before working inside your computer](#). After working inside your computer, follow the instructions in [After working inside your computer](#). For more safety best practices, see the Regulatory Compliance home page at dell.com/regulatory_compliance.
-  **CAUTION:** Solid-state drives are fragile. Exercise care when handling the hard drive.
-  **CAUTION:** To avoid data loss, do not remove the solid-state drive while the computer is in sleep or on state.

Prerequisites

Remove the [base panel](#).

Procedure

- 1 Remove the screw that secures the solid-state drive to the computer base.

2 Slide and remove the solid-state drive from the solid-state drive slot.

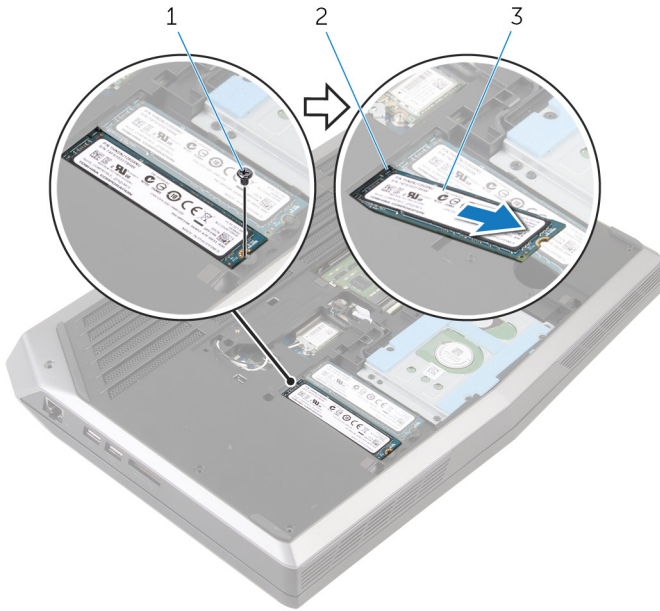

1 screw

2 solid-state drive slot

3 solid-state drives (2)

Replacing the solid-state drives

 **WARNING:** Before working inside your computer, read the safety information that shipped with your computer and follow the steps in [Before working inside your computer](#). After working inside your computer, follow the instructions in [After working inside your computer](#). For more safety best practices, see the Regulatory Compliance home page at dell.com/regulatory_compliance.

 **CAUTION:** Solid-state drives are fragile. Exercise care when handling the hard drive.

Procedure

- 1 Slide the solid-state drive into the solid-state drive slot.
- 2 Align the screw hole on the solid-state drive with the screw hole on the computer base.
- 3 Replace the screw that secures the solid-state drive to the computer base.

Post-requisites

Replace the [base panel](#).

Removing the hard drive

 **WARNING:** Before working inside your computer, read the safety information that shipped with your computer and follow the steps in [Before working inside your computer](#). After working inside your computer, follow the instructions in [After working inside your computer](#). For more safety best practices, see the Regulatory Compliance home page at dell.com/regulatory_compliance.

 **CAUTION:** Hard drives are fragile. Exercise care when handling the hard drive.

 **CAUTION:** To avoid data loss, do not remove the hard drive while the computer is in sleep or on state.

Prerequisites

Remove the [base panel](#).

Procedure

- 1 Remove the keyboard-backlight cable, keyboard cable, and macro-keys cable from the routing guides on the computer base.

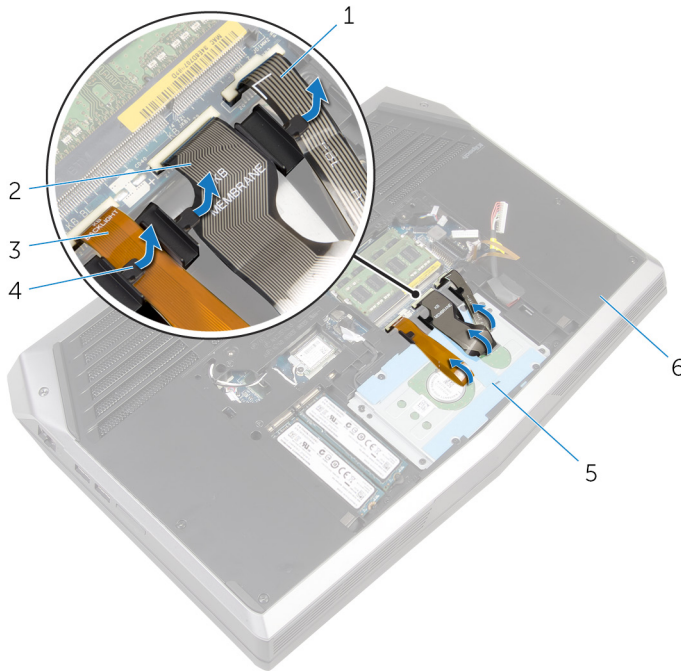

- | | | | |
|---|--------------------------|---|--------------------|
| 1 | macro-keys cable | 2 | keyboard cable |
| 3 | keyboard-backlight cable | 4 | routing guides (3) |
| 5 | hard-drive assembly | 6 | computer base |

- 2 Remove the screws that secure the hard-drive assembly to the computer base.
- 3 Using the pull tab, disconnect the hard-drive cable from the system board.
- 4 Note the hard-drive cable routing and remove the cable from the routing guides on the computer base.

- 5** Lift and slide the hard-drive assembly off the computer base.

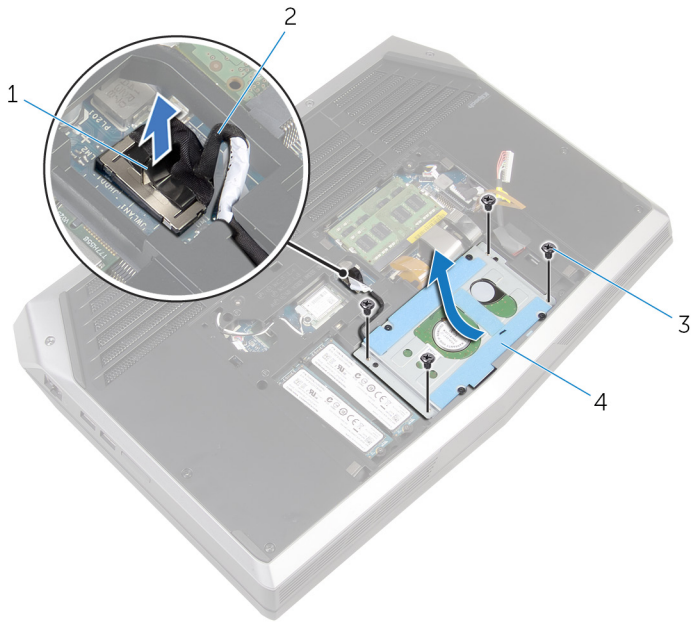

1 pull tab

2 hard-drive cable

3 screws (4)

4 hard-drive assembly

- 6** Remove the screws that secure the hard-drive bracket to the hard-drive assembly.

7 Lift the hard-drive bracket off the hard-drive assembly.

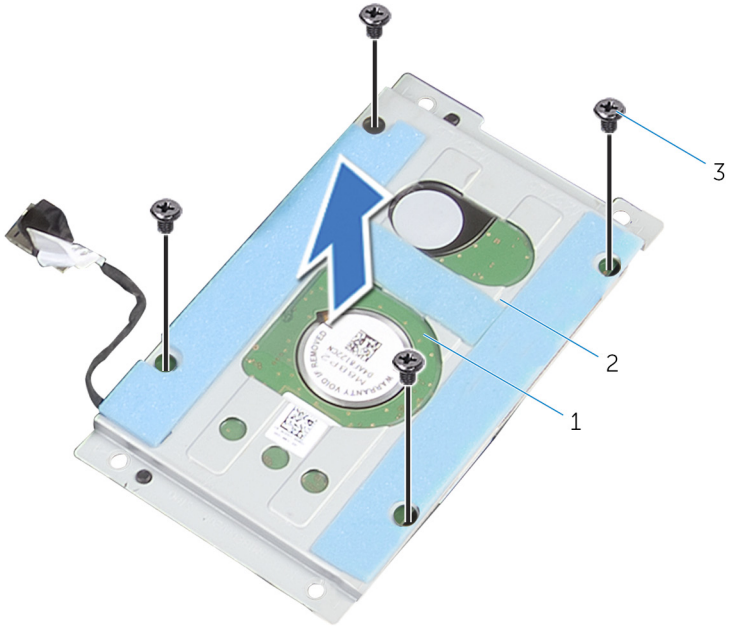

1 hard-drive assembly

2 hard-drive bracket

3 screws (4)

8 Disconnect the interposer from the hard drive.

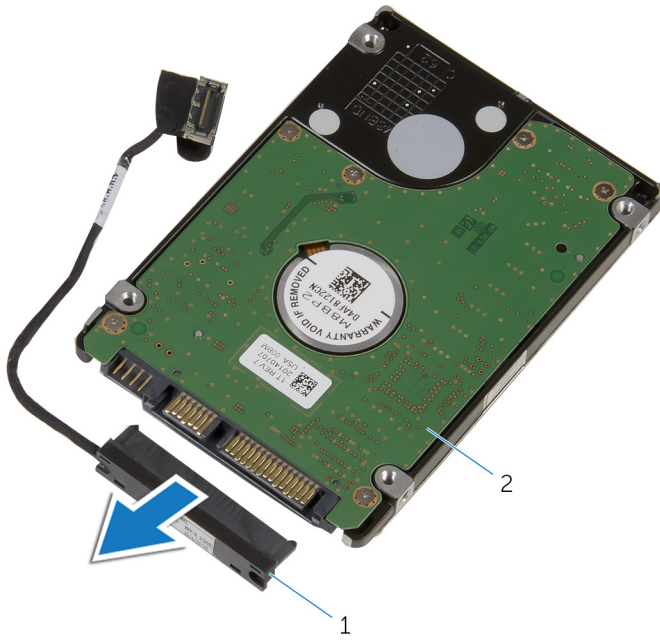

1 interposer

2 hard drive

Replacing the hard drive

 **WARNING:** Before working inside your computer, read the safety information that shipped with your computer and follow the steps in [Before working inside your computer](#). After working inside your computer, follow the instructions in [After working inside your computer](#). For more safety best practices, see the Regulatory Compliance home page at dell.com/regulatory_compliance.

 **CAUTION:** Hard drives are fragile. Exercise care when handling the hard drive.

Procedure

- 1 Connect the interposer to the hard drive.
- 2 Align the screw holes on the hard-drive bracket with the screw holes on the hard-drive assembly.
- 3 Replace the screws that secure the hard-drive bracket to the hard-drive assembly.
- 4 Slide the hard-drive assembly under the tab on the computer base and align the screw holes on the hard-drive assembly with the screw holes on the computer base.
- 5 Replace the screws that secure the hard-drive assembly to the computer base.
- 6 Route the hard-drive cable through the routing guides on the computer base.
- 7 Connect the hard-drive cable to the system board.
- 8 Route the keyboard-backlight cable, keyboard cable, and macro-keys cable through the routing guides on the computer base.

Post-requisites

Replace the [base panel](#).

Removing the wireless card



WARNING: Before working inside your computer, read the safety information that shipped with your computer and follow the steps in [Before working inside your computer](#). After working inside your computer, follow the instructions in [After working inside your computer](#). For more safety best practices, see the Regulatory Compliance home page at dell.com/regulatory_compliance.

Prerequisites

Remove the [base panel](#).

Procedure

- 1 Remove the screw that secures the wireless-card bracket to the system board.
- 2 Lift the wireless-card bracket off the wireless card.
- 3 Disconnect the antenna cables from the wireless card.

4 Lift and slide the wireless card out of the wireless-card slot.

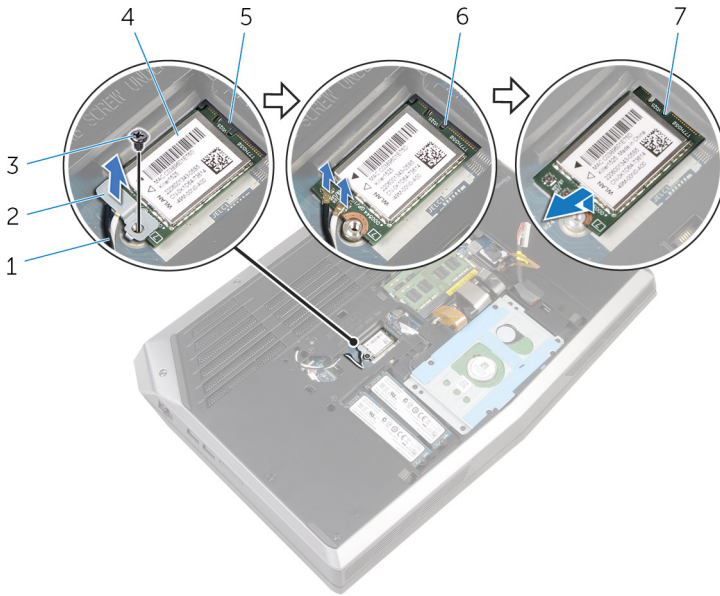

1 antenna cables (2)

3 screw

5 wireless-card slot

7 notches (2)

2 wireless-card bracket

4 wireless card

6 tabs (2)

Replacing the wireless card

 **WARNING:** Before working inside your computer, read the safety information that shipped with your computer and follow the steps in [Before working inside your computer](#). After working inside your computer, follow the instructions in [After working inside your computer](#). For more safety best practices, see the Regulatory Compliance home page at dell.com/regulatory_compliance.

Procedure

 **CAUTION:** To avoid damaging the wireless card, do not place any cables under it.

- 1 Align the notches on the wireless card with the tabs on the wireless-card slot.
- 2 Slide the wireless-card at an angle into the wireless-card slot.
- 3 Connect the antenna cables to the wireless card.

A label at the tip of the antenna cables indicates color scheme for the wireless card supported by your computer.

Connectors on the wireless card	Antenna-cable sticker color
Auxiliary	White
Main	Black

- 4 Press the other end of the wireless card down and align the screw hole on the wireless-card bracket with the screw hole on the system board.
- 5 Replace the screw that secures the wireless-card bracket to the system board.

Post-requisites

Replace the [base panel](#).

Removing the palm rest



WARNING: Before working inside your computer, read the safety information that shipped with your computer and follow the steps in [Before working inside your computer](#). After working inside your computer, follow the instructions in [After working inside your computer](#). For more safety best practices, see the Regulatory Compliance home page at dell.com/regulatory_compliance.

Prerequisites

- 1 Remove the [base panel](#).
- 2 Remove the [memory modules](#).
- 3 Remove the [solid-state drives](#).

Procedure

- 1 Remove the keyboard cable, keyboard-backlight cable, and macro-keys cable from the routing guides on the computer base.

- 2** Lift the latches and disconnect the keyboard-backlight cable, keyboard cable, macro-keys cable, and macro-keys backlight cable from the system board.

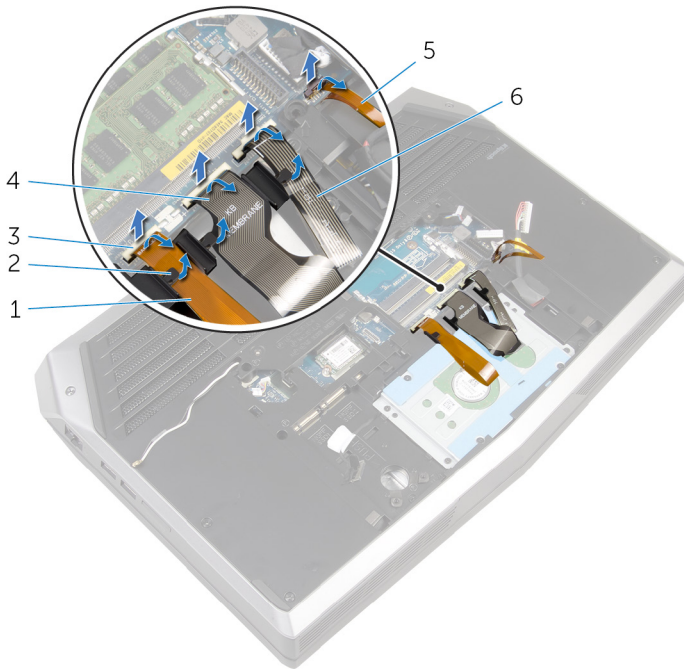

- | | | | |
|---|----------------------------|---|--------------------|
| 1 | keyboard-backlight cable | 2 | routing guides (3) |
| 3 | latches (4) | 4 | keyboard cable |
| 5 | macro-keys backlight cable | 6 | macro-keys cable |

- 3** Remove the screws that secure the palm-rest assembly to the computer base.



1 screws (15)

2 computer base

- 4** Turn the computer over and open the display as far as possible.
5 Lift the computer base and rest the display on a clean and flat surface.

- 6** Push the palm-rest assembly from the release hole to release it from the tabs on the computer base.

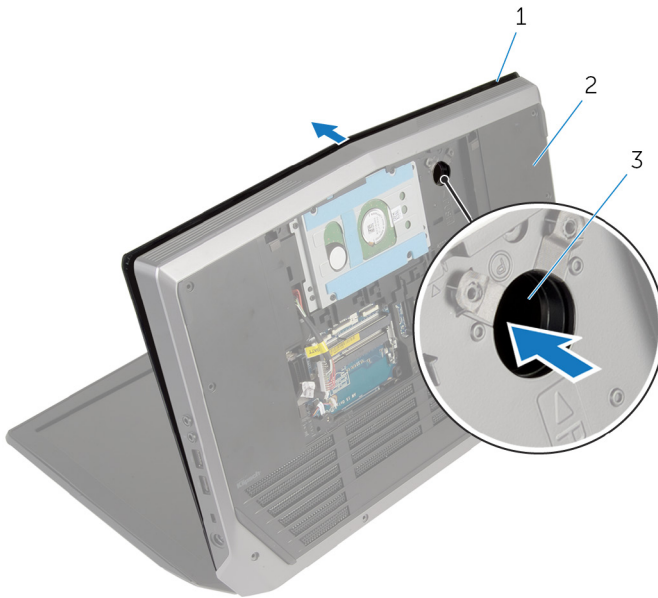

1 palm-rest assembly

2 computer base

3 release hole

- 7** Place the computer in an upright position.

- 8** Using a plastic scribe, pry up along the edges of the palm-rest assembly.

- 9** Gently lift the palm-rest assembly and remove the keyboard cable, keyboard-backlight cable, macro-keys cable, and macro-keys backlight cable from the slot on the computer base.



1 palm-rest assembly

2 plastic scribe

- 10** Carefully turn the palm-rest assembly over and disconnect the power-button board cable from the system board.

11 Lift the palm-rest assembly off the computer base.

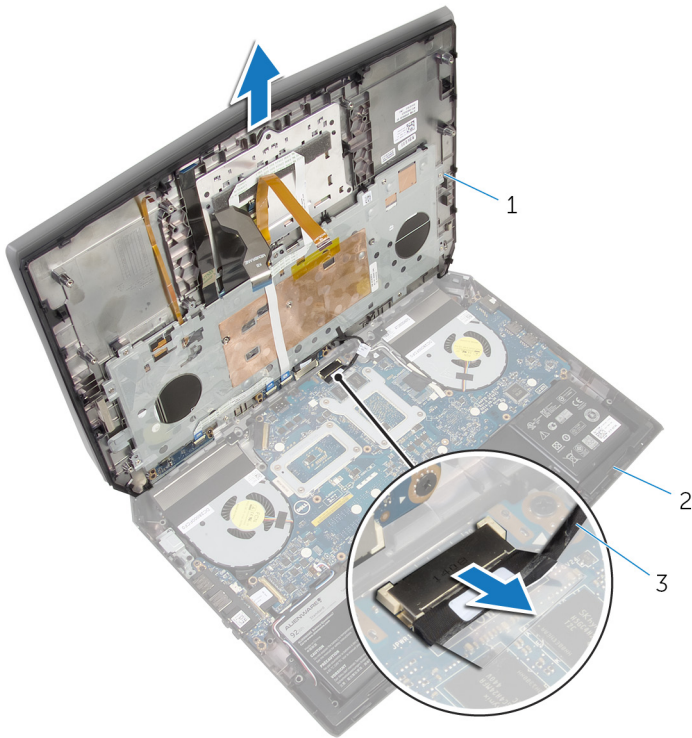

1 palm-rest assembly

2 computer base

3 power-button board cable

12 Turn the palm-rest assembly over.

13 Follow the procedure from step 1 to step 6 in "Removing the [keyboard](#)".

14 Follow the procedure from step 1 to step 4 in "Removing the [power-button board](#)".

15 Follow the procedure from step 1 to step 3 in "Removing the [status-light board](#)".

16 Follow the procedure from step 1 to step 5 in "Removing the [touch pad](#)".

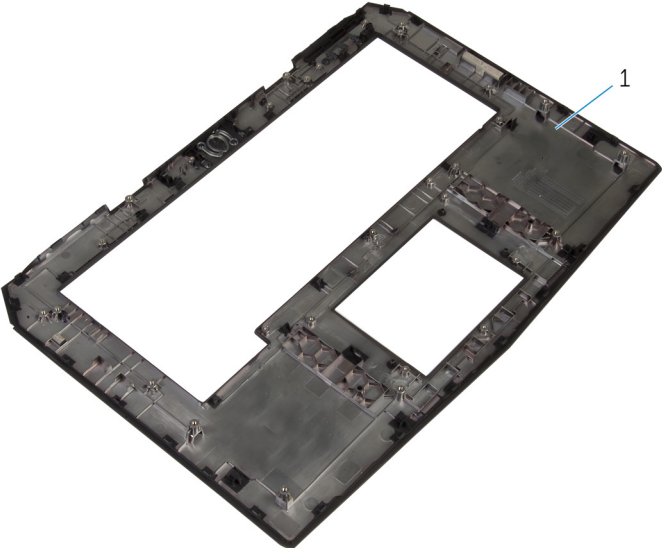

1 palm-rest assembly

Replacing the palm rest



WARNING: Before working inside your computer, read the safety information that shipped with your computer and follow the steps in [Before working inside your computer](#). After working inside your computer, follow the instructions in [After working inside your computer](#). For more safety best practices, see the Regulatory Compliance home page at dell.com/regulatory_compliance.

Procedure

- 1 Follow the procedure from step 1 to step 5 in "Replacing the [touch pad](#)".
- 2 Follow the procedure from step 1 to step 3 in "Replacing the [status-light board](#)".
- 3 Follow the procedure from step 1 to step 4 in "Replacing the [power-button board](#)".
- 4 Follow the procedure from step 1 to step 7 in "Replacing the [keyboard](#)".
- 5 Connect the power-button board cable to the system board.
- 6 Carefully turn the palm-rest assembly over and slide the keyboard cable, keyboard-backlight cable, macro-keys cable, and macro-keys backlight cable into the slot on the computer base.
- 7 Align the palm-rest assembly on the computer base and snap it into place.
- 8 Close the display and turn the computer over.
- 9 Replace the screws that secure the palm-rest assembly to the computer base.
- 10 Slide the keyboard-backlight cable, keyboard cable, macro-keys cable, and macro-keys backlight cable into the system board and press down on the latches to secure the cables.
- 11 Route the keyboard-backlight cable, keyboard cable, and macro-keys cable through the routing guides on the computer base.

Post-requisites

- 1 Replace the [solid-state drives](#).
- 2 Replace the [memory modules](#).
- 3 Replace the [base panel](#).

Removing the touch pad



WARNING: Before working inside your computer, read the safety information that shipped with your computer and follow the steps in [Before working inside your computer](#). After working inside your computer, follow the instructions in [After working inside your computer](#). For more safety best practices, see the Regulatory Compliance home page at dell.com/regulatory_compliance.

Prerequisites

- 1 Remove the [base panel](#).
- 2 Remove the [memory modules](#).
- 3 Remove the [solid-state drives](#).
- 4 Follow the procedure from step 1 to step 12 in "Removing the [palm rest](#)".

Procedure

- 1 Lift the latches and disconnect the touch-pad cable and touch-pad buttons cable from the touch pad.
- 2 Peel off the touch-pad cable from the touch pad.

3 Remove the screws that secure the touch-pad bracket to the palm-rest assembly.

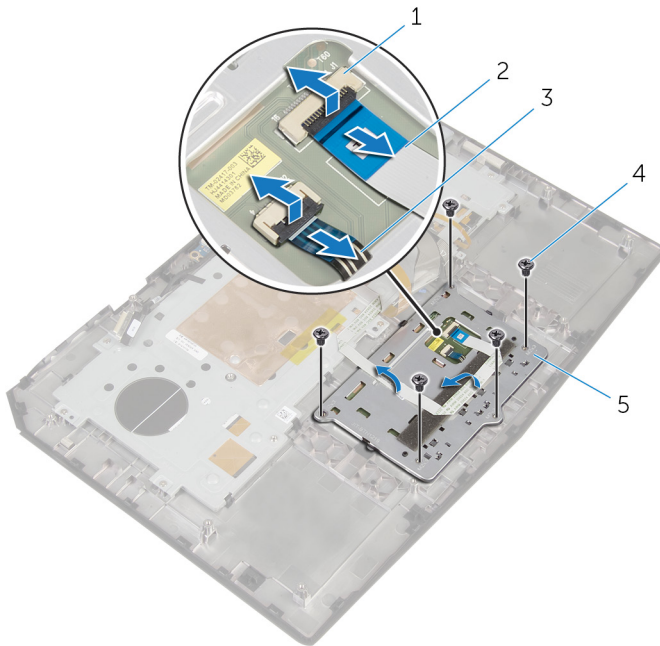

1 latches (2)

2 touch-pad cable

3 touch-pad buttons cable

4 screws (5)

5 touch-pad bracket

- 4** Release the tabs that secure the touch-pad bracket to the palm-rest assembly and lift the touch-pad bracket off the palm-rest assembly.

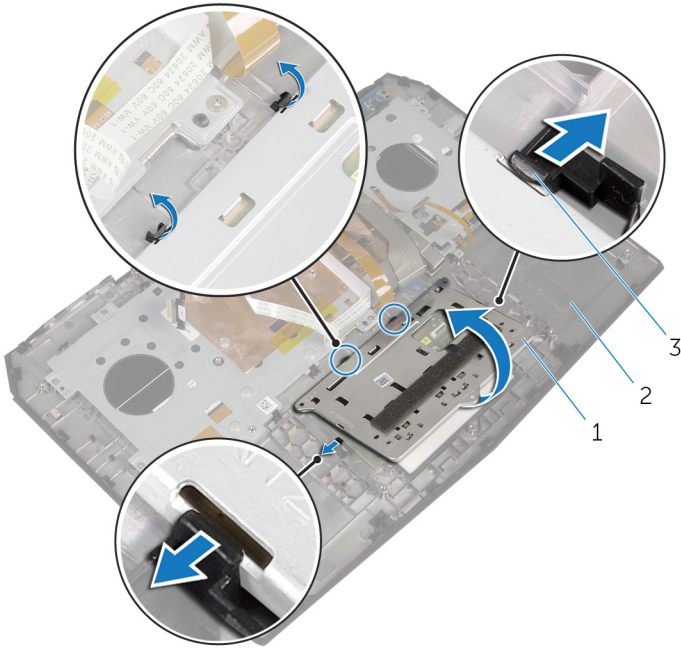

1 touch-pad bracket

2 palm-rest assembly

3 tabs (4)

5 Lift the touch pad off the palm-rest assembly.

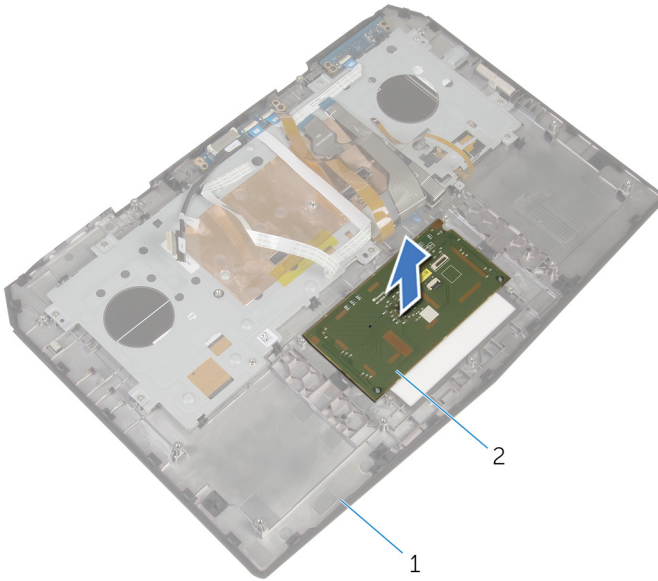

1 palm-rest assembly

2 touch pad

Replacing the touch pad



WARNING: Before working inside your computer, read the safety information that shipped with your computer and follow the steps in [Before working inside your computer](#). After working inside your computer, follow the instructions in [After working inside your computer](#). For more safety best practices, see the Regulatory Compliance home page at dell.com/regulatory_compliance.

Procedure

- 1 Using the alignment posts on the palm-rest assembly, place the touch pad on the palm-rest assembly.
- 2 Align the screw holes on the touch-pad bracket with the screw holes on the palm-rest assembly and snap the touch-pad bracket into place.
- 3 Replace the screws that secure the touch-pad bracket to the palm-rest assembly.
- 4 Adhere the touch-pad cable to the touch pad.
- 5 Slide the touch-pad cable and touch-pad buttons cable into the touch pad and press down on the latches to secure the cables.

Post-requisites

- 1 Follow the procedure from step 5 to step 11 in "Replacing the [palm rest](#)".
- 2 Replace the [solid-state drives](#).
- 3 Replace the [memory modules](#).
- 4 Replace the [base panel](#).

Removing the keyboard



WARNING: Before working inside your computer, read the safety information that shipped with your computer and follow the steps in [Before working inside your computer](#). After working inside your computer, follow the instructions in [After working inside your computer](#). For more safety best practices, see the Regulatory Compliance home page at dell.com/regulatory_compliance.

Prerequisites

- 1 Remove the [base panel](#).
- 2 Remove the [memory modules](#).
- 3 Remove the [solid-state drives](#).
- 4 Follow the procedure from step 1 to step 11 in “Removing the [palm rest](#)”.

Procedure

- 1 Lift the latches and disconnect the touch-pad cable and the status-light cable from the power-button board.

- 2 Note the touch-pad cable and status-light cable routings and peel off the cables from the keyboard bracket.

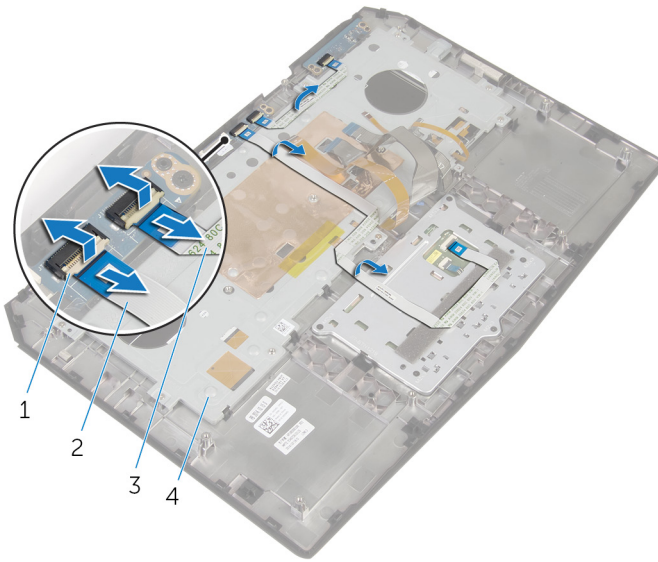

- | | | | |
|---|--------------------|---|------------------|
| 1 | latches (2) | 2 | touch-pad cable |
| 3 | status-light cable | 4 | keyboard bracket |

- 3** Remove the screws that secure the keyboard bracket to the palm-rest assembly.

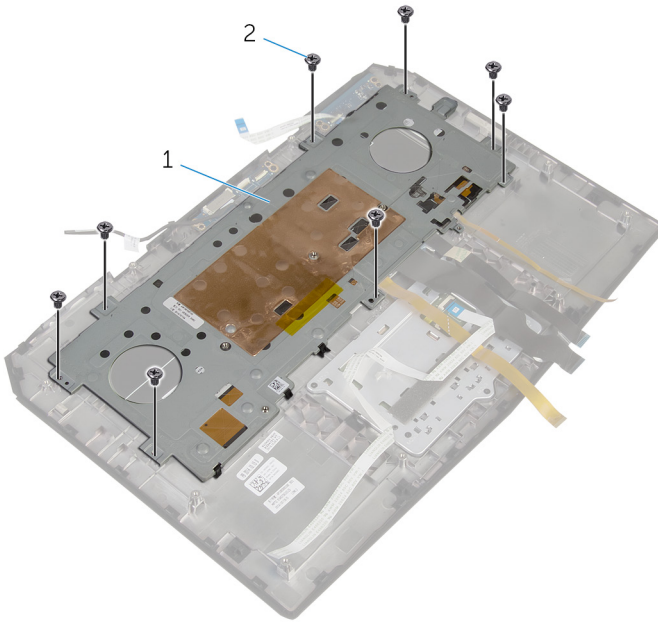

1 keyboard bracket

2 screws (8)

- 4 Lift the keyboard bracket at an angle and remove it from the tabs on the palm-rest assembly.

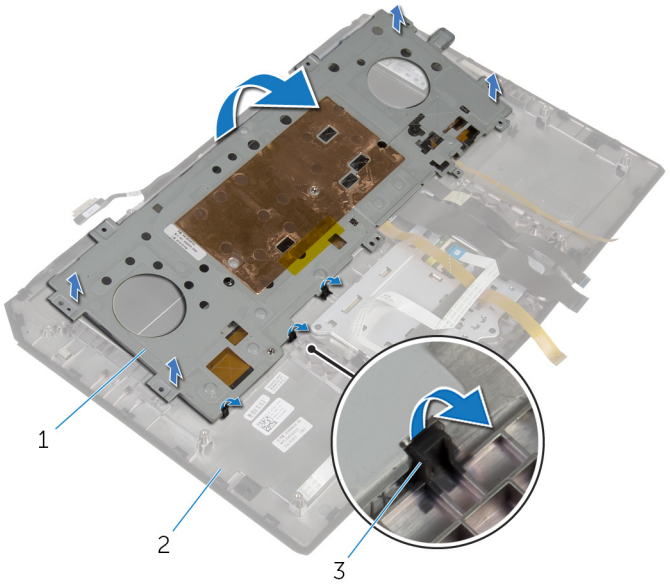

1 keyboard bracket

2 palm-rest assembly

3 tabs (3)

5 Remove the screws that secure the keyboard to the palm-rest assembly.

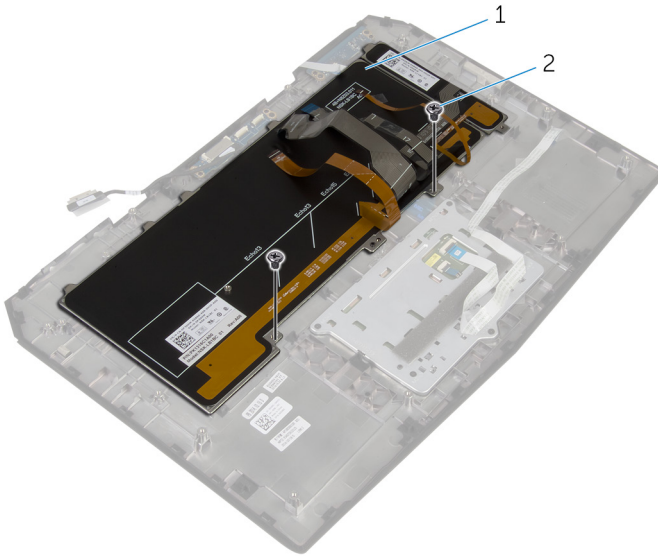

1 keyboard

2 screws (2)

6 Lift the keyboard at an angle and remove it from the tabs on the palm-rest assembly.

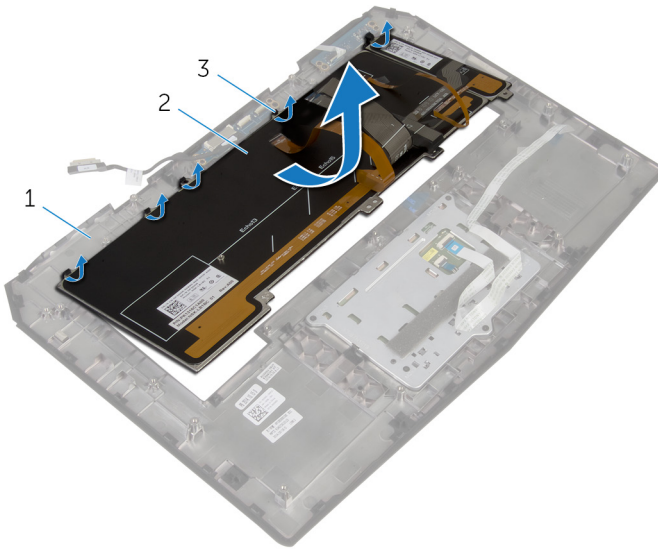

1 palm-rest assembly

2 keyboard

3 tabs (5)

Replacing the keyboard

 **WARNING:** Before working inside your computer, read the safety information that shipped with your computer and follow the steps in [Before working inside your computer](#). After working inside your computer, follow the instructions in [After working inside your computer](#). For more safety best practices, see the Regulatory Compliance home page at dell.com/regulatory_compliance.

Procedure

 **CAUTION:** Make sure that no cables are under the keyboard.

- 1 Slide the keyboard under the tabs on the palm-rest assembly.
- 2 Align the screw holes on the keyboard with the screw holes on the palm-rest assembly.
- 3 Replace the screws that secure the keyboard to the palm-rest assembly.
- 4 Align the screw holes on the keyboard bracket with the screw holes on the palm-rest assembly and snap the keyboard bracket into place.
- 5 Replace the screws that secure the keyboard bracket to the palm-rest assembly.
- 6 Adhere the touch-pad cable and status-light cable to the keyboard bracket.
- 7 Slide the touch-pad cable and the status-light cable into the power-button board and press down on the latches to secure the cables.

Post-requisites

- 1 Follow the procedure from step 5 to step 12 in "Replacing the [palm rest](#)".
- 2 Replace the [solid-state drives](#).
- 3 Replace the [memory modules](#).
- 4 Replace the [base panel](#).

Removing the power-button board



WARNING: Before working inside your computer, read the safety information that shipped with your computer and follow the steps in [Before working inside your computer](#). After working inside your computer, follow the instructions in [After working inside your computer](#). For more safety best practices, see the Regulatory Compliance home page at dell.com/regulatory_compliance.

Prerequisites

- 1 Remove the [base panel](#).
- 2 Remove the [memory modules](#).
- 3 Remove the [solid-state drives](#).
- 4 Follow the procedure from step 1 to step 12 in “Removing the [palm rest](#)”.

Procedure

- 1 Lift the latches and disconnect the touch-pad cable and status-light cable from the power-button board.

- 2** Disconnect the power-button board cable from the power-button board.

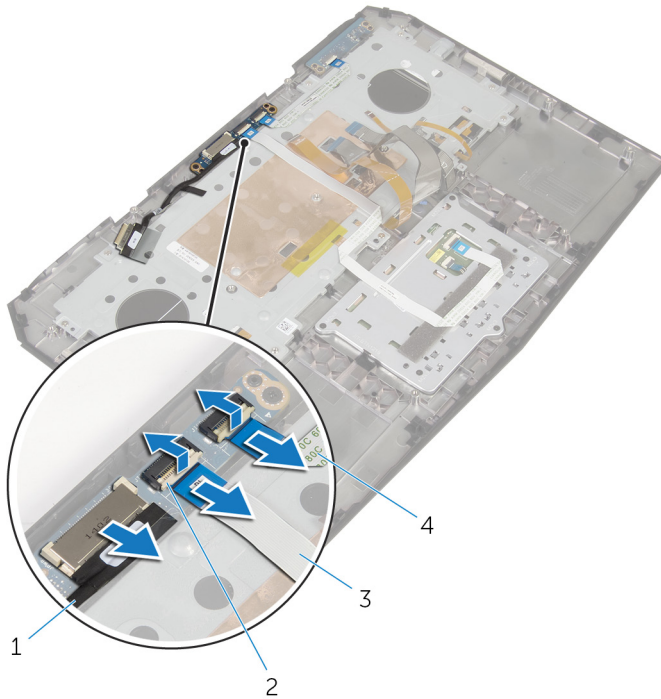

- | | | | |
|---|--------------------------|---|--------------------|
| 1 | power-button board cable | 2 | latches (2) |
| 3 | touch-pad cable | 4 | status-light cable |

- 3** Remove the screws that secure the power-button board to the palm-rest assembly.

4 Lift the power-button board off the palm-rest assembly.

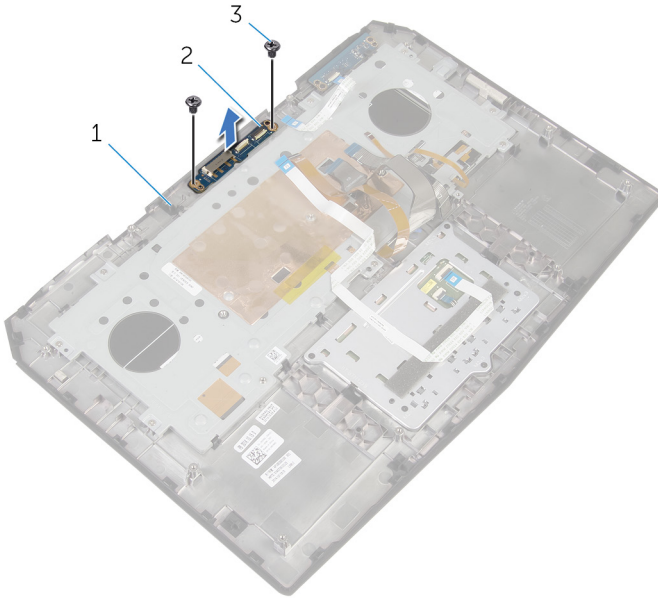

1 palm-rest assembly

2 power-button board

3 screws (2)

Replacing the power-button board



WARNING: Before working inside your computer, read the safety information that shipped with your computer and follow the steps in [Before working inside your computer](#). After working inside your computer, follow the instructions in [After working inside your computer](#). For more safety best practices, see the Regulatory Compliance home page at dell.com/regulatory_compliance.

Procedure

- 1 Align the screw holes on the power-button board with the screw holes on the palm-rest assembly.
- 2 Replace the screws that secure the power-button board to the palm-rest assembly.
- 3 Slide the touch-pad cable and status-light cable into the power-button board and press down on the latches to secure the cables.
- 4 Connect the power-button board cable to the power-button board.

Post-requisites

- 1 Follow the procedure from step 5 to step 11 in "Replacing the [palm rest](#)".
- 2 Replace the [solid-state drives](#).
- 3 Replace the [memory modules](#).
- 4 Replace the [base panel](#).

Removing the status-light board



WARNING: Before working inside your computer, read the safety information that shipped with your computer and follow the steps in [Before working inside your computer](#). After working inside your computer, follow the instructions in [After working inside your computer](#). For more safety best practices, see the Regulatory Compliance home page at dell.com/regulatory_compliance.

Prerequisites

- 1 Remove the [base panel](#).
- 2 Remove the [memory modules](#).
- 3 Remove the [solid-state drives](#).
- 4 Follow the procedure from step 1 to step 12 in "Removing the [palm rest](#)".

Procedure

- 1 Lift the latch and disconnect the status-light board cable from the status-light board.

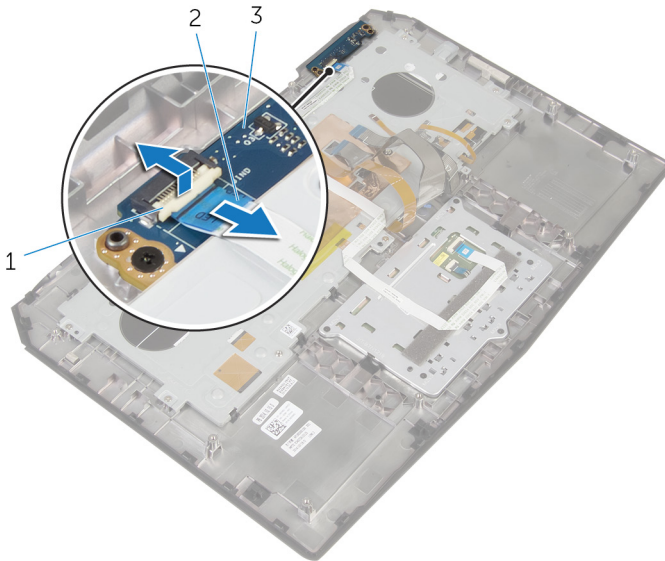

- | | | | |
|---|--------------------|---|--------------------------|
| 1 | latch | 2 | status-light board cable |
| 3 | status-light board | | |

- 2 Remove the screws that secure the status-light board to the palm-rest assembly.

3 Lift the status-light board off the palm-rest assembly.

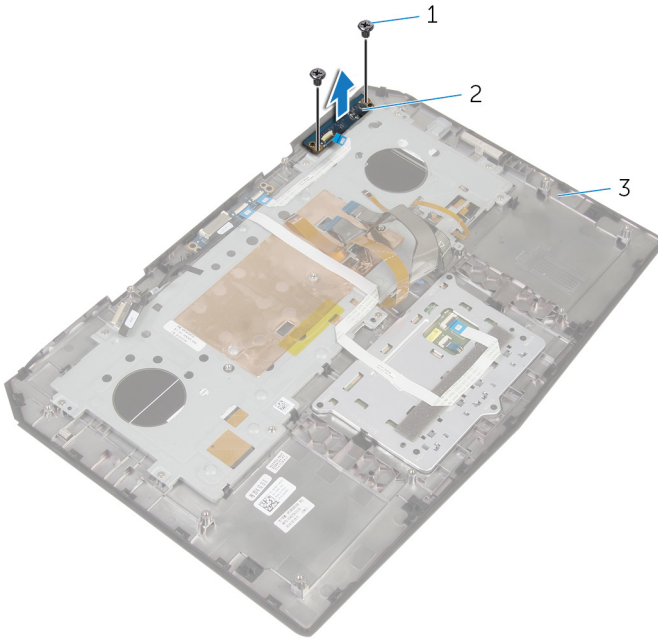

1 screws (2)

2 status-light board

3 palm-rest assembly

Replacing the status-light board

 **WARNING:** Before working inside your computer, read the safety information that shipped with your computer and follow the steps in [Before working inside your computer](#). After working inside your computer, follow the instructions in [After working inside your computer](#). For more safety best practices, see the Regulatory Compliance home page at dell.com/regulatory_compliance.

Procedure

- 1 Align the screw holes on the status-light board with the screw holes on the palm-rest assembly.
- 2 Replace the screws that secure the status-light board to the palm-rest assembly.
- 3 Slide the status-light board cable into the status-light board and press down on the latch to secure the cable.

Post-requisites

- 1 Follow the procedure from step 5 to step 11 in “Replacing the [palm rest](#)”.
- 2 Replace the [solid-state drives](#).
- 3 Replace the [memory modules](#).
- 4 Replace the [base panel](#).

Removing the I/O board



WARNING: Before working inside your computer, read the safety information that shipped with your computer and follow the steps in [Before working inside your computer](#). After working inside your computer, follow the instructions in [After working inside your computer](#). For more safety best practices, see the Regulatory Compliance home page at dell.com/regulatory_compliance.

Prerequisites

- 1 Remove the [base panel](#).
- 2 Remove the [memory module](#).
- 3 Remove the [solid-state drives](#).
- 4 Follow the procedure from step 1 to step 11 in “Removing the [palm rest](#)”.

Procedure

- 1 Lift the latch and disconnect the I/O-board cable from the I/O board.
- 2 Remove the screws that secure the I/O-board to the computer base.

3 Lift the I/O board off the computer base.

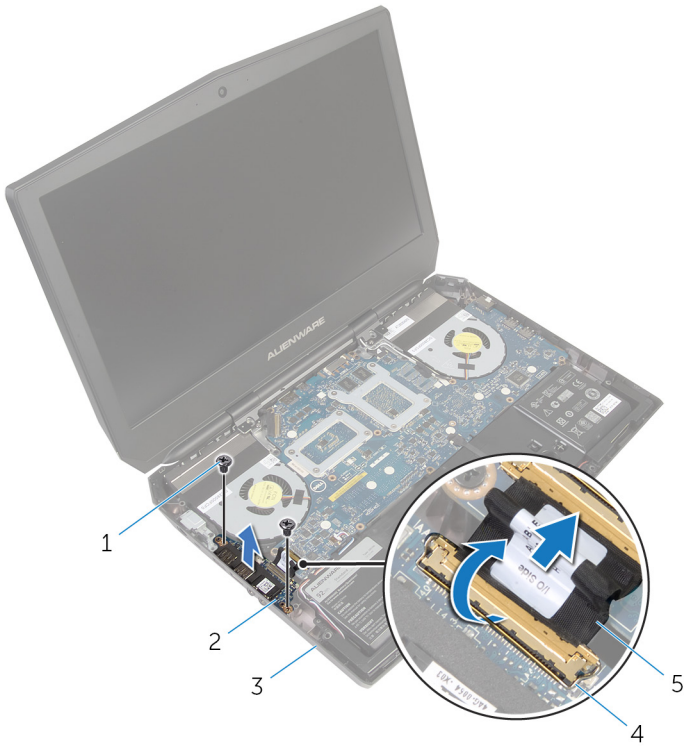

1 screws (2)

2 I/O board

3 computer base

4 latch

5 I/O-board cable

Replacing the I/O board



WARNING: Before working inside your computer, read the safety information that shipped with your computer and follow the steps in [Before working inside your computer](#). After working inside your computer, follow the instructions in [After working inside your computer](#). For more safety best practices, see the Regulatory Compliance home page at dell.com/regulatory_compliance.

Procedure

- 1 Align the screw holes on the I/O board with the screw holes on the computer base.
- 2 Replace the screws that secure the I/O board to the computer base.
- 3 Slide the I/O-board cable into the I/O board and press down on the latch to secure the cable.

Post-requisites

- 1 Follow the procedure from step 5 to step 11 in "Replacing the [palm rest](#)".
- 2 Replace the [solid-state drives](#).
- 3 Replace the [memory module](#).
- 4 Replace the [base panel](#).

Removing the speakers



WARNING: Before working inside your computer, read the safety information that shipped with your computer and follow the steps in [Before working inside your computer](#). After working inside your computer, follow the instructions in [After working inside your computer](#). For more safety best practices, see the Regulatory Compliance home page at dell.com/regulatory_compliance.

Prerequisites

- 1 Remove the [base panel](#).
- 2 Remove the [memory modules](#).
- 3 Remove the [solid-state drives](#).
- 4 Follow the procedure from step 1 to step 11 in “Removing the [palm rest](#)”.

Procedure

- 1 Disconnect the speaker cable from the system board.
- 2 Peel of the tape and disconnect the front AlienFX LED cable from the system board.

- 3** Note the front AlienFX LED cable routing and peel off the cable from the battery.



- | | | | |
|---|-------------------------|---|--------------|
| 1 | speaker cable | 2 | tape |
| 3 | front AlienFX LED cable | 4 | speakers (2) |

- 4** Remove the speaker cable from the routing guides on the battery and computer base.

5 Lift the speakers along with its cable off the computer base.

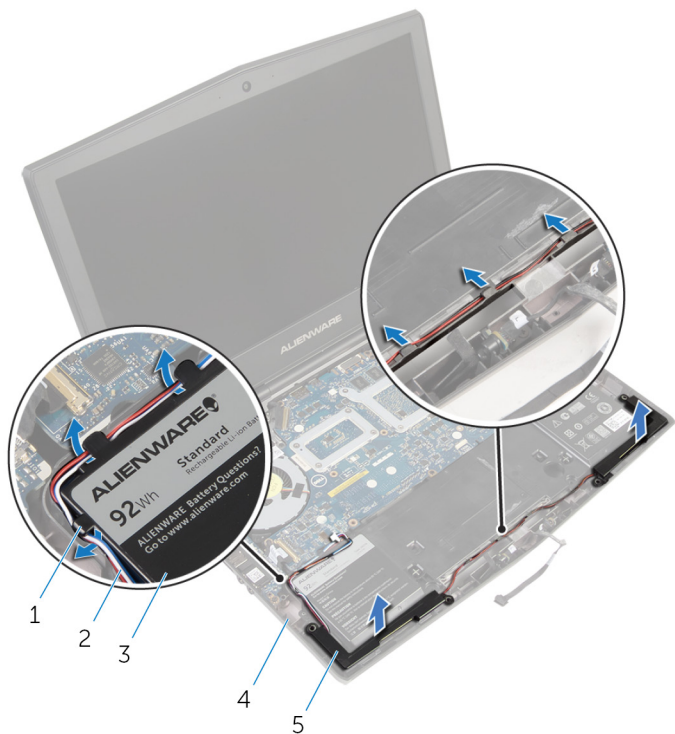

1 routing guides (6)

2 speaker cable

3 battery

4 computer base

5 speakers (2)

Replacing the speakers



WARNING: Before working inside your computer, read the safety information that shipped with your computer and follow the steps in [Before working inside your computer](#). After working inside your computer, follow the instructions in [After working inside your computer](#). For more safety best practices, see the Regulatory Compliance home page at dell.com/regulatory_compliance.

Procedure

- 1 Using the alignment posts, place the speakers on the computer base.
- 2 Route the speaker cable through the routing guides on the battery and computer base.
- 3 Adhere the front AlienFX LED cable to the battery.
- 4 Connect the front AlienFX LED cable to the system board and secure it with the tape.
- 5 Connect the speaker cable to the system board.

Post-requisites

- 1 Follow the procedure from step 5 to step 11 in “Replacing the [palm rest](#)”.
- 2 Replace the [solid-state drives](#).
- 3 Replace the [memory modules](#).
- 4 Replace the [base panel](#).

Removing the front AlienFX LED boards

 **WARNING:** Before working inside your computer, read the safety information that shipped with your computer and follow the steps in [Before working inside your computer](#). After working inside your computer, follow the instructions in [After working inside your computer](#). For more safety best practices, see the Regulatory Compliance home page at dell.com/regulatory_compliance.

Prerequisites

- 1 Remove the [base panel](#).
- 2 Remove the [memory modules](#).
- 3 Remove the [solid-state drives](#).
- 4 Follow the procedure from step 1 to step 11 in “Removing the [palm rest](#)”.

Procedure

- 1 Remove the screws that secure the front AlienFX LED boards to the computer base.
- 2 Lift the front AlienFX LED boards and disconnect the front AlienFX LED board cables from the front AlienFX LED boards.
- 3 Remove the screws that secure the front AlienFX LED boards to the tubes.

4 Lift the front AlienFX LED boards of the tubes.

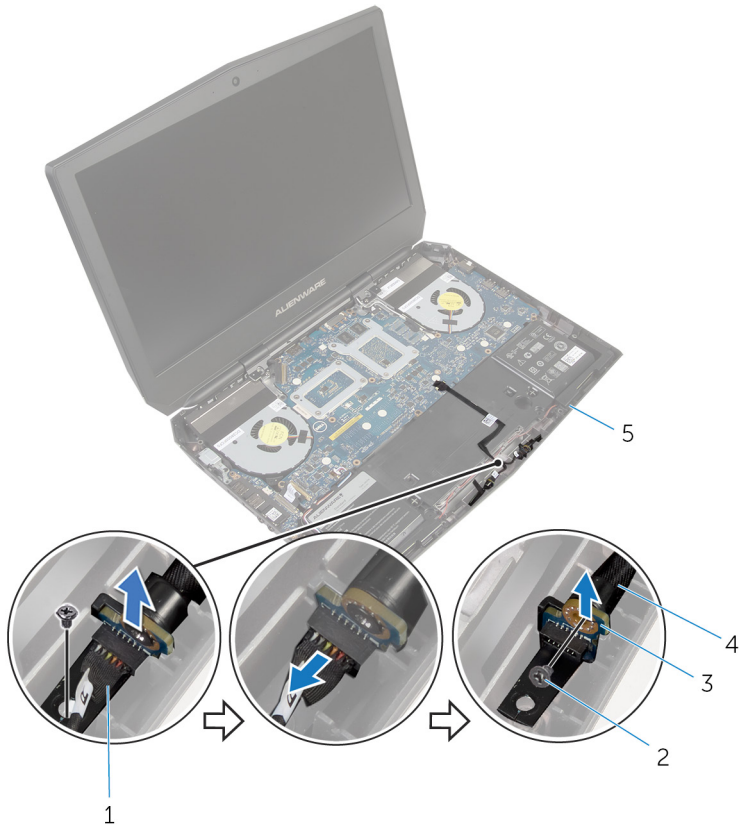

- | | | | |
|---|------------------------------------|---|------------|
| 1 | front AlienFX LED board cables (2) | 2 | screws (4) |
| 3 | front AlienFX LED boards (2) | 4 | tubes (2) |
| 5 | computer base | | |

Replacing the front AlienFX LED board

 **WARNING:** Before working inside your computer, read the safety information that shipped with your computer and follow the steps in [Before working inside your computer](#). After working inside your computer, follow the instructions in [After working inside your computer](#). For more safety best practices, see the Regulatory Compliance home page at dell.com/regulatory_compliance.

Procedure

- 1 Align the screw holes on the front AlienFX LED boards with the screw holes on the tubes.
- 2 Replace the screws that secure the front AlienFX LED boards to the tubes.
- 3 Connect the front AlienFX LED board cables to the front AlienFX LED boards.
- 4 Align the screw holes on the front AlienFX LED boards with the screw holes on the computer base.
- 5 Replace the screws that secure the front AlienFX LED board to the computer base.

Post-requisites

- 1 Follow the procedure from step 5 to step 11 in “Replacing the [palm rest](#)”.
- 2 Replace the [solid-state drives](#).
- 3 Replace the [memory modules](#).
- 4 Replace the [base panel](#).

Removing the hinge covers



WARNING: Before working inside your computer, read the safety information that shipped with your computer and follow the steps in [Before working inside your computer](#). After working inside your computer, follow the instructions in [After working inside your computer](#). For more safety best practices, see the Regulatory Compliance home page at dell.com/regulatory_compliance.

Prerequisites

- 1 Remove the [base panel](#).
- 2 Remove the [memory modules](#).
- 3 Remove the [solid-state drives](#).
- 4 Follow the procedure from step 1 to step 11 in “Removing the [palm rest](#)”.

Procedure

- 1 Remove the screws that secure the hinge covers to the computer base.
- 2 Open the display as far as possible.

3 Remove the hinge covers from the computer base.

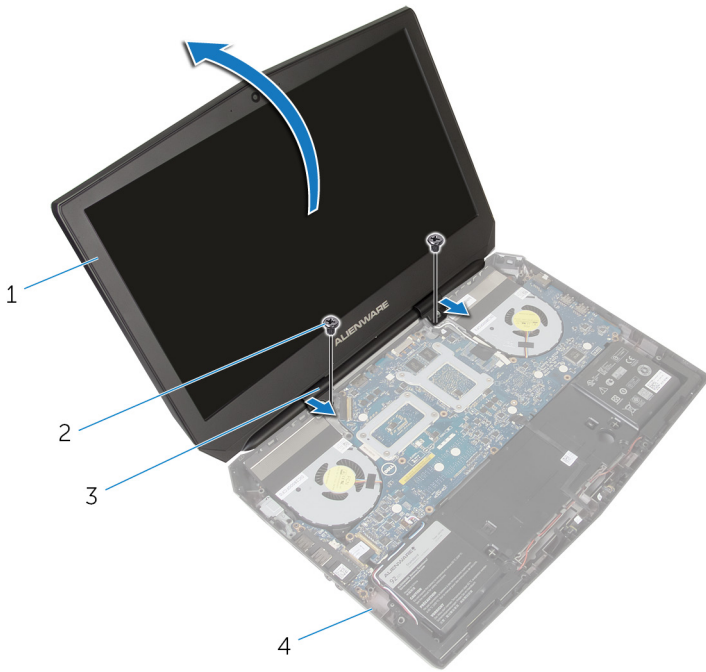

1 display assembly

2 screws (2)

3 hinge covers (2)

4 computer base

Replacing the hinge covers



WARNING: Before working inside your computer, read the safety information that shipped with your computer and follow the steps in [Before working inside your computer](#). After working inside your computer, follow the instructions in [After working inside your computer](#). For more safety best practices, see the Regulatory Compliance home page at dell.com/regulatory_compliance.

Procedure

- 1 Align the screw holes on the hinge covers with the screw holes on the computer base and snap the hinge covers into place.
- 2 Replace the screws that secure the hinge covers to the computer base.

Post-requisites

- 1 Follow the procedure from step 5 to step 11 in “Replacing the [palm rest](#)”.
- 2 Replace the [solid-state drives](#).
- 3 Replace the [memory modules](#).
- 4 Replace the [base panel](#).

Removing the display assembly



WARNING: Before working inside your computer, read the safety information that shipped with your computer and follow the steps in [Before working inside your computer](#). After working inside your computer, follow the instructions in [After working inside your computer](#). For more safety best practices, see the Regulatory Compliance home page at dell.com/regulatory_compliance.

Prerequisites

- 1 Remove the [base panel](#).
- 2 Remove the [memory modules](#).
- 3 Remove the [solid-state drives](#).
- 4 Remove the [wireless card](#).
- 5 Follow the procedure from step 1 to step 11 in “Removing the [palm rest](#)”.
- 6 Remove the [hinge covers](#).

Procedure

- 1 Close the display and turn the computer over.
- 2 Remove the antenna cables from the routing guide on the computer base.

- 3 Remove the screws that secure the display assembly to the computer base.



- | | | | |
|---|------------------|---|---------------|
| 1 | display assembly | 2 | computer base |
| 3 | screws (2) | | |

- 4 Turn the computer over and open the display as far as possible.
- 5 Carefully remove the antenna cables through the slot on the computer base.
- 6 Peel off the adhesive tape that secures the antenna cables to the system board.
- 7 Remove the antenna cables from the routing guide on the display hinges.
- 8 Lift the latch and disconnect the display cable from the system board.

- 9** Peel off the adhesive tape, disconnect the logo-board cable from the system board, and remove it from the routing guide on the display hinges.

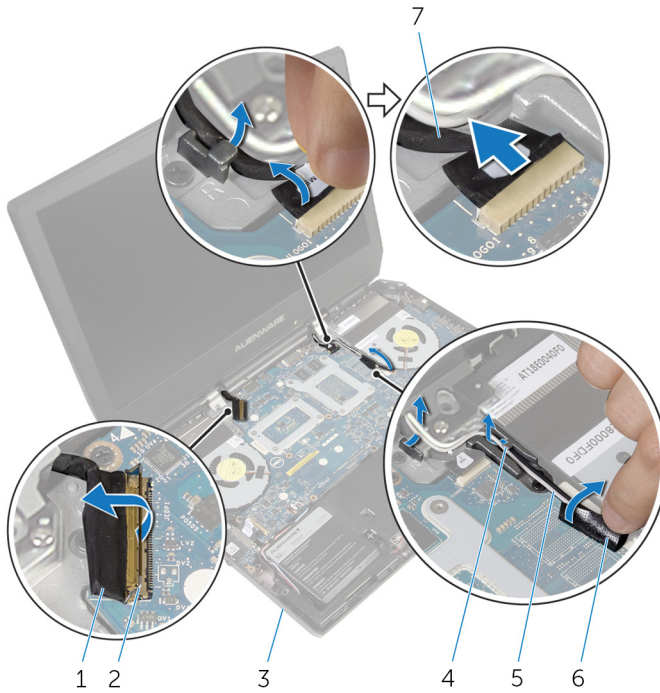

- | | | | |
|---|--------------------|---|--------------------|
| 1 | display cable | 2 | latch |
| 3 | computer base | 4 | routing guides (2) |
| 5 | antenna cables (2) | 6 | adhesive tapes (2) |
| 7 | logo-board cable | | |

- 10** Remove the screws that secure the display assembly to the computer base.

11 Lift the display assembly off the computer base.

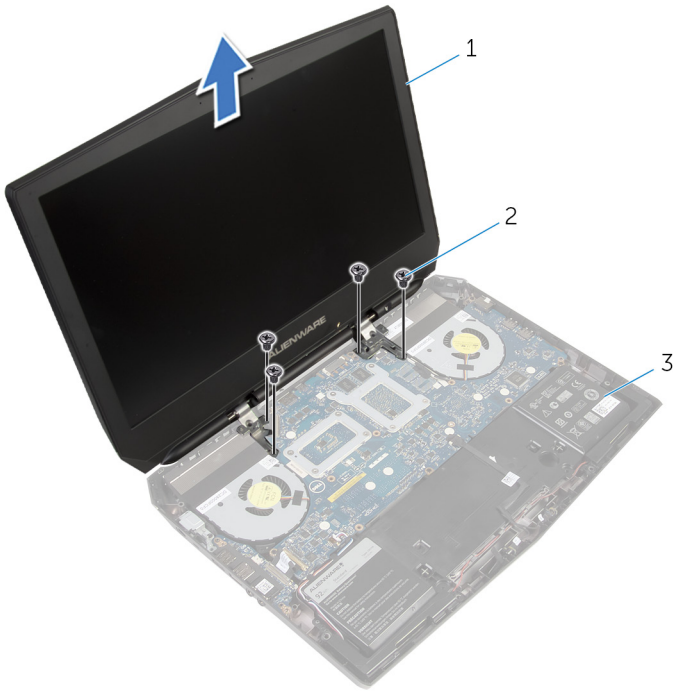

1 display assembly

2 screws (4)

3 computer base

Replacing the display assembly

 **WARNING:** Before working inside your computer, read the safety information that shipped with your computer and follow the steps in [Before working inside your computer](#). After working inside your computer, follow the instructions in [After working inside your computer](#). For more safety best practices, see the Regulatory Compliance home page at dell.com/regulatory_compliance.

Procedure

- 1 Align the screw holes on the display hinges with the screw holes on the computer base.
- 2 Replace the screws that secure the display hinges to the computer base.
- 3 Route the logo-board cable through the routing guide on the display hinge.
- 4 Connect the logo-board cable to the system board and secure it with the tape.
- 5 Slide the display cable into the system board and press down on the latch to secure the cable.
- 6 Route the antenna cables through the routing guide on the display hinges.
- 7 Adhere the adhesive tape that secure the antenna cables to the system board.
- 8 Slide the antenna cables through the slot on the computer base.
- 9 Close the display and turn the computer over.
- 10 Route the antenna cables through the routing guide on the computer base.
- 11 Replace the screws that secure the display assembly to the computer base.
- 12 Turn the computer over and open the display as far as possible.

Post-requisites

- 1 Replace the [hinge covers](#).
- 2 Follow the procedure from step 5 to step 11 in "Replacing the [palm rest](#)".

- 3** Replace the [wireless card](#).
- 4** Replace the [solid-state drives](#).
- 5** Replace the [memory modules](#).
- 6** Replace the [base panel](#).

Removing the display bezel



WARNING: Before working inside your computer, read the safety information that shipped with your computer and follow the steps in [Before working inside your computer](#). After working inside your computer, follow the instructions in [After working inside your computer](#). For more safety best practices, see the Regulatory Compliance home page at dell.com/regulatory_compliance.

Prerequisites

- 1 Remove the [base panel](#).
- 2 Remove the [memory modules](#).
- 3 Remove the [solid-state drives](#).
- 4 Remove the [wireless card](#).
- 5 Follow the procedure from step 1 to step 11 in “Removing the [palm rest](#)”.
- 6 Remove the [hinge covers](#).
- 7 Remove the [display assembly](#).

Procedure

- 1 Using your fingertips, carefully pry up the inside edges of the display bezel.

- 2** Carefully lift the display bezel and turn it over.



1 display bezel

- 3** Lift the latches and disconnect the display-board cables from the logo board.

4 Peel off the adhesive tape and disconnect the logo-board cable from the logo board.

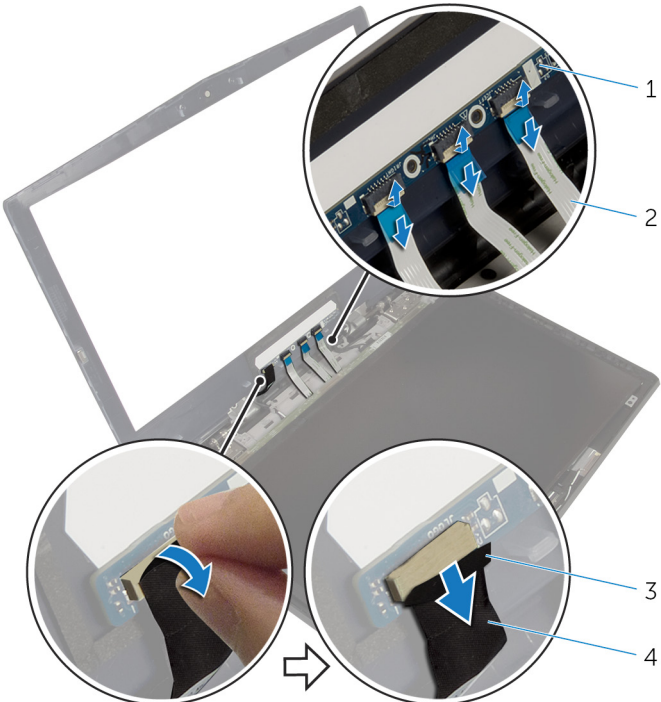

- 1 logo board
- 2 display-board cables (3)
- 3 adhesive tape
- 4 logo-board cable

- 5 Follow the procedure from step 1 to step 2 in “Removing the [logo board](#)”.



- 1 display bezel

Replacing the display bezel



WARNING: Before working inside your computer, read the safety information that shipped with your computer and follow the steps in [Before working inside your computer](#). After working inside your computer, follow the instructions in [After working inside your computer](#). For more safety best practices, see the Regulatory Compliance home page at dell.com/regulatory_compliance.

Procedure

- 1 Follow the procedure from step 1 to step 2 in “Replacing the [logo board](#)”.
- 2 Connect the logo-board cable to the logo board and secure it with the adhesive tape.
- 3 Slide the display-board cables into the logo board and press down on the latches to secure the cables.
- 4 Carefully turn the display bezel over.
- 5 Align the display bezel with the display back-cover and gently snap the display bezel into place.

Post-requisites

- 1 Replace the [display assembly](#).
- 2 Replace the [hinge covers](#).
- 3 Follow the procedure from step 5 to step 11 in “Replacing the [palm rest](#)”.
- 4 Replace the [wireless card](#).
- 5 Replace the [solid-state drives](#).
- 6 Replace the [memory modules](#).
- 7 Replace the [base panel](#).

Removing the display panel



WARNING: Before working inside your computer, read the safety information that shipped with your computer and follow the steps in [Before working inside your computer](#). After working inside your computer, follow the instructions in [After working inside your computer](#). For more safety best practices, see the Regulatory Compliance home page at dell.com/regulatory_compliance.

Prerequisites

- 1 Remove the [base panel](#).
- 2 Remove the [memory modules](#).
- 3 Remove the [solid-state drives](#).
- 4 Remove the [wireless card](#).
- 5 Follow the procedure from step 1 to step 11 in “Removing the [palm rest](#)”.
- 6 Remove the [hinge covers](#).
- 7 Remove the [display assembly](#).
- 8 Follow the procedure from step 1 to step 4 in “Removing the [display bezel](#)”.

Procedure

- 1 Remove the screws that secure the display panel to the display back-cover.

2 Gently lift the display panel and turn it over.

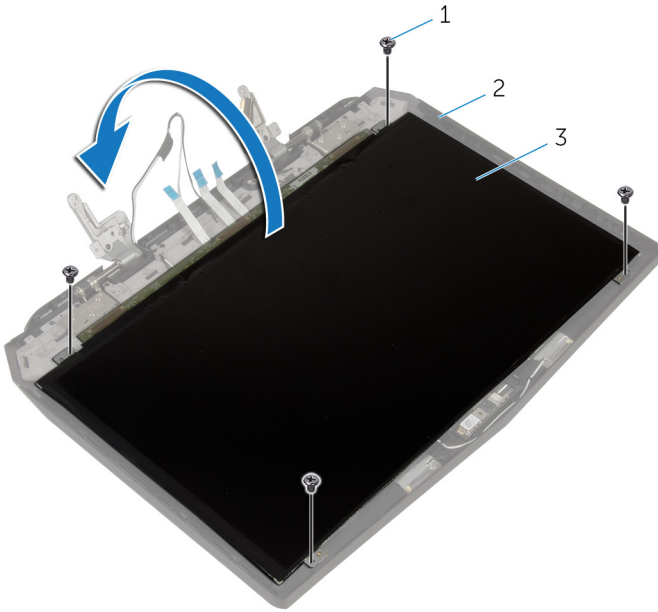

1 screws (4)

2 display back-cover

3 display panel

3 Lift the latch and disconnect the display cable from the display panel.

4 Lift the display panel off the display back-cover.

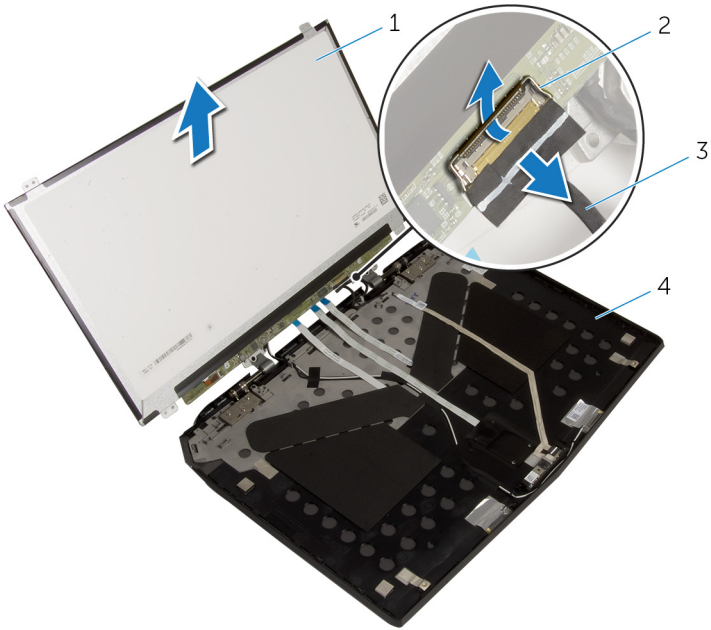

1 display panel

3 display cable

2 latch

4 display back-cover

Replacing the display panel



WARNING: Before working inside your computer, read the safety information that shipped with your computer and follow the steps in [Before working inside your computer](#). After working inside your computer, follow the instructions in [After working inside your computer](#). For more safety best practices, see the Regulatory Compliance home page at dell.com/regulatory_compliance.

Procedure

- 1 Slide the display cable into the display panel and press down on the latch to secure the cable.
- 2 Turn the display panel over.
- 3 Align the screw holes on the display panel with the screw holes on the display back-cover.
- 4 Replace the screws that secure the display panel to the display back-cover.

Post-requisites

- 1 Follow the procedure from step 2 to step 5 in “Replacing the [display bezel](#)”.
- 2 Replace the [display assembly](#).
- 3 Replace the [hinge covers](#).
- 4 Follow the procedure from step 5 to step 11 in “Replacing the [palm rest](#)”.
- 5 Replace the [wireless card](#).
- 6 Replace the [solid-state drives](#).
- 7 Replace the [memory modules](#).
- 8 Replace the [base panel](#).

Removing the display hinges



WARNING: Before working inside your computer, read the safety information that shipped with your computer and follow the steps in [Before working inside your computer](#). After working inside your computer, follow the instructions in [After working inside your computer](#). For more safety best practices, see the Regulatory Compliance home page at dell.com/regulatory_compliance.

Prerequisites

- 1 Remove the [base panel](#).
- 2 Remove the [memory modules](#).
- 3 Remove the [solid-state drives](#).
- 4 Remove the [wireless card](#).
- 5 Follow the procedure from step 1 to step 11 in “Removing the [palm rest](#)”.
- 6 Remove the [hinge covers](#).
- 7 Remove the [display assembly](#).
- 8 Follow the procedure from step 1 to step 4 in “Removing the [display bezel](#)”.

Procedure

- 1 Remove the screws that secure the display hinges to the display back-cover.

2 Lift the display hinges off the display assembly.

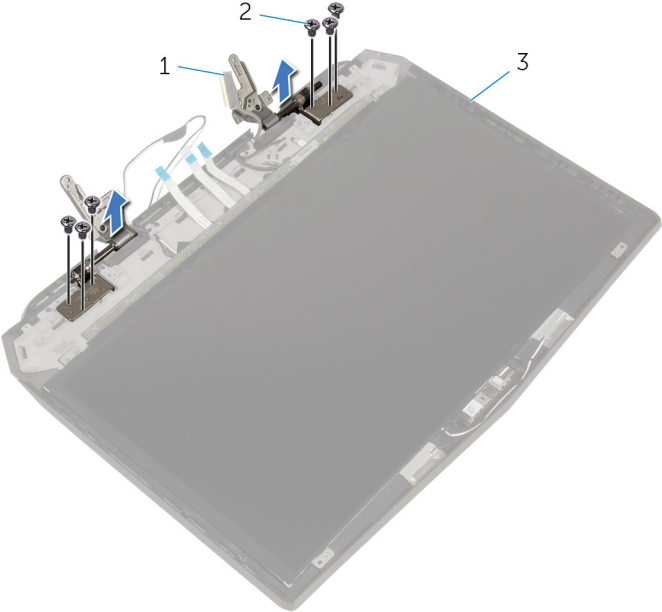

1 display hinges (2)

2 screws (6)

3 display back-cover

Replacing the display hinges



WARNING: Before working inside your computer, read the safety information that shipped with your computer and follow the steps in [Before working inside your computer](#). After working inside your computer, follow the instructions in [After working inside your computer](#). For more safety best practices, see the Regulatory Compliance home page at dell.com/regulatory_compliance.

Procedure

- 1 Align the screw holes on the display hinges with the screw holes on the display back-cover.
- 2 Replace the screws that secure the display hinges to the display back-cover.

Post-requisites

- 1 Follow the procedure from step 2 to step 5 in “Replacing the [display bezel](#)”.
- 2 Replace the [display assembly](#).
- 3 Replace the [hinge covers](#).
- 4 Follow the procedure from step 5 to step 11 in “Replacing the [palm rest](#)”.
- 5 Replace the [wireless card](#).
- 6 Replace the [solid-state drives](#).
- 7 Replace the [memory modules](#).
- 8 Replace the [base panel](#).

Removing the display back-cover



WARNING: Before working inside your computer, read the safety information that shipped with your computer and follow the steps in [Before working inside your computer](#). After working inside your computer, follow the instructions in [After working inside your computer](#). For more safety best practices, see the Regulatory Compliance home page at dell.com/regulatory_compliance.

Prerequisites

- 1 Remove the [base panel](#).
- 2 Remove the [memory modules](#).
- 3 Remove the [solid-state drives](#).
- 4 Remove the [wireless card](#).
- 5 Follow the procedure from step 1 to step 11 in “Removing the [palm rest](#)”.
- 6 Remove the [hinge covers](#).
- 7 Remove the [display assembly](#).
- 8 Follow the procedure from step 1 to step 4 in “Removing the [display bezel](#)”.
- 9 Remove the [display panel](#).
- 10 Remove the [display hinges](#).
- 11 Remove the [camera](#).

Procedure

- 1 Note the display-board cable routing and remove the cable from the routing guides on the display back-cover.

2 Peel off the display board and camera cable from the display back-cover.

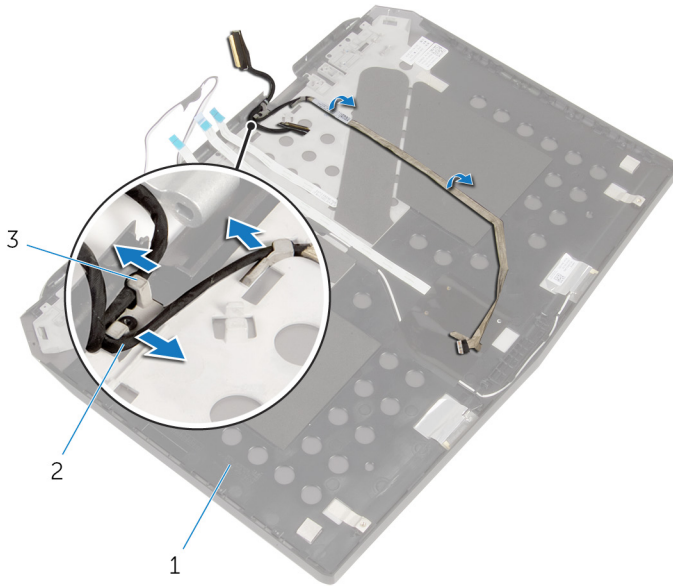

1 display back-cover

2 display board and camera cable

3 routing guides (3)

3 Follow the procedure from step 1 to step 4 in "Removing the [Alienware AlienHead LED board](#)".

- 4 Follow the procedure from step 1 to step 4 in "Removing the [display-panel AlienFX LEDs](#)".

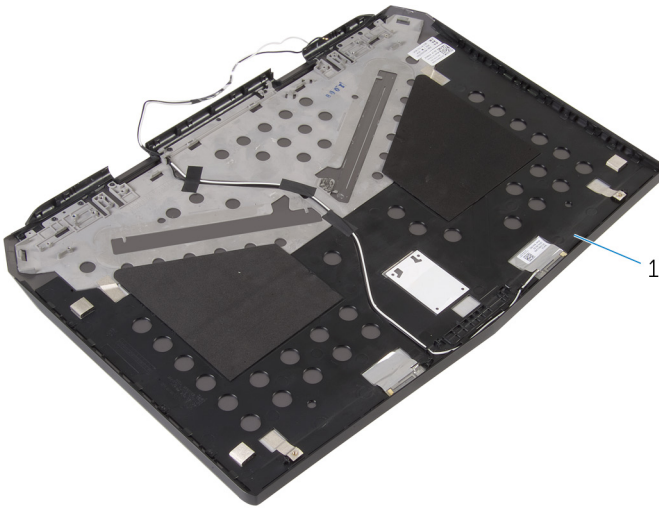

- 1 display back-cover

Replacing the display back-cover



WARNING: Before working inside your computer, read the safety information that shipped with your computer and follow the steps in [Before working inside your computer](#). After working inside your computer, follow the instructions in [After working inside your computer](#). For more safety best practices, see the Regulatory Compliance home page at dell.com/regulatory_compliance.

Procedure

- 1 Place the display back-cover on a clean and flat surface.
- 2 Follow the procedure from step 1 to step 3 in “Replacing the [Alienware AlienHead LED board](#)”.
- 3 Follow the procedure from step 1 to step 3 in “Replacing the [display-panel AlienFX LEDs](#)”.
- 4 Adhere the display board and camera cable to the display back-cover.
- 5 Route the display-board cable through the routing guides on the display back-cover.

Post-requisites

- 1 Replace the [camera](#).
- 2 Replace the [display hinges](#).
- 3 Replace the [display panel](#).
- 4 Follow the procedure from step 2 to step 5 in “Replacing the [display bezel](#)”.
- 5 Replace the [display assembly](#).
- 6 Replace the [hinge covers](#).
- 7 Follow the procedure from step 5 to step 11 in “Replacing the [palm rest](#)”.
- 8 Replace the [wireless card](#).
- 9 Replace the [solid-state drives](#).
- 10 Replace the [memory modules](#).
- 11 Replace the [base panel](#).

Removing the camera



WARNING: Before working inside your computer, read the safety information that shipped with your computer and follow the steps in [Before working inside your computer](#). After working inside your computer, follow the instructions in [After working inside your computer](#). For more safety best practices, see the Regulatory Compliance home page at dell.com/regulatory_compliance.

Prerequisites

- 1 Remove the [base panel](#).
- 2 Remove the [memory modules](#).
- 3 Remove the [solid-state drives](#).
- 4 Remove the [wireless card](#).
- 5 Follow the procedure from step 1 to step 11 in “Removing the [palm rest](#)”.
- 6 Remove the [hinge covers](#).
- 7 Remove the [display assembly](#).
- 8 Follow the procedure from step 1 to step 4 in “Removing the [display bezel](#)”.
- 9 Remove the [display panel](#).

Procedure

- 1 Peel off the tape that secures the camera cable to the camera and disconnect the camera cable from the camera module.

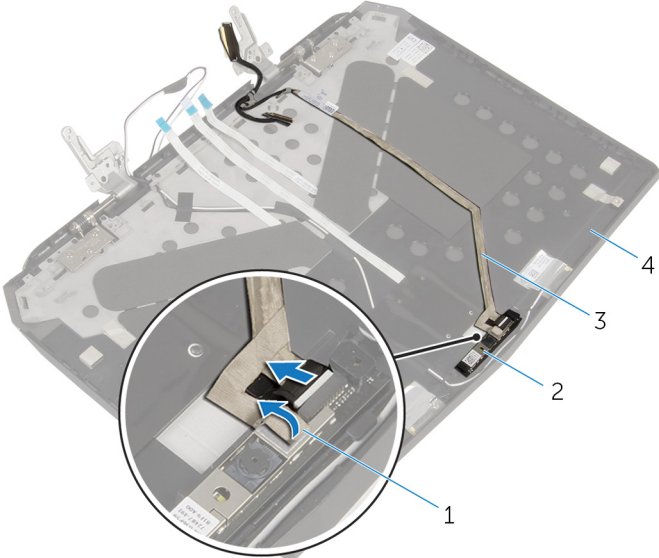

- 1 tape
- 2 camera module
- 3 camera cable
- 4 display back-cover

- 2** Note the location of the camera module and pry it off the display back-cover using a plastic scribe.

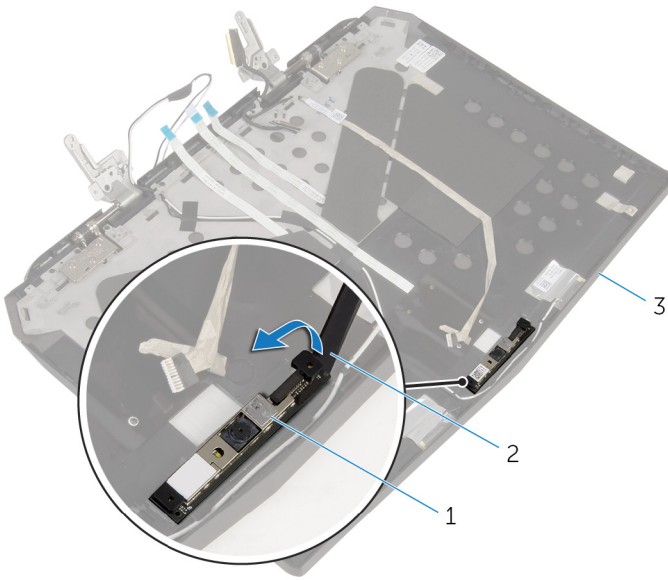

- 1 camera module
3 display back-cover

- 2 plastic scribe

Replacing the camera



WARNING: Before working inside your computer, read the safety information that shipped with your computer and follow the steps in [Before working inside your computer](#). After working inside your computer, follow the instructions in [After working inside your computer](#). For more safety best practices, see the Regulatory Compliance home page at dell.com/regulatory_compliance.

Procedure

- 1 Using the alignment posts, adhere the camera module to the display back-cover.
- 2 Connect the camera cable to the camera module and adhere the tape that secures the camera cable to the camera module.

Post-requisites

- 1 Replace the [display panel](#).
- 2 Follow the procedure from step 2 to step 5 in "Replacing the [display bezel](#)".
- 3 Replace the [display assembly](#).
- 4 Replace the [hinge covers](#).
- 5 Follow the procedure from step 5 to step 11 in "Replacing the [palm rest](#)".
- 6 Replace the [wireless card](#).
- 7 Replace the [solid-state drives](#).
- 8 Replace the [memory modules](#).
- 9 Replace the [base panel](#).

Removing the Alienware AlienHead LED board

 **WARNING:** Before working inside your computer, read the safety information that shipped with your computer and follow the steps in [Before working inside your computer](#). After working inside your computer, follow the instructions in [After working inside your computer](#). For more safety best practices, see the Regulatory Compliance home page at dell.com/regulatory_compliance.

Prerequisites

- 1 Remove the [base panel](#).
- 2 Remove the [memory modules](#).
- 3 Remove the [solid-state drives](#).
- 4 Remove the [wireless card](#).
- 5 Follow the procedure from step 1 to step 11 in "Removing the [palm rest](#)".
- 6 Remove the [hinge covers](#).
- 7 Remove the [display assembly](#).
- 8 Follow the procedure from step 1 to step 4 in "Removing the [display bezel](#)".
- 9 Remove the [display panel](#).
- 10 Follow the procedure from step 1 to step 2 in "Removing the [display back-cover](#)".

Procedure

- 1 Peel off the tape that secures the Alienware AlienHead LED board to the display back-cover.

- 2** Note the Alienware AlienHead LED cable routing and peel off the cable from the display back-cover.

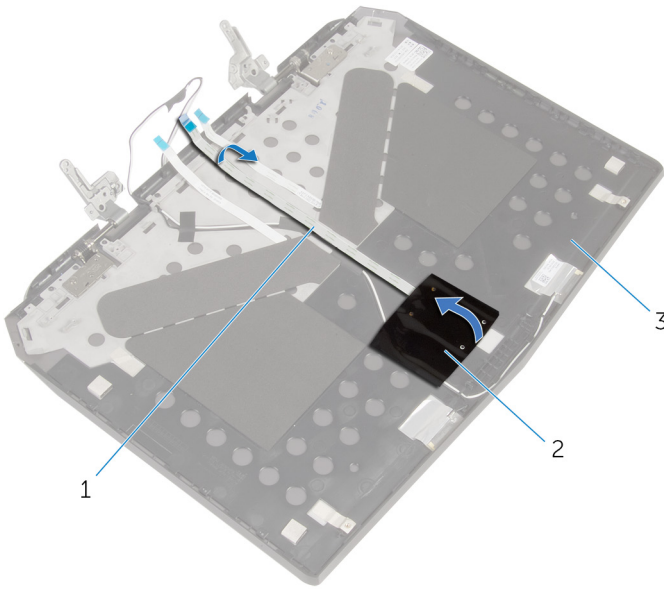

- 1 Alienware AlienHead LED cable
- 2 tape
- 3 display back-cover

- 3** Note the location of the Alienware AlienHead LED board and peel off the Alienware AlienHead LED board from the display back-cover.

- 4** Lift Alienware AlienHead LED board along with its cable off the display back-cover.

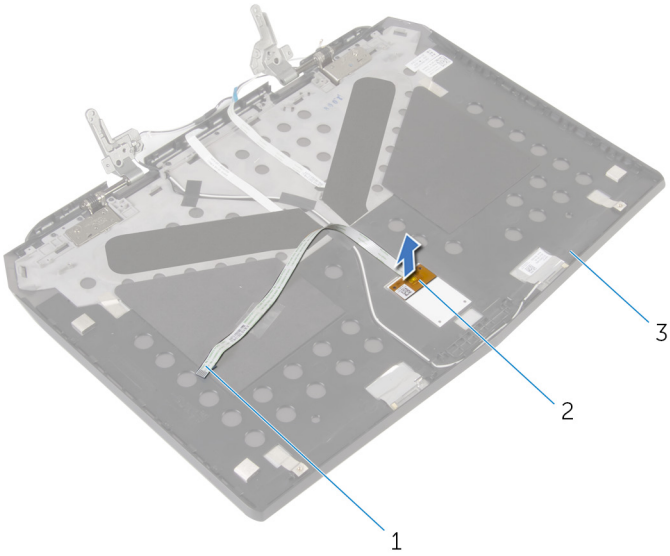

1 Alienware AlienHead LED cable

2 Alienware AlienHead LED board

3 display back-cover

Replacing the Alienware AlienHead LED board



WARNING: Before working inside your computer, read the safety information that shipped with your computer and follow the steps in [Before working inside your computer](#). After working inside your computer, follow the instructions in [After working inside your computer](#). For more safety best practices, see the Regulatory Compliance home page at dell.com/regulatory_compliance.

Procedure

- 1 Adhere the Alienware AlienHead LED board to the display back-cover.
- 2 Route the Alienware AlienHead LED cable on the display back-cover and adhere it to the display back-cover.
- 3 Adhere the tape that secures the Alienware AlienHead LED board to the display back-cover.

Post-requisites

- 1 Follow the procedure from step 4 to step 5 in "Replacing the [display back-cover](#)".
- 2 Replace the [display panel](#).
- 3 Follow the procedure from step 2 to step 5 in "Replacing the [display bezel](#)".
- 4 Replace the [display assembly](#).
- 5 Replace the [hinge covers](#).
- 6 Follow the procedure from step 5 to step 11 in "Replacing the [palm rest](#)".
- 7 Replace the [wireless card](#).
- 8 Replace the [solid-state drives](#).
- 9 Replace the [memory modules](#).
- 10 Replace the [base panel](#).

Removing the display-panel AlienFX LEDs



WARNING: Before working inside your computer, read the safety information that shipped with your computer and follow the steps in [Before working inside your computer](#). After working inside your computer, follow the instructions in [After working inside your computer](#). For more safety best practices, see the Regulatory Compliance home page at dell.com/regulatory_compliance.

Prerequisites

- 1 Remove the [base panel](#).
- 2 Remove the [memory modules](#).
- 3 Remove the [solid-state drives](#).
- 4 Remove the [wireless card](#).
- 5 Follow the procedure from step 1 to step 11 in "Removing the [palm rest](#)".
- 6 Remove the [hinge covers](#).
- 7 Remove the [display assembly](#).
- 8 Follow the procedure from step 1 to step 4 in "Removing the [display bezel](#)".
- 9 Remove the [display panel](#).
- 10 Follow the procedure from step 1 to step 2 in "Removing the [display back-cover](#)".

Procedure

- 1 Peel off the tapes that secure the display-panel AlienFX LEDs to the display back-cover.

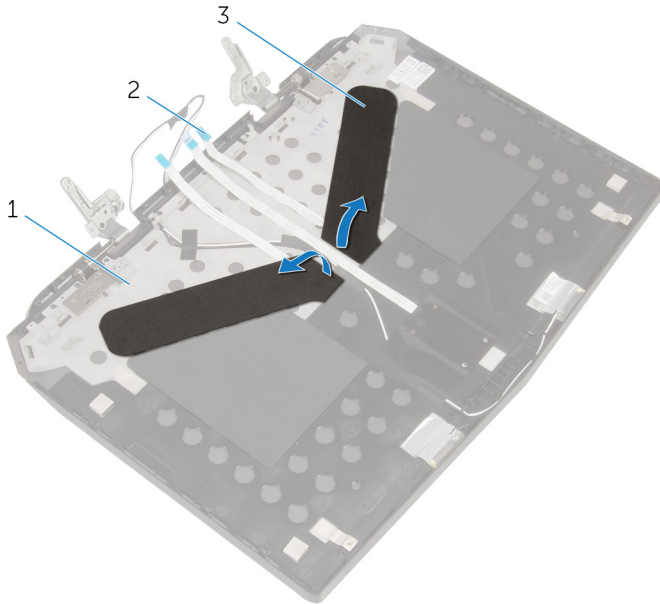

1 display back-cover

2 display-panel AlienFX LED cables (2)

3 tapes (2)

- 2 Note the routing of the display-panel AlienFX LED cables and peel off the cables from the display back-cover.
- 3 Note the location of the display-panel AlienFX LEDs and peel off the LEDs from the display back-cover.

- 4** Lift the display-panel AlienFX LEDs along with the cables off the display back-cover.

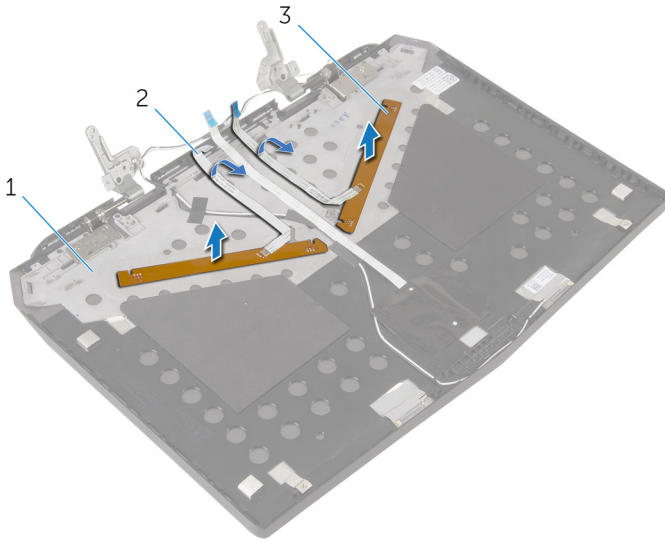

1 display back-cover

2 display-panel AlienFX LED
cables (2)

3 display-panel AlienFX LEDs
(2)

Replacing the display-panel AlienFX LEDs



WARNING: Before working inside your computer, read the safety information that shipped with your computer and follow the steps in [Before working inside your computer](#). After working inside your computer, follow the instructions in [After working inside your computer](#). For more safety best practices, see the Regulatory Compliance home page at dell.com/regulatory_compliance.

Procedure

- 1 Adhere the display-panel AlienFX LEDs to the display back-cover.
- 2 Route the display-panel AlienFX LED cables on the display back-cover and adhere the cables to the display back-cover.
- 3 Adhere the tapes that secure the display-panel AlienFX LEDs to the display back-cover.

Post-requisites

- 1 Follow the procedure from step 4 to step 5 in "Replacing the [display back-cover](#)".
- 2 Replace the [display panel](#).
- 3 Follow the procedure from step 2 to step 5 in "Replacing the [display bezel](#)".
- 4 Replace the [display assembly](#).
- 5 Replace the [hinge covers](#).
- 6 Follow the procedure from step 5 to step 11 in "Replacing the [palm rest](#)".
- 7 Replace the [wireless card](#).
- 8 Replace the [solid-state drives](#).
- 9 Replace the [memory modules](#).
- 10 Replace the [base panel](#).

Removing the logo board



WARNING: Before working inside your computer, read the safety information that shipped with your computer and follow the steps in [Before working inside your computer](#). After working inside your computer, follow the instructions in [After working inside your computer](#). For more safety best practices, see the Regulatory Compliance home page at dell.com/regulatory_compliance.

Prerequisites

- 1 Remove the [base panel](#).
- 2 Remove the [memory modules](#).
- 3 Remove the [solid-state drives](#).
- 4 Remove the [wireless card](#).
- 5 Follow the procedure from step 1 to step 11 in “Removing the [palm rest](#)”.
- 6 Remove the [hinge covers](#).
- 7 Remove the [display assembly](#).
- 8 Follow the procedure from step 1 to step 4 in “Removing the [display bezel](#)”.

Procedure

- 1 Turn the display bezel over and place it on a clean and flat surface.

- 2** Note the location of the logo board and pry the logo board off the display bezel using a plastic scribe.

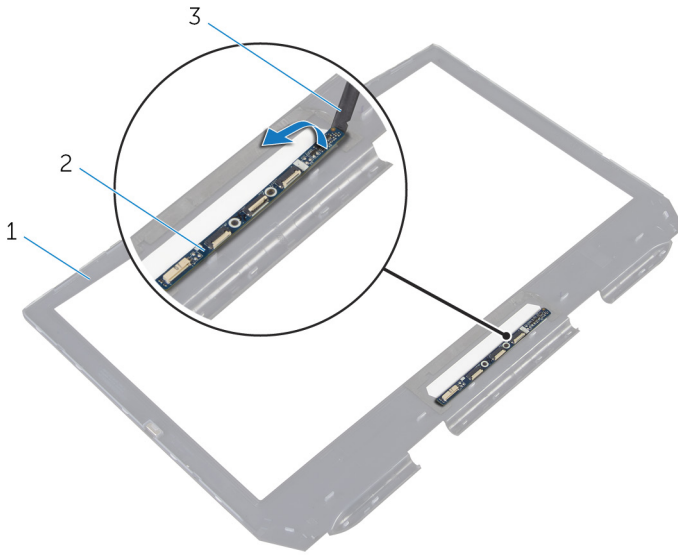

1 display bezel

2 logo board

3 plastic scribe

Replacing the logo board



WARNING: Before working inside your computer, read the safety information that shipped with your computer and follow the steps in [Before working inside your computer](#). After working inside your computer, follow the instructions in [After working inside your computer](#). For more safety best practices, see the Regulatory Compliance home page at dell.com/regulatory_compliance.

Procedure

- 1 Adhere the logo board to the display bezel.
- 2 Turn the display bezel over.

Post-requisites

- 1 Follow the procedure from step 2 to step 5 in “Replacing the [display bezel](#)”.
- 2 Replace the [display assembly](#).
- 3 Replace the [hinge covers](#).
- 4 Follow the procedure from step 5 to step 11 in “Replacing the [palm rest](#)”.
- 5 Replace the [wireless card](#).
- 6 Replace the [solid-state drives](#).
- 7 Replace the [memory modules](#).
- 8 Replace the [base panel](#).

Removing the system board

 **WARNING:** Before working inside your computer, read the safety information that shipped with your computer and follow the steps in [Before working inside your computer](#). After working inside your computer, follow the instructions in [After working inside your computer](#). For more safety best practices, see the Regulatory Compliance home page at dell.com/regulatory_compliance.

 **NOTE:** Your computer's Service Tag is stored in the system board. You must enter the Service Tag in the BIOS setup program after you replace the system board.

 **NOTE:** Replacing the system board removes any changes you have made to the BIOS using the BIOS setup program. You must make the desired changes again after you replace the system board.

 **NOTE:** Before disconnecting the cables from the system board, note the location of the connectors so that you can reconnect them correctly after you replace the system board.

Prerequisites

- 1 Remove the [base panel](#).
- 2 Remove the [memory modules](#).
- 3 Remove the [solid-state drives](#).
- 4 Remove the [wireless card](#).
- 5 Follow the procedure from step 1 to step 11 in "Removing the [palm rest](#)".
- 6 Remove the [hinge covers](#).
- 7 Remove the [display assembly](#).

Procedure

- 1 Turn the computer over.
- 2 Disconnect the fan cables and power-adaptor port cable from the system board.

- 3** Using the pull tab, disconnect the hard-drive cable from the system board.

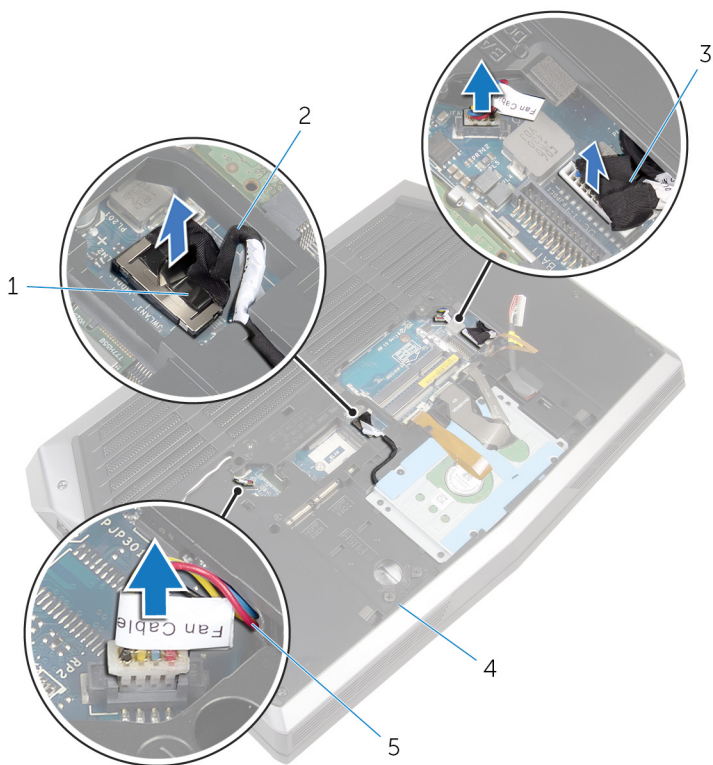

- | | | | |
|---|--------------------------|---|------------------|
| 1 | pull tab | 2 | hard-drive cable |
| 3 | power-adaptor port cable | 4 | computer base |
| 5 | fan cables (2) | | |

- 4** Turn the computer over.
- 5** Lift the latch and disconnect the I/O-board cable from the system board.
- 6** Disconnect the speaker cable from the system board.

- 7** Peel the tape and disconnect the front AlienFX LED cable from the system board.

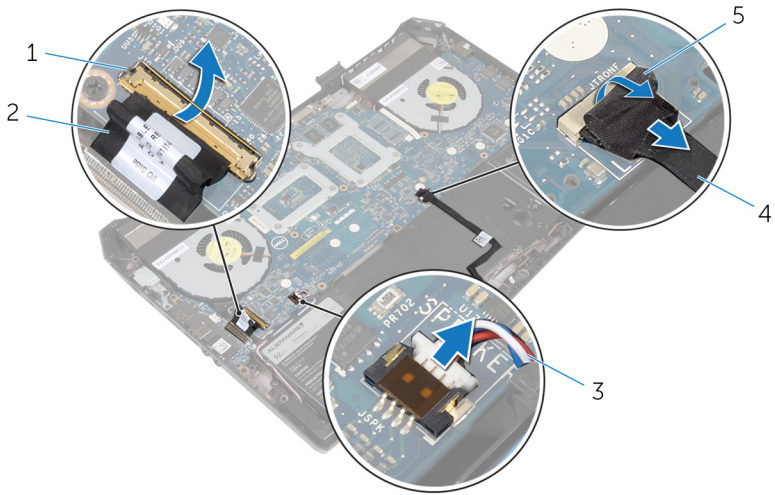

- | | | | |
|---|---------------|---|-------------------------|
| 1 | latch | 2 | I/O-board cable |
| 3 | speaker cable | 4 | front AlienFX LED cable |
| 5 | tape | | |

- 8** Remove the screws that secure the system board to the computer base.
- 9** Lift the system board at an angle and slide the ports on the system board out of the slots on the computer base.

10 Lift the system board off the computer base.

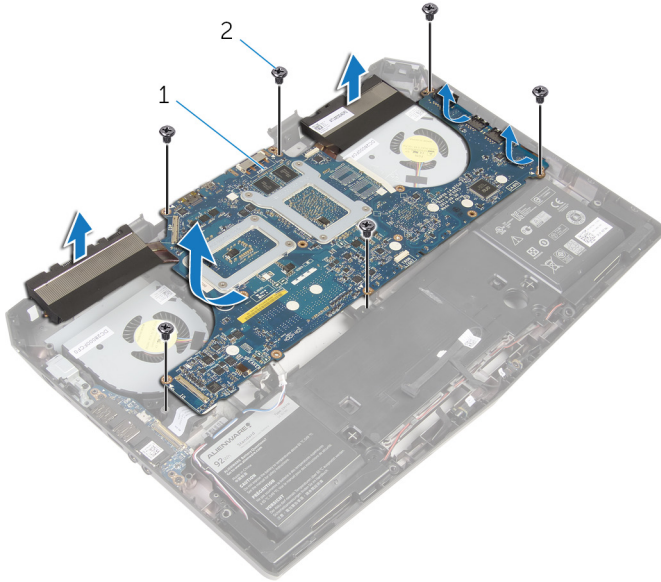

1 system board

2 screws (6)

11 Turn the system board over.

12 Follow the procedure from step 1 to step 2 in "Removing the [heat-sink assembly](#)".

13 Follow the procedure from step 1 to step 2 in "Removing the [coin-cell battery](#)".

Replacing the system board

 **WARNING:** Before working inside your computer, read the safety information that shipped with your computer and follow the steps in [Before working inside your computer](#). After working inside your computer, follow the instructions in [After working inside your computer](#). For more safety best practices, see the Regulatory Compliance home page at dell.com/regulatory_compliance.

 **NOTE:** Your computer's Service Tag is stored in the system board. You must enter the Service Tag in the BIOS setup program after you replace the system board.

 **NOTE:** Replacing the system board removes any changes you have made to the BIOS using the BIOS setup program. You must make the desired changes again after you replace the system board.

Procedure

- 1 Follow the procedure from step 1 to step 2 in "Replacing the [coin-cell battery](#)".
- 2 Follow the procedure from step 1 to step 2 in "Replacing the [heat-sink assembly](#)".
- 3 Turn the system board over.
- 4 Slide the ports on the system board into the slots on the computer base and align the screw holes on the system board with the screw holes on the computer base.

 **CAUTION:** Make sure that no cables are under the system board.



- 5 Replace the screws that secure the system board to the computer base.
- 6 Slide the I/O-board cable into the system board and press down on the latch to secure the cable.
- 7 Connect the speaker cable to the system board.
- 8 Connect the front AlienFX LED cable to the system board and secure it with the tape.
- 9 Turn the computer over.
- 10 Connect the fan cables, power-adapter port cable, and hard-drive cable to the system board.

11 Turn the computer over.

Post-requisites

- 1** Replace the [display assembly](#).
- 2** Replace the [hinge covers](#).
- 3** Follow the procedure from step 5 to step 11 in “Replacing the [palm rest](#)”.
- 4** Replace the [wireless card](#).
- 5** Replace the [solid-state drives](#).
- 6** Replace the [memory modules](#).
- 7** Replace the [base panel](#).

Removing the heat-sink assembly

-  **WARNING:** Before working inside your computer, read the safety information that shipped with your computer and follow the steps in [Before working inside your computer](#). After working inside your computer, follow the instructions in [After working inside your computer](#). For more safety best practices, see the Regulatory Compliance home page at dell.com/regulatory_compliance.
-  **WARNING:** The heat sink may become hot during normal operation. Allow sufficient time for the heat sink to cool before you touch it.
-  **CAUTION:** For maximum cooling of the processor, do not touch the heat transfer areas on the heat sink. The oils in your skin can reduce the heat transfer capability of the thermal grease.

Prerequisites

- 1 Remove the [base panel](#).
- 2 Remove the [memory modules](#).
- 3 Remove the [solid-state drives](#).
- 4 Remove the [wireless card](#).
- 5 Follow the procedure from step 1 to step 11 in “Removing the [palm rest](#)”.
- 6 Remove the [hinge covers](#).
- 7 Remove the [display assembly](#).
- 8 Follow the procedure from step 1 to step 11 in “Removing the [system board](#)”.

Procedure

- 1 In sequential order (as indicated on the heat-sink assembly), loosen the captive screws that secure the heat-sink assembly to the system board.

2 Lift the heat-sink assembly off the system board.

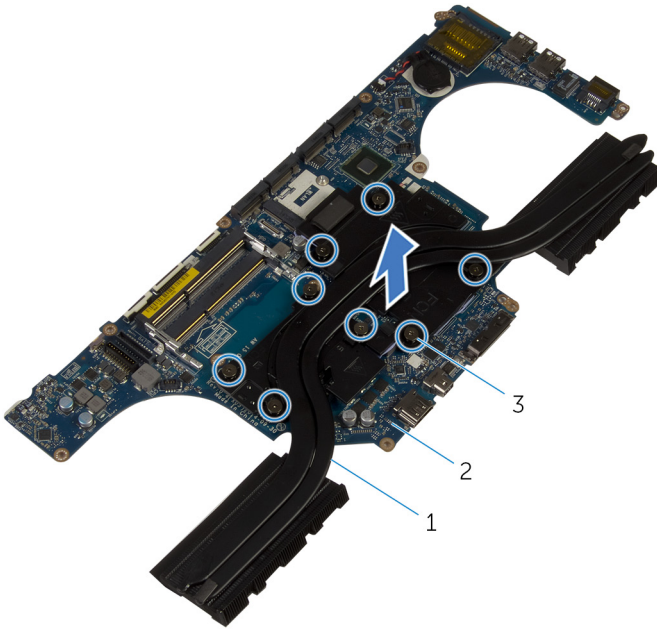

1 heat-sink assembly

2 system board

3 captive screws (8)

Replacing the heat-sink assembly

 **WARNING:** Before working inside your computer, read the safety information that shipped with your computer and follow the steps in [Before working inside your computer](#). After working inside your computer, follow the instructions in [After working inside your computer](#). For more safety best practices, see the Regulatory Compliance home page at dell.com/regulatory_compliance.

 **CAUTION:** Incorrect alignment of the heat sink can cause damage to the system board and processor.

Procedure

- 1 Align the screw holes on the heat-sink assembly with the screw holes on the system board.
- 2 In sequential order (indicated on the heat-sink assembly), tighten the captive screws that secure the heat-sink assembly to the system board.

Post-requisites

- 1 Follow the procedure from step 3 to step 11 in “Replacing the [system board](#)”.
- 2 Replace the [display assembly](#).
- 3 Replace the [hinge covers](#).
- 4 Follow the procedure from step 5 to step 11 in “Replacing the [palm rest](#)”.
- 5 Replace the [wireless card](#).
- 6 Replace the [solid-state drives](#).
- 7 Replace the [memory modules](#).
- 8 Replace the [base panel](#).

Removing the fans



WARNING: Before working inside your computer, read the safety information that shipped with your computer and follow the steps in [Before working inside your computer](#). After working inside your computer, follow the instructions in [After working inside your computer](#). For more safety best practices, see the Regulatory Compliance home page at dell.com/regulatory_compliance.

Prerequisites

- 1 Remove the [base panel](#).
- 2 Remove the [memory module](#).
- 3 Remove the [solid-state drives](#).
- 4 Remove the [wireless card](#).
- 5 Follow the procedure from step 1 to step 11 in “Removing the [palm rest](#)”.
- 6 Remove the [hinge covers](#).
- 7 Remove the [display assembly](#).
- 8 Follow the procedure from step 1 to step 10 in “Removing the [system board](#)”.

Procedure

- 1 Remove the screws that secure the processor fan and video-card fan to the computer base.

2 Lift the processor fan and video-card fan off the computer base.

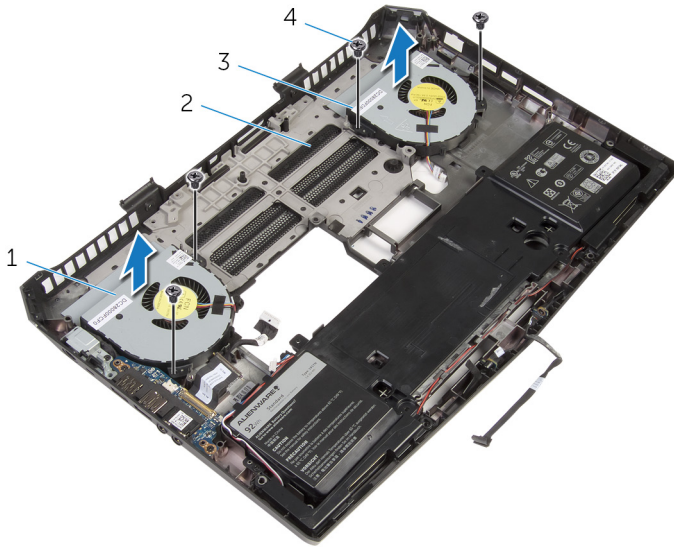

1 processor fan

2 computer base

3 video-card fan

4 screws (4)

Replacing the fans



WARNING: Before working inside your computer, read the safety information that shipped with your computer and follow the steps in [Before working inside your computer](#). After working inside your computer, follow the instructions in [After working inside your computer](#). For more safety best practices, see the Regulatory Compliance home page at dell.com/regulatory_compliance.

Procedure

- 1 Align the screw holes on the processor fan and video-card fan with the screw holes on the computer base.
- 2 Replace screws that secure the processor fan and video-card fan to the computer base.

Post-requisites

- 1 Follow the procedure from step 4 to step 11 in "Replacing the [system board](#)".
- 2 Replace the [display assembly](#).
- 3 Replace the [hinge covers](#).
- 4 Follow the procedure from step 5 to step 11 in "Replacing the [palm rest](#)".
- 5 Replace the [wireless card](#).
- 6 Replace the [solid-state drives](#).
- 7 Replace the [memory module](#).
- 8 Replace the [base panel](#).

Removing the power-adapter port



WARNING: Before working inside your computer, read the safety information that shipped with your computer and follow the steps in [Before working inside your computer](#). After working inside your computer, follow the instructions in [After working inside your computer](#). For more safety best practices, see the Regulatory Compliance home page at dell.com/regulatory_compliance.

Prerequisites

- 1 Remove the [base panel](#).
- 2 Remove the [memory modules](#).
- 3 Remove the [solid-state drives](#).
- 4 Remove the [wireless card](#).
- 5 Follow the procedure from step 1 to step 11 in “Removing the [palm rest](#)”.
- 6 Remove the [hinge covers](#).
- 7 Remove the [I/O board](#).
- 8 Remove the [display assembly](#).
- 9 Follow the procedure from step 1 to step 10 in “Removing the [system board](#)”.

Procedure

- 1 Remove the screws that secure the power-adapter port bracket to the computer base.
- 2 Lift the power-adapter port bracket off the power-adapter port.
- 3 Note the power-adapter port cable routing and remove the cable from the routing guides on the computer base.

4 Lift the power-adapter port along with its cable off the computer base.

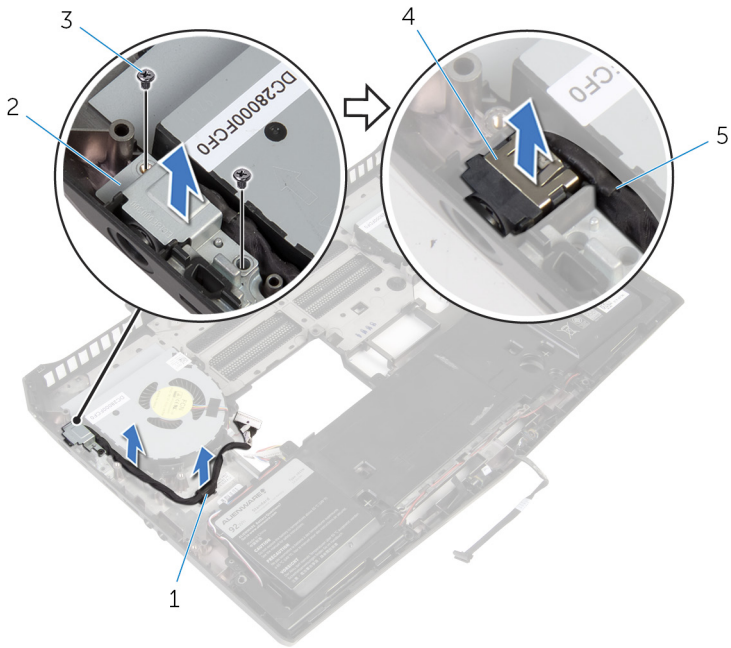

1 routing guide

2 power-adapter port
bracket

3 screws (2)

4 power-adapter port

5 power-adapter port cable

Replacing the power-adapter port

 **WARNING:** Before working inside your computer, read the safety information that shipped with your computer and follow the steps in [Before working inside your computer](#). After working inside your computer, follow the instructions in [After working inside your computer](#). For more safety best practices, see the Regulatory Compliance home page at dell.com/regulatory_compliance.

Procedure

- 1 Slide the power-adapter port into the slot on the computer base.
- 2 Align the screw holes on the power-adapter port bracket with the screw holes on the power-adapter port.
- 3 Replace the screws that secure the power-adapter port bracket to the computer base.
- 4 Route the power-adapter port cable through the routing guides on the computer base.

Post-requisites

- 1 Follow the procedure from step 4 to step 11 in "Replacing the [system board](#)".
- 2 Replace the [display assembly](#).
- 3 Replace the [I/O board](#).
- 4 Replace the [hinge covers](#).
- 5 Follow the procedure from step 5 to step 11 in "Replacing the [palm rest](#)".
- 6 Replace the [wireless card](#).
- 7 Replace the [solid-state drives](#).
- 8 Replace the [memory modules](#).
- 9 Replace the [base panel](#).

Removing the coin-cell battery

 **WARNING:** Before working inside your computer, read the safety information that shipped with your computer and follow the steps in [Before working inside your computer](#). After working inside your computer, follow the instructions in [After working inside your computer](#). For more safety best practices, see the Regulatory Compliance home page at dell.com/regulatory_compliance.

 **CAUTION:** Removing the coin-cell battery resets the BIOS settings to default. It is recommended that you note the BIOS settings before removing the coin-cell battery.

Prerequisites

- 1 Remove the [base panel](#).
- 2 Remove the [memory modules](#).
- 3 Remove the [solid-state drives](#).
- 4 Remove the [wireless card](#).
- 5 Follow the procedure from step 1 to step 11 in “Removing the [palm rest](#)”.
- 6 Remove the [hinge covers](#).
- 7 Remove the [display assembly](#).
- 8 Follow the procedure from step 1 to step 11 in “Removing the [system board](#)”.

Procedure

- 1 Disconnect the coin-cell battery cable from the system board.

- 2 Using a plastic scribe, gently pry out the coin-cell battery from the system board.

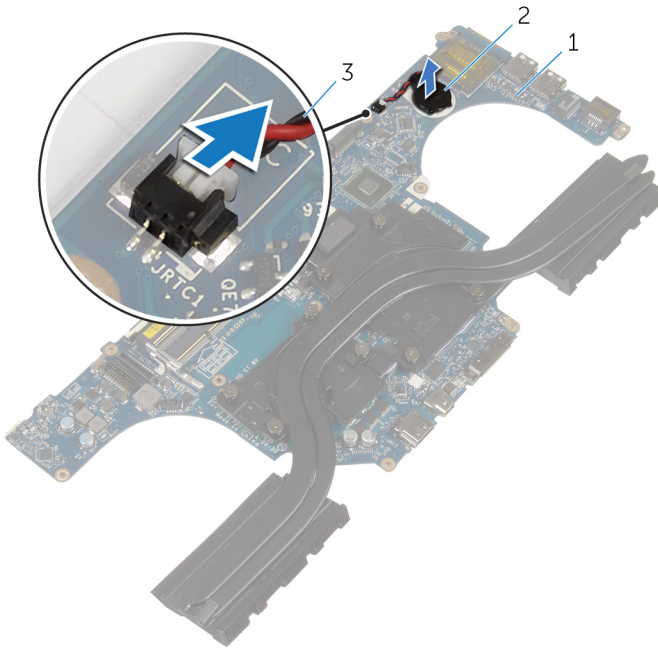

1 system board

2 coin-cell battery

3 coin-cell battery cable

Replacing the coin-cell battery

 **WARNING:** Before working inside your computer, read the safety information that shipped with your computer and follow the steps in [Before working inside your computer](#). After working inside your computer, follow the instructions in [After working inside your computer](#). For more safety best practices, see the Regulatory Compliance home page at dell.com/regulatory_compliance.

Procedure

- 1 Adhere the coin-cell battery to the system board.
- 2 Connect the coin-cell battery cable to the system board.

Post-requisites

- 1 Follow the procedure from step 3 to step 11 in "Replacing the [system board](#)".
- 2 Replace the [display assembly](#).
- 3 Replace the [hinge covers](#).
- 4 Follow the procedure from step 5 to step 11 in "Replacing the [palm rest](#)".
- 5 Replace the [wireless card](#).
- 6 Replace the [solid-state drives](#).
- 7 Replace the [memory modules](#).
- 8 Replace the [base panel](#).

Removing the battery



WARNING: Before working inside your computer, read the safety information that shipped with your computer and follow the steps in [Before working inside your computer](#). After working inside your computer, follow the instructions in [After working inside your computer](#). For more safety best practices, see the Regulatory Compliance home page at dell.com/regulatory_compliance.

Prerequisites

- 1 Remove the [base panel](#).
- 2 Remove the [memory modules](#).
- 3 Remove the [solid-state drives](#).
- 4 Remove the [wireless card](#).
- 5 Follow the procedure from step 1 to step 11 in “Removing the [palm rest](#)”.
- 6 Remove the [hinge covers](#).
- 7 Remove the [display assembly](#).
- 8 Follow the procedure from step 1 to step 10 in “Removing the [system board](#)”.

Procedure

- 1 Remove the speaker cable from the routing guides on the battery.

- 2** Note the front AlienFX LED cable routing and peel off the cable from the battery.

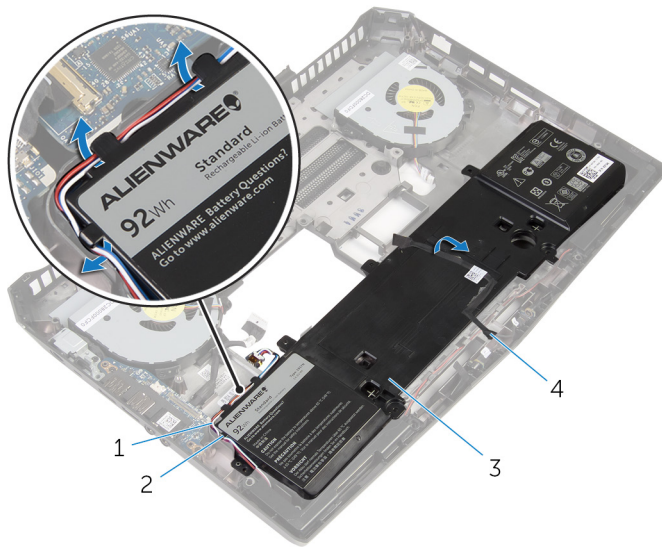

- | | | | |
|---|---------------|---|-------------------------|
| 1 | speaker cable | 2 | routing guides (3) |
| 3 | battery | 4 | front AlienFX LED cable |

- 3** Remove the screws that secure the battery to the computer base.

4 Lift the battery off the computer base.

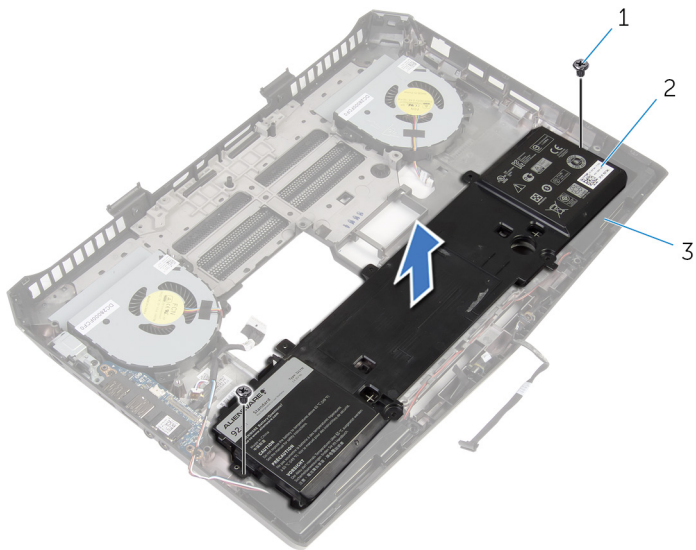

1 screws (2)

2 battery

3 computer base

Replacing the battery



WARNING: Before working inside your computer, read the safety information that shipped with your computer and follow the steps in [Before working inside your computer](#). After working inside your computer, follow the instructions in [After working inside your computer](#). For more safety best practices, see the Regulatory Compliance home page at dell.com/regulatory_compliance.

Procedure

- 1 Align the screw holes on the battery with the screw holes on the computer base.
- 2 Replace the screws that secure the battery to the computer base.
- 3 Adhere the front AlienFX LED cable to the battery.
- 4 Route the speaker cable through the routing guides on the battery.

Post-requisites

- 1 Follow the procedure from step 4 to step 11 in "Replacing the [system board](#)".
- 2 Replace the [display assembly](#).
- 3 Replace the [hinge covers](#).
- 4 Follow the procedure from step 5 to step 11 in "Replacing the [palm rest](#)".
- 5 Replace the [wireless card](#).
- 6 Replace the [solid-state drives](#).
- 7 Replace the [memory modules](#).
- 8 Replace the [base panel](#).

Removing the computer base

 **WARNING:** Before working inside your computer, read the safety information that shipped with your computer and follow the steps in [Before working inside your computer](#). After working inside your computer, follow the instructions in [After working inside your computer](#). For more safety best practices, see the Regulatory Compliance home page at dell.com/regulatory_compliance.

Prerequisites

- 1 Remove the [base panel](#).
- 2 Remove the [memory modules](#).
- 3 Remove the [solid-state drives](#).
- 4 Follow the procedure from step 1 to step 5 in “Removing the [hard drive](#)”.
- 5 Remove the [wireless card](#).
- 6 Remove the [I/O board](#).
- 7 Follow the procedure from step 1 to step 11 in “Removing the [palm rest](#)”.
- 8 Remove the [hinge covers](#).
- 9 Remove the [speakers](#).
- 10 Remove the [front AlienFX LED boards](#).
- 11 Remove the [display assembly](#).
- 12 Follow the procedure from step 1 to step 10 in “Removing the [system board](#)”.
- 13 Remove the [fans](#).
- 14 Remove the [battery](#).
- 15 Remove the [power-adaptor port](#).

Procedure

After performing the prerequisites, we are left with the computer base.

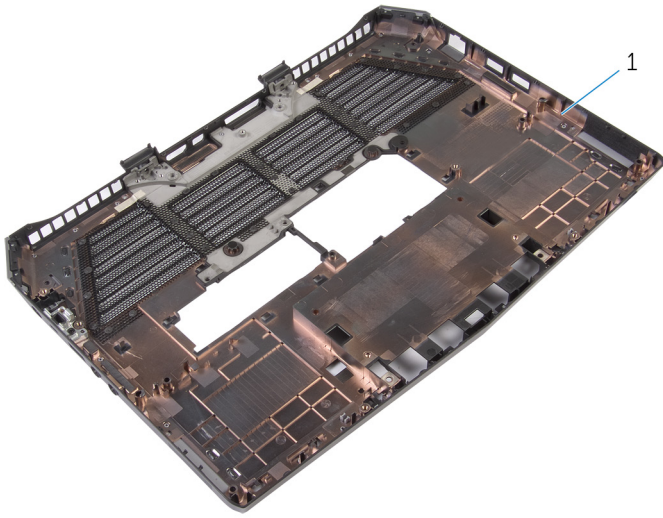

1 computer base

Replacing the computer base



WARNING: Before working inside your computer, read the safety information that shipped with your computer and follow the steps in [Before working inside your computer](#). After working inside your computer, follow the instructions in [After working inside your computer](#). For more safety best practices, see the Regulatory Compliance home page at dell.com/regulatory_compliance.

Procedure

Place the computer base on a flat surface.

Post-requisites

- 1 Replace the [power-adaptor port](#).
- 2 Replace the [battery](#).
- 3 Replace the [fans](#).
- 4 Follow the procedure from step 4 to step 11 in "Replacing the [system board](#)".
- 5 Replace the [display assembly](#).
- 6 Replace the [front AlienFX LED board](#).
- 7 Replace the [speakers](#).
- 8 Replace the [hinge covers](#).
- 9 Follow the procedure from step 5 to step 11 in "Replacing the [palm rest](#)".
- 10 Replace the [wireless card](#).
- 11 Replace the [I/O board](#).
- 12 Follow the procedure from step 4 to step 7 in "Replacing the [hard drive](#)".
- 13 Replace the [solid-state drives](#).
- 14 Replace the [memory modules](#).
- 15 Replace the [base panel](#).

BIOS setup program

Overview

 **CAUTION:** Unless you are an expert computer user, do not change the settings in the BIOS setup program. Certain changes can make your computer work incorrectly.

 **NOTE:** Before you change BIOS setup program, it is recommended that you write down the BIOS setup program screen information for future reference.

Use BIOS setup program to:

- Get information about the hardware installed in your computer, such as the amount of RAM, the size of the hard drive, and so on.
- Change the system configuration information.
- Set or change a user-selectable option, such as the user password, type of hard drive installed, enabling or disabling base devices, and so on.

Entering BIOS setup program

- 1 Turn on (or restart) your computer.
- 2 During POST, when the Alienware logo is displayed, watch for the F2 prompt to appear and then press F2 immediately.

 **NOTE:** The F2 prompt indicates that the keyboard has initialized. This prompt can appear very quickly, so you must watch for it, and then press F2. If you press F2 before the F2 prompt, this keystroke is lost. If you wait too long and the operating system logo appears, continue to wait until you see the operating system's desktop. Then, turn off your computer and try again.

BIOS setup program options

 **NOTE:** Depending on your computer and its installed devices, the items listed in this section may or may not appear.



Main

System Time	Displays the current time in hh:mm:ss format.
System Date	Displays the current date in mm/dd/yyyy format.
BIOS Version	Displays the BIOS version.
Product Name	Displays the model number of your computer.
Service Tag	Displays the service tag of your computer.
Asset Tag	Displays the asset tag of your computer.
CPU Type	Displays the processor type.
CPU Speed	Displays the processor speed.
CPU ID	Displays the processor identification code.
L1 Cache	Displays the processor L1 cache size.
L2 Cache	Displays the processor L2 cache size.
L3 Cache	Displays the processor L3 cache size.
Integrated Graphics	Displays the integrated graphics.
Discrete Graphics 1	Displays the first discrete graphics installed on your computer.
Fixed HDD	Displays the type of hard-drive installed.
Second HDD	Displays the type of secondary hard-drive installed.
Third HDD	Displays the type of third hard-drive installed.
Fourth HDD	Displays the type of fourth hard-drive installed.
Fifth HDD	Displays the type of fifth hard-drive installed.
AC Adapter Type	Displays the type of AC adapter connected to your computer.

Main

System Memory	Displays the system memory.
Extended Memory	Displays the extended memory.
Memory Speed	Displays the memory speed.

Advanced

Intel(R) SpeedStep (TM)	<p>Allows you to disable or enable Intel (R) SpeedStep Technology.</p> <p>Default: Enabled</p> <p> NOTE: If enabled, the processor clock speed and core voltage are adjusted dynamically based on the processor load.</p>
Virtualization	<p>Allows you to disable or enable the Intel Virtualization technology.</p> <p>Default: Enabled</p>
VT for Direct I/O	<p>Allows you to disable or enable a Virtual Machine Monitor (VMM) to use the additional hardware capabilities provided by Intel(R) Virtualization Technology for Direct I/O.</p> <p>Default: Enabled</p>
Integrated NIC	<p>Allows you to disable or enable the on-board LAN controller.</p> <p>Default: Enabled</p>
USB Emulation	<p>Allows you to enable or disable the USB emulation feature. This feature defines how the BIOS, in the absence of a USB-aware operating system, handles USB devices. USB emulation is always enabled during POST.</p> <p>Default: Enabled</p> <p> NOTE: You cannot boot any type of USB device (floppy, hard drive, or memory key) when this option is disabled.</p>
USB PowerShare	<p>Allows you to charge USB devices when the computer is turned off or in standby mode.</p>

Advanced

	Default: Enabled
USB Wake Support	Allows you to enable USB devices to wake the computer from standby or to disable the USB wake support feature. Default: Disabled  NOTE: If USB PowerShare is enabled, a device connected to the USB PowerShare connector may not wake the computer.
SATA Operation	Allows you to configure the operating mode of the integrated SATA hard-drive controller. Default: AHCI
Adapter Warnings	Allows you to choose if the computer should display warning messages when you use AC adapters that are not supported by your computer. Default: Enabled
Function Key Behavior	Allows you to set function key or multimedia key as the default function key behavior. Default: Function key
Express Charge	Allows you to charge your computer battery using Standard Charge or Express Charge mode. Default: Express Charge
Touchpad Backlight	Allows you to set the touch pad backlight to be on or in auto mode.
Battery Health	Displays the battery health.

Advanced-Miscellaneous Devices

External USB Ports	Allows you to disable or enable the external USB ports. Default: Enabled
USB debug	Allows you to enable or disable USB port for Windows debugging. Default: Disabled

Advanced-Performance options with Alienware Graphics Amplifier

Overclocking Feature	Allows you to enable or disable global overclocking feature. Default: Disabled
	 NOTE: The following features are available only when the Overclocking Feature is enabled.
Non-Turbo Flex Support	Allows you to enable or disable non-turbo flex support. Default: Enabled
Flex Ratio Override	Allows you to set the flex ratio override value.
Override Turbo Settings	Allows you to enable or disable the override turbo settings. Default: Enabled
Long Duration PWR Limit	Allows you to set the turbo mode long duration power limit.
Long Duration Time Window	Allows you to set the turbo mode time value in seconds.
Short Duration PWR Limit	Allows you to enable or disable short duration power limit. Default: Enabled
Short Duration PWR Limit Options	Allows you to set the turbo mode power limit value in watts.
Bus Clock	
Current Frequency	Displays the current bus clock frequency.
New Frequency in 10 KHz increments	Allows you to set the bus clock frequency in increments of 10 KHz.
Apply New Bus Clock Frequency	Applies the new bus clock frequency immediately, temporarily, or permanently.
Intel Graphics Turbo Overclocking	Allows you to disable or enable the Intel Graphics Turbo Overclocking feature.

Advanced-Performance options with Alienware Graphics Amplifier

Memory Override Support Allows you to enable or disable the memory override option support.
Default: Disabled

Security

Unlock Setup Status Displays if the setup status is unlocked.
Default: Unblocked.

Admin Password Status Displays if the administrator password is clear or set.
Default: Not set

System password Status Displays if the system password is clear or set.
Default: Not set

HDD password Status Displays if the hard drive password is clear or set.
Default: Not set

 **NOTE:** The password is set for all the installed hard drives on your computer.

Service Tag Displays the Service Tag of the computer when the Service Tag is present. Displays a field to input the Service Tag manually when the Service Tag is absent.

 **NOTE:** The Service Tag option is available only when the Service Tag is not set.

Admin Password Allows you to set the administrator password. The administrator password controls access to the BIOS setup program utility.

System Password Allows you to set the system password. The system password controls access to the computer at boot.

Security

HDD password	Allows you to set, change, or delete the hard-drives password.
Password Change	Allows you to permit or deny system password or HDD password changes. Default: Permitted

Exit

Save Changes and Reset	Allows you to exit BIOS setup program and save your changes.
Discard Changes and Reset	Allows you to exit BIOS setup program and load previous values for all BIOS setup program options.
Restore Defaults	Allows you to restore default values for all BIOS setup program options.
Discard Changes	Allows you to load previous values for all BIOS setup program options.
Save Changes	Allows you to save the changes for all BIOS setup program options.

Boot sequence

This feature allows you to change the sequence of devices that your computer attempts to boot from. If the computer cannot boot from the device you select, it attempts to boot from the next bootable device. You can use this feature to change the:

- Current Boot Sequence — change the boot sequence for the current boot, for example, to boot from the optical drive to run Alienware Diagnostics from the Drivers and Utilities disc or to reinstall your operating system using an external media. The previous boot sequence is restored at the next boot.
- Future Boot Sequence — change the boot sequence for all future boots, for example, to boot from the primary hard drive.

Boot options



NOTE: The following boot options are available only when the Boot List Option is set to Legacy.

Floppy (Diskette Drive) — The computer attempts to boot from the floppy disk drive. If no operating system is on the drive, the computer generates an error message.

Hard Drive — The computer attempts to boot from the primary hard drive. If no operating system is on the drive, the computer generates an error message.

CD/DVD/CD-RW Drive — The computer attempts to boot from the optical drive. If no disc is in the drive, or if the disc is not bootable, the computer generates an error message.

USB Storage Device — Insert the memory device into a USB connector and restart the computer. When **F12 Boot Options** appear in the lower-right corner of the screen, press F12. The BIOS detects the device and adds the USB flash option to the boot menu.

 **NOTE:** To boot to a USB device, the device must be bootable. To ensure that your device is bootable, check the device documentation.

Network — The computer attempts to boot from the network. If no operating system is found on the network, the computer generates an error message.

Changing boot sequence for the current boot

- 1 If you are booting from a USB device, connect the USB device to a USB port.
- 2 Turn on (or restart) your computer.
- 3 When **F2 Setup**, **F12 Boot Options** appear in the lower-right corner of the screen, press F12.

 **NOTE:** If you wait too long and the operating system logo appears, continue to wait until you see the Microsoft Windows desktop. Then, shut down your computer and try again.

The **Boot Options** appears, listing all available boot devices.

- 4 On the **Boot Options**, select the device you want to boot from and press Enter.

For example, if you are booting to a USB hard drive, highlight **USB Hard Disk** and press Enter.

Changing boot sequence for future boots

- 1 Enter BIOS setup program.
See "[Entering BIOS setup program](#)".

- 2 Use the arrow keys to highlight the **Boot** menu option and press Enter to access the menu.





NOTE: Note your current boot sequence in case you want to restore it.

- 3 Navigate to **Set Boot Priority** to configure the boot priority.
- 4 Use the arrow keys to highlight the boot priority and press Enter to display the different devices.
- 5 Select the device and press Enter to set the boot priority.

Flashing the BIOS

You may need to flash (update) the BIOS when an update is available or when you replace the system board. To flash the BIOS:

- 1 Turn on the computer.
- 2 Go to **dell.com/support**.
- 3 Click **Product Support**, enter the Service Tag of your laptop and click **Submit**.
 -  **NOTE:** If you do not have the Service Tag, use the auto-detect feature or manually browse for your computer model.
- 4 Click **Drivers & downloads**.
- 5 Scroll down to **Or, show me all available drivers for ...** and select **BIOS** from the **Category** drop-down list.
 -  **NOTE:** In the **Change OS** drop-down list, select the operating system installed on your computer.
- 6 Expand **BIOS** to view the available BIOS files.
- 7 Click **Download File** to download the latest version of the BIOS for your computer.
- 8 Save the file and once the download is complete, navigate to the folder where you saved the BIOS update file.
- 9 Double-click the BIOS update file icon and follow the instructions on the screen.

Getting help and contacting Alienware



Self-help resources

You can get information and help on Alienware products and services using these online self-help resources:

Self-Help Information	Self-Help Options
Accessing Windows Help	Windows 8.1 —Open the Search charm, type Help and Support in the search box and press Enter. Windows 7 —Click Start → Help and Support .
Information about Alienware products and services	See alienware.com .
Troubleshooting information, user manuals, setup instructions, product specifications, technical help blogs, drivers, software updates, and so on	See alienware.com/gamingservices .
Videos providing step-by-step instructions to service your computer	see youtube.com/alienwareservices .

Contacting Alienware

To contact Alienware for sales, technical support, or customer service issues, see **alienware.com**.

-  **NOTE:** Availability varies by country and product, and some services may not be available in your country.
-  **NOTE:** If you do not have an active internet connection, you can find contact information on your purchase invoice, packing slip, bill, or Dell product catalog.
-  **NOTE:** If you are in the United States, call 1-800-ALIENWARE for help on your Alienware computer.