

TABLE OF CONTENTS

INTRODUCTION AND BATTERY TERMINOLOGY 3

TECHNOLOGY COMPARISON 4-5

- Primary Alkaline
- Nickel-Cadmium and Nickel-Metal Hydride
- Lithium-Ion

RECHARGEABLE ALKALINE AA & AAA
PERFORMANCE DATA 6-12

- Constant Current Discharge Capacity
- Multiple Cycle Capacities
- Capacity Fade and Depth of Discharge
- Partial Discharge
- Cumulative Discharge Capacity
- High-Current Pulse Response
- Cell Impedance
- Discharge Rate and Available Capacity
- Temperature Performance
- Self Discharge

RECHARGEABLE ALKALINE CHARGING METHOD 13-14

- Charge Acceptance

RECHARGEABLE ALKALINE BATTERY
MANAGEMENT GUIDELINES 14-18

- Continuous Load Current Limits
- Discharge Monitoring and Termination
- Quiescent Current
- Series Battery Packs
- Low Battery Warning
- Storage and Replacement
- Battery Management IC's
- Software-Based Battery Management

CELL DIMENSIONAL SPECIFICATIONS 19

- Cells

RECHARGEABLE ALKALINE BATTERY CHARGER
SPECIFICATIONS 20

PRODUCT AVAILABILITY 20

BATTERY CHARGING TERMINAL CONTACTS 21

APPLICATIONS ENGINEERING WORKSHEET 22-23



The High Performance Alkaline Battery in a Rechargeable Alkaline System



Description

Rayovac's Rechargeable Alkaline batteries offer the high performance attributes of regular alkaline batteries combined with the cost and environmental benefits of a rechargeable system.

Features

- Long life
- Reusable
- Come charged and ready to use
- Hold a charge up to five years in storage
- No memory problems
- Discharge voltage profile simplifies low-battery detection
- Meet worldwide environmental standards
- Available in standard AAA, AA, C, and D cell sizes

Typical Applications

- Handheld PCs
- Electronic Organizers
- Cellular Phones
- Cordless Household Phones
- Toys and Games
- Portable Data Terminals
- Digital Cameras
- Personal Care Products
- Test Equipment
- Personal Audio/Video

Technical Data Summary

Nominal No-Load Voltage: 1.5V DC

Recommended Operating Currents: 600 mA max continuous;
1A max pulse

Temperature Range: -10°C to 50°C

Capacity Retention: >95% after one year @ 20°C

INTRODUCTION

The Rayovac Rechargeable Alkaline Battery System represents a new alternative for the designer of portable battery-operated equipment. Prior to the introduction of the Rechargeable Alkaline product system most portable equipment was constrained to use either single-use disposable alkaline batteries or other systems such as Nickel-Cadmium (NiCd) or Nickel-Metal Hydride (NiMH).

Rechargeable Alkaline bridges the gap between the single-use primary alkaline and the traditional choices in other rechargeable battery systems. It combines many of the benefits of both conventional alkaline and rechargeable nickel-based systems.

Rechargeable Alkaline Manganese batteries have existed in the laboratory for many years. However, Rechargeable Alkaline offers a significant and proven solution to the shortcomings of previous efforts in rechargeable alkaline battery technology. Rayovac has optimized the features to provide a reliable, consumer-safe battery system. The design of the Rechargeable Alkaline system has the benefits of high capacity and excellent shelf life in an environmentally responsible formula.

Rechargeable Alkaline can be an excellent power source for many battery-operated products when one considers design tradeoffs such as cost, battery run-time, storage characteristics, and environmental impact.

This guide compares Rechargeable Alkaline technology to other common battery technologies, and shows performance data for the AA and AAA cell sizes (the most popular standard sizes for portable products). This guide also provides recommendations for obtaining the best performance from Rayovac's Rechargeable Alkaline system.

BATTERY TERMINOLOGY

Different battery technologies can be compared in terms of certain key performance parameters such as capacity, rate capability, self-discharge rate and rechargeability (or recharge cycle life). No "ideal" battery satisfies all possible requirements equally well, however different battery technologies have been developed which optimize certain parameters.

System designers who develop battery-operated equipment should first determine which battery performance characteristics are most relevant for their application. They can then select the appropriate battery technology, cell type, and configuration that best meet the requirements for their product.

Capacity refers to the amount of energy that a battery can deliver to a load. This is often expressed in units of Ampere-hours, reflecting the ability to deliver a specified current to a load (device) for a given duration of time. Battery capacity can also be expressed in terms of Watt-Hours. Batteries with a higher capacity will provide longer device operation time.

The *rate capability* is the maximum continuous or pulsed output current that a battery can provide. An ideal battery would have an infinite rate capability. A very simple representation of a battery in electrical circuit terms is that of a voltage source in series with a resistance. This *internal resistance* parameter varies according to the electrochemical system, cell design, and operating conditions. It is responsible for the limitation in actual rate capability as well as the reduction in available capacity (due to the internal resistive losses) at higher discharge rates.

The *self-discharge rate* is the rate at which a battery loses its charge during storage or no-load conditions. Secondary (rechargeable) batteries usually have a higher self-discharge rate than primary (non-rechargeable) batteries. Rechargeable batteries with a high self-discharge rate require charging prior to use after periods of storage. They are often left connected to their chargers when not being used.

Rechargeable batteries also have a finite *cycle life*. After a number of discharge and recharge cycles, the useful capacity of the battery begins to decrease with each successive cycle. At the end of cycle life, the battery will no longer be able to deliver any useful amount of energy, regardless of how long it is recharged.

TECHNOLOGY COMPARISON

Rechargeable Alkaline Batteries combine some of the characteristics of conventional alkaline and rechargeable nickel-based battery products. They have a higher initial capacity than NiCd and NiMH cells, but not as high as primary alkaline. Unlike primary alkaline, they can be recharged and reused, but not for as many cycles as NiCd and NiMH.

Primary Alkaline

Primary (non-rechargeable) alkaline batteries must be discarded after a single use. They have very good energy density when operated at low and moderate discharge rates (typically up to hundreds of milliAmperes) and have excellent charge retention during storage. Attempting to recharge these batteries may result in internal short-circuits between the anode and cathode, internal gas generation and probable leakage. Both primary and Rechargeable alkaline batteries can be safely disposed of in landfills with no toxic material concerns.

Rechargeable Alkalines are generally interchangeable with primary alkaline batteries. However, they do have a slightly higher internal resistance characteristic than primary alkaline batteries. Rechargeable Alkaline batteries may provide shorter run-times when compared to primary alkalines in applications that require high continuous or pulse current loads.

At low and moderate drain rates (where the effect of the internal resistance in the Rechargeable Alkaline battery is less significant), the performance of Rechargeable Alkaline can be close to that of primary alkalines. The general operation, discharge curve shape, and storage (charge retention) characteristics of Rechargeable Alkaline and primary alkaline batteries are very similar.

The advantage of Rechargeable Alkaline batteries over primary alkalines is the reusability of the Rechargeable Alkaline system. Rechargeable Alkaline batteries can be recharged because they have different internal construction and chemical composition compared to primary alkalines. While the performance of a Rechargeable Alkaline on a single discharge cycle may be less than that of a primary alkaline, the rechargeability of the Rechargeable Alkaline system allows a single cell to provide a cumulative capacity equivalent to dozens of single-use cells.

Over a period of several charge/discharge cycles, Rechargeable Alkaline batteries can represent a significant cost savings to the end user over single-use disposable alkaline batteries. Rechargeable Alkaline also presents a more environmentally responsible alternative to the large number of primary alkaline batteries that would require disposal over time when used throughout the lifetime of a given electronic product.

NiCd and NiMH

NiCd and NiMH batteries can be recharged and reused many times and they have a very low internal resistance, allowing delivery of their rated capacity at high current loads.

As a result, NiCd and NiMH are appropriate choices for high-current products that require many frequent charge/discharge cycles, such as power tools or notebook computers. However, their capacity in products such as portable audio equipment, palmtop computers, electronic games and toys or other low-power equipment can be substantially less than that of primary alkalines. In devices which may not fully discharge the battery on each use, NiCd cells can develop "memory effect" which reduces the run-time available for each use.

In addition, NiCd and NiMH cells are more expensive and have very poor shelf life characteristics. In fact, a fully charged battery will discharge itself over time when left in storage, requiring another recharge prior to use after the storage period.

Finally, NiCd batteries contain Cadmium and require special handling for disposal or recycling. NiMH batteries are perhaps less objectionable environmentally than the NiCd batteries, but may still be subject to local environmental regulations in some areas.

A Rechargeable Alkaline battery lasts nearly as long as a single-use alkaline battery on its first use. While the Rechargeable Alkaline battery provides reduced capacity for each successive discharge, it operates longer than a similar-sized NiCd cell for approximately the first full discharges. This is illustrated in Graph 1 below.

Graph 1: Discharge Profile Comparison Primary Alkaline, NiCd, and Rechargeable Alkaline—100mA Discharge to 1.0V

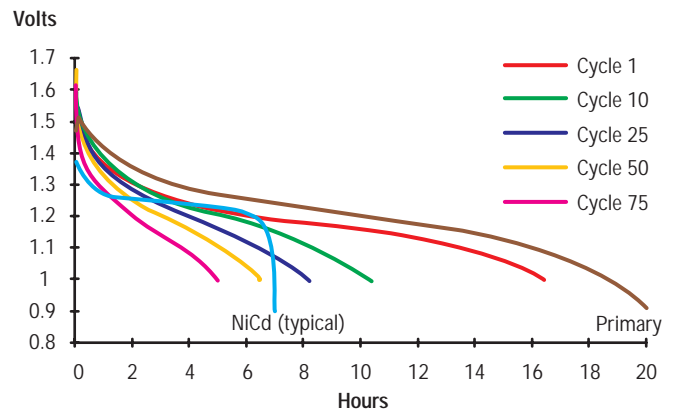

Lithium-Ion

Lithium-Ion technology is the newest battery technology for portable devices. It provides significant performance advantages, particularly in terms of its light weight, high energy density, and good charge-retention characteristics compared to NiCd and NiMH systems.

Due to their different cell voltage (roughly 3.5V/cell), Lithium-Ion batteries must be provided in unique sizes that will typically not be compatible with the standard AA or AAA battery. The main disadvantage of Lithium-Ion technology is its cost. The high cost of this technology may restrict its use for inexpensive electronic equipment.

Rechargeable Alkaline batteries provide an excellent combination of features for cost-sensitive applications that need high capacity, low self-discharge characteristics and rechargeability. Rechargeable Alkaline is particularly well suited for intermittent-discharge applications that may not fully drain the batteries prior to each recharge.

Advantages of Rechargeable Alkaline Batteries

- High capacity for low-power devices
- Batteries stay charged when not in use
- No “memory effect”
- Lower cost than any other rechargeable cylindrical cell type
- Easily and inexpensively replaced by consumers when new batteries are needed
- Environmentally friendly technology



Comparison of AA-Cell Characteristics: Rechargeable Alkaline, NiCd, and NiMH

<i>(Approximate Values)</i>	Rechargeable Alkaline	NiCd	NiMH
Nominal Capacity, mAh (varies with load)	1600 (initial)	750	1100
Usable Cycles (varies with discharge level)	100+	200+	300+
Nominal Voltage Range (under load)	0.9 to 1.4	1.0 to 1.3	1.0 to 1.3
Weight	22g	22g	26g
Gravimetric Energy Density (Watt-hr/kg)	80 (initial)	41	51
Volumetric Energy Density (Watt-hr/liter)	220 (initial)	115	170
Continuous Output Current (maximum recommended)	600 mA	>5A	>2A
Peak Output Current	1A	>10A	>10A
Fast Charge Time (after discharge to 0.9V @ 300 mA)	2-4 Hrs	1 Hr	1 Hr
Self-discharge Rate (room temperature)	0.01% per day	1% per day	4% per day
Typical Retail Replacement Cost (4-cell pack)	\$5.00	\$10.00-\$30.00	\$60.00+
Safely Disposable	Yes	No	Unknown

Note: Battery performance will vary with load and environmental conditions. The comparison chart represents typical values at nominal load and temperature conditions (approximately 100 mA load at room temperature) and is a guideline of what can be reasonably expected under these conditions. It is not a definitive product specification because of the variability in characterizing different battery systems under different operating conditions.

RECHARGEABLE ALKALINE PERFORMANCE DATA

AA Cell

The Graphs in this guide allow system designers to estimate the performance of Rechargeable Alkaline AA cells in their applications. Graphs for AAA cells start on page 12.

The run-time from a fresh set of batteries can be estimated by the initial capacity curves shown below. The run-time from a set of batteries after multiple charge and discharge cycles can be estimated from the cycle capacity curves.

Constant Current Discharge Capacity

Graphs 2 and 3 below show the voltage profile for constant current discharge at various rates of discharge. The curves show the capacity of a new cell on its first discharge.

Graph 2: AA Cell Initial Capacity—Low Current Discharge

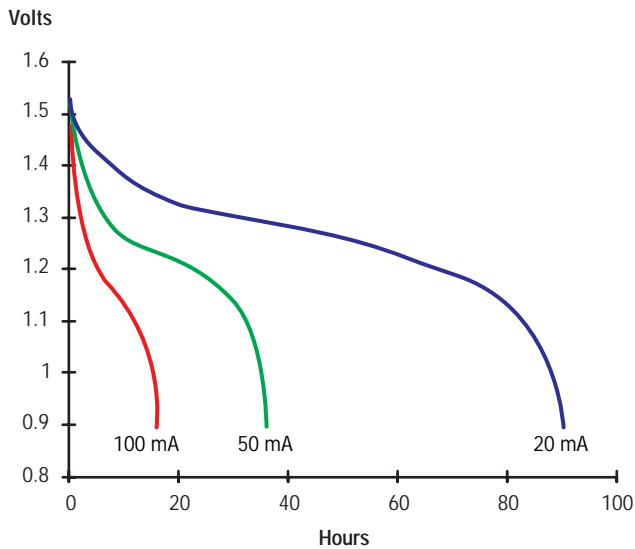

Graph 3: AA Cell Initial Capacity—High Current Discharge

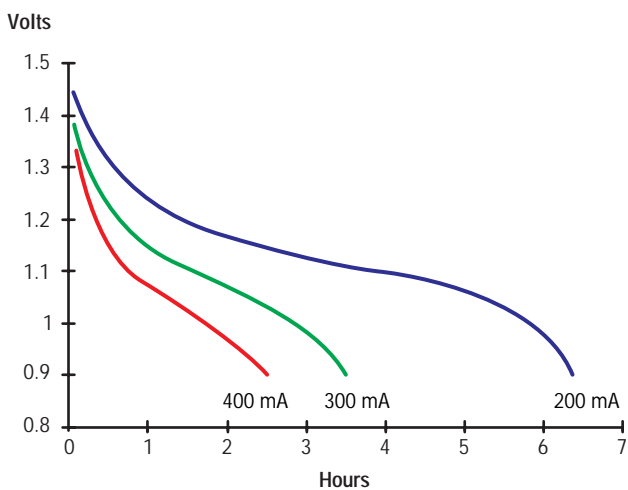

The capacity of a cell for a specific operating condition (cutoff voltage and drain rate) is determined by multiplying the discharge rate by the time at which the voltage curve crosses the cutoff point used in the application.

- A Rechargeable Alkaline AA cell that is drained at 50 mA to a voltage of 1.0 will give about 32 hours of use. It will have delivered (50 x 32) or 1600 milliAmp-hours of capacity.
- If another AA cell is drained at 400 mA to a voltage of 1.0, it will operate for about 1.6 hours on initial use, resulting in (400 x 1.6) or 640 milliAmp-hours.
- Both cells were discharged to the same endpoint voltage. Even though the cell that was loaded at 400 mA had a much higher rate of discharge, it was subjected to a much lower depth of discharge.

For comparison, a primary Alkaline AA cell would deliver around 2000 milliampere hours, and a typical consumer-grade NiCd would deliver 600 to 700 milliampere hours under these conditions.

The graphs show that the milliAmp-hours capacity available from the cell decreases with higher load rates. This loss is due to the internal resistance of the cell, which becomes more significant at higher rates.

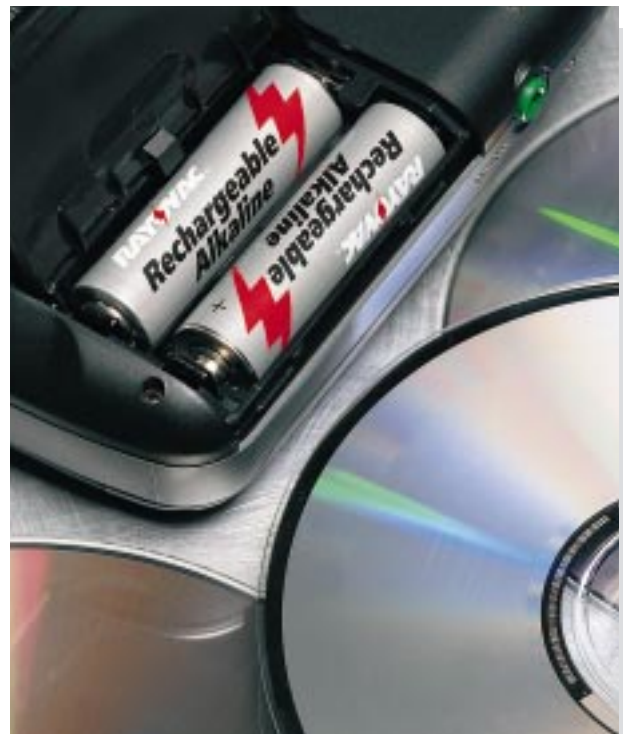

Multiple Cycle Capacities

The following graphs show the effect of charge/discharge cycles on cell capacity at specific discharge rates. In each graph, the voltage profiles show results from the same cell for multiple discharges at the specified drain rate.

Graph 4: AA Cell Cycle Capacities—50 mA Discharge

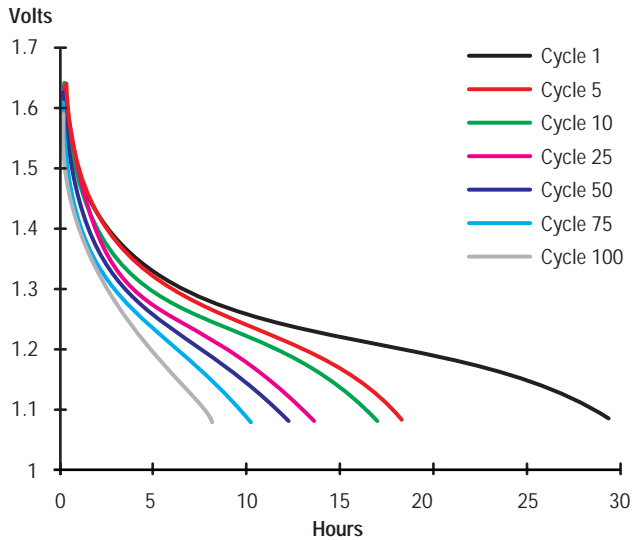

Graph 5: AA Cell Cycle Capacities—100 mA Discharge

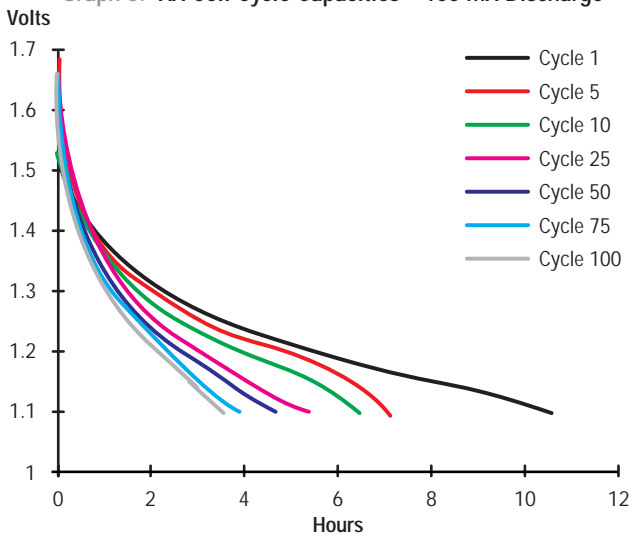

Graph 6: AA Cell Cycle Capacities—200 mA Discharge

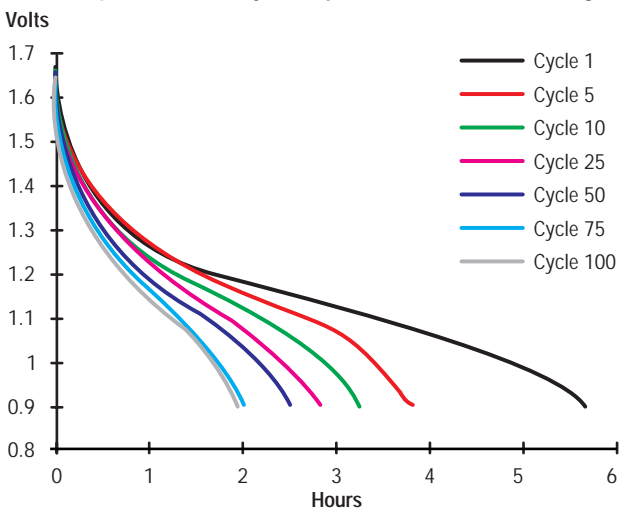

Graph 7: AA Cell Cycle Capacities—300 mA Discharge

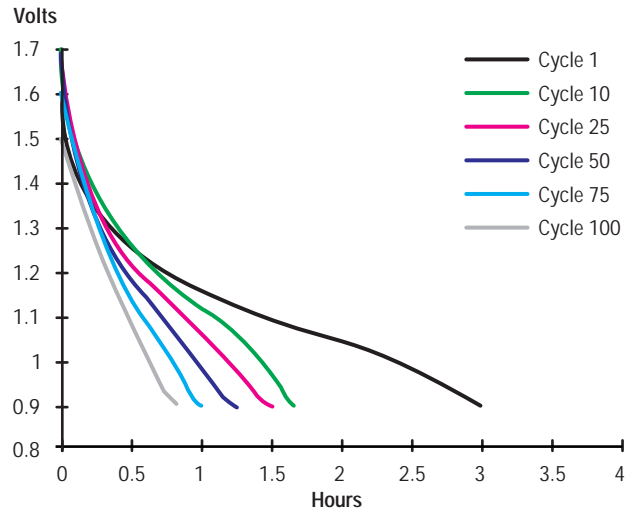

Capacity Fade

On each successive discharge, the capacity of the battery will be lower in comparison to the previous cycle. Graph 8 approximates the loss in capacity as a function of discharge cycle (when the cell is fully drained prior to recharge). The batteries can continue to be cycled if desired, but the battery performance will continue to diminish.

Graph 8: Typical AA and AAA Cell Capacity Fade

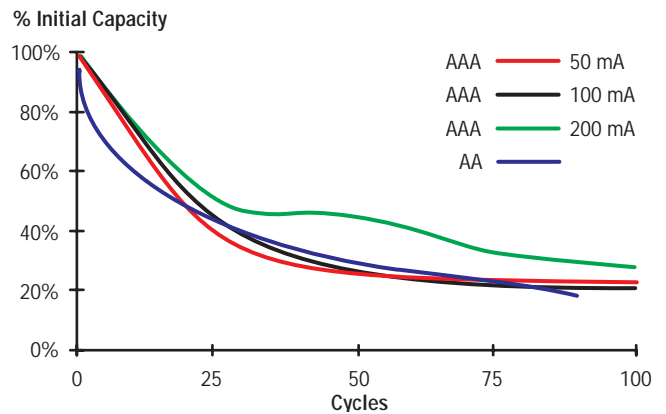

The degree of capacity fade will not be the same in all applications. It depends on factors such as the rate of discharge and the endpoint voltage at which the discharge is terminated. These relate to the "depth of discharge," or the amount of energy withdrawn from the battery prior to recharge for each cycle.

Capacity Fade and Depth of Discharge

The *depth* of discharge is not the same as the *rate* of discharge. Depth of discharge refers to the total amount of capacity withdrawn from the battery, while rate of discharge is the level of current being drawn from the cell at a given time.

Example:

- A portable device is powered by four AA-cells and has a minimum operating voltage of 4.0 volts. Cutoff voltage is therefore 1.0V/cell. Operating current is 100 mA.
- On initial use the 100 mA discharge curve crosses 1 volt at approximately 16 hours.
- Approximate initial capacity obtained from a Rechargeable alkaline AA cell:
 $(100 \text{ mA}) \times (16 \text{ hours}) = 1600 \text{ mAh}$.

The degree of capacity fade at a specific discharge rate will be less if the discharge is stopped at a higher voltage, since not as much capacity is withdrawn from the cell prior to recharge. Similarly, for a fixed endpoint voltage the capacity fade is less pronounced for higher discharge rates because the endpoint voltage is reached earlier due to internal resistance losses.

If a cell is terminated at a higher endpoint voltage it will not deliver as much energy during each discharge cycle. As a result, the benefits of reduced capacity fade may not be as significant when the total run-time of the device over the total useful lifetime of the battery is considered (i.e., the designer can choose between a few long cycles with a high cutoff voltage, depending on the application and use mode of the device).

Partial Discharge Characteristics

NiCd and NiMH batteries generally provide the best service when fully discharged before recharge. This type of usage with rechargeable alkalines produces the effect shown in the earlier multiple-cycle discharge curves (page 7), where the capacity of the cell is reduced with each discharge cycle. Under these conditions, the capacity of the 25th cycle is about half of the initial capacity.

Under partial discharge conditions, the reusable alkaline cell can last for several hundred cycles with very little degradation from one cycle to the next. Graphs 9-10 illustrate the response of a reusable alkaline cell subjected to a repetitive short discharge of 400 mA for 10 minutes. After each discharge, the cell was recharged. Graph 11 illustrates several hundred of these short cycles, the cell response was not significantly different than on the first few cycles. After every 200 of these short discharges, the cell was fully discharged to demonstrate that the capacity of the cell is still available for long discharges if required (i.e., no "memory effect" had developed).

Graph 9: AA Cell Repetitive Short Discharge—Cycles 1-4
(400 mA for 10 minutes, recharge after each discharge)

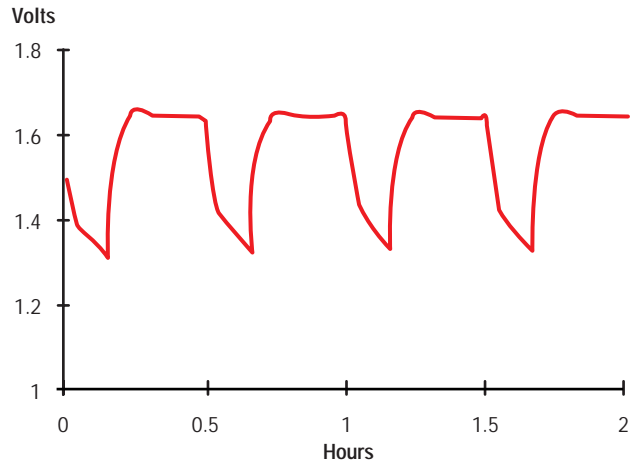

Graph 10: AA Cell Repetitive Short Discharge—Cycles 1797-1800
(400 mA for 10 minutes, recharge after each discharge)

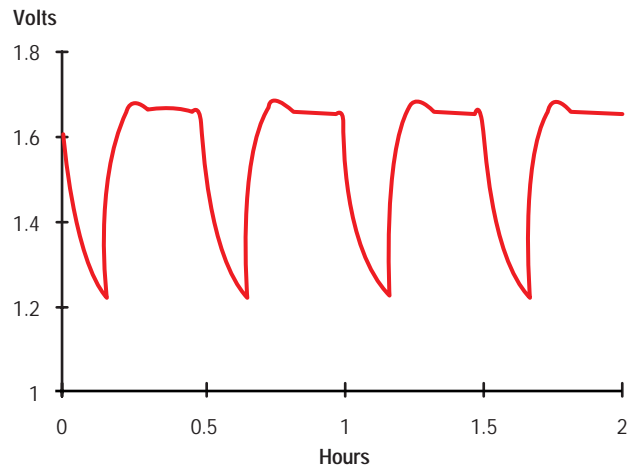

Graph 11: Reserve Capacity After Repeated Short Cycles
(Full discharge at 300 mA after every 200th shallow discharge)

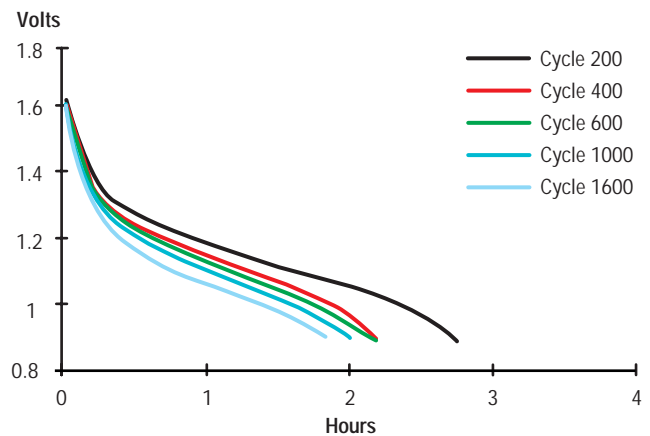

This type of intermittent usage mode may be representative of products such as cellular phones, cordless telephones, electric shavers or emergency lighting devices.

Most applications will fall somewhere in between the extreme cases of full discharge on every use and the extremely short partial cycling shown. The Rechargeable Alkaline system performs well under these conditions.

In graphs 12-15 a Rechargeable Alkaline AA cell was drained at the stated discharge rate for the stated time per cycle. This type of usage corresponds to many devices that may be used for a fixed period of time and then recharged on a regular schedule. Hundreds of these partial cycles were provided before the cell could no longer deliver the required run-time.

Graph 12: Rechargeable Alkaline AA Cell - Partial Discharge
 50 mA for 6 hours
 (300 mAh total discharge)

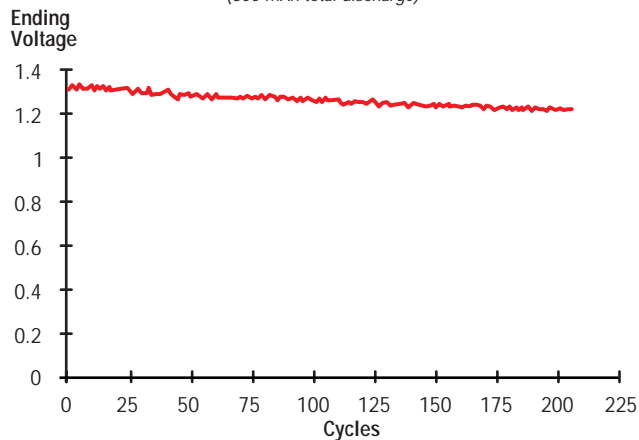

Graph 13: Rechargeable Alkaline AA Cell - Partial Discharge
 200 mA for 90 minutes
 (300 mAh total discharge)

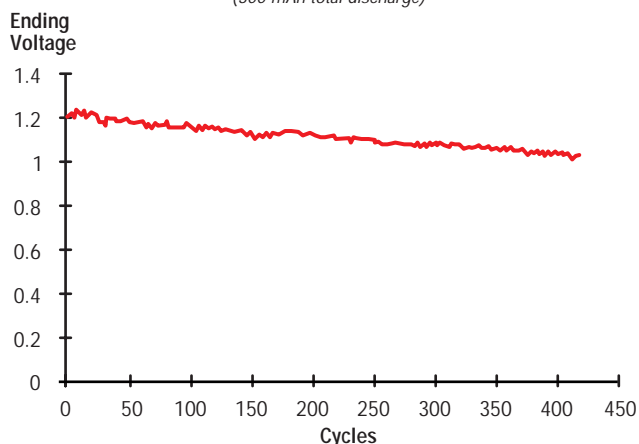

Graph 14: Rechargeable Alkaline AA Cell - Partial Discharge
 400 mA for 45 minutes
 (300 mAh total discharge)

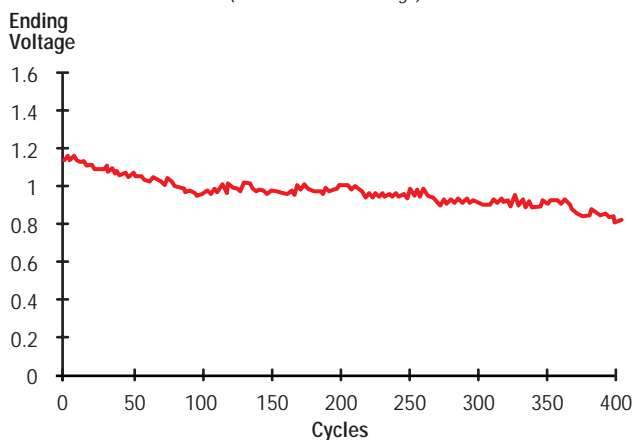

Graph 15: Rechargeable Alkaline AA Cell - Partial Discharge
 600 mA for 10 minutes, Recharge 30 minutes

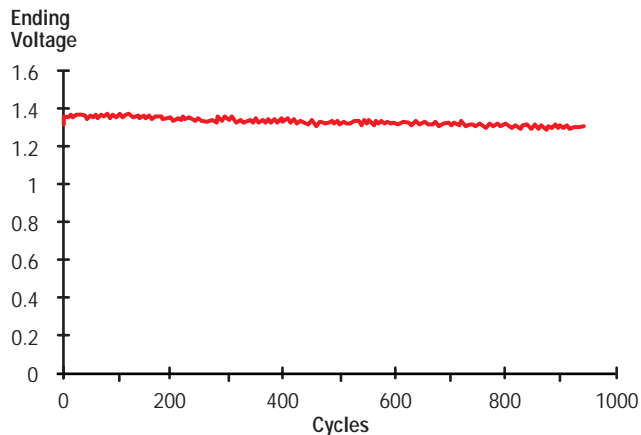

Cumulative Discharge Capacity

The following graphs show the cumulative capacity obtained over several cycles at specific discharge rates. Each discharge was terminated at a cell voltage of 0.9 volts. While the low rate discharge curves showed a higher degree of capacity fade than at high rates, it can be seen that the total capacity delivered is still higher when the cell is discharged at low drain rates to the same endpoint voltage.

Graph 16: AA Cell Cumulative Discharge Capacity

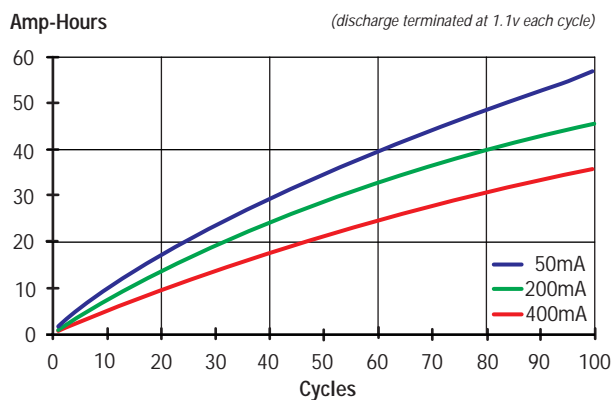

Graph 17: AAA Cell Cumulative Discharge Capacity

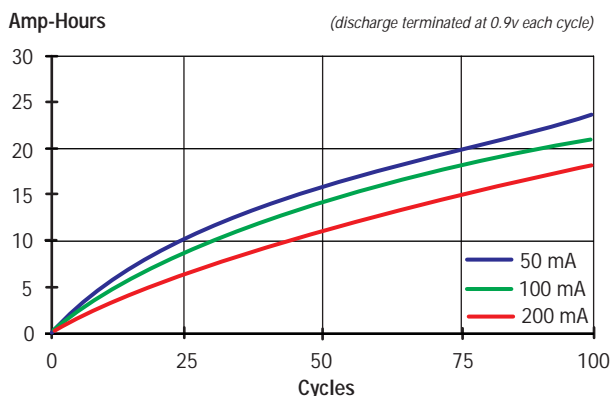

In summary, applications which have high depth of discharge will see the most pronounced capacity fade. This is particularly noticeable in very low-current devices because the battery can be very deeply discharged at low currents (20 mA or less).

Applications with a very shallow discharge will be able to obtain a greater number of discharge cycles from Rechargeable Alkaline cells because of the reduced level of capacity fade. The standard claim of 25 cycles for Rechargeable Alkaline batteries is based on typical use in consumer products. For certain applications with shallow discharges and frequent recharges, hundreds of usable cycles can be obtained.



The curves have a decreasing slope as the cycle count increases, which indicates diminishing discharge capacity with each successive cycle. However, the positive slope at the end of the graph shows that there are usable cycles left in the cells. If a battery was at the absolute end-of-life, recharging it would not restore any capacity and thus the cumulative capacity curve would be flat. The number of usable cycles in a given application will depend on the point at which the operating time for the batteries in the device falls below a minimum acceptable level.

High-Current Pulse Response

Graph 18 below illustrates the response of the Rechargeable Alkaline AA cell when subjected to a 1A pulsed load. The pulsed load was applied to a fully-charged cell for one minute. When the load level is reduced to 200 mA the cell voltage recovers to a normal operating level.

The cell was then discharged at a steady-state load condition of 200 mA until the voltage fell to 1.0 volt, representing an almost fully-discharged condition. The test was repeated over 25 full discharge cycles with similar results, and cycle 10 is shown below as a typical response.

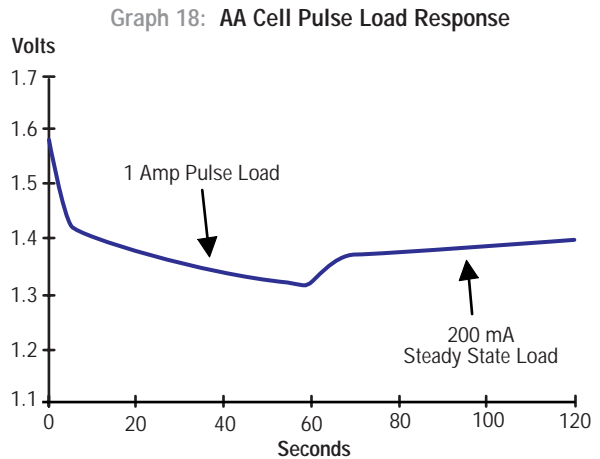

Cell Impedance

A standard method used to measure cell impedance consists of applying a low-level audio-frequency current signal to the cell and measuring the corresponding voltage change. The ratio of the measured voltage to the known input current is the cell impedance at the given signal frequency. This value provides a general indication of the rate capability of the cell relative to other cell types. Measured values for Rechargeable Alkaline AA cells are typically 0.15Ω to 0.20Ω for fully charged cells.

The effective source impedance of a cell under closed-circuit operating conditions is a function of several variables such as load level, state of charge, age of the cell, and operating frequency.

The parameter that is generally of most significance in an electronic system is the amount of sag (loss in terminal voltage) seen at the power source during a load transient. While this can be approximated based on the measured impedance of the battery, a more accurate estimate requires that a test similar to that shown in the previous illustration of pulse load response be performed at the load levels of interest for a particular application.

Discharge Rate and Available Capacity

Rechargeable Alkaline cells have a greater internal resistance than NiCd and NiMH batteries. Therefore, the battery is not able to deliver energy as efficiently at high rates of discharge due to internal resistance losses. A Rechargeable Alkaline battery will provide significantly higher capacity than a NiCd at low currents, but this advantage diminishes with increased loads as shown.

Graph 19: Effect of Discharge Rate on Capacity

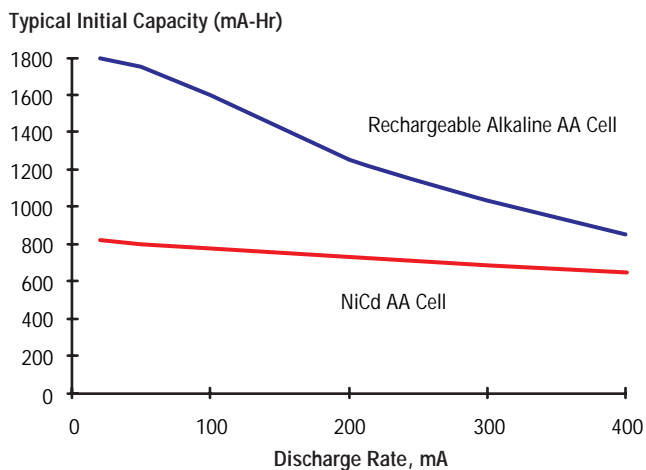

Temperature Performance

Chemical reaction rates are decreased at low temperatures. All batteries suffer from a loss in performance (particularly rate capability and high-rate capacity) at lower temperatures when compared to room-temperature performance.

Similarly, at slightly elevated temperatures, a greater amount of capacity can be delivered by the cells. However, as the temperature increases beyond a certain level, internal pressure buildup, caused by gas formation internal to the cell, may cause cell failure.

Rechargeable Alkaline batteries provide best performance at moderate temperatures, generally between 0° and 50°C (32° to 122°F). An approximate indication of cell response at varying temperatures is illustrated below.

Graph 20 Effect of Temperature on Capacity

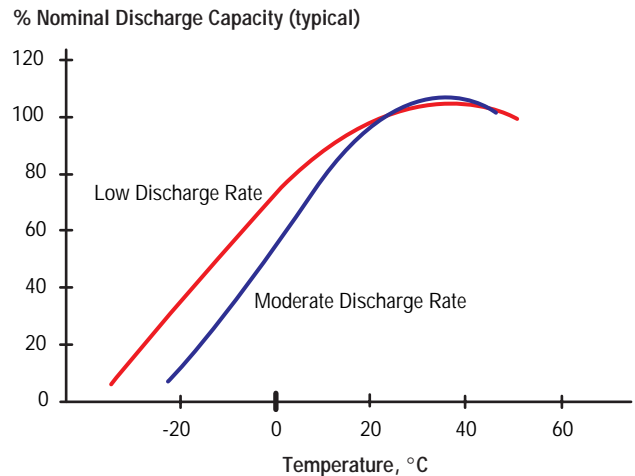

Self-Discharge

Rechargeable Alkaline batteries are similar to primary alkaline batteries in their ability to retain their charge after periods of storage. Most other commercially available rechargeable battery systems exhibit a rapid self-discharge characteristic in which they are unable to remain charged when not in use. An approximate comparison is illustrated in the following graph.

Graph 21: Estimated Charge Retention in Storage

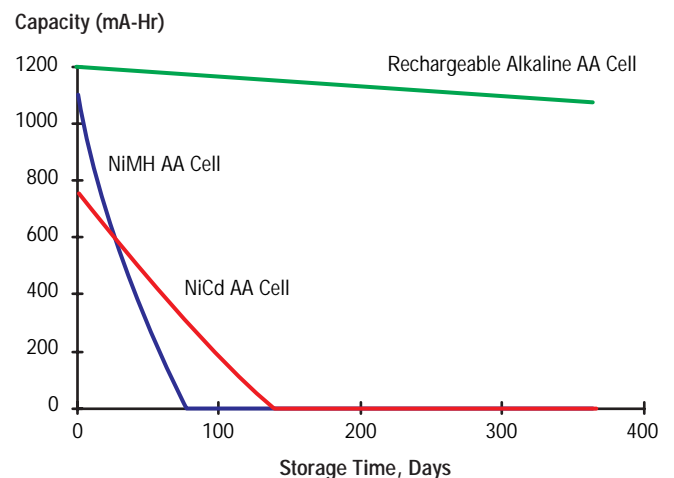

Rechargeable Alkaline batteries retain their charge when not in use; therefore, they do not require a "trickle charge" to keep them ready to use during storage.

AAA Performance Data

The graphs below illustrate the performance characteristics of the AAA size Rechargeable Alkaline battery.

Constant Current Discharge Capacity

Graph 22: AAA Cell Initial Capacity—Low Current Discharge

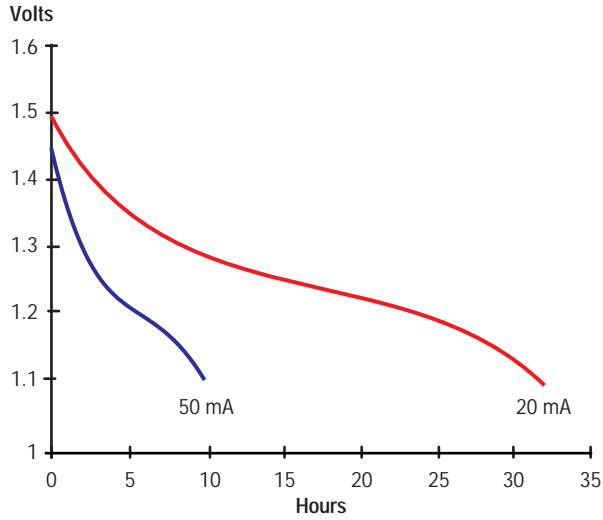

Multiple Cycle Capacities

Graph 24: AAA Cell Cycle Capacities—20mA

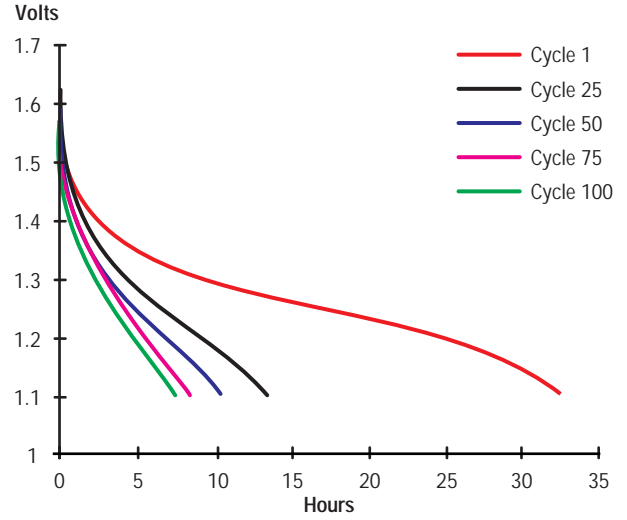

Graph 23: AAA Cell Initial Capacity—High Current Discharge

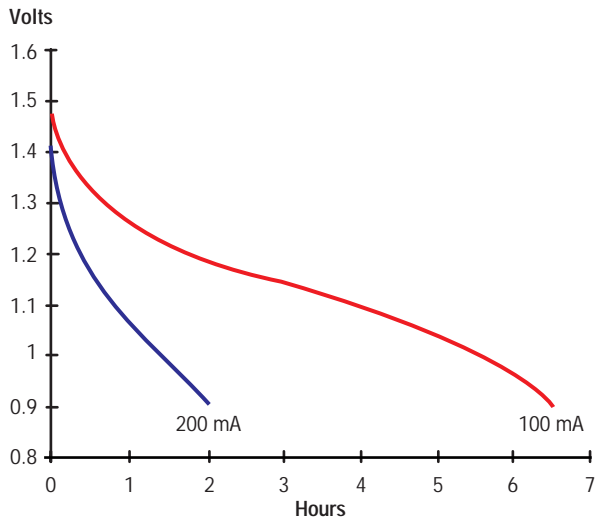

Graph 25: AAA Cell Cycle Capacities—100 mA

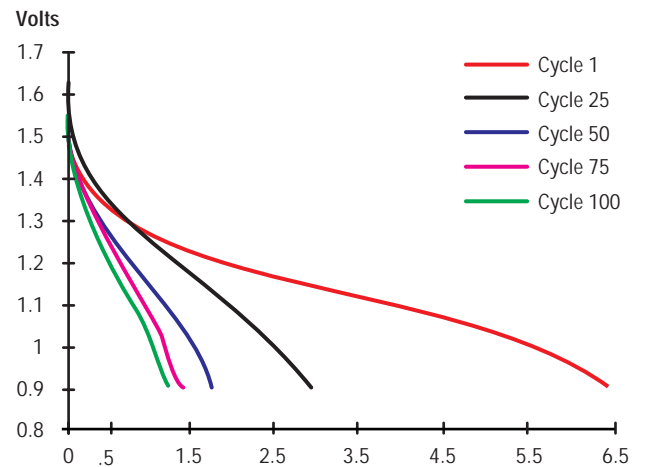

RECHARGEABLE ALKALINE CHARGING METHOD

Different battery types require different charging methods to optimize charge acceptance, maximize service life and ensure safety.

Methods of charging that have been used in NiCd systems such as continuous trickle-charging or fast charging with $-\Delta V$ termination are not suitable for use with Rechargeable Alkalines. Rechargeable Alkaline batteries should not be charged with constant-current chargers, because damage may occur if high current is forced into them after they have reached a partially recharged state.

The charge method used for Rayovac's Rechargeable Alkaline system applies pulses of current to the battery as indicated in Graph 26. When the current is interrupted, the cell voltage is measured. The open-circuit voltage (OCV) measurement during the pulse off-time compensates for the internal resistance component of the voltage during charge.

Graph 26: Pulse Charge / OCV-Sensing

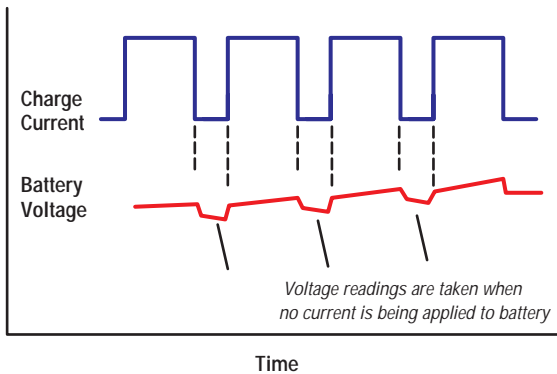

If the cell's open-circuit voltage is above 1.65V, subsequent pulses are blocked until the OCV decreases. As the battery charges, a greater portion of the pulses are blocked because the OCV stays above 1.65V for a longer period of time. This pulse-skipping causes the average current to taper to zero as the battery fills up, as illustrated in Graph 27.

Graph 27: Typical Average Current / Voltage Profile for Rechargeable Alkaline Pulse/Taper Charge Method

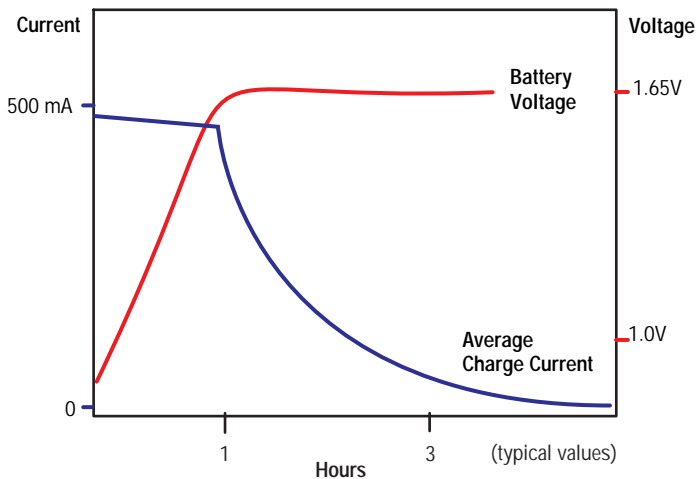

This charge method is implemented in the Rechargeable Alkaline Chargers using a custom IC developed for Rechargeable Alkaline charge control. The architecture of the Rechargeable Alkaline Charger is shown below.

Graph 28: Rechargeable Alkaline Charger Block Diagram

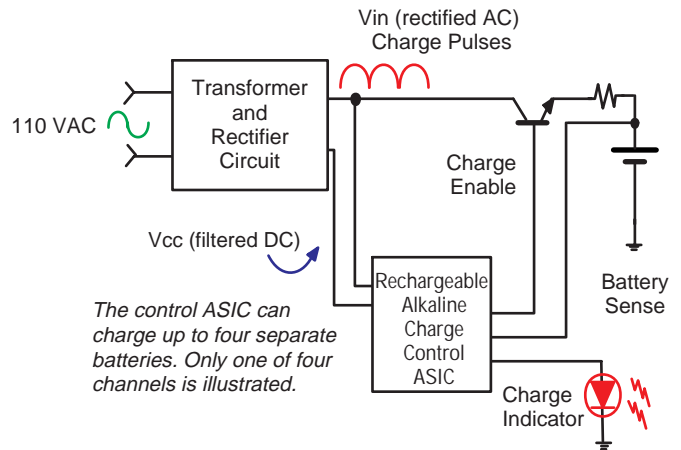

RECHARGEABLE ALKALINE BATTERY MANAGEMENT GUIDELINES

Charge Acceptance

The following graph shows the time required to restore the AA cell to a given state of charge after various discharge conditions. Both cells were recharged in the PS3 Rechargeable Alkaline Charger after being discharged at different rates to the same endpoint voltage. The PS3 charger applies pulses with a maximum duty cycle of approximately 70% on / 30% off at a peak pulse amplitude of 500 to 750 mA (depending on line and load conditions).

Graph 29: Charge Time for Different Discharge Conditions

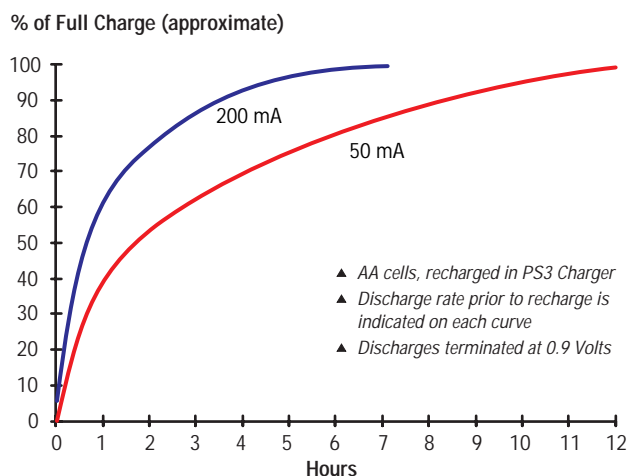

The illustration above shows the same peak charge rate for two AA cells, each discharged at their respective rates. The length of time required to reach full charge is higher for the low-rate case even though the endpoint voltages of both discharges are the same. This is due to the low-rate battery having a significantly greater depth of discharge (as described in the earlier section on Cycle Life and Capacity Fade). Since the batteries were recharged at the same rate, the low-rate had been drained more and required a longer charge time to complete a full charge.

For purposes of this illustration, *full charge* is defined as the point when the average charge current delivered to the cell had tapered to a negligibly low value (a few milliamps or less). This means that the amount of capacity being added to the battery by the charger was asymptotically approaching zero. The LED-out point for Rechargeable Alkaline Charger corresponds to roughly 75% full, depending on the discharge condition, cell size and charge type.

The performance and service life of almost any battery technology can be improved by the use of battery management circuitry to control the charging and discharging of the battery. The battery management issues for Rechargeable Alkaline batteries are discussed here.

Continuous Load Current Limits

The AA cell size can deliver reasonable performance at rates of approximately 400 to 500 mA continuous discharge (250 mA for AAA). Peak or instantaneous currents can be approximately twice as high (1A for AA, 500 mA for AAA), but the internal resistance of the cell will cause a drop in the terminal voltage of the battery during these transients. Rechargeable Alkaline batteries are best for moderate and low-power devices.

Discharge Monitoring and Termination

The most important factor in maintaining the rechargeability of Rechargeable Alkaline batteries is the avoidance of overdischarge or cell reversal. The discharge curves (Graphs 2 and 3) shown earlier illustrates the cell voltage drops rapidly after discharging below one volt. When multiple cells are connected in series, there will be some degree of mismatch between the cells. One cell in the set will reach the low voltage point first and then rapidly drop to zero (or negative) voltage, while the other cells are still delivering energy to the load. In systems operating from primary batteries, the end point voltage is not a concern. Once the batteries have been depleted, they are replaced with new cells. With Rechargeable batteries, however, the repeated or extended reversal of cells will reduce the performance of the battery after subsequent recharges.

Battery management circuitry can sense cell voltages and automatically shut off the load (or indicate a low battery warning) when a low cell voltage is observed. The low-voltage threshold is typically between 0.8 and 1.1 volts per cell and can be adjusted for the operating loads of the system. When cells are connected in series, voltage sensing is most effective when the voltage of each individual cell is sensed rather than the sum of all cells. This accounts for any cell variation that may exist. If this is not possible, the voltage cutoff for the series stack should be set high enough so that cell reversal is unlikely.

The cumulative output for the AA cell over multiple discharge cycles is shown below for 50, 100, and 200 mA discharge rates. Graphs 30, 31 and 32 show the effect of setting the discharge limit to 0.9, 1.0, or 1.1 volts per cell.

Graph 30: AA Cell Life-Cycle Capacity — 50 mA Load

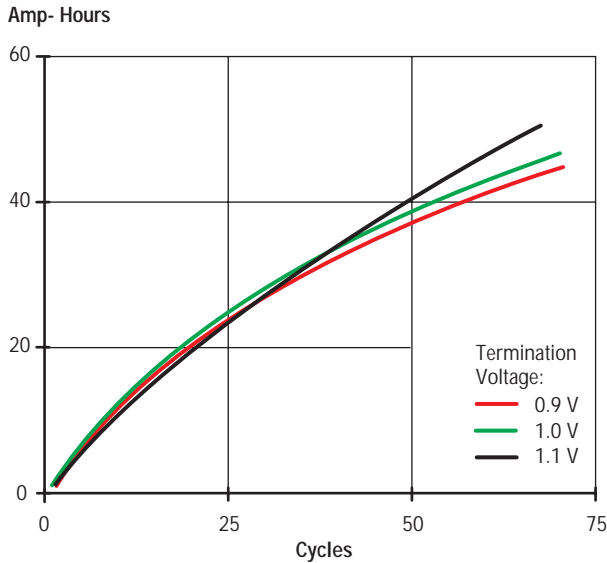

Limiting the depth of discharge will reduce the loss in available capacity for each successive discharge cycle. Depth of discharge can be controlled by setting the end-of-discharge termination voltage.

A high cutoff voltage may reduce the level of capacity fade, it can also reduce the run-time available for a given discharge cycle. The reason for the battery to cross the minimum allowed voltage sooner is that the termination threshold is high. A high cutoff voltage may result in many short discharge cycles (with only slight capacity fade from one discharge to the next). A low cutoff may result in fewer long discharge cycles (each discharge takes the maximum capacity out of the cell, resulting in greater capacity fade from one discharge to the next).

Graph 31: AA Cell Life-Cycle Capacity—100 mA Load

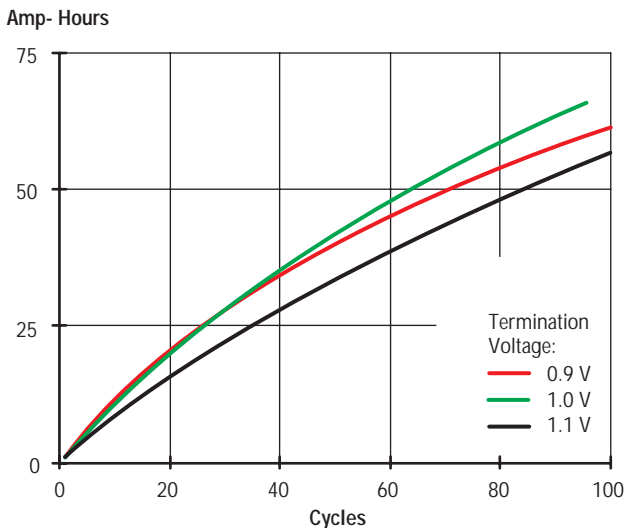

The goal of battery management circuitry is to optimize the tradeoff between single-cycle capacity and multiple-cycle battery life. This provides the maximum cumulative capacity (total run-time of a product) over the service life of the batteries.

At higher discharge rates, the internal resistance (IR) losses in the cell will cause the voltage to drop before all of the available capacity in a cell is withdrawn. At lower rates of discharge, the IR losses are less significant, allowing the possibility of deeper discharge (more capacity withdrawn) when the cell is operated down to a given end-point voltage. Consequently, high discharge rates allow lower cutoff voltages without impacting cycle life. Lower discharge rates should have higher endpoint voltages to avoid deep discharging the cells (which reduces capacity on successive cycles).

Graph 32: AA Cell Life-Cycle Capacity—200 mA Load

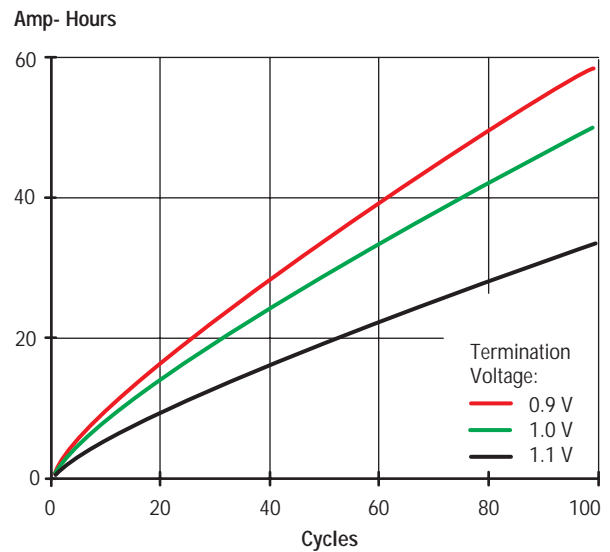

The low rate curves illustrate that even though a low endpoint voltage may yield a slightly higher capacity in early cycles, a higher voltage cutoff results in a greater total capacity delivered over the life of the cells. For the higher rates of discharge, the depth of discharge on each cycle is low enough that the lower cutoff voltages do not significantly affect the capacity fade from one cycle to the next.

Discharge Rate	Preferred End-of-Discharge Termination Threshold
50 mA	1.1 volt / cell
100 mA	1.0 volt / cell
≥ 200 mA	0.9 volt / cell

Optimal End-of-Discharge Limits

Quiescent Current

Some battery management circuits for NiCd and NiMH systems have operating currents in the range of a few hundred microamps. This current could fully drain a small cell in one or two months. Background currents at this level are not a problem with these chemistries, since their self-discharge rate can drain the cells in a few weeks even with no load connected.

Rechargeable Alkaline may be preferred in many applications over primary batteries, because of their excellent charge retention in storage. The load current placed on the cells by the battery management circuit must be very low in order to maintain the low self-discharge after weeks or months of storage.

Series Battery Packs

Most battery management circuits generally consider the entire battery pack as a single quantity, with a single measurement for the pack voltage and/or temperature. This measurement controls the charge and discharge termination for the pack. Any mismatch in capacity or state-of-charge between individual cells leads to overcharge or over-discharge of some cells. NiCd systems can tolerate limited amounts of continuous overcharge, but Rechargeable Alkaline (as well as Lithium-Ion) systems will be damaged by overcharge. Monitoring each cell in a multicell battery pack (rather than a single pack measurement) allows the charge controller to avoid overcharge of any cell in the pack regardless of cell-to-cell variations.

Similarly, individual-cell monitoring during discharge can prevent deep-discharge of any cell in a pack. By incorporating this technique into the low-battery shutoff control circuitry, cell matching within a Rechargeable Alkaline pack can be maintained for multiple usage cycles.

Low-Battery Warning and Fuel Gauging

Rechargeable Alkaline and disposable alkalines have a sloped discharge profile in comparison with the relatively flat discharge of NiCd/NiMH systems. The shape of the alkaline discharge curve allows low-battery warning circuits to trigger on the instantaneous battery voltage during discharge.

A circuit that can detect multiple voltage trip points can be used to generate an approximate (four- or five-segment) fuel gauge. These circuits (such as multiple-stage comparators) may be significantly simpler to design than the coulomb-counting circuits that are required for many NiCd/NiMH or Lithium-Ion systems.

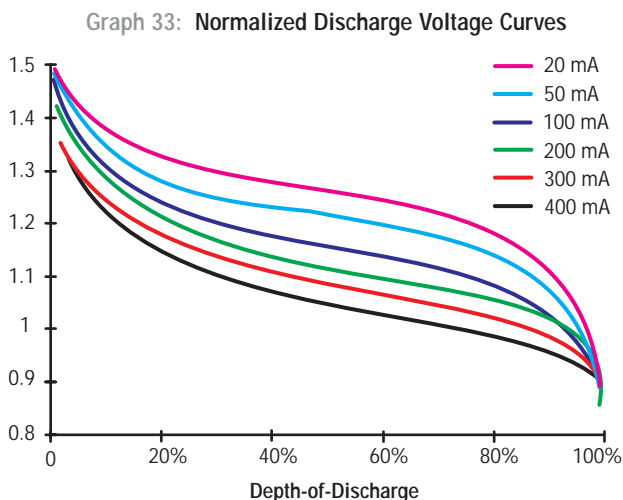

The trip point of a low-battery detection circuit for alkaline systems should be adjusted for the load current. The normalized discharge curves of a Rechargeable Alkaline AA batteries at various constant current loads are shown in Graph 33. While a loaded voltage of 1.1 volts/cell may be near the end-of-life for low current applications (see the 20 mA curve), it may be nearly 75% of full capacity for high current drains (such as the 400 mA case).

Exact discharge curves for the batteries will vary with each application. The power consumption and use patterns of the portable device should be characterized before selecting the thresholds for low-battery warning and fuel gauging circuits.

For systems with relatively constant loads, a fixed reference value can be selected after the system power demands are known. Devices with variable loads should use a variable reference circuit for best accuracy.

Storage and Replacement

The storage characteristics of Rechargeable Alkaline batteries are generally comparable to primary alkaline batteries. High temperature storage conditions will reduce the shelf life of the batteries and should be avoided. Rechargeable Alkaline batteries will retain their capacity best if left in a fully charged state prior to storage.

Circuitry connected to the batteries should not place a continuous load on the cells during periods of storage, as this could overdischarge them. (This is referred to as a "loaded storage" condition that is considered undesirable for any rechargeable battery system). For example, a load placed on the battery terminals as part of a battery monitoring circuit should be disconnected when the device is not in use or it could eventually deep-discharge the cells. This will reduce the rechargeability of the cells.

As with any battery system, when cells are replaced at the end of their useful cycle life, all cells in the device should be replaced simultaneously.

Rechargeable Alkaline Battery Management ICs

Benchmark Microelectronics has developed two integrated circuits specifically for use with Rechargeable Alkaline battery technology. The bq2902 manages the charge and discharge control of two cells in series. The bq2903 device works with 3- and 4-cell battery packs.

The bq2902 and bq2903 devices satisfy all of the basic requirements discussed for Rechargeable Alkaline battery management in an OEM device. These ICs provide the system designer with low cost, single-chip Rechargeable Alkaline battery management for portable systems.

Both devices require a current-limited DC power source to charge the batteries. The DC power is pulse-modulated by the chip to provide the appropriate charge method for the batteries. The bq2902 and bq2903 generate drive signals for optional external LEDs to indicate charge status (in-progress, completed, or fault conditions such as missing or damaged cells). A typical 4-cell application is illustrated in Graph 34.

When the charging power supply is removed, the batteries are continuously monitored for an end-of-discharge condition. The chip will disconnect the battery stack from the load if any cell falls below the end-of-discharge voltage. The IC also puts itself into a low-power “sleep” mode after discharge termination. The chip wakes up and re-initiates charging whenever the external DC input is detected.

The bq2902 and bq2903 provide a pin (“VSEL”) which can be connected to the system power rail (BAT1P), left open, or tied to the battery return (VSS). This allows the system designer to set the end-of-discharge threshold at 1.1, 1.0, or 0.9 V/cell as desired. The bq2903 also has provisions to control an external MOSFET switch to allow the use of the IC with high current loads.

Graph 34: 4 Cell Rechargeable Alkaline / bq2903 System

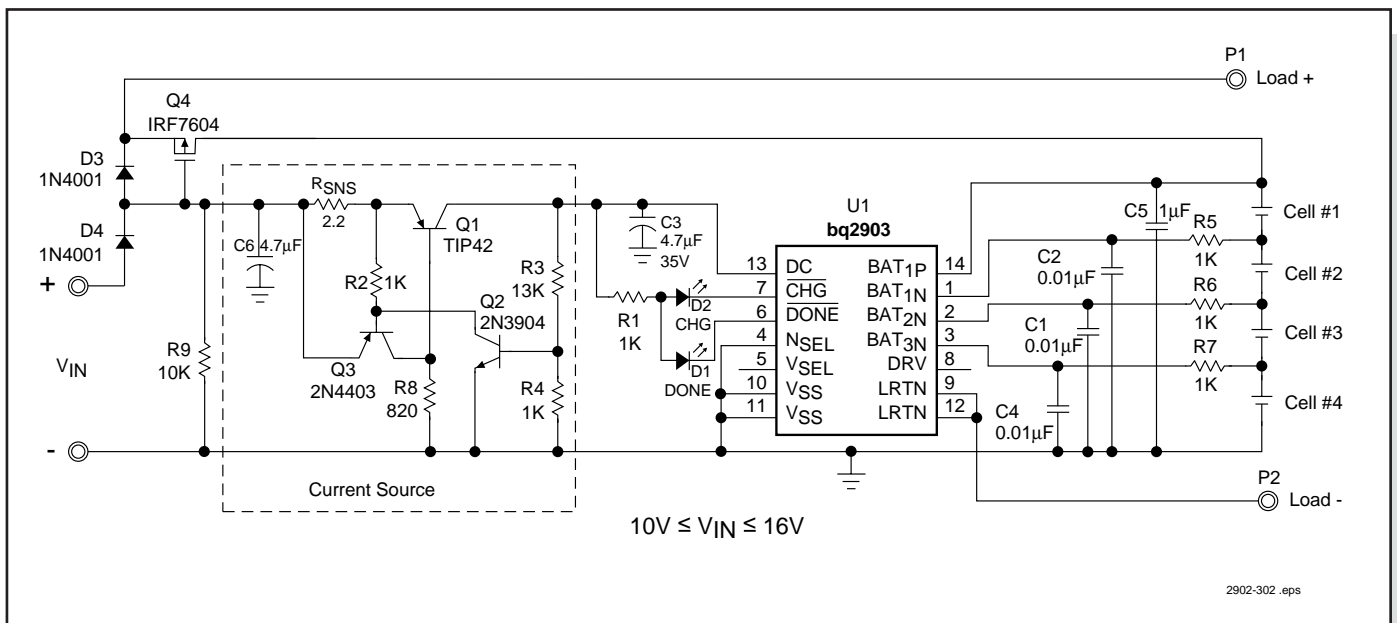

Software-Based Battery Management

The charge and battery control algorithm for Rechargeable Alkaline cells can be imbedded in a microcontroller. The basic principles are to:

- 1) Prevent over-discharge of the cells during battery operation. This is done to ensure rechargeability, maintain cycle life, and provide reliable operation.
- 2) Control/limit the charging of the battery. Recharging should restore the batteries to a “full” condition without overcharging. Overcharging can result in cell leakage.

The architecture for a Rechargeable Alkaline based power system is shown in Graph 35.

The illustration shows a six-cell application. The architecture can be modified to accommodate different pack configurations as required by changing the voltage output of the charge supply, and by the appropriate selection of power-switching

elements. The controller may be a programmable microcontroller device, which typically requires a regulated voltage for its power supply.

The controller monitors the voltages of each cell in the stack. It also determines whether the charge supply is connected. If a voltage is observed on the DC_IN line, the processor executes the instructions for the charge-mode of operation. If no voltage is seen on DC_IN, then the processor operates in the discharge monitoring mode.

The charge and discharge enable switches [Q1 & Q2] are controlled from the processor. If the cells require charging and the charge supply is available, the processor will modulate Q1 as needed to apply charge pulses to the cell stack. In the discharge mode, Q2 is enabled, allowing current to flow to the load until the batteries reach the minimum allowed voltage level. The end-of-discharge limit will be a function of the application requirements and load level of the device.

Graph 35: 6 Cell Rechargeable Alkaline Power System Architecture

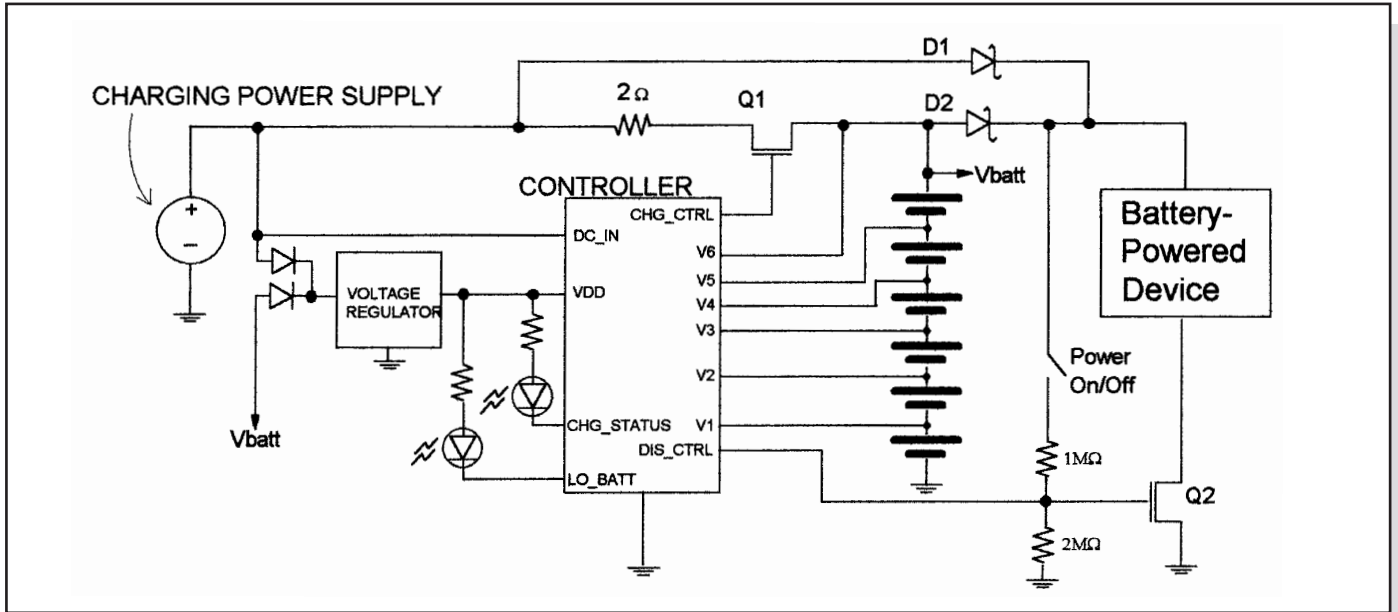

Graph 35 shows that power to the load can be taken from either the battery or the external power supply. Some applications may function from batteries only, with the external supply used only for battery charging, not for device operation. In this case, the power sharing, or steering diodes, can be eliminated [D1 = open circuit; D2 = short]. Additional functions may be implemented such as extra LEDs for fuel gauging, audible low battery warnings, etc. The basic software control functions of the microprocessor will remain as described.

Several I/O pins are required for battery monitoring, charge switch control, discharge switch control, and LED control. However, the memory and computational performance requirements for the CPU are not severe due to the relatively low measurement and charging frequency. The basic microprocessor tasks are:

- Detect external power source
- Determine mode of operation: charge, discharge, or power-down [off/standby]
- Monitor voltages for each cell [various A/D methods may be applicable]
- Apply charge pulses if connected to charge supply
- Indicate charge status [external LEDs]
- Automatically disconnect load when batteries are depleted to prevent overdischarge
- Optional: Provide low-battery warning or fuel gauge

Exact implementation details will depend on the specific CPU and system/application requirements.

Please contact an Application Engineer in Rayovac's OEM/Technical Products division at 608/275-4694 prior to proceeding with any microprocessor-based Rechargeable Alkaline circuit design.

Summary

Portable electronic devices span a very wide range of applications, power requirements, and cost levels. Many moderate and low-power devices may benefit from the use of Rechargeable Alkaline batteries as the power source.

Rechargeable Alkaline technology requires the use of special battery management techniques for optimal performance. The basic recommendations for a practical Rechargeable Alkaline battery management system are:

- Pulse-modulated charging, controlled by open-circuit voltage measurement
- End-of-discharge termination at 0.9, 1.0, or 1.1V/cell, based on nominal load conditions
- Pack control based on individual-cell monitoring to avoid overcharge or overdischarge of any cell
- Very low operating and standby currents to maintain charge retention in storage

DIMENSIONAL SPECIFICATIONS

All dimensions are ANSI standard

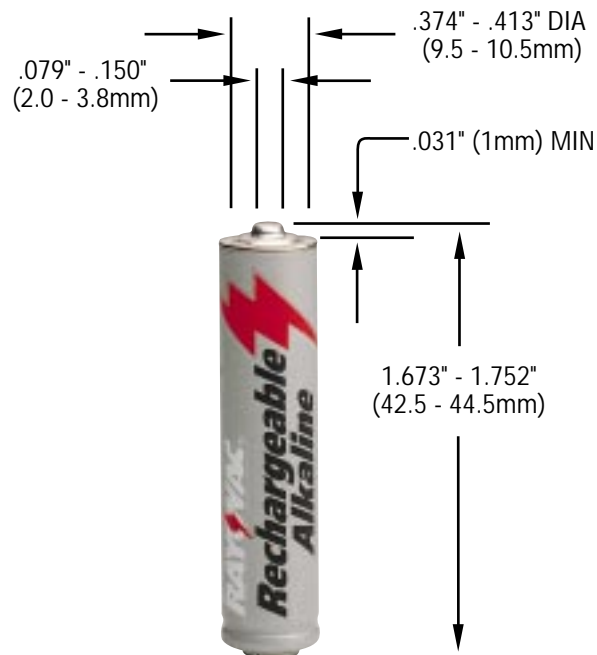

AAA Size RENEWAL® Battery

(Rayovac Part No. 724)
0.360 ounces per cell

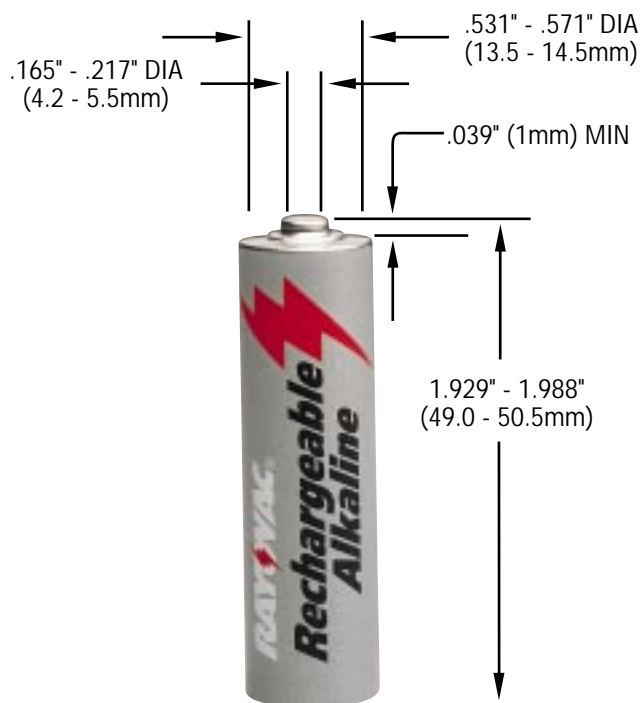

AA Size RENEWAL® Battery

(Rayovac Part No. 715)
0.750 ounces per cell

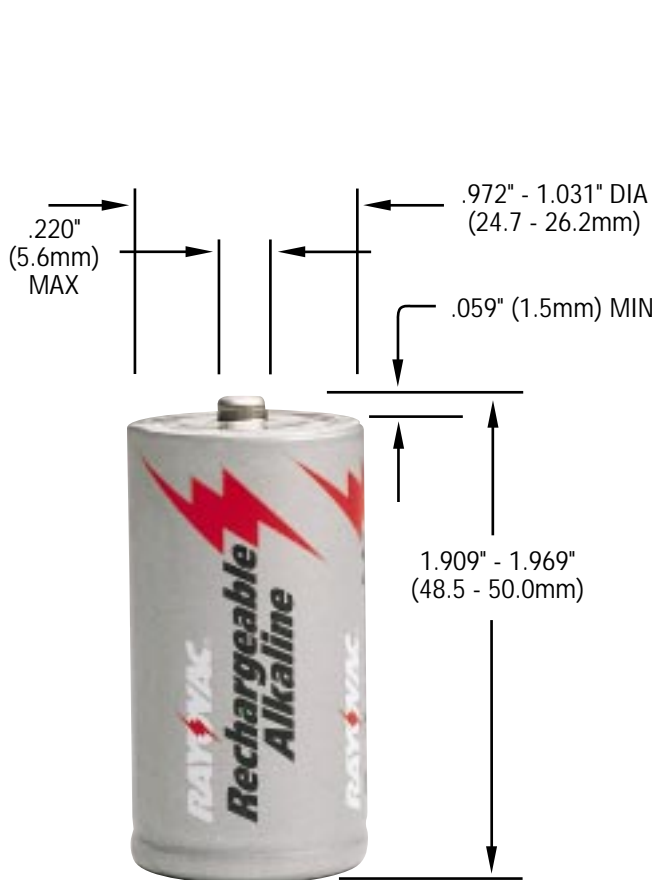

C Size RENEWAL® Battery

(Rayovac Part No. 714)
2.20 ounces per cell

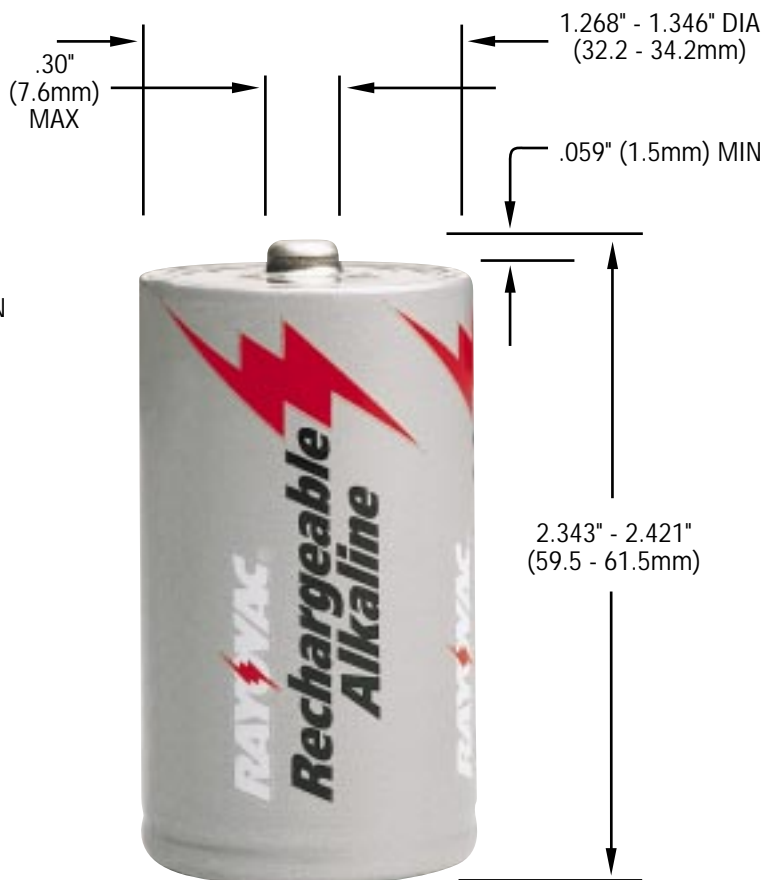

D Size RENEWAL® Battery

(Rayovac Part No. 713)
4.54 ounces per cell

RECHARGEABLE BATTERY CHARGER SPECIFICATIONS



Rechargeable Battery Charger PS1

Physical Size: 4 5/8 x 3 1/8 x 1 3/8 inches
117 x 79 x 35 mm

Battery Types: Rechargeable Alkaline, Nickel Metal Hydride (NiMh) and Nickel Cadmium (NiCd)

Battery Sizes: AA and AAA Rechargeable batteries

Battery Quantity: Any combination of one to four AA and AAA can be charged at one time.

LED Indicators: Indicate battery inserted and charging properly

Charging Current: 200 mA typical

Electrical Input: 120 volts AC
60 Hertz
6 watts

Rechargeable Battery Charger PS3

Physical Size: 8 3/4 x 3 5/8 inches
222 x 92 x 57 mm

Battery Types: Rechargeable Alkaline, Nickel Metal Hydride (NiMh) and Nickel Cadmium (NiCd)

Battery Sizes: D, C, AA and AAA Rechargeable batteries

Battery Quantity: Designed to charge up to eight AA/AAA or four C/D batteries.

LED Indicators: Charging lights go on indicating charger is plugged in and ready to charge batteries. The light will go out when the batteries are fully charged.

Charging Current: 470 mA maximum average

Electrical Input: 115 volts AC
60 Hertz
12 watts

PRODUCT AVAILABILITY

Stock No.	Description	Case Pack	Case Weight-Pounds	Case Cubic Feet
713 Bulk	Rechargeable Alkaline Cells D Size	105	29.75	.29
714 Bulk	Rechargeable Alkaline Cells C Size	168	27.75	.29
715 Bulk	Rechargeable Alkaline Cells AA Size	585	30.50	.29
724 Bulk	Rechargeable Alkaline Cells AAA Size	1000	26.00	.30
713-2	Rechargeable Alkaline D Size Carded 2 Pack	10	6.15	.12
714-2	Rechargeable Alkaline C Size Carded 2 Pack	10	3.17	.09
715-4	Rechargeable Alkaline AA Size Carded 4 Pack	10	2.33	.06
715-SF	Rechargeable Alkaline AA Size Shrink Wrapped 4 Pack	24	5.00	.05
724-4	Rechargeable Alkaline AAA Size Carded 4 Pack	10	1.25	.04
PS1	Rechargeable Battery Charger, 4 Position AA/AAA	6	4.37	.20
PS3	Rechargeable Battery Charger, 8 Position AA/AAA/C/D	6	12.8	.66

BATTERY CHARGING TERMINAL CONTACTS



- Rechargeable Alkaline AA and AAA cells have an exposed metal surface on the top of the cell case.
- Conventional alkaline cells have an insulating layer covering this surface.
- Rayovac has developed a charge contact that allows only Rechargeable Alkaline batteries to charge but discharge any chemistry.

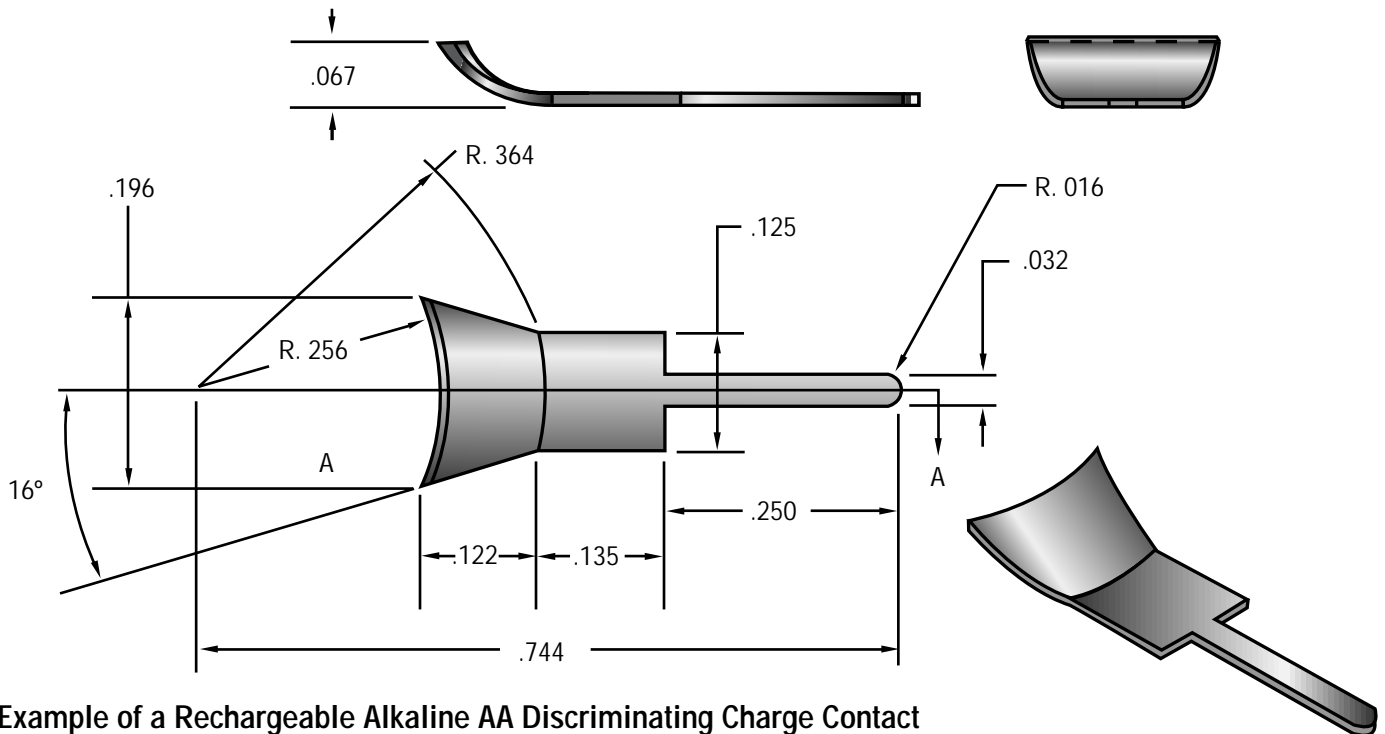

Example of a Rechargeable Alkaline AA Discriminating Charge Contact



Discriminating Charge Contacts

By utilizing a contact system that exploits the differences in insulating layers between Rechargeable Alkaline cells and other cell chemistries, this is a contact scheme that allows for discharge of any cell chemistry but discriminately charging only Rechargeable Alkaline only.

Contact Rayovac Applications Engineering for the latest charging terminal contact designs.



RECHARGEABLE ALKALINE APPLICATIONS ENGINEERING WORKSHEET

Mail, or fax to the Rayovac OEM Sales Department for technical assistance with your application.
Telephone 608-275-4694, Fax 608-275-4973, web site: www.rayovac.com, 601 Rayovac Drive, Madison, WI 53711.

Customer Information

Name _____ Title _____
 Company _____ Phone _____
 Address _____ Fax _____

Application Description

Battery Requirements

Voltage: _____ min, _____ typ, _____ max
 Current: _____ min, _____ typ, _____ max
 Pulse Loads: Peak Value _____
 Pulse Duration _____ Frequency _____

Battery Operating Time _____
 Estimated Cell Count _____
 Cell Size (D, C, AA, AAA) _____

Temperature Range

Storage _____ min, _____ max, _____ typ (°C/°F)
 Operation _____ min, _____ max, _____ typ (°C/°F)

Desired Battery Control Circuitry

Rayovac Charge Control IC _____
 Custom/OEM Hardware _____
 Microprocessor-based control algorithm _____
 Other _____

Charging Requirements

Direct connection to AC power _____
 External AC Adapter _____
 Recharge while device is operating _____
 Battery Charging external to product _____
 Battery Charging Time _____

Action Needed

- Samples: Type _____ Quantity _____
 Sales/Applications Engineering to call
 Additional Product Literature _____
 Other _____



RECHARGEABLE ALKALINE APPLICATIONS ENGINEERING WORKSHEET

Mail, or fax to the Rayovac OEM Sales Department for technical assistance with your application.
Telephone 608-275-4694, Fax 608-275-4973, web site: www.rayovac.com, 601 Rayovac Drive, Madison, WI 53711.

Customer Information

Name _____ Title _____
 Company _____ Phone _____
 Address _____ Fax _____

Application Description

Battery Requirements

Voltage: _____ min, _____ typ, _____ max
 Current: _____ min, _____ typ, _____ max
 Pulse Loads: Peak Value _____
 Pulse Duration _____ Frequency _____

Battery Operating Time _____
 Estimated Cell Count _____
 Cell Size (D, C, AA, AAA) _____

Temperature Range

Storage _____ min, _____ max, _____ typ (°C/°F)
 Operation _____ min, _____ max, _____ typ (°C/°F)

Desired Battery Control Circuitry

Rayovac Charge Control IC _____
 Custom/OEM Hardware _____
 Microprocessor-based control algorithm _____
 Other _____

Charging Requirements

Direct connection to AC power _____
 External AC Adapter _____
 Recharge while device is operating _____
 Battery Charging external to product _____
 Battery Charging Time _____

Action Needed

Samples: Type _____ Quantity _____
 Sales/Applications Engineering to call
 Additional Product Literature _____
 Other _____

ENGINEERING NOTES

