

ATS651LSH

Two-Wire Self-Calibrating Differential Speed and Direction Sensor with Vibration Immunity

Package SH

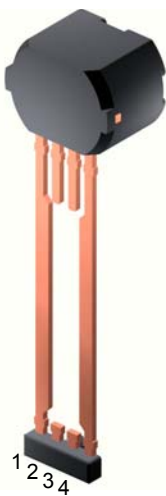

1. VCC
2. Test pin, Channel 1
3. Test pin, Channel 2
4. GND

ABSOLUTE MAXIMUM RATINGS

Supply Voltage*, V_{CC}	28 V
Reverse-Supply Voltage, V_{RCC}	-18 V
Reverse-Output Voltage, V_{ROUT}	-50 mA
Temperatures	
Operating Ambient, T_A	-40°C to 150°C
Junction, $T_{J(MAX)}$	165°C
Storage, T_S	-65°C to 170°C

*Refer to Power Derating section

The ATS651LSH is a mechatronics component with an integrated Hall-effect sensor and magnet, providing an easy-to-use solution for speed and direction sensing applications. The solid thermoset molded plastic package contains a samarium cobalt magnet and a Hall-effect IC optimized to the magnetic circuit. This sensor module has been designed specifically for high reliability in the harsh automotive environment.

The IC employs patented algorithms for the special operational requirements of transmission applications. This two-wire device communicates the speed and direction of a ferrous target via a pulse width modulation (PWM) output protocol. The ATS651LSH is particularly adept at handling vibration without sacrificing maximum air gap capability or creating an erroneous “direction” pulse. Even the higher angular vibration caused by engine cranking is completely rejected by the device. The advanced vibration detection algorithm systematically calibrates the sensor on the true rotation signals from the first three and a half teeth, not on vibration, thus always guaranteeing an accurate signal in running mode.

Patented running mode algorithms also protect against air gap changes, whether or not the target is in motion. Direction information is always available on the first magnetic edge after a direction change. Advanced signal processing and innovative algorithms make the ATS651LSH an ideal solution for a wide range of speed and direction sensing needs.

The device package is lead (Pb) free, with 100% matte tin plated leadframe.

Features and Benefits

- Rotational direction detection
- Fully optimized digital differential gear-tooth sensor
- Single-chip sensing IC for high reliability
- Small mechanical size (8 mm diameter × 5.5 mm vertical, flat-to-flat)
- Internal current regulator for 2-wire operation
- Automatic Gain Control (AGC) and reference adjust circuit
- 3-bit factory trimmed for tight pulse width accuracy
- True zero-speed operation
- Wide operating voltage range
- Undervoltage lockout
- Defined power-on state
- ESD and reverse polarity protection



Use the following complete part numbers when ordering:

Part Number	Packing*
ATS651LSHTN-T	13-in. reel, 800 pieces/reel

*Contact Allegro for additional packing options.

ATS651LSH

Two-Wire Self-Calibrating Differential Speed and Direction Sensor with Vibration Immunity

Functional Block Diagram

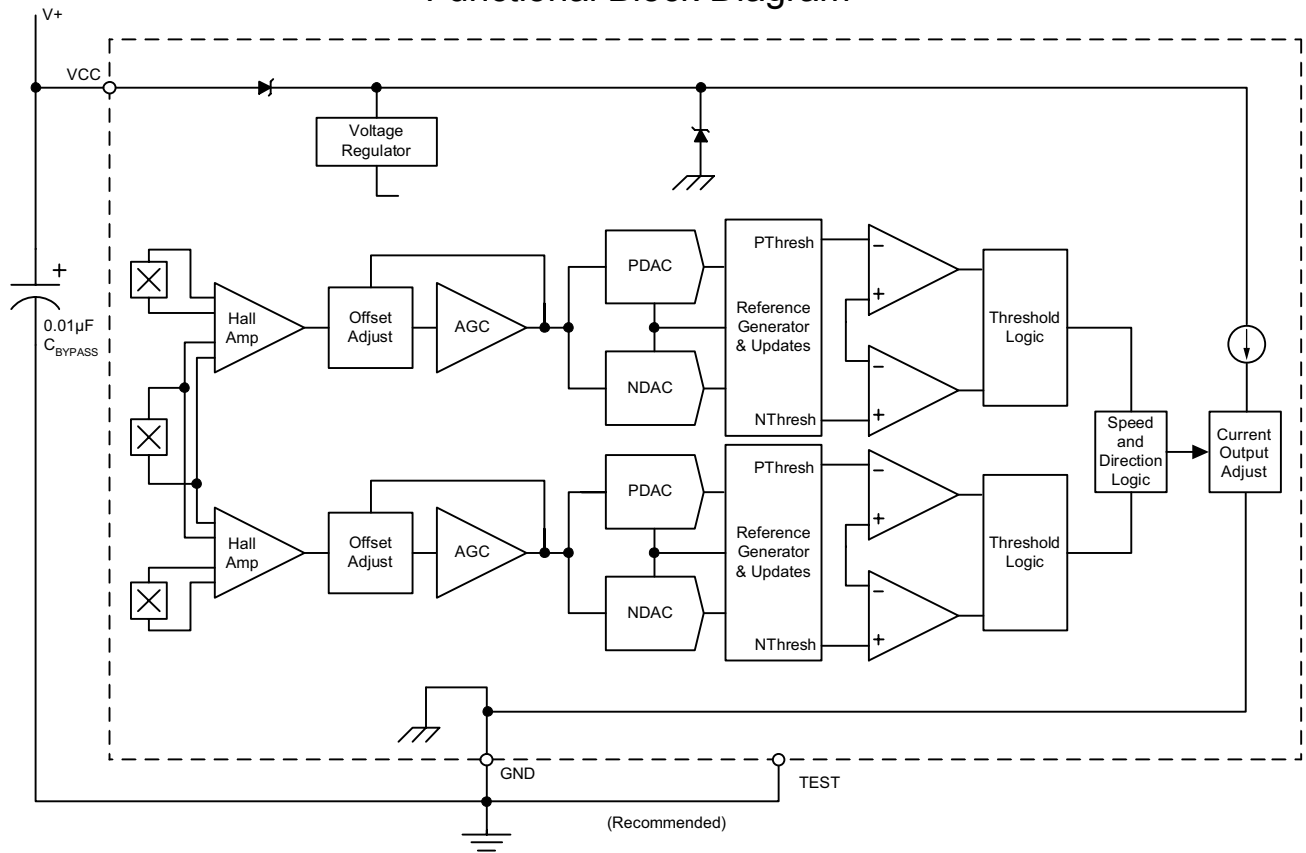

Typical Application Diagram

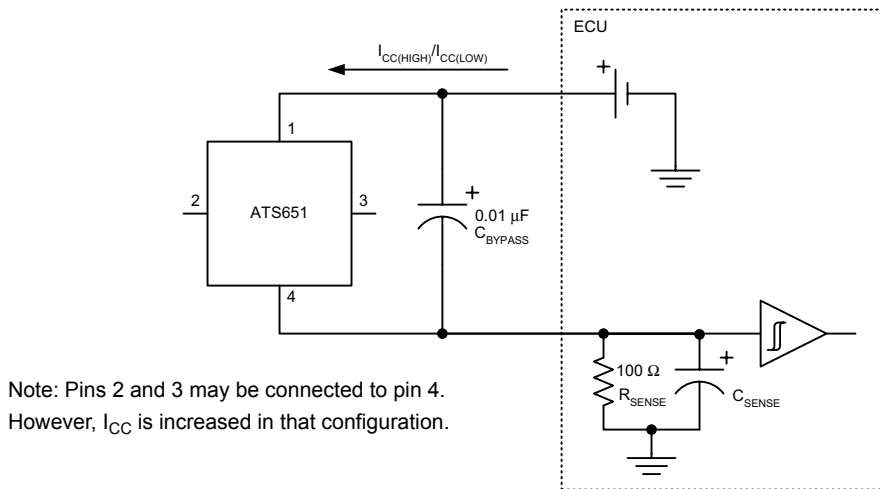

ATS651LSH

Two-Wire Self-Calibrating Differential Speed and Direction Sensor with Vibration Immunity

Device Characteristics Tables

ELECTRICAL CHARACTERISTICS Valid for $-40^{\circ}\text{C} \leq T_A \leq 150^{\circ}\text{C}$, $T_J \leq 165^{\circ}\text{C}$, unless otherwise noted

Characteristics	Symbol	Test Conditions	Min.	Typ.	Max.	Units
Supply Voltage	V_{CC}	Running, $T_J \leq 165^{\circ}\text{C}$	4.3	–	24	V
Undervoltage Lockout	$V_{CC(UV)}$	$V_{CC} = 5 \rightarrow 0\text{ V}$	–	–	4.3	V
Reverse Supply Current	I_{RCC}	$V_{CC} = -18\text{ V}$	–	–	-10	mA
Supply Zener Clamp Voltage	V_Z	$I_{CC(Low)max} + 3\text{ mA}$	28	–	40	V
Supply Zener Resistance	R_Z		–	20	–	Ω
Output Current Slew Rate	SR_I	$I_{(High)} \rightarrow I_{(Low)}$, $I_{(Low)} \rightarrow I_{(High)}$ $R_{SENSE} = 100\ \Omega$, $C_{SENSE} = 10\text{ pF}$, 10 to 90% points	2	16	–	mA/ μs
Power-On State	POS	I_{ON} state	–	$I_{CC(Low)}$	–	mA
Power-On Time ¹	t_{PO}	Gear speed < 100 rpm	–	–	1	ms
Supply Current	$I_{CC(Low)}$	Low-current state	4	7	9	mA
	$I_{CC(High)}$	High-current state	12	14.5	17	mA
Supply Current Difference	ΔI_{CC}	$I_{CC(High)} - I_{CC(Low)}$; difference between high-current state level and low-current state level	5.3	–	–	mA

CALIBRATION

Direction Information ²	N_{Dir}	First output transition	–	–	8	Edge
Speed Information ²	N_{Spd}	First output transition	–	–	8	Edge
Direction Change Detection ³	N_{CD}	Running mode direction change	–	–	1	Edge
Signal Variation ⁴ (At calibration)	E_{CAL}	Over four edges	–	–	± 0.3	mm

DAC CHARACTERISTICS

Dynamic Offset Cancellation ⁵		As shipped	–	± 60	–	G
--	--	------------	---	----------	---	---

¹Power-On Time is the time required to complete the internal automatic offset adjust; the DACs are then ready for peak acquisition.

²Edge count is based on mechanical edges. First output edge is available on or before N_{Dir} or N_{Spd} edges.

³Edge count is based on mechanical edges. On the N_{CD} edge, direction and speed information is valid.

⁴If the peak-to-peak amplitude of the signal varies more than the specified amount during the direction verification process, then additional edges may be required for calibration.

⁵The device will compensate for magnetic and installation offsets up to ± 60 gauss. Offsets greater than ± 60 gauss may cause inaccuracies in the output.

OPERATING CHARACTERISTICS Using Reference Target 60-0 and valid over operating temperature range

Characteristics	Symbol	Test Conditions	Min.	Typ.	Max.	Units
Operational Air Gap Range*	AG_{OP}	Within specification	0.5	–	2.8	mm
Operating Signal Range	Sig	Within specification	30	–	1200	G

*Operational Air Gap Range is dependent on the available differential magnetic field. The available field is dependent on target geometry and material, and should be independently characterized. The field available from the Reference Target is given in the Reference Target Parameters section of this datasheet.

Continued on the next page...

ATS651LSH

Two-Wire Self-Calibrating Differential Speed and Direction Sensor with Vibration Immunity

Device Characteristics Tables (Continued)

SWITCHING CHARACTERISTICS Valid for $-40^{\circ}\text{C} \leq T_A \leq 150^{\circ}\text{C}$, $T_J \leq 165^{\circ}\text{C}$, unless otherwise noted

Characteristics	Symbol	Test Conditions	Min.	Typ.	Max.	Units
Operate Point	B_{OP}	% of peak-to-peak referenced from PDAC to NDAC, $AG_{OP} < AG_{OP(max)}$	–	58	–	%
Release Point	B_{RP}	% of peak-to-peak referenced from PDAC to NDAC, $AG_{OP} < AG_{OP(max)}$	–	42	–	%
Axial/Radial Runout ¹ (Multiple teeth)	$RO_{A/R}$		–	–	± 1.75	mm
Sudden Air Gap (Single tooth)	ΔAG_{SAG}	Instantaneous air gap change (<500 Hz)	–	–	± 0.4	mm
Incremental Air Gap (Consecutive edges)	ΔAG_{IR+}	Air gap change between edges @ >8 kHz	–	–	± 0.1	mm
		Air gap change between edges @ 8-4 kHz			± 0.15	mm
	ΔAG_{IR-}	Air gap change between edges @ <4 kHz	–	–	± 0.2	mm
Vibration Immunity (At power-on)	ROT_{VIBS}	Rotation allowed due to vibration with temperature change less than 10°C	–	–	± 0.75	($^{\circ}$)
Vibration Immunity ² (Running)	ROT_{VIBR}	Rotation allowed due to vibration with temperature change less than 10°C	–	–	± 0.35	($^{\circ}$)
Maximum Operating Frequency ³	f_L	Rotation Left (target rotation CCW, pin 1 to pin 4), $t_{LD} = 38 \mu\text{s}$	6	–	–	kHz
	f_R	Rotation Right (target rotation CW, pin 4 to pin 1), $t_{LD} = 38 \mu\text{s}$	12	–	–	kHz

¹Inclusive of all Sudden Air Gap and Incremental Air Gap changes during operation.

²Device may output one reverse pulse at the start of vibration.

³Maximum Operating Frequency may be increased if the customer can resolve Minimum Low-State Duration levels down to the specified value.

Continued on the next page...

ATS651LSH Switchpoints

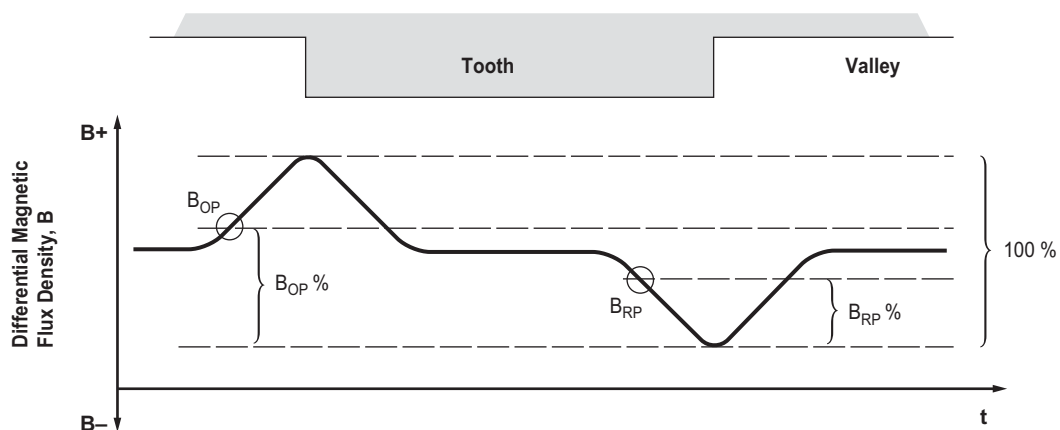

ATS651LSH

Two-Wire Self-Calibrating Differential Speed and Direction Sensor with Vibration Immunity

Device Characteristics Tables (Continued)

Protocol Pulse Characteristics Valid for $-40^{\circ}\text{C} \leq T_A \leq 150^{\circ}\text{C}$ ($T_J \leq 165^{\circ}\text{C}$), unless otherwise noted

Characteristics	Symbol	Test Conditions	Min.	Typ.	Max.	Units
Minimum Low-State Duration*	t_{LD}	Falling edge to subsequent rising edge.	10	–	–	μs
Pulse Width Right	$t_{W(R)}$		38	45	52	μs
Pulse Width Left	$t_{W(L)}$		76	90	104	μs
Protocol Pulse Width Tolerance	E_{PPW}	Reference Target	–15	–	15	%

*Maximum Operating Frequency may be increased if the application controller can resolve Minimum Low-State Duration levels down to the specified value.

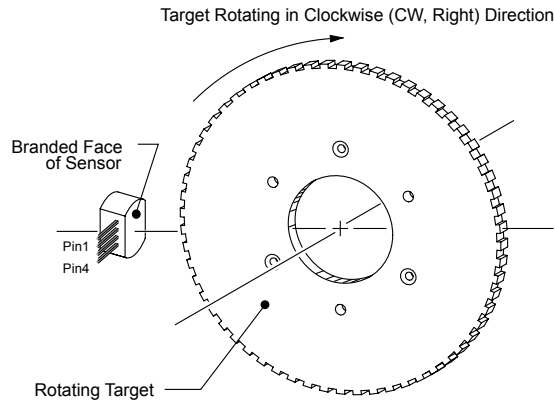

ATS651LSH

Two-Wire Self-Calibrating Differential Speed and Direction Sensor with Vibration Immunity

Reference Target Parameters

REFERENCE TARGET CHARACTERISTICS 60-0 (60 Tooth Target)

Characteristics	Symbol	Test Conditions	Typ.	Units	Symbol Key
Outside Diameter	D_o	Outside diameter of target	120	mm	
Face Width	F	Breadth of tooth, with respect to sensor	6	mm	
Circular Tooth Length	t	Length of tooth, with respect to sensor; measured at D_o	3	mm	
Circular Valley Length	t_v	Length of valley, with respect to sensor; measured at D_o	3	mm	
Tooth Whole Depth	h_t		3	mm	
Material		Low Carbon Steel	-	-	

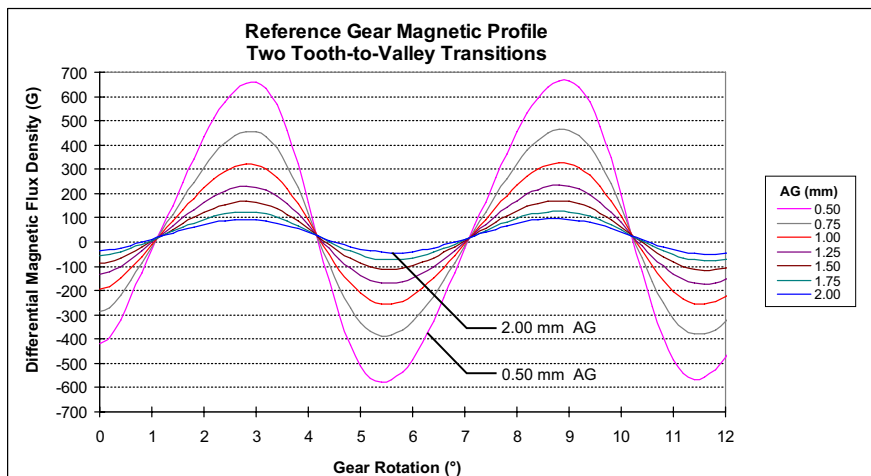
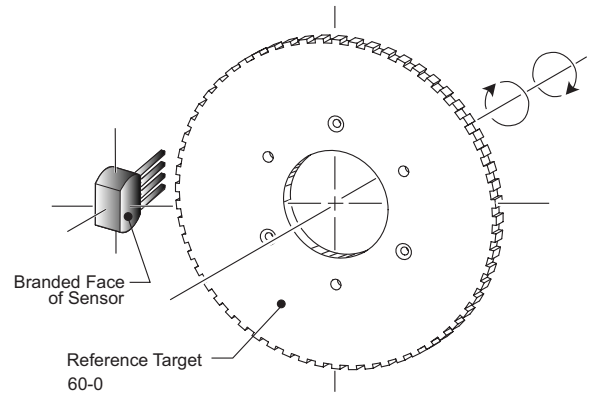
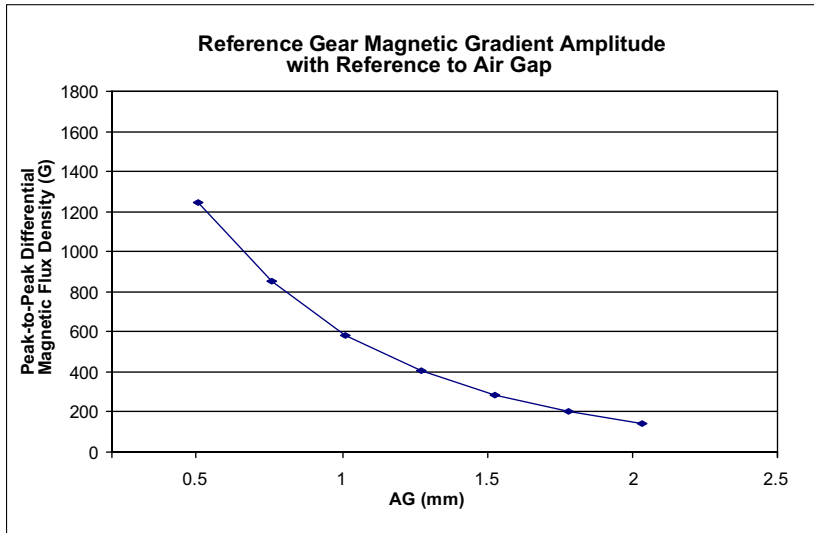

ATS651LSH

Two-Wire Self-Calibrating Differential Speed and Direction Sensor with Vibration Immunity

Characteristic Data

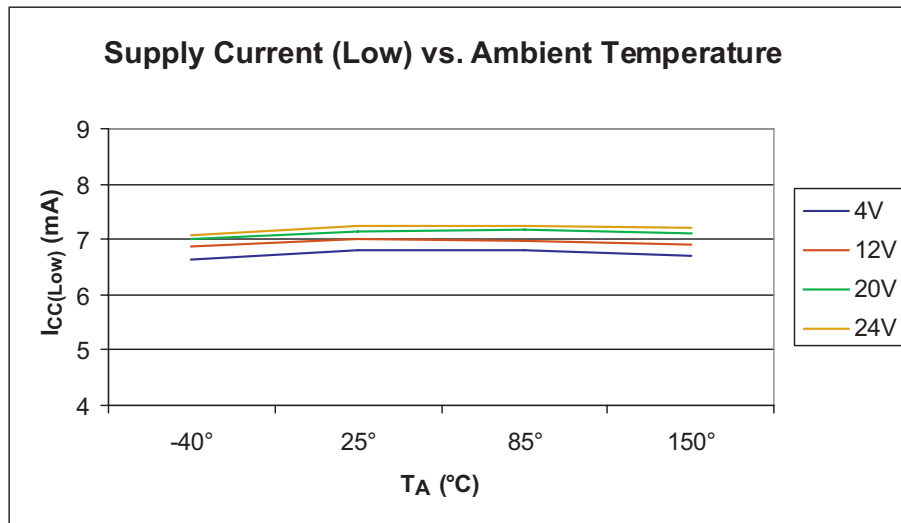
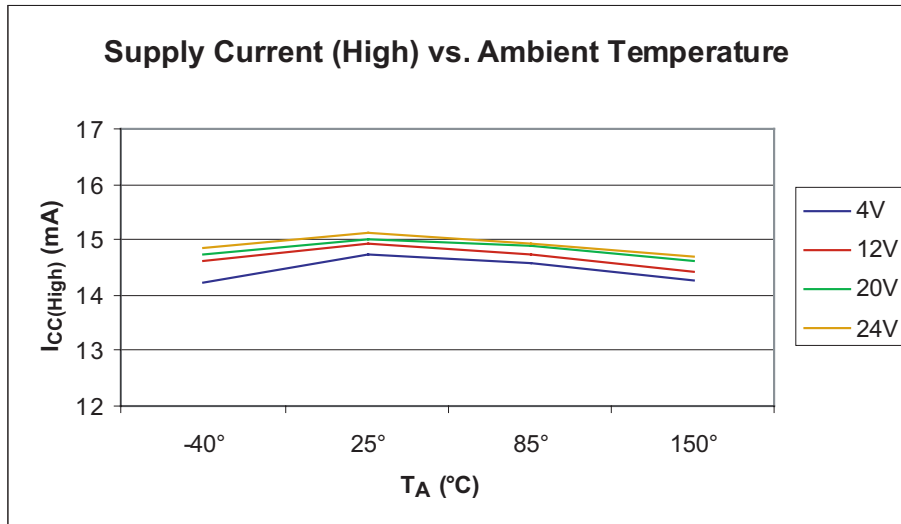

ATS651LSH

Two-Wire Self-Calibrating Differential Speed and Direction Sensor with Vibration Immunity

Characteristic Data (Continued)

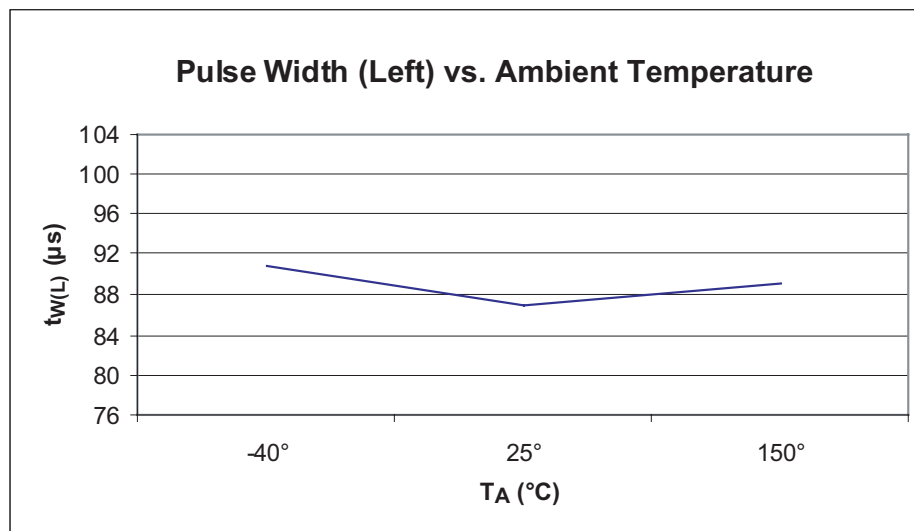
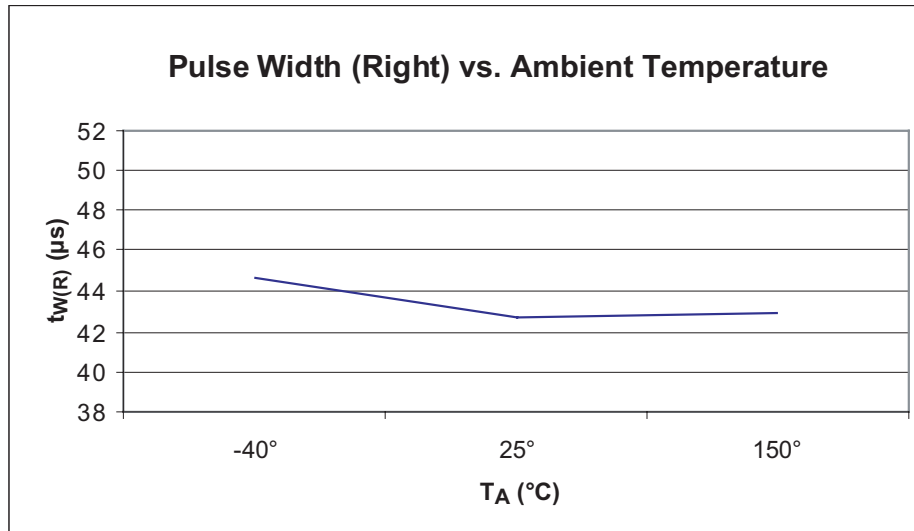

SENSOR EVALUATION: EMC Characterization Only*

Test Name	Reference Specification
ESD – Human Body Model	AEC-Q100-002
ESD – Machine Model	AEC-Q100-003
Conducted Transients	ISO 7637-1
Direct RF Injection	ISO 11452-7
Bulk Current Injection	ISO 11452-4
TEM Cell	ISO 11452-3

*Please contact Allegro MicroSystems for EMC performance.

ATS651LSH

Two-Wire Self-Calibrating Differential Speed and Direction Sensor with Vibration Immunity

THERMAL CHARACTERISTICS may require derating at maximum conditions, see application information

Characteristic	Symbol	Test Conditions	Min.	Typ.	Max	Units
Package Thermal Resistance	$R_{\theta JA}$	1-layer PCB with copper limited to solder pads	126	–	–	°C/W
		2-layer PCB with 3.57 in. ² of copper area each side connected by thermal vias	84	–	–	°C/W

Power Derating Curve

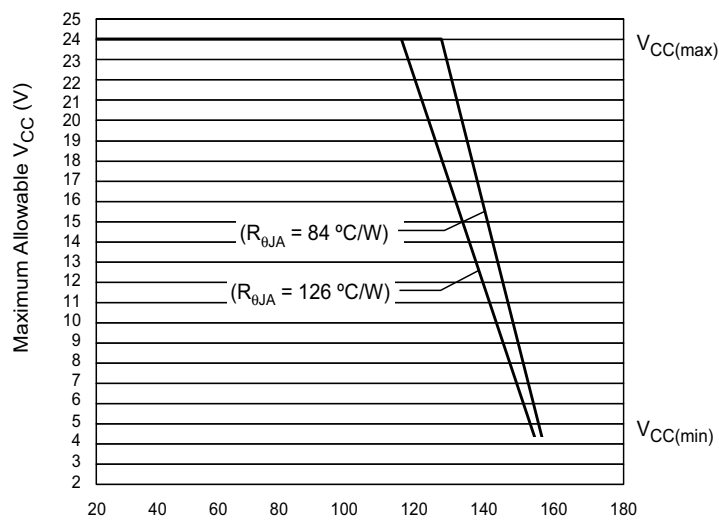

Maximum Power Dissipation, $P_{D(max)}$

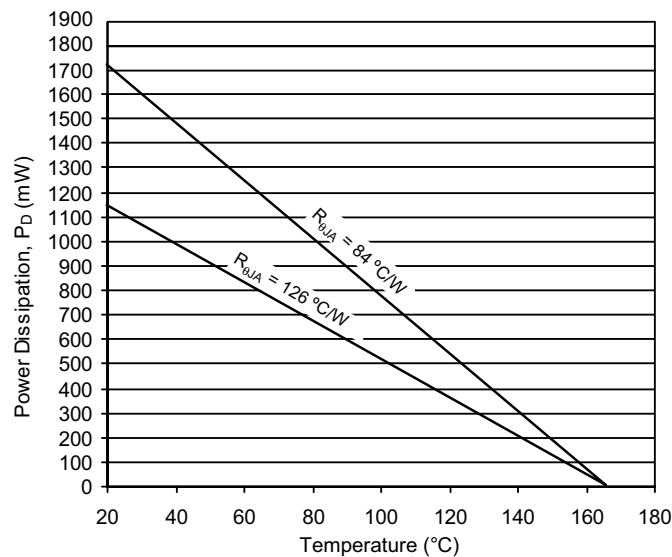

ATS651LSH

Two-Wire Self-Calibrating Differential Speed and Direction Sensor with Vibration Immunity

Applications Information

Data Protocol Description

Rotation Right. Referring to figure 1, a ferrous target passes in front of the sensor (not shown) in the direction indicated. Each tooth of the target generates a pulse from the sensor. Each pulse provides speed and direction data. Speed is provided by the pulse rate, while direction is obtained by measuring the width

of the pulses. A 45 μs pulse indicates rotation in the clockwise direction.

Rotation Left. Referring to figure 2, when the target changes direction, the sensor outputs a current pulse of or 90 μs , twice as long as the Rotation Right pulse width. The maximum speed is limited by the width of the pulse and the shortest Low-State Duration the controller can resolve.

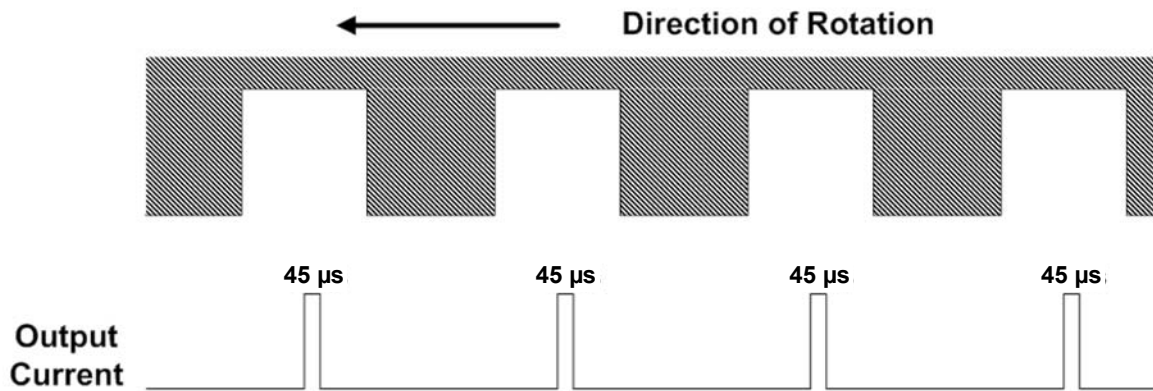

Figure 1. Target rotation to the right (CW) relative to the sensor gives forward speed.

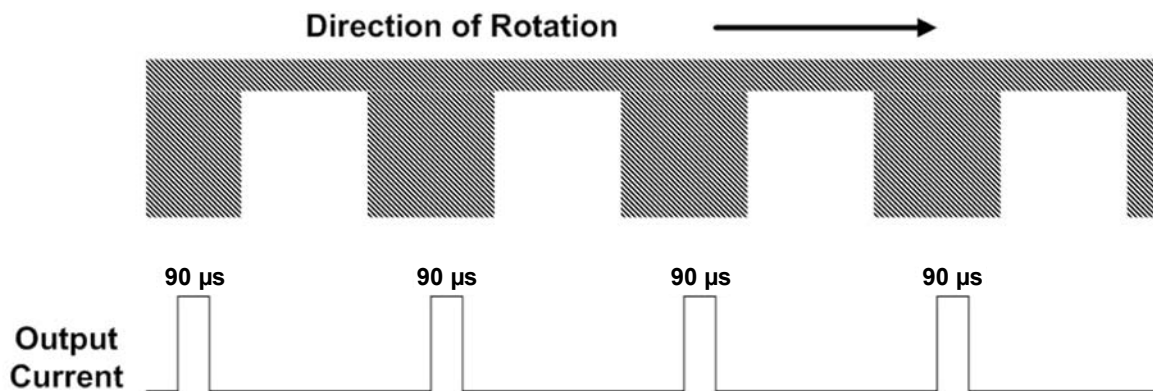

Figure 2. Target rotation to the left (CCW) relative to the sensor gives reverse speed.

ATS651LSH

Two-Wire Self-Calibrating Differential Speed and Direction Sensor with Vibration Immunity

Power Derating

The device must be operated below the maximum junction temperature of the device, $T_{J(\max)}$. Under certain combinations of peak conditions, reliable operation may require derating supplied power or improving the heat dissipation properties of the application. This section presents a procedure for correlating factors affecting operating T_J . (Thermal data is also available on the Allegro MicroSystems Web site.)

The Package Thermal Resistance, $R_{\theta JA}$, is a figure of merit summarizing the ability of the application and the device to dissipate heat from the junction (die), through all paths to the ambient air. Its primary component is the Effective Thermal Conductivity, K , of the printed circuit board, including adjacent devices and traces. Radiation from the die through the device case, $R_{\theta JC}$, is relatively small component of $R_{\theta JA}$. Ambient air temperature, T_A , and air motion are significant external factors, damped by overmolding.

The effect of varying power levels (Power Dissipation, P_D), can be estimated. The following formulas represent the fundamental relationships used to estimate T_J , at P_D .

$$P_D = V_{IN} \times I_{IN} \quad (1)$$

$$\Delta T = P_D \times R_{\theta JA} \quad (2)$$

$$T_J = T_A + \Delta T \quad (3)$$

For example, given common conditions such as: $T_A = 25^\circ\text{C}$, $V_{CC} = 5\text{ V}$, $I_{CC} = 14\text{ mA}$, and $R_{\theta JA} = 126\text{ }^\circ\text{C/W}$, then:

$$P_D = V_{CC} \times I_{CC} = 12\text{ V} \times 4.0\text{ mA} = 70.0\text{ mW}$$

$$\Delta T = P_D \times R_{\theta JA} = 70.0\text{ mW} \times 126\text{ }^\circ\text{C/W} = 8.8^\circ\text{C}$$

$$T_J = T_A + \Delta T = 25^\circ\text{C} + 8.8^\circ\text{C} = 23.8^\circ\text{C}$$

A worst-case estimate, $P_{D(\max)}$, represents the maximum allowable power level ($V_{CC(\max)}$, $I_{CC(\max)}$), without exceeding $T_{J(\max)}$, at a selected $R_{\theta JA}$ and T_A .

Example: Reliability for V_{CC} at $T_A = 150^\circ\text{C}$, package SH, using the PCB with least exposed copper.

Observe the worst-case ratings for the device, specifically: $R_{\theta JA} = 126^\circ\text{C/W}$, $T_{J(\max)} = 165^\circ\text{C}$, $V_{CC(\max)} = 28\text{ V}$, and $I_{CC(\max)} = 16.8\text{ mA}$.

Calculate the maximum allowable power level, $P_{D(\max)}$. First, invert equation 3:

$$\Delta T_{\max} = T_{J(\max)} - T_A = 165^\circ\text{C} - 150^\circ\text{C} = 15^\circ\text{C}$$

This provides the allowable increase to T_J resulting from internal power dissipation. Then, invert equation 2:

$$P_{D(\max)} = \Delta T_{\max} \div R_{\theta JA} = 15^\circ\text{C} \div 126\text{ }^\circ\text{C/W} = 119\text{ mW}$$

Finally, invert equation 1 with respect to voltage:

$$V_{CC(\text{est})} = P_{D(\max)} \div I_{CC(\max)} = 119\text{ mW} \div 16.8\text{ mA} = 7.1\text{ V}$$

The result indicates that, at T_A , the application and device can dissipate adequate amounts of heat at voltages $\leq V_{CC(\text{est})}$.

Compare $V_{CC(\text{est})}$ to $V_{CC(\max)}$. If $V_{CC(\text{est})} \leq V_{CC(\max)}$, then reliable operation between $V_{CC(\text{est})}$ and $V_{CC(\max)}$ requires enhanced $R_{\theta JA}$. If $V_{CC(\text{est})} \geq V_{CC(\max)}$, then operation between $V_{CC(\text{est})}$ and $V_{CC(\max)}$ is reliable under these conditions.

This value applies only to the voltage drop across the ATS651LSH chip. If a protective series diode or resistor is used, the effective maximum supply voltage is increased.

For example, when a standard diode with a 0.7 V drop is used:

$$V_{S(\max)} = 7.1\text{ V} + 0.7\text{ V} = 7.8\text{ V}$$

ATS651LSH

Two-Wire Self-Calibrating Differential Speed and Direction Sensor with Vibration Immunity

Package SH, 4-pin SIP

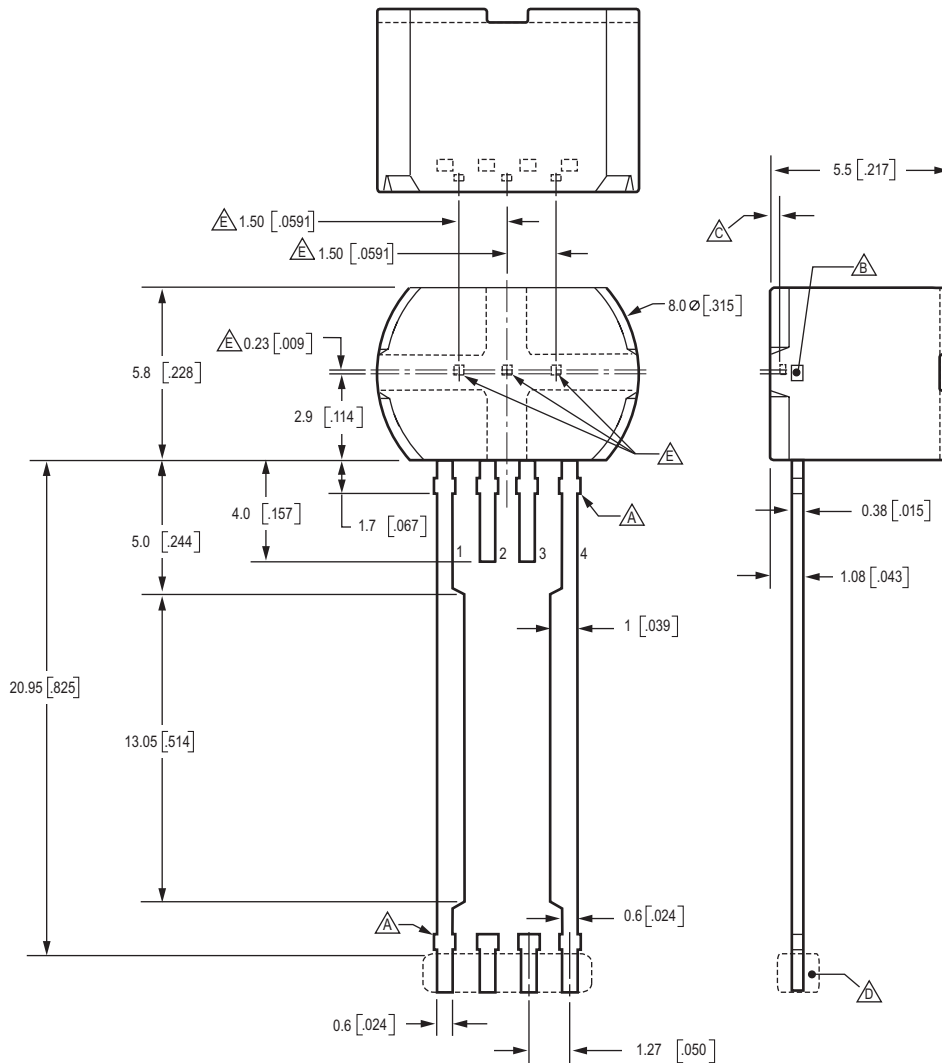

Preliminary dimensions, for reference only
 Untoleranced dimensions are nominal.
 Dimensions in millimeters
 U.S. Customary dimensions (in.) in brackets, for reference only
 Dimensions exclusive of mold flash, burrs, and dambar protrusions
 Exact case and lead configuration at supplier discretion within limits shown

- Dambar removal protrusion (16X)
- Metallic protrusion, electrically connected to pin 4 and substrate (both sides)
- Active Area Depth, 0.43 [017]
- Thermoplastic Molded Lead Bar for alignment during shipment
- Hall elements (3X); controlling dimension inches

The products described herein are manufactured under one or more of the following U.S. patents: 5,045,920; 5,264,783; 5,442,283; 5,389,889; 5,581,179; 5,517,112; 5,619,137; 5,621,319; 5,650,719; 5,686,894; 5,694,038; 5,729,130; 5,917,320; and other patents pending.

Allegro MicroSystems, Inc. reserves the right to make, from time to time, such departures from the detail specifications as may be required to permit improvements in the performance, reliability, or manufacturability of its products. Before placing an order, the user is cautioned to verify that the information being relied upon is current.

Allegro products are not authorized for use as critical components in life-support devices or systems without express written approval.

The information included herein is believed to be accurate and reliable. However, Allegro MicroSystems, Inc. assumes no responsibility for its use; nor for any infringement of patents or other rights of third parties which may result from its use.

Copyright © 2005 Allegro MicroSystems, Inc.