



Relays

Technical Information

Relay Classification

| Model | Mounting | Enclosure Ratings | Features |
|--|------------------|-------------------|---|
| G4W  | Discrete | Unsealed | Designed for manual soldering |
| G2R  | | Semi-sealed | Design inhibits flux intrusion into the casing at the terminals during soldering. |
| G6A  | | Fully sealed | Sealed resin casings and covers, limiting damage from corrosive atmospheres. |
| G6S  | Surface mounting | | Surface mounting relays permit automatic reflow soldering. |

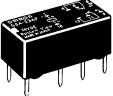
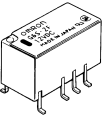
Construction

SEALING

Unsealed

Relays of this type are intended for manual soldering. No measures are taken against penetration of flux and cleaning solvent into the relay. This type of relay cannot be immersion-cleaned.

Semi-Sealed

Special design construction prevents flux from penetrating into the relay housing, for example, due to capillary action up the terminals when the relay is soldered onto a PCB. This type of relay also cannot be immersion-cleaned.

Fully Sealed

Fully sealing prevents not only flux, but also cleaning solvent from penetrating into the relay housing. Therefore, this type of relay can be immersion-cleaned. Relays are each tested before being shipped. The relay is immersed in fluorocarbon solution for 1 minute, at a temperature of 70°C +5°C/-0°C, to see if gases escape from the relay. The following figure illustrates the test conditions.

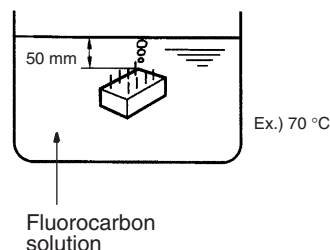

| Classification | Unsealed | | Semi-Sealed | |
|-------------------------------------|---|--|---|--|
| Construction | Terminals separated from PCB | Contacts located at upper part of relay case | Press-fit terminals Terminals separated from PCB Resin seal | Inserted terminals Terminals separated from PCB 0.3 mm min. base thickness |
| Features | Terminals are separated from PCB surface when relay is mounted. | Contacts are positioned away from base. | Terminals are pressed into base. | Terminals are inserted into base 0.3 mm min. thick. |
| Automatic flux application | Poor | Poor | Good | Good |
| Automatic soldering | Poor | Poor | Good | Good |
| Automatic cleaning | Poor | Poor | Poor | Poor |
| Manual soldering | Good | Good | Good | Good |
| Penetration of dust | Fair | Fair | Fair | Fair |
| Penetration of corrosive gas | Poor | Poor | Poor | Poor |

| Classification | Fully Sealed | Surface Mounting |
|-------------------------------------|---------------------------------------|--|
| Construction | Press-fit terminals Resin seal | Resin seal Glue pad |
| Features | Terminals, base, and case are sealed. | Terminal and base, as well as the base and casing, are sealed. |
| Automatic flux application | Good | Good |
| Automatic soldering | Good | Good |
| Automatic cleaning | Good | Good |
| Manual soldering | Good | Good |
| Penetration of dust | Good | Good |
| Penetration of corrosive gas | Fair | Fair |

Operation

Single-side Stable Relays (Standard)

The contacts of this simple type of relay momentarily turn ON and OFF, depending on the energized state of the coil.

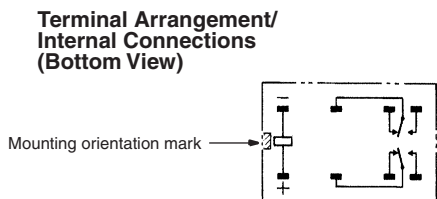

Single-winding, Latching Relays

Unlike the dual-winding latching relay, the single-winding latching relay has only one coil. This coil, however, serves as both the set and reset coils, depending on the polarity (direction) of current flow. When current flows through the coil in the forward direction, it functions as a set coil; when current flows through the coil in the reverse direction, it functions as a reset coil.

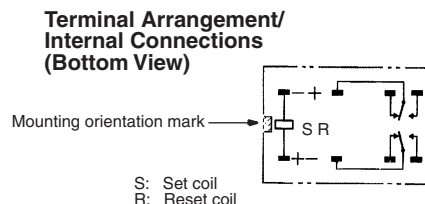

Dual-winding, Latching Relays

This latching relay has two coils: set and reset. It can retain the ON or OFF states even when a pulsating voltage is supplied, or when the voltage is removed.

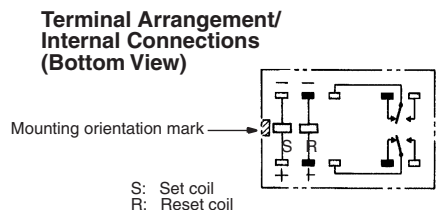

Built-in Diode

A diode is built into some relays, wired in parallel with the coil to absorb the counterelectromotive force (counter emf) generated by the coil.

Built-in Operation Indicator

Some relays are provided with a light-emitting diode (LED), wired in parallel with the coil. This permits a fast-check of the relay's operating status.

Contact Styles

Contact ratings are generally indicated according to resistive loads and inductive loads ($\cos\phi = 0.4$ or $L/R = 7$ ms). Contact shape and material are also shown to guide the customer in selection of a model suitable for the intended load and required service life.

When used at extremely low loads, the failure rate differs according to the contact material and contact method, as shown in the figure. For example, in comparing a single contact point with a bifurcated contact point, the bifurcated contact model has higher parallel redundancy and will therefore exhibit a lower failure rate.

Example

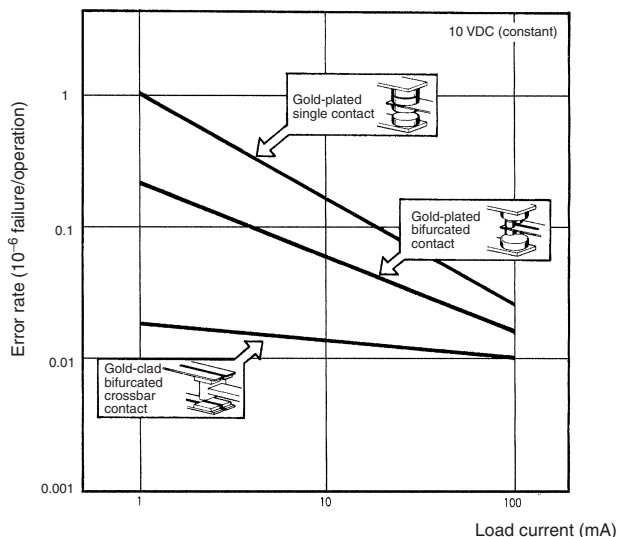

Terminals

■ Straight PCB Terminals

PCB terminals are normally straight.

Self-clinching (S-shaped) PCB Terminals

Some relays have terminals that are bent into an "S" shape. This secures the PCB relay to the PCB prior to soldering, helping the terminals stay in their holes and keeping the relay level.

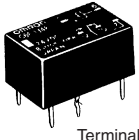

Terminal

Gull-wing SMT terminal

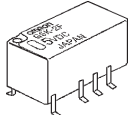

Quick-connect terminal

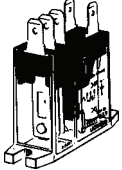

"Inside L" SMT terminal

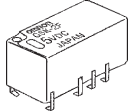

Plug-in terminal

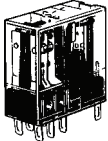

Dimensions

For miniature relays, the maximum dimensions and the average values () marked with an asterisk are provided to aid the customer in designing.

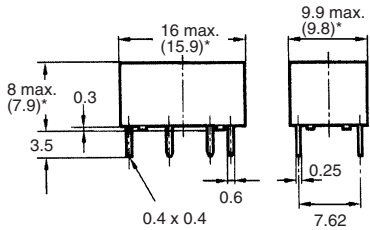

*Average value

■ Mounting Orientation Mark

On the top of all OMRON relays is a mark indicating where the relay coil is located. Knowing the coil location aids in designing PCBs when spacing components. Also, pin orientation is easy to discern when automatic or hand-mounting relays.

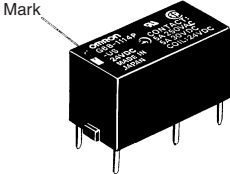

On dimensional drawings in all OMRON literature this mark is left-oriented. Mounting holes, terminal arrangements, and internal connections follow this alignment. The following two symbols are used to represent the orientation mark.

| Drawing view | Bottom | Top |
|--------------|----------------|---|
| Detail | Mounting holes | Terminal arrangement/ internal connections |
| Symbol | | |
| Example | | |

■ Terminal Arrangement/Internal Connections

Top View

If the terminal arrangement of a relay can be seen from above the PCB, the top view of the relay is provided in the Dimensions section of the catalog or data sheet.

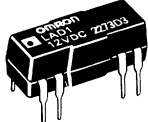

Bottom View

If the relay's terminals cannot be seen from above the PC board, as in this example, a bottom view is shown.

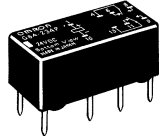

Rotation Direction to Bottom View

The bottom view shown in the catalog or data sheet is rotated in the direction indicated by the arrow, with the coil always on the left.

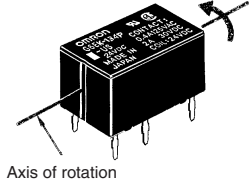

Moving Loop System

In the U.S.A., the National Association of Relay Manufacturers (NARM) in April 1984, awarded OMRON for monumental advances in relay technology, as embodied in the Moving Loop System.

This unique relay construction maximizes electrical and permanent magnet energy. A high-efficiency magnet adds to the magnetic flux of the relay coil, which also allows for tighter packing of relay parts. Relays having such a coil are known as "polarized relays." Details of construction are shown below.

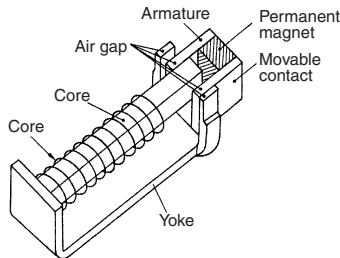

The moving loop design has similarities with polarized relays; however, the following two features make for a large performance distinction.

A permanent magnet is placed in the vicinity of the "working gaps." The flux energy of this permanent magnet complements that of the electrical coil. This increased efficiency enables the mechanism holding the contacts closed to ultimately switch larger loads, and at the same time reduces the power consumed by the coil.

The following diagram shows concentric lines of magnetic flux when the permanent magnet is placed near the working gap.

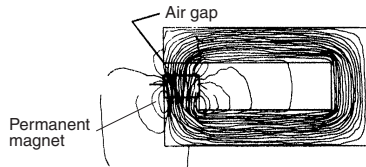

Conventional Relay Coil

The following diagram shows the lines of magnetic flux when the permanent magnet is placed away from the working gap. These lines of flux detract from the total strength of the coil.

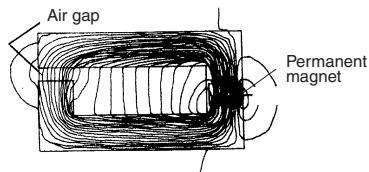

When the switching voltage is removed from the coil, the collapse of the magnetic flux created by the permanent magnet and the electrical coil provides the force to return the relay contacts to the reset position. Note the flux path and magnet polarity in the illustration overleaf.

Operating Principle, Moving Loop

| | |
|--|--|
| Release | |
| Transition from release to operation (operating voltage supplied) | |
| Operation | |

Super Moving Loop System

A very small high-sensitivity magnetic circuit is incorporated to further minimize the conventional moving loop system.

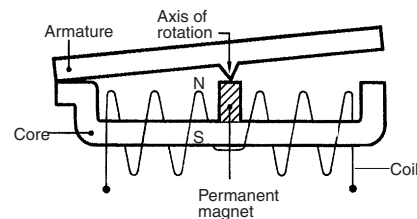

This magnetic circuit has the following features:

- High-efficiency polarized magnetic circuit utilizes power of both attraction and repulsion.
- Balanced armature system improves resistance to both vibration and impacts.
- Ideal mechanism for a low-profile relay.

| | |
|--|--|
| Release | |
| Transition from release to operation (operating voltage supplied) | <p>The armature sees saws due to the attraction and repulsion torque exerted on the armature by the coil voltage and the permanent magnet.</p> |
| Operation | |

Note: The above applies to a latching relay.

Glossary

Terms Related to Contacts

Carry Current

The value of the current which can be continuously applied to the relay contacts without opening or closing them, and which allows the relay to stay within the permissible temperature rise.

Maximum Switching Current

A current which serves as a reference in determining the performance of the relay contacts. This value will never exceed the current flow. When using a relay, do not exceed this value.

Contact Form

OMRON uses the following relay terminology for the various polarity and switch configurations.

- 1 FORM A: SPST-NO
- 1 FORM B: SPST-NC
- 1 FORM C: SPDT
- 2 FORM C: DPDT

Contact symbols

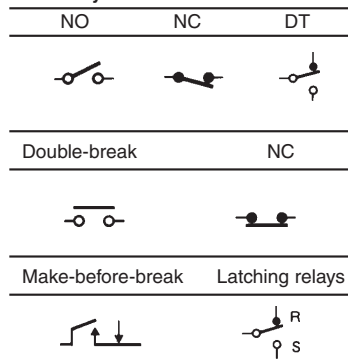

Make-before-break (MBB) Contact

A contact arrangement in which part of the switching section is shared between both an NO and NC contact. When the relay operates or releases, the contact that closes the circuit operates before the contact that opens the circuit releases. Thus both contacts are closed momentarily at the same time.

Contact Resistance

The total resistance of the conductor, as well as specific resistivities such as of the armature and terminal, and the resistance of the contacts. This value is determined by measuring the voltage drop across the contacts by applying test currents as shown in the table below.

| Rated current (A) | Test current (mA) |
|-------------------|-------------------|
| Under 0.01 | 1 |
| 0.01 to 0.1 | 10 |
| 0.1 to 1 | 100 |
| Over 1 | 1000 |

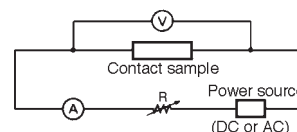

A: Ammeter V: Voltmeter R: Variable resistor

For most applications, use at least 1 A, 5 VDC for contact resistance measurements.

Maximum Switching Capacity

The maximum value of the load capacity which can be switched without problem. When using a relay, do not exceed this value.

For example, when maximum switching voltage V_1 is known, maximum switching current I_1 can be obtained at the point of intersection on the characteristic curve "Maximum Switching Capacity" shown below. Conversely, maximum switching voltage V_1 can be obtained if I_1 is known.

$$\text{Maximum switching current } (I_1) = \frac{\text{Max. switching power [W(VA)]}}{\text{Max. switching voltage } (V_1)}$$

$$\text{Maximum switching voltage } (V_1) = \frac{\text{Max. switching power [W(VA)]}}{\text{Max. switching current } (I_1)}$$

For instance, if the maximum switching voltage = 40 V
Maximum switching current = 2 A (see circled point on graph below.)

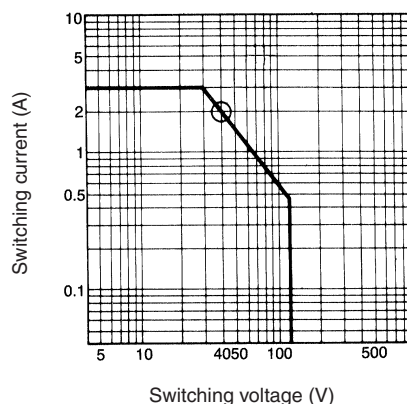

The life expectancy of the relay can be determined from the electrical service life curve shown below, based on the rated switching current (I₁) obtained above. For instance, the electrical service life at the obtained maximum switching current of 2 A is slightly over 300,000 operations (see circled point on graph below).

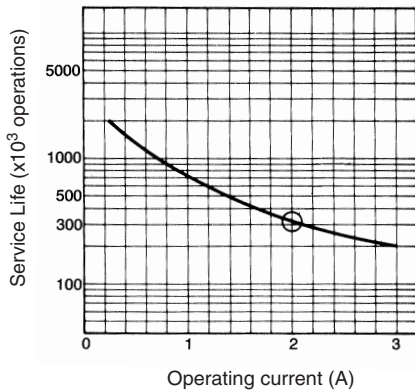

However, with a DC load, it may become difficult to break the circuit of 48 V or more due to arcing. Determine the suitability of the relay in actual usage testing.

The correlation between the contact ratings is shown in the following figure:

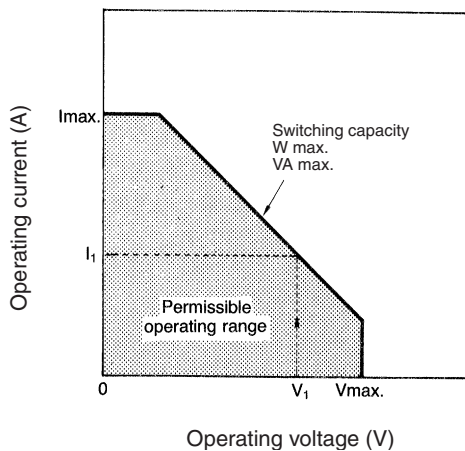

Minimum Permissible Load

The minimum permissible load indicates the lower limit of switching capability of a relay as the reference value. Such minute load levels are found in microelectronic circuits. This value may vary, depending on operating frequency, operating conditions, expected reliability level of the relay, etc. It is always recommended to double-check relay suitability under actual load conditions.

In this catalog, the minimum permissible load of each relay is indicated as a reference value. It indicates failure level at a reliability level of 60% (λ_{60}). $\lambda_{60}=0.1 \times 10^{-6}/\text{operation}$ means that one failure is presumed to occur per 10,000,000 (ten million) operations at a reliability level of 60%.

Number of Poles

The number of contact circuits. See Contact Form for reference.

Terms Related to Coils

Rated Coil Voltage

A reference voltage applied to the coil when the relay is used under normal operating conditions.

Coil Symbols

| Single-sided stable | | Double-winding Latching | | Single-winding Latching |
|---------------------|---------------|-------------------------|---------------|-------------------------|
| Polarized | Non-polarized | w/4 terminals | w/3 terminals | |
| | | | | |

Coil Resistance (Applicable to DC-switching Relays only)

The resistance of the coil is measured at a temperature of 23°C with a tolerance of $\pm 10\%$ unless otherwise specified. (The coil resistance of an AC-switching type relay may be given for reference when the coil inductance is specified.)

Cold Start

The ratings set forth in the catalog or data sheet are measured at a coil temperature of 23°C unless otherwise specified.

Maximum Voltage

The maximum value of permissible over voltage in the operating power supply to the relay coil.

Minimum Pulse Width

The minimum value of the pulse voltage required to set and reset a latching relay at a temperature of 23°C.

Must Operate (Must Set) Voltage

The threshold value of a voltage at which a relay operates when the input voltage applied to the relay coil in the reset state is increased gradually.

Must Release (Must Reset) Voltage

The threshold value of a voltage at which a relay releases when the rated input voltage applied to the relay coil in the operating state is decreased gradually.

Power Consumption

The power (= rated voltage x rated current) consumed by the coil when the rated voltage is applied to it. A frequency of 60 Hz is assumed if the relay is intended for AC operation. The current flows through the coil when the rated voltage is applied to the coil at a temperature of 23°C. The tolerance is $\pm 15\%$ unless otherwise specified.

■ Terms Related to Electrical Characteristics

Dielectric Strength

The critical value which a dielectric can withstand without rupturing when a high-tension voltage is applied for 1 minute between the following points:

- Between coil and contact
- Between contacts of different poles
- Between contacts of same poles
- Between set coil and reset coil
- Between current-carrying metal parts and ground terminal

Note that normally a leakage current of 3 mA is detected; however, a leakage current of 1 mA to 10 mA may be detected on occasion.

Electrical Service Life

The life of a relay when it is switched at the rated operating frequency with the rated load applied to its contacts.

High-frequency Isolation (Applicable to High-frequency Relay only)

The degree of isolation of a high-frequency signal, which is equivalent to the insulation resistance of ordinary relays.

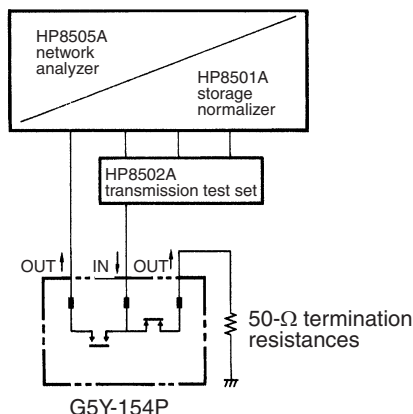

The following characteristics are measured with contacts unrelated to the measurement terminated at 50Ω, when a signal is applied from input terminal 11 to output terminal 8 or from input terminal 11 to output terminal 14 of the sample.

- Isolation characteristics
- Insertion loss characteristics
- Return loss

The following conversion formula converts from return loss to VSWR.

$$VSWR = \frac{1 + 10^{-\frac{x}{20}}}{1 - 10^{-\frac{x}{20}}}$$

where,
x = return loss

High-frequency Switching Power (Applicable to High-frequency Relays Only)

The power of a high-frequency signal that can be switched.

High-frequency Transmitted Power (Applicable to High-frequency Relays Only)

The transmission capacity of a high-frequency signal.

Impulse Withstand Voltage

The critical value which the relay can withstand when the voltage surges momentarily due to lightning, switching an inductive load, etc. The surge waveform which has a pulse width of ±1.2 x 50 μs is shown below:

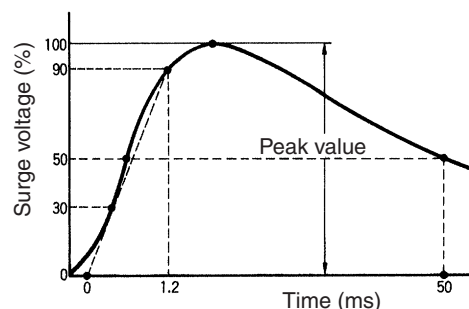

Insertion Loss (Applicable to High-frequency Relays Only)

The attenuation of a high-frequency signal in a transmission line and is equivalent to the contact resistance of ordinary relays.

Insulation Resistance

The resistance between an electric circuit such as the contacts and coil, and grounded, non-conductive metal parts such as the core, or the resistance between the contacts. The measured values are as follows:

| Rated insulation voltage | Measured value |
|--------------------------|----------------|
| 60 V max. | 250 V |
| 61 V min. | 500 V |

Maximum Operating Frequency

The frequency or intervals at which the relay continuously operates and releases, satisfying the rated mechanical and electrical service life.

Mechanical Service Life

The life of a relay when it is switched at the rated operating frequency without the rated load.

Operate Bounce Time

The bounce time of the normally open (NO) contact of a relay when the rated coil voltage is applied to the relay coil at an ambient temperature of 23°C.

Operate Time

The time that elapses after power is applied to a relay coil until the NO contacts have closed, at an ambient temperature of 23°C. Bounce time is not included. For the relays having an operate time of less than 10 ms, the mean (reference) value of its operate time is specified as follows:

| | |
|--------------|--|
| Operate time | 5 ms max. (mean value: approx. 2.3 ms) |
|--------------|--|

Release Bounce Time

The bounce time of the normally closed (NC) contact of a relay when the coil is de-energized at an ambient temperature of 23°C.

Release Time

The time that elapses between the moment a relay coil is de-energized until the NC contacts have closed, at an ambient temperature of 23°C. (With a relay having SPST-NO or DPST-NO contacts, this is the time that elapses until the NO contacts have operated under the same condition.) Bounce time is not included. For the relays having an operate time of less than 10 ms, the mean (reference) value of its operate time is specified as follows:

| | |
|--------------|--|
| Release time | 5 ms max. (mean value: approx. 2.3 ms) |
|--------------|--|

Reset Time (Applicable to Latching Relays Only)

The time that elapses from the moment a relay coil is de-energized until the NC contacts have closed, at an ambient temperature of 23°C. (With a relay having SPST-NO contacts, this is the time that elapses until the NO contacts have operated under the same condition.) Bounce time is not included. For the relays having a reset time of less than 10 ms, the mean (reference) value of its reset time is specified as follows:

| | |
|------------|--|
| Reset time | 5 ms max. (mean value: approx. 2.3 ms) |
|------------|--|

Set Time

The time that elapses after power is applied to a relay coil until the NO contacts have closed, at an ambient temperature of 23°C. Bounce time is not included. For the relays having a set time of less than 10 ms, the mean (reference) value of its set time is specified as follows:

| | |
|------------|--|
| Reset time | 5 ms max. (mean value: approx. 2.3 ms) |
|------------|--|

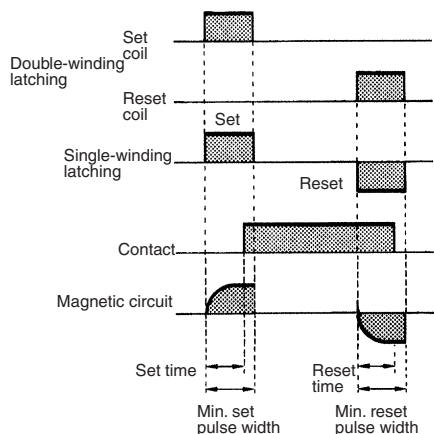

Shock Resistance

The shock resistance of a relay is divided into two categories: “Mechanical Durability” which quantifies the characteristic change of, or damage to, the relay due to considerably large shocks which may develop during the transportation or mounting of the relay, and “Malfunction Durability” which quantifies the malfunction of the relay while it is in operation.

Stray Capacitance

The capacitance measured between terminals at an ambient temperature of 23°C and a frequency of 1 kHz.

VSWR (Applicable to High-frequency Relays Only)

Stands for voltage standing-wave ratio. The degree of reflected wave that is generated in the transmission line.

Vibration Resistance

The vibration resistance of a relay is divided into two categories: “Mechanical Durability” which quantifies the characteristic changes of, or damage to, the relay due to considerably large vibrations which may develop during the transportation or mounting of the relay, and “Malfunction Durability” which quantifies the malfunction of the relay due to vibrations while it is in operation.

$$a = 0.002f^2A$$

where,

a: Acceleration of vibration (G-force equivalence)

f: Frequency (Hz)

A: Double amplitude (in.)

Precautions

Basic Information

Before actually committing any component to a mass-production situation, OMRON strongly recommends situational testing, in as close to actual production situations as possible. One reason is to confirm that the product will still perform as expected after surviving the many handling and mounting processes that are involved in mass production. Also, even though OMRON relays are individually tested a number of times, and each meets strict requirements, a certain testing tolerance is permissible. When a high-precision product uses many components, each depends upon the rated performance thresholds of the other components. Thus, the overall performance tolerance may accumulate into undesirable levels. To avoid problems, always conduct tests under the actual application conditions.

General

To maintain the initial characteristics of a relay, exercise care that it is not dropped or mishandled. For the same reason, do not remove the case of the relay; otherwise, the characteristics may degrade. Avoid using the relay in an atmosphere containing chemicals such as sulfuric acid (SO₂), hydrogen sulfide (H₂S), or other corrosive gases. Do not continuously apply a voltage higher than the rated maximum voltage to the relay. Never try to operate the relay at a voltage and a current other than those rated.

If the relay is intended for DC operation, the coil has a polarity. Pay particular attention to this polarity. Connect the power source to the coil in the correct direction. Do not use the relay at temperatures higher than that specified in the catalog or data sheet.

The storage for the relay should be in room temperature and humidity.

Coil

AC-switching Relays

Generally, the coil temperature of the AC-switching relay rises higher than that of the DC-switching relay. This is because of resistance losses in the shading coil, eddy current losses in the magnetic circuit, and hysteresis losses. Moreover, a phenomenon known as “chatter” may take place when the AC-switching relay operates on a voltage lower than that rated. For example, chatter may occur if the relay’s supply voltage drops. This often happens when a motor (which is to be controlled by the relay) is activated. This results in damage to the relay contacts by burning, contact weld, or disconnection of the self-holding circuit. Therefore, countermeasures must be taken to prevent fluctuation in the supply voltage.

One other point that requires attention is the “inrush current.” When the relay operates, and the armature of the relay is released from the magnet, the impedance drops. As a result, a current much higher than that rated flows through the coil. This current is known as the inrush current. (When the armature is attracted to the magnet, however, the impedance rises, decreasing the inrush current to the rated level.) Adequate consideration must be given to the inrush current, along with the power consumption, especially when connecting several relays in parallel.

DC-switching Relays

This type of relay is often used as a so-called “marginal” relay that turns ON or OFF when the voltage or current reaches a critical value, as a substitute for a meter. However, if the relay is used in this way, its control output may fail to satisfy the ratings because the current applied to the coil gradually increases or decreases, slowing down the speed at which the contacts move. The coil resistance of the DC-switching relay changes by about 0.4% per degree C change in the ambient temperature. It also changes when the relay generates heat. This means that the pickup and dropout voltages may increase as the temperature rises.

Coil Operating Voltage Source

If the supply voltage fluctuates, the relay will malfunction regardless of whether the fluctuation lasts for a long time or only for a moment.

For example, assume that a large-capacity solenoid, relay, motor, or heater is connected to the same power source as the relay, or that many relays are used at the same time. If the capacity of the power source is insufficient to operate these devices at the same time, the relay may not operate, because the supply voltage has dropped. Conversely, if a high voltage is applied to the relay (even after taking voltage drop into account), chances are that the full voltage will be applied to the relay. As a consequence, the relay’s coil will generate heat. Therefore, be sure 1) to use a power source with sufficient capacity and 2) that the supply voltage to the relay is within the rated must operate voltage range of the relay.

Lower Limit Pickup Voltage

When a relay is used at high temperatures, or when the relay coil is continuously energized, the coil temperature rises and coil resistance increases. Consequently, the pickup voltage increases. This increase in the pickup voltage requires attention when determining the lower-limit pickup value of the pickup voltage. An example and outline for determining this lower-limit pickup voltage is given below for reference when designing a power source appropriate for the relay.

Assuming a coil temperature rise of 10°C, the coil resistance will increase about 4%. The pickup voltage increases as follows:

Rated values of Model G5LE are taken from catalog or data sheet.

Rated voltage: 12 VDA

Coil resistance: 360Ω

Pickup voltage: 75% max. of rated voltage at 23°C coil temperature

The rated current that flows through this relay can be obtained by dividing the rated voltage by the coil resistance. Hence,

$$12 \text{ VDC} \div 360\Omega = 33.3 \text{ mA}$$

However, the relay operates at 75% maximum of this rated current, i.e., 25mA (= 33 mA x .75). Assuming that the coil temperature rises by 10°C, the coil resistance increases 4% to 374Ω (= 360Ω x 1.04). The voltage that must be applied to the relay to flow an operating current of 25 mA through the relay under this condition is 25 mA x 374Ω = 9.35 V.

Coil Temperature vs. Must Operate/release Voltage

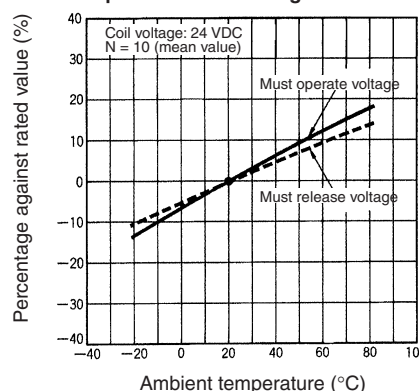

The minimum must operate voltage can be determined by this expression.

$$E_T > E \times \frac{E_{pv} + 5}{100} \times \left(\frac{T - T_a}{234.5 + T_a} + 1 \right) [V]$$

where,

E (V): Rated coil voltage

E_{pv} (%): Must operate voltage

T_a: Coil temperature for determining E_{pv} (20°C, unless otherwise specified)

T (°C): Ambient operating temperature

E_T (V): Minimum must operate voltage

Note: In the above expression, T is taken to be the result of energization of the coil, when the coil temperature is the same as the ambient temperature.

Coil Input

To guarantee accurate and stable relay operation, the first and foremost condition to be satisfied is the application of the rated voltage to the relay. Additionally, details concerning the type of the power source, voltage fluctuation, changes in coil resistance due to temperature rise and the rated voltage must also be considered. If a voltage higher than the rated maximum voltage is applied to the coil for a long time, layer short-circuiting and damage to the coil by burning may take place.

Coil Temperature Rise

When a current flows through the coil, the coil's temperature rises to a measurable level, because of copper loss. If an alternating current flows, the temperature rises even more, due not only to the copper loss, but additionally to the iron loss of the magnetic materials, such as the core. Moreover, when a current is applied to the contact, heat is generated on the contacts, raising the coil temperature even higher (however, with relays whose switching current is rated at 2 A or lower, this rise is insignificant).

Temperature Rise by Pulsating Voltage

When a pulsating voltage having an ON time of less than 2 minutes is applied to the relay, the coil temperature rise varies, and is independent of the duration of the ON time, depending only on the ratio of the ON time to the OFF time. The coil temperature in this case does not rise as high as when a voltage is continuously applied to the relay.

| Energization time | Release temperature rise |
|-------------------------|--------------------------|
| Continuous energization | 100% |
| ON:OFF = 3:1 approx. | 80% |
| ON:OFF = 1:1 approx. | 50% |
| ON:OFF = 1:3 approx. | 35% |

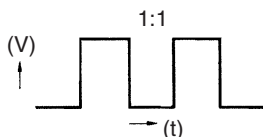

Changes in Must Operate Voltage by Coil Temperature Rise (Hot Start)

The coil resistance of a DC-switching relay increases (as the coil temperature rises) when the coil has been continuously energized, de-energized once, and then immediately energized again. This increase in the coil resistance raises the voltage value at which the relay operates. Additionally, the coil resistance rises when the relay is used at a high ambient temperature.

Maximum Must Operate Voltage

The maximum voltage applicable to a relay is determined in accordance with the coil temperature rise and the coil insulation materials' heat resistivity, electrical as well as mechanical life, general characteristics, and other factors.

If a voltage exceeding the maximum voltage is applied to the relay, it may cause the insulation materials to degrade, the coil to be burnt, and the relay to malfunction at normal levels.

The coil temperature must not exceed the temperature that the coil can withstand.

How to Calculate Coil Temperature

$$t = \frac{R2 - R1}{R1} (234.5 + T1) + T1 \text{ [}^\circ\text{C]}$$

where,

- R1 Ω: coil resistance before energization
- R2 Ω: coil resistance after energization
- T1 (°C): coil temperature (ambient) before energization
- t (°C): coil temperature after energization

Before using the relay confirm no problems occur.

DC Input Power Source

Pay attention to the coil polarity of the DC-switching relay. Power sources for DC-operated relays are usually a battery or a DC power supply, **either with a maximum ripple of 5%**. If power is supplied to the relay via a rectifier, the pickup and dropout voltages vary with the ripple percentage. Therefore, check the voltages before actually using the relay. If the ripple component is extremely large, chatter may occur. If this happens, it is recommended that a smoothing capacitor be inserted as shown in the following diagram.

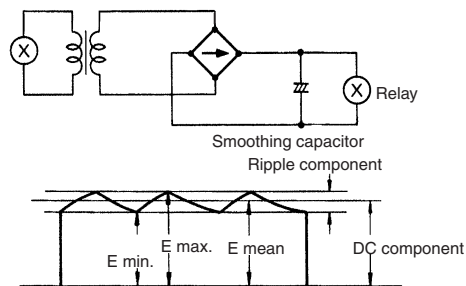

$$\text{Ripple percentage} = \frac{E_{\text{max.}} - E_{\text{min.}}}{E_{\text{mean}}} \times 100$$

- where,
- E max.: maximum value of ripple component
- E min.: minimum value of ripple component
- E mean: mean value of DC component

The use of a regulated, filtered power supply is preferred for DC coils.

If the voltage applied to the DC-operated coil increases or decreases slowly, each contact of a multi-pole contact relay may not operate at the same time. It is also possible for this situation to result in the must operate voltage varying each time the relay operates. Either way, circuit sequencing will not be correct. In critical applications, the use of a Schmitt circuit is recommended to reshape the DC waveform to trigger all contacts of the relay at the same time.

Relay Driving Signal Waveform

A long rise time and/or fall time of the signal driving the relay may prolong the operate time and/or release time of the relay. This situation may shorten the life expectancy of the contacts. If this situation cannot be avoided, providing a Schmitt trigger circuit at the circuit stage preceding the relay circuit will shape a waveform with sharp transitions, as shown in the following diagram:

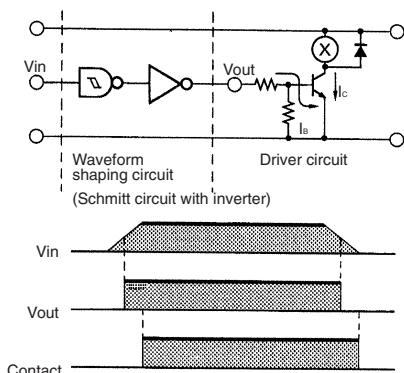

If the Schmitt trigger circuit is configured of transistors, a residual voltage may exist in the output of the circuit. Therefore, confirm that the rated voltage is present across the relay coil, or that the residual voltage drops to zero when the relay releases.

Cyclic Switching of AC Load

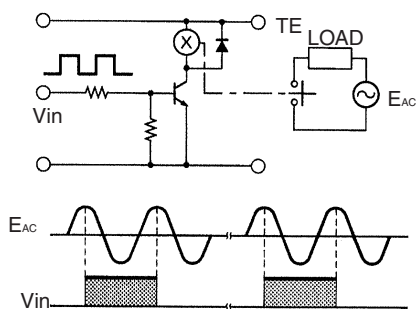

If the relay operates in synchronization with the supply voltage, the life of the relay may be shortened. When designing the control system in which the relay is used, estimate the life of the relay and thus the reliability of the overall system under actual operating conditions. Moreover, construct the circuit so that the relay operates in a random phase or in the vicinity of the zero point.

Dark Current in OFF Time

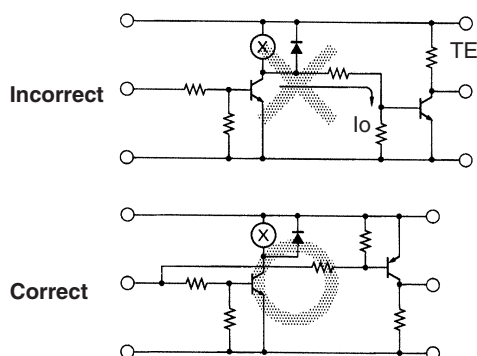

A circuit that produces a control output as soon as the relay operates must be carefully designed. In the first example, electrode dark current flows as shown when the relay operates. When dark current flows into the relay coil, the relay's resistivity to shock and vibration may degrade.

Overcoming Chatter in DC Relays

Use a full wave rectified signal that is filtered and regulated to control the coil of a DC relay. Ensure that the maximum ripple is 5%.

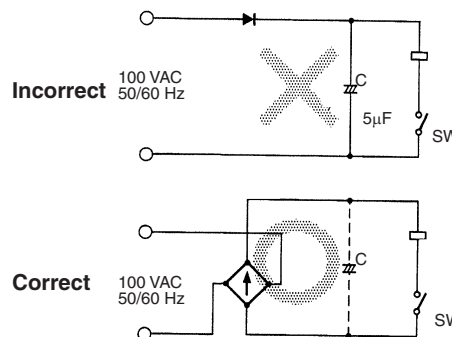

Voltage Considerations for AC Relays

The voltage applied to the relay must be a sine wave. When a commercial power source is used, there should be no problem. However, if an AC stabilized power source is used, either chatter or abnormal heating may occur, depending on the wave distortion of the power source. A shading coil is used to suppress beat in an AC current coil, but wave distortion defeats this function.

When a motor, solenoid, transformer, or other device is connected to the same power line source as the relay controller, and any of these devices causes a drop in the line voltage, the relay may chatter, damaging the contact. This commonly occurs when a small transformer is added to the line, when the transformer is too small, when long wiring is used, or when thin wiring is used in the customer's premises. Be aware of this phenomenon, as well as normal voltage fluctuations. Should this problem occur, check the change in voltage with a synchroscope or the like, and take appropriate countermeasures. Effective countermeasures include replacing the relay with a special relay suited to the circumstances, or use of a DC circuit and inclusion of a capacitor to compensate for the voltage change, as shown in the following circuit diagram.

Voltage change compensation circuit incorporating a capacitor

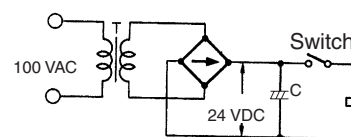

Notes on Correct Use

■ Driving by Transistor

When a transistor is used to drive the relay, be sure to ground the emitter of the transistor.

When the transistor is used in emitter-follower configuration (i.e., the collector is grounded), give adequate consideration to the voltage across the collector and emitter. The required voltage must be applied to the relay.

NPN transistor

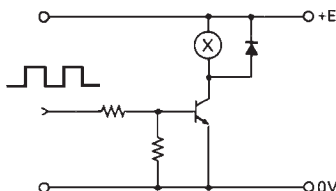

PNP transistor

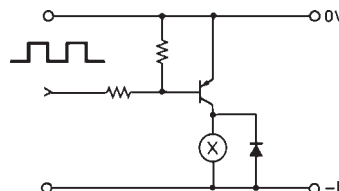

Advice on selecting a transistor for driving the relay

1. From the relay catalog or data sheet, ascertain the following coil characteristics:

Rated voltage _____ VDC

Rated current _____ mA

Coil resistance _____ Ω

2. Determine the lower- and upper-limit values of the pickup voltage from the rated voltage.

Lower-limit pickup voltage _____ V

Upper-limit pickup voltage _____ V

(If surge is contained in the rated voltage, obtain the maximum value including the surge.)

3. By determining the component for suppressing surge, obtain the dielectric strength of the transistor for driving the relay.

<In the case of diode>

(Upper-limit of pickup voltage + 0.6) × 2* ≅ V_{CEO} ≅ V_{CBO} = _____ V

<In the case of diode and zener diode>

(Upper-limit of pickup voltage + 0.6 + breakdown voltage**) × 2* ≅ V_{CEO} ≅ V_{CBO} = _____ V

<In the case of varistor>

(Upper-limit pickup voltage + varistor voltage***) × 2* ≅ V_{CEO} ≅ V_{CBO} = _____ V

<In the case of RC>

(Upper-limit pickup voltage + surge voltage****) × 2* ≅ V_{CEO} ≅ V_{CBO} = _____ V

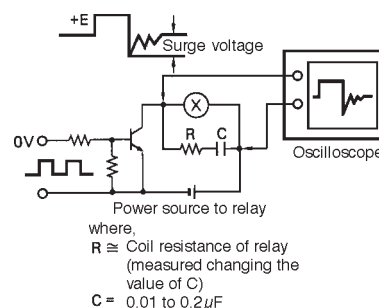

4. Determine collector current I_c.

I_c = Upper-limit pickup voltage/Coil resistance × 2*

5. Select the transistor that satisfies the conditions determined in steps 3 and 4.

6. After selecting the transistor, observe the I_c vs. V_{CE} characteristics of the transistor indicated in its ratings.

The characteristic curve illustrates the relation between collector current I_c and collector-emitter voltage V_{CE} at base current I_B. From this graph, obtain collector-emitter voltage V_{CE} where,

I_c = Maximum value of must operate voltage/Coil resistance

I_B = Base current of the switching transistor which is determined by the driver stage.

Thus, Collector-emitter voltage V_{CE} = V

Use the transistor in its switching (saturation) area. An adequate base current is required.

Note:

* This safety factor must be determined by the user.

** The breakdown voltage differs depending on the component. If multiple zener diodes are to be used, use their maximum breakdown voltage.

*** The varistor voltage differs depending on the component. In addition, the varistor voltage of a single varistor may vary depending on the current. Consult the manufacturer of the varistor to be used to determine the varistor voltage.

**** The surge voltage differs depending on the type and rating of the relay, and the constants of C and R of the circuit in which the relay is used. Positively determine the surge voltage by experiment.

I_C vs. V_{CE} characteristics

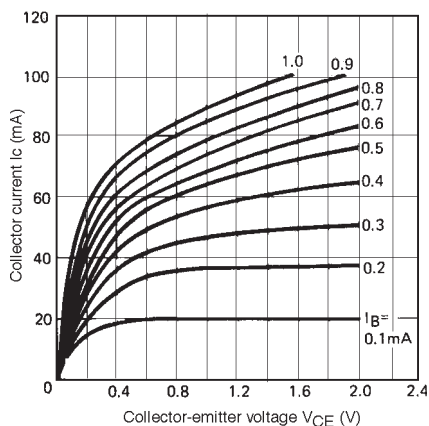

7. Using the following formula, calculate the power dissipated by the transistor to confirm that it is within the range of permissible power dissipation of the transistor.

Total power dissipation P_T = Collector dissipation P_C + Base dissipation P_B where,

P_C = Maximum value of pickup voltage / Coil resistance $\times V_{CE}$
(V_{CE} is determined in step 6.)

$P_B = I_B \times 0.6$ to 1

(For details on I_B , refer to step 6.)

Confirm that P_T obtained by the above formula is within the curve representing the total power dissipation vs. ambient temperature characteristics.

Total power dissipation vs. ambient temperature

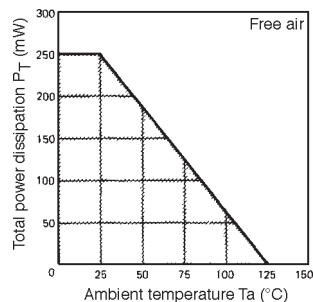

In case the total dissipation exceeds the permissible power dissipation, either attach a radiator plate to the transistor, or replace the transistor.

8. Determine the supply voltage to the relay.

The maximum and minimum values of the supply voltage to the relay are determined by the following expressions using the upper- and lower-limit values of the pickup voltage V_{CE} obtained in step 6.

Maximum supply voltage = Upperlimit pickup voltage + V_{CE}

Minimum supply voltage = Lowerlimit pickup voltage + V_{CE}

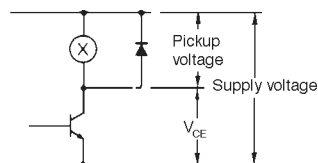

9. Verify that the following conditions are satisfied.

$V_{CEO} > (\text{Maximum supply voltage} + \text{surge voltage}) \times \text{safety factor}^*$

$V_{CBO} > (\text{Maximum supply voltage} + \text{surge voltage}) \times \text{safety factor}^*$

* Determine the safety factor giving consideration to external surge (such as lightning and surge from other devices).

10. Check the following items during actual use of the relay.

- Is the upper-limit value of the pickup voltage equal to or less than the rated value when the maximum supply voltage is applied?
- Is the lower-limit value of the pickup voltage equal to or more than the rated value when the minimum supply voltage is applied?
- Are the above conditions satisfied within the operating temperature range?
- Is there any abnormality found in a test run?

In addition to checking the above items, take into consideration the items listed in this table.

| | | |
|---|------|------|
| Rated voltage of relay | Low | High |
| Coil current* | High | Low |
| I_C of switching transistor | High | Low |
| V_{ECO} , V_{CEO} of switching transistor** | Low | High |
| Driving current of transistor | High | Low |
| Voltage drop V_{CE} in transistor | High | Low |
| Total power dissipation P_T of transistor | High | Low |

* Inversely proportional to voltage

** Often used V_{CEO} : 35 to 60 V

From the above discussion, the best relay coil should be rated at 12 VDC or 24 VDC when the relay is driven by a transistor.

Driving by Darlington-Connected Transistors

To reduce the current of the transistor to drive the relay (i.e., base current of the transistor), two transistors may be used, via Darlington connection. Darlington connected transistors are available enclosed in a single package.

NPN-NPN Darlington Connection

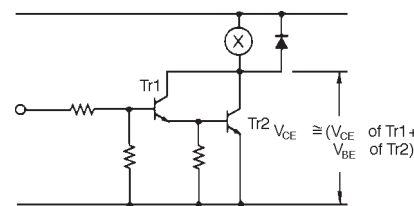

When the Darlington-connected transistors are used, the required value of V_{CE} is higher than when using a single transistor. For this reason, consideration must be given to designing the total power dissipation and supply voltage for the second transistor, Tr2.

■ Driving by IC

Recently, an IC on which multiple driving transistors are integrated has become available. The designing of the circuit or PCB to drive multiple relays, a small-size solenoid, or a small-size lamp can be simplified by using this IC. Consult the manufacturer of the IC for details. For V_{CE} , refer to the description of the related voltage and surge suppressor.

Dimensions Connection (Top view)

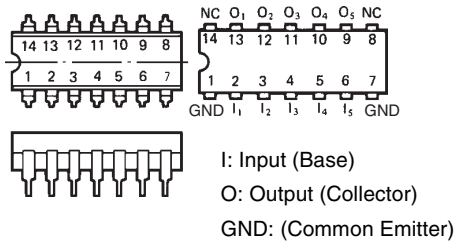

Equivalent circuit

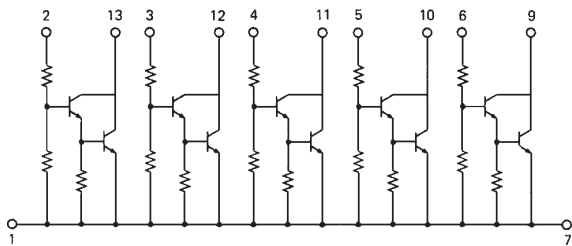

■ Driving by TTL

TTLs can be divided into two types by classification of the output: totem-pole and open-collector outputs. Connection of each type of TTL is described below.

Use a diode as surge suppressor.

In the specifications of some ICs, such a phrase as “fan-out 10” may be used in place of the legend I_{OL} . This denotes that 10 standard TTLs can be connected in parallel. In terms of current, fan-out 1 equals 1.6 mA. Hence,

$$\text{Fan-out } n = 1.6 \times n \text{ (mA)}$$

1. To drive a relay by the totem-pole output of a TTL, these conditions must be satisfied:

- I_{OL} (low-level output current) > Maximum supply voltage/Coil resistance.
- I_{OH} (high-level output current) < Rated current x pickup voltage (%) / Coil resistance
- Minimum supply voltage (4.75 V) – Maximum V_{OL} (low-level output voltage) > Lower-limit value of pickup voltage (Refer to Driving by Transistor)

Totem-pole output

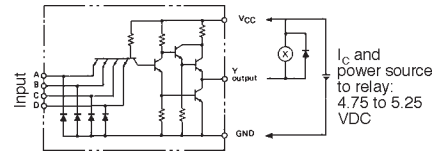

2. To drive a relay with open-collector output type TTL, a degree of freedom is allowed in the ratings of the relay coil. However, these conditions must be satisfied:

- I_{OL} > Maximum supply voltage to the relay coil/Coil resistance
- I_{OH} < Rated current x pickup voltage (%) / 200
- V_O = Dielectric strength of the output transistor (Refer to Driving by Transistor.)
- V_{OL} = Collector emitter voltage V_{CE} of the output transistor (Refer to Driving by Transistor.)

Open-collector output

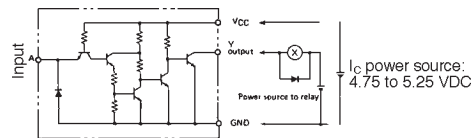

The above description of the standard TTL is applicable when using S, H, and LS type TTLs.

■ Driving by Other Switching Devices

Consult the manufacturer of the switching device. The upper- and lower-limit values of the pickup voltage can be determined in the same manner as described in Upper-limit Pickup Voltage and Lower-limit Pickup Voltage.

Example of Driving by SCR

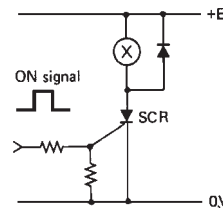

■ Designing Power Circuit

Since many documents and reference books on the power circuit are available, a detailed description is omitted here.

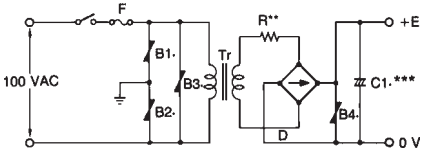

* In the circuit above, varistors B_1 and B_2 are used to protect the power circuit elements, as well as elements related to the power circuit, in case the voltage on the power line experiences surges (due to lightning or the surge voltage generated in other devices connected to the power circuit). Connect an appropriate surge suppressor across the output terminals of the power circuit to prevent a surge voltage from being generated. The surge suppressor must keep the surge voltage, if generated, from exceeding the breakdown voltage of each element in the power circuit.

** Resistor R protects diode bridge D from the inrush current that flows through the power circuit upon power application. Although the resistance of R is determined according to the resistance of the load coil and the ratings of the diodes, the use of a resistor having a resistance of 0.1 to 100Ω is recommended.

*** C_1 is a smoothing capacitor. Its capacitance must be as large as possible to reduce the surge percentage.

■ Connection of Surge Suppressor

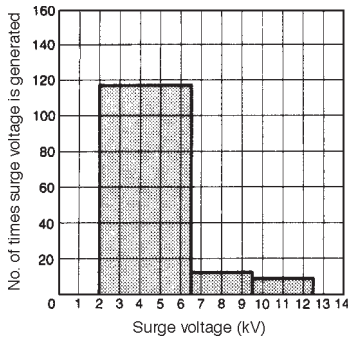

Note: This graph is plotted by measuring the surge voltage in the line of low-tension overhead wiring (cable length: 200 to 500 m).

When connecting a surge suppressor, pay attention to the following points:

1. Place the surge suppressor near the device to be protected. For example, to protect a device from external surge, set the surge suppressor at the inlet of the device's power cable. To suppress an internal surge, the suppressor must be placed near the surge generating source.

External surge

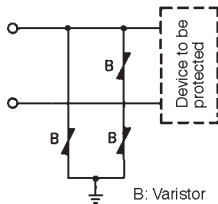

Internal surge

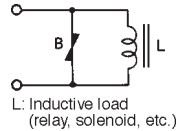

2. The cable for connecting the surge suppressor must be as short as possible in length, and thick enough in diameter so that it can sufficiently withstand the surge current. The short length and thick diameter are important to reduce the inductance and generated voltage, and to protect the device from heat damage.
3. When using a surge suppressor between cable and ground, the lower the ground resistance of the surge suppressor, the better the protective effect of the surge suppressor. Perform grounding at a ground resistance of 10Ω or less.

■ Countermeasures Against Supply Voltage Fluctuation

In case the supply voltage fluctuates heavily, insert a regulated voltage circuit or constant-voltage circuit in the application circuit as shown below.

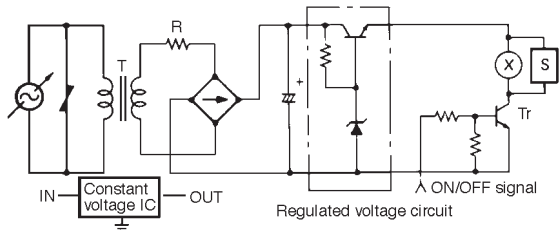

Relays consume more power than semiconductor elements. The following circuit configuration is recommended to improve the characteristics.

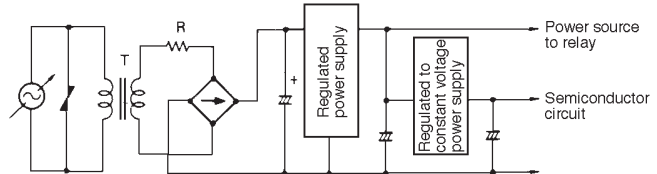

Countermeasures Against Inrush Current

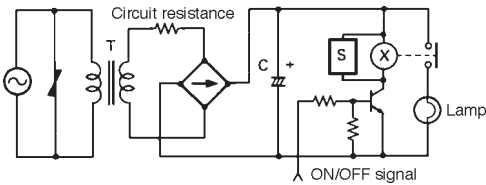

If a load such as a capacitor or lamp through which an inrush current flows is connected to the power source and contact of the relay, the supply voltage may drop when the contact is closed, causing the relay to abnormally release.

Increasing the capacity of the transformer or providing an additional control circuit can be used to prevent this drop in the supply voltage. On some occasions, use of the following circuit may prevent voltage drop.

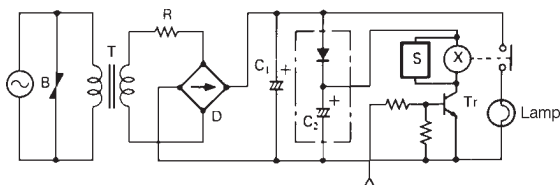

The same circuit also applies when the relay is driven by a battery.

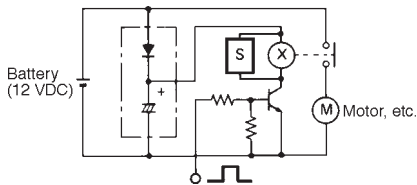

Designing Power-Conserving Driver Circuit with Single-Winding Latching Relay (Pat. 1239293)

This section introduces a patented drive circuit for the single-winding latching relay that can be driven on several milliwatts. This drive circuit not only allows the relay to be used in the same manner as semiconductor devices but also offers a wide range of applications.

Operating principle

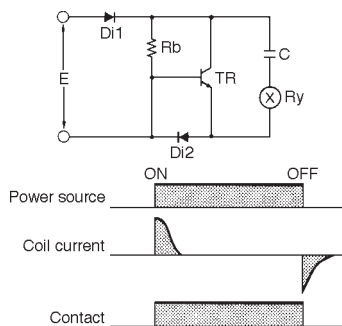

Set

When a specified voltage is applied across E, the current flows through the circuit in the sequence of diode Di1, capacitor C, relay Ry, and diode Di2. C is then charged, setting the relay.

Energization

When C has been fully charged, the relay is biased by the current flowing from Di1 to Rb. C does not discharge. The power consumption at this time is very small, several milliwatts at best, and its value can be calculated as follows:

$$P = (E - V_F)^2 / R_b$$

where,

P: power consumption

V_F : voltage drop across diode Di1

The current that is to flow through Rb at this time is dependent on the transfer ratio h_{ie} of transistor TR which is required for TR to turn ON.

Reset

When the voltage placed across E is removed, the electricity charged in C is discharged, causing the current to flow through the circuit in the sequence of Rb, the base, and the emitter of TR. In this way, the relay is reset by the current flowing in the direction opposite to when the relay is set.

The following equivalent circuits respectively illustrate the current flows when the relay is set, energized, and reset.

Set

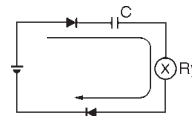

Energization

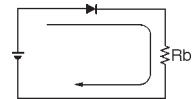

Reset

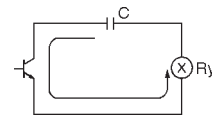

Circuit design

Fundamental

Generally, the latching relay is set and reset when a pulse having a square waveform is applied to it for a short time. The minimum pulse width required to set and reset the relay is predetermined.

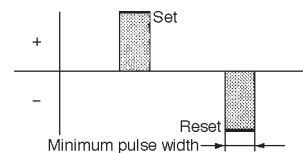

The charging current shown in the above equivalent circuit diagrams, has a sawtooth waveform that can be expressed by the following formula, because it is the primary circuit of C and R.

$$i = E - 2VF/R e^{-t/CR}$$

(2 Forward voltage diode drops)

If applied voltage E and the rated coil voltage of the relay are the same, the current to the relay falls short by the quantity indicated by the shaded portion in the following figure.

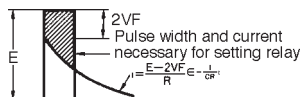

Therefore, the current must be applied to the relay as follows when designing this driver circuit.

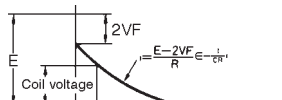

Time constant

When the rated voltage is applied to the relay, time A in the timing chart below is required to turn ON the contacts. After this time has elapsed, time B is required until the armature attraction to the magnet is complete.

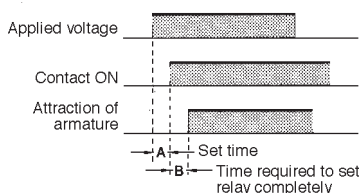

Therefore, it is apparent that time constant T obtained as the product of C and R must be equal to or longer than the sum of A and B. Actually, however, T should not be equal to the sum of A and B but must be longer than that to ensure the stable operation of the circuit. Thus,

$$T = A + B + X$$

where X is the time margin.

The set time A of OMRON's moving-loop relays (with a pickup power of 200 mW) is rated at about 3 milliseconds. Time constant T for them should be about three times that of A. The following graph illustrates this. This graph indicates that, if C is completely charged (I_{PEAK}), it takes $4.6T$ to discharge I to 1%. Note that time constant T is broken down into three segments. The first $1/3T$ equals A, the second $1/3T$, B. The remaining $1/3T$ is the time margin expressed as X in the above equation. T is three times A.

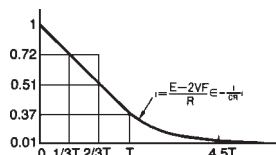

Voltage drop E1 across the total resistance of the capacitance C's resistance and relay coil's internal resistance is the difference between the supply voltage E and voltage drops across two diodes:

Di1 and Di2. Hence,

$$E_1 = E - 2VF$$

Assuming the supply voltage to be 5 V and VF to be 0.6 V,

$$E_1 = 5 - 2 \times 0.6 = 3.8 \text{ V}$$

From E1 and the above graph, the required coil voltage of a relay can be obtained. Again assuming the E, i.e., the supply voltage of a single-winding latching relay is 5 V, the coil voltage is:

$$3.8 \times 0.72 = 2.7 \text{ V}$$

At this time, the capacitance of C is 246.9 μF , according to the equation shown in the above graph.

Coil ratings and capacitance of C

In the example, the coil voltage obtained by calculation is 2.7 V, which is 0.3 V less than the value at which the coil voltage of commercially available standard latching relay is rated. The standard coil voltages of relays at a supply voltage of 6, 9, 12, and 24 V can be respectively calculated in the same way. Table 1 compares the results of the calculation and the coil voltages of standard relays.

| Supply voltage | Coil voltage (calculated) | Standard voltage | Coil resistance |
|----------------|---------------------------|------------------|-----------------|
| 5 V | 2.7 V | 3 V | 45 Ω |
| 6 V | 3.5 V | 3 V | 45 Ω |
| 9 V | 5.6 V | 5 V | 125 Ω |
| 12 V | 7.8 V | 6 V | 405 Ω |
| 24 V | 16.4 V | 12 V | 720 Ω |

| Supply voltage | Coil voltage (calculated) | Coil resistance | Capacitance of C |
|----------------|---------------------------|-----------------|-------------------|
| 5 V | 2.7 V | 45 Ω | 280 μF |
| 6 V | 3.5 V | 45 Ω | 142 μF |
| 9 V | 5.6 V | 125 Ω | 54 μF |
| 12 V | 7.8 V | 405 Ω | 40 μF |
| 24 V | 16.4 V | 720 Ω | 6.5 μF |

The calculated coil voltages significantly deviates from the standard values. It is therefore necessary to determine the time constant of the relay by adjusting the capacitance of C when the relay coil is to operate on the standard voltage.

As an example, calculate the capacitance of C and time constant T of a relay with a rated supply voltage of 5 V. The coil voltage E_1 has been calculated above (3.8 V). To determine how much current I flows through the coil at 3.8 V, from Table 1, note that the coil resistance is 45 Ω . So,

$$I = 3.8/45 = 84.4 \text{ mA}$$

Therefore, the peak current of capacitor C to be used must be 84.4 mA.

Remember, that time A of an OMRON relay is 3 ms. Capacitance C must be a value that allows 66.6 mA to flow through 3 ms after 5 V is applied to the relay.

Thus,

$$66.6 = 84.4 e^{-1/45 \times 3 \times 10^{-3}}$$

From this,

$$C = 280 \mu\text{F}$$

At this time, time constant T is:

$$280 \times 10^{-6} \times 45 = 12.6 \text{ ms}$$

By calculating the C of each of the relays listed in Table 1, the values in Table 2 are obtained.

Again, these calculated capacitances deviate from the commercially available standard capacitors. There is no problem in using standard capacitors but, if the cost and circuit space permit, it is recommended to use two or more capacitors so that a capacitance as close to the calculated value as possible is obtained. At this time, pay attention to the following points:

- Confirm that the relay operates normally even when the supply voltage is brought to 80%-120% of the rated value.
- Even if a voltage of two or three times the rated voltage is applied to this driver circuit, the coil wire will not sever. That is why, for example, when the driver circuit is mounted in an automobile where a supply voltage of 12 VDC is available from the battery, it is recommended to use a relay whose coil voltage is rated at 6 VDC, taking a voltage fluctuation of 8 to 16 VDC into consideration.

Determining Rb

The current flows into Rb should be enough to turn ON TR when the relay is reset. When determining value of Rb, the following points must be noted:

- TR must be sufficiently turned ON even when T equals the time constant.
- Give adequate consideration to changes in the due to changes in ambient temperature. Simple as it is, the driver circuit introduced here can efficiently control the relay, consuming a tiny amount of power.

An experiment reveals that the relay sufficiently operates with a capacitance of $100\ \mu\text{F} + 47\ \mu\text{F}$ where the relay is rated at a supply voltage of 5 VDC and a coil voltage of 3 VDC. It can therefore be said that the capacitance can be lower than the calculated value. This is because the time constant is determined with a relatively wide margin. So it is recommended to perform experiments to determine the time constant.

Application circuit example

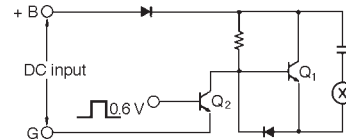

The TTL output of a solid-state switch can be used as Q₂.

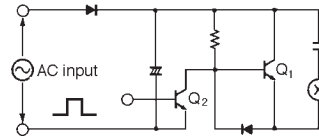

Half-wave rectified AC power is applied to the circuit. Q₁ is the output of a TTL, and drives the relay.

Contacts

The contacts are the most important constituent of a relay. Their characteristics are significantly affected by factors such as the material of the contacts, voltage and current values applied to them (especially, the voltage and current waveforms when energizing and de-energizing the contacts), the type of load, operating frequency, atmosphere, contact arrangement, and bounce. If any of these factors fail to satisfy predetermined values, problems such as metal deposition between contacts, contact welding, wear, or rapid increase in the contact resistance may occur.

■ Switching voltage (AC, DC)

When a relay breaks an inductive load, a fairly high counterelectromotive force (counter emf) is generated in the relay's contact circuit. The higher the counter emf, the greater the damage to the contacts. This may result in a significant decrease in the switching capacity of DC-switching relays. This is because, unlike the AC-switching relay, the DC-switching relay does not have a zero-cross point. Once arc has been generated, it does not easily diminish, prolonging the arc time. Moreover, the unidirectional flow of the current in a DC circuit may cause metal degradation to occur between contacts and the contacts to wear rapidly (this is discussed later).

Despite the information a catalog or data sheet sets forth as the approximate switching power of the relay, always confirm the actual switching power by performing a test with the actual load.

■ Switching Current

The quantity of electrical current which flows through the contact directly influences the contact characteristics. For example, when the relay is used to control an inductive load such as a motor or a lamp, the contacts will wear faster, and metal decomposition between the mating contacts will occur more often as the inrush current to the contacts increases. Consequently, at some point the contacts may weld.

■ Contact Materials

Selection of an appropriate contact material according to the load to be opened or closed is important. Several contact materials and their properties are listed below.

| Examples of Contact Materials | |
|-------------------------------|---|
| P. G. S. Alloy | This material has excellent corrosion resistance and is suitable for very small current circuits. Au : Ag : Pt = 69 : 25 : 6 |
| AgPd | This material exhibits good corrosion and sulphur resistance. In a dry circuit, it attracts organic gas to generate a polymer, therefore it is usually plated with gold or other material. |
| Ag | This material has the highest electric and heat conductivities among all metals. It exhibits low contact resistance, but easily forms sulfide film in a sulfide gas environment. This may result in defective contact performance at a low-voltage small-current operation. |
| AgCdO | This material exhibits the same high electric conductivity as silver, low contact resistance, and excellent deposition resistance. It easily forms sulfide film in a sulfide gas environment. |
| AgNi | This material exhibits the same high electric conductivity as silver and excellent arc resistance. |
| AgSnIn | This material exhibits excellent deposition resistance and exhaustion resistance. |
| AgW | This material exhibits a high hardness and melting point. It also exhibits excellent arc resistance and superior resistance to deposition and transfer. However, it shows high contact resistance and inferior environmental resistance. |

■ Contact Protection Circuit

A contact protection circuit, designed to prolong the life of the relay, is recommended. This protection will have the additional advantages of suppressing noise, as well as preventing the generation of carbide and nitric acid, which otherwise would be generated at the contact surface when the relay contact is opened. However, unless designed correctly, the protection circuit may produce adverse effects, such as prolonging the release time of the relay.

The following table lists examples of contact protection circuits.

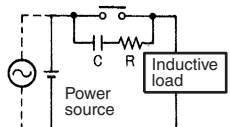
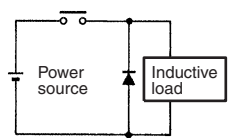
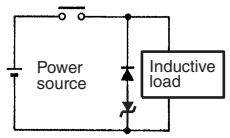
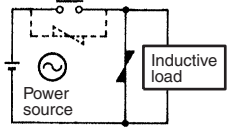
| Circuit example | Applicability | | Features and remarks | Element selection |
|---|---------------|------|--|--|
| | AC | DC | | |
|  | Fair | Good | Load impedance must be much smaller than the RC circuit when the relay operates on an AC voltage. | Optimum C and R values are: C: 1 to 0.5 μ F for 1-A switching current R: 0.5 to 1 Ω for 1-V switching voltage These values do not always agree with the optimum values due to the nature of the load and the dispersion in the relay characteristics. Confirm optimum values experimentally. Capacitor C suppresses discharge when the contacts are opened, while resistor R limits the current applied when the contacts are closed the next time. Generally, employ a capacitor C whose dielectric strength is 200 to 300 V, or more than double the switching voltage. If the circuit is powered by an AC power source, employ an AC capacitor (non-polarized). |
| | Good | Good | This circuit is effective if connected across the load when the supply voltage is 24 to 48 V. When the supply voltage is 100 to 240 V, connect the circuit across the contacts. | |
| Diode | N/A | Good |  The diode protects the coil from any inductive kickback. Relays with a diode connected in parallel with the relay coil tend to experience increased release times. | Employ a diode having a reverse breakdown voltage of more than 10 times the circuit voltage and a forward current rating greater than the load current. A diode having a reverse breakdown voltage two to three times that of the supply voltage can be used in an electronic circuit where the circuit voltage is not particularly high. |
| Diode + Zener Diode | N/A | Good |  This circuit effectively shortens release time in applications where the release time of a diode protection circuit proves to be too slow. | The zener diode breakdown voltage should be about the same as the supply voltage. |
| Varistor | Good | Good |  By utilizing the constant-voltage characteristic of a varistor, this circuit prevents high voltages from being applied across the contacts. This circuit also somewhat delays the release time. This circuit, if connected across the load, is effective when the supply voltage is 24 to 48 V. If the supply voltage is 100 to 240 V, connect the circuit across the contacts. | — |

Avoid use of a surge suppressor in the manner shown below.

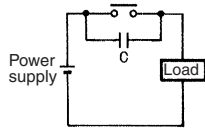
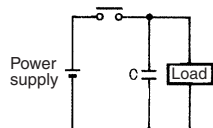
| | |
|---|---|
|  |  |
| This circuit arrangement is very effective for diminishing sparking (arcing) at the contacts, when breaking the circuit. However, since electrical energy is stored in C (capacitor) when the contacts are open, the current from C flows into the contacts when they close. Therefore, metal degradation is likely to occur between mating contacts. | This circuit arrangement is very useful for diminishing sparking (arcing) at the contacts when breaking the circuit. However, since the charging current to C flows into the contacts when they are closed, metal degradation is likely to occur between the mating contacts. |

Although it is considered that switching a DC inductive load is more difficult than a resistive load, an appropriate contact protection circuit can achieve almost the same characteristics.

Latching Relays

- Avoid use in locations subject to excessive magnetic particles or dust.
- Avoid use in magnetic fields (over 8,000 A.m).
- Take measures to preventing problems caused by vibration or shock. Problems may originate from other relay(s) operating or releasing on the same panel.
- Avoid simultaneous energization of the set and reset coils, even though both coils can be continuously energized.
- Avoid use under conditions where excessive surge-generating sources exist in the coil power source.
- When planning to mount multiple relays side-by-side, observe the minimum mounting interval of each type of relay.

■ Drive Circuit (Double-winding Relays G5AK, G6AK, G6BK, etc.)

When a DC-switching latching relay is used in one of the circuits shown in the following diagram, the relay contacts may be released from the locked state unless a diode (enclosed in the dotted box in the circuit diagram) is connected to the circuit.

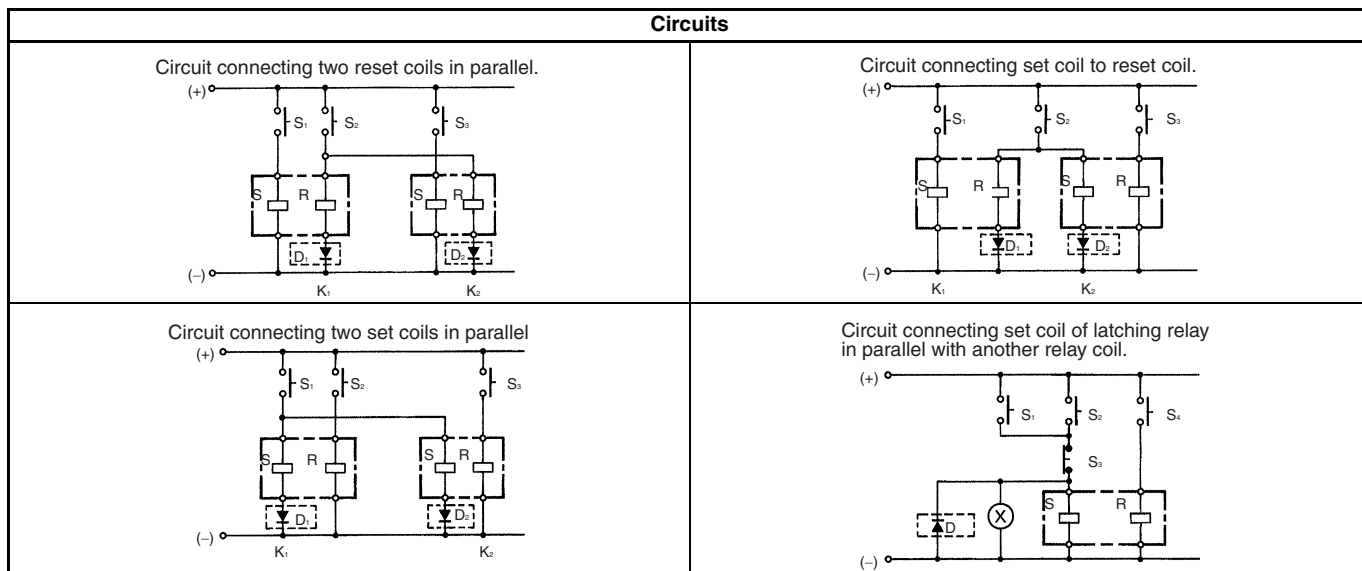

When connecting a diode to the relay circuit, be sure to use a diode with a repetitive peak-inverse voltage, and a DC reverse voltage sufficient to withstand external noise or surge. Also be sure that the diode has an average rectified current greater than the coil current.

If the contact of the relay is used to de-energize the relay, the relay may not operate normally. Avoid using the relay in a circuit like the one shown below:

Incorrect Use:

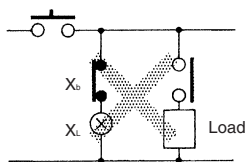

X₁: Latching relay
X₂: NC contact of relay

PCB Design

■ Soldering

As demands for more compact electronic devices have grown, so have demands declined for the plug-in relays that requires a bulky socket for connection. This trend has led to the development of relays that can be soldered directly onto the PCB. Smaller relays have made possible great density increases on the PCB, which in turn reduces the size of the product or device. However, unless the relay is fully sealed, when soldered onto a PCB, flux may penetrate into the housing, adversely affecting the internal circuitry.

The following points will help when designing a product which uses relays. This section points out details to be noted when soldering a relay to a PCB.

■ PCB Materials

Generally, the substrate of a PCB is made of glass epoxy (GE), paper epoxy (PE), or paper phenol (PP). Of these, the glass-epoxy or paper-epoxy PCB is recommended for mounting relays. See the following table

| Item | Epoxy Based | | Phenol-based |
|----------------------------|---|------------------|---|
| | Glass Epoxy (GE) | Paper Epoxy (PE) | Paper Phenol (PP) |
| Electrical characteristics | High insulation resistance. Insulation resistance hardly affected by humidity. | Fair | Insulation resistance degraded by humidity. |
| Mechanical characteristics | Little expansions/shrinkage caused by change in temperature or humidity. Suitable for through-hole PCBs and multi-layered PCBs. | Fair | Much expansion/shrinkage caused by changes in temperature or humidity. Not suitable for through-hole PCB. |
| Cost Effectiveness | Expensive | Fair | Fair |

■ PCB Thickness

PCBs having a thickness of 0.8, 1.2, 1.6, or 2.0 mm are generally used. A PCB that is 1.6 mm thick is best for mounting a PCB relay, considering the weight of the relay and the length of the terminals. (The terminal length of OMRON relays is 3, 3.5, or 4.0 to 5.0 mm.)

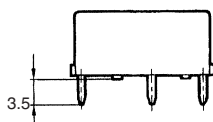

■ Terminal Hole Diameter and Land Diameter

Select the appropriate terminal hole and land diameters from the following table, based on the PCB mounting hole drawing. Land diameters may be reduced to less than those listed below if the through-hole connection process is to be employed.

| Terminal Hole and Land Diameters | | |
|----------------------------------|-----------|-----------------------|
| Terminal Hole Diameter | | Minimum Land Diameter |
| Normal | Tolerance | |
| 0.6 mm | ±0.1 mm | 1.5 mm |
| 0.8 mm | | 1.8mm |
| 1.0 mm | | 2.0mm |
| 1.2 mm | | 2.5mm |
| 1.3 mm | | 2.5mm |
| 1.5 mm | | 3.0mm |
| 1.6 mm | | 3.0mm |
| 2.0 mm | | 3.0mm |

■ PCB Selection

In general, relays are directly mounted and soldered onto a PCB. Although seemingly an uninvolved process, soldering and its related processes of flux application, relay mounting, heat application, and washing can be detrimental to a relay's performance. For example, if the PCB were to warp, the internal mechanism of the relay could become distorted, degrading the performance characteristics. Thus it could be said that the relay's characteristics are also affected by the size, thickness, and material of the PCB. Therefore, carefully select a PCB that will not jeopardize the performance of the relay.

■ Shape of Lands

The land section should be on the center line of the copper-foil pattern, so that the soldered fillets become uniform.

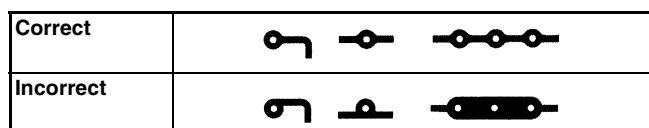

A break in the circular land area will prevent molten solder from filling holes reserved for components which must be soldered manually after the automatic soldering of the PCB is complete.



■ Conductor Width and Thickness

The following thickness of copper foil are standard: 35 μm and 70 μm. The conductor width is determined by the current flow and allowable temperature rise. Refer to the chart below.

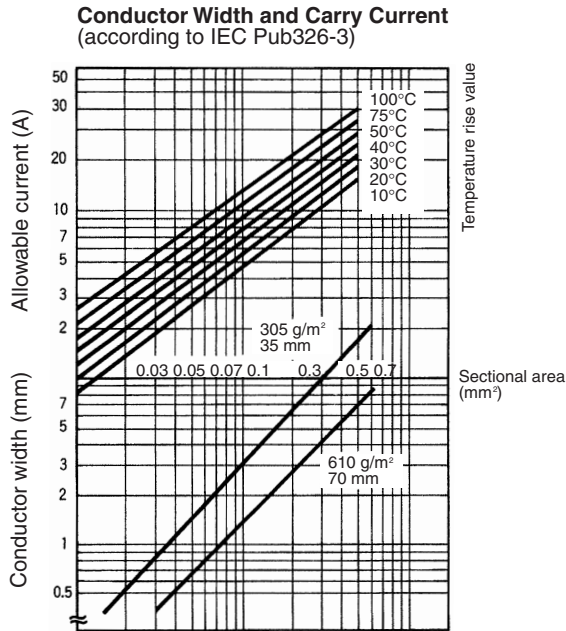

■ Conductor Pitch

The conductor pitch on a PCB is determined according to the insulation resistance between conductors and the environmental conditions under which the PCB is to be placed. The following graph shows the general relationship between the voltage between conductors and the conductor pitch on a PCB. However, if the PCB must conform to safety organization standards (such as UL, CSA, VDE, etc.), priority must be given to fulfilling their requirements.

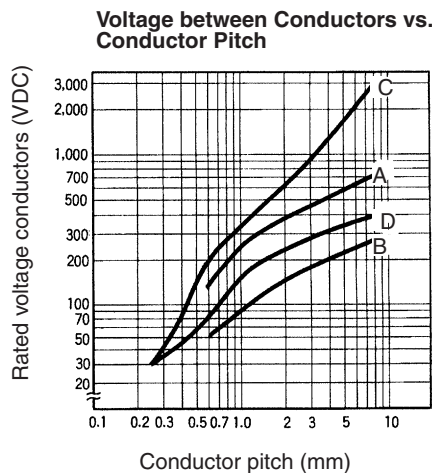

- A = w/o coating at altitude of 3,000 m max.
- B = w/o coating at altitude of 3,000 m or higher but lower than 15,000 m
- C = w/coating at altitude of 3,000 m max.
- D = w/coating at altitude of 3,000 m or higher

■ Temperature and Humidity

PCBs expand or contract with changes in temperature. Should expansion occur with a relay mounted on the PCB, the internal components of the relay may be shifted out of operational tolerance. As a result, the relay may not be able to operate with its normal characteristics.

PCB materials have “directionality,” which means that a PCB generally has expansion and contraction coefficients 1/10 to 1/2 higher in the vertical direction than in the horizontal direction. Conversely, its warp in the vertical direction is 1/10 to 1/2 less than in the horizontal direction. Therefore, take adequate counter-measures against humidity by coating the PCB. Should heat or humidity be entirely too high, the relay’s physical characteristics will likewise be affected. For example, as the heat rises the PCB’s insulation resistance degrades. Mechanically, PCB parts will continue to expand as heat is applied, eventually passing the elastic limit, which will permanently warp components.

Moreover, if the relay is used in an extremely humid environment, silver migration may take place.

■ Gas

Exposure to gases containing substances such as sulfuric acid, nitric acid, or ammonia can cause malfunctions such as faulty contacting in relays. They can also cause the copper film of a PCB to corrode, or prevent positive contacts between the PCB’s connectors. Of the gases mentioned, nitric acid is particularly damaging as it tends to accelerate the silver migration. As a counter-measure against gas exposure damage, the following processes on the relay and PCB have proved useful.

| Item | Process |
|-----------------------|---|
| Outer casing, housing | Sealed construction by using packing, etc. |
| Relay | Use of simplified hermetically sealed type relay, DIP relay |
| PCB, Copper Film | Coating |
| Connector | Gold-plating, rhodium-plating process |

■ Vibration and Shock

Although the PCB itself is not usually a source of vibration or shock, it may simplify or prolong the vibration by sympathetically vibrating with external vibrations or shocks. Securely fix the PCB, paying attention to the following points.

| Mounting Method | Remarks |
|-----------------|---|
| Rack Mounting | No gap between rack’s guide & PCB |
| Screw Mounting | Securely tighten screw. Place heavy components such as relays on part of PCB near screws. Attach rubber washers to screws when mounting components that are affected by shock (such as audio devices.) |

Mounting Considerations

Depending on where the relay is mounted, the function of the relay (and the performance of the circuit which includes the relay) may be adversely affected.

The relay may malfunction if it is mounted near a transformer or other device that generates a large magnetic field, or much heat. Provide an adequate distance between the relay and such devices.

Also, keep the relay away from semiconductor devices, if they are to be mounted on the same PCB.

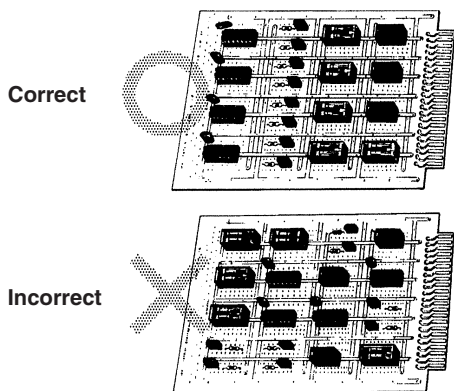

Mounting Direction

To allow a relay to operate to its full capability, adequate consideration must be given to the mounting direction of the relay. Relay characteristics that are considerably influenced by mounting direction are shock resistance, life expectancy, and contact reliability.

Shock Resistance

Ideally, the relay must be mounted so that any shock or vibration is applied to the relay at right angles to the operating direction of the armature of the relay. Especially when a relay's coil is not energized, the shock resistance and noise immunity are significantly affected by the mounting direction of the relay.

Life Expectancy

When switching a heavy load that generates arc (generally, a load having a greater impedance than that of the relay coil), substances spattered from the contact may accumulate in the vicinity, resulting in degradation of the insulation resistance of the circuit. Mounting the relay in the correct direction is also important in preventing this kind of degradation of the insulation resistance.

Contact Reliability

Switching both a heavy and a minute load with a single relay contact is not recommended. The reason for this is that the substances scattered from the contact when the heavy load is switched degrade the contact when switching the minute load. For example, when using a multi-pole contact relay, avoid the mounting direction or terminal connections in which the minute load switching contact is located below the heavy load switching contact.

Mounting Interval

When mounting multiple relays side by side on a PCB, pay attention to the following points:

When many relays are mounted side by side, they may generate an abnormally high heat due to the thermal interference between the relays. Therefore, provide an adequate distance between the relays to dissipate the heat. When using a relay, be sure to check the minimum mounting interval.

Also, if multiple PCBs with relays are mounted to a rack, the temperature may rise. In this case, preventive measures must be taken so that the ambient temperature falls within the rated value.

Pattern Layout

Countermeasures Against Noise

The relay can be a noise source when viewed from a semiconductor circuit. This must be taken into consideration when designing the layout positioning of the relay and other semiconductor components on the PCB.

- Keep the relay away from semiconductor components as far away as possible.
- Locate the surge suppressor for the relay coil as close to the relay as possible.
- Do not route wiring for signals such as audio signals that are likely to be affected by noise below the relay.
- Design the shortest possible pattern.
- One method for separating the power source and relay from other electronic components is to use shielded patterns.

Conformal Coating

Coating the PCB is recommended to prevent the circuitry from being degraded by harmful gases. When coating the PCB, care should be taken to avoid relay contamination. Otherwise, faulty contact of the relay may occur due to sticking or coating. Some coating agents may degrade or adversely affect the relay. Select the coating agent carefully.

| Type of Coating | | |
|-----------------|--|--|
| Item | Applicability to PCB with relays mounted | Feature |
| Epoxy | Good | Good insulation. Applying this coating is a little difficult, but has no effect on relay contact. |
| Urethane | Good | Good insulation and easy to coat. Be careful not to allow the coating on the relay itself, as thinner-based solvents are often used with this coating. |
| Silicon | Poor * | Good insulation and easy to coat. However, silicon gas may cause contact contamination and misoperation. |

* Satisfactory for sealed, but totally unsatisfactory for unsealed relays.

Automatic Mounting of Relay on PCB

Through-hole Mounting

The following tables list the processes required for mounting a relay onto a PCB and the points to be noted in each process.

Process 1: Placement

Do not bend any terminal of the relay to use it as a self-clinching relay or the relay may malfunction.

It is recommended to use magazine-packaged self-clinching relays for placement onto the PCB.

| Possibility of Automatic Placement | | | |
|------------------------------------|----------|-----------------|--------------|
| Construction | Unsealed | Flux protection | Fully sealed |
| Magazine-packaged relay | NO | YES | YES |
| Self-clinching relays | | | |

Process 2: Flux Application

To apply flux to a flux protection or fully sealed relay, a sponge soaked with flux can be used. Place the relay in the holes drilled in the PCB and press the PCB (with the relay still mounted) firmly against the sponge. The flux will be pushed up the relay's contact legs, and through the PCB holes. This method must never be applied with an unsealed relay because the flux will penetrate into the relay.

Use a non-corrosive rosin-type flux or water washable organic flux.

For the flux solvent, use an alcohol-based solvent, which tends to be less chemically reactive.

Apply the flux sparingly and evenly to prevent penetration into the relay. When dipping the relay terminals into liquid flux, be sure to adjust the flux level, so that the upper surface of the PCB is not flooded with flux.

| Possibility of Dipping Method | | |
|-------------------------------|-----------------|--------------|
| Unsealed | Flux protection | Fully sealed |
| NO | YES | YES |

Process 3: Transportation

When the PCB is transported, the relay mounted on the PCB may be lifted from the board surface due to vibration. This can be prevented if the relay mounted on the PCB has self-clinching terminals.

Process 4: Preheating

Preheat the PCB at a temperature of 100°C maximum within a period of approximately one minute for smooth soldering. The characteristics of the relay may change if it is heated at a high temperature for a long time.

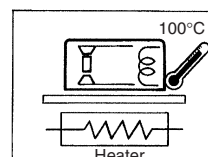

| Possibility of Preheating | | |
|---------------------------|-----------------|--------------|
| Unsealed | Flux protection | Fully sealed |
| NO | YES | YES |

Process 5: Soldering

Flow soldering is recommended to assure a uniform solder joint.

- Solder: JIS Z3282, H60, or H63*
- Solder temperature and soldering time: 250°C, 5 s max.
- Adjust the level of the molten solder so that the PCB is not flooded with solder.

| Possibility of Automatic Soldering | | |
|------------------------------------|-----------------|--------------|
| Unsealed | Flux protection | Fully sealed |
| NO | YES | YES |

Manual Soldering

Complete the soldering operation quickly. Use the correct wattage of soldering iron. Do not overheat while smoothing the applied solder with the tip of the iron.

- Solder: JIS Z3282, H60, or H63 (containing resin-type flux)
- Soldering iron: rated at 30 to 60 W
- Tip temperature: 280°C to 300°C
- Soldering time: 3 s max.
- The following table contains recommended solders:

| Type | Sparkle solder |
|----------------------------|-------------------|
| Applicable solder diameter | 0.03 to 0.06 in. |
| Sn | 58.8% |
| Flux content | 1.67% |
| Impurities | JIS Z3282 Class A |
| Spread rate | 90% |
| Storage | 3 months max. |

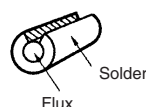

Possibility of Manual Soldering

| Unsealed | Flux protection | Fully sealed |
|----------|-----------------|--------------|
| YES | YES | YES |

The solder in the illustration shown above is provided with a cut section to prevent the flux from splattering.

Process 6: Cooling

Upon completion of automatic soldering, use a fan or other device to forcibly cool the PCB. This helps prevent the relay and other components from deteriorating due to the inertial heat of soldering.

Fully sealed relays are washable. Do not, however, put fully sealed relays in a cold cleaning solvent immediately after soldering or the seals may be damaged.

| Flux protection | Fully sealed |
|-----------------|--------------|
| Necessary | Necessary |

Process 7: Cleaning

Avoid cleaning the soldered terminals whenever possible. When a resin-type flux is used, no cleaning is necessary. If cleaning cannot be avoided, exercise care in selecting an appropriate cleaning solvent.

| Cleansing Method | | |
|--|-----------------|---|
| Unsealed | Flux protection | Fully sealed |
| Boiling cleaning and immersion cleaning are not possible. Clean only the back of the PCB with a brush. | | Boiling cleaning and immersion cleaning are possible. Ultrasonic cleaning will have an adverse effect on the performance of relays not specifically manufactured for ultrasonic cleaning. When cleaning the G2R or any other relay, the ambient temperature must be within the permissible ambient operating temperature range of the relay. |

| List of Cleaning Solvents | | |
|---------------------------|---|---|
| Solvent | | Fully Seated |
| Chlorine-based | Perochlene Chlorosolder Trichloroethylene | Yes |
| Water-based | Indusco Holys | Yes |
| Alcohol-based | IPA Ethanol | Yes |
| Others | Thinner Gasoline | No |
| Cleaning method | | Automatic cleaning Ultrasonic cleaning (see note 4) |

- Note:**
1. Consult your OMRON representative before using any other cleaning solvent. Do not use Freon-TMC-based, thinner-based, or gasoline-based cleaning solvents.
 2. Worldwide efforts are being made at discontinuing the use of CFC-113-based (fluorochlorocarbon-based) and trichloroethylene-based cleaning solvents. The user is requested to refrain from using these cleaning solvents
 3. It may be difficult to clean the space between the relay and PCB using hydrogen-based or alcohol-based cleaning solvent. It is recommended the stand-off-type be used G6A□-ST when using hydrogen-based or alcohol-based cleaning solvents.
 4. Ultrasonic cleaning may have an adverse effect on the performance of relays not specifically manufactured for ultrasonic cleaning. Please refer to the model number to determine if your relay is intended to be cleaned ultrasonically.
 5. Contact Omron representative for recommended cleaning procedures of specific relays.

Process 8: Coating

Do not apply a coating agent to any flux-resistant relay or relay with a case because the coating agent will penetrate into the relay and the contacts may be damaged.

Some coating agents may damage the case of the relay. Be sure to use a proper coating agent.

Do not fix the position of relay with resin or the characteristics of the relay will change.

| Resin | Fully Sealed |
|----------|--------------|
| Epoxy | YES |
| Urethane | YES |
| Silicone | NO |
| Fluorine | YES |

■ Surface Mounting

The following tables list the processes required for mounting a relay onto a PCB and the points to be noted in each process.

Process 1: Cream Solder Printing

Do not use a cream solder that contains a flux with a large amount of chlorine or the terminals of the relay may be corroded.

Process 2: Relay Mounting

The holding force of the relay holder must be the same as or more than the minimum holding force value required by the relay.

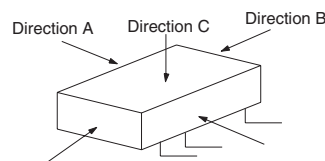

| Direction | G6H | G6S |
|-----------|------------|------------|
| A | 200 g max. | 200 g max. |
| B | 500 g max. | 500 g max. |
| C | 200 g max. | 200 g max. |

Process 3: Transportation

The relay may be dismounted by vibration during transportation. To prevent this, it is recommended an adhesive agent be applied to the relay's gluing part (protruding part) to tack the relay.

| Adhesive Agent Application Methods | |
|------------------------------------|------------------------|
| Dispenser Method | Screen-printing Method |
| NO | YES |

Process 4: Soldering Reflow

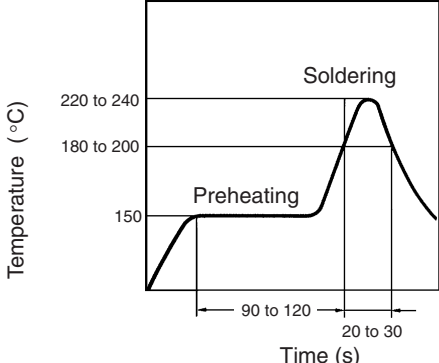
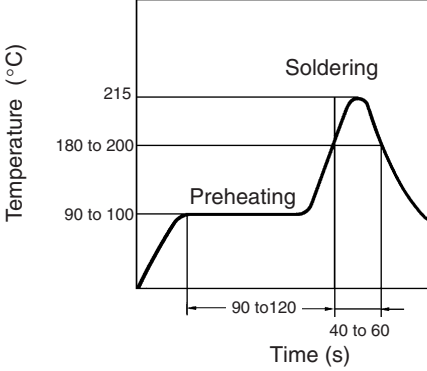
| IRS (infrared soldering) | VPS (vapor-phase soldering) |
|--|--|
| <p>The following recommended soldering conditions show the temperature changes of the PCB surface. The conditions vary with the relay model.</p> <p>Do not put the relay in a cold cleaning solvent immediately after soldering or the seal of the relay may be damaged.</p> <p>Recommended IRS Conditions (G6H-2F)</p>  | <p>Do not put the relay in a cold cleaning solvent immediately after soldering or the seal of the relay may be damaged.</p> <p>Recommended VPS Conditions (G6H-2F)</p>  |

Process 5: Cleaning

Boiling cleaning and immersion cleaning are recommended.

Ultrasonic cleaning will have an adverse effect on the performance of relays not specifically manufactured for ultrasonic cleaning.

| List of Cleaning Solvents | | |
|---------------------------|---|---|
| Solvent | | Fully Seated |
| Chlorine-based | Perochlene Chlorosolder Trichloroethylene | Yes |
| Water-based | Indusco Holys | Yes |
| Alcohol-based | IPA Ethanol | Yes |
| Others | Thinner Gasoline | No |
| Cleaning method | | Automatic cleaning Ultrasonic cleaning (see note 4) |

- Note:**
1. Consult your OMRON representative before using any other cleaning solvent. Do not use Freon-TMC-based, thinner-based, or gasoline-based cleaning solvents.
 2. Worldwide efforts are being made at discontinuing the use of CFC-113-based (fluorochlorocarbon-based) and trichloroethylene-based cleaning solvents. The user is requested to refrain from using these cleaning solvents
 3. It may be difficult to clean the space between the relay and PCB using hydrogen-based or alcohol-based cleaning solvent. It is recommended the stand-off-type be used G6A--ST when using hydrogen-based or alcohol-based cleaning solvents.
 4. Ultrasonic cleaning may have an adverse effect on the performance of relays not specifically manufactured for ultrasonic cleaning. Please refer to the model number to determine if your relay is intended to be cleaned ultrasonically.
 5. Contact Omron representative for recommended cleaning procedures of specific relays.

Terms and Conditions of Sale

1. **Offer; Acceptance.** These terms and conditions (these "Terms") are deemed part of all quotations, acknowledgments, invoices, purchase orders and other documents, whether electronic or in writing, relating to the sale of products or services (collectively, the "Products") by Omron Electronic Components LLC ("Seller"). Seller hereby objects to any terms or conditions proposed in Buyer's purchase order or other documents which are inconsistent with, or in addition to, these Terms.
2. **Prices; Payment.** All prices stated are current, subject to change without notice by Seller. Buyer agrees to pay the price in effect at time of shipment. Payments for Products received are due net 30 days unless otherwise stated in the invoice.
3. **Discounts.** Cash discounts, if any, will apply only on the net amount of invoices sent to Buyer after deducting transportation charges, taxes and duties, and will be allowed only if (i) the invoice is paid according to Seller's payment terms and (ii) Buyer has no past due amounts owing to Seller.
4. **Currencies.** If the prices quoted herein are in a currency other than U.S. dollars, Buyer shall make remittance to Seller at the then current exchange rate most favorable to Seller and which is available on the due date; provided that if remittance is not made when due, Buyer will convert the amount to U.S. dollars at the then current exchange rate most favorable to Seller available during the period between the due date and the date remittance is actually made.
5. **Governmental Approvals.** Buyer shall be responsible for, and shall bear all costs involved in, obtaining any government approvals required for the importation or sale of the Products.
6. **Taxes.** All taxes, duties and other governmental charges (other than general real property and income taxes), including any interest or penalties thereon, imposed directly or indirectly on Seller or required to be collected directly or indirectly by Seller for the manufacture, production, sale, delivery, importation, consumption or use of the Products sold hereunder (including customs duties and sales, excise, use, turnover and license taxes) shall be charged to and remitted by Buyer to Seller.
7. **Financial.** If the financial position of Buyer at any time becomes unsatisfactory to Seller, Seller reserves the right to stop shipments or require satisfactory security or payment in advance. If Buyer fails to make payment or otherwise comply with these Terms or any related agreement, Seller may (without liability and in addition to other remedies) cancel any unshipped portion of Products sold hereunder and stop any Products in transit until Buyer pays all amounts, including amounts payable hereunder, whether or not then due, which are owing to it by Buyer. Buyer shall in any event remain liable for all unpaid accounts.
8. **Cancellation; Etc.** Orders are not subject to rescheduling or cancellation unless Buyer indemnifies Seller fully against all costs or expenses arising in connection therewith.
9. **Force Majeure.** Seller shall not be liable for any delay or failure in delivery resulting from causes beyond its control, including earthquakes, fires, floods, strikes or other labor disputes, shortage of labor or materials, accidents to machinery, acts of sabotage, riots, delay in or lack of transportation or the requirements of any government authority.
10. **Shipping; Delivery.** Unless otherwise expressly agreed in writing by Seller:
 1. Shipments shall be by a carrier selected by Seller;
 2. Such carrier shall act as the agent of Buyer and delivery to such carrier shall constitute delivery to Buyer;
 3. All sales and shipments of Products shall be FOB shipping point (unless otherwise stated in writing by Seller), at which point title to and all risk of loss of the Products shall pass from Seller to Buyer, provided that Seller shall retain a security interest in the Products until the full purchase price is paid by Buyer;
 4. Delivery and shipping dates are estimates only.
 5. Seller will package Products as it deems proper for protection against normal handling and extra charges apply to special conditions.
11. **Claims.** Any claim by Buyer against Seller for shortage or damage to the Products occurring before delivery to the carrier must be presented in writing to Seller within 30 days of receipt of shipment and include the original transportation bill signed by the carrier noting that the carrier received the Products from Seller in the condition claimed.
12. **Warranties.** (a) **Exclusive Warranty.** Seller's exclusive warranty is that the Products will be free from defects in materials and workmanship for a period of twelve months from the date of sale by Seller (or such other period expressed in writing by Seller). Seller disclaims all other warranties, express or implied. (b) **Limitations.** SELLER MAKES NO WARRANTY OR REPRESENTATION, EXPRESS OR IMPLIED, ABOUT NON-INFRINGEMENT, MERCHANTABILITY OR FITNESS FOR A PARTICULAR PURPOSE OF THE PRODUCTS. BUYER ACKNOWLEDGES THAT IT ALONE HAS DETERMINED THAT THE PRODUCTS WILL SUITABLY MEET THE REQUIREMENTS OF THEIR INTENDED USE. Seller further disclaims all warranties and responsibility of any type for claims or expenses based on infringement by the Products or otherwise of any intellectual property right. (c) **Buyer Remedy.** Seller's sole obligation hereunder shall be to replace (in the form originally shipped with Buyer responsible for labor charges for removal or replacement thereof) the non-complying Product or, at Seller's election, to repay or credit Buyer an amount equal to the purchase price of the Product; provided that in no event shall Seller be responsible for warranty, repair, indemnity or any other claims or expenses regarding the Products unless Seller's analysis confirms that the Products were properly handled, stored, installed and maintained and not subject to contamination, abuse, misuse or inappropriate modification. Return of any Products by Buyer must be approved in writing by Seller before shipment. Seller shall not be liable for the suitability or unsuitability or the results from the use of Products in combination with any electrical or electronic components, circuits, system assemblies, or any other materials or substances or environments. Any advice, recommendations or information given orally or in writing are not to be construed as an amendment to the above warranty.
13. **Limitation on Liability; Etc.** SELLER SHALL NOT BE LIABLE FOR SPECIAL, INDIRECT, INCIDENTAL OR CONSEQUENTIAL DAMAGES, LOSS OF PROFITS OR PRODUCTION OR COMMERCIAL LOSS IN ANY WAY CONNECTED WITH THE PRODUCTS, WHETHER SUCH CLAIM IS BASED IN CONTRACT, WARRANTY, NEGLIGENCE OR STRICT LIABILITY. Further, in no event shall liability of Seller exceed the individual price of the Product on which liability is asserted.
14. **Indemnities.** Buyer shall indemnify and hold harmless Seller, its affiliates and its employees from and against all liabilities, losses, claims, costs and expenses (including attorney's fees and expenses) related to any claim, investigation, litigation or proceeding (whether or not Seller is a party) which arises or is alleged to arise from Buyer's acts or omissions under these Terms or in any way with respect to the Products. Without limiting the foregoing, Buyer (at its own expense) shall indemnify and hold harmless Seller and defend or settle any action brought against Seller to the extent that it is based on a claim that any Product made to Buyer specifications infringed intellectual property rights of another party.
15. **Property; Confidentiality.** The intellectual property embodied in the Products is the exclusive property of Seller and its affiliates and Buyer shall not attempt to duplicate it in any way without the written permission of Seller. Notwithstanding any charges to Buyer for engineering or tooling, all engineering and tooling supplied by Seller to Buyer relating to the Products are confidential and proprietary, and Buyer shall limit distribution thereof to its trusted employees and strictly prevent disclosure to any third party.
16. **Miscellaneous.** (a) **Waiver.** No failure or delay by Seller in exercising any right and no course of dealing between Buyer and Seller shall operate as a waiver of rights by Seller. (b) **Assignment.** Buyer may not assign its rights hereunder without Seller's written consent. (c) **Law.** These Terms are governed by Illinois law (without regard to conflict of law principles). Federal and state courts in Illinois shall have exclusive jurisdiction for any dispute hereunder. (d) **Amendment.** These Terms constitute the entire agreement between Buyer and Seller relating to the Products, and no provision may be changed or waived unless in writing signed by the parties. (e) **Severability.** If any provision hereof is rendered ineffective or invalid, such provision shall not invalidate any other provision. (f) **Setoff.** Buyer shall have no right to set off any amounts against the amount owing in respect of this invoice. (g) **Definitions.** As used herein, "including" means "including without limitation".

Certain Precautions on Specifications and Use

1. **Suitability for Use.** Seller shall not be responsible for conformity with any standards, codes or regulations which apply to the combination of the Product in Buyer's application or use of the Product. At Buyer's request, Seller will provide applicable third party certification documents identifying ratings and limitations of use which apply to the Product. This information by itself is not sufficient for a complete determination of the suitability of the Product in combination with the end product, machine, system, or other application or use. Buyer shall be solely responsible for determining appropriateness of the particular Product with respect to Buyer's application, product or system. Buyer shall take application responsibility in all cases but the following is a non-exhaustive list of applications for which particular attention must be given:
 - (i) Outdoor use, uses involving potential chemical contamination or electrical interference, or conditions or uses not described in this document.
 - (ii) Energy control systems, combustion systems, railroad systems, aviation systems, medical equipment, amusement machines, vehicles, safety equipment, and installations subject to separate industry or government regulations.
 - (iii) Use in consumer products or any use in significant quantities.
 - (iv) Systems, machines and equipment that could present a risk to life or property. Please know and observe all prohibitions of use applicable to this product.

NEVER USE THE PRODUCT FOR AN APPLICATION INVOLVING SERIOUS RISK TO LIFE OR PROPERTY WITHOUT ENSURING THAT THE SYSTEM AS A WHOLE HAS BEEN DESIGNED TO ADDRESS THE RISKS, AND THAT THE OMRON PRODUCT IS PROPERLY RATED AND INSTALLED FOR THE INTENDED USE WITHIN THE OVERALL EQUIPMENT OR SYSTEM.
2. **Programmable Products.** Seller shall not be responsible for the user's programming of a programmable product, or any consequence thereof.
3. **Performance Data.** Performance data given in this publication is provided as a guide for the user in determining suitability and does not constitute a warranty. It may represent the result of Seller's test conditions, and the users must correlate it to actual application requirements. Actual performance is subject to Seller's Warranty and Limitations of Liability.
4. **Change in Specifications.** Product specifications and accessories may be changed at any time based on improvements and other reasons. It is our practice to change part numbers when published ratings or features are changed or when significant construction changes are made. However, some specifications of the Product may be changed without any notice. When in doubt, special part numbers may be assigned to fix or establish key specifications for your application. Please consult with your Seller representative at any time to confirm actual specifications of purchased Product.
5. **Errors and Omissions.** The information in this publication has been carefully checked and is believed to be accurate; however, no responsibility is assumed for clerical, typographical or proofreading errors, or omissions.
6. **RoHS Compliance.** Where indicated, our products currently comply, to the best of our knowledge as of the date of this publication, with the requirements of the European Union's Directive on the Restriction of certain Hazardous Substances ("RoHS"), although the requirements of RoHS do not take effect until July 2006. These requirements may be subject to change. Please consult our website for current information.

Complete "Terms and Conditions of Sale" for product purchase and use are on Omron's website at www.components.omron.com – under the "About Us" tab, in the Legal Matters section.

ALL DIMENSIONS SHOWN ARE IN MILLIMETERS.

To convert millimeters into inches, multiply by 0.03937. To convert grams into ounces, multiply by 0.03527.

OMRON®

**OMRON ELECTRONIC
COMPONENTS LLC**

55 E. Commerce Drive, Suite B
Schaumburg, IL 60173

847-882-2288

OMRON CANADA, INC.

885 Milner Avenue
Toronto, Ontario M1B 5V8

416-286-6465

OMRON ON-LINE

Global - <http://www.omron.com>

USA - <http://www.components.omron.com>

Canada - <http://www.omron.ca>