

How Solar Cells Work

In the 1950s scientists tinkering with semiconductors found that by introducing small, minutely controlled amounts of certain impurities called dopants to the semiconductor matrix, the density of free electrons could be shepherded and controlled. The dopants, similar enough in structure and valence to fit into the matrix, have one electron more or less than the semiconductor; for example, doping with phosphorus, which has five valence electrons, produces a (negative) n-type semiconductor, with an extra electron which can be dislodged easily. Aluminum, boron, indium, and gallium have only three valence electrons, and so a semiconductor doped with them is (positive) p-type, and has “holes” where the missing electrons ought to be. These holes behave just like electrons, except that they have an opposite, positive charge. Holes are theoretical, but so are electrons, and either or both may or may not exist, but we know for sure that if one exists, they both do, because we can't create something out of nothing in the physical world. It is important to understand that, although loosely bonded or extra carriers exist in a substance, it is still neutral electrically, because each atom's electrons are matched one for one by protons in the nucleus.

The fun begins when the two semiconductor types are intimately joined in a pn-junction, and the carriers are free to wander. Being of opposite charge, they move toward each other, and may cross the junction, depleting the region they came from, and transferring their charge to their new region. This produces an electric field, called gradient, which quickly reaches equilibrium with the force of attraction of excess carriers. This field becomes a permanent part of the device, a kind of slope that makes carriers tend to slide across the junction when they get close.

When light strikes a photovoltaic cell, atoms are bombarded with photons, and give up electrons. When an electron gets lopped off an atom, it leaves behind a hole, which has an equal and opposite charge. Both the electron, with its negative charge, and the hole, with its positive charge, begin a random walk generally down the gradient. If either carrier wanders across the junction, the field and the nature of the semiconductor material discourage it from recrossing. A proportion of carriers which cross this junction can be harvested by completing a circuit from a grid on the cell's surface to a collector on the backplane. In the cell, the light “pumps” electrons out one side of the cell, through the circuit, and back to the other side, energizing any electrical devices (like the battery in the diagram) found along the way.

This information was reprinted from The Independent Home by Michael Potts.

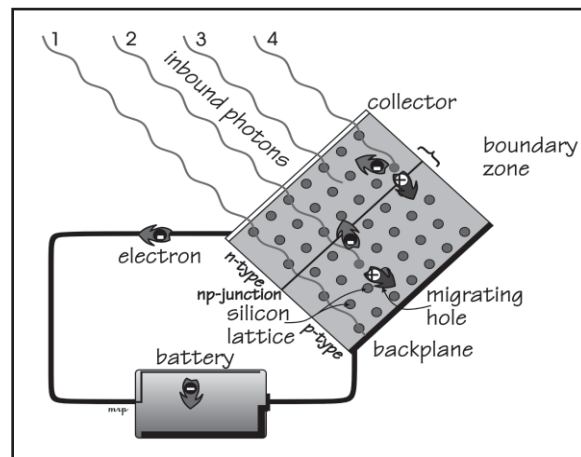

Contents	Page
Utility Intertie Design Information	4-5
Off-Grid Design Information	8-11
Solar Modules	12-21
PV Mounting Structures	22-37
Wind Turbines and Accessories	38-41
Micro Hydropower	42-45
Charge Controllers	46-51
Diversion Loads	52
Utility-Intertie Inverters	55-61
Sinewave Inverters/Chargers	62-74
Autotransformers	68-69
Modified Sine Wave Inverters	74-75
Meters and Meter Accessories	77-81
Batteries	94-102
Battery Chargers/Converters	103-104
Battery Accessories	105-109
PV Array Wiring	110-113
Overcurrent Protection	114-118
Transfer Switches	119
Timers and Switches	120-121
Wire & Wiring Accessories	122-123
Water Pumps	124-137
Water Heating	138-141
Fans & Controls	142-144
Lighting	145-149
Tubular Skylights	150
Refrigerators	151-153
Composting Toilets	154-156
Rechargeable Batteries & Chargers	157
Wire Loss Chart	158
Index	159-160

2 - YOU CAN MAKE YOUR OWN ELECTRICITY

For decades people who live off-grid, not connected to utility electric transmission lines, have generated their own power with solar energy. Now, people who live on the grid can economically install and obtain the benefits of solar and renewable energy systems.



Generate Green Power

Generate electricity with the sun, wind or water—producing no pollution or emissions.

Gain power independence

With the use of batteries, or eventually stored hydrogen, you can rely on your own generating capacity, and not on public utilities

Ensure reliable power

With a battery back-up system, you can keep your appliances running during utility power outages.

Create safe, clean power

Unlike fossil fuel back-up generators, solar creates no noise, smell or pollution and requires no fuel storage.

Feed green power back to the utilities

In many states, you can send your home-generated power back to the utility and get credit for the power you feed into the utility grid.

Obtain tax credits and rebates

Tax credits and rebates are available in many states to people and businesses who install solar powered products.

INTRODUCTION - 3

Now is the time to become your own Power Producer. We can help with all of your power system needs.

By harnessing the power of the sun, wind or water, people all over the world produce their own pollution-free reliable electricity. Technological advances, government assistance, the need for reliable power, and the desire to reduce the use of fossil fuels have made renewable energy systems attractive to people in the United States and worldwide.

Solar technology makes it possible for home and business owners to have dependable power from renewable sources. Mass production has significantly reduced the price of renewable energy systems and their components. Solar and battery-based backup power systems can ensure reliable power even when the utility grid is down. When the utility grid is working, systems feed solar-generated electrons back into the utility grid.

The use of renewable sources such as wind, water and sun, increases our energy self-sufficiency and fosters economic and national security. As more families, individuals and businesses generate their own renewable electricity we will reduce pollution, provide more electricity for all to use, reduce the use of fossil fuels, and make the electricity on the grid "greener".

Deregulation has created an atmosphere of change in the United States. We are experiencing higher electricity rates and electricity shortages. Laws, referred to as "Net Metering", allow solar-energy-system owners to feed their generated electricity back to the utility. The system owner receives a credit or payment for solar electrons fed into the grid. In other words, you pay only for the net electricity you consume - the amount of electricity you take from the utility minus the amount you generate and feed back from your solar system. With a solar electric system, you can provide yourself with some protection from the fluctuating prices of fuel, because your system's fuel is the sun. Additionally, state, local and federal tax incentives and rebates have made obtaining a system more economical.

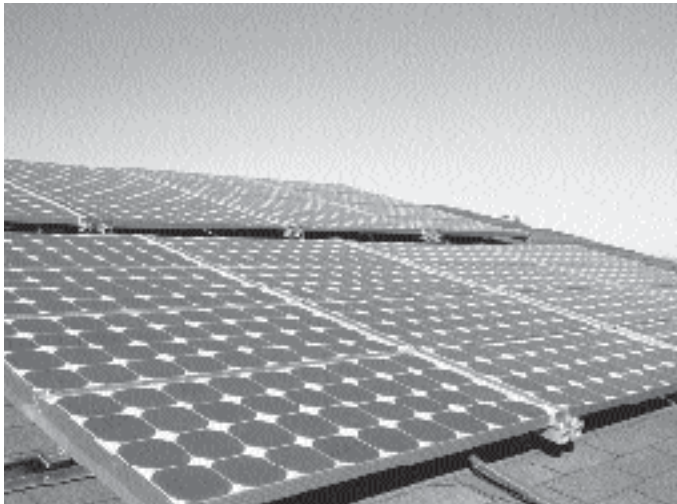

Types of Power Systems

Power systems vary in design depending on what energy sources are used and what purpose they must fulfill. The next few pages have information to help you design the systems listed below.

Utility-Intertie Solar Systems

Sometimes called "gridtie", these systems can be used anywhere that the electric utility allows "net metering," where a solar or wind powered system turns your electric meter backwards when it is producing more power than you are using. This type of system provides no back-up power when utility power fails.

Utility-Intertie Solar Systems with Backup

A utility-intertie system with battery backup feeds excess solar electricity to the grid and provide back up power when the utility grid is down. With this type of system you sacrifice some power generation efficiency in exchange for power whenever there is a power failure. The amount of backup power depends on the size of the battery and electrical loads.

Off-Grid Power Systems

This type of power system is independent of the utility grid. It can use solar electric modules, a wind generator or a micro-hydroelectric generator or a combination of any or all of them to produce your electric power. The owner of this type of system often uses a gas or diesel generator for backup when the power system does not meet all of the user's needs.

Determine What System Meets Your Needs

Use the charts and worksheets on the following pages to become familiar with the design of these systems and consult your solar power system professional installer to pick out the exact components.

State and Federal Incentives

There is a federal tax incentive called the "Energy Credit" that allows businesses to take a 15% credit for renewable energy equipment (solar electric, solar thermal and wind powered systems). In addition, there is an accelerated 5-year depreciation schedule that allows businesses to write 100% of the systems cost off their taxable income over the first five years.

Many states offer rebates and tax incentives to home owners to lower the installed cost of a utility connected power system.

If you have access to the world wide web, look at <http://www.dsireusa.org/> for more information about incentives in your area.

4 - UTILITY INTERTIE PV SYSTEM DESIGN

Utility Intertie Tie System Design

Budget, roof dimensions and other site-specific factors often call for custom system design. If you are planning to mount your array on a roof, decide which module best fits into the available roof space, taking into consideration obstructions such as chimneys, plumbing vents and skylights. See solar module section for dimensions of modules. A grid-connected PV system consists of PV modules, output cables, module mounting structures, AC and DC disconnect switches, inverter(s), grounding equipment and metering system.

The Worksheet below will help you decide what size PV array would be required to eliminate your electric bill. This will be the largest system that would be cost effective to install. A smaller system can reduce part of your bill, or eliminate higher cost electricity in locations that have progressively increasing rates as consumption increases. Use this information and the amount of available space to get a rough idea of your PV array size.

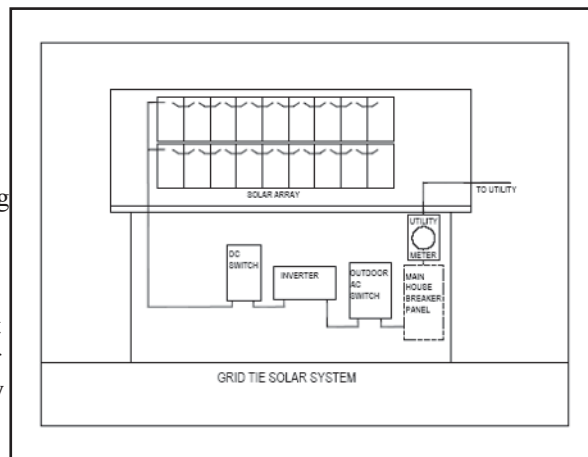

TO DETERMINE THE PV ARRAY SIZE FOR A GRID CONNECTED SYSTEM

Step 1 FIND YOUR MONTHLY AVERAGE ELECTRICITY USEAGE FROM YOUR ELECTRIC BILL

This will be in kilowatt-hours (kWh). Because of air conditioning, heating and other seasonal usage, it is a good idea to look at several bills. You can add the typical summer, fall, winter and spring bills and divide by four to find the average monthly usage.

Step 2 FIND YOUR DAILY AVERAGE ELECTRICITY USE -

Divide the monthly average number of kWh use by 30 (days).

Step 3 FIND YOUR LOCATION'S AVERAGE PEAK SUN HOURS PER DAY

See the chart and listings on pages 10 and 11. For example, the average for California is 5 peak sun hours

Step 4 CALCULATE THE SYSTEM SIZE (AC WATTS) TO PROVIDE 100% OF YOUR ELECTRICITY

Divide your daily average electricity use by the average sun hours per day. For example, if the daily average electricity use is 30 kWh, and the site is in California, then the system size would be:
 $30 \text{ kWh} / 5 \text{ h} = 6 \text{ kW AC}$

Step 5 CALCULATE THE NUMBER OF PV MODULES REQUIRED FOR THIS SYSTEM

Divide the system AC watts in Step 4 by the CEC watt rating of the modules to be used, then divide by the inverter efficiency, usually 0.94 and you get the total number of modules required. (Round this number up)

Use the chart on the next page to determine possible array size/inverter combinations

This chart shows inverter and module combinations for common modules used in grid connected systems. For a given inverter and module combination, the chart shows the acceptable number of series strings of modules and the number of modules per string for temperatures between 14°F and 104°F. Where the inverter will support more than one string of modules, the chart shows the number of modules that can be used with multiple strings. Sizing is accurate in locations where the maximum temperature is lower than 104°F or the minimum temperature is higher than 14°F. In locations where the minimum temperature is lower than 14°F, the maximum number of modules per string may be lower. String sizes followed by *** may have some derating in full sun.

The lower section of the chart shows inverter models that are designed to work on 3-phase AC voltage systems that have 208 VAC line to line, or 277 VAC line to neutral. SMA 1800 and 700 watt inverters operate on 120 VAC, which can be used line to neutral on 240 VAC single phase and 208 VAC 3-phase systems.

In the chart on the next page, the line labeled **CEC Watts** is the expected output of the modules at normal operating temperature, in full sun. The line below this, labeled **Ratio**, is the output at operating temperature divided by the label rating of the module. Modules with a higher ratio give you more actual output power per rated watt.

The approximate power output of a system in full sun will be the number of modules times the CEC rating of the modules times the inverter efficiency from second column on the table. Other factors, such as high or low temperature, shading, array orientation and dirt on the modules, will affect the system's actual output.

6 - BATTERY BACKUP SYSTEMS

Grid Connected Inverters with Battery Backup

Utility intertie systems with battery back-up are configured differently and are much more complex than battery-less intertie systems. They really need to be custom designed. If you need a back-up system, consult with your dealer to determine all of the system components that you will need. You can use the following steps to determine the multifunction inverter size and the battery capacity that your system will require.

Following steps 1-5 on page 4 will determine the size of the PV array needed to provide all or part of the generated power required. Calculate the inverter size and battery capacity needed using the worksheet below. The Beacon Power M5 is a 5000 watt Grid Tie / Battery Backup inverter. The Outback PS1-3048 3kw inverter and a PS1-3648 2.5 kw inverter are both complete systems for Grid Tie and Battery Backup. These inverters are ready to use with the addition of a PV array and 48 volt battery bank.

Outback also makes inverters and switchgear that can be assembled into larger Grid Tie / Battery Backup systems.



Step 1 FIND THE POWER REQUIREMENTS (WATTS) FOR THE APPLIANCES YOU NEED TO POWER DURING A BLACK-OUT

Make a list of the loads and appliances that you absolutely need to power during an outage. Only list the essential items since the system size (and cost) will vary widely with power needed. The wattage of individual appliances can usually be found on the back of the appliance or in the owners manual. You can use a Kill-a-Watt meter for better measurements (page 77). If an appliance is rated in amps, multiply amps by the operating voltage (120 or 240) to find watts. **Add up the wattage** of all the items on your list to arrive at the total amount of watts that you need to run all at the same time. This will determine the size of the multifunction inverter that you will need.

Step 2 DECIDE THE BLACKOUT DURATION YOU WANT TO BE PREPARED FOR

Power outages last from a portion of an hour to a day (or more). Again, this decision will greatly affect the system size and cost, so it is more cost effective to stay on the conservative side.

Step 3 FIND THE AMOUNT OF STORED POWER REQUIRED

Multiply the power requirements (in step 1) by duration in hours (in step 2). The result will be in watt-hours. For instance, if you need to power 1000 watts of appliances for 2 hours, you would need to have 2000 watt-hours (or 2 kWh) of stored power.

Step 4 CALCULATE THE POWER STORAGE NEEDED

Multiply the figure arrived at in step 3 by 1.7. In the example, 2 kWh X 1.7 = 3.4 kWh of stored power needed.

Step 5 CALCULATE BATTERY CAPACITY NEEDED

Divide the power storage requirement needed from step 4 by the DC voltage of the system (usually 48V, but sometimes 24V) to get battery amp-hour (AH) capacity. See the battery section for more information on batteries. Most back-up systems use sealed batteries due to their greatly reduced maintenance requirements, and because they can be more easily placed in enclosed battery compartments.

GRID-TIE WIND POWER - 7

Whisper Link Grid Connected Wind System

Enjoy the benefits of utility power while reducing your electric bill every time the wind blows. The Whisper Link wind system can reduce or eliminate your monthly electric bill if your location has enough wind. The Whisper wind turbine can be directly connected to the electrical grid through an SMA Windy Boy inverter.

The Whisper Link grid-tie concept is the lowest cost energy producing home system on the market today. Depending on your wind speed, a Whisper Grid Tie system may significantly reduce or even eliminate your monthly electrical bill.

Keep in mind, these systems are not for everyone. If you live in an urban or city environment or if your State does not allow the use of small systems to connect to the grid then it is likely a grid-tied wind system can not work for you. However, according to U.S. census data, there are more than 17 million homes in America that could use a Whisper Link system. Is your home one of them?

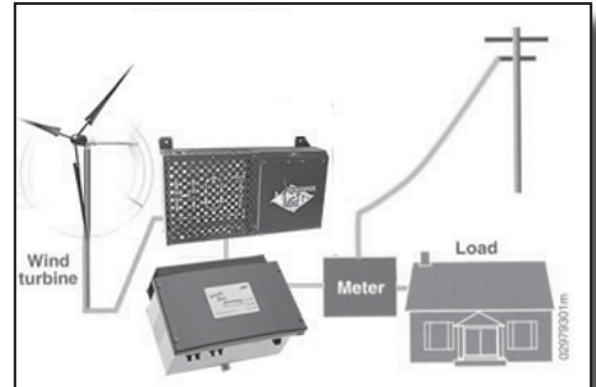

Siting

Proper siting is very important to the performance and longevity of your wind turbine. A poorly sited wind turbine will bring nothing but poor performance, maintenance issues and frustration. For a wind turbine to operate effectively, it needs to be placed in good clean wind above obstructions which cause turbulence.

Your site should:

- 1) Be free from trees and other obstructions within a 250 foot radius of the site.
- 2) Be able to locate a tower where the top of it would be at least 20 feet above any surrounding object within that 250 foot radius.

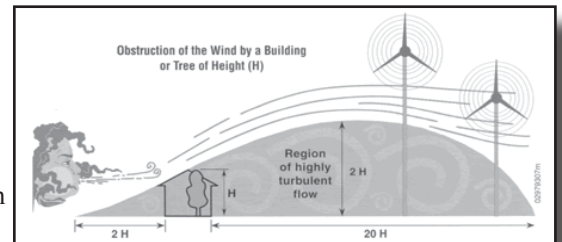

Determining The Wind Speed In Your Area

Now that you know you have a good spot to locate your wind turbine, next we need to determine if you have enough wind. There are a number of ways to determine if you have a wind resource in your area.

You need a minimum average wind speed of 9 MPH (about 4.2 M/S) for your small wind system to be practical.

The National Renewable Energy Labs and a number of private and state organizations have been developing high resolution wind maps which offer resolutions up to 1 sq km. Currently, only certain states have an active map. Keep in mind, any data that is a class two or higher means you have enough wind at your site. Visit State Wind Resource Maps to see your state's wind map.

□ you are. However, if the country side is very hilly then location to location will have a different wind speed.

Looking at the trees can give you a fairly accurate determination of wind speed. If small trees sway, the wind speed is around 20 MPH. If large branches are in motion the wind speed is greater than 25 MPH. If trees are permanently deformed by the wind, there is likely to be a good wind resource in the area. See the Wind Power section of this catalog for more information.

Incentives

If you have determined that you have a proper location and you have a wind resource of at least 9 mph, you will need to ensure that your state allows the connection of a small wind turbine into the grid and perhaps offers incentives.

More than half the States in the Union offer incentives. These range from no tax on renewables to discounts on the Whisper Link system by up to 70 percent! Click on The Database of State Incentives for Renewable Energy, <http://www.dsireusa.org>, then select your state to see what programs are available. Incentives are not critical but they can significantly reduce cost of your

□ ing law must be in place.

Whisper System

The Whisper Link System includes a Whisper 200 1kW wind generator, an intertie inverter and control unit. A tower is not included. See Whisper 100/200 tower kits on page 39. Tower kits do not include pipe, which can be obtained locally. Your utility may have requirements for AC and DC disconnects .

Description	Item Code	Price
Whisper Link Grid Tie Wind System	16.1201	\$4,995

8 - OFF GRID SYSTEM DESIGN

SYSTEM SIZING INFORMATION

The size of a solar electric system depends on the amount of power that is required (watts), the amount of time it is used (hours) and the amount of energy available from the sun in a particular area (sun-hours per day). The user has control of the first two of these variables, while the third depends on the location.

Conservation

Conservation plays an important role in keeping down the cost of a photovoltaic system. The use of energy efficient appliances and lighting, as well as non-electric alternatives wherever possible, can make solar electricity a cost competitive alternative to gasoline generators and, in some cases, utility power.

Cooking, Heating, & Cooling

Conventional electric cooking, space heating and water heating equipment use a prohibitive amount of electricity. Electric ranges use 1500 watts or more per burner, so bottled propane or natural gas is a popular alternative to electricity for cooking. A microwave oven has about the same power draw, but since food cooks more quickly, the amount of kilowatt hours used may not be large. Propane and wood are better alternatives for space heating. Good passive solar design and proper insulation can reduce the need for winter heating. Evaporative cooling is a more reasonable load than air conditioning and in locations with low humidity, the results are almost as good. One plus for cooling—the largest amount of solar energy is usually available when the temperature is the highest.

Lighting

Lighting requires the most study since so many options exist in type, size, voltage and placement. The type of lighting that is best for one system may not be right for another. The first decision is whether your lights will be run on low voltage direct current (DC) or conventional 110 volt alternating current (AC). In a small home, an RV, or a boat, low voltage DC lighting is often the best choice. DC wiring runs can be kept short, allowing the use of fairly small gauge wire. Since an inverter is not required, the system cost is lower. When an inverter is part of the system, a home will not be dark if the inverter fails and the lights are powered directly by the battery. In addition to conventional-size medium-base low voltage bulbs, the user can choose from a large selection of DC fluorescent lights, which have 3 to 4 times the light output per watt of power used compared with incandescent types. Halogen bulbs are 30% more efficient and actually seem almost twice as bright as similar wattage incandescents because of the spectrum of light they produce. High quality fluorescent lights are available for 12 and 24 volt systems.

In a large installation or one with many lights, the use of an inverter to supply AC power for conventional lighting is cost effective. AC compact fluorescent lights will save a tremendous amount of energy. It is a good idea to have a DC-powered light in the room where the inverter and batteries are in case there is a problem. AC light dimmers will only function properly on AC power from inverters that have pure sine wave output.

Refrigeration

Gas powered absorption refrigerators are a good choice in small systems if bottled gas is available. Modern absorption refrigerators consume 5-10 gallons of LP gas/month. If an electric refrigerator will be used in a stand-alone system, it should be a high efficiency type. Some high-efficiency conventional AC refrigerators use as little as 1200 watt-hours of electricity/day at a 70° average air temperature. A comparably sized Sun Frost refrigerator/freezer uses half that amount of energy and a Sundanzer refrigerator (without a freezer) uses less than 100 watt-hours per day. The higher cost of good quality DC refrigerators is made up by savings in the number of solar modules and batteries required.

Major Appliances

Standard AC electric motors in washing machines, larger shop machinery and tools, swamp coolers, pumps, etc. (usually 1/4 to 3/4 horsepower) require a large inverter. Often, a 2000 watt or larger inverter will be required. These electric motors are sometimes hard to start on inverter power, they consume relatively large amounts of electricity, and they are very wasteful compared to high-efficiency motors, which use 50% to 75% less electricity. A standard washing machine uses between 300 and 500 watt-hours per load, but new front-loading models use less than 1/2 as much power. If the appliance is used more than a few hours per week, it is often cheaper to pay more for a high-efficiency appliance rather than make your electrical system larger to support a low-efficiency load. Vacuum cleaners usually consume 600 to 1000 watts, depending on how powerful they are, about twice what a washer uses, but most vacuum cleaners will operate on inverters larger than 1000 watts because they have low-surge motors.

Small Appliances

Many small appliances such as irons, toasters and hair dryers consume a very large amount of power when they are used but by their nature require very short or infrequent use periods, so if the system inverter and batteries are large enough, they will be usable. Electronic equipment, such as stereos, televisions, VCR's and computers have a fairly small power draw. Many of these are available in low voltage DC as well as conventional AC versions, and in general, DC models use less power than their AC counterparts.

OFF-GRID LOADS WORKSHEET - 9

Use this worksheet to determine the total energy in amp-hours per day used by all the AC and DC loads in your system.

Calculate your AC loads

If there are no AC loads, skip to Step 5

1. List all AC loads, wattage and hours of use per week in the spaces provided. Multiply watts by hours/week to get watt-hours per week (WH/Wk.). Add up all the watt hours per week to determine AC watt-hours per week. Use a separate sheet of paper if you need to list more loads than the space below allows

NOTE: Wattage of appliances can usually be determined from tags on the back of the appliance or from the owner's manual. If an appliance is rated in amps, multiply amps by operating voltage (120 or 240) to find watts.

Description of AC loads run by inverter	Watts	x	Hours/Week	=	Watt Hours/Week
Total Watt Hours / Week					

2. Convert to DC watt-hours per week. Multiply line 1 by 1.15 to correct for inverter loss. _____

3. Inverter DC input voltage; usually 12, 24 or 48 volts. This is DC system voltage. _____

4. Divide line 2 by line 3. This is total DC amp-hours per week used by AC loads. _____

Calculate your DC loads

5. List all DC loads in the space provided below. If you have no DC loads, enter "0" in line 7 and proceed to line 8.

Description of DC loads	Watts	x	Hours/Week	=	Watt Hours/Week
Total Watt Hours / Week					

6. DC system voltage. Usually 12, 24, or 48 volts. _____

7. Find total amp-hours per week used by DC loads. Divide line 5 by line 6. _____

8. Total amp-hours per week used by AC loads from line 4. _____

9. Add lines 7 and 8. This is total amp-hours per week used by all loads. _____

10. Divide line 9 by 7 days. This is total average amp-hours per day that needs to be supplied by the battery _____
Enter this number on line 1 on the PV Array Design Worksheet on page 10, and on line 1 of the Battery Sizing Worksheet on page 97

10 - OFF-GRID PV ARRAY DESIGN WORKSHEET

Use this worksheet to calculate the total number of solar modules required for your system

To find average sun-hours per day in your area (line 3), check local weather data, look at the map below or find a city on the next page that has similar weather to your location. If you want year- round autonomy, use the lowest of the two figures. If you want 100% autonomy only in summer, use the higher figure. If you have a utility intertie system with net metering, use the yearly average figure. The peak amperage of the module you will be using can be found in the module specifications. You can also get close enough if you divide the module's rated wattage by the peak power point voltage, usually 17 to 17.5 for a 12 volt module or 34 to 35 volts for a 24 volt module.

- Step 1 Total average amp-hours per day needed from the System Loads Worksheet, line 10 _____
- Step 2 Multiply line 1 by 1.2 to compensate for loss from battery charge / discharge _____
- Step 3 Average sun-hours per day in your area _____
- Step 4 Divide line 2 by line 3. This is the total solar array amps required _____
- Step 5 Optimum or peak amps of solar module used. See module specifications _____
- Step 6 Total number of solar modules in parallel required. Divide line 4 by 5 _____
- Step 7 Round off to the next highest whole number _____
- Step 8 Number of modules in each series string to provide DC battery voltage - See chart below _____
- Step 9 Total number of solar modules required. Multiply line 7 by line 8. _____

Nominal System Voltage	Number of Series Connected Modules Per String	
	Volts	12V Module
12	1	N/A
24	2	1
48	4	2

The Charts below show Sun-Hours per Day for the U.S.

Yearly Average

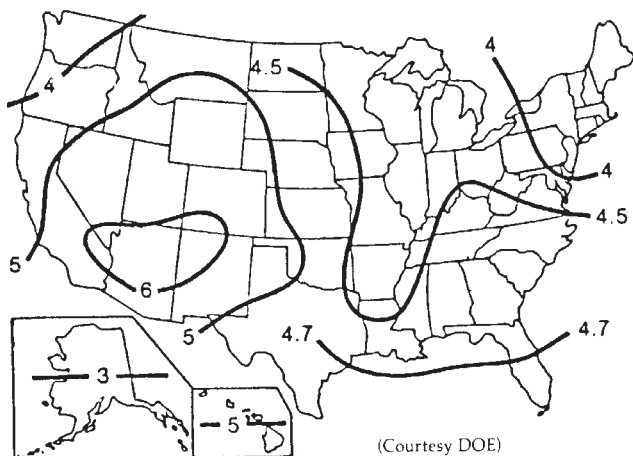

Four-Week Average, 12/7-1/4

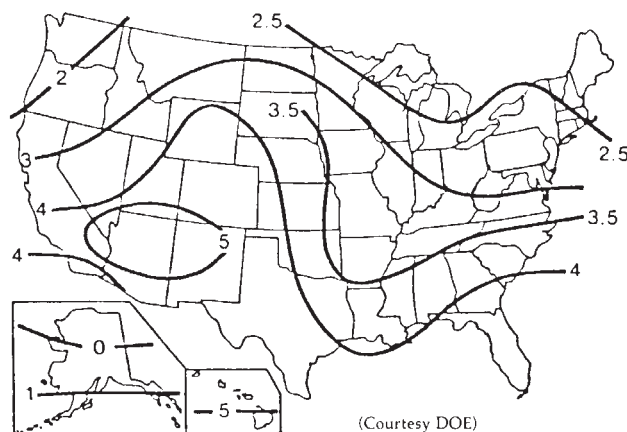

SOLAR INSOLATION - 11

Solar Insolation

This chart shows solar insolation in kilowatt-hours per square meter per day in many U.S. locations. For simplicity, we call this figure “sun-hours per day.” To find average sun-hours per day in your area (line 3), check local weather data, look at the map on the previous page or find a city in the table below that has similar weather to your location. If you want year-round autonomy, use the lowest of the two figures. If you want only 100% autonomy in summer, use the higher figure. If you want a utility intertie system, and you have net metering available in your state, use the average figures.

State	City	High	Low	Avg
AK	Fairbanks	5.87	2.12	3.99
AK	Matanuska	5.24	1.74	3.55
AL	Montgomery	4.69	3.37	4.23
AR	Bethel	6.29	2.37	3.81
AR	Little Rock	5.29	3.88	4.69
AZ	Tuscon	7.42	6.01	6.57
AZ	Page	7.30	5.65	6.36
AZ	Pheonix	7.13	5.78	6.58
CA	Santa Maria	6.52	5.42	5.94
CA	Riverside	6.35	5.35	5.87
CA	Davis	6.09	3.31	5.10
CA	Fresno	6.19	3.42	5.38
CA	Los Angeles	6.14	5.03	5.62
CA	Soda Springs	6.47	4.40	5.60
CA	La Jolla	5.24	4.29	4.77
CA	Inyokern	8.70	6.87	7.66
CO	Grandby	7.47	5.15	5.69
CO	Grand Lake	5.86	3.56	5.08
CO	Grand Junction	6.34	5.23	5.85
CO	Boulder	5.72	4.44	4.87
DC	Washington	4.69	3.37	4.23
FL	Aplachicola	5.98	4.92	5.49
FL	Belie Is.	5.31	4.58	4.99
FL	Miami	6.26	5.05	5.62
FL	Gainsville	5.81	4.71	5.27
FL	Tampa	6.16	5.26	5.67
GA	Atlanta	5.16	4.09	4.74
GA	Griffin	5.41	4.26	4.99
HI	Honolulu	6.71	5.59	6.02
IA	Ames	4.80	3.73	4.40
ID	Boise	5.83	3.33	4.92
ID	Twin Falls	5.42	3.42	4.70
IL	Chicago	4.08	1.47	3.14
IN	Indianapolis	5.02	2.55	4.21
KS	Manhattan	5.08	3.62	4.57
KS	Dodge City	6.50	4.20	5.60
KY	Lexington	5.97	3.60	4.94
LA	Lake Charles	5.73	4.29	4.93
LA	New Orleans	5.71	3.63	4.92
LA	Shreveport	4.99	3.87	4.63
MA	E. Wareham	4.48	3.06	3.99
MA	Boston	4.27	2.99	3.84
MA	Blue Hill	4.38	3.33	4.05
MA	Natick	4.62	3.09	4.10
MA	Lynn	4.60	2.33	3.79
MD	Silver Hill	4.71	3.84	4.47
ME	Caribou	5.62	2.57	4.19
ME	Portland	5.23	3.56	4.51
MI	Sault Ste. Marie	4.83	2.33	4.20
MI	E. Lansing	4.71	2.70	4.00
MN	St. Cloud	5.43	3.53	4.53
MO	Columbia	5.50	3.97	4.73
MO	St. Louis	4.87	3.24	4.38
MS	Meridian	4.86	3.64	4.43
MT	Glasgow	5.97	4.09	5.15
MT	Great Falls	5.70	3.66	4.93
MT	Summit	5.17	2.36	3.99
NM	Albuquerque	7.16	6.21	6.77
NB	Lincoln	5.40	4.38	4.79
NB	N. Omaha	5.28	4.26	4.90
NC	Cape Hatteras	5.81	4.69	5.31
NC	Greensboro	5.05	4.00	4.71
ND	Bismark	5.48	3.97	5.01
NJ	Sea Brook	4.76	3.20	4.21
NV	Las Vegas	7.13	5.84	6.41
NV	Ely	6.48	5.49	5.98
NY	Binghampton	3.93	1.62	3.16
NY	Ithica	4.57	2.29	3.79
NY	Schenetady	3.92	2.53	3.55
NY	Rochester	4.22	1.58	3.31
NY	New York City	4.97	3.03	4.08
OH	Columbus	5.26	2.66	4.15
OH	Cleveland	4.79	2.69	3.94
OK	Stillwater	5.52	4.22	4.99
OK	Oklahoma City	6.26	4.98	5.59
OR	Astoria	4.76	1.99	3.72
OR	Corvallis	5.71	1.90	4.03
OR	Medford	5.84	2.02	4.51
PA	Pittsburg	4.19	1.45	3.28
PA	State College	4.44	2.79	3.91
RI	Newport	4.69	3.58	4.23
SC	Charleston	5.72	4.23	5.06
SD	Rapid City	5.91	4.56	5.23
TN	Nashville	5.20	3.14	4.45
TN	Oak Ridge	5.06	3.22	4.37
TX	San Antonio	5.88	4.65	5.30
TX	Brownsville	5.49	4.42	4.92
TX	El Paso	7.42	5.87	6.72
TX	Midland	6.33	5.23	5.83
TX	Fort Worth	6.00	4.80	5.43
UT	Salt Lake City	6.09	3.78	5.26
UT	Flaming Gorge	6.63	5.48	5.83
VA	Richmond	4.50	3.37	4.13
WA	Seattle	4.83	1.60	3.57
WA	Richland	6.13	2.01	4.44
WA	Pullman	6.07	2.90	4.73
WA	Spokane	5.53	1.16	4.48
WA	Prosser	6.21	3.06	5.03
WI	Madison	4.85	3.28	4.29
WV	Charleston	4.12	2.47	3.65
WY	Lander	6.81	5.50	6.06

12 - PV MODULES

Shell Solar PowerMax-Ultra PV Modules

The new Shell PowerMax Ultra™ solar cells are based on several exciting and patented developments in technology. A new Shell silicon nitride anti-reflection coating traps more light than coatings previously used resulting in 10% higher cell efficiency. This new line of Shell modules are designed for both on and off grid applications. A torsion and corrosion resistant frame insures dependable performance, even under high snow and wind loads.

Shell Solar has 30 years' experience in mono-crystalline technology backed by its patented PowerMax® efficiency-enhancing technology and a cumulative installed volume of nearly 300MW worldwide. Shell Solar Industries, formerly Siemens Solar, and before that Arco Solar, was one of the first large-scale US manufacturers of photovoltaic modules.

Most Shell modules have a 20 amp series fuse rating which allows the use of two parallel strings of modules with one series fuse. Made in USA.

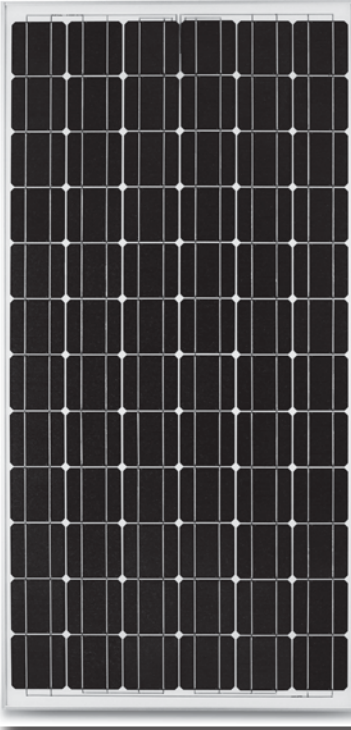

Ultra 165-PC / Ultra 175-PC Modules

These are Shell's largest PV modules, designed for use in high-voltage grid-connected applications as well as in large industrial and off-grid applications for 24- or 48-volt battery charging. We recommend using these modules where arrays of more than 1 kw are specified. These modules use 72 Powermax Ultra™ 5" square single-crystalline cells in series behind tempered glass, with anodized aluminum frames and a conduit-ready junction box with bypass diodes and Multi-Contact® output cables. The Multi Contact® output cables are easily removed if conduit or other wiring method is desired.

- Output is nominal 24 volts
- Certified for IEC61215
- UL1703 Listed
- 25-year warranty
- TÜV Isolation Class II

Module		Ultra165-PC	Ultra175-PC
Peak Power	Watts	165	175
Peak power voltage	Volts	35	35.4
Peak power current	Amps	4.72	4.95
Open circuit voltage	Volts	44.5	44.6
Short circuit current	Amps	5.4	5.43
Max. system voltage	Volts	600	
Nominal voltage	Volts	24	
Series Fuse Rating		20A	
Length		63.6" (1622mm)	
Width		32.1" (814mm)	
Depth (including j-box)		2.2" (56mm)	
Weight		38 lbs	
Item Code		11.2272	11.2274
List Price		\$1095	\$1165

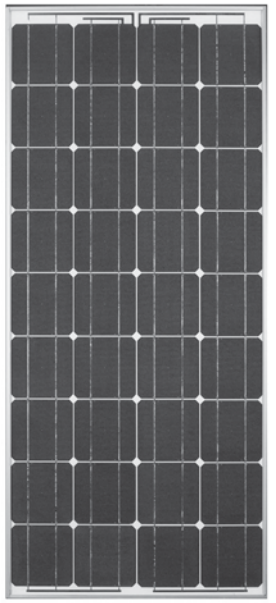

SQ80-P/SQ85-P Modules

The Shell Solar SQ80-P and SQ85-P modules have 36 Powermax Ultra™ 5" square single-crystalline cells in series behind tempered glass, with anodized aluminum frames and a conduit-ready junction box with bypass diodes. These modules have a 12 volt nominal output and are the best choice for systems under 1 kW, as well as for solar direct applications such as to power DC fans and water pumps.

- Certified for IEC61215
- UL1703 Listed
- 25-year warranty
- FM approved
- TÜV Isolation Class II

Module		Ultra 80-P	Ultra 85-P
Peak Power	Watts	80	85
Peak power voltage	Volts	16.9	17.2
Peak power current	Amps	4.76	4.95
Open circuit voltage	Volts	21.8	22.2
Short circuit current	Amps	5.35	5.45
Max. system voltage	Volts	600	600
Nominal voltage	Volts	12	
Series Fuse Rating		20 Amp	
Length		47.2" (1200mm)	
Width		20.8" (527mm)	
Depth (including j-box)		1.3" (33mm)	
Weight		16.7 lbs	
Item Code		11.2247	11.2249
List Price		\$528	\$565

40 - 50 WATT PV MODULES - 13

Shell PowerMax Plus 50 Watt Module

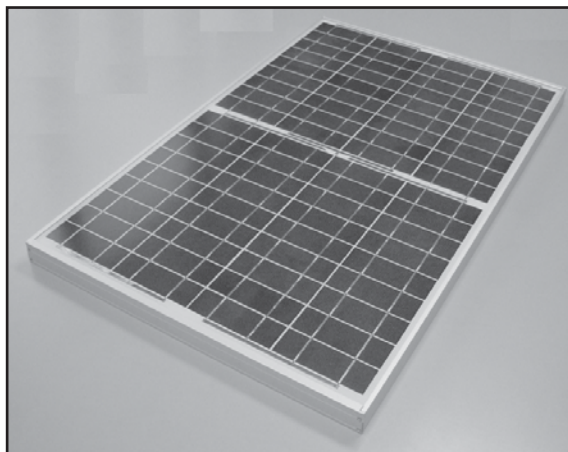

Shell replaced the SM-line with this new, more powerful PowerMax Plus 50 line of small modules. They have a new, low-profile junction box with field replaceable diodes. Each module is individually boxed to simplify field transportation. The Plus 50 is shade tolerant due to the use of two strings of 36 cells in parallel. 25-year warranty. *Available Summer 2005*

Shell ST40 40 Watt CIS Thin-film Modules

The Shell ST40 modules have the highest power output per square inch in a thin-film. CIS (Copper Indium Diselenide) thin-film products offer high power in industrial and rural applications where space is not a limitation. CIS modules are particularly suitable for low-light level environments and where uniform appearance and aesthetics are important. The ST40 module has a Procharger-S junction box that accepts single conductor wire.

- 10 year warranty
- UL 1703 listed



Shell Module		Plus 50	ST40
Number of cells		72	42
Peak Power	Watts	50	40
Peak power voltage	Volts	17	16.6
Peak power current	Amps	3.26	2.41
Open circuit voltage	Volts	21.7	23.3
Short circuit current	Amps	3.58	2.68
Max. system voltage	Volts	600	600
Nominal voltage	Volts	12	12
Length		33.9" (861mm)	50.9"
Width		21.2" (536mm)	12.9"
Depth (including j-box)		1.3" (35mm)	1.3"
Weight (lbs)		16	15.4
Item Code		11.2207	11.2324
Price		\$350	\$302

GEPV-050 50 Watt Module

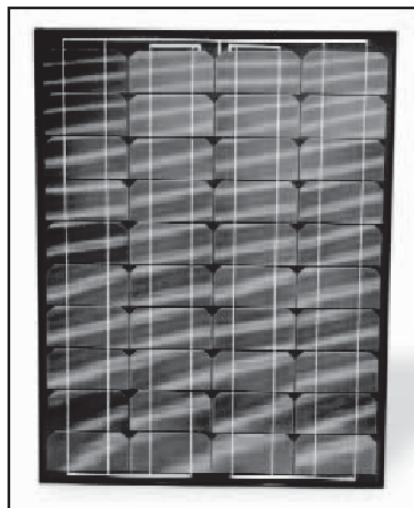

GE 50 watt modules are made with 40 mono-crystalline cells by GE Energy. This aluminum framed module is ideal for off-grid applications. Dimensions are 33.8" x 26" x 1.4". 25 year warranty. UL Listed.

Module		GEPV-050
Number of cells		40
Peak Power	Watts	50
Peak power voltage	Volts	17.3
Peak power current	Amps	2.9
Open circuit voltage	Volts	22
Short circuit current	Amps	3.3
Max. system voltage	Volts	600
Series Fuse Rating		5A
Weight (lbs)		15.4
Item Code		11.6254
List Price		\$350

14 - EVERGREEN SOLAR MODULES

Evergreen EC-100 Series Modules

PV modules produced by Evergreen Solar are distinctive in their appearance because they incorporate proprietary crystalline silicon technology known as String Ribbon. This technology enables an innovative approach to manufacturing dependable and cost-effective PV modules. In the String Ribbon technique, two high temperature strings are pulled vertically through a shallow silicon melt, and the molten silicon spans and freezes between the strings. The process is continuous: long strings are unwound from

This advantage in material efficiency means String Ribbon yields over twice as many solar cells per pound of silicon as conventional methods. Additionally, the resulting distinctive shape of the solar cell allows for a high packing density. EC-100 series modules are field-selectable to nominal 12 or 24-volt configurations. They are shipped in the 12 volt configuration with removable Multi-Contact cables. **If you plan to use a 24 volt configuration, ask for a 24 volt diode jumper when ordering (11.5301)**

Evergreen modules are UL listed and have a 25 year warranty.

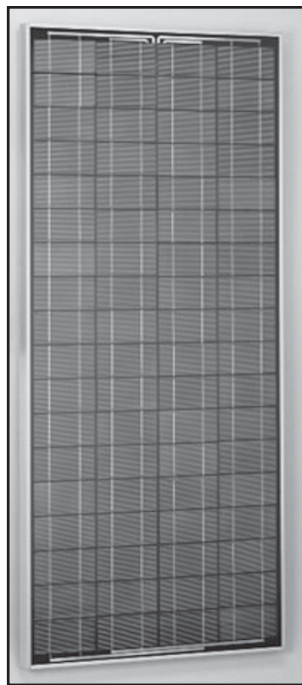

Module		EC-110	EC-115
Number of cells		72	72
Peak Power	Watts	110	115
Peak power voltage	Volts	16.4 / 32.7	16.5 / 33
Peak power current	Amps	6.72 / 3.36	6.97 / 3.48
Open circuit voltage	Volts	20 / 40	20 / 40
Short circuit current	Amps	7.6 / 3.84	7.71 / 3.86
Max. system voltage	Volts	600	600
Nominal voltage	Volts	12 / 24	12 / 24
Series fuse rating		10 Amps	
Length	inch (mm)	62.4 (1585)	
Width	inch (mm)	24.4" (620mm)	
Depth (including j-box)	inch (mm)	1.38" (35mm)	
Weight (lbs)	lbs.	30	30
Item Code		11.5332	11.5334
Price		\$725	\$750

Evergreen Sunplicity Flat Roof Mounting System

The simple solution for PV installation on commercial, industrial and institutional buildings

Sunplicity is a non-penetrating mounting system designed for mounting Evergreen EC-100 series modules on flat roofs of 5-degree pitch or less. Held in place by its own weight and an aerodynamic cowling system, the Sunplicity system means fast, cost effective installation—allowing you to get the job done more efficiently and cost effectively than ever before.

Sunplicity's breakthrough grounding system means electrical hook-up is easier, too. The system's metal frame matrix provides an electrically continuous grounding path, making it possible to ground modules very quickly.

Made of long lasting and environmentally sound materials—aluminum, steel and recycled rubber—the Sunplicity system is built with a 25-year design life. It adds less than 5 lbs./sq. ft. to the structural load, making it ideal for most flat roof installations.

Sunplicity stands up to wind and weather. A breeze to install, the system can handle much more than a breeze: Sunplicity is rated for wind speeds as high as 130 MPH, depending on project-specific conditions. The mounting system design also eliminates pooling of water and is self-cooling to improve efficiency and maximize electrical output.

Please call for a system quote



SHARP PV MODULES - 15

Sharp Solar Modules







Sharp 175W, 167W, 165W, 140W and 70W modules feature watertight MC connector-cable output for quick, fool-proof series connections, making these modules a great choice for grid-tie systems. The 175-watt modules are single-crystal. All others are polycrystalline.

The 70-watt modules are the PV industry's first triangular modules, and they come in left or right configurations to fit angled roof eaves. The 70 watt triangular modules and 140-watt rectangular modules have black anodized frames and are designed to be used together. Use Unirac SunFrame mounts with bronze color for a crisp, clean appearance.

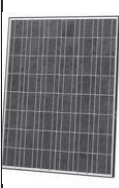
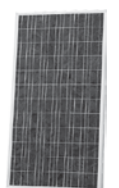
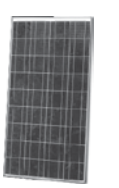
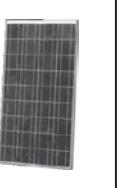
Sharp 80W and 123W modules are designed for nominal 12 volt operation and have conduit ready junction boxes.

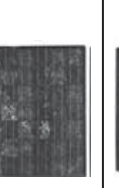
All Sharp modules feature extremely stout frames, tempered, low-reflection glass covers, built-in bypass diodes and 25-year warranties. UL listed.

Module		NT-175U1	ND-167U3	NE-165U1	ND-L3EJE	NE-80EJE	ND-70ELU	ND-N0ECU	ND-70ERU
									
									
Number of cells		72	48	72	36	36	21	42	21
Peak Power	Watts	175	167	165	123	80	70	140	70
Peak power voltage	Volts	35.4	23.5	34.6	17.2	17.1	9.98	19.95	9.98
Peak power current	Amps	4.95	7.1	4.77	7.16	4.67	7.02	7.02	7.02
Open circuit voltage	Volts	44.4	29.0	43.1	21.3	21.3	12.43	24.85	12.43
Short circuit current	Amps	5.55	7.91	5.46	8.1	5.3	7.81	7.81	7.81
Max. system voltage	Volts	600	600	600	600	600	600	600	600
Series Fuse Rating	Amps	10	15	10	15	10	15	15	15
Output Wiring		MC Cables	MC Cables	MC Cables	J-Box	J-Box	MC Cables	MC Cables	MC Cables
Weight (lbs)		37.5	35.3	37.5	31	21	27	32	27
Length	Inches	62	52.3	62	59	47.3	45.9	45.9	45.9
Width	Inches	32.5	39.53	32.5	26	21.2	39	39	39
Depth	Inches	1.8	1.8	1.8	1.8	1.8	1.8	1.8	1.8
Frame Color		Clear	Clear	Clear	Clear	Clear	Bronze	Bronze	Bronze
Item Code		11.8116	11.8114	11.8112	11.8109	11.8106	11.8128-R	11.8124	11.8128-L
Price		\$1,050	\$1002	\$990	\$800	\$520	\$546	\$756	\$546

16 - UNI-SOLAR PV MODULES

UNI-SOLAR Framed Photovoltaic Modules

These glass-free modules can be utilized in a wide variety of applications from fence charging to telecommunications. The large

UNI-SOLAR® framed solar module uses UniSolar's proprietary Triple Junction spectrum-splitting thin film amorphous silicon cell design to achieve high performance. Encapsulated in UV-stabilized polymers and framed with anodized aluminum. A Galvalume steel backing provides stiffness to the module. Bypass diodes are connected across each cell, allowing the modules (excluding the US-5's) to produce power even when partially shaded. US-32, US-64, EC62 and EC124 modules are equipped with weather-resistant junction boxes to accept 1/2-inch conduit. Max system voltage rating is 600VDC. The ECO-62 is the same size as

10 year warranty on 5-11 watt. 20 year warranty on 32, 62 and 64 W modules. UL listed

Module		US-64	US-32	US-11	US-5
Peak power	Watts	64	32	10	5
Peak power voltage	Volts	16.5	16.5	16.5	16.5
Peak power current	Amps	3.88	2.4	0.62	0.3
Open circuit voltage	Volts	23.8	23.8	23.8	23.8
Short circuit current	Amps	4.8	2.4	0.78	0.37
Nominal voltage	Volts	12	12	12	12
Series fuse rating		8	4	1.5	0.75
Weight (lbs)		20.2	10.6	3.6	2.5
Length	Inches	53.78	53.78	19.33	19.33
Width	Inches	29.18	15.07	15.08	8.07
Item Code		11.3110	11.3119	11.3125	11.3128
Price		\$459	\$252	\$143	\$66

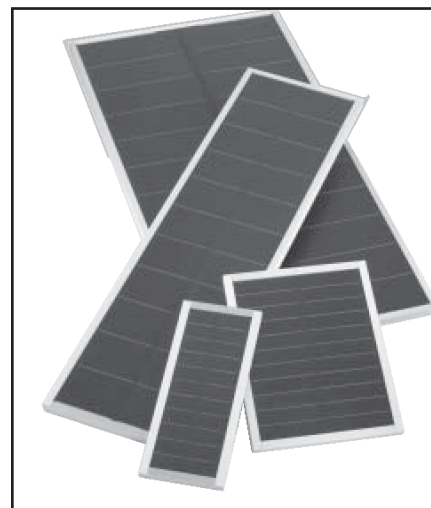

UNI-SOLAR® FLX Flexible PV Modules

UNI-SOLAR® Flexible panels can be mounted on curved surfaces such as hatch covers, decks and vehicle roofs, or tied down on sail covers, dingies, and canvas awnings. For battery maintenance and to improve battery system reliability, the USF battery charger is flexible, reliable and cost-effective for many applications. Each UNI-SOLAR® flexible solar battery charger uses United Solar's proprietary Triple Junction spectrum-splitting thin film amorphous silicon cell design to achieve high performance. The FLX modules have a cord with a 2-pin SAE-connectors and a fused battery connector that fits the SAE-connector. Other accessories are listed below.

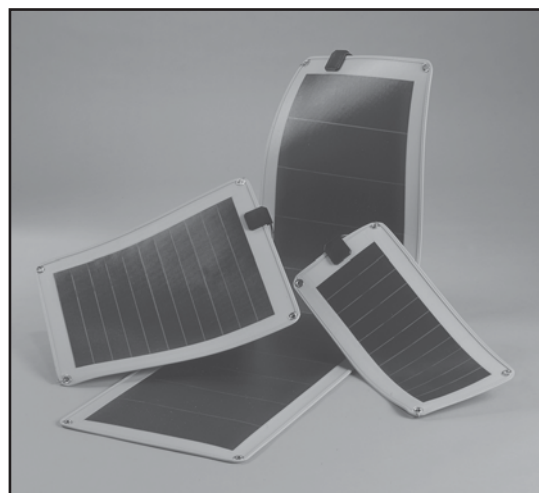

Module		FLX-32	FLX-11	FLX-5
Peak power	Watts	32	10.3	5
Peak power voltage	Volts	16.5	16.5	16.5
Peak power current	Amps	1.94	0.62	0.3
Open circuit voltage	Volts	23.8	23.8	23.8
Short circuit current	Amps	2.4	0.78	0.37
Length	Inches	56.27	21.8	21.8
Width	Inches	16.7	16.7	9.71
Weight	Lbs.	4.7	2	1.18
Item Code		11.3165	11.3168	11.3171
Price		\$318	\$157	\$89

Uni-Solar Flex Accessories	Item Code	Price
Auto Cigarette Lighter Plug Adapter	11.3160	\$10
10 Foot Extension Cable	11.3161	\$9
"Y" Connector	11.3163	\$25

SMALL PV MODULES - 17

Small Glass/Aluminum Framed Modules

These small modules are glass laminated in aluminum frames with a small junction box on the back. They have sturdy aluminum frames, tempered glass covers and come with a 10 year warranty. Made in India.

Inches

Module		AE-20G	AE-10G	AE-5G
Peak Power	Watts	20	12	5
Peak power voltage	Volts	16.4	16.4	16.4
Peak power current	Amps	1.22	0.61	0.31
Nominal voltage	Volts	12	12	12
Length	Inches	21.3	17.4	16.8
Width	Inches	17.7	11.4	6.1
Item Code		11.9022	11.9020	11.9018
Price		\$220	\$120	\$82

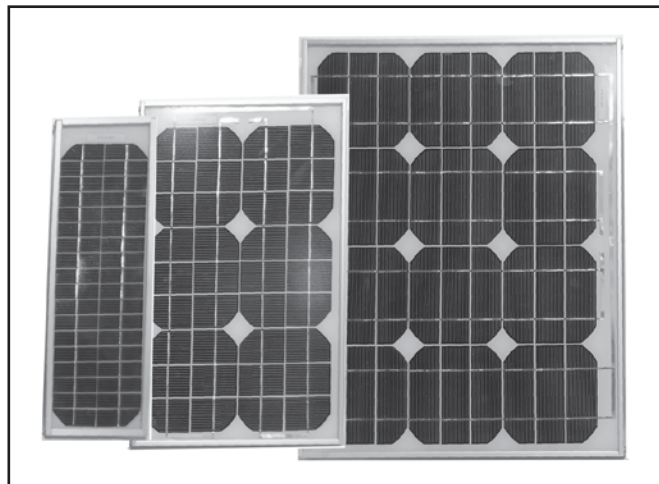

Lightweight Laminated Modules

We make these modules for powering fans, pumps and for trickle charging batteries. They are made by laminating 36 solar cells between layers of EVA plastic with a Tedlar cover and a fiberglass-reinforced plastic back. They have a six foot cable attached to the front of the module on one end. Made in USA. 3 year warranty.

Module		AE-20L	AE-10L	AE-5L
Peak Power	Watts	20	10	5
Peak power voltage	Volts	16.4	16.4	16.4
Peak power current	Amps	1.22	0.61	0.31
Nominal voltage	Volts	12	12	12
Length	Inches	25	13	13
Width	Inches	13	13	7
Manufactured in:		Mexico	Mexico	Mexico
Item Code		11.9121	11.9019	11.9010
Price		\$220	\$120	\$88

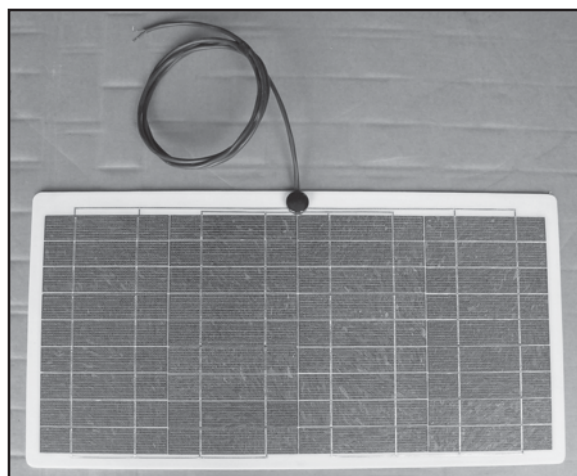

Auto Battery Maintainer

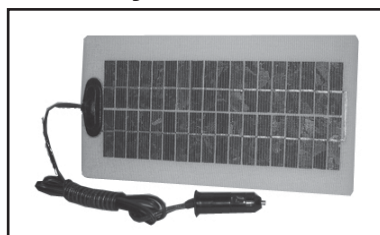

The 1.5 watt module has a car cigarette lighter plug on the cord for easy car battery trickle charging in vehicles that have an active cigarette lighter when the ignition switch is turned off. 1-year warranty. 8" x 3"

Description	Item Code	Price
1.5 Watt Battery Maintainer	11.9007	\$35

12V 28 Watt Fountain Pump Module

We designed this fiberglass laminated module to power small 12 volt bilge pumps for use in fountains directly without using a battery or control.

Typical modules with 36 cells have a peak power voltage of 17 volts and go over 20 volts with no load connected. We use 28 cells in series to keep the voltage low and use larger cells than you would normally find in a 28 watt module to increase current.

The result is a module with a 2.1 amp output at 13.6 volts in full sun. The open circuit voltage is 15.5 volts so it stays in the operating range of any small pump designed to run on a 12 volt battery with a draw of 2 amps or less. Dimensions are 21.3" x 19" x .25". 2-year warranty.

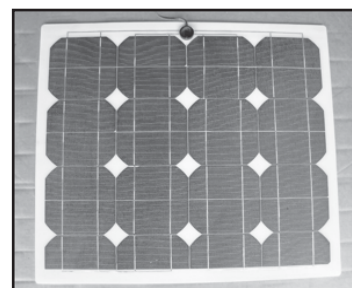

Description	Item Code	Price
28 Watt Fountain Pump Module	11.9028	\$180

18 - BUILDING INTEGRATED PV MODULES

MSK Photovol™ Glass - Semi-transparent Glass that Generates Electricity!

Photovol™ Glass is a revolutionary new building material that transforms any glazed surface into an environmentally sound power station. It is ideal for curtain walls and all other vertical or horizontal glazed surfaces. It is based on amorphous silicon solar technology developed by MSK in conjunction with Kaneka and the Japanese architects Taiyo Industries. During the manufacturing process a laser scribes a series of ultra fine lines, allowing 10% of visible light to be transmitted through the panel. This level of light transmission is optimal to allow sufficient light into the building in cloudy conditions while protecting against excessive solar gain. It cuts out glare, blocks 98.9% of ultra-violet light and solar heat gain. Multicontact cables come from one of the longer sides.

Photovol™ Glass is a one meter square semi-transparent solar panel when framed, designed to fit a wide range of building applications. Its extremely high aesthetic standards combined with the unique edge-mounted electrical connection system guarantee the highest quality appearance. Due to its unique uniform finish, the panel functions as a rear display screen, making Photovol™ Glass the first solar panel that can be utilized both day and night! A standard projector is mounted on the ceiling or floor inside the building. Large-scale displays can easily be formed by combining multiple units. Photovol™ Glass is laminated in double glass and is available in either 10.5 mm standard glass or 13.5 mm strengthened glass thickness.

Thermal Performance

A 10% visible light transmission is optimal to allow sufficient light in cloudy conditions. Photovol™ Glass absorbs more solar heat than low-e glass, drastically reducing the annual electricity demand for your building by reducing the need for air conditioning and heating. The electricity generated through photovoltaics (PV) can be used to further offset electrical loads.

Design Options

Standard Photovol™ Glass panels are 44 watts per square meter with a 10% light transmittance. It can also be made as a 50 watt panel with 5% transmittance and as a 55 watt panel with 1% light transmittance.

Standard thicknesses of 10.5 mm and 13.5 mm are available. Photovol™ Glass can be manufactured to your required specifications, including laminating the glass at a specified thickness or glazing the panel into insulating glass units to obtain a lower U-Value.

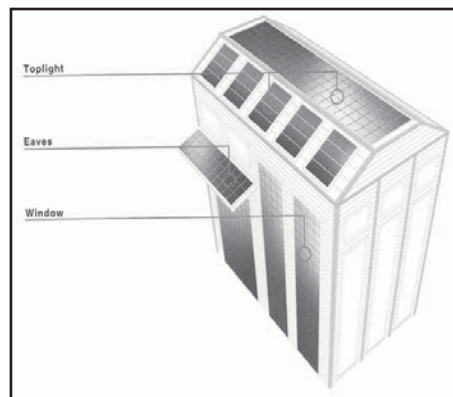
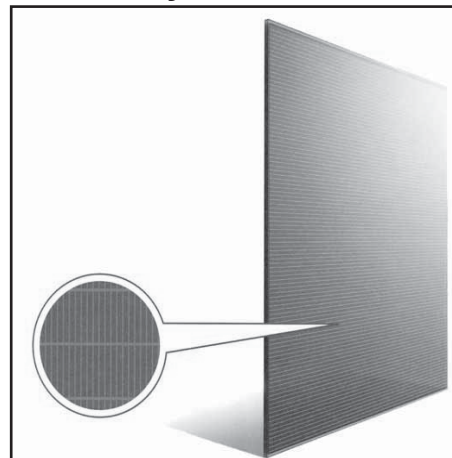

Installation Examples

The picture at left is taken inside the MSK Factory in Fukuoka, Japan. It covers 180 m² and produces 7 kW of electricity.

The picture at right is the Kanazawa Bus Terminal in Kanazawa, Japan. It covers 3000 m² and produces 120 kW of electricity. Photo used with permission from Taiyo Kogyo Corporation.



MSK Model Number	Power Watts	Voltage @peak	Amps @peak	Volts (open circuit)	Amps (short circuit)	Dimensions inches (mm)	Glass Thickness and Type	Item Code	Price
MST-44T1010	44	59.6	0.74	91.8	0.972	38.6 x 37.4 (980 x 950)	10.5 mm Float	11.3441	\$825
MST-44T1013							13.5 mm Tempered	11.3445	\$930

PORTABLE PV MODULES - 19

UniSolar Folding Solar Modules

The UNI-PAC® has been field-proven as dependable and easy to use for military units, trekkers, climbers and professional photographers. They depend on the UNI-PAC® for field communications, emergency power and battery maintenance.

The unique design of the UNI-PAC® features a lightweight construction without glass or fragile crystalline to break, crack, or add on extra weight. The tough nylon fabric covering allows the unit to be folded to a convenient book size, for easy storage and transport. The UNI-PAC® 10 offers dual voltage charging for 12V and 24V, the UNI-PAC® 15 and the UNI-PAC® 34 are for 12V charging. The UNI-PAC® was designed to meet military requirements for durability, performance and reliability. Tefzel (by DuPont) serves as a strong, long-lasting front cover. Individual solar laminates contain by-pass diodes, making the UNI-PAC® solar chargers tolerant of severe shadow or partial covering. The UNI-PAC® 15 and 34 have a 2-pin SAE-connector and a fused 2 foot battery cable that fits the SAE connector. The UNI-PAC® 10, 15 and 34 are covered by a 5-year warranty.

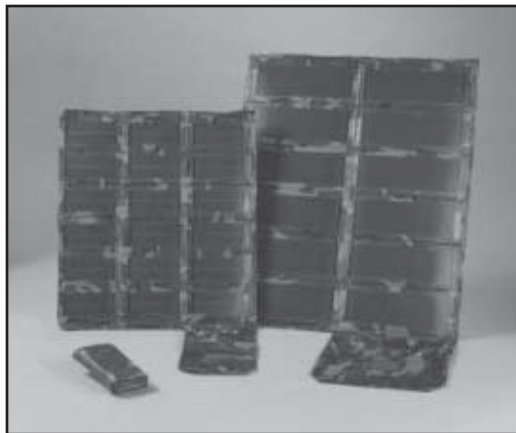

Module		UNI-PAC 34	UNI-PAC 15	UNI-PAC 10	
Peak Power	Watts	34	15.8	10.5	
Nominal Voltage	Volts	24	12	12	24
Peak power voltage	Volts	17.6	17.6	17.6	35.2
Peak power current	Amps	1.9	0.9	0.6	0.3
Open circuit voltage	Volts	25.2	26.0	26.0	51.9
Short circuit current	Amps	2.4	1.1	0.7	0.4
Dimensions (opened)	Inches	55.9 x 33.9	45.2 x 27.6	46 x 19.5	
Dimensions (folded)	Inches	17 x 7 x 2	9.5 x 5.5 x 3	10 x 5 x 2	
Weight	Lbs.	4.7	3.25	2.1	
Item Code		11.3180	11.3183	11.3186	
Price		\$180	\$100	\$60	

NotePower Portable Folding Solar Modules

If you're interested in getting more runtime from your notebook computer when you are away from the power lines, our NotePower portable solar module is just what you need. If you want to take your computer on safari or telecommute from a beach in the tropics, you can unfold the NotePower solar array, plug in a DC charging adapter and you will be charging your computer battery as long as the sun is shining. A 10 foot cord allows you to be in the shade while your solar module is in the sun. The folding module weighs less than 5 pounds and measures 12" x 14" when closed. The NotePower solar charger can charge other 12 volt powered devices with rechargeable batteries, too. A portable cellular phone with a DC charging cord can be plugged into the cigarette lighter output of the NotePower solar charger and recharged also. Use with our Smart Adapter on page 76 to charge electronic devices with coaxial DC input jacks. Warranty: 2 year warranty



Module		NotePower 30	NotePower 20
Peak Power	Watts	30	20
Peak power voltage	Volts	15	15
Peak power current	Amps	2.0	1.3
Open circuit voltage	Volts	18	18
Short circuit current	Amps	2.2	1.5
Dimensions (opened)	Inches	37" x 14"	25" x 14"
Dimensions (folded)	Inches	12.4 x 14 x 1	12.4 x 14 x 1
Weight	Lbs.	5.0	4.5
Item Code		11.9037	11.9034
Price		\$345	\$249

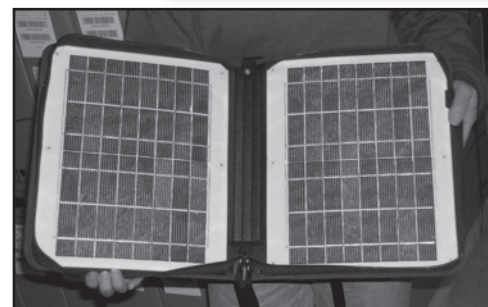

20 - POWERFILM FLEXIBLE PV

NEW! PowerFilm Roll Up Modules

These new super-light weight rollable marine grade modules are flexible enough to roll around a 3" diameter tube for storage. Wrap around straps keep them rolled up and a 15 foot cord makes it easy to connect to any of the accessories. These modules are great for backpacking, camping and trekking. .



PowerFilm Model >		R15-1200	R15-600	R15-300
Peak Power	Watts	18	9	4.5
Peak Power Voltage	Volts	15.4	15.4	15.4
Peak Power Current	Amps	1.2	0.6	0.3
Nominal voltage	Volts	12	12	12
Length	inches	73	38	21
Width	inches	12	11.5	11.5
Weight	lbs	1.9	1	0.5
Item Code		11.5105	11.5103	11.5101
Price		\$375	\$198	\$102

Rollup Module Accessories

The items listed below connect to the output cord of the Rollup Modules. The RA-6 Daisy chain accessory allows parallel connection of a second module

PowerFilm Accessories	Item Code	Price
RA-1 Male Cigarette Lighter Adapter	11.5121	\$8.50
RA-2 Female Cigarette Lighter Adapter	11.5122	\$8.50
RA-3 Battery Charger for AA & AAA	11.5123	\$16.00
RA-4 Standard Charger Pack	11.5124	\$45.00
RA-5 Delux Universal Charger Pack	11.5125	\$120.00
RA-6 Daisy Chain Adapter	11.5126	\$8.50
RA-7 15 Foot Extension Cord	11.5127	\$10.50
RA-8 Extension Cord w/ Battery Clips	11.5128	\$14.50
RA-9 Powerfilm Charge Control	11.5129	\$32.00

Ultra Flexible Plastic Solar Modules

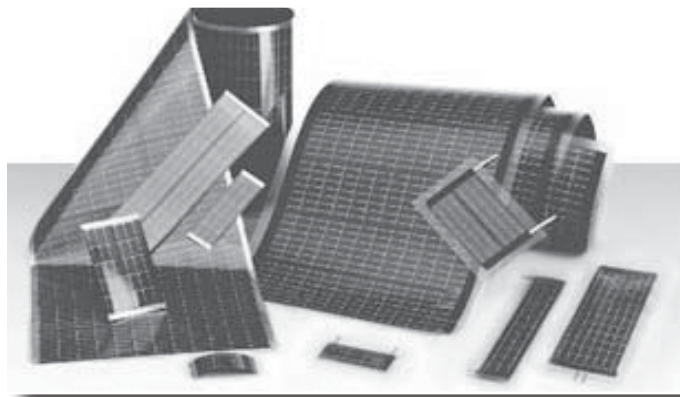

PowerFilm® is the world's leading thin film photovoltaics. PowerFilm products are paper thin, offer unsurpassed flexibility, are durable, and have a significant weight advantage over heavier metal-based and glass-based solar modules.

Technology

Imagine taking paper-thin plastic film and making it generate power again and again. That's PowerFilm. PowerFilm integrated solar modules have a paper thin durable polymer substrate 2 mils (0.05 mm) or less thick and are monolithically integrated. Environmentally-friendly amorphous silicon is the semiconductor absorber layer. PowerFilm is developed and manufactured by Iowa Thin Film Technologies (ITFT). Founded in 1988, ITFT is the leader in monolithically-integrated semiconductor devices on plastic, using its proprietary roll-to-roll manufacturing technology platform.

PowerFilm® Wireless Electronics Series

Modules in the PowerFilm® Wireless Electronics Series offer a new opportunity to solve the old problem of limited power for wireless electronics for portable and remote applications. PowerFilm® Wireless Electronics modules are lightweight, paper thin, and durable. Their ultra-thin profile enables them to be easily integrated with devices for solar recharging or direct powering. Modules have been specifically developed to recharge AA, AAA, and 6- and 12-volt batteries. These modules do not have a UV-stabilized surface. For connection, just solder or crimp to the copper tape.

PowerFilm® RC Aircraft Series

The PowerFilm® RC Aircraft Series modules are designed to be easily integrated with RC Aircraft. These PowerFilm® modules are very lightweight, wires can be soldered on the back of the module via the extended copper tape, and have an extra edge seal for protection from fuel contamination and weather. Modules are available with a strong pressure sensitive adhesive for simple bonding. These modules do not have a UV-stabilized surface. For connection, just solder to the copper tape.

PowerFilm® WeatherPro™ Series

The PowerFilm® WeatherPro™ Series is the right choice for permanent outdoor applications that are directly exposed to the elements. The especially rugged construction of these PowerFilm® modules includes a UV-stabilized surface, extra edge seal for weather protection, and tin-coated copper leads that extend from the module. Coating the leads with an RTV silicon compound can provide a tightly-sealed package.

POWERFILM FLEXIBLE PV - 21

PowerFilm Small Modules

The PowerFilm product line offers a full line of products for diverse applications and environments. The line ranges from small 3-volt modules for wireless electronics to modules 20-Watts and larger. There are PowerFilm solar modules specifically designed for wireless electronics, RC aircraft, and permanent outdoor applications. PowerFilm can be easily integrated with devices. Its thin profile and flexibility make it a top choice of product designers and engineers.

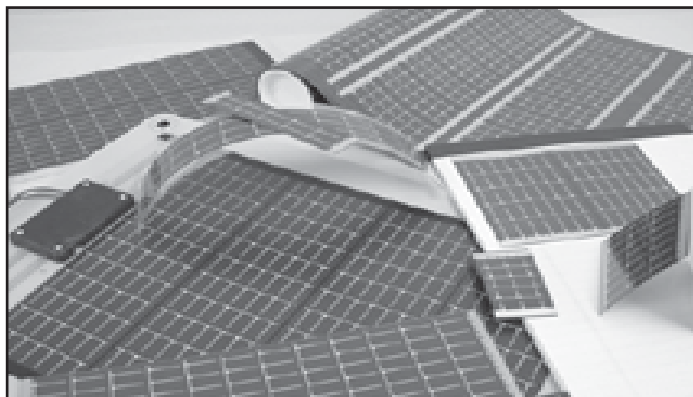

PowerFilm Specifications and Prices

PowerFilm® Wireless Electronics Series									
Product	Operating Voltage	Operating Current	Typ Voc	Typ Isc	Total Size (in.)	Total Thickness	Weight	Item Code	Price
SP3-37	3 V	22 mA	4.1 V	30 mA	2.5 x 1.5	0.2mm (8mil)	0.7g (0.03oz)	11.5011	\$3.95
TX3-25	3 V	25 mA	4.1 V	40 mA	4.5 x 1.0	0.2mm (8mil)	0.8g (0.03oz)	11.5013	\$2.95
MP3-37	3 V	50 mA	4.1 V	60 mA	4.5 x 1.5	0.2mm (8mil)	1.2g (0.04oz)	11.5015	\$5.95
MPT3.6-75	3.6 V	50 mA	4.8 V	65 mA	2.9 x 3.0	0.2mm (8mil)	1.6g (0.06oz)	11.5017	\$8.95
MPT3.6-150	3.6 V	100 mA	4.8 V	130 mA	2.9 x 5.9	0.2mm (8mil)	3.1g (0.1oz)	11.5019	\$17.95
SP4.2-37	4.2 V	22 mA	5.9 V	30 mA	3.3 x 1.5	0.2mm (8mil)	0.8g (0.03oz)	11.5021	\$5.95
MPT4.8-75	4.8 V	50 mA	6.4 V	65 mA	3.7 x 3.0	0.2mm (8mil)	1.9g (0.07oz)	11.5023	\$11.95
MPT4.8-150	4.8 V	100 mA	6.4 V	130 mA	3.7 x 5.9	0.2mm (8mil)	3.9g (0.1oz)	11.5025	\$22.95
MPT6-75	6 V	50 mA	8.0 V	65 mA	4.5 x 3.0	0.2mm (8mil)	2.3g (0.08oz)	11.5027	\$13.95
MPT6-150	6 V	100 mA	8.0 V	130 mA	4.5 x 5.9	0.2mm (8mil)	4.6g (0.1oz)	11.5029	\$27.95
MP7.2-75	7.2 V	100 mA	10.5 V	125 mA	10.0 x 3.0	0.6mm (24 mil)	12.9g (0.5oz)	11.5031	\$24.95
MP7.2-150	7.2 V	200 mA	10.5 V	150 mA	10.0 x 5.9	0.6mm (24 mil)	25.9g (0.9oz)	11.5033	\$39.95
MPT15-75	15.4 V	50 mA	19 V	60 mA	10.0 x 3.0	0.6mm (24 mil)	13.0g (0.5oz)	11.5035	\$26.95
MPT15-150	15.4 V	100 mA	19 V	120 mA	10.0 x 5.9	0.6mm (24 mil)	26.0g (0.9oz)	11.5037	\$44.95
PowerFilm® RC Aircraft Series									
RC7.2-37	7.2 V	50 mA	10.5 V	60 mA	10.6 x 2.2	0.2mm (8mil)	3.5g (0.1oz)	11.5051	\$16.95
RC7.2-37 PSA	7.2 V	50 mA	10.5 V	60 mA	10.6 x 2.2	0.2mm (8mil)	4.4g (0.2oz)	11.5053	\$19.50
RC7.2-75	7.2 V	100 mA	10.5 V	125 mA	10.6 x 3.5	0.2mm (8mil)	5.9g (0.2oz)	11.5055	\$29.95
RC7.2-75 PSA	7.2 V	100 mA	10.5 V	125 mA	10.6 x 3.5	0.2mm (8mil)	7.6g (0.3oz)	11.5057	\$32.95
PowerFilm® WeatherPro™ Series									
P7.2-75	7.2 V	100 mA	10.5 V	125 mA	10.6 x 3.9	1.1mm (44 mil)	31.3g (1.1oz)	11.5071	\$39.95
P7.2-150	7.2 V	200 mA	10.5 V	250 mA	10.6 x 6.9	1.1mm (44 mil)	54.9g (1.9oz)	11.5073	\$59.95
PT15-75	15.4 V	50 mA	19 V	60 mA	10.6 x 3.9	1.1mm (44 mil)	31.8g (1.1oz)	11.5075	\$39.95
PT15-150	15.4 V	100 mA	19 V	120 mA	10.6 x 6.9	1.1mm (44 mil)	56.4g (2.0oz)	11.5077	\$59.95
PT15-300	15.4 V	200 mA	19 V	250 mA	10.6 x 12.8	1.1mm (44 mil)	94.5g (3.3oz)	11.5079	\$99.95



22 - UNIRAC SOLARMOUNT

SolarMount is a fast, easy, and safe way to install a PV array in virtually any roof or ground installation. Bottom mounting clips and tilt legs supplement traditional top mounting clamps, so the system now accommodates the widest variety of installations and assembly preferences—on the roof and on the ground. Any framed module, 64 watt or larger, sold in North America can be mounted using SolarMount.

Once you've selected PV modules and planned your installation layout, you're ready to choose SolarMount components. The chart below shows what components to use if you are top mounting the modules. The chart on the next page shows what parts to use if you are bottom mounting the modules. If you need tilt legs for the mounts, see the explanation on page 27. Rail and parts to complete your mounting system can be found on pages 24 to 27.

Top Mount Sizing - Clamp sizes and rail set lengths

Use this chart to determine the size of top mounting clamps for your modules and the length of the rails required for your array. When sizing is complete, rails, clamps, □

(Pro-Paks) . See pages 24 and 25 for pricing.

All UniRac components have a 10-year product warranty and a 5-year finish warranty.

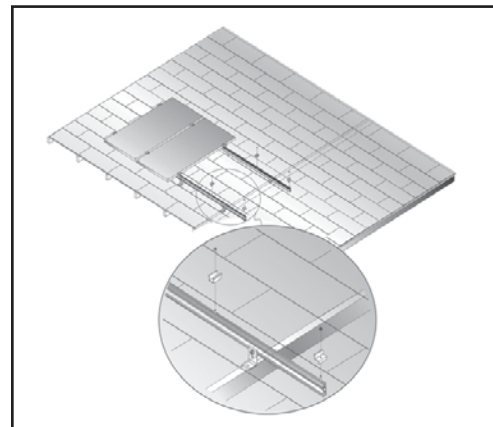

Module Brand and Model		Clamp Size	Rail length (inches) by number of modules per row										
			2	3	4	5	6	7	8	9	10	11	12
BP Solar	BP380, BP485	E	48	72	96	120	144	168	180	204	226	252	276
	BP3125	E	60	96	120	144	168	204	226	252	288	312	336
	BP3160, BP4160, BP4170	E	72	106	132	168	204	240	264	300	324	360	396
Evergreen	EC110, EC115	C	60	84	120	144	168	192	216	252	276	300	324
GE Energy	GE65, GE70	C	48	72	96	120	144	156	180	204	226	252	264
	GE100, GE110	C	60	84	120	144	168	192	226	252	276	300	336
	GE165	C	84	132	168	204	240	288	324	360	396		
Isofoton	I-100	D	60	84	120	144	168	192	216	252	276	300	324
	I-150S	D	96	132	180	216	264	300	348	384	432		
	I-165	D	84	120	168	204	288	324	360	396			
Kyocera	KC80, KC120-1, KC125G	C	60	84	120	144	168	192	216	252	276	300	324
	KC167G, KC187G	C	84	132	168	204	252	288	324	372	408		
Mitsubishi	MF120EC3	F	60	84	120	144	168	192	216	240	276	300	324
	MF165EB3	F	72	106	132	168	204	240	264	300	336	360	396
Matrix / Photowatt	PW750	A	48	72	96	120	144	168	192	216	240	264	288
	PW1250	D	84	132	168	204	240	288	324	360	396		
	PW1650	D	96	144	180	226	264	312	360	396			
RWE	ASE300	E	106	168	216	264	312	372	420				
Sanyo	HIT-190	H	84	120	156	192	226	264	300	336	372	408	
Sharp Solar	NE-80U1	C	48	72	96	120	144	156	180	204	226	252	276
	ND-L3EJE (123 watt)	F	60	84	120	144	168	192	226	252	276	300	336
	ND-167U1	G	84	132	168	216	252	288	336	372	408		
	ND-167U3	F	84	132	168	216	252	288	336	372	408		
	NE-165U1, NT-185U1	F	72	106	144	180	204	240	276	312	348	372	408
Shell Solar	SQ80, SQ85	C	48	72	96	120	144	156	180	204	226	252	264
	SQ165, SQ175	D	72	106	144	168	204	240	276	300	336	372	408
UniSolar	US64	B	72	96	132	156	192	216	252	276	312	336	372
	ES62T	D	72	106	132	168	204	240	264	306	324	360	396

Choose a Top or Bottom Mounting System

23

On pitched roofs, mount rails either parallel or perpendicular to the rafters.

Assembly sequence is a common determining factor. Select top-mounting clamps if you prefer to install modules last—after you've attached rails to installed footings. This sequence is especially convenient with modules that have MC cables. Select bottom mounting clips if you plan to attach modules to rails prior to final installation. This sequence is well suited whenever modules must be pre-wired. Bottom-mounting clips use space more efficiently because they do not require the 1" space between modules required by top clamps.

The use of top mounting clamps is generally easier when flush-mounting to a roof. Always use top-mounting clamps when flush mounting to standoffs. If using bottom-mounting clamps with L-feet, follow the installation manual carefully to make sure footing slots are accessible during final installation.

In roof mounts, when using top mounting clamps, no extra roof bracing is needed since rails or mounting feet can be adjusted to match rafter spacing. With bottom-mounting clamps, spacing between the rails depends on spacing between the mounting holes of your particular PV module, and it is unlikely that they will match rafter spacing. In that case, place a stringer over the roof or mounting blocks beneath it. Never attach footings to the sheathing alone—such an arrangement will not meet code and will leave the installation and roof vulnerable to severe damage from wind.

Bottom Mounting Sizing - Rail set lengths

This chart lists the length of the rails required for your array. When sizing is complete, rails, splices, and L-feet may be ordered in two ways: (See next page)

- Kits contain just the right quantities for a given installation.
- Pro-Pak pricing offers bulk components, best for installers who regularly use Solarmount

Order 4 bottom mounting clips (p. 25) for every module to be mounted.

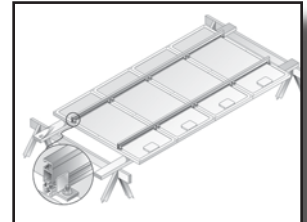

Module Brand and Model		Rail length (inches) by number of modules per row										
		2	3	4	5	6	7	8	9	10	11	12
BP Solar	BP380, BP485	48	72	96	106	132	156	180	192	216	240	264
	BP3125	60	84	106	144	168	192	216	240	276	300	324
	BP3160, BP4160, BP4170	72	96	132	156	192	226	252	288	312	348	384
Evergreen	EC102, EC110, EC115	60	84	106	132	156	180	216	240	264	288	312
GE Energy	GE65, GE70	48	72	84	106	132	156	168	192	216	240	252
	GE100, GE110	60	84	106	132	156	192	216	240	264	288	312
	GE165	84	120	156	192	240	276	312	348	384	432	
Isofoton	I-100	60	84	106	132	156	192	216	240	264	288	312
	I-150S	84	132	168	216	252	300	336	372	420		
	I-165	84	120	156	192	240	276	312	348	384	420	
Kyocera	KC80, KC120-1, KC125G	60	84	106	132	156	180	216	240	264	288	312
	KC158G, KC167G, KC187G	84	120	156	204	240	276	312	360	396	432	
Mitsubishi	MF120EC3	60	84	106	132	156	180	204	240	264	288	312
	MF165EB3	72	96	132	168	192	226	252	288	324	348	384
Matrix Solar / Photowatt	PW750	48	72	96	120	132	156	180	204	226	252	264
	PW1250	84	120	156	192	240	276	312	348	384	432	
	PW1650	96	132	180	216	264	300	348	384	432		
RWE Schott	ASE300	106	156	204	264	312	360	408				
Sharp Solar	NE-80U1	48	72	84	106	132	156	168	192	216	240	252
	ND-L3EJE (123 watt)	60	84	106	132	168	192	216	240	264	288	324
	ND-167U1, ND-167U3	84	120	168	204	240	288	324	360	396		
	NE-165U1, NT-185U1	72	106	132	168	204	240	264	300	336	360	396
Shell Solar	SQ80, SQ85	48	72	84	106	132	156	168	192	216	240	252
	SQ165, SQ175	72	106	132	168	204	226	264	300	324	360	396
Unisolar	US64	60	96	120	156	180	216	240	264	300	324	360
	ES62T	72	96	132	168	192	226	252	288	324	348	184

24 - UNIRAC SOLARMOUNT

SolarMount™ Rail Sets

Each included in four-rail kits. To determine row lengths required from your installation, see the sizing chart on page 22 for arrays with inches and longer ship by truck.

Two-rail kits - include L-feet						
Unirac Part No.	Rail Length (inches)	No. of L-feet	Shipping wt (lbs)	Item Code	Price	
300201	48	4	13	14.1020	\$99	Ship UPS
300202	60	4	14	14.1024	\$114	
300203	72	4	16	14.1028	\$129	
300204	84	4	17	14.1032	\$144	
300205	96	4	19	14.1036	\$159	
300206	106	4	20	14.1040	\$174	
300207	120	6	22	14.1044	\$194	Ship by Truck Freight
300208	132	6	24	14.1048	\$209	
300209	144	6	25	14.1052	\$224	
300210	156	6	27	14.1056	\$239	
300211	168	6	28	14.1060	\$254	
300212	180	6	30	14.1064	\$274	
300213	192	8	31	14.1068	\$289	
300214	204	8	33	14.1072	\$304	
300215	216	8	34	14.1076	\$319	

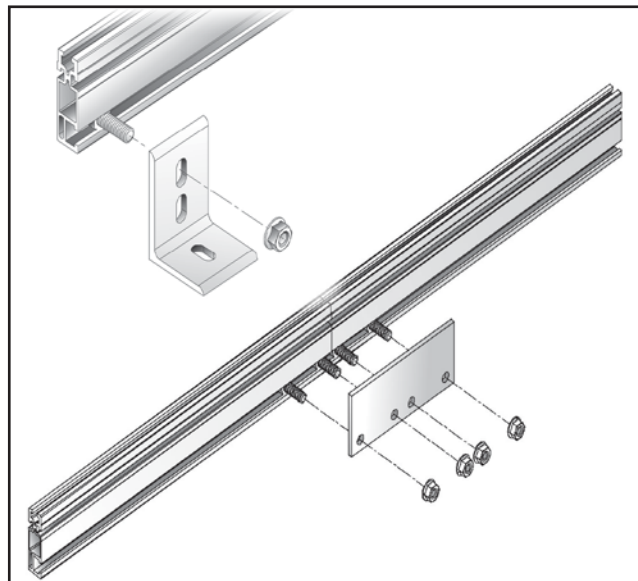

Bulk Rail Bundles

Bulk bundles consist of 8 rails and do not include L-feet or hardware. See the sizing chart (page 22-23) to determine rail length appropriate for your installation. If desired rail length exceeds 240 inches, order a splice (pg. 26) and two segments. Spliced segments should be equal or as close to equal as possible.

Four-rail kits - include L-feet - Ship by Truck						
Unirac Part No.	Rail Length	Segment length	No. of L-feet	Shipping wt (lbs)	Item Code	Price
300224	226	106/120	10	40	14.1000	\$349
300225	240	120/120	10	42	14.1001	\$364
300226	252	132/120	10	44	14.1002	\$379
300227	264	132/132	10	46	14.1003	\$389
300228	276	144/132	10	47	14.1004	\$404
300229	288	144/144	10	48	14.1005	\$419
300230	300	156/144	12	50	14.1006	\$439
300231	312	156/156	12	52	14.1007	\$454
300232	324	168/156	12	53	14.1008	\$469
300233	336	168/168	12	54	14.1009	\$484
300234	348	180/168	14	56	14.1010	\$499
300235	360	180/180	14	58	14.1011	\$509
300236	372	192/180	14	59	14.1012	\$524
300237	384	192/192	14	60	14.1013	\$539
300238	396	204/192	14	62	14.1014	\$554
300239	408	204/ 204	14	64	14.1015	\$569
300240	420	216/ 204	16	65	14.1016	\$589
300241	432	216/ 216	16	66	14.1017	\$599

8- piece bulk rail bundles					
Unirac Part No.	Rail Length (inches)	Shipping wt (lbs)	Item Code	Price	
300101	48	32	14.0810	\$230	Ship UPS
300102	60	40	14.0811	\$270	
300103	72	48	14.0812	\$310	
300104	84	54	14.0813	\$350	
300105	96	62	14.0814	\$390	
300106	106	68	14.0815	\$430	
300107	120	80	14.0820	\$475	
300108	132	88	14.0821	\$520	Ship by Truck Freight
300109	144	95	14.0822	\$565	
300110	156	102	14.0823	\$610	
300111	168	109	14.0824	\$655	
300112	180	116	14.0825	\$700	
300113	192	123	14.0826	\$745	
300114	204	130	14.0827	\$790	
300115	216	137	14.0828	\$835	
300116	228	144	14.0831	\$870	
300117	240	152	14.0829	\$915	

UNIRAC SOLARMOUNT - 25

Top Mounting Clamp Sets

See sizing chart page 22 to determine clamp size letter. Call for modules not found on chart.

Includes all clamps and hardware to attach the indicated number of PV modules to 1 pair of rails. Replace the "x" in the item code with the letter A-H to order the correct clamp set.

Top Mounting Clamp Sets Size A - F					
No. of Modules	Shipping wt. (lbs)	Clear Anodized		Dark Bronze	
		Item Code	List Price	Item Code	List Price
2	1	14.1080-x	\$19.00	14.1081-x	\$25.00
3	2	14.1084-x	\$22.50	14.1082-x	\$29.75
4	2	14.1088-x	\$26.00	14.1083-x	\$34.50
5	2	14.1092-x	\$29.50	14.1085-x	\$39.25
6	2	14.1096-x	\$33.00	14.1086-x	\$44.00
7	2	14.1100-x	\$36.50	14.1087-x	\$48.75
8	3	14.1104-x	\$40.00	14.1089-x	\$53.50
9	3	14.1105-x	\$43.50	14.1090-x	\$58.25
10	3	14.1106-x	\$47.00	14.1091-x	\$63.00
11	3	14.1101-x	\$50.50	14.1093-x	\$67.75
12	3	14.1102-x	\$54.00	14.1094-x	\$72.50

Top Mounting Clamp Sets for Lipped Frame Modules					
No. of Modules	Shipping wt. (lbs)	Dark Bronze - G (Sharp)		Dark Bronze - H (Sanyo)	
		Item Code	List Price	Item Code	List Price
2	1	14.1135	\$25.00	14.1146	\$18.50
3	2	14.1136	\$29.00	14.1147	\$21.00
4	2	14.1137	\$33.00	14.1148	\$23.50
5	2	14.1138	\$37.00	14.1149	\$26.00
6	2	14.1139	\$41.00	14.1150	\$28.50
7	2	14.1140	\$45.00	14.1151	\$31.00
8	3	14.1141	\$49.00	14.1152	\$33.50
9	3	14.1142	\$53.00	14.1153	\$36.00
10	3	14.1143	\$57.00	14.1154	\$38.50
11	3	14.1144	\$61.00	14.1155	\$41.00
12	3	14.1145	\$65.00	14.1156	\$43.50

Bottom Mount Clips

Order 4 clips for each module in your array. Clips are packed with stainless steel bolts and flange nuts. For use with all modules with mounting holes on the backs of their frames.

UniRac Number	Bottom mount clips with stainless steel T-bolts and flange nuts	Wt. (lbs.)	Item Code	List Price
321002	20 ea. Clips	5	14.0875	24.00
321218	4 ea. Clips	1	14.0879	5.20
321001	1 ea. Clip	1	14.0877	1.40

Pro-Pak Top Clamps

See sizing chart page 22 to determine clamp size letter. Call for modules not found on chart.

End clamps: Order 4 for each row of modules you plan to mount. Mid clamps: For each row, take one less than the number of modules in the row and multiply that figure by 2.

UniRac Number	Desdcription	Wt. (lbs.)	Item Code	List Price
	End clamps with stainless steel T-bolts and flange nuts			
320012	20 ea. A clamps	6	14.0840	39.00
320001	1 ea. A clamp	1	14.0850	2.25
320013	20 ea. B clamps	6	14.0841	39.00
320002	1 ea. B clamp	1	14.0851	2.25
320014	20 ea. C clamps	6	14.0842	39.00
320003	1 ea. C clamp	1	14.0852	2.25
320081	20 ea. C clamps; dark bronze	6	14.0861	54.00
320117	1 ea. C clamp, dark bronze	1	14.0862	3.00
320015	20 ea. D clamps	6	14.0843	39.00
320004	1 ea. D clamp	1	14.0853	2.25
320185	20 ea. D clamps dark bronze	6	14.0863	54.00
320173	1 ea. D clamp dark bronze	1	14.0864	3.00
320016	20 ea. E clamps	6	14.0844	39.00
320005	1 ea. E clamp	1	14.0854	2.25
320082	20 ea. E clamps; dark bronze	6	14.0848	54.00
320118	1 ea. E clamp, dark bronze	1	14.0858	3.00
320017	20 ea. F clamps	6	14.0845	39.00
320006	1 ea. F clamp	1	14.0855	2.25
320123	20 ea. F clamps dark bronze	6	14.0846	54.00
320124	1 ea. F clamp dark bronze	1	14.0856	3.00
320083	20 ea. G clamps dark bronze	6	14.0847	54.00
320007	1 ea. G clamps dark bronze	1	14.0857	3.00
Mid clamps with stainless steel T-bolts and flange nuts				
320020	20 ea. A-B-C mid clamps	6	14.0867	39.00
320008	1 ea. A-B-C mid clamp	1	14.0866	2.25
320084	20 ea. A-B-C mid clamps, bronze	6	14.0865	54.00
320119	1 ea. A-B-C mid clamp, dark bronze	1	14.0876	3.00
320021	20 ea. D-E-F mid clamps	6	14.0869	39.00
320009	1 ea. D-E-F mid clamp	1	14.0868	2.25
320085	20 ea. D-E-F mid clamps bronze	6	14.0878	54.00
320120	1 ea. D-E-F mid clamp, dark bronze	1	14.0870	3.00
320087	20 ea. G mid clamps, dark bronze	6	14.0871	39.00
320122	1 ea. G clamp, dark bronze	1	14.0872	2.23
H Clamps below are used as mid and end clamps - includes hex bolts				
320086	20 ea. H clamps, dark bronze	6	14.0873	44.00
320121	1 ea. H clamp, dark bronze	1	14.0874	2.50

26 - UNIRAC SOLARMOUNT

Splices, Standoffs, L-feet, Flashings and Accessories

Bulk components are ideal for large installations and for contractors installing many roof mount systems. Standoffs, L-foot and splices in bulk save money. Flashings, shims, hanger bolts and cable ties help create a clean professional looking installation. Bulk packs will be drop-shipped from the manufacturer. Please allow 3 to 4 weeks for delivery.

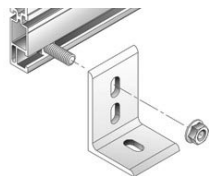

Standoffs are also available in bulk packs of 12. Please call for price.

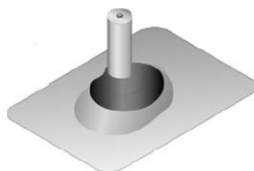

Shims

Horseshoe shaped shims level or raise standoffs and L-feet to precisely align rails. Shims come in three color-coded thicknesses in packs of 20.

UniRac Number	Description	Wt. (lbs.)	Item Code	List Price
	L-foot with s/s bolts and flange nuts, no lag bolts			
310006	20 ea. L-feet	10	14.0891	69.00
310002	1 ea. L-foot	0.5	14.0892	4.00
Flat-top two piece aluminum standoffs (11/8" O.D. shaft, with s/s hardware, 2 lag bolts)				
310027	1 ea. 3 in. aluminum 2-piece standoffs	1	14.1251	11.00
310028	1 ea. 4 in. aluminum 2-piece standoffs	1	14.1252	11.75
310029	1 ea. 6 in. aluminum 2-piece standoffs	1	14.1253	13.25
310030	1 ea. 7 in. aluminum 2-piece standoffs	1	14.1254	14.00
Flat-top one piece steel standoffs (15/8" O.D. shaft, zinc plated, with s/s hardware, 2 lag bolts)				
310009	1 ea. 3 in. flat-top steel standoffs	1.5	14.1220	17.00
310010	1 ea. 4 in. flat-top steel standoffs	1.5	14.1224	17.50
310011	1 ea. 6 in. flat-top steel standoffs	2	14.1228	18.00
310012	1 ea. 7 in. flat-top steel standoffs	2	14.1232	18.50
Raised-flange steel standoffs (15/8" O.D. shaft, zinc plated, with 2 lag bolts)				
310017	1 ea. 3 in. raised-flange steel standoffs	1.5	14.1236	18.00
310018	1 ea. 4 in. raised-flange steel standoffs	1.5	14.1240	18.50
310019	1 ea. 6 in. raised-flange steel standoffs	2	14.1244	19.00
310020	1 ea. 7 in. raised-flange steel standoffs	2	14.1248	19.50
Hanger bolts - Use with L-feet to support rails above tile or metal roofing				
310025	1 ea. 8" long x 3/8" diameter hanger bolt w. s/s nut and washers	0.5	14.1256	9.00
310046	20 ea. 8" long x 3/8" diameter hanger bolt w. s/s nut and washers	5	14.1257	153.00
310026	1 ea. 3/8" hanger bolt driver - allows easy installation of hanger bolts	0.5	14.1258	12.50
Splices				
310216	20 ea. splice plates with s/s bolts and flange nuts	15	14.0888	170.00
310214	1 ea. splice plates with s/s bolts and flange nuts	1	14.1261	10.00
310204	20 ea. splice bars with s/s self tapping screws	10	14.0889	98.00
310202	1 ea. splice bars with s/s self tapping screws	1	14.1262	5.65
No-Calk™ collar Flashings for steel standoffs				
990101	12 ea. galvanized, 121/2" x 83/4" base,(Oatey # O-11840)	11	14.0621	75.50
990102	12 ea. aluminum, 121/2" x 83/4" base(Oatey # O-12920)	11	14.0623	111.00
990103	12 ea. soft aluminum, 18" x 18" base,(Oatey # O-12836)	14	14.0625	158.50
Flashings for aluminum standoffs				
990109	12 ea. galv., 121/2" x 83/4" base, No-Calk (Oatey # O-11830)	11	14.0629	81.00
310044	12 ea. aluminum, 12" x 9" base - all metal	12	14.0633	78.00
310045	12 ea. soft aluminum, 18" x 18" base - 12" x 9" all metal	14	14.0635	98.00
Cable ties and shims				
990104	100 ea. push mount cable ties, black	1	14.0895	12.00
990105	20 ea. 1/16" shims (blue plastic)	0.5	14.0649	1.50
990106	20 ea. 1/8" shims (red plastic)	0.5	14.0651	3.00
990107	20 ea. 1/4" shims (black plastic)	1	14.0653	4.50
990108	20 ea. tapered shims (black plastic)	1	14.0655	11.00

UNIRAC SOLARMOUNT - 27

Low Profile Tilt Legs

Low profile orientation minimizes the vertical height of your array to hide an array behind a parapet or minimize wind loading. You can also optimize tilt angle on a pitched roof to maximize system performance. In low profile arrays, tilt angle depends on leg length and the location of the module mounting holes. Each low profile tilt leg kit contains one square tube and one strut.

Tilt angles for low profile legs

Choose (a) the correct maximum leg extension for your tilt angle and (b) the number of kits required from the charts below. Then choose the correct kit model from the price list.

Quantity of tilt legs required

The number of tilt legs required in a low profile array depends on the length of the mounting rails.

Quantity of Legs Required	
Rail Length (inches)	No. of Legs Required
48 to 106	2
120 to 180	3
192 to 216	4
226 to 288	5
300 to 336	6
348 to 408	7
420 to 432	8

High Profile Adjustable Tilt Legs



In high profile arrays, tilt angle depends on the length of the legs and the rails. To determine the length of your rails, consult the sizing charts on page 22 (for top mounting arrays) or page 23 (for bottom mounting arrays). Quantity of tilt legs required: Order one high profile tilt leg kit for each rail kit.

Rails 120 inches and longer require leg kits with 4 legs per kit. One long and one short leg per rail.

If ordering bulk rail packs, order one high profile tilt leg kit for each pair of rails required in your installation. Do not use high profile legs with rails longer than 180 inches. Never use spliced rails with this configuration.

Sizing Chart for Low-Profile Tilt Legs

Angle Range is in degrees from horizontal

Low Profile Leg Length		12 inch	30 inch	44 inch
Unirac Number		310121	310122	310123
Item Code		14.1185	14.1189	14.1193
Price		\$30	\$37	\$43
Module Make and model		Tilt angle range (degrees)		
RWE	ASE 300	6-13	13-34	20-50
GE Energy	GE75	9-20	21-54	31-60
	GE110	7-17	17-43	23-60
	GE150	6-13	14-34	20-51
BP Solar	275, 380, 485, SX75TU	9-20	21-53	31-60
	3160, 4160, 5170	7-15	16-40	23-60
	SX110, SX120	8-17	18-44	26-60
	SX150	7-15	16-40	23-60
Evergreen	EC110, EC115	7-16	16-40	24-60
Kyocera	KC80, KC120, KC125G	11-25	27-60	39-60
	KC187G	8-17	18-45	26-60
	KC167G	9-19	20-50	29-60
Photowatt	PW750,1250,1650	9-20	21-52	30-60
Sharp	80	9-20	21-54	31-60
	123	7-16	17-43	25-60
	165, 175, 185	7-16	16-40	24-60
Shell	SQ 80, 85	9-20	21-54	31-60
	SQ165, 175	7-15	16-39	23-60
UniSolar	US-64, ES-62	8-18	19-47	27-60
	US-116, ES-124	4-10	10-26	15-39

Sizing Chart for High-Profile Tilt Legs

Angle Range is in degrees from horizontal

1 Leg Per Rail (2 Legs Per Kit) - for rails 48 to 106 inches			
Maximum Leg Length	12 inch	44 inch	72 inch
Unirac Number	310107	310108	310109
Item Code	14.1160	14.1164	14.1168
Price	\$43	\$66	\$86
Rail Length	Tilt angle range (degrees)		
48	10 - 23	33 - 60	N/A
60	8 - 18	26 - 60	48 - 60
72	7 - 16	22 - 60	36 - 60
84	5 - 12	17 - 47	28 - 60
96	5 - 11	16 - 43	26 - 60
106	4 - 10	15 - 39	24 - 60
2 Legs Per Rail (4 Legs Per Kit) - for rails 120 to 180 inches			
Maximum Leg Length	18 inch	64 inch	104 inch
Unirac Number	310111	310112	310110
Item Code	14.1172	14.1176	14.1180
Price	\$79	\$132	\$176
Rail Length	Tilt angle range (degrees)		
120	5 - 10	17 - 38	27 - 60
132	6 - 10	17 - 37	26 - 60
144	6 - 9	16 - 33	19 - 43
156	5 - 10	14 - 30	22 - 49
168	5 - 7	13 - 28	20 - 46
180	3 - 7	12 - 26	19 - 43

28 - UNIRAC S5 MOUNTS FOR METAL ROOFING

SolarMount® / S-5!™ PV Clamp Sets for Standing Seam Roofing

S-5! PV clamps provide non-penetrating attachment points to standing seam metal roofs. Select SolarMount end clamps and mid clamps and attach modules directly to the S-5! clamp without mounting rails. Use end clamps on the edge of the array and mid clamps between rows within the array. End clamps and mid clamps are anodized. S-5! clamps are mill finish.

Use the application chart below to find the size, C, D, E or F, that fits the modules being used. Order End clamps for outside rows of modules and mid clamp for internal rows.

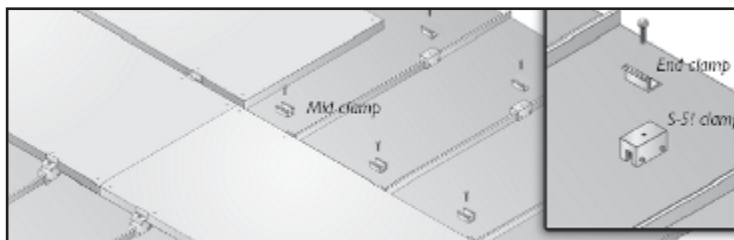

S5 Application Chart		
Size	Frame Thickness	Fits these modules
C	34 - 36 mm	Evergreen, GE Energy, Kyocera, Sharp NE-80U1, Shell SQ80/SQ85, SunWize (<150 watts)
D	38 - 40 mm	Isofoton, Kaneka, Photowatt PW1250, PW1650, Shell SQ165/SQ175
E	50 - 52 mm	BP Solar, RWE Schott ASE300
F	45 - 47 mm	Mitsubishi, Schott SAPC165, Sharp ND-L3EJE, ND-167U3, NE-165U1, NT-185U1, SunPower

Description	Quantity per pack	Ship wt. (lbs)	Clear Anodized			Dark Bronze Anodized		
			UniRac no.	Item Code	Price	UniRac no.	Item Code	Price
S-5! + Mid Clamp Set C & D	1	0.5	321224	14.1281	18.00	321226	14.1301	18.75
	20	10	321236	14.1282	320.00	321238	14.1302	335.00
S-5! + End Clamp Set C	1	0.5	321228	14.1283	18.00	321232	14.1303	18.75
	20	10	321240	14.1284	320.00	321244	14.1304	335.00
S-5! + End Clamp Set D	1	0.5	321229	14.1285	18.00	321233	14.1305	18.75
	20	10	321241	14.1286	320.00	321245	14.1306	335.00
S-5! + Mid Clamp Set E & F	1	0.5	321225	14.1287	18.00	321227	14.1307	18.75
	20	10	321237	14.1288	320.00	321239	14.1308	335.00
S-5! + End Clamp Set E	1	0.5	321230	14.1289	18.00	321234	14.1309	18.75
	20	10	321242	14.1290	320.00	321246	14.1310	335.00
S-5! + End Clamp Set F	1	0.5	321231	14.1291	18.00	321235	14.1311	18.75
	20	10	321243	14.1292	320.00	321247	14.1312	335.00

UniRac Small Module Side of Pole Mounts

These mounts are ideal for small PV modules. They have an adjustable tilt angle from 10 to 60 degrees. All components are made from mill finish aluminum and stainless steel. U-bolts attaching to a 2" pole are included.

Unirac Number	Dimensions		Unisolar		AEE			Item Code	Price
	Rail	Channel	US5	US11	AE5G	AE10G	AE20G		
400002	10"	10"	X		X			14.2201	\$67
400006	12"	10"				X		14.2203	\$68
400026	22"	25"					X	14.2213	\$85
400016	16"	10"		X				14.2211	\$70

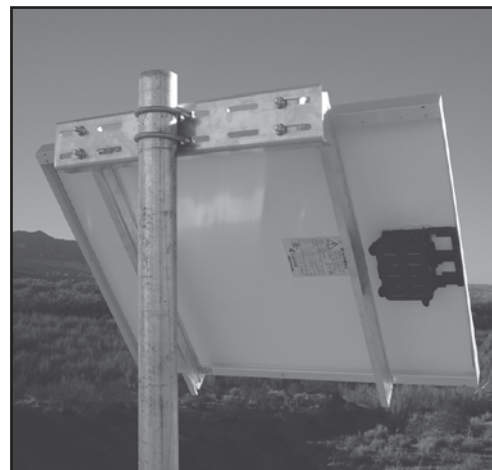

UNIRAC SUNFRAME - 29

PV Mounting System for Pitched Roofs

SunFrame is the only PV module mounting system designed to enhance the appearance of the home. Add aesthetics to the benefits of PV power. When an installation has to look great, SunFrame offers finish choices and low, clean lines that become as natural a part of a home as a skylight. It delivers the installation ease you've come to expect from UniRac while meeting both the Uni-form and California building codes.

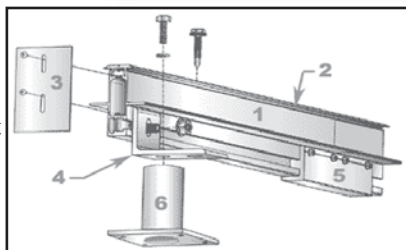

Components

1. Inter-module rails provide support shelves for the modules. Depending on the modules' thickness, its upper surface can be as little as 2.125 inches above the roof. Rails come in bulk packs of eight 192" pieces in clear anodized or dark bronze finish.
2. 192" module-specific cap strips secure modules and finish the array topside, forming a gap-free frame. Self-drilling screws at 16" intervals provide holding power. Order cap strips for the module brand and model to be installed. Cap strips are available in clear or dark bronze anodized finishes.
3. End caps finish rail ends to complete the frame.
4. L-feet attach directly through asphalt shingle roofs and support the rails one-half to three-quarters of an inch above the roof surface to provide convective air flow for ventilation.
5. Splices safely extend rails.
6. Standoffs (optional), designed for standard flashing, support L-feet above tile or shake roofs. See pg. 26.

Figure Number	Description	Frame Depth	Weight (lbs.)
Rails (1)	8 ea. 192 inch long bottom rail		144
	8 ea. 96 inch long bottom rail		72
	1 ea. 96 inch long bottom rail		10
Cap Strips (2)	8 ea. 192 in. for GE, Kyocera 125G, 167G, Evergreen	(C) 34 - 36 mm	42
	8 ea. 96 in. for GE, Kyocera 125G, 167G, Evergreen		23
	1 ea. 192 in. for GE, Kyocera 125G, 167G, Evergreen		6
	8 ea. 192 in for Shell, Matrix 1250,1650, Isofoton	(D) 38 - 40 mm	42
	8 ea. 96 in. for Shell, Matrix 1250,1650, Isofoton		23
	1 ea. 96 in. for Shell, Matrix 1250,1650, Isofoton		6
	8 ea. 192 in. for BPSolar, RWE ASE300	(E) 49 - 51 mm	42
	8 ea. 96 in. for BPSolar, RWE ASE300		23
	1 ea. 96 in. for BPSolar, RWE ASE300		6
	8 ea. 192 in. for Sharp 123, 165, 185, Mitsubishi	(F) 45 - 47 mm	45
	8 ea. 96 in. for Sharp 123, 165, 185, Mitsubishi		25
	1 ea. 96 in. for Sharp 123, 165, 185, Mitsubishi		6
	8 ea. 192 in. for Sanyo (Lipped Modules)	(H) Lipped Frame	42
	8 ea. 96 in. for Sanyo (Lipped Modules)		23
	1 ea. 96 in. for Sanyo (Lipped Modules)		6
8 ea. 192 in. for Sharp (Lipped Modules) 70, 140, 167	(G) Lipped Frame	45	
8 ea. 96 in. for Sharp (Lipped Modules) 70, 140, 167		25	
1 ea. 96 in. for Sharp (Lipped Modules) 70, 140, 167		6	
Screws	Pack of 100 Cap Strip Screws		2
	Pack of 10 Cap Strip Screws		1
End Caps (3)	Pack of 20 End Plates w/stainless screws		1
	Pack of 2 End Plates w/stainless screws		1
L-feet (4)	20 ea. L-feet with stainless bolts and flange nuts		5
	1 ea. L-feet with stainless bolts and flange nuts		1
Splice Bars (5)	20 ea. Splice Bars w/ stainless self-taping screws		10
	1 ea. Splice Bars w/ stainless self-taping screws		10

Clear Anodized			Dark Bronze Anodized		
Unirac #	Item Code	Price	Unirac #	Item Code	Price
302006	14.0707	\$1,065.00	302005	14.0705	\$1,215.00
302008	14.0714	\$560.00	302007	14.0706	\$635.00
302010	14.0709	\$77.00	302009	14.0704	\$87.00
321106	14.0723	\$385.00	321103	14.0721	\$435.00
321112	14.0722	\$205.00	321110	14.0720	\$230.00
321113	14.0718	\$29.00	321111	14.0719	\$33.00
321107	14.0725	\$385.00			
321114	14.0716	\$205.00			
321115	14.0724	\$29.00			
321108	14.0729	\$435.00	321104	14.0727	\$475.00
321118	14.0730	\$230.00	321116	14.0728	\$250.00
321119	14.0763	\$33.00	321117	14.0764	\$36.00
321109	14.0731	\$435.00	321126	14.0732	\$475.00
321120	14.0733	\$230.00	321127	14.0734	\$250.00
321121	14.0735	\$33.00	321128	14.0736	\$36.00
			321129	14.0737	\$490.00
			321130	14.0738	\$260.00
			321131	14.0739	\$37.50
			321105	14.0740	\$510.00
			321122	14.0745	\$270.00
			321123	14.0746	\$39.00
321102	14.0743	\$47.00	321101	14.0741	\$58.00
321125	14.0744	\$5.50	321124	14.0742	\$6.75
310211	14.0754	\$36.00	310210	14.0751	\$36.00
310213	14.0755	\$4.00	310212	14.0752	\$4.00
310006	14.0891	\$69.00	310005	14.0893	\$72.00
310002	14.0892	\$4.00	310001	14.0894	\$4.25
310204	14.0759	\$102.00	310203	14.0757	\$108.00
310202	14.0760	\$5.65	310201	14.0761	\$5.90

30 - UNIRAC LARGE ARRAY MOUNTS

Unirac U-LA Series Large Array Mounting System

U-LA is a cost-effective way of mounting PV arrays employing 20 or more large modules. It can mount any framed PV module, and array size is limited only by the space at the site. SolarMount rail lengths of up to 14 feet will accommodate as many as eight 80-watt or five 165-watt modules, depending on manufacturer and model. The east-west dimension, and therefore the total number of modules, is limited only by available space at the installation site. Tilt angles can be as high as 55 degrees, depending on wind load requirements.



The user or installer provides concrete and 2- or 3-inch Schedule 40 or 80 steel pipe or rigid conduit readily available from most hardware, building supply, electrical supply or plumbing supply stores.

Unirac provides:

- * A custom layout with specifications that can be used to obtain a building permit and PE certification.
- * Truss components to join the pipe into a rigid support structure.
- * SolarMount rail sets, laboratory tested and installation-friendly.
- * Module attachment hardware that's right for the modules and assembly sequence you've chosen.

Unirac will design and quote a custom system that fits your requirements and unique site. Download the U-LA Large PV Array Design Questionnaire (PDF, 470 KB) and fax the information it requests. They will quote the system in one to three business days.

You can find the U-LA design questionnaire at http://www.unirac.com/pdfs/ds_ula.pdf

Security Hardware

Security hardware dramatically increases the difficulty and time required for a thief to dismantle a PV array and steal its components. Breakaway nuts work well in conjunction with top mounting clamps and footing bolts. Note that starhead bolt heads do not fit into SolarMount rail slots (where standard bolt heads are inaccessible). Use them with bottom mounting module clips and other locations where heads are exposed.

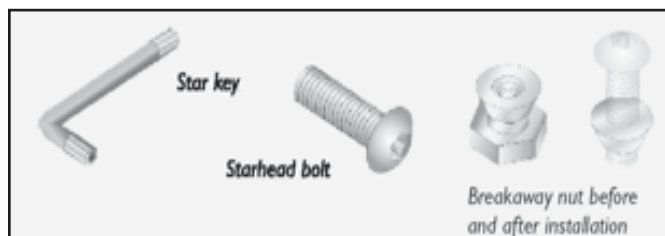

Unirac No.	Description	Quantity	Item Code	Price
321205	Starhead bolt, s/s, 1/4" x 3/4"	1	14.2113	\$1.30
321220	Starhead bolt, s/s, 1/4" x 3/4"	20	14.2114	\$22.00
321206	Starhead bolt, s/s, 3/8" x 11/4"	1	14.2115	\$3.45
321221	Starhead bolt, s/s, 3/8" x 11/4"	20	14.2116	\$60.00
321207	Breakaway nut, aluminum, 1/4"	1	14.2105	\$1.25
321222	Breakaway nut, aluminum, 1/4"	20	14.2106	\$21.00
321208	Breakaway nut, aluminum, 3/8"	1	14.2109	\$1.65
321223	Breakaway nut, aluminum, 3/8"	20	14.2110	\$28.00
321209	Star Key (Tool) 1/4"	1	14.2125	\$16.50
321210	Star Key (Tool) 3/8"	1	14.2126	\$20.00

SIDE-OF-POLE MOUNTS - 31

PowerFab Side-Of-Pole (SPM) Mounts

SPM mounts are available in painted steel and mill-finish aluminum versions. Stainless steel module mounting hardware is provided with all mounts. For harsh environments, anodized aluminum mounts are available. Add 30% to the price of the aluminum mounts in the chart below.

Stainless steel band clamps are provided with each mount for attachment to poles. Most models can be attached to flat vertical surfaces using installer-supplied lag bolts or through bolts.

Most SPM mounts can be shipped by UPS. Lines highlighted in grey must go by truck.

Mounts for other modules are available. Call for information.

For mounts for modules under 40 watts, see page 28.

Module Type	Manufacturer's Part	Mount Material	No. of Modules	Item Code	Price
Evergreen EC110, EC115	DP-SPM1-EC110-ALUM	Alum	1	13.3684	\$221
	DP-SPM2-EC110-ALUM	Alum	2	13.3686	\$336
	DP-SPM3-EC110-ALUM	Alum	3	13.3689	\$441
	DP-SPM4-EC110-ALUM	Alum	4	13.3690	\$572
Shell SP80, SP85	DP-SPM1-SP80, SP85-ALUM	Alum	1	13.3852	\$137
	DP-SPM1-SP80, SP85-STEEL	Steel	1	13.3853	\$115
	DP-SPM2-SP80, SP85-ALUM	Alum	2	13.3854	\$273
	DP-SPM2-SP80, SP85-STEEL	Steel	2	13.3855	\$215
	DP-SPM3-SP80, SP85-ALUM	Alum	3	13.3856	\$335
	DP-SPM3-SP80, SP85-STEEL	Steel	3	13.3857	\$280
	DP-SPM4-SP80, SP85-ALUM	Alum	4	13.3858	\$385
	DP-SPM4-SP80, SP85-STEEL	Steel	4	13.3859	\$335
Shell SQ165 SQ175	DP-SPM1-SP150-ALUM	Alum	1	13.3899	\$237
	DP-SPM1-SP150-STEEL	Steel	1	13.3900	\$225
	DP-SPM2-SP150-ALUM	Alum	2	13.3901	\$390
	DP-SPM2-SP150-STEEL	Steel	2	13.3902	\$335
	DP-SPM3-SP150-ALUM	Alum	3	13.3903	\$475
	DP-SPM4-SP150-ALUM	Alum	4	13.3904	\$630
Shell ST40	DP-SPM1-SM46-55-ALUM	Alum	1	13.3943	\$105
	DP-SPM1-SM46-55-STEEL	Steel	1	13.3944	\$110
	DP-SPM2-SM46-55-ALUM	Alum	2	13.3945	\$252
	DP-SPM2-SM46-55-STEEL	Steel	2	13.3946	\$194
	DP-SPM3-SM46-55-ALUM	Alum	3	13.3947	\$294
	DP-SPM3-SM46-55-STEEL	Steel	3	13.3948	\$215
	DP-SPM4-SM46-55-ALUM	Alum	4	13.3949	\$326
	DP-SPM4-SM46-55-STEEL	Steel	4	13.3950	\$257
Unisolar US32	DP-SPM1-US32-ALUM	Alum	1	13.3988	\$110
	DP-SPM1-US32-STEEL	Steel	1	13.3989	\$116
	DP-SPM2-US32-ALUM	Alum	2	13.3990	\$263
	DP-SPM2-US32-STEEL	Steel	2	13.3991	\$215
Unisolar US64	DP-SPM1-US64-ALUM	Alum	1	13.3996	\$221
	DP-SPM1-US64-STEEL	Steel	1	13.3997	\$215
	DP-SPM2-US64-ALUM	Alum	2	13.3998	\$331
	DP-SPM2-US64-STEEL	Steel	2	13.3999	\$289

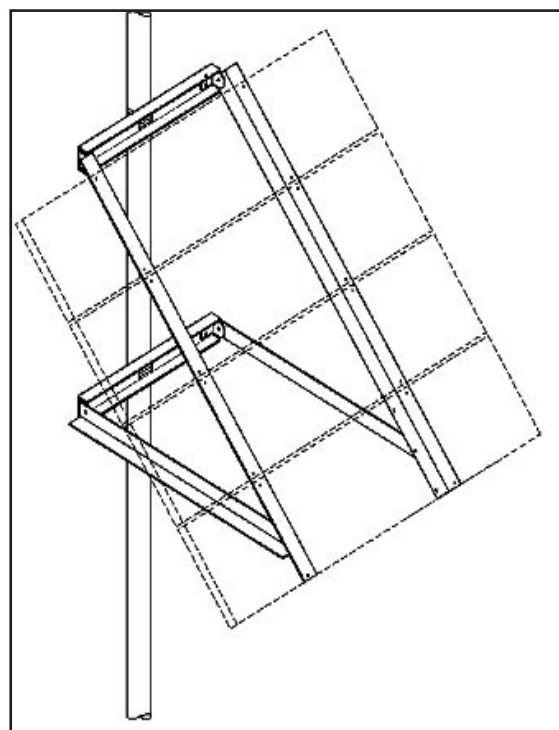
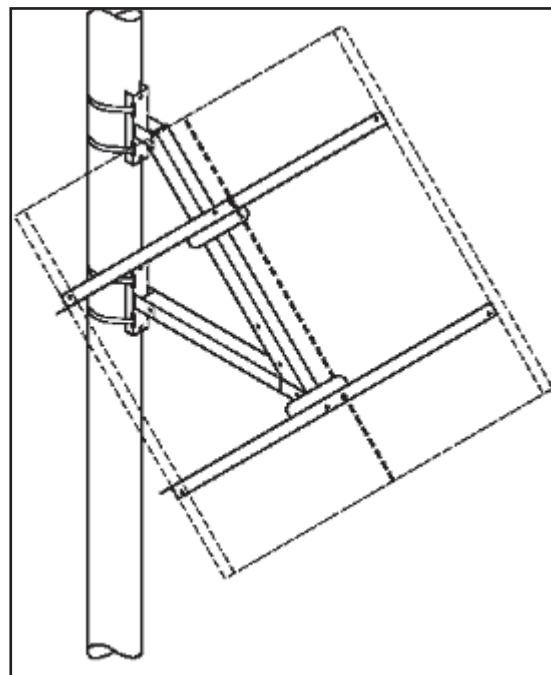

32 - TOP-OF-POLE MOUNTS

DP&W Pole Top Mounts

Standard TPM mounts have heavy steel mounting sleeves, elevation pivots and strongbacks that are painted with durable outdoor paint. The module rails are 6061-T6 mill-finish structural aluminum angle. Stainless steel module mounting hardware is provided. Standard top-of-pole mounts are adjustable from 15 degrees to 65 degrees in 10-degree increments and fit on schedule 40 steel pipe.

For harsh environments, these mounts are available with hot-dip-galvanized steel and anodized aluminum. Multiply price by 1.8 for this addition.

Mounts with gray shading ship by truck freight. All other mounts can be shipped by UPS.

Mounts for other modules are available. Call for information.

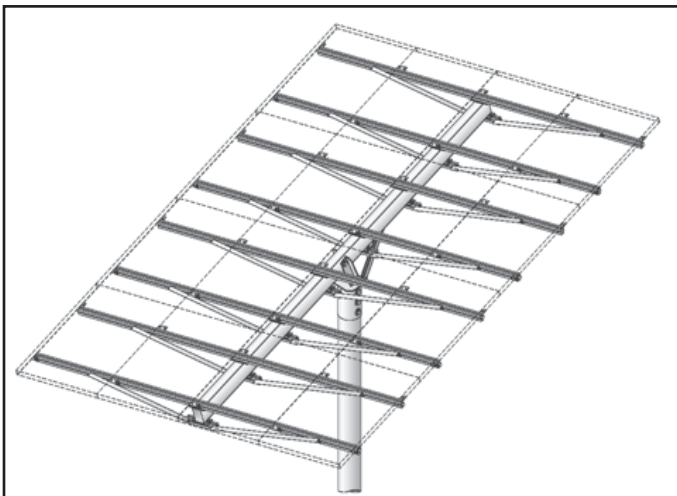

Module Type	DPW Part No.	No. of Modules	Pole Size (Schd 40)	Item Code	Price
Evergreen EC110, EC115	DP-TPM1-EC110	1	2	13.4407	\$143
	DP-TPM2-EC110	2	3	13.4409	\$297
	DP-TPM3-EC110	3	3	13.4411	\$363
	DP-TPM4-EC110	4	4	13.4413	\$506
	DP-TPM6-EC110	6	6	13.4415	\$788
	DP-TPM8-EC110	8	6	13.4417	\$874
	DP-TPM9-EC110	9	6	13.4418	\$1,308
	DP-TPM10-EC110	10	6	13.4419	\$1,081
	DP-TPM12-EC110	12	8	13.4421	\$1,276
	DP-TPM14-EC110	14	8	13.4423	\$1,452
	DP-TPM16-EC110	16	8	13.4424	\$1,872
DP-TPM18-EC110	18	8	13.4425	\$2,080	
Sharp 80	DP-TPM1-SH80	1	2	13.4801	\$132
	DP-TPM2-SH80	2	2	13.4802	\$142
	DP-TPM3-SH80	3	2.5	13.4803	\$275
	DP-TPM4-SH80	4	3	13.4804	\$295
	DP-TPM6-SH80	6	4	13.4805	\$470
	DP-TPM8-SH80	8	4	13.4806	\$555
	DP-TPM10-SH80	10	6	13.4807	\$855
	DP-TPM12-SH80	12	6	13.4808	\$965
	DP-TPM14-SH80	14	6	13.4809	\$1,065
DP-TPM16-SH80	16	6	13.4810	\$1,240	
Sharp 123	DP-TPM1-SH123	1	2	13.4830	\$132
	DP-TPM2-SH123	2	2.5	13.4831	\$255
	DP-TPM3-SH123	3	3	13.4832	\$295
	DP-TPM4-SH123	4	4	13.4833	\$460
	DP-TPM6-SH123	6	6	13.4834	\$595
	DP-TPM8-SH123	8	6	13.4835	\$835
	DP-TPM10-SH123	10	6	13.4836	\$1,015
	DP-TPM12-SH123	12	6	13.4837	\$1,115
Sharp 165 Sharp 185	DP-TPM1-SH165	1	2	13.4867	\$137
	DP-TPM2-SH165	2	3	13.4868	\$295
	DP-TPM3-SH165	3	4	13.4865	\$450
	DP-TPM4-SH165	4	4	13.4869	\$535
	DP-TPM6-SH165	6	6	13.4870	\$860
	DP-TPM8-SH165	8	6	13.4871	\$1,105
	DP-TPM9-SH165	9	6	13.4877	\$1,310
	DP-TPM10-SH165	10	8	13.4872	\$1,375
	DP-TPM12-SH165	12	8	13.4873	\$1,820
	DP-TPM14-SH165	14	8	13.4874	\$1,950
	DP-TPM16-SH165	16	8	13.4875	\$2,340
DP-TPM18-SH165	18	8	13.4876	\$2,665	

POLE TOP MOUNTS - 33

Module Type	DPW Part No.	No. of Modules	Pole Size (Schd 40)	Item Code	Price
Shell ST40	DP-TPM1-SM46-55	1	2	13.4729	\$121
	DP-TPM2-SM46-55	2	2	13.4731	\$132
	DP-TPM3-SM46-55	3	2	13.4733	\$154
	DP-TPM4-SM46-55	4	2.5	13.4735	\$242
	DP-TPM6-SM46-55	6	3	13.4739	\$297
	DP-TPM8-SM46-55	8	4	13.4741	\$460
Shell SQ80 SQ85	DP-TPM1-SQ80	1	2	13.4643	\$132
	DP-TPM2-SQ80	2	2	13.4645	\$142
	DP-TPM3-SQ80	3	2.5	13.4647	\$275
	DP-TPM4-SQ80	4	3	13.4649	\$295
	DP-TPM6-SQ80	6	4	13.4651	\$470
	DP-TPM8-SQ80	8	4	13.4653	\$555
	DP-TPM10-SQ80	10	6	13.4655	\$855
	DP-TPM12-SQ80	12	6	13.4656	\$965
	DP-TPM16-SQ80	16	6	13.4659	\$1,240
Shell SQ165 SQ175	DP-TPM1-SQ175	1	2	13.4661	\$137
	DP-TPM2-SQ175	2	3	13.4663	\$295
	DP-TPM4-SQ175	4	4	13.4665	\$535
	DP-TPM6-SQ175	6	6	13.4667	\$860
	DP-TPM8-SQ175	8	6	13.4669	\$1,105
	DP-TPM10-SQ175	10	8	13.4671	\$1,375
	DP-TPM12-SQ175	12	8	13.4673	\$1,820
	DP-TPM14-SQ175	14	8	13.4674	\$1,950
	DP-TPM18-SQ175	18	8	13.4676	\$2,665
UniSolar US64	DP-TPM1-US64	1	2	13.4984	\$138
	DP-TPM2-US64	2	2.5	13.4985	\$259
	DP-TPM4-US64	4	3	13.4986	\$435
	DP-TPM6-US64	6	6	13.4987	\$621
	DP-TPM8-US64	8	6	13.4988	\$828
	DP-TPM10-US64	10	6	13.4989	\$1,116
	DP-TPM12-US64	12	6	13.4990	\$1,173
	DP-TPM14-US64	14	8	13.4991	\$1,452
	DP-TPM16-US64	16	8	13.4992	\$1,937
GE Energy	DP-TPM1-GE45/50	1	2	13.4091	\$132
	DP-TPM2-GE45/50	2	2	13.4093	\$149
	DP-TPM4-GE45/50	4	2.5	13.4097	\$303
	DP-TPM6-GE45/50	6	3	13.4099	\$413
	DP-TPM8-GE45/50	8	4	13.4101	\$535
	DP-TPM10-GE45/50	10	4	13.4102	\$811
	DP-TPM12-GE45/50	12	6	13.4103	\$897

Module Type	DPW Part No.	No. of Modules	Pole Size (Schd 40)	Item Code	Price
Kyocera KC50/60	DP-TPM1-KC50/60	1	2	13.4509	\$132
	DP-TPM2-KC50/60	2	2	13.4511	\$149
	DP-TPM4-KC50/60	4	3	13.4513	\$303
	DP-TPM6-KC50/60	6	3	13.4515	\$413
	DP-TPM8-KC50/60	8	4	13.4517	\$558
	DP-TPM10-KC50/60	10	4	13.4519	\$811
	DP-TPM12-KC50/60	12	6	13.4520	\$897
	Kyocera KC70/80	DP-TPM1-KC70/80	1	2	13.4521
DP-TPM2-KC70/80		2	2	13.4523	\$165
DP-TPM3-KC70/80		3	2.5	13.4524	\$286
DP-TPM4-KC70/80		4	3	13.4525	\$314
DP-TPM6-KC70/80		6	4	13.4527	\$518
DP-TPM8-KC70/80		8	4	13.4529	\$587
DP-TPM10-KC70/80		10	6	13.4531	\$903
DP-TPM12-KC70/80		12	6	13.4533	\$1,012
DP-TPM16-KC70/80		16	6	13.4535	\$1,300
Kyocera 120/125	DP-TPM1-KC120	1	2	13.4481	\$132
	DP-TPM2-KC120	2	2.5	13.4483	\$255
	DP-TPM3-KC120	3	3	13.4484	\$295
	DP-TPM4-KC120	4	4	13.4485	\$460
	DP-TPM6-KC120	6	4	13.4487	\$595
	DP-TPM8-KC120	8	6	13.4489	\$835
	DP-TPM10-KC120	10	6	13.4491	\$1,015
	DP-TPM12-KC120	12	6	13.4493	\$1,115
	DP-TPM16-KC120	16	8	13.4490	\$1,785
Kyocera KC167	DP-TPM1-KC167	1	2	13.4539	\$143
	DP-TPM2-KC167	2	3	13.4540	\$314
	DP-TPM3-KC167	3	4	13.4541	\$473
	DP-TPM4-KC167	4	4	13.4542	\$564
	DP-TPM6-KC167	6	6	13.4543	\$903
	DP-TPM8-KC167	8	6	13.4544	\$1,162
	DP-TPM10-KC167	10	6	13.4545	\$1,411
	DP-TPM12-KC167	12	8	13.4546	\$1,911
	DP-TPM14-KC167	14	8	13.4547	\$2,048
DP-TPM16-KC167	16	8	13.4548	\$2,457	
DP-TPM18-KC167	18	8	13.4549	\$2,795	

34 - NON-PENETRATING ROOF MOUNTS

ConSole Non-penetrating Mounts for Flat Roofs

The ConSole is an innovative system, specially designed for mounting solar panels on flat roofs. It consists of a polyethylene tub that can be filled with ballast at the installation site. The top face holds the module at a 25 degree angle from horizontal. Use one Console for each module.

This complete system includes the ConSole, aluminum rails and all mounting hardware. Installation is quick and easy: simply mount the profiles on the solar panel, add ballast such as gravel or concrete, and fix the solar panel onto the ConSole. The curves in the design protect the roof from damage. They are stackable for easy transport and storage.

In order to resist wind loading, the ConSole has to be ballasted with tiles or gravel. The amount of ballast depends on the height of the building and its location (see table).

The ConSole is produced from 100% recycled chlorine-free polyethylene (HDPE), has a long lifetime and requires no maintenance. Each ConSole weighs approximately 11 pounds and has a 2-1/2 inch wide mounting border.

We stock one size that fits Shell SQ150,165,175 modules and Sharp 165,175 and 185 watt modules.

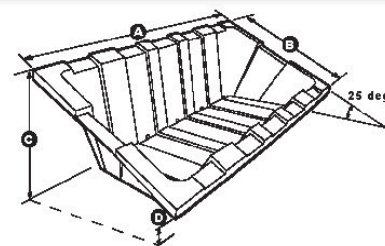
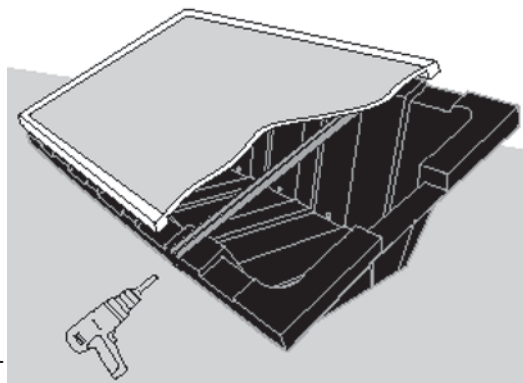

ConSole Model #	Dimensions inches (cm)				Ballast Required lbs. (kg)		Item Code	Price Each
	A	B	C	D	H < 25	25 < H < 65		
4.1	63 (160)	41 (105)	22 (55)	3 (8)	141 (64)	227 (103)	14.8841	\$95

DP&W POWER TUBE™ COMMERCIAL RACKING SYSTEM FOR FLAT ROOFS

POWER TUBE is designed for 10KW or larger PV systems and features top-clamping module attachment and no roof penetrations. They are made from all aluminum and stainless components and can provide a 5- or 10-degree module tilt angle.

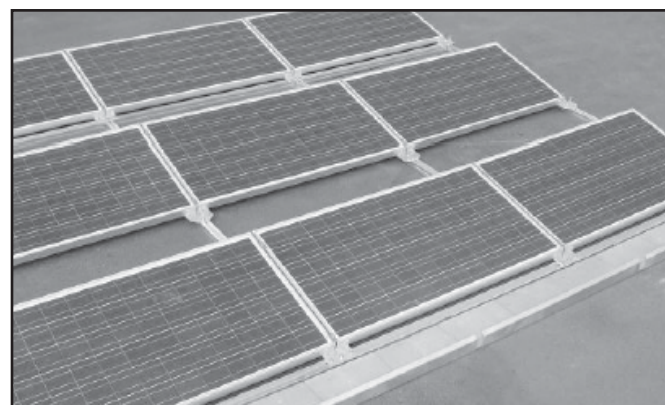

This mounting system is held on the roof by three things:

1. the weight of the modules and racking components
2. concrete blocks (17lb, 2.25"x8"x16"- quantity varies with site)
3. all components are inter-connected

The POWER TUBE Commercial Racking System with modules and ballast blocks weighs approximately 5.8 pounds per square foot of the area it covers (based on a system for Sharp 165 modules at a 10-degree tilt and spaced for a latitude of 40-degrees).

The cost varies with module brand, module dimensions and the spacing required between rows to avoid shading (which depends on the module width, tilt angle and site latitude). For estimating purposes use a list price of \$165.00/module for Sharp SH165/175/185, Shell SQ165/175 or BP150/160 modules. Ballast blocks are supplied by the installer and will cost about \$.75 each (for a system with 60 Sharp 165 modules you will need 136 blocks).

The POWER TUBE CRS system has been reviewed and stamped by a civil engineer licensed in the State of New Mexico. The system conforms to ASCE Standard 7-98 for the following applications:

- Tilt Angle 5-degrees, exposure rating C - 125 mph winds
- Tilt Angle 10-degrees, exposure rating C - 90 mph winds

Please call for a quote on your system needs.

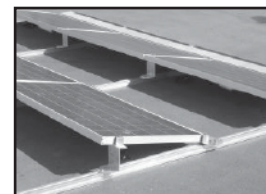

ZOMEWORKS PASSIVE TRACKERS - 35

Zomework Passive Track Rack™

The Zomeworks passive Track Rack™ uses no motors, no gears and no controls that can fail. The sun's heat moves liquid from side to side, allowing gravity to turn the Track Rack™ and follow the sun.

The Zomeworks Universal Rack System allows for almost limitless adjustment in both the east-west and north-south directions. Available in five standard sizes for holding 2 to 32 modules, Universal Track Racks are designed to fit all common photovoltaic modules, including ASE, GE Energy, BP Solar, Evergreen, Kyocera, Photowatt/Matrix, Shell, Uni-Solar, and most other popular modules. This flexibility translates to faster delivery, better quality and overall economy. The F-Series Track Racks™ ship partially assembled for easy installation. All of these mounts are designed for 90 MPH Wind Loads, come with stainless steel and zinc-plated hardware and have a 10-year standard warranty.

Please specify how many of which brand of module are to be placed on the tracker. The tracker will be customized with the correct amount of hardware, and in some cases the rail length will be adjusted for better fit. Module quantities followed by an asterisk (*) require an additional rail at an extra charge. See below.

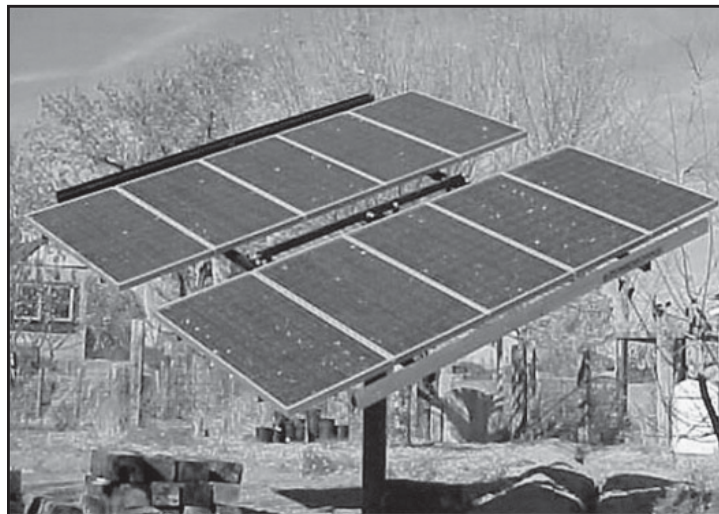

Zomeworks Model	UTR020	UTRK040	UTRF64	UTRF90	UTRF120	UTRF168
Item Code	14.9020	14.9043	14.9064	14.9090	14.9120	14.9128
Price	\$566	\$1100	\$1,525	\$1,725	\$1,948	\$2599
Pole Size Sch 40 Steel	2.5"	3"	6"	6"	6"	6"
Min. Pole Height	76"	84"	96"	108"	120"	120"
Min. Pole Depth	38"	42"	48"	54"	60"	60"
Shipping Weight	101 lbs	170 lbs	400 lbs	490 lbs	525 lbs	525 lbs
Module Type	Number of modules that fit each model (below)					
Evergreen						
EC110, 115	1 - 2	4	6	8 - 10	12	14 - 16*
Kyocera						
KC-60	1 - 2	4	6 - 8 - 10		12-14*-18*	14-16* to 21*
KC-80	1 - 2	4 - 6	8 - 10		12-14* to 18*	16*-20*,22** to 26**
KC-120, 125G	1-2	4	6-8	10-12	14-16*	14-16*
KC-167	1	2	4	6	8	10-12*
Shell						
SQ80, 85	1-2	4	6-8	10-12	14	16-18* to 22*
SQ165, 175	1	2	4	6	8	10-12
Sharp						
165W, 175W, 185W	1	2	4	6	8	10-12
Unisolar						
US-32	1-2-3	6	8-10	12-14-16	18-20	22-24-26* to 30*
US-64	1-2	4	6	8	10	12-14*
GE Energy						
GE70	1-2	4	6-8-10	12	14	18-20* to 24*
GE110	1-2	4	6	8	10-12	14-16*
Additional rail for mounts with quantity followed by * in chart				14.9155		\$200

36 - WATTSUN TRACKERS

Wattsun Active Trackers automatically track the sun from east to west using electronic sensors and motor or actuator drives. During partly cloudy conditions, the tracker fixes on the the brightest area of the sky, capturing the maximum amount of sunlight available. At night it returns to the morning sunrise position, ready to start tracking when the sun rises again. Tracking can increase a PV array's power production from 10% to 50% depending on the season and location. They are particularly effective when greater power is required in the summer months, such as when a large amount of water pumping is needed. Wattsun trackers deliver a significant increase in the amount of water pumped and provide a more constant water flow during the day. The gallons per day increase is greatest in the summer when water is needed the most. They may also be cost effective for net-metered utility intertie systems that can produce large amounts of electricity in the summer, to be used as credit towards a high winter power bill.

Tilt & Roll Trackers automatically track the sun by rotating east to west around the north-south axis. The elevation tilt (or seasonal adjustment) is done manually two to four times a year. These trackers use a linear actuator drive for their single axis movement.

The **TR-15U** tilt & roll tracker is designed for small two module arrays. It is now universal - meaning it can hold nearly any pair of standard 40 to 85 watt 12V modules, or any single 24V module that is not larger than 15 square feet in size. Mounts on a 2" Schedule 40 steel pole.

The **TR-55** tilt & roll tracker is perfect for small battery charging or water pumping applications. The controller used to power the drive motor on the TR-55 is identical to the one supplied with the larger drives. Mounts on a 4" Schedule 40 steel pole.

Azimuth trackers automatically track the sun's path by rotating the PV array around the pipe mast. Unlike tilt & roll trackers, azimuth trackers provide greater stability for larger arrays. The corners do not protrude down towards the ground or stick up in the air to catch the wind. The bottom edge of the array always remains parallel to the ground and requires less ground clearance than tilt & roll trackers. Wattsun's azimuth trackers provide nearly 270 degrees of rotational movement and can adjust from 5 to 75 degrees of elevation tilt.

The **AZ-125** gear drive, azimuth tracker comes standard as a single axis tracker with manual seasonal tilt adjustment. It is powered by a 24VDC drive motor running a high quality worm and gear drive. With the addition of the Dual-Axis Option (order separately), the AZ-125 can capture virtually all of the power the sun delivers. Mounts on a 6" Schedule 40 steel pole.

The **AZ-225** gear drive, azimuth tracker is for very large arrays. It can hold over 2kW of solar modules. It is powered by a 24VDC motor running a Heavy Duty Ball Bearing/ Worm Gear Drive. It comes standard with the Dual-Axis Option, enabling it to capture the maximum amount of solar energy. Mounts on a 8" OR 10" Schedule 40 steel pole. 10" poles will require an 8" section welded to top.

If your system voltage is not 24VDC, you will need a Wattsun Voltage Converter. See option chart below.

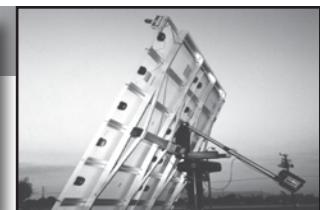

< Module	Module Quantity	Wattsun Drive	Dual Access	Steel Pipe ID	Ships Via	Item Code	Price
RWE ASE 300	1	TR-55	N/A	4"	UPS	14.7106	\$1,195
	2	AZ-125	Optional	6"	UPS	14.7109	\$1,345
	4	AZ-125	Optional	6"	Truck	14.7111	\$2,195
	6	AZ-225	Included	8"	Truck	14.7113	\$4,125
	8	AZ-225	Included	10" *	Truck	14.7108	\$4,995
Evergreen EC 115	1	TR-25U	N/A	2.5"	UPS	14.7330	\$595
	2	TR-25U	N/A	2.5"	UPS	14.7331	\$595
	4	TR-55	N/A	4"	UPS	14.7333	\$1,245
	6	AZ-125	Optional	6"	Truck	14.7335	\$1,975
	8	AZ-125	Optional	6"	Truck	14.7337	\$1,995
	10	AZ-125	Optional	6"	Truck	14.7339	\$2,495
	12	AZ-225	Included	8"	Truck	14.7341	\$4,125
	18	AZ-225	Included	10" *	Truck	14.7345	\$4,995
GE Energy 110	1	TR-25U	N/A	2.5"	UPS	14.7141	\$595
	2	TR-25U	N/A	2.5"	UPS	14.7143	\$595
	4	TR-55	N/A	4"	Truck	14.7145	\$1,245
	6	AZ-125	Optional	6"	Truck	14.7147	\$1,975
	8	AZ-125	Optional	6"	Truck	14.7149	\$1,995
	10	AZ-125	Optional	6"	Truck	14.7151	\$2,195
	12	AZ-125	Optional	6"	Truck	14.7153	\$2,495
	20	AZ-225	Included	10" *	Truck	14.7155	\$4,995
GE Energy 165	1	TR-25U	N/A	2.5"	UPS	14.7120	\$595
	2	TR-55	N/A	4"	UPS	14.7122	\$1,245
	4	AZ-125	Optional	6"	Truck	14.7124	\$1,995
	6	AZ-125	Optional	6"	Truck	14.7126	\$2,195
	8	AZ-225	Included	8"	Truck	14.7128	\$2,495
	12	AZ-225	Included	10" *	Truck	14.7132	\$4,495

Voltage Conversion to 24 VDC	Description	Item Code	Price
12-24 15W for 12V Battery	Required for 12 VDC AZ-125 Trackers. Not required for TR-25U or TR-55 Trackers on 12V	14.7118	\$125
48-24 LVC	Steps down 48V from battery or 36V from array to 24VDC for controller on TR-Series Tracker or AZ-125 Tracker.	14.7116	\$58
EQ-24/48-05	Steps down 48V from battery to 24V for controller. One required per three TR-Series, two AZ-125 or one AZ-225.	14.7114	\$250
EQ-24/48-10	Steps down 48V from battery to 24V. Will power four AZ-125 Trackers or 3 AZ-225 Trackers	38.8748	\$235
DR-4524 For Pumping	Accepts 120-370 VDC input to power tracker controller from a high voltage water pumping array. Needs to be mounted in a raintight box if located outside. Also accepts 115 or 230 volt AC for one AZ-125 Tracker.	14.7110	\$165
DR-120-24 (For Grid-Tie)	Accepts 115 or 230 VAC input to power tracker controller from the AC Grid when no back up battery bank is present. One required per two AZ-125 trackers or one AZ-225 Tracker. Needs to be mounted in a raintight box if located outside.	14.7115	\$165

WATTSUN TRACKERS - 37

< Module	Module Quantity	Wattsun Drive	Dual Access	Steel Pipe ID	Ships Via	Item Code	Price
ISOFO TON 165	1	TR-25U	N/A	2.5"	UPS	14.7973	\$595
	2	TR-55	N/A	4"	UPS	14.7975	\$1,245
	4	TR-55	N/A	4"	UPS	14.7977	\$1,295
	6	AZ-125	Optional	6"	Truck	14.7979	\$1,995
	8	AZ-125	Optional	6"	Truck	14.7981	\$2,195
	9	AZ-125	Optional	6"	Truck	14.7983	\$2,495
	12	AZ-225	Included	8"	Truck	14.7985	\$4,125
	16	AZ-225	Included	10" *	Truck	14.7987	\$4,995
Kyocera 80	2	TR-25U	N/A	2.5"	UPS	14.7423	\$595
	4	TR-55	N/A	4"	UPS	14.7425	\$1,195
	6	TR-55	N/A	4"	UPS	14.7427	\$1,295
	8	TR-55	N/A	4"	UPS	14.7429	\$1,345
	10	AZ-125	Optional	6"	Truck	14.7431	\$1,975
	12	AZ-125	Optional	6"	Truck	14.7433	\$1,995
	16	AZ-125	Optional	6"	Truck	14.7435	\$2,195
	24	AZ-225	Included	8"	Truck	14.7436	\$4,495
Kyocera 120 / 125	1	TR-25U	N/A	2.5"	UPS	14.7385	\$595
	2	TR-25U	N/A	2.5"	UPS	14.7387	\$595
	4	TR-55	N/A	4"	Truck	14.7389	\$1,245
	6	AZ-125	Optional	6"	Truck	14.7391	\$1,975
	8	AZ-125	Optional	6"	Truck	14.7393	\$1,995
	10	AZ-125	Optional	6"	Truck	14.7395	\$2,195
	12	AZ-125	Optional	6"	Truck	14.7397	\$2,495
	15	AZ-225	Included	8"	Truck	14.7394	\$4,195
	16	AZ-225	Included	8"	Truck	14.7396	\$4,295
	18	AZ-225	Included	8"	Truck	14.7399	\$4,495
20	AZ-225	Included	10" *	Truck	14.7398	\$4,995	
Kyocera 167	1	TR-25U	N/A	2.5"	UPS	14.7400	\$595
	2	TR-55	N/A	4"	UPS	14.7402	\$1,245
	4	TR-55	N/A	4"	UPS	14.7401	\$1,295
	6	AZ-125	Optional	6"	Truck	14.7403	\$1,995
	8	AZ-125	Optional	6"	Truck	14.7405	\$2,195
	9	AZ-125	Optional	6"	Truck	14.7406	\$2,495
	12	AZ-225	Included	8"	Truck	14.7407	\$4,125
	16	AZ-225	Included	10" *	Truck	14.7408	\$4,995
Sanyo 190	1	TR-25U	N/A	2.5"	UPS	14.7541	\$595
	2	TR-55	N/A	4"	UPS	14.7542	\$1,245
	4	TR-55	N/A	4"	UPS	14.7544	\$1,295
	6	AZ-125	Optional	6"	Truck	14.7546	\$1,995
	8	AZ-125	Optional	6"	Truck	14.7548	\$2,195
	9	AZ-125	Optional	6"	Truck	14.7549	\$2,495
	12	AZ-225	Included	8"	Truck	14.7552	\$4,125
	16	AZ-225	Included	10" *	Truck	14.7556	\$4,995

< Module	Module Quantity	Wattsun Drive	Dual Access	Steel Pipe ID	Ships Via	Item Code	Price
Sharp 185 / 175	1	TR-25U	N/A	2.5"	UPS	14.7648	\$595
	2	TR-55	N/A	4"	UPS	14.7649	\$1,195
	6	AZ-125	Optional	6"	Truck	14.7653	\$1,995
	8	AZ-125	Optional	6"	Truck	14.7655	\$2,195
	9	AZ-125	Optional	6"	Truck	14.7656	\$2,495
	12	AZ-225	Included	8"	Truck	14.7657	\$4,125
	16	AZ-225	Included	10" *	Truck	14.7658	\$4,995
Shell Solar 80 / 85	2	TR-25U	N/A	2.5"	UPS	14.7729	\$595
	4	TR-55	N/A	4"	UPS	14.7731	\$1,245
	6	TR-55	N/A	4"	UPS	14.7733	\$1,295
	8	TR-55	N/A	4"	UPS	14.7735	\$1,325
	12	AZ-125	Optional	6"	Truck	14.7739	\$1,995
	18	AZ-125	Optional	6"	Truck	14.7741	\$2,495
	24	AZ-225	Included	8"	Truck	14.7743	\$4,125
	28	AZ-225	Included	8"	Truck	14.7744	\$4,995
Shell Solar 165 / 175	1	TR-25U	N/A	2.5"	UPS	14.7716	\$595
	2	TR-55	N/A	4"	UPS	14.7717	\$1,195
	6	AZ-125	Optional	6"	Truck	14.7721	\$1,995
	8	AZ-125	Optional	6"	Truck	14.7723	\$2,195
	12	AZ-225	Included	8"	Truck	14.7727	\$4,125
	16	AZ-225	Included	10" *	Truck	14.7728	\$4,995
SunPower 90	2	TR-25U	N/A	2.5"	UPS	14.7829	\$595
	4	TR-25U	N/A	2.5"	UPS	14.7830	\$595
	6	TR-55	N/A	4"	UPS	14.7831	\$1,295
	8	TR-55	N/A	4"	UPS	14.7832	\$1,325
	10	AZ-125	Optional	6"	Truck	14.7833	\$1,975
	12	AZ-125	Optional	6"	Truck	14.7834	\$1,995
SunPower 210	1	TR-25U	N/A	2.5"	UPS	14.7843	\$595
	2	TR-55	N/A	4"	UPS	14.7844	\$1,245
	6	AZ-125	Optional	6"	Truck	14.7845	\$1,995
	8	AZ-125	Optional	6"	Truck	14.7846	\$2,495
	12	AZ-225	Included	8"	Truck	14.7847	\$4,495
	16	AZ-225	Included	10" *	Truck	14.7848	\$4,995
Uni-Solar 64	2	TR-25U	N/A	2.5"	UPS	14.7855	\$595
	4	TR-55	N/A	4"	Truck	14.7857	\$1,295
	8	AZ-125	Optional	6"	Truck	14.7861	\$1,995
	12	AZ-225	Optional	8"	Truck	14.7863	\$4,125

* These trackers require a larger than standard pole size. Consult your dealer for specific details.

38 - WIND POWER INFORMATION

DO YOU HAVE A GOOD SITE FOR WIND POWER?

Wind powered battery charging systems can be cost-effective if the average wind speed is nine miles per hour (mph) or more at the location of the wind generator. If you are using wind in combination with photovoltaic power, it may be cost effective if good wind is available only during part of the year. The power available from the wind is proportional to the cube of the wind speed. When the wind speed doubles, the power delivered is eight times as great. Most wind generators are designed to deliver maximum power at a wind speed of 30 mph. At 15 mph, they will deliver about 1/8 their rated power. A wind generator should be mounted at least 20 feet higher than any obstruction within 300 feet to avoid turbulence. You can expect the power output of a wind generator to decrease roughly 3% for every 1000 feet of elevation. That means that you'll get 70% of the power at 10,000 feet elevation.

Measuring Wind Speed

You can use one of the measuring devices on **page 39** to determine wind speed.

The Kestrel wind speed indicator works like a speedometer, displaying current wind speed, but does not record available wind power over time.

The Wind Watcher monitors historical data as well as wind speed so you can install it and let it record for several months to get an idea your location is a cost effective site for a wind system.

If you measure wind speed at ground level, you can expect about 1.5 times the wind speed 30 feet up, which equates to about three times the power. At 120 feet above the ground, wind speed will be twice what is measured at ground level and power output will be more than twice the output at 30 feet.

If you do not have a wind gauge, you can get a rough idea of wind speed from the table below.

Wind Speed (MPH)	Wind Effect
0-1	Smoke rises vertically
2-3	Direction of wind shown by smoke drift but not by wind vanes.
4-7	Wind felt on face; leaves rustle; ordinary wind vane moved by wind
8-12	Leaves and twigs in constant motion; wind extends a light flag
13-18	Raises dust, loose paper; small branches are moved
19-24	Small trees in leaf begin to sway; crested wavelets form on inland waters
25-31	Large branches in motion; whistling heard in power lines; umbrella use is difficult.

Towers

We do not recommend mounting wind generators on roofs. Though it is possible with a wind generator of 500 watts or less output, it will be noisy. Larger wind generators could cause severe damage to the building. Freestanding towers, guyed towers or guyed poles may be used with wind generators. Wind generators can be mounted on freestanding towers designed for antennas. They require a large, engineered concrete base for support, but since they do not require guy wires, they can be installed in the smallest space. Guyed steel truss towers, also designed for antenna mounting, are less costly and require a large area for guy wire placement. A tilt-up pole tower is the most economical and the easiest to install. Wiring and mounting of the wind generator are done before the tower is erected. No climbing is necessary. Steel tubing can be bought locally to save freight.

Wiring

It is important to avoid excessive loss of power from voltage drop in wire from the wind generator to the batteries. It is not necessary to use a wire size that minimizes voltage drop for maximum generator output. It will be more economical to choose a wire size that gives a 2% voltage drop at the average generator output for your site.

The Air403 has two wire DC output. Use the wire loss chart on page 158 to decide on wire size.

The Whisper wind generators have 3-phase AC output that is rectified to DC at the control box. Wire size can be smaller on these machines. Use a wire designed to carry the rated current of the generator you are using, but remember, three conductors are required. A wire sizing chart is provided in the owners manual.

WIND POWER - 39

Wind Watcher Data Logger

The WindWatcher 2 channel wind energy monitor provides basic wind speed, direction, and wind power density information in an easy-to-install, easy-to-use package.



Instantaneous and historical wind data are available at the touch of a button. The WindWatcher provides a professional quality, complete assessment. It records monthly wind speed average, monthly maximum wind speed, monthly average power density, monthly power density speed, and monthly wind direction average. Sensor mounts on a 1/2" diameter tube or Z mast below.

A 2 line x 20 character Liquid Crystal Display (LCD) and 4 navigation buttons allow the user to read and program the Wind Watcher via on-screen menus. It mounts into any US standard 2-gang electrical box or the included surface-mount enclosure with 4 screws and it operates on a single D-cell battery for one year. Weight 0.34 kg (0.75 pounds) Dimensions 11.9 cm x 11.9 cm (4.7 inches x 4.7 inches)

A 200P wind direction vane and Z mast can be ordered separately if wind direction measurement is desired.

Description	Item Code	Price
Wind Watcher	16.0231	\$425
200P Wind Direction Vane	16.0232	\$175
Z-mast with clamps	16.0233	\$25

Kestrel 1000 Pocket Wind Meter

The Kestrel 1000 measures instantaneous, maximum and average wind speeds. (Measurement unit options are knots, meters per second, kilometers per hour, miles per hour, feet per minute and Beaufort.) Measurement units can be changed at any time. Accurate, tough and affordable. Requires no setup. (Just hold it up to measure wind speed.) Large, easy-to-read liquid crystal display. Ultralight impeller turns on jewel bearings. Excellent accuracy (+/-3%). Measure down to 0.3 m/s. Impeller and protective housing pop out for easy and inexpensive replacement. Built to withstand daily use in tough outdoor conditions. Includes slip-on hard case that protects the impeller, buttons and display from damage in your pocket or toolbox. Completely waterproof and it floats. The replaceable battery provides 400 hours of use. 1 year warranty.



Description	Item Code	Price
Kestrel 1000 Pocket Wind Meter	16.0253	\$85
Kestrel 1000 Replacement Impeller	16.0255	\$19

Guyed Tower Kits and Accessories

Southwest Windpower has designed a series of tower kits for AIR and Whisper wind turbines. Each tower kit comes with all hardware necessary to install a tower, except guy supports, pipe and cement. The installation can take as little as half of a day without a crane or large foundation. All parts bolt or clamp together and no welding is required.

AIR Tower Kits

AIR Tower kits are available in roof mount, 27' (8.1m) and 45' (13.5m) heights. These kits are Professional Engineer Certified (PE Certified). Purchase 1-7/8" steel tubing from chain link fence supplier.

Roof mounts include vibration isolators, wall brace clamps and a safety leash, but do not include pole or lag screws.

Whisper 100/200 Tower Kits

Whisper 100/200 tower kits come in 24' (7.2m), 30' (9m), 50' (15m), 65' (19.5m), and 80' (24m) heights. These tower kits use 2-1/2" (63.5mm) CQ40 fence pipe or schedule 40 water pipe. Actual O.D. is 2.875" (73mm)

Whisper 500 Tower Kits

Whisper 500 Tower Kits are available in 30' (9.1m), 42' (12.8m) and 70' (21.3m) heights.

Earth Auger Sets

Screw-in "auger" type guy anchors can be used in loamy and gravelly soils. Other soil types may require concrete footings or expansion bolts. Use 36" and 48" augers with AIR and Whisper 100/200 installations and 48" and 60" augers on Whisper 500 installations. Consult an engineer or geologist if you have questions about guy supports.

	Description	Item Code	Price
AIR Tower Kits	Air Marine Tower Hardware kit	16.1128	\$169
	9' Air Marine Aluminum Mast and 2 Stays	16.1131	\$179
	Roof Kit without roof seal	16.1134	\$85
	Roof Kit with roof seal	16.1137	\$99
	Roof Seal - for Roof Mount Kit	16.1140	\$31
	27' AIR Guyed Tower Kit (AIR ONLY)	16.1086	\$139
	45' AIR Guyed Tower Kit (AIR ONLY)	16.1092	\$252
Whisper Tower Kits	Whisper 100 & 200 24' Guyed Tower Kit	16.1083	\$230
	Whisper 100 & 200 30' Guyed Tower Kit	16.1089	\$385
	Whisper 100 & 200 50' Guyed Tower Kit	16.1095	\$480
	Whisper 100 & 200 65' Guyed Tower Kit	16.1098	\$620
	Whisper 100 & 200 80' Guyed Tower Kit	16.1101	\$740
	Whisper 500 30' Guyed Tower Kit	16.1110	\$846
	Whisper 500 42' Guyed Tower Kit	16.1104	\$920
	Whisper 500 70' Guyed Tower Kit	16.1107	\$1,260
Guy Augers	36 Auger Set of 4 24' 27' Towers	16.1113	\$73
	36 Galvanized Auger Set of 4 - 24' 27' Towers	16.1116	\$145
	48 Auger Set of 4 32' - 50' Towers	16.1119	\$85
	48 Galvanized Auger Set of 4 32'-50' Towers	16.1122	\$170
	60 Galvanized Auger Set of 4 65'-80' Towers	16.1125	\$200

40 - SOUTHWEST WINDPOWER

AIR-X Land Wind Generators

The new AIR-X has a peak output of 400 watts at 28 mph (12.5 m/s) wind speed and is suitable for locations where wind speeds reach up to 100 mph. Carbon reinforced blades and a microprocessor based speed control result in quieter operation and improved battery charging capability. AIR-X is available in 12 and 24 volt versions. AIR403 is available in a 48 volt version. The housing is unpainted aluminum and the tower weight is 17 pounds. 3 year warranty.



AIR-X Marine Wind Generators

The AIR-X Marine is a corrosion-proofed version of the AIR-X Land, designed for coastal and nautical applications. A white powder-coated housing and sealed electronics prevent damage from salt spray. A 12 and 24 volt version is available. Weight is 17 pounds. 3 year warranty.

Description	Item Code	Price
AIR-X 12V Land	16.1032	\$680
AIR-X 24V Land	16.1035	\$680

Description	Item Code	Price
AIR-X 12V Marine	16.1050	\$875
AIR-X 24V Marine	16.1053	\$875
AIR Accessories	Item Code	Price
Stop Switch	16.1351	\$17

AIR Shutoff/Circuit Breaker

This interlocked pair of 60 amp circuit breakers protects wind generator-to-battery wiring and allows you to disconnect and stop the wind generator for service. UL listed breakers and NEMA 1 enclosure. For indoor mounting only. Can be used with all AIR-X and AIR403 wind generators.



Description	Item Code	Price
AIR Shutoff/Circuit Breaker	16.9003	\$100

AIR-Industrial Wind Generators

The Air-Industrial is capable of resisting the harsh environments that generally accompany mountaintop telecommunication sites, environmental monitoring sites and off-shore oil platforms. It has specially formulated blade material that can stand up to sub-zero temperatures and its blades are spaced further from the tower so that it can operate at sustained winds up to 130 miles per hour. Maintenance-free performance, easy installation and high power output make AIR-Industrial ideal for any remote battery charging application.

AIR-Industrial turbines do not have internal controllers. An external controller must be installed on the battery bank. The recommended external controller is a Xantrex C40 set in "diversion load" configuration and an air or water heating diversion load. The AIR-Industrial is available alone, or with a charge control and diversion load as a package.

3 year warranty.

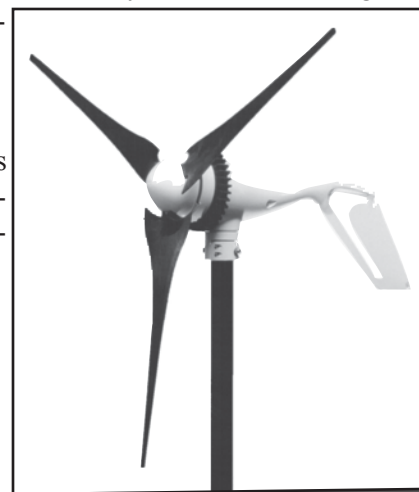

Description	Item Code	Price
AIR403 12V Industrial w/o control	16.1056	\$920
AIR403 24V Industrial w/o control	16.1062	\$920
AIR403 48V Industrial w/o control	16.1074	\$920
AIR403 12V Industrial Package	16.1059	\$1,150
AIR403 24V Industrial Package	16.1065	\$1,150
AIR403 48V Industrial Package	16.1077	\$1,150

WHISPER WIND GENERATORS - 41

Whisper 100 Wind Generator

The Whisper 100 is designed to operate in a site with medium to high wind speed averages of 12 mph and greater. With its brushless alternator and high efficiency composite airfoil blade design, it delivers 900 watts peak power at 28 mph (12.5 m/s). It can provide 100+ kWh per month, 3.4 kWh per day, in a 12 mph average wind speed location. The 100, with its 7 ft. (2.1m) rotor diameter and 40 sq. ft. swept area, is rugged enough for extreme environments. The 3-blade design lasts longer and is more stable in turbulent wind. The Marine version is sealed and powder-coated for use in coastal and nautical environments.

The Whisper 100 is shipped in a 24 volt configuration, but can easily be changed to 12, 36, or 48 volts by the installer. The included controller is adjustable for use with 12, 24, 36 and 48 volt battery systems and the voltage can be adjusted for any battery type. The control can be set to stop the blade from spinning when the battery is fully charged, avoiding wear when power is not needed.

Whisper 200 Wind Generator

The Whisper 200 is designed for the user who lives in low to moderate wind speed averages (less than 12 mph). The bigger brother to the 100, the 200 features a 10 ft (3.1m) 3-blade rotor diameter and an 80 sq. ft. swept area that provides the user with greater output at low wind speed averages. The 200 has twice the swept blade area, providing double the potential energy, compared to the 100. It delivers 1000 watts peak power at 28 mph (12.5 m/s), but has a higher output than the 100 at lower windspeeds.

The Whisper 200 is shipped in a 24 volt configuration, but can easily be changed to 12, 36, or 48 volts by the installer. The included controller is adjustable for use with 12, 24, 36 and 48 volt battery systems and the voltage can be adjusted for any battery type. The control can be set to stop the blade from spinning when the battery is fully charged, avoiding wear when power is not needed.



Description	Weight	Item Code	Price
Whisper 100 w/Charge Control 24V	73 lb.	16.1154	\$2,085
Whisper 100 Marine w/Charge Control 24V	80 lb.	16.1162	\$2,305
Whisper 200 w/Charge Control 24V	85 lb.	16.1180	\$2,490
Whisper 200 Marine w/Charge Control 24V	90 lb.	16.1189	\$2,822
Charge Control Display for 100/200	1lb.	16.1211	\$99
Wind Speed Sensor - Anemometer	2 lb.	30.3446	\$84

Whisper 500 Wind Generator

The Whisper 500 is a 3000-watt rated turbine that will deliver in excess of 500 KWH per month in a 12 mph wind. This machine has a 14-foot, 2 blade rotor providing 500 sq. ft. of swept area. It features a handmade fiberglass and foam core blade for smooth, high efficiency operation and low wind start-up. It also incorporates the patented "angle governor" design for quiet operation in high winds. The 500 is an excellent machine for village power projects, farms, ranches, back-up power and remote homes with large energy demands. The Whisper 500 comes in two boxes and is shipped truck freight.

The Whisper 500 is available in a 24 volt and a 48 volt version.

Description	Weight	Item Code	Price
Whisper 500 w/ Charge Control 24V	310 lb.	16.1143	\$7,095
Whisper 500 w/ Charge Control 48V	310 lb.	16.1149	\$7,095

Tech Tip

Whisper 100, 200 and 500 Wind Generators are shipped with a Whisper Charge Control that is specifically designed to optimize the performance of your Whisper Wind Turbine. When batteries are fully charged, the wind turbine automatically shuts down. The control has a "Selectable Silent Mode" setting that allows the user to select any specific period to automatically turn the wind turbine on or off.

This new control and all of the Whisper 100 and 200 wind generators are adjustable from 12v to 48v. Even if you change system voltage in the future, it's easy to re-configure the voltage in a few short steps.

An optional digital display may be added to the control to display total kilowatt hours, peak amps, peak and average wind speed to measure wind speed, optional wind speed sensor must be ordered.

42 - HYDROELECTRIC INFORMATION

HOW MUCH POWER CAN YOU GENERATE?

The amount of power available depends on the dynamic head, the amount of water flow and the efficiency of the turbine generator combination. To get an idea about available power in watts, **multiply the head in feet, times flow in GPM, times 0.18 times turbine efficiency.** Turbine efficiency ranges from 25% to 50%, with higher efficiency at higher heads. To get a rough idea, use 0.30 (representing 30%) as a multiplier for efficiency. The Harris Pelton turbines are well suited to higher head and lower flow situations. Flow is limited by nozzle size (a maximum 1/2"). With the Harris, adjustment to variable flows is as easy as switching a valve and dialing in the alternator. Harris turbines are now available with permanent magnet (PM) alternators. This option provides up to 50% efficiency. Higher flows are accommodated by the ESD Turgo Turbines. They can have nozzles of up to 1" diameter, and provide better efficiency at low heads. The HI-Power Hydros are ideal for sites where water is available at long distances from power needs. They generate 100+ volts AC that is stepped down and rectified at the batteries. This allows the use of relatively small wire for a distance of up to 10,000 feet. They can also deliver up to 3600 watts where higher power is needed.

Pipelines

A hydroelectric turbine operates from the pressure at the bottom end of a pipeline. This pressure, usually measured in pounds per square inch (PSI), is directly related to the head, or vertical distance from where the water goes into the pipe at the top of the pipeline, to the turbine located at the bottom of the pipeline. The pressure at the lowest point of a pipeline is equal to 0.433 times the head, (the vertical distance in feet). Pressure is important because it is a determining factor in how much power is available and what type of pipe is required. Polyethylene pipe can be used for pressures up to 100 PSI, PVC pipe is available with pressure ratings from 160 to 350 PSI and steel pipe can withstand 1000 PSI or more. Check with your local plumbing supplier for pipe ratings. Pipe diameter is very important. All pipelines will cause the water flowing in them to lose some energy to friction. The pipe must be large enough for the maximum quantity of water it will carry. The pressure at the bottom of a pipeline when water is not flowing is called **static pressure**. When water is flowing through the outlet or nozzle of the hydroelectric turbine, the pressure at the outlet is the **dynamic pressure** or running head. If you install a gate valve on the pipeline just above the turbine and a pressure gauge on a "T" fitting just above the gate valve, you will read the static pressure on the gauge when the valve is closed and the dynamic pressure when the valve is opened. The maximum power that can be delivered by a pipeline will occur when the dynamic pressure is approximately 2/3 of the static pressure. The actual flow rate of the water in a hydroelectric system is determined by the diameter of the nozzle. We will supply a turbine with the proper size nozzle for your site, depending on the head, flow, length and diameter of the pipe. We carry hydroelectric generators made by Energy Systems and Design, HI-Power Hydroelectric, and Harris Hydroelectric. Use the descriptions on the following pages to help determine which turbine will work best for your site and power requirements.

Let us help you design the system

If you think you have a suitable site, contact us and we will help you choose the best unit for your situation. Please provide us with the following information about your site when calling:

1. **Head** – The total vertical elevation from the place where the water enters the pipe to the point where the turbine will be located.
2. **Flow** – The number of gallons per minute that are available.
3. **Distance** – The length of pipe that will be necessary to carry the water from the pickup to the turbine. If the pipe is already installed what is the type and diameter?
4. **Location** – Distance from turbine to batteries.

Nozzle Selection

Power output of a hydroelectric generator is determined by the pressure of the water at the nozzle and the amount of water flowing out of the nozzle. The larger the nozzle, the greater the flow will be. The nozzle must also be sized small enough to keep your pipeline full and keep the speed of the water in the pipe below five feet per second. The **nozzle selection chart** on the next page shows water flow through various size nozzles at given pressures. Use this chart to determine what size nozzle and how many nozzles you need to accommodate the flow of water you have and to deliver the amount of power you need. A pressure gauge in the pipe feeding your turbine, installed before the shutoff valve, can help you check proper operation and diagnose problems. When the valve is shut off, the gauge will read the static pressure in pounds per square inch PSI (head in feet x .433). When the valve is turned on the gauge will read a lower (dynamic) pressure.

The difference between these two pressures represents your loss to friction in the pipe. The greater the flow, the greater your loss will be. (See pipe loss chart on the next page for PVC pipe.)

HYDROELECTRIC INFORMATION - 43

Water Flow Information for Pumping and Hydroelectric Design

Flow Through Nozzles

The chart below shows flow through various nozzles in GPM at a range of heads from 5 feet to 400 feet. Use chart to choose what nozzle size to use and how many nozzles a turbine must have to give the required flow to use all of the water available in the system.

Head		Nozzle Diameter											RPM for 4" Turbine
Feet	PSI	1/8"	3/16"	1/4"	5/16"	3/8"	7/16"	1/2"	5/8"	3/4"	7/8"	1.0"	
5	2.2	-	-	-	-	6.18	8.4	11	17.1	24.7	33.6	43.9	460
10	4.3	-	-	3.88	6.05	8.75	11.6	15.6	24.2	35	47.6	62.1	650
15	6.5	-	2.68	4.76	7.4	10.7	14.6	19	29.7	42.8	58.2	76	800
20	8.7	1.37	3.09	5.49	8.56	12.4	16.8	22	34.3	49.4	67.3	87.8	925
30	13	1.68	3.78	6.72	10.5	15.1	20.6	26.9	42	60.5	82.4	107	1140
40	17.3	1.94	4.37	7.76	12.1	17.5	23.8	31.1	48.5	69.9	95.1	124	1310
50	21.7	2.17	4.88	8.68	13.6	19.5	26.6	34.7	54.3	78.1	106	139	1470
60	26	2.38	5.35	9.51	14.8	21.4	29.1	38	59.4	85.6	117	152	1600
80	34.6	2.75	6.18	11	17.1	24.7	33.6	43.9	68.6	98.8	135	176	1850
100	43.3	3.07	6.91	12.3	19.2	27.6	36.6	49.1	76.7	111	150	196	2070
120	52	3.36	7.56	13.4	21	30.3	41.2	53.8	84.1	121	165	215	2270
150	65	3.76	8.95	15	23.5	33.8	46	60.1	93.9	135	184	241	2540
200	86.6	4.34	9.77	17.4	27.1	39.1	53.2	69.4	109	156	213	278	2930
250	108	4.86	10.9	19.9	30.3	43.6	59.4	77.6	121	175	238	311	3270
300	130	5.32	12	21.3	33.2	47.8	65.1	85.1	133	191	261	340	3590
400	173	6.14	13.8	24.5	38.3	55.2	75.2	98.2	154	221	301	393	4140

Pipe Loss Chart

Use the chart below to determine what pipe size is required to efficiently allow necessary flow for your power need. Once you know the required flow for your system (gpm), find the head loss for various pipe sizes. Multiply the head loss number by the length of the pipe divided by 100 and you will get the loss of head for that pipe size. The actual head minus the head loss will give you the effective head in the system.

Pipe Friction Loss Chart - Head loss in feet per 100 feet of Schedule 40 PVC pipe																								
		Flow (GPM)																						
		1	2	3	4	5	7	10	15	20	25	30	40	50	60	70	80	100	150	200	250	300	400	500
PIPE DIAMETER (Inches)	1/2	2.08	4.16	8.7	14.8	23.5	43																	
	3/4	0.51	1.02	2.2	3.7	5.73	10.5	20.1	42.5															
	1	0.1	0.55	0.68	1.15	1.72	3.17	6.02	12.8	21.8	32.9	46.1												
	1-1/4	0.03	0.14	0.19	0.31	0.44	0.81	1.55	3.28	5.59	8.45	11.9	20.2	30.5	45.6									
	1-1/2		0.07	0.08	0.13	0.22	0.38	0.72	1.53	2.61	3.95	5.53	9.43	14.3	20	28.6	36.7							
	2			0.03	0.05	0.07	0.11	0.21	0.45	0.76	1.15	1.62	2.75	4.16	5.84	7.76	9.94	15.1	34.8	59.3				
	2-1/2				0.03	0.04	0.05	0.09	0.19	0.32	0.49	0.68	1.16	1.75	2.46	3.27	4.19	6.33	13.4	25.0	37.8	46.1		
	3						0.02	0.03	0.07	0.11	0.17	0.23	0.4	0.6	0.85	1.13	1.44	2.18	4.63	7.88	11.9	18.4	40.1	
	4										0.04	0.06	0.11	0.16	0.22	0.3	0.38	0.58	1.22	2.08	3.15	4.41	7.52	
	5											0.03	0.04	0.05	0.07	0.1	0.13	0.19	0.4	0.69	1.05	1.46	2.49	3.76
6														0.02	0.03	0.04	0.05	0.08	0.16	0.28	0.43	0.6	1.01	1.53

44 - HYDROELECTRIC TURBINES

Harris Pelton Turbines

- Head Range: 20 to 600 feet
- Flow Range: 4 to 250 GPM
- Maximum 12-Volt Power: 700 watts
- Maximum 24-Volt Power: 1400 watts
- Maximum 48-Volt Power: 2500 watts

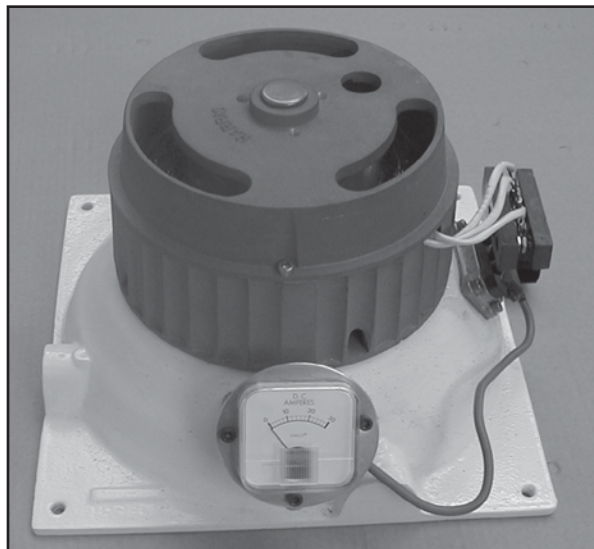

This hydroelectric battery charger uses a cast bronze pelton wheel and a heavy duty automobile alternator or a brushless permanent magnet alternator in a white powder-coated aluminum housing. They are available with one, two or four nozzles, depending on water flow and power requirements. (PVC manifold with one shut-off valve on two-nozzle machines and 3 shut-off valves on 4-nozzle machines is available) These turbines can be fitted with nozzles up to 1/2" in diameter. Each hydroelectric system is custom-built to match your site specifications. Please tell us your head, flow, pipe size and length, electrical transmission line length and battery voltage when ordering. Allow two to three weeks for delivery. The permanent magnet brushless alternator (PM) pictured above is 15-30% more efficient than the automotive alternator (HD), produces less heat and lasts longer. 1-year warranty.

Description	Item Code	Price
Harris HD 1 Nozzle 12/24V	17.1015	\$900
Harris HD 2 Nozzle 12/24V	17.1018	\$1,140
Harris HD 2 Nozzle 12/24V w /Manifold	17.1021	\$1,220
Harris HD 4 Nozzle 12/24V	17.1024	\$1,320
Harris HD 4 Nozzle 12/24V w/ Manifold	17.1027	\$1,495
Harris PM 1 Nozzle 12/24V	17.1030	\$1,695
Harris PM 2 Nozzle 12/24V	17.1032	\$1,800
Harris PM 4 Nozzle 12/24V	17.1034	\$1,950
Add for 48 volt operation for above	17.1036	\$200

HI-Power Hydroelectric Generators

- Head Range: 60 to 500 feet
- Flow Range: 10 to 400 gpm
- Maximum Power: 3600 Watts
- Efficiency: 30% to 60%
- Transmission Voltage: 110V to 440V
- Battery Voltage: 12V, 24V, 48V

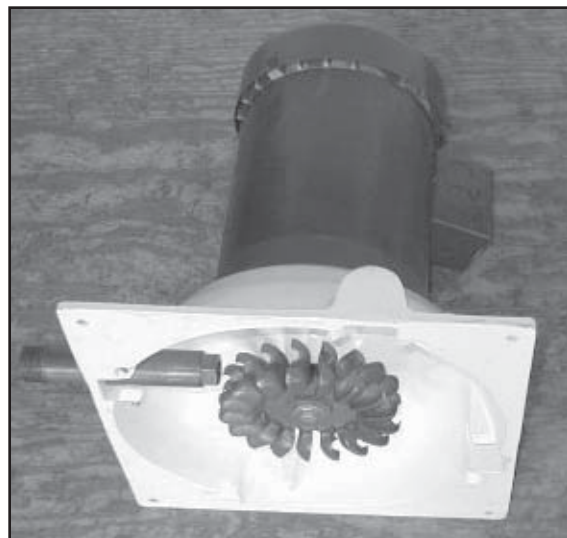

HI-Power Hydroelectric generators are ideal for sites where water is far from power needs (up to 10,000 feet), or when greater power is required. High transmission voltage can be sent over a mile before being 'stepped down' to battery voltage. It comes complete with step down transformer, rectifier, fuses and amp meter. Use a diversion type regulator with these units.

These hydroelectric generators use brushless alternators for reliability and versatility. They produce 110V, 220V, or 440V "wild" (unregulated) AC, which is then stepped down with the supplied transformer and rectifier. The heavy-duty brushless alternator is housed on the Harris housing and uses the Harris Bronze Pelton Wheel for flows up to 200 gpm and the ESD Turgo Wheel and housing for flows 200 to 400 gpm. Available in 4 sizes ranging from 600 to 3600 watts. The HV600 is available with 2 or 4 nozzles. The larger units come with 4 nozzles. 2 year warranty.

Description	Item Code	Price
HV 600 - 600 Watt 2 Nozzle	17.2025	\$2,500
HV 600 - 600 Watt 4 Nozzle	17.2028	\$2,600
HV 1200 - 1200 Watt 4 Nozzle	17.2030	\$3,000
HV 1800 - 1800 Watt 4 Nozzle	17.2031	\$3,500
HV 3600 - 3600 Watt 4 Nozzle	17.2034	\$5,000
HI-Power Turgo Option	17.2037	\$600

HYDROELECTRIC TURBINES - 45

ES&D Stream Engine Turbines

- Head Range: 5 to 200 feet
- Flow range: 10 to 400 GPM
- Maximum Power: 1000 Watts
- Voltage is user-set from 12 to 48 VDC

ES&D hydroelectric battery chargers use a cast bronze turgo runner to drive a long-life, brushless permanent magnet alternator. A simple change of wiring in the junction box allows this turbine to charge 12, 24, or 48-volt battery systems. These turbines come with cut-to-size nozzles that can be user-set for up to 1", allowing a very large flow in low head situations. They can operate on heads as low as five feet with a flow of 40 GPM.

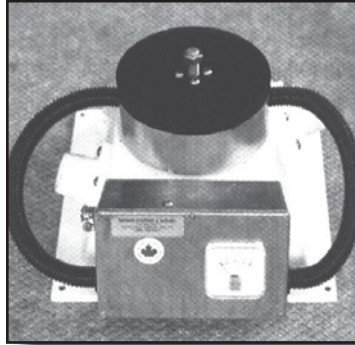

Description	Item Code	Price
ES&D 2 Nozzle Stream Engine	17.3241	\$1,895
ES&D 4 Nozzle Stream Engine	17.3244	\$2,045

ES & D Water Baby

- Head Range: 50 to 500 feet
- Flow range: 3 to 30 GPM
- Maximum Power: 350 Watts
- Voltage is user-set from 12 to 48 VDC

This new tiny turbine, a miniature version of the Stream Engine above, is ideal for sites with good head, but with very little flow. Two models are available; one for 12 to 48 volt charging and one for high voltage transmission. At 3 GPM and 100 feet of head, the Waterbaby will charge at 25 watts.



Description	Item Code	Price
ES&D 1 Nozzle Water Baby - 12 - 48V	17.3245	\$1,195
ES&D 2 Nozzle Water Baby - 12 - 48V	17.3247	\$1,315
ES&D 4 Nozzle Water Baby - 12 - 48V	17.3249	\$1,595
ES&D 1 Nozzle Water Baby - High Voltage	17.3252	\$1,195
ES&D 2 Nozzle Water Baby - High Voltage	17.3254	\$1,315
ES&D 4 Nozzle Water Baby - High Voltage	17.3256	\$1,595

ES&D's microhydro systems employ high efficiency, precision-cast parts, and non-corrosive alloys for long life and durability. A digital multimeter accompanies each turbine for measuring output amperage. These units can be used in stand-alone, or grid-tied systems.

ESD LH1000 Low Head Generator

- Head Range: 2 to 10 feet
- Flow range: 200 to 1000 GPM
- Maximum Power: 1000 Watts
- Voltage is user-set from 12 to 120 VDC

The LH1000 employs a brushless, permanent magnet alternator which is adjustable, enabling the user to match turbine output to electrical load. It has a higher efficiency than previous lowhead alternators, and is capable of outputs over 1 kW, while requiring virtually no maintenance.

The LH1000, like the Stream Engine, is designed to operate in conjunction with battery-based power systems. To gain enough head to operate the LH1000, water is channeled into a sluiceway. The turbine is mounted in a 7" opening in the sluice bottom, with the draft tube extending to the tailwater below. The water turns the propeller, creating shaft power. This, in turn, powers the generator, producing electricity.

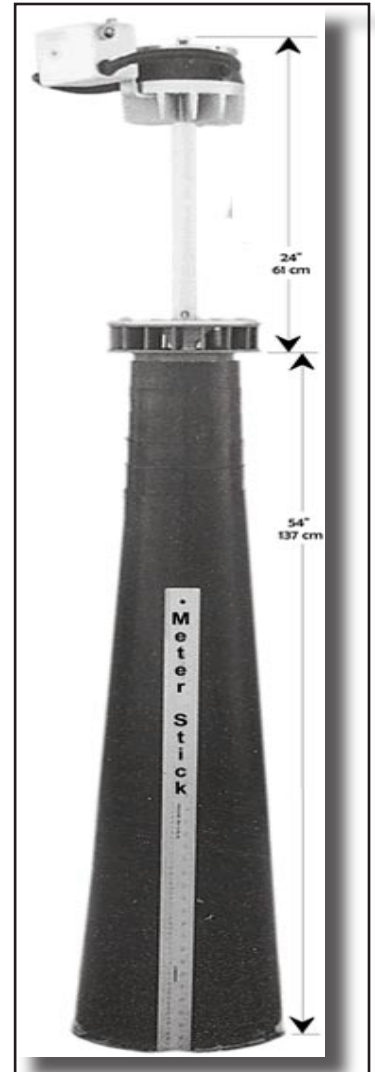

Description	Item Code	Price
ES&D LH1000 Low Head Hydro	17.3023	\$1,895

46 - OUTBACK MPPT CHARGE CONTROLLER

Maximum Power Point Tracking

Maximum Power Point Tracking (MPPT) allows a PV array to deliver up to 30% more power to a battery than it would if it were connected directly to the battery. This type of charge control costs more, but under certain conditions can be very cost-effective. A 20% power increase on a 1000-watt PV array is like getting 200 additional watts. At \$6 per watt, this is a savings of \$1200.

A photovoltaic (PV) array is a constant current device. The current (amps) from a PV module remains relatively constant over a wide range of voltage. For example a typical 75-watt module delivers 4.45 amps at up to 17 volts when the sky is clear and temperature is cool. Traditional PV controllers connect the PV array directly to the battery until it reaches a full charge voltage. When this 75-watt module is connected directly to a battery in a low state of charge it will begin charging at 12 volts. The PV panel still provides about the same current, but, because PV output voltage is lower, it can only deliver 53 watts to the battery. This wastes up to 22 watts or 30% of the available power. MPPT charge controls use this extra voltage to boost charging amps to the battery. Outback and Blue Sky charge controls also allow the use of an array voltage higher than the nominal battery voltage so smaller wire may be used.

Since the battery voltage rises when charging and the maximum power point of the PV module falls as it warms up, a 10 to 20% increase is more realistic. MPPT charge controls are most effective in cool climates and/or when the PV array is charging batteries that are at a low state of charge.

OutBack MX60 MPPT Charge Controller

Maximum power point tracking enables a PV system to achieve its highest possible performance. Rated for up to 60 amps of DC output current, the OutBack MX60 can be used with battery systems from 12 to 60 VDC with PV open circuit voltage as high as 140 VDC. The MX60's setpoints are fully adjustable to allow use with virtually any battery type, chemistry and charging profile. The OutBack MX60 allows you to use a higher output voltage PV array with a lower voltage battery - such as charging a 12 or 24 VDC battery with a 48 VDC PV array. This reduces wire size and power loss from the PV array to the battery/inverter location and can maximize the performance of your PV system. The OutBack MX60 comes standard with an easy to use and understand display of the PV system's performance. The four line, 80 character, backlit LCD display is also used for programming and monitoring of the system's operation. The OutBack MX60 can also be connected to the OutBack MATE system controller and display to allow monitoring of up to eight MX60 controllers from a distant location - up to 300 feet away. The MATE also includes an optoisolated RS232 port for connection to a PC computer for data logging and system monitoring.

Dimensions 14.5"H x 5.75"W x 5.75"D - Weight 12 lb.
2-year warranty - extended warranty available.

Outback Model	Description	Item Code	Price
MX60	Outback 60A MPPT Charge Control	20.2015	\$649
RTS	Remote Temperature Sensor with 20' cable	30.4190	\$29
MATE	System Control - Shipped with a 50ft cable	30.4180	\$295



BLUE SKY MPPT CHARGE CONTROLLERS - 47

Blue Sky Solar Boost MPPT Charge Controls

The Blue Sky Solar Boost features full reverse polarity protection, PWM charging and selectable charge voltage for flooded and gel lead-acid batteries. Output current limiting eliminates worry about overload or nuisance fuse blow when PV output is unexpectedly high. An equalize function is also included to periodically condition liquid electrolyte lead-acid batteries. An optional user friendly digital display is available to monitor PV charge performance. The display shows battery voltage, solar current, charge current and charge mode. It can be provided in the controller, as a remote panel installed up to 300' away, or both. Optional temperature compensation of charge voltage is also available to further improve charge control and battery performance. Selectable compensation curves support lead-acid and Ni-Cad batteries. Solar Boost controls available with or without a digital display and an optional remote display that can be mounted up to 300 feet from the control is also available.

3-year limited warranty.

Solar Boost 50L

This charge control can be used on 12 and 24 volt systems. It can also be used to charge a 12 volt battery from a 24 volt array. Maximum open-circuit PV array voltage is 57 VDC.

Solar Boost 6024H

The 6024H is designed for charging 12 or 24 volt batteries from 36, 48 or 60 volt PV arrays (maximum open circuit voltage is 140). This allows for a much smaller wire size between the array and battery in large systems. Maximum charge current is 60 amps at 12 or 24 volts.

Solar Boost 3048

SB3048 is designed to charge 24 and 48 volt battery systems from a 48 to 60 volt array (maximum open circuit voltage is 140). Maximum charge current is 30 amps output at 24 or 48 VDC.

NEW! Solar Boost 3024i

SB3024i is designed to charge 12 and 24 volt battery systems from a 24 volt array (maximum open circuit voltage is 57). Maximum charge current is 30 amps output at 12 or 24 VDC. The new IPN network interface coordinates multiple controllers and shares temp sensors and display.

Optional Equipment

A remote temperature probe and a remote digital display that can be mounted up to 300 feet away can be used with all of the Solar Boost controls. Optional shunts allow the digital displays to monitor other charging sources and loads.

Blue Sky SB2000E MPPT Charge Control

The Solar Boost 2000E provides a precision Multi-stage PulseWidth Modulation (PWM) MPPT charge control system to ensure the battery is properly and fully charged, resulting in enhanced battery performance with less battery maintenance. An equalize function is also included to periodically condition liquid electrolyte lead-acid batteries. A built in LCD digital display monitors solar charge performance. The display shows battery voltage, solar panel current and output charge current. You can actually see current boost working by noting the difference between solar panel current and output charge current. A charge status LED indicates the present charge mode, and shows when the battery has become fully charged. This 25-amp current boosting solar charge controller mounts in a 5-11/16" x 3-15/16" cut-out and is wired from the rear. 3-year limited warranty.



Model	Description	System Voltage	Charge Amps	Item Code	Price
SB50L	Charge Control	12 or 24	50	20.3140	\$432
SB50DL	Control w/ Digital Display	12 or 24	50	20.3137	\$514
SB50PDL	Front Cover w/ Digital Display for SB50L			20.3134	\$119
SB6024HL	Charge Control	12 or 24	60	20.3143	\$518
SB6024HDL	Control w/ Digital Display	12 or 24	60	20.3146	\$599
SB6024HPDL	Front Cover w/ Digital Display for SB6024HL			20.3147	\$119
SB3048L	Charge Control	24 or 48	30	20.3128	\$493
SB3048DL	Control w/ Digital Display	24 or 48	30	20.3125	\$575
SB3048PDL	Front Cover w/ Digital Display for SB3038L			20.3131	\$119
SB3024i	Charge Control	12 or 24	30	20.3155	\$299
IPNPRO-S	IPN ProRemote display w/ 500 amp shunt			20.3161	\$199
IPNPRO-S	IPN ProRemote display			20.3162	\$169
IPNREM	IPN Basic Remote - coming soon			20.3163	call
Model	Description of Optional Accessories			Item Code	Price
SB50RD25	Remote Digital Display w/ 25 ft. cable			20.3152	\$112
930-0022-20	Battery Temperature Sensor			20.3149	\$29
CS-100	Remote Shunt 100A/100mV			28.9245	\$30
506-0003-01	Remote Shunt 500A/50mV			28.9253	\$30



Description	System Voltage	Charge Amps	Item Code	Price
SB2000E Charge Control	12	25	20.3122	\$236
Wall Mount Box			20.3119	\$30
Temperature Sensor w/ 20 ft cord			20.3149	\$30

48 - MORNINGSTAR CHARGE CONTROLS

Morningstar TriStar Charge Controllers

The TriStar pulse width modulated (PWM) controller can operate as a solar charge control, a load control, or a diversion regulator in 12, 24 or 48 volt systems. It can operate in only one of these modes at a time, but two or more controllers can be used to provide multiple functions. PWM operation may be changed to on/off operation to prevent telecom noise. Two models are available with UL current ratings of 45 and 60 amps. A choice of 7 different setpoints are easily selectable with DIP switches. An RS-232 communications enables PC connection to adjust control setpoints and data logging. An optional digital display may be mounted on the front of the controller or up to 100 feet away using 4-conductor phone cable with RJ-11 jacks. Battery temperature compensation may be added with the optional temperature sensor. Knock-outs on the bottom of the charge control match knock-out spacing on the Xantrex DC-175/250 disconnect and the Outback PS2DC and PS4DC power system components, allowing easy mounting on either.

Dimensions: 10.25"H x 5"W x 2.8"D, weight is 3.5 lb..

5-year warranty. UL Listed

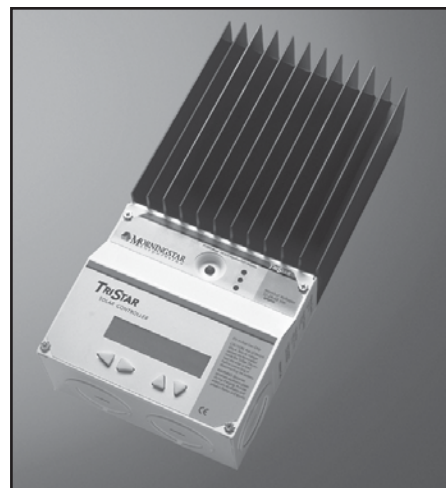

Model	Description	System Voltage	Charge Amps	Item Code	Price
TS-45	Tristar 45 Charge Control	12, 24 or 48	45	20.1105	\$169
TS-60	Tristar 60 Charge Control	12, 24 or 48	60	20.1108	\$218
RTS	Battery Temperature Sensor			20.1141	\$32
TS-M	Digital Display mounts on front of Charge Control			20.1113	\$99
RM	Remote Display with 100 ft. cable			20.1115	\$136

Morningstar ProStar Charge Controllers

Recently revised, this sophisticated line of PV charge controls incorporates constant voltage PWM to make maximum use of valuable PV power. They have automatic equalization, temperature compensation and very high efficiency. Can be used on 12, 24 and 48 volt systems with sealed, gel and wet-cell lead-acid batteries. Front panel LED's indicate when the batteries are being charged and relative battery state-of-charge. Reverse polarity protection on input and output. In the event of a load short circuit, the load is automatically disconnected. "M" models include LCD meter of battery voltage, PV charging current, and load current. LVD is current-compensated to prevent false disconnect when the battery is heavily loaded. Units are conformal coated to guard against corrosion.

Dimensions: 6.01" x 4.14" x 2.2". 5 year warranty.



Model	Description	System Voltage	Charge Amps	Item Code	Price
PS-15	ProStar 15	12 or 24	15	20.1120	\$112
PS-15M	ProStar 15 w/ Digital Display	12 or 24	15	20.1123	\$179
PS-15M-48V	ProStar 15 48Volt w/ Display	48	15	20.1126	\$222
PS-15M-48-PG	48Volt w/ Display & Positive Ground	48	15	20.1129	\$239
PS-30	ProStar 30	12 or 24	30	20.1132	\$152
PS-30M	ProStar 30 w/ Digital Display	12 or 24	30	20.1135	\$219
PS-30M-PG	30 w/ Digital Display & Positive Ground	12 or 24	30	20.1138	\$236
RTS	Battery Temperature Sensor			20.1141	\$32

MORNINGSTAR CHARGE CONTROLS - 49

Morningstar SunSaver Charge Controls

The SunSaver is a very reliable charge controller and uses the same battery charging algorithm as the ProStar and offers many of the advantages of the ProStar for smaller systems, at a reduced cost. Constant voltage pulse width modulation (PWM) charging is a proven advance compared to the common on/off PV regulators. SunSavers are field-selectable for sealed or flooded batteries. A rugged anodized aluminum case and epoxy encapsulated electronics ensure durability and longevity. A temperature compensation sensor in the charge control varies full charge voltage with temperature. They have LED charging and load control indicators in LVD models. 5-year warranty. Dimensions: 6" x 2.2" x 1.3".



Model	Description	System Voltage	Charge Amps	LVD Amps	Item Code	Price
SS-6-12V	SunSaver 6	12	6	No	20.1245	\$48
SS-6L-12V	SunSaver 6 w/ LVD	12	6	6	20.1248	\$59
SS-10-12V	SunSaver 10	12	10	No	20.1230	\$55
SS-10L-12V	SunSaver 10 w/ LVD	12	10	10	20.1233	\$70
SS-10L-24V	SunSaver 10 w/ LVD	24	10	10	20.1236	\$76
SS-20L-12V	SunSaver 20 w/ LVD	12	20	20	20.1239	\$95
SS-20L-24V	SunSaver 20 w/ LVD	24	20	20	20.1242	\$101

Morningstar SunLight Charge Control with Lighting Control

The SunLight has all of the features of the SunSaver control. It also has a rotary switch that allows it to turn on the loads after dusk for 2, 4, 5, 8, or 10 hours. It also has the option to turn loads on at dusk, off and on again before dawn. In this configuration, you can choose the following settings (in hours): 3/off/1, 4/off/2, or 6/off/2. On from dusk to dawn is also possible. A test button turns light on for five minutes. Five year warranty. Dimensions: 6.6" x 2.2" x 1.3".

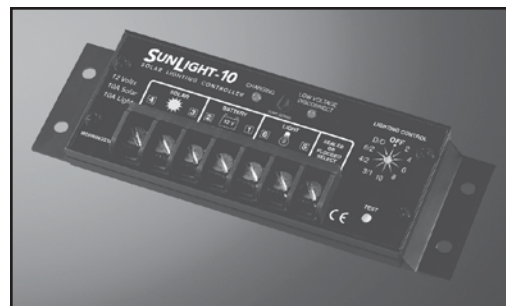

Model	Description	System Voltage	Charge Amps	LVD Amps	Item Code	Price
SL-10L-12V	SunLight w/ LVD	12	10	10	20.1218	\$108
SL-10L-24V	SunLight w/ LVD	24	10	10	20.1221	\$116
SL-20L-12V	SunLight w/ LVD	12	20	20	20.1224	\$141
SL-20L-24V	SunLight w/ LVD	24	20	20	20.1227	\$148

Morningstar SunGuard Charge Control

The SunGuard uses the same charging circuit as the SunSaver. It is ideal where a 12-volt low-power control is needed. It can control up to 75 watts of PV module(s). Since it is epoxy encapsulated, it can be used outdoors in a harsh environment. Dimensions are 2.5" x 2" x 1.6" with wire leads for connecting module and battery. 5-year warranty.

Model	Description	System Voltage	Charge Amps	LVD Amps	Item Code	Price
SG-4	SunGuard	12	4.5	No	20.1215	\$30



50 - XANTREX CHARGE CONTROLS

Xantrex C-35, C-40 and C-60 PWM Controllers

The Xantrex C-35, C-40, and C-60 PWM controllers can be used as PV charge controls, DC load controls or DC diversion regulators in 12, 24 and 48* volt systems. They operate in only one mode at a time, so to provide both PV charge control and low battery load disconnect, two controls must be used. As DC load controls they disconnect the load at a user settable low voltage and reconnect at a higher voltage reconnect point. As diversion controllers they send excess power to a “dummy load” such as a water or space heater to regulate hydroelectric or wind generators. All of the Xantrex controllers, when used as a charge control, have field-adjustable bulk and float setpoints and perform automatic equalization every 30 days or whenever LVD is reached. Equalization can be manually initiated with automatic shut-off. Order the optional temperature sensor for more accurate battery charge control. The optional LCD Digital Display shows battery voltage, array amps and watts, cumulative amp-hours and a separately resettable “trip” amp-hour measurement. The digital display is available for mounting on the front of the charge control, or with a 50 or 100 foot cable for remote mounting in a double-gang electrical box. UL-listed. 2-year warranty.



*Only the C40 can be used in 48 volt systems.

Model	Description	System Voltage	Max PV Amps	Item Code	Price
C-35	Charge Control	12 or 24	35	20.8004	\$119
C-40	Charge Control	12, 24 or 48	40	20.8005	\$159
C-60	Charge Control	12 or 24	60	20.8009	\$199
BTS/15	Battery Temperature Sensor with 15 foot cable			20.8025	\$29
BTS/35	Battery Temperature Sensor with 35 foot cable			20.8029	\$32
CM	Digital Display mounts on front of charge control			20.8016	\$99
CMR50	Remote Display with 50 foot cable			20.8019	\$126
CMR100	Remote Display with 100 foot cable			20.8017	\$146

Xantrex C-12 Charge / Lighting Control

The Trace C-12 controller is PWM microprocessor based and ideal for small village power systems, vacation homes, outdoor area lighting, sign lighting, and bus shelters. It has a 12 amp low voltage disconnect and an automatic lighting control. The lighting control turns the light on at dusk, then has an adjustable duration timer for 2 to 8 hours of run time, or can be set to run all night. If the battery gets low, lights are turned off. User-adjustable LVD set points. Dimensions: 6.5” x 4.3” x 1.5”. UL-listed. 2-year warranty.

For use in 12 volt systems only. Can be mounted outdoors.

Model	Description	System Voltage	Max PV / Load Amps	Item Code	Price
C-12	Charge Control / Lighting Control	12	12 / 12	20.8002	\$110



CHARGE AND GEN START CONTROLS - 51

SCI RV Charge Controllers

These charge controllers are designed for the RV market where thousands are used every year by motorhome manufacturers. They are designed to flush-mount in a rectangular cut-out. They have a digital amp and volt meter for accurate information and an LED bar graph display for at-a-glance battery status. Charging is set to stop at 14.4 volts and resume at 13.0, but the full charge level can be adjusted by turning a small screw on the back of the circuit board. Terminal strip on back of unit accepts up to 10 AWG stranded wire.

or off. The Shell RV20, manufactured for Shell by Specialty Concepts has the fuse holders on the front panel. There is no switch for the digital meter. The meter automatically switches between amps and volts so you just have to watch for a few seconds to get both readings. The optional black anodized aluminum box can be used to surface-mount this control on a wall. Knock-outs are provided for wiring.

Dimensions: 7.5"W x 4.25"H x 1.5"D. 5-year warranty.

Model	System Voltage	Charge Amps	Item Code	Price
Mark15/12	12	15	20.4215	\$119
Mark22/12	12	22	20.4217	\$129
Shell RV20	12	20	20.4223	\$80
Surface Mount Box			20.4211	\$25



GENERATOR START CONTROLS

Automatic Generator Start Control by Battery Voltage

The Solar Converters GS2-AC automatically controls starting and stopping of generators used as back-power sources in off-grid systems. It starts the generator when battery voltage drops below the low setpoint. When the battery gets to the high setpoint the GS-2 stops the generator. It supports 2, 3 and 4 wire systems as well as advanced control systems. The setpoints can be adjusted for 12, 24 or 48 volt battery systems. Circuitry can operate between 10 and 63 volts DC. The generator may be remotely started by a single pole switch or any dry contact closure. A 5 second time delay on voltage sensing prevents false triggering during motor starting surges. Circuit uses less than 20 mA when not starting generator. Optional temperature sensor allows the voltage setpoints to be temperature compensated. NEMA-3R raintight enclosure 10" x 8" x 4". 1-year warranty .

Solarcon Model	Description	Item Code	Price
GS-2	Automatic Generator Start Control	20.6239	\$365

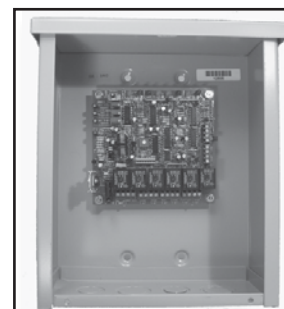

Generator Start Control Module

The GSCM is a micro-processor based generator starting controller that receives start commands from the 12 volt output from an Outback FX inverter aux relay, a user supplied switch, an auxiliary relay in an inverter, a voltage controlled relay, a timer or any user-supplied contact closure and automatically controls a gas/propane or diesel powered generator or pump. It is totally sealed for harsh environment operation.

The GSCM provides contact signal relays to start the engine and disconnect the starter when a minimum generator frequency output

flashed to indicate the cause of the shutdown. Manually resetting the GSCM removes the lockout and allows the generator to restart if called. The GSCM is powered by 12 to 24V DC from a battery bank and will start generators for 12 to 48V systems. For 48V systems the GSCM must be powered by a 24V or less tap on the 48V battery bank. The GSCM provides a 30 day exercise function which can be synchronized with a photovoltaic input to only start each 30 day period at the beginning of the solar charge day. A user supplied DC relay can be energized during the 30 day generator exercise to override a battery charge controller and allow the battery bank to equalize by charging the batteries above the normal charger cut-off point during the exercise period. 2-year limited warranty. Dimensions are 5.5" x 3.3" x 1.5".

Model	Description	Item Code	Price
GSCM	Generator Start Control Module	20.6341	\$285

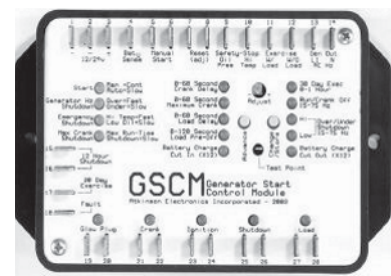

52 - LOAD DIVERSION

Diversion Load Information

In most hydroelectric and wind-powered battery charging systems, the charging source cannot be disconnected from the batteries while running without the possibility of damaging them from over-voltage.

The typical way to regulate battery charging voltage with this type of generating system is to use a "load diversion" type charge control. The Morningstar TS45 and TS60 and the Xantrex C-35, C-40 and C-60 can be configured for this mode of charge control. A diversion-type charge control also may be used in a PV system. If the array is much larger than necessary to charge the battery, excess power can be used to heat water by using a water heating diversion load.

In operation, when battery voltage reaches the full charge setting in the charge control, it begins to divert power to the diversion load. The control uses pulse width modulation to turn the load on just enough to keep the battery voltage from rising further. To determine wattage of these diversion loads at other voltages, use Ohm's Law formula: **Voltage = Amps x Ohms**

The critical requirements are that the diversion load can dissipate more watts than the charging source can deliver, and that the maximum amperage that the load can draw is smaller than the maximum diversion rating of the charge control. Order one or more loads with a total current (amps) draw greater than your charging system's maximum output, but no more than the maximum power rating of the charge control in the diversion mode. We recommend that you do not use a load that draws more than 75 percent of the maximum rating of the charge control. For example, if the charging source can deliver 20 amps at 24 volts, use a 30 amp diversion load with a 40 amp or larger charge control.

Low Voltage Water Heating Element

These low-voltage water-heating elements are for use as diversion loads for wind or hydroelectric systems. Use one or more of these heating elements with a charge control designed for load diversion, such as the Xantrex C40 or C60, Morningstar TS-45 or TS-60 or the Outback MX-60 to turn your excess power into hot water. They fit most standard electric water heaters with screw-in elements. We have one model for 12 volt and 24 volt systems and another for higher power 24 volt systems and 48 volt systems. Each unit has two elements that can be wired in series or parallel or used individually, depending on voltage and desired amp draw. See the chart to determine what each element will draw at various charging voltages.

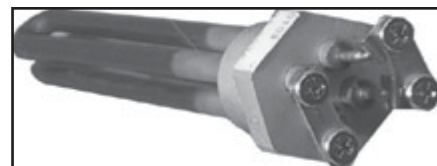

If your water heater tank is designed for square flange elements, use one square flange adapter for each element. 1" male pipe threads. 2-year warranty.

Regulation Voltage >			14.00		28.00		56.00		Item Code	Price
Model	Wiring	Ohms	Amps	Watts	Amps	Watts	Amps	Watts		
12v / 24v	Series	0.96	14.6	204	29.2	817			21.9275	\$90
	Single	0.48	29.2	408						
	Parallel	0.24	58.3	817						
24v / 48v (12v also)	Series	2.48	5.6	79	11.3	316	22.6	1265	21.9279	\$90
	Single	1.24	11.3	158	22.6	632				
	Parallel	0.62	22.6	316	45.2	1265				
Square Flange Element Adapter									21.9285	\$12

Air Heating Diversion Loads

These resistive loads enclosed in vented aluminum boxes can be used in 12, 24 and 48 volt diversion regulation systems. The aluminum box may get very hot in operation. It should be mounted at least 12" from any flammable material.

HL-100 is shipped as a 4-ohm resistor and can be reconfigured as a 1, 0.5 or 0.25 ohm resistor by easily changing connections in the terminal block.

HL-75 is shipped as a 3-ohm resistor and can be reconfigured as a 0.75-ohm resistor by changing connections in the terminal block. See chart below for diverted amps at various voltages. Warranty: 2 years.



Model Number	Resistance Setting	Diversion Load Amps at Volage Below						Item Code	Price
		14V	15V	28V	30V	56V	60V		
HL-100	0.5/0.25	28/56	30/60					21.9330	\$235
	1 ohm	14	15	28	30				
	4 ohms	3.5	3.8	7	7.5	14	15		
HL-75	0.75 ohms	19	20	38	40			21.9335	\$235
	3 ohms	4.7	5	9.3	10	19	20		

VOLTAGE SWITCHES AND RELAYS - 53

Voltage-Controlled Switches

These are user-adjustable voltage activated relays with SPDT (single pole, double throw) contacts rated for 30 amps. The relay coil in the "Active-High" version is powered when the voltage rises to the high set-point. The relay in the "Active-Low" is powered when voltage drops to the low set point. The SPDT relay allows the voltage controlled switch to either connect or disconnect a circuit when it operates or to turn one thing on while turning another thing off.

Voltage settings are user-adjustable and can be read with a voltmeter. An active high relay can be used as a DC pump controller, a diversion load control or to operate a large relay for a high powered charge control. An active low can be used as a 2-wire generator start control or as a low battery voltage load disconnect. These devices consume 17mA when off. Maximum switched current is 30A at 12/24VDC, 3A at 48VDC. VCS-1 measures approx. 3"x5.3"x1.75".

VCS-2 comes in a 5"x7"x2" enclosure.

One year warranty.

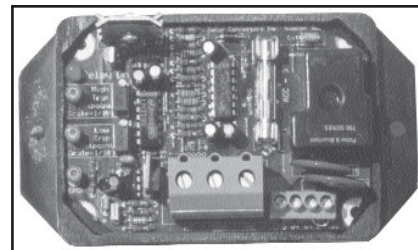

Model	Mode of Operation	Enclosure	Item Code	Price
VCS-1AH	Active High	No	20.6218	\$96
VCS-2AH	Active High	Yes	20.6215	\$118
VCS-1AL	Active Low	No	20.6221	\$96
VCS-2AL	Active Low	Yes	20.6224	\$118

SPDT 12V 40A Relay

These single pole, double throw 40 amp enclosed relays are widely used in the automotive industry. Wires may be attached with 1/4" quick connect terminals or the relay socket below may be used. Nominal operating current is 140mA. Relay socket has 2 feet of wire.

SPST N.O. 12V 75A Relay

This enclosed single pole, single throw relay has one set of contacts that close when power is applied to the coil terminals. It can be used to turn on 12 volt loads of up to 75 amps. Power terminals are 10-32 screws and coil terminals are 1/4" quick disconnects. 300mA is nominal operating current.

DPDT 30A Relays

These double-pole, double-throw relays can be used for up to 30 amps at 12 or 24 volts DC or 120/240 volts AC. All contact surfaces are silver alloy with gold flashing. Contact terminals are #8-32 screws and coil terminals are #6-32 screws. Relays with 120 VAC or 240 VAC coils can be used to build simple transfer switches. Relays with DC coils can be used for remote operation of pumps and fans. By connecting a relay with a DC coil to a voltage controlled switch (page 49) AC or DC loads may be turned on or off based on battery voltage levels.

Battery Isolator Relay

This relay is designed to isolate a second battery in a vehicle. The contact terminals are connected between the positive terminal of the starting battery and the positive terminal of the second battery. The negative terminals of both batteries are connected to the vehicle chassis. One of the coil terminals is connected to chassis ground and the other coil terminal is connected to the ignition switch or fuse box. When the vehicle is running, both batteries are connected together in parallel and being charged by the alternator. When the ignition switch is off, the contacts are open, disconnecting the second battery from the vehicle electrical system. 80 Amp maximum continuous current. 12 volt coil.

Description	Coil Current	Item Code	Price
40 A SPDT 12V Relay	140 mA	53.8290	\$8
Relay Socket for 40 A relay		53.8291	\$4
75 A SPST Relay	300 mA	53.8293	\$18
DPDT 30A Relay - 12VDC coil	170 mA	53.8281	\$40
DPDT 30A Relay - 24VDC coil	53 mA	53.8287	\$40
DPDT 30A Relay - 120VAC coil	83 mA	53.8278	\$40
DPDT 30A Relay - 240VAC coil	42 mA	53.8284	\$40
Dual Battery Isolator Relay		53.8272	\$20

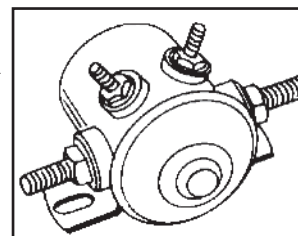
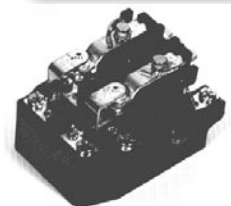

54 - INVERTER INFORMATION

Stand-Alone Inverters



Stand-Alone Inverters convert DC power stored in batteries to AC power that can be used as needed. Select an inverter for your power system based on the maximum load you will be powering, the maximum surge required, AC output voltage required, input battery voltage and optional features needed. High quality stand-alone inverters are available in sizes from 100 watts, for powering notebook computers and fax machines from your car, to 60 kilowatts, for powering a commercial operation. The size of an inverter is measured by its maximum continuous output in watts. This rating must be larger than the total wattage of all of the AC loads you plan to run at one time. Wattage of most AC loads can be determined from a tag or label on the appliance, usually located near where the power cord enters, or from the owner's manual. If the inverter is expected to run induction motors, like the ones found in top loading washers, dryers, dishwashers and large power tools, it must be designed to surge, or deliver power many times its rating for short periods of time while these motors start. Stand-alone inverters are available with two basic power output waveforms: modified square wave (often called modified sine wave) and sine wave. Intertie, multifunction inverters and utility companies deliver a sine wave. Xantrex DR series and Samlex PSE inverters have modified square wave output with harmonic distortion of around 40%. They are an economical choice in power systems where waveform is not critical. Their high surge capacity allows them to start large motors while their high efficiency makes them economical with power when running small loads like a stereo or a small light. They can power most lighting, televisions, appliances and computers very well. Unfortunately, this type of inverter may destroy some rechargeable tools and flashlights, and laser printers and copiers. They may not allow many laser printers, copiers, light dimmers and some variable speed tools to operate. Equipment with silicon controlled rectifiers (or SCRs) will not operate. Some audio equipment will have a background buzz that may be annoying to music connoisseurs.

Exeltech, Xantrex SW Series, SMA Sunny Island and Outback FX inverters are sine wave inverters. Sine wave inverters have a higher cost, but they can operate almost anything that can be operated on utility power. Exeltech sinewave inverters are an excellent choice for power systems running audio or telecommunications equipment and other electronics that are waveform-sensitive. The Outback and Xantrex SW series

inverters can be ganged together for up to 36 kW of output and can operate off-grid or intertied. We now carry Samlex Sine Wave PST inverters for a lower cost, small system Sine Wave alternative.

Utility-Intertie Inverters

Intertie inverters convert DC power from PV modules into AC power to be fed into the utility grid. There are two major types of utility inverters; string inverters and low voltage input inverters.

The SMA Sunny Boy, Fronius and Xantrex GT-3 inverters are string inverters. The name "string" comes from the way the PV modules are wired together, in series to achieve a higher voltage. These inverters are designed to run at voltages up to 600 VDC. String wiring is faster to install, more efficient and allows the use of smaller gauge wire. DC voltage this high can be deadly, so string inverters should be installed and serviced by qualified electricians.



A utility-tie PV system uses the utility company as a storage battery. When the sun is shining, your electricity comes from the PV array, via the inverter. If the PV array is making more power than you are using, the excess can be sold to the utility (power company) through your electric meter. If you use more power than the PV array can supply, the utility makes up the difference. This type of system makes the most sense if you have utility power, because there are no batteries to maintain or replace. Unfortunately, if the utility power goes down, this type of inverter will go off, too.

Multifunction Inverters

Using a multi-function inverter allows you to sell excess power to the utility, and also maintain a battery bank for standby power in the event of a utility power failure. The Outback GFX and Xantrex SW series are primarily stand-alone inverters that can function as an intertie inverter at the same time, but with a slightly lower efficiency than an inverter designed for intertie only. The new Beacon Power M5



INVERTER INFORMATION - 55

is an intertie inverter that is designed to provide battery backup when the utility fails. The SMA Sunny Island inverter is designed to work with a Sunny Boy inverter to provide utility intertie with battery backup.

In a typical installation, the inverter is connected to a battery bank, the utility power lines, a standby generator and the house load center. If the utility is available, the inverter will supply the house loads from the utility. If the utility fails, the inverter will supply power to the loads from the battery.

When the utility is available again, the inverter will switch the loads back to the utility, and recharge the batteries. If the batteries become fully charged by another power source, such as photovoltaic modules or a wind or hydroelectric generator, excess power may be sold back to the utility.

Output Voltage

We sell inverters that supply standard 120VAC 60 HZ (and stacked inverters for 240VAC), such as one gets from utility companies and fuel-powered generators. Most of them can be special ordered with other output voltages and frequencies for use anywhere in the world. See our export models and contact us with any special requirements that you have.

Interference

The electronic circuitry in inverters may cause problems with radio and television reception, noise on telephones and buzz in audio equipment. Sine wave inverters cause the least amount of interference. Interference can be minimized by locating the inverter very close to the batteries, twisting together the cables that connect the inverter to the battery, running AC lines separate from other wiring (such as telephone wires) and locating the inverter away from appliances that are susceptible to interference. All inverters cause interference on AM radio!

Wiring Considerations

Stand-alone inverters require very high current from a battery to operate large loads. A 2000 watt inverter running at full power in a 12 volt system will be drawing nearly 200 amps from the battery. Large cables and good connections are required for proper operation.

Use caution when plugging a small inverter into a lighter outlet located far from a battery. Typical DC house wiring may have insufficient wire sizes and too much voltage drop to supply the current required by these inverters. All battery based inverters require proper fusing between the battery and the inverter.

Xantrex GT3.0 Grid Tie Inverter

The Xantrex GT 3.0 Inverter has an integrated, lockable 600 volt PV/Utility disconnect switch which may eliminate the need for external disconnects in some locations. Its attached wiring box provides protection for all AC and DC connections, eliminating exposed wiring during inverter installation and removal. The wiring box includes eight 3/4 inch knockouts and easy access DC and AC terminal blocks that accept wire sizes from #14 to #6 AWG.

The GT 3.0 is packaged in a NEMA 3R enclosure for outdoor installation. It incorporates a slotted, hook-style back plate. For large systems, multiple inverters can be mounted side by side centered on standard 16" stud spacing to reduce visible conduit and make installations look more attractive.

GT inverters come standard with a backlit 16-character two line Liquid Crystal Display. The display provides inverter power, daily and lifetime energy production, PV array voltage and current, utility voltage and frequency, time online "selling" today, fault messages, and two installer customizable screens. Tapping a finger close to the LCD activates the backlight display. With each tap, the display cycles through all the communication screens. The LCD is always on standby, ready to provide information even at night. When inverters are daisy chained using standard CAT5 Ethernet cable, each inverter display will report the output of the entire system. The GT 3.0 offers an isolated RS232 port and two Xanbus RJ45 communication ports. No additional communication ports or cards are needed to connect a PC. Xantrex offers the GT Solar Inverter Viewer software, which can be downloaded from their Web site. The GT 3.0 provides 3000 watts of power up to 30°C (86°F) and 2,500 watts of power up to 45°C (113°F). For added protection from heat in desert extremes or south facing inverter installations, an optional fan kit can be ordered.

UL listed. 5- year warranty.



Description	Item Code	Price
Xantrex GT3 3000 Grid Intertie Inverter	30.1831	\$2,500
Xantrex GT3 Fan Kit	30.1836	\$150

56 - SMA GRID TIE INVERTERS

SMA Sunny Boy Grid Tie Inverters



The SMA Sunny Boy inverters are the most widely used grid-tied PV inverter in Europe and the US. SMA inverters available in sizes from 700 watt to 6000 watts allow them to fit a wide range of applications from small residential systems to very large 3-phase industrial systems.

The 700U, 1100U and 6000U inverters come with LCD digital monitors that display instantaneous power output, energy delivered during the current day and since the installation. The 2500U and 1800U come "display-ready" allowing the monitoring features to be added by plugging in an optional display card. This display card cannot be used if optional remote communication modules are used in the 1800U and 2500U inverters. The 2500U is available for use on 240 VAC and 208 VAC power. The 6000U can be used on 208, 240 and 277 VAC power. SMA offers a wide range of accessories for communications and monitoring of the system.

The 6000U is in a NEMA 3R enclosure. All of the smaller inverters are housed in a completely sealed stainless steel enclosure. Outdoor installation is recommended for the sealed inverters so natural air flow can cool the heatsink. If these inverters are installed inside, the SunnyBreeze on the next page is recommended. The 6000U has active cooling.

The chart on page 4 and 5 shows a typical module string size for many PV module brands that can be used with each inverter. This number can vary depending on maximum and minimum temperatures in the location where the system is installed. For more details, consult your dealer or go to <http://www.sma-america.com> on the web to use SMA's excellent string-sizing software.

UL listed.

SMA inverters have a 5-year warranty.



Model	Electrical Specifications							Item Code	Price
	Maximum AC Power	DC Array Voltage	LCD Display	Inverter Efficiency	Maximum DC Current	AC Output Volts	Weight		
SB 6000U	6000	207-600	Yes	94%	A	208/240/277	137	30.3097	\$4,890
SWR 2500U Display-ready	2500	250-600	Optional	94%	13A	240VAC	70	30.3100-L	\$2,800
SWR 2500U 208 Display-ready	2100	250-600	Optional	94%	13A	208VAC	70	30.3102	\$2,770
SWR 1800U Display Ready	1800	156-400	Optional	93%	12A	120VAC	60	30.3104	\$2,370
SWR LCD	LCD Display for SWR 1800U and 2500U display-ready inverters						2	30.3130	\$129
SB1100U SBD	1100	139-400	Yes	93%	9.5A	240VAC	56	30.3109	\$2,150
SB700U SBD	700	75-250*	Yes	93%	4.3-6.6*	120VAC	43	30.3113	\$1,855

*DC Array voltage is adjustable on SB700U.

SunnyBoy Mounting Panel and Accessory Kit

High strength marine grade aluminum back plate makes any Sunny Boy 1800 or 2500 watt inverter installation quick and makes it look clean and professional. Stainless steel nut inserts on the plate make mounting the inverter and SquareD DC and AC disconnects from the front. Stainless steel hardware for equipment mounting, non-metallic conduit and fittings are included.

The sun shade bolts to the mounting plate and prevents direct sunlight from hitting the inverter.

Description	Item Code	Price
Mouning Kit for Sunny Boy Inverters	30.3201	\$154
Sun Shade for Mounting Kit	30.3203	\$38



SMA GRID TIE INVERTERS - 57

Sunny Boy Control and Monitoring

No matter how many inverters you have, it is possible to collect all of the information from the entire system into a computer, or send it via modem to any computer in the world. SMA control and monitoring systems can be very complex. Consult with your dealer to determine which communications method is best for you.



Model	SMA Sunny Boy Monitoring and Display Accessories	Item Code	Price
SWR LCD	Sunny Boy LCD Display for use in SWR 2500U and SWR 1800U display ready inverters	30.3130	\$165
SBC Light	Sunny Boy Control Light - Remote display unit with 4-line LCD display for SMA inverters. Can monitor up to 20 inverters. Powerline carrier communications ready. PC communications cable is included.	30.3124	\$667
SBC	Sunny Boy Control - All features of the SBC Light above. Can monitor up to 30 inverters. Two programmable dry-contact signal relays. Can accommodate an RS-485-N module for hard-wire connection to inverters.	30.3125	\$1,150
SBC-485	SBC above with RS-485-N module installed	30.3127	\$1,325
SBC Plus	All features of the SBC above plus 8 analog inputs with programmable gain including 2 PT100 temperature sensor inputs, 8 programmable digital inputs (2 are pulse counting), and additional port for serial display or second computer and programmable variable	30.3126	\$2,292
SBC Plus-485	SBC Plus with an RS-485-N module installed on the communications port for hard wire connection to inverters.	30.3149	\$2,467
Model	SMA Sunny Boy Accessory Description	Item Code	Price
RS-232-N	Module for remote communication between Sunny Boy without display and a Windows based PC. Requires cable and Sunny Data software. Maximum distance from PC to inverter is 50 feet. Software is available on the web from www.sma-america.com	30.3122	\$175
RS-485-N	Module for remote communication between multiple Sunny Boy Inverter(s) without display and Sunny Boy Controls. A 4 conductor cable required between inverters. RS485 Cable is required between one inverter and Sunny Boy Control. One module is required for each inverter and one for the Control is required. Controls with 485 modules installed are available above.	30.3123	\$175
NLM-N	Powerline Carrier Module - Allows remote communication between multiple Sunny Boy inverters (without internal display) and Sunny Boy Control, Control Light or Control Plus. May require power line noise filtering in some applications	30.3121	\$167
XPCP1	Powerline carrier phase coupler allows carrier signal to be transmitted from one phase to another. One is required on 208/240 Volt inverters.	30.3161	\$100
PZZ01	Powerline carrier phase coupler for 208/240 volt 3-phase circuits - allows carrier signal to be transmitted from one phase to the other two and isolates the powerline communications circuit from noise from the rest of the distribution system.	30.3163	\$140
XPPF	Plug-in Noise Filter for 120 volt wall sockets - 5 Amp Maximum - to be used with powerline communications	30.3165	\$80
XPF	In-line Noise Filter for 120/240 VAC circuits - to be used with powerline communications	30.3167	\$160
RS232 Cable	Cable to connect Control to single inverter using RS232 modules - 50 feet (15 meter)	30.3147	\$84
RS485 Cble	Cable to connect Control to multiple inverters using RS485 modules - 50 feet (15 meter)	30.3148	\$84
Sunny Breeze	Sunny Breeze - Cooling fan for indoor installations where natural air flow is minimal or absent	30.3140	\$135

SMA Combo-Switch



This 600 VDC rated disconnect has a built-in 4 input fused array combiner. Four 10 amp 600 VDC fuses are included. Bring up to 8 module strings together, two into each fuse holder. This is ideal for the 6000U inverter. NEMA 3R outdoor enclosure. 5 year warranty. ETL listed.



Description	Item Code	Price
SMA DC Disconnect & Combiner	30.3181	\$580

58 - FRONIUS GRID TIE INVERTERS

FRONIUS IG Inverters

The FRONIUS IG inverters offer high efficiency, precision MPP-tracking, and intelligent thermal management, all of which result in superior energy output from grid-tied photovoltaic systems. Its wide input voltage range (150-450 volts) permits the use of modules in any power and voltage range. Their light weight and innovative mounting hardware make them very easy to install.

Built-in DC and AC disconnects eliminate the need for external breakers in some cases, reducing total system costs. FRONIUS IG inverters come standard with an integrated LCD that displays and records over 20 parameters pertaining to inverter and system operation. Fronius inverters have 3 expansion slots that allow you to add features, such as external sensors and remote displays. You can use a personal computer to update the inverter with the latest software upgrades.

The larger inverters, (over 3kw) are built with the same power stages as the smaller ones, but use 2 of them. When these inverters see less than 1/2 array capacity, one stage turns off giving the inverter higher efficiency than their competitors during periods of low insolation. UL listed. 5-year warranty.

Model	Maximum AC Power	DC Array Voltage	LCD Display	Inverter Efficiency	Maximum DC Current	AC Output Volts	Weight (lbs.)	Item Code	Price
IG 5100	5100 W	150-450	Yes	94.4%	33.9A	240VAC	42	30.3407	\$4,130
IG 4500-LV	4500 W	150-450	Yes	94.4%	29.3A	208VAC	42	30.3412	\$4,130
IG 4000	4000 W	150-450	Yes	94.4%	26.1A	240VAC	42	30.3405	\$3,790
IG 3000	2700 W	150-450	Yes	94.4%	18A	240VAC	26	30.3403	\$2,950
IG 2500-LV	2350 W	150-450	Yes	94.4%	16.9A	208VAC	26	30.3410	\$2,680
IG 2000	2000 W	150-450	Yes	94.4%	13.6A	240VAC	26	30.3402	\$2,565



FRONIUS IG DatCom Accessories

Remote data communications and data logging features can easily be added to transform the inverter into a sophisticated data acquisition system and weather monitoring station. DatCom components and accessories connect to the inverter and each other with standard Cat-5 network cables and RS-232 cables.

Datalogger Boxes

Datalogging requires a COM card to be installed in each inverter in the system and a Datalogger Box. The Datalogger Box st

allow you to monitor your PV system from anywhere in the world. Two versions of the Datalogger Box are available. The Datalogger Easy monitors one IG inverter. The Datalogger Pro can monitor up to 100 IG inverters.

Sensor Box and Sensors

A Sensor Box is required to add weather sensors to your data acquisition system. The Sensor Box has 6 inputs, two for measuring temperature, one for measuring irradiance, two digital inputs for a wind speed sensor and/or kilowatt hour meter and one 20 mA current interface for a humidity sensor.

Model	Accessory Description	Item Code	Price
COM Card, Retrofit	Communications card for all Fronius IG Inverters	30.3425	\$135
Datalogger Pro Box	Control and Monitoring data storage and PC interface for up to 100 IG inverters	30.3431	\$790
Datalogger Easy Box	Control and Monitoring data storage and PC interface for 1 IG inverter	30.3435	\$440
Sensor Box	Monitoring interface with 6 sensor input channels	30.3442	\$790
Sensor, Wind Speed	For measuring wind speed. Sensor box (above) is required.	30.3446	\$84
Sensor, Ambient Temperature	For measuring outside temperature. Sensor box (above) is required.	30.3448	\$50
Sensor, Module Temperature	For measuring Module temperature. Sticks to back of PV module. Sensor box (above) is required.	30.3449	\$105
Sensor, Irradiance	Reference PV cells for measuring solar insolation. Sensor box (above) is required.	30.3444	\$240
RS232 Null Modem Cable	For connection of Datalogger Box to PC or Modem.	30.3453	\$32
Cat-5 Cable 3 foot	Network Cable for connecting inverters to each other or between Sensor Box and Datalogger Box	30.3455	\$5
Cat-5 Cable 65 foot	Network Cable for connecting inverter to Datalogger.	30.3457	\$44
Cat-5 Cable 196 foot	Network Cable for connecting inverter to Datalogger.	30.3459	\$160

INDUSTRIAL GRID TIE INVERTERS - 59

Xantrex Technology PV Series Industrial Inverters

The PV Series grid interconnect inverter makes industrial-commercial power production more affordable and attractive than ever! These power conversion centers take renewable energy generated DC power in the range of 300-480 VDC and outputs 208 VAC three-phase power. The ability to parallel multiple inverters for system growth makes the Xantrex PV Series universal for commercial scale grid interconnect systems.

The inverter matrix utilizes insulated gate bi-polar transistor (IGBT) technology essential for highly efficient large scale power production. A digital signal processor (DSP) controls the operation of the inverter and implements the peak power tracker function for optimizing the power delivery.

Complete inverter kits, include inverter, isolation transformer, AC and DC disconnects, combiner boxes and fuses for NEC code compliant installation, are available in 208V 3-phase and 480V 3-phase. UL listed. 5-year warranty. *PV100208 and PV225208 come with AC and DC disconnects.

Xantrex Model	PV-10208	PV-15208	PV-20208	PV-30208	PV-45208	PV-100208*	PV-225208*	
Continuous Output (kW)	10	15	20	30	45	100	225	
Max DC Amps	31.9	48.8	63.8	90	150	300	675	
Ship Weight (lbs.)	115	160.0	160	260	260	1140	2150	
Height (inches)	26	28	28	54	54	83	89	
Width (inches)	16	24	24	36	36	76	102	
Depth (inches)	12	15	15	19	19	20	27	
Item Code	30.1845	30.1851	30.1857	30.1863	30.1869	30.1871	30.1875	< Inverter Only
Price	\$8,473	\$12,220	\$15,452	\$20,989	\$29,647	\$69,241	\$114,697	
Item Code	30.1847	30.1853	30.1859	30.1865				< 208 V Kit
Price	\$12,258	\$17,396	\$21,138	\$27,775				
Item Code	30.1849	30.1855	30.1861	30.1867				< 480 V Kit
Price	\$12,083	\$17,221	\$20,861	\$27,155				



Sunny Central 125U 125 KW Inverter

The Sunny Central design incorporates the same proven MPP tracker found in more than 250,000 fielded Sunny Boys. The high efficiency power stage produces a perfect AC sine wave that exceeds the latest FCC and IEEE requirements. The AC system isolation transformer is incorporated into the inverter cabinet and is disconnected whenever the inverter is not producing power. Robust design allows full power operation with ambient temperatures up to 45°C. In higher ambient temperatures the inverter protects itself by reducing output power to safely regulate internal component temperatures. The enclosure is powder coated stainless steel and aluminum designed for long term outdoor installation in the harshest of environments. The power electronics are sealed in an isolated enclosure and kept cool with an air-to-air heat exchanger. The magnetics and isolation transformer are housed in a separate enclosure, thermally isolated from sensitive electronics. Integrated AC and DC switchgear isolates the Sunny Central from all power sources during periods of non-operation. The Sunny Central is equipped with a special version of the Sunny Boy Control Plus advanced data acquisition and control system. A 4-line display and keypad allow simple system configuration and monitoring. A wide variety of different interfaces for plant monitoring and remote configuration with a PC are also available.

UL listed.

5-year warranty.

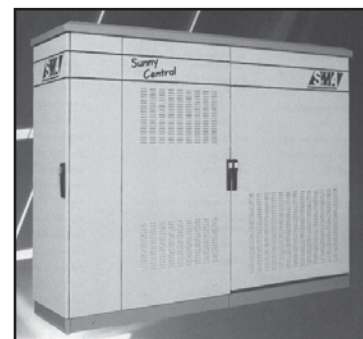

Sunny Central 125 Specifications	
Item Code	30.3190
Price	\$95,000
Nominal AC Power Output	125 kW (at 45 °C)
AC Input Voltage	422 - 528 Vac (480 Vac nominal)
DC Input Voltage	275 - 600 Vdc
Peak inverter efficiency	94 % (including grid transformer)
Maximum DC current	400 Adc
Power consumption	30 W standby
Ambient temperature	-25°C +50°C
Size	92.5" W x 71" H x 24 D inches
Weight	3307 lbs.

60 - BEACON GRID TIE/BATTERY INVERTER

Smart Power M5 Inverter from Beacon Power



The Smart Power™ M5 inverter from Beacon Power Corporation is a holistically engineered power conversion system designed specifically for utility-intertie applications with automatic backup power. The M5 uses an innovative two-stage electrical architecture to achieve 93 percent efficiency. It is the first charger / inverter system to combine high efficiency in grid-connected PV operation with the capability of instantaneous backup power.

The first stage of this two-stage inverter is a high-efficiency Maximum Power Point Tracking DC-DC voltage converter that optimally processes photovoltaic power (48-120 VDC) and converts it to battery voltage. The second stage is a utility grid-tied DC-to-AC inverter. Together, these two stages provide a highly reliable source of AC power, capable of operating in stand-alone and grid-parallel modes, with an automatic fast transfer between the two. It has full battery charge-control independent of PV voltage, and it minimizes grid-connect power loss and extends battery life. It is designed to be used with a 48-volt battery bank of at least 100 amp/hours of AGM or Gel type batteries.

The Smart Power M5 comes as a fully integrated, single-box solution in an outdoor-rated enclosure containing all necessary ground fault protection, disconnects and circuit breakers. An RS-485 serial communications link with standard RJ-11 connectors allows for connection to a PC utilizing the optional Smart Power Monitor software package. No-load loss is less than 20 watts. A single reprogrammable microcontroller provides complete, highly flexible system control and is field-programmable with operating parameters stored in non-volatile memory. A simple front panel LED display shows system operating status. With simplified programming and data retrieval, flexible

operating modes, and intelligent user and wiring interfaces, the Smart Power M5 is easy to install, set up, and operate.

The M5 is UL and CEC listed and comes with a standard 5-year warranty. Dimensions are 16"W x 10"D x 42"H and the weight is 120 lbs. Shipping weight of 150 lbs. allows for shipment via standard ground and air carriers.

Battery Enclosure

The Beacon battery enclosure complements the M5 system, with a matching powder-coated steel finish. The two shelves hold up to eight (8) Group 27/31 batteries. It's designed to be rainproof and earthquake-proof (with optional straps), and is available with or without a side-mounted 175-amp breaker. Like the M5, the Battery Cabinet features a simple and elegant design that's quick and easy to assemble and integrate.



Beacon Power PV String Combiners

This is a newly designed, outdoor-rated (NEMA Type 4) PV string combiner box that offers versatility and functionality in one rugged package. The white powder-coated steel enclosure holds up to 12 CBI® UL-listed 125 VDC PV breakers or UL-listed disconnect type, finger-safe fuse holders for Cooper-Bussmann® type ABC fuses (sold separately - see page 110). These are compatible with 12, 24, 48, and 60 VDC PV systems with Voc ratings of up to 125 VDC. The combiner features a continuous hinged, gasketed cover with integral latch, along with a removable component mounting plate.

The mounting plate includes a DIN rail for mounting the PV breakers or fuse holders and includes DIN end brackets. The DIN rail mount can also be used for up to nine finger-safe midjet 600 VDC fuse holders that accept 13/32" x 1.5" Littelfuse® Type KLKD 600 VDC fast-acting fuses. See page 111 for Outback OBPV breakers and OBF fuses and holders to fit the Beacon Power combiner. The DIN rail may be positioned vertically or horizontally by rotating the mounting plate. Dimensions: 12" H x 12" W x 3.5" D Weight: 13 lbs.

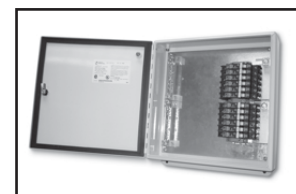

The Basic PV combiner (not pictured) is in a NEMA 3R enclosure. It has 12 PV input circuits and 2 outputs, allowing the array to be divided in half and each side connected to different inverter input breakers. It uses type ABC fuses.

Description	Weight (lb.)	Item Code	Price
Beacon M5 Utility Intertie Inverter	150	30.6850	\$6,999
Smart Power Monitor Software	1	30.6872	\$250
Beacon Battery Cabinet	100	30.6865	\$799
Battery Cabinet w/ Breaker Box	115	30.6867	\$949
Breaker Box	15	30.6869	\$250
Earthquake Kit for Battery Cabinet	15	30.6871	\$99
Beacon Array Combiner - NEMA 4	13	30.6875	\$199
Basic Array Combiner - NEMA 3R	15	53.2713	\$150

OUTBACK GRID-TIE WITH BATTERY BACKUP - 61

Outback GTFX and GVFX Grid Intertie Inverters and Systems

The Outback GTFX and GVFX series is a grid-tie version of the FX inverters. Available as either turbo cooled and sealed, the GTFX, or internally ventilated, the GVFX. With these inverters you can sell solar, wind and hydro power back to the utility grid. When the utility power goes out, the inverter will automatically switch to battery power and your renewable sources to run your critical loads. The inverter can be set so that either utility power or your renewable sources will recharge the battery after an outage. To prevent AC power draw at night, automatic "silent" sell mode is built in. Stacked inverters optimize conversion efficiency by matching the number of inverters to the amount of power being sold or used. Daily energy production is within a few percentage points



of a batteryless grid tie system (depending on battery bank). 2 inverters can be stacked for 120/240v output. Until the improved generator interface is developed, they are not recommended for off-grid use.

Outback Sealed Grid-Tie Inverters									
Outback Model	Continuous Watts	Battery Voltage	AC Out Volts/Hertz	No Load Draw	Charger Amps	Peak AC Surge	Weight (lbs.)	Item Code	Price
GTFX2524	2500	24VDC	120V/60Hz	18-20W	55A	70A	66	30.4025	\$1,995
GTFX3048	3000	48VDC	120v/60Hz	21-23W	35A	70A	66	30.4030	\$2,345
Outback Vented Grid-Tie Inverters									
GVFX3524	3500	24VDC	120V/60Hz	18-20W	85A	70A	62	30.4032	\$2,345
GVFX3648	3600	48VDC	120v/60Hz	21-23W	45A	70A	62	30.4036	\$2,345

Outdoor Systems

The OBPS1 systems below are factory wired, pre-programmed and fully ETL listed as complete grid-tie battery back-up solutions. Even the battery interconnecting cables and conduit are included to eliminate all guess work and difficult to find parts. The PS1 includes a type 3R rainproof enclosure which provides flexibility in where you choose to install the system, allowing for installation in limited space or outdoors.

Outback Model	System Type	Inverter(s) Qty - Model	Rated Power KW - AC Output	DC Voltage	Battery Charger	Item Code	Price
OBPS1-GTFX3048	PS1	1 - GTFX3048	3.0KW 120V	48 VDC	45 AMP	30.4611	\$4,795.00
OBPS1-GVFX3648	PS1	1 - GVFX3648	3.6KW 120V	48 VDC	45 AMP	30.4615	\$4,795.00
PS1-BE	Battery Box - Holds 4 Group 31 sealed batteries					30.4631	\$599.00



Indoor Systems

We also offer pre-wired and tested one and two inverter grid intertie systems for indoor installation (OBPS2). Choose a 24 or 48 volt system and sealed or ventilated inverters

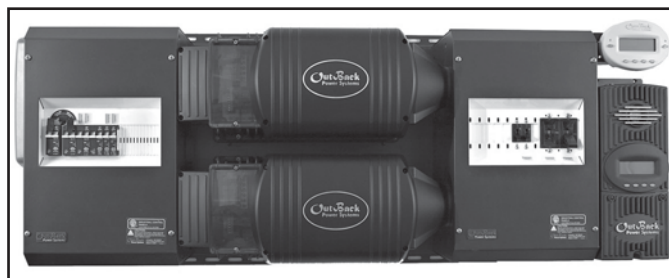

Outback Model	System Type	Inverter(s) Qty - Model	Rated Power KW - AC Output	DC Voltage	Battery Charger	Item Code	Price
Indoor Sealed Grid-tie Systems							
OBPS2-GTFX2524S	PS2	1 - GTFX2524	2.5KW 120V	24 VDC	55 AMP	33.1076	\$3,193.00
OBPS2-GTFX2524D	PS2	2 - GTFX2524	5KW 120/240V	24 VDC	110 AMP	33.1078	\$5,676.00
OBPS2-GTFX3048S	PS2	1 - GTFX3048	3.0KW 120V	48 VDC	35 AMP	33.1084	\$3,483.00
OBPS2-GTFX3048D	PS2	2 - GTFX3048	6.0KW 120/240V	48 VDC	70 AMP	33.1086	\$6,256.00
Indoor Ventilated Grid-tie Systems							
OBPS2-GVFX3524S	PS2	1 - GVFX3524	3.5KW 120V	24 VDC	85 AMP	33.1080	\$3,600.00
OBPS2-GVFX3524D	PS2	2 - GVFX3524	7KW 120/240V	24 VDC	170 AMP	33.1082	\$6,491.00
OBPS2-GVFX3648S	PS2	1 - GVFX3648	3.6KW 120V	48 VDC	45 AMP	33.1088	\$3,592.00
OBPS2-GVFX3648D	PS2	2 - GVFX3648	7.2KW 120/240V	48 VDC	90 AMP	33.1090	\$6,474.00

**ETL Listed
5-year warranty**

62 - OUTBACK SINE WAVE INVERTERS

Outback Inverters

The OutBack inverter is a modular “building block” sine-wave inverter/charger that can be used for both residential and commercial stand-alone and grid-connected applications with battery energy storage. Inverters are available in sealed, fan-cooled or higher powered ventilated versions. Each inverter/charger module is a complete power conversion system - DC to AC inverter, battery charger and AC transfer switch. Additional inverter/chargers can be added at any time in either parallel (120VAC), series (120/240VAC), or even three-phase (120Y208 VAC) configurations, allowing the system to be tailored to the specific needs of the application, both at the time of installation and into the future. With the addition of an X-240 autotransformer, multiple inverter systems can be set up to provide 120/240 VAC split-phase output with the ability to provide full power on either 120 VAC leg of the system. Up to ten inverters can be connected together to provide up to 36 kW of continuous power capacity with the use of the HUB and the MATE controller. The inverter’s powerful battery charger operates in five stages: BULK (constant current output), ABSORB (constant voltage output), FLOAT (reduced voltage output), SILENT (no charger output) and EQUALIZE (constant voltage regulation overcharging). Charge time in each stage is adjustable to provide control and to maximize the performance of the charger and battery system.

Each Outback inverter has one programmable, auxiliary relay output connection (AUX). The AUX terminal provides 12 VDC output to run 12V cooling or ventilation fans or operate an external relay to perform other functions, such as remote generator starting (two-wire), to disconnect external charging sources (such as PV), or to turn on a diversion load for voltage regulation.

The built-in transfer switch is rated for 60 amps. When an external source of AC power (either a generator or the utility grid) is detected at the “AC In” terminal on the inverter, the switch operates to transfer the loads to the external power source, and then activates the battery charger to re-charge the battery bank.

Dimensions: 16.25”L x 8.25”W x 11.5H. ETL listed to UL1741 2-year warranty.



Outback FX Sealed Inverters with Turbo Fan

The OutBack FX-series is designed to survive harsh environments anywhere in the world. Their unique sealed, gasketed die-cast aluminum chassis protects and keeps the power conversion components cool - without requiring outside air to be blown through the sensitive electronics. This reduces the major causes of inverter failure - corrosion, dust, insect and animal damage. They can be used in high ambient temperature applications up to 60°C with reduced output ratings.

Outback Sealed/Turbo Cooled Off-Grid Inverters									
Outback Model	Continuous Watts	Battery Voltage	AC Out Volts/Hz	No Load Draw	Charger Amps	Peak AC Surge	Weight (lbs.)	Item Code	Price
FX2012T	2000	12VDC	120V/60Hz	19-21W	100	70A	66	30.4147	\$1,995
FX2024T	2300	24VDC	120V/60Hz	18-20W	55	70A	66	30.4152	\$1,895
FX2548T	2800	48VDC	120v/60Hz	21-23W	35	70A	66	30.4153	\$2,345
Export Models - can be connected in parallel or 3-phase Y 400VAC									
FX2012ET	2000	12VDC	230V/50Hz	19-21W	100	70A	62	30.4140	\$1,995
FX2024ET	2300	24VDC	230V/50Hz	18-20W	55	70A	62	30.4144	\$2,095
FX2348ET	2600	48VDC	230V/50Hz	21-23W	35	70A	62	30.4142	\$2,345

Outback MATE Remote Monitor and Control

The OutBack MATE is a complete system controller and display for both the OutBack inverter/charger and MX60 MPPT PV charge controller. It provides a display of the operation as well as allows control and adjustment of the setpoints. The OutBack MATE also coordinates the operation of the entire system to maximize performance and to prevent multiple products from conflicting. A single OutBack MATE is able to connect to multiple inverter/chargers, MX60 MPPT PV charge controllers and any other OutBack power conversion and control products offered in the future. A maximum of ten OutBack products will be able to be connected to a single MATE via CAT 5 ethernet type cabling with 8 wire RJ45 modular connectors and the OutBack HUB communication manager. The OutBack MATE also includes an opto-isolated RS232 port with a DB9 jack for connection to the serial port of a PC computer.

The new Mate-2 has a flush-mount black face for panel or in-wall mounting. 2-year warranty.

Outback Model	Outback Mate System Monitor and Control	Item Code	Price
MATE	System Control - Shipped with a 50ft CAT 5 cable	30.4180	\$295
MATE-2	Flush-mount version	30.4181	\$295



OUTBACK SINE WAVE INVERTERS - 63

Outback VFX Ventilated Inverters

The OutBack VFX series is a ventilated version of the original sealed FX series modular inverter/charger that can be used for both small and large power systems. By allowing cooler outside airflow through the internal electronics, more AC power is available and operation in extremely hot environments is improved compared to the sealed FX series. The full screened vent openings are “bug-proof” and the die-cast aluminum chassis protects and keeps the power conversion components cool in very hot environments even when operated at high power for extended periods. The VFX can be used in high ambient applications up to 60°C (with reduced output ratings) Ventilated inverters are a better choice when generator powered battery charging is an important part of system battery charging. The fan cooling allows far higher continuous battery charging current which results in shorter generator run time.

ETL listed. 2-year warranty

Dimensions: 16.25”L x 8.25”W x 11.5”H.

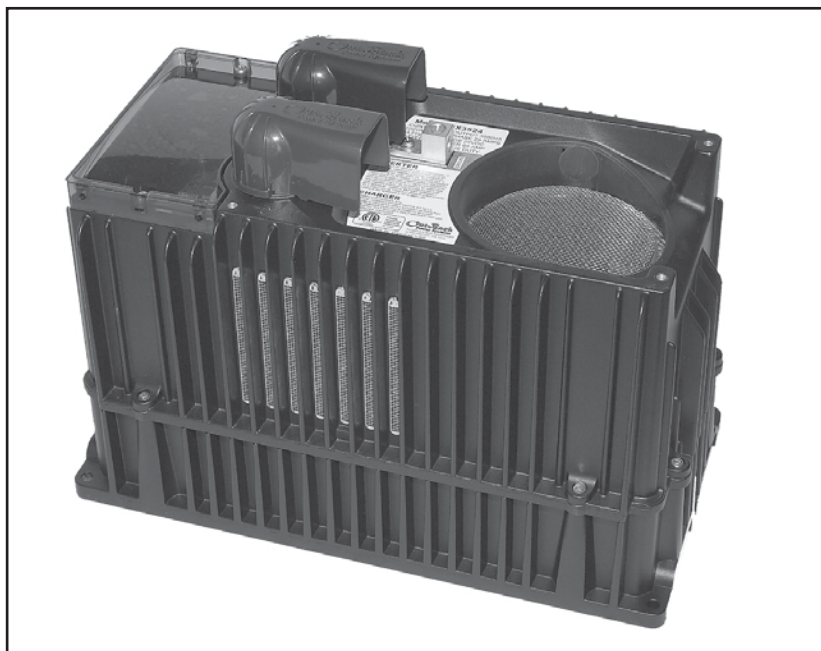

Outback Ventilated Fan Cooled Inverters									
Outback Model	Continuous Watts	Battery Voltage	AC Out Volts/Hz	No Load Draw	Charger Amps	Peak AC Surge	Weight (lbs.)	Item Code	Price
VFX2812	2800	12VDC	120V/60Hz	19-21W	125	70 A	60	30.4149	\$2,345
VFX3524	3500	24VDC	120V/60Hz	18-20W	65	70 A	60	30.4155	\$2,345
VFX3648	3600	48VDC	120v/60Hz	21-23W	45	70 A	62	30.4157	\$2,345
Export Models									
VFX2612E	2600	12VDC	230V/50Hz	19-21W	125	70 A	60	30.4134	\$2,345
VFX3024E	3000	24VDC	230V/50Hz	18-20W	65	70 A	60	30.4136	\$2,345
VFX3048E	3000	48VDC	230V/50Hz	21-23W	45	70 A	62	30.4138	\$2,345

Outback FX Inverter Accessories

Use these accessories to mount the inverter to an Outback Power Center, to connect it to conduit or to stack multiple inverters. A Hub is required to connect more than one inverter to the same load or to connect inverters, MATEs and MX charge controllers to allow programming and monitoring of the entire system by the MATE. The remote temperature sensor is important for accurate battery charging, especially if the batteries get very warm or cold. If used with a HUB, one temp. sensor can be shared by all inverters and MX charge controllers.

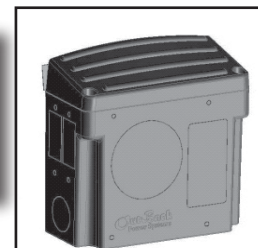

Outback Model	Outback Inverter Accessories	Item Code	Price
FX-DCA	Aluminum 2" conduit adapter - required to mount an FX2000 to a PS2DC or PS4DC	30.4163	\$45
FX-ACA	AC wiring compartment extension and 2" conduit adapter - includes two 1" conduit knockouts and an AC outlet knockout	30.4166	\$35
HUB-4	Stacking kit for up to 4 inverters and charge controls - includes cables	30.4185	\$195
HUB-10	Stacking kit for up to 10 inverters and charge controls - includes cables	30.4188	\$375
RTS	Remote Temperature Sensor with 20' cable	30.4190	\$29

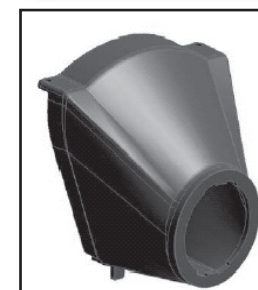

64 - OUTBACK POWER SYSTEMS

OutBack PS2 Power Systems - for up to two inverters

The OutBack PS2 Power System includes compact enclosures for all of the AC and DC components of a renewable energy power conversion system using one or two Outback inverters and a drilled and tapped mounting plate with hardware. The PS2 system saves time, money and space by combining the disconnects, overcurrent protection devices, grounding and control components into easy to install enclosures. AC and DC enclosures are ETL listed. Indoor type NEMA1 powdercoated steel. Enclosure dimensions are 18.5"H x 11.5"W x 9"D . Enclosures and plate are sold separately below.



PS2MP Power System Mounting Plate

The PS2MP is designed to mount the PS2DC and PS2AC with one or two OutBack inverters. It is UPS shippable and includes equipment mounting hardware. Dimensions: 20"H x 44"W x .75"D



PS2AC enclosure includes the following:

- Dual 50 amp input/output bypass assembly
- Dual 50 amp breaker for inverter AC input
- One 20 amp AC breaker.
- One 15 amp AC outlet (mounts on side of cabinet) with one 15 amp breaker
- Ground terminal bus bar bonded to cabinet
- Insulated color coded bus bars for all AC wiring
- Knockouts for 8 additional OutBack AC load breakers.
- Provisions for mounting an X-240 and fan.
- Knockouts on five surfaces to facilitate conduit and inverter connections



PS2DC enclosure includes the following:

- One battery circuit breaker: 100, 175 or 250 A, depending on inverter used
- Knockouts for one additional inverter battery breaker and eight 3/4" DC breakers.
- 500 amp 50 mV DC current shunt standard
- Battery negative/ground bus bar standard
- Battery positive bus bar for DC loads and PV arrays included standard
- Side mounting brackets for an OutBack MX60 and an OutBack MATE.
- Knockouts for battery conduit, MX60 interconnect and stacking another PS2DC
- Mounting for a 120mm sq x 32mm thick 12V DC boxer fan (powered by an inverter/charger's auxiliary relay)
- For negative or positive ground systems
- Knockouts on five surfaces to facilitate conduit, inverter and control connections.
- Grommets included for MX60 and MATE wiring.
- Knockouts for two MX60 controllers on top of enclosure

Outback Model	PS2DC Power System Boxes Description	Weight	Item Code	Price
PS2DC	DC Enclosure - empty - without breakers, wiring accessories or shunt	20	30.4307	\$266
PS2DC-100	DC enclosure with 100A main for 1 FX2548T, FX2348ET or GTFX3048 inverter	22	30.4309	\$325
PS2DC-175	DC enclosure with 175A main for 1 FX 24 volt inverter or VFX 48 volt inverter	22	30.4311	\$385
PS2DC-250	DC enclosure with 250A main for 1 12 volt inverter or VFX 24 volt inverters, FX2012T	22	30.4312	\$385

Outback Model	PS2AC Power System Boxes Description	Weight	Item Code	Price
PS2AC-50D	Enclosure for two inverters w/50A 2-pole Bypass Breaker	22	30.4379	\$385
PS2AC-50DE	Enclosure for two inverters w/50A Bypass Breaker for Export (230 VAC 50 Hz)	22	30.4381	\$449

Outback Model	Accessories	Weight	Item Code	Price
PS2MP	Mounting plate for PS2 enclosures and up to 2 FX-series inverters.	24	30.4456	\$129



POWER SYSTEM COMPONENTS - 65

OutBack Power Systems - for up to 4 Outback Inverters

The OutBack PS Power System is the ideal AC and DC enclosure system for a medium to large size renewable energy power conversion system. It is designed to accompany up to four Outback inverter/chargers, two SW (not SWPlus), or two DR inverters.

OutBack Power System Mounting Plate

The PSMP is a two part UPS-shippable mounting plate used for assembling a complete wall-mounted power system. It is pre-drilled to accommodate a PSDC and a PSAC with up to four OutBack inverter/chargers or one or two Xantrex DR or SW inverters. Includes equipment mounting hardware.

Dimensions: 36"H x 50"W x 1"D



OutBack PSAC Standard Features and Components

ETL listed indoor type powdercoated steel enclosure

Quad 60A or 100A input / output bypass assembly

Ground terminal bus bar bonded to cabinet

Knockouts for 13 additional OutBack AC load breakers or eight QOU style breakers.

Provisions for mounting two X-240 transformers and two fans

Knockouts on five surfaces to facilitate conduit and inverter connections

Insulated color coded bus bars for all AC wiring

Enclosure Dimensions: 32.5"H x 10.5"W x 9"D.

Outback PSDC Standard Features and Components

ETL listed indoor type powdercoated steel enclosure with plenty of conduit knockouts

One inverter battery circuit breaker: 100 amp, 175 amp, or 250 amp

Knockouts for three additional inverter battery breakers and ten 3/4" breakers.

1000 amp 100 mV DC current shunt standard

Battery negative/ground bus bar standard

Battery positive bus bar for DC loads and PV arrays included standard

Knockouts for battery conduit, MX60 interconnect and stacking another PSDC

For negative or positive ground systems

Knockouts on five surfaces to facilitate conduit and inverter connections

Mounting provisions for two DC12-FAN kits (recommended for quad stack configurations)

Knockouts on top and side for Outback, Xantrex C-series or Blue Sky charge controls

Enclosure Dimensions: 32.5"H x 16"W x 9"D Weight: 38 lbs.



OutBack Model	PSAC Description	Weight	Item Code	Price
PSAC-60Q	PSAC with Quad 60A Bypass Switch for 120/240VAC - for use with four OutBack inverters	32	30.4386	\$549
PSAC-100Q	PSAC with Quad 100A Bypass Switch for 120/240VAC - for use with four OutBack inverters	32	30.4387	\$599
PSAC	PSAC empty enclosure - without breakers or wiring accessories - for custom systems	31	30.4390	\$284
OutBack Model	PSDC Description	Weight	Item Code	Price
PSDC-100	DC enclosure with 100A main for 1 FX2548T, FX2348ET or GTFX3048 inverter	40	30.4318	\$459
PSDC-175	DC enclosure with 175A main for 1 FX 24 volt inverter or VFX 48 volt inverter	41	30.4317	\$519
PSDC-250	DC enclosure with 250A main for 1 FX2012T inverter or VFX 24 volt inverters	42	30.4314	\$519
OutBack Model	Accessories	Weight	Item Code	Price
PSMP	Mounting Plate for PS enclosures and up to 4 Outback inverters	46	30.4455	\$179

66 - POWER SYSTEM COMPONENTS



Accessories for Outback Power System Enclosures

Model #	PS2AC and PSAC Options	Item Code	Price
OBAC-15	15A Circuit Breaker one-pole for 120VAC (OutBack)	30.4415	\$15
OBAC-15D	15A Circuit Breaker two-pole for 120/240VAC (OutBack)	30.4416	\$35
OBAC-20	20A Circuit Breaker one-pole for 120VAC (OutBack)	30.4418	\$15
OBAC-25D	25A Circuit Breaker two-pole for 120/240VAC (OutBack)	30.4421	\$35
OBAC-50	50A Circuit Breaker one-pole for 120VAC (OutBack)	30.4422	\$15
OBAC-50D	50A Circuit Breaker two-pole for 120/240VAC (OutBack)	30.4423	\$35
AC-30	30A Circuit Breaker one-pole for 120VAC (Square-D QOU - Use in PSAC only)	30.4409	\$25
AC30D	30A Circuit Breaker two-pole for 120/240VAC (Square-D QOU - Use in PSAC only)	30.4412	\$50
AC-60	60A Circuit Breaker one-pole for 120VAC (Square-D QOU - Use in PSAC only)	30.4403	\$25
AC-60D	60A Circuit Breaker two-pole for 120/240VAC (Square-D QOU - Use in PSAC only)	30.4406	\$50
X-240	4kVA 120/240VAC Autotransformer- includes a 25A 2-pole breaker for manual control and overload protection	30.4424	\$290
X-Fan	Fan Kit for X-240 - increases continuous power rating of X-240 to 6 kVA - 120VAC powered - PSAC only	30.4427	\$29
Additional AC Input/Output/Bypass Assemblies for PSAC			
Add as needed for additional inverter/chargers. AC-IOB units are packed as complete kits. Additional TBBs or TBB-Rs may be required for 120/240VAC applications			
AC-IOB-30	AC I/O/Bypass breaker assy. 30A 120VAC for adding one Xantrex DR inverter/charger or other small inverter - requires 3 brkr. spaces	30.4397	\$85
AC-IOB-60	AC I/O/Bypass breaker assy. 60A 120VAC for adding one OutBack FX or Xantrex SW inverter/chargers - requires 3 brkr. spaces	30.4400	\$85
AC-IOB-60D	AC I/O/Bypass breaker assy. 60A 120/240V for adding two series stacked OutBack or Xantrex SW inverters - requires 6 brkr. spaces	30.4401	\$159
AC-IOB-60Q	AC I/O/Bypass breaker assy. 60A 120/240VAC for adding four series stacked OutBack FX inverter/chargers - requires 9 brkr. spaces	30.4398	\$169
AC-IOB-100Q	AC I/O/Bypass breaker assy. 100A 120/240VAC for adding four series stacked OutBack FX inverter/chargers - requires 9 brkr. spaces	30.4399	\$219
Model #	PS2DC and PS4DC Options	Item Code	Price
OBDC250	DC Breaker 250A 125VDC	30.4326	\$119
OBDC175	DC Breaker 175A 125VDC	30.4329	\$119
OBDC100	DC Breaker 100A 125VDC	30.4332	\$59
OBDC70	DC Breaker 70A 125VDC	30.4334	\$29
OBDC60	DC Breaker 60A 125VDC	30.4335	\$29
OBDC50	DC Breaker 50A 125VDC	30.4337	\$29
OBDC40	DC Breaker 40A 125VDC	30.4338	\$29
OBDC30	DC Breaker 30A 125VDC	30.4341	\$25
OBDC20	DC Breaker 20A 125VDC	30.4347	\$25
OBDC15	DC Breaker 15A 125VDC	30.4344	\$25
OBDC10	DC Breaker 10A 125VDC	30.4348	\$25
OBDC5	DC Breaker 5A 125VDC	30.4349	\$25
OBDC1	DC Breaker 1A 125VDC	30.4350	\$25
OBDC-GFP/2	Ground fault protection system for 2 arrays of up to 60A each - uses 3 spaces in box >	30.4323	\$129
BB	Battery Bus with black and red insulators	30.4357	\$75
CCB	Bracket to mount 2 MX60 or RVPP charge controls or 3 Xantrex C-series charge controls on the side of the PSDC	30.4320	\$39
Model #	Bus Bars for AC and DC Enclosures	Item Code	Price
TBB	Terminal Bus Bar Kit Black	30.4353	\$19
TBB-W	Terminal Bus Bar Kit White	30.4354	\$19
TBB-R	Terminal Bus Bar Kit Red	30.4355	\$19
GBB	Ground Bus Bar Kit	30.4356	\$15

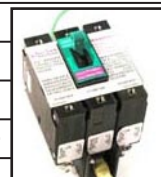

CUSTOM OFF-GRID POWER SYSTEMS 67

Outback Assembled Power Systems

NEC compliant preassembled power system

ETL listed to UL standards

Power Systems include inverter(s), AC enclosure inverter bypass, DC enclosure, inverter disconnect breaker and shunt, all mounted to a back plate and wired. Charge controllers and battery cables and displays are not included.

Charge controllers, additional AC and DC input and load breakers can be added at the time of preassembly or in the field. Some options are listed below.

Many other options are available. Please contact us for more information. Power systems ship by truck freight.



Outback Model	System Type	Inverter(s) Qty - Model	Rated Power KW - AC Output	DC Voltage	Battery Charger	Item Code	Price
OBPS2-FX2024TS	PS2	1 - FX2024T	2.3KW 120V	24 VDC	55 AMP	33.1021	\$3,093
OBPS2-FX2024TD	PS2	2 - FX2024T	4.6KW 120/240V	24 VDC	110 AMP	33.1023	\$5,766
OBPS4-FX2024TD	PS4	2 - FX2024T	4.6KW 120/240V	24 VDC	110 AMP	33.1025	\$6,309
OBPS4-FX2024TQ	PS4	4 - FX2024T	8KW 120/240V	24 VDC	220 AMP	33.1027	\$10,607
OBPS2-VFX3524S	PS2	1 - VFX3524	3.5KW 120V	24 VDC	85 AMP	33.1029	\$3,600
OBPS2-VFX3524D	PS2	2 - VFX3524	7KW 120/240V	24 VDC	170 AMP	33.1031	\$6,781
OBPS4-VFX3524D	PS4	2 - VFX3524	7KW 120/240V	24 VDC	170 AMP	33.1033	\$7,281
OBPS4-VFX3524Q	PS4	4 - VFX3524	14KW 120/240V	24 VDC	340 AMP	33.1035	\$12,795
OBPS2-FX2548TS	PS2	1 - FX2548T	2.8KW 120V	48 VDC	30 AMP	33.1037	\$3,483
OBPS2-FX2548TD	PS2	2 - FX2548T	5.6KW 120/240V	48 VDC	60 AMP	33.1039	\$6,546
OBPS4-FX2548TD	PS4	2 - FX2548T	5.6KW 120/240V	48 VDC	60 AMP	33.1041	\$7,080
OBPS4-FX2548TQ	PS4	4 - FX2548T	11.2KW 120/240V	48 VDC	120 AMP	33.1043	\$12,171
OBPS2-VFX3648S	PS2	1 - VFX3648	3.6KW 120V	48 VDC	45 AMP	33.1045	\$3,592
OBPS2-VFX3648D	PS2	2 - VFX3648	7.2KW 120/240V	48 VDC	90 AMP	33.1047	\$6,764
OBPS4-VFX3648D	PS4	2 - VFX3648	7.2KW 120/240V	48 VDC	90 AMP	33.1049	\$7,296
OBPS4-VFX3648Q	PS4	4 - VFX3648	14.4KW 120/240V	48 VDC	180 AMP	33.1051	\$12,603
Power Systems with Xantrex SW-series Inverters							
OBPS4-SW4024S	PS4	1 - SW4024	4.0 Kw	24 VDC	120 amp	33.1103	\$4,995
OBPS4-SW4024D	PS4	2 - SW4024	8.0 Kw	24 VDC	240 amp	33.1105	\$8,995
OBPS4-SW4048S	PS4	1 - SW4048	4.0 Kw	48 VDC	60 amp	33.1107	\$4,995
OBPS4-SW4048D	PS4	2 - SW4048	8.0 Kw	48 VDC	120 amp	33.1109	\$8,995
OBPS4-SW5548S	PS4	1 - SW5548	5.5 Kw	48 VDC	70 amp	33.1111	\$5,695
OBPS4-SW5548D	PS4	2 - SW5548	11.0 Kw	48 VDC	140 amp	33.1113	\$9,995
Power Systems Installed Options							
Outback Mate	Remote Monitor and control - allows inverter, charger programming					33.1259	\$295
Outback RTS	Remote Temperature Sensor installed on the power system					33.1257	\$29
Outback MX60	Outback MX60 60 amp MPPT Charge Control with breakers, installed in 12, 24 or 48 volt system					33.1201	\$724
Trace C-40	C40 charge controller installed with 60 amp breakers 12, 24 or 48 VDC					33.1205	\$259
Trace CM	Digital meter mounted on the front of the charge control.					33.1209	\$99
Morningstar TS-45	TS-45 charge controller installed with 60 amp breakers 12, 24 or 48 VDC					33.1211	\$259
Morningstar TS-60	TS-60 charge controller installed with 60 amp breakers 12, 24 or 48 VDC					33.1213	\$279
Trimetric Meter	Amp hour meter - installed in PSDC 24 volt system					33.1215	\$211
Trimetric Meter	Amp hour meter - installed in PSDC 48 volt system					33.1216	\$285
OBDC-GFP2	Ground fault interrupter for up to two PV arrays installed in DC system box					33.1221	\$129
X240	Autotransformer 120/240 4kVA (included in multiple inverter FX and VFX systems)					33.1253	\$300
Hub 10 Upgrade	Replace standard Hub 4 with Hub 10					33.1265	\$180

68 - SINE WAVE INVERTER & TRANSFORMERS

SMA SI4248U Sunny Island Inverter



The Sunny Island SI4248U is new to the USA, but has been available in a 230 volt 50 Hz version for use in Europe and developing countries for many years. It is a bi-directional battery inverter for stand-alone, off-grid applications or for adding battery backup to grid intertie systems that use SMA Sunny Boy inverters.

As a stand alone inverter, the Sunny Island converts DC electricity from a 48 volt battery to 120 VAC power. If a generator is used for backup power, it becomes a battery charger when the generator is running and can support the generator output when the load is larger than the generator can power alone. Several Sunny Island inverters can be combined with PV modules, wind, hydroelectric and fossil fuel generators to form a mini-grid remote power system. The SI4248U manages battery charging and can start and stop the generator when necessary.

When used to provide battery backup to a Sunny Boy grid-connected system, the Sunny Island AC input is connected to a circuit breaker in the main load center and its output is connected to an AC subpanel which is fed by the output of the Sunny Boy inverter(s) and which powers critical loads that will receive backup power in the event of a power failure. The Sunny Island is also connected to a 48 volt battery bank.

When the grid is operating, the Sunny Island passes the power generated by the PV system to the main load center and on to the grid. It also manages the batteries and

charges them when necessary. When grid power fails, the Sunny Island supplies AC power to the subpanel, keeping the critical loads running. The AC power supplied to this subpanel keeps the Sunny Boy inverters in the PV systems operating. Power from the PV system can supply the critical load subpanel. If the PV system is generating more power than the loads require, the excess power is used by the Sunny Island to charge the batteries. If the demand from the loads is greater than the PV system can supply, the Sunny Island supplies the extra power necessary to keep the loads running. During the grid failure, the power system becomes a power “island” and continues to use all of the PV power.

ETL listed.

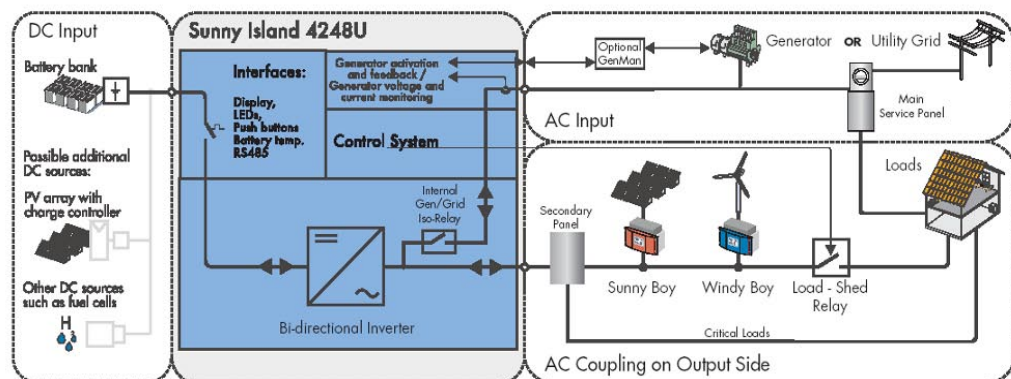

SMA Model	Battery Volts	AC Volts / Hz	Continuous Watts	Charge Amps	Weight (Lbs)	Item Code	Price
SI4248U	48	120 / 60	4200	100	86	30.3094	\$5,500

Toroid Autotransformers

These AC step-up and step-down transformers are greater than 98% efficient and cause less than 0.2% idle loss at no load. They are nearly silent when operating. Use an autotransformer as a step-down to connect the 240 volt output of a generator to the 120 volt input on an inverter. This allows full output power of a 240 volt generator to be used for battery charging. Autotransformers can step-up voltage to operate 240 volt appliances and motors from the 120 volt output of an inverter. NEMA3R enclosures with knockouts for conduit. 2-year warranty.



Description	Dimensions (inches)	Item Code	Price
2.5 kW Autotransformer	8 x 8 x 4	38.9437	\$225
4 kW Autotransformer	10 x 10 x 4	38.9440	\$340
8 kW Autotransformer	12 x 10 x 6	38.9445	\$595

xantrex**SINE WAVE INVERTERS - 69****Xantrex SW Series Inverters**

The Xantrex SW inverter provides sine wave output with high surge, low idle current, and high efficiency. It can be used for off-grid or utility intertie systems with battery back-up. It is over 90% efficient through most of its load range, peaking at 95-96% efficiency.

The SW inverters can be programmed to perform automatic generator start and stop, automatic load sensing and generator support, and includes protective circuitry which guards against downtime. Three user adjustable voltage-controlled relays are provided to control charging sources and loads. LED status indicators report the status of eight system conditions. Selecting modes, enabling features and adjusting of parameters are easily accomplished by moving through a menu tree that is displayed on the control panel's LCD read-out. Doubling as a meter, the LCD readout displays inverter AC amps, input AC amps, load AC amps, battery volts, and output voltage and frequency. Adjustable "search mode" can reduce idle power draw to 1 watt when not operating any AC loads.

All Xantrex SW inverters include a built-in, programmable, three-stage battery charger, with manual equalize mode, designed for maximum charging efficiency with minimum generator run time. A remote battery temperature sensor is included.

Two SW inverters can be connected in series in a 120V/240V split-phase configuration (with twice the wattage), with the addition of the SWI stacking interface cable. Or, two inverters can be connected in parallel for twice the output wattage at 120V with the SWI/PAR stacking interface cable.

SW Series dimensions: 15" x 22.5" x 9".
2 year warranty.

UL listed. 2-year warranty.

**Xantrex GTI**

A Grid Tie Interface (GTI) is required when connecting SW inverters in utility-tie applications. Software/hardware revision 4.2 or higher SW inverter is required to connect the SW4024, SW4048, or SW5548 to the GTI.

SW Series Domestic Voltage Inverters

Xantrex Model	Battery Volts	AC Volts / Hz	Continuous Watts	Charge Amps	Weight (Lbs)	Item Code	Price
SW4024	24	120/60	4000	120	111	30.1015	\$3,495
SW4048	48	120/60	4000	60	111	30.1018	\$3,495
SW5548	48	120/60	5500	75	143	30.1021	\$3,995

SW Series Export Voltage Inverters

Xantrex Model	Battery Volts	AC Volts / Hz	Continuous Watts	Charge Amps	Weight (Lbs)	Item Code	Price
SW3024E	24	230/50	3300	100	111	30.1033	\$3,495
SW3048E	48	230/50	3300	50	111	30.1036	\$3,495
SW4548E	48	230/50	4500	60	143	30.1039	\$3,995

Voltages for Japan and Korea are also available - please call

SW Series Accessories

Xantrex Model	Description	Weight (Lbs)	Item Code	Price
SWRC/25	Remote Control for SW with 25" Cable	2	30.1069	\$295
SWRC/50	Remote Control for SW with 50" Cable	2	30.1072	\$329
SWCB	Conduit Box for SW series - for DC side of inverter	8	30.1051	\$94
SWI	Stacking Cable for SW	2	30.1057	\$45
SWI/PAR	Sinewave Parallel Stacking Interface	44	30.1060	\$345
SWI/PAR/E	Parallel Stacking Interface for export "E" and "W" models	44	30.1066	\$345
SWCA	SW Communications Adapter - Connects SW to a computer	1	30.1048	\$175
GTI	Grid Tie Interface	44	30.1075	\$449

Xantrex T-240

Use this to power 240 volt appliances on 120 volt inverters. Indoor enclosure, steel powder-coated white. Maximum load is 4.5 kilowatts. (For smaller or larger loads, see our transformers at left.) Consumes 12 watts at idle. Includes 2 pole 25 amp QOU circuit breaker/disconnect and has room for 3 other QOU AC breakers. #14 to #2 hookup wire size.

Dimensions: 6.3" x 21" x 7".

UL listed. 2 year warranty.

Xantrex Model	Description	Item Code	Price
T240	4 kW Autotransformer	30.1402	\$350

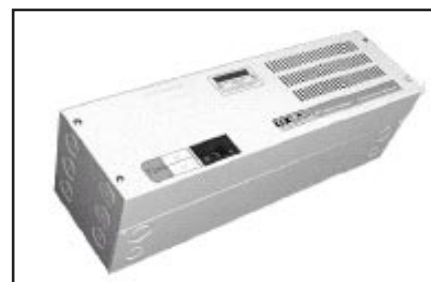

70 - SINE WAVE INVERTERS

Xantrex SW Plus

The New SW Plus Inverter/Charger, like the SW, is designed to provide homes with a completely independent power supply. They can be programmed to operate as a stand-alone inverter, a generator hybrid, for utility management, or for back-up power. Surge power has been improved. The SW Plus cannot be used as a utility-tied sell-back inverter. All program settings are stored in flash memory so they are maintained even if the inverter is disconnected from the battery. Two SW Plus inverters can be stacked to provide up to 11 kW of 120/240 VAC power. The inverter communications adapter interfaces with a personal computer.

The SW Plus can be programmed to start and stop generators with the addition of a GSM. The ALM can be added to control loads for power diversion regulations or to control a battery vent fan. ETL listed. 2-year warranty. Dimensions are 15" x 22.5" x 9"

The SW Plus Long DC Conduit Box (**DCCB-L**) connects to the DC side of one or two inverters and provides a centralized location for the DC circuit breakers and PV Ground Fault Protection (GFP) breakers. It is also designed to incorporate up to two charge controllers, and cabling for a battery meter (there is a space on the front cover to mount a Xantrex TM500A meter). The DCCB-L includes a 175 or 250 amp circuit breaker, a DC negative bus bar and 500A/50 mV shunt, battery cables (1 set) and a ground wire connected to the ground bar. For expandability, the Long DC Conduit Box is designed so that a second DCCBL can be added on for additional breaker spaces, wiring, room and controller mounting spaces. Knockouts are provided for 1/2", 3/4" and 2" sizes. Certified to meet UL1741-2001.

The SW Plus Long AC Conduit Box (**ACCB-L**) connects to the AC side of one or two SW Plus inverters. It is designed to protect the wiring connections to the inverter and provides room for up to nine additional AC disconnect breakers (Square D, Type QOU, DIN rail mounted) to protect user-specified loads. The ACCB-L includes an AC bypass switch (for a single AC input source) and input/output wiring attached to the AC Input/Output Terminals, a Neutral bar with neutral wire installed, and an isolated HOT bar.

1 or 2 inverters and AC and DC Conduit Boxes can be bolted to the 2-piece back plate to build a power panel. Other options at right can be added to the system.



SW Plus Inverters							
Model	Battery Volts	AC Volts / Hz	Continuous Watts	Charge Amps	Weight (Lbs)	Item Code	Price
SW-Plus2524	24	120/60	2500	70	105	30.1009	\$2,299
SW-Plus4024	24	120/60	4000	70	113	30.1010	\$2,800
SW-Plus2548	48	120/60	2500	40	105	30.1012	\$2,299
SW-Plus4048	48	120/60	4000	40	113	30.1013	\$2,800
SW-Plus5548	48	120/60	5500	40	136	30.1014	\$3,500

SW Plus Series Accessories			
Model	Description	Item Code	Price
GSM	Generator Start Module - 2 or 3 wire gen start	30.1085	\$159
ALM	Auxiliary Load Module - User adjustable relays	30.1087	\$159
ICA	Communications adapter for connection to a PC	30.1088	\$175
ICM/25	Full function remote control with 25 foot cord	30.1089	\$275
ICM/50	Full function remote control with 50 foot cord	30.1090	\$295
ISC-S	Stacking cable for 2 SW Plus 120/240V output	30.1093	\$45
DCCB-L-175	DC Conduit Box for 1 or 2 inverters w/175A Main	30.1097	\$675
DCCB-L-250	DC Conduit Box for 1 or 2 inverters w/250A Main	30.1098	\$675
GJ175F-PCK	Additional 175A Breaker & wire for 2nd Inverter	30.1114	\$175
GJ250F-PCK	Additional 250A Breaker & wire for 2nd Inverter	30.1115	\$175
ACCB-L-L1	AC side conduit box w/AC bypass-disconnect	30.1101	\$475
ACCB-L2-PCK	Additional Bypass Breaker Assembly for 2nd Inverter	30.1102	\$120
CC-CPK	Wiring Kit for C40 or C60 Charge Control	30.1126	\$35
XBP	Back Plate - 2 piece for 1 or 2 SWPlus Inverters	30.1107	\$425
XBP-DC	Back Plate Extension for 2nd DC Conduit Box	30.1108	\$150
PVGFP-CF-1	PV Ground Fault Protection - 1 Pole	30.1141	\$275
PVGFP-CF-2	PV Ground Fault Protection - 2 Pole	30.1142	\$325
PVGFP-CF-3	PV Ground Fault Protection - 3 Pole	30.1143	\$375
TX4K	Autotransformer 4 kw	30.1151	\$750
TX6K	Autotransformer 6 kw	30.1153	\$800

xantrex**XANTREX POWER PANELS - 71****SW Plus Assembled Power Panels**

Factory-built and NEC compliant pre-assembled power system to UL standards. Systems include inverter(s), ACCB-L, AC inverter bypass, DCCB-L with inverter disconnect breaker and shunt mounted on a metal back plate.

Charge controllers and battery cables and displays are not included. Charge controllers, additional AC and DC input and load breakers can be added at the time of preassembly or in the field. Some options are listed below. Many other options are available. Please contact us for more information. ETL listed. Ships by truck freight.



Power Systems with SW Plus Sine Wave Inverters								
Xantrex Model	Qty of inverters	Inverter Model	Continuous Power	Input Voltage	Output	Battery Charger	Item Code	Price
PP-SW Plus2524/S	1	SWPlus2524	2.5 kW	24 VDC	120 VAC	70 Amp	33.3101	\$4,054
PP-SW Plus2524/D	2	SWPlus2524	5 kW	24 VDC	120/240 VAC	140 Amp	33.3104	\$6,778
PP-SW Plus2548/S	1	SWPlus2548	2.5 kW	48 VDC	120 VAC	40 Amp	33.3107	\$4,054
PP-SW Plus2548/D	2	SWPlus2548	5 kW	48 VDC	120/240 VAC	80 Amp	33.3111	\$6,778
PP-SW Plus4024/S	1	SWPlus4024	4 kW	24 VDC	120 VAC	120 Amp	33.3114	\$4,555
PP-SW Plus4024/D	2	SWPlus4024	8 kW	24 VDC	120/240 VAC	240 Amp	33.3117	\$7,780
PP-SW Plus4048/S	1	SWPlus4048	4 kW	48 VDC	120 VAC	60 Amp	33.3121	\$4,555
PP-SW Plus4048/D	2	SWPlus4048	8 kW	48 VDC	120/240 VAC	120Amp	33.3124	\$7,780
PP-SW Plus5548/S	1	SWPlus5548	5.5 kW	48 VDC	120 VAC	70 Amp	33.3127	\$5,255
PP-SW Plus5548/D	2	SWPlus5548	11 kW	48 VDC	120/240 VAC	140 Amp	33.3131	\$9,180

Xantrex SW Plus Power System Optional Equipment			
Installed Option	Installed Option Description	Item Code	Price
Outback MX60	MX60 Charge controller installed with 60 amp breaker	33.3201	\$728
Xantrex C-40	C40 Charge or load control installed, includes 60 amp DC breaker 12, 24, or 48 VDC	33.3205	\$240
Xantrex C-60	C60 charge or load or diversion controller installed with 60 amp breaker 12, or 24 VDC 48A (Max)	33.3203	\$284
Xantrex CM	LCD Digital Display for C series installed	33.3208	\$99
Xantrex BTS	Battery temperature sensor for C series control	33.3209	\$29
Morningstar TS-60	TS-60 charge or load or diversion controller installed with 60 amp breaker 12, 24 or 48 VDC	33.3211	\$302
Morningstar TSM	LCD Digital display for Tristar installed	33.3212	\$99
Morningstar RTS	Battery temperature sensor for Tristar	33.3213	\$29
TM500A-24V	Xantrex TM500A meter installed in 24V Power Panel	33.3217	\$195
TM500A-48V	Xantrex TM500A meter installed in 48V Power Panel	33.3218	\$235
Trimetric-24V	Trimetric meter installed in 24V power system	33.3221	\$211
Trimetric-48V	Trimetric meter installed in 48V power system	33.3223	\$285
DCCB-L ADD	Additional DCCB-L and backplate	33.3251	\$600
PDB-6	PDB-6 Power block installed	33.3255	\$120
PDB-12	PDB-12 Power block installed	33.3257	\$120
PVGFP-CF-1	PV Ground Fault Protection - 1 Pole - Installed in DCCB	33.3261	\$270
PVGFP-CF-2	PV Ground Fault Protection - 2 Pole - Installed in DCCB	33.3262	\$295
PVGFP-CF-3	PV Ground Fault Protection - 3 Pole - Installed in DCCB	33.3263	\$320
PVGFP-CF-4	PV Ground Fault Protection - 4 Pole - Installed in DCCB	33.3264	\$345
TX4K	Autotransformer 4 kw installed in ACCB	33.3241	\$780
TX6K	Autotransformer 6 kw installed in ACCB	33.3243	\$830

72 - SINE WAVE INVERTERS

Exeltech Sine Wave N+1 Redundant Inverters

The Exeltech MX series inverters are a true sine-wave, very versatile, custom inverter designed for use where reliability is extremely important. MX systems can be configured with power levels from 1000 Watts to 20KW at 120Vac output, 40KW at 240Vac bi-phase, or 60KW at 208Vac 3 phase. Power levels are expandable, and inverter modules can be upgraded or replaced, and if designed as a redundant system, replacement can occur while the system is on line without interruption in power to your loads. The output voltage is precisely regulated, such that no measurable voltage change occurs on the output when the input voltage changes over its wide voltage range. Less than 0.5 volt change in output voltage will occur when the output load varies from 0 to 100% of rated power. With distortion of 2% maximum, this offers the cleanest sine wave power available. The system is extremely compact and lightweight. Modules, cards and cages are combined to create the inverter needed. MX inverters are available with 12, 24, 36, 48, 96, 108 and 120 VDC input voltage.

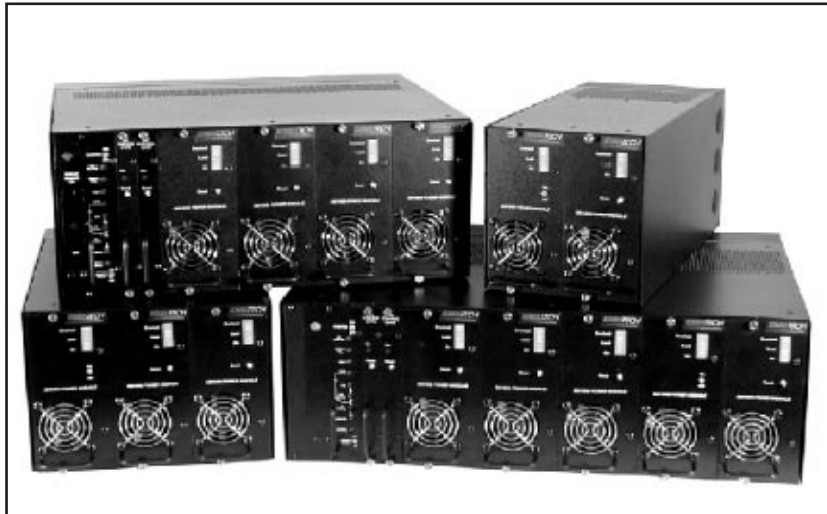

A **Master Module** combines the control signals of a Control Card with a Power Module. This is a space saving solution when redundancy is not necessary. The Master Module provides control signals to up to 19 power modules.

The **Power Module** is a 1000 watt slave power inverter. It requires drive signals from a Master Module or Control Card. This module is the backbone of the inverter system and will be the majority of the modules in most systems.

The **Control Card** provides all the control functions for the Power Modules. Adding a second Control Card provides redundant operation as only one Control Card is required to operate the system.

The **Alarm Card** is necessary in a redundant system. It allows the inverter to detect a control card failure and switch to the backup Control Card. The Alarm Card provides LED indicators for DC On, inverter on, load presence, inverter fail, breaker open, high temperature, and low voltage and "form-C" contact closures for minor failure, major failure, inverter failure, bypass, DC failure, and AC failure.

The **Transfer Switch** allows the inverter to automatically switch between inverter power and a secondary source of AC power. The transfer switch has a maximum capacity of 50Amps and a typical transfer time of 4ms.

Determine the approximate price by adding the cost of the components needed from the chart below. For 120/240V operation, use twice as many Master Modules or Control Cards and Cages. For 3-Phase use 3 times as many Master Modules or Control Cards and Cages.

Exeltech MX inverters will be factory assembled to your specifications. To order an MX inverter please call your vendor or i□ requirement, transfer switch requirement and cage size and they will give you a final quote.

Requirements	MX Component	Description	Price
Choose One	Master Module	Use 1 per system if you are not building a redundant system	\$716
	Control Card	Use 2 in each system for redundant operation	\$238
Choose as many as necessary	Power Module	Use one for each 1000 watts output if using Control Cards or 1 less than total output required if using a Master Module. Add 1 additional for N+1 redundancy.	\$701
Choose One	Rack A 19"	1 required - holds Transfer Switch/Alarm Module and 2 Control Cards with up to 4 Power Modules or 1 Master Module with up to 4 Power Modules	\$701
	Rack A 23"	1 required - holds Transfer Switch/Alarm Module and 2 Control Cards with up to 5 Power Modules or 1 Master Module with up to 5 Power Modules	\$701
Choose One	Rack B 19"	Holds up to 5 Power Module - for expansion only. Width must match Rack A Choice	\$701
	Rack B 23"	Holds up to 6 Power Module - for expansion only. Width must match Rack A Choice	\$701
Optional	Transfer Switch	Optional on Redundant and Non-redundant systems	\$533
	Alarm Card	1 Required for redundant systems	\$238



SINE WAVE INVERTERS - 73

Exeltech XP Series Sine Wave Inverters

Exeltech XP inverters are the most affordable, high-performance true sine wave inverters on the market. They feature sophisticated protection circuitry, making them immune from damage by overloads, short circuits, overtemperature and input polarity reversal. XP series are excellent for telecommunications, audio recording equipment, or any loads that require an excellent waveform. Efficiency = 87-89% (distortion <2%). XP inverters can run on the high charging voltages needed to charge alkaline batteries. 120 VAC output. 1 year warranty.

Model #	Battery Voltage		No-load Watts	Dimensions (Inches)	Weight (Lbs)	Item Code	Price
XP 125 SERIES							
XP125/12	12V	125	5	4.65 x 2 x 6.75	2.3	30.6021	\$250
XP125/24	24V	125	5	4.65 x 2 x 6.75	2.3	30.6024	\$315
XP125/48	48V	125	5	4.65 x 2 x 6.75	2.3	30.6025	\$335
XP125/120	120	125	5	4.65 x 2 x 6.75	2.3	30.6026	\$335
XP 250 SERIES							
XP250/12	12V	250	6	5.23 x 2.77 x 10.38	5	30.6027	\$425
XP250/24	24V	250	6	5.23 x 2.77 x 10.38	5	30.6030	\$425
XP 250/48	48V	250	6	5.23 x 2.77 x 10.38	5	30.6032	\$493
XP250/120	120	250	6	5.23 x 2.77 x 10.38	5	30.6035	\$493
XP 1100 SERIES							
XP1100/12 LI	12V	1100	10	7.7 x 3.6 x 14.77	12	30.6072	\$759
XP1100/24 LI	24V	1100	10	7.7 x 3.6 x 14.77	12	30.6078	\$759
XP1100/48	48V	1100	15	7.7 x 3.6 x 14.77	12	30.6075	\$1175
XP1100/120	120	1100	15	7.7 x 3.6 x 14.77	12	30.6080	\$1175



Samlex Sine Wave Inverters

Samlex Sine Wave Inverters offer the first low-cost high-quality small sine wave inverters for remote homes, RVs and boats. The output is overload protected. All these inverters have AC recepticals and low battery alarms. 120 VAC output. If you plan to use these inverters with reactive load, such as motors and compact fluorescent lights or other ballasted light, size the inverter for 4 times the continuous watts required.

1 year warranty.



Samlex Model	Battery Voltage	Continuous Watts	Surge Watts	Dimensions (Inches)	Weight (Lbs)	Item Code	Price
PST-15S-12A	12V	150	250	2.4 x 4.7 x 7.4	2.6	30.7123	\$169
PST-30S-12A	12V	300	500	4.7 x 11.22 x 2.4	3.9	30.7126	\$195
PST-60S-12A	12V	600	1000	9.3 x 13.2 x 3.3	6.6	30.7129	\$399
PST-100S-12A	12V	1000	1500	9.3 x 15.5 x 3.3	8.8	30.7130	\$649
S-1500-112B2	12V	1500	2000	15.4 X 10.8 X 4.1	15.4	30.7131	\$899
PST-60S-24A	24V	600	1000	9.3 x 13.2 x 3.3	6.6	30.7132	\$334
PST-100S-24A	24V	1000	1500	9.3 x 15.5 x 3.3	8.8	30.7134	\$575
S1500-124B2	24V	1500	2000	15.4 X 10.8 X 4.1	15.4	30.7135	\$985
S1500-148B2	48V	1500	2000	15.4 X 10.8 X 4.1	15.4	30.7148	\$985

74 - XANTREX INVERTERS



Xantrex ProSine Inverters

ProSine 1000 and 1800 are compact and lightweight true sine wave inverters with automatic power-saving search-mode when no load is present. These models have NO internal battery charger. The LCD meter control panel on inverter shows battery voltage, amps from battery, and bar graph of AC output watts and indicates overload, overheat, high or low voltage. CSA approved to UL standards.

ProSine 2000/12 is a 2000 watt sine wave inverter with a 4500 watt surge for 5 seconds, plus a 3-stage standby 100 ampere battery charger. An LCD display/remote control panel and 70 foot cable are included. When there is no load on the inverter it goes into an idle mode of under 2 watts to save power. It is protected against short circuit, over-temperature, overload, and low voltage. Operating temperature 0° F to 158° F. for better cold tolerance. The ProSine 2000 has a 30 amp AC transfer relay that passes utility or generator power to house when generator or utility is connected, and charges battery. Then when generator (or utility) cuts off it automatically switches back to inverter within 16 milliseconds. The battery charger maintains 100 amp charge with AC input as low as 90 volts and can be adjusted for wet, AGM or gel batteries. Included battery temperature sensor adjusts charge voltage for hot or cold batteries. To avoid exceeding the amp rating of your generator the battery charger can automatically back off charge rate when you operate large AC loads. Includes hardwire terminals for code legal AC in and out connections. No outlets.



ProSine Model	Battery Volts	AC Volts / Hz	Continuous Watts	Charge Amps	Weight (Lbs)	Item Code	Price
1000/12V Hardwire	12	120/60	1000	N/A	15	30.0914	\$940
1000/24V Hardwire	24	120/60	1000	N/A	15	30.0916	\$1,030
1800/12V Hardwire	12	120/60	1800	N/A	16	30.0917	\$1,350
1800/24V Hardwire	24	120/60	1800	N/A	16	30.0924	\$1,480
2000/12V Hardwire	12	120/60	2000	100	24	30.0921	\$2,000



Xantrex XPower 1500 Power Pack

XPower Powerpack 1500 is a portable power system that can supply up to 1500 watts of household electricity. It consists of a battery pack that stores electrical energy, an inverter that converts 12 volts from the battery pack to household power, two standard AC outlets, and a DC power outlet that is used to run 12 volt products. These components are packaged into a rugged "cart" with a removable waist handle that allows XPower Powerpack 1500 to be wheeled from room-to-room or outdoors over rough terrain. Recharge XPower from a standard wall outlet with the included AC charger or recharge from your car, truck or RV with the included DC charging cable. Battery capacity is 60 AH. 1-year warranty.



Xantrex XPower Powerpack 300Plus

Powered by a rechargeable battery, XPower Powerpack 300Plus provides up to 300 watts of AC power and can jump-start a car, truck, boat or small RV. It can also operate a wide range of 12 volt automotive and marine products. Ideal for power emergencies, XPower Powerpack 300Plus comes with a built-in fluorescent emergency light and jump-start cables. Built-in a 20 amp-hour battery. It will power a cordless telephone for up to 40 hours, a laptop computer for six hours, and a portable stereo for 17 hours. The fluorescent light that comes with it will run for up to 25 hours on a full charged battery. Recharge XPower from a standard wall outlet with the included AC charger. 1 year warranty.



Xantrex XPower Mobile-Plugs

The XPower Mobile-Plug 75 is the smallest inverter on the market today. It incorporates high frequency technology to convert power from a vehicle's battery (12-volt DC) into standard utility power (120-volt AC, 60 Hz) through a single, three prong outlet. By plugging the XPower Mobile-Plug 75 into a vehicle's lighter socket, users can recharge and run electronic devices such as cell phones, camcorders, and most laptop computers and PDAs - without the need for multiple adapters. It will run 75 watts for 5 minutes and 60 watts continuously.

The XPower Mobile-Plug 175 is a higher power version with a 175 watt output. 1 year warranty on both units.



Description	Item Code	Price
XPower Powerpack 1500	30.1518	\$370
XPower Powerpack 300 Plus	30.1513	\$130
XPower Mobile Plug 75	30.0075	\$30
XPower Mobile Plug 175	30.0081	\$45

xantrex**MODIFIED SQUARE WAVE INVERTERS -****DR Series Inverters**

Xantrex DR series inverters have plenty of power to run microwave ovens, refrigerators, vacuum cleaners and power tools. They were originally designed as a standby power system to keep lights and refrigerators going in Caribbean countries that are plagued with numerous power failures. Their powerful battery charger quickly charges batteries and holds them in float condition. When the power goes off, the inverter goes on, keeping everything running.

The DR inverters are available for 12 volt systems in 1500 and 2400 watt versions. The 24 volt versions are available in 1500, 2400 and 3600 watt versions. The output is 120 volt AC, but with the optional stacking cable, two units of the same input voltage can be connected for up to 7200 watts of 120/240 volt AC power, allowing the pair to operate large 240 volt appliances like pumps, as well as typical 120 volt appliances.

Export models are available in 230 volt/50 HZ, 105 volt/50 HZ, 105 volt/60 HZ and 220 volt/60 HZ outputs. Call for those not listed. Export models cannot be stacked.

DR inverter dimensions are 20" x 8.5" x 8". ETL listed to UL standards. 2-year warranty.

DR Series Domestic Voltage Inverters							
Xantrex Model	Battery Volts	AC Volts / Hz	Continuous Watts	Charge Amps	Weight (Lbs)	Item Code	Price
DR1512	12	120/60	1500	70	40	30.1243	\$850
DR2412	12	120/60	2400	120	52	30.1249	\$1,100
DR1524	24	120/60	1500	35	39	30.1246	\$850
DR2424	24	120/60	2400	70	47	30.1252	\$1,100
DR3624	24	120/60	3600	70	47	30.1255	\$1,350

DR Series Export Voltage Inverters							
Xantrex Model	Battery Volts	AC Volts / Hz	Continuous Watts	Charge Amps	Weight (Lbs)	Item Code	Price
DR1512E	12	230/50	1500	70	39	30.1258	\$850
DR1524E	24	230/50	1500	35	39	30.1261	\$850
DR2424E	24	230/50	2400	70	47	30.1267	\$1,100

DR Series Accessories				
Xantrex Model	Description	Weight (Lbs)	Item Code	Price
DRCB	Conduit Box for DR series	1	30.1270	\$69
DRI	Stacking Cable for DR	2.5	30.1273	\$85
RC8/25	Remote On/Off Switch w/25 ft Cable	2	30.1276	\$54
RC8/50	Remote On/Off Switch w/50 ft Cable	2	30.1279	\$69
RC8/100	Remote On/Off Switch w/100 ft Cable	2	30.1282	\$94
BTS/15	Temperature Sensor 15'	2	20.8025	\$29
BTS/35	Temperature Sensor 35'	1	20.8029	\$32

Samlex Modified Sine Wave inverters

Samlex Modified Sine Wave inverters are your value-priced solution to mobile power requirements. They provide modified sine-wave output with over voltage, under voltage, overload and thermal protection, and low voltage alarm. Samlex 1000, 1500 and 2500 watt inverters have dual LED bar graph meters indicating battery current and voltage. Cigarette plug included only on 140 and 300. Larger units need to be hard-wired to battery. If you plan to use these inverters with reactive loads, such as motors and compact fluorescent lights or other ballasted lights, size the inverter for 4 times the continuous watts required. 1 year warranty.



Model	Battery Voltage	Continuous Watts	Surge Watts	Dimensions (Inches)	Weight (Lbs)	Item Code	Price
SI-175HP	12V	175	300	1.6 x 4.7 x 5.4	1.8	30.7220	\$40
SI-400HP	12V	400	600	2.4 x 6.3 x 6.3	2.9	30.7223	\$67
SI-750HP	12V	750	1500	2.4 x 6.3 x 11.4	5.3	30.7227	\$164
PSE-12125A	12V	1250	2500	3.5 x 9.4 x 12.3	8	30.7229	\$366
PSE-12175A	12V	1750	3500	3.5 x 9.4 x 17	10	30.7232	\$470
PSE-12275A	12V	2750	4500	6.3 x 9.4 x 18.2	19	30.7235	\$806
PSE-24100A	24V	1000	2000	3.5 x 9.4 x 13.5	9	30.7238	\$448
PSE-24150A	24V	1500	3000	3.5 x 9.4 x 18.2	12.4	30.7241	\$530
PSE-24250A	24V	2500	4500	6.3 x 8.5 x 19.5	22	30.7244	\$866

76 - DC TO DC CONVERTERS

Solar Converters DC “Autotransformers”

These high-efficiency DC to DC converters can be used to step-up or step-down battery voltage. These converters are bi-directional so they can be used to increase or decrease voltage. They can be used to operate 12 volt loads on a 24 or 48 volt battery system or to run a 24 volt refrigerator on a 48 volt battery system. See the chart below for up and down voltage and current limits. 1-year warranty.

Solarcon Model	Voltage	Amps @ Low Voltage	Amps @ High Voltage	Item Code	Price
EQ 12/24-20	12/24	20	10	38.8209	\$180
EQ 12/24-50	12/24	50	25	38.8751	\$390
EQ 12/48-10	12/48	10	2.5	38.8745	\$235
EQ 12/48-30	12/48	30	7.5	38.8760	\$475
EQ 24/48-10	24/48	10	5	38.8748	\$235
EQ 24/48-30	24/48	30	15	38.8754	\$500



Vanner Voltmaster Battery Equalizer

This device allows you to power 12 volt and 24 volt loads from a 24 volt battery system without unbalancing the voltage in part of the battery bank. Without this device, if you draw 12 volt from part of a 24 volt battery bank, and charge the bank with a 24 volt charging system, the half of the bank that the 12 volt loads are not connected to will always be at a higher state of charge. This device allows you to draw 12 volts from the “lower half” of the bank while continuously recharging the “lower half” from the upper half. It automatically stops charging when the upper and lower half are at equal voltages. The 60-20A amp version can maintain even battery voltage with up to 20 amps of draw on 12 volt circuits. The 65-60A allows the battery to supply up to 60 amps at 12 volts continuously. Inverters or other loads that are intermittently larger than the equalizer’s capacity can be used as long as the average amp draw over time is less than the capacity of the device.

Vanner Model	Voltage	Description	Item Code	Price
60-20A	12/24	20 Amp Battery Equalizer	45.8107	\$350
65-60A	12/24	60 Amp Battery Equalizer	45.8112	\$600



DC Smart Adapter

The Smart Adapter is a high efficiency DC to DC converter that converts the 16 volt output of a solar module or the 12 volt output from a car lighter socket to the voltage required to charge many brands of notebook computer battery or a cell phone, or power a device with a co-ax power jack that can operate on 30 watts or less at 6 to 19 volts. It can be used to power and charge small notebook computers, PDA’s and phones directly from a car cigarette lighter socket. Output voltage is adjustable from 6 to 19 volts. Choose one of the three enclosed coaxial ends included or purchase a specialty plug from an electronics supplier. Warranty: 1 year warranty

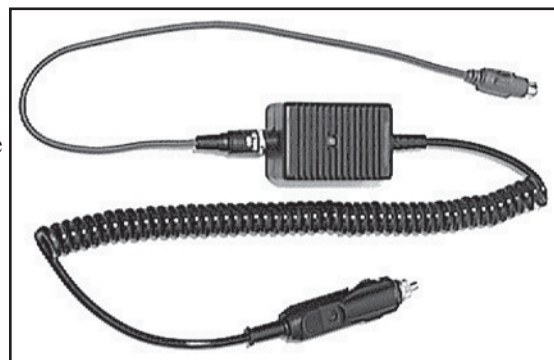

Description	Item Code	Price
Smart Adapter	30.8875	\$79

METERS - 77

Digital DC Volt & Amp Meters

Measure amps and volts in 12, 24 or 48 volt systems with these high-quality, low-cost LCD digital meters. The surface mount, 3" x 2" x 1" plastic enclosure can be easily attached to wood or metal surfaces with two screws. Terminal strip on the back of the meter accepts 14 to 22 AWG wire.



Amp meters are available with a 100A/100mV shunt for measuring up to 100 amps with 0.1 amp resolution, a 500A/50mV shunt to measure up to 500 amps with 1 amp resolution or without a shunt for installations that already have a shunt. Current draw is only 20mA. Amp meter requires 4 conductor wire; volt meter requires 2 conductor wire. Use 22 gauge or larger for up to 50 feet. Use 18 AWG for up to 150 feet. 2 year warranty.

Description	Item Code	Price
Digital Volt Meter 11 to 65 VDC	28.9228	\$42
Digital Amp Meter w/o Shunt	28.9257	\$42
Digital Amp Meter w/ 100A Shunt	28.9259	\$65
Digital Amp Meter w/ 500A Shunt	28.9261	\$65

Hoyt Induction Amp Meters

These meters read DC amps from a wire that is placed in the slot frame on the rear of the meter case. No electrical connection is needed. The 30 amp meter will work with wires up to 8 gauge. The dual range meter has a 75 amp scale and a 600 amp scale. This amp meter will work with wire up to 2/0 gauge.



Description	Item Code	Price
Hoyt 30A Induction Meter	28.8045	\$22
Dual Range 0-75 / 0-600 ADC	28.8049	\$25

Analog Amp Meters

These high quality amp meters mount in a 72 mm square hole. The meter movement is very smooth and accurate. The shunt is built-in to the 30 amp meter so it can be in series with the load to be measured on the negative or positive wire. The 60 amp meter comes with a separate shunt. The mounting plate in the table below holds 1 meter and mounts in a 2-gang wire mold deep switch box.



Description	Item Code	Price
Analog Meter 0-30A DC	28.7332	\$12
Analog Meter 0-60A DC	28.7362	\$18
Mounting Plate for 2-gang Wiremold Box	28.9015	\$5

AC Kilowatt-Hour Meter

These E-Z Read cyclometer GE Utility Grade meters have been removed from service and reconditioned and certified. If you are selling power back to the utility grid, you can keep track of how much power your system is generating. Order one of the raintight meter bases to mount and connect wires to the meter. For use on 120 or 120/240 VAC systems. Maximum current 100 amps. GE Model I-70S - CEC approved.



Kilowatt-Hour Meter Sockets

We stock two types of kilowatt hour meter bases. The cast, low-cost round base has 1-1/2" threaded holes in the top and bottom. The Milbank brand sheetmetal base is 8" W x 11.5" H (shown with meter mounted). Both are for single phase 2 or 3 wire 100 amp service and both come with sealing ring. Raintight, NEMA 3R for outdoor use.



Description	Item Code	Price
GE Kilowatt Hour Meter w/ EZ-Read Cyclometer	28.3015	\$30
GE Kilowatt Hour Meter w/ Conventional Dial	28.3018	\$32
Kilowatt Hour Meter Socket - Round	28.3025	\$16
Kilowatt Hour Meter Base - NEMA-3R	28.3027	\$48

Kill-a-Watt AC Meter

This kilowatt-hour meter is easy to set-up and use. It gives the user power usage information for individual appliances, displaying true power consumed (including power factor information), and keeps track of cumulative kilowatt-hours, cumulative time the meter has been plugged in, and amount of money the electricity consumed costs. A 15 amp circuit breaker protects against overloads. UL listed.



Description	Item Code	Price
Kill-A-Watt Portable Kilowatt Hour Meter	28.2005	\$50

Low Cost Digital Multimeter

Measure DC volts, AC volts, up to 10 amps AC or DC current, ohms, continuity and test diodes with this 9 volt powered (battery included). This inexpensive troubleshooting tool is made in China.

Dimensions are 2.75" x 5" x 1".

Description	Item Code	Price
Digital Multimeter	28.8031	\$19



78 - BATTERY AMP HOUR METERS

Tech Tip - Amp Hour Meters

With the use of an Amp-Hour meter, you can tell the condition of your batteries at a glance. An amp-hour meter is the best indicator of your system's condition. As you use power, the meter counts how many amp hours are used. As the battery is charged, the meter goes backwards, toward zero. When the battery is full, the meter reads zero. This type of meter is a must for nickel-cadmium and nickel-iron batteries, where it is hard to tell state of charge from voltage, or specific gravity. The main destroyer of lead acid batteries is sulfation caused by undercharging. These sophisticated meters help you keep track of your battery's state of charge so you can keep 'em charged. Get maximum life out of your batteries and save money and system down time.

Note: Amp hour meters lose accuracy if batteries are always run in a very discharged state.

Xantrex Link 10 Meters

Link 10 meters provide complete battery status information for one and two battery banks, respectively. Simple and easy-to-use digital display shows volts, amps, amp hours consumed, and operating time remaining. They also have an easy to read multi-color LED bar graph. The Link 10 allows you to select Automatic, Sleep and Scanning modes and automatically calculates and displays charging efficiency. By adding an optional prescaler, Link 10 can monitor battery banks up to 500 volts.



The splash proof panel allows for outdoor mounting and hands free operation. They display key historical battery information such as charge efficiency, deepest discharge, and average discharge and they are compatible with 12 and 24 volt DC systems. The shunt is included with all models. The Link 10 Choice has an RS232 Serial Data Port and alarm switch. The Accessories include Prescalers (0-100 or 0-500 volts) to extend voltage range covered by your meter.

One year warranty

Description	Item Code	Price
Link-10 Standard - Meter w/ 500A/50mV shunt	28.1128	\$250
Link-10 Choice - Meter w/ 500A shunt & RS232 port	28.1125	\$350
Pre-scaler 0-100V - Use with battery higher than 24V	28.1131	\$95
Pre-scaler 0-500V - For use with battery up to 500V	28.1134	\$95
Temperature Sensor - Increases meter accuracy	28.1137	\$57
Mounting Bracket	28.9014	\$7
Meter Wire 8-conductor 18 AWG (price/ft)	50.1252	\$1

Xantrex TM-500A



The TM-500A is similar to the Trimetric Meter in a special package with fuse and fuse holder. An improved display shows volts, amps, amp-hours and percent without changing mode. Very easy to install and use. Installation is simplified with a special shunt that includes a phone-type jack. Install the shunt, plug the special six-conductor cable in to the shunt and meter and all the connections are made! Meter shows days since fully charged, cumulative amp hours, recharge indicator, low voltage indicator, and full charge indicator. Comes with a 50' six conductor cable with jacks, fuse, and a special 500A/50mV shunt. Also is capable of turning DR, PS, and UX inverters on and off. 2550 amp-hour max battery size. Longer length cables are available for long runs. Use the 48 volt adapter for 48 volt systems.

The TM-500A is not recommended for use with Outback PS2DC and PS4DC power system boxes because the Outback shunts will not match the shunt circuit board that comes with the meter.

Dimensions: 4.55" x 4.55" x 1.725". 2 year warranty.

Xantrex Model	Description	Item Code	Price
TM-500A	Amp Hour Meter w/shunt	28.1405	\$245
TM-500NS	Amp Hour Meter w/o shunt	28.1403	\$195
TM48	48 Volt Adapter	28.1413	\$40
TC25	25 foot cable	28.1421	\$22
TC50	50 foot cable	28.1422	\$36

BATTERY MONITORS - 79

Trimetric 2020

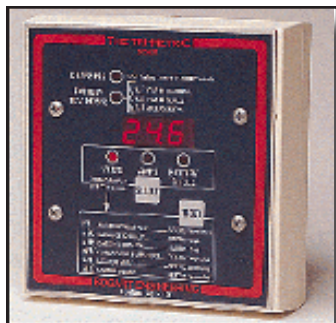

This amp-hour meter for 12 or 24 (and 48 with adapter) volt battery systems reads volts, amps and amp-hours on an LED display. Amp-hours can be displayed in actual amp-hour numbers, or as “% full”. An LED lights when the battery is charging and flashes when the battery has been fully charged. Another LED flashes when batteries should be recharged, equalized, and during low battery voltage. It also records minimum and maximum voltage, days since batteries were last charged, days since equalized, and total lifetime amp-hours withdrawn from the batteries. The Trimetric can be located hundreds of feet away from batteries using inexpensive 4 conductor twisted pair meter wire. For 48 V systems or additional lightning protection on 12/24 V systems, use a 48 V adapter with the meter. A shunt is required for operation. Use

the 500 Amp shunt if you have a 12 V inverter larger than 800 watts or a 24 V inverter larger than 1600 watts. Use the 1000 Amp 100mV shunt for systems with stacked SW inverters or where continuous current is over 300 amps. The 1000A/100mV shunt has the same resistance as the 500A/50mV shunt and may be used interchangeably. Order shunt separately. Allows for a maximum battery bank size of 2500 amp hours. The positive lead to the Trimetric should be fused with a 1 amp fuse. Flush mount or use Wiremold box to mount. Made in USA. Dimensions: 4.5” x 4.75”. 2 year warranty.

Description	Item Code	Price
Trimetric 2020 AH Meter	28.0020	\$175.00
48 Volt Adapter	28.0023	\$28.00
Surface Mount Box	28.0026	\$11.00
500A/50mV Shunt	28.9253	\$30.00
100A/100mV Shunt	28.9245	\$30.00
1000A/100mV Shunt	28.9254	\$47.00
4 Conductor 22 AWG Wire	50.1243	\$0.20
4 Conductor 18 AWG Wire	50.1237	\$0.45

Pentametric Battery Monitor



The Pentametric monitor measures 1 or 2 battery systems with a common negative. With one battery system, battery current plus two charging sources/loads can be measured.

The new PentaMetric battery monitor system offers a lot more capability than the TriMetric monitor. The complete system consists of 3 parts: Input unit (near batteries), Display unit (shown above) and computer

interface unit. It can monitor up to 3 shunts: For example; measure total solar input and wind input independently in addition to monitoring battery “state of charge”. You can access the data with display unit (shown above) with LCD display and buttons up to 1000 feet from batteries. An optional computer interface with (Windows) software allows you to control and read out all data from the computer. It has a relay output to control a generator or external alarm and it has audible and visual alarms for high and low battery conditions.

Basic measurements include:

2 voltage channels: 8-100 volts. (For example you can monitor volts from two battery systems.

3 amperage channels ± 0.1 -200 Amps (with 100A/100mV shunt). ± 0.1 -1000 Amps (with 500A/50mV or 1000A/10mV shunt) Each of these requires a separate shunt.

Temperature -20 to +65 degrees C.

Secondary measurements

Amp hour (3 channels) to $\pm 83,000$ Amp-hours
 Cumulative (negative) battery amp hours. (2 channels)
 Smoothed (time filtered) Amps
 Smoothed (time filtered)
 Volts (2 channels) 0-100 Volts.
 Watts(2 channels) ± 0.1 - 20,000 watts
 Watt-hours(2 channels) $\pm 21,000$ kilowatt hours
 Battery %full (2 channels) 0-100%
 Days since batteries charged (2 channels) .01-250 days
 Days since batteries equalized (2 channels) .01-250 days

Data logging functions.

There are 3 types of data logging functions. With the computer interface all 3 types can be output to spreadsheet file.

1. “Periodically logged data” can record any or all of the following at regular intervals: once per day to up to once per minute, Amp hours (3 channels), Watt hours (2 channels), Temperature max/min (1 channel), Volts (1 channel), Amps (1 channel)

2. “Battery discharge voltage profile” data logs volts and amps every time charge level changes by 5% (or 10%) for 1 or 2 battery systems.

3. “Battery cycle efficiency data” documents system efficiency for up to 2 battery systems.

***8 conductor wire below is ok for measuring 1 battery. One additional conductor will be required for 2 batteries.**

Description	Item Code	Price
Pentametric Display Unit PM-100D	28.0011	\$199.00
Pentametric Input Unit PM-5000U	28.0013	\$220.00
Computer Interface PM-100C	28.0015	\$100.00
500A/50mV Shunt	28.9253	\$30.00
100A/100mV Shunt	28.9245	\$30.00
8 Conductor 22 AWG Wire / per foot*	50.1255	\$0.20

80 - REMOTE MONITORING

Why use Monitoring Tools?

Residential and commercial installers, and owners of systems of any size can now benefit from system monitoring and display tools. These products provide knowledge and control over energy system generation and demand. Residential and commercial system owners can monitor their PV installations and see the impact of changes in consumption as well as actual system impacts such as tree shading or equipment degradation over time. Residential and commercial installers can check system performance, diagnose system issues, and take corrective actions quickly and cost-effectively.

Monitoring and display products help you see the condition and performance of your residential and commercial energy system in real-time. Over time your solar energy generation and demand fluctuates. Periodic meter readings provide only a vague glimpse at the long-term changes, while telling you nothing about short-term performance issues. Good monitoring and display tools can help reveal trends, transient issues, cost savings opportunities, and emerging issues. Advanced monitoring tools are remotely accessible via the Internet. They feature real-time graphics, and historical system performance data. Get the knowledge and control you need to obtain maximum performance and cost savings over the lifetime of your system.

Monitoring systems typically consist of hardware that connects to the energy system, and software that collects, stores, and displays the data. Older systems required proprietary data acquisition products and dedicated hardware for data storage and display. Such systems usually entailed substantial training, high costs, and inflexible features requiring consulting and custom programming.

Fat Spaniel Technologies PV2Web™ Monitoring and Visualization Tools

Finally, a monitoring and display product with residential and commercial installers and system owners in mind! Fat Spaniel Technologies' simple, powerful, and field proven PV2Web™ monitoring and visualization solution works with your residential or commercial PV or wind system to provide visually engaging, real-time displays. PV2Web™ allows you to manage and view your solar energy system or whole-building energy picture in a single view. There is no software to install or maintain and you can view the system information from any Internet-enabled device. View your system anytime, anywhere using a web browser, mobile phone, or PDA. With PV2Web™, residential and commercial installers can assure customers that the system specified is delivered and operating properly. PV2Web™ provides views for post-installation support and can alert you to emerging system issues.

PV2Web™ Residential Solution

Maximize Your Savings and Increase Your Control Through Greater Knowledge.

Fat Spaniel Technologies' PV2Web™ Residential Solution gives the residential system owner the monitoring and visualization tools to understand and manage their solar energy system. PV2Web™ Residential Solution allows you to improve your net-metering results and reduce your electricity bill by managing your energy use.

Image at right is a typical Simple View showing real-time and historical data about energy generation and usage, savings, and daily, weekly and monthly comparisons. For an interactive view of a live system, go to <http://www.fatspaniel.com> and click on the import/export graphic in the upper left corner of the page.



Residential Solution Features

- View real-time and historical energy production and usage
- Improve net-metering results
- Access your system information anytime, anywhere
- Show off the environmental benefits of your installation
- Automated alerts reduce service calls
- View one or many systems, from a single inverter to large commercial installations.
- CEC approved as an eligible system performance meter

Fat Spaniel monitoring can qualify your PV system for the California performance-based rebate program

REMOTE MONITORING - 81

PV2Web™ Commercial Solution

With Fat Spaniel Technologies' PV2Web™ Commercial Solution, you get an accurate and real-time view of your savings and production, whenever and wherever you need it. PV2Web™ allows you to view your whole-building energy picture by monitoring one or many building systems in a single view.

The image at right is a typical Commercial Simple View showing real-time and historical data. For an interactive view of a live system, go to <http://www.fatspaniel.com> and click on the import/export graphic in the upper right hand corner of the page.

Commercial Solution Features

- View one or many building systems, from a single inverter to multi-inverter installations
- Reduce your energy bill through tighter management of energy production and usage.
- Improve net-metering results by maximizing export and load-shifting
- View real-time and historical energy production and usage
- Access your system information anytime, anywhere
- Show off the environmental benefits of your installation
- Automated alerts reduce service calls
- CEC approved as an eligible system performance meter

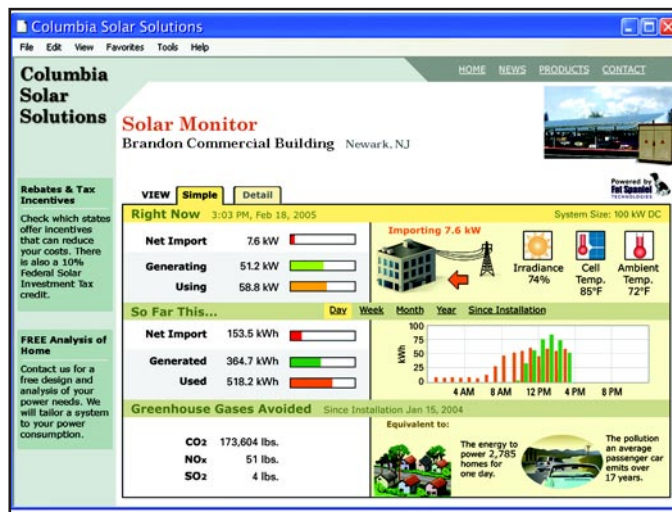

PV2Web™ Custom Commercial View

Custom Commercial views are available to view selected aspects of your whole-building energy picture. Monitor one or many building systems in a single view. Call for more information.

PV2Web™ Installer Administrative Solution

The Fat Spaniel Technologies' PV2Web™ Installer Administrative Solution can help you improve customer service and support to your residential and commercial customers. Offer a higher level of customer support by resolving system issues before the customer is aware of a problem. Resolve issues quickly without a costly on-site visit.

The image at right shows a typical Installer Administrative view showing real-time and historical information about each inverter's voltage, current and power output, with alert conditions highlighted.

Installer Administrative Solution Features:

- Installer's view only
- Quickly diagnose systems without an onsite visit
- View output and environmental conditions
- Multiple string Views
- Alerts history

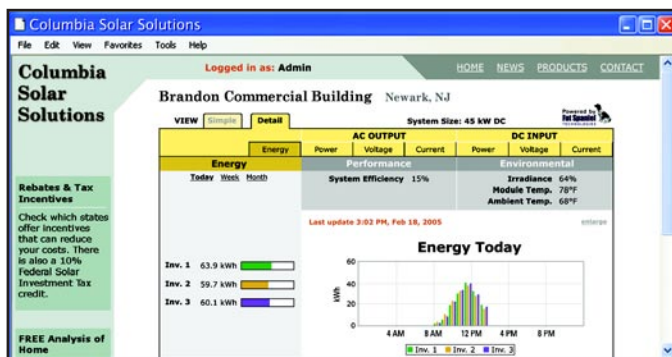

Pricing worksheet for standard commercial PV installations, with Executive and Administrative views hosted on the Fat Spaniel Technologies website.

PV2Web™ Residential Solution Pricing			
Code	Description	Item Code	Price
PVR1-BB	Basic PV monitoring, single inverter. Includes hardware, software license and 5 years monitoring and support. Choose this option if you have Broadband access onsite	29.1141	\$1,428
PV2Web™ Commercial Solution Pricing			
Code	Description	Item Code	Price
PVC1-BB	Per-site monitoring equipment for an inverter-independent solution. Basic commercial 3-phase PV monitoring, single inverter. Includes hardware, software license and 5 years monitoring and support. Choose this option if you have Broadband access onsite.	29.1148	\$2,380

Manage Your Energy Systems

with Live Data
Over the Internet

The **Industry Leader**
in **Web-Enabled,**
"Anytime, Anywhere"
Energy **Monitoring.**

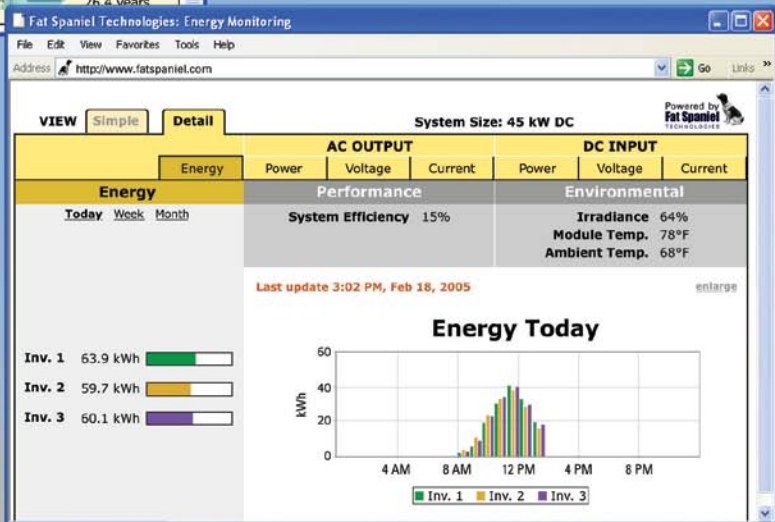

- ### Commercial, Residential & School Solutions
- Easy to install hardware
 - Turnkey monitoring service
 - Automated system alerts
 - Downloadable performance reports
 - Custom & branded views
 - Add live data to your web site



See our live web monitoring views:
www.fatspaniel.com

Shell Solar

Solar Electric Products

You have the vision. Shell Solar can help you make it a reality.

Shell Solar, Camarillo, California



www.shell.com/solar



Backup Power the Easy and Elegant Way!

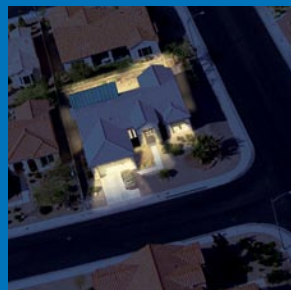

The Premier Green Choice for 24-hour Energy Independence

The Beacon Smart Power M5 makes providing PV-powered backup simple and attractive. The M5 has a proven track record of dependable and reliable field performance, providing customers with clean, efficient, solar power whenever the sun shines. Even better, the M5 is continuously ready to automatically transfer PV or battery power to run critical loads whenever the grid goes down.

The M5 features:

- Highly accurate Maximum Power Point Tracking
- Patented anti-islanding technology
- Integrated, compact single-box solution, includes charge-controller, inverter & switchgear
- NEMA 3R outdoor rating
- Approved for rebates in CA, NY, NJ and other states
- NYSERDA, CEC and UL approved

Installed on AEE's headquarters



Now available: battery cabinet, battery disconnect and string combiner with matching appliance-like look

Enquire about our Certified Installer program

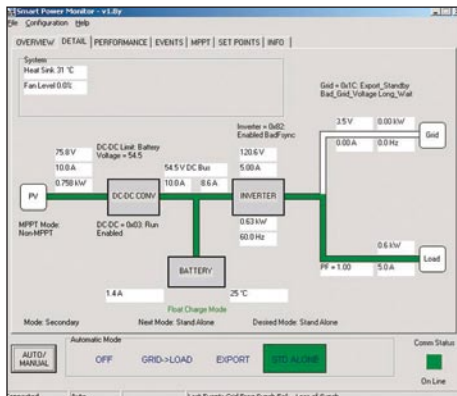

Smart Power Monitor software monitors more than 20 system parameters so you can see how much power is being produced and where it's going.



Pure brilliance.

**We're fully integrated,
so you get the best in solar**

Producing our own wafers, cells, and modules assures that the highest quality components go into every one of our panels. And since they're made with String Ribbon™ technology, our panels take advantage of one of the newest, fastest-growing, most environmentally friendly manufacturing processes available in the world.

Evergreen Solar is a fully integrated, independent company. Solar is our *only* business. Our commitment to the environment is matched only by our commitment to our customers. Visit our website to learn more. If, like us, you want the best in solar, go with the pure choice.

Think ever green.



1-866-357-2221 www.evergreensolar.com





POWER-FAB
QUALITY HARDWARE FOR THE PV INDUSTRY



Best Engineered Top-of-Pole Mounts
(photo courtesy Meridian Energy, Texas)

- ✓ TOP-of-POLE
- ✓ SIDE-of-POLE
- ✓ POWER TUBE™
COMMERCIAL
RACKING SYSTEM
- ✓ POWER-RAIL™
- ✓ POWER-GRID™
- ✓ ROOF/GROUND
- ✓ BATTERY /EQUIP
ENCLOSURES
- ✓ BATTERY
CABINETS



Strongest Side-of-Pole Mounts
Model # DP-SPM2-SQ80-MA

Since 1993 Direct Power and Water Corporation has been providing high quality mounting structures to the most demanding installers for standard and custom applications.



Versatile Ground Mounts



Rugged Battery Enclosures
Model# DP-BB2-8D-HC



User-friendly Power-Rail™
(photo: Renewable Energy Svcs, Hawaii)

POWER-FAB PV HARDWARE
MANUFACTURED BY DIRECT POWER AND WATER CORP.

4000-B VASSAR DRIVE NE
ALBUQUERQUE, NM 87107
800-260-3792

WEBSITE: www.power-fab.com
EMAIL: info@directpower.com

Smart choice for power



Save more than time

Our new Xantrex GT 3.0 Grid Tie Solar Inverter costs less per watt and is easier to install than any other grid tie inverter on the market.

When Xantrex set out to develop our new grid tie inverter, we listened to the experts – renewable energy dealers and installers. The result is a high performance three-kilowatt string inverter that offers superior PV energy harvest, easy installation, state-of-the-art design and high reliability. And with an MSRP of only \$2500 for 3000 watts of power, our GT 3.0 also offers the best price/performance in the industry.

For details on our breakthrough inverter, visit www.xantrex.com/griddtie. Or call 1-800-234-6431 and we'll send you our new brochure.

Xantrex GT 3.0 Grid Tie Solar Inverter

- ▶ New York State Public Service Commission Listed
- ▶ CEC listed
- ▶ Breakthrough price/performance
- ▶ Superior PV energy harvest
- ▶ All-in-one three kilowatt system design
- ▶ Lightweight, easy to install

www.xantrex.com

SMA America's Solar Family... Something to Smile About

SMA America has long been a leader in solar technology, with a growing family of products. From our Sunny Boy 700U to the Sunny Island 4248U, we specialize in the most powerful, efficient, reliable and flexible photovoltaic inverters on the market today.

That's because our philosophy is, quite simply, understand what our customers want, and provide it. So we work hard to meet your family's needs, whether residential or commercial, on-grid or off-grid.

Our dealers and installers are also a part of our family, trained as SMA Solar Pros to design and implement Sunny Boy solar electric power systems. Call us to find the Solar Pro nearest you.

We're especially proud of the newest SMA family member, the Sunny Island 4248U. This commercial-grade inverter works seamlessly with existing systems, and can be used for either off-grid needs or as backup to grid-tied systems, using smart technology to deliver peak efficiency and dependability.

SMA America: the best in solar technology. From our family... to yours.



SMA America:
Here we grow again!



Sunny Island 4248U
Perfect for off-grid
energy, or as
backup power to
on-grid systems!

SMA America, Inc.
12438 Loma Rica Drive
Grass Valley, CA 95945
Tel. 1.530.273.4895
Fax 1.530.274.7271
Email: info@sma-america.com
Web: www.sma-america.com

SMA America is pleased to introduce the newest addition to our product line: the Sunny Island 4248U.

The Sunny Island 4248U is a 4200 Watt commercial grade inverter that's ideal for off-grid systems, or as backup power for on-grid systems. It is the result of years of dedicated research and development, and the finest in solar technology – and it shows.

Built for flexibility, the Sunny Island 4248U can be incorporated into current systems, or used on its own. Rely on it to generate power off-grid practically anywhere... or depend on it as backup to on-grid systems when power is lost. And, it does it all at 95% peak efficiency – among the best in the industry.

The Sunny Island 4248U: the future of solar technology is here.

Solar Today...
Energy Tomorrow



Reliability and now Flexibility

One turbine, any voltage (12-48V)

With new looks and new names, the Whisper 100 (formerly the Whisper H40) and the Whisper 200 (formerly the Whisper H80) are more reliable and quieter than ever. We are constantly testing, researching and refining our products to create the most affordable and reliable small wind turbines available...

...another reason why we sell more wind turbines than anyone else.

WHISPER 200

WHISPER 100

New **bushing** provides superior **reliability** and smoother operation

Your Whisper's **voltage** is now **field adjustable** to grow with your RE system

A **four bearing spindle** benefits both **efficiency and reliability**

Upgraded **yaw shaft** provides **optimal current path**

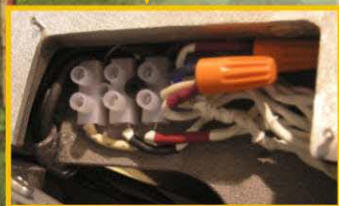

Southwest Windpower

Renewable Energy Made Simple

2131 N. First Street
Flagstaff, AZ 86004 USA
Tel 928-779-9463 • Fax 928-779-1485
www.windenergy.com
info@windenergy.com



How Much Power Can You Handle?

Now you can handle a lot more, thanks to the new Fronius IG 4000 and IG 5100 grid tied inverters that output up to 5,100 Watts. Yet still weigh only 42 pounds, about one-third of the competition's weight.

The key is that these units use the same proven hardware and software as the 60,000 IG units already operating worldwide. It's like having two inverters in one easy-to-install box, but with the advantages of even greater part-load efficiency and increased longevity due to the new IGs' load-sharing ability.

You also get everything you'd expect from the leader in inverter technology: built in disconnects, a user-friendly LCD, and the easiest, most flexible performance monitoring system available. All protected by conformal coating to handle even the harshest environments.

Get a handle on the world's lightest, easiest-to-install inverters. Put our 60 years of design and manufacturing experience to work on your next job.

Fronius USA LLC 5266 Hollister Avenue #117, Santa Barbara, CA 93111
Tel: 805-683-2200 Email: pv-us@fronius.com Web: www.fronius.com



POWERING YOUR FUTURE

PV MODULE FRAMING AND MOUNTING SYSTEM FOR PITCHED ROOFS

SUNFRAME®

U.S. and other patents pending.

Add aesthetics to the benefits of PV power

Low clean lines. Your choice of clear or dark bronze anodized finish. Like a skylight, SunFrame becomes a natural feature of any home.

SunFrame also meets strict structural standards, including Uniform and California building codes, and delivers the installation ease you've come to expect from UniRac.



UNIRAC®

THE STANDARD IN PV MOUNTING STRUCTURES™

www.unirac.com

UniRac, Inc.

505.242.6411

505.242.6412 fax

3201 University Blvd SE, Suite 110 • Albuquerque NM 87106-5635 USA

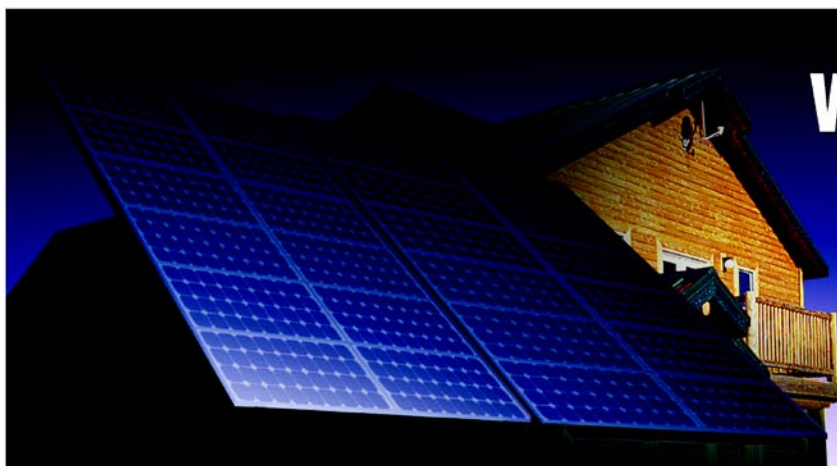

Working For Your Environment.

DEKA SOLAR
RENEWABLE ENERGY GEL BATTERIES



TECHNOLOGICALLY-ADVANCED AND ENVIRONMENTALLY-CONSCIOUS.

East Penn recycles 100% of scrap lead-acid batteries at our state-of-the-art, E.P.A. permitted recycling facility. In fact, we safely recycle 20,000 batteries a day on site.

We are the world's largest and most modern single-site battery manufacturer offering premium quality valve regulated lead acid batteries in both Gel and AGM types to exceed the solar industry's high standards.

QUALITY SYSTEM
CERTIFIED TO
ISO 9001

PROVEN PRODUCT IN DEMANDING PHOTOVOLTAIC APPLICATIONS • LESS THAN 2% PER MONTH STAND LOSS MEANS LITTLE DETERIORATION DURING TRANSPORT AND STORAGE
U.L. RECOGNIZED COMPONENT • MINIMUM MAINTENANCE • COMPETITIVE WARRANTY • MADE IN THE U.S.A.



DOMESTIC INQUIRIES:
800-372-9253 • solarinquiries@mkbattery.com

EAST PENN
manufacturing co., inc.

INTERNATIONAL INQUIRIES:
610-682-3263 • www.dekabatteries.com

INCREASE YOUR SOLAR OUTPUT

With our Solar Boost™ Maximum Power Point Tracking (MPPT) solar charge regulators.

Patented MPPT technology extracts more power from the PV array – up to 30% more power. Cooler climates may extract even more!

Solar Boost charge controllers are available in a variety of sizes. Most are ETL listed for UL1741, CSA/CE requirements.

Our family is growing. New SB3024i and IPN ProRemote incorporate more features and more functions utilizing our IPN high speed digital network. Includes an auxiliary output that serves as 20 amp load controller or 2 amp battery charger.

IPN-ProRemote Display provides complete charge control and battery system monitoring, eliminating the need for a separate battery monitor device.



Contact us today for more information.
Visit our web site www.blueskyenergyinc.com
or email to: sales@blueskyenergyinc.com

800-493-7877 or 760-597-1642
Fax 760-597-1731

2598 Fortune Way, Suite K
Vista, CA 92081 USA



94 - BATTERY INFORMATION

Battery Information And Sizing

All stand-alone and battery backup PV systems require battery storage. Photovoltaic modules charge the batteries during daylight hours and the batteries supply the power when it is needed, often at night and during cloudy weather. Utility intertie systems supply power directly to the utility grid; no battery storage is needed. The two most common types of rechargeable batteries in use today are lead-acid and alkaline. Lead acid batteries have plates made of lead, mixed with other materials, submerged in a sulfuric acid solution. We do not list nickel-cadmium batteries in this catalog because of their high cost and environmental problems related to disposal. Nickel-Metal Hydride and Lithium Ion batteries look promising for the future, but at this time their price is much too high for the size needed for all but the smallest of remote lighting systems.

Battery Size

The size of the battery bank required depends on the storage capacity required, the maximum discharge rate, the maximum charge rate, and the minimum temperature at which the batteries will be used. When designing a power system, all of these factors are looked at and the one requiring the largest capacity will dictate battery size. Temperature has a significant effect on lead-acid batteries. At 40°F they will have 75% of rated capacity, and at 0°F their capacity drops to 50%. The storage capacity of a battery, the amount of electrical energy it can hold, is usually expressed in amp-hours. If one amp is used for 100 hours, then 100 amp-hours have been used. A battery in a PV power system should have sufficient amp-hour capacity to supply needed power during the longest expected period of cloudy weather. A lead-acid battery should be sized at least 20% larger than this amount. If there is a source of backup power, such as a standby generator with a battery charger, the battery bank does not have to be sized for worst-case weather conditions.

Lead-Acid Batteries

Lead-acid batteries are the most common in PV systems because their initial cost is lower and because they are readily available nearly everywhere in the world. There are many different sizes and designs of lead-acid batteries, but the most-important designation is whether they are deep-cycle batteries or shallow-cycle batteries. Shallow cycle batteries, like the starting batteries in automobiles, are designed to supply a large amount of current for a short time and to stand mild overcharge without losing electrolyte. But they cannot tolerate being deeply discharged. If they are repeatedly discharged more than 20% their life will be very short. These batteries are not a good choice for a PV system. Deep cycle batteries are designed to be repeatedly discharged by as much as 80% of their capacity so they are a good choice for PV systems. Even though they are designed to withstand deep cycling, these batteries will have a longer life if the cycles are shallower. All lead-acid batteries fail prematurely when they are not recharged completely after each cycle. Letting a lead-acid battery stay in a discharged condition for days at a time will cause a permanent loss of capacity. Sealed deep-cycle lead-acid batteries (gel cells and absorbed glass mat) are maintenance free. They never need watering or an equalization charge. Sealed batteries require very accurate regulation to prevent over-charge and overdischarge. Either of these conditions will drastically shorten their lives. We recommend sealed batteries for remote, unattended power systems.

Caring For Lead-Acid Batteries

Always use extreme caution when handling batteries and electrolyte. Wear gloves, goggles and old clothes. "Battery acid" will burn skin and eyes and destroy cotton and wool clothing.

The quickest way to ruin lead-acid batteries is to discharge them deeply and let them stand "dead" for an extended period of time. The positive plates change from lead oxide when charged to lead sulfate when discharged. If they remain in the lead sulfate state for a few days, part of the plate does not return to lead oxide when the battery is recharged. The parts of the plates that become "sulfated" no longer store energy.

Batteries that are deeply discharged and then charged partially on a regular basis can fail in less than one year. Check your batteries on a regular basis to be sure they are getting charged. Use a hydrometer to check the specific gravity of your lead-acid batteries. If batteries are cycled very deeply and then recharged slowly, the specific gravity reading will be lower because of incomplete mixing of electrolyte. Check the electrolyte level in wet-cell batteries at least four times a year and top-off each cell with distilled water. Do not add water to discharged batteries. Electrolyte is absorbed when batteries are discharged. If you add water at this time and then recharge the battery, electrolyte will overflow and make a mess. Keep the tops of your batteries clean and check that cables are tight. Do not tighten or remove cables while charging or discharging. Any spark around batteries can cause a hydrogen explosion inside, and ruin one of the cells, and you. It is a good idea to do an equalizing charge when some cells show a variation of 0.05 specific gravity from each other. This is a long steady overcharge, bringing the battery to a gassing or bubbling state. Do not equalize sealed or gel-type batteries.

With proper care, lead-acid batteries will have a long service life and work very well in almost any power system. With poor treatment lead-acid battery life will be very short.

We strongly recommend the use of an amp-hour meter with all battery systems. See pages 78 and 79.

**BATTERY WARRANTIES DO NOT
COVER DAMAGE DUE TO POOR
MAINTENANCE OR LOSS OF
CAPACITY FROM SULFATION**

BATTERY WIRING DIAGRAMS - 95

BATTERY WIRING DIAGRAMS

The diagrams below show typical 12, 24 and 48 volt battery wiring configurations. Batteries can deliver extremely high current. Always install fuse protection on any positive wiring connected to batteries.

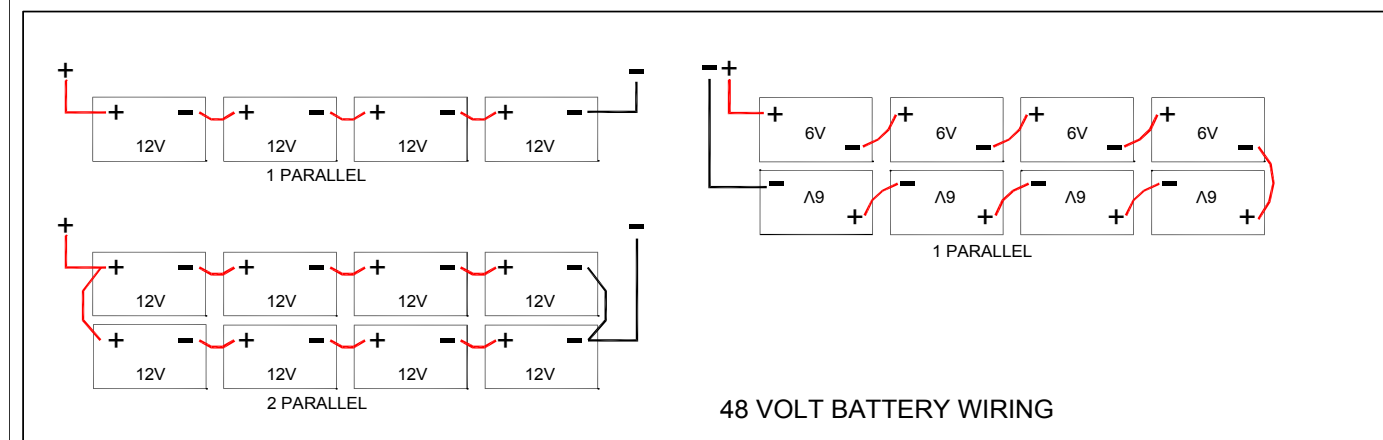
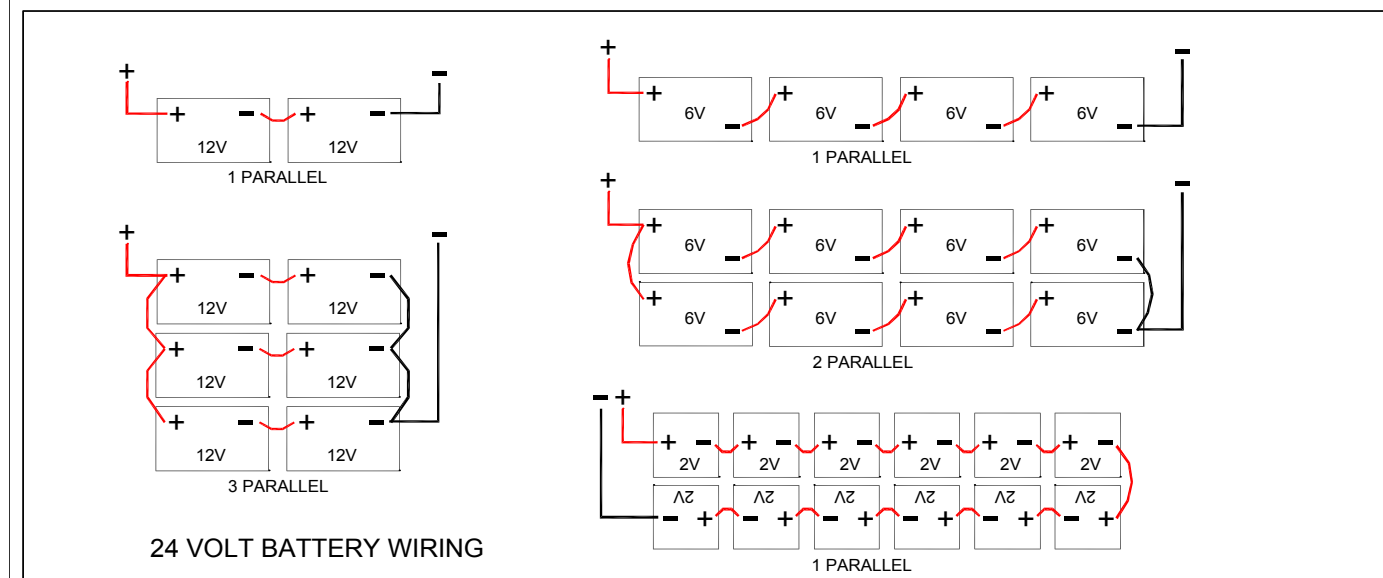
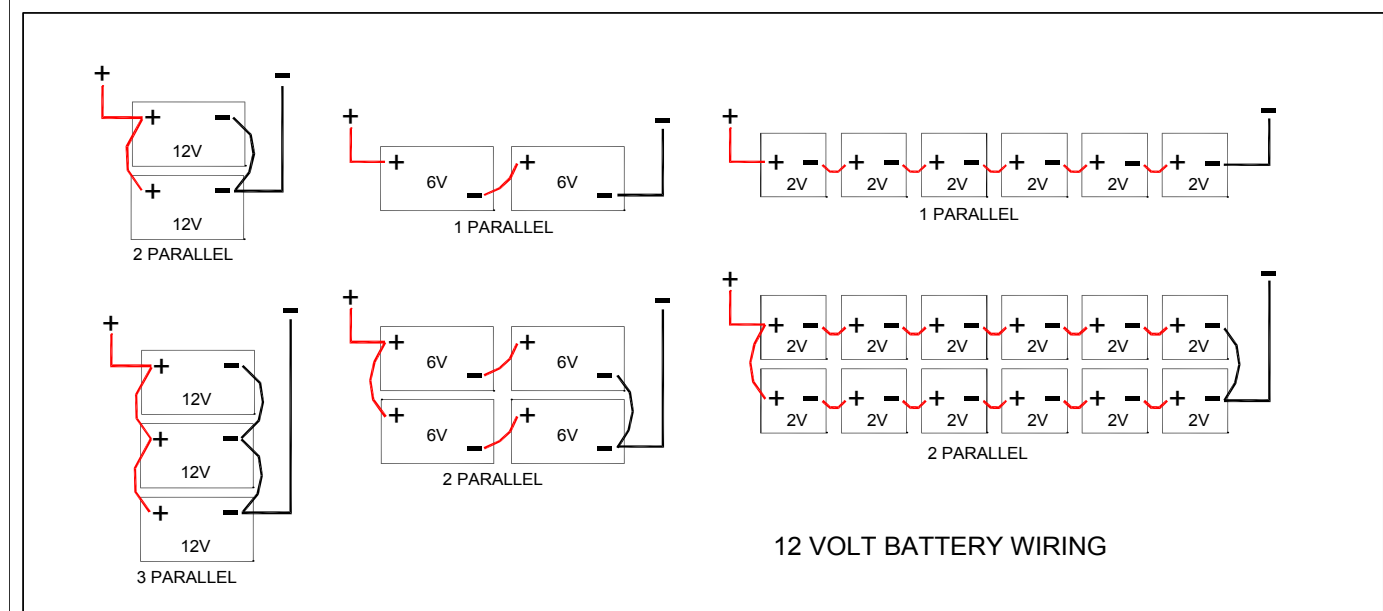

96 - BATTERY INFORMATION

Battery State-of-Charge

Battery state-of-charge (SOC) can be measured by an amp-hour meter, voltage or by specific gravity. Some care and knowledge is required to interpret state-of-charge from voltage or specific gravity readings. We recommend amp-hour meters for all systems with batteries.

Amp-Hour Meters

An

ies charged. At a glance the user can see system voltage, current, and battery condition. (See the meter section for more information on amp-hour meters.)

Measuring Battery State-of-Charge

Battery voltage will vary for the same state-of-charge depending on whether the battery is being charged or discharged, and what the current flow is in relation to the size of the battery. The chart below will give you an idea of state-of-charge for various battery conditions in flooded cell lead-acid batteries. Voltage varies with temperature. While charging, a lower temperature will increase battery voltage. Full charge voltage on a 12 volt battery is 0.9 volts higher at 32°F than at 70°F. While discharging, a higher temperature will increase battery voltage. There is little temperature effect while a battery is standing.

(This information courtesy of Ralph Heisy, Bogart Engineering.)

Battery Condition @ 77°F	Nominal Battery Voltage		
	12V	24V	48V
Battery during equalization charge	Over 15	Over 30	Over 60
Battery near full charge while charging	14.4 to 15.0	28.8 to 30.0	57.6 to 60.0
Battery near full discharge while charging	12.3 to 13.2	24.6 to 26.4	49.2 to 52.8
Battery fully charged with light load	12.4 to 12.7	24.8 to 25.4	49.6 to 50.8
Battery fully charged with heavy load	11.5 to 12.5	23.0 to 25.0	46.0 to 50
No charge or discharge for 6 hours - 100% charged	12.7	25.4	50.8
No charge or discharge for 6 hours - 80% charged	12.5	25	50
No charge or discharge for 6 hours - 60% charged	12.2	24.4	48.8
No charge or discharge for 6 hours - 40% charged	11.9	23.8	47.6
No charge or discharge for 6 hours - 20% charged	11.6	23.2	46.4
No charge or discharge for 6 hours - Fully discharged	11.4	22.8	45.6
Battery near full discharge while discharging	10.2 to 11.2	20.4 to 22.4	40.8 to 44.8

Hydrometers

A hydrometer is very accurate at measuring battery state-of-charge if you measure the electrolyte near the plates. Unfortunately, you can only measure the electrolyte at the top of the battery. When a battery is being charged or discharged, a chemical reaction takes place at the border between the lead plates and the electrolyte. During charging, the electrolyte changes from water to sulfuric acid. The acid becomes stronger and the specific gravity rises as the battery charges. Near the end of the charging cycle gas bubbles rising through the acid stirs the fluid to mix it. It takes several hours for the electrolyte to mix so that you get an accurate reading at the top of the battery. Always try to take readings after a period of no charge or discharge.

Hydrometer Readings

The chart below shows battery state-of-charge at various specific gravities. These readings are correct at 75 degrees F.

State of Charge	Specific Gravity
100% Charged	1.265
75% Charged	1.239
50% Charged	1.2
25% Charged	1.17
Fully Discharged	1.11

BATTERY INFORMATION - 97

Battery Sizing Worksheet

Use this worksheet to determine what size battery is required for your system. Battery size is measured in amp-hours. This is a measure of battery capacity. Battery voltage is determined by the number of "cells" in series. All lead-acid battery cells have a nominal output of 2 volts. Actual cell voltage varies from about 1.7 volts at full discharge to 2.4 volts at full charge. 12 volt lead-acid batteries are made of 6 separate cells in one case. 6 volt batteries are made of 3 cells in one case. Putting battery cells in parallel increases amp-hour capacity, but does not change voltage.

Battery Temperature	Multiplier
80°F/26.7°C	1
70°F/21.2°C	1.04
60°F/15.6°C	1.11
50°F/10.0°C	1.19
40°F/4.4°C	1.3
30°F/-1.1°C	1.4
20°F/-6.7°C	1.59

Step 1 Total average amp-hours per day required from the Systems Load Worksheet, line 9: _____

Step 2 Maximum number of continuous cloudy days expected in your area : _____

Step 3 Multiply line 1 by line 2: _____

Step 4 Divide line 3 by 0.8 to maintain a 20% reserve after deep discharge period. (Dividing line 3 by a more conservative 0.5 will maintain a 50% reserve and increase battery life): _____

If no special conditions below apply, skip to line 9:

Special Condition #1: Heavy Electrical Load

Step 5 Maximum amperage that will be drawn by the loads for 10 minutes or more : _____

Step 6 Multiply line 5 by line 5.0 _____

Special Condition #2: High Charge Current

Step 7 Maximum output amperage of PV array or other battery charger : _____

Step 8 Multiply line 7 by 10.0 hours: _____

Step 9 Amp hours from line 4, 6 or 8, whichever is largest : _____

Step 10 If you are using a lead acid battery, select the multiplier from the Battery Temperature Chart above which corresponds to the battery's wintertime average ambient temperature _____

Step 11 Multiply line 9 by line 10. This is your optimum battery size in amp-hours: _____

Step 12 Amp-hours of battery chosen. (Industrial Cell, T105=220, L16=350, etc.): _____

Step 13 Divide line 11 by line 12. This is the total number of batteries in parallel required _____

Step 14 Round off to the next highest whole number. This is the number of parallel strings required. _____

Step 15 To determine the number of batteries required in series, divide the system voltage (12, 24,48) by the voltage of the chosen battery (2V, 6V or 12V). _____

Step 16 Multiply line 14 by line 15. This is the total number of the chosen battery needed for the system _____

98 - COMMERCIAL DEEP CYCLE BATTERIES

Trojan Commercial Deep Cycle Lead Acid Batteries

These batteries have been used in off-grid power systems in remote cabins for the past 25 years with great success. Because of their low initial cost, they are the most affordable true-deep cycle batteries. The T105 golf car battery is designed to be used in small electric vehicles where they are cycled heavily and last about 2 years. In a remote home system where they are cycled down 20% every day they can last 3 to 6 years. The L-16 battery is designed for electric floor scrubbing machines. They are a heavy duty cousin of the golf car battery with much thicker lead plates and nearly twice the capacity. The L-16 is available in a standard and a high-capacity version. The standard version holds more electrolyte and has a slightly longer life.

The SCS-series 12 volt marine batteries are Trojan's top of the line 12 volt deep cycle batteries. They are designed for marine and RV use and work well in small cabin systems where 110 to 130 amp hours is enough storage.



Model #	Volts	Capacity (AH) 20 Hour Rate	Dimensions (in)	Weight (lbs)	Item Code	Price
T-105	6	225	10.375 x 7.125 x 11.25	62	40.1939	\$90
L-16PO	6	390	11.625 x 7 x 16.75	113	40.1963	\$220
L-16HC	6	420	11.625 x 7 x 16.75	121	40.1964	\$230
SCS150	12	110	11.25 X 6.75 X 9.75	50	40.1921	\$105
SCS225	12	130	13.25 X 6.75 X 9.75	66	40.1927	\$119

Dyno 2 Volt 1050 Amp Hour Battery

This is an L16 battery with the three cells connected in parallel for 2-volt output. It is a great choice for remote homes where batteries need to be moved by hand, but where a 1000 to 2000 amp hour battery is required. For a 1000 amp hour system, all batteries are wired in series, eliminating parallel connections.

It has the same kilowatt hour capacity as a standard L-16. Use 6 for a 12 volt system, 12 for a 24 volt system and 24 for a 48 volt system.

Model #	Volts	Capacity (AH) 20 Hour Rate	Dimensions (in)	Weight (lbs)	Item Code	Price
L-16-2	2	1050	12.32 x 7.125 x 16.5	118	40.1993	\$220



Water Miser Battery Caps

Water Misers are molded plastic "flip-top" vent caps designed to reduce and ease maintenance on flooded Lead-Acid batteries. There is no need to remove the caps when charging, filling, or equalizing the batteries. When charging, the plastic pellets capture up to 90% of the moisture and acid droplets. This reduces acid fumes, corrosion, and keeping the battery tops much cleaner and dryer. Excess water is dropped back into the battery cell. Water loss is reduced, which extends time between watering.

These caps fit the batteries on this page as well as all batteries with standard caps.

Description	Item Code	Price
Water Miser Battery Cap	40.9913	\$8.50



Automatic battery watering systems are available. Contact your dealer for information and pricing.

INDUSTRIAL BATTERIES - 99

Yuasa Hup Solar-One 2100 Cycle Batteries

The Hup Solar-One battery is optimized for solar power systems. It has a slightly enlarged steel case that allows the individual plastic 2 volt cells to be removed, making the battery easier to move without a forklift or crane. Batteries are designed to withstand 2100 cycles to an 80% depth of discharge over a 10 year period. They will withstand 4,000 cycles to 50% depth of discharge and 6,000 cycles to 20% depth of discharge. Their 10 year warranty covers full credit for defects in materials or workmanship in the first 5 years and prorated credit over the second five year period. Each Solar-One 12 volt battery is made up of six 2-volt cells. Order two for 24 volt systems and four for 48 volt systems. The -13, -21 and -25 batteries are usually available from stock. Other sizes are made to order; please allow up to 6 weeks for delivery.



Cell Type	Capacity @ 20 Hr Rate	Weight (lbs.)	Dimensions L" x W" x 25" H	Item Code	Price
SO-6-85-17	845 A-H	642	40" x 7.75"	40.5269	\$1,934
SO-6-85-19	950 A-H	708	40" x 8.25"	40.5272	\$2,067
SO-6-85-21	1055 A-H	780	40" x 8.75"	40.5275	\$2,228
SO-6-85-23	1160 A-H	859	40" x 9.0"	40.5278	\$2,447
SO-6-85-25	1270 A-H	936	40" x 10.25"	40.5281	\$2,573
SO-6-85-27	1375 A-H	1002	40" x 11.25"	40.5284	\$2,738
SO-6-85-29	1482 A-H	1086	40" x 12.0"	40.5287	\$3,113
SO-6-85-31	1585 A-H	1152	40" x 12.75"	40.5290	\$3,245
SO-6-85-33	1690 A-H	1236	40" x 13.5"	40.5293	\$3,394

IBE POWR-Plus Solar Batteries

POWR-Plus batteries are designed to give more energy and maximum battery life. All batteries are custom built when an order is received. Years of experience in the development and construction of batteries and battery chargers, has given IBE the inside edge on the construction of truly quality batteries. They call it "integrated performance." Prompt and professional "service after sales" is offered by their in-house repair shop for both warranted and non-warranted repairs.



All batteries have high capacity industrial type deep cycle cells with flag type terminals on the positive and negative posts. Heat sealed cell covers eliminate the major source of electrolyte leakage, reducing corrosion build-up. Tough steel cases are powder coated for acid resistance and have lifting handles.

Cycle life of these batteries is 5,000 cycles at 20% depth of discharge or 1500 cycles at 80% depth of discharge.

We list 12 volt packs that can be combined for 24 or 48 volt systems. IBE can also supply 2 volt cells and 4 volt packs with the same high quality cells, for use when the batteries must be moved by hand. We can supply 24 and 48 volt packs in single cases if required.

IBE batteries have an 8-year warranty. The first 5 years is full replacement. The last 3 years are prorated.

Cell Type	Capacity @ 20 Hr Rate	Capacity @ 100 Hr Rate	Weight (lbs.)	Dimensions L" x W" x 24" H	Item Code	Price
12V POWR-Plus Solar Batteries						
PP-6-85-9	418 A-H	510 A-H	490	21.5 x 6.62	40.7209	\$1,229
PP-6-85-11	523 A-H	638 A-H	630	26.5 x 6.62	40.7211	\$1,382
PP-6-85-13	627 A-H	765 A-H	670	30.75 x 6.62	40.7213	\$1,493
PP-6-85-15	732 A-H	893 A-H	710	18 x 13	40.7215	\$1,698
PP-6-85-17	836 A-H	1020 A-H	790	20.25 x 13	40.7217	\$1,848
PP-6-85-19	941 A-H	1148 A-H	905	22.38 x 13	40.7219	\$2,034
PP-6-85-21	1046 A-H	1275 A-H	1006	24.75 x 13	40.7221	\$2,171
PP-6-85-23	1160 A-H	1403 A-H	1080	27 x 13	40.7223	\$2,304
PP-6-85-25	1255 A-H	1530 A-H	1160	29.25 x 13	40.7225	\$2,516
PP-6-85-27	1359 A-H	1658 A-H	1240	31.5 x 13	40.7227	\$2,663
PP-6-85-29	1464 A-H	1785 A-H	1325	33.75 x 13	40.7229	\$2,913
PP-6-85-31	1568 A-H	1913 A-H	1389	36 x 13	40.7231	\$3,177
PP-6-85-33	1673 A-H	2040 A-H	1480	38.25 x 13	40.7233	\$3,497
4V POWR-Plus Solar Batteries						
PP-2-85-9	418 A-H	510 A-H	170	7.38 x 6.62	40.7125	\$497
PP-2-85-11	523 A-H	638 A-H	180	8.88 x 6.62	40.7127	\$550
PP-2-85-13	627 A-H	765 A-H	200	10.32 x 6.62	40.7129	\$588
PP-2-85-15	732 A-H	893 A-H	234	6.88 x 13	40.7131	\$657
2V POWR-Plus Solar Batteries						
PP-1-85-17	836 A-H	1020 A-H	138	6.62 x 6.88	40.7155	\$399
PP-1-85-19	941 A-H	1148 A-H	146	6.62 x 7.62	40.7157	\$429
PP-1-85-21	1046 A-H	1275 A-H	168	6.62 x 8.38	40.7159	\$451
PP-1-85-23	1160 A-H	1403 A-H	180	6.62 x 9.12	40.7161	\$473
PP-1-85-25	1255 A-H	1530 A-H	194	6.62 x 9.88	40.7163	\$510
PP-1-85-27	1359 A-H	1658 A-H	208	6.62 x 10.62	40.7165	\$533
PP-1-85-29	1464 A-H	1785 A-H	224	6.62 x 11.38	40.7167	\$575
PP-1-85-31	1568 A-H	1913 A-H	238	6.62 x 12.12	40.7169	\$619
PP-1-85-33	1673 A-H	2040 A-H	252	6.62 x 12.88	40.7171	\$672

100 - SURRETTE/ROLLS BATTERIES

Surrette Deep Cycle Industrial Flooded Batteries



These are the new generation, dual container, deep cycle batteries from Surrette. (S-460 and S-530 are not dual container). They are high capacity batteries with heavy duty plate grid to resist positive plate breakdown. The plates are double insulated with glass mat and a polyethylene envelope, eliminating the possibility of separator misalignment, cracked separators, treeing or shorting at the bottoms or sides. These batteries are rated at 3200 cycles at 50% depth of discharge. Each 2 volt cell is built into its own lightweight container made of durable polypropylene with the cover heat bonded to the container, thus acid leakage is eliminated.



The cells are then assembled into a tough, lightweight polyethylene outer container with a removable lid. Even if the outer container were to break, the battery would still be operable without acid spills. The individual cells are bolted together (CS and KS series) allowing the battery to be disassembled and the cells can be independently removed. This facilitates easy on-site installation, disassembly, assembly, or replacements of individual cells without special skills or tools.

All Surrette CS & KS deep cycle solar batteries come with a 10 year warranty, 3 year full warranty, and 7 years pro-rated.

Freight is free on orders that weigh over 2000 pounds, going to many non-residential locations east of the Mississippi river in the continental US. On S460 and S530 free freight is on pallets of 18. These batteries can only be shipped in pallets of 18.

Freight is free on orders that weigh over 4000 pounds, going to many non-residential locations west of the Mississippi river. On S460 and S530 free freight is on two pallets of 18. Please contact us with the destination zip code to find out if free freight is available.

If a lift gate is required, add \$35.00. For a residential delivery add \$50. If the freight company is required to call ahead, add 25.00.

Surrette Model	Battery Voltage	Capacity (AH)		Rated Cycles (50% DOD)	Warranty (years)	Dimensions (inches)			Weight wet / dry	Item Code	Price
		20 hr Rate	100 hr Rate			L	W	H			
KS-33	2	1700	2500	3300	10	12.5	6.25	24.75	240 / 205	40.2220	\$617
4-CS-17P	4	546	770	3200	10	14.38	8.25	18.25	128 / 98	40.2223	\$382
4-KS-21P	4	1104	1557	3200	10	15.75	9.38	24.75	267 / 186	40.2226	\$772
4-KS-25P	4	1350	1900	3200	10	15.75	10.63	24.75	315 / 220	40.2229	\$963
S-460	6	350	460	1000	7	12.28	7.12	16.75	117 / 90	40.2106	\$222
S-530	6	400	530	1000	7	12.28	7.12	16.75	125 / 105	40.2109	\$254
6-CS-17PS	6	546	770	3200	10	22	8.25	18.25	221 / 178	40.2232	\$573
6-CS-21PS	6	683	963	3200	10	22	9.75	18.25	271 / 217	40.2235	\$717
6-CS-25PS	6	820	1156	3200	10	22	11.25	18.25	318 / 254	40.2238	\$861
8-CS-17PS	8	546	770	3200	10	28.25	8.25	18.25	294 / 238	40.2247	\$765
8-CS-25PS	8	820	1156	3200	10	28.25	11.25	18.25	424 / 342	40.2250	\$1,148
12-CS-11PS	12	357	503	3200	10	22	11.25	18.25	272 / 220	40.2259	\$749

SEALED INDUSTRIAL BATTERIES - 101

GNB Absolyte IIP Industrial Sealed Batteries

The Absolyte battery was developed by GNB, in conjunction with Sandia National Laboratories, as the first VRLA, large capacity, deep-cycle battery for photovoltaic applications. This design provides for extended partial state of charge operation and allows for deep discharge recovery. Their wide band of temperature operation, from -40°C (-40°F) to +50°C (122°F), retains more capacity in cold temperatures than traditional flooded batteries. Life expectancy in float conditions is 20 years @ 25°C (77°F) with proper charging. Life expectancy in cycling conditions is 1200 cycles to 80% DOD with proper charging. Sealed cells with absorbed glass mat (AGM) separators eliminate the need for periodic water additions as found in flooded cells. Periodic visual inspections, voltage readings, and connection retorquing is all that is required.

Protective steel tray housings offer maximum installation flexibility and the Absolute IIP is qualified to stack horizontally up to eight high for use in 1997 UBC/2001 CBC Seismic Zone IV (at or below grade). This provides for high capacity in a small footprint and frees up floor space for other equipment and because they are sealed, they do not require a separate battery room.

They are IEC 896, BS 6290, UL Recognized, ISO 9001:2000, designed to meet Telcordia SR4228 and GR-63-CORE (NEBS).

APPLICATIONS

Absolyte IIP batteries are ideal for photovoltaic and alternative energy applications including:

- Village Electrification
- Telecommunications
- Residential Power
- Railroad Signal
- Navigational Aids

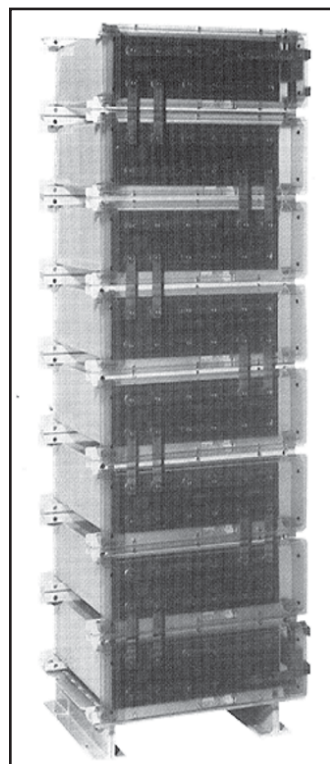

GNB Part Number	Volts	Capacity (AH)		Length (in.)	Width (in.)	Height (Depth) (in.)	Weight (lbs.)	Item Code	Price
		20 Hr rate	100 Hr rate						
6-Cell 12 Volt Batteries									
6-50A05	12	120	140	17.19	8.53	16.22	157	40.4409	\$894
6-50A07	12	182	220	21.69	8.53	16.22	209	40.4412	\$1,060
6-50A09	12	240	290	26.19	8.53	16.22	252	40.4415	\$1,253
6-50A13	12	360	440	35.19	8.53	16.22	356	40.4421	\$1,077
6-90A07	12	300	365	21.69	8.53	23.56	316	40.4430	\$1,060
6-90A09	12	400	490	26.19	8.53	23.56	396	40.4433	\$1,558
6-90A11	12	500	610	30.69	8.53	23.56	477	40.4436	\$1,834
6-90A13	12	600	730	35.19	8.53	23.56	557	40.4439	\$2,143
6-90A15	12	700	855	39.69	8.59	23.56	637	40.4442	\$2,355
3-Cell 6 Volt Batteries									
3-100A19	6	1,020	1,200	26.75	8.59	26.38	470	40.4322	\$1,528
3-100A21	6	1,140	1,330	29.00	8.59	26.38	515	40.4325	\$1,657
3-100A27	6	1,460	1,730	35.75	8.59	26.38	653	40.4334	\$2,057
3-100A29	6	1,580	1,860	38.00	8.59	26.38	704	40.4337	\$2,210
3-100A31	6	1,700	1,995	40.25	8.59	26.38	750	40.4340	\$2,366
3-100A33	6	1,820	2,130	42.50	8.59	26.38	795	40.4343	\$2,516
2 Volt Cells									
1-100A39	2	2,040	2,400	19.93	8.53	26.38	328	40.4225	\$1,099
1-100A45	2	2,340	2,795	22.18	8.59	26.38	374	40.4228	\$1,259
1-100A51	2	2,700	3,190	24.50	8.59	26.38	424	40.4231	\$1,404
1-100A57	2	3,060	3,590	26.75	8.59	26.38	470	40.4234	\$1,528
1-100A63	2	3,420	3,990	29.00	8.59	26.38	515	40.4237	\$1,659
1-100A69	2	3,780	4,390	31.25	8.59	26.38	561	40.4240	\$1,783
1-100A75	2	4,080	4,790	33.50	8.59	26.38	608	40.4243	\$1,908
1-100A81	2	4,440	5,185	35.75	8.59	26.38	653	40.4246	\$2,057
1-100A87	2	4,800	5,585	38.00	8.59	26.38	704	40.4249	\$2,209
1-100A93	2	5,100	5,985	40.25	8.59	26.38	750	40.4252	\$2,365
1-100A99	2	5,460	6,385	42.50	8.59	26.38	795	40.4255	\$2,517

102 - SEALED BATTERIES

MK Sealed PV/Solar Batteries

MK sealed batteries are designed for maintenance free operation for the life of the battery. Sealed construction eliminates periodic watering, corrosive acid fumes and spills. Tank formed plates ensure voltage matching between cells. They are all rated non-spillable by ICAO, IATA, and DOT, which means easy transportation by air and no special containers are needed. 1 year warranty.



Sealed Gel Batteries

The gelled electrolyte won't stratify, so no equalization charging is required. Less than 2% per month standby loss means low discharge during transport and storage.

Gel batteries are best for cycling operations and where very cold temperatures are expected. They can operate at temperatures from -76 to 140 F.

Sealed AGM Batteries

These are completely sealed, absorbed glass mat, valve regulated batteries with efficient recombination. They are UL recognized components to UL standard MH17218. AGM batteries are recommended for battery backup standby power systems where batteries are in float service with occasional deep discharges. They can operate at temperatures from -40 to 140 F.

Delivery is easy from one of 20 MK warehouses all across the US.

Battery Type	Model Number	Volts	Terminals	Capacity (AH)		Dimensions (in)	Weight (lbs)	Item Code	Price
				20 hr Rate	100 hr Rate				
Sealed Gel Solar Batteries	SU1-SLD-G	12	T874	31.2	36.1	7.8 x 5.2 x 7.3	24	40.3015	\$95
	S222NF-SLD-G	12	T881	50	57	9.38 x 5.5 x 9.25	38	40.3018	\$145
	S24-SLD-G	12	T881	73.6	84	10.9 x 6.8 x 9.9	53.6	40.3022	\$189
	S27-SLD-G	12	T876	86.4	99	12.75 x 6.75 x 9.75	63.2	40.3024	\$214
	S31-SLD-G	12	T876	97.6	108	12.94 x 6.75 x 9.75	71.7	40.3027	\$252
	S4D-SLD-G	12	T975	183	210	20.8 x 8.5 x 10	130	40.3030	\$461
	S8D-SLD-G	12	T975	225	265	20.8 x 11 x 10	161	40.3033	\$553
	SV6GC-SLD-G	6	T881	180	198	10.3 x 7.2 x 10.9	69	40.3036	\$252
Sealed AGM Solar Batteries	8AU1	12	T874	32.5	37	7.8 x 5.2 x 7.3	24	40.3117	\$86
	8A22NF	12	T881	55	63	9.38 x 5.5 x 9.25	38	40.3120	\$128
	8A24	12	T881	79	91	10.9 x 6.8 x 9.9	53.6	40.3123	\$160
	8A27	12	T876	92	106	12.75 x 6.75 x 9.75	63.2	40.3126	\$192
	8A31	12	T876	105	116.2	12.94 x 6.75 x 9.75	71.7	40.3129	\$227
	8A4D	12	T975	200	216	20.8 x 8.5 x 10	130	40.3132	\$420
	8A8D	12	T975	245	257	20.8 x 11 x 10	161	40.3135	\$495
	8AGC2	6	T881	200	220	10.3 x 7.2 x 10.9	69	40.3137	\$235

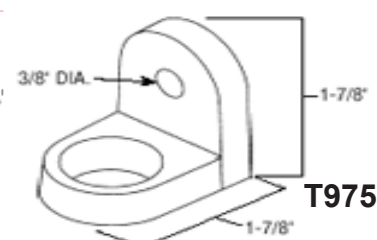
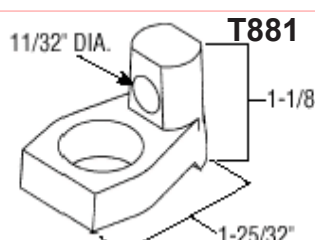
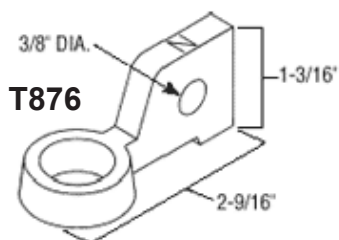
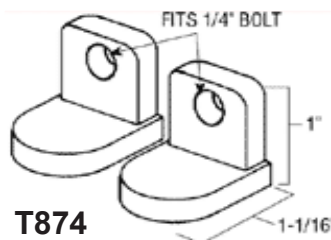

BATTERY CHARGERS - 103

IBE Generator Powered Chargers



All the GPU models are designed with simple and time proven controlled reactance transformer and saturable reactor circuits, which requires the least amount of AC power, little or no maintenance and provides a true constantly tapering charge. The IBE charger is regulated by the "ON CHARGE" battery voltage to control the output dc current. The charger is protected against: overloads, short circuits, line voltage surges and reversed battery connections.

Design features include full magnetic control that automatically allows for full taper charge from high rate to maximum safe finish rate. The charging rate is easily re-adjusted to accommodate aging batteries or batteries with faulty cells.

Ten year limited warranty.

IBE Model	Volts	AC kW Required	Max DC Current		Weight (lbs)	Item Code	Price
			Start	Continuous			
6GPU60	12	0.84	60	42	48	45.4105	\$650
6GPU70	12	1.1	70	49	68	45.4107	\$780
6GPU90	12	1.4	90	63	76	45.4109	\$870
6GPU100	12	1.6	100	70	83	45.4111	\$940
6GPU125	12	1.9	125	88	102	45.4117	\$1,070
6GPU150	12	2.3	150	105	115	45.4119	\$1,180
6GPU170	12	2.6	170	119	120	45.4121	\$1,280
6GPU200	12	3.1	200	140	130	45.4123	\$1,445
6GPU240	12	3.7	240	168	150	45.4125	\$1,790
6GPU270	12	4.2	270	189	180	45.4127	\$2,040
12GPU60	24	1.9	60	42	75	45.4145	\$810
12GPU70	24	2.2	70	49	82	45.4147	\$930
12GPU90	24	2.9	90	63	103	45.4149	\$1,075
12GPU100	24	3.1	100	70	114	45.4151	\$1,155
12GPU115	24	3.6	115	81	132	45.4153	\$1,275
12GPU125	24	4.1	125	88	138	45.4155	\$1,370
12GPU150	24	4.7	150	105	154	45.4157	\$1,470
12GPU170	24	5	170	119	160	45.4159	\$1,565
12GPU200	24	6	200	140	178	45.4161	\$1,755
12GPU240	24	7	240	168	204	45.4163	\$1,990
12GPU270	24	8	270	189	220	45.4165	\$2,290
24GPU60	48	3.8	60	42	112	45.4207	\$1,290
24GPU70	48	4.4	70	49	143	45.4209	\$1,440
24GPU90	48	5.8	90	63	154	45.4211	\$1,580
24GPU100	48	6	100	70	165	45.4213	\$1,720
24GPU115	48	6.8	115	81	182	45.4215	\$1,880
24GPU125	48	7.7	125	88	188	45.4217	\$1,990
24GPU150	48	9.3	150	105	196	45.4219	\$2,120
24GPU170	48	10.5	170	119	204	45.4221	\$2,310
24GPU200	48	12.5	200	140	227	45.4223	\$2,570

Xantrex Truecharge 40+ Charger

TRUECHARGE 40+ is a high reliability 40 amp electronic battery charger for deep cycle batteries. Switch settings give correct charge for wet, gel cell, or absorbed glass mat batteries. Selectable 2 or 3 stage charging where 3 stage includes float charge. Manual equalize charge button. Manual or automatic temperature compensation. Optional temperature sensing probe to correct charge voltage for actual battery temperature. This charger has full 40 amp output even with low cost generators, which is important when using the charger with a 1000 to 3000 watt generator. Dimensions: 2.75" x 6.7" x 15.1". 1-year warranty.



Description	Item Code	Price
Truecharge40+ Charger	45.2885	\$450
Temperature Sensor	45.2889	\$30
Remote Control Panel	45.2888	\$40

104 - BATTERY CHARGERS

Iota DLS Converter/Chargers

The DLS series converter/power supply output is so clean and ripple-free, it can be used with or without a battery. The DLS series converter/charger quickly and efficiently charges batteries from the full rated output of the DLS. The DLS then maintains the batteries, only putting into the battery what is required by load or self discharge, cutting back to milliamps as the battery requires. Low and transient AC line voltage can be a major cause of converter/power supply failure. The DLS series converter/power supply is protected against low line voltage, as well as spikes coming from the AC power source or from improperly adjusted generators.

When used as a power supply, the DLS model will only supply what is required by the load. When not in use it is essentially off, reducing electricity usage. External fuses can be quickly and easily replaced.

Chargers have 120 VAC input. 75 amp and larger charges have 120V 20 Amp plugs. 2-year warranty

Iota IQ-4 Smart Controller

The IQ-4 makes the DLS charger into 3 stage charge with bulk, absorption and float charging. If the battery remains in float stage for 7 days, it delivers a bulk charge.

The IQ-4 is not recommended for generator powered battery charging if generator is only run for short periods of time.

Iota Model	Battery Volts	Charge Amps	Dimensions (inches)	Weight (lbs)	Item Code	Price
DLS-15	12	15	7 x 6.5 x 3.5	4	45.2112	\$132
DLS-30	12	30	7 x 6.5 x 3.5	5.5	45.2115	\$171
DLS-45	12	45	7 x 6.5 x 3.5	5.5	45.2118	\$183
DLS-55	12	55	7 x 6.5 x 3.5	5.5	45.2121	\$215
DLS-75	12	75	10 x 6.5 x 3.5	7.8	45.2124	\$440
DLS-90	12	90	10 x 6.5 x 3.5	7.8	45.2127	\$497
DLS-27/15	24	15	7 x 6.5 x 3.5	5.5	45.2130	\$281
DLS27/25	24	25	7 x 6.5 x 3.5	5.5	45.2133	\$335
DLS-27/40	24	40	10 x 6.5 x 3.5	7.8	45.2136	\$545
DLS-54/15	48	15	10 x 6.5 x 3.5	7.8	45.2148	\$545
IQ-4	12	Smart Controller for 12V Chargers			45.2103	\$30



Samlex Battery Chargers

These compact, light weight, multi-stage battery chargers are designed to charge and maintain Lead/Acid and Gel-cell batteries, without supervision. Safely charge and condition marine, recreational vehicle, industrial and automotive batteries. They can charge multiple banks of batteries.

1-year warranty.

Chargers have 120 VAC input.



Samlex Model	Battery Volts	Bulk Voltage	Float Voltage	Max DC Current	Amp Meter	Isolated Banks	Dimensions (inches)	Weight (lbs)	Item Code	Price
SEC-1215A	12	14.4	13.8	15	Yes	3	8.4 x 8.4 x 3.25	5.0	45.3073	\$152
SEC-1230A	12	14.4	13.8	30	Yes	3	10.7 x 8.4 x 3.25	5.3	45.3076	\$278
SEC-1245A	12	14.4	13.8	45	No	2	12 x 9 x 4	11.1	45.3079	\$406
SEC-2415A	24	28.8	27.6	15	Yes	3	10.7 x 8.4 x 3.3	5.3	45.3082	\$278
SEC-2425A	24	28.8	27.6	25	No	2	12 x 9 x 4	11.1	45.3085	\$406

BATTERY RACKS - 105

Outback Power System Rack (PSR)

This is a combined battery cabinet and system component rack for batteries, disconnects, over current protection devices and even the inverter/charger in a single enclosure. The PSR is a powder coated steel enclosure with internal support frame, shelves and removable side and top panels for indoor use. The PSR is also available frame only version (PSR-FO).

It holds up to eight Group 27/31, eight T105, four L16, or two 8D type batteries in its standard configuration. With one extra shelf, it will hold 12 Group 27/31 batteries and with 2 extra shelves it can hold four 8D batteries. Dimensions: 43"H x 34"W x 17"D.

It is packaged disassembled for easy shipping and must be assembled at the site with a screwdriver.

- All sides and top can be removed with conduit attached on the PSR
- Includes DC breaker bracket which holds up to five small breakers and one large breaker
- Easily connected to various power inverters or the OutBack PSDC via 2" conduit
- Circuit breakers are easily added in the field
- PSRs can be directly mated end to end for large storage battery systems



Optional Components

- PSR-SK - Additional shelf kit for use with more batteries or components
- One OBDC-100, 175 or 250 DC breaker for disconnecting the inverter/battery system
- OBDC-GFP/2 - Dual circuit 60 amp PV ground fault protection system for one or two PV controllers (only one OBDC-GFP/2 fits)
- OBDC 5 to 70 amp breakers for DC loads and inputs
- PSR-SZ4 - Seismic zone 4 Kit to meet UBC earthquake safety requirements
- PSR-HDT - Heavy Duty Top for mounting an inverter directly on top of a PSR cabinet – indoor use only
- PSR-BCK – Lockable breaker cover kit for PSR only
- PSR-MP - Mounting plate for mounting inverters or PV charge controllers inside PSR



For OBDC Breakers, See page 66

Outback Part #	Description	Item Code	Price
PSR	Battery and Power System Rack	30.4519	\$649
PSR-FO	Battery Rack - Frame only	30.4528	\$399
Optional Components			
PSR-3RK	Outdoor Kit includes an insulated rain-proof cover, gasketing and a plastic breaker cover	30.4525	\$149
PSR-SK	Additional Shelf Kit	30.4531	\$89
PSR-SZ4	Seismic Zone 4 Kit	30.4537	\$89
PSR-HDT	Heavy Duty Top	30.4522	\$79
PSR-SCT	Spill Containment Tray - Fits one shelf	30.4534	\$29
PSR-MP	Mounting Plate attached to the inside back of the PSR for mounting inverters or electrical components	30.4470	\$39
PSR-BCK	Breaker Cover Kit with mounting screws and padlock hasp	30.4540	\$19
PSR-MMA	Allows side mounting of Beacon M-5 Inverter	30.4545	\$39

Spill Containment Tray

This tray holds four Group 31, T105 or L16 batteries. The tray has enough capacity to hold one ruptured battery cell's spilled electrolyte. Fits on one PSR shelf. Molded acid resistant polyethylene plastic. See table above for PSR-SCT pricing.



See Page 60 for Beacon Battery Cabinet

106 - BATTERY ENCLOSURES

Battery and Control Enclosures

These NEMA3R enclosures were made to contain complete industrial quality power systems for remote applications. They hold 1 or 4 Group 31 or smaller batteries and can be mounted to either a 2 to 6 inch pole, a flat surface or a concrete pad. The included pole mounting hardware is designed so as not to allow removal from the outside of the enclosure. They feature hinged doors with secure locking latches, passive ventilation and a white powder coat finish. Both models have an internal control enclosure at the top of the box with a hinged door with dead-front cut-outs for 3 CD or CF type circuit breakers (see page 116) and a 7 x 15 inch removable control panel for pre-assembly of electrical components. They have eight 1/2" knockouts on the bottom and one 3/4" knockout in the lower back.



Holds # of Batteries	Material	Dimensions (in) H x W x D	Weight (lbs)	Item Code	Price
1	Steel	25.5 x 20 x 8.5	58	48.4301	\$425
4	Aluminum	38.1 x 20 x 17.3	102	48.4305	\$600

Pole Mount Aluminum Battery Boxes

Side of pole mount aluminum NEMA 3R hinged door boxes are available for several battery sizes and battery/equipment configurations. They are made to order and can be built to meet specific application requirements. They are made from 0.125" 5052- H32 aluminum with white powder coating. The doors have padlock hasps and stainless steel continuous hinges. Each box has a removable control mounting plate, screened vents and two 7/8" wire entrance holes.

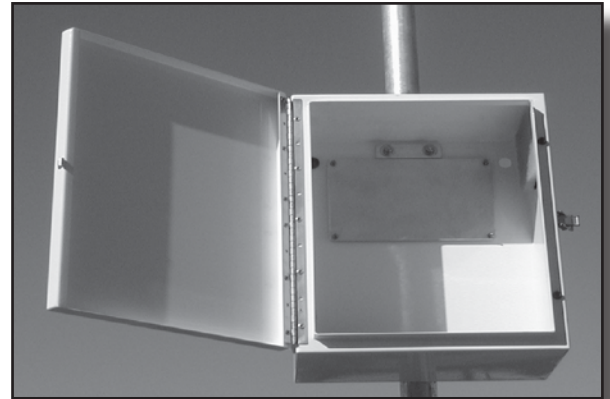

Battery Size	Batteries Spaces	Dimensions (in) D x W x H	Item Code	Price
Group 27, 30	1	9 x 16 x 20	48.4179	\$495
Group 27, 30	2	16 x 16 x 20	48.4188	\$660
Group 27, 30	4	16 x 16 x 20	48.4200	\$840
Group 27, 30	6	16 x 25 x 34	48.4201	\$1,020
Golf Cart	2	14 x 18 x 22	48.4197	\$545
Golf Cart	4	14 x 18 x 36	48.4203	\$680
4D	1	12 x 24 x 22	48.4282	\$630
4D	2	12 x 24 x 36	48.4291	\$790
8D	1	15 x 24 x 22	48.4285	\$690
8D	2	15 x 24 x 36	48.4294	\$865



BATTERY CABLE LUGS & TOOLS - 107

Plated Copper Lugs

These UL Listed lugs are made from tin plated copper tubing with 3/8" holes. They can be soldered or crimped to stranded cable.

Description	Item Code	Price
Copper Lug 3/8" Ring #6	51.3240	\$0.86
Copper Lug 3/8" Ring #4	51.3237	\$0.92
Copper Lug 3/8" Ring #2	51.3234	\$1.04
Copper Lug 3/8" Ring #2/0	51.3231	\$1.44
Copper Lug 3/8" Ring #4/0	51.3228	\$1.96

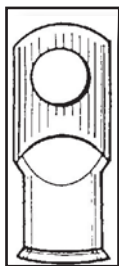

Cable Crimper

Use Crimper to crimp battery terminals, copper lugs and splices on wire from 8 gauge to 4/0. Adjustable crimp dies are clearly marked and easy to rotate into position. This 26" tool gives you plenty of leverage for quality crimping. Made in U.S.A. UL listed for use with lugs at left.

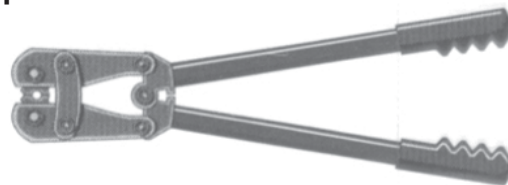

Compression Terminals

These solid brass terminals allow good connections to large gauge wire without the need of special tools or soldering. You just remove insulation from the end of the cable, insert in the terminal and tighten the nut with a wrench.

Description	Item Code	Price
Compression Lug #4	51.3366	\$4.95
Compression Lug #1 - #2	51.3363	\$5.18
Compression Lug # 1/0	51.3369	\$5.29
Compression Lug # 2/0	51.3372	\$6.79
Compression Lug # 4/0	51.3375	\$7.48



Cable Cutter

Cut cable up to 6/0 AWG with this 22" long hand-held or bench mount cutter with removable carbon steel blades. Use this tool for cutting large cable to make inverter cables and battery interconnects. Made in U.S.A.



Description	Item Code	Price
Cable Cutter 22 Inch Bench Mount	94.0003	\$78
Cable Cutter with 22 Inch Handles	94.0004	\$78
Cable Crimper with 26 Inch Handles	94.0011	\$220

SB Connectors

The Anderson SB connector has been the #1 quick disconnect for over 20 years for battery powered vehicles and fork lifts. Use them to make quick disconnects on battery or inverter cables. Two connectors of the same size and color will mate. The 50 amp version is ideal for PV arrays and motors. The 175 and 350 amp units are used on battery and inverter cables. 175 amp connectors fit 1/0 wire. Contacts must be crimped or soldered. We stock the following colors in the larger versions: yellow (Y) for 12V, red (R) for 24V, blue (B) for 48V. The 50 amp connectors come with terminals for up to #6 wire and are available in gray only. Order two of the same size and color to mate.

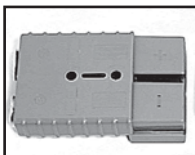

Hammer Crimp Tool

This simple, inexpensive crimping tool can be used to crimp connectors on 8 through 4/0 AWG wire. Spring loaded pin locks in up position for loading connector and cable. When released, the pin holds the connector securely during crimping. Use with a hammer or vice.

Description	Item Code	Price
Hammer Crimp Tool	94.0013	\$36

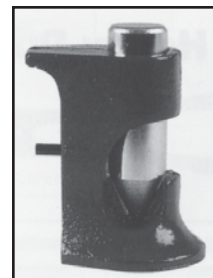

Heat Shrink Tubing

Use this tubing to insulate copper lugs and compression terminals. Tubing shrinks and glue inside melts when heated with a heat gun or torch, sealing wires against corrosion and moisture. Maximum shrinkage is listed below. Sold in 6" lengths.

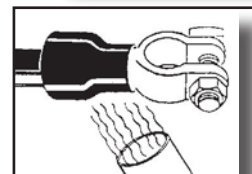

Model #	Max Amps	Color	Wire Size	Item Code	Price
SB50A	50	Grey	up to 6	51.7052	\$6.00
SB175A	175	Yellow	1/0	51.7019	\$18.98
SB175A	175	Red	1/0	51.7022	\$18.98
SB175A	175	Blue	1/0	51.7025	\$18.98
SB350A-2	350	Yellow	2/0	51.7031	\$27.00
SB350A-2	350	Red	2/0	51.7034	\$27.00
SB350A-2	350	Blue	2/0	51.7037	\$27.00
SB350A-4	350	Yellow	4/0	51.7040	\$31.00
SB350A-4	350	Red	4/0	51.7046	\$31.00
SB350A-4	350	Blue	4/0	51.7049	\$31.00

Description	Shrinks to	Item Code	Price
Heat Shrink Tubing 1/2" X 6" Black	3/16"	51.1132-B	\$0.96
Heat Shrink Tubing 1/2" X 6" Red	3/16"	51.1132-R	\$0.96
Heat Shrink Tubing 3/4" X 6" Black	1/4"	51.1135-B	\$2.00
Heat Shrink Tubing 3/4" X 6" Red	1/4"	51.1135-R	\$2.00
Heat Shrink Tubing 1" X 6" Black	3/8"	51.1137-B	\$3.00
Heat Shrink Tubing 1" X 6" Red	3/8"	51.1137-R	\$3.00

108 - BATTERY / INVERTER CABLES

Why Use Such Large Cable?

Low voltage power systems with inverters can have very high current flows in the cables that connect the inverter to the batteries. Large AC loads like microwave ovens, toasters, irons and washers can cause an inverter operating on a 12 volt battery to draw over 100 amps. Large motors may draw 300 - 500 amps at startup. Using the proper size wire between batteries, and from batteries to the inverter, will enable proper operation of the appliance. Cables that are too small will limit the current available to the inverter and may prevent a large load from operating.

Heavy Duty Battery Interconnects

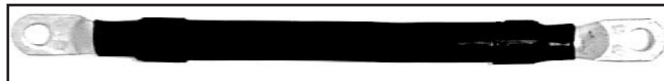

Use these cables between individual battery cells or between battery banks. Circuits protected by 250 amp breakers or 400 amp fuses should use 4/0 cables. Use 2/0 cables for 175 amp breakers and 200 amp fuses. Use #2 cables for 110 amp or smaller fuses or breakers. Cables with 1 Red end 1 black end are used for series battery interconnects.

Battery to Main Load Center Cables

Use these cables between a battery bank and an inverter, fuse or power center. They have flexible stranded UL Listed copper wire and 3/8" diameter lugs. Lug barrels are covered with glue-filled heat-shrink tubing. Cables are marked in red and black heat-shrink at each end.

Use cables with 1 lug to connect a Xantrex DC Disconnect to a battery or anywhere the wire will be attached to a compression connection.



Cables with 2 Lugs

Cable AWG	Length (ft.)	Color	Item Code	Price
4/0	5	Red	52.4005-R	\$37
	5	Black	52.4005-B	\$37
	10	Red	52.4010-R	\$66
	10	Black	52.4010-B	\$66
2/0	5	Red	52.2005-R	\$27
	5	Black	52.2005-B	\$27
	10	Red	52.2010-R	\$48
	10	Black	52.2010-B	\$48
2	3	Red	52.1003-R	\$13
	3	Black	52.1003-B	\$13
	5	Red	52.1005-R	\$17
	5	Black	52.1005-B	\$17

Cables with 1 Lug

Cable AWG	Length (ft.)	Color	Item Code	Price
4/0	5	Red	52.4105-R	\$36
	5	Black	52.4105-B	\$36
	10	Red	52.4110-R	\$65
	10	Black	52.4110-B	\$65

Replace "-C" with -R for Red, -B for Black or BR for one end Red and one end Black

Wire size (AWG)	Length of Cable	Item Code	Price
2	9"	52.5116-C	\$6.50
2	12"	52.5118-C	\$7.00
2	20"	52.5120-C	\$8.50
2/0	9"	52.5122-C	\$8.00
2/0	12"	52.5121-C	\$8.50
2/0	20"	52.5124-C	\$10.00
4/0	12"	52.5142-C	\$12.00
4/0	20"	52.5145-C	\$17.00

Light Duty Battery Interconnects

Use these cables between batteries where charge and discharge current will not exceed 50 amps. These cables are often used in golf cart and automotive applications.



Length of Cable	Wire size (AWG)	Wire Color	Item Code	Price
9"	6	Black	52.5106-B	\$2.30
9"	6	Red	52.5106-R	\$2.30
12"	6	Black	52.5108-B	\$2.88
12"	6	Red	52.5108-R	\$2.88
24"	4	Black	52.5112-B	\$4.10
24"	4	Red	52.5112-R	\$4.10
36"	4	Black	52.5114-B	\$4.60
36"	4	Red	52.5114-R	\$4.60

BATTERY ACCESSORIES - 109

Battery Desulfator

The BD-10 Battery Desulfator rejuvenates weak and dead batteries. It uses sharp spikes of current forced into the battery to “jar” sulfate crystals and cause mechanical and electrical resonance to grind them down, removing sulfation from battery plates. It can be used for 12, 24 and 48 volt batteries. Voltage and pulse strength is adjustable. Two wire connect to positive and negative battery terminals. 1 year warranty.



Description	Item Code	Price
BD-10 Battery Desulfator	45.7105	\$120

NanoPulser Battery Conditioner

Lead-sulfate is created when a battery is discharged. Then, when charged, in principle all lead-sulfate changes back to its component materials --- lead, lead dioxide and sulfuric acid. However, as batteries age, hard lead-sulfate crystallizes on the surface of the electrode plates. This non-conductive material films the surface of the electrode plate causing a reduction in surface area needed for electro-chemical reaction of the battery. It also reduces the batteries’ component materials needed for the reaction. NanoPulser applies a weak but sharp electrical pulse that inhibits the buildup of hard sulfates as well as gently dissolving the sulfate coating without damaging the electrode plates. With NanoPulser installed, batteries maintain a high level of capacity and prolonged life as well.



Current consumption is 30 to 50 mA and it turns off completely when battery voltage gets too low.

Choose the NanoPulser that matches your battery voltage.

Description	Item Code	Price
NanoPulser PG12N - 12V	45.7124	\$80
NanoPulser PG24N - 24V	45.7126	\$120
NanoPulser PG48H - 48V	45.7129	\$200

Hydrometers

Reads actual specific gravity for an accurate measurement of battery state of charge. Float type has built-in thermometer for temperature correction. Variation of .20 or greater specific gravity between battery cells indicates a need for battery equalization charging or a weak cell.



Description	Item Code	Price
Hydrometer Float Type	46.0154	\$7
Hydrometer Dial Type	46.0156	\$7

Zephyr Power Vent Battery Box Vent

Lead-acid batteries produce hydrogen gas when charging. But if the battery box is left open to vent gas in cold climates, the batteries get too cold and battery capacity is significantly reduced. A vent that solves this problem is especially important when battery boxes are placed in basements, garages and sheds. When heat rises in the structure, a low pressure area forms around the box, cool air flows into the box and gasses vent into the structure. The Power Vent controls battery box venting, removing hydrogen gas while reducing cold air infiltration into the box. The Power Vent contains a gravity-operated damper that normally stays closed. When connected to a voltage controlled relay the fan operates only when the batteries are being charged and blows gas vapors out. Designed for battery banks under 2200 AH and charge rates under 125 amps. Fan can be operated from the aux relay on a Xantrex SW inverter, from the auxiliary relay of an Outback FX inverter (use 12v fan for all Outback inverter voltages) or by a voltage controlled switch (sold separately on page 53.) The 12/24 volt unit uses 3 watts and pushes air at 6 cfm with a 360° maximum change of direction. Dimensions: 4” diameter x 7.25” with a 2” PVC pipe socket on the inlet and outlet. The 48 volt unit uses 6 watts and pushes 8 cfm with a 360° maximum change of direction. Dimensions: 4” diameter x 10” with a 2” PVC pipe socket on the inlet and outlet.



Description	Item Code	Price
Power Vent 12V	85.8205	\$79
Power Vent 24V	85.8207	\$79
Power Vent 48V	85.8209	\$104

Quick-Cote Anti-corrosion Protectant

Quick-Cote offers a complete acid neutralizing coating, formulated especially for battery terminals and exposed electrical connections. The 8 ounce can has a brush-on applicator that will give years of use and cannot clog like aerosol coatings.



Description	Item Code	Price
Quick Cote	46.0195	\$12

110 - PV ARRAY COMBINERS

AEI 12 Circuit Combiner Box

This PV Array Combiner Box, is designed to combine the output of up to 12 (PV) source circuits. It has 12 circuits in two banks for 6 fused inputs and a positive and negative output for each bank. This allows the division of a large array into two wire pairs that can be connected to two charge controls. It is like having two combiners in one NEMA 3R lockable enclosure. Each circuit can accept up to 15 Amps of PV input current up to a total maximum of 120 Amps. It may be used with 12, 24 and 48 VDC PV systems.

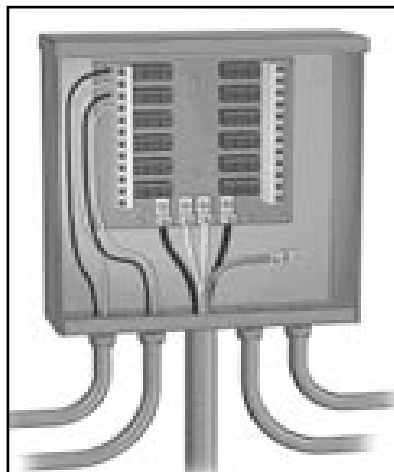

Beacon Part #	Description	Weight (lbs.)	Item Code	Price
BC12	Combiner Box - 10 circuit	12	53.2713	\$199

Type ABC Fuses for Combiner Boxes

These fuses can be used with the Xantrex, Connect and AEI Combiner boxes. Use a fuse equal to or less than the series fuse rating of the modules being protected.

Fuse Part #	ABC Fuse Sizes	Weight (lbs.)	Item Code	Price
ABC-5	5 Amp Fuse for Combiner	1	53.2721	\$1.20
ABC-6	6 Amp Fuse for Combiner	1	53.2724	\$1.20
ABC-8	8 Amp Fuse for Combiner	1	53.2727	\$1.20
ABC-10	10 Amp Fuse for Combiner	1	53.2730	\$1.20
ABC-15	15 Amp Fuse for Combiner	1	53.2733	\$1.20

DC Ground Fault Protection

These specially designed Xantrex circuit breakers meet the NEC requirement for Ground Fault Protection of PV arrays mounted on roofs of dwellings. Each pole can carry up to 100 amps for arrays up to 100 VDC open circuit. UL listed.

GFP Enclosure

The GFP enclosure is specially designed to house the Xantrex ground fault protectors (see above) and is white powder-coated. It can also be used with up to 5 CD type DC (lug type) circuit breakers (page 116) with the optional mounting plate.

Model	Description	Item Code	Price
PVGFP-1	Ground Fault Protection 1 Pole	30.1423	\$275
PVGFP-2	Ground Fault Protection 2 Pole	30.1426	\$325
Enclosure for GFP Breakers		53.0090	\$107
Mount for CD-style Breakers		53.0094	\$20

Connect PCB10 Combiner Box

The Connect Energy's PV Array Combiner Box, PCB10, is designed to combine the output of multiple solar electric (PV) source circuits. The PCB10 has 10 fused circuits in a NEMA 3R lockable enclosure. Each circuit can accept up to 15 Amps of PV input current up to a total maximum of 64 Amps. The PCB10 may be used with 12, 24 and 48 VDC PV systems and can handle a maximum 125 VDC input and includes built-in lightning protection. protection. UL listed. Use Type ABC Fuses. Dimensions are 8"W x 10"H x 4"D.

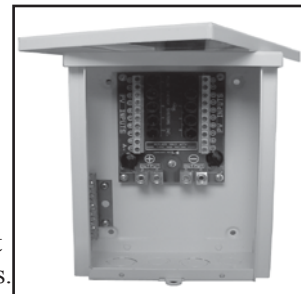

Connect Part #	Description	Weight (lbs.)	Item Code	Price
PCB10	Combiner Box - 10 circuit	8	53.2709	\$229

PACS-2 Unfused Combiner

This unfused array combiner allows connection of up to eight positive and eight negative #10 AWG wires to output cables of up to 2/0 AWG. This is useful for connecting array wiring



to larger wire that runs from a roof or pole mount to a power system center. Includes a Delta 300 VDC lightning arrestor and grounding terminal. NEMA 3R rain tight enclosure.

Part #	Description	Weight (lbs.)	Item Code	Price
PACS-2	Unfused Combiner Box	9	53.2717	\$175

PV ARRAY COMBINERS - 111

Outback PSPV Array Combiner Box



The PSPV outdoor, rainproof powder-coated aluminum array combiner can be used with a wide variety of PV system designs and module configurations. It can be installed on vertical or sloped surfaces (14-90 degrees from horizontal) or pole mounted and configured with DC breakers for low voltage systems (under 140 VDC) or touch safe type fuse holders for high voltage systems (up to 600 VDC). The PSPV is designed to provide NEC code compliant overcurrent protection and interconnection of multiple PV panels or subarrays into one or more PV arrays for connection to charge controllers or inverter systems. The PSPV is easily field configured to match your system design and ampacity requirements. It is shipped without the breakers or fuse holders

installed. Order the quantity, type and amperage needed.

Snap in DIN rail mounting system has spaces for up to twelve DC rated PV breakers for 12, 24, 48 and 60 VDC PV arrays with open circuit voltages up to 140 VDC, or up to seven touch safe type midget fuse holders for high voltage PV arrays up to 600 VDC.

Dual positive breaker combiner busbars with #1/0 AWG set-screw compression type box lug terminals for output wiring provide one or two PV output circuits. There is one PV negative terminal bus bar with mounting holes for an additional bus bar.

Wire access is through four 3/4 and 1 inch conduit knock-outs, one on the bottom, back and each side. Ample space provided on bottom and back to allow up to a 2 inch conduit punch for large cabling. Eight 1/2 inch knockouts on bottom for PV module or subarray input conduits or strain reliefs. A #1/0 AWG ground lug can be mounted either on the inside or outside surface. ETL Listed. NEMA 3R.

Dimensions: 13.1"H x 9.2"W x 3.5"D.

Outback Part #	Description	Weight (lbs.)	Item Code	Price
PSPV	Array Combiner Box	6	53.3019	\$139
Array Breakers, Fuses and Bus Bars				
OBPV-6	6 Amp 125 VDC PV Array Breaker	1	53.3021	\$12
OBPV-9	9 Amp 125 VDC PV Array Breaker	1	53.3023	\$12
OBPV-10	10 Amp 125 VDC PV Array Breaker	1	53.3026	\$12
OBPV-15	15 Amp 125 VDC PV Array Breaker	1	53.3029	\$12
OBPV-20	20 Amp 125 VDC PV Array Breaker	1	53.3030	\$12
OBFH	600 VDC Array Fuse Holder	1	53.3040	\$18
OBF-4	4 Amp 600 VDC KLKD Fuse	1	53.3051	\$18
OBF-6	6 Amp 600 VDC KLKD Fuse	1	53.3050	\$18
OBF-8	8 Amp 600 VDC KLKD Fuse	1	53.3048	\$18
OBF-10	10 Amp 600 VDC KLKD Fuse	1	53.3046	\$18
OBF-15	15 Amp 600 VDC KLKD Fuse	1	53.3043	\$18
OBF-20	20 Amp 600 VDC KLKD Fuse	1	53.3042	\$18
OBF-30	30 Amp 600 VDC KLKD Fuse	1	53.3041	\$18
TBB	Terminal Bus Bar - Black Insulator	1	30.4353	\$19
TBB-W	Terminal Bus Bar - White Insulator	1	30.4354	\$19
TBB-R	Terminal Bus Bar - Red Insulator	1	30.4355	\$19
GBB	Ground Bus Bar	1	30.4356	\$15

Outback PSSB 600 VDC Array Disconnect

PSSB is a PV array disconnect designed specifically to work with the SMA Sunny Boy line-tie inverter systems. It can also be used with other high voltage utility interactive PV inverters or other applications such as large inverter power systems or water pumping systems. It can also be used as a standard 600 VDC disconnect for a single high voltage PV array. The PSSB is designed to provide NEC code compliant overcurrent protection and disconnect means of up to six separate low voltage PV subarrays to form a single high voltage PV array for connection to a high voltage PV inverter. An optional AC breaker disconnect can also be field installed inside the same enclosure to provide a local means of disconnect at the location of the inverter. Or add a second 6-pole breaker.

Outdoor, rainproof powder coated aluminum enclosure can be installed on vertical or sloped surfaces down to a 3/12 pitch (14 degrees). For subarrays of 48 vdc nominal with an open circuit of less than 100 vdc maximum.

ETL Listed. NEMA 3R.

Dimensions: 13.1"H x 9.2"W x 3.5"D.

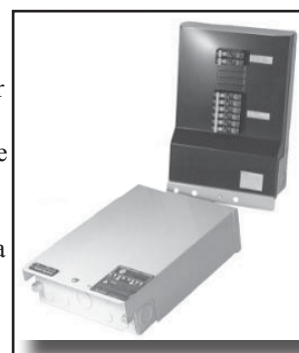

Outback Part #	Description	Weight (lbs.)	Item Code	Price
PSSB	Outback PSSB 600 VDC PV Combiner - Six 15 amp inputs	6	53.3071	\$245
Array Breakers, Fuses and Bus Bars				
OBAC-15D	AC Breaker Disconnect - 2 pole 15A to provide AC disconnect for inverter	1	53.3076	\$35
OBSB-15	Additional Segmenting Breaker 600 VDC 15 A	1	53.3074	\$110
PSSB-MP	Mounting Plate for PSSB and Sunny Boy Inverter	1	53.3080	\$99
GBB	Ground Bus Bar	1	30.4356	\$15

112 - LIGHTNING PROTECTION / GROUNDING

Why Have Surge Protection

Photovoltaic, wind and hydroelectric systems usually have long runs of exposed wire that can pick up surges from lightning, even if the lightning strike is not nearby. These power surges can damage sensitive electronic components in meters, charge controls and inverters. Surges can also damage telephone, audio and video equipment connected to the power system. It is a good idea to install surge protection on all incoming wires in the system, including incoming PV, wind or hydroelectric power lines, AC generator lines, telephone and antenna leads. Proper grounding is absolutely necessary for lightning protection to be effective. In the event of a direct strike, damage may occur, even with surge protectors installed.

Delta Lightning Arrestors



The Delta Lightning Arrestors have a max current rating of 60,000 amps and 2,000 joules per line. Response time is 25ns to clamp 50,000 amps. Mounts easily in a 1/2" knockout.

Install the DC version for surge protection on wires coming from a PV array, DC wind generator or DC hydroelectric turbine. Use the 600 VDC unit for high-voltage grid-tie PV arrays. Lightning protection can be installed in a combiner box, DC load center or intertie inverter.

The AC versions can be mounted in your AC load-center to protect 120/240 VAC equipment and on AC wiring running outside of the building, to generators, pumps or outbuildings. All units are waterproof.

Delta Model	Description	Item Code	Price
LA302DC	Arrestor for up to 300 VDC	53.4115	\$32
LA602DC	Arrestor for up to 600 VDC	53.4109	\$34
LA302R	Arrestor for up to 300 VAC	53.4112	\$34
LA303R	Arrestor for up to 300 VAC 3-Phase	53.4118	\$40

PolyPhaser DC Lightning Protectors

PolyPhaser Lightning Protectors set the standard for the lightning protection industry. They are the product of choice in the telecom industry. Designed to protect PWM switching and relay type charge controls, these units can handle the high voltage of open circuit arrays and will not cause power robbing voltage drop. Models are available for 12 and 24 volt negative ground systems and 48 volt negative and positive ground systems. Maximum continuous current 50 amps.



Model	System Voltage	Description	Item Code	Price
IS17NG	12	17V Negative Ground	53.4165	\$204
IS35NG	24	35V Negative Ground	53.4168	\$222
IS60NG	48	60V Negative Ground	53.4171	\$211
IS60PG	48	60V Positive Ground	53.4174	\$211

Lay-in Lugs for Module Grounding

These tin plated copper lugs have stainless steel set screws and come with stainless steel thread-forming screws and lock washers, to meet NEC requirements for connecting a continuous ground wire to all modules in an array and having the ability to remove a module without breaking grounding continuity for the rest of the array. Sold in packages of 10 with thread-forming screws.



Description	Item Code	Price
Bag of 10 Lay-in Lugs w/screws	51.3414	\$28

Cable Clip

Use this clip to keep module interconnect cables neatly connected to module frames so they do not drop below the array. Bags of 100 clips with anti-corrosion coating.

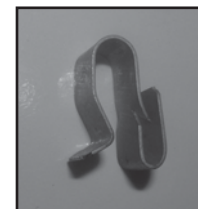

Description	Item Code	Price
Bag of 100 Clips	52.9101	\$35

MULTICONTACT CABLES & PARTS - 113

MultiContact Array Output Cables

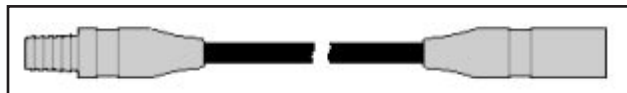

Use these output cables between PV arrays with MultiContact cable outputs, and junction boxes or intertie inverters. They have a male connector on one end and a female connector on the other end. Use them to extend module output cables or cut anywhere along the wire to obtain the needed length of male and female cable to run from the ends of a module string to a combiner box or to an inverter. For example, if you need a 30' male and a 20' female, order a 50' cable. Made with black #10 AWG USE-2 sunlight-resistant cable.

MC Male/Female Cable Length (Ft.)	Item Code	Price
6	52.9107	\$17.25
15	52.9111	\$20.70
30	52.9115	\$23.00
50	52.9116	\$26.45
100	52.9118	\$46.00

MultiContact Color-Coded Array Cables



Use these output cables between PV arrays with MultiContact cable outputs, and junction boxes or intertie inverters. White cables have a MC connector that fits the module negative output cable. Red and Black cables have a MC connector that fits the module positive output cable. Made from #10 AWG USE-2 sunlight-resistant cable.

MC Cable Description	Item Code	Price
#12 AWG White Negative 70 ft.	52.9073	\$29
#12 AWG Black Positive 70 ft.	52.9072	\$29
#12 AWG Red Positive 70 ft.	52.9071	\$29
#10 AWG White Negative 100 ft.	52.9083	\$40
#10 AWG Black Positive 100 ft.	52.9082	\$40
#10 AWG Red Positive 100 ft.	52.9081	\$40

MultiContact Cable Ends

The tools at right are required to attach these connectors to #10 AWG stranded wire.

Description	Item Code	List Price
Male Connector - Fits + Cables on Module	99.1403	\$2.80
Female Connector - Fits - Cable on Module	99.1401	\$3.20
UL Label	99.1405	\$0.10

Waterproof Strain Reliefs

Use the 1/2" threaded connectors to provide a waterproof entrance or exit for wiring on PV module junction boxes, outdoor combiner boxes, and junction boxes. Use the 3/4" connector for larger cables up to 5/8" diameter. They are made of Nylon with Buna-N seals and are resistant to salt water, weak acids, weak alkalis, alcohol, ether, esters, ketones, and mineral, animal and vegetable oils. The threads are 1/2" or 3/4" NPT. Non-corrosive and suitable for direct burial installations. The oval hole 1/2" strain relief works great for two conductor TC cable used for module interconnects and for PV outputs or for UF cable. The two-hole 1/2" connector is designed for use with two #10 or #12 type USE conductors like the ones used for MultiContact PV output cables. UL listed. Suitable for use in NEMA 4, 6 and 12 applications.

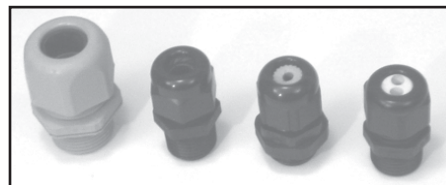

Strain Relief Description	Fits Cable Size	Item Code	Price
1/2" Thread w/ 1 round hole	USE #12 & #10	54.3243	\$3.75
1/2" Thread w/ 2 round holes	USE #12 & #10	54.3252	\$4.80
1/2" Thread w/ 1 round hole	.25" to .5" dia. wire	54.3241	\$2.60
1/2" Thread w/ 1 oval hole	14/2,12/2,10/2 TC	54.3257	\$4.40
3/4" Thread w/ 1 round hole	.4" to .7" dia. Cable	54.3246	\$3.90
Steel lock nut 1/2"		54.3238	\$0.18
Steel lock nut 3/4"		54.3244	\$0.20

MultiContact Branch Connectors

These waterproof Y-connectors make it possible to parallel wire PV modules with MultiContact output cables. Maximum current allowed through these connectors is 30 amps.



Description	Item Code	Price
MC Branch Cable Coupler Female - 2 Male	52.9103	\$18.40
MC Branch Cable Coupler Male - 2 Female	52.9104	\$19.55

Multi-Contact Cable Tools

The tools listed below are required to fabricate MC cables in the field.

Description	Item Code	Price
MC Insulator Installation Tool	94.0108	\$540.00
Crimping Tool for MC Conductor Pins	94.0103	\$410.00

114 - SAFETY SWITCH DISCONNECTS

Square-D 240 and 600 Volt Nema 3R Safety Switch Disconnects

According to the National Electric Code, section 690.15, PV arrays must have a disconnecting means to isolate the inverter from the PV power source. Utility intertie inverters that utilize PV arrays with voltages above 250VDC require a disconnect rated for 600VDC to perform this function. The Square-D 600 VDC 30 amp 3-pole safety switches are UL listed to handle 13A at 600VDC per pole. They can be used for disconnecting up to three PV arrays for three grid-tie inverters. It has wiring lugs that are rated to accept two #14 to #10 wires in each lug. This allows the disconnect switch to also act as a string combiner in systems that utilize two strings of PV modules per inverter. All other Square D 600 VDC disconnects are rated for disconnecting one string at full rated power.

Many utilities require an AC disconnect between an intertie inverter and the AC load center, close to the AC service entrance, with a visible and lockable handle. A 30 amp 240 volt disconnect is good for up to 5kW at 240 VAC (one or two 2500W intertie inverters) and the 60 amp disconnect is good for up to 12.5kW (three to five 2500W intertie inverters). For connection of multiple inverters to one of these disconnects, use an AC load center, with a circuit breaker for each inverter installed, as an AC combiner box between the inverters and the disconnect switch. The breakers can be back-fed with the inverter outputs and the load center main lugs will handle the combined outputs to be connected to the AC disconnect.

Use Class-R fuses of the proper amperage for fused disconnects. Use the hubs on the next page to connect conduit or a kWh meter socket to the top of the disconnect. Disconnects are raintight (NEMA 3R) for outdoor use. Order the neutral bus bar and ground bus bar if you need to land these conductors in the disconnect switch box. See next page for accessories.

Amps	AC / DC	Fused	Poles	Neutral Kit	Ground Kit	Dimensions (in.) H x W x D	Weight (lbs.)	Square-D Model	Item Code	Price
600 Volt AC or DC 3 Pole NEMA 3R Heavy Duty Switches										
30	Yes	No	3*	SN03	GTK03	14.88 x 6.63 x 4.88	9.3	HU361RB	53.2312	\$165
30	Yes	Yes	3*	SN03	GTK03	14.88 x 6.63 x 4.88	9.8	H361RB	53.2313	\$260
* Uses 2 poles in series for 600VDC, except for pv where all 3 poles may be used for 600 VDC at 13 amps per pole										
60	Yes	No	3**	SN0610	GTK0610	17.50 x 9.00 x 6.38	16	HU362RB	53.2339	\$380
60	Yes	Yes	3**	SN0610	GTK0610	17.50 x 9.00 x 6.38	16	H362RB	53.2341	\$480
100	Yes	No	3**	SN0610	GTK0610	21.25 x 8.50 x 6.38	24	HU363RB	53.2357	\$530
100	Yes	Yes	3**	SN0610	GTK0610	21.25 x 8.50 x 6.38	24	H363RB	53.2355	\$750
200	Yes	No	3**	SN20A	PKOGTA2	29.25 x 17.25 x 8.50	44	HU364RB	53.2364	\$640
200	Yes	Yes	3**	SN20A	PKOGTA2	29.25 x 17.25 x 8.50	44	H364RB	53.2374	\$1,025
** Uses 2 poles (and 2 fuses) in series for 600VDC										
240 Volt AC / 125 Volt DC*** NEMA 3R Heavy Duty Switches										
30	Yes	Yes	3	Included	GTK03	14.88 x 6.63 x 4.88	9.8	H321NRB	53.2315	\$314
60	Yes	Yes	3	Included	GTK03	14.88 x 6.63 x 4.88	10	H322NRB	53.2336	\$503
100	Yes	Yes	3	Included	GTK0610	21.25 x 8.50 x 6.38	19	H323NRB	53.2351	\$722
200	Yes	Yes	3	Included	PKOGTA2	29.25 x 17.25 x 8.50	43	H324NRB	53.2363	\$988
*** Switches are rated for 250VDC but available fuses are only rated for 125VDC										
240 Volt AC only NEMA 3R General Duty Switches										
30	AC Only	No	2	N/A	PK3GTA1	9.63 x 7.25 x 3.75	4.4	DU221RB	53.2318	\$83
30	AC Only	Yes	2	Included	PK3GTA1	9.63 x 7.25 x 3.75	4.5	D221NRB	53.2326	\$90
30	AC Only	No	3	N/A	PK3GTA1	9.63 x 7.25 x 3.75	4.7	DU321RB	53.2319	\$139
30	AC Only	Yes	3	Included	PK3GTA1	9.63 x 7.25 x 3.75	5.1	D321NRB	53.2329	\$139
60	AC Only	Yes	2	Included	GTK03	14.88 x 6.63 x 4.88	9.7	D222NRB	53.2334	\$141
60	AC Only	No	3	N/A	PK3GTA1	9.63 x 7.25 x 3.75	5	DU322RB	53.2342	\$222
60	AC Only	Yes	3	Included	GTK03	14.88 x 6.63 x 4.88	9.8	D322NRB	53.2343	\$210
100	AC Only	Yes	2	Included	GTK0610	17.50 x 8.50 x 6.50	16	D223NRB	53.2358	\$227
100	AC Only	No	3	N/A	GTK0610	17.50 x 8.50 x 6.50	15	DU323RB	53.2359	\$386
100	AC Only	Yes	3	Included	GTK0610	17.50 x 8.50 x 6.50	16	D323NRB	53.2361	\$386
200	AC Only	Yes	2	Included	PKOGTA2	29.25 x 17.25 x 8.25	29	D224NRB	53.2371	\$513
200	AC Only	Yes	3	Included	PKOGTA2	29.25 x 17.25 x 8.25	30	D324NRB	53.2372	\$853



FUSES & FUSE HOLDERS - 115

Square D Disconnect Accessories

Field installable service ground and neutral bus bars and hubs for the safety disconnect switches on the previous page. See table to determine which neutral and ground to use.

Neutral & Ground Accessories	Item Code	Price
SN03 Neutral Bus Bar	53.2389	\$52
SN0610 Neutral Bus Bar	53.2381	\$71
SN20ANeutral Bus Bar	53.2383	\$133
GTK03 Ground Bus Bar	53.2387	\$8
PK3GTA1 Ground Bus Bar	53.2395	\$8
GTK0610 Ground Bus Bar	53.2386	\$13
PKOGTA2 Ground Bus Bar	53.2388	\$38

Conduit Hubs	Item Code	Price
Top Mount Hub 3/4"	53.2305	\$22
Top Mount Hub 1"	53.2306	\$22
Top Mount Hub 1-1/4"	53.2307	\$22
Top Mount Hub 1-1/2"	53.2308	\$22
Top Mount Hub 2"	53.2309	\$40

Class R Fuses

These Class-R fuses can be used in AC circuits up to 250V or DC circuits up to 125V. They have the high amp interrupting capacity (AIC) required for fusing circuits powered by batteries and for protecting Square-D brand circuit breakers. They can be used to protect wiring to small inverters (100-700 watts) and wiring from charging sources. Use these fuses in fused safety disconnect switches on the previous page and in the fuse blocks at right. UL listed

Amps	250VAC/125VDC	
	Item Code	Price
10	53.2441	\$5
15	53.2444	\$5
20	53.2450	\$5
30	53.2456	\$5
40	53.2462	\$8
50	53.2465	\$8
60	53.2468	\$8
70	53.2469	\$18
80	53.2475	\$18
90	53.2476	\$18
100	53.2474	\$18
125	53.2478	\$48
150	53.2479	\$48
200	53.2480	\$48



600VAC/VDC	
Item Code	Price
53.2442	\$11
53.2447	\$11
53.2453	\$11
53.2459	\$11
53.2463	\$24
53.2466	\$24
53.2471	\$24
53.2470	\$46
53.2472	\$46
53.2473	\$46
53.2477	\$46
53.2481	\$80
53.2482	\$80
53.2483	\$80



Class R Fuse Blocks

Use these fuse blocks with the Class-R 250 volt fuses. Bare wire ends fit into the screw terminals on each end of the fuse block. The small fuse block holds 10-30A fuses and accepts up to #2 wire. The medium size block holds 40-60A fuses and accepts up to #2 wire also. The large size block holds a 100A fuse and accepts up to #1/0 wire. Small and medium size blocks are available in one or two pole versions.

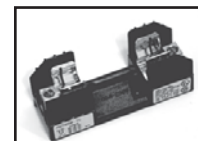

Description	Item Code	Price
Class R Fuse Block 0.1-30A, 1-Pole	53.2423	\$5
Class R Fuse Block 0.1-30A, 2-Pole	53.2426	\$12
Class R Fuse Block 31-60A, 1-Pole	53.2429	\$9
Class R Fuse Block 31-60A, 2-Pole	53.2432	\$16
Class R Fuse Block 61-100A, 1-Pole	53.2435	\$25

Inline ATC Fuse Holder

The waterproof cover makes this an excellent choice to fuse a single circuit, indoors or out. Cut wire loop and splice into the line to be protected. We recommend these with 1 amp fuses below in the positive power line for Trimetric, Link and Trace TM500A meters. Low voltage DC use only.

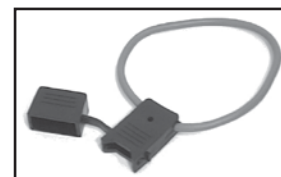

Description	Item Code	Price
ATC Inline Holder 18 awg	53.2663	\$3.00
ATC Inline Holder 10 awg	53.2669	\$3.00

ATC Fuses

ATC blade-type fuses were designed for low voltage DC circuits for the automotive industry. They are very popular in autos and RVs. They are not approved by the National Electrical Code for use in homes, but they are often used to provide circuit protection in remote cabin power systems. They are sold in boxes of 10 fuses.

Description	Item Code	Price
ATC Fuse 1A	53.2629	\$0.40
ATC Fuse 3A	53.2631	\$0.40
ATC Fuse 5A	53.2633	\$0.40
ATC Fuse 10A	53.2635	\$0.40
ATC Fuse 15A	53.2637	\$0.40
ATC Fuse 20A	53.2639	\$0.40
ATC Fuse 30A	53.2641	\$0.40

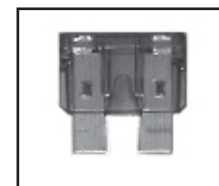

116 - DC OVERCURRENT PROTECTION

Xantrex DC Disconnect

The Xantrex DC Disconnect is a white, powder-coated indoor enclosure with conduit knockouts for connection to inverters, batteries, DC charging sources, charge controllers and DC load centers. It comes with one 175A or 250A circuit breaker for an inverter (with space for a second breaker for a second inverter - order separately) that meets the National Electric Code requirements for disconnection and overcurrent protection of battery-based power systems. There are knockouts on the sides for four 15 to 100 amp DC breakers used for charging sources and DC loads. Use the DC Bonding Block (DCBB - order separately below) for connecting the negative cables and for single-point DC system grounding. There are pre-drilled places inside for two metering shunts. Knock-outs on the top are provided for mounting two Xantrex C-Series or OutBack MX-60 PV charge controllers, or one RVPP Solar Boost PV charge controller. Knockouts on the sides are designed for mounting two Xantrex SW, SW-Plus, or DR inverter/chargers with their optional conduit boxes and 2" offset nipples.

Order 175A or 250A DC **surface mount** circuit breakers listed below for adding second inverter breaker. Order 15A to 100A DC **panel mount** circuit breakers to use in the DC Disconnect side spaces.

Use the DC175 for the Xantrex SW4048, SW-Plus 2524 & 2548, DR1512, DR1524, and DR2424 inverters. Use the DC250 for the Xantrex SW4024, SW5548, DR2412, and DR2436 inverters. ETL listed to UL508. Dimensions: 21" H x 10.5" W x 5" D. Weight: 14 lbs

Xantrex Model	Description	Item Code	Price
DC250	Xantrex 250A DC Disconnect	30.1414	\$329
DC175	Xantrex 175A DC Disconnect	30.1411	\$329
DCBB	DC Bonding Block	30.1417	\$50



DC Circuit Breakers

These single pole circuit breakers are UL listed for use in DC circuits with voltages up to 125VDC. They are commonly used in DC power centers as overcurrent protection and disconnecting means between PV arrays and charge controllers, between charge controllers and batteries, between other DC charging sources (such as wind and hydro generators) and batteries, and as outputs to DC loads. They have the high amp interrupting capacity (AIC) needed between batteries and Square-D QO and QOU circuit breakers and load centers for 12V and 24V systems. Breakers are Heinneman, Airpax, or Carlingswitch brand.

They are available in two different configurations:

Panel (Front) Mount Breakers

The **panel mount** version is designed to be mounted from the front, behind a panel with rectangular knock-outs. They have stud terminals on their back side for wire connection with a ring terminal or a barrel connector. The 15A to 30A breakers have a #10 stud terminal, and the 50A to 100A breaker have a 1/4" stud terminal.

Use panel mount breakers in the side spaces of the Xantrex DC Disconnect and Power Modules, and in the medium and large breaker spaces in the OutBack PS2DC and PS4DC.

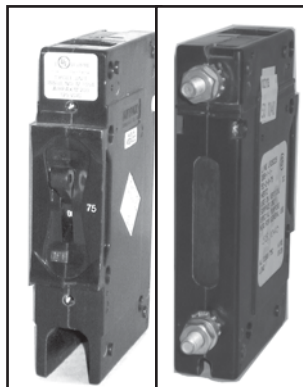

Surface Mount Breakers

The **surface mount** version is designed to be mounted on a flat surface behind the breaker and has lug type terminals that accept wire sizes from #14 to #2 AWG on the 15A to 100A sizes, and wire up to 250MCM on the larger breakers. Surface mount breakers can be used in the GFI Enclosure (page 108), in some older power centers, and to mount in custom combiner boxes and power centers. Use these breakers in the 175A and 250A sizes for mounting in the front spaces of the Xantrex DC Disconnect for use as inverter breakers (GJ1 Mount Kit required).



Panel Mount DC Circuit Breakers Stud Terminal			
Model Number	Amps	Item Code	Price
CD10-PM	10	53.1010	\$25
CD15-PM	15	53.1015	\$25
CD20-PM	20	53.1020	\$25
CD30-PM	30	53.1025	\$25
CD50-PM	50	53.1030	\$25
CD60-PM	60	53.1035	\$35
CD75-PM	75	53.1040	\$35
CD100-PM	100	53.1050	\$39
GJ1-175-B3	175	30.4329	\$119
GJ1-250-B3	250	30.4326	\$119

Surface Mount DC Circuit Breakers Lug Terminals			
Model Number	Amps	Item Code	Price
CD10-SM	10	53.1011	\$25
CD15-SM	15	53.1016	\$25
CD20-SM	20	53.1021	\$25
CD30-SM	30	53.1026	\$25
CD50-SM	50	53.1031	\$25
CD60-SM	60	53.1036	\$35
CD75-SM	75	53.1041	\$35
CD100-SM	100	53.1051	\$39
CD110-SM	110	53.1055	\$60
GJ1-175-SM	175	53.1056	\$119
GJ1-250-SM	250	53.1061	\$119
GJ1 Rear Mounting Kit		53.1066	\$10

FUSES / CIRCUIT BREAKERS - 117

Class T Fuse Blocks with Fuses

Use these single pole fuse blocks to fuse inverters or other large loads. Holders with set screw lugs accept up to 2/0 wire in the 110A and 200A sizes and up to 4/0 wire in the 300A and 400A sizes.

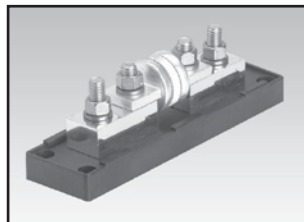

On stud mount holders, a 5/16" bolt at each end of the fuse allows connection of a cable with a ring lug terminal end. To connect an inverter, order two cables with lugs on both ends: one to go from the battery to the fuse and one to go from the fuse to the inverter.

Class T fuses exceed the 10,000 amp interrupting capacity (AIC) required to protect Square-D brand circuit breakers in DC load centers. They are UL listed for up to 160VDC and NEC approved for inverter use. A fuse comes installed in the block. Order spare fuses separately.

Xantrex Model	Description	Item Code	Price
TFB110C	110A fuse and holder w/screw lug	53.2515	\$53
TFB200C	200A fuse and holder w/screw lug	53.2532	\$53
TFB300C	300A fuse and holder w/screw lug	53.2550	\$75
TFB400C	400A fuse and holder w/screw lug	53.2562	\$75
TFB110	110A fuse and holder w/studs	53.2512	\$53
TFB200	200A fuse and holder w/studs	53.2526	\$53
TFB300	300A fuse and holder w/studs	53.2544	\$75
TFB400	400A fuse and holder w/studs	53.2559	\$75

Class T Fuses - JJN Series

These class T Fuses are rated for 160 VDC and 300 VAC as protection for circuit breakers, load centers and inverters where high available short circuit currents are possible. These fuses fit the fuse blocks above and the Inline holder at right.

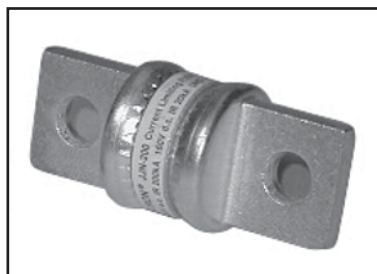

Inline Class T Fuse Receptacle



This is a great way to retrofit an inverter cable with an NEC approved fuse. To install the fuse holder and fuse, just cut the positive cable, remove an inch of insulation from each side of the cut, insert the wire in the terminal blocks, tighten the set screws and tighten the strain relief at each end of the holder. The fuse is not included. It holds 110 to 400 amp fuses. Order fuse below on left. Dimensions are 11" x 2.5" x 3".

Description	Item Code	Price
Class T Inline Fuse Holder	53.2563	\$38

Square-D QO Circuit Breakers

QO circuit breakers snap into QO load centers on the next page. They are UL listed for DC branch circuits up to 48VDC (not for use in 48V systems). They can also be used for 120VAC (1-pole) or 120/240VAC (2-pole) circuits. Circuit breakers in 10A to 30A sizes can handle one or two #14 to #10 wires or one #8 wire. Circuit breakers 40A to 70A will handle #8 to #2 wire sizes.

QOU circuit breakers are designed for surface or din rail mounting and are used in the Xantrex T-240 and in SWPlus AC conduit boxes.

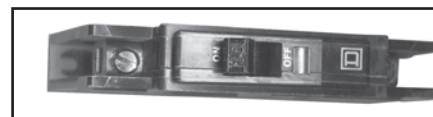

Description	QO Breakers			QOU Breakers		
	Part #	Item Code	Price	Part #	Item Code	Price
10 Amp 1 Pole	QO110	53.2063	\$12	QOU110	53.2006	\$25
15 Amp 1 Pole	QO115	53.2065	\$12	QOU115	53.2009	\$25
20 Amp 1 Pole	QO120	53.2071	\$12	QOU120	53.2015	\$25
30 Amp 1 Pole	QO130	53.2075	\$12	QOU130	53.2024	\$25
40 Amp 1 Pole	QO140	53.2080	\$12	QOU140	53.2030	\$25
50 Amp 1 Pole	QO150	53.2083	\$12	QOU150	53.2036	\$25
60 Amp 1 Pole	QO160	53.2086	\$12	QOU160	53.2042	\$25
70 Amp 1 Pole	QO170	53.2090	\$28	QOU170	53.2048	\$38
15 Amp 2 Pole	QO215	53.2065	\$22	QOU215	53.2012	\$50
20 Amp 2 Pole	QO220	53.2073	\$22	QOU220	53.2018	\$50
30 Amp 2 Pole	QO230	53.2077	\$22	QOU230	53.2027	\$50
40 Amp 2 Pole	QO240	53.2081	\$22	QOU240	53.2033	\$50
50 Amp 2 Pole	QO250	53.2084	\$22	QOU250	53.2039	\$50
60 Amp 2 Pole	QO260	53.2088	\$22	QOU260	53.2045	\$50

Model	Description	Item Code	Price
TF110	110A replacement fuse	53.2509	\$18
TF200	200A replacement fuse	53.2520	\$18
TF300	300A replacement fuse	53.2538	\$38
TF400	400A replacement fuse	53.2556	\$38

118 - LOAD CENTERS

Square-D QO Load Centers

Square D brand load centers can be used for multiple purposes, for wiring that meets the National Electric Code (NEC). All of these can be used as AC load centers or sub-panels. Panels using QO plug in breakers are rated up to 50VDC for use as 12V or 24V DC load centers. They can also be used to combine the AC output from multiple inverters feeding the grid.

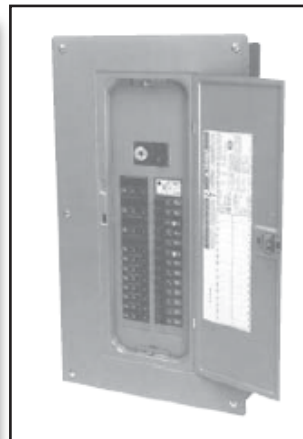

When used as DC load centers they should be protected by a high interrupt capacity fuse or circuit breaker between the load center and the battery. Use one of the Class T or Class R fuses, or the DC breakers used in the Outback and Xantrex DC power centers.

When used to combine the AC output of multiple grid tie inverters, and meet the requirements of NEC 690.64(B)(2) the bus amp rating for the load center must be larger than the sum of all of the overcurrent devices feeding it, from both the utility and all inverters.

The 277/480 V load centers can be used to combine the output from multiple SMA6000U inverters to feed a 277Y/480VAC grid interconnection. One 30A continuous duty breaker is used for each inverter that is set up for 277V hot to neutral.

Load centers are not supplied with any breakers – order breakers separately on page 117 (except the 277V breaker on this page). Order accessories on page 119.

120/240 Volt AC Single Phase Main Lug Load Centers

Spaces (single)	Bus Amp Rating	Outdoor	Cover	Max wire in main lug	Ground Kit for this unit	Dimensions (in.) H x W x D	Weight (lbs.)	Square-D Model	Item Code	Price
2	70	Yes	INCL.	# 4	PK4GTA	9.38 x 4.88 x 4	5.0	QO24L70RB	53.2141	\$60
2	70	No	INCL.	# 4	PK4GTA	9.30 x 4.81 x 3.19	3.8	QO24L70S	53.2144	\$50
6	100	Yes	INCL.	# 1	PK7GTA	12.62 x 8.88 x 4.27	9.7	QO612L100RB	53.2147	\$54
6	100	No	INCL.	# 1	PK7GTA	12.57 x 8.88 x 3.8	8.3	QO612L100DS	53.2153	\$46
12	125	Yes	INCL.	# 2/0	INCL.	19 x 14.25 x 4.5	23	QO112L125GRB	53.2163	\$190
12	125	No	Add	# 2/0	INCL.	18 x 14.25 x 3.75	15	QO112L125G	53.2162	\$85
12	200	Yes	INCL.	250 kcmil	INCL.	26.25 x 14.25 x 4.5	27	QO112L200GRB	53.2165	\$320
12	200	No	Add	250 kcmil	PK15GTA	29.86 X 14.25 X 3.75	18	QO112L200G	53.2164	\$177

Uses QO plug in breakers

120/208 Volt AC Three Phase Main Lug Load Centers

12	125	Yes	INCL.	# 2/0	INCL.	19.00 x 14.25 x 4.52	22	QO312L125GRB	53.2181	\$323
12	125	No	Add	# 2/0	INCL.	19.00 x 14.25 x 3.75	11	QO312L125G	53.2183	\$221
18	200	Yes	INCL.	250 kcmil	INCL.	30.00 x 14.25 x 4.52	31	QO318L200GRB	53.2185	\$412
18	200	No	Add	250 kcmil	INCL.	30.00 x 14.25 x 3.75	17	QO318L200G	53.2187	\$295

Uses QO plug in breakers

277/480 Volt AC Three Phase Main Lug Load Centers

12	125	Yes	INCL.	250 kcmil	PK9GTA	26.00 x 20.00 x 6.50	36	NF412L1 (MH26WP)	53.2191	\$2,319
12	125	No	INCL.	250 kcmil	PK9GTA	26.00 x 20.00 x 5.75	22	NF412L1 (MH26,NC26S)	53.2193	\$1,264
30	250	Yes	INCL.	350 kcmil	PK18GTA	38.00 x 20.00 x 6.50	42	NF430L2 (MH38WP)	53.2195	\$2,556
30	250	No	INCL.	350 kcmil	PK18GTA	38.00 x 20.00 x 5.75	27	NF430L2 (MH38,NC38S)	53.2197	\$1,603
Circuit Breaker, single pole, 277 Volt, 30A continuous duty rated							1	EDB14030	53.2111	\$85

TRANSFER SWITCHES - 119

Square-D Load Center Covers and Ground Bus Bars for Load Centers on Page 118				
Description	Weight (lbs)	Square D Model	Item Code	Price
Surface Cover for 12 space 125A load centers, 53.2162 & 53.2183	6.0	QOC16US	53.2159	\$18.00
Flush Cover for 12 space 125A load centers, 53.2162 & 53.2183	7.0	QOC16UF	53.2156	\$21.50
Surface Cover for all 200A indoor load centers, 53.2164 & 53.2187	9.2	QOC30US	53.2169	\$58.00
Flush Cover for all 200A indoor load centers, 53.2164 & 53.2187	11	QOC30UF	53.2170	\$58.00
Ground Bus Bar for 2 space load centers		PK4GTA	53.2390	\$6.00
Ground Bus Bar for 6 space load centers		PK7GTA	53.2391	\$7.00
Ground Bus Bar for 12 space load centers		PK9GTA	53.2392	\$10.00
Ground Bus Bar for 12 space 200A load center		PK15GTA	53.2393	\$23.00
Ground Bus Bar for 30 space load centers		PK18GTA	53.2394	\$25.00

Inverter Bypass Switch

Wired between any 120 VAC inverter/charger, generator and load center, this unit allows you to bypass the inverter in the event of an inverter failure. After the bypass switch is thrown, the generator is connected directly to the load center. The inverter can then be removed for repair. This is designed for inverters with built-in transfer switches. Maximum current is 60 amps. Dimensions: 13.5" x 6.25" x 3.5".

All components are UL Listed.

Description	Weight	Item Code	Price
Inverter Bypass Switch	7 lbs	53.7819	\$110



IOTA Automatic Transfer Switches

Safely connect an inverter and an AC generator to the same house wiring. These automatic transfer switches can be used with inverters that don't have built-in transfer switch capability. If the generator is not running, then the inverter is connected to the house wiring. When the generator is started, the house wiring is automatically disconnected from the inverter and connected to the generator. A time delay feature allows the generator to warm up before the transfer takes place.

These transfer switches are particularly useful in RV and Marine installations where both the hot and neutral terminals must be switched. They can be used between an inverter and a generator, between an inverter and shore power, or a generator and shore power. Two transfer switches can be used if switching between all three power sources is desired.

Indoor rated housings have conduit knockouts on all four sides. 30A and 50A units have a plastic housing and 100A units have a metal housing. ETL listed to UL1008



Model	AC Volts	Max Amps	Generator max kW	Dimensions (in)	Weight	Item Code	Price
ITS-30R	120	30A	4kW	7.5"H x 8.5"H x 4"D	2 lbs	53.8041	\$80
ITS-50R	120/240	50A	12kW	7.5"H x 8.5"H x 4"D	3 lbs.	53.8053	\$180
ITS-100R	120/240	100A	24kW	10"H x 12"W x 4"D	15 lbs.	53.8056	\$798

120 - DC TIMERS / MOTION SENSOR

24 Hour Quartz Timer

This 12-volt time control switch has a very accurate quartz clock movement with 200 hour internal power reserve, so it keeps time even if it is disconnected from the battery or the battery gets low. It uses 10 mA to operate and can switch up to 20 amps. Single pole double throw contacts can turn one thing on while turning another off. The timer has three ON/OFF operations per day. Order extra trippers for more ON/OFFs per day. Minimum ON or OFF time is 15 minutes. It can be used to start and stop generators with proper generator control circuitry. This is a dry-contact unit. Relay requires separate power to operate. Use 24 volt adapter to operate timer on 24 volts. 1-year warranty.



Description	Item Code	Price
12V Quartz 24 Hour Timer	54.7138	\$90.00
Extra Tripper - Red	54.7144	\$1.50
Extra Tripper - Blue	54.7141	\$1.50
24 Volt Adapter for Timer	54.7139	\$8.00

12 Volt Photoswitch

This is our basic light-controlled switch. It turns lights on at sunset and off at sunrise and can be used for billboard lighting or other outdoor lighting applications where the lights will be on all night. The PC120 is environmentally-sealed in a plastic enclosure with mounting tabs. Electrical connections are made to four 8" wire leads coming out of the back of the unit, two for 12-volt power in and two for connection to the light or other load that you want to turn on at night. Maximum load current is 20 amps. Current consumption is 3 mA in daylight and 90mA when load is turned on. If you need a light control as well as a PV charge control and low battery voltage protection, use the Xantrex C-12 or Morningstar Sunlight charge control. Dimensions: 3" x 2" x 2". 1-year warranty.

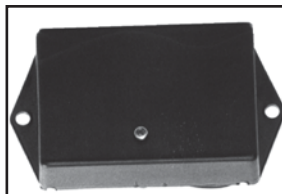

Description	Item Code	Price
Photoswitch 12V 20 Amp	54.7219	\$42

"T" Rated Switches

These switches are made for AC or DC wiring and they fit standard wiring boxes to simplify house wiring. By using a pair of 3-way switches, you can turn on a light in one place and turn it off in another place. Switch current rating is 10 amps maximum. Maximum voltage is 125VDC.

Description	Item Code	Price
T Rated On/Off Switch - Ivory	54.7307	\$5.00
T Rated On/Off Switch - Brown	54.7288	\$5.00
T Rated 3-Way Switch - Ivory	54.7303	\$7.00
T Rated 3-Way Switch - Brown	54.7289	\$7.00

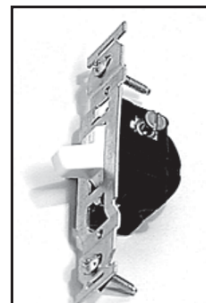

FlexCharge Timer

The Flexcharge digital timer is a 7-day, 8-event digital clock based programmable load controller. Multiple load ON and OFF times can be programmed and each day can be programmed with it's own unique timing pattern. Eight ON an eight OFF events can be programmed independently. For example: use one ON event to have a light come on at 7pm every day then use seven OFF events to turn the light off at a different time each day. The replaceable internal battery maintains the clock and programmed memory in the event of a system power failure (for up to 3 months). Consumes less then 3mA in standby mode. Internal DPST(double-pole-single-throw) relay switch can turn one load on at the same time that it turns another load off. Timer switch can handle up to 8 amps of inductive load or up to 16 amps of resistive load, at 6 to 36 VDC or 120VAC. Timer requires 12V DC or AC to operate. Reverse polarity protected. Manual override allows the user to turn the load ON or OFF as desired. Easy to use terminal block for wiring. Dry contacts.

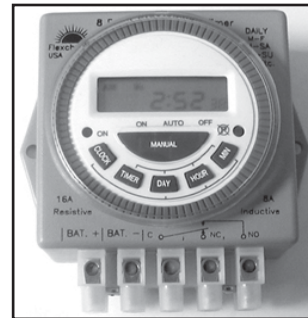

1-year warranty Dimensions: 3.9"W x 3.8"H x 2"D

Description	Item Code	Price
Flexcharge Timer	54.7120	\$80

12V Motion Sensor Switch

RAB motion and heat sensing switch is 12 volt DC powered so it works full time even if your inverter is in standby or off. Turns lights on at approach, and holds for adjustable time, 5 seconds to 20 minutes after motion stops. Sensitivity distance is adjustable, up to about 50 feet out, farther in colder weather. Connect directly to any 12 volt light, or use a 12 volt relay to switch 120 volt lights. Set for night only operation, or use as security alarm, by setting for day/night operation. Switches 5 amp DC, uses only 7 milliamp idle, 40 milliamps when activating.

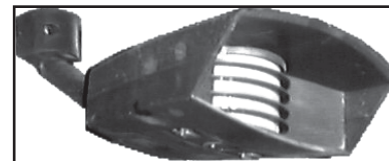

Description	Item Code	Price
12V Motion Sensor Switch	54.7237	\$85

TERMINAL BLOCKS & SWITCHES - 121

Battery Selector Switch

This high current switch is designed for battery switching in boats but can be used in land-based units. It permits selection between one of two batteries or the connection of both batteries in parallel. The "off" position also acts as a battery disconnect. Many people are using these to choose between two banks of batteries or between a main battery and a back-up battery. The switch surface mounts with a slot for wires to enter from the bottom. Wires connect to 5/16" brass bolts. Capacity is 250 amps continuous and 360 amps intermittent. For use on 6, 12, 24 or 32 volt systems. UL listed for marine use.

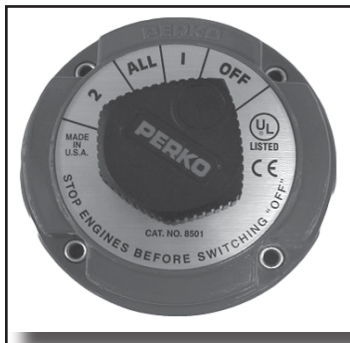

Description	Item Code	Price
Battery Selector Switch	53.8267	\$32

Power Distribution Blocks

Use these blocks to split primary power into secondary circuits, or join cables from a solar array to a power lead-in cable. Install cables and tighten set screws. Terminal blocks are made of zinc plated aluminum for use with aluminum or copper conductors. 2 poles. Primary side accepts one large cable; secondary side accepts 6 smaller cables. UL-recognized for up to 600 volts.



Primary Wire Size (AWG)	Secondary Wire Size (Qty)	Amp Rating	Item Code	Price
#8 to 2/0	#14 to #6 (6)	175	54.1024	\$40
#6 to 6/0	#14 to #4 (6)	350	54.1027	\$52

Splicer Blocks

Use these blocks to splice wires of up to #2/0 gauge. They are UL-recognized and CSA certified for up to 600 volts. The terminal blocks are made of zinc-plated aluminum, for use with aluminum or copper conductors. 2 pole and 3-pole blocks. One connection on each side.

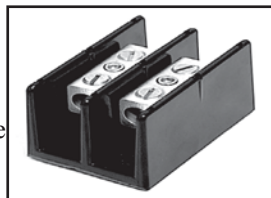

Wire Size (AWG)	Poles	Amp Rating	Item Code	Price
#8 to 2/0	2	175	54.1030	\$15
#8 to 2/0	3	175	54.1033	\$18

Wall Outlets and Plugs for 12 and 24VDC

In our search for an economical, NEC approved outlet to use for low voltage systems, we have decided upon something that is readily available, a 240 volt, 15 amp receptacle. Our choice of this configuration is based on the assumption that PV-powered remote homes will not normally have appliances that use 240 volts at 15 amps. If you have a large power tool it will usually have a 240 volt 20 amp plug on it. The receptacles are duplex (two outlets) and they fit standard wiring boxes and standard duplex receptacle covers.

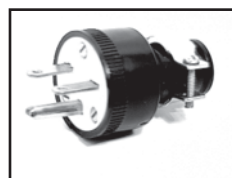
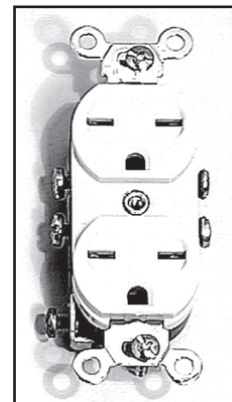

Description	Item Code	Price
DC Outlet - Brown	55.1060	\$6.00
DC Outlet - Ivory	55.1063	\$6.00
Plug - Black Rubber	55.1057	\$5.00

Barrel Connectors

These UL listed connectors are tin-plated high strength aluminum alloy. They can be used with copper or aluminum wire. Set screw holds wire in terminal. Single-and double-barrel connectors.

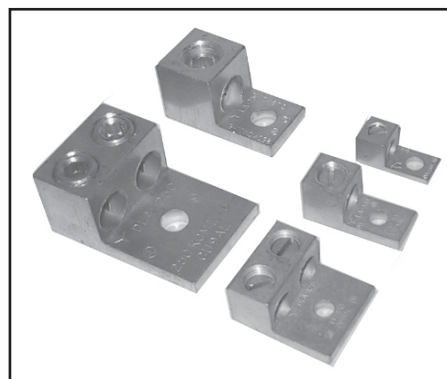

Type	Wire Size (AWG)	Hole Size	Item Code	Price
Single	14 to 2	1/4"	51.3319	\$1.84
Single	14 to 2/0	1/4"	51.3327	\$2.69
Double	14 to 2/0	1/4"	51.3324	\$6.50
Single	6 to 4/0	3/8"	51.3334	\$8.25
Double	6 to 4/0	3/8"	51.3330	\$20.00

122 - WIRE

Tray Cable (TC)



This 2 conductor flexible wire is excellent for outdoor applications like PV array lead-in and sub array wiring. It may be buried directly in the ground or exposed to direct sunlight. 10 and 12 gauge are good for array interconnects. UL listed, stranded type THHN / THWN conductors. Conductor insulation is red and black.

Description	Item Code	Price / ft.
8 AWG 2-Conductor TC Cable	50.1156	\$1.44
10 AWG 2-Conductor TC Cable	50.1162	\$0.69
12 AWG 2-Conductor TC Cable	50.1174	\$0.58
16 AWG 2-Conductor TC Cable	50.1177	\$0.30
18 AWG 2-Conductor TC Cable	50.1180	\$0.25

Duplex Primary Cable

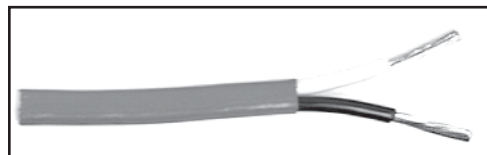

This cable has two flexible stranded conductors covered with a vinyl jacket. It is commonly used for low voltage house wiring. Since it is stranded, it can be used in boats and RVs where vibration is encountered. Conductor insulation is black and white.

Description	Item Code	Price / ft.
#8-2C Duplex Primary	50.1544	\$0.94
#10-2C Duplex Primary	50.1547	\$0.58
#12-2C Duplex Primary	50.1550	\$0.40
#14-2C Duplex Primary	50.1553	\$0.30

Meter & Control Wire - See pages 78 and 79

Submersible Pump Wire - See page 125

Direct Burial/Sunlight Resistant Cable



Type USE single conductor copper wire for lead-in from PV arrays, wind and hydroelectric systems. It may be used for AC or DC wiring up to 600 volts. Insulation is black crosslinked polyethylene. UL listed, USE-2 RHH / RHW-2.

Description	Item Code	Price / ft.
#4/0, AWG USE Single Conductor	50.1012	\$3.93
#2/0, AWG USE Single Conductor	50.1015	\$2.85
#1, AWG USE Single Conductor	50.1019	\$2.51
#2, AWG USE Single Conductor	50.1021	\$1.54
#4, AWG USE Single Conductor	50.1024	\$1.06
#6, AWG USE Single Conductor	50.1027	\$0.72
#8, AWG USE Single Conductor	50.1030	\$0.48
#10, AWG USE Single Conductor	50.1033	\$0.40
#12, AWG USE Single Conductor	50.1036	\$0.24

UL Listed Battery Cable



This fine stranded, very flexible cable is UL listed for use as battery cable. It is rated MTW or THW or AWM, 600 volt, sunlight resistant, direct burial, 105C. Available with red or black insulation.

Description	Item Code	Price / ft.
X-Flex Battery Cable 4/0 Black	50.1470	\$5.46
X-Flex Battery Cable 4/0 Red	50.1472	\$5.46
X-Flex Battery Cable 2/0 Black	50.1476	\$4.05
X-Flex Battery Cable 2/0 Red	50.1478	\$4.05
X-Flex Battery Cable 2 AWG Black	50.1487	\$2.58
X-Flex Battery Cable 2 AWG Red	50.1488	\$2.58

DC WIRING ACCESSORIES - 123

Wall Plate Lighter Receptacle

This receptacle comes with a chrome plated cover that fits a standard single gang outlet box. This heavy duty outlet is made of brass and steel so it can handle up to 20 amps. The positive connection is a 10-32 threaded stud with nuts. The negative connection is a short piece of 18 gauge wire. If you plan to use more than 10 amps, replace negative wire with 12 AWG. The negative connection of the outlet is connected to the steel cover, so it is a good idea to use a steel junction box with the negative wire connected to the box as well as the negative lead on the outlet.



55.1038 Wall Plate Receptacle \$5.

Lighter Plug

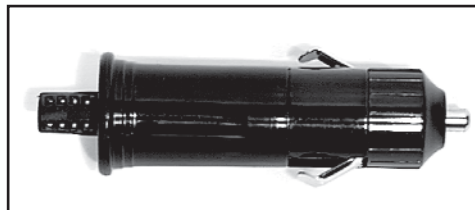

This heavy-duty plug is made from high heat thermoset plastic to prevent distortion at high temperatures. It comes with an easy to replace 3 amp glass fuse, but any AGC type fuse up to 15 amps may be used. Wire connections should be soldered. Screw together assembly requires no tools.

55.1027 Lighter Plug \$3

Extension Cord with Battery Clips

Ten foot extension cord with lighter receptacle at one end and color coded battery clips at the other. 16 gauge wire.



55.1035 Extension Cord w/Clips \$11.

Double Receptacle

Plug two devices into the same outlet with this heavy duty "Y" connector. Leads are 6 inches long 16 gauge wire.

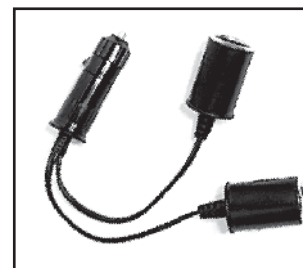

55.1030 In-Line Double Receptacle \$7

Lighter Plug Extension Cord

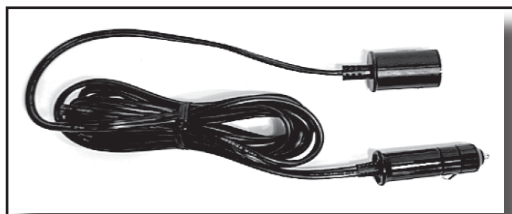

Fifteen foot extension cord with lighter plug at one end and lighter receptacle at the other. 16 gauge wire.

55.1036 Lighter Extension Cord \$9

In-Line Lighter Receptacle

Lighter receptacle with a 12 inch 16 AWG wire. Maximum current is 10 amps.

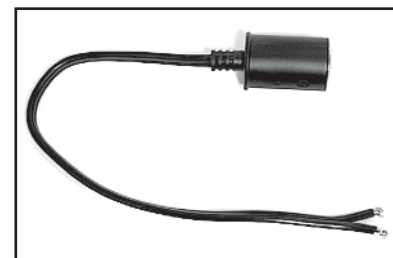

55.1033 In-Line Receptacle w/12" Wire \$5

RV Roof Connector

The roof outlets are typically installed on RV roofs to allow for later installation of PV modules without adding a new roof penetration. They are a great waterproof method to bring wires through an RV roof. Cords below mate to roof outlet. They are typically used to connect PV modules to the roof outlet. Cable 55.1110 and 55.1113 have unjacketed wire with 1 red conductor and one black conductor. Cable 55.1111 has 20 feet of jacketed type TC cable with red and black conductors.

- 55.1109 RV Roof Outlet \$4
- 55.1110 Connector with 5' #12 AWG cable \$5
- 55.1111 Connector with 20' #10 AWG cable \$20
- 55.1113 Connector with 10 inch cable \$3

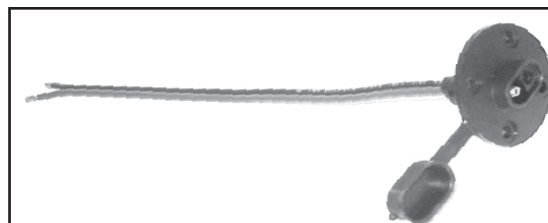

124 - WATER PUMPING INFORMATION

Basic Pumping Information

The sun is the natural source of energy for an independent water supply. Solar pumps operate anywhere that the sun shines, and the longer it shines, the more water they pump. When it's cloudy, they pump less water, but often you need less water when it is cloudy. Photovoltaic modules, the power source for solar pumping, have no moving parts, require no maintenance and last for decades. A properly designed solar pumping system will be efficient, simple and reliable.

Solar water pumping systems operate on direct current. The output of the solar power system varies throughout the day and with changes in weather conditions. The nature of variable electricity in the form of direct current (DC) is quite different from conventional, steady alternating (AC) current from the utility grid or a generator. To use solar energy economically, the pumping system must utilize the long solar day, drawing a minimum of power. This means pumping slower than conventional pumps. Pumping at rates of less than 6 GPM requires different mechanisms from the conventional (centrifugal) pumps.

Small solar pumps are unique, both electrically and mechanically. The most efficient pumps are "positive displacement" pumps; that pump a certain amount of water with each rotation. If it is cloudy or early morning, the pump will receive less energy and run slower. A "positive displacement" pump will pump approximately $\frac{1}{2}$ as much water with $\frac{1}{2}$ as much energy.

Conventional AC pumps are usually centrifugal pumps that turn at high speed to pump as many gallons per minute as possible. They also consume a large amount of power. If you run a centrifugal pump at $\frac{1}{2}$ speed, it pumps $\frac{1}{4}$ the water. Their efficiency is very low at low speeds and when pumping against high pressure.

If your water sources are remote from power lines, add up your long-term costs of fuel and repairs on generators, or the cost of utility line extensions. Now consider the savings with a solar pump that needs attention only once every 2 to 20 years depending on model.

Solar powered pumps can provide an equal volume of water per day without the high and inefficient energy demands of a large capacity AC pump. Instead of pumping a large volume of water in a short time and turning off, the solar pump works slowly and efficiently all day. Often a solar pump will work fine in a well with a recovery rate too slow for a conventional AC pump.

Solar Submersible Pumps

If you are pumping from a well, we have solar pumps that can deliver from 1 gallon per minute (GPM) to over 75 GPM.

The smallest pump, the low power diaphragm pump from

Shurflo, operates from two 50 to 75 watt solar modules, depending on the head (vertical distance) they are pumping. It can pump 500 to 1000 gallons per day and lift water 200 feet. This pump requires service every 2 to 4 years.

If you have a higher lift, need more water or want a pump that does not require service for 15 to 20 years, the Grundfos SQFlex pump is a good choice. The SQFlex can lift water 525 feet and can pump over 20,000 gallons per day at lower lifts.

For greater water needs or deeper wells, the Grundfos SQ-series AC submersible pump can easily be powered by an inverter or generator.

Larger conventional single and three phase AC pumps, up to 10 HP, can be solar powered with the Aerovironment AC Pump Controller and a large PV array.

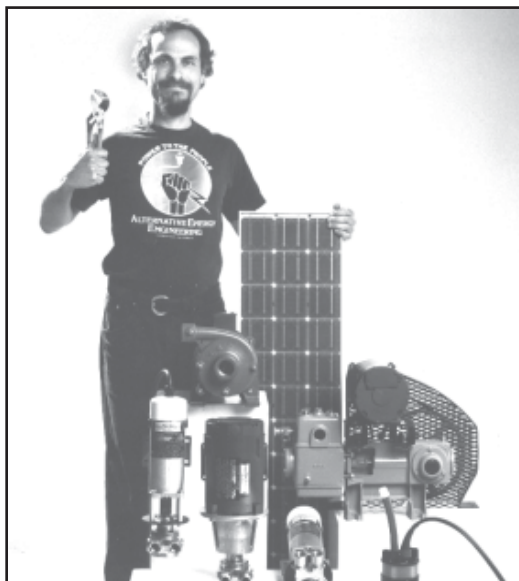

Surface Pumping

Surface pumps are less expensive than DC submersibles, where applicable. A surface pump is not submersible. It can draw water from a dug well, spring, pond, river or tank, and push it far uphill and through a long pipeline to fill a storage tank or to pressurize it for home use or for irrigation, livestock, etc. The pump may be placed at ground level, or suspended in a well in some cases.

All pumps are better at pushing than pulling. Surface pumps must be placed no higher than 10 or 20 feet above the surface of the water source at sea level (subtract one foot per 1000 ft. Elevation). Suction piping must be oversized a bit and

not allow air entrapment (much like a drain line) and should be as short as possible. Pumps can push very long distances. The vertical lift and flow rates are the primary factors that determine power requirements.

Pressurization

Many conventional AC powered water systems pump from a well or other water source, into a pressure tank that stores water and stabilizes the pressure for household use. When you turn on water in the house, an air-filled bladder in the tank forces the water into the pipes. When the pressure drops, a pressure switch turns on the pump, refilling and repressurizing the tank. This works fine because of the ability of the AC pump to deliver a volume of water larger than the household uses. This can work in systems with an inverter large enough to run a standard AC pump. However, this will not work with pumps operating directly from PV modules. First, the sun may not be shining when you need pressure. Second, many solar pumps deliver water too slowly to keep up with household use.

There are two ways to solve this problem. A non-pressurized water tank can be located high enough above the house for gravity to supply the water pressure. This can be on a hill or a

PUMP CABLE AND FLOAT SWITCHES - 125

tower. Water pressure in PSI = Head in feet times 0.433. For reasonable pressure the tank needs to be at least 40 feet above the house. If this is not possible, a battery operated pressure booster pump can fill a pressure tank as needed from a storage tank that is filled by a solar pump during the day. The Flowlight Booster pump, as well as the Shurflo 2088 pumps can be used for this purpose. You must use a pump that can deliver the maximum GPM required by the house, or have a pressure tank that is large enough to make up the difference between what the pressure pump can deliver and what is required, for the amount of time it is required. This is called the "drawdown volume" of the tank. Air filled pressure tanks can be obtained locally from a pump dealer.

Calculation of Solar Power Needs

With all solar powered pumps, the necessary solar array can be determined by looking at the watts required for the head and flow in your situation. Solar array watts should be at least 20% higher than the power required by the pump in your situation. If you use a larger array or a tracking array, the pump will operate at it's maximum output for more hours of the day, delivering more gallons per day.

If the pump runs on 24 volts, you can use pairs of 12V solar modules wired in series or 24V modules. Two solar modules with total wattage equivalent to or exceeding the wattage required by the pump must be used. If the pump uses 48 volts, you can use groups of four 12V solar modules wired in series or group of two 24V modules whose total wattage exceeds the pump's power requirement.

Linear Current Boosters

Linear Current Boosters are used in solar direct pumping applications. They can achieve 30 - 90 percent increase in your water pumped than connecting the motor directly to the solar panels. We can special order 90 V units that can operate 12, 24, 36 and 48 volt pumps from several modules in series. This will be useful where the panels must be a long distance from the motor, allowing wiring with a smaller wire size as the current is reduced. The wire savings alone can easily pay for the controller. Call for details.



Submersible Pump Cable

10/2 without ground pump cable is for the Shurflo 9300 submersible pump. 2 conductor with ground pump cable is required for Grundfos SQFlex and SQ AC pumps.

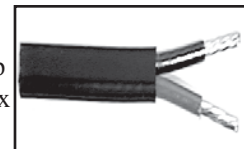

Sensor Wire

This 3-conductor, 22-gauge direct-burial wire can be used between water level sensors and pump controls in pumping applications where you must sense water level in a remote tank or in a well.

Splice Kit

This kit contains crimp splices and heat shrng tubing for splicing AWG 10 or 12 submersible pump wire for use under water.

Description	Item Code	Price / Ft.
10/2 without Ground	50.1637	\$0.75
12/2 w/Ground	50.1635	\$0.67
10/2 w/Ground	50.1638	\$1.01
8/2 w/Ground	50.1643	\$2.25
Sensor wire 22/3	50.1273	\$0.28
Splice Kit	75.0130	\$12.00

Float Switch

The SPDT float switch can be used to control a pump in tank filling or tank emptying operation. Contacts located in the float will switch at 12 degrees above and below horizontal. Use a pipe clamp or cable tie to secure the cable to a pipe or weight in tank. The length of cable from clamp to float determines the difference between turn-on level and turn-off level. For larger pumps, use float switch to turn a relay on and off and let relay contacts control pump. Safe for domestic water systems. 2 year warranty.

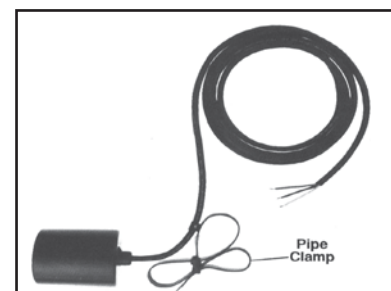

On When Full is used to turn on a pump when a tank is full and pump it down. **Off When Full** turns the pump off when a tank is filled. These are SPST switches.

Description of Operation	Maximum Amps	Item Code	Price
SPDT Three Wire	5	75.5270	\$45
On when Full	13	75.4420	\$26
Off when Ful	13	75.4422	\$26
On when Full	25	75.4407	\$70
Off when Full	25	75.4410	\$70

Solar Connverters Model #	Array Volts Nominal	Current Max Amps	Item Code	List Price
PPT 12/24-7	12 or 24	7	75.0124	\$102
PPT 12/24-15	12 or 24	15	75.0126	\$235
PPT 12/24-30	12 or 24	30	75.0128	\$428
PPT 48-10	48	10	75.0136	\$250

126 - SOLAR SUBMERSIBLE PUMPS

Grundfos SQFlex Submersible Pumps

This is the ultimate submersible pump for water lifts of up to 525 feet. They can be directly powered by solar or wind power or can be run on an inverter, a generator, a battery or the utility grid, or any combination of these sources. Virtually any source of power, 30-300 VDC and 90-240 VAC can be used to run the pump, and with the name Grundfos on it, you know it is built to last and is maintenance-free. Some SQFlex pumps will fit into a 3" well.

Seven pump models can deliver from 4 GPM at 525 feet to 50 GPM at 20 feet of head with 1 kilowatt solar array or less. Helical rotor pumps for high head applications and centrifugal pumps for low head applications assure a pump that is efficient for any application. The SQFlex has built-in protection from dry-running, overload and overheating.

The SQFlex pump can run on a solar arrays starting at 129 watts. The array must have an operating voltage over 30 volts. The array can be made any combination of 3 or more 12 volt nominal modules in series or 2 or more 24 volt nominal module.

Grundfos also has a specially designed Whisper 100, 1KW wind generator with 150 VDC output for applications using wind power. Please contact us for information.

Optional Controls

The **CU200** interface box communicates with the pump and monitors operating conditions. Built-in diagnostics indicate faults and dry-running, display operating status, power consumption and water level switch input.

The **Water Level Switch** interfaces with the CU200 control to turn off the pump when a tank is full.

The **IO100** is a simple control box with cable terminations and a manual on/off switch. It is a great interface between a solar array and the pump to allow you to turn off the high voltage array when working on the pump.

The **IO101** is an interface for using AC backup on a solar pump. An automatic transfer switch disconnects the solar array when AC power from a generator, utility connection or inverter is present. When AC power stops, it automatically reconnects the array to let the sun continue pumping.

The **IO102** interface unit is used for systems powered exclusively by a wind turbine or by a combination of wind and PV.



You can use several controls if you need more features than one control can provide.

The SQFlex pumps will not function with a GFCI in the supply circuit, and should not be used where a GFCI is required.

Use the table on next page to choose a pump. Left Column shows total head in feet and meters. The top row shows array wattage/number and suggested type of modules. Boxes show seasonal pump performance and maximum flow as shown in the sample box below.

75 SQF-3	Pump Model #
22,040	Estimated Daily Summer Volume (GPD)
14,630	Estimated Daily Winter Volume (GPD)
52	Peak Flow Rate (GPM)

Select the row with the head (total lift) that most closely matches your application. Move across the row to the column that contains the desired daily volume or peak flow rate. Note the pump model in that block and wattage of the PV array in that column.

****Note:** Daily volume and flow calculations are based on 38° North latitude location, fixed array tilt of 38° and 4.5 kWh/m² (POA) winter, and 7.5 kWh/m² (POA) summer solar insolation. The pump model is optimized for summer operation. Up to 40% more water can be pumped in the summer if the array is on a tracking mount. The output can vary with different locations and years, and is not guaranteed.

Grundfos SQFlex Pumps and Accessories	Item Code	Price
SQFlex 3 SQF-2 Pump - 3"	75.1012	\$1,574
SQFlex 6 SQF-2 Pump - 3"	75.1015	\$1,574
SQFlex 11 SQF-2 Pump - 3"	75.1018	\$1,574
SQFlex 25 SQF-3 Pump - 4"	75.1021	\$1,574
SQFlex 25 SQF-6 Pump - 4"	75.1024	\$1,574
SQFlex 40 SQF-3 Pump - 4"	75.1027	\$1,574
SQFlex 75 SQF-3 Pump - 4"	75.1030	\$1,574
IO100 Interface Box	75.1039	\$119
IO101 Interface Box (115V)	75.1036	\$337
CU200 Interface for multiple sources	75.1033	\$266
Level Switch (Use with CU200 only)	75.1042	\$21
Whisper 200 Wind Turbine - 150 V	16.1199	\$2005
IO102 Wind Turbine Breaker Box	75.1040	\$217
Tower Kit 30 foot for Whisper 200	16.1089	\$385
Tower Kit 50 Foot for Whisper 200	16.1095	\$480
Auger/Anchor (set of 4) for towers	16.1119	\$70
Pressure Switch (use with CU200 only)	75.1044	\$67

SOLAR SUBMERSIBLE PUMPS - 127

Estimated Water Production from SQFlex Pumps Summer and Winter Volumes and Peak Flow Rates Based on Solar Array Wattage

Head feet (m)	Module Module W # modules Array W	SQ80	SQ80	SQ80	SQ80	SQ80	SQ80	SQ80	SQ80
		80 3	80 4	80 5	80 6	80 8	80 10	80 12	80 14
		240	320	400	480	640	800	960	1120
6 (2)	Model	75 SQF-3	75 SQF-3	75 SQF-3	75 SQF-3	75 SQF-3	75 SQF-3	75 SQF-3	75 SQF-3
	7.5 kWh/m ²	14,377	19,936	24,262	27,899	34,173	38,103	41,175	42,175
	4.5 kWh/m ²	8,655	12,895	16,469	19,642	24,778	27,924	30,806	32,677
	Max flow	32.6	42.0	49.4	54.6	64.1	70.4	74.6	75.6
25 (8)	Model	25 SQF-3	40 SQF-3	40 SQF-3	40 SQF-3	75 SQF-3	75 SQF-3	75 SQF-3	75 SQF-3
	7.5 kWh/m ²	4,603	6,811	9,363	11,718	17,363	21,378	25,138	26,872
	4.5 kWh/m ²	2,375	3,414	5,230	6,932	10,155	13,346	16,427	18,696
	Max flow	11.6	15.8	22.1	27.3	39.9	47.3	53.6	59.9
50 (15)	Model	11 SQF-2	11 SQF-2	11 SQF-2	11 SQF-2	25 SQF-6	25 SQF-6	25 SQF-6	25 SQF-6
	7.5 kWh/m ²	3,016	4,116	4,961	5,532	8,369	10,631	12,590	13,527
	4.5 kWh/m ²	1,891	2,696	3,410	4,046	4,788	6,502	8,080	9,286
	Max flow	6.6	8.6	10.0	10.5	20.0	24.2	27.3	30.5
75 (23)	Model	11 SQF-2	11 SQF-2	11 SQF-2	11 SQF-2	11 SQF-2	25 SQF-6	25 SQF-6	25 SQF-6
	7.5 kWh/m ²	2,250	3,243	4,140	4,800	5,762	7,102	8,732	9,651
	4.5 kWh/m ²	1,306	2,008	2,652	3,252	4,280	3,784	4,927	6,056
	Max flow	5.3	7.1	8.8	9.8	10.5	16.8	21.0	21.0
100 (30)	Model	11 SQF-2	11 SQF-2	11 SQF-2	11 SQF-2	11 SQF-2	11 SQF-2	11 SQF-2	11 SQF-2
	7.5 kWh/m ²	1,491	2,339	3,126	3,909	5,044	5,586	5,897	6,009
	4.5 kWh/m ²	753	1,295	1,847	2,410	3,445	4,143	4,558	4,746
	Max flow	3.7	5.6	7.1	8.6	10.3	10.5	10.5	10.5
125 (38)	Model	6 SQF-2	11 SQF-2	11 SQF-2	11 SQF-2	11 SQF-2	11 SQF-2	11 SQF-2	11 SQF-2
	7.5 kWh/m ²	1,058	1,746	2,440	3,086	4,405	5,027	5,429	5,550
	4.5 kWh/m ²	582	889	1,339	1,798	2,747	3,493	4,048	4,317
	Max flow	2.5	4.3	5.8	7.1	9.7	10.2	10.2	10.2
150 (46)	Model	6 SQF-2	6 SQF-2	11 SQF-2	11 SQF-2	11 SQF-2	11 SQF-2	11 SQF-2	11 SQF-2
	7.5 kWh/m ²	912	1,393	1,928	2,555	3,718	4,551	4,981	5,191
	4.5 kWh/m ²	474	799	961	1,380	2,197	2,938	3,560	3,913
	Max flow	2.2	3.3	4.8	6.2	8.5	9.9	9.9	9.9
175 (53)	Model	3 SQF-2	6 SQF-2	6 SQF-2	6 SQF-2	11 SQF-2	11 SQF-2	11 SQF-2	11 SQF-2
	7.5 kWh/m ²	783	1,231	1,633	2,024	3,149	4,015	4,553	4,791
	4.5 kWh/m ²	470	683	952	1,253	1,760	2,412	3,053	3,494
	Max flow	1.8	2.9	3.8	4.6	7.4	9.1	9.6	9.6
200 (61)	Model	3 SQF-2	6 SQF-2	6 SQF-2	6 SQF-2	11 SQF-2	11 SQF-2	11 SQF-2	11 SQF-2
	7.5 kWh/m ²	734	1,071	1,474	1,846	2,631	3,469	4,052	4,365
	4.5 kWh/m ²	432	567	834	1,086	1,373	1,952	2,508	3,018
	Max flow	1.7	2.6	3.5	4.3	6.4	8.1	9.2	9.2
250 (76)	Model	3 SQF-2	3 SQF-2	6 SQF-2	6 SQF-2	6 SQF-2	6 SQF-2	11 SQF-2	11 SQF-2
	7.5 kWh/m ²	623	903	1,135	1,496	2,076	2,379	3,091	3,451
	4.5 kWh/m ²	353	549	585	822	1,288	1,705	1,633	2,053
	Max flow	1.5	2.0	2.7	3.6	4.6	4.7	7.5	7.5
300 (91)	Model	3 SQF-2	3 SQF-2	3 SQF-2	3 SQF-2	6 SQF-2	6 SQF-2	6 SQF-2	6 SQF-2
	7.5 kWh/m ²	527	790	996	1,127	1,785	2,085	2,304	2,379
	4.5 kWh/m ²	281	456	633	807	994	1,363	1,671	1,821
	Max flow	1.3	1.8	2.2	2.3	4.3	4.5	4.5	4.5
350 (107)	Model	3 SQF-2	3 SQF-2	3 SQF-2	3 SQF-2	6 SQF-2	6 SQF-2	6 SQF-2	6 SQF-2
	7.5 kWh/m ²	417	663	881	1,032	1,457	1,862	2,059	2,192
	4.5 kWh/m ²	194	364	518	679	754	1,083	1,387	1,600
	Max flow	1.1	1.6	2.0	2.2	3.6	4.4	4.4	4.4
390 (119)	Model	3 SQF-2	3 SQF-2	3 SQF-2	3 SQF-2	3 SQF-2	6 SQF-2	6 SQF-2	6 SQF-2
	7.5 kWh/m ²	327	568	772	943	1,166	1,418	1,551	1,615
	4.5 kWh/m ²	133	291	437	574	849	897	1,088	1,197
	Max flow	0.9	1.4	1.8	2.2	2.3	3.2	3.2	3.2
450 (137)	Model	3 SQF-2	3 SQF-2	3 SQF-2	3 SQF-2	3 SQF-2	3 SQF-2	3 SQF-2	3 SQF-2
	7.5 kWh/m ²	172	327	574	683	943	1,143	1,243	1,339
	4.5 kWh/m ²	28	133	289	380	574	822	943	1,014
	Max flow	0.5	0.9	1.4	1.6	2.2	2.3	2.3	2.3
500 (152)	Model		3 SQF-2	3 SQF-2	3 SQF-2	3 SQF-2	3 SQF-2	3 SQF-2	3 SQF-2
	7.5 kWh/m ²		176	334	360	772	975	1,070	1,128
	4.5 kWh/m ²		34	137	255	437	622	822	918
	Max flow		0.5	0.9	0.9	1.8	2.3	2.3	2.3

DC SUBMERSIBLE PUMPS - 129

Shurflo 9300 Submersible Pump

Use this lightweight submersible pump for livestock, irrigation or remote home application with low water requirements. The 9300 is a positive displacement diaphragm type pump with very high efficiency, but a much shorter life than centrifugal or helical rotor pumps. Diaphragm should be replaced every two to four years, depending on pumping volume.

The Shurflo 9300 can be operated on a 12 or 24-volts battery or, with the use of one of the Shurflo Pump Controls, directly on a PV array. The pump can lift 1.3 GPM to 230 ft. and can pump nearly 2 GPM from very shallow wells. It measures only 3.75" diameter x 12" long.

The 902-200 controller comes in an outdoor enclosure with water level sensors and sensor wire. It can be operated from a 12V or 24V array. The 902-100 control must be mounted in a dry location and used with a 24V array

Performance on a 12-volt battery will be less than 1/2 the flow on the chart at right. 1 year warranty.

Array Direct Performance (24V Array)

Vertical Lift	Minimum Solar Array Size	Flow Rate (GPM)	Amps @ 30V
20	2 x 32 Watts	1.95	1.5
40	2 x 32 Watts	1.90	1.7
60	2 x 50 Watts	1.81	2.1
80	2 x 50 Watts	1.76	2.4
100	2 x 50 Watts	1.71	2.6
120	2 x 50 Watts	1.68	2.8
140	2 x 80 Watts	1.65	3.1
160	2 x 80 Watts	1.63	3.3
180	2 x 80 Watts	1.55	3.6
200	2 x 80 Watts	1.52	3.8
230	2 x 80 Watts	1.36	4.1

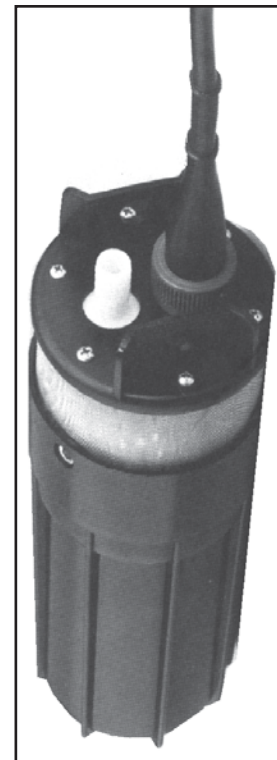

Description	Voltage / Wattage	Wt. (lbs.)	Item Code	Price
Shurflo 9300 Submersible Pump	24 VDC	6	75.5817	\$689
Shurflo 902-100 Pump Controller	24 VDC, 150 W max.	6	75.5823	\$122
Shurflo 902-200 Pump Controller	12-24 VDC, 150 W max	6	75.5820	\$273

LVM Submersible Pumps

LVM pumps are constructed of polyacetal plastic, enabling them to pump almost any liquids. They are small enough to enter the opening in a five gallon container or a 2" well casing. The outlet is a 1/2" hose barb. The intake has a removable strainer with another hose barb for inline use. These pumps can be used for most general intermittent pumping applications, like hosing down cars, vans, boats, pumping into and from containers, emptying bilges, etc. LVM 105 comes with battery clips. These pumps are designed for 12 volt operation and will be damaged by array direct operation if voltage goes above 15 volts. Made in England.



Model Number	Current (amps)	Flow Rate (GPM) at 0 PSI	Pressure (Max PSI) at 0 Flow	Maximum Head (Feet)	Dimensions (in.)	Weight (lb)	Cable Length	Item Code	Price
LVM105	4.5	4	14	32	1.5 x 6.54	1.1	12 ft	75.8052	\$79
LVM107	2	2	11	20	1.5 x 5.67	0.5	3 ft	75.8054	\$55
LVM111	6	6	14	32	1.5 x 6.54	1.5	12 ft	75.8058	\$95

130 - DC FOUNTAIN PUMPS

Aquasolar 200 Fountain Pumps

These small solar-direct submersible water pumps are ideal for fountains, solar displays and remote, very small pumping needs. Model 200 is designed to be powered by a 10 watt PV module or a 12 volt battery. **We recommend using a 20 watt PV module for better performance in array-direct operation. This allows the pump to run at full power when tilt angle and light conditions are less than perfect.** It pumps over 2 gallons per minute at 18 volts when powered by a 10 watt module in full sun. The pump housing acts as an intake screen. The built-in outlet adapter can receive ½” or ¾” pipe thread. Maximum lift is 4’ at 18VDC and 6’ at 24VDC. Maximum voltage is 24VDC. Dimensions: 6.0” x 4.5” diameter.

Unlike other 12 volt fountain pumps they can operate continuously on the 16 to 20 volt open circuit output of 12 volt PV modules. They are made in Germany and are very high quality pumps. Cord length is 15 feet. 3 year warranty.



Model Number	Dimensions (in.)	Weight (lb)	Cable Length	Item Code	Price
200	6 x 4.5	2.1	15 ft	75.8134	\$150

Pulsing Solar Fountain Kit

The Solar Stream LJ-01 solar fountain pump provides a unique feature for any pond, garden pool, or business display. Powered by a 3 Watt photovoltaic module, the fountain sends a stream of water 6 feet into the air two times a second in full sun. The pump is a stainless steel cylinder 6 inches high and 3 inches in diameter. It fits into a 5 inch foam collar that allows the pump to float at the waters surface. An 8 foot cord allows connection to the commercial grade 3 Watt photovoltaic module which is supplied with the kit.

These pumps have only one moving part – a free piston. Electricity from sunlight (from the PV module) charges a capacitor. When the capacitor voltage reaches a fixed level (about 16 Volts), an electronic switch feeds the capacitor energy into the pump coil which drives the piston, creating a pulse of water. The more sunlight, the more pulses of water are delivered.

Model Number	Description	Item Code	Price
LJ-01	Solar Fountain Pump Kit	75.8157	\$150



Portable Water Filter Bottle

This 22 ounce bottle has a built-in charcoal filtration system capable of 99% reduction in all 4 areas of contamination; aesthetic, microbiological, chemical and dissolved solids. It can be used to filter virtually any freshwater source. It can be used on water from mountain lakes, streams, rivers and tap water. It effectively reduces 99.99% of contaminants such as cryptosporidium, giardia, E-coli and more! It reduces lead and other heavy metals, chlorine, VOC's, bad tastes & odors!

Description	Item Code	Price
Portable Water Filter	78.1108	\$25
Replacement Filter Cartridge	78.1109	\$15



DC PISTON PUMPS - 131

Solar Force Piston Pumps

Pumps more water with less power. Out lasts 10 small diaphragm pumps. Tolerates dirty water. Life expectancy is 20 years with 2 to 6 year owner performed maintenance schedule. Cast iron body, brass cylinder and valve seats, oil bath crankcase, and pre-t

available for battery or direct solar power. 12, 24, 48, or 90 volt DC, or 120 or 240 volt AC. Use battery models for home system. Use solar direct with panels and with 15 amp LCB for pumping when no battery system is nearby. Two year warranty.

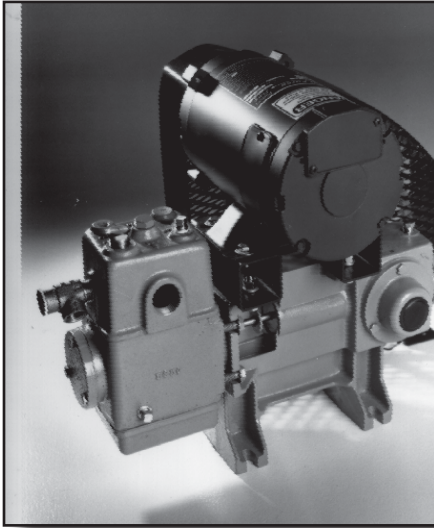

Vertical Lift (feet)	Pressure (PSI)	Model 3010			Model 3020			Model 3040		
		Battery Only			PV or Battery			PV or Battery		
		GPM	LPM	Watts	GPM	LPM	Watts*	GPM	LPM	Watts*
20	8.7	5.9	22.3	77	5.2	19.7	110	9.3	35.2	168
40	17.4	5.6	21.3	104	5.2	19.7	132	9.3	35.2	207
60	26.0	5.3	20.2	123	5.1	19.2	154	9.2	34.9	252
80	35.0	5.2	19.7	152	5.1	19.2	182	9.2	34.9	286
100	43.0	5.1	19.2	171	5	18.9	202	9.1	34.5	322
120	52.0	4.9	18.7	200	5	18.9	224	9.1	34.5	364
140	61.0	4.9	18.7	226	5	18.9	252	9.1	34.5	403
160	70.0				4.9	18.6	269			
180	78.0				4.9	18.6	280			
200	86.0				4.8	18.2	308			
220	95.0				4.7	17.8	314			

* Watts listed is pump power used. For array direct operation array must be at least 20% larger

Solar Force Pump Description	Nominal Volts	Power Source	Weight (lbs.)	Item Code	Price
Solar Force Piston Pump 3010-12-B	12	Battery	55	75.4265	\$1,085
Solar Force Piston Pump 3010-24-B	24	Battery	55	75.4267	\$1,085
Solar Force Piston Pump 3020-12-PV	12	PV	70	75.4273	\$1,525
Solar Force Piston Pump 3020-24-PV	24	PV	70	75.4277	\$1,510
Solar Force Piston Pump 3020-48-PV	48	PV	70	75.4281	\$1,525
Solar Force Piston Pump 3040-12-PV	12	PV	70	75.4287	\$1,595
Solar Force Piston Pump 3040-24-PV	24	PV	70	75.4291	\$1,585
Solar Force Piston Pump 3040-48-PV	48	PV	70	75.4295	\$1,595
Solar Force Piston Pump 3020-12-B	12	Battery	70	75.4271	\$1,340
Solar Force Piston Pump 3020-24-B	24	Battery	70	75.4275	\$1,340
Solar Force Piston Pump 3020-48-B	48	Battery	70	75.4279	\$1,350
Solar Force Piston Pump 3040-12-B	12	Battery	70	75.4285	\$1,425
Solar Force Piston Pump 3040-24-B	24	Battery	70	75.4289	\$1,415
Solar Force Piston Pump 3040-48-B	48	Battery	70	75.4293	\$1,395
Solar Force Piston Pump 3020-120VAC	120	120 VAC	70	75.4269	\$1,350
Solar Force Piston Pump 3040-120VAC	120	120 VAC	70	75.4283	\$1,340

Solar Force Pump Accessories

Heavy Duty Pressure Switch	75.4297	\$75	EZ Install Kit for Solar Force	75.4248	\$135
1-1/4" Foot Valve (use if pump is higher than source)	75.4212	\$25	Surge Tank	75.4250	\$90
Seal & Belt Kit for 3010B	75.4251	\$46	PK-3010B Parts Kit	75.4257	\$160
Seal & Belt Kit for 3020PV	75.4252	\$75	PK-3020B Parts Kit	75.4258	\$160
Seal & Belt Kit for 3040PV	75.4253	\$75	PK-3040B Parts Kit	75.4259	\$160
Seal & Belt Kit for 3020B	75.4254	\$46	PK-3020PV Parts Kit	75.4260	\$210
Seal & Belt Kit for 3040B	75.4255	\$46	PK-3040PV Parts Kit	75.4261	\$210

132 - POSITIVE DISPLACEMENT PUMPS

Dankoff Slowpump

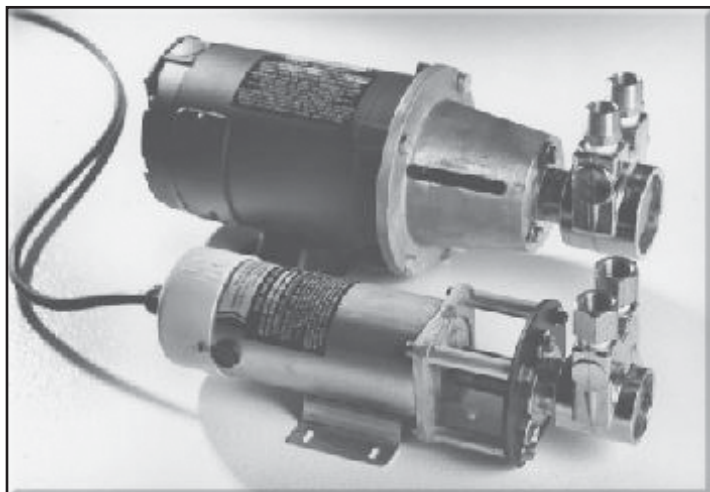

The Slowpump can push water as high as 450 vertical feet. It runs on very little power, with or without batteries, to supply between 200 and 2600 gallons of water per day. The positive displacement vane pump mechanism is housed in forged brass, and lasts for years of all-day

running. 5 micron filtration is required to protect the pump. For PV-direct (no batteries in system) array, watts must exceed pump watts by 20% or more, and a linear current booster controller is required (page 123). The sizing chart shows the gallon per minute (GPM) output from the pump and power (Watts) consumed by the pump for various vertical lifts. (This is the lift from the water level to the top of the tank that the water is pumped to). The performance in the chart is measured at array direct voltage. The peak power voltage of typical solar modules is 17 Volts. A battery powered system will have 15% lower flow and wattage. To estimate gallons per day delivery, multiply GPM figure by 60 and then by the peak sun hours per day in your location. Using a tracker with your solar modules will give you approximately 40%-50% more water in the summer. Slowpumps are available with 1/2 HP motors for greater lift.

NOTE: Pumps listed 12 or 24 Volts may be used with batteries or array direct. The 36PV/48B pumps can be run PV direct with a 36V array or from a 48V battery bank. For 120VAC operation order the desired pump and the Slowpump AC Option.

Warranty is one year.

Description	Item Code	Price
Slowpump 1304-12	75.4155	\$475
Slowpump 1304-24	75.4157	\$475
Slowpump 1308-12	75.4159	\$475
Slowpump 1308-24	75.4161	\$475
Slowpump 1310-12	75.4163	\$475
Slowpump 1310-24	75.4165	\$475
Slowpump 1322-12	75.4167	\$475
Slowpump 1322-24	75.4169	\$475
Slowpump 1303-12	75.4171	\$475
Slowpump 1303-24	75.4173	\$475
Slowpump 2505-12	75.4175	\$475
Slowpump 2505-24	75.4177	\$475
Slowpump 2507-12	75.4179	\$475
Slowpump 2507-24	75.4181	\$475
Slowpump 1408-24B	75.4185	\$695
Slowpump 1408-36PV/48B	75.4187	\$695
Slowpump 1404-24B	75.4189	\$695
Slowpump 1404-36PV/48B	75.4191	\$695
Slowpump 1403-24B	75.4193	\$695
Slowpump 1403-36PV/48B	75.4195	\$695
Slowpump 2605-24B	75.4197	\$695
Slowpump 2605-36PV/48B	75.4199	\$695
Slowpump 2607-24B	75.4201	\$695
Slowpump 2607-36PV/48B	75.4203	\$695
Slowpump AC Option	75.4183	\$145

Vert. Lift	1322		1310		1308		1304		1303		2503		2505		2507		1403		2605		2607					
	GPM	Watts	GPM	Watts	GPM	Watts	GPM	Watts	GPM	Watts	GPM	Watts	GPM	Watts	GPM	Watts	GPM	Watts	GPM	Watts	GPM	Watts				
20	0.51	27	0.92	29	1.25	30	1.75	37	2.5	48	2.5	48	3.25	52	4	57										
40	0.51	32	0.92	41	1.25	48	0	53	2.5	60	2.5	60	3.23	69	3.05	78										
60	0.51	36	0.89	46	1.2	54	1.68	64	2.4	78	2.4	78	3.15	90	3.9	102										
80	0.49	40	0.88	51	1.2	60	1.64	73	2.3	93	2.3	93	3.1	106	3.9	120										
100	0.49	45	0.88	57	1.2	66	0	82	2.3	105	2.3	105	3.08	124	3.85	144										
120	0.48	50	0.88	61	1.2	66	1.62	90	2.25	121	2.25	121	3.02	142	3.8	165										
140	0.48	56	0.88	66	1.2	75	1.6	100	2.2	138	2.2	138	2.92	166	3.65	195										
160	0.47	62	0.87	74	1.2	84	0	112	2.2	153	2.2	153	2.85	187							4.30	283				
180	0.47	68	0.86	82	1.18	93	1.57	122	2.15	165	2.15	165	2.75	205					3.35	280	4.25	305				
200	0.47	74	0.85	89	1.16	99	1.56	133	2.15	180	2.15	180							3.33	296	4.20	338				
240	0.45	90	0.83	105	1.14	117	1.54	152	2.15	204	2.15	204					1408	1404	2.55	266	3.30	331	4.05	396		
280	0.44	102	0.81	120	1.1	135	1.51	175											GPM	Watts	GPM	Watts	4.00	444		
320	0.41	120	0.79	138	1.1	153	1.48	196													1.66	255	2.50	338	3.20	410
360	0.41	134	0.76	154	1.05	171															1.62	280	2.50	374	3.16	450
400	0.4	150	0.73	176	1	198															1.64	312	2.50	406		
440	0.39	168	0.7	202	1.1	269															1.1	269	1.66	342	2.50	451

DC PRESSURE PUMPS - 133

Flowlight Booster Pump

The Flowlight Booster Pumps provide “town pressure” for home water supplies where 12, 24 or 48 volt power is available. They have a longer life and greater flow rate than Flojet and Shurflo booster pumps and they use less than ½ the energy consumed by an AC jet pump running on an inverter. The Flowlight Booster pump will be damaged if it runs dry or is used for pumping rusty or dirty water, so order a filter and dry run switch. To make installation and service easy, flexible hose connectors with ¾“ threaded adapters are included. A minimum 40 gallon pressure tank is required for all Flowlight booster pump installations (available locally from a pump supplier). The standard Flowlight model has the highest flow. Use only where suction lift is less than 10 feet. The low flow model has a higher pressure capacity and should be used where suction lift is greater than 10 feet or where suction pipe is less than 1” inside diameter. Maximum suction lift is 20 feet at sea level for low flow model. Use the 115 VAC pump where DC wiring is not feasible, like long wire runs. It has similar high efficiency and low starting surge. It can run on less than a 500 watt inverter. Dimensions: 16.5" in length.

1-year warranty.

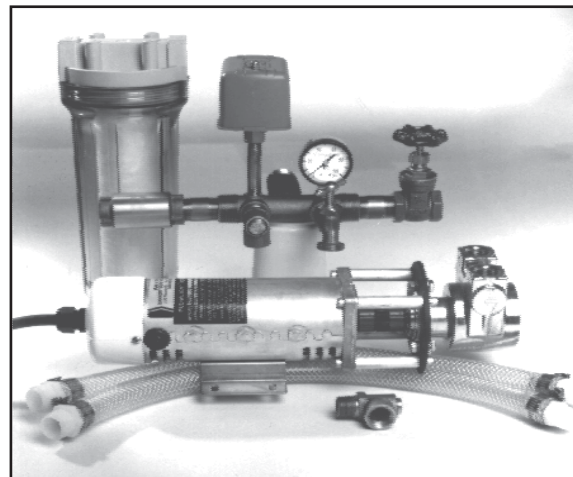

Description	Voltage	MAX. GPM	Pressure (PSI)	DC Amps	Weight (lb.)	Item Code	Price
Standard 12V	12 VDC	4.5	30	13.0	15	75.4125	\$540
			40	15.0			
			50	16.0			
Standard 24V	24 VDC	4.5	30	6.5	15	75.4127	\$540
			40	7.5			
			50	8.0			
Standard 48V	48 VDC	4.5	30	3.5	15	75.4129	\$695
			40	4.0			
			50	4.5			
Standard 12VAC	120 VAC	4.5	30	1.5	15	75.4131	\$630
			40	1.6			
			50	1.7			
Low Flow 12V	12 VDC	3.4	30	10.0	15	75.4121	\$520
			40	11.0			
			50	12.0			
Low Flow 24V	24 VDC	3.4	30	5.0	15	75.4123	\$520
			40	7.5			
			50	8.0			

Accessories for Slowpump and Booster Pump	Weight (lbs.)	Item Code	Price
EZ Installation Kit for Booster Pump - includes accessory t-fitting, adjustable pressure switch, pressure gauge, check valve, drain valve, shut-off valves and pipe nipples	5	75.4205	\$98
Inline Filter Housing for Slowpump and Booster (has 3/4" female pipe fittings)	3	78.1125	\$35
Filter cartridge for Housing Above - 5 Micron	4	78.1130	\$4
Pressure Switch - off at 40 PSI and on at 20 PSI	1	71.4135	\$25
Dry Run Switch for Slowpump 1300/1400	1	75.4213	\$50
Dry Run Switch for Slowpump 2500/2600 and Booster	1	75.4215	\$50
Intake Strainer/ Foot Valve	2	75.4211	\$73
30 inch Filter Foot Valve Assembly for Shallow Wells	3	75.4207	\$70
Filter Cartridge 30" for Filter Assembly Above (3-pack)	2	75.4209	\$44

134 - DC PRESSURE PUMPS

Shurflo 2088 Pressure Pumps

These positive displacement diaphragm pumps make excellent household pressure pumps if you need less flow than the booster pumps on the previous page deliver. The Shurflo 2088 pumps up to 3.6 gallons per minute, are designed for **continuous duty operation with addition of optional heat sink**, and they can be run dry without harm. They have a built-in pressure switch and 1/2" male pipe thread ports for easy connection to common plumbing fittings. Home pressurization installation requires a precharged water tank. For general water pumping, this pump can self prime to 10 feet and lift water up 100 feet. The 120 volt AC version can run on a 200 watt inverter and can be 1000 feet from the inverter using 12 gauge wire. Dimensions: 4.45" x 12.4" x 5".

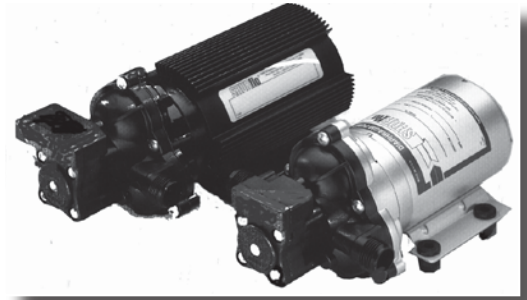

Shurflo Part Number	Description	Voltage	MAX. (GPM)	Pressure (PSI)	Flow (GPM)	Amps	Item Code	Price
2088-443-144	Standard Pump - 3.5 GPM open flow, 45 PSI Demand Switch, 1/2" MSPT ports	12VDC	3.5	10	2.83	5.80	75.5625	\$98
				30	2.31	8.00		
				40	2.02	9.10		
2088-514-145	Premium Pump with Fan Cooled Motor 3.6 GPM open flow, 45 PSI Demand Switch, 1/2" MSPT ports, Splash-proof motor	12VDC	3.5	10	2.9	5.60	75.5613	\$155
				30	2.3	8.40		
				40	2.07	9.00		
2088-514-144	High Flow Pump - 3.8 GPM open Flow, 45 PSI Demand Switch, 1/2" MSPT ports	12VDC	3.8	10	3.3	7.90	75.5615	\$160
				30	2.5	10.00		
				40	2.2	10.50		
2088-414-534	Premium Pump with Splash-Proof Motor 3.6 GPM open flow, 45 PSI Demand Switch, 1/2" MSPT ports	12VDC	3.6	10	2.9	5.60	75.5616	\$186
				30	2.3	8.40		
				40	2.07	9.00		
2088-474-144	Standard Pump - 3.0 GPM open flow, 45 PSI Demand Switch, 1/2" MSPT ports	24VDC	3	10	2.8	2.41	75.5628	\$102
				30	1.75	2.73		
				40	1.25	2.71		
2088-574-534	Premium Pump with Splash-Proof Motor 3.6 GPM open flow, 45 PSI Demand Switch, 1/2" MSPT ports	24VDC	3.6	10	3.17	3.10	75.5619	\$186
				30	2.63	4.10		
				40	2.34	4.50		
2088-594-154	Standard Pump - 3.3 GPM open flow, 45 PSI Demand Switch, 1/2" MSPT ports	120VAC	3.3	10	2.6	0.58	75.5622	\$144
				30	2.08	0.76		
				40	1.85	0.94		

Shurflo Pump Accessories

Use the 2 Gallon Pre-charged pressure tank to extend the life of your Shurflo pump. The tank helps provide a smooth flow in your pumped water system and reduces motor heating and pressure switch wear by decreasing the number of on/off cycles. Internal bladder is precharged to 20 PSI.

Adapters fit the Straight Pipe Thread on the 2088 pumps and allow connection of tapered pipe thread fitting. Right angle fittings have wingnut fitting that can be tightened by hand. Straight fitting has a hex nut cast into it.

Shurflo Part Number	Description	Item Code	Price
3400-002	Vertical 2 Gallon Pre-Charged Pressure Tank - Stainless steel with 3/4" male NPT port	75.5730	\$130
170-061-20	Twist-on Water Strainer - 50 mesh screen 1/2" FPST inlet	75.5784	\$10
8-035	Adapter w/Wingnut - Right Angle 1/2" FSPT to 1/2" NPT for 2088 Pumps	75.5735	\$2
8-155-01	Adapter w/Wingnut - Right Angle 1/2" FSPT to 5/8" Barb for 2088 Pumps	75.5763	\$2
8-205-00	Adapter - Straight 1/2" FSPT to 1/2" NPT Male for 2088 Pumps	75.5760	\$2
34-006	5" Heat Sink for continuous duty pump operation	75.5766	\$24

HIGHLIFTER PUMPS - 135

HighLifter Water Powered Water Pumps

The High Lifter is a powerful water pump designed to move water uphill without using gasoline or electricity. By harnessing the energy of piped water pressure from an uphill source, the High Lifter pump can drive a portion of this water through another pipe to a tank higher than the water source. Pistons provide the pumping action and water is the only lubricant used. With adequate water and pressure it can pump up to 1500 gallons of water per day as high as 300 feet, or it can pump 200 gallons per day as high as 1000 feet! It can also pump smaller amounts on as little as one quart per minute of source water, and can pump to lower elevations with as little as a 30 foot drop from the water source. It is self-starting and requires no lubrication, priming, or tuning, and is quiet compared to gas engine pumps. Due to its light weight, ease of installation, and lack of fuel requirements, it is ideally suited for hilly or remote terrain. Simply run a pipe downhill to your High Lifter from a pond, stream, or spring, lay out a pipe to your high tank, and start pumping! Designed to be installed and maintained by the user with basic hand tools, the High Lifter requires little attention other than filter cleaning for years of hard working service. Depending on how clean the water source is, a High Lifter can operate continuously for 1-3 years between piston replacement service, or even longer if the inlet water is processed through a settling tank to remove grit. The High Lifter is an efficient, economical, and reliable way to handle many water pumping requirements. It can be effectively used for domestic water pumping, garden water supply, irrigation, range cattle, etc. All High Lifter parts are made of stainless steel, Teflon, and acrylic, so they are safe for drinking water. Pump is 26" long. 1 year warranty on materials and workmanship.

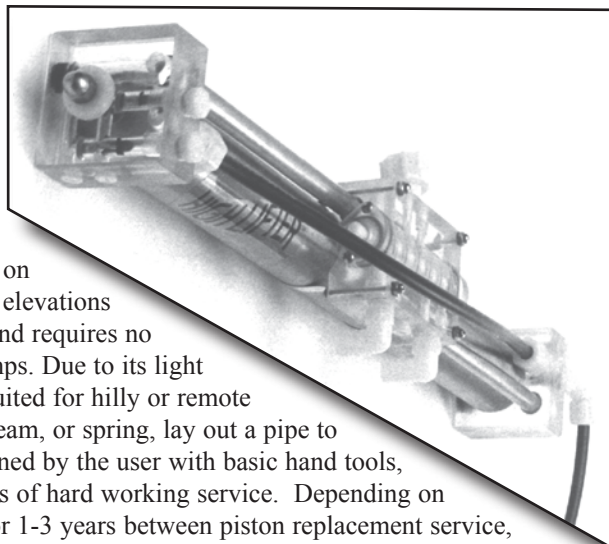

As illustrated in the graph, the High Lifter responds to both inlet and output pressure. Because the High Lifter utilizes inlet water pressure to pump water, locating the pump farther down from the water source will yield greater delivery or higher pumping elevations. The higher the upper tank is located, the slower the pump will work. If the upper tank is placed too high, the pump will stall (with no damage to the pump) and no water will be pumped.

To determine how much water will be pumped, find the net lift for either the 4.5:1 or 9:1 pump on the left side of the graph. Move across the graph horizontally to the right until you cross the curve for the fall (inlet pressure). From the point where lift and fall cross, move vertically down to the bottom of the graph and read the Delivery (gal./day) for the type of pump being used. To get this delivery amount, the input flow to the pump must be equal to or greater than the Flow (gal./min) at the top of the chart in line with the point where the lift and fall lines cross. If the input flow is less than this number, the output will be correspondingly lower.

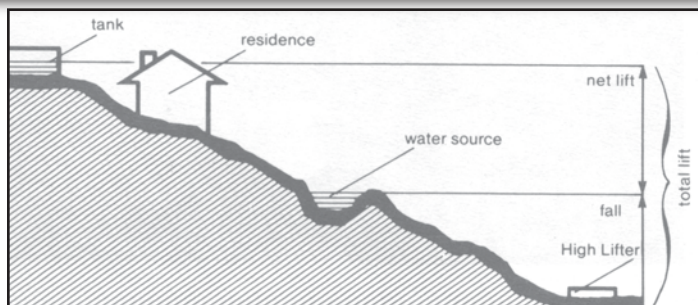
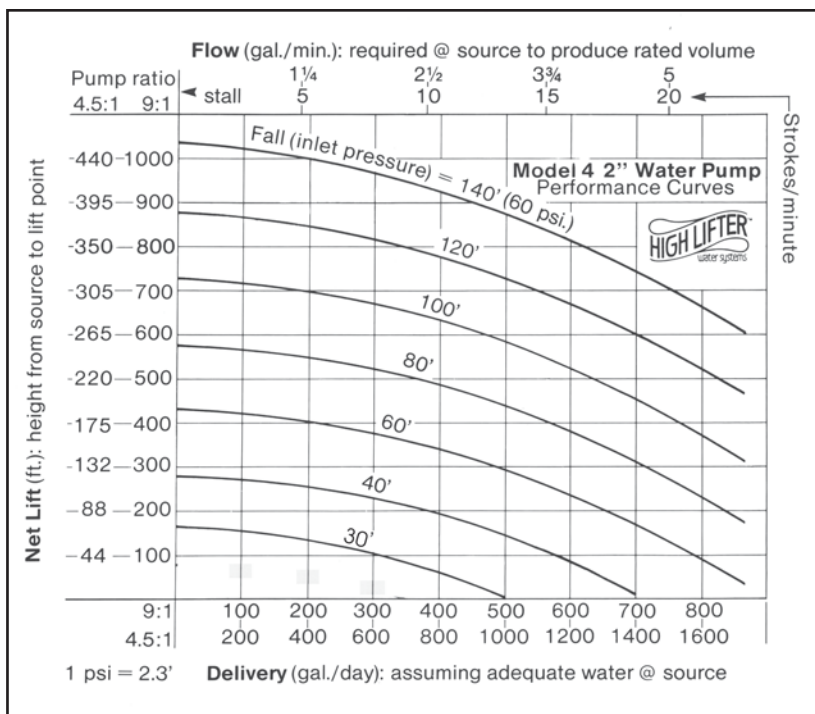

The picture above shows a typical installation using the Highlifter to fill a tank. Note that "net lift is the vertical distance from the water source to the tank.

Model #	Pump Ratio	Maximum Output/Day	Maximum Net Lift	Maximum Total Lift	Item Code	Price
H44	4.5:1	1500 gal	440 ft.	580 ft.	75.9002	\$935
H49	9.1:1	750 gal	1000 ft.	1140 ft.	75.9005	\$935

136 - HYDRAULIC RAM PUMPS

Hydraulic Ram Pump Info and Formula

As little as 3 feet fall from the water source to the pump at a flow rate of 1 to 3 gpm can provide up to 10 feet of vertical lift per foot of fall. For example, if you need to pump water 30 feet uphill, then you will require a minimum fall of 3 feet (a 10 to 1 ratio). However, in order to achieve a greater output of water at this lift, it is better to keep the fall-lift ratio as small as practical. You can achieve a 5 to 1 ratio by increasing the fall of the water to 6 feet ($6 \times 5 = 30$). The actual output of a ram can be calculated with this formula: $V \times F \times 0.5 / E = D$. V is the available water flow in GPM, F is the vertical fall from the water source to the ram, E is the vertical lift from the ram to the top of the delivery pipe and D is the water delivered in GPM.

Note: The drive pipe must be 3 to 5 times as long as the vertical inlet fall for proper operation. On Folk rams, steel pipe must be used for the drop pipe. The delivery height can be no more than 15 times the intake fall height.

Folk Heavy Duty Hydraulic Rams

These rams are made from cast aluminum alloy and stainless steel and are very heavy-duty. They can pump a maximum of 500 feet of head and operate from a fall of 50 feet or less. There are six models to choose from. The amount of water each size can pump is determined by the inlet flow, inlet fall and delivery height. Each size ram has a range of inlet flow it can operate from. If you have more flow, there is no problem, but if you have less flow, the ram will not operate.

Multiple ram pumps can be used if you need to pump more water than one pump can deliver.

Intake Flow Range (GPM)	Intake Pipe Size	Discharge Pipe Size	Item Code	Price
2 - 4	1"	1"	75.8601	\$1,045
2 - 7	1-1/4"	1"	75.8603	\$1,045
3 - 15	1-1/2"	1"	75.8605	\$1,045
6 - 30	2"	1-1/4"	75.8607	\$1,595
8 - 45	2-1/2"	1-1/4"	75.8609	\$1,595
15 - 75	3"	1-1/4"	75.8611	\$1,595



B & L Hydraulic Rams

The B & L Ram operates like the Folk Ram above, but is made of plastic and is not recommended for pumping more than 150 feet of head. As little as a two foot (0.6 meters) fall from the water source to the pump at a flow rate of 3 gallons per minute will drive a small system and provide up to 20 feet of vertical lift to the discharge point.

The 1" Ram requires 3-gpm water flows. The 1.5" and 2" models require the same minimum amount of water flow, but will pump more volume than the smaller version.

If you need to move a large volume of water for pond filling or irrigation, the B & L MAGNUM 3" ram will do the job for you! It will, depending on your setup and circumstances deliver from 2,000 to 10,000 gallons per day. Discharge is 2". There are NO cutoff valves supplied with pump. Order intake strainer separately.

B & L Model	Intake Flow Range (GPM)	Intake Pipe Size	Discharge Pipe Size	Item Code	Price
BLS100	3 - 4	1"	1"	77.3124	\$193
ITS010	Intake Strainer for 1" Ram			77.3112	\$22
BLS150	3 - 15	1-1/2"	1"	77.3127	\$225
ITS015	Intake Strainer for 1-1/2" Ram			77.3115	\$27
BLS200	3 - 30	2"	1-1/4"	77.3130	\$240
ITS020	Intake Strainer for 2" Ram			77.3118	\$40
BLS300	15 - 75	3"	1-1/4"	77.3121	\$500

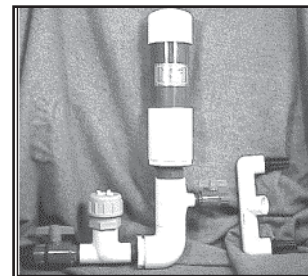

DC CIRCULATOR PUMPS - 137

EL-SID Brushless Water Circulators

These tiny brushless, magnetic drive circulators can be driven by PV modules or 12 volt batteries for closed-loop circulation in solar water heating systems, individual space heat zones and individual loop radiant floor loops. Use of several small pumps in a radiant floor system allows each loop to be controlled by a different thermostat. **Model SID10** is designed to be powered by a 10 watt PV module and can pump 2.5 gallons per minute at no head and ½ GPM at 2.5 feet of head at 17 volts input. It can circulate water in a well designed solar water heating system with two 4 x 10 collectors. **Model SID10B** is designed to be battery powered and has the same specifications at 12 volts. Dimensions: 4" x 4" x 5".

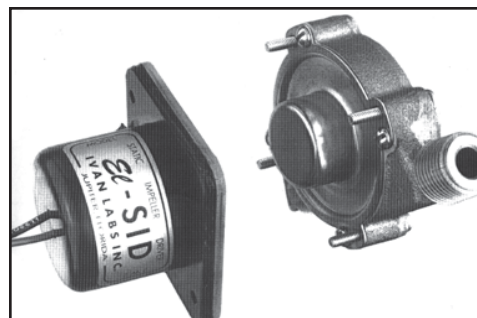

30,000 Hour Life Expectancy

Model Number	Flow (GPM) at No Head	Volts (Max)	Amps	Weight (lbs.)	Item Code	Price
EL-SID 10PV-12	2.5	18	0.9	2	75.7218	\$255
EL-SID 10B-12	2.5	15	0.45	2	75.7219	\$255

Hartel MD10HEH Circulator

This pump has an electronically commutated, high efficiency brushless motor with a 30,000 hour life expectancy. It may be operated from an 18 to 22 watt solar module or directly from a 12 volt battery system. They work great for closed loop solar water heating systems and radiant floor heating. The graph shows this pumps performance at various heads and flows, at different input voltages.

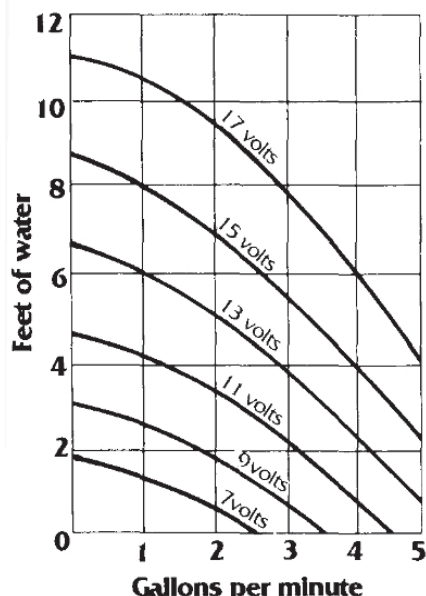
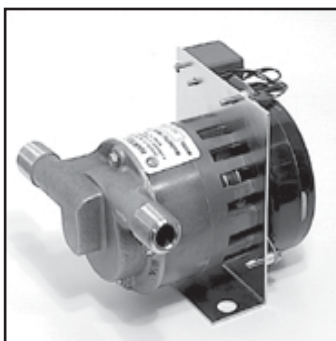

Hartel MD3DCL Circulator

This pump has an economical brush-type motor that may be used with a 12 or 24 volt battery system, or directly from an 18 watt 12 volt PV module. It has a 7,000 hour life expectancy. It works well as a circulating pump between a tank and solar collector in a domestic hot water system. It also functions well as a circulating pump in a radiant floor heating system that requires less than 5 GPM of circulation. Brushes last for 3-5 years and are easily replaced without removing pump from plumbing.

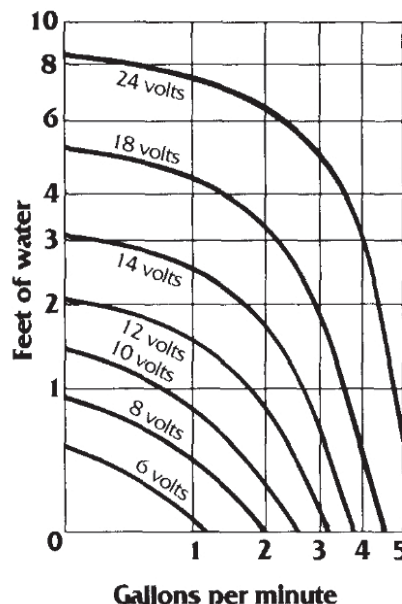

Model Number	Operating Voltage	Pipe Connections	Dimensions (in)	Item Code	Price
MD-10-HEH	6-16 VDC	1/2" MNPT	5.25 x 9	75.7237	\$387
MD-3-DCL	2-24 VDC	1/2" MNPT	5.25 x 7.75	75.7241	\$203

138 - TANKLESS WATER HEATERS

Tankless Water Heaters

Since a tank-less water heater has neither a storage tank to keep heated all day, nor a pilot light, it burns gas only when you need hot water. This eliminates standby heat loss, which can be as high as 3-4% every hour for storage tank type water heaters. This higher efficiency can allow you to save up to 50% off your utility costs. Since there is no tank to fill, there is no end to your supply of hot water. Depending on the model, Takagi tank-less water heaters deliver between 200 gallons and 500 gallons of hot water every hour on demand. Tank-less systems guarantee that an endless supply of water is available to residences, commercial spaces or anywhere a constant source of hot water is needed.

Bosch/Aquastar Pro-Tankless Water Heaters

The 635ES is the most powerful offering. Its compact size and sealed combustion enables installation in small spaces. This unit yields enough power to supply two showers simultaneously and features an adjustable temperature control for improved comfort. It is designed to use outside air for combustion and it requires 120 VAC power at all times.

The 425 Series tankless water heaters supply one major hot water outlet at a time (Example: One shower running at a time). They are sized for most homes and small businesses.

The 425 EF has a built-in power vent system for through wall exhaust which requires 120 VAC power at all times. It comes with an exhaust flue terminator.

The Bosch 425HX uses a hydro-generated ignition. Bosch engineers installed a small turbine wheel inside the unit attached to an electromagnetic wire. When you open a faucet, the flow of the water spins the turbine wheel, which spins two dissimilar magnets, that in turn sends a 1.5 volt DC current through the wire, and provides the spark to ignite the gas burners.

The Aquastar 125BS is designed for use with preheated water from solar hot water heating systems. Its gas burner can modulate down to 22,000 BTUs to supply just the required amount of heat to water that is not quite warm enough. This unit has a standing pilot that burns all of the time.

The Aquastar 38B compact tankless water heater for low-volume applications, is perfect for camps, cottages and barns where a small amount of on demand hot water is desired.

How Does a Tankless Water Heater Work?

- The Process:
1. A hot water tap is turned on.
 2. Water enters the heater.
 3. The water flow sensor detects the water flow.
 4. The computer automatically ignites the burner.
 5. Water circulates through the heat exchanger.
 6. The heat exchanger heats the water to the designated temperature.
 7. When the tap is turned off, the unit shuts down.

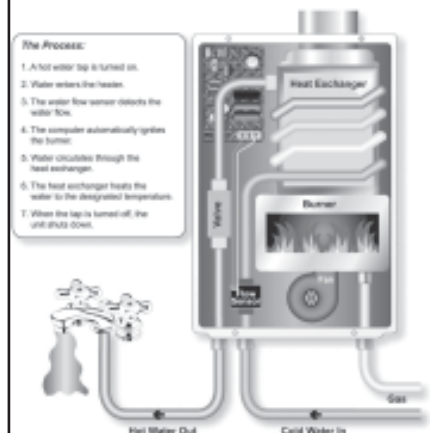

	Model >	38B	425HN	425EF	125BS	635ES
Power Input	BTU Max	38,000	117,000	117,000	117,000	175,000
Efficiency	%	80	82	80	82	87
Energy Factor		.66	.78	.78	.69	.85
Flue Size	Inches	4	5	4	5	3
Gas Pipe Size	Inches	1/2	1/2	1/2	1/2	3/4
Water Pipe Size	Inches	1/2	1/2	1/2	1/2	3/4
Min. Water Flow	GPM	0.6	0.5	0.5	0.5	0.8
120 VAC Required		No	No	Yes	No	Yes
Height	Inches	25.38	29.75	29.75	29.75	23.5
Width	Inches	10.63	18.25	18.25	18.25	15.75
Depth	Inches	9.13	8.75	8.75	8.75	8.5
Weight	Lbs.	25	40	44	44	47
Flow Rates						
60°F Temp. Rise	GPM	1	3.1	3.1	3.1	4.9
70°F Temp. Rise	GPM	0.6	2.6	2.6	2.6	4.2
90°F Temp. Rise	GPM	0.5	2.0	2.0	2.0	3.3
Item Code	LP Gas	83.1009	83.1026	83.1024	83.1017	83.1029
Item Code	Nat. Gas	n/a	83.1022	83.1023	83.1021	83.1027
Price		\$390	\$800	\$949	\$900	\$1300

TANKLESS WATER HEATERS - 139

Takagi TK-Series Tankless Water Heaters

These are state-of-the-art high-output units featuring pilotless electronic ignition, computerized control, power ventilation, and freeze protection for outdoor or indoor operation down to 10°F. They are very efficient but all of them require AC power for operation. They will consume AC power from the system 24 hours per day.

T-KD20 uses a "Direct Vent System". With a three-inch round combustible air intake vent and four-inch round exhaust power vent, it is designed to work when indoor combustion air is not available, making it the perfect system for climate-controlled environments such as colder areas.

T-H1 is the newest member of Takagi Tankless water heater family. With 95% energy efficiency, the T-H1 is the most technologically advanced water heater on the instantaneous water heater market today. The new T-H1 is equipped with a Pre-Heating system and Built in Neutralizer that provides greater efficiency and reliability. Designed for heavy residential use with flows up to 10 GPM.

T-K Jr. is the most compact unit in the Takagi line. Designed to produce endless hot water and radiant heating for smaller homes, The T-K Jr. uses the same innovative technology as the original Takagi units - only on an even smaller scale.

Note: The Takagi Tankless water heater must be vented in accordance with the section on venting of equipment in the latest edition of the National Fuel Gas Code. This is a Category III appliance, and must be vented accordingly. The following are UL listed or CSA certified manufacturers: ProTech Systems FasNSeal, Z-Flex Inc. Z-Vent II. Heat-Fab Inc. Saf-T Vent and Flex-L. They require 4" vent pipe. Connect the vent pipe to the unit so that it is sealed airtight. Follow the vent pipe manufacturer's instructions when installing the vent pipe. Do not common vent this appliance with any other vented appliance.

	Model	T-M1	T-H1	T-K2	T-KJR	T-KD20
Power Input	BTU x1000	235	190	185	140	185
Flue Size	Inches	4	4	4	4	4
Gas Pipe Size	Inches	3/4	3/4	3/4	3/4	3/4
Water Pipe Size	Inches	3/4	3/4	3/4	3/4	3/4
Min. Water Flow	GPM	0.75	0.75	0.75	0.75	0.75
Max. Water Flow	GPM	9.6	7.2	6.9	5.8	6.9
120 VAC Required		Yes	Yes	Yes	Yes	Yes
Height	Inches	24	28.5	24	20	24
Width	Inches	18	119	18	14	18
Depth	Inches	9	12	9	6	9
Weight	Lbs.	70	90	60	30	60
Flow Rates	Flow Rates					
77°F Temp. Rise	GPM	5	4	4	3	4
Item Code	LP Gas	83.1071	83.1073	83.1075	83.1077	83.1079
Item Code	Nat. Gas	83.1072	83.1074	83.1076	83.1078	83.1080
Price		\$1750	\$3100	\$725	\$625	\$950



Model	Description	Fits	Item Code	Price
TK-BK01	Wall Mounting Brackets	all, not required for T-KJr, T-M1	83.1091	\$25
TK-TV01	Wall Ventilation Terminator	T-KJr, T-K2, T-K1S, T-M1	83.1092	\$108
TK-TV03	Exhaust Backflow Prevention Kit	All	83.1093	\$50
TK-TV04	Outside Installation Venting Cap	T-KJr, T-K2, T-K1S	83.1094	\$60
TK-TV05	Wall Ventilation Terminator	T-KD20	83.1095	\$130
TK-TV06	Outside Installation Venting Cap	T-M1	83.1096	\$116
TK-TV07	Direct Vent Conversion	T-H1	83.1097	\$102
TK-RE01	Temperature Remote Controller	T-KJr, T-K2, T-K1S, T-KD20	83.1098	\$135
TM-RE10	Temperature Remote Controller	T-M1	83.1099	\$289
TK-RE02	Temperature Remote Controller	T-KJr, T-K2, T-K1S, T-KD20	83.1101	\$170

140 - SOLAR TANKS / TANKLESS HEATERS

Infinion Tankless Water Heaters

With the Infinion tankless water heater, you'll enjoy constant comfort, conservation and peace of mind with tankless water heating, at a cost you can easily afford. The Infinion is a very simple tankless water heater that does not require electricity so it is ideal for remote cabins, park bathrooms or any locations where power is not available. There are two models which are the same except that one has a standing pilot light and one has a D-cell powered battery spark ignition. The spark ignition model comes with easily replaceable D-cell batteries that last 2-years or more. You get a range of safe, comfortable water heating with dual temperature and capacity controls. The Infinion is carefully engineered, using quality materials but without unnecessary bells and whistles. You get ninety years of tankless water heater experience in the Infinion design. Take advantage of excellent performance in a simple package. Both units have a BTU (temperature adjustment knob) and a 5 year parts warranty and a 10-year heat exchanger warranty.

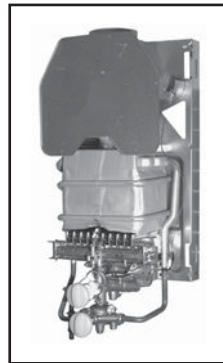

	Model	C13	C13E
Ignition Type		Pilot	Spark
Power Input	BTU Max	105,000	
Flue Size	Inches	5	
Gas Pipe Size	Inches	1/2	
Water Pipe Size	Inches	1/2	
Min. Water Flow	GPM	0.66	
120 VAC Required		No	
Height	Inches	28.13	
Width	Inches	14.94	
Depth	Inches	10.81	
Weight	Lbs.	37	
Flow Rates			
60°F Temp. Rise	GPM	2.64	
70°F Temp. Rise	GPM	1.90	
90°F Temp. Rise	GPM	0.66	
Item Code	LP Gas	83.0991	83.0995
Item Code	Nat. Gas	83.0992	83.0996
Price		\$495	\$595

Drainback Solar Storage Tanks

Super insulated atmospheric pressure "drain-back" tanks are suitable for open or closed loop solar applications. No servicing is required except periodically checking the water in the water level inside the tank and to maintain a neutral PH for protection of the copper heat exchangers. All components in the tank are easily accessible in the field by removing the lid. Tanks come with [2] installed sensors, Taco brand pump flanges and a finned-coil heat exchanger sized for 3/4" water lines. Tanks are available with additional heat exchangers in any size and configuration for solar hot water, spas, pools and radiant floors. Custom sizes and capacities available to over 1,200 gallons! Custom applications are available, including closed-loop solar applications.

Model #	Series	Gal	Dimensions (in.)			Item Code	Price
			L	W	H		
303036	70	68	30	30	36	84.3105	\$1,795
303052	100	106	30	30	52	84.3107	\$2,195
383052	150	143	38	30	52	84.3109	\$2,395
383852	200	191	38	38	52	84.3111	\$2,695
543852	300	288	54	38	52	84.3113	\$3,395
703852	400	385	70	38	52	84.3115	\$3,895
863852	500	482	86	38	52	84.3117	\$4,595
1023852	600	579	102	38	52	84.3119	\$5,095
Additional copper heat exchanger installed in tank when ordering						84.3126	\$250

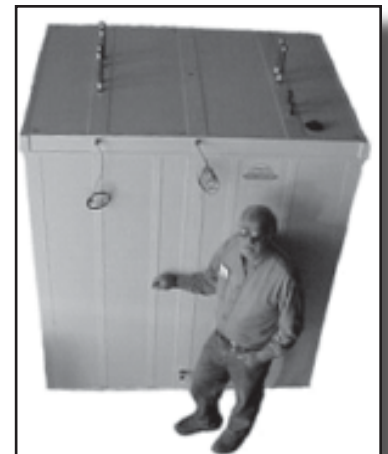

SOLAR HOT WATER COLLECTORS - 141

CopperHeart Integral Collector Storage System

The CopperHeart integral collector storage system, or ICS, combines thermal collection and storage in a single unit. The CopperHeart is designed to meet the international demand for a simple, durable and inexpensive domestic water heating system. The CopperHeart typically serves as a solar preheater to an existing electric or gas water heater, but may be used as the primary water heater in certain climates. ICS units are excellent choices for residential new construction in the U.S. Sunbelt or other mild climates that do not experience hard freeze conditions.



COPPERHEART - INTEGRAL COLLECTOR STORAGE (ICS)

Model	Capacity (gal)	Width	Length	Depth	Weight	Connection Pipe Dia.(in.)	Item Code	Price
CP-20	21	36.5	50.25	6.88	154	3/4	84.1163	\$1,359.60
CP-30	32	36.5	78.25	6.88	210	3/4	84.1165	\$1,828.25
CP-40	42	36.5	98.25	6.88	264	3/4	84.1167	\$2,060.00

COPPERHEART SERIES - Mounting Hardware

MTG-C-FK	Flush Mount Kit	84.1169	\$35.00
MTG-C-024	Horizontal Tilt Mount Kit - 24" Legs	84.1171	\$125.00

Empire Flat Plate Collectors

This collector combines high performance, a sleek profile and extraordinary durability. The Imperial's "I-Beam" construction makes this collector the perfect choice for areas that may experience very high wind loads. The Imperial 4' X 10' has been wind load tested by the Miami Test Lab to withstand wind loads up to 180 mph. The heavy extruded anodized aluminum framewall protects this collector in the world's harshest environments.

EMPIRE SERIES Liquid Flat Plate Glazed Collectors

Model	Description	Item Code	Price
EP-32	4 x 8 Painted Absorber w/Anodized AL Frame	84.1044	\$744.45
EP-40	4 x 10 Painted Absorber w/Anodized AL Frame	84.1045	\$870.45
EC-32	4 x 8 Black Chrome Absorber w/Anodized AL Frame	84.1054	\$862.05
EC-40	4 x 10 Black Chrome Absorber w/Anodized AL Frame	84.1055	\$1,123.75

EMPIRE SERIES - Mounting Hardware

MTG-E-FK	Flush Mount Kit	84.1060	\$35.00
MTG-E-SOP	Stand-off Angle Mounting Plate Set (4 ea.)	84.1062	\$12.00
MTG-E-100	Angle Mounting Plate Set (4 ea.)	84.1064	\$9.25
MTG-E-TK	Tilt Mount Kit (Order Legs Below)	84.1065	\$34.00
C-SSN	Empire Mounting Clip w/ Strut Nut Assembly	84.1066	\$7.32
C-SSN-024	Empire Mounting Clip w/ Strut Nut Assembly (24 ea.)	84.1068	\$175.68
MTG-E-024	Horizontal Tilt Mount Kit - 24" Legs	84.1070	\$44.75
MTG-E-036	Horizontal Tilt Mount Kit - 36" Legs	84.1071	\$50.75
MTG-E-048	Horizontal Tilt Mount Kit - 48" Legs	84.1072	\$56.75

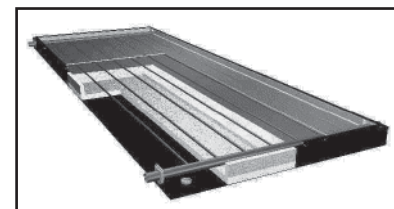

Pallet, Crating and Packaging Charges:

Less than pallet lot domestic shipments incur a minimum crating charge of \$100.00. Crating charges are waived for full pallet lot orders. For orders of more than one pallet, but less than two pallets, a crating charge of \$60 will be applied. Pallets, regardless of size, are charged at \$34. Pallets in good condition may be returned for full credit. Export shipments incur a pallet charge of \$34 per pallet and a minimum export crating charge of \$110 per pallet. Full pallets are defined for Flat Plate Collectors as 12 collectors and for CopperHearts as 7 collectors.

142 - DC FANS

12 and 24 Volt Remote Control Ceiling Fans

This is a 42" four-blade ceiling fan with oak or white painted wood blades and a bright brass housing. The 3-speed reversible motor is controlled by infrared remote control and draws 1.2 amps (on 12V models) at high speed, .75 amp at medium speed and .5 amp at low speed. This fan is designed for surface mounting on a flat ceiling. An 8" swivel pendant mount for pitched ceilings is available as an option. They are available for 12 or 24 volt DC operation. CSA/UL approved

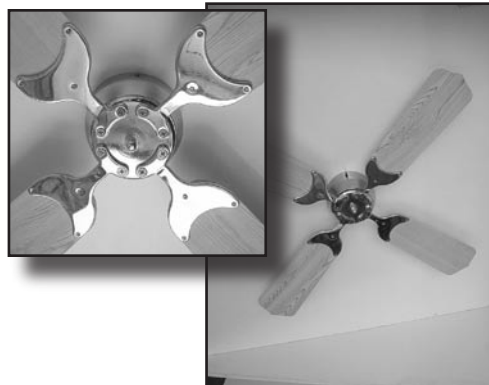

Description	Item Code	Price
12 Volt Ceiling Fan 12V 42" White / Brass w/ Remote	85.7214	\$120
12 Volt Ceiling Fan 12V 42" Oak / Brass w/ Remote	85.7216	\$120
24 Volt Ceiling Fan 12V 42" Oak / Brass w/ Remote	85.7419	\$120
24 Volt Ceiling Fan 12V 42" White / Brass w/ Remote	85.7418	\$120
Ceiling Fan Hanging Kit - 8"	85.7425	\$20

RCH Fanworks 42" Vari-Fan

The Vari-Fan can be operated at 12 or 24 V DC. At 24 volts, it moves more air. The Vari-Fan comes with a matte black finish, but it can be easily painted. The main body parts (the black parts) of the Vari-Fan are made from injection molded ABS plastic insuring a lightweight, very durable fan that will stand up to a variety of environments from extreme heat and cold and high humidity to very dry. The Vari-Fan will not corrode, dent, or show minor scratches. The Vari-Fan is a dual mount ceiling fan - close mount or down rod, 4 or 5 blade fan - it's your choice. Every thing you need, comes in the box with the fan, how you mount it is your decision.



RCH Fanworks Vari-Cyclone

The Vari-Cyclone is a high efficiency version of the already very efficient Vari-Fan line of DC powered ceiling fans. The Vari-Cyclone's 60" fan blades, designed by the Florida Solar Energy Center in cooperation with a major fan manufacture, utilize "Gossamer Wind Technology" found only in AC powered ceiling fans until now. In tests conducted by the Florida Solar Energy Center, the 3-blade Vari-Cyclone showed a 22.8% increase in cubic feet per minute (CFM) over the 5-blade, 42" Vari-Fan. 12 or 24 volt operation.



Fan Speed Controls

If you are using a Fanworks fan on 12 volts, you can increase air movement and power consumption with the 85.9169 control, which takes 12 volts and steps it up to 24 volts. The 24 volt input control is for use on 24 volt battery systems.

Description	Item Code	Price
RCH Fanworks 42" Vari-Fan 12/24 Volt Ceiling Fan	85.7445	\$140
RCH Fanworks 3-Blade 60" Vari-Cyclone White Painted	85.7453	\$225
RCH Fanworks 3-Blade 60" Vari-Cyclone unpainted	85.7456	\$210
Fan Speed Control 12V In/ 0-24V Out w/Reverse Switch	85.9169	\$93
Fan Speed Control 24V In/ 0-24V Out w/Reverse Switch	85.9170	\$45

Brushless DC Axial Fans

These 12 and 24 VDC fans are quiet, powerful and use very little power. Solid state electronics allow a minimum of EMI/RFI emission. Precision ball bearings ensure a long life. They are primarily used to cool electronic equipment, but they also work well as circulators inside or outside ducts. Their very low current draw makes them ideal for continuous duty applications.



CFM	Volts	Amps	Dimensions	Item Code	Price
95	10 - 15	0.61	4.7" x 4.7" x 1"	85.8112	\$29
105	16 - 28	0.25	4.7" x 4.7" x 1"	85.8113	\$18

12V Oscillating 8" Table Fan

This 2 speed fan draws 2 amps on the high setting and 1.2 amps on low. A switch on the motor locks the fan in one position or allows it to oscillate. It moves a lot of air and is fairly noisy on the high setting.

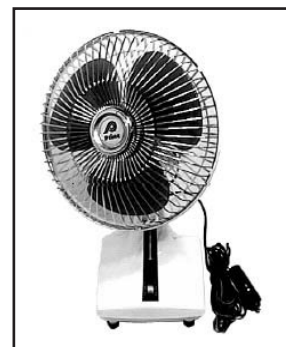

Description	Item Code	Price
12V Oscillating Table Fan	85.9155	\$38

SOLAR POWERED FANS - 143

Solar Fan Info

Fans are nearly ideal solar powered loads. They can run directly off DC (as with all of the following products). Solar powered fans run when they are most needed, when the sun is shining. During summer months, your attic temperatures can reach 150°F. High temperatures cause an increase in temperature in the living space and an increase in energy consumption by air conditioning equipment. Forced ventilation will circulate cooler air through the attic space and lower the temperature. Fan and solar module combinations allow daytime ventilation and air circulation anywhere the sun shines. They are great for greenhouses, kennels, barns and attics where AC power is not available. The solar module runs the fan at full power in full sun and at a slower speed in overcast weather. Operation is automatic. When the sun shines on the solar module, the fan begins to operate. The 12" and 16" solar fan kits include fan, solar module and 20' of two conductor wire.

Solar Attic Fan

The Solar Attic Fan is a simple and environmentally sensible solution that can save you money. Powered completely by free solar energy, this sleek and efficient vent is both compact and quiet. Fully operational right from the box, it installs easily, with no electrical wiring, no expensive electrician and city permits. And let's not forget powerful! Operating at a whopping 850 cfm, a single unit can fully vent up to 1200 square feet. Place it wherever you need improved circulation; attics, lofts, workshops, storage sheds, garages, even barns. These attic fans are available with a flush mount solar modules or with a tiltable mount solar module. 5-year warranty

Description	Item Code	Price
Solar Attic Fan with Adjustable Module	85.7077	\$459



Solar Fan Kit

These solar fans include our venturi fan below, a 20 watt solar module with a 20' cord and mounting hardware. The 12" fan will deliver up to 800 CFM, and the 16" fan will deliver up to 1300 CFM when the module is in full sun. The reversible, ball bearing PM motor allows the fan to be used for intake or exhaust by reversing the wire at the motor. 2-year warranty.

Description	Item Code	Price
Solar Fan Kit w/12" Fan and 20 Watt Module	85.9113	\$275
Solar Fan Kit w/16" Fan and 20 Watt Module	85.9117	\$290

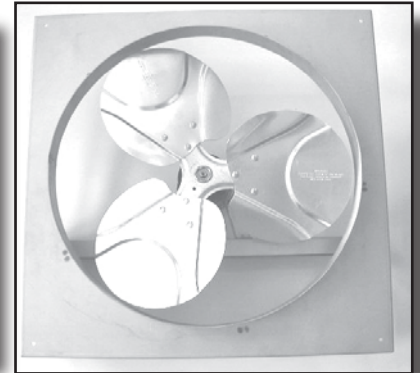
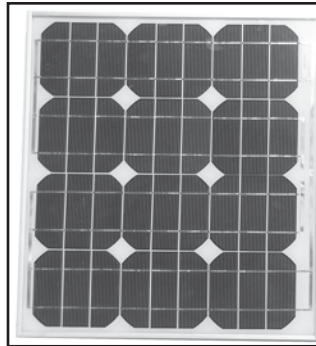

DC Powered Venturi Fans

These fans have a 3-wing blade mounted in a square steel ring frame style venturi for easy mounting. They can be used on existing battery systems or with other module combinations with up to 30 VDC. The 12" fan fits between 16"-on-center studs and delivers approximately 500 CFM at 12 volts and 1200 CFM at 24 volts. The 16" fan fits between 24"-on-center studs and delivers 750 CFM at 12 volts and 1800 CFM at 24 volts. 1-year warranty

Blade Diameter	Frame Dimensions	Amps (12VDC)	Amps (24VDC)	Weight (lbs.)	Item Code	Price
12"	15" x 15"	0.7	2	14	85.9112	\$155
16"	20" x 20"	0.9	2.4	16	85.9116	\$170

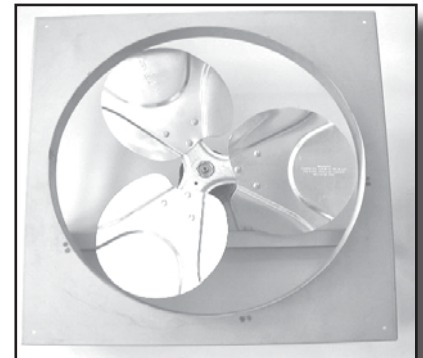

144 - EVAPORATIVE COOLERS

DC Powered Evaporative Coolers

The SOLAR CHILL solar powered evaporative cooling system is available in five sizes and 2 DC voltages(12, and 24 volts DC). The rust-proof housings are built of 304 stainless steel, and use a 6" thick fluted pad as the wet cooling media. This pad is the most efficient evaporative cooling media in the world, and it will last five years with minimal maintenance. SOLAR CHILLS use only 25 to 130 watts! Only 80 Watts for 4500 cubic feet per minute (CFM). Use the 24" or 2-20" if the cooler will be connected to ductwork. Optional rheostats may be used to slow fan speed. Optional Control Packages with clean out pumps are available.

For array direct operation of evaporative coolers use an array with atleast the recommended watts and choose a Linear Current Booster on page 125 with the correct amp and voltage rating.

Model	Nominal Voltage	Dimensions H" x L" x W"	Fan Diameter	Current Amps	Recommended PV Watts	Air Flow (CFM)	Weight (lbs.)	Item Code	Price
1412HP	12	18.5 x 19 x 17	14"	3	45 - 65	900	36	85.6606	\$637
2012HP	12	26 X 21.5 X 24	20"	4.4	85 - 130	2400	56	85.6609	\$675
2412HP	12	35.5 X 22 X 36	24"	6.7	110 - 180	4500	110	85.6611	\$925
2-2012HP	12	29 X 22 X 48	2 X 20"	8	150 - 240	4800	120	85.6613	\$1023
1424HP	24	18.5 x 19 x 17	14"	1.5	45 - 65	1100	36	85.6623	\$650
2024HP	24	26 X 21.5 X 24	20"	2.9	85 - 130	2500	56	85.6626	\$703
2-2024HP	24	29 X 22 X 48	2 X 20"	5.4	150 - 240	5000	120	85.6628	\$1,137

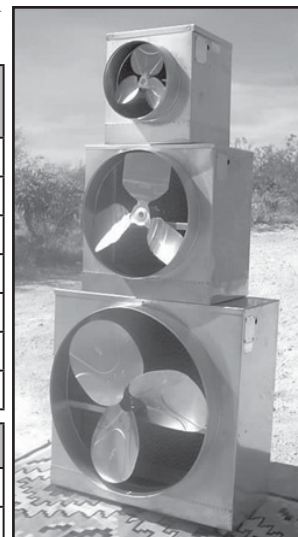

Solar Chill Accessories			
Cooler Leg Kit - Galvanized Roof Mount		85.6662	\$24
Replacement Pump - 12 Volt		85.6664	\$21
Replacement Pump - 24 Volt		85.6666	\$29
Evaporative Cooler Thermostat		85.6668	\$22
5 Minute Mechanical Timer for Cleanout Pump		85.6670	\$16
Control Box - 6" x 9" x 2.25"		85.6672	\$32
Control Package - cleanout pump, thermostat, switches, cleanout timer in stainless steel box - 12V		85.6674	\$99
Control Package - cleanout pump, thermostat, switches, cleanout timer in stainless steel box - 24V		85.6676	\$109
On / Off Switch for Solar Chill Coolers - Rated at 15 amps		85.6684	\$8
Variable Speed Rheostat - 2.5 Amp Use with 1224HP and 1624HP		85.6691	\$56
Variable Speed Rheostat - 3.5 Amp Use with 1212HP and 2024HP		85.6694	\$60
Variable Speed Rheostat - 4.7 Amp Use with 2012HP		85.6695	\$64
Variable Speed Rheostat - 7.0 Amp Use with 2412HP and 2-2024HP		85.6697	\$70
Knob for Rheostat		85.6699	\$4
Diffuser Grill 14 inch		85.6705	\$40
Diffuser Grill 20 inch		85.6707	\$41
Diffuser Grill 24 inch		85.6709	\$55

Thermostats

These thermostats can switch up to 22 amps at 120 VAC and they work fine for up to 10 amps at 12 or 24 VDC. Use them with DC fans to turn the fans on or off as temperature changes. They mount in a standard 2" x 4" electrical box. The Attic Fan Thermostat has single pole contacts that close (turn fan on) as temperature rises. Its adjustment range is 90°F to 130°F. When the thermostat reaches the turn-on temperature, it must fall by 15°F before it will turn off. The Heat/Cool Thermostat has double throw contacts, so it can be used to turn a fan on as the temperature rises or as it falls, depending on how it is wired. Its range is 50°F to 90°F and its differential is 2°F.

Description	Range	Item Code	Price
Attic Fan Thermostat	90°F to 130°F	85.8036	\$35
Heating and Cooling Thermostat	50°F to 90°F	85.8032	\$30



SOLAR POWERED LIGHTING - 145

EverLite Solar LED Spotlight

This is a high-tech Solar Spotlight with eight ultra-bright, 50,000 mcd white LEDs and a built-in nickel-metal hydride battery pack. The lightweight 2 pound EverLite is ideal for camping, backpacking or other outdoor activities. It operates 24 hours or more from its fully-charged battery and provides 12 hours of light output from about 3 hours of charging in full sun or 10 hours of gray overcast sky. The solar panel sits on the ground or can be mounted to almost any surface. It connects to the light with a 15-foot detachable cord that can be disconnected to make the light portable. EverLite's waterproof design makes it suitable for outdoor use. The lamp turns off when you fold it down into the closed position. When unfolded, it automatically turns on at dusk and turns off at dawn.



The Compact Everlite has the same bright light, with half the battery and charging capacity. It runs for 12 hours on a full charge and provides 6 hours of light output from about 3 hours of charging in full sun.

Optional chargers include a 12 VDC Charger with a cigarette lighter plug, a 12 volt hard-wire kit for permanent connection to a 12 volt battery system, and a 120 VAC charger. All of the optional chargers plug into the same jack as the solar module.

Other optional accessories allow the EverLite battery pack to charge cell phones and other portable devices. The 12 volt converter has a cigarette lighter receptacle to plug in a standard cell phone car charger. The 5 volt converter can recharge or operate your personal CD player, electronic game, or PDA, and comes with 6 different DC plug styles that will fit most handheld electronic devices.



EverLite has a 2 year replacement warranty for any defects in parts or workmanship.

EverLite Part #	Description	Item Code	Price
EL-5	Everlite Solar Spotlight	66.7145	\$99
EL-6	EverLite Compact Solar Spotlight	66.7146	\$60
EA-3	AC Charger	66.7149	\$10
EA-4	12 Volt Charger	66.7147	\$10
EA-5	12 Volt Hardwire Charger	66.7151	\$10
EA-1	12 Volt Converter	66.7152	\$19
EA-2	5 Volt Converter	66.7153	\$19
AF-1	Nylon Travel Case	66.7155	\$19

Solar Motion Sensor Outdoor Light

This solar powered light has a motion detector and photocell so that it comes on only at night when it detects motion. Lights stay on 1-1/2 minutes after motion stops. 15 feet of wire connects the light to the solar panel.



Includes two 5 watt replaceable halogen lamps enclosed in adjustable fixtures (one on either side of motion detector).

1-year warranty.

Description	Item Code	Price
Solar Motion Sensor Light	66.7005	\$96

Solar Lantern



THE LOGIC LANTERN from Holland is really a sophisticated solar powered lighting system. Charging is controlled by a microcomputer which automatically selects the battery float and boost level according to ambient temperature and battery use. It even has temperature compensation. When charging the battery, the light is automatically turned off. One three-color led indicates battery state of charge. The indicator blinks during charging and is continuously on when the battery is full or when the lamp is on. The indicator blinks fast when the electronic unit is overheated. After a low voltage disconnect, the led lights up red for 10 seconds before turning off. Two pushbutton switches are used to select 4.3 or 2.5 watts of fluorescent light. Intelligent high-efficiency ballast is protected against tube short circuit, open circuit and overheating. Quick-start electronics provide longer lamp life. The intelligent converter keeps power consumption stable within 1.5% independent of battery voltage. The 12 Volts / 3 Ah sealed battery can be charged with the included 4 watt solar module or with the included plug-in charger. Weight 5.4 lb. 1-year warranty

Description	Item Code	Price
Logic Lantern	66.7127	\$90

146 - DC FLUORESCENT LIGHTS

Low Voltage Compact Fluorescent Lamps

CFL lamps provide very high illumination levels with an 80% savings in power consumption over incandescent lamps. These high quality DC lamps are designed to be used in 12 volt and 24 volt battery systems. Cool-white 6400°K lamps provide a bright blue-white glow. Warm-white 2700°K lamps provide a light similar to incandescent lamps. The life span of the lamp is more than 6,000 hours. A special electronic circuit guarantees more than 50,000 switching cycles. The lamps have a standard E27/Edison socket. Spiral lamps are ideal in locations where the U-tube lamps are too long. 2 year warranty

Nominal Voltage	Lamp Type	Watts	Color Temperature	Dimensions L" x Diam "	Item Code	Price
12	Spiral	7.5	2700K	4½ x 1¼	66.2131	14.00
12	Spiral	11	2700K	4½ x 1¼	66.2138	14.00
12	Spiral	11	6400K	5 x 2¼	66.2139	14.00
12	3 U Tube	15	2700K	5¾ x 2	66.2146	16.50
12	Spiral	15	2700K	5 x 2¼	66.2150	20.00
12	3 U Tube	15	6400K	5¾ x 2	66.2154	16.50
12	3 U Tube	20	2700K	5¾ x 2	66.2158	18.00
12	Spiral	20	2700K	5 x 2¼	66.2162	21.00
12	3 U Tube	20	6400K	5¾ x 2	66.2166	18.00
24	3 U Tube	15	2700K	5¾ x 2	66.2255	18.00
24	3 U Tube	20	6400K	5¾ x 2	66.2259	18.00



Thin-Lite Low Voltage Fluorescent Lighting

Thin-Lite 12 and 24 volt fluorescent fixtures are both efficient and attractive. Anodized aluminum housing and clear acrylic diffuser lenses provide high light output on three sides. They are designed for commercial and industrial vehicles, and for use in remote area housing, schools and medical facilities in conjunction with alternative sources of energy. Comes with tube and ballast. Some models come with a switch on the side. These fixtures use the same standard fluorescent tubes as AC fluorescent fixtures. Replacements can be purchased locally. 1-year warranty

193



181 & 281



194



957

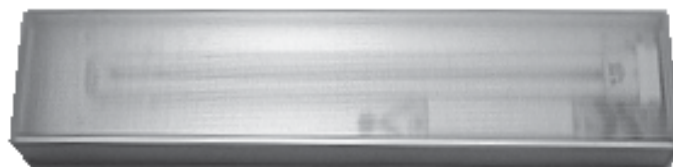

Thin-Lite Model	Fluorescent Tube Watts	# of Tubes	Lumens	Volts	Amps	Switch	Dimensions L" x W" x D"	Item Code	Price
193	15	1	870	12	1.3	Yes	18 x 2.25 x 2.44	66.2431	\$35
194	15	2	1740	12	2.1	Yes	18 x 4.5 x 1.5	66.2439	\$48
181	20	1	1250	12	1.6	No	24 x 3.63 x 3.5	66.2435	\$47
957	36	1	2618	12	2.45	No	18.9 x 4.5 x 1.5	66.2441	\$62
281	20	1	1250	24	0.8	No	24 x 3.63 x 3.5	66.2464	\$55

INCANDESCENT LIGHTING - 147

12 & 24 Volt Medium Base Bulbs

These low cost bulbs are the least efficient of all lamps that we sell, but they are still more than 30% more efficient than 120 volt lamps. They have a standard medium base, so they fit into standard sockets found in most 110 VAC fixtures. AC lamp sockets rated for up to 300 watts at 110 V A C can usually handle up to 50 watts at 12 VDC. Use 600 watt rated sockets for 100 watt 12 volt bulbs. 300 watt rated sockets are good for 100 watts at 24 volts.



Volts	Watts	Length	Item Code	Price
12	5	3	66.0019	\$6
12	25	4"	66.0025	\$2
12	50	4"	66.0029	\$2
12	75	5"	66.0033	\$4
12	100	5.5	66.0037	\$4
24	25	4"	66.0139	\$5
24	50	4"	66.0143	\$5
24	100	5.5	66.0147	\$9

12 Volt Candelabra Base Lamps

The 6 watt miniature screw or "candelabra" base bulbs look like regular nightlight bulbs. The 15, 25 and 40 watt bulbs have a decorative candle flame shape.



Volts	Watts	Length	Item Code	Price
12	6	1.75"	66.0061	\$1.85
12	15	3.5"	66.0065	\$2.50
12	25	3.5"	66.0069	\$2.50
12	40	3.5"	66.0073	\$2.50

12 Volt MR-16 Flood Lamps

Tungsten-halogen bulb with a multifaceted dichroic reflector provides sharp, clean light and excellent color rendition. These bulbs have a GX5.3 2 pin base and will fit a medium base socket when used with the MR-16 adapter. These lamps have a glass cover over the halogen lamp to prevent damage from splashed water or human contact.



Volts	Watts	Item Code	Price
12	20	66.1332	\$4
12	35	66.1334	\$4
12	50	66.1336	\$8

Halogen BiPin Lamps

These tiny halogen lamps are very bright. They are recommended for locations where they will not get wet or be looked at directly.

Volts	Watts	Item Code	Price
12	20	66.1310	\$4
12	50	66.1314	\$4
24	20	66.1311	\$4
24	50	66.1315	\$5



GX5.3 to Medium Base Adapter

This adapter allows 12 volt MR-16 reflector lamps and halogen bi-pin lamps to be used in any standard medium base socket powered by 12 volts. Lamps plug into holes in adapter. A tight friction fit allows adapter to be used safely with lamp pointing downward.



Description	Item Code	Price
Medium Base Adapter	66.1340	\$9

148 - 12 VOLT LED LIGHTING

How Do You Compare LED Light Output to Other Sources?

The most common measurement of light output is the lumen, a unit of light flow or luminous flux. The lumen rating of a lamp is a measure of the total light output of the lamp. Most light sources are labeled with an output rating in lumens. Lumens measure how much light actually falls on a surface.

The unit of measure commonly used to describe LED intensity is the millicandela (mcd). 1000 millicandela equals 1 candela. The candela is a unit of luminous intensity. One candela is defined as the luminous intensity of 1/600,000 square meter of projected area of a blackbody radiator operating at the temperature of solidification of platinum under pressure of 101,325 Newtons per square meter. This simply means that candela measures how much light is produced as measured at the light source.

How do you convert lumens to mcd? There is not an exact conversion since they are different types of measurements but here is a rough conversion: If you multiply the number of lumens by 80 you can get the equivalent millicandelas (mcd).

A 15 watt fluorescent tube has an output of 870 lumens. It would take approximately 70,000 mcd to equal the same light output. White LEDs have a light output of between 2,000 and 10,000 mcd, depending on their quality and the angle of spread of their beam. The narrower the beam, the higher the mcd rating.

CAUTION: The light output from Super Bright Leds is intense enough to injure human eyes at close range. You should never look directly at the LED source for more than a few seconds.

LUXEON 12 Volt LED Flood Lamp



Screw-in. Notice wide light spread angle. LUXEON new technology is too bright to look directly into. Has internal voltage regulator for constant full brightness with varying battery voltage.

Description	Watts	Item Code	Price
Luxeon LED Flood	4	66.4107	\$55

12 Volt Par30 LED Flood



These LED flood lights are made with very bright 12,000 mcd white LEDs PAR-type glass flood light housings. The 18 LED lamp makes a great reading light if you are within 3 to 4 feet. The 45 LED lamp is extremely bright and easy to read under from 5 to 6 feet away. They have an expected life of 10 years or more. 2-year warranty

12 Volt LED Cabin Light

This high-efficiency wall mount 12 volt light has an adjustable swivel that puts the light where you want it. It has a push button on/off switch and three ultra-bright white LEDs. All parts are plastic. Power consumption is only 30mA, less than 1/2 watt!



Description	Watts	Item Code	Price
LED Cabin Light	0.5	66.4503	\$32



Description	Watts	Diameter	Length	Item Code	Price
Par20 18 LED Flood	1.73	2.5"	3.00"	66.4128	\$35
Par30 45 LED Flood	4.32	3.7"	3.25"	66.4131	\$45
Par38 99 LED Flood	9.50	3.7"	3.25"	66.4135	\$90

DC LIGHTS - 149

Osram Co-Pilot Halogen Lights



These 12-volt, 5-watt lights have a flat black finish with a flexible arm and focused reflector. The lights use very little power but focus a large amount of quality light in a small area. They are great for reading and hand tasks. The base is designed to be permanently mounted to the work surface with two screws or plugged into a cigarette lighter plug in the case of the 7" model.

Description	Item Code	Price
Copilot 20" 5W 12V	66.1285	\$30
Copilot 12" 5W 12V	66.1288	\$30
Copilot 7" 5W 12V w/lighter plug	66.1291	\$28
5W Replacement Bulb	66.1328	\$7

12 Volt Vandal Resistant Wall Fixture

This is a vandal resistant surface mounting wall fixture for interior or exterior use where vandalism may be a problem. It is an excellent choice for park and campground use to light walkways, restrooms and carpools as part of a solar electric power system. The heavy gauge steel housing and clear prismatic polycarbonate diffuser insure a long life. It uses an energy-efficient 13 watt D/E tube.

Description	Watts	Item Code	Price
12 Volt Vandal Resistant Light	13	66.2481	\$72

12V Fluorescent Outdoor Flood Light

These weather-proof lights are designed to meet the demand for solar powered sign lighting and area lighting. They have 1/2" male pipe thread mounts and can be used for up lighting or down lighting. They use an electronic ballast that will operate down to -20 ° F. Replacement fluorescent tube is S/E 13 watt tube. This light uses 1 amp at 12VDC.

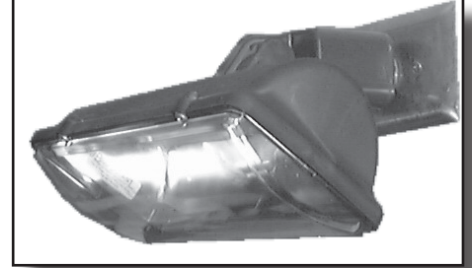

Description	Watts	Item Code	Price
12 Fluorescent Flood	13	66.2478	\$75

12V Low Pressure Sodium Outdoor Light

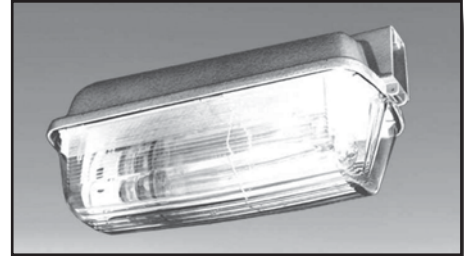

These are 12 volt versions of common LPS street lights. Low pressure sodium give the most lumens per watt of power consumed, but the light is an orange-pink color.

Cast aluminum housing has a vandal resistant polycarbonate diffuser. A wall or wood pole mount bracket is included. Warm-up time is 7 to 10 minutes. A 1 to 15 hours adjustable timer may be used or by-passed. Weight is 6.30 lb (2.857 kg)

Model	Watts	Lumens	Item Code	Price
LPS-118LT	18	1800	66.5818	\$380
LPS-135LT	35	4800	66.5821	\$380

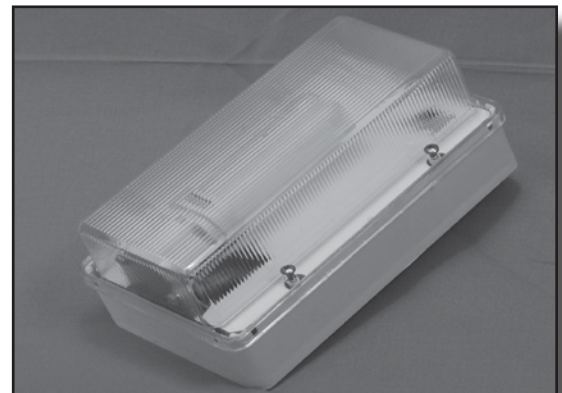

150 - TUBULAR SKYLIGHTS

Natural Light Tube Skylights

Tired of fumbling in the hallway to find the light switch? Do you often find you're wearing one black sock and one blue sock? Let's face it, not every space in the home is optimally illuminated. But as electricity costs continue to climb, many of us might suffer the dark to save some money.

A better idea is to harness the natural light of the sun. In addition to being free, sunlight is psychologically and physiologically better for us. Sunlight offers the full visible spectrum of light which

reduces eye strain, helps us to see better, makes our belongings look their true color and helps us, our pets and even plants to synthesize nutrients for healthier living. For about the cost of a nice light fixture, you can bring the soft warm light of the sun into virtually any space in your home. Installed on any roof surface in under two hours, you will quickly realize the cost benefits of a tubular skylight over incandescent lighting and even traditional skylights. In addition to the free daytime operating cost, Natural Light tubular skylights do not contribute to heat loss or gain, unlike standard framed-in skylights. And did you know that electric lights can add 40% of the average heat gain in a home? As a bonus, Natural Light tubular skylights often qualify for local tax credits as an energy conservation device. Check with your local dealer or local conservation authority. Not only are tubular skylights a better choice for day lighting, but Natural Light tubular skylights are one of the best in their class with high standards for quality and functionality. The Dome is constructed of high impact modified acrylic. Considerably stronger than regular acrylic, it easily withstands wide temperature variations. This material is also UV stabilized, absorbing 99% of UV rays while maintaining optic clarity.

The Roof Jack is .080 aluminum, making it one of the thickest flashings on the market. Its unique forward sloping design eliminates light robbing elbows in most installations and it fits on any flat or pitched roof. The round seamless flange is designed to uniformly expand and contract under changing environmental conditions ensuring years of leak free operation. Easily paintable to blend in with your roof, its low, unobtrusive profile makes it appealing to home owners associations.

The Stress Collar is exclusive to Natural Light tubular skylights. This seamless aluminum collar is factory fastened to the dome and functions to equalize the stress around it. The collar is connected to the roofjack eliminating screws into the dome; avoiding the major cause of leakage.

The Light Pipe is silver coated aluminum with a total reflectivity of 98%. The pipe is easily trimmed with shears during installation. Each skylight comes with two 2-foot sections. Order 6" more than the distance from the roof to the ceiling.

The Trim Ring is seamless aluminum. Powder coated for durability, it will blend into any decor.

The Diffuser is designed with a precise arc for exact light dispersion without spot lighting or glare. Available in soft white or prismatic, it snaps into the trim ring for a snug, dust and moisture free seal.

The 25 year warranty is the best in the industry!



Tubular Skylights					
Model Size	Coverage Area	Wattage Output Equivalent	Maximum Tube Length	Item Code	Price
10"	150 sq. ft.	300	18'	67.1011	\$228
13"	300 sq. ft.	500	20'	67.1013	\$288
18"	500 sq. ft.	1000	20'	67.1015	\$415
Evening Light Kit - 1 socket				67.1028	\$29
Evening Light Kit - 2 sockets				67.1029	\$48

Extra Tubing - 2 Ft. Section	
Item Code	Price
67.1022	\$36
67.1024	\$41
67.1026	\$60

LP GAS REFRIGERATION - 151

Servel Americana 400 LP Gas Refrigerator-Freezer

This time proven, 2 door 8 cubic foot refrigerator freezer combination can maintain 6 degree F in the freezer and 39 degrees F in the refrigerator when the outside temperature is 110 degrees F. The refrigerator section is 6.4 cubic feet, and the top freezer section is 1.6 cubic feet. Overall dimensions are 63-1/2" high, 23" wide, 26-1/2 " deep. The door openings are reversible. The average gas usage is 1/4 gallon of propane in 24 hours. Piezo lighter and temperature adjustment are accessible on the front without opening door. This refrigerator is not AGA approved. Servel offers a 1 year warranty.



Model	Description	Weight	Item Code	Price
400W	Servel Americana LP Gas Refrigerator - white	195	80.1105	\$1,350
400A	Servel Americana LP Gas Refrigerator - almond	195	80.1107	\$1,350

Frostek LP Gas Chest Freezer

This is the largest gas freezer available; over eight cubic feet of reliable long-term food storage. Its powerful cooling unit cools down to 10 degrees F. An exterior thermometer tells you the precise interior conditions without opening the door. Smooth, rust-proof steel cabinet with tough, gray leathergrain finish resists scratches and dents! Non-electric, thermostatic control ensures even temperatures and non-electric push-button ignition gives match-less starting. High quality craftsmanship -- No moving parts in cooling unit, so no mechanical wear-and-tear. AGA and CGA approved. LP gas only. Total capacity: 8.50 cu ft. Dimensions 38"H x 44"W x 31"D. *Gas Use: 7.5-10.9 lb/wk or 1.8-2.5 gal/week. Max burner output: 1800 btu. Weight: 275 lb shipping, 220 lb net. *(Fuel use is approximate, based on average operation at 70-80% power.)

IMPORTANT: The Frostek is best suited for keeping frozen food frozen. (It may take several days to totally freeze food that is room temperature.) Once partially filled with frozen food, up to 12 lb of non-frozen food can be added per 24 hrs.

Three-year warranty. Made in Canada (cooling unit made in Italy).



Model	Description	Weight (lbs.)	Item Code	Price
CF240LP	Frostek 8 Cu. Ft. LP Gas Freezer	270	80.1024	\$2100
2452500	High Altitude Gas Orifice for 2500 to 5000 ft.	1	80.1031	\$9
2455000	High Altitude Gas Orifice for 5000 to 7500 ft.	1	80.1032	\$9
2457500	High Altitude Gas Orifice for altitude over 7500 ft.	1	80.1033	\$9



Peerless-Premier Gas Ranges

We sell Peerless gas ranges because they are the only ranges we've found that have a spark ignition in the oven instead of the "glow bar" that most ranges come with. Glow bars use 300 to 400 watts of electricity whenever the gas range is on, which can be a large load for an off-grid home. Peerless has a large variety of ranges from 24" to 36" in width. They can be set for natural gas, but can easily be adjusted for LP gas. See all of the available styles, sizes and colors on their web site:

<http://www.premierrange.com/gasranges.htm>

Contact us for pricing and a freight quote for the range you are interested in.

152 - DC REFRIGERATION

SunFrost Refrigerators and Freezers

SunFrost refrigerators are the most energy-efficient upright refrigerators available. They keep food fresher longer by maintaining high humidity, which prevents freezer burn and wilting caused by water loss in food. Defrosting is seldom needed: frost buildup is extremely slow because water vapor in the refrigerator section from moist room air or food is not transformed into ice. When defrosting is needed, usually once or twice a year, just transfer frozen food to the refrigerator section and turn it off for 30 minutes. Ice quickly falls off the smooth flat surfaces in large pieces.

The Sun Frost refrigerator comes finished on the outside with white laminate, but it can be ordered in natural wood or any of over 100 colors or shades of Formica or Nevamar to match kitchen decor. The spacious, well-lit interior, made from sturdy fiberglass reinforced plastic, is easy to clean. There are no exposed ducts, tubing or hard to reach corners. All of the shelves are adjustable.

The Sun Frost refrigerator should provide well over 15 years of trouble free operation. The only moving part is a hermetically sealed compressor. The brushless motor used in the DC models eliminates periodic servicing.

Low Voltage DC Models - Energy use listed in the table below is for 12 VDC. On 24 VDC systems the same amount of energy is used (½ as many amp hours per day).

When ordering, please specify whether you want the hinge on the left or right. If a color is not specified, the Sun Frost comes in white Formica. (For a different color add \$130. For a natural wood veneer, add \$180.) Sun Frost refrigerators are also available without a finish, with unfinished birch plywood, ready for custom covering by your cabinet-maker. Prices include crating charge. Sun Frost refrigerators are shipped by truck freight. All Sun Frost refrigerators are custom made so delivery times will vary. Call for exact lead time. 2 year warranty.



Model	12/24 VDC Volt Models	AH/day @ 12V		Inside Volume cu ft.		Dimensions H" x W" x D"	Weight (lbs.)	Item Code	Price
		at 70 F	at 90 F	Refrig	Freezer				
RF19	19 cu ft. 1/2 Refrig - 1/2 Freezer	62	82	8.07	8.07	66 x 34.5 x 27.5	320	80.2330	\$2,860
R19	19 cu ft. Refrigerator only	28	46	16.1	-	66 x 34.5 x 27.5	310	80.2322	\$2,630
F19	19 cu ft. Freezer only	100	130	-	16.1	66 x 34.5 x 27.5	320	80.2314	\$2,915
RF16	16 cu ft. Refrig / Freezer	42	58	10.4	3.91	62 x 34.5 x 27.5	300	80.2328	\$2,915
RF12	12 cu ft. Refrig / Freezer	24	43	8.07	2.05	49 x 34.5 x 27.5	230	80.2326	\$2,129
R10	10 cu ft. Refrig / Freezer	15	25	9.13	-	43.5 x 34.5 x 27.5	215	80.2320	\$1,640
F10	10 cu ft. Freezer only	55	70	-	9.13	43.5 x 34.5 x 27.5	215	80.2312	\$1,745
RF4	4 cu ft. Refrig / Freezer	13	19	3.16	0.68	31.5 x 34.5 x 27.5	160	80.2332	\$1,430
R4	4 cu ft. Refrigerator only	9	13	9.91	-	31.5 x 34.5 x 27.5	160	80.2324	\$1,430
F4	4 cu ft. Freezer only	28	36	-	3.91	31.5 x 34.5 x 27.5	160	80.2316	\$1,430
Model	120 VAC Models	Kilowatt Hours Per Day @ 120 VAC		Refrig	Freezer	Dimensions H" x W" x D"	Weight (lbs.)	Item Code	Price
RF19A	19 cu ft. 1/2 Refrig / 1.2 Freezer	0.77	1.0	8.07	8.07	66 x 34.5 x 27.5	310	80.2427	\$2,705
R19A	19 cu ft. Refrigerator only	0.35	0.58	16.1	-	66 x 34.5 x 27.5	310	80.2419	\$2,775
F19A	19 cu ft. Freezer only	1.25	1.63	-	16.1	66 x 34.5 x 27.5	310	80.2413	\$2,758
RF16A	16 cu ft. Refrig / Freezer	0.49	0.79	10.4	3.91	62 x 34.5 x 27.5	300	80.2425	\$2,657
RF12A	12 cu ft. Refrig / Freezer	0.3	0.53	8.07	2.05	49 x 34.5 x 27.5	230	80.2423	\$1,949
Options									
Color Finish instead of White - add:								80.2560	\$80
Wood Veneer Finish - add:								80.2562	\$130
Storage Cabinet 24" high w/2 drawers goes under RF12 - White						24 x 34 x 27.5	110	80.2550	\$370
Storage Cabinet 13" high w/2 drawers goes under RF16 - White						13 x 34 x 27.5	60	80.2544	\$320
Stand 4" high goes under RF19 - White						4 x 34 x 27.5	25	80.2556	\$99

DC REFRIGERATION - 153

SunDanzer 12 or 24 Volt Refrigerators and Freezers

Save on system costs with SunDanzer battery-powered solar refrigerators and freezers. These highly efficient units with exceptionally low energy consumption require a smaller photovoltaic (PV) system for your refrigeration needs. SunDanzer units feature 4.33" (110 mm) of polyurethane insulation and coated steel cabinets. The brushless DC motor compressor operates on 12 or 24 VDC. A patented low-frost system reduces frost build-up for low maintenance. SunDanzer chest-style refrigerators and freezers are easy to clean using the drain hole at the bottom of the unit. With thick insulation and a refrigeration system optimized for solar, SunDanzer refrigerators and freezers provide outstanding, economical and reliable operation. SunDanzer cabinets are commercially produced by one of the world's leading appliance manufacturers. Warranty: 1 year.



Model	12/24 VDC Volt Models	AH/day @ 12V			Outside Dimensions H" x W" x D"	Weight (lbs.)	Item Code	Price
		at 70 F	at 90 F	110 F				
DCR165	165L (5.8 cu ft.) Refrigerator	6.5	14	29	40 x 30 x 37	120	80.2119	\$949
DCR225	225L (8 cu ft.) Refrigerator	7.5	17	33	50 x 30 x 37	140	80.2123	\$1,049
DCF165	165L (5.8 cu ft.) Freezer	23	37	64	40 x 30 x 37	120	80.2117	\$949
DCF225	225L (8 cu ft.) Freezer	30	44	68	50 x 30 x 37	140	80.2121	\$1,049

SunDanzer BFR Series Battery-Free Solar Refrigerator

Using space age technology, SunDanzer also offers a revolutionary design for true "plug and play" operation, eliminating the need for batteries and charge controllers. During cloudy weather, internal thermal storage keeps products cold for up to 7 days. The BFR Series is designed for use in locations with at least 5 peak sun-hours per day. The highly efficient system, developed at NASA, uses a variable speed compressor and peak power tracking. For areas with less than 5 sun-hours per day, the DC Series is recommended. Warranty: 1 year.

Model	Battery Free Model	Outside Dimensions H" x W" x D"	Weight (lbs.)	Item Code	Price
BFR105	105L (3.7 cu ft.) Refrigerator	40 x 30 x 37	200	80.2130	\$1,599

SunFrost Vaccine Refrigerator

World Health Organization tested & approved. For the past 12 years SunFrost refrigerators/freezers have been used in more than 50 countries and have an excellent track record. Sun Frost units are very ruggedly constructed and will provide many years of reliable operation, even in the harshest environments. The SUN FROST RFVB provides a means of storing vaccines and medical supplies without the use of fossil fuels. Not only is the need for a fuel supply eliminated, but the unit operates more reliably than kerosene powered refrigerators. The RFVB can freeze 2.2 Kg of ice per day, but will use approximately 50% more power than the figures in the chart below. The evaporator in the RFVB is protected by a fiberglass liner and cannot be punctured while defrosting, a common problem in many manual defrost refrigerators. Also contributing to the longevity of the cooling system is the compressor's low percentage of run time, only 19% in a 32° C (90° F) room. The RFVB is the most efficient vaccine refrigerator available. The cost of a solar power system is typically more than the cost of the refrigerator, so efficiency is of prime importance in reducing system costs. 2 year limited warranty. Call for system design help.

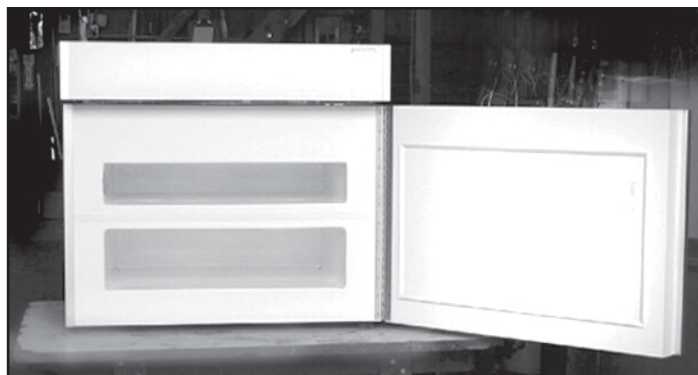

Sunfrost Model	12/24 VDC Volt Models	AH/day @ 12V		Inside Volume cu ft.		Dimensions H" x W" x D"	Weight (lbs.)	Item Code	Price
		at 70 F	at 90 F	Refrigerator	Freezer				
RFVB	4 cu ft. Vaccine Refrig/Freezer	13	18	1.8	1.2	31.5 x 34.5 x 27.5	160	80.2503	\$1,800

154 - COMPOSTING TOILETS

Sun Mar Composting Toilets

Sun-Mar Toilets convert human waste to fertilizing soil while waste liquids are filtered by the living compost and carried up the vent stack as evaporate, or drained. To achieve this, Sun-Mar uses a unique three chamber system with each chamber having its own independent environment for optimum efficiency. The first chamber is the composting Bio drum where the compost is kept perfectly oxygenated, moist and warm. A bulking mixture of coarse peat moss and hemp core (Compost Sure) is added to the drum to provide the necessary organic carbon to maintain the correct carbon/nitrogen balance in the compost. The second chamber is the evaporating chamber from where the liquid is evaporated and carried up the vent stack or drained. On electric models, evaporation is further assisted by a thermostatically controlled heater beneath the floor of the evaporating chamber. Because air is being pulled continuously into the toilet system, a partial vacuum is maintained to help prevent any smell escaping. An overflow drain in the rear drains any excess liquid that cannot be evaporated. The user must provide a safe place for this liquid to drain. The third chamber is the compost finishing drawer, into which compost from the drum is extracted by rotating the drum in the opposite direction and the composting process is completed.

In selecting the right model, the most important questions are: How many people will use the unit, and is electricity available? It is generally advised, in order to maintain a good margin of safety, to select a unit with more capacity than needed. Also, if electricity is available all the time an electric model should be selected since they have higher evaporation capacities. Freezing temperatures will halt composting action, and if temperatures surrounding the unit remain below 50 degrees F for extended periods, a small heat source should be employed with the unit to keep the composting active.

Sun Mar Self Contained Toilets

Self-contained units are installed directly in the bathroom. They are available in both electric and non-electric versions. Electric units plug into a regular three pin outlet to power a fan and a thermostatically controlled heating element in the base of the unit. The unit is normally unplugged if it is not being used for 3 days or more. Composting capacity varies with the size of the Bio-drum. Electric units normally have more capacity than non-electric units because they have extra warmth and air movement.

Although advertised composting capacities can be doubled for short periods, Sun-Mar has found that wherever possible it is always better to have a good margin of safety. So, pick a unit with more capacity than you really need.

The most important advantages of self-contained units are that they need no plumbing or water connection so they are quick and easy to install, they cost less than central units because there is no separate toilet and they are more suited to winter operations than central units, because it is often easier to keep the bathroom warm. Since the whole waste stream is recycled, approvals are not normally required. Cleaning is simple. A bowl liner beneath the seat can be removed for cleaning whenever necessary. The high quality, high gloss fiberglass finish is perfect for indoor installations.

The Sun-Mar Mobile family of composting units are the first composting toilets specifically designed to recycle waste on boats and recreational vehicles. Less pump-outs! No more chemical toilets! Recycling brings freedom, with the ODOR-FREE operation of a Sun-Mar.



EXCEL



EXCEL NE



COMPACT



SPACESAVER



MOBILE

Model	Description	Weight	Item Code	Price
Excel	The preferred self-contained electric model for heavy / residential use	100	88.1005	\$1,339
Excel NE	Self contained unit w/ 4" vent at the top rear of the unit. No Fan	95	88.1007	\$1,139
Excel AC/DC	Excel with 4" vent, 12V fan and 120V heater	95	88.1013	\$1,439
Compact	4" Vent stack and no electric heating element. A 12V fan is optional	80	88.1009	\$1,239
Space Saver	Medium capacity electric model with small (19" x 22") footprint	80	88.1001	\$1,239
Mobile	Self contained for RVs and boats. 110V heater, 12V fan, 19" x 22"	80	88.1017	\$1,239
Mobile (hull shape)	Same as above, but with a sloped back to mount against a boat hull	80	88.1019	\$1,239

COMPOSTING TOILETS - 155

Sun Mar Central Composting Toilets

Central composting systems have an elegant 1 pint flush or dry toilet in the bathroom, with the composting unit installed under a building or at the side of a building. For units with 1 pint toilets, installation involves hooking up the water and mounting the toilet in the bathroom, connecting 3" ABS plumbing pipe (not included) from the toilet to the composter, and erecting the 2" vent stack supplied with the unit (4" on non-electric units). If a Dry Toilet is used, the toilet itself must be positioned directly over the composting unit for chute installation. The Sun-Mar Dry Toilet and Sealand 1 Pint Flush toilets are purchased separately. 12 volt fans should be installed in the vent stack of all non-electric Dry toilet (A/F) units, with all AC/DC units, and with the non-electric version of the Centrex 3000. 12 Volt fans are optional with all non-electric Central units. With a flush toilet, evaporating all liquids can be difficult. Any excess liquid is able to drain out of the overflow drains which should always be hooked up to a collecting tank or an approved handling facility.

Centrex 1000

The Centrex 1000 model is ideal for light seasonal use. In light to medium seasonal use the 1000 is typically able to hold compost for the full season, and compost needs extraction only in the Spring. The AC model use a maximum of 3.6 kilowatt hours per day and is suitable for use by 5 to 7 people. The on-electric (NE) model is suitable for use by 4 to 6 people. The AC/DC model can be used where some AC power is available, but DC power is available to run a fan all of the time.

Centrex Model	Description	Weight	Item Code	Price
1000 (AC)	For underneath or beside building. 110 V 260W heater & 30W fan	100	88.1021	\$1,299
1000 AC/DC	Dual vent stacks (2"&4"). 12V fan, 110V AC heating element	100	88.1023	\$1,399
1000 N.E.	4" Vent stack and no electric heating element. A 12V fan is optional.	90	88.1025	\$1,099



Centrex 2000 and Centrex 3000

Perfect for medium to heavy seasonal or light residential use, the Centrex 2000 allows for both a longer composting cycle, and larger waste volumes than the 1000 models. The increased surface area in the evaporating chamber coupled with the larger heating element also provides better evaporation on electric units. When used seasonally by up to 7-9 adults, compost will normally only need removing annually each spring. In residential use compost will have to be extracted more frequently. When used residentially by up to 4 adults, some compost will need to be emptied into the finishing drawer once every few months. The Centrex 2000 AC model features a 370 watt thermostatically controlled heater in a sealed compartment under the unit and the standard Sun-Mar 30 watt turbo fan, with a 2" vent stack to remove evaporating liquid and fresh odors. The NE model is suitable for 3 to 5 people in continuous use. Units are available for 1 pint and dry toilets.

The Centrex 3000 NE (Non-Electric) employs a continuous flow design for very heavy cottage or medium residential use. Rotation of the drum moves compost along the larger and longer 3000 series drum, before it drops automatically into the collection housing at the end of the unit. Under normal operating conditions the drum will not have to be turned backwards for emptying. When used seasonally by up to 10 adults, compost will normally only need to be removed from the collection chamber annually at the beginning of the following season.

Centrex Model	Description	Weight	Item Code	Price
2000 (AC)	For underneath or beside building. 110 V, 350W heater & 30W fan	118	88.1027	\$1,529
2000 AC/DC	Dual vent stacks (2"&4"). 4" stack includes 12V fan, 110V AC element	124	88.1029	\$1,629
2000 N.E.	4" Vent stack and no electric heating element. A 12V fan is optional.	108	88.1031	\$1,379
2000A/F (AC)	2000 (AC) for use with Dry Toilet.	118	88.1033	\$1,579
2000A/F (AC/DC)	AC/DC version for use with dry toilet	124	88.1035	\$1,679
2000A/F N.E.	Non-electric Dry Toilet version	108	88.1037	\$1,429

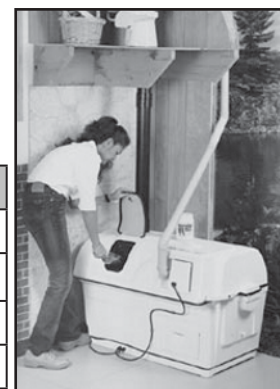

3000 AC	High capacity, 110 V 250W heater (x2) & 30W fan	217	88.1039	\$1,749
3000 AC/DC	As above, with dual vent stacks (2"&4"). 4" stack includes 12V fan	222	88.1041	\$1,849
3000 N.E.	Non-electric version 4" Vent stack . A 12V fan is optional	202	88.1043	\$1,589
3000A/F (AC)	High capacity, use with Dry Toilet. 110 V AC, 250W heater (x2)	217	88.1045	\$1,799
3000A/F AC/DC	As Centrex 3000A/F with dual vent stacks (2"&4"), 12V fan 110 v elements	222	88.1047	\$1,899
3000 N.E.	Non-electric version of the Centrex 3000A/F. A 12V fan is optional	202	88.1049	\$1,639



156 - COMPOSTING TOILET ACCESSORIES

Sun-Mar Composting Toilet Accessories

Sun-Mar offers a selection of 1 pint flush toilets for use with regular Centrex 1000, 2000, and 3000 series central composting toilet systems. More than one "1 pint flush" toilet can be installed with these units if necessary. The constraint is the number of people using the system rather than the number of toilets.

The Sealand 510 Plus has a regular sized toilet seat and is 2" longer and 1" wider than the Sealand 2010. In some instances extra height is needed to allow the toilet to gravity feed to the composting unit. Where this is the case, the Sealand 511 Plus (large bowl) or the Sealand 2011 (small bowl), low profile models with a 10" seat height, can be mounted on a platform.

For Sun-Mar installations, we recommend the 510 Plus as the unit of choice as it has the size and appearance of a "regular" toilet. The 2010 is suitable if you have a very limited space in which to install the unit. Sealand toilets are available in either White or Bone. They come complete except for the required 3" four (4) bolt floor flange.

The Sun-Mar Dry Toilet is designed for use with the waterless Centrex 1000 AC/DC & NE and 2000 AF (Air Flow) family and Centrex 3000 AF family of central composting systems. Available in either White or Bone, the Dry Toilet has a seat height of 15" and a "regular sized" toilet seat.

The 12 Volt Fan is meant to accelerate airflow in all non-electric units. It comes pre-installed in an 11" piece of 4" diameter vent pipe so that it will fit inline in your vent stack. It also protects against downdraft and increases the evaporative performance of your non-electric unit by about 10 to 15% (still not enough to evaporate all liquids on an NE). Its purchase is optional with an Excel NE, a Centrex 2000 NE, or a Centrex 1000 NE. The 12 and 24 volt fans can be used in homes with power systems of those voltages. In a remote location a solar panel, charge control and marine deep cycle battery can be used to power the fan.



Model	Description	Item Code	Price
Sealand 510 Plus-W	One pint flush toilet for central units - 17" height	88.1055	\$269
Sealand 510 Plus-B	One pint flush toilet for central units - 17" height	88.1056	\$269
Sealand 511 Plus-W	One pint flush toilet for central units - 13" height for platform installation	88.1057	\$269
Sealand 511 Plus-B	One pint flush toilet for central units - 13" height for platform installation	88.1058	\$269
Sealand 2010 -W	One pint flush toilet for central units - 17" height	88.1071	\$269
Sealand 2010 -B	One pint flush toilet for central units - 17" height	88.1072	\$269
Sealand 2011 -W	One pint flush toilet for central units - 13" height for platform installation	88.1073	\$269
Sealand 2011 -B	One pint flush toilet for central units - 13" height for platform installation	88.1074	\$269
Sun-Mar Dry Toilet -W	Air Flush Chute Toilet for A/F central unit - white	88.1081	\$249
Sun-Mar Dry Toilet -B	Air Flush Chute Toilet for A/F central unit - bone	88.1082	\$249
12V 1.4W DC Fan	Fits into vent stack of NE units to increase air flow	88.1083	\$46
12V 3.4W DC Fan	Fits into vent stack of NE units to increase air flow	88.1085	\$46
24V 3.3W DC Fan	Fits into vent stack of NE units to increase air flow (24V systems)	88.1087	\$46
5W Solar Panel	To charge battery for 1.4W fan	11.9018	\$82
10W Solar Panel	To charge battery for 3.4W fan	11.9020	\$120
Charge Control	Morningstar SS6L-12 protects battery from overcharge/discharge	20.1248	\$59
Ecolet Mobile Heater	Additional 12V 120W heater for Ecolet MOBILE	88.1091	\$75
Fan Speed Control	Install in 120V fan door cover to regulate fan speed	88.1092	\$40
A/F Extension	Extra 29" section for extra height between A/F toilet and central unit	88.1093	\$55
Microbe Mix	Dried aerobic microbes & enzymes to start composting	88.1094	\$204
Compost Quick	Combination toilet bowl cleaner and compost accelerator (Case of 12)	88.1095	\$156
Compost Sure	Mixture of coarse peat moss & hemp stalk bulking material	88.1096	\$75

RECHARGABLE BATTERIES - 157

Nickel Metal Hydride Batteries

NiMH batteries have up to twice the power of Nickel-Cadmium rechargeable batteries, can be recharged or topped off anytime, and don't have the memory effect. Their only drawback is all NiMH self discharge about half their energy in two months without use. They are best used in devices that use up batteries quickly, like digital cameras, portable entertainment devices and flashlights in constant use. They can be recharged about 500 times and last for years. Unlike Nickel-Cadmium batteries, Nickel-Metal Hydride batteries do not contain toxic substances



Description	Item Code	Price
Nickel Metal Hydride AAA Cell 750 mAh	87.2019	\$1.60
Nickel Metal Hydride AA Cell 2200 mAh	87.2021	\$2.20
Nickel Metal Hydride C Cell 4500 mAh	87.2022	\$8.00
Nickel Metal Hydride D Cell 9000 mAh	87.2024	\$11.00

QuickCharger

The Quick-Charger sets a new standard in battery charger's for today's ultra-high capacity NiMH and NiCad batteries. Ordinary charger's aren't able to charge NiMH and NiCads to their full capacity, and often generate heat while charging that shortens the life of the battery. The QuickCharger's sophisticated internal computer charges your batteries quickly without overheating. NiCad batteries can be automatically discharged prior to charging to improve capacity and life. The computer also uses a trickle charge on fully charged batteries so the batteries can sit in the charger until you need them. It can recharge up to four D, C, AA, AAA batteries, analyze batteries for their charge and capacity, and rejects damaged batteries. Negative pulse charging and Intelligent Discharge System (IDS) prevents memory effect and overcharging. Soft Start function prevents overheating of battery, helping extend battery life. The QuickCharger can fully charge 2 AA Nickel Metal Hydride batteries in about 2-1/2 hours. This charger is powered by 120 VAC through a wall transformer (included) with a 12VDC output and can easily be adapted to operate from 12VDC.



87.2219 Quick Charger NI-CD/NI-MH \$50

AccuManager20 Fast Charger



This new super-fast charger can be powered by AC power or 12 VDC from a car cigarette lighter outlet and will charge Nickel-Cadmium, Nickel-Metal-Hydride and Rechargeable-Alkaline batteries at the same time. One to four AAA, AA, C, D and two 9V batteries can be charged in any combination of sizes and battery chemistry at the same time.

The AccuManager20 automatically recognizes each battery type and charges them separately.

87.2216 Accumanager Charger \$65

Soltronix™ Headphone Radio

The Soltronix™ Headphone Radio is a solar recharging AM/FM headphone radio with superb sound. The solar module allows it to operate on just solar power in as little thirty percent of full sunlight. Additional power generated goes to charging the battery while the headphones are still operating! When the headphones are off all power generated by the module goes to charging the included NiMH battery. One hour of charging in bright sunlight a windowsill gives 1-2 hours of playtime, and a fully charged battery provides over 18 hours of playtime. The user benefits both from the savings and convenience of not having to change batteries.



87.0136 Soltronix Headphone Radio \$40

158 - WIRE LOSS AND AMPACITY INFORMATION

12 VOLT 2% WIRE LOSS CHART

Maximum distance one-way in feet of various gauge two conductor copper wire from power source to load for 2% voltage drop in a 12 volt system. You can go twice the distance where a 4% loss is acceptable. Do not exceed the 2% drop for wire between PV modules and batteries. A 4 to 5% loss is acceptable between batteries and lighting circuits in most cases. Multiply distances by 2 for 24 volts and by 4 for 48 volts.

AMPS	#14	#12	#10	#8	#6	#4	#2	1/0	2/0	4/0
1	45	70	115	180	290	456	720			
2	22.5	35	57.5	90	145	228	360	580	720	1060
4	10	17.5	27.5	45	72.5	114	180	290	360	580
6	7.5	12	17.5	30	47.5	75	120	193	243	380
8	5.5	8.5	15	22.5	35.5	57	90	145	180	290
10	4.5	7	12	18	28.5	45.5	72.5	115	145	230
15	3	4.5	7	12	19	30	48	76.5	96	150
20		3.5	5.5	9	14.5	22.5	36	57.5	72.5	116
25			4.5	7	11.5	18	29	46	58	92
30			3.5	6	9.5	15	24	38.5	48.5	77
40				4.5	7	11.5	18	29	36	56
50					5.5	9	14.5	23	29	46
100						4.6	7.2	11.5	14.5	23
150								7.7	9.7	15
200									7.3	11

Maximum Ampacities for Wire

Allowable ampacities of conductors (wires) in conduit, raceway, cable or directly buried, based on ambient temperature of 30°C (86°F). NEC allows rounding up cable ampacity to next size standard fuse or breaker.

* The national electrical code (NEC) specifies that the overcurrent protection device not exceed 30A for 10 AWG wire, 20A for 12 AWG wire and 15A for 14 AWG wire.

Wire Size	Copper Conductor Temp. Rating		Aluminum Cond. Temp. Rating	
	75°C (167°F)	90°C (194°F)	75°C (167°F)	90°C (194°F)
*14	20	25		
*12	25	30	20	25
*10	35	40	30	35
8	50	55	40	45
6	65	75	50	60
4	85	95	65	75
2	115	130	90	100
1	130	150	100	115
1/0	150	170	120	135
2/0	175	195	135	150
3/0	200	225	155	175
4/0	230	260	180	205

INDEX - 159

Automatic Transfer Switch	119	Heat Shrink Tubing	107
Autotransformer	68-69	Highlifter Pump	135
Batteries	98-102	Hydraulic Ram	136
Batteries, Commercial Deep Cycle	98	Hydroelectric Generators	42-45
Batteries, Sealed	101-102	Hydrometers	109
Battery Chargers	103-104	IBE Chargers	103
Battery Desulfator	109	IBE Industrial Batteries	99
Battery Enclosures	105-106	Interconnects, Battery	108
Battery Equalizers	76	Inverter Bypass Switch	119
Battery Information	94-97	Inverters, Grid Tie	55-61
Battery Selector Switch	121	Iota DLS Converter/Chargers	104
Battery Vent Fan	109	Kil-A-Watt Meter	77
Beacon Power Inverter	60	Kilowatt Hour Meter	77
Building Integrated PV	17-18	Lantern	145
Cable & Wire Tools	107	Lay-in Lug	112
Ceiling Fan	142	LED Lighting	148
Charge Controls	46-51	Lighter Plugs	123
Cigarette Lighter Plugs	123	Lighting, Compact Fluorescent	146
Circulator Pumps	137	Lighting, Low Voltage	147
Clip, Cable	112	Lightning Protection	112
Composting Toilets	154-156	Linear Current Booster	125
Connectors, SB	107	Link 10 Meter	78
Crimping Tool	107	Load Center	118
DC Disconnect	114,116	LP Gas Refrigerators	151
DC Lights	146-149	Lugs	107
DC Pressure Booster Pumps	133-134	MC Cables	113
DC-DC Converter	76	Meter, AC Kilowatt-Hour	77
Delta Surge Arrestor	112	Meter, Analog Amp	77
Digital Meter	77	Meters and Meter Accessories	77
Disconnect	114	MorningStar Charge Controls	48-49
Diversion Load , Air Heater	52	Motion Sensor Switch	120
DR Inverters	54	Mounting Structures	22-37
Evaporative Cooler	144	MPPT Charge Controls	46-47
Evergreen PV Modules	14	Muffin Fans	142
Exeltech Inverters	72-73	Multimeter	77
Fans	142-143	Multimeter, Digital	77
Fat Spaniel Monitoring	80-81	Nickell Metal Hydride Batteries	157
Float Switch	125	NotePower Solar Charger	19
Fluorescent Lights	146	Nozzle Flow Chart	43
Fountain Pump	130	Outback FX Inverters	61-63
Freezers	151-153	Outback FX Options	63
Fronius Inverters	58	Outback Mate & Options	63
Fuses	115-117	Outback MX60	46
Generator Start Control	51	Outback Power System Battery Rack (PSR)	105
Ground Fault Protection	110	Outback Power Systems	64-67
Grundfos Submersible Pumps	126-128	Outback PowerSystems & Options	64-67

160 - INDEX

Outback PSPV Array Combiner Boxes	111	SQFlex Pumps	126-127
Pentametric Meter	79	Storage Tanks, Solar Thermal	140
Photo Switch	120	Strain Reliefs	113
Piston Pump	131	Submersible Pumps	126-129
Plugs & Receptacles, Cigarette Lighter	123	SunFrame	29
Plugs and Outlets	121	Sunny Boy Inverters	56-57
Pole Mounts	28,31-33	Sunny Central	55
Power Distribution Block	121	Surrette Batteries	98
Power Panels, Xantrex	71	Switches	120
Powerfilm	20-21	T-240, Autotransformer	69
PSSB Accessories	111	Tankless Water Heaters	138-140
Pumps	126-137	Terminals	107
PV Array Combiner	110-111	Thermostat	144
QO Circuit Breaker	117	Time Switch	120
Quick Charger	157	Toriod Autotransformers	68
Quick-Cote Anticorrosion Protectant	109	Towers for Wind Generators	39
Refrigerators	151-153	Trackers	35-37
Relay	53	Transfer Switch	119
RV Roof Connector	123	T-rated Switch	120
S5 Clamps	28	Trimetric Meter	79
Samlex Inverters	73,75	UniRac LA Series	30
Security Hardware	30	Unirac SolarMount	22-28
Shell Solar Modules	12, 13	Uni-Solar Modules	16,17,19
Shunt		Venturi Fans, DC powered	143
Shurflo Pressure Pumps	134	Volt & Amp Meters, Digital	77
SineWave Inverters	61-73	Voltage Controlled Switch	53
Skylights	150	Water Heating Elements	52
Slow Pump	132	Water Miser Caps	97
Small PV Modules	15	Wattsun Trackers	36-37
Smart Adapter	76	Wind Generators	7, 40-41
Solar Fans	143	Wind Information	38
Solar Insolation	10-11	Wind Speed Monitor	39
Solar Lights	145	Wire	122
Solar Modules	12-21	Wire Loss Chart	157
Solar Thermal Equipment	140-141	X-Power Power Packs	74
Spill Containment Tray	105	Yuasa Hup Solar-One Batteries	99
Splicer Block	121	Zomeworks Trackers	35