



Technical Information

22



Table of Contents

Technical Information	Page No.
Conductors	22.2–22.5
Table 1: Solid Copper Wire, American Wire Gage	22.2
Table 2: Stranded Copper Wire, American Wire Gage	22.3
Table 3: Current Ratings for Belden® Electronic Cables	22.4
Table 4: Metric/Imperial/Circular Mills/AWG Equivalents	22.5
Insulations and Jackets	22.6–22.11
Insulations: Overview	22.6
Jackets: Overview	22.6
Characteristics of Popular Insulation and Jacket Compounds	22.7
Table 4: Comparative Properties of Plastic Compounds	22.8
Table 5: Comparative Properties of Fluoropolymers	22.9
Table 6: Comparative Properties of Rubber Insulations	22.10
Table 7: Nominal Temperature Ranges	22.11
Shielding and Armoring	22.12–22.14
Shielding: Overview	22.12
Characteristics of Belden Shield Types	22.13
Foil Shields	22.13
Braid Shields	22.13
Spiral/Serve Shields	22.13
“French Braid” Shields	22.13
Combination Shields	22.13
Shield Types: Application Guide	22.14
Table 8: Relative Cost Comparison of Shield Types	22.14
Table 9: Shield Performance Comparison	22.14
Armoring: Overview	22.14
Metric Conversions	22.15–22.16
Table 10: Temperature Conversions	22.15
Table 11: Distance and Weight Conversion Formulas	22.15
Table 12: Conductor Size Equivalents	22.16
Belden Color Code Charts	22.17–22.19
Cable Standards Reference Guide	22.20
National Electrical Code (NEC)	22.20
Impact of NEC	22.20
Intended Uses of Appliance Wiring Materials (AWM)	22.20
C(UL) Certifications	22.20
FT1 Vertical Flame Test	22.20
FT4 Vertical Flame Test — Cables in Trays	22.20
FT6 Horizontal Flame and Smoke Test	22.20
NEC Cable Substitution Chart	22.21
Canadian Electrical Code (CEC) Substitution Chart	22.22
Terms of Use of Master Catalog	22.22
Environmental Regulations and Compliance	22.23
Cable Packaging	22.24
UnReel®	22.24
Reel-in-a-Box	22.24
Glossary	22.25–22.36

The information, graphs, tables and illustrations presented in this section are provided to assist Belden customers with the selection of the most appropriate cable for their application. For further assistance, contact Belden Technical Support at: **1-800-BELDEN-1**.

Conductors

Table 1: Solid Copper Wire, American Wire Gage

Gage (AWG)	Nominal OD		Nominal Circular MIL Area	Nominal Weight (Lbs. per 1000 Ft.)	Nominal Resistance @ 68°F (Ω /1000 Ft.)
	Inches	mm			
10	.1019	2.60	10380.0	31.43	.9989
11	.0907	2.30	8234.0	24.92	1.260
12	.0808	2.05	6530.0	19.77	1.588
13	.0720	1.83	5178.0	15.68	2.003
14	.0641	1.63	4107.0	12.43	2.525
15	.0571	1.45	3260.0	9.858	3.184
16	.0508	1.29	2583.0	7.818	4.016
17	.0453	1.15	2050.0	6.200	5.064
18	.0403	1.02	1620.0	4.917	6.385
19	.0359	.912	1200.0	3.899	8.051
20	.0320	.813	1020.0	3.092	10.15
21	.0285	.724	812.1	2.452	12.80
22	.0253	.643	640.4	1.945	16.14
23	.0226	.574	511.5	1.542	20.36
24	.0201	.511	404.0	1.223	25.67
25	.0179	.455	320.4	.9699	32.37
26	.0159	.404	253.0	.7692	40.81
27	.0142	.361	201.5	.6100	51.47
28	.0126	.320	159.8	.4837	64.90
29	.0113	.287	126.7	.3836	81.83
30	.0100	.254	100.5	.3042	103.2
31	.0089	.226	79.7	.2413	130.1
32	.0080	.203	63.21	.1913	164.1
33	.0071	.180	50.13	.1517	206.9
34	.0063	.160	39.75	.1203	260.9
35	.0056	.142	31.52	.09542	331.0
36	.0050	.127	25.00	.07568	414.8
37	.0045	.114	19.83	.0613	512.1
38	.0040	.102	15.72	.04759	648.6
39	.0035	.089	12.20	.03774	847.8
40	.0031	.079	9.61	.02993	1080.0

Information from National Bureau of Standards Copper Wire Tables — Handbook 100.

Unparalleled Performance

Belden is one of only a very few cable manufacturers to draw and anneal its own conductors. This is a time-consuming process, but it allows us to ensure signal integrity, as well as proper physical characteristics.

In addition, the standards under which we design and manufacture our fiber optic cabling are among the strictest in the industry. The result is a comprehensive offering of products which give unparalleled performance and can satisfy your most demanding operating and environmental challenges.

Conductors

Table 2: Stranded Copper Wire, American Wire Gage

Gage (AWG)	Stranding (Nom. AWG)	Min. Average OD of Strand	Approximate OD		ASTM Min. Circular MIL Area	Min. Weight (Lbs./1000 Ft.)	Max. Resistance* @ 68°F (Ω/1000 Ft.)
			Inches	mm			
36	7x44	.0019	.006	.152	25	.076	414.8
34	7x42	.0024	.0075	.191	39.7	.121	260.9
32	7x40	.0030	.0093	.236	64	.195	164.1
32	19x44	.0018	.010	.254	64	.195	164.1
30 ♦	7x38	.0038	.012	.305	100	.304	112.0
30	19x42	.0023	.012	.305	100	.304	112.0
28 ♦	7x36	.0048	.015	.381	159	.484	70.7
28 ♦	19x40	.0029	.016	.406	159	.484	70.7
27	7x35	.0054	.017	.432	202	.614	55.6
26 ♦	7x34	.0060	.019	.483	253	.770	44.4
26	10x36	.0050	.021	.533	253	.770	44.4
26 ♦	19x38	.0036	.020	.508	253	.770	44.4
24 ♦	7x32	.0076	.024	.610	404	1.229	27.7
24	10x34	.0064	.024	.610	404	1.229	27.7
24 ♦	19x36	.0046	.024	.610	404	1.229	27.7
24 ♦	42x40	.0031	.023	.584	404	1.229	27.7
22 ♦	7x30	.0096	.030	.762	640	1.947	17.5
22 ♦	19x34	.0058	.031	.787	640	1.947	17.5
22	26x36	.0050	.030	.762	640	1.947	17.5
20 ♦	7x28	.0126	.038	.965	1020	3.103	10.9
20	10x30	.0101	.037	.940	1020	3.103	10.9
20 ♦	19x32	.0073	.037	.940	1020	3.103	10.9
20	26x34	.0063	.036	.914	1020	3.103	10.9
20 ♦	42x36	.0049	.038	.965	1020	3.103	10.9
18 ♦	7x26	.0152	.048	1.22	1620	4.93	6.92
18	16x30	.0101	.047	1.19	1620	4.93	6.92
18 ♦	19x30	.0092	.049	1.24	1620	4.93	6.92
18 ♦	42x34	.0062	.047	1.19	1620	4.93	6.92
18 ♦	65x36	.0050	.047	1.19	1620	4.93	6.92
16 ♦	7x24	.0192	.060	1.52	2580	7.85	4.35
16 ♦	19x29	.0117	.058	1.47	2580	7.85	4.35
16	26x30	.0100	.059	1.50	2580	7.85	4.35
16 ♦	65x34	.0063	.059	1.50	2580	7.85	4.35
16	105x36	.0050	.059	1.50	2580	7.85	4.35
14 ♦	7x22	.0242	.076	1.93	4110	12.50	2.73
14 ♦	19x26	.0147	.071	1.80	4110	12.50	2.73
14 ♦	42x30	.0099	.075	1.91	4110	12.50	2.73
14	105x34	.0063	.075	1.91	4110	12.50	2.73
12 ♦	7x20	.0305	.096	2.44	6530	19.86	1.71
12 ♦	19x25	.0185	.093	2.36	6530	19.86	1.71
12 ♦	65x30	.0100	.095	2.41	6530	19.86	1.71
12	165x34	.0063	.095	2.41	6530	19.86	1.71
10	37x26	.0167	.115	2.92	10380	31.58	1.08
10	65x28	.0126	.120	3.05	10380	31.58	1.08
10	105x30	.0099	.118	3.00	10380	31.58	1.08

*AWG 10 through 30 per UL Subject 13.

Belden has standardized on the stranded conductors used in the design of all Belden® products. These preferred constructions, based on standard industry practices, are marked with a ♦ symbol.

Conductors

Table 3: Current Ratings for Belden® Electronic Cables

The maximum continuous current rating for an electronic cable is limited by conductor size, number of conductors contained within the cable, maximum temperature rating of the cable, and environmental conditions such as ambient temperature and air flow. To use the current capacity chart, first determine conductor size, temperature rating, and number of conductors from the applicable product description for the cable of interest.

Next, find the current value on the chart for the proper temperature rating and conductor size. To calculate the maximum current rating/conductor, multiply the chart value by the appropriate conductor factor. The chart assumes cable is surrounded by still air at an ambient temperature of 25°C. Current values are in RMS Amperes and are valid for copper conductors only. For conditions other than specified, contact Belden Technical Support at: **1-800-BELDEN-1**.

Note: Current ratings are intended as general guidelines for low power electronic communications and control applications. Current ratings for power applications generally are set by regulatory agencies such as UL, CSA, NEC, and others.

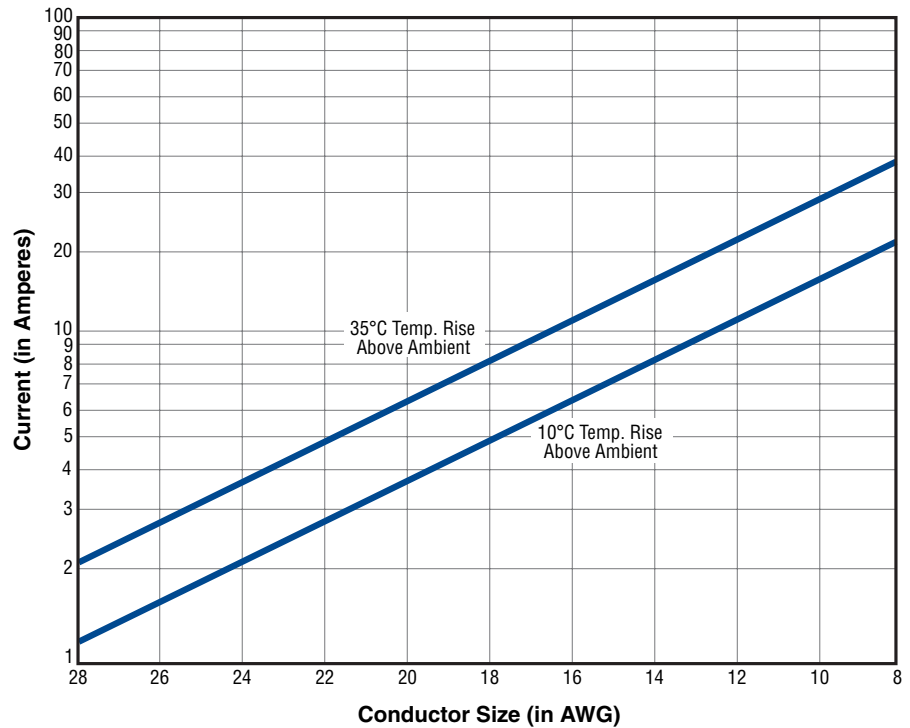

Current Ratings

No. of Conductors*	Factor
1	1.6
2 to 3	1.0
4 to 5	.8
6 to 15	.7
16 to 30	.5

*Do not count shields unless used as conductor.

Conductors

Table 4: Metric / Imperial / AWG Equivalents
(Square Millimeters / Square Inches / Circular Mils / AWG)

Sq. mm	Sq. in.	Cir. mils	AWG	Sq. mm	Sq. in.	Cir. mils	AWG	Sq. mm	Sq. in.	Cir. mils	AWG
1000	1.550	1974000		55	.0853	108570		5.00	.00775	9870	
975	1.511	1924700		—	—	105600	1/0	4.75	.00736	9377	
950	1.472	1875300		50	.0775	98700		4.50	.00698	8883	
925	1.434	1826000		45	.0698	88830		4.25	.00659	8390	
900	1.395	1776600		—	—	83690	1	—	—	8230	11
875	1.356	1727300		40	.0620	78960		4.00	.00620	7896	
850	1.317	1677900		35	.0542	69090		3.75	.00581	7403	
825	1.279	1628600		—	—	66360	2	3.50	.00542	6909	
800	1.240	1579200		30	.0465	59220		—	—	6530	12
775	1.201	1529900		—	—	52620	3	3.25	.00504	6416	
750	1.163	1480500		25	.0388	49350		3.00	.00465	5922	
725	1.124	1431200		—	—	41740	4	2.75	.00426	5429	
700	1.085	1381800		20.0	.0310	39480		—	—	5180	13
675	1.046	1332500		19.5	.0302	38490		2.50	.00388	4935	
650	1.008	1283100		19.0	.0294	37510		2.25	.00349	4422	
625	.969	1233800		18.5	.0287	36520		—	—	4110	14
600	.930	1184400		18.0	.0279	35530		2.00	.00310	3948	
575	.891	1135100		17.5	.0271	34550		1.75	.00271	3455	
550	.853	1085700		17.0	.0264	33560		—	—	3260	15
525	.814	1036400		—	—	33090	5	1.50	.00233	2961	
500	.775	987000		16.5	.0256	32560		—	—	2580	16
475	.736	937700		16.0	.0248	31580		1.25	.00194	2468	
450	.698	888300		15.5	.0240	30600		—	—	2050	17
425	.659	839000		15.0	.0233	29610		1.00	.00155	1974	
400	.620	789600		14.5	.0225	28620		.90	.00140	1777	
375	.581	740300		14.0	.0217	27640		—	—	1620	18
350	.542	690900		13.5	.0209	26650		.80	.00124	1579	
325	.504	641600		—	—	26420	6	.75	.00116	1481	
300	.465	592200		13.0	.0201	25660		.70	.00109	1382	
275	.426	542900		12.5	.0194	24680		—	—	1290	19
250	.388	493500		12.0	.0186	23690		.60	.00093	1184	
225	.349	444200		11.5	.0178	22700		—	—	1029	20
200	.310	394800		11.0	.0171	21710		.50	.000775	987	
175	.271	345500		—	—	20820	7	—	—	—	
150	.233	296100		10.5	.0163	20730		—	—	—	
125	.1938	246800		10.0	.0155	19740		9.5	.01472	18753	
—	—	211600	4/0	9.5	.01395	17766		9.0	.01395	17766	
100	.1550	197400		8.5	.01317	16779		8.5	.01317	16779	
95	.1472	187530		—	—	16510	8	—	—	16510	8
90	.1395	177660		8.0	.01240	15792		8.0	.01240	15792	
—	—	167800	3/0	7.5	.01163	14805		7.5	.01163	14805	
85	.1317	167790		7.0	.01085	13818		7.0	.01085	13818	
80	.1240	157920		—	—	13090	9	—	—	13090	9
75	.1163	148050		6.5	.01008	12831		6.5	.01008	12831	
70	.1085	138180		6.0	.00930	11844		6.0	.00930	11844	
—	—	133100	2/0	5.5	.00853	10857		5.5	.00853	10857	
65	.1008	128310		—	—	10380	10	—	—	10380	10
60	.0930	118440		—	—	—		—	—	—	

To Convert:	Multiply by:
Inches to millimeters	25.4
Millimeters to inches	.03937

Insulations and Jackets

Overview

Insulations

Belden expends a great amount of time and effort to formulate its own insulations. As a result, Belden® insulations provide superior performance under a variety of hostile environmental conditions. Belden cables are available in UL Listed and CSA Approved insulation compounds.

Among the insulations we utilize are:

- **Polyethylene**
- **Polyvinyl-chloride (PVC)**
- **Polypropylene**

Also available are:

- **Datalene®** — For computer and data transmission. Datalene is crush resistant, lightweight, and offers good performance characteristics over a wide range of temperatures.
- **Teflon® Insulated Plenum & High-Temperature Cables** — For data communications, instrumentation/control, and other commercial and industrial applications. Plenum cables eliminate the need for conduit and reduce installation time.

Jackets

Belden electronic cables are manufactured in a wide selection of jacketing materials.

- **Flamarrest®** — A Belden jacketing innovation, Flamarrest is a low-smoke, flame retardant compound that is five times more flexible than fluorocopolymer. Cables jacketed with Flamarrest are cost efficient and easy to install.

Also included in our wide selection of jacketing compounds are:

- **Polyvinyl-chloride**
- **Polyethylene**
- **Polyurethane**
- **Teflon**
- **Tefzel®**
- **Halar®**
- **Neoprene**
- **EPDM**
- **Hypalon®**
- **Silicone rubber**
- **Natural rubber**

Special compounds and variations of standard compounds are used as well.

Teflon, Tefzel and Hypalon are DuPont trademarks.
Halar is an Ausimont Corporation trademark.

Insulations and Jackets

Typical Characteristics of Popular Insulation and Jacketing Compounds

EPDM

EPDM (ethylene-propylene-diene elastomer) is a chemically cross-linked elastomer with excellent flexibility at high and low temperatures (150° to -55°C). It has good insulation resistance and dielectric strength, as well as excellent abrasion resistance and mechanical properties. EPDM also has better cut-through resistance than Silicone rubber, which it replaces in some applications.

EPDM is compatible with most varnishes, but after the dip and bake cycle varnish tends to adhere to the insulation (because EPDM, unlike some rubber insulations, does not exude oils or waxes). As lead wires are pulled apart for termination, the varnish cracks, sometimes breaking the insulation.

To resolve this problem, a stearic solution is applied to the lead wire during the put-up process. This ensures that rigid varnish does not cause EPDM insulation to rupture when the wire is terminated.

Field evaluations by numerous users reveal that the coated EPDM has excellent varnish resistance at least equal to synthetic elastomers, cross-link polyethylene, or Silicone glass braid in dip and bake systems.

Flamarrest®

Flamarrest is a plenum grade chloride-based jacketing material with low smoke and low flame spread properties. Cables jacketed with Flamarrest meet the ANSI/NFPA Standard 262-1985 (UL910), Plenum Cable Flame Test.

Halar®

Thermoplastic fluoropolymer material with excellent chemical resistance, electrical properties, thermal characteristics, and impact resistance. The temperature rating is -70°C to 150°C.

Neoprene

The temperature range of this material can vary from -55°C to 90°C. The actual range would depend on the formulation used. Neoprene is both oil-resistant and sunlight-resistant, making it ideal for many outdoor applications. The most stable colors are Black, Dark Brown, and Gray. The electrical properties are not as good as other insulation materials. Because of this, thicker insulation should be used. Typical designs where this material is used are lead wire insulation and cable jackets.

Polyethylene (Solid and Foamed)

A very good insulation in terms of electrical properties. Low dielectric constant, a stable dielectric constant over all frequencies, very high insulation resistance. In terms of flexibility, polyethylene can be rated stiff to very hard, depending on molecular weight and density—low density being the most flexible, with high-density, high-molecular weight formulation being very hard. Moisture resistance is rated excellent. Black and specially formulated colored versions have excellent weather resistance. The dielectric constant is 2.3 for solid insulation and typically 1.64 for foam designs. Flame retardant formulations are available with dielectric constants ranging from about 1.7 for foam flame retardant to 2.58 for solid flame retardant polyethylene.

Polypropylene (Solid and Foam)

Similar in electrical properties to polyethylene. This material is primarily used as an insulation material. Typically, it is harder than polyethylene. This makes it suitable for thin wall insulations. UL maximum temperature rating may be 60°C, 80°C or 105°C. The dielectric constant is 2.25 for solid and typically 1.55 for foam designs.

Polyurethane

This material is used primarily as a cable jacket material. It has excellent oxidation, oil, and ozone resistance. Some formations also have good flame resistance. It is a hard material with excellent abrasion resistance. It has outstanding "memory" properties, making it an ideal jacket material for retractile cords.

PVC

Sometimes referred to as vinyl or polyvinylchloride. Extremely high or low temperature properties cannot be found in one formulation. Certain formulations may have -55°C to 105°C rating. Other common vinyls may have -20°C to 60°C. There are many formulations for the variety of different applications. The many varieties of PVC also differ in pliability and electrical properties. The price range can vary accordingly. Typical dielectric constant values can vary from 3.5 to 6.5.

Rubber

The description of rubber normally includes natural rubber and SBR compounds. Both of these materials can be used for insulations and jackets. There are many formulations of these basic materials. Each formulation is for a specific application. Some formulations are suitable for -55°C minimum, while others are suitable for 75°C maximum.

Silicone

This is a very soft insulation which has a temperature range from -80°C to 200°C. It has excellent electrical properties plus ozone resistance, low moisture absorption, weather resistance, and radiation resistance. It typically has low mechanical strength and poor scuff resistance.

Teflon®

This material has excellent electrical properties, temperature range and chemical resistance. It is not suitable where subjected to nuclear radiation and does not have good high voltage characteristics. FEP Teflon is extrudable in a manner similar to PVC and polyethylene. This means that long wire and cable lengths are available. TFE Teflon is extrudable in a hydraulic ram type process. Lengths are limited due to amount of material in the ram, thickness of the insulation, and preform size. TFE must be extruded over a silver- or nickel-coated wire. The nickel- and silver-coated designs are rated 260°C and 200°C maximum, respectively. The cost of Teflon is approximately 8 to 10 times more per pound than PVC compounds.

Tefzel®

Fluorocopolymer thermoplastic material having excellent electrical properties, heat resistance, chemical resistance, toughness, radiation resistance, and flame resistance. The temperature rating is -65°C to 150°C.

Teflon and Tefzel are DuPont trademarks.
Halar is a Solvay Solexis trademark.

Insulations and Jackets

Table 4: Comparative Properties of Plastic Insulating and Jacketing Compounds

Properties	PVC	LDPE	Cellular Polyethylene	HDPE	Polypropylene	Cellular Polypropylene	PUR	Nylon	CPE	Flamarrest®
Oxidation Resistance	E	E	E	E	E	E	E	E	E	E
Heat Resistance	G-E	G	G	E	E	E	G	E	E	G-E
Oil Resistance	F	G-E	G	G-E	F	F	E	E	E	F
Low-Temperature Flexibility	P-G	E	E	E	P	P	G	G	E	P-G
Weather, Sun Resistance	G-E	E	E	E	E	E	G	E	E	G
Ozone Resistance	E	E	E	E	E	E	E	E	E	E
Abrasion Resistance	F-G	G	F	E	F-G	F-G	O	E	E-O	F-G
Electrical Properties	F-G	E	E	E	E	E	P	P	E	G
Flame Resistance	E	P	P	P	P	P	P	P	E	E
Nuclear Radiation Resistance	F	G-E	G	G-E	F	F	G	F-G	O	F
Water Resistance	F-G	E	E	E	E	E	P-G	P-F	O	F
Acid Resistance	G-E	G-E	G-E	E	E	E	F	P-F	E	G
Alkali Resistance	G-E	G-E	G-E	E	E	E	F	E	E	G
Aliphatic Hydrocarbons Resistance (Gasoline, Kerosene, etc.)	P	G-E	G	G-E	P-F	P	P-G	G	E	P
Aromatic Hydrocarbons Resistance (Benzol, Toluol, etc.)	P-F	P	P	P	P-F	P	P-G	G	G-E	P-F
Halogenated Hydrocarbons Resistance (Degreaser Solvents)	P-F	G	G	G	P	P	P-G	G	E	P-F
Alcohol Resistance	P-F	E	E	E	E	E	P-G	P	E	G
Underground Burial	P-G	G	N/A	E	N/A	N/A	G	P	E-O	P

CPE = Chlorinated Polyethylene • HDPE = High-density Polyethylene • LDPE = Low-density Polyethylene • PUR = Polyurethane

These ratings are based on average performance of general purpose compounds.
Any given property can usually be improved by the use of selective compounding.

Legend

P	Poor
F	Fair
G	Good
E	Excellent
O	Outstanding

Insulations and Jackets

Table 5: Comparative Properties of Fluoropolymer Insulating and Jacketing Compounds

Properties	FEP Teflon®	Tefzel® (ETFE)	PTFE Teflon	Solef® / Kynar® (PVDF) / PVF	Halar® (E-CTFE)
Oxidation Resistance	O	E	O	O	O
Heat Resistance	O	E	O	O	O
Oil Resistance	O	E	E-O	E	O
Low-Temperature Flexibility	O	E	O	F	O
Weather, Sun Resistance	O	E	O	E-O	O
Ozone Resistance	E	E	O	E	E
Abrasion Resistance	E	E	O	E	E
Electrical Properties	E	E	E	G-E	E
Flame Resistance	O	G	E	E	E-O
Nuclear Radiation Resistance	P-G	E	P	E	E
Water Resistance	E	E	E	E	E
Acid Resistance	E	E	E	G-E	E
Alkali Resistance	E	E	E	E	E
Aliphatic Hydrocarbons Resistance (Gasoline, Kerosene, etc.)	E	E	E	E	E
Aromatic Hydrocarbons Resistance (Benzol, Toluol, etc.)	E	E	E	G-E	E
Halogenated Hydrocarbons Resistance (Degreaser Solvents)	E	E	E	G	E
Alcohol Resistance	E	E	E	E	E
Underground Burial	E	E	E	E	E

These ratings are based on average performance of general purpose compounds.
Any given property can usually be improved by the use of selective compounding.

Legend	
P	Poor
F	Fair
G	Good
E	Excellent
O	Outstanding

Teflon and Tefzel are DuPont trademarks.
Halar is a Solvay Solexis trademark.
Solef is a Solvay trademark.
Kynar is a Atofina Chemical Corporation trademark.

Insulations and Jackets

Table 6: Comparative Properties of Rubber Insulations

Properties	Rubber	Neoprene	Hypalon® (Chlorosulfonated Polyethylene)	EPDM (Ethylene-Propylene- Diene Elastomer)	Silicone
Oxidation Resistance	F	G	E	E	E
Heat Resistance	F	G	E	E	O
Oil Resistance	P	G	G	P	F-G
Low-Temperature Flexibility	G	F-G	F	G-E	O
Weather, Sun Resistance	F	G	E	E	O
Ozone Resistance	P	G	E	E	O
Abrasion Resistance	E	G-E	G	G	P
Electrical Properties	G	P	G	E	G
Flame Resistance	P	G	G	P	F-G
Nuclear Radiation Resistance	F	F-G	E	G	E
Water Resistance	G	E	E	G-E	G-E
Acid Resistance	F-G	G	E	G-E	F-G
Alkali Resistance	F-G	G	E	G-E	F-G
Aliphatic Hydrocarbons Resistance (Gasoline, Kerosene, etc.)	P	G	F	P	P-F
Aromatic Hydrocarbons Resistance (Benzol, Toluol, etc.)	P	P-F	F	F	P
Halogenated Hydrocarbons Resistance (Degreaser Solvents)	P	P	P-F	P	P-G
Alcohol Resistance	G	F	G	P	G

These ratings are based on average performance of general purpose compounds. Any given property can usually be improved by the use of selective compounding.

Legend

P	Poor
F	Fair
G	Good
E	Excellent
O	Outstanding

Hypalon is a DuPont trademark.

Insulations and Jackets

Table 7: Nominal Temperature Range for Various Insulating and Jacketing Compounds

Compound	Normal Low	Normal High	Special Low	Special High
Chlorosulfonated Polyethylene (Hypalon®)	-20°C	90°C	-40°C	105°C
EPDM (Ethylene-Propylene-Diene Monomer)	-55°C	105°C	—	150°C
Neoprene	-20°C	60°C	-55°C	90°C
Polyethylene (Solid and Foamed)	-60°C	80°C	—	—
Polypropylene (Solid and Foamed)	-40°C	105°C	—	—
Rubber	-30°C	60°C	-55°C	75°C
FEP Teflon®	-70°C	200°C	—	—
PVC	-20°C	80°C	-55°C	105°C
Silicone	-80°C	150°C	—	200°C
Halar®	-70°C	150°C	—	—
Tefzel®	-65°C	150°C	—	—
PTFE Teflon	-70°C	260°C	—	—
CPE	-35°C	90°C	-45°C	105°C
Solef® / Kynar®	-20°C	150°/125°C	-40°C	150°/150°C
Flamarrest®	-20°C	75°C	—	—

Hypalon, Teflon and Tefzel are DuPont trademarks.
 Halar is a Solvay Sollexis trademark.
 Solef is a Solvay trademark.
 Kynar is a Atofina Chemical Corporation trademark.

Shielding and Armoring

Overview

Innovative Leadership

The evolution of technology maintains steady demand for sophisticated cable shielding. Belden meets that demand with innovative shielding and shield effectiveness testing methods to supply you with high quality, dependable cable.

With the creation of trademarked shield designs and patented test methods, Belden has earned a reputation for innovation and leadership that is unequalled in the wire and cable industry. In addition, Belden offers the broadest line of shielded multi-conductor, coaxial and flat cable in the industry.

Several unique Belden innovations are utilized across a wide range of shielding applications:

- **Beldfoil®** — The first aluminum/polyester foil developed for use as a cable shield. Provides 100% shield coverage for optimum protection.
- **Duofoil®** — Consists of an aluminum-poly-aluminum laminate wrapped around the cable's dielectric core. Provides 100% physical coverage, and improves shield reliability and flex life.

Belden also utilizes a number of innovative techniques to apply shielding to multi-conductor and paired cables:

- **“French Braid” Shields** — Belden's patented “French Braid” shield is a double spiral (double serve shield) with the two spirals tied together by one weave.

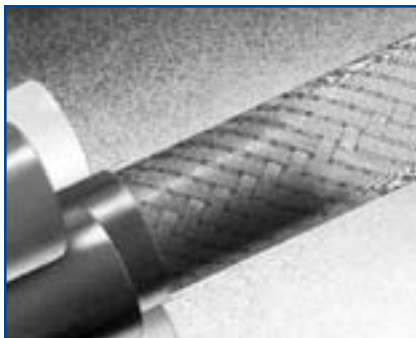

Belden's patented “French Braid” shield.

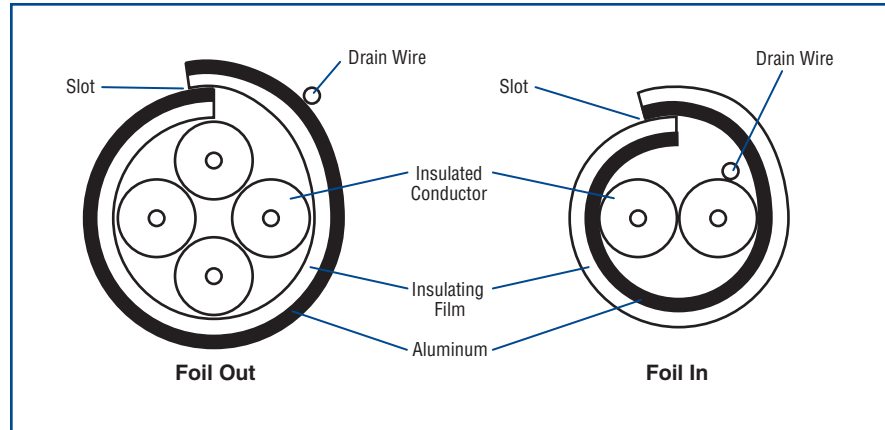

Figure 1: Foil shield configurations without shorting folds.

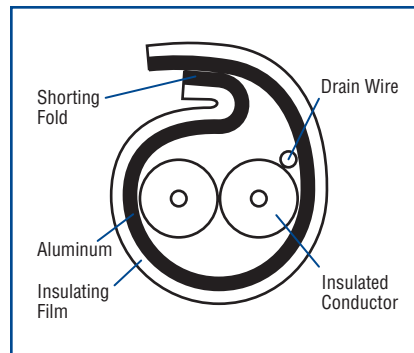

Figure 2: Foil shield configuration with shorting fold.

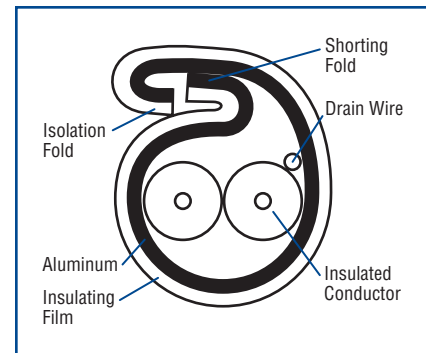

Figure 3: Foil shield with Z-Fold reduces crosstalk in multi-pair applications.

- **Shorting Fold** — Belden uses a shorting fold technique to maintain metal-to-metal contact for improved high frequency performance. Without the shorting fold, a slot is created through which signals can leak and cause interference. (See Figures 1 and 2 above.)

- **Z-Fold®** — Belden improves on the traditional shorting fold by employing a Z-Fold designed for use in multi-pair applications to reduce crosstalk. The Z-Fold (see Figure 3) combines an isolation and a shorting fold. The shorting fold provides metal-to-metal contact while the isolation fold keeps shields from shorting to one another in multi-pair, individually shielded cables.

The use of either a shorting fold or a Z-Fold increases the foil shield's range of effectiveness to higher frequencies.

Shielding and Armoring

Characteristics of Belden® Shield Types and Armor Styles

Foil Shields

Foil shields consist of aluminum foil laminated to a polyester or polypropylene film. The film gives the shield mechanical strength and bonus insulation. Foil shields provide 100% cable coverage, necessary for electrostatic shield protection. Because of their small size, foil shields are commonly used to shield individual pairs of multi-pair data cables to reduce crosstalk. They have less weight, bulk and cost less than spiral or braid shields and are generally more effective than braid shields in RF ranges. Foil shields are more flexible than braid but have a shorter flex life than spiral or braid.

Drain wires are used with foil shields to make termination easier and to ground electrostatic discharges. The shortcomings in using the foil shield include higher DC resistance and lower mechanical strength than braid or spiral shields.



Braid Shields

A braid shield consists of groups of tinned or bare copper or aluminum strands, one set woven in a clockwise direction and interwoven with another set in a counter-clockwise direction.

Braid shields provide superior structural integrity, while maintaining good flexibility and flex life. These shields are ideal for minimizing low frequency interference and have lower DC resistance than foil. Braid shields are effective at audio, as well as RF ranges. Generally, the higher the braid coverage, the more effective the shield. However, the trade-off between cost and braid coverage must be considered. Typical braid coverages are between 80% and 95%. Coverage of 100% is unattainable with a braid shield. Other features to consider when choosing a braid shield are the weave angle, strand diameter, number of carriers (strand groups) and the number of ends (strands).

Braid shields are generally bulkier and heavier than other shields and, in some cases, harder to terminate because the braid may be combed out and pigtailed.

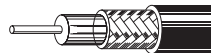

Spiral/Serve Shields

A spiral/serve shield consists of wire (usually copper) wrapped in a spiral around the inner cable core.

Superior flexibility and flex life, ease of termination and up to 97% coverage are the advantages of spiral shields. They are best suited for audio applications. As a rule, spiral shields are not effective above the audio frequency range due to the coil effect produced by the inductance of served wire strands.



“French Braid” Shields

Belden’s patented “French Braid” shield is a double spiral (double serve shield) with the two spirals tied together by one weave. This construction provides improved flex life over standard spiral shields, improved flexibility over conventional braid shields, and lower levels of microphonic or triboelectric noise than either spiral or conventional braid shields.



Combination Shields

Combination shields consist of more than one layer of shielding. They provide maximum shield efficiency across the frequency spectrum. The combination foil/braid shield combines the advantages of 100% foil coverage, plus the strength and low DC resistance of the braid.

Belden has also developed a number of shielding configurations for use with broadband coaxial cables.

- **Duobond®**
Duobond is essentially the same construction as Duofoil® (a laminated tape of foil/film/foil), but with an extra layer of adhesive bonding the foil shield to the dielectric core. This foil shield provides 100% coverage and insures maximum shield protection.

- **Duobond II (Foil/Braid)**

Combines Duobond with an outer braid, applied for greater protection against interference and to increase the overall tensile strength.



- **Duobond III (Tri-Shield)**

Utilizes the Duobond II design (foil/braid) plus a surrounding layer of Duofoil. The extra foil layer improves shield reliability and provides an additional interference barrier.



- **Duobond Plus®** — Features foil/braid/foil construction with a shorting fold in the outermost foil. This fold prevents a slot opening from being created in the shield, thereby preventing signal egress or ingress.

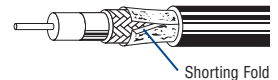

- **Duobond IV (Quad Shield)**

Offers an extra layer of braid shield (foil/braid/foil/braid) for improved strength and durability.



Other combination shields are available such as the foil/braid/foil/braid used on the Ethernet cables, braid/braid or foil/spiral.

Armoring

Belden’s innovative technology delivers maximum effectiveness to meet the performance requirements of a wide range of applications.

Belden also has the capability to protect electronic, instrumentation, and control cables with interlocking steel or aluminum armor.

Shielding and Armoring

Shield Types Application Guide, Table 8: Relative Cost Comparison of Shield Types

Table 9: Shield Performance Ratings

Shield Types Application Guide

Choose a Foil Shield...

- For protection against capacitive (electric field) coupling where shield coverage is more important than low DC resistance.
- When possible sources of interference include TV signals, crosstalk from other circuits, radio transmitters, fluorescent lights or computing equipment.
- For MATV, CATV, video, networking, computer I/O cables in office, industrial or commercial environments where ambient EMI levels are low.

Choose a Braid Shield...

- For superior performance against diffusion coupling, where low DC resistance is important, and to a lesser extent, capacitive and inductive coupling.
- When possible sources of interference exhibit low impedance characteristics, such as motor control circuits and switches which operate inductive loads.
- For computer to terminal interconnect for process, instrumentation or control applications.

Choose a Spiral Shield...

- For functional shielding against diffusion and capacitive coupling at audio frequencies only.
- When possible sources of interference are power lines and fluorescent lights.
- For applications when flexibility and flex life are major concerns, such as microphone and audio cables and retractile cords.

Choose a Combination Shield...

- For shielding against high frequency radiated emissions coupling and ESD. Combines the low resistance of braid and 100% coverage of foil shields.
- When possible sources of interference include radio transmitters, TV stations, printed circuit boards, back planes, motor control circuits and computing equipment.
- For Video, CATV, MATV, networking, computer I/O cables and computer-aided manufacturing applications.

Table 8: Relative Cost Comparison

Relative cost comparisons are based on coaxial cable. Chart shows relative shield cost as one component of the total cost of the cable. *These cost ratings may change depending on the physical construction of the cable.*

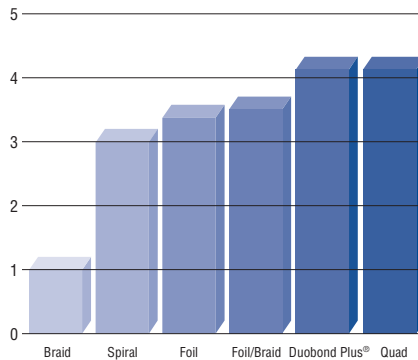

Table 9: Shield Performance Comparison Chart

Frequency Range and Types of Interference Anticipated	Cable Shield Ratings*				
	Braid (95% Coverage)	Spiral	Foil	Foil/Braid	Foil/Braid/Foil Duobond Plus®
Frequency: DC					
Capacitive	A	AA	AAA	AAA	AAA
Diffusion	AAA	A	C	AAA	AAA
Diffusion/Inductive	—	—	—	—	—
Diffusion/Inductive/Capacitive	—	—	—	—	—
Frequency: 15 kHz					
Capacitive	A	AA	AAA	AAA	AAA
Diffusion	AAA	B	C	AAA	AAA
Diffusion/Inductive	AA	C	A	AA	AAA
Diffusion/Inductive/Capacitive	—	—	—	—	—
Frequency: 10 MHz to 1000 MHz					
Capacitive	A	AA	AAA	AAA	AAA
Diffusion	—	—	—	—	—
Diffusion/Inductive	B	C	A	AA	AAA
Diffusion/Inductive/Capacitive	B	C	A	AA	AAA

*Although ratings shown in Table 9 are based on shielded coaxial cable test results, these ratings also pertain to shielded multi-conductor and flat cable where shield types are available.

Note: Shield effectiveness decreases as frequency increases. Therefore, ratings in one frequency category do not imply equal shield effectiveness in other frequency categories.

Shield Rating Key	
AAA	Best
AA	Better
A	Good
B	Functional
C	Unsatisfactory
—	Not Applicable

Metric Conversions

Table 10: Temperature Conversion Chart and Formula

Table 11: Distance and Weight Conversion Formulas

Table 10: Temperature Conversion Chart

°C ↔ °F	°C ↔ °F	°C ↔ °F	Temp. Conversion Formulas			
210	410	125	257	40	104	$^{\circ}\text{C} = \frac{5}{9} (^{\circ}\text{F} - 32)$
205	401	120	248	35	95	
200	392	115	239	30	86	$^{\circ}\text{F} = \frac{9}{5} ^{\circ}\text{C} + 32$
195	383	110	230	25	77	
190	374	105	221	20	68	
185	365	100	212	15	59	
180	356	95	203	10	50	
175	347	90	194	5	41	
170	338	85	185	0	32	
165	329	80	176	-5	23	
160	320	75	167	-10	14	
155	311	70	158	-15	5	
150	302	65	149	-20	-4	
145	293	60	140	-25	-13	
140	284	55	131	-30	-22	
135	275	50	122	-35	-31	
130	266	45	113	-40	-40	

Table 11: Distance and Weight Conversion Formulas

To Convert:	Multiply by:
Inches to millimeters	25.4
Millimeters to inches	.03937
Meters to feet	3.2808
Feet to meters	.3048
Kilometers to feet	3280.8
Feet to kilometers	.0003048
Kilograms to pounds	2.205
Pounds to kilograms	.4536
Pounds/1000 feet to pounds/1000 meters	3.2808
Pounds/1000 feet to kilograms/1000 meters	1.4882
Kilograms/1000 meters to pounds/1000 feet	.6719

Metric Conversions

Table 12: Conductor Size Equivalents (mm²/inch²/circular mils /AWG)

Sq. mm	Sq. in.	Cir. mils.	AWG	Sq. mm	Sq. in.	Cir. mils.	AWG	Sq. mm	Sq. in.	Cir. mils.	AWG
1000	1.550	1974000		55	.0853	108570		5.00	.00775	9870	
975	1.511	1924700		—	—	105600	1/0	4.75	.00736	9377	
950	1.472	1875300		50	.0775	98700		4.50	.00698	8883	
925	1.434	1826000		45	.0698	88830		4.25	.00659	8390	
900	1.395	1776600		—	—	83690	1	—	—	8230	11
875	1.356	1727300		40	.0620	78960		4.00	.00620	7896	
850	1.317	1677900		35	.0542	69090		3.75	.00581	7403	
825	1.279	1628600		—	—	66360	2	3.50	.00542	6909	
800	1.240	1579200		30	.0465	59220		—	—	6530	12
775	1.201	1529900		—	—	52620	3	3.25	.00504	6416	
750	1.163	1480500		25	.0388	49350		3.00	.00465	5922	
725	1.124	1431200		—	—	41740	4	2.75	.00426	5429	
700	1.085	1381800		20.0	.0310	39480		—	—	5180	13
675	1.046	1332500		19.5	.0302	38490		2.50	.00388	4935	
650	1.008	1283100		19.0	.0294	37510		2.25	.00349	4422	
625	.969	1233800		18.5	.0287	36520		—	—	4110	14
600	.930	1184400		18.0	.0279	35530		2.00	.00310	3948	
575	.891	1135100		17.5	.0271	34550		1.75	.00271	3455	
550	.853	1085700		17.0	.0264	33560		—	—	3260	15
525	.814	1036400		—	—	33090	5	1.50	.00233	2961	
500	.775	987000		16.5	.0256	32560		—	—	2580	16
475	.736	937700		16.0	.0248	31580		1.25	.00194	2468	
450	.698	888300		15.5	.0240	30600		—	—	2050	17
425	.659	839000		15.0	.0233	29610		1.00	.00155	1974	
400	.620	789600		14.5	.0225	28620		.90	.00140	1777	
375	.581	740300		14.0	.0217	27640		—	—	1620	18
350	.542	690900		13.5	.0209	26650		.80	.00124	1579	
325	.504	641600		—	—	26420	6	.75	.00116	1481	
300	.465	592200		13.0	.0201	25660		.70	.00109	1382	
275	.426	542900		12.5	.0194	24680		—	—	1290	19
250	.388	493500		12.0	.0186	23690		.60	.00093	1184	
225	.349	444200		11.5	.0178	22700		—	—	1029	20
200	.310	394800		11.0	.0171	21710		.50	.000775	987	
175	.271	345500		—	—	20820	7	—	—	—	
150	.233	296100		10.5	.0163	20730		—	—	—	
125	.1938	246800		10.0	.0155	19740		—	—	—	
—	—	211600	4/0	9.5	.01472	18753		—	—	—	
100	.1550	197400		9.0	.01395	17766		—	—	—	
95	.1472	187530		8.5	.01317	16779		—	—	—	
90	.1395	177660		—	—	16510	8	—	—	—	
—	—	167800	3/0	8.0	.01240	15792		—	—	—	
85	.1317	167790		7.5	.01163	14805		—	—	—	
80	.1240	157920		7.0	.01085	13818		—	—	—	
75	.1163	148050		—	—	13090	9	—	—	—	
70	.1085	138180		6.5	.01008	12831		—	—	—	
—	—	133100	2/0	6.0	.00930	11844		—	—	—	
65	.1008	128310		5.5	.00853	10857		—	—	—	
60	.0930	118440		—	—	10380	10	—	—	—	

Belden® Color Code Charts

Color Code Chart No. 1

Cond. No.	Color
1	Black
2	White
3	Red
4	Green
5	Brown
6	Blue
7	Orange
8	Yellow
9	Purple
10	Gray
11	Pink
12	Tan

18 Gage conductors in cables 8446 through 8449 are Black and White.

Color Code Chart Nos. 2 and 2R — ICEA (Insulated Cable Engineers Association) Standard*

Cond. No.	Color
1	Black
2	White
3	Red
4	Green
5	Orange
6	Blue
7	White/Black Stripe
8	Red/Black Stripe
9	Green/Black Stripe
10	Orange/Black Stripe
11	Blue/Black Stripe
12	Black/White Stripe
13	Red/White Stripe

Cond. No.	Color
14	Green/White Stripe
15	Blue/White Stripe
16	Black/Red Stripe
17	White/Red Stripe
18	Orange/Red Stripe
19	Blue/Red Stripe
20	Red/Green Stripe
21	Orange/Green Stripe
22	Black/White/Red
23	White/Black/Red
24	Red/Black/White
25	Green/Black/White
26	Orange/Black/White

Cond. No.	Color
27	Blue/Black/White
28	Black/Red/Green
29	White/Red/Green
30	Red/Black/Green
31	Green/Black/Orange
32	Orange/Black/Green
33	Blue/White/Orange
34	Black/White/Orange
35	White/Red/Orange
36	Orange/White/Blue
37	White/Red/Blue
38	Black/White/Green
39	White/Black/Green

Cond. No.	Color
40	Red/White/Green
41	Green/White/Blue
42	Orange/Red/Green
43	Blue/Red/Green
44	Black/White/Blue
45	White/Black/Blue
46	Red/White/Blue
47	Green/Orange/Red
48	Orange/Red/Blue
49	Blue/Orange/Red
50	Black/Orange/Red

* 2 = Spiral Stripe
2R = Ring Band Striping

Color Code Chart No. 3 for Paired Cables (Belden Standard)

Pair No.	Color Combination
1	Black & Red
2	Black & White
3	Black & Green
4	Black & Blue
5	Black & Yellow
6	Black & Brown
7	Black & Orange
8	Red & White
9	Red & Green
10	Red & Blue

Pair No.	Color Combination
11	Red & Yellow
12	Red & Brown
13	Red & Orange
14	Green & White
15	Green & Blue
16	Green & Yellow
17	Green & Brown
18	Green & Orange
19	White & Blue
20	White & Yellow

Pair No.	Color Combination
21	White & Brown
22	White & Orange
23	Blue & Yellow
24	Blue & Brown
25	Blue & Orange
26	Brown & Yellow
27	Brown & Orange
28	Orange & Yellow
29	Purple & Orange
30	Purple & Red

Pair No.	Color Combination
31	Purple & White
32	Purple & Green
33	Purple & Blue
34	Purple & Yellow
35	Purple & Brown
36	Purple & Black
37	Gray & White

Color Code Chart No. 4 for Paired Cables

Pair No.	Color Combination
1	White & Blue
2	White & Orange
3	White & Green
4	White & Brown
5	White & Gray

Pair No.	Color Combination
6	Red & Blue
7	Red & Orange
8	Red & Green
9	Red & Brown
10	Red & Gray

Pair No.	Color Combination
11	Black & Blue
12	Black & Orange
13	Black & Green
14	Black & Brown
15	Black & Gray

Pair No.	Color Combination
16	Yellow & Blue
17	Yellow & Orange
18	Yellow & Green
19	Yellow & Brown
20	Yellow & Gray

Pair No.	Color Combination
21	Purple & Blue
22	Purple & Orange
23	Purple & Green
24	Purple & Brown
25	Purple & Gray

Color Code Chart No. 5 for Paired Cables (Western Electric Standard)

Pair No.	Color Combination
1	White/Blue Stripe & Blue/White Stripe
2	White/Orange Stripe & Orange/White Stripe
3	White/Green Stripe & Green/White Stripe
4	White/Brown Stripe & Brown/White Stripe
5	White/Gray Stripe & Gray/White Stripe

Pair No.	Color Combination
6	Red/Blue Stripe & Blue/Red Stripe
7	Red/Orange Stripe & Orange/Red Stripe
8	Red/Green Stripe & Green/Red Stripe
9	Red/Brown Stripe & Brown/Red Stripe
10	Red/Gray Stripe & Gray/Red Stripe

Pair No.	Color Combination
11	Black/Blue Stripe & Blue/Black Stripe
12	Black/Orange Stripe & Orange/Black Stripe
13	Black/Green Stripe & Green/Black Stripe
14	Black/Brown Stripe & Brown/Black Stripe
15	Black/Gray Stripe & Gray/Black Stripe

Pair No.	Color Combination
16	Yellow/Blue Stripe & Blue/Yellow Stripe
17	Yellow/Orange Stripe & Orange/Yellow Stripe
18	Yellow/Green Stripe & Green/Yellow Stripe
19	Yellow/Brown Stripe & Brown/Yellow Stripe
20	Yellow/Gray Stripe & Gray/Yellow Stripe

Pair No.	Color Combination
21	Purple/Blue Stripe & Blue/Purple Stripe
22	Purple/Orange Stripe & Orange/Purple Stripe
23	Purple/Green Stripe & Green/Purple Stripe
24	Purple/Brown Stripe & Brown/Purple Stripe
25	Purple/Gray Stripe & Gray/Purple Stripe

Belden® Color Code Charts

Color Code Chart No. 6

Position No.	Color	Position No.	Color
1	Brown	13	White/Orange
2	Red	14	White/Yellow
3	Orange	15	White/Green
4	Yellow	16	White/Blue
5	Green	17	White/Purple
6	Blue	18	White/Gray
7	Purple	19	White/Black/Brown
8	Gray	20	White/Black/Red
9	White	21	White/Black/Orange
10	White/Black	22	White/Black/Yellow
11	White/Brown	23	White/Brown/Green
12	White/Red	24	White/Black/Blue

Chart No. 9: IBM RISC System/6000

Cond. No.	Color	Pair No.	Color Combination
1	White over Blue	1	White over Blue & Blue over White
2	White over Orange	2	White over Orange & Orange over White
3	White over Green	3	White over Green & Green over White
4	White over Brown		
5	White over Gray		
6	White over Red		
7	White over Yellow		

Chart No. 10: Fiber Optics*

Fiber/Tube No.	Color
1	Blue
2	Orange
3	Green
4	Brown
5	Gray
6	White
7	Red
8	Black
9	Yellow
10	Purple
11	Rose
12	Aqua

*Per TIA/EIA 598-A

Color Code Chart No. 7 for Snake Cables

Pair No.	Color Combination	Pair No.	Color Combination	Pair No.	Color Combination	Pair No.	Color Combination
1	Brown	16	Gray/Yellow Stripe	31	Blue/Purple Stripe	46	Lime/Black Stripe
2	Red	17	Gray/Green Stripe	32	Blue/Gray Stripe	47	Lime/Tan Stripe
3	Orange	18	Gray/Blue Stripe	33	Blue/White Stripe	48	Lime/Pink Stripe
4	Yellow	19	Gray/Purple Stripe	34	Blue/Black Stripe	49	Aqua/Brown Stripe
5	Green	20	Gray/Gray Stripe	35	Blue/Tan Stripe	50	Aqua/Red Stripe
6	Blue	21	Gray/White Stripe	36	Blue/Pink Stripe	51	Aqua/Orange Stripe
7	Purple	22	Gray/Black Stripe	37	Lime/Brown Stripe	52	Aqua/Yellow Stripe
8	Gray	23	Gray/Tan Stripe	38	Lime/Red Stripe	53	Aqua/Green Stripe
9	White	24	Gray/Pink Stripe	39	Lime/Orange Stripe	54	Aqua/Blue Stripe
10	Black	25	Blue/Brown Stripe	40	Lime/Yellow Stripe	55	Aqua/Purple Stripe
11	Tan	26	Blue/Red Stripe	41	Lime/Green Stripe	56	Aqua/Gray Stripe
12	Pink	27	Blue/Orange Stripe	42	Lime/Blue Stripe	57	Aqua/White Stripe
13	Gray/Brown Stripe	28	Blue/Yellow Stripe	43	Lime/Purple Stripe	58	Aqua/Black Stripe
14	Gray/Red Stripe	29	Blue/Green Stripe	44	Lime/Gray Stripe	59	Aqua/Tan Stripe
15	Gray/Orange Stripe	30	Blue/Blue Stripe	45	Lime/White Stripe	60	Aqua/Pink Stripe

Color Code Chart No. 8 for DataTwist® Cables (Modified Western Electric)

Pair No.	Color Combination	Pair No.	Color Combination	Pair No.	Color Combination	Pair No.	Color Combination	Pair No.	Color Combination
1	White/Blue Stripe & Blue	6	Red/Blue Stripe & Blue/Red Stripe	11	Black/Blue Stripe & Blue/Black Stripe	16	Yellow/Blue Stripe & Blue/Yellow Stripe	21	Purple/Blue Stripe & Blue/Purple Stripe
2	White/Orange Stripe & Orange	7	Red/Orange Stripe & Orange/Red Stripe	12	Black/Orange Stripe & Orange/Black Stripe	17	Yellow/Orange Stripe & Orange/Yellow Stripe	22	Purple/Orange Stripe & Orange/Purple Stripe
3	White/Green Stripe & Green	8	Red/Green Stripe & Green/Red Stripe	13	Black/Green Stripe & Green/Black Stripe	18	Yellow/Green Stripe & Green/Yellow Stripe	23	Purple/Green Stripe & Green/Purple Stripe
4	White/Brown Stripe & Brown	9	Red/Brown Stripe & Brown/Red Stripe	14	Black/Brown Stripe & Brown/Black Stripe	19	Yellow/Brown Stripe & Brown/Yellow Stripe	24	Purple/Brown Stripe & Brown/Purple Stripe
5	White/Gray Stripe & Gray/White Stripe	10	Red/Gray Stripe & Gray/Red Stripe	15	Black/Gray Stripe & Gray/Black Stripe	20	Yellow/Gray Stripe & Gray/Yellow Stripe	25	Purple/Gray Stripe & Gray/Purple Stripe



Belden® Color Code Charts

ICEA Table E1*

Cond. No.	Base Color	Tracer	Tracer	Cond. No.	Base Color	Tracer	Tracer
1	Black	—	—	26	Orange	Black	White
2	White	—	—	27	Blue	Black	White
3	Red	—	—	28	Black	Red	Green
4	Green	—	—	29	White	Red	Green
5	Orange	—	—	30	Red	Black	Green
6	Blue	—	—	31	Green	Black	Orange
7	White	Black	—	32	Orange	Black	Green
8	Red	Black	—	33	Blue	White	Orange
9	Green	Black	—	34	Black	White	Orange
10	Orange	Black	—	35	White	Red	Orange
11	Blue	Black	—	36	Orange	White	Blue
12	Black	White	—	37	White	Red	Blue
13	Red	White	—	38	Black	White	Green
14	Green	White	—	39	White	Black	Green
15	Blue	White	—	40	Red	White	Green
16	Black	Red	—	41	Green	White	Blue
17	White	Red	—	42	Orange	Red	Green
18	Orange	Red	—	43	Blue	Red	Green
19	Blue	Red	—	44	Black	White	Blue
20	Red	Green	—	45	White	Black	Blue
21	Orange	Green	—	46	Red	White	Blue
22	Black	White	Red	47	Green	Orange	Red
23	White	Black	Red	48	Orange	Red	Blue
24	Red	Black	White	49	Blue	Red	Orange
25	Green	Black	White	50	Black	Orange	Red

Pair cables are Black, White and numbered. Triad cables are Black, White, Red and numbered.

ICEA Table E2*

Cond. No.	Base Color	Tracer	Cond. No.	Base Color	Tracer
1	Black	—	19	Orange	Blue
2	Red	—	20	Yellow	Blue
3	Blue	—	21	Brown	Blue
4	Orange	—	22	Black	Orange
5	Yellow	—	23	Red	Orange
6	Brown	—	24	Blue	Orange
7	Red	Black	25	Yellow	Orange
8	Blue	Black	26	Brown	Orange
9	Orange	Black	27	Black	Yellow
10	Yellow	Black	28	Red	Yellow
11	Brown	Black	29	Blue	Yellow
12	Black	Red	30	Orange	Yellow
13	Blue	Red	31	Brown	Yellow
14	Orange	Red	32	Black	Brown
15	Yellow	Red	33	Red	Brown
16	Brown	Red	34	Blue	Brown
17	Black	Blue	35	Orange	Brown
18	Red	Blue	36	Yellow	Brown

Pair cables are Black, Red and numbered. Triad cables are Black, Red, Blue and numbered. Colors repeat after 36 conductors. There are no Green or White conductors or stripes.

*Reference ICEA S-73-532

ICEA Method 4: All conductors Black*

Cond.	Conductor Printing	Cond.	Conductor Printing
1 st	"1-ONE-1"	26 th	"26-TWENTY-SIX-26"
2 nd	"2-TWO-2"	27 th	"27-TWENTY-SEVEN-27"
3 rd	"3-THREE-3"	28 th	"28-TWENTY-EIGHT-28"
4 th	"4-FOUR-4"	29 th	"29-TWENTY-NINE-29"
5 th	"5-FIVE-5"	30 th	"30-THIRTY-30"
6 th	"6-SIX-6"	31 st	"31-THIRTY-ONE-31"
7 th	"7-SEVEN-7"	32 nd	"32-THIRTY-TWO-32"
8 th	"8-EIGHT-8"	33 rd	"33-THIRTY-THREE-33"
9 th	"9-NINE-9"	34 th	"34-THIRTY-FOUR-34"
10 th	"10-TEN-10"	35 th	"35-THIRTY-FIVE-35"
11 th	"11-ELEVEN-11"	36 th	"36-THIRTY-SIX-36"
12 th	"12-TWELVE-12"	37 th	"37-THIRTY-SEVEN-37"
13 th	"13-THIRTEEN-13"	38 th	"38-THIRTY-EIGHT-38"
14 th	"14-FOURTEEN-14"	39 th	"39-THIRTY-NINE-39"
15 th	"15-FIFTEEN-15"	40 th	"40-FORTY-40"
16 th	"16-SIXTEEN-16"	41 st	"41-FORTY-ONE-41"
17 th	"17-SEVENTEEN-17"	42 nd	"42-FORTY-TWO-42"
18 th	"18-EIGHTEEN-18"	43 rd	"43-FORTY-THREE-43"
19 th	"19-NINETEEN-19"	44 th	"44-FORTY-FOUR-44"
20 th	"20-TWENTY-20"	45 th	"45-FORTY-FIVE-45"
21 st	"21-TWENTY-ONE-21"	46 th	"46-FORTY-SIX-46"
22 nd	"22-TWENTY-TWO-22"	47 th	"47-FORTY-SEVEN-47"
23 rd	"23-TWENTY-THREE-23"	48 th	"48-FORTY-EIGHT-48"
24 th	"24-TWENTY-FOUR-24"	49 th	"49-FORTY-NINE-49"
25 th	"25-TWENTY-FIVE-25"	50 th	"50-FIFTY-50"

Cable Standards Reference Guide

National Electrical Code (NEC)[®] Catalog Reference Information

The National Electrical Code is a set of guidelines describing procedures which minimize the hazards of electrical shock, fires, and explosions caused by electrical installation. The text of the NEC is contained in nine chapters, each chapter broken into individual articles.

NEC types are acronyms consisting of a prefix describing cable type (e.g. coax, CATV, fiber optic) and a suffix indicating the type of flame test it has passed and where it can be installed. Articles describing wire and cable products — including required cable markings — are listed in the chart to the right.

Impact of the NEC

Almost everyone involved with wire and cable is affected by the National Electrical Code. In particular, the following groups must incorporate NEC guidelines into their work: OEM engineers, wire and cable product engineers, distributors, installers, and architects.

Although NEC covers wire and cable installed in factories, office buildings, hotels, motels, apartment buildings, residences, and all cables which pass through any floor, wall, ceiling, or which travel in ducts, plenums, and other air handling spaces, each individual municipality, city, county, or state can decide whether or not they wish to adopt the 2002 NEC as law. Local authorities having jurisdiction enforce their own codes. They have the right to accept or refuse any installation in accordance with their own local laws. One of the organizations local inspectors rely on to test wire and cable is Underwriters Laboratories (UL).

Intended Uses of Appliance Wiring Materials (AWM)

In the past, AWM cable was incorrectly used to wire buildings—this was never its intended use.

AWM cable is intended for internal wiring of factory-assembled, listed appliances such as computers, business machines, ranges, washers, dryers, radios, and televisions.

In some cases, AWM cable may be used for external connection. In these situations, the user should be aware that AWM cable temperatures and voltage ratings may differ from NEC ratings.

NEC Article/Type	Description	Installation Type				
		Plenum	Riser	Commercial	Residential	
725	CL2	Class 2 cables	CL2P	CL2R	CL2	CL2X*
	CL3	Class 3 cables	CL3P	CL3R	CL3	CL3X*
	PLTC	A stand-alone class. This is a power limited tray cable — a CL3-type cable which can be used outdoors, is sunlight- and moisture-resistant and must pass the Vertical Tray flame test.	(none)	(none)	PLTC	(none)
760	FPL	Power limited, fire protective signaling circuit cable	FPLP	FPLR	FPL	(none)
770	OFC	Fiber cable also containing metallic conductors	OFCP	OFCR	OFCG, OFC	(none)
	OFN	Fiber cable only containing optical fibers	OFNP	OFNR	OFNG, OFN	(none)
800	CM	Communications	CMP	CMR	CMG, CM	CMX*
	MP	Multi-Purpose Cables	MPP	MPR	MPG, MP	(none)
820	CATV	Community antenna television and radio distribution system	CATVP	CATVR	CATV	CATVX**
830	BM	Network-powered broadband communications cable	BLP	BMR	BM	BLX

*Cable diameter must be less than 0.250" **Cable diameter must be less than 0.375"

C(UL) Certifications

UL/NEC-Approved cables may also be C(UL)/CEC-Approved as communications cables meeting the requirements of the Bi-National Standard CSA C22.2 No. 214/UL 444 and Section 60 of the Canadian Electrical Code, Part I (CEC). The C(UL) cable designation (and its meaning) would be one of the following:

1. **CMP** — Cable meeting CSA FT7 or NFPA 262 (UL 910);
2. **CMR** — Cable meeting UL 1666;
3. **CMG** — Cable meeting CSA FT4;
4. **CM** — Cable meeting UL 1685 (UL 1581, Sec. 1160) Vertical-Tray;
5. **CMX** — meeting UL 1581, Sec. 1080 (VW-1);
6. **CMH** — Cable meeting CSA FT1.

NOTE: The CSA flame tests are defined in CSA C22.2 No. 0.3 as follows:

FT1 Vertical Flame Test — per C.S.A. C22.2 No. 0.3-92 Para 4.11.1

A finished cable shall not propagate a flame or continue to burn for more than one (1) minute after five (5) fifteen (15) second applications of the test flame. There is an interval of fifteen (15) seconds between flame applications. The flame test shall be performed in accordance with Para 4.11.1 of Canadian Standards Association (CSA) Standard C22.2 No. 0.3. In addition, if more than 25% of the indicator flag is burned, the test cable fails.

FT4 Vertical Flame Test — Cables in Cable Trays per C.S.A. C22.2 No. 0.3-92 Para 4.11.4

The FT4 Vertical Flame Test — Cables in Cable Trays is similar to the UL-1685 Vertical Tray Flame Test, but is more severe. The FT4 test has its burner mounted at 20° from the horizontal with the burner ports facing up. The UL-1685 Vertical Tray has its burner at 0° from the horizontal. The FT4 samples must be larger than 13mm (.512") in diameter.

If not, then the cable samples are grouped in units of at least three (3) to obtain a grouped overall diameter of 13mm. The UL-1581 Vertical Tray does not distinguish on cable size. The FT4 has a maximum char height of 1.5 m (59") measured from the lower edge of the burner face. The UL-1685 has a flame height allowable up to approximately 78" measured from the burner.

FT6 Horizontal Flame & Smoke Test — per C.S.A. C22.2 No. 0.3-92 Appendix B

Belden[®] products passing the FT6 Horizontal Flame and Smoke Test are designated FT6 in the column where the trade number appears. This test is for cables which must pass a Horizontal Flame and Smoke Test in accordance with ANSI/NFPA Standard 262-1985 (UL-910). The maximum flame spread shall be 1.50 meters (4.92 ft.). The smoke density shall be 0.5 at peak optical density and 0.15 at maximum average optical density.

National Electrical Code and NEC are registered trademarks of the National Fire Protection Association, Inc., Quincy, MA.



For more information, contact [Belden Technical Support: 1-800-BELDEN-1 • www.belden.com](mailto:TechnicalSupport@belden.com)

Cable Substitution Chart

Per 2005 NEC®

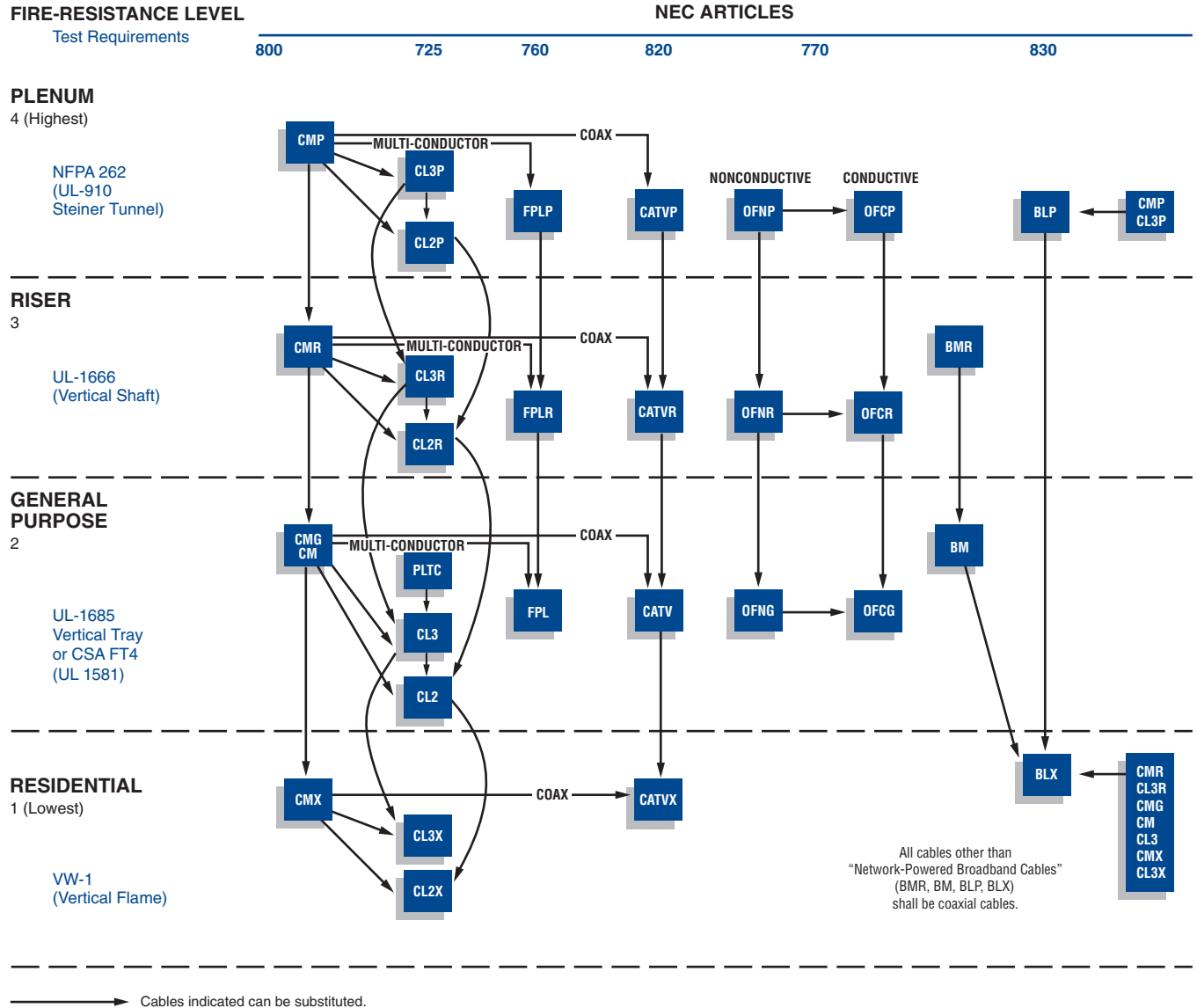

NEC Type	Definition
CMP, CMR, CMG, CM, CMX	Communications Cables
CL3P, CL3R, CL3, CL3X, CL2P, CL2R, CL2, CL2X	Class 2 and Class 3 Remote-Control, Signaling and Power Limited Cables
FPLP, FPLR, FPL	Power Limited Fire Alarm Cables
CATVP, CATVR, CATV, CATVX	Community Antenna Television and Radio Distribution Cables
OFNP, OFNR, OFNG, OFN	Nonconductive Optical Fiber Cables
OFCP, OFCR, OFCG, OFC	Conductive Optical Fiber Cables
PLTC	Power Limited Tray Cables
BMR, BM, BLP, BLX	Network-powered Broadband Communications Cable

National Electrical Code and NEC are registered trademarks of the National Fire Protection Association, Inc., Quincy, MA.

Canadian Electrical Code (CEC) Substitution Chart

Terms of Use of Master Catalog

Cable Substitution Hierarchy as per C22.2 #214 — Communication Cables

Canadian Electrical Code, Part 1, Table 19, Note 22:

The following cable substitution may be used:

- a.** Communication cables marked MPP, CMP, MPR, CMR, MPG, CMG, MP, CM, CMX, CMH, FT6, and FT4 have been found to meet the standard criteria for FT1.
- b.** Communication cables marked MPP, CMP, MPR, CMR, MPG, CMG, and FT6 have been found to meet the standard criteria for FT4.
- c.** Communication cables marked MPP and CMP have been found to meet the standard criteria for FT6.

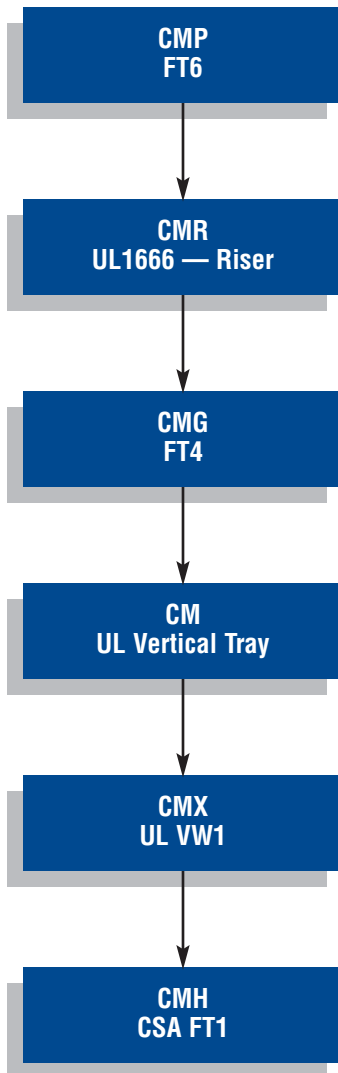

Terms of Use of Master Catalog

Use of Information; Disclaimers

Although Belden Electronics Division (“Belden”) makes every reasonable effort to ensure their accuracy at the time of this publication, information and specifications described in this catalog are subject to change without notice. The most current product information may be found by accessing our Website at www.belden.com or contacting Belden Technical Support at 1-800-BELDEN-1.

Belden provides the information and specifications in this catalog on an “AS IS” basis, with no representations or warranties, whether express, statutory or implied. WITH RESPECT TO SUCH INFORMATION AND SPECIFICATIONS, BELDEN DISCLAIMS ALL WARRANTIES OF MERCHANTABILITY, FITNESS FOR INTENDED PURPOSE AND NON-INFRINGEMENT. IT ALSO EXCLUDES ANY EXPRESS OR IMPLIED WARRANTIES ARISING FROM ANY COURSE OF DEALING, USAGE, TRADE PRACTICE OR PERFORMANCE. BELDEN’S SOLE WARRANTIES ARE AS BELDEN MAY PROVIDE IN (AND SUBJECT TO THE TERMS AND LIMITATIONS OF) SEPARATE WARRANTY DOCUMENTATION.

In no event will Belden be liable for any damages (including consequential, indirect, incidental, special, punitive, or exemplary damages) whatsoever, even if Belden has been advised of the possibility of such damages, whether in an action under contract, negligence or any other theory, arising out of or in connection with the use, inability to use, or performance of the information, specifications or products described in this catalog.

Belden’s Terms and Conditions of Sale

All sales of Belden® products are subject to Belden’s standard terms and conditions of sale.

Intellectual Property Protection

All trademarks or registered trademarks mentioned in this catalog are property of their respective owners. The information contained in this catalog is protected by copyright. No part of this catalog may be reproduced by any means without the prior written permission from Belden.

U.S. Export Laws

The United States Export Controls laws prohibit the export of certain technical data and software to certain territories. No content from this catalog may be reproduced or otherwise exported in violation of United States Law.

Environmental Regulations and Compliance

Heavy Metal Free, RoHS and Prop 65

Over the past several years, increased attention has been placed upon the potential environmental impacts of electronic products. Both voluntary and regulatory measures have been taken to address some of these concerns. Already in place are California Proposition 65 and the European Union End-of-Life Vehicle (ELV) and Flame Retardant Directives. The next major impact will be the European Union Restriction on Hazardous Substances (RoHS) Directive that will restrict the use of heavy metal substances (Lead, for example) in electronic products in July 2006. There are also several states and countries currently considering their own legislation on this topic.

The use of materials that are environmentally friendly is of growing concern to Belden, its customers and to the global community. Belden is engaged in a division-wide project to integrate into its product designs and supplier requirements a formalized program to restrict the use of these materials by January 2006. The following list of materials represents examples of substances that Belden is eliminating or reducing in certain applications:

- Asbestos and its compounds
- Cadmium and its compounds
- Chromium VI and its compounds
- Lead and its compounds
- Mercury and its compounds
- Polybrominated biphenyls (PBBs) and their ethers/oxides (PBDEs, PBBEs)
- Di-(2-ethylhexyl)phthalate (DEHP)
- Penta-, Octa- BDE Brominated flame retardants

As a result of this project, many of Belden's products are now, heavy metal free and meet the requirements of both RoHS and California Proposition 65. For a more detailed definition of the above named regulations, please consult the glossary of terms located in the back of the catalog. Contact Belden Customer Service or visit www.belden.com for more specific product details and current compliance information.

RoHS Compliance

Unless so marked, cables in this catalog do not contain any of the following restricted substances, as an intentional additive, and is therefore compliant with European Directive 2002/95/EC (RoHS), European Directive 2000/53/EC (ELV), European Directive 2003/11/EC (BFR), European Directive 2002/96/EC (WEEE), and California Proposition 65 Consent Judgement for Wire & Cable Manufacturers [San Francisco Superior Court Nos. 312962 and 320342] (Prop 65).

For customer convenience, Belden products that are in compliance with these directives contain the identification "ROHS" within the text of the jacket surface printing and also an environmentally friendly logo (as shown at right) on package labeling.



Substance	Maximum Concentration*
Lead	0.03%
Mercury	0.10%
Hexavalent Chromium	0.10%
PBB, PBDE**	0.10%
Cadmium	0.01%

*Per homogeneous material, as trace or contaminate amount.

**Some Belden cables may contain Decabromodiphenyl Oxide/Ether (PBDE) as a flame retardant. This substance is currently exempt from RoHS.

In addition, Belden products do not contain Asbestos and its compounds or Di-(2-ethylhexyl)phthalate (DEHP).

This determination is based upon information obtained from sources which Belden believes are reliable, and from random sample testing at the Belden Engineering Center; however, the information is provided without any representation of warranty, expressed or implied, regarding accuracy or correctness. Belden does not specifically run any analysis on our raw materials or end product to measure for these substances.

The information provided in this catalog, and the identification of materials listed as reportable or restricted within the catalog, is correct to the best of Belden's knowledge, information and belief at the date of its publication. The information provided in the catalog is designed only as a general guide for the safe handling, storage, and any other operation of the product itself or the one that it becomes a part of. This catalog is not to be considered a warranty or quality specification. Regulatory information is for guidance purposes only. Product users are responsible for determining the applicability of legislation and regulations based on their individual usage of the product.

Cable Packaging

Belden, a recognized leader in state-of-the-art packaging design, has introduced a variety of packaging styles and options for the convenience of our customers:

UnReel®

A wide variety of Belden® cable and plenum cable is available in Belden's UnReel cardboard dispenser.

Belden UnReel is a unique packaging/dispensing system developed to save time, cut costs and labor, and eliminate the need for dereeling equipment.

Lightweight and more economical than conventional drums or reels, UnReel dispensers have pre-punched handles for easy, individual transport as well as rectangular boxes for easy pallet delivery and storage. Unreeled cable pays out smoothly and evenly with no kinking, twisting, or backlashing. It also rolls out 60% faster per hour than conventionally packaged cable.

UnReel ships, stores and dispenses in one carton, which — since its introduction — has always been fully recyclable and biodegradable. Look for the letter “U” in the put-up (“Length”) description.

Reel-In-A-Box

Belden's Reel-In-A-Box facilitates cable payout, making installations quicker and easier. And because it's primarily corrugated fiberboard material with plastic inserts, it weighs less than wooden crate reels. That makes it easier to handle and dispose of, as well as less costly to ship.

A 5" barrel, standard on every Belden® Reel-In-A-Box, helps eliminate memory — a typical problem encountered with 3" barrels used by other manufacturers.

The new Reel-In-A-Box is extremely durable. It has passed cold drop tests to -30°C, which translates to maximum protection on the job as well as in shipping. Look for the letter “A” in the put-up description.

Glossary of Terms

5-Mil Copper — Solid Copper Shield. Provides added electrical protection.

802.14 — IEEE's Cable TV MAC and PHY Protocol Working Group.

10GBASE-T — IEEE standard for 10 Gigabit Ethernet transmission over copper.

10GX[®] — Belden's most advanced end-to-end UTP structured cabling system delivering guaranteed performance of 625 MHz and data-rates of 10Gb/s.

A — Ampere.

ABR — Available Bit Rate.

Abrasion Resistance — Ability of a wire, cable or material to resist surface wear.

Abrasion Stripper — More accurately described as "buffing stripper," which is a motorized device for removing flat cable insulation by means of one or two buffing wheels that melt the insulation and brush it away from the conductors.

AC — Alternating current. Electric current that alternates or reverses polarity in a cyclical manner (e.g. 60 Hz AC power).

Accelerated Aging — A test that simulates long time environmental conditions in a relatively short time.

ACMC — Alien Crosstalk Margin Computation is the Pass/Fail criteria to determine if a channel complies with 10GBASE-T Alien noise requirements.

ACR — Attenuation Crosstalk Ratio. The difference between attenuation and crosstalk, measured in dB, at a given frequency. Important characteristic in networking transmission to assure that signal sent down a twisted pair is stronger at the receiving end of the cable than are any interference signals imposed on that same pair by crosstalk from other pairs.

ADSL — Asymmetric Digital Subscriber Line.

AES/EBU — Informal name of a digital audio standard established jointly by the AES (Audio Engineering Society) and EBU (European Broadcast Union) organizations.

AF — Audio frequency.

AFEXT — Alien far-end crosstalk loss is a measure of the unwanted signal coupling from near-end disturbing channel pairs into a disturbed pair of a neighboring channel or part thereof, measured at the far-end.

Air Core — Cables that are not gel filled.

Air-Gap Dielectric — A coaxial design in which a monofilament of plastic holds the center conductor in place in a hollow plastic tube allowing the remainder of the dielectric to be air. Typical velocities of up to 84% can be achieved in this design.

Alien crosstalk — A measure of the unwanted signal coupling between cabling or components in close proximity.

Alloy — A combination of two or more different polymers/metals. Usually combined to make use of different properties of each polymer/metal.

Alpeth — Coated Aluminum Polyethylene. Basic sheath.

Alternating Current (AC) — Electric current that alternates or reverses polarity in a cyclical manner (e.g. 60 Hz AC power).

AM — Amplitude modulation.

Ambient — Conditions that exist in the environment of the cable. Conditions existing at a test or operating location prior to energizing equipment (e.g. ambient temperature).

American Wire Gage (AWG) — A standard for expressing wire diameter. As the AWG number gets smaller, the wire diameter gets larger.

Ampacity — Current handling capability expressed in amperes. The maximum current a conductor can carry without being heated beyond a safe limit.

Ampere — A standard unit of current. Defined as the amount of current that flows when one volt of electromotive force (EMF) is applied across one ohm of resistance. One ampere of current is produced by one coulomb of charge passing a point in one second.

Amplitude — The magnitude of a current or voltage. It can be the maximum, minimum, average or RMS value of an alternating current (AC) signal. These four magnitudes are the same for a direct current (DC) signal.

Analog — Representation of data by continuously variable quantities as opposed to a finite number of discrete quantities in digital.

Analog Signal — An electrical signal which varies continuously, not having discrete values. Analog signals are copies or representations of other waves in nature. An analog audio signal, for instance, is a representation of the pressure waves which make up audible sound.

ANEXT — Alien near-end crosstalk loss is a measure of the unwanted signal coupling from near-end disturbing channel pairs into a disturbed pair of a neighboring channel or part thereof, measured at the near-end.

Anneal — To soften and relieve strains in any solid material, such as metal or glass, by heating to just below its melting point and then slowly cooling it. Annealing generally lowers the tensile strength of the material, while improving its flex life and flexibility.

ANSI — American National Standards Institute.

ASP — Aluminum Steel Polyethylene. Provides mechanical and electrical protection.

ASTM — The American Society for Testing and Materials, a standards organization which suggests test methods, definitions and practices.

Asynchronous Transfer Mode — The SONET standard for a packet switching technique which uses packets of a fixed length.

ATM — Asynchronous Transfer Mode.

Attenuation — The decrease in magnitude of a signal as it travels through any transmitting medium, such as a cable or circuitry. Attenuation is usually expressed logarithmically as the ratio of the original and decreased signal amplitudes. It is usually expressed in decibels (dB).

Audio — A term used to describe sounds within the range of human hearing (20 Hz to 20 kHz). Also used to describe devices which are designed to operate within this range.

Audio Frequency — Frequencies within the range of human hearing (approximately 20 Hz to 20 kHz).

Augmented Category 6 — TIA standard for a cabling system and components specified to 500MHz to support 10GBASE-T and other high frequency applications.

AWG — American Wire Gage. A wire diameter specification. The smaller the AWG number, the larger the wire diameter.

AWM — Appliance Wiring Material. A UL designation for a type of wire.

Backbone — The cable used to connect all systems of a multi-level distributed system to an intermediate system.

Backshell — Housing on a connector that covers the area where the cable conductors connect to the connector contacts. It can be a metal housing providing continuity of the shield through IDC connectors.

Balanced Line — A cable having two identical conductors which carry voltages opposite in polarity, but equal in magnitude with respect to ground, suitable for differential signal transmission.

Balun — Balanced to unbalanced (Bal-un) transformer used to connect an unbalanced transmission line (i.e. coaxial cable) to a balanced system or cable, or vice versa. It can also provide impedance transformation, as 300 ohm balanced to 75 ohm unbalanced.

Bandwidth — The difference between the upper and lower limits of a given band of frequencies. It is expressed in Hertz. The range of frequencies that a transmitted communications signal occupies or that a receiving system can accept. For example, it takes more bandwidth to download a photograph in a second than to download a page of text. Virtual reality and three-dimensional audio/visual presentations require even more.

Baud — Rate of digital transmission equal to the reciprocal of the time of one output signaling element.

Bel — A unit that represents the logarithm of the ratio of two levels. One bel equals the base 10 logarithm of the ratio of two power levels. It is also equal to the base 10 logarithm of square of the ratio of two voltage or current levels, provided the impedances are the same at the two levels. (See *dB*.)

Belden — A leading manufacturer of the specialty wire, cable and fiber products needed for new applications in data, audio, video and voice signal transmission, among other things.

Belflex[®] — A premium hybrid matte-finish jacket material that exhibits superior flexibility at low temperatures along with resistance compared to standard PVC jacketing materials.

Beldfoil[®] — Belden trademark for highly effective electrostatic shield of reinforced metallic foil.

Glossary of Terms

- Beldsol™** — Solderable Belden magnet wire combining insulating films of polyurethane for excellent dielectric characteristics and nylon for mechanical protection.
- Bend Loss** — A form of increased attenuation caused by (a) having an optical fiber curved around a restrictive radius of curvature or (b) microbends caused by minute distortions in the fiber imposed by externally induced perturbations.
- Bend Radius** — Radius of curvature that a flat, round fiber optic or metallic cable can bend without any adverse effects.
- Binder** — A tape or thread used for holding assembled cable components in place.
- Bit** — One binary digit.
- Bit Error Rate** — The number of errors occurring in a system per unit of time (e.g. bits per second).
- Bits Per Second** — The number of binary bits that can be transmitted per second (bps), i.e. Mbps (Mega = million), Gbps (Giga = billion).
- BNC** — Abbreviation for "Bayonet Neil-Concelman." A coaxial cable connector used extensively in video and RF applications and named for its inventors.
- Bonded** — 1) Adhesive application of a metallic shielding tape to the dielectric of a coaxial cable to improve electrical performance and ease of connector installation. Also refers to adhesive application of a metallic shielding tape to the jacket of a cable. 2) Steel is bonded to polyethylene with a copolymer adhesive. All Stalpath and some ASP cables are bonded. Provides extra strength to jacket, primarily used in underground applications.
- Bonded ASP** — Aluminum Steel Polyethylene where the steel is bonded to polyethylene for strength. Filled cables for use in ducts.
- Bonding** — The method used to produce good electrical contact between metallic parts of any device. Used extensively in automobiles and aircraft to prevent static buildup. Also refers to the connectors and straps used to bond equipment.
- Booster** — An amplifier inserted into a cable to increase the signal amplitude in order to compensate for signal loss due to attenuation. This extends the transmission range of the cable. Transformers may be employed to boost AC voltages. The term booster is also applied to amplifiers used in television receiving antenna systems.
- BPS** — Bits per second. (See *Bits Per Second*.)
- BPSK** — Binary Phase Shift Keying. A type of digital transmission where two phases of the signal are possible to represent binary one and zero.
- Braid** — A group of textile or metallic filaments interwoven to form a tubular flexible structure which may be applied over one or more wires or flattened to form a strap.
- Braid Angle** — The angle between a strand of wire in a braid shield and the longitudinal axis (i.e. axis along the length of the center) of the cable it is wound around.
- Breakdown Voltage** — The voltage at which the insulation between two conductors will fail and allow electricity to conduct or "arc."
- Breakout** — The point at which a conductor or conductors are separated from a multi-conductor cable to complete circuits at various points along the main cable.
- BRI** — Basic Rate Interface ISDN.
- Broadband** — The technique used to multiplex multiple networks on a single cable without interfering with each other. Technologies that allow you to transmit or receive higher volumes of data at higher speeds.
- Buffer** — A protective coating over an optical fiber.
- Buffing Stripper** — A motorized device for removing flat cable insulation by means of one or two buffing wheels that melt the insulation and brush it away from the conductors. Also called Abrasion Stripper.
- Bunch Strand** — Conductors twisted together with the same lay and direction without regard to geometric pattern.
- Buried** — Cables that are required to go underground.
- Bus-bar Wire** — Uninsulated tinned copper wire used as a common lead.
- Butyl Rubber** — A synthetic rubber with good electrical insulating properties.
- Byte** — A group of eight adjacent binary digits (8 bits).
- C** — Capacitance (electrical). Celsius (temperature).
- Cable** — A group of individually insulated conductors or subcomponents twisted helically.
- Cable Modem** — A device that enables you to hook up your PC to a local cable TV line and receive data at much faster rates than telephone modems and ISDN lines. A strong competitor to DSL telephone service.
- Cabling** — The grouping or twisting together of two or more insulated conductors or subcomponents to form a cable.
- CACSP** — Coated Aluminum, Coated Steel, Polyethylene. Provides additional strength and protection.
- California Proposition 65 (Prop 65)** — Refers to the California Proposition 65 Consent Judgement for wire & cable manufacturers (San Francisco Superior Court nos. 312962 and 320342). **Compliant Products** have less than 300ppm of lead (by weight) in their outer surface layer. **Exempt Products** are those that are infrequently handled, manufactured before September 2003, distributed/sold outside the State of California, internal components not normally accessible to the consumer, or contain Prop 65 substances as part of the internal conductor or other component not normally accessible to the consumer. Contact Belden Customer Service or visit www.belden.com for product specific details.
- Canadian Electrical Code (CEC)** — Canadian version of the US National Electrical Code (NEC).
- CAP** — Carrierless Amplitude Phase Modulation.
- Capacitance** — The ability of a dielectric material between conductors to store energy when a difference of potential exists between the conductors. The unit of measurement is the farad. Cable capacitance is usually measured in picofarads (pF).
- Capacitive Crosstalk** — Cable crosstalk or interference resulting from the coupling of the electrostatic field of one conductor upon one or more others.
- Capacitive Reactance** — The opposition to alternating current due to the capacitance of a capacitor, cable or circuit. It is measured in ohms and is equal to $1/(2 \cdot \pi \cdot f \cdot C)$ where π is approximately 3.1416, f is the frequency in Hz and C is the capacitance in farads.
- Capacitor** — Two conducting surfaces separated by a dielectric material. The capacitance is determined by the area of the surfaces, type of dielectric and spacing between the conducting surfaces.
- Carrier Strip** — Also referred to as substrate. A film that is on one side of a laminated flat cable.
- CASPIC** — Coated Aluminum, Coated Steel.
- Category** — Rating of a local area network (LAN) cable established by TIA/EIA to indicate the level of electrical performance.
- Category Cables** — Belden manufactures Category 3 to 7 cables, all high performance twisted pair data cables. The higher the category number, the greater the bandwidth. Category 7 is currently the highest performance telecommunication wire available. Ours is certified to applicable UL standards.
- CATV** — Abbreviation for Community Antenna Television. Cable TV.
- CB** — Citizens band.
- CBR** — Constant Bit Rate.
- CCTV** — Closed-circuit television.
- Cellular Polyethylene** — Expanded or "foam" polyethylene, consists of individual closed cells of inert gas suspended in a polyethylene medium. The result is a desirable reduction of the dielectric constant compared to solid polyethylene, which decreases attenuation and increases the velocity of propagation.
- Center-to-Center Distance** — Pitch. Nominal distance from center-to-center of adjacent conductors within a cable. When conductors are flat, pitch is usually measured from the reference edge of a conductor to the reference edge of the adjacent conductor.
- Channel** — The horizontal cable including the workstation outlet and patch panel in the telecommunications closet plus a maximum combined length of up to ten meters of patch cable at each end (maximum length of 100 meters).
- Characteristic Impedance** — In a transmission cable of infinite length, the ratio of the applied voltage to the resultant current at the point the voltage is applied. Or the impedance which makes a transmission cable seem infinitely long, when connected across the cable's output terminals.

Glossary of Terms

- Chrominance Signal** — The portion of a video signal that contains the color information.
- Circuit** — A system of conducting media designed to pass an electric current.
- Circular Mil** — Area of a wire that is one-thousandth of an inch (.001 inch, one mil) in diameter. This area is $\pi/4$ of a square mil. The circular mil area (CMA, cmil) equals the diameter in mils squared. By knowing the CMA of various conductors, they can be used to determine what conductivity and gage size various combinations will produce.
- Cladding** — A low refractive index material that surrounds the core of an optical fiber causing the transmitted light to travel down the core and protects against surface contaminant scattering or a layer of metal applied over another. Cladding is often chosen to improve conductivity or to resist corrosion.
- CO** — Central Office.
- Coaxial Cable** — A cylindrical transmission line composed of a conductor centered inside a metallic tube or shield, separated by a dielectric material, and usually covered by an insulating jacket. Used by cable TV companies to distribute signals to homes and businesses. Also used by telephone companies in some applications and by cellular telephone, radio and television installations.
- Coil Effect** — The inductive effect exhibited by a spiral-wrapped shield, especially above audio frequencies.
- Color Code** — A system of different colors or stripes used to identify components of cables such as individual conductors or groups of conductors.
- COLS** — Commercial Online Service.
- Component Video** — The unencoded output of a camera, video tape recorder, etc., whereby each red, green, and blue video signal is transmitted down a separate cable (usually coax) to improve picture quality. Can also refer to a video system where the luminance and chrominance video components are kept separate.
- Composite Cable** — Cable having conductors with two or more AWG sizes or more than one cable type.
- Composite Video** — The encoded output of a camera, video tape recorder, etc., whereby the red, green and blue video signals are combined with the synchronizing, blanking and color burst signals and are transmitted simultaneously down one cable.
- Concentric Stranding** — A group of uninsulated wires twisted together and containing a center core with subsequent layers spirally wrapped around the core with alternating lay directions to form a single conductor.
- Conductivity** — The ability of a material to allow electrons to flow, measured by the current per unit of voltage applied. It is the reciprocal of resistivity and is measured in siemens (S) or mhos.
- Conductor** — A substance, usually metal, used to transfer electrical energy from point to point.
- Conduit** — A tube of metal or plastic through which wire or cable can be run. Used to protect the wire or cable and, in the case of metal conduit, to contain the fire of a burning wire or cable.
- Connector** — A device designed to allow electrical flow from one wire or cable to a device on another cable. A connector will allow interruption of the circuit or the transfer to another circuit without any cutting of wire or cable or other preparation.
- Copperweld®** — Trademark of Copperweld Steel Co. for copper-clad steel conductor.
- Cord** — A very flexible insulated cable.
- Core** — The light conducting central portion of an optical fiber with a refractive index higher than that of the cladding. The center of a cable construction. Most often applies to a coaxial cable, where the core is the center conductor and the dielectric material applied to it.
- Corona** — The ionization of gasses about a conductor that results when the potential gradient reaches a certain value.
- Coupling** — The transfer of energy (without direct electrical contact) between two or more cables or components of a circuit.
- Coverage** — How well a metal shield covers the underlying surface. Measured in percent.
- CPE** — Chlorinated polyethylene can be used as either a thermoplastic or thermoset. It is a tough chemical- and oil-resistant material and makes an excellent jacket for industrial control cable. As a thermoset, it can be used as an oil-resistant cord jacket. Other outstanding properties include low water absorption and superior crush resistance, which are important attributes in industrial control applications.
- CPS** — Abbreviation for cycles per second. This term has been replaced by Hertz in common usage.
- CPU** — Central Processing Unit.
- Crosstalk** — A type of interference caused by signals from one pair or cable being coupled into adjacent pairs or cables. Can occur with audio, data or RF signals.
- CRT** — Cathode Ray Tube.
- CSA** — Abbreviation for Canadian Standards Association, the Canadian version of the Underwriters Laboratories.
- CSMA/CD** — Carrier Sense Multiple Access/ Collision Detection.
- CSR** — Customer Service Representative.
- CUPIC** — Copper.
- Current Carrying Capacity** — The maximum current a conductor can carry without being heated beyond a safe limit. Ampacity.
- Current Loop** — A two wire transmit/receive interface.
- Current, Alternating (AC)** — Electric current that alternates or reverses polarity in a cyclical manner (e.g. 60 Hz AC power).
- Current, Direct (DC)** — Electrical current whose electrons flow in one direction only and is generally constant.
- Cut-through Resistance** — A test to determine the ability of a material to withstand the application of blades or sharp edges without being cut.
- D1** — A component digital video recording format that conforms to the CCIR-601 standard. Records on 19 mm magnetic tape. (Often used incorrectly to indicate component digital video.)
- D2** — A composite digital video recording format. Records on 19 mm magnetic tape.
- D3** — A composite digital video recording format. Records on 1/2 inch (12.7 mm) magnetic tape.
- Daisy Chain** — A cable assembly with three or more termination areas.
- Datalene®** — Belden trademark for foam polyolefin.
- DAVIC** — Digital Audio Video Council.
- dB** — Decibel.
- DBS** — Direct Broadcast Satellite.
- DC** — Direct current.
- DC Resistance** — See *Resistance*.
- Decibel (dB)** — A decibel is one-tenth of a bel and is equal to 10 times the logarithm of the power ratio, 20 times the log of the voltage ratio, or 20 times the log of the current ratio. Decibels are also used to express acoustic power, such as the apparent level of a sound. The decibel can express an actual level only when comparing with some definite reference level that is assumed to be zero dB.
- Delay Line** — A transmission line or equivalent device designed to delay a wave or signal for a specific length of time.
- DEPIC** — Dual Expanded Plastic Insulated Conductor (Foam Skin). Decreases outside diameter of cable.
- Derating Factor** — A multiplier used to reduce the current carrying capacity of conductors in more adverse environments, such as higher temperature, or where multiple conductors are together in one conduit.
- DES** — Data Encryption Standard.
- DHCP** — Dynamic Host Configuration Protocol.
- Dielectric** — An insulating (nonconducting) medium. It is the insulating material between conductors carrying a signal in a cable. In coaxial cables it is between the center conductor and the outer conductor. In twisted pair cables it is the insulation between conductors plus any surrounding air or other material.
- Dielectric Breakdown** — Any change in the properties of a dielectric that causes it to become conductive. Normally a catastrophic failure of an insulation because of excessive voltage.

Glossary of Terms

Dielectric Constant

— Also called relative permittivity. That property of a dielectric which determines the amount of electrostatic energy that can be stored by the material when a given voltage is applied to it. Actually, the ratio of the capacitance of a capacitor using the dielectric to the capacitance of an identical capacitor using a vacuum (which has a dielectric constant of 1) as a dielectric. A number which indicates the quality of a material to resist holding an electrical charge when placed between two conductors.

Dielectric Heating — The heating of an insulating material when placed in a radio-frequency field, caused by internal losses during the rapid polarization reversal of molecules in the material.

Dielectric Loss — The power dissipated in a dielectric as the result of the friction produced by molecular motion when an alternating electric field is applied.

Dielectric Strength — The voltage an insulation can withstand before it breaks down. Usually expressed as volts per mil.

Dielectric Withstand Voltage — The voltage an insulation can withstand before it breaks down. Usually expressed as volts per mil.

Digital Signal — An electrical signal which possesses two distinct states (on/off, positive/negative).

Dispersion — The cause of bandwidth limitations in an optical fiber. Dispersion causes a broadening of input pulses along the length of the fiber. Two major types are (a) mode dispersion caused by differential optical path lengths in a multimode fiber, and (b) material dispersion caused by a differential delay of various wavelengths of light in a wave guide material.

Distortion — Any undesired change in a wave form or signal.

Distribution Cable — In a CATV system, the transmission cable between the distribution amplifier and the drop cable.

Disturbed Conductor — A conductor that receives energy generated by the field of another conductor or an external source, e.g. the quiet line.

DMT — Discrete Multitone.

DOCSIS — Data Over Cable Service Interface Specification™. Defines interface requirements for cable modems involved in high-speed data distribution over cable television system networks.

Drain Wire — A non-insulated wire in contact with parts of a cable, usually the shield, and used in the termination to that shield and as a ground connection.

Drop Cable — In a CATV system, the transmission cable from the distribution cable to a dwelling.

DSL — Digital Subscriber Line. A technology for bringing high-bandwidth information to homes and small businesses over ordinary copper telephone lines. A DSL line can carry both data and voice signals, with the data part of the line remaining continuously connected. Currently competes with the cable modem in bringing broadband services to homes and small businesses.

Duobond® II — Belden trademark for a laminated shielding tape consisting of heat sensitive adhesive, aluminum foil, polyester or polypropylene and aluminum foil.

Duobond Plus® — Belden trademark for a foil/braid/foil connection with a shorting fold in the outermost shield.

Duofoil® — Belden trademark for a shield in which metallic foil is applied to both sides of a supporting plastic film.

DVB — Digital Video Broadcasting.

E — Voltage (electromotive force).

Earth — British terminology for zero-reference ground.

Edge Margin — Margin.

EFP — Electronic Field Production. Video production for commercials, television shows and other non-news purposes done outside the studio.

EIA — Electronic Industries Association (formerly RMA or RETMA).

Elastomer — Any material that will return to its original dimensions after being stretched or distorted.

Electromagnetic — Referring to the combined electric and magnetic fields caused by electron motion through conductors.

Electromagnetic Coupling — The transfer of energy by means of a varying magnetic field. Inductive coupling.

Electron Volt — A measure of the energy gained by an electron passing through an electric field produced by one volt.

Electrostatic — Pertaining to static electricity or electricity at rest. An electric charge, for example.

Electrostatic Coupling — The transfer of energy by means of a varying electrostatic field. Capacitive coupling.

ELFEXT — Equal Level Far End Crosstalk (dB). A subtraction of attenuation from FEXT. By subtracting the attenuation, ELFEXT negates the effects of attenuation on the interference as it propagates down the cable, thus bringing it to an equal level.

Elongation — The increase in length of a wire or cable caused by longitudinal tension.

EMF — Electromotive force (voltage).

EMI — Electromagnetic Interference.

End of Life Vehicle (ELV) — Refers to EU directive 2000/53/EC (18-SEPT-2000), which bans the use of certain substances in automobiles. This would require the use of a HMF or RoHS compliant cable.

Energy — The capability of doing work.

Energy Dissipation — Loss of energy from a system due to the conversion of work energy into an undesirable form, usually heat. Dissipation of electrical energy occurs when current flows through a resistance.

ENG — Electronic News Gathering.

EPDM — Ethylene-propylene-diene monomer rubber. A chemically cross-linked elastomer with good electrical insulating properties and excellent flexibility at high and low temperatures. It has good insulation resistance and dielectric strength, as well as excellent abrasion resistance and mechanical properties. EPDM has better cut-through resistance than Silicone rubber, which it replaces in some applications.

EPR — Ethylene-propylene copolymer rubber. A material with good electrical insulating properties.

Equilay — More than one layer of helically laid wires with the length of the lay the same for each layer.

ETP — Abbreviation for a copper refining process called Electrolytic Tough Pitch. This process produces a conductor that is 99.95% pure copper (per ASTM B115) resulting in high conductivity.

eV — Electron volt.

Expanded Polyethylene — Expanded or “foam” polyethylene, consists of individual closed cells of inert gas suspended in a polyethylene medium, resulting in a desirable reduction of the dielectric constant.

Extruded Cable — Conductors are simultaneously insulated and the cable is formed by a continuous extrusion process.

f — Frequency.

Farad — A unit of capacity that will store one coulomb of electrical charge when one volt of electrical pressure is applied.

FAS — Fire Alarm and Signal Cable, CSA (Canadian Standards Association) Cable Designation.

FAQ — Frequently Asked Question.

FCFC — Abbreviation for flat conductor flat cable.

FDDI — Fiber Distributed Data Interface.

FEC — Forward Error Correction.

Feedback — Energy that is extracted from a high-level point in a circuit and applied to a lower level. Positive feedback reduces the stability of a device and is used to increase the sensitivity or produce oscillation in a system. Negative feedback, also called inverse feedback, increases the stability of a system as the feedback improves stability and fidelity.

Feeder Cable — In a CATV system, the transmission cable from the head end (signal pickup) to the trunk amplifier. Also called a trunk cable.

FEP — Fluorinated ethylene-propylene. A thermoplastic material with good electrical insulating properties and chemical and heat resistance.

Ferrous — Composed of and/or containing iron. A ferrous metal exhibits magnetic characteristics.

FEXT — Far End Crosstalk. Crosstalk induced on the pairs, measured at the far end of the cable, referenced to the near end input signal. Usually expressed in decibels (dB).

Fiber — A single, separate optical transmission element characterized by core and cladding.

Glossary of Terms

Fiber Optics — Light transmission through optical fibers for communication and signaling. A technology that transmits information as light pulses along a glass or plastic fiber. Optical fiber carries much more information than conventional copper wire and is generally not subject to interference. Most telephone company long-distance lines are optical fiber. See RUS 1755.900.

Fiber to the home (FTTH) — A technology that provides voice, data and video services from the phone company's branch office to local customers over an all-fiber optic link. Still in its infancy, FTTH technology is substantially more expensive and labor-intensive to install and maintain than competing technologies.

Field — An area through which electric and/or magnetic lines of force pass.

Filled — Cables that are gel filled.

Fillers — Non-conducting components cabled with the insulated conductors or optical fibers to impart roundness, flexibility, tensile strength or a combination of all three to the cable.

Flamarrest® — Belden trademark for a plenum grade chloride-based thermoplastic jacketing material with low smoke and low flame spread properties; more flexible than traditional fluorocopolymer jacket materials. Cables jacketed with Flamarrest meet the ANSI/ NFPA Standard 2621-985 (UL-910) Flame Test.

Flame Resistance — The ability of a material not to fuel a flame once the source of heat is removed.

Flat Cable — Also referred to as planar and/or ribbon cable. Any cable with two or more parallel conductors in the same plane encapsulated by insulating material.

Flat Conductor — A conductor with a width-to-thickness ratio of arbitrarily 5 to 1 or greater.

Flat Conductor Cable — A flat cable with a plurality of flat conductors.

Flex Life — The qualification of the number of times a cable may bend before breaking.

Flexibility — The ability of a cable to bend in a short radius. The ability of a cable to lay flat or conform to a surface as with microphone cables.

FlexPoint PCB — Belden's patent-pending 10GX® Module design which reduces the compensation circuitry's time delay, ensuring stable high performance and enabling transmission rates of 625 MHz and data-rates of 10Gb/s.

Floating — Referring to a circuit which has no connection to ground.

Fluorocopolymer — Generic term for PVDF.

FM — Frequency modulation.

Foam Polyethylene — Expanded or "foam" polyethylene, consists of individual closed cells of inert gas suspended in a polyethylene medium, resulting in a desirable reduction of the dielectric constant.

FR-TPE — FR-TPE, flame retarded thermoplastic elastomer, is a rubber-like plastic that has properties similar to rubber yet is processed as a thermoplastic. It is used as the insulation and jacket in an all TPE construction which meets UL 13 and 1277 industrial cable requirements. It has good electrical properties, abrasion resistance, colorability and flame retardance. This compound is ideal for cold weather applications.

FREP — Flame retardant ethylene propylene is a special flame retardant version of EPDM rubber. It is designed for use as an industrial control insulation and has excellent electrical characteristics, deformation resistance and also meets the flame retardant needs of industrial control cables.

Frequency — The number of times a periodic action occurs in one second. Measured in Hertz.

Frequency Response — The amplitude versus frequency characteristics of a device. Also may refer to the range of frequencies over which the device operates within prescribed performance.

Frequency, Power — Normally, the 50 or 60 Hz power used to operate most AC powered equipment. The frequency of AC power supplied by electric utilities companies.

FSK — Frequency Shift Keying.

FTTC — Fiber-to-the-Curb.

Gage — The physical diameter of a wire. A standard for expressing wire diameter. As the AWG number gets smaller, the wire diameter gets larger.

Gain — The increase of voltage, current, or power over a standard or previous reading. Usually expressed in decibels (dB).

Geosol — A solderable, extra tough film insulation developed by Belden for use in geophysical cables and miniature cables.

Giga — One billion.

Gigahertz (GHz) — A unit of frequency equal to one billion Hz.

GND — Ground.

Gopher — Gopher Resistant Copper Alloy. Provides shield and added protection in a single layer.

GOPIC — Gopher.

Graded-Index — A type of optical fiber in which the refractive index of the core is in the form of a parabolic curve, decreasing toward the cladding. This type of fiber provides high bandwidth capabilities.

Ground — An electrical connection between a circuit and the earth. Also refers to a conductor connected to earth. In some instances, can refer to a central metallic point designated as having zero potential.

Ground Conductor — A conductor in a transmission cable or line that is grounded.

Ground Loop — A completed circuit between shielded pairs of a multiple pair created by random contact between shields. An undesirable circuit condition in which interference is created by ground currents when grounds are connected at more than one point.

Ground Potential — The potential of the earth. A circuit, terminal, or chassis is said to be at ground potential when it is used as a reference point for other potentials in the system.

H — Symbolic designation for magnetic field intensity. Abbreviation for henrys (unit of inductance).

Halar® — A Solvay Solexis trademark for thermoplastic fluoropolymer material with excellent chemical resistance, electrical properties, thermal characteristics and impact resistance.

Haloarrest® I — Haloarrest I is a non-halogenated flame retarded thermoplastic polyolefin with excellent low smoke and flame properties. It is used as a jacket over the XLPE insulated singles (non-XHHW), and the entire construction meets the UL 13 and 1277 specifications as a non-halogenated PLTC/TC cable. Haloarrest I meets the European Specifications on acid gas evolution and % Halogen content. This jacket can also be used with XHHW conductors for wet ratings.

Harness — A flat cable or group of cables, usually with many breakouts with the wire ends prepared for termination or terminated to connectors and ready to install.

HDSL — High bit-rate Digital Subscriber Line.

Headroom — The amount by which a cable ACR exceeds the specified requirements. The TIA/EIA-568B standard specifies a minimum of 10 dB of ACR for Category 5e certification at 100 MHz.

Heavy Metal Free (HMF) — General term for a product or material that does not contain restricted heavy metals, such as Lead or Cadmium. See also Restriction of Hazardous Substances.

Henry — Unit of inductance (H) that will produce a voltage drop of one volt when the current changes at the rate of one ampere per second.

Hertz (Hz) — Unit of frequency equal to one cycle per second.

Heterogeneous Insulation — A cable insulating system composed of two or more layers of different insulating materials.

HF — High Frequency. International Telecommunication Union designation for the 3 to 30 MHz band of frequencies.

HFC — Hybrid Fiber/Coaxial.

High Frequency — International Telecommunication Union designation for the 3 to 30 MHz band of frequencies.

Homogeneous Insulation — A complete cable insulation structure whose components cannot be identified as layers of different materials.

Hook-Up Wire — Single conductor wire with various types of insulation.

Horizontal Cable — Cable used between the workstation outlet and the telecommunications closet. Limited to 90 meters maximum per TIA/EIA-568B.1.

HSCDS — High-Speed Cable Data Service.

Glossary of Terms

HTML — Hypertext Markup Language.

HTTP — Hypertext Transfer Protocol.

Hum — Term used to describe noise in an audio, video or other system that comes from 60 Hz power or its harmonic(s). So named for the low-frequency humming sound produced in audio systems. Usually hum is the result of undesired coupling from a 60 Hz source or of inadequate filtering of the DC output of an AC input power supply.

Hypalon® — A DuPont trade name for a synthetic rubber (chlorosulfonated polyethylene) used as insulating and jacketing material for wire and cable.

I — Symbol used to designate current.

I/O Interconnection — Input/Output interface to the outside world.

I²R — Formula for power in watts, where I = current in amperes, R = resistance in ohms.

ICEA — Insulated Cable Engineers Association.

IDC — Insulation Displacement Connector. Type of connector where contact is made to the cable conductor(s) by cutting through the individual conductor's insulation. The conductor does not need to have its insulation removed prior to connection. Flat cable often uses IDCs to simultaneously connect all conductors.

IDSL — ISDN Digital Subscriber Line.

IEEE — Institute of Electrical and Electronic Engineers.

IETF — Internet Engineering Task Force.

IF — Intermediate Frequency.

IFB — Interrupted Feedback (Foldback). A monitoring scheme often used in television where the feed of program audio to an on-air person can be interrupted with directions, cues or other information. Usually integrated into the intercom system.

IGMP — Internet Group Management Protocol.

Impedance — The total opposition that a circuit offers to the flow of alternating current or any other varying current at a particular frequency.

Impedance Match — A condition whereby the impedance of a particular circuit, cable or component is the same as the impedance of the circuit, cable or device to which it is connected.

Impedance Matching Stub — A section of transmission line or pair of conductors cut to match the impedance of a load. Also called matching stub.

Impedance Matching Transformer — A transformer designed to match the impedance of one circuit to that of another.

Impedance, Characteristic — In a transmission cable of infinite length, the ratio of the applied voltage to the resultant current at the point the voltage is applied. Or the impedance which makes a transmission cable seem infinitely long, when connected across the cable's output terminals.

Impedance, High — Generally, the area of 25,000 ohms or higher.

Impedance, Low — Generally, the area of 1 through 600 ohms.

Index Edge — Reference Edge.

Inductance — The property of wire which stores electrical current in a magnetic field around the wire. By coiling wire, the effect can be intensified. It is measured in Henrys.

Induction — The phenomenon of a voltage, magnetic field or electrostatic charge being produced in an object from the source of such fields.

Induction Heating — Heating a conducting material by placing it in a rapidly changing magnetic field. The changing field induces electric currents in the material and losses account for the resultant heat.

Inductive Crosstalk — Crosstalk resulting from the coupling of the electromagnetic field of one conductor upon another.

Injection Laser Diode — Sometimes called the semiconductor diode. A laser in which the lasing occurs at the junction of N-type and P-type semiconductor materials.

INMS — Integrated Network Management System.

Input — A signal (or power) which is applied to a piece of electric apparatus or the terminals on the apparatus to which a signal or power is applied.

Insertion Loss — A measure of the attenuation of a cable and/or component(s) by determining the output of a system before and after the device is inserted into the system.

Insulation — A material having good dielectric properties which is used to separate close electrical components, such as cable conductors and circuit components.

Insulation Displacement Connector (IDC) — A mass termination connector for flat cable with contacts that displace the conductor insulation to complete termination.

Insulation Stress — The molecule separation pressure caused by a potential difference across an insulator. The practical stress on insulation is expressed in volts per mil.

Interface — The region where two systems or a major and a minor system meet and interact with each other.

Interference — Disturbances of an electrical or electromagnetic nature that introduce undesirable responses into other electronic equipment.

Intermediate Frequency — A frequency to which a signal is converted for ease of handling. Receives its name from the fact that it is an intermediate step between the initial and final conversion or detection stages.

Ionization — The formation of ions. Ions are produced when polar compounds are dissolved in a solvent and when a liquid, gas, or solid is caused to lose or gain electrons due to the passage of an electric current.

Ionization Voltage — The potential at which a material ionizes. The potential at which an atom gives up an electron.

IP — Internet Protocol.

IPCDN — IP Over Cable Data Network working group of the IETF.

IR — Insulation Resistance.

IR Drop — The designation of a voltage drop in terms of current and resistance. (See also *Voltage Drop*.)

IRC — Inter Relay Chat.

IRS — Ignition Radiation Suppression.

Integrated Services Digital Network — An alternative to telephone modems that allows digital transmission over ordinary telephone copper wire and other media. Home and business users can get highly graphic Web pages more quickly through ISDN adapters than through dial-up connections.

ISO — International Standards Organization.

Isolation — The ability of a circuit or component to reject interference, usually expressed in dB.

ISP — Internet Service Provider.

ITFS — Instructional Television Fixed Service.

ITU — International Telecommunications Union.

Jacket — Pertaining to wire and cable, the outer protective covering that may also provide additional insulation.

Jumper — A short length of conductor or flat cable used to make a connection between terminals or around a break in a circuit or between circuit boards.

kB — Kilobyte.

keV — 1000 electron volts.

Kilo — One thousand.

KPSI — Tensile strength in thousands of pounds per square inch.

kV — Kilovolt (1000 volts).

kVA — Kilo Volt-ampere. One thousand volt-amperes (VA). (See also *VA*.)

kW — Kilowatt.

L — Symbol for inductance.

Laminated Cable — Insulated or uninsulated wires which are encapsulated by two sheets of laminate material to maintain a predetermined pitch.

LAN — Local Area Network. A data network connecting any number of users, intended to serve a small area. A group of computers and associated devices that shares a common communications line and typically shares the resources of a single processor or server within a small geographic area.

Laser — A coherent source of light with a narrow beam and a narrow spectral bandwidth (about 2nm).

Lay — The length measured along the axis of a wire or cable required for a single strand (in stranded wire) or conductor (in cable) to make one complete turn about the axis of the conductor or cable. In a twisted pair cable, the lay length is the distance it takes for the two wires to completely twist around each other.

Glossary of Terms

- Lay Direction** — The direction of the progressing spiral twist in a cable while looking along the axis of the cable away from the observer. The lay direction can be either left or right.
- Lead Dress** — The placement or routing of wiring and component leads in an electrical circuit.
- Lead Free** — Unless otherwise specified, a homogeneous material containing less than 300ppm of lead (Pb) which is not intentionally added. See also *Heavy Metal Free*.
- Lead-in** — The cable that provides the path for RF energy between the antenna and the receiver or transmitter.
- Leakage** — The undesirable passage of current over the surface of or through an insulator.
- LEC** — Local Exchange Carrier.
- Level** — A measure of the difference between a quantity or value and an established reference.
- LF** — Low frequency. International Telecommunication Union designation for the 30 to 300 kHz band of frequencies.
- Light Emitting Diode (LED Source)** — A semiconductor device that emits incoherent light formed by the P-N junction. Light intensity is roughly proportional to electrical current flow.
- Limpness** — The ability of a cable to lay flat or conform to a surface as with microphone cables. The ability of a cable to bend in a short radius.
- Line Drop** — A voltage loss occurring between any two points in a power or transmission line. Such loss or drop is due to the resistance, reactance or leakage of the line. (See also *Voltage Drop* and *IR Drop*.)
- Line Equalizer** — A reactance (inductance and/or capacitance) connected in series with a transmission line to alter the frequency-response characteristics of the line.
- Line Level** — Refers to the output voltage level of a piece of electronic equipment. Usually expressed in decibels (e.g. 0 dBV).
- Line Voltage** — The value of the potential existing on a supply or power line.
- LMDS** — Local Multipoint Distribution Service
- Load** — A device that consumes power from a source and uses that power to perform a function.
- Loaded Line** — A transmission line that has lumped elements (inductance or capacitance) added at uniformly spaced intervals. Loading is used to provide a given set of characteristics to a transmission line.
- Loading** — A transmission line that has lumped elements (inductance or capacitance) added at uniformly spaced intervals. Loading is used to provide a given set of characteristics to a transmission line.
- Local Area Network** — A data network connecting any number of users, intended to serve a small area. (See also *LAN*.)
- Long-wire Antenna** — An antenna conductor length in excess of one-half of a wavelength.
- Loss** — Energy or signal lost without accomplishing useful work.
- Lossy** — Having high losses resulting in efficiency.
- Low Frequency** — International Telecommunication Union designation for the 30 to 300 kHz band of frequencies.
- Luminance Signal** — The portion of the composite video signal that represents the brightness or the black and white information.
- m** — Prefix for milli or one-thousandth.
- M** — Mutual inductance. The abbreviation for mega or 1 million. And also indicates 1000 (one thousand) feet in the wire industry. Lower case m is for milli or one-thousandth. (See also *m*.)
- M'** — Notation representing 1000 feet.
- mA** — milliampere (one-thousandth of an ampere).
- MAC** — Media Access Control (layer of OSI Reference Model).
- MAN** — Metropolitan Area Network.
- Manufacturing Automation Protocol** — A manufacturing automation protocol based on IEEE 802.4 standards.
- MAP** — Manufacturing Automation Protocol.
- Margin** — Distance between reference edge of cable and nearest edge of first conductor or center of first conductor.
- Mass-Termination** — The process of simultaneously terminating all conductors in a single operation.
- Matrix IDC™** — Belden's patent pending 10GX® Module IDC design which reduces the ANEXT between pairs of adjacent modules by 15dB, enabling transmission rates of 625 MHz and data rates of 10Gb/s.
- Matte Finish PVC** — A special formulation of PVC which very closely looks and feels like rubber.
- MATV** — Abbreviation for Master Antenna Television.
- MB** — Megabyte.
- Mbps** — Mega bits per second. The number of bits, in millions, transmitted per second.
- MCNS** — Multimedia Cable Network System Partners Ltd.
- MDS** — Multipoint Distribution System.
- Mega** — Prefix meaning million.
- Megahertz (MHz)** — Unit of frequency equal to one million Hertz.
- Metropolitan Area Network (MAN)** — A data network intended to serve the area of a city or an area of similar size.
- mfd** — Microfarad (one-millionth of a farad). Modern abbreviation is μF (lower case Greek *mu* followed by F).
- Mho** — The unit of conductance equal to the reciprocal of the unit of resistance (ohm).
- MHz** — Megahertz. (See also *Megahertz*.)
- Micro** — Prefix meaning one-millionth.
- Microfarad** — One-millionth of a farad (μf , μfd , mf and mfd are common abbreviations).
- Micromicrofarad** — One-millionth of a microfarad ($\mu\mu\text{f}$, $\mu\mu\text{fd}$, mmf , mmfd are common abbreviations). Modern usage is picofarad (pF).
- Micron** — Millionth of a meter. (μ is a common abbreviation).
- Microphonics** — Noise caused by mechanical excitation of a system component. In a single-conductor microphone cable, for example, microphonics can be caused by the shield rubbing against the dielectric as the cable is flexed.
- Mil** — A unit of length equal to one thousandth of an inch (.001).
- Milli** — Prefix meaning one-thousandth.
- Mitigation** — Strategies or methods to improve Alien Crosstalk performance in the field for 10G transmission over installed-base cabling.
- Mode** — A single electromagnetic wave traveling in an optical fiber.
- Modem** — Modulator-Demodulator. Device that converts signals in one form to another form compatible with another kind of equipment.
- Modulation** — Altering the characteristics of a carrier wave to convey information. Modulation techniques include amplitude frequency, phase, plus many other forms of on-off digital coding.
- Molded Cable** — Cable assemblies with molded connectors on one or both ends.
- Mono Filament** — A single strand filament as opposed to a braided or twisted filament.
- MSO** — Multiple System Operator. Cable TV term referring to companies that operate multiple cable TV systems in numerous cities.
- MTP** — Simple Mail Transfer Protocol.
- Multi-Conductor Cable** — Cable with more than one conductor.
- Multiplex** — A technique for putting two or more signals into a single channel.
- Mutual Capacitance** — Effective capacitance between two conductors when the effects of the other conductors and shield, if present, are removed.
- mV** — Millivolt (one-thousandth of a volt).
- mW** — Milliwatt (one-thousandth of a watt).
- Mylar®** — DuPont trademark for polyethylene terephthalate (polyester) film.
- N** — Type of coaxial connector named after its inventor, Paul Neil of Bell Labs. Also the symbol for Newton.
- Nano** — One-billionth.
- Nanometer (nm)** — One billionth of a meter.
- Nanosecond** — One billionth of a second.

Glossary of Terms

NAP — Network Access Point.

National Electrical Code (NEC) — A publication of the National Fire Protection Association (NFPA) which outlines requirements for electrical wiring and building construction.

NBR — Butadiene-acrylonitrile copolymer rubber, a material with good oil and chemical resistance.

NEC — National Electrical Code.

NEMA — National Electrical Manufacturers Association.

Neoprene — A synthetic rubber with good resistance to oil, chemical, and flame. Also called polychloroprene.

Network — A method of data communications between computers.

NEXT — Near-end Crosstalk. Crosstalk induced on the pairs, measured at the end near the transmitter. Usually expressed in decibels (dB).

NFPA — National Fire Protection Association.

Nibble — One half byte (4 bits).

NOC — Network Operations Center.

Noise — In a cable or circuit, any extraneous signal which tends to interfere with the signal normally present in or passing through the system.

NOMEX® — DuPont trademark for a temperature-resistant, flame-retardant nylon.

Non-Paired Cable — Cable with two or more cabled conductors that are not in a paired configuration.

Non-Plenum — A description for a cable that does not meet the requirements of NFPA 262 (UL 910) CMP flame test. Such a cable cannot be installed in an area that is used for air return (plenum).

Notch — The removal of the web section between conductors of a flat cable to aid in stripping, slitting and termination.

NTSC — National Television System Committee. Organization that formulated standards for the current U.S. color television system. This system is used in most countries of the Americas and in other parts of the world. It was designed to be compatible with the existing monochrome TV sets, so that they would not become obsolete. Color televisions would also be able to receive monochrome transmissions. NTSC uses a 3.579545 MHz subcarrier whose phase varies with the instantaneous hue of the televised color and whose amplitude varies with the instantaneous saturation of the color. NTSC employs 525 lines per frame, 29.97 frames per second and 59.94 fields per second.

Numerical Aperture (NA) — A measure of the angular acceptance for a fiber. It is approximately the sine of the half-angle of the acceptance cone.

Nylon — An abrasion-resistant thermoplastic with good chemical resistance.

OFDM — Orthogonal Frequency Division Multiplexing.

OFHC — Abbreviation for oxygen-free, high conductivity copper. It has 99.95% minimum copper content and an average annealed conductivity of 101% compared to standard copper.

Ohm — The unit of electrical resistance. The value of resistance through which a potential difference of one volt will maintain a current of one ampere.

Ohm's Law — Stated $E=IR$, $I=E/R$ or $R=E/I$. The current I in a circuit is directly proportional to the voltage E , and inversely proportional to the resistance R .

Optical Waveguide Fiber — A transparent filament of high refractive index core and low refractive index cladding that transmits light.

OSI — Open System Interconnect (Model for networking protocols).

OSS — Operations Support Systems.

Output — The useful power or signal delivered by a circuit or device.

Ozone — Extremely reactive form of oxygen, normally occurring around electrical discharges and present in the atmosphere in small but active quantities. In sufficient concentrations it can break down certain rubber insulations under tension (such as a bent cable).

Paired Cable — Cable with conductors cabled in groups of two.

PAL — Phase Alternation Line. PAL is a European color TV system featuring 625 lines per frame, 25 frames and 50 fields per second. Used mainly in Europe, China, Malaysia, Australia, New Zealand, the Middle East, and parts of Africa. PAL-M is a Brazilian color TV system with 525 lines per frame, 30 frames and 60 fields per second.

Parallel Circuit — A circuit in which the identical voltage is presented to all components, with current dividing among the components according to the resistances or the impedances of the components.

Parallel Digital — Digital information that is transmitted in parallel form. The digits are sent on separate conductors rather than sequentially on one transmission line (serial). Often used informally to refer to parallel digital television signals.

PASP — Polyethylene Aluminum Steel Polyethylene. Provides additional lightning and gopher protection.

Patchcord — A flexible piece of cable terminated at both ends with plugs. Used for interconnecting circuits on a patchboard, in a wiring closet or at the work area.

PC — Personal Computer.

PE — Polyethylene.

Peak — The maximum instantaneous value of a varying current or voltage.

Peel Strength — The force necessary to separate two adjacent conductors of a bonded or laminated flat cable.

Periodicity — The uniformly spaced cable impedance variations that result in addition of the reflections of a signal. The distance between them is the half wavelength of the most affected frequency. Multiples of that frequency are also affected. Even very slight variations, which appear over and over in a construction or installation, can have major effects on signal integrity because of periodicity.

Permanent Link — The horizontal cable including the workstation outlet and patch panel in the telecommunications closet plus two meters of cable at each end for testing. Limited to a maximum of 90 meters in TIA/EIA-568B.1.

PFA — Perfluoroalkoxy.

Phase — An angular relationship between waves.

Phase Shift — A change in the phase relationship between two alternating quantities.

Photodetector (Receiver) — Converts light energy to electrical energy. The silicon photo diode is most commonly used for relatively fast speeds and good sensitivity in the .75 micron to .95 micron wavelength region. Avalanche photodiodes (APD) combine the detection of optical signals with internal amplification of photo-current. Internal gain is realized through avalanche multiplication of carriers in the junction region. The advantage in using an APD is its higher signal-to-noise ratio, especially at high bit rates.

PHY — Physical (layer of OSI Reference Model). (See also *Physical Layer*.)

Physical Layer — The actual portion of a network that is used to physically connect computers of a network and over which the data is transmitted — the cable.

PIC — Plastic Insulated Conductor. Provides strong insulation.

Pickup — Any device which is capable of transforming a measurable quantity of intelligence (such as sound) into relative electrical signals (e.g. a microphone).

Pico — One-trillionth.

Picofarad — One trillionth of a farad. A micromicrofarad. Abbreviated pF in modern usage or mmF in earlier usage.

Pin-diode — A photodetector used to convert optical signals to electrical signals in a receiver. (See also *Photodetector*.)

Pitch — Nominal distance from center-to-center of adjacent conductors within a cable. When conductors are flat, pitch is usually measured from the reference edge of a conductor to the reference edge of the adjacent conductor. Spacing.

Planar Cable — Also referred to as flat and/or ribbon cable. Any cable with two or more parallel conductors in the same plane encapsulated by insulating material.

Plastic — High polymeric substances, including both natural and synthetic products that are capable of flowing under heat and pressure, called thermoplastics. Unlike rubber and other thermoset compounds, plastics can be remelted and reused.

Plasticizer — A chemical added to plastics to make them softer and more flexible.

Plenum — A compartment or chamber to which one or more air ducts are connected and that forms part of the air distribution system. A description for a cable that passes the NFPA 262 (UL-910) CMP flame test requirements.

Plug — A male housing with male or female contacts.

Glossary of Terms

Point-to-Point Wiring — Wiring that consists of continuous conductors terminated at each end to circuit destination.

Polarization — The orientation of a flat cable or a rectangular connector (e.g. for gray flat cable), the colored edge indicating the number one conductor.

Polybutadiene — A type of synthetic rubber often blended with other synthetic rubbers to improve their properties.

Polyethylene (PE) — A thermoplastic material having excellent electrical properties. Low dielectric constant, a stable dielectric constant over all frequencies, very high insulation resistance. In terms of flexibility, polyethylene can be rated stiff to very hard, depending on molecular weight and density — low density being the most flexible and the high-density, high-molecular weight formulation being very hard. Moisture resistance is rated excellent.

Polymer — A substance made of many repeating chemical units or molecules. The term polymer is often used in place of plastic, rubber or elastomer.

Polyolefin — Any of the polymers and copolymers of the ethylene family of hydrocarbons, such as polyethylene and polypropylene.

Polypropylene (PP) — A thermoplastic similar to polyethylene but stiffer and having a higher softening point (temperature). This material is primarily used as an insulation material. Typically, it is harder than polyethylene. This makes it suitable for thin wall insulations. The dielectric constant is 2.25 for solid and 1.55 for cellular designs.

Polyurethane (PUR) — Broad class of polymers noted for good abrasion and solvent resistance. Can be in solid or cellular form. This thermoplastic material is used primarily as a cable jacket material. It has excellent oxidation, oil, and ozone resistance. Some formulations also have good flame resistance. It is a hard material with excellent abrasion resistance. It has outstanding memory properties, making it an ideal jacket material for retractile cords.

Polyvinyl Chloride (PVC) — A general purpose thermoplastic used for wire and cable insulation and jackets.

Portable Cordage — Cable with two or more twisted conductors for flexible applications. Also called flexible cord.

POTS — Plain Old Telephone Service. Sometimes used in discussions of new telephone technologies in which the question of whether and how existing voice transmission for ordinary telephone communication can be accommodated. For example, DSL and ISDN provide part of their channels for POTS, while using most of their bandwidth for digital data transmission.

Potting — Sealing by filling with a substance to exclude moisture.

Power — The amount of work per unit of time. Usually expressed in watts. Power equals the product of voltage and current ($P = V \times I$).

Power Loss — The difference between the total power delivered to a circuit, cable or device and the power delivered by that device to a load.

Power Ratio — The ratio of power appearing at the load to the input power.

PP — Polypropylene.

PPP — Point-to-Point Protocol.

Precision Video — Video coaxial cables having very tight electrical tolerances in impedance, velocity of propagation, attenuation and return loss. Used in high quality applications such as live broadcast in network studios and pre- or post-production facilities.

Premise Cabling — Refers to the entire cabling system used for voice, data, video and power on a user's premise. For Local Area Networks, the cabling of choice includes unshielded twisted pairs (UTP), fiber optic and coaxial cables. Of these, the UTP market is the largest, with greatest demand for cables with four pairs that meet certain standards of performance, such as Category 5 and Category 5e.

PRI — Primary Rate Interface ISDN.

Prop 65 — See *California Proposition 65*.

Propagation Delay — Time required for a signal to pass from the input to the output of a device.

PSALFEXT — Power sum alien equal level far-end crosstalk is a computation of the unwanted signal coupling between pairs in cabling in close proximity from multiple transmit signals at the near-end into another pair measured at the far-end, and relative to the received signal level.

PSAFEXT — Power sum alien far-end crosstalk loss is a computation of the unwanted signal coupling between pairs in cabling in close proximity from multiple transmit signals at the near-end into another pair measured at the far-end.

PSANEXT — Power sum alien near-end crosstalk loss is a computation of the unwanted signal coupling between pairs in cabling in close proximity from multiple transmit signals at the near-end into a pair measured at the near-end.

Pseudo Random NRZ — A wave form of binary signals that may be used in a computer system. It is called NRZ, Non-Return to Zero, because the voltage does not return to zero after each bit.

PSTN — Public Switched Telephone Network.

Pulse — A current or voltage which changes abruptly from one value to another and back to the original value in a finite length of time. Used to describe one particular variation in a series of wave motions.

Put-up — Packaging of finished wire or cable.

PVC — Polyvinyl Chloride. (See also *Polyvinyl Chloride*.)

PVDF — Polyvinylidene Fluoride.

QAM — Quadrature Amplitude Modulation.

QOS — Quality of Service.

QPSK — Quaternary Phase Shift Keying or Quadrature PSK.

Quad — A four conductor cable. Also called star quad.

R — Symbol for resistance.

Radio Frequency (RF) — Radio Frequency. Includes frequencies from a few kilohertz to several gigahertz. Used to transmit information from point to point over the airwaves or cable.

RAM — Random Access Memory.

Rated Temperature — The maximum temperature at which an electric component can operate for extended periods without loss of its basic properties.

Rated Voltage — The maximum voltage at which an electric component can operate for extended periods without undue degradation or safety hazard.

RDC — Regional Data Center.

Reactance — A measure of the combined effects of capacitance and inductance on an alternating current. The amount of such opposition varies with the frequency of the current. The reactance of a capacitor decreases with an increase in frequency; the opposite occurs with an inductance.

Receiver — A unit that converts an RF signal to another type of signal (e.g. radio, television). Also refers to an electronic package that converts light energy to electrical energy in a fiber optic system. (See also *Photodetector*.)

Receptacle — A female housing with male or female contacts.

Reference Edge — Edge of cable or conductor from which measurements are made, such as in flat cable. Sometimes indicated by a thread, identification stripe or printing. Conductors are usually identified by their sequential position from the reference edge, with number one conductor closest to this edge.

Reflection — The change in direction (or return) of waves striking a surface. For example, electromagnetic energy reflections can occur at an impedance mismatch or variation in a transmission line, causing standing waves.

Reflection Loss — The part of a signal which is lost due to reflection of power at a line discontinuity.

Refractive Index — The ratio of light velocity in a vacuum to its velocity in the transmitting medium.

Registration — Alignment of one object with relation to another. In flat cables it involves aligning conductors with contacts or solder pads. Also called register.

Repeater — A receiver and transmitter combination used to regenerate an attenuated signal.

Resistance — In DC circuits, the opposition a material offers to current flow, measured in ohms. In AC circuits, resistance is the real component of impedance, and may be higher than the value measured at DC.

Resonance — An AC circuit condition in which inductive and capacitive reactances interact to cause a minimum or maximum circuit impedance.

Glossary of Terms

Restricted Flame Retardants — Refers to the EU directive 2003/11/EC (6-FEB-2003), which bans the use of Penta- and Octa- BDE compounds. Belden is currently using these substances in certain CPE jacket materials only, and plans to phase out usage by January 2006. Contact Belden Customer Service or visit www.belden.com for product specific details.

Restriction of Hazardous Substances (RoHS) — Refers to the EU directive 2002/95/EC (27-JAN-2003) which bans the use of certain substances as of July 2006. The following items are of primary concern in cables, namely: Asbestos and its compounds, Cadmium and its compounds, Chromium VI and its compounds, Lead and its compounds, Mercury and its compounds, and Polybrominated Biphenyls (pbbs) and their ethers/oxides (PBDEs, PBBEs). Contact Belden Customer Service or visit www.belden.com for product specific details.

Retractable Cord — A cord having specially treated insulation or jacket so that it will retract like a spring. Retractability may be added to all or part of a cord's length.

Return Loss — Measure of signal reflections from a cable or device with a fixed, standard reference impedance on the measuring equipment. Expressed in decibels (dB).

RF — Radio Frequency.

RFI — Radio Frequency Interference.

RFP — Request for Proposals.

RG/U — RG is the abbreviation for radio guide, a military designation for a coaxial cable, and U stands for universal.

RGB — Abbreviation for the three parts of color video signal: red, green and blue. Also refers to multi-coaxial cables carrying these signals.

Ribbon Cable — A flat cable made with parallel round conductors in the same plane. Also referred to as planar and/or flat cable. Any cable with two or more parallel conductors in the same plane encapsulated by insulating material.

Ringing Out — The process of locating or identifying specific conductor paths by means of passing a current through selected conductors.

Riser — The system of pathways that are provided to run riser cables from one floor to another.

RJ-45 — Modular telecommunications connector.

RL — Return Loss.

RMS — Root-mean-square.

Rope Strand — A conductor composed of groups of twisted strands.

Round Conductor Flat Cable (RCFC) — A cable made with parallel round conductors in the same plane.

Routing — The path followed by a cable or conductor.

RSVP — Resource Reservation Protocol.

RTP — Real-Time Transport Protocol.

Rubber (Wire Insulation) — A general term used to describe wire insulations made of thermosetting elastomers, such as natural or synthetic rubbers, neoprene, Hypalon® butyl rubber and others.

RUS 1755.900 (aka PE90) — A specification for fiber optic cables currently in high demand by the telecommunications industry. Only a handful of U.S. manufacturers can produce fiber optic cables to this specification. Belden is one of them.

S-CDMA — Synchronous Code Division Multiple Access.

S-HDSL — Single-pair High bit-rate Digital Subscriber Line.

SAE — Society of Automotive Engineers.

SBR — A copolymer of styrene and butadiene. Also GR-S or Buna-S. Most commonly used type of synthetic rubber.

ScTP — Screened Twisted Pair. Premise network cable with an overall foil shield.

SDI — Serial Digital Interface.

SDSL — Symmetric Digital Subscriber Line.

SEALPIC — Aluminum Shield. Sealed Aluminum.

Self-extinguishing — The characteristic of a material that extinguishes its own flame after the igniting flame is removed.

Self-Support — Undulated core with aluminum, polyethylene and a support strand. For aerial use.

Semiconductor — In wire industry terminology, a material possessing electrical conductivity that falls somewhere between that of conductors and insulators. Usually made by adding carbon particles to an insulator. Not the same as semiconductor materials such as silicon, germanium, etc. Used for making transistors and diodes.

Semi-Solid Dielectric — A coaxial design in which a monofilament of plastic holds the center conductor in place in a hollow plastic tube allowing the remainder of the dielectric to be air. Typical velocities of up to 84% can be achieved in this design.

Separator — Pertaining to wire and cable, a layer of insulating material such as textile, paper, Mylar®, etc., which is placed between a conductor and its dielectric, between a cable jacket and the components it covers, or between various components of a multiple-conductor cable. It can be utilized to improve stripping qualities, flexibility or can offer additional mechanical or electrical protection to the components it separates.

Serial Digital — Digital information that is transmitted in serial form. SDI informally refers to serial digital television signals that conform to the SMPTE 259M standard.

Serial Digital Interface — Informally refers to serial digital television signals that conform to the SMPTE 259M standard.

Series Circuit — A circuit in which the components are arranged end to end to form a single path for current.

Serve Shield — A metallic shield consisting of several strands of wire, helically wound and laid parallel around a cable core in only one direction, as opposed to the two directions with interleaving of a braid shield.

Shannon Capacity — A theoretical calculation of the maximum available data-rate for a channel.

Sheath — Pertaining to wire and cable, the outer protective covering, also called jacket, that may also provide additional insulation.

Shield — A tape, serve or braid (usually copper, aluminum or other conductive material) placed around or between electric circuits or cables or their components, to prevent signal leakage or interference.

Shield Coverage — The optical percentage of a cable actually covered by shielding material.

Shield Effectiveness — The relative ability of a shield to screen out undesirable interference or prevent signal leakage out of the cable. Frequently confused with the term shield coverage.

Shield Percentage — The percentage of physical area of a circuit or cable actually covered by shielding material.

Shielded Armored — Types of Shield: Aluminum, Aluminum/Steel and Copper. Cables that require some sort of shield.

Signal — Any visible or audible indication which can convey information. Also, the information conveyed through a communication system.

Signal Conductor — A conductor in a transmission cable or line that carries electrical signals.

Signal to Noise Ratio — Ratio of desired signal to undesired signal (noise) that is often expressed in decibels. Commonly used interchangeably with Attenuation Crosstalk Ratio (ACR) — the difference between attenuation and crosstalk, measured in decibels (dB), at a given frequency. Important characteristic in networking transmission to assure that signal sent down a twisted pair is stronger at the receiving end of the cable than are any interference signals imposed on that same pair by crosstalk from other pairs.

Silicone — A material made from silicon and oxygen. Can be in thermosetting elastomer or liquid form. The thermosetting elastomer form is noted for high heat resistance. This is a very soft thermoset insulation. It has excellent electrical properties plus ozone resistance, low moisture absorption, weather resistance, and radiation resistance. It typically has low mechanical strength and poor scuff resistance.

Single-mode Fiber — An optical fiber wave guide in which only one mode will propagate. The fiber has a very small core diameter of approximately 8 micro meters. It permits signal transmission at extremely high bandwidths and is generally used with laser diodes.

Single-ended — Unbalanced, such as grounding one side of a circuit or transmission line.

Sinusoidal — Varying in proportion to the sine of an angle or time function. Ordinary alternating current is sinusoidal.

Hypalon is a DuPont trademark.

Glossary of Terms

- SIS** — Single conductor having synthetic thermosetting insulation of heat-resistant, moisture-resistant, flame-retarding grade. Also made with chemically cross-linked polyethylene insulation. Used for switched wiring only.
- Skew Rays** — A ray that does not intersect the fiber axis. Generally, a light ray that enters the fiber core at a very high angle.
- Skin Effect** — The tendency of alternating current to travel only on the surface of a conductor as its frequency increases.
- SMA** — Subminiature A connector commonly used in VHF, UHF, RF and microwave applications.
- SMB** — Subminiature B connector snap-mount connector.
- SMC** — Subminiature C connector.
- Snake Cable** — A name given to individually shielded or individually shielded and jacketed, multi-pair audio cables. Used in the connection of multi-channel line level audio equipment.
- SNMP** — Simple Network Management Protocol.
- SNR** — Signal to Noise Ratio.
- SONET** — Synchronous Optical Network.
- Source** — The device from which a signal is marked into a cable. The device (usually LED or laser) used to convert an electrical information-carrying signal into a corresponding optical signal for transmission by an optical wave guide.
- Spacing** — The distance between the centers of two adjacent conductors. Pitch.
- Span** — The distance between the center of the first conductor and the center of the last conductor in a flat cable.
- Spectral Bandwidth** — The difference between wavelengths at which the radiant intensity of illumination is half its peak intensity.
- Spectrum** — Frequencies that exist in a continuous range and have a common characteristic. A spectrum may be inclusive of many spectrums (e.g. the electromagnetic radiation spectrum includes the light spectrum, radio spectrum, infrared spectrum, etc.).
- Speed of Light (c)** — Approximately 2.998×10^8 meters per second.
- SpiralFlex™** — Belden's patent-pending cable design for the 10GX® Cable which increases randomization and pair separation, enabling transmission rates of 625 MHz and data-rates of 10Gb/s.
- Splitter** — A device that sends the signal from one source to two or more receiving devices by allocating a portion of the signal to each receiver (e.g. cable TV splitter). A device that divides a high bandwidth signal into two or more lower bandwidth signals, each carrying a selected frequency range. Users connected to a DSL line, for example, may have a splitter installed at their home or business to divide the incoming signal into low frequencies to send to their phone and high frequencies for data to the computer.
- SRL** — Structural Return Loss.
- Stalpeth (DUCTPIC)** — Aluminum steel bonded to the polyethylene jacket. Helps minimize jacket damage.
- Standing Wave** — The stationary pattern of waves produced by two waves of the same frequency traveling in opposite directions on the same transmission line. The existence of voltage and current maxima and minima along a transmission line is a result of reflected energy from an impedance mismatch.
- Standing Wave Ratio (SWR)** — A ratio of the maximum amplitude to the minimum amplitude of a standing wave stated in current or voltage amplitudes. (See also *Standing Wave*.)
- Star Quad** — Term given to 4-conductor microphone cables where the conductors are spiraled together, which, when connected in an x configuration, greatly increases common mode noise rejection.
- Static Charge** — An electrical charge that is bound to an object. An unmoving electrical charge.
- Stay Cord** — A component of a cable, usually of high tensile strength, used to anchor the cable ends at their points of termination and keep any pull on the cable from being transferred to the electrical conductors.
- Step Insulated** — Process of applying insulation in two layers. Typically used in shielded networking cables such that the outer layer of insulation can be removed and remaining conductor and insulation can be terminated in a RJ-45 type connector.
- Step-index Fiber** — An optical fiber in which the core is of a uniform refractive index with a sharp decrease in the index of refraction at the core/cladding interface.
- STP** — Shielded Twisted Pair(s).
- Strain Gage** — A device for determining the amount of strain (change in dimensions) when a stress is applied.
- Strand** — A single uninsulated wire.
- Stranded Conductor** — A conductor composed of several strands or groups of uninsulated wires.
- Strip** — To remove insulation from a cable or wire.
- Stripping Groove** — The controlled thinning of the lamination between two conductors in a flat cable to allow easy hand separation. Tear feature.
- Structural Return Loss** — Magnitude of the internal cable reflections, measured in decibels (dB), relative to the actual cable impedance, not the system impedance. Measure of signal reflections caused by the structure of the cable without the additional reflections from any impedance mismatch between the cable and the measuring equipment. Measure of internal cable reflections using a reference impedance in the measuring equipment that is adjusted to the nominal or average impedance of the cable. (See also *Return Loss*.)
- Surge** — A temporary and relatively large increase in the voltage or current in an electric circuit or cable. Also called transient.
- S-Video** — Transmission method for video in which the two parts of the signal, the chrominance and luminance, are sent on separate transmission lines to provide better picture quality.
- Sweep Test** — Testing a characteristic of a cable or device across a range of frequencies. In cable, it usually implies return loss or structural return loss. (See also *Return Loss* or *Structural Return Loss*.)
- TCP/IP** — Transmission Control Protocol/Internet Protocol.
- TDMA** — Time Division Multiple Access.
- Tear Feature** — The controlled thinning of the lamination between two conductors in a flat cable to allow easy hand separation.
- Teflon®** — DuPont Company trademark for fluorocarbon resins.
- Tefzel®** — DuPont Company trademark for a ETFE. Fluorocopolymer thermoplastic material which has excellent electrical properties, heat resistance, chemical resistance, toughness, radiation resistance and flame resistance.
- Temperature Rating** — The maximum temperature at which the insulating material or cable may be used in continuous operation without change in its basic properties.
- Tensile Strength** — The pull stress required to break a bare wire.
- TFE** — Tetrafluoroethylene. A thermoplastic material with good electrical insulating properties and chemical and heat resistance.
- Thermal Rating** — The temperature range in which a material will perform its function without undue degradation.
- Thermoplastic** — A material which will soften, flow or distort appreciably when subjected to sufficient heat and pressure. Examples are polyvinyl chloride and polyethylene.
- Thermoset** — A material which will not soften, flow or distort appreciably when subjected to heat and pressure. Vulcanizable. Examples are rubber and neoprene.
- TIA** — Telecommunications Industry Association. Body which authored the TIA/EIA-568-B Commercial Building Telecommunications Wiring Standard in conjunction with EIA.
- TIA/EIA-568-B** — Commercial Building Telecommunications Wiring Standard defines a generic telecommunications wiring system for commercial buildings that will support a multi-product, multi-vendor environment. It also provides direction for the design of telecommunications products for commercial enterprises.
- Tinsel** — A type of electrical conductor composed of a number of tiny threads, each thread having a fine, flat ribbon of copper or other metal closely spiraled about it. Used for small size cables requiring limpness and extra-long flex life.
- Topcoated Wire** — Conductor produced by applying a layer of tin over a stranded bare copper conductor holding the strands together allowing easier soldering and preventing the fraying of strands.
- TP-PMD** — Twisted Pair-Physical Medium Dependent.

Glossary of Terms

- Transducer** — A device for converting one form of energy to another, such as mechanical energy to electrical energy.
- Transfer Impedance** — For a specified cable length, transfer impedance relates to a current on one surface of a shield to the voltage drop generated by this current on the opposite surface of the shield. Transfer impedance is used to determine shield effectiveness against both ingress and egress of interfering signals. Cable shields are normally designed to reduce the transfer of interference — hence, shields with lower transfer impedance are more effective than shields with higher transfer impedance.
- Transmission Line** — An arrangement of two or more conductors, such as a coaxial cable or a waveguide used to transfer signal energy from one location to another.
- Transmission Line Cable** — Two or more conductors placed within a dielectric material in such a way as to control the electrical characteristics.
- Transmitter** — Equipment that generates RF or electrical signals for transmission through the air or space or over a transmission line. Also refers to the electronic package that converts electrical energy to light energy in a fiber optic system.
- Triad Cable** — Cable with three twisted conductors.
- Triaxial Cable** — A cable construction having a conductor and two isolated braid shields, all insulated from each other. A coaxial cable with a second braid applied over an inner jacket and an outer jacket applied over the outer braid. Commonly used in television camera systems.
- Triboelectric Noise** — Noise generated in a shielded cable due to variations in capacitance between the shield and conductors as the cable is flexed.
- Trunk Cable** — In a CATV system, the transmission cable from the head end (signal pickup) to the trunk amplifier. Also called a feeder cable.
- Turn-key** — A contractual arrangement in which one party designs and installs a system and turns over the keys to another party who will operate the system.
- TVRO** — TV Receive Only.
- Twin-lead** — A transmission line having two parallel conductors separated by insulating material. Line impedance is determined by the diameter and spacing of the conductors and the insulating material and is usually 300 ohms for television receiving antennas.
- Twinax Cable** — Cable with two twisted conductors with established electrical properties (one pair = two conductors sharing a common axis = twinax).
- Twisted Pair** — Two lengths of insulated conductors twisted together. The traditional method for connecting home and many business computers to the telephone company. Gets its name because two insulated copper wires are twisted together, both of which are needed for each connection. In commercial environments, performance of data transmission can be improved by adding a composite tape to the wire. This is known as shielded twisted pair.
- Two-pair Premise Wiring** — Refers to the two pairs of voice grade (low bandwidth) twisted pair wire installed in most homes since the 1950s. The extra pair makes it possible for you to add another line when you need it.
- UHF** — Ultra High Frequency. International Telecommunications Union designation for the 300 to 3000 MHz band of frequencies.
- UL** — Underwriters Laboratories. A nonprofit organization which tests and verifies construction and performance of electronic parts and equipment, including wire and cable.
- UM** — Unsoldered Mechanical Protection. Additional steel and polyethylene over inner polyethylene jacket. Provides additional mechanical protection.
- Unbalanced Line** — A transmission line in which voltages on the two conductors are unequal with respect to ground. A coaxial cable is a common type of unbalanced line.
- Unilay** — A conductor with more than one layer of helically laid wires with the direction of lay and length of lay the same for all layers.
- UTP** — Unshielded Twisted Pair(s).
- V** — Volt. (See also *Volt*.)
- VA** — Volt-ampere. Measure of apparent power in a reactive circuit found by multiplying the voltage by the current.
- VC/MTM** — Variable Constellation/ Multi-Tone Modulation.
- VDSL** — Very high bit rate Digital Subscriber Line.
- Velocity of Propagation (VP)** — The transmission speed of electrical energy in a length of cable compared to speed of light in free space. Usually expressed as a percentage.
- VHF** — Very High Frequency. International Telecommunications Union designation for the 30 to 300 MHz band of frequencies.
- VHS** — Abbreviation for Video Home System.
- Video** — Pertaining to picture information in a television system.
- VLF** — Very Low Frequency. International Telecommunications Union designation for the 3 to 30 kHz band of frequencies.
- Volt** — A unit of electromotive force.
- Voltage** — Electrical potential of electromotive force expressed in volts.
- Voltage Drop** — The voltage developed across a component or conductor by the current flow through the resistance or impedance of the component or conductor.
- Voltage Rating** — The highest voltage that may be continuously applied to a cable construction in conformance with standards or specifications.
- Voltage Standing Wave Ratio** — Ratio of maximum voltage of the standing wave to the minimum voltage of the standing wave. (See also *Standing Wave Ratio*.)
- VSWR** — Voltage Standing Wave Ratio.
- VW-1** — A flammability rating established by Underwriters Laboratories for wires and cables that pass a specially designed vertical flame test, formerly designed FR-1.
- W** — Symbol for watt or wattage.
- Wall Thickness** — The thickness of an insulation or jacket.
- WAN** — Wide Area Network.
- Watt** — A unit of electrical power.
- Wave Form** — A graphical representation of a varying quantity. Usually, time is represented on the horizontal axis, and the current or voltage value is represented on the vertical axis.
- Wavelength** — The distance between positive peaks of a signal. As the frequency increases, and waves get closer together, the wavelength decreases.
- WCS** — Wireless Communications Service.
- Wire** — A conductor, either bare or insulated.
- Wireless** — Really a misnomer. Belden makes a variety of cables needed to build the transmitting infrastructure required to support wireless devices. Wireless is a technology that allows a device (phone, pager or satellite dish) to be unconnected from the transmission point of a voice, video or data signal. The transmission infrastructure required to support such wireless devices is a wired platform of transmission towers and stations that communicate point to point and to telephone central offices.
- X** — Symbol for reactance.
- X-Bar™** — The X-Bar is a plastic device that is used for installing 10GX® Cable onto a 10GX Module, optimizing the termination process and practically eliminating performance variation due to termination variances.
- XLPE** — Crosslinked polyethylene is a thermoset and is crosslinked by radiation, thermally, or by moisture. XLPE offers a wide range of operating temperatures, excellent deformation, abrasion, and flame resistance. XLPE can be formulated with halogenated or non-halogenated flame retardant packages. Some grades are also rated XHHW-2 which offers excellent wet electrical properties.
- XLR** — A multi-pin audio connector (typically 3 pins) used in microphone, line level and snake cable audio connections.
- XPE-PVC** — Expanded Polyethylene-Polyvinyl Chloride. Fire retardant.
- Z** — Symbol for impedance.