

Digital Link Presents:

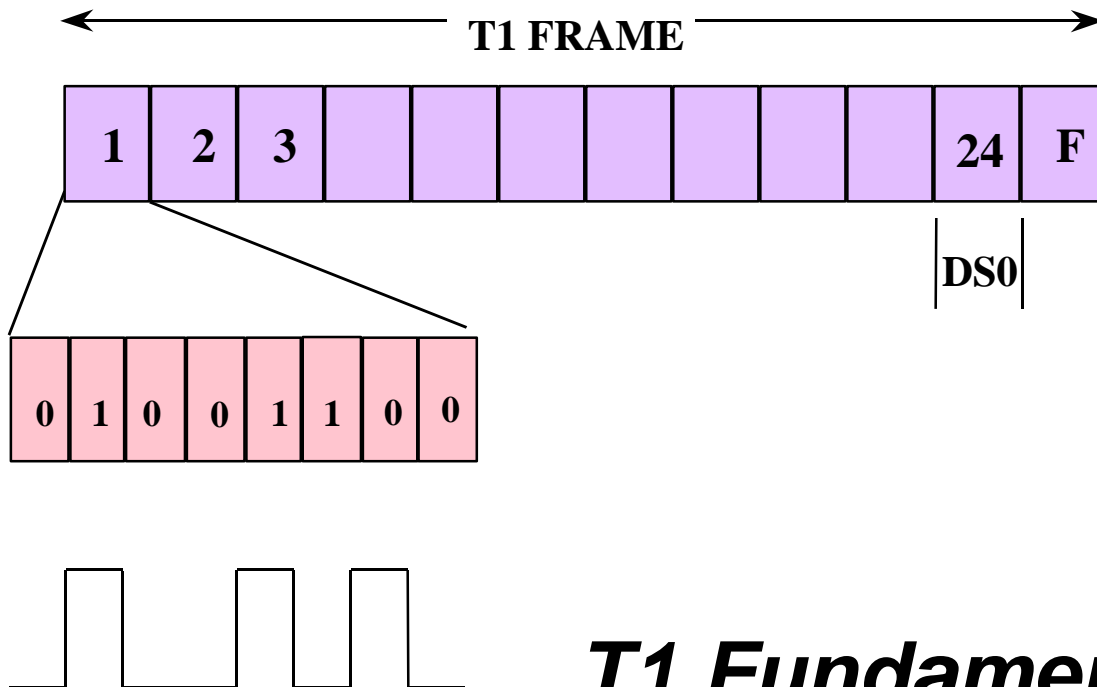

T1 Fundamentals

i Copyright © 1996, Digital Link Digital Link Corporation

World copyright reserved. No part of this publication may be stored in a retrieval system, transmitted, or reproduced in any way, including but not limited to photocopy, photograph, magnetic, chemical, or other record, without the prior agreement and written permission of Digital Link Corporation.

**Digital Link Corporation 217 Humboldt Court Sunnyvale, California 94089 (408) 745-6200
FAX (408) 745-6250**

Digital Link

Course Objectives:

Upon completion of this course the student will be able to:

- **Understand the basic T1 transmission concepts**
- **Understand how the T1 frame is constructed.**
- **Discern the differences between ESF and SF framing formats.**
- **List the main benefits of the ESF framing format**
- **Be able to accurately match ESF error events with their functions.**
- **Understand how ESF registers are used in trouble isolation**
- **Describe T1 alarm states (Blue, Yellow, Red).**
- **Understand the wiring that is used on T1 lines and cables that are used.**
- **Define the coding methods used on T1 circuits (B8ZS and AMI)**
- **Understand the differences between format and logic errors.**
- **Understand T1 troubleshooting techniques and equipment**

What is T1?

A T1 is a Time Division Multiplexed, full duplex, synchronous data transmission technique. It has an operational line data rate of 1.544Mbps. Below is a list of general information that applies to a T1 line.

Time Division Multiplexing (TDM) is a means to carry multiple voice and data conversations across a single line. It is a very reliable means of communications as it allows time slots to be dedicated to each conversation (be it voice, data, fax or video). On the other hand, it is inefficient since if only a few time slots are needed the unused time slots will be idle. This will be discussed further later.

Full duplex operation is a method of transmission that enables information to be both transmitted and received at the same time.

The aggregate speed of a T-1 is 1.544Mbps. Only 1.536Mbps is usable as 8kbps is used for overhead.

Fractional T-1 is supported by the telephone carriers as a method to reduce cost to their customers. Some customers don't need to use all time slots on a T-1, so FT1 is a way to get greater efficiency using TDM to pay only for the number of time slots you need.

DS1 is the tariffed service from the carriers. DS refers to Digital Signal and has references at different levels such as: DS0 (64Kbps), DS2(6Mbps) and DS3(45Mbps). It defines the type of service that the customer will receive, the costs and the signal format. T-1 is what the DS1 signal becomes when it is placed on a "Terrestrial" line.

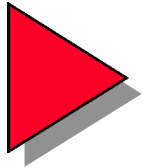

What is T1?

- **Multiplexing of 24 Voice/Data Channels**
- **Full duplex four wire facility**
- **Operates at 1.544Mbps**
- **Supports fractionalized services**
- **All major carriers provide service**
- **DS1 Vs. T1**

T-1 Transmission Concepts

Nyquist Criterion-

Harry Nyquist discovered in the late 1920's that in order to sample an analog signal so that it can be represented in a digital format (and later be reconstructed back to its original form) that the analog signal needs to be sampled at twice the highest frequency of the analog signal.

Since the average human speaks within the frequency range of 300-3300hz(cycles/sec), it was decided that the maximum frequency to represent a voice signal should be 4000hz. When we apply this to the Nyquist's theorem we discover that the minimum sampling rate necessary to digitize an analog signal of 4000hz is $2 \times 4000\text{hz} = 8000\text{hz} = 8000\text{samples/sec}$.

PAM-

When an analog signal is sent through a sampler device it will create a digital waveform with varying amplitudes. The digital waveform that is created has gone through a process called pulse amplitude modulation.

PAM takes amplitude values of the analog signals during the sampling period. As there is no such thing as a true impulse function to sample the signal, the original analog signal at this stage would look as if someone had taken snap shots of it at particular instances of time.

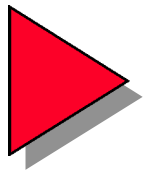

T-1 Transmission Concepts

Why is the T1 data line rate 1.544 Mbps?

Nyquist Criterion

- **Sampling**
- **Pulse Amplitude Modulation (PAM)**

Pulse Code Modulation (PCM)

- **Companding**
- **MU Law 255**

Once signal is digitized how is it put together?

- **Time Division Multiplexing (TDM)**

Analog To Digital Conversion

Quantizing-

Quantization is the process in which ranges of values will be grouped together into a single value. This process would be similar to counting from 1 to 10. Once you start counting most people will chose quantized unit increments, unless specified otherwise. This is because there are an infinite number of values between 1 and 10. We could say that anything from 0 to 1 is a value of 1, and anything greater than 1 but less than or equal to 2 is a value of 2 and so on up to 10. This would be a form of quantization.

Experiments have shown that in order to reproduce a voice signal, of good quality, that there must be 2048 uniform quantized levels. This equates to 11 bits of resolution(or dynamic range). To reduce the number of quantum steps, the analog signal is compressed prior to coding. Compression is accomplished through a technique called companding. Companding is based upon the MU-law. This is explained on the next page.

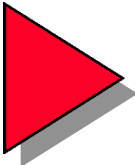

Analog To Digital Conversion

Analog to digital conversion:

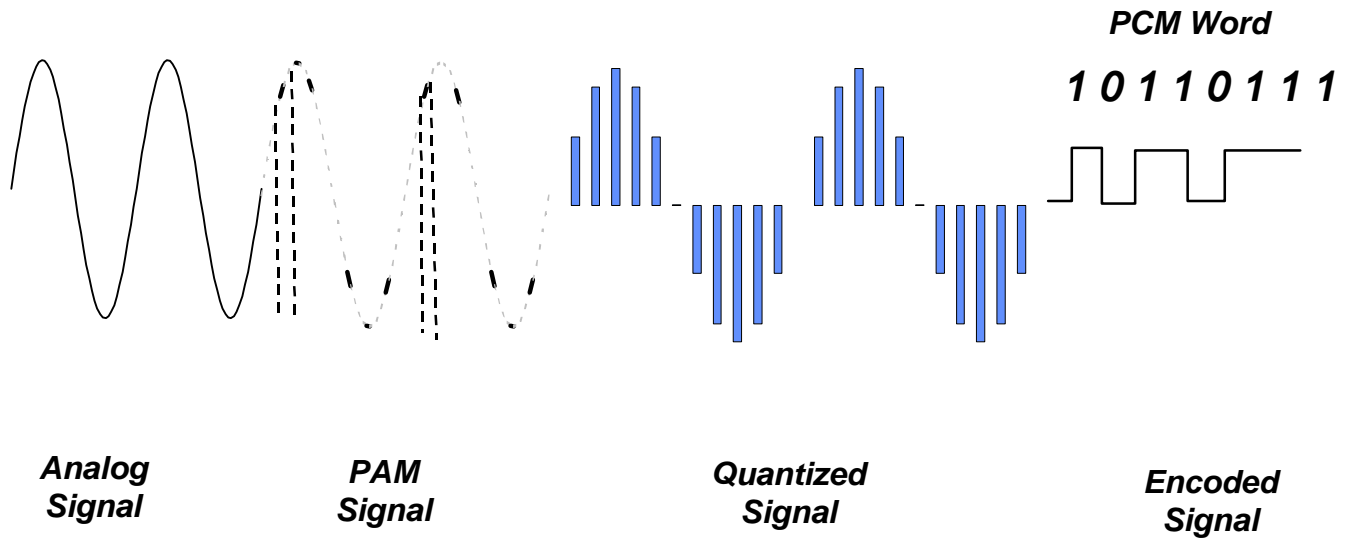
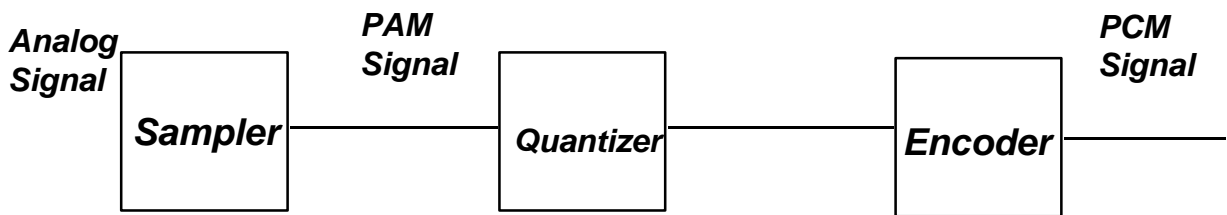

Pulse Code Modulation

PCM-

Once the PAM signal is quantized, the signal is then put through an encoder. This encoders' operation is based on a law called the MU Law. The MU Law is a logarithmic function that assists with the quantization and compression of the analog signal. The MU law divides the quantization scale into 255 discrete units of two separate sizes. The first divides the scale into 16 segments(or chords) spaced logarithmically(8 for positive and 8 for negative). Each chord is then broken down into 16 linear steps.

The method of companding allows voice to be accurately portrayed using 8bits instead of 11. One bit is used for polarity, three bits are used to identify the proper chord, and 4 bits are used to represent the proper step. In the following picture, since the polarity is positive for the sampled amplitude and on the 3rd chord and the 8th step, the encoded word would be 10111000. The process of compressing the analog signal prior to coding (and consequentially expanding the signal after decoding) is called companding.

Once the receiving unit receives the encoded information it is able to reproduce the original signal precisely. The receiver will know that the information that is being received is sampled at the Nyquist frequency for voice which is 8000 times per second. The receiver then will be able to reproduce the accurate voltage level representation of the original transmitted voice signal and connect this into a speaker in the phone so it can be heard.

The PCM process also explains why 64kbit/s are needed to send a voice signal across a digital line.

8bits/sample	- Each voltage level is represented by the PCM word
<u>X 8000Samples/sec</u>	- To ensure enough samples to represent the analog signal
64, 000 bits/sec	

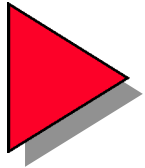

Pulse Code Modulation

PCM

- Based on MU-Law 255
- Each sampled value is assigned an 8 bit value.

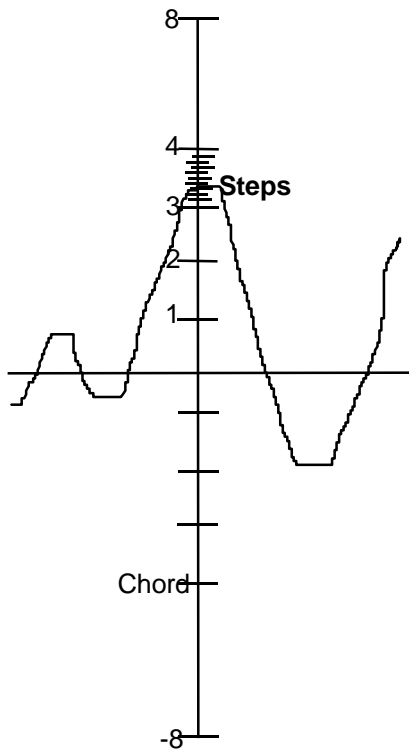

PCM Word

P	C	C	C	S	S	S	S
---	---	---	---	---	---	---	---

P=Polarity
C=Chord
S=Step

Time Division Multiplexing

TDM -

The adjoining figure is a good example of how voice and data can share the same physical medium (i.e. wire, T1). A TDM mux will take samples of the incoming signals by port and allocate them into the correct time slots on the output. To do this there must be a way to tell where each time slot begins and where it ends. This is accomplished with the use of a framing bit that will allow the remote end unit to synchronize to the local unit and thus be able to differentiate between time slots.

The US standards defined the DS1 service to allow 24 voice signals to go across a single line. Therefore 24 time slots were selected to be used for the TDM mux. In the UK they use 32 time slots with only 30 for use of data/voice.

There are also a few other ideas that go along with some of the concepts we have so far discussed.

- Channelized data- This is the ability to subdivide a higher transmission rate into multiple lower-rate channels.
- Non Channelized data- This means that full T1 must be used.
- Channel Bank- A channel bank is a type of mux that can take an analog signal in on a single port, convert it to a digital signal, and put it out on a single time slot. A channel bank will have 24 ports and will provide a completely channelized service. In the early days when there was not an adequate means for an end user to send data traffic across a digital line, they would run the data to a 9.6kbps modem (which has an analog output) and connect it to a channel bank port to get both Voice and Data on a single line.



Time Division Multiplexing

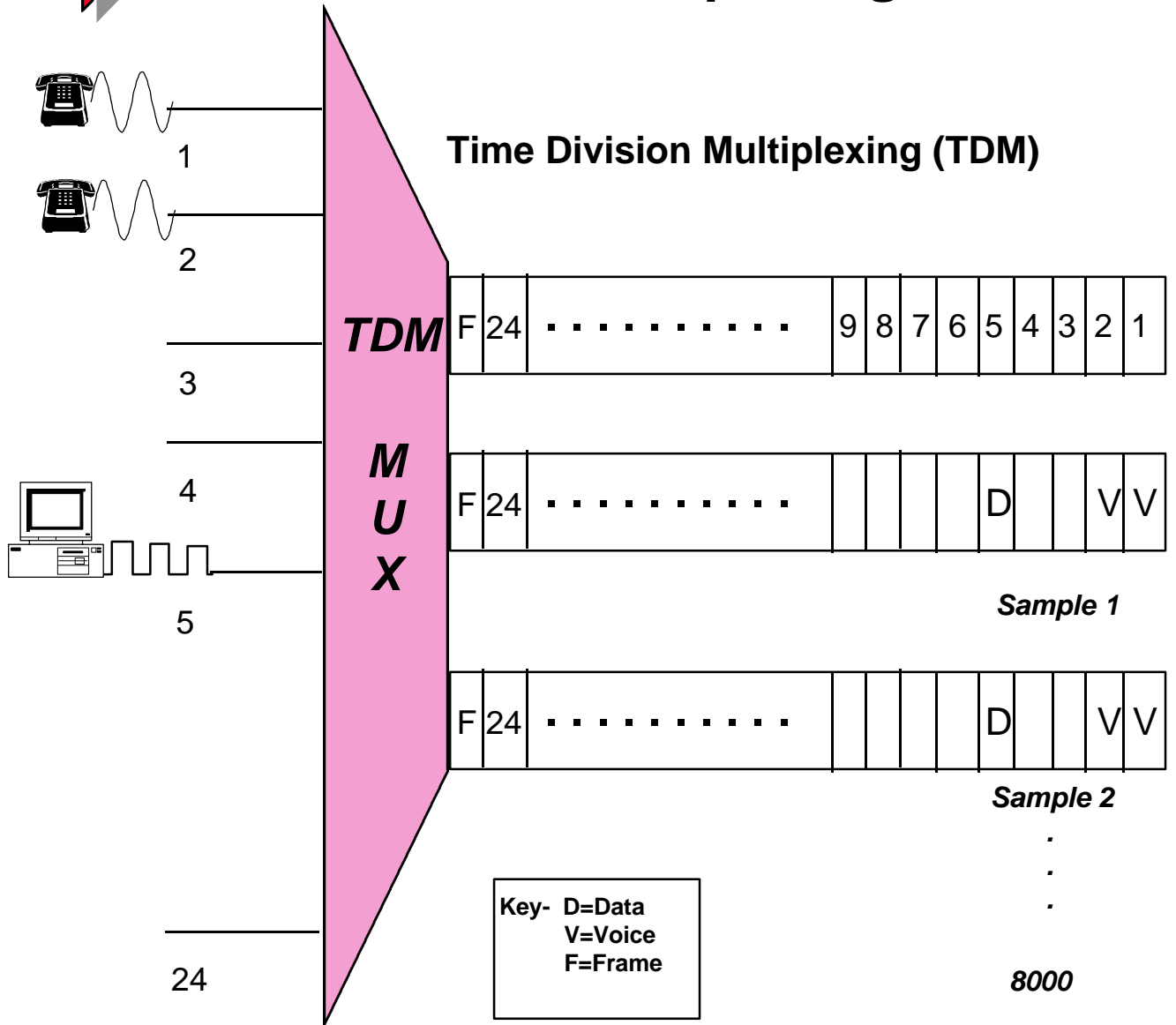

Basic Concepts: Implications

A T-1 is often known as a 'digital pipe'. This means that anything that can be digitized can be sent across a T-1. The T1 digital pipe has a line rate of 1.544Mbps which was obtained by the following equations:

24 Samples	- # of channels that are allowed for a TDM mux in US.
<u>X</u> 8 Bits/Sample	- # of bits in PCM signal used to encode single voice amplitude.
192 Bits	- # of data bits used for 24 channels
+ 1 Bit	- 1bit of overhead used for framing.
193 Bits	- Total number of bits in a T1 frame.
<u>X</u> 8K Samples/Sec	- Required Nyquist rate to adequately reproduce voice.
1.544 Mbps	- Total line rate on a T1 facility.

Voice definitely can be digitized as was seen previously. High speed data from routers, computer-aided design and manufacturing tools, and video applications already exist in a digital world and therefore do not need to go through the processes previously discussed as they are already PCM signals.

Digital communications opens a big market into the telecommunications industry. Now companies that had to have separate networks for each application as well as wasted valuable throughput by converting a digital signal to analog then back to digital(through a channel bank), could connect directly into a digital network. This opened the market to multi-media applications. One could now send voice, data, and video across the same physical wires.

Most of the applications today use routers and bridges for high speed data, PBX (Private Branch Exchange) for voice applications, and video codecs for video conferencing.

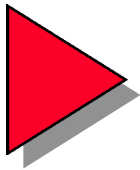

Basic Concepts: Implications

If something can be digitized, it can be sent over the digital pipe (T-1)

- **Voice**
- **High Speed Data**
- **CAD/CAM**
- **Video**

History of T1

AT&T introduced T1 technology in the early 1960's to combat the growing problem of space restrictions between central offices(CO). Every time a new phone line was needed for a new customer, the telephone company would have to run a pair of wires not only to the new location, but also to the central office(if multiple phone lines in a district required more bandwidth). As a region started to become large enough to warrant its' own local central office, new wires would need to be run between all the currently existing CO systems. The addition of a new CO would cause a geometric increase in the number of wires that would be needed to run between offices. It became necessary to provide a more efficient system before all the cable conduits were filled to capacity and consequentially brought the existing system to its' knees.

Another problem was signal quality. As an analog signal travels over a wire and gets amplified over and over again, it eventually will become extremely distorted. This is why, before the digital systems were created, long distance calls would often sound very weak and distorted. Once the digital system was in place, regeneration of the signal was possible. Digital pulses are not just amplified, but are completely regenerated to their original form, thus increasing signal quality. The benefit of higher quality communications is what made networking of data communications equipment possible. Since data streams are just a string of 1's and 0's, if one bit out of a 1000 byte message is lost, the whole message will have to be re-transmitted.

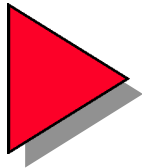

History of T1

- **Developed in early 1960's.**
- **Offered as private facility service in late 1970's to early '80's**
- **Private T1 backbones driven by voice and decrease in T1 tariffs**
- **DACS-based Fractional T1 services in late 1980's**

Cable Congestion

In the beginning AT&T used T1 technology only between carrier offices. This where the cabling problems were the worst. As was stated earlier every time a new area would become large enough for a new CO, new cables would have to be run to every CO in the area. Also, the cost of the T1 technology didn't make it practical for public use, nor did the public as of yet have a great need for complete digital network to interconnect their systems (as computers were still relatively new).

Over time as the computer industry started booming, it became apparent that there was a need to interconnect computer systems. Due to the low speed of the computers that were available in the early 1970's it was possible to carry digital signals from computers over analog lines with the use of modems. In 1983 telco companies started to offer private facility services to the T1 system. This was driven by a great need to have reliable data communications and interconnections at higher rates as well as a decrease in T1 tariffs.

In the late 1980's telco's were offering DACS (Digital Access Cross-Connect Systems) services. These were based upon the T1 services previously offered, but were more cost effective. As touched on earlier time division multiplexing is not efficient if one doesn't need a full T1. The introduction of DACS technology allowed the end user to pay for a full T1 only from the local CO to the local customer premises. Between carrier offices the user would only have to pay for however many time slots he purchased. The advantage of this is that the customer is able to pay a reduced monthly tariff as well as be able to expand the current services up to a full T1 data rate at a later date if needed.

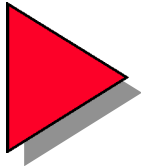

Cable Congestion

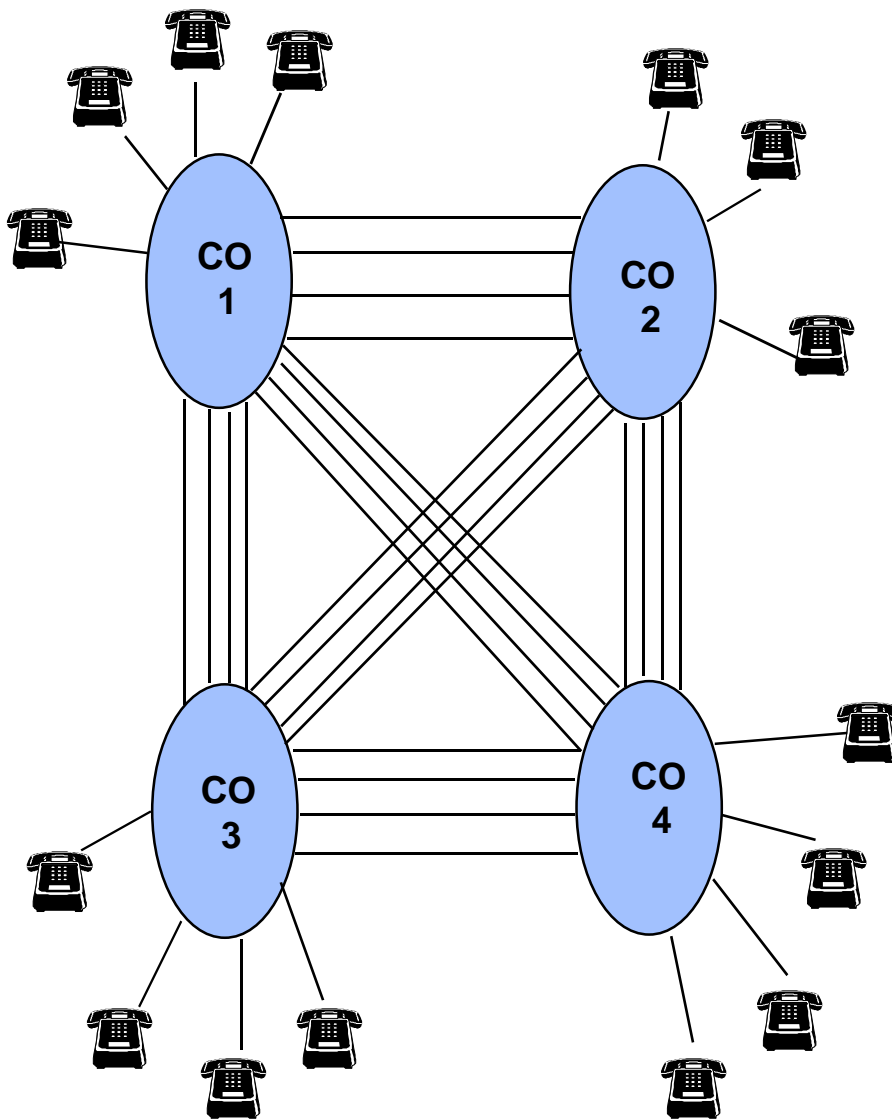

T-1 Issues

When the T1 system was created there were many concerns that needed to be addressed. The first was how to construct the frame. Once the frame was built the next concern was how to format and maintain synchronization between the T1 frames. The last issue was how to maintain synchronization on the T1 line itself. AT&T stated in Pub 62411 that if more than 15 zeros were transmitted in a row across a T1, that there could be no guarantees regarding the integrity of the data and the timing used to extract it. Since a T1 line relies on its timing from the data itself, if a period of absence of signal occurs, it would cause the network repeaters to 'fall asleep'. This would cause timing slips in the signal and disrupt user data.

Alarms were also needed to be able to determine where problems were occurring. New definitions had to be created to help isolate network problems on digital lines. The use of red, yellow and blue alarms assisted in discovering these problems.

Signaling also was involved. Since T1 was initially created for voice only, there was a need to provide signaling information for phone information. Signaling is the method that phone information such as Off hook, busy, etc. may be sent to the receiving switch or PBX so that phone calls can be placed.

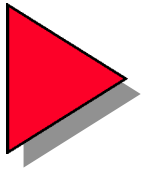

T-1 Issues

- **Building the T-1 Frame**
- **Framing**
- **Formatting**
- **Signaling**
- **Line Coding**
- **Pulse Density**
- **Errors and Alarms**

T1 Frame

Building the T1 frame-

The T1 frame is represented by a composite of 24 separate DS0 channels, each representing a PCM encoded voice signal. (As previously discussed, each PCM encoded voice signal is represented using 8bit encoding for the analog signal values.) Each channel is time division multiplexed in a round robin method to insure that each channel is transmitted in turn. To denote the beginning of each T1 frame a special bit is added. This bit is what differentiates D4 framing from ESF. More will be discussed about this later.

Since each signal is sampled at 8000 times/sec, it can be seen that a T1 frame once sampled is comprised of 24 64kb/s DS0's (time slots or channels). When multiplied out this total comes to 1.536Mb/s. This is what is referred to as the throughput of the T1 line. The framing bit which is also sampled at 8000times/s will add an additional 8Kb/s to the T1 signal. Therefore stated clearly:

The line rate of a T1 is 1.544Mb/s, where 1.536Mb/s is the user actual throughput.

Components of a T1

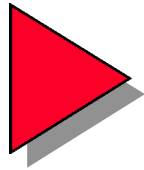

T1 Frame

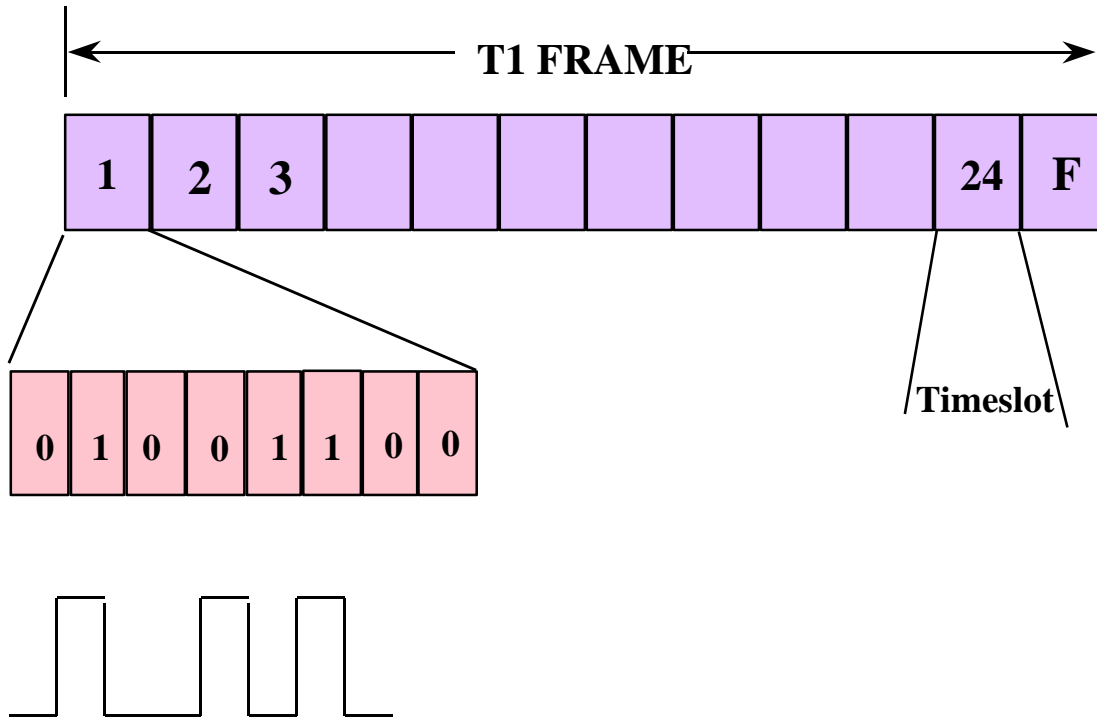

Framing

Framing-

One of the more important features in T1 technology is the existence of framing. T1 framing is essential in providing synchronization of data across the T-span. The framing formats of T1s has evolved significantly since the early 1960's. Initially, frame formats were geared toward voice and analog data only. The early formats (D1, D2, D1D, D3) were replaced with the advanced formats used today, namely D4 and ESF.

D4, also referred to as SF or superframe, format relied on the use of 12 framing bits obtained by grouping 12 T1 frames together into a 'super frame'. These framing bits were used extensively for frame synchronization on the digital line. We will look into how this was accomplished a little later.

ESF, also referred to as extended super frame, format was created in the early 1980's by AT&T. AT&T found that the SF format was lacking in particular areas of performance. ESF took the previous idea of grouping 12 frames together, and created the extended superframe to group 24 frames together. The expanded frame format allowed for greater error performance and analysis to be done on the T1 lines without affecting user traffic.

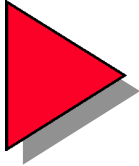

Framing

- **D4 Super Frame**
- **ESF Extended Super Frame**
- **Signaling**

Framing: Super Frame (D4)

D4 Frame Format-

If we examine just the F bits or the 193rd bit of each T1 frame we will see that these bits form a unique pattern that repeats with every superframe. In this way the receivers can lock onto the framing pattern.

The way the receivers work is by first buffering 12 frames (2316 bits), then the receivers assume that the first bit is a frame bit. The receiver then counts 192 bits and looks at the next bit. Then another 192 bits are counted and the 193rd bit is examined. The receiver will match its information to the pattern shown in the following diagram. If the frame pattern isn't reproduced, it assumes that the first bit was not the framing bit and moves onto the next one. This is done till all 192 bits are checked. Once the frame pattern is established the receivers will declare frame synchronization. Receivers have 50ms to resync once sync is lost (per AT&T 62411).

The synchronization bits are further split to provide two separate functions. One is to provide Terminal Framing (Ft) to identify the frame boundaries. The second purpose is to provide Signal Framing (Fs) to identify frame 6 and 12 in which signaling bits, A and B respectively, are transmitted when an application is channelized voice. Signaling will be discussed a later.

Note: All 8000 bits for framing are used to obtain synchronization.



Framing: Super Frame (D4)

- Provides point of reference for each bit location
- Repetitive sequence permits synchronization
- Locates signals for voice communications
- Uses 8Kbps of the T-1 digital pipe

0
1
0
0
0
1
1
0
1
1
1
0

Framing: Super Frame (D4)

D4 Framing Continued-

The adjoining diagram shows a detailed breakdown of the D4 framing structure. The 12 frames together form a super frame. In the 6th and 12th frames of the super frame robbed bit signaling occurs. Robbed bit signaling robs the LSB (least significant bit) in every channel of the T1 frames six and twelve. The PBX uses these bits to control functions that are used in the standard phone applications. These include picking up the receiver, dialing and hanging up the receiver. The 8th bit (LSB) in the PCM word in T1 frame 6 is designated as signaling type A. In the 12th frame the signaling bit is called type B. For extended superframe signaling type C and D will occur in the 18th and 24th frames. In the next couple pages we will discuss these topics in greater detail.

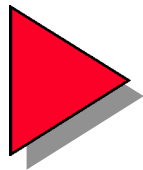

Framing: Super Frame (D4)

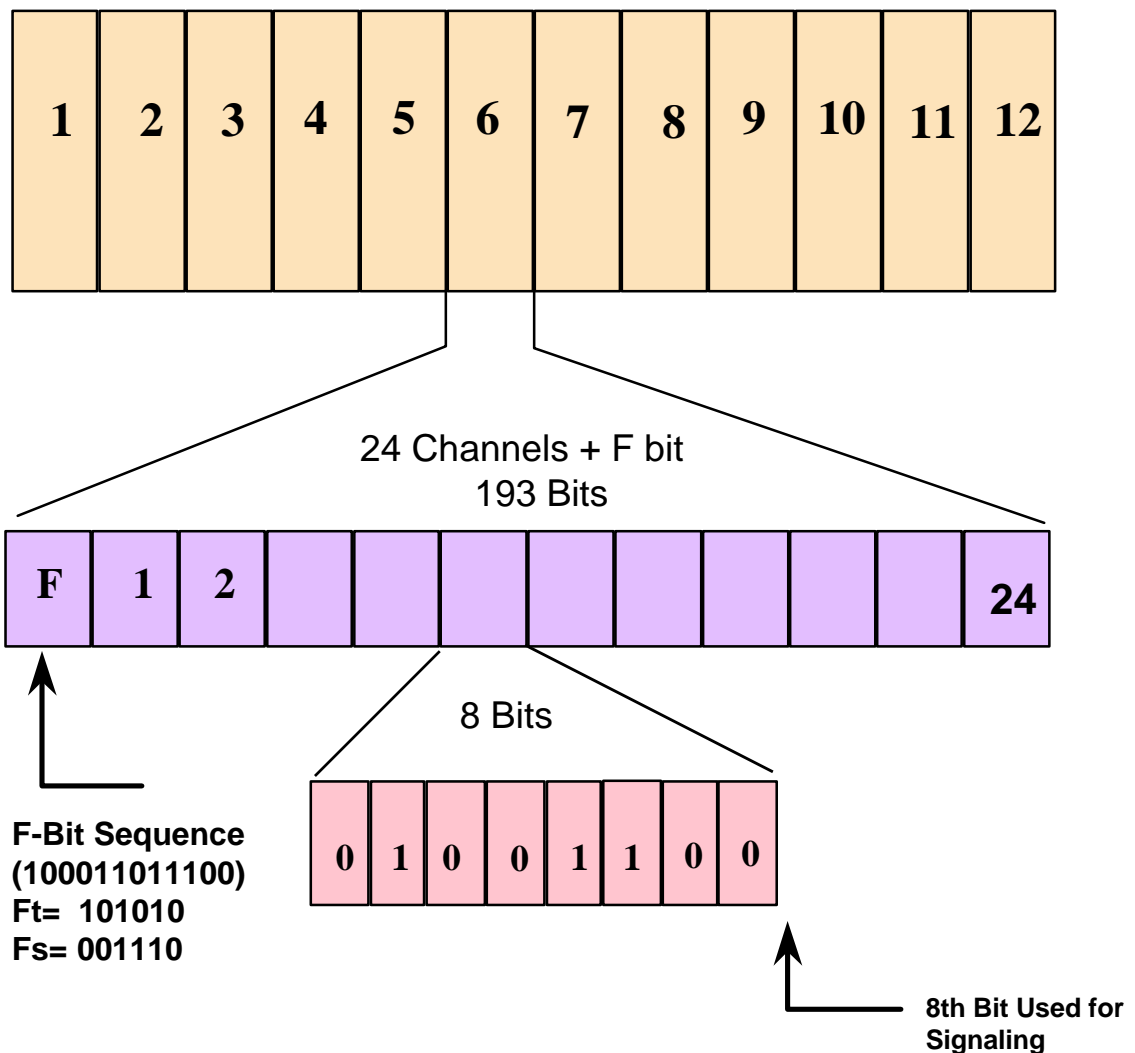

In Frame 6 & 12 the 8th bit (LSB) of all channels is for signaling

Framing: Signaling

Signaling-

What are some of the characteristics found in the common phone? First off, to initiate a call, one would pick up the receiver (go off hook) and listen for the 'dial tone'. Digits are then entered to establish a call to the receiving party. The receiving party's phone will then ring or return a busy tone. When the call is completed one would place the receiver back in its cradle (go on hook) and the call would now be complete.

Off hook, the dialing digits, the ringing or busy signal, and on hook are all components that are commonly used in telephone conversations and are known as signaling elements. In environments that use channel banks or PBX's for voice applications, signaling elements allow the phone system to determine whether the incoming or outgoing calls are within the same company (DID- direct inward dial) or out to the telephone company (DOD- direct outward dial). In order for signaling to be recognized it must take up space in the data channel. This is done by a process called robbed bit signaling.

Robbed bit signaling will take the 8th bit of every time slot in frames 6 and 12 for D4 and frames 6,12,18,24 in the ESF frame format. These bits are used to control the phone systems so that it will know when a phone line is vacant or being used. Since each time slot represents a single phone conversation, the bit robbing must occur in every time slot in the particular T1 frame. Frame 6 robbed bits are referred to as A bits. Frame 12, 18 and 24 (18 and 24 for ESF only) are referred to as B, C, and D bits respectively.

For voice applications, the robbing of bits in frame 6,12,18,24 are not of great importance in terms of phone quality. Since the 8th bit of PCM words represents voltage or amplitude levels, the loss of the LSB (least significant bit) will not be able to be noticed by the end user.

For data communications traffic, the robbing of these bits would be fatal. However, since the signaling bits are generated and removed by the channel bank, PBX or associated phone equipment, the data traffic is not affected. If signaling were used on a data line, the actual throughput would have to be throttled back to 56k (or 7 bit PCM words) per channel, yielding a T1 line rate of 1.344Mbps.

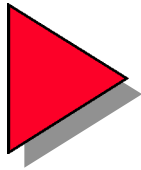

Framing: Signaling

- **Voice Applications**
- **Inserted by PBX**
- **Passed through CSU as data**
- **Signaling bits are included in the data channel**
- **Overwrites the 8th bit of every 6th frame**
- **A/B bits are used for D4, A/B/C/D bits are for ESF**
- **Sends On/Off hook, Busy, Dial tone**

Framing: Extended Super Frame (ESF)

Extended Super Frame Format (ESF)-

In the early to mid 1980's, AT&T suggested the implementation of ESF to provide non-disruptive error detection and perform non-service-affecting diagnostics on T1 circuits. The increased diagnostic capabilities of ESF were warranted due to an increase in customer concerns due to performance conditions on T1 circuits.

Since the purpose of ESF was to increase customer reliability, it was designed such that the enhanced features would not take away from the customers' throughput. This was accomplished by redefining the super frame to contain 24 T1 frames (thus extended super frame). By changing the definition of the super frame the same 8K that was used for framing bits in D4 mode could now be used more efficiently.

The ESF frame has 24 framing bits that are used for enhanced functions not covered in the D4 format. Only 6 bits are used for the framing synchronization. The repetitive bit pattern used for synchronization is 001011. 6 bits are used for a CRC(cyclic redundancy check) that uses an algorithm to verify all 4632 bits in the ESF frame. The final 12 bits are used for a facility data link(FDL). This implies that of the original 8k that was used for synchronization in the D4 frame format, is broken down to 2k, 2k, 4k for synchronization, CRC check and FDL respectively. The FDL is a means through which the telephone carrier can pro-actively monitor the T1 line without affecting the user data.

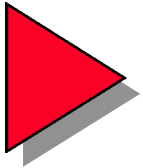

Framing: Extended Super Frame (ESF)

- **Accomplishes all functions of D4**
- **Cyclic redundancy check to monitor T-1 quality**
- **Provides FDL (Facility Data Link)**
- **It still only uses 8 Kbps of T-1 digital pipe**

1
D
C
D
O
D
C
D
O
D
C
D
1
D
C
D
O
D
C
D
1
D
C
D

Framing: Extended Super Frame (ESF)

Extended Super Frame Format-

The adjoining figure shows all the T1 frames and the associated framing bits as they make up the ESF frame. There are 24 T1 frames in an ESF frame. In each T1 frame the framing bits are used to perform their various functions, be it the synchronization, CRC check or FDL.

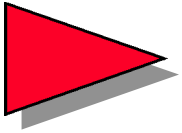

Framing: Extended Super Frame (ESF)

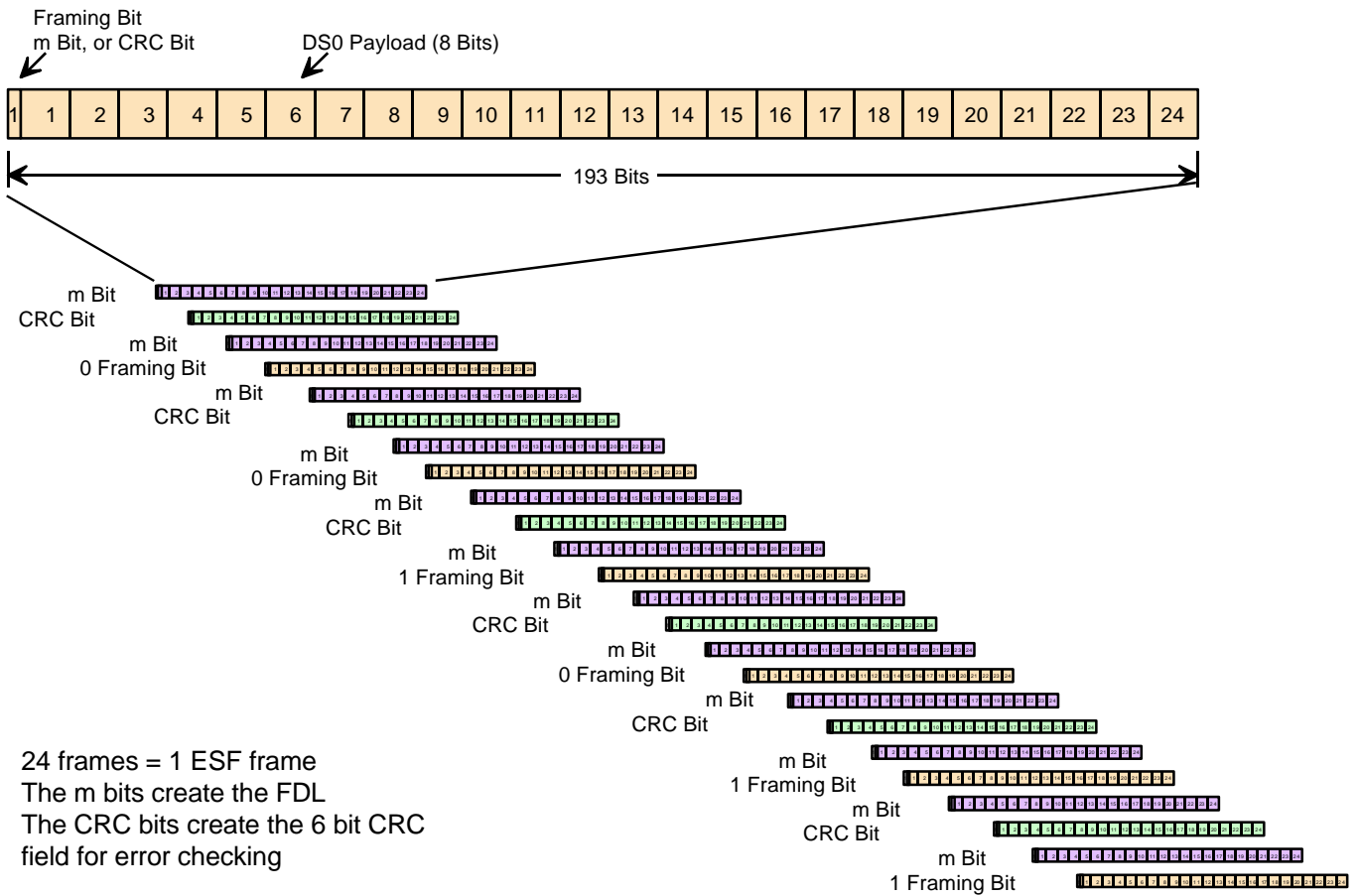

Framing: ESF Benefits

The main benefits of ESF framing are listed to the right. Of the three, one of the most helpful of features is the facility data link. The facility data link provides the carrier with a method to be proactive and possibly correct problems before they occur.

The FDL uses a 14 byte packet (HDLC in nature) that is transmitted using the FDL bits in the ESF frame. The T-carrier uses a device at the carrier office called an LMU (line monitoring unit) which is bridged onto the line and will read the FDL data. If errors are occurring then an alarm will be generated by the LMU and the problem T1 can be tested or set to out of service (and possibly patched around) until the problem can be corrected.

Benefits that are also associated with the ESF FDL include specific carrier registers that are required in ESF CSUs. These registers allow the carriers to have access to a history of the problems that have occurred on T1s over a 24 hour period. Since the FDL is not in constant use, the CSU that is terminating the T1 can also use the FDL link for proprietary functions. For instance, Digital Link and many other equipment vendors will use the FDL as a method to have a communications link to the remote CSU. This is very advantageous as a local user can now easily see statistics, carrier registers on both the local and far end, as well as verify and change configurations.

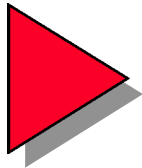

Framing: ESF Benefits

- **Provides continuous, non-interruptive measurement of T-1 system quality**
- **Allows end to end communications**
- **Provides CRC-6 error checking capabilities**

Framing: ESF: FDL (Facility Data Link)

FDL-

The use of the FDL is primarily used within the carrier network. The carrier network is composed of a LEC (Local Exchange carrier) and the IEC (Inter Exchange Carrier). The LEC controls the circuit from the local carrier office to the the customer premises. The IEC controls the circuits between local carriers.

The main advantage of the facility data link is that it allows the carrier to be proactive in solving T1 circuit problems. The FDL has assisted the carrier in maintaining a 98% efficiency, guaranteeing system up time.

Two specifications were developed to govern communications across the FDL. The first method was created by AT&T and was titled technical reference 54016. This method required the CSU to store performance information for the past 24 hours in 15 minute increments. The LMU, which is bridged onto the T1 line, would send a poll requesting information and the attached CSU would respond with the performance information the LMU requested.

During the break up of AT&T it was decided that the LMU could not communicate past the point of demarcation(this is a point that identifies where the telcos responsibility ends and the customers' responsibility begins). Due to the mandate required by the AT&T break up, ANSI (American National Standards Institute) developed the requirement that the CSU must transmit it's performance data towards the network once per second. This eliminated the need for the LMU to poll the CSUs as the performance information was always being sent. This document was referred to by ANSI as specification T1.403.

Note: If the T1 is being sent through a DACS then the FDL will be lost. This is due to the DACS reframing the data and therefore destroying all FDL information. On the previous page we discussed benefits of remote communications to the far end CSU. If a DACS is on the line, this feature of remote communication and any other proprietary management capabilities would be lost.

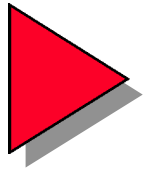

Framing: ESF: FDL (Facility Data Link)

- Carrier uses T1.403 protocol for performance
- AT&T 54016
- Central Office uses LMU for testing
- CSU gathers performance statistics
- Messages are sent out each second

Framing: F bits for BERT Testing

There are two primary purposes for F-Bits (framing bits) on a T1. Not only do they allow the receivers to lock onto the repetitive pattern to ensure frame alignment and synchronization, but they can also be used for **In Service Monitoring**. This means that the framing bit pattern within a T1 frame can be examined for errors, giving the telephone company a good indication of the bit error rate (BERT) of the T1 line.

Other BERT patterns that are found in external test equipment or intelligent DSU/CSUs, can send various patterns that are used to stress certain characteristics on a T1 line. The QRSS (quasi random signal source), 2^{20} or 2^{23} patterns have bits that repeat in a certain order so that the external test equipment, which is designed to monitor errors in each pattern, can determine if an error has occurred during transmission. The framing pattern can be thought of in the same way. When errors occur on the line, there will likely be errors in the framing bits as well as the data bits. In this way, the carriers and customers alike can determine the bit error rate on the line without intrusively taking the circuit down to do testing.

It is important to note that although bit errors in the framing bits indicate that a problem exists on the T1 line, to get a true reading of the error rate on the line can't be accomplished without external test equipment.

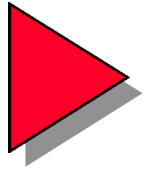

Framing: F bits for BERT Testing

- Synchronization pattern characteristics
 - **Pattern repeats every SF or ESF**
 - **It is unique (not mistaken for Data)**
 - **Frame bits are similar to bit patterns**
- Pattern is known in CSU's and Test sets
- Provides in-service monitoring
- Customer and Carriers become proactive in monitoring their circuits

Line Coding: Pulse Density

Pulse Density-

When transmitting on a T1, timing and synchronization come from the bits being transmitted. Devices that exist on the T1 line are very sensitive to the bits being transmitted and they use the data pulses to assist in keeping timing and synchronization in tack. To ensure that there are enough data pulses on the line the 'ones density rule' was invented.

The 'ones density rule' states: In every 24 bits of information to be transmitted, there must be at least three pulses, and no more that 15 zeros may be transmitted consecutively. A more stringent requirement set forth by AT&T is : In every 8 bits of information, at least one pulse must be present.

This is very important. If your data must have at least one pulse per byte, then you have to change the way that data is delivered to the network. A method called 'pulse stuffing' was invented to adopt the one pulse in every 8 bits requirement. This method automatically ensures ones density by taking the 8th bit in every byte and setting it to a value of 1. The consequences of setting every eighth bit to a 1 in every DS0 implies that the throughput per T1 channel will be reduced to 56Kbps resulting in a net throughput for the T1 to 1.344Mbps. This method is called forced mode of operation on Digital Link products.

To avoid having to use pulse stuffing other methods to meet ones density were invented. B8ZS is the line coding that is used to ensure 1's density without using pulse stuffing. This will be discussed, as well as other methods, in the next few pages.

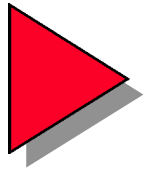

Line Coding: Pulse Density

- No more than 15 “0”s
- Average 3 pulses in every 24
- AT&T enhanced definition to be 1 pulse in every 8

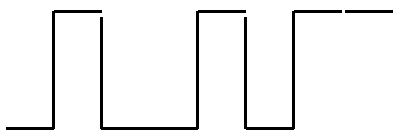
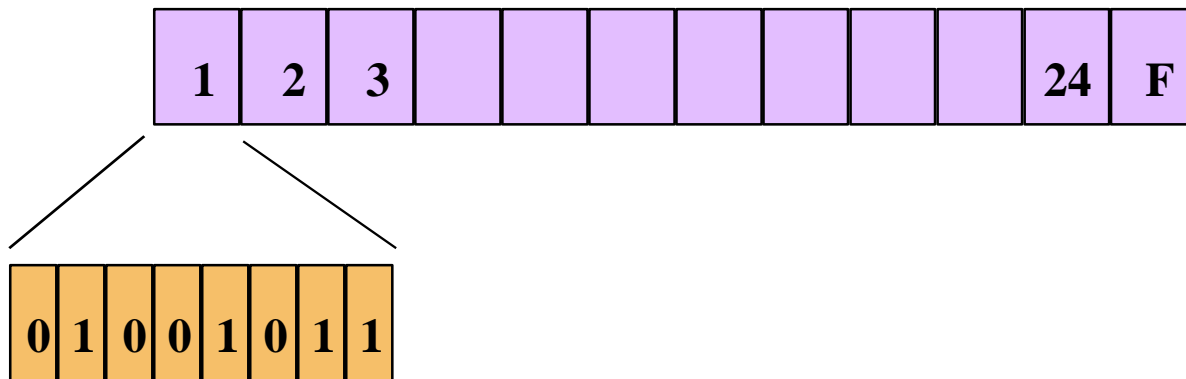

- 7 bits/byte for each DS0
- 8,000 bytes/sec as frames are built
- 56,000 bits/sec for each DS0

Digital Link

Line Coding: Alternate Mark Inversion (AMI)

Alternate Mark Inversion (AMI)-

There are two main line coding technologies that are used on T1 lines. The first is AMI. AMI is a coding technique that states when two successive logical level 1 states (presence of a pulses) occur the second pulse will be of opposite polarity. Any logic levels of 0(absence of pulses) will be transmitted as a zero. If there are zeros in-between the two pulses the second pulse will still have an opposite polarity. An AMI line encoded signal is the same thing as a Bipolar return to zero signal.

In the diagram that follows a monopolar(or unipolar non-return to zero) signal is shown to contrast to a Bipolar signal. Most customer equipment such as routers, workstations or computers will transmit data in a unipolar way. This data will then be encoded into the bipolar format for more efficient transmission to the T1 network(this is one of the functions of the DSU). The principal reason for translating a unipolar signal to a bipolar signal is that bipolar signals can be driven farther than unipolar signals before regeneration is needed. This reduces the number of regenerators that will be needed on the T1 line. A T1 signal can be driven up to 4000ft before it needs to be regenerated.

Another benefit of an AMI line is that two successive pulses must be of alternate polarity. For instance if the first pulse is +3V the next pulse will be -3V. If two successive pulses are +3V (or of the same polarity) it is a violation to the bipolar format. This type of error is termed as a **BPV**(bipolar violation) and is indicative of **format errors** on the T1 line. This could be due to a misconfiguration or too high of signal levels on a T1 line due to an open circuit. The existence of BPVs on a T1 line indicates T1 network problems and can be used to assist in diagnosing problems in a network.

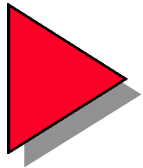

Line Coding: Alternate Mark Inversion (AMI)

Each successive pulse must have an opposite polarity

Data Stream →

1 0 1 0 0 1 0 1 1 0

Monopolar



Bipolar

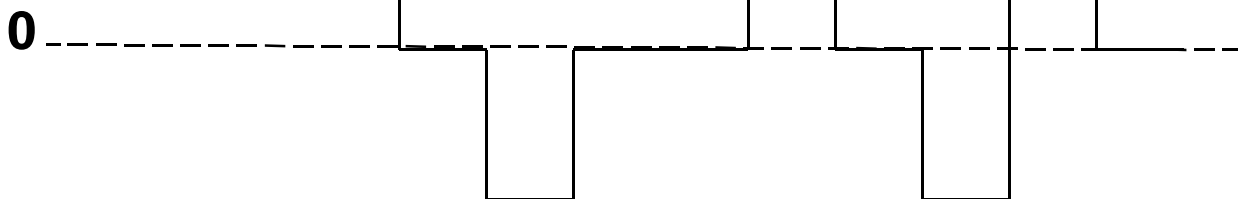

Line Coding: Bipolar 8 Zero Substitution (B8ZS)

B8ZS (Bipolar 8 Zero Substitution)-

The second type of line coding is B8ZS. B8ZS was created in the Mid 1980's to allow clear channel capabilities over a T1 line. AMI line encoding does not provide a method to maintain adequate ones density and thus must use pulse stuffing to ensure line integrity. As discussed earlier this means that the user will be able to use only 56K of each DS0.

B8ZS line encoding provides a method for the user to get a full 64K DS0 for user data. This is done by replacing a group of 8 zeros with intentional bipolar violations. This is the only time that BPVs are allowed on the telco facility. The receivers on the T1 line must be configured to look for the B8ZS encoding, else the line will see the substitution for the zeros to be format errors on the line. B8ZS is recognized on the T1 line by the location of the violations in the fourth and seventh positions in the substituted word. By using B8ZS, pulse stuffing is not required and therefore the user will get a full 64K DS0.

Some of the problems on T1 can be attributed to a device on the T1 line being configured for AMI and therefore the BPV violations that are intentionally inserted are registered as line errors.

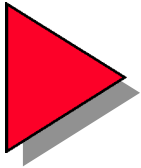

Line Coding: Bipolar 8 Zero Substitution (B8ZS)

AMI

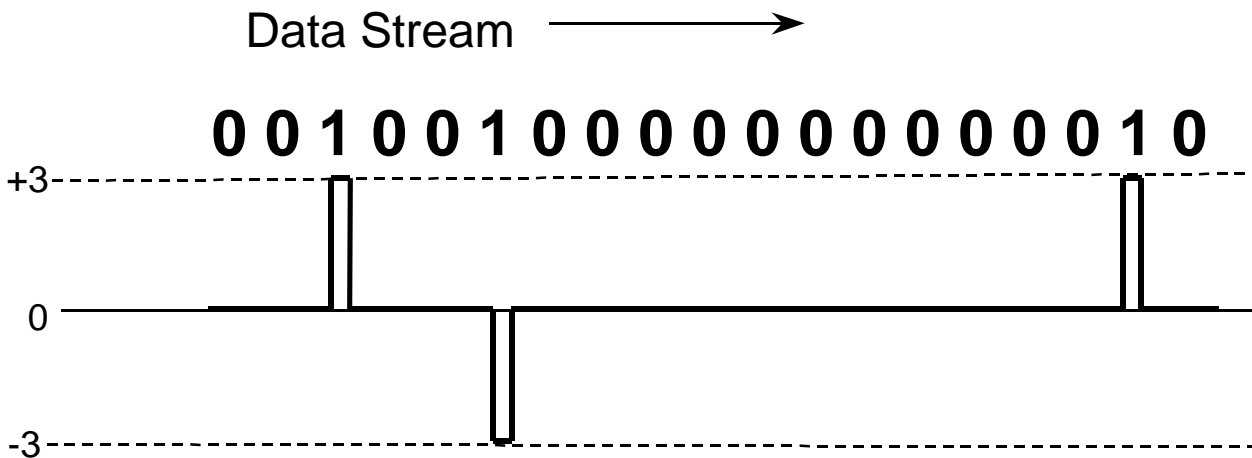

B8ZS

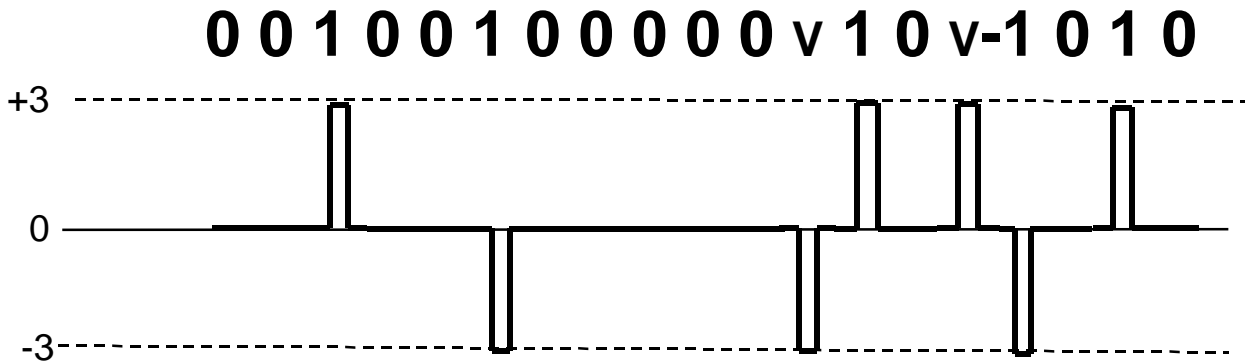

Line Coding: Clear Channel

Clear Channel-

The ability for the user to use all the bits in the data portion of the T1 frame for their own use is called Clear Channel Signaling. Clear channel means that pulse stuffing is not necessary to meet ones density. Most people will associate clear channel capability with B8ZS. This is because B8ZS has the ability to meet pulse density without using pulse stuffing. There are alternate methods that CSUs can apply that will allow clear channel capabilities over an AMI line.

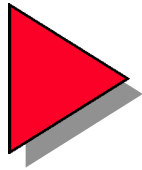

Line Coding: Clear Channel

- **12.5% of the digital pipe is wasted to satisfy bit density requirement**
- **Ability to use the 12.5% is called “Clear Channel”**

Data Coding: HDLC

HDLC(High Level Data Link Control)-

HDLC is an encapsulation protocol that is used in many data communications systems, including WAN, LAN, and ISDN environments. In the HDLC frame there is a flag which marks the beginning and end of each frame("01111110"). If the bit sequence were to be repeated inadvertently in any location in the HDLC frame it would cause the frame to terminate prematurely. To avoid an unexpected termination of the HDLC frame, the transmitter of the frame will perform a function called zero-bit insertion. In this process the transmitter will scan the sender's data, looking for the bit sequence 011111. If it finds this sequence, the transmitter will insert a zero immediately after the fifth one. On the receive circuitry the reverse process is done so that original data is not altered.

This implies that in a HDLC frame no more than five ones can be transmitted consecutively. This means that at least one zero must be present in six consecutive bits. With this knowledge we can develop a means to maintain ones density on a T1 line. This is done on Digital Link products by inverting all the 1s to 0s and 0s to 1s. This occurs before each bit is placed onto a T1 line. The reverse is done on the remote side of the T1 circuit, so that the original HDLC data is not corrupted. Since we know that in the HDLC frames there are at least one zero in every 6 bits, if this is inverted we have at least one 1 in every 6 bits, thus maintaining ones density.

The big advantage of this method of coding allows for clear channel capabilities on an AMI facility.

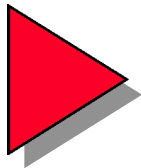

Data Coding: HDLC

Data Stream

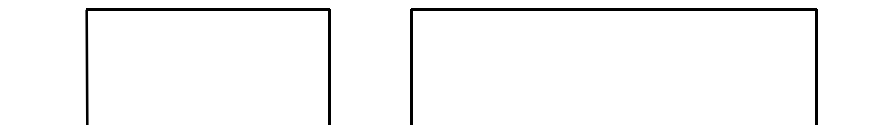

01110111110

Invert Data Stream

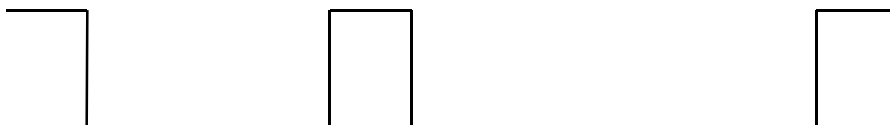

10001000001

FRACTIONAL T-1

Fractional T-1(FT1)-

Until 1989, organizations that required data transportation capability in excess of that offered by DDS (Dataphone Digital Service) services were forced to migrate to a T-carrier service or obtain multiple subrate circuits. In migrating to a T-carrier service the end-user had to pay for twenty-four 64kbps channels on a four-wire circuit regardless of the number of channels they actually needed. If they chose to use a subrate circuit solution, the cost to install the individual DDS circuits as well as the associated cost to install multiple DTE equipment made it an uneconomical solution.

Based on the high cost solutions to get greater than a 64kbps channel, several communications carriers started to offer a FT1 service. FT1 is a channelized service where data can be allocated on a per channel basis. Therefore the end-user could now purchase 1 or more DS0's on a T-1 and reduce the cost of having to pay for a Full T1.

FT1 has many advantages. One of the advantages is that the end-user would only have to pay full T1 rates from the CPE(customer premises equipment) to the LEC (local exchange carrier) and in-between the LEC (Local exchange carriers) they only had to pay for those time slots that were being used. In addition to reduced costs, the FT1 service allowed a great measure of expandability.

For Example:

If a company had a need to install two 64Kbps DS0s/channels for a particular application for connecting two LANs together and were able to foresee that they would need four DS0s by the end of next year, it would save a lot of time, installation charges, and frustration by having a FT1 service. To install two new lines at 64Kbps in the next year would cost money to install the new 64K lines, additional money in DTE equipment, as well as a lot of time spent in getting the telephone company out to install. If a FT1 solution were used the customer could place a call to the telco company and make a few configuration changes and have the higher rate service in a day.

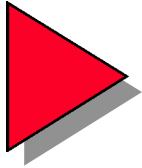

FRACTIONAL T-1

- **Channelized Data**
- **64 kbps Increments (DS0)**
- **Tariffed by Long Distance Carriers**
- **Uses Full T1 Local Access Circuits**

Fractional T-1: Applications: Pt-Pt

To accomplish FT1 services a device called a DACS (Digital Access Crossconnect System) is located in the local CO(Central Office) to break down the T1 frame to corresponding 64k channels. These channels or time slots are then reframed with other customers data channels to the far end CO where they would be placed on the corresponding T1s to each remote location.

In the following example two customers in San Francisco and Seattle would have a Full T1 run between each site and their corresponding LEC. At each site there would be a DSU/CSU(VX Encore) that would ensure that the data that was being received and transmitted was sent on the correct time slots that were paid for and which correlated to the carriers' configuration (all the rest of the time slots are stuffed with ones.) Between the LEC in San Francisco and Seattle only the time slots that were purchased would be sent across the T1 link. The data that was sent from the San Francisco CO would be grouped together with other customers data at that CO(Via a DACS) that was also heading toward the Seattle CO. All the customers would share the cost of the long distance run and thus save money by not having to pay for any unused bandwidth that would have been present in a Full T1. In Seattle a DACS would breakdown the incoming T1 and send the DS0s to each customers full T1 to their remote sites. The efficiency of sharing the unused part of the T1s over the long distance run can significantly save the end-users a lot of money.

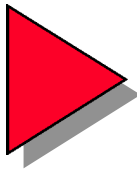

Fractional T-1: Applications: Pt-Pt

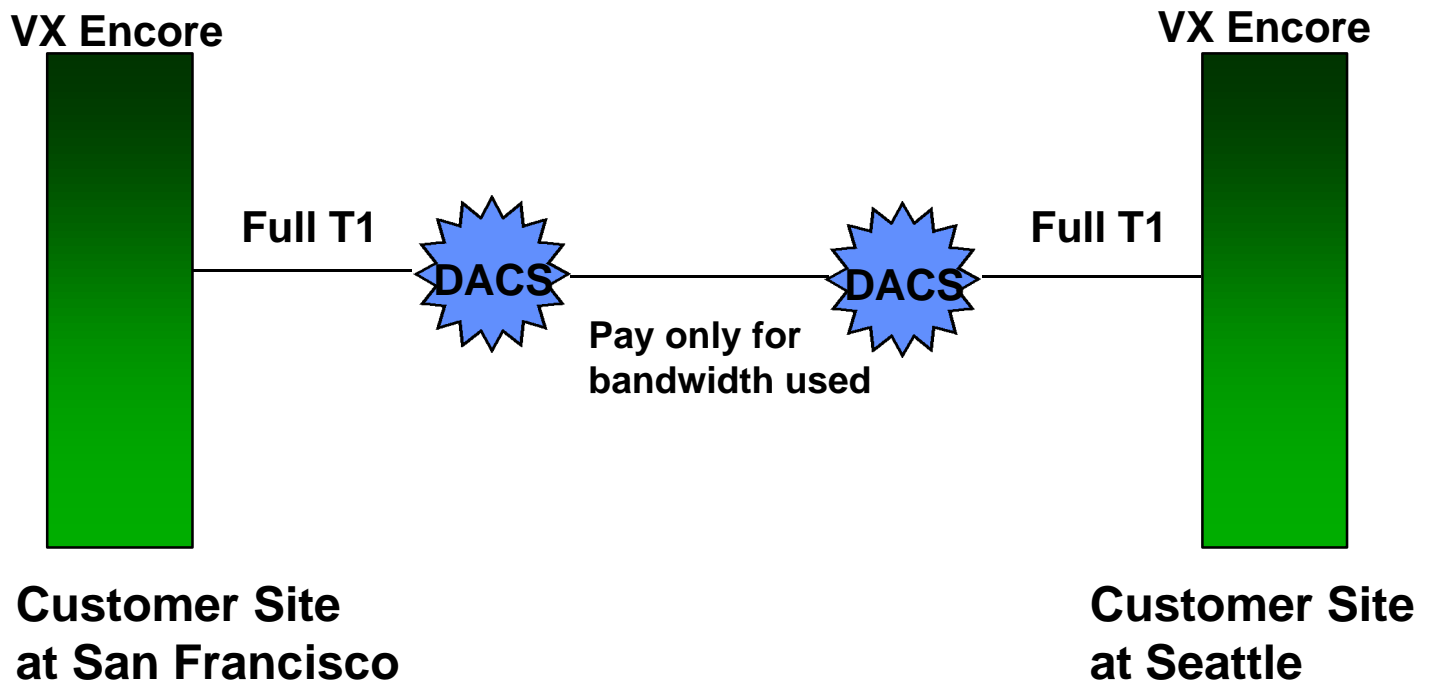

Note: The local access to Fractional T-1 always operates at 1.544 Mbps

Digital Link

Fractional T-1: Applications: Multiple DTE Ports

In the following application the customer has decided to add an additional port to the DSU/CSU to expand his service to include eight more time slots for another router or piece of DTE equipment. Data port #1 will supply a clock at the rate of 256kbps(4 time slots) and Data port #2 will supply a clock rate of 512kbps (8 time slots). The DSU/CSU will frame the incoming data so that it corresponds with the time slots that were agreed upon by the user and the CO. This way the DACS at the CO will know where to look for data. The unused data channels will be set to 1s.

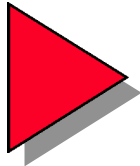

Fractional T-1: Applications: Multiple DTE Ports

DTE1 (256Kb/s)

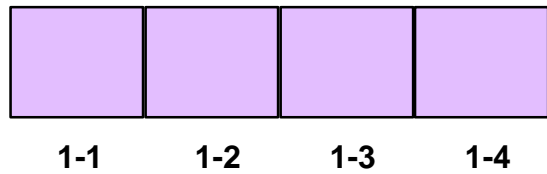

DTE2 (512Kb/s)

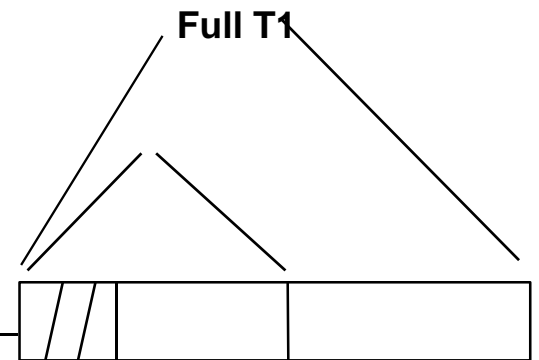
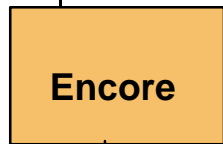
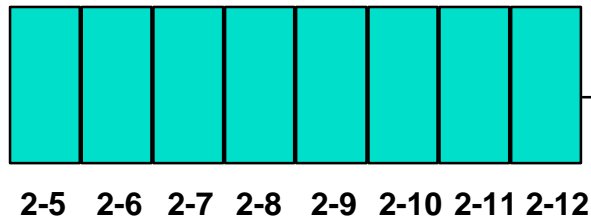

1 2 3 4 5 6 7 8 924



1 1 1 1 2 2 2 2 2 2 2 U U U U U U U U U U U U U U U U

Fractional T-1: Applications: Fan Out

In this application we can see how FT1 can play a critical role in linking multiple sites to a center hub location in San Francisco. Multiple DACS in the telephone network allows for several remote sites to have a data link to a central hub location. Note that in this example that San Francisco will have link to all customer sites, but remote sites don't have the ability to communicate to one another.

It is important at this time to introduce network timing. A lot of problems can be avoided in a network by ensuring there is only one timing source on the network. This is called a master-slave clocking arrangement. In this case the DACS would have to be the master clock. Since a DACS handles breaking down the T1 frames into corresponding DS0s, the DACS will generally have a very accurate clock on the line. The DACS clock ensures that all the data is sent and received in the correct time positions so that the receiving device can accurately locate all bits in the T1 frame. The receiving device can also receive clocking from the incoming data pulses and thus preserve the overall network clock that will be passed to the next device. If there were multiple clocks on the network, one device may be looking for data pulses in incorrect locations in time (since the other device would be isolating data based on its own clock which may be different from the clock that generated the data) and thus cause distortion to the data.

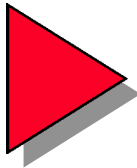

Fractional T-1: Applications: Fan Out

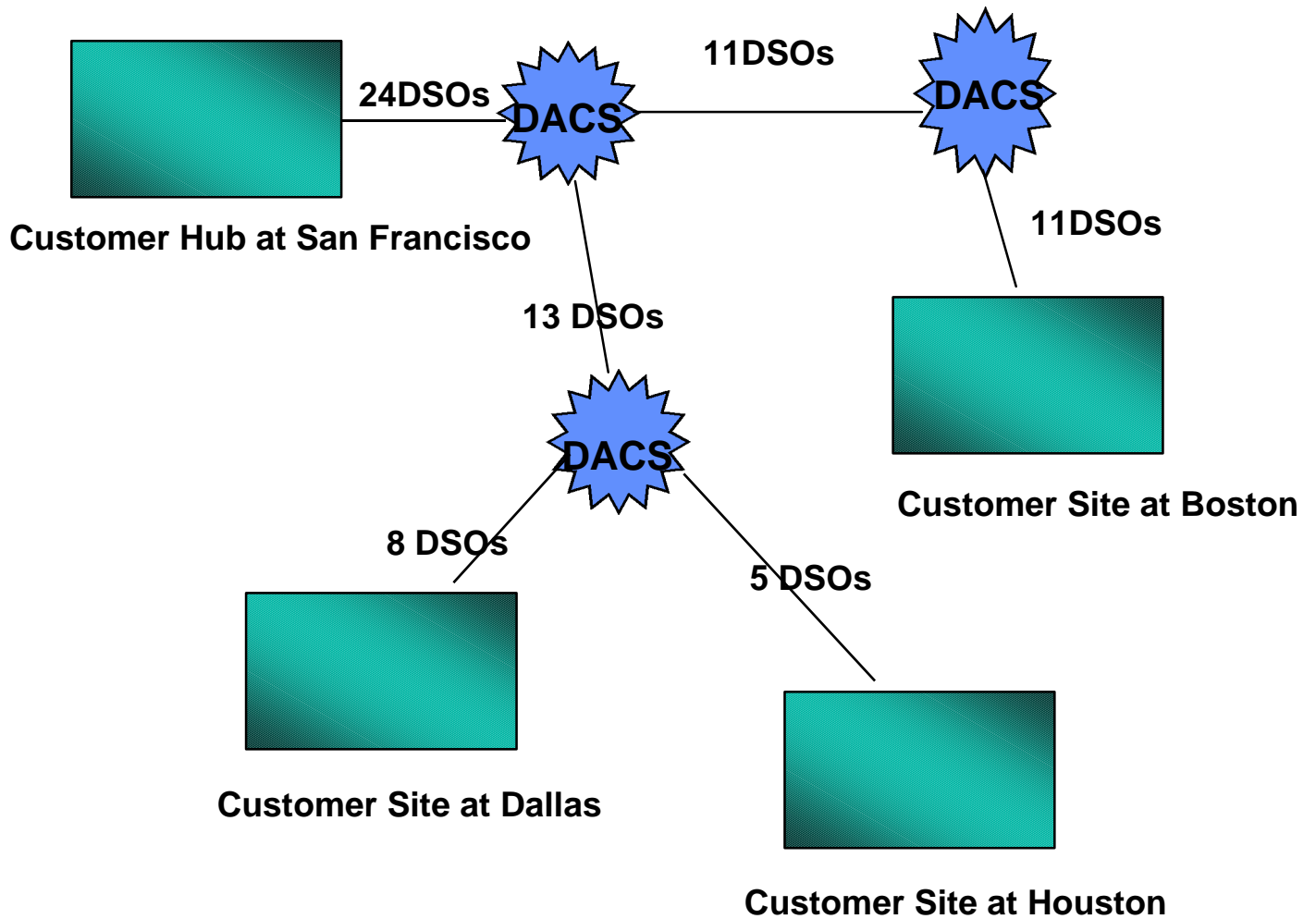

Frame Relay

Frame Relay-

Frame relay is commonly referred to as a “packet based” technology. A **packet** is a bundle of data that is organized in a specific way for transmission. The data is placed in a particular manner such that vital information can be obtained and is called a **frame**. The frame controls vital information such as addressing, error checking, and start and stop sequences.

Each frame that is generated by the DTE equipment will be placed upon the physical medium, be it FT1, T1 or T3, and sent out to the local carrier office. The local carrier will then have equipment that will strip off the T1 data (the individual frames) and route them through the telco facilities to the far end destination. Frame Relay is referred to as a **connection-oriented** protocol. This is because before a connection can be established between two devices a call setup procedure must be followed. This procedure establishes a permanent virtual connection between the remote units and the local unit.

The two main benefits associated with frame relay are reduced costs and the capability of maintaining multiple connections to several remote locations using a single physical connection to the carrier (FT1, T1 or T3). Reduced costs are achieved by the same principles behind FT1 in that you only have to pay for each packet that is sent. The benefit of being able to establish multiple remote connections via a single local connection point saves not only money, but saves resources as well. If we tried to gain the same benefits of frame relay by using T1 technology only, it would require several T1s to be run from the local site to each remote location and as the network grew, the number of T1's required to maintain full communication between all sites would become unfeasible.

One of the limitations of frame relay is **latency**. Latency is the delay that occurs by routing each packet through the telephone network. Packets that are sent may take different routes in the telco “cloud” and it is possible that a packet that was sent later from the local DTE device could be received first at the remote end. Therefore the packet will have to be buffered in the end DTE equipment until the full packet can be processed. The latency inherent in Frame Relay makes it unacceptable for voice or video applications that need to be transmitted and received in a “real-time” environment.

The key point in this discussion is that frame relay can be transmitted across a T1 and is used for data only. It allows for inter-connectivity between multiple sites using only a single connection to the carriers.

Frame relay goes beyond the scope of this course. A separate course is available for frame relay and ATM technologies.

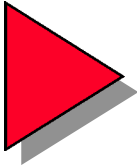

Frame Relay

- **Uses FT1, T1, T3**
- **Packet Technology**
- **Connection oriented**
- **Latency problems result in data traffic only**
- **Provides Cost effective inter-connectivity for multiple locations**

Frame Relay: Application

Frame Relay Application-

Frame relay as discussed previously is good for multiple site connectivity. This picture shows how frame relay can be used to connect to three different locations. The key difference between frame relay and FT1 is that frame relay allows all sites to communicate to one another without having to have a permanent T1 connection to each site. Only a single connection is required from the user site to the local carrier at the central office and the carrier will route the information to the correct remote site.

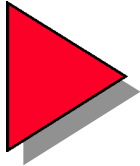

Frame Relay: Application

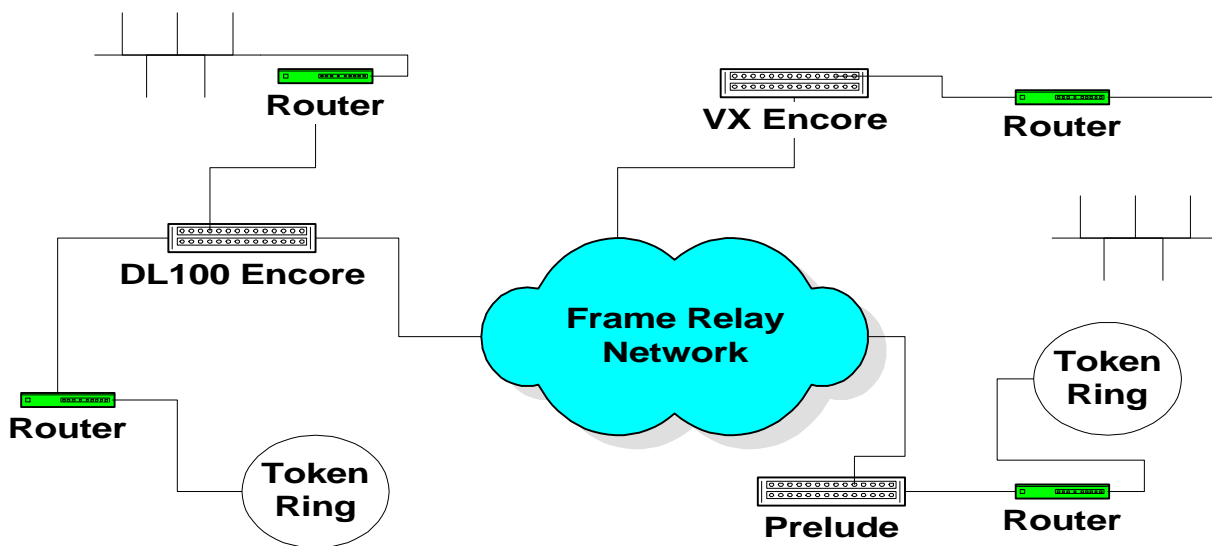

SMDS

Switched Multi-Megabit Data Services (SMDS) -

SMDS is a **cell based** technology. Cell based technology simply means that the data that is sent out on the network is of fixed length. To convert the incoming data from the DTE equipment to a fixed length cell, a DSU is required to segment the data and place it into a T1/T3 frame format. The incoming cells from the network will then be re-assembled prior to being sent to the DTE. This process is commonly referred to as **SAR** (Segmentation and Re-assembly).

The main advantage to using a cell based technology is that is easier for the network equipment to process fixed length cells than variable length packets. It allows for more efficient operation and thus a cost reduction to the end user. The telephone company will charge the SMDS user based on the class of service that is desired.

Data from the DTE device is segmented down into cells and then placed into a T1/T3 frame. SMDS can handle data and packetized voice and video applications.

SMDS is said to be a **connectionless service** as call setup is not required.

SMDS goes beyond the realm of this course. If you desire more information and training on SMDS a separate course is available from Digital Link.

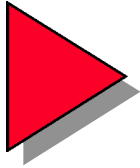

SMDS

- **T1 and T3**
- **Switched Multi- Megabit Data Services**
- **Connectionless Service**
- **Cell Based Technology**
- **Needs special DSU/CSU to Xmit to network**

SMDS: Application

SMDS-

In this picture we see that a special DSU/CSU is required to accomplish SMDS technology. This DSU/CSU will segment the data from the DTE device and send out cells to the telco network to be processed. It allows for multiple sites to be linked together without the need of individual T1s being run to each site.

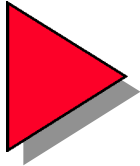

SMDS: Application

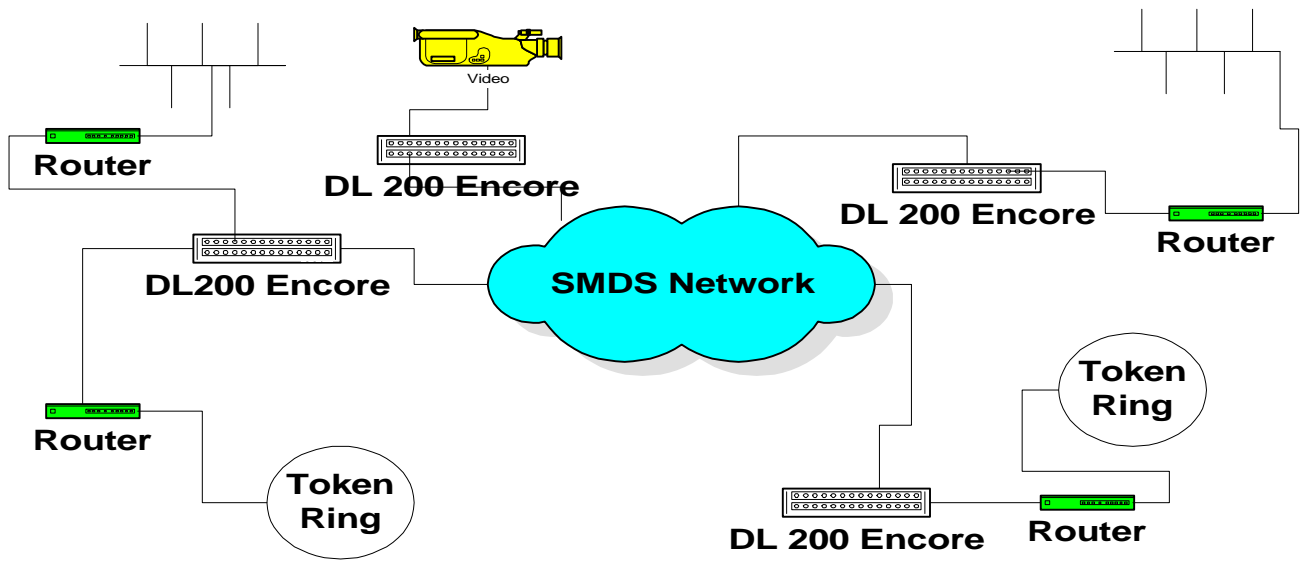

Asynchronous Transfer Mode (ATM)

ATM-

ATM like SMDS is a cell based technology. As such it is more efficient than packet switched technologies such as Frame Relay and ISDN (Integrated Services Digital Network). Since ATM is a connection oriented service is better able to provide voice, data and video.

ATM is mostly used in T3 applications, but can now be found on T1 services.

ATM goes beyond the realm of this course. If you desire more information and training on ATM a separate course is available from Digital Link.

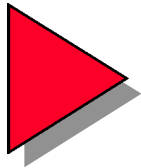

Asynchronous Transfer Mode (ATM)

- **T1 and T3 Access**
- **Connection Oriented**
- **Supports Data, Voice and Video**
- **Cell based technology**
- **Cost effective for multiple locations**

T1 Alarms And Errors

Troubleshooting T1 networks can be a trying exercise. In many user applications the T1 link is critical to network operation. This means that if the link goes down, many people will be beating on your door to get answers and to isolate any problem.

In order to understand how to isolate problems on a T1 line you have to understand the basic diagnostic capabilities and alarms that are available for your use. There are several characteristics that are required on a T1 that can be used to assist you in your isolation process.

The first step in isolating any problem is to become familiar with your configuration options. You will need to be able to find what type of T1 line framing and coding are being used. The ESF frame format has enhanced capabilities which allow the user to gain a greater understanding on what is occurring in the network. We will discuss in the next few pages on how best to isolate network problems as they occur.

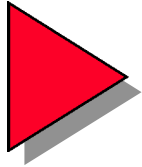

T1 Alarms And Errors

ARGHHHH!!!!!!!!!! My network is down! How do I diagnose my problem??????



Troubleshooting T1 Tips

In this section we will discuss various tell tale signs that your T1 network is experiencing difficulties. Initially we will discuss the three main T1 alarm states that can assist in pin pointing network problems. We will then investigate ESF alarm declarations and the different types of errors that can be found on T1s and why ESF performs better for trouble isolation techniques.

Wiring problems are common on T1s. Using the proper type of cable and wiring it correctly is essential. We will show the pin out and connectors that are currently used for T1s.

External test equipment is often the best way to isolate network problems. We will discuss the different types of network test equipment that are available and how best to use these devices to isolate network problems.

Troubleshooting T1 Tips

- Look at T1 Alarm States
- Know definitions of carrier ESF declarations (per TR62411)
- Understand wiring concepts
- Know and use test equipment
- Be aware of common network problems
- Isolate problems using loopbacks

T1 Alarm States

•**Red CFA (Carrier failure alarm)**- This alarm is generated by the receipt of 2 - 3 seconds of continuous LOS or OOF. An OOF is declared when any 2/4 consecutive frame synchronization bits are incorrect. The alarm is cleared in about 10-20 seconds of receiving a good network signal. Upon declaration of a red alarm a yellow alarm is generated.

•**Yellow CFA**- A yellow alarm is received if the far end unit is in a red alarm condition. In D4 framing, a yellow alarm is declared when 0s are present in the second position in every byte (channel) in the DS1 frame. In ESF, a repetitive 16 bit pattern consisting of 8 ones followed by 8 zeros in the FDL for a minimum of one second is indicative of a yellow alarm state.

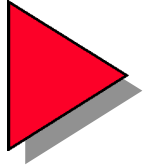

T1 Alarm States

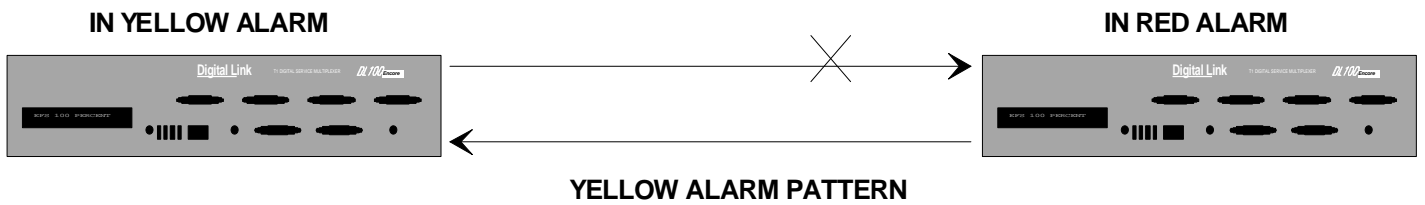

- Red Alarm
- Yellow Alarm

T1 Alarm States (AIS)

- **AIS (Alarm Indication Signal)**- Upon loss of DTE equipment AT&T specification TR62411 suggests that an Unframed all 1s be sent on a DTE loss of signal. As this is an alarm that is created for a CSU, if DSU portion loses signal a framed all 1s is sent. AIS is also known as a blue or keep alive signal. This alarm will indicate that a device on the T1 or connected to the CSU has failed. If an AIS alarm is received a yellow alarm will be generated.

In the adjoining picture it is shown that for a DSU/CSU to declare an AIS or Blue alarm that a LOS must have occurred in the carrier network, before the last regenerator in the network. The Blue alarm will cause the DSU/CSU to send a yellow alarm pattern. Regenerators are similar in functionality to a stand-alone CSUs.

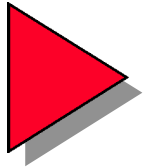

T1 Alarm States(AIS)

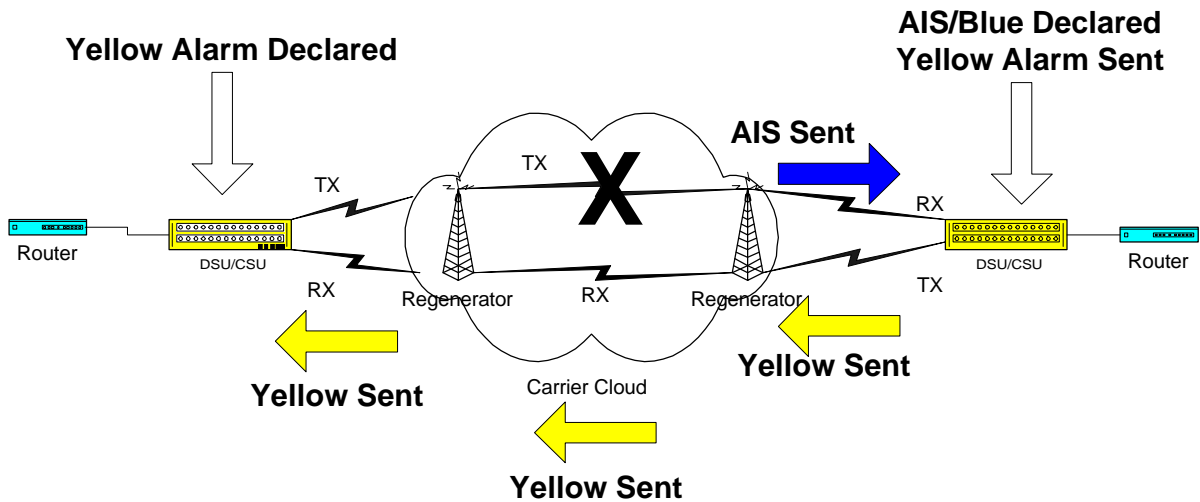

- **Blue/AIS Alarm**
- **Yellow Alarm**

Types of Errors on a T1

All errors on a T1 can be broken down into two major categories, format and logic errors.

Format errors on a T1 are errors that violate the signaling format set forth by AT&T and ANSI (in specs 62411 and T1.403 respectively). These are conditions that we discussed earlier. They may be errors in the coding method, such as BPVs, or violations in the number of pulses received. Both D4 and ESF will be able to detect format errors.

Logic errors on a T1 are errors that are introduced by the insertion or removal of pulses in the data stream. These errors will be shown in greater detail in the next figure. Logic errors in the data stream may not necessarily cause format errors on the line. Unless logic errors occur within the framing bits of the T1, the D4 frame format will not be able to detect them. One of the advanced characteristics in the ESF frame format allows for additional trouble isolation through its CRC check, which will be enable DSU/CSUs to detect additions or removal of pulses within the T1 data stream. There are also additional ESF alarm states that are stored in 24 hours statistics that are available through the FDL. The additional alarm states will be described shortly.

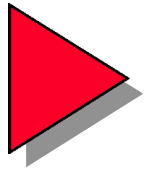

Types of Errors on a T1

Format Errors-

Errors that violate DS1 signaling specification

- BPV, Loss of Signal, Loss of Frame, Excessive Zeros, Ones density violations, Incorrect pulse widths, Incorrect signal levels.

Logic Errors

Errors that occur when a pulse is added or removed from the data stream, hence, the data is altered.

- Won't always produce format errors.
- Multiple Logic errors may keep AMI coding intact.
- D4 framing format will not detect logic errors unless they are in the framing bits

Logic Errors Vs. Format Errors

This picture shows that if pulses are inserted or removed, sometimes a format error will not occur. In D4 format, errors will not be seen unless the pulse removal or insertion occurs in the framing bits in the T1 frame. In the ESF format, both types of errors (format and logic) can be detected by the CRC check. The CRC 6 capabilities of the ESF frame will compute a value representing of all bits within the frame before it gets sent out to the T1 network. The receiving device will reverse the computation to ensure there aren't any errors within the bit stream. In this, we can see that ESF format will have a better capability to detect errors on the T1.

The enhanced capabilities of the ESF frame allows the carrier to determine accurately the true performance of the line. With the CRC check we see that the ESF frame can determine errors in the data stream as well as in the frame bits. In the ESF frame format the FDL also gives us the capability to view the statistics on the line in 15 min intervals for 24 hours. The next page shows the statistics that can be obtained in an ESF CSU that will allow greater trouble isolation on a T1.

As discussed earlier, in AT&T's 54016 specification, statistics are held within the CSU and are held in three registers. These are termed the Carrier registers. The carrier registers hold data in three locations. The registers are titled the Current 15 minute interval, the 24 interval and the detailed 24 hour interval (that holds the data for each 15min interval over 24 hours). In ANSI T1.403 the statistics are sent towards the T1 every second. In TR54016 these values have to be polled.

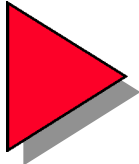

Logic Errors Vs. Format Errors

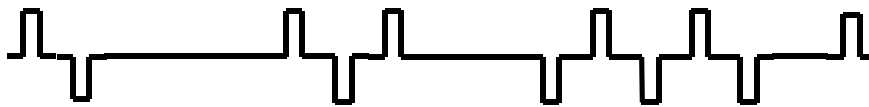

Normal Bipolar Signal

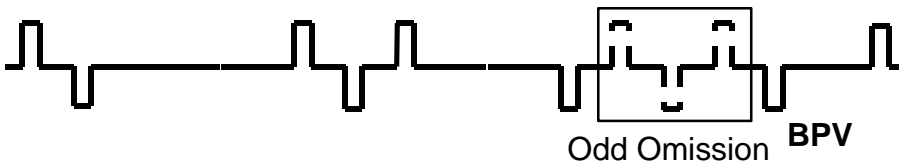

Same Signal with an odd omission

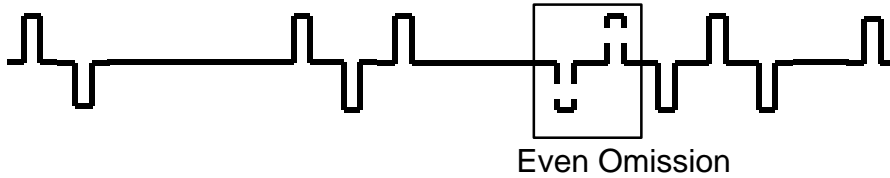

Original Signal with an even omission

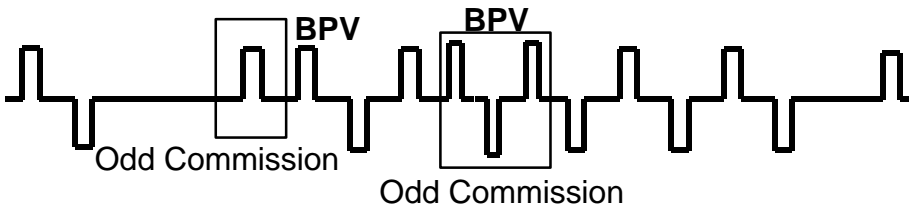

Original Signal with an odd commission

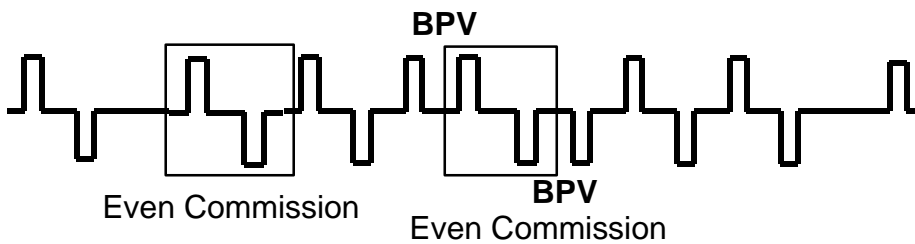

Original Signal with an even Commission

ESF Alarm Declarations

On the next page are the errors that can be detected and stored in the ESF statistics registers. Note that most of these ESF alarm conditions rely on the added feature in an ESF frame that allows for CRC checking. Common alarms like LOS and LOF will also be detected in a D4 CSU, but they do not have to be logged in a register (although some vendors do put a D4 statistics log for user convenience).

Format errors will be detected by both a ESF CSU and D4 CSU.

Logic errors will be detected only by and ESF CSU.

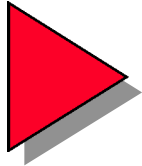

ESF Alarm Declarations

- **Loss of Frame (LOF) (OOF)**- 2/4 framing errors
- **Loss of Signal(LOS)**- 175 consecutive instances of no pulses
- **ESF Error Event**- CRC6 or OOF
- **CRC Error Event**- Logic error
- **Errored Second (ES)**- One or more CRC6 or OOF
- **Severely Errored Seconds (SES)**- 320 or more CRC6 or OOF
- **Unavailable Seconds(UAS)** - Service unavailable
- **Unavailable Signal State(USS)**- 10 SES.
- **Bursty Erred Seconds (BES)**- >1 but <320 CRC errors.

Wiring On T1 Port

Upon initial installation of a T1 circuit, most problems are caused by incorrect wiring of the four T1 leads.

The first consideration in wiring a T1 is to ensure that a high quality cable is being used. Typical brand names for a T1 cable is ABAM or T-Screen. These types of cables are individually twisted and shielded cables. The transmit and receive pair must be on their own twist. That is Tx Tip and Ring must be twisted together. A T1 cable is a 4 wire full duplex cable. This means that there are two wires for transmit and two wires for receive so that communications can occur in both directions (towards the network and towards the DTE device) on the line at the same time. The two wires for TX and RX are named Tip and Ring. Tip is a positive representation of the signal and Ring is the negative.

If the wires in the TX and RX pair were twisted incorrectly, a phenomenon called cross talk will result on the T1 and errors such as BPV, CRCs, and LOS may occur. Typical wire gauge is 22-26 gauge.

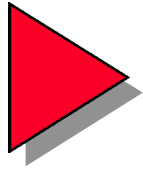

Wiring On T1 Port

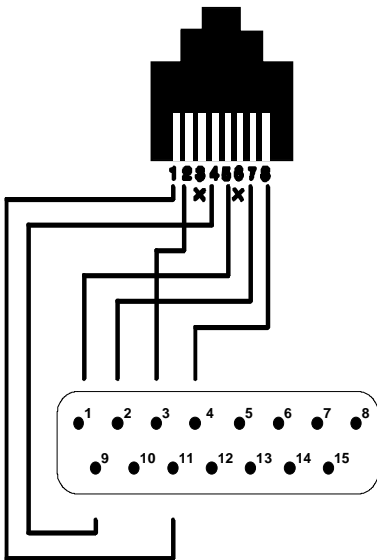

Signal Name	RJ48	Direction	DB15
Net Receive Ring (R)	1	<	11
Net Receive Tip (T)	2	<	3
Net Transmit Ring (R1)	4	>	9
Net Transmit Tip (T1)	5	>	1
Dra in Wire	7		2
Dra in Wire	8		4

Test Equipment

There are many vendors that make equipment to troubleshoot data communication lines. TTC is the most renowned and has become a leader in the manufacturing of test equipment. IDS also creates test equipment that is less expensive, but is equally good for testing data networks.

There are two areas for WAN connectivity that need to be tested. One is the network connection and the other is the DTE uni-polar synchronous connection.

- T-Berd 209/211- This is used to test the network by providing T1 frame formatted patterns to isolate any network problems. It can also be used with fractional T-1's or in a unframed format
- Fireberd 6000- Is generally used to test the DTE interface and supports synchronous protocols like V.35/RS449. It sends a synchronous data pattern to test the DTE equipment and connected devices. The F.B.6000 offers the ability to change modules and thus has the ability to also perform as a direct T1 test set as well like the T-Berd 209.

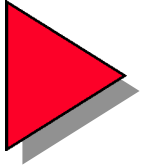

Test Equipment

- **Network test equipment-**
 - T-Berd

- **Data communications test equipment-**
 - Fireberd

Test Equipment: Patterns

Both the T-berd and the Fireberd use complicated test patterns to ensure the integrity of the digital line. Here are the most important patterns and why they are used.

- Mark-** All ones, fixed 'keep alive' signal. Test maximum power level for T1. Stresses repeater power requirements.
- 1:1-** Fixed pattern of alternating marks and spaces. Minimum stress on clocking circuits.
- 1:7-** 1 mark followed by 7 zeros. Test the one's density requirements on T1.
- 3:24-** 1000 1000 1000 0000 0000 0000. Test the max excessive zero requirements.
- 2047-** $2^{11}-1$ pseudorandom pattern with max 10 sequential 0's, and 11 1's. Mainly used to test DDS circuits for low rates.
- $2^{20}-1$ -** Pseudorandom pattern with max of 19 0's, 20 1's. Higher stress pattern to test excess 0's.
- $2^{23}-1$ -** Pseudorandom pattern with max of 22 0's and 23 1's. Highest stress for pseudorandom.
- QRSS (quasi-random signal source)-**
 $2^{20}-1$ pattern that is modified to xmit maximum of 14 consecutive zeros. Best for simulation of live data.

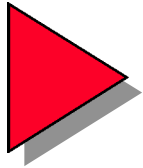

Test Equipment: Patterns

Test equipment stresses the line using complicated patterns.

Patterns:

- Mark-** Tests for power levels on a T1. Stresses repeaters
 - 1:1-** Stresses clocking circuits
 - 1:7-** Tests ones density on a line
 - 3:24-** Stresses one's density rule
 - 2047-** Pseudorandom pattern
Mainly used to test DDS circuits for low data rates
 - 2²⁰-1-** Pseudorandom pattern. High stress pattern to test excess zeros
 - 2²³-1-** Pseudorandom pattern. Highest stress pattern that can be used (most sequential zeros and ones). Tests excess 0s
- QRSS (quasi-random signal source)-**
2²⁰-1 pattern that is modified to xmit only 14 consecutive 0s. Best for simulation of live data.

Common Network Problems

BPV- BPVs are one of the most common errors that appear on a copper T1 facility. They can be caused by bad signal levels on the wire or opens in the circuit. They also may be caused by a device on the line has an improper coding style (i.e. B8ZS). Problems may be isolated using the test equipment discussed before in conjunction with loopbacks.

Frame and CRC errors- These errors stored and used for performance monitoring. They can indicate that a line is degrading or a component on the network is failing. CRC errors can be detected in the ESF framing format only.

Wiring- All wires should be good quality T1 cable. Specs call for the cable to be 100 ohms, 24 gauge, individually twisted and shielded cable pairs. Levels on the T1 line must not be less than -24 - 26 DB.

Jitter and Wander- Jitter is defined as a phase displacement in time of a signal from its original position. Due to the many components used on a T1 line(multiplexers, DACS, regenerators) there is always going to be processing time to pass the signal through the circuitry. This time delay is termed as jitter. A certain amount of jitter is allowed on a T1. Low levels of jitter (below 10HZ) is called wander. Jitter may cause timing slips or CRC errors.

Timing Slips- Timing slips are most often caused by having multiple clocks on a single line or by high levels of jitter. Uncontrolled slips may be caused when clocking or jitter problems are so severe that the buffers in the attached equipment must be cleared and the framing is lost. Controlled slips occur when the T1 equipment clears its buffers, but maintains framing.

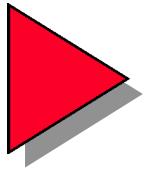

Common Network Problems

- **Bipolar Violations (BPV's): Only on copper**
- **Framing Errors**
- **CRC-6 Errors (ESF only)**
- **Wiring and signal levels**
- **Jitter and Wander**
- **Timing slips**

Troubleshooting: Loopbacks

In trouble shooting T1 networks there are three main loopback tests that can be performed.

Net Loopback- This is a required loopback from AT&T spec. 62411. The network loopback is actuated by the telephone company or from CSUs through the front panel or terminal interfaces. Its main purpose is to allow the network to troubleshoot network problems. It is actuated by a 10000 repetitive unframed pattern and can be taken down by a 100 unframed pattern. It loops the network signal back towards the network, thus allowing the carrier to test the integrity of the T1 line. The framing is not regenerated. This test will test the LBO on the DSU/CSU and the network.

Payload Loopback- This is a required loopback from AT&T spec 62411. It loops that data from the network back towards the network. This test tests not only the T1, but the DSU/CSU as well. The data is reframed and regenerated before being sent back towards the network.

DTE Loopback- This loopback is used to test the attached DTE equipment and the DSU/CSU. It loops the data from the DTE back towards the DTE. It runs through the internal circuitry of the DSU/CSU and through a simulated 4000ft line before being sent back towards the DTE.

Note: Depending on the specification that is used the loop up and loop down codes may be different for the network and the payload loopbacks. T1.403 sends loop up and loop down codes across the FDL, where TR54016 sends the loop up and down codes in-band.

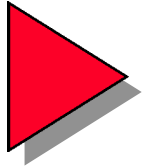

Troubleshooting: Loopbacks

- Helps to isolate network and DTE problems
- Required by carriers for DSUs and CSU's
- Three Types
 - Network, Payload and DTE

Troubleshooting: Loopbacks

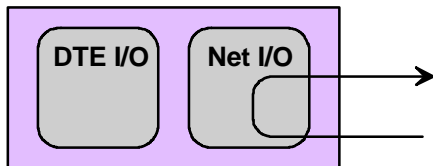

Network (Line) Loopback

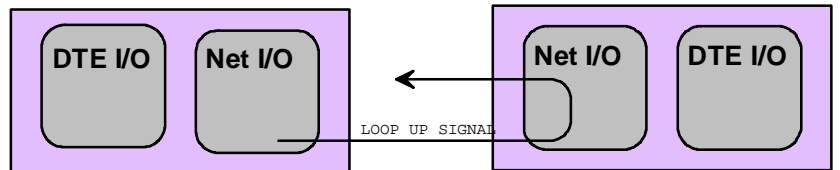

Remote Network (Line) Loopback

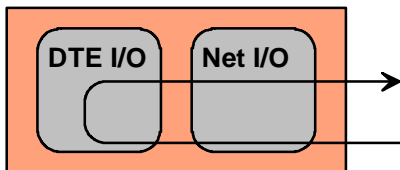

Full Payload Loopback

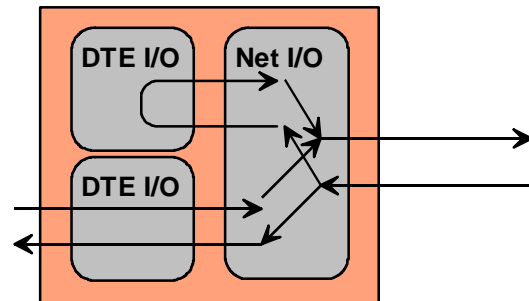

Fractional Payload Loopback

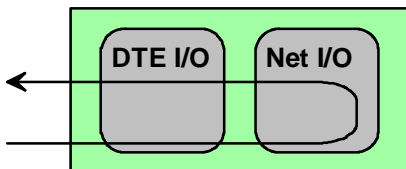

Full DTE Loopback

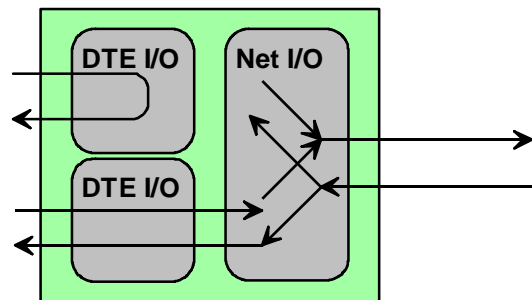

Fractional DTE Loopback

**DTE Loopback- Not actuated from the network.
Can only be actuated by CSU locally/terminal or through
the DTE device.**

This page is intentionally left blank

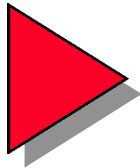

Summary

In conclusion, the principles that have been discussed and shall be understood are:

- **Analog to digital conversion.**
- **The basics on how the T1 frame is constructed**
 - 193 bits. 192 bits for data, 1 bit for overhead
 - 24 8 bit channels
- **The different framing methods and their benefits.**
 - ESF has CRC, FDL as wells as performance registers. ESF can detect both logic and format errors on a line.
 - D4 only uses overhead for synchronization. Limited in seeing only format errors.
- **Different T1 alarm states.**
 - RED, YELLOW, BLUE (AIS)
- **The different coding technologies used on a T1 and why one is better than another.**
 - B8ZS and AMI
 - Clear channel
- **How to troubleshoot network problems and the tools available.**
 - Wiring, ESF registers, External test equipment, and T1 loopbacks.

This page is intentionally left blank

References

- **AT&T TR 62411**
 - **Accunet T1.5 Service: Description and Interface Specification**
- **AT&T TR 54016**
 - **Requirements For Interfacing Digital Terminal Equipment To Services Employing The Extended Superframe Format**
- **ANSI T1.403**
 - **Carrier to Customer Installation DS1 Metallic Interface**
- **Bud Bates:**
 - **Introduction to T1/T3 Networking**
- **Gilbert Held:**
 - **Digital Networking and T-Carrier Multiplexing**
- **George E. Friend:**
 - **Understanding Data Communications**

Notes



A series of 20 horizontal lines for writing notes, evenly spaced and extending across the page.