

# Verifying the Agreed Framework

*April 2001*



The **Center for Global Security Research (CGSR)**, established in 1996, brings together diverse expert communities to address common challenges with significant policy implications. The Center studies how technology can enhance national security and expand knowledge of the policy–technology interface. The CGSR draws strength from its affiliation with the Lawrence Livermore National Laboratory (LLNL), a Department of Energy national laboratory managed by the University of California. By supporting research that explicitly considers both technical and policy factors involved in defense programs, arms control, nonproliferation, peacekeeping, and related international issues, the Center contributes to national and international security.

Center for Global Security Research  
Lawrence Livermore National Laboratory  
P.O. Box 808 (L-189)  
Livermore, CA 94551  
Phone: 925.422.6141  
Fax: 925.422.5252  
Web: <http://cgsr.llnl.gov>

The **Center for International Security and Cooperation (CISAC)** is a multidisciplinary community dedicated to research and training in issues of international security. The Center, part of the Institute for International Studies (IIS) at Stanford University, promotes a creative and collaborative environment in which scholars, scientists, government officials, military officers, and business leaders can produce policy-relevant research to address complex international problems.

Center for International Security and Cooperation  
Stanford University  
Encina Hall  
Stanford, CA 94305-6165  
Phone: 650.723.9625  
Fax: 650.723.0089  
Web: <http://cisac.stanford.edu>

# Verifying the Agreed Framework

*April 2001*

Michael May, General Editor  
Chaim Braun  
George Bunn  
Zachary Davis  
James Hassberger  
Ronald Lehman  
Wayne Ruhter  
William Sailor  
Robert Schock  
Nancy Suski



## GLOSSARY

### AF

Agreed Framework, signed in 1994 between the US and the DPRK, to negotiate nuclear issues on the Korean peninsula

### Agreement for Cooperation

what US law requires the US government to negotiate with countries (including the DPRK) before US nuclear materials or US nuclear components can be provided for reactors for those countries, including the ROK reactors which KEDO plans to send to DPRK pursuant to the AF

### BOL

Beginning of Life, generally used with BOL fuel, the first cycle in a reactor

### Burnup

a measure of the thermal energy produced per mass of fuel (usually measured in megawatts-thermal-days per tonne [MWth-d/t])

### Control rods

rods of neutron-absorbing material inserted into the core of a reactor to control its operations. Pushing in the rods decreases the rate of reaction, while removing the rods increases the rate of reaction.

### Core

the central part of a nuclear reactor containing the fuel rods, moderator, and control rods, where the nuclei of the fuel fission and release energy

### DPRK

Democratic People's Republic of Korea, commonly called North Korea

### Enrichment

the process of increasing the concentration of one isotope of a given element (in the case of uranium, increasing the concentration of uranium-235). Also, the resulting concentration of that isotope.

### EOL

End of Life, generally used with EOL fuel, the third cycle in a reactor

### Fissile material

material composed of atoms that fission when irradiated by slow ("thermal")

neutrons. The most common of these materials are uranium-235 ( $^{235}\text{U}$ ) and plutonium-239 ( $^{239}\text{Pu}$ ). Uranium-233 ( $^{233}\text{U}$ ) is also fissile.

### Fuel-fabrication facility/plant

facility where nuclear materials (e.g., enriched or natural uranium) are fabricated into fuel elements to be inserted into a reactor

### Fuel-grade plutonium

plutonium containing less than 80 percent plutonium-239 ( $^{239}\text{Pu}$ ) and 7 to 18 percent plutonium-240 ( $^{240}\text{Pu}$ )

### Gas-graphite reactor

a nuclear reactor cooled by a gas and moderated by graphite

### Highly enriched uranium (HEU)

uranium in which the percentage of uranium-235 ( $^{235}\text{U}$ ) is raised ("enriched") from a natural level of 0.71 percent to greater than 20 percent. All HEU can be used to make nuclear explosives, although a very large quantity is required for HEU enriched to only 20 percent.

### IAEA

International Atomic Energy Agency

### INFCIRC

Information Circular, a series of IAEA documents regarding safeguards, etc.

### IRT reactor

Soviet-designed research reactor fueled with enriched uranium and moderated with water

### KEDO

Korean Peninsula Energy Development Organization

### KSNP

Korea Standard Nuclear Plant

### Kumho site

location where the KEDO-supplied reactors are being built in North Korea

### Light-water reactor (LWR)

a reactor that uses ordinary water as a moderator and coolant and low-enriched uranium as fuel

### Low-enriched uranium (LEU)

uranium containing more than 0.71 percent and less than 20 percent uranium-235 ( $^{235}\text{U}$ ). Most modern light-water power reactors use 3–5 percent LEU. LEU is insufficiently enriched in  $^{235}\text{U}$  to be used for nuclear explosives.

### Magnox

uranium nuclear fuel with magnesium-alloy cladding. Because this cladding corrodes easily, this type of fuel is difficult to store safely for a long period of time or dispose of in a geologic repository. Typically, irradiated magnox fuel is reprocessed shortly after it is removed from the reactor core.

### MW(e)

Megawatt-electric, used in reference to a nuclear power plant, equals one million watts of electricity

### MW(th)

Megawatt-thermal, one million watts of heat

### Natural uranium

uranium containing 0.71 percent uranium-235 ( $^{235}\text{U}$ )

### NPT

Non-Proliferation Treaty

### Nuclear fuel cycle

the entire life cycle of nuclear fuel, including the front end (initial mining, milling, conversion, enrichment and fuel fabrication), reactor irradiation (and resulting power generation), and the back end (including spent-fuel storage, reprocessing and recycling, and disposal)

### ROK

Republic of Korea, commonly called South Korea

**Safeguards Agreement** An agreement of a country having nuclear activities with the IAEA providing for safeguards (nuclear material accounting and control plus periodic inspections) to assure that nuclear material is not diverted to nuclear explosives

# CONTENTS

<b>Introduction: Verification and the Challenges to Constructive Engagement with North Korea</b>	<b>1</b>
Technical Questions, Strategic Implications	1
Nuclear Cooperation: Two Sides of a Coin	2
Means Versus Ends	3
Program Management, IAEA Interaction, and Challenges to Preventive Diplomacy	3
Dynamics of Technology–Policy Interaction	4
By What Standard Shall We Judge, and When?	5
<b>Verifying the Agreed Framework: Executive Summary</b>	<b>7</b>
Safeguarding the Nuclear-Power Reactors Provided by KEDO	7
Verification of the DPRK’s Declaration and of the Disposal and Dismantlement of Identified or Suspect Nuclear Facilities	8
Verification of DPRK’s Declaration	8
Verification of the Disposal and Dismantlement of Identified Yongbyon Facilities	9
Verification Regarding Other Suspect Facilities	10
Possible Adverse Developments	10
Further Delays	10
Non-Cooperation with the IAEA’s Verification of Compliance	10
Need for an Amended DPRK Declaration	11
Disagreements Over Material To Be Transferred from the DPRK	11
Disagreements Over the Site of Ultimate Disposition	12
Disagreements Over the Extent of Safeguards for KEDO Reactors	12
Interference with Safeguards for KEDO Reactors	12
Abrogation of AF or NPT after the KEDO Reactors Are Installed	12
Executive Summary Conclusions	13
Organization of Report	13
Authors and Sponsors	13
<b>Chapter 1 A Brief History of the DPRK’s Nuclear Weapons-Related Efforts</b>	<b>15</b>
1.1 Early History	15
1.2 Attempts To Restrain the DPRK From Making Nuclear Weapons	16
1.3 Agreed Framework of October 1994	17
Notes to Chapter 1	20
<b>Chapter 2 Currently Applicable Safeguards and Related Agreements</b>	<b>23</b>
2.1 The Existing IAEA–DPRK Safeguards Agreement	23
2.2 New Information That the IAEA May Ask of All States Under INFCIRC 153 Safeguards	24
2.3 Additions to INFCIRC 153 Safeguards for States Willing To Agree to a New INCFIRC 540 Safeguards Protocol	24
2.3.1 Safeguards on Existing ROK LWRs—Models for the DPRK LWRs	25
2.4 Major Challenges Ahead to the Implementation of the Agreed Framework	26
2.4.1 Completion of a “Significant Portion” of the First Reactor in the ROK and Reactor Buildings in the DPRK	26
2.4.2 Financing	26
2.4.3 Nuclear Liability	26
2.4.4 US–DPRK “Agreement for Cooperation” and IAEA Inspection of Undeclared Facilities	26
2.4.5 Improving North Korea’s Electricity Distribution System	27
Notes to Chapter 2	27
<b>Chapter 3 The KEDO Reactors and Associated Facilities and Activities</b>	<b>29</b>
3.1 Introduction	29
3.2 The KEDO Site	29
3.3 Nuclear-Power Development Along the Shores of the East Sea	30
3.4 Site Work to Date	31
3.5 Nuclear-Fuel Shipments Into and Out of the Site	33
3.6 Electricity Transmission Issues	35
3.7 The ROK’s Energy Development Issues	37
Notes to Chapter 3	39

<b>Chapter 4 Safeguards on the KEDO Reactors</b>	<b>41</b>
4.1 Introduction	41
4.2 Project Organization To Supply the KEDO Reactors	41
4.3 Description of the KEDO Reactors	42
4.4 Refueling Operation in the KEDO Reactors	45
4.4.1 The Special Problem of the Beginning-of-Life and End-of-Life Fuel Discharges	49
4.5 IAEA Safeguarding of Nuclear Fuel in the KEDO Reactors	50
4.5.1 The Safeguards Goals for Quantity and Timeliness	50
4.5.2 The Safeguards Accounting Process	51
4.5.3 Material Balance Area in KEDO-type Reactors	51
4.5.4 The Containment and Surveillance Process	52
4.5.5 Safeguards Inspections During Routine Plant Operation	53
4.5.6 The Physical Inventory Verification Type of Safeguards Inspection	54
4.6 Assessment of Additional Measurements and Inspections	55
4.6.1 Measures for Strengthened Safeguards Under INFCIRC 153: Environmental Sampling	55
4.6.2 Measures for Strengthened Safeguards Under INFCIRC 153: Remote Monitoring	55
4.6.3 Measures for Strengthened Safeguards Under INFCIRC 153: Other Recommended Steps	56
4.6.4 Satellite Remote Sensing	56
4.7 Conclusions	57
Notes to Chapter 4	58
<b>Chapter 5 Diversion and Misuse Scenarios for Light-Water Reactors</b>	<b>59</b>
5.1 Scope and Intent	59
5.2 Scenarios	59
5.2.1 Scenario: Covert Diversion of Spent Fuel Produced During Normal Reactor Operations	60
5.2.2 Scenario: Covert Materials Production	61
5.2.3 Scenario: Short-Cycling the Reactor	62
5.2.4 Scenario: Overt Reconfiguration of the Reactor for Materials Production	63
5.3 Consequences	64
5.4 Preventive Measures	65
Notes to Chapter 5	66
<b>Chapter 6 Known and Suspected Nuclear-Related Facilities in the DPRK</b>	<b>67</b>
6.1 Inspection, Dismantlement, and Disposal Requirements for Existing Nuclear Facilities	67
6.1.1 “Full-Compliance” Inspections by the IAEA	67
6.1.2 Disposal of Spent Fuel	67
6.1.3 Dismantlement of Gas-Graphite Reactors	67
6.2 The Facilities at Yongbyon	67
6.2.1 The IRT-2000 Research Reactor	68
6.2.2 Isotope Production Laboratory Near the IRT-2000 Reactor	68
6.2.3 Probable Undeclared Waste Site South of the IRT-2000 Reactor	68
6.2.4 Declared Waste Site	68
6.2.5 Graphite-Moderated Reactor	68
6.2.6 Fuel Reprocessing Facility	69
6.2.7 Undeclared Waste Storage Building	70
6.2.8 Other Unfinished Reactors	70
6.3 Verification of the Initial DPRK Declaration	70
6.4 Verification of Fuel Disposal and Facility Dismantlement	74
6.4.1 Spent-Fuel Disposition	74
6.4.2 Dismantlement	74
6.5 How Much Verification Is Enough?	76
Notes to Chapter 6	78
<b>Chapter 7 Timeline for Verification and Safeguards</b>	<b>79</b>
Completion of a Significant Portion of the Project Site at Kumho, DPRK, and of the First KEDO Reactor in the ROK	79
IAEA Declaration that the DPRK Is in Compliance with Its Safeguards Agreement	79
Start of Delivery of Key Nuclear Components of the First KEDO Reactor to the Kumho Site Simultaneously with Start of Transfer of DPRK’s Spent Fuel from Yongbyon to Its Ultimate Disposition	80

Simultaneous Completion of Yongbyon Spent-Fuel Transfer and of the First KEDO Reactor . . . .	80
Dismantlement of DPRK's Graphite-Moderated Reactors and Related Facilities Begins . . . . .	81
Deliveries of the Nuclear Components for the Second KEDO Reactor in Parallel with Proportional Steps by the DPRK To Dismantle All Its Graphite Reactors . . . . .	81
Completion of Second KEDO Reactor at Kumho . . . . .	81
Shipping Spent KEDO Reactor Fuel When Appropriate Out of the DPRK . . . . .	81
<b>Chapter 8 Potential Adverse Developments . . . . .</b>	<b>83</b>
8.1 Benchmark Scenario: The DPRK Fully Cooperates with the IAEA Regarding Existing Agreements . . . . .	83
8.2 Scenario 1: The DPRK Maintains Its Present Level of Cooperation . . . . .	84
8.3 Scenario 2: The DPRK Attempts Covertly To Divert or Hide Nuclear Material . . . . .	85
8.4 Scenario 3: The DPRK Abrogates the Agreed Framework or Other Key Agreement . . . . .	85
8.5 Scenario 4: The US or the ROK Is Unable or Unwilling To Meet Its Commitments under the Agreed Framework Even Though the DPRK Does . . . . .	87
8.6 Predicting the Future . . . . .	87
Notes to Chapter 8 . . . . .	88
<b>Verifying the Agreed Framework: Conclusions and Recommendations . . . . .</b>	<b>89</b>
Safeguarding the KEDO Reactors . . . . .	89
Past DPRK Nuclear Activities . . . . .	89
Possible Adverse Developments . . . . .	90

## FIGURES

Introduction Figure. Parallel interaction paths related to the Agreed Framework (AF) and the Democratic People's Republic of Korea (DPRK) . . . . .	6
Figure 1-1. General map of the Korean peninsula . . . . .	15
Figure 3-1. General map of the DPRK . . . . .	29
Figure 3-2. Locations of nuclear reactors around the East Sea . . . . .	30
Figure 3-3. The vicinity of the Light-Water Reactor (LWR) project . . . . .	32
Figure 3-4. Artist's conception of the future site for the KEDO reactors . . . . .	32
Figure 3-5. Scope of the grading efforts in the construction area . . . . .	33
Figure 4-1. Organization chart for the supply of a Korean Standard Nuclear Plant (KSNP) reactor . .	41
Figure 4-2. Side view of a Korean Standard Nuclear Plant (KSNP) building . . . . .	42
Figure 4-3. A top view of the Korean Standard Nuclear Plant (KSNP) reactor . . . . .	43
Figure 4-4. Schematic of the primary system layout in the containment building . . . . .	44
Figure 4-5. Internal layout of the Korean Standard Nuclear Plant (KSNP) reactor vessel . . . . .	45
Figure 4-6. Schematic of a fuel assembly . . . . .	47
Figure 4-7. Fuel transfer process . . . . .	48
Figure 4-8. The relationships between plutonium production, quality, and burnup . . . . .	48
Figure 4-9. Light-Water Reactor (LWR) layout showing the containment and surveillance process . .	52
Figure 4-10. Advanced camera-seal system implemented in the Republic of Korea (ROK) reactors . .	53
Figure 4-11. Additional monitoring measures that could augment existing safeguards activities at the KEDO reactors . . . . .	57
Figure 5-1. Plutonium discharged from LWR operations . . . . .	64
Figure 6-1. Satellite image of the Yongbyon site in 2000 . . . . .	67
Figure 6-2. The buried and the new waste site near the uncompleted 50-MW(e) graphite reactor . .	69
Figure 6-3. Satellite image showing the plutonium separation building and associated buildings and the suspect waste building . . . . .	70
Figure 6-5. The measurements at the radiochemical lab . . . . .	72
Figure 6-4. Nuclear program at 5-MW(e) graphite reactor and radiochemical lab . . . . .	72
Figure 6-6. The suspected route used to produce plutonium with the IRT-2000 research reactor . .	73

## **TABLES**

---

Executive Summary Table. Envisaged time sequence of events . . . . .	11
Table 3-1. Status of nuclear power plants in South Korea . . . . .	38
Table 4-1. Characteristics of the Korean Standard Nuclear Plant (KSNP) . . . . .	46
Table 4-2. Commercial remote-sensing platforms . . . . .	57
Table 5-1. Accumulation of Light-Water Reactor (LWR) plutonium in spent fuel. . . . .	64
Table 6-1. Visits and inspections by the IAEA of North Korean facilities . . . . .	71
Table 7-1. Summary of steps bearing on verification . . . . .	82

## **SIDEBARS**

---

<i>Spent Fuel and Plutonium</i> . . . . .	48
<i>Significant Quantities</i> . . . . .	50
<i>Plutonium and Weapons</i> . . . . .	59



# INTRODUCTION: VERIFICATION AND THE CHALLENGES TO CONSTRUCTIVE ENGAGEMENT WITH NORTH KOREA

RONALD F. LEHMAN, II

The Agreed Framework (AF) between the United States of America and the Democratic People's Republic of Korea (DPRK), signed in Geneva on October 21, 1994, has become the centerpiece of recent US efforts to reduce the threat of conflict with North Korea. In particular, it seeks to bring the DPRK into compliance with its obligations under the nuclear Non-Proliferation Treaty (NPT) not to acquire nuclear weapons. The AF document sets goals, outlines programs, initiates a US-led nuclear-power consortium, and notes linkages. The AF refers to a wider range of diplomatic and international security initiatives, such as the NPT and the agreement on denuclearization of the Korean Peninsula, and is meant to reinforce others, including those related to the reconciliation of the two Koreas.

The effect of each step taken or not taken under the AF will have a significant impact broadly on North-South Korean relations, economic and humanitarian interaction, East Asian security, US national security and foreign policy, Western alliances, and nonproliferation in the region and around the globe. The larger message of the agreement is clear—as North Korea complies with international norms, relations with the outside world increasingly will be normalized, informally and formally. Aid and trade are to grow with the reduction of military threats and the expansion of political dialog and contacts. As its engine, the AF sets in motion a remarkable joint nuclear-energy project that is a central focus here.

## Technical Questions, Strategic Implications

In this report, we examine several issues related to that cooperative nuclear project, especially monitoring and verification of nuclear-material production in the DPRK. The safeguarding of the light-water reactors (LWRs) to be supplied to the DPRK is given particularly careful scrutiny. In focusing on nuclear cooperation with North Korea, we are vividly aware that success or failure in meeting the technical challenges posed by that project can have a wider impact. Compressed schedules, cultural differences, and a limited history of cooperation with Pyongyang are among the internal factors that could result in a failure to meet program deadlines or objectives. External factors that could derail the process are perhaps even more numerous and involve major conflicting interests. Thus, in support of our technical analysis of verification issues, we have highlighted a number of scenarios involving delay or disputes that could come into play because of developments both within and outside the reactor project. Such scenarios must influence how we think about verification. Each, however, also has overarching strategic implications.

We recognize the primacy of these broader strategic considerations even if our interest here is the heart of the AF—its procurement for the DPRK of two LWRs and the linked, verified cessation and dismantlement of the DPRK's nuclear weapons program. The new reactors are being provided by an organization created for that purpose, the Korean Peninsula Energy

Development Organization (KEDO). Procurement and construction by KEDO of these reactors compels the major parties—the US, Japan, the Republic of Korea (ROK), and the DPRK—to find ways to cooperate. Although each delay or setback has resulted in more public questioning of the LWR procurement, as each step is taken, commitment to the program has grown stronger among those economic and political entities within the party states who see their stakes in the effort increase.

Provision of the LWR reactors, however, is contingent upon Pyongyang resolving with the International Atomic Energy Agency (IAEA) existing concerns that the DPRK is developing nuclear weapons. The triggers leading to the confrontation in early 1993 were apparent discrepancies in Pyongyang's initial nuclear declaration to the IAEA. At a minimum, these suspect discrepancies must be resolved for reactor construction to proceed to the installation of certain critical nuclear components, as agreed in the framework.

Even if a mutually acceptable agreement on a declaration is reached with the IAEA, further progress toward normalization of relations between the DPRK and most of the rest of the world is, in reality, inevitably linked to greater confidence that North Korea has abandoned the rest of its nuclear-weapons program. The two LWRs are a major part of that confidence-building, but only part. Mere completion of the reactors cannot ultimately be the standard by which success is judged. Still, the

nuclear-reactor project serves as a major pacemaker and bellwether of the status of the AF and its non-proliferation objectives.

## Nuclear Cooperation: Two Sides of a Coin

Inherently, the AF seeks to manage relations between adversaries trying to find their way to safer ground in a changing world. The US has been motivated in creating the AF as much by the risks of failing to act as by the prospects for success. The AF has become our most ambitious laboratory for defining and assessing “constructive engagement.” As the recent restatement of the compromise by former Secretary of Defense William Perry and the related negotiations on North Korean ballistic missiles suggest, the AF is subject to “re-invention.” Indeed, the AF itself is a reconfiguration of the earlier agreements it references on North–South reconciliation and denuclearization of the Korean peninsula. This variability in implementing mechanisms is inevitable in any framework built on a process in which a regime, such as North Korea, frequently tests whether it can gain more from delay, brinkmanship, and even threats of war than from the reduction of tensions and expansion of cooperation.

The AF also brings together allies balancing their collective and separate interests. For the United States, Japan, and the ROK, the AF tests their ability to work together successfully under post-Cold War conditions to reshape the Cold War legacy of a divided Korea. It remains a test they could still fail, and the price of failure could well be fissures between friends as well as dangerous new confrontations with Pyongyang. Our allies weigh constantly whether we are too forceful or too restrained, a debate echoed in the domestic debate in many capitals, including our own.

Despite some uncertain steps, however, the US and its allies thus far have traveled in the same general direction, retaining their cohesion in the face of both euphoria and disappointment.

The AF is mainly about Pyongyang’s normalization with the West. Russia and China may share some of the West’s concern about proliferation on the Korean Peninsula, but they are likely more ambivalent about the overall thrust of the AF. Nevertheless, successful implementation of the AF may benefit from engagement with China and, to a lesser extent, Russia and the nations of Western Europe, as well as others. In some situations, carrots such as trade and recognition are involved. In other instances, sticks such as United Nations Security Council debate and action have been involved. These interactions also reflect the uncertainties of a world in transition. What is a common cause on one day becomes a source of tension on another. Not all of the issues involved are grave, but some of the political concerns and security calculations of the key nations involved are serious, even vital. Clearly, the outcome of the Korean engagement matters greatly to Chinese and Russian strategic assessments of security in Northeast Asia, just as it does to the US and its allies in Asia. Success in achieving reductions in tensions on the Korean Peninsula could aid significantly in the evolution of relations with Russia and China. Unfortunately, North Korea also has the potential to be a tragic spoiler in what had been substantial reductions in the adversarial psychology of the great military and economic powers.

Success or failure in stopping the North Korean nuclear-weapons program—one of the most difficult remaining challenges to an almost universal commitment to nuclear nonproliferation—can have a

powerful impact on other nations. This includes those seeking weapons, such as Iraq and Iran, and those such as Japan, South Korea, and Taiwan who have thus far been willing to forgo nuclear weapons they could easily manufacture. The precedents set with North Korea under the AF also affect the standards applied by other nations in their nuclear trade and technology transfer.

Through the AF, we seek to use nuclear and energy cooperation with North Korea to strengthen the global nonproliferation regime, yet not every important actor has chosen to interpret it that way. Moscow has already cited the AF as a rationale for Russian nuclear-reactor deals with Iran, and New Delhi suggests it is evidence of a double-standard nuclear suppliers have applied against India. Indeed, Indian hawks have asserted that the respect given to North Korea because of its nuclear-weapons program further validates India’s own weapons program. Whether real or contrived, such assertions remind us that our diplomacy in Northeast Asia is watched closely elsewhere.

The game of carrot and stick with North Korea is meant to reinforce international norms. It is built upon the notion that abandoning nuclear-weapons programs brings tangible benefits, but this engagement could also suggest to those already receptive that nuclear blackmail might pay. Success in bringing about compliance with the NPT in the near-term, however, will still leave us with the classic long-term question that can be applied to many parties to the NPT: namely, will easier access to technology under the NPT now facilitate future nuclear-weapons efforts? Thus, the value of the AF must be judged ultimately by the net contributions it makes to international security in the region and around the world. The full

measure of its merit is to be found in that broader policy context.

## Means Versus Ends

That the AF is bigger than just the freezing of the DPRK's nuclear-weapons program and the creation of KEDO, with the provision of two new safeguarded reactors to North Korea, deserves special mention up front. The bigger picture will also deserve further examination after our analysis of the prospects for verification of nuclear-materials production and NPT compliance has been presented. Admittedly, this study has homed in on the prospects for verification of the dismantlement of the DPRK's nuclear-weapons program, especially the dismantlement of the reactors and reprocessing facilities at Yongbyon and the implementation of verifiable safeguards on the KEDO nuclear-reactor program. The core of our study is thus purposefully narrow, but understanding the implications of each step or misstep from a broader perspective is even more important. Completion of the KEDO reactors would be a hollow achievement if nonproliferation goals were not achieved. Elimination of the Yongbyon facilities would be inadequate if the DPRK finds another path to the procurement of fissile material or weapons. On the other hand, failure to complete the reactors might not be a waste if our international security objectives are otherwise accomplished.

A number of paths may reach our goal. For example, the provision of non-nuclear electric power plants may be cheaper, faster, and more conducive to long-term non-proliferation objectives. Additional non-nuclear power plants undoubtedly will be necessary if normalization brings with it extensive economic growth. On the other hand, the provision of electricity by any means that does not address the

near-term danger posed by the existing North Korean nuclear-weapons program would greatly undermine the immediate nonproliferation objectives embodied in the AF, especially compliance with the NPT. Here we build upon the current approach. In undertaking this study of the DPRK's nuclear program, however, we are acutely aware that verification of the AF is a means and not an end.

In this study of the interaction of technology with policy—in this case, DPRK's compliance with the NPT—we reference the history of US interactions with North Korea on the nuclear question. We do not intend here to re-open the debate over the wisdom of the AF or the process by which it was achieved. We begin our substantive analysis with the AF as it now stands. Our objective is enhancing the prospects that it could achieve its goals. We examine technical and programmatic hurdles to be overcome in the implementation of the current IAEA and KEDO programs, and we explore means to ensure that verification milestones and standards can be met. We also seek to illuminate the wider implications of success or failure at various stages. This inevitably raises questions about alternative tactics and even exit strategies. If the implementation of the AF is delayed or derailed, will we still be able to achieve our goals? And by what means? In some cases, our analysis may suggest the need for advance consideration of options beyond the scope of this discussion.

## Program Management, IAEA Interaction, and Challenges to Preventive Diplomacy

Implementing even the KEDO portion of the AF is already behind schedule. Difficult program management, business, safety, and legal decisions pertaining to the LWR

and Nuclear Cooperation Agreement are ahead. For example, under US law, a nuclear cooperation agreement must be reached, but North Korean noncompliance with the NPT presents legal and political obstacles. The “when” and “what” of the US nuclear cooperation agreement is thus complicated by the hovering question of “how?” Key business and budget strategies must await agreement on liability, specific arrangements for fresh-fuel supply and spent-fuel disposition, clarification as to participation in day-to-day reactor operations, availability of an integrated infrastructure such as a distribution grid in the DPRK, completion of more comprehensive training, etc. Thus, important questions of “who” and “how much” also remain. These implementation uncertainties all affect the confidence in verification and on the calculations of the risks and benefits of the AF, especially to the degree that timing is viewed as a critical factor.

Verification of initial declarations and implementation of safeguards by the IAEA over the necessary DPRK nuclear infrastructure create a number of “make or break” milestones. Delay in reaching these moments of truth has not made them any easier. Indeed, the passage of time may make some issues more difficult to resolve. Recognition that acceptable confirmation of initial or even amended declarations may be problematical has already reopened debate over minimum acceptable requirements. Even the question of whether the safeguards developed post-Iraq should be applied remains open and under discussion in some circles.

This question of the adequacy of safeguards is but a subset of the larger question of whether mere verification that material has not been diverted from indigenous reactors and facilities is sufficient.

Certainly, the real nuclear threat environment is larger. Although it is true that the IAEA's request for special inspections, which resulted in a confrontation in 1993, was related to efforts to resolve discrepancies in the DPRK's declaration, the rejection called into question the ability to verify that no broader nuclear-weapons program is underway by other means. In contrast, South Africa was receptive to special inspections that in turn resolved discrepancies about its dismantled nuclear-weapons program. The United States government and others continue to believe that North Korea has had underway an extensive effort to acquire nuclear weapons and has achieved much progress in that effort on its own. Pyongyang's emphasis on self-reliance has complicated efforts to understand and restrain the North Korean nuclear program.

We have long focused on the impressive efforts by which Pyongyang has acquired an indigenous capability to produce nuclear weapons, especially in light of its political and economic isolation. In this age of globalization of technology, a deeper perspective may be necessary. The "loose nukes" and "loose nuclear material controls" associated with the breakup of the Soviet Union, and the emergence of gray and black markets among nations of concern, such as those described by the Rumsfeld Commission, suggest that indigenous sources of nuclear capability are only a part of the problem. In short, even as KEDO program slip-page puts off dismantlement of the Yongbyon facilities, nuclear weapons-relevant activities outside as well as inside these installations also could undermine the AF or stall its implementation.

Implementation and verification of the KEDO reactor program and with it, the AF, face other large, crosscutting issues as well.

Uncertainty about the DPRK's capability and intentions was greatly increased in the face of the provocative testing of long-range missiles, including one launch over Japan of a missile Pyongyang subsequently declared to be a space launch vehicle. Whatever it says about intentions, DPRK's willingness to sell ballistic missiles to other troubled regions of the world, such as the Middle East and South Asia, has underscored the dangers associated with Pyongyang's possible two-way trade in Weapons-of-Mass Destruction (WMD) technology with other potential proliferators. Money is highly fungible, and payments received from missile sales make it easier to support military and WMD programs, especially given the otherwise miserable economic performance of the DPRK. And what goods other than cash does North Korea get in return for its missile and other sales? Has North Korea received inputs to its nuclear-weapons program from outside its borders? To deal with missile launches and military trade, the US has been negotiating on terms to obtain a freeze on the DPRK's missile program. Engagement has begun on this issue, but the prospect of being confronted with one WMD or military challenge after another is worrisome given the many types of weapons and means of delivery that might be deployed or marketed.

Trade in WMD reminds us that Pyongyang has continuously sought new access to resources and new bargaining leverage. Whether raising the specter of war, threatening to withdraw from the NPT or other agreements, or highlighting the economic misery of its own people, the DPRK has become adept at identifying means to strengthen its negotiating positions. It has been a "tit-for-tat" process and more. Movement toward a more comprehensive approach as embodied in the Perry and Armitage Reports seeks to deal

with this problem. Such approaches broaden the arena of engagement by expanding the linkage of progress on verification and security with progress on political normalization and economic benefits. Such linkage is explicit in the AF just as it was explicit in the earlier efforts it refers to such as the 1991 North-South Joint Declaration on the Denuclearization of the Korean Peninsula and other aspects of the North-South dialog.

Such a comprehensive strategy may reduce the tendency for both sides to become preoccupied with tactical leverage at the expense of strategic advancement. More importantly, it recognizes the fundamental substantive relationship between enhancing real security, including verification, and broader human interactions and openness. Emphasis on a more comprehensive strategy, however, may also subject progress on the KEDO reactor project and Yongbyon dismantlement to a less buffered linkage to the ups and downs of engagement and confrontation. Thus, issues such as family reunification and high-level meetings such as the recent summit by the heads of state of the two Koreas may add to the dynamics of the AF project management and verification.

### Dynamics of Technology-Policy Interaction

The AF lies squarely at the beginning of a process that has been punctuated on both sides by—

1. Delayed implementation,
2. Disagreement over compliance,
3. Near dissolution of fundamental agreements, and
4. Brinkmanship, including saber rattling.

Prudence dictates analyses of these and possible future crises. This seems inherent in a process involving efforts at cooperation by parties deeply divided over political, economic, and security objectives and with fundamentally different views on openness.

Verification issues take on greater significance in such an environment. Indeed, verification issues have been associated more or less with most of these past confrontations with North Korea over the nuclear question. As we have examined verification of nuclear-material production and related activities, we have tried to keep this in mind. To understand how verification might become involved in a crisis again, one must look beyond the simple history of implementation of IAEA obligations and examine several paths that parallel interaction between the IAEA and the DPRK (Introduction Figure, page 6). Lack of time and a more technical interest preclude our dealing with all of these interactions other than to mention their significance. Notable among these parallel paths are—

1. The total nuclear programs of the DPRK (military and civilian).
2. Related bilateral and regional efforts to engage Pyongyang on the nuclear question.
3. Other North Korean and regional military activities.
4. Broader NPT-related activity.
5. Wider defense and arms control developments.
6. The larger process of political change in the Koreas.
7. Related political events around the world.

These interrelated dynamics work for and against confidence. In some cases, developments in the

different arenas for cooperation, competition, and conflict simply reflect progress or regression on the nonproliferation front. In other cases, they reinforce progress or amplify setbacks. Thus, positive feedback may result in a de facto hierarchy of security-building arrangements, but negative feedback may amplify setbacks and encourage the widening of fissures. In some cases, strategic or tactical considerations involving either international or domestic politics may result in progress in one arena being deliberately associated with stalemate or loss in another.

Much has been written on the motivations and negotiating tactics of the DPRK, the ROK, the US and others involved with the North Korean nuclear debate. Although the dynamics of interaction frequently repeat themselves, much disagreement exists among experts over interpretation. Is North Korea afraid that resolving uncertainty will reveal a secret program it claims does not exist? Or, alternatively, is Pyongyang afraid to reveal that the program is thus far unsuccessful, thus depriving it of bargaining power? Both could be true at different times or even at the same time.

### By What Standard Shall We Judge, and When?

Our primary interest in this report is the verification of nuclear-material production and the reduction of risk associated with diversion or breakout. Fundamental to any such effort is the ability to monitor activities, a main concern of this study. Technology such as instrumentation, sensors, sampling, tagging, diagnostics, and communications contribute significantly here. Yet, verification has always been a larger process than monitoring. Verification assessments involve—

- The ability to make judgments about the meaning of obligations.
- The centrality of provisions.
- The probabilities of cheating.
- The risks associated with non-compliance.
- The timeliness of warning obtained.
- The efficacy of redress or enforcement.
- Other related costs and gains.

Not all of these elements are dealt with at length in this work. Nevertheless, risks and benefits must be weighed against their impact on the ends for which any agreement is a means and against the consequences and options if those ends are not met. Verification may never be perfect, but effective verification can contribute significantly to confidence. Inadequate verification can lead to overconfidence and miscalculation.

In the language of the AF, the definitions of clear success or obvious failure are relatively easy to understand. Whatever the debate over the amount of potential weapons-grade material that can be accumulated under various scenarios, if the DPRK truly abandons its nuclear-weapons program, the central goal will have been achieved. Effective verification of the AF can help us know if this has happened, but that knowledge is not guaranteed. If the DPRK develops and manufactures or otherwise obtains or retains nuclear weapons—whether that is one weapon or many—the AF will have failed to meet its explicit objective. Verification measures may give us earlier indications of this undesired outcome, but again perfect warning is not in the cards. If the DPRK uses the AF for continued leverage, verification measures may help us manage this dynamic more

# INTRODUCTION

effectively, but we must still recognize that these negotiations take place against a complex geopolitical, legal, and economic backdrop.

The AF offers important nonproliferation opportunities and verification tools, yet, the AF aspires to contribute more. If the military threat on the Korean Peninsula is greatly diminished and relations among the nations involved are normalized on a sound basis, the achievements of the AF will be even more solid. Cooperation on verification may facilitate normalization. Indeed, it may facilitate political change in North Korea. If tensions

return to Cold War levels, confidence in actual achievements of the AF will be reduced. Compliance disputes under the AF can be both a cause and an effect of such tensions.

Clear success and obvious failure may be easiest to understand, but in the history of negotiations with North Korea, success and failure are normally not so clear. As the above discussion of the dynamics of engagement on the Korean peninsula suggests, every success brings with it a price. Every advance stimulates the grounds for new steps backward. The value of every specific objective gets re-evaluated. If

war is avoided, what has been lost? If war is only delayed and ultimately made even more destructive, what has been gained? Will delay mean more or less chance that nuclear weapons will be deployed or even used by North Korea? Will delay now mean more or less reform, and over what timeframe and circumstances? Will delay affect international cohesiveness in support of the IAEA or in the United Nations Security Council of US nonproliferation and other foreign-policy objectives? These larger questions must be kept in mind as we examine potential failure modes and consider means to prevent failure.

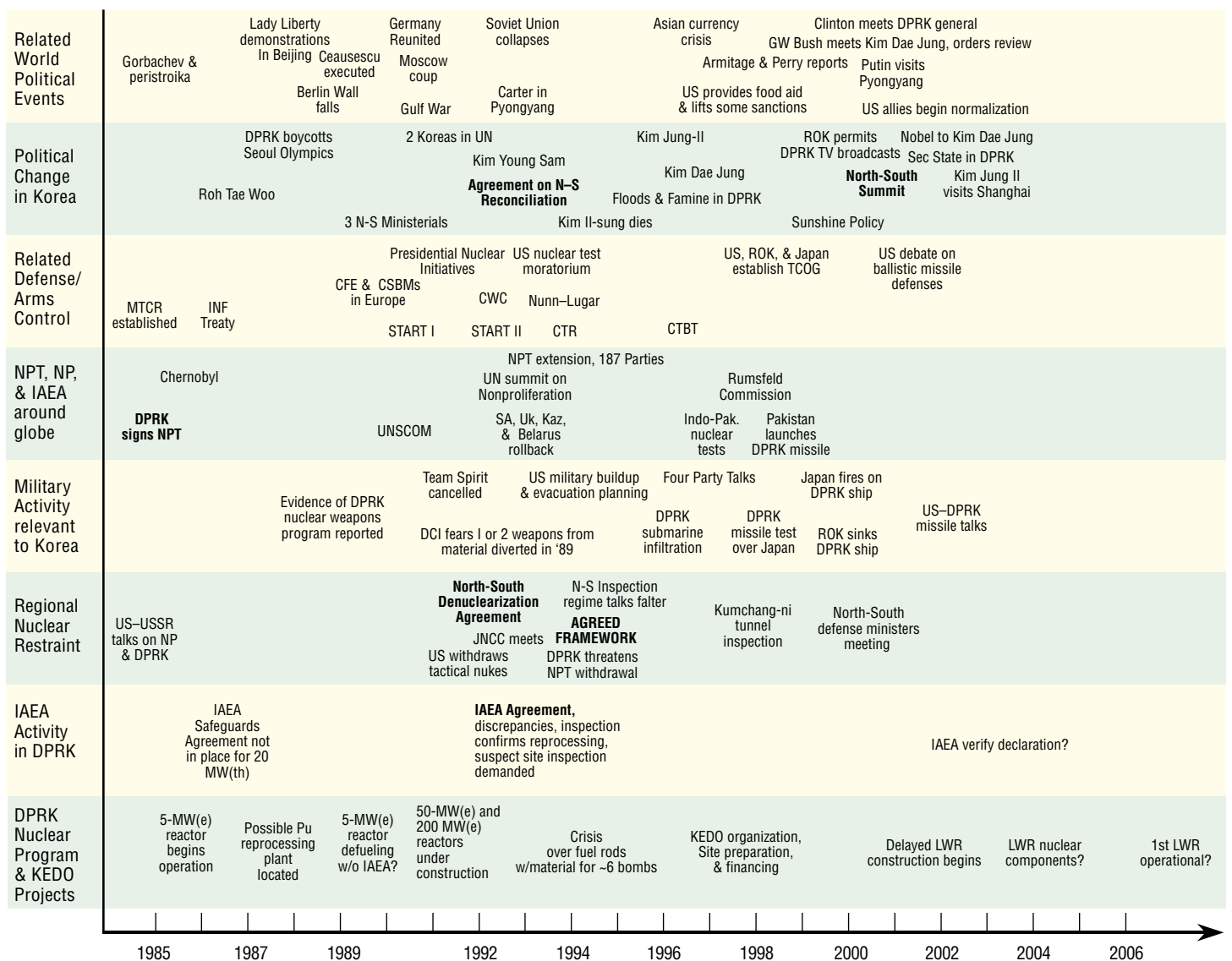

Introduction Figure. Parallel interaction paths related to the Agreed Framework (AF) and the Democratic People's Republic of Korea (DPRK).

# VERIFYING THE AGREED FRAMEWORK: EXECUTIVE SUMMARY

Under the 1994 Agreed Framework (AF) between the United States and the Democratic People's Republic of Korea (DPRK), the US and its allies will provide two large nuclear-power reactors and some other benefits to the DPRK in exchange for an agreement by the DPRK, inter alia,

- To declare how much nuclear-weapon material it has produced,
- To identify, freeze, and eventually dismantle specified facilities for producing this material,
- To remain a party to the nuclear Non-Proliferation Treaty (NPT) and allow the implementation of its safeguards agreement.

The AF and associated agreements are now being carried out according to a complex and currently delayed schedule. Benefits have been provided to the DPRK, the site for the two nuclear-power reactors has been largely prepared, and construction has begun on some components. For its part, the DPRK has declared some nuclear-weapon material and has identified and frozen some facilities for producing this material.

As evidenced by the current discussion of the AF, including President Bush's statement at the White House on March 7, 2001, verification is an essential part of any agreement with North Korea, including the AF. In what follows, we provide an assessment of whether such verification can be

accomplished and what is needed to accomplish it. Given the US goal of nuclear non-proliferation on the Korean peninsula, central questions include the following: How verifiable are the provisions of the AF and ancillary agreements such as the Supply Agreement? How well can it be verified that the DPRK has no access to nuclear weapon-usable material? What is the potential impact of delays, disagreements, and lack of cooperation on verification? This report is devoted to answering those questions.

Our general answer is that verification can be accomplished to a satisfactory degree of accuracy on most counts, but that special effort will be needed from the International Atomic Energy Agency (IAEA), as well as support from the US and the Republic of Korea (ROK). Furthermore, cooperation and openness from the DPRK are essential for accurate and complete verification of the AF.

Our more specific answers are presented under three headings: one dealing with the nuclear-power reactors to be provided by the Korean Energy Development Organization (KEDO), one dealing with known or suspected nuclear-materials production facilities in the DPRK, and one dealing with possible adverse developments affecting verification and safeguards. These answers provide the basis for some analysis of what the US and its allies will and will not know under various, possible future circumstances, and how to minimize the

risks of diversion of nuclear material for nuclear weapons.

## Safeguarding the Nuclear-Power Reactors Provided by KEDO

KEDO is a consortium sponsored by the US but mostly funded by the ROK. The two large nuclear-power reactors to be provided by KEDO under the AF are of a relatively well-understood type built and operated by the ROK called the Korea Standard Nuclear Plant (KSNP). In what follows, we refer to them as KEDO Reactors 1 and 2.

The fresh nuclear fuel for these reactors contains no nuclear weapon-usable material. On the other hand, like all current nuclear-power reactors, these reactors produce reactor-grade plutonium along with energy for electricity. This plutonium, albeit not ideal, can be used to make nuclear weapons. Significant amounts of this plutonium are left in the highly radioactive spent fuel when that fuel is taken out of the reactors. The main objective of the IAEA safeguards is to detect the diversion or clandestine production of nuclear material in a timely fashion.

KSNPs have a well-developed and effective safeguards package agreed to between ROK and the IAEA.\* A similar safeguards package (INFCIRC 403) has been agreed to between the IAEA and the DPRK. These safeguards have been developed in accordance with

\* The IAEA is charged by the NPT with verifying that the nuclear facilities of non-nuclear-weapon NPT parties are used for peaceful purposes and not to make nuclear weapons. The actual measurements and accounting practices used for such verification are called "safeguards."

a model agreement known as INFCIRC 153. They comprise measurements, inspections, accounting procedures and other measures, examined in detail in the report.\*

The safeguards applicable to the KSNP reactors are adequate to detect in a timely fashion (defined by IAEA as three months) attempts at covert diversion of “significant quantities” of nuclear material, in this case plutonium (defined by the IAEA on the advice of nuclear-weapons member states as eight kilograms). Effective safeguards require that monitoring and data-transmission equipment be properly installed and maintained and kept secure. In the case of remote monitoring, the transmission of data must also be secure and uninterrupted. Equally important are properly trained inspectors and the timely review of all safeguards-relevant information. Cooperation and openness on the part of the DPRK on these matters are essential.

Safeguards are not fixed for all time but are improved as time goes on. Advanced technologies within INFCIRC 153 include environmental sampling of air, water, soil, and vegetation near inspection sites, and secure remote monitoring in real time of key entry points, locks, seals, power output, and other facets of reactor operations. All require reliable means of transmission, as well as an automated review and analysis of acquired data. Several enhancement measures, now in demonstration stage, could be applied to the data-transmission program. These technologies are currently being tested in the ROK and in other NPT parties with INFCIRC 153 safeguards. The implementation in the DPRK of such improved safeguards systems would add significantly to their effectiveness.

Using these technologies, if inspectors are promptly available and allowed to investigate any questionable event, the safeguards package should be able to detect attempts at covert diversion of plutonium in quantities smaller than eight kilograms (down perhaps to the amount contained in a single fuel pin, a few tens of grams) in a shorter time than three months (depending on inspector availability).

We considered overt and covert diversion and misuse scenarios. We could not find credible covert diversion and misuse scenarios under the conditions stated above for the KEDO reactors. On the other hand, overt action to break out of the safeguards agreement is always possible, as discussed under the “Possible Adverse Developments” heading later on in the Executive Summary.

In reaching the above conclusion, we emphasize two conditions that must be met:

1. The IAEA will continue to require technical and financial assistance from the US and other member states to implement an effective safeguards regime at the KEDO reactors.
2. The DPRK must fully commit to the terms and conditions of its safeguards agreement. This will require providing the IAEA inspectors full and prompt access to nuclear facilities for the purposes of performing inspections and equipment installation and maintenance, as well as providing all requested information in a timely fashion.

After being taken out of the reactor, the highly radioactive, plutonium-containing spent fuel usually spends several years in

spent-fuel pools under video surveillance by the IAEA, until its radioactivity has decayed sufficiently to allow its being placed into dry storage casks or removed to a storage facility away from the reactor. Provisions for that part of the process, which are some years in the future, have not been specified or agreed to in detail. Under the AF, the DPRK must allow the removal of this spent fuel at the request of KEDO. In the case of the DPRK, it may be desirable to remove spent fuel from the country as soon as is practicable. This is particularly true for fuel removed early in the reactor lifetime. The highest quality plutonium exists in the very first reactor cycle and it will be the first to lose radioactivity. We note that final or long-term storage of spent fuel away from the reactors is a problem that has not been resolved anywhere and which is more political than technical.

### Verification of the DPRK’s Declaration and of the Disposal and Dismantlement of Identified or Suspect Nuclear Facilities

Verifying the DPRK’s declaration and its disposal and dismantlement of identified or suspect nuclear facilities is a complex task. Neither the scope of activities to be verified nor the history of the DPRK’s nuclear program is fully known at this time. The task may be broken down and analyzed as follows.

#### Verification of DPRK’s Declaration

The DPRK has declared the existence of the following facilities as subject to inspections, six at Yongbyon and one at Taechon:

\* Note that IAEA safeguards are not required positively to establish the physical diversion of material. To establish a violation of an INFCIRC 153-type safeguards agreement, it is enough for the IAEA Board of Governors to conclude that “the Agency is not able to verify that there has been no diversion of nuclear material required to be safeguarded under the Agreement to nuclear weapons or other nuclear explosive devices.”



- Two reactors that were in operation, one of which is subject to the freeze.
- One reactor that remains incomplete.
- A fuel-fabrication facility.
- A radioisotope laboratory.
- A waste site.
- A reactor under construction at Taechon that also remains incomplete.

Plutonium-containing fuel has been withdrawn from one of the Yongbyon reactor cores and is stored in cans in a nearby pool.

The DPRK further declared that it had separated a small quantity (less than 100 grams) of plutonium.

The DPRK's initial declaration to the IAEA identifying facilities and quantities of nuclear material subject to safeguards appears to be incomplete. At least one undeclared waste site has been identified, probably containing additional plutonium-containing wastes, and there is evidence for more fuel removal and more plutonium-separation activity than the DPRK has declared. While estimates of plutonium production vary, there is strong evidence that the DPRK separated more than its original declaration of less than 100 grams. An amended declaration will very likely be required for the IAEA to complete its verification activities. With such an amended declaration, the US and other interested parties would have more complete and reliable knowledge of the DPRK's nuclear materials and facilities, and more complete and ongoing safeguards over such material and facilities would be possible.

The DPRK must provide unhindered access for the purpose of measurements and inspections at all identified and suspect DPRK nuclear facilities wherever located.

According to the IAEA, the path forward to determine the correctness and completeness of the initial declaration has been developed, including planning for contingencies. It includes plans for the cases where large amounts of radioactive wastes are discovered in previously hidden waste sites. There is no plan to attempt to verify the accuracy and completeness of the initial declaration unless access to the suspect waste sites is granted, if the Agency stays with the recommendations of former Director-General Hans Blix. The details of the IAEA's plan are not public information. With DPRK cooperation, the process is estimated to take 2–4 years.

A review of the methods available to the IAEA indicates that where the full panoply of IAEA measurements and inspections are brought to bear, there will be reasonable confidence (i.e., as good confidence as there is with respect to other states that have ended their nuclear weapons activities and joined the NPT as non-nuclear weapons states) that past nuclear activities have been generally identified. The exact quantity of plutonium separated can only be approximately determined. Depending on the reactor operating history available, there may not be high confidence in the exact number of kilograms separated. We note three points:

1. The IAEA is likely to need additional resources to prepare for and carry out its verification activities in the DPRK. The US and other states supporting nuclear nonproliferation

objectives could work with the IAEA to develop plans and resources adequate to this task, anticipating and preparing for the specific verification problems to be encountered.

2. Information provided by third parties not limited to the US has been and will continue to be an essential support to the IAEA.
3. The US and other states supporting nuclear nonproliferation objectives, including especially the ROK and Japan, must support the IAEA in maintaining the highest standards of verification.

### Verification of the Disposal and Dismantlement of Identified Yongbyon Facilities

Plans for disposing of existing DPRK spent fuel have not been finalized. So long as the spent fuel and separated material are continuously monitored by the IAEA, they do not pose a serious verification problem.

While it is understood the fuel will leave the DPRK, the destination for the fuel has not been determined. Only the Sellafield plant in the United Kingdom currently has facilities specifically for handling the Magnox type of fuel used in the Yongbyon reactors.\* According the AF timetable, arrangements must be made by the time the first KEDO reactor is completed. Disagreement over the destination for this spent fuel could result in significant delays in completing the KEDO reactors. Perhaps of most concern is the access the DPRK would have to the weapons-usable material in the spent fuel should it decide to abrogate the AF.

After the first KEDO reactor has been completed and the DPRK's spent fuel has been removed from

\* Magnox fuel readily corrodes and is unsuitable for long-term storage or geologic disposal.

Yongbyon, the DPRK will be required to dismantle its frozen nuclear facilities. The IAEA has compiled considerable information regarding decommissioning that should help the DPRK in the dismantling effort. The major dismantlement challenge will be dealing with the radioactivity in the reactor and other facilities. While the basic industrial processes for decommissioning and dismantling nuclear facilities are reasonably well understood, this is an expensive and complex undertaking. The cost to dismantle these facilities, based on past experience, is likely to be at least a few hundred million dollars. Some of the crucial pipes and the special equipment will have to be removed or destroyed early in the process to make the dismantlement verifiably irreversible.

### Verification Regarding Other Suspect Facilities

There have been and may eventually again be facilities other than those at Yongbyon that come under suspicion of being used for nuclear-material production, storage, or other nuclear activities. These could pose different verification problems than the Yongbyon facilities. Some additional methods beyond INF-CIRC 153, notably broader environmental sampling away from declared sites and easier inspections at undeclared facilities would be useful—and could be necessary—to detect these facilities. Satellite monitoring and other third-party information are needed as well. With these tools, the uncertainty associated with the detection of undeclared activities would be diminished.

At the same time, “false positives,” such as the supposed but now known to be non-existent reactor at Kimchang Ni, can pose problems for both IAEA and US credibility and for effective cooperation. Being overly suspicious poses problems for effective verification just as not being suspicious enough.

### Possible Adverse Developments

Adverse developments are usefully considered in the framework of the time sequence of events envisaged by the AF. This time sequence, together with its implications for verification and safeguards, is summarized in the **Executive Summary Table** (next page). The time sequence presented is not complete. A number of other important steps are linked to the time sequence. The steps summarized in the Table are those which require verification or safeguards or which bear on the timing of verification and safeguards. The steps in the left-hand column are shown in time order. As actual dates have slipped and are likely to continue to slip, no dates are shown. Only the sequence of events is used.

We note, in connection with the sequence of events in the table, the crucial link between Steps 2 and 3, i.e., the IAEA declaring the DPRK to be in compliance, the delivery of nuclear components to KEDO Reactor 1, and the necessary Agreement for Cooperation with the US. No Congressional review of an Agreement for Cooperation and no provision of nuclear components to the DPRK is possible until the IAEA is satisfied that the DPRK’s reports on all its nuclear materials and facilities are accurate and complete.

### Further Delays

Delays have occurred and are likely to continue to occur for a variety of legal, financial, and political reasons. A number of these reasons are noted in the report. Delays before any KEDO reactor is completed puts off the eventual IAEA declaration of DPRK’s compliance and the attendant knowledge of what material and facilities the DPRK actually has. The ability of the IAEA to verify the initial DPRK

declaration could decay to an extent that depends on the techniques to be used—and that we cannot fully assess. A lessening of the IAEA’s ability to reconstruct the reactor’s operating history could be important in estimating the amount of plutonium separated. On the other hand, verification that the DPRK does not have a program at Yongbyon is not affected by delays so long as the Yongbyon site continues to be verifiably frozen. In essence, delays at this stage mean that the situation remains frozen with no additional source of nuclear material provided to the DPRK.

Delays after either or both KEDO reactors are completed and delays in the DPRK’s allowing special inspections or additional safeguards measures could have more serious consequences, and are discussed below.

### Non-Cooperation with the IAEA’s Verification of Compliance

Limited or lack of cooperation on the part of the DPRK has much the same effect as delays at this stage of the AF. Non-cooperation at Yongbyon and other possible sites of past activities has taken the form of not allowing access by IAEA inspectors to undeclared suspect facilities, limiting IAEA measurements where inspectors are allowed, and preventing off-site environmental sampling. Continuation of this behavior, either in the form of outright denial or undue delay, would have the effect, under the AF, of preventing delivery of key nuclear components for the KEDO Reactor 1 to the DPRK. Citing the time necessary to complete the verification exercise, the IAEA’s Director-General has repeatedly requested the DPRK to get started as soon as possible. They have given no indication that they are ready to proceed.

Executive Summary Table. Envisaged time sequence of events.

Step	Verification Issue	Possible Problems
Partial completion of KEDO Reactor 1 in the ROK and partial preparation of Kumho site in the DPRK	None but the IAEA wants to start the next step early (2-4 years needed)	Financial and legal delays cause some loss of data at Yongbyon
IAEA declaration that the DPRK is in compliance with its agreements	Verification of accuracy and completeness of the DPRK's initial declaration on all nuclear materials in the DPRK, at Yongbyon, and possibly elsewhere	<ol style="list-style-type: none"> <li>1. DPRK does not open suspect sites to the IAEA.</li> <li>2. The IAEA's activities are interfered with.</li> <li>3. Initial declaration is wrong—can it be amended?</li> </ol>
Delivery of KEDO Reactor 1's key nuclear components starts. Transfer of Yongbyon spent fuel (and other material?) to "ultimate disposition" starts.	Safeguards for KEDO Reactor 1 are installed. Transfer of Yongbyon spent fuel (and other material?) to "ultimate disposition" verified.	<ol style="list-style-type: none"> <li>1. Disagreements over the extent of safeguards.</li> <li>2. Disagreements over site of disposition.</li> <li>3. Disagreements over what is to be transferred.</li> </ol>
Simultaneous completion of previous steps	Safeguards on KEDO Reactor 1 operational. Disposition site monitored.	Same as previous, plus interference with KEDO Reactor 1 safeguards
Dismantlement of Yongbyon facilities in parallel with delivery of KEDO Reactor 2's key nuclear components	Safeguards for KEDO Reactor 2 are installed. Dismantlement verified.	<ol style="list-style-type: none"> <li>1. Disagreements over extent of safeguards.</li> <li>2. DPRK abrogation.</li> <li>3. US or ROK non-compliance with AF.</li> </ol>
Simultaneous completion of previous steps	Safeguards on KEDO Reactor 2 operational	<ol style="list-style-type: none"> <li>1. Interference with safeguards.</li> <li>2. DPRK abrogation. Disposition of KEDO spent fuel. Monitoring disposition site(s). Disagreement over site of disposition.</li> </ol>

### Need for an Amended DPRK Declaration

When the IAEA is allowed to carry out inspections and measurements at Yongbyon and at such other sites as may be needed, the IAEA is likely to conclude that more plutonium-containing fuel and/or more separated plutonium exists in the DPRK than the DPRK originally reported. In that case, it would become an issue for negotiation between the US and the DPRK whether an amended DPRK declaration would be presented and allowed under the AF. From a verification point of view, the situation would be better than it is now: the US and other interested parties would have more complete and reliable knowledge of the DPRK's nuclear material and facilities, and

more complete ongoing safeguards over such material and facilities would be possible. As noted earlier, however, there is an irreducible uncertainty in verification of the amount of plutonium separated.

### Disagreements Over Material To Be Transferred from the DPRK

A verification issue would arise if the DPRK took a narrow view of what it was obligated to allow to transfer out of the country under the AF, for instance, restricting the transfer to spent fuel from specified Yongbyon facilities rather than from all relevant facilities. If these facilities had been identified and inspected, and nuclear material to be safeguarded found there, it seems unlikely that the DPRK would not allow its transfer, but

nevertheless that could occur under pretext of safety or environmental considerations. In that case, or in any case of a disagreement over the transfer of nuclear material, the IAEA would have to monitor the material in the DPRK on a continuing basis. If the DPRK were to abrogate the AF in the future, it would regain access to this material.

Such a disagreement could bring the AF to an end. Because, however, a transfer takes place simultaneously with the installation of key nuclear components in KEDO Reactor 1, it is desirable that an explicit agreement be reached regarding what materials are to be transferred, including material that may be found in suspect but not identified facilities.

## Disagreements Over the Site of Ultimate Disposition

So long as the sites of ultimate disposition for the DPRK's nuclear material are outside the DPRK and otherwise acceptable to the US, no verification issue is likely to arise from disagreements over this issue, except that such disagreements could prolong the time that the material remains in the DPRK and that the IAEA has to monitor it. Again, such delays would mean that, if the DPRK were to abrogate the AF during that period, it would regain access to this material. It is highly desirable that full agreement be reached regarding the site of ultimate disposition before the KEDO reactors come on line.

## Disagreements Over the Extent of Safeguards for KEDO Reactors

As reviewed above, there are useful advanced technologies that the IAEA can use over and above the measures in place at most reactors, but still within the INFCIRC 153 package of safeguards. Though that package of safeguards has proven its worth, the new measures, together with the enhancement measures for the data transmission, would add significantly to assurance of compliance with the NPT. The specific package to be implemented at the KEDO reactors has to be negotiated, and disagreements could occur over application of these safeguards. Depending on the outcome of the negotiations, the effectiveness of safeguards could be less than optimal.

Successful negotiations for installing these measures in the DPRK will depend on similar measures being implemented into the ROK. In general, the role of the ROK is crucial in the safeguards area as well as in all other aspects of the KEDO program. Given that the new measures are increasingly being tested and adopted in many countries, however, and given that

some of them can give early warning of illicit activity, significant disagreement over cooperation on this issue should be taken quite seriously.

## Interference with Safeguards for KEDO Reactors

Once safeguards have been agreed to and are operational, interference with their operation in any form (e.g., denial or delay of needed access, late or incomplete records, interference with transmission of data, unreliable power supply, or interference with updating of equipment) could seriously affect the assurance that nuclear material, in particular spent fuel, is not being diverted. The seriousness would depend on the details of the particular situation, but it would be particularly damaging to verification if it occurred after the initial refueling, when the initial load of spent fuel contains plutonium that is particularly attractive for weapons use. The fuel initially discharged contains enough plutonium to make 10–20 nuclear-explosive devices, for instance, of the type tested in 1945 at Trinity. Spent fuel must normally spend several years in cooling ponds under safeguards before it can be moved. Once it is removed from the pool building, it must remain the subject of continuing safeguards in the DPRK until it is removed from the DPRK, at which time safeguards appropriate to the new location are imposed. This location is likely to be the ROK and removing spent fuel from the DPRK is thus likely to depend on having storage facilities in the ROK.

The IAEA safeguards are normally aimed at detecting the diversion of eight kilograms of weapon-usable material within a period of three months. It would be desirable to have the ability to detect the diversion of smaller amounts within a shorter period. As noted

earlier, remote monitoring coupled with prompt readout of data at the IAEA and the availability of inspectors in the region could reduce the warning time to that period. Lack of cooperation with such measures should be considered significant.

## Abrogation of AF or NPT after the KEDO Reactors Are Installed

No safeguards can prevent overt acts such as the abrogation of agreements and the expulsion of inspectors. In the case of abrogation, the US would know how much potential nuclear-weapon material is in the DPRK initially. It would, as now, externally monitor such large-scale activities as reactor operations and the construction of facilities, and it would to some extent identify major activities. It would be possible to estimate how much plutonium is made in reactor operations subsequent to abrogation. Handling the radioactive spent-fuel rods and separating the plutonium are major operations, requiring facilities recognizable by national technical means. The facilities, however, might be hidden underground.

Once the facilities are built and the procedures practiced (without actually having light-water reactor (LWR) spent-fuel assemblies available for realistic tests), the time needed to separate several bombs' worth of material might be only days or weeks if all went according to plan. In view of others' experience, however, the time needed is likely to be much longer. The IAEA's Standing Advisory Group on Safeguards Implementation has estimated that the time required to convert plutonium in spent fuel into a weapon is one to three months, compared to seven to ten days for metallic plutonium.

It is possible to remove plutonium-containing spent fuel from the reactor site sooner than normal practice. Such early removal may be desirable in the case of the so-called "Beginning of Life" fuel, which is more desirable for weapons use and which will be the first to cool (i.e., lose radioactivity) sufficiently to be handled. An agreement to do this would best be reached ahead of time. Covert removal of such fuel, or later fuel, by the DPRK would be difficult as the casks needed to remove the fuel are large enough to have satellite signatures, and as the fuel would have to be replaced in the pool covertly. Removing spent fuel from the DPRK as soon as is practical minimizes the advantage of overt fuel diversion after a possible abrogation.

## Executive Summary Conclusions

While more complete conclusions and recommendations are presented at the end of the report, briefly the bottom lines are as follows:

1. With adequate preparation and support of the IAEA, and with full cooperation of the DPRK with all measures called for in the AF and in the safeguards packages (standard and additional) applicable to the KEDO-type reactors, the AF can be adequately verified.
2. For this to take place, the DPRK must reach a decision to make its operations in the nuclear area, past and present, actual and suspected, fully open. Such openness will be readily evident at the working inspectors' level.
3. The IAEA is likely to need additional resources to prepare for and carry out its verification activities in the DPRK. The US and other states supporting

nuclear non-proliferation objectives, including especially the ROK and Japan, must support the IAEA in maintaining the highest standards of verification.

The parties to the AF are faced with both opportunities and challenges. The opportunities for the DPRK include not only the provision of electricity at concessionary rates,\* but also the opportunity to become fully cooperative and open in an important area of international concern. Obviously, these opportunities are also challenges, both for the DPRK and for the US, ROK, and other KEDO members. The challenges include the challenge of verification that has been taken up in this report.

We conclude, based on the considerations of this report, that the challenges of verifying the Agreed Framework can be met, under the conditions outlined in this report and summarized here. With these conditions met, verification is robust under most scenarios.

## Organization of Report

Chapter 1 provides a brief history of the DPRK's nuclear program and its interactions with the IAEA and other countries. A summary and analysis of the AF and related agreements that are now or will be in force is given.

Chapter 2 summarizes the safeguards and how they are applied under existing agreements. Possible additional agreements that the IAEA has reached with other countries are also discussed.

Chapter 3 describes the KEDO reactor site, nuclear reactor activities in East Asia, and related issues such as fuel shipment and electricity provision.

Chapter 4 provides a detailed description of the KEDO reactors and the safeguards expected to be applied under the present agreements.

Chapter 5 describes diversion and misuse scenarios for light-water reactors, such as the KEDO reactors, and their possible consequences.

Chapter 6 provides a description of known and suspect nuclear-related facilities in the DPRK, specifically at Yongbyon and Taechon, and of the methods that can be used to assess how much plutonium has been produced and separated.

Chapter 7 summarizes the sequence of activities envisaged by the AF and notes what there will be to verify and what measures of verification will take place as the agreement is carried out.

Chapter 8 examines the process of implementation under assumptions of varying degrees of DPRK cooperation or obstruction.

The Conclusions and Recommendations section provides a brief summary of the principal conclusions and recommendations made in the report. The recommendations are not separated from the conclusions.

## Authors and Sponsors

The work presented in this report was undertaken at the suggestion of former Secretary of Defense and now Stanford Professor William J. Perry. The sponsoring organizations were the Center for International Security and Cooperation of the Institute for International Studies at Stanford University, directed by Professor Scott Sagan and Professor Chris Chyba, and the Center for Global

\* Such provision depends on a number of other developments, such as improvements in the DPRK electrical grid.

## EXECUTIVE SUMMARY

Security Research at Lawrence Livermore National Laboratory, directed by Dr. Ronald Lehman. The project was carried out under the leadership of Professor Michael May of Stanford University.

The Stanford authors were Professor Michael May (general editor, Executive Summary, Chapters 7 and 8), Professor George Bunn (Chapters 1 and 2), Dr. Chaim Braun (Chapters 3 and 4), and Dr. William Sailor (Chapters 6 and 8).

The Lawrence Livermore contributors were Drs. Zachary Davis (Chapter 8), James Hassberger (Chapters 4 and 5), Ronald Lehman (Overview), Wayne Ruhter (Chapter 5), Robert Schock, and Nancy Suski (Chapter 8).

Every author contributed to the Conclusions and Recommendations, and also reviewed the other authors' chapters. Everyone also contributed to the Executive Summary.

In the process of preparing this report, the authors convened two workshops, one at Stanford University in September 2000, and one at the Lawrence Livermore National Laboratory in January–February 2001. During the course of these workshops, the authors received invaluable suggestions, information, and criticisms from a number of people who had had experience with the AF, the IAEA, the DPRK, nuclear-reactor safeguards, and other relevant topics. The authors greatly profited from these and are grateful to all those who took the time to read and critique early versions of this report and to contribute to the workshops. Special thanks are owed Richard Hooper, who contributed significantly to several

parts of the report. Errors and omissions, of course, are solely the responsibility of the authors.

In this report, the authors do not take a position on the desirability of the Agreed Framework, the future of the DPRK, or the desirable US policy in these matters. It is likely that views on these matters differ among the individual authors. The report is solely an assessment of safeguards and verification.

The report does not represent the views of Stanford University or any of its institutes or centers, nor those of the Lawrence Livermore National Laboratory, the Department of Energy, the US Government, or the University of California.

The authors are grateful to the Carnegie Corporation of New York for their support of this work at Stanford.

# CHAPTER 1

## A BRIEF HISTORY OF THE DPRK'S NUCLEAR WEAPONS-RELATED EFFORTS

This chapter is not a complete history but only highlights those aspects of the history and of the agreements entered into by the Democratic People's Republic of Korea (DPRK) that bear on the safeguards and verification of nuclear facilities and activities. We note and summarize agreements relevant to safeguarding the Korean Energy Development Organization (KEDO) reactors and verifying the frozen or dismantled status of nuclear weapons-related facilities.

### 1.1 Early History

The Soviet Union began training North Koreans on nuclear matters in the early 1950s. In 1965, the Soviets provided a small, 2-MW(th), light-water-moderated, research reactor that burned highly enriched uranium: the IRT-2000 research reactor subsequently upgraded to 4 MW. Then, to reduce its reliance on outside assistance, the DPRK began mining or producing uranium and graphite, began experimenting with plutonium separation, and built a graphite-moderated reactor that burned natural (unenriched) uranium. It was similar in design to the reactors used by Great Britain to make the plutonium best suited for weapons. It was a 5-MW(e), 20-MW(th)\* reactor used to irradiate fuel rods from which the DPRK later extracted plutonium. This reactor can probably produce enough plutonium for approximately one bomb per year.<sup>1</sup>

This reactor is located, along with most of the other known nuclear facilities, at Yongbyon in central North Korea (Fig. 1-1). Also at Yongbyon are—

- a radiochemical laboratory for plutonium separation.
- a 50-MW(e), partially built gas-graphite reactor. Its construction has halted, and it has never been operated.
- a small highly enriched uranium (HEU) research reactor that has been decommissioned.



Figure 1-1. General map of the Korean peninsula.

\* While the DPRK usually designates its reactors by their electrical rating, that rating is the product of the reactor's thermal power and the efficiency of the rest of the plant at converting that power into electricity. From the point of view of assessing a plutonium-making capability, the thermal rating—usually three to four times the electric rating—is more relevant. Typically, every megawatt of thermal power will generate about half a gram of plutonium per day (actual numbers vary with the type of fuel, reactor design, etc).

- buildings, tunnels, and other facilities that have not been declared by the DPRK but that may have been used to store undeclared spent fuel for a plutonium recovery program.

The entire set of facilities at Yongbyon is analyzed in detail in Chapter 6.

The DPRK also has a partially built, 200-MW(e) gas-graphite reactor located at Taechon, and a sub-critical nuclear facility at a university in Pyongyang.<sup>2</sup> Construction on the 200-MW(e) reactor has also been halted.

In 1985, the Soviet Union persuaded the DPRK to join the Non-Proliferation Treaty (NPT) by promising two light-water reactors (LWRs) that were better for producing electric power than graphite reactors but not as good for producing weapons-grade plutonium. Later, the DPRK said it was unable to meet its commitment to pay for even the site-survey conducted by the Soviet Union at a new location in the area now proposed for the new LWRs (see Fig. 1-1). At the end of 1991, after the Soviet Union dissolved into its former republics, Russia withdrew the Soviet promise to provide LWRs to the DPRK.

## 1.2 Attempts To Restrain the DPRK From Making Nuclear Weapons

Though a party to the NPT from 1985, the DPRK did not accept the comprehensive International Atomic Energy Agency (IAEA) safeguards agreement covering all its nuclear activities required by the NPT for seven years. In 1991, the first Bush administration developed a program to restrain the DPRK from making nuclear weapons. The program relied on South Korean and Soviet efforts as well as those of the US. In 1991

came the Bush–Gorbachev announcements of withdrawals of American and Soviet tactical weapons from other countries.<sup>3</sup> In December 1991, President Roh Tae Woo announced publicly, and in the presence of President Bush, that there were no US tactical nuclear weapons in the ROK.<sup>4</sup> South Korea announced a plan for a nuclear-weapon-free Korean peninsula and engaged the North in negotiations that produced a general declaration to this end at the beginning of 1992. This Joint Declaration on North–South Denuclearization not only called for a nuclear-weapon-free peninsula but also prohibited both the North and the South from possessing facilities for enriching uranium or for separating plutonium from spent reactor fuel. Moreover, it provided for reciprocal inspections—of the DPRK by the Republic of Korea (ROK) and vice versa.<sup>4</sup>

Despite lengthy negotiations, the two countries could not agree on the sites in each country that would be inspected by the other. Later in 1992, however, the DPRK accepted the NPT-required safeguards agreement for inspection of all its nuclear installations by the IAEA (INFCIRC 153 safeguards). In accordance with this agreement, the DPRK provided the IAEA with a report that was supposed to declare all its nuclear material and facilities for IAEA inspection. When the IAEA's Director-General Hans Blix visited these facilities in 1992, he reported among other things that the DPRK had a continuing interest in securing LWRs. At that time, however, South Korea rejected the idea of helping the DPRK acquire them.<sup>5</sup>

Before the end of 1992, information from IAEA inspectors based on environmental samples they had taken at the Yongbyon facilities and from US satellite photographs of the area suggested that the DPRK had probably separated more plutonium from its small

graphite reactor's irradiated fuel than the DPRK had reported to the IAEA.<sup>6</sup> When the IAEA requested that special inspections take place at two undeclared sites in the Yongbyon area, which satellite photographs suggested might be places where the DPRK had hidden the products of unreported plutonium separation, the DPRK resisted strenuously.

After the IAEA's Board of Governors insisted on these special inspections, the DPRK announced it was withdrawing from the NPT and gave the required 90-day notice. In the IAEA discussions that followed, China opposed going to the U.N. Security Council for an order imposing economic sanctions on the DPRK if it withdrew from the NPT. As a result, the IAEA's Board of Governors simply reported to the Security Council what had happened. The Board also used its authority to terminate all IAEA technical assistance to the DPRK. Subsequently, the DPRK ended its membership in the IAEA. This, of course, did not affect the DPRK's obligation to comply with the NPT or the safeguards agreement made pursuant to the NPT. The Security Council then called upon the DPRK to permit the IAEA inspections but did not order sanctions if the DPRK refused, probably because of the likelihood of a Chinese veto.<sup>7</sup>

China urged negotiations with the DPRK. In consultation with South Korea and Japan, the US renewed such negotiations. On the last day of the 90-day notice period for withdrawal from the NPT—June 11, 1993—the DPRK announced that it would remain a party to that treaty, at least for the time being. In a joint statement with the US, the DPRK said it had “decided unilaterally to suspend as long as necessary the effectuation of its withdrawal from” the NPT. Both governments “expressed support for the North–South Joint Declaration of the Denuclearization



of the Korean Peninsula in the interest of nuclear non-proliferation goals.”<sup>8</sup> Both sides agreed to general principles about the application of IAEA safeguards and the need for a “fundamental solution of the nuclear issue on the Korean peninsula.” But, there was no agreement by the US to provide LWRs to the DPRK and no agreement by the DPRK to freeze the operation of its small graphite reactor or the construction of its two bigger graphite reactors.<sup>9</sup>

Further DPRK–US negotiations produced an agreement in July of 1993 on the following joint statement:

“Both sides recognize the desirability of the DPRK’s intention to replace its graphite-moderated reactors and associated nuclear facilities with light-water-moderated reactors (LWRs). As part of the final resolution of the nuclear issue, and on the premise that a solution related to the provision of LWRs is achievable, the USA is prepared to support the introduction of LWRs and to explore with the DPRK ways in which the LWRs could be obtained.”<sup>10</sup>

Both sides also agreed to the “full application” of IAEA safeguards to the DPRK’s nuclear facilities. The DPRK promised to begin consultations with the IAEA on safeguards as soon as possible. Both re-affirmed the importance of implementing the North–South Joint Declaration on Denuclearization, and the DPRK said it was prepared to begin North–South talks on nuclear and other issues. Finally, the US and the DPRK agreed to meet soon to resolve remaining questions including those “relating to the introduction of LWRs.”<sup>11</sup>

Meeting again in August 1993, the DPRK rejected a US proposal to freeze its nuclear program in exchange for conventional power stations but agreed “to replace its graphite-moderated reactors and related facilities with light-water reactor (LWR) power plants,” and the US agreed “to make arrangements for the provision of LWRs of approximately 2,000 MW(e)” to the DPRK. The US also agreed to make interim energy arrangements so long as the graphite-moderated reactors were not operated. DPRK agreed to “freeze construction” of the two such reactors still under construction, to “forego reprocessing” of spent fuel and to “seal” the radiochemical laboratory where it said reprocessing had taken place. It also promised to remain a party to the NPT and to allow IAEA inspections. In addition, it declared its continuing willingness to implement the North–South Joint Declaration on Denuclearization.<sup>12</sup>

But, the DPRK continued to disagree with the IAEA over the scope of IAEA inspections, with the ROK and US over whether the annual Team Spirit ROK–US military exercise would be conducted in South Korea that year, and with the ROK over inspections pursuant to the North–South Joint Declaration on Denuclearization. The DPRK shut down its small graphite reactor, which by then may have contained enough unseparated plutonium for at least one bomb. It soon began unloading the fuel rods from the reactor without waiting for IAEA inspectors to test samples of material from them as they were taken out. Such tests could have determined which fuel rods had been in the reactor for a long time and which had not, and thereby improve the estimate of how much plutonium had been made within the fuel rods. This DPRK move prompted fear that the DPRK intended to acquire the plutonium for weapons.

Efforts to agree on a U.N. Security Council sanctions resolution failed to gain China’s assent. At the same time, US satellite photographs showed the North Korean military forces moving to a war footing. The Pentagon estimated that a war would result in 300,000 to 500,000 military casualties in the first 90 days. No estimates were given for civilian deaths. Both the ROK and Japan opposed going to war with the DPRK.<sup>13</sup>

Then, in a June 1994 visit to DPRK, sanctioned by President Clinton, former President Jimmy Carter met with the DPRK’s leader Kim Il Sung and reported to the press afterwards that the crisis was over. He said that the DPRK had agreed not to reprocess the spent fuel from the small graphite reactor that had been shut down, to accept IAEA inspection of its reactors and other facilities declared by it to the IAEA, and to freeze its existing nuclear program. In return, the DPRK expected assistance in securing LWRs and an end to US efforts to impose sanctions if IAEA inspectors were denied access to other locations. Thereupon, the ROK announced that it was prepared to provide technology and major financing to the DPRK for two LWRs.<sup>14</sup> It may be noted that this is essentially the same agreement as the one from the previous year, but the DPRK had now prevented the IAEA from making possibly key measurements on its spent fuel, and had delayed the US from imposing sanctions if the DPRK prevented the IAEA from inspecting suspect facilities.

### 1.3 Agreed Framework of October 1994

When US and DPRK negotiators met again, they produced the Agreed Framework (AF) of October 1994 that gave more detail to the basic agreement announced in the August 1993 joint statement and in President Carter’s press conference.

The relevant terms of the AF and the subsequent Supply Agreement that implements much of it are as follows:

1. The DPRK and the US would “cooperate to replace the DPRK’s graphite-moderated reactors and related facilities with light-water reactor (LWR) power plants.” Operation of the small graphite reactor is to be “frozen” and subject to continuing inspection by the IAEA. Construction of two larger unfinished graphite reactors is also to be frozen. Later, all three are to be dismantled. Spent fuel from the small reactor has been removed by the DPRK as indicated. Canning of all accessible spent fuel rods was completed in April 2000, and the rods remain stored in a cooling pond near the reactor. Pursuant to future US–DPRK negotiations, the fuel will be disposed of “in a safe manner that does not involve reprocessing in the DPRK.”<sup>15</sup> There is no requirement that the DPRK’s small Yongbyon research reactor or its sub-critical research facility in Pyongyang be dismantled.
2. The US would make arrangements for provision of the LWRs to the DPRK through “an international consortium” which the US would form and for which it would be the principal point of contact. This consortium, which became known as the Korean Energy Development Organization (or KEDO), would enter into a “Supply Contract” for the LWRs with the DPRK.<sup>16</sup> At the end of 1995, the DPRK and KEDO signed the Supply Contract for the LWRs. In addition to the US, KEDO executive board members include South Korea, Japan, and the European Union. More than a dozen other members are in KEDO, including Australia, New Zealand, Canada, Poland, and Argentina.

3. In the AF, the DPRK promised that it would “freeze” not only the three graphite reactors but also the related facilities, which it had declared to the IAEA. In the meantime, the US and KEDO agreed to make arrangements for periodic delivery of oil to the DPRK to offset the energy foregone due to the freeze on the graphite reactors.<sup>17</sup>
4. DPRK agreed to remain a party to the NPT. It also agreed to “allow implementation of its safeguards agreement under the Treaty [NPT].” However, the US promised the DPRK that the IAEA would not be permitted at first to verify the accuracy of the DPRK’s initial report on all its nuclear material. This verification could be carried out by, e.g., inspecting the two undeclared and disputed sites where products of earlier separations are believed by the IAEA and US to be hidden. Inspection for this purpose would come later:

“When a significant portion of the LWR project is completed, but before delivery of key nuclear components, the DPRK will come into full compliance with its safeguards agreement with the IAEA (INFCIRC 403), including taking all steps that may be deemed necessary by the IAEA, following consultations with the Agency with regard to verifying the accuracy and completeness of the DPRK’s initial report on all nuclear material in the DPRK.”

Thus, before delivery of “key nuclear components,” the DPRK must permit the IAEA to inspect the two sites where the US and the IAEA believe has the hidden products of its small graphite reactor’s earlier operation. There

is evidence, discussed in Chapter 6, that measurements on these products would show that the DPRK removed from the reactor more irradiated fuel than it reported to the IAEA—presumably to separate out the plutonium.<sup>18</sup>

5. “Key nuclear components” include items such as nuclear material, reactors, the equipment attached to reactors other than the turbine generators, the equipment that controls the level of power in reactor cores, and any other components “which normally contain or come in direct contact with or control the primary coolant.” These include, for example, reactor pressure vessels, as well as reactor control rods, pressure tubes, etc.<sup>19</sup>
6. The Supply Agreement states that “the provision of the LWR project and the performance steps...are mutually conditional.”<sup>20</sup> As a result, KEDO’s delivery schedule is “integrated” with the DPRK’s performance schedule in several ways. This integration is to be accomplished as follows:

First, the DPRK’s acceptance of IAEA inspections at the disputed and undeclared sites is not required until “a significant portion of the LWR project is completed but before delivery of key nuclear components.” This language brought objections from the IAEA because it postpones the “full-scope” inspections necessary to determine whether the DPRK has separated more plutonium than it reported—as is suspected. Major construction of reactor buildings at Kumho (the proposed LWR site) and delivery of non-nuclear components including turbine generators—a “significant portion” of the LWR project—will likely have taken place first.<sup>21</sup> On the other hand, the DPRK is not entitled to any key nuclear components if it does not permit these IAEA inspections. Some, including

the IAEA Deputy Director for Safeguards, believe that the agreement will likely break down at this point because the DPRK will resist the inspections necessary to bring it into compliance with its safeguards agreement.<sup>22</sup> Others experts believe, even if the DPRK cooperates with the IAEA to permit these inspections, the whole process will require so much investigative work and materials testing that it will likely take two years or more, thus delaying provision of the nuclear components and completion of the program.<sup>23</sup>

Second, when delivery of the "key nuclear components" for the first LWR begins, the transfer of spent fuel from the small graphite reactor must begin. The transfer is to be completed when this first LWR is completed. Again, if the DPRK delays delivery of spent fuel, KEDO can delay delivery of LWR components.<sup>24</sup>

Third, "when the first LWR is completed [at Kumho], the DPRK will begin dismantlement of its frozen graphite-moderated reactors and related facilities, and will complete such dismantlement when the second LWR is completed." Thus, KEDO must complete the first LWR before any of the graphite reactors are dismantled but can schedule deliveries for the second LWR based upon the DPRK's performance of its dismantlement obligations. The deliveries of the nuclear components for the second LWR can be staged in parallel with proportional steps by DPRK to dismantle all its graphite reactors.

Thus, the Supply Agreement contemplates reciprocal steps of performance to assure each side that the other is doing its part. An agreement that has not been made public provides more detail. And the Supply Agreement calls for negotiation of still another protocol defining the reciprocal steps further.<sup>25</sup>

7. The model for the LWRs will be "selected by KEDO" but was promised to be "the advanced version of US-origin design and technology currently under production."<sup>26</sup> In fact, the reactors will be manufactured in South Korea using as models two existing ROK reactors based on a US-origin Combustion Engineering design but including refinements of that design.

8. The DPRK must eventually repay KEDO for the LWRs "on a long-term, interest-free basis."<sup>27</sup> KEDO will provide nuclear fuel for the initial loading of the LWRs. The DPRK promises to use the reactors, technology, and nuclear material involved "exclusively for peaceful, non-explosive purposes." In addition, it promises not to reprocess or increase the enrichment level of any nuclear material acquired pursuant to the agreement, and not to transfer any nuclear material, equipment, or technology acquired pursuant to the agreement outside the territory of the DPRK except for the spent fuel transfer already described.<sup>28</sup>

9. The AF provided that the DPRK and the US would conclude "an agreement for cooperation in the peaceful uses of nuclear energy" as necessary.<sup>29</sup> Later, the Supply Agreement said "In the event that US firms will be providing any key nuclear components," such an agreement would be negotiated "prior to the delivery of such components."<sup>30</sup> These provisions entail a complication.

Agreements for cooperation on peaceful uses of nuclear energy with other nations are authorized by the US Atomic Energy Act (Section 123). Before they can enter into force, they must lay over in Congress for 90 days of continuous session without passage of a joint resolution of opposition. No agreement for cooperation has yet been

submitted to Congress. Under recent legislation, an agreement for cooperation indeed cannot be submitted at this time.

Recent legislation requires that the President, when submitting such an agreement with the DPRK, certify that IAEA inspections—such as those required by the AF—establish the accuracy and completeness of the report the DPRK made to the IAEA when inspections began in 1992. For example, the inspections must establish that there has been no clandestine production of plutonium.<sup>31</sup> Thus, IAEA "full-scope" inspections that may well take two to four years must precede congressional action on an agreement for cooperation.

The basic nonproliferation compliance requirements of the agreements referred to above are as follows:

1. In the NPT, the DPRK has agreed "not to manufacture or otherwise acquire" nuclear weapons. In the NPT, it has also agreed to accept IAEA safeguards on its nuclear activities for the purpose of fulfilling this obligation.
2. The DPRK's safeguards agreement (IAEA INFCIRC 403) says that the IAEA shall "verify" the "findings" of the DPRK's accounting and control system showing that "there has been no diversion of nuclear material from peaceful uses to nuclear weapons." The agreement is based on the IAEA's 1972 model agreement for NPT safeguards, the only model available at the time (IAEA INFCIRC 153). Details of safeguards implementation for the reactors now in the DPRK appear in a confidential "subsidiary arrangement" agreement with the IAEA. Details for LWR safeguards implementation will be negotiated with the IAEA in another "subsidiary arrangement."
3. The AF goes beyond the basic NPT obligation "not to

manufacture or otherwise acquire nuclear weapons." For example, in it the DPRK has agreed to "take steps to implement the North-South Declaration on Denuclearization of the Korean Peninsula." This contains provisions prohibiting either the DPRK or the ROK from enriching uranium or separating plutonium. The AF also requires that the DPRK remain a party to the NPT. Finally, as already indicated, the AF requires that the DPRK "come into full compliance with its safeguards agreement" before the delivery of "key nuclear components." Full compliance includes taking all steps that may be deemed necessary by the IAEA "with regard to verifying the accuracy and completeness of the DPRK's initial report on all nuclear material in the DPRK." This report is the one that the 1991-92 IAEA measurements and environmental monitoring suggested may be inaccurate because it does not report all the plutonium the IAEA suspects the DPRK separated before it submitted the report.

The AF and Supply Agreement are being implemented by KEDO and the DPRK with considerable success so far, though at a slower rate than the AF contemplated. The survey for the Kumho site has been completed and major construction to make roads and build buildings for the LWRs and the personnel who will operate them has taken place. KEDO has awarded a "turn-key contract" for the manufacture of the LWRs to KEPSCO, a South Korean company, which in turn has

or will award contracts to four other South Korean companies for nuclear components. Delays have resulted because of difficulties on both sides, and completion is now hoped for by 2007 rather than the 2003 date targeted in the AF. Further delay is likely given the anticipated problems described.

### Notes to Chapter 1

1. David Albright, and Kevin O'Neill, eds., *Solving the North Korean Nuclear Puzzle* (Institute for Science and International Security, Washington, D.C., 2000), Chapter 1, pp. 15-29.; M.J. Mazaar, *North Korea and the Bomb* (MacMillan, London, 1995), pp. 25, 29, and 36; V.I. Denisov, "Nuclear Institutions and Organizations in North Korea," in *The North Korean Nuclear Program*, J.C. Moltz and A.Y. Mansourov, eds. (Routledge, New York, 2000), pp. 21-26; A. Zhebin, "A Political History of Soviet-North Korean Nuclear Cooperation," in Moltz and Mansourov, pp. 27-34.
2. D. Albright, F. Berkhout, and W. Walker, *Plutonium and Highly Enriched Uranium 1996: World Inventories, Capabilities, and Policies* (Oxford University Press, New York, 1997), pp. 282-84; R.W. Jones and M.G. McDonough, *Tracking Nuclear Proliferation* (Carnegie Endowment, Washington, D.C., 1998), pp. 158-59.
3. G. Bunn, *Arms Control by Committee* (Stanford University Press, Stanford, California, 1992), pp. 251-52.
4. Mitchell Reiss, *Bridled Ambition: Why Countries Constrain Their Nuclear Capabilities*, (Woodrow Wilson Center, Washington, D.C., 1995), p. 239; Foreign Broadcast Information Service, FBIS-EAS-91-243 (December 18, 1991), p. 14.
5. Mazaar, pp. 84, 86.
6. Mazaar, pp. 94-95; Reiss, pp. 246-49.
7. Reiss, pp. 250-53.
8. Joint Statement of the DPRK and the USA, New York, June 11, 1993.
9. Joint Statement of the DPRK and the USA, New York, June 11, 1993.
10. Agreed Statement between the USA and the DPRK, Geneva, June 11, 1993.
11. Agreed Statement between the USA and the DPRK, Geneva, June 11, 1993.
12. Agreed Statement between the USA and the DPRK, Geneva, August 12, 1993.
13. Reiss, pp. 259, 265-71.
14. Mazaar, pp. 162-63; Reiss, pp. 271-72, p. 275; Leon Sigal, *Disarming Strangers* (Princeton University Press, Princeton, 1998), pp. 155-62.
15. Agreed Framework, pars. I, 1 and I, 3.
16. Agreed Framework, par. I, 1.
17. Agreed Framework, par. I, 2.

- |   |   |   |
|---|---|---|
| <p>18. Agreed Framework, par. IV.</p> <p>19. The Supply Agreement refers for its definition of “key nuclear components” to the “Trigger List” developed by the Nuclear Suppliers’ Group to implement the export controls required by Art. III, par. 2 of the Non-Proliferation Treaty. See M.M. El Baradei, E.I. Nwogugu, and J.M Rames, <i>The International Law of Nuclear Energy</i> (Nijoff, Dordrecht, Netherlands, 1993), pp. 1,520–33.</p> <p>20. Non-Proliferation Treaty, Art. III, par. 1.</p> <p>21. Supply Agreement, Art. III and Annex 4.</p> | <p>22. Statement of Pierre Goldschmidt to William Sailor at the International Nuclear Materials Manangement (INMM) Annual Meeting in July 2000.</p> <p>23. David Albright, “Inconsistencies in North Korea’s Declaration to the IAEA” and “How Much Plutonium Did North Korea Produce?” Chaps. IV and VI in Albright and Kevin O’Neill, eds., <i>Solving the North Korean Nuclear Puzzle</i> (Institute for Science and International Security, Washington, D.C., 2000).</p> <p>24. Supply Agreement, Annex 3.</p> <p>25. Supply Agreement, Art. III, 3; Reiss, pp. 276–77.</p> | <p>26. Supply Agreement, Art. I.</p> <p>27. Supply Agreement, Art. II.</p> <p>28. Supply Agreement, Art. XIII</p> <p>29. Agreed Framework, Art. I, 1.</p> <p>30. Supply Agreement, Annex 3, par. 4.</p> <p>31. North Korean Threat Reduction Act of 1999, Sect. 821-23 of P.L. 103-113. See Henry Sokolski, “Implementing the DPRK Nuclear Deal: What US Law Requires,” <i>Nonproliferation Review</i> (Fall–Winter, 2000), pp. 146, 148.</p> |
|---|---|---|



## CHAPTER 2

# CURRENTLY APPLICABLE SAFEGUARDS AND RELATED AGREEMENTS

### 2.1 The Existing IAEA–DPRK Safeguards Agreement

The IAEA–DPRK Safeguards Agreement is a standard agreement based on the IAEA’s 1971 “model safeguards agreement,” INFCIRC 153.<sup>1</sup> Among other things, it provides—

1. The DPRK (Democratic People’s Republic of Korea, or North Korea) must establish and maintain a system of accounting and control that will enable the International Atomic Energy Agency (IAEA) to verify the DPRK’s accounting for its nuclear material at Yongbyon, Kumho, or any other location. It must permit the IAEA to make “independent measurements and observations” to assure the “timely detection of diversion of significant quantities of nuclear material from peaceful nuclear activities to the manufacture of nuclear weapons or of other nuclear-explosive devices or for purposes unknown, and deterrence of such diversion by the risk of early detection.”<sup>2</sup> This is the standard for the IAEA’s INFCIRC 153 safeguards agreements.
2. From the design of a proposed reactor, the IAEA will select “key measurement points,” called “strategic points,” to be used to measure the nature and quantities of nuclear material, and to determine its flow and inventory. These strategic points will determine the “material balance areas” where the DPRK (subject to checks by IAEA inspectors) will measure what comes into the

areas, what goes out, and what is there at the time of measurement.<sup>3</sup>

For the IAEA staff to designate these points and areas, decide where sensors and cameras should be placed, and perhaps even suggest minor changes in design that would help in safeguarding, the papers showing the design of the reactor should be submitted to the IAEA well in advance of the reactor’s installation—although this IAEA suggestion is sometimes ignored by reactor builders.

3. The DPRK is required to provide the IAEA with two kinds of accounting reports for each material balance area: “inventory change reports” and “material balance reports.”<sup>4</sup> The inventory change reports are to be sent to the IAEA within 30 days after the end of the month in which the change occurred. The material balance reports are to show the balance based on a physical inventory of nuclear material in the material balance area and are due within 30 days after the inventory has been taken. More details for the light-water reactors (LWRs) should appear in IAEA–DPRK “subsidiary arrangements” for the LWRs. These arrangements have not yet been negotiated.
4. The IAEA has the right to conduct “routine inspections” to verify the information supplied by the DPRK’s accounting system. It can examine the DPRK’s accounting records, make independent measurements, verify the functioning and calibration of measuring instruments and

control equipment, apply surveillance and containment measures (e.g., TV monitoring cameras focused on the reactors and seals on the reactors that, when broken, show the reactor could have been opened when the inspectors were not present). It can also use other unspecified methods “which have been demonstrated to be technically feasible.”<sup>5</sup>

5. The Safeguards Agreement calls for one routine inspection per year for small facilities and for material balance areas outside all facilities’ annual throughput of nuclear material not exceeding five kilograms. For facilities with an annual throughput exceeding five kilograms, the “number, intensity, duration, timing, and mode of routine inspections... shall be no more intensive than is necessary and sufficient to maintain continuity of knowledge of the flow and inventory of nuclear material...” The Agreement goes on to specify standards for determining the “maximum routine inspection effort” in such cases.<sup>6</sup> Presumably an IAEA–DPRK negotiation will determine this effort at a later time.

At the time the IAEA–DPRK Safeguards Agreement went into effect (1992), the Agreed Framework (AF) had not been negotiated and the safeguards contemplated in the Safeguards Agreement were for graphite-moderated reactors. The changes required will not be made in the Safeguards Agreement itself but in the subsidiary arrangements for the LWRs.

6. Under the Safeguards Agreement, the IAEA also has the right to conduct “special inspections” if, for example, it decides that the routine inspections and the information and explanation provided by the DPRK “is not adequate for the Agency to fulfill its responsibilities under this Agreement.” As summarized in Chapter 1, the IAEA secretariat tried to institute a special inspection in 1992 to determine if the DPRK had separated more plutonium than it had reported. The IAEA may again seek special inspections when the time comes under the AF for the IAEA to inspect sites not declared as nuclear by the DPRK to determine whether the DPRK’s original declaration of its nuclear materials and facilities is accurate and complete. The IAEA is more likely to simply insist that the DPRK comply with the AF provision requiring it to take “all steps that may be deemed necessary by the IAEA...with regard to verifying the accuracy and completeness of the DPRK’s initial report on all nuclear material in the DPRK.”

## 2.2 New Information That the IAEA May Ask of All States Under INFCIRC 153 Safeguards

As we have seen, “when a significant portion of the LWR project is completed but before delivery of key nuclear components,” the DPRK must provide information showing where all the nuclear material in its original inventory has gone.<sup>7</sup> Under “Part 1” of the IAEA’s “93+2” decisions to strengthen safeguards, the DPRK could also be asked by the IAEA to provide certain information about its past dealings with nuclear material. In describing the 93+2 safeguards requirements, the IAEA legal staff concluded, and the Board accepted, that Part 1 information, though not always

requested in the past, was included in INFCIRC 153, the model safeguards agreement upon which the DPRK’s agreement is based.<sup>8</sup> [Neither the DPRK nor the Republic of Korea (ROK, or South Korea) has agreed to accept the new IAEA model safeguards protocol resulting from the 93+2 proceedings.] Some of the Part 1 information that could be asked of the DPRK for IAEA use in safeguarding the new reactors is as follows:

- Responses to a detailed questionnaire showing the DPRK’s system of accounting and control for nuclear material including the scope and timing of the DPRK’s own inspections and related activities relevant to IAEA safeguards.
- Information on past nuclear activities relevant to assessing the DPRK’s declarations of present nuclear activities, including the completeness and correctness of its initial report on nuclear material. (There is already a major dispute between the DPRK and the IAEA over accounting for the nuclear material in the DPRK’s initial report. The IAEA suspects that some of the fuel rods, after radiation in the small graphite reactor, were reprocessed to extract plutonium, after which the plutonium and the wastes were hidden from IAEA inspectors.)
- Information on decommissioned nuclear facilities, and on other locations previously containing nuclear material that had hot cells or where activities relating to conversion and reprocessing of fuel fabrication took place. (This may produce IAEA questions on the DPRK radiochemical lab or on a smaller chemical separation facility that the IAEA Director-General Blix suspected the DPRK once had.)
- Access to existing historical accounting and operating

records predating the entry into force of an INFCIRC 153 safeguards agreement. (Given the length of time the DPRK operated nuclear facilities before it agreed to its INFCIRC 153 safeguards agreement, this could produce more IAEA questions.)

- Information on other locations containing nuclear material. (This should include the disputed, undeclared sites.)

The provisions of the AF and Supply Agreement (summarized in Chapter 1) that deal with these issues are thus reinforced by the IAEA Board’s decision that safeguards agreements like the one applying to the DPRK require the DPRK to supply information of this kind. Moreover, in adopting its 93+2 decisions, the IAEA made clear that remote monitoring from a distant, safeguarded reactor to IAEA headquarters in Vienna using communications equipment attached to cameras and other control and surveillance devices installed at the reactor could be requested by IAEA inspectors under an INFCIRC 153 safeguards agreement. Acceptance by the government where the reactor was located of a 93+2 strengthened protocol for its safeguards agreement was not necessary.

## 2.3 Additions to INFCIRC 153 Safeguards for States Willing To Agree to a New INFCIRC 540 Safeguards Protocol

The IAEA “93+2” decision deals with subjects beyond the INFCIRC 153 safeguards agreements, subjects requiring negotiation of an amendment or “protocol” to existing agreements. In its 1996 report on 93+2 to a conference of its members, the IAEA described the new information that would be required as part of what it called the “Part 2” amendments to be incorporated in a new Protocol to the standard



INFCIRC 153 safeguards agreement.<sup>9</sup> The model agreement for this new protocol is in IAEA INF-CIRC 540. The new protocol requires, for example, information *not involving* nuclear material including:

- nuclear research activities and future plans for nuclear developments;
- all activities related to the enrichment of uranium, reprocessing of spent fuel, or treatment of nuclear waste before the activities involve nuclear material;
- activities in buildings on sites of nuclear facilities;
- acquisition of a long list of equipment and non-nuclear material related to the operation of nuclear facilities;
- information on materials containing uranium or thorium too low in concentration to be “nuclear material” within the IAEA definition.

The INFCIRC 540 protocol’s requirements were also intended to permit access to a greater range of locations than under INFCIRC 153, for example, of sites not declared by the facility’s government. These had been available for inspection in the past only through “special inspections,” which produced much controversy between the IAEA and the DPRK. If the IAEA interprets the “special inspection” provision as originally intended and as interpreted in its 1993 case involving the DPRK, inspections at other than the declared reactor sites should be possible with the DPRK’s cooperation without amending the DPRK’s safeguards agreement to add the INFCIRC 540 protocol requirements. Indeed, the AF requires that the DPRK take “all steps that may be deemed necessary by the IAEA...with regard to verifying the accuracy and com-

pleteness of the DPRK’s initial report on all nuclear material in the DPRK.”

Even under an INFCIRC 540 protocol, however, a government official can prevent IAEA inspectors from going to places they have not inspected before. The main difference may in practice be a difference in the “threshold showing” necessary to justify going beyond routine inspection sites. For special inspections of non-routine, undeclared sites under INFCIRC 153 safeguards when a government asks for justification, inspectors must argue that they simply can’t do their jobs without the special inspection. For visits to non-routine, undeclared sites under INFCIRC 540 safeguards, when the host government asks why, the inspectors should only have to show that a question or inconsistency has arisen that necessitates an inspection to resolve. In either case, the cooperation of the host government is likely to be the most important factor. Clearly, if the DPRK does not cooperate by taking “all steps that may be deemed necessary by the IAEA,” the language quoted at the end of the preceding paragraph, it will violate an important requirement of the AF.

INFCIRC 540 protocols also permit “environmental monitoring” at other locations than those declared by the operator. The IAEA has been doing “environmental monitoring” at some routine inspection sites in other countries. Presumably, it will do this at the DPRK’s routine inspection sites (if it has not already). The hope of INFCIRC 540 is that this form of monitoring will become much more common. But, the host government’s cooperation will still be necessary to permit the inspectors to go to non-routine locations to take their samples—from the environment, the air, the leaves, the ground, etc. Again, the

language quoted in the two preceding paragraphs from the AF may be helpful in producing DPRK cooperation.

One of the promises of providing INFCIRC 540 information is that it will permit closer cooperation between the IAEA, the operators, and the government officials responsible for nuclear activities. This will result in many fewer inspections for countries like Canada or Japan where a tremendous share of the total IAEA inspections costs has gone in the past. In general, adoption of INFCIRC 540 protocol would have, it was hoped, produced a major reduction in the number of inspections in countries that accepted the new safeguards. IAEA safeguards experts question, however, whether that is an objective worth pursuing with the DPRK. Some believe that having more inspections in the DPRK pursuant to DPRK’s existing Safeguards Agreement will be more valuable than attempting to apply the INFCIRC 540 protocol to the DPRK.<sup>10</sup>

### 2.3.1 Safeguards on Existing ROK LWRs—Models for the DPRK LWRs

The DPRK is to receive two pressurized LWRs of 1,000-MW(e) capacity each, based on a US Combustion Engineering Company design that has been refined by South Korean reactor designers. Two reactors of this design are operating in South Korea. They are both subject to INFCIRC 153 safeguards and are good models for the safeguards anticipated for the two DPRK LWRs. Safeguards on large LWRs of 1,000-MW(e) power or more do not vary a great deal from one reactor to another.<sup>11</sup> Thus, the IAEA safeguards on the KEDO reactors in Kumho will likely be very similar to the safeguards on the ROK reactors expected to be the models for the KEDO reactors.

## 2.4 Major Challenges Ahead to the Implementation of the Agreed Framework

Most of this report is dedicated to the technical means for verifying that the plutonium produced in the new LWRs at Kumho is not diverted to weapons purposes; that the graphite reactors and other nuclear facilities at Yongbyon and Taechon are dismantled as required by the AF; and that the spent fuel now at Yongbyon is not diverted but is delivered to KEDO when the AF and Supply Agreement require it to be. Other major challenges, however, lie ahead that can prevent or delay implementation of the AF.

### 2.4.1 Completion of a “Significant Portion” of the First Reactor in the ROK and Reactor Buildings in the DPRK

This step has been delayed so far by about four years for many reasons. There is potential for more delay from the challenges listed below, including the liability problem. Completion is not now expected before 2004, a year after the original target for completion of the entire project. After completion of this “significant portion” but before “delivery of key nuclear components,” the DPRK must “come into full compliance with its safeguards agreement...with regard to verifying the accuracy and completeness” of its 1992 report to the IAEA on “all nuclear material in the DPRK.” This major verification problem is discussed in Chapter 6. It holds the potential for causing substantial further delay and expense. KEDO estimates provide only a few months’ time for IAEA inspection after a significant portion of the first reactor is built in the ROK and the DPRK becomes obligated by the

AF to accept comprehensive IAEA inspections. If the DPRK refuses inspections before this obligation comes into force, as it has so far, and if, based on IAEA expectations, the IAEA inspections and review take two or more years, major additional costs to KEDO for the reactor will be caused by the delay. The reactor is being built under a fixed-cost contract that assumes only a few months will be needed for the IAEA’s inspection and review.

### 2.4.2 Financing

South Korea carries the major burden of financing now. The US has paid for most of the heavy fuel oil delivered to the DPRK to fuel its electricity supply, but has not paid for much else. Japan has made major contributions to the already large costs of construction. Australia and the European Union have made smaller ones. Completing construction at Kumho and building the reactors in North Korea will be very costly, and disputes continue over how much each of the interested parties should pay.

### 2.4.3 Nuclear Liability

This applies, for example, to potential liability if one of the LWRs has a major accident during operations, and some people receive high doses of radioactivity. Congress has prohibited the US from agreeing to indemnify a US manufacturer that provides major components for the DPRK reactors. As a result, General Electric has turned down an offer to provide the turbine generators for the DPRK’s reactors. Two Japanese firms, who seem somewhat less concerned about the liability problem, will now supply them. South Korea wants KEDO, the European Union, Japan, and the US to assume this liability. Negotiations have not yet produced an agreement to share this liability risk.

But, looking to the future, this could become a major problem again.

### 2.4.4 US–DPRK “Agreement for Cooperation” and IAEA Inspection of Undeclared Facilities

This problem was discussed in Chapter 1. Negotiating and implementing a US agreement for cooperation with the DPRK permitting the export of necessary nuclear components by American manufacturers seems tightly tied to satisfying the IAEA that the DPRK has declared and reported all its nuclear materials and facilities—that the DPRK has not, for example, separated more plutonium than it has declared. Even if the DPRK cooperates fully in the IAEA special or other inspections, the process of reconstructing what happened to all nuclear materials in the DPRK from the time it joined the NPT to the present is likely to take two to four years. No Congressional review of an agreement for cooperation and no provision of nuclear components to the DPRK appears likely until this process is completed and the IAEA is satisfied that the DPRK’s reports on all its nuclear materials and facilities are accurate and complete. By one estimate, the IAEA would have to complete its inspections and make a decision favorable to DPRK within about 30 months if the export licensing of a US nuclear component or components is not to delay completion of the Kumho project under the present time schedule—which has already been delayed several years beyond the original the original 2003 target date.<sup>12</sup>

If the IAEA takes around 24 months for its inspections and appraisal, the inspections should begin by mid-2001. But, under the AF, the time has not yet come for the IAEA inspections to begin, as Chapter 1 shows. Implementation

of pertinent provisions of the AF may well be delayed for years beyond the four it has already been delayed, unless the DPRK agrees to earlier inspections. And, of course, if the IAEA inspections and appraisal do not produce the required result, implementation of the AF pursuant to its present terms could end. In Chapter 8, after more complete discussions and assessments of verification and safeguards procedures, we return to the question of how various eventualities could affect verification and safeguards and vice versa.

#### 2.4.5 Improving North Korea's Electricity Distribution System

Before it will be safe to turn the LWRs on, major expensive improvements in the DPRK's electrical distribution system are necessary. North Korea does not appear to have the resources to pay for these improvements, and neither KEDO nor any of its participants has agreed to pay for them. This problem is discussed in Chapter 3, which also describes the area where the reactors for the DPRK will go and what has been done so far.

#### Notes to Chapter 2

1. The DPRK Safeguards Agreement is IAEA INFCIRC 403, May 1992.
2. DPRK Safeguards Agreement, Art. 7.
3. DPRK Safeguards Agreement, Arts. 46, 98 (m) and (s).
4. DPRK Safeguards Agreement, Art. 63 (b).
5. DPRK Safeguards Agreement, Arts. 72, 74.
6. DPRK Safeguards Agreement, Arts. 79, 80.
7. See Chap. 1, par. 3 and DPRK Safeguards Agreement, Arts. 8, 49, 63–68.
8. See the report by the IAEA Director-General to the IAEA General Conference, *Strengthening the Effectiveness and Improving the Efficiency of the Safeguards System*, GC(40)/17 (August 23, 1996), Annex II, pp. 5–7.
9. Report of the IAEA Director-General to the General Conference, *Strengthening the Effectiveness and Improving the Efficiency of the Safeguards System*, GC(40)/17 (August 23, 1996), Annex II, pp. 7–15.
10. Personal communication in August 2000 from James Larrimore, former IAEA safeguards expert. Rich Hooper, the IAEA official most closely associated with leading the development of the 93+2 revisions, believes these revisions should be used in the DPRK if the DPRK's consent to doing so can be obtained. Personal communication in September 2000.
11. Personal communication from James Larrimore, August 2000.
12. Henry Sokolsky, "Implementing the DPRK Nuclear Deal: What U.S. Law Requires," *Nonproliferation Review* (Fall–Winter, 2000), p. 149.

CURRENTLY APPLICABLE SAFEGUARDS AND RELATED AGREEMENTS

**THE KEDO REACTORS AND ASSOCIATED FACILITIES AND ACTIVITIES**

**3.1 Introduction**

This chapter includes a discussion regarding the location of the Korean Energy Development Organization (KEDO) reactors in the Democratic People’s Republic of Korea (DPRK, or North Korea) as well as the location of other nuclear-power plants along the shores of the East Sea. The discussion is limited to the large-sized, power-producing reactors that KEDO will provide to the DPRK under the terms of the Agreed Framework (AF). Further items discussed here are site-work progress to date, proposed shipments of nuclear fuel into and out of the reactor site, transmission of the generated electricity out of the site, and related Republic of Korea (ROK, or South Korea) energy-development issues. All of these issues bear on our main topic of safeguards and verification and what will be known under various circumstances.

The proposed power reactors to be built at the Kumho site are often referred to interchangeably as the KEDO reactors (for their provider organization), the Korean Standard Nuclear Plant (KSNP) reactors (for their model name), or the Kumho Pressurized-Water reactors (PWRs) for their general design category. We attempt to use these acronyms where they fit best, but we remind the reader that they refer to the same two PWR-type reactors to be built at Kumho under KEDO’s sponsorship based on the KSNP model. We remind the reader also that PWRs, as well as Boiling-Water Reactors (BWRs) are types of reactors within the general category of Light-Water Reactors (LWRs).

A description of the KSNP reactors (the portions relevant to the safeguards program), a discussion of the proposed safeguards measures, and possible additions to them are provided in Chapters 4 and 5. Other chapters address issues related to the smaller graphite-moderated reactors installed or under construction before the AF at Yongbyon and elsewhere.

**3.2 The KEDO Site**

The KEDO reactors will be built on the shores of the East Sea, sometime referred to as the Sea of Japan. (We will use the term East Sea to avoid the clash of perceptions as to the proper name for that sea.) The KEDO reactors will be located 30 kilometers (19 miles) north of the village of Sinpo about midway

along the DPRK’s East Sea coastline, a distance of slightly more than 160 kilometers (100 miles) from the ROK’s border to the south, and about 288 kilometers (180 miles) from the Russian border to the northeast. The nearest town to the site is Kumho, and we have chosen to refer to the site as the Kumho site so as to be consistent with other publications that also refer to the Kumho site.<sup>1</sup> The location of the Sinpo village is shown in Fig. 3-1. The Kumho site is located in a rural area away from the main population centers around the Pyongyang area to the west and around Congjin close to the Russian border to the north. The climate at the site is dry and cooler than in Pyongyang or Seoul, though the seaside location moderates the winter temperatures.



Figure 3-1. General map of the DPRK.

## The KEDO Reactors and Associated Facilities and Activities

The Kumho site had already been selected for three Russian 1,000-MW(e) VVER-1000 reactors and had been cleared as a prospective nuclear-power plant site. Russia (then the Soviet Union) had promised those reactors to the DPRK as a part of the international nuclear electrification program of the Comecon Organization and in the expectation of transmitting a part of the electric output to the Vladivostok area. In fact, two similar reactors (though of a more updated design) are now being constructed in the People Republic of China (PRC), in Tinwan, Jiangsu Province.<sup>2</sup> Early site work for the Russian reactors project in Kumho began in 1990 and ceased with the collapse of the Soviet Union and in face of the DPRK's apparent inability to pay the cost of this large project with its own resources. KEDO

has inherited the original Russian plant site as this was the only location in the DPRK that had been surveyed for the construction of a large civilian power plant.

There were several advantages for originally choosing the Kumho site as a prospective nuclear site:

- A seaside site that can use seawater for condenser cooling. The seaside location and availability of barge-docking facilities at Sinpo and on site permit the shipment of heavy equipment items as well as fresh and spent fuel, rather than relying on the dilapidated road and rail networks.
- Location in a low-density rural area, thus minimizing potential routine or accidental radiation exposure.

- A hard-rock site with adequate bedrock area at grade level, thus allowing the entire reactor building to be constructed above grade as the Russian design required.
- Mid-way location between the DPRK load center at the Pyongyang area and the Russian load center at Vladivostok.

On the other hand, the distance from the load centers requires the construction of high-voltage transmission lines to transmit the large amount of electricity generated on site to the ultimate consumers.

### 3.3 Nuclear-Power Development Along the Shores of the East Sea

The KEDO reactors at the Kumho site will join the large number of other nuclear facilities located along the shores of the East Sea. The four littoral states—the ROK, DPRK, Russia, and Japan—have turned the East Sea into one of the most heavily 'nuclearized' areas of the world.<sup>3</sup> The ROK and Japan have located several large plant clusters along the shores of the East Sea (Fig. 3-2). The ROK has located three of its four nuclear sites on the eastern part of the peninsula, starting with Kori—the first nuclear-power station of 2,940 MW(e) net capacity—extending to Wolsung, the Korean-Canadian CANDU reactors station of 2,800 MW(e) capacity, and to the Ulchin station with 3,900 MW(e) installed capacity that includes the first of the series of the standardized KSNP plants, two of which are planned for the KEDO site. Two KSNP reactors, each one similar in size to the KEDO station, are planned for the Kori and the Ulchin sites. Additionally, a new nuclear site will be opened up in Bonji I1, just north of the Wolsung station. That site could accommodate four KSNP

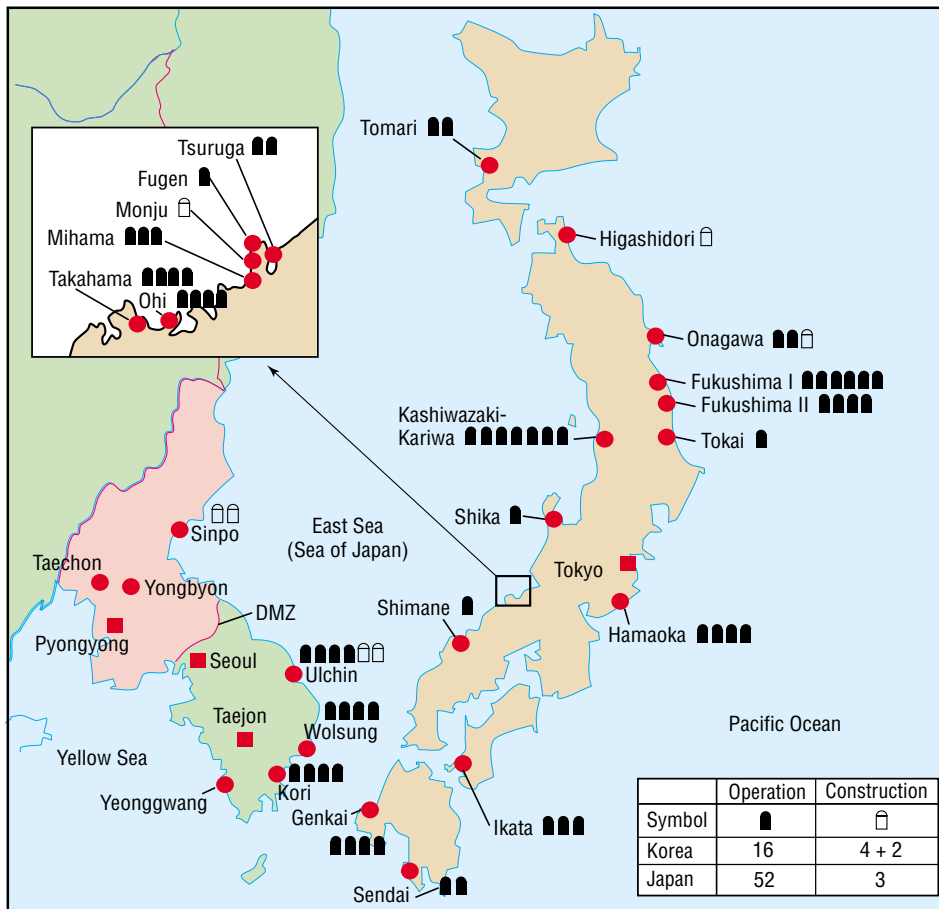

Figure 3-2. Locations of nuclear reactors around the East Sea.

reactors or four advanced CANDU reactors, and has been re-designated in early 2001 as a KSNP site.<sup>4,5</sup>

Should relations between the DPRK–ROK continue improving—and should the ROK’s nuclear program suffer from lack of nuclear sites, as discussed later—then it is possible to assume that additional ROK reactors will be built on DPRK sites, probably starting at the Kumho site, to generate power for transmission to the ROK. This will result eventually in additional nuclear stations located on the DPRK section of the East Sea coastline.

The Russian Navy has major nuclear facilities southeast of the Vladivostok area, including Chazhma Bay (nuclear submarine refueling and defueling), Bolshoy Kamen (defueling and dismantlement of nuclear submarines), and Pavlovsk Bay (operational submarine base), all on the shores of the East Sea. A large part of the nuclear-powered surface ships and submarines of Russian Navy’s Pacific Fleet are home-ported at these harbors. Naval facilities in this area include storage of spent fuel and low-level waste from Pacific Fleet ships and submarines. Spent-fuel and radioactive-waste storage sites are near Dunai on the Shkotovo Peninsula, and a floating liquid-radioactive-waste filtration plant (the Landysh) at Bolshoy Kamen. All these facilities need upgrading to Western radiation-exposure and emissions-control standards. The Russians have long-term plans for the construction of the Primorski Kray nuclear-power station north of Vladivostok, and discussions have been held since 1995 with both Russian and Canadian organizations to that purpose.

The extensive, peaceful nuclear-power program in Japan has resulted in a large number of nuclear sites located on the shores of the East Sea. Among the more important facilities, we should mention four. The

national fuel-cycle center in Rokkasho Mura, located at the northern tip of the main island of Honshu along the bay connecting the East Sea and the Pacific Ocean, includes a uranium-enrichment plant, a French-designed fuel-reprocessing plant of 800 tonnes per year capacity now under construction, a large-sized spent-fuel storage pool, and the prospective Higashidori nuclear-power plant site. The Kashiwazaki-Kariwa nuclear-power station, with five 1,100-MW(e) BWR-5 reactors and two 1,350-MW(e) advanced BWRs, is the largest nuclear station in the world with more than 8,000 MW(e) of installed capacity. The Japan Atomic Power Company (JAPCO) has new prototypes station in Tsuruga that includes, among others, the 150-MW(e) plutonium-burning Fugen Advanced Thermal Reactor (ATR) and the 250-MW(e) Monju experimental Liquid Metal Fast Breeder Reactor (LMFBR). And lastly, three PWR stations of the Kansai Electric Power Company are clustered at the Mihama, Takahama, and Ohi sites with a total installed net capacity exceeding 9,200 MW(e).

The profusion of nuclear-power stations and fuel-cycle facilities located on the shores of the East Sea, to which the KEDO reactors will be the latest addition, may well require the littoral states to reach agreements about regulating water effluents and air emissions from these facilities. Such agreements may well have to include provisions for emissions monitoring, effluent control standards and cross boundary pollutant damages, and third-party liability in cases of nuclear accidents. In fact, it may be to the advantage of these states to harmonize and improve their nuclear-insurance regulations to meet current standards, at least at the levels proposed by the International Atomic Energy Agency (IAEA). Implementing such measures will be essential for the well-being of the citizens of all the four states involved, if nuclear

power is to grow at the announced levels and provide the energy benefits promised.

### 3.4 Site Work to Date

KEDO initiated preliminary work at the Kumho site shortly after its inception. Major work at the site was initiated only after the signing of the Preliminary Works Contract (PWC) between KEDO and Korea Electric Power Corporation (KEPCO) in August 1997. The PWC has been incorporated into the main Turn Key Contract (TKC) between KEDO and KEPCO, signed in December 1999, and it is now included in the overall KEPCO scope for the KEDO reactors. The full value of the PWC site-related work scope is estimated at \$93 million, out of a total KEPCO work scope under the TKC, estimated at \$4,080 million. Information on the work progress to date can be obtained from the KEDO Annual Reports.<sup>6</sup> As part of its activities, KEDO has opened an office in Kumho to act as a consular office for staff from KEDO member countries without diplomatic relations with the DPRK, and to interact with the DPRK General Bureau (GB) for the LWR Project on project- and site-related issues. KEDO also cooperates with the DPRK regulatory authority—the State Nuclear Safety Regulatory Commission (SNSRC) on matters related to the safety evaluation of the KSNP reactors and to the training of nuclear-plant operators and maintenance crews.

Site activities to date have concentrated on three areas (**Fig. 3-3**), including the construction housing and warehouses area, the reactors site, and the process-water intake site, some 16 kilometers away from the reactors site.<sup>7</sup> KEDO has also interconnected all three sites with a road system considered among the best in that region of the DPRK. The housing area now includes facilities for several hundred construction

## The KEDO Reactors and Associated Facilities and Activities

workers and visitors. It includes medical, dining, banking, and recreational facilities. Construction and design offices were also built, as well as warehouses for the construction equipment and supply items. KEDO has also established independent supplies of reliable electricity, potable water, communications system, and constructed environmental monitoring facilities and a sanitary-waste treatment facility.

A site view<sup>7</sup> of the future KEDO reactors is shown in Fig. 3-4. In terms of work to date, KEPSCO under the PWC has concentrated on site-grading and removing a large hill from the area where the reactors are to be constructed. The scope of the grading effort is graphically depicted in Fig. 3-5 where the dimensions of the graded area are shown in relation to the size of the future KSNPs.<sup>7</sup> In total, about 4 million cubic meters of rock and soil have been removed down to the bedrock. The exposed bedrock at grade level now forms the 'platform' over which the base mats for the two reactor plants will be laid. The excavated rock materials are used to create the cooling-water intake and discharge structures, and to build the breakwater for the docking harbor on site, which will be used to barge-transport heavy equipment items to the construction site.

With the signing of the major TKC, the direct responsibility for the KSNP reactor construction has devolved to KEPSCO as the KEDO General Contractor. KEDO itself continues to negotiate with the DPRK authorities various other contracts that will govern the construction work and the reactors' commissioning and operations phases. A Memorandum of Understanding was signed with the DPRK on September 1999 regarding environmental protection and indemnification. An Operators' Training Protocol was completed on April 2000 and is

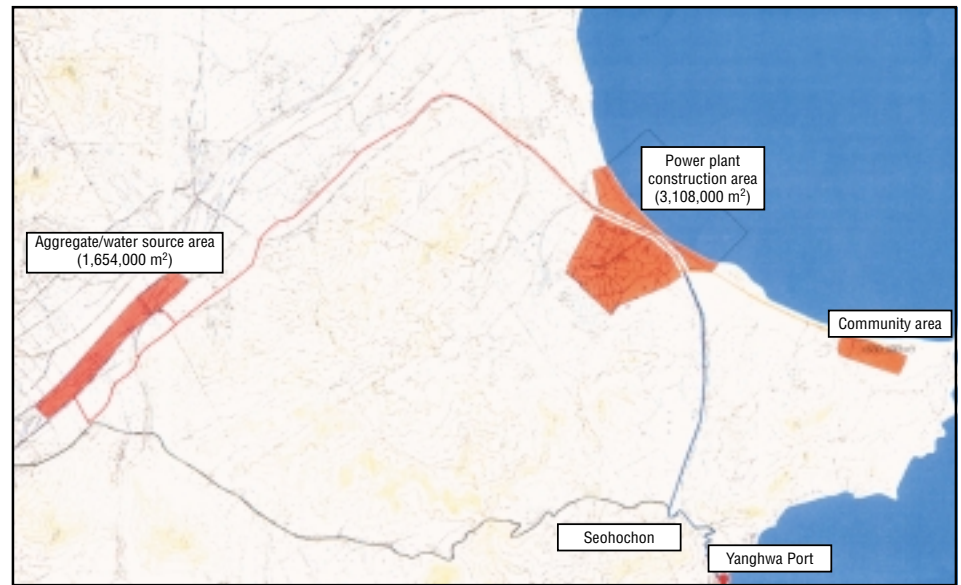

Figure 3-3. The vicinity of the Light-Water Reactor (LWR) project.

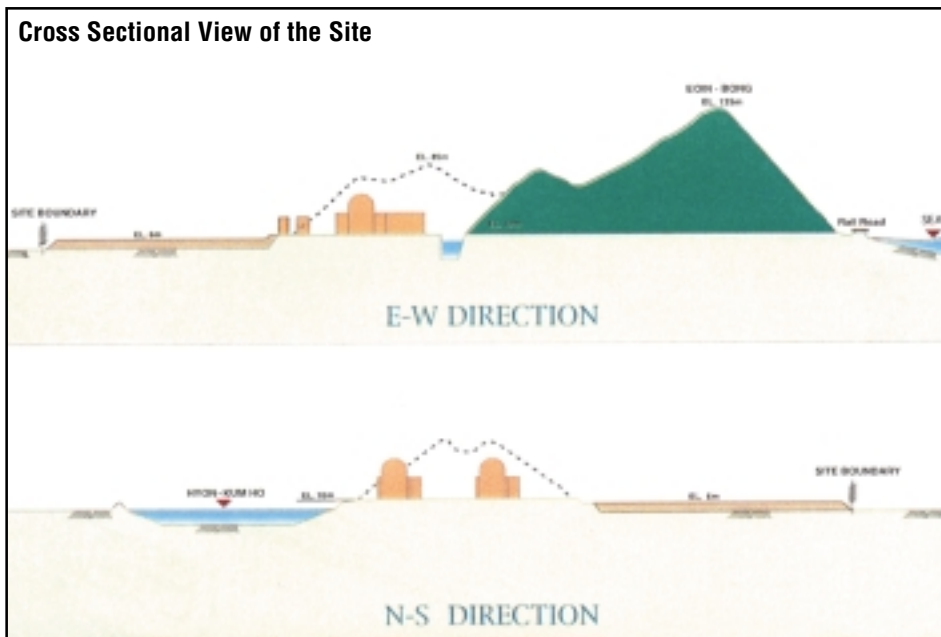
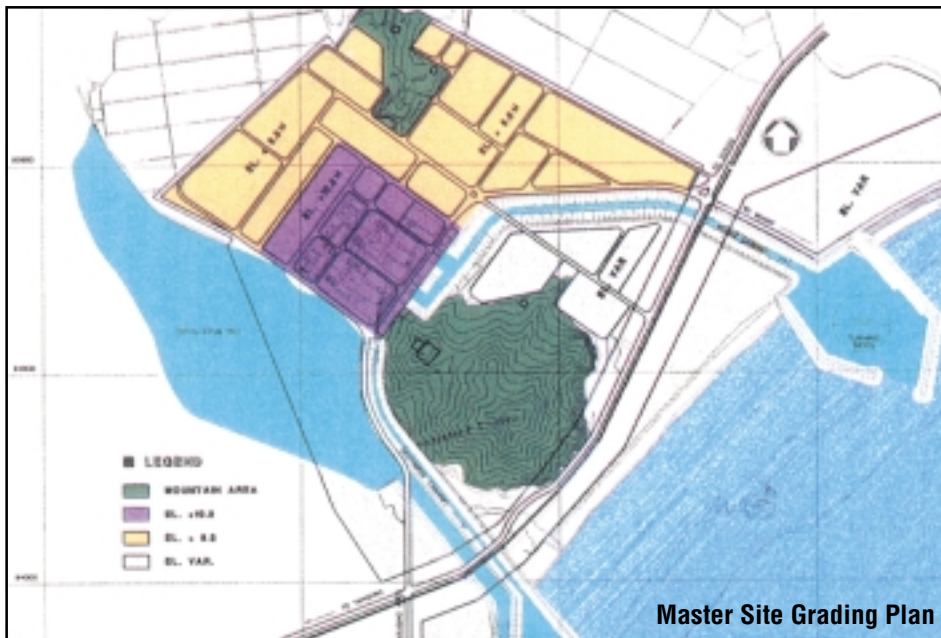

Figure 3-4. Artist's conception of the future site for the KEDO reactors. From a KEPSCO-KEDO brochure supplied by J. Mulligan, KEDO, June 2000.

signed. Substantial progress was achieved by July 2000 on a Protocol dealing with Quality Assurance and LWR Equipment Warranties. KEDO has negotiated with the IAEA to conduct a Standard Design Safety Review of the proposed Kumho reactors by mid-

2001. KEDO is discussing with the DPRK the strengthening of its regulatory agency—the SNSRC. As a part of its extensive safety-related discussions with the DPRK, KEDO has transferred to the DPRK copies of the ROK regulatory agencies' Safety Review Guidelines, the ROK





**Master Site Grading Plan**

- Power Block Area
  - Graded elevation: EL 10.0 m (above MSL)
  - Graded area: about 220,000 m<sup>2</sup>
- Temporary Facilities Area
  - Graded elevation: EL 6.0 m (above MSL)
  - Graded area: about 780,000 m<sup>2</sup>
- Total Volume/Area
  - About 6,000,000 m<sup>3</sup>/1,000,000 m<sup>2</sup>

Figure 3-5. Scope of the grading efforts in the construction area (according to a KEDO brochure).

Atomic Energy Act and Enforcement Decrees, and a number of codes and standards adopted in the ROK's nuclear energy program. KEDO has also conducted detailed discussions and seminars with the DPRK SNSRC and GB regarding the application and implementation of those documents. A Preliminary Safety Analysis Report (PSAR) for the KEDO reactors has been submitted to the DPRK regulatory agency as a part of the application for a construction permit.

**3.5 Nuclear-Fuel Shipments Into and Out of the Site**

Fresh nuclear fuel to the KEDO reactors and spent nuclear fuel discharged from the reactors will be shipped in and out of the Kumho site by barge to the ROK because road and rail links between the DPRK and the ROK have not yet been established. A trial opening of the Seoul–Pyongyang rail line occurred in October 2000; however, commercial rail service between the two countries is speculative. Furthermore, the status of road and rail overpasses, underpasses, and junctions that need to be traversed, as well as the general condition of the transportation routes may not allow bulky, overweight spent-fuel (and even the lighter fresh fuel) transporters. A heavy spent-fuel-cask rail car may weigh about 100 tons. It is not clear that the DPRK rail network could safely carry cars of this weight. Should a transportation accident happen due to the inadequate maintenance of the road or rail links and various junctions along the routes, the accident consequences may be severe, and the fuel insurers may not even allow such transportation.

From a non-proliferation perspective, once spent fuel is moved out of the Kumho site, the shorter the time period as it moves through DPRK territory, the less chance for attempted fuel diversion, or for delaying the spent-fuel

## The KEDO Reactors and Associated Facilities and Activities

transport and using it as a bargaining chip in some future negotiations. From all the perspectives mentioned above, moving the fuel in and out of the Kumho site by barge is the feasible and desirable transportation mode.

As discussed in Chapter 4, each of the two KSNP reactors on site at Kumho will be refueled every 15 months, as is the practice with all the other KSNP reactors operated by KEPCO. In general, it is KEDO's intention, as much as possible, to build the Kumho reactors like all other KSNP reactors operated in the ROK. This issue is discussed next.

A typical KSNP reactor requires 60 new assemblies of fresh fuel loaded into the core every 15 months. In parallel, 60 assemblies of spent fuel are discharged from the reactor and stored in the spent fuel storage pool, located in the fuel building adjacent to the reactor containment building. Each assembly weighs slightly more than half a ton (1,000 pounds). A fresh fuel load then weighs less than 35 tons. The fresh-fuel assemblies are only slightly radioactive and can be handled by hand, with most of the alpha activity of the low-enriched uranium (LEU) being contained in the zirconium oxide-clad material. Thus, the fresh fuel shipment into the Kumho site does not pose any transportation difficulties and can be carried out by two commercial trucks.

It is likely, though not yet established, that the DPRK will purchase its natural uranium in the world markets and ship it to one of the major uranium enrichment vendors, such as the United States Enrichment Corporation (USEC), for enrichment. The LEU produced by USEC will be converted to uranium oxide in the US and then shipped to the ROK's fuel-fabrication plant, operated by KEPCO Nuclear Fuel Company (KNFC) in

Taejon (see Fig. 3-2). KNFC fabricates all the fuel assemblies for the nuclear plants in Taejon, and it will likely fabricate the fuel assemblies for the KEDO reactors just as it fabricates fuel assemblies for all other KSNP reactors. From Taejon, the fabricated fuel assemblies will be trucked onto a barge docked in the designated ROK harbor and the barge will carry the nuclear-fuel shipment to the Kumho barge harbor, whence the fresh fuel will be tracked to the reactor fuel buildings. The DPRK operator will take custody of the fresh fuel at the barge-docking facility and move it to the fuel-storage facility in the plant.

Unlike the fresh-fuel-shipment process, which is quite straightforward, the issue of spent-fuel shipment is more complicated. Spent fuel discharged from the reactor is highly radioactive. Current industry practices call for keeping the spent-fuel assemblies in the spent fuel storage pool in the fuel building on site until their residual radioactivity has been sufficiently reduced through the natural decay of the short-lived fission products before shipping the assemblies in a heavily shielded container. Usually, spent fuel is kept in wet storage on site for at least ten years. Most spent fuel storage pools can be further re-racked and equipped with neutron absorber plates to increase their storage capacity to more than 20 years' worth of discharge, while avoiding potential nuclear criticality accidents. Under these conditions, and assuming the KEDO reactors reach commercial operation in 2008, it may not be necessary to ship spent fuel out of the Kumho site prior to 2020, unless so required by non-proliferation considerations or by special contract conditions. It is more likely that with proper standardized re-racking measures, the KEDO reactors' spent fuel will not have to be moved out of the storage pools in the reactor's fuel buildings prior to 2030.

At this point, KEPCO has not yet developed its long-range, spent-fuel management plan for its KSNP reactors. KEPCO may well decide to keep all old spent KSNP fuel discharge in concrete dry-storage casks at each site, rather than remove the spent fuel to a central storage facility. At this time, no ROK-centralized, away-from-reactor, spent-fuel storage facility has been developed and built by KEPCO. Thus, the DPRK authorities may well decide, all other things being equal, to keep the KEDO reactors' old discharged fuel in the spent fuel pools in the reactor buildings and then in dry storage casks on site at Kumho, until KEPCO's spent-fuel disposal plans are firmed, assuming the spent fuel will be disposed of in the ROK. Alternately, if by mutual agreement between the DPRK and other countries involved, the spent fuel is to be removed from the Kumho site as quickly as feasible, a storage facility in the ROK or a third country has to be so designated, and, assuming it is a new storage site, that facility has to be designed, licensed, and built. That process may require 20 years or more due to potential public opposition to storing spent fuel from a different country. If the KEDO reactors' fuel is shipped to an existing storage facility, e.g., in the UK, France, or the PRC, high storage fees may be imposed, assuming the spent fuel will not be reprocessed. Thus, the fate of the KEDO reactors' spent fuel is yet quite uncertain, though adequate time remains before the spent-fuel storage pools on site run out of storage capacity.

Once a decision is made to remove the spent fuel from the Kumho site, it is necessary to bring a heavily shielded storage cask to the site. Such a cask, depending on the number of spent fuel assemblies it carries, can weigh up to 100 tons and is usually rail-mounted. The cask has to be barge-shipped into the site and then

moved by rail from the barge harbor on site to the fuel building at each reactor. The spent fuel is loaded into the cask in a special section of the spent fuel pool inside the reactor building (discussed in Chapter 4). The loaded and sealed cask is then lowered into its rail carriage and moved into the barge, which carries it to its destination in the ROK or beyond. There, the spent fuel is removed and the cask readied for another shipment. The logistics and the financial arrangement for spent-fuel disposition have not yet been made.

### 3.6 Electricity Transmission Issues

As important as the fuel shipment into the site is the issue of electricity transmission out of the site. The US Energy Information Administration estimates the total electricity-generating capacity of the DPRK by January 1998 as 10,000 MW(e),<sup>8</sup> with a total generation in 1998 of 32.0 billion KWh. Hydroelectric plants provide 50 percent of the installed capacity and 70 percent of generation nation-wide, and the rest is provided by a mix of coal- and oil-fired thermal power plants. Peter Hayes of the Nautilus Institute<sup>9</sup> provides a similar estimate for total installed capacity—9.75 GWe. According to Hayes, the DPRK energy crisis of 1996 resulted in only 2-3 GWe of installed capacity in operation by the year 2000 due to the lack of commercial fuel, cancellation of subsidized oil supply from Russia, and drought seasons. Total generation by 2000 is estimated at only 15.0 billion KWh. The KEDO reactors will inject a 2,000-MW(e) capacity increment into the DPRK's power grid, with each reactor generating about 7.0 billion KWh per year (assuming annual operation at 80 percent capacity). Evidently, the KEDO project will become a major generating center in the DPRK, providing about a third of all generation from the Kumho site by 2010,

when both reactors reach commercial operation. In fact, the total generation from both reactors by 2010 will nearly equal the total commercial electricity generation in the DPRK in 2000.<sup>9</sup> Hayes' low estimate of the DPRK total generation may itself be an overestimation. It was reported in December 2000 that the DPRK has demanded direct electricity supply from the ROK as a pre-condition to a continued North-South dialog.<sup>10</sup> This would indicate that available fuel stockpiles at the DPRK's power plants are lower than expected. The DPRK may barely be able to provide on its own even its most essential power supplies. This situation, while increasing the leverage of the US and the ROK in dealing with the DPRK, will also create several problems, the four most important ones being the disposition of the generated electricity, network stability, reliability of power transmission, and the supply of high-quality power in-house.

The electricity generation from the KEDO reactors beyond 2010 will likely significantly exceed the total demand of the DPRK, assuming other existing generating plants are brought again into commercial operation once economic recovery is underway. Eventually, the DPRK will have to earn hard currency to pay its obligations to the KEDO participants, principally the ROK and Japan, and return at least a portion of their investments in the Kumho reactors, and to provide a cash-flow stream to support plant operations and maintenance. Both supply-and-demand considerations, as well as hard-currency requirements, imply that a large portion of the generated power will have to be dedicated for exports out of the DPRK. The only nearby countries that can take the KEDO reactors output are the ROK, the PRC, or Russia, though an underwater cable in the East Sea that connects the KEDO reactors to Japan is being considered.

Of these three, Russia is in most immediate need for power import due to severe energy shortage in the Vladivostok and the Primorsk regions. Russia may, however, lack the hard currency required for such energy export. Furthermore, the transmission links from the Kumho site to the Russian border are the longest, thus requiring more investments in rebuilding and upgrading the DPRK transmission network. Nearer-term interconnections may include ROK-DPRK, PRC-DPRK or ROK-DPRK-PRC links.

Shipping the KEDO reactors' power to market via the ROK-DPRK transmission link has been costed and is the most technically feasible and potentially near-term option. Even now there exist limited diurnal and seasonal electricity interchanges between the ROK and the DPRK. Transmitting the KEDO reactors output to the ROK would expand the existing ad hoc arrangements several-fold. Given the high-growth rate of electric demand in the ROK—now that the country's economy is emerging from the 1998 financial crisis—having access to the KEDO reactors will defer a new power-plant project by several years, which will be beneficial considering the paucity of new plant sites available in the ROK. The DPRK will benefit from the energy payments received. KEPCO has by now evaluated the feasibility and the cost of creating such transmission interlinks and will most likely be ready to implement such a project once international financing is available and the political approvals are obtained. The main problem with this concept is the political dimension. Connecting the ROK and the DPRK transmission networks will require integrated operation of both networks, most likely under the technical control of the more advanced ROK side. This dependency on uninterrupted transmission flows could lead to a loss of political freedom of action

unacceptable to the DPRK leadership. Thus, technical and political feasibility considerations seem to operate in different directions as related to the large-scale ROK–DPRK transmission link. In December 2000, the DPRK requested electricity supplies from the ROK. Should this prove politically and technologically feasible, it will resolve part of the problems involved in eventually transmitting electricity from the KEDO reactors out of the DPRK.

Another option would be to connect the KEDO reactors to the PRC's Northeast Power Network. Such an arrangement would bring additional power supply to the fast-expanding PRC energy market and would defer the need to construct new, mainly coal-fired plants in the northeastern provinces by several years. Deferring additional coal-fired capacity would reduce regional air pollution and may qualify the PRC for carbon-emissions reduction credits under the Clean Development Mechanism of the Kyoto Protocol. The major problem with the DPRK–PRC transmission link is the longer transmission lines required from the Kumho site to the Chinese border—500 kilometers as compared with the transmission lines from the site to the ROK—about 200 kilometers.<sup>9</sup>

A more stable, long-term solution might be a three-party transmission interlink connecting the ROK network to the DPRK network at the Kumho site and then further connecting to the PRC's Northeast Power Network. Such an arrangement could benefit all three parties, but connecting the currently decrepit DPRK transmission network to another country, let alone integrating it to two different networks, would be difficult. Before discussing regional transmission schemes, it is necessary to consider some of the practical concerns related to integrating the KEDO reactors into the DPRK's transmission network. These

concerns relate to the stability of the existing DPRK transmission grid, the hurdles of interconnection to other grids, and the interaction of the grid with the KEDO reactors.

Network stability problems occur when a large-capacity generation plant or load center appears in the transmission network, thus creating a large electricity source in the network, which if lost due to a technical problem, may result in high electric currents in the grid that may exceed its carrying capacity. As a general rule, a single generation node should not exceed 7 to 10 percent of the total system generation for stability and reliability. Because the KEDO generating plant will exceed the limits of this network stability–reliability rule, it will be necessary to transmit power out of the site through several high-voltage transmission lines that overlay the current lower voltage transmission system and interconnect to it at several different nodes through step-down transformers. Furthermore, because the DPRK's total generating capacity once the KEDO reactors are in operation will exceed demand for years to come, it may be necessary to back down (or, in fact, defer restarting) some of the existing fossil thermal plants to make room for the newer, more efficient, and more cost-effective nuclear plants.

Nuclear plants are generally designed to operate at base load and are not well optimized to meet a fluctuating load. Thus, the DPRK's electric system planners may choose to utilize their hydroelectric plants at full capacity during the good hydro months and their nuclear plants as base load units. However, some of the thermal plants cannot shut down due to local network stability problems in sections of the transmission network. The DPRK's system planners will have an intricate job of balancing the transmission network and

assuring its stability after introducing the large-sized KEDO reactors into their national grid. While these issues can be resolved using advanced electrical engineering equipment and software tools, these are not the problems that the DPRK planners have encountered to date, and they may face many new challenges, including some possible reactor-safety issues. In this context, it is noteworthy that in early 2001, several large European engineering companies such as Asea Braun Boveri Group (ABB) of Switzerland and Siemens AG of Germany expressed interest in supplying electric transmission and distribution equipment to the DPRK in order to upgrade the entire country transmission grid.<sup>11</sup> These initiatives were launched at the behest of the European Union, which is interested in upgrading its involvement in resolving the Korean Peninsula dispute. It is not clear, however, who will pay for these grid upgrades, and how will the DPRK earn the hard currency to pay for the new electric transmission equipment.

As noted, the high-voltage (345 kV or 500 kV) transmission lines out of the Kumho site will form a separate network that will overlay the existing mainly 220-kV transmission grid and interconnect with it near load centers. The DPRK's electric planners favor the 500-kV lines, while the backbone of the much larger ROK transmission grid is the 345-kV high-voltage lines. Assuming each line from the site carries the electrical output of one KSNP reactor, then at least two high-voltage lines have to be constructed. From reliability and redundancy perspectives, three lines will take care of potential outages in either of the two other high-voltage lines or their step-up and step-down transformers. The three lines option is more expensive than the two lines option, both in terms of direct investments, right-of-way requirements, and line maintenance expenses, though

it avoids the need for using other, less optimal reliability measures.

The DPRK does not have the resources to finance construction of these high-voltage lines. Financing has to be provided by international lending institutions or from contributions by third parties. Extending the high-voltage transmission lines to the ROK or PRC grids, as discussed above, could bring in the hard currency required to pay for the transmission lines, as well to pay back the investment costs in the reactors, which the DPRK is obligated to do.

Another problem affecting the integration of the KEDO reactors into the DPRK grid as well as any interconnection with the ROK or the PRC grids is that the DPRK network operates at an effective frequency of 50 Hz, whereas both the ROK and PRC networks operate at 60 Hz. The Kumho area transmission network operates at a 60-Hz frequency, while other regions of the DPRK's grid operate at 50 Hz. The KEDO reactors, being similar to other ROK KSNP reactors, are designed to operate at 60 Hz. In addition, both voltage and frequency on the DPRK grid fluctuate around the nominal values at wider amplitudes than are acceptable from stability considerations in the more modern and mature ROK and PRC grids. At the interlink points, it may be required to install AC–DC–AC converters to eliminate voltage and frequency fluctuations in the DPRK grid. Similar measures may be needed when providing in-house power from the DPRK grid to the KEDO reactors. While these problems can be resolved by standard electric transmission equipment, these will increase the cost of the entire AF project. These difficulties could be relevant to the question whether

“reactor completion” means the point in time when the reactors can generate as per the KEDO Supply Agreement, or whether the completion date is the time when the plant's electric output reaches the ultimate consumers.

The cost and completion date issues become particularly pointed when the need for the KEDO reactors to receive external power from the grid is considered. The two KEDO reactors consume in-house about 60 MW(e) per unit, or a total of 120 MW(e). This load is required to operate the four large primary coolant pumps in each reactor, the feedwater pumps, and all other lighting, air conditioning, and various equipment. The in-house power supply needs to be high quality and stable so as not to interrupt, slow down, or shut down any continuously operated, electrically driven equipment. If, due to grid problems unrelated to the reactors, the network voltage or frequency sags below pre-determined safety margins, some electrical apparatus may need to be shut down. This could start a sequence of events leading to a full-plant shutdown, further exacerbating the initial grid problem. In the extreme, disruption of off-site power could, if no other countermeasures are available, lead to various nuclear accident chains. In the more likely event, a prompt shutdown of a reactor due to inadequate off-site power supply could lead to a major electric grid operations disruption, and, in the extreme, to a large-scale network collapse.

It is evident that just as the new plant affects grid operations and stability, so does grid stability affect the operation of the new plant. The DPRK has agreed to provide 220-kV commissioning power from the DPRK's 220-kV network. Maintaining the required

high quality of the external power supply (minimizing voltage and frequency fluctuations) is the challenge here. Should external power within the acceptable voltage and frequency ranges not be provided, KEDO may hypothetically have to install its own power supply on site in the form of a gas turbine, additional emergency diesel generators, or solid-state rectifiers, or AC–DC–AC converters to improve the shape and quality of the grid-supplied power. It is not clear that these options will be acceptable to the safety regulator. All these options would further increase the cost of the project and might delay completion date, with associated verification consequences. KEDO, however, will not ship nuclear fuel to the Kumho site unless acceptable sources of off-site power are established.

### 3.7 The ROK's Energy Development Issues

The KEDO project is of value to the ROK for obvious non-proliferation and political considerations, discussed elsewhere in this report. Additional energy development issues, however, provide the ROK with further justification for the project. These issues are briefly reviewed here because they could affect judgments regarding timing and verification issues.

First, the ROK is embarked on a significant nuclear-power expansion program, but there are not enough sites available in the ROK in which to build the proposed number of nuclear power plants. **Table 3-1**<sup>12</sup> includes a list of potential new ROK plants, several of which do not yet have a site designation.\* It may make sense, with the general warming of relations between the ROK and the DPRK, and as a part of a long-term plan

\* The KSNP program now extends over the Yeonggwang 3 and 4 plants—the pre-series, Ulchin 3 and 4 plants—the reference units, Yeonggwang 5 and 6, Ulchin 5 and 6, the New (Shin)-Kori 1 and 2, and the KEDO reactors. Further nuclear-plant construction in the ROK may be based on the newer Korea Next-Generation Reactor plants for which no sites have yet been designated. While two (or four) more units may ultimately be built in the New Kori site, and the New (Shin)-Wolsung site may contain four new KSNP or KNGR-type reactors, no other nuclear sites have been dedicated in the ROK.

## The KEDO Reactors and Associated Facilities and Activities

Table 3-1. Status of nuclear power plants in South Korea (l = in operation, w = under construction, m = in planning).

Plant	Unit	Rx.Type	Capacity (Mwe)	Reactor	Manufacture TG	Commercial Operation	Remarks
Kori	Unit 1	PWR	587	WH	GEC	1978.4	● Turnkey
Kori	Unit 2	PWR	650	WH	GEC	1983.7	● Turnkey
Kori	Unit 3	PWR	950	WH	GEC	1985.9	● Non-Turnkey
Kori	Unit 4	PWR	950	WH	GEC	1986.4	● Non-Turnkey
Yeonggwang	Unit 1	PWR	950	WH	WH	1986.8	● Non-Turnkey
Yeonggwang	Unit 2	PWR	950	WH	WH	1987.6	● Non-Turnkey
Yeonggwang	Unit 3	PWR	1,000	KHIC/CE	KHIC/GE	1995.3	● Non-Turnkey
Yeonggwang	Unit 4	PWR	1,000	KHIC/CE	KHIC/GE	1996.1	● Non-Turnkey
Yeonggwang	Unit 5	PWR	1,000	KHIC/CE	KHIC/GE	2001.6	▶ Non-Turnkey
Yeonggwang	Unit 6	PWR	1,000	KHIC/CE	KHIC/GE	2002.6	▶ Non-Turnkey
Ulchin	Unit 1	PWR	950	Framatome	Alstome	1988.9	● Non-Turnkey
Ulchin	Unit 2	PWR	950	Framatome	Alstome	1989.9	● Non-Turnkey
Ulchin	Unit 3	PWR	1,000	KHIC/CE	KHIC/GE	1998.6	▶ Non-Turnkey
Ulchin	Unit 4	PWR	1,000	KHIC/CE	KHIC/GE	1999.6	▶ Non-Turnkey
Wolsung	Unit 1	PHWR	678.7	AECL	NEI/Parsons	1983.4	● Turnkey
Wolsung	Unit 2	PHWR	700	AECL/CE	KHIC/GE	1997.6	▶ Non-Turnkey
Wolsung	Unit 3	PHWR	700	AECL/CE	KHIC/GE	1998.6	▶ Non-Turnkey
Wolsung	Unit 4	PHWR	700	AECL/CE	KHIC/GE	1999.6	▶ Non-Turnkey
New	Unit 1	PWR	1,000	Unspecified	Unspecified	2003.6	○
New	Unit 2	PWR	1,000	Unspecified	Unspecified	2004.6	○
New	Unit 3	PWR	1,000	Unspecified	Unspecified	2005.6	○
New	Unit 4	PWR	1,000	Unspecified	Unspecified	2006.6	○
New	Unit 5	PHWR	700	Unspecified	Unspecified	2006.3	○

to interconnect the infrastructures of the two countries, for the ROK to build some of its future nuclear plants in the DPRK, ship some of the power south, and use the electricity sales revenues to pay the construction costs in the DPRK sites. Should such a program materialize, the KEDO project would be the first of its kind, with other similar projects (built under bilateral ROK–DPRK agreements) to follow. The creation of the special ROK–DPRK currency-clearing mechanism, which applies to financial settling of bilateral transactions between the two countries only, may ease inter-Korean joint projects, so long as all payments are ultimately guaranteed by the ROK. Such a construction program of ROK reactors in DPRK sites would further increase the number

of nuclear facilities located on the East Sea, as discussed previously.

Second, KEPCO is embarked on large-scale, nuclear-plant standardization programs, starting with the KSNP program and extending to the 1,300-MW(e) Korea Next-Generation Reactor, now in the design and licensing stages. KEPCO would like each of its nuclear plants built in the DPRK to be identical to its existing plants in the ROK, save for minimal site-specific modifications. A standardization program would ease the licensing burden on the regulatory agencies, reduce plant capital cost, simplify operations maintenance and refueling procedures, and reduce the annual electricity production costs. In this context, the General Electric Company (GE) decision not to

allow the KEDO project to use GE-designed turbines, as they were used in all other ROK KSNP reactors, could deal a blow to the KEPCO standardization program in its first application beyond the ROK borders. GE is concerned with the lack of adequate regulation governing third-party nuclear liability issues in the DPRK, as discussed in Chapter 2. Because these issues were not resolved, KEDO is now negotiating with the ROK turbine manufacturer, Hanjung, and with a consortium of the Japanese electrical-equipment vendors, Toshiba and Hitachi, to provide the turbine generators for the KEDO reactors, thus making them somewhat different from all other ROK-located KSNP reactors that use the GE turbine, manufactured by Hanjung under license in the ROK.

Hanjung (Korea Heavy Industries and Construction) is the design and manufacturing contractor for the Nuclear Steam Supply System and the Turbine Generator (TG). Because GE prohibits Hanjung from using its technology for the KEDO TGs, Hanjung will need to license new TG technology from another vendor, e.g., the Japanese manufacturers Toshiba or Hitachi. Both Toshiba and Hitachi design and build TGs for GE-designed BWRs built under license in Japan. While Toshiba and Hitachi have close working relations with GE and are licensors of GE technologies, they have not built PWR-type TGs that operate at different pressure and temperatures than BWR turbines. Should the TG technology finally chosen for the KEDO reactors be different from that used for other KSNP plants, this will cause significant changes in the Balance of Plant (BOP) design. These may include redoing the entire BOP heat balance, sizing up of equipment items, and changing the dimensions and the design of the TG building. The changes required in the BOP may delay completion of the entire KEDO Project and cause further delays in meeting some of the DPRK's non-proliferation obligations, tied to the reactors' completion dates.

KEPCO has targeted various East Asia nuclear markets, particularly the PRC as potential opportunities to export the standardized KSNPs. The KEDO project is perceived by KEPCO to be the first example of building standardized KSNPs outside the DPRK, thus serving as a reference plant for future third-party sales. Should different turbines be used in the KEDO reactors, as compared with the ROK KSNPs, the value of the KEDO project as a demonstration or reference plant for further potential exports, as well as serving as a lead project for other KSNPs to be built in the DPRK, would diminish.

### Notes to Chapter 3

1. David Albright and Kevin O'Neill, eds., *Solving the North Korean Nuclear Puzzle* (Institute of Science and International Security, Washington D.C., 2000).
2. A. Nechaev and S. Onufrienko, "Full Speed Ahead for China's First VVER-1000s Modern Power Systems," *Atomenergoprojekt*, February 2000, pp. 41–43.
3. Byung-Koo Kim, Director, Technology Center for Nuclear Control, Korea Atomic Energy Research Institute (KAERI), "KEDO LWR Project for International Cooperation and Nonproliferation," Presentation at the Monterey Institute for International Studies, Monterey, California, July 24, 2000.
4. Nuclear Engineering International, *1997 World Nuclear Industry Handbook* (Wilmington Business Publishing, Ruislip, United Kingdom, 1997).
5. Central Research Institute of Electric Power industry (CRIEPI), *Nuclear Power Stations in Japan 1995*, Tokyo, Japan, 1995.
6. Korean Peninsula Energy Development Organization, *KEDO at Five—Annual Report 1999/2000*, New York, NY, September 2000.
7. J.B. Mulligan, Director for Project Operations, KEDO, personal communication, New York, NY, September 2000.
8. Lowell Feld, US Energy Information Administration, *North Korea Country Analysis Brief*, Washington, D.C., June 21, 2000.
9. Peter Hayes, Nautilus Institute for Security and Sustainable Development, "DPRK Energy Dilemmas and Regional Security," Presentation to the Asia/Pacific Research Center, Stanford University, Stanford, California, October 10, 2000.
10. Ji-Ho Kim, "Minister Denies 'Backstage Accord' on Power Supply to North Korea," *The Korea Herald*, "Seoul, Korea, December 21, 2000.
11. Jay Solomon, "Europe Engineers Wait for U.S. Move to Offer Energy Help to North Korea," *The Wall Street Journal*, March 21, 2001.
12. Korea Electric Power Corporation, *Korean Standard Nuclear Power Plant (KSNP)*, Seoul, Korea, 1996.

## The KEDO Reactors and Associated Facilities and Activities



# CHAPTER 4

## SAFEGUARDS ON THE KEDO REACTORS

### 4.1 Introduction

This chapter begins with a description of the Korean Standard Nuclear Plant (KSNP) reactors deployed in the Republic of Korea (ROK) and proposed for the Korean Energy Development Organization (KEDO) project at the Kumho site in the Democratic People's Republic of Korea (DPRK). The parts of the reactor plant relevant to the safeguards program are presented so as to provide the proper context for the safeguards discussion that follows. Most of this chapter describes in detail the International Atomic Energy Agency (IAEA) safeguards program as applied to a KSNP-type of nuclear-power plant. In this discussion, we assume that the safeguards program now applied to the ROK's nuclear plants will equally apply (at the least) to similar reactors in the DPRK. The description of the safeguards program stresses both the accounting process and the measurement process during normal operation and during refueling outages. We conclude the chapter with a discussion of additional measurements and inspections possible under the IAEA safeguards agreement now in force with the DPRK, together with a brief assessment of other verification measures.

### 4.2 Project Organization To Supply the KEDO Reactors

Figure 4-1 is an organization chart for the supply of a standard KSNP reactor in the ROK.<sup>1</sup> This figure depicts the contractors' organization assembled to supply a KSNP reactor in the ROK. Since the signing of the Turn Key Contract between KEDO and Korean Electric Power

Corporation (KEPCO) in December 1999, this organization chart applies equally to the KEDO reactors' project with the following modifications:

1. KEPCO, who does not own the KEDO reactors, has assumed the role of the general contractor for the Kumho Site Nuclear Project, with KEDO being the overall owner for whom KEPCO manages the project. This arrangement is different from all other KSNP projects where KEPCO is both the owner and the general contractor.
2. KOPEC-A/E (Korea Power Engineering Company) has assumed sole Architect/Engineering (A/E) responsibility for the KEDO reactors subcontracting to KEPCO and has canceled its

consulting contract with the US firm of Sargent & Lundy (S&L). S&L was the original non-Korean A/E of Yeonggwang 3 and 4 (the pre-KSNP plants) and (in a reduced capacity) the remainder of the KSNP reactors. KOPEC has carried increasing A/E responsibilities in the ROK's KSNP plants.

3. Hanjung (Korea Heavy Industries and Construction) remains the design and manufacturing contractor for the Nuclear Steam Supply System (NSSS) and the Turbine Generator (TG). However, the TG to be used in the KEDO reactors will not be based (under license) on the General Electric (GE) turbines like the rest of the KSNP plants because GE did not obtain the measures of relief it sought from nuclear liability.

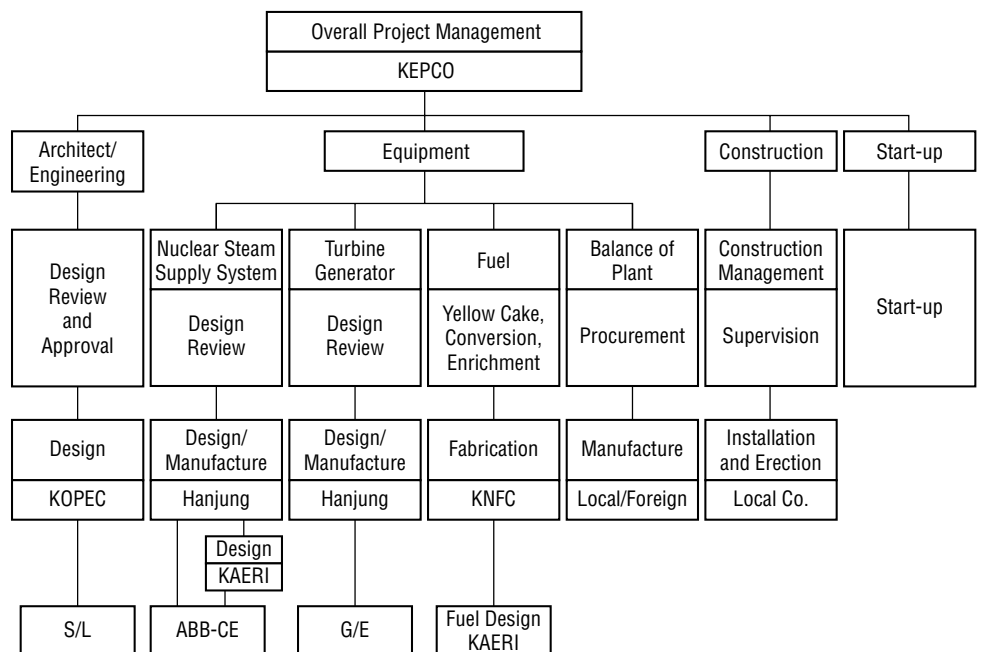

Figure 4-1. Organization chart for the supply of a Korean Standard Nuclear Plant (KSNP) reactor. KOPEC stands for Korea Power Engineering Company. KNFC stands for Korean Nuclear Fuel Corporation.

4. The Korean Atomic Energy Research Institute's (KAERI) responsibilities for system design have been transferred to the systems design department of KOPEC (KOPEC-SD).

### 4.3 Description of the KEDO Reactors

The KEDO reactors are the KSNP design, a modification and scale-down of the System 80 design of Combustion Engineering Company (formerly ABB/CE, now Westinghouse Electric Corporation, a unit of British Nuclear Fuel Ltd.). The System 80 design, in turn, is based on an improved design of the 1,300-MW(e) reactors built in the Palo Verde plant in Arizona. KEPCO has built two plants of the System 80 design—the Yeonggwang 3 and 4 units. This design was enhanced by KEPCO, adjusted to Korean conditions, and renamed the Korean Standard

Nuclear Plant. The first two units of the KSNP series of standardized plants were the Ulchin 3 and 4 plants, the reference plants of the series. Four other plants of this series are under construction in the ROK; two additional ones were announced and the two KEDO reactors, planned as identical to other KSNP units, are further extensions of this ROK series.

A description of the KSNP plants is available in References 1-3 (see the Notes at the end of this chapter) as well as in many other nuclear-engineering publications. The discussion here is limited to the parts of the plant relevant to the refueling operations and to which safeguards arrangements apply. A side cut of a KSNP building is shown in Fig. 4-2.<sup>1</sup> The containment building is in the center, with the fuel building on the right. The left side of the figure includes the TG building and other Balance of Plant (BOP) facilities—essential for

the energy-conversion part of the plant but not related to the nuclear fuel or to safeguards arrangements. The nuclear reactor itself is in the lower part of the containment building. During routine operations, the reactor pressure vessel is closed and the entire vessel is immersed in a large water pool.

During routine operations, access to the containment building is limited and tightly controlled. The two major entries into the containment building are through personnel access port(s), camera-monitored and controlled by the site-security force, and through the large equipment hatch. The equipment hatch is regularly tightly sealed to completely isolate the containment building from the outside for safety considerations. Additionally, the IAEA places its own seal on the equipment hatch and installs a remotely monitored camera in the reactor building surveying the equipment

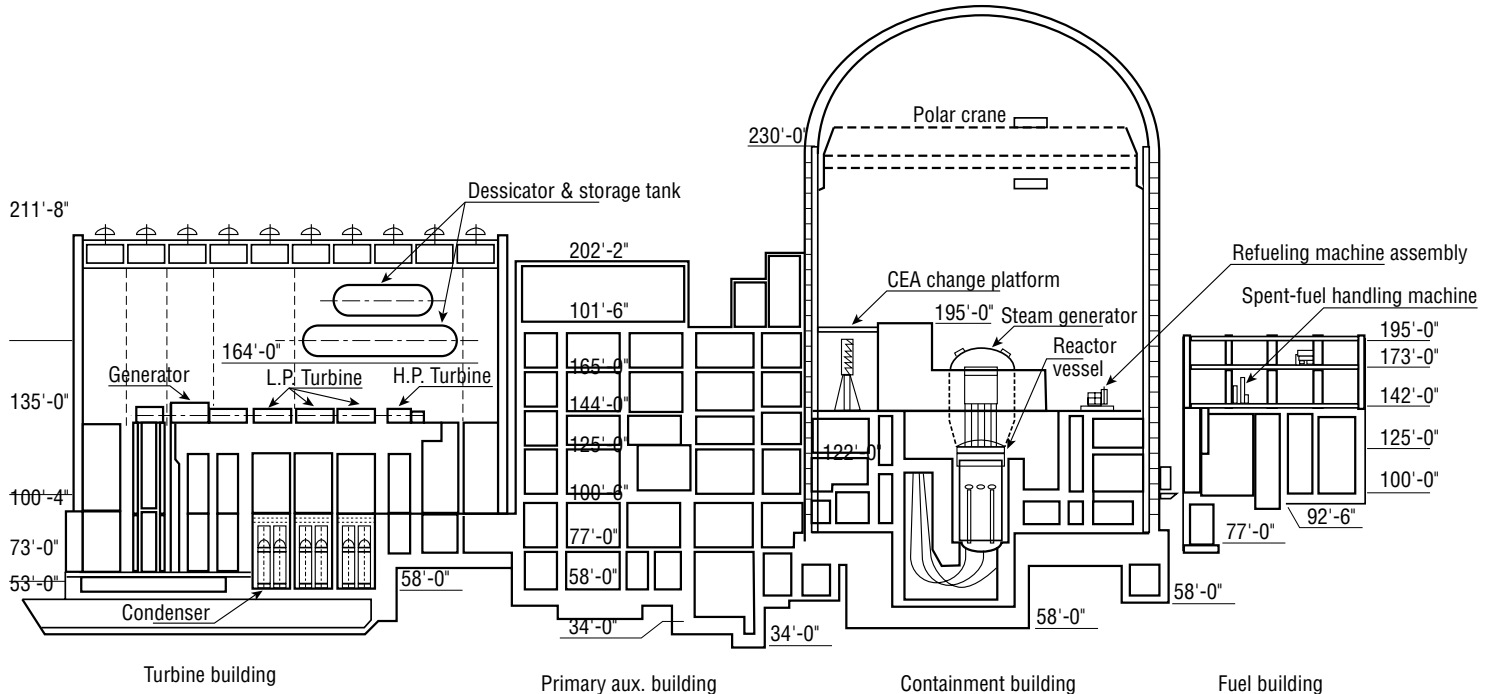

Figure 4-2. Side view of a Korean Standard Nuclear Plant (KSNP) building (adapted from Reference 1).

hatch area. These two measures are intended to ensure that no large-scale equipment, such as spent-fuel storage casks, can be brought into the containment building to surreptitiously remove fuel elements from the core.

Fresh fuel elements are brought into the nuclear plant and spent fuel elements are taken out of the plant through the fuel building. The fuel building contains the receiving area for the fresh-fuel-element containers, the water pool in which the fresh fuel elements are stored prior to their insertion into the reactor core during the refueling operation, the transfer canal from the fuel building to the containment building, the spent-fuel storage pool, and the spent-fuel cask loading area.

By far, the largest part of the fuel building is the spent-fuel storage pool, sized to contain the routine discharges of at least 10 years of operation, plus additional capacity for a full-core discharge in case all the nuclear fuel from the reactor's pressure vessel must be removed to maintain or repair the vessel or its internal components. It is possible through re-racking and installing of neutron-absorbing plates to increase the storage capacity of the spent-fuel storage pool to about 20 years' worth (maintaining the full-core discharge capability) while avoiding criticality concerns. Once the capacity of the spent-fuel storage pool is reached, the spent fuel already in the pool must be removed either to storage pools at other reactors, to an away-from-reactor storage facility, or to dry storage in steel or concrete casks at the reactor site or at a remote centralized facility. Because the operating life of a KSNP is expected to be at least 40 years and could well be extended to 60 years, the disposition of its spent fuel outside of the containment building is a matter of

safeguards concern. In case of the KEDO reactors, assuming commercial operation by 2010, a detailed plan for disposing of old and discharged spent fuel will have to be in place no later than 2030.

A top-down (footprint) view of a KSNP reactor is shown in **Figure 4-3**.<sup>1</sup> As seen, the parts of the plant of concern to the safeguards program—the containment building, the fuel building, and the fuel-transfer canal—are a relatively small part of the overall plant buildings' area. The major part of the plant is taken up by the auxiliary building around the containment building, and by the TG building, and by the TG building.

A particular point of concern to the safeguards program is the horizontal fuel-transfer canal located in the lower part of the containment building and connected to the bottom part of the spent-fuel storage pool in the fuel building. The IAEA installs a seal on the moveable bridge on top of the fuel-transfer canal. A remotely monitored camera is installed by the IAEA on the fuel building's wall facing the fuel-transfer canal and the IAEA seal on the

bridge. Any surreptitious attempt to move spent fuel through the transfer canal from the reactor to the fuel building, or to remove fuel from the fresh or spent-fuel storage pools in the fuel building, will be detected.

**Figure 4-4** is a schematic of the primary system equipment layout in the containment building.<sup>2</sup> The equipment arrangement of the KSNP reactor is unique among Pressurized-Water Reactor (PWR) designs. This design is built on two large steam generators, each connected through a "hot leg" pipe to the reactor vessel. The discharge from each steam generator is divided and sent through two large primary pumps through two large pipes, "the cold legs" back into the reactor vessel. Most 1,000-MW(e) PWRs are built on a three-loop design, with each of the three loops containing its own steam generator. The System 80 design with only the two "hybrid" loops is also distinguished by having two very large steam generators. Because the equipment hatch is sized to pass through the largest equipment item in the containment building, the System 80 design has a large hatch

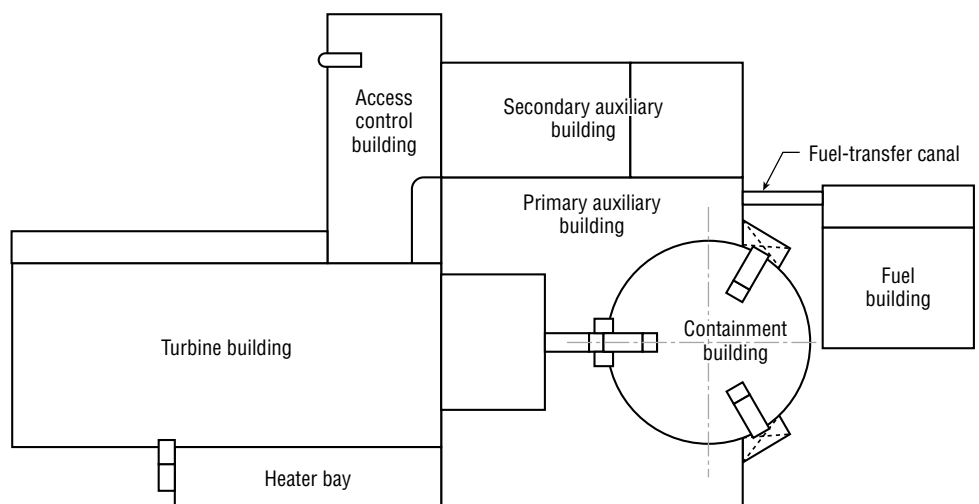

Figure 4-3. A top view of the Korean Standard Nuclear Plant (KSNP) reactor.

# SAFEGUARDS ON THE KEDO REACTORS

	Development of Korean PWRs			
	Kori 1	Kori 3	Yeonggwang 3	KSNP
Gross capacity (MWe)	587	550	1000	1000
Comm op. date	1978.4	1985.9	1995.3	
General layout				
Containment building				
Type	Steel containment	Pre-stressed concrete	Pre-stressed concrete	Pre-stressed concrete
ID (m)	32	39.6	43.9	43.9
Design pressure (lb/in <sup>2</sup> (g))	43	60	54	57
Free volume (m <sup>3</sup> )	41,000	61,000	76,000	76,000
Reactor coolant loops				
Loops	2	3	2	2
No. of fuel assemblies	121	157	177	177
Reactor ID (cm)	132	157	162/396.9	162/396.9
Inlet/outlet temperature (°C)	282.6/320.2	291.9/326.9	295.8/327.3	295.8/327.3

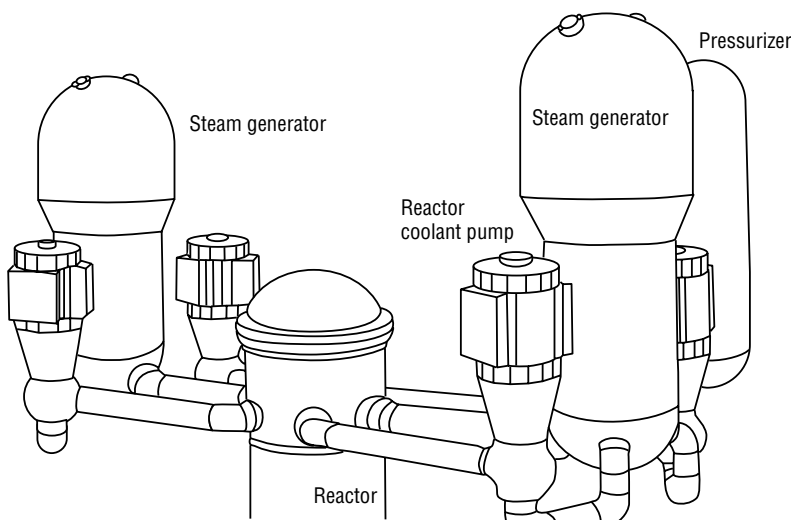

Figure 4-4. Schematic of the primary system layout in the containment building.

capable of passing through a large steam generator and is certainly capable of passing through even the largest spent-fuel storage cask.

Figure 4-5 shows the internal layout of the KSNP reactor vessel.<sup>2</sup> The reactor core, in which the fuel elements are contained, is located in the lower half of the pressure vessel below the two outlet nozzles of the two hot legs and the four inlet nozzles of the cold legs. The water in the primary system (the reactor vessel, the tubes side in the two steam generators, the four primary pumps, and the pressurizer) enters the reactor vessel through the inlet nozzles, flows down around the circumference of the vessel, enters the reactor core area from the bottom part and flows upwards through the core volume inbetween the fuel elements. Water is heated on its passage through the core and then exits the reactor vessel through the two hot legs on its way to the steam generators. The steam generators produce steam in the secondary system (the vessel side of the two steam generators, the TG, condenser, and the feedwater heating system) that rotates the TG machinery to generate electricity. Table 4-1 summarizes design data for the KSNP reactor.<sup>2</sup>

The upper part of the reactor-vessel internals contains the control rods' guide tubes and the portions of the control rods withdrawn from the reactor core to achieve criticality in the core and maintain a stable nuclear chain reaction. The upper part of the vessel is also filled with primary system water, which provides extra water volume in the vessel for emergency cooling purposes, increasing the safety margins of the entire reactor system. The control rods are connected through the top of the reactor vessel with the Control-Rod Drive Mechanisms (CRDMs) that govern the vertical movements of the rods in and out of the reactor's core.

## 4.4 Refueling Operation in the KEDO Reactors

Of particular interest from a proliferation perspective is the time required to access the reactor core and its fuel assemblies. This takes at least two to four days with a relatively experienced crew and may take longer. First, it takes about two days for the reactor to cool and depressurize and for the intense radioactivity to subside to tolerable levels. Second, the vessel head and CRDM mechanisms must be removed. This takes an additional one-half to two days.

The time between refueling (also called the cycle time) depends on a number of variables, including the design burnup (a measure of the total energy supplied by a given mass of fuel), and the design of the fuel and reactor. Most PWRs operating today are transitioning from a one-year cycle to an eighteen-month cycle and some to a two-year cycle. These cycle times are “nominal” and can vary in practice with power demand or to take advantage of personnel availability. Current PWRs of the KSNP vintage are designed to operate at a design burnup of 45 to 50 MWd/kg, and there is interest in increasing these burnup levels still further to about 70 MWd/kg. The transition to higher design burnup levels and longer residence times in the core (longer cycles) means that over time a smaller amount of spent fuel is generated that has to be stored, monitored, and disposed of.

One-third of the core is replaced at each refueling. Fuel will normally reside in the reactor’s core for three full cycles, four and one-half years, before being discharged as spent fuel. In practice, both the refueling schedule and the fraction of the core replaced each time can vary between cycles depending on the operating history of the plant.

Generally, the reactor is refueled by—

1. **Shutting the reactor down, allowing it to cool, and removing the pressure vessel top (or head) and the associated equipment.**
2. **Removing the oldest fuel from the reactor.** This is the fuel that has resided in the core for three full cycles, and therefore has achieved its nominal design burnup. This fuel is generally in the center of the core. This fuel is sent to the spent-fuel storage pool.
3. **Shuffling the remaining in-reactor fuel to different positions within the core.** This is done to level the reactivity and power distribution in the core.
4. **Inserting the fresh fuel.** The fresh fuel is inserted into the outer periphery of the core. The higher reactivity of the fresh fuel compensates for the lower neutron flux and the higher neutron leakage rate from the core at the periphery.
5. **Reinstalling and bolting the pressure vessel head and reconnecting the CRDMs.**

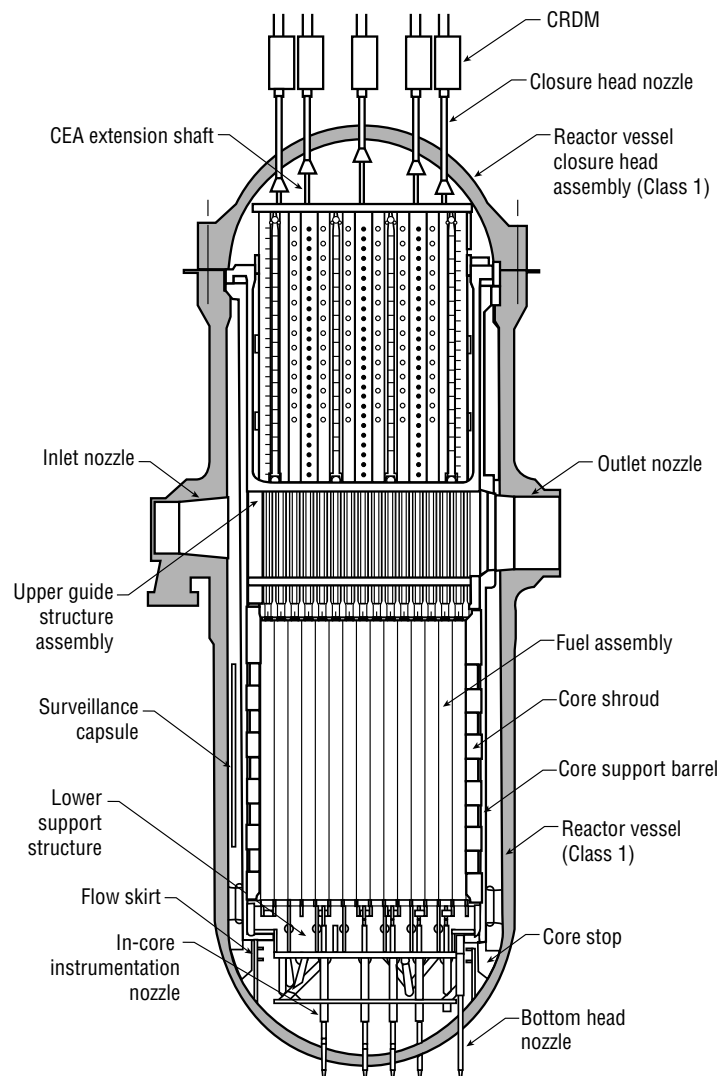

Figure 4-5. Internal layout of the Korean Standard Nuclear Plant (KSNP) reactor vessel.

## 6. Restarting the reactor.

In the US, the shortest reactor refueling operation has been accomplished in just 16 days (the current US record), although the average is approximately 34 days. The actual time required to refuel a reactor varies depending on the type of reactor, the skill and experience of the operators, and the maintenance (both scheduled and unexpected) required during the outage.

As seen in Table 4-1, the reactor core contains 177 assemblies. Each one-third-core refueling results in 59 assemblies withdrawn from the core as spent fuel and 59 fresh fuel assemblies inserted into the core. **Figure 4-6** is a schematic of a fuel assembly.<sup>3</sup> Each assembly weighs slightly over 600 kilograms (more than half a ton) and contains 236 long- and small-diameter fuel rods arranged in a square 16 x 16 lattice with an empty "water hole" in the center. Each fuel rod contains a number of cylindrical fuel pins or pellets stacked in a column and held in a zircalloy tube.

During refueling, each fuel assembly is inspected before being inserted or reinserted into the reactor. The level of detail to which each assembly is inspected can vary. For example, fuel that has been in the reactor for two cycles may be inspected more thoroughly than fuel in for only one cycle. If there are indications of problems (such as detection of fission-product gases released from a leaking fuel pin), a more rigorous inspection may ensue. Fuel that is damaged or otherwise suspect is not reinserted into the reactor, but sent to the spent-fuel storage pool. Depending on the type and extent of damage, the rejected fuel assembly may be placed in an intermediate sleeve (and the entire assembly placed in the spent-fuel storage pool) to minimize contamination of the spent-fuel storage pool. Alternately, a

Table 4-1. Characteristics of the Korean Standard Nuclear Plant (KSNP).

<b>Reactor</b>	
Type	PWR
Thermal output	2815 MW(th)
Coolant flow rate	$121.5 \times 10^6$ lb/h
Design pressure	2,500 lb/in <sup>2</sup>
Operating Pressure	2,500 lb/in <sup>2</sup>
Design temperature	650°F
Inside diameter at shell	162 in
Overall height	48 ft
<b>Fuel</b>	
Number of fuel assemblies	177
Number of UO <sub>2</sub> fuel rods per assembly	236 (16 X 16)
Fuel weight	188,609 lb
Core height (active)	150.0 in
Core diameter (equivalent)	123.0 in
Clad material	Zircaloy-4
Clad thickness	0.025 in
<b>Reactor coolant system</b>	
Number of loops	2
Hot leg/cold leg	42/30 in
Reactor inlet temperature	564.5°F
Reactor outlet temperature	621.2°F
Total coolant volume	11,315 ft <sup>3</sup>
<b>Control rods</b>	
Number of control assemblies	73
Number of rods per assembly	4 or 12
Material (full/part strength)	B, C/Inconel
<b>Steam generators</b>	
Type, number of units	Vertical U-tube, 2
Steam flow per steam generator	$6.354 \times 10^6$ lb/hr
Steam pressure at full power	1,070 lb/in <sup>2</sup>
Steam temperature at full power	550.5°F
Maximum moisture	0.25%
Feedwater temperature	450°F
<b>Reactor coolant pumps</b>	
Number	4
Motor/type	AC Induction/ Vertical, centrifugal
Design capacity	82,500 gal/min
Design head	340 ft
<b>Containment</b>	
Type	Prestressed cylindrical concrete with steel liner
Inside diameter	144 ft
Height	216 ft
Free volume	$2.73 \times 10^6$ ft <sup>2</sup>
Liner thickness	0.144 in
<b>Turbine</b>	
Number	4 (high 1, low 3)
Type	Serial 6 flow arrangement
RPM	1,800
Generator Number, type	1, 4 poles (1,800 RPM)
Voltage	22 kV, 3 phases
Frequency	60 Hz
Net electrical output	1,000 MW(e)
<b>Condenser</b>	
Number, type	3, once-through sea water cooling
Pump type	Vertical, Centrifugal

leaking fuel rod can be removed from an assembly (underwater) and a new rod inserted so that the repaired assembly can be reinserted into the core.

A reactor operator normally has a supply of fresh fuel on hand. Immediately prior to a refueling, there is at least one-third of a core of fresh fuel available. This stock is accumulated over the course of some months, as it was not likely delivered in a single shipment. Because of the possibility of defective fuel, reactor operators normally keep a small stock of additional (beyond that required for the next refueling) fresh-fuel assemblies on hand. Partial refueling may occur between normal fueling outages. Although unusual, this can occur if, for example, failed fuel is detected during operation (usually by detection of fission-product gases such as iodine).

The spent fuel assemblies discharged from the reactor are moved by the charge/discharge machine away from the pressure vessel and placed in a horizontal position on a trolley that carries them through a transfer canal (a tunnel) leading from the containment building to the fuel building. **Figure 4-7** is a schematic of the fuel transfer process.<sup>2</sup> Once in the fuel building side of the canal, the fuel assembly is brought again to an upright position and is carried underwater to its storage position in the spent-fuel storage pool. The position and identity of each assembly in the storage pool are recorded and verified by the IAEA safeguards inspectors on their periodic inventory-verification visits to the plant.

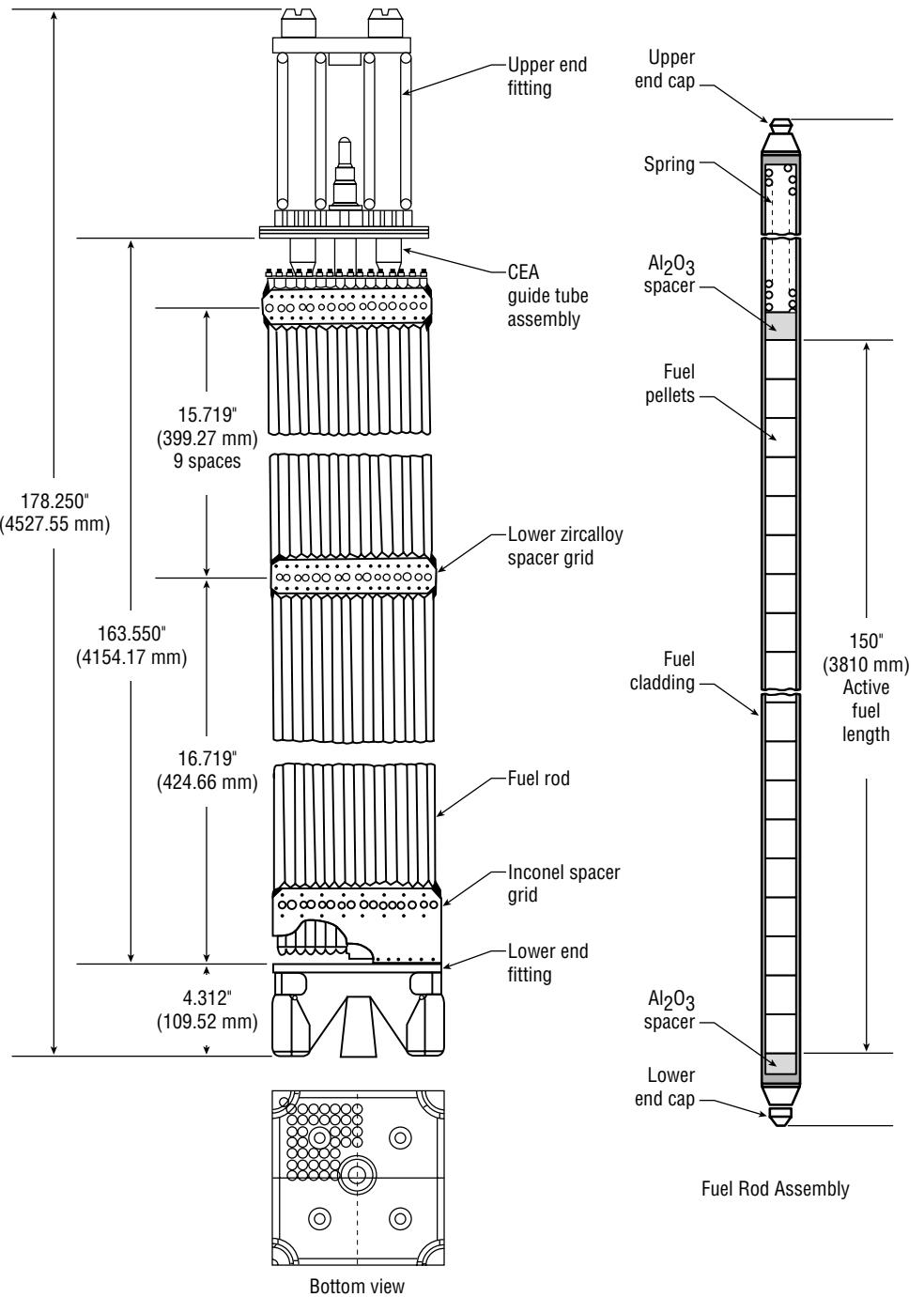

Figure 4-6. Schematic of a fuel assembly.

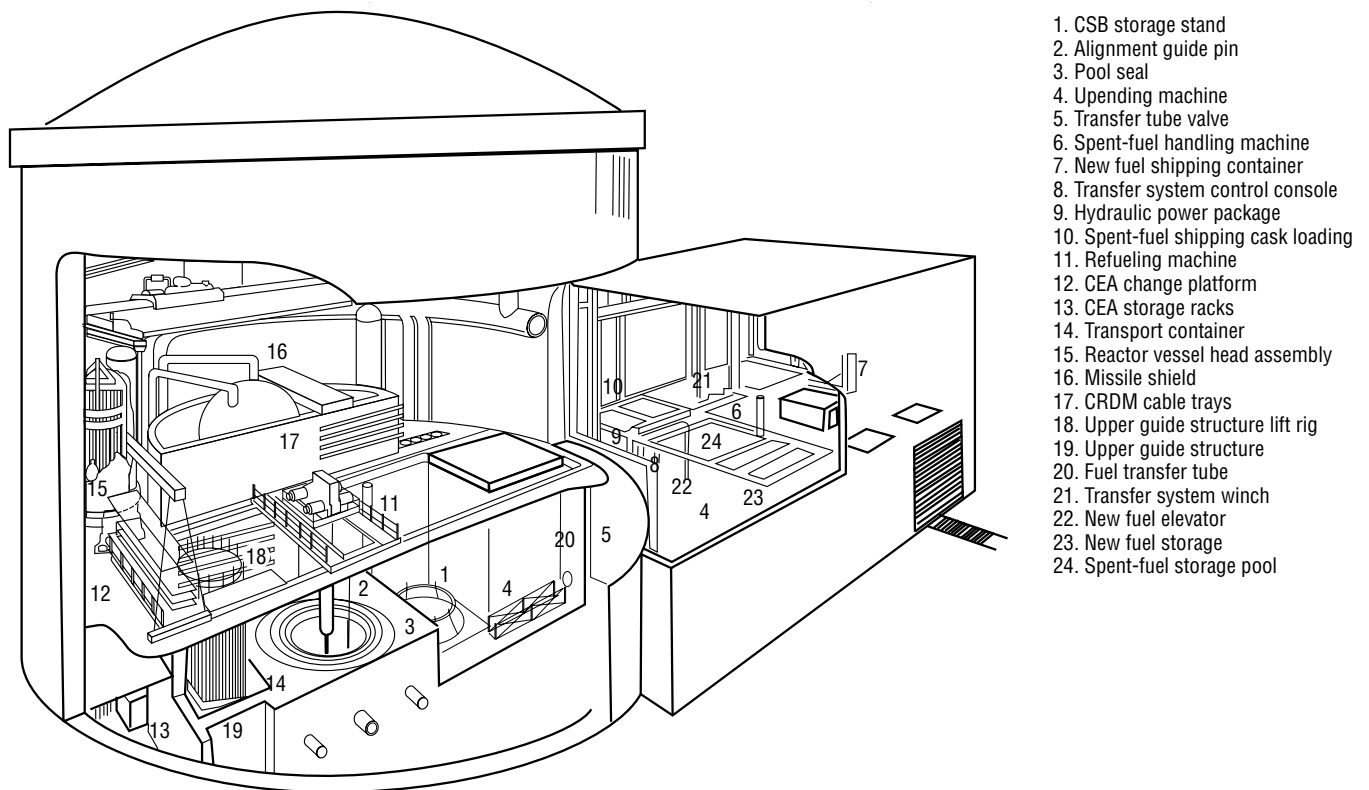

Figure 4-7. Fuel transfer process.

1. CSB storage stand
2. Alignment guide pin
3. Pool seal
4. Upending machine
5. Transfer tube valve
6. Spent-fuel handling machine
7. New fuel shipping container
8. Transfer system control console
9. Hydraulic power package
10. Spent-fuel shipping cask loading
11. Refueling machine
12. CEA change platform
13. CEA storage racks
14. Transport container
15. Reactor vessel head assembly
16. Missile shield
17. CRDM cable trays
18. Upper guide structure lift rig
19. Upper guide structure
20. Fuel transfer tube
21. Transfer system winch
22. New fuel elevator
23. New fuel storage
24. Spent-fuel storage pool

## SPENT FUEL AND PLUTONIUM

Light-Water Reactors (LWRs) fueled with Low-Enriched Uranium (LEU) (essentially all of them) inescapably produce plutonium as a byproduct. The quantity and quality of the plutonium are both affected by plant operations, with the principal variable being the total irradiation of the fuel in the reactor. Fuel irradiation is referred to as burnup and is a measure of the total energy produced by a unit mass of fuel. Fresh LEU fuel has no plutonium and the total amount of plutonium in the fuel increases with increasing burnup.

Plutonium is produced primarily by neutron capture in  $^{238}\text{U}$ , the most abundant isotope of uranium in LEU fuel. This produces primarily  $^{239}\text{Pu}$ , the isotope best suited to weapons applications. However, the quality of the plutonium produced

(measured as the fraction that is  $^{239}\text{Pu}$ ) decreases with increasing burnup. As the reactor continues to operate (and burnup increases), some of the plutonium itself captures additional neutrons. Some of it then fissions, contributing a significant amount to the total energy generated by the reactor, and some is converted to the so-called "higher isotopes" of plutonium. The higher even-isotopes of plutonium, in particular, do not fission efficiently in a thermal reactor and thus accumulate (at the expense of the  $^{239}\text{Pu}$ ). Other nuclear reactions also contribute to the production of troublesome isotopes (such as  $^{238}\text{Pu}$ ), with the fraction of these isotopes also increasing with increasing burnup. These other isotopes of plutonium may themselves be used in a weapon, but they make design, manufacturing, handling, and relia-

bility of a weapon containing such isotopes difficult.

For the plutonium in spent fuel to be used in a weapon, it must first be extracted from the spent fuel. Although the basic chemistry for extracting plutonium from spent LWR fuel is well known (the so-called "PUREX" process), the process is significantly complicated by the existence of both nuclear radiation and the heat output of the spent fuel. Both the radiation and heat exacerbate handling, influence safety, and complicate the chemical processing. Both slowly decay with time so that these complications are somewhat less onerous for "older" spent fuel (spent fuel discharged from the reactor several years past) than for "younger" spent fuel (recently discharged).



#### 4.4.1 The Special Problem of the Beginning-of-Life and End-of-Life Fuel Discharges

A reactor can be considered to have three distinct phases in its overall life cycle: beginning of life (BOL), equilibrium, and end of life (EOL). Most of the reactor's lifetime is in the equilibrium part of the life cycle where spent fuel is put in the reactor, remains for three cycles, and then is removed as spent fuel.

Early in the reactor's operating life (the BOL), much of the fuel in the core is very fresh, without the buildup of fission-product poisons, plutonium, and other elements that affect the reactivity of the fuel. For this reason, some of the BOL fuel is supplied with lower enrichment than fuel used later in the equilibrium part of the lifecycle. In the "initial core," the lowest enrichment fuel goes into the center zone of the core, medium-enrichment fuel goes into the intermediate zone, and nominal enrichment fuel is placed in the outer zone. This arrangement mimics the reactivity distribution of a core later in its life.

At the first refueling, the central zone of the core is removed and sent to the spent fuel pool, just as normal spent fuel. However, this fuel has been in the reactor for only one cycle, and therefore has only one-third the "nominal" burnup. As Fig. 4-8 shows, reduced burnup introduces two effects that have important implications for proliferation:

- The total quantity of plutonium in that spent fuel is reduced because of the reduced burnup,

*but*

- The quality of the plutonium for weapon use is higher than for full-burnup spent fuel.

Similarly, at the second refueling, the spent fuel removed has seen only two cycles, so the quantity and quality of its plutonium lies roughly mid-way between that of one-cycle and three-cycle or full-burnup spent fuel. Roughly, the BOL portion of the reactor lifetime can be considered to last for the first three cycles.

A similar situation occurs at the end of the reactor life. At the next-to-the-last refueling, the fresh fuel inserted into the reactor will only remain in the reactor for two cycles, and that inserted during the last refueling will remain in the reactor for only a single cycle. The implications of the EOL part of the lifecycle are similar to those at the BOL: some of the EOL spent fuel will have seen only one or two cycles, and thus has plutonium of higher quality, albeit lesser quantity.

Thus, three "types" of spent fuel are generated as a result of normal plant operations:

1. Of greatest concern is the spent fuel discharged during the BOL and EOL, which has much less

than nominal burnup. The earliest discharged BOL fuel has seen only one cycle of operation and will only have 12 to 15 MWd/kg burnup (assuming a "nominal" 45 MWd/kg design burnup). The first cycle discharges spent fuel containing approximately 100 kilograms of plutonium, of which over 80 percent is  $^{239}\text{Pu}$ . The one-cycle EOL spent fuel will have similar characteristics.

2. The second refueling discharges fuel at approximately 30 MWd/kg, yielding some 175 kilograms of plutonium containing roughly 65 percent  $^{239}\text{Pu}$ . The two-cycle EOL spent fuel will also have similar characteristics.
3. Each equilibrium refueling (45 MWd/kg) discharges fuel containing about 288 kilograms of plutonium with about 57 percent  $^{239}\text{Pu}$  content.\*

Due to their higher  $^{239}\text{Pu}$  quality (and thus increased attractiveness for weapon use), both the BOL and EOL discharged fuel assemblies merit special attention and verification efforts.

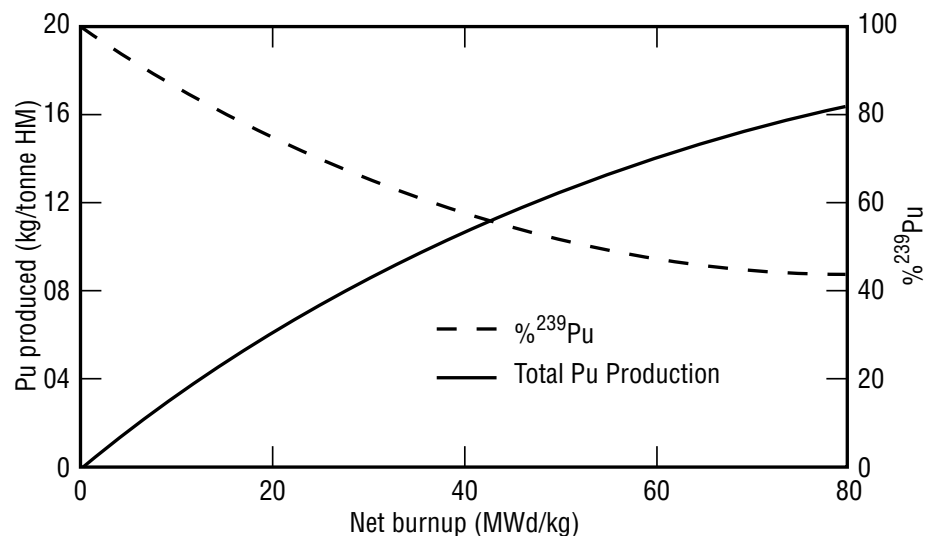

Figure 4-8. The relationships between plutonium production, quality, and burnup. At very low burnup, very little plutonium is produced but that produced is primarily  $^{239}\text{Pu}$ . At higher burnup, the total amount of plutonium produced becomes substantial, but the fraction of  $^{239}\text{Pu}$  decreases significantly.

\* The values cited in this paragraph, as well as in Fig. 4-8, were developed from a variety of data from different LWR reactor designs, using various initial enrichments, design burnups and operating cycles. They are intended for illustration only, and are not representative of any particular reactor or operating scenario.

It is important to note that this low-burnup fuel issue is not unique to the BOL and EOL parts of the reactor life cycle. At all times, the reactor core itself will contain a mix of lower, medium, and higher burnup material. What differentiates this in-core material is that the lower and medium burnup in-core fuel is not normally discharged from the reactor, and therefore considered somewhat less available.

#### 4.5 IAEA Safeguarding of Nuclear Fuel in the KEDO Reactors

The following discussion of IAEA safeguards aims at describing the actual implementation of safeguards agreements related to nuclear-power plants such as the KEDO reactors. The application of safeguards measures to commercial LWRs and particularly to 1,000-MW(e)-class PWRs such as the KSNP reactors is described in References 4 and 5, both of which relate to safeguarding nuclear-power plants in the Korean Peninsula. We assume that the safeguard measures applied to the ROK's KSNP reactors will apply as a minimum to the KEDO reactors. In fact, the IAEA might well insist on further enhancements within its agreements with the DPRK, and some of these are described in Section 4.6 and Reference 6. Until the appropriate Facility Agreements are signed between the IAEA and the DPRK, we will not know what these will be. An IAEA perspective on the general type of IAEA safeguard measures applied to typical LWRs is presented in References 6 and 7. An ROK perspective on developing a lead project on safeguards enhancements that will equally apply in the ROK and the DPRK, and which could in fact apply to all other LWRs is presented in Reference 5. Some problem areas in implementing safeguard measures related to

the Agreed Framework are discussed in Reference 8, and the IAEA safeguards requirements related to the DPRK nuclear program are discussed in Reference 6.

##### 4.5.1 The Safeguards Goals for Quantity and Timeliness

The standard IAEA approach to LWR plant safeguards for signatories to the Non-Proliferation Treaty (NPT) is the IAEA "Model Safeguards Agreement," INFCIRC 153 of 1971, and its specific application to the DPRK is documented in IAEA INFCIRC 403 of May 1992. In general, the purpose of LWR-type safeguards agreements is to verify that nuclear materials are not diverted to produce nuclear weapons or other nuclear-explosive devices. The verification process is achieved through the inspection measures described next. The purpose of these inspections is two-fold: first, the Quantity Component is meant to provide assurance that there has occurred no diversion of a Significant Quantity (SQ) of various nuclear materials over a Materials Balance Period (MBP); and second, the Timeliness Component is meant to provide timely detection against abrupt diversion of a SQ of nuclear

materials within specified time periods between periodic inspections of the LWR. The inspection goal for each LWR is attained if all the quantity and timeliness criteria specified in the Facility Agreement signed between the IAEA and the host nation of the specific LWR are met.

In terms of the timeliness criterion, the IAEA defines the frequency of inspections as:

- one year for fresh Low-Enriched Uranium (LEU) fuel (FF),
- three months for reactor core fuel containing bred plutonium (CF),
- three months for spent LWR fuel outside the reactor core (in the spent-fuel storage pool) and containing plutonium (SF).

The choice of the time period between inspections is predicated on the IAEA's assumptions regarding the time required from diversion through fissile-material refining to the manufacturing of a completed nuclear-explosive device. Based on the details of the specific Facility Agreement, the IAEA must perform interim visits at the frequencies mentioned above to ensure that no diversion of nuclear materials has occurred during the period since the last inspection.

Significant Quantities (SQs) of nuclear materials are defined as the approximate quantities of materials required to manufacture a nuclear-explosive device. The International Atomic Energy Agency (IAEA) has defined SQ based on direct use of fissile materials as—

- 8 kilograms of plutonium,
- 25 kilograms of  $^{235}\text{U}$  contained in Highly Enriched Uranium (HEU),
- 8 kilograms of  $^{233}\text{U}$ .

The IAEA further defined the SQ for uranium requiring additional processing (indirect use) as—

- 75 kilograms of  $^{235}\text{U}$  contained in Low-Enriched Uranium (LEU),
- 10 tons of natural uranium,
- 20 tons of depleted uranium.

These various forms of uranium require further enrichment to extract adequate amount of fissile  $^{235}\text{U}$  for direct use in weapons production.

The IAEA meets its safeguarding obligations through item accounting and independent measurement, and through Containment and Surveillance (C&S) measures. Item accounting includes record checking at various locations, physical identification, counting, non-destructive measurements, and examinations to verify the integrity (over time) of different items. In a nuclear plant, the items inspected and verified are the fuel assemblies, and in few cases of leaking pins—individual fuel rods. Inspections are performed using non-destructive procedures. C&S measures complement accounting and inspection by providing seals at critical points in the reactor plant to prevent unauthorized entry, and by operating surveillance systems to detect undeclared movement of nuclear materials or attempts to tamper with the containment system or the IAEA seals and safeguard devices. The C&S system is particularly applicable to highly radioactive nuclear materials, which cannot be inspected from nearby and thus are remotely monitored. In practice, the C&S system applies mostly to the plutonium-bearing CF in the containment building and the SF in the spent-fuel storage pool in the fuel building. Both the accounting and the C&S measures, which are the heart of the safeguards regime, are described in the next section.

#### 4.5.2 The Safeguards Accounting Process

The IAEA safeguards regime is basically a large-inventory accounting system, systematically applied to account for all nuclear materials at all the declared nuclear facilities in each country. Full inventory (statistically complete) is taken at appropriate frequencies based on the timeliness criterion to ensure that no diversion which could have led to the manufacture of nuclear-explosive devices has taken place since the last inspection and inventory. In each country, the accounting process starts from the country's

borders and narrows down to the specific plant and specific Material Balance Areas (MBAs) within each plant. At the country level, the accounting process may include unprocessed or partially processed materials such as natural, enriched, or depleted uranium. At the power-plant level, the accounting process deals with specific numbers of assemblies at different locations in differing time periods.

To carry out the accounting process, the IAEA relies first on examinations of records. These include both country reports and specific facility records. The IAEA further:

- checks domestic and international materials transfers,
- attempts to confirm that no unrecorded production of direct-use materials (measured in SQ) has taken place,
- confirms the absence of borrowed nuclear materials,
- correlates all the above with the data from its last interim inspection,
- and, out of these data, recreates an updated material balance that accounts for the whereabouts and disposition of all nuclear materials at the time of the specific inspection.

This material-balancing process occurs both at the national and at the facility levels with the records from each level aggregating (or disaggregating, as the case may be) to the other level.

At the facility level, in particular, the IAEA's records examination may include several activities:

- Examination of the facility's accounting records such as the general ledger, receipt and shipping records, inventory documentation, etc.

- Examination of the facility's operating records such as the operations logbook, assembly history cards, core fuel maps, pool fuel maps, etc.
- Reconciliation of the accounting records, the operating records, and the results of the last inventory inspection.
- Comparison of the facility records with the country reports and specific notifications, to allow vertical reconciliation.
- Preparation of the summary results of the inventory inspection that will become the baseline for the next inspection.

The above activities are supplemented by physical inspections and verification examinations of the FF, CF, and the SF, to make sure that the facility records correspond to the results of the actual inspections on site. At the power plant, this means that the office records related to the number of assemblies at various locations in the plant coincide with the results of the plant inspections and assembly counting on site.

#### 4.5.3 Material Balance Area in KEDO-type Reactors

A KEDO-type, 1,000-MW(e) PWR includes three MBAs during which an inventorying process is undertaken between each periodic inspection and the next. The MBAs include:

- **FF Storage with Key Measurement Point A.** This balance is applicable to LEU only. It is based around the FF pool in the fuel building and the reactor core in the containment building (at refueling outages). This material balance considers new FF brought into the plant, FF in storage at the FF pool in the fuel building, and FF loaded into the reactor core during a refueling outage.

- CF with Key Measuring Point B.** This balance is updated during scheduled refueling outages, which occur in a KEDO-type reactor every 18 months. Special inspections are also held if for any reason the reactor was shut down, the pressure vessel top was removed, and core fuel was discharged. The assembly balance is held between the numbers of assemblies in the core as of the last inspection (CF), the number of spent-fuel assemblies removed from the core (SF), and the number of fresh fuel assemblies added to the core (FF). Core-fuel inventorying has to consider both the enriched  $^{235}\text{U}$  in the FF and CF (as well as the unfissioned  $^{235}\text{U}$  in the SF), the bred plutonium growth and fissioning in the CF, and the discharged plutonium in the SF.

- SF with Key Measurement Point C.** The spent-fuel storage pool is the most sensitive part of the safeguarding process, considering that at each 18-month interval, an additional 59 SF assemblies are added to the pool, and that the short-lived fission products decay at a fast rate. After 18 years of operation, close to 600 assemblies will have accumulated in a KEDO-type reactor's SF pool, all of which have to be accounted for, based on the timeliness criterion, every three months. As detailed earlier, the first core (BOL) assemblies with a high  $^{239}\text{Pu}$  fraction are particularly sensitive, especially after its (relatively lower) activity has decayed for 18 years.

The material balance on the SF pool includes:

- the inventory as of the last inspection,
- additional SF discharged from the core in the latest refueling outage (assuming one has occurred since the last inspection),

- SF removed from the storage pool for dry-cask storage on site or to another SF storage pool,
- SF removed from the pool to a centralized away-from-reactors storage facility,
- SF removed for direct disposal.

The SF material balance has to consider both the plutonium content in the various SF assemblies and the residual  $^{235}\text{U}$  remaining in the SF.

In each periodic inspection, described next, a material balance is carried out on each MBA, and it is required that each of the balances properly close and that all three balances correspond to the facility records, taking into account the plant's operating history. Given this multi-layered, inventory-taking process, it is now necessary to discuss the C&S process, and following that, the inspection process.

#### 4.5.4 The Containment and Surveillance Process

The C&S measures implemented by the IAEA are aimed at complementing the accounting process by

placing seals at strategic locations to prevent access to nuclear materials and by installing surveillance cameras to check for suspicious movements in the containment or fuel buildings. The IAEA standard method of installing C&S equipment is shown schematically in Fig. 4-9.<sup>4</sup> The IAEA installs a seal and a surveillance camera in the containment building, and another seal and a camera in the fuel building. Some variation on this basic scheme involving additional seals also exists, as seen in Fig. 4-9. An additional temporary surveillance camera is installed by the IAEA in the containment building during a refueling outage.

The seal in the containment building is placed on the large equipment hatch, and the camera is pointed at the hatch. The purpose of observing the equipment hatch is to make sure it is not opened surreptitiously to admit a heavy shielded cask into the containment building to remove core fuel or spent-fuel assemblies from the building. Both the CF and SF assemblies, being highly radioactive, require large-sized holding casks that cannot pass through the narrow personnel access ports and

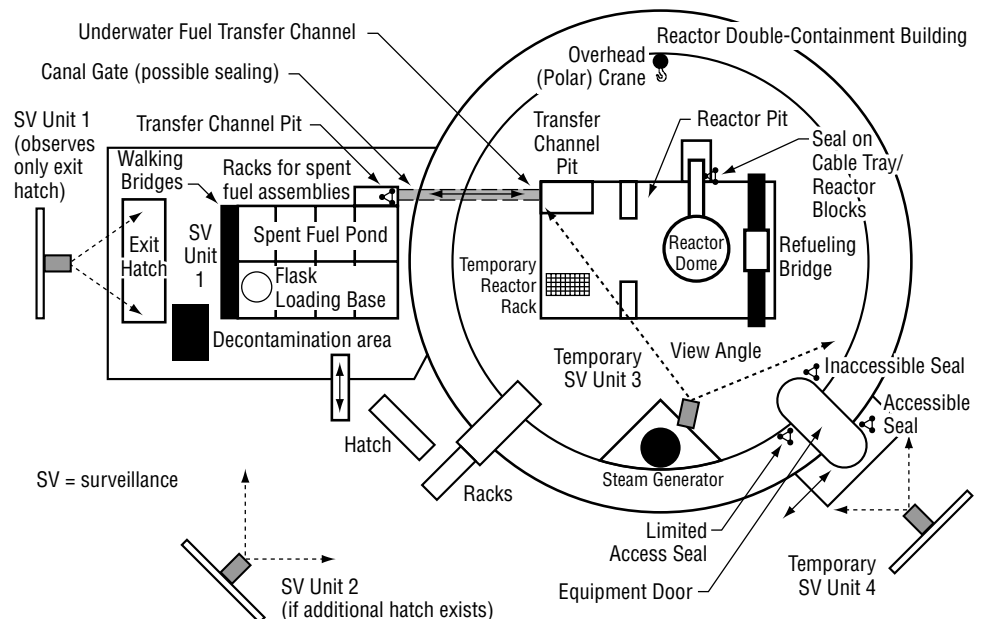

Figure 4-9. Light-Water Reactor (LWR) layout showing the containment and surveillance process.

that can only be brought into the containment building through the equipment hatch.

The seal in the fuel building is installed on the bridge above the transfer canal from the reactor to the fuel building. The purpose of this seal is to reveal any unauthorized use of the transfer canal, for instance, to remove CF or SF fuel from the containment building to the fuel building. The wide-angle-lens camera on the wall of the fuel building covers the entire fuel pools area, including the fresh and spent fuel pools, the cask-loading and unloading areas, and the fuel-transfer canal. This camera tracks and records all movements within the fuel building and can record any unauthorized transfers of fuel in or out of the building or the storage pools.

In some cases, additional seals are placed on the cable-tray bridge connecting the reactor pressure vessel top and the side of the containment building. These seals reveal access to the reactor top, which has to be opened to divert CF or SF from the reactor core. The IAEA does not routinely install a third seal and camera in the plant, within the reactor building and facing the top of the reactor vessel and CRDM assembly, and the cable-tray bridge leading to it. During outages, the IAEA does rig a temporary camera in the containment building facing the open top of the pressure vessel and records the entire sequence of the refueling operation for later review. Routine installation of a third seal and camera would heighten confidence that the reactor vessel is not being tampered with and is desirable in this case.

Even more desirable is an advanced seal-camera system implemented on a trial basis in three ROK reactors, shown schematically in Fig. 4-10.<sup>5</sup> This scheme is based on two camera-seal pairs, one installed in the containment building and the

other in the fuel building. The unique aspect of this scheme is that all cameras and seals are connected via to a server that records the sensors' data and transmits them via an Internet uplink or a satellite uplink to the IAEA in Vienna every three minutes. The server is located in the fuel building and is placed inside a secured box to prevent tampering. This remote-control data-gathering allows a near-real-time inspection of the status of the equipment hatch and the fuel pools areas by the IAEA safeguards experts, thousands of miles from the actual nuclear plants in the Korean Peninsula. If this proves to work effectively—and all indications are that it will—the IAEA will consider this system as an equipment enhancement package that matured with new technologies, and which should be implemented at all reactors under safeguards. The data-gathering and transmission systems should themselves be hardened and monitored so that they cannot be spoofed or interfered with without warning.

This experimental program not only provides an immediate view of the sensitive parts of a nuclear plant located anywhere in the

world, but is also quite economical in terms of conserving scarce IAEA resources. Installing this system in the KEDO reactors, in parallel with its installation in all the ROK's nuclear plants, would significantly enhance the KEDO reactors' safeguards, particularly if the system is installed on three camera-seal systems. Until there is considerable positive experience of cooperation with the DPRK, however, the system should not be used as a reason to reduce actual visual inspections by trained inspectors.

#### 4.5.5 Safeguards Inspections During Routine Plant Operation

The safeguards accounting process and the verification of the integrity of the containment measures and surveillance devices are carried out by the IAEA safeguards inspectors during plant inspections. The purpose of the inspections is to confirm the operators' recorded inventory of nuclear materials and to reconcile the records with the IAEA's independent measurements. Each inspection is conducted by MBAs and is considered valid for a specified Material Balance Period. Two types of Inventory Verification inspections are carried out:

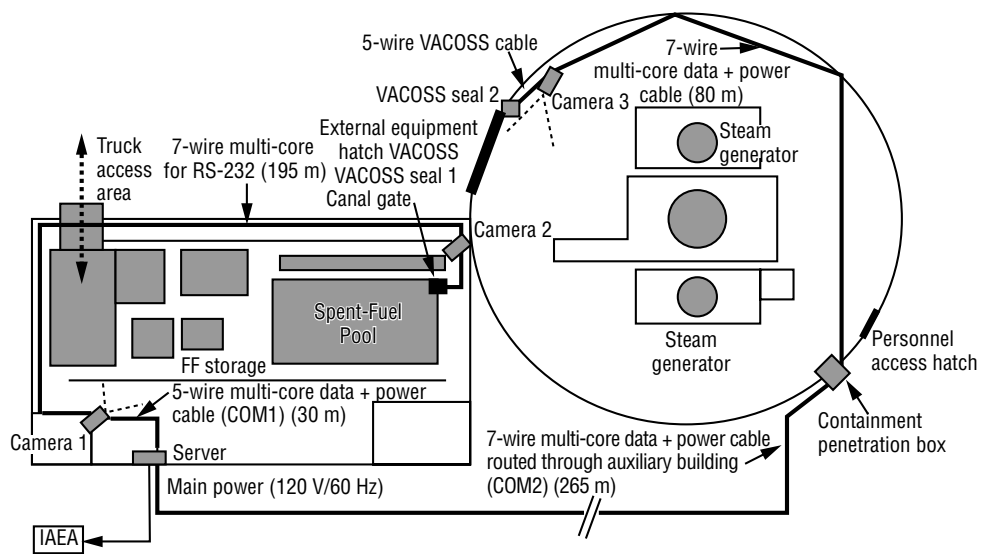

Figure 4-10. Advanced camera-seal system implemented in the Republic of Korea (ROK) reactors.

- **Physical Inventory Verification (PIV).** This inspection coincides with the physical inventory taken by the operator, most importantly during refueling outages. The detailed fuel accounting possible during such inspections allows closing of the Material Balance Period.
- **Interim Inventory Verification (IIV).** This inspection is carried out during the periods inbetween two PIVs. Its purpose is to verify the status of CF and SF materials within the plant for meeting the timeliness component of the safeguards goals. Alternatively, the IIV is used to re-establish the continuity of knowledge of the status of the nuclear-materials inventory following a safeguards breakdown episode, e.g., a failure of the surveillance system.

IIV inspections are carried out four times a calendar year, with the maximum time between two consecutive inspections being no longer than three months and three weeks. The period between inspections is governed by the timeliness criterion for inspecting plutonium-bearing fuels (CF and SF), which is three months. Because the reactor pressure vessel is closed during an IIV and the plant is in routine operation, the scope of the inspection is limited to verifying the C&S measures and inspecting the spent fuel. CF inventory is verified by checking the integrity of the seal(s) and the surveillance camera in the containment building. The SF inventory in the fuel building is verified by checking the status of the C&S measures in the fuel building, by item counting of SF assemblies in the spent-fuel storage pool, and by carrying out non-destructive examination of SF assemblies using Cherenkov radiation-viewing devices. Because refueling outages in KEDO-type PWRs occur nominally every 18 months, the period between two refueling outages will be covered

(from a safeguards perspective) by one PIV inspection, one PIV-equivalent inspection, and four IIVs.

#### 4.5.6 The Physical Inventory Verification Type of Safeguards Inspection

The most comprehensive type of a safeguards inspection is the PIV inspection. The PIV is carried out nominally once every calendar year to correspond to the timeliness criterion for LEU in the fresh fuel. The maximum allowed time between two consecutive PIVs should not exceed 14 months, except if the PIV schedule coincides with a refueling outage. PIVs are carried out at yearly intervals even for reactors operating on an 18 months' refueling cycle. The PIV is carried out based on the nuclear-materials inventory records provided by the reactor operator. The IAEA inspects the plant records, reconciles them with the country statement, conducts its own inventory of the fuel in the plant, and further reconciles its own measurements with the plant records. If the IAEA can close the MBAs within the plant, and the total plant balance, the Material Balance Period can be closed.

Two types of PIV are carried out, depending on the plant's refueling outage schedule: a PIV during a routine plant operation with a closed core (called a PIV-equivalent inspection) and a PIV during a refueling outage. A PIV-equivalent inspection is similar to an IIV, except that for completion of the material balances, the FF inventory is also determined. The fresh fuel on hand is a part of the FF inventory buildup toward the next refueling outage. The inspection activity for the FF assemblies includes item counting, serial-number identification of individual assemblies and comparison with the plant records, and non-destructive assay (NDA). The inspection activity for CF is similar to the one carried out

during an IIV and includes replacing the seals on the equipment hatch and on the transfer-canal bridge gate, and inspecting the operating status of the surveillance camera in the containment building. The inspection activity for the SF is identical to that carried out during an IIV. It includes verifying the status of the C&S measures installed in the fuel building, item counting of the SF assemblies in the pool, and NDA inspection of the SF assemblies using Cherenkov radiation-viewing devices.

The most complex type of PIV occurs during a refueling operation, when the IAEA inspectors have to coordinate their inspection activities with the refueling work of the plant operators and with the physical inventory undertaken by the operators for completion of the plant's own records. The IAEA activities when a PIV coincides with a refueling outage can be divided into three distinct phases. Prior to the outage, the IAEA carries out Pre-PIV activities, which include removing the seals from the equipment hatch, the fuel-transfer canal gate, and the top of the reactor core (if applicable), installation of a third temporary, camera in the containment building facing the pressure vessel, and inventorying the fresh fuel in the fresh fuel pool prior to insertion into the reactor. At the end of the core refueling and before the closing of the pressure vessel, the IAEA conducts its own independent inspection of the fuel in the core. For the fresh fuel (both in the core and remaining in the FF pool), this includes item counting of assemblies, identification of individual-assembly serial numbers, and NDA. For the core fuel, this includes item counting of assemblies in the core, serial-number identification of FF assemblies in the core, and inspection of the permanent surveillance camera in the containment building. For the spent fuel, this includes assembly item counting and inspection of the surveillance equipment in the fuel building.

After the pressure vessel has been closed, the IAEA conducts Post-PIV activities. These include placing new seals on the equipment hatch, the spent-fuel transfer canal gate, and the vessel head assembly bridge; removing the temporary camera from the reactor hall; re-inspecting the spent-fuel storage pools including SF assemblies item counting; inspecting all irradiated assemblies or parts of assemblies using Cherenkov and gamma-ray detectors; and verifying the status of the C&S equipment in the fuel building. At the end of these inspection activities, the IAEA compares its own inventory records with the plant operators' records and reconciles the differences.

## 4.6 Assessment of Additional Measurements and Inspections

The package of safeguards described in Section 4.5 has been adequate to prevent any covert diversion from safeguarded power reactors to date. The international community has not yet encountered a premeditated NPT breakout attempt by a determined and a resourceful country relying on the nuclear materials accumulated in a LWR plant. As discussed in Chapter 2, the currently applicable IAEA safeguards agreement with the DPRK (that follows INFCIRC 153) allows for additional measurements and inspections beyond the measurements and inspections at the reactors that have just been described. In this section, we discuss these additional measurements and inspections briefly together with their utility.

### 4.6.1 Measures for Strengthened Safeguards Under INFCIRC 153: Environmental Sampling

Under INFCIRC 153, the IAEA can carry out environmental sampling only at places to which it otherwise has access to at declared

sites but not at undeclared places without getting permission or requesting a "special inspection." The utility and practicality of environmental sampling in and around nuclear facilities have been validated through field trials at the invitation of a number of member states. Samples can be collected from water, air, soil, and vegetation. Each has its own features. Water sampling has been shown to be an effective and relatively low-cost technique for both short- and long-range detection of nuclear activities, but a clandestine facility can prevent water-borne effluents from reaching the sampled bodies of water. Air-sampling techniques can be applied to both airborne gases, such as  $^{85}\text{Kr}$ , and airborne radionuclides associated with particulates, such as  $^{129}\text{I}$  and  $^{106}\text{Ru}$ . Some radioisotopes can only be detected locally, some as far away as 100 kilometers from the site of emission. In some cases, highly sensitive modern analytic capabilities are needed, e.g., for sampling of emitted particulates. Signatures in soil and vegetation generally cannot be detected at ranges greater than approximately 10 kilometers and would be useful in the neighborhood of declared, and, in a special inspection, suspect facilities. While environmental sampling cannot provide 100 percent certainty of detecting covert or illegal activities, it faces a prospective diverter with a significant chance of detection, particularly if diverted material is not simply transported and stored, but is involved in some industrial process. The latter would have to take place if spent fuel is to be reprocessed to yield its plutonium.

### 4.6.2 Measures for Strengthened Safeguards Under INFCIRC 153: Remote Monitoring

As discussed in Section 4.5.4, field trials of remote monitoring of camera-seal systems are being successfully completed, though this measure has not been routinely

implemented in safeguard systems. In addition to the camera-seal system, other sensors can also be remotely monitored:

- Portal monitors, video, and TESA-type locks<sup>9</sup> that record entry and exit information (personnel, date, and time), and monitor nominal reactor operations, the movement (or non-movement) of nuclear material, and detect interference with containment or tampering with IAEA safeguards devices, samples or data.
- Reactor-emission sensors to provide facility data from operating reactors.
- Tamper-resistant electrical power monitors that would continually monitor and transmit to remote locations the current and voltage in an electrical transmission line, electrical substation, or power line entering and leaving the facility.
- Neutron spectrum and fluence monitors to indicate reactor performance between inspections.

This additional monitoring has yet to be tested. For several of the sensors, new procedures and portable instrumentation must be developed.

Monitoring systems require reliable and sure means of data transmission to the analyzing organization. The DPRK (or power reactor vendors) will also probably require secure data transmissions. Three separate requirements (reliability, surety and security) can be provided by e-commerce communication technologies.<sup>10</sup>

Reliability of the data provides for recoverable data in the case of communication errors, potential partial signal jamming, possible component failure, and power system vagaries. Surety is the portion

of the data system that encapsulates the signal and metadata (time-stamps, identification, and status records) to ensure an unambiguous data source and accuracy of attached metadata. Security is communication and data encapsulation that ensures the message contents are not usefully disclosed to a third party. Reliability is provided by redundancy, error correction and backup components, and systems. Surety is provided by authenticated timestamps, digital signatures, and checksums. Security is provided by encryption, tamper-detection systems and secure communications channels.

Another necessary feature of any unattended monitoring system is automated review and analysis of acquired data. The classic method is the review of video-monitoring data at video review stations after the fact. Typically, surveillance tapes are collected from the sealed monitoring units by inspectors and returned to a “home” facility for review. The tapes contain time-lapse images of the items being monitored. Existing video review stations allow the review of imagery at increased speeds. Yet, even with time compression of the monitoring system and review speed, each hour of human review time can currently only evaluate a little over a day of surveillance data from a single sensor. This makes clear the very labor-intensive nature of current video review efforts. An automated assessment tool for the video or other signal data streams that detect and assess changes and conditions indicating safeguards significant events is needed. Otherwise it may be weeks or months before information is reviewed. In certain cases, this may be too late.

#### 4.6.3 Measures for Strengthened Safeguards Under INFCIRC 153: Other Recommended Steps

Other recommended safeguard measures include:

- A Safeguards Center, a dedicated room for safeguards equipment and activities, is a recommended security consideration.
- A redundant stable, uninterruptible power supply. Protection is needed against loss of power for safeguards equipment.
- Adequate training for the DPRK situation, including red-teaming the particular physical and operational circumstances.
- Updating equipment and training on a regular basis.

Safeguards—no matter how well designed—are only as good as the training, maintenance, and support systems that implement them. Given the DPRK’s record of limited cooperation, inspectors will need to be trained to look beyond the conventional monitoring and inspection points for unexpected activities. All of these recommended steps necessitate that the IAEA and its member states pay special attention to the funding additional inspectors and equipment needed for safeguarding the KEDO reactors.

In conclusion, the additional measures and inspections described would clearly lower the probability of covert diversion from a safeguarded reactor. Absent any instance of such covert diversion from a safeguarded reactor, it is not possible to make this conclusion quantitative. Red-teams could bring out some covert diversion possibilities that these additional measures and inspections would

prevent. A systems approach to the overall package of safeguards must be taken to ensure that the particular additional measures are those that add the most assurance for the money invested. The authors of this report have not had either the time or the specific data needed to carry out such an approach, which is rather the province of the IAEA.

#### 4.6.4 Satellite Remote Sensing

Satellite-based remote sensing is not a part of the IAEA safeguards package, but if carried out by the US or other member state, is a useful addition to safeguards. Satellite-based remote sensing may prove particularly applicable to detecting an “intent-to-abrogate” from requirements of the NPT treaty and IAEA agreements.

Reliable and informative remote sensing suffers from a number of difficulties. The weather does not always cooperate, the observed party may conceal facilities, equipment, and evidence from overhead view, and current commercial technology (and marketability) limits GSD (Ground Sample Distance) to a minimum of one meter, so that only items the size of automobiles or larger can be clearly distinguished.\* Nevertheless, remote sensing can be the only source of timely information when trying to monitor broad areas, restricted facilities, or suspect sites in an uncooperative state. In particular, the following can be done:

**What can be monitored?** High-resolution imaging systems can monitor specific items and changes at a nuclear site. Synthetic aperture radar can evaluate conducting items (fences, transmission lines, pipelines, railways, equipment, and some industrial structures).

**Shipping casks.** Individual fuel shipping casks are large enough to be imaged from space, but the casks

\* High-contrast items smaller than the GSD limit can be imaged, but they cannot be unambiguously identified.



need identifying marks to be tracked from satellites. The state of a cask's contents cannot be determined from space, but if infrared imagery can determine the surface temperature of a shipping cask, it might be possible to infer something about spent-fuel contents. Satellite imagery could also be used to count casks at a dry storage facility.

**Cooling units, associated pumps, and exchangers.** The thermal state of elements of an industrial site can be evaluated by infrared imagery. The thermal output of a reactor can be estimated from temperature changes in exposed cooling water flows and cooling structures. The operational status of site facilities can be evaluated by monitoring the temperature of exposed heat exchangers, steam pipes, HVAC equipment, power transmission components, and gas-exhaust plumes.

**Facility construction at declared facilities.** High-resolution imagery of sites clearly identifies outdoor changes associated with construction. Earthmoving, grading, plowing, disturbances from heavy vehicles, building construction, and security perimeters are typically easily distinguished. Change-detection techniques allow analysts to focus quickly on changes in sites between images acquired on different dates, thus highlighting the effects of construction changes. Determining the nature of the construction and purpose of facilities are more difficult, but satellite imagery can direct the planning and conducting of ground-based inspections.

**What is the response time scale of satellite remote sensing systems?** The time scale for monitoring by satellite is determined by the orbital dynamics of the resources used and the local conditions at the

site to be monitored. In the case of SAR, weather conditions are not important. Commercial satellites in polar orbits revisit exact positions in 15–26 day cycles. More frequent imaging of locations can be performed by systems with the capability to acquire images at angles other than perpendicular to the earth's surface. This additional capability allows images of a site to be acquired as frequently as once every 3–4 days.

**Remote-sensing resources.** Table 4-2 lists some commercial, space-based remote-sensing platforms.\* A number of additional imaging systems are planned for the next decade. The yet-to-be-deployed systems will generally not add significantly new technical capabilities in the near term. Additional systems will provide greater revisit frequency, and perhaps an independent

imagery supply of a particular country. Hyper-spectral imagery at high spatial resolution, not yet developed, might identify specific chemical species on surfaces and in gas and liquid plumes. This development might provide significant new monitoring capabilities.

**Figure 4-11** shows how the various additional monitoring measures considered in this section could augment existing safeguards activities at the KEDO reactors.

Table 4-2. Commercial remote-sensing platforms.

System	Nominal resolution (m)	Revisit frequency (days)
IKONOS	1	14
SPOT	10	4
IRS	5	5
LANDSAT	15	?

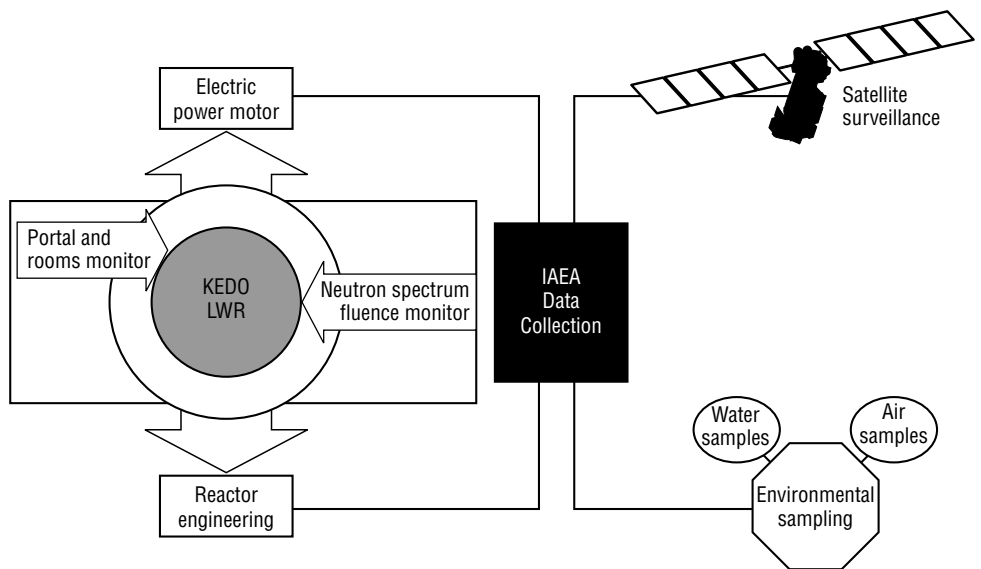

Figure 4-11. Additional monitoring measures that could augment existing safeguards activities at the KEDO reactors.

\* LANDSAT is a US government system, but the images are available commercially.

## 4.7 Conclusions

As the foregoing discussion indicates, the IAEA safeguards under the applicable agreements—if carried out with adequate funding, cooperation of the host country, and preferably with augmentation from national technical means—provide high assurance that no nuclear-materials diversion has taken place since the last inspection. Indeed, the global record to date suggests that no fuel diversion from a civilian LWR under safeguards has taken place. Both the quantity and the timeliness criteria on which the entire accounting and inspection system are based have proven adequate so far. Including the additional measures permitted under the applicable agreements and discussed above, safeguards in our opinion will give high assurance that *covert* programs at or near any inspected locale are not going on.

The international community has not yet encountered an *overt* premeditated NPT breakout by a determined and a resourceful country relying on the nuclear materials accumulated in a LWR plant. That option cannot be completely ruled out but only protected against. In such a case, IAEA safeguards—supplemented by other indications of diversion discussed in Chapter 5—should provide timely warning, which is to say, warning time shorter than the time required from diversion through fissile-material refining to the manufacturing of a completed nuclear-explosive device.

## Notes to Chapter 4

1. Korea Electric Power Corporation, *Korean Standard Nuclear Power Plant (KSNP)*, Seoul, Korea, 1996.
2. Byung Ryung Lee, Keun Sun Chang, and Jun Seok Yang, *Korean Standard Nuclear Plants: Safer, Simpler, and Easier to Build* (Korea Atomic Energy Research Institute, Nuclear Engineering International, August 1992), pp. 29–35.
3. Korea Heavy Industries & Construction Co. Ltd. (Hanjung), Nuclear Power Plant, Seoul, Korea, October 2000.
4. Yousry Abushady, International Atomic Energy Agency, “Inspection Activities at Light Water Reactors,” Paper presented at the 2000 Workshop on IAEA Safeguards, NTC/KAERI, Taejon, Republic of Korea, August 9, 2000.
5. Byung-Koo Kim, Korea Atomic Energy Research Institute, “KEDO LWR Project for International Cooperation and Non-Proliferation,” Paper presented at the Monterey Institute of International Studies, Monterey, California, July 24, 2000.
6. Neil Harms and Perpetua Rodriguez, International Atomic Energy Agency, *Safeguards at Light Water Reactors: Current Practices, Future Directions*, IAEA Bulletin 38/4, pp. 1-6, Vienna, Austria, September 29, 2000.
7. O.J. Heinonen, International Atomic Energy Agency, “Additional Protocol and Safeguards Agreements—The New Non-Proliferation Standard,” Paper presented at the 12<sup>th</sup> Pacific Basin Nuclear Conference, Seoul, Republic of Korea, October 30, 2000.
8. Daniel A. Pinkston, Center for Nonproliferation Studies, Monterey Institute of International Studies, “Implementing the Agreed Framework and Potential Obstacles,” Paper presented at the 12<sup>th</sup> Pacific Basin Nuclear Conference, Seoul, Republic of Korea, October 30, 2000.
9. TESA Entry Systems, P.O. Box 620138, Atlanta, GA 30362-2138.
10. D.R. Manatt, R.B. Melton, C.E. Smith, and S.M. Deland, “International Safeguards Data Authentication,” Lawrence Livermore National Laboratory, Paper presented at the 37<sup>th</sup> Annual International Nuclear Materials Management meeting, Naples, Florida, July 28–August 1, 1996 (UCRL-JC-124825).

## 5.1 Scope and Intent

This chapter briefly describes a few scenarios by which a Light-Water Reactor (LWR) could conceivably be exploited for the purposes of—

1. diverting spent fuel to support weapons acquisitions, or
2. misusing the reactor to improve the quality of plutonium found in spent fuel.

Exploitation of an LWR for proliferant purposes requires bypassing safeguards, either covertly or overtly (by abrogating treaty obligations). Access to the reactor and to the spent fuel produced as a result of reactor operations is largely limited to the operations involved in refueling the reactor. This chapter also looks briefly at major signatures and other indicators that might serve as early warnings of potential proliferant activities. We also look at some of the technical options that could reduce the consequences of diversion or misuse and those that can improve the reliability and/or decrease the response time of safeguards measures.

There are scenarios by which an LWR power plant can “indirectly support” the development of nuclear weapons. For example, LWR construction and operation can justify the development of an underlying infrastructure and serve as a cover for a nuclear-weapons program. Some technologies associated with LWR operations, such as core physics computer codes, could be used for calculating weapon-materials produc-

## PLUTONIUM AND WEAPONS

While all plutonium isotopes can be used in a weapon, not all isotopes are equally desirable. So-called “weapons-grade” plutonium has 90 percent (or more) of the isotope  $^{239}\text{Pu}$  and little of the other isotopes. All the “even” isotopes cause problems because they emit neutrons, which can lead to premature detonation and impaired reliability. The isotope  $^{240}\text{Pu}$  is the most common of these.  $^{238}\text{Pu}$  is also problematic because it produces a great amount of heat in addition to neutrons. Even the “odd” isotope,  $^{241}\text{Pu}$ , is somewhat less desirable than  $^{239}\text{Pu}$  because of its higher neutron and heat production rates. Because all these other isotopes of plutonium are less desirable than  $^{239}\text{Pu}$ , we can approximate the weapons-usable “quality” of reactor plutonium as indicated by the concentration of  $^{239}\text{Pu}$ .

tion, either in the LWR or in other types of reactors (assuming the cross-section libraries for other types of reactors are available). Such indirect scenarios are not discussed here.

## 5.2 Scenarios

The most important vulnerabilities with LWR nuclear-power plants are associated with plutonium: either that generated normally during reactor operations and bound up in spent fuel, or that potentially generated as the result of improper use of the reactor. Because plutonium is created in the LWR fuel as it is being used, the major proliferation concern is the diversion of spent fuel. As already noted, although the plutonium in spent LWR fuel (so-called “reactor-grade” plutonium) is not ideal for nuclear weapons, it is considered usable, and thus an attractive target for theft or diversion of spent fuel resulting from normal reactor operations. Vulnerabilities associated with fresh fuel are minimal, as fresh LEU fuel has no value to a potential proliferator unless that

proliferator has the facilities and capabilities for further enriching uranium. Other vulnerabilities associated with LWR plants are also relatively limited. Misuse of ancillary capabilities (such as gloveboxes) or the application of skills, knowledge, and expertise to a weapons-development program offer little of value to potential proliferators and are capabilities relatively easy to obtain.

The fact that spent LWR fuel is not ideal for weapons leads to the second concern: the intentional misuse of the reactor for producing plutonium with improved isotopic composition. Two scenarios are offered that could be used by proliferators to covertly produce such plutonium. A proliferator could substitute so-called “target” assemblies (assemblies specially designed to produce plutonium) in place of normal fuel assemblies, or could arrange to have some fuel removed prematurely from the reactor by making it appear to be “failed fuel.” A common feature of these scenarios is that the material to be diverted in either case ends up in

the spent-fuel storage pool. Thus, both of these scenarios share many features.

The last two scenarios discussed will be the overt misuse of the reactor to produce “weapons-grade” plutonium, either through “short cycling” the reactor or through modifications to the reactor core design. While these two scenarios could be attempted covertly, the complexity and signatures associated with these scenarios are of sufficient magnitude that detection is essentially assured and abrogation of the Democratic People’s Republic of Korea’s (DPRK) international commitments is required. We also briefly discuss the other options that the DPRK may have should it choose to abrogate its obligations.

The reactors for the DPRK use a fuel assembly designed to be “reconstituted,” that is, they are designed to facilitate the replacement of individual fuel pins by the plant operators. This is done to maximize fuel utilization in the event that a few fuel pins become defective or damaged during operation. This fact leads to the possibility of a variant of the spent-fuel diversion scenario, the potential diversion of individual spent-fuel pins.

The main advantage of this variant to a potential proliferator is that a single spent-fuel pin, or even a few spent-fuel pins, might be more easily removed from the spent fuel building without detection. The radiation from a few such pins can be shielded with a smaller cask (several centimeters of lead pipe might be sufficient shielding,<sup>1</sup> and the heat load from a few pins can be more readily dealt with by filling the cask with water for short periods of time.

There are several difficulties (from the proliferator’s perspective) to this variant. First, relatively

little plutonium is in an individual fuel pin [a single Beginning of Life (BOL) pin contains only about 7 grams of plutonium, a normal burnup fuel pin contains about 21 grams of plutonium). Thus, many (several hundred to a thousand) would have to be diverted (probably over a long period of time) to accumulate a significant stock of plutonium.

Second, the diverted rods would have to be replaced with fuel pins that matched those removed, both in terms of appearance and possibly radiation characteristics. If only one or a few pins were removed from a given fuel assembly, matching the radiation characteristics may not be required, as the signature from the total fuel assembly would change only a few percent, probably within the errors inherent in safeguards instrumentation.

Third, the operations would have to be carried out without alerting the safeguards inspectors. The fuel-reconstitution station is in the spent-fuel storage pool visible to the safeguards cameras. While the cameras can probably identify that operations are proceeding at that station, they may not discern the details of the operation. Thus, while a proliferator will need to justify fuel-reconstitution operations on a specific fuel assembly, the extent of those operations may not be observed.

Finally, even though it would be easier to shield and transport a few spent fuel pins, it is not trivial to do so without risk of detection. The fuel pins are long, so a shield cask would also be quite long, and therefore likely visible to surveillance cameras. The fuel pins could be cut or chopped into shorter lengths, but that would require specialized equipment, and even if accomplished with minimal equipment, it would release considerable radioactive fission gasses and likely trigger radiation monitors. Packing

the fuel-pin sections into a shorter but larger diameter cask would also exacerbate heat removal.

Because of the difficulties associated with this variant, and especially in light of the small amount of plutonium in each fuel pin, this appears an unlikely scenario for large-scale diversion. However, this scenario may serve as an attractive prelude to abrogation, by providing material to perform initial testing of a covert reprocessing plant and associated weapons material infrastructures and designs.

### 5.2.1 Scenario: Covert Diversion of Spent Fuel Produced During Normal Reactor Operations

The diversion of spent fuel requires overcoming three obstacles: safeguards, radiation, and heat.

First, to covertly divert significant quantities of spent fuel successfully, the safeguards surveillance systems monitoring the spent-fuel storage pool and access portals have to be compromised. Current IAEA safeguards are specifically tailored to address this issue, and R&D continues on ways to improve the reliability of spent-fuel surveillance methods.

Second, even the least radioactive spent fuel requires transport in a heavily shielded container, and the activities associated with removing spent fuel from storage, and preparing and loading it into the transport casks require sufficient manpower that much of the operating staff would have to be involved in the operation.

Third, “young” spent fuel (spent fuel discharged less than several years) produces a great amount of heat and must be cooled to prevent damage or even melting (especially of very young spent fuel.)

The combination of the latter two obstacles places tough requirements on the design of the shipping cask. Shortcuts in the handling and transport of young spent fuel greatly increase the risk of fuel damage and poses significant personnel hazards.

Both the radiation and heat produced by spent fuel decays slowly with time, so older spent fuel can represent a greater diversion risk than fresher spent fuel. Because the oldest spent fuel (the BOL spent fuel) is also the spent fuel with the highest quality plutonium, this tendency is reinforced, and there is a desire (from a nonproliferation view) to preferentially relocate the oldest spent fuel and place it under more effective international control.

Spent-fuel storage pools do not normally have enough capacity to store all the spent fuel discharged during the life of a plant. As spent fuel ages, and the heat and radiation generated by the spent fuel lessen, the spent fuel can safely be stored in dry casks at the reactor site. These casks are very large, bulky, and difficult to transport without specialized equipment. Removing fuel from the casks is a difficult procedure owing to the high radiation field. The casks have tamper-proof seals to detect any attempt to open the casks. Safeguards of dry-cask storage areas rely on surveillance monitoring and on periodic inspections of inventory and cask-seal integrity. The size of the casks makes them detectable from satellites, providing additional surveillance certainty. Thus, diversion attempts on dry-cask storage areas incur difficulties similar to diversion attempts from spent-fuel storage pools, but they could also be detected from surveillance satellites.

Diversion of spent fuel has a number of signatures, especially in a once-through fuel cycle. First, the movement of the spent fuel itself is observed via the installed safeguards measures. Cameras and portal seals verify the security of access,

and advanced notice of spent-fuel storage facility activities involving the movement of spent fuel is normally required. Related signatures include evidence of intrusion or illicit activities detected directly by the monitoring equipment and evidence of manipulation of the monitoring equipment (perhaps observed as failures in the monitoring equipment). Raising spent fuel from the storage pool increases the radiation level in the facility and is readily detectable.

Because the diversion of spent fuel requires the transport of the material away from the reactor site, a transport cask is needed. Even a cask designed to bare minimum requirements will be large and bulky, and likely observed from surveillance satellites, although the cask may be on site for a relatively short time (on the order of hours.)

For spent-fuel diversion to remain undetected, the diverted spent fuel must be replaced with a dummy that mimics the appearance and characteristics of the diverted fuel assemblies. Safeguards practices include periodic surveys of spent fuel to verify both the appearance and the nuclear characteristics of the material. A dummy fuel assembly with such characteristics presents similar radiation hazards to normal spent fuel. This in turn requires remote handling during the manufacture, necessitating potentially observed facilities. Transport requires a similar (or same) shipping cask as normal spent fuel. Movement of the dummy assembly into the spent-fuel storage area entails the same observables as moving the real spent fuel out.

### 5.2.2 Scenario: Covert Materials Production

The ability to covertly misuse an LWR to produce better quality plutonium than that found in normal spent fuel is limited. It is technically

feasible to introduce a small number of target assemblies specially designed to improve the production of weapons-quality plutonium. Lu, et al. estimated that as much as 8 kilograms of plutonium/year could be produced in a Pressurized-Water Reactor (PWR) by populating normally empty control-rod guide tubes with special target pins, and that this might be accomplished without substantially affecting reactor operating characteristics.<sup>1</sup> The physics and cycle length of the LWR core make it unlikely that a target assembly could produce high-quality plutonium if left in the core for the entire 4.5-year life of a normal fuel assembly. However, if left in the core for only a single cycle, the plutonium produced by special target assemblies could have as much as 90 percent <sup>239</sup>Pu.

During refueling, LWR operators inspect fuel assemblies before reinserting them back into the core; they inspect more carefully if fuel damage is indicated. It is feasible that a potential proliferator could arrange to have some fuel or target assemblies modified to appear defective as a justification for removing them at relatively low burnups.

The possibility of defective fuel presents additional safeguards implications. Any fuel (either failed or not) removed before achieving nominal burnup will have a plutonium isotopic composition similar to BOL fuel, and thus represent a more attractive diversion target. Thus, there is some incentive for verifying that only truly failed fuel is removed prematurely from the reactor. The fuel designed for these reactors is expected to be "reconstituted," that is, in the event of fuel failures, individual fuel pins can be replaced and the bundle reinserted into the reactor. On the one hand, this increases the number of accountable items because individual fuel pins become accountable.

On the other hand, it reduces the accumulation of low-burnup spent fuel because only those failed fuel pins remain in the spent-fuel storage pool.

Such a scenario requires several steps. First, an expectation of failed fuel needs to be established to prepare the inspector to accept the unusual fuel change-out. This requires spoofing the reactor failed-fuel monitoring equipment. Such an expectation also serves to mask the true intent of the mis-identification of the failed fuel. Alternately, a fresh fuel element might be covertly “pre-damaged” prior to the initial insertion into the reactor so that it would be a truly “failed” fuel element at the next refueling. Because fresh fuel will be imported into the DPRK, pre-damaging it would require cooperation from the country of origin, presumably the Republic of Korea (ROK), or the fuel would have to be covertly damaged at the plant site.

Second, the “failed” fuel would have to be “identified,” likely through spoofing of fuel inspection procedures or by contaminating (or otherwise camouflaging) the fuel to appear failed.

Third, the evidence of failed fuel would have to be sufficient to convince the on-site refueling inspector.

From there, the “failed” fuel would be placed in the spent-fuel storage pool. Generally, failed or suspect fuel is first placed in a specialized storage cask (or sleeve) to isolate the failed fuel and minimize potential for contaminating the spent-fuel storage pool. Once in the storage pool, the fuel is no more or less vulnerable to diversion than any other spent fuel, with the slight possible complication of (perhaps) needing to remove the fuel assemblies from the failed-fuel storage cask.

An advantage (to the proliferator) of this scenario is that it provides a mechanism for producing spent fuel of higher plutonium quality within the normal operating procedures of the reactor. Conversely, the use of reconstituted fuel assemblies significantly reduces the amount of low-burnup spent fuel that could be accumulated under such a scenario.

Such a scenario has several observables. First, utilization of special target assemblies to optimize plutonium production requires obtaining such assemblies and introducing them into the normal fuel supply. Arranging for fuel assemblies to fail (or to appear failed) requires similar efforts. Accomplishing such a feat requires fooling of safeguards, either by falsifying records and/or swapping target assemblies for real fuel assemblies, as well as avoiding detection during fuel handling and fuel inspection. Safeguards practices are specifically designed to detect the introduction of extraneous fuel assemblies into the fuel supply.

The second observable occurs in the need to manufacture the target assemblies, which would require the acquisition of a number of items and materials subject to various export and nuclear-supplier restrictions. The target assemblies have to be indistinguishable from the real fuel assemblies, have the serial numbers of the real fuel assemblies, and the real fuel assemblies being replaced have to be covertly removed from the site.

The third observable in the scenario requires some justification for removing the special assemblies before the end of the normal fuel life, most likely after a single cycle.

Finally, even if such assemblies are successfully irradiated, they end up in the spent-fuel storage pool and must be covertly removed.

### 5.2.3 Scenario: Short-Cycling the Reactor

A reactor can be operated for less than its normal cycle, reducing burnup and improving the quality of the plutonium in the spent fuel. This “short-cycling” can be either covert or overt. Covert short-cycling of the reactor is limited to premature discharge of only a few fuel assemblies, perhaps as “failed fuel” as discussed previously. Premature discharge of more than one or two such assemblies is so unusual that detection is essentially certain and the scenario must be considered overt. There are few “legitimate” reasons for short-cycling a reactor, and these are generally for safety-related issues such as component failure (including severely failed fuel), system leaks, and control problems. Most safety- and control-related reactor shutdowns do not necessitate opening the reactor, let alone handling fuel.

Thus, if potential proliferators wanted to short-cycle a reactor to covertly produce plutonium of higher quality, they need to concoct a relatively elaborate scheme to make the early shutdown appear justified, especially one that requires even partial unloading of the reactor core. Even if such a covert scenario were followed, it would be limited to the diversion of very few fuel assemblies, owing in part to the necessity to have replacement fresh fuel available. Normally, a reactor operator maintains a small stock of fresh fuel in the event that a fuel element requires replacement, but fuel is relatively reliable, and the necessary stock of surplus fuel is small.

In addition, once the short-cycle fuel was removed from the reactor, it would eventually have to be diverted from the spent-fuel storage pool, as in Scenario 1.

Short-cycling a reactor creates a number of observable signatures related to the loss of power. First is the loss of power to the grid that may be detected if the power grid has “external” connections (especially if significant power is normally exported, or is monitored). Second is the loss of “dump heat” that can be remotely detected by the loss of infrared signals.\* Both signatures should be detected promptly, and certainly within the time needed to cool the reactor prior to removing the head and gaining access to the fuel (which normally takes a few days).

Diverted short-cycle spent fuel must be replaced if the reactor is to remain operating. Thus, replacement fresh fuel has to be obtained (probably in advance of the reactor shutdown) and this has to occur many months sooner than for normal reactor operations. The early accumulation of fresh fuel would thus indicate possible reactor short-cycling.

In the event of overt short-cycling of the reactor with a goal to obtain plutonium with 90 percent  $^{239}\text{Pu}$ , burnup would be limited to no more than about 7 MWd/kg, limiting the reactor cycle time to approximately 9 months. Assuming an industry average of 40 days per refueling outage and refueling of the entire core, the reactor could produce as much as 150 kilograms of plutonium (containing approximately 90 percent  $^{239}\text{Pu}$ ) every 10 months.†

If the goal is to obtain a limited quantity of 90 percent  $^{239}\text{Pu}$  with a minimum of observables, then the reactor could simply be shut down within about 9 months of the last refueling. At equilibrium, one-third of the core (the last fresh fuel

reload) would contain approximately 50 kilograms of plutonium with about 90 percent  $^{239}\text{Pu}$ . In such a case, the primary observable would be the premature shutdown of the reactor.

We note again that the previous two paragraphs apply to overt diversion, in which case the DPRK abrogates the Agreed Framework (AF) and withdraws effectively from the Non-Proliferation Treaty (NPT).

#### 5.2.4 Scenario: Overt Reconfiguration of the Reactor for Materials Production

While LWRs can be short-cycled to improve the isotopic composition of plutonium found in the spent fuel, such an approach is costly—both in terms of operating costs and lost revenues. Weapon-material production through the use of special target assemblies or through the reuse of failed fuel offers very limited capabilities for material production. To provide significant increases in material quality and quantity requires the introduction of a large number of target assemblies. Target assemblies using depleted uranium, arranged as a blanket surrounding the core (a region of reduced neutron flux) would help extend the cycle time of the reactor, while helping to improve the quality of the plutonium produced. However, such an approach significantly reduces the total amount of reactivity in the core (a measure of how much “active” fuel is in the core), significantly affects the thermal and nuclear performance of the reactor, and dramatically affects the performance of the reactor control systems. These effects lead to the need to substantially reconfigure the

reactor core to achieve significant increases in the quantity and quality of discharged plutonium.

Such modifications are expensive and time-consuming and require significant reactor-design capabilities. Moreover, the modified reactor would require fuel substantially different from that normally used, probably requiring much higher enrichments than normal LWR fuel. Thus, besides the design and manufacturing efforts associated with the core reconfiguration, a source of fuel and enrichment capabilities also has to be provided.

The modifications necessary to achieve these goals could not go unnoticed under any inspection regime, and an overt abrogation of treaty responsibilities would appear necessary. While design and construction of the modifications might proceed before any overt display of intent, the lack of known enrichment capabilities in the DPRK means that an external source of fuel would be an essential element of such an approach.

In a worst-case scenario, one in which all modifications were compatible with the existing core internal structures and all materials (including both modified fuel assemblies and target assemblies) were available prior to modifying the reactor core, the substitution could not proceed without notice by the inspectors. On the other hand, it may be feasible that the modifications could proceed in approximately the same time as required for a normal refueling (perhaps as little as 15 days, but more likely 30–60 days). This means that the rest of the world could expect at least 15 days to respond to an abrogation before

\* Only about one-third of the power produced in the reactor is turned into electricity, the remaining two-thirds is wasted and dumped to the environment. The dumped-heat infrared signature of an operating reactor is easily detected from satellites.

† These data are obtained from the rough approximations of plutonium production in LWRs described earlier. Plutonium production rates vary broadly with fuel enrichment, and using lower fuel enrichments would likely reduce cost and optimize plutonium production. Significant additional analysis is required to determine more accurate estimates of fuel requirements and of material production and plutonium isotopic contents at these lower burnups.

reactor restart (and some additional time—on the order of several weeks—before significant plutonium could be accumulated.)

### 5.3 Consequences

The primary consequence of diverting spent fuel from an LWR is tied to the quality and quantity of the plutonium contained in the spent fuel. Normal reactor operations result in the discharge of nearly 300 kilograms of reactor-grade plutonium every 18 months, with lesser discharges of somewhat higher quality plutonium during the beginning of the reactor life. The spent fuel discharged during the beginning and end of reactor life, while still not considered “weapons-grade” would be somewhat less difficult to design and fabricate into a weapon than the higher burnup equilibrium fuel. Because all plutonium produced as a result of LWR operations is considered “weapons-usable,” these differences must be considered differences in degree, not differences in kind. An approximation of the projected accumulations of spent fuel is summarized in **Table 5-1** and **Fig. 5-1**.\*

In addition to these spent-fuel discharges, there is also partially spent fuel in the reactor at all times. At any refueling, there remains in the reactor one-third core of 1-cycle fuel (containing approximately 100 kilograms of low-burnup plutonium) and one-third core of 2-cycle fuel (containing approximately 275 kilograms of medium burnup plutonium). At the end of the reactor lifetime, this “in-core” fuel is discharged (shown in Table 5-1 and Fig. 5-1).

This in-core fuel is of most concern during the reactor’s BOL period. As previously noted, at the end of the first cycle, the core fuel contains approximately 300 kilograms

Table 5-1. Accumulation of Light-Water Reactor (LWR) plutonium in spent fuel.

Time from First Startup (years)	Discharged Low-Burnup Pu (kg)	Discharged Medium-Burnup Pu (kg)	Discharged High-Burnup Pu (kg)	Cumulated Total Pu (kg)
1.25	100	0	0	100
2.5	—	175	0	275
4	—	—	275	550
5.5	—	—	288	838
—	—	—	—	—
40	100	175	288	7,737
<b>Total Discharges</b>	<b>200</b>	<b>350</b>	<b>7,187</b>	<b>7,737</b>

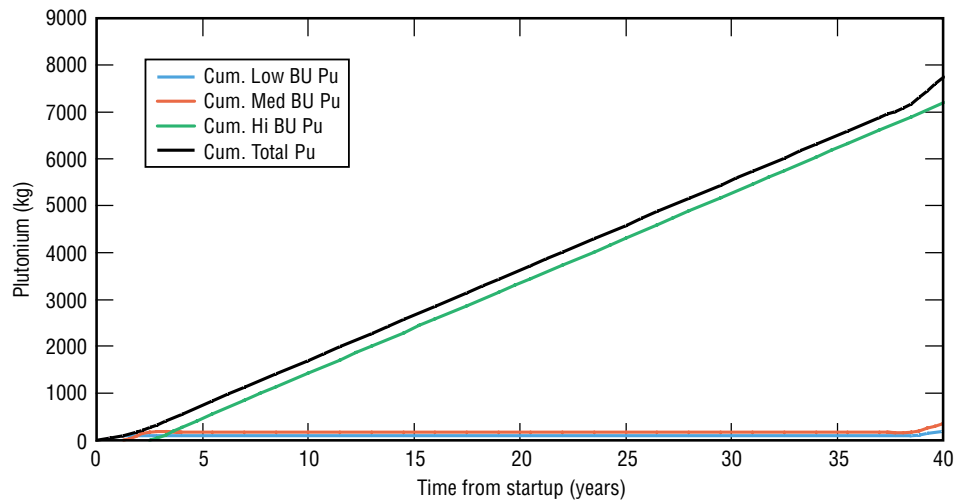

Figure 5-1. Plutonium discharged from LWR operations (BU = burnup).

of low-burnup plutonium, 100 kilograms of which is normally discharged. Thus, should the DPRK decide to abrogate its obligations at the end of the first cycle, there would be approximately 300 kilograms of low-burnup plutonium available.

As already discussed, overt short-cycling of an LWR could produce as much as 150 kilograms of essentially “weapons-grade” plutonium roughly every 10 months, and there some potential that smaller amounts could be accumulated through some of the scenarios discussed here. Safeguards have been designed to help detect such activities and minimize the

potential for such attempts. Thus, production of substantial quantities of low-burnup plutonium and subsequent diversion of it likely requires an overt abrogation of treaty obligations.

Exploitation of the plutonium produced in an LWR requires reprocessing to extract the plutonium. Although reprocessing of spent LWR fuel is similar to the reprocessing of spent fuel from graphite reactors (of which the DPRK has experience), there are some notable differences. First, LWR fuel is clad with zircalloy, a very durable alloy that complicates dissolution of the fuel (as compared with magnesium-clad metal

\* The values for accumulated plutonium shown in Table 5-1 and Figure 5-1 refer to the plutonium content of freshly discharged spent fuel and do not account for the decay of plutonium, mostly associated with the decay of the short-lived isotope <sup>241</sup>Pu.



fuel that is easily dissolved.) The LWR fuel must be mechanically chopped into small pieces, and the toughness of the alloy makes this a difficult process. Second, the complexity and size of the LWR fuel assembly (hundreds of very long pins as opposed to the single short slug of a graphite reactor fuel element) further complicates this process. Third, the combination of the zirconium and oxide fuel makes the chemical dissolution step itself slower than dissolution of the magnesium-clad metal fuel used in the graphite reactors. Finally, spent LWR fuel has higher radiation levels than graphite reactor fuels, due both to its higher burnup and the fact that the fuel assemblies themselves are much larger. In short, even if an active reprocessing capability for the graphite reactor fuel is available, a new front-end to the reprocessing facility must be provided to prepare the spent fuel for reprocessing. This front-end needs to be co-located with and likely contiguous to the rest of the reprocessing facility, as the dissolved fuel is too radioactive to be reasonably shipped.

## 5.4 Preventive Measures

As just described, reducing the proliferation risk associated with potentially weapons-usable plutonium generated by reactor operations fall into several broad areas:

1. Reducing access to plutonium-containing materials,
2. Reducing the quantity or quality of the plutonium in spent fuel,
3. Reducing the desirability of misusing the LWR for weapon-material production.

For practical purposes, all covert scenarios for misusing an LWR for weapon-material acquisition can be reduced to the issue of spent-fuel diversion. LWR power plants, by

nature, are quite robust against misuse or modification for weapon-materials production. As has been discussed, such misuse is expensive, time-consuming, and involves sufficient, easily detected observables. Because the DPRK reactors are copies of existing designs, there are few, if any, substantial modifications to the reactors or the plants that could significantly reduce the risk of misuse, a risk that appears relatively low to begin with. Remote monitoring of plant-operating characteristics, both directly (through telemetry of plant parameters) and indirectly (through remote surveillance), discussed in Chapter 4, is an area of technology that could improve the ability of the safeguards community to detect and reduce the attractiveness of any of the scenarios discussed.

Increasing the burnup capability of LWR fuel is the most promising near-term approach to enhancing the intrinsic proliferation resistance of the LWR fuel cycle, including those in the DPRK. In addition to reducing the quantity and overall quantity of plutonium resulting from LWR operations, it can reduce overall fuel cycle costs and thus is an attractive option for the reactor operator, and could be implemented within the AF. Research is underway, both in the US and abroad, to extend the burnup capability of LWR fuel, and this option could become available in time.

Other technologies have been proposed to further enhance the proliferation resistance of LWR plants and associated fuel cycles. Most, if not all, of these options fall far outside the bounds of current LWR practice and are likely unacceptable within the guidelines of the AF. One example is the addition of substances to fresh fuel to make fresh fuel radioactive as a deterrent to theft and diversion. Such an approach, while feasible, introduces complications that significantly increase the cost of the

fuel, reduces safety, and complicates transport, inspection, and handling. Moreover, such an approach deals only with the proliferation risk of fresh LEU fuel, a risk already considered very low. As such, it is unlikely that such measures would be willingly accepted by any plant operator.

The issue of the higher-quality spent fuel resulting from BOL operations can be eliminated by initially fueling the reactor with partially irradiated fuel, such that all BOL spent fuel would be exposed to full design burnup on discharge. That approach introduces a number of technical and operational challenges and is outside the bounds of current reactor operations. Partially irradiated fuel rods are much more prone to damage during handling and transport than fresh fuel and introduce significant risks for fuel failures on re-irradiation. The operational challenges include, among others (1) identifying a source of the partially irradiated fuel, (2) licensing the partially irradiated fuel following the additional handling and transportation involved, and (3) ensuring personal protection and facility safety when introducing partially irradiated fuel into the reactor operations normally designed to handle fresh fuel. None of these steps are even remotely practical or economic.

Diversion of individual fuel pins can be impeded by eliminating the ability to reconstitute fuel. This is technically easy to accomplish; indeed, not all LWR fuel is designed to be reconstituted. However, several issues need to be solved before implementing such an option. First is licensing. The current licensed fuel design for these reactors is reconstitutable, and any new design would have to be licensed. Second, is the issue of reciprocity. Because the ROK reactors use reconstitutable fuel, the DPRK is unlikely to accept different treatment. Third is the

cost. A new fuel design would be more costly (mainly due to licensing costs), but would also be slightly more costly to operate. Fuel is designed to be reconstituted to gain maximum life out of each fuel assembly. A failed single pin in a non-reconstitutable assembly can lead to premature discharge of the entire assembly.

In summary, the best practicable methods for preventing the diversion scenarios outlined are the ones described in Chapter 4,

Section 4.6. These methods, under the conditions recommended, protect against covert scenarios so that other methods of attaining a weapon capability, other than covert diversion from the KEDO reactors, would probably be chosen by any proliferator. Overt diversion, the abrogation of agreements, cannot be prevented by safeguards, though they can be warned about and damage can be limited. This overt scenario is discussed in Chapter 8.

### Notes to Chapter 5

1. M.S. Lu, R.B. Zhu, and M. Todosow, *Unreported Plutonium Production in Light-Water Reactors*, Brookhaven National Laboratory, Upton, New York, ISPO-282, TS-88-1 (February 1988).

**KNOWN AND SUSPECTED NUCLEAR-RELATED FACILITIES IN THE DPRK**

**6.1 Inspection, Dismantlement, and Disposal Requirements for Existing Nuclear Facilities**

**6.1.1 “Full-Compliance” Inspections by the IAEA**

The Agreed Framework (AF) provides that the Democratic People’s Republic of Korea (DPRK) must come into “full compliance with its safeguards agreement with the International Atomic Energy Agency (IAEA)” when a “significant portion of the Light-Water Reactor (LWR) project is completed, but before delivery of key nuclear components.” This means completion, to a stage still to be agreed on, of the buildings for the turbine generators for the first LWR at Kumho and delivery of its turbine generator but not the LWR itself or key nuclear components for it. Thus, before IAEA inspection is required of facilities other than those “declared” to the IAEA by the DPRK when the DPRK accepted its safeguards agreement, the Korean Energy Development Organization (KEDO) must complete major construction of buildings at Kumho and deliver much of the non-nuclear equipment for electric generation. The specific stage of construction and delivery required is to be agreed in a “delivery protocol.”

Believing that the inspections and analysis necessary to show “full compliance” will take two to three years, the IAEA has been pushing the DPRK to permit these inspections to begin even though

the completion of construction of the LWR buildings and the delivery of the turbine generator are still a year or more ahead.

**6.1.2 Disposal of Spent Fuel**

When the transfer of key nuclear components to Kumho for the first LWR takes place, the DPRK is obligated by the AF to begin transfer of the spent fuel stored in the cooling pond near the small graphite reactor at Yongbyon. Transfer will presumably continue during the period of delivery and installation of key nuclear components for the second LWR at Kumho because the spent fuel is all to be transferred to “ultimate disposition” by the time that LWR is completed at Kumho. The AF does not specify where the spent fuel is to go but says that DPRK and the US will “cooperate... to dispose of the fuel in a safe manner that does not involve reprocessing in the DPRK.” Thus, where the spent fuel will go and how it will be transported still remains to be decided.

**6.1.3 Dismantlement of Gas-Graphite Reactors**

When the first LWR is completed at Kumho, the dismantlement of the three existing gas-graphite reactors and “related facilities” at Yongbyon, Taechon, and elsewhere must begin. This dismantlement must be completed by the DPRK when the LWR project (including installation of the second LWR) is completed at Kumho. More agreement than this on how this dismantlement will be scheduled, including how it will be coordinated with steps toward installation of the second LWR at

Kumho, remains to be negotiated. The technical problems do not appear to be major, but how the dismantlement will take place and where the dismantled parts of facilities will go remains to be decided.

**6.2 The Facilities at Yongbyon\***

The main site for the North Korean nuclear program was the Yongbyon Nuclear Center, about 100 kilometers north of Pyongyang, on the Kuryong River (Fig. 6-1). Many of the facilities at the site have been “frozen” as a

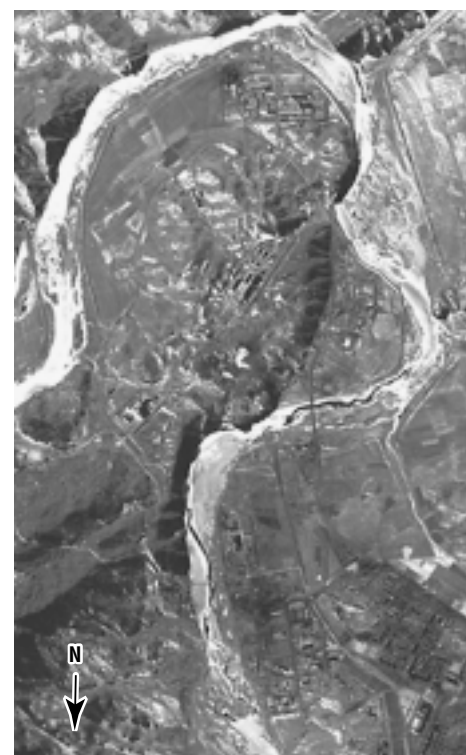

Figure 6-1. Satellite image of the Yongbyon site in 2000 (used with permission from Space Imaging). The facility extends on both sides of the river throughout essentially the entire photograph.

\* Much of Sections 6.2 and 6.3 is taken from David Albright and Kevin O’Neill, eds., *Solving the North Korean Nuclear Puzzle*, Institute for Science and International Security Press, Washington, D.C., 2000.

result of the Agreed Framework (AF) of 1994, but the site as a whole is still active.

The site includes facilities for fuel manufacture, three nuclear reactors, at least one hot-cell facility, at least one spent-fuel reprocessing facility and several waste sites. There is also a high-explosives testing area, which has been inactive since at least 1992.

The North Koreans reported to the IAEA that the site was dedicated to the pursuit of peaceful nuclear energy and there was no weapons program; however, inspections, measurements, and satellite photographs have shown suspicious activities. As of this writing, it has not been determined exactly which of the Yongbyon facilities were for weapons-manufacturing and which (if any) were for energy production. It is possible that entire site was a dedicated weapon facility that used a peaceful cover story. Given the activities observed, it is unlikely that the site was dedicated entirely to peaceful purposes.

Uranium mining, milling, and refining operations were carried out at other sites in North Korea. The DPRK has sufficient domestic uranium resources to be self-sufficient. Estimates of the capacity of North Korea's uranium mining and milling operations in 1992 range from 300 tonnes to 1,800 tonnes per year. There are no known uranium isotopic-enrichment facilities in the DPRK. The reactor program was to operate with fuels of natural enrichment, with the exception of the Soviet-supplied IRT-2000 research reactor.

In the rest of this section, we focus on the main facilities, declared and suspected, at Yongbyon.

### 6.2.1 The IRT-2000 Research Reactor

In 1965, the IRT-2000 reactor was commissioned in Yongbyon. The reactor is light-water-cooled and moderated, uses enriched uranium fuel, and was designed to operate at a power level of 2 MW(th) [later the power level was increased to 4 MW(th) and then 8 MW(th)]. Soviet nuclear reactor specialists departed the DPRK after the reactor was completed, but continued to cooperate on agreements to supply the enriched fuel.<sup>1</sup> The reactor was placed under IAEA safeguards in 1977. This reactor is not frozen and is not scheduled to be dismantled under the AF.

### 6.2.2 Isotope Production Laboratory Near the IRT-2000 Reactor

In the northern part of Yongbyon, there is a set of laboratory buildings including one designated as the Isotope Production Laboratory. In this building, there are hot cells for handling radioactive material. This is where North Korea first produced plutonium, generated in uranium targets in the IRT-2000 reactor. They have admitted to the production of less than of gram of the material by this means. This laboratory is not frozen under the AF.

### 6.2.3 Probable Undeclared Waste Site South of the IRT-2000 Reactor

Near the (uncompleted) 50-MW(e) graphite reactor is an undeclared waste site that was probably in operation from the 1970s until August 1992. From satellite imagery (Fig. 6-2), it was determined that the undeclared waste site contains two cylindrical tanks, each about 5.8 meters in diameter, in addition to a rectangular arrangement. This type of waste

site is commonly associated with IRT reactors. Iraq, for example, has an almost identical facility at the Tuwaitha Nuclear Research Center. It has two dry wells for storage of irradiated fuel elements, plus two cylindrical tanks for storage of liquid radioactive waste. The site at the Yongbyon facility was covered with dirt in August 1992, and the road leading to the site was hidden by freshly planted trees. Some of the trees then died within a few months, and more vegetation was planted. The IAEA has not been allowed access to the waste stored at this site, but it is suspected that further waste from processing IRT reactor targets is stored there.

### 6.2.4 Declared Waste Site

Nearby, there is a declared waste site that did not exist until mid-1992. The North Koreans, nevertheless, stated that this site has been active since 1977, holding solid waste in 28 steel-lined storage pits (upgraded to 42 pits in 1990). The deliberate concealment of the older waste site, together with the false history of the declared site, make it appear that the IRT-2000 reactor produced significant amounts of plutonium, and that the wastes have been concealed.

### 6.2.5 Graphite-Moderated Reactor

In the early 1980s, construction of a nominally 5-MW(e), 20-MW(th) graphite-moderated power reactor was started in Yongbyon. A decision to seek nuclear weapons could already have been made at this time, and the graphite-reactor technology would be easily adapted to a dual-use role. The reactor design is said to be based on the Calder Hall reactors, originally built to produce electricity and support the British nuclear-weapons program.

The Yongbyon design uses uranium-alloy (99.5 percent uranium, 0.5 percent aluminum) fuel rods in magnesium-alloy (99.5 percent Mg,

0.5 percent Zr) tubes. The rods are 2.9 centimeters in diameter and 52 centimeters long and contain 6.24 kilograms of the uranium alloy. The tube walls are roughly a millimeter

thick but there are longitudinal fins, bringing the outer diameter to about 5 centimeters. Cooling is by forced convection with carbon dioxide gas under 6 bars of pressure.

The reactor core consists of a set of large graphite blocks, with 812 vertical holes (“channels”) bored in them for the fuel and coolant. The channels are 6.5 centimeters in diameter. There are 10 fuel rods per channel, stacked vertically. The diameter of the core is 6.4 meters and the height, not including reflectors, is 6 meters. While the core is about half the physical size of the Calder Hall units, the maximum thermal power is only about one-tenth that of the Calder Hall units.

### 6.2.6 Fuel Reprocessing Facility

During the late 1980s, a fuel-reprocessing facility was constructed. The facility is housed in a building 192 meters long and six stories tall, quite visible in satellite photographs (Fig. 6-3). In 1994, the facility had a nominal capacity to reprocess 220–250 tonnes of Magnox spent fuel per year, using two PUREX processing lines, if the lines are operated 24 hours per day, 300 days per year.\*

The spent fuel from the Magnox reactor would be transported to the south end of the reprocessing facility by truck in buckets within shielded casks. The buckets and fuel rods would then be moved to the north side of the building by remotely operated vehicle and the processing occurs in the southerly direction.

Along the eastern side of the building is a complex set of storage tanks within shielded vaults that contain liquid processing wastes of low- and intermediate-radiation levels. At the southeastern end of the building is a vault containing two storage tanks for highly radioactive fission-products. About 120 meters east of the reprocessing building is an L-shaped building associated with the storage of highly radioactive waste. There are four tanks just south of this building in an underground vault that contain



Figure 6-2. The buried and the new waste site near the uncompleted 50-MW(e) graphite reactor. Only the new waste site was declared and the IAEA has not yet been allowed to inspect the buried waste site (used with permission from Space Imaging).

\* The PUREX process, or Plutonium Uranium Reductive Extraction, is used ubiquitously to reprocess spent fuel. See Benedict, Pigford, and Levi, *Nuclear Chemical Engineering* (McGraw-Hill Book Company, New York, 1981).



Figure 6-3. Satellite image showing the plutonium separation building and associated buildings and the suspect waste building, the so-called Building 500 where nuclear waste from undeclared reprocessing campaigns is suspected to be hidden. The waste could include 50 tons of uranium and 30 kilocuries of  $^{137}\text{Cs}$  (used with permission from Space Imaging).

most of the volume of the declared reprocessing high-level waste.

### 6.2.7 Undeclared Waste Storage Building

An undeclared waste storage building (sometimes called Building 500) is located about 300 meters east of the main reprocessing building. This building, built primarily in 1991, is 18 meters high (including the basement), 24 meters wide, and 67 meters long. The basement has four large pits for liquid-waste storage tanks and six smaller compartments for storage of containerized solid wastes. The basement is covered with concrete slabs for shielding. Trenches were dug and pipes were installed from the main reprocessing building in the winter of 1991-92. It is suspected that these pipes pumped aqueous radioactive wastes containing fission products and spent uranium

from undeclared reprocessing campaigns in 1989-91. Inspectors who visited this building during the third ad hoc inspection of September 1992 were told incorrectly that this building had no basement, and that it was a workshop for military vehicles.

### 6.2.8 Other Unfinished Reactors

Construction began on two other graphite reactors, one a nominally 50-MW(e) reactor at Yongbyon and another a 200-MW(e) reactor at Taechon. Neither of these two reactors was completed. The reactor graphite had been installed at the 50 MW(e) reactor but not at the 200 MW(e) reactor at the time of the freeze.

It has been speculated that the 50-MW(e) reactor at Yongbyon was to have been the main producer of weapon materials (in conjunction

with the reprocessing facility) and the Taechon reactor was to be for electrical production only.

## 6.3 Verification of the Initial DPRK Declaration

The IAEA inspections were meant to verify the correctness and completeness of the initial declaration of nuclear materials that the DPRK provided to the IAEA on May 4, 1992. The declaration includes statements as to—

1. The nuclear-material inventory of seven facilities declared by the DPRK to the IAEA as subject to safeguards.
2. Design information of those seven facilities.
3. A list of locations of nuclear materials outside these facilities.
4. A list of nuclear facilities under construction or planned.
5. A list of scientific institutions.
6. A list of nuclear facilities related to the nuclear industry.

The first IAEA visit occurred on May 11–16, 1992, and was followed by six ad hoc inspections to determine the correctness and completeness of the initial declaration. These inspections and some meeting and correspondence dates associated with those inspections are listed in **Table 6-1**. Attempts to inspect two undeclared facilities at the Yongbyon site in early 1993 under “special inspection” authority were blocked. The DPRK then announced that it was withdrawing from the Non-Proliferation Treaty (NPT). Although its withdrawal was suspended, the DPRK has never allowed IAEA special inspections. The IAEA began conducting inspections at the 5-MW(e), 20-MW(th) gas-graphite reactor and the other two unfinished graphite

reactors and related nuclear facilities declared by the DPRK starting shortly after the AF was signed.

The declaration claimed that the very first core-load of fuel was still

in the 5-MW(e) graphite reactor and that only a few defective fuel rods had ever been removed. To the contrary, evidence leads to the suspicion that beginning in 1989 large amounts of spent fuel from

the reactor had been reprocessed and several kilograms of plutonium removed. The nature of the discrepancy is shown schematically in **Fig. 6-4**, which shows a suspect path employing the 5-MW(e) graphite reactor.

Table 6-1. Visits and inspections by the IAEA of North Korean facilities.

Dates	Purpose and accomplishments
May 11–16, 1992	Initial official visit by Director-General Hans Blix and delegation.
May 26–June 5, 1992	First ad hoc inspection to verify the initial declaration.
July 8–18, 1992	Sampling of radiochemical lab includes swipes in and around five glove boxes that compose the plutonium-production area of the lab.
September 11–14, 1992	Visits to radiochemical lab and fuel-fabrication complex. Acting on suggestions made by the US, there are visits to the high-explosive facility and to Building 500, which appears to be a single-story building under military control.
November 2–13, 1992	IAEA provides DPRK with details of the inconsistencies and requests an explanation. Answers are not satisfactory to IAEA, who has been shown US satellite photos of the construction of Building 500 and the trenches leading to it.
December 22, 1992	Hans Blix requests extraction of samples around basement of building in question.
January 5, 1993	DPRK's Atomic Energy Minister Choi rejects Blix's request.
January 1993	Agency task force summarizes inconsistencies and makes recommendations for a set of measurements on reactor fuel.
January 20–22, 1993	El Baradei of IAEA visits Pyongyang to request special inspections of the two undeclared waste sites. Response is that the sites are military and non-nuclear—there will be no inspections.
January 26–February 6, 1993	Sixth ad hoc inspection. Extensive meetings and discussions between IAEA team and DPRK officials discussing isotopic inconsistencies found in swipe samples from radiochemical lab.
February 22–23, 1993	IAEA Board of Governors meets and discusses findings of inconsistencies. Satellite photos are shown. Board decides to support Blix, and declares that inspection of additional sites is essential to ensure verification of compliance with the agreement.
March 12, 1993	DPRK announces its intention to withdraw from the NPT.
May 10–14, 1993	Seventh ad hoc inspection team visits Yongbyon and performs maintenance and replacement of safeguards equipment at reactor.
June 11, 1993	DPRK announces suspension of NPT withdrawal, based on negotiations with US Assistant Secretary of State Gallucci.

From satellite imagery of the steam emitted from the reactor's cooling tower, a rough power history of the reactor was determined. The design of the reactor does not require the reactor to be shut down to remove some of the fuel. However, it was determined that significant outages had occurred during operation, which would allow large fractions of the core inventory to be removed, depending on the speed of the refueling machines available. It has been estimated that during a 70-day outage in 1989, half the core could have been removed with a single refueling machine, or the entire core could have been removed with two refueling machines. Based on these rough estimates, it is likely that up to 50 tons of fuel was processed in the radiochemical laboratory, which then may have produced as much as 8.5 kilograms of plutonium. If this were the case, there would be tens of kilocuries of radioactive fission products, and tens of tons of uranium sludge in the basement of Building 500.

The North Koreans declared that the reactor operated with only one core load of fuel from 1986 until 1994, when the entire core inventory was removed and put in the spent-fuel storage pool. Currently, about 8,000 rods are sealed in cans in the fuel pool, representing this one full core load. Only about a 100 rods were otherwise removed from the core because they had failed during reactor operation. Of those rods, they were able to take 86 from the spent-fuel storage pool and transfer them to the radiochemical lab for "hot tests" of the facility. The other rods, they claimed, were too badly damaged

## KNOWN OR SUSPECTED NUCLEAR-RELATED FACILITIES IN THE DPRK

to be removed from the pool and are still in the sludge in the bottom of the pool. For “cold tests” of the radiochemical lab, they claim to have used 172 fresh fuel rods. The “radiochemical lab” (reprocessing facility) was therefore declared to have only processed 86 irradiated rods and 172 fresh fuel rods. It was claimed that the processing occurred in a single campaign, consisting of three batches, in 1990. The amount of plutonium declared was a uniform metal sample of 62 grams.

As was mentioned in Table 6-1, the IAEA inspectors visiting the radiochemical lab in July of 1992 took a variety of samples, including swipe samples in the plutonium area of the lab. Some of the information from those measurements is shown in Fig. 6-5. In this figure, the PUREX process is broken down into its four stages. The in-process waste in the tanks in each of the stages was analyzed for the plutonium isotopic content. The fraction of the plutonium that was  $^{240}\text{Pu}$  was different in the tank inventory than in the plutonium metal sample shown the IAEA, which could indicate the wastes that were in the tanks were not the wastes resulting from the manufacture of the plutonium sample. This result in itself is not a “smoking gun,” however, because there may have been very different extraction efficiencies in the three batches and the three batches may have had different irradiation histories.

Swipe samples taken in the plutonium area of the facility provided more evidence of undeclared reprocessing campaigns. Using sophisticated techniques, the fractional content of  $^{240}\text{Pu}$  was determined for individual dust particles. This fraction was found to vary from particle to particle, clustered in three groups, whereas the plutonium metal sample shown the inspectors was uniform. This is a very unlikely result, unless there

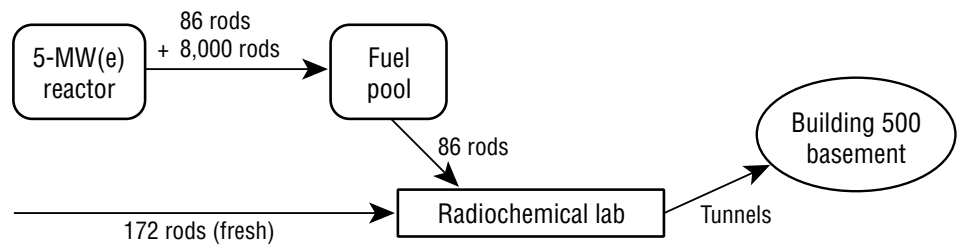

Figure 6-4. Nuclear program at 5-MW(e) graphite reactor and radiochemical lab. Declared quantities are shown as numerical values. It is suspected that as much as one additional core was processed without declaration and the wastes could be stored in Building 500, an undeclared waste site.

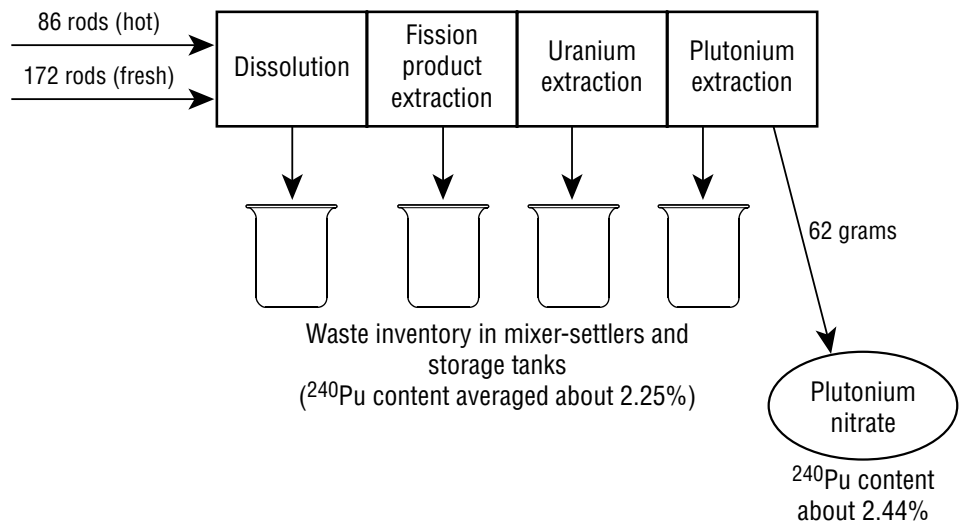

Figure 6-5. The measurements at the radiochemical lab, shown broken down into the four stages of the PUREX process. The declared input and output processing quantities are shown.

were undeclared processing campaigns. Additionally, the ratio of  $^{241}\text{Am}$  to  $^{241}\text{Pu}$  was measured for these dust particles.  $^{241}\text{Pu}$  has a 14-year half-life, and decays to  $^{241}\text{Am}$ . The ratio  $^{241}\text{Am}/^{241}\text{Pu}$  should therefore indicate the amount of time elapsed since the plutonium was separated, as long as the initial separation was clean and the sampling and analysis were performed without the introduction of bias. This measurement indicated that reprocessing had occurred in three separate campaigns, in 1989, 1990, and 1991.

Because of the hidden waste site apparently associated with the IRT reactor, there is also an issue associated with that reactor. The

means by which the reactor could have been used to produce plutonium is described schematically in Fig. 6-6. The reactor used enriched uranium oxide fuel, not of sufficient enrichment for use in weapons. The fresh fuel was supplied by the Soviet Union, and spent fuel was stored in a storage canal near the reactor. It is suspected that targets made of natural uranium were irradiated in the neutron flux in the core of the reactor, and then transferred to the “Isotope Production Laboratory” or other facility near the IRT for plutonium removal. The total amount of plutonium that could be made by this route is probably less than four kilograms.



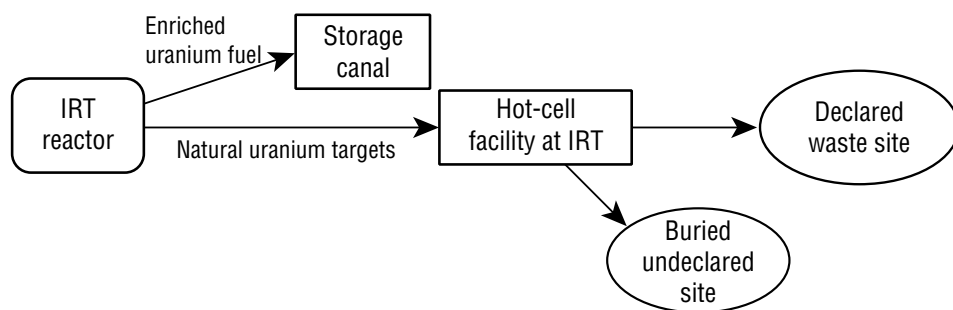

Figure 6-6. The suspected route used to produce plutonium with the IRT-2000 research reactor.

It is not clear that the building identified to the IAEA inspectors as the Isotope Production Laboratory is the facility that would have been used for this process. The North Koreans may plausibly have had a pilot reprocessing plant somewhere that enabled them to scale up to the large scale used in the Radiochemical Lab. They have denied there was a pilot facility and none has been found.

The path forward for the IAEA to determine the correctness and completeness of the initial declaration has been developed, including planning for contingencies. This plan, which is not public information, will be presented to the IAEA Board of Governors sometime in the future. It includes plans for the cases where large amounts of radioactive wastes are discovered in previously hidden waste sites. There is no plan to attempt to verify the accuracy and completeness of the initial declaration unless access to the two suspect waste sites is granted, if the agency stays with the recommendations of former IAEA Director-General Hans Blix.

One core load of spent fuel remains in the pool near the 5-MW(e) graphite reactor. To prevent corrosion, the fuel has been placed in an argon atmosphere within stainless-steel cans kept underwater for cooling. The information as to where each fuel rod was located within the reactor was

lost when the DPRK refused to permit IAEA inspectors to be present and to sample materials from the rods from each of a number of key locations in the reactor when the DPRK removed the rods. Allowing such sampling could have allowed a more accurate reconstruction of how much plutonium was produced and when.

It will be important to perform measurements on the fuel along with isotopic depletion calculations to verify the reactor operation history. Spontaneously emitted neutron rate measurements can be used to estimate the  $^{240}\text{Pu}$  content of the fuel. From the  $^{240}\text{Pu}$  content *per unit mass* of fuel, the plutonium production can be estimated. It will be difficult to infer accurately the reactor's operational history with this information alone, so that further analysis or data may be required. It would be helpful to have the reactor operator's log books for the years when the reactor operated. Perhaps more information could be obtained by gamma-ray spectral analysis of structural materials within the empty reactor.

If an assay of the suspect waste sites is found to contain significant amounts of fission products or uranium sludge, there will be a need for the DPRK to amend its initial declaration. It would then have to reveal the appropriate amount of separated plutonium, which may be as much as 10 kilograms. An

additional facility (for plutonium storage) may have to be declared to the IAEA.

Even if there is openness on the part of the DPRK, there may still be ambiguity due to the imprecision of the assay methods or the permanent loss of operating records. As an example, suppose that an assay of the suspect waste sites determines that a "missing" 8 kilograms of separated plutonium should be accounted for. Suppose that by this time North Korea has changed their declaration, claiming that 6 kilograms of plutonium was produced and they show this amount to the IAEA. Even if the DPRK were to open many of the facilities at Yongbyon to inspection and grant interviews with workers, the discrepancy between 6 and 8 kilograms may never be fully resolved.

The size of the IAEA-allowed discrepancy would be partially based on the estimated accuracy of the assay (see Section 6.5). Time is a factor, because a more detailed assay will require more time. A realistic goal may be ~25 percent of the amount of plutonium inferred by the waste site inspections, which in this particular example would be 2 kilograms. If full cooperation had been given to the IAEA, they may accept that the verification process is complete, provided that there were no more facilities or sites they felt that they needed to inspect. It is unlikely that any discrepancy over a few kilograms would be allowed if there were signs that North Korea was still concealing information. In addition, any discrepancy larger than one weapon's worth of plutonium (~8 kilograms) would probably not be tolerated by the US Congress, regardless of the apparent degree of DPRK cooperation.

## 6.4 Verification of Fuel Disposal and Facility Dismantlement

### 6.4.1 Spent-Fuel Disposition

The spent fuel at the 5-MWe graphite reactor is kept in canisters manufactured by NAC Corporation of Atlanta, Georgia constructed of stainless steel, filled with inert gas, and equipped with a pressure relief valve. The canisters were designed so as to fit within a shielded shipping cask, also manufactured by NAC Corporation. No agreement has been worked out between the DPRK and the US on exactly how the canisters will be shipped. It is known that the US government paid the cost of the canisters to begin with, which indicates the shipping will probably also be paid for by the US. If the destination for the fuel is Russia or China, it could be transported over land. Otherwise, ship transportation will be required, which will increase cost.

The fuel is in poor condition and there may be some significant safety issues when shipping these materials. The magnesium cladding was extensively corroded before the fuel was containerized. In some canisters, apparently, uranium hydride has formed from the reaction between uranium metal and water. This reaction releases oxygen and has caused overpressure. The sludge in the bottom of the spent-fuel storage pool, which may contain as much as a kilogram of plutonium, should also be canned and shipped. Wherever the fuel is shipped, it will have to undergo sorting into a multitude of waste streams, including bare uranium rods, rods with intact cladding, and fuel sludge. The sludge and cladding can probably be converted directly into waste forms, but the uranium metal may require processing before it is in a suitable waste form for disposal.

The best place to send the fuel for technical reasons is the Sellafield plant in the UK, where Magnox fuel is routinely reprocessed. For example, the Tokai-1 nuclear power plant in Japan was a Magnox reactor that operated from 1965–1998. During this time, the fuel was sent by ship to Sellafield for reprocessing. The UK still operates a dozen or more Magnox reactors; the Magnox reprocessing facility at the Sellafield plant is scheduled to operate until at least 2011. If Sellafield were chosen, it may have to store the resulting reprocessing wastes, which is unusual, because the wastes are ordinarily returned to the customer.

Other locations, which could in theory process the fuel, include Tomsk in Russia, Sichuan in China, and the Savannah River Site (SRS) in Aiken, South Carolina. These sites have facilities specifically for processing uranium metal fuel and are preferable for technical reasons to sites that process commercial uranium-oxide fuels. The complication of the magnesium cladding could introduce significant pretreatment costs. While the Russian and Chinese locations would entail lower transportation costs, it is an open issue whether safety standards at those plants would be considered adequate.

Both the SRS and the Idaho National Environmental and Engineering Lab (INEEL) now accept reactor spent fuel (for storage) from other countries as part of the National Spent Nuclear Fuel Program.<sup>2</sup> Of these two sites, the INEEL site has more diversity in its operations and accepts more different types of fuel than the SRS, which only accepts aluminum-clad uranium-metal fuel. In any case, the fuel is ultimately to be buried as waste in the National Repository (currently thought to be Yucca Mountain in Nevada), along with thousands of tons of aluminum-

clad fuel from past US operations at Savannah River and a large variety of fuels from INEEL. Some of the aluminum-clad fuel at SRS will probably be chemically processed into other forms before ultimate disposal. Additionally, over 2,000 tons of aluminum-clad spent fuel is being put in dry storage at the Hanford site and is tentatively being packaged for disposal without further processing.<sup>3</sup>

If one of the sites in the US is chosen for the spent fuel, there is certain to be some opposition from state governments. A lesson from several cases of such opposition in the US, however, is that state governments may be willing to consider limited and well-defined shipments of spent nuclear fuel of overriding national security interest. There are also some legal barriers to sending the fuel to either site that would have to be overcome. The current program accepts fuel irradiated in foreign research reactors, but it only covers fuel that is of US origin, and the Yongbyon fuel is certainly not of US origin. The existing Environmental Impact Statement (DOE/EIS-218F) would also have to be modified for this fuel.

### 6.4.2 Dismantlement

Some important verification issues in the dismantlement process are called for in the AF. After the first LWR has been completed, the DPRK will be required to dismantle its frozen nuclear facilities. If this part of the AF actually takes place, the DPRK will have already come into compliance with its INFCIRC 153 IAEA requirements and will have allowed all of its spent fuel to be removed from Yongbyon. While it is the responsibility of the DPRK to dismantle its own facilities, it may be in the interests of US national security to assist the DPRK in its effort. The IAEA can also provide some help (if the DPRK re-joins it).

There are three stages of decommissioning as far as the IAEA is concerned<sup>4</sup>:

**Stage 1 (“safe storage”):** The outer contamination barrier is kept as it was during operation, but the mechanical opening systems are permanently blocked and sealed (valves and plugs, etc.). The containment building is kept in a state appropriate to the remaining hazard and the atmosphere inside the building is subject to appropriate control. Access to the building is allowed, subject to monitoring and surveillance procedures.

**Stage 2 (“cocooning”):** The outer contamination barrier is reduced to a minimum size and all parts easily dismantled are removed. The sealing of that barrier is reinforced by physical means and the biological shield in a reactor is extended if necessary so that it completely surrounds the barrier. After decontamination to acceptable levels, the containment building and the nuclear ventilation system may be modified or removed if they are no longer required for radiological safety.

**Stage 3 (“greenfield”):** All materials, equipment, and parts of the plant in which activity remains significant despite decontamination are removed. In all remaining parts, contamination has been reduced to acceptable levels. The plant and site are released for unrestricted use. From the point of view of radiological protection, no further surveillance, inspections, or tests are necessary.

The first of two major dismantlement challenges at Yongbyon is the 5-MW(e) graphite reactor, which operated for several years and should be quite radioactive. Fortunately, there is some international experience

with similar facilities. A verified cocooning of the graphite reactor could be performed relatively quickly compared to the greenfield approach. The process is deemed “irreversible” if the reactor is taken to a state where it would be cheaper for the DPRK to begin an entire new reactor construction project rather than reactivate the old reactor. Emphasis would be placed on removing and destroying critical reactor components such as control rod drives. The steam generators could be destroyed *in situ* by filling them with concrete. The empty core of the reactor could also be filled with concrete. The reactor graphite may be poisoned by the introduction of a boron-containing spray or resin that would render it permanently useless for nuclear purposes.

The US has recently obtained extensive experience cocooning its own graphite reactors, many of which are located at the Hanford Reservation in Washington. These old reactors, built to produce plutonium for weapons, were nearly identical to one another and were each rated at 425 MW(th). Five are being cocooned now, and one is complete. As experience has been gained, the cost per reactor has gone down. The typical cost is about \$25 million each (130 man-years labor each). The key to the low cost is the use of the existing outer concrete shield that surrounds each reactor as a major part of the cocoon.

The Yongbyon reactor is much smaller and is also less radioactive than the Hanford reactors. Its outer concrete shield wall is similar in thickness to those of the Hanford reactors. In theory, therefore, it should not be significantly more difficult to entomb.

It is to be remembered that the North Koreans have no experience with nuclear decommissioning. It therefore may be advisable to hire a private company to do the project management and provide technology. Obviously, the North Koreans may press that their own labor will be used and may attempt to engage the US in paying for costs not directly related to reactor entombment, such as site cleanup and waste disposal. A decision will have to be made as to the scope of US involvement in those other activities.

Handling the radioactive graphite core blocks is time-consuming and presents a radiological risk to workers because of the debris and dust. This is part of the reason why greenfield costs estimates are so much higher than the actual costs at Hanford.\* It is probably undesirable for these reasons to take the Yongbyon reactor to the final state of decommissioning.

The Yongbyon reactor should easily be brought to a safe storage state within a three-year period. Because of the special security issues surrounding this reactor, some critical pipes and possibly the reactor vessel itself could be cut with a saw to provide assurance that the Stage 1 decommissioning will not be reversed. The steam generators, the refueling machines, and control rod drives should be removed and destroyed. Cocooning could begin as soon as Stage 1 is complete.

The other two graphite reactors, one located at Yongbyon and the other at Taechon, could be taken to more advanced stages of decommissioning. Of some concern is the disposition of the nuclear-grade graphite from the 50-MW(e) reactor, which should be treated in some way so that it cannot be used to reconstruct the reactor.

\* The final greenfield decommissioning costs for the Hanford reactors has been estimated to be in the billions of dollars.

The second dismantlement challenge is the Radiochemical Lab at Yongbyon. Experience obtained at the Eurochemic Reprocessing Plant in Belgium (and at other reprocessing plants) should provide some assistance. This facility was constructed in the early 1960s and was owned by a 13-nation consortium. It went into active operation in July 1966 as a demonstration plant with a 60-ton annual capacity. Between 1966 and 1974, about 180 tons of low-enriched uranium fuel and 30 tons of high-enriched uranium fuel were reprocessed. After its shutdown in January 1975, the plant was decontaminated during the years 1975-79 for keeping it in a safe, standby condition. Decommissioning began in 1991 and the plant has been completely decommissioned as of today, except for the outer structure and the floor.

In 1987, the first decommissioning phase was estimated to require a team of 20 dismantlement operators and 17 technical and safety assistance to work for 11 years. Total cost was estimated at \$172 million. In 1992, the cost estimate was revised upward to \$235 million, reflecting increased waste disposal costs. Progress reports published over the last few years have confirmed that the 1992 estimate is correct to within about 25 percent. Waste management and disposal costs are more than a quarter of the total cost. A computerized data-management system has been set up to keep detailed records of costs, hours worked, and wastes produced to enable the OECD countries to make estimates for future decommissioning activities.<sup>5</sup>

The Yongbyon plant had a total capacity of the plant in 1994 of about 220 tons/year (with two lines). One of those lines has never been tested or contaminated. The radioactive waste tanks and contaminated concrete will be the

most time-consuming components to dismantle. It is to be remembered that far more fuel in total was processed at Eurochemic than at Yongbyon. The cost and manpower estimates for the Eurochemic plant are therefore reasonable upper limits for the corresponding numbers at Yongbyon.

Again, it may be sensible to engage a Western company for project management and technology know-how. For instance, modern remotely operated machines could cut some of the more radioactive pipes and remove some of the more contaminated equipment. In any case, the assistance should focus on the rapid, verifiable, and irreversible destruction of components and subsystems of greatest concern to US national security, such as remote manipulators and leaded-glass windows. Help provided to the North Koreans for activities that do not directly affect verification process, such as general site cleanup, geological waste disposal, and shallow land burial of wastes should be provided only if it furthers US national interests. If the DPRK rejoins the IAEA, some assistance can be provided for additional site cleanup through that mechanism.

## 6.5 How Much Verification Is Enough?

Verification of the completeness of a state's initial report, particularly for states that have, or are suspected of having, produced weapons-usable nuclear material prior to entry into force of their safeguards agreement, is complex. The process involves a detailed review of facility-operating histories, a comparison of facilities and nuclear material types and amounts with other information available to the IAEA and the resolution of any resulting inconsistencies. The objective is a high level of assurance that the nuclear material

declared and presented to the IAEA is consistent with what could have been produced.

Cooperation between the IAEA and a state is necessary for the successful implementation of safeguards in any context. The level of cooperation essential to the process of verifying the completeness of an initial declaration goes beyond that required to implement the safeguards agreement or even an Additional Protocol (INFCIRC 540) to that agreement. It can be argued that the state is obliged to provide any existing facility-operating records to the extent they are pertinent to assessing the completeness of present declarations. However, the process may require access to individuals (e.g., knowledgeable facility personnel) and locations (e.g., locations beyond declared nuclear sites) that the state is not legally obliged to provide (at least, without resort to a request for a special inspection). Further, the verification process does not provide certainty and while a high level of openness regarding a state's past and current nuclear activities is a necessity, it may not be sufficient depending on the level of ambiguity judged politically acceptable at the time. Technical aspects of the verification exercise are important determinants, but the final judgement regarding how much verification is enough will likely be political in nature.

At the point when the process of verifying the completeness of the DPRK's initial declaration was stopped, the DPRK was not in compliance with their Safeguards Agreement. There were a number of major inconsistencies between the DPRK's declarations and the IAEA's inspection results. If anything, the situation has worsened in that the possibilities of reconstructing and in some sense verifying historical activities degrades with time. There is no metric or

quantitative measure of a state's intent; however, when the process of verifying the completeness of the DPRK's initial declaration resumes, the DPRK's intentions to be open (or not open) should become visible quickly. The DPRK knows the actions necessary to come into compliance with their Safeguards Agreement. It is aware that its initial declaration needs to be amended. It is aware that the IAEA has and will continue to receive and make use of information from third parties that could result in IAEA requests for access to locations not identified in their initial declaration.

Several parties, working in other areas, have indicated that, with patience and perseverance, they have obtained cooperation from the DPRK necessary to make progress. This has not been IAEA's experience. When inspections first got underway in late May 1992, the IAEA enjoyed a high level of cooperation from the DPRK. This cooperation disappeared quickly as problems developed. Today, the DPRK accepts the continuous presence of IAEA inspectors to monitor the freeze as prescribed in the AF and they accept safeguards on declared nuclear material per the Safeguards Agreement. They have steadfastly refused any actions requested by the IAEA that would have the effect of improving the IAEA's position to deal with the verification of the DPRK's initial declaration once that exercise gets underway again.

Citing the time necessary to complete the verification exercise, the IAEA's Director-General has repeatedly requested the DPRK to get started as soon as possible. They have given no indication that they are ready to proceed. Still, the IAEA can do a number of things to prepare now. The first is to develop

as comprehensive and detailed picture of past activities as possible through collection and evaluation of information from open sources and third parties, together with IAEA inspection data and DPRK declarations. The Agency should also anticipate and prepare specific verification measures including measurement methods and develop agreed standards that at least bind the ambiguities.

The support provided to the IAEA is a real issue. Most importantly, the IAEA is struggling today to maintain the *routine* implementation of safeguards. Resources will be stretched very thin when they prepare for and effectively respond to the DPRK verification problem. The IAEA also needs information provided by third parties and states other than the US. The IAEA also needs political support to deal with the likely pressure to accept a lower verification standard (i.e., a higher level of ambiguity).

Finally, the evolving NPT verification framework provides another avenue that could be pursued with the DPRK. Beginning in the early 1990s and continuing through the decade that followed, the IAEA has been involved in an extensive effort to improve the effectiveness and efficiency of its safeguards system. IAEA's Programme 93+2, the cornerstone of this effort, concluded in May 1997 when the IAEA's Board of Governors approved the "Model Protocol Additional to the Agreement(s) Between State(s) and the International Atomic Energy Agency" (referred to as the Additional Protocol and published as INFCIRC 540). The Additional Protocol is designed, through greatly expanded nuclear openness and inspector access, to improve the IAEA's capability to detect undeclared nuclear material and activities and thus increase assurances

that state's nuclear material are complete as a continuing feature in verifying compliance with the NPT commitments. At this time, 55 states, including Japan, the Republic of Korea (ROK) and the US, have signed Additional Protocols to their Safeguards Agreement with the IAEA. Nineteen, including that for Japan, have entered into force.

There is no legal obligation for a state to accept the Additional Protocol, but KEDO principals would not be asking the DPRK to accept a more intrusive verification regime that they, themselves, have not indicated a willingness to accept. The presence of an Additional Protocol is not likely to be a determining feature in the verification of the DPRK's initial report (either the DPRK provides the required cooperation or they don't), but it could simplify things. Under an Additional Protocol, IAEA inspectors would have access to any location on a nuclear site (e.g., the Yongbyon site), other locations involved in the production or storage of source material, and any other location in the DPRK for the purpose of collecting environmental samples. The DPRK has good reason to be familiar with the power of environmental sampling and this might encourage them to be more forthcoming regarding the whole of their past and current nuclear program. Certainly, should the verification of the DPRK initial declaration come to a successful conclusion, an Additional Protocol would be very helpful in assuring the DPRK's continuing compliance with their NPT commitments.

## Notes to Chapter 6

1. G. Kaurov, "A Technical History of Soviet-North Korean Nuclear Relations," in J.C. Moltz and A.Y. Mansourov, eds. *The North Korean Nuclear Program: Security, Strategy and New Perspectives from Russia* (Routledge Press, 2000), pp. 17–18.
2. National Spent Nuclear Fuel Program web site, <http://nsnfp.inel.gov>.
3. M. Gerber, "Removing the K-Basins Fuel: Downpayment on Protecting the Columbia River," *Radwaste Solutions Magazine*, American Nuclear Society, March/April 2001.
4. International Atomic Energy Agency, *State of the Art Technology for Decontamination and Dismantling of Nuclear Facilities*, Technical Reports Series No. 395, Vienna, 1999.
5. L. Teunckens, P. Lewandowski, and E. Trauwaert, "Taking it Apart: The Eurochemic Reprocessing plant," *Nuclear Engineering International*, August, 1994.

## CHAPTER 7

# TIMELINE FOR VERIFICATION AND SAFEGUARDS

In this chapter, we present a simplified timeline that focuses on verification and safeguards issues. The chapter contains no new material. Rather, the material relevant to the Agreed Framework (AF) timeline from earlier is brought together and the implications for verification and safeguards of each step in the timeline are noted. Based on this timeline, Chapter 7 presents an analysis of what can go right and wrong with the AF from the viewpoint of verification and safeguards.

Seven major time-linked steps in the AF and related agreements may be identified, of which all but the first require verification or safeguards:

1. Completion of a significant portion of the project site at Kumho, DPRK (Democratic People's Republic of Korea, or North Korea), and of the first Korean Energy Development Organization (KEDO) reactor in the Republic of Korea (ROK, or South Korea).
2. International Atomic Energy Agency (IAEA) declaration that the DPRK is in compliance with its safeguards agreement.
3. Start of the delivery of key nuclear components of the first KEDO reactor to the Kumho project site simultaneously with the start of the transfer of DPRK spent fuel from Yongbyon to its ultimate disposition.
4. Completion of Yongbyon spent-fuel transfer and of the first KEDO reactor simultaneously.

5. Dismantlement of DPRK graphite-moderated reactors and related facilities at Yongbyon begins.
6. Deliveries of the nuclear components for the second KEDO reactor in parallel with proportional steps by the DPRK to dismantle all its graphite reactors.
7. Completion of second KEDO reactor at Kumho.

In addition, another step is not explicitly linked to the timeline but must be carried out if verification that the DPRK does not have nuclear weapons-usable material is to be complete:

8. Transfer of KEDO spent fuel when appropriate out of the DPRK.

We review briefly what information is expected from each step, how long each step will take, and what must take place before the step can be taken.

### Completion of a Significant Portion of the Project Site at Kumho, DPRK, and of the First KEDO Reactor in the ROK

Before the DPRK is obligated by the AF to permit the IAEA to inspections beyond the DPRK's declared facilities, a "significant portion of the Light-Water Reactor (LWR) project" at the Kumho site must be completed. The steps to be completed have been spelled out in Chapter 1. They include—

- Completion by KEDO of site preparation, excavation, and

major building construction at Kumho.

- Completion of the nuclear-plant design for the LWRs by the ROK.
- Delivery of the turbine generators for the first LWR, with other delivery details still to be agreed on.

As noted earlier, it would be advantageous to South Korea, the major nuclear-reactor supplier and provider of money, for the IAEA and the DPRK to begin negotiations soon on the special expanded inspections and to get them started before too much is invested in site preparation, construction, and manufacturing. But, there is no DPRK obligation to permit these IAEA inspections prior to those investments, and the DPRK has not volunteered so far to cooperate on this matter. If it does not, the inspections of undeclared facilities cannot begin for 2–3 years at least, more if the current problems holding up delivery of the turbine generators are not resolved in that time.

### IAEA Declaration that the DPRK Is in Compliance with Its Safeguards Agreement

After the step above, the DPRK is obligated to come into full compliance with its safeguards agreement, including taking all measures that may be deemed necessary by the IAEA "to verify the accuracy and completeness of the DPRK's initial declaration [to the IAEA] on all nuclear materials in the DPRK." These measures, and the information they will yield, include—

- Visual inspections of all declared and undeclared suspect facilities at Yongbyon (detailed in Chapter 6), including possible undeclared waste sites, to identify facilities used for plutonium production and separation, waste storage, radiochemistry, and any other potential nuclear weapon-related activity.
- Measurements, including swipe and particle assays, of all equipment, surfaces, and other material at these facilities that could contain or have contained any product associated with the production and storage of plutonium.
- Analysis of at least some of the spent fuel from the reactor at Yongbyon, and of any waste or other relevant material recovered.
- Identification and visits to sites, other than those at Yongbyon, suspected of being used for nuclear materials-related activities. If identified, measurements similar to those at Yongbyon have to be made. Identification of sites outside of Yongbyon may require some use of national technical means of surveillance as well as cooperation from the DPRK.

These measures should yield an estimate of the amount of nuclear-weapon material made and of the forms it may be stored in, together with an estimate of the capability of the DPRK to make more such material. They could also yield information regarding what other parts of a nuclear-weapon program the DPRK has carried out. They could lead to a need to modify the original DPRK declaration, which in turn, could jeopardize the AF.

Verification of accuracy and completeness of the DPRK's declaration is needed for the IAEA to declare that the DPRK is in compliance. The time needed to complete this verification is difficult to estimate. The Director-General of the

IAEA has told both the IAEA General Conference and the U.N. General Assembly that he believes it will take 3–4 years for the IAEA to complete this task, presumably assuming DPRK cooperation.

If insufficient cooperation is forthcoming, attempts to complete this step could bring about an indefinite delay. Furthermore, if the DPRK declaration and the IAEA findings cannot be brought into agreement, the AF could end. We discuss the implications of those two outcomes in Chapter 8.

The AF is silent on what should be done if spent fuel, waste, or separated plutonium is found outside the ponds where the declared spent fuel is stored at Yongbyon. Thus, the outcome of this key step is both crucial and indeterminate. Whatever the outcome, at this point, no nuclear fuel or key nuclear component would have been delivered to the KEDO reactor site.

### **Start of Delivery of Key Nuclear Components of the First KEDO Reactor to the Kumho Site Simultaneously with Start of Transfer of DPRK's Spent Fuel from Yongbyon to Its Ultimate Disposition**

After the DPRK comes into compliance, and simultaneously with the start of delivery of key nuclear components to the first KEDO reactor, the DPRK is obligated to begin the transfer of spent fuel from the cans in the small graphite reactor pools to "its ultimate disposition," outside the DPRK if that is what KEDO wants. The spent fuel is to be completely transferred by the time the first KEDO reactor is completed.

If identification of the material to be transferred is complete and reliable, verification of this step is straightforward so long as the ulti-

mate disposition site is outside the DPRK and under the IAEA's jurisdiction and control. If the material were to remain in the DPRK, continuing verification and accountability would be required.

The time needed to ship spent fuel and any separated plutonium identified out of the DPRK is probably measured in months once all preparations, both operational and diplomatic, have been made. Those preparations, however, could take much longer. Shipping appropriate to the transport of spent fuel must be made available. Possible sites for disposal are discussed in Chapter 6, Section 6.4.

### **Simultaneous Completion of Yongbyon Spent-Fuel Transfer and of the First KEDO Reactor**

Upon completion of the spent-fuel transfer from Yongbyon, the first KEDO reactor can be completed. All safeguards for that reactor (discussed in detail in Chapter 4) must be installed and operational before operations can begin. Until operations begin, there will be no nuclear weapon-usable material in the reactor. About two years of prior training in maintaining the safeguards and in material accountancy are needed before the reactor can begin operation. The time needed after the completion of the first two steps noted above, and after the training has taken place, has been estimated at about a year, depending on the detailed circumstances. Delays could be incurred owing to technical and legal problems associated with the reactor itself and its safeguards, or to problems external to the reactor installation, such as the lack of an adequate electrical grid to accept the power. These problems have been mentioned previously.

The information expected from this step will continue to flow as the reactor operates. As noted in



Chapter 4, Section 4.5, the global record to date suggests that no fuel diversion from a commercially operated LWR has taken place. It seems to us highly unlikely that such a diversion could be carried out undetected if the safeguards described are adequately implemented. As noted at the end of Section 4.5, the additional measures and inspections described could be useful in further lowering the probability that covert diversion could take place from a safeguarded reactor. Further, as noted in Section 4.6, satellite monitoring, which is not a part of IAEA safeguards, could—in case of some intent to abrogate—give information as to the time of the diversion and the amount and form of the material involved.

### Dismantlement of DPRK's Graphite-Moderated Reactors and Related Facilities Begins

### Deliveries of the Nuclear Components for the Second KEDO Reactor in Parallel with Proportional Steps by the DPRK To Dismantle All Its Graphite Reactors

The timing of these parallel procedures is complex and may be contentious. Only some of the agreements between KEDO and the DPRK have been made public. Among possible points of contention particularly relevant to verification are—

- The precise meaning of “dismantlement” and of “ultimate disposition” of the dismantled parts. Chapter 6, Section 6.4 outlines some technical possibilities, but they are suggestions only.
- The nature and extent of “related facilities” at Yongbyon and possibly elsewhere.

- The possibilities that nuclear facilities not covered by the AF but implicitly covered by the 1992 ROK–DPRK Joint Denuclearization declaration, to which the two parties recently recommitted themselves, exist.
- The question of who pays for the dismantling.

Auxiliary agreements and protocols covering those points are needed. Absent knowledge of these agreements and protocols, estimates of time and verification beyond the ones made in Chapter 6, which are based on analogy with plans for dismantling similar but larger facilities, cannot be made. According to those estimates, dismantlement would take several years owing to the radioactivity in some of the buildings, but irreversible changes could be brought about sooner.

### Completion of Second KEDO Reactor at Kumho

The same verification and safeguards comments can be made here as were made in connection with the completion of the first KEDO reactor.

### Shipping Spent KEDO Reactor Fuel When Appropriate Out of the DPRK

According to the Supply Agreement (Art. VIII, par. 3), “KEDO and the DPRK shall cooperate to ensure the safe storage and disposition of the spent fuel from the LWR plants. If requested by KEDO, the DPRK shall relinquish any ownership rights over the LWR spent fuel and agree to the transfer of the spent fuel out of its territory as soon as technically possible after the fuel is discharged, through appropriate commercial contracts.”

The spent fuel from the LWR reactors provided by KEDO will be high-burnup fuel, not nearly as suitable for weapons use as the fuel from the Yongbyon reactors would have been, but nevertheless a potential proliferation risk. Such fuel is left in cooling ponds at the reactor site for a period of years. After the radioactivity in the fuel assemblies has decayed sufficiently to permit handling the assemblies on dry land, the assemblies can be placed in casks and kept in dry storage for an indefinite period of time. Such dry storage is in use in the US for example, but so far it has not been practiced in Asia. The assemblies continue to become less and less radioactive over the years and must continue to be monitored and accounted for until ultimately disposed of.

If the plutonium-containing spent fuel from the KEDO reactors is not to be left indefinitely in the DPRK, facilities for ultimate disposal or at least long-term dry storage must be found. This problem is not unique to the DPRK's KEDO reactors and must be solved for all Asian and other countries that use nuclear power, although the DPRK case is particularly sensitive. Discussions about disposal and long-term storage for spent nuclear fuel in Asia have been going on for years inconclusively. The existence of spent DPRK fuel may add to the incentives for resolving them.

**Table 7-1** summarizes in a simplified way the steps outlined in this chapter. It does not contain all the linkages and details described above but may serve as a useful reminder of the overall pattern of activities bearing on or associated with verification.

Table 7-1. Summary of steps bearing on verification.

Step	Verification Issue	Possible Problems
Partial completion of KEDO Reactor 1 in the ROK and partial preparation of Kumho site in the DPRK	None but the IAEA wants to start the next step early (2-4 years needed)	Financial and legal delays cause some loss of data at Yongbyon
IAEA declaration that the DPRK is in compliance with its agreements	Verification of accuracy and completeness of the DPRK's initial declaration on all nuclear materials in the DPRK, at Yongbyon, and possibly elsewhere	<ol style="list-style-type: none"> <li>1. DPRK does not open suspect sites to the IAEA.</li> <li>2. The IAEA's activities are interfered with.</li> <li>3. Initial declaration is wrong—can it be amended?</li> </ol>
Delivery of KEDO Reactor 1's key nuclear components starts. Transfer of Yongbyon spent fuel (and other material?) to "ultimate disposition" starts.	Safeguards for KEDO Reactor 1 are installed. Transfer of Yongbyon spent fuel (and other material?) to "ultimate disposition" verified.	<ol style="list-style-type: none"> <li>1. Disagreements over the extent of safeguards.</li> <li>2. Disagreements over site of disposition.</li> <li>3. Disagreements over what is to be transferred.</li> </ol>
Simultaneous completion of previous steps	Safeguards on KEDO Reactor 1 operational. Disposition site monitored.	Same as previous, plus interference with KEDO Reactor 1 safeguards
Dismantlement of Yongbyon facilities in parallel with delivery of KEDO Reactor 2's key nuclear components	Safeguards for KEDO Reactor 2 installed. Dismantlement verified.	<ol style="list-style-type: none"> <li>1. Disagreements over extent of safeguards.</li> <li>2. DPRK abrogation.</li> <li>3. US or ROK non-compliance with AF.</li> </ol>
Simultaneous completion of previous steps	Safeguards on KEDO Reactor 2 operational	<ol style="list-style-type: none"> <li>1. Interference with safeguards.</li> <li>2. DPRK abrogation.</li> </ol>
Disposition of KEDO spent fuel	Monitoring disposition site(s)	Disagreement over site of disposition

## CHAPTER 8 POTENTIAL ADVERSE DEVELOPMENTS

We present a benchmark cooperation scenario plus four other scenarios that among them bracket possible degrees of cooperation of the Democratic People's Republic of Korea (DPRK) with safeguarding and verification efforts. These scenarios do not capture variations in other dimensions—such as financial, regulatory, diplomatic—to which they are nevertheless linked. They serve as a rough framework for evaluating potential failure modes of the Agreed Framework (AF) and their implications for verification and safeguards.

### 8.1 Benchmark Scenario: The DPRK Fully Cooperates with the IAEA Regarding Existing Agreements

This scenario is given to provide a success benchmark for comparison. Under this scenario, the DPRK would—

- Allow the International Atomic Energy Agency (IAEA) to carry out inspections at suspect facilities soon.
- Allow measurements on the Yongbyon spent fuel and provide reactor logbooks and other documentation to help reconstruct the operating history.
- Cooperate with the IAEA in issuing a modified declaration that would reconcile the discrepancies between its previous declaration and IAEA measurements (see Chapter 6) and allow verification of that declaration. While estimates of past plutonium production vary, there is strong

evidence that the DPRK separated more than its original declaration of less than 100 grams. If so, an amended declaration will be required for the IAEA to certify the DPRK's plutonium holdings.

- Permit IAEA inspections, measurements, and environmental monitoring at all sites where nuclear activities subject to safeguards may have occurred.
- Begin early training of its personnel in nuclear-material accountability.
- Participate positively in negotiations aimed at taking spent fuel out of the DPRK (the DPRK may not be the main problem in these negotiations, but its early cooperation would facilitate them).

Fully satisfactory implementation of the DPRK's safeguards agreement with the IAEA will require that the DPRK cooperate with the application of advanced safeguards technologies as they evolve. As discussed in Chapter 2, even without the implementation of the "Additional Protocol" (INF-CIRC 540), the IAEA has the right to utilize remote and unattended monitoring systems, request ad hoc and special inspections, and review the data collected by the DPRK's national system of materials control and accounting. The DPRK will be required to make accurate measurements of several key parameters, such as the quantities of nuclear material received, produced, shipped, lost or otherwise removed from inventory, and the quantities of material in inventory. Procedures must be implemented for identifying, reviewing, and

evaluating differences in shipper/receiver measurements; taking physical inventory; evaluating accumulations of unmeasured inventory and unmeasured losses; and providing reports to the Agency in accordance with its safeguards agreement. These safeguards measures will be applied to all nuclear material subject to safeguards, including the IRT research reactor, the light-water reactor (LWR) power plants, and their related facilities.

Evidence to date indicates that the DPRK has not implemented such rigor in its nuclear-materials accounting activities in the past, nor has it operated nuclear facilities on the scale of the Korean Energy Development Organization (KEDO) reactors. Perhaps implicit in the AF and the formulation of KEDO is the provision of necessary training and technical support to the DPRK to assure that the DPRK is prepared to accept this responsibility. As we have learned from other cooperative threat-reduction programs, increased openness with respect to the peaceful use of nuclear material is key to building a sustainable nonproliferation regime.

Even with full cooperation from the DPRK, verification of past activities is likely to take years. Early DPRK cooperation with such measures as described above, especially pertaining to verification activities at Yongbyon, would relieve pressure on the time schedule and allow for earlier operation of the KEDO reactors. Reconstruction of past activities at inspected sites (declared and suspect) could be as accurate, and knowledge that nuclear-weapons activities have

ceased at these facilities could be as assured as was the case for South Africa.<sup>1</sup> The safeguarding of the KEDO reactors would be positively affected: there would be greater assurance that inspections, measurements, materials accounting, and data transmission would be carried out as specified in the safeguards agreement.

This scenario would represent a departure from past experience. It would speed progress on the measurable requirements of the AF, mainly contained in Articles I and IV having to do with nuclear activities and energy supplies. It could ease working toward normalization of economic and political relations, and toward peace and security, as called for in Articles II and III. Such increased DPRK cooperation could lessen any incipient strain among KEDO members stemming from the members' different relative priority among these goals.

## 8.2 Scenario 1: The DPRK Maintains Its Present Level of Cooperation

Under this scenario, further delays can be expected. In this event, one must consider the ramifications of continued delay on security planning in the ROK, US, and throughout the region, a consideration that goes beyond what this report has undertaken to do. As time passes, there is continued opportunity for improved relations between the North and South, significant investment in KEDO by member states, as well as possibly an opportunity for the DPRK to tamper with materials and records needed for complete verification. Continued delays could lead to an inability to certify the DPRK declarations and possibly result in a breakdown of the cooperation between the ROK, US, and Japan. In particular, verification could almost surely not be accomplished

on the presently anticipated time scale in two areas:

- Reconciling the data taken and to be taken by the IAEA regarding activities at Yongbyon with the DPRK declaration of these activities. The consequence of a failure to certify the DPRK's declaration will be a function of when and how this failure occurs. Given the history of interactions with the DPRK, issues of uncertainty in the IAEA measurements may arise. There is no predetermined standard by which "acceptable" uncertainty is measured. In fact, this is often a function of specific measurement technologies employed and the openness of the inspected party to the IAEA. As with so many things in the nonproliferation regime, it is a subject of negotiation.
- Assuring that no further nuclear-weapons-related work is going on in the DPRK, and that no separated undeclared plutonium is stored anywhere. The AF does not freeze nuclear facilities or activities other than those frozen at Yongbyon. Although the question of plutonium production at these facilities is in the forefront of most verification efforts, providing a determination of the "completeness" of the DPRK declaration is paramount to the continued movement of the DPRK towards membership in good standing in the Non-Proliferation Treaty (NPT), which is required by the AF.

As discussed in Chapter 2, though it has rarely occurred, access to "undeclared" sites or to locations suspected of containing "undeclared" nuclear material is possible under the model IAEA safeguards agreement (INFCIRC 153). Several provisions under the DPRK's safeguards agreement (INFCIRC 403) could assist the

IAEA in making a determination of "completeness" with respect to declared nuclear facilities and materials. These include:

- Provision and verification of design information,
- Notification of new facilities or modifications to existing facilities, and
- Access for routine, ad hoc, and special inspections.
- In particular, "special" inspections may be requested in cases where the information provided to the IAEA is not adequate for the Agency to fulfill its responsibilities. Special inspections may be requested at "undeclared" facilities.

It was the request for a "special" inspection of two undeclared waste sites at Yongbyon that precipitated the DPRK to withdraw from the NPT. It seems likely that the IAEA will require access to these undeclared sites to verify the DPRK's declarations. A full understanding of the operation of the IRT research reactor (discussed in Chapter 6) and the disposition of nuclear materials associated with its operation are among steps necessary to provide confidence that the DPRK has no undeclared nuclear programs. In addition, there may be other special inspections required to fully determine that the DPRK has no undeclared nuclear facilities, nuclear-material inventory, or activities. This would require better DPRK cooperation than has taken place, and probably cannot be done perfectly. The best that could be done would be to identify and make measurements of the type described in Chapters 4 and 6 on any facility where plutonium is thought to have been made and separated. Some of these measurements could become difficult or impossible as time goes on.

### 8.3 Scenario 2: The DPRK Attempts Covertly To Divert or Hide Nuclear Material

While declared facilities at Yongbyon are verifiably frozen, overt diversion or hiding of material from the suspect but undeclared facilities at Yongbyon and elsewhere in the DPRK is feasible so long as the extensive IAEA inspections and measurements discussed above have not taken place, as noted in Chapter 6. Early inspection of suspect undeclared facilities and measurements of what is found there could help identify hidden material and prevent future diversions. Without such inspections and measurements, it cannot be known whether or not nuclear material additional to the declaration remains hidden. The techniques discussed in Chapter 4, Section 6, particularly environmental monitoring at sites other than the declared sites, would go some ways toward reducing the likelihood of successful covert diversion or hiding.

Continued assistance from the US and other member states will be required for the IAEA to provide assurance that the DPRK is not engaging in clandestine nuclear activities. Early warning of potential illicit activities through the use of satellite imagery and other technical means is critical. In addition, it is important to have a well-executed and coordinated approach with respect to investigating perceived clandestine activities.

Attempts by the DPRK to divert or hide nuclear material would be incompatible with the AF. Delays in carrying out the inspections and measurements discussed above at Yongbyon and elsewhere could lead to increased suspicions that material was diverted from inspections and hidden. In particular, if the DPRK were to delay effective IAEA inspections while continuing on the path of warming relations

between the North and South, verification problems could evoke different responses from the KEDO members with respect to continuation of the AF. If the DPRK were to refuse to allow access to facilities and information needed by the IAEA to verify declarations, it is difficult to imagine that the US would continue with its part of the AF. It is less certain what position KEDO member states might take, especially in light of domestic, bilateral, and regional political pressures.

These comments pertain to material and facilities at Yongbyon and possibly elsewhere in the DPRK but not to the KEDO reactors. Covert diversion or hiding of nuclear material generated in the course of operating the KEDO reactors would be far more difficult, as discussed in Chapters 4 and 5. So long as the IAEA and its member states are successful in obtaining full enforcement of safeguards, we believe that the probability of covert diversion from the KEDO reactors is very low. The main covert diversion or hiding problem, at least in the first many years of the AF, is connected with the earlier DPRK activities at Yongbyon and possibly elsewhere.

### 8.4 Scenario 3: The DPRK Abrogates the Agreed Framework or Other Key Agreement

If the DPRK were to abrogate its agreements, and for instance, expel the IAEA inspectors, it would have control over any nuclear material left at Yongbyon and other possible sites (and over spent fuel left at the KEDO reactor site if abrogation occurs after the KEDO reactor(s) have begun operation). This is, of course, an argument for removing such material from the DPRK as soon as is practicable. Fuel can be safely, and more or less routinely, removed after 2–3 years. The fuel

discharged from the KEDO reactors will most probably be US-obligated, which will require that the US approve any movement or retransfer of the fuel.

We note parenthetically that the DPRK previously (in 1994) gave a 90-day notice of intent to withdraw from the NPT, which it then “suspended.” This may leave the length of notice that may be given of any future intent to withdraw ambiguous.

In the case of abrogation, the outside world would know how much potential nuclear-weapon material there is in the DPRK at least as well as it knows now, better if inspections and removal operations at Yongbyon have been carried out. It would, as now, be able to externally monitor such large-scale activities as continued reactor operations, construction of facilities, and, to some extent, identification of major activities, as discussed in Chapter 4, Section 6. It would not be possible to know accurately how much plutonium is made in reactor operations subsequent to abrogation, should those occur, nor how much is separated, or how it is being used.

It is to be remembered that no nuclear components will be delivered to the KEDO site until a bilateral nuclear cooperation agreement is signed, which will first require that the DPRK is in full compliance with its IAEA safeguards obligations. For this to occur, there must first be a dramatic change in the openness of the regime, as stated above. The LWR reactors would begin operation only after the DPRK has verifiably given up its Yongbyon program and its store of spent fuel.

Once these factors are considered, there is still the chance that relations with the North could change again a second time. The situation could deteriorate in the

future, after the Yongbyon spent fuel has been removed and the only plutonium available to the DPRK would be that in the spent fuel at the KEDO site.

If safeguards at the KEDO reactors were abrogated, for instance following a DPRK declaration of a state of emergency, foreigners such as IAEA inspectors or Republic of Korea (ROK) personnel would be forced to leave the country. Remote monitoring equipment would be disconnected or removed. After such a set of events, the risk of diversion of fuel becomes a very serious concern.

Because of the highly radioactive nature of the fuel and high heat-generation rate for the first few years after discharge from the reactor core, the older fuel in the pool would be the most likely diversion target. The 59 assemblies discharged initially from the first core load, as was mentioned in Chapter 4, weigh about 0.6 ton each and contain 3 kilograms of plutonium. The burnup will be about 12–15 MWd/ton, and these assemblies would possess the best weapon-quality plutonium of any of the fuel that has cooled for a significant amount of time. In theory, the DPRK could take those 59 assemblies and make between 10 and 20 atomic bombs of the type detonated at the Trinity test. That test, it is to be remembered, used about 6 kilograms of weapon-grade plutonium in an “implosion” configuration and generated over 10 kilotons of explosive energy. While possible in principle, the effort to turn this plutonium into a set of explosive devices would face formidable obstacles.<sup>2</sup>

Because the plutonium is not separated from the fission products of the spent fuel, chemical separation must be carried out with very radioactive material. Each assembly, even if it had cooled for

15 years, would be extremely radioactive, exposing an unprotected individual to a lethal dose of more than 1,000 rads every hour at a distance of one meter. Each fuel assembly would probably require a ton or more of shielding in order to remove it from the spent-fuel storage pool. A shielded, remotely operated reprocessing facility would have to be built somewhere and tested without being detected. The testing would be hard to conceal, if it used “hot” materials, because of the release of radioactive material such as <sup>85</sup>Kr into the environment, which could be detected by remote sensors operated by US intelligence. Another problem for the DPRK would be that the zirconium cladding on the fuel is extremely difficult to dissolve in a simple PUREX facility such as the one that they built at Yongbyon. The cladding must be chopped away with a heavy, remotely operated machine before fuel dissolution.

On the other hand, its experience at constructing and operating the Yongbyon facilities would help the DPRK in building this hypothetical reprocessing laboratory. Rather than build a very large facility such as the one at Yongbyon, the DPRK could rely on a simpler and lower-cost facility designed to separate enough plutonium for a few weapons, with little attention paid to health or safety. The greatest problem would be the requirement to carry the main reprocessing steps with remotely operated equipment. If the facility is built ahead of time and the procedures practiced (without actually having LWR spent-fuel assemblies available for realistic tests), in principle the time needed to separate the requisite amount of material might be only days or weeks if all went according to plan. In practice, however, the time needed is likely to be much longer. The IAEA’s Standing Advisory Group on

Safeguards Implementation has estimated that the time required to convert plutonium in spent fuel into a weapon would be one to three months, compared to seven to ten days for metallic plutonium.<sup>3</sup>

If the DPRK were to overtly abrogate specifically to obtain as much high-quality plutonium as possible, then one might predict the more likely times that such an event would occur. The highest quality plutonium exists early in the very first reactor cycle. If the DPRK were to overtly abrogate specifically to obtain as much high-quality plutonium as possible, then one might predict the more likely times that such an event would occur. The highest quality plutonium exists early in the very first reactor cycle. During initial start-up, the entire core is at very low burnup. If the DPRK were to shut the reactor down early (before the first normal refueling), it would be possible to recover spent fuel with very good plutonium isotopics. As an example, if the reactor were shut down after 4 to 6 months, the spent fuel would have only 5,000–7,500 MWd/MT, and could contain about 100 kilograms of essentially weapons-grade plutonium (~90% <sup>239</sup>Pu). At any other time in the reactor’s lifetime, the quantity of this high-quality plutonium decreases because of additional burnup (although the total plutonium inventory increases). Thus, if obtaining comparatively high-quality plutonium for weapons were a goal, one might expect abrogation to occur at about the time the first one-third core fuel is actually removed from the reactor. We emphasize, however, that even high-burnup, reactor-grade plutonium can be used for weapons. To gain an absolute maximum inventory of high-quality plutonium, this would occur during the first refueling of the second reactor. In that case, the total

inventory of high-quality plutonium would be approximately 400 kilograms (100 kilograms of Beginning-of-Life fuel in the first reactor's spent-fuel pool, plus 300 kilograms in the second reactor's core). The time required to gain access to this material (i.e., the time needed to prepare the reactor for refueling and start unloading the core) provides some (albeit limited) response time to such an event.

In either case, the challenges of rapidly removing and transporting the fuel from the reactor site would be significant. Sufficient transport casks would have to be acquired and pre-positioned near the reactor site. Even though the DPRK may be willing to take significant safety compromises in shipping the fuel, the fact that it must remove the fuel with no time for cooling means that the casks must be capable of providing both cooling and shielding, a serious engineering task.

Presumably, for such a scenario to be attractive to the DPRK (given the potentially severe response from the US and other states), it must also be prepared to use the material quickly. This means the DPRK would need to have a reprocessing facility ready and waiting. There would also be an incentive to have performed some testing, possibly "hot" testing of the equipment and processes. To do hot testing would require some spent fuel with which to test the systems. This spent fuel could come from the diversion of a few individual fuel pins, as discussed in Chapter 5. If this were the case, then abrogation would be more likely to occur after startup of the second reactor, as the first reactor would have to operate for some time to provide the irradiated individual fuel pins for the hot-testing program. Thus, such diversion could serve as an indicator of an intent to abrogate.

## 8.5 Scenario 4: The US or the ROK Is Unable or Unwilling To Meet Its Commitments under the Agreed Framework Even Though the DPRK Does

This might be the case, for instance, if a US administration determines the AF is not in the US interest, or if Congress prevents the completion of a nuclear cooperation agreement. New US legislation will make gaining acceptance (non-objection) from Congress more difficult and will probably put off negotiation of an Agreement for Cooperation. Lack of an Agreement would prevent installation of nuclear components of US origin. Again, at that point, no nuclear fuel would have been delivered to the KEDO reactor, and, of course, no plutonium would have been made there.

A similar issue may arise regarding nuclear liability. As noted in Chapter 2, Congress has prohibited the US from agreeing to indemnify a US manufacturer that provides nuclear components for the DPRK reactors. General Electric has indicated that it will not provide such components without indemnification. Negotiations have not yet produced an agreement to share this liability risk.

The scenario could also be brought about if KEDO ran into financial difficulties, perhaps owing to delays. The ROK is the principal financial backer of KEDO; its contribution, in financial and other areas, is crucial to the successful completion and safeguarding of the KEDO reactors. The ROK could also decide to revisit its level or conditions of support if political conditions change between the two Koreas.

Such a scenario could occur before or after the verification of accuracy and completeness of the

DPRK declaration had been completed. If verification has not been completed, the DPRK might delay completion of that step, bringing the verification situation closer to what it was before the AF was signed, i.e., incomplete knowledge of prior DPRK activities and an incomplete KEDO reactor. Thus, failure on the part of the US to meet its commitments to the AF in a timely way could, depending on the timing, itself jeopardize verification that the DPRK does not possess nuclear materials or facilities to carry out a nuclear program. At the same time, if IAEA inspectors remained at the Yongbyon site, activities there would continue to be verifiably frozen. The key factor is continued presence and access by the IAEA inspectors, not the pace of the AF itself, although the two are clearly linked.

## 8.6 Predicting the Future

The scenarios presented attempt to capture some of the key questions and decision points that may occur. The DPRK's efforts at normalization of relations with the US and the ROK over the past ten years or so may make some of the more dire scenarios unlikely, but they remain possibilities. At the least, the DPRK has shown that it is capable of some risky negotiating ploys.

Delays in carrying out the Agreed Framework may present benefits to some parties as well as dangers, such as were pointed out above. All parties to the Agreed Framework have, from time to time, taken actions that delayed implementation. Competing domestic, budgetary, and security interests have regularly taken precedence over the Agreed Framework. Some proponents of the Agreed Framework never intended to build the promised reactors, but rather sought to freeze plutonium production while the DPRK ground toward an expected decline.

Despite the many hardships imposed on the North Korean people, however, few experts predict a DPRK collapse. Indeed, the countries with the most at stake—South Korea, China, the United States, and Japan—have gone to some length to prevent a collapse. Beyond nonproliferation, the Agreed Framework is part of a “soft landing” strategy that seeks to contain the DPRK’s problems through an extended period of reconciliation with South Korea. Continued delay could endanger this strategy. The development of contingency plans in cooperation with the ROK and Japan must be part of an execution strategy for the Agreed Framework.

The Agreed Framework faces its parties with both opportunities and challenges. The opportunities for the DPRK include not only the

provision of electricity at concessionary rates, but also the opportunity to become fully cooperative and open in an important area of international concern. Obviously, these opportunities are also challenges, both for the DPRK and for the US, ROK, and other KEDO members. The challenges include the challenge of verification that has been taken up in this report.

We believe, based on the considerations of this report, that the challenges of verifying the Agreed Framework can be met, under the conditions outlined. In essence, these conditions account for the IAEA to be ready and capable of special efforts in this case, efforts that will probably require enhanced US and ROK support, and for the DPRK to fully cooperate with the IAEA, and open as to its past activities. In other words, the Agreed Framework is verifiable, but

whether it will be verified is up to the parties. With these conditions met, verification is robust under most scenarios.

## Notes to Chapter 8

1. National Academy of Sciences, *Management and Disposition of Excess Weapons Plutonium*, Report of the Committee on International Security and Arms Control (National Academy Press, Washington, D.C., 1994), p. 151.
2. David Albright and Kevin O’Neill, eds., *Solving the North Korean Nuclear Puzzle*, Institute for Science and International Security Press, Washington, D.C., 2000), Chapter 3, p. 9.
3. Albright and O’Neill, Chapter 8, p. 4.



## Verifying the Agreed Framework: Conclusions and Recommendations

### Safeguarding the KEDO Reactors

- The applicable International Atomic Energy Agency (IAEA) safeguards are adequate for the timely detection of the diversion of nuclear material. Timeliness is taken as the estimated time to convert diverted nuclear material into weapons-usable form.
- Advanced safeguards technologies, such as real-time remote monitoring, are being tested on the type of reactors being provided by Korean Peninsula Energy Development Organization (KEDO). Upon completion of this testing, it will be desirable to implement these measures in the Democratic People's Republic of Korea (DPRK) as they will enhance the effectiveness of safeguards. Implementation by the Republic of Korea (ROK) is probably a prerequisite to implementation by the DPRK.
- All safeguards-relevant monitoring and data-transmission equipment must properly and securely installed and adequately maintained, and data transmission must be secure and uninterrupted. The IAEA must also have adequate resources to ensure that inspectors are properly trained, and that safeguards-relevant information is reviewed in a timely manner.
- Full cooperation and openness by the DPRK is essential to the successful implementation of its IAEA Safeguards Agreement.

- The IAEA is under severe budget constraints and the member states (in particular, the US, ROK, and Japan) can usefully assist the IAEA by making available the technical and financial resources necessary to implement the DPRK's Safeguards Agreement.
- Removal of Beginning-of-Life fuel from the DPRK as soon as practical is desirable due to both the quality of the contained, weapons-usable plutonium in such fuel and the fact that it will be the first to cool (i.e., lose radioactivity), which facilitates ease of handling. Negotiating an agreement for such removal as early as possible would be useful.

### Past DPRK Nuclear Activities

- The DPRK's initial declaration to the IAEA identifying facilities and quantities of nuclear material subject to safeguards appears to be incomplete. At least one undeclared waste site has been identified, probably containing additional plutonium. There is evidence indicating more fuel removal and more plutonium-separation activity than the DPRK has declared.
- An amended DPRK declaration, confirmed by IAEA inspections and measurements, will very likely be required. With such an amended declaration, the US and other interested parties would have more complete and reliable knowledge of the DPRK's nuclear materials and facilities, and more complete and ongoing safeguards over such material and facilities would be possible.
- With adequate preparation and unhindered measurements and inspections (including access to appropriate records), the IAEA can assess past DPRK nuclear activities to reasonable accuracy and confidence. With DPRK cooperation, the process is estimated to take 2–4 years.
- The exact quantity of plutonium separated can only be approximately determined. Depending on the reactor operating history available, there may not be high confidence in the exact number of kilograms separated.
- The IAEA is likely to need added resources to prepare for and deal with the problem of verifying the DPRK declaration, and beyond this, to verify that the DPRK is complying with the Non-Proliferation Treaty as required by the Agreed Framework.
- Access to third-party information provided by member states will continue to be an important part of IAEA verification and safeguards activities.
- The US and other states supporting nuclear non-proliferation objectives, especially the ROK and Japan, need to support the IAEA in maintaining a "standard of verification" for the DPRK, as expected for other member states.
- The Agreed Framework requires dismantlement and disposal of the identified nuclear facilities at Yongbyon after the first KEDO reactor has been completed. The cost to dismantle these facilities, based on past experience, is likely

## CONCLUSIONS AND RECOMMENDATIONS

to be at least a few hundred million dollars.

- Spent fuel of the type at the Yongbyon site cannot be stored indefinitely. It will have to be transported to a facility that can safely handle and treat this type of spent fuel within a few years. Such an operation raises significant technical and political challenges. Negotiating and identifying a site to which this material can be removed should be done as early as possible.
- Some of the crucial pipes and the special equipment at the identified Yongbyon facilities must be removed or destroyed to make the dismantlement verifiably irreversible. It is desirable to do this as soon as possible.

### Possible Adverse Developments

- Delays at this point of implementation of the AF have little direct effect on verification ability. Delays later, after one or both KEDO reactors are completed, for instance in allowing special inspections (in addition to those before completion and already requested as part of the Supply Agreement), could have more serious consequences.
  - Disagreement over the need for an amended DPRK declaration or over the means used by IAEA to verify the declaration could prevent the US and other interested parties from having a full knowledge of past DPRK activities.
  - Failure to remove the Yongbyon spent fuel would leave weapons-usable material in the DPRK.
  - Failure to dismantle and dispose of identified nuclear facilities in the DPRK would leave them available for later use.
- Lack of agreement over or interference with the extent and nature of advanced safeguards technologies to be applied to the KEDO reactors could limit the effectiveness of the IAEA's safeguards.
  - Abrogation and other overt violation of the Agreed Framework or Non-Proliferation Treaty cannot be prevented by verification measures. Early removal of spent KEDO fuel would minimize the amount of plutonium-containing material in the DPRK in the event of overt abrogation. Application of additional methods beyond INFCIRC 153, notably broader environmental sampling and easier inspections at undeclared facilities, would diminish the uncertainty associated with the detection of undeclared activities and increase the warning time of possible overt violations.

## DISCLAIMER

This document was prepared as an account of work sponsored by an agency of the United States Government. Neither the United States Government nor the University of California nor any of their employees, makes any warranty, express or implied, or assumes any legal liability or responsibility for the accuracy, completeness, or usefulness of any information, apparatus, product, or process disclosed, or represents that its use would not infringe privately owned rights. Reference herein to any specific commercial product, process, or service by trade name, trademark, manufacturer, or otherwise, does not necessarily constitute or imply its endorsement, recommendation, or favoring by the United States Government or the University of California. The views and opinions of authors expressed herein do not necessarily state or reflect those of the United States Government or the University of California, and shall not be used for advertising or product endorsement purposes.

Work performed under the auspices of the U. S. Department of Energy by the University of California Lawrence Livermore National Laboratory under Contract W-7405-Eng-48.

This report has been reproduced directly from the best available copy.

Available to DOE and DOE contractors from the  
Office of Scientific and Technical Information  
P.O. Box 62, Oak Ridge, TN 37831  
Prices available from 423.576.8401  
<http://apollo.osti.gov/bridge/>

Available to the public from the  
National Technical Information Service  
U.S. Department of Commerce  
5285 Port Royal Rd.,  
Springfield, VA 22161  
<http://www.ntis.gov/>

or

Lawrence Livermore National Laboratory  
Technical Information Department's Digital Library  
<http://www.llnl.gov/tid/Library.html>



G1210

