



**POWER
MANAGEMENT**

**DSP Switcher™ MDx-G15z/MDx-G16/
MDx-G30z/MDx-G31 Series**

Non Isolated, Step-Down Switching Regulator
Module with AnyVoltage™ Technology. Single
and Dual Output Voltage up to 3 Amps Peak.

Advance Specifications, Patent Pending

Doc. No. MV-S101948-00, Rev. C
August 26, 2004



MDx-G15z/MDx-G16/MDx-G30z/MDx-G31
Non Isolated, Step-Down Switching Regulator Module with AnyVoltage™ Technology.
Single and Dual Output Voltage up to 3 Amps Peak.

Document Status	
Advance Information	This document contains design specifications for initial product development. Specifications may change without notice. Contact Marvell Field Application Engineers for more information.
Preliminary Information	This document contains preliminary data, and a revision of this document will be published at a later date. Specifications may change without notice. Contact Marvell Field Application Engineers for more information.
Final Information	This document contains specifications on a product that is in final release. Specifications may change without notice. Contact Marvell Field Application Engineers for more information.
Revision Code:	Rev. C
Advance	Technical Publication: 1.1

No part of this document may be reproduced or transmitted in any form or by any means, electronic or mechanical, including photocopying and recording, for any purpose, without the express written permission of Marvell. Marvell retains the right to make changes to this document at any time, without notice. Marvell makes no warranty of any kind, expressed or implied, with regard to any information contained in this document, including, but not limited to, the implied warranties of merchantability or fitness for any particular purpose. Further, Marvell does not warrant the accuracy or completeness of the information, text, graphics, or other items contained within this document.

Marvell products are not designed for use in life-support equipment or applications that would cause a life-threatening situation if any such products failed. Do not use Marvell products in these types of equipment or applications.

Marvell assumes no responsibility, either for use of these products or for any infringements of patents and trademarks, or other rights of third parties resulting from its use. No license is granted under any patents, patent rights, or trademarks of Marvell.

These products may include one or more optional functions. The user has the choice of implementing any particular optional function. Should the user choose to implement any of these optional functions, it is possible that the use could be subject to third party intellectual property rights. Marvell recommends that the user investigate whether third party intellectual property rights are relevant to the intended use of these products and obtain licenses as appropriate under relevant intellectual property rights.

With respect to the products described herein, the user or recipient, in the absence of appropriate U.S. government authorization, agrees:

- 1) Not to re-export or release any such information consisting of technology, software or source code controlled for national security reasons by the U.S. Export Control Regulations ("EAR"), to a national of EAR Country Groups D:1 or E:2;
- 2) Not to export the direct product of such technology or such software, to EAR Country Groups D:1 or E:2, if such technology or software and direct products thereof are controlled for national security reasons by the EAR; and,
- 3) In the case of technology controlled for national security reasons under the EAR where the direct product of the technology is a complete plant or component of a plant, not to export to EAR Country Groups D:1 or E:2 the direct product of the plant or major component thereof, if such direct product is controlled for national security reasons by the EAR, or is subject to controls under the U.S. Munitions List ("USML").

At all times hereunder, the recipient of any such information agrees that they shall be deemed to have manually signed this document in connection with their receipt of any such information. Copyright © . Marvell International Ltd. All rights reserved. Marvell, the Marvell logo, Moving Forward Faster, Alaska, Fastwriter, GalNet, PHYAdvantage and Pretera are registered trademarks of Marvell. Discovery, DSP Switcher, GalTis, Horizon, Libertas, Link Street, NetGX, RADLAN, Raising The Technology Bar, The Technology Within, UniMAC, Virtual Cable Tester, and Yukon are trademarks of Marvell. All other trademarks are the property of their respective owners.

Non Isolated, Step-Down Switching Regulator Module with AnyVoltage™ Technology. Single and Dual Output Voltage up to 3 Amps Peak.

SIP Package

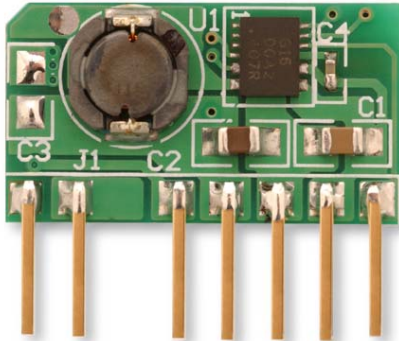

DIP Package

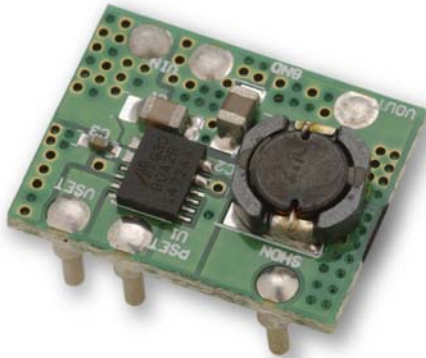

SMT Package



FEATURES/BENEFITS

- True "plug-n-play" solution
- No external components required - except a single voltage programming resistor
- Tiny footprint, vertical and horizontal options
- Input voltage range: 3V to 5.5V
- Programmable output voltage: 0.72V to 3.63V
- 2% output voltage tolerance
- 1 MHz switching frequency
- 95% efficiency—no heatsink required
- Ultra-fast transient response
- Low output ripple and noise
- AnyVoltage™ Technology provides 64 output selections and shortens design cycles
- Output voltage margining capability for easy system testing and qualification
- High reliability - lowest component count
- Works with any external capacitive load (low ESR, high ESR)
- Built-in undervoltage lockout, thermal protection, and current limit
- Control IC and passive kit components are available for high volume user



OVERVIEW

The MDx-G15z/MDx-G16/MDx-G30z/MDx-G31 Series¹ is a high-performance, non-isolated, DC-DC converter module for point-of-load (POL) applications. It functions as a synchronous step-down (buck) switching regulator in a small form factor. The module includes a proprietary Marvell[®] integrated regulator device. The switching frequency for the regulator is 1 MHz, and no external components are required (except one voltage programming resistor, see [Section 2.1 "Output Voltage - AnyVoltage™ Technology" on page 10](#)).

Ultra-high conversion efficiency (typically 95%) allows for the use of the MDx-G15z/MDx-G16/MDx-G30z/MDx-G31 Series without any heatsink. Additionally, the MDx-G15z/MDx-G16/MDx-G30z/MDx-G31 includes an innovative single resistor method² to program the output voltage. This voltage is defined by the user with an external resistor.

The MDx-G15z/MDx-G16/MDx-G30z/MDx-G31 Series operates from an input voltage range of 3V to 5.5V, making the device well suited for portable applications. The output voltage range is 0.72V to 3.63V, supporting future devices down to 65 nm geometries.

Other key features include an internal current limit, an undervoltage lockout, a thermal shutdown, and an ambient temperature range of -40°C to 85°C

-
1. The MDx-G15z/MDx-G16/MDx-G30z/MDx-G31 series includes MDS-G15z, MDD-G15z, MDT-G15z, MDS-G16, MDD-G16, MDT-G16, MDS-G30z, MDD-G30z and MDT-G30z, MDS-G31, MDD-G31 and MDT-G31
 2. Patent Pending

APPLICATIONS

- Point-of-load power supplies
- Networking/Datacom systems
- Portable computing
- Workstation and Servers
- DSP power supplies
- LAN/WAN
- Enterprise Networks
- Industrial Controls

DEVICE FEATURE DIFFERENCES

Table below summarizes the feature differences between MDx-G15z, MDx-G16, MDx-G30z, and MDx-G31.

Features	MDx-G15z	MDx-G16	MDx-G30z	MDx-G31
Output Current	1.5A	1.5A	3.0A	3.0A
Packages	<ul style="list-style-type: none"> • 8-Pin SIP • 7-Pin DIP • 7-Pin SMT 	<ul style="list-style-type: none"> • 7-Pin SIP • 6-Pin DIP • 6-Pin SMT 	<ul style="list-style-type: none"> • 8-Pin SIP • 7-Pin DIP • 7-Pin SMT 	<ul style="list-style-type: none"> • 7-Pin SIP • 6-Pin DIP • 6-Pin SMT
LDO	LDO Voltage Option	No LDO	LDO Voltage Option	No LDO

PRODUCT SELECTOR TABLE

Part Number	Description	LDO Output Voltage	Output Current	Package
MDS-G15B	SIP Module: 1.5A Pk Switching Reg. with LDO	3.3V	1.5A	8-pin SIP
MDS-G15E	SIP Module: 1.5A Pk Switching Reg. with LDO	2.5V	1.5A	8-pin SIP
MDD-G15B	DIP Module: 1.5A Pk Switching Reg. with LDO	3.3V	1.5A	7-pin DIP
MDD-G15E	DIP Module: 1.5A Pk Switching Reg. with LDO	2.5V	1.5A	7-pin DIP
MDT-G15B	SMT Module: 1.5A Pk Switching Reg. with LDO	3.3V	1.5A	7-pin SMT
MDT-G15E	SMT Module: 1.5A Pk Switching Reg. with LDO	2.5V	1.5A	7-pin SMT
MDS-G16	SIP Module: 1.5A Pk Switching Reg.	--	1.5A	7-pin SIP
MDD-G16	DIP Module: 1.5A Pk Switching Reg.	--	1.5A	6-pin DIP
MDT-G16	SMT Module: 1.5A Pk Switching Reg.	--	1.5A	6-pin SMT
MDS-G30B	SIP Module: 3A Pk Switching Reg. with LDO	3.3V	3.0A	8-pin SIP
MDS-G30E	SIP Module: 3A Pk Switching Reg. with LDO	2.5V	3.0A	8-pin SIP
MDD-G30B	DIP Module: 3A Pk Switching Reg. with LDO	3.3V	3.0A	7-pin DIP
MDD-G30E	DIP Module: 3A Pk Switching Reg. with LDO	2.5V	3.0A	7-pin DIP
MDT-G30B	SMT Module: 3A Pk Switching Reg. with LDO	3.3V	3.0A	7-pin SMT
MDT-G30E	SMT Module: 3A Pk Switching Reg. with LDO	2.5V	3.0A	7-pin SMT
MDS-G31	SIP Module: 3A Pk Switching Reg.	--	3.0A	7-pin SIP
MDD-G31	DIP Module: 3A Pk Switching Reg.	--	3.0A	6-pin DIP
MDT-G31	SMT Module: 3A Pk Switching Reg.	--	3.0A	6-pin SMT



Table of Contents

SECTION 1. SIGNAL DESCRIPTION.....	7
1.1 Pin Diagram for MDx-G15z & MDx-G30z	7
1.2 Pin Diagram for MDx-G31	8
1.3 Pin Description	9
SECTION 2. FUNCTIONAL DESCRIPTION	10
2.1 Output Voltage - AnyVoltage™ Technology	10
2.2 Output Voltage Margining.....	10
2.3 Undervoltage Lockout (UVLO)	12
2.4 Thermal Shutdown	12
SECTION 3. ELECTRICAL SPECIFICATIONS	13
3.1 Absolute Maximum Ratings	13
3.2 Recommended Operating Conditions	13
3.3 Electrical Characteristics.....	14
3.4 Startup Waveforms.....	15
3.5 Load Transient Response Waveforms	18
3.5.1 G30 Step-Down Regulator	18
3.5.2 LDO Regulator.....	19
3.6 Switching Waveforms	20
3.7 Efficiency.....	21
SECTION 4. MECHANICAL DRAWINGS.....	23
4.1 Mechanical Dimensions for MDx-G15z & MDx-G30z.....	23
4.2 Mechanical Dimensions for MDx-G16 & MDx-G31	26
SECTION 5. ORDERING INFORMATION.....	29
5.1 Ordering Part Numbers and Package Markings	29

Section 1. Signal Description

1.1 Pin Diagram for MDx-G15z & MDx-G30z

Figure 1: MDx-G15z & MDx-G30z Package - Component View

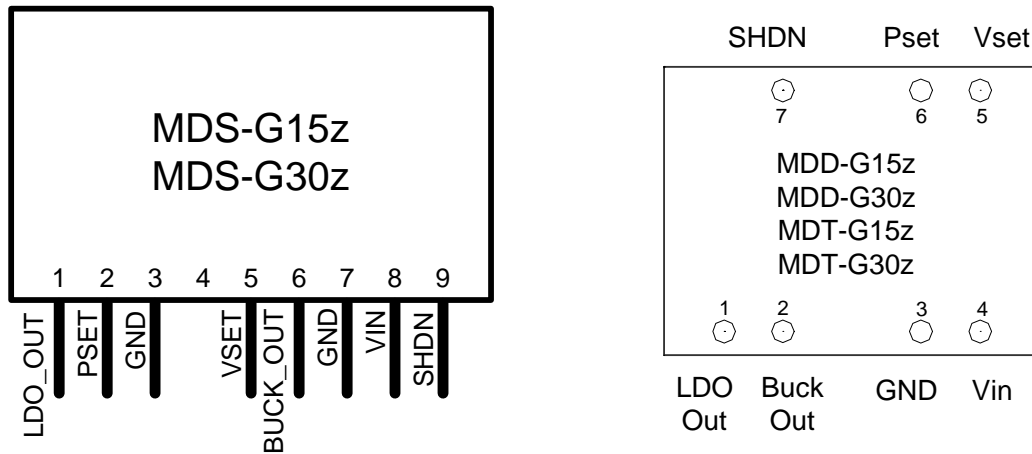
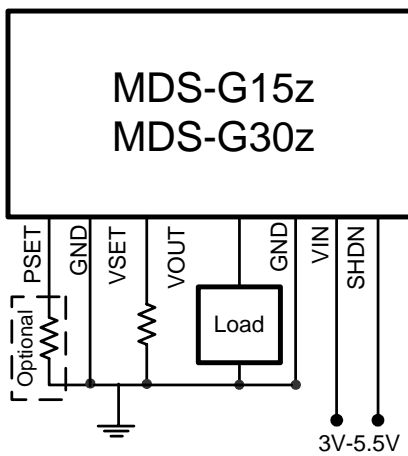

Figure 2: Connection Block Configuration Sample for MDx-G15z & MDx-G30z



1.2 Pin Diagram for MDx-G31

Figure 3: MDx-G16 & MDx-G31 Package - Component View

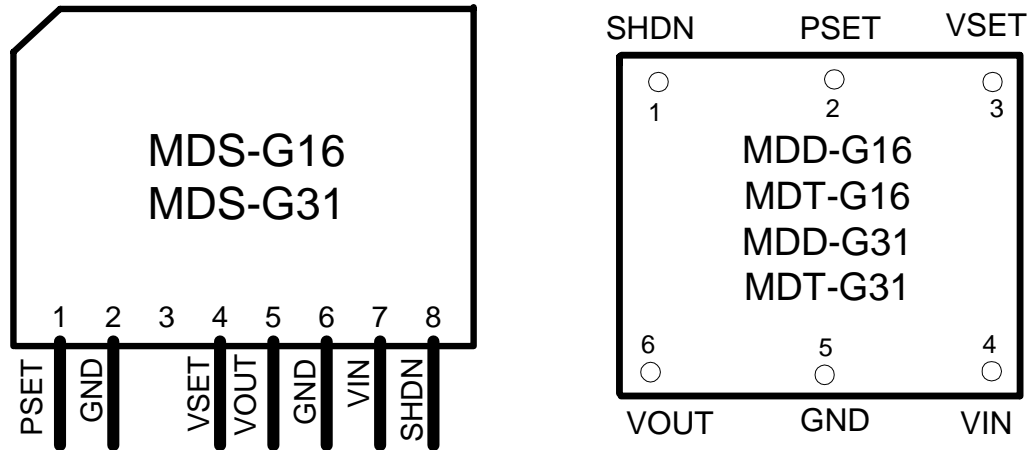
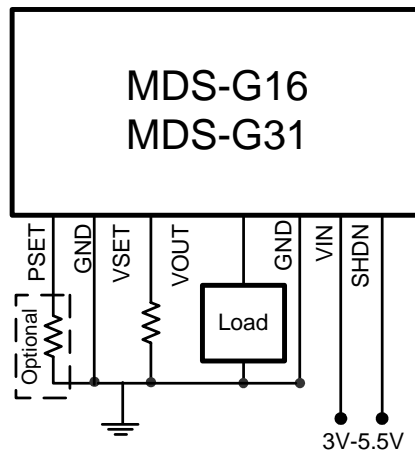

Figure 4: Connection Block Configuration Sample for MDx-G16 & MDx-G31



1.3 Pin Description

Name	Pin Description
LDO_OUT ¹	Secondary Output Voltage. Connect directly to load with a short wide PCB trace.
PSET	Percent Set. An external resistor is connected to the ground to trim the set voltage by the percentage value. See Table 1 in the Section 2.1 "Output Voltage - AnyVoltage™ Technology" on page 10 for resistor values and percentage options. The total capacitance across this pin and GND should be less than 15 pF. Shorting this pin to ground, floating this pin, or using $R_{VSET} > 619K$ or $R_{VSET} < 7.68K$ does not affect the set voltage. A resistor with tolerance better than 2% must be used. If this pin is not used, it should be tied to GND.
GND	Power ground. Connect these two pins to a suitable low-impedance ground plane.
NC	Not connected. No pin.
VSET	Voltage set. An external resistor is connected to ground to set the output voltage of the switching regulator. See Table 1 in the Section 2.1 "Output Voltage - AnyVoltage™ Technology" on page 10 for resistor values and output voltage options. The total capacitance across this pin and GND should be less than 15 pF. Shorting this pin to ground, floating this pin, or using $R_{VSET} > 619K$ or $R_{VSET} < 7.68K$ disables the switching regulator. A resistor with tolerance better than 2% must be used.
BUCK_OUT ²	Primary Output Voltage. Connect directly to load with a short wide PCB trace.
VOUT ³	Output voltage. Connect directly to load with a low impedance PCB trace.
VIN	3V - 5.5V Input voltage.
SHDN	Shutdown. Logic low ($\leq 0.8V$) enables the regulator. Logic high ($\geq 2.0V$) disables the regulator. The high signal has to be at least 20 μs to disable the regulator.

1. This pin is present in MDx-G15z & MDx-G30z only.
2. This pin is present in MDx-G15z, & MDx-G30z only.
3. This pin is present in MDx-G16, & MDx-G31 only.



Section 2. Functional Description

2.1 Output Voltage - AnyVoltage™ Technology

The output voltage of the MDx-G15z/MDx-G16/MDx-G30z/MDx-G31 Series is programmed by using the look-up [Table 1](#) to select the resistor value for the VSET and PSET pins. The VSET pin sets the output voltage, and the PSET pin trims the set voltage to a percentage value.

For example, to program 2.25V output, a 165K resistor is selected for the VSET pin, and an 11K resistor is selected for the PSET pin. The 165K resistor sets the output voltage to 2.5V and the 11K resistor trims the set voltage off by 10% (or -10%). Using a resistor value greater than 619K or less than 7.68K for the VSET pin disables the switching regulator and sets the SW pin to high impedance. Using a resistor value greater than 619K or less than 7.68K for the PSET pin does not affect the set voltage. If not used, the PSET pin should be tied to ground.

Table 1: AnyVoltage™ Programming Table

		PSET								
		-10.0%	-7.5%	-5.0%	-2.5%	Open /GND	2.5%	5.0%	7.5%	10.0%
		11k	18.7k	31.6k	53.6k		97.6k	165k	280k	475k
VSET	GND	0.000	0.000	0.000	0.000	0.000	0.000	0.000	0.000	0.000
	11k	0.720	0.740	0.760	0.780	0.800	0.820	0.840	0.860	0.880
	18.7k	0.900	0.925	0.950	0.975	1.000	1.025	1.050	1.075	1.100
	31.6k	1.080	1.110	1.140	1.170	1.200	1.230	1.260	1.290	1.320
	53.6k	1.350	1.388	1.425	1.463	1.500	1.538	1.575	1.613	1.650
	97.6k	1.620	1.665	1.710	1.755	1.800	1.845	1.890	1.935	1.980
	165k	2.250	2.313	2.375	2.438	2.500	2.563	2.625	2.688	2.750
	280k	2.700	2.775	2.850	2.925	3.000	3.075	3.150	3.225	3.300
	475k	2.970	3.053	3.135	3.218	3.300	3.383	3.465	3.548	3.630
	Open	0.000	0.000	0.000	0.000	0.000	0.000	0.000	0.000	0.000

2.2 Output Voltage Margining

A useful application of the Marvell® AnyVoltage™ technology is “output voltage margining”. Voltage margining is commonly used during system qualification to evaluate operation at “corner” conditions of voltage, temperature etc. Typically, output voltage will be offset up and down by some percentage (margin) of the nominal value. For the MDx-G15z/MDx-G16/MDx-G30z/MDx-G31 Series the VSET pin/resistor controls the nominal voltage of the switching regulator output while the PSET pin/resistor controls the margin voltage. As can be seen in [Table 1](#), the PSET pin allows the margin to be set as high as 10% above and as low as -10% below the nominal setpoint estab-

lished by VSET. Depending on the value of the PSET resistor intermediate points of $\pm 7.5\%$, $\pm 5\%$ and $\pm 2.5\%$ can also be accessed.

For example, if an application calls for a nominal output voltage of 1.5V then Table 1 prescribes a value of R1 for the VSET resistor. This selection is shown in Figure 6 connected to the VSET pin. To offset the voltage above and below the nominal value, the PSET pin can be used with resistor values again from Table 1. Additionally, switches S1 and S2 can be alternately closed to select from the two resistors - R3 and R2 (offset values) for PSET. If more offsets are required more switches and resistors may be used. As shown in the figures below, if S1 is closed and S2 opened a positive 5% offset would be added to the nominal 1.5V output yielding 1.575V. Conversely, if S1 is opened and S2 closed the output would be offset to -5% from 1.5V, or 1.425V. Finally with both S1 and S2 opened the output would return to the nominal 1.5V. Thus voltage margining can be simply and reliably implemented with a minimum of components and design effort.

Figure 5: Output Voltage Margining for MDx-G15z & MDx-G30z

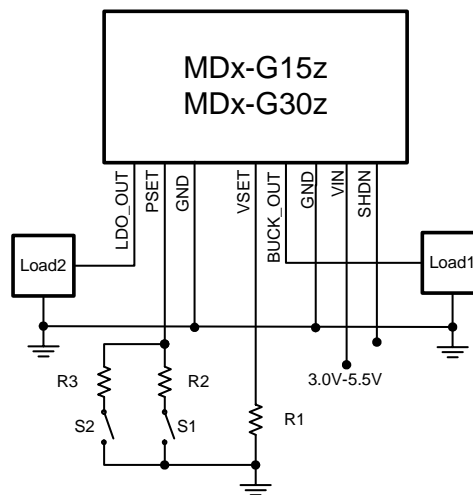
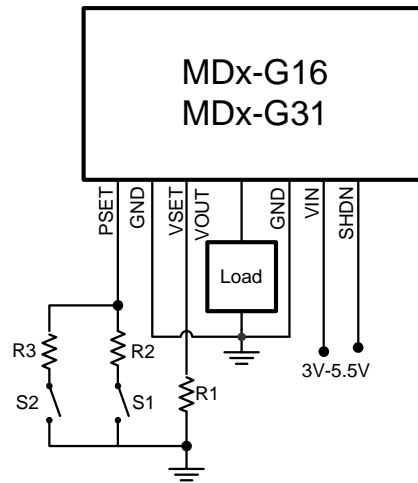



Figure 6: Output Voltage Margining for MDx-G16 & MDx-G31



2.3 Undervoltage Lockout (UVLO)

The MDx-G15z/MDx-G16/MDx-G30z/MDx-G31 Series incorporates undervoltage-lockout circuitry to disable the step-down regulator when the input voltage is below 2.75V (typical). The step-down regulator is enabled when the input voltage is above 2.85V (typical).

2.4 Thermal Shutdown

If the junction temperature of the Control IC on MDx-G15z/MDx-G16/MDx-G30z/MDx-G31 Series exceeds 150°C (typical), the thermal shutdown circuitry disables the step-down regulator. The step-down regulator is enabled when the junction temperature falls to 120°C (typical).

Section 3. Electrical Specifications

3.1 Absolute Maximum Ratings

Stresses above those listed in Absolute Maximum Ratings may cause permanent device failure. Functionality at or above those limits is not implied. Exposure to absolute maximum ratings for extended periods may affect device reliability.

Parameter	Symbol	Range	Units
Input Voltage to GND	V_{IN}	-0.3 to 6.0	V
Voltage Set to GND	V_{SET}	-0.6 to ($V_{IN} + 0.3$)	V
Percentage Set Voltage to GND	V_{PSET}	-0.6 to ($V_{IN} + 0.3$)	V
Shutdown Voltage to GND	V_{SHDN}	-0.6 to ($V_{IN} + 0.3$)	V
Storage Temperature Range	T_{STOR}	-65 to +150	°C
Output Current (Peak) for MDx-G30z & MDx-G31	I_{OUT}	3.0	A
Output Current (Peak) for MDx-G15z & MDx-G16	I_{OUT}	1.5	A
LDO Current	I_{OUTLDO}	800	mA

3.2 Recommended Operating Conditions¹

Parameter	Symbol	Range	Units
Input Voltage	V_{IN}	3 to 5.5	V
Operating Temperature Range ²	T_{OP}	-40 to +85	°C

1. This device is not guaranteed to function outside the specified operating range.
2. This device is guaranteed to meet the specifications from 0°C to 70°C. Any specifications that pertain to the operating temperature range -40°C to +85°C are assured by design, characterization, and correlation with statistical process controls.



3.3 Electrical Characteristics

The following applies unless otherwise noted: $V_{IN} = 5.0V$. $T_A = 25^\circ C$. **Bold values indicate $-40^\circ C \leq T_A \leq 85^\circ C$.**

Parameter	Symbol	Condition	Min	Typ	Max	Units
Input Voltage Range	V_{IN}		3.0		5.5	V
Total Quiescent Current (No Load)	I_{IN}			1.3		mA
Shutdown Supply Current	I_{IN}	$V_{SHDN} = V_{IN} = 5.5V$		1	10	μA
Undervoltage Lockout	V_{UVLO}	High threshold, V_{IN} increasing		2.85	3.00	V
		Low threshold, V_{IN} decreasing	2.65	2.75		V
Shutdown Input Voltage Logic	V_{SHDN}	Enable regulator			0.8	V
		Disable regulator	2.0			V
Shutdown Input Current	I_{SHDN}	$V_{SHDN} = GND$ or 5.5V			± 1	μA
Over-Temperature Thermal Shutdown	T_{OTS}	T_J increasing (disable regulator)		150		$^\circ C$
		T_J decreasing (enable regulator)		120		$^\circ C$
Switching Frequency	f_{SW}			1		MHz
Line Regulation		$I_{OUT} = 2A$		0.2		%
		$V_{IN} = 3.0V$ to 5.5V				
Load Regulation		$I_{OUT} = 0.2A$ to 2.0A		0.5		%
Line Regulation LDO		$I_{OUT} = 800$ mA $V_{IN} = 4.0V$ to 5.5V		0.2		%
Load Regulation LDO		$I_{OUT} = 10$ mA to 800 mA		0.5		%
Input Current Ripple	I_{IN} ripple	$V_{OUT} = 0.8V$ $I_{OUT} = 2A$ (without external filter)		15		mA pk-pk
Input Voltage Ripple	V_{IN} ripple			50		mV pk-pk
Output Voltage Accuracy				± 2		%
Output Voltage Noise		$I_{OUT} = 2.0A$ $V_{OUT} = 1.8V$		8.0		mV RMS
Material Rating						
Flammability Rating		UL94V-0				
Material Type		FR4-PCB				

3.4 Startup Waveforms

Start-up Using the Shutdown Pin

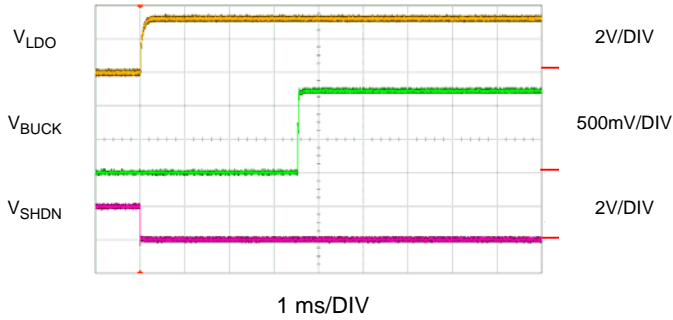

$V_{IN} = 5.0V$ $t_{DLY} \sim 3.5 \text{ ms}$
 $V_{LDO} = 3.3V$
 $V_{BUCK} = 1.2V$
 $I_{LOAD} = \text{No Load}$

Turn Off Using the Shutdown Pin

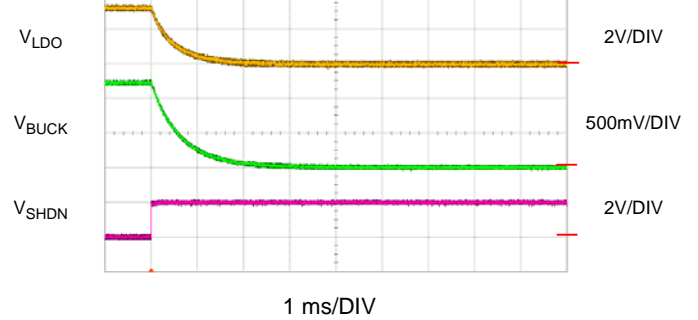

$V_{IN} = 5.0V$
 $V_{LDO} = 3.3V$
 $V_{BUCK} = 1.2V$
 $I_{LOAD} = \text{No Load}$

Enable Threshold at $V_{IN} = 3.0V$

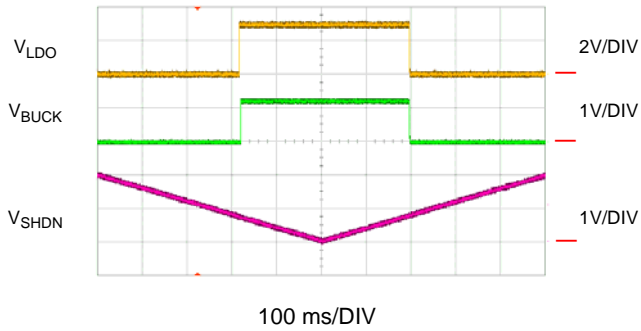

$V_{IN} = 5.0V$ $V_{TH} = 0.7V \text{ (Note)}$
 $V_{LDO} = 3.3V$
 $V_{BUCK} = 1.2V$
 $I_{LOAD} = 10 \text{ mA}$

Enable Threshold at $V_{IN} = 5.0V$

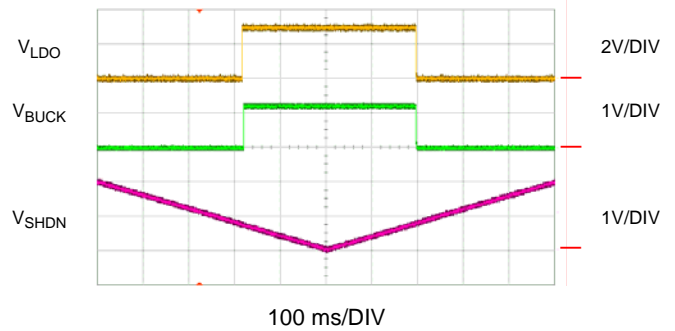

$V_{IN} = 5.0V$ $V_{TH} = 0.9V \text{ (Note)}$
 $V_{LDO} = 3.3V$
 $V_{BUCK} = 1.2V$
 $I_{LOAD} = 10 \text{ mA}$

NOTE: There is a delay (3.5 ms typ) before the output voltage turns on. The actual threshold is before delay.



MDx-G15z/MDx-G16/MDx-G30z/MDx-G31
Non Isolated, Step-Down Switching Regulator Module with AnyVoltage™
Technology. Single and Dual Output Voltage up to 3 Amps Peak.

VIN Soft Start

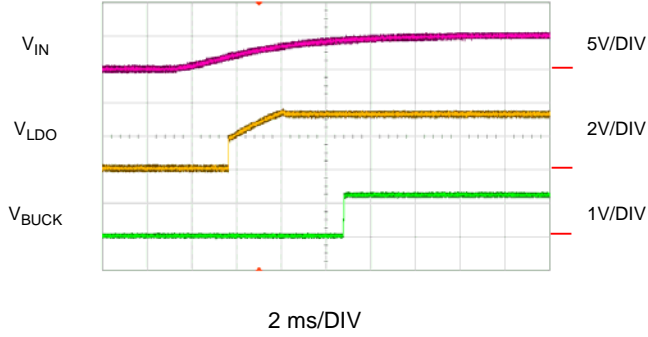

$V_{IN} = 5.0V$
 $V_{LDO} = 3.3V$
 $V_{BUCK} = 1.2V$
 $I_{LOAD} = \text{No Load}$

VIN Hot Plug

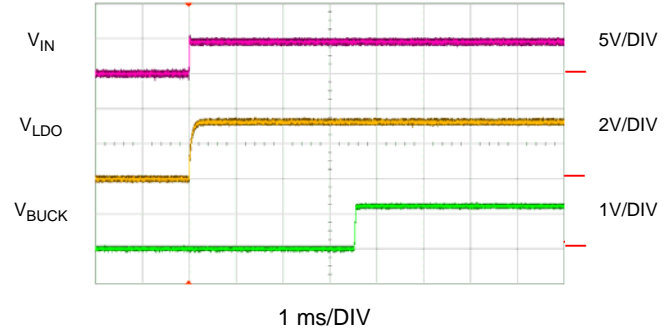

$V_{IN} = 5.0V$
 $V_{LDO} = 3.3V$
 $V_{BUCK} = 1.2V$
 $I_{LOAD} = \text{No Load}$

G30 Step-down Output Rise Time

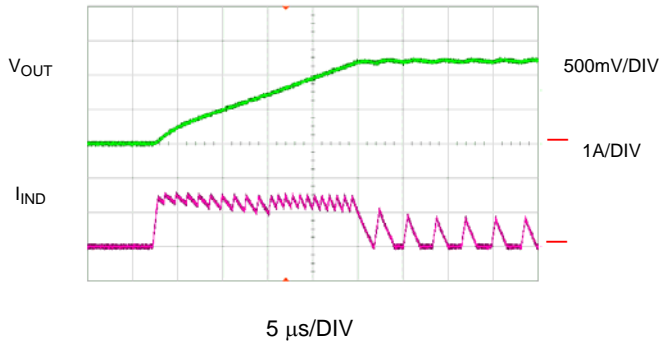

$V_{IN} = 5.0V$
 $V_{OUT} = 1.2V$
 $I_{LOAD} = 500 \text{ mA}$

G30 Soft Start Current Limit

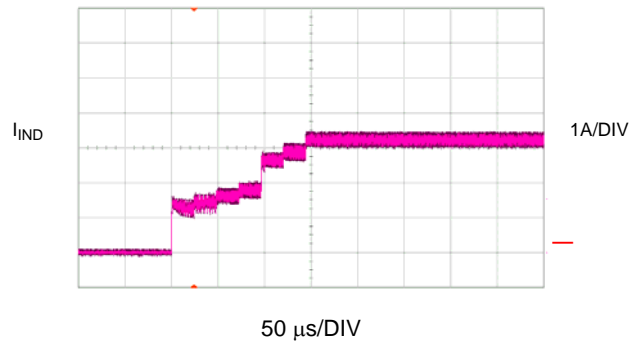

$V_{IN} = 5.0V$
 $V_{OUT} = 3.3V$

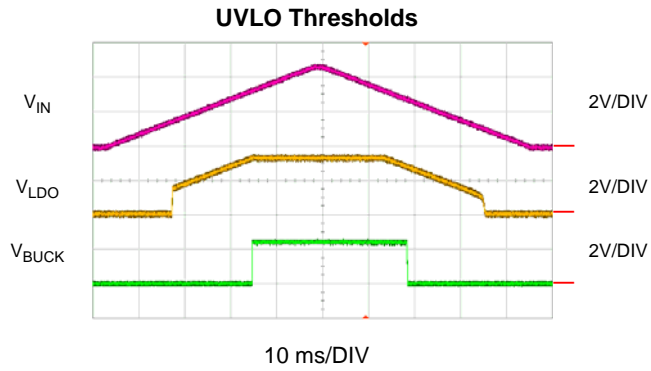

$V_{IN} = 5.0V$	$V_{HTH} = 2.966V$
$V_{LDO} = 3.3V$	$V_{LTH} = 2.767V$
$V_{BUCK} = 1.2V$	
$I_{LOAD} = 10\text{ mA}$	



3.5 Load Transient Response Waveforms

3.5.1 G30 Step-Down Regulator

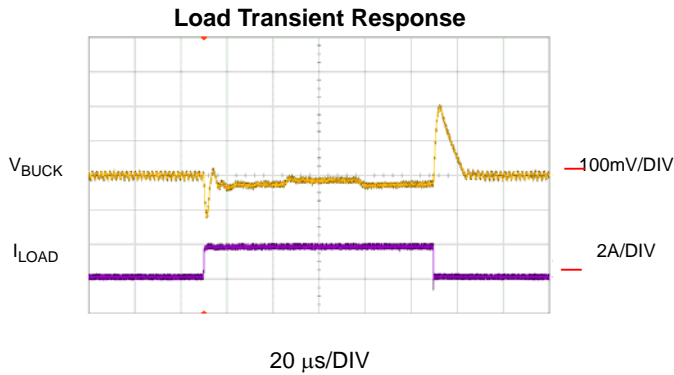

$V_{IN} = 5.0V$ $I_{LOAD} = 0.2A$ to 2A
 $V_{BUCK} = 1.2V$

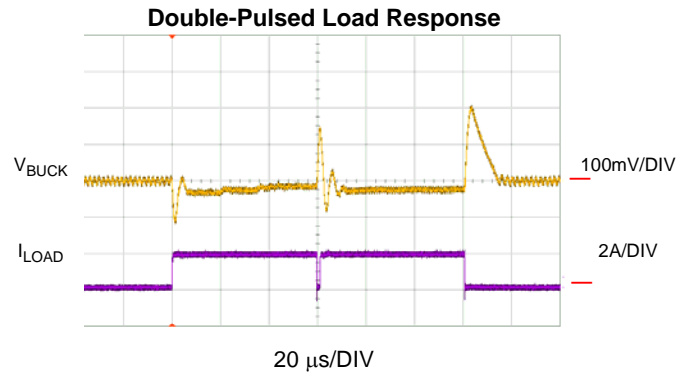

$V_{IN} = 5.0V$ $I_{LOAD} = 0.2A$ to 2A
 $V_{BUCK} = 1.2V$

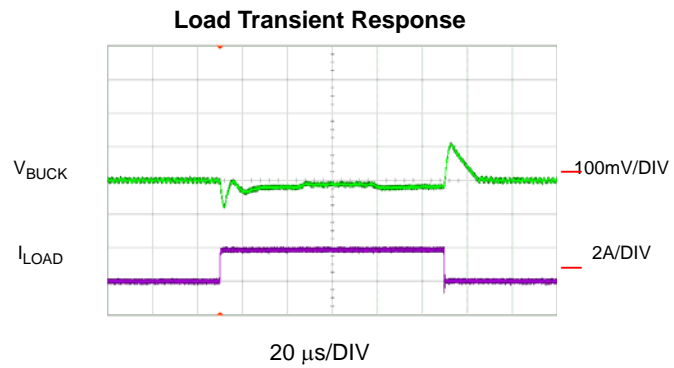

$V_{IN} = 5.0V$ $I_{LOAD} = 0.2A$ to 2A
 $V_{BUCK} = 1.2V$ $t_{RISE} \sim 6A/\mu S$
Additional $C_{OUT} = 22 \mu F$ $t_{FALL} \sim 129A/\mu S$

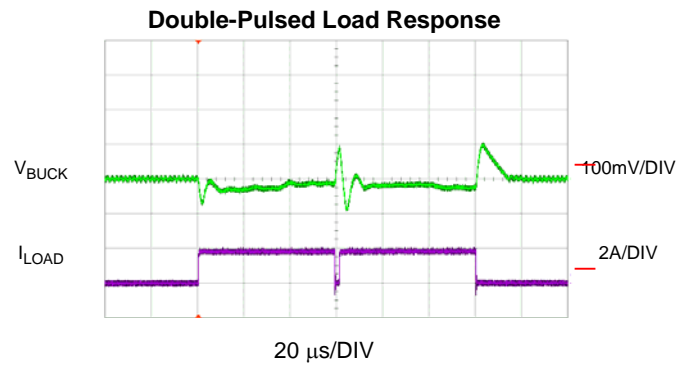

$V_{IN} = 5.0V$ $I_{LOAD} = 0.2A$ to 2A
 $V_{BUCK} = 1.2V$ $t_{RISE} \sim 6A/\mu S$
Additional $C_{OUT} = 22 \mu F$ $t_{FALL} \sim 129A/\mu S$

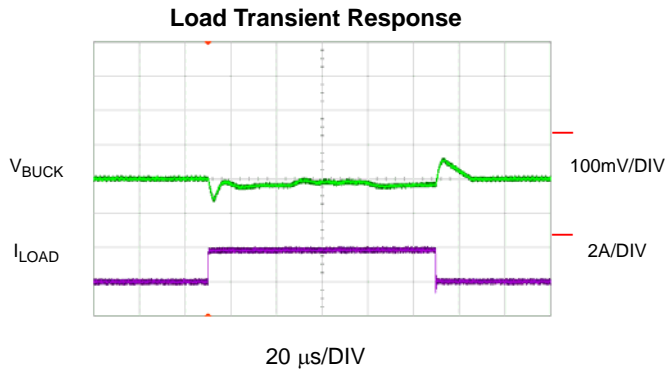

$V_{IN} = 5.0V$ $I_{LOAD} = 0.2A$ to $2A$
 $V_{BUCK} = 1.2V$
Additional $C_{OUT} = 2X22 \mu F$

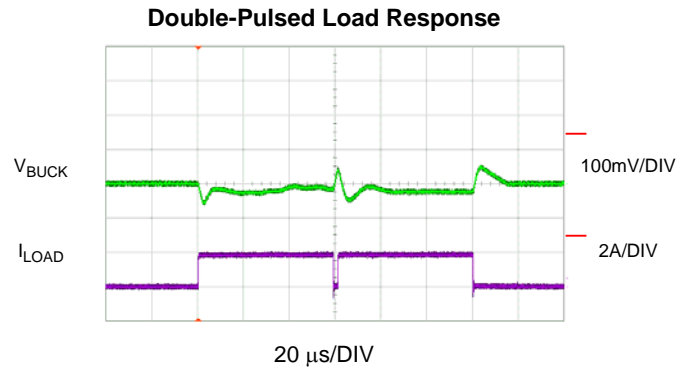

$V_{IN} = 5.0V$ $I_{LOAD} = 0.2A$ to $2A$
 $V_{BUCK} = 1.2V$
Additional $C_{OUT} = 2X22 \mu F$

3.5.2 LDO Regulator

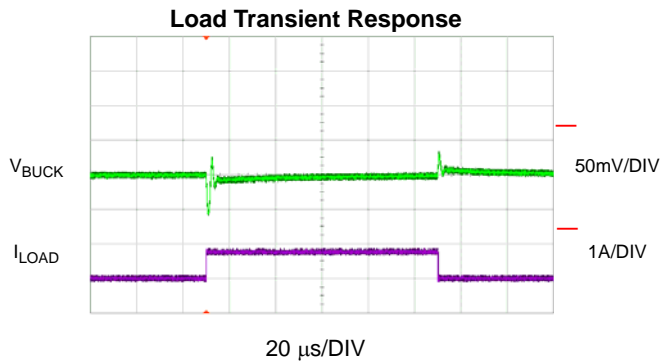

$V_{IN} = 5.0V$ $I_{LOAD} = 0.2A$ to $0.8A$
 $V_{LDO} = 3.3V$

3.6 Switching Waveforms

Switching Waveforms - CCM mode

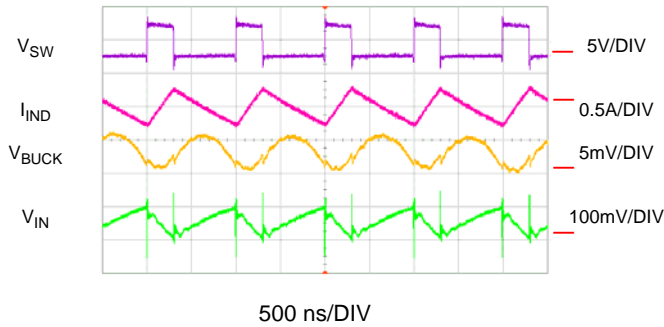

$V_{IN} = 5.0V$ $V_{IN(P-P)} = 200.2\text{ mV}$
 $V_{BUCK} = 1.2V$ $I_{IND(P-P)} = 601.5\text{ mA}$
 $I_{OUT} = 2A$ $I_{IND(PK)} = 2.3A$
 $V_{OUT(P-P)} = 6.3\text{ mV (Note)}$ $Freq = 1\text{ MHz}$

Switching Waveforms - DCM mode

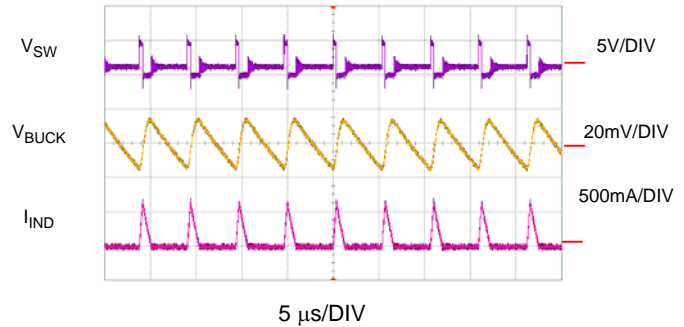

$V_{IN} = 5.0V$ $I_{IND(PK)} = 670.4\text{ mA}$
 $V_{BUCK} = 1.2V$ $Freq = 185\text{ kHz}$
 $I_{OUT} = 50\text{ mA}$
 $V_{OUT(P-P)} = 31.4\text{ mV (20 MHz BW)}$

Output Ripple Voltage

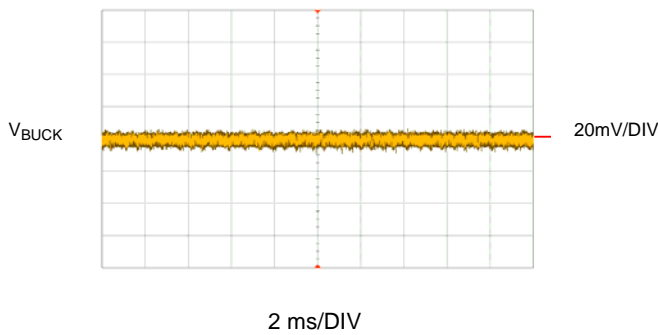

$V_{IN} = 5.0V$
 $V_{BUCK} = 1.2V$
 $I_{OUT} = 2A$
 $V_{OUT(P-P)} = 15.7\text{ mV (Note)}$

Ringing Frequency

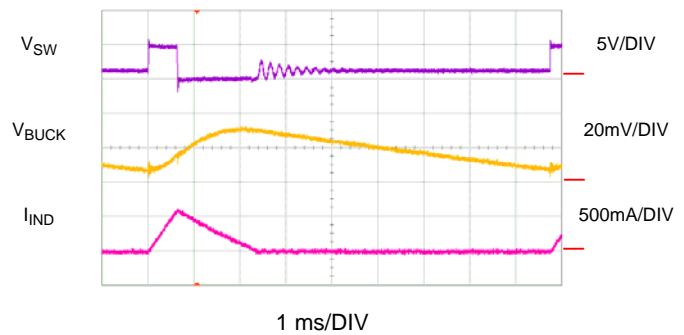

$V_{IN} = 5.0V$
 $V_{BUCK} = 1.2V$
 $I_{OUT} = 50\text{ mA}$
 Ringing Freq = 10 MHz

NOTE: For repeatability of measuring output ripple ($V_{OUT(P-P)}$), the test procedure is to set the scope bandwidth to 20MHz and uses a coax cable with very short leads terminated into 50Ω. The coax leads must be routed away from the switching node as much as possible.

3.7 Efficiency

G30 EFFICIENCY VS. OUTPUT CURRENT

$V_{IN} = 5.0V @ 25^{\circ}C$

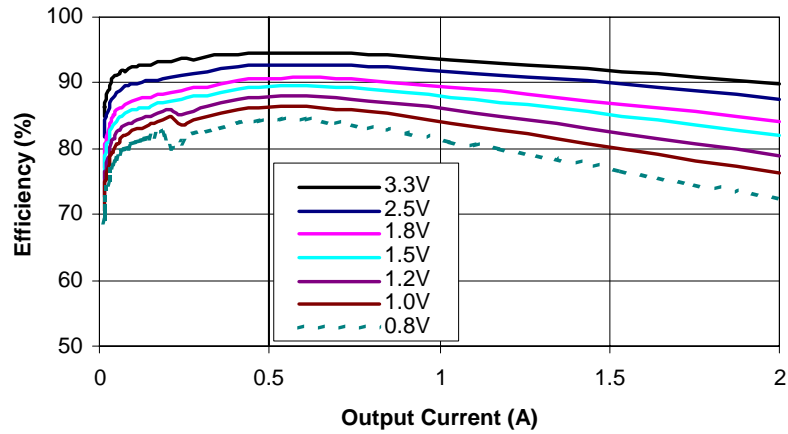

G30 EFFICIENCY VS. OUTPUT CURRENT

$V_{IN} = 3.3V @ 25^{\circ}C$

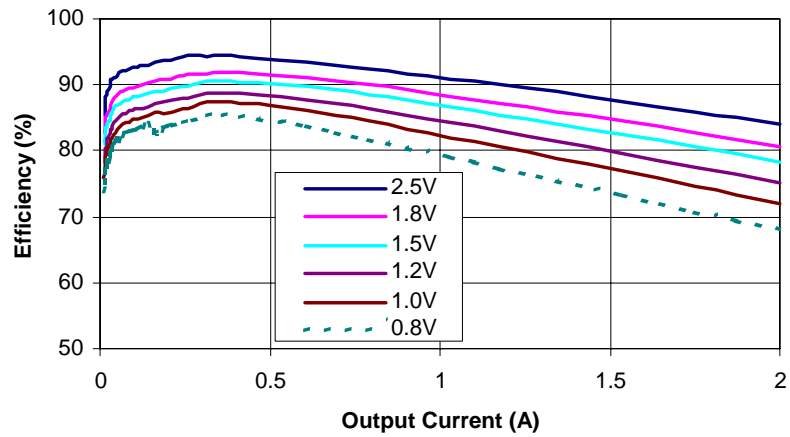



MDx-G15z/MDx-G16/MDx-G30z/MDx-G31
Non Isolated, Step-Down Switching Regulator Module with AnyVoltage™
Technology. Single and Dual Output Voltage up to 3 Amps Peak.

THIS PAGE LEFT INTENTIONALLY BLANK

Section 4. Mechanical Drawings

4.1 Mechanical Dimensions for MDx-G15z & MDx-G30z

Figure 7: MDS-G15z & MDS-G30z Series Mechanical Dimensions

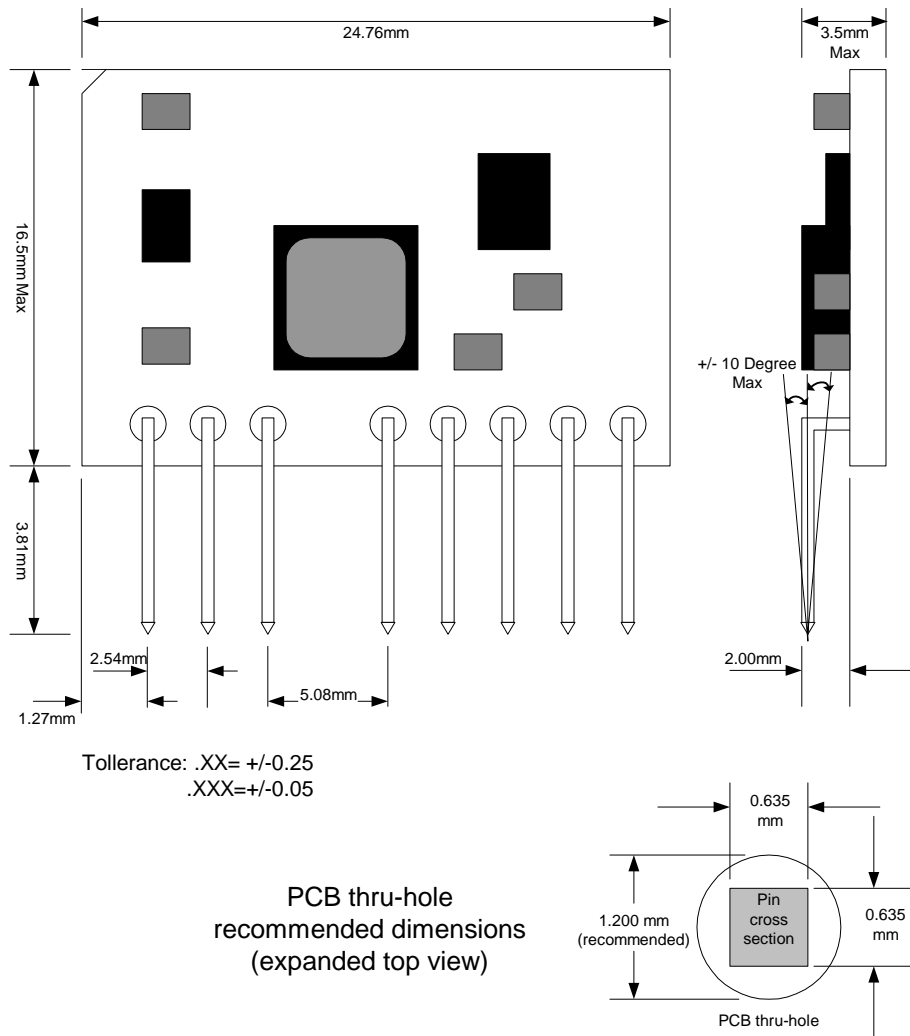



MDx-G15z/MDx-G16/MDx-G30z/MDx-G31
Non Isolated, Step-Down Switching Regulator Module with AnyVoltage™
Technology. Single and Dual Output Voltage up to 3 Amps Peak.

Figure 8: MDD-G15z & MDS-G30z Series Mechanical Dimensions

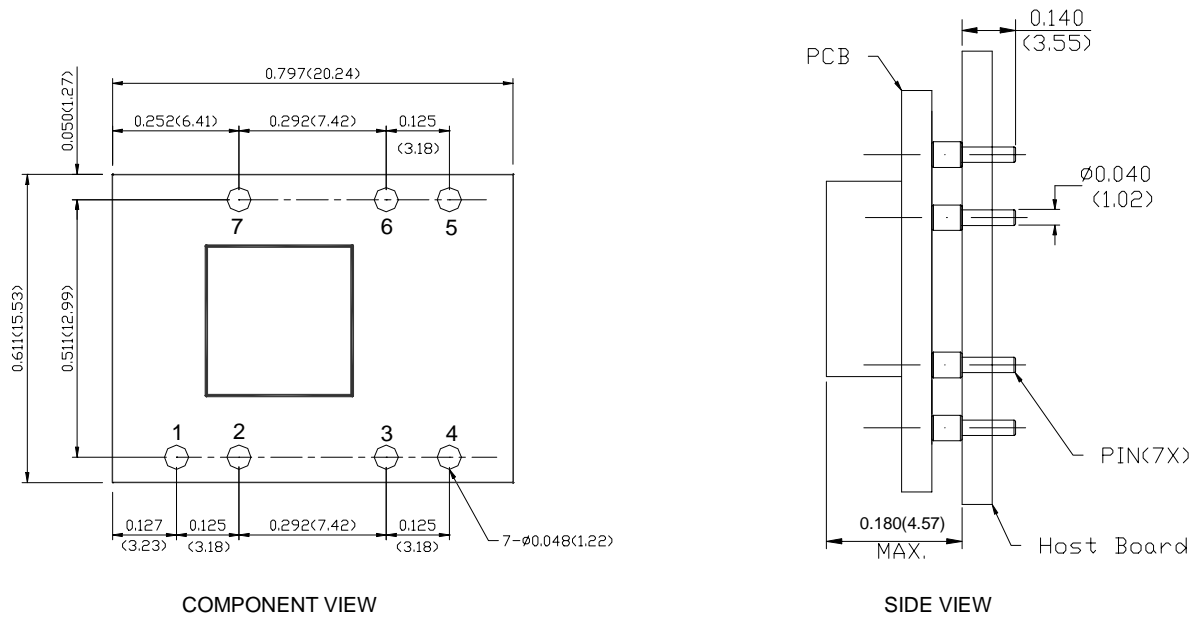
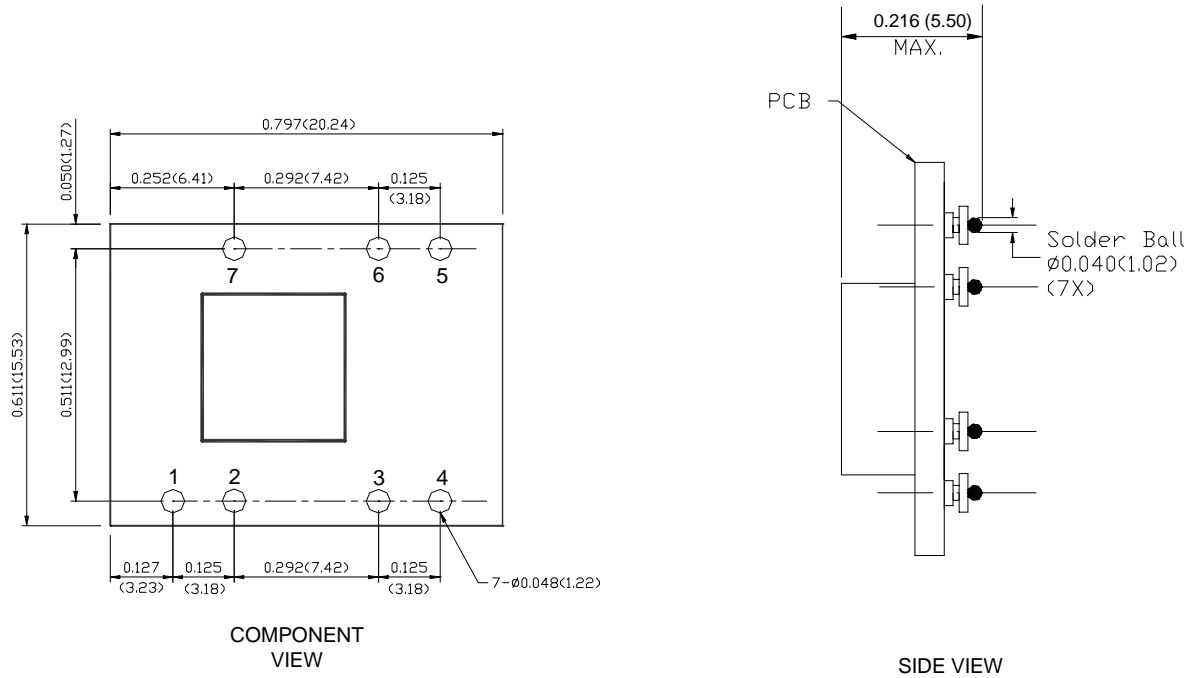

Figure 9: MDT-G15z & MDS-G30z Series Mechanical Dimensions





4.2 Mechanical Dimensions for MDx-G16 & MDx-G31

Figure 10: MDS-G16 & MDS-G31 Series Mechanical Dimensions

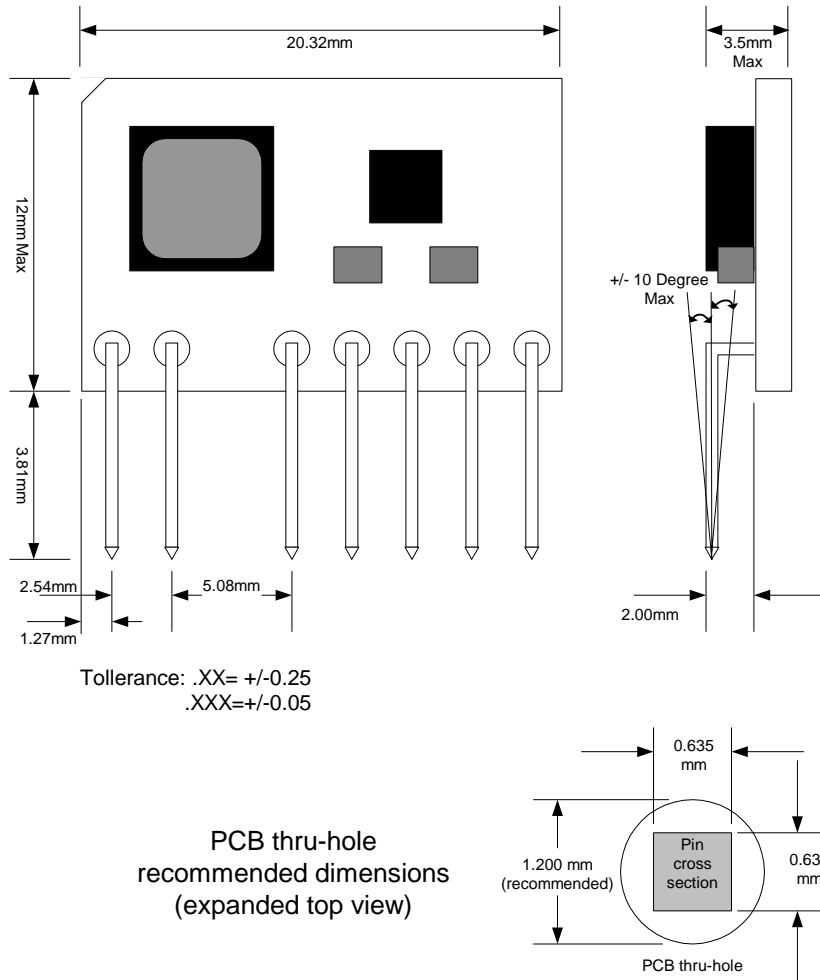
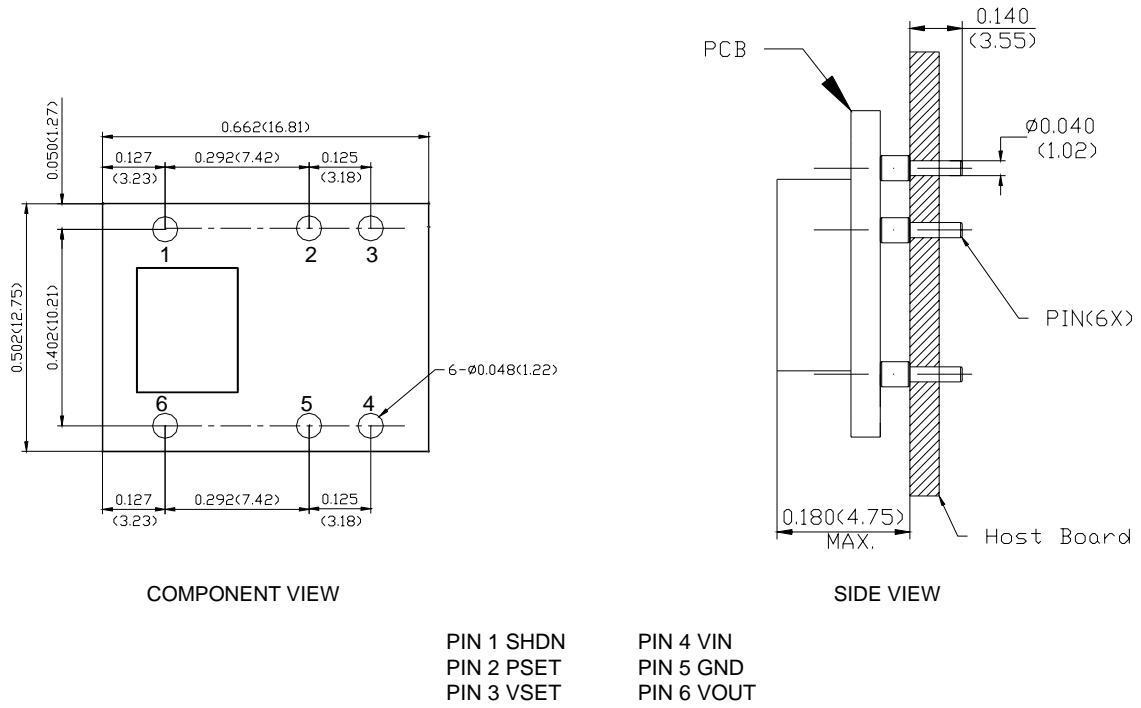

Figure 11: MDD-G16 & MDS-G31 Series Mechanical Dimensions





MDx-G15z/MDx-G16/MDx-G30z/MDx-G31
Non Isolated, Step-Down Switching Regulator Module with AnyVoltage™
Technology. Single and Dual Output Voltage up to 3 Amps Peak.

Figure 12: MDT-G16 & MDS-G31 Series Mechanical Dimensions

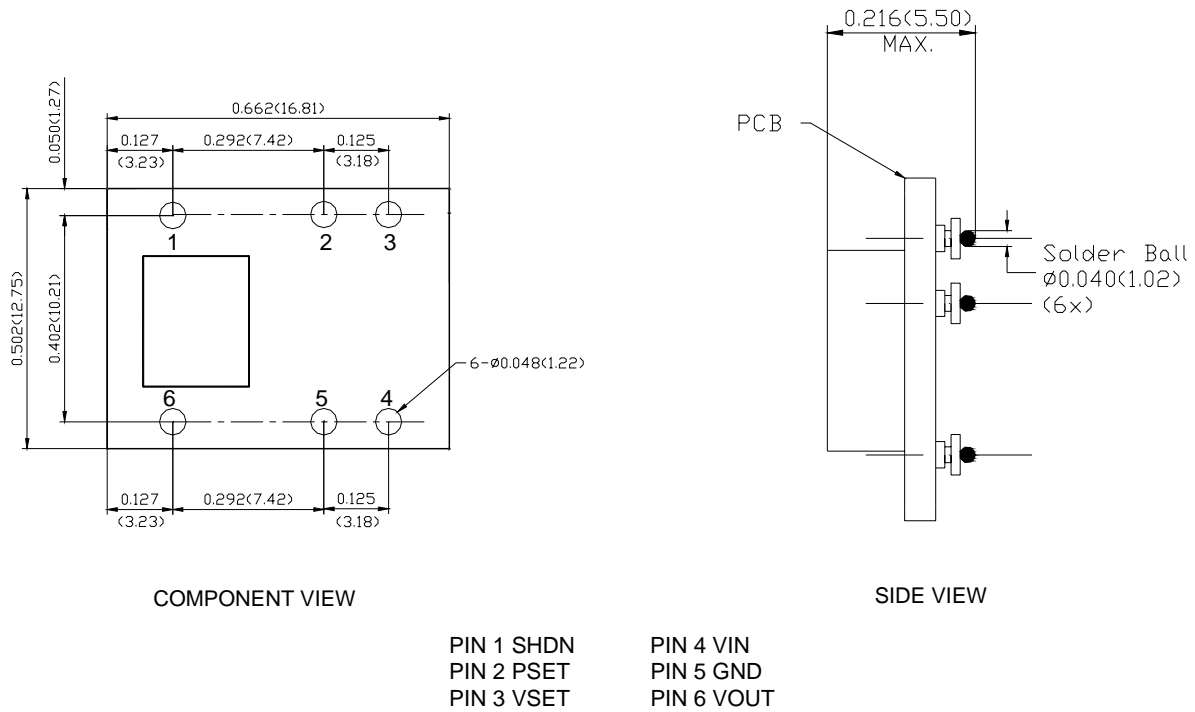

Section 5. Ordering Information

5.1 Ordering Part Numbers and Package Markings

Figure 13 shows the ordering part numbering scheme for the MDS-G31 part. Markings for the other variants are similar. For complete ordering information, contact your Marvell® FAE or sales representative.

Figure 13: MDx-G15z & MDx-G30z Sample Ordering Part Number

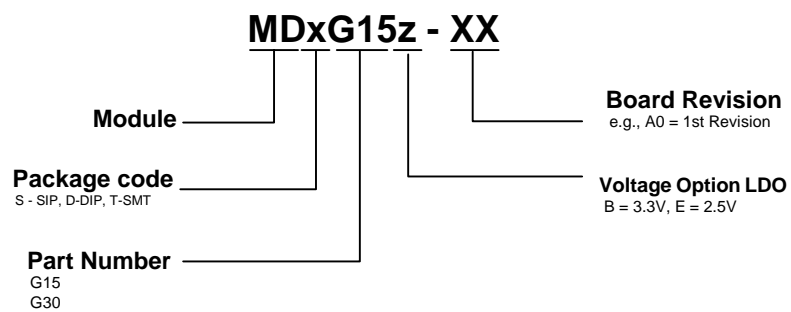
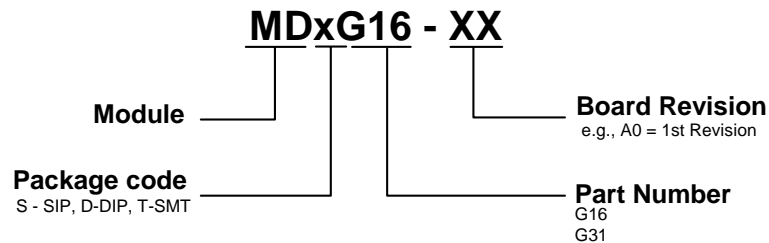

Figure 14: MDx-G16 & MDx-G31 Sample Ordering Part Number





MDx-G15z/MDx-G16/MDx-G30z/MDx-G31
Non Isolated, Step-Down Switching Regulator Module with AnyVoltage™
Technology. Single and Dual Output Voltage up to 3 Amps Peak.

The standard ordering part number for the respective solutions are shown in [Table 2](#).

Table 2: Ordering Part Numbers

Part Number	Marking	Switcher Output Voltage	LDO Output Voltage	Output Current	Ambient Temperature Range ¹	Package
MDS-G15B-YY ²	B0	Programmable	3.3V	1.5A	-40°C to 85°C	8-pin SIP
MDS-G15E-YY ²	E0	Programmable	2.5V	1.5A	-40°C to 85°C	8-pin SIP
MDD-G15B-YY ²	B0	Programmable	3.3V	1.5A	-40°C to 85°C	7-pin DIP
MDD-G15E-YY ²	E0	Programmable	2.5V	1.5A	-40°C to 85°C	7-pin DIP
MDT-G15B-YY ²	B0	Programmable	3.3V	1.5A	-40°C to 85°C	7-pin SMT
MDT-G15E-YY ²	E0	Programmable	2.5V	1.5A	-40°C to 85°C	7-pin SMT
MDS-G16-YY ²	--	Programmable	--	1.5A	-40°C to 85°C	7-pin SIP
MDD-G16-YY ²	--	Programmable	--	1.5A	-40°C to 85°C	6-pin DIP
MDT-G16-YY ²	--	Programmable	--	1.5A	-40°C to 85°C	6-pin SMT
MDS-G30B-YY ²	B0	Programmable	3.3V	3.0A	-40°C to 85°C	8-pin SIP
MDS-G30E-YY ²	E0	Programmable	2.5V	3.0A	-40°C to 85°C	8-pin SIP
MDD-G30B-YY ²	B0	Programmable	3.3V	3.0A	-40°C to 85°C	7-pin DIP
MDD-G30E-YY ²	E0	Programmable	2.5V	3.0A	-40°C to 85°C	7-pin DIP
MDT-G30B-YY ²	B0	Programmable	3.3V	3.0A	-40°C to 85°C	7-pin SMT
MDT-G30E-YY ²	E0	Programmable	2.5V	3.0A	-40°C to 85°C	7-pin SMT
MDS-G31-YY ²	--	Programmable	--	3.0A	-40°C to 85°C	7-pin SIP
MDD-G31-YY ²	--	Programmable	--	3.0A	-40°C to 85°C	6-pin DIP
MDT-G31-YY ²	--	Programmable	--	3.0A	-40°C to 85°C	6-pin SMT

1. The device is guaranteed to meet specifications from 0°C to 70°C. Any specifications that pertains to the operating temperature range -40°C to 85°C are assured by design, characterization, and correlation with statistical process controls.

2. YY is the revision number of the part.

Figure 15 shows a typical package marking for the MDx-G15z part. Markings for the other variant is similar.

Figure 15: MDx-G15z package marking and Pin 1 location

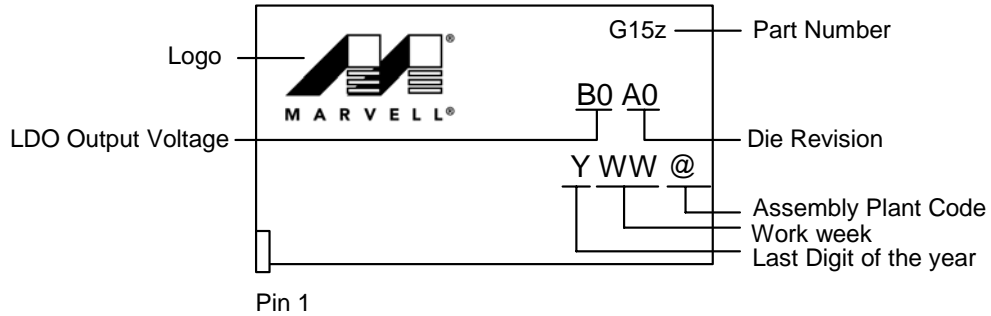
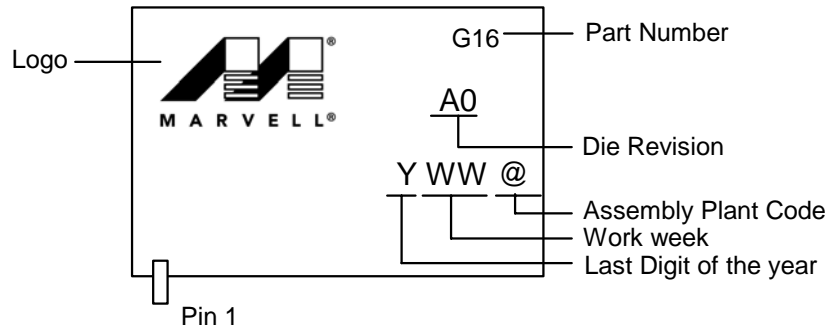

Figure 16 shows a typical package marking for the MDx-G16 part. Markings for the other variant is similar.

Figure 16: MDx-G16 package marking and Pin 1 location





MOVING FORWARD
FASTER®

Marvell Semiconductor, Inc.

700 First Avenue
Sunnyvale, CA 94089

Phone 408.222.2500
Fax 408.752.9028

www.marvell.com

US and Worldwide Offices

Marvell Semiconductor, Inc.

700 First Avenue
Sunnyvale, CA 94089
Tel: 1.408.222.2500
Fax: 1.408.752.9028

Marvell Asia Pte, Ltd.

151 Lorong Chuan, #02-05
New Tech Park
Singapore 556741
Tel: 65.6756.1600
Fax: 65.6756.7600

Marvell Japan K.K.

Shinjuku Center Bldg. 50F
1-25-1, Nishi-Shinjuku, Shinjuku-ku
Tokyo 163-0650
Tel: 81.(0).3.5324.0355
Fax: 81.(0).3.5324.0354

Marvell Semiconductor Israel, Ltd.

Moshav Manof
D.N. Misgav 20184
Israel
Tel: 972.4.999.9555
Fax: 972.4.999.9574

Worldwide Sales Offices

Western US Sales Office

Marvell
700 First Avenue
Sunnyvale, CA 94089
Tel: 1.408.222.2500
Fax: 1.408.752.9028
Sales Fax: 1.408.752.9029

Central US Sales Office

Marvell
11709 Boulder Lane, Ste. #220
Austin, TX 78726
Tel: 1.512.336.1551
Fax: 1.512.336.1552

Eastern US/Canada Sales Office

Marvell
Parlee Office Park
1 Meeting House Road, Suite 1
Chelmsford, MA 01824
Tel: 978 250-0588
Fax: 978 250-0589

Europe Sales Office

Marvell
3 Clifton Court
Corner Hall
Hemel Hempstead
Hertfordshire, HP3 9XY
United Kingdom
Tel: 44.(0).1442.211668
Fax: 44.(0).1442.211543

Israel Sales Office

Marvell
Ofek Center Bldg. 2, Floor 2
Northern Industrial Zone
LOD 71293
Israel
Tel: 972.8.924.7555
Fax: 972.8.924.7554

China Sales Office

Marvell
5J, 1800 Zhongshan West Road
Shanghai, China 200233
Tel: 86.21.6440.1350
Fax: 86.21.6440.0799

Japan Sales Office

Marvell
Shinjuku Center Bldg. 50F
1-25-1, Nishi-Shinjuku, Shinjuku-ku
Tokyo 163-0650
Tel: 81.(0).3.5324.0355
Fax: 81.(0).3.5324.0354

Taiwan Sales Office

Marvell
2Fl., No. 1, Alley 20, Lane 407
Ti-Ding Blvd., Nei Hu District
Taipei, Taiwan 114, R. O. C
Tel: (886-2).8177.7071
FAX: (886-2).8752.5707

For more information, visit our website at: www.marvell.com