

**Canon**

# **EOS-1D**

## **Mark III DIGITAL**

**WHITE PAPER**



**THE CANON EOS-1D  
MARK III CAMERA:**

**EOS REBORN**

<b>Table of Contents</b>	<b>I. OVERVIEW</b>	<b>4</b>
	<b>II. SUMMARY OF NEW AND IMPROVED FEATURES</b>	<b>7</b>
	<b>III. IMAGE QUALITY IMPROVEMENTS</b>	<b>9</b>
	New 10.1 Megapixel Sensor	9
	Dual DIGIC III Image Processors	11
	Noise Reduction	12
	Highlight Tone Priority	12
	New sRAW Image Size	13
	<b>IV. EOS INTEGRATED CLEANING SYSTEM</b>	<b>14</b>
	Self-Cleaning Sensor Unit	14
	Dust Delete Data	15
	<b>V. INCOMPARABLE EOS AUTOFOCUS, NOW EVEN BETTER</b>	<b>16</b>
	AF System	16
	AF Unit	18
	AF Start Button	19
	AF Point Selection	19
	Focusing Computation	19
	AI Servo AF	20
	Automatic AF Point Selection	21
	AF Point Expansion	21
	AF Micro-adjustment	21
	Speedlite Compatibility	22
	<b>VI. LIVE VIEW MODE</b>	<b>23</b>
	Camera Live View Mode	23
	Remote Live View Mode	24
	Focusing	24
	Metering and Exposure	24
	Function Settings	25
	Info Display	26
	Shooting Sequence	26
	Thermal Issues	27
	<b>VII. IMAGE RECORDING AND STORAGE</b>	<b>28</b>
	Recording Methods	28
	External Recording Media	28
	Data Safety when Compartment Cover is Opened	28
	In-Camera File Copying & Naming Options	29
	<b>VIII. ROCK SOLID RELIABILITY</b>	<b>31</b>
	Improved Body Design and Construction	31
	Dimensions and Weight	32
	Mechanical Components	32

Electronic Components	33
RoHS Compatibility	33
Shutter	34
Silent Mode	34
10 fps	35
Metering and Exposure Control	35
Safety Shift	36
Interface	37
Power	37
<b>IX. CONTROL AND DISPLAY</b>	<b>40</b>
Ease of Operation	40
LCD Display Panels	41
LCD Monitor	41
Viewfinder	42
Menu Functions	44
Playback and Display Options	45
White Balance	47
Custom Functions	47
Saving and Registering Settings	51
My Menu	52
Picture Style	52
Camera Direct Functions	52
<b>X. SOFTWARE PACKAGE, COMPATIBILITY AND ACCESSORIES</b>	<b>54</b>
Software: EOS DIGITAL Solution Disk, Version 14	54
Dedicated Wireless File Transmitter WFT-E2A	55
Original Data Security Kit OSK-E3	56
Canon EF16-35mm f/2.8L II USM Lens	56
Canon EOS System Compatibility	58
<b>XI. SPECIFICATIONS</b>	<b>59</b>
<b>XII. CONCLUSION</b>	<b>63</b>

# I. OVERVIEW

Professional photographers know what they want in a camera. Above all, the camera must be dependable—able to come through in shooting situations that are far less than ideal... even in harsh environmental and handling conditions. The camera must be responsive—reacting instantly to the photographer’s input... able to capture, within a heartbeat, the image in the mind’s eye. It must provide a sophisticated feature set that makes it versatile and adaptable and, yet, does not compromise operability. And, of course, it must deliver image quality beyond reproach—which, in the digital era, means not only noise-free detail, richness of color, and depth of tone, but also sufficient data density to satisfy the widest range of output applications. Today, there is one Digital Single-Lens-Reflex (DSLR) camera that meets these criteria as no other: the Canon EOS-1D Mark III. Redesigned and re-engineered from the ground up, Canon’s newest flagship EOS is destined to become the next "must have" DSLR for professionals.

At a blazing 10 frames per second (fps), the 10.1-megapixel Canon EOS-1D Mark III is the world’s fastest DSLR camera (as of February 2007). It is nearly 20% faster than the 8.5 fps EOS-1D Mark II N that it replaces, and it is crushingly faster than anything else with comparable resolution. While this speed will make great headlines, it is but a small part of the repertoire of a stunning machine that sets new benchmarks in virtually every category of professional DSLR performance and then creates new categories where professional DSLR cameras have never gone. The sum is a camera that is the epitome of professional excellence in every respect. It will go everywhere, do everything and appeal to (almost) everyone.

The EOS-1D Mark III is the product of a “reset to zero” design program. As the newest camera in Canon’s 1-series, it inherits a legacy of strength, reliability, control, flexibility and image quality that is second to none in the world of photography. When planning for it began, Canon was in the enviable position of being able to identify every possible aspect of professional DSLR performance that could be improved in some way. They relied on their legendary manufacturing expertise to bring the new ideas to fruition.

The EOS-1D Mark III uses a new, 10.1-megapixel image sensor, designed and manufactured by Canon on semiconductor manufacturing equipment that is also designed, manufactured and maintained by Canon. The sensor uses Canon’s proprietary CMOS technology with several significant advances. Canon has managed to increase the proportion of each pixel that is sensitive to light, called the fill factor. For any given pixel size, the greater the fill factor, the more light each pixel can capture, resulting in better color and less noise. Needless to say, this is not off-the-shelf technology.

Canon has also found a way to reconfigure the microlenses that distribute light to individual pixels. The spaces between them are smaller and the way light strikes the sensor is more intelligent. The result is that less light is lost, again improving image quality. Some of the benefit of this sophistication can be found in the new ISO range of the EOS-1D Mark III, 100 to 3200 with extensions to 50 and 6400, the last figure unimaginable in a DSLR until now. Photographers will be amazed when they discover the high quality and low noise of ISOs 3200 and 6400 on the 1D Mark III.

The beautiful signal from the sensor is sent via a very fast 8-channel readout to two new DIGIC III imaging engines. In the past, one such device has always sufficed, but with the EOS-1D Mark III, there was to be no compromise of either speed or image quality. The Dual DIGIC III Image Processors perform parallel processing, common nowadays in serious computers but unique among cameras, to speed through information. Their workload is increased by the fact that the new sensor captures 14-bit depth color rather than 12. The result, particularly because the 1D Mark III has the horsepower to handle these files, is exquisite gradation, 16,384 levels per color rather than 4,096 at 12 bits. Even when JPEGs (at 8 bits) are created, they are made from a superior file and the difference can be seen. Prints made from 1D Mark III files are spectacular.

The dual processors make themselves known, too, in the burst performance of the EOS-1D Mark III. Large size JPEGs at compression level 8 (of 10) can be fired in barrages of 110 frames (at 10 frames per second with 10.1-megapixel files). RAW images can be shot in bursts of 30. Paparazzi of the world, your new camera has arrived.

Canon has been an acknowledged leader in autofocus technology for many years. The EOS-1D Mark III project presented Canon engineers with the opportunity to perform a complete reconsideration of professional autofocus. The result is an entirely new Area AF sensor that has 19 high-precision, cross-type AF points and 26 assist AF points. The cross-type points are spread out, reaching even the extreme edges of the Area AF coverage area. The logic of AF point selection has been reconsidered, too. Any of the cross-type points can be manually selected, and they can be sorted into an outer group and an inner group so you don't have to cycle through 45 AF points any more to get to the one you want to use. Micro adjustment of autofocusing accuracy is now possible, something many pros didn't even know they could wish for, but which they will adopt with great enthusiasm. Even focus-tracking sensitivity is now adjustable.

Have you ever put your camera in a spot where it was hard to look through the finder? Too high? Too low? Edge of a precipice? In the rafters at Madison Square Garden or on the inside railing at Churchill Downs? Canon has the answer: a professional Live View system, usable with camera only (you can see what the lens sees on the new, large 3.0-inch LCD monitor), or by remote control, either with a wire from the camera to a computer (in a studio, perhaps) or wirelessly with the new WFT-E2A Dedicated Wireless File Transmitter. When a computer is involved, the newly updated EOS Utility 2.0 software (included with the camera) takes care of just about everything—virtually real-time viewing, focusing, exposure, composition, firing—the lot.

There's much, much more: a professional, fully-integrated cleaning system, a new shutter rated at 300,000 cycles, highlight tone priority, safety shift, a completely revised and simplified set of controls and menus, a new recording format, a silent mode, a new magnesium alloy mirror box, an intelligent new lightweight and compact battery... and that's not all. And, we can't forget to talk about the value propositions that the EOS-1D Mark III represents. The text that follows will tell you all about them.

<sup>1</sup> Actual selling prices are set by dealers and may vary.

## II. SUMMARY OF NEW AND IMPROVED FEATURES

- World's fastest AF DSLR with approximately 10 fps continuous shooting in One-Shot AF or AI Servo AF
- Maximum burst (JPEG Large, compression level 8) approximately 110 shots; RAW, approximately 30 shots (based on Canon's testing standards)
- Dual DIGIC III Image Processors for fine detail, natural color reproduction and high-speed performance
- ISO 100-3200 with ISO speed extension, L = 50, H = 6400
- 14-bit A/D conversion for fine gradation
- Live View in camera and remote, wired and wireless
- New 45-point Area AF sensor with 19 high-precision, cross-type points (f/2.8 compatible), 26 standard-precision Assist AF points
- New AF point selection methods
- AF micro-adjustment (fine adjustment of AF point of focus)
- Adjustable operation characteristics for AF point selection, shutter release priority and focus-tracking sensitivity with AI Servo AF
- New methods of AF point expansion during manual AF point selection
- New 10.1-megapixel CMOS sensor, APS-H size
- Improved microlens array and pixel fill factor plus optimized photodiode structure to increase light-reception efficiency
- Professional EOS Integrated Cleaning System with Self-Cleaning Sensor Unit, Dust Delete Data acquisition
- RAW, sRAW (new Small RAW), RAW+JPEG, sRAW+JPEG, JPEG+JPEG simultaneous recording
- Increased shutter durability of approximately 300,000 cycles
- Large and bright 3.0-inch LCD monitor with 230,000 pixels and wide viewing angle
- Five custom WB settings
- Selectable noise reduction for high ISO images, 50% less shadow noise for all images
- Selectable Highlight Tone Priority
- High-speed shutter with 1/8000 sec. maximum speed and high-speed X-sync at 1/300 sec. with EX Speedlites
- Startup time approx. 0.2 sec.
- Shutter release time lag approx. 55 ms. (approximately 40 ms. at maximum aperture with C. Fn IV -13-1) and viewfinder blackout time 80 ms. at 1/250 or higher
- Compatible with SDHC (SD High-Capacity) memory cards as well as high capacity CF cards
- Compatible with USB 2.0 Hi-Speed image transfer
- Faster writing to memory card
- High-magnification, wide-coverage viewfinder and improved focusing screen with 100% finder coverage
- 63-zone metering sensor for more stable exposure control with ambient light and flash

- High-capacity, lightweight and compact lithium-ion battery with estimated battery life display
- Enhanced recording options include automatic switching of recording media, separate recordings to media and identical recordings to multiple media
- Silent mode for single images
- Image copying and backup to external media enabled
- ISO speed safety shift
- ISO speed and metering pattern always displayed in viewfinder and on top LCD data panel
- New control layout with SET button, AF On button and Multi-Controller
- Displayable camera settings and better image information during playback
- Histogram display, jump display, error code display, and shooting settings display
- Chassis, mirror box, and exterior covers made of magnesium alloy
- Maintains water resistance with new 580EX II Speedlite
- Personal Functions consolidated with Custom Functions, resulting in 57 Custom Functions in 4 groups
- Custom Function settings can be registered and called up
- Camera settings can be saved and read
- Camera's basic settings can be registered and applied
- New “My Menu” function can be registered and displayed at startup
- Camera direct printing (PictBridge) improved and DPOF print ordering provided
- Direct printing of RAW and sRAW images
- Direct image transfer
- Wireless/wired LAN for image transfers via new WFT-E2A dedicated Wireless File Transmitter
- External USB recording media and GPS unit usable via the WFT-E2A
- Verification data can be generated, encrypted and appended to the image with new Original Data Security Kit OSK-E3
- Compatible with original image verification system
- Speedlite Custom Functions settable with the camera when the 580EX II Speedlite is attached
- New software package includes Digital Photo Professional 3.0 and EOS Utility 2.0
- New EF 16–35mm f/2.8L II USM lens features improved peripheral image quality

<sup>2</sup> Actual price set by dealers and may vary.



# III. IMAGE QUALITY IMPROVEMENTS

Image quality improvements over the EOS-1D Mark II N are as follows:

- Higher resolution with 10.10 megapixels versus 8.2
- Improved gradation with 14-bit A/D conversion and DIGIC III
- ISO 3200 now within the standard ISO setting range, thanks to an improved sensor signal-to-noise ratio and DIGIC III
- Noise reduction provided for high ISO speeds (C. Fn II -2-1)
- Noise prone to occur at high ISO speeds is reduced
- At low ISO speeds, noise in the shadow areas is further reduced
- Priority for highlight detail can be set (C. Fn II -3-1)
- Image detail from the grays to highlights is improved and loss of highlight detail is reduced



## New 10.1 Megapixel Sensor

The EOS-1D Mark III's new, Canon-designed and manufactured, APS-H-size, CMOS single-plate sensor advances the state of the art in professional DSLR sensor design. APS-H is the largest sensor that can be imaged in one pass using cutting edge semiconductor manufacturing technology. The imaging area of the new CMOS sensor measures 28.1 x 18.7mm, appreciably larger than APS-C and about the same size as the sensors in the EOS-1D Mark II and Mark II N.

The lens magnification factor is 1.3x. Shadow noise at all comparable ISO speed settings is 50% less than with the EOS-1D Mark II N. The sensor features high-speed signal reading (approx. 10 fps), low power consumption, and Live View shooting.

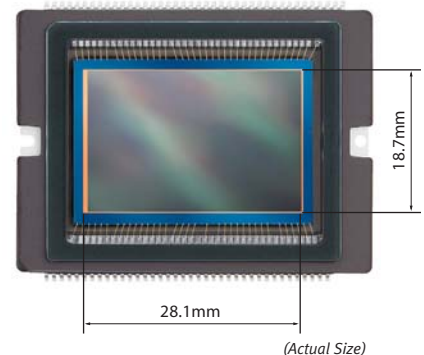

Combining the superb image capture capabilities of the new sensor with advanced Dual DIGIC III Image Processors, the EOS-1D Mark III offers the widest ISO range of any DSLR in the world (as of February 2007). The standard range of 100–3200 can be extended to a remarkable 50–6400.\* More important, the low-noise performance at high ISO settings makes the entire range usable in real-world shooting situations.

\* CIPA standard output sensitivity. Recommended exposure index.

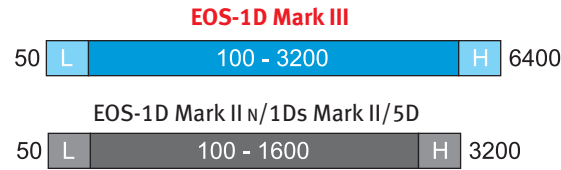

The EOS-1D Mark III sensor has 10.1 effective megapixels, a 25% increase over the 8.2 megapixels of the EOS-1D Mark II. Individual pixel size on the 1D Mark III's sensor is 7.2µm, the same size as the pixels of the EOS-1Ds Mark II.

**Pixels Size and ISO Speed**

Camera	Pixels Size	ISO Speed
EOS-1D Mark III	7.2 x 7.2	100- <b>3200</b> , L(50), H( <b>6400</b> )
EOS-1D Mark II N	8.2 x 8.2	100-1600, L(50), H(3200)
EOS-1Ds Mark II	7.2 x 7.2	100-1600, L(50), H(3200)
EOS 5D	8.2 x 8.2	100-1600, L(50), H(3200)
EOS 30D	6.4 x 6.4	100-1600, H(3200)
EOS Digital Rebel XTi	5.7 x 5.7	100-1600

Although the pixel size of the 1D Mark III is 1 micron smaller than the pixel size of the EOS-1D Mark II and Mark II N, the photodiode size of both sensors is the same, thanks to the optimized photodiode construction and more sophisticated processing of the 1D Mark III.

By optimizing the gap between the on-chip microlenses and improving the fill factor (photodiode area divided by total pixel size) of each pixel, light-gathering efficiency has been improved. Also, by optimizing the photodiode's structure, light-reception efficiency has been improved. Additionally, the second-generation, on-chip noise removal circuit and the noise reduction technology explained below combine to remove noise effectively. This has enabled the EOS-1D Mark III to be the first EOS DSLR camera to have ISO 3200 as part of its standard ISO speed range. Dynamic range at low ISO speeds is about the same with the 1D Mark III as it is with the EOS-1D Mark II and Mark II N despite the 1D Mark III's increased resolution.

A second-generation, on-chip, noise-reduction circuit is provided. To achieve even less

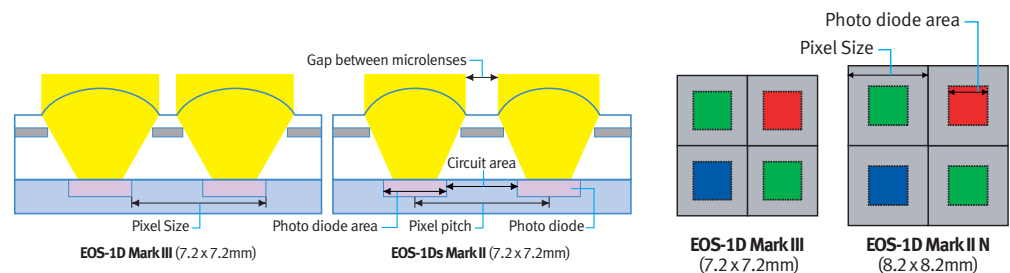

noise, the EOS-1D Mark III has a new feed-through output amp that attains both high speed and low noise. Low noise is also achieved with an improved manufacturing process, an optimized pixel amp and an optimized reading circuit.

As with the EOS-1D Mark II N, single-line, 8-channel reading is employed. With a faster output amp and optimized read circuit, a continuous shooting speed of approximately 10 fps is attained.

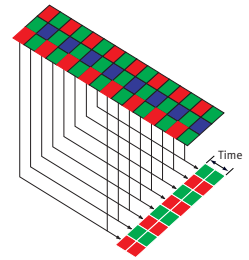

To minimize the higher power consumption required by the faster signal reading, the output amp's power consumption has been reduced. Also, as in the EOS-1D Mark II N, during long exposures, power to the output amp is turned off and the standard current driving the circuit is also cut off to save power. In addition, during Live View shooting, the power distribution for the signal-reading operation is optimized for more pinpoint power-saving control.

Previously, in front of the sensor, there was an infrared-absorption glass integrated with a three-layer, optical crystal plate for point image separation. However, for the Self Cleaning Sensor Unit, the infrared-absorption glass is now separate from the three-layer, optical crystal plate. This makes the dust-shaking plate lighter, saving power and making it easier to control.

The infrared filter has a hybrid construction; it has an infrared-absorption glass with multiple coatings to reflect infrared and ultraviolet rays, the same construction found in EOS-1D series cameras. It effectively reduces red fringing and color casts caused by reflections of the sensor surface. The low-pass filter for point image separation has a phase plate (which converts linear polarization to circular polarization) sandwiched by two single crystal plates. It is optimized for the sensor pitch so the light flux is separated into the horizontal and vertical directions and the fine horizontal- and vertical-line patterns are cleanly separated, effectively reducing color artifacts such as moiré.

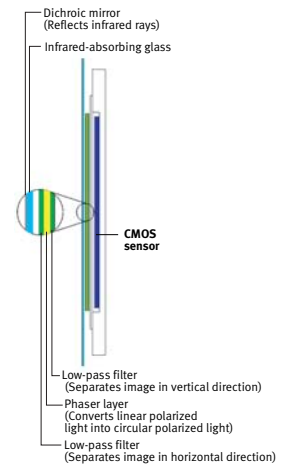

### Dual DIGIC III Image Processors

DIGIC II, a high-performance imaging engine that has been used since the EOS-1D Mark II in 2004, has been a major feature of Canon digital cameras because of its very fine image detail, natural color reproduction and high-speed signal processing. DIGIC III retains the DIGIC II's basic concept and improves upon it with higher performance and faster speed. To cope with the voluminous signal processing required by the EOS-1D Mark III's 10.10 megapixels and top continuous shooting speed of 10 fps, Dual DIGIC III Image Processors are incorporated for parallel signal processing. The CMOS sensor reads out to the dual DIGIC III Image Processors simultaneously in 8 channels.

By having 2 processors handle the workload, image processing is now approximately 1.5x faster; Compact Flash™ access speed is now 1.3x faster, and SD card access is now 2x faster compared to the EOS-1D Mark II n. The extra power of Dual DIGIC III Image Processors has also allowed analog-to-digital conversion to improve from 12 to 14 bits per channel, meaning that tonal gradation for RAW images is now divided into 16,384 separate levels per channel rather than 4,096. When saved as a 16-bit TIFF image, the image retains the full range of tones obtained with 14 bits. Also, JPEG images, at 8 bits per color, are generated from the 14-bit data. Tonal skipping is thereby reduced substantially, improving gradation and overall image quality.

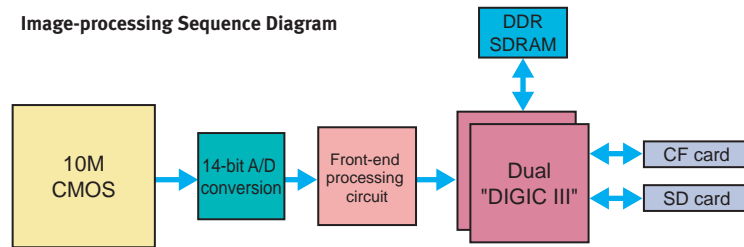

**Noise Reduction** Noise reduction for long exposures is equivalent to that on the EOS-1D Mark II n. When [C. Fn II-1; 1: Auto] is set, 1 sec. and longer exposures will undergo noise reduction automatically, depending on the amount of noise detected in the image data. If [C. Fn II-1; 2: On] is set, all 1 sec. and longer exposures will undergo noise reduction.

Now, noise reduction for pictures taken at a high ISO speed is provided via [C. Fn II-2]. Although this feature works at all ISO speeds, it is especially effective for high ISO speeds. At low ISO speeds, noise reduction is not really necessary. However, applying noise reduction can reduce noise within shadow areas taken under low light.

**Highlight Tone Priority** This new feature extends the dynamic range of highlights by about one stop and improves gradation within highlight areas. By expanding the range from the correct exposure level (18% gray) to the maximum allowable highlight level, the gradation from the grays to the highlights becomes smoother and loss in highlight detail is minimized. If [C.Fn II-3; 1: Enable] is set, the settable ISO speed range will be ISO 200- 3200. The display will show "200" with the zeros in smaller characters. Depending on shooting conditions, noise in the shadow areas may increase slightly.



**New sRAW Image Size** In addition to RAW, JPEG Large, Medium 1, Medium 2, and Small, the EOS-1D Mark III features a new image size, sRAW or Small RAW. sRAW images have approximately one-fourth the pixel count, 2.5 megapixels, and approximately half the file size of RAW images. Just like regular RAW images, sRAW images can be adjusted and processed with the provided software. The feature is expected to appeal to wedding photographers, for example, who do not need full resolution for wedding candids but who do need the postproduction control RAW offers.

**Image-recording Pixels**

Image-recording Quality	Pixels	Image Type
Large	3,888 x 2,592 approx. 10.1 Megapixels	JPEG
Medium 1	3,456 x 2,304 approx. 8.0 Megapixels	
Medium 2	2,816 x 1,880 approx. 5.3 Megapixels	
Small	1,936 x 1,288 approx. 2.5 Megapixels	
RAW	3,888 x 2,592 approx. 10.1 Megapixels	Lossless RAW
sRAW	1,936 x 1,288 approx. 2.5 Megapixels	

# IV. EOS INTEGRATED CLEANING SYSTEM

The EOS-1D Mark III incorporates the EOS Integrated Sensor Cleaning System, which is a complete anti-dust system. It suppresses dust generation and dust adhering to the sensor, removes dust and makes any remaining dust less noticeable.

- The shutter has been improved to generate less dust
- The body cap has also been improved to generate less dust
- The low-pass filter's anti-static charge surface prevents attracting dust due to static charge
- The sensor unit is self-cleaning
- Dust Delete Data is obtained and appended to images.
- Manual cleaning of the imaging sensor is still an option

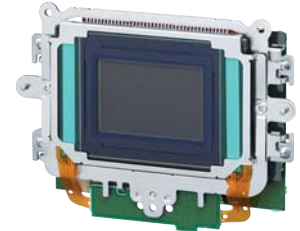

## Self-Cleaning Sensor Unit

The new, compact Self-Cleaning Sensor Unit for the APS-H size imaging sensor has been designed for the EOS-1D Mark III and is different from the EOS Digital Rebel XTi/400D Digital's unit. (The Dust Delete Data specifications are the same as with the EOS Digital Rebel XTi/400D Digital.) On the front infrared-absorption glass, two thin, single-layer piezo-electric elements are attached. By applying ultrasonic vibration to the infrared-absorption glass, the adhering dust is shaken off. The removed dust particles are stuck onto absorbent material around the infrared-absorption glass. Also, to prevent dust from entering the sensor unit, the assembly is secured with sealing material around the perimeter. Another camera maker vibrates an extra glass plate dedicated to dust removal. Because the EOS-1D Mark III vibrates the infrared-absorption glass directly, the optical performance is not degraded by an extra layer of glass and the unit can be kept compact. The Self-Cleaning Sensor Unit can therefore be incorporated in a conventional size body.

Operation timing is either auto or manual. The default setting has the unit operating for about 3.5 sec. whenever you turn the power switch ON or OFF. While the unit is operating, the LCD monitor displays a logo indicating that sensor cleaning is being executed. If the menu is set to [Auto cleaning: Disable], the auto cleaning is not executed.

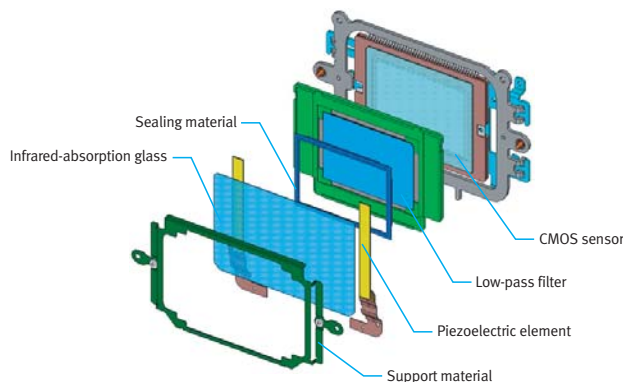

When the menu is set to [Clean now], you can clean the sensor whenever you wish. It takes about 4 sec. During the cleaning, ultrasonic vibration is applied to the infrared-absorption glass and the shutter is cocked three times so that the dust falls off the infrared-absorption glass and any dust resettling on the shutter curtains is also shaken off. During sensor cleaning, whether started automatically or manually, pressing the shutter button halfway or pressing the Menu button will immediately terminate the cleaning and the camera will be ready to shoot. Because the unit has very low power consumption, cleanings do not significantly affect the number of possible shots, even if the default Auto setting is selected.

To prevent the piezo-electric elements from overheating and to ensure proper cleaning, the unit cannot operate again within 3 sec. of finishing operation. Also, if the unit operates five times successively at intervals shorter than 10 sec., it will not operate again for 10 sec. During the stoppage, the [Clean now] menu option cannot be selected.

### Dust Delete Data

The position of dust particles adhering to the infrared absorption glass can be detected and acquired as Dust Delete Data. This data is appended to the image data. The information is used by Digital Photo Professional (DPP) 3.0 to erase the dust spots on the image. When you select the [Dust Delete Data] menu, the unit will first execute the cleaning operation automatically. Then you can photograph a plain, white subject at infinity. The Dust Delete Data will thereby be obtained. It is preferable that you shoot in the aperture-priority AE mode at f/22. This same Dust Delete Data will then be appended to images until it is updated again. If you change lenses, you should obtain the Dust Delete Data again for best results. DPP erases the dust spots on the image by detecting the position of the dust spots based on the appended Dust Delete Data. It will then erase the dust spot only if it deems that doing so will be effective. If the [Clear all camera settings] menu command is selected, all the camera settings will be cleared and the Dust Delete Data will also be cleared.



# V. INCOMPARABLE EOS AUTOFOCUS, NOW EVEN BETTER

**AF System** Canon EOS-1 series cameras are legendary for their superior autofocus ability. Many professional photographers rate Canon's autofocus as one of the main reasons that they use Canon equipment. The new autofocus system of the EOS-1D Mark III represents a complete reconsideration of professional autofocus. In addition to a new sensor chip, sophisticated new manufacturing technologies have made it possible to reconfigure the concave submirror and the very clever secondary image formation lens. The result is greater sensitivity, easier and more logical navigation, higher precision and significantly better real-world performance.

In the 45-point AF system used by such cameras as the EOS-1v, 1D, 1Ds, 1D Mark II, 1Ds Mark II and 1D Mark II N, there are 7 cross-type, high-precision sensors grouped around the center of the frame. Any of the 45 points could be selected by navigating around the frame. This is the configuration of the previous 45-point AF array:

Here is the new AF point layout:

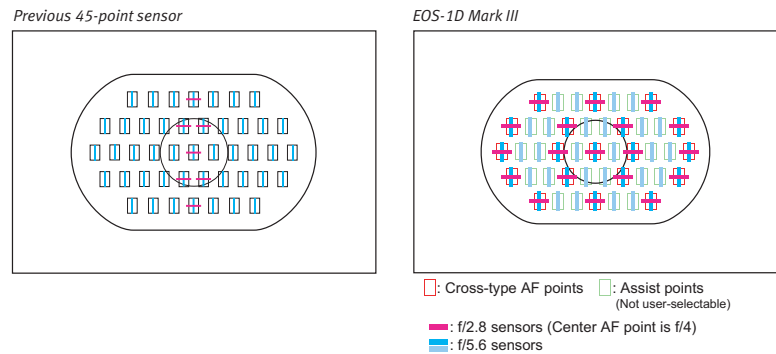

Note that the 19 high-precision, cross-type points are no longer clustered solely in the center of the frame. The 26 Assist AF points are horizontal-line sensitive at f/5.6, are not user selectable, and operate not only in AI Servo AF mode, but in One-Shot AF as well (C. Fn III-8, 1/2). The Assist AF points achieving focus light up with the super-imposed display (SI).

The EOS-1D Mark III features higher precision AF with the 19 user-selectable, cross-type AF points and improved lowlight AF performance. Also, to attain AI Servo AF for 10 fps, the focus computing is faster and an AF adjustment option function is provided. The AF sensor, AF algorithm, and AF-related electronic circuitry have been newly designed especially for the 1D Mark III. Because of improved computing performance and faster reading from the sensor, the AF speed, predictive AF performance, and matching accuracy of the target subject are all the same as with the EOS-1D Mark II N despite the 10 fps continuous shooting speed of the 1D Mark III. Of course, at 8.5 fps, the 1D Mark II N was no slouch itself.



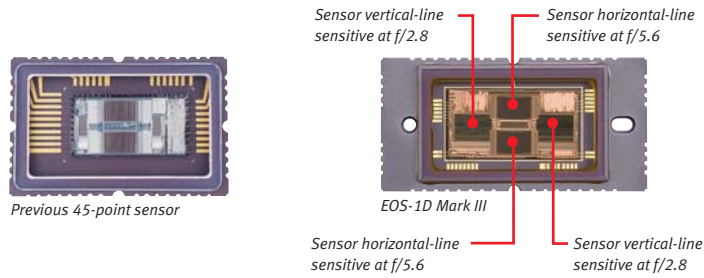

The 19 cross-type AF points take advantage of the following technologies:

- With finer processing steps, the peripheral circuit could be made smaller and the f/2.8 AF sensor area could be expanded
- The secondary image-forming lens (see diagram) is glass mold. By incorporating a newly-developed aspherical surface on the lens, the focusing area of the f/2.8 light flux could be expanded

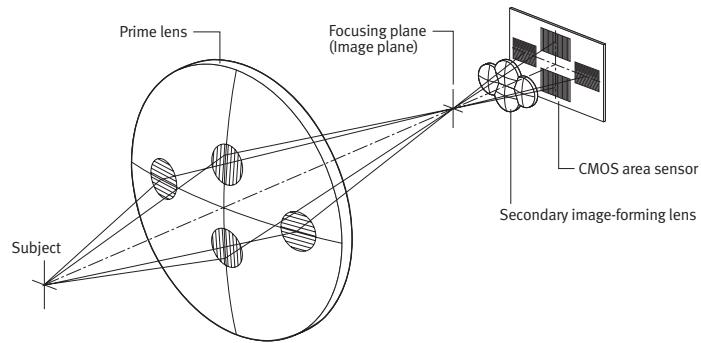

As with the EOS-1D Mark II N, the center AF point is a cross-type sensor. It is vertical-line sensitive with maximum apertures as small as f/4, and horizontal-line sensitive with maximum apertures as small as f/8. If the maximum aperture of the attached lens or lens/extender combination is f/4 or faster, high-precision, cross-type focusing is possible. If the maximum aperture of the attached lens or lens/extender combination is f/8 or faster, horizontal-line sensitive AF is possible. Compared with the other 18 cross-type AF points, the center AF point's focusing line width is larger while the fill factor for each pixel is larger (f/2.8 field of view). Also, the number of focusing lines increases along with the brightness (f/5.6 field of view) to attain higher pre-cision. Gross defocus is also detected. The camera can also detect a grossly defocused subject 1.8 times better than with the EOS-1D Mark II N.

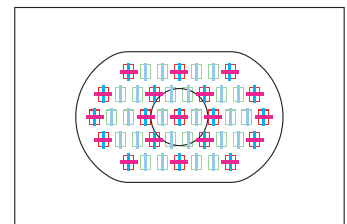

■ Cross-type AF points    ■ Assist points (Not user-selectable)  
■ f/2.8 sensors (Center AF point is f/4)  
■ f/5.6 sensors

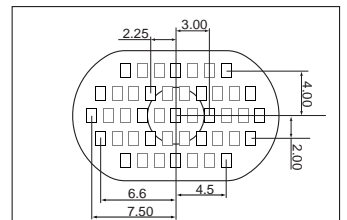

The 18 cross-type AF points other than the center AF point detect vertical lines at  $f/2.8$  and horizontal lines at  $f/5.6$ . If the maximum aperture of the lens or lens/extender combination in use is  $f/2.8$  or larger, high-precision, cross-type focusing is possible. Also, if the maximum aperture of the lens or lens/extender combination in use is  $f/5.6$  or larger, horizontal-line sensitive AF is possible.

The Assist AF sensors are horizontal-line sensitive at  $f/5.6$ . They have the same focusing detection performance as the EOS-1D Mark II's AF points (other than that camera's seven cross-type sensors). The EOS 5D's Assist AF points operate only during AI Servo AF when the camera is set for automatic

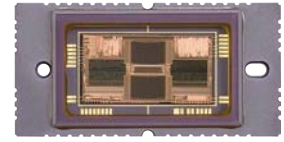

AF Sensor

AF point selection or the center AF point is manually selected and focusing point expansion is activated. However, with the EOS-1D Mark III, the Assist AF points now also operate during One-Shot AF when the camera is set for automatic AF point selection, or when any cross-type focusing point is manually selected and focusing point expansion is activated. The Assist AF points achieving focus also light up with the SI display. While the high-precision, cross-type AF points have substantial coverage in the Area AF, the center AF point can use cross-type focusing with  $f/4$  and faster lenses and still can focus with  $f/8$  lenses. The AF operation certainly befits an EOS-1D series camera.

For lowlight focusing, the EOS-1D Mark III is twice as sensitive as the EOS-1D Mark II. The CMOS AF sensor's pixel sensitivity has been improved, thanks to improved pixel characteristics, an improved pixel fill factor due to finer semiconductor manufacturing processes, and optimized pixel size. As a result, the 1D Mark III's AF sensitivity has been improved to EV -1 through EV 18 (at 23°C/73°F, ISO 100).

### AF Unit

As with previous EOS cameras, the TTL-SIR (Through-the-Lens Secondary Image Registration) focusing principle is employed. The light flux passes through the camera lens and passes through the half mirror at the center of the main mirror. The light flux proceeds downward by reflecting off the oblong, concave secondary mirror to a fully reflective mirror in the base of the camera's mirror chamber. Then it passes through an infrared-absorption glass, a secondary image-forming lens, and a cover glass before reaching the AF sensor. The AF unit uses materials having minimal swelling and moisture absorption characteristics, and the secondary image-forming lens is made of glass mold highly resistant to changes in size due to fluctuations in temperature and humidity. The AF unit is therefore very stable.

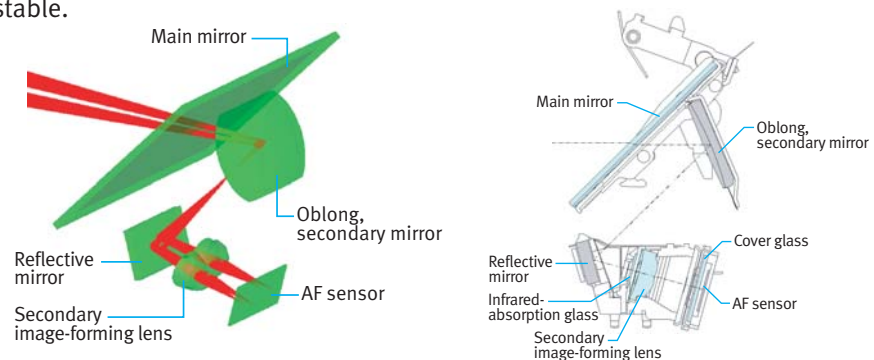

Also, the secondary image-forming lens is optimized for the f/5.6 and f/2.8 light flux by having a different surface shape for the respective light flux entering the lens. The top and bottom light flux is compatible with f/5.6, while the left and right light flux is compatible with f/2.8. The rear side of the secondary image-forming lens features a newly-developed aspherical surface compatible with f/2.8 lenses.

**AF Start Button**

The EOS-1D Mark III has a new AF Start (AF-ON) button that can be used to execute AF and metering. We know that many pros using the EOS-1D series cameras have set C. Fn 04-1 to use the AE lock button for AF. The technique is called "autofocus with your thumb" or "back button focus."



The 1D Mark III now provides a new AF start button dedicated to AF. Pressing the AF start button executes AF and metering. C. Fn IV-1,3 (AE lock/metering + AF start) is equivalent to C. Fn 04-1 in previous cameras.

**AF Point Selection**

The AF points can be put to work in several different ways. First, the AF points can be automatically selected by the camera from among the 45 points. Second, any one of 19 can be selected manually by the user. With C. Fn III -9-1/2, the manually-selectable AF points can be limited to 9 inner or outer AF points (including the center AF point). The AF point selection procedure is the same in either case. Press the AF selection button, then turn the Quick Control Dial or Main Dial to select the desired AF point. Pressing the Multi-Controller will select the center AF point. With the center AF point selected, pressing the Multi-Controller will set automatic AF point selection.

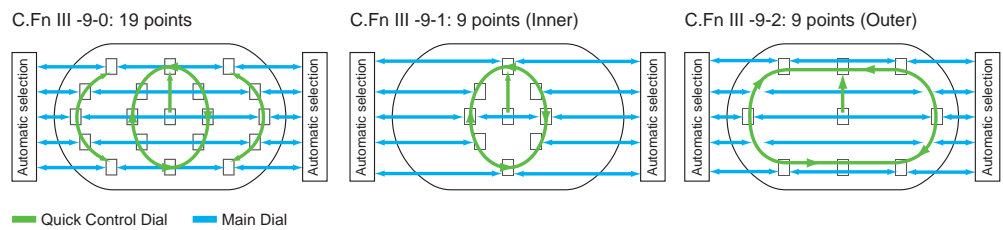

**Focusing Computation**

As with the EOS-1D Mark II N, two separate CPU processors are used, one for AF processing (including lens driving) and one for the camera. To attain 10 fps with AI Servo AF, the AF CPU and camera CPU are both the latest microcomputers (AF CPU: 48 MHz, 32-bit RISC; Camera CPU: 40 MHz, 32-bit RISC). The computing speed is 3 times faster than the 1D Mark II N's CPUs.

**AI Servo AF** Predictive AF can track a subject approaching at about 31 mph up to about 26.2 ft. away with an EF300mm f/2.8L IS USM lens. This is the same as with the EOS-1D Mark II N. However, improvement in focusing detection performance enables subject tracking at 10 fps.

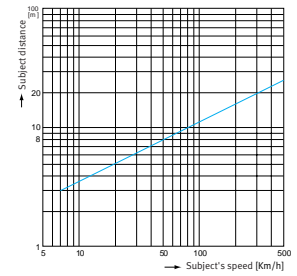

During AI Servo AF when the camera is focusing on a subject and something closer enters the picture, the camera can either start focusing on that closer subject or ignore it as an obstruction:

- AI Servo AF tracking method > Main focus point priority (C. Fn III-4,0): The camera will start focusing on the closer subject that entered the picture. When the center AF point detects that closer subject, the focusing priority will then shift to the main AF point.
- AI Servo tracking method > Continuous AF track priority (C. Fn III-4,1): The camera will ignore any closer subject entering the picture. The focus-tracking immediately before the obstacle entered the picture will continue, and the AF point can shift to any other one while tracking the original subject instead of being fixed at the main AF point.

C. Fn III-3 (AI Servo 1st/2nd image priority) is for setting the priority on focusing or on the shutter release for the first and following shots during continuous shooting.

- 0: Focusing priority takes effect for the first shot as well as for the second and following shots with focus tracking.
- 1: Focusing priority takes effect for the first shot, and priority on continuous shooting speed (more than the focus tracking of the subject) takes effect for the following shots.
- 2: Shutter-release priority takes effect for the first shot (overriding focus). For the following shots, priority on continuous shooting speed takes effect more than with option 1.

When "Focusing (subject-tracking) priority" is selected and the subject distance changes, the continuous shooting speed may become irregular. When "Drive speed priority" is selected, the focusing might be slightly off, but the shooting speed will be fixed. Setting 2 is effective for press photographers who put priority on capturing the moment.

C. Fn III -3 can be set to change operation characteristics when you press the shutter button completely in one stroke. Settings 0 and 1 are the same as on the EOS-1D Mark II N. When focusing is possible, the lens is driven to match the focusing result obtained immediately before shutter release. After the lens is driven, the picture is taken. If focusing is not possible, the picture will be taken immediately. With setting 2, the picture will be taken immediately regardless of whether focus has been achieved or not.

During low-speed continuous shooting, the subject distance can change significantly between shots. The slower the continuous shooting speed, the more the lens is driven between shots to detect the subject. Thus, subject tracking is more precise. Also, with the EOS-1D Mark III, the improved AF computing performance enables the lens to be driven more to detect the subject than with the EOS-1D Mark II N. AI Servo AF therefore becomes

more precise. At the standard setting, the subject tracking sensitivity level is the same as with the 1D Mark II N. Once an AF point starts tracking the subject, the tracking response is impressive. (Subject-tracking sensitivity can be adjusted with C. Fn III –2, Slow to Fast, -2 to +2.)

Even if AI Servo AF is used to focus on a still subject, stable control is enabled so that the lens drive isn't constantly fine-tuning. If the subject starts to move, the focusing responds immediately to detect the subject constantly.

**Automatic AF Point Selection**

The high detection-sensitive, cross-type AF points are now spread out over the Area AF. When One-Shot AF is combined with automatic focusing point selection, as with the EOS 5D and 30D, the selection of the Area AF's bottom AF points is eliminated. From among the remaining AF points, the AF point on the closest subject is set to be the main AF point. This is a change from the Area AF of previous EOS-1D cameras where the main AF point was set at where the most AF points lit up. The concept of eliminating the selection of the least reliable AF points is the same as before. With the new algorithm, AF point selection becomes more stable and consistent even if the area of the main AF point is smaller. When AI Servo AF is combined with automatic focusing point selection, the EOS-1D Mark III's behavior is the same as previous EOS-1D class cameras, where the subject is initially acquired by center focusing point and subsequently tracked by all 45 points as necessary.

**AF Point Expansion**

AF expansion with a manually selected focusing selected point, C. Fn III –8, differs from the EOS-1D Mark II N's settings. Depending on the AF mode (One-Shot AF or AI Servo AF) and focal distance, the AF point area does not change. With setting 1 (Enable left/right assist points), the expanded area (on the left and right of the manually-selected AF point) is enabled at all times. With setting 2 (Enable surrounding assist points), the expanded area is enabled by one point all around the selected AF point.

With One-Shot AF, when focus is achieved with an Assist AF point, the Assist AF point will light up via the SI display. With AI Servo AF, the manually-selected AF point and Assist AF point will not be displayed.

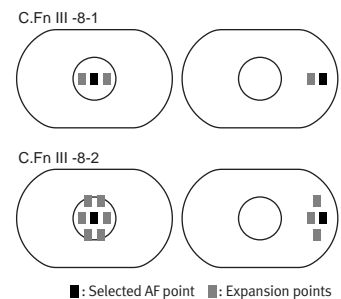

**AF Micro-adjustment**

AF precision is adjusted for the camera and lens to fall within the lens' maximum aperture's depth of focus. However, there are users who want to adjust it more minutely. They have had to go to a Canon Service Center to have it done. AF micro-adjustment is a feature developed for these users. The user himself can now finely adjust the AF focusing position. The adjustment range is ±20 steps in front of (-) or behind (+) the point of focus.

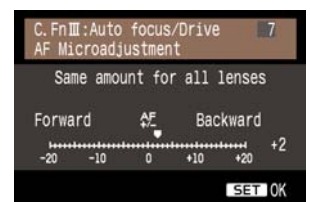

C.Fn III-7

The adjustment increment of one step differs depending on the maximum aperture of the lens. You should shoot, check the focus, and adjust it. Repeat this procedure to adjust the point of focus. When a lens registered with a point-of-focus adjustment is attached, the point of focus will be automatically shifted by the correction amount set.

If you set 1 (Adjust all lenses by the same amount) or 2 (Adjust by lens) and press the INFO button, the adjustment screen will appear. The focus shift amount per step is calculated by multiplying the maximum aperture's single-side depth of focus by 1/8. If 1 is set, the focus shift amount will always be the same number of steps (but the actual amount will vary according to maximum aperture) for all lenses. If 2 is set, the focus shift amount will change for each different lens. You can register the focusing shift amount for up to 20 lenses. Then, when you use one of the registered lenses, the focus will shift by the set amount.

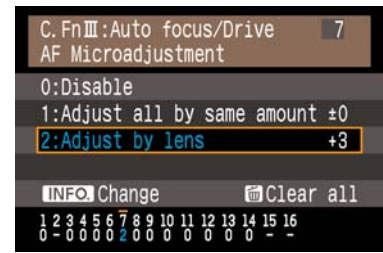

AF Microadjustment

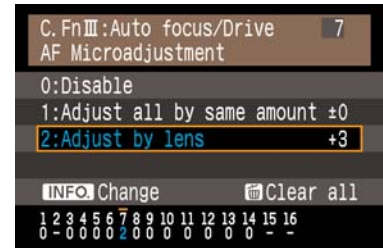

Adjust all lenses by same amount

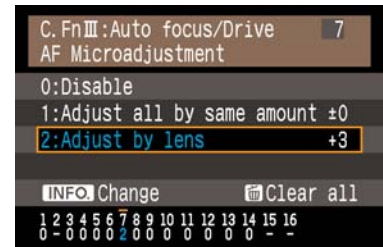

Adjust individually for each lens

Note that since the camera does not recognize the unique ID of the lens, the same shift amount will be applied to the same lens model even if it has a different serial number. In the case of zoom lenses which have variable maximum apertures, the focus shift amount is technically different at the wide-angle end and telephoto end. However, since the focus shift amount cannot be adjusted individually for the wide and telephoto ends (there is only one shift amount per lens), adjusting it for the telephoto end is better. If an extender can be attached, the camera recognizes whether it is 1.4x or 2x and makes a different shift adjustment from when no extender is attached. When an extender is attached, the adjustment screen will display the lens name and extender name. To delete the registered lens settings, select 1 or 2, then press the Erase button. All the registered AF micro-adjustment settings will be cleared.

### Speedlite Compatibility

When the 580EX II, 430EX, 220EX, or ST-E2 is attached to the camera, an AF-assist beam linked to the AF point can be emitted automatically whether AF point selection is automatic or manual. This will help the camera to focus. With other EOS-dedicated Speedlites, the AF-assist beam might not align with the selected AF point.

# VI. LIVE VIEW MODE

Live View is a significant addition to the professional DSLR shooter's arsenal. It is a terrific problem-solver for all those situations in which it would be awkward, difficult or impossible to look through the viewfinder to compose, meter and shoot. In response to the particular requests of studio and remote sports photographers, EVF (electronic viewfinder) shooting with a computer, wired or wireless, is now possible with the EOS-1D Mark III. By connecting the camera via USB to a computer with the EOS Utility 2.0 software provided, the computer will display in real-time the image output by the camera's imaging element. Then you can check and adjust the focus, subject framing and so forth in real-time and shoot remotely. With the optional Wireless File Transmitter WFT-E2A attached, you can use a wireless LAN and see the Remote Live View on a computer without using a cable. Key features of Live View include a 100% field of view, precise manual focusing with 5x and 10x magnification, the ability to previsualize exposure, framing and focusing on a computer monitor, easy checking for moiré and false color, displays of film-related aspect ratios, and a video-out terminal for TV display.

## Camera Live View Mode

Instead of looking through the viewfinder, you can shoot while viewing the scene on the camera's LCD monitor. This feature was mainly designed for shooting still-life subjects. Compared to looking through the viewfinder, it provides the following advantages:

1. The real-time picture can be magnified by 5x or 10x to help make focusing more precise.
2. Shoot while checking the composition on the LCD monitor.
3. You can check the exposure on the LCD monitor before taking the picture (with C. Fn IV -16-1 and aperture stopped down).

This is very convenient when you shoot on a tripod or a studio stand or shoot macro images. With [Live View shoot: Enable] set and the camera ready to shoot, press the SET button. The reflex mirror will then lock up, the shutter will open, and the image output from the CMOS sensor will be displayed in real-time and 100% image coverage on the camera's LCD monitor. Press the SET button again and the reflex mirror will go back down and the Live View shooting will end.

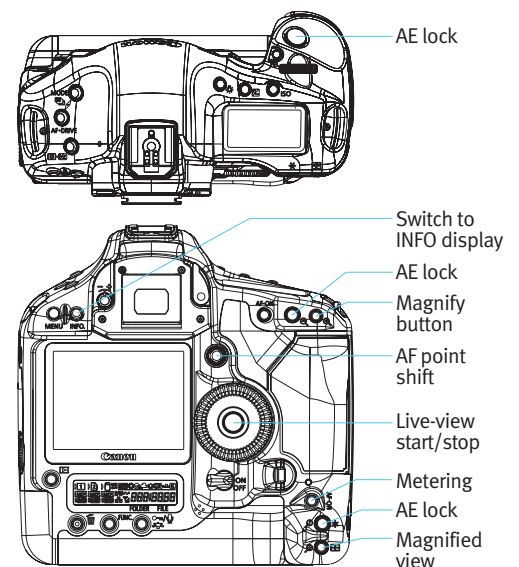

## Remote Live View Mode

Remote Live View Mode is controlled through EOS Utility 2.0 (a major upgrade from version 1.1), included on the EOS Digital Solution Disk Ver.14. The camera can be connected either wired with the provided USB 2.0 Hi-Speed cable, or wirelessly with the WFT-E2A. To get started, the camera must be set to Live View. Then, click the [Starting Live View] button on the Remote Live View screen.

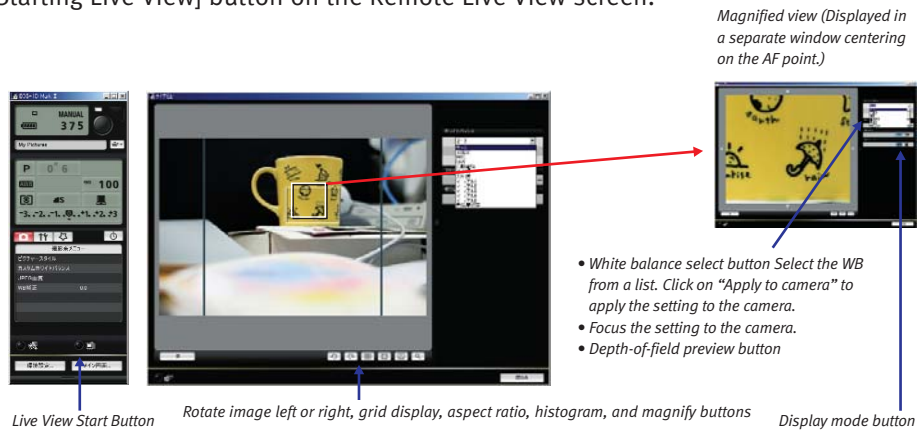

## Focusing

Focusing is manual only with Live View. Use the Multi-Controller to select the AF point aimed over the area you want to focus, then press the Magnify button to enlarge the image by 5x or 10x at the AF point's position. Press the button again to return to normal view. At 5x or 10x magnification, you can focus manually while looking at the LCD monitor. To make it easier to focus during the magnified view, image sharpness is applied at a higher setting than it really is.

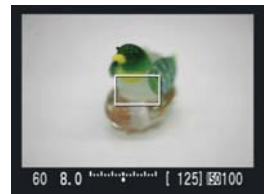

Pressing the depth-of-field preview button stops down to the aperture which will be used to take the picture. It will simulate the shooting exposure and you can check both the exposure level and depth of field. If you use depth-of-field preview during regular viewfinder shooting, the viewfinder will look dark and it may be difficult to see the depth of field. However, with Live View shooting, a clever simulation is displayed so checking the depth of field is easier as long as the exposure setting is near the metering's correct exposure.

## Metering and Exposure

Evaluative metering with the imaging element is used. The metering mode cannot be changed. The metering range is EV 0 to EV 20 (at 23°C/73°F, with EF 50mm f/1.4 USM lens). Any shooting mode and drive mode can be used. Also, AE lock, exposure compensation, AEB, and depth-of-field preview are possible. During magnified view, AE lock is automatically applied to the meter reading for the entire image. If C. Fn IV -16 [Live View exposure simulation] is set to [1: Enable (simulates exposure)] and the shooting mode is P, Tv, Av, or M, then the LCD monitor's brightness will change in response to the exposure setting so you can see how the exposure will look before you take the picture. When you press the shutter button completely, the opened shutter will close; the shutter will be cocked and released, and the picture will be taken.



If flash is used, the mirror must come down briefly. Pressing the shutter button completely will cancel the mirror lockup and the metering sensor will execute E-TTL II flash metering control (preflash fired and the correct flash output is retained). Then the reflex mirror is locked up again and the picture is taken. For continuous shooting, the same 10 fps maximum shooting speed as with normal shooting can be achieved. During continuous shooting, the LCD monitor is off. After the shooting ends, the captured image is displayed on the LCD monitor. When the image display ends, the camera returns to the Live View display automatically.

As with viewfinder shooting, pressing the AE lock button during Live View shooting will lock the current exposure and an asterisk will appear on the LCD monitor. During magnified view, AE lock will be applied automatically to the exposure level of the full view display. The Tv and Av settings will be displayed in orange. During the magnified view, the AE lock button will not work. With C. Fn IV -16-1, the picture brightness is also locked.

Normally, the Live View picture displayed by the LCD monitor is always displayed at the correct brightness, regardless of the exposure setting, for easy viewing similar to compact digital cameras. However, if C. Fn IV -16 [Live View exposure simulation] is set to 1, the picture is displayed based on the exposure setting's brightness. This enables you to see the exposure condition before taking the picture. The picture will be displayed at almost the same brightness as how the actual exposure will look. However, under low light or bright light (outside the displayable brightness range), the picture brightness might not look the way the actual exposure will be. Exposure simulation will not work with flash or bulb exposures. If you press the depth-of-field preview button, exposure simulation will be active at all times regardless of the C. Fn IV -16 setting.

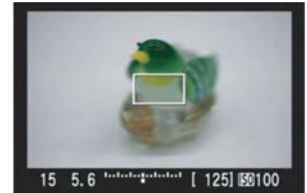

## Function Settings

The metering mode is set to AF point-linked evaluative metering. Other shooting settings (shooting mode, drive mode, image size, ISO speed, exposure compensation, etc.) can be set in the same way as during viewfinder shooting. The metering timer is 16 sec. (including AE lock). Focus presets with super telephoto lenses cannot be used. Even during Live View shooting, the power will turn off after the [Auto power off] time elapses. During Live View display, pressing the MENU or playback button will terminate the Live View shooting and the menu screen and image playback will appear.

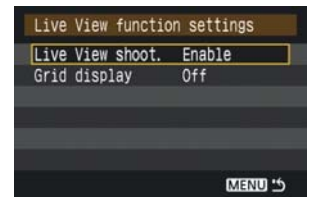

Live view function settings

**Info Display** Below the image, the shutter speed, aperture, exposure level (exposure compensation amount, AEB level), flash exposure level, shots remaining, and ISO speed are displayed. In the magnified view, the magnified location, magnification, and AE lock status are displayed on the right of the image. In addition, when you press the INFO button, the Picture Style, battery check, AE lock status, and flash-ready are also displayed on the lower left of the image. If C. Fn IV -16-1 is set and you press the INFO button again, a brightness or RGB histogram appears on the right of the image. (For flash shots and bulb, the histogram display will be grayed out.)

Press the INFO button again and only the Live View image (without information) will be displayed. If [Grid display: On] has been set, a four-line grid will be displayed on the image. This can be used to check the vertical or horizontal orientation of the image. The grid appears only in the full view mode (not in the magnified view). Also, with C. Fn IV -14 [Add aspect ratio information] set anywhere from 1 to 6, you can shoot in the same aspect ratio as 6 x 4.5cm, 6 x 6 cm, 6 x 7cm, and 4 x 5 in., corresponding to medium- and large-format film sizes. When this feature is set, vertical lines matching the respective aspect ratio will appear on the screen. You can then compose the subject within this frame. Since the aspect ratio information will be appended to the image, when you open the image with Digital Photo Professional 3.0, the image will be displayed in the aspect ratio that was set. Note that the image areas outside the vertical lines are not actually deleted and that when the image is played back with the camera, the vertical lines matching the aspect ratio will also appear.



Grid display

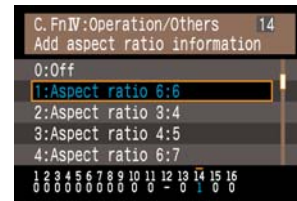

C.Fn IV-14-1 (aspect ratio 6:6)



Aspect ratio display (6:6)



Information display 4

**Shooting Sequence** During Live View shooting, the picture is displayed and then the reflex mirror locks up automatically to maintain Live View display (and returns later). The Live View display's frame rate is approx. 30 fps. The picture remains smooth even if you change the camera's direction or if the subject moves. If the camera direction is changed to a scene with a very different light level, the Live View picture's brightness will be thrown off for a moment. If this happens, wait until the picture brightness stabilizes again before shooting.

If the light source changes, the Live View picture may flicker. If this happens, stop the Live View shooting and press the SET button to start the Live View shooting again. During continuous shooting, the exposure for the first shot will also be applied to subsequent shots. If the sun or other bright light source enters the picture, the bright area might look dark. However, it will be correctly recorded as a bright area. Note that FE lock and modeling flash cannot be used.

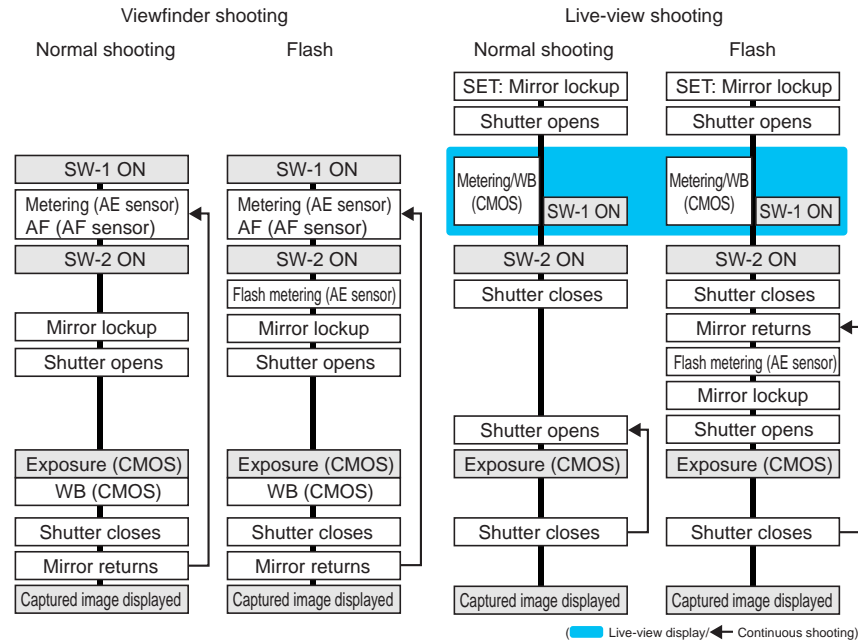

### Thermal Issues

With Live View shooting, the camera's internal temperature increases due to heat from the CMOS sensor, and other components. For normal shooting, this is not a problem. There is no Live View operation limit at 23°C/73°F for Remote Live View shooting and Camera Live View shooting, whether you use a memory card or external recording media via the WFT-E2A. However, if the camera is under direct sunlight or near hot studio lights during Live View shooting, the camera's internal temperature will increase more than usual and the screen may show a warning icon shaped like a thermometer. If the warning icon appears, you can continue shooting and the operation will not be forced to terminate if you are using a memory card. However, since the image quality might degrade, it is recommended that you stop shooting if the warning icon appears. If you use a MicroDrive and you keep shooting even when the warning icon appears, the Live View shooting will terminate automatically after the internal temperature reaches a certain level. This is to protect the MicroDrive from the heat. If the Live View shooting terminates automatically, Live View shooting will not be possible until the internal temperature goes down.

# VII. IMAGE RECORDING AND STORAGE

**Recording Method** With DIGIC III and improved card writing, the data writing speed is approximately 30% faster than with the EOS-1D Mark II N.

The EOS-1D Mark II N provided three recording methods:

- Recording to only one memory card
- Recording the same image to both the CF and SD cards
- Recording the RAW image to the CF card and JPEG image to the SD card, or vice versa

The EOS-1D Mark III offers some new and highly flexible image recording options. With the WFT-E2A wireless transmitter, USB 2.0 Hi-Speed external recording media can also be used. Compatible devices range from popular and convenient USB thumb drives to large-capacity hard drives as long as they can be attached via USB.

**External Recording Media** With the CF card, SD card, and external media, the following recording functions can be used:

- Standard: There is no automatic switching of recording media
- Automatic switching of recording media: When the current recording medium becomes full, the camera switches to another automatically and continues recording without interruption
- Separate recording: A captured image can be recorded in different image sizes on different media. Each recording medium can be set to record a specific image size (L, M1, M2, S, RAW, sRAW) for each shot
- Recording of identical images: The same image is recorded to all recording media. This is also possible with RAW+JPEG and sRAW+JPEG

SDHC (SD High-Capacity) is a new memory card standard (SDA Ver.2.00) established by the SD Card Association in 2006 to handle high-capacity data from 2GB to 32GB. Because it is compatible with SDHC, the camera can be used with SD cards having a capacity up to 32GB.

**Data Safety when Compartment Cover is Opened** With the EOS-1D Mark II N, if the memory card slot cover is opened inadvertently during the writing to the card, the writing stops immediately. The writing resumes when the slot cover is closed again. With the EOS-1D Mark III, if the slot cover is opened during the writing operation, an alarm sounds and a warning message appears on the screen to indicate that writing is in progress. The card writing now continues even if the slot cover is opened. Also, if you set the power switch to <OFF> during the card writing, a message appears on the screen to indicate that writing is in progress. After the writing is completed, the power turns off. This works the same way as with the EOS Digital Rebel XTi/400D Digital.

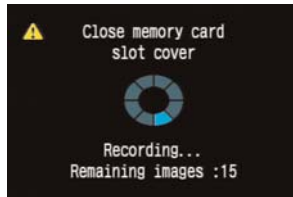

On-screen message  
if the slot cover is opened



On-screen message  
if the power switch is set to <OFF>

## In-Camera File Copying & Naming Options

Any image stored in a memory card or external media can be copied to another recording medium (CF card, SD/SDHC card, or external media). Select the recording medium containing the images you want to copy using the [Record funct+media/folder sel.] menu, and individually checkmark the images to be copied. Then, select or create the folder in the target medium to which you want to copy the images. All the images in the selected folder can be copied to another folder which you select or create. Also, all the images in the specified folder can be copied to the target medium with the same folder name and same image numbering copied as well.

The images stored in the DCIM folder in the CF or SD card can be backed up to external media via the WFT-E2A. A folder is created automatically in the external medium and is named with a six-digit date (yyddmm) and two-digit number (00 to 99). Inside it, a DCIM folder is created to which all the images are saved. Either select a target folder in the external medium or create a new folder with an eight-character name. Inside it, the images will be saved to the DCIM folder.

When creating or selecting a folder, the screen now shows the image of the lowest and highest image file number on the right.



Creating and selecting a folder

In addition to the [Preset code] and [User setting1] each having 4 characters, [User setting 2] with 3 characters + 1 Image size character is newly provided. When [User setting 2] is set, the image size that has been set for shooting is appended automatically to the file name as the fourth character from the left (ex: xxxx0001.JPG). You can thereby know the image size by seeing the file name instead of having to open the image file. The appended characters are L for Large/RAW, M for Medium1, N for Medium2, and S for sRAW. RAW and JPEG can be distinguished with the extension.

### Recording Quality Specifications

Image Size	Pixels [Approx. MB]	File Size [Approx. MB]	Possible Shots [Approx.]	Maximum Burst [Approx.]		Printing Size	
				Hi-Speed	Low-Speed		
L (Large)	10.1 (3,888x2,592)	3.5	260	110	260	A3 or Larger	
M1 (Medium1)	8.0 (3,456x2,304)	2.8	320	130	320	Around A3	
M2 (Medium2)	5.3 (2,816x1,880)	2.1	420	140	420	Around A4	
S (Small)	2.5 (1,936x1,288)	1.2	710	160	710	Around A5	
RAW	10.1 (3,888x2,592)	13.0	66	30	35	A3 or Larger	
RAW+	L (Large)		13.0+3.5	52	22	27	—
	M1 (Medium1)		13.0+2.8	54	22	27	
	M2 (Medium2)		13.0+2.1	56	22	27	
	S (Small)		13.0+1.2	60	22	27	
sRAW	2.5 (1,936x1,288)	7.6	110	46	70	Around A5	
RAW+	L (Large)		7.6+3.5	76	28	35	—
	M1 (Medium1)		7.6+2.8	81	28	35	
	M2 (Medium2)		7.6+2.1	87	28	35	
	S (Small)		7.6+1.2	95	28	35	

\* The number of possible shots (battery life) and continuous shooting speed are based on Canon's testing standards and a 1GB CF card.

\* The size of one image, number of possible shots (battery life), and continuous shooting speed are based on JPEG quality 8, ISO 100, and the Standard Picture Style. (These figures vary depending on the subject, memory card brands, ISO speed, Picture Style, etc.)

You can protect individual images, all images in a folder, or all images on the card. Alternately, you can cancel image protection. You can erase individual images, all images in a folder, all images in the card, or just check-marked images (a new feature). Unprotected images will be erased.

# VIII. ROCK SOLID RELIABILITY

## Improved Body Design and Construction

The EOS-1D Mark III retains and refines the beautiful curved surfaces and superb basic layout of the EOS-1 series. Ease of operation and holding comfort have been improved appreciably, as has ease of operation with accessories. The new camera is designed to be easier to understand and more reassuring. The massive strength of its magnesium alloy body and chassis, combined with complete environmental sealing, means that the 1D Mark III stands with its forebears as an instrument worthy of the photographers who risk their lives daily to take pictures.

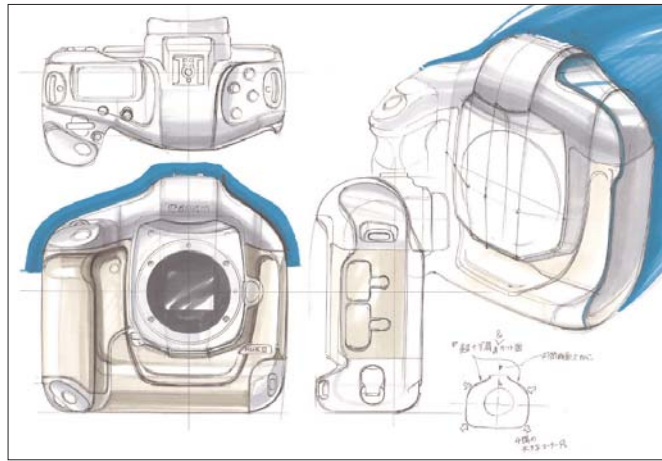

Most of the major body components are arranged in the same way as with the EOS-1D Mark II N. The following major units are new or different:

- Self Cleaning Sensor Unit
- LCD monitor now 3.0 inches (was 2.5 inches)
- To attain 10 fps, two drive motors are incorporated
- Extension system terminal is provided for the WFT-E2A Wireless File Transmitter

Lower cost has been achieved with a less costly imaging element developed and manufactured by Canon and by downsizing electronic circuits with smaller boards and higher circuit integration resulting in fewer parts.

### Weight

Item	EOS-1D Mark III	EOS-1D Mark II N
Optics	27	24
Mechanical Parts	675	616
Electrical Parts	1,481	1,529
Lead Wires	42	42
Total (Official)	2,247	2,234
Screws and washers	325	306
Total	2,572	2,540

\* The shutter unit is counted as 1 part.

\* The DC/DC converter is counted as 1 part.

\* The E-ring is counted as a washer.

\* The official total excludes the screws and washers.

## Dimensions and Weight

The dimensions of the EOS-1D Mark III are (W x H x D): 156 x 156.6 x 79.9 mm/6.1 x 6.2 x 3.1 inches. The weight is 1155 g/40.7 oz. (body only, no battery, no memory cards), 1335 g/47.1 oz. (with battery). Compared to the EOS-1D Mark II N, the height is 1 mm shorter; the body-only weight is a significant 70 g/2.5 oz. lighter, and the weight with battery is a remarkable 225 g/7.9 oz. lighter. The LP-E4 battery of the EOS-1D Mark III weighs 180 g/6.3 oz.; the NP-E3 weighs 335 g/11.8 oz.

### Weight

Image-recording Quality	Body Only	With Battery
EOS-1D Mark III	1,155g/40.7oz.	1,335g/47.1oz.
EOS-1D Mark II N	1,225g/43.2oz.	1,560g/55.0oz.

## Mechanical Components

Because of its lightweight and strength, magnesium alloy is used for the top, front, and rear covers as well as for the memory card slot covers. The chassis and mirror box are also made of magnesium alloy (instead of the EOS-1D Mark II N's aluminum die cast) to make the body very strong, rigid, and light. The magnesium alloy also works as an electro-magnetic shield. Except for its deeper black color, the paint finish on the exterior covers is the same as the 1D Mark II N's. It is highly durable, allowing minimal wear even under harsh conditions.



To equal the legendary excellent water- and dust-resistant construction of the EOS-1D Mark II N, measures are incorporated at 76 places around the camera controls and along cover seams. Also, O-rings are used on the memory card slot covers and the battery compartment, and silicon rubber is employed around the top and rear covers and buttons where the user can see it and feel reassured. The EOS-1D Mark III's hot shoe is shaped to resist water with a rib around its perimeter. When the Speedlite 580EX II is attached, water resistance is maintained. When a water-resistant EF lens is attached to the camera, the entire camera-and-lens outfit will be water-resistant.

### Location of major water-resistant measures

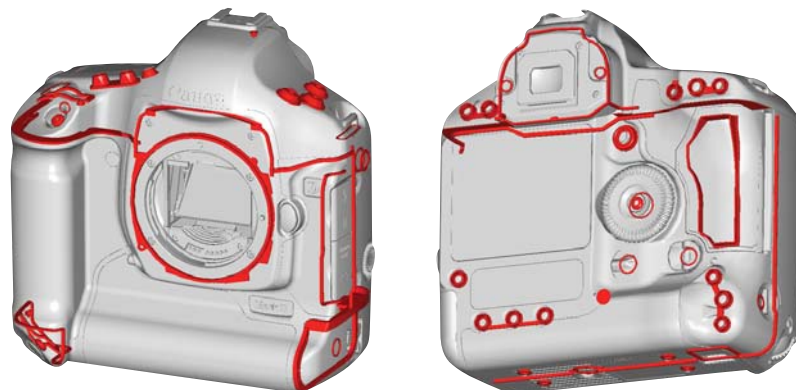



## Electronic Components

The main electronic boards are the imaging-control board, digital-control board, camera-control board, display-control board, and power supply board. There are also flexible boards mounted with various sensors and other boards and flexible boards. There are 15 hard boards and 27 flexible boards (including FFC).

### 1) Imaging-control board

This board outputs the pulse controlling the driving of the CMOS sensor. It also converts the analog signal output from the CMOS sensor into a digital signal for output. For the EOS-1D Mark III, it also has an EEPROM to store the analog system's adjustment values.

### 2) Digital-control board

This has the DIGIC III and other digital image-processing circuits, a memory circuit which includes the DDR SDRAM for the image buffer memory, and various TFT driver circuits for the TFT monitor's display control. This board has connectors to enable connection with interfaces such as USB, VIDEO, extension system terminal for the WFT-E2A, CF card, and SD memory card.

### 3) Camera-control board

This board has the main microcomputer IC for camera operation control. It controls various sensors and mechanical components. It also has an IC for AF control, EFIC as the interface for the lens and external Speedlite, and EEPROM to save various adjustment data.

### 4) Display-control board

Equipped with the display IC for driving and controlling the LCD panel, viewfinder display, and superimposed display. It also has the motor driver IC for the drive control of the shutter's motor.

### 5) Power supply board

This board has the power supply circuit and supplies power from this board to the camera's various boards.

### 6) Self Cleaning Sensor Unit board

This board is for driving and controlling the Self Cleaning Sensor Unit. It consists of the power supply section, an oscillator circuit to generate the drive signal, the driver section which outputs the drive signal, and the sensor circuit which detects the oscillator condition. It is controlled by a signal from the camera control board.

## RoHS Compatibility

The RoHS directive (Restriction of the use of certain Hazardous Substances in electrical and electronic equipment) restricts the use of six toxic substances: Lead, mercury, cadmium, hexavalent chromium, polybrominated biphenyl, and polybrominated diphenyl ether. It applies to products sold in the EU. All of the EOS-1D Mark III's parts conform to this directive.

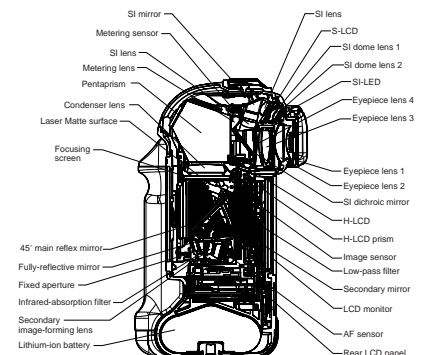

**Shutter** While based on the EOS-1D Mark II N's shutter unit, the EOS-1D Mark III's shutter unit has been improved to increase durability and to reduce the generation of dust. It is now rated for 300,000 shutter cycles. (The 1D Mark II N's shutter unit durability rating is 200,000 cycles.) To attain this level of ruggedness, surface finish and heating processes in manufacturing have been changed for specific highly durable parts. To increase stability and shutter precision, a photo reflector (PR) is newly employed to detect the slit-passing time. For the X-sync contact, the mechanical contact has been eliminated to prevent contact scorching and wear. By employing PR signals for the electronic X-sync contact (a semiconductor switch), reliability is improved. By optimizing the sync timing, an X-sync speed of 1/300 sec. is now attained with EX-series Speedlites. With non-EX Speedlites, the X-sync speed will be 1/250 sec., the same as the EOS-1D Mark II N's.

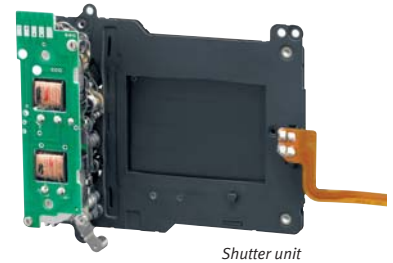

**Shutter Design Specifications**

Item	Specification
1. Type	Vertical travel, focal-plane shutter
2. Shutter curtain type	Parallelogram link type
3. Shutter curtain blades	1st curtain: 4 blades, 2nd curtain: 4 blades, total 8
4. Shutter curtain materials	1st curtain: Two carbon blades, two duralumin blades 2nd curtain: Two carbon blades, two duralumin blades
5. Drive system	1st curtain: Dedicated torsion spring 2nd curtain: Dedicated torsion spring
6. Speed control method	Mechanical shutter with tension released by a rotary magnet, all shutter speeds electronically-controlled
7. Curtain speed	Approx. 2.3ms/21.0mm
8. Shutter speed range	1/8000 sec. – 30 sec. bulb
9. Max. flash sync.	1/300 sec.
10. Signals	1. X-sync, 2. 2nd curtain travel-completed signal

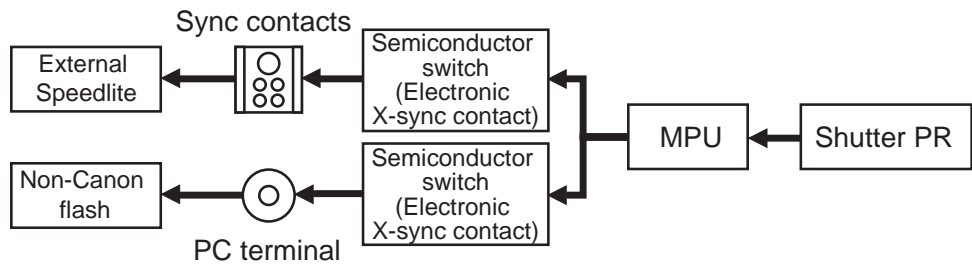

**Silent Mode** A new and useful silent single shooting mode has been added to the regular complement of single shooting, high-speed continuous (10 fps), low-speed continuous (3 fps), 10-sec. self-timer and 2-sec. self-timer. During normal shooting, a magnet is used to release the tension and the reflex mirror's downward motion is spring-driven. In the silent single shooting mode, Pulse Width Modulation (PWM) control is employed to lower the effective voltage. The motor's rpm is lowered and the reflex mirror is slowly put back down. PWM control is also applied to the shutter-cocking motor to make it silent. The operation noise of the mirror going back down is approx. 77 dB for normal single shooting. In the silent single shooting mode, it is much quieter at approx. 70 dB. After shooting in the silent single shooting mode and SW2-OFF occurs, the shutter will be cocked. You can thereby control the timing of the operation noise.

A top continuous shooting speed of 10 fps is attained in both the One-Shot AF and AI Servo AF modes even though the EOS-1D Mark III has about 1.23 times more pixels than the EOS-1D Mark II N. This was made possible by the new drive mechanism (a new bound/bounce prevention mechanism for the reflex mirror's downward motion, a dedicated motor for mirror cocking, and a dedicated motor for shutter cocking), a CMOS sensor enabling 8-channel high-speed signal reading, a newly-developed shutter unit, and Dual DIGIC III Image Processors for high-speed image processing.

**10 fps** DDR SDRAMs with double the capacity of the EOS-1D Mark II N's memory chips are employed for the buffer memory, facilitating high-speed data transfer. Together with Dual DIGIC III Image Processors for parallel processing of images, a maximum burst of approximately 110 shots in JPEG Large (quality 8), approximately 30 shots in RAW, and approximately 22 shots in RAW+JPEG is attained at 10 fps. The maximum burst varies depending on the subject, memory card performance, recording quality, ISO speed, drive mode and Picture Style setting.

**Maximum burst**

	<b>EOS-1D Mark III (10.1M/10fps)</b>	1D MarkII N (8.2M/8.5fps)
JPEG Large	<b>110</b>	48
RAW	<b>30</b>	22
RAW + JPEG Large	<b>22</b>	19

\*The number of maximum burst apply to a 1GB (for EOS-1D Mark III)/512MB (for 1D MarkII N) Memory Card based on Canon's testing standard.

The shutter-release mechanism is the same as the EOS-1D Mark II N's. The shutter-release stroke and torque are the same as well. However, to make vertical shooting feel the same as horizontal shooting, the vertical grip's shutter-release stroke and torque have been altered. They are now almost the same as with horizontal shooting. Also, to make the camera operation feel the same as that of the 1D Mark II N, the shutter-release time lag from SW-1 ON is 55 ms (up to 3 stops from the maximum aperture). The viewfinder blackout time is 80 ms (87 ms with the 1D Mark II N). The shutter-release time lag at maximum aperture can be shortened to approx. 40 ms with C. Fn IV-13 [Shortened release time lag].

**Shutter-release stroke and pressure**

State	Stroke	Pressure
Normal position SW-1 ON	0.6mm	85g /3.0 oz.
SW-1 ON to SW-2 ON	0.3mm	350g /12.3 oz.
Beyond SW-2 ON	0.2mm	-

**Metering and Exposure Control**

The EOS-1D Mark III incorporates a newly-developed, 63-zone metering sensor linked to the 19 AF points. The metering sensor is located at the rear of the pentaprism. The 19 AF points in the Area AF are a highly favorable match for the metering sensor's zones. The metering range is EV 0 to EV 20 (at 23°C/73°F, EF 50mm f/1.4 USM lens, ISO 100).

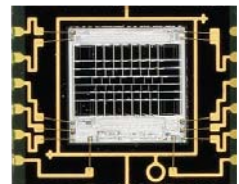

The new evaluative metering algorithm is based on the algorithm for the previous 21-zone and 35-zone metering systems. With the optimized 63-zone metering sensor and improved algorithm, more consistent and correct ambient and flash exposures are obtained with less influence by the subject. The basic concepts for the evaluative metering algorithm are:

1. Metering is weighted on the linked AF point.
2. If there is a very bright object in the picture, the exposure will be increased.
3. In backlit scenes, the exposure will be increased. With dark backgrounds, the exposure will be reduced.

The E-TTL II autoflash algorithm uses the newly-developed 63-zone metering sensor. While based on the previous algorithm which weighted the metering based on the preflash reading, this algorithm has been further improved to obtain consistent flash exposures. The major improvements are:

1. Correct flash exposures are obtained even with off-center subjects.
2. The incorporation of lens distance information has been optimized to obtain more accurate flash exposures even with highly reflective backgrounds.

The following metering modes are provided: evaluative, partial, spot, and center-weighted average (the same as the EOS-1D Mark II N). Also, multiple spot metering and AF point-linked spot metering is possible with C. Fn I -7-1. Partial metering reads approximately 13.5% of the viewfinder and spot metering reads approximately 3.8%. The ISO bracketing feature has been eliminated because a survey has shown it to be used very infrequently.

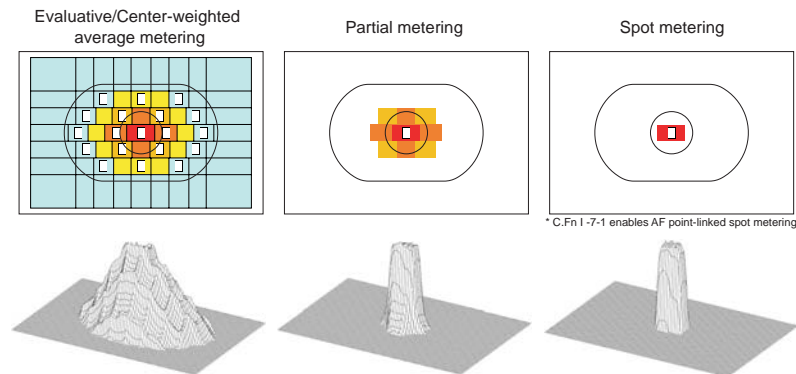

The following shooting modes are provided: P, Tv, Av, M, and Bulb (the same as the EOS-1D Mark II N). A convenient and helpful ISO speed safety shift is provided via C.Fn I -8-2. If the correct exposure cannot be obtained with the P, Tv, or Av mode, the ISO speed is automatically shifted within ISO 100 - 3200 to obtain the correct exposure.

**Safety Shift** Safety Shift is a practical feature that is enabled/disabled through C.Fn I-8. 0 disables the function. 1 enables either a shutter or an aperture preferred shift and 2 enables an ISO shift. The function makes it less likely that a busy shooter will get caught out as conditions change rapidly.

**Interface** The USB 2.0 Hi-Speed is now incorporated, replacing IEEE 1394/Firewire. Thanks to the higher efficiency of the internal interface with DIGIC III, data transfer speed is much faster than with the EOS-1D Mark II N. Since the USB speed also greatly depends on the personal computer hardware environment, the transfer speed might not be about 2.5 times as fast in all user environments. The USB interface cable is about 6.6 ft./2m long with both ends having a ferrite core-equipped A: Mini B connector. It can be used to connect the camera to a personal computer, printer, external media (via WFT-E2A), or GPS. An optional 16.4 ft./5m cable has also been developed.

A cable protector for the EOS-1D Mark III has also been developed to prevent deformation or damage of the terminal due to excessive strain on the terminal, to reduce wear, and to prevent the USB cable from being disconnected accidentally. The cable protector is designed to be usable even while the WFT-E2A is attached to the camera.

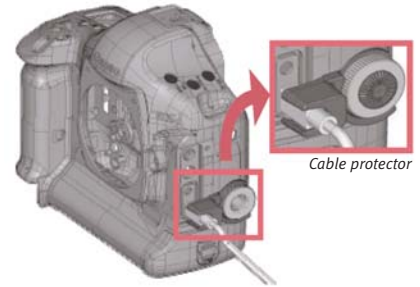

A 15-pin extension system terminal is provided for connection to the Wireless File Transmitter WFT-E2A. Because this terminal is located behind the USB and other connections, the other terminals can still be used even while the WFT-E2A is attached. Terminals other than these are the same as with the EOS-1D Mark II N: PC terminal, video out terminal (NTSC/PAL), and remote control terminal (N3 type).

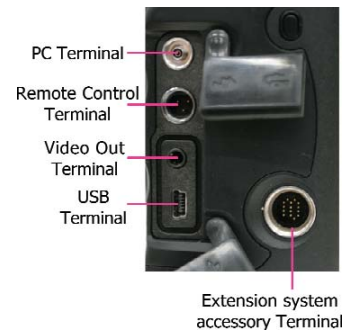

**Power** The EOS-1D Mark III's power source system has been changed from the old EOS-1D power source system. The new, dedicated, high-performance, lithium-ion Battery Pack LP-E4 (3 cells, 11.1V, 2300 mAh) is compact and lightweight, taking full advantage of current lithium-ion technology. Compared to the NP-E3, it is much smaller (40% less volume) and lighter (46% lighter). It can also communicate the following information with the camera: Power source type, remaining capacity 6-level icon, display in 1% increments, shutter count, and recharge performance (3 levels). This information can be viewed with the [Battery info.] menu. The new system also consists of Battery Charger LC-E4 and AC Adapter Kit ACK-E4.

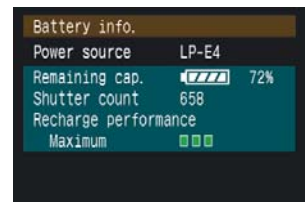

Battery Info.



Battery Pack LP-E4

An IC chip in the battery tracks battery information. Battery level is displayed upon communication with the chip. The remaining battery level is indicated by a battery icon indicating one of six levels on the top LCD panel, in the viewfinder (during metering), and on the menu screen [Battery info.]. If communication with the battery chip fails, a communication error message will appear. By selecting [OK], you can continue shooting. (The battery icon will be displayed as empty.)

Icon	Level (%)
	100 – 70
	69 – 50
	49 – 20
	19 – 10
	9 – 1
	0

The [Battery info.] screen shows battery-related information:

- Power source: The battery type is communicated and displayed
- Remaining capacity: When Battery Pack LP-E4 is used, the battery icon indicates the remaining capacity in one of six levels and in 1% increments (Under very low temperatures, using the WFT-E2A + external media, if the current capacity indicates 10%, the display may suddenly change to 0%)
- Shutter count: After the LP-E4 is fully charged, the number of shots taken with that battery will be displayed. This number is retained even when the battery is removed. The number will be reset when the battery is recharged
- Recharge performance: Upon communication with the battery, the battery's recharge performance is displayed in one of three levels. A degraded/older battery will have a lower capacity that can be recharged. Fewer shots can be taken with that battery than with a new battery. When a degraded/older battery is fully charged, the remaining capacity will still indicate 100%

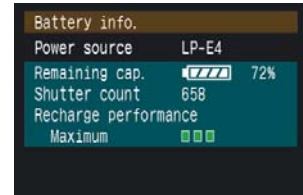

Battery Info.

After the battery undergoes 20 discharging and charging cycles, a message recommending battery calibration will appear on the bottom of the screen the next time the battery is installed. Calibration is performed with Battery Charger LC-E4 to find out the battery's capacity so that the remaining battery level can be indicated accurately. Each time the battery is recharged and used or discharged naturally, a slight discrepancy between the battery's remaining capacity information and the actual remaining capacity develops.



Battery Charger LC-E4

With repeated recharge/discharge cycles, this discrepancy can become a large one. By performing calibration to discharge the entire battery and by recharging the battery fully, accurate battery capacity information can be obtained. Two battery packs can be attached to the LC-E4. It takes about 120 min. to recharge one battery pack. The charger is compatible with DC power (12V/24V) so you can connect it to a car battery with Car Battery Cable CB-570 to recharge the battery pack.

Thanks to the newly-developed, large-capacity (2300 mAh), lithium-ion battery pack, the new DIGIC III imaging engine, revised circuits, the new LCD monitor with low power consumption, and fine power control, the number of possible shots is approximately 2200 at 23°C/73°F and 1700 at 0°C/ 32°F. (The EOS-1D Mark II N: 1200 shots at 23°C/ 73°F or 800 shots at 0°C/32°F)

For the date/time (backup) battery, the same CR2025 lithium battery as the EOS-1D Mark II N is used. The battery life is 5 years.

The AC Adapter Kit ACK-E4 supplies household AC power to the EOS-1D Mark III. It consists of the AC adapter, power cord, and DC coupler. The DC coupler has a DC cord. The plug at the end of the DC cord connects to the AC adapter's terminal; it prevents accidental disconnection. The previous AC Adapter Kit had the DC cord and AC adapter as one unit, and the plug was connected to the DC coupler.



*AC Adapter Kit ACK-E4*

# IX. CONTROLS AND DISPLAY

## Ease of Operation

In order to provide ease of operation that befits a new-generation EOS-1D series camera, Canon has thoroughly investigated ways to make camera operation easier. The camera retains the EOS Digital line's basic operation method with the Main Dial, Quick Control Dial, Multi-Controller, SET button, and other buttons to select and set various functions. Also, the ISO speed button, AF Start (AF-ON) button, Picture Style button, and Memory selection/Image size/White balance function button have been newly added to make camera operation easier.

With the older EOS-1D series cameras, the basic shooting operation logic consisted of holding down a button and turning the Main Dial or Quick Control Dial to select a setting. However, with the EOS-1D Mark III, when you press a button, it remains active for a while so you can let it go and then turn a dial to set something. Also, the three buttons on the top left of the camera accept double pressing. You can therefore set something (except AEB) with just one button.

With the EOS 5D and 30D, the Multi-Controller serves as the AF point selector. However, with the EOS-1D Mark III, we concluded that it was best to use the Quick Control Dial or Main Dial to select one of the 19 AF points. The Multi-Controller serves as a supplemental camera control for the digital operation's UI. If you press the AF point selection button and then press the Multi-Controller, the center AF point/automatic AF point selection can be made. Any other AF point (other than center AF point) cannot be selected.

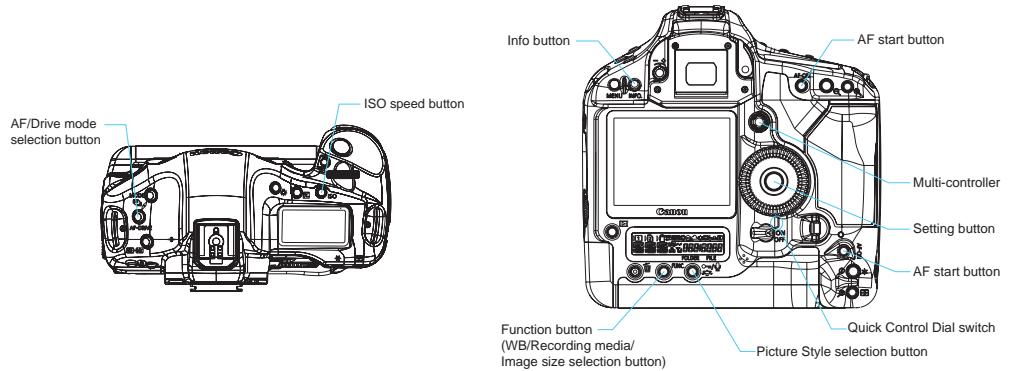



## LCD Display panels

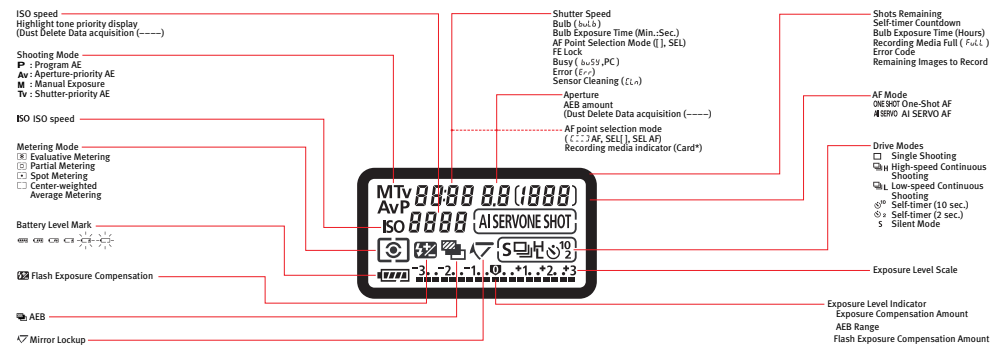

When the camera is ready to shoot, the ISO speed is now always displayed on the top LCD panel. The mirror lockup icon and the Silent drive mode icon have also been added. With the battery check detection system, the battery check indicator now shows 6 levels instead of 4. This gives you a more precise indication of battery level. Since the Personal Functions have been consolidated with the Custom Functions, the # (P. Fn) icon has been discontinued.

The image size indicator for the external media and respective recording media and icons for B/W shooting, white balance correction, and LAN connection have been added to the rear LCD panel. You can rearrange the layout of the TFT panel yourself using the Func. button to toggle the display.

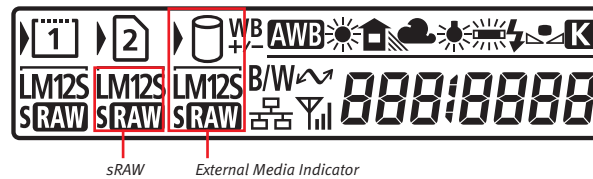

The B/A and G/M bias icon for WB correction/bracketing have been discontinued. The WB correction amount and BKT level indicator have also been discontinued.

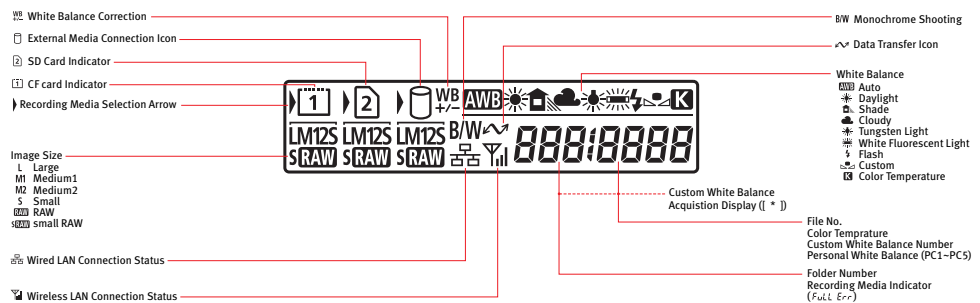

## LCD Monitor

The large 3.0-in. TFT monitor (1.4 times larger in area than 2.5 inches) features approximately 230,000 pixels, a wide-viewing angle (140° both vertically and horizontally), high-level brightness, and low power consumption. The LCD monitor is backlit with four LED modules. The maximum brightness is about 1.8 times brighter than the EOS-1D Mark II n's LCD monitor, making it easier to see the image on the LCD monitor even in bright outdoor conditions. The brightness adjustment has therefore been increased to seven levels (from five) to make the camera more adaptable to environmental

conditions. A large, clear grey scale is provided for guidance. Also, the color reproduction range has been increased and gamma is added to simulate a personal computer monitor. Thus, color reproduction is improved to make the images look more natural.

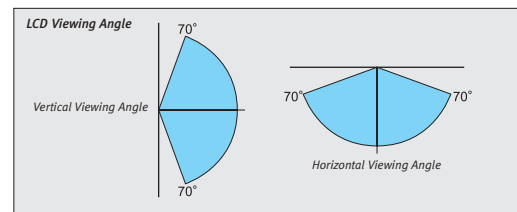

The number of dots comprising a character is the same as with the EOS 5D for Japanese, Simplified Chinese, Mandarin, and Korean. For other languages, the number of dots for a character is the same as with the EOS-1D Mark II N. However, the larger 3.0-in. LCD monitor makes the character's display size bigger, making it easier to read.

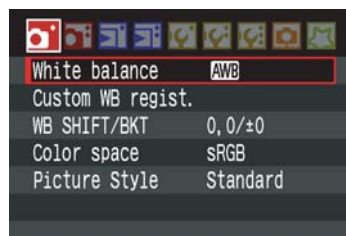

*EOS-1D Mark III (3.0 inch)*



*EOS-1D Mark II N (2.5 inch)*

## Viewfinder

The viewfinder design is entirely new and is now easier to see, clearer, and sharper. The viewfinder has approximately 100% coverage, 0.76x magnification, a 30° angle of view, a 20mm eyepoint, -3 to 1 dpt. dioptic adjustment, and an eyepiece shutter which is now gray to make it easier to see when it is closed. By comparison, the EOS-1D Mark II N has approximately 0.72x magnification and a 28.2° angle of view.

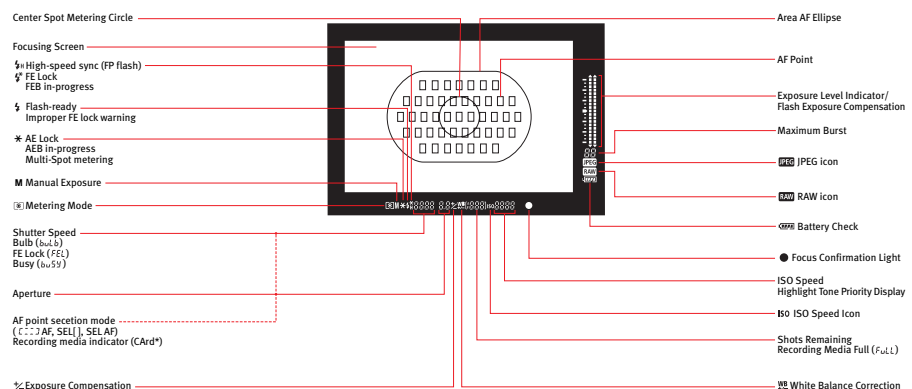

The viewfinder's optics have been developed to achieve best-in-class performance. The same highly refractive material found in the EOS-1D Mark II N is used for the pentaprism of the EOS-1D Mark III. To improve viewfinder magnification, a larger pentaprism is employed. The basic configuration of the eyepiece optics is the same as with the 1D Mark II N, with 4 lens elements. However, by increasing lens power, high magnification is attained. To improve lens sensitivity for higher magnification, the mechanical parts configuration is of higher precision.

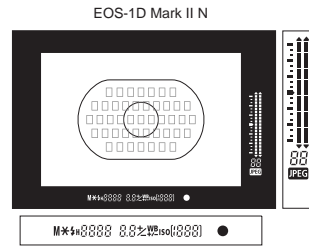
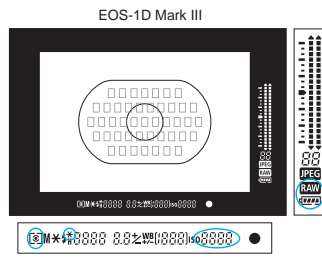

### Major Viewfinder Specifications

Item	EOS-1D Mark III	EOS-1D Mark II N
Coverage [Approx. %]	100	
Magnification	0.76	0.72
Viewing angle [°]	30	28.2
Eye point [Approx. mm]	20	
Dioptic adjustment [dpt]	-3 - +1	

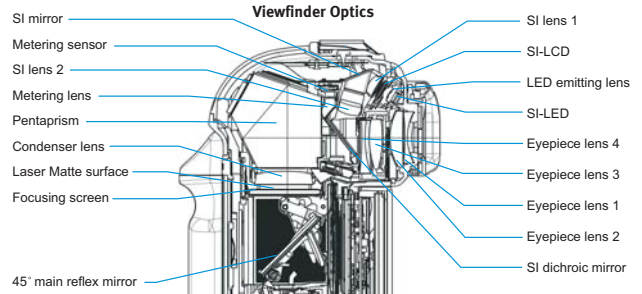

The basic configuration and performance of the SI (superimposed) display optics are the same as those of the EOS-1D Mark II N. However, to match the improved eyepiece optics, the SI LCD and SI lens 2 have been changed.

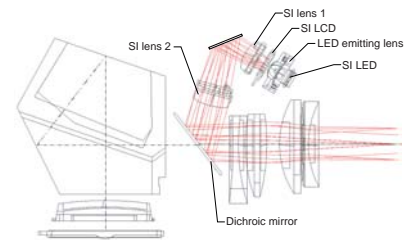

The Ec-C IV focusing screen is a Laser Matte unit whose molding method has been improved over the previous Ec-C III focusing screen's. It makes it easier to focus and provides natural-looking background blur (bokeh). It is also brighter and less grainy, making it a very well-balanced focusing screen. With the improved molding method, image transfer is better. The dispersion characteristic is improved, and the screen is brighter with minimal flare. The fresnel lens area is especially improved for image transfer, increasing the peripheral brightness and making the screen look clearer overall.

Compared to the EOS-1D Mark II N's Ec-C III standard focusing screen, the Ec-C IV is brighter, less grainy, and better balanced. The EOS-1D Mark III is compatible with all Ec focusing screens used by EOS-1 series cameras.

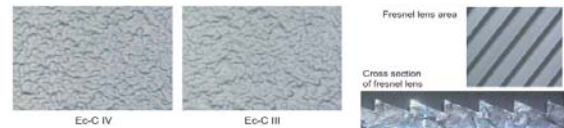

Since the eyepiece frame now has a different shape to accommodate the bigger eyepiece lens, viewfinder accessories dedicated to the EOS-1D Mark III have been developed at the same time: Eyecup Eg, Dioptic Adjustment Lenses Eg (7 types: -4, -3, -2, 0, +1, +2, +3), and Anti-fog Eyepiece Eg. Note that the old EOS-1 viewfinder accessories Eyecup Ec-II, Rubber Frame Ec, and Anti-fog Eyepiece Ec are not interchangeable with the Eg-series accessories. The newly-developed, standard Eyecup Eg has an improved mount for attaching it to the eyepiece. It is now less prone to detach inadvertently compared to the old eyecup.



## Menu Functions

The Main Dial is used to select the menu tab; the Quick Control Dial is used to select the menu option (each tabbed menu does not require vertical scrolling). Then, the SET button is pressed to register the setting. This ease of operation is new. (With the EOS 5D and 30D, the Quick Control Dial is used to scroll. With the EOS Digital Rebel XTi/400D Digital, the Cross keys are used to select the tab and menu option. This operation method makes it quick and easy to find and set the menu option from among the many menus organized under nine tabs (Shooting 1 & 2, Playback 1 & 2, Set-up 1, 2, & 3, Custom Functions, and My Menu). All the menu items are visible on one screen. Also, the tab design has been changed to make it easier to distinguish; it also becomes bigger when selected. With the Multi-Controller, only the menu tab and first layer of menu options can be selected. Pressing the center does not set anything. It also does not work with the second layer of menu options and beyond.

On one screen, up to 7 menu options can be displayed. This is one fewer than the 8 items the EOS-1D Mark II N's screen can show. However, together with the bigger 3.0-inch screen, the EOS-1D Mark III's menus are easier to read.

**Table 3 Menu Functions**

Legend	
<span style="background-color: #d9ead3; border: 1px solid black; display: inline-block; width: 15px; height: 10px;"></span>	New EOS feature
<span style="background-color: #fff2cc; border: 1px solid black; display: inline-block; width: 15px; height: 10px;"></span>	Newly-added feature already in another EOS camera
<span style="background-color: #d9ead3; border: 1px solid black; display: inline-block; width: 15px; height: 10px;"></span>	Improved/consolidated feature

Shooting 1	Set-up 1
<span style="background-color: #d9ead3; border: 1px solid black; display: inline-block; width: 15px; height: 10px;"></span> White balance	Auto power off
<span style="background-color: #d9ead3; border: 1px solid black; display: inline-block; width: 15px; height: 10px;"></span> Custom WB regist.	<span style="background-color: #d9ead3; border: 1px solid black; display: inline-block; width: 15px; height: 10px;"></span> Record func+media/folder sel.
<span style="background-color: #fff2cc; border: 1px solid black; display: inline-block; width: 15px; height: 10px;"></span> WB SHIFT/BKT	File numbering
Color space	<span style="background-color: #d9ead3; border: 1px solid black; display: inline-block; width: 15px; height: 10px;"></span> File name setting
Picture Style	Auto rotate
	Format

Shooting 2	Set-up 2
JPEG quality	<span style="background-color: #d9ead3; border: 1px solid black; display: inline-block; width: 15px; height: 10px;"></span> LCD brightness
<span style="background-color: #d9ead3; border: 1px solid black; display: inline-block; width: 15px; height: 10px;"></span> Image size	<span style="background-color: #d9ead3; border: 1px solid black; display: inline-block; width: 15px; height: 10px;"></span> Date/Time
<span style="background-color: #d9ead3; border: 1px solid black; display: inline-block; width: 15px; height: 10px;"></span> Review time	<span style="background-color: #d9ead3; border: 1px solid black; display: inline-block; width: 15px; height: 10px;"></span> Language
<span style="background-color: #fff2cc; border: 1px solid black; display: inline-block; width: 15px; height: 10px;"></span> Beep	Video system
<span style="background-color: #fff2cc; border: 1px solid black; display: inline-block; width: 15px; height: 10px;"></span> Shoot w/o card	<span style="background-color: #d9ead3; border: 1px solid black; display: inline-block; width: 15px; height: 10px;"></span> Battery info.
<span style="background-color: #fff2cc; border: 1px solid black; display: inline-block; width: 15px; height: 10px;"></span> Dust Delete Data	<span style="background-color: #d9ead3; border: 1px solid black; display: inline-block; width: 15px; height: 10px;"></span> Live View function settings
	<span style="background-color: #d9ead3; border: 1px solid black; display: inline-block; width: 15px; height: 10px;"></span> External Speedlite control

Playback 1	Set-up 3
<span style="background-color: #d9ead3; border: 1px solid black; display: inline-block; width: 15px; height: 10px;"></span> Protect images	<span style="background-color: #d9ead3; border: 1px solid black; display: inline-block; width: 15px; height: 10px;"></span> Save/load settings on media
Rotate	<span style="background-color: #d9ead3; border: 1px solid black; display: inline-block; width: 15px; height: 10px;"></span> Regist/apply basic settings
<span style="background-color: #d9ead3; border: 1px solid black; display: inline-block; width: 15px; height: 10px;"></span> Erase images	<span style="background-color: #fff2cc; border: 1px solid black; display: inline-block; width: 15px; height: 10px;"></span> Clear all camera settings
<span style="background-color: #d9ead3; border: 1px solid black; display: inline-block; width: 15px; height: 10px;"></span> Print order	<span style="background-color: #fff2cc; border: 1px solid black; display: inline-block; width: 15px; height: 10px;"></span> Sensor cleaning
<span style="background-color: #fff2cc; border: 1px solid black; display: inline-block; width: 15px; height: 10px;"></span> Transfer order	Firmware Ver. *
<span style="background-color: #d9ead3; border: 1px solid black; display: inline-block; width: 15px; height: 10px;"></span> Image copy	<span style="background-color: #d9ead3; border: 1px solid black; display: inline-block; width: 15px; height: 10px;"></span> WFT settings
<span style="background-color: #d9ead3; border: 1px solid black; display: inline-block; width: 15px; height: 10px;"></span> External media backup	

Playback 2	Custom Functions
Highlight alert	<span style="background-color: #d9ead3; border: 1px solid black; display: inline-block; width: 15px; height: 10px;"></span> C.Fn I :Exposure
AF point disp.	<span style="background-color: #d9ead3; border: 1px solid black; display: inline-block; width: 15px; height: 10px;"></span> C.Fn II :Image/Flash exp/Disp
Histogram	<span style="background-color: #d9ead3; border: 1px solid black; display: inline-block; width: 15px; height: 10px;"></span> C.Fn III :Auto focus/Drive
Enlarge display	<span style="background-color: #d9ead3; border: 1px solid black; display: inline-block; width: 15px; height: 10px;"></span> C.Fn IV :Operation/Others
<span style="background-color: #fff2cc; border: 1px solid black; display: inline-block; width: 15px; height: 10px;"></span> Image jump w/	Clear all Custom Func. (C.Fn)
	<span style="background-color: #d9ead3; border: 1px solid black; display: inline-block; width: 15px; height: 10px;"></span> C.Fn setting register/apply

My Menu
<span style="background-color: #d9ead3; border: 1px solid black; display: inline-block; width: 15px; height: 10px;"></span> My Menu settings

**Playback and Display Options**

There are four display options:

1. Single image
2. Single image + Image size
3. Shooting information
4. Histogram (1. Brightness, 2. RGB)

Each time you press the INFO button, the display changes in this sequence. With the EOS-1D Mark III, display options 2 and 4 are new. You can also set the display for highlight warning (highlight areas with no image will blink) and AF point.

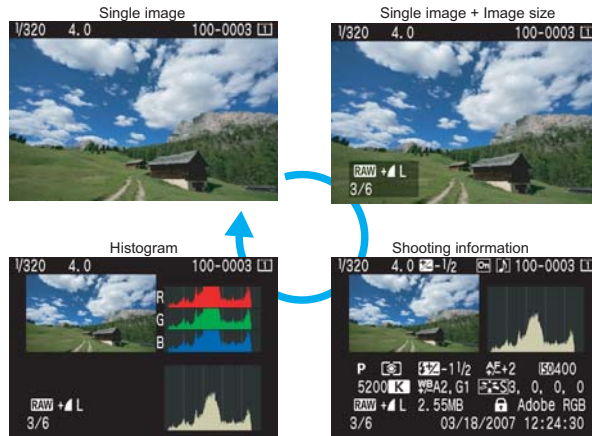

For images shot with the Wireless File Transmitter WFT-E2A + GPS, the GPS information (longitude, latitude, altitude, UTC) will be displayed below the histogram. With the WFT-E2A + external media, images recorded in the CF/SD card can also be backed up to external media.

During single image playback, you can press the Reduce button to display the 4-image index or 9-image index.



Unlike the EOS 5D, 30D, and EOS Digital Rebel XTi/400D Digital, the image jump setting is done with the menu. With the [Image jump with Main Dial] menu, you can choose to jump through the images by 1, 10, or 100 images. Alternately, you can jump by one screen, the shooting date, or folder. When you turn the Main Dial during image playback, you can jump through the images according to your menu setting.

For continuous shooting, only the last image taken will be displayed. During automatic image review, you can protect the image, delete the image, or record sound.



*Jump display*

During single image playback or INFO display, press the Magnify button to magnify the image. When you hold down the Magnify/Reduce button, you can zoom in or out between 1.5x and 10x in 15 steps. By turning the Quick Control Dial during the magnified view, you can view another image at the same magnified position. With the [Enlarge display] menu, you can also start the magnified view from a manually selected AF point, as you can with the EOS-1D Mark II N. The choice is [Enlarge from image center] or [Enlarge from selected AF point].



Magnified view

With the menu, you can now also erase, protect or cancel an individual image.



Protect images

Press the SET button to rotate the image by 90°, 270°, or 0° (in this sequence). Rotated display can be set for 1. Manual, or 2. Auto rotate.

On the menu screen, you can now checkmark each image you want to erase, then erase all of them at once. Erasing all images must now be done with the menu to prevent accidental erasure. (Erasing all images cannot be done during image playback.)

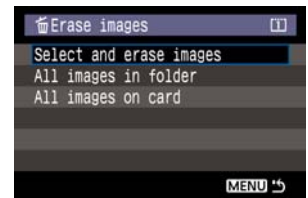

Erase images

During image playback, you can press the Protect/Record button for 2 sec. to record sound up to 30 sec. long.

While the camera is ready to shoot, you can press the INFO button to display the camera settings on the LCD monitor (the same as with the EOS 5D). You can also display the shooting settings (C. Fn II -9-1) as displayed on the LCD panel and in the viewfinder. If an error occurs, the LCD monitor displays the error number and the description.



Error display

Video output is compatible with NTSC and PAL depending on the video OUT terminal.

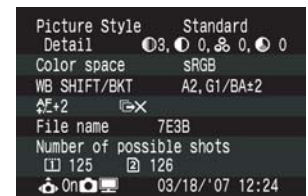

Camera settings display



Shooting settings display

**White Balance** The white balance and color temperature settings are the same as those on the EOS-1D Mark II N. Now white balance can be set with the menu in addition to setting it while looking at the rear LCD panel. The lowest color temperature has been extended by 300°K, and the settable range has been expanded to 2500°K–10000°K in 100°K increments. The Custom white balance can now be registered with up to 5 images shot on the spot, in addition to registering it with an image in the memory card. The registered Custom WB data can also be captioned. Up to 5 Personal white balance settings can be registered (PC1–PC5). On the EOS-1D Mark II N, 3 settings could be registered.

The Custom white balance function has been improved. It is still set with the [Custom WB regist.] menu and, as with previous cameras, you can select an image stored in the memory card and obtain and register the custom WB data. Now, you can also take a picture and register the custom WB data. Up to 5 custom WB data items can be registered, a useful upgrade.

**Major Viewfinder Specifications**

WB Mode	Color Temperature (Kelvin)
1. Auto (AWB)	Approx. 3,000-7,000
2. Daylight	Approx. 5,200
3. Shade	Approx. 7,000
4. Cloudy	Approx. 6,000
5. Tungsten light	Approx. 3,200
6. White fluorescent light	Approx. 4,000
7. Flash	Approx. 6,000
8. Custom (MWB) 1-5	Approx. 2,000-10,000
9. Color Temperature	Approx. 2,500-10,000
10. PC-1 – PC-5*	–

\* Up to five white balance data set with the provided software can be registered.

**Custom Functions** The old Personal Functions have been consolidated with Custom Functions (C.Fn), 57 in all, with a new numbering system. They are organized in groups I to IV. Custom Functions are now pleasantly faster to select and set.

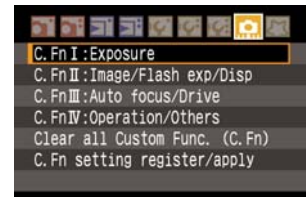

Custom functions

With Speedlite 580EX II attached, you can set or cancel the Speedlite's Custom Functions (C.Fn-0 to C.Fn-18) with the camera. You can also use the camera to set the Speedlite's flash mode, flash exposure compensation amount, FEB, flash sync, and other Speedlite functions. With an EX-series Speedlite other than the 580EX II, the camera cannot set or clear the Speedlite's functions and Custom Functions.

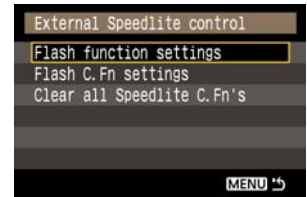

External speedlite control

With the 580EX II, the following Custom Functions are available:

**Flash C.Fn Settings**

No	Item	No	Description	No	Item	No	Description
0	Distance indicator display	0	Meters (m)	6	Quickflash w/continuous shot	0	Disabled
		1	Feet (ft)			1	Enabled
1	Auto power off	0	Enabled	7	Test firing with autoflash	0	1/32
		1	Disabled			1	Full output
2	Modeling flash	0	Enabled (DOF preview butt.)	8	AF-assist beam firing	0	Enabled
		1	Enabled (Test firing butt.)			1	Disabled
		2	Enabled (with both buttons)	9	Auto zoom for sensor size	0	Enabled
		3	Disabled			1	Disabled
3	FEB auto cancel	0	Enabled	10	Slave auto power off timer	0	60 minutes
		1	Disabled			1	10 minutes
4	FEB sequence	0	0 → - → +	11	Slave auto power off cancel	0	Within 8 hours
		1	- → 0 → +			1	Within 1 hour
5	Flash metering mode	0	E-TTL II	12	Flash recycle w/ exter. power	0	Flash and external power
		1	TTL			1	External power source
		2	External metering: Auto	13	Flash exposure metering set.	0	Speedlite button and dial
		3	External metering: Manual			1	Speedlite dial only

The Custom Functions corresponding to the EOS-1D Mark II N's C. Fn and P. Fn are shown here. New and substantially altered Custom Functions are explained below.

### Corresponding Custom Functions

No.	Custom Function	EOS-1D Mark II n Function	No.	Custom Function	EOS-1D Mark II n Function
<b>C.Fn I: Exposure</b>			<b>C.Fn III: Autofocus/Drive</b>		
1	Exposure Level Increments	Same as C.Fn-06	1	USM Lens Electronic MF	Same as C.Fn-07
2	ISO Speed Setting Increments	New	2	AI Servo Tracking Sensitivity	Same as C.Fn-20
3	Set ISO Speed Range	Moved to [ISO Expansion]. Setting the max. and min. ISO Speeds are new	3	AI Servo 1st/2nd Image Priority	C.Fn-21's function expanded
4	Bracketing Auto Cancel	C.Fn-09 and P.Fn-09 are dispersed	4	AI Servo AF Tracking Method	New
5	Bracketing Sequence	to C.Fn I-4 and 5	5	Lens Drive When AF Impossible	Same as P.Fn-14
6	Number of Bracketed Shots	Same as P.Fn-08	6	Lens AF Stop Button Function	Same as C.Fn-19. 6 added.
7	Spot Metering Link to AF Point	C.Fn-13 now separate and independent	7	AF Microadjustment	New
8	Safety Shift	Setting 1 is same as C.Fn-16, and setting 2 is new	8	AF Expansion With Selected Point	Based on C.Fn-17
9	Select Usable Shooting Modes	Same as P.Fn-01	9	Selectable AF Point	C.Fn-13 now separate and independent
10	Select Usable Metering Modes	Same as P.Fn-02	10	Switch to Registered AF Point	Same as C.Fn-18
11	Metering Pattern in Manual Mode	Same as P.Fn-03	11	AF Point Auto Selection	C.Fn-11-2 and P.Fn-17/18 consolidated together
12	Set Shutter Speed Range	Same as P.Fn-04	12	AF Point Display During Focus	Based on C.Fn-10
13	Set Aperture Value Range	Same as P.Fn-05	13	AF Point Brightness	C.Fn-10-3 now independent
14	Apply Shooting/Metering Mode	Based on P.Fn-06. Function partially expanded	14	AF-Assist Beam Firing	Same as P.Fn-15
15	Flash Sync. Speed in Av Mode	Same as EOS 5D C.Fn-03 (Sync speed differs)	15	Mirror Lockup	Same as C.Fn-12, and 2 added
<b>C.Fn II: Image/Flash Exposure/Display</b>			16	Continuous Shooting Speed	Same as P.Fn-19
1	Long Exposure Noise Reduction	Same as [Noise reduction]	17	Limit Continuous Shot Count	Same as P.Fn-20
2	High ISO Speed Noise Reduction	New	<b>C.Fn IV: Operation/Others</b>		
3	Highlight Tone Priority	New	1	Long Exposure Noise Reduction	Same as [Noise reduction]
4	E-TTL II Flash Metering	Same as C.Fn-14	2	AF-ON/AE Lock Button Switch	New
5	Shutter Curtain Sync.	Same as C.Fn-15	3	Quick Control Dial in Metering	New
6	Flash Firing	Same as EOS 5D C.Fn-07	4	SET Button When Shooting	Same as EOS 5D C.Fn-01
7	Viewfinder Info. During Exposure	Same as C.Fn-01	5	Tv/Av Setting for Manual Exposure	Same as C.Fn-05
8	LCD Panel Illumination During Bulb	Same as P.Fn-24	6	Dial Direction During Tv/Av	New (Similar to P.Fn-27)
9	INFO Button When Shooting	New	7	Av Setting Without Lens	C.Fn-05-2/3 now separate and independent
			8	WB + Media/Image Size Setting	New
			9	Button Function	New
			10	Button Function When  <OFF>	P.Fn-30 Expanded
			11	Focusing Screen	Same as C.Fn-00
			12	Timer Length For Timer	Same as P.Fn-23
			13	Shortened Release Timer Lag	Same as P.Fn-26
			14	Add Aspect Ratio Information	New
			15	Add Original Decision Data	Same as P.Fn-31
			16	Live View Exposure Simulation	New

C. Fn I-3 is an expanded version of the EOS-1D Mark II N's [ISO expansion]. By selecting [Register], the upper limit can be set to H (ISO 6400) and the lower limit can be set to L (ISO 50). If both H and L are set, it will be the same as the previous camera's [ISO expansion: On].



C.Fn I-3

The EOS-1D Mark II N's C. Fn-09, [Auto bracketing sequence/cancel], has been split into C. Fn I-4 and 5, [Bracketing sequence]. Both functions can now be set separately.

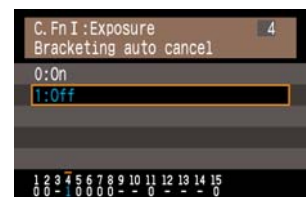

C.Fn I-4



- [0: On]

The AEB and WB-BKT setting will be canceled when the power switch is set to <OFF> or if the camera settings are cleared. AEB will also be canceled if Bulb is set or if the flash is ready. With the EOS-1D Mark III, the bracketing will not be canceled even if the lens is changed, the card slot is opened, or the battery is removed.

- [1: Off]

Even if the power switch is set to <OFF>, AEB and WB-BKT setting will not be canceled. When the flash is ready, AEB will be canceled. However, the AEB level will be retained in memory.

C. Fn I –8 [Safety shift], is an expanded version of the EOS-1D Mark II n's C. Fn-16 [Safety shift in Av or Tv]. The function [2: Enable (ISO speed)] works in the P, Tv, and Av modes. If subject brightness changes erratically and the correct autoexposure cannot be obtained, the ISO speed is shifted automatically within ISO 100–3200 to obtain a correct exposure. Safety shift overrides the following settings: C. Fn I -3 [Set ISO speed range], C. Fn I -12 [Set shutter speed range], and C. Fn I -13 [Set aperture value range]. During continuous shooting, safety shift might be applied even if flash is used. It depends on the shooting conditions.

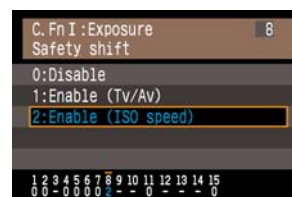

C.Fn I-8

If C. Fn II –3, [Highlight tone priority], is on, safety shift will be applied within ISO 200 - 3200. Safety shift to the ISO speed expanded range (L and H) will not occur. However, shifting from L or H to ISO 100–3200 can occur. Even if C. Fn I -2 [ISO speed setting increments] is set to 1 stop, the safety shift will occur in 1/3-stop increments.

The basic function of C. Fn I –14, [Apply shooting/metering mode], is the same as P. Fn-06 [Registers and switches the shooting mode and metering mode]. While you hold down the AE lock button during shooting, the registered setting (shooting mode, metering mode, shutter speed, aperture, or exposure compensation) is applied. With the EOS-1D Mark III, you can set the AE lock button to execute AF. Unlike the EOS-1D Mark II n, you need not press any button to register the setting. Everything can be done with the menu screen. Since the 1D Mark III does not have an Assist button, press the AE button to apply the registered setting.

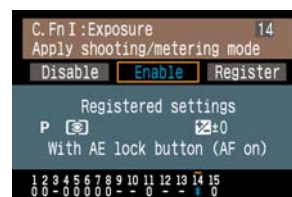

C.Fn I-14

C. Fn II –9, [INFO button when shooting] is a new function. When [0: Displays camera settings] is set, you can now press the INFO button to display the camera settings while the camera is ready to shoot. This is similar to the EOS 5D and 30D. Note that if [1: Displays shooting functions] is set, shooting-related settings as shown on the top LCD panel and in the viewfinder will be displayed. As with the EOS Digital Rebel XTi/400D Digital, you can then set the shooting functions while looking at the LCD monitor. This is convenient



C.Fn II-9

when it is difficult to view the top LCD panel while shooting, such as when the camera is pointed straight down. Also, while the shooting functions are displayed, you can press the AF point selection button to select an AF point on the LCD monitor.



Shooting function display

C. Fn III –6, [Lens AF stop button function], is the same function as the EOS-1D Mark II n's C. Fn-19 except for the addition of [6: AF point history selection]. When 6 is set, you can switch between the current AF point and the previously-selected AF point by holding down the lens AF Stop button and pressing the FE lock button.

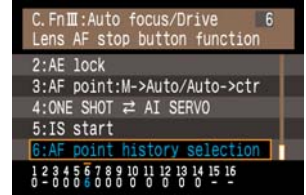

C.Fn III-6

C. Fn III –10, [AF point auto selection], consolidates the EOS-1D Mark II n's C.Fn-11-2 and P.Fn-17/18 to suit the EOS-1D Mark III's AF point selection specifications. For AF point selection, you can enable or disable automatic selection. The setting before the slash is the Quick Control Dial operation while metering is active with C. Fn IV 3-1 set. The setting after the slash is Main Dial's operation when the AF selection button is pressed.

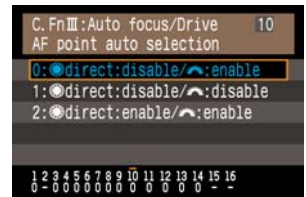

C.Fn III-10

C. Fn IV –6, [Dial direction during Tv/Av], is a new function, similar to P. Fn-27. When [1: Reverse direction] is set, turning the dial to set the shutter speed or aperture will work in the reverse direction. In the manual exposure mode, the setting direction of the Main Dial and Quick Control Dial will be reversed. In other shooting modes, the Main Dial's setting direction will be reversed. This will make the Quick Control Dial's setting direction the same for both the manual exposure mode and exposure compensation setting. With previous EOS-1D cameras, even with P. Fn-27, the Quick Control Dial's setting direction could not be made the same for the manual exposure mode and exposure compensation setting.

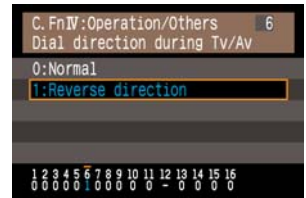

C.Fn IV-6

C. Fn IV –8, [WB + media/image size setting], is a new function. When the camera is ready to shoot and you press the Function button, you can choose to set the white balance, memory card, and image size with the rear LCD panel or with the menu screen. With [1: LCD monitor], each time you press the Function button, the menu screen will change for setting the white balance, image size, recording function, and media folder setting.

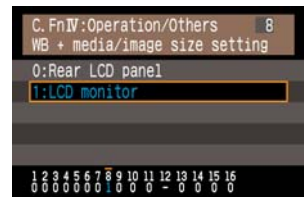

C.Fn IV-8

C. Fn IV –10, [Button function when Quick Control Dial <OFF>], is an expanded version of P. Fn-30. When [1: Disable Main Dial/Quick Control Dial, Multi- controller] is set and the power switch is set to ON, the Main Dial, Quick Control Dial and Multi-Controller will not be able to change any settings. This prevents accidental changing of the settings. The function is very convenient and eliminates a source of anxiety for many photographers who shoot in chaotic conditions.

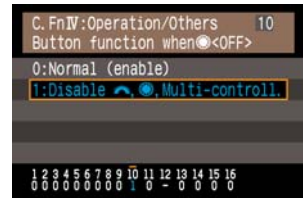

C.Fn IV-10

## Saving and Registering Settings

Registering Custom Function settings works the same way as the EOS-1D Mark II N's P. Fn-00. With [C. Fn setting register/apply], you can register up to three sets of Custom Function settings in the camera. You can use each set suiting a specific genre of shooting such as sports, landscapes and so forth. When you apply a set of Custom Function settings, the camera's Custom Function settings will change instantly accordingly. Note that C. Fn III -7 [AF Micro-adjustment] and C. Fn IV -11 [Focusing Screen] settings will not be included in the registered Custom Function settings.



C.Fn setting register/apply

[Save camera settings to media] is an expanded version of the EOS-1D Mark II N's [Save camera settings] function. Up to 10 sets of camera settings can now be saved to one recording medium. With [Save/ load setting on media], the camera's current settings can be saved as a file to a memory card. When this file is read, the camera will be set to the file's saved camera settings. The same file can be read by multiple EOS-1D Mark III cameras or you can use different camera settings for different shooting situations. The date/time, language, video output format settings, C. Fn III-7 and C. Fn IV-11 are not saved and included.

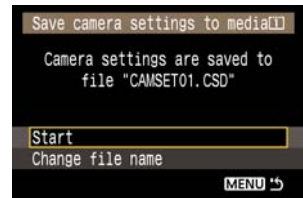

Save camera settings

[Register basic camera settings] is an expanded version of P. Fn-25, [Sets the default settings when the CLEAR button is ON]. With [Regist/load basic settings], you can register basic settings such as the shooting mode, metering mode, and drive mode in the camera. When these settings are applied, the camera settings will switch to the registered settings.

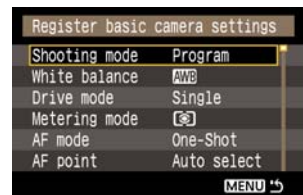

Register basic camera settings

This is convenient when you often have to switch camera settings instantly to suit a particular shooting situation. The following settings can be registered: Shooting mode, white balance, drive mode, metering mode, AF mode, AF point, color space, image size, and Picture Style (9 settings).

**My Menu** Up to six frequently-used menu options and Custom Functions can be registered in the user-friendly feature, My Menu. The menu's top-level options, the Custom Function's top-level settings, and all Custom Functions can be registered. You can change the order of the menu items, delete menu items, or delete all the menu items. Also, if [Display from My Menu: Display] is set, pressing the Menu button will display the My Menu (tab) first. EOS Utility can also be used to set My Menu and register it in the camera.



*My menu settings*



*My menu (example)*

**Picture Style** The Picture Style and their respective effects are the same as with the EOS-1D Mark II n. The back of the camera has the new Picture Style button that also functions as the Protect/Sound recording button. When the camera is ready to shoot, you can press this button to display the Picture Style screen as a short cut. The Picture Style menu screen also shows an icon in front of each Picture Style.

**Camera Direct Functions** To improve the camera's operation with Canon printers, Canon has made four improvements to PictBridge: faster printing speed, printing layout, printing effects, and cable disconnection after data transfer completion. The EOS-1D Mark III supports all of the above as well as RAW and sRAW image printing via PictBridge. Any Canon or non-Canon old or new PictBridge printer can be used to print images. RAW images not taken with the 1D Mark III cannot be printed from the 1D Mark III to a PictBridge printer. With RAW/sRAW + JPEG images, the JPEG image is printed.

The [Red-Eye 1] printing effect has been added to: [Off], [On], [Vivid], [NR], [Vivid+NR], and [Face brightener]. When [Red-Eye 1] is used for a flash shot containing red eye, the red eye can be corrected before printing.

Due to the high-end features now available with PictBridge and the widespread sales of PictBridge printers by Canon and other makers, the EOS-1D Mark III does not support Canon's BubbleJet Direct and CP Direct. It supports only PictBridge. If the iP6700D for the Japanese market or the PIXMA iP6320D, iP6310D, or iP6700D for the overseas market is connected to the camera, the feature extension screen cannot be displayed (therefore [Red-eye corr.] cannot be selected). Therefore, [Red-Eye 1] is newly provided as an optional printing effect. If the connected printer has Red-eye Correction and Facial Brightness Correction, the feature extension screen's [Red-eye corr.] can be used. ([Red-eye 1] will not appear as an optional printing effect. Because the EOS-1D Mark III is not compatible with

Canon's BubbleJet Direct and CP Direct, when the CP500, CP400, CP330, CP300, CP220 or CP200 is used, PictBridge takes effect and the printer's full potential can be used. (The CP500, CP400, CP330, CP300, CP220 and CP200 provide both CP Direct and PictBridge and ordinarily give priority to CP Direct.) Also, with the CP730, CP720, CP710, CP510, an improved communication algorithm has improved the printing speed.

The [By Folder] button has been added. You can now select the folder whose images (all of them) are to be printed. Alternately, you can just cancel the printing. Other features are the same as those of the EOS-1D Mark II n.

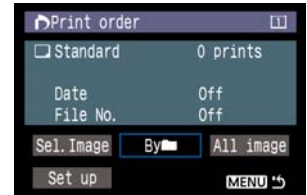

*Print order*

By using the camera controls, you can transfer JPEG, RAW or sRAW images directly to a Mac or Windows computer with the EOS Digital Solution Disk Ver.14 installed. The options are:

- (1) All images: All images stored in the memory card are transferred to the PC.
- (2) All images not yet transferred: Only images that haven't been transferred to the computer are automatically selected for transfer.
- (3) Images marked for transfer: Select images individually [Sel. image] or select all images [All image] to be transferred to the personal computer: Up to 998 images can be selected for the transfer.
- (4) Select and transfer: Select the images to be transferred and they will be transferred one by one.
- (5) Personal computer wallpaper: Select the image to be the personal computer's wallpaper, then transfer it (JPEG only).



*Direct transfer*

# X. SOFTWARE PACKAGE, COMPATIBILITY AND ACCESSORIES

## Software: EOS Digital Solution Disk, Version 14

The EOS DIGITAL Solution Disk, Ver.14 that is included with the EOS-1D Mark III contains major upgrades to two key programs, EOS Utility 2.0 and Digital Photo Professional 3.0, as well as a minor upgrade to ZoomBrowser EX/ImageBrowser (now version 5.8). DPP, a favorite of professionals and advanced amateurs, is now much faster, easier to use and more capable. These changes are:

### Operating system compatibility

- All the software components are compatible with Windows Vista, XP Pro/Home SP2 (not SP 0 or 1), 2000 Pro SP 4 (not SP 0 to 3)
- EU 2.0 and DPP 3.0 are Universal Binary and run at native speed on Intel Macs with OS 10.4.7 or higher and PPC Macs running 10.4.3 or higher

### Major Viewfinder Specifications

	Windows		Macintosh	
	Version	Support OS	Version	Support OS
Zoom Browser EX/ Image Browser	5.8	2000/XP Vista	5.8	10.3– 10.4
Digital Photo Professional	3.0		3.0	
EOS Utility	2.0*		2.0**	
Application software (K245)	3.0		3.0	
Application software (K241)	1.0		–	
Photo Stich	3.3		3.3	
PTA WIA/TWAIN Driver	1-D Mark III exclusive	2000	–	

\* EU 2.0 does not support WIN2000 when using PTP-IP connection, via WFT

\*\* EU 2.0 does not support MAC OS10.3 when using PTP-IP connection, via WFT

### Major upgrade to EOS Utility (version 1.1 to 2.0)

- Elegant new black and DPP-based window design
- Easier to use
- Compatible with the EOS-1D Mark III
- Live View shooting (see Live View discussion)
- Display of a grid showing the camera's horizontal/vertical orientation in the Remote Live View window
- Display of a frame showing the image's specified aspect ratio in the Remote Live View window
- Bulb shooting
- My Menu settings
- Links with the software for optional accessories (WFT-E1, WFT-E2/E2A and Windows only Original Data Security Kit OSK-E3)
- Major upgrade to Digital Photo Professional (version 2.2 to 3.0)
- Compatible with the EOS-1D Mark III and 14-bit RAW
- Improved color matching with DIGIC III

- Supports Small RAW/sRAW images
- Supports the dust erasure function
- GPS data display
- Image display that supports images with a designated aspect ratio
- Enhanced main window functions
- Single-image display for RAW+JPEG images
- Thumbnail image rearranging using drag & drop
- Frame display in trimmed images
- Image adjustments using the tool palette
- Enhanced edit window functions
- Faster image display using 1/4 size image processing
- New algorithm for high-speed display of RAW images (Fit to window display/50% display), rough develop first, approximately 3x faster (\* Win XP, Pentium 4, 3.4 Ghz)
- Addition of a multi-image synchronizing/comparison function for magnified images
- Improved dynamic range adjustment histogram
- Start editing immediately (even while images are still in mosaic state)
- Addition of the noise reduction function to the tool palette
- Trimmed images indicated in main window thumbnails
- Image information dialog box now adjustable
- Simultaneous creation of JPEG and TIFF (16-bit or 8-bit) images when RAW images are converted and saved
- A minor upgrade to ZoomBrowser EX/ImageBrowser (version 5.7 to 5.8)
- The only changes to the specifications of ZoomBrowser EX/ImageBrowser and the linked applications (RAW Image Task, PhotoStitch, etc.) are to provide compatibility with the EOS-1D Mark III and Windows Vista. No new functions have been added.

### **Dedicated Wireless File Transmitter WFT-E2A**

The Wireless File Transmitter WFT-E2A is a speedier, handier and more flexible evolution of the WFT-E1A. Three communication modes are available: FTP, PTP and HTTP. (Transmission of select images is now possible with the SET button.) It supports IEEE 802.11 b/g and 100 BASE-TX LANs, both wired and wireless. Image transmission is faster than with the previous unit. Its dust- and water- resistance performance is about the same, despite the addition of an extra port. Wireless transmission incorporates a security function. The WFT-E2A is equipped with a USB 2.0 Hi-Speed host interface so that it can be connected to an external medium (such as a USB flash drive, a self-powered portable HDD or a photo storage device) to store images, or, very usefully, to a GPS receiver (including some Garmin and Magellan products—details to be advised).

The new unit is dedicated to the EOS-1D Mark III and gets its power from the camera and the antenna is embedded. The result is a decrease in weight from 165g to 75g and a similar decrease in size. There is an improved connection wizard and the WFT-E2A features easier setting than WFT-E1A.

Because it is a wireless LAN apparatus, the same as the WFT-E1A, the WFT-E2A can be used only in the countries and regions where Canon has acquired relevant licenses. Photographers must obey local regulations where the equipment is used, not purchased.

For example, for outdoor use, the unit is prohibited in France and an approval is required in Italy and Latvia.

WFT-E2, 13 channels available in the following countries: Japan, France, Italy, Germany, UK, Netherlands, Spain, Belgium, Luxemburg, Ireland, Denmark, Greece, Portugal, Austria, Finland, Sweden, Poland, Hungary, Czech, Slovakia, Slovenia, Estonia, Latvia, Lithuania, Cyprus, Malta, Iceland, Norway, Switzerland, Australia, New Zealand, China and Singapore  
WFT-E2A, 11 channels available in the USA and Canada, in addition to the countries listed above.

**Original Data Security Kit  
OSK-E3**

Original Data Security Kit OSK-E3 is an optional accessory with the same original data verification features as the DVK-E2 plus new functions that expand its usefulness. With the EOS-1D Mark III, GPS data can be added to the metadata.

Image data encryption/decryption (secured transmission) is also possible with the EOS-1D Mark III. Designed for press applications, this feature will prevent the wrongful use of images intercepted at public events. With the OSK-E3, the images themselves are encrypted. Encryption of images requires the use of a registered camera and the Original Data Security (OS) card. Decrypting image files on the OS card and viewing or saving them requires user authentication.

The kit consists of the Original Data Security (OS) card, the USB reader/writer, and the dedicated application programs (in the EOS Digital Solution Disk). The OSK-E3 can be used with images taken by the EOS-1D Mark III, EOS-1Ds Mark II, 1Ds, 1D Mark II N, 1D Mark II, 5D, 30D, 20D, and 20Da. The encryption feature can be used only with the EOS-1D Mark III.

**Canon EF 16–35mm  
f/2.8L II USM Lens**

The Canon EF 16–35mm f/2.8L USM is a wide-angle zoom lens covering focal lengths from 16mm upwards that has enjoyed strong support from many professional and high-end amateur users. Many photographers renowned for the technical and aesthetic excellence of their work name this lens as their favorite, the one they would take on a job or journey if they could have just one lens. Some photographers carry two of them on an extended project because it is the one lens they cannot afford to lose. At the same time, there has been strong demand from the market for an improvement in the peripheral image quality in wide-angle shots. In response to this demand, Canon has developed the EF 16–35mm f/2.8L II USM as the successor to the EF16–35mm f/2.8L USM. This is a high-performance L-series lens, specifically designed for improved peripheral image quality in wide-angle shots that will meet the strict requirements of professional and high-end amateur users more successfully than its predecessor.

Its features include:

- L-type wide-angle zoom lens covering the ultra-wide-angle 16–35mm range
- 3 high-precision aspherical lens elements, each of a different type: ground in G1, replica in G2, and GMo in G16, 16 elements in 12 groups, total, giving it even better image quality than its predecessor



- 2 UD lens elements (G12 and G15) minimize lateral chromatic aberration (a wide angle lens design problem) to produce superb image quality with excellent resolution and contrast and little or no color bleed around the outline of the subject
- Lens disposition and coatings optimized to minimize the ghosting and flare that tend to occur when the lens is used with a digital camera
- High resistance to dust and water droplets
- Circular aperture produces beautiful out-of-focus images
- Internal focusing (some elements of the second group, G5 to G7, move for focusing), ring USM, high-speed CPU and new AF algorithms for fast and quiet autofocusing
- Front element does not rotate during focusing and zooming (convenient with polarizer use)
- Manual focusing enabled even during the AF mode (full-time mechanical manual focus)
- Optical system constructed using only lead-free glass
- Uses new EW-88 petal-shaped lens hood
- Slightly larger than previous lens: filter diameter 82mm, was 77mm; length 111.6mm, was 103mm; weight 635g, was 600g

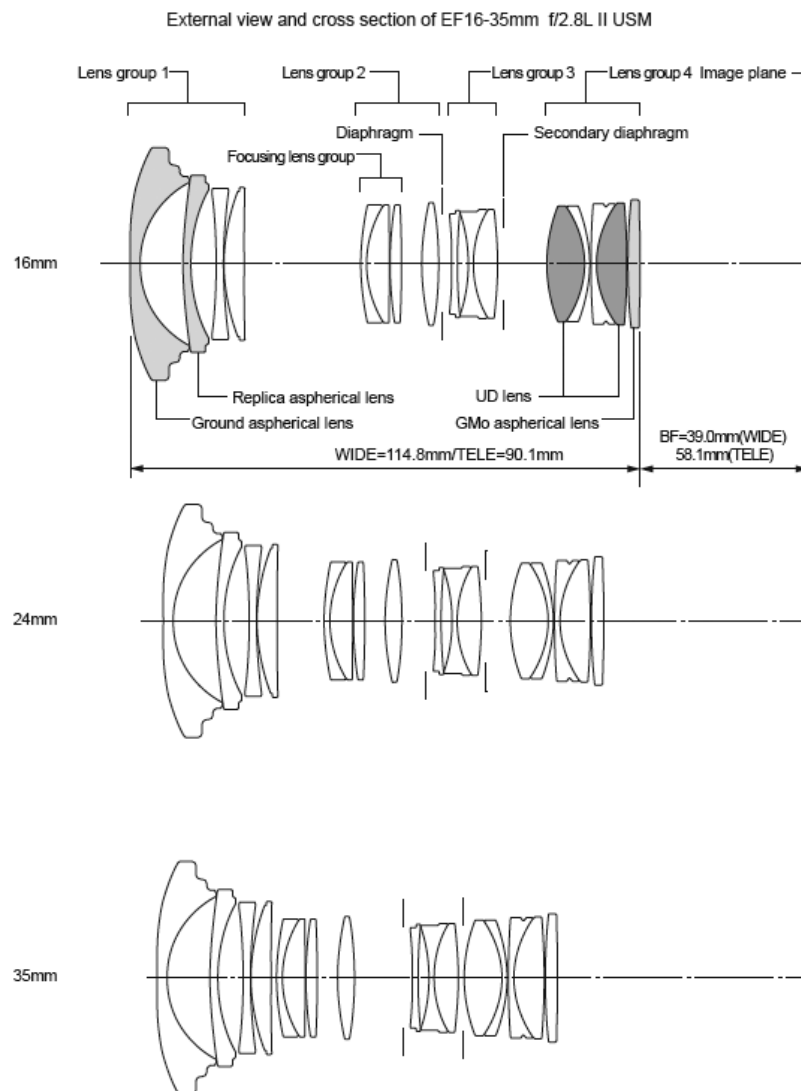

**Canon EOS System  
Compatibility**

The EOS-1D Mark III is compatible with virtually all of the vast Canon EOS System with the exception of EF-S lenses that are designed for smaller sensors. As a practical matter, this means an endless array of new and older equipment is available to buy throughout the world, to rent as necessary, and to borrow from in-house pools. A Canon photographer can always upgrade, downsize, augment or back up as requirements dictate.

**System Chart**

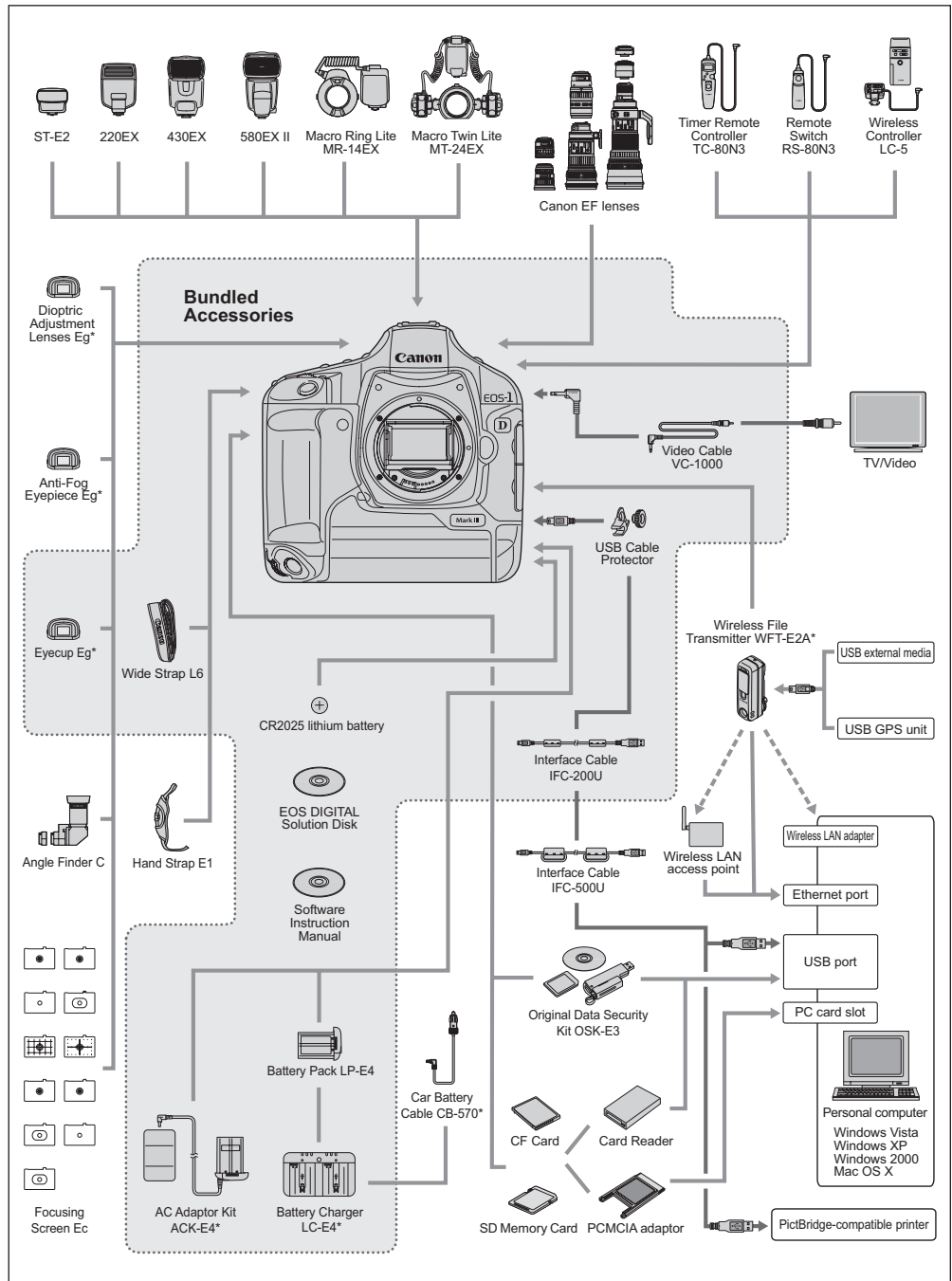

# XI. SPECIFICATIONS

<b>Type of Camera</b>	<p><b>Type:</b> Digital AF/AE SLR</p> <p><b>Recording Medium:</b> CF Card Type I and II, SD/SDHC Memory Card (1 slot each), External media</p> <p><b>Image Size:</b> 1.11 x 0.74 in./28.1 x 18.7mm (APS-H size sensor)</p> <p><b>Compatible Lenses:</b> Canon EF lenses (except EF-S lenses)</p> <p><b>Lens mount:</b> Canon EF mount</p> <p><b>Lens Focal Length Conversion Factor:</b> 1.3x</p>
<b>Image Sensor</b>	<p><b>Type:</b> High-sensitivity, high-resolution, single-plate, CMOS sensor</p> <p><b>Effective Pixels:</b> Approx. 10.10 megapixels</p> <p><b>Total Pixels:</b> Approx. 10.70 megapixels</p> <p><b>Aspect Ratio:</b> 3:2 (Horizontal : Vertical)</p> <p><b>Color Filter System:</b> RGB primary color filters</p> <p><b>Low-pass Filter:</b> Fixed position in front of the CMOS sensor</p> <p><b>Dust Delete Feature:</b> (1) Self Cleaning Sensor Unit, (2) Dust Delete Data, (3) Manual Sensor Cleaning</p>
<b>Recording System</b>	<p><b>Recording Format:</b> DCF 2.0 (Exif 2.21): JPEG, RAW and RAW+JPEG simultaneous recording provided backup image recording enabled (Same image recordable on CF card and SD/SDHC memory card)</p> <p><b>Image Compression:</b> JPEG, RAW (Canon .CR2)</p> <p><b>File size:</b> Large: Approx. 10.1MB (3,888 x 2,592), Medium 1: Approx. 8.0MB (3,456 x 2,304), Medium 2: Approx. 5.3MB (2,816 x 1,880), Small: Approx. 2.5MB (1,936 x 1,288), RAW: Approx. 10.1MB (3,888 x 2,592), sRAW: Approx. 2.5MB (1,936 x 1,288)</p> <p><b>Color Space:</b> Selectable between sRGB and Adobe RGB</p> <p><b>Picture Style:</b> Six preset Picture Style settings plus three user-defined custom Picture Style settings with individual adjustments for Sharpness, Contrast, Saturation, Color tone; Filter effect, Toning effect for black &amp; white images</p> <p><b>Interface:</b> USB 2.0 Hi-Speed, mini-B port. NTSC/PAL for video output</p>
<b>White Balance</b>	<p><b>Settings:</b> Auto, Daylight, Shade, Cloudy, Tungsten Light, White Fluorescent Light, Flash, Custom 1–5, user-set Color Temperature, PC-1 to PC-5 (Total 10 settings)</p> <p><b>Auto White Balance:</b> Auto white balance with the image sensor</p> <p><b>Color Temperature Compensation:</b> White balance bracketing: +/- 3 stops in 1-stop increments, White balance correction: blue/amber bias +/- 9 levels, magenta/green bias +/- 9 levels. When blue/amber bias and magenta/green bias set with White balance correction, white balance bracketing cannot be set together during white balance bracketing.</p>

**Viewfinder** **Type:** Eye-level SLR with fixed pentaprism  
**Coverage:** Approx. 100% horizontally and vertically  
**Magnification:** 0.76x (-1 dpt with 50mm lens at infinity)  
**Eyepoint:** Approx. 20mm  
**Dioptric Adjustment Correction:** -3.0 to +1.0 diopter  
**Mirror:** Quick-return half mirror (Transmission: reflection ratio of 37:63)  
**Viewfinder Information:** AF (AF points, focus confirmation light), Exposure (metering mode, spot metering area, shutter speed, aperture, manual exposure, AE lock, ISO speed, exposure level, exposure compensation, exposure warning), Flash (flash ready, high-speed sync, FE lock, flash exposure level), Image (JPEG recording, RAW recording, shots remaining, white balance correction, memory card information), Battery check  
**Depth-of-Field Preview:** Enabled with depth-of-field preview button  
**Eyepiece Shutter:** Built-in

**Autofocus** **Type:** TTL-AREA-SIR AF-dedicated CMOS sensor  
**AF points:** 19 cross-type AF points (plus 26 Assist AF points)  
**AF Working Range:** EV -1 –18 (ISO 100 at 73°F/23°C)  
**Focusing Modes:** Autofocus (One-Shot AF, Predictive AI Servo AF), Manual Focus (MF)  
**AF point Selection:** Automatic selection; Manual AF point selection: 19 AF points, Inner 9 AF points (C.Fn III-9-1), Outer 9 AF points (C.Fn III-9-2)  
**Selected AF point Display:** Superimposed in viewfinder and on LCD panel  
**AF-assist Beam:** None. Emitted by EX-series Speedlite

**Exposure Control** **Metering Modes:** 63-zone TTL full aperture metering. 1. Evaluative metering (linkable to all AF points); 2. Partial metering (approx. 13.5% of screen); 3. Spot metering (approx. 3.8% of screen): Center spot metering, AF point-linked spot metering, Multi-spot metering (max. 8 spot metering entries); 4. Centerweighted average metering  
**Metering Range:** EV 0–20 (ISO 100 at 73°F/23°C with EF 50mm f/1.4 USM lens, ISO 100)  
**Exposure Control Systems:** Program AE (shiftable), Shutter speed-priority AE, Aperture-priority AE, E-TTL II program AE (Evaluative flash metering, Averaged flash metering), Manual  
**ISO Speed Range :** Equivalent to ISO 100–3200 (in 1/3-stop or whole stop increments), ISO speed can be expanded to ISO 50 and 6400 (Standard Output Sensitivity. Recommended Exposure Index)  
**Exposure Compensation:** AEB: +/-3 stops in 1/3- or 1/2-stop increments; Bracketing methods: 1. Shutter speed-priority AE, 2. Aperture-priority, 3. Program AE, 4. Manual: +/-3 stops in 1/3-stop or 1/2-stop increments  
**AE Lock:** Auto: Applied in One-Shot AF mode with evaluative metering when focus is achieved; Manual (user-set): By AE lock button in all metering modes

<b>Shutter</b>	<p><b>Type:</b> Vertical-travel, mechanical, focal-plane shutter with all speeds electronically controlled</p> <p><b>Shutter Speeds:</b> 1/8000 to 30 sec. (1/3-stop increments), X-sync at 1/300 sec.</p> <p><b>Shutter Release:</b> Soft-touch electromagnetic release</p> <p><b>Self-Timer:</b> 10 sec. delay, 2 sec. delay</p> <p><b>Remote Control:</b> N3 type terminal</p>
<b>External Speedlite</b>	<p><b>EOS External Flash or Dedicated Speedlite:</b> E-TTL II autoflash with EX Series Speedlites</p> <p><b>PC Terminal:</b> Provided</p>
<b>Drive System</b>	<p><b>Drive Modes:</b> Single, silent, high-speed continuous (approx. 10 fps), low-speed continuous (approx. 3 fps), 10- or 2-sec. self-timer</p> <p><b>Continuous Shooting Speed:</b> Approx. 10 fps (at a shutter speed of 1/500 sec. or faster in all recording modes)</p> <p><b>Max. Burst During Continuous Shooting:</b> JPEG: approx. 110 frames (Large/Fine); RAW: approx. 30 frames; RAW+JPEG: approx. 22 frames (Large/Fine)</p>
<b>LCD Monitor</b>	<p><b>Type:</b> TFT color, liquid-crystal monitor</p> <p><b>Monitor Size:</b> 3.0 in.</p> <p><b>Pixels:</b> Approx. 230,000 pixels</p> <p><b>Coverage:</b> Approx. 100%</p> <p><b>Brightness Control:</b> 7 levels provided</p>
<b>Playback</b>	<p><b>Image Display Format:</b> Single image, 4-image index, 9-image index, Jump, Magnified zoom (approx. 1.5x to 10x), Histogram, Auto rotate, Rotate</p> <p><b>Highlight Alert:</b> In the single image display and (INFO) display, the highlight areas with no image data will blink</p>
<b>Image Protection and Erase</b>	<p><b>Protection:</b> Single image, all images in a folder, or all images in the memory card can be protected or cancel the image protection</p> <p><b>Erase:</b> Single image, all images in a folder, all images in the memory card or check-marked images can be erased or unprotected.</p> <p><b>Direct Printing from the Camera:</b> Enabled</p> <p><b>Compatible Printers:</b> CP and SELPHY Compact Photo Printers, PIXMA Photo Printers and PictBridge compatible printers (via USB Interface Cable IFC-400PCU)</p> <p><b>Settings:</b> Print quantity, style (image, paper size, paper type, printing effects, layout, date, file number), trimming</p>

**Sound Recording** **Recording Method:** The voice annotation recorded with the built-in microphone is attached to the image  
**File Format:** WAV  
**Recording Time:** Max. 30 sec. per recording

**Menus** **Menu Categories:** 1. Shooting, 2. Playback, 3. Setup, 4. Custom function/My Menu  
**LCD Monitor Languages:** 18 (English, German, French, Dutch, Danish, Portuguese, Finnish, Italian, Norwegian, Swedish, Spanish, Greek, Russian, Polish, Simplified/Traditional Chinese, Korean, Japanese)

**Power Source** **Battery:** One dedicated lithium-ion battery LP-E4, AC power can be supplied via the AC Adapter Kit ACK-E4  
**Battery check:** Automatic  
**Power Saving:** Provided. Power turns off after 1, 2, 4, 8, 15, 30 min.  
**Back-up Battery:** One CR2025 lithium battery

**Dimensions (W) x (H) x (D):** 6.1 x 6.2 x 3.1 in./156 x 156.6 x 79.9mm  
**Weight (Body only):** 40.7 oz./1,155g

#### Dimensions and Weight

**Operating Temperature Range:** 32–113°F/0–45°C  
**Operating Humidity Range:** 85% or less

#### Operating Conditions

All the specifications above are based on Canon's testing standards. The camera's specifications and physical appearance are subject to change without notice.

## XII. CONCLUSION

The EOS-1D Mark III is the ultimate instrument for high pressure, high-speed photography, and it can do much, much more. It has the image quality, the ease of control, the speed and the flexibility to adapt brilliantly to just about any condition. Features such as the new integrated cleaning system make it easier to live with. With Live View, the possibilities are limited only by the imagination. The Dual DIGIC III Image Processors give it dazzling speed and the 14-bit output will help to make superb prints and magnificent magazine spreads. The battery data is a source of reassurance. Additions such as safety shift, high-light tone priority and high ISO noise reduction make stress-free success a given.

The retail price of the EOS-1D Mark III at introduction will be very similar to the price at which the EOS-1D Mark II N debuted. Considering all the improvements and meaningful new functions, the new camera is a stunning deal whether it replaces or adds to existing equipment, or represents the beginning of a great new adventure.

DSLR cameras are mature products today; people in the market for one have clear expectations and requirements. Looking forward, it seems that the EOS-1D Mark III has everything most working photographers could want for years to come: the best autofocus, the lowest noise and the best high ISO performance, beautiful color and excellent resolution, ease of use and thoughtful controls, exceptional reliability, an extensive system, highly controllable flash, and a little less weight, too.

Because the value and the performance are so strong, Canon can expect to sell the EOS-1D Mark III to serious photographers of every stripe. Certainly, they will grow even more delighted with the camera over time.

<sup>3</sup> Actual prices are set by dealers and may vary.

Contents ©2007 by Canon U.S.A., Inc. All Rights Reserved. Canon, EOS, DIGIC, PIXMA and SELPHY are registered trademarks of Canon Inc. in the United States, and may also be registered trademarks or trademarks in other countries. All other products and brand names are registered trademarks, trademarks or service marks of their respective owners.

Excerpts from this material may be quoted in published product reviews and articles. For further information, please contact Canon U.S.A., Inc. Public Relations Dept., (516) 328-5000