

Apothecary's Cabinet

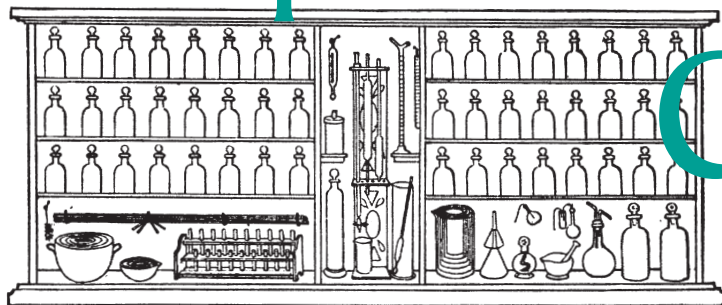

No. 10, Fall 2006

News and Notes from the American Institute of the History of Pharmacy

Preparing and Dispensing Prescriptions during the Civil War Era

by Guy R. Hasegawa*

INTEREST in the Civil War era seems unending. For most students of American history, the period's political and military aspects take center stage, while the more mundane facets of life are overlooked. How, for example, was everyday pharmacy practiced? A thorough answer to this question would occupy much more space than is available here, so this article goes no further than the basics of dispensing simple oral medications in American pharmacies. Although pharmacy has changed tremendously since the mid-1800s, some of the challenges that pharmacists faced then still exist today.

Drug Supplies

Although some prescriptions might call for just a single item kept by pharmacists in ready-to-dispense form, most required some manipulation of ingredients. A vital preliminary to dispensing a proper prescription was making sure that the ingredients were of appropriate quality. Pharmacists—and physicians who prepared and dispensed their

own drugs—generally purchased raw materials from wholesalers or importers. There was no effective regulation of drugs, so conscientious pharmacists learned to discern acceptable items from those that were of poor quality, mislabeled, or adulterated. The experienced pharmacist, for example, could often tell potent from sub-potent vegetable drugs and was on the lookout for substances used surreptitiously to dilute expensive items. Military personnel who dispensed drugs—surgeons and hospital stewards—generally received their goods from supply officers called medical purveyors but sometimes had to obtain items locally from wholesalers or pharmacies.

Raw drugs often required grinding or conversion into standard

intermediate forms that were used in prescriptions. Dried, crushed bark, for example, could be treated with water to form an infusion or decoction, or with alcohol to form a tincture. These forms could be concentrated by the application of heat to form fluid extracts, which could be further concentrated to form solid extracts.

The Written Prescription

Civilian prescriptions were frequently written on any handy piece of paper. Other than the date and patient's name, which often did not appear, and the physician's signature or initials, the prescription typically had four parts. First was the super-prescription, which consisted of the ab-

The American Institute of the History of Pharmacy is a unique organization dedicated to the preservation of pharmacy's heritage. The Apothecary's Cabinet is a publication from AIHP that takes a popular look at the history of pharmacy in its many facets.

THIS PUBLICATION IS FUNDED IN PART BY THE AIHP PHARMACY EDUCATION FUND.

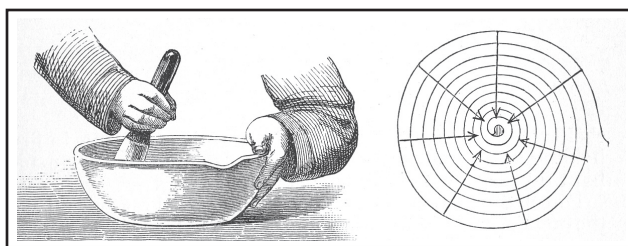

In trituration, the pestle was worked in a circular motion from the center of the mortar outward and then in the opposite direction back toward the center (Coblentz, page 121).

abbreviation *Rx* for the Latin word *recipe*, meaning “take thou.” This was the beginning of instructions to the pharmacist. Second was the inscription, which listed the ingredients and amounts for the entire batch that was to be prepared—say, for a dozen pills. Third was the subscription, or directions for combining and dividing the preparation (e.g., “mix and divide into 12 pills”), and fourth was the signatura, which indicated the directions for use (e.g., “one pill four times a day”).

The inscription and subscription were typically written in Latin, and numbers in the inscription were indicated in lower case Roman numerals after the abbreviations for the units of weight or measure. For example, “4 grains” was written as “gr. iv.” (This convention is not followed in the remainder of this article.) Latin was considered the universal language of science, so a properly written prescription could theoretically be understood by any competent pharmacist in Europe or the United States. Moreover, Latin names for medicines were distinctive and similar, if not identical, throughout the “civilized world.” According to Joseph Remington, it was “frequently necessary, and always advisable, to withhold from a patient the names and properties of the medicinal agents administered,” and using Latin terms usually accomplished this. Since the directions for use would have to be communicated to the patient, prescribers were less concerned about whether patients

could read the signatura and often wrote that section of the prescription in English.

The physician, if a purist, would write the ingredients in a predetermined order. First would be the basis, or the most important therapeutic agent. Second would be an adjuvant, a component that made the body more susceptible to the actions of the basis or gave the basis a specific direction. Third would be a corrective, which was meant to lessen or remove undesirable properties of the basis or adjuvant. Fourth would be the excipient, a component that ensured the proper incorporation of the other ingredients. Fifth would be the diluent, which by increasing the preparation’s volume, allowed for its safer or more convenient administration. Not all prescriptions contained all five types of component, and for practical purposes, the order in which the ingredients were listed mattered little, because it had nothing

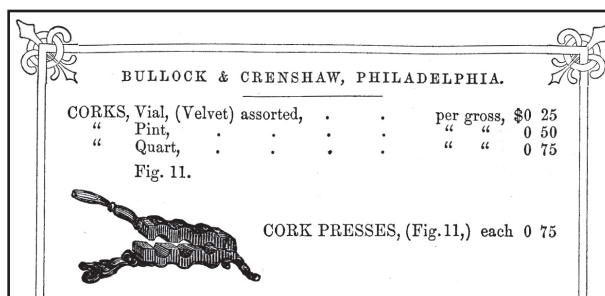

Bullock & Crenshaw of Philadelphia offered a cork press in their catalog for \$.75 in 1857. (Courtesy AIHP Kremers Reference Files.)

to do with how they were actually mixed. Excipients and diluents, even if they were needed in the finished formulation, were often omitted from the written prescription, and their choice was left to the judgment of the pharmacist.

Weights and Measures

The writing and preparation of prescriptions employed the apothecary system of weights and measures.

Apothecary's Cabinet • No. 10, Fall 2006 ISSN 1534-4509

Editor: Gregory J. Higby

Assistant Editor: Elaine Condouris Stroud

Publisher: American Institute of the History of Pharmacy, located at the University of Wisconsin School of Pharmacy,

777 Highland Ave., Madison, Wisconsin 53705-2222 Phone (608) 262-5378, email AC@aih.org; www.aihp.org.

THE AMERICAN INSTITUTE OF THE HISTORY OF PHARMACY is incorporated under Wisconsin statute 180 as a non-profit organization devoted to advancing knowledge and understanding of the place of pharmacy in history. It publishes *Pharmacy in History*, *Apothecary's Cabinet*, occasional monographs, and pamphlets; it fosters humanistic teaching in pharmaceutical education; confers awards for outstanding achievement in its field; sponsors historical meetings and exhibits; collects and preserves source materials; and serves as a center for research and information.

PUBLICATION PRICES: *Apothecary's Cabinet* is distributed free of charge to schools of pharmacy upon request. This and other publications of the AIHP may be obtained through membership (\$50 per year for individuals, \$100 for institutions); individual copies of *Apothecary's Cabinet* are \$2.00.

(The metric system existed but was not widely used at the time in the United States.) Apothecary weight units included the Troy grain (gr.), scruple (℥), drachm (ʒ), ounce (℥), and pound (℔) (20 gr. = 1 ℥, 3 ℥ = 1 ʒ, 8 ʒ = 1 ℥, and 12 ℥ = 1 ℔). Although some expensive apothecary weight sets contained weights up to 2 ℔, the heaviest apothecary weight in the sets used by most pharmacists was 2 ʒ, and if that was insuf-

weights.) Medical purveyors in the United States Army used a pound that was equivalent to 16 ℥ (7680 gr.) and thus differed from the apothecary pound (5760 gr.) and the avoirdupois pound (7000 gr.).

A well-equipped pharmacy might contain one or two fine stationary balances encased in glass for protection from dust and moisture. Hand-held balances, although generally less reliable, were commonly

measure) (60 ℥ = 1 ℥, 8 ℥ = 1 ℥, 16 ℥ = 1 O, 8 O = 1 Cong.). Although pharmacies sold marked glasses that patients could use to measure their doses in apothecary volumes, physicians frequently prescribed doses in less formal units; a drop, teaspoonful, dessertspoonful, tablespoonful, wineglassful, and teacupful were very roughly equal to 1 ℥, 1 ℥, 2 ℥, 4 ℥, 2 ℥, and 4 ℥ (1 gill), respectively.

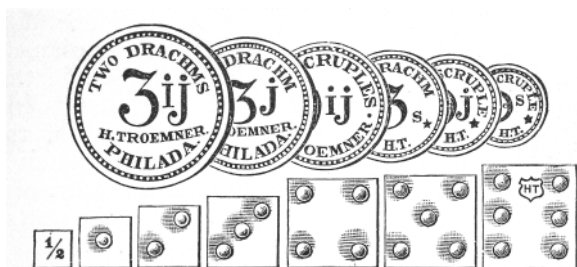

Brass apothecary weights, ranging from 0.5 grain to 2 drachms (Coblentz, page 31).

ficient for the prescription at hand, the pharmacist employed avoirdupois weights, which were also based on the Troy grain (27.34 gr. = 1 drachm [dr.], 16 dr. = 1 ounce [oz.], and 16 oz. = 1 pound [lb.]). A pharmacist wanting to weigh 1 ℥ (480 gr.), for example, would use a 1 oz. avoirdupois weight (437.5 gr.) plus a 2 ℥ apothecary weight (40 gr.) to arrive at an approximation (477.5 gr.) of the desired weight. Avoirdupois weight was also used for measuring bulk quantities. (The ounces and pounds commonly used in the United States today are avoirdupois

used when portability was a must, as was often the case for physicians who prepared their own medicines and for military medical personnel on the move. Large, relatively crude balances were used for weighing bulk quantities.

Apothecary volumes (measures) were comparatively simple; some are commonly used today. Pharmacists used graduates marked in minims (℥), fluidrachms (℥), or fluidounces (℥) and larger measuring devices for pints (O, for *octarius*, an ancient Roman measure) and gallons (Cong., for *congius*, another Roman

Interpreting the Prescription

Upon receipt of a prescription, the conscientious civilian pharmacist made sure to regard the slip with apparent seriousness and confidence while in view of the patient. Any doubts about the meaning or appropriateness of the prescription were to be concealed until the pharmacist could retreat behind the counter, since a quizzical look or a shake of the head might raise a doubt in the patient's mind about the competence of the prescriber. If the writing could not be deciphered or if it seemed to indicate an erroneous order, the physician was contacted, or the prescription was filled in a manner that the pharmacist considered safe or correct.

"The reading of a prescription," said Edward Parrish, "frequently requires more skill and judgment than *compounding* it." A pharmacist identified only as "Apothecary" wrote in the *American Medical Times* about the difficulties that he and his colleagues faced in interpreting written prescriptions:

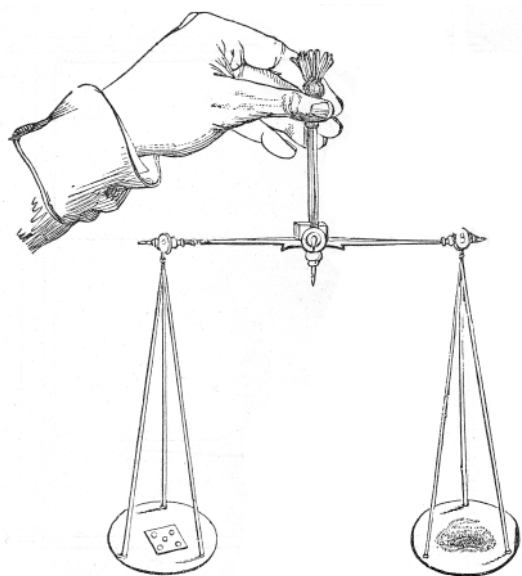

Hand-held balance (Parrish, page 42).

What doctor would willingly accept a promissory note, illegibly written on the margin of a newspaper, on a scrap of envelope, or on a dirty blue tobacco wrapper? and yet each of these, in medical hands, has played the important part of prescription-bearing. . . . Prescriptions often degenerate into mere arbitrary ciphers, a series of crotchets and quavers [quarter and eighth notes, respectively, in music notation], that leave to the imagination of the apothecary an open scale from aq. font. [aqua fontana, or spring water] to aq. fort. [aqua fortis, or nitric acid]. The quirks and squirms intended to characterize drachms are embellished into ounces, and those intended for ounces are curtailed to drachms. . . . [I have] received prescriptions so confusedly crowded on a shapeless bit of paper, as to have suggested even to the mind of the physician writing them, the necessity

for a verbal explanation through the patient to the apothecary, of what he (the physician) had written, and in other cases, what he omitted to write for want of room.

Preparing the Prescription

Medications prepared in drug-stores were delivered or handed directly to patients. In military hospitals, written prescriptions were taken to the pharmacy, and the finished medicines, many of which required compounding, were sent to the ward for administration by hospital stewards or nurses. In the field, it was common for surgeons to order single doses of medicines to be measured and administered on the spot. Many such doses, such as mercury pills, were pre-made.

While the compounding of some prescriptions required only the accurate measurement and simple mixing of ingredients, others called on the pharmacist to employ a good deal of experience, knowledge, skill, and art. Diluents and excipients, for example, had to be chosen so that they would not react in an undesirable way with the prescribed drug. A pharmacist was expected to produce a therapeutically acceptable and

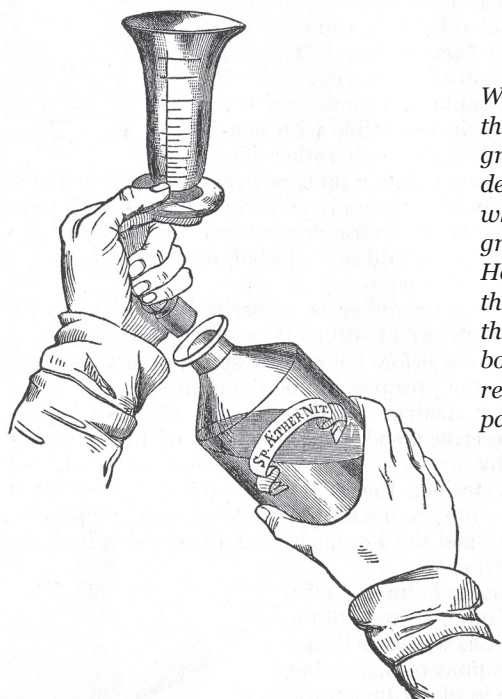

When measuring a liquid, the base of the graduate was grasped with the thumb and index finger and held at eye level, while the bottle stopper was grasped with the little finger. Holding the stopper kept it and the counter clean and reminded the pharmacist to close the bottle immediately after use and return it to the shelf (Parrish, page 808).

pharmaceutically elegant preparation, in many cases without having worked before with the combination of ingredients and quantities specified in the prescription.

Other than measuring devices, mortars and pestles were perhaps the most versatile and commonly used pharmacy implements. Large metal mortars and pestles, for instance, were employed for contusion, the pounding and beating of chopped, dried vegetable drugs into finer particles; this hard and tedious work was usually assigned to an apprentice. Smaller Wedgwood or porcelain models were used to reduce substances into powders (a process called trituration), mix powders, dilute powders in fluid, and prepare pill masses and ointments. A variety of spatulas was kept on hand for use with mortars and pestles, removing solid drugs from bottles, weighing, and other applications. Many physicians and military pharmacists performed only simple pharmaceutical operations, and they might have no implement more complex than a pill machine (described below). Processes such as distillation and evaporation required additional apparatus and a relatively spacious

and permanent work facility.

Oral Liquids

The preparation of oral liquids might require only the measuring of a pre-made tincture or the simple mixture of fluid ingredients. On the other hand, it might require the dissolving of a solid, and if the solvent was not specified, the pharmacist had to select one that was compatible and palatable. Solids that were not easily soluble might have to be ground in a mortar to a fine powder to increase their surface area. The solvent was often added directly to the mortar while the pestle was used to stir. Insoluble solids necessitated the preparation of a suspension or emulsion.

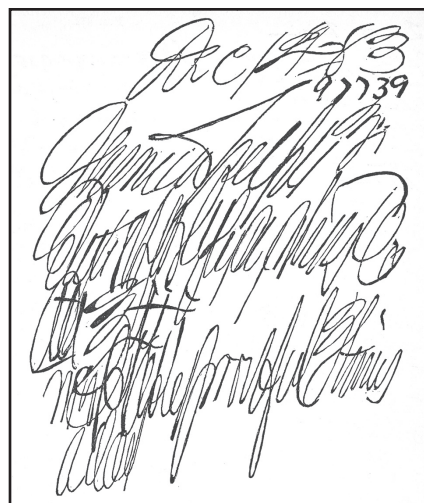

"A prescription which illustrates the evils of a flourishing style. . . . Whilst it was not difficult of interpretation to those familiar with the physician's method, it proved to be a puzzle to the inexperienced." (Remington, page 921).

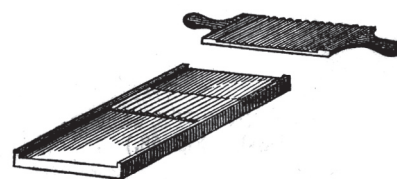

Brass and wood pill machines were advertised by Bullock & Crenshaw in their 1857 catalog. (Courtesy AIHP Kremers Files.)

Liquids were dispensed in corked glass vials or bottles. To stopper a vial or bottle, a cork was soaked in water for a few minutes, squeezed in a cork press, and pushed into the neck. The cork was sometimes covered with paper, tin foil, or kid leather, which was secured with string tied around the vial or bottle neck. Not only did this procedure add a touch of elegance, it served at a sort of tamper-proof seal. In tying, said Remington, "A knot with short ends . . . is less likely to be interfered with by a messenger, on account of difficulty of retying it." A label was pasted to the vial or tied to the vial's neck. Tying was preferred in the military, because used bottles were collected, washed, and reissued, and pasted labels could be hard to remove. Labels ideally contained the patient's name and directions for use. Although the constituents of the prescription were not indicated on civilian labels, they were included on military labels if the medication was to be given by a caregiver.

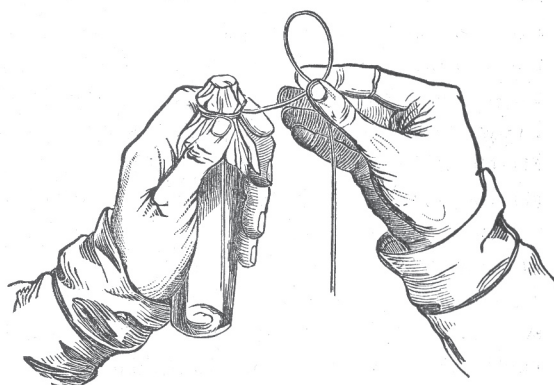
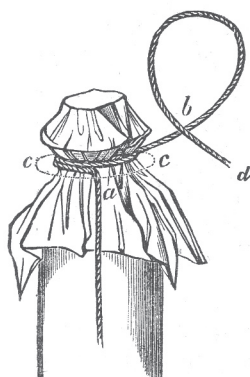

Covering the cork and tying a knot on a vial (Mohr, Redwood, Procter, page 430).

Oral Solids

It was common to dispense oral solids as powders, with each dose individually packaged in a folded paper; compressed tablets and capsules were uncommon. The ingredients for the entire prescribed batch of powder were combined, and the mixture was divided into the requisite number of doses. Each dose was placed on a piece of paper, which was folded and put in an envelope or box for dispensing. The patient unfolded the paper, emptied the powder into water or some other fluid, and drank it.

Administration of oral medications as powders might be impossible (e.g., if all the ingredients were not in dry form) or undesirable (e.g., if the powder was unpalatable when mixed in fluid). In such cases, pills were often prescribed. Pills were made by mixing dry or semisolid constituents with a binder to create a mass resembling cookie dough, which was then divided into the required number of doses. Among the common dosage forms prepared by pharmacists, pills could be the most

challenging to compound properly. Since prescriptions for pills might not specify the excipients or diluents, the pharmacist had to select constituents to make a pill mass of appropriate moistness, hardness, and cohesion. Furthermore, the order and manner in which the ingredients were mixed could be vital, and knowledge of these factors was often acquired only by experience. Common excipients included honey, syrup, alcohol, and bread crumbs.

Pill ingredients were usually mixed with a mortar and pestle or with a spatula on the surface of a pill tile. The tile, typically made of porcelain, often had a ruler-like scale with every sixth mark numbered;

at every scale mark. If many pills were to be made, the pharmacist could employ a pill machine, which consisted of a flat wooden base, into which was set a series of parallel metal grooves that were semicircular in cross section, and a separate wooden slat with matching grooves. The pill cylinder was placed on the base at the edge of and perpendicular to the grooves, the slat was placed so that its grooves matched those of the platform, and when the pharmacist slid the grooves together, the pill cylinder was cut into equal parts that fell into a trough at the end of the base. "In the U.S. Army laboratories," said Parrish, "immense numbers of pills are made with these machines by female operatives."

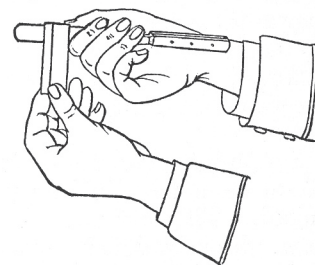
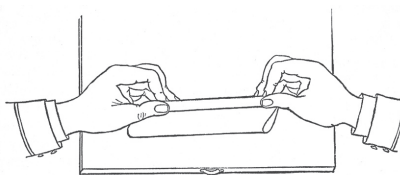

Folding a powder paper (left) and creasing the end folds (Remington, page 954).

pills were commonly prescribed in multiples of six. The mass was rolled with a spatula into a cylinder until it reached from the zero mark on the tile's scale to the number that represented the prescribed number of pills. The pharmacist then cut the cylinder with the edge of the spatula

Whether the pill cylinder was cut on a pill tile or a pill machine, the resultant pieces were rolled into spheres, usually between the fingers. A pill finisher or pill roller was a flat-surfaced tool that could also be used to roll the pieces against the pill tile to form spheres. The pills were often

dusted with powder (e.g., powdered licorice root, sifted arrowroot) to prevent them from sticking to each other, and were set aside to dry.

If a pill's taste was especially vile, even when swallowed quickly, it could be coated with a substance (e.g., gelatin) to conceal the taste. The same purpose could be accomplished by coating the pills with silver or gold. This was done by placing moist undusted pills with a few pieces of silver or gold leaf into a pill silverer, an apparatus that formed a hollow sphere when assembled. A few shakes of the silverer would result in metal-covered pills. Pharmacists realized that coating pills might prevent their absorption in the gastrointestinal tract.

Pills made in bulk for later dispensing were stored in a glass bottle, and those for a specific prescription were usually dispensed in a two-part, flat cylindrical pill box, which was labeled.

Pharmacist Department

Parrish included in his pharmacy textbook some suggestions, many of which would not be out of place today, for desirable behavior in the pharmacy. For example:

- Never put up an article without you are certain it is right.
- Every person entering the store, whether pauper or president, infant or adult, white or colored, must be treated with courtesy and kindness.
- Boisterous mirth and sullen temper are to be equally avoided as productive of neither business nor business character.
- There are to be no masters and no servants. All useful employment is honorable. Indolence is a disgrace.

Pharmacists and physicians collaborated in concealing from patients the nature of their prescriptions. According to Remington,

An apothecary has no right to reveal to a patient the character or medicinal effect of the ingredients which enter into a prescription. When the names of the ingredients . . . are persistently demanded by the patient, the dispenser can [state] that it is a breach of etiquette

to reveal the character of the ingredients, and . . . that it shows a lack of confidence in the prescriber on the part of the patient. . . . The pharmacist . . . is ethically bound to sustain [the physician] and cheerfully co-operate with him.

Pharmacy leaders like Parrish promoted professional behavior, yet pharmacy, like medicine, was commonly considered a trade rather than a profession. There were few pharmacy schools, and most pharmacists were not pharmacy graduates. The probability that professional deportment was not universal is suggested by the following remarks from William Procter's American edition of Mohr and Redwood's 1849 pharmacy textbook:

The dispenser who licks the lip of the syrup-bottle, after pouring out what he requires; who removes any foreign body from a mixture by putting his finger into it, or puts a cork between his teeth to soften it and make it fit the mouth of a bottle, might be compared to an ill-bred person, who, at meal-time, drinks from the decanter, helps himself to salt with his fingers, or cuts bread from the loaf with a knife which has just been in his mouth. He who prepares the dose for the sickly, and often fastidious patient, should be especially careful that he add no repulsiveness to that which, of necessity, belongs to the prescribed remedy.

Conclusion

Compared with their modern counterparts, dispensing pharmacists of the Civil War era were more concerned with obtaining drugs of adequate quality, dealing with confusing units of weight, and spontaneously compounding relatively complex formulations. Pharmacists of the period kept patients in the dark about the nature of their prescriptions. Like today's pharmacists, however, those of the mid-1800s handled illegible and irrational prescriptions and had to draw on a considerable store of drug knowledge to ensure that patients received the most useful form of prescribed medicine.

References and Suggested Reading

"Apothecary." *Medical Prescription Writing*. *Am. Med. Times* (1862) 5:220-221,

letter.

Coblentz, V. *Handbook of Pharmacy*, 2nd ed. (Philadelphia: P. Blakiston, Son & Co., 1897).

Hasegawa, G. R. "Pharmacy in the American Civil War," *Am. J. Health-Syst. Pharm.* (2000) 57: 475-89.

Mohr, F., Redwood, T., Procter, W. *Practical Pharmacy* (Philadelphia: Lea and Blanchard, 1849).

Parrish, E. *A Treatise on Pharmacy*, 3rd ed. (Philadelphia: Henry C. Lea, 1867).

Pereira, J. *Physicians' Prescription Book*, 14th ed. (Philadelphia: Lindsay and Blakiston, 1865).

Remington, J. P. *The Practice of Pharmacy: A Treatise* (Philadelphia: Lippincott, 1886).

Smith, G. W. *Medicines for the Union Army* (Madison, WI: American Institute of the History of Pharmacy, 1962).

Wood, G. B., Bache, F. *The Dispensatory of the United States of America*, 11th ed. (Philadelphia: Lippincott, 1858).

Woodward, J. J. *The Hospital Steward's Manual* (Philadelphia: Lippincott, 1862).

*Senior Editor, *American Journal of Health-System Pharmacy*, American Society of Health-System Pharmacists, 7272 Wisconsin Avenue, Bethesda, MD 20814

Based on a lecture presented at the 13th National Convention of the Society of Civil War Surgeons, Chattanooga, Tennessee, 25 March 2006.

What Is It?

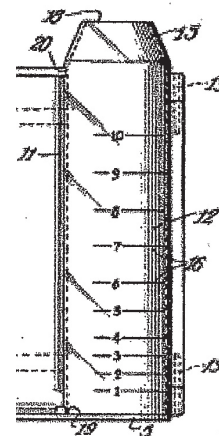

For explanation, see page 14.

Apothecary's Cabinet Author and Title Index (No. 1-10)

(Articles are listed by both author and title, with author names in *italics*. Notes and other items without authors are listed separately. The issue number is listed first in **bold**, followed by the page numbers.)

- AIHP Celebrates 60 Years (note) (2:6)
Ali, Monica and Warren, Flynn, Edwin W. Grove, Pharmacist, Entrepreneur, and Host to the Rich and Famous (6:9-10)
 Boom and Bust: Sassafras (8:9), *Cowen, David L.*
 Century of Change: The Coming of Miracle Drugs (2:1-5), *Swann, John P.*
 Cigarette Cards (3:4), *Helfand, William H.*
 Collecting Pharmaceutical Antiques (3:1-3), *Harris, Michael and Richardson, Charles*
Cowen, David L., Boom and Bust: Sassafras (8:9); History of Pharmacy and the History of the South (6:1-5); Industrial Origins and Pharmacy (5:10); Le Coquetier (1:13); Swallowing the Pill (4:6); The Drugstore and the Telephone (3:11); Tying the Knot—*Secundum Artem* (2:13)
 Decorative Style in American Pharmacy (note) (2:6)
Drachms & Scruples: apothecary (1:14); avoidupois (2:14); boluses (7:14); bougies (7:14); cements (7:14); cerate (2:14); collodions (7:14); cones, medicated (8:15); confection [O.E.D.] (2:14); confections (6:14); congius (2:14); cucufa (5:14); drachm (1:14); dragées (5:14); draughts (5:14); drops (6:14); drug (1:14); electuaries (6:14); elixirs (3:14); emulsions (6:14); extracts (3:14); fluidglycerates (6:14); fomentations (6:14); grain (2:14); magmas (4:14); menstruum (2:14); milks (4:14); moxa (8:15); mull (2:14); pasta (3:14); pearls (4:14); pencils (4:14); pharmacist (1:14); scruple (1:14); spasmadraps (5:14); tablets (9:14); tincture (2:14); wafers (9:14)
 Drugs for Feudal Japan—A Woodcut (7:7-9), *Sonnedecker, Glenn*
 Drugstore and the Telephone (3:11), *Cowen, David L.*
 Early Drug Wholesalers, (2:8-9), *Higby, Gregory J.*
 eAuctions and Pharmaceutical Antique Collecting—eCaveat Emptor (4:1-4), *Palmieri, Anthony, III*
 Edwin W. Grove, Pharmacist, Entrepreneur, and Host to the Rich and Famous (6:9-10), *Ali, Monica and Warren, Flynn*
 Emergence of American Pharmacy (3:7-10), *Higby, Gregory J.*
 Essay on "History" (4:12-13), *Zellmer, William*
 Evolution of Drug Containers (8:5-8), *Griffenhagen, George*
 Formation and Early Work of the Drug Laboratory, USDA Bureau of Chemistry (9:1-9), *Swann, John P.*
 Glass Label Bottles in Pharmacy (note), (1:11)
 Greenies at Home (1:9), *Helfand, William H.*
Griffenhagen, George, Evolution of Drug Containers (8:5-8); Philatelic Practicing Pharmacists (7:11-13); Philatelic Recognition of History of Pharmacy (1:6-8)
Harris, Michael R., A Note on Historical Plague Prevention (10:8-9)
Harris, Michael and Richardson, Charles, Collecting Pharmaceutical Antiques (3:1-3)
Hassegawa, Guy R., Preparing and Dispensing Prescriptions during the Civil War Era (10:1-6)
 Headline: Lewis & Clark Bought Imported Drugs! (8:1-4), *Higby, Gregory J.*
Helfand, William H., Cigarette Cards (3:4); The Greenies at Home (1:9); New York Quinine and Chemical Works (5:9); Nineteenth-Century Manufacturing Promotion (4:10); Parson's Purgative Pills (7:6); Sears Roebuck & Co. (6:11); Smoke Ball Cure (2:7)
Higby, Gregory J., Early Drug Wholesalers, (2:8-9); Emergence of American Pharmacy (3:7-10); A Pioneer Herbal Drug: The Early History of American Ginseng (5:1-6); Headline: Lewis & Clark Bought Imported Drugs! (8:1-4); Pharmacy in the American Century (1:1-5)
 History of Pharmacy and the History of the South (6:1-5), *Cowen, David L.*
 Industrial Origins and Pharmacy (5:10), *Cowen, David L.*
 Le Coquetier (1:13), *Cowen, David L.*
 New York Quinine and Chemical works illustration (5:9), *Helfand, William H.*
News and Notes: 125 Years of Pharmacy (Oswald's Pharmacy, Naperville, Illinois) (2:11); Approximate Measures (4:5); Harper's Weekly Cartoon (4:5); How to make colored water in show globes (3:6); International Congress on the Iconography and Cult of Saints Cosmas and Damian (10:12); New Orleans Pharmacy Museum (6:6-7); New UW-Madison Pharmacy Building (3:13); Pharmacy Compounding Museum (2:10); Pharmacy Education in 1910 (3:5); Salk Exhibit at University of Pittsburgh Pharmacy Museum (1:10); Youngken Herbarium Donated to American Botanical Council (2:10)
 Nineteenth-Century Manufacturing Promotion (4:10), *Helfand, William H.*
 A Note on Historical Plague Prevention, *Harris, Michael R.* (10:8-9)
Obos, Lee Anna, Throop Pharmacy Museum (5:7-8)
Palmieri, Anthony, III, eAuctions and Pharmaceutical Antique Collecting—eCaveat Emptor (4:1-4)
Parrish, Edward, "What is in a Name" Edward Parrish on the Profession of Pharmacy (1866) (7:5)
 Parson's Purgative Pills (7:6), *Helfand, William H.*
 Pharmacy and Exploration (4:7-8), *Stroud, Elaine C.*
 Pharmacy in the American Century (1:1-5), *Higby, Gregory J.*
 Pharmacy over the Moon (4:8-9), Staiger, Christiane
 Philatelic Practicing Pharmacists (7:11-13), *Griffenhagen, George*
 Philatelic Recognition of History of Pharmacy (1:6-8), *Griffenhagen, George*
Pinchak, Frank, William Jennings Bryan, Clarence Darrow, and Pharmacist F. E. Robinson (10:9-12)
 Pioneer Herbal Drug: The Early History of American Ginseng (5:1-6), *Higby, Gregory J.*
 Pioneer Village Apothecary Shop (Spring Mill State Park, Mitchell, IN) (8:11-12), *Zacharias, Mark*
 Preparing and Dispensing Prescriptions during the Civil War Era, *Hassegawa, Guy R.* (10:1-6)
Richardson, Charles, and Harris, Michael, Collecting Pharmaceutical Antiques (3:1-3), Collecting Pharmaceutical Antiques (3:1-3)
 Sears Roebuck & Co. (6:11), *Helfand, William H.*
 Smoke Ball Cure (2:7), *Helfand, William H.*
Sonnedecker, Glenn, Drugs for Feudal Japan—A Woodcut (7:7-9)
Staiger, Christiane, Pharmacy over the Moon (4:8-9)
Stroud, Elaine C., Who are they now? (5:11); Pharmacy and Exploration (4:7-8)
 Swallowing the Pill (4:6), *Cowen, David L.*
Swann, John P., A Century of Change: The Coming of Miracle Drugs (2:1-5); The Formation and Early Work of the Drug Laboratory, USDA Bureau of Chemistry (9:1-9)
 Throop Pharmacy Museum (5:7-8), *Obos, Lee Anna*
 Tying the Knot—*Secundum Artem* (2:13), *Cowen, David L.*
Warren, Flynn and Ali, Monica, Edwin W. Grove, Pharmacist, Entrepreneur, and Host to the Rich and Famous (6:9-10)
 What is in a Name? Edward Parrish on the Profession of Pharmacy (1866) (7:5), *Parrish, Edward*
What is it? "cantar" for weighing opium (8:15); pharmaceutical novelty ("pille-nehmer") (9:12); Konseal apparatus (1:14); Pill machine in drawer (2:14); Mechanical Pill Roller for the Prescription Counter (7:14); Michael Powder Divider (6:13); Pill-making machine (5:13); Practical Sponge Holder (4:13); Set of auricles (3:14); Tablet Counting Device (10:14)
 Who are they now? (5:11), *Stroud, Elaine C.*
 William Jennings Bryan, Clarence Darrow, and Pharmacist F. E. Robinson, *Pinchak, Frank* (10:9-12)
Zacharias, Mark, Pioneer Village Apothecary Shop (Spring Mill State Park, Mitchell, IN) (8:11-12)
Zellmer, William, Essay on "History" (4:12-13)

A Note on Historical Plague Prevention

By Michael R. Harris

IF you visit Venice during pre-Lenten carnival, you might see revelers wearing a bird-like mask that is sold in the famous mask stores of the city. The mask pokes fun at the plague doctors who wore it as a protective device in the seventeenth and eighteenth centuries. Historically, the stylized mask has had a traditional role in French and Italian theater. In comic productions, pompous doctors wore a plague outfit consisting of a mask resembling a long-billed bird head, long protective robes of heavy fabric or leather, a large hat in the style often worn by university academics, and a white wooden stick that showed status as a public health official. The white stick was a practical tool to test if a fallen citizen was dead, and the heavy garments were a protection from the unseen disease. We know now that fleas from infected rats transmitted the disease and the heavy fabric or leather could have offered some protection from the deadly fleas. The third accoutrement of the plague doctor was the unique bird-head-shaped mask. Today the masks that are sold in Venice are stylized with a very large beak and a pair of black-rimmed pince-nez eyeglasses painted on, indicating that the wearer could read and therefore was a scholar. The beak of the mask holds the most interest for historians of pharmacy—inside the beak at the very tip of the mask a small sponge or balled piece of cloth about two inches in diameter was placed. This absorbent material was soaked with a vinegar solution containing a number of aromatic herbs and spices.

With the belief that disease is carried in the air or in a miasma, people felt they could best protect themselves with strong pleasant smelling vapors that would drive off the foul airs. At that time foul air was a constant in the environment. Refuse was simply dumped in the street; horse and animal manure covered every

“Apothecary” is derived from the Greek word for store room, and came to refer to one who kept a store or shop of non-perishable commodities, such as spices, drugs, comfits, preserves, etc. (from OED). Indicative of the fact that preventative preparations of the time were made from herbs and spices, London apothecaries were originally part of the Grocer’s guild before they separated in 1617.

road; bathing was rare, and the use of soap even rarer. Those who could afford it would carry flowers or other sweet smelling devices such as an orange covered with cloves stuck into the skin of the fruit.

An “Apothecary” or “Spicer” used wine or vinegar as the vehicle of choice to make up a solution of botanical products. Since a majority of the preparations of the time were made from herbs and spices, English



Doktor Schnabel, engraving by Paul Fürst (after J. Columbina) Rome, 1656.

apothecaries were originally part of the Pepperer and Spicer’s guild before they separated in 1617. The apothecary would use his most aromatic and expensive herbs and spices in the preparation of the protective solution: cloves, cinnamon, rosemary, thyme, garlic, pepper, sage, rose oil, and flower petals, etc., would commonly be the items of choice.

A product that is a direct descendant of these aromatic preparations can still be found today. In the southern United States stores devoted to Hoodoo, Voodoo, and spiritual products and candles carry “Four Thieves Vinegar,” as an item that will protect you from evil. You wear it or spread it on the floor or walls of your house. Similar products are mentioned in several histories of the plague. The common story goes that a group of thieves were robbing people who died of the plague. By extension it was believed that because the thieves did not succumb to the disease, they had a method of preventing the plague and allowing them to rob the dead without contacting the disease. The truth is that thieves died of the plague as often as anyone else. You could not tell if a dead person had been a thief before dying from the plague. There were many myths that were too good not to be true—and so it is with the Four Thieves Vinegar.

A recently published book, *The Element Book of 5000 Spells* (2004), by Judika Illes lists a formula and tells the tale of the Four Thieves Vinegar. The author attributes the preparation to the thieves of plague folklore dating from the crusades to the eighteenth century, and taking place in London, Marseilles, or somewhere in Italy. All three locations were major sites of plague. The story goes—according to Illes—that four thieves were

caught robbing the dead and traded their formula for their freedom, divulging the following:

1. A base of wine or cider vinegar
2. Crushed garlic cloves—the more garlic the better
3. Thieves three and four listed one or more of the botanical ingredients: black pepper, whole cayenne or other chili pepper, coriander, lavender, mint, rosemary, rue, sage, thyme, or wormwood.

The herbs listed as ingredients would be an interesting set for investigation. Some reflect importation from the Americas or the Far East. It is curious that some of the most popular aromatic spices used in Europe in the fourteenth through eighteenth centuries—cloves, nutmeg, and cinnamon—are not included.

Judika Illes lists several uses for the Four Thieves Vinegar. My favorite involves taking the business card of someone to whom you owe money and placing it in a glass. Then you pour the vinegar preparation into the glass, covering the card. This will drive away the lender and keep you from having to pay the debt.

For further reading, Caroline Morrow Long's *Spiritual Merchants: Religion, Magic, and Commerce* (2001) presents an interesting story of the Hoodoo and Voodoo in America, and the pharmacies that were part of its history.



Two modern examples of "Four Thieves Vinegar." (From the Collection of Michael Harris.)

William Jennings Bryan, Clarence Darrow, and Pharmacist F. E. Robinson

By Frank Pinchak*

IN 1977 my family and I were in Athens, Tennessee, to attend a wedding. On the return trip to the airport, we saw a sign for Dayton, TN, and because there were three hours until departure, we turned off I-75 to visit arguably the most famous courtroom in America. The road ran down to the river where a small barge-ferry, pushed along on a cable, crossed us over to Dayton. A resident gave us directions with a sly wink, saying, "You want the Monkey Courthouse. . . . Straight ahead, . . . Can't miss it."



At the museum in the Rhea County Courthouse in Dayton, the exhibit shows a replica of the drugstore of pharmacist F. E. Robinson, also known as the "hustling druggist." As president of the county school board, Robinson directed the trial project from the first day. (Photo credit: Frank Pinchak.)

The beautiful Romanesque/Italian villa-style building with its three-story clock tower, was built in 1891. The second-floor courtroom has been kept, without any changes, exactly as it was in 1925: jury chairs with high backs and soft cushions for comfort, slightly creaky floors, and the wide, extremely tall windows stretching high as though seeking divine answers to the mighty questions put forth by the trial.

A request for postcards directed us across the street to Robinson's drugstore, operated by Wallace E. Robinson, known to everyone as "W.E." He lit up as he learned I was a fellow pharmacist curious for information. With delight he showed his gallery of framed trial photographs on the wall. I then shared my interest in the happenings as dramatized in *Inherit the Wind*. With a chuckle and a shake of his head as though he heard this story many times before, he told us more about the trial. Much more.

He contended that the motion picture was 100 percent incorrect. In actuality, the Dayton civic leaders had cooked up the spectacular monkey-business, and the ringmaster running the circus was a pharmacist, his father,



Photo credit: Bryan College

At Robinson's drugstore in Dayton, Tennessee, the city fathers made plans in 1925 that started the Scopes evolution trial (photo courtesy Bryan College).

Frank Earle Robinson, known to locals as "F.E."

Subsequent visits to Dayton over a twenty-five-year period allowed research for this piece. On a recent trip, the helpful staff at Dayton's library welcomed us and directed us to the *History of Rhea County*, which contains a factual account of the "World's Most Famous Court Trial," written by Richard M. Cornelius. A prolific writer and expert on the event, Cornelius is Professor Emeritus of English and Archivist at nearby Bryan College. This article draws on his work.

Most individuals living today have formed their impressions of the 1925 Scopes Evolution Trial from stage, motion picture, and television adaptations of the play, *Inherit the Wind*, by Jerome Lawrence and Robert Lee. Even though the authors included a disclaimer that their work

was not based on actual history, the contributions of these entertainment writers was definitely biased on the side of Darwin. The name of pharmacist F. E. Robinson, who instigated the affair, was never mentioned.

One must recall the attitudes of the 1920s, and that Tennessee was solidly within the so-called "Bible Belt." Religion was intertwined with politics and, as always, politicians were not going to alienate voters. The State Legislature had been hotly debating a bill about the teaching of Darwin's evolution theory versus biblical theology. While fighting carried on, William Jennings Bryan was lecturing in Nashville on "Is the Bible True?" Reprints of Bryan's speech were blanketed on the members provoking them to cut off debate.

That time, the place, and the mixture of politics and religion all came together when Representative

John W. Butler introduced House bill 185. The bill stated, "That it shall be unlawful for any teacher in any of the universities, Normals, and all other public schools of the state which are supported in whole or in part by the public school funds of the State, to teach any theory that denies the Divine Creation of man as taught in the bible, and to teach instead that man descended from a lower order of animals." The bill passed the Tennessee House by a vote of 71 to 5 and the state Senate 24 to 6. Eight days later it was signed by the governor (21 March 1925).

On the morning of 4 May 1925, George W. Rappleyea, a New Yorker and manager of a failing coal and mining business in Dayton was reading his morning issue of the *Chattanooga Times* at his usual wire-legged table by the soda fountain in Robinson's drugstore. He read that,

"The American Civil Liberties Union was announcing its search for a Tennessee teacher who is willing to accept its services in testing the law in its courts." Dayton had been sending out pamphlets extolling the attributes of the city as a location for industry. The stagnant economy was all too well known by the profit-minded Rappleyea who instantly saw the public relations potential awaiting any city smart enough to offer up one of its own teachers. Seated in the opposite chair at the table was the chairman of the county school board, pharmacist Frank Earle Robinson. Robinson, known in the area as "The Hustling Druggist," immediately saw the possibilities and began calling the appropriate local officials.

The next day a meeting was held in the drugstore to discuss the possibility of Dayton's offer to make a test case of the new law. Present were several city attorneys, the Superintendent of Schools and John T. Scopes. Scopes was coach of boys' sports at the high school and taught math, physics, and chemistry. He was recruited for the case when the regular biology teacher refused. All present agreed the effort would be part prank and part sincere, with the primary purpose of pushing Dayton into the spotlight with the intent of improving the local economy. However, the plotters never anticipated just how fast things would move, and the international attention to come.

Quickly a warrant was filled out, the press and the ACLU were alerted, and a law school dean offered his services to Scopes. The next day Scopes got to the biology class and barely had checked attendance when police officials entered the class and arrested him. (Years later Scopes's son revealed his father told him he never had a chance to utter a word about evolution to the class.)

The World's Christian Fundamentalists quickly entered the fray and announced that none other than William Jennings Bryan would participate in the trial without remuneration. Bryan was a former Secretary

of State, a three-time presidential candidate, and spokesman for the Fundamentalists. The little town's cause was halfway there.

The world focused on Dayton the next day when the famous criminal lawyer Clarence Darrow, internationally renowned for his successful efforts in preventing the execution of the notorious thrill murderers Leopold and Loeb, offered his services, at no charge, to Scopes. The production now had a scrapper-antagonist in the cast.

Robinson's committee was deluged. The entire communications network descended on Dayton: Three new wire services, 120 reporters, 65 telegraph operators, all sending breaking news out to a world intent on following the trial. Refreshment stands, monkey souvenirs, chimpanzees and trainers, all seemed to mushroom overnight. The *Chicago Tribune* sent a crew from its radio station WGN that did the first national broadcast of an American trial. Dayton's population swelled from 1800 to about 5000.

Robinson's group also had to head off the city of Chattanooga, 40 miles away, that had recently arrested a teacher and was attempting to have their own trial. The Dayton boosters saved the day by moving everything up a few months, and calling Scopes back from a family vacation in Kentucky for indictment again. Even a fake fight was staged to liven up the media that had been losing interest in the matter.

The trial was held in the hot month of July. Local and national bigwigs were on the teams of prosecution and defense. Notables such as Arthur Garfield Hayes and Dudley Field Malone helped Darrow with the defense. Bryan had the aid of his son William Jennings Bryan, Jr., from California, along with local law and biblical experts.

The trial began with the usual slow first day of choosing jurors. However, Darrow speeded things up for everyone by *agreeing* with the prosecution, stating that the law was the law, but that the goal of the defense was to take the case higher, eventually to the Supreme Court.

The agnostic Darrow also challenged the daily prayer at the start of the proceedings. The case was rife with violations. Scopes and Darrow, while the trial was on, coached some of the prospective student witnesses to testify that Scopes had taught them about evolution.

A high point of the trial came when Darrow had Bryan sworn in as a witness. It was so hot the judge convened the court outside on a specially built platform on the grass. For that day the motion picture has Spencer Tracy making a fool of the stubborn fundamentalist played by actor Frederick March. Actually Bryan got the best of most of the confrontation. He had agreed to take the stand only if he, in turn, could cross-examine Darrow. At times the trial slowed down. At one point, the judge cited Darrow for contempt.

Things got hotter. Both Bryan and Darrow had received threats. The sheriff secretly met with the judge to seek quick closure, fearing violence. Judge Raulston closed the trial on the tenth day; he charged the jury and even allowed Darrow to address them. Darrow told the jury the defense did not care about the verdict either way, that it was their wish to take the matter to a higher court. The jury was out nine minutes, came back and found Scopes guilty. He was fined \$100.

Bryan had a heart attack five days later and died. Six months passed and the case came up on appeal. A split decision was announced by the Tennessee Supreme Court, which ordered a retrial. This was rejected for political reasons hinging on elections coming up the next year, and the case was closed. Years later, in 1967, the 1925 Butler Act was repealed.

F. E. Robinson expanded his business to a second store in a nearby town. He helped found Bryan College in Dayton and also served as Chairman of the Board. He died in 1957. Bryan College is one of William Jennings Bryan's many legacies. Many prominent citizens, some of whom had been on opposite sides during the trial, founded it in 1930.

Second International Congress on the Iconography and Cult of Saints Cosmas and Damian

Saints Cosmas and Damian are regarded as the patrons of physicians and pharmacists. The brothers, sometimes referred to as twins, healed the sick but accepted no money for their services. Devotion towards these two saints soon spread throughout the Christian world after their death, probably in the third century. And in the Southern parts of Italy this reverence existed in great abundance, displayed in paintings and statues in churches and homes, and expressed through prayers and invocations.

Various aspects of the iconography and the cult linked to these two saints will be discussed in great detail during this Second International Congress, held in beautiful Irpinia, in Southern Italy, close to Melfi.

The Congress, dedicated to the memory of Irpinian pharmacist Generoso Nevola, will be held between 29 September and 1 October 2006, in the Irpinian localities of Mercogliano, Altavilla, and Nusco. The Congress is being organized under the auspices of the International Society for the History of Pharmacy, the *Académie Internationale d'histoire de la Pharmacie*, the *Federazione degli Ordini dei Farmacisti Italiani*, the *Accademia Nazionale delle Scienze Lettere ed Arti di Modena* and the *Accademia di Storia dell'Arte Sanitaria*.

Twenty-seven oral presentations will be made by researchers from Italy, France, Germany, Greece, Switzerland, and Norway. The abstracts of these presentations are available on-line, together with the program, on the websites of the major European societies for the history of pharmacy, as well as from the website of the International Society for the History of Pharmacy (www.histpharm.org).

On the occasion of this Congress, an exhibition "The Saints Cosmas and Damian: History, Myths and Legends" will be set up at the Institute of the Benedictine Nuns of Montevergine in Mercoglia. The exhibition will include descriptions of religious manifestations of this cult in traditional prayers and holy pictures. It will remain open until 1 October 2006 and a catalogue on CD will be published. (For more information send an e-mail to Amelia Nevola or Rita Testa at congresso@irpinianblog.org.) The proceedings of the Congress will also be published. (Send an e-mail to Patrizia Catellani at patcat@interview.it for information.)

For any further information visit www.irpinianblog.org, or contact the organizing secretariat at congresso@irpinianblog.org, or fax 0039 0825 788795.

Isabella C. Grima



The institution is an accredited, non-denominational Christian liberal arts college.

We returned several years ago to find Robinson's drugstore closed. The founder's son had died also. The city, like many American cities, had its share of empty



Photo credit: Frank Pinchak

boarded-up storefronts. The courthouse was designated a National Historic Landmark in 1977, with a million-dollar structural and preservation project completed in 1979. There is a wonderful museum in the basement featuring life-size photographs of Bryan and Darrow. Exhibit cases are full of actual items and other memorabilia of the trial that made Dayton the center of the nation from May through August of 1925.

A bridge now replaces the tiny ferry that took us to that beautiful, quiet, and peaceful little town, where everything runs at a relaxed, enjoyable pace. Anyone can do as we did—step back in time to the 1920s for a look at an incredible moment in American history.

The trial exists now in an annual play production of *Destiny in Dayton*, put on by Bryan College and the Dayton Community, based on the court transcript of the trial. The motion picture of *Inherit the Wind* is a staple of television, and much material is available on the internet.

And finally, what about those hand-fans that everyone—including the lawyers—used during that hot month of July? The museum has one. It bears an advertisement for Robinson's drugstore.

*Past President, N.J. Pharmacists Association.

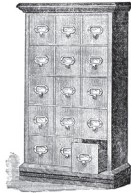

COLLECTOR'S CORNER

The AIHP brings together those who wish to buy, sell, or trade artifacts or books related to the history of pharmacy. Free advertising is available to members (\$5 a line to non-members). Send copy to AIHP, 777 Highland Ave, Madison, WI 53705, or NOTES@aihpa.org.

OLD NEUROLOGY BOOKS: Dr. Perlmutter, a neurologist in Naples, Florida has a "shelf" of old Neurology books that belonged to his father. He has no use for them, and is willing to give them to an interested collector. He may be contacted at Perlmutter Health Center, David Perlmutter, MD, 239-649-7400. His web site is www.perlhealth.com.

WANTED: Show globes, fancy apothecary bottles, porcelain jars, trade catalogs, window pieces, patent medicines, and advertising. Contact Mart James, 487 Oakridge Rd., Dyersburg, TN 38024; (731) 286-2025; e-mail: kjames@cableone.net.

WANTED: Books & journals on Pharmacy (pre-1920), Pharmacognosy, Herbal/Botanic Medicine, Eclectic & Thomsonian Medicine, Phytochemistry, and Ethnobotany. I will purchase one title or entire libraries. David Winston, Herbalist & Alchemist Books, P.O. Box 553, Broadway, NJ 08808, (908) 835-0822, fax: (908) 835-0824, e-mail: dwherbal@nac.net.

THE SNAKE-OIL SYNDROME, by A. Walker Bingham; 196 pages oversized, more than 500 illustrations, 60 pages in full color. An in-depth reference work on patent medicine advertising in the context of efficacy and the selling images used. Cross-indexed by subject and product names, with notes, bibliography, and list of public collections. Hardcover, \$44.00 postpaid from the Christopher Publishing House, 24 Roackland Street, Hanover, MA 12339.

FOR SALE: CD on Dr. Hatchett's Drug Store Museum (small town drugstore, southwest Georgia). Consisting of almost 200 pages it describes many off-the-counter medicines and patent medicines as well as other mainly early- and mid-twentieth-century products. Includes product composition, period advertising, prices, manufacturers, history, dosage, etc.

Includes index by product and manufacturer. Available through Stewart County Historical Commission, P.O. Box 818, Lumpkin, Georgia 31815 for \$12 a CD. Questions may be sent to Allen Vegotsky (a.vegotsky@worldnet.att.net).

WANTED: Rennebohm prescription bottles or any Rennebohm products. Contact Beth Fisher to donate, fisher@aihpa.org, or 608-262-5378.

WANTED TO BUY: Eye baths or eyewash cups with advertising (usually on the bottom) from American drugstores. Please describe embossing, color, shape, price. I am a pharmacist, collector, and AIHP member. Contact Ronald "Tracy" Gerken, 1131 Kings Cross, Brunswick, GA 31525; 912-269-2074; 1gerken@bellsouth.net.

WANTED: Philatelic items (U.S. and worldwide) related to pharmacy, drugs or medicinal plants. Interested in a wide range of philatelic items including postage stamps, advertising stamps, envelopes, postmarks/cancellations, philatelic literature relating to pharmacy. Contact Jack Chen, 7854 Calmcrest Drive, Downey, CA 90240; (909) 469-5602 or via email jackjchen@msn.com.

WANTED: Surgical related items from the 18th and 19th century. Instruments, books, etchings, photos and anything of interest. Contact Dr. Alan Koslow at koslow@mchsi.com or (515) 267-1821.

FOR SALE: Extensive antique collection: Queen Anne balance with City of New York seals, pill roller, assorted pill bottles, stone mortar believed to be 15th or 16th century. A bronze mortar, as pictured in the Pill Rollers (p. 65), and 20 additional brass mortars of various ages. Pictures available or may be viewed in person at Boynton Beach, FL. Contact Herb Leonard (561) 364-8967.

FOR SALE: One-hundred-year-old historical pharmacy documents containing historical signatures. A Doctor In Pharmacy certificate issued to Ephraim Shaw Tyler in 1902 and signed by Joseph P. Remington and Henry Kraemer and others and issued to Ephraim Shaw Tyler by the Alumni Association of the Philadelphia College of Pharmacy in 1902. Both are well framed. Contact Charles R. Weiss at (330) 633-4342 or CWEISS6@juno.com.

FOR SALE: Own a piece of the financial history of drug, chemical, pharmaceutical, and health care companies. Stock/Bond certificates (cancelled) are both history and an artform. Most priced under \$7.00 each. Send SASE for list. Interested in buying similar items. Wayne Segal, Box 181, Runnemede, NJ 08078. e-mail WaynePharm@aol.com.

GOOD HEALTH TO ALL FROM REXALL! I collect anything made for the Rexall Store. Especially want early consumer products and pharmacy items manufactured by the United Drug Company (1903-46, Boston). Also Rexall AD-VANTAGES magazines, calendars, almanacs, photos, and other franchise and advertising materials. United Drug brands: Puretest, Firstaid, Elkay, Kandleek, Jonteel, Liggett's, Fenway, Harmony (cosmetics), Electrex (appliances), Old Colony (inks), Klenszo, etc. What have you? Frank Sternad, P.O. Box 560, Fulton, CA 95439; (707) 546-3106, e-mail fsternad@sonic.net.

FOR SALE: Apothecary Antiques including drug jars, apothecary bottles, manufacturing tools, medical instruments including leech jar and various dental items; books dealing with the above subjects available, catalogues issued. Always buying similar items or collections. John S. Gimesh, MD., 202 Stedman St., Fayetteville, NC 28305; (910) 484-2219.

What Is It?

This edition of *What Is It?* is a bit tricky. We cropped off only a part of the item. Here is the complete illustration showing the patent drawing of a “tablet counting device,” which later became known across the USA as an Abbott counting tray. In November 1950, Mack R. Fields received patent number 2,530,009 for this clever implement.

Quoted below is an excerpt from the patent application describing its utility. As you can see, the inventor was especially proud of the graduated cylinder, a feature usually ignored by most pharmacists.

“This invention relates to a tablet counting device, and it has particular reference to a device adapted for use by pharmacists in filling prescriptions, which call for a specified number of tablets, pills, or the like, which are usually carried in stock in bulk form.

“A common practice followed by pharmacists when filling a prescription calling for a specified number of tablets, is to pour an unmeasured quantity of the tablets on a paper, or other clean surface, and to separate from such quantity the required number of tablets by means of a spatula. After the required number are separated, then they are ordinarily moved over the edge of the table surface on which they were counted, and caught in the hand or other receptacle, from which they may be poured into another container in which they are to be dispensed to the customer.

“The containers employed for dispensing pharmaceuticals vary considerably, each pharmacist having his own selection of various sizes and forms or kinds of containers, such as hinged or slip cover boxes, tubular paper board receptacles, glass vials, bottles, etc., etc. The selection of a container of the right size for a given number of tablets has heretofore been a matter of guess work since no standards are available which indicate the number of tablets of a given size which can be placed in a given container. The erroneous selection of a too small container causes trouble in that the too small container must be emptied thoroughly, cleaned, and returned to stock and a larger container substituted.

“The main objects of the invention are to provide a device whereby the counting out of a specified number of tablets, pills or the like, is facilitated, and whereby the selection of the proper size of receptacle in which to dispense the tablets, etc., is also facilitated.

“Another object of the invention is to provide a device for the purpose indicated, which will encourage the exercise of proper precautions for maintaining sterility of the product handled, and in general, it is the

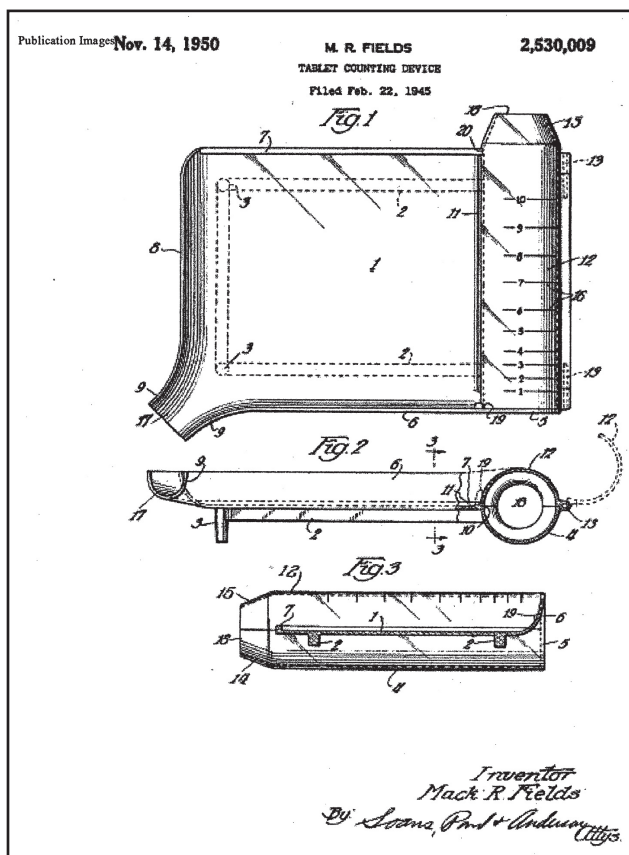

object of the invention to provide an improved device of the character indicated. . . .

“The cover 12 is also provided with a series of graduation marks 1 to 10 inclusive, as shown in Fig. 1, . . . These graduations are designed to indicate to the user of the device the proper size of container in which the combined tablets should be packaged.”

(Source: www.uspto.gov)

• • • • • Travel Grants Available • • • • •

The Historical Collections unit of the University of Alabama at Birmingham offers a limited number of modest travel grants to pursue historical research at the Alabama Museum of the Health Sciences, Reynolds Historical Library, or University Archives. Resources include material on southern medicine and health care, the Civil War, eighteenth- and nineteenth-century pharmaco-therapeutics, and more. For application details and further information go to <http://www.uab.edu/reynolds/fellowship.htm>.



A Backward Glance at American Pharmacy

EDITED BY GREG HIGBY

100 Years Ago

The steady growth of the mail order business is a menace to retail stores of every kind, which the druggist cannot afford to overlook. Nor is the damage done to existing trade relations confined to the retail business, for the jobber [wholesaler], too, will be eliminated when the mail order houses [e.g., Sears, Roebuck & Co.] have succeeded in driving the retail trade out of existence. Thousands of country stores have been driven into bankruptcy and the retail business in small towns has been seriously affected, especially in the Northwestern section of the United States, where the mail order houses have put forth their greatest effort. These houses are doing all that they can to insure the passage of a parcels post measure, which would enable them to compete with the retail trade in the remotest sections, and we are confident that if the parcels post measure were enacted fully one-half the retail drug trade of the United States would be driven out of existence within five years. . . . It is to prevent [this occurrence] that the American Pharmaceutical Association adopted a resolution memorializing Congress in opposition to the enactment of a law providing for a parcels post, and every individual pharmacist should make it his business to see that his own political representatives are made fully aware of his active opposition. . . . Without such active opposition, however, there is strong probability that the mail order houses will succeed, which will mean the annihilation of a very considerable proportion of the retail business of the United States. [The law authorizing the U.S. parcel post passed in 1912 with service beginning in 1913.—Ed.] (*American Druggist and Pharmaceutical Record*, September 24, 1906:190)

National Pharmacy Week Proclamation

75 Years Ago

The White House
September 25, 1931

The observance of National Pharmacy Week, October 11th to 17th, is an appropriate time to recognize the service which pharmacy renders to the public health. Research in scientific laboratories constantly adds to the armamentarium of our health forces. The drug stores of the land are the channels through which these new resources for treatment of the sick and the prevention of disease are brought promptly within reach of the people. Pharmacists are the indispensable allies of the physicians. The importance of high standards of product and professional practice in pharmacy may well be more generally recognized, and Pharmacy Week is a commendable educational effort to that end. —Herbert Hoover (*Druggists Circular*, October 1931:5)

50 Years Ago

“Rock ‘n roll” music blaring forth from juke boxes in a few Massachusetts drug stores has goaded the state pharmacy board into action. The board prefers “subdued background music” as more fitting to the atmosphere of drug stores, and less disquieting to the composure of patrons. Accordingly, the board has ordered juke box operators serving drug stores to “tone down the volume and do away with ‘rock ‘n roll’ records in the machines they lease to drug stores.” . . . If the operators refuse to cooperate, direct action against drug store owners is planned in the form of orders to restore decorum. The board has received numerous complaints that “rock ‘n roll” addicts among the blue-jeaned teen-age set have created disturbances in drug stores where juke boxes offer the latest records. The teen-agers “take over and confusion is the result.” (*American Druggist*, September 24, 1956:20)

25 Years Ago

A two-year-old California group representing pharmacy technicians is quietly going national. Already, the Association of Pharmacy Technicians has enlisted more than 300 dues-paying members, including a few participants from such far-flung locales as Canada, Puerto Rico, Florida, Illinois and New York. Potential long-range membership is probably considerable. Most authorities estimate roughly that there are two technicians overall for each of the approximately 145,000 U. S. Pharmacists in practice today. . . . Among the tasks the group is preparing to perform, the most important are selecting a single widely accepted title for technicians, delineating clearer definitions of professional standards for technicians, and deciding whether new technicians should take tests for licensure or certification. (*American Druggist*, September 1981:25)

CALL FOR PAPERS

AIHP Section on Contributed Papers at the APhA Annual Meeting 17-19 March 2007 Atlanta, Georgia

•Titles and 200-word abstracts for 15-minute podium presentation must be received by October 1, 2006. With your abstract please include name, affiliation, address, phone number, and email address if available. Electronic submission is preferred.

•Send abstracts to Rita L. Benischek, AIHP Section Chair Contributed Papers:
email:rlbenischek@aol.com
phone: 405-525-0571
mailing address (hardcopies): 406 NW 35th St., Oklahoma City, OK 73118

•For additional information, contact the AIHP office (608-262-5378);
email (abstracts@aihp.org).

from a unique agency of pharmacy
The American Institute of the History of Pharmacy
777 Highland Ave., Madison, WI 53705-2222

Non-Profit Org.
U.S. Postage
PAID
Madison, Wisconsin
Permit 881