

On Campus User

ILLiad TN: 827367

Call #: 621.384205 EX71 v.7 1930
**Location: Library Storage (Physics-
Math-Astronomy Library) -- click
REQUEST button**

Special Instructions: LSF
**Journal Title: Experimental wireless & the
wireless engineer**

Volume: 7 Issue: not in Inspec
Month/Year: October 1930
Pages: 536-541

Article Author: Stephen Butterworth

Article Title: Theory of filter amplifiers

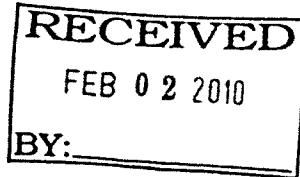

2009097405

**University of Texas Libraries
Interlibrary Services**

NEED BY DATE: 07/31/2010

**CUSTOMER HAS REQUESTED:
Mail to Address**

EMAIL: Ldallas@austin.utexas.edu
ARIEL: 128.83.205.172

Larayne Dallas (dallaslj)
**Engineering Library; ECJ 1.300
s5435**
p.o. box P, TX 78713-7330

2/3/10
The University of Texas Libraries

On the Theory of Filter Amplifiers.*

By *S. Butterworth, M.Sc.*

(Admiralty Research Laboratory).

THE orthodox theory of electrical wave filters has been admirably presented by Mr. M. Reed in recent numbers of *E.W. & W.E.* (p. 122, March, 1930 *et seq.*), and it is not proposed in the present Paper to add to or to repeat any of that theory. In this work the problem of electrical filtering is attacked from a new angle in which use is made of systems of simple filter units separated by valves so that we combine in one amplifier the property of filtering with that of amplification. The simple units employed can, in the case of low pass filters, be so designed that they take up little more space than the anode resistance employed in the ordinary straight resistance capacity amplifier. The writer has constructed filter units in which the resistances and inductances are wound round a cylinder of length 3 in. and diameter 1½ in., while the necessary condensers are contained within the core of the cylinder. Units so constructed can be made of the plug-in type to admit of ready replacement. In the case of band pass filters it should be possible to design the intervalve system so as to have all the elements on two such cylindrical units. It is therefore clear that it is possible to obtain compact filter amplifier systems even if the degree of amplification is pushed to many stages.

The theory given below has been embodied in a set of design tables so that the task of the designer is reduced to as small proportions as possible.

Apart from the compactness of the system the filter amplifier has an advantage over the orthodox filter systems in that the effect of resistance is under complete control so that we may construct filters in which the sensitivity is uniform in the pass region.

1. General Scheme.

An ideal electrical filter should not only completely reject the unwanted frequencies but should also have uniform sensitivity for the wanted frequencies. In the usual type

of filter circuit, the first condition is generally approximately fulfilled, but the second condition is usually either not obtained or is approximately arrived at by an empirical adjustment of the resistances of the elements.

The following theory was developed primarily in order to arrive at a logical scheme of design for low pass filters, but it will be shown that it is possible to make use of the theory for band pass, band stop, and high pass filters.

The theory of the general filter-circuit of the Campbell type including resistance is not attempted, but it is shown how to obtain the best results from a two element filter and then how to combine any number of elementary pairs, separated from each other by valves, so as to approach closer and closer to the ideal filter as the number of stages are increased. In this way we can combine amplification and filtering properties in one unit, a combination that is often required in the applications of filter circuits.

This procedure also frees us from the necessity of considering the impedances of the circuits with which the filter is to be associated so that the filter amplifier may be used for a variety of circuits provided suitable input and output transformers are employed.

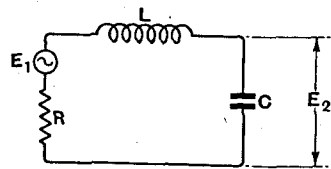

Fig. 1.

Further, in the Campbell filters, the elements (except the first and last) are similar, but in the present design we have assumed at first that we have perfect freedom in regard to the electrical constants of the elements and then these have been chosen with a view to obtaining the nearest approximation to the condition of uniform sensitivity in the "pass" region, and zero sensitivity in the "stop" region.

* The author is indebted to the Admiralty for permission to publish this paper.

MS. received by the Editor, May, 1930.

In the case of the low pass filter, if f_0 is the "cut off" frequency and f (xf_0) is any other frequency, the aim is to obtain a filter factor F , that is, the ratio of the output e.m.f. to the input e.m.f., of the form

$$F = (1 + x^m)^{-1} \dots \dots \dots (1),$$

where m increases with the number of elements employed. It is clear that as m increases,

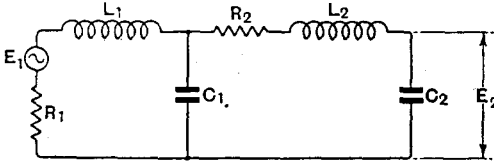

Fig. 2.

F will approximate more and more closely to the value unity when x is less than unity, and to zero when x is greater than unity.

For the case of a one element filter (Fig. 1), it is shown that by making $1/2\pi\sqrt{LC}$ equal to the cut off frequency and $L/C = \frac{1}{2}R^2$ we obtain a filter factor

$$F = (1 + x^4)^{-1} \dots \dots \dots (2).$$

If this element follows a valve of known impedance, R is fixed, so that L/C is fixed. The value of LC follows from the required cut off frequency so that the numerical design is completely fixed.

For the case of a two element filter (Fig. 2) a filter factor

$$F = (1 + x^8)^{-1} \dots \dots \dots (3)$$

may be obtained by satisfying four equations involving the seven quantities $f_0, R_1, L_1, C_1, R_2, L_2, C_2$.

For a given cut off frequency (f_0) and input resistance (R_1) we have thus four equations for five unknowns so that we are left with one further choice. It is convenient to choose a practically realisable value for $R_2/2\pi f_0 L_2$ and then the values of all the electrical constants follow.

For a series of two element filters interposed between valves we make use of the equation (see Todhunter's Trigonometry, p. 307)

$$1 + y^{2m} = (1 + 2y \cos \pi/2m + y^2) (1 + 2y \cos 3\pi/2m + y^2) \dots (1 + 2y \cos (2m-1)\pi/2m + y^2)$$

Thus if we employ n intervalve elements

and design the s th member so as to have a filter factor

$$F_s = (1 + 2x^4 \cos \theta + x^8)^{-1} \dots \dots (4)$$

in which $\theta = \cos(2s-1)\pi/2n$ then from the above equation the whole filter factor will be

$$F = (1 + x^{8n})^{-1} \dots \dots \dots (5).$$

The characteristics to be expected on this scheme are shown by the curves of Fig. 3. Curve A refers to a single element and curve B to a pair of elements, while curves C, D and E are for two three and six pairs respectively, each pair being an intervalve element. By adding the usual resistance capacity combination between the filter element and the grid as in Fig. 5, we thus obtain a filter amplifier having practically uniform pass sensitivity.

2. Low Pass Filter. One Element. Fig. 1.

A source of e.m.f. is applied to a circuit of inductance L , resistance R and capacity C . This, of course, is the ordinary resonating circuit and if the applied e.m.f. (E_1) has

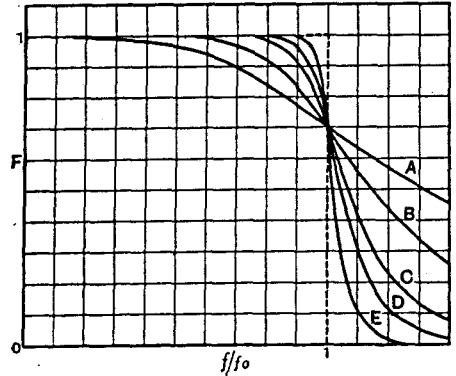

Fig. 3.

pulsatance ω , the output e.m.f. (E_2) is such that

$$(E_1/E_2)^2 = \frac{R^2\omega^2C^2 + (1 - \omega^2LC)^2}{1 + \omega^2(R^2C^2 - 2LC) + \omega^4L^2C^2} \dots (6).$$

$$\text{Let } LC = 1/\omega_0^2 \text{ and make } R^2 = 2L/C \text{ (7).}$$

Then if $\omega/\omega_0 = x, (E_1/E_2)^2 = 1 + x^4$ the filter factor

$$F = (1 + x^4)^{-1} \dots \dots \dots (8)$$

when condition (7) is satisfied.

3. Low Pass Filter. Pair of Elements. Fig. 2.

Generalise the circuit as in Fig. 4 for the purpose of carrying out the necessary algebra.

Z_1, Z_2, z_1, z_2 are the vector impedances of the various arms and on applying Ohm's Law we have

$$E_1/E_2 = (1 + Z_1/z_1) (1 + Z_2/z_2) + Z_1/z_2 \quad (9)$$

where E_1 and E_2 have now vector values.

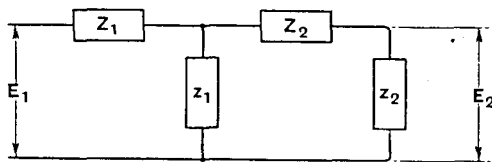

Fig. 4.

Let

$$L_1 C_1 = 1/\omega_1^2, L_2 C_2 = 1/\omega_2^2, R_1/\omega_1 L_1 = P_1, R_2/\omega_2 L_2 = P_2 \quad \dots (10)$$

Then since

$$\left. \begin{aligned} Z_1 &= R_1 + j\omega L_1, z_1 = 1/j\omega C_1 \\ Z_2 &= R_2 + j\omega L_2, z_2 = 1/j\omega C_2 \end{aligned} \right\} \quad \dots (11)$$

we have

$$\left. \begin{aligned} 1 + Z_1/z_1 &= 1 - \omega^2/\omega_1^2 + jP_1\omega/\omega_1 \\ 1 + Z_2/z_2 &= 1 - \omega^2/\omega_2^2 + jP_2\omega/\omega_2 \end{aligned} \right\} \quad (12)$$

Also put

$$\omega/\omega_1 = x/a, \omega/\omega_2 = ax, C_2/C_1 = \beta \quad \dots (13)$$

so that

$$x^2 = \omega^2/\omega_1\omega_2, a^2 = \omega_1/\omega_2 \quad \dots (14)$$

Then on substitution in (9)

$$\left. \begin{aligned} E_1/E_2 &= (1 - x^2/a^2 + jP_1x/a) \\ (1 - a^2x^2 + jP_1ax) &+ \beta(-x^2/a^2 + jP_1x/a) \end{aligned} \right\} \quad \dots (15)$$

Separate real and imaginary parts, square and add, and we obtain

$$\left. \begin{aligned} 1/F^2 &= 1 + (B^2 - 2A)x^2 + (2 + A^2 - 2BC) \\ &x^4 + (C^2 - 2A)x^6 + x^8 \end{aligned} \right\} \quad \dots (16)$$

in which

$$\left. \begin{aligned} A &= (1 + \beta)/a^2 + a^2 + P_1P_2 \\ B &= P_1(1 + \beta)/a + P_2a \\ C &= P_1a + P_2/a \end{aligned} \right\} \quad \dots (17)$$

If we can so choose the circuit constants that the coefficients of x^2, x^4, x^6 vanish then the filter factor will become

$$F = (1 + x^8)^{-1} \quad \dots (18)$$

The conditions that these coefficients vanish are

$$B^2 = C^2 = 2A, 2 + A^2 = 2BC \quad \dots (19)$$

On eliminating B and C we have

$$A^2 - 4A + 2 = 0 \quad \dots (20)$$

that is $A = 2 \pm \sqrt{2}$.

But examination of (17) shows that A must be greater than 2 so that the only realisable root is

$$A = 2 + \sqrt{2} = 3.414 \quad \dots (21)$$

and then $B = C = 2.613 \quad \dots (22)$.

Using these in (17) we have three equations to find a, β, P_1, P_2 . One of these may be fixed arbitrarily. It is convenient to fix P_2/a , that is, by (14) $R_2/\sqrt{\omega_1\omega_2}L_2$, and since also by (14) $\sqrt{\omega_1\omega_2}$ is the cut of pulsance (ω_0 say) we choose R_2/ω_0L_2 arbitrarily.

Then (17) fixes a, β, P_1, P_2 . But a^2 is the ratio ω_1/ω_2 and $\omega_1\omega_2$ is fixed by the required cut off pulsance, so that ω_1, ω_2 are fixed. The design is now completely fixed when the input resistance R_1 is specified, for P_1 determines L_1 , then ω_1 determines C_1 , β determines C_2 , ω_2 determines L_2 and P_2 determines R_2 .

4. Calculation of P_1, P_2, a, β .

The solution of equations (17) is facilitated by making use of the following substitutions.

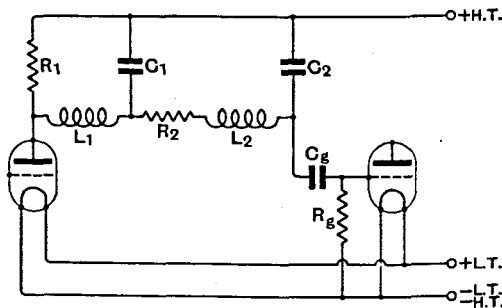

Fig. 5.

Put

$$\left. \begin{aligned} a^2 - (1 + \beta)/a^2 &= v, a^2 + (1 + \beta)/a^2 = \\ &2 + kv \end{aligned} \right\} \quad \dots (24)$$

so that

$$\left. \begin{aligned} a^2 - 1 &= \frac{1}{2}(1 + k)v, 1 - (1 + \beta)/a^2 = \\ &\frac{1}{2}(1 - k)v \end{aligned} \right\} \quad \dots (25)$$

Then, solving the last two of equations (17)

for P_1 and P_2 and putting $B = C = \sqrt{2A}$ we find with the help of (25)

$$P_1\alpha = (\mathbf{1} + k)\sqrt{A/2}, P_2\alpha = (\mathbf{1} - k)\sqrt{A/2} \quad \dots (26).$$

Using these in the first of equations (17) we obtain

$$2 + kv = (\mathbf{1} + k^2)A/2 \quad \dots (27).$$

The numerical calculations can now be carried out thus:—

P_2/α is fixed arbitrarily, then, using the value of A in (21), k follows from (26). $P_1\alpha$ follows then from (26).

The value of v is next found from (27) and then α^2 and β are obtained from (25).

5. Design Tables.

The designer is given the values of R_1 and the cut off pulsance ω_0 and requires the correct values of L_1, L_2, C_1, C_2 and R_2 .

TABLE I.
SINGLE INTERVALLE ELEMENT. FIGS. 2, 6, 7 and 8.

R_2/ω_0L_2	X_1	X_2	Y_1	Y_2	R_2/R_1
0.00	0.3827	1.584	0.9277	0.6560	0.0000
0.05	0.3902	1.664	0.9019	0.7201	0.0823
0.10	0.3979	1.761	0.8798	0.7966	0.1761
0.15	0.4060	1.869	0.8577	0.8846	0.2803
0.20	0.4144	1.990	0.8353	0.9873	0.3980
0.25	0.4232	2.128	0.8128	1.108	0.5320

For this purpose it is convenient to construct Tables giving

$$X_1 = \omega_0L_1/R_1, X_2 = \omega_0L_2/R_1, \quad \text{and } R_2/R_1$$

$$Y_1 = \mathbf{1}/\omega_0C_1R_1, Y_2 = \mathbf{1}/\omega_0C_2R_1.$$

These quantities can be calculated as follows when $P_1\alpha, P_2/\alpha$ and β are known.

$$X_1 = \mathbf{1}/P_1\alpha$$

$$X_1/Y_1 = \omega_0^2L_1C_1 = \omega_1^2L_1C_1 + \omega_2/\omega_1 = \mathbf{1}/\alpha^2$$

$$Y_1/Y_2 = C_2/C_1 = \beta$$

$$X_2/Y_2 = \omega_0^2L_2C_2 = \omega_2^2L_2C_2 + \omega_1/\omega_2 = \alpha^2$$

$$R_2/R_1 = X_2 P_2/\alpha$$

giving in turn the quantities required.

Table I is the Design Table for a single pair of elements the values of R_2/ω_0L_2 in the first column being assumed.

6. Multistage Filter Amplifiers. Fig. 5.

In a filter amplifier having n intervalle stages the filter for the s th stage must be designed so that

$$A^2 - 4A + 2 = 2 \cos(2s - \mathbf{1})\pi/2n \quad \dots (28)$$

{see equations (4) and (16)} while

$$B^2 = C^2 = 2A \quad \dots (29).$$

as before.

The solution of (28) is

$$A = 4\cos^2(2s - \mathbf{1})\pi/8n \quad \dots (30)$$

so that the design is exactly as in section (4) except that we use (30) for A instead of (21).

TABLE II.
TWO INTERVALLE STAGES.

R_2/ω_0L_2	X_1	X_2	Y_1	Y_2	R_2/R_1	Stage.
0.00	0.3605	1.582	1.027	0.5556	0.000	1
	0.4252	1.749	0.7507	0.9808	0.000	2
0.05	0.3671	1.669	1.007	0.6082	0.0834	1
	0.4345	1.879	0.7233	1.129	0.0940	2
0.10	0.3740	1.762	0.9877	0.6672	0.1762	1
	0.4441	2.069	0.6951	1.322	0.2069	2
0.15	0.3811	1.869	0.9688	0.7350	0.2803	1
	0.4540	2.318	0.6670	1.578	0.3478	2
0.20	0.3885	1.984	0.9450	0.8115	0.3968	1
	0.4647	2.704	0.6364	1.974	0.5407	2
0.25	0.3962	2.113	0.9312	0.8988	0.5281	1
	0.4758	3.333	0.6054	2.620	0.8332	2

Tables II and III are the Design Tables for two stage and three stage systems respectively while Table IV holds for four, five and six stage systems.

Fig. 5 shows the nature of the intervalle system, R_g and C_g being the usual resistance capacity elements.

7. Band Pass Filters. Fig. 6.

Starting with a low pass filter system suppose we put in series with L_1, L_2 the capacities C_1, C_2 and in parallel with the capacities C_1, C_2 the inductances L_1, L_2 .

TABLE III.
THREE INTERVALLE STAGES.

Stage 2 as in Table I.

R_2/ω_0L_2	X_1	X_2	Y_1	Y_2	R_2/R_1	Stage.
0.00	0.3566	1.587	1.046	0.5412	0.0000	1
	0.4456	1.983	0.6763	1.307	0.0000	3
0.05	0.3631	1.674	1.026	0.5921	0.0837	1
	0.4558	2.267	0.6461	1.599	0.1133	3
0.10	0.3698	1.770	1.008	0.6497	0.1770	1
	0.4664	2.715	0.6148	2.059	0.2715	3
0.15	0.3768	1.876	0.9889	0.7147	0.2814	1
	0.4776	3.548	0.5823	2.910	0.5322	3
0.20	0.3840	1.995	0.9706	0.7884	0.3985	1
	0.4893	5.720	0.5483	5.104	1.144	3
0.25	0.3915	2.123	0.9524	0.8725	0.5307	1
	0.5015	27.43	0.5125	26.84	6.858	3

Let these new capacities and inductances be such that

$$L_1C_1' = L_2C_2' = L_1C_1 = L_2C_2 = \mathbf{1}/\omega^2 \alpha \quad (31).$$

Then the generalised circuit (Fig. 4) will have for its vector impedances

$$\left. \begin{aligned} Z_1 &= R_1 + j\zeta L_1, z_1 = 1/j\zeta C_1 \\ Z_2 &= R_2 + j\zeta L_2, z_2 = 1/j\zeta C_2 \end{aligned} \right\} \dots (32)$$

in which $\zeta = \omega - \omega_a^2/\omega$.

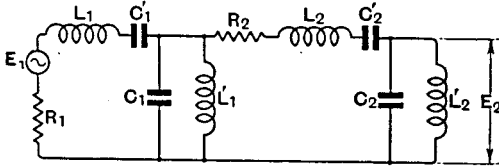

Fig. 6.

Now (32) is of the form (11) so that the whole of the low pass filter theory will hold. The interpretation of x however is now

$$x = \zeta/\sqrt{\omega_1\omega_2} = (\omega - \omega_a^2/\omega)/\sqrt{\omega_1\omega_2} \quad (33).$$

The form of the filter factor shows that the cut off pulsances are such as to satisfy $x = \pm 1$ or

$$\omega - \omega_a^2/\omega = \pm\sqrt{\omega_1\omega_2} \quad \dots (34).$$

TABLE IV.
FOUR INTERVAL STAGES.

$R_2/\omega_0 L_2$	X_1	X_2	Y_1	Y_2	R_2/R_1	Stage.
0.00	0.3553	1.588	1.052	0.5364	—	1
	0.3695	1.576	0.9838	0.5916	—	2
	0.4009	1.608	0.8463	0.7617	—	3
	0.4574	2.265	0.6358	1.630	—	4
0.05	0.3617	1.676	1.033	0.5868	0.0838	1
	0.3764	1.661	0.9635	0.6490	0.0831	2
	0.4091	1.706	0.8221	0.8491	0.0853	3
	0.4681	2.769	0.6039	2.146	0.1384	4

FIVE INTERVAL STAGES.

$R_2/\omega_0 L_2$	X_1	X_2	Y_1	Y_2	R_2/R_1	Stage.
0.00	0.3546	1.589	1.055	0.5342	—	1
	0.3636	1.579	1.012	0.5676	—	2
	0.4147	1.662	0.7912	0.8713	—	4
	0.4650	2.562	0.6104	1.951	—	5
0.05	0.3610	1.677	1.036	0.5843	0.0839	1
	0.3703	1.665	0.9917	0.6219	0.0833	2
	0.4234	1.782	0.7652	0.9859	0.0891	4
	0.4780	3.387	0.5773	2.793	0.1694	5

For Stage 3, see Table I.

SIX INTERVAL STAGES.

$R_2/\omega_0 L_2$	X_1	X_2	Y_1	Y_2	R_2/R_1	Stage.
0.00	0.3543	1.590	1.057	0.5330	—	1
	0.3734	1.574	0.9658	0.6087	—	3
	0.3942	1.592	0.8742	0.7180	—	4
	0.4702	2.865	0.5930	2.272	—	6
0.05	0.3607	1.678	1.038	0.5830	0.0839	1
	0.3805	1.660	0.9449	0.6685	0.0830	3
	0.4021	1.685	0.8508	0.7965	0.0843	4
	0.4816	4.146	0.5592	3.571	0.2073	6

For Stages 2 and 5, see Table II.

Putting $\sqrt{\omega_1\omega_2} = \omega_0$ as before we have now two cut off pulsances (ω_a, ω_b) given by

$$\left. \begin{aligned} \omega_a &= \frac{1}{2}\omega_0 + \sqrt{\omega_a^2 + \frac{1}{4}\omega_0^2} \\ \omega_b &= -\frac{1}{2}\omega_0 + \sqrt{\omega_a^2 + \frac{1}{4}\omega_0^2} \end{aligned} \right\} \dots (35)$$

(33) shows that if $\omega a > \omega > \omega_b$, x is less than unity so that the filter is now a band pass filter having cut off pulsances given by (35). The width of the band is $\omega_a - \omega_b = \omega_0$ and the centre of the band is

$$\omega_r = \frac{1}{2}(\omega_a + \omega_b) = \sqrt{\omega_a^2 + \frac{1}{4}\omega_0^2} \quad \dots (36).$$

Hence for a given centre ω_r and given band width ω_0 we use the low pass filter Tables to calculate the circuit constants together with equations (31) and (36).

It is interesting to notice that for a given band width the values of L_1, L_2, C_1, C_2 and R_2 are fixed and adjustment of L'_1, L'_2, C'_1 and C'_2 simultaneously shifts the band bodily along the frequency scale.

8. High Pass Filters. Fig. 6.

In the low pass system let the inductances be replaced by capacities and the capacities by inductances. Since $j\omega L$ becomes $1/j\omega C$ and *vice versa*, terms such as $\omega^2 LC$ are replaced by $1/\omega^2 LC$ that is, if $LC = 1/\omega_1^2$ we replace ω/ω_1 by ω_1/ω . Hence x is now interpreted as ω_0/ω and the pass region is for pulsances greater than ω_0 .

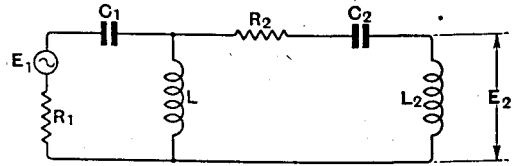

Fig. 7.

In the Design Tables we now interpret X_1, X_2, Y_1, Y_2 as follows:—

$$\left. \begin{aligned} X_1 &= 1/\omega_0 C_1 R_1, X_2 = 1/\omega_0 C_2 R_1 \\ Y_1 &= \omega_0 L_1/R_1, Y_2 = \omega_0 L_2/R_1 \end{aligned} \right\} \dots (37)$$

9. Band Stop Filters. Fig. 8.

These are obtained from high pass filters by putting inductances L'_1, L'_2 in parallel with the capacities C_1, C_2 and capacities C'_1, C'_2 in series with the inductances L_1, L_2 . The values of the new capacities and inductances are obtained from

$$L'_1, C_1 = L'_2 C_2 = L_1 C'_1 = L_2 C'_2 = 1/\omega_a^2 a \quad \dots (38).$$

in which $\omega_a^2 = \omega_r^2 - \frac{1}{4}\omega_0^2$
 ω_r = mid point of stop region.
 ω_0 = width of stopped band.

DESIGN TABLES.

A. Method of use for Low Pass Filters. Fig. 2.

The given quantities are the cut off pulsance and the input resistance R_1

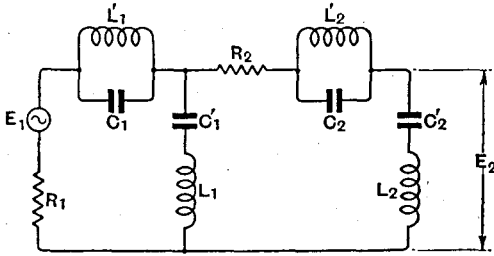

Fig. 8.

(fixed by the valve employed and its associated anode resistance).

Assume a value for $R_2/\omega_0 L_2$ and then read off X_1, X_2, Y_1, Y_2 from the appropriate Table.

Then

$$L_1 = X_1 R_1 / \omega_0, L_2 = X_2 R_1 / \omega_0, C_1 = 1 / Y_1 \omega_0 R_1, C_2 = 1 / Y_2 \omega_0 R_1$$

If R_1 is in ohms, then the calculated values of L_1, L_2 are in henrys and those of C_1, C_2 are in farads.

B. Use for Band Pass Filters. Fig. 6.

ω_0 is now the band width and L_1, L_2, C_1, C_2 are calculated as above. L'_1, L'_2, C'_1, C'_2 are calculated from

$$L'_1 C_1 = L'_2 C_2 = L_1 C'_1 = L_2 C'_2 = 1 / \omega_a^2$$

in which $\omega_a^2 = \omega_r^2 - \frac{1}{4}\omega_0^2$ and ω_r is the mid point of the band.

C. Use for High Pass Filters. Fig. 7.

ω_0 is the cut off pulsance and

$$C_1 = 1 / X_1 \omega_0 R_1, C_2 = 1 / X_2 \omega_0 R_1, L_1 = R_1 Y_1 / \omega_0, L_2 = R_1 Y_2 / \omega_0$$

the units being as before.

D. Use for Band Stop Filters. Fig. 8.

ω_0 is the band width and ω_r the mid point of the band. Calculate L_1, L_2, C_1, C_2 as in (C) and then L'_1, L'_2, C'_1, C'_2 as in (B).