

# INSTRUCTION MANUAL FOR

STAINLESS  
STEEL



CALIBER  
9mm & .40 S&W

## RUGER® SR-SERIES

SR9®, SR9c™, & SR40™

MANUAL SAFETY MODEL PISTOLS



**READ THE INSTRUCTIONS AND  
WARNINGS IN THIS MANUAL CAREFULLY  
BEFORE USING THIS FIREARM**

**For Product Service on This Model Please Call:  
(928) 778-6555 (See p. 33)**

THIS INSTRUCTION MANUAL SHOULD ALWAYS ACCOMPANY THIS FIREARM AND BE  
TRANSFERRED WITH IT UPON CHANGE OF OWNERSHIP, OR WHEN THE FIREARM IS LOANED  
OR PRESENTED TO ANOTHER PERSON

## State-By-State Warnings

Certain states require by law that their own specified warning notices in larger-than-normal type be conspicuously included by the manufacturer, distributor, or retail dealer with firearms sold in that state. Sturm, Ruger sells its products in compliance with applicable laws and regulations. Because our products may be sold in these states, we include the following:

### California:

#### **▲ WARNING**

“Children are attracted to and can operate firearms that can cause severe injuries or death. Prevent child access by always keeping guns locked away and unloaded when not in use. If you keep a loaded firearm where a child obtains and improperly uses it, you may be fined or sent to prison.”

#### **▲ ADVERTENCIA**

“A los niños los atraen las armas de fuego y las pueden hacer funcionar. Ellos pueden causarse lesiones graves y la muerte. Evite que los niños tengan acceso a las armas de fuego guardándolas siempre con llave y descargadas cuando no las esté utilizando. Si usted tiene un arma de fuego cargada en un lugar en que un niño tiene acceso a ella y la usa indebidamente, le pueden dar una multa o enviarlo a la carcel.”

### Connecticut:

“UNLAWFUL STORAGE OF A LOADED FIREARM MAY RESULT IN IMPRISONMENT OR FINE.”

### Florida:

“IT IS UNLAWFUL, AND PUNISHABLE BY IMPRISONMENT AND FINE, FOR ANY ADULT TO STORE OR LEAVE A FIREARM IN ANY PLACE WITHIN THE REACH OR EASY ACCESS OF A MINOR UNDER 18 YEARS OF AGE OR TO KNOWINGLY SELL OR OTHERWISE TRANSFER OWNERSHIP OR POSSESSION OF A FIREARM TO A MINOR OR A PERSON OF UNSOUND MIND.”

## **Maine:**

“ENDANGERING THE WELFARE OF A CHILD IS A CRIME. IF YOU LEAVE A FIREARM AND AMMUNITION WITHIN EASY ACCESS OF A CHILD, YOU MAY BE SUBJECT TO FINE, IMPRISONMENT OR BOTH. KEEP FIREARMS AND AMMUNITION SEPARATE. KEEP FIREARMS AND AMMUNITION LOCKED UP. USE TRIGGER LOCKS.”

## **Maryland:**

“WARNING: Children can operate firearms which may cause death or serious injury. It is a crime to store or leave a loaded firearm in any location where an individual knew or should have known that an unsupervised minor would gain access to the firearm. Store your firearm responsibly!”

## **Massachusetts:**

“WARNING FROM THE MASSACHUSETTS ATTORNEY GENERAL: This handgun is not equipped with a device that fully blocks use by unauthorized users. More than 200,000 firearms like this one are stolen from their owners every year in the United States. In addition, there are more than a thousand suicides each year by younger children and teenagers who get access to firearms. Hundreds more die from accidental discharge. It is likely that many more children sustain serious wounds, or inflict such wounds accidentally on others. In order to limit the chance of such misuse, it is imperative that you keep this weapon locked in a secure place and take other steps necessary to limit the possibility of theft or accident. Failure to take reasonable preventive steps may result in innocent lives being lost, and in some circumstances may result in your liability for these deaths.”

“IT IS UNLAWFUL TO STORE OR KEEP A FIREARM, RIFLE, SHOTGUN OR MACHINE GUN IN ANY PLACE UNLESS THAT WEAPON IS EQUIPPED WITH A TAMPER-RESISTANT SAFETY DEVICE OR IS STORED OR KEPT IN A SECURELY LOCKED CONTAINER.”

**New Jersey:**

“IT IS A CRIMINAL OFFENSE TO LEAVE A LOADED FIREARM WITHIN EASY ACCESS OF A MINOR.”

**New York City:**

“THE USE OF A LOCKING DEVICE OR SAFETY LOCK IS ONLY ONE ASPECT OF RESPONSIBLE FIREARM STORAGE. FOR INCREASED SAFETY, FIREARMS SHOULD BE STORED UNLOADED AND LOCKED IN A LOCATION THAT IS BOTH SEPARATE FROM THEIR AMMUNITION AND INACCESSIBLE TO CHILDREN AND OTHER UNAUTHORIZED PERSONS.”

**North Carolina:**

“IT IS UNLAWFUL TO STORE OR LEAVE A FIREARM THAT CAN BE DISCHARGED IN A MANNER THAT A REASONABLE PERSON SHOULD KNOW IS ACCESSIBLE TO A MINOR.”

**Texas:**

“IT IS UNLAWFUL TO STORE, TRANSPORT, OR ABANDON AN UNSECURED FIREARM IN A PLACE WHERE CHILDREN ARE LIKELY TO BE AND CAN OBTAIN ACCESS TO THE FIREARM.”

**Wisconsin:**

“IF YOU LEAVE A LOADED FIREARM WITHIN THE REACH OR EASY ACCESS OF A CHILD YOU MAY BE FINED OR IMPRISONED OR BOTH IF THE CHILD IMPROPERLY DISCHARGES, POSSESSES, OR EXHIBITS THE FIREARM.”

\* \* \* \* \*

Please check with your licensed retailer or state police for additional warnings which may be required by local law or regulation. Such regulations change constantly, and local authorities are in the best position to advise you on such legal matters.

## WHY ARE WE INCLUDING A FIRED CARTRIDGE CASE WITH EVERY RUGER PISTOL AND REVOLVER?

Certain states and jurisdictions require that all newly manufactured pistols and revolvers must be accompanied by a cartridge case, which has been test fired from that gun at the factory. The case must be placed in a sealed container bearing certain information concerning this test cartridge.

At the time of retail sale in those jurisdictions, firearms dealers must forward the test cartridge to a designated destination such as their State Police Laboratory. As independent Ruger Distributors have nationwide markets without territorial restrictions, we have decided to include a fired cartridge case with all new Ruger pistols and revolvers to minimize the possibility of inadvertent non-compliance with these laws.

Retail customers located in other states, where laws or regulations do not require the dealer to so act, may be assured that the fired cartridge case they receive with the firearm at the time of retail purchase is proof that your new Ruger firearm has undergone our normal test firing procedures during manufacture.

## LOCKING DEVICE INSTALLATION INSTRUCTIONS



### WARNING – USE OF LOCKING DEVICES



- Always keep your firearm pointed in a safe direction, including when you are installing or removing your locking device.
- Always verify that your firearm is completely **unloaded** (see pgs. 18 - 19) before installing your locking device.
- Do not install locking devices in the trigger guard; always keep your fingers and locking device outside the trigger guard during device installation and removal.
- Store firearms, ammunition and keys separately and securely, away from children and careless adults; do not store your firearm with the keys in the locking device.
- Do not attempt to work the action of your firearm with the locking device in place; this may damage your firearm.
- While locking devices are an important aid to security measures, they are not a substitute for safe firearm handling and proper storage. Remember that any mechanical device can be bypassed with enough time, knowledge, determination and equipment.

**LOCKING DEVICES MUST BE USED  
SAFELY AND RESPONSIBLY**

**Use the Correct Lock:** While the basic locking device is substantially similar for all Ruger® firearms, due to the different shapes of the many Ruger® firearms, some firearms utilize different locking devices. The lock with a 5" shackle is for use with **RUGER® SR-SERIES** Manual Safety Model Pistols. **It is very important to use the correct locking device!**

**To Install the Factory-Supplied Locking Device:**

1. **Keep the muzzle pointed in a safe direction and your fingers outside the trigger guard at all times!**
2. **Be sure the firearm is completely unloaded (see Unloading Instructions pgs. 18 - 19) and contains no cartridges or cartridge cases!**
3. Open the action completely. Use the slide stop to keep the action open during installation of the locking device.
4. Remove the magazine from your pistol and apply the locking device by placing the shackle of the lock into your pistol as shown in Figure 1, below.
5. Close the lock by pressing the shackle into the body of the lock (the part that receives the key) as tightly together as possible. The lock has bumpers and the shackle is coated with a non-marring material that will not harm the metal finish of your firearm or its high-strength polymer frame.
6. Once the lock is securely closed, remove the key and pull firmly on the lock to test the connection and be sure it is locked. **Do not leave or store your firearm with the key in the lock!** Store your locked unloaded firearm and the key in secure, separate locations, away from ammunition, children, or unauthorized adults.

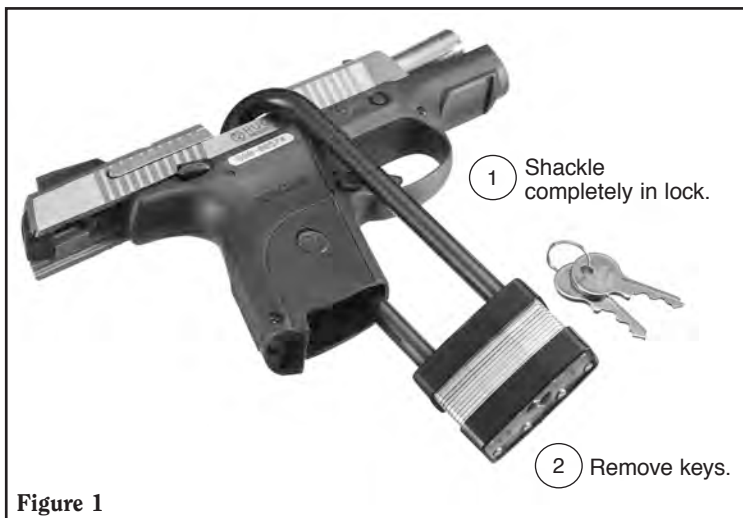

*Correct Installation of Lock*

## FIREARMS SAFETY - YOUR RESPONSIBILITY

### **SAFETY MUST BE THE FIRST AND CONSTANT CONSIDERATION OF EVERY PERSON WHO HANDLES FIREARMS AND AMMUNITION.**

This Instruction Manual is designed to assist you in learning how to use and care for your **RUGER® SR-SERIES** pistol properly. Please contact us if you have any questions. Only when you are certain you fully understand the Manual and can properly carry out its instructions should you practice loading, unloading, etc. with live ammunition. If you have any doubts about your ability to handle or use a particular type of gun safely, you should seek supervised instruction. Such personalized instruction is often available from gun dealers, gun clubs or police departments. If none of these sources can help you, contact the National Rifle Association, 11250 Waples Mill Road, Fairfax, VA 22030-7400. They will assist you.

The person possessing a gun has a full-time job. You cannot guess; you cannot forget. You must know how to use your firearm safely. **Do not use any firearm without having a complete understanding of its particular characteristics and safe use.** Remember: There is no such thing as a foolproof gun.

## **TABLE OF CONTENTS**

State-By-State Warnings	2
Locking Device Installation Instructions	5
General Information and Mechanical Characteristics	8
Nomenclature	9
Operation of Manual Safety	10
Striker Status Indicator	12
Ammunition	13
To Load and Fire	14
Operation of Loaded Chamber Indicator	16
Operation of Magazine Disconnect	17
Dry Firing	18
To Unload	18
To Reload The Pistol	20
To Extract and Eject a Chambered Cartridge	20
To Clear a Malfunction ("Jam")	21
To Minimize Malfunctions ("Jams")	22
To Disassemble	23
To Reassemble	26
Reversing the Backstrap	28
Magazine Inspection and Care	30
Care and Cleaning	31
Storage	32
Sight Adjustment	33
Service and Parts Policy	33
Shipping Firearms for Repair	33
Ordering Parts	35
SR9 Parts List	36
SR40 Supplemental Parts List	37
SR9 Exploded View	38
SR9c Parts List	39
SR9c Exploded View	41
<b>The Basic Rules of Safe Firearms Handling</b>	<b>42</b>
Warranty Information	48

"SR9c" and "SR40" are Sturm, Ruger trademarks.

"SR9" and "Ruger" are registered U.S. trademarks.



## WARNINGS OF GREAT IMPORTANCE ARE FOUND ON THE FOLLOWING PAGES:

Locking Devices	5	Slide Retraction	19
Alterations	8	Malfunctions	21
Manual Safety	11	Disassembly	25
Ammunition	13	Lubrication	31
Lead Exposure	13	Storage	32
Firing	15	Shipping	33
Handling	17	Parts Purchasers	34
Unloading	18		

OTHER CAUTIONS AND WARNINGS APPEAR THROUGHOUT THE MANUAL.

**FIREARMS ARE DANGEROUS WEAPONS - READ THE INSTRUCTIONS AND WARNINGS IN THIS MANUAL THOROUGHLY AND CAREFULLY BEFORE USING.**



## WARNING - ALTERATIONS



This product was designed to function properly in its original condition. Alterations can make it unsafe. Do not alter any part or add or substitute parts or accessories not made by Sturm, Ruger & Co. Inc.

**DO NOT ALTER ANY GUN**

## GENERAL INFORMATION AND MECHANICAL CHARACTERISTICS

**RUGER® SR-SERIES** pistols are centerfire, striker-fired, magazine-fed, autoloading, recoil-operated pistols chambered for the 9mm Parabellum (SR9 & SR9c) or .40 S&W (SR40) cartridges. **SR-SERIES** pistols incorporate a different “link-less” design in the barrel locking/unlocking system than earlier Ruger P-Series pistols, and features a streamlined slide and high performance glass-filled nylon grip frame. They have a unique, new modular construction in which the entire steel camblock assembly (which contains the barrel locking system, recoil absorption block, and steel slide rails) and trigger mechanism assembly can be inserted and removed as units. They include the following features with which users should be thoroughly familiar:



# NOMENCLATURE

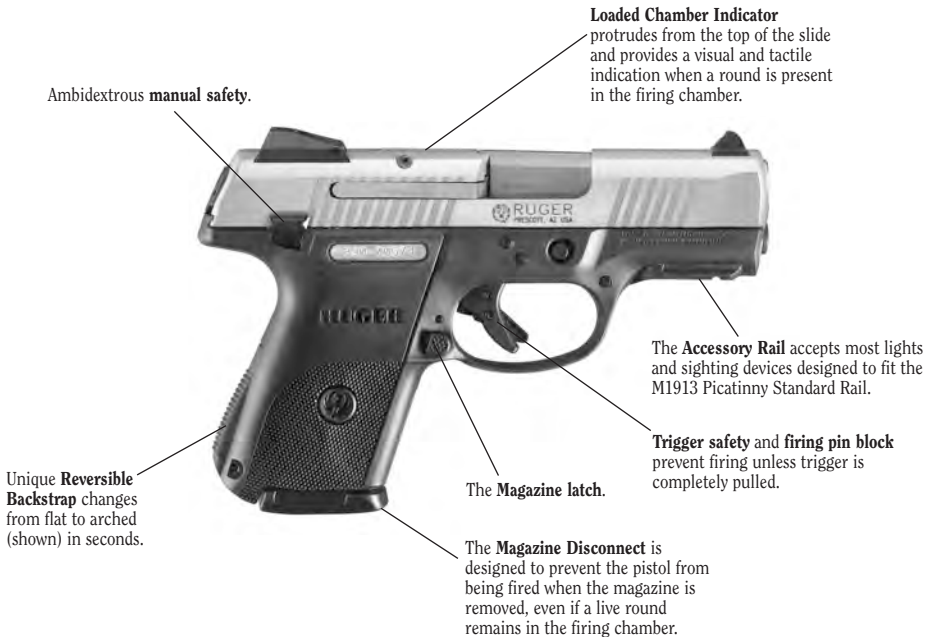

**Action:** The action of the Ruger **SR-SERIES** of pistols is of the improved striker-fired type that utilizes a tilting barrel design in which the barrel and slide are locked together at the moment of firing. The internal striker is partially cocked by the closing action of the slide. Pulling the trigger fully to the rear completes the cocking of the striker, releases the internal striker block, and disengages the internal trigger safety. The last bit of trigger pull fires the pistol. After firing, the barrel and slide recoil to the rear a short distance while still locked together. After this initial movement, the barrel is cammed downward from its locked position, permitting full recoil of the slide and the extraction and ejection of the spent cartridge case. Upon return of the slide to its forward position by the recoil spring, the barrel is cammed back upward into its locked position in the slide.

The user of this or any autoloading pistol must always remember that when fired, it automatically reloads and recocks itself, so that simply pulling the trigger will fire the pistol again. Therefore, an autoloading pistol user must be particularly conscious to always keep the pistol pointed in a safe direction.

**Slide Stop:** When the last shot has been fired and the magazine is empty, the slide stop automatically holds the slide open. When there is an empty magazine in the pistol and the slide is retracted manually, the slide stop will also automatically hold the slide open. If a loaded magazine is inserted in the pistol when the slide is closed and the slide is then retracted fully, the slide stop will not automatically hold open the slide. The user can actuate the slide stop mechanism to hold the slide open at any time by retracting the slide and pushing the slide stop up.

The slide stop can be released by drawing back slightly on the slide and depressing the slide stop thumbpiece. When the slide is released, it will move forward under pressure from the recoil spring.

The slide stop is spring loaded downward. Therefore, when there is a loaded magazine in place and the pistol is jarred, the slide can fly forward and chamber a cartridge. For this reason and as an essential safety practice, **the user should always be careful to keep fingers away from the trigger, keep the safety on, and always keep the pistol pointed in a safe direction.**

**Magazines:** The 17-rd and extended 10-rd 9mm Parabellum magazines designed for the SR9 and SR9C are interchangeable with each other, but are not interchangeable with other Ruger 9mm Parabellum magazines or Ruger pistol magazines of any other caliber even though they may appear similar.

## OPERATION OF MANUAL SAFETY

The model you have selected is equipped with ambidextrous manual safety levers. To engage the manual safety, **point the pistol in a safe direction.** **NOTE:** The slide must be fully forward before the safety can be moved upwards. Move either the right- or left-hand safety lever upward and fully to the “safe” position. When the safety is moved fully upward to the “safe” position, the red oval on the left side of the slide will be fully covered by the left safety lever and a white dot will be visible. If any red is showing, the safety is not in the “safe” position. **Do not attempt to engage the safety while pulling the trigger.**

The safety mechanism provides that the trigger cannot be pulled unless the safety is disengaged. Like the 1911 pistols, the manual safety lever locks the slide shut, ensuring that the pistol will be ready to fire when the safety is disengaged. To disengage the manual safety, point the pistol in a safe direction and push either safety lever fully downward. The red oval signifies that the safety is disengaged and the pistol is ready to fire.

Additionally, the pistol has a separate internal striker block which will not allow the striker to move forward and contact the cartridge until the operator pulls the trigger with the safety off (in its “fire” position).

The safety should be in its “safe” position at all times except when the user is deliberately positioned to fire at a selected target. When the safety is in the “fire” position (safety lever down) the red oval is exposed just above the safety lever. See Figures 2 and 3, below, which illustrate the two positions of the safety.

### “SAFE” POSITION



FIGURE 2

### “FIRE” POSITION



FIGURE 3



## WARNING - MANUAL SAFETY



Placing the safety in an intermediate position between “safe” and “fire” can result in the user thinking the pistol is in a safe or fire position when it is not. Pulling the trigger with the safety in an intermediate position may cause the pistol to fire. Therefore, always move the safety fully to its intended position and then check to be sure it is where you want it to be. Unless the red oval is fully covered by the safety lever, the safety is not “ON.” Unless the red oval is fully visible, the pistol is not absolutely ready to fire.

**NEVER PUT SAFETY 1/2 ON**

## STRIKER STATUS INDICATOR

Your **SR-SERIES** pistol is equipped with a Striker Status Indicator. The back of the striker is visible when the action is semi-cocked. (See Figure 4.)



FIGURE 4

As the trigger is pulled, the striker can be seen moving backward. (See Figure 5.)



FIGURE 5

When the striker is released by the trigger, it disappears from view. (See Figure 6.)



FIGURE 6

Your **SR-SERIES** pistol also is equipped with an internal striker blocker that prevents the striker from contacting the primer of a cartridge in the chamber until the trigger is pulled. An additional trigger safety blocks trigger bar movement until the trigger is pulled. An internal trigger bar interlock prevents the trigger bar from moving down to release the striker until it is moved back by trigger movement.

# AMMUNITION



The **RUGER® SR-SERIES** pistols are chambered for the 9mm Parabellum (SR9 and SR9c) or .40 S&W (SR40) cartridges. Do not attempt to load any other cartridges into the magazine or chamber of the pistol.

The **SR-SERIES** pistols are compatible with all factory ammunition of the correct caliber loaded to U.S. Industry Standards, including high-velocity and hollow-point loads, loaded in brass, aluminum, or steel cartridge cases. No 9mm Parabellum or .40 S&W ammunition manufactured in accordance with NATO, U.S., SAAMI, or CIP standards is known to be beyond the design limits or known not to function in these pistols.

 <b>WARNING – AMMUNITION</b>	
	Death, serious injury, and damage can result from the use of wrong ammunition, bore obstructions, powder overloads, or incorrect cartridge components.  <u>Always</u> wear shooting glasses and hearing protection.
<b>IMPROPER AMMUNITION DESTROYS GUNS</b>	

## AMMUNITION (CARTRIDGES) NOTICE

WE SPECIFICALLY DISCLAIM RESPONSIBILITY FOR ANY DAMAGE OR INJURY WHATSOEVER OCCURRING IN CONNECTION WITH, OR AS A RESULT OF, THE USE IN RUGER FIREARMS OF FAULTY, OR NON-STANDARD, OR “RE-MANUFACTURED”, OR HAND-LOADED (RELOADED) AMMUNITION, OR OF CARTRIDGES OTHER THAN THOSE FOR WHICH THE FIREARM WAS ORIGINALLY CHAMBERED.

 <b>WARNING - LEAD EXPOSURE</b>	
	Discharging firearms in poorly ventilated areas, cleaning firearms, or handling ammunition may result in exposure to lead and other substances known to the state of California to cause birth defects, reproductive harm, and other serious physical injury. Have adequate ventilation at all times. Wash hands thoroughly after exposure.
<b>SHOOTING OR CLEANING GUNS MAY EXPOSE YOU TO LEAD</b>	

## TO LOAD AND FIRE

Practice this important aspect of safe gun handling with an unloaded pistol until you can perform each of the steps described below with skill and confidence. **But before you do anything with the pistol, first read completely through this manual.**

1. **Be certain the muzzle is pointed in a safe direction.** (See “The Basic Rules of Safe Firearms Handling,” page 42.)
2. Pull the slide fully to the rear until the slide stops, and lock it open. (See Figure 7.)
3. Press the magazine latch inward from either side and remove the magazine from the frame. **NOTE:** The magazine is designed to fall free of the frame of its own weight when unloaded, the slide is locked open and the pistol is held in the normal firing position. You should always prevent possible damage to the magazine by not letting it drop to the ground unless rapid reloading is absolutely necessary.
4. For the 10-rd magazines, place ten or fewer 9mm Parabellum cartridges into the magazine from the top. For the 17-rd magazine, place seventeen or fewer cartridges in the magazine. For the 15-rd magazine, place fifteen or fewer cartridges in the magazine. The magazine has holes on the side to assist in counting the number of cartridges in the magazine. **NOTE:** When using the 17-round magazine in the **SR9c™**, use the Magazine Adapter to ensure reliable feeding.
5. Insert the magazine into the frame, taking care that the magazine is locked in place by the magazine latch. Slamming the magazine into the frame forcibly is not necessary.
6. Hold the pistol firmly in the shooting hand but **do not touch the trigger. Keep the pistol pointed in a safe direction.** With the thumb and forefinger of the other hand grasp the rear of the slide and pull the slide to the rear as far as it will go (see Figure 7, below and “Slide Retraction Warning”, p. 19). When released, the slide will fly forward to strip the top cartridge from the magazine and chamber it.

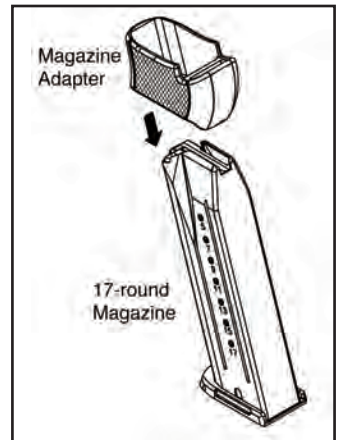
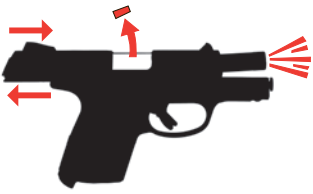

**FIGURE 7**  
Retracting the Slide

- Engage the safety by moving the safety lever fully upward.

**WARNING:** The pistol is ready for instant use once the slide moves forward if the safety is in the “fire” position. Be careful!

- If the pistol is not to be fired immediately, the safety should be immediately placed into the fully upward “safe” position (see Figure 2, p. 11). If the pistol is to be fired immediately, the manual safety can remain downward to its “fire” position (see Figure 3, p. 11). The striker is still blocked at all times by the internal striker blocker and the trigger bar cannot move to complete cocking of the striker unless the trigger is pulled all the way to the rear to fire the pistol.
- The pistol is ready for instant use once the safety is disengaged. When the pistol is in the semi-cocked mode (See Figure 4, p. 12), the first shot can be fired by pulling the trigger all the way to the rear, which fully cocks the striker and then fires the pistol. Subsequent shots are fired until the magazine is empty, the striker being semi-cocked by the slide as it recoils from each shot.

 <b>WARNING - FIRING</b>	
	The slide automatically opens and shuts quickly while firing. Keep face and hands away from rear. Hot brass is ejected quickly and can burn you. Always shooting glasses and hearing protection.
<b>SLIDE OPENS FAST - HOT BRASS EJECTED</b>	

- Immediately following the firing of a shot, and if a subsequent shot is not to be fired at once, put the safety in its “safe” position (lever fully upward and red oval completely covered) while the pistol is still pointing in a safe direction downrange.
- When the last cartridge loaded into the pistol has been fired, the magazine follower presses the slide stop upward to engage the slide, automatically holding the action open. If the slide is shut, the shooter should always assume that there is a cartridge in the chamber!

Don't rely on your memory or the word of others to know if a gun or magazine is loaded. Visually inspect the magazine and chamber to be certain.

## OPERATION OF LOADED CHAMBER INDICATOR

You should always treat every gun as though it is loaded and always keep the muzzle pointed in a safe direction. Never rely upon any safety or mechanical device to justify unsafe or careless gun handling. In order to assist you in determining the presence of a cartridge in the chamber of your **RUGER® SR-SERIES** pistol, and to comply with state laws, the **SR-SERIES** is equipped with a loaded chamber indicator. The indicator appears on the top of the slide. (See “Nomenclature,” p. 9.)

When the chamber is empty, the loaded chamber indicator should be flush with the top of the slide. (See Figure 8A, below.)

When the chamber is loaded, the forward portion of the loaded chamber indicator should protrude from the top of the slide. When the chamber contains a cartridge, a red bar should be visible on either side of the loaded chamber indicator. (See Figure 8B, below.)

### OPERATION OF LOADED CHAMBER INDICATOR

**Indicator  
Flush  
With Top**

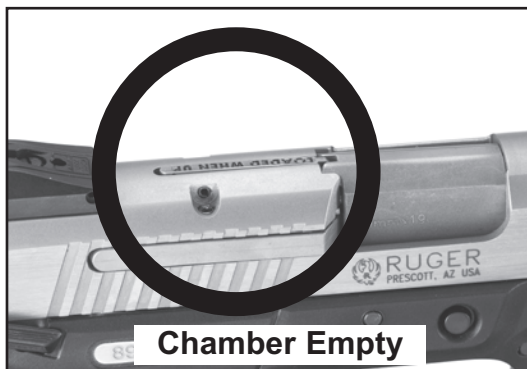

Figure 8A

**Indicator  
Protrudes  
From  
Top -  
Red Bar  
Visible**

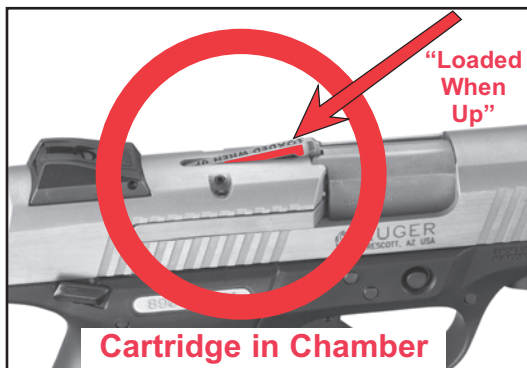

Figure 8B



**NEVER RELY ON YOUR MEMORY OR ANY LOADED CHAMBER INDICATOR TO KNOW IF A GUN IS LOADED. ANY MECHANICAL DEVICE CAN FAIL. ALWAYS VISUALLY CHECK THE CHAMBER BY RETRACTING THE SLIDE AND EXAMINING THE CHAMBER TO BE SURE WHETHER IT IS EMPTY OR LOADED.**



## OPERATION OF MAGAZINE DISCONNECT

Your **RUGER® SR-SERIES** pistol is equipped with a magazine disconnect. This device prevents firing if the magazine is removed from the pistol. You will not be able to use your **SR-SERIES** pistol as a single loader (unless you place one cartridge in the magazine and insert it into the pistol) or to fire the pistol with the magazine out of the pistol.



**REMEMBER THAT A ROUND MAY STILL BE IN THE CHAMBER AND THAT THE PISTOL MAY STILL BE LOADED EVEN IF THE MAGAZINE IS REMOVED. AS SOON AS AN EMPTY MAGAZINE IS INSERTED, A ROUND IN THE CHAMBER CAN BE FIRED BY PULLING THE TRIGGER.**

**BE CAREFUL! AS ALWAYS, YOU SHOULD NOT RELY UPON THE MAGAZINE DISCONNECT OR ANY OTHER MECHANICAL DEVICE OR SAFETY TO JUSTIFY CARELESS OR UNSAFE HANDLING OF ANY FIREARM.**

Don't rely on your memory or the word of others to know if a gun or magazine is loaded. Visually inspect the magazine and the chamber to be certain.



### WARNING - HANDLING



Do not load the pistol until you are ready to use it, and unload it immediately when you have completed shooting. (See "Warning - Unloading" on page 18.)

If dropped or struck, the pistol may fire. Keep chamber empty unless actually firing! Use the safety lever before moving with pistol or when not actually firing.

For maximum safety when carrying the pistol with a loaded magazine in place, the chamber should be empty, the slide should be closed, and the safety should be in the "ON" position. If placed into a holster, check it to be sure that the slide is not retracted far enough to chamber a cartridge from the magazine.

The user should never depend on any mechanical device to justify careless handling or permitting the pistol to point in an unsafe direction. The shooter should always be alert to the possibility of accidental discharge. **The only absolutely safe pistol is one in which the slide is open, the chamber is empty, and there is no magazine in the gun.**

**ANY GUN MAY FIRE IF DROPPED**

## DRY FIRING

Going through the actions of cocking, aiming and pulling the trigger on an unloaded gun is known as “dry firing.” It can be useful to learn the “feel” of your pistol. Be certain that the pistol is fully unloaded (both the chamber and magazine are empty) and that the pistol is pointing in a safe direction even when you are practicing dry firing. The **RUGER® SR-SERIES** pistols can be dry-fired without damage to the striker or other components as long as an empty magazine is inserted.



**CAUTION:** Dry firing your **RUGER® SR-SERIES** with the magazine removed may result in damage or unnecessary wear to the magazine disconnect mechanism and/or striker.

**NOTE:** When dry firing the **SR-SERIES** pistols, the trigger will not automatically move forward to reset. The slide must be retracted at least 1/2” to reset the trigger and firing mechanism.

## TO UNLOAD

**WARNING:** This sequence must be followed exactly as outlined. Failure to do so can result in the chamber being unintentionally loaded with a live cartridge!

1. The muzzle of the pistol must be pointing in a safe direction at all times, and fingers should be outside of the trigger guard.
2. Remove the magazine from the pistol by pushing in on the magazine latch. **REMEMBER** that even though the magazine has been removed, a live round may remain in the chamber. (See “Warning - Unloading,” below.)
3. Hold the pistol firmly and grasp the slide. Retract the slide to its rearmost position briskly to extract and eject any chambered cartridge. Always double check visually that the chamber, breech-face, and the interior of the frame are clear of any live rounds. When the slide is fully retracted, push upward on the slide stop, then allow the slide to move forward until it comes to rest with the rear projection of the slide stop resting in the notch on the lower left side of the slide.

 <b>WARNING - UNLOADING</b>	
	Removing magazine does not unload pistol! To unload, first remove magazine, then pull slide to rear, eject chambered cartridge, and visually inspect chamber to be sure it is empty. Always point the pistol in a safe direction when loading or unloading.
	Removing the magazine should prevent the pistol from firing – but never rely on this as any other mechanical safety device to justify careless handling of any firearm.
<b>REMOVING MAGAZINE DOES NOT UNLOAD CHAMBER</b>	

## CORRECT UNLOADING SEQUENCE



## WARNING - SLIDE RETRACTION

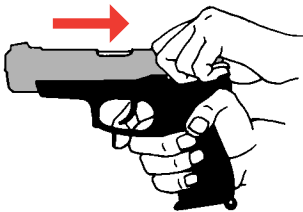

The slide should always be pulled rearward (“retracted”) by pulling the rear portion of the slide in the vicinity of the serrations. **Always keep fingers away from trigger!**

**Never put any part of your hands or body over the muzzle while retracting the slide** for loading, unloading, inspection, or clearing a malfunction.

**KEEP HANDS AWAY FROM MUZZLE AND FINGER OFF TRIGGER**

4. To close the slide, **again check to be sure the chamber and breech-face are empty.** Pull the slide to its rearmost position and release it. The slide will snap forward. Keep fingers out of ejection port on top of slide!
5. If the magazine contains cartridges, they can be removed by sliding each cartridge forward and out of magazine, one at a time, until the magazine is empty.
6. Push the empty (unloaded) magazine into frame until the magazine latch locks it in place. **Remember that doing so deactivates the magazine disconnect and a cartridge left in the chamber will now fire if the trigger is pulled. Be careful!**

## TO RELOAD THE PISTOL

1. Firing all cartridges in the magazine and the chamber will cause the slide to automatically lock open. **Keep the pistol pointed in a safe direction.** Press in on either magazine latch with the thumb or forefinger. The magazine will fall free of the pistol of its own weight if the slide is locked open. To avoid the possibility of damage to the magazine, do not let it fall to the ground unless rapid reloading is absolutely necessary.
2. Insert a loaded magazine. **WARNING: The slide stop is held in place by the slide pressing against the rear of the slide stop. Therefore, when there is a loaded magazine in place and the pistol is jarred, the slide can fly forward and chamber a cartridge. For this reason and as an essential safety practice, the pistol should always be pointed in a safe direction.**
3. Release the slide to move forward by pulling the slide fully to the rear and release it. A cartridge will be chambered when the slide shuts. **WARNING: The pistol is ready to fire. If you are not going to immediately shoot the pistol, engage the safety by moving the safety lever upward so that the red oval is fully covered and the white dot is exposed.** When you are finished firing the pistol, unload it completely (see pages 18 - 19).



## TO EXTRACT AND EJECT A CHAMBERED CARTRIDGE

When the pistol is fired, the same gas pressure that drives the bullet forward also acts through the cartridge case to push the slide to the rear. The action causes extraction and ejection of the fired cartridge case. If a cartridge fails to fire or if the shooter wishes to eject the chambered cartridge manually, follow the procedure "To Unload," p. 18. When the slide is operated by hand, there can be a failure to extract the cartridge from the chamber, or a failure to eject the cartridge clear of the pistol. These failures usually are the result of the slide not being pulled rearward vigorously.

The gun user must:

1. Always visually check the chamber and the breech-face after opening the slide to eject a chambered cartridge. If the slide is not vigorously retracted when being operated by hand, the extracted cartridge can be “ejected” into the magazine-well of the grip frame or remain held to the breech-face by the extractor.
2. Thoroughly clean the chamber and the extractor as often as necessary.

If an empty magazine is in the pistol when the slide is being hand retracted to extract a cartridge, the cartridge may drop on top of the magazine or remain held to the breech-face by the extractor. Then when the slide goes forward, the cartridge will be chambered again! **Remember — always remove the magazine before clearing the chamber, and visually ensure that no cartridges remain anywhere in the gun.**

 <b>WARNING - MALFUNCTIONS</b>	
	<p>Any autoloading pistol may occasionally malfunction. If a cartridge hangs up, jams, or binds when being chambered, do not attempt to force it into the chamber by pushing or striking the slide. Carefully remove it.</p> <p>Most failures of a cartridge to feed or to chamber properly are caused by a damaged magazine, incorrect gun handling, insufficient lubrication, or improper ammunition.</p> <p>Whatever the cause, the user of the pistol must, above all, recognize that any cartridge jam can result in a potentially very dangerous situation of a cartridge discharging before it is properly chambered. If this happens, the cartridge case may rupture and its fragments fly out of the ejection port of the pistol with sufficient force to cause serious injury. <b>Always wear shooting glasses!</b></p>
	<b>HITTING PRIMER CAN BURST CARTRIDGE</b>

## TO CLEAR A MALFUNCTION (“JAM”)

1. **Be certain the muzzle is continually pointed in a safe direction.**
2. If possible, remove the magazine. It may be necessary to manually remove a jammed cartridge that has only been partially stripped from the magazine. If so, use extreme care. Lock the slide open with the slide stop before attempting

to clear the jam. Drawing the slide fully to the rear may bring the jammed cartridge along. **Keep your face away from the ejection port during this operation.** When attempting to clear a jam, use only wood “tools” so that the cartridge will not be damaged or the primer ignited. A 3/16” wooden dowel with a point on one end is useful. Carefully remove the jammed cartridge from the chamber and dispose of it properly.

3. Visually check to make sure that all cartridges have been removed from the pistol. Safely dispose of any cartridges involved in a malfunction incident. Do not use damaged ammunition in any firearm.

## TO MINIMIZE MALFUNCTIONS (“JAMS”)

1. If it appears that the jam was caused by the type of ammunition being used, try another brand, type, or lot number. Remember — use only factory ammunition of the correct caliber.
2. If changing ammunition does not at once eliminate malfunctions, then the following steps should be taken:
  - a. Thoroughly clean the pistol, paying particular attention to the removal of accumulated grease and dirt. Use a bristle brush and solvent to remove grease and fouling from the breech-face, extractor, chamber, and feed ramp area immediately behind the chamber.
  - b. Check to be sure that the magazine spring firmly returns the magazine follower to the top of the magazine.
  - c. Check the magazine lips to be certain that they are free of nicks and burrs and that they are not deformed or cracked.
  - d. Remove excess oil and solvent from all cleaned components, load the magazine, and try the pistol again. Make sure you are following the correct loading and firing sequence as described in this manual.
  - e. If none of the above steps is effective, try a different magazine of Ruger manufacture. If a new magazine does not function correctly, return the pistol and magazines to the Ruger Product Service Department. (See “Shipping Firearms For Repair” on page 33.)
  - f. **Alterations to the pistol or use of non-Ruger magazines and accessories may cause malfunctions. See “Warning - Alterations” on page 8.**

## TO DISASSEMBLE

**Be sure pistol is unloaded!**

1. **Keep pistol pointed in a safe direction.** Press down on the magazine latch and remove the magazine. (See Figure 9.)

**NOTE:** Trigger should be in the forward position in order to disassemble the pistol.



2. Pull the slide to the rear and lock into the open position by pressing upward on rear of the slide stop. (See Figure 10.) **Again, be sure chamber is empty!**



3. Keep upward pressure on the slide stop to prevent forward movement of slide. The open slide is under strong spring tension and could injure fingers if allowed to slam shut. Insert finger (or another non-metallic object such as the eraser end of a pencil) through the top of the slide and push the ejector downward and forward until it locks in its forward position. (See Figure 11.) This will permit forward movement of the slide off the front of the frame.

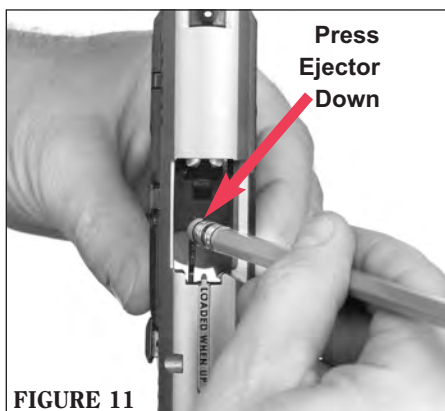

Further disassembly is impossible unless this is done.

4. Remove fingers (or whatever you used to push the ejector forward) from ejection port. From the right side of the pistol, press inward on the takedown pin (see Figure 12a) and remove it from the pistol (see Figure 12b).

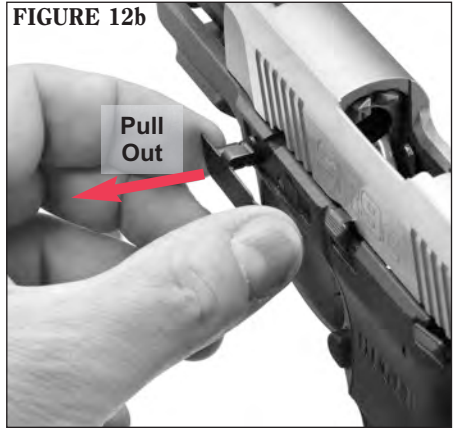

5. Carefully allow the slide to move forward until it is no longer under spring tension. Now push the slide forward and remove the entire slide assembly from the frame. (See Figure 13.)

6. With the slide held upside down, slightly depress the recoil spring to disengage it from its seat against the barrel lug. (See Figure 14.) Lift the recoil spring forward and upward to remove it from the slide.





7. Move the barrel slightly forward to disengage it from the slide. Lift the barrel up and out of the slide. (See Figure 15.) Your pistol is now field stripped and ready for cleaning.

There is normally no need for further disassembly of the pistol.

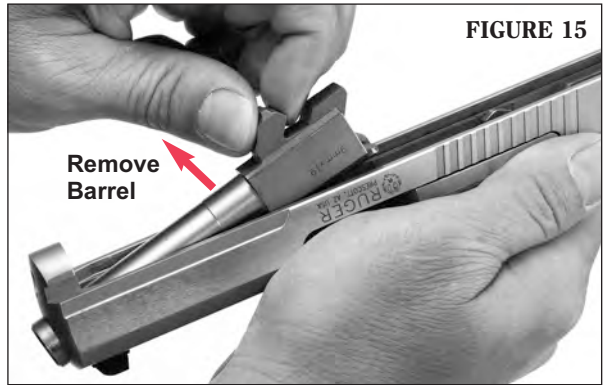

FIGURE 15



<b>⚠ WARNING - DISASSEMBLY</b>	
	<p>Always unload a firearm before cleaning, lubrication, disassembly or assembly.</p>
<b>UNLOAD BEFORE DISASSEMBLY</b>	

## TO REASSEMBLE

1. Be certain the chamber and magazine are empty. Always keep the pistol pointed in a safe direction.

2. With the slide held upside down, replace the barrel and push it rearward into its locked position. (See Figure 17.)

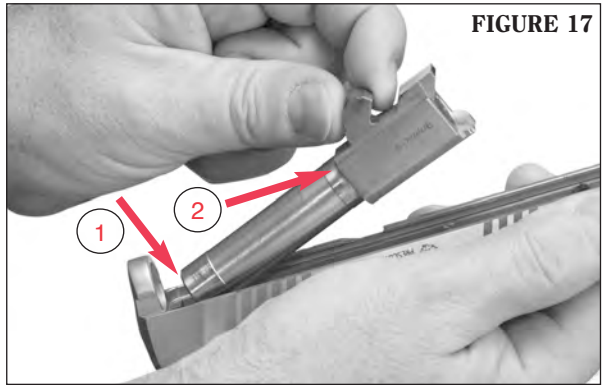

3. Place the recoil spring assembly into position. Make sure that the plastic end of the recoil spring goes into the slide. (See Figure 18.)

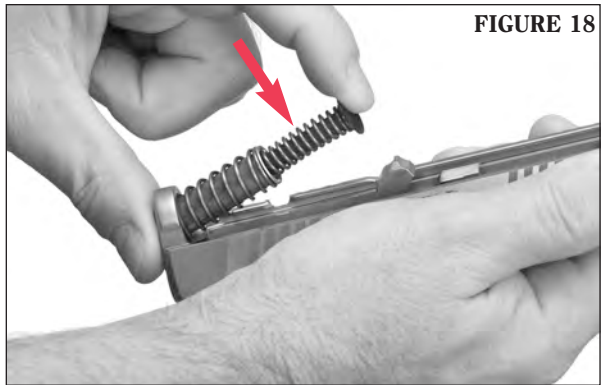

4. Be certain that ejector is pulled down and locked in its lower (forward) position. Push the trigger into its fully forward position. (See Figure 19.)

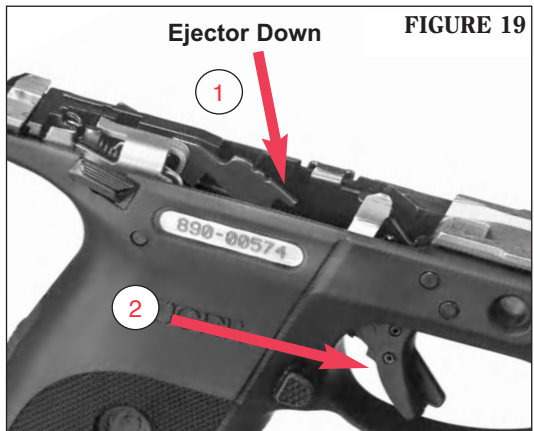

5. Replace the slide onto frame. Pull the slide fully back and lock it into position by pushing upward on the slide stop. (See Figure 20.)

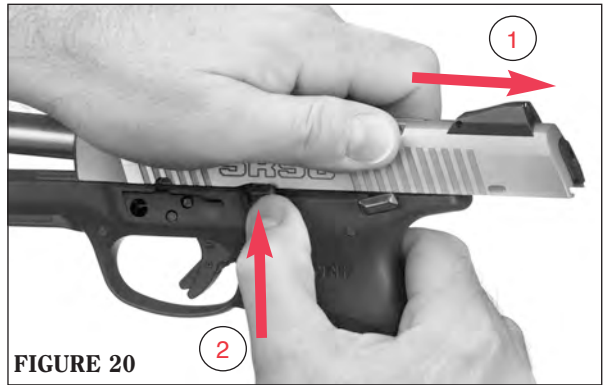

6. Now push the takedown pin all the way through the frame to the right. (See Figure 21.)
7. Allow the slide to move fully forward by retracting the slide and allowing it to move forward. (See Figure 22.)
8. Replace the empty magazine in frame through butt of pistol. (See Figure 23.) This action returns the ejector to its working position. This pistol will not function normally unless the ejector is in its Upward (rearward) position.

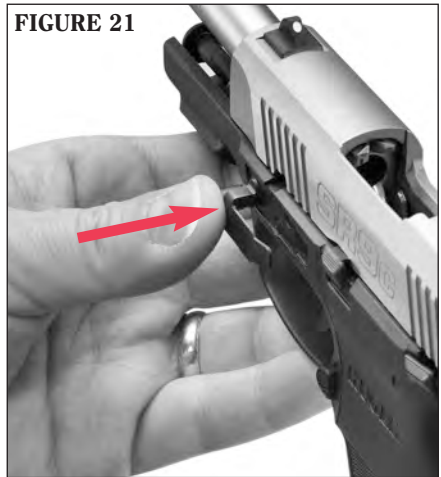

## REVERSING THE BACKSTRAP

To accommodate personal grip preferences and styles, the **SR-SERIES** is equipped with a unique reversible backstrap. One side provides an arched surface; the reverse side is flat.

1. To reverse the backstrap, begin by removing the backstrap retaining pin using a correctly sized Allen wrench or large paper clip (shown here). Simply push the pin and set it aside. (See Figure 24.)



**FIGURE 24**

2. Slide the backstrap down and out of the grip frame. (See Figure 25a.)

**NOTE:** The full size **SR9** and **SR40** have a backstrap bushing which must remain in the correct position during assembly. (See Figure 25b.)



3. Now reverse the backstrap (see Figure 26a), slide it back into the grip frame (Figure 26b) and reinsert the pin. Be careful to push the pin in far enough so that it is centered in the grip frame.

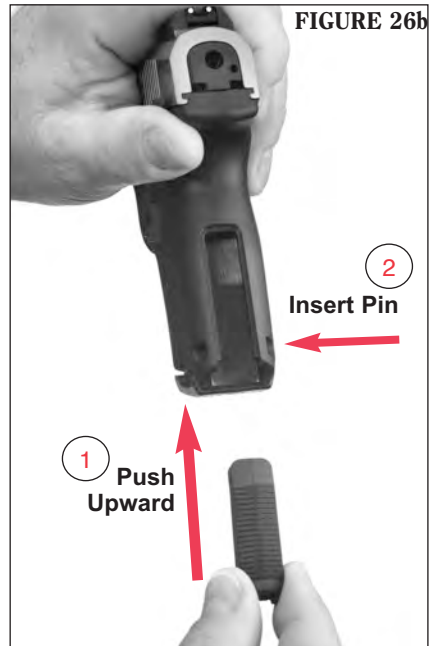

## MAGAZINE INSPECTION AND CARE

Check the magazine frequently. The magazine follower must move freely and have adequate tension so that each cartridge is quickly raised to the feeding position. The magazine lips should be clean and free of cracks, dents, or nicks, so that cartridges are held in their proper feeding position.

If the magazine becomes dirty, it should be disassembled and thoroughly cleaned. **Be sure the magazine is unloaded before disassembly.** All **RUGER® SR-SERIES** magazines are manufactured with a snap-on base. The following disassembly instructions apply:

**Snap-On Base** - Use a punch to press in on the magazine spring seat where it protrudes into the hole in the magazine floorplate. Slide the magazine floorplate toward the front of the magazine, taking care to prevent the forcible ejection of the magazine spring seat and compressed magazine spring. Withdraw the magazine spring seat, magazine spring, and magazine follower from the magazine body. Reassemble in reverse order.

When cleaning is necessary, use a solvent that will not rust the metal components or adversely affect the magazine body. After the magazine has been soaked to loosen foreign matter, be certain to shake it vigorously (with the loading opening away from you) to remove solvent or residue from within the magazine. **Penetrating oils and solvents inside a magazine can "kill" or weaken cartridge primers or powder which can result in failures to fire or other possibly dangerous malfunctions, such as leaving a bullet in the bore!**

After cleaning always check to be certain that the magazine follower movement and tension are correct, and that no solvent or debris remain. **Improper reassembly of the magazine spring can cause failure to feed, which is a potentially dangerous malfunction. If cleaning does not restore proper tension, or if you experience a problem with the magazine, don't use it. Get a new one.**

**DAMAGED, NON-STANDARD, OR IMPROPERLY ASSEMBLED MAGAZINES SHOULD NOT BE USED. THEY CAN CAUSE THE PISTOL TO MALFUNCTION.**

# CARE AND CLEANING



## Make Sure Gun Is Unloaded!

**BEFORE CLEANING, BE CERTAIN THE PISTOL AND ITS MAGAZINE CONTAIN NO CARTRIDGES.** (See “Warning - Unloading,” p. 18.) **KEEP THE PISTOL POINTED IN A SAFE DIRECTION.**

At regular intervals, or whenever the pistol has been exposed to sand, dust, extreme humidity, condensation, immersion in water, or other adverse conditions, disassemble, clean, and oil it. Proper periodic maintenance is essential to the reliable functioning of any firearm.

To clean the pistol, proceed as follows:

1. Disassemble (fieldstrip) the pistol to the extent described on pages 23 - 25.
2. Using a cleaning rod, run a solvent-wetted patch through the bore several times. Then attach a solvent-wetted bristle brush to the rod and run it back and forth the full length of the bore as many times as necessary to remove grease and dirt from the bore and chamber. Clean bore with dry patches and examine. Bore fouling can contribute to reduced accuracy, and grease accumulation in the chamber can interfere with proper feeding of cartridges from the magazine.
3. Using powder solvent on a clean patch or bristle brush, remove powder residue from all components of the pistol. After cleaning, run a dry patch through the bore, then follow with a patch that is very lightly oiled. Wipe all surfaces clean with cloth, then wipe all surfaces with a patch or cloth that has been very lightly oiled.
4. **NOTE:** Only a light application of oil is needed to provide adequate lubrication of moving parts and to prevent rust. Excess accumulations of oil tend to attract particles of dust and dirt and may congeal in cold weather, which can interfere with the safe and reliable function of the pistol.
5. Before firing, remove all oil and grease from the bore.

 <b>WARNING - LUBRICATION</b>	
	Firing a pistol with oil, grease, or any other material even partially obstructing the bore may result in damage to the pistol and serious injury to the shooter and those nearby. Do not spray or apply lubricants directly on ammunition. If the powder of a cartridge is affected by the lubricant, it may not be ignited, but the primer firing may push the bullet into the bore where it may be lodged. <b>Firing a subsequent bullet into the obstructed bore may damage the pistol and cause serious injury or death to the shooter and those nearby.</b> Use lubricants properly. You are responsible for the proper care and maintenance of your firearms.
	<b>IMPROPER LUBRICATION DESTROYS GUNS</b>

# STORAGE



GUNS SHOULD NOT BE STORED LOADED!

**USE THE LOCKING DEVICE SUPPLIED WITH THE PISTOL TO RENDER IT INOPERATIVE FOR SAFE STORAGE.**

(SEE PAGE 5)

*Do not* keep your pistol in a leather, fabric or canvas holster when it is stored. These materials attract moisture, even though the holster may appear to be perfectly dry.

Sturm, Ruger also offers gun safes for sale as a means to secure more than one firearm. Please call the Heritage Safe Company at 1-800-515-7233 for details and ordering information.

	
<h2>WARNING – STORAGE</h2>	
	<p>Never place or store any firearm in such a manner that it may be dislodged. Firearms should always be stored securely and unloaded, away from children and careless or unauthorized adults. Use the locking device originally supplied with this firearm for storage.</p>
	<p>The use of a locking device or safety lock is only one aspect of responsible firearms storage. For increased safety, firearms should be stored unloaded and locked in a location that is both separate from their ammunition and inaccessible to children and any other unauthorized person.</p>
<b>STORE SECURELY &amp; UNLOADED</b>	



## SIGHT ADJUSTMENT

**RUGER® SR-SERIES** pistols are equipped with a rear sight which is adjustable for both windage and elevation.

**To adjust for elevation**, rotate the screw in the rear sight clockwise or counter-clockwise to lower or raise the sight, respectively. (See Rear Sight Elevation Adjustment photo.) Note that lowering the rear sight will lower the point of impact, and raising the rear sight will raise the point of impact.

**To adjust for windage**, after the rear-sight lock screw has been loosened using a 5/64" Allen wrench, the rear sight can be drifted laterally in its dovetail on the top of the slide by tapping it with a wooden- or plastic-headed hammer or similar implement. Move the rear sight in the direction you want the shot to move on the target. After the rear sight is adjusted, tighten the rear-sight lock screw. Both front and rear sights are provided with white-dot inserts for rapid target acquisition and easy alignment of the sights to obtain a correct sight picture.



**REAR SIGHT  
ELEVATION ADJUSTMENT**

## SERVICE AND PARTS POLICY

If you have any questions with regard to the performance of your **RUGER® SR-SERIES** pistol, please write or call (928-778-6555) our Product Service Department in Prescott, Arizona, fully describing all circumstances and conditions involved. If you should return your pistol to the factory for repair, or order parts for it, please comply with the following suggestions for prompt service:



**WARNING—BEFORE SHIPPING ANY FIREARM, BE ABSOLUTELY CERTAIN THAT IT AND ITS MAGAZINE ARE UNLOADED. DO NOT SHIP CARTRIDGES WITH A FIREARM.**

## SHIPPING FIREARMS FOR REPAIR:

**RUGER® SR-SERIES** of pistols returned to the factory for services or repair should be sent to: Sturm, Ruger & Company, Inc., Product Service Department, 200 Ruger Road, Prescott, AZ 86301-6181. Telephone (928) 778-6555.



Guns should be sent prepaid. We will not accept collect shipments.

The Federal Gun Control Act, as well as the laws of most States and localities, do not prohibit an individual (who is not otherwise barred from purchasing or possessing a firearm) from shipping a firearm directly to the manufacturer for repair. However, before you ship your pistol to us, be certain that your State or locality does not have a law or regulation which will prohibit you from receiving the pistol from us after it has been repaired. If such receiving is prohibited, then please have a Federally Licensed Firearms Dealer ship the gun to us. If your pistol is sent to us by a dealer, it will be returned to that dealer after being repaired. If a handgun (pistol or revolver) is shipped by an individual who does not hold a Federal Firearms License, it must be shipped for overnight delivery via U.P.S., Federal Express or other, similar private overnight service. NOTE: Firearms may not be shipped via U.S. Mail. Persons who do not hold a Federal Firearms License are prohibited by Federal law from shipping a handgun by Mail. Handguns mailed in violation of the law are impounded by the Post Office.

Please do not include holsters, custom grip panels, or accessories with a firearm being shipped to the factory for service. **DO NOT SEND GUN BOXES OR LITERATURE THAT YOU CONSIDER TO BE COLLECTOR'S ITEMS – THESE ARE INVARIABLY DAMAGED OR DESTROYED IN SHIPMENT.** Always insure your shipment.

Enclose a letter which includes your name, address, telephone number, and serial number and model of the firearm. Describe in detail the trouble you have experienced with your firearm, or the work you wish to have done. Merely stating that the firearm “needs repair” is inadequate information. Please enclose copies of any previous correspondence.

All work performed is subject to a minimum labor charge and charges for shipping and handling. Most models can be reblued, but custom gunsmithing service or nonstandard alterations are NOT AVAILABLE from Ruger Product Service Departments. Please contact the Product Service Department for pricing information.

	
<b>WARNING - PARTS PURCHASERS</b>	
	It is the purchaser's responsibility to be absolutely certain that any parts ordered from the factory are correctly fitted and installed. Firearms are complicated mechanisms and <b>IMPROPER FITTING OF PARTS MAY RESULT IN A DANGEROUS MALFUNCTION, DAMAGE TO THE FIREARM, AND SERIOUS INJURY TO THE SHOOTER AND OTHER PERSONS.</b> The purchaser and installer of parts must accept full responsibility for the correct adjustment and functioning of the pistol after such installation.
<b>PARTS MUST FIT CORRECTLY</b>	

## ORDERING PARTS

Please contact our Prescott, Arizona Product Service Department for parts availability and current prices. All parts orders for **RUGER® SR-SERIES** of pistols should be sent to: Sturm, Ruger & Company, Inc., Parts Department, 200 Ruger Road, Prescott AZ 86301-6181, (928) 778-6555. We cannot comply with open account or C.O.D. requests. Payment in full via credit card (Visa or MasterCard only), money order or certified bank check (no personal checks, please) is required before any service will be performed. Please provide your credit card number, your name as it appears on the credit card, and the expiration date. All parts orders are subject to a minimum charge and charges for shipping and handling. Order parts by Part Name and Part Number and include the entire serial number of the firearm for which the parts are being ordered. There is a minimum labor charge plus a shipping and handling charge if the parts are factory fitted. All factory fitted parts are fit on an exchange basis only. We will not return the replaced parts. Please contact the Product Service Department for pricing information.

Because it is a serial numbered component, the **RUGER® SR-SERIES** frame is defined as a "firearm" by Federal law and is not sold as a separate component.

\*Parts designated by an asterisk must be factory fitted. These parts are fitted on an exchange basis only. We will not return the replaced parts. We will not return any part that is broken, malfunctioning, badly worn or has been modified. See "Warning - Parts Purchasers," above.



**CAUTION: A gun containing modified, broken, malfunctioning, or badly worn parts should not be fired!**

### **RUGER® SR9® PRODUCT SAFETY WARNING AND RECALL NOTICE**

We have determined that some Ruger SR9 pistols manufactured between October 2007 and April 2008 can, under certain conditions, fire if dropped with their manual safeties in the "off" or "fire" position. The pistols will not fire if the manual safety is in the "on" or "safe" position.

We will retrofit all Ruger SR9 pistols starting with serial number prefix "330" (330-xxxx) with the new trigger group **at no charge** to our customers.

In order to ensure correct fitting, the new parts must be installed at our Ruger factory in Prescott, Arizona. We will remove the old parts and install the new trigger group promptly, at no charge, and will return the pistol to you. The old parts will not be returned.

Please contact us by going online at [www.ruger.com/SR9Recall/](http://www.ruger.com/SR9Recall/); e-mail at [SR9Recall@ruiger.com](mailto:SR9Recall@ruiger.com); fax (928) 541-8873; or by calling our Prescott Product Service Department at (928) 778-6555.

# RUGER® SR9®

## PARTS LIST

Design, prices and specifications subject to change without notice.

SPECIFY MODEL AND CALIBER WHEN ORDERING

(See Exploded View on Page 38)

Key No.	Part Name	Part No.	Model
* 1	Slide	KVS00100B	KBSR9 & KODBSR9 – blackened steel
		KVS00100	SR9 – stainless model
2	Front Sight	VS03200	SR9
3	Loaded Chamber Indicator	KVS11000	SR9
4	Loaded Chamber Indicator Spring	KVS05900	SR9
5	Loaded Chamber Indicator Pin	KVS06310	SR9
6	Extractor Pivot Pin	KVS06304	SR9
7	Extractor	KVS01400B	KBSR9 & KODBSR9 – blackened steel
		KVS01400	SR9 – stainless model
8	Extractor Spring	VS06450	SR9
9	Rear Sight Elevation Screw	VS08010	SR9
10	Rear Sight Leaf	VS03350	SR9
11	Rear Sight Pivot Pin	VS06309	SR9
12	Rear Sight Base	VS03300	SR9
13	Rear Sight Elevation Spring	MR05906	SR9
14	Rear Sight Lock Screw	V08001	SR9
* 15	Barrel – 9mm	KVS00600	SR9
16	Striker Blocker Spring	KVS05601	SR9
17	Striker Blocker	VS02110	SR9
18	Magazine Disconnect	VS05000	SR9
19	Striker Cover Spring	VS05320	SR9
20	Striker Cover Plunger	VS05310	SR9
21	Striker Cover	VS02300	SR9
22	Striker	KVS01100	SR9
23	Striker Cross Pin	KVS05150	SR9
24	Striker Spring	VS01850	SR9
25	Striker Spring Cup	VS02450	SR9
26	Striker Shaft	VS01150	SR9
27	Guide Rod Assembly	VS02050-100	SR9
28	Camblock	KVS07000	SR9
29	Trigger Pivot Pin	VS06710	SR9
30	Camblock Pin, Front Retainer	VS05301	SR9
31	Camblock Pin Retainer	VS05302	SR9
32	Magazine Disconnect Spring	KVS05611	SR9
33	Slide Stop Lever Assembly	VS03700-100	SR9
34	Trigger, Inner	VS03910	SR9
35	Trigger, Inner Spring	KVS03011	SR9
36	Trigger, Outer	VS03911	SR9
37	Trigger Outer Pin	VS06711	SR9
38	Magazine Latch Spring	VS02700	SR9
39	Magazine Latch	VS02600	SR9
40	Trigger Bar	KVS01700	SR9
41	Trigger Bar Spring	VS05400	SR9
42	Ejector	VS00900	SR9

Key No.	Part Name	Part No.	Model
43	Trigger Bar Lift Spring	VS05411	SR9
44	Trigger Bar Reset	VS01750	SR9
45	Trigger Bar Spring Mounting Pin	VS05450	SR9
46	Thumb Safety Assembly	VS15000	SR9
47	Ejector Pivot Pin	VS01250	SR9
48	Safety Detent Plunger	VS04600	SR9
49	Safety Detent Spring	VS04100	SR9
50	Camblock Pin, Front	VS06308	SR9
51	Takedown Pin Assembly	VS37550	SR9
52	Camblock Pin, Lower	VS06307	SR9
53	Camblock Pin, Upper	VS06306	SR9
54	Magazine Latch Pivot Pin	VS04700	SR9
55	Magazine Latch Thumbpiece	VS02651	SR9
56	Fire Control Housing Pin	VS06305	SR9
57	Backstrap Pin	VS02550	SR9
58	Backstrap Insert	VS02400	SR9
59	Backstrap Bushing	VS02560	SR9
60	Magazine Loading Tool	VS06010	SR9
61	Magazine - 17-round	VS00500	SR9
62	Magazine - 10-round	VS00501	SR9
63	Fire Control Housing	VS00212	SR9

**Also Available, but Not Illustrated**

Case Only	PGC-CF-B	SR9
-----------	----------	-----

\* PARTS SO MARKED MUST BE FACTORY FITTED

## RUGER® SR40™ SUPPLEMENTAL PARTS LIST

Design, prices and specifications subject to change without notice.

SPECIFY MODEL AND CALIBER WHEN ORDERING

(See Exploded View on Page 38)

Key No.	Part Name	Part No.	Model
* 1	Slide	VS00110	SR40 – blackened steel
		KVS00110	SR40 – stainless model
3	Loaded Chamber Indicator	KVS11001	SR40
7	Extractor	VS01421	SR40 – blackened steel
		KVS01421	SR40 – stainless model
* 15	Barrel – .40 S&W	KVS00610	SR40
27	Guide Rod Assembly	VS02040-100	SR40
42	Ejector	VS00901	SR40
62	Magazine - 10-round	VS00511	SR40
64	Magazine - 15-round	VS00510	SR40

\* PARTS SO MARKED MUST BE FACTORY FITTED

# RUGER® SR9® - SR40™

## EXPLODED VIEW

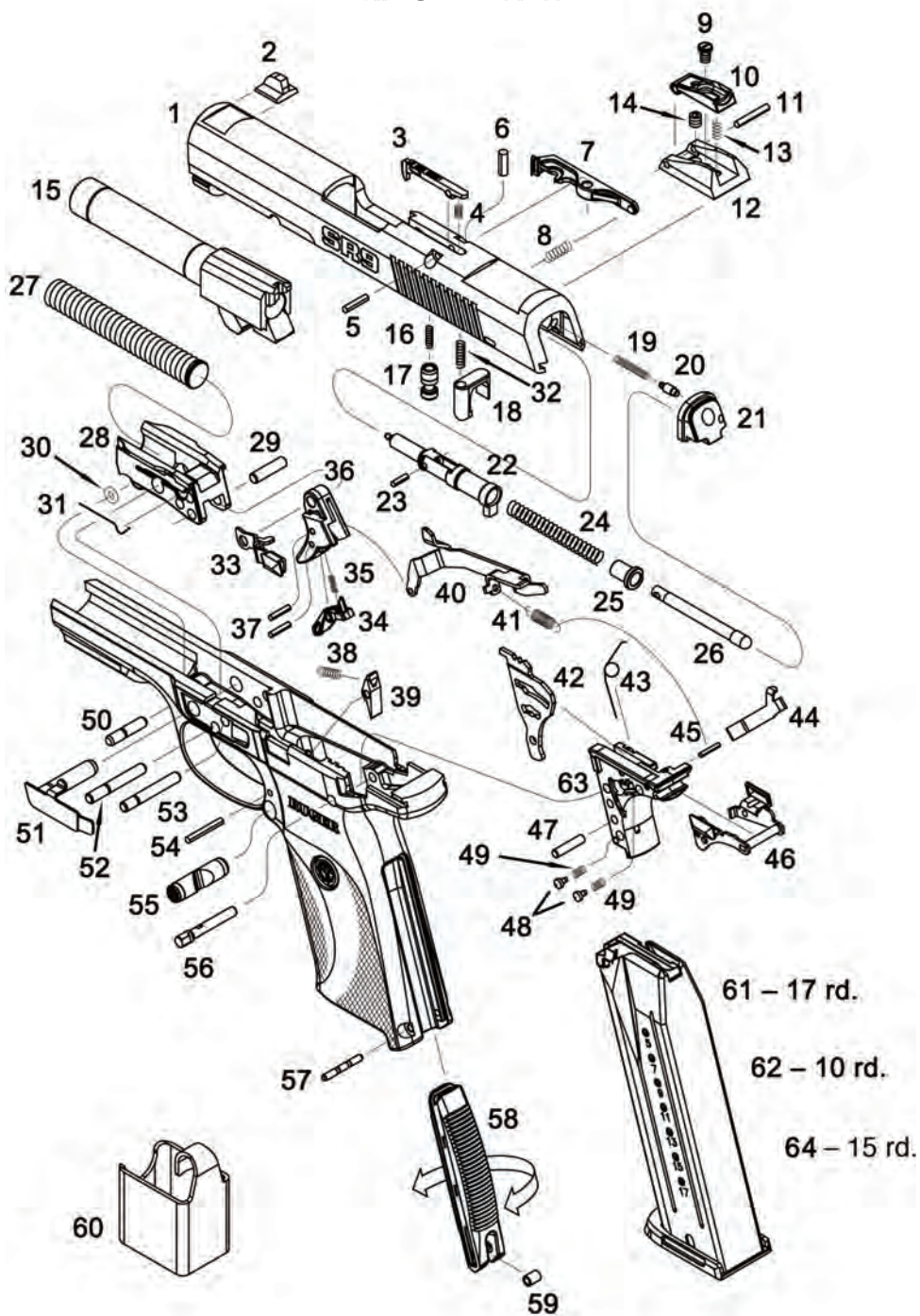

# RUGER® SR9c™

## PARTS LIST

Design, prices and specifications subject to change without notice.

SPECIFY MODEL AND CALIBER WHEN ORDERING

(See Exploded View on Page 41)

Key No.	Part Name	Part No.	Model
* 1	Slide	VS00105B KVS00105	KBSR9C – blackened steel SR9C – stainless model
2	Front Sight	VS03220	All SR9C Models
3	Loaded Chamber Indicator	KVS11000	All SR9C Models
4	Loaded Chamber Indicator Spring	KVS05900	All SR9C Models
5	Loaded Chamber Indicator Pin	KVS06310	All SR9C Models
6	Extractor Pivot Pin	KVS06304	All SR9C Models
7	Extractor	KVS01420B KVS01420	KBSR9C – blackened steel SR9C – stainless model
8	Extractor Spring	VS06450	All SR9C Models
9	Rear Sight Elevation Screw	VS08010	All SR9C Models
10	Rear Sight Leaf	VS03350	All SR9C Models
11	Rear Sight Pivot Pin	VS06309	All SR9C Models
12	Rear Sight Base	VS03300	All SR9C Models
13	Rear Sight Elevation Spring	MR05906	All SR9C Models
14	Rear Sight Lock Screw	V08001	All SR9C Models
* 15	Barrel – 9mm	KVS00650	All SR9C Models
16	Striker Blocker Spring	KVS05601	All SR9C Models
17	Striker Blocker	VS02110	All SR9C Models
18	Magazine Disconnect	VS05000	All SR9C Models
19	Striker Cover Spring	VS05320	All SR9C Models
20	Striker Cover Plunger	VS05310	All SR9C Models
21	Striker Cover	VS02300	All SR9C Models
22	Striker	VS01101	All SR9C Models
23	Striker Cross Pin	KVS05150	All SR9C Models
24	Striker Spring	VS01860	All SR9C Models
25	Striker Spring Cup	VS02450	All SR9C Models
26	Striker Shaft	VS01150	All SR9C Models
27	Guide Rod Assembly	VS02060-100	All SR9C Models
28	Camblock	KVS07010	All SR9C Models
29	Trigger Pivot Pin	VS06710	All SR9C Models
30	Camblock Pin, Front Retainer	VS05301	All SR9C Models
31	Camblock Pin Retainer	VS05302	All SR9C Models
32	Slide Stop Spring	VS04500	All SR9C Models
33	Slide Stop	VS03700	All SR9C Models
34	Trigger, Inner	VS03910	All SR9C Models
35	Trigger, Inner Spring	KVS03011	All SR9C Models
36	Trigger, Outer	VS03911	All SR9C Models
37	Trigger Outer Pin, 2 Req'd	VS06711	All SR9C Models
38	Magazine Latch Spring	VS02700	All SR9C Models
39	Magazine Latch	VS02601	All SR9C Models
40	Trigger Bar	KVS01710	All SR9C Models
41	Trigger Bar Spring	VS05400	All SR9C Models
42	Ejector	VS00900	All SR9C Models
43	Trigger Bar Lift Spring	VS05411	All SR9C Models



<b>Key No.</b>	<b>Part Name</b>	<b>Part No.</b>	<b>Model</b>
44	Trigger Bar Reset	VS01760	All SR9C Models
45	Trigger Bar Spring Mounting Pin	VS05450	All SR9C Models
46	Thumb Safety Assembly	VS15000	All SR9C Models
47	Ejector Pivot Pin	VS01250	All SR9C Models
48	Safety Detent Plunger, 2 Req'd	VS04600	All SR9C Models
49	Safety Detent Spring, 2 Req'd	VS04100	All SR9C Models
50	Camblock Pin, Front	VS06308	All SR9C Models
51	Takedown Pin Assembly	VS37550	All SR9C Models
52	Camblock Pin, Lower	VS06307	All SR9C Models
53	Camblock Pin, Upper	VS06306	All SR9C Models
54	Magazine Latch Pivot Pin	VS04700	All SR9C Models
55	Magazine Latch Thumbpiece	VS02652	All SR9C Models
56	Fire Control Housing Pin	VS06305	All SR9C Models
57	Backstrap Pin	VS02550	All SR9C Models
58	Backstrap Insert	VS02410	All SR9C Models
59	Magazine Loading Tool	VS06010	All SR9C Models
60	Magazine - 17-round	VS00500	All SR9C Models
61	Magazine - 10-round, long	VS00501	All SR9C Models
	Magazine - 10-round, short	VS00550	All SR9C Models
62	Fire Control Housing	VS00212	All SR9C Models
63	Magazine Adapter, Black	VS00590	SR9C, KBSR9C
64	Floorplate Finger Extension	VS01060	All SR9C Models
65	Magazine Disconnect Spring	VS05601	All SR9C Models

**Also Available, but Not Illustrated**

Case Only	PGC-CF-B	All SR9C Models
-----------	----------	-----------------

\* PARTS SO MARKED MUST BE FACTORY FITTED



# RUGER® SR9c™

## EXPLODED VIEW

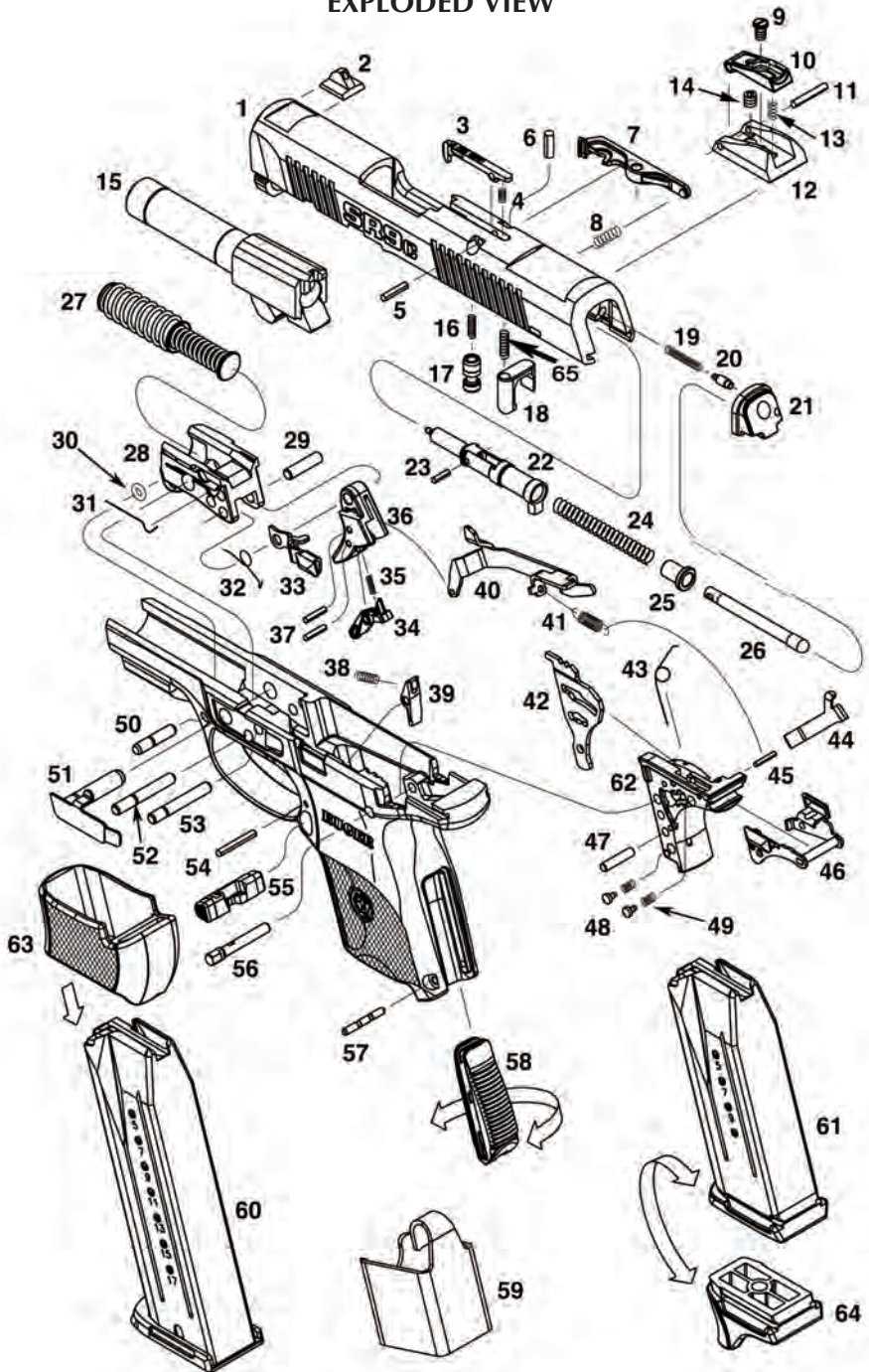

## THE BASIC RULES OF SAFE FIREARMS HANDLING

We believe that Americans have a right to purchase and use firearms for lawful purposes. The private ownership of firearms in America is traditional, but that ownership imposes the responsibility on the gun owner to use his firearms in a way which will ensure his own safety and that of others. When firearms are used in a safe and responsible manner, they are a great source of pleasure and satisfaction, and represent a fundamental part of our personal liberty.

Firearms do not cause accidents! Firearms accidents are almost always found to have been the result of carelessness, or ignorance on the part of the shooter of the basic rules of safe gun handling.

The following rules must be observed by gun users at all times. Safe gun handling is not just desirable, it is absolutely essential to your safety, the safety of others, and the continuation of gun ownership and sport shooting as we know it today.

### 1. LEARN THE MECHANICAL AND HANDLING CHARACTERISTICS OF THE FIREARM YOU ARE USING.

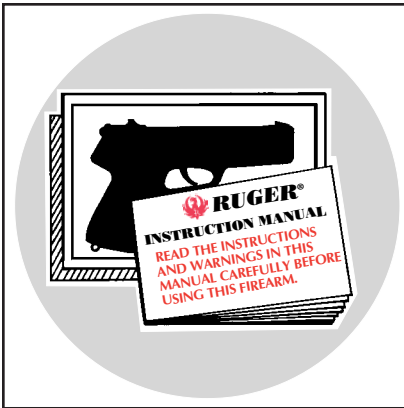

Not all firearms are the same. The method of carrying and handling firearms varies in accordance with the mechanical provisions for avoiding accidental discharge and the various proper procedures for loading and unloading. No person should handle any firearm without first having thoroughly familiarized himself with the particular type of firearms he is using, and with safe gun handling in general.

### 2. ALWAYS KEEP THE MUZZLE POINTED IN A SAFE DIRECTION.



Be sure of the bullet stop behind your target, even when dry-firing. Never let the muzzle of a firearm point at any part of your body or at another person. This is particularly important when loading or unloading a firearm. In the event of an accidental discharge, no injury can occur as long as the muzzle is pointing in safe direction. A safe direction means a direction which will not permit a discharged bullet to strike a person, or to strike an object from which the bullet may ricochet.

A safe direction must take into account the fact that a bullet may penetrate a wall, ceiling, floor, window, etc., and strike a person or damage property. Make it a habit to know exactly where the muzzle of your gun is pointing whenever you handle it, and be sure that you are always in control of the direction in which the muzzle is pointing, even if you fall or stumble. Keep your finger off the trigger until you are ready to shoot.

### 3. FIREARMS SHOULD BE UNLOADED WHEN NOT IN USE.

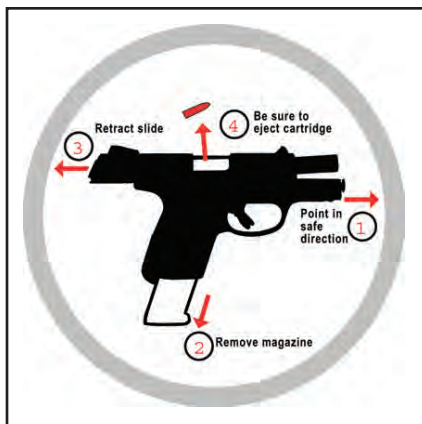

Firearms should be loaded only when you are in the field or on the target range or shooting area, ready to shoot. Firearms and ammunition should be securely locked in safes, racks or cabinets, or by using the locking device supplied with the firearm when not in use. Ammunition should be safely stored separate from firearms. Store your firearms out of sight of visitors and children. It is the gun owner's responsibility to be certain that children and persons unfamiliar with firearms cannot gain access to firearms, ammunition, or components.

### 4. BE SURE THE BARREL IS CLEAR OF OBSTRUCTIONS BEFORE SHOOTING.

Even a bit of mud, snow or excess lubricating oil or grease in the bore may cause the barrel to bulge, or even burst on firing, and can cause injury to the shooter and bystanders. Be sure that you are using ammunition of the proper caliber and loading for the gun you are using. If the report or recoil on firing seems weak, or doesn't seem quite right, CEASE FIRING IMMEDIATELY, unload your firearm, and check to be sure that no obstruction has become lodged in the barrel. Never try to shoot an obstruction out!





## 5. BE SURE OF YOUR TARGET BEFORE YOU SHOOT.

Don't shoot unless you know exactly where your bullet is going to strike. Be sure of the bullet stop behind your target, even when dry-firing with an unloaded gun. If you are in the field hunting, do not fire at a movement or noise. Take the time to be absolutely certain of your target before you pull the trigger.

## 6. WEAR SHOOTING GLASSES AND HEARING PROTECTORS WHEN YOU SHOOT.

All shooters should wear protective shooting glasses and adequate hearing protection when shooting. Exposure to shooting noise can damage hearing, and adequate eye protection when shooting is essential.



## 7. NEVER CLIMB A TREE OR FENCE WITH A LOADED FIREARM.

Put the firearm down carefully before climbing a fence, and unload it before climbing or descending a tree or jumping over a ditch or other obstruction. Never pull or push a loaded firearm toward yourself or another person. When in doubt, or whenever you are about to do anything awkward, unload your gun!

### 8. DON'T SHOOT AT A HARD SURFACE, OR AT WATER.

Bullets can glance off many surfaces like rocks or the surface of water and travel in unpredictable directions with considerable velocity.



### 9. NEVER TRANSPORT A LOADED FIREARM.

Firearms should always be unloaded before being moved or placed in a vehicle. A suitable carrying case or scabbard should be used to carry an unloaded firearm to and from the shooting area.

### 10. AVOID ALCOHOLIC BEVERAGES WHEN SHOOTING.

Don't drink until the day's shooting is over. Handling firearms while under the influence of alcohol in any form, or medications that could affect your judgement or co-ordination, constitutes a criminal disregard for the safety of others.



## A BRIEF ACCOUNT OF AN EXTRAORDINARY ACHIEVEMENT: RUGER FIREARMS

Sturm, Ruger & Company, Inc., had its beginning in a small machine shop occupying a rented frame building in Southport, Connecticut. In January, 1949, with an initial investment of only \$50,000 and an idea, William B. Ruger and Alexander M. Sturm started production of a .22 caliber autoloading pistol—a design which was so successful that it became the cornerstone upon which one of the most comprehensive lines of sporting firearms ever made in America was established. After Alex Sturm's death in 1951, William B. Ruger continued to direct the Company until his death in 2002. William B. Ruger, Jr. continued to provide guidance, which helped make this Company a sound and successful enterprise, until his retirement in 2006. The Company has continued to prosper, under new management and guidance from our Board, with new products and fresh perspectives.

Ruger, in this relatively short time, has established itself as a leading small arms design organization, developing a unique and broad line of fine quality sporting, military and police firearms to become one of the world's most famous producers of revolvers, pistols, rifles and shotguns. Since 1949 Ruger craftsmen have built many millions of firearms.

During its five decades of growth and progress under the leadership of William B. Ruger, the Company developed a business philosophy and implemented policies which represent a constructive influence in the life of modern America. From the beginning, Ruger played a positive role in conservation efforts and has supported the interests of shooters through such groups as the National Rifle Association, National Shooting Sports Foundation, and many regional sportsmen's organizations.

The Company has always endeavored to market its firearms for constructive and recreational purposes, to emphasize the traditional and responsible aspects of shooting, to render meaningful public services, and to encourage shooters in constructive, responsible, and safe participation in the shooting sports. Its motto, "Arms Makers For Responsible Citizens," exemplifies this Company philosophy.

Today, Ruger is particularly mindful of those elements which have contributed to the creation of its success, and extends heartfelt thanks to its many loyal employees and customers.

The firearms catalog, and instruction manuals for all Ruger firearms, can be downloaded from our website at:

**[www.ruger.com](http://www.ruger.com)**

## NOTES

## WHY NO WARRANTY CARD HAS BEEN PACKED WITH THIS NEW RUGER FIREARM

The Magnuson-Moss Act (Public Law 93-637) does not require any seller or manufacturer of a consumer product to give a written warranty. It does provide that if a written warranty is given, it must be designated as "limited" or as "full" and sets minimum standards for a "full" warranty. Sturm, Ruger & Company, Inc. has elected not to provide any written warranty, either "limited" or "full", rather than to attempt to comply with the provisions of the Magnuson-Moss Act and the regulations issued thereunder. There are certain implied warranties under state law with respect to sales of consumer goods. As the extent and interpretation of these implied warranties varies from state to state, you should refer to your state statutes. Sturm, Ruger & Company wishes to assure its customers of its continued interest in providing service to owners of Ruger firearms.



**STURM, RUGER & Company, Inc.**

**200 Ruger Road**

**Prescott, Arizona 86301 U.S.A.**

**www.ruger.com**

**Arms Makers For Responsible Citizens®**

**A COPY OF THE INSTRUCTION MANUAL FOR ANY RUGER  
FIREARM IS AVAILABLE FROM THE FACTORY FREE ON REQUEST, OR IT MAY  
BE DOWNLOADED FROM OUR WEBSITE AT WWW.RUGER.COM.**

**THESE INSTRUCTION MANUALS CONTAIN IMPORTANT  
WARNINGS WHICH MUST BE UNDERSTOOD  
BEFORE USING THESE FIREARMS.**

"22/45," "22 Charger," "LCP," "LCR," "Model 96," "P90," "P91," "P93," "P94," "P95," "P97," "P345D," "Mark III," "P345PR," "SR-22," and "SR-556" are RUGER TRADEMARKS. "RUGER," THE STURM, RUGER LOGO, "AC-556," "Arms Makers For Responsible Citizens," "10/22," "All-Weather," "Bearcat," "Blackhawk," "Gold Label," "GP100," the Hard-R Logo, "Hawkeye," "M77," "Mini Thirty," "Mini-14," "Old Army," "P345," "P85," "Redhawk," "Ruger Titanium," "Ruger 77/17," "Ruger 77/22," "Ruger 77/44," "Ruger 77/50," "Ruger SP101," "Ruger Vaquero," "Security-Six," "Service-Six," "Single-Six," "Speed-Six," "SR9," the "SR" Design, "Super Redhawk Alaskan" and "Target Grey" are REGISTERED U.S. TRADEMARKS.

"DEERFIELD" is a registered trademark of Blount, Inc.