

Bureau Enquêtes-Accidents



REPORT

TRANSLATION

*on the accident on 12 November 1999
North of Pristina (Kosovo)
to the ATR 42-300 registered F-OHFV
operated by SI FLY*

F-FV99112A

F O R E W O R D

This report presents the technical conclusions reached by the BEA on the circumstances and causes of this accident.

In accordance with Annex 13 of the Convention on International Civil Aviation, with EC directive 94/56 and with Law N°99-243 of 29 March 1999, the analysis of the accident is intended neither to apportion blame, nor to assess individual or collective responsibility. The sole objective is to draw lessons from this occurrence which may help to prevent future accidents or incidents.

Consequently, the use of this report for any purpose other than for the prevention of future accidents could lead to erroneous interpretations.

SPECIAL FOREWORD TO ENGLISH EDITION

This report has been translated and published by the BEA to make its reading easier for English-speaking people. As accurate as the translation may be, please refer to the original text in French.

Table of Contents

FOREWORD	2
SYNOPSIS	9
ORGANISATION OF THE INVESTIGATION	10
1 - FACTUAL INFORMATION	11
1.1 History of Flight	11
1.2 Injuries to Persons	12
1.3 Damage to Aircraft	12
1.4 Other Damage	12
1.5 Personnel Information	12
1.5.1 Flight Crew	12
1.5.1.1 Captain	12
1.5.1.2 Copilot	14
1.5.1.3 Flight Attendant	16
1.5.2 Air Traffic Controller	16
1.6 Aircraft Information	17
1.6.1 Airframe	17
1.6.2 Engines	17
1.6.3 Equipment	17
1.6.4 Weight and Balance	20
1.6.5 Maintenance	20
1.7 Meteorological Conditions	20
1.7.1 General Situation	20
1.7.2 Situation at the Aerodrome	21
1.7.3 Observations at the Site	21
1.8 Aids to Navigation	21
1.9 Telecommunications	23
1.9.1 Communications with Pristina Approach	23
1.9.2 Radar Data	25

1.10 Aerodrome Information	26
1.10.1 History	26
1.10.2 Infrastructure	27
1.10.3 Airspace	27
1.11 Flight Recorders	28
1.11.1 Types and Readout Operations	28
1.11.1.1 Cockpit Voice Recorder	28
1.11.1.2 Flight Data Recorder	28
1.11.2 CVR Readout	29
1.11.3 Readout of FDR Data	30
1.12 Wreckage and Impact Information	32
1.12.1 Description of Site and Area	32
1.12.2 Information Gathered from the Wreckage	35
1.13 Medical and Pathological Information	36
1.14 Fire	36
1.15 Survival Aspects	36
1.16 Tests and Research	36
1.16.1 Identification of the CRC	36
1.16.2 History of the GPWS and the Radio Altimeter	37
1.16.3 GPWS	38
1.16.3.1 Examination	38
1.16.3.2 Simulations	38
1.16.3.2.1 AlliedSignal Simulation	38
1.16.3.2.2 Aérospatiale Matra Simulation	39
1.16.4 Examination of GPS	39
1.16.5 Crew Fatigue	39
1.17 Information on Organisations and Management	40
1.17.1 Information on the Operator	40
1.17.1.1 History and Structure	40
1.17.1.2 Operational Documentation	41
1.17.1.2.1 Operations Manual	41
1.17.1.2.2 Manuale Operativo	42
1.17.1.2.3 Instructions for Operations on the Rome-Pristina Line	43
1.17.1.2.4 Aeronautical Documentation	44
1.17.1.3 Entry into Service of Rome-Pristina Line	44
1.17.1.3.1 History	44
1.17.1.3.2 Flight preparation	45
1.17.1.4 Operation of the Rome-Pristina Line	45
1.17.2 Information on the Organisation of Pristina Aerodrome	46
1.17.3 Operational Procedures used by the Pristina ATC organisation	47
1.18 Supplementary Information	49
1.18.1 Aeronautical Documentation	49

1.18.1.1 Aeronautical Information Manual	49
1.18.1.2 Air traffic flow management Information Messages	49
1.18.1.3 SPINS	50
1.18.1.4 NOTAMs issued by KFOR	51
1.18.1.5 Summary	52
1.18.2 Terminology	52
1.18.3 Use of Radar on Approach	52
1.18.4 Testimony	54
1.18.4.1 Si Fly's Director of Operations	54
1.18.4.2 Si Fly's Technical Director	55
1.18.4.3 ATC Personnel	56
1.18.4.4 French Military Pilots	56
1.18.5 Other Airlines Serving Pristina	56
2 - ANALYSIS	58
2.1 Conduct of the Flight	58
2.2 GPWS Serviceability	59
2.3 The Operator and the Oversight	60
2.4 Approach Control	62
2.5 Aeronautical Information	64
3 - CONCLUSIONS	66
3.1 Findings	66
3.2 Causes	68
4 - RECOMMENDATIONS	69

Table of illustrations

Figure 1 : Track of the accident flight	11
Figure 2 : Captain's activity in the week preceding the accident	14
Figure 3 : Copilot's activity in the week preceding the accident	15
Figure 4 : GPWS and GS push buttons	18
Figure 5 : Three-position GPWS switch in NORMAL position	18
Figure 6 : Three-position GPWS switch in OFF position	18
Figure 7 : Crew Alert Panel	19
Figure 8 : Situation at altitude, 12 november 1999 at 10 h 30 UTC	20
Figure 9 : Radar Data	25
Figure 10 : Track of KSV 3275	26
Figure 11 : View of accident site	32
Figure 12 : Side view of site	32
Figure 13 : Accident site seen from above	33
Figure 14 : Debris	35
Figure 15 : Radar Vector Chart	48
Figure 16 : Organisation of airspace in Kosovo	49
Figure 17 : Track of F-OHFV on 10 November 1999	59
Figure 18 : Relative position of aircraft F-OHFV and HCN 993 when HCN 993 took number one position for landing	63

Glossary

AIM	Air traffic flow management Information Message
AIP	Aeronautical Information Publication
APP	Approach Control
ASR	Airport Surveillance Radar
ATC	Air Traffic Control (in general)
ATPL	Airline Transport Pilot Licence
CAM	Cockpit Area Microphone
CC	Cabin Crew
CRC	Continuous Repetitive Chime
CRM	Crew Resource Management
CTR	ATC Control Zone
CVR	Cockpit Voice Recorder
DGAC	General Civil Aviation Directorate (France)
DME	Distance Measuring Equipment
ENAV	Italian Air Traffic Control Organisation
FAA	Federal Aviation Administration (USA)
FATCA	Yugoslav Federal Air Traffic Control Organisation
FCOM	Flight Crew Operating Manual
FDR	Flight Data Recorder
FIR	Flight Information Region
FIS	Flight Information Service
FRY	Federal Republic of Yugoslavia
ft	feet
FYROM	Former Yugoslav Republic of Macedonia
GPS	Global Positioning System
GPWS	Ground Proximity Warning System
hPa	Hectopascal
ICAO	International Civil Aviation Organisation
IFR	Instrument Flight Rules
ILS	Instrument Landing System
IMC	Instrument Meteorological Conditions
JSP	Joint Services Publication
KFOR	Kosovo Force
kHz	Kilohertz
kt	Knot
LARS	Lower Airspace Radar Service

LLZ	Localizer
MEL	Minimum Equipment List
METAR	Regular meteorological report for aircraft
MHz	Megahertz
MM	Middle Marker
MSA	Minimum Safety Altitude
MTA	Military Technical Agreement
NATO	North Atlantic Treaty Organisation
NDB	Non Directional radio Beacon
NM	Nautical Mile
NOTAM	Notice to Airmen
OM	Outer Marker
PF	Pilot Flying
PNF	Pilot Not Flying
QFU	Runway magnetic bearing
QNH	Altimeter setting to obtain aerodrome elevation when on the ground
RAF	Royal Air Force
RAIM	Receiver Autonomous Integrity Monitoring
Ralt	Radio Altimeter
RAMCC	Regional Air Movement Control Centre
RAS	Radar Advisory Service
RIS	Radar Information Service
SAR	Search And Rescue
SB	Service Bulletin
SPINS	Special Instructions
SRA	Surveillance Radar Approach
TACAN	Tactical Air Navigation aid (UHF)
TAT	Total Air Temperature
TC	Terminal Control
TMA	Terminal Control Area
UN	United Nations
UNACC	United Nations Air Co-ordination Cell
UNMIK	United Nations interim Mission in Kosovo
USSFIM	United States Standard Flight Inspection Manual
UTC	Universal Time Co-ordinated
VASIS	Visual Approach Slope Indicator System
VFR	Visual Flight Rules
VMC	Visual Meteorological Conditions
VOR	VHF Omnidirectional Radio
WFP	World Food Program

SYNOPSIS

Date and time

Friday 12 November 1999
at 10 h 15¹

Aircraft

ATR 42-300 registered F-OHFV

Site of accident

On approach to Pristina aerodrome

Owner

GIE Avions de Transport Régional

Type of flight

Public Transport of passengers
Flight KSV 3275

Operator

Si Fly
Piazzale Ungheria n°58
90143 Palermo - Italy

Persons on board

2 flight crew
1 cabin crew
21 passengers

Summary

Arriving from Rome, the ATR 42 registered F-OHFV chartered by the World Food Program was going to land at Pristina. The meteorological conditions at the aerodrome corresponded to visibility of four thousand metres with a layer of compact clouds at three thousand feet. In radar and radio contact with the military air traffic control organisation for an ILS approach, the aircraft, which was outbound to the north at an altitude of 4,600 feet, entered a sector where the minimum safety altitude is 6,900 feet and struck a mountain whose peak is at 4,650 while turning to return towards the airport.

Consequences

	People			Equipment	Third Parties
	Killed	Injured	Unhurt		
Crew	3	-	-	Destroyed	-
Passengers	21	-	-		-

¹ All times in this report are UTC, except where otherwise specified. One hour should be added to express Pristina time on the day of the accident.

ORGANISATION OF THE INVESTIGATION

On Friday 12 November at around 15 h 00 UTC, the BEA was advised of the accident to the ATR 42 registered F-OHFV, operated by the Italian airline Si Fly, during its approach to Pristina aerodrome in Kosovo. In accordance with paragraph 5.2 of Annex 13 of the Convention on International Civil Aviation, the State of Occurrence not being an ICAO contracting State, and in application of L 7111-IV of the French Civil Aviation Code, a technical investigation was launched by the BEA.

Subsequently, and in accordance with Annex 13, an Italian accredited representative, as representative of the State of the Operator, accompanied by several Italian civil aviation experts, and an accredited representative from Canada, as representative of the State of the engine Manufacturer, joined the investigation along with an expert from KFOR and observers from the ICAO and UNMIK.

On Saturday 13 November, a team of four investigators, accompanied by two experts from the aircraft manufacturer, went to Pristina. Upon arrival they got in touch with UNMIK and KFOR officials.

On Sunday 14 November, the two flight recorders recovered at the site of the accident were transported to the BEA laboratories by UNMIK policemen. Readout and analysis began on 15 November. At the same time, two of the investigators accompanied by the two experts from the manufacturer went to the accident site to study the site and the wreckage. The other two investigators met with the military air traffic control personnel at Pristina aerodrome. A fifth investigator from Paris went to Rome and Ancona in Italy.

On Thursday 18 November, five work groups were formed, in co-ordination with the Investigator in Charge, to decide upon and gather the information necessary for the investigation in the following areas :

- Operational aspects
- Air traffic aspects
- Site and wreckage, aircraft characteristics
- Readout of recorders and examination of equipment
- Meteorological aspects

These groups have worked uninterruptedly since then, so as to complete the investigation as quickly as possible.

On Saturday 20 November, on the basis of its initial findings, the BEA issued a first safety recommendation. A preliminary report, based on the findings up until mid-December, was drawn up and made public at the end of the year. A final meeting was held on the 20 and 21 January 2000 about the established facts, analytical elements and proposed recommendations.

1 - FACTUAL INFORMATION

1.1 History of Flight

On 12 November 1999 at 8 h 11, the ATR 42-300 registered F-OHFV, operated by the Italian airline Si Fly and chartered by the World Food Program, took off from Rome to undertake Flight KSV 3275 to Pristina with three crew members and 21 passengers on board.



Figure 1 : Track of the accident flight

At 9 h 57 min 34 s, the flight was transferred by Skopje control to the Pristina military air traffic control organisation. The latter identified it on radar and the crew replied "Flight condition is now VFR" to a request from the controller.

At 9 h 58 min 32 s, the approach controller proposed ILS interception headings to the crew. The crew accepted the controller's proposal, the latter specifying that the radar information service was limited because of poor radar performance. He then requested that the crew turn left towards heading 350 and indicated a QNH of 1028.

At 9 h 59 min 08 s, the controller requested that KSV 3275 descend initially to 5200 feet. Four minutes later, he asked them to turn on heading 340 and to descend to 4 600 feet and.

At 10 h 10 min 50 s, the crew was advised that they were number two behind a faster plane 5 NM in front and the controller asked them to continue on the same

heading.

At 10 h 13 min 18 s, the crew called the controller and told him "*I want² to land*". The controller then requested that they turn left on heading 270 and, a few seconds later, that they indicate their estimated position relative to the PRI beacon. The crew said that they were at 15 NM, then the controller gave them heading 180 to the left.

At 10 h 14 min 33 s, the CRC alarm was heard, the crew noted 240 feet on the radio altimeter. Two seconds later the aircraft struck high ground.

At 20 h 41, the wreckage was spotted by an army helicopter 25 NM north of the aerodrome, at an altitude of 1 350 metres, at reference 042°58' N-021°03' E. It had struck a mountain approximately fifteen metres from the summit.

1.2 Injuries to Persons

Injuries	Crew Members	Passengers	Others
Fatal	3	21	-
Serious	-	-	-
Slight/None	-	-	-

1.3 Damage to Aircraft

The aircraft was completely destroyed on impact with the ground.

1.4 Other Damage

There was no third party damage.

1.5 Personnel Information

1.5.1 Flight Crew

1.5.1.1 Captain

Male, aged 59.

Aeronautical qualifications

- Commercial Pilot Licence (Italian level 3) n°3948 obtained 10 July 1971
- Instrument Flight Rating 6 December 1969, valid until 26 February 2000
- Airline Transport Pilot Licence (ATPL) in 1989 by equivalence with Italian level 3 Licence, valid until 14 July 2000
- Main type ratings : FK27, DC9/MD80

² Doubtful words

- ATR 42 type rating in July 1995

Professional experience before the day of the accident

- Total flying hours : 18 000
- In the previous 30 days : 96
- Flying hours on type : 5 000
- Eighteen flights into Pristina since 17 October 1999

Previous professional experience

- Pilot in the Italian Air Force until 1970. Successive ratings on AT6, MB326, C119, C45, P166, B48
- Civil pilot from 1970, for the following companies :
 - Aero Trasporti Italiani from 1st March 1970 to 31 December 1986 as copilot. Captain training course on DC9 in July 1985
 - Unifly Express from 1st April 1986 to 1st June 1990, as copilot on F27.
 - Miniliner Srl from 1st June 1990 to 29 November 1990 then from 8 May 1991 to 31 May 1991, as Captain on F27.
 - Eurofly Sfa from 2 June 1992 to 30 September 1993 as Captain on DC9.
 - TEA Italia Spa from 2 July 1993 to 30 November 1993.
 - Air Sicilia from 1st August 1995 to 11 August 1997, as Captain on ATR 42.
 - Itlair Spa from 24 August 1997 to 16 August 1999, as Captain on ATR 42.
 - Si Fly from 1st September 1999 as Captain on ATR 42. Also instructor and in-flight inspector.

Since the 1st of November, the Captain had flown fifty-two hours. He had had two non-flying days, on the 4th when he was available for the Director of flight operations, and the 6th when he had a rest day. Between the 7th and the day of the accident, he had flown thirty-two hours. The day before the accident, he had ferried from Ancona to Rome beginning his duty period at 5 h 45. His day continued with the Rome-Pristina-Tirana-Pristina-Rome line.

On the day of the accident, he went on duty at the Rome Ciampino airport, situated at around 20 minutes from his home. The arrival normal time before takeoff for a scheduled flight is 45 minutes.

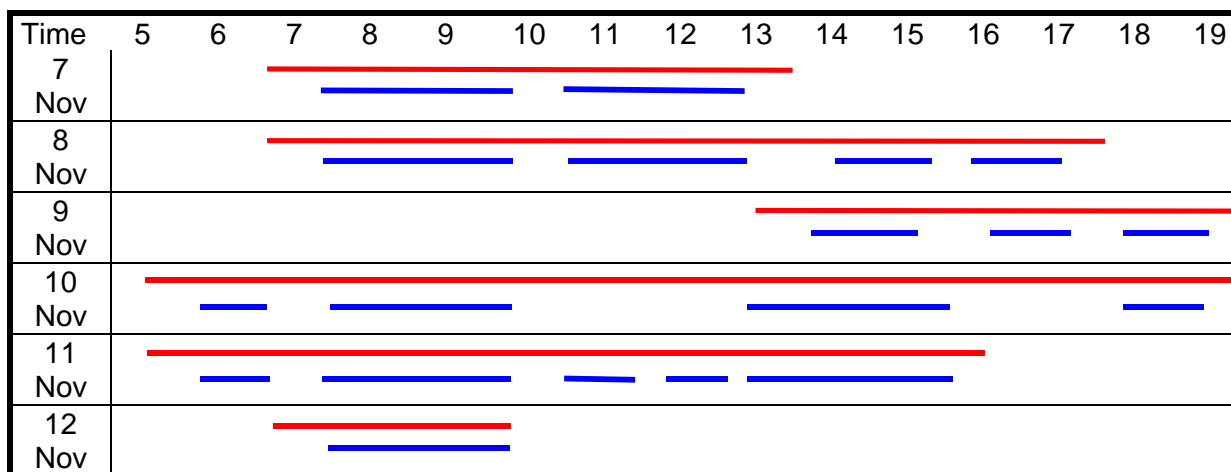

Figure 2 : Captain's activity in the week preceding the accident

— service time
 — flying hours

The Captain was employed as flight crew under a contract with Si Fly up until the age limit for him of 19 December 1999. The Italian regulations do not permit flight crew to fly after the age of sixty for public transport.

The Captain had undergone satisfactory checks on a simulator on 26 February 1999 and in-flight on 14 October 1999.

1.5.1.2 Copilot

Male, aged 49.

Aeronautical qualifications

- Commercial Pilot Licence (Italian level 3) n°9862 obtained 12 November 1991
- Commercial Helicopter Pilot's Licence obtained 14 November 1985
- Instrument Flight Rating 27 August 1990, valid until 30 March 2000
- ATPL # 0225 obtained 9 February 1999 valid until 9 February 2000
- Type ratings : DA50 and ATR 42 (February 1998)

Professional experience before the day of the accident

- Total flying hours : 5 000, including 2,100 on helicopter
- In the previous 30 days : 68 h 37 min
- Flying hours on type : 1,500
- Fourteen flights into Pristina since 20 October 1999

Previous professional experience

- Aeroplane and helicopter Pilot in the Italian Air Force until 1997. Ratings on MB326, P148, P166, SH3D, A109, AB47G2, AB47J, AB204, PD808 and DA50.
- Commercial pilot from 1998, for the following companies :
 - Itlair from 1998 to September 1999, as Copilot on ATR 42.
 - Si Fly from 19 October 1999 as Copilot on ATR 42.

Since the beginning of November, he had flown forty-three hours. He had had two non-flying days, on the 4th when he was available for the Director of flight operations, and the 6th when he had a rest day. Between the 7th and the 12th, he had flown 27 h 30 min. The day before the accident, he had done the Rome-Pristina-Tirana-Pristina-Rome route with the same Captain.

On the day of the accident, he went on duty at Rome Ciampino airport, situated at around 15 kilometres from his home, for an eight o'clock takeoff.

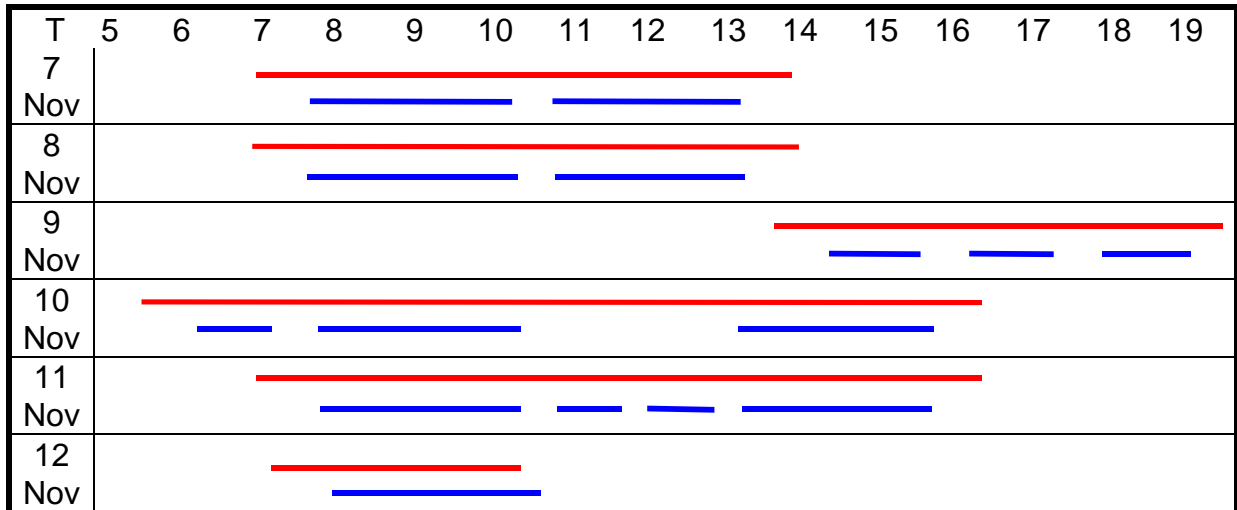

Figure 3 : Copilot's activity in the week preceding the accident

— service time
 — flying hours

The copilot had undertaken three flights with the Si Fly Chief pilot as Line Oriented Flight Training (LOFT). On 30 October 1999 he had been checked satisfactorily in-flight. He was in the course of upgrading to Captain status. During the accident flight, he was Pilot Flying.

*
 * *

Both pilots had obtained French validation of their Italian licences by decision SFACT N° 991379 on 10 September 1999 in the context of the dry-leasing of the ATR 42 registered F-OHFV by Si Fly.

No evidence of the flight crew's participation in a specific Crew Resource Management (CRM) course was found, nor of any airline internal training course. Italian regulations do not require such training.

They had undertaken 13 flights into Pristina as a crew from 20 October 1999.

1.5.1.3 Flight Attendant

Female, aged 25.

- Possessed all of the certificates and qualifications required for her position.
- Employed by Si Fly since 1st September 1999.
- Activity since her recruitment by the airline : 137 h 44
- Activity in the preceding 5 days : 26 hours.

1.5.2 Air Traffic Controller

Male, aged 40.

- Royal Air Force non-commissioned officer, entered the service on 14 December 1982.
- Assistant controller, he followed the controller training course and qualified in November 1990. Specialised in Terminal Control (TC), he was then posted to three RAF units with exclusively military activities where he acquired the relevant local qualifications.

Note : the airfields where he had been posted, Marham, Wainfleet and Cranwell, are all located on plains and receive no civil traffic.

Arriving in Pristina on 15 September 1999, he took up the post of Aerodrome Controller (ADC). He had been trained to operate the radar for four or five hours in this post and, after the posting of an officer authorised to certify training, obtained qualifications as Terminal Control Radar Approach and Director - TC(Ralt) and TC (Dir) on 1st November 1999.

On the day of the accident, he had reported for duty at 7 h 30. According to the November ATC Watch Roster, he was supposed to serve as ADC for the morning. Because of the unavailability of the Approach Controller, the officer in charge of control had designated him to fulfil the role of TC (Dir).

	8		9		10		11		12	
	AM	PM	AM	PM	AM	PM	AM	PM	AM	PM
ADC				CTL						C
APP	CTL							CTL	CTL	
SRA					CTL					CTL
ASST										

CTL : Task performed

C : Task originally scheduled in the November Watch Roster.

1.6 Aircraft Information

1.6.1 Airframe

- Manufacturer : Aérospatiale / Alenia
- Type : ATR 42-300
- Serial number : 12
- Airworthiness Certificate : n° 250948 on 15 July 1999, valid until 13 January 2000, issued by the DGAC in accordance with certificate type n° 176.
- Entry into service in 1986.
- Flying hours to 11 November 1999 : 24 930.
- Number of cycles to 11 November 1999 : 32 810.

1.6.2 Engines

- Manufacturer : Pratt & Whitney Canada
- Type :
 - left : PW 121, serial number 121 056,
 - right : PW 120, serial number 120 184.
- Flying hours to 11 November 1999
 - left : 11 784 (of which 2 906 since the last general overhaul),
 - right : 22 427 (of which 3 321 since the last general overhaul).
- Number of cycles to 11 November 1999
 - left : 14 489,
 - right : 28 840.

1.6.3 Equipment

The aircraft was equipped with :

- a Dorne and Margolin type DMET 8 emergency locator transmitter. This did not work on impact and was not found.
- a Bendix KLN 90A Global positioning System (GPS) with RAIM (Receiver Autonomous Integrity Monitoring) function which warns the crew when the navigation system can no longer be used with the required precision. The last GPS software update was on October 30 1999. The following update was scheduled for 2 December 1999.
- an AlliedSignal Mark II Ground Proximity Warning System (GPWS), serial number 10100. The aircraft's technical documentation does not mention this computer, but mentions another, serial number 6697, installed on 21 July 1999 and returned to the maintenance workshop in Dinard on 13 September 1999 with the note "to be repaired" (see. § 1.16).

The GPWS layout is shown in appendix 2. The main technical characteristics and the aural warnings of the GPWS installed on the aircraft are as follows :

- **Mode 1** - Excessive Descent Rate with "Sink Rate" aural warning then "Whoop Whoop Pull Up",

- **Modes 2 et 2B** - Excessive Closure Rate with "Terrain Terrain" aural warning then "Whoop Whoop Pull Up",
- **Mode 3** - Descent after Take/Off with "Don't sink" aural warning.
- **Mode 4A** - Proximity to Terrain, gear up with "Too Low Gear" aural warning then "Too Low Terrain".
- **Mode 4B** - Proximity to Terrain, flaps up with "Too low Flaps" aural warning then "Too Low Terrain".
- **Mode 5** - Descent below Glideslope with "Glideslope" aural warning.
- **Mode 6** - Descent below Minimum with "Minimum" aural warning.

Two identical push-buttons (left and right positions) connected in parallel are linked to the two integrated GPS and GPWS lights :

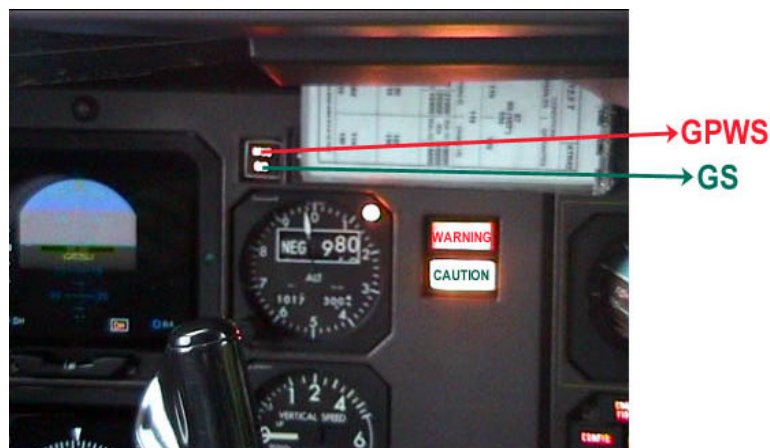

Figure 4 : GPWS and GS push buttons

GPWS : lights up red as long as one of modes 1, 2, 3, 4 is active. A spoken warning corresponding to the active mode is broadcast.

GS : lights up amber as long as mode 5 is active. A spoken warning corresponding to the active mode is broadcast.

A 3-position GPWS switch is installed in the left position :



Figure 5 : Three-position GPWS switch in NORMAL position



Figure 6 : Three-position GPWS switch in OFF position

1. The **NORM** position allows all warnings to be activated.
2. The **FLAP OVRD** position allows inhibition of warnings in mode 4 during a landing with flaps in configuration other than "landing".
3. The **OFF** position cuts out all warnings.

The system can be tested on the ground or above 1000 feet radio altimeter in flight by pressing one of the **GPWS/GS** push-buttons. Details of the test appear in the ATR 42 FCOM documentation (see appendix 2).

The GPWS has an integrated test, which, in case of breakdown of one of the parts of the system, can display a "GPWS FAULT" warning on the Crew Alert Panel (CAP) : the "GPWS FAULT" warning is also displayed when the GPWS switch is in the OFF position.

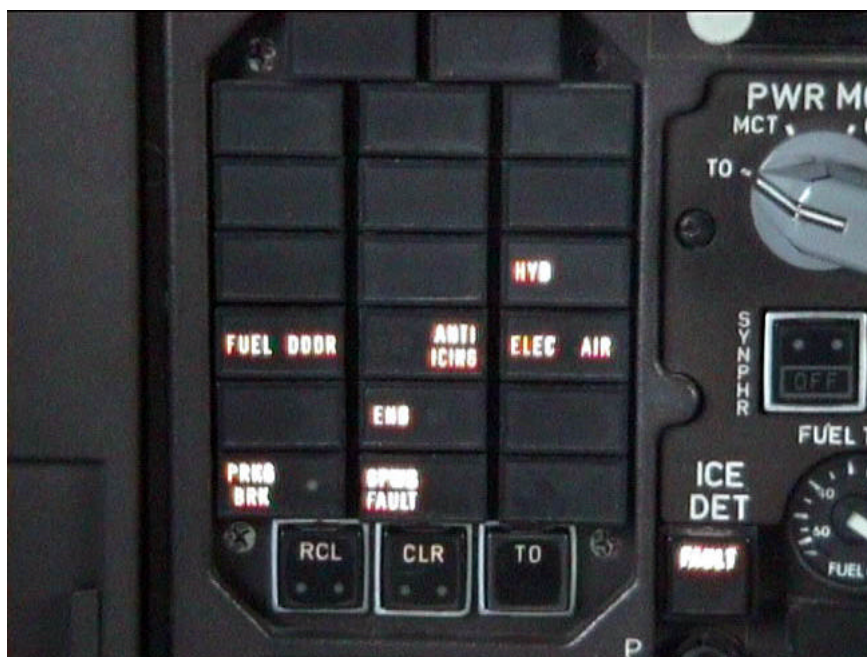

Figure 7 : Crew Alert Panel

According to the Si Fly MEL (see appendix 3), a failure of the GPWS in modes 1 to 4 grounds the aircraft in two days.

This GPWS was the subject of three Service Bulletins :

- Two issued by ATR, SB 34-0078 of 19 August 1986 and 34-0115 of 18 September 1998 which concerned replacement of connecting cables and a modification in the orientation of the radio altimeter aerial,
- One issued by AlliedSignal in 1993 which recommended the installation of a voltage divider on the Mark II 088 GPWS to transform the calculator's IAS entry into MACH so as to eliminate false alarms which could be generated in clean configuration.

None of these 3 SB's was applied to the F-OHFV.

1.6.4 Weight and Balance

The aircraft was within operating limits for weight and balance.

1.6.5 Maintenance

At the time of its delivery to Si Fly, the aircraft had completed maintenance checks A (400 hours), C (3,200 hours), 1 year, 2 year, 4 year, 8 year, 12 year, as well as structural and wingbox checks, all performed by ATR.

The first type A check after the delivery of the aircraft should have been carried out in Ancona on the 13 and 14 November 1999 by Société Coopérative Aéronautique (Dinard-Pleurtuit Aerodrome) with the participation of Si Fly technicians.

Since the beginning of operations by Si Fly, the aircraft Logbook show no GPWS breakdowns.

1.7 Meteorological Conditions

1.7.1 General Situation

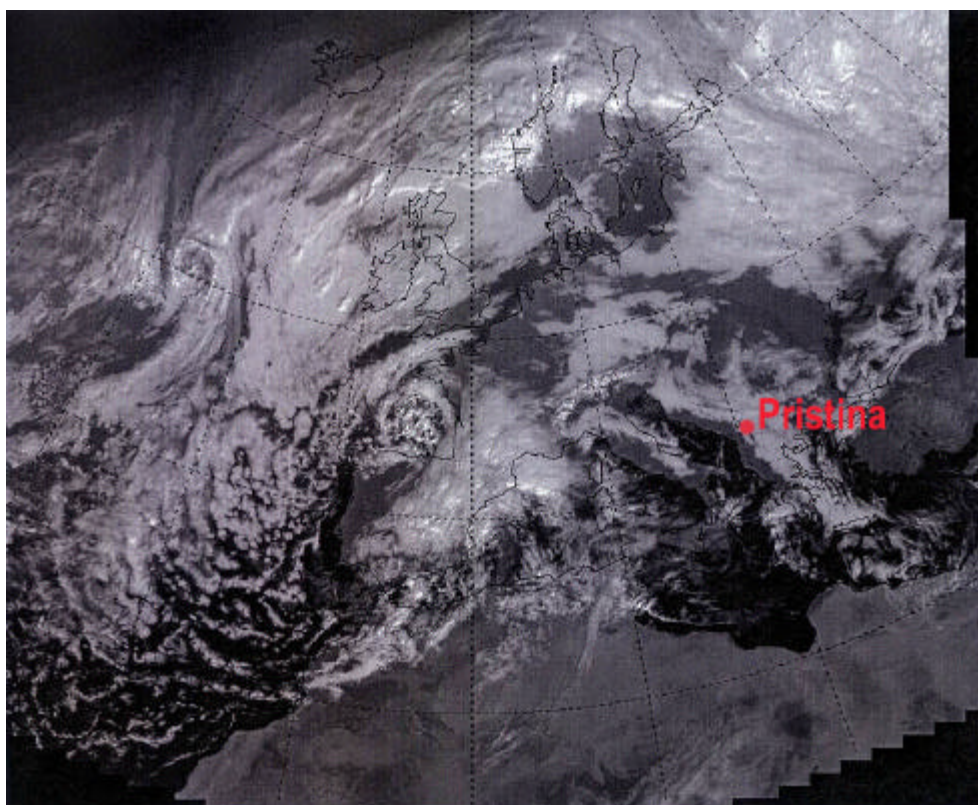

- LUNRIRS, version 1.4 -

- Edition du 19/11/1999 -

Figure 8 : Situation at altitude, 12 november 1999 at 10 h 30 UTC

From Slovenia to Greece and from Italy to Bulgaria, the winds at altitude were very weak from the north. They were sufficient to create a foehn effect under the

mountain winds which left the whole coast and the Adriatic Sea free of cloud. On the mountains, the cloud cover consisted of stratus and strato-cumulus in thin layers no higher than 3000 m. The 0 °C isotherm was situated at 2,100 m, which posed a risk of moderate icing at the peaks of the strato-cumulus.

Situation on the Ground

The situation on the ground was controlled by a 1035 hPa anticyclone centred south of Belgrade which was generating variable weak to nil winds, generally north-west but aligned with valleys according to exposure to the sun.

At 9 o'clock, several meteorological stations broadcast misty visibility (less than 5,000 m) north of Kosovo. At 10 o'clock, the visibility at Pristina was 4,000 m with dry mist and a uniform cloud layer at 1,000 m. At Skopje (80 km to the south) the sky was identical with 10 km visibility.

1.7.2 Situation at the Aerodrome

Meteorological information about Pristina aerodrome, broadcast by the RAF meteorological service, was as follows :

METAR

120950Z 34007kt 4000 HZ FEW010 BKN020 OVC030 05/01 Q1028 GRN=
121050Z 36006kt 4000 HZ FEW010 BKN020 OVC030 05/01 Q1027 GRN=

TAF

120800Z 120918 33008kt 4000 HZ FEW012 BKN020 BECMG 0911 6000
BKN025=

1.7.3 Observations at the Site

A helicopter pilot who was flying in the accident area at around 13 h 00 noticed a compact layer of clouds towards 1,000 m, all of the peaks being covered.

1.8 Aids to Navigation

Pristina aerodrome is equipped with :

- a SIEMENS PLESSEY WATCHMAN airport surveillance radar (ASR). This is a primary radar broadcasting in the S band (10 cm), equipped with an interference echo suppression system and with a range of 60 NM. It can be equipped to receive secondary radar data, connected or from a distance.
- a Thomson CSF 371 ILS (PRS 110,10 MHz) on runway 17 comprising a localizer (LLZ) a Glide Slope with a 3° incline, an outer marker (OM) and middle marker (MM), situated respectively at 2.2 NM and 0.6 NM from the runway

threshold. As of 29 July 1999, the ILS did not have any remote monitoring equipment and it appears that before the conflict there was no surveillance of the beacons.

- a high-powered NDB (PRI 364kHz) with a theoretical range of 100 NM, positioned 8.6 NM from the threshold of runway 17 and connected up with a route marker beacon (FM, 75 MHz).
- two low-powered NDBs (L) connected up with the ILS markers, BA 420 kHz with the OM and VS 320 kHz with the MM. BA had been destroyed, along with outer marker, during the fighting in 1999.
- two other NDBs on the runway 35 approach centreline, DO 350 kHz switchable to VS and RBT 399 kHz situated at 2.2 NM from the threshold of the runway. DO had not been transmitting for at least six months. RBT was also out of service, since parts had been removed for use on RV.
- a TRN-26 TACAN identified as TCW which transmitted on channel 34X.

Note should also be made of two nearby VOR-DMEs dedicated to en route navigation, Budisavci (BUI, 115.20 MHz) about 28 NM west, which had not transmitted for about one year previously and, 35 NM north-east, Blace (BLC, 116.10 MHz).

Calibration of some of this equipment had been carried out in July 1999 by a Spanish Air Force team in accordance with the rules laid down by Annex 10 to the Chicago Convention, Doc. 8071 (ICAO) and the FAA USSFIM 8200-1. The following results were obtained :

- PRI 364 kHz was classified as unrestricted. A 20 NM circuit performed on 24 July 1999 confirmed a usable signal at 6000 feet for the 135°-350° sector, at 7000 feet for the 350°-250° sector, at 10,000 feet for the 250°-135° sector. The NDB approach path and the arrival and departure tracks published in the Yugoslav Aeronautical Information Publication were checked.
- the PRS ILS was classified as unserviceable. The localizer which was checked on 23 July and the glide slope which was checked on 24 July, performed in accordance with conditions set out in Annex 10 and Doc. 8071 but, to be serviceable, this navaid would have had to be completed by at least two marker beacons (OM and MM) in working order. Only the MM was working. Alternatively, a distance indication supplied by the TACAN could have replaced the inoperative OM, but for this configuration to be validated, the system would also have needed remote monitoring equipment.
- the radar checked on 25 July 1999 was classified as unrestricted.
- the TACAN checked on 23 July 1999 was classified as unrestricted.

A second inspection, undertaken on 4 September, concluded that the OM was in working order. The MM was not supplied with electricity on the day of this check. Consequently, when this marker beacon is working again, the ILS for runway 17 could be classified as unrestricted. However, we may note that this navaid is supplied with neither a backup power supply nor remote monitoring.

The following table summarises the results of the calibrations and the remarks made during an inspection carried out by the RAF from the 22 to the 29 July 1999.

	RAF Inspection	July Calibration	September Calibration
PRI NDB	Beam at half power, awaiting transistors	unrestricted	
ILS PRS	No longer any remote monitoring equipment	unusable	unrestricted if MM is working
OM	unusable	unusable	unrestricted
MM		working	No power supply on the day of the calibration
L BA	unusable		unusable
L VS			
ASR radar		unrestricted	
TACAN TCW		unrestricted	
NDB RBT	unusable		
L DO	unusable		

1.9 Telecommunications

No radio communications or radar data are recorded at Pristina Aerodrome.

1.9.1 Communications with Pristina Approach

The following details are taken from the Cockpit Voice Recorder (see 1.11.2). The numbers refer to the track included in paragraph 1.9.2.

① 9 h 58 min 06 s, KSV 3275 contacted Pristina Approach "one four zero flight level inbound XAXAN point four miles". The controller replied "Kosovo three two seven five roger identified what are your flight conditions sir?". The reply was "flight conditions is now is VFR".

② 9 h 58 min 32 s, the controller proposed "Kosovo three two seven five roger just confirm you want the vectors for the ILS" adding "three two seven five roger radar information service limited due to poor radar performance turn left heading three five zero". The crew accepted.

③ 9 h 58 min 50 s, the controller transmitted "Kosovo three two seven five set Pristina QNH one zero two eight report set" then "Kosovo three two seven five descent report five thousand two hundred feet initially". Both sets of information were read back.

10 h 00 min 05 s another aircraft with call sign Juliet Golf November contacted Pristina Approach "good morning sir we expect to land at time one zero two eight and request last weather please". The controller replied "Juliet Golf November eight zero roger timed at o nine fifty zulu, runway one seven, surface wind three four zero seven knots, four thousand meters in haze, the cloud two at one thou-

sand and eight at three thousand, outside air plus five and the QNH one zero two eight"

10 h 02 min 31 s, another aircraft with call sign "Freedom one" called up on the frequency.

④ 10 h 03 min 23 s, the controller transmitted "Kosovo three two seven five turn left heading three four zero" and continued "and descent report four thousand six hundred feet". The crew read this back.

10 h 04 min 22 s, another aircraft contacted Pristina Approach "radar good morning Hotel Charlie November nine nine three passing XAXAN flight level one four zero". The controller asked them for their flight conditions and proposed headings to intercept the ILS. He specified "Hotel Charlie November nine nine three roger radar information service limited due to poor radar performance you are number two in a pattern". The aircraft was authorized to descend to five thousand two hundred feet.

⑥ 10 h 06 min 25 s, the controller asked "Kosovo three two seven turn right heading three five zero" and "Kosovo three two seven five cockpits checks report complete". The crew had him repeat the request and replied "no completed the... the gear is up again".

10 h 08 min 02 s, the controller asked Hotel Charlie November "what's your level passing". The latter replied "one hundred ten thousand feet". The controller continued "nine nine three you're number one now you're much faster than Kosovo three two seven five". He specified "turn left heading three three zero".

10 h 08 min 54 s, Juliet Golf November announced it was at XAXAN at FL 140. The controller identified it and specified "you're number three in the pattern".

10 h 09 min 47 s, the controller asked "nine nine three roger descend report four thousand six hundred feet".

10 h 09 min 59 he asked "Juliet Golf November eight zero descend report five thousand two hundred feet" then "can you limit your speed".

⑦ 10 h 10 min 50 s, after a call from KSV 3275, the controller replied "you're number two to a much faster aircraft just ahead of you now by five miles" then "just maintain your heading on what you are on the moment".

10 h 11 min 07 s, the controller asked "Hotel Charlie November nine nine turn left heading two seven zero base leg" and one minute later "roger Charlie November nine nine three turn left heading two one zero report the localizer established".

⑧ 10 h 13 min 18 s, KSV 3275 called back and said, "*I want*³ to land". The controller answered "roger turn left heading two seven zero".

³ Doubtful words

10 h 13 min 38 s, the controller authorized Hotel Charlie November to land and ⑨ 10 h 14 min 06 s he asked "Kosovo three two seven five what is your estimated position from the Papa Romeo India ". KSV 3275 replied "euh fifteen nautical miles now heading two seven zero ".

⑩ 10 h 14 min 20 s, the controller continued "Kosovo three two seven five roger turn left heading one eight zero". The information was read back. That was the last message from KSV 3275.

10 h 14 min 39 s, the recording ended.

1.9.2 Radar Data

At the time of the accident, a French Air Force AWACS was on a mission in the region. Information relevant to the tracks of KSV 3275 and HCN 993 was provided to the investigators. It showed an approximate speed of 250 kt for KSV 3275 and of 400 kt for HCN 993. It allowed them to validate the track calculated from the parameters recorded on the aircraft's Flight Data Recorder (see 1.11.3) and to determine the relative position of the two aircraft at the moment when HCV 993 became number one for landing (see § 2.2).

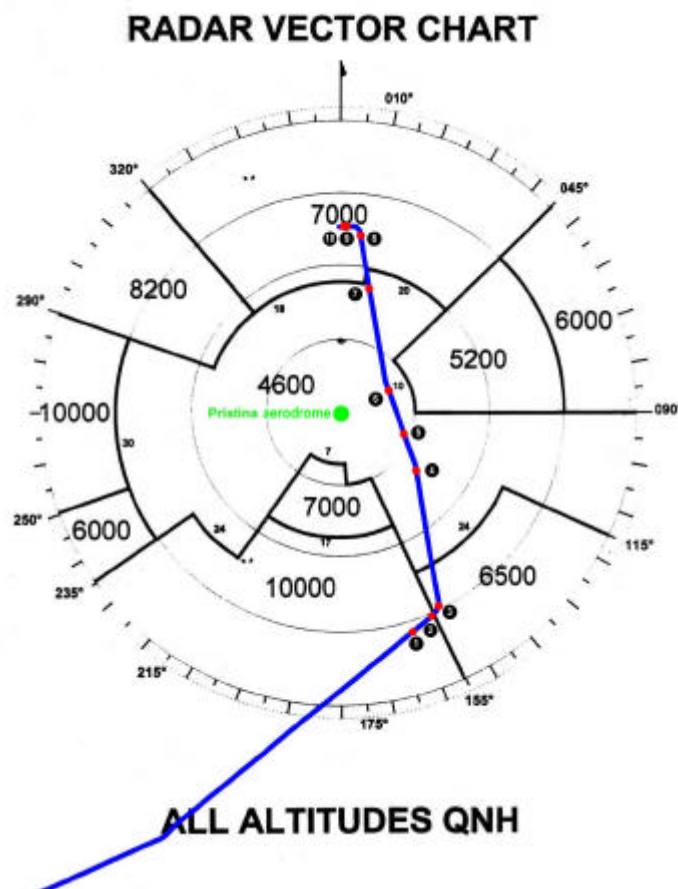

Figure 9 : Radar Data

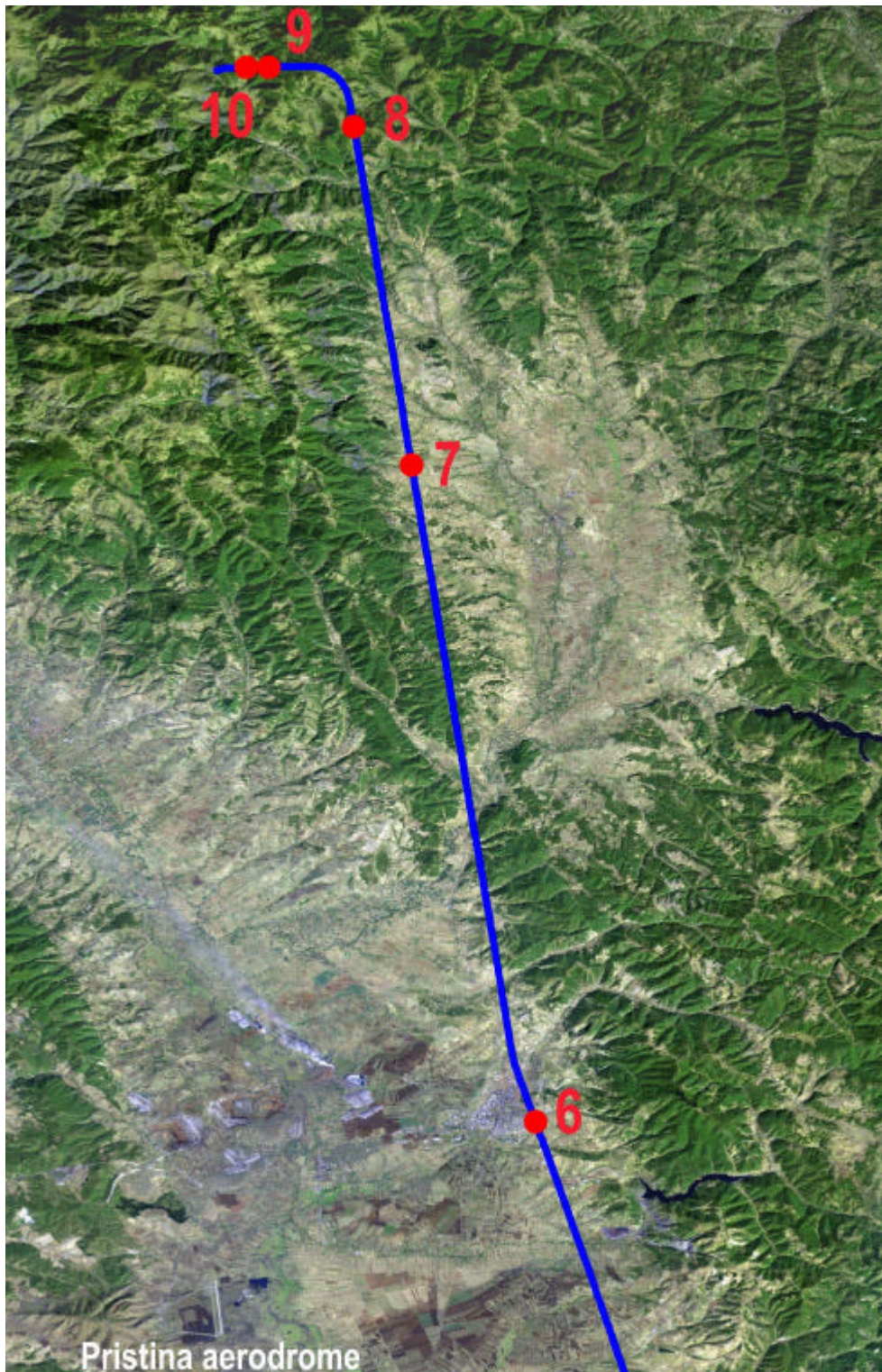

Figure 10 : Track of KSV 3275

1.10 Aerodrome Information

1.10.1 History

Following acts of war in March 1999, Pristina aerodrome (LYPR), managed up to then by the Federal Republic of Yugoslavia, was closed.

On 10 June 1999, through Resolution 1244, the United Nations handed over the management of the administration and of all civil activities in Kosovo to the United Nations Interim Mission in Kosovo (UNMIK) and confirmed the presence of an international force to maintain peace on the territory (KFOR).

In addition, a Military Technical Agreement (MTA) was signed between KFOR, the Federal Republic of Yugoslavia and the Serb republic. This agreement stipulates that the airspace above Kosovo, as well as an area 25 kilometers beyond its frontiers (Air Security Zone) would be controlled by KFOR.

The Helsinki agreements of 18 June 1999, which define Russia's participation in Kosovo, passed the management of Pristina aerodrome infrastructures to the Russian Army. The types of service which should be provided by air traffic control, corresponding to ICAO and NATO norms, are defined.

At the same time, KFOR and UNMIK mandated the Royal Air Force (United Kingdom) to undertake air traffic control services in Kosovo air space and at Pristina Aerodrome, as well as meteorological and operational services at the aerodrome.

A RAF detachment arrived on 25 June 1999. The aerodrome reopened on 6 July 1999. The first civil flight landed at Pristina on 6 July and the first commercial flight took place on 15 October.

Until the closure of the aerodrome to civil aircraft after the accident, around thirty military and civil aircraft used the facility daily.

1.10.2 Infrastructure

Pristina Aerodrome has a 17/35 runway, with an exact QFU of 174°/354°, and is 2,500 m long and 45 m wide. Topographic altitude at threshold 17 is 1788 feet. A taxiway parallel to the runway allows access to the parking area near the terminal.

During the bombardments in March 1999, the control tower was destroyed. When the field was re-opened by KFOR, a provisional tower was installed. A portable primary radar supplied by the RAF is installed next to it.

The terminal situated west of the runway near the threshold of runway 17 houses the RAF meteorological services and the operations office.

The main electrical power supply and telephone and surveillance links are in very bad condition. The cables are not ducted and are simply buried.

1.10.3 Airspace

As a tactical military airspace, the entire airspace over the territory of Kosovo is not classified according to ICAO criteria. It is similar to class G airspace. Only the Pristina CTR is class D, from the ground to 5,000 feet. There is no TMA associated with this CTR.

1.11 Flight Recorders

1.11.1 Types and Readout Operations

Two flight recorders were installed on board the aircraft.

Cockpit Voice Recorder (CVR)

- make : Fairchild
- type number : 92-A100-83
- serial number : 61669

Flight Data recorder (FDR)

- make : Fairchild
- type number : 17M-800-251
- type number : 3596

Both models have magnetic tape.

UNMIK officers found the recorders on 13 November, the day after the accident. Two members of the UNMIK police took them under seal to the BEA on the evening of Sunday 14 November. The operations to open the recorders, filmed and recorded with an explanation of steps undertaken, took place on the Monday morning. An ICAO representative participated in the work to transcribe and analyse the recordings, which lasted for two weeks.

1.11.1.1 Cockpit Voice Recorder

The outer casing of the CVR was damaged by the impact. The protective box was intact and there was no difficulty in extracting the tape. The tape wind and recording mechanisms, along with the magnetic tape, were in good condition.

1.11.1.2 Flight Data Recorder

The outer casing of the FDR was damaged by the impact. The protective box was intact and there was no difficulty in extracting the tape. The tape wind and recording mechanisms, along with the magnetic tape, were in good condition.

The tape was rewound onto a new reel and was read out on a six-track player. The recording was of good quality and had few desynchronised elements. The event was identified on track two, which was read out first.

The read out of the other tracks took several days. Each evening, after working on the tapes, they were placed under seal in the presence of the ICAO representa-

tive and put in the safe.

The validated parameter grid made possible the conversion of the recorded data into usable physical format.

The aircraft's track (see 1.9.2) was calculated from the recorded parameters, through integration of the recorded parameters for airspeed and magnetic bearing, taking into account an average wind varying between legs on the route, and by positioning the points at the start and the end on their known positions. A good approximation of the ground track was thus obtained, more so since the wind in the area under consideration was very weak. Bearing in mind the calculating method, the error is of the order of a hundred metres near the ends of the track and is at its greatest in the middle of the track (a few NM).

1.11.2 CVR Readout

The CVR recording was synchronised with the aid of FDR data. A parameter which corresponds to radio broadcasts is recorded on the FDR and its alignment with the communications between the aircraft and the ATC recorded on the CVR made it possible to time the audio recording thanks to the UTC time recorded by the FDR.

A transcription of recordings related to the flight and to the accident is attached in appendix 4. The crew did not use the aircraft intercom.

During the work on the CVR with the representatives of the Italian Civil Aviation Authority the latter, who knew both pilots, identified their voices. The CAM 1 (first voice heard on the CVR) was thus attributed to the copilot, CAM 2 (second voice heard) was attributed to the Captain. The latter was handling the VHF communications with ATC and the PAM operations and was thus apparently the Pilot Not Flying.

The following details may be noted (radio conversations presented in paragraph 1.9.1.1 are not repeated) :

- 9 h 47 min 22 s, copilot "facciamo un ILS per pista diciasette" (we're going to do an ILS on runway seventeen).
- 9 h 47 min 30 s, copilot "abbiamo girato vettorati paralleli all ILS virando verso Pristina" (we turned vectored parallel to the ILS turning towards Pristina).
- 9 h 47 min 51 s, copilot "assumi heading uno sette tre due mila cinque quaranta" (take heading two seven three two thousand five forty).
- 9 h 48 min 00 s, copilot "duecento piedi di radar altimetro" (200 feet radar altimeter).
- 9 h 48 min 16 s, copilot "imposti glide slope out duemilacento settanta duemila e quatro il circling duemila sei trentatre" (put the glide slope on OUT two thou-

sand one hundred and seventy two thousand and four, the runway circuit is two thousand six thirty three).

- 9 h 48 min 25 s, copilot "per l'avvicinamento tieniti fino a due e cinquanta e poi viriamo a sinistra per andare (*) Pristina" (for the Approach you keep on till two and fifty and then we turn left to go (*) Pristina).
- 9 h 49 min 31 s, Captain "approach briefing conducted MEA checked and landing data bugs (*) torque".
- 9 h 53 min 08 s, copilot "quanti ostacoli" (so many obstacles).
- 10 h 04 min 05 s, Captain "... radio altimetro duecento" (radio altimeter two hundred), copilot "anche for me" (for me too).
- Between 10 h 06 min 37 s et 10 h 11 min 36 s, the crew tried to contact Kosovo Whiskey four several times without success..
- 10 h 08 min 19 s, after the controller gave heading 355° at HCN 993, copilot "ma questo per loro è sottovento ?" (that's downwind for them, is it ?).
- 10 h 10 min 57 s, Captain "uh ci ha messo davanti quell'altro" (he's put the other one in front).
- 10 h 12 min 27 s, Captain "undici miglia" (eleven nautical miles).
- 10 h 12 min 35 s, copilot "cazzo io ancora sto qui davanti pero' quello che cazzo ci sta'... porca miseria !" ((...) I'm up here in front, but what's that other one doing (...)).
- 10 h 12 min 51 s, Captain "hanno traffico militare e fanno passa' loro" (they have military traffic and they're letting it pass ahead).
- From 10 h 14 min 33 s, CRC is heard until the end.
- 10 h 14 min 37 s, copilot "duecentoquaranta di radar altimetro" (two hundred and forty on the "radar" altimeter).
- 10 h 14 min 39 s, end of recording.

1.11.3 Readout of FDR Data

The graphs which were drawn from reading out the parameters are shown in appendix 5. The following lists some significant parameters for the end of the flight, which was carried out on autopilot and in clean configuration :

Note : the recorded altitudes are the pressure altitudes, i.e. adjusted to an altimeter setting of 1013 hPa. Four hundred and twenty feet (15 hPa x 28 ft) should be added to obtain the real altitude at QNH 1028 hPa.

NB : the numbers refer to the track attached in 1.9.2.

- ❶ 9 h 58 min 06 s
 - altitude : 14 041 feet
 - heading : 050°
 - speed : 205.9 kt
 - torque : 86.4 %(1)
85.2 %(2)
 - TAT : - 2.8°
- ❷ 9 h 58 min 50 s
 - altitude : 14 034 feet
 - heading : 045 °
 - speed : 206.4 kt
 - torque : 86.7 %(1)
85.3 %(2)
 - TAT : - 2.8°
- ❸ 10 h 03 min 23 s
 - altitude : 8 480 feet
 - heading : 351°
 - speed : 213.7 kt
 - torque : 39.7 %(1)
42.7 %(2)
 - TAT : +6.5°
- ❹ 10 h 04 min 48 s
 - altitude : 6 648 feet
 - heading : 341°
 - speed : 218.7 kt
 - torque : 40.6 %(1)
42.4 %(2)
 - TAT : +7.9°
- ❺ 10 h 06 min 25 s
 - altitude : 4 527 feet
 - heading : 340°
 - speed : 208.8 kt
 - torque : 36.4 %(1)
35.3 %(2)
 - TAT : +4.5°
- ❻ 10 h 10 min 50 s
 - altitude : 4 233 feet
 - heading : 350°
 - speed : 166.7 kt
 - torque : 42.4 %(1)
45.3 %(2)
 - Ralt : 2 271 feet
 - TAT : +3.2°
- ❼ 10 h 13 min 18 s
 - altitude : 4 240 feet
 - heading : 350°
 - speed : 160.2 kt
 - Ralt : 2 119 feet
 - torque : 42.4 %(1)
45.2 %(2)
 - TAT : +3.2°
- ❽ 10 h 14 min 06 s
 - altitude : 4 240 feet
 - heading : 269°
 - speed : 158.9 kt
 - torque : 45.7 %(1)
44.9 %(2)
 - Ralt : 939 feet
 - TAT : +3.2°
- 10 h 14 min 11 s :
 - altitude : 4 240 feet
 - heading : 269°
 - speed : 159.6 kt
 - torque : 47.4 %(1)
45.3 %(2)
 - Ralt : 655 feet
 - TAT : +3.2°
- ❿ 10 h 14 min 20 s
 - altitude : 4 233 feet
 - heading : 269°
 - speed : 159 kt
 - torque : 46.8 %(1)
45.3 %(2)
 - Ralt : 1 033 feet
 - TAT : +2.6°
- 10 h 14 min 35 s
 - altitude : 4 233 feet
 - heading : 253°
 - speed : 160.3 kt
 - torque : 47.2 %(1) 46
%(2)
 - Ralt : 241 feet
 - Roll : -27° (left)
 - TAT : +3.8°
- 10 h 14 min 38 s
 - altitude : 4 233 feet
 - heading : 243°
 - speed : 157.9 kt
 - torque : 47.1 %(1)
45.7 %(2)
 - Ralt : 35 feet
 - Roll : -27° (left)
 - TAT : +4.5°

1.12 Wreckage and Impact Information

1.12.1 Description of Site and Area



Figure 11 : View of accident site

The accident site is situated 25 NM north of Pristina Aerodrome (10 NM NE of Mitrovica) at an altitude of 4,600 feet. The first impact occurred 15 metres from the top of a ridge, in a rocky mid-mountain area. The peaks in this area vary between 3,380 and 5,800 feet.

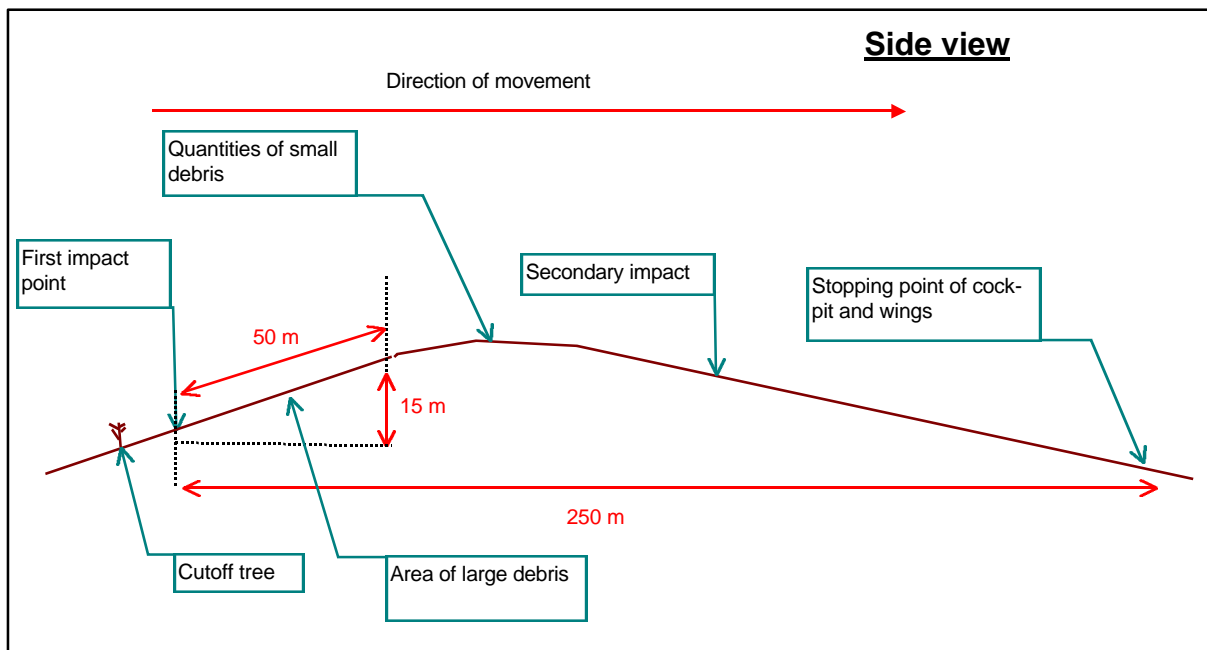

Figure 12 : Side view of site

Twenty-five metres before the impact point, the top of a seven-metre-tall tree had been chopped off on the right side of the track. Then the point of impact of the engine and left propeller slashes were found.

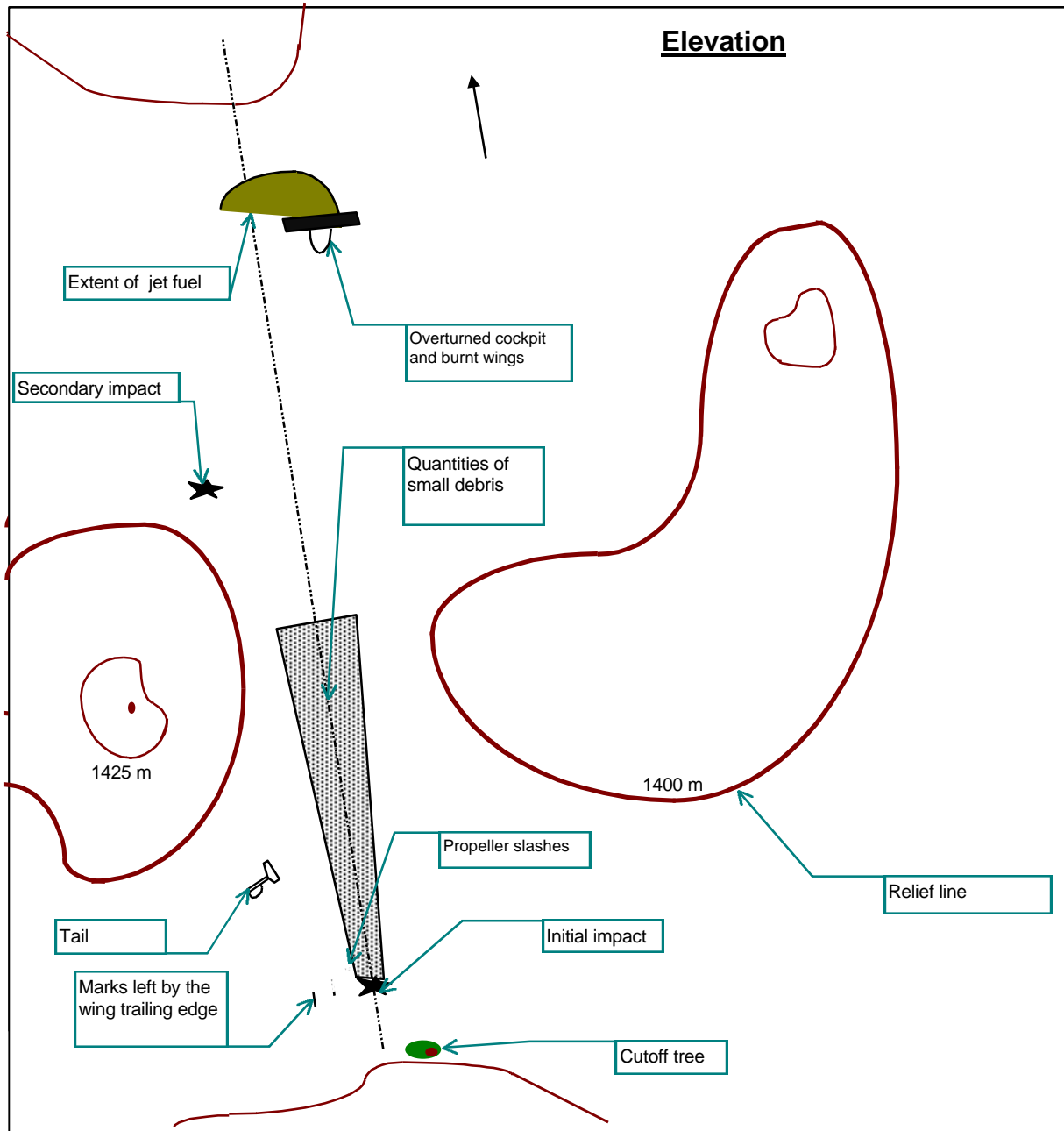

Figure 13 : Accident site seen from above

The fuselage impact point was a little further, about fifty metres from the top of the ridge. The tail, from which half of the left stabiliser was detached, was found on the left.

The debris was then spread about over a length of about 250 m on a line at 250°, on either side of a pass. The lower part of the fuselage had disintegrated on the rocks on a slope rising at 30 %. On the other side of the ridge, the two main landing gears were found in relatively good condition, along with two items of electrical equipment (the GPS and an ADC) and the right engine.

At the end of the track, at about 150 m after the ridge, the main part of the fuselage was found : the upper part of the cockpit, the left engine and the wings, showing signs of fire. The cockpit and the wings were upside down. Slightly to the right the engine control pedestal was found.



Figure 14 : Debris

The GPWS computer was found beyond the pass in the direction of the track. The references noted on the equipment were as follows : manufacturer : AlliedSignal, GPWS Mark II computer 965-0476-088, serial number 10100. Despite extensive additional searches, the left side panel, where the GPWS switch is situated, could not be found.

1.12.2 Information Gathered from the Wreckage

A certain amount of information could be ascertained from the wreckage, despite extensive destruction.

- The landing gear control lever was in the UP position. Considering the condition of the wheels, we can therefore assume that the landing gear was retracted at the time of the impact.
- The altimeter on the left instrument panel indicated 4 600 feet. It was set at 1028 hPa.
- The backup altimeter showed 5 000 feet for a setting of 30,31 inches of mercury.
- The Power Management Panel button was in the CRZ (Cruise) position.
- Some Jeppesen charts were found at the site.

1.13 Medical and Pathological Information

The crew should have been autopsied and the passengers' injuries noted. For humanitarian reasons, the investigators accepted that this be done in Rome. No results have been communicated to them.

1.14 Fire

A fire broke out near the fuel tanks after the accident. The fire affected the wings and cockpit.

1.15 Survival Aspects

At 10 h 20, a note was made in the ATC Duty Logbook of the loss of radio and then radar contact with KSV 3275.

The same document, based on information received from RAF operations, indicates that at 12 h 30 flight KSV 3275 had landed in Tirana. An undated note cancels this information.

At 10 h 45, KFOR was informed of the loss of radio/radar contact. Land patrols were sent out immediately to obtain information from the population.

At 13 h 30, SAR operations were started with four helicopters.

From 15 h 45 onwards, the search continued in the dark, with four other helicopters equipped with infrared cameras and night vision apparatus.

At 20 h 41, a helicopter discovered the wreckage. A medical team and troops were deployed to the spot.

Note : the emergency locator transmitter from F-OHFV was never heard.

1.16 Tests and Research

1.16.1 Identification of the CRC

Given the aircraft's configuration (flaps 0) and flight profile, only the LANDING GEAR NOT DOWN warning could have caused the Continuous Repetitive Chime to be set off, as recorded from 10 h 14 min 33 s onwards (see 1.11.2).

In fact, this warning signal is activated if at least one of the three landing gear mechanisms is not locked down and if one of the power levers is in idle position, which corresponds to an angle (PLA) below 54°. It then :

- Flashes the WARNING lights
- Sets off the CRC
- Lights the landing gear handle red

- Lights the red LDG GEAR NOT DOWN warning light on the warning panel.

A calculated reconstitution of the position of the levers shows that they were at about 54°, though it is not possible to say whether the position was greater or lesser than the value indicated. For a lesser position, the warning alarm should have been set off below 500 feet (radio altimeter), in other words about six seconds before the impact. Since this duration corresponds with that recorded on the CVR, we can conclude that it was the LDG GEAR NOT DOWN warning which was activated.

1.16.2 History of the GPWS and the Radio Altimeter

When it was delivered, the aircraft was equipped with a GPWS computer S/N 9143. During the check flight conducted by a mixed Aérospatiale/ Si Fly crew, it was noted that the GPWS generated warning alarms during landing. The computer was therefore replaced by computer S/N 6697.

During the month of September, Si Fly ordered a GPWS computer from ATR. This was the computer S/N 10100 which was found in the wreckage. The replacement of the computers took place on 13 September 1999 and was carried out by Si Fly on a Work Order basis. This operation is not noted in the aircraft's Logbook.

GPWS Computer S/N 6697 was sent to Dinard for repair in the LAB workshops. Workbench examination showed a connection fault on the power supply card. This fault caused intermittent lighting of the GPWS FAILED light on the test bench. It would have provoked lighting of the GPWS FAULT light in the cockpit.

In addition, in a letter dated 24 September 1999, Si Fly informed ATR that despite the replacement of the computer, the GPWS was still not working properly and the "FAULT" indication was still "ON". Suspecting that the failure might originate in the radio altimeter, Si Fly also requested that ATR send them a new radio altimeter.

A radio altimeter S/N 4940 was sent to Si Fly on 8 October 1999. After replacement, Si Fly was supposed to send the old radio altimeter back to ATR, which they had not done at the time of the accident. Further, the operator ordered the kit for the SB 34-0078 of 19 August 1996, which concerned the replacement of the radio altimeter coaxial cable and the modification of the position of the radio altimeter aerial. This SB was to be applied during the type A maintenance check scheduled for the 12 and 13 November.

Application of SB 34-0115 of 18 September 1998 had also been proposed by ATR in its reply to the letter of the 24th.

1.16.3 GPWS

1.16.3.1 Examination

Examination of the GPWS computer found in the wreckage was performed in AlliedSignal's laboratories in the USA, in the presence of an investigator from the BEA.

In the condition in which the computer was found, the GPWS was capable of generating the Glideslope warning. In addition, the AUDIO module, when installed on another piece of equipment, was able to reconstitute all of the warnings.

After replacing the computer components damaged by the impact, the bench test carried out on the GPWS showed no anomalies.

Analysis of the functions of the components which were damaged showed that one or more failures of these circuits before the impact would have :

- Caused false alarms
- Possibly been detected during the GPWS self-test but without having any effect on mode 2 alarms.

Note : The equipment manufacturer mentioned a possible, though unlikely, failure which would prevent the mode 2 alarms without being detectable during the self-test.

1.16.3.2 Simulations

At the request of the BEA, some simulations were undertaken by AlliedSignal and by Aérospatiale Matra, based on data from the FDR relating to the aircraft's track, with the GPWS selector switch in the NORM and FLAPS OVERRIDE positions. They all caused alarms to be set off for the last seconds of the flight.

1.16.3.2.1 AlliedSignal Simulation

GPWS Selector in NORM position

Time -31s	to -29s	⇒ Ralt between 800 et 688 feet	⇒ "Terrain, Terrain" 2 times.
Time -29s	to -27s	⇒ Ralt between 688 et 661 feet	⇒ "Whoop Whoop Pull Up" 2 times.
Time -27s	to -7s	⇒ Ralt between 661 et 561 feet	⇒ "Terrain, Terrain" 13 times.
Time -7s	to 0s	⇒ Ralt between 561 et 35 feet	⇒ "Whoop Whoop Pull Up" 3 times.

GPWS Selector in FLAPS OVERRIDE position

Time -26s	to -27s	⇒ Ralt towards 657 feet	⇒ "Terrain, Terrain" once.
Time -7s	to -5s	⇒ Ralt between 446 et 331 feet	⇒ "Too low Terrain" once.
Time -5s	to -4s	⇒ Ralt between 331 et 259 feet	⇒ "Terrain, Terrain" once.
Time -4s	to 0s	⇒ Ralt between 259 et 35 feet	⇒ "Whoop Whoop Pull Up" once.

1.16.3.2.2 Aérospatiale Matra Simulation

Zone	Time (sec)	Radio altitude rate (ft/min) *	Radio Altitude (ft)	Alarms Normally Associated	
				GPWS Selector not in "FLAPS OVERRIDE" position	GPWS Selector in "FLAPS OVERRIDE" position
1	-56 to -49	-2050	2150 to 1900	Outside of alarm zone	
2	-49 to -44	-3650	1900 to 1550	Outside of alarm zone	
3	-44 to -36	-3100	1550 to 1120	Outside of alarm zone	
4	-36 to -34	-325	1120 to 1100	Outside of alarm zone	
5	-34 to -29	-5100	1100 to 725	Terrain Terrain Whoop Whoop Pull Up (every 0,75s)	On edge of alarm zone at 800 ft (imprecise measurement ?)
6	-29 to -12	Ralt rate > 0	725 to 1200	Terrain Terrain (every 0,75s)	Outside of alarm zone
7	-12 to -5	-6720	1200 to 400	Whoop Whoop Pull Up (every 0,75s)	From 800 feet (t-9s), Terrain Terrain Whoop Whoop Pull Up (every 0,75s)
8	-5 to 0	-3750	400 to 50	Whoop Whoop Pull Up (every 0,75s)	Terrain Terrain then Whoop Whoop Pull Up (every 0,75s) until 200 feet (t-3s)

* : slope estimated in graphic mode based on FDR radio altitude parameter.

1.16.4 Examination of GPS

Examination of the recovered GPS was performed in the Honeywell laboratories in Kansas in the presence of a BEA investigator.

Last known position : N 42° 58.27' - E 21° 03.98'.

- Last active Waypoint :
 - TYPE = NDB
 - PRI
 - Pristina
 - FRQ 364 NDB
 - N 42° 43.71' - E 21° 01.09'.
- Active flight plan : PLN n° 0 (LIRA - PRA - LAT - FRS - TEA - AMSOR - EKTOL - GIOIA - BRD - GOKEL - LATI - MAVAR - XAXAN - PRI - LYPR)

1.16.5 Crew Fatigue

At the request of the BEA, the Laboratoire d'Anthropologie Appliquée (Applied Anthropology Laboratory, University of Paris V) conducted a study to evaluate the level of fatigue of the two pilots, based on available documents and on the model developed in the context of its research work in the domain of aeronautics.

According to this model, a pilot's level of fatigue particularly depends on :

- The duration of his duty periods,
- The number of duty periods which begin early in the morning. The workload associated with a series of flights causes greater fatigue when the flights are early in the morning.

The model evaluates fatigue on a five-level scale from 0 to 100 :

- 0 to 20 very slight
- 21 to 40 slight
- 41 to 60 average
- 61 to 80 high
- 81 to 100 very high.

Taking aside the regulatory aspects⁴, we may note that the crew of the ATR had been faced with a heavy workload in the five days before the accident. On the days of the 10th and 11th November, the duty period started at about 5 h 30.

Two aggravating factors were noticed concerning the Captain :

- relatively late ends to his duty periods, probably leading to a lack of sleep,
- a very long working day on 10 November, of 14 and a half hours, followed by five flights the following day.

Based on the model, the crew's level of fatigue before the accident was thus estimated at 69.5 for the Captain and 65 for the Copilot.

1.17 Information on Organisations and Management

1.17.1 Information on the Operator

1.17.1.1 History and Structure

The first Air Operator Certificate was issued to Si Fly by the Italian Civil Aviation Authority (ENAC) on 10 August 1999, with a validity of one year. The company headquarters is in Palermo. Its technical and operational base is at Ancona aerodrome.

When it was founded, SI Fly carried out only charter flights and its fleet consisted of the ATR 42-300 registered F-OHFV. Subsequently, Si Fly undertook scheduled domestic flights to Albenga. A second ATR 42-300, registered F-OICG was added to its fleet on 27 October 1999. The company is in possession of JAR 145 for line maintenance of the ATR 42-300's. It does not apply the JAR-OPS regulations not yet implemented in the Italian regulations.

The Si Fly company organisation chart shows an Operations Department (whose Director is also the Chief Pilot) and a Technical Department. A Training office and an Airport Operations office are attached to the Operations Department. In the context of the Si Fly's JAR 145 authorisation, a Quality Control element in Technical Inspection is directly attached to the airline's Board of Directors. For Operations there is no real quality assurance system, though a systematic analysis of flight dossiers is carried out.

⁴ The Italian regulations limit flying hours to 100 hours over a 30 day period. In France, the limit is 95 hours. In Europe, the JAA have not yet defined common rules.

On the day of the accident, Si Fly had twenty-four employees, including four Captains (including the Chief Pilot), four Copilots and three cabin crew. Two Captains were qualified as Instructors and Flight inspectors. The airline's activity in the month of October and up until the day of the accident was divided between the following destinations :

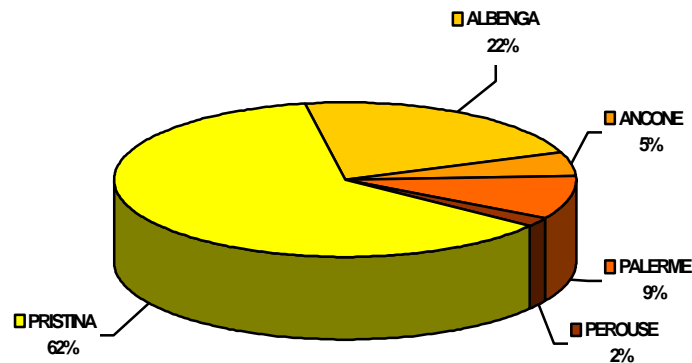

1.17.1.2 Operational Documentation

1.17.1.2.1 Operations Manual

Regulatory Requirements

For public air transport, the regulations in force in Italy oblige operators to possess an Operations Manual (*manuale delle operazioni*) which includes the following elements :

- an Operation Manual (*manuale operativo*) which corresponds to the "Generalities" section of the Operations Manual as understood in the JAR-OPS,
- an Aircraft Operation Manual (*manuale d'impiego dell'aeromobile*),
- a Training Manual (*manuale dell'addestramento*),
- a Route manual (*manuale di rotta*).

This documentation, along with all of its amendments, must be registered with the Italian authorities. Any technical element which does not make specific reference to documentation certified by these authorities or to their technical directives must be approved.

Description

Si Fly's documentation for Flight Crew includes :

- the *manuale operativo* itself, which describes all the general rules and standards applicable to all cockpit crew,
- an *Operation Manual* which corresponds to the *manuale d'impiego dell'aeromobile* and which includes information relative to the use of the ATR 42,
- a *manuale assistenti di volo* which relates to the cabin crew,

- the *manuale di rotta*, which is in fact the AIP and Jeppesen documentation.

1.17.1.2.2 Manuale Operativo

Si Fly's *manuale operativo* is dated 1st May 1999, its last update on 24 July 1999. Chapter 4 (see appendix 6), which describes the various steps in the performance of a flight, specifies that :

4.10.1.6.1 Use of check-lists

All aircraft are equipped with checklists placed in the cockpit. The use of these checklists by cockpit crew members is obligatory.

4.10.1.6.3 Application

These checklists are based on the call-response principle.

4.10.5 Application of the Rules of the Air

4.10.5.2 Application of Instrument Flight Rules (IFR)

All commercial flights shall take place according to Instrument Flight Rules.

4.10.5.4.1 ATC Authorisations

Before accepting an ATC clearance, the Captain must make sure that they are compatible with flight conditions and with aircraft performance.

4.10.5.4.2 Separation with terrain

Aircraft collision avoidance with terrain is not included in the services provided by the ATC service. It is the responsibility of the pilot to make sure that ATC clearances ensure safety in this domain.

Exception is made in cases where an IFR flight is conducted under radar vectoring.

Radar Control

4.10.5.5.2 Radar monitoring

When navigation is performed by the pilot, radar surveillance service include providing the pilot with information and indications concerning significant modifications to his track relative to the last clearance received.

The radar surveillance service does not ensure separation with terrain.

Under radar surveillance, the pilot must respect the published Minimum Safety Altitudes.

4.10.5.5.3 Radar vectoring

During radar vectoring, navigation is performed by the controller giving precise headings to the pilot.

... the radar controller shall assign altitudes to the pilot which ensure the safety prescribed margins for separation with terrain.

... nevertheless, all onboard radionavigation equipment must be used to check the position of the aircraft and to check the safety margins relative to obstacles.

If an altitude which is assigned by the controller is different from that which is applicable, the crew shall request clarification.

N.B. the preceding extracts are translated from the Italian.

1.17.1.2.3 Instructions for Operations on the Rome-Pristina Line

Si Fly published a document entitled *Specifiche operative* (see appendix 7), referenced as CO N. 99/01 and dated 10 October 1999, which describes the characteristics of flight KSV 3275. Reference is made, amongst other things, to the frequency of operations, the airspace, the minima and to the procedure for use of the ILS. The following extracts are translated from the Italian :

1. Si Fly operates flight KSV 3275, of which the characteristics follow, on behalf of WFP/Balmoral,:

*Monday, Wednesday, Friday, and Sunday : Rome-Pristina-Rome
Tuesday, Thursday : Rome-Pristina-Tirana-Pristina-Rome*

2. SITUATION : Pristina aerodrome is in Kosovo, an area under UN international jurisdiction. As indicated in the relevant NOTAMs, this aerodrome has no radionavigation aids with the exception of the ILS, whose operation is not, incidentally, guaranteed. A military radar unit, which can provide limited ATC service, is installed on this aerodrome. ...

...

5. AIR SPACE : Entry into Kosovo air space is done through corridors whose entry point is XAXAN and exit point is SARAX, separation of traffic flow being performed by level. ATC services are provided by PRISTINA APPROACH which provides information on the availability/non-availability of radar services. In case of non-availability of radar services, the aircraft must position itself.

6. MINIMA : takeoff for Pristina is only possible if diversion to Tirana is available. Instrument approaches are only authorised for runway 17. The approach procedure requires minima of 2500 feet visibility and a decision height of 600 feet. Approach without G/S is not authorised. When conditions allow, a visual approach is permitted. In case of non-availability of radar surveillance, the approach may only be conducted if it is possible to perform a VISUAL approach.

7. SPECIAL PROCEDURE FOR USE OF THE ILS : using the GPS, identify overhead PRI, perform the standard entry while waiting and intercept the LOC, then follow the G/S information only after a positive identification of the signal. Information supplied by the radar, possible vectors and instructions, must always be crosschecked with onboard indications and the MSA rigidly adhered to.

This note is signed by the Director of Operations. A series of NOTAMs concerning TIRANA and PRISTINA aerodromes is attached to it.

1.17.1.2.4 Aeronautical Documentation

Si Fly uses aeronautical documentation published by Jeppesen. For the en route section, this means the EUROPE - LOW ALTITUDE EN ROUTE CHARTS 10 E(LO). The aerodrome part includes the following charts for Pristina :

- a standard approach chart dated 14 August 1998,
- an ILS RWY 17 plate dated 26 March 1999,
- an ILS or NDB RWY 17 plate dated 25 December 1998,
- an NDB RWY 17 plate dated 26 March 1999.
- Three standard departure procedure plates, dated 14 August 1998
- An aerodrome chart,
- An obligatory visual manoeuvre chart, dated 25 December 1998.

Note should be made that plates ILS RWY 17 and NDB RWY 17 indicate that the procedure is temporary and that reference should be made to the NOTAM charts which are featured at the beginning of the Jeppesen documentation, as follows :

"Pristina, Yugoslavia, apt clsd for civil traffic.

Ufn communication procedure for arr/de acft estbld :

1 - Inbound acft should contact Pristina APP on 118.77(5) 10 minutes before Blace to co-ordinate FL overhead Blace VORDME.

2 - Outbound acft towards Blace VORDME should contact Belgrade ACC on 130.32(5)/123.07(5) immediately after takeoff and may leave Pristina TMA on Belgrade ACC confirmation of Pristina APP issuance of flight level overhead Blace VORDME. Ufn all IAP's suspended.

SIDS 10-3A MEKEN 1B,1C, Valjevo R-150/83 DME fix coords changed to 043°05,9N-020°45,9E

1.17.1.3 Entry into Service of Rome-Pristina Line

1.17.1.3.1 History

Si Fly performed flight KSV 3275 in the context of a lease contract with Balmoral Central Contracts. The latter company possessed a valid public air transport certificate issued by the Republic of South Africa. It performed flights itself on behalf of the WFP between Rome and Pristina with a CASA 235 aircraft, before signing with Si Fly.

The lease contract between Balmoral Central Contracts and the WFP dates from 16 July 1999. It stipulates that all necessary authorisations for operation of the flight will be obtained by the WFP. The contract mentions a co-ordinator appointed by each of the parties to ensure co-operation in the operation of the aircraft. It authorises sub-contracting, on condition that the sub-contractor be ap-

proved by the WFP. The contract gives no details of the operational aspects of the co-operation between the two parties.

The contract between Balmoral Central Contracts and Si Fly, on a 30-day renewable basis, is dated 19 October 1999. It stipulates that it is Balmoral Central Contracts' responsibility to obtain the necessary authorisations for the operation of the flight.

The Si Fly Director of operations stated that the contract between Balmoral Central Contracts and Si Fly was established a few days before the beginning of flights to Pristina. This resulted in a briefing, one part of which concerned technical services available at Pristina (navigation aids, generalities on the ATC service, ground assistance). No technical documentation was passed on. The first flight to Pristina took place with a Balmoral Central Contracts technical co-ordinator and no specific remarks were made. The operational instructions established by Si Fly for the Rome-Pristina route were neither brought to the attention of nor requested by Balmoral Central Contracts.

1.17.1.3.2 Flight preparation

A study of the line, dated 7 November 1999, was carried out by Si Fly. It includes :

- NOTAMs concerning Pristina aerodrome supplied by the Azienda Autonoma Assistenza Al Volo Traffico Aereo General. The most recent NOTAM is from 26 October 1999 and indicates that "the aerodrome is closed to civil air traffic".
- Jeppesen Electronic Airport Directory charts concerning the Rome-Ciampino and Pristina aerodromes. The Pristina one, dated 13 November 1999, indicates "Rwy Cat IFR".
- a copy of the air traffic flight plan, under the flight number KSV 3275, dated 9 November 1999, for the Rome Ciampino-Pristina route.
- the various diversion aerodromes for this route.
- a copy of the technical flight plan for this route.
- a side view of the minimum safety altitudes and of the flight levels for this route.
- a copy of the Jeppesen charts of Pristina.
- a table of landing limitations at Pristina.

1.17.1.4 Operation of the Rome-Pristina Line

According to information supplied by Si Fly, the daily preparation of flights was carried out by the operations office. The operations agent prepared the flight dossier which contained the latest meteorological information and the latest NOTAMs. This dossier was given to the Captain who checked the validity of its contents.

After each flight had returned to base, the operational dossier was returned to the Operations Department and was analysed systematically with respect to delays, fuel consumption, crew logbook entries and technical logs. The study of the flight dossiers for the Rome-Pristina line had not brought to light any significant prob-

lems, either in the operational or in the technical areas.

On 12 November, the crew of flight KSV 3275 had taken charge of the aircraft at Rome Ciampino. They had completed the flight dossier, which had been prepared previously at Ancona, with the latest meteorological information and the latest NOTAMs obtained from the ATC office.

Meteorological information is supplied to the ATC office by a military organisation, the Brigata Spazio Aereo. The NOTAMs are issued by the Italian air traffic control organisation (ENAV).

The crew was not in possession of the following documents (see 1.18.1) :

- AIMs issued by Eurocontrol,
- SPINS established by RAMCC,
- SPINS prepared by UNACC,
- NOTAMs issued by KFOR.

1.17.2 Information on the Organisation of Pristina Aerodrome

The Russian detachment is in charge of the infrastructure and its protection, as well as the inspection and the maintenance of the runways and taxiways. The operational part of the aerodrome is managed by the Royal Air Force (ATC, operations, meteorology).

A team of eight Royal Air Force airmen handles ATC services. This team includes a Senior Controller (SATCO), five Controllers and two assistants.

The different control posts are :

- In the tower
 - one ADC (TWR) post to handle aerodrome control,
 - an assistant.
- In the premises serving for the approach control
 - an APP post to handle approach control in and around the CTR,
 - a final approach control on surveillance radar.

The posting of the controllers and the ATC services provided are defined in the Royal Air Force Joint Services Publication (JSP 318A). Operational Orders specify the organisation and the specific procedures associated with the Pristina organisation.

The five controllers can work in either tower or radar control posts. Their activities are organised on a monthly duty roster.

A letter of agreement between the Former Yugoslavia Republic of Macedonia's (FYROM) General Aviation Directorate and NATO establishes handoff procedures between the Skopje control centre and the Pristina organisation. These procedures are described hereafter.

1.17.3 Operational Procedures used by the Pristina ATC organisation

All aircraft arrive at Pristina under an IFR flight plan. Bearing in mind the state of

the radio-electric equipment, no procedure with instruments is practically possible at Pristina. This is mainly due, as far as approach to runway 17 is concerned, to the failure of the PRI NDB. This explains why the aerodrome is usable only under daytime VFR according to the AIM and the SPINS (see 1.18).

Only one arrival itinerary is possible. The Skopje control centre hands off aeroplanes going to Pristina via XAXAN waypoint at flight level 140. The forecast overhead time is transmitted by telephone to the Pristina approach controller, who takes over the flight from that moment on (see fig.16).

In addition, there are no documents indicating that aircraft arriving at Pristina must change flight rules and change to VFR. In practice, IFR flight plans remain active until landing.

Common practice at Pristina is to ask pilots their flight conditions and to offer radar vectoring to intercept the runway 17 ILS at 4,600 feet regardless of the flight conditions. Aircraft are vectored towards the north to go past the eastern edge of the CTR then to fix on the ILS by a left turn. The altitude instructions are given by the controller in accordance with the safety altitudes defined in the Radar Vector Chart (see fig.15).

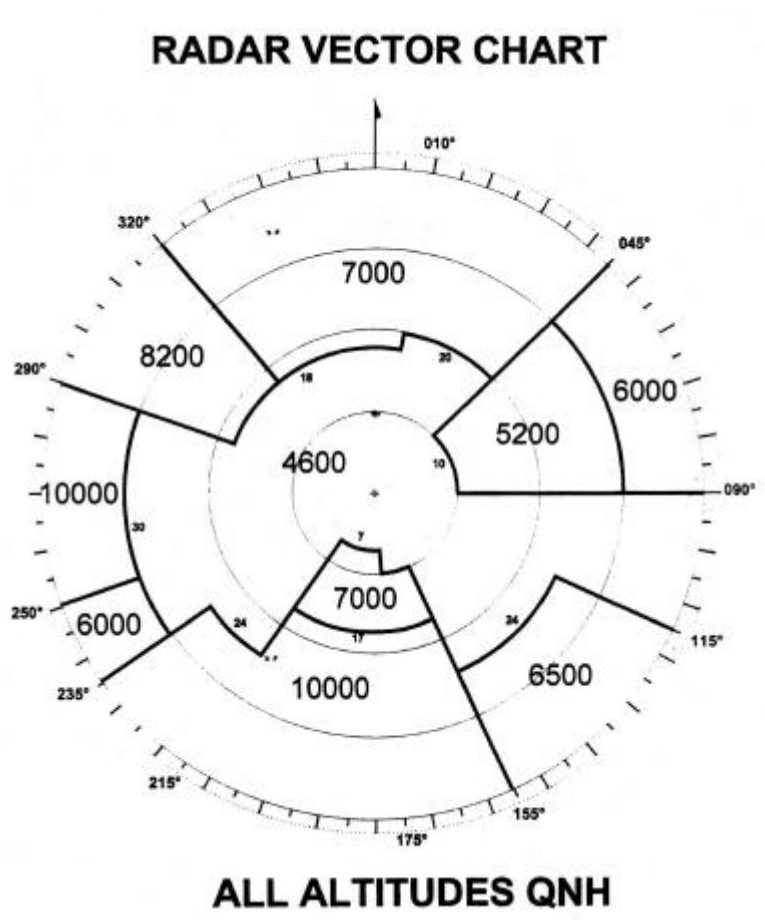

Figure 15 : Radar Vector Chart

Note : according to JSP 318A, pilots must notify the ATC of any change in flight conditions. This is not part of civil standards and practices.

Aircraft are handed off to the tower at 20 NM for visual approaches and at 8 NM if the meteorological conditions are a visibility over 3,7 km and a ceiling above 700 feet. They remain in contact with approach control down to the ground when meteorological conditions are inferior to the values mentioned above.

A departure track is planned towards the Skopje FIR with handoff at the SARAX waypoint at flight level 130. A direct departure track after takeoff can also be authorised.



Figure 16 : Organisation of airspace in Kosovo

1.18 Supplementary Information

1.18.1 Aeronautical Documentation

1.18.1.1 Aeronautical Information Manual

Federal Republic of Yugoslavia Aeronautical Information Publication (AIP) include information about Pristina aerodrome which was valid before the events in Kosovo. Two AIP supplements deal with Pristina. The first gives details of temporary modifications in the approach and departure procedures and the second contains co-ordinates of the aerodrome's characteristic points.

The Yugoslav Federal Air Traffic Authority (FATCA) issued NOTAMs which indicate :

- NDB RBT and BA locator non-availability between 6 July and 6 August 1999.

- Arrival and departure procedures for military and humanitarian flights between Pristina and the Skopje FIR from 6 August to 31 December 1999 (in accordance with a letter of agreement between the two organisations).
- The closure of the aerodrome to civil traffic from 26 October 1999 to 26 January 2000.

1.18.1.2 Air traffic flow management Information Messages

AIMs contain proposals to re-route flights and other information relating to traffic flow. They are published by Eurocontrol and sent to subscriber aeronautical information services and subscriber airlines. France, for example, has 218 subscribers. AIMS, which are normally used for air traffic flow management, are not distributed as NOTAMs.

For Pristina, information prepared locally by KFOR is transmitted to COMAIRSOUTH in Naples via the regional level RAMCC in Vicenza. Once validated, it is sent to the NATO HQ in Brussels which, in collaboration with Eurocontrol, formats it for civil aviation. We may note that this information goes far beyond air traffic flow management.

The AIM of 21 October 1999, at 16 h 03, indicates that, until further notice, the NOTAMs issued by the FATCA are not valid.

The AIM of 21 October 1999, at 16 h 04, valid until further notice, relates to the use of airspace and procedures at Pristina. It details :

- restrictions related to operations at Pristina aerodrome
- conditions for allocation of landing slots,
- the inbound and outbound paths (levels and headings),
- conditions for the opening and the use of the aerodrome,
- the condition of radar, radio-navigation and final approach equipment.

The AIM of 21 October 1999, at 16 h 04, valid until further notice, concerning Pristina aerodrome :

- gives the opening times of the aerodrome,
- gives details of time required to obtain permission from UNMIK and determines the notice period for a request for a slot,
- gives details of aerodrome radio-navigation aids,
- announces the publication of approach charts by the RAF in the near future.

1.18.1.3 SPINS

The Special Instructions published by the RAMCC in Vicenza are aimed at all non-military operators in the skies above the Balkan area of responsibility, notably Kosovo.

Specifically, the SPINS dated 15 October 1999 specify that operators must sign a Release of Liability and ensure that crews are informed of the procedures in force. They also give details of the regulatory role of the RAMCC, the conditions for operating flights and the evolving nature of the situation, which necessitates a permanent update of information (NOTAMs and AIMs).

SPINS are also issued by UNACC (United Nations Air Co-ordination Cell, Geneva). They give details of the type of UN flights and the opening periods and conditions of use for Pristina, as well as references to be taken into account in flight operations. They also specify that the NOTAMs issued by the Federal Republic of Yugoslavia are not officially recognised.

Note : UNACC publishes a daily programme of humanitarian flights after co-ordinating with the RAMCC.

1.18.1.4 NOTAMs issued by KFOR

KFOR HQ issued NOTAMs whose distribution was limited to KFOR and NATO. One of these documents, n° 221 of 15 October 1999 at 6 h 45 concerning navigation aids and ATC services, indicates that :

- ATC services are provided by an RAF detachment following the regulations in JSP 318A,
- radar services are provided with the aid of a Plessey WATCHMAN mobile radar without a secondary radar and with several blind spots, and therefore radar service is limited,
- a radar vector chart including radar MSAs has been designed by the RAF,
- the ILS and the OM are serviceable and that the PRI NDB is not serviceable and that, in its absence and when the radar is broken down or on maintenance, no IFR procedures are available. At such times, only a flight information service will be offered and all flights must be conducted under VFR,
- the radar, TACAN, ILS and PRI were satisfactorily calibrated from 22-25 July 1999 and the ILS and OM were again calibrated on 4 September 1999,
- the runway 17 VASIS is serviceable but has not been calibrated.

1.18.1.5 Summary

The following table gives the essential information contained in the various documents mentioned in the previous paragraphs.

	AIM	RAMCC SPINS	UNACC SPINS	FRY NO-TAMs	Jeppesen	KFOR NO-TAMs
PRI	x 16h06					x
ILS	x 16h04 ◆ 16h06					◆
OM						◆
MM						
RBT				x	x	
BA	x			x		
VS						
TACAN	◆ 16h06					
RADAR	x 16h04 ◆ 16h06					
VFR Only	x	x			x	
CIV				x	x	
IAP					x	
Airline Access	NO	NO	NO	YES	YES	NO

x : unserviceable

◆ : serviceable

Note : ICAO Annex 15 specifies, in chapter 3, the various responsibilities and duties of States concerning the collection and distribution of aeronautical information. It is completed by Doc. 8126-AN/872 which gives details of structures and rules to observe for the collection and distribution of this information. These documents provide that a State may entrust to another State the distribution of aeronautical information which concerns its airspace, but gives no guidance on the procedures to be used when a territory is not under the authority of a contracting State. The overall situation in Kosovo did not conform to the provisions of Annex 15.

1.18.2 Terminology

The terminology used by the controller conforms to the terms of JSP 318A. It differs from ICAO terminology published in Doc. 9432-AN/925 in the use of the phrase "*cockpit checks report complete*", which is not applicable to a civil aircraft.

1.18.3 Use of Radar on Approach

Flight KSV 3275 was in contact with the controller in the APP position who was undertaking the job of TC (Dir) defined in chapter 31 of JSP 318A. Paragraph 3103-2 specifies that :

In directing aircraft towards the final approach by the most direct route, the Director should take account of :

- a. *Known high ground and obstacles.*
- b. *Areas of radar shadow.*
- c. *Danger, Prohibited and Restricted Areas.*

- d. Radar clutter.
- e. Other Traffic.
- f. Separation.

The types of service which may be provided by RAF controller are defined in chapter 16 of JSP 318A :

- a. Radar Control.
- b. Radar Advisory Service (RAS).
- c. Radar Information Service (RIS).
- d. Procedural Service.
- e. Flight Information Service (FIS).

Operational Order n° 4 provides that a pilot requesting radar service receives the Radar Information Service in Visual Meteorological Conditions and Radar Advisory Service in Instrument Meteorological Conditions.

Flight KSV 3275 received RIS. This service is defined as follows in paragraph 1604 of JSP 318A :

RIS is an air traffic radar service in which the controller will inform the pilot of the bearing, distance and, if known, the level of the conflicting traffic. No avoiding action will be offered. The pilot is wholly responsible for maintaining separation from other aircraft whether or not the controller has passed traffic information.

Under RIS the following conditions apply :

- a) *The service may be requested under any flight rules or meteorological conditions.*
- b) *The controller will only update details of conflicting traffic, after the initial warning, at the pilot's request or if the controller considers that the conflicting traffic continues to constitute a definite hazard.*
- c) *The controller may provide radar vectors for the purpose of tactical planning or at the request of the pilot. However, vectors will not be provided to maintain separation from other aircraft, which remains the responsibility of the pilot. There is no requirement for a pilot to accept vectors.*
- d) *The pilot must advise the controller before changing level, level band or route.*
- e) *RIS may be offered when the provision of a RAS is impracticable.*
- f) *Requests for a RIS to be changed to a RAS will be accepted subject to the controller's workload ; prescribed separation will be applied as soon as practicable. If a RAS cannot be provided, the controller will continue to offer a RIS.*
- g) *For manoeuvring flights which involve frequent changes of heading or flight level, RIS may be requested by the pilot or offered by the controller. Information on conflicting traffic will be passed with reference to cardinal points. The pilot must indicate the level band within which he wishes to operate and is responsible for selecting the manoeuvring area but may request the controller's assistance in finding a suitable location. The controller may suggest repositioning on his own initiative but the pilot is not bound to comply.*
- h) *The pilot remains responsible for terrain clearance. ATSU's providing a RIS will set a level or levels below which vectors will not be provided, except when specified otherwise by the regulatory authority.*

Note : Military ATSU's are authorized by MOD DNO ASP, MOD (PE) and HQ NATO to disregard the condition at sub para h regarding levels below which vectors will not be provided to pilots in receipt of a RIS.

The principles of limited radar service are detailed in paragraph 1609. Radar service is considered as limited if the controller cannot provide traffic separation or and/or traffic information to the full extent specified in the definitions of the services and associated conditions.

There is no direct equivalent with radar functions (vectoring, assistance and surveillance) defined in Doc. 4444 - RAC/501 (Procedures for air navigation services, rules of the air and air traffic control services).

N.B. Under radar vectoring, which is characterised by the transmission of heading and altitude instructions, a civil controller must pay attention to obstacle clearance margins, even if this does not absolve the pilot from remaining vigilant and, if necessary, refusing any instruction which he might judge to be incompatible with flight safety. The investigators were told that this provision is also applicable in the Italian Air Force.

1.18.4 Testimony

In the course of the investigation, investigators collected the following testimony :

1.18.4.1 Si Fly's Director of Operations

Si Fly's Director of Operations, who is also Chief Pilot, flew the Rome-Pristina line several times as Captain. He also collected the information on Pristina aerodrome and wrote the operational instructions.

Before the start of flights to Pristina, he had acquainted himself with the NOTAMs in force and the procedures published by Jeppesen and he had received a briefing from the Rome correspondent of Balmoral. He knew that the aerodrome was closed to civil traffic but since he had a flight number, KSV 3275, attributed by the UN, he possessed the necessary authorisations to go into Pristina.

In the course of this briefing, he also discovered that the radio-navigation equipment, apart from the ILS, was unusable. He had understood that the capacity of the radar service were limited, in that the number of aircraft being handled at any one time was low, which was why there were slots at Pristina. No mention had been made of a limitation on the services provided.

The documentation used to perform the approach was the Jeppesen ILS Rwy 17 plate. This was a temporary procedure. As far as he was concerned, this implied that this procedure was applicable, although the NOTAMs, also published by Jeppesen and mentioned in the plate, mentions the suspension of all instrument procedures.

He was not informed that the aerodrome was only accessible under daytime VFR.

He had conducted the first flight into Pristina with the representative of Balmoral on board. He had flown the line several times afterwards. His feeling was that it was an easy flight. The ATC was efficient and he had always thought that they provided a radar vectoring service. He did not, however, have at his disposal minimum radar safety altitude charts. For him, this implied that under radar vectoring he had to respect the minimum safety altitudes. In general, the controller asked them to descend to 4,600 feet at the end of the downwind leg⁵, at the same time as turning to intercept the LOC. He had never had any problem with the ILS and had noticed that the OM was working.

Si Fly's operational instructions for Pristina require crews to check the coherence of the glide signal. This means that the overhead altitude of at least one of the points in the procedure must be checked. In fact, the crews used the PRI overhead, identified by the GPS since the beacon was not working, or the OM.

With regard to the meteorological conditions encountered, horizontal visibility was often bad. The Director of Operations did not remember having had, or another crew having had, a very low ceiling.

Furthermore, since the beginning of operations, there had been no problems concerning the functioning of the GPWS.

1.18.4.2 Si Fly's Technical Director

The Italian investigators assisting in the investigation interviewed Si Fly's Technical Director. He told them that he had had no formal communications with ATR regarding the letter of 24 September 1999 (see 1.16.2). He also stated that : This correspondence was purely of a commercial nature, in order to acquire equipment for stock :

- from the beginning of operations on 11 August 1999 and until 12 November, no mention concerning the GPWS was made in the Logbook. The replacement of the computer mentioned in the letter of 24 September was made for convenience. The equipment was sent back to ATR with a label mentioning it was in working order,
- for the radio altimeter, the only operation undertaken concerned work on the EFIS control panel. This operation was noted in the Logbook,
- the radio altimeter P/N 9599-607-14562 s/n 4940, ordered from ATR, was to be found in the Si Fly store,
- Si Fly had decided to apply SB ATR 42-34-0078 during the first routine maintenance scheduled for 13 November.

1.18.4.3 ATC Personnel

The KFOR Director of Operations stated, during a meeting with BEA investigators, that Pristina aerodrome was only accessible under Visual Flight Rules because

⁵ This altitude corresponds to the radar MSA. It is below the MSA and the altitude of the ILS procedure.

the ILS was not usable due to frequent electrical power cuts.

In interviews with investigators, controllers stated that they didn't know about NOTAMs issued by Belgrade and had no idea what aeronautical documentation was available to flight crews coming to Pristina. They applied the instructions laid down in JSP 318A as well as the operational orders for Pristina aerodrome. Since receiving the results of the calibration carried out in July, they radar vectored aircraft from XAXAN until interception of the ILS. They knew that the PRI NDB was not working and that consequently an instrument approach was not possible. They knew the performance limitations of their radar and informed crews thereof on first radio contact. They were aware that the aerodrome was accessible only under daytime VFR.

Note : despite their requests, the investigators were not able to meet the controller who had been in contact with F-OHFV.

1.18.4.4 French Military Pilots

During an interview with a French Air Force pilot who carried out regular flights to Pristina, he stated that the Air Force, after an evaluation of the navigation aids installed at Pristina, had decided not to use instrument approaches, and that the PRI NDB had never worked. For Air Force liaison aircraft, the necessary condition to continue an approach to Pristina aerodrome was visibility of the ground below an altitude of 6,500 feet. If this condition was not met, the plane diverted to Skopje.

French Army helicopter pilots also confirmed to the investigators that the PRI NDB was not working and that they found its position with the aid of the GPS.

1.18.5 Other Airlines Serving Pristina

The BEA contacted airlines serving Pristina through each country's investigation organisation. The replies received show a wide disparity in the preparation and operation of flights into Pristina.

All of the operators knew of the SPINS supplied by the RAMCC and had Jeppesen charts for Pristina aerodrome. Apart from these documents, the documentation available was very variable and depended on the steps taken before the beginning of flights.

Most of the operators limited themselves to studying the documents mentioned and did not set up special operational instructions or procedures for serving Pristina. One operator had conducted a first daytime VFR flight, and, seeing local conditions and equipment, had decided that flights would only be conducted under these rules.

Two operators obtained additional documents from UNMIK or the RAF which led one of them to establishing specific training for pilots serving Pristina, and led the

other to increase the minima in the Jeppesen procedure and to give instructions which corresponded to the terms of the AIMs.

Finally, two operators sent a study mission to Pristina before undertaking commercial flights. They defined their own airline arrival procedures using the radar and the ILS, with associated instructions, and their crew received special training followed by a check flight.

Note : With the exception of their initial evaluation of steps to be taken for the opening up of the route, none of the operators noted any particular difficulties or identified any incidents which could have led them to a fresh examination of the operating conditions at Pristina. What is more, it should be noted that, before the investigation, nobody could have noticed the disparity between the different procedures established, since they resulted from internal decisions made by each operator.

2 - ANALYSIS

2.1 Conduct of the Flight

The cockpit crew of KSV 3725 was made up of two former Italian Air Force pilots. The Captain, who was approaching retirement, was scheduled to end his activities as a pilot in December 1999 after 29 years as an airline pilot. The Copilot, on the other hand, had only entered civil aviation in February 1998. They both had wide experience of the ATR 42.

The preparation for the arrival at Pristina was rapid and incomplete. No safety altitudes were called out by the Copilot (PF) in the arrival briefing. No questions were asked by the Captain. The large number of flights which these two pilots had made to Pristina could have created a certain sense of routine, more so in that they knew they were, as usual, going to get assistance from the ATC. They may have believed that the radar service provided by the controller was included in the approach control service and that, because of this, the instructions they received ensured that they would clear any obstacles. They could not, however, have been unaware that the military radar unit only provided a limited service. This information featured in their specific instructions, though without any specifics on the nature of the limitation.

The conduct of the approach shows a clear lack of procedural discipline. They failed to check the aircraft's track and the altitudes given by the ATC caused no comments although they were lower than the MSA on the approach chart used by Si Fly's crews. This absence of comments is even more surprising given the fact that the operator did not, according to its Director of Operations, know the radar minimum safety altitudes at Pristina. The lack of procedural discipline is confirmed by the selection of a DH of 200 feet whereas the Operations Manual calls for a DH of 600 feet for this ILS. What is more, the crew also prepared an ILS approach without glide path, a procedure which is not authorised by the airline.

The Operations Manual specifies that, in all circumstances, the crew must be well informed of the aircraft's position so as to check the corresponding safety altitudes. The crew appears in fact to have been constantly aware of the aircraft's position since PRI was the active point on its GPS. In fact, the crew answered the controller very quickly when he asked for their position, though no surprise or reaction is noticeable at that time. There was also no surprise or reaction when the CRC was activated, only an announcement of the radio altitude (240 feet) being made, four seconds after the alarm.

As we have seen, this lack of procedural discipline and the passivity of the crew may be explained in part by the daily routine of these flights, but fatigue also appears to be a contributory factor. The study undertaken did in fact show a high level of fatigue, in particular for the Captain. Moreover, note should also be made that this study did not take into account the concentration and workload, which the (recent) first flights, and difficult approaches to Pristina and Tirana had probably entailed. This state of fatigue promoted hypovigilance on the part of the crew, lulled by what appeared to be radar vectoring and made confident by the success

of their previous approaches.

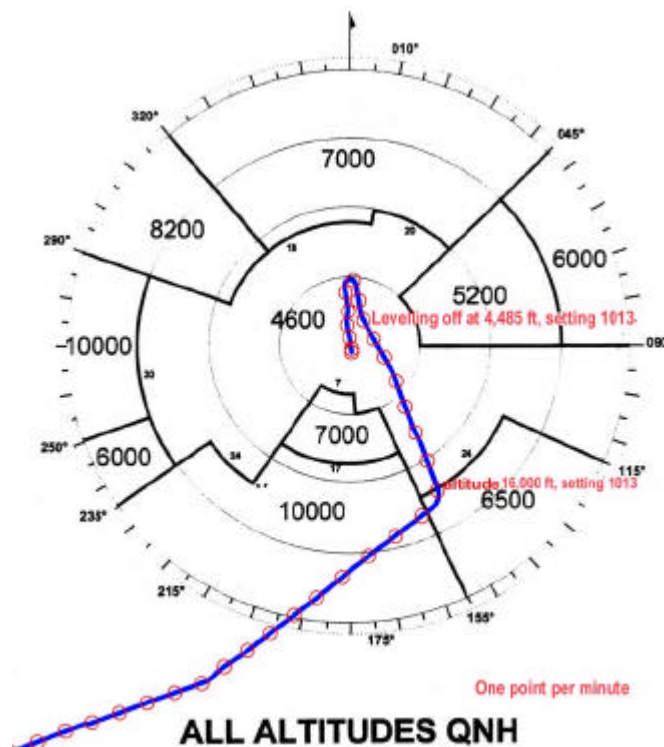

Figure 17 : Track of F-OHFV on 10 November 1999

More generally, analysis of the event does not show structured teamwork : imprecise preparation of the arrival, absence of callouts of safety altitudes or of the beginning of the procedure, absence of crosschecks. Furthermore, the investigation did not find any evidence of organised training on crew teamwork or on Crew Resource Management.

The event also shows the crew's lack of knowledge of its Operations Manual or the lack of importance they appeared to attach to respect for the instructions in this manual, at least with regard to flights conducted in a specific context, in this case that of humanitarian flights.

We have seen that the crew's state of fatigue and its ignorance of the limits of radar vectoring at Pristina meant that they were unable to identify the critical situation in which they found themselves. It is likely that good teamwork and strict application of the Operations Manual would have avoided them being in this situation, left to their own devices.

2.2 GPWS Serviceability

The GPWS did not work as the aircraft approached the ground. Simulations undertaken during the investigation both by the aircraft manufacturer and the equipment maker showed that the alarms should have been set off during the last thirty seconds of flight. Such alarms might have led the crew to react and avoid a collision with the high ground.

The investigation demonstrated that system failures had been noted several times, although this information does not appear in the aircraft's Logbook and those responsible at Si fly stated the contrary (1.18.4). Accordingly, two hypotheses can be offered to explain the absence of the alarm :

- The computer initiated a FAULT on the CAP, which meant that the equipment was not working, whatever the selector position might be ;
- The crew put the switch in the OFF position (lighting up FAULT on the CAP) because false alarms were activated in flight.

A third hypothesis can be rejected. We saw in paragraph 1.16.3 that the examination could not rule out possible failures in some components damaged in the accident, and that in one case the system would not have worked in mode 2 without GPWS FAULT appearing on the CAP. This is however incompatible with the contents of the letter of 24 September in which the operator wrote that, despite the change of computer, the FAULT was still "ON".

Consequently, the aircraft was flying with an inoperative or disconnected GPWS, and the crew must have been aware of this situation.

Examination of the facts leads to two further remarks :

- We saw that the SB's designed to improve the reliability of the system and limit the number of false alarms had not been applied, either by ATR during the last type C check before Si Fly leased the aircraft, or by Si Fly. In fact, the application of such SB's is not mandatory. The fact that the role of the GPWS is to warn the crew of a dangerous situation implies an immediate and vigorous reaction. False alarms, since they create doubts, rapidly reduce its effectiveness.
- If it had been necessary, the test described in the ATR FCOM would have informed the crew on the real operational condition of the GPWS. However, this test is not included in the pre-flight checks published by ATR and used by Si Fly. Note that crews are only asked to check that the switch is in the NORM position. No system function test is provided for.

2.3 The Operator and the Oversight

Contact was only established between Si Fly and Balmoral a few days before the beginning of flights. Considering the urgency of operating flights into Pristina, it is unlikely that Balmoral carried out a detailed check of Si Fly's organisation ; the fact that the latter was in possession of an Air Operator Certificate seems to have sufficed.

There was also no written transmission of information or instructions and no documentation of a technical nature was given to Si Fly. Only a verbal presentation was made by the technical co-ordinator of Balmoral. Thus, the operator did not have access to the SPINS since Balmoral, which was responsible for obtaining the necessary authorisations for operation of the flight, did not pass them on to them.

Si Fly was in possession of the Jeppesen documentation, which specified that instrument approaches to Pristina were suspended. Specific instructions had been written before the first flight and had subsequently been neither modified nor completed. Their author, the Director of Operations and Chief Pilot, in fact stated that he considered this line to be easy and that he did not know that the aerodrome was accessible only under daytime VFR.

These instructions were not brought to the attention of Balmoral, which had not requested them either. Thus, with the exception of the first flight, which was performed in the presence of its technical co-ordinator, it is clear that Balmoral, responsible to the WFP, counted entirely on Si Fly to execute the technical part of the contract.

Another important element to consider is the rapid change in the volume of activity which the contract brought to Si Fly. We have seen that the flying hours into Pristina represented almost two thirds of the operator's activity for the period in October and the first days of November, even though the Pristina service had only begun late in the month. In addition, this large-scale activity was of a precarious nature, since the contract was of a thirty-day renewable kind. Such a situation is hard to manage, especially for a recently created operator with limited management structures, which had not yet stabilised its operating methods. This led, logically, to failures to respect operational standards.

The operator appeared on the surface to be serious and well organised, according to the documentation they provided. We may, however, cast doubt on the practical effectiveness of Si Fly's Operation Manual, to judge by the knowledge that the crew showed of it. This type of document is supposed to serve as a guide to optimise and simplify the crew's work, which presumes that it is known and respected. It is not a mere regulatory requirement, necessary to obtain the air transport certificate.

Thus, the Chief Pilot had established good instructions for the arrival at Pristina (respect for MSA's and checking ATC instructions, in particular). However, it is clear from his statements that, at the end of the downwind leg, he himself descended under radar vectoring below the MSA.

Finally, the repeated failures of the GPWS had led to no operational instructions. Some steps had been taken but, since the beginning of operations into Pristina, no action had been taken on the aircraft itself (see 1.16.2). The company nevertheless had JAR 145 authorisations for line maintenance of its aircraft. It is clear that those in positions of responsibility were conscious of the problem, but that since they could not ground the aircraft during this period of intense activity, they were waiting for the fleet to be reinforced with the arrival of the second ATR and the type A maintenance visit of 13 and 14 November. This probably explains why the aircraft Logbook fails to contain any mention of GPWS failures. These failures were certainly known to all the crews since they had existed since the time the aircraft was put into service, and it is impossible not to know of such a problem within such a small structure.

What is more, Si Fly had only four crews for two aircraft, one of the Captains additionally holding the posts of Director of Operations and Chief Pilot. This explains the intensity of the flying hours performed by the two pilots which though in conformity with the Italian regulations, regularly approached the limits thereof. The lack of any reaction to this ratio by the organisation responsible for oversight is astonishing.

To summarise, we see a recently created airline undergoing rapid development, thus in a financially weak position, having had no time to stabilise itself, or to acquire collective experience in its structures and procedures. This context is a significant factor in understanding this accident.

It is likely that a strict follow-up of Si Fly's activities by the agency responsible for oversight, as well as inspections during scheduled flights, could have quickly brought to light certain anomalies, such as the low aircraft/crew ratio or the overwhelming part played by the lease in the airline's activity, or some failings such as those concerning the keeping of the Logbook, or respect for the Operation Manual. Similarly, integration of the JAR OPS provisions into the Italian regulations would have contributed to an improvement, amongst other things, in the structure of the crew's teamwork.

2.4 Approach Control

We have seen that the provision of ATC services was performed to the RAF rules set out in JSP 318A. Civil crews serving Pristina did not, for the most part, know its contents, nor the specifications linked with the operation of Pristina, which were only described in detail in aeronautical documentation which was not available to civilians.

The approach controller on duty on the day of the accident was not familiar with civil procedures. Having arrived recently, he had received about five hours training on the Pristina approach radar. He had successfully passed a test of his ability, probably using criteria related to military procedures alone. The low density of traffic probably made it difficult to check how at ease he was at simultaneously controlling and managing several aircraft of varying performance.

Two aircraft, including flight KSV 3725, contacted him within seven minutes, the faster one last. Both of them stated they were flying under visual meteorological conditions. Flight KSV 3725 was initially informed that it was number one for landing then the controller reversed the landing order. The accompanying radar image shows the position of the two planes at this precise moment. No sure explanation of this change of strategy can be given, since it has not been possible to meet the controller, but he was perhaps surprised by the speed of the second aircraft (about 400 kt) or perhaps momentarily confused the two radar returns. Indeed, he told flight KSV 3275 that a faster plane was 5NM "ahead of you".

RADAR VECTOR CHART

Position of **F-OHFV** and **HCN 993** at 10:08 UTC

These relative positions must be viewed with caution due to the low sample rate of data related to HCN 993, and to the difference of around 3 minutes between the UTC time on F-OHFV's FDR and that of the AWACS which recorded the track of HCN 993

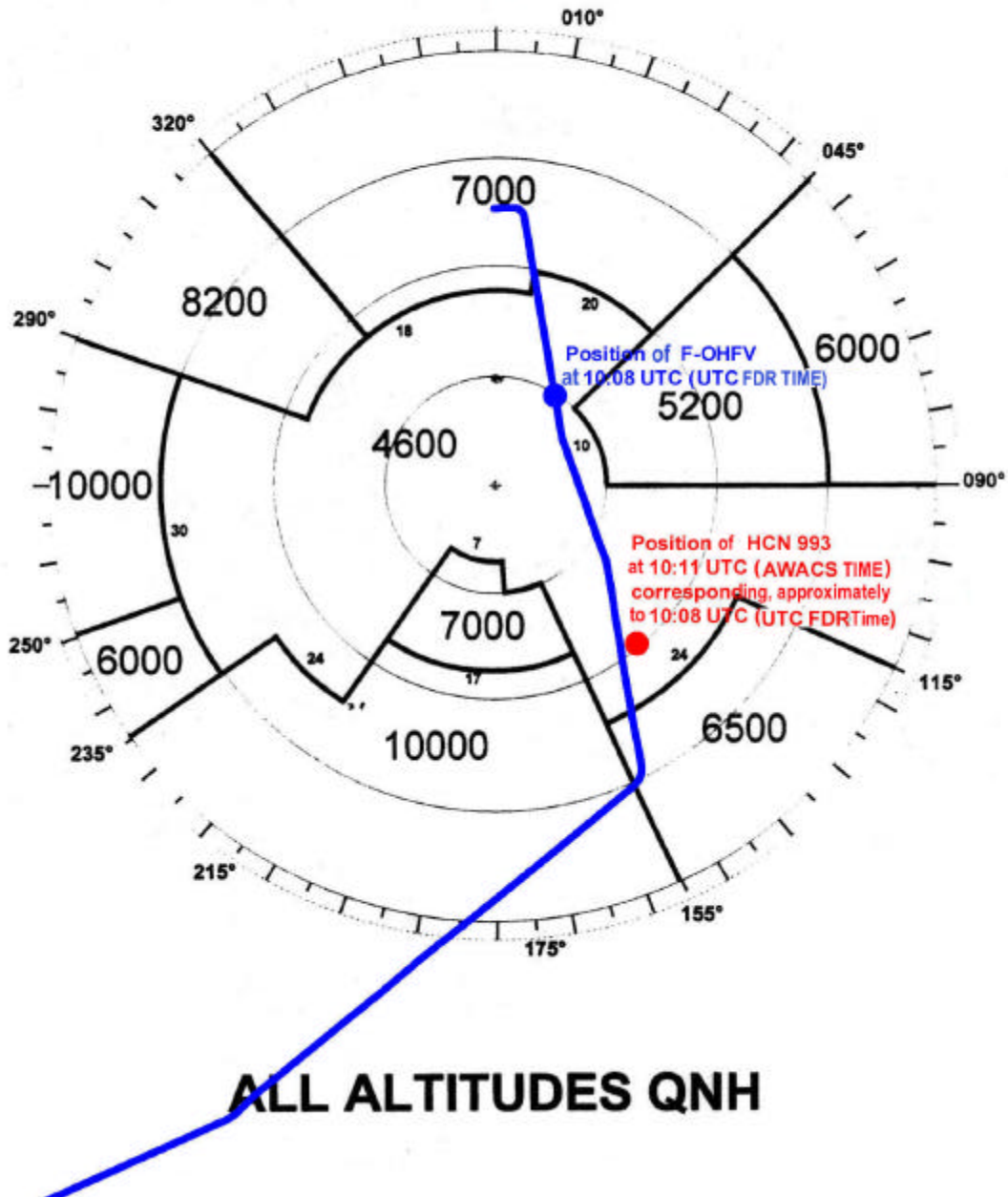

Figure 18 : Relative position of aircraft F-OHFV and HCN 993 when HCN 993 took number one position for landing

After announcing the type of service provided, RIS in this case, the controller gave headings and altitudes to flight KSV 3725 which were in accordance with the minimum radar safety altitudes in the sector to vector it towards the ILS interception point. However, having changed its position to number two for approach, he had to extend its track away to the north a little more than he had planned, which took the aircraft into an area where the radar minimum safety altitude went up from 4,600 to 7,000 feet. This manoeuvre probably led to the loss or clutter of the ATR's radar signal, because of poor detection in this mountainous region. This

loss, along with the fact that the controller was probably focused on the track of the aircraft which was now number one, apparently caused him to forget flight KSV 3725.

When the crew called him back, he gave them a westerly heading before asking the crew their estimated position in relation to PRI. The crew's reply led the controller to give, blindly, a heading of 180° to bring the aircraft back towards the airport. The altitude at which the aircraft was flying relative to its estimated position did not provoke any reaction from the controller. This may be explained by the fact that he may have thought that the aircraft was still in visual meteorological conditions. The crew had not in fact advised him of a change in their flight conditions. A study of meteorological conditions at the aerodrome and examination of the FDR TAT parameter, which moves from +7.9° to +3.2° in a few minutes during the descent, shows that flight KSV 3725 was probably flying in a layer of compact cloud from an altitude of 6,000 feet down to the point of impact, thus for approximately eight minutes. This information on a change in flight conditions is not applied in civil procedures but highly important in the procedure in use with the RAF, since it modified the radar service provided. We should also note that the controller's attentiveness to safety altitudes had doubtless not been developed in his personal experience, since he had only worked on aerodromes in flat areas, nor by the fact that under RIS conditions, a British military controller is not directly responsible for anti-collision measures.

Note : During the first contact with flight KSV 3275, the controller did not transmit meteorological information and the crew did not ask for any. Since this information was subsequently transmitted on the approach frequency to another aircraft, the crew must nevertheless have been aware of it.

2.5 Aeronautical Information

Information available for users via the usual civil channels was limited to NOTAMs issued by Belgrade. This was in fact confirmed by the investigation : when the investigators asked the French aeronautical information service for the NOTAMs relevant to Pristina, only those issued by Belgrade were supplied to them. It was the only information distributed in accordance with Annex 15.

Operators clearly did not take this information into account since they received authorisations to land at Pristina from the RAMCC. At that time, the RAMCC supplied them with SPINS, thus with information specific to the flights undertaken. We have seen that Balmoral did not pass on the SPINS to Si Fly.

Information issued by KFOR through Eurocontrol's AIMs was not available for users who were not subscribers to the AIMs. This type of message being normally intended for flight management, it is not at all surprising that operators did not look for them since, as previously mentioned, they received their authorisations to land at Pristina from the RAMCC.

KFOR also issued military NOTAMs. These documents were totally inaccessible to civil operators using the usual channels. However, they showed that the radar service was provided according to JSP 318A, which might have pushed civil op-

erators to get further information on the nature of the service provided.

Information about Pristina therefore came from five different sources, or rather six since Jeppesen, whose aeronautical information is widely used, had extrapolated certain information by mentioning that the instrument approach procedures were suspended. Furthermore, this information could present certain ambiguities and might not completely conform to everyday reality. Thus crews, although informed of the impossibility of conducting an instrument approach, were regularly offered radar vectoring by controllers to intercept the runway 17 ILS in low visibility conditions.

The existence of disparate and sometimes contradictory information (see table in 1.18.1.5), which was more or less easily accessible, did not favour a uniform and rigorous application of clear procedures. Information gathered from operators who carried out humanitarian or commercial flights into Pristina showed the diversity of the procedures adopted. Also, French military forces, used to such aerodromes just after a war, made special provisions for landings at Pristina.

The aforementioned shows the great importance which must be given to aeronautical information, both in terms of quality and distribution. To be coherent and known to all, it must be written in the same format and be accessible through one channel. This is precisely the intention of the provisions of ICAO Annex 15.

3 - CONCLUSIONS

3.1 Findings

- The aircraft possessed a valid airworthiness certificate. It was maintained in accordance with the regulations in force.
- The operator had four crews at its disposal for two aircraft. One of the Captains was also Chief Pilot and Director of Operations.
- Flights to Pristina were conducted within the framework of a short-term lease contract. They represented almost two thirds of the operator's overall activity.
- The crew possessed the requisite certificates, licences and qualifications to undertake the flight.
- The pilots had flown a large number of hours in the preceding days. This activity remained, however, within the limits authorised by the applicable regulations.
- The Copilot was at the controls.
- The meteorological conditions at the aerodrome and in the area of the accident did not correspond to those applicable for Visual Flight Rules (VFR).
- Information on access to the aerodrome and on the condition of its equipment came from five different sources. It was ambiguous, even contradictory.
- The distribution of this information was not carried out in accordance with Annex 15 to the Chicago Convention. The specific instructions for operations at the aerodrome, including those specifying its being accessible only under day-time VFR, were not available through the information channels normally used by civil operators.
- The documentation used by the operator indicated that the aerodrome was closed to civil traffic and that instrument approach procedures were suspended until further notice. The operator had, however, received authorisation to land at Pristina and its crews were regularly provided with radar vectoring for interception of ILS 17.
- The operator's instructions relative to the Rome-Pristina line specified that a military radar unit was installed at the aerodrome and that they could provide a limited ATC service.
- According to various concordant sources, the PRI NDB had not worked since the re-opening of the aerodrome and ILS 17 was subject to frequent failures.
- Air Traffic Control services at Pristina were provided following RAF procedures in JSP 318A, which differ from civil standards and practices.

- The approach controller had no experience of civil procedures before his arrival at Pristina.
- The approach controller had gone on duty at 7 h 30. He was handling approach services alone at the time of the event.
- The approach controller extended flight KSV 375's track at an altitude of 4,600 feet so a faster aircraft could pass in front of it. During this manoeuvre he appears to have forgotten KSV 375, until the crew called him back.
- The crew did not have the radar minimum safety altitude chart in their possession.
- The Chief Pilot, author of the instructions for operations on the Rome-Pristina line, stated that he did not know that the aerodrome was only accessible under Visual Flight Rules.
- No evidence was found of the pilots having followed a CRM training course.
- In their arrival briefing, the crew did not mention any safety altitudes.
- The crew believed that they were under radar vectoring, as defined by the ICAO.
- Upon request from the controller, the crew identified their position in relation to the PRI beacon, without any particular comments.
- The GPWS warning alarm did not sound. The system had broken down or had been switched off, and the crew could not have been unaware of this.
- Repeated failures of this system had been noticed during the operation of the aircraft. No mention had been made in the aircraft's Logbook. No special instructions had been applied by the crews.
- Six seconds before the collision, the CRC alarm sounded, without any reaction from the crew.
- Two seconds before the collision, the Copilot announced a height of 240 feet, without any other reaction from the crew.
- The aircraft, still at an altitude of 4,600 feet, crashed into a mountain whose peak was at 4,650 feet, in an area where the minimum safety altitude is 6,900 feet.

3.2 Causes

The collision of Flight KSV 3275 with high ground was due :

- to teamwork which lacked procedural discipline and vigilance during manoeuvres in a mountainous region with poor visibility.
- to the aircraft being kept on its track and then forgotten by a military controller unused to the mountainous environment of the aerodrome and to preventing the risk of collisions with high ground, within the framework of the radar service he was providing.
- to the operator's critical situation as a new company highly dependant on the lease contract, favouring a failure to respect procedures.
- to the opening of the aerodrome to civil traffic without an advance evaluation of the operating conditions or of the conditions for distribution of aeronautical information.

The following factors contributed to the accident :

- crew fatigue, favouring a lowering of vigilance.
- undertaking the flight with an unserviceable or disconnected GPWS.

4 - RECOMMENDATIONS

4.0 Interim Recommendation

On the basis of its first observations and in order to ensure safety, the BEA recommended, on 20 November 1999 that :

- **an evaluation of the conditions for the operation of Pristina aerodrome be carried out and procedures be put into effect which are compatible with the rules laid down by the ICAO, and that civil flights serving Pristina be immediately suspended while these measures are put into effect.**

- **particular attention should be paid to the following points :**
 - **the reliability of the radio-navigation aids used, both in terms of their power supply and the quality of the information supplied ;**
 - **approach, go round and departure procedures ;**
 - **control procedures and terminology ;**
 - **documentation published and distributed to crews.**

UNMIK and KFOR immediately followed up this safety recommendation. The aerodrome was immediately closed to civil traffic and a team of ICAO experts was sent to Pristina the following week.

4.1 - Pristina aerodrome was re-opened in July 1999. For this purpose, special procedures, relating in particular to air traffic control and to distribution of regulatory information, were put in place without any detailed checks as to their conformity to international civil norms and practices. The investigation showed that the use of the aerodrome under these conditions by civil aircraft contributed to the accident. Consequently, the BEA recommends that :

- **the opening to international civil traffic of an aerodrome which is not under the effective authority of a contracting State be subject, henceforth, to a complete audit by the ICAO.**

4.2 - The investigation demonstrated the inadequacy of the crew's teamwork with regard to briefings, callouts and crosschecks. The operator does not apply the JAR OPS, which is not yet obligatory under Italian regulations. Consequently, the BEA recommends that :

- **the Italian civil aviation authorities, along with those of any other member states of the JAA in the same situation, apply the JAR OPS regulations in the shortest possible time.**

4.3 - One of the basic tenets of air transport safety is the oversight exercised by the civil aviation authorities over operators. In this context, the investigation showed the importance of reinforced oversight of start-up operators or, more generally, those undergoing significant change. Consequently, the BEA recommends that :

- **civil aviation authorities exercise reinforced surveillance of companies with a recently acquired air transport certificate or where there is significant change in an operator's structure or activity.**

4.4 - The investigation brought to light failures in the GPWS during operation of aircraft F-OHVI. Service Bulletins which had been issued by the equipment manufacturer and the aircraft manufacturer to improve the operation of the GPWS were not applied on this aircraft. The GPWS is a piece of essential equipment, since it is the last resort in case of a deteriorating situation. Consequently, the BEA recommends that :

- **the airworthiness authorities make any modifications mandatory which are designed to improve the operation of equipment of last resort, such as the GPWS.**

4.5 - The investigation showed the absence of any GPWS alarms before the accident. No test of correct operation of the system is required before the flight. In addition, the regulations concerning the Minimum Equipment List are not precise in the case of a GPWS failure, and the current proposed JAR OPS amendment allows for the possibility of six flights or twenty-five hours of flight or two calendar days after the failure of one of modes 1 to 4 of the system. Consequently, the BEA recommends that :

- **a complete test of the GPWS system be included in the pre-flight checklist ;**
- **where there is a GPWS mode failure, the JAR OPS 1 amendment make the takeoff of a public transport aircraft subject to establishing and following alternate procedures according to the type of operation and environment.**

4.6 - The emergency locator transmitter installed on board did not work after the accident. This delayed discovery of the wreckage and, incidentally, obliged the search and rescue helicopters to undertake night searches in conditions which were particularly dangerous for the crews. It is not the first time that failure of this type of emergency equipment to operate has been noted following an aircraft accident. These failures and the delays they generate could cause the possible death of survivors or prolong their suffering. Consequently, the BEA recommends that :

- **the ICAO take the initiative in the near future to re-examine the standards applicable to emergency locator transmitters so as to ensure that they correspond to the objective of operating correctly after an accident in order that the aircraft's location be established rapidly ; and**
- **in parallel, the study of supplementary or replacement systems which permit rapid and precise identification of the location of an accident aircraft be considered as a priority.**

Appendices

APPENDIX 1

Pristina ILS 17 Jeppesen approach procedure map

APPENDIX 2

GPWS Test

APPENDIX 3

Extract from Si Fly MEL concerning GPWS

APPENDIX 4

CVR Transcript

APPENDIX 5

FDR graphs

APPENDIX 6

Extract from Si Fly Operation Manual

APPENDIX 7

CO N.99/01

LTPK
PRISTINA

26 MAR 99 (11 01)

ILS Rwy 17

*PRISTINA Approach (APP/TWR)				
118.77				
LOC PRS 110.1	Final Apch Crs 173°	GS LOM 2539' (751')	ILS DA(H) 1988' (200')	Apt Elev 1788' RWY 1788'
MISSED APCH: Climb STRAIGHT AHEAD to 2450', then turn LEFT to PRI NDB climbing to 5000' and hold.				

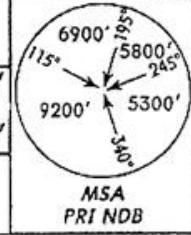

Alt Set: hPa Rwy Elev: 64 hPa Trans level: By ATC Trans alt: 10000' (8212')

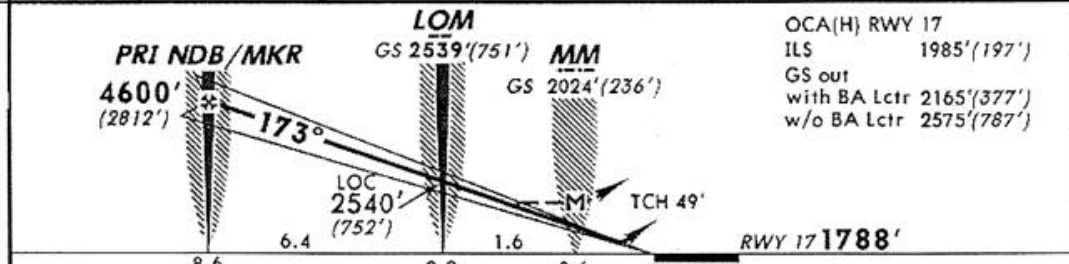
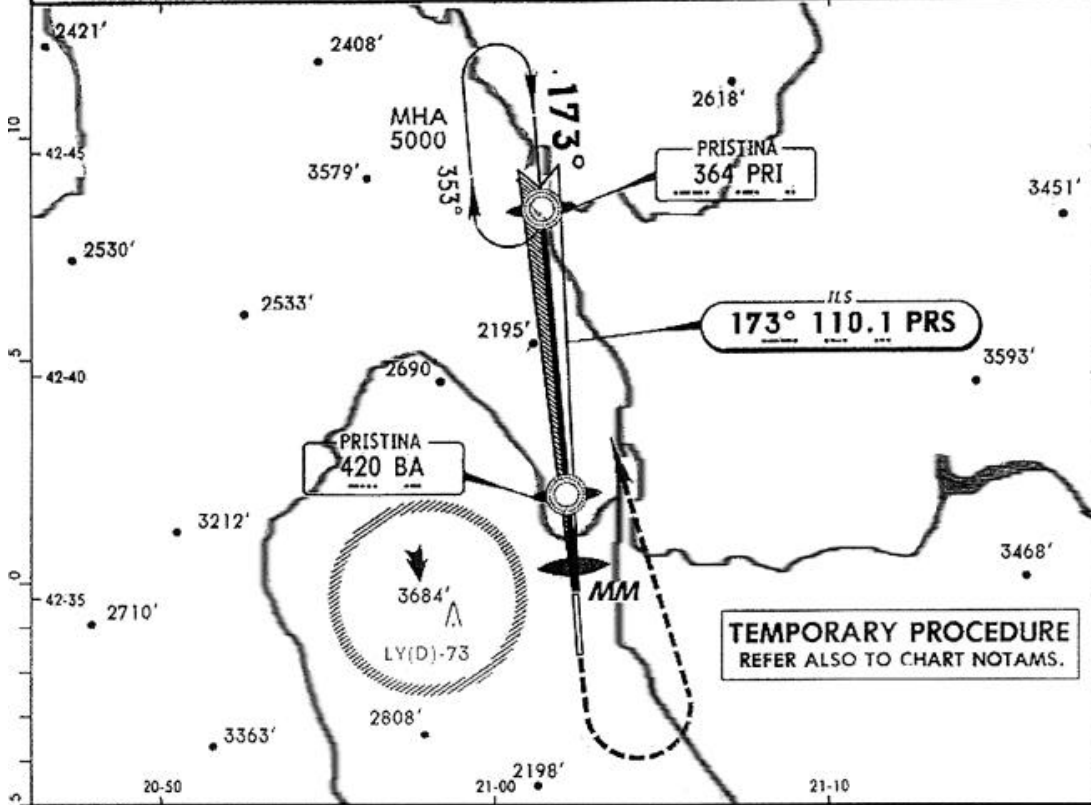

OCA(H) RWY 17
ILS 1985' (197')
GS out
with BA Lctr 2165' (377')
w/o BA Lctr 2575' (787')

Gnd speed-Kts	70	90	100	120	140	160	ALS VASI VASI 2450'	
ILS GS 3.00° or LOC Desc Grad	5.2%	377	485	539	647	755		862
MAP at MM								

STRAIGHT-IN LANDING RWY 17 CAT A: Missed apch climb grad min 2.8% ILS LOC (GS out)				CIRCLE-TO-LAND Not Authorized at NIGHT and West of apt			
DA(H) 1988' (200') FULL ALS out		with BA Lctr <input checked="" type="checkbox"/> MDA(H) 2170' (382') ALS out		w/o BA Lctr <input type="checkbox"/> MDA(H) 2580' (792') ALS out		Max Kts MDA(H)	
A				2400m	100	2630' (842')	2400m
B		2400m		2800m	135	2630' (842')	2800m
C	1200m			4400m	180	2630' (842')	4400m
D		2800m		4800m	205	2630' (842')	5.2km

MM out: NOT AUTHORIZED.
 CHANGES: Temporary procedure. © JEPPESEN SANDERSON, INC., 1999. ALL RIGHTS RESERVED.

	NAVIGATION SYSTEM		1.15.40	
	P 1	020		
	GPWS		MAR 94	

AA

The Ground Proximity Warning System (GPWS) provides visual and aural alerts in case of dangerous flight path conditions which would result in inadvertent ground contact if maintained. The system generates alerts only between 50 ft and 2500 ft AGL.

Six alert modes are established with defined danger envelopes :

- Mode 1 excessive sink rate.
- Mode 2 excessive terrain closure rate.
- Mode 3 descent after take off.
- Mode 4 inadvertent proximity to terrain with landing gear or flaps not in landing configuration.
- Mode 5 descent below ILS glideslope.
- Mode 6 descent below minimums.

The GPWS includes :

- a GPWS computer
- two GPWS/GS lights
- a GPWS FAULT amber light on CAP.
- a GPWS selector
- several aural alert channels

For operation, the system requires data supply from ADC 1, ILS 2, radio altimeter, flaps position transmitter and gear lever position transmitter.

Mode 5 is active whenever a valid ILS glideslope signal is supplied. If the ILS converter signals no computed data, mode 5 alert is inhibited. The mode 5 alert is also inhibited in back course operation.

Visual alert is provided :

- in mode 1, 2, 3, or 4 by illumination of the GPWS red lights, one on each pilots panel.
- in mode 5 by illumination of the GS amber lights, one on each pilots panel.

The aural alerts are voice alerts which segregate the various alert modes.

Mode 5 alerts may be inhibited by pressing one of the GPWS/GS pb below 1000 ft. The GPWS selector on the captain side panel is provided to avoid nuisance alerts in mode 4 caused by flap position when a landing has to be performed with reduced flap setting. In case of GPWS malfunction, all alerts can be inhibited by selection to OFF. The system can be tested on ground and in flight above 1000 ft radio height by pressing one of the GPWS/GS lt.

ELECTRICAL SUPPLY

EQUIPMENT	DC BUS SUPPLY (C/B)	AC BUS SUPPLY (C/B)
GPWS computer	- Nil -	115 VAC BUS 2 (on overhead panel CMPTR)
GPWS alerts	DC BUS 1 (on overhead panel WARN)	- Nil -
GPWS FAULT IND	DC BUS 2 (on overhead panel)	- Nil -

Mod : 1977

 ATR 42 F.C.O.M.	NAVIGATION SYSTEM GPWS	1.15.40		
		P 2	001	
				MAR 94

AA

ALERT

CONDITION	VISUAL	AURAL
GPWS computer internal failure or power supply loss or input supply loss	- GPWS FAULT amber light on CAP	None

SCHEMATICS

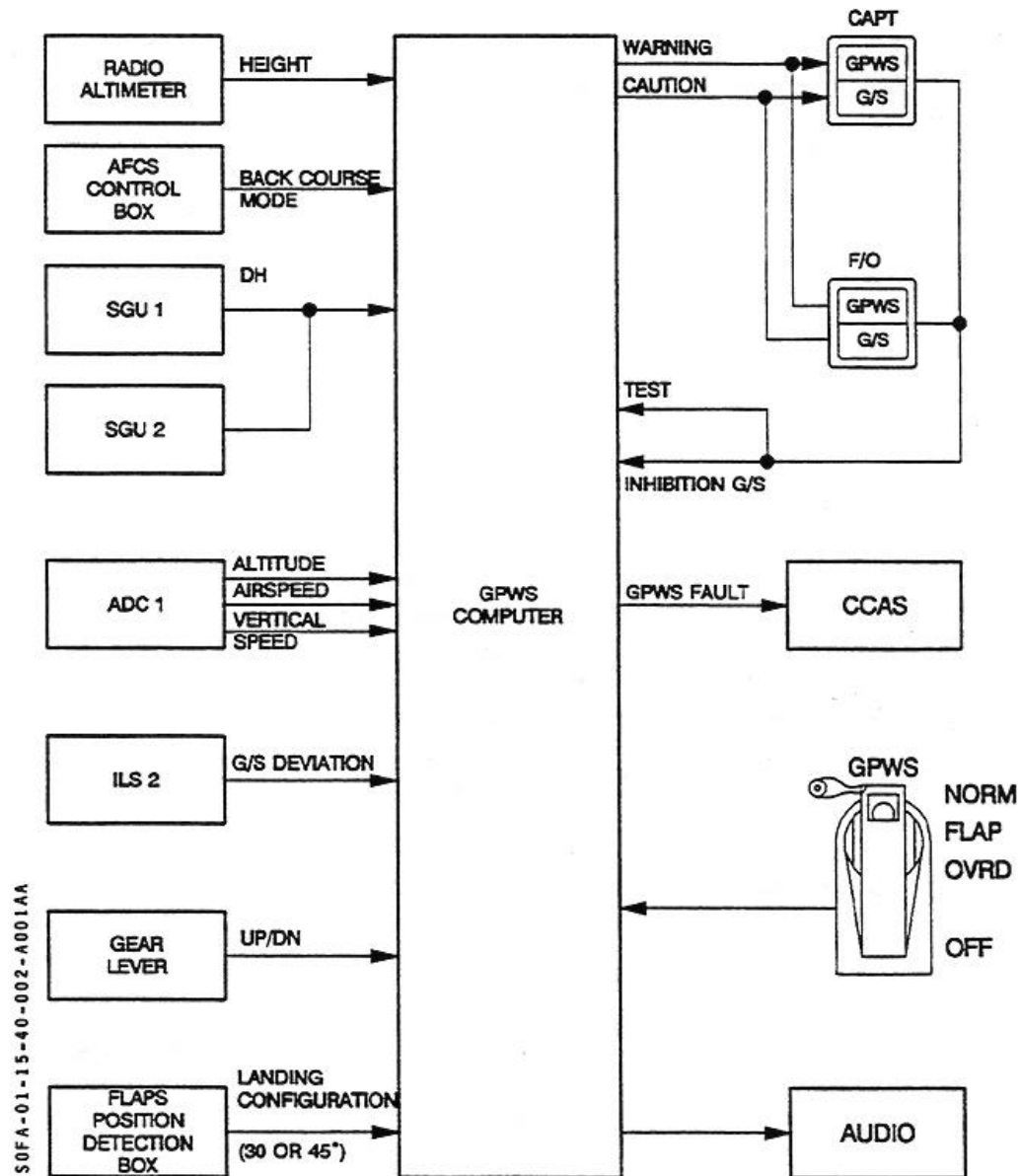

R

	NAVIGATION SYSTEM	1.15.40		
		P 7	001	
	GPWS			MAR 94

AA

GPWS – G/S PB

SOFA-01-15-40-007-A001AA

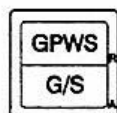

The pbs on CAPT and F/O panel are identical and connected in parallel. GPWS and G/S indications are integrated into the pbs.

GPWS illuminates red as long as any mode 1-2-3-4 alert is activated. The illumination is accompanied by the voice alert for the particular mode.

G/S illuminates amber as long as a mode 5 alert is activated. The illumination is accompanied by the voice alert for this particular mode.

- Pressed *
- * On ground, or above 1000 ft with gear up, will perform the system test
 - GPWS FAULT amber light illuminates on CAP
 - G/S amber lights illuminate on both pilots panels
 - voice alert "GLIDE SLOPE" is given
 - one second time delay
 - GPWS red lights illuminate on both pilots panels
 - voice alert "WHOOOP WHOOOP PULL UP" is given several times
 - GPWS red lights extinguish
 - G/S lights and GPWS FAULT light will extinguish as soon as the pb is released
 - * below 1000 ft, will inhibit the mode 5 alerts (aural and visual).

GPWS SELECTOR

SOFA-01-15-40-007-B001AA

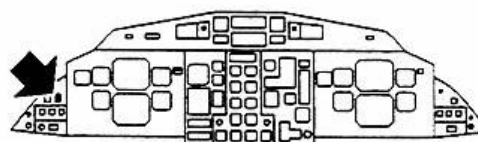
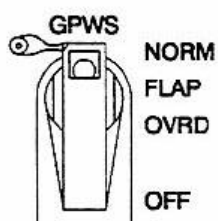

The selector is guarded in the NORM position

NORM all alerts are operative

FLAP OVRD mode 4 alert caused by flap extension, at less than landing configuration is inhibited to avoid nuisance warnings in case of landing with reduced flap setting.

OFF all mode alerts are inhibited.

R

<i>Pi Fly</i>	MINIMUM EQUIPMENT LIST	SECTION 4
Aircraft: MSN: 012 Reg.: F-OHFV	Rev. 02	Date: 30Sep 99 Page 30/012

1. ATA CHAPTER					
	2. ITEM	3. REPAIR INTERVAL CATEGORY			
		4. NUMBER INSTALLED			
		5. NUMBER REQUIRED FOR DISPATCH			
		6. REMARKS OR EXCEPTION			
		NAVIGATION			

27-1	Standby horizon		1	1	
29-1	RMI	C	2	1	* Provided respective information is available on adjacent EHST.
33-1	Radio navigation system Marker beacon system	C	1	0	* Provided approach minimums does not require its use.
41-1	c. Weather radar	C	1	0	* Flight in VMC-VFR conditions is allowed provided flight is not conducted in known or forecast stormy conditions.
	d. Radome bonding adhesive tapes	C	6	7	Provided flight is not conducted in stormy conditions.
42-1	Radio altimeter	C	1	0	Refer to 34-55-1
48-1	GPWS				
	5. Terrain avoidance (modes 1-4)	A	1	0	* Provided: 3. two VHF navigation systems operate normally, and 4. operations are limited to not more than two flight days.
	6. Test mode	A	1	0	* Provided: 3. GPWS is considered inoperative, and 4. Operations are limited to not more than two flight days.
	7. Glideslope Deviation Lt (Mode 5)	B	2	0	*
	8. Minimums warning	C	1	0	*
51-1	DME	C	2	0	* Provided procedures are not based on.

CVR Transcript

FOREWORD

The following is a transcript of elements which were comprehensible, at the time of the preparation of the present report, on the cockpit voice recorder. This transcript contains conversations between crew members, radiotelephonic messages between the crew and Air Traffic Control services and various noises corresponding, for example, to the use of controls or to the alarms.

The reader's attention is drawn to the fact that the recording and transcription of the CVR are only a partial reflection of events and of the atmosphere in the cockpit. Consequently, the utmost care is required in the interpretation of this document.

The translation has been performed for the requirements of safety.

GLOSSARY

UTC Time	UTC time recorded on board
Ctl	Air Traffic Control
ops	Operations
PA	Public Address, message from the cabin crew
Flying Pilot	The Pilot flying the aircraft, in this case the First Officer
(*)	Words or groups of words not understood
(@)	Various noises, alarms
(...)	Words or groups of words which, at the time they were spoken neither interfered with the normal conduct of the flight nor add any elements useful for the analysis or understanding of this event.
Example	The words or groups of words in italics in the copilot, captain and VHF columns are doubtful. The words or groups of words noted in italics in the observation column are a translation into English of the communications in Italian.

UTC time	Copilot	Captain	VHF	Observations
09h 46mn 07			(ctl) Kosovo three two seven five report position	
11		(vhf) my position is twelve miles to run to Mavar point	ditto CdB	
15			(ctl) three two seven five roger contact Skopje one two zero decimal five seven	
20		(vhf) two zero five seven thank you sir	ditto CdB	
34		(vhf) Skopje good morning Kosovo three two seven five	ditto CdB	
36			(ctl) Kosovo three two seven five good morning (*) radar contact	
40		(vhf) radar contact in bound Mavar	Ditto CdB	
51				Sound similar to the closing of a door
09h 47mn 12				Sound similar to the use of seatbelts
22	facciamo un ILS per pista diciassette			We're going to do an ILS for runway 17
26	dieci otto cinque e tre le minime			Eighteen five and three the minima
30	abbiamo girato vettorati paralleli all ILS virendo verso Pristina			We have turned under radar vectoring parallel to the ILS turning towards Pristina
34			(ctl) Kosovo three two seven five from your present position direct to Xaxan	
38		(vhf) direct to Xaxan thank you sir euh madam	Ditto CdB	
51	assume heading uno sette tre due mila cinque quaranta			Take heading one seven three two thousand five forty
09h 48mn 00	duecento piedi di radar			200 feet radar altimeter

UTC time	Copilot	Captain	VHF	Observations
	altimetro			
09	questo è Gatuslago			It's Gatuslago
16	imposti glide slope out duemilacento settanta duemila e quattro il circling duemila sei trentatre			Put the glideslope out two thousand one hundred seventy two thousand and four the runway circuit is two thousand six thirty three
25	per l'avvicinamento tieniti fino a due e cinquanta e poi viriamo a sinistra per andare (*) Pristina			For the approach you keep on until two and fifty and then you turn left to go towards(*) Pristina
33	(*) dieci e uno			(*) ten and one
58		quattro e sei ?		Four and six ?
59		quattro e sei ?		Four and six ?
09h 49mn 02	quattro e sei			Four and six
18			(ctl) Kosovo three two seven five descent flight level one four zero	
22		(vhf) descending one four zero leaving one seven zero Kosovo three two seven five	ditto CdB	
27	(*) four zero seven descent check list			
31		approach briefing performed MEA checked and landing data bugs (*) torque		
37	cento per cento (*) quattordici e cinque (*)			A hundred per cent (*) fourteen and five (*)
45	novantasette cento ventuno quarantasei			Ninety seven one twenty-one forty
52	(*)			
55		landing data bug and torque cento per cento landing elevation milleotto vanno bene		landing data bug and torque a hundred per cent landing elevation milleotto it's good
09h 50mn 00		CCAS		
01	recall			

UTC time	Copilot	Captain	VHF	Observations
04		(*)		
05		stand by altimeters		
08	trenta trenta sei			Thirty thirty six
09		e va bene		That's okay
10		mille diciotto		Thousand eighteen
12	eh ?			
13		ice protection ? va bene ?		ice protection ? is it okay
16	ice protection non li tolgo per adesso			ice protection I'm not taking them off for the moment
24		(*)		
38		con il sistema fasten seat belts e poi vediamo		With the fasten seat belts system and then we'll see
40	okay			
42		descent check list ancora		descent check list again
50		la prossima l'aspetti		Next time wait for it
09h 51mn 38				altitude alert
42		one thousand to		
43	one thousand to			
09h 53mn 08	quanti ostacoli			So many obstacles
18		(vhf) Kosovo three two seven five reaching and maintaining one four zero	ditto CdB	
21	one four zero			
25			(ctl) roger sir	
09h 57mn 34			(ctl) Kosovo three two seven five contact Pristina one one eight decimal seven seven good day	
39		(vhf) one one eight seven seven bye	ditto CdB	
58		(vhf) Pristina approach Kosovo three two seven five good morning	ditto CdB	

UTC time	Copilot	Captain	VHF	Observations
09h 58mn 02			(ctl) Kosovo three two seven five Pristina approach good morning pass message	
06		(vhf) one four zero flight level inbound Xaxan point four miles	ditto CdB	
12			(ctl) Kosovo three two seven five roger identified what are your flight conditions sir ?	
16		che ha detto ?		What did he say ?
18	flight ?			
22	(*)			
25			(ctl) Kosovo three two seven five what are your flight conditions ?	
28		(vhf) flight condition is now is V F R	ditto CdB	
32			(ctl) Kosovo three two seven five roger confirm you want the vectors for the I L S	
37	yes	(vhf) euh yes sir	ditto CdB	
38			(ctl) three two seven five roger radar information service limited due to poor radar performance turn left heading three five zero	
45		(vhf) turning left three five zero Kosovo three two seven five	ditto CdB	
50			(ctl) Kosovo three two seven five set Pristina Q N H one zero two eight report set	
56	Q N H one zero three			
57		(vhf) one zero two eight copied	ditto CdB	
09h 59mn 00			(ctl) Kosovo three two seven five descend report five thousand	

UTC time	Copilot	Captain	VHF	Observations
			two hundred feet initially	
05	five thousand two hundred feet			
08		(vhf) euh descending five thousand two hundred feet Kosovo three two seven five leaving one four zero	ditto CdB	
13			(ctl) roger sir how many persons on board including the crew	
18		(vhf) euh twenty one people on board plus three crew	ditto CdB	
23			(ctl) Kosovo three two seven five roger	
24		prova a chiamare quello vah !		Try to call that one !
30		(vhf) Whiskey four this is Kosovo three two seven five good morning	ditto CdB	
40		era chi whiskey four ?		Who was it, whiskey four ?
45		(vhf) Whiskey four Kosovo three two seven five good morning	ditto CdB	
56				Interference on the VHF
10h 00mn 00		piccola peste		Little pest
05			Pristina from Juliet Golf November eight zero good morning	
11			(ctl) Juliet Golf November eight zero Pristina approach good morning pass your message	
15			good morning Sir we expect to land at time one zero two eight and request last weather please	

UTC time	Copilot	Captain	VHF	Observations
20			(ctl) Juliet Golf November eight zero roger timed at o nine fifty Zulu runway one seven surface wind three four zero seven knots four thousand meters in haze the cloud two at one thousand six at two thousand and eight at three thousand outside air plus five and the Q N H one zero two eight	
42			I understood the Q N H one zero two eight and the runway in use one seven	
47			(ctl) affirm Sir	
48			now release by Skopje	
51			(ctl) roger eight Sir	Cabin gong on the P A
52		one zero two eight facciamo (*)		Let's do one zero two eight (*)
53				P A announcement then in English (see under) may I have your attention please all passengers are kindly request to fasten their seat belts thank you
54		(*)	Pristina operation (*) six zero four leaving (*) zero three southwest	
10h 01mn 01		(*) approach briefing (*) performed MEA checked the landing data bugs (*) torque	(*) request to leave your frequency call you back in about two hours when in are returning	(*) approach briefing (*) performed MEA checked the landing data bugs (*) torque
03		(*) l'abbiamo messo nove quattro nove sette cento	(ctl) (*) zero four roger cleared en route good day thank's for the call	(*) we put it at nine four nine seven hundred
06			thank you	
10	sette cento ventuno e quarantasei			Seven twenty one and forty six
11		ventuno e quarantasei		twenty one and forty six

UTC time	Copilot	Captain	VHF	Observations
		landing elevators forecast by de-iceing fasten seat belts l'abbiamo gia' inserito (* ice il sistema		six landing elevators forecast by de-iceing fasten seat belts we've already entered it (*) ice the system
21		no questo é ancora presto		No it's too soon
24		ho fatto la discesa confermata la discesa stiamo attraversando i cento ora che arriviamo è inutile consumare le lampadine		I've started the descent and confirm descent we are crossing the hundred and as we have time to arrive useless to wear out the bulbs
32		perché anche quelle funzionano a tempo capito ?		Because even those have a life span you see
38		poi data beta passando i cento (*)		Then data beta when passing the hundred
43		d'accordo non ti preoccupare metto in conto		Okay don't worry I'll note it down
46		trenta trentasei okay		Thirty thirty six okay
10h 02mn 16			Tirana from Juliet Golf November eight zero checking mother point at time flight level two seven zero	
24			(ctl) Juliet Golf November you're still on Pristina frequency	
27			excuse me	
31			Pristina approach it's Freedom one	
34			(ctl) Freedom one Pristina pass message	
36			roger Freedom one just departing out of Pristina city about three k's east eh west east of Kosovo Polje proceeding to Krossna	
46			(ctl) Freedom one roger report going en route	

UTC time	Copilot	Captain	VHF	Observations
50			Freedom one roger	
52	riprova un po vai			Try again a bit go on
56		ci riprovo		I'm going to try
59		(vhf) Whiskey four good morning Kosovo three two seven five	ditto CdB	
10h 03mn 10			(ctl) Kosovo three two seven five turn left heading three four zero	
18		(vhf) Kosovo three two seven five confirm	ditto CdB	
23			(ctl) Kosovo three two seven five turn left heading three four zero	
27		(vhf) turning left three four zero heading	ditto CdB	
29			(ctl) and descend report four thousand six hundred feet	
32		(vhf) four thousand six hundred descending	ditto CdB	
38	four thousand six approach check list			
43	okay let's go			
50		cabin attend advice approaching lights on seat belts lights on cabin altitude mille piedi scende si è quasi rifermato euh poco piu' di tre il differenziale gli altimetri mille e ventotto ottomila radio altimetro duecento		cabin attend advice approaching lights on seat belts lights on cabin altitude one thousand feet Descend has almost stopped the differential err a little more than three the altimeters one thousand twenty eight eight thousand radioaltmeter two hundred
10h 04mn 05				
06	anche for me			For me too
09		descending and approach list completed		
12	ok			
22			radar good morning Hotel Charlie	

UTC time	Copilot	Captain	VHF	Observations
			November nine nine three passing Xaxan flight level one four zero	
30			(ctl) Hotel Charlie November nine nine three Pristina approach identified turn left heading three four zero what are your flight conditions Sir ?	
38			Victor Mike Charlie	
41			(ctl) Hotel Charlie November nine nine three roger just confirm you require vectors for the ILS ?	
46			affirm wind check ?	
48			(ctl) Hotel Charlie November nine nine three roger radar information service limited due to poor radar performance you're number two in a pattern	
55			roger	
56			(ctl) Hotel Charlie November nine nine three set Pristina Q N H one zero two eight	
10h 05mn 01			one zero two eight Q N H	
05			(ctl) Hotel Charlie November nine nine three descend report five thousand two hundred feet initially	
10			descending to five thousand two hundred feet initially on Q N H one zero two eight	
16			(ctl) Hotel Charlie November nine nine three request the number of persons on board including the	

UTC time	Copilot	Captain	VHF	Observations
			crew	
21			Three	
23			(ctl) Roger	
27		three solo crew		
28	eh ?			
30		ha solo equipaggio		Only one crew
35	(*) portano merci			(*) they(re carrying cargo
41	(*)			
42			Pristina Hotel Charlie November niner niner three please again the heading ?	
47			(ctl) Hotel Charlie November nine nine three roger set your heading three five zero	
51			three five zero niner niner three	altitude alert
56	one thousand			
57		one thousand to (*)		
10h 06mn 01	livello due			Level two
03			(*) approach Freedom one clear the centreline outbound to the west	single Chime
04				Single Chime
11			(ctl) Freedom one say again ?	
25			(ctl) Kosovo three two seven five turn right heading three five zero	
31		(vhf) three two seven five three five zero heading	ditto CdB	
34			(ctl) affirm sir	
37		(vhf) Kosovo Whiskey four Kosovo three two seven five	ditto CdB	
48		(vhf) Kosovo for check frequency one two three four five	ditto CdB	
10h 07mn 01		non c'è nessuno		There's nobody

UTC time	Copilot	Captain	VHF	Observations
06		lascia stare (*)		Let's drop it(*)
07	ci abbiamo provato			We tried
24			(ctl) Kosovo three two seven five cockpits checks report complete	
30			Pristina freedom one clear of your zone switching good day	
35			(ctl) Freedom one good day Sir	
37		non risponde		There's no reply
40			(ctl) Kosovo three two seven five do you copy cockpit checks report complete	
44	checked ?			
45		(vhf) check sorry ?	ditto CdB	
47			(ctl) cockpit checks report completed	
50		(vhf) not completed the... the gear is up again	ditto CdB	
56			(ctl) roger no problem sir	
58		(vhf) I will do	ditto CdB	
10h 08mn 01	hai capito quello che voleva ?			Did you understand what he wanted ?
02		(*)	(ctl) Hotel Charlie November nine nine three what's your level passing ?	
06	(*)		one hundred euh ten thousand feet	
10	ma prima di metterci in due		(ctl) roger nine nine three turn right euh heading three five five just to avoid the danger area	But before we go into two
13		loro mettono giu' adesso"		They are putting it down now
15			three five five heading euh niner niner three	
19	ma questo per loro è sottovento ?			But for them it's downwind ?

UTC time	Copilot	Captain	VHF	Observations
20		check cockpit si		
22			(ctl) nine nine three you're number one now you're much faster than Kosovo three two seven five	
28			roger	
29			okay request short-in	
32			(ctl) euh nine nine three say again ?	
35			request short-in	
37			(ctl) euh roger if you're happy ? Just stand by	
43			(ctl) nine nine three roger turn left heading three three zero	
47			turning left heading three three zero	
54			Pristina from Juliet Golf November eight zero Xaxan flight level one four zero	
10h 09mn 03			(ctl) Juliet Golf November eight zero Pristina approach identified what are your flight conditions Sir ?	
13			flight conditions from Juliet Golf November eight zero is euh... euh Victor Mike	
19			(ctl) Juliet Golf November eight zero roger radar information limited due to poor radar performance you're number three in the pattern set Pristina Q N H one zero two eight	
26			one zero two eight Q N H	
30			(ctl) Juliet Golf November eight zero make your heading	

UTC time	Copilot	Captain	VHF	Observations
			zero one zero	
37	(*)			
38			euh zero one zero you confirm for Juliet Golf ?	
41			(ctl) affirm Sir	
43			okay	
44			five thousand two hundred feet euh niner niner three	
47			(ctl) nine nine three roger descend report four thousand six hundred feet	
52	(*)		descending four thousand six hundred feet niner niner three	
59			(ctl) Juliet Golf November eight zero descend report five thousand two hundred feet	
10h 10mn 04			five thousand and two hundred feet Juliet Golf November eight zero	
11		ti è piaciuto eh ?		You liked it, eh ?
	allora diciamo approach level			So let's announce the approach level
16			you confirm for Juliet Golf November eight zero five thousand two hundred feet ?	
23	(*)		(ctl) affirm Sir and can you limit your speed (*)?	
34			euh limiting our speed	
40		(vhf) Kosovo three two seven five	ditto CdB	
43			(ctl) Kosovo three two seven five Pristina pass message	
48		(vhf) Kosovo check	ditto CdB	
49		vediamo un po' che dice		Let's see what he says

UTC time	Copilot	Captain	VHF	Observations
50			(ctl) you are loud and clear Sir you're number two to a much faster aircraft just ahead of you now by five miles	
56		(vhf) okay	ditto CdB	
57		euh ci ha messo davanti quell'altro		They've put the other one in front
10h 11mn 00			(ctl) just maintain your heading on what you what you are on the moment	
07			(ctl) euh Hotel Charlie November nine nine three turn left heading two seven zero base leg	
13			turn left heading two seven zero niner nine three base leg	
25			(ctl) Juliet Golf November eight zero request number of persons on board including the crew	
31			total passengers on board is euh fifty two	
36		(vhf) Whiskey four good morning Kosovo three two seven five for check	ditto CdB (ctl)(*) sir	
38				
44		Tirana era quattro (*) ?		is Tirana four (*) ?
45			(ops) euh Kosovo three two seven five Whiskey (*) go ahead	
51		(vhf) I have on board two one people and estimate at two one Pristina	ditto CdB	
58			(ops) you have two one passengers would you confirm	
10h 12mn 04		(vhf) affirmative two one passengers and	ditto CdB	

UTC time	Copilot	Captain	VHF	Observations
		two one estimating		
08			(ctl) roger Charlie	(ops) (*)
11			November nine nine three turn left heading two one zero report the localizer established	
13			turn left heading two one zero wilco	
27		undici miglia		Eleven nautical miles
35	cazzo io ancora 'sto qui davanti pero' quello che cazzo ci sta'... porca miseria !			(...) me again, I'm in front, but what is he ... (...) !
40			(ctl) Juliet Golf November eight zero turn left heading three six zero	
42			left three six zero Juliet Golf November eight zero	
50	digli we have			Tell him we have
51		hanno traffico militare e fanno passa' loro		They've got military traffic and they're letting it pass in front
10h 13mn 04			(ctl) Hotel Charlie November nine nine three just confirm your gear is down	
09			(*) clearance	
11			(ctl) roger Sir	
13		(vhf) Kosovo three two seven five	ditto CdB	
15			(ctl) three two seven five Pristina	
18		(vhf) I I want to land	ditto CdB	
20			(ctl) roger turn left heading two seven zero	
24		(vhf) two seven zero turning left	ditto CdB	
28		eh cazzo		eh (...)
38			(ctl) Hotel Charlie November nine nine	

UTC time	Copilot	Captain	VHF	Observations
10h 14mn 06			three you're cleared to land on runway one seven circuit is clear the wind three three zero seven knots	
	43		cleared to land runway one seven	
			(ctl) Kosovo three two seven five what is you estimated position from the Papa Romeo India	
	14	position rispetta Papa Romeo India		position relative to Papa Romeo India
	15		(vhf) euh fifteen nautical miles now heading two seven zero	
	20		(ctl) Kosovo three two seven five roger turn left heading one eight zero	
	24		(vhf) turning left one eight zero	
	27		(ctl) apologies for the delay sir	
	30		eh eh cazzo	eh eh (...)
	31		(@)	Alternator sound
	33			continuous repetitive chime to the end (6 seconds)
	37	duecentoquaranta di radar altimetro		Two hundred and forty on the radar altimeter
	10h 14mn 39			End of recording

F-OHFV

ATR 42, Si Fly 12/11/1999, Pristina (KOSOVO)

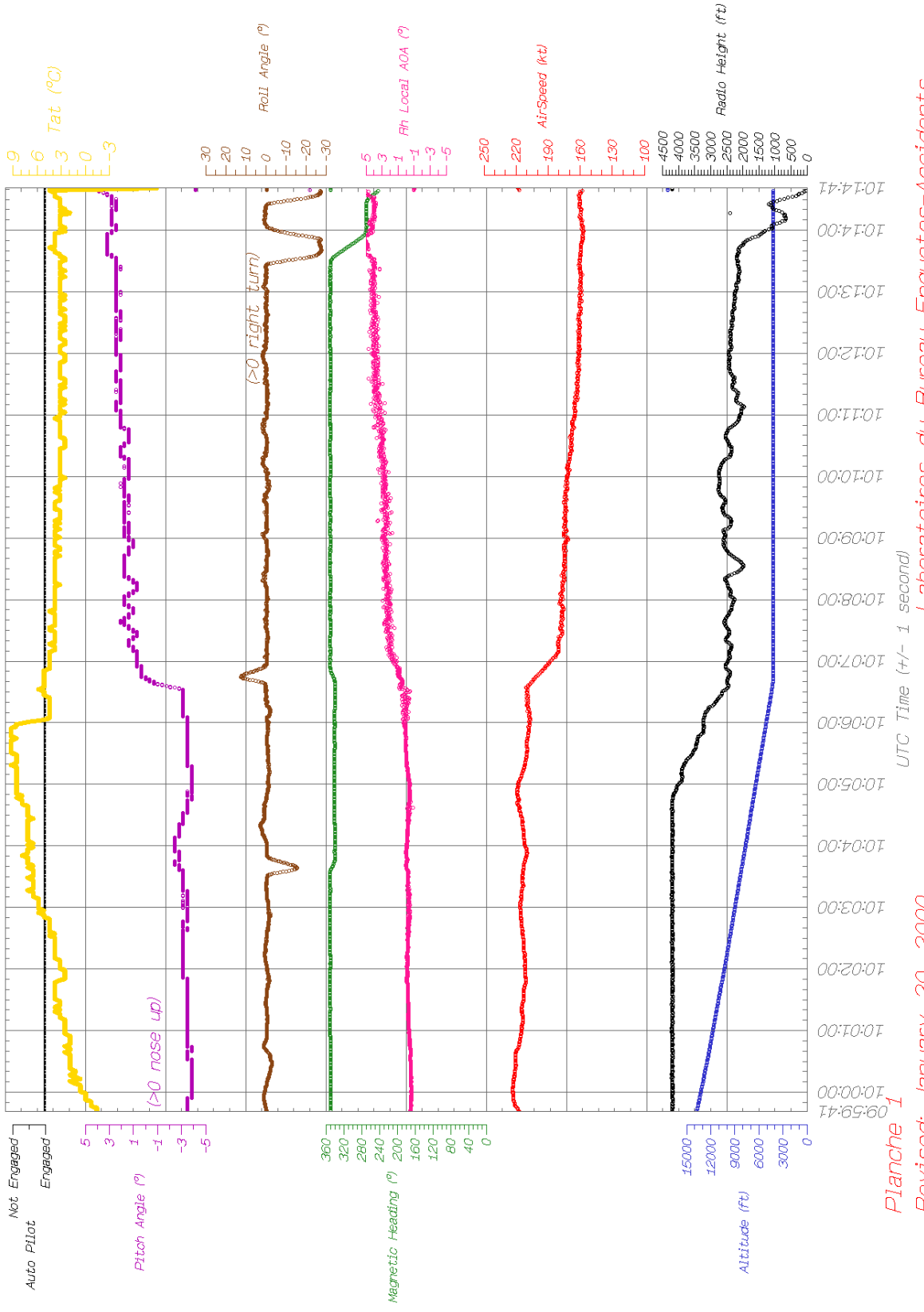

Pianche 1
 Revised: January 20, 2000
 Laboratoires du Bureau Enquetes-Accidents

F-OHFV

12/11/1999, Pristina (KOSOVO)

ATR 42, Si Fly





Planche 4

Revised: January 20, 2000

Laboratoires du Bureau Enquetes-Accidents

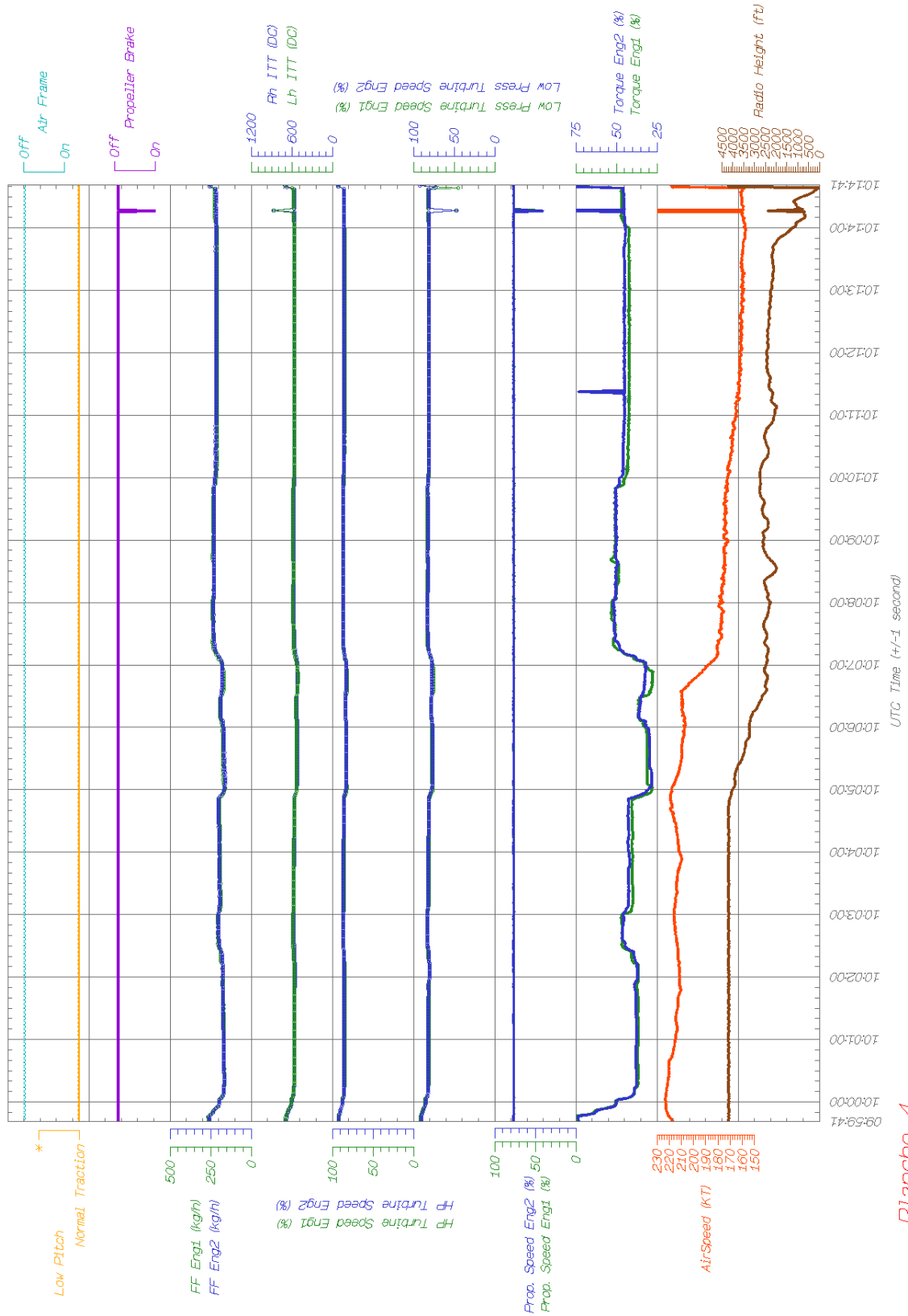
	Manuale Operativo Norme Operative di volo NORME GENERALI PER L'EFFETTUAZIONE DEL VOLO	04.10	Pag - 7 -
		01 MAG 1999	

04.10.1.6. USO DELLE "CHECK-LIST"

1.6.1 Generalità

Tutti gli aa/mm hanno in dotazione "check-list" appropriate, poste in cabina di pilotaggio in ubicazioni prestabilite; l'uso di queste "check -list" in dotazione è obbligatorio per i membri dell'equipaggio di condotta.

1.6.2 Denominazioni

Le "check list" di cui al punto precedente sono di due tipi:

Normal Check List

Abnormal & Emergency Check List.

1.6.3 Modalità di esecuzione

Una "check list", o parte di essa, si definisce:

a CHIAMATA / RISPOSTA (Challenge / response): il membro di equipaggio incaricato della lettura legge ad alta voce la chiamata. L'appropriato membro di equipaggio deve rispondere alla chiamata solamente, dopo aver controllato l'esistente configurazione. Se la configurazione osservata non è in accordo con la risposta della "check list", egli deve intraprendere l'azione, correttiva necessaria prima di rispondere.

Se l'azione correttiva non è possibile, la risposta dovrà essere modificata per rispecchiare la reale situazione (riposta specifica).

Quando la risposta della "check list" è "as reqd" la risposta del CM interessato rifletterà la reale configurazione dell'impianto che dovrà essere corretta qualora non corrisponda alla configurazione voluta in quella fase operativa.

L'altro membro dell'equipaggio deve esercitare il controllo incrociato della risposta,

UNILATERALE (Unilateral): il membro di equipaggio incaricato della lettura la esegue silenziosamente, verificando che tutte le azioni prescritte siano state compiute.

Se un'azione, o il risultato di un'azione, risultasse in disaccordo con la "check list" ne deve dare annuncio.

ATTIVA (Do-list): il membro di equipaggio incaricato della lettura deve leggere ad alta voce la chiamata, l'azione relativa alla chiamata ed identificare il CM a cui l'azione è attribuita.

Questi deve eseguire l'azione corrispondente alla chiamata e darne conferma verbale.

Se l'azione non è possibile, la risposta deve essere modificata per rispecchiare la situazione reale.

1.6.4 "Normal Check List"

	Manuale Operativo Norme Operative di volo NORME GENERALI PER L'EFFETTUAZIONE DEL VOLO	04.10	Pag - 8 -
		01 MAG 1999	

La "Normal Check List" serve a verificare azioni già compiute e, in particolare, per ogni fase di volo, quelle la cui omissione potrebbe compromettere il regolare svolgimento delle fasi successive. Essa è suddivisa nelle seguenti parti:

- COCKPIT CREW CHECK
- BEFORE START
- AFTER START
- TAXIING
- BEFORE TAKE OFF *
- AFTER TAKE OFF
- DESCENT
- APPROACH
- FINAL
- AFTER LANDING
- PARKING
- LEAVING THE AIRPLANE

NOTA: Tutte le parti della "Normal Check List" sono del tipo "Chiamata / risposta" ad eccezione delle parti "After take off" e "After landing" che sono del tipo "Unilaterale".

1.6.5 Lettura della "Normal Check-List"

La lettura di ciascuna parte della "Normal Check List" deve essere ordinata, con ciascun membro dell'equipaggio di condotta al proprio posto, dal CM1 al suolo e dal PF (Pilot Flying) in volo.

La "check list" viene letta:

- dal CM2 quando l'aeromobile è fermo o si sposta con l'ausilio di mezzi che non siano la spinta dei propri motori (Cockpit Crew Check, Before Start, After Start, Parking, Leaving the airplane);
- dal CM2 a terra o dal PNF in volo, quando l'aeromobile si muove con i propri mezzi (Taxing, Before Take Off, After Take Off, Descent, Approach, Final, After Landing).

Al termine di ciascuna parte della "check list", il membro di equipaggio incaricato della lettura deve annunciare: ".....check list completed".

La lettura della "check list" deve essere temporaneamente sospesa quando ciò si renda necessario per altre esigenze operative (comunicazioni radio, manovra dell'a/m, ecc.)

1.6.6 "Abnormal & Emergency Check List"

Le "Abnormal & Emergency Check List", pubblicate insieme in forma di libretto (Booklet), comprendono le procedure anormali, di emergenza, oltre a qualche procedura selezionata tra le condizionali e in esso riportata per motivi di praticità di esecuzione.

Nel libretto, inoltre, è stato riprodotto l'indice delle procedure condizionali e l'elenco delle procedure anormali e/o di emergenza contenute solo nei rispettivi capitoli dell'Operations Manual.

In alcune procedure sono state selezionate specifiche azioni da eseguire a memoria dietro ordine del Comandante e chiamate ad alta voce dal CM prima di essere eseguite.

	Manuale Operativo Norme Operative di volo NORME GENERALI PER L'EFFETTUAZIONE DEL VOLO	04.10	Pag - 11 -
		01 MAG 1999	

TERMINE DELLA PROCEDURA	<p>Una volta che la procedura anomala o di emergenza è stata iniziata essa essere continuata sino alla fine o alla parola "END".</p> <p>Il Comandante, comunque, potrà far sospendere momentaneamente l'ese della procedura solo quando la condizione anomala o di emergenza si positivamente corretta.</p> <p>Fa eccezione il caso in cui la procedura anomala o di emergenza debba interrotta per intraprendere la procedura "Passenger Evacuation".</p> <p>Le restrizioni risultanti dall'avaria dovranno essere osservate per il resto dei meno che non sia diversamente previsto, anche se la procedura è completata.</p> <p>Alla fine della procedura il PNF ne ripeterà il titolo ed annuncerà: "...pr completed".</p>
--------------------------------	---

04.10.5. NORME APPLICATIVE DELLE REGOLE DELL'ARIA

04.10.5.1. GENERALITÀ

La conoscenza e l'osservanza delle "Regole dell'Aria" sono un fattore essenziale per la sicura e regolare condotta del volo.

Le "Regole dell'Aria" sono completate dalle norme particolari qui di seguito riportate.

04.10.5.2. APPLICAZIONE DELLE REGOLE IFR

Tutti i voli commerciali debbono essere pianificati e condotti esclusivamente secondo le regole del volo strumentale (IFR), indipendentemente dalle condizioni meteorologiche previste ed esistenti.

NOTA: Eventuali eccezioni per i voli di addestramento o di trasferimento dovranno essere specificate e autorizzate caso per caso.

04.10.5.3. CONTROLLO DELLO SPAZIO CIRCOSTANTE / SEPARAZIONE A VISTA DA ALTRO TRAFFICO

E' essenziale che venga sempre assicurato da parte dell'equipaggio il controllo visuale dello spazio esterno, anche se il volo segue le norme IFR.

In condizioni di volo a vista (VMC) il controllo dello spazio esterno è particolarmente necessario durante le salite e le discese nelle aree ad intenso traffico.

Si deve comunque considerare la possibile presenza di aeromobili in volo secondo le regole VFR (anche entro spazi controllati), costituenti traffico non conosciuto da parte dell'ente ATC.

L'ascolto continuo delle comunicazioni in fonìa è una funzione integrativa indispensabile.

Eventuali istruzioni ATC a mantenere VMC per la separazione a vista da altro traffico possono essere richieste o accettate solamente durante le ore diurne e limitatamente a brevi segmenti della traiettoria di volo, a condizione che l'ente ATC abbia fornito le necessarie informazioni di "traffico essenziale" e siano state verificate le condizioni atte a garantire la sicurezza del volo.

Si fa presente al riguardo che quando un volo IFR viene istruito a mantenere VMC, la responsabilità dell'ente ATC per la separazione da altro traffico viene a cessare.

Spetta pertanto al pilota che ha ricevuto tale autorizzazione assicurarsi per tutta la validità dell'autorizzazione stessa, di operare in modo da non creare rischi di collisione.

	Manuale Operativo Norme Operative di volo NORME GENERALI PER L'EFFETTUAZIONE DEL VOLO	04.10	Pag - 12 -
		01 MAG 1999	

04.10.5.4. AUTORIZZAZIONI ATC

5.4.1 Verifica della compatibilità

Il Comandante, prima di accettare una "clearance" ATC, deve accertarsi che quanto da essa previsto sia compatibile con le condizioni di volo e con le prestazioni dell'a/m.

5.4.2 Separazione dal terreno

Tra le attribuzioni del servizio di Controllo del Traffico Aereo non è compresa quella della prevenzione delle collisioni tra l'aeromobile ed il terreno. Pertanto è responsabilità del pilota assicurarsi che qualsiasi autorizzazione ATC garantisca la sicurezza a tale riguardo.

Fa eccezione il caso in cui il volo IFR è sotto guida radar ("radar vectoring").

04.10.5.5. CONTROLLO RADAR

5.5.1 Generalità

Si ha controllo radar del traffico aereo quando le informazioni ottenute tramite postazioni radar sono direttamente impiegate nell'espletamento dei servizi di controllo del traffico aereo. Il controllo radar si esplica sotto forma di *sorveglianza* ("radar monitoring") e di *guida* ("radar vectoring"). Al fine di accelerare ordinatamente i flussi di traffico, il controllo radar consente l'applicazione di separazioni ridotte fra gli aa/mm (ved. Cap. 8).

5.5.2 "Radar monitoring"

Quando la navigazione è condotta dal pilota per conto proprio, il servizio di sorveglianza radar (radar monitoring) è inteso fornire al pilota informazioni e indicazioni circa eventuali significative deviazioni della traiettoria dell'a/m dalla "clearance" assegnata.

Il servizio di sorveglianza radar non prevede interventi ai fini della corretta separazione dell'a/m dal terreno.

Sotto "radar monitoring" vanno perciò rispettate le altitudini minime di sicurezza pubblicate, come applicabili.

5.5.3 "Radar vectoring"

Durante un "radar vectoring" la navigazione viene condotta mediante l'assegnazione da parte del controllore al pilota, di specifici valori di prua.

	Manuale Operativo Norme Operative di volo NORME GENERALI PER L'EFFETTUAZIONE DEL VOLO	04.10	Pag - 13 -
		01 MAG 1999	

Se la guida radar ha luogo in prossimità del terreno, il controllore radar **deve assegnare quote** che assicurano la prescritta separazione dal terreno fino al momento in cui il pilota non sia in grado, ed in tal senso istruito, di condurre la navigazione per conto proprio.

Tuttavia anche sotto guida radar vanno utilizzate tutte le radioassistenze disponibili ed ogni altro mezzo idoneo per verificare la posizione dell'a/m e gli adeguati margini di sicurezza dagli ostacoli (mediante il confronto con le minime di settore le minime di griglia, ecc.).

Se una quota minima radar assegnata sembra sensibilmente diversa da quella che si presume applicabile, vanno chiesti i chiarimenti del caso.

La particolare circostanza del trovarsi sotto guida radar non deve infine indurre a rilassare la consueta vigilanza delle indicazioni strumentali per il rispetto delle quote assegnate: un'involontaria mancata ottemperanza può non essere infatti rilevata, e quindi segnalata al pilota da parte del controllo radar.

5.5.4 Inizio e termine

Il servizio di controllo radar può avere inizio, nei riguardi di ogni singolo a/m, solo in seguito alla certa identificazione di esso sullo schermo da parte del controllore; il pilota ne è informato con la frase "radar identified" seguita dalla posizione osservata.

Il termine viene annunciato con la frase "radar control (oppure "radar service") terminated".

Eventuali interruzioni accidentali vengono rese note con "identification lost ") e le istruzioni del caso.

04.10.5.6. IMPIEGO DEL "TRANSPONDER"

5.6.1 Generalità

Un corretto impiego dell'"ATC transponder" di bordo è di primaria importanza in considerazione del fatto che tale apparato:

costituisce parte integrante del sistema SSR (radar secondario di sorveglianza) per il controllo radar del traffico aereo;
determina la cospicuità elettronica dell'a/m nei riguardi di altri aa/mm dotati di TCAS.

5.6.2 Efficienza

L'obbligo o meno del "transponder" è indicato nelle normative AIP ove sono dettagliate, le eventuali restrizioni che potrebbero essere applicate dall'ATC per un'avaria, parziale o totale, al "transponder" (anche in relazione all'eventuale obbligatorietà del TCAS).

In generale, in caso di avaria durante il volo in aree dove il "transponder" è obbligatorio, gli enti ATC interessati dovrebbero, secondo l'ICAO, collaborare perché il volo prosegua regolarmente per la destinazione.

Tuttavia, in particolari contesti operativi, la continuazione del volo può non essere consentita e, se l'avaria ha luogo subito dopo il decollo, può essere richiesto al pilota di rientrare all'aeroporto di partenza (o di proseguire solo fino all'aeroporto più vicino ove sia disponibile assistenza tecnica per il ripristino dell'efficienza del "transponder").

In caso di avaria accertata prima della partenza, se non sono possibili interventi tecnici di ripristino dell'efficienza del "transponder", dovrebbe essere consentito il volo di trasferimento al più vicino aeroporto ove tali interventi sono possibili; in tal caso l'ATC può imporre restrizioni, in relazione alla situazione del traffico, circa l'orario di partenza, la quota di volo e/o l'istadamento, senza escludere ulteriori modifiche durante il volo.

5.6.3 Modalità di impiego

	Manuale Operativo Norme Operative di volo NORME GENERALI PER L'EFFETTUAZIONE DEL VOLO	04.10	Pag - 14 -
		01 MAG 1999	

In condizioni normali il "transponder" va sempre impiegato durante il volo come previsto dall'ICAO: secondo le indicazioni dell'ATC con cui si è in contatto radiotelefonico; oppure secondo quanto previsto e riportato sul Route Manual.; oppure su 2000 in aree dove non ne è previsto l'impiego o in mancanza di diverse istruzioni.

NOTA: Il "transponder" va attivato al più tardi possibile prima del decollo ed va escluso appena possibile dopo l'atterraggio sugli aa /mm ove tali commutazioni non avvengano automaticamente.
 Per casi di emergenza a bordo o di avaria radio sono previsti codici speciali, come dettagliato nel Cap. 9 di questo Manuale.

La funzione IDENT va momentaneamente attivata solo su richiesta ATC.

Per "transponder" di modo A/C, il riporto automatico della quota di volo (modo C) va sempre inserito, a meno di specifica richiesta in contrario da parte ATC.

5.6.4 Discordanza del codice o della quota

Ogni qualvolta l'ATC osserva discordanza fra il codice assegnato ad un a/m e quello letto sullo schermo radar, può essere richiesto al pilota di riciclare il codice o di commutare apparato.

Se ciò non dà esito e siano escluse circostanze eccezionali (come ad es. interferenza illecita a bordo dell'a/m) verrà richiesta conferma al pilota della corretta selezione del codice assegnato. Se la discordanza permane, può essere richiesta la disattivazione del "transponder".

Se viene osservata discordanza fra la quota riportata dal pilota e quella letta sullo schermo radar e questa ecceda le tolleranze prescritte (in genere ± 300 ft), il pilota ne viene informato con la richiesta di verificare la corretta regolazione dell'altimetro asservito al modo C e/o di confermare la quota del momento (approssimata ai 100 ft più vicini).

Se la discordanza permane, può essere richiesta la disattivazione del modo C (purché ciò non comporti, per il tipo di apparato, la disattivazione totale del "transponder").

04.10.5.7. REGOLAZIONE DEGLI ALTIMETRI BAROMETRICI

Sotto l'altitudine (o il livello) di transizione gli altimetri barometrici di CM1 e CM2 vanno sempre regolati sul QNH locale più aggiornato.

Nella tabella di pagina seguente sono riepilogate le regolazioni degli altimetri barometrici per le varie fasi del volo, nel rispetto di quanto previsto dall'ICAO.

Le indicazioni degli altimetri CM1 e CM2 vanno frequentemente confrontate in ogni fase del volo, in modo particolare dopo ogni cambio di regolazione.

04.10.6. IMPIEGO DEL RADIOALTIMETRO

Il radioaltimetro è da considerare in generale strumento ausiliario di avviso della vicinanza del terreno.

Durante gli avvicinamenti il radioaltimetro va predisposto:

	Specifiche operative CO N. 99/01 Volo KSV3275	Pag. 1
		10/10/99

Volo KSV3275 CIA-PRN-TIA-PRN-CIA o CIA-PRN-CIA

SPECIFICHE OPERATIVE.

1. La SIFLY SRL opera per conto della WFP/Balmoral Il volo KSV3275 con il seguente operativo :
CIA ETD0800 ETA1030 PRN ETD1100 ETA1330 CIA 1030507
CIA ETD0800 ETA1030 PRN ETD1100 ETA1145 TIA ETD1215 ETA1300 PRN ETD1330 ETA1600 CIA 0204000
2. **SITUAZIONE** : L'aeroporto di Pristina si trova nel Kosovo, zona sottoposta alla giurisdizione Internazionale dell'ONU. Sull'aeroporto come dai notam in vigore non sono disponibili radioassistenze ad eccezione dell'ILS il cui funzionamento, peraltro, non è garantito. Sullo stesso aeroporto è installata una unità radar militare che può fornire limitate prestazioni ATC. I collegamenti aeronautici a punti fissi non sono disponibili. Informazioni meteo sono comunque rilevate, trasmesse e rese disponibili. I servizi di supporto a terra quali carburante ed handling sono forniti dalla RAF.
3. **CARICO PAGANTE** : E' autorizzato l'imbarco di 40 passeggeri, numeri eccedenti dovranno essere autorizzati di volta in volta. Il controllo di sicurezza del bagaglio sarà assicurato in Italia dalle autorità Italiane mentre a Pristina sarà assicurato dalla Polizia Militare. Non è ammesso l'imbarco di merci o bagagli non accompagnati ad eccezione della posta ONU/WFP.
4. **CARBURANTE**: Dovrà essere imbarcata una quantità di carburante necessaria a consentire l'arrivo sull'aeroporto di Pristina ed il dirottamento su un Aeroporto Italiano (BDS), orientativamente 2500 Kg minimo.
5. **SPAZIO AEREO** : L'ingresso nello spazio aereo del Kosovo avviene per corridoi di cui uno per l'entrata al punto XAXAN e uno per l'uscita nel punto SAXAN, la separazione dei flussi è garantita per livelli. Il controllo del traffico e quindi la discesa e la salita viene assicurata da PRISTINA AVVICINAMENTO il quale informa anche sulla disponibilità/indisponibilità del servizio radar. Nel caso di indisponibilità del servizio radar viene richiesta la capacità di autoposizionarsi.
6. **MINIME** : E' consentito il decollo per destinazione Pristina solamente quando l'alternato Tirana sia disponibile. Sono consentiti avvicinamenti strumentali solo per pista 17. Procedura di avvicinamento consentita con minime pari a 2500 mt VIS e 600 ft di DH. Non è consentito l'avvicinamento GS out. ~~Possibilmente~~ Quando le condizioni lo consentono si potrà effettuare un' avvicinamento visual. Nel caso di indisponibilità del radar monitoring l'avvicinamento è consentito solo quando sia possibile effettuare un VISUAL.
7. **PROCEDURE PARTICOLARI PER L'UTILIZZO DELL'ILS** : Con l'utilizzazione del GPS identificare la verticale di PRI, effettuare l'ingresso standard nella holding ed intercettare il LOC, seguire poi l'informazione GS solo dopo positiva identificazione dei segnali. Le informazioni fornite dal radar e gli eventuali vettoramenti e le istruzioni dovranno sempre essere confrontati con le indicazioni di bordo e le MSA scrupolosamente osservate.

\\Dov-3\C\DocOVL\Circolari operative\SP9901.doc