

AD-771 161

ATTACK HELICOPTER EVALUATION, BLACKHAWK
S-67 HELICOPTER

George M. Yamakawa, et al

Army Aviation Systems Test Activity
Edwards Air Force Base, California

July 1972

DISTRIBUTED BY:

NTIS

National Technical Information Service
U. S. DEPARTMENT OF COMMERCE
5285 Port Royal Road, Springfield Va. 22151

DISCLAIMER NOTICE

The findings of this report are not to be construed as an official Department of the Army position unless so designated by other authorized documents.

~~REPRODUCTION LIMITATIONS~~

~~Reproduction of this document in whole or in part is prohibited except with permission obtained through the Commanding General, USAAVSCOM, AFN: AMSAV EP, PO Box 209, St. Louis, Missouri 63166. DDC is authorized to reproduce the document for United States Government purposes.~~

DISPOSITION INSTRUCTIONS

Destroy this report when it is no longer needed. Do not return it to the originator.

TRADE NAMES

The use of trade names in this report does not constitute an official endorsement or approval of the use of the commercial hardware and software.

←

BY.....	
DISTRIBUTION STATEMENT CODES	
Dist.	Avail. and/or Control
A	

UNCLASSIFIED

Security Classification

AD 771161

DOCUMENT CONTROL DATA - R & D

(Security classification of title, body of abstract and indexing annotation must be entered when the overall report is classified)

1. ORIGINATING ACTIVITY (Corporate author) US ARMY AVIATION SYSTEMS TEST ACTIVITY EDWARDS AIR FORCE BASE, CALIFORNIA 93523		2a. REPORT SECURITY CLASSIFICATION UNCLASSIFIED	
		2b. GROUP	
3. REPORT TITLE ATTACK HELICOPTER EVALUATION, BLACKHAWK S-67 HELICOPTER			
4. DESCRIPTIVE NOTES (Type of report and inclusive dates) FINAL REPORT, MAY 1972 through JUNE 1972			
5. AUTHOR(S) (First name, middle initial, last name) GEORGE M. YAMAKAWA, Project Officer ALBERT L. WINN, Project Engineer RAYMOND B. SMITH, Project Engineer ROY L. ANDERSON, JR., SP-4, US Army Project Engr		WARRFN E. GRIFFITH II, MAJ, AR US Army Project Pilot WILLIAM R. HORTON, MAJ, FA US Army Project Pilot	
6. REPORT DATE JULY	7a. TOTAL NO. OF PAGES	7b. NO. OF REFS 11	
8a. CONTRACT OR GRANT NO.	8b. ORIGINATOR'S REPORT NUMBER(S) USAASTA PROJECT NO. 72-09		
8c. PROJECT NO. AVSCOM PROJECT NO. 72-09	8d. OTHER REPORT NO(S) (Any other numbers that may be assigned this report) NA		
10. DISTRIBUTION STATEMENT Distribution limited Other requests for ATTN: AMSAV-EF, F Approved for public release, distribution unlimited. 8/72 [Signature]			
11. SUPPLEMENTARY NOTES Reproduced by NATIONAL TECHNICAL INFORMATION SERVICE U S Department of Commerce Springfield VA 22151		12. SPONSORING MILITARY ACTIVITY US ARMY AVIATION SYSTEMS COMMAND ATTN: AMSAV-EF PO BOX 209, ST LOUIS, MISSOURI 63166	
13. ABSTRACT The U.S. Army Aviation Systems Test Activity (USAASTA) conducted an evaluation of the Sikorsky S-67 Blackhawk helicopter during the period 25 May to 13 June 72. The S-67, a derivative of the Sikorsky S-61 (SH-3), was tested at the contractor's facility near Stratford, Connecticut. Performance, handling qualities and mission suitability were evaluated to provide data for use in determining Advanced Aerial Fire Support System effectiveness model inputs, validating material need requirements and validating contractor claims. Twenty six hours of flight time were required for these tests. At takeoff power, the standard day out-of-ground effect hover ceiling at a 20,270 pound gross weight was 2500 feet. At sea level, 95°F day, the out-of-ground-effect hover maximum gross weight was 18,630 pounds. The level flight airspeed in the clean configuration at normal rated power was 172 KTAS and the specific range at that airspeed was 0.107 nautical air miles per pound of fuel. Deceleration maneuvers met the requirement of MIL-H-8501A. Maximum lateral acceleration was 0.28g, and was limited to the left by power available and to the right by the requirement for full left pedal control. The vibration levels in forward flight were very low and enhanced the accomplishment of all tasks. During engagement of targets in diving flight the speed brakes increased the available time on target. The gust response was heavily damped in all axes. This characteristic aided the pilot in making precise attitude changes in turbulent conditions. The stable and consistently linear longitudinal trim control position gradient decreased pilot effort required while changing airspeed. There were 16 handling quality shortcomings noted. Long term longitudinal trim tasks were degraded by a noticeable delay in pitch response, excessive control system friction, weak control centering and essentially neutral control position and force gradients.			

DD FORM 1473
1 NOV 66REPLACES DD FORM 1473, 1 JAN 64, WHICH IS
OBSOLETE FOR ARMY USE.UNCLASSIFIED
Security Classification

180

UNCLASSIFIED

Security Classification

14. KEY WORDS	LINK A		LINK B		LINK C	
	ROLE	WT	ROLE	WT	ROLE	WT
Attack Helicopter Evaluation performance, handling qualities, and mission suitability Advance Aerial Fire Support System model inputs validating requirements and contractor claims airspeed was 172 KTAS maximum lateral acceleration was limited vibration levels were low increased target time decreased pilot effort 16 shortcomings longitudinal trim degraded						

UNCLASSIFIED

Security Classification

RDTE PROJECT NO.
AVSCOM PROJECT NO. 72-09
USAASTA PROJECT NO. 72-09

ATTACK HELICOPTER EVALUATION
BLACKHAWK S-67 HELICOPTER

FINAL REPORT

GEORGE M. YAMAKAWA
PROJECT OFFICER

ALBERT L. WINN
PROJECT ENGINEER

RAYMOND B. SMITH
PROJECT ENGINEER

ROY J. ANDERSON, JR.
SP-4
US ARMY
PROJECT ENGINEER

WARREN E. GRIFFITH II
MAJ, AR
US ARMY
PROJECT PILOT

WILLIAM R. HORTON
MAJ, FA
US ARMY
PROJECT PILOT

JULY 1972

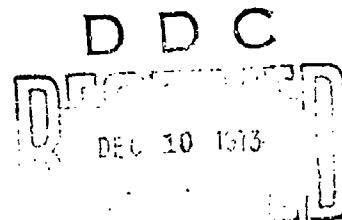

~~Distribution limited to US Government agencies only, test and~~

Approved for public release, distribution unlimited.

~~AMEAV EE, P.O. Box 209, San Diego, Missouri 65166~~

US ARMY AVIATION SYSTEM TEST ACTIVITY
EDWARDS AIR FORCE BASE, CALIFORNIA 93523

ABSTRACT

The U.S. Army Aviation Systems Test Activity (USAASTA) conducted an evaluation of the Sikorsky S-67 Blackhawk helicopter during the period 25 May to 13 June 1972. The S-67, a derivative of the Sikorsky S-61 (SH-3), was tested at the contractor's facility near Stratford, Connecticut. Performance, handling qualities and mission suitability were evaluated to provide data for use in determining, Advanced Aerial Fire Support System effectiveness model inputs, validating material need requirements and validating contractor claims. Twenty six hours of flight time were required for these tests. At takeoff power, the standard day out-of-ground effect hover ceiling at a 20,270 pound gross weight was 2500 feet. At sea level, 95°F day, the out-of-ground-effect hover maximum gross weight was 18,630 pounds. The level flight airspeed in the clean configuration at normal rated power was 172 KTAS and the specific range at that airspeed was 0.107 nautical air miles per pound of fuel. Deceleration maneuvers met the requirement of MIL-H-8501A. Maximum lateral acceleration was 0.28g, and was limited to the left by power available and to the right by the requirement for full left pedal control. The vibration levels in forward flight were very low and enhanced the accomplishment of all tasks. During engagement of targets in diving flight the speed brakes increased the available time on target. The gust response was heavily damped in all axes. This characteristic aided the pilot in making precise attitude changes in turbulent conditions. The stable and consistently linear longitudinal trim control position gradient decreased pilot effort required while changing airspeed. There were 16 handling quality shortcomings noted. Long term longitudinal trim tasks were degraded by a noticeable delay in pitch response, excessive control system friction, weak control centering and essentially neutral control position and force gradients.

TABLE OF CONTENTS

	<u>Page</u>
INTRODUCTION	
Background	1
Test Objectives	1
Description	1
Scope of Test	2
Methods of Test	2
Chronology	2
RESULTS AND DISCUSSIONS	
General	4
Performance	4
General	4
Hover Performance	5
Level Flight Performance	5
Forward Flight Acceleration and Deceleration Performance	6
Lateral Acceleration Performance	10
Handling Qualities	10
General	10
Control System Characteristics	11
Takeoff and Landing Characteristics	14
Sideward and Rearward Flight Characteristics	16
Lateral Acceleration Handling Qualities	17
Control Positions in Trimmed Forward Flight	17
Trimmability	18
Static Longitudinal Stability	19
Static Lateral-Directional Stability	19
Dynamic Stability	20
Controllability	23
Maneuvering Stability	26
Simulated Engine Failure Characteristics	26
Autorotational Characteristics	28
Automatic Stabilization System Characteristics	29
Miscellaneous Engineering Tests	29
Cockpit Evaluation	29
Weight and Balance	33
Ground Operation Characteristics	34
Engine Characteristics	35
Airspeed System Calibration	35
Vibration Characteristics	36

	<u>Page</u>
Mission Suitability Tests	36
Mission Maneuvers	36
Forward Area Concealment	39
Maintenance Characteristics	40
 CONCLUSIONS	
General	43
Shortcomings Affecting Mission Accomplishment	43
Specification Compliance	45
 RECOMMENDATION	 47
 APPENDIXES	
A. References	48
B. Aircraft Description	49
C. Flight Control Description	53
D. Photographs	66
E. Handling Qualities Rating Scale	76
F. Data Analysis Methods	77
G. Test Instrumentation	81
H. Test Data	85
 DISTRIBUTION	

INTRODUCTION

BACKGROUND

1. The S-67 Blackhawk is a prototype attack helicopter designed and built by Sikorsky Aircraft Division (SAD) of United Aircraft Corporation under an in-house funded program independent of any military requirement. The design phase was initiated on 20 November 1969 and construction began 15 February 1970. The first flight of the S-67 was on 20 August 1970. The US Army Aviation Systems Test Activity (USAASTA) was tasked by US Army Aviation Systems Command (AVSCOM) test request (ref 1, app A) to conduct an evaluation of the S-67 helicopter to support the Attack Helicopter Requirement Evaluation (AHRE) being performed for the US Army Combat Developments Command.

TEST OBJECTIVES

2. The objectives of the S-67 attack helicopter evaluation were as follows:
- a. To provide data for use in determining Advance Aerial Fire Support Systems (AAFSS) effectiveness model inputs.
 - b. To provide data for validating material need (MN) requirements.
 - c. To provide data for validating contractor claims.

DESCRIPTION

3. The S-67 is a two-place, twin-turbine, high-speed, armed helicopter. It incorporates five-bladed main and tail rotors and is powered by two T58-GE-5 turbine engines. A wing provides additional lift and attachment points for external stores. The wing panels have speed brakes to control dive airspeed and increase deceleration capability. The main rotor blades feature swept tips designed to enhance high-speed capability. A stability augmentation system (SAS) and a feel augmentation system (FAS) are incorporated to improve handling qualities. A detailed description of the S-67 is contained in appendix C. Photographs of the test aircraft are presented in appendix D.

SCOPE OF TEST

4. The Sikorsky S-67 was evaluated to determine aircraft performance, handling qualities, and maintenance characteristics. The tests were conducted at the Stratford, Connecticut plant of SAD from 25 May to 13 June 1972. During this flight program 25 test flights were conducted for a total of 26 productive hours. Handling qualities and vibrations were evaluated with respect to the applicable requirements of military specification MIL-H-8501A (ref. 2, app. A). Test configurations consisted of the following: clean (no external stores), external stores (two XM159 pods on each wing with thirteen 2.75-inch rockets in the outboard pods only), and TOW mission (two XM159 pods on each wing with nine, 2.75-inch rockets in each pod). Test conditions are shown in table 1.

5. The flight restrictions and operating limitations applicable to this evaluation are contained in the pilot's checklist (ref. 3, app. A) as modified by the safety-of-flight release (refs. 4, 5, and 6).

METHOD OF TEST

6. Established flight test techniques and data reduction procedures were used (refs 7 and 8, app A). The test methods are briefly described in the Results and Discussion Section of this report. A Handling Qualities Rating Scale (HQRS) was used to augment pilot comments relative to handling qualities (app E). Data reduction techniques utilized are described in appendix F.

7. The flight test data were obtained from test instrumentation displayed on the pilot and copilot/gunner panels and recorded on magnetic tape. A detailed listing of the test instrumentation is contained in appendix G.

CHRONOLOGY

8. Chronology of the S-67 attack helicopter evaluation is as follows:

Test directive received	9 March 1972
Test started	25 May 1972
Test completed	13 June 1972

Table 1. Test Conditions.¹⁻²

Type of Test	Nominal Gross Weight (lb)		Nominal Density Altitude (ft)	Nominal Trim Calibrated (kts)
	Clean ³	Stores ⁴⁻⁵		
Hover performance	16900 to 17430		240 to 1600	0 ⁶
Level flight performance	17000 to 17990	18120 to 18250 ⁴	1500 to 5120	40 to 180
Acceleration and Deceleration performance		18000 to 18500 ⁴	-700	0 to 150
Lateral flight performance and agility		18330 to 18650 ⁵	-350 to 530	0 to 25
Takeoff and landing	16900 to 17990	17540 to 18630 ⁴	Sea level	--
Sideward and rearward flight		18300 to 18740 ⁵	-1150 to-1510	0 to 25
Control positions in trimmed forward flight	16900 to 17990	18120 to 18250 ⁴	1500 to 5120	40 to 180
Trimability	16900 to 17990	17540 ⁴ to 18550	1500 to 6020	40 to 180
Static longitudinal stability		17700 to 18550 ⁴	2990 to 3390	82 to 171
Static lateral directional stability		17830 to 18350 ⁴	2740 to 3430	82 to 168
Dynamic stability		17740 to 18630 ⁴	780 to 3880	82 to 168
Controllability		17540 to 18630 ⁴	780 to 3880	0 to 168
Maneuvering stability		17540 to 18520 ⁴	2750 to 6020	82 to 168
Simulated engine failure		18290 to 18590 ⁴	3370 to 3820	80 to 155
Autorotational characteristic		18290 to 18590 ⁴	3370 to 3880	80 to 155
Automatic stabilization system characteristic		17540 to 18700 ⁴	Sea level to 4400	82 to 168
Typical mission maneuver		17750 to 18560 ⁴	-890 to 4740	0 to 160

¹ Rotor speed: 211 RPM; cg range 273.4 to 275.1 (aft)² Not all variables tested at all weights, configurations, and speeds.³ Clean: no external stores⁴ External stores: Two XM159 pods on each wing; thirteen 2.75-inch rockets outboard pods only.⁵ TOW: two XM159 pods on each wing; nine 2.75-inch rockets each pod.⁶ In-ground effect (10 ft. main landing gear height); out-of-ground effect (100 ft. main landing gear height).

RESULTS AND DISCUSSIONS

GENERAL

9. The performance and handling qualities of the S-67 were evaluated under a variety of operating conditions. Mission suitability and miscellaneous engineering tests were also conducted. At take-off power, the standard day out-of-ground effect hover ceiling at a 20,270-pound gross weight was 2500 feet. At sea level, 95°F day, the out-of-ground effect hover maximum gross weight was 18,630 pounds. The level flight airspeed in the clean configuration at normal rated power was 172 KTAS and the specific range at that airspeed was 0.107 nautical air miles per pound of fuel. Deceleration maneuvers met the requirements of MIL-H-8501A. Maximum lateral acceleration was 0.28g and was limited to the left by power available and to the right by the requirement for full left pedal control. The vibration levels in forward flight were very low and enhanced the accomplishment of all tasks. During engagement of targets in diving flight, the speed brakes increased the available time on target. The gust response was heavily damped in all axes. This characteristic aided the pilot in making precise attitude changes in turbulent conditions. The stable and consistently linear longitudinal trim control position gradient decreased pilot effort required while changing airspeed. There were 16 handling quality shortcomings noted. Long term longitudinal trim tasks were degraded by a noticeable delay in pitch response, excessive control system friction, weak control centering and essentially neutral control position and force gradients.

PERFORMANCE

General

10. Hover performance testing was conducted in-ground-effect (IGE) at 10-foot wheel height and out-of-ground effect (OGE). Level flight performance was evaluated with the W/σ range from 17,767 to 21,110 pounds. Forward flight acceleration and deceleration performance was evaluated at a near sea level density altitude in the airspeed range from hover to the speed at normal rated power (dash speed). Lateral acceleration performance was conducted at a 40-foot wheel height. At takeoff power, the standard day out-of-the-ground effect hover ceiling at a 20,270-pound gross weight was 2500 feet. At sea level, 95°F day, the out-of-ground effect hover maximum gross weight was 18,630 pounds. The level flight airspeed in the clean configuration at normal rated power was 172 KTAS and the specific range at that airspeed was

0.107 nautical air miles per pound of fuel. Deceleration maneuvers met the requirements of MIL-H-8501A. Maximum lateral acceleration was 0.28g, and was limited to the left by power available and to the right by the requirement for full left pedal control.

Hover Performance

11. Out-of-ground-effect and IGE hover testing was accomplished at near sea level conditions using tether lines anchored to a concrete deadman to provide 10-foot and 100-foot main landing gear heights as shown in photographs 9 and 10, appendix D. A calibrated load cell was installed between the bottom of the cable and the deadman to measure cable tension. A two axis accelerometer was also installed in the load cell to provide a cockpit presentation of cable angle information. The test was conducted by stabilizing load cell readings at predetermined engine torque values up to the maximum gross weight of 20,270 pounds authorized by reference 5, appendix A. Tests were conducted within a rotor speed range of 199 to 217 rpm.

12. The results of the hover tests are presented in figures 1 through 7, appendix H. The standard day OGE and IGE hover ceilings at the maximum allowable gross weight of 20,270 pounds are 2500 and 6300 feet, respectively. At sea level, 95°F day, the OGE hover maximum gross weight was 18,630 pounds.

Level Flight Performance

13. Level flight performance tests were conducted to determine power required and fuel flow as functions of airspeed. In addition, specific range, long range cruise speed (V_{cruise}), endurance speed (speed at minimum power required for level flight) and maximum level flight airspeed at takeoff power (V_{max}) were determined. Data were obtained in stabilized level flight at incremental airspeeds from 40 KTAS to V_{max} . A constant ratio of gross weight/density altitude (W/σ) was maintained by increasing altitude as fuel was consumed. Tests were conducted at the conditions listed in table 1. The results of these tests are presented nondimensionally in figures 8 and 9, appendix H., and dimensionally in figures 10 through 14. Aircraft specific range, maximum endurance, V_{cruise} , and V_{max} in level flight for clean and external stores configuration are summarized in figures 15 through 18.

14. The increase in equivalent flat plate area for the external stores configuration is presented in figure A. The effect of external stores on flat plate area is nonlinear with the minimum increase of 3 square feet occurring between 96 and 132 KTAS, and the highest

equivalent flat plate area increase of 7 square feet occurring at 170 KTAS. With the speed brakes extended at 145 KTAS, the equivalent flat plate area increased by 37 square feet over the clean configuration. Landing gear extension at 98 KCAS with controls fixed resulted in a 3 KCAS reduction. Figure B presents a comparison of the level flight power required for the clean and external stores configuration for sea level standard day conditions, 211 rpm and 18,700 pounds. As shown in figure B, endurance performance is virtually unaffected by the addition of external stores. At normal rated power the airspeed (V_H , 172 KTAS) was reduced by 9 knots and the specific range reduced by 7 percent.

Forward Flight Acceleration and Deceleration Performance

15. Forward flight constant altitude accelerations and decelerations were performed in the external stores configuration at an average gross weight of 18,450. Tests were conducted in the airspeed range from hover to V_H . Accelerations were initiated from a stabilized 50-foot hover with the landing gear retracted. Maximum power (transmission limit) was applied and constant altitude was maintained by varying pitch attitude during the acceleration. The maneuver was timed from the application of power to the attainment of the target airspeed. Decelerations were initiated from stabilized level flight 50 feet above the ground at V_H . Entry into the maneuver consisted of a rapid collective control reduction to near zero torque and a flare to maintain constant altitude. During tests employing speed brakes, the speed brakes were extended as collective was reduced. The maneuver was timed from the initiation of collective control reduction to attainment of V_{cruise} and termination at a stabilized hover. Time histories of representative accelerations and decelerations are presented in figures 19 and 20, appendix H. Acceleration and deceleration times are presented in table 2.

16. The maximum nose down attitude during accelerations was 18 degrees and did not restrict the pilot's field of view. The maximum nose up attitude during the acceleration was 22 degrees. At this nose high attitude, the pilot's field of view to the front was completely blocked and ground orientation was limited to sideward reference. The field of view to the sides was sufficient for adequate ground orientation. As the helicopter approached hover and the nose was lowered sufficient field of view to the front was provided. The nose high attitude during deceleration did not limit maximum deceleration performance. The deceleration characteristics met the requirements of paragraph 3.2.5, of MIL-H-8501A.

FIGURE A
CHANGE IN EQUIVALENT FLAT PLATE AREA
DUE TO CONFIGURATION CHANGES

ROTOR SPEED = 211 RPM
CG LOCATION = 274 IN. (AFT)

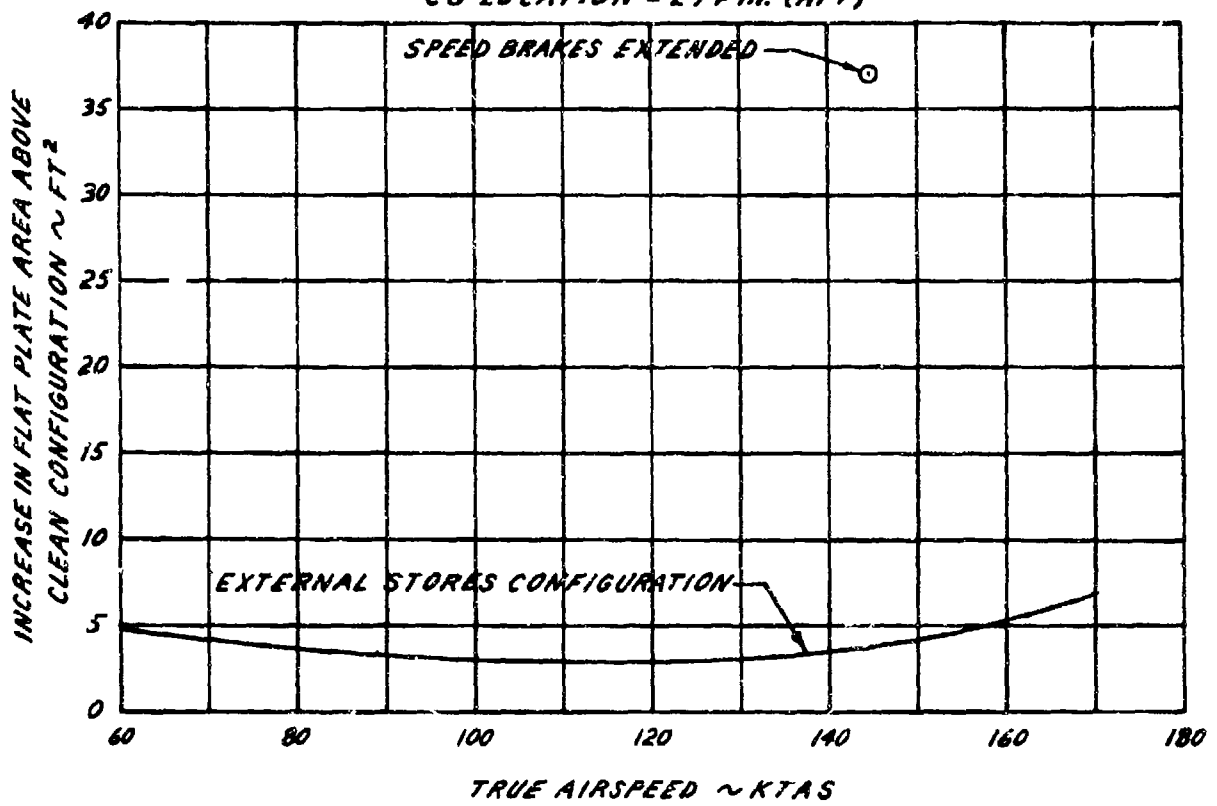

FIGURE 10
 LEVEL FLIGHT PERFORMANCE COMPARISON
 S-47 WITH HELICOPTER
 T60-GR-2 ENGINES
 SEA LEVEL STANDARD DAY

GROSS WEIGHT = 18,000 LB
 ALTITUDE = 10,000 FT (ASL)

ROTOR SPEED = 211 RPM
 CY = 0.00558

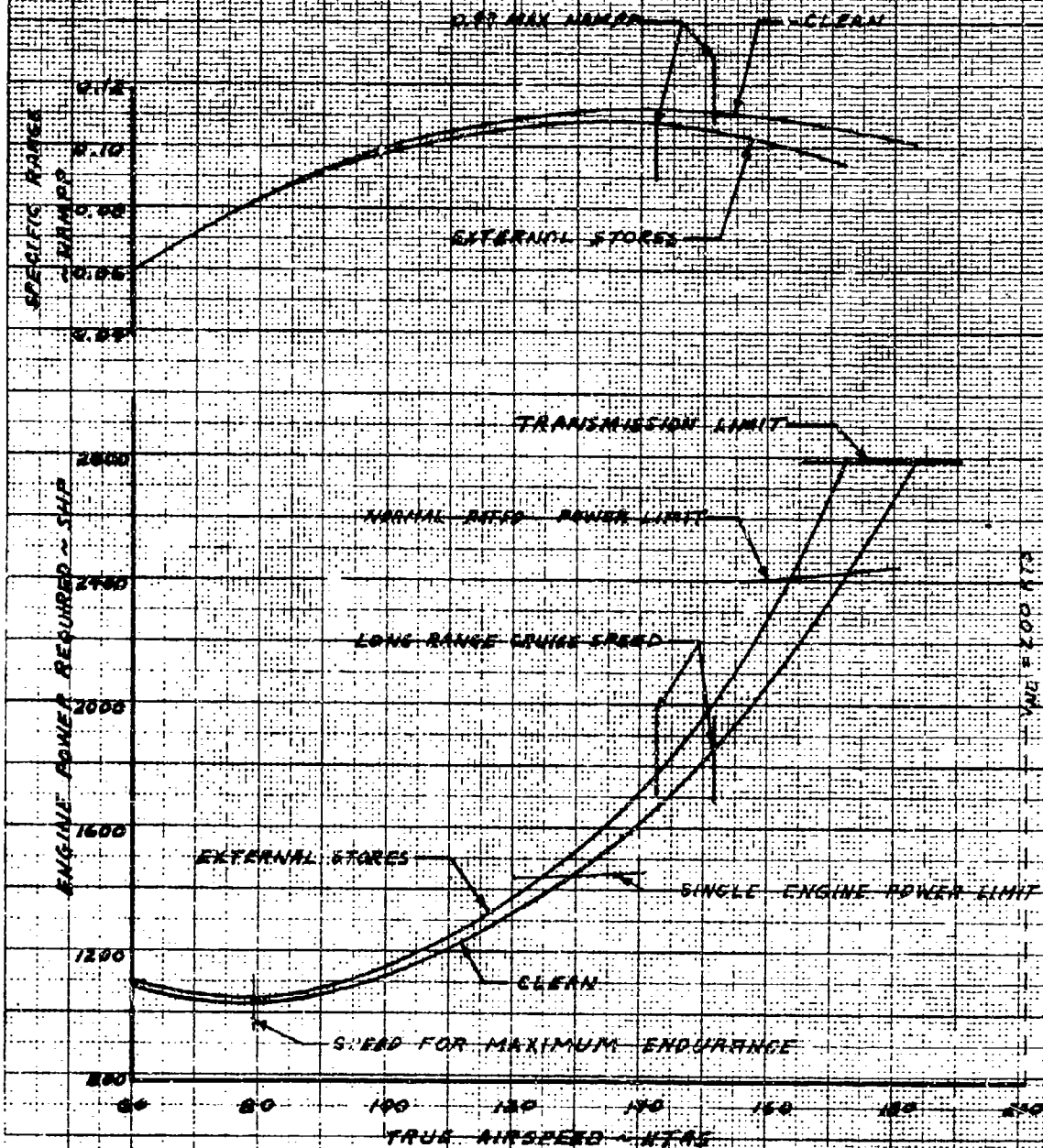

Table 2. Acceleration - Deceleration Performance.¹
Aircraft, S/N N671SA

Flight Condition	Time (sec)
Hover to V_H	35
Cruise to V_H	5
V_H to cruise, speed brake extended	2
V_H to cruise, speed brake retracted	6
V_H to hover, speed brake extended	31
V_H to hover, speed brake retracted	36

¹ Test condition. gross weight: 18,450 pounds, center of gravity: 274.0 (aft), Density altitude: -740 feet, outside air temperature: 10.3°C, Rotor speed: 210 rpm, configuration: external stores.

Table 3: Maximum Lateral Flight Performance.¹

Roll Angle	Acceleration (g)	Airspeed (kts)	Time (sec)	Distance (ft)
19° right	0.28	10	2.6	19
		20	4.4	65
		25	5.3	100
29° left	0.28	10	2.2	15
		20	3.8	52
		25	4.5	75

¹ Test condition. gross weight: 18,400 lb. center of gravity: 275.0 (aft) density altitude: -350 ft. outside air temperature 17.5°C rotor speed: 212 rpm, configuration: TOW.

Lateral Acceleration Performance

17. The lateral acceleration performance was evaluated by conducting lateral accelerations and reversals in ground effect (wheel height, 40 feet) in the TOW configuration at an average gross weight of 18,480 pounds. Acceleration was accomplished by the selection of a predetermined bank angle with a rapid lateral control motion while simultaneously changing collective to maintain constant altitude during the acceleration to the 25 KTAS sideward limit. The test was conducted at bank angles up to the maximum angle at which a constant altitude could be maintained while using maximum power or the bank angle at which constant heading could no longer be maintained. Performance data were recorded with a ground positioned grid camera. A ground pace vehicle was used to determine limit sideward speed. Surface winds were less than 3 knots. Reversals could not be performed from bank angles in excess of 10 degrees because of the contractors restriction. A fly away recovery was used from bank angles in excess of 10 degrees. Representative time histories of lateral performance are presented in Figures 21 and 22, appendix H. The data are presented in table 3.

18. The maximum bank angle in left sideward flight was approximately 29 degrees and was limited by the power available to maintain constant height. It was necessary for the pilot to closely monitor engine power to preclude an over torque condition. The maximum bank angle in right sideward flight was approximately 19 degrees and was limited by the requirement for full left pedal control deflection at the limit speed (25 KTAS). Maximum acceleration achieved to the left and right was 0.28g and the corresponding time to limit speed was 4.5 and 5.3 seconds, respectively. During the acceleration there was no cue, other than judgment of ground speed, to alert the pilot of reaching limit sideward velocity. Limit sideward velocity could only be determined from the pace vehicle.

HANDLING QUALITIES

General

19. The handling qualities of the S-67 helicopter were evaluated under a variety of operating conditions. The gust response was heavily damped in all axes. This characteristic aided the pilot in making precise attitude changes in turbulent conditions. The stable and consistently linear longitudinal trim control position gradient decreased pilot effort required while changing airspeed. There were 16 handling quality shortcomings noted. Long term longitudinal trim tasks were degraded by a noticeable delay in

pitch response, excessive control system friction, weak control centering, and essentially neutral control position and force gradients.

Control System Characteristics

20. Control system characteristics were measured on the ground with engines and the rotor stopped and electrical and hydraulic power furnished by external sources. Both the primary and auxiliary hydraulic systems were pressurized. Control measurements were made in conditions simulating taxi, hover, and forward flight at 80, 140, and 180 KCAS. These conditions were simulated by introducing appropriate electrical signals to the FAS and pressurizing the pitot-static system to correspond to desired airspeeds. All switches and systems were set to duplicate normal operating conditions. Control displacement and force measurements were recorded on magnetic tape. Control system characteristics in flight were qualitatively evaluated to be essentially the same as those observed under the above described static test conditions.

21. In the taxi mode, longitudinal control centering was provided by an electrical spring which produced a positive control centering force of approximately 5 pounds. This force remained constant with any magnitude of displacement from trim. Lateral control centering was provided by a mechanical spring that produced a 1.5 pound breakout and friction force with a 0.8-pound-per-inch linear gradient for control displacements from trim. The cyclic control force system was sufficient during ground/taxi operations to maintain the control at any selected position within the trim authority band. The longitudinal and lateral control system characteristics in the taxi mode were satisfactory.

22. In the hover mode, including sideward and rearward flight and forward flight to airspeeds of approximately 40 KCAS, longitudinal and lateral control force characteristics were solely a function of system friction. No trim reference system was operational in this flight regime for longitudinal or lateral control. The lack of positive longitudinal and lateral self-centering in a hover failed to meet the requirements of paragraph 3.2.3, MIL-H-8501A. Lateral friction was 0.8 pounds, met the requirements of paragraph 3.3.11, MIL-H-8501A, and was satisfactory. Longitudinal friction in hover was measured both on the ground and during hovering flight. Test results are presented in figure 23, appendix H. Longitudinal friction was approximately 2.25 pounds. The longitudinal control friction characteristics failed to meet the requirements of paragraph 3.2.7, MIL-H-8501A, by 0.75 pounds (50 percent).

This high level of friction was objectionable to the pilot in that small, precise control inputs were masked. Considerable pilot compensation was required during precision hovering tasks (HQRS 5). The excessive longitudinal control friction in the hover mode is a shortcoming that should be corrected.

23. In forward flight from 40 to 80 KCAS, lateral control force characteristics were identical to those in the hover mode. Above 80 KCAS, the lateral control FAS components were automatically activated and provided positive lateral control centering and force characteristics essentially identical to those of the taxi mode. The lateral control force characteristics in forward flight met the requirements of paragraphs 3.3.11, 3.3.13 and 3.3.14, MIL-H-8501A, and were satisfactory.

24. Longitudinal control FAS components were automatically activated at 40 KCAS but their contributions were masked by friction and were undetectable by the pilot below 80 KCAS. Above 80 KCAS, longitudinal control force characteristics were shaped by the system friction (fig. 23, app. H) and the pitch FAS gains. Pitch FAS gain characteristics were measured at three airspeeds and are presented in figure 24. Longitudinal control force characteristics in forward flight failed to meet the requirements of paragraph 3.2.7, MIL-H-8501A, by 0.75 pounds (50 percent). The wide friction band masked trim in forward flight, disrupting all longitudinal control force cues to the pilot for small airspeed or pitch attitude corrections. Considerable pilot compensation was required to make precise airspeeds changes in forward flight (HQRS 5). The excessive longitudinal control system friction above 80 KCAS is a shortcoming which should be corrected.

25. Longitudinal centering characteristics in forward flight varied with airspeed and are presented in table 4. The longitudinal control self-centering characteristics in forward flight did not meet the requirements of paragraph 3.2.3, MIL-H-8501A in that positive centering was not provided. The longitudinal control self-centering characteristics in forward flight are unsatisfactory. The excessive centering error at forward flight airspeeds increased the pilot workload and required moderate pilot compensation to maintain the desired aircraft pitch attitude (HQRS 4). The excessive longitudinal control centering error in forward flight is a shortcoming which should be corrected.

Table 4. Longitudinal Control Centering Characteristics.

Airspeed (KCAS)	Centering Error (Inches from Trim)
80	± 1.7
140	± 0.7
180	± 0.4

26. The directional control system rate damping characteristics and breakout including friction are presented in figure 25, appendix H. Pedal breakout, including friction, was 3.5 pounds left and 6.0 pounds right. The average force-rate pedal gradient was 50 pounds/inch/second right and 60 pounds/inch/second left. Additionally the directional control system had no centering characteristics. The lack of positive directional control self-centering failed to meet the requirements of paragraph 3.3.10, MIL-H-8501A. The directional control characteristics met the requirements of paragraphs 3.3.13 and 3.3.14, MIL-H-8501A. The directional control system is satisfactory.

27. Collective control forces were constant at all test conditions. Figure 26, appendix H presents a plot of collective control displacement versus control force. The average breakout and friction in the center 80 percent of control movement was 4.2 pounds, which exceeds the 3 pound maximum allowable force requirements of paragraph 3.4.2, MIL-H-8501A by 1.2 pounds (40 percent). Limit control forces measured at the extremities of control throw were 16 pounds which exceeds the 7 pound maximum allowable force requirements of paragraph 3.4.2 by 9 pounds (129 percent). The collective control did not creep and met that requirement of paragraph 3.4.2, MIL-H-8501A. Movement of the collective control caused no objectionable forces in the cyclic control. The collective control system met the requirements of paragraph 3.4.3, MIL-H-8501A. The collective control characteristics are satisfactory.

Takeoff and Landing Characteristics

28. Takeoff and landing characteristics were qualitatively evaluated throughout the test with SAS and FAS on and off at an aft cg and gross weights from 16,900 to 18,740 pounds. Operations were conducted in surface winds from calm to maximum gusts of 15 knots. The hover landing and takeoff started or ended at a 10 foot tail wheel hover height. Running landings and takeoffs were also evaluated.

29. Liftoff to a hover was characterized by a noticeable requirement for aft longitudinal cyclic displacement to keep from rolling forward, as power was initially applied by a forward displacement to preclude aft translation as the main landing gear left the ground. The bank attitude change from ground attitude to a hover was 2 degrees left wing down. The pitch attitude change from the ground attitude to a hover was 7 degrees nose up. The large pitch attitude change required moderate effort to perform hover landings and takeoffs (HQRS 4). This is a shortcoming which should be corrected. There was no ground resonance tendency noted during these tests.

30. Running takeoffs at ground speeds up to 35 knots were easily accomplished in all of the wind conditions experienced during the test. Precise directional control was easily maintained with the tail wheel both locked and unlocked. Satisfactory running takeoffs were accomplished with minimal pilot effort (HQRS 3). The helicopter met the requirement of paragraph 3.5.4.2 of MIL-H-8501A.

31. Running landings, with and without power, were accomplished at touchdown speeds from 15 to 35 knots. The helicopter touched down tail wheel first and 10 to 12 degrees nose high. This nose high attitude was disconcerting and uncomfortable. The nose dropped through a considerable distance prior to main landing gear touchdown and moderate pilot compensation was necessary to accomplish a smooth precise touchdown (HQRS 4). The excessive nose high attitude during running landings is a shortcoming which should be corrected. Running landings with sidedrift were not evaluated. Within the scope of these tests, the requirements of paragraph 3.5.4.3 of MIL-H-8501A were met.

32. Slope landings were evaluated in the external stores configuration at 18,500 pounds gross weight and an aft cg. Photographs 11 and 12, appendix D, depict representative slope landings. The test area was a grassy slope located at the contractor site. The main landing gear brakes were locked and the tail wheel lock was engaged for the test. Test results are presented in table 5. Cyclic centering forces associated with the taxi detent induced objectionable stick jump as the weight of the aircraft was placed on the main gear. While on the ground this detent could be moved with the cyclic trim system, however, the detent position in relation to cyclic control position could not be determined until the system was energized upon landing. Stick jump occurred at the most critical point of a slope landing and the fact that the pilot could not determine the detent position in relation to the cyclic position required considerable pilot compensation to maintain the precise control necessary during slope landings (HQRS 5). The stick jump associated with taxi detent engagement is a shortcoming which should be corrected.

Table 5. Slope Landings¹

Aircraft Relation to Slope	Slope ² Angle (deg)	Aircraft Pitch Attitude (deg)	Aircraft Roll Attitude (deg)
Nose Up	5	6°	2 left wing down
Nose Up	10	11	1 left wing down
Left wing up	5	2	8 right wing down
Right wing up	5	0	8 left wing down
Nose Down	5	-6	1 right wing down

¹ Gross weight: 18,500 pounds. center of gravity: 272.9 (aft). density altitude: 900 feet. rotor speed: 211 rpm.

² Limited by safety of flight release.

33. In-ground-effect hover characteristics were qualitatively evaluated during all tests. The aircraft was stable in hover with and without SAS. Precise hover was easily established with minimal pilot compensation (HQRS 3). During the IGE hover and slope landing tests torque surges up to ± 10 percent were experienced. These surges were not experienced during the OGE hover test and probably occurred due to reingestion of exhaust gases. The engine inlets are very close together and usually both engines were affected simultaneously. These surges resulted in yaw attitude changes of ± 5 degrees and a slight rolling tendency of less than 2 degrees. Torque surges were random both in magnitude and frequency of occurrence and materially increased the pilot workload. Maximum pilot effort was required to accomplish a satisfactory landing in calm or tail wind conditions (HQRS 6). Torque surge during IGE hover is a shortcoming which should be corrected.

Sideward and Rearward Flight Characteristics

34. Sideward flight test results are presented in figure 28, Appendix H. Lateral control position changes from hover to 5 KTAS were small. Above 5 KTAS the control position changes were stable (lateral control displacement in the direction of flight). The magnitude of the control position change for hover to limit sideward velocity did not exceed one inch. The directional control position changes with airspeed were stable except near 10 KTAS in left sideward flight and near 15 KTAS in right sideward flight where gradient reversals occurred. The reversals did not degrade for the pilot's ability to stabilize at these speeds. The magnitude of the directional control position change from hover to limit sideward velocity did not exceed 1.6 inches. Longitudinal control position changes from hover did not exceed one inch and presented no control problem. During right sideward flight at 25 KCAS, the maximum allowable sideward velocity, 14 percent of left pedal control remained. Control margins were adequate at all speeds tested, but the safety-of-flight release prevented investigation to the 35-knot sideward flight requirement of MIL-H-8501A. Within the scope of this test, the trim control position characteristics in sideward flight are satisfactory.

35. During left sideward flight at approximately 15 KTAS, there was a lateral oscillation, at a frequency of approximately 4 1/2 hertz, that appeared undamped as long as the pilot attempted to hold the controls fixed. A time history of this oscillation is shown in figure 29, appendix H. Roll rate oscillations caused unintentional lateral control inputs. The inputs were opposite to the roll rate and at the same frequency. This oscillation was very uncomfortable. This oscillation would require considerable pilot effort to make a

hover landing with a left crosswind of approximately 15 knots, particularly if the terrain were sloped or uneven. The undamped lateral oscillation at approximately 15 KTAS in left sideward flight is a shortcoming which should be corrected.

Lateral Acceleration Handling Qualities

36. The lateral acceleration handling qualities were evaluated during the lateral acceleration performance testing at the conditions outlined in table 1. Representative time histories of lateral accelerations are presented in figures 21 and 22, appendix H. A complete evaluation of the rapid reversal could not be accomplished due to the contractor imposed restriction preventing reversals from greater than a 10 degree bank angle. A fly away recovery was used for lateral acceleration maneuvers at bank angles in excess of 10 degrees. During lateral accelerations, the pilot was required to closely monitor engine torque to prevent exceeding the aircraft limits. Moderate pilot effort was required to maintain altitude and heading during the maneuver (HQRS 4). Roll attitude control was not difficult. Rapid reversals at bank angles up to 10 degrees were easily accomplished in both directions. The excessive pilot workload required to maintain heading and altitude during maximum lateral accelerations is a shortcoming which should be corrected.

Control Positions in Trimmed Forward Flight

37. Control positions in trimmed forward flight were evaluated from 37 KCAS to V_{max} with SAS and FAS on. Tests were conducted in the clean and external stores configuration at an aft cg. Figures 30 through 34, appendix H, present the results of this test.

38. The longitudinal trim control position gradient in level flight was positive and essentially linear at all airspeeds above 50 KCAS and essentially neutral at lower airspeeds. The positive and consistent longitudinal control trim position gradient decreased pilot workload in changing airspeeds and was a major contributor to the pilot's ability to quickly and accurately attain a desired airspeed (HQRS 2). Within the scope of the test, the longitudinal trim changes with power met the requirement of paragraph 3.2.10.2 of MIL-H-8501A, and are satisfactory. Extension or retraction of the landing gear at 98 KCAS required less than 0.1 inch of longitudinal control motion to maintain the trim airspeed, and the pilot could easily maintain attitude and airspeed (HQRS 2).

39. The nominal lateral trim control position gradient was 0.012 inches per knot. During airspeed changes such as in accelerations, decelerations, or dives the lateral trim shift was objectionable. Within the scope of this test, the lateral trim changes with power met the requirements of paragraph 3.3.17, MIL-H-8501A. The excessive lateral trim shift with airspeed was objectionable in that moderate pilot effort was required in making frequent lateral trim corrections when changing airspeeds (HQRS 4). This shortcoming should be corrected.

40. The directional control trim shift was approximately 1.2 inches of right control input as trim airspeed changed from 40 to 178 KCAS. The nominal directional trim control position gradient was 0.008 inches per knot. This directional control trim shift was objectionable in that considerable pilot compensation and attention was required to maintain balanced flight with speed changes (HQRS 5). This shortcoming should be corrected.

Trimmability

41. The trimmability characteristics were evaluated concurrently with other testing. The directional and collective controls did not have trim systems. Cyclic trim was accomplished through the use of trim wheels mounted on the cyclic hand grip (photo 13, app. D). These trim wheels commanded a control trim position. Trim rate was a function of how fast the wheels were operated. During ground operations (FAS taxi mode), the cyclic trim system was responsive to pilot demands. Trim rates were satisfactory and the pilot could readily trim the cyclic control at any selected position. Cyclic trim characteristics were satisfactory throughout the flight envelope in that longitudinal and lateral controls forces could be readily trimmed to zero (HQRS 2). There was no stick jump associated with activation of the trim controls. Within the scope of this test, the trimmability characteristics met the applicable requirements of paragraphs 3.2.3 and 3.3.10, MIL-H-8501A and are satisfactory.

42. In trimmed level flight at approximately 150 KCAS, there was a large trim shift with speed brake extension. One inch of aft cyclic and 0.6 inch of right lateral cyclic were required to maintain constant attitude following speed brake extension. These trim shifts corresponded to 6 pounds aft longitudinal force and 3 pounds right lateral force. The excessive trim shift resulting from speed brake extension and retraction required considerable pilot compensation to satisfactorily maintain aircraft attitude

(HQRS 5). The excessive trim shift associated with speed brake extension and retraction is a shortcoming which should be corrected.

Static Longitudinal Stability

43. Static longitudinal stability characteristics were evaluated at 82, 120, 151 and 171 KCAS in level flight at an average density altitude of 3140 feet. An additional test was also conducted at 120 KCAS with the speed brakes extended. Tests were conducted at an average gross weight of 18,125 pounds at an aft cg in the external stores configuration. The aircraft was trimmed in steady-heading, zero sideslip, level flight. With the collective control held fixed, the aircraft was stabilized at incremental speeds greater and less than the trim speed. Test results are presented in figures 35 and 36, appendix H.

44. The longitudinal static stability, as indicated by the variation of longitudinal control position with airspeed, was stable at 82 KCAS, less stable at 120 KCAS, and essentially neutral at 151 and 171 KCAS. At 82 KCAS, longitudinal control position variation from trim was less than 0.5 inch for airspeed changes of 20 KCAS either side of the trim speed. This small control displacement resulted in a control force of less than one pound for the 20 KCAS variation from trim. As trim airspeed was increased, longitudinal control displacement and forces for 20 KCAS changes from trim were even smaller in magnitude. At 171 KCAS, the longitudinal control position and force gradients were essentially neutral. Forces measured at all test airspeeds fell within the friction band of the longitudinal control system. The aircraft exhibited a weak tendency to return to trim at all airspeeds which is objectionable. Within the scope of this test, the longitudinal static stability characteristics did not meet the requirements of paragraph 3.2.10, MIL-H-8501A in that static longitudinal control position and force gradients were essentially neutral at all airspeeds tested. The weak return to trim characteristics required considerable pilot effort in maintaining desired pitch attitudes and airspeeds (HQRS 5). This is a shortcoming which should be corrected.

Static Lateral-Directional Stability

45. Static lateral-directional stability characteristics were evaluated at 82, 151, and 168 KCAS in level flight at an average density altitude of 3170 feet. Tests were conducted in the external stores configuration at an average gross weight of 18,080 pounds with an aft cg. The aircraft was trimmed in zero sideslip flight at the desired airspeed. With the collective

control fixed, and maintaining a steady heading, at the trim airspeed, the aircraft was then stabilized at incremental sideslip angles on both sides of trim to the limits of the sideslip envelope. Test results are presented in figures 37 through 39, appendix H.

46. Static directional stability, as indicated by the variation of directional control position with sideslip, was strongly positive at all test airspeeds. Directional control position variation was essentially linear at all airspeeds and was increasingly positive as airspeed increased.

47. Dihedral effect, as indicated by the variation of lateral control position with sideslip, was positive and essentially linear at 151 and 168 KCAS. At 82 KCAS the lateral control position gradient was positive for sideslip angles within 5 degrees of trim and essentially neutral at greater sideslip angles. The neutral lateral control position gradient was not objectionable.

48. Side force characteristics, as indicated by the variation of bank angle with sideslip, were strongly positive and linear at all airspeeds. Side-force characteristics increased significantly with increasing airspeed.

49. Pitch with sideslip occurred at all trim airspeeds. Increasing aft displacement of the longitudinal control was required with increasing left sideslips to counteract a nose-down moment. In right sideslips, the pitching moment was nose-up (forward cyclic) for very small sideslips and then reduced to near zero as the sideslip was increased to the right envelope limit. The mild pitching with sideslip was not objectionable.

50. Indicated airspeed error with sideslip was qualitatively evaluated by rapidly yawing into and out of the steady-heading sideslip and noting any variation in indicated airspeed. Over the test airspeed band indicated airspeed variation due to sideslip was estimated to be less than 2 KIAS.

51. The static lateral-directional characteristics are satisfactory and, except for the essentially neutral lateral control position gradient at 82 KCAS in sideslip angles greater than 5 degrees, met the requirements of paragraph 3.3.9, MIL-H-8501A.

Dynamic Stability

52. The longitudinal and lateral-directional dynamic stability characteristics were evaluated in OGE hover and in forward flight at airspeeds of 80, 150 and 165 KCAS with SAS and FAS on and off. Tests were conducted at the conditions listed in table 1.

53. Short period gust response characteristics were obtained by rapidly displacing the desired control one inch from trim for a duration of 0.5 seconds and returning the control to trim position while recording subsequent aircraft response. Time histories of representative simulated gust responses are presented in figures 40 through 43, appendix H. Test results are summarized in table 6. The short period response of the helicopter was similar for all test conditions and was completely deadbeat in all axes. The normal acceleration following aft pulse inputs reached a maximum of 1.17g at the 167 KCAS trim airspeed. During the subsequent nose down motion the normal acceleration decreased to 0.70g. This decrease in load factor (0.30g) exceeds the requirements of paragraph 3.2.11.2, MIL-H-8501A by 0.05g (17 percent). The short-period response characteristics met the requirements of paragraph 3.2.11 of MIL-H-8501A. The deadbeat short-period characteristics enhance the pilot's ability to make small, precise longitudinal corrections and reduce the workload required to maintain precise attitudes in turbulent conditions (HQRS 2). The short period dynamic response characteristics are satisfactory.

Table 6. Longitudinal Short-Period Response¹

Calibrated Airspeed (KCAS)	Stability Augmentation System	Damping
84	OFF	Deadbeat
151	ON	Deadbeat
168	ON	Deadbeat

¹ Gross weight: 18,080 lb, center of gravity: 274.0 in. (aft) density altitude: 3260 ft., outside air temperature: 15.5°C, rotor speed: 211 rpm, configuration: external stores.

54. Lateral-directional gust response was evaluated by releases from steady-heading sideslips and inducing directional control doublets. The results are presented in table 7. There was no evidence of a lateral-directional oscillation. Aircraft response was deadbeat about all axes. This deadbeat lateral-directional response is highly desirable and required no pilot compensation (HQRS 2).

Table 7. Lateral-Directional Response.¹

Calibrated Airspeed (KCAS)	Stability Augmentation System	Damping
80	OFF	Deadbeat
152	ON	Deadbeat
170	ON	Deadbeat

¹ Gross weight: 18,340 lb, center of gravity: 274.0 in (aft), density altitude: 3300 ft, outside air temperature: 15.2 °C, rotor speed: 211 rpm, configuration: external stores.

55. Turns with lateral cyclic only were evaluated at speeds above 80 KCAS with SAS on. A lateral cyclic control step input to produce a 30 degree roll displacement in 6 seconds resulted in slight adverse yaw which was not objectionable. Pedal-fixed turns were easily accomplished. The pedal fixed turn characteristics of the helicopter met the requirements of paragraphs 3.3.9.1 and 3.3.9.2 of MIL-H-8501A.

56. The long term aircraft response characteristics were evaluated with SAS ON and OFF by exciting the long period mode of the aircraft and recording time histories of the resultant motion. The response following release from 10 knots off trim was oscillatory and at 153 and 167 knots recovery was required within 1 cycle to avoid exceeding the airspeed limit. The long term response was evaluated by longitudinal pulse inputs of 1 inch for 0.5 seconds. Test results are presented in figures 44 and 55, appendix H and are summarized in table 8. The response was essentially neutral at 84 KCAS and divergent at 153 and 167 KCAS. The SAS had no effect on long term characteristics. Long term response was easily excited. These characteristics would require considerable pilot effort during instrument flight conditions (HQRS 5). This is a shortcoming which should be corrected. The long term dynamic characteristics met the requirements of paragraph 3.2.11, MIL-H-8501A.

Table 8. Longitudinal Long-Term Response.¹

Calibrated Airspeed (KCAS)	Stability Augmentation System	Damping Ratio	Damped Frequency (htz)	Natural Frequency (htz)	Damping
84	OFF	0	0.180	0.180	Neutral
153	ON	- 0.07	0.170	0.170	Slightly Negative
167	ON	- 0.13	0.175	0.176	Slightly Negative

¹ Gross weight: 18,070 lb, center of gravity: 274.0 in. (aft), density altitude: 3140 ft., outside air temperature: 15.3°C, rotor speed: 211 rpm, configuration: external stores.

Controllability

57. Controllability characteristics with SAS and FAS on were evaluated in forward flight and hover at gross weights of 17,540 to 18,630 pounds at an aft cg. Single axis control step inputs were applied to the longitudinal, lateral, and directional controls using mechanical fixtures to obtain the desired control input size. The control inputs were held constant and the subsequent angular displacement (control power), angular rate (control response), and angular acceleration (control sensitivity) were measured. The results of these tests are presented in figures 46 through 54, appendix H. The control power characteristics during OGE hover are summarized in table 9 and compared with the requirements of MIL-H-8501A.

Table 9. OGE Hover Control Power and Damping.¹

Axes	Direction	Control Power (degrees in one sec.)		Damping (ft lb/rad/sec.)	
		Test	MIL 8501	Test	MIL 8501
Pitch	Fwd.	3.2	1.7	65,300	18,772
	aft	1.5			
Roll	Left	0.7 ²	1.0 ²	24,036	13,939
	Right	1.5 ²			
Yaw	Left	4.0	4.1	16,202	62,472
	Right	3.7			

¹ Gross weight: 17,540 to 18,630, center of gravity: 275.0 (aft), density altitude: 780 ft, outside air temperature: 20.5°C, rotor speed: 211 rpm, configuration: external stores.

² Degrees in 1/2 sec.

58. Longitudinal controllability characteristics are presented in figures 46 through 48, appendix H. Longitudinal control sensitivity varied from a minimum of 8 deg/sec² per inch of control displacement in hover to a maximum of 23 deg/sec² per inch in forward flight at 164 KCAS. Longitudinal control response varied from 11 deg/sec per inch in a hover to 13 deg/sec per inch at 164 KCAS. The average longitudinal control power varied from 2.5 to 7 degrees per inch of control travel at hover and 165 KCAS, respectively. As shown in table 9, aft cyclic longitudinal control power in hover failed to meet the requirements of paragraph 3.2.13, MIL-H-8501A by 0.2 degrees (11 percent). The helicopter met the requirements of paragraphs 3.2.1, 3.2.2, 3.2.6, 3.2.9, 3.2.12 and 3.2.15, MIL-H-8501A. The longitudinal controllability characteristics permitted smooth, precise control of aircraft attitude and airspeed at a hover and airspeeds below approximately 120 KCAS. Although longitudinal control sensitivity

essentially tripled from hover to 164 KCAS, this variation with airspeed was compatible with the longitudinal control force characteristics of the FAS during maneuvering flight. The pitch rate response time constant (time to 63 percent maximum pitch rate) varied in forward flight from approximately 0.9 at 80 KCAS to 0.5 above 150 KCAS. This long time constant was manifested as a noticeable pitch rate response delay following a control input. The pitch rate response delay resulted in an objectionable tendency toward overcontrolling by the pilot and required considerable pilot compensation for adequate control of pitch attitude and airspeed (HQRS 5). The excessive pitch rate response delay is a shortcoming which should be corrected.

59. Lateral controllability characteristics are presented in figures 49 through 51, appendix H. The average lateral sensitivity was 20 deg/sec² per inch of control travel in hover increasing to approximately 23 deg/sec² per inch of control travel at 164 KCAS. The lateral control response varied from approximately 10 to 17 deg/sec per inch of control travel as airspeed increased from hover to 164 KCAS. The average roll displacement at 1/2 second was 1.2 degrees per inch of control travel throughout the envelope. Control power failed to meet the requirement of paragraph 3.3.18, MIL-H-8501A, 1.0 degrees per inch of control travel in 1/2 second, by 0.3 degrees (30 percent). The lateral controllability characteristics met the requirements of paragraphs 3.3.4, 3.3.15, 3.3.16 and 3.3.19, MIL-H-8501A. The lateral controllability characteristics are satisfactory.

60. Directional controllability test results are presented in figures 52 through 54, appendix H. Directional control sensitivity was 21 deg/sec² per inch of control travel during hover and decreased linearly to 16 deg/sec² per inch of control travel at 164 KCAS. Directional control response varied from 33 deg/sec per inch of travel during hover to 3.5 deg/sec per inch of travel at 164 KCAS. Yaw attitude change was 2.0 degrees in 1 second for a 0.5 inch directional control step input. Compliance with paragraph 3.3.5, MIL-H-8501A could not be determined due to restrictions of reference 4. The directional rate damping presented in table 9 fails to meet the 62,472 foot-pound per radian per second requirement of paragraph 3.3.19, MIL-H-8501A, by 46,270 foot-pounds per radian per second (75 percent). The directional controllability characteristics met the requirements of paragraphs 3.3.6, 3.3.7 and 3.3.16, MIL-H-8501A. The directional controllability characteristics are satisfactory.

Maneuvering Stability

61. Maneuvering stability characteristics were evaluated at an aft cg and an average gross weight of 18,150 pounds in the external stores configuration with SAS and FAS on. The variation of longitudinal control position and control force with normal acceleration was determined by trimming the aircraft in coordinated level flight at the desired airspeed and then rolling the aircraft to incremental bank angles, both left and right. Collective control was fixed and airspeed was held constant during the maneuver. Data were recorded at each stabilized bank angle. Data were also recorded during steady pull-ups and pushovers at the trim airspeed. Maneuvering stability characteristics are presented in figures 55 through 59, appendix H.

62. The variation of longitudinal control position with normal acceleration (stick fixed stability) was positive and essentially linear at trim airspeeds from 82 to 168 KCAS. The longitudinal control position gradient varied from approximately 2 inches per g at 82 KCAS to 0.4 inches per g at 168 KCAS. The variation of longitudinal control force with normal acceleration (stick free stability) was positive and linear. The longitudinal control force gradient was approximately 7.5 pounds per g for all airspeeds tested. The variation of longitudinal control position and force with airspeed is satisfactory

63. It was easy to stabilize the aircraft at desired bank angles up to 45 degrees (approximately 1.4g). At 122 KCAS with bank angles above 45 degrees, the aircraft exhibited an annoying random oscillation in pitch. As a result pitch attitude and sideslip were difficult to control precisely. This characteristic was not as strong at 150 KCAS. The maneuvering stability characteristics met the requirements of paragraph 3.2.11.1, MIL-H-8501A. The maneuvering stability characteristics are satisfactory.

Simulated Engine Failure Characteristics

64. The response of the helicopter to a sudden single-engine failure was evaluated during hover, maximum rated power climbs, low power descents, and in forward level flight at airspeeds to 160 KCAS. Flight controls were held fixed for 2 seconds following the power loss or until the minimum transient rotor speed, or an aircraft attitude or angular rate that dictated recovery, was reached. Test conditions and results are presented in table 10.

Table 10. Single Engine Failure Test Conditions and Results.¹

Flight Condition	Entry Airspeed (KCAS)	Entry Torque (%)	Collective Control Delay Time (sec)	Rotor Speed Decay Rate (rpm/sec)
Level Flight	74	39	N/R ²	5.9
Level Flight	94	44	N/R ²	6.5
Level Flight	123	57	N/R ²	7.0
Level Flight ³	152	81	4.0	7.6
Level Flight ⁴	152	83	2.9	6.6
Level Flight ⁵	153	82	3.4	6.2
Level Flight	152	77	4.0	6.6
Level Flight	163	103	1.8	11.5
Climb	80	103	1.1	12.0
Dive w/speed brakes	141	69	2.1	5.8

¹ SAS ON, FAS ON, controls fixed, #1 engine failure, rotor speed: 211 rpm

² Movement of collective control was not required.

³ SAS OFF

⁴ Controls free

⁵ #2 engine failure

65. Aircraft response following a single-engine sudden power loss was mild, as evidenced by a slight left yaw, left roll, and pitch-down. The aircraft attitude change at 2 seconds was less than 10 degrees in all axes. When recovery was necessary prior to 2 seconds, minimum transient rotor speed was the critical parameter. During maximum power climbs and at the maximum level flight test airspeed (163 KCAS), rotor speed decayed at approximately 12 rpm per second following power loss. Sudden single-engine power reductions with the speed brakes extended resulted in essentially identical aircraft reaction. In all flight conditions, the pilot could maintain control with minimal effort (HQRS 3). Within the scope of this test, aircraft response characteristics following sudden single-engine power loss are satisfactory.

66. Sudden single-engine power failure characteristics during low power descents were qualitatively evaluated during landing approaches and simulated target tracking maneuvers. Typical pilot response times and corrective actions were observed following unannounced, simulated sudden single-engine failures. During one approach, the pilot was not aware that a single-engine power loss had occurred until verbally informed by the copilot approximately 5 seconds after the power loss had been induced. During low-power, descending-flight conditions and periods of moderate pilot workload, such as a landing approach or a target tracking maneuver, insufficient cues are available to warn the pilot of an engine failure. During such maneuvers, the pilot must continually monitor the engine instruments to provide adequate detection of an engine failure and is therefore subjected to a considerable increase in pilot workload (HQRS 5). The lack of adequate single-engine failure warning during low power descents is a shortcoming which should be corrected.

Autorotational Characteristics

67. A limited evaluation of steady-state autorotational characteristics was conducted during the simulated single-engine tests. The average gross weight was 18,250 pounds and the cg location was 273 inches (aft). Autorotations were evaluated in straight-ahead descent and up to 30 degree bank turns, left and right, at 69 KCAS. Desired rotor speed was easily maintained with collective pitch and left and right turns were easily accomplished. Steady-state autorotations were easily performed with minimal pilot compensation (HQRS 3). Within the scope of this test, the autorotational characteristics met the requirements of paragraph 3.3.8 of MIL-H-8501A.

Automatic Stabilization System Characteristics

68. Failures of the SAS and FAS were qualitatively evaluated throughout the flight envelope. Two SAS failure modes were evaluated: go-dead (SAS OFF) and hardover failures. Go dead failures were introduced by turning off the SAS system with the control switch. Hardover SAS failures were evaluated by introducing 100 percent hardover signals into the SAS system with a pulser box, a device used to artificially simulate aerodynamic perturbations and system failures. Pitch and roll go-dead failures were introduced by turning off the FAS system. hardovers were not true hardovers in that the system is comprised of two hydraulic servos in parallel and a greater displacement of one over the other automatically shuts down the system rather than allowing servo limit travel.

69. The dynamic stability characteristics with SAS off were not materially different from the characteristics with SAS on. SAS go dead failures produced a very slight nose down and left roll tendency. SAS hardovers were very mild in all axes when conducted with controls free. Delays of approximately 5 seconds were possible before pilot corrective action was necessary following SAS hardover. Controls fixed hardovers produced almost no detectable response. Within the scope of this test, the aircraft response to SAS failures met the requirements of paragraph 3.5.9, MIL-H-8501A. The aircraft response to SAS failure was satisfactory.

70. Pitch and roll FAS go dead failures produced no noticeable aircraft response. Pitch hardovers were artificially introduced and were evaluated with controls free and fixed. Control free hardovers were characterized by a rapid 1 inch stick displacement and a corresponding pitch rate. The control reaction and the resulting pitch rate were not violent and the pilot could re-enter the control loop and easily regain control. Control fixed hardovers were identified by a momentary control force pulse of approximately 6 pounds which was easily controlled by the pilot.

MISCELLANEOUS ENGINEERING TESTS

Cockpit Evaluation

71. A qualitative evaluation of the cockpit was conducted throughout the test program. Six items were highly desirable and 18 shortcomings were noted. The environmental control unit requires further testing.

72. The six highly desirable cockpit environment characteristics were:

a. A radio transmitter selector switch on the collective pitch control provided the capability of transmitting on different radios without removing either hand from the controls to operate a selector switch. The selected transmitter was clearly identified by a lighted display on the instrument panel. Five transmitters could be accommodated by the system.

b. A start-fuel interrupter button was incorporated on the cyclic control grip providing momentary interruption of start fuel flow to the engine for controlling temperature during engine start.

c. A digitally tuned automatic direction finder (ADF) radio receiver permitted rapid and accurate frequency selection, thereby reducing pilot workload.

d. Emergency egress from either cockpit was provided by activation of a quick-release mechanism which released the top mounted hinges of the normal entrance door allowing it to fall away from the aircraft. The opposite canopy could likewise be released, thus providing for emergency egress on both sides of either cockpit.

e. Cockpit seats were comfortable with or without parachutes. Adequate headroom and vertical seat adjustment were available to accommodate a wide range of body sizes.

f. Constant altitude was easily maintained by reference to a radar altimeter. The radar altimeter is a highly desirable feature.

73. Eighteen shortcomings were noted.

a. The caution/advisory warning light panel was located such that displayed information could not be readily interpreted. In bright ambient light conditions, interpretation of displayed information in direct sunlight was impossible unless the pilot removed his right hand from the cyclic control to shield the panel lights. Additionally, the pilot's right leg and knee obstructed view of a portion of the panel.

b. External handles were not installed to activate the canopy emergency quick release mechanism. The only means of gaining emergency access to either cockpit was through operation of the normal cockpit entrance door handle or destruction of the canopy. Since the cockpit entrance doors are on opposite sides of the aircraft, emergency access to one cockpit could be limited to canopy destruction if the aircraft rolled onto its side following a crash landing.

c. Steps and hand holds were not installed on the aircraft for cockpit ingress/egress. Ingress/egress would be severely hampered in forward area field sites where ground support equipment and personnel are not available. In the event of an emergency landing or crash where the aircraft remained upright, access to and removal of an unconscious crewmember from the aft cockpit would be virtually impossible and very time consuming from the forward cockpit.

d. Canopy door closure could not be accomplished without assistance. During operations at remote sites, ground personnel may not be available to assist in closing the canopy doors. Failure to properly secure the canopy door(s) would preclude aircraft operation.

e. Complete flight controls (wheel brakes and engine speed selector levers) were not provided in the copilot/gunner cockpit. Ground speed control on a smooth surface without the use of wheel brakes was limited and emergency stops could not be accomplished without wheel brakes. The copilot could not control engine speed if the speed levers in the pilot's cockpit were positioned below the governing range or placed in the ground idle detent. The lack of wheel brakes and engine speed selector levers in the copilot cockpit precludes safe accomplishment of aviator training which represents a significant portion of any aviation unit's flying program.

f. At high collective control positions, the pilots arm position was unnatural and uncomfortable.

g. The master caution system was activated during normal landing gear retraction. Activation of the emergency warning system for a condition other than a situation requiring immediate pilot action is unsatisfactory.

h. Unsatisfactory location of the radio/intercom press-to-talk switch on the collective control grip interfered with conduct of pilot tasks requiring removal of the left hand from the collective control. Many emergency actions would require the left hand to be removed from the collective grip and during normal tasks, such as radio tuning, that required use of the right hand, the left hand was used to monitor or move the cyclic control. Radio/intercom use was prohibited unless the left hand was positioned on the collective control grip.

i. Unsatisfactory location of the navigation and communication radio control panels required a downward and rearward movement of the pilot's head for visual reference to these panels. In addition to totally disrupting the pilot's reference to the instrument panel and external visual cues, the required head motion was extremely conducive to vertigo during periods of reduced visibility or instrument flight conditions.

j. Unsatisfactory location of the parking brake handle interfered with full right directional control movement during aircraft operation. The right ankle strap of the standard Army flight trousers caught on the handle preventing forward movement of the right leg.

k. Pilot's forward field-of-view was mildly distorted by the curved canopy above the copilot/gunner station.

l. Pilot field-of-view to the left and right front quadrants was restricted by bulky canopy support structure.

m. Lack of a storage compartment in either cockpit for normal crewmember equipment such as maps, checklists, and log books was unsatisfactory. Such items littered the cockpit during flight and during maneuvering flight conditions could fall into a location inaccessible to the pilot or copilot.

n. Lack of a rotor speed warning system to warn of rotor speed excursion outside the normal operating range.

o. Lack of a gage or device to monitor generator output. Generator condition monitoring was limited to a light on the caution panel which only activated if the generator completely failed.

p. Display of information by use of back-lighted switches (landing gear condition, VGI select, HSI select, turn rate mode, fuel flow, roll FAS engage, and SAS engage) was unsatisfactory. Displayed information was difficult to interpret in bright ambient light conditions and impossible to interpret in direct sunlight unless the switches were shielded from the light by the pilot's hand.

q. Adequate leg room for a tall pilot was not available. With the seat full aft and adjusted vertically to provide satisfactory field-of-view, pilot leg position prevented achieving full lateral control movement with the cyclic control in the full aft position as shown in figure 60, appendix H. Approximately two inches additional aft seat adjustment is desirable to accommodate tall pilots.

r. Location of the seat belt attachment hardware caused mild discomfort in that it protruded above the seat and rubbed against the crewmember's hip.

74. The aircraft was equipped with an environmental control unit (ECU) for both cockpits, the equipment bay, and the passenger/cargo compartment. The maximum ambient air temperature observed during the test was approximately 85°F. With this outside air temperature and the ECU temperature selector set full cold in the automatic mode, the system was marginally effective. Further testing is required in order to determine the performance of the system in hot weather conditions.

Weight and Balance

75. The aircraft weight and longitudinal center of gravity were determined prior to testing. The basic aircraft weight, including instrumentation, was 15,330 pounds, with the cg located at station 280.5 (aft). The instrumentation and avionics gear was estimated to weight 1,805 pounds. The resulting aircraft basic weight was estimated to be 13,534 pounds with the cg at station 276.3 (aft). The aircraft weight breakdown is presented in Table 11.

76. The external stores configuration had a total of 4 XM-159 rocket pods mounted on the wing hard points. Thirteen 28 pound inert rockets were loaded in each outboard pod and the inboard pods remained empty.

77. The TOW configuration was simulated using four XM-159 pods with nine 28 pound rockets in each pod.

Table 11. Weight and Balance.

Item	Weight (lb)	Moment Arm (in)
Basic Aircraft	13,534	276.3
Aircraft w/test instrumentation	15,339	280.5
XM-159 pod w/o rockets	79	269.7
XM-159 pod w/9 rockets	339	269.7 inboard or 277.0 outboard
XM-159 pod w/13 rockets	442	277.0

Ground Operation Characteristics

78. Engine starting procedures were easily accomplished. The number one engine (left) was started first and placed in ACCESSORY DRIVE to provide power to electrical and hydraulic systems. The number one engine had a battery start capability although normal starts were made with an external power source. With the number one engine in ACCESSORY DRIVE all hydraulic control system and electrical system checks could be accomplished. This was a very desirable characteristic. Rotor engagement was smooth and required minimal pilot effort. On one occasion the rotor brake failed to disengage and the engagement was aborted. Failure of the rotor brake to disengage is a shortcoming which should be corrected.

79. Taxi operations were generally confined to paved surfaces in winds up to 20 knots. A 20 percent increase in collective was required to initiate forward movement, however, much less was required to maintain taxi speed. Stops could be made with cyclic and collective only and required 3 to 4 aircraft lengths (approximately 200 to 250 feet) to stop from a 10 knot taxi speed. Taxi turns at normal taxi speed (fast walk) with neutral cyclic resulted in an outside wing down attitude of 2 to 3 degrees. This attitude change during ground turns was uncomfortable. The pilot compensated for the uncomfortable feeling by applying lateral cyclic in the direction of turn. The excessive roll tendency during ground turns increased pilot workload during taxi operations and is a shortcoming, correction of which is desirable. Taxi characteristics were also evaluated on sod surfaces at speeds up to 3 to 4 knots. There were no ground resonance tendencies observed and there were

no instances of droop stop pounding. The aircraft would probably meet the requirements of paragraph 3.3.1 and met the requirements of paragraph 3.5.3 of MIL-H-8501A.

80. Engine shutdown was accomplished with a minimum of pilot effort. During rotor coast-down the cyclic had to be centrally positioned to preclude droop stop pounding. Cues provided by the tip path plane's relationship to the canopy were sufficient to easily accomplish the necessary centering. The rotor brake enhanced the rotor shutdown characteristics in that the rotor could be decelerated quickly through the speed region where there was little or no control of the tip path plane.

Engine Characteristics

81. The engine manufacturer's data (General Electric source deck No. P58115-A for a T57-GE5 engine) was used to calculate specification engine performance at a power turbine speed of 19,726 rpm (211 rotor rpm) at various conditions of power setting, altitude, temperatures, and ram effect. Engine characteristics are presented in figures 61 through 74, appendix H. Engine inlet temperature, inlet pressure, and exhaust pressure losses were zero, as determined by the engine manufacturer (ref 9, app A and para 5, app F).

82. Power turbine speed and rotor speed were displayed by a triple-needle tachometer. Within the normal operating range of the engines, engine and main rotor speed remained matched and were easily controlled by the pilot. Desired engine/rotor speeds were displayed in percent and could be readily selected by the pilot by use of the engine beeper trim switches located on the collective control grip. Rotor speed variation with normal power changes was less than 2 percent.

83. Engine torque splits of 4 to 5 percent were common unless both engines were beepered to the desired operating range from the low power side. Accurate matching of engine torque required moderate pilot effort for desired performance. Excessive engine torque splits experienced with collective control changes is a shortcoming which should be corrected.

Airspeed System Calibration

84. The ship's airspeed system was calibrated by the contractor using the photo grid method. An automax camera was used to record the flight path of the aircraft. The contractor's calibration was validated by USAASTA using the pacer method. The results of these tests are presented in figure 75, appendix H. The maximum position error was 6.5 knots at 38 KIAS and gradually decreased to zero error within the airspeed range of 140 to 200 KIAS. The position error characteristics of the ship's airspeed system are satisfactory.

Vibration Characteristics

85. Vibration data were gathered concurrently with performance and stability and control tests. Vibration sensors were installed at the following fuselage stations: gunner instrument panel (FS 53.0); gunner seat (FS 83.5); pilot instrument panel (FS 113.5); pilot seat (FS 141.5); and center of gravity (FS 275.0). The measured vertical and lateral vibration characteristics at frequencies corresponding to 1 and 5 cycles per main rotor revolution are presented in figures 76 through 85, appendix H. The longitudinal vibration characteristics at the instrument panels are presented in figures 86 and 87. These figures show the average single amplitude which occurred over a 7-rotor-revolution data sample at each test condition.

86. As shown in figures 76 through 87, 1/rev vibration levels at all locations were less than 0.04g during all test conditions. The highest vibration was a 5/rev., 0.31g lateral vibration recorded at the gunner's station in a dive at 199 KCAS. The 0.31 at the 5/rev frequency exceeded the 0.20g limit of paragraph 3.7.1(b), MIL-H-8501A by 0.11g (55 percent). A maximum value of 0.43g occurred at the gunner's panel in the lateral axis at the high speed dive of 199 KCAS. This amplitude was within the 1.4g limit of MIL-STD-810B (ref 11, app A) which applies to instrument panel vibration levels. At 39 KCAS, the highest 5/rev vertical value recorded was 0.24g at the pilot's station. This vibration level exceeded the requirement of paragraph 3.7.1(b), MIL-H-8501A, by 0.09g (60 percent). At the higher frequencies of 10/rev the vibration level was insignificant. Although the 5/rev vibration amplitude at the gunner's station (0.31g lateral at 199 KCAS) exceeded the 0.20g limit imposed by MIL-H-8501A, the vibrations felt by the gunner were not objectionable and did not cause any noticeable discomfort. The 5/rev vibration amplitude at the pilot's station (0.24g vertical vibration at 39 KCAS) caused discomfort to the pilot and was objectionable in that it blurred vision of the instrument panel. The excessive 5/rev vibration noted at 39 KCAS is a shortcoming which should be corrected. The extremely low vibration levels noted in forward flight enhanced accomplishment of all tasks.

MISSION SUITABILITY TESTS

Mission Maneuvers

87. The mission maneuver capability of the S-67 attack helicopter was evaluated by conducting accelerations, decelerations, low speed nap-of-the-earth flight, high speed low level flight, bob-ups, target acquisition, target tracking and rapid target shift maneuvers.

The helicopter was configured with external stores at an average gross weight of 18,160 pounds and a cg location of FS 275 (aft).

88. The acceleration of the helicopter from hover to 60 KIAS required no large control motions or forces. A nose-low attitude of 20 degrees was required during the acceleration and minimal pilot attention was required to maintain ground clearance. The acceleration from hover to 60 KIAS was accomplished with minimal pilot compensation (HQRS 3). The deceleration characteristics of the helicopter from 60 KIAS to hover were similar to the characteristics observed during the acceleration. Adequate engine power was available to rapidly terminate at a hover. Forward field of view was restricted during the deceleration but did not limit the maneuver. Minimal pilot compensation was required to decelerate from 60 KIAS to a hover (HQRS 3).

89. Low-speed nap-of-the-earth flight was evaluated by flying at low altitude (less than 50 feet) over rolling, wooded terrain at airspeeds from 30 to 70 KIAS. Cyclic and pedal control force harmony was poor, however, minimal pilot effort was required to perform maneuvers required during low speed, nap-of-the-earth flight (HQRS 3). An adequate power margin was available at all times. Engine acceleration from low-power settings was slightly slow but did not degrade the maneuvering capability. During low level turns, the large rotor disc was constantly within the pilot's field of view. This visual cue gave the pilot an erroneous impression of height above the ground which continually resulted in initiation of a slight climb rather than maintaining a level turn.

90. High speed, low level flight was evaluated by flying over wooded rolling terrain at less than 100 feet at airspeeds between 100 and 140 KIAS. Rapid turns associated with nap-of-the-earth terrain following required large lateral and directional control movements and high control forces. With FAS engaged, cyclic control forces were harmonious. With the lateral FAS disengaged, cyclic control harmony was degraded, but roll response appeared much improved. Pedal and cyclic control force harmony was poor.

91. Fractional load factor maneuvering was accomplished from 110 to 130 KIAS. Terrain following push-overs to 0.5g resulted in a slight left roll which was easily corrected by the pilot. A transient torque increase was associated with rapid left rolls. During flight conditions requiring maximum power, this characteristic required close attention to prevent exceeding engine torque limits.

92. A pop-up maneuver was accomplished from 40 KIAS in nap-of-the-earth flight. Collective and cyclic were used to climb over a

masking object and target acquisition was simulated. Break off and reversal of direction was accomplished at 70 KIAS. The aircraft responded well and no control difficulties were observed. Target acquisition was accomplished with minimal pilot effort (HQRS 3). The response at the break off was good and the helicopter was easily maneuvered back to an area behind the entry position. A hover-up (bob-up) maneuver was accomplished to evaluate characteristics during simulated mask-breaking and target acquisition. Control excursions were minimal, vertical control was good and pilot effort was not a factor (HQRS 2). An illustration of the pop-up and bob-up maneuvers is shown in figure C. Within the scope of this test, the pop-up and bob-up characteristics are satisfactory.

93. The aircraft incorporated a cruise guide indicator (CGI) that displayed loads imposed on the rotor system. In conjunction with the CGI, a variable-intensity collective control shaker began operating at a CGI valve of 35 percent and increased in intensity up to the maximum continuous CGI limit of 60 percent. The variation of intensity was small and was of little value in determining the exact CGI value within that range. During high-speed maneuvering using the power for level flight, the cruise guide limit was frequently reached prior to reaching the limit load factor (2.2g). For example, only 1.9, 1.5, and 1.4g could be attained at 120, 150, and 168 KCAS, respectively, at the power required for level flight. To gain full use of the load factor capability of the aircraft during turns, the collective control had to be lowered thus sacrificing either airspeed or altitude. This additional control task during nap-of-the-earth maneuvering required considerable pilot workload (HQRS 5). The inability to maintain constant altitude and airspeed while maneuvering to the limit load factor is a shortcoming which should be corrected.

94. To quantify the helicopter's ability to deliver fire from fixed stores (time on target), the time was measured for the helicopter to accelerate through an increment of airspeed following a pushover straight ahead to a 20-degree nose-down attitude. Entries were made from level flight at 110 and 140 KCAS with speed brakes extended and retracted. From the 110 KCAS initial condition, 17.5 seconds were required to accelerate to 160 KCAS with speed brakes extended and 13.5 seconds were required with speed brakes retracted. Speed brakes significantly increased available time on target and reduced pilot effort required to deliver effective fire on a target (HQRS 3). Speed brakes are a highly desirable feature.

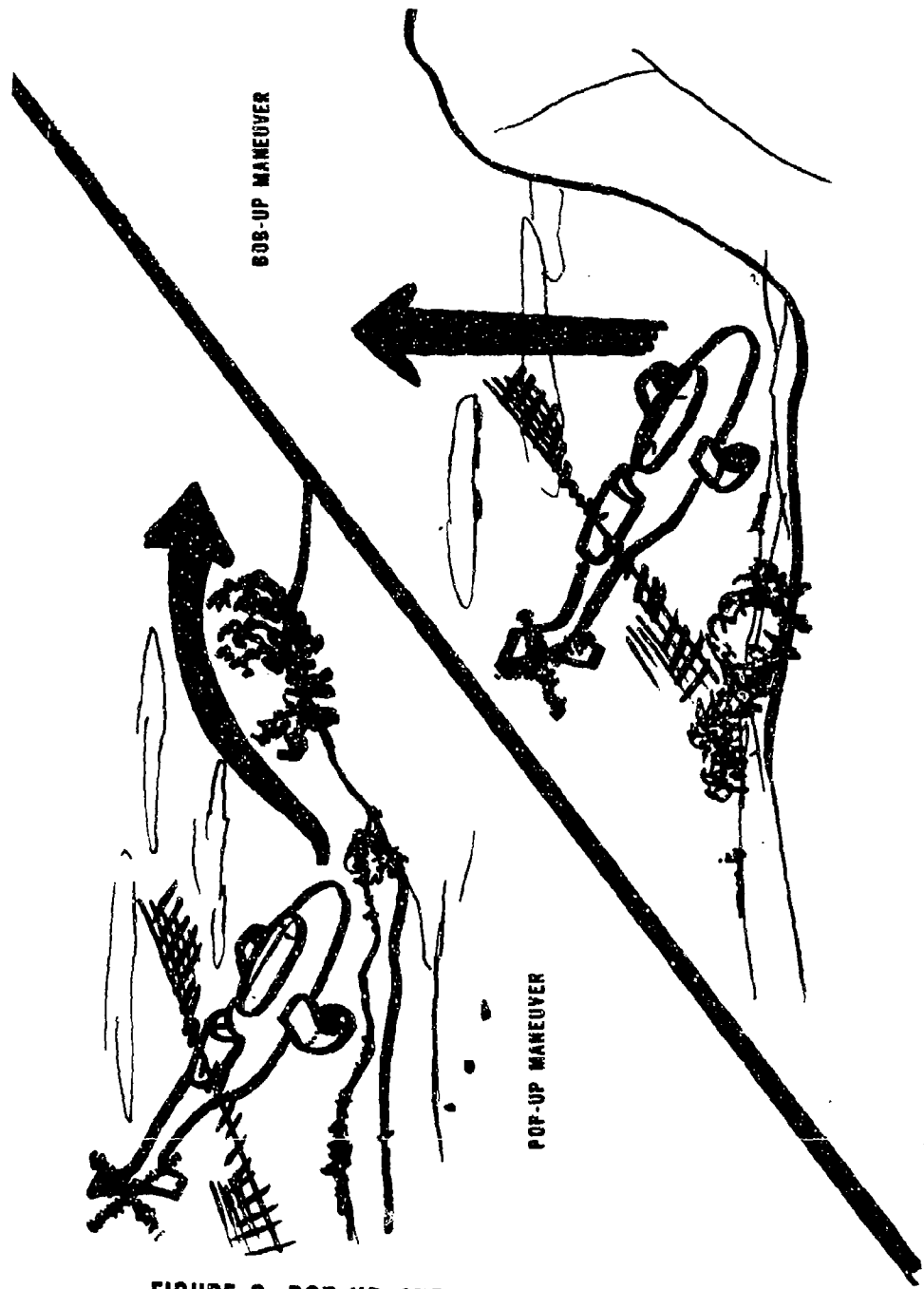

FIGURE C. POP-UP AND BOB-UP MANEUVERS.

31a

95. Target acquisition, tracking, and shifting was evaluated by rolling into a simulated firing dive, both left and right, from approximately 90 KCAS. The evaluation was made with speed brakes extended and retracted and SAS ON and OFF. In all cases, initial target acquisition was easily accomplished (HQRS 3) and required minimal time. Tracking the target as airspeed increased was difficult if coordinated flight was maintained. There was a requirement for the pilot to continuously add right pedal to maintain coordinated flight during the dive. Moderate pilot effort (HQRS 4) was required to maintain coordinated flight during target tracking. With speed brakes retracted coordinated flight during the dive was more difficult as the speed change was faster. With SAS ON, very slight pitch and yaw oscillations were observed which would not seriously degrade the accuracy of fixed weapons. With SAS OFF, these oscillations increased in magnitude and accuracy would be degraded.

96. Rapid target shifts required large cyclic and pedal displacements and control forces were high. With SAS ON, considerable pilot compensation was required to quickly stabilize on a new target in coordinated flight (HQRS 5). The excessive pilot effort required to quickly shift targets and stabilize on a new target in coordinated flight is a shortcoming which should be corrected.

Forward Area Concealment

97. The S-67 helicopter forward area concealment characteristics were evaluated at a 16,200-pound gross weight and an aft cg of 273 inches. Ground maneuverability was investigated by moving the aircraft on paved hardstand, a plowed soil area with a California Bearing Ratio (CBR) that varied from 2.0 to 4.0, and a grass sod area with a CBR of 9.0. External propulsion for the tests was provided by manpower, an aircraft tug, and two standard Army tactical trucks (1/4-ton, M-151 and 1-1/4-ton, M-715). Tail wheel steering was accomplished with a tow bar similar to the universal tow bar. Main gear tow attachment required a nonstandard 20-foot long tow bar. Engines and rotors were stopped during the tests.

98. Movement on paved hardstand required eight men to move the aircraft. One man was in the cockpit to operate the brakes, one steered the movable tail wheel with the tow bar, and six men were required to push the aircraft across the ramp. Handholds or hardpoints were not provided, but the wing leading and trailing edges were satisfactory for "push points". These points were not marked as designated handling points, and critical or vulnerable areas such as antenna bases were not marked so as to prevent damage. Within the scope of this test, ground maneuverability of the S-67 on a paved surface was satisfactory.

99. The aircraft was pushed from the paved surface onto an adjacent grass sod area using an additional four men (ten pushers). The aircraft main gear rolled only 4 feet beyond the hardstand before progress was stopped. The main gear sunk into the sod approximately 1-1/2 inches and the aircraft could not be moved by the ten men. Moving the S-67 aircraft by manpower on grass sod (CBR 9) is unsatisfactory.

100. Two attempts were made to tow the helicopter into a plowed soil area (CBR 2.0 to 4.0). The first attempt employed the 1/4 ton truck towing from the tail wheel. A safety shear pin parted as the aircraft was being moved to the test area. The second attempt was made towing from the front. This test was incomplete in that the aircraft could not be towed through the area surrounding the plowed soil plot. This surrounding area was a firm soil base with 2 to 4 inches of loose dirt on top. Attempts were made to tow the helicopter forward with the 1/4-ton and 1-1/4-ton trucks as well as the aircraft tug which was equipped with wheel chains. None of the vehicles were able to move the helicopter. A maximum pull force of 4200 pounds was measured during these tests. After the attempt by the aircraft tug proved unsuccessful the contractor requested testing be terminated. The helicopter could not be towed across soil with a CBR of 2.0 to 4.0 or equivalent cone index. Landing gear door ground clearance was 9 3/4 inches and gun turret ground clearance was 10 1/4 inches. Within the scope of this test, the ground handling characteristics of the S-67 aircraft over unprepared surfaces is unsatisfactory.

Maintenance Characteristics

101. The maintainability characteristics of the S-67 helicopter were evaluated throughout conduct of the flight test program. Evaluated characteristics included ground support equipment, accessibility, interchangeability, identification, servicing, fasteners, cables/connectors, and safety. Failures and maintenance actions were also recorded. Available contractor technical documents, historical data, and current maintenance procedures were reviewed. This maintainability evaluation was limited by a number of constraints. The minimal number of program flight hours provided limited opportunity to observe component repair and replacements, thus necessitating a qualitative evaluation of the aircraft in lieu of the desired quantitative evaluation. No formal remove/replace tests were conducted, and the team was instructed to perform the evaluation on a noninterference basis. The aircraft was fully instrumented, a condition that resulted in maintenance complications that would not normally exist on an operational aircraft. The observations were

divided into five categories: 1) Airframe/Landing Gear/Fuel System, 2) Engines, 3) Flight Controls/Main Rotor/Power Train, 4) Hydraulics, 5) Instruments/Cockpit/Electronics.

102. Maintenance of the airframe, landing gear, and fuel systems to include inspection and cleaning, was encumbered by the following shortcomings which should be corrected.

a. Lack of work platforms increased maintenance time and effort. This was particularly true in the tail and main rotor sections due to the height above ground of these areas.

b. Lack of quick release access panels.

c. Lack of hinges or other captive devices on existing panels.

d. Landing gear design provides inadequate ground clearance that could result in damage to gear doors and brakes during unimproved area operations.

e. Fuel cells are difficult to remove because prior removal of the FAS hydraulic system is required.

103. Engines maintenance was hampered by inaccessibility to several components or work areas. The following shortcomings, which should be corrected, were identified:

a. Inboard sides of the engines were inaccessible.

b. Accessory components, lines, and hoses congested the area between the engines and the engine deck which resulted in unnecessary chafing of lines and hoses and made cleaning of the engine deck difficult.

104. The following shortcomings, which should be corrected, were identified in the Flight Controls/Main Rotor/Power Train area.

a. The main rotor head fairing precludes rapid and comprehensive visual inspection of the rotor head components to include the droop stops, traps foreign matter during normal operation, and is time consuming to remove.

b. Cleaning of the main rotor and transmission areas resulted in spillage of cleaning fluids into adjacent compartments housing electrical components.

c. The tail rotor drive shaft access panel was awkward to handle.

d. External work platforms were required to perform maintenance/inspection of the tail rotor drive shaft due to the height of the tail boom above the ground.

e. Dirt and moisture collected in the tail rotor drive shaft tunnel.

f. Tail rotor drive shaft links were not interchangeable.

g. Tail rotor gear box sight gages were not visible without removal of the fairing.

105. The following shortcomings, which should be corrected, were identified in the hydraulic system.

a. Servicing, inspecting, or removing and replacing components in the hydraulics compartment was extremely difficult due to the cramped work area.

b. Hydraulic reservoir sight gage windows were too small and poorly lighted.

c. Primary servos did not have protective covers to shield them from the elements.

106. One shortcoming was noted in the Instruments/Cockpit/Electronics area. Cockpit door seals were mounted on the door frame which is the path of ingress/egress to the cockpits. The seals were very susceptible to damage. Location of the cockpit door seals is a shortcoming which should be corrected .

107. The following highly desirable maintenance characteristics were noted on the aircraft.

a. The Blade Inspection Method (BIM), allowed rapid inspection of the spar of the main rotor blades for cracks by checking a sight gage on each blade which indicated the nitrogen pressurization level in the spar.

b. Main rotor blades were pretracked.

c. Tail rotor blades were interchangeable.

d. Cockpit instrument installation allowed rapid, easy access for maintenance.

108. A large portion of the maintenance shortcomings were due to the lack of inspection/work panels and platforms. Overall, the maintainability characteristics of the S-67 helicopter are satisfactory.

CONCLUSIONS

GENERAL

109. The following conclusions were reached upon completion of testing.

a. The following highly desirable features were identified:

- (1) Deadbeat short-period gust response characteristics (HQRS 2) (paras 53 and 54).
- (2) Radio transmitter selector switch on collective (para 72a).
- (3) Start-fuel interrupter button (para 72b).
- (4) Digitally tuned ADF radio (para 72c).
- (5) Emergency egress capability from either cockpit (para 72d).
- (6) Comfortable cockpit seats (para 72e).
- (7) Radar altimeter (para 72f).
- (8) Rotor brake (para 80).
- (9) Extremely low vibration levels (para 86).
- (10) Speed brakes (para 94).

b. Thirty-nine shortcomings were noted.

Shortcomings Affecting Mission Accomplishment

110. Correction of the following shortcomings is desirable. These shortcomings are listed in the order that they appear in the text and not necessarily in the order to importance.

- a. Excessive longitudinal control system friction (HQRS 5) (paras 22 and 24).
- b. Excessive longitudinal centering error in forward flight (HQRS 4) (para 25).
- c. Large pitch attitude change from ground attitude to stabilized hover (HQRS 4) (para 29).
- d. Excessive nose high attitude during running landings (HQRS 4) (para 31).

- e. Stick jump associated with taxi detent engagement (HQRS 5) (para 32).
- f. Torque surges during IGE hover (HQRS 6) (para 33).
- g. Undamped lateral oscillation at approximately 15 KTAS in left sideward flight (para 35).
- h. Excessive pilot workload required to maintain heading and altitude during maximum lateral acceleration (HQRS 4) (para 36).
- i. Excessive lateral trim shift with airspeed (HQRS 4) (para 39).
- j. Objectionable directional control trim changes with speed (HQRS 5) (para 40).
- k. Excessive trim shift with speed brake extension and retraction (HQRS 5) (para 42).
- l. Weak return to longitudinal trim characteristics (HQRS 5) (para 44).
- m. Neutral to unstable long term response (HQRS 5) (para 56).
- n. Excessive pitch rate response delay (HQRS 5) (para 58).
- o. Lack of adequate single-engine failure warning during low power descents (HQRS 5) (para 66).
- p. Location of the caution/advisory panel (para 73a).
- q. Lack of external cockpit emergency access handles (para 73b).
- r. Lack of steps and handholds for cockpit ingress/egress (para 73c).
- s. Canopy door closure could not be accomplished without assistance (para 73d).
- t. Lack of full flight controls in the copilot/gunner cockpit (para 73.e).
- u. Unnatural and uncomfortable arm position at high collective control positions (para 73f).
- v. Activation of master caution system during normal landing gear retraction (para 73g).
- w. Unsatisfactory location of the radio/intercom press-to-talk switch (para 73h).

- x. Unsatisfactory location of navigation and communication radio control panels (para 73i).
- y. Unsatisfactory location of parking brake handle (para 73j).
- z. Pilot's forward field-of-view mildly distorted by curved canopy (para 73k).
- aa. Pilot's forward field-of-view restricted by canopy support structure (para 73l).
- ab. Lack of equipment storage compartments in either cockpit (para 73m).
- ac. Lack of rotor speed warning system (para 73n).
- ad. Lack of generator output indication (para 73o).
- ae. Unsatisfactory display of information on back-lighted switches (para 73p).
- af. Inadequate leg room for a tall pilot (para 73q).
- ag. Unsatisfactory location of seat belt attachment hardware (para 73r).
- ah. Failure of rotor brake to disengage (para 78).
- ai. Excessive roll tendency during ground turns (para 79).
- aj. Excessive engine torque splits with collective control changes (para 83).
- ak. Excessive 5/rev vertical vibration at 39 KCAS (para 86).
- al. Inability to maintain constant altitude and airspeed while maneuvering to the limit load factor (HQRS 5) (para 93).
- am. Inability to shift to and stabilize on a new target (HQRS 5) (para 96).

Specification Compliance

111. Within the scope of this test, the S-67 helicopter failed to meet the following requirements of the military specification, MIL-H-8501A:

- a. Paragraph 3.2.3 - Lack of positive longitudinal self-centering (paras 22 and 25).
- b. Paragraph 3.2.7 - Longitudinal control friction forces of 2.25 pounds exceeded the 1.5-pound limit by 0.75 pounds (50 percent) (paras 22 and 24).
- c. Paragraph 3.3.10 - Lack of positive directional control self-centering (para 26).
- d. Paragraph 3.4.2 - Collective control friction forces of 4.2 pounds in the center 80 percent of control movement exceeded the 3-pound requirement by 1.2 pounds (40 percent) (para 27).
- e. Paragraph 3.4.2 - Collective control friction forces of 16 pounds at the extremities exceeded the 7-pound limit by 9 pounds (129 percent) (para 27).
- f. Paragraph 3.2.10 - Static longitudinal control position and force gradients were essentially neutral at all airspeeds tested (para 44).
- g. Paragraph 3.2.11.2 - Normal acceleration during nose-down motion following an aft pulse exceeded the 0.25g limit by 0.05g (17 percent) (para 53).
- h. Paragraph 3.2.13 - Aft longitudinal control power was less than the required 1.7 degrees per inch of control travel in 1 second by 0.2 degrees (11 percent) (para 58).
- i. Paragraph 3.3.18 - Left lateral control power less than the required 1.0 degree per inch of control travel in 1/2 second by 0.3 degrees (30 percent) (para 59).
- j. Paragraph 3.3.19 - Directional rate damping less than the 62,472 ft-lb/rad/sec requirement by 46,270 ft-lb/rad/sec (75 percent) (para 60).
- k. Paragraph 3.7.1(b) - Lateral vibration at the gunner's station at 199 KCAS exceeded the 0.20g limit by 0.11g (55 percent) (para 86).
- l. Paragraph 3.7.1(b) - Vertical vibration at the pilot station at 39 KCAS exceeded the 0.15g limit by 0.09g (60 percent) (para 86).

RECOMMENDATION

112. The shortcomings, correction of which is desirable, should be corrected.

APPENDIX A. REFERENCES

1. Letter, AVSCOM, subject: Attack Helicopter Evaluation of the S-67 Helicopter, Project No. 72-09, 9 March 1972.
2. Military Specification, MIL-H-8501A, *Helicopter Flying and Ground Handling Qualities; General Requirements For*, 7 September 1967, with Amendment 1, 3 April 1962.
3. S-67 Blackhawk Pilot's Checklist, 1 May 1972.
4. Letter, AVSCOM, AMSAV-EF, subject: Safety of Flight Release for the Sikorsky S-67 Blackhawk Flight Evaluation, 23 May 1972.
5. Message, AVSCOM, AMSAV-EF 06-01, subject: Safety of Flight Release for the Sikorsky S-67 Blackhawk Flight Evaluation, 011610Z June 1972.
6. Letter, AVSCOM, AMSAV-EF, subject: Safety of Flight Release for the Sikorsky S-67 Blackhawk Flight Evaluation, 9 June 1972.
7. Flight Test Manual, Naval Air Test Center, FTM No. 101, *Helicopter Stability and control*, 10 June 1968.
8. Flight Test Manual, Naval Air Test Center, FTM No. 102, *Helicopter Performance Testing*, 28 June 1968.
9. Letter, General Electric, subject: T58-5/5A1 Engine Inlet on S-67 Blackhawk, 25 April 1972.
10. Specification E 1096-A, Model Specification Engine, Aircraft, Turboshaft: T58-GE-5, General Electric Company, 4 January 1966.
11. Military Standard, MIL-STD-810B, *Environmental Test Methods*, 15 June 1967.

APPENDIX B. AIRCRAFT DESCRIPTION

GENERAL

The S-67 aircraft is a high-speed derivative of the Sikorsky S-61 (SH-3D) helicopter. The narrow, low-drag airframe was designed to meet the high speed requirements of the attack mission. The cockpit is arranged in tandem with the copilot-gunner in the forward seat and the pilot in the aft, elevated seat. The pilot has visibility down to minus 15 degrees over the nose. Two T58-GE-5 engines are mounted in the main rotor pylon above the fuselage center section.

The main rotor hub, tail rotor, drive system, and transmission systems are all SH-3D dynamic components. The main rotor has five S-61F blades each with a twist of -4 degrees. The 22-inch blade tips are swept back 20 degrees to delay tip Mach number effects. A main rotor bifilar pendulum type absorber tuned to counteract inplane rotor loads was installed on top of the main rotor head. The rotor control system uses SH-3D components and the Ch-54 automatic flight control system. The fixed-wing type control surfaces include the stabilator, a vertical stabilizer, and sponsons with stub wings. The vertical stabilizer is fixed. The tail wheel is attached to the base of the lower, ventral fin, and the retractable main landing gear is housed in the wing sponsons. Wings are attached to the sponsons for additional lift and attachment points for armament. The wing panels have speed brakes to control dive angle and increase deceleration capability.

Principal dimensions and general data for the S-67 aircraft are as follows:

MAIN ROTOR

Diameter	62 feet
Normal tip speed (104 percent N_R)	686 ft/sec
Disc area	3019 ft ²
Solidity	0.0781
Number of blades	5
Blade chord	1.52 ft
Blade twist	- 4 degrees

Airfoil section
Articulation
Tip sweep

NACA 0012 MOD
Full Flapping & Lagging
20 degrees

TAIL ROTOR

Diameter	10 ft 7 in.
Tip speed	700 ft/sec
Disc area	83.9 ft ²
Solidity	0.1885
Number of blades	5
Blade chord	0.612 ft
Blade twist	0 degree
Airfoil section	NACA 0012 MOD
Pitch flap coupling	45 degrees

FUSELAGE

Overall length	64 ft 1 in.
Overall height	16 ft 3 in.
Overall width	27 ft 4 in.
Wheel tread	7 ft
Wheel base	36 ft 2 in.

STABILATOR

Root chord	4 ft 2 in.
Tip chord	2 ft
Taper ratio	0.48
Area	50 ft ²
Span	15 ft 6 in.
Aspect ratio	4.8
Airfoil (root)	NACA 0015
Airfoil (tip)	NACA 0012

VERTICAL FIN

Root chord	7 ft 6 in.
Tip chord (upper)	2 ft 10 in.
Tip chord (lower)	3 ft 9 in.
Taper ratio (upper)	0.62
Taper ratio (lower)	0.5
Total area	68.7 ft ²
Aspect ratio	2.65
Airfoil section	NACA 4415

WING

Root chord	4ft 6 in.
Tip chord	1 ft 11.5 in.
Overall span	27 ft 4 in.
Total exposed area	58 ft ²
Incidence	8 degree
Dihedral	10 degrees
Quarter chord sweep	10 degree 45 min
Taper ratio (exposed)	0.44
Aspect ratio	8.0
Airfoil section, root	NACA 4415
Airfoil section, tip	NACA 4412

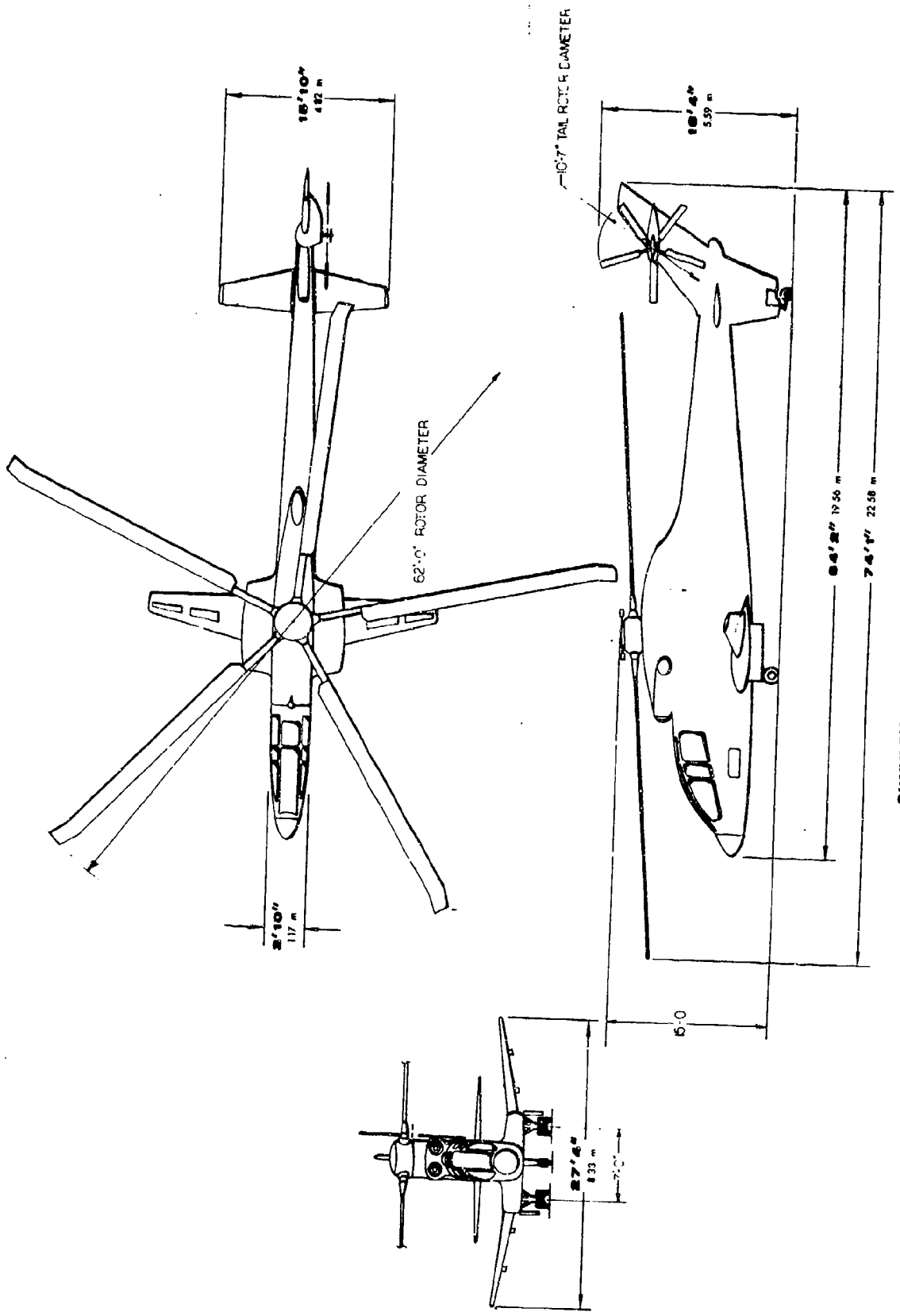

SIKORSKY S-67

APPENDIX C. FLIGHT CONTROL DESCRIPTION

GENERAL

1. Longitudinal, lateral, and directional flight control are provided by conventional cyclic, collective and pedal controls (fig. 1). Dual, interconnected flight controls with identical throw limits are provided in each cockpit. Conventional cyclic controls in each cockpit have a control throw range of 11.3 inches longitudinally and 11.8 inches laterally. Collective pitch controls, with a total travel of 9.8 inches, are identical except for incorporation of a twist grip friction adjustment feature on the pilot's collective control. Directional control pedals have a total travel of 6.5 inches and are adjustable only in the pilot's (aft) cockpit. Toe brakes are operable only from the pilot's station. The stabilator, a moveable horizontal stabilizer located at the base of the vertical stabilizer above the ventral fin, is coupled to the longitudinal movement of the cyclic control through push-pull rods, and a two stage hydraulic servo. Stabilator movement is linear with fore/aft cyclic control motion in an angle of incidence range of + 10.5 degrees to -16.3 degrees. Electro-hydraulically actuated speed brakes on the upper and lower surfaces of both wings are controllable with a two position switch located on the collective control stick in each cockpit.

CONTROL LINKAGES

2. The conventional controls (collective pitch, cyclic, and directional control pedals) are connected to a four channel electro-hydraulic auxiliary servo located aft of the pilot. The electro-hydraulic valves sum the pilot's mechanical signals with electrical Stability Augmentation System (SAS) inputs. The four auxiliary servo output motions are mechanically combined in a mixer assembly to provide appropriate signals to move three primary servos. In addition to combining control motions, the mixer provides cross coupling for other functions. These functions are: (a) collective to directional coupling to compensate automatically for power changes and, (b) collective to lateral coupling to offset the tail rotor thrust produced by the collective to directional coupling. The auxiliary servo pitch output feeds through unchanged to position the stabilator.

S-67 FLIGHT CONTROLS SYSTEM

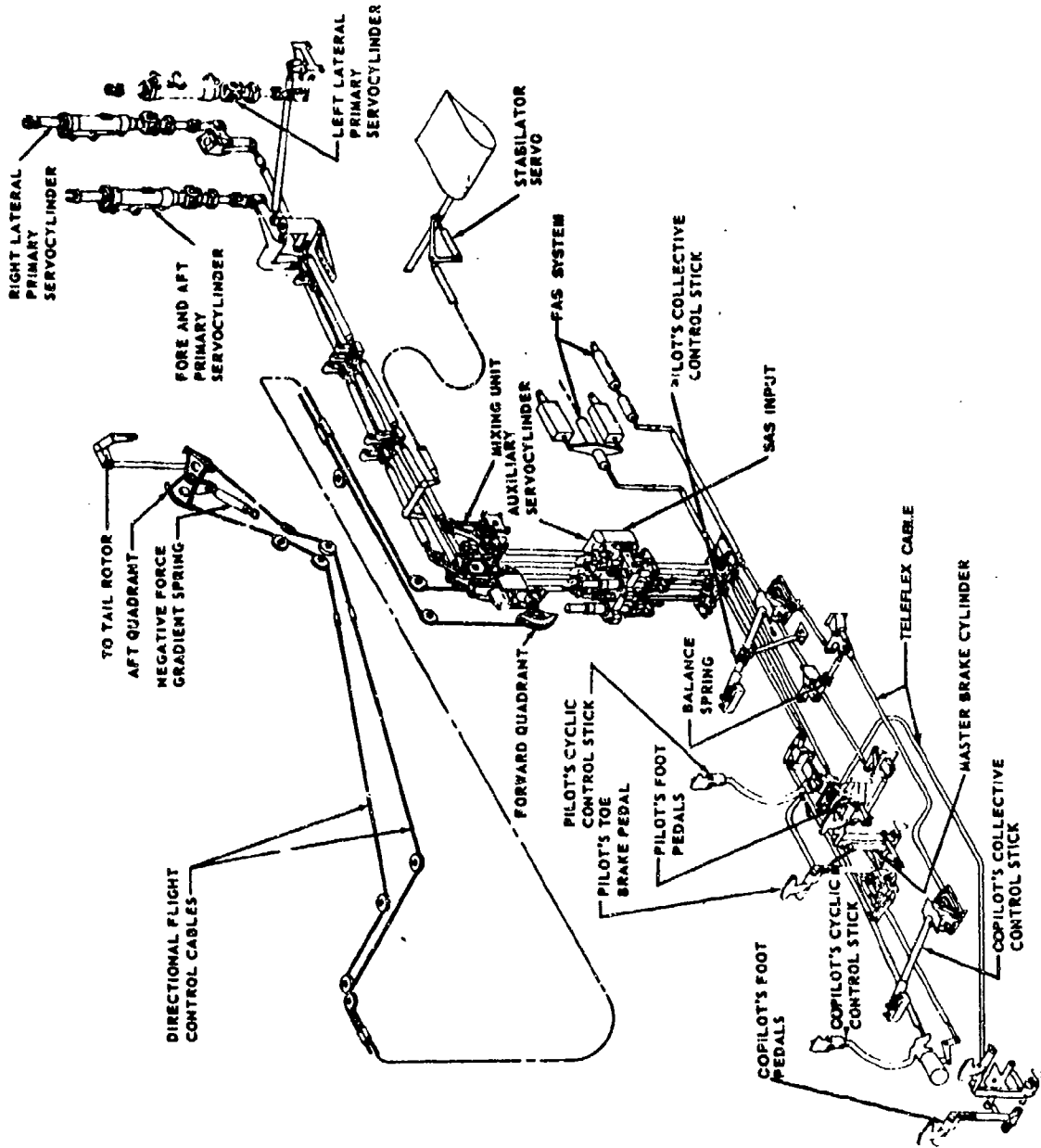

FIGURE 1. FLIGHT CONTROL GENERAL LAYOUT

All control motions from the auxiliary servo are transmitted via push rods and cranks except for cables which are used for the tail rotor. Normally, the primary servos position the main rotor and oppose return loads. A negative force gradient spring at the tail rotor quadrant opposes aerodynamic loads generated by the tail rotor. A tandem servo positions and opposes those loads generated by the stabilator. The auxiliary servo mixer, intermediate control rods and tail rotor cables are designed to accept flight loads.

SERVO CYLINDERS

3. The auxiliary servo has the following functions:

- (a) Overcome system friction to the primary and stabilator servos and the tail rotor controls.
- (b) Introduce limited authority pitch, roll, and yaw SAS signals into the control system without creating force or motion feedback to the cockpit controls.
- (c) Provide lateral control trim through an electro-hydraulic actuator in series with a gradient spring.
- (d) Provide a directional pedal damper to limit the rate of application of pedal motion.
- (e) Oppose main rotor loads with the primary servo inoperative.
- (f) Provide a direct mechanical linkage to the primary servos, tail rotor and stabilator systems when the auxiliary servo is not powered.

The design permits introduction of electrical SAS signals to cause a proportionate piston displacement and accommodates SAS hardover without stick feed-back forces.

The primary servo system consists of three single-stage, power operated actuators which are trunnion mounted to the main transmission. The primary servos hydraulically oppose main rotor steady and vibratory loads. The primary servo system can be turned off hydraulically. When this occurs, the auxiliary servo opposes rotor system loads. The stabilator servo is a two stage, power operated servo which always opposes stabilator loads. The stabilator, auxiliary, and primary systems are interlocked electrically to insure that at least one stage of boost is available to oppose main rotor and stabilator loads.

STABILITY AUGMENTATION SYSTEM

4. In addition to the servo boosted control system, two automatic systems affect the handling qualities under all flight conditions. One of these systems is the SAS which provides short term damping in pitch and yaw only.

The pitch axis SAS incorporates a rate gyro to measure body pitch rate and is filtered to eliminate steady state signals that occur during turns. This signal is also filtered to provide an approximation of pitch attitude. The sum of these signals is fed to the pitch axis auxiliary servo in addition to the pilot's input. The pitch axis servo output is fed mechanically to the primary servos and to the stabilator (fig. 2).

The yaw axis SAS (fig. 3) uses a rate gyro to measure turn rate. The rate gyro signal is filtered to eliminate steady state signals during turns above 80 KIAS. Below this speed, the signal is pure rate. The SAS yaw input signal is summed with the pilot's input at the auxiliary yaw servo and mechanically changes the collective pitch of the tail rotor blades.

FEEL AUGMENTATION SYSTEM

5. The second automatic system employed in the control system is the Feel Augmentation System (FAS), an adaptive mechanism that provides the pilot with a constant longitudinal stick force per g of approximately 7.5 pounds per g at airspeeds above 80 KIAS. Below 80 KIAS, the control forces are reduced linearly with airspeed to zero at 40 KIAS. In the airspeed regime from 40 to 80 KIAS, the pitch FAS inputs are small in magnitude and are masked by the control system friction. Below 40 KIAS forward flight and during hover, the only control force present in the cyclic control system is the inherent system friction.

Figure 4 presents a block diagram of the pitch channel FAS. The FAS is based on the measurement of aircraft load factor in a manner that is sensitive only to aircraft pitch rates. The technique is to calculate the acceleration action on the helicopter as its flight path describes an arc in space. In coordinated flight this is achieved by multiplying airspeed and body pitch rate measurements. Since a pitch rate gyroscope detects the pitch rate for any aircraft attitude, the technique works during all maneuvers. The produce yields the primary feel cue during maneuvering flight.

5-67 STABILITY AUGMENTATION SYSTEM (SAS)

PITCH

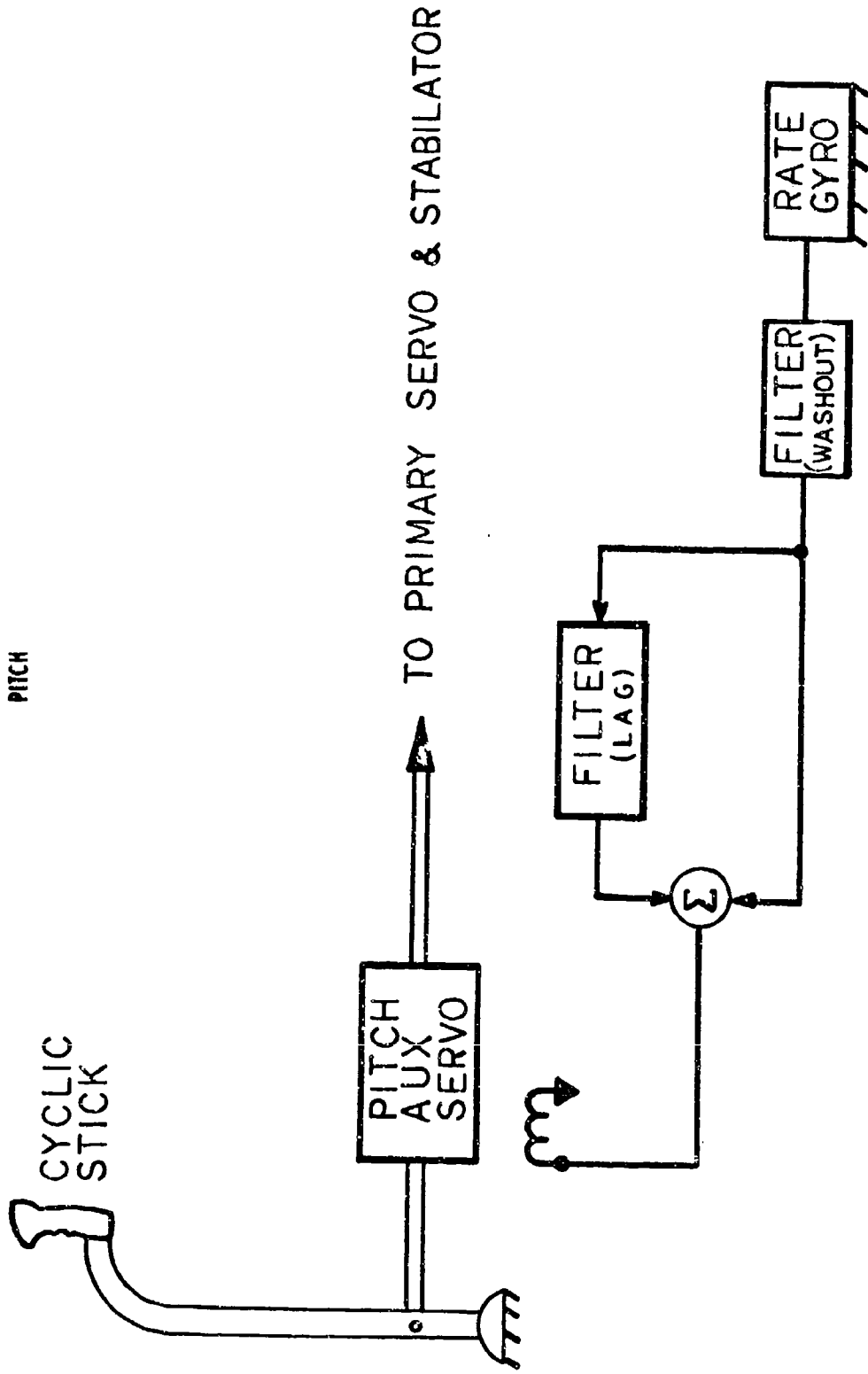

FIGURE 2. STABILITY AUGMENTATION SYSTEM (PITCH)

S-67 STABILITY AUGMENTATION SYSTEM (SAS)

YAW

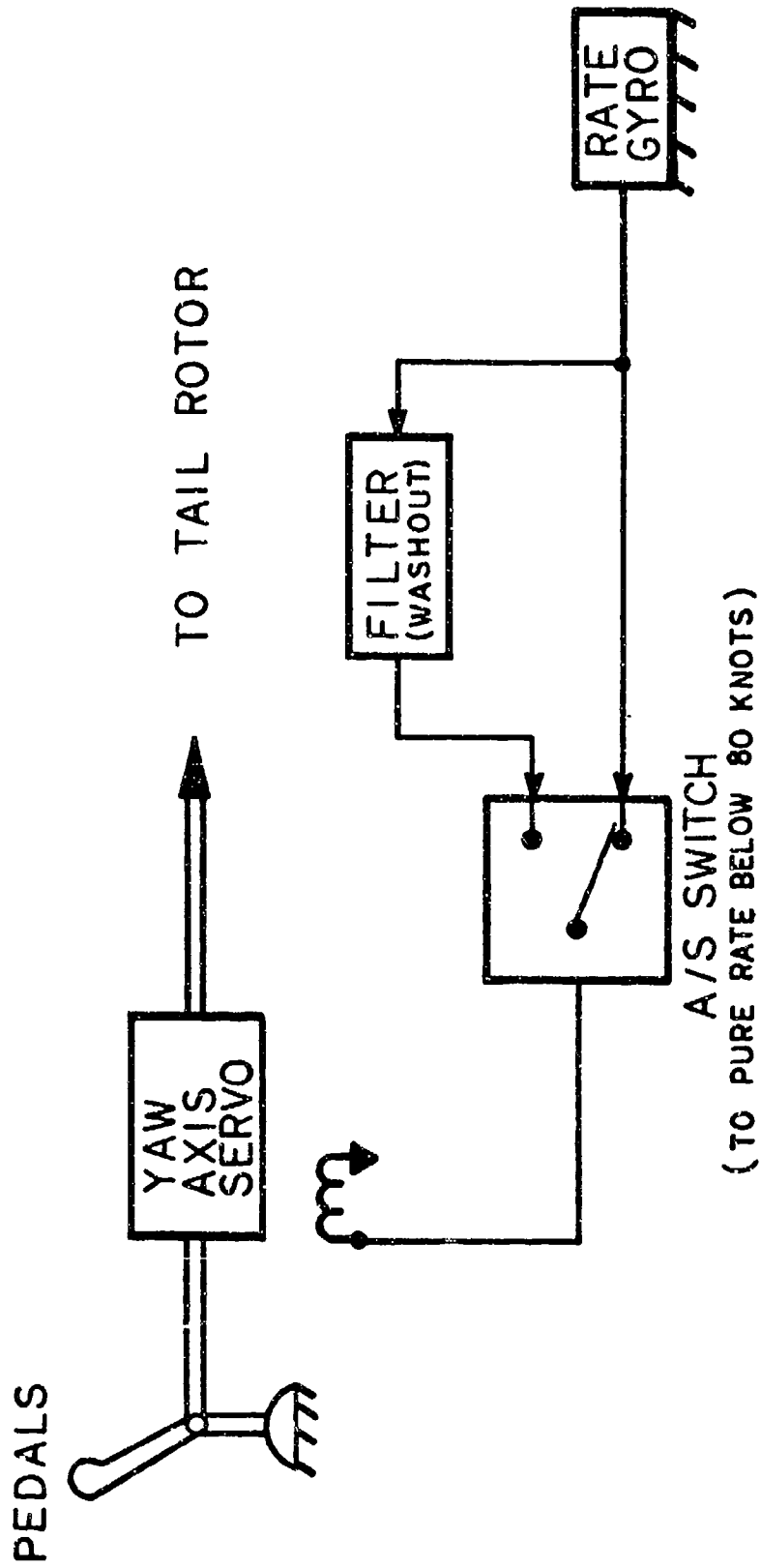

FIGURE 3. STABILITY AUGMENTATION SYSTEM (YAW)

5-67 FEEL AUGMENTATION SYSTEM (FAS)
PITCH

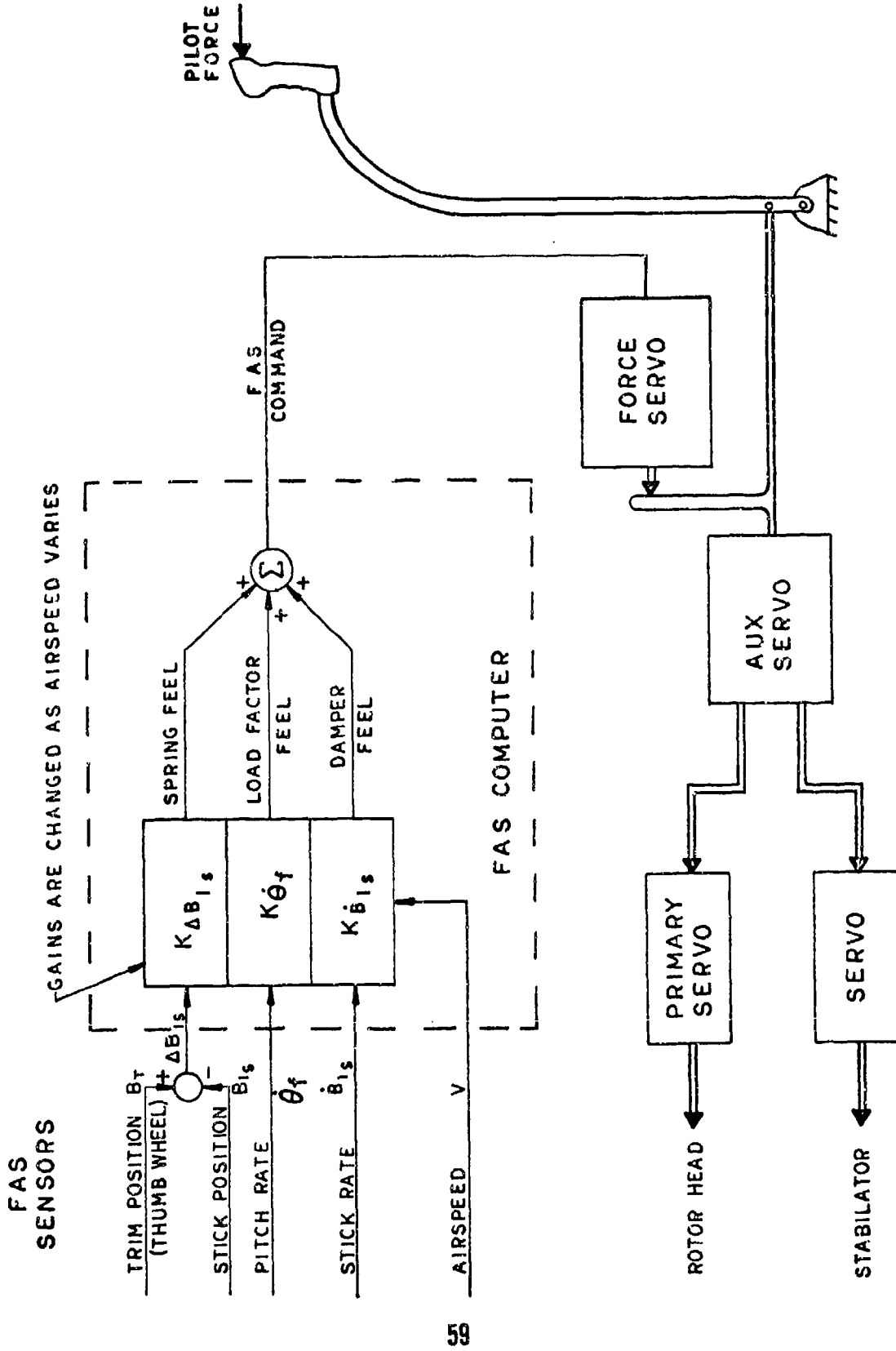

FIGURE 4. FEEL AUGMENTATION SYSTEM (PITCH)

Two additional signals form a part of the FAS force exerted on the pilot's hand through the cyclic pitch control. One is a spring force generated by a signal proportional to the difference between the stick trim position ($B\delta$) and the actual control position ($K_f \theta_f$).

No breakout is associated with this electrical spring, except during taxi. The spring constant, (K_{B1s}) is programmed to change with

airspeed. This signal is used to provide a trim capability and to improve stick-free stability. The other FAS signal is a damper force proportional to the rate of pitch control stick displacement. The damper gain (K_{B1s}) is also programmed with airspeed. The manner in

which the three FAS signals are programmed as a function of airspeed determines the cyclic pitch control feel that the pilot experiences during maneuvers.

An amplifier sums the three FAS signals and applies an electrical current to a hydraulic servo valve whose differential pressure output is proportional to the current. The pressure difference acts across a piston to create the FAS force that the pilot feels during maneuvers. This force is exerted on the pitch control rod at the input side of the auxiliary servo.

An integral part of the pitch FAS is the cyclic control stick trim system. The desired pitch trim position is commanded by the position of a trim wheel mounted on the side of the cyclic grip so that forces caused by an out-of-trim condition can be reduced to zero. Each signal path of the pitch FAS described above has a matching path to provide a fault detection criterion.

In the roll axis, FAS forces result from purely mechanical devices and the control force depends upon rate and displacement of lateral cyclic (fig. 5). The damper provides a feel proportional to the rate of stick displacement. A spring with approximately one pound breakout provides a force proportional to displacement with sufficient centering action to trim the control. The auxiliary servo trim valve is used in conjunction with the roll trim thumb wheel to change the lateral stick trim reference point. The damper and spring have been sized to produce an acceptable level of control harmony.

5-67 FEEL AUGMENTATION SYSTEM (FAS)

ROLL

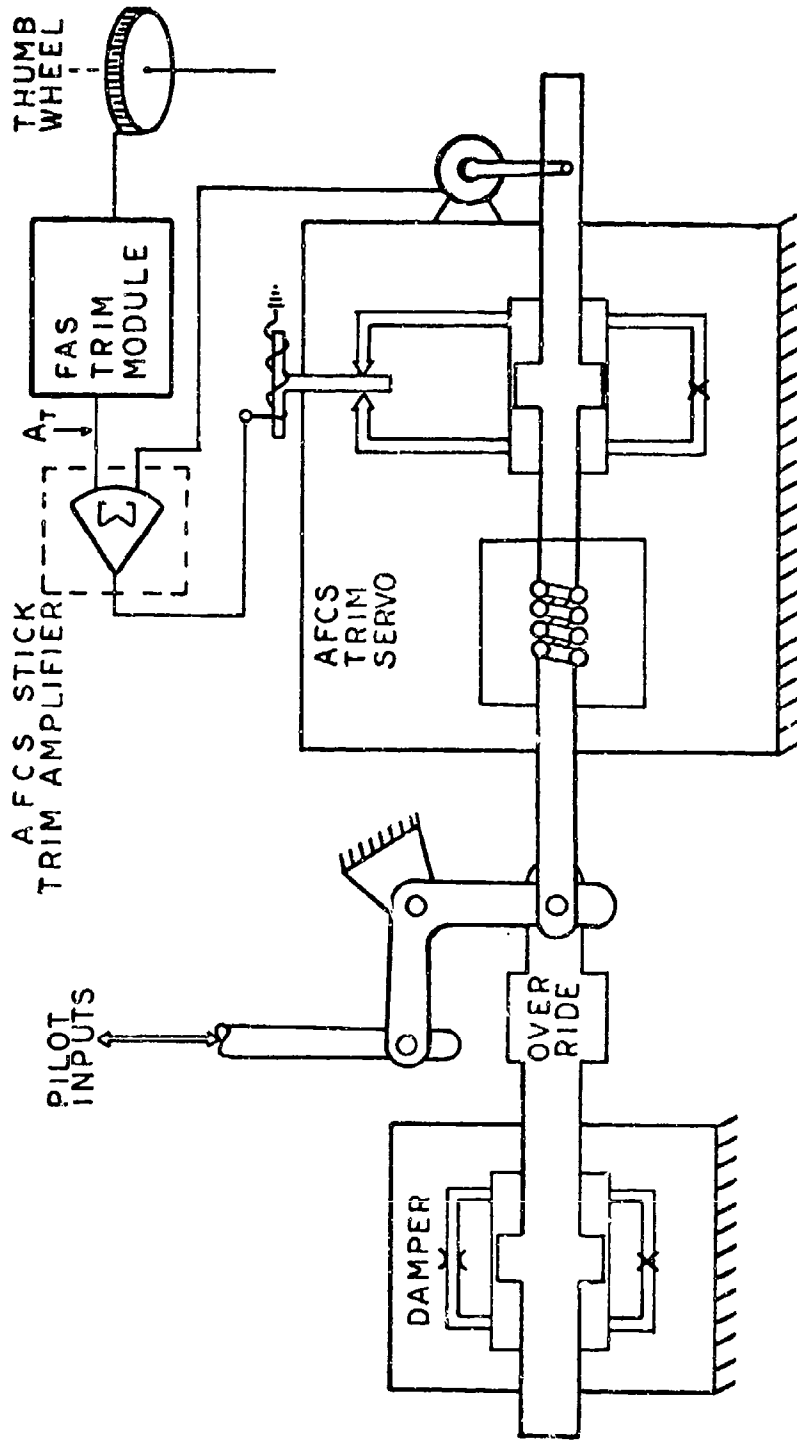

FIGURE 5. FEEL AUGMENTATION SYSTEM (ROLL)

In the S-67 helicopter, a collective control shaker exerts a vibratory force cue on the collective control. It provides the pilot with a feel for rotor control loads without requiring continuous attention to the cruise guide indicator. A functional block diagram of the device is shown in figure 6. The control shaker is a constant frequency device that varies the amplitude of vibration in response to control loads. The frequency of vibration is approximately 25 hz in the plane that is perpendicular to normal collective motion, so that the vibrations are not transmitted to the control system. The shaping network can be adjusted to initiate control vibration at the desired rotor control load level and also to increase the vibration amplitude with increasing rotor system control load.

With the collective control shaker, the pilot enters a maneuver without having to watch the cruise guide indicator. If control loads increase above the normal operating level, the control begins to vibrate. This operating level is not the rotor control load limit, but is a well defined value above which further collective or cyclic control inputs would cause the control loads to increase rapidly. The intensity of vibration indicates the level of control loads. FAS fault detection was designed into the pitch channel of the FAS to detect any component failure that would cause either a large or a rapid control displacement. After a FAS shutdown, the FAS actuator becomes a passive hydraulic damper. This feature enables smooth transition from FAS "on" to FAS "off". The pitch FAS consists of dual sensors, computers, and actuators, as shown in figure 7. The output of the twin FAS actuators are compared by a mechanical yoke for fault detection, as shown in figure 8. The yoke transmits the sum of the FAS forces to the control rod as control feel, but a force mismatch between the twin actuators exceeding the detent mechanism level will cause the yoke to tilt, triggering the shutdown mechanism. The detent mechanism level is 20 pounds at the yoke, or 5 percent of the maximum force capability of the actuator. Yoke tilt angle is monitored by dual synchros, and fault detection occurs when the yoke angle exceeds 3 degrees. Transition from the normal operating mode to the shutdown mode occurs rapidly and before the control can move.

The roll channel FAS uses the existing roll trim servo valve, which is rendered safe by a rate limitation. The added hydraulic damper is a passive device, so fault detection is not required. Protection from a jammed damper is provided by an override spring capsule with an override force of 15 pounds. Since the collective channel FAS vibrations are not transmitted to the helicopter control system, no control inputs can result from failure of the collective FAS.

5-67 FEEL AUGMENTATION SYSTEM (FAS)
COLLECTIVE

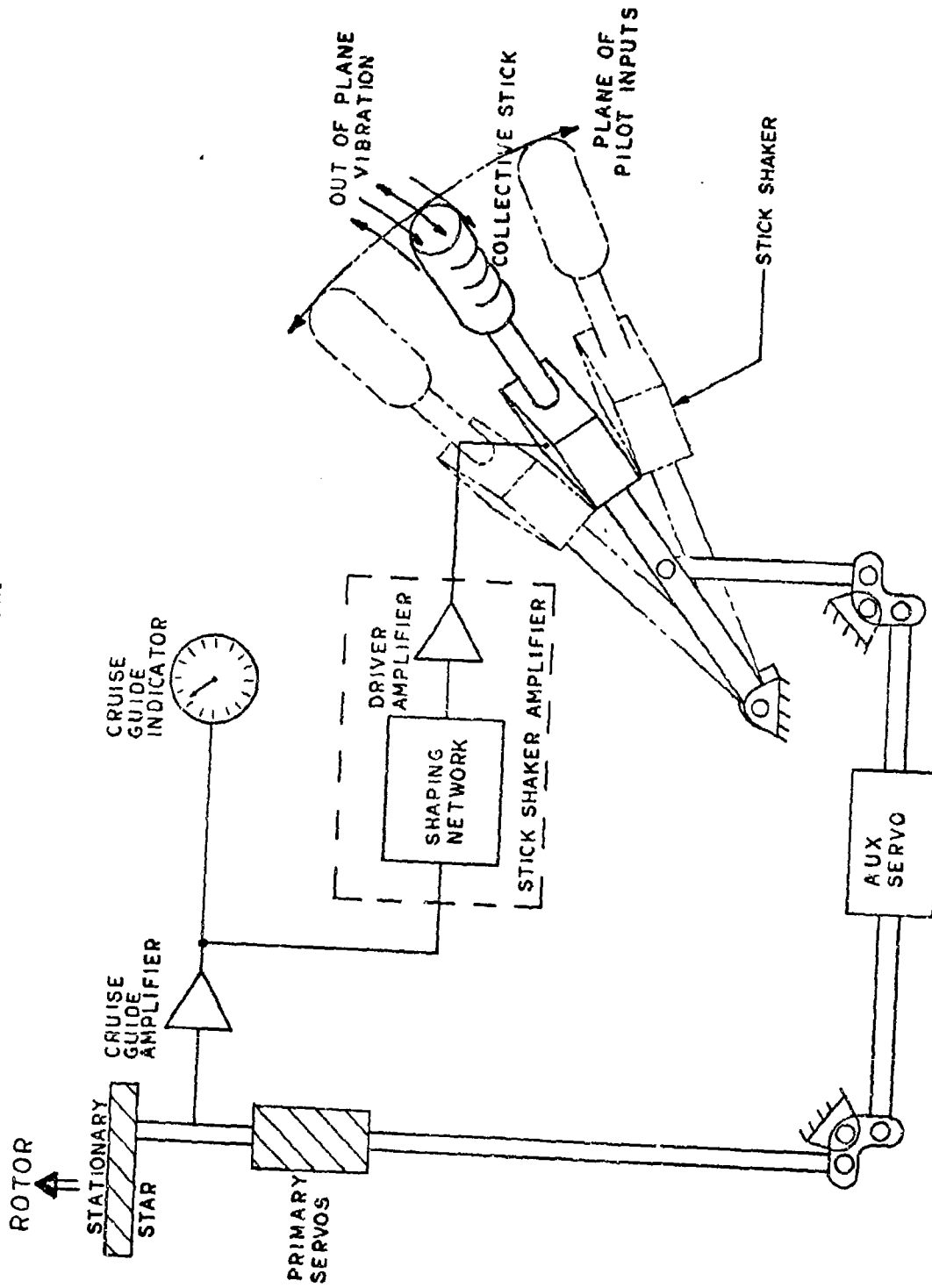

FIGURE 6. FEEL AUGMENTATION SYSTEM (COLLECTIVE)

5-67 FEEL AUGMENTATION SYSTEM REDUNDANCY
PITCH

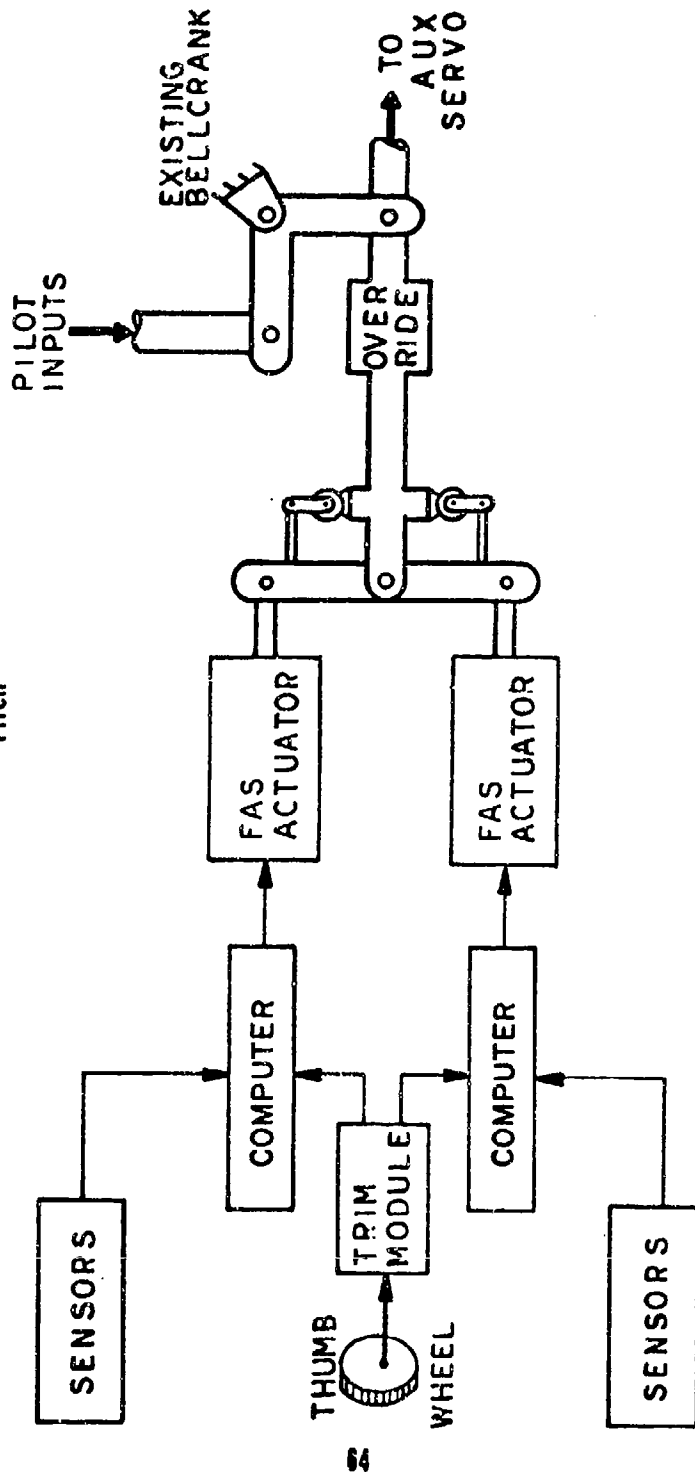

FIGURE 7. FEEL AUGMENTATION SYSTEM REDUNDANCY (PITCH)

5-67 FAS FAULT DETECTION AND SHUTDOWN SYSTEM

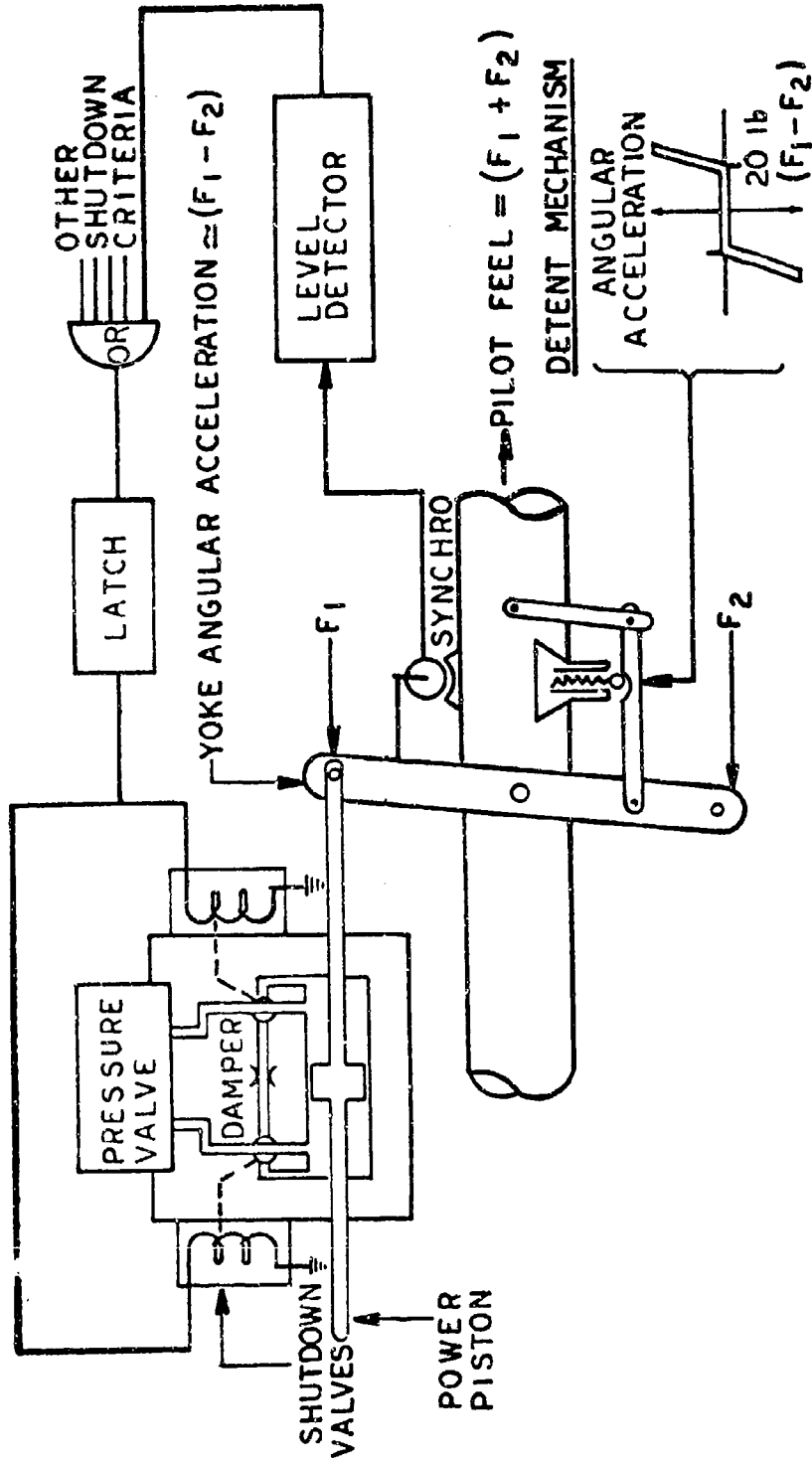

FIGURE 8. FAS FAULT DETECTION AND SHUTDOWN SYSTEM

APPENDIX D. PHOTOGRAPHS

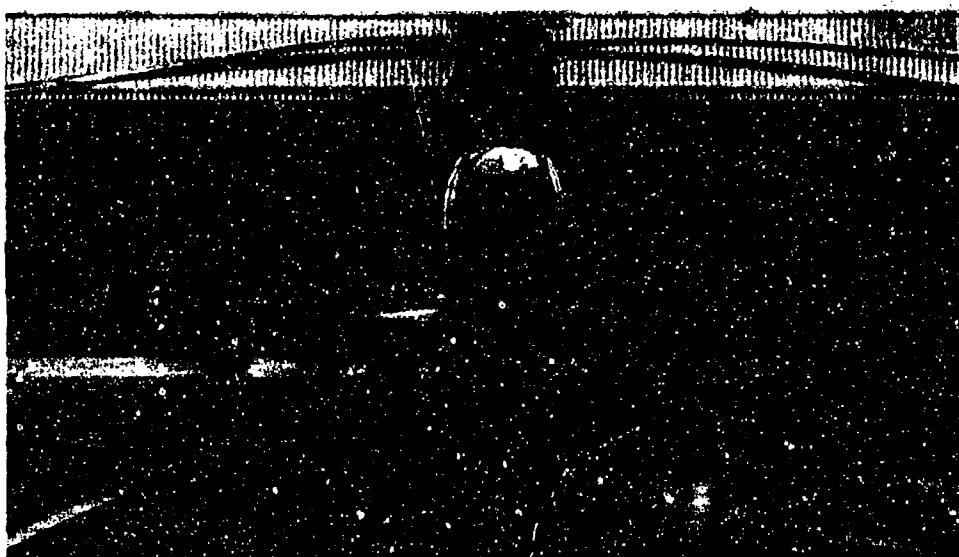

PHOTO 1. FRONT VIEW, TOW CONFIGURATION

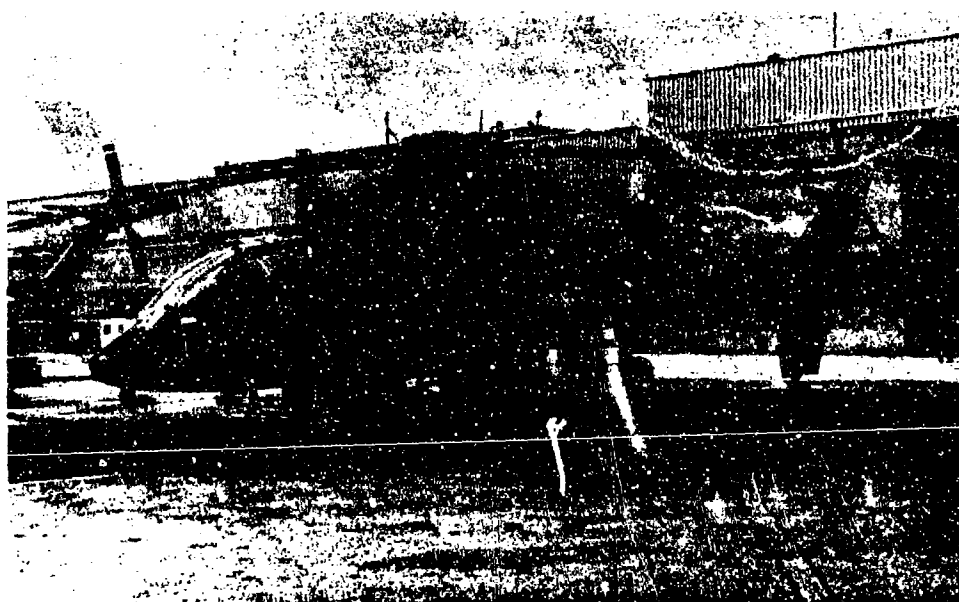

PHOTO 2. LEFT FRONT VIEW, EXTERNAL STORES CONFIGURATION

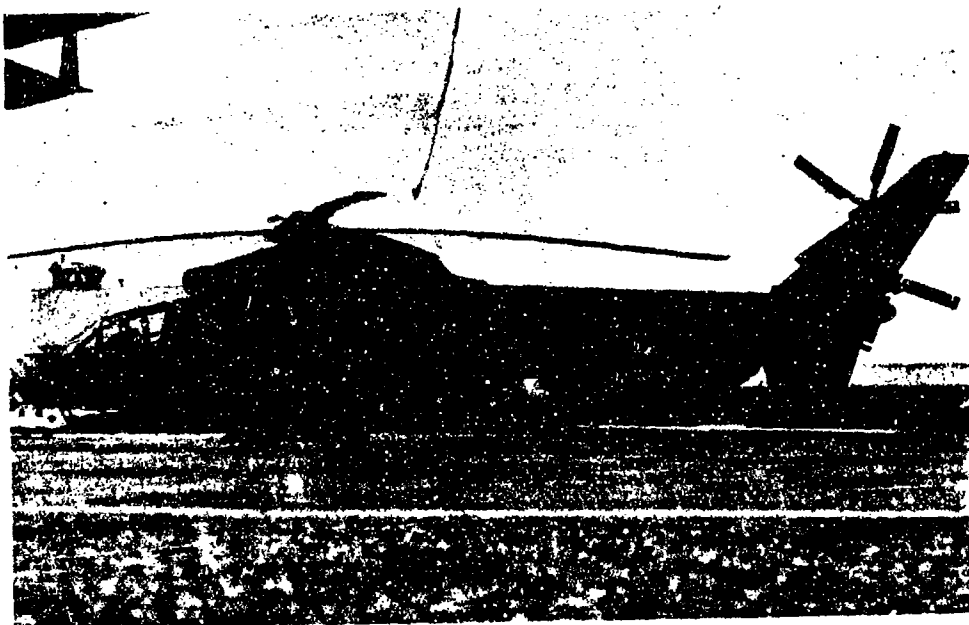

PHOTO 3. LEFT SIDE VIEW, TOW CONFIGURATION

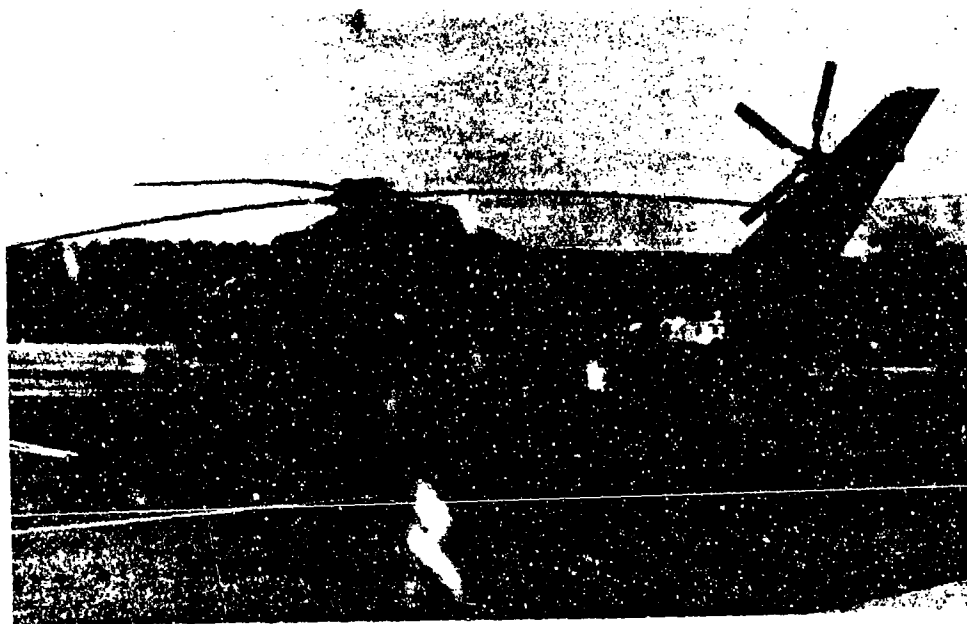

PHOTO 4. LEFT REAR VIEW, TOW CONFIGURATION

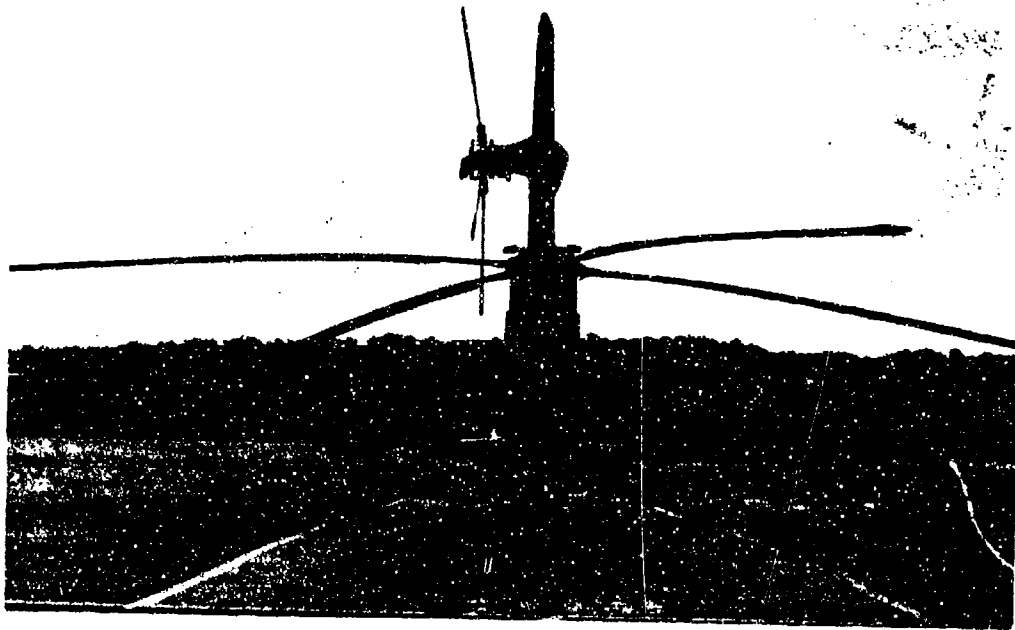

PHOTO 5. REAR VIEW, CLEAN CONFIGURATION

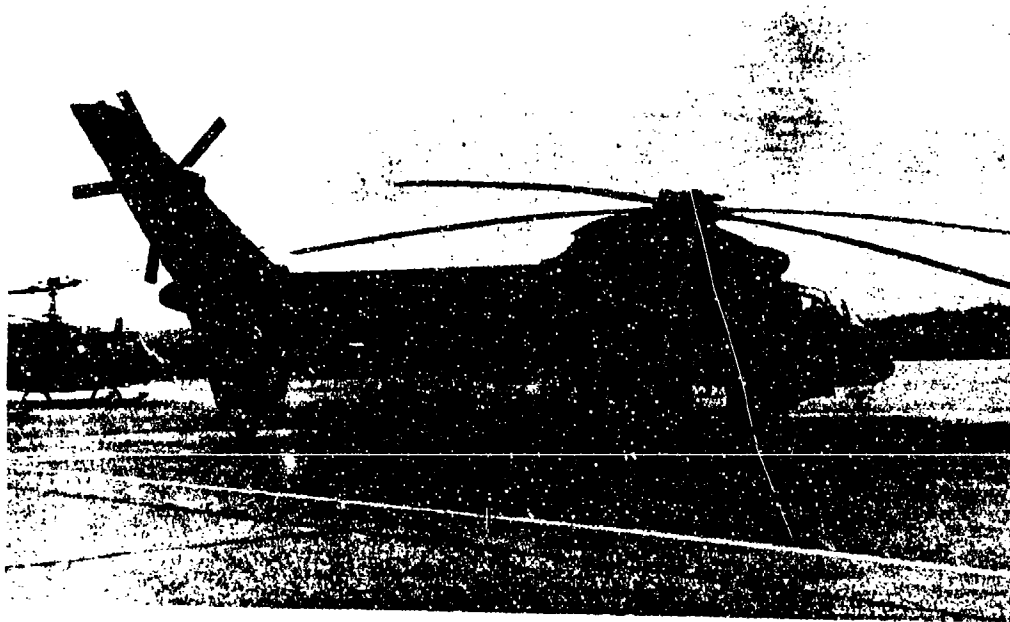

PHOTO 6. RIGHT REAR VIEW, TOW CONFIGURATION

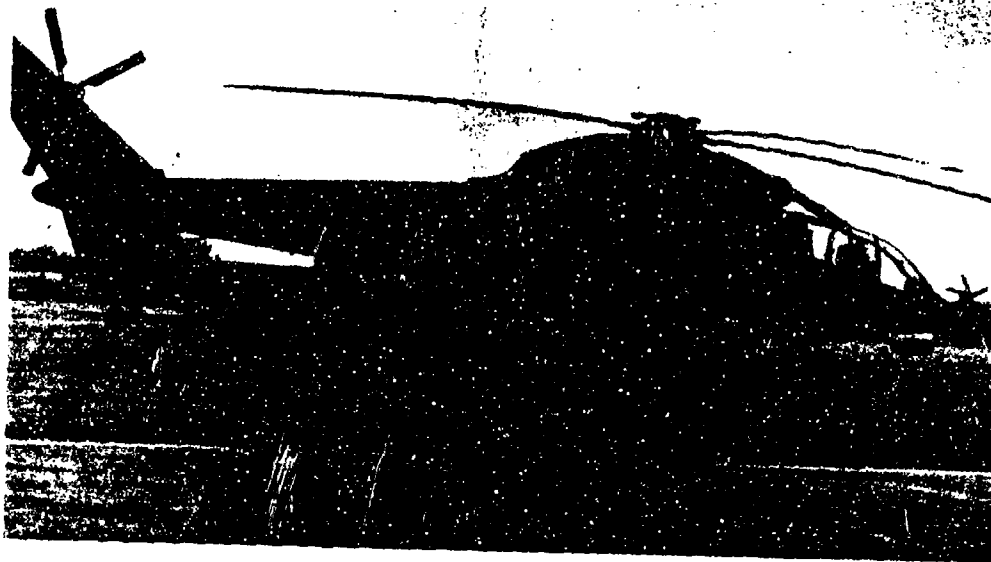

PHOTO 7. RIGHT SIDE VIEW, TOW CONFIGURATION

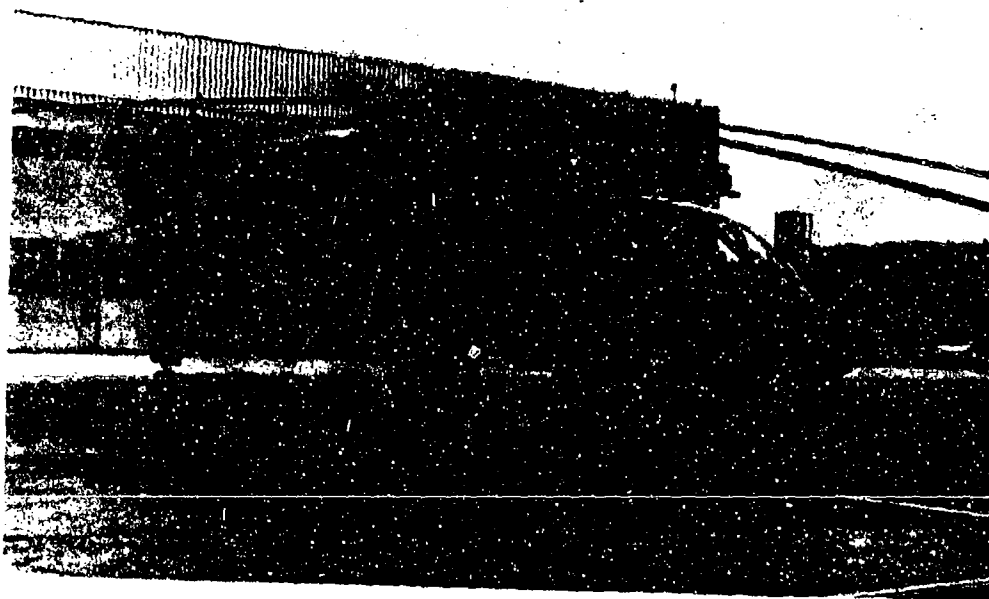

PHOTO 8. RIGHT FRONT VIEW, CLEAN CONFIGURATION

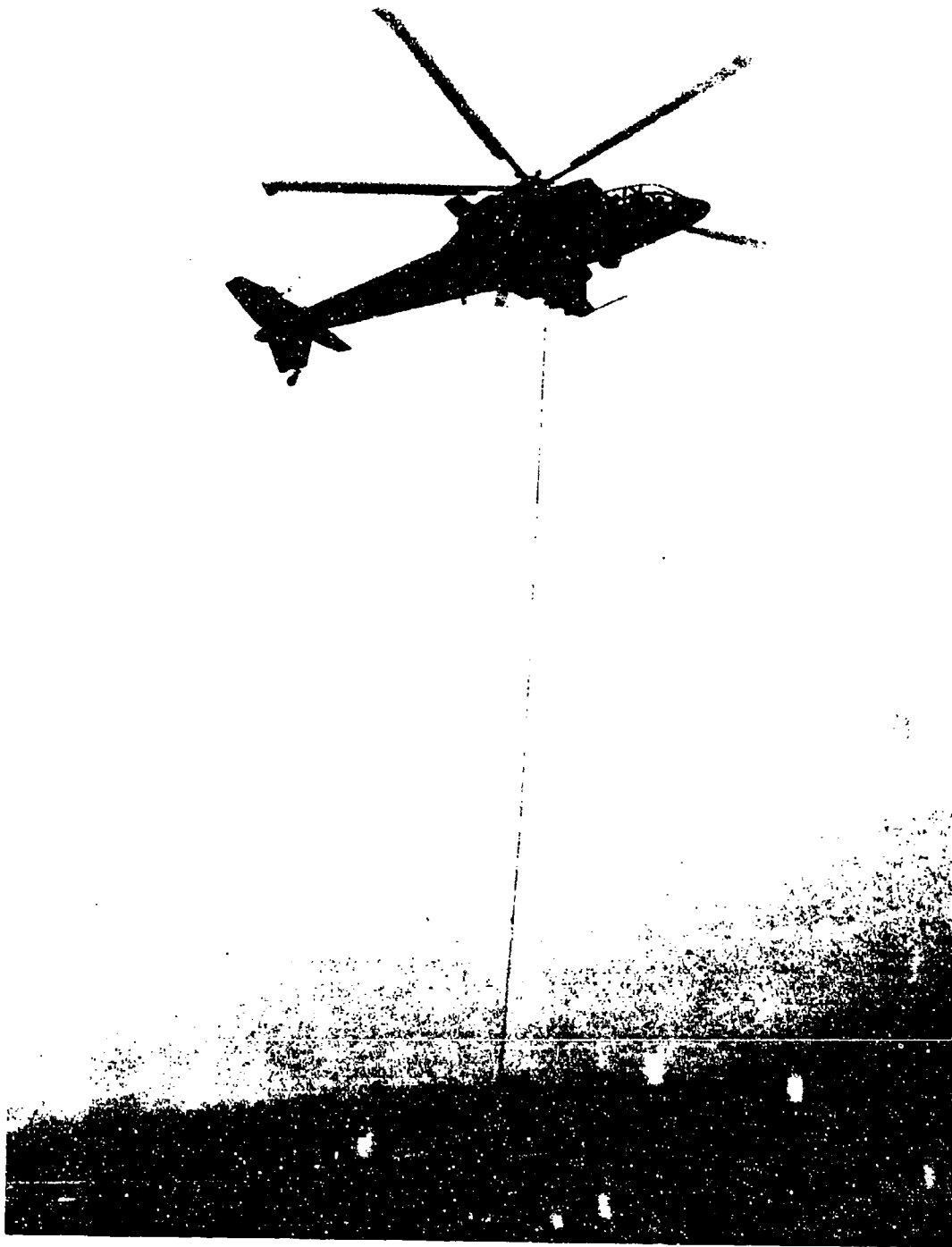

PHOTO 9. TETHERED HOVER OGE (100 FEET)



PHOTO 10. TETHERED HOVER IGE (10 FEET)



PHOTO 11. 5° SLOPE LANDING, NOSE DOWN



PHOTO 12. 5° SLOPE LANDING, NOSE UP

LONGITUDINAL TRIM WHEEL

LATERAL TRIM WHEEL

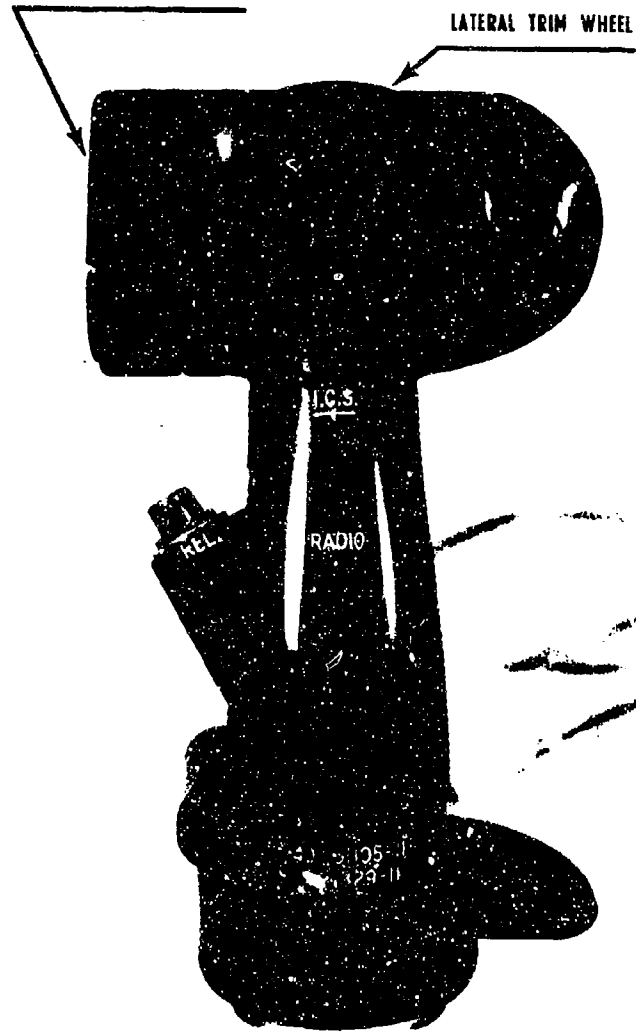

PHOTO 13. CYCLIC CONTROL GRIP

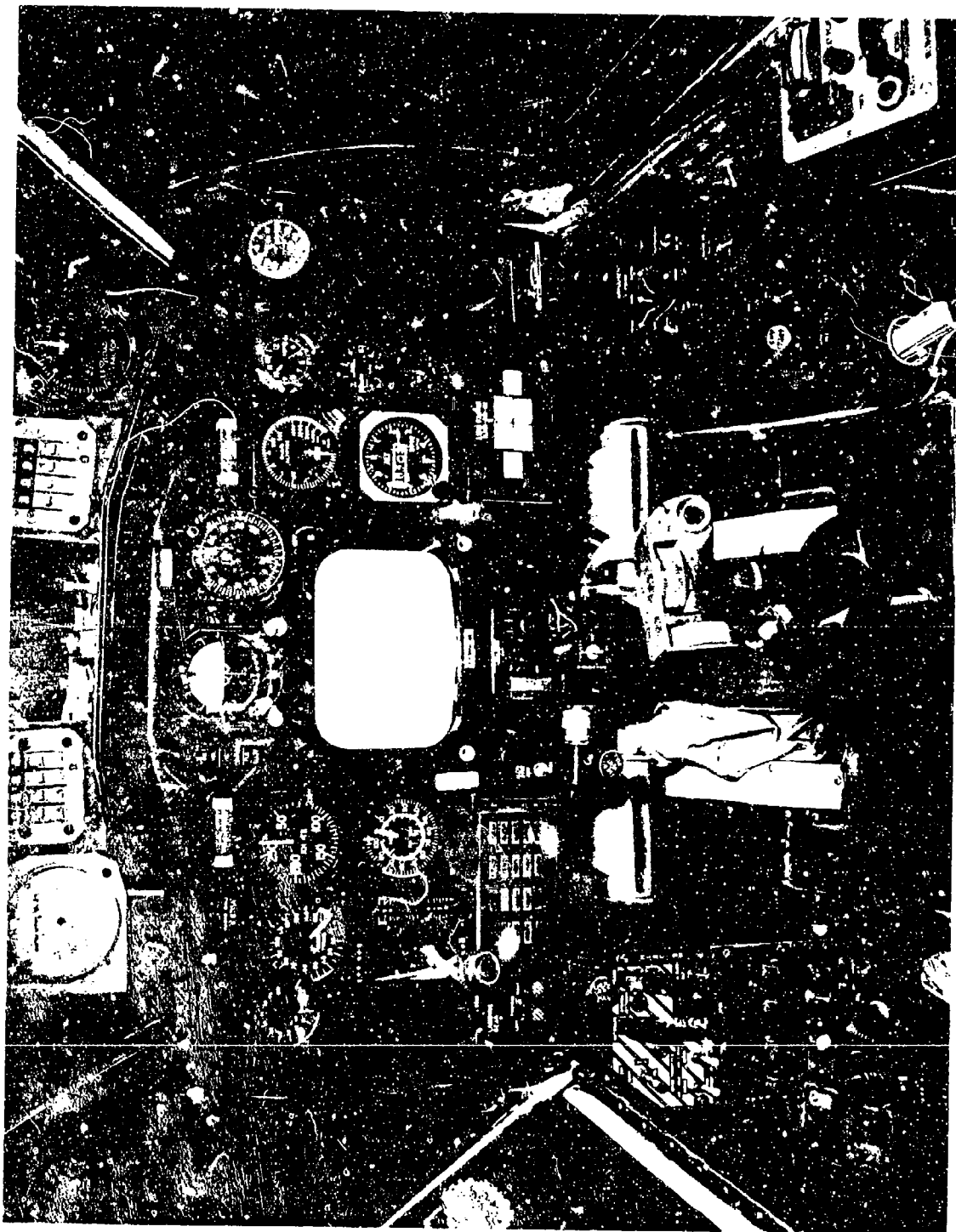

PHOTO 14. GUNNERS INSTRUMENT PANEL

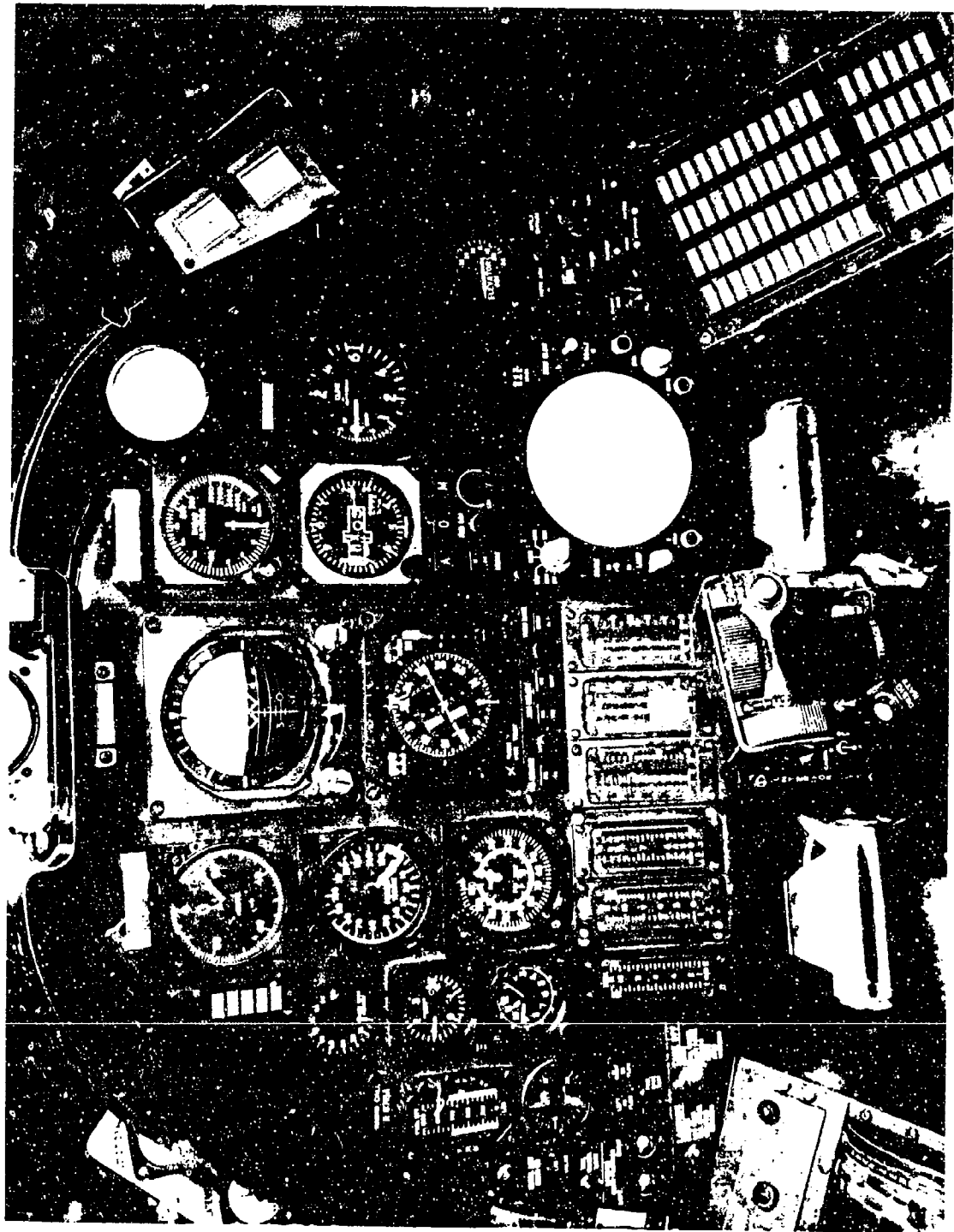
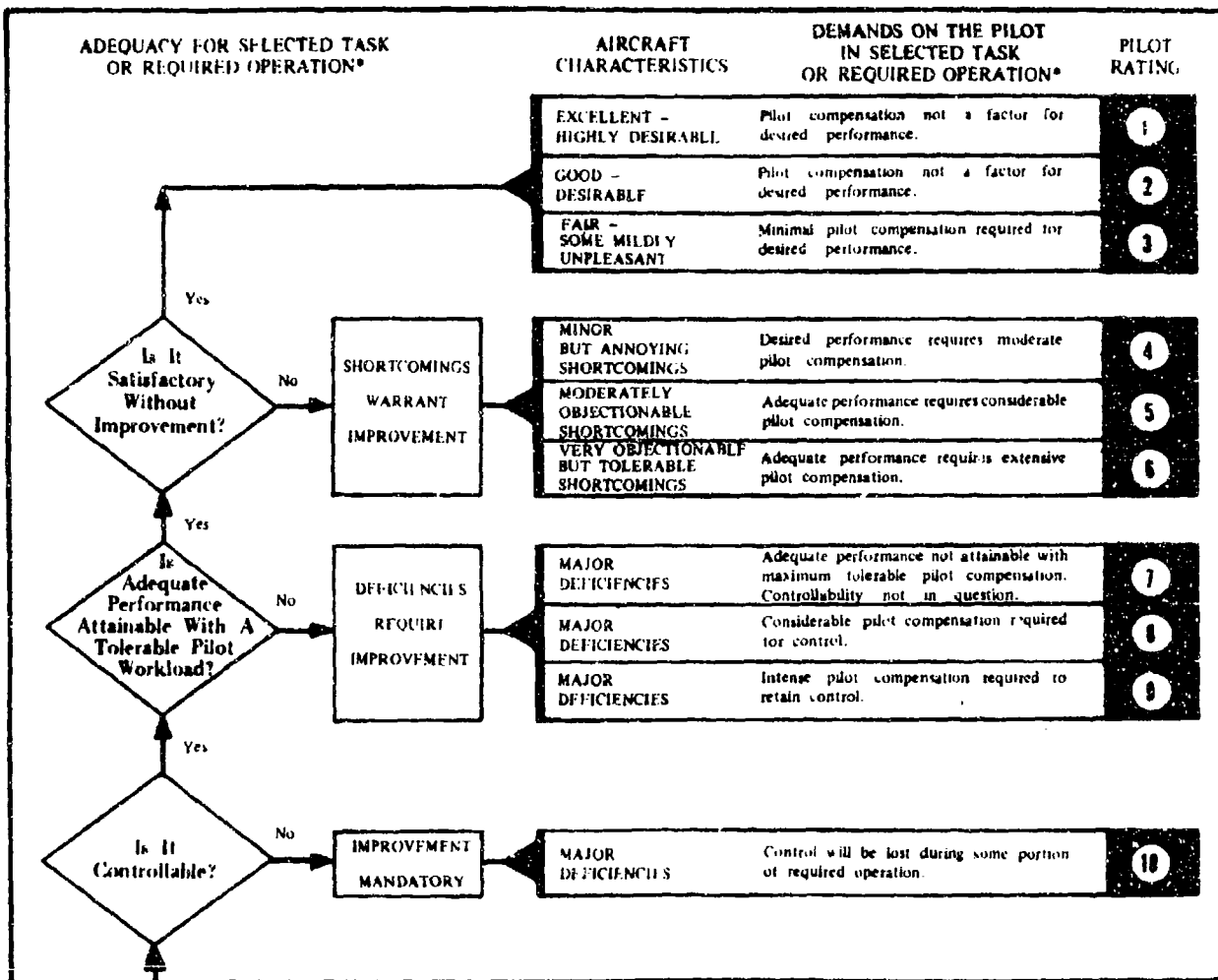

PHOTO 15. PILOT INSTRUMENT PANEL

APPENDIX E. HANDLING QUALITIES RATING SCALE



PILOT DECISIONS

*Based Upon Cooper-Harper Handling Qualities Rating Scale (Ref NASA TN D 5153) And Definitions In Accordance With AR 310-25

*Definition of REQUIRED OPERATION involves designation of flight phase and/or subphases with accompanying conditions.

APPENDIX F. DATA ANALYSIS METHODS

INTRODUCTION

1. This appendix contains some of the data reduction and analysis methods used to evaluate the S-67. The topics discussed include:

- a. Shaft horsepower required.
- b. Shaft horsepower available
- c. Tail rotor performance
- d. Level flight performance and specific range.

GENERAL

2. The helicopter performance test data was generalized through the use of nondimensional coefficients. The purpose is to accurately obtain performance at conditions not specifically tested. The following coefficients were used to generalize test results obtained during the test program:

- a. Coefficient of power (C_p):

$$C_p = \frac{\text{SHP} \times 550}{\rho A (\Omega R)^3} \quad (1)$$

- b. Coefficient of thrust (C_T):

$$C_T = \frac{W}{\rho A (\Omega R)^2} \quad (2)$$

- c. Advance ratio (μ):

$$\mu = \frac{1.6889 \times V_T}{\Omega R} \quad (3)$$

d. Advancing tip mach number (M_{TIP})

$$M_{TIP} = \frac{1.6889 V_T + \Omega R}{a} \quad (4)$$

where: SHP = Engine output shaft horsepower
550 = Conversion factor (ft-lb/sec per SHP)
 ρ = Air density (slug/ft³)
A = Main rotor disc area (ft²)
 Ω = Main rotor angular velocity (radians)
R = Main rotor radius (ft)
W = Gross weight (lb)
1.6889 = Conversion factor (ft/sec per knot)
 V_T = True air speed (kt)
a = Speed of sound (ft/sec)

SHAFT HORSEPOWER REQUIRED

3. Engine output shaft horsepower was determined from a calibrated torque meter installed at the main rotor transmission. The relation between torquemeter output (psi) and engine output, Q (ft-lb) is 100 percent torque = 73.656 psi = 337 ft-lb.

4. Engine output shaft horsepower was determined from the following equation:

$$SHP = \frac{2\pi \times GR \times Nr \times Q}{33,000} \quad (5)$$

where: Q = Engine output shaft torque (ft-lb)
Nr = Main rotor rotational speed (rpm)
33,000 = Conversion factor (ft-lb/min per shp)
GR = Gear ration of the output shaft rotational speed to the main rotor rotational speed (93.4)

SHAFT HORSEPOWER AVAILABLE

5. Shaft horsepower available for a specification engine was derived from General Electric source deck T-58-GE-5, Engine specification model power program, No. P58115-A. Program output was verified by comparison to Model Specification, Engine, Aircraft, Turboshaft: T56-GE-5, General Electric Co., No. E1096 dated 4 Jan 1966 (ref. 10, app. A). Zero inlet losses, zero exhaust pressure loss, no horsepower extraction and anti-ice OFF were used in the program. The assumption of inlet and exhaust losses is based upon prior analysis of S-61 (H-3). Bleed air losses for the environmental control unit was determined by the following empirical formula:

$$W_B = 0.1954 + 0.00644 P_a \quad (6)$$

where: W_B = Mass air flow (lb/sec)

P_a = ambient pressure (lb/in)

TAIL ROTOR PERFORMANCE

6. During the hover performance tests, tail rotor performance parameters were recorded. Terms in equations 1, 2, and 5 which apply to the main rotor, were replaced by tail rotor parameters to non-dimensionalize tail rotor performance. The terms redefined are as follows:

SHP = Tail rotor shaft horsepower (equation 5)
 A = Tail rotor disc area (ft²)
 Ω = Tail rotor angular velocity (radians/sec)
 R = Tail rotor radius (ft)
 W = Tail rotor thrust (lb)
 Q = Tail rotor torque (ft-lb)
 GR = Tail rotor gear ration (6.123)

Tail rotor thrust was determined from the following equation:

$$W = \frac{Q_{MR}}{l_t} \quad (7)$$

Where: Q_{MR} = Main rotor shaft torque (ft-lb)

l_t = Perpendicular distance between center lines of main and tail rotor shafts (36.96 ft)

LEVEL FLIGHT PERFORMANCE AND SPECIFIC RANGE

7. Level flight performance was defined by measuring the shaft horsepower required to maintain level flight throughout the airspeed range of the helicopter. The results of each level flight were presented as shaft horsepower standard, tip mach number, and specific range.

8. Test-day level flight power was corrected to standard-day conditions by assuming that the test-day dimensionless parameters, C_{P_t} , C_{T_t} , and μ_t , are independent of atmospheric conditions. Consequently, the standard-day dimensionless parameters, C_{P_s} , C_{T_s} , and μ_s , are identical to C_{P_t} , C_{T_t} , and μ_t , respectively.

From the definition of (equation 1) the following relationship can be derived:

$$SHP_s = SPH_t \times \frac{\rho_s}{\rho_t} \quad (8)$$

where: SHP = Engine output shaft horsepower
 ρ = Air density (slugs/ft³)
 Subscript t = Test day
 Subscript s = Standard day

9. Specific range was calculated using the level flight performance curves and the specification installed-engine fuel flow characteristics at 5-percent conservatism.

$$NAMPP = \frac{V_T}{W_f} \quad (9)$$

where: NAMPP = Nautical air miles per pound of fuel (Naut mi/lb)

V_t = True airspeed (kt)

W_f = Fuel flow (lb/hr)

APPENDIX G. TEST INSTRUMENTATION

Flight test instrumentation was installed in the test helicopter prior to the start of this evaluation. Data from the instrumentation was recorded from 3 sources: Pilot's panel, copilot/engineer panel and PCM magnetic tape. The flight test instrumentation was installed and maintained by Sikorsky Aircraft.

Pilot Panel:

Airspeed (Ship's system)
Altitude (Ship's system)
Rate of Climb
Rotor Speed (Main)
Engine Torque
Sensitive angle of sideslip
Center-of-Gravity Normal Acceleration
Longitudinal Control Position
Lateral Control Position
Directional Control Position
Collective Control Position
Turbine Inlet Temperature
Time of Day
Pilot Event
Pilot Cockpit Temperature
Expanded Rotor Speed, N_R (digital)
Cable Tension
Cable Angle

Copilot/Engineer Panel:

Airspeed (ship's system)
Altitude (ship's system)
Rotor speed (main)
Engine Torque
Free air temperature
Fuel used (totalizer)
Gas producer speed
Time of Day
Correlation counter
Engineer event
Copilot cockpit temperature

Magnetic Tape:

Airspeed (ship's system)
Altitude (ship's system)
Rate of climb
Rotor speed (main)
Engine torque
Free air temperature
Fuel used (totalizer)
Fuel temperature
Engine fuel flow
Gas producer speed
Sensitive angle of sideslip

Center-of-gravity normal acceleration
Longitudinal control position
Lateral control position
Directional control position
Collective control position
Turbine inlet temperature
Tape running time
Correlation counter
Pilot event
Engineer event
Longitudinal control force
Lateral control force
Directional control force
Collective control force
Timer 10 cps square wave
Pitch attitude
Roll attitude
Yaw attitude
Pitch rate
Roll rate
Yaw rate
Main rotor shaft bending
Expanded Main Rotor Speed, N_R
Cable tension
Cable angle
Longitudinal Auxiliary Servo position
Lateral Auxiliary Servo position
Collective Auxiliary Servo position
Directional Auxiliary Servo position
ICS voice
Main Rotor 5/rev contractor
Main Rotor 1/rev contractor
Tail Rotor 1/rev contractor
External light correlation
Vibration:
Pilot seat vertical (FS 141.5,BL 7.0L,WL 128.0)
Pilot seat lateral (FS 141.5,BL 7.0L,WL 128.0)
Copilot/gunner seat vertical (FS 83.5,BL 7.0R,WL 108.0)
Copilot/gunner seat lateral (FS 83.5, BL7.0R,WL 108.0)
Center of gravity vertical (FS 275.0, BL 9.5 R,WL 128.0)
Center of gravity lateral (FS 275.0,BL 9.5R,WL 128.0)
Pilot instrument panel vertical (FS 113.5,BL2.5L,WL 162.0)
Pilot instrument panel lateral (FS 113.5,BL2.5L,WL 162.0)
Pilot instrument panel longitudinal(FS113.5,BL2.5L,WL 162.0)
Copilot instrument panel vertical (FS 53.0,BL0.0,WL 137.0)
Copilot instrument panel lateral (FS 53.0,BL0.0, WL 137.0)
Copilot instrument panel longitudinal(FS53.0,BL0,0,WL 137.0)
Pitch acceleration

Roll acceleration
Yaw acceleration
Center of gravity lateral acceleration
Angle of attack
Main rotor shaft torque (2 measurements)
Tail rotor shaft torque
Speed brake position
SAS actuator position (each axis)
Stabiliator position

APPENDIX H. TEST DATA

85 W

FIGURE 1
SUMMARY POWER CAPABILITY COMPARISON
3-47 SIA-1001A
150-80-5 ENGINES
TARCOF POWER

- NOTES**
- 1. POWER AVAILABLE BASED ON GENERAL ELECTRIC SOURCE DELTA 10 ASQUA-A
 - 2. POWER DATA DERIVED FROM FIGURES 2 AND 3
 - 3. ROTOR SPEED = 210 RPM
 - 4. WIND LESS THAN 4 KNOTS
 - 5. VERTICAL DISTANCE FROM BOTTOM OF WHEEL TO MAIN ROTOR CENTROID = 146.2 FT

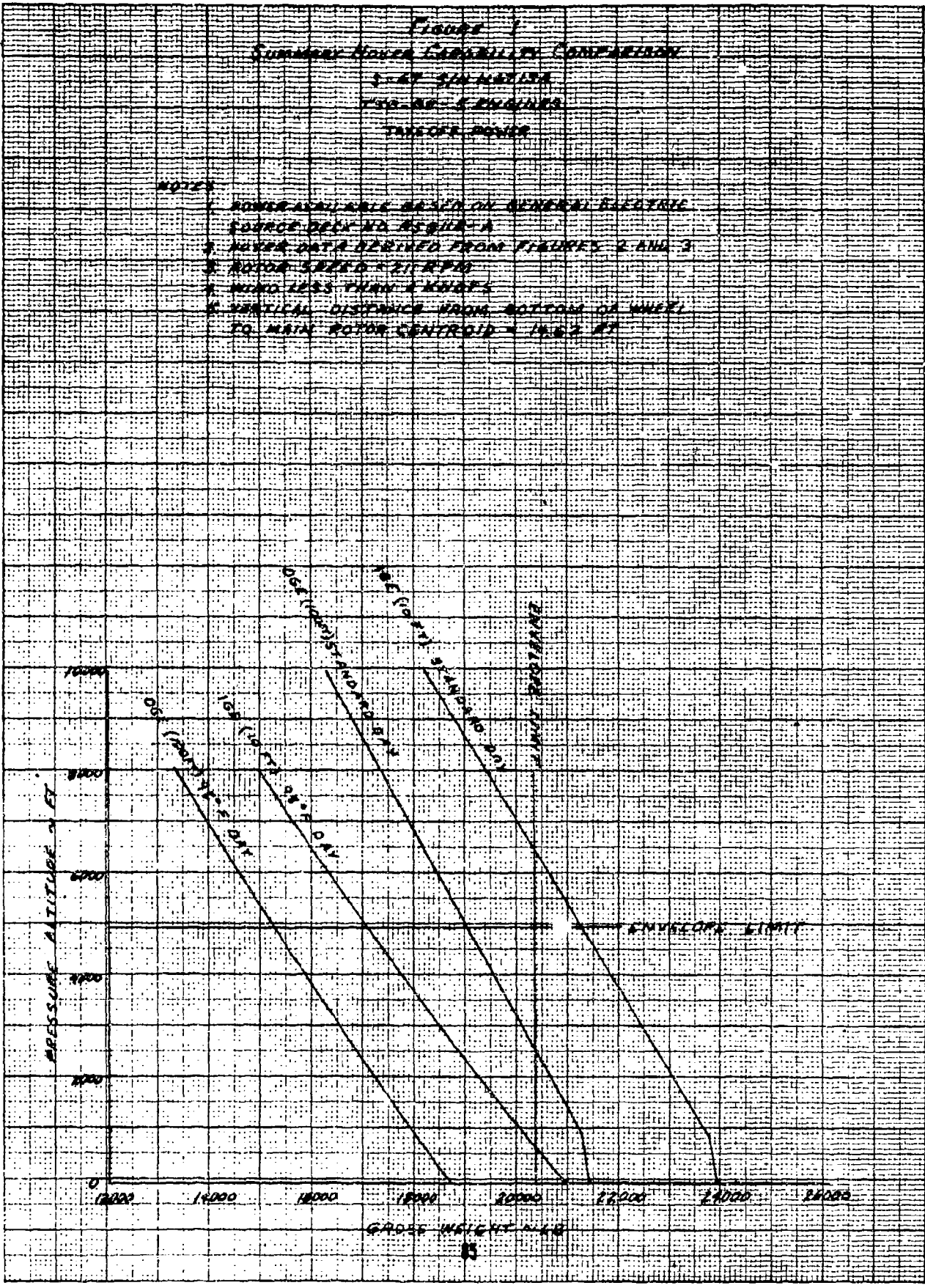

FIGURE 2
NON-DIMENSIONAL HOVERING PERFORMANCE

S-61 HELICOPTER
100 HP ENGINE
WHEEL HEIGHT = 10 FT

SYMBOL	WIND SPEED KNOTS	PLAT %C
O	251	18.3
D	194	19.4
A	217	22.8

- NOTES:**
1. TETHERED HOVER TECHNIQUE
 2. WIND LESS THAN 4 KNOTS
 3. VERTICAL DISTANCE FROM BOTTOM OF WHEEL TO MAIN ROTOR CENTERLINE = 16.2 FT

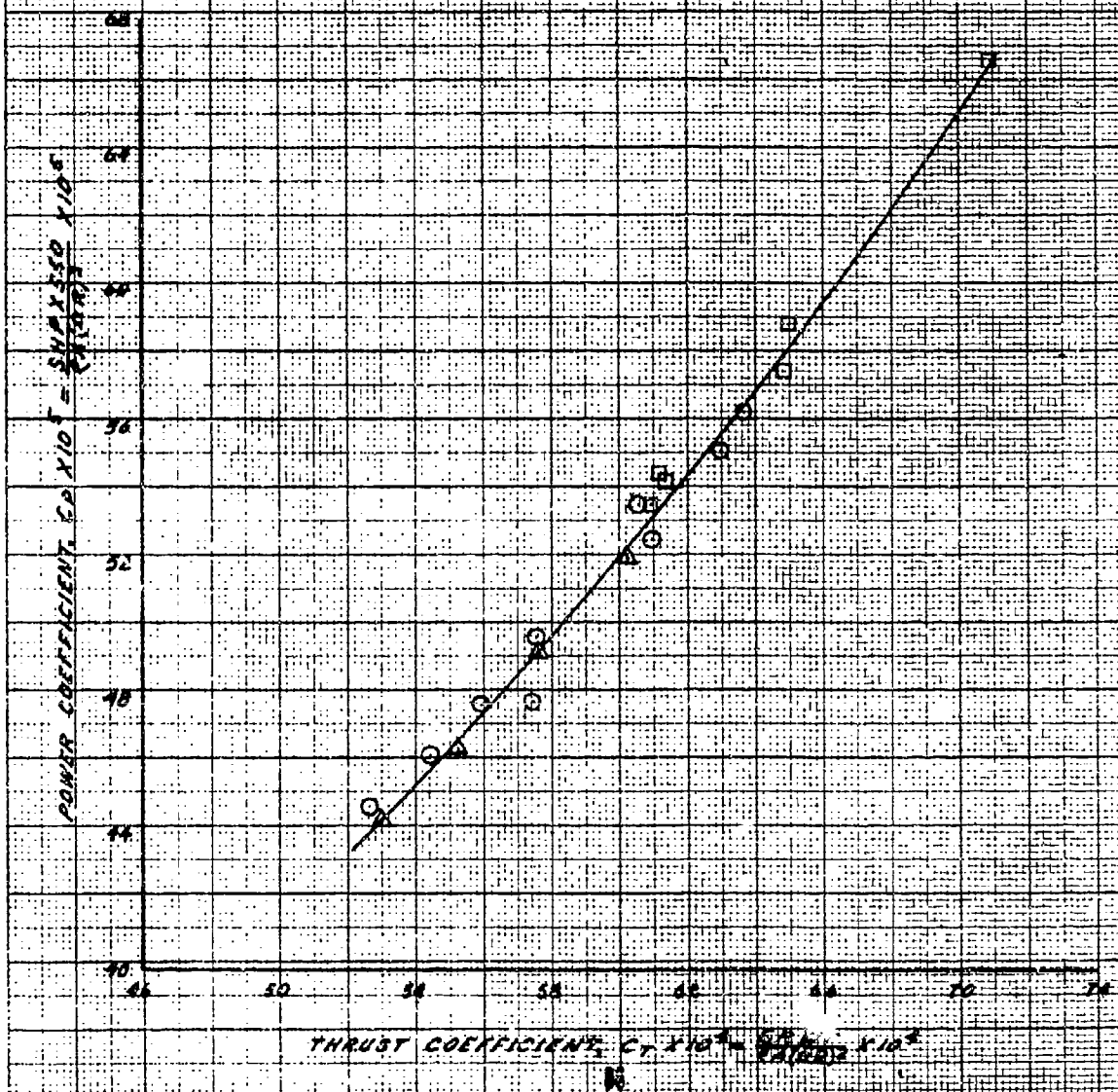

FIGURE 3
NON-DIMENSIONAL HOVERING PERFORMANCE

5.67 STROKE
TRB-F-5 ENGINES
WHEEL HEIGHT = 10.6 FT

SYMBOL	ROTOR SPEED RPM	DATA TYPE
○	211	26.8
◐	184	27.8
△	217	26.0

NOTES:

1. TETHERED HOVER TECHNIQUE
2. WIND LESS THAN 3 KNOTS
3. VERTICAL DISTANCE FROM BOTTOM OF WHEEL TO MAIN ROTOR CENTROID = 14.62 FT
4. SHADED SYMBOLS DENOTE FREE RIGID HOVER

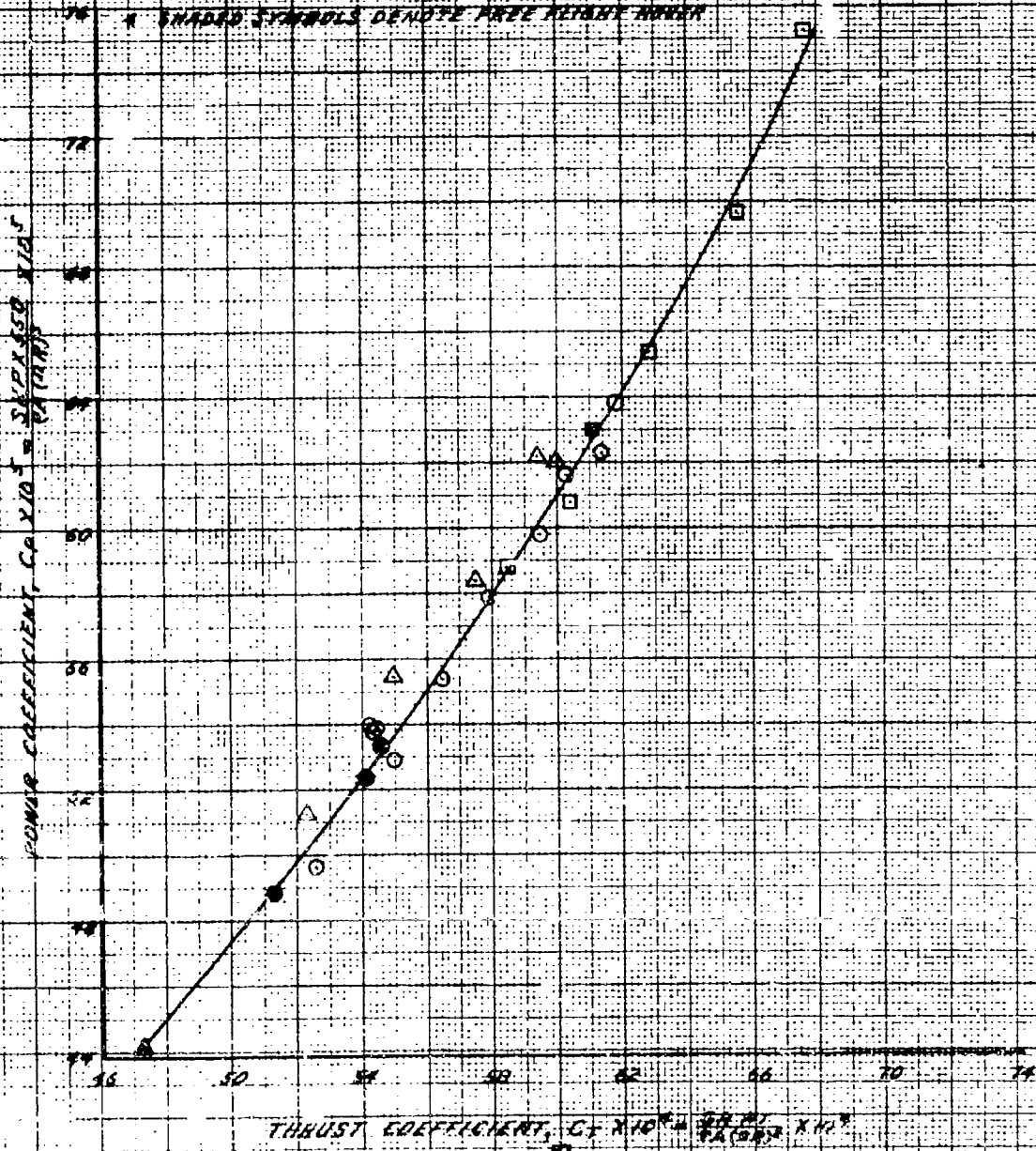

FIGURE A
 NON-DIMENSIONAL TAIL ROTOR PERFORMANCE
 S-67 SIMULATIONS
 FOR GE-6 ENGINES
 WHEEL HEIGHT = 10 FT

SYMBOL	WIND SPEED KNOTS	DATA TYPE
□	201	Z-A
□	199	Z-B
△	217	Z-A

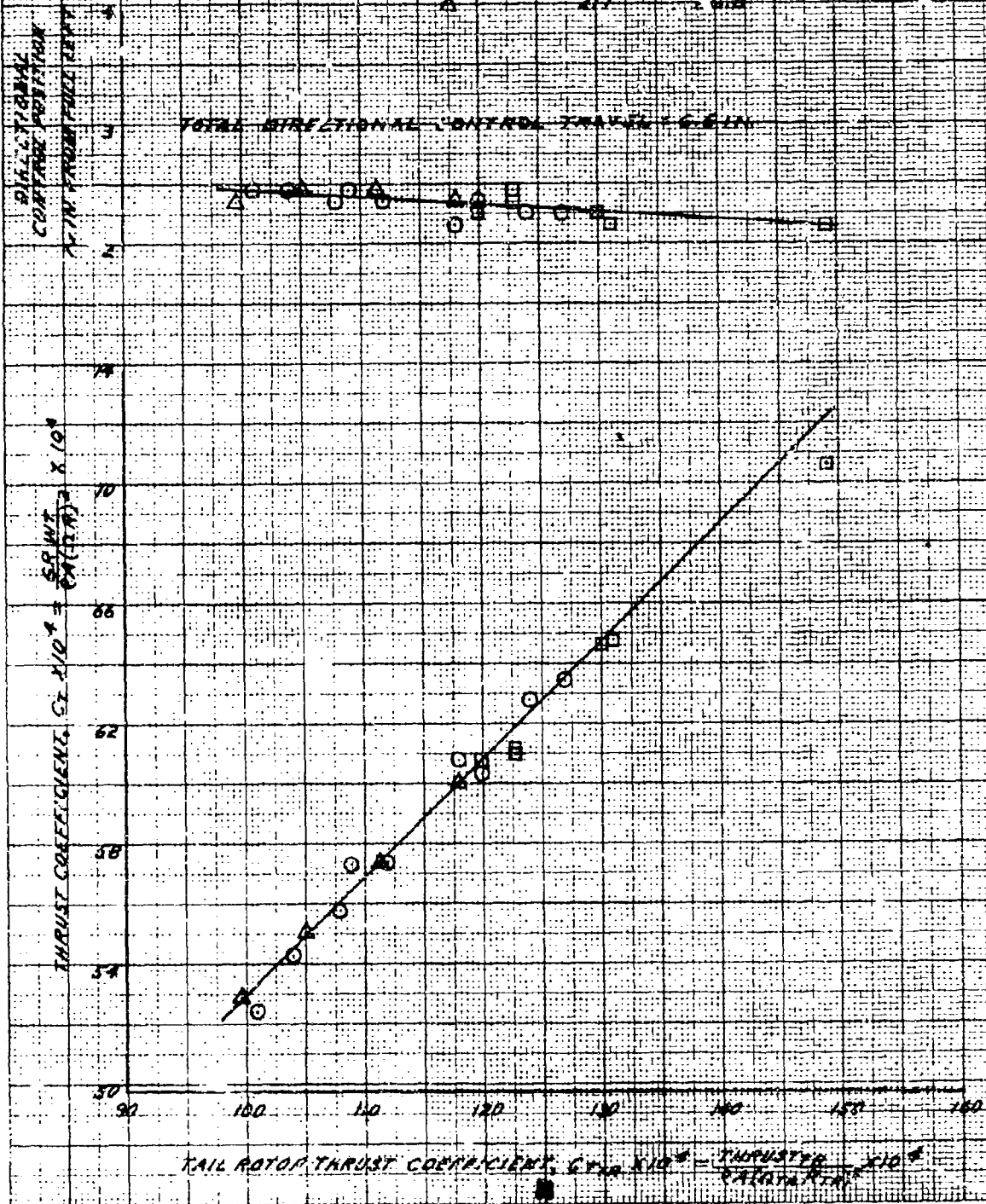

FIGURE 5
 NON-DIMENSIONAL TAIL ROTOR PERFORMANCE
 S-61 SH-60A
 TWO GE ENGINES
 WEIGHT 11000 LB

SYMBOL	ROTOR SPEED % RPM	GRWT % W
○	20	10.7
□	100	10.6
△	207	10.8

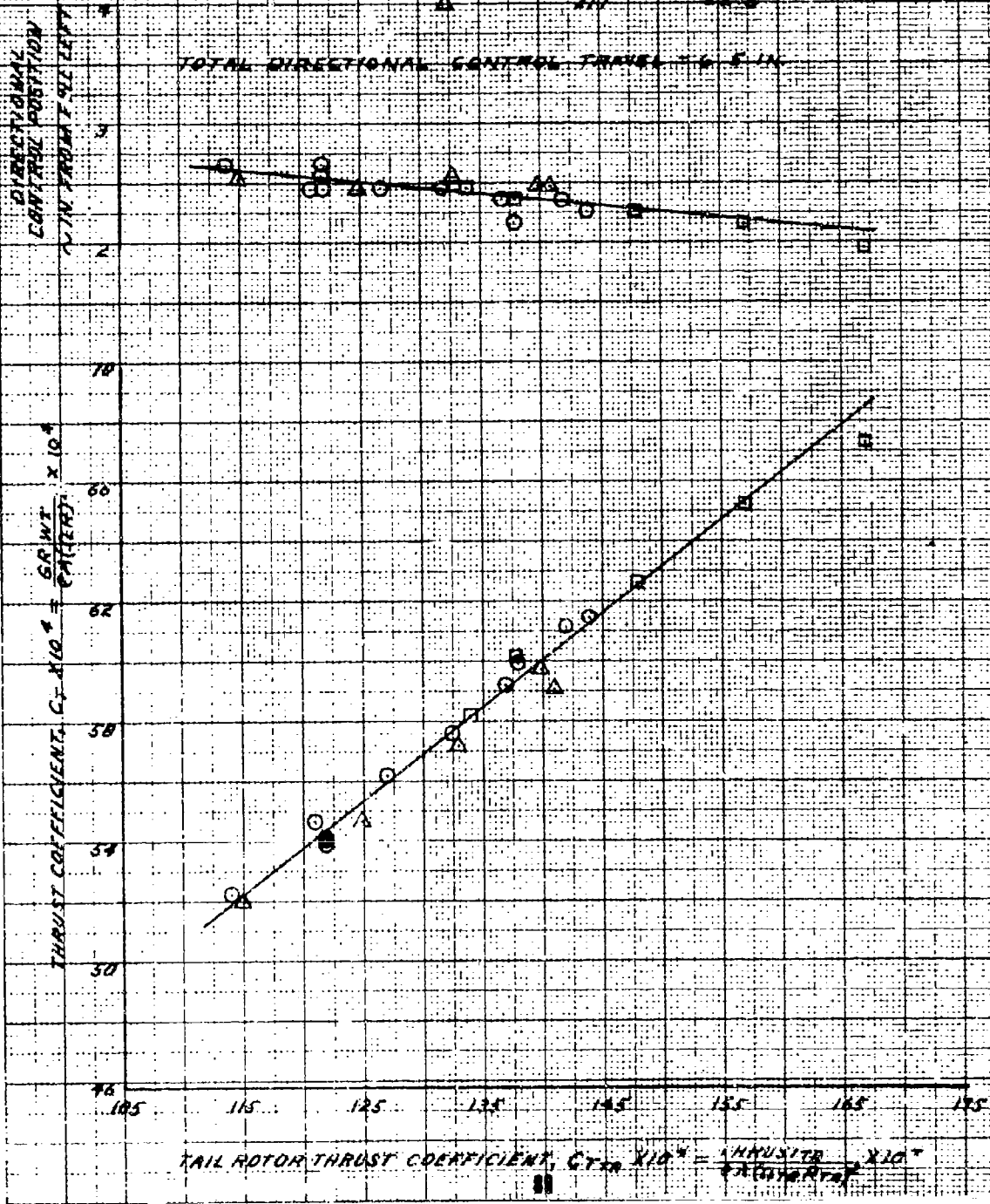

FIGURE 6
 NON-DIMENSIONAL TAIL ROTOR POWER PERFORMANCE
 S-47 SYN ROTOR
 PSC-BOLT ENGINE
 MODEL WEIGHT 4100 LB

SYMBOL	ROTOR SPEED - RPM	CAT - %
O	211	26.3
□	199	27.8
△	217	26.0

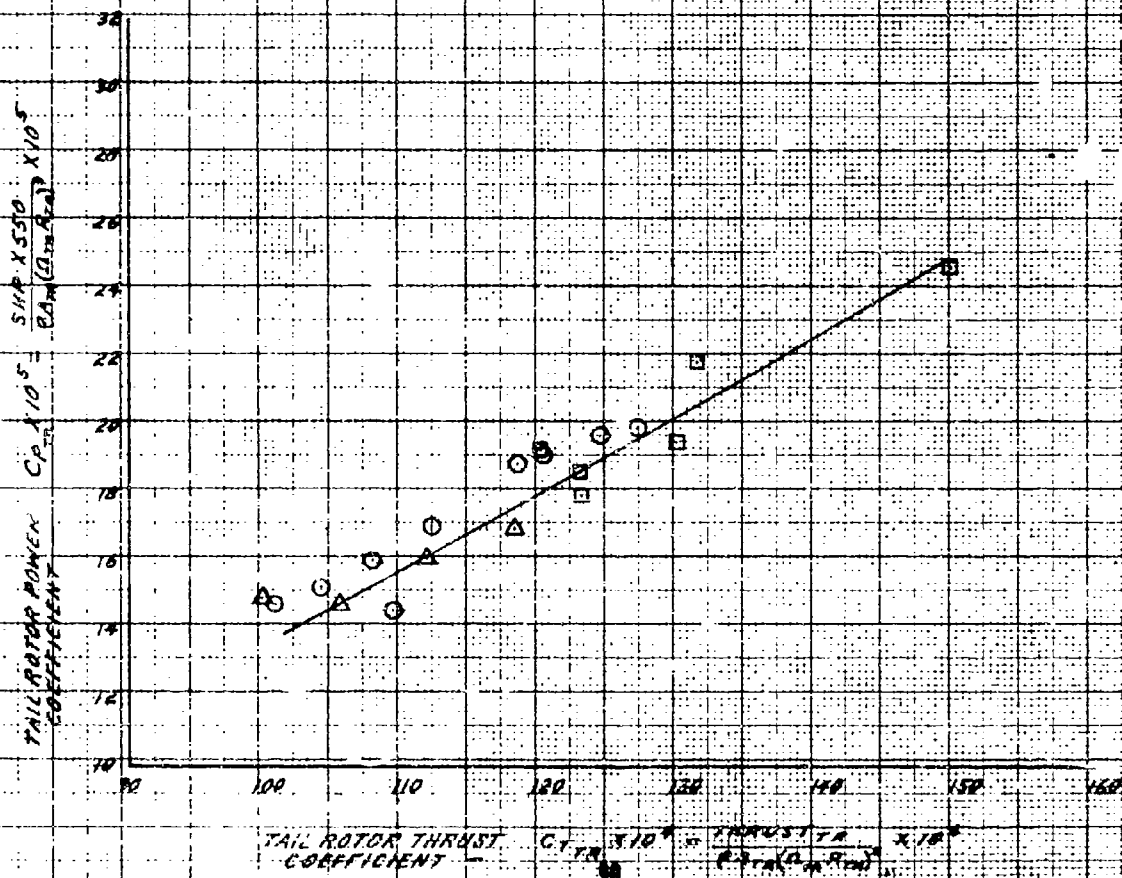
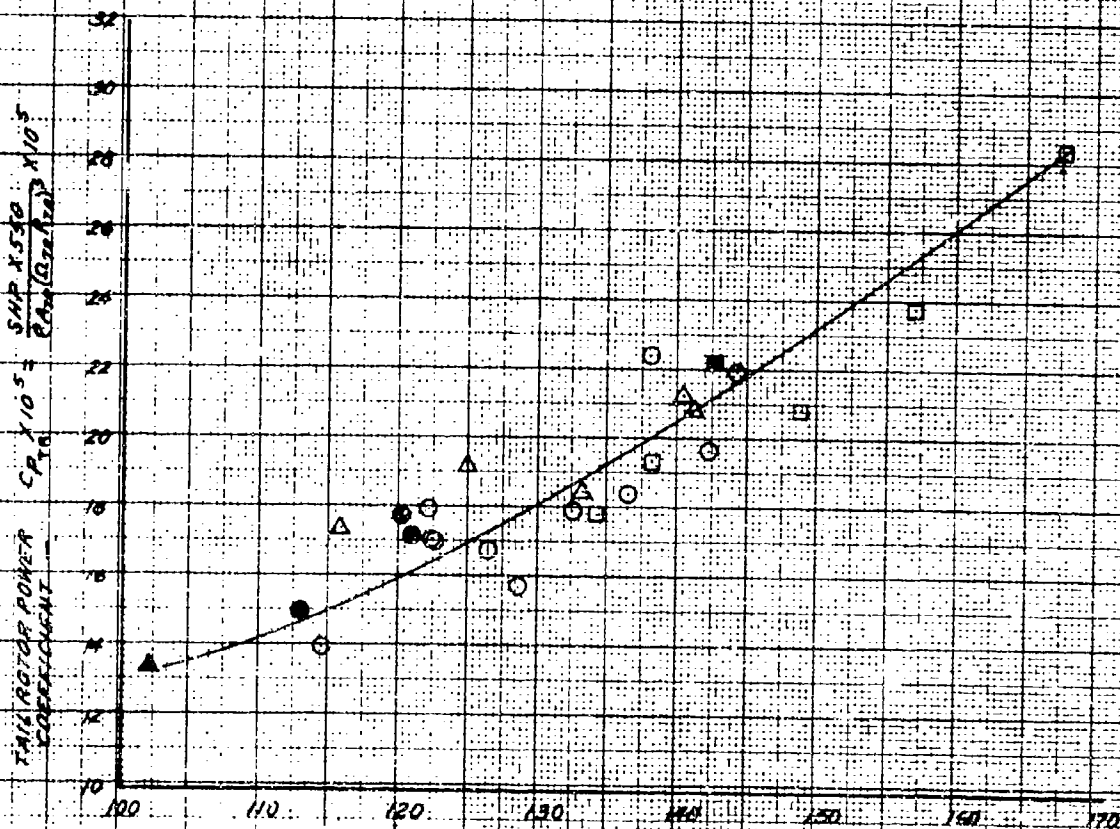

Figure 7
 Non-Dimensional Tail Rotor Power Performance
 S-67 Synthesis
 Teledyne Engines
 Wind Tunnel Data

Symbol	Rotor Speed % RPM	CT _T
○	211	16.8
□	199	18.8
△	217	22.8

NOTE: SHADED SYMBOLS DENOTE FREE FLIGHT DATA



$$C_{PT} \times 10^5 = \frac{SHP \times 550}{P_{out} (Gross)} \times 10^5$$

$$C_{T_T} \times 10^3 = \frac{T_{TR}}{W} \times 10^3$$

FIGURE 8
NON-DIMENSIONAL LEVEL FLIGHT PERFORMANCE
S-67 SIMULATOR
TSD-66-5 (REVISED)

NOTES:

1. ROTOR SPEED - 411 RPM
2. AVG CG LOCATION - 27.3 IN (AFT)
3. CONFIGURATION - 1 LEAF
4. CURVES DERIVED FROM FIGURES 10 THROUGH 14

POWER COEFFICIENT, $C_P \times 10^5 = \frac{SWR \times 550 \times 1.18}{P_{AVG} \times 33000}$

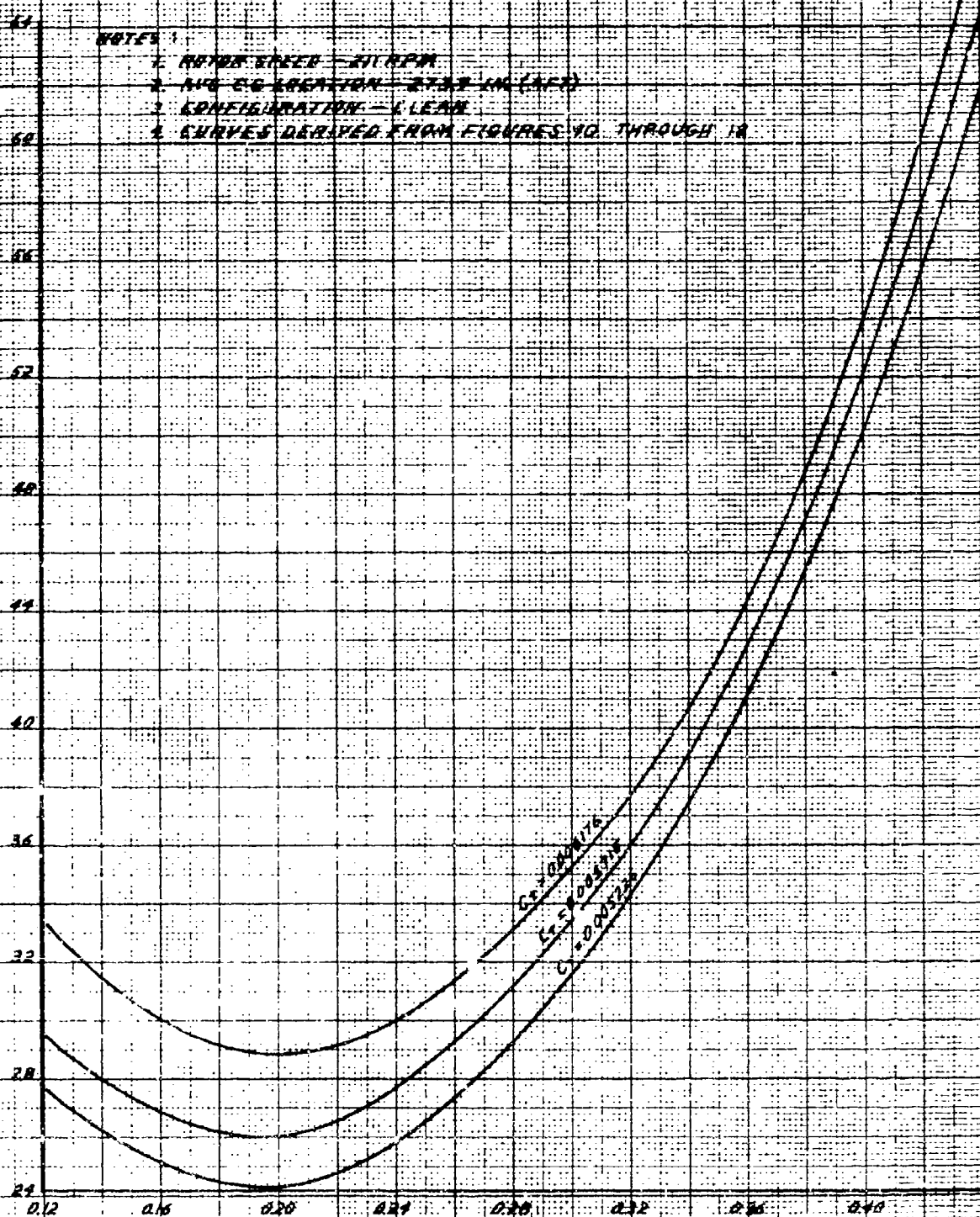

ADVANCE RATIO, $x = \frac{VT}{118}$

FIGURE 9
 NON-DIMENSIONAL POWER PLANT PERFORMANCE
 S-60 SIMULATOR
 F3040-2 ENGINE

- NOTES:
1. ROTOR SPEED = 211 RPM
 2. TYPE G2 OPERATION - TYPE 100 (LAPD)
 3. CONFIGURATION - EXTERNAL STORES
 4. CURVES DERIVED FROM FIGURES 13 AND 14

POWER COEFFICIENT, $C_P \times 10^5 = \frac{SHP \times 550}{PA \times 10^5}$

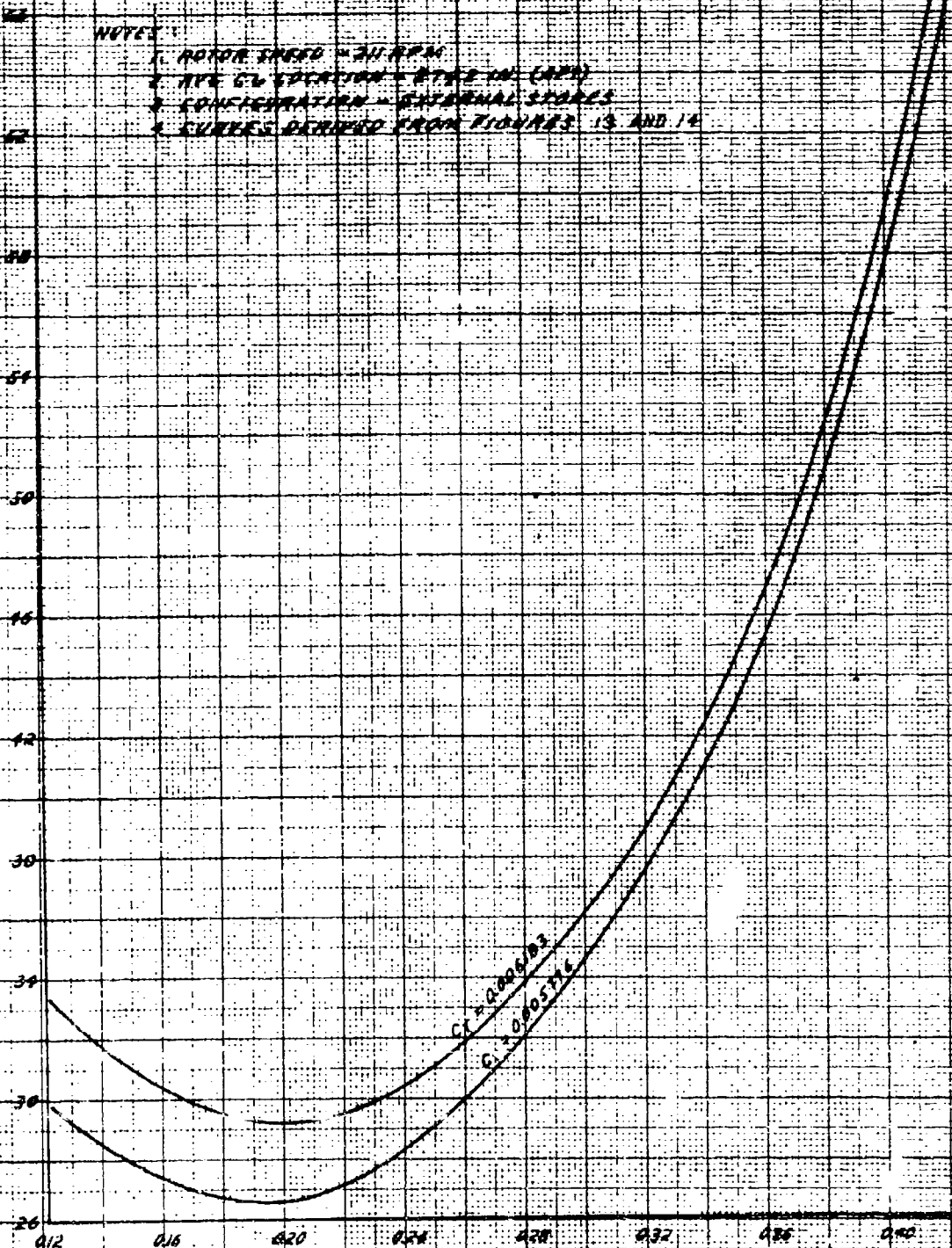

ADVANCE RATIO, $\mu = \frac{V_A}{V_R}$

FIGURE 10
LEVEL FLIGHT PERFORMANCE
S-47 SUPERLISA
T30-DE-6 ENGINE

Avg GROSS WEIGHT	Avg FC LOCATION	Avg DENSITY ALTITUDE	Avg WTF	Avg MOTOR SPEED	Avg CF	CONFIGURATION
WT	IN IN	FT	°C	RPM		
1700	8740(AFT)	1500	13.5	212	0.841.3	CLEAN

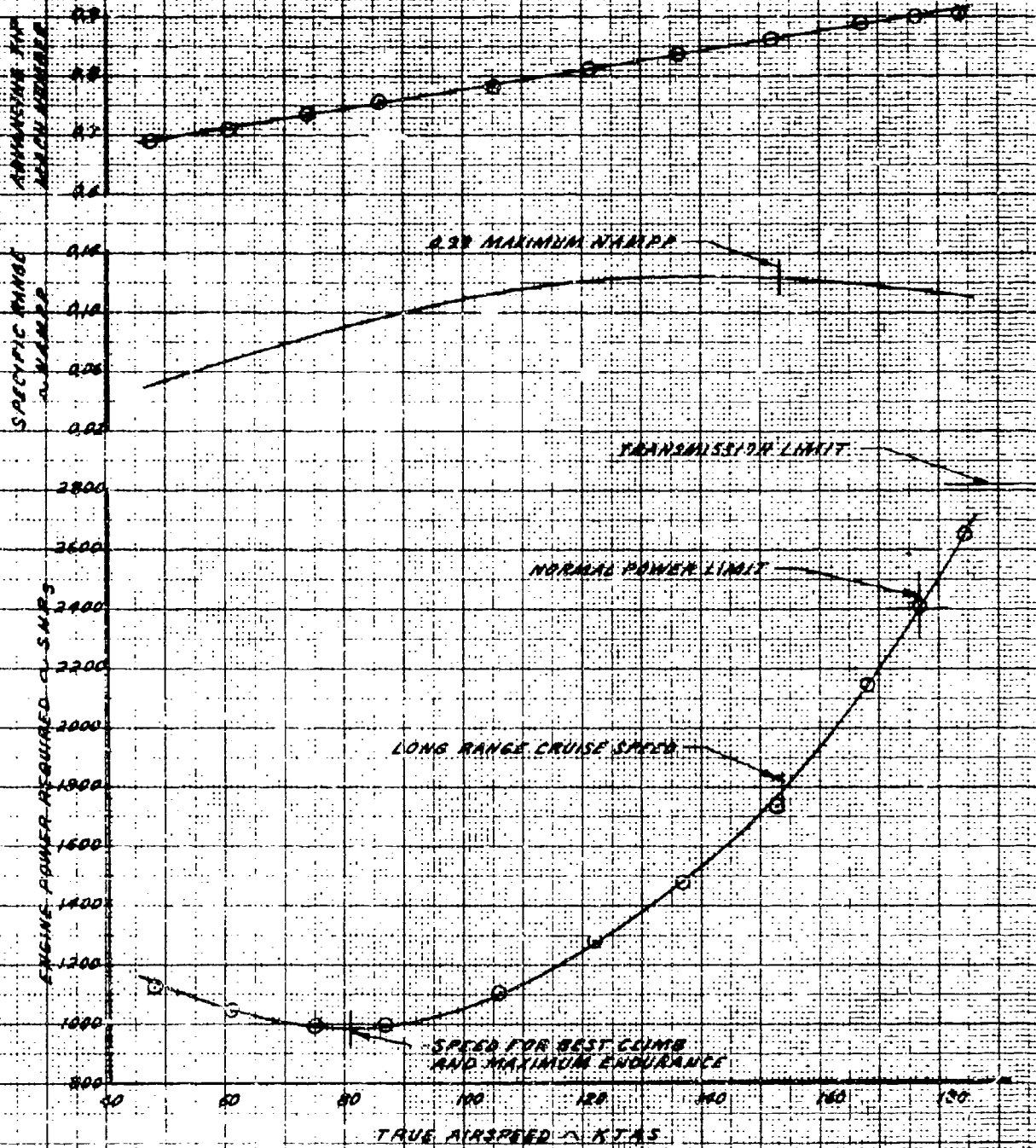

FIGURE VI
LEVEL FLIGHT PERFORMANCE
S-57 SAILBOAT
T30-82 - 3 ENGINES

WIND DIRECTION	WIND SPEED KTS	WIND CORRECTION ANGLE DEGREES	WIND CORRECTION MILES	WIND CORRECTION TIME HOURS	WIND CORRECTION MILES	WIND CORRECTION TIME HOURS
1700	27.0	11.0	1.5	0.1	1.5	0.1

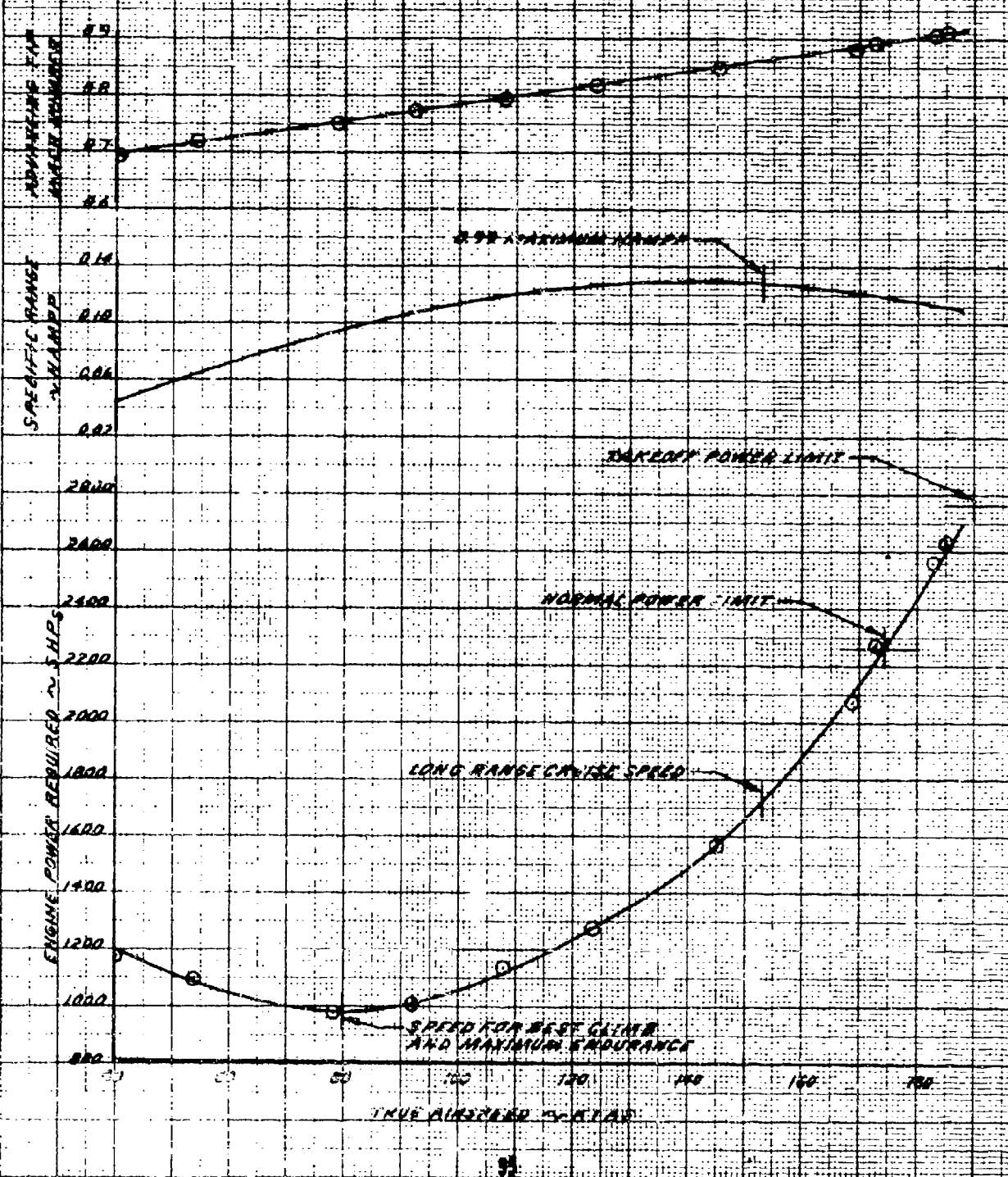

FIGURE 12
LEVEL FLIGHT PERFORMANCE
S-67 SYN MEXISA
T5B-GE-5 ENGINES

Avg Gross Weight	Avg EG Location	Avg Density Altitude	Avg WAT	Avg RPM	Avg Configuration
WT	IN	FT	KG	RPM	TYPE
17320	875 (APP)	3750	145	232	20000

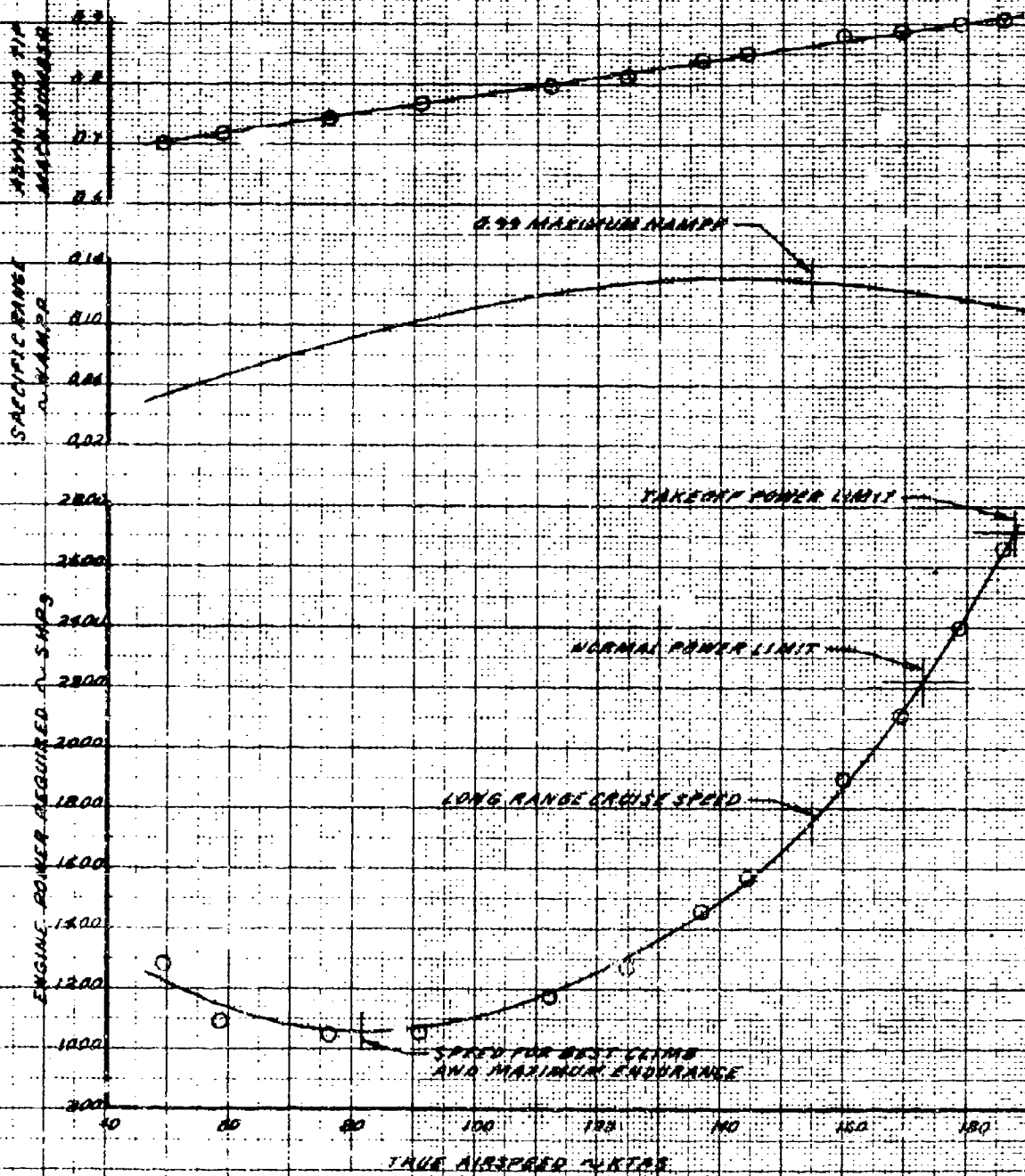

FIGURE 13
 LEVEL FLIGHT PERFORMANCE
 S-67 STINGIER
 T20-GE-600-100

Avg Gross Weight	Avg Sea Level Altitude	Avg Density Altitude	Avg Drag	Avg Mach Speed	Avg Configuration
18110	21450 FT	2000	157	0.78	EXTERNAL STORES

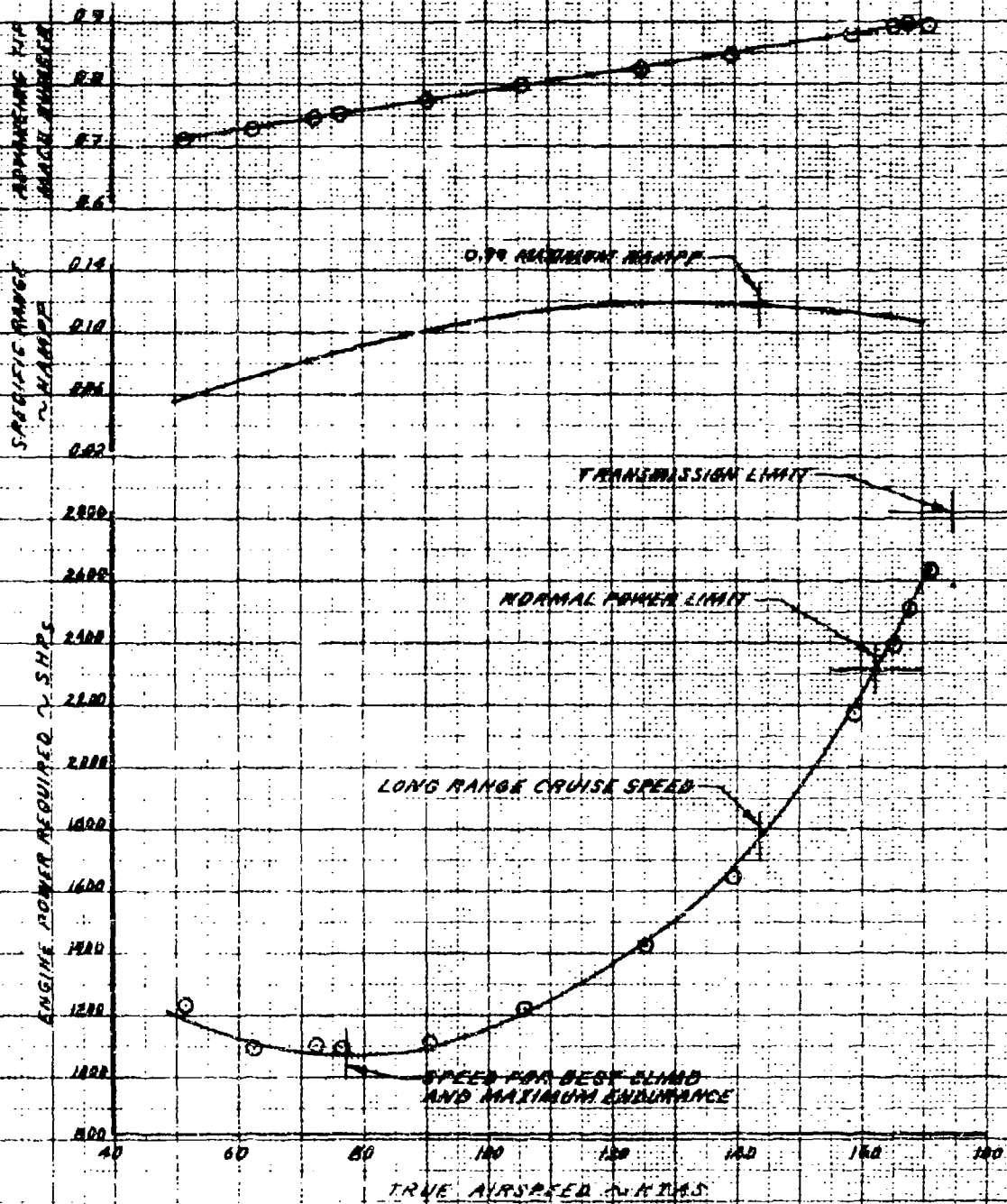

FIGURE 14
LEVEL FLIGHT PERFORMANCE
S-57 SARAWATKA
T58-GE-3 ENGINES

AWS GROSS WEIGHT	AWS CG LOCATION	AWS DENSITY ALTITUDE	AWS WTF	AWS ROTOR SP. RPM	AWS CONFIGURATION
NIB	NIR	NFP	NFC	NRPB	ET
18750	AYRO(AFP)	4800	167	212	180618 EXTERNAL STORES

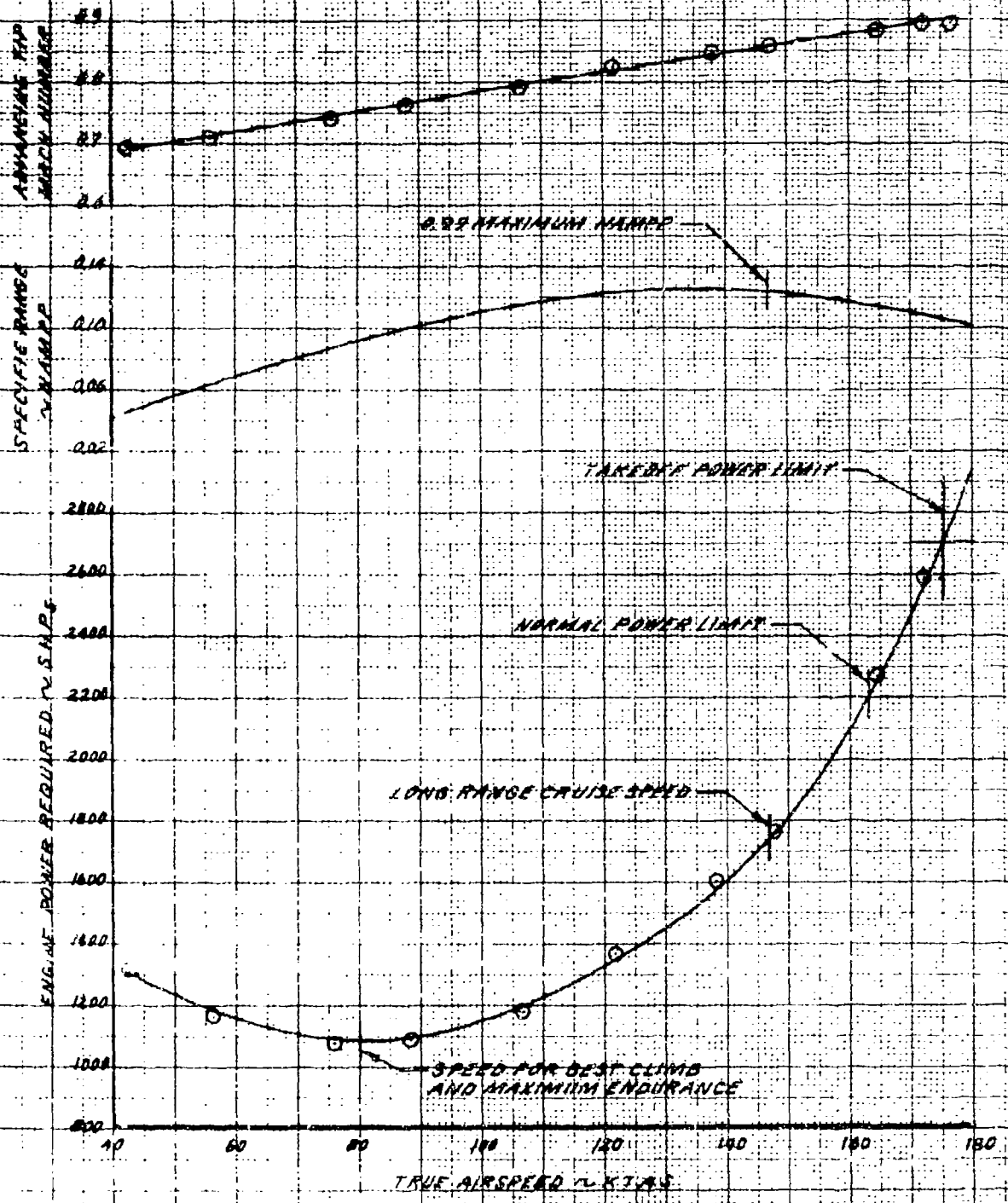

FIGURE 15
 LONG RANGE SUMMARY
 5-67 SIMULATION
 YF-02 - 2 ENGINES
 51 "HEARD DAY"

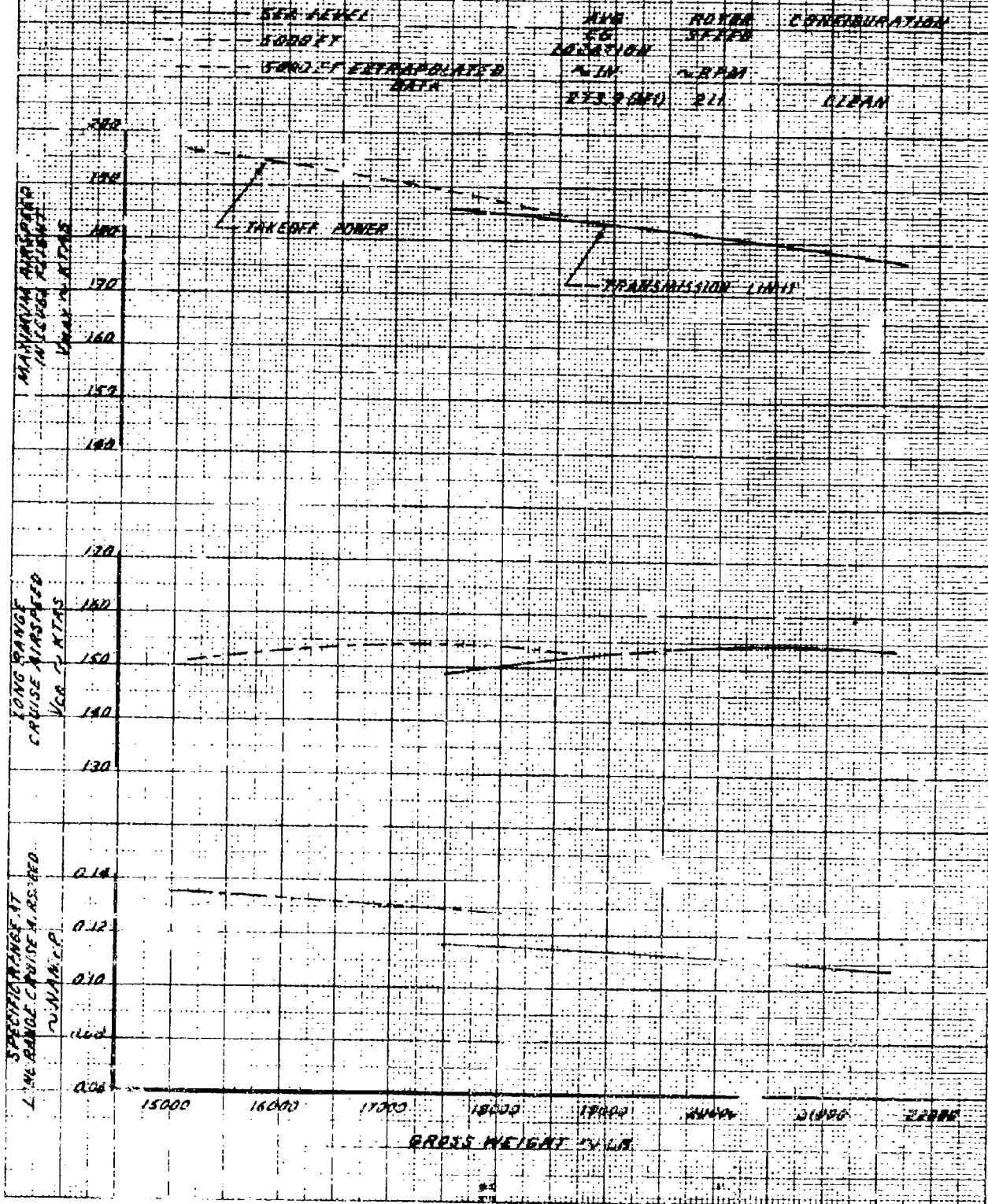

FIGURE 16
LONG RANGE SUMMARY
S-67 SUBMAYSA
Y-50 BY J. J. HARRIS
STANDARD DAY

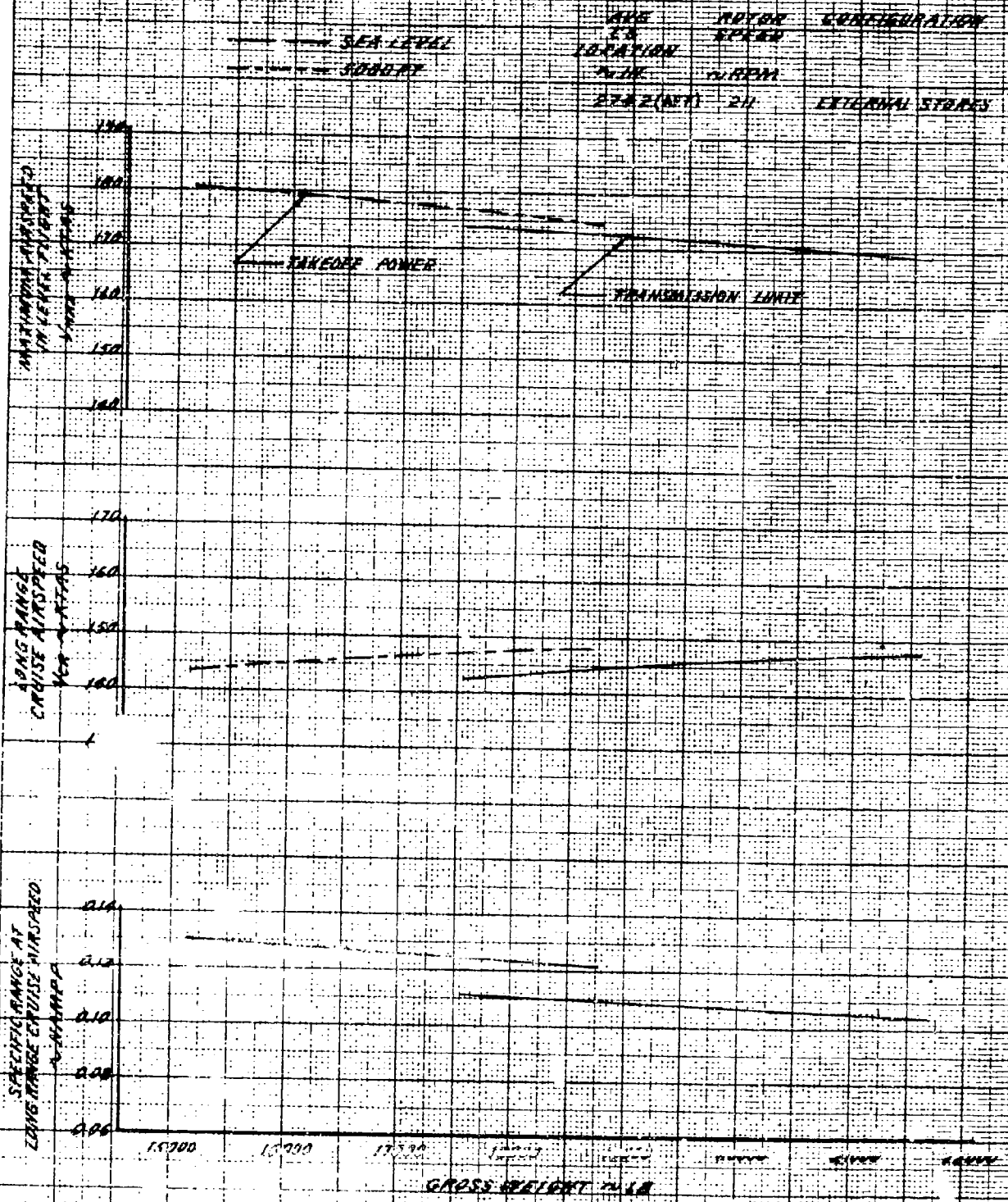

FIGURE 17
MAXIMUM ENDURANCE
S-67 SUPERHOG
T38-GE-3 ENGINES
STANDARD DAY

SEA LEVEL	WING	WATER	CONFIGURATION
00000 FT	10	0000	
	100	0000	
	2700 (MPL)	20	CLEAN

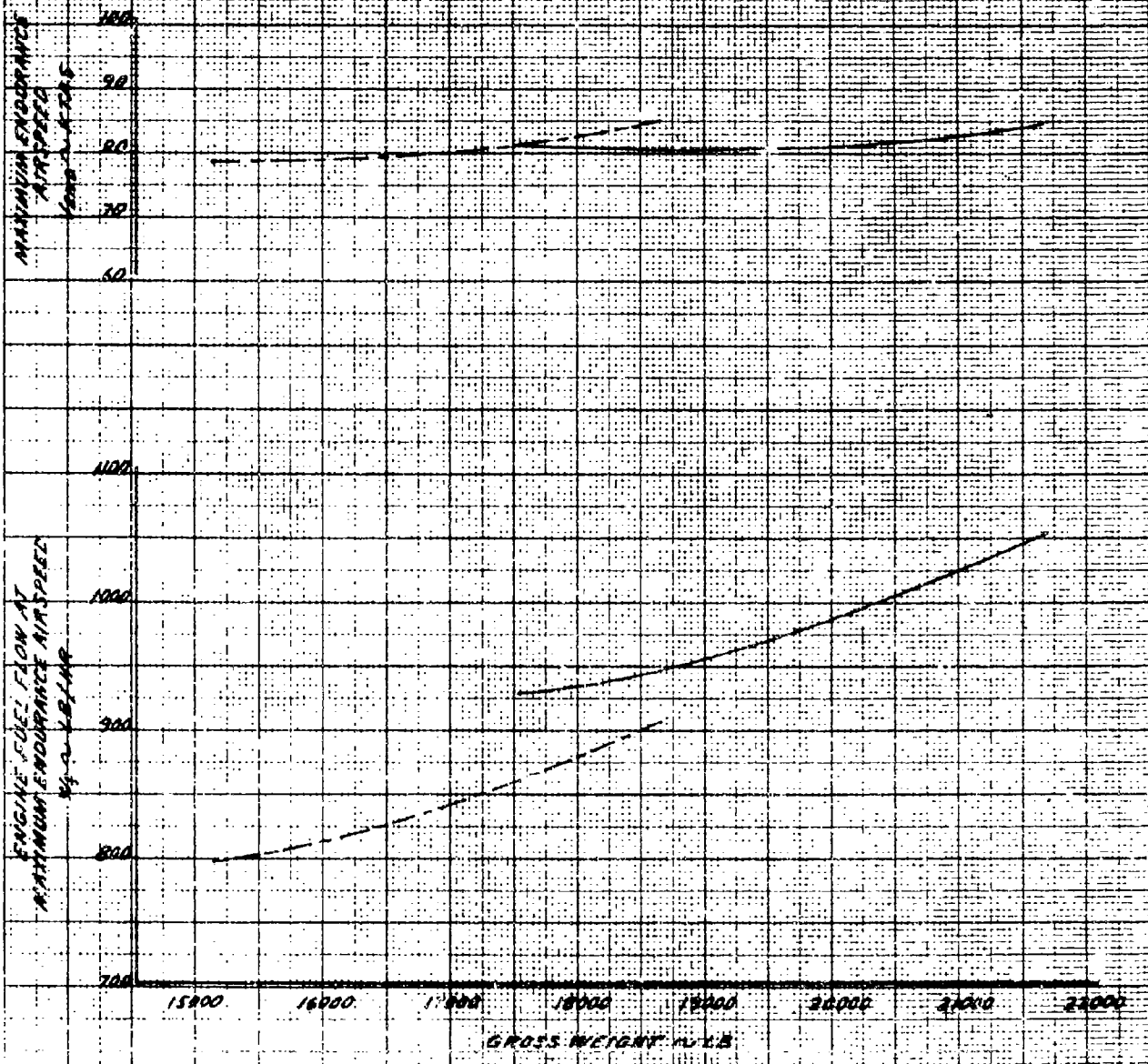

FIGURE 18
MAXIMUM ENDURANCE
S-57 STRENGTH
750 HP - 5 ENGINES
STANDARD DAY

SEA LEVEL	HP	POWER	CONFIGURATION
3000 FT	750	5 ENGINES	
	LOCATION		
	10200		
	2702 (W)	21	EXTERNAL STORES

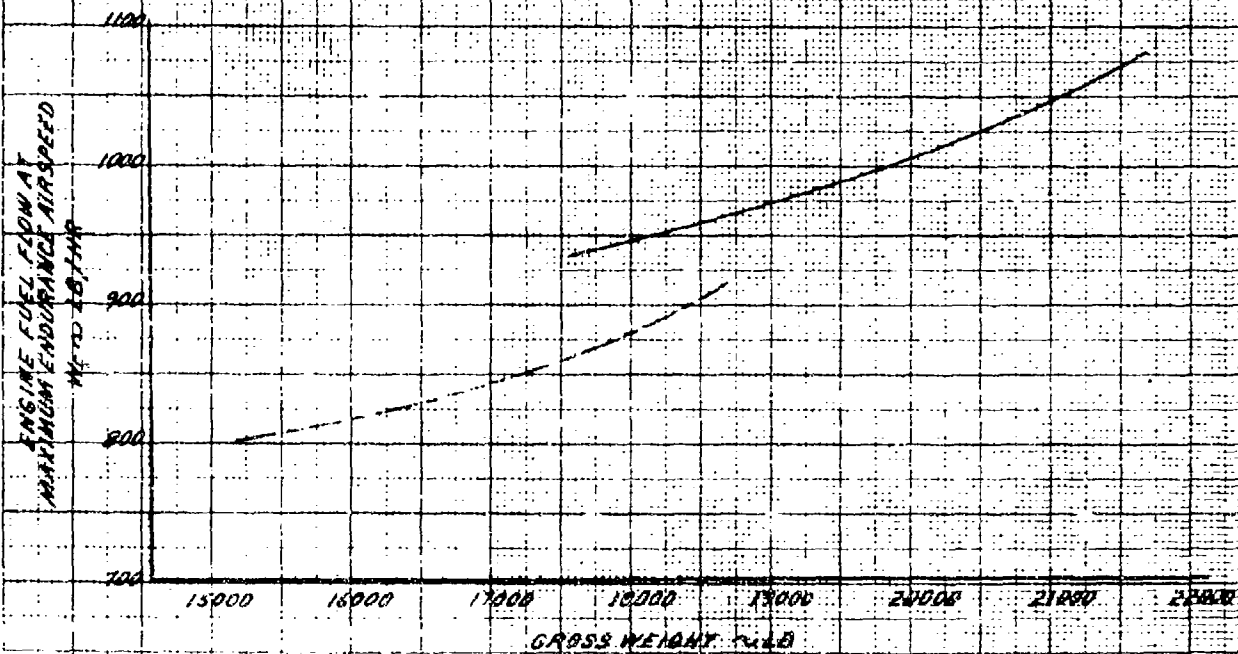
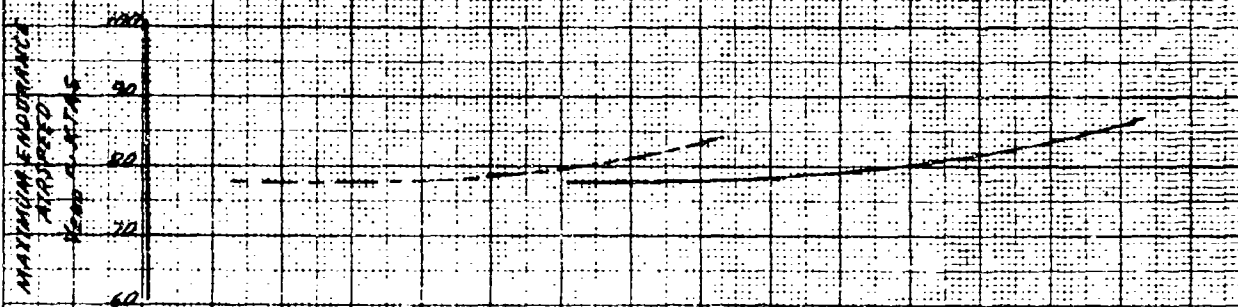

FIGURE 19
ACCELERATION FROM HOVER TO VH

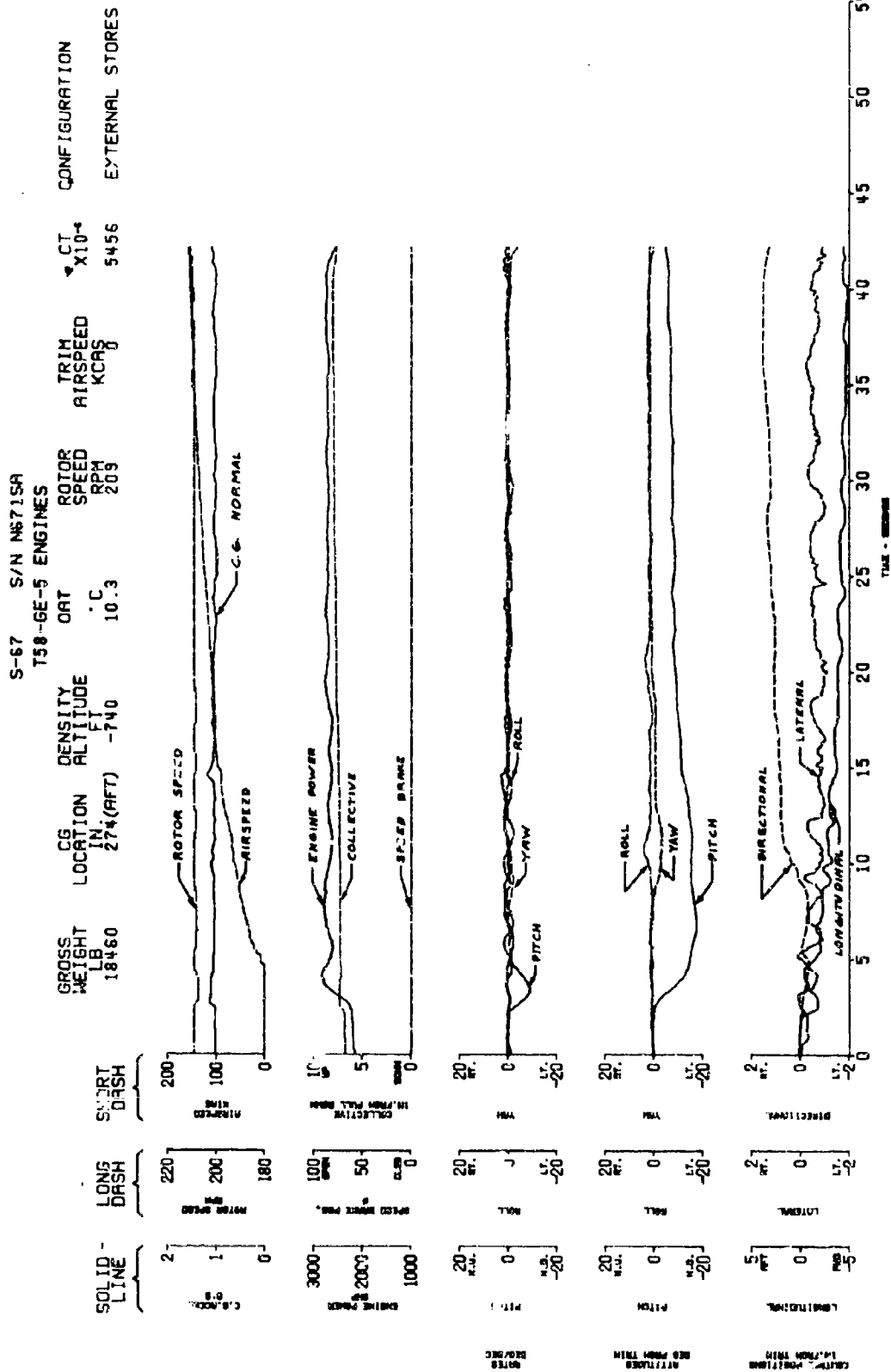

FIGURE 20
DECELERATION FROM V_H TO HOVER

S-67 S/N N671SR
T58-GE-5 ENGINES
ORIGINATOR
TRIM AIRSPEED
KIAS 151
CT X10⁻⁴ 54.12
CONFIGURATION EXTERNAL STORES

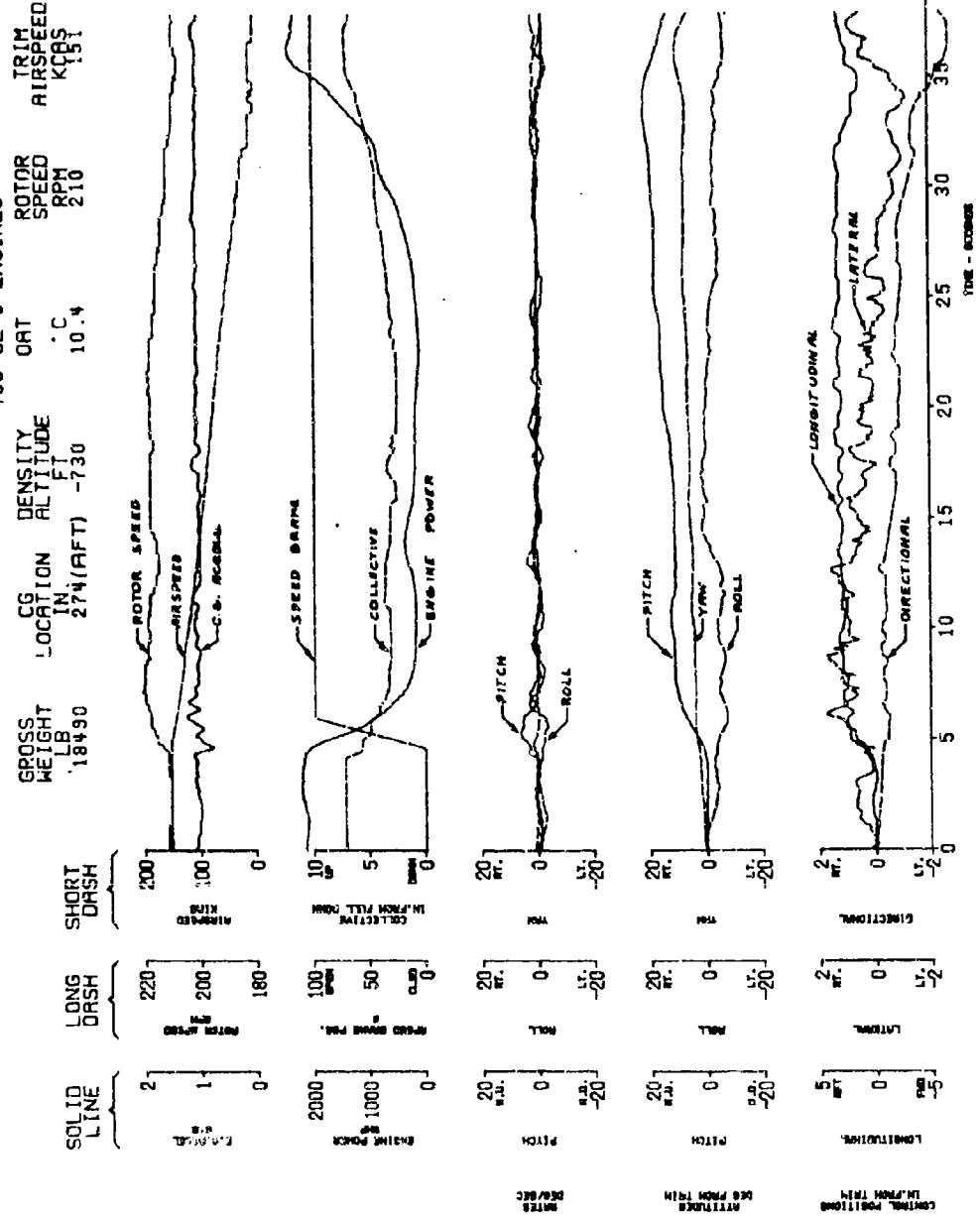

FIGURE 21
TIME HISTORY OF RIGHT LATERAL ACCELERATION

S-67 S/N N6715A
T58-GE-5 ENGINES
CT X10-4
5357 TOW

GROSS WEIGHT 18460
CG LOCATION IN. 275(AFT)
DENSITY ALTITUDE FT. -350
ROTOR SPEED RPM 212
DRT .C 17.5

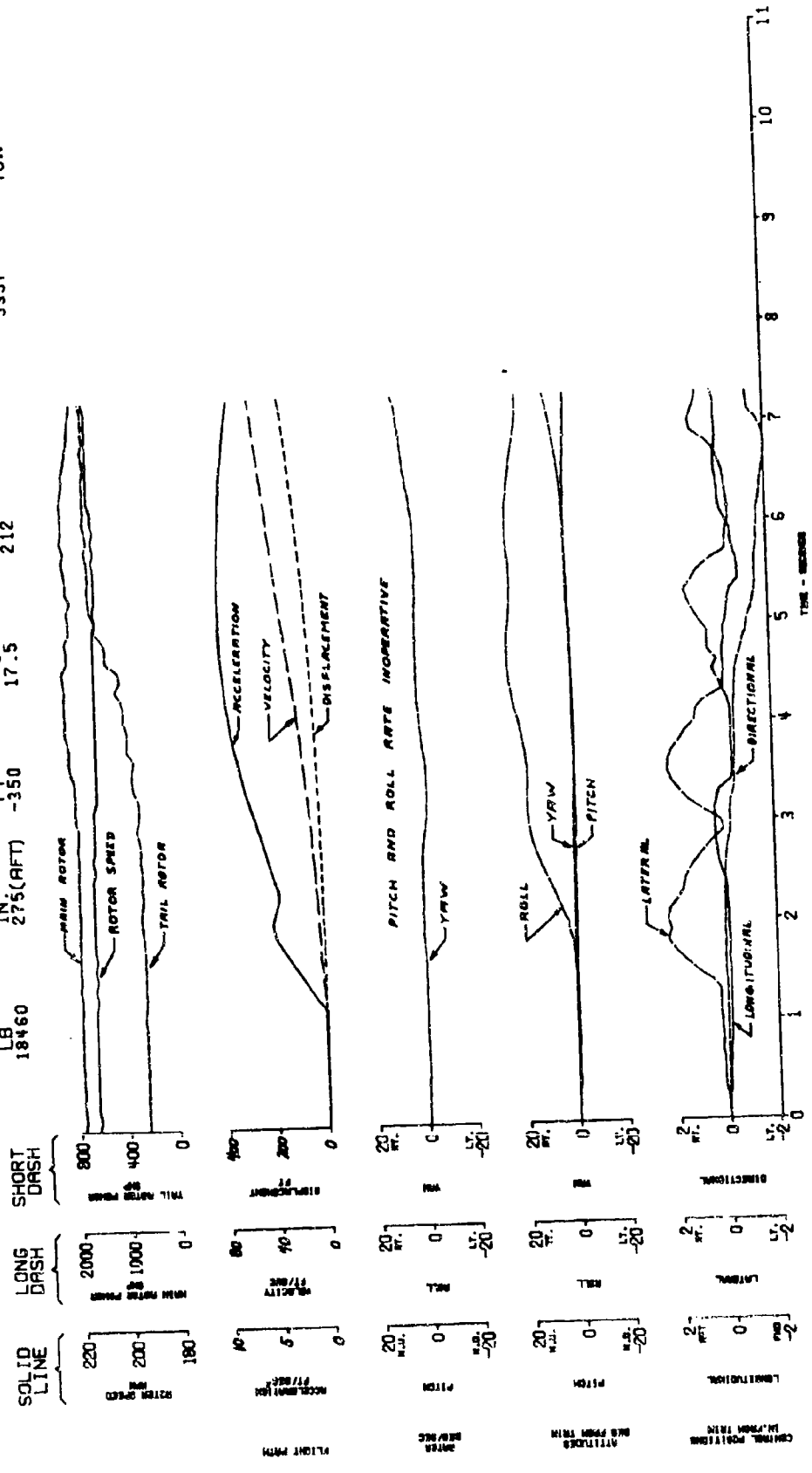

FIGURE 22
TIME HISTORY OF LEFT LATERAL ACCELERATION

S-67 S/N N671SA
T58-GE-5 ENGINES
CT X10-4
5321
CONFIGURATION
TOW

GRUSS WEIGHT 18330
CG LOCATION 275(AFT)
DENSITY ALTITUDE -350
ORAT 17.5
ROTOR SPEED RPM 212

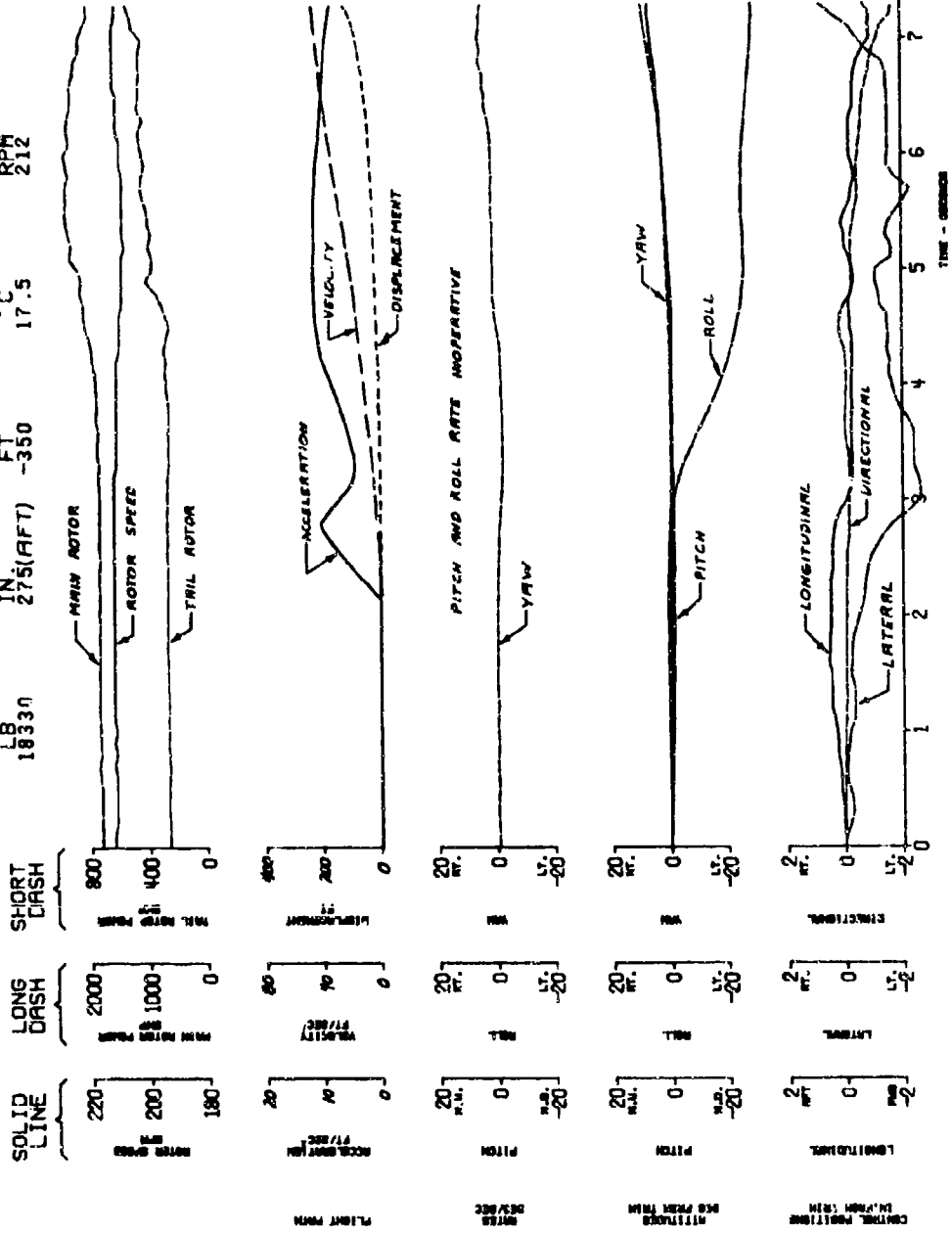

FIGURE 23
LONGITUDINAL CONTROL SYSTEM CHARACTERISTICS
5-ST SIMULATOR

NOTES:

1. TEST CONDUCTED ON GROUND WITH ENGINES AND MOTORS STOPPED
2. HYDRAULIC AND ELECTRICAL POWER FROM EXTERNAL SOURCES
3. ALL SWITCHES AND SYSTEMS SET TO DUPLICATE NORMAL IN-FLIGHT CONDITIONS
4. TOTAL LONGITUDINAL CONTROL TRAVEL 10.0 IN.
5. POWER LINKS REMOVE IN FLIGHT TEST TAKEN FROM ICE HOOPER

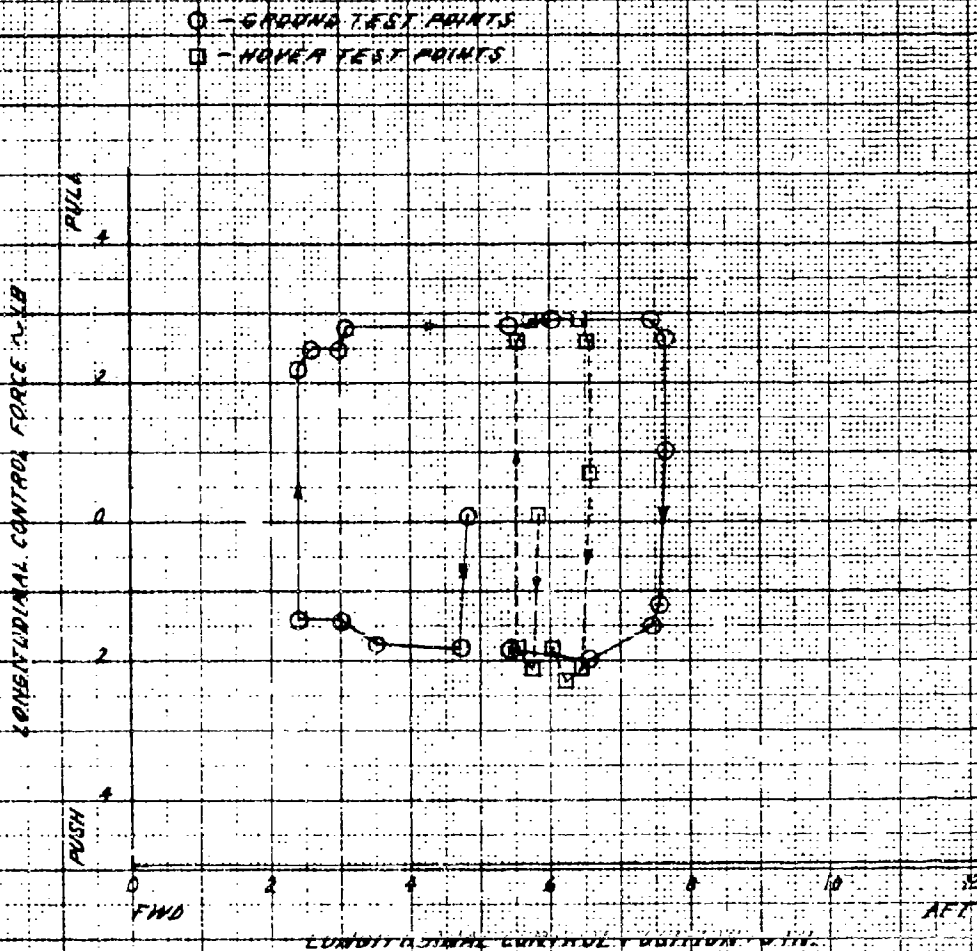

FIGURE E-4
 FUEL AUGMENTATION SYSTEM LEAD
 PITCH CONTROL GAIN PROGRAM
 F-87 SIMULATOR

NOTES:

1. TEST CONDUCTED ON GROUND WITH ENERGIES AND RESERVES SUPPLIED
2. HYDRAULIC AND ELECTRICAL POWER FROM WATSONVILLE SOURCE
3. FIRST STATIC SYSTEM PRESUMED TO SIMULATE SELECT 2 AIRSPEEDS
4. PITCH ZERO ARTIFICIALLY ADJUSTED TO SIMULATE SELECTED AIRCRAFT PITCH RATES

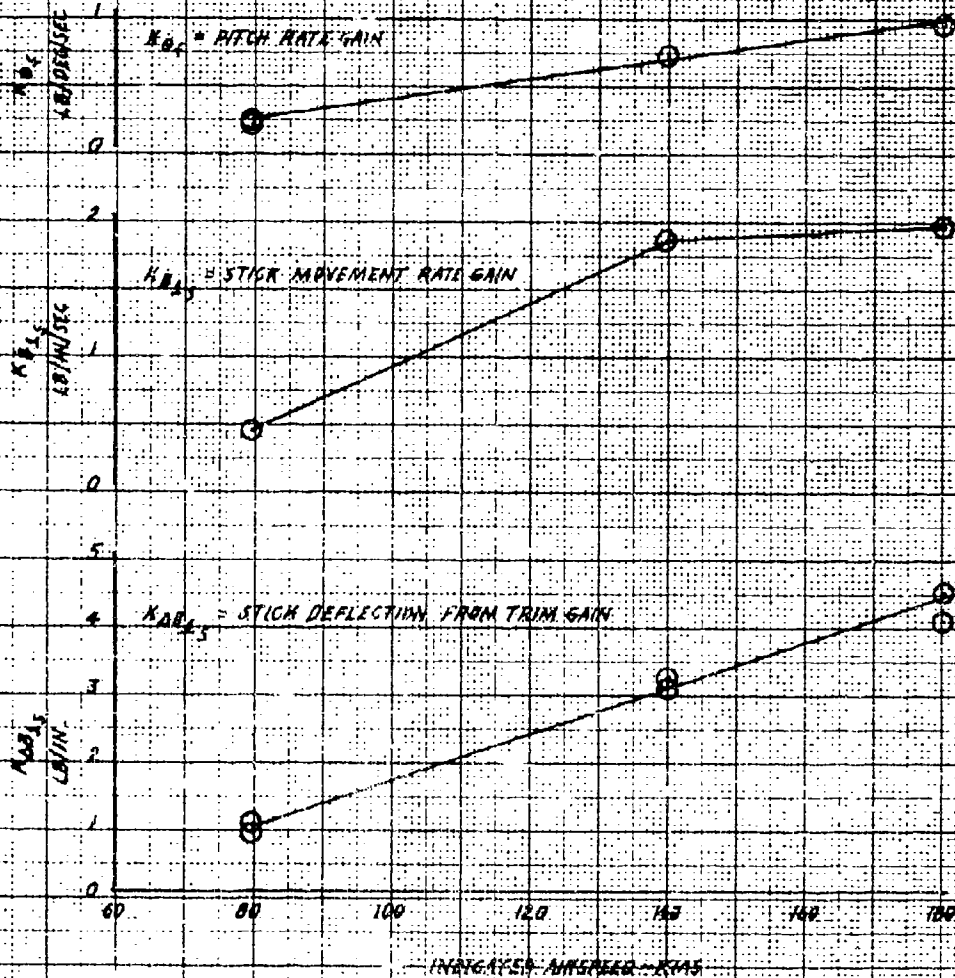

FIGURE 25
DIRECTIONAL CONTROL SYSTEM CHARACTERISTICS
 S-87 SIN 60715A

NOTES:

1. TEST CONDUCTED ON GROUND WITH ENGINES AND MOTORS STOPPED
2. HYDRAULIC AND ELECTRICAL POWER FROM EXTERNAL SOURCES
3. ALL SWITCHES AND SYSTEMS SET TO OPERATE NORMALLY IN READY CONDITION
4. TOTAL DIRECTIONAL CONTROL TRAVEL = 6.5 IN.
5. BREAKOUT INCLUDING FRICTION FORCE = 5.0 LB. RT. 3.5 LB. LT.
6. CONSTANT FORCE APPLIED AT JOY PEDALS USING A HAND-HELD FORCE GAGE

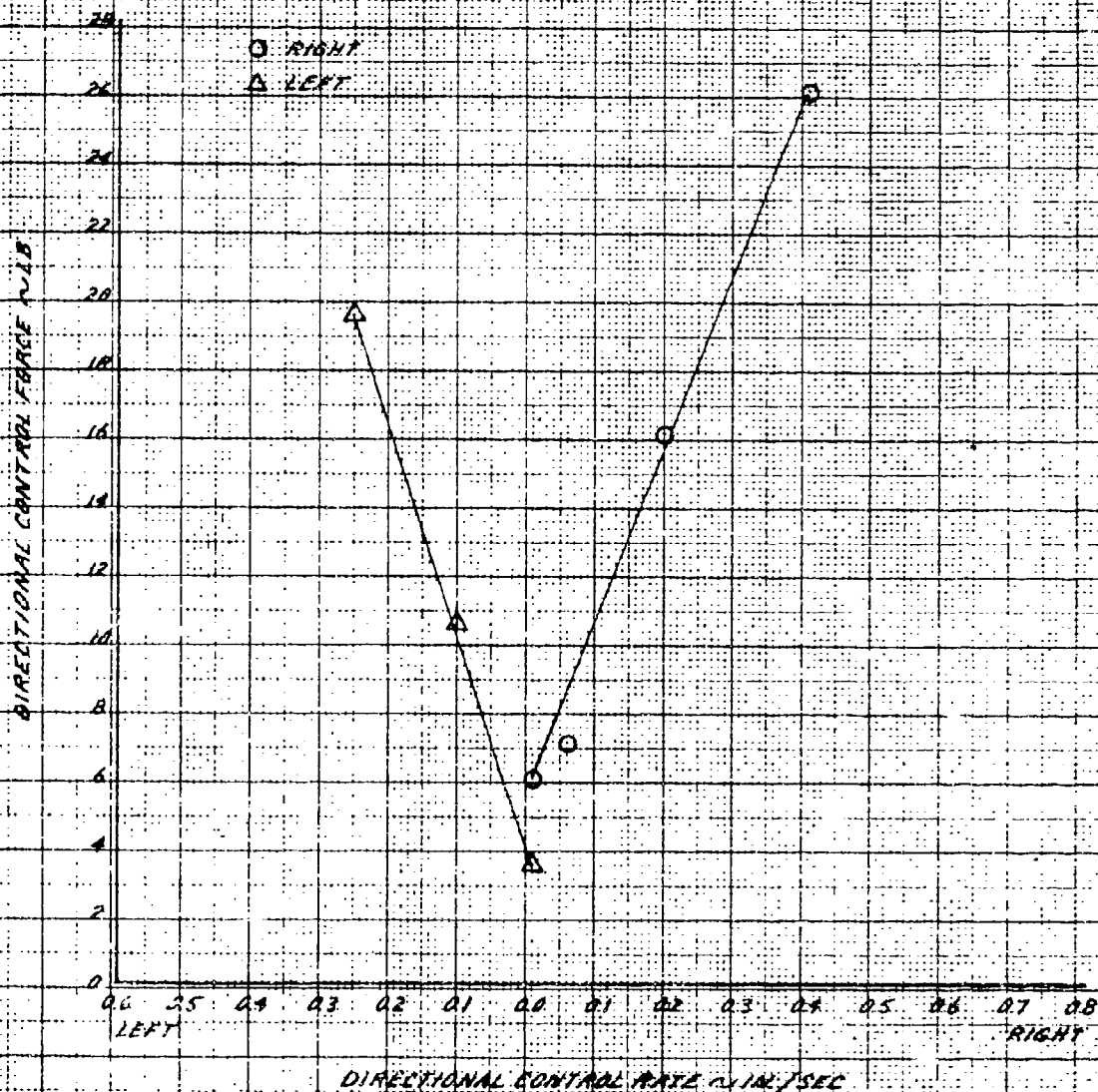

FIGURE 26
COLLECTIVE CONT. '92 SYSTEM CHARACTERISTICS
5-47 SERVO ACTION

NOTES:

1. TEST CONDUCTED ON GROUND WITH ENGINES AND ROTORS STOPPED
2. HYDRAULIC AND ELECTRICAL POWER FROM EXTERNAL SOURCES
3. ALL SWITCHES AND SYSTEMS SET TO DUPLICATE NORMAL IN FLIGHT CONDITIONS
4. TOTAL COLLECTIVE CONTROL TRAVEL = 5.8 IN.

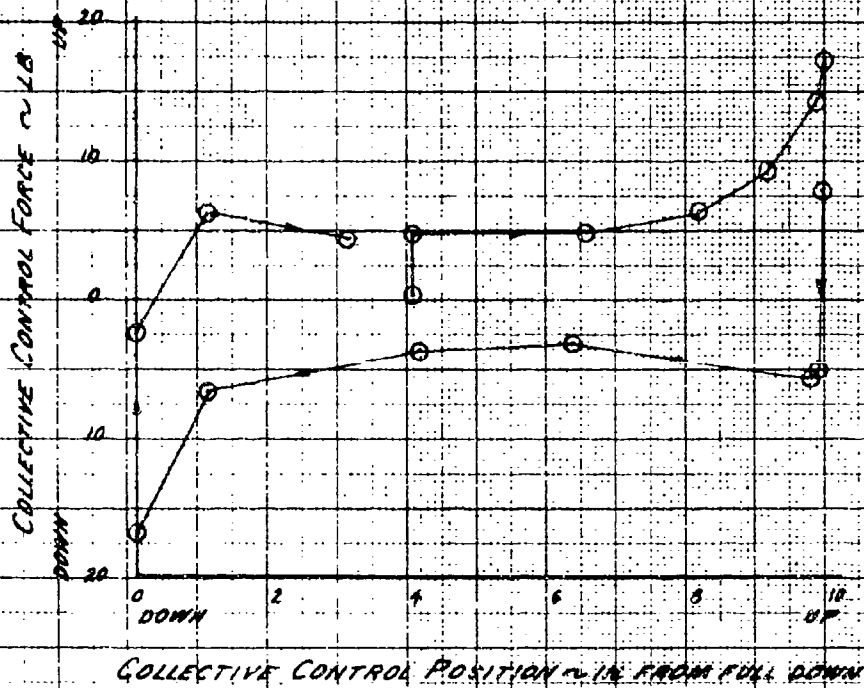

FIGURE 27
CONTROL POSITIONS IN FORWARD FLIGHT
S-87 SIMULATOR

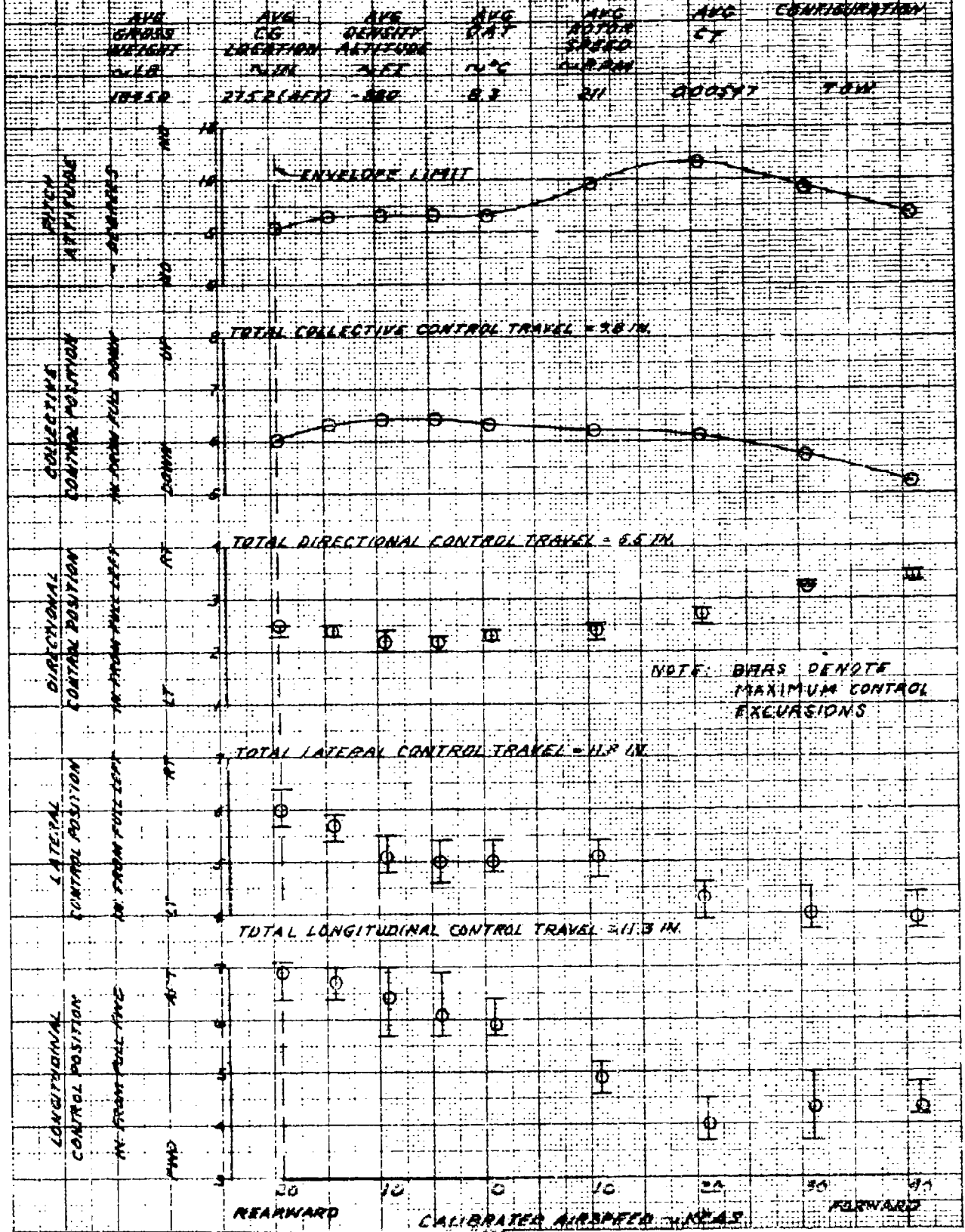

FIGURE 28

CONTROL POSITIONS IN SIDEWARD FLIGHT

S-17 S/N 10715A

AVG GROSS WEIGHT	AVG CG LOCATION	AVG DENSITY ALTITUDE	AVG IAS	AVG AIRSPEED	AVG CT	CONFIGURATION
LBS	IN	FEET	KTS	MPH		T.O.W
10450	23.1	1475	83	211	0.00527	

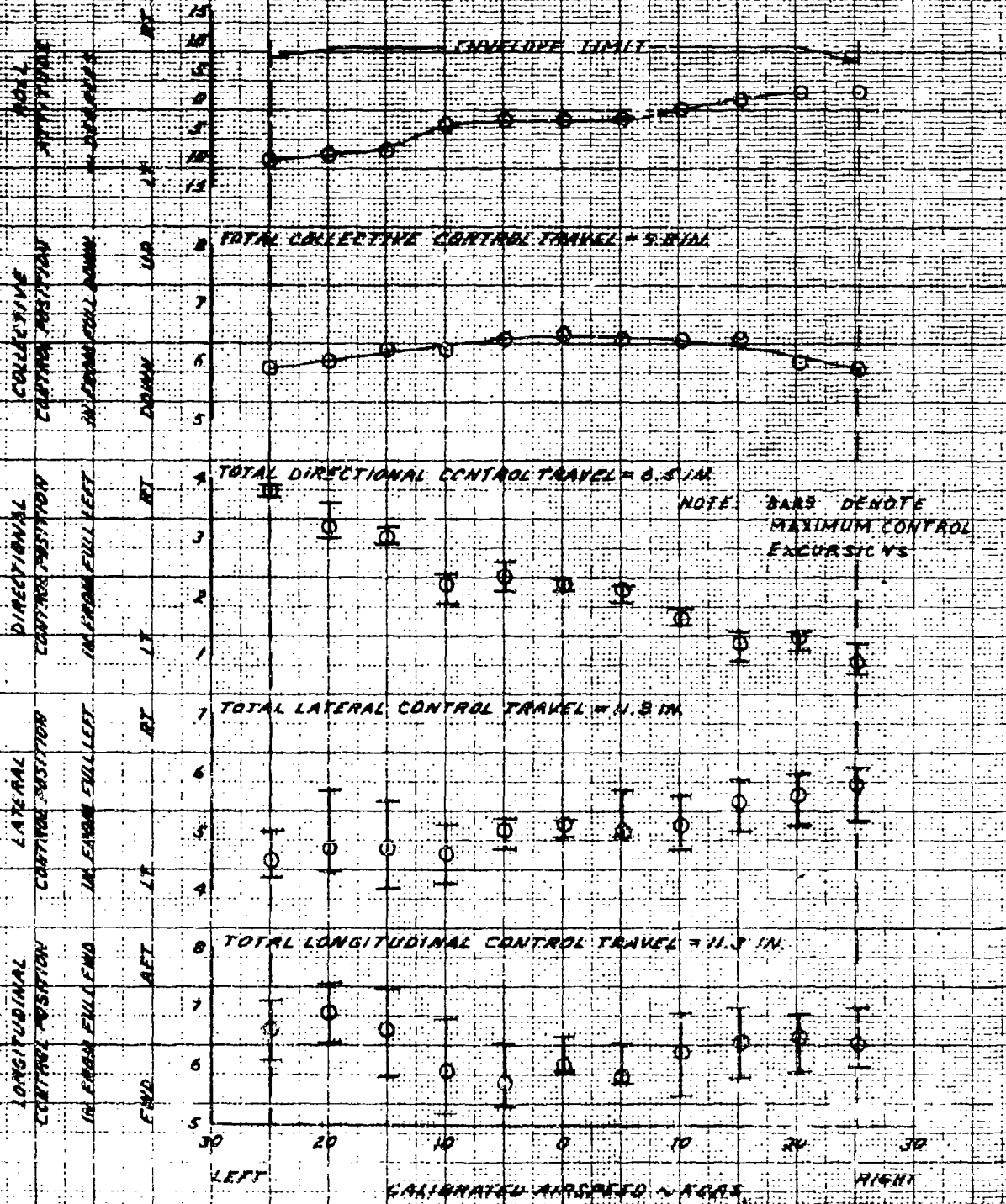

FIGURE 23
16 KTS LEFT SIDEWIND FLIGHT

S-67 S/N N6715A
T58-GE-5 ENGINES
CT X10-4
5192
CONFIGURATION
TOW

GROSS WEIGHT 18680
CG LOCATION IN 275(AFT)
DENSITY ALTITUDE -1510
ROTOR SPEED RPM 213
OAT °C 9.0

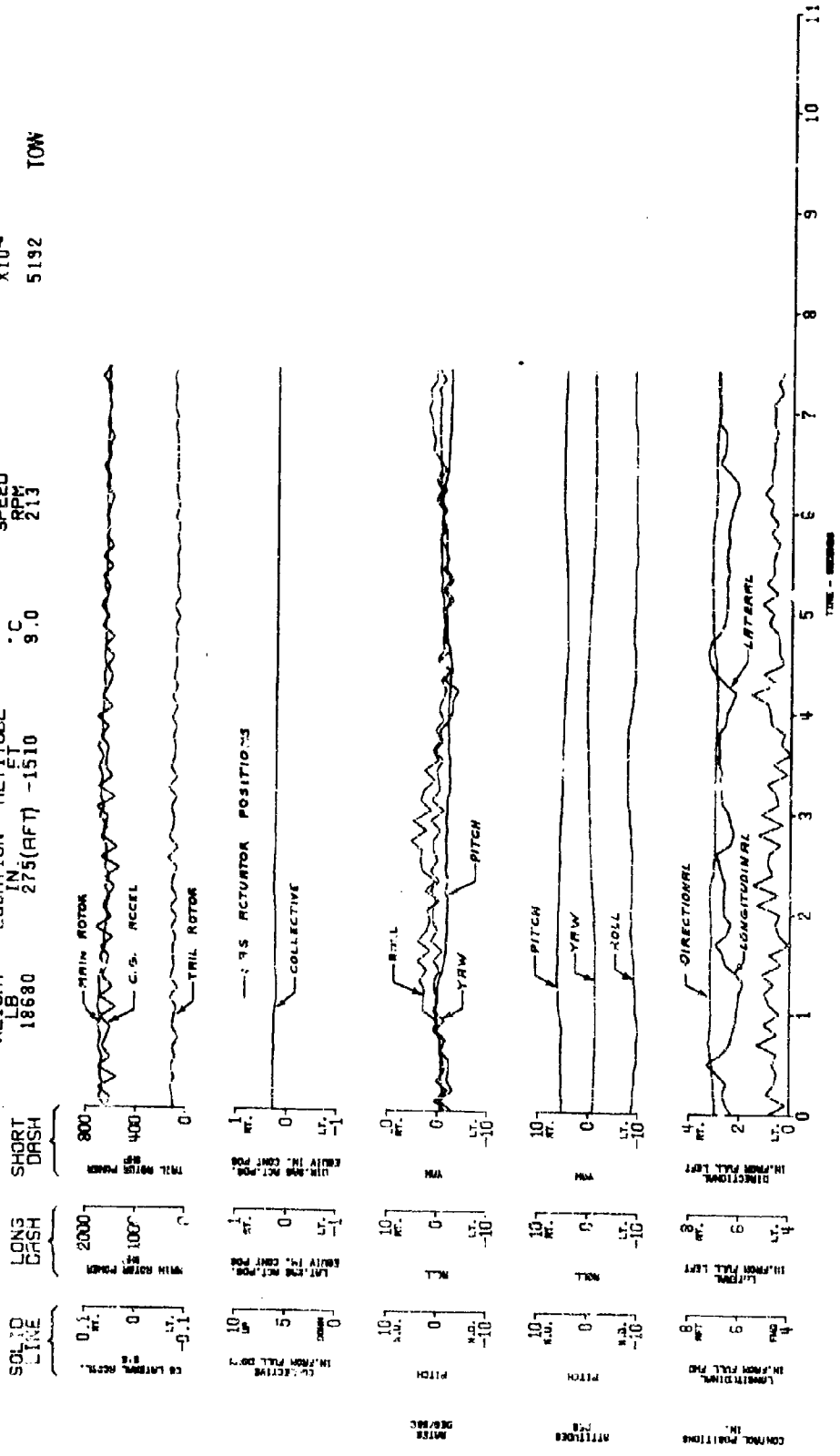

FIGURE 30

CONTROL POSITIONS IN TRIMMED FORWARD FLIGHT

C-47 AIRCRAFT

AIR WEIGHT	Avg CG LOCATION	Avg WING SPAN	Avg WING AREA	Avg ROTOR SPEED	Avg CY REV	CONFIGURATION
1500	2740 (ACT)	1500	191.5	25	0.00571	CLEAN

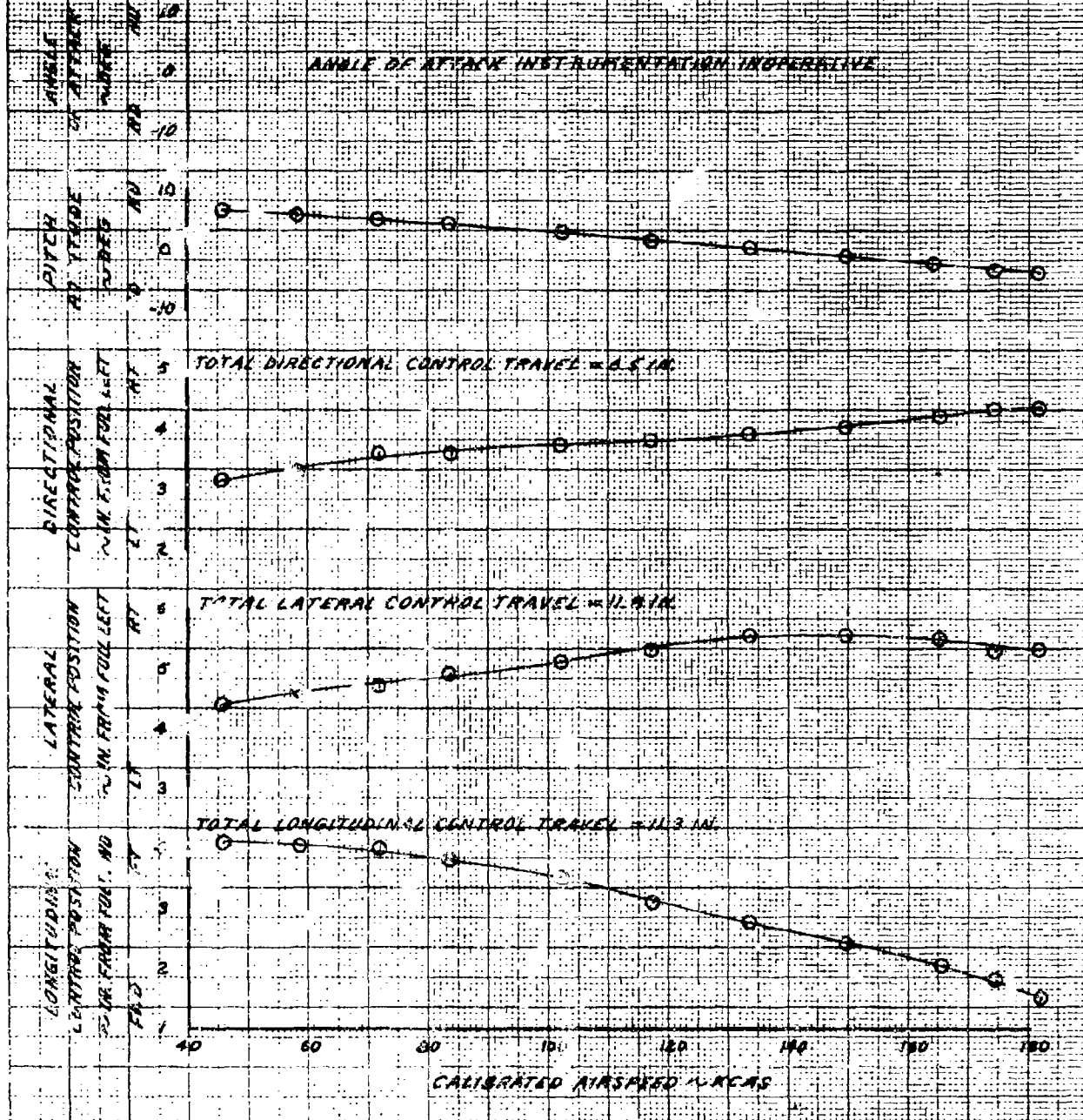

FIGURE 31
CONTROL POSITIONS IN TRAINED FORWARD FLIGHT
3-07 3000158

AVE GROSS WEIGHT	AVE CG LOCATION	AVE WING AREA	AVE WING SPAN	AVE WING DIPPER	AVE CONFIGURATION
WLB	IN IN	SQ FT	FT	DEGREES	
11800	2700 (CG)	1150	87	0.18	CLEAN

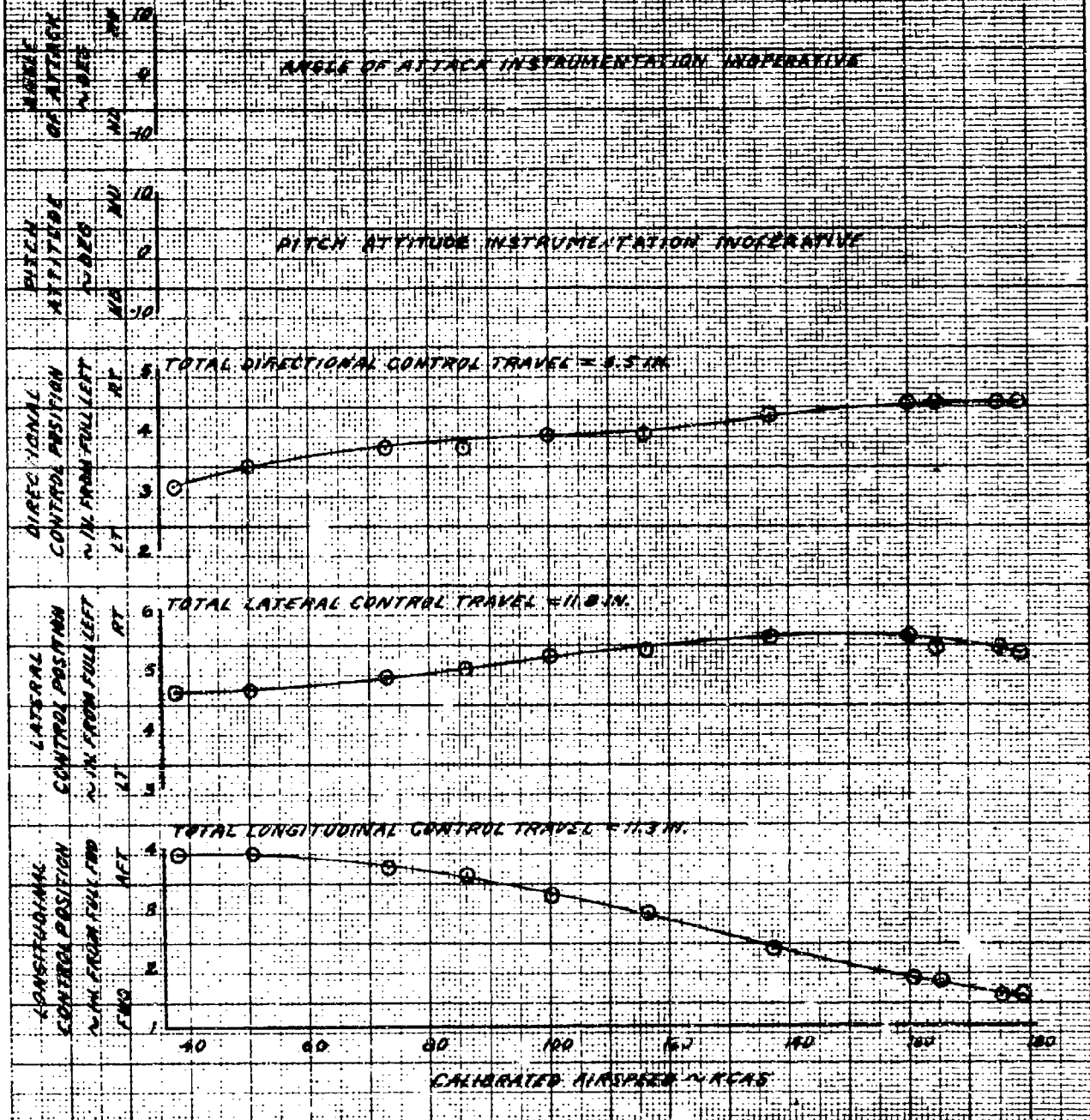

FIGURE 32
CONTROL POSITIONS IN TRAINED FORWARD FLIGHT
5-87 5TH WTS-54

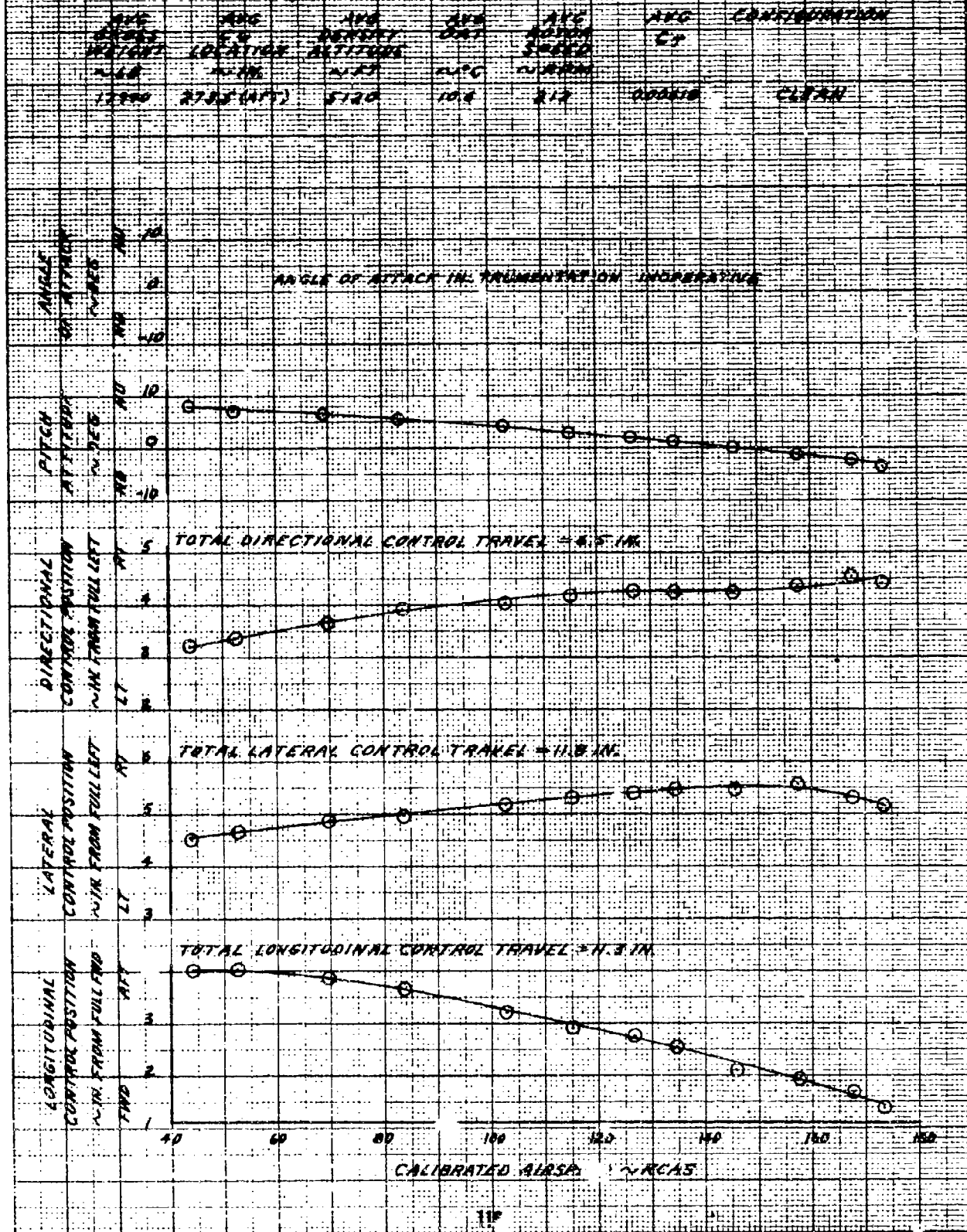

FIGURE 3
CONTROL POSITIONS IN DETERMINED FORWARD FLIGHT
5-67 SIMULATOR

Avg Roll Rate 1/10	Avg Pitch Rate 1/10	Avg Yaw Rate 1/10	Avg Alt 100	Avg Heading Speed 1000	Avg CT	Equivalent Wind Direction Speeds
1.2	1.2	1.2	10.9	1.2	1.2	1.2

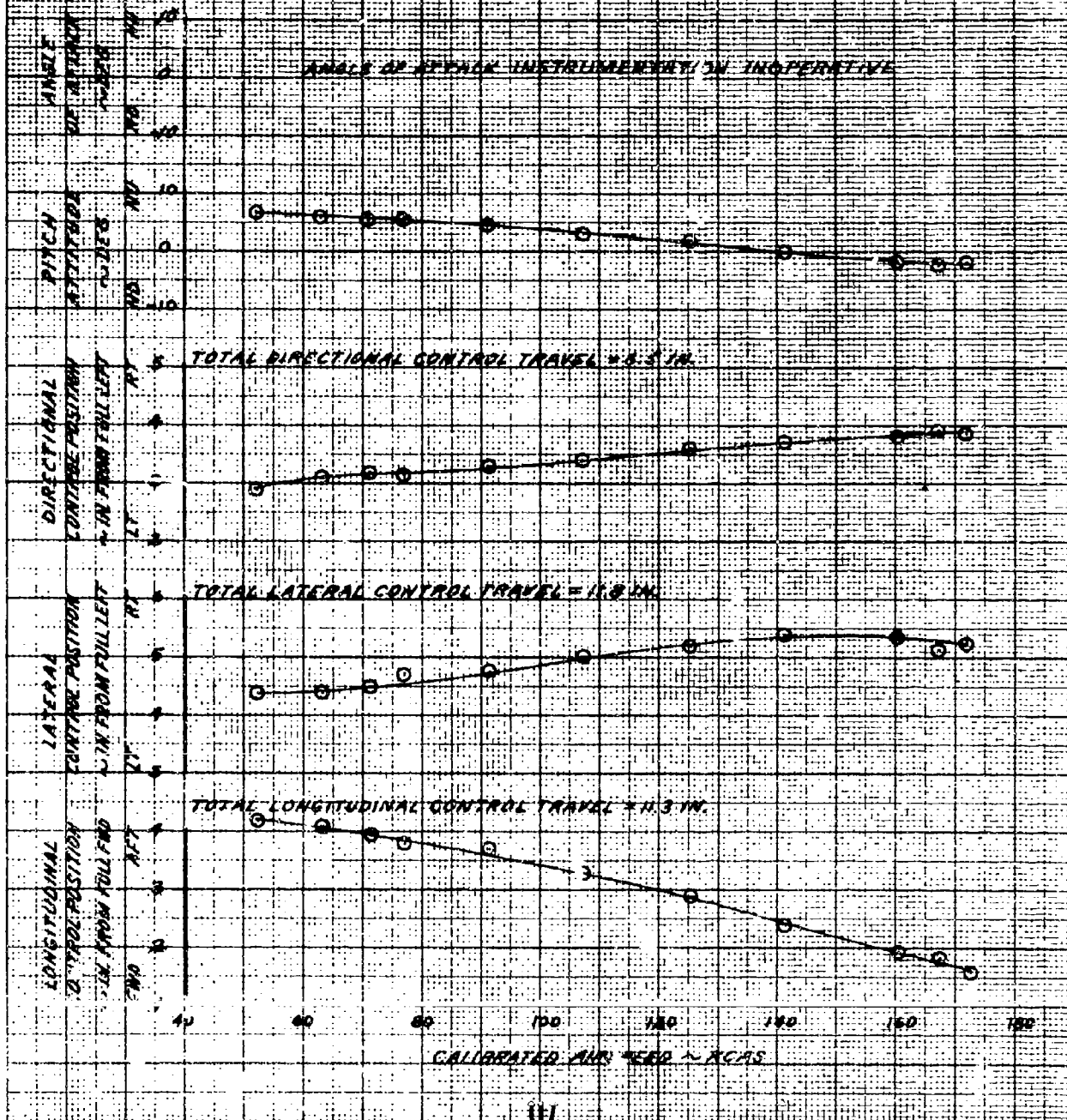

FIGURE 34
CONTROL POSITIONS IN TRAINED FORWARD FLIGHT
S-67 SIMULATOR

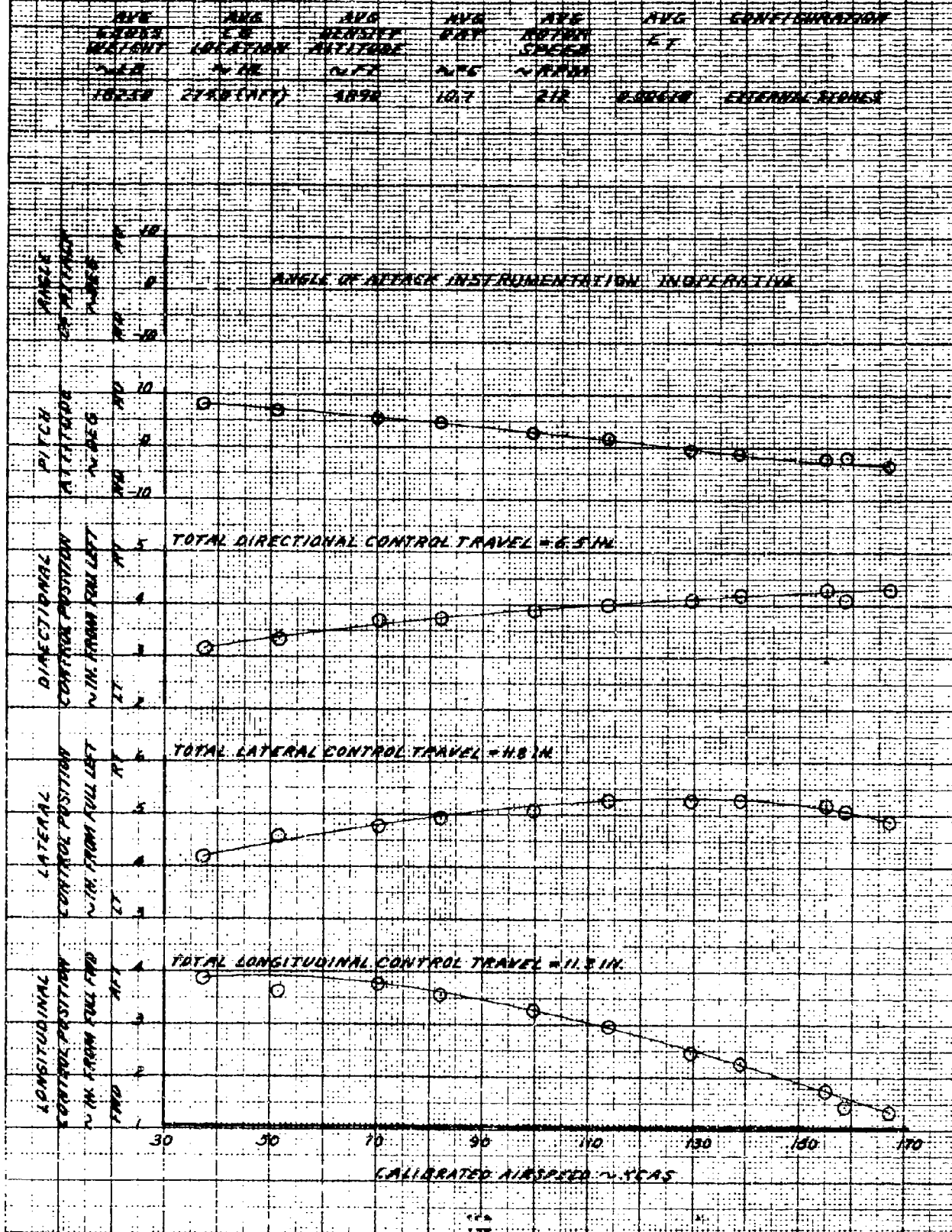

FIGURE 3-5
STATIC LONGITUDINAL STABILITY

SPEED	S BY STABILITY					AVG CONFIDENCE INT	EXTERNAL STORES
	AVE	AVE	AVE	AVE	AVE		
	STABILITY	STABILITY	STABILITY	STABILITY	STABILITY		
18350	1.18	1.18	1.18	1.18	1.18	EXTERNAL STORES	
18800	1.18	1.18	1.18	1.18	1.18	EXTERNAL STORES	
17100	1.18	1.18	1.18	1.18	1.18	EXTERNAL STORES	

NOTE: SHARPER SYMBOLS & NOISE FROM

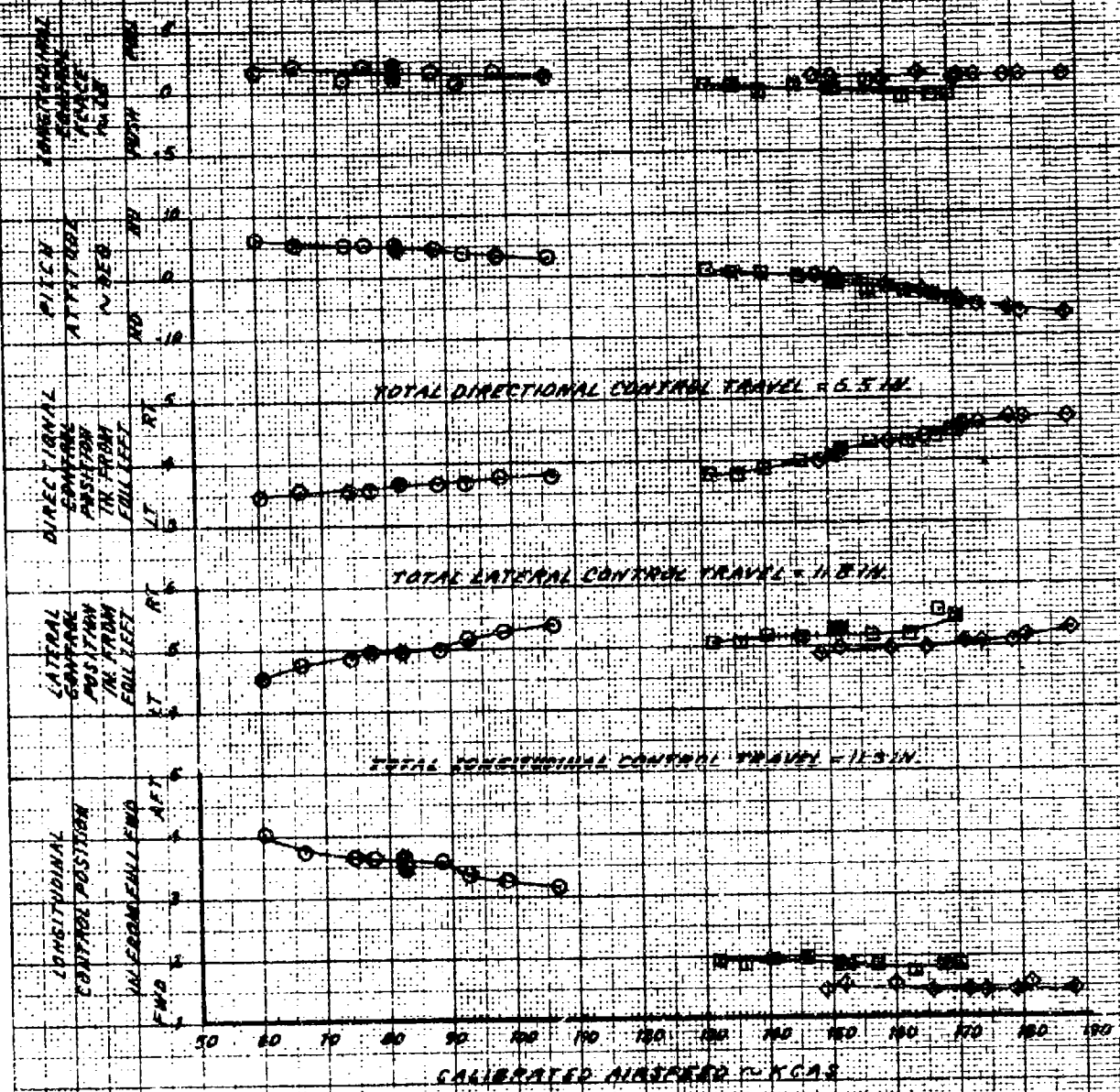
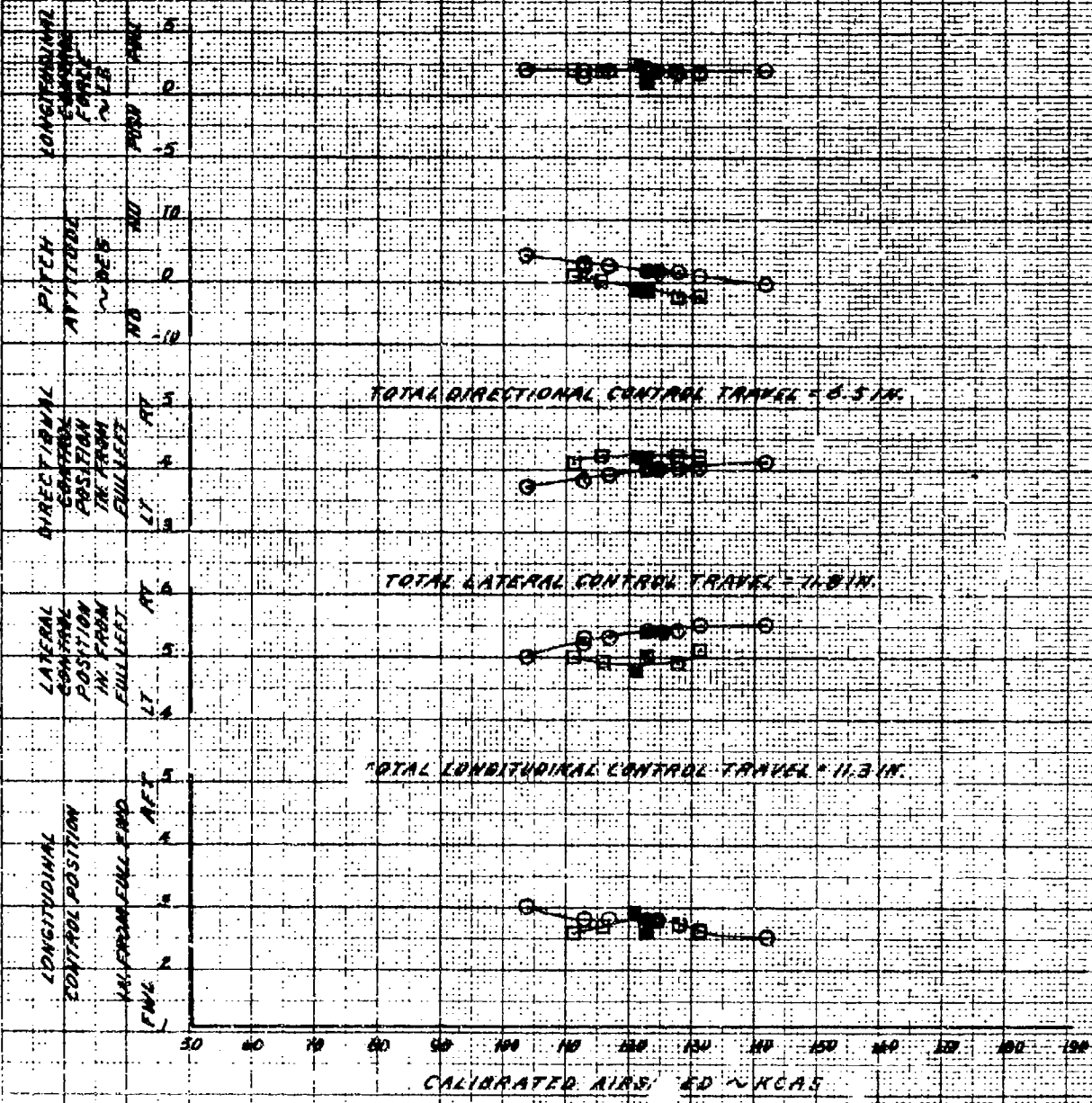

FIGURE 36
STATIC LONGITUDINAL STABILITY
3-47 5740254

SYMBOL	Avg EXPER WEIGHT ~LB	Avg EX APLATION ~IN	Avg DENSITY ACTITUDE ~IN	Avg DENSITY ACT ~IN	Avg DENSITY ACT ~IN	Avg DENSITY ACT ~IN	CONSIDERATION
○	1830	278 (IN)	3180	11.8	318	00058	APPROXIMATE
□	1870	278 (IN)	3390	12.7	312	00058	APPROXIMATE SPEED BRAKE OUT

NOTE - GRADED SYMBOLS DENOTE TRIM



STEERING CHARACTERISTICS

3-27-57
 100 MPH

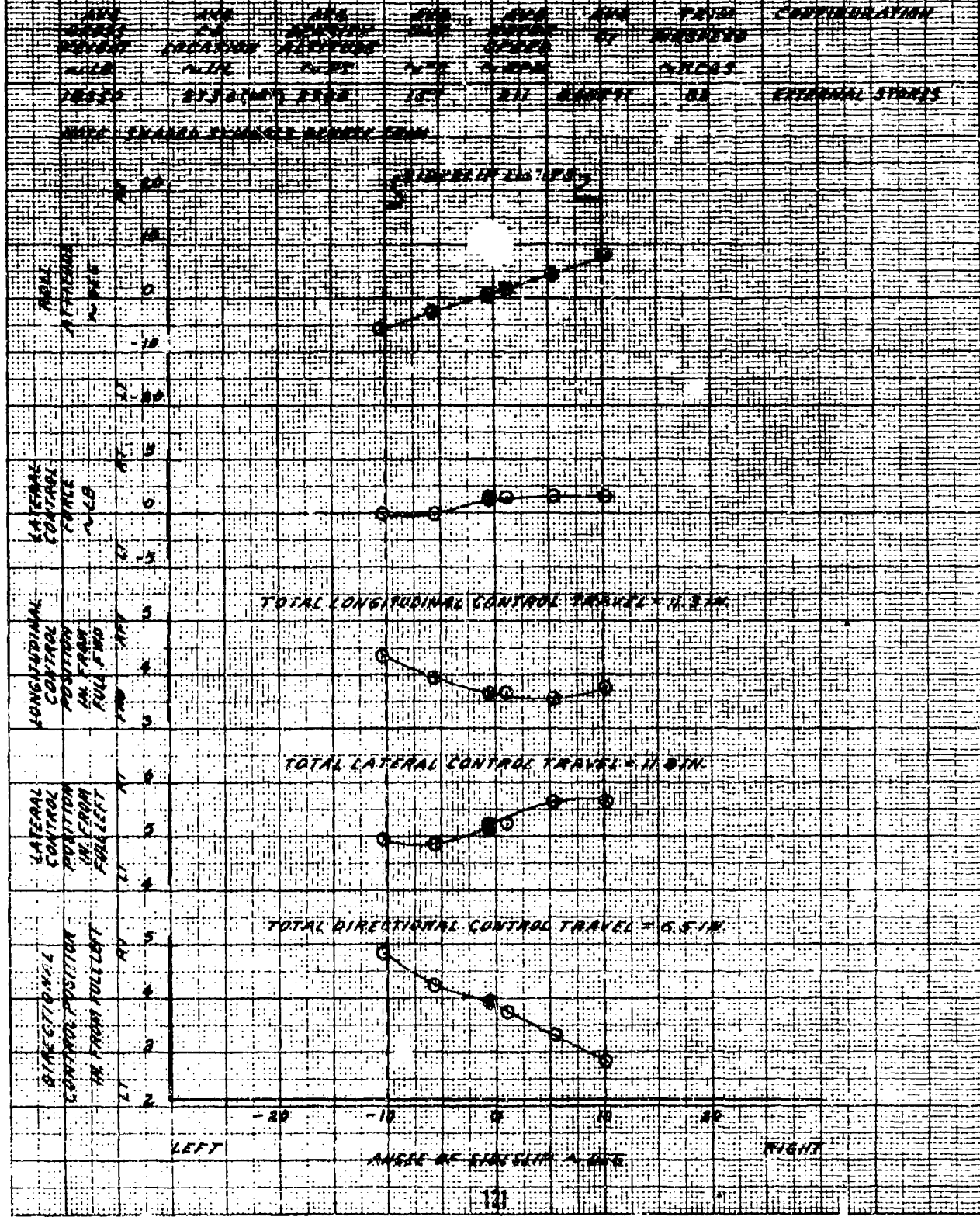

FIGURE 30
STATIC LATERAL DIRECTIONAL STABILITY
IN A STEADY STATE
APPROACH

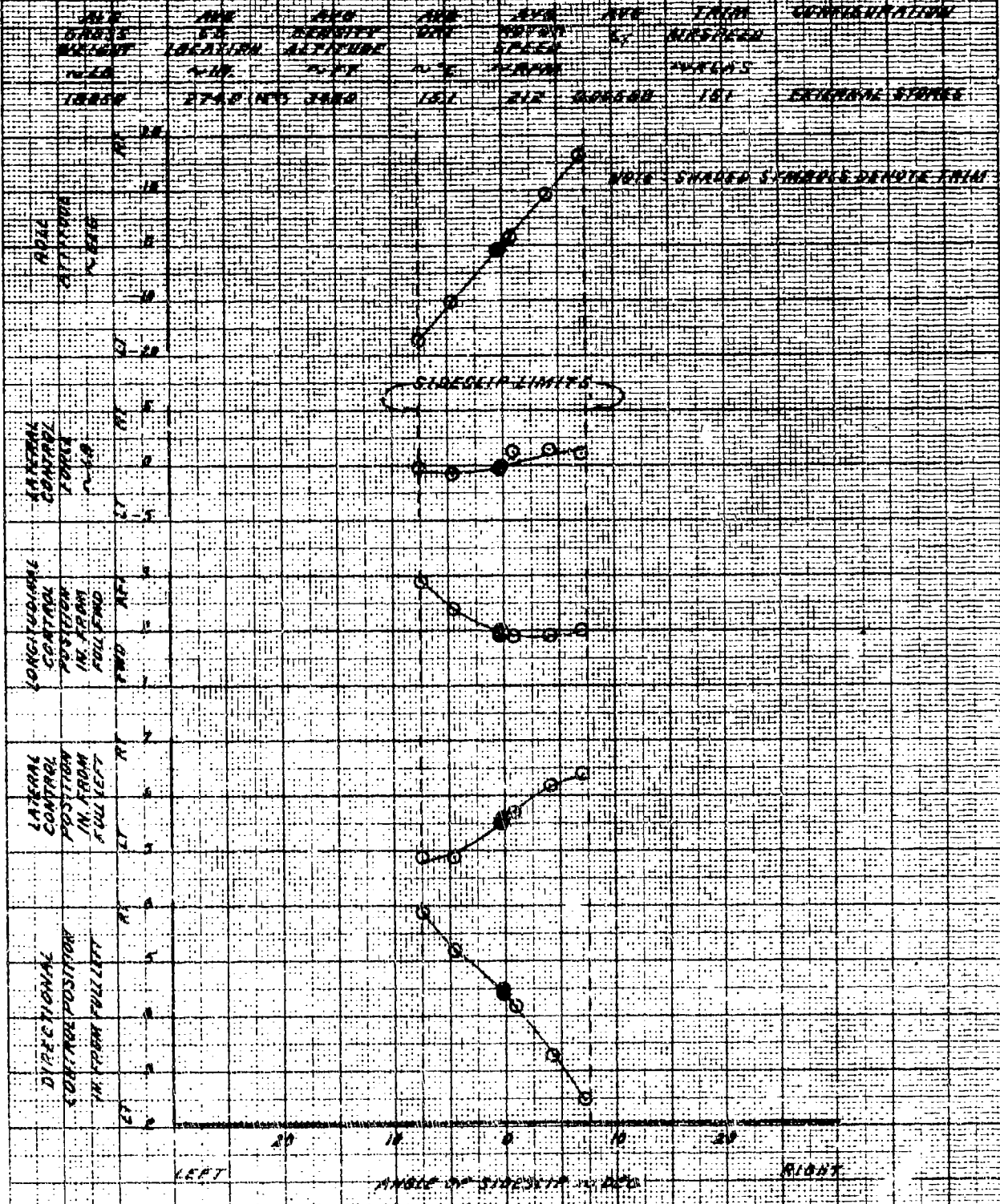

FIGURE 29
STATIC LATERAL DIRECTIONAL STABILITY
S-27 SIMULATOR
LEVEL FLIGHT

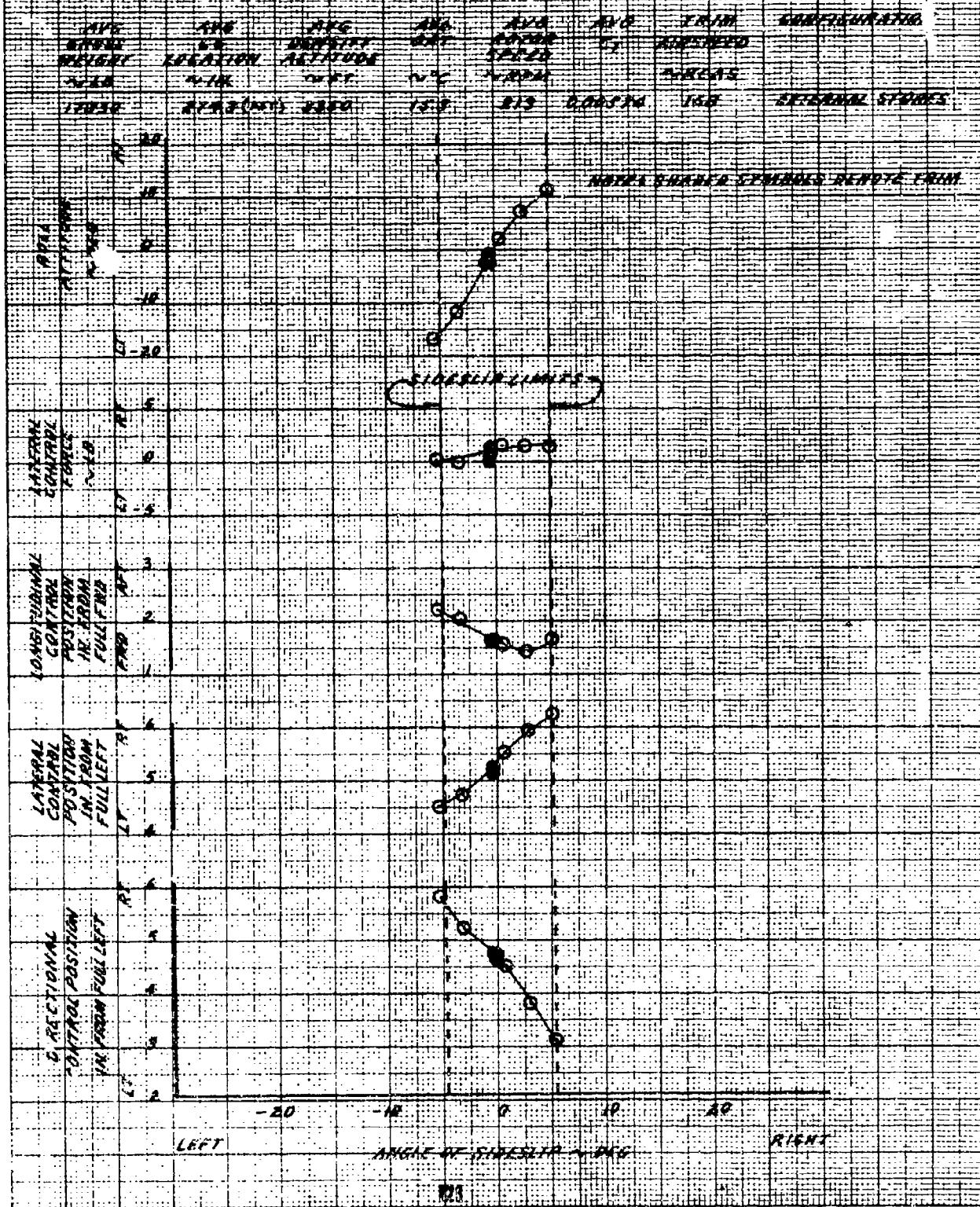

FIGURE 40
AFT LONGITUDINAL PULSE

S-67 S/N N6715A

TRIM AIRSPEED KCRAS 0
CONFIGURATION EXTERNAL STORES

CT X10-4 5521

ROTOR SPEED RPM 212

DAT 24.2

DENSITY ALTITUDE FT 1280

CG LOCATION IN 275 (AFT)

GROSS WEIGHT LB 18130

SRS ACTUATOR POSITION INSTRUMENTATION INDICATIVE
ANGLE OF ATTACK INSTRUMENTATION INDICATIVE

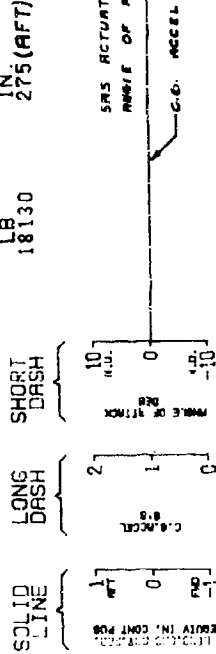

FIGURE 41
AFT LONGITUDINAL PULSE

S-57 S/N N6715A

CT CONFIGURATION
X10-4
6012 EXTERNAL STORES

TRIM AIRSPEED
KCRS
168

ROTOR SPEED
RPM
210

OAT °C
17.0

DENSITY ALTITUDE
FT
3760

CG LOCATION
IN
274(AFT)

GROSS WEIGHT
LB
17980

SOLID LINE LONG DASH SHORT DASH

LONG. ENG. ACT. POS. (Scale 0 to 1)
C.G. MARG. (Scale 0 to 2)
SCALE OF ATTACK (Scale 0 to 2)

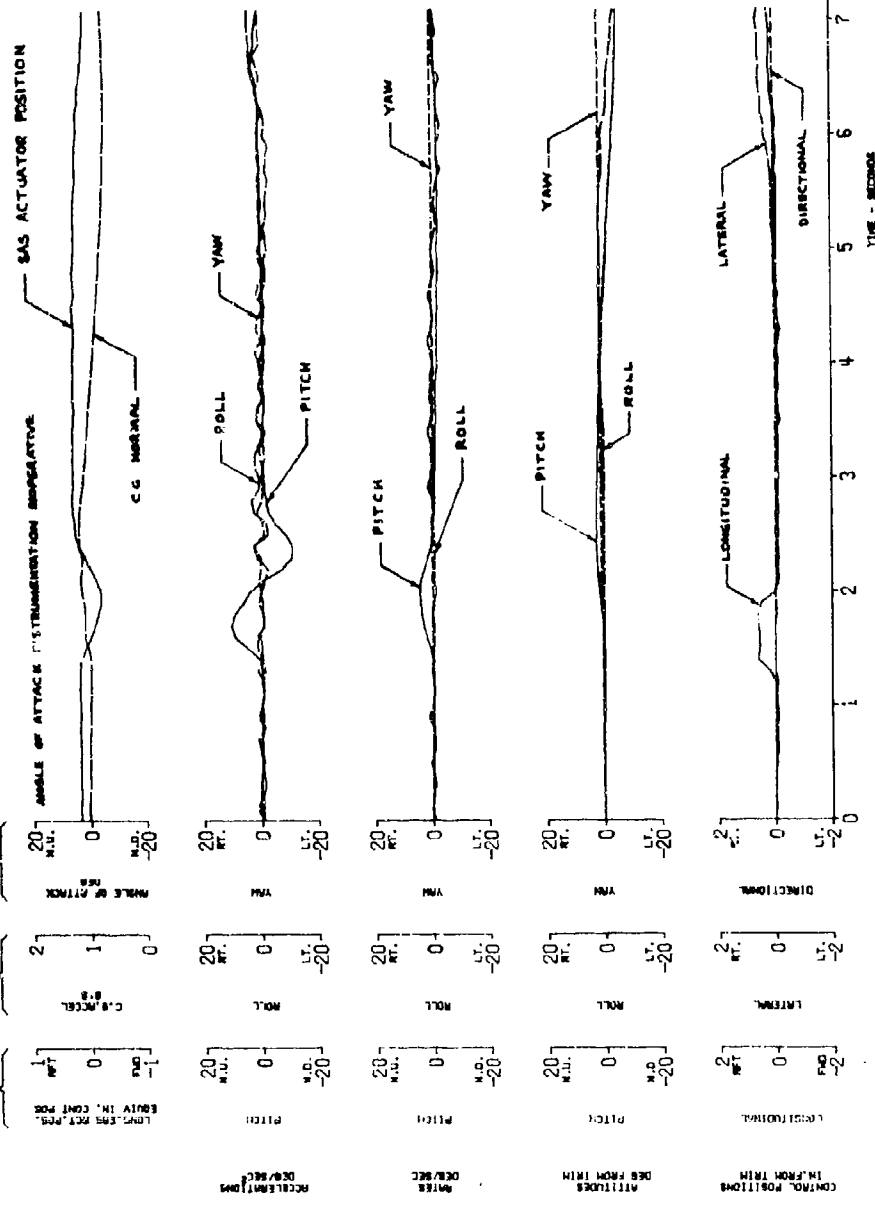

FIGURE 42
RIGHT LATERAL PULSE

S-67 S/N N671SA

GROSS WEIGHT 16130
CG LOCATION 275 (AFT)
DENSITY ALTITUDE 850
ROTOR SPEED 212 RPM
TRIM AIRSPEED 0 KCAS
CONFIGURATION 5458 EXTERNAL STORES

SRS RETURTOR POSITION INSTRUMENTATION MODERATIVE
ANGLE OF SIDESLIP INSTRUMENTATION MODERATIVE

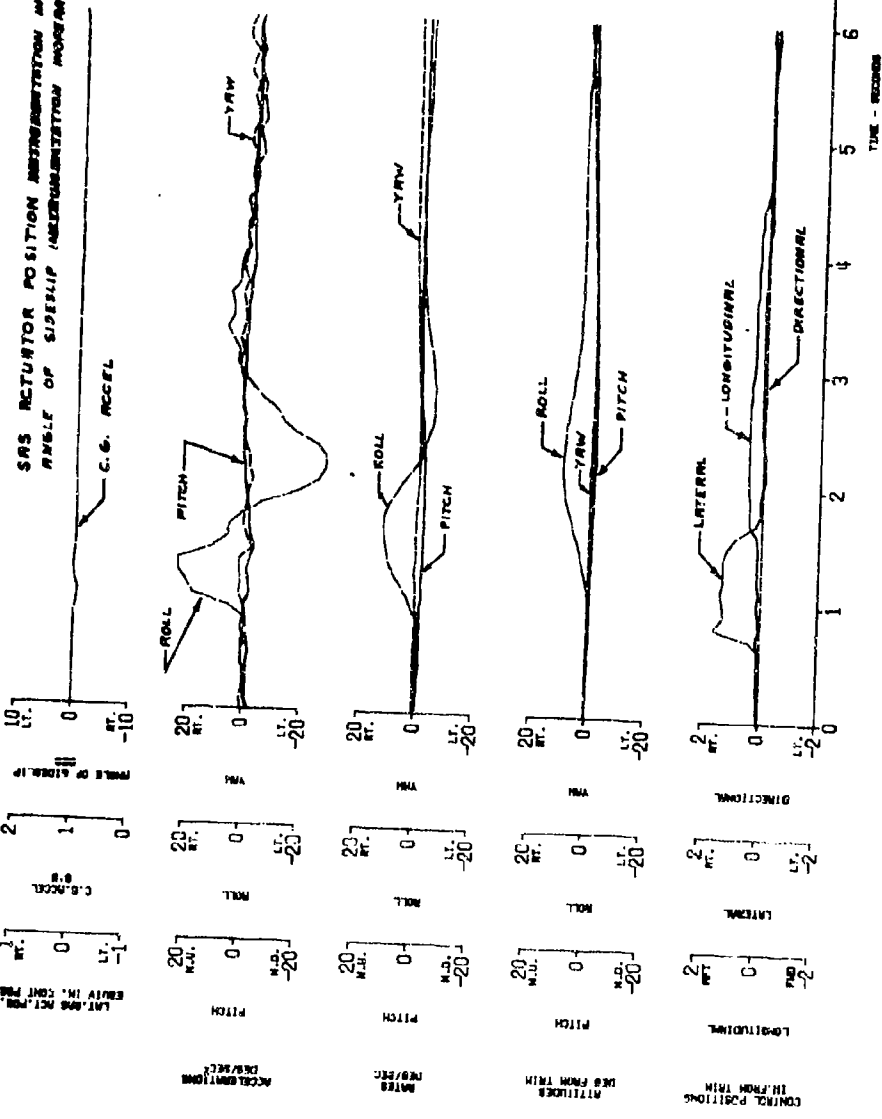

FIGURE 43
RIGHT LATERAL PULSE

S-67 S/N N671SA

GROSS WEIGHT 18340 LB
CG LOCATION 274 (AFT) IN
DENSITY ALTITUDE 3690 FT
OAT .C
RPM 208
RPM 208
AIRSPEED 152 KCAS
TRIM X104
CONFIGURATION EXTERNAL STORES

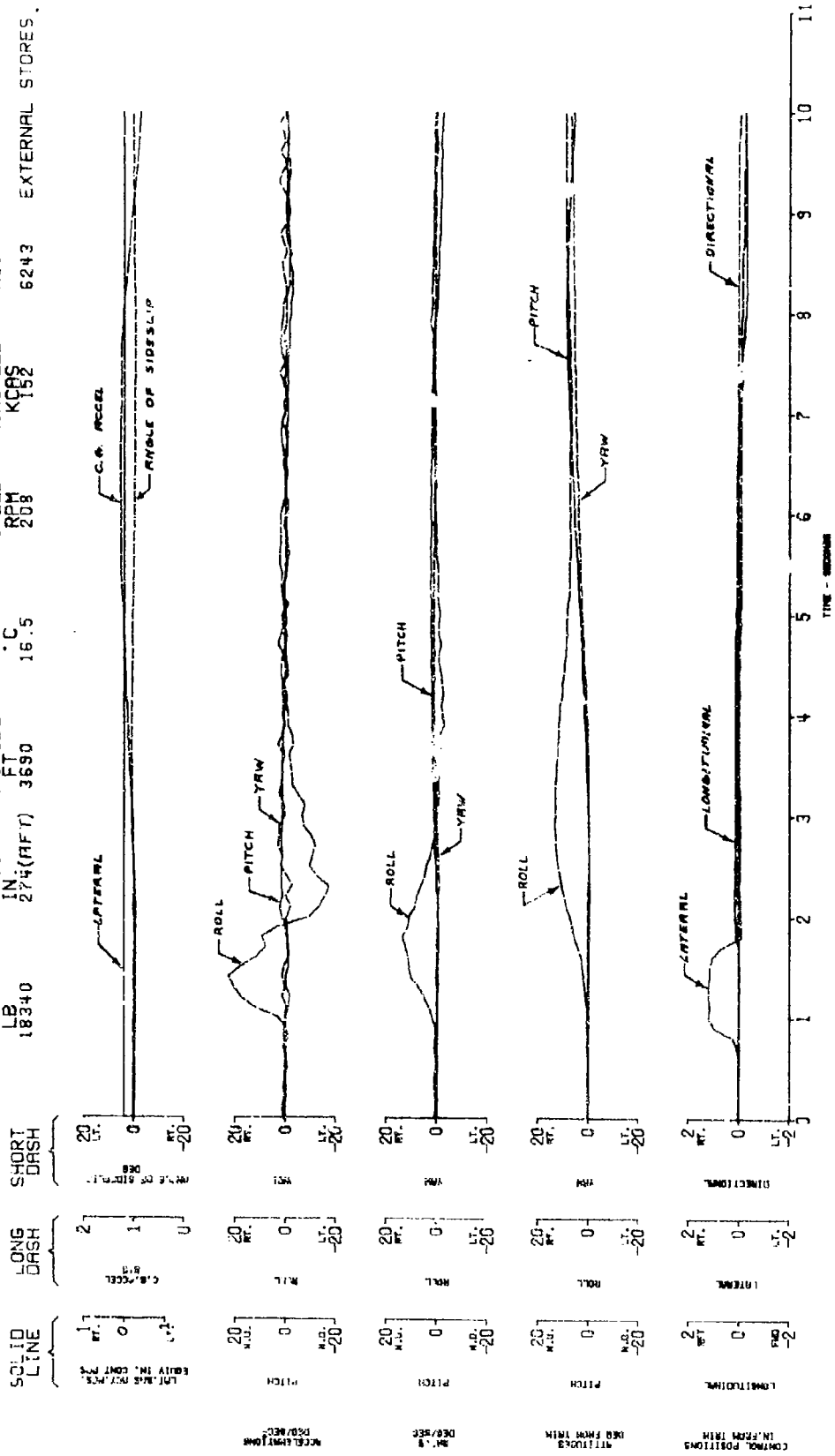

FIGURE 44
LONG PERIOD CHARACTERISTICS

S-67 S/N N671SA

GROSS WEIGHT 18410 LB
CG LOCATION 274 (AFT) IN
DENSITY ALTITUDE 2760 FT
OAT 11.8 °C
ROTOR SPEED 213 RPM
TRIM AIRSPEED 84 KCAS
CT X10⁻⁴ 5803
CONFIGURATION EXTERNAL STORES

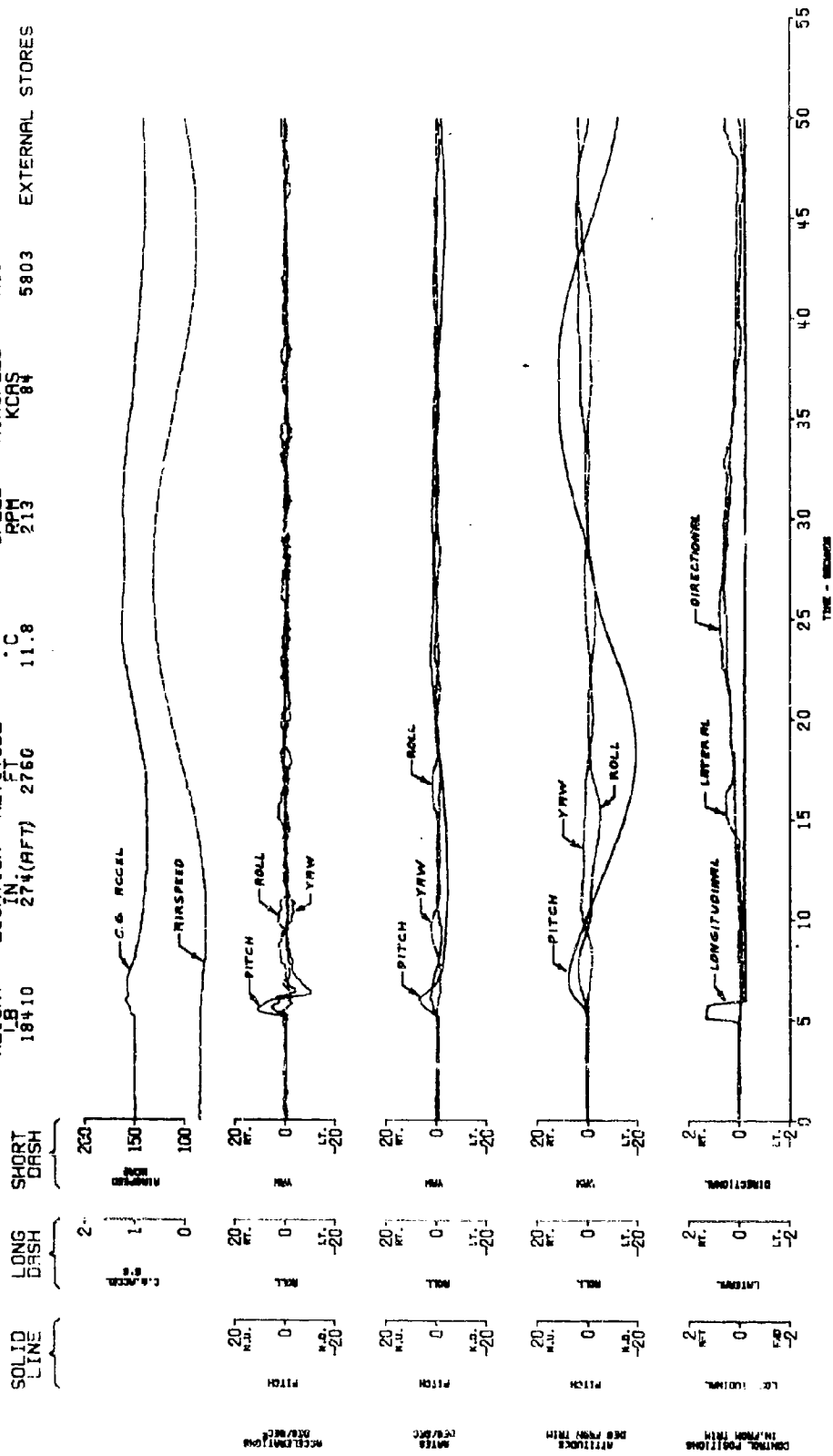

FIGURE 44
LONG PERIOD CHARACTERISTICS (CONTINUATION)

S-67 S/N N6715A

CONFIGURATION
EXTERNAL STORES.

TRIM AIRSPEED
KCAS 84

ROTOR SPEED
RPM 213

OAT
°C 11.8

DENSITY ALTITUDE
FT 2760

CG LOCATION
IN. 274(AFT)

GROSS WEIGHT
LB 18410

SHORT DASH

LONG DASH

SOLID LINE

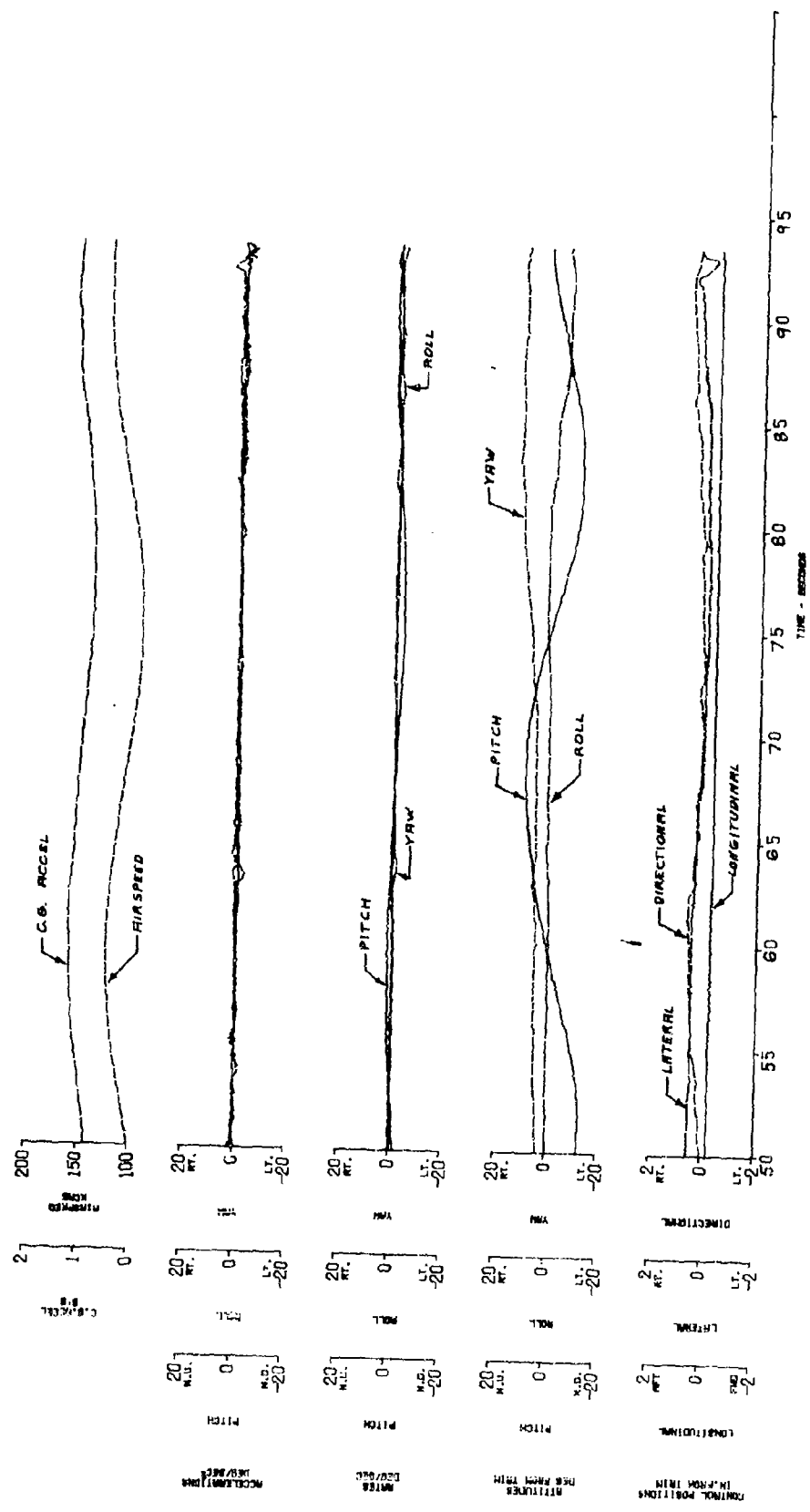

FIGURE #5
LONG PERIOD CHARACTERISTICS

S-57 S/N N6715A

GROSS WEIGHT 17770
CG LOCATION IN. 274(AFT)
DENSITY ALTITUDE FT 3310
OAT °C 17.1
ROTOR SPEED RPM 208
TRIM AIRSPEED KCAS 153
CT X10⁻⁴ 5973
CONFIGURATION EXTERNAL STORES

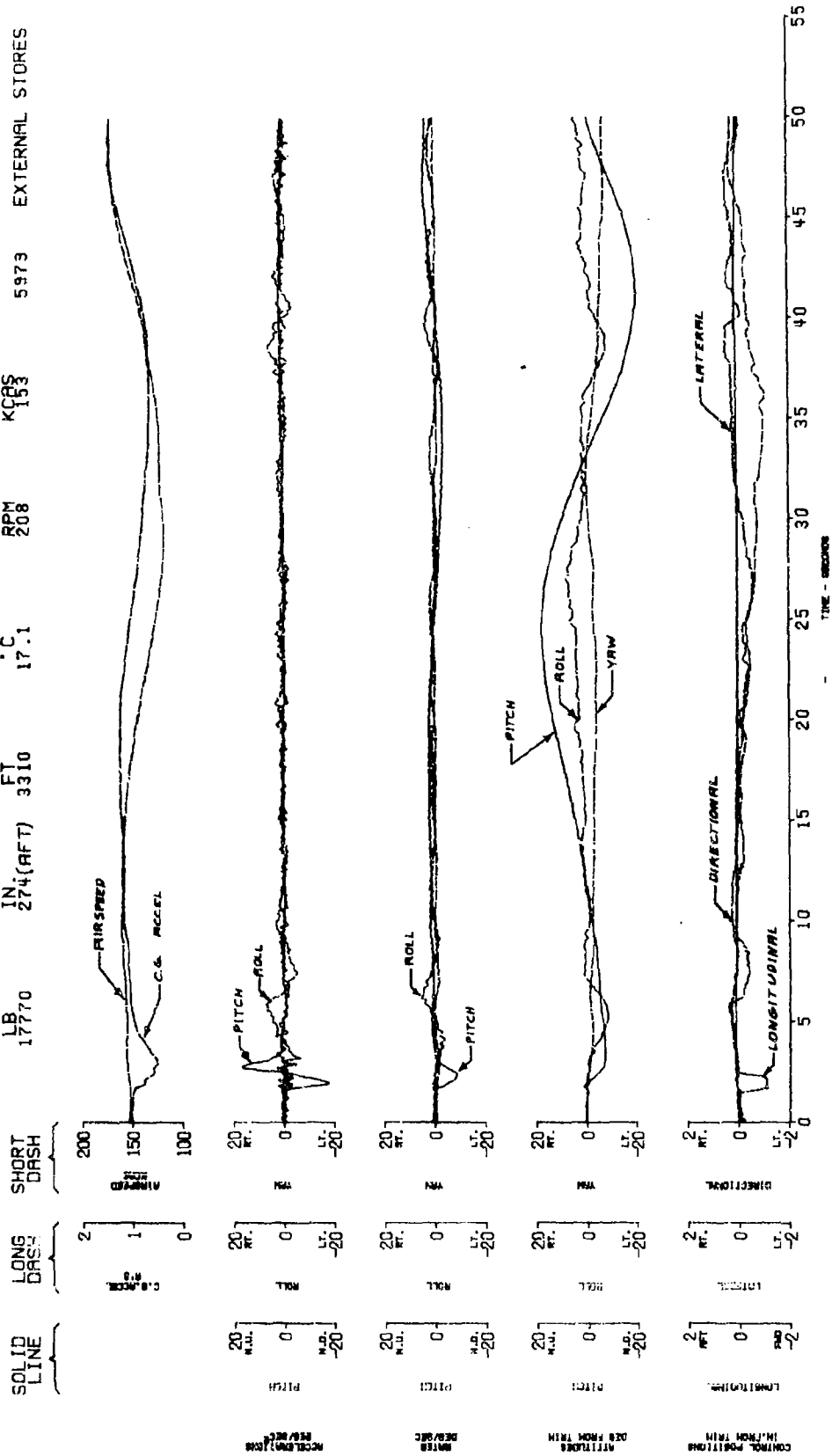

FIGURE 45
LONG PERIOD CHARACTERISTICS (CONTINUATION)

S-67 S/N N6715A

GROSS WEIGHT 17770
CG LOCATION IN 274(AFT)
DENSITY ALTITUDE FT 3310
OAT °C 17.1
ROTOR SPEED RPM 208
TRIM AIRSPEED KCRS 153
CT X10⁻⁴ 5879
CONFIGURATION EXTERNAL STORES

SOLID LINE
LONG DASH
SHORT DASH

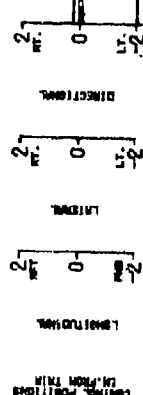
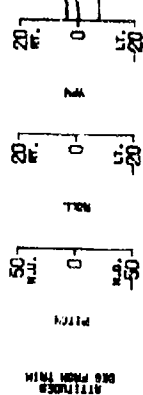
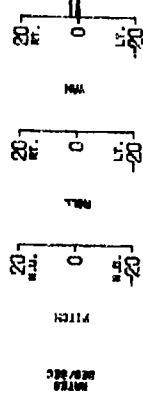
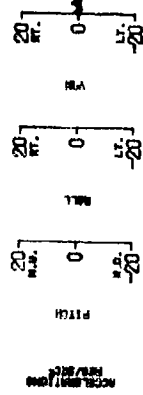

FIGURE 49
SUMMARY LONGITUDINAL CONTROL RESPONSE AND SENSITIVITY
JET SIMULATOR
EXTERNAL STORES

SYMBOL	AVG GROSS WEIGHT WLB	AVG CG LOCATION IN	AVG DENSITY ALTITUDE FT	AVG REFER SPEED WPM	FLIGHT CONDITION
○	14000	276.6 (NFT)	1100	412	HOVER
□	14200	275 (NFT)	3200	411	LEVEL FLIGHT

NOTES: DERIVED FROM FIGURES 47 AND 48

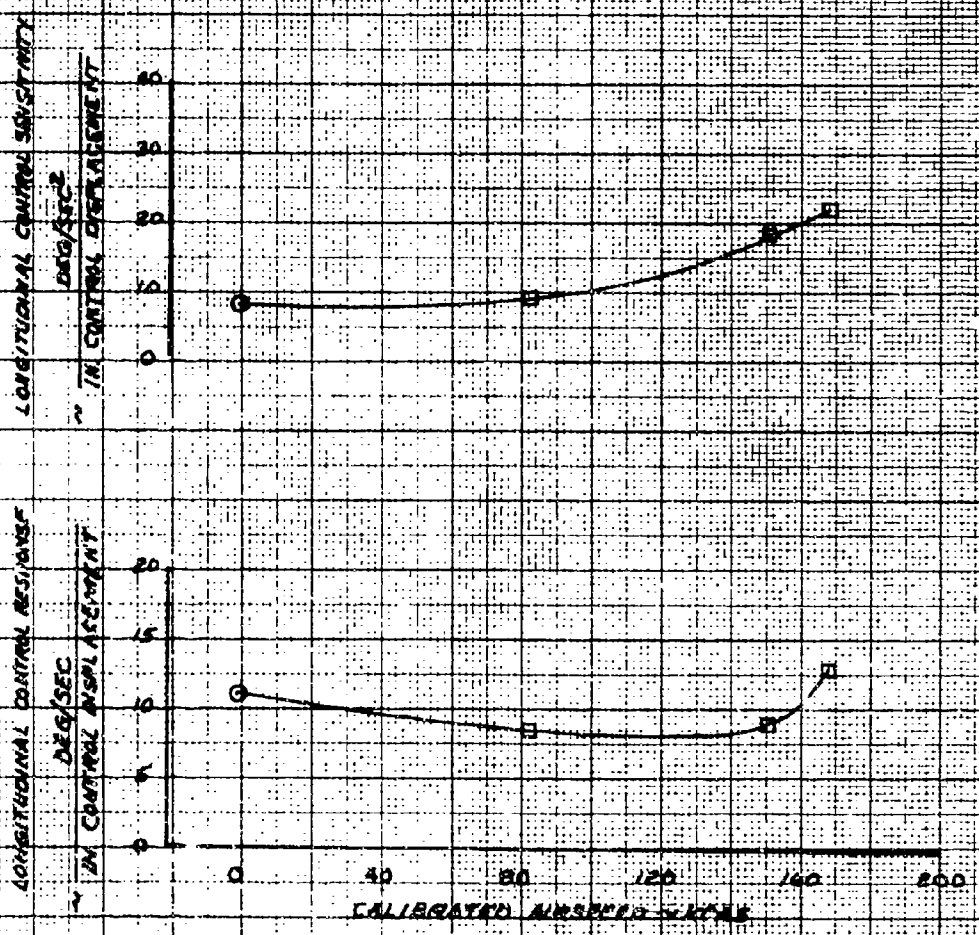

FIGURE 47

LONGITUDINAL CONTROL RESPONSE AND SENSITIVITY

S-47 SIMULATED

CONTROL	AVG PITCH SENSITIVITY	AVG PITCH SENSITIVITY	AVG ROLL SENSITIVITY	AVG YAW SENSITIVITY	AVG PITCH SPEED	AVG PITCH CY	TYPE AIRFRAME	CONFIGURATION
ALL	ALL	ALL	ALL	ALL	ALL	ALL	ALL	ALL
○	10000	10000	1000	1000	100	10000	10000	10000
□	10000	10000	1000	1000	100	10000	10000	10000

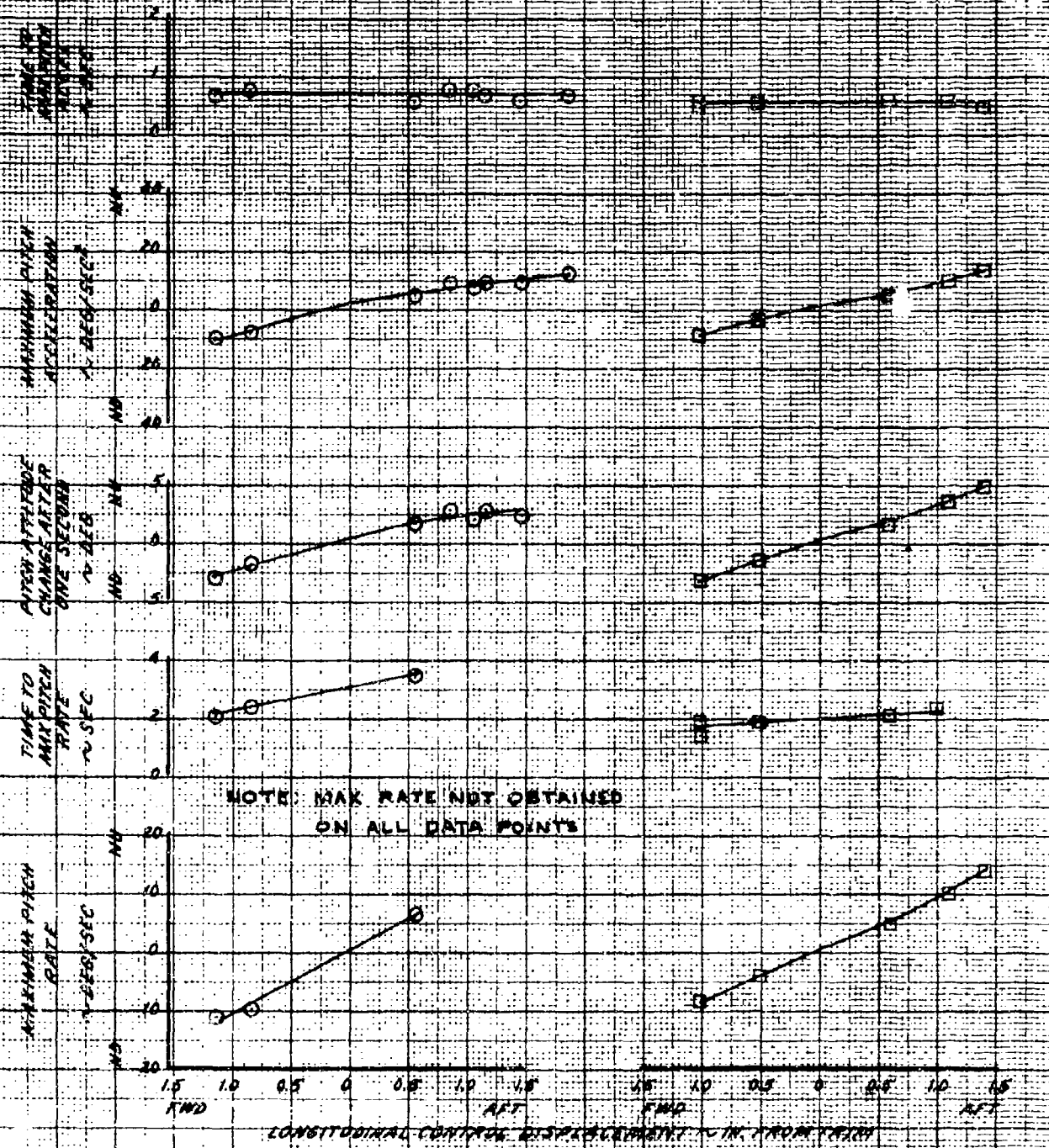

FIGURE 4B
LONGITUDINAL CONTROL RESPONSE AND SENSITIVITY
5-07 SIMULATOR

SPINDLE	AVG ERROR WEIGHT % LB	AVG LR LOCATION % IN	AVG SENSITV ACCELING % FT	AVG VMT % FT	AVG INSTR SCALE % IN	AVG LY % IN	FORM ASSUMED % IN	CONFIGURATION
○	1.210	2.74(AFT)	3.380	10.1	2.00	0.7000	152	EXTERNAL STORES
□	1.0070	2.76(AFT)	3.280	10.7	2.18	0.6985	168	EXTERNAL STORES

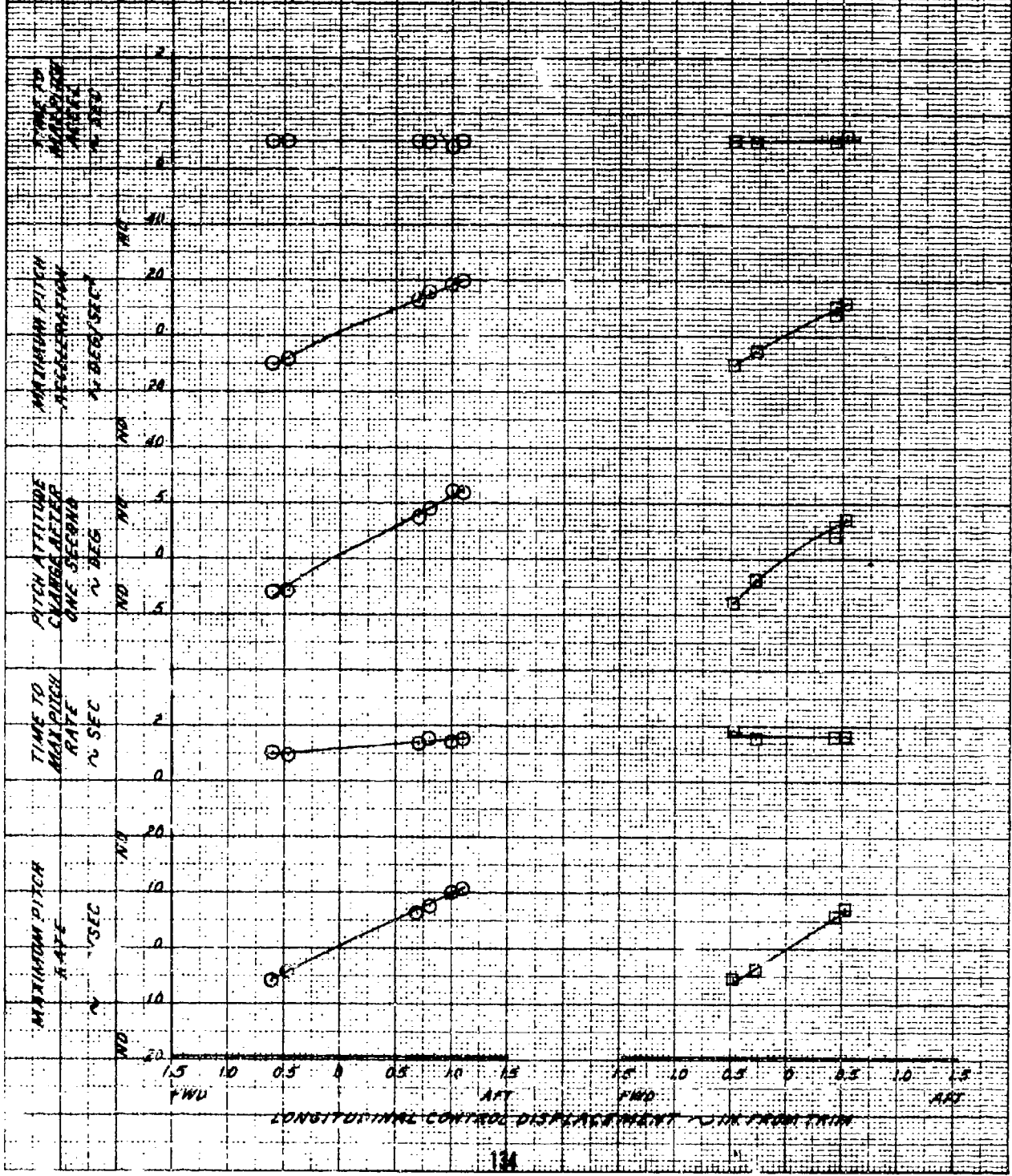

FIGURE 49
SUMMARY LATERAL CONTROL RESPONSE AND SENSITIVITY
PER STRENGTH
EXTERNAL ERROR

EXTERNAL ERROR	AIR SPEED KNOTS M.L.S.	AIR SIC LOCATION P-IN	AIR WEIGHT LBS P-F	AIR ROTAR SPEED RPM	FLIGHT CONDITION
○	14000	2700000	280	800	HOVER
□	16000	2700000	3200	200	LOW ALT FLIGHT

NOTE: DERIVED FROM FIGURES 40 AND 41

LATERAL CONTROL SENSITIVITY
 $\frac{deg/sec^2}{in \text{ CONTROL DISPLACEMENT}}$

LATERAL CONTROL RESPONSE
 $\frac{deg/sec}{in \text{ CONTROL DISPLACEMENT}}$

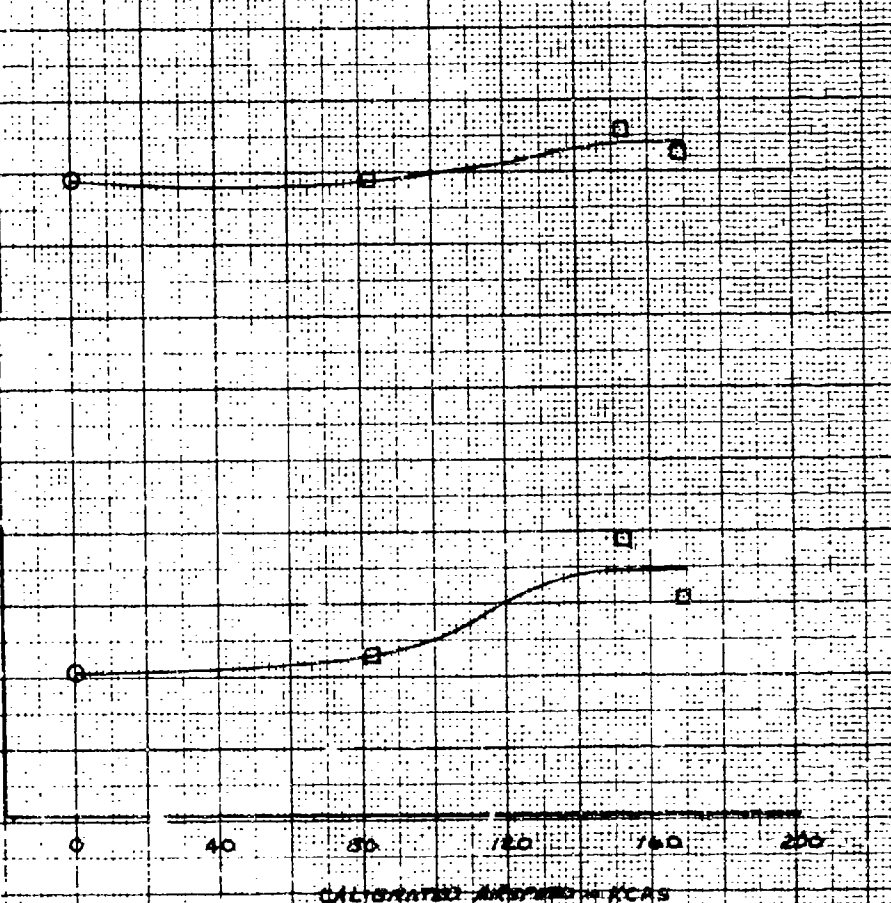

FIGURE 30
LATERAL CONTROL RESPONSE AND SENSITIVITY
S-67 SEA ROYAL

SYMBOL	AVE WINGS WEIGHT ~ LB	AVE GE ACCELERATION ~ G	AVE DENSITY ALTIMETER ~ FT	AVE DWT ~ LB	AVE ROTOR SPEED ~ RPM	AVE CY ~ RPM	FRONT RETRICED ~ IN	RETRICED ~ IN
○	18000	270000	100	202	210	2000	1012	EXTERNAL STORES
□	18207	270000	200	167	21	2000	62	EXTERNAL STORES

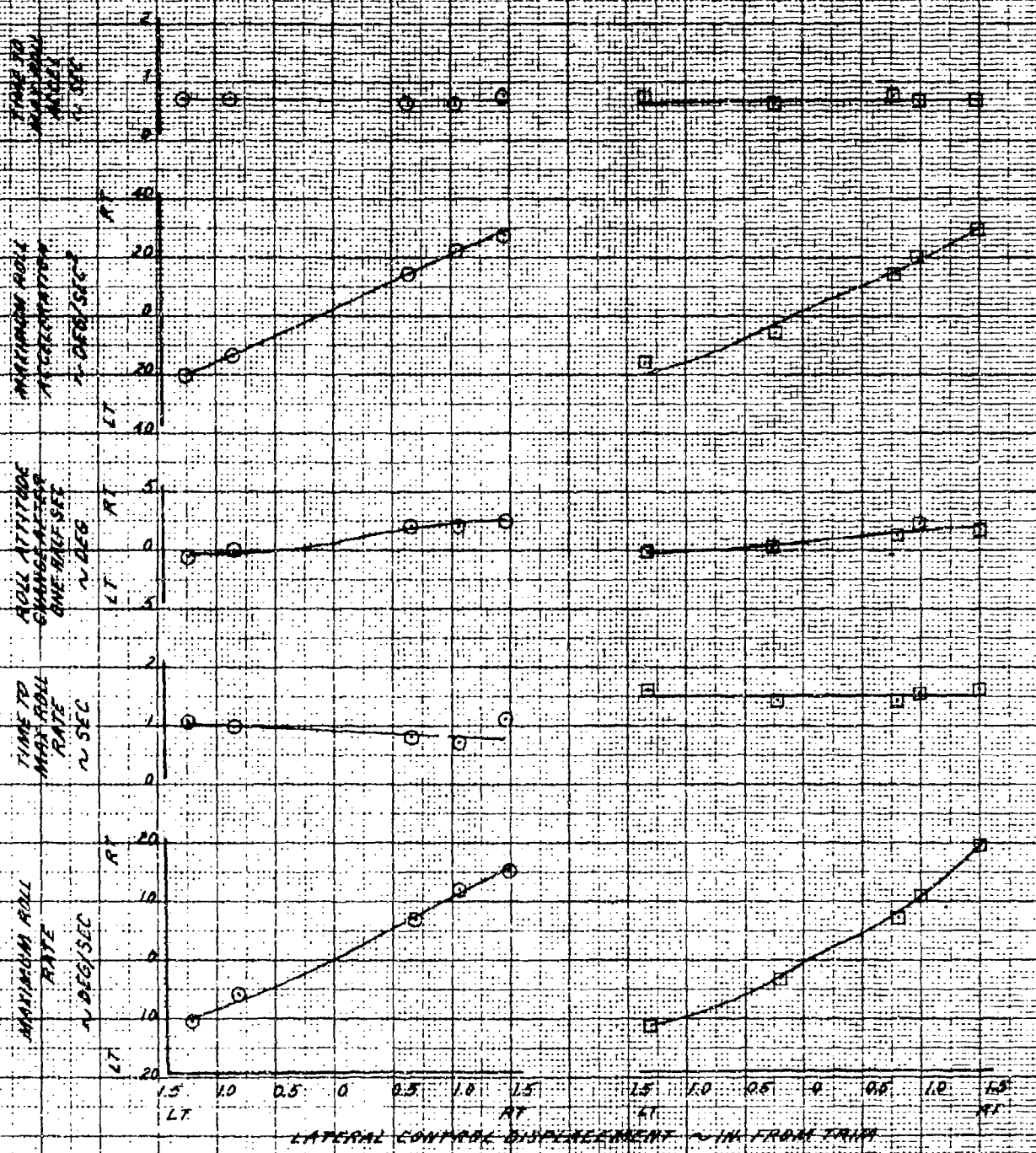

FIGURE 51
LATERAL CONTROL RESPONSE AND SENSITIVITY
5-RT SYNTHESIS

SIGNAL	AVG ROLL RATE % Δ	AVG FB LATERAL ACCEL % Δ	AVG SENSITV ALITUDE % Δ	AVG RPT % Δ	AVG RPT SPEED % Δ	AVG ET	FORM AIRSPEED % Δ	CONFIGURATION
○	18.2%	27.3 (AFT)	34.7%	1.1	200	0.0025	100	EXTERNAL STORES
□	18.6%	27.3 (AFT)	34.7%	1.3	210	0.0025	100	EXTERNAL STORES

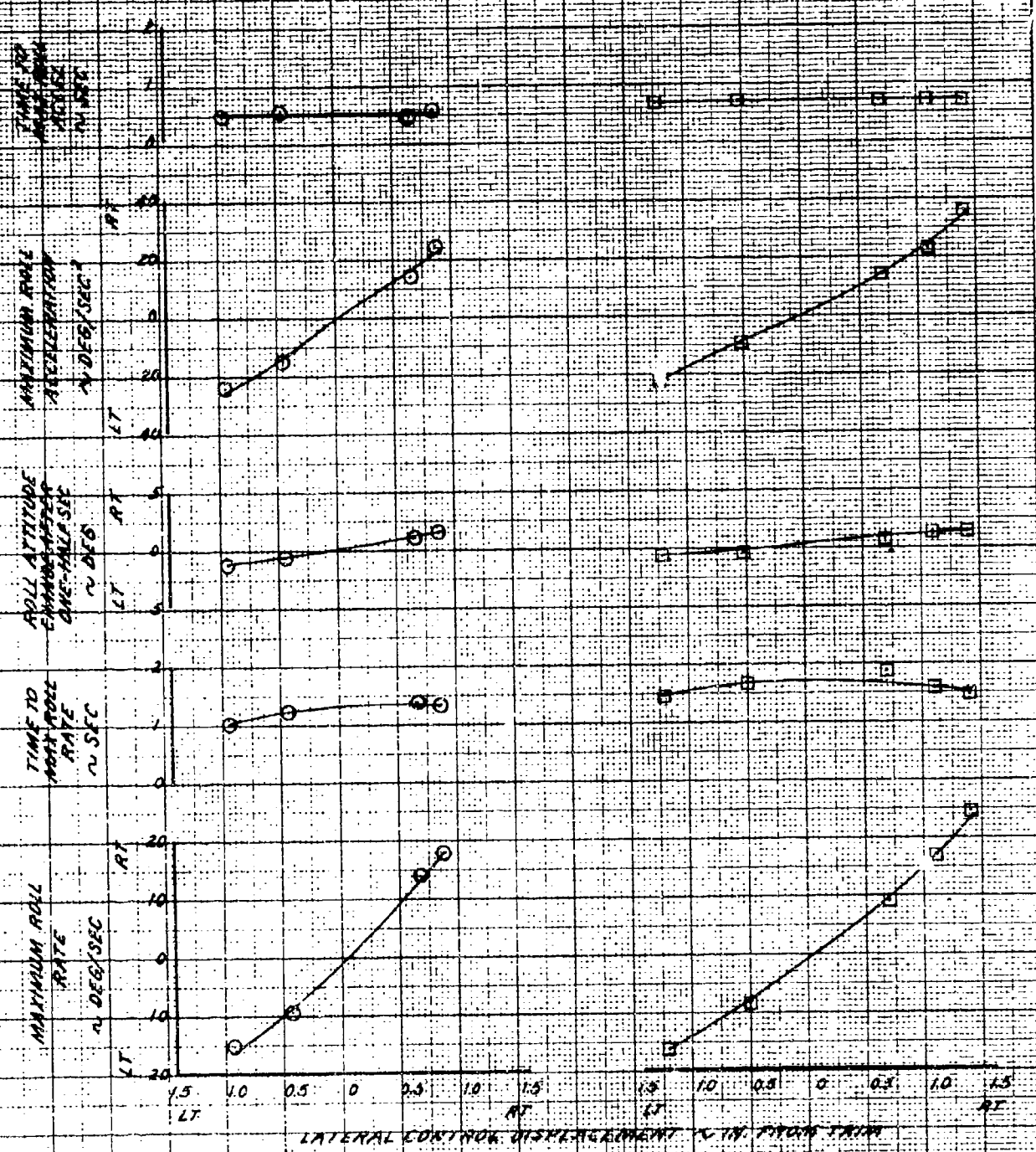
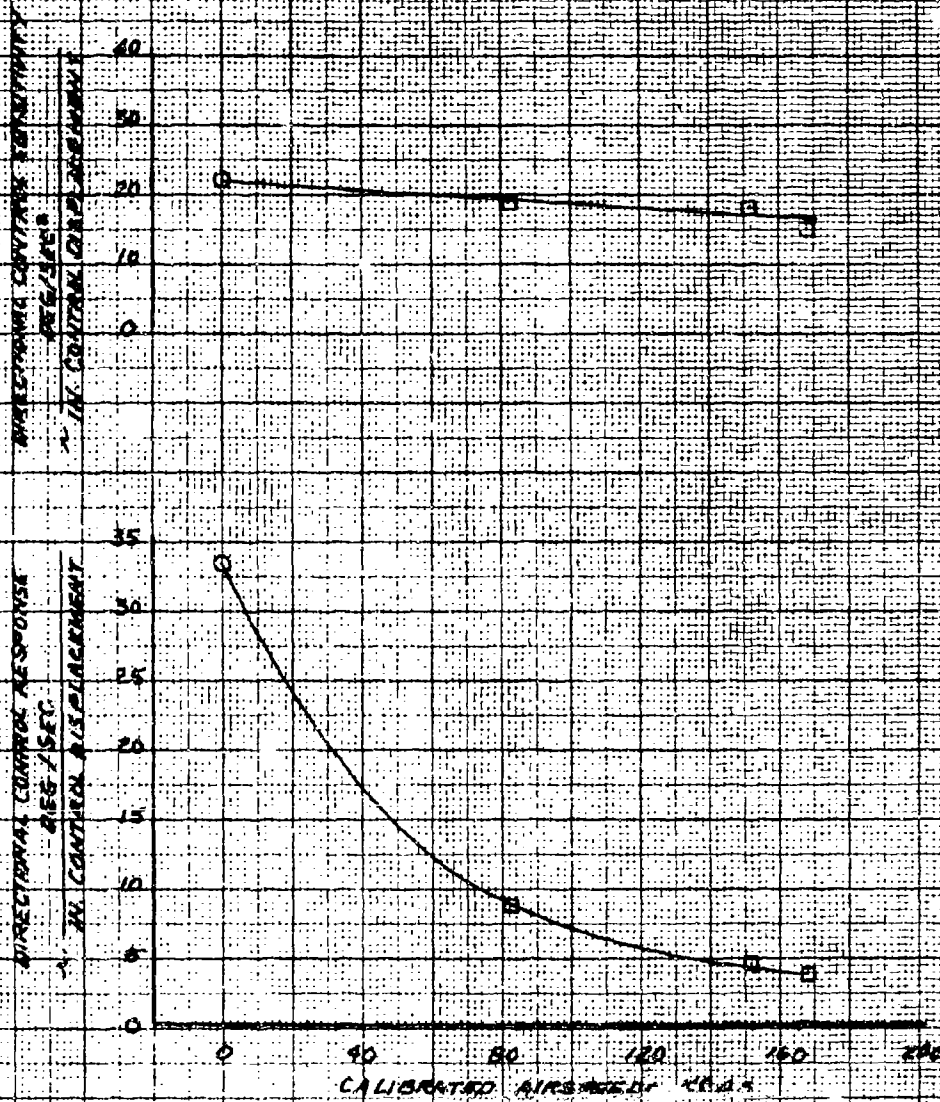

FIGURE 5-2
Summary Operational Control Response and Sensitivity
ERT Simulation
External Storage

SYSTEM	Avg Error Weight	Avg Error Location	Avg Density Altitude	Avg Error Spread	Flight Condition
0	10000	250 (100)	1250	212	10000
10	11570	250 (100)	1250	212	10000

NOTE: DERIVED FROM FIGURES 5-3 AND 5-4



FIELD 53
DIRECTIONAL CONTROL RESPONSE AND SENSITIVITY

SERIES	S-RT SYSTEM		S-RT SYSTEM		S-RT SYSTEM		S-RT SYSTEM	
	AVG WEIGHT N. DEG	AVG ELEVATION N. DEG	AVG DEPVT N. DEG	AVG ALT N. DEG	AVG SPEED N. DEG	AVG CY N. DEG	AVG MOMENT N. DEG	AVG EXTERNAL N. DEG
○	10000	100000	1000	100	100	10000	10000	EXTERNAL STAGES
□	10000	100000	1000	100	100	10000	10000	EXTERNAL STAGES

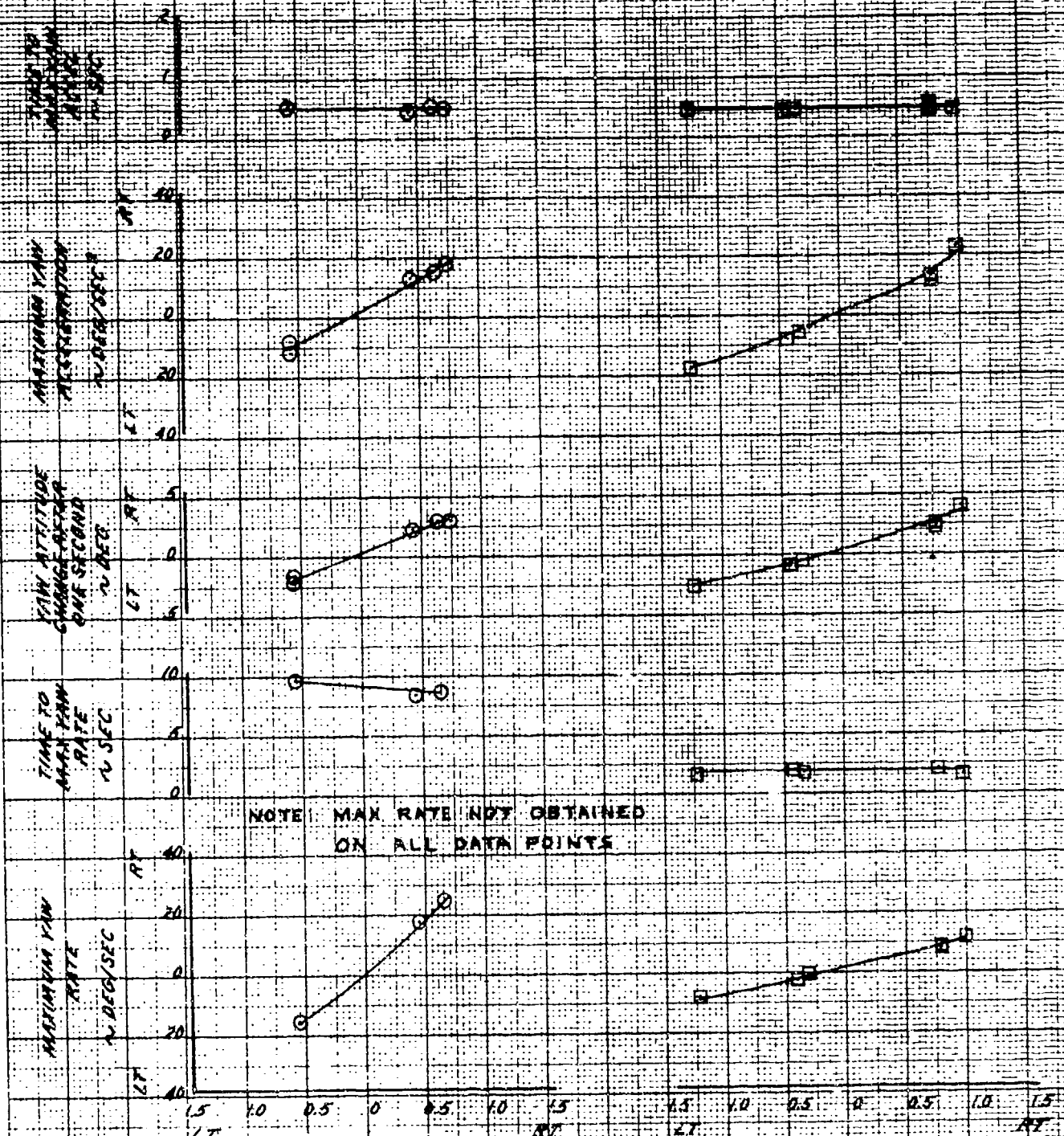

FIGURE 54
DIRECTIONAL CONTROL RESPONSE AND SENSITIVITY
S-E-T SIMULATOR

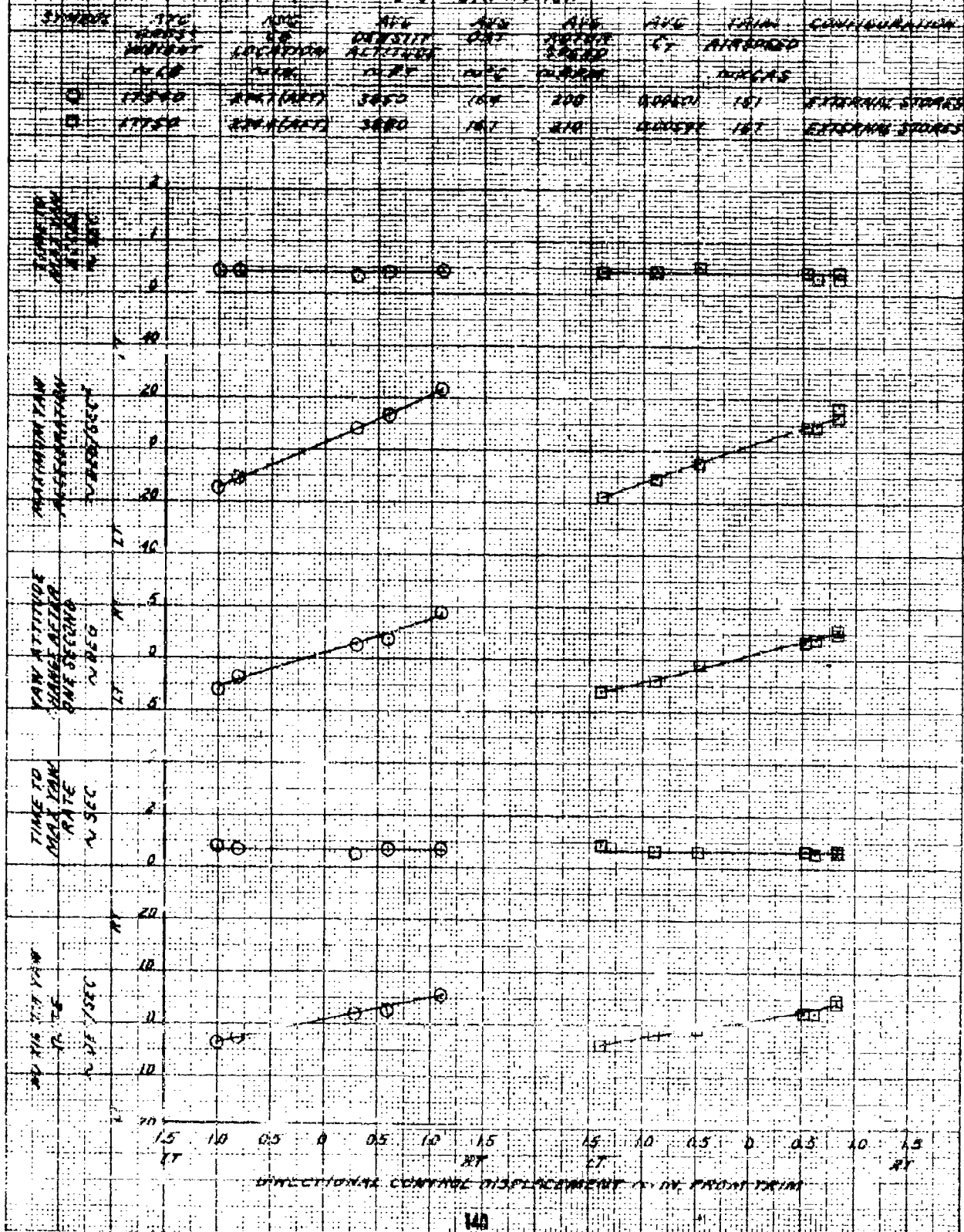

FIGURE 53

MANEUVERING 35 gals/hr. Cunningham

5-87 ST. MARY'S
EXTERNAL STORES

AVE STORE WEIGHT	AVE CG LOCATION	DENSITY ALTITUDE RANGE	AVE WIND SPEED
~ LB	~ IN	~ FT	~ KPH
1855	2763	3050-6020	24

NOTE: DERIVED FROM FIGURES
52 THROUGH 54

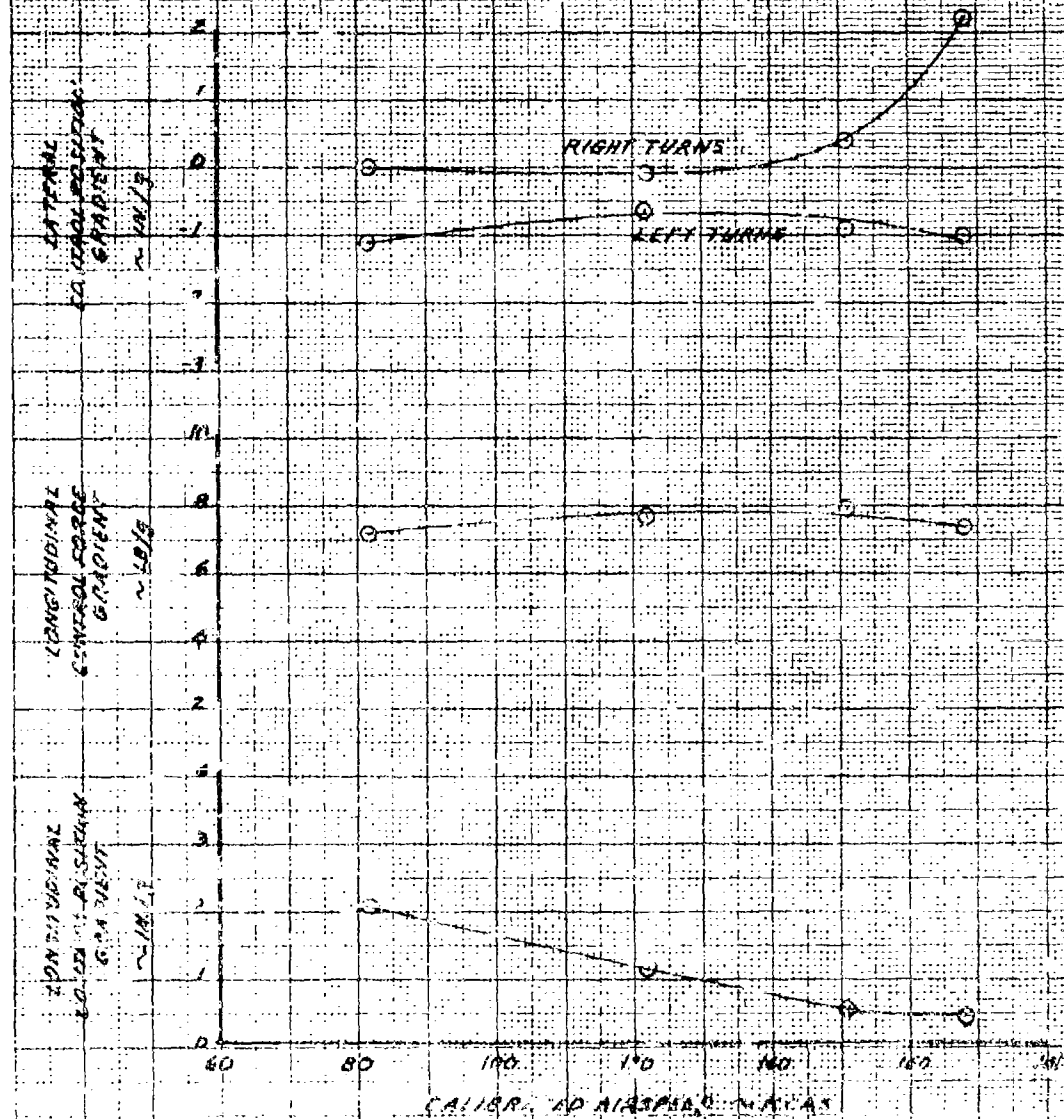

FIGURE 56
 ROLLOVER STABILITY
 S-07 5/14/64
 DETERMINED BY:

WIND	WIND DIRECTION	WIND SPEED	WIND ANGLE	WIND TYPE	WIND CLASS	WIND CLASS	WIND CLASS
0	180	25	0	0	0	0	0

NOTES:
 1. SMOOED CURVES INDICATE TURN
 2. TANK 2, NOTE LEFT TURN

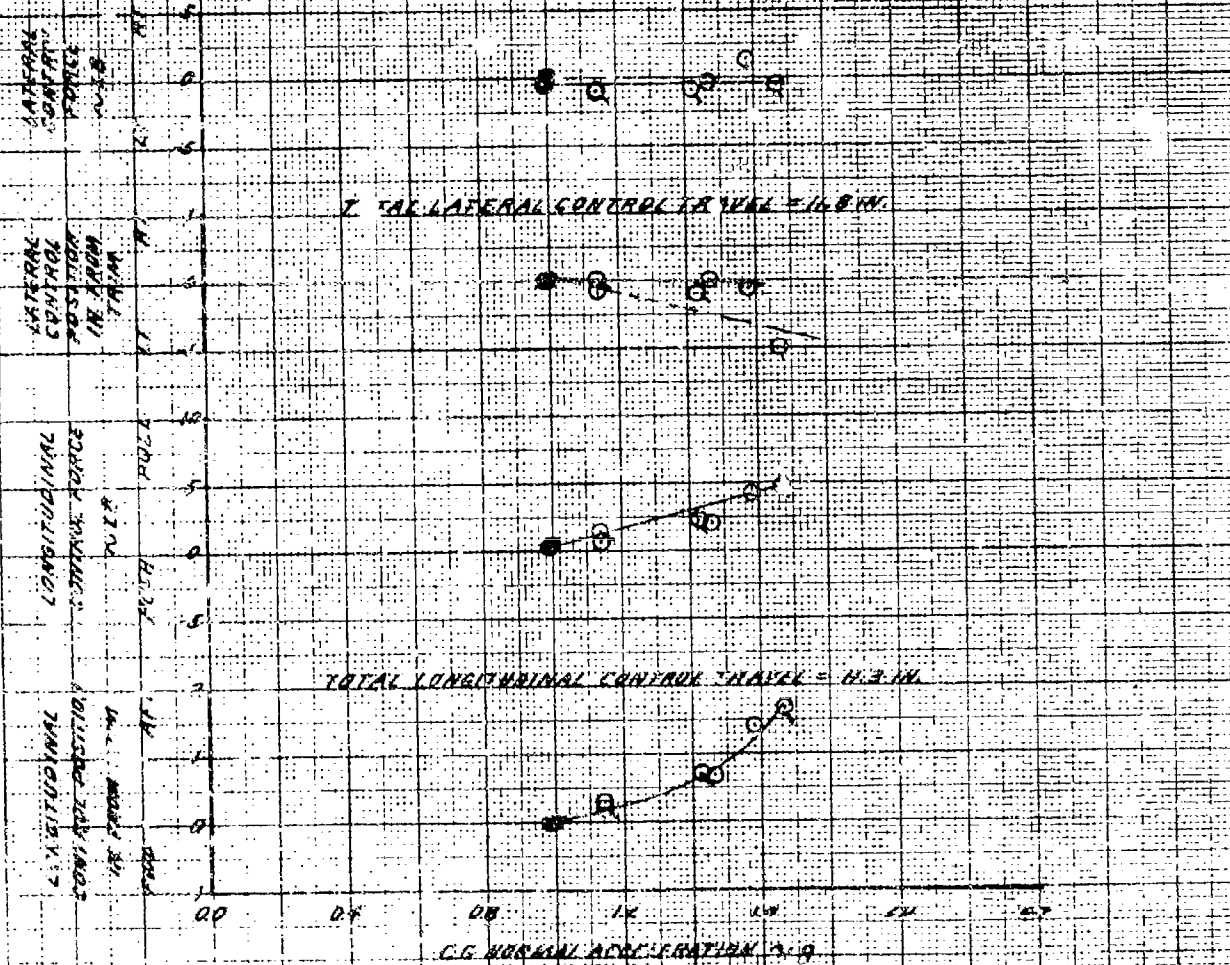

FIGURE 5-1
MANEUVERING STABILITY
S-67 SIMNETISH
TERMINAL STOPS

SYMBOL	AVE WING WEIGHT WLB	AIR C.O. LOCATION WTR	AIR DENSITY ALTITUDE 10 FT	AIR DENSITY WAT 151	AIR DENSITY SPEED WPM	AIR DENSITY G	TRIM AIRSPEED KIAS	FLIGHT CONDITION
○	18,160	FORWARD	2000	58	211	0.00598	122	STEADY TURN
□	18,160	TRIM	2000	151	212	0.00598	122	PUSH OVER

NOTES:
 EXPANDED SYMBOLS DENOTE TRIM
 & TRIM DENOTE LEFT TURN

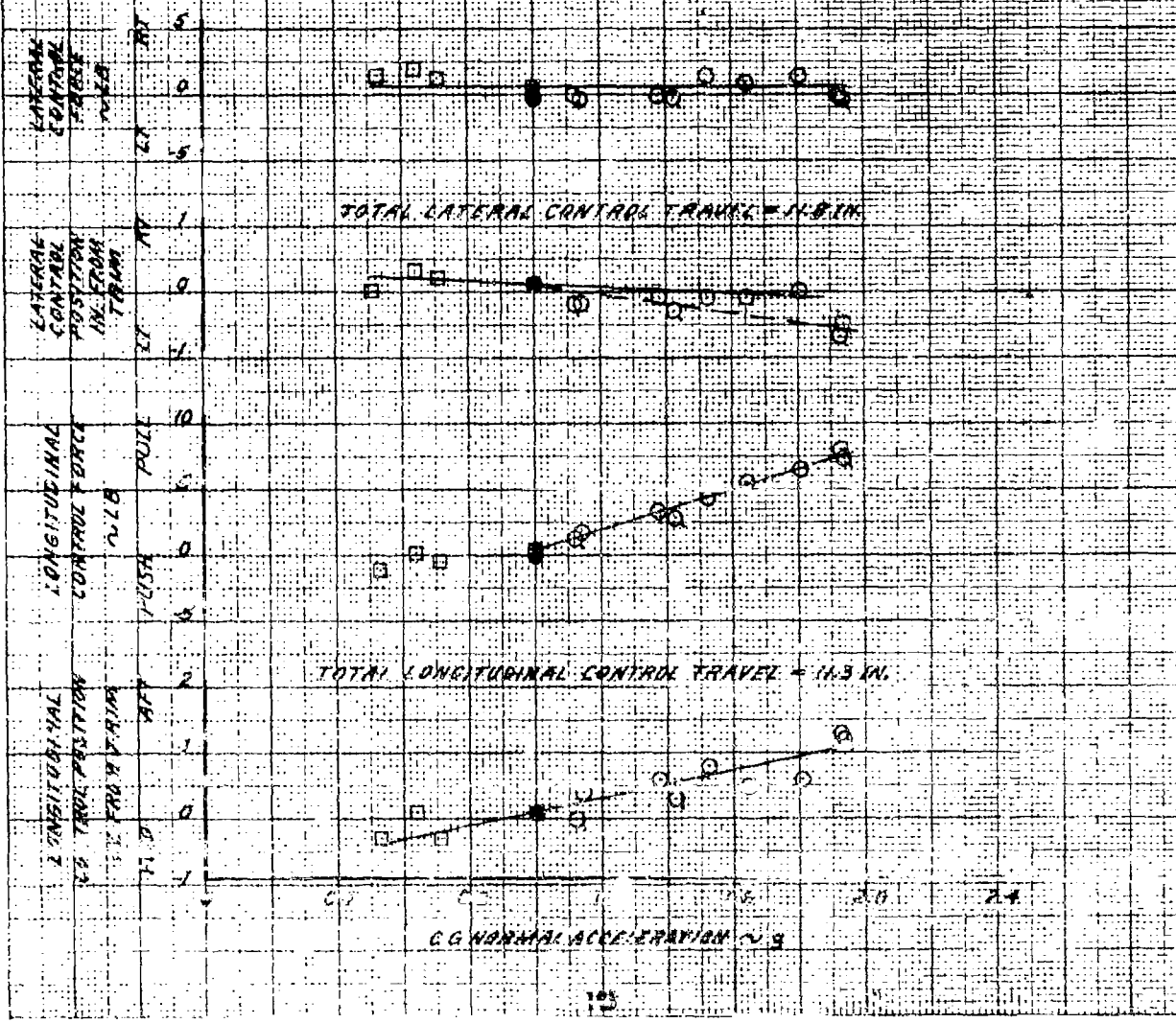

FIGURE 5B
MANEUVERING STABILITY
5-67 S/N 42154
EXTERNAL STORES

SPINNEL	AVG GROSS WEIGHT N·LB	AVG CG LOCATION IN IN.	AVG DENSITY ALTITUDE FT	AVG MACH NO.	AVG MACH SPEED FT/SEC	A/G G	TRIM NUMBER IN DEGS	A/G TRIM
○	17810	275.1(M7)	2235	1.1	210	0.0320	181	STEADY TURN
□	17860	272.8(M7)	2230	1.15	216	0.0329	181	STEADY TURN
△	18470	274.8(M7)	2200	1.19	218	0.0330	183	PUSH OVER
◇	17700	278.1(M7)	2220	1.20	216	0.0329	185	PULL UP

NOTES:
 1. SHADDED SYMBOLS DENOTE TRIM
 2. SYMBOLS DENOTE LEFT CURVE
 3. □ DENOTES 25 DEGREE SETTING

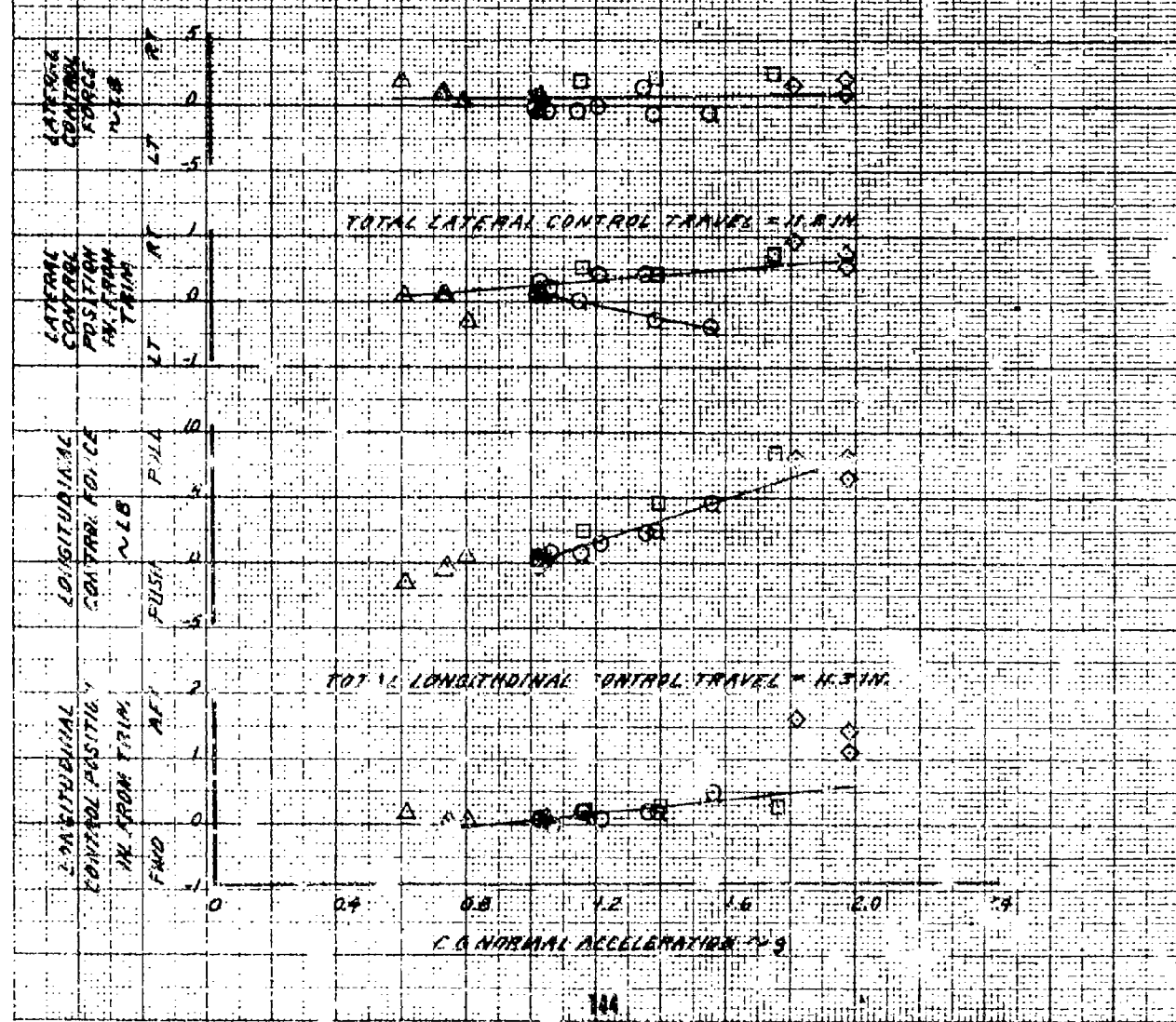

FIGURE 69
MANEUVERING STABILITY
5 BY SIX KILIA
EXPERIMENTAL STORES

SYMBOL	AVG SPEED KTS	AVG S.G. LOCATION	AVG DENSITY ACTIVITY	AVG WIND KTS	AVG WIND DIRECTION	AVG CL	TRIM AIRSPEED KTS	TRIM POSITION
	1010	2010	3010	4010	5010		6010	STERN TURN
	1010	2010	3010	4010	5010		6010	PUSH OVER

NOTES:
 SYMBOLS SHOWS AIRSPEED TRIM
 * FALLS BEHIND LETTERS

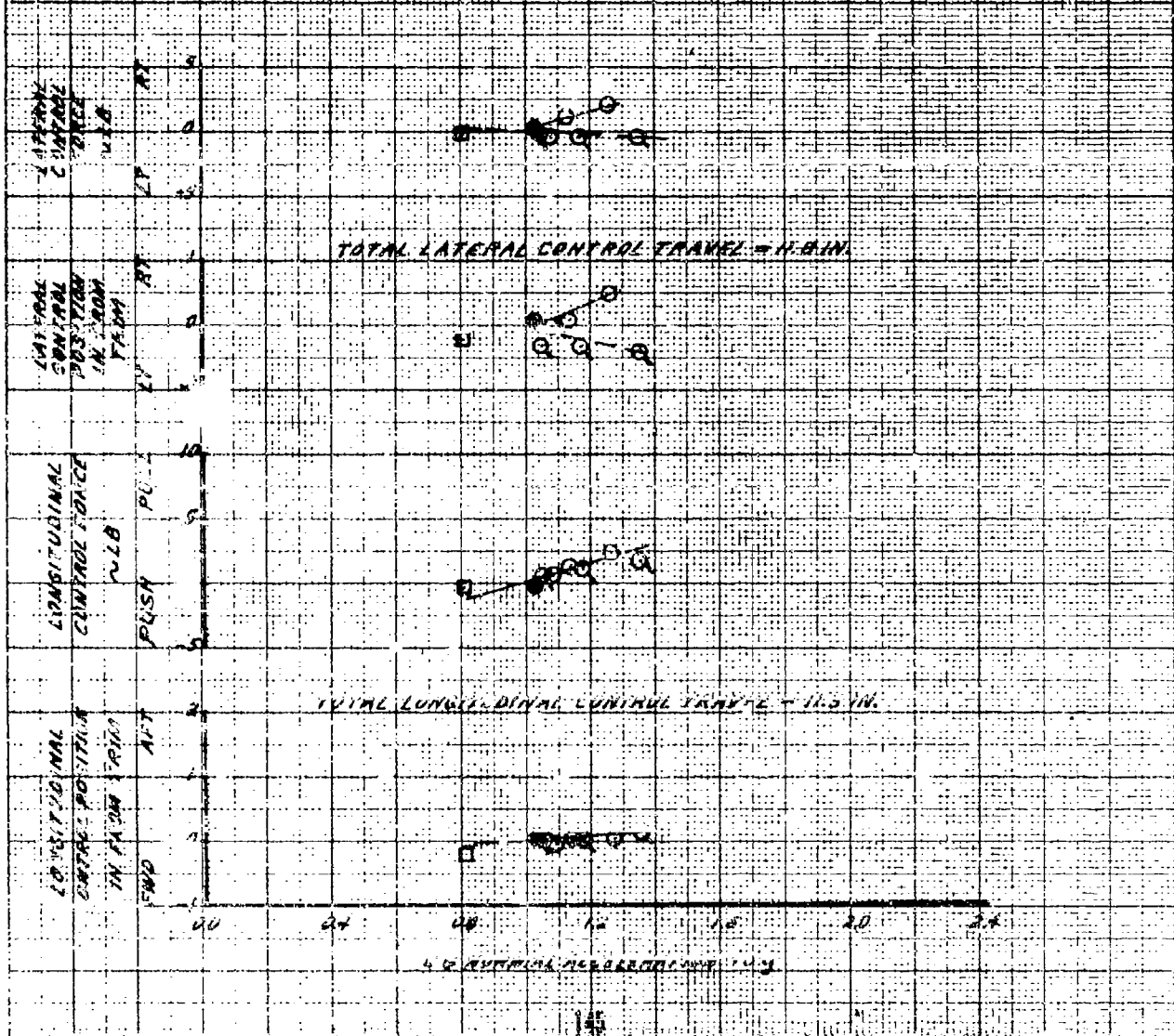

FIGURE 60
CYCLIC STEER CONTROL PATTERN
S BY SENEZISH

NOTES:

- 1 TEST CONDUCTED IN BRUNN WITH AIRHORN AND ROTORS STOPPED
- 2 HYDRAULIC AND ELECTRICAL POWER FROM EXTERNAL SOURCES
- 3 ALL SWITCHES AND SYSTEMS SET TO DUPLICATE NORMAL IN-BUSBY EQUIPMENT
- 4 TOTAL LONGITUDINAL CONTROL TRAVEL = 11.3 IN
- 5 TOTAL LATERAL CONTROL TRAVEL = 11.3 IN
- 6 COLLECTIVE CONTROL POSITION DID NOT EXCEED CYCLIC MOVEMENT LIMITS

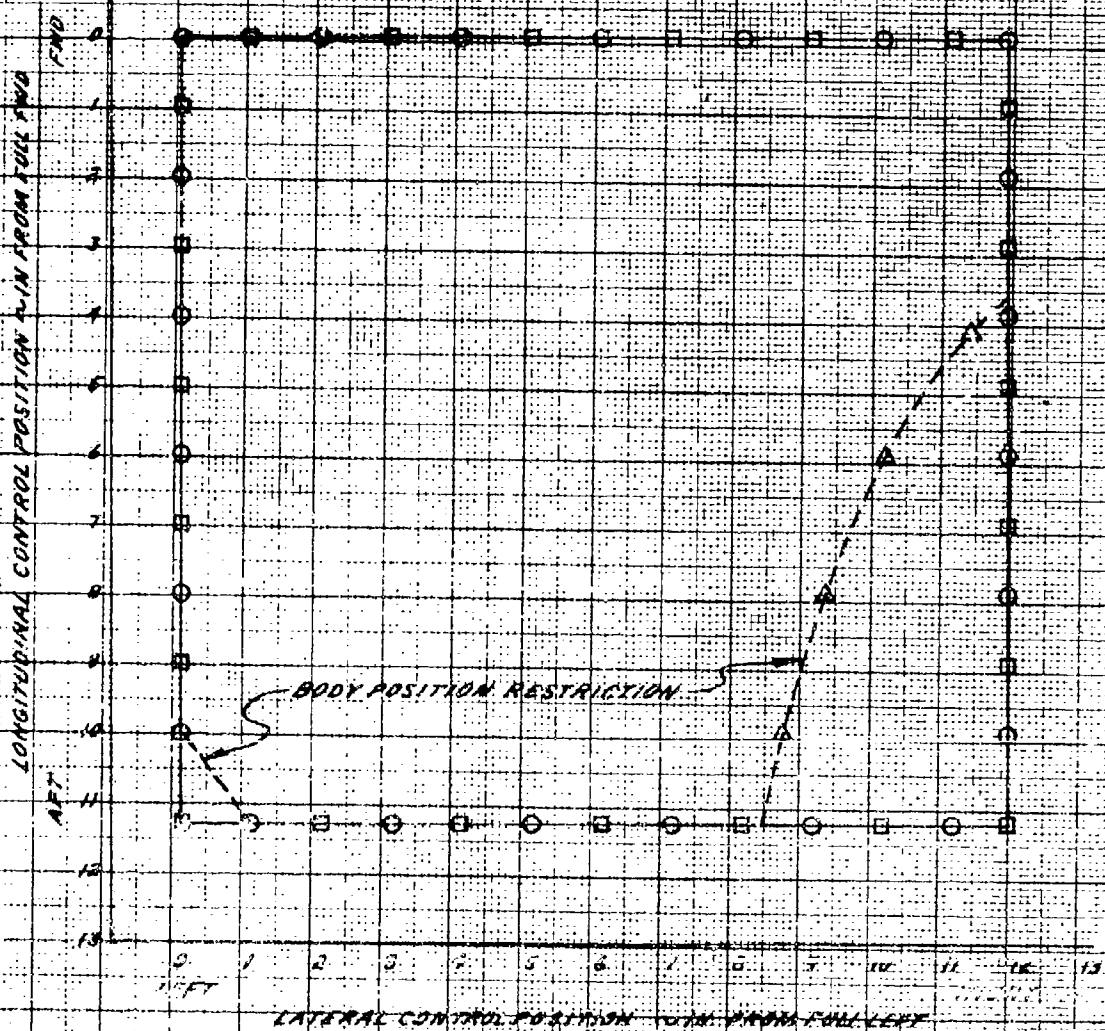

FIGURE #1
 TARGET SHAFI HORSEPOWER AVAILABLE
 5 WT S/N 10150A
 TOR-60 5.000000
 ROTOR SPEED 10.000000

NOTES:

- 1. STATIC CONDITIONS
- 2. ECM AIR BLEED ON
- 3. SWIFT-100 OFF
- 4. LEAD INLET LOSS
- 5. LEAD EXHAUST PRESSURE LOSS
- 6. NO HP EXTRACTION
- 7. BASED ON GENERAL ELECTRIC SOURCE OFER NO. 10010-A

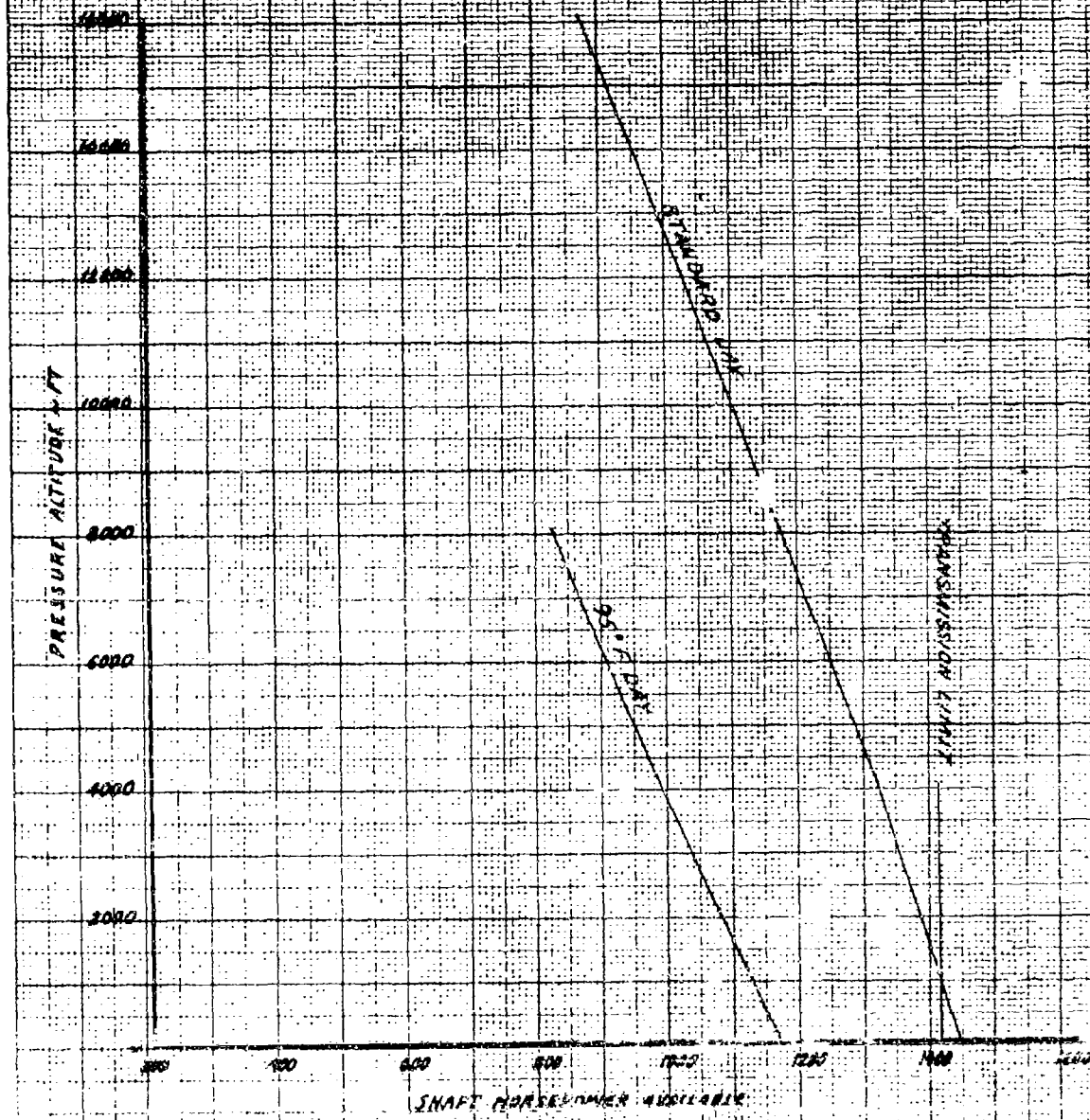

FIGURE 28
MILITARY SHAFT HORSEPOWER AVAILABLE
5-67 S/N 6155A
T60-30 - ENGINE
ROTOR SPEED - 211 RPM

- NOTES**
1. STATIC CONDITIONS
 2. ECH AIR BLEED ON
 3. 100% - 100% RPM
 4. BEND INLET ANGLE
 5. ZERO EXHAUST PRESSURE LOSS
 6. NA 810 - 211 RPM
 7. BASED ON GENERAL ELECTRIC SOURCE DECA NO. 4000-G-A

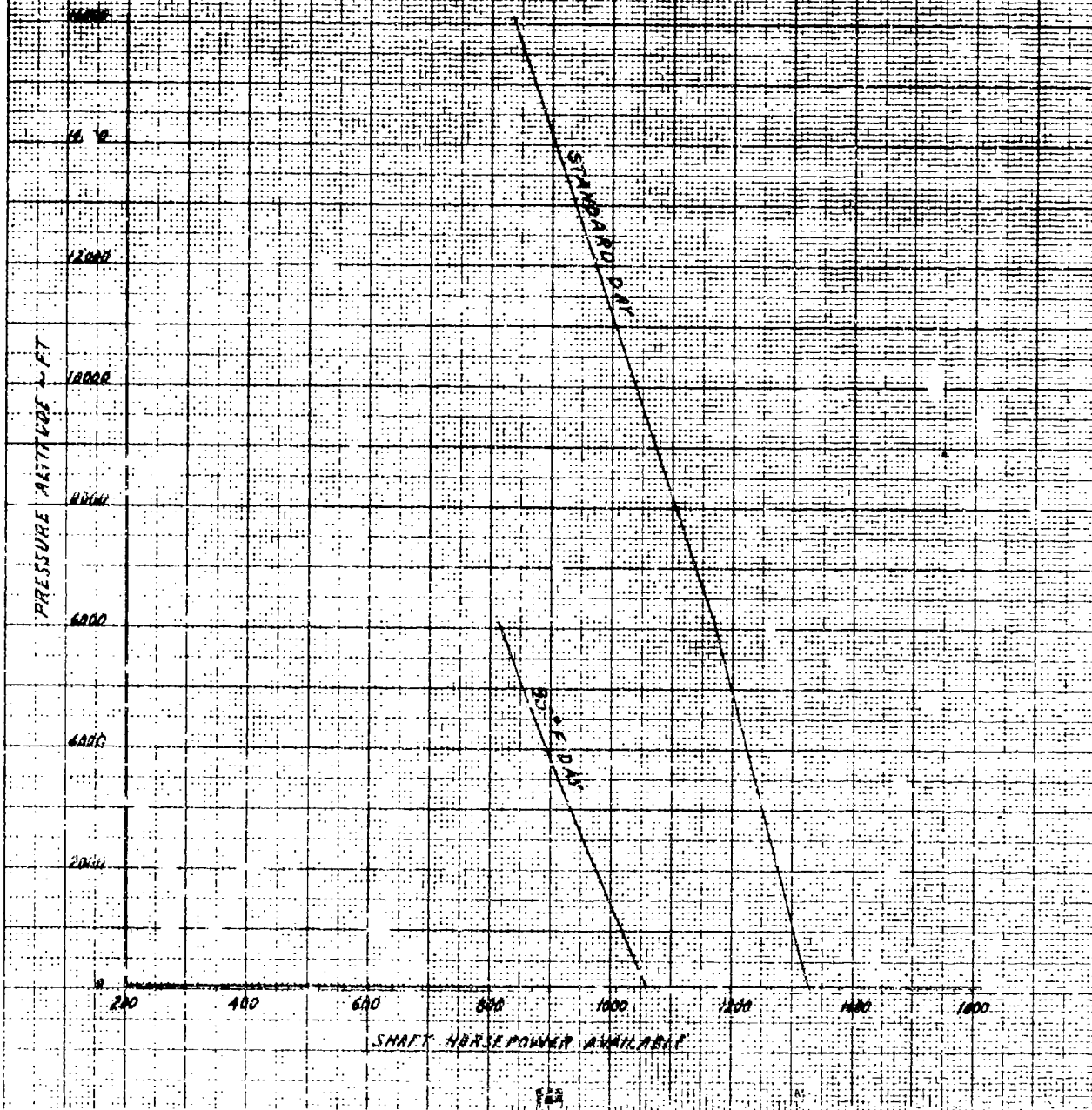
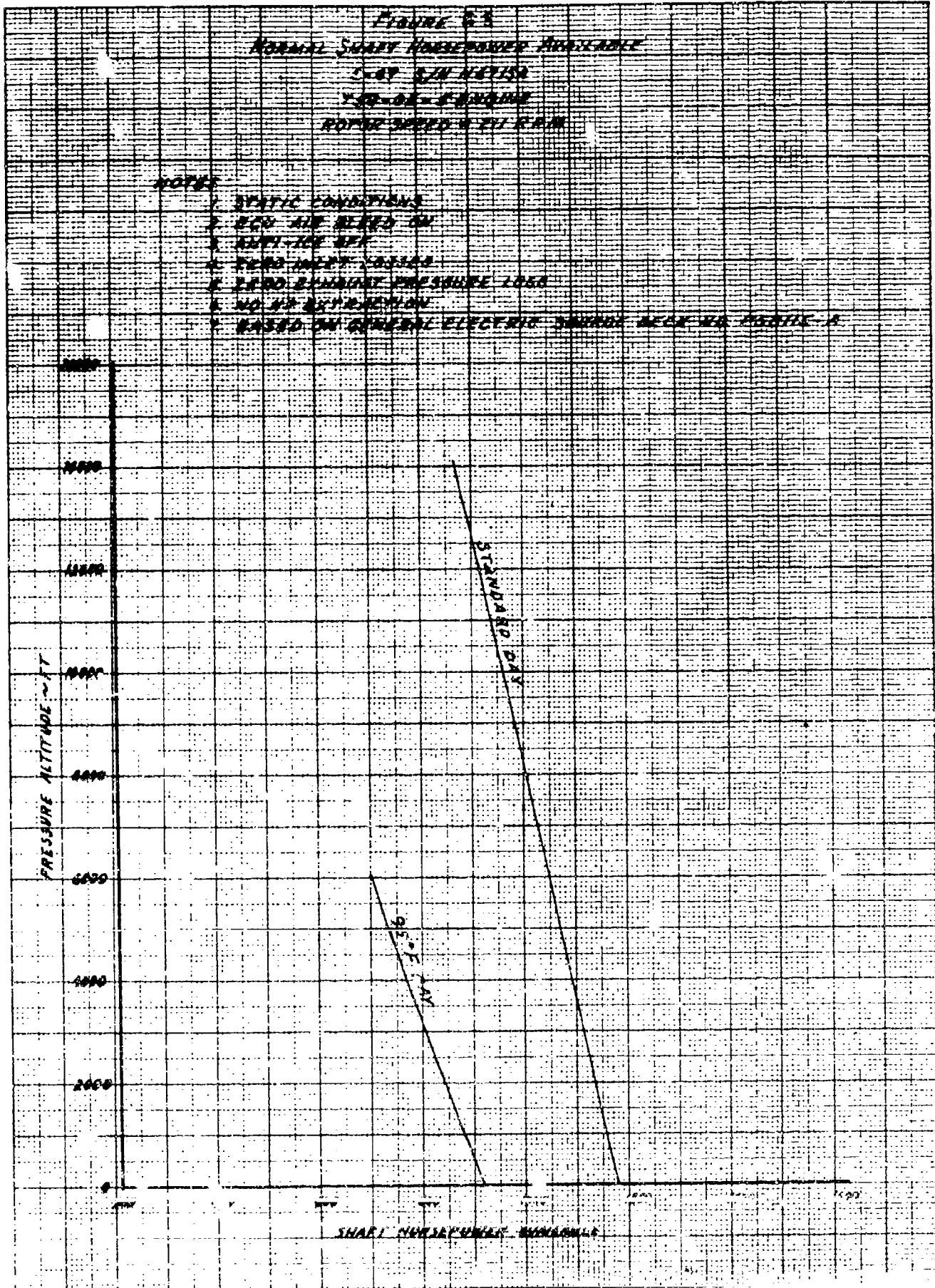

FIGURE 23
NORMAL SHARY PERFORMANCE AVAILABLE
1-87 GJM HELICOPTER
Y-20-02-000000
ROTOR SPEED 271 RPM

- NOTES**
- 1. STATIC CONDITIONS
 - 2. 100% AIR BLEED ON
 - 3. 100% ICE OFF
 - 4. 100% WPT LOSS
 - 5. 100% EXHAUST PRESSURE LOSS
 - 6. NO WPT EXTENSION
 - 7. BASED ON GENERAL ELECTRIC ENGINE MODEL 605-1A



SHARY HORSEPOWER AVAILABLE

FIGURE 6A
 SHARP HORSEPOWER AVAILABLE WITH PAM EXHAUST

5-167 5A1045A
 T58-GE-5 ENGINE
 TAKEOFF POWER - STANDARD DAY
 ROTOR SPEED = 211 RPM
 FCU AIR BLEED ON

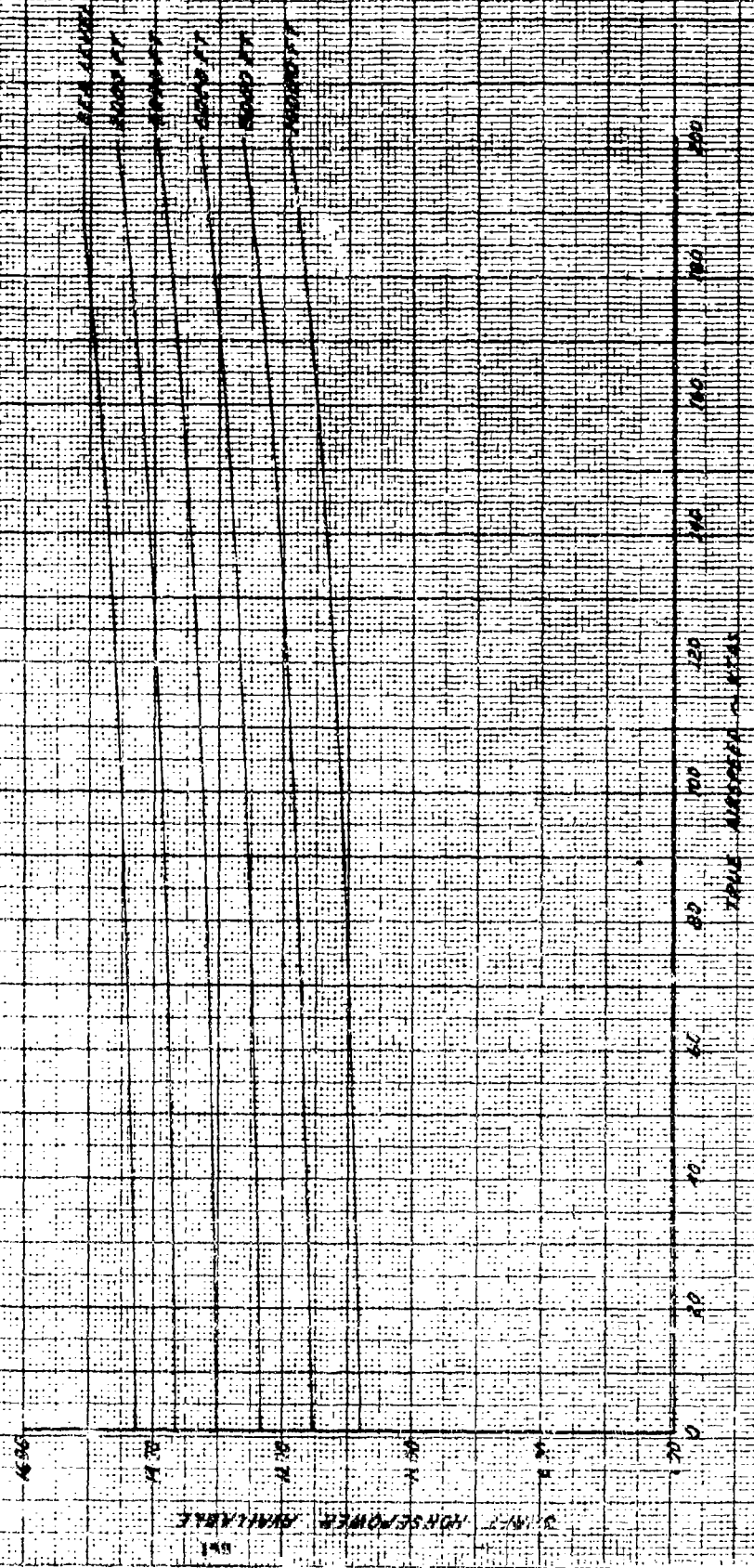

FIGURE 65
 SWAST HORSEPOWER AVAILABLE WITH DAM PRESSURE

5-67 5/8" NAD/SM
 T80-DE-5 ENGINE
 MILITARY POWER - STANDBY ONLY
 MOTOR SPEED = 217 RPM
 FUEL AIR BLEED IN

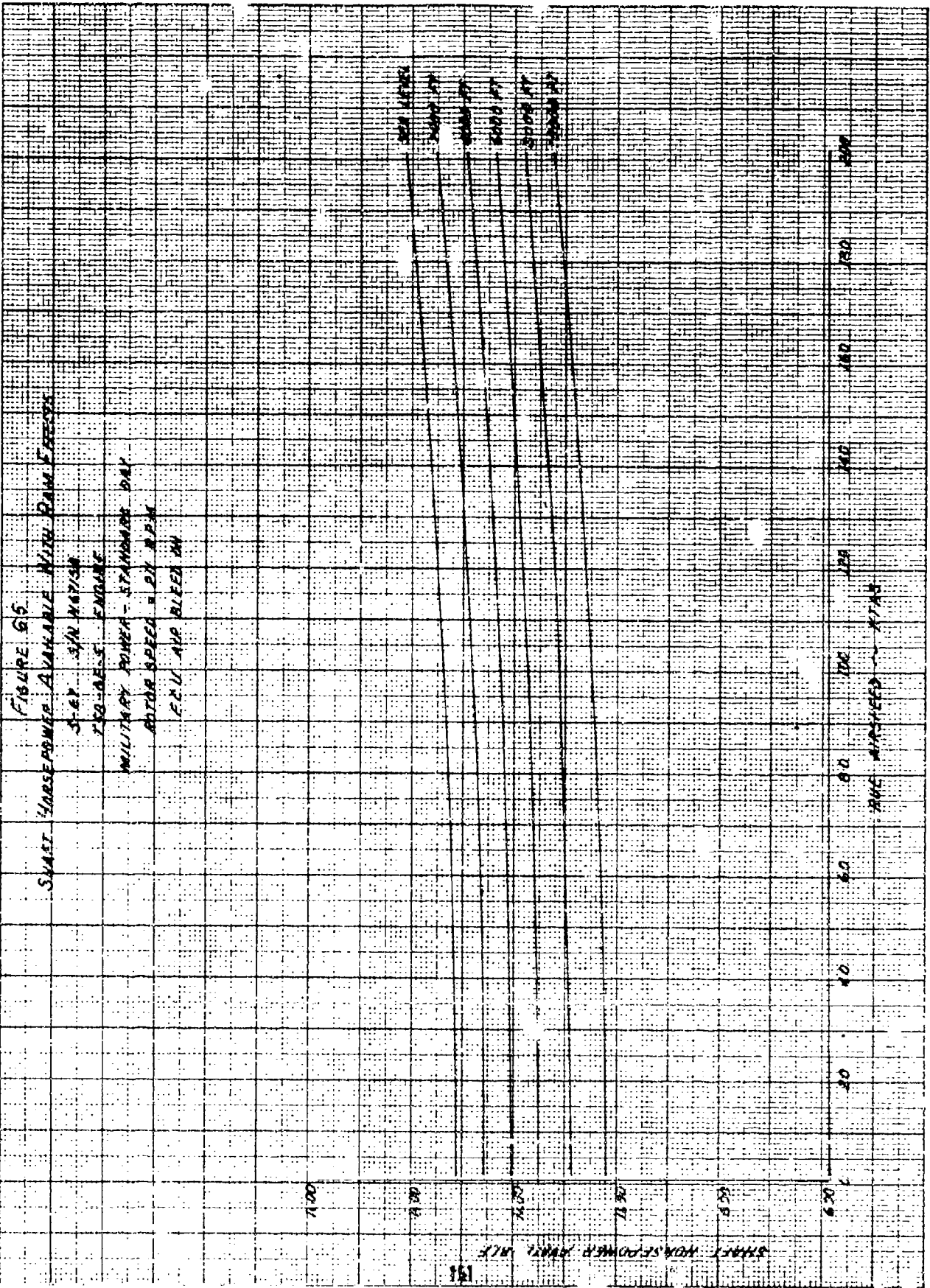
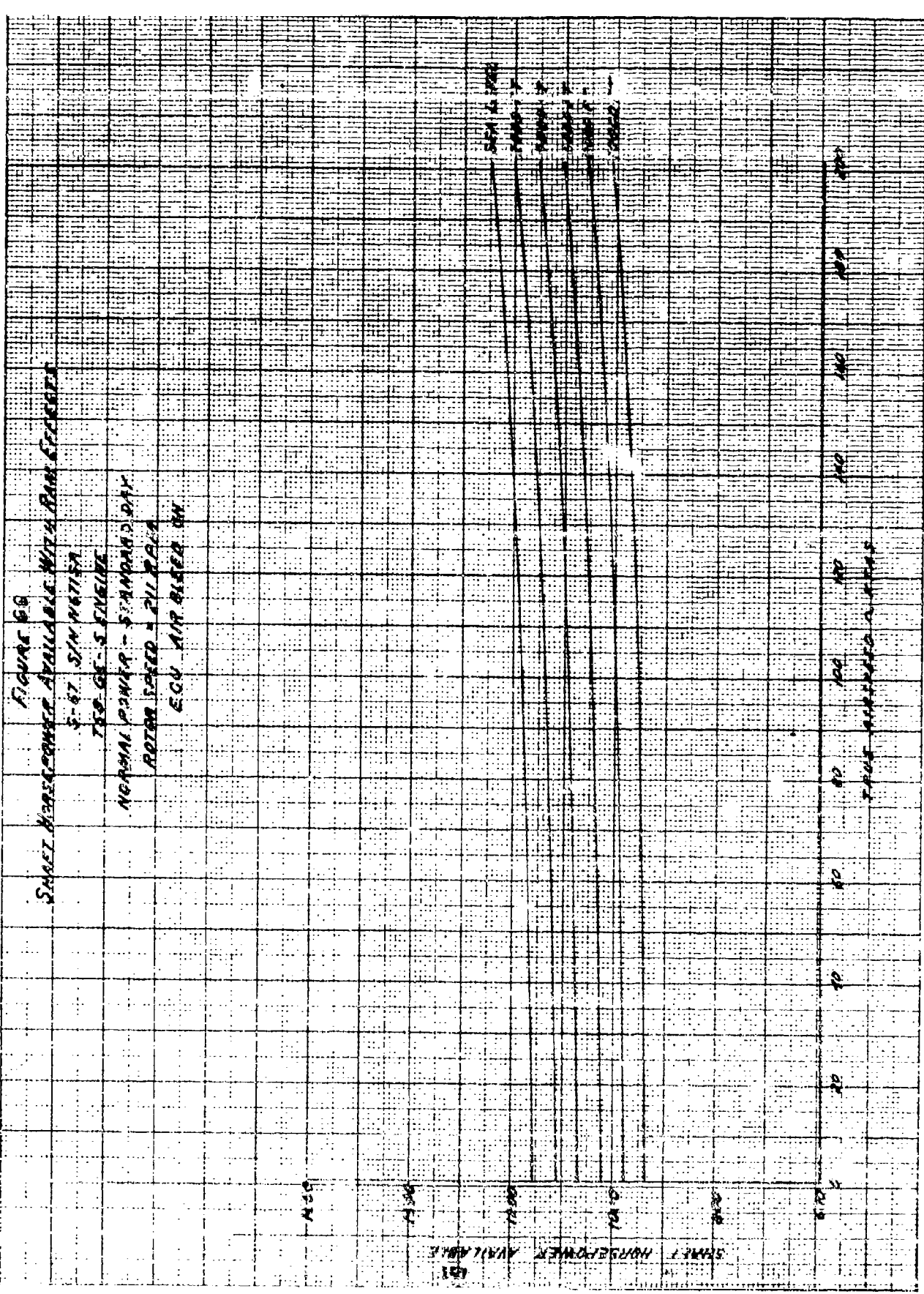

FIGURE 68
SMART HPPERFORMANCE AVAILABLE WITH 4 BANK ECCECEPT

5-87 51N HAT15A
750-GE-5 FINELINE

NORMAL PUMP - STANDARD DAY
ROTOR SPEED - 2711 RPM
ECU AIR BLEED ON



SMART HPPERFORMANCE AVAILABLE

SMART HPPERFORMANCE AVAILABLE

FIGURE 67

REARBEEL ENGINE CHARACTERISTICS

5000 RPM NATURAL
1300 RPM'S IN PROPORT
ROTARY SPEED FORWARD

NOTES:

1. ϕ_c BASED ON CIP
2. ϕ_c BASED ON CIT
3. SAEG. CURVE BASED ON THE FOLLOWING
 - a. STATIC CONDITIONS
 - b. E.C.V. AIR BLEED ON
 - c. ANTI ICE OFF
 - d. EXHAUST INLET LOSSES
 - e. ZERO EXHAUST PRESSURE LOSS
4. 145 HP EXTRACTION
5. GENERAL ELECTRIC SOURCE DECK NO. P. 61151-A
6. CIRCLED SYMBOLS DENOTE INSTALLED TEST ENGINE

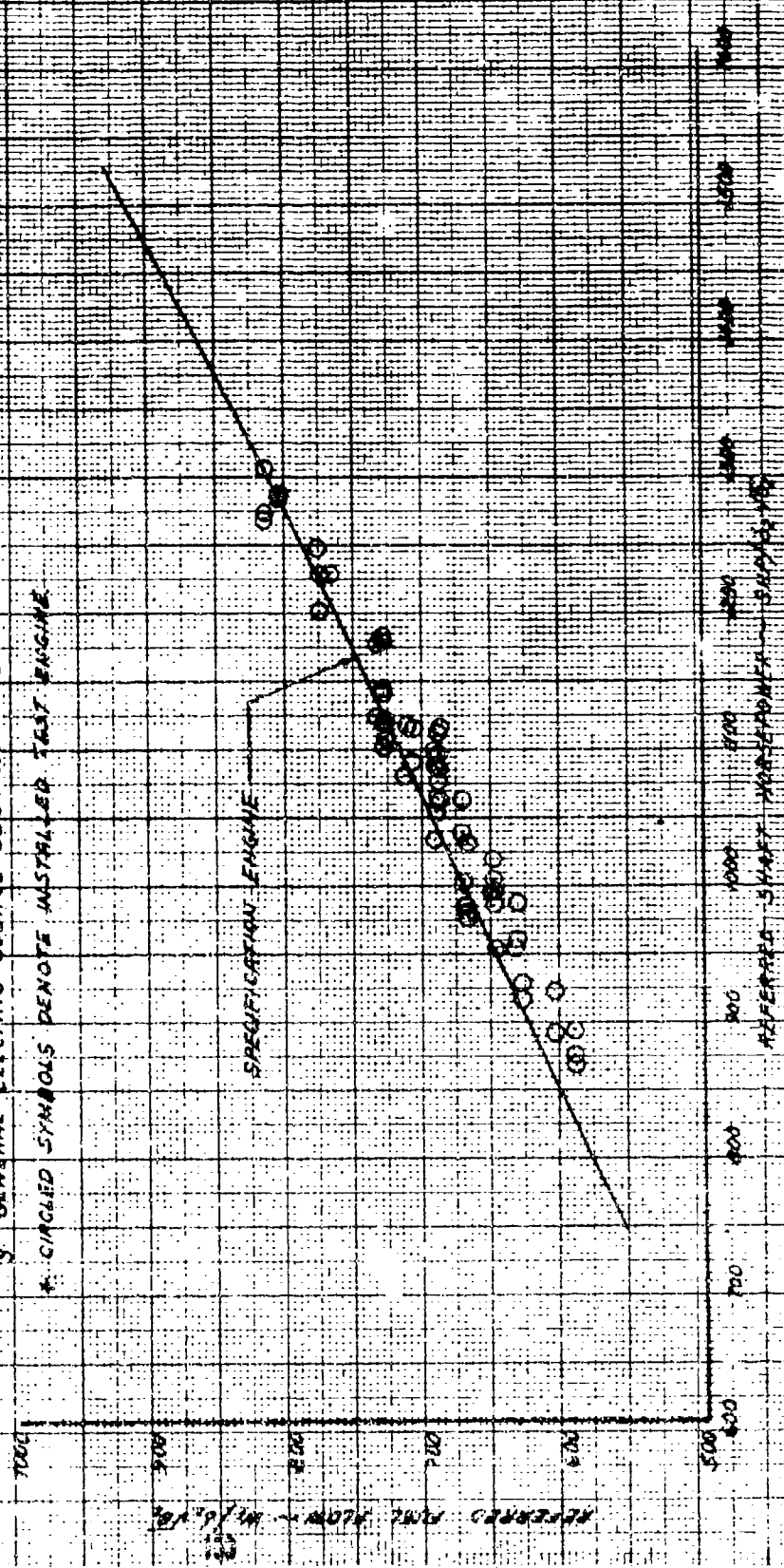

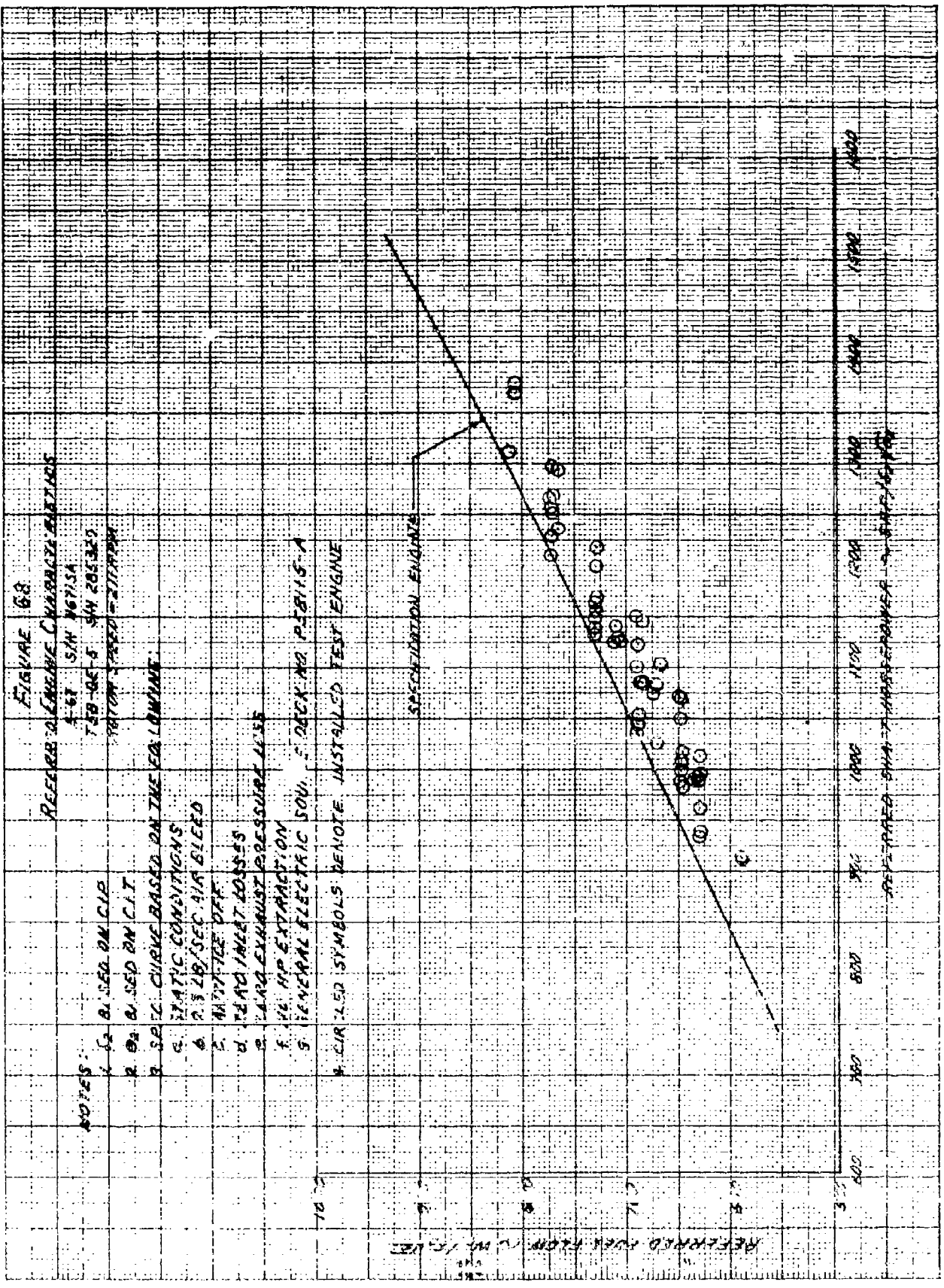

FIGURE 69
REFORCEL ENGINE CHARACTERISTICS
S-07 514 10715A
TOR 60-5 514 29000A7
ROTAR SPEED - 911 RPM

NOTES

1. η_c BASED ON CIP
2. η_b BASED ON CIP
3. SPEC. CURVE BASED ON THE FOLLOWING:
 - a. STATIC CONDITIONS
 - b. FGD AIR BLEED ON
 - c. 10% IGE DRX
 - d. ZERO INLET LOSSES
 - e. ZERO EXHAUST PRESSURE LOSS
 - f. NO HP EXTRACTION
 - g. REVERSE ELECTRIC SOURCE DECK NO. 15071L-11
4. CIRCLED BY "X"OLS DENOTE INSTALLED TEST ENGINE

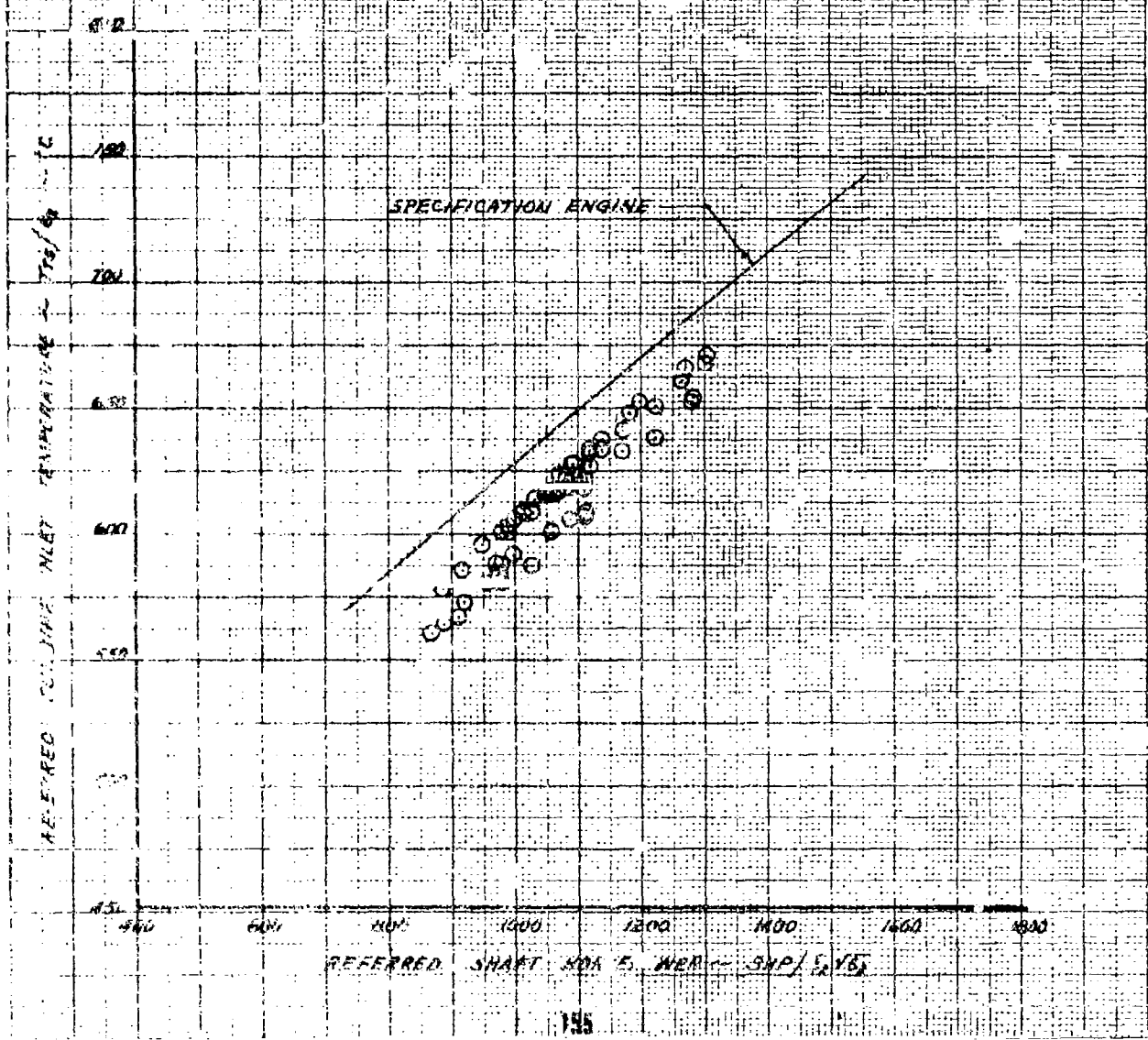

FIGURE 10
REFERRER ENGINE CHARACTERISTICS
5% AT SEA TESTS
1400-60-5 WINDWARD
WATER SPEED = 21.1 KNOTS

- NOTES:**
 1. STATIC CONDITIONS
 2. EQUILIBRIUM ON
 3. 100% ICE OFF
 4. REEVE TAULT LOSS
 5. ZERO EXHAUST PRESSURE LOSS
 6. NO HP EXTRACTION
 7. BASED ON GENERAL ELECTRIC BRIDGE DECK NO. 10110-A
 8. CIRCLED SYMBOLS DENOTE INSTALLED TEST ENGINE

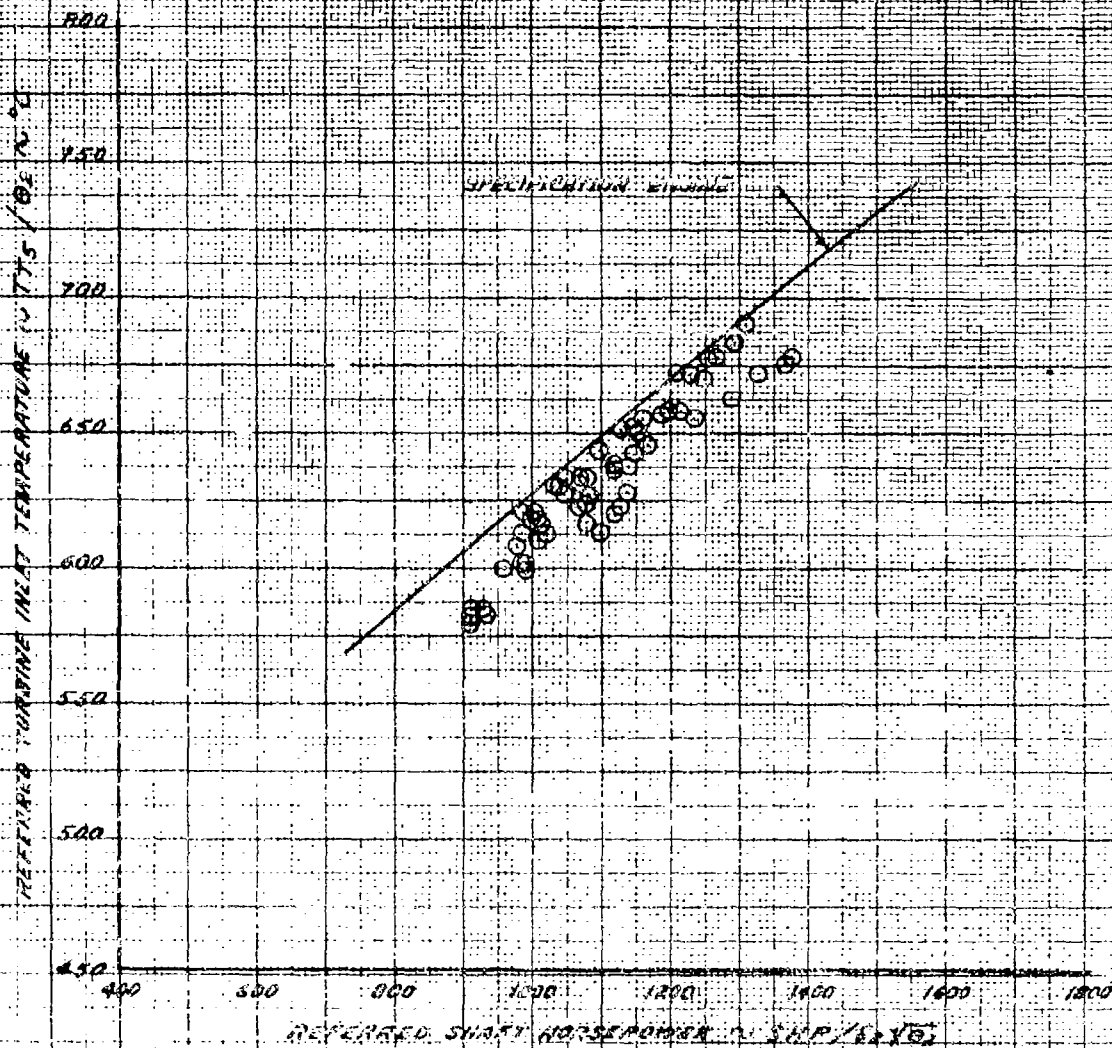

FIGURE 71
REFERRAL ENGINE CHARACTERISTICS
3507 RPM ROTOR
100 GALS. MIN FUEL
WATER SPEED 20 KNOTS

NOTES:

1. IS BASED ON CIP
2. IS BASED ON CIP
3. SPEC. CURVE BASED ON THE FOLLOWING:
 - A. STATIC CONDITIONS
 - B. 100% AIR BLEED ON
 - C. AIR-ICE OFF
 - D. ZERO INLET LOSSES
 - E. ZERO EXHAUST PRESSURE LOSS
 - F. NO HP EXTRACTION
 - G. GENERAL ELECTRIC SOURCE DECK NO. P6015-A
4. CIRCLED SYMBOLS DENOTE INSTALLED TEST ENGINE

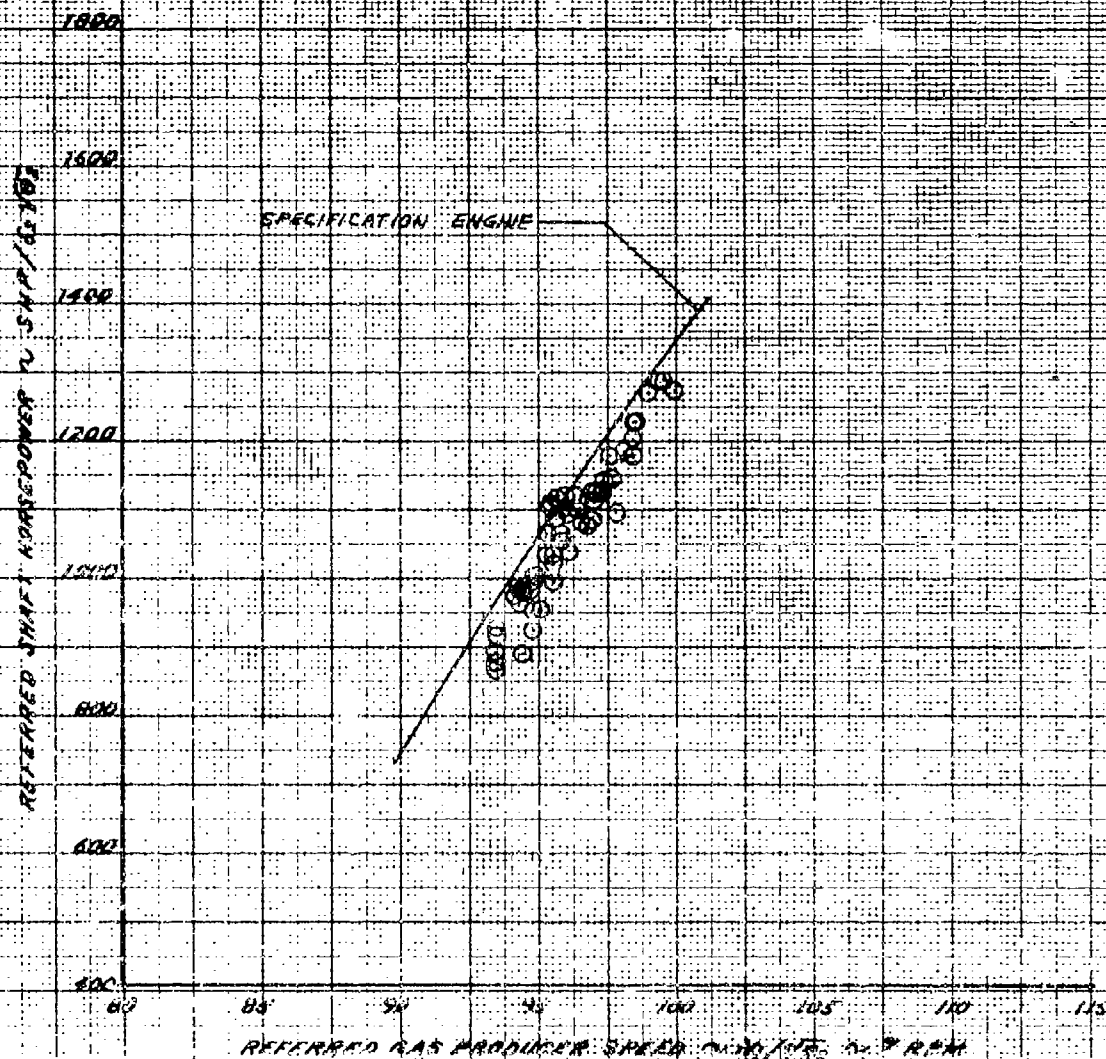

FIGURE 18
REFERRED ENGINE CHARACTERISTICS

1.5% NO_x @ 100 RPM
AUTUMN-SPRING-ENGINE

- NOTES:**
- 1. \dot{V}_2 BASED ON GYP
 - 2. \dot{V}_2 BASED ON CIT
 - 3. SPEED CURVE BASED ON THE FOLLOWING:
 - A. STATIC CONDITIONS
 - B. ANTI-ICE OFF
 - C. ZERO INLET LOSSES
 - D. ZERO EXHAUST PRESSURE LOSS
 - E. NO HP EXTRACTION
 - F. GENERAL ELECTRIC SOURCE TEST NO. P58715-A
 - 4. CIRCLED SYMBOLS DENOTE INSTALLED TEST ENGINE

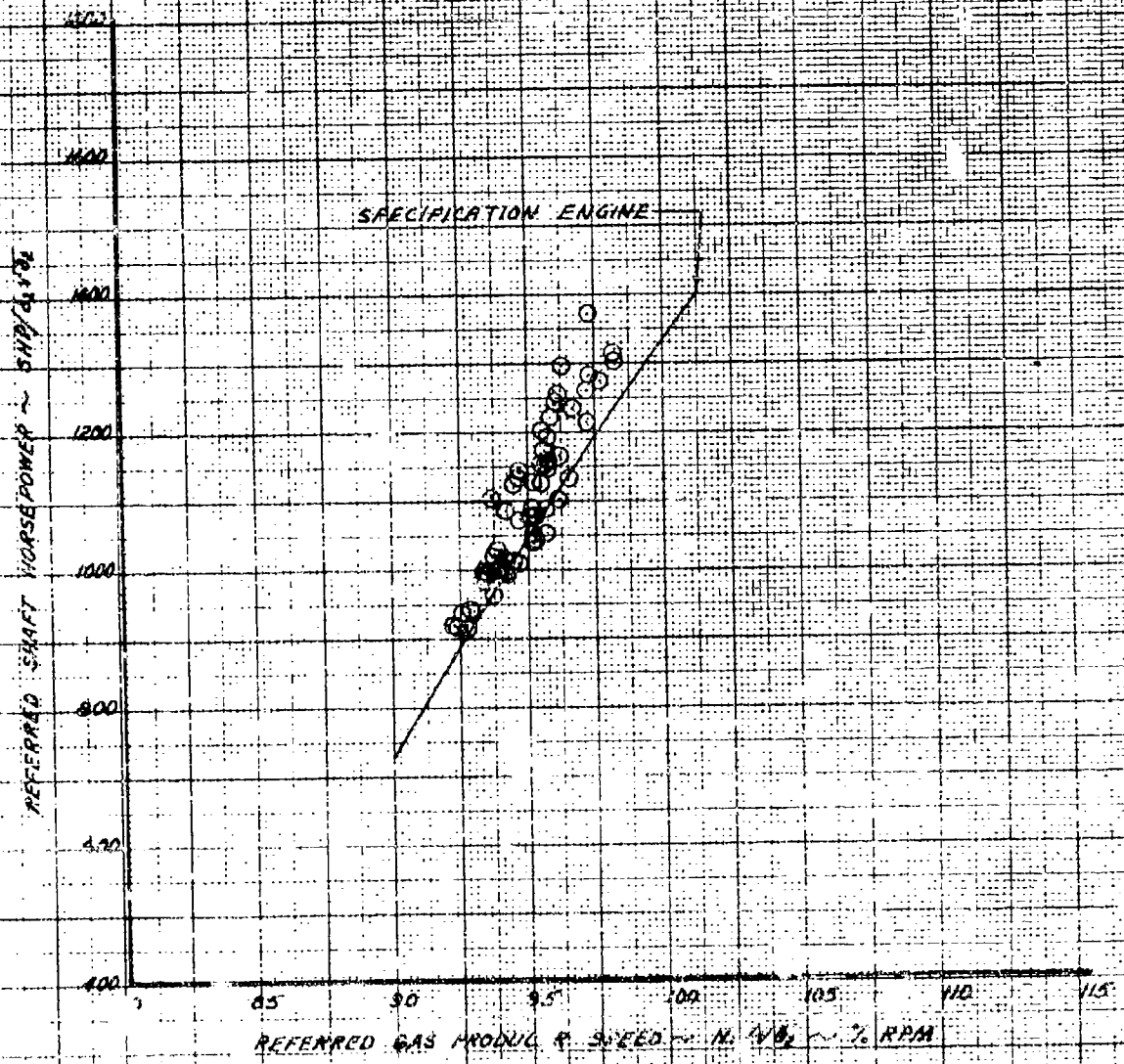

FIGURE 13
PERFORMANCE CHARACTERISTICS
3-67 514 HETISA
1.00 IN. 2. 30. 2.00 IN. 3.00 IN.
ROTARY SPEED - 200 RPM

NOTES

1. η_c BASED ON CIP
2. η_e BASED ON CIP
3. SPEC. CURVE BASED ON THE FOLLOWING:
 - a. STATIC CONDITIONS
 - b. 100% AIR FLOW ON
 - c. 100% AIR FLOW
 - d. ZERO INLET LOSSES
 - e. ZERO EXHAUST PRESSURE LOSS
 - f. NO HP EXTRACTION
 - g. GENERAL ELECTRIC SOURCE UNDER NO PRESSURE
4. CIRCLED SYMBOLS DENOTE INSTALLED TEST ENGINE

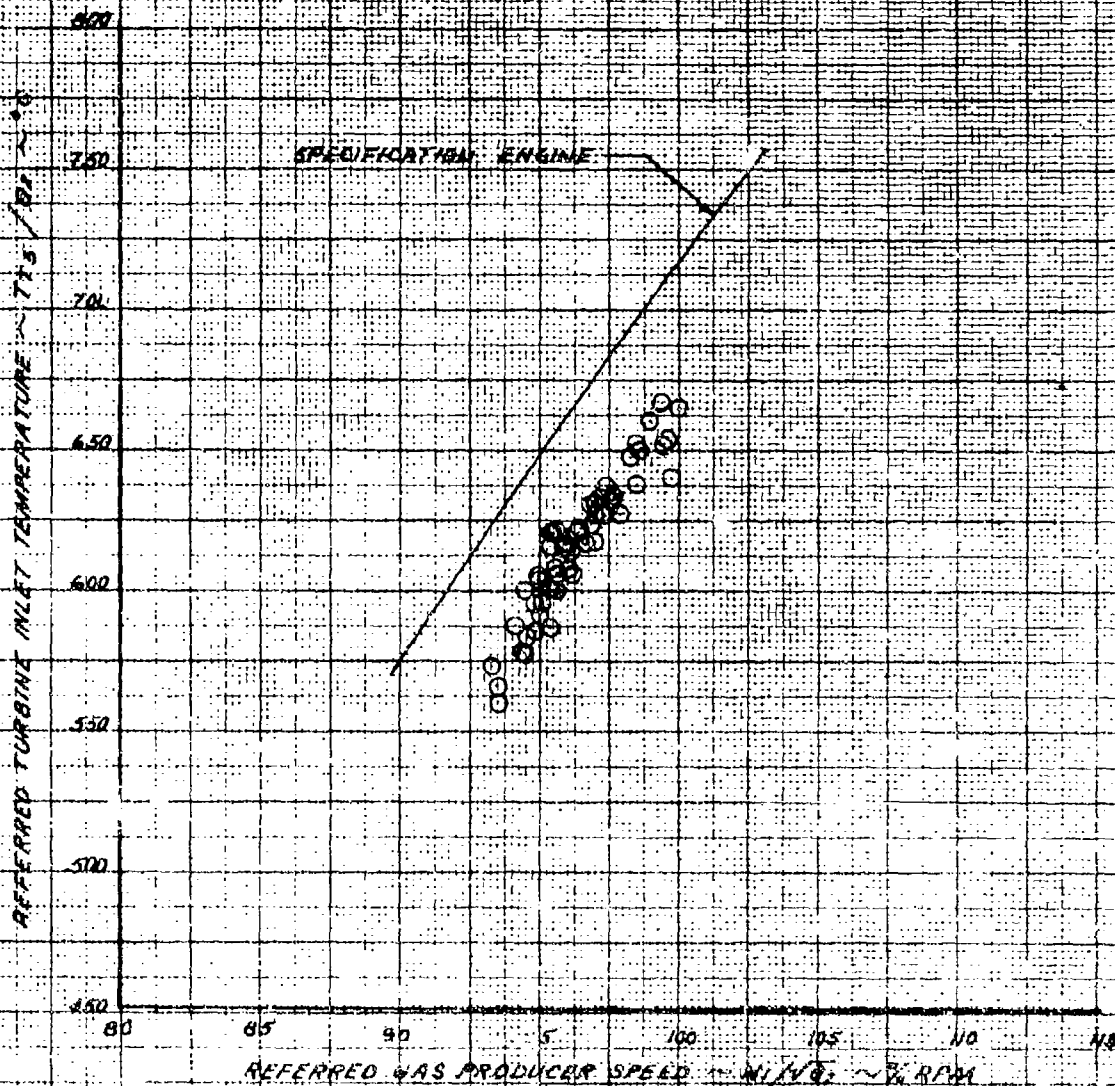

FIGURE 24
REFERRER ENGINE CHARACTERISTICS
 0-87 5/16 X 1/16
 100 02 0 3/4 X 200 000
 ROTARY SPEED 200 RPM

NOTES:

1. BASED ON EIP
2. BASED ON EIT
3. SPEC. CURVE BASED ON THE FOLLOWING:
 - a. STATIC CONDITIONS
 - b. 2.5 INCHES AIR BELEN
 - c. 100% ICE OFF
 - d. ZERO INLET LOSSES
 - e. ZERO EXHAUST PRESSURE LOSS
 - f. NO HP EXTRACTION
 - g. GENERAL ELECTRIC SOURCE DECK NO. PSEBTS-A
4. CIRCLED SYMBOLS DENOTE INSTALLED TEST ENGINE

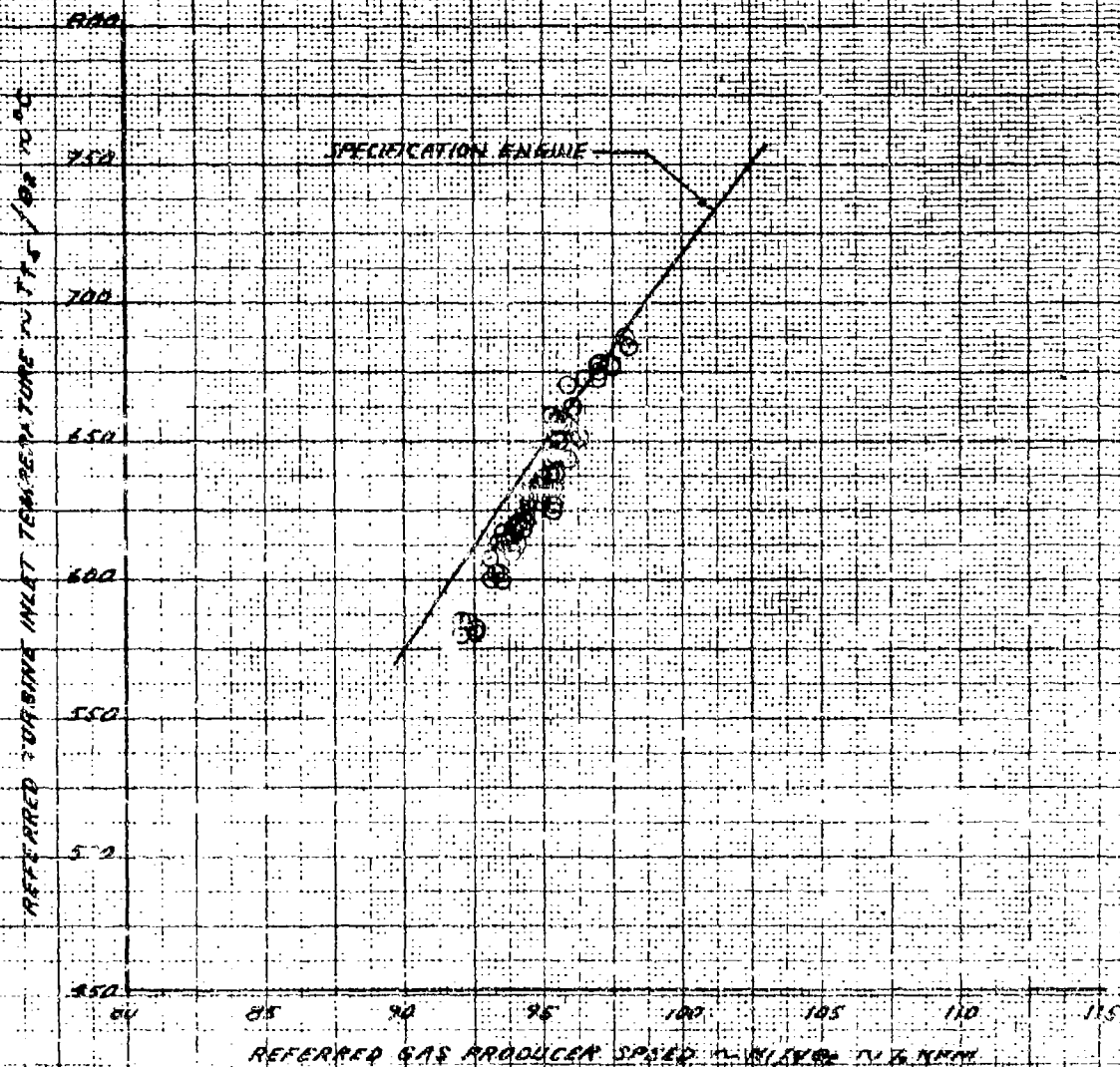

FIGURE 15
AIRSPEED CALIBRATION
S-47 GUNNERIAN
SWAN SYSTEM
PROBING METHOD
PAGE METHOD

Avg WINDS	Avg EA	Avg DENSITY	Avg DAY	Avg MOTOR SPEED	Avg GAS	CONFIGURATION	FLIGHT CONDITION
MPH	INCH	PCF	°E	RPM	INCH	CLEAN	LEVEL/CLIMB
1750	27.5 (1.87)	220	112	211	40000	CLEAN	LEVEL/CLIMB

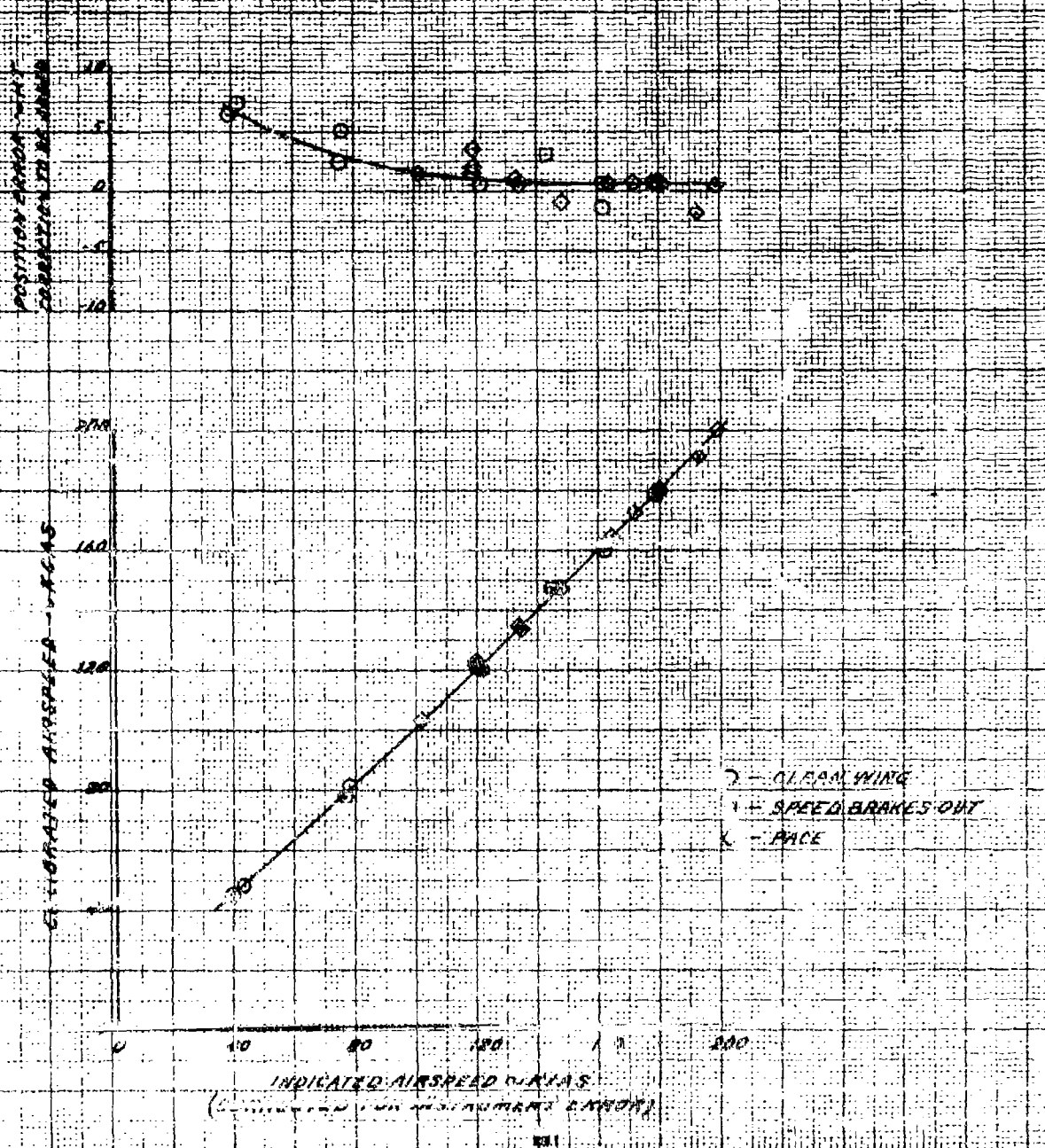

FIGURE 10
VIBRATION CHARACTERISTICS
S-67 SIMULATOR
50 VERTICAL

STANDARD	Avg WEIGHT	Avg LOCATION	Avg HEIGHT	Avg DIA	Avg SPEED	Avg D	CONFIGURATION
	LBS	IN	FT	IN	RPM	IN	
0	17000	27.0 (APT)	1.000	1.30	212	0.0023	CLEAN
1	17900	27.0 (APT)	3.125	10.0	212	0.0014	CLEAN
2	18200	27.0 (APT)	8.000	10.7	212	0.0010	EXTERNAL STORES

NOTES:

1. OPEN CIRCLES DENOTE LEVEL POINT
2. SHADED CIRCLES DENOTE DIVE
3. ACCELEROMETER LOCATION: PORTED BE WTR. 41.1800

S.M.I. - AMPL. OF VIBRATORY ACCL'S. 7.10.1.9

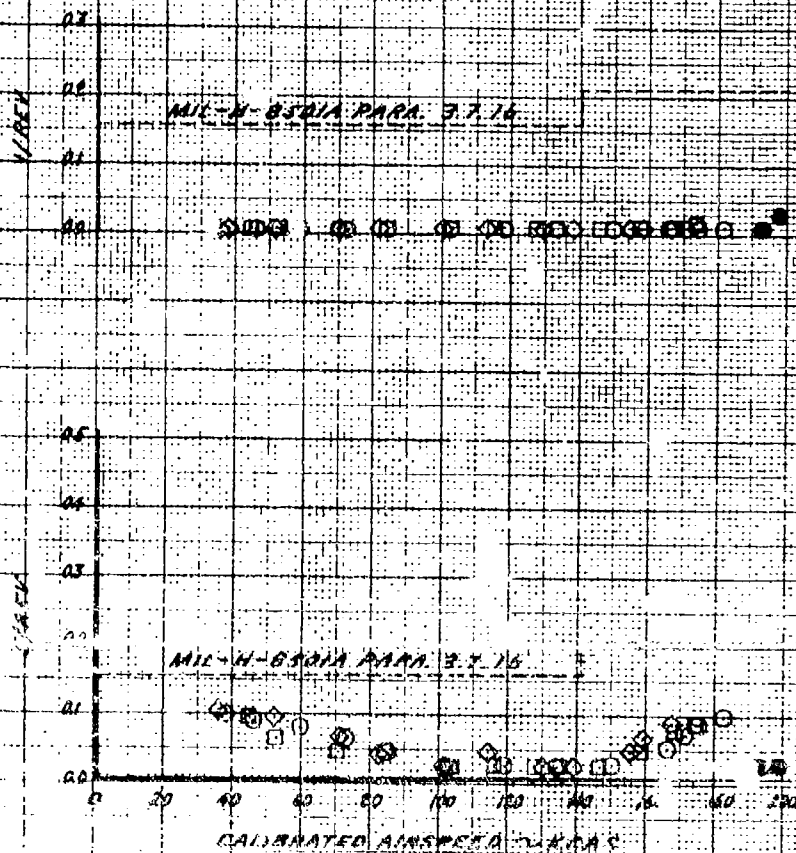

FIGURE 77
VIBRATION CHARACTERISTICS
5-07 SIMONIS
PILE# VERTICAL

SYMBOL	AVG DEPTH METERS	AVG TO LOCATION MTR	AVG DENSITY KG/CM ³	AVG DWT MTR	AVG WATER MTR	AVG CY	CONFIGURATION
○	17000	2740 (OFF)	1.500	13.2	210	0.00033	CLEAN
○	17500	2735 (OFF)	1.510	10.6	210	0.00010	CLEAN
○	18000	2740 (OFF)	1.500	10.7	210	0.00010	EXTERNAL SPURS

○ OPEN SYMBOLS DENOTE LEVEL FLIGHT
 ○ SHADDED SYMBOLS DENOTE DIVE
 ○ ACCELEROMETER LOCATIONS: PG 14.5 BL 10.1 WL 100.0

SINGLE AMPLITUDE VIBRATORY ACCELERATION G'S

1/REV

1/REV

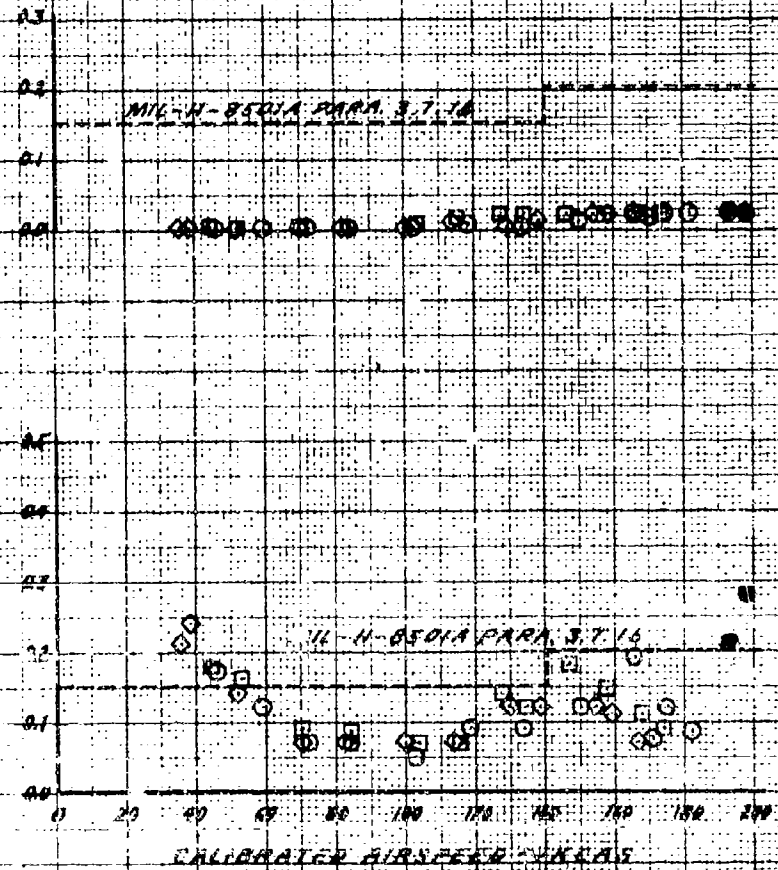

FIGURE 78
VIBRATION CHARACTERISTICS
8-67 SIMULTANEOUS
CORNER READINGS

SYMBOL	Avg GROSS WEIGHT LBS	Avg SEA LOCATION N/E	Avg DEPTH ALTITUDE FEET	Avg DAY MAG	Avg RITCH SPEED KNOTS	Avg CY %	CONFIGURATION
○	17000	STANDARD	1000	18.5	212	00000	FLANK
◐	17000	STANDARD	5120	18.5	212	00000	FLANK
◑	10250	STANDARD	5000	19.7	212	00000	ANTENNA STORES

- NOTES:
1. OPEN SYMBOLS DENOTE LEVEL FLIGHT
 2. SHADED SYMBOLS DENOTE DIVE
 3. ACCELEROMETER LOCATION: FS OR A OR TOP OR L OR B

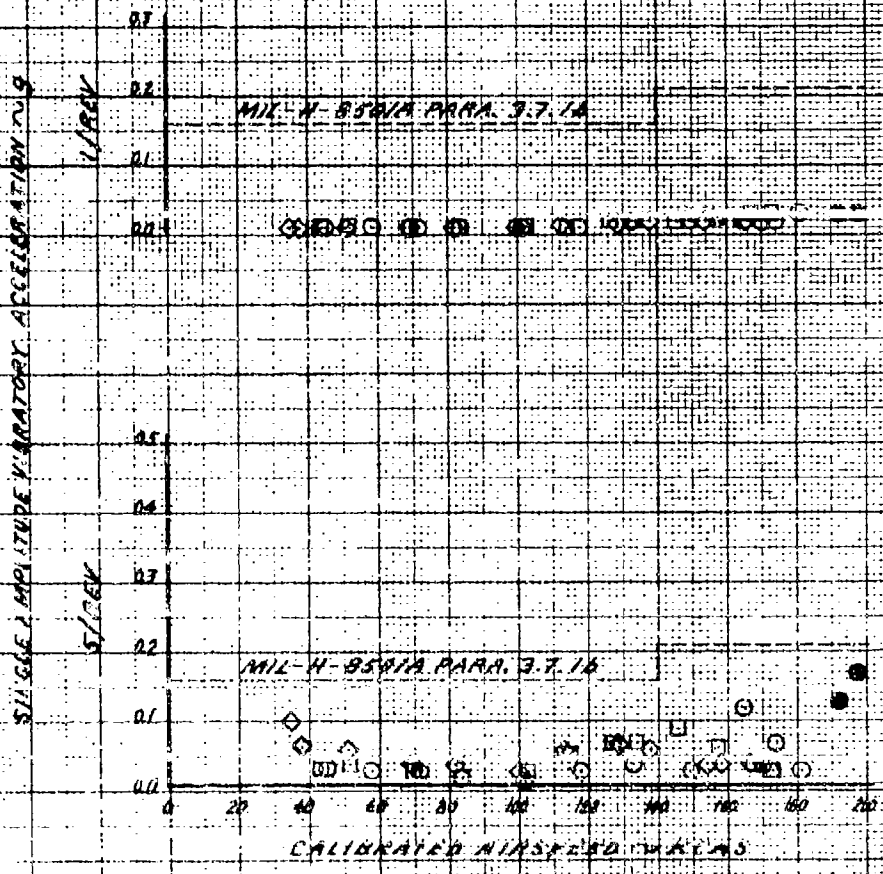

FIGURE 79
 VIBRATION CHARACTERISTICS
 S-OF SENSORS
 TEST RANGE VARIATION

STATION	AVG GROSS RANGE FT	AVG TO LOCATION FT	AVG DEPTH ALTIMETER FT	AVG WIND SPEED MPH	AVG WIND DIRECTION	AVG TEMPERATURE °F	CONTOUR VARIATION
0	1700	STANDARD	1500	13.5	210	60.529	CLEAR
1	1700	STANDARD	1500	10.5	210	60.518	CLEAR
2	1800	STANDARD	1600	10.7	210	60.518	EXTENSIVE STORMS

NOTES:

1. OPEN STATIONED DEW POINT LEVEL RECORD
2. STANDARD STATIONED DEW POINT DATA
3. AC ELECTROMETER LOCATION: AS 1100' ON 2-24' W. 162° O.

SINGLE AMPLITUDE VIBRATION ACCELERATION'S

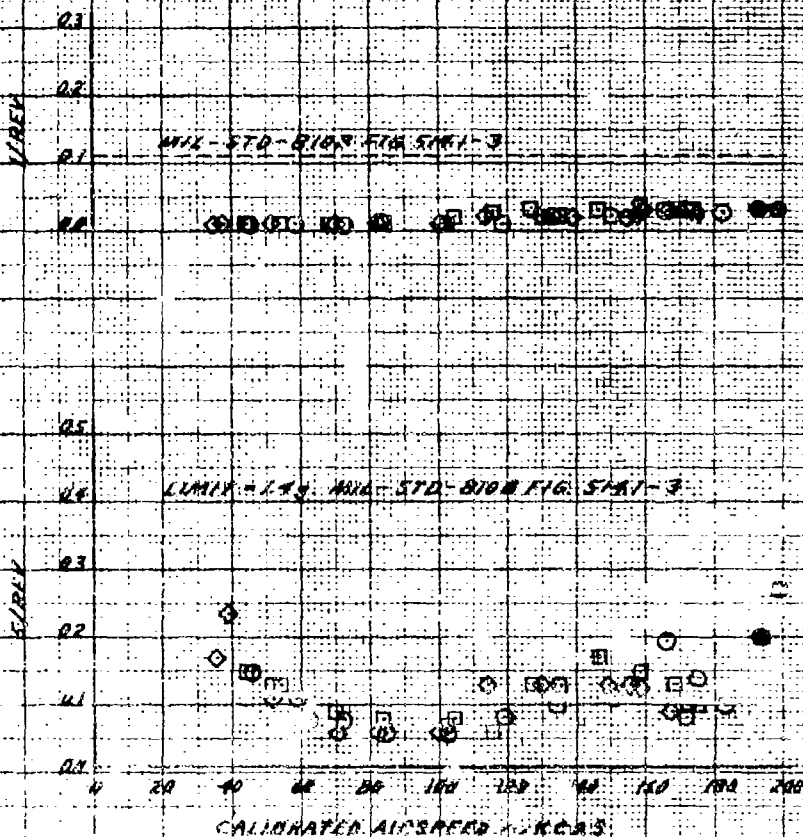

FIGURE 2

SWAYED SYMBOLS DENSITY DATA
 5-27-57
 SUMMER PANEL PERIOD

NUMBER	TIME	TYPE	AREA	SWAY	AREA	TYPE	PREPARATION
	DATE	CLASS	MEANING	TYPE	CLASS	TYPE	
	TIME	CLASS	MEANING	TYPE	CLASS	TYPE	
1	17000	R70.0 (A70)	1500	13.5	210	R00523	CLEAN
2	17000	R73.0 (A73)	5100	10.5	210	R00610	CLEAN
3	18000	R70.0 (A70)	3000	10.7	210	R00610	EXCESSIVE STAIN

NOTES:
 1. OPEN SYMBOLS DENSITY LEVEL FLIGHT
 2. SWAYED SYMBOLS DENSITY DATA
 3. ACCELEROMETER LOCATION: PS 53.0 BL 0.0 WL 154.0

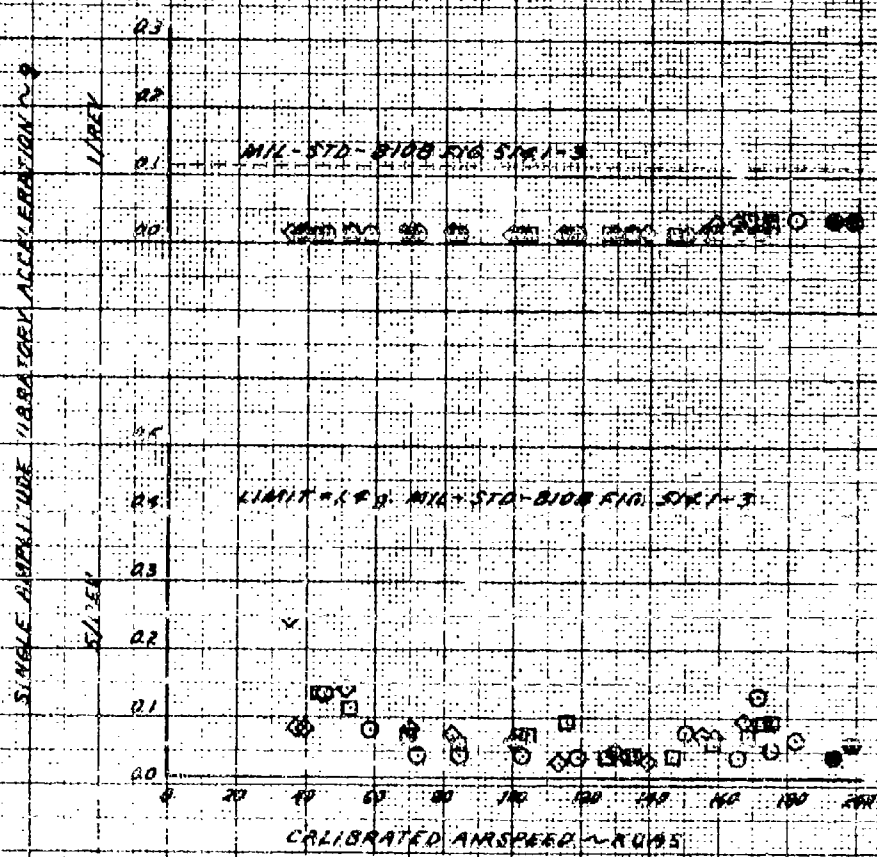

FIGURE B1
VIBRATION CHARACTERISTICS
S-27 MIL-B-8015A
COLLAPSED

SERIAL	AMP PERCENT LEVEL	AMP G VIBRATION LEVEL	AMP DENSITY ALTITUDE	AMP G ALT	AMP PERCENT LEVEL	AMP G ALT	CONFIRMATION
0	1.000	2.000 (RMS)	1500	15.0	0.10	0.0050	GREEN
1	1.7500	2.000 (RMS)	1500	10.0	0.10	0.0050	GREEN
2	2.0000	2.000 (RMS)	1500	10.0	0.10	0.0050	EXTERNAL STRESS

NOTES:
 1. OPEN SYMBOLS DENOTE LEVEL FLIGHT
 2. SOLID SYMBOLS DENOTE DIVE
 3. ACCELEROMETER LOCATION: AS SHOWN ON FIG. MIL-10050

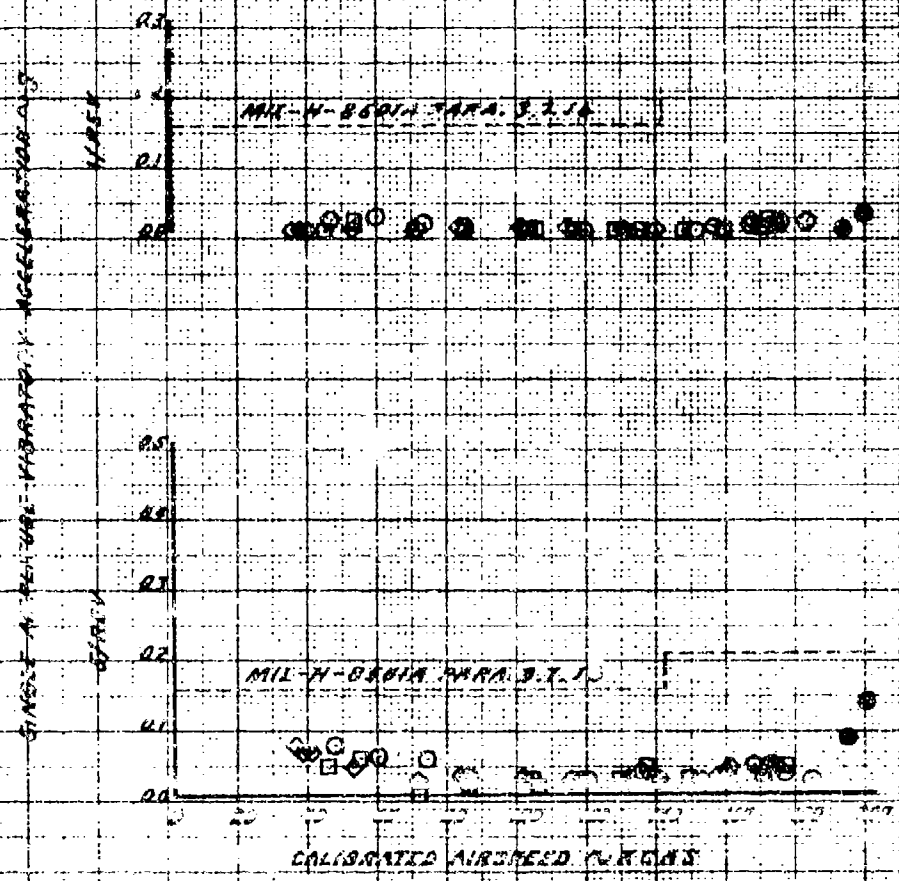

FIGURE 25
VIBRATION CHARACTERISTICS
OF SIMULATED
PIRE EXTENSION

CONFIGURATION	AVG GROSS HEIGHT	AVG CG LOCATION	AVG WING HEIGHT	AVG WING SPAN	AVG WING AREA	AVG WING LOAD	CONFIGURATION
1	17.00	27.00 (NET)	15.00	13.5	212	15.6	CLEAN
2	17.00	27.00 (NET)	15.00	13.5	212	15.6	CLEAN
3	17.00	27.00 (NET)	15.00	13.5	212	15.6	EXTENSION STAGES

NOTES:

1. OPEN SPARKS DURING LEVEL FLIGHT
2. SHADED SYMBOLS DENOTE GIVE
3. ACCELEROMETER OPERATION: PM 1405 ON 702 WA 108.0

1 % G AMPLITUDE VIBRATORY ACCELERATION

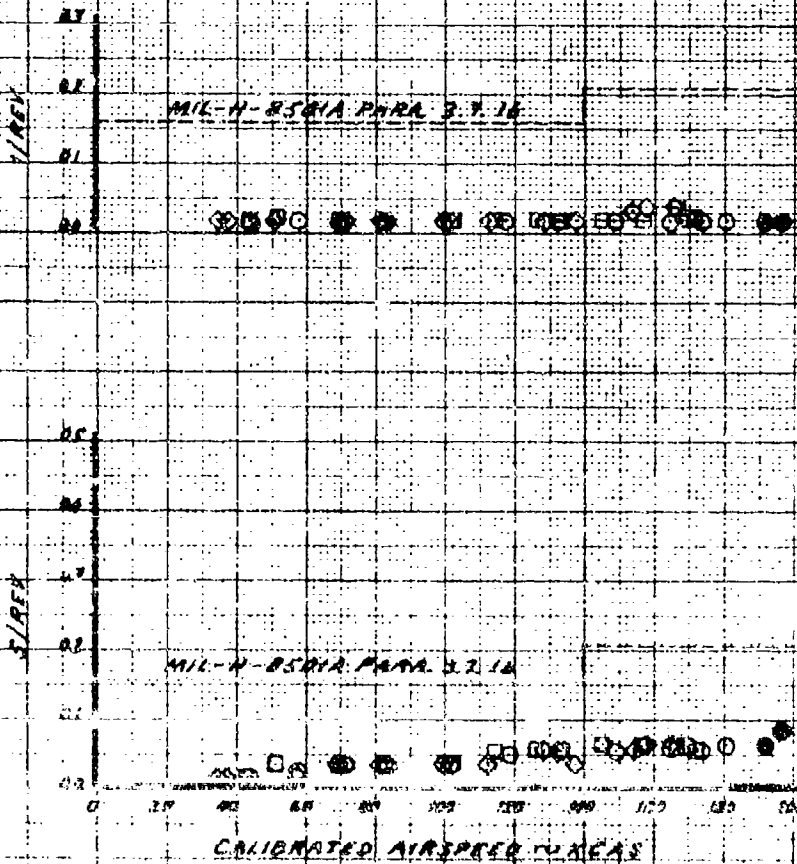

FIGURE B3
VIBRATION CHARACTERISTICS
8-67 SIMULTANEA
GUNNER LATERAL

SPEED	AVG SPEED MILES PER HOUR	AVG TO ORIENTATION MILES	AVG DENSITY ALTITUDE M FT	AVG DAYS	AVG PERCENT SPEED	AVG G	CONFIGURATION
○	17000	2750 (MFT)	1.80	13.5	212	0.00523	CLEAN
□	17397	2735 (MFT)	5.10	10.5	212	0.00618	CLEAN
○	18216	2720 (MFT)	3.00	10.7	212	0.00618	EXTERNAL STORES

NOTES:
 1. OPEN SYMBOLS DENOTE LEVEL FLIGHT
 2. CLOSED SYMBOLS DENOTE DIVE
 3. ACCELEROMETER LOCATION: AS 03.5 BL TOR WL 100.0

20000
18000
16000
14000
12000
10000
8000
6000
4000
2000
0

25
20
15
10
5
0

MIL-H-8501A PARA 37.10

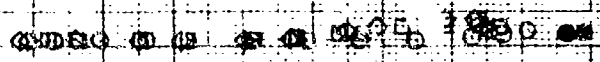

MIL-H-8501A PARA 37.10

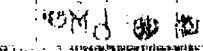

0 20 40 60 80 100 120 140 160 180 200

CALIBRATED AIRSPEED MACH 0.5

FIGURE 64
VIBRATION CHARACTERISTICS
S-47 SIMULATOR
PILOT PARALLEL TRACK

SYMBOL	AVG SPEED MPH	AVG SQ LOCATION NORTH	AVG DENSITY ALTITUDE FEET	AVG DPT ANGLE	AVG ROTOR SPEED RPM	AVG GT	CONFIGURATION
○	17000	2780 (ACT)	1500	12.5	212	0.00223	CLEAN
○	17900	2780 (ACT)	5100	10.6	212	0.00218	CLEAN
○	18200	2780 (ACT)	4800	10.7	212	0.00219	EXTERNAL STORES

NOTES:

1. OPEN SYMBOLS DENOTE LEVEL FLIGHT
2. SHARPER SYMBOLS DENOTE DIVE
3. ACCELEROMETER LOCATION FS (13.5) BK 2.6L WL 162.0

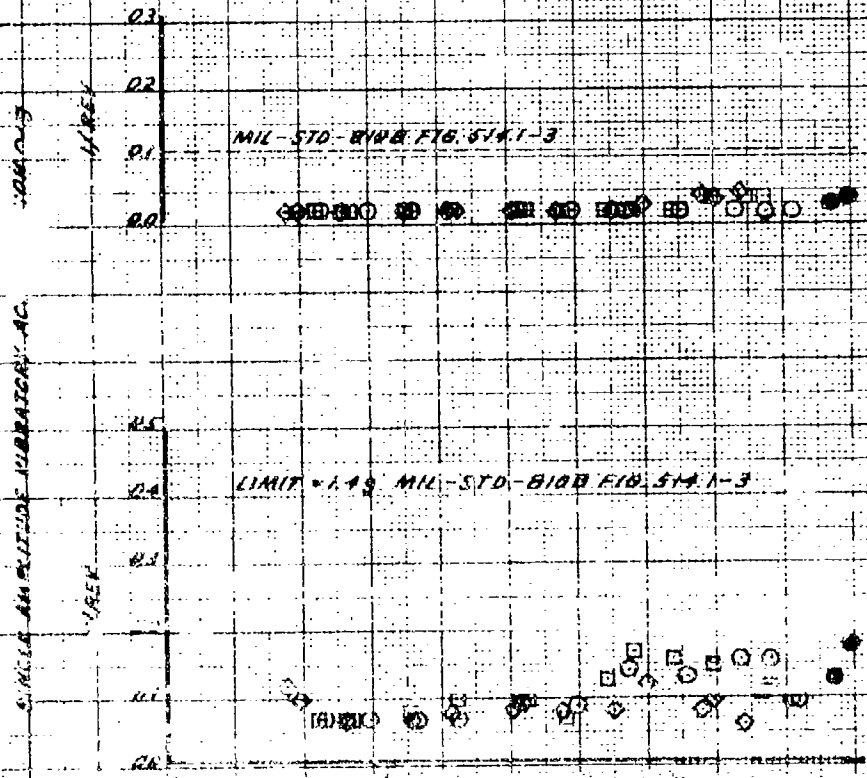

VIBRATION CHARACTERISTICS

S-OF SIMANISA
JUNIOR PANEL AREA

SIGNAL	AVG WINGS HEIGHT IN LB	AVG WING LOCATION IN LB	AVG DENSITY ALTIMETER IN FT	AVG DAS IN FT	AVG WIND SPEED IN MPH	AVG CY	CONFIGURATION
○	17000	2700(NET)	1500	13.5	210	000109	CLEAR
□	17500	2735(NET)	5100	1.0	210	000010	CLEAR
○	18250	2700(NET)	4030	1.7	210	000010	EXTERNAL STORES

NOTES

1. OPEN SYMBOLS DENOTE LEVEL FLIGHT
2. SHADDED SYMBOLS DENOTE DIVE
3. ACCELERATION LOCATION AS 02.0 01.0 01.0 137.0

SINGLE AMPLITUDE VIBRATION ACCELERATION

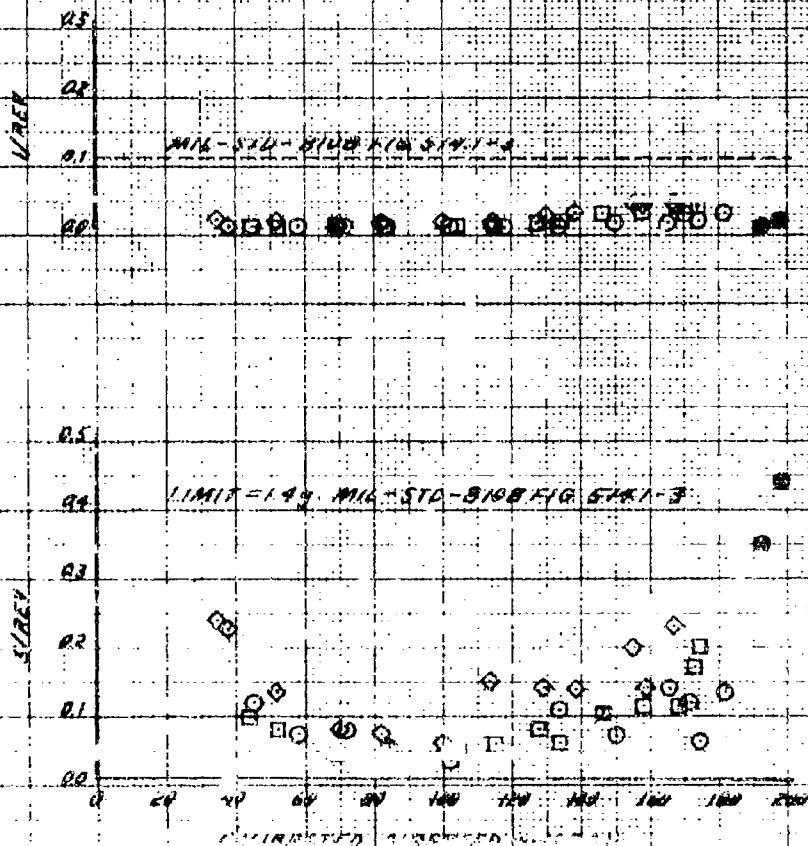

FIGURE E
 VIBRATION CHARACTERISTICS
 S-67 SIMULATOR
 FIRST RANGE: FEDERAL

SYMBOL	TYPE EQ WEIG W/E	TYPE EQ CREATIVE W/E	AVG DENSITY ALTITUDE W/E	AVG DPT W/E	AVG WIND SPEED KMPH	AVG SUN FT	CONCENTRATION
○	TYPE 1	TYPE 1	TYPE 1	TYPE 1	TYPE 1	TYPE 1	CLEAN
◐	TYPE 2	TYPE 2	TYPE 2	TYPE 2	TYPE 2	TYPE 2	EXTERNAL STORES

NOTES:

1. OPEN SYMBOLS DENOTE LEVEL FLIGHT
2. SHADDED SYMBOLS DENOTE DIVE
3. ACCELEROMETER LOCATION: FS USA BL 2.5L WL 16210

S-67 AIRCRAFT LABORATORY ACCELERATION 1.9

G-REX

G-REX

0.3
0.2
0.1
0.0
-0.1
-0.2
-0.3

MIL-STD-810B FIG. 5-01-3

LIMIT = 1.9 MIL-STD-810B FIG. 5-01-3

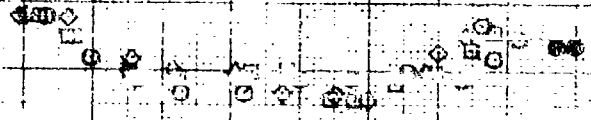

CALIBRATED AIRSPEED - KNOTS

FIGURE 87
VIBRATION CHARACTERISTICS
5-GT SIGNALISE
GUNNER PANEL LONGITUDE

SYMBOL	AVE GROSS WEIGHT LBS	AVE LG LOCATION IN	AVE DENSITY ALTITUDE FT	AVE DRT TUS	AVE APPROX SPEED MPH	AVE GT	CONFIGURATION
○	17400	2720(AFT)	7500	13.6	212	0.00523	CLEAN
◻	17900	2730(AFT)	6100	10.6	212	0.00610	CLEAN
◊	18250	2740(AFT)	7800	10.7	212	0.00610	EXTERNAL STORES

- NOTES:
1. OPEN SYMBOLS DENOTE LEVEL FLIGHT
 2. SHADED SYMBOLS DENOTE DIVE
 3. ACCELEROMETER LOCATION: FS 53.0 ON GO WL 189.0

TABLE 88: VIBRATION ACCELERATION $\times g$

