

FTD-TT-64-833



07-018-008

TRANSLATION

(U) FISHBED C/E AERIAL TACTICS

5 NOVEMBER 1965

~~NO FOREIGN DISSEM~~

**FOREIGN TECHNOLOGY
DIVISION**



AIR FORCE SYSTEMS COMMAND

WRIGHT-PATTERSON AIR FORCE BASE

OHIO

T65-0593
5 Nov 65

Classified

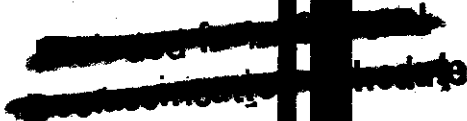

~~EXCLUDED FROM AUTOMATIC
REGRADING: PART 1, 1200.10~~
PPLY

DECLASSIFIED LAW E.O. 12958

REVIEWED BY Robert L. Young / NAIC/PA

DATE 11 MAY 98

Copy Nr. 9

1. Information conflicting with or pertinently affecting that contained in this publication should be forwarded by the recipient directly to:

Commander
Foreign Technology Division
Air Force Systems Command
Wright-Patterson Air Force Base, Ohio

This in no way abrogates or alters responsibility for sending such information or any pertinent intelligence data through already established intelligence collection channels of the various services or agencies of the U.S. government.

2. ~~WARNING: This document contains information affecting the national defense of the United States within the meaning of the Espionage Law, Title 18, U.S.C., Sections 793 and 794. Its transmission or the disclosure of its contents in any manner to an unauthorized person is prohibited by law.~~

~~This publication has been designed to meet the specific needs of the recipient for intelligence. Further dissemination by the recipient or parts of the whole to subordinate elements must be based on the specific need to know of the recipient to perform their assigned missions. (Authority: AFCIN Policy Letter 205-5 dated 20 Feb 59)~~



DEPARTMENT OF THE AIR FORCE
AIR INTELLIGENCE AGENCY

11 May 1998

MEMORANDUM FOR NAIC/TA (Mr Reinhardt)

FROM: NAIC/PA

SUBJECT: Declassification of ATIC/FTD Documents

IAW Executive Order 12958, the attached documents have been reviewed by NAIC/PA, NAIC/DXH, and NAIC/TAA and were determined to be eligible for declassification. As an NAIC Original Classification Authority, please review the attached FTD documents and indicate whether you concur with our findings. If you have any questions please contact me at 7-6487 or R755.

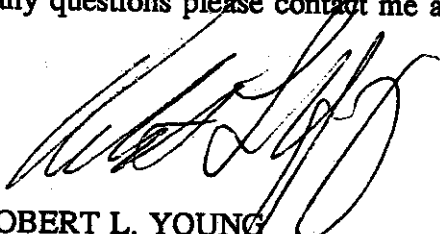
ROBERT L. YOUNG
Historian

1st Ind, NAIC/TA

To: NAIC/HO

Concur / ~~Non-concur~~

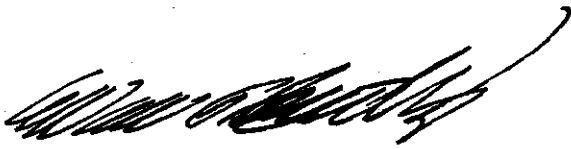
WARREN T. REINHARDT
Original Classification Authority

4 Attachments

1. (S/NF) Photo Intelligence Guide - Oct 1972
2. (S) FISHBED Weapon System, T67-10394
3. (S/NF) FISHBED C/E Aerial Teactics, T65-0593
4. (S/NF) FISHBED Weapon System, ST-CS-09-27-73

(This Page Unclassified When Separated From Attachments)

"Freedom Through Vigilance"

~~NOT RELEASABLE TO
FOREIGN NATIONALS~~

~~SECRET~~ T

NO FOREIGN DISSEM

FOREIGN TECHNOLOGY TRANSLATION

FTD-TT-64-833

EDITED TRANSLATION

~~SECRET~~

MANUAL ON THE TECHNIQUES OF PILOTING AND
MILITARY USE OF THE MIG-21F-13

(TITLE UNCLASSIFIED)
FISHBED C/E AERIAL TACTICS

5 NOVEMBER 1965

DECLASSIFIED IAW E.O. 12958
REVIEWED
BY Robert L. Young, NWC/PA
DATE 11 May 80

DEPUTY FOR AEROSPACE WEAPON SYSTEMS

FOREIGN TECHNOLOGY DIVISION
AIR FORCE SYSTEMS COMMAND
WRIGHT-PATTERSON AIR FORCE BASE
OHIO

T65-0593

~~SECRET~~ T

[REDACTED]

TABLE OF CONTENTS

	Page Nr.
Chapter I. Principles of Aerial Combat	1
Chapter II. Target Search and Interception	87
Chapter III. Aerial Engagement With Bombers	139
Chapter IV. Aerial Combat Between MiG-21f-13's and Enemy Fighters	181
Chapter V. Aerial Combat Training	225
Chapter VI. Gunnery Training Against Air and Ground Targets	237

LIST OF ILLUSTRATIONS

Figure 1. Area of Possible Fighter Approach Along a Pursuit Curve	6
Figure 2. Fighter Approach Over a Passing-Parallel Course	8
Figure 3. Schematic of Fighter Approach by the "Wave-Downward" Method	11
Figure 4. Approach Time When Approaching by "Wave- Downward" and by a Straight Line	12
Figure 5. Change in Altitude, Speed, and Range When Approaching by the "Wave-Downward" Method	14
Figure 6. Approach With Lead Angle	16
Figure 7. Trajectory of Fighter When Approaching a Maneuvering Target	19
Figure 8. Change in Area of Effective Bomber Maneuvering	22
Figure 9. Area of Effective Bomber Maneuvering	23
Figure 10. Approach With Properly Selected Negative Lead Angles	25

List of Illustrations (Continued)

Page Nr.

Figure 11.	Optimum Negative Lead Angles for Target Speeds of 700-810 Knots	26
Figure 12.	Interceptor G-Load and Angular Velocity VS Target Angular Velocity	28
Figure 13.	Ballistic Characteristics of R-3S Type Rockets	33
Figure 14.	Determining the Range of Rocket Launching Distances	35
Figure 15.	Dimensions of R-3S Rocket TGS Seizing Area at an Altitude of 50,000 Feet	36
Figure 16.	Change in R-3S Rocket TGS Target Seizing Distance in Relation to Altitude and Target	38
Figure 17.	Change in R-3S Rocket Launching Distances at Various Altitudes in Relation to Approach Rates	40
Figure 18.	Permissible Distances for Launching R-3S Rockets	42
Figure 19.	Rocket Launching Zone	46
Figure 20.	Zone of Launching R-3S Rockets Against a Bomber	48
Figure 21.	Areas of Possible Attack by the MiG-21f-13	51
Figure 22.	Areas of Possible Attacks by the MiG-21f-13	52
Figure 23.	Change in Necessary G-Load of R-3S Rockets	55
Figure 24.	Pursuit Curves VS Various Target Maneuvers	56
Figure 25.	Zones of Ineffective Defensive Target Maneuvers	58
Figure 26.	Conditions for Executing the Attack Against a Maneuvering Target	59
Figure 27.	Effect of Speed Ratio on Conditions When Attacking a Maneuvering Target	61

~~SECRET~~

List of Illustrations (Continued)

Page Nr.

Figure 28.	Probability of Entering Into Attack	68
Figure 29.	Probability of Entering Into Attack	69
Figure 30.	Probability of Entering Into Attack Against a Maneuvering Target	71
Figure 31.	Hit Probability for Various Launch Conditions	72
Figure 32.	Hit Probability for Various Launch Conditions	74
Figure 33.	Available Time for Launching Rockets by a Pair of Fighters Against Fighter Type Aircraft	78
Figure 34.	Available Time for Launching Rockets by a Pair of Fighters Against Bomber Type Aircraft	79
Figure 35.	Pair Attack Against a Maneuvering Target	83
Figure 36.	Interval and Angle of Turn When Spreading the Formation	84
Figure 37.	Interception by Profile I, First Condition	91
Figure 38.	Interception by Profile I, Second Condition	92
Figure 39.	Interception by Profile II, First Condition	93
Figure 40.	Interception by Profile II, Second Condition	94
Figure 41.	Interception by Profile III, First Condition	95
Figure 42.	Interception by Profile III, Second Condition	96
Figure 43.	Aircraft Acceleration - Time Graph, with Afterburner	100
Figure 44.	Distance During Acceleration with Full Afterburner	101
Figure 45.	Fuel Consumption During Acceleration with Full Afterburner	102
Figure 46.	Mach No. VS Altitude During Zoom	111

[REDACTED]

Table of Contents (Continued)

Page Nr.

Figure 47.	Distances - Prior to Zoom and at Conclusion of Zoom	113
Figure 48.	Distances - Prior to and at Completion of Zoom	114
Figure 49.	Altitude Loss During a Turnover	118
Figure 50.	Transparent Overlay Used for Vectoring Fighters at 20,000 Feet Against Low Flying Targets	119
Figure 51.	Schematic of Low-Altitude Intercept Through the Clouds	121
Figure 52.	Transparent Overlay Used For Vectoring Fighters at 6,000 Feet Against Low Flying Targets	122
Figure 53.	Duration of Air Duty in the Patrol Zone	123
Figure 54.	Interception Boundaries	127
Figure 55.	Viewing Angles From a MiG-21f-13	130
Figure 56.	Tactical Formation of a Pair	133
Figure 57.	Descent During Landing Approach From Boundary	136
Figure 58.	Graph for Calculating Descent From Boundary	137
Figure 59.	Principal Method of Launching Rockets	142
Figure 60.	Aiming and Launching Rockets	144
Figure 61.	Aiming and Launching Rockets	146
Figure 62.	Aiming and Launching Rockets	147
Figure 63.	Sideways Attack From the Rear	149
Figure 64.	Top Rear Attack	150
Figure 65.	Attack From Pitching	152
Figure 66.	Zooming Attack	163

~~SECRET~~

List of Illustrations (Continued)	<u>Page Nr.</u>
Figure 67. Dependence of Target Sighting Angles on Intervals	164
Figure 68. Minimum Pull-Out Distance to Avoid Collision	166
Figure 69. Sequential Attack of a Pair	172
Figure 70. Necessary Distance from the Target to Lead the Fighter into a Maneuver	185
Figure 71. Ratio of Overtake Times	186
Figure 72. Duration of Tracking in a Turn	189
Figure 73. Duration of Tracking Time During a Hard Turn	191
Figure 74. Tracking Duration During Half-Roll	192
Figure 75. Maximum Available Load Factor	194
Figure 76. Minimum Radii of Stable Horizontal Turns	195
Figure 77. Turn Diameter and Time for 180° Turns	196
Figure 78. Horizontal Turning Maneuver Attack	197
Figure 79. Attack With Employment of Ascending Maneuver	199
Figure 80. Characteristics of a Slanting Half-Loop	201
Figure 81. Comparison of Turn Characteristics in a Descending Maneuver	202
Figure 82. Attacking the Enemy During Descending Maneuver	203
Figure 83. Acceleration Time	206
Figure 84. Changes in Distance When Overtaking an Enemy	207
Figure 85. Change in Distance When Evading an Attacker	209
Figure 86. Turning Toward Enemy with Subsequent Attack	210

~~SECRET~~

~~SECRET~~

List of Illustrations (Continued)

Page Nr.

Figure 87.	Reduction of Distance Between Aircraft when Executing an Irregular Roll	212
Figure 88.	Deployment of Pair in Horizontal and Vertical Planes	214
Figure 89.	Deployment of Pair in Ascending Maneuver	215
Figure 90.	Attack From the Rear Upper Side	220
Figure 91.	Attack During Turn	223
Figure 92.	Attack During Ascending Maneuver	224
Figure 93.	Execution of Maneuver When Cannons and Rockets are Fired Against an Aerial Target	240
Figure 94.	Ground Target Detection Distance and Altitudes	247
Figure 95.	30° Dive Angle Gunnery Pattern	254
TABLE I.	Theoretical Rocket-Launching Ranges	43
TABLE II.	Maximum Available G-Load of R-3S Rockets	45
TABLE III.	Probability of an Interceptor Being Hit During Pull-Out	64
TABLE IV.	Probability of an Interceptor Being Hit During One Complete Attack	65
TABLE V.	Safe Pull-Out Distance to Avoid Collision	65
TABLE VI.	Probability of Entering Into Attack Against a B-52 or B-58 Type Aircraft	75
TABLE VII.	Probability of Striking a Target with Cannon Fire on One Attack	76
TABLE VIII.	Probable Effectiveness of Unguided S-5m Rockets	77
TABLE IX.	MiG-21f-13 Climb Profiles	98

~~SECRET~~

List of Illustrations (Continued)		<u>Page Nr.</u>
TABLE X.	Climb to 62,000 Feet Using Zoom Maneuver	98
TABLE XI.	Mach No. VS Altitude for a Climbing Turn From 26,000 to 41,000 Feet	104
TABLE XII.	Mach No. VS Altitude for a Climbing Turn From 33,000 to 43,000 Feet	104
TABLE XIII.	Mach No. VS Altitude for a Climbing Turn from 36,000 to 46,000 Feet	104
TABLE XIV.	Static Climb Times	106
TABLE XV.	Zoom Climb from 49,000 to 62,000 Feet	106
TABLE XVI.	Interceptor to Target Distances	106
TABLE XVII.	Zoom Parameters to 62,000 Feet	107
TABLE XVIII.	Zoom Parameters to 79,000 Feet	110
TABLE XIX.	Maximum Available Time at Altitude	110
TABLE XX.	Possible Flight Profiles	116
TABLE XXI.	Possible Profiles from Alert Position	116
TABLE XXII.	Descent Parameters When $V_{int} = 485$ Knots and $d = 2.2$ NM	121
TABLE XXIII.	Average Range for Low Altitude Visual Detection	154
TABLE XXIV.	Zoom Parameters	160
TABLE XXV.	Initial Position Sighting Angle Values	160
TABLE XXVI.	Zoom Parameters	161
TABLE XXVII.	Sighting Angles and Altitude Differences for Interceptor Target Distances of 1.6 - 1.9 NM	168
TABLE XXVIII.	Distance Between Aircraft for a Two-Ship Flight Making Sequential Attacks	171

~~SECRET~~

~~SECRET~~

List of Illustrations (Continued)

Page Nr.

TABLE XXIX.	Target Dimensions in Thousandths	178
TABLE XXX.	Time From TGS Lock-On to Permissible Launch Range	179
TABLE XXXI.	Turning Angles and Firing Distances	198
TABLE XXXII.	Data for a MiG-21f-13 Attacking a Fighter that is Conducting a Slanting Half-Loop	204
TABLE XXXIII.	Data for a MiG-21f-13 Attacking a Fighter that is Conducting a Split-S	205
TABLE XXXIV.	Values at the Completion of a Deployment Maneuver	216
TABLE XXXV.	Average Visual Detection Ranges	246
TABLE XXXVI.	10-15 Degree Dive Angle Attack	249
TABLE XXXVII.	30° Dive Angle Attack Parameters	253

CHAPTER I

PRINCIPLES OF AIR COMBAT

A need for continuous development and perfection of intercept tactics has resulted from the rapid changes in aviation equipment, the vast improvements in speed and altitude capabilities, and the increased fire power at the disposal of both the interceptor and bomber aircraft.

A commander must know how to determine realistically what combat tactics are to be used in any given air situation. He must take into consideration the armament and characteristics of the aircraft involved plus the strong and weak points of the enemies tactics.

Successful solutions to tactical problems are possible only by thorough investigation and study of the experimental results accumulated by interceptor units.

This chapter will discuss the characteristics of the basic stages of air combat which pertain to the MiG-21f-13 aircraft. These characteristics will then be used to analyze some tactics applicable to air combat.

TYPES OF AIR COMBAT

Air combat is the principal form of tactical activity engaged in by fighter aircraft. Air engagements are divided into "single" and "group" engagements, depending on the number of interceptors involved. A single air engagement is one carried out by one interceptor against any number of enemy aircraft. In a group engagement, the interceptors maintain mutual fire and tactical support among themselves.

Single MiG-21f-13 air engagements can be conducted in clear air mass conditions either by day or by night. Group engagements (under the same conditions) can be conducted by day only.

Air engagements are further distinguished by the type of enemy aircraft involved - bombers, fighters, and reconnaissance or transport aircraft, both with and without fighter escort. When the enemy aircraft are fighter-escorted, the engagement is called a "mixed group" engagement. Interceptor aircraft can also participate in the aerial destruction of enemy guided missiles.

~~SECRET~~

The nature of the target determines not only the interceptor forces necessary for the destruction of the target, but also the tactics to be employed in the engagement.

As air battles can be conducted at nearly all altitudes, and altitude has a considerable effect on the nature of the engagement, engagements are further classified by altitudes.

Such as:

- medium and high altitude (3000-40,000 feet);
- stratosphere (at altitudes not exceeding the tactical ceiling of the interceptor);
- near-ceiling altitude;
- dynamic altitude (at interceptor ceiling).

Depending on the time of day, air battles can further be divided into day and night engagements. Also, there are morning battles with pre-dawn take-offs and twilight battles with night landings.

An air engagement consists of (a) the approach, (b) the attack and (c) the maneuvering between aircraft.

THE MiG-21f-13 APPROACH TO THE TARGET

The approach portion of an engagement begins at the moment of visual target detection by the interceptor and concludes when the interceptor arrives at the firing position.

The desired result of the approach to the target places the MiG-21f-13 within the launching range of the R-3S rocket. The interceptor should arrive rapidly and remain hidden from the enemy. Continued concealment can be attempted in several ways: by approaching from a blind sector of the enemy aircraft, by approaching from the direction of the sun, by a pair of interceptors simultaneously approaching from different directions, and by not using the SRD-5 mk radio range finder until the firing range is reached.

A rapid approach is made by exceeding the target speed and by approaching on a flight path which uses the minimum of flight time needed to reach the point of attack.

It is necessary that the approach maneuver be simple and direct as complicated maneuvering usually causes a loss of time, especially when flying in formation.

~~SECRET~~

~~SECRET~~

A pair of interceptors should maintain the same formation during the approach as the one they desire to have when reaching the point of attack. Rearrangement to tactical formation usually leads to a loss of flight speed and hence increases the approach time.

The approach may be made in various ways:

- by pursuit curve;
- at parallel headings;
- with positive or negative angle of lead.

An attack employing R-3S rockets and/or cannons is possible from the rear hemisphere only, therefore, the GCI controller must vector the fighter to the rear of the target. The sighting of the enemy ordinarily takes place in the forward hemisphere of the interceptor as it flies on a passing or passing-intersecting heading with the target.

At the moment of sighting the target, the position of the interceptor with respect to the enemy may not correspond to the conditions necessary for an approach by any of the above-mentioned methods, hence a turn must usually be executed to get into a pursuit curve.

The selection of the approach method is determined by the conditions of that particular air situation and the distance out when the target is observed.

Selection of the proper approach method is a prerequisite to a successful attack. To attain the maximum effect in an air engagement, it is not sufficient to merely select the proper approach but it is imperative that the approach be skillfully executed. The success of the approach is determined by the method selected plus how well the basic approach parameters are carried out. These basic parameters are:

- rate of approach;
- angle to the target at the beginning of the approach (track crossing angle, TCA);
- counter-maneuvers taken against the evasive or aggressive maneuvers of the target.

The speed of the interceptor during the approach stage should assure a high probability of entering into attack and favorable conditions for executing the attack.

Theoretical calculations and experimental flights show that the optimum closing speed upon detection of the target at a distance of 4-5 miles is 80-160 knots. When overtaking a maneuvering target, the optimum closing speed is near the limiting overtake speed of 160 knots.

The initial track crossing angle must be selected by considering the minimum possible approach time plus the probability of entering into an attack. With an increase in TCA, the probability of entering into an attack decreases. For example, at a target detection range of 4 nautical miles and a closing rate of 160 knots, the change in angle from a 6 o'clock position to an angle of 50 degrees off the tail reduces the probability of entering into an attack from 0.75 to 0.10.

Flying experience has established that reliable target detection takes place at a range of 2.5 to 3.5 nautical miles. The minimum amount of approach time will be taken when the aspect angle is quite high (approximately 50°). Considering all factors, the optimum initial angle-off is from 15° to 30°.

The peculiarities of the MiG-21f-13 (the pilot's forward view is hampered by the effects of the bullet proof windscreen and the sight reflector) make feasible only one basic approach method. In practice, a combination of various approach methods will be used which include individual elements of each of the following methods.

APPROACH BY PURSUIT CURVE

The MiG-21f-13 can make its approach by pursuit curve from the range of reliable target-observation gained through the ASP-5nd sight reflector and the bullet-proof glass of the windscreen.

In the approach by pursuit curve, the interceptor pilot constantly keeps the nose of his aircraft (velocity vector of the interceptor) on the target. By this method, the aiming curve is a continuation of the approach curve and the pilot need not execute any additional maneuvers in order to arrive on the aiming curve.

The great advantage of this method is the simplicity of its execution. The pilot needs only to keep the nose of the aircraft on the target, or align the target with the pipper of the ASP-5nd sight (when the sight is in the caged position) and approach to the permissible launch-range of the R-3S rockets. Without changing the flight regime, he may then launch the rockets or upon reaching

cannon range, open fire with the cannons. By changing the speed of the aircraft, it is possible to change the amount of time spent on the firing pass.

(Note: Figure 1 and formulas 1 and 2 have been translated from the original but FTD has not verified their correctness.)

To determine the conditions under which it is possible and advisable to employ the pursuit-curve approach method, let us examine Figure 1 where are shown the regions of possible target approach, depending on the various flight conditions.

(Figure 1)

As is evident from the drawing, the zone of possible approach is limited by the maximum pursuit curve tangent to the boundary of the zone of high G-loads. The direction to the tangent point for the case of a nonmaneuvering target is determined by the equation:

$$\cos q_k = \frac{V_{int}}{2V_{tar}} \quad (1)$$

In the stratosphere and at altitudes close to the flight ceiling of the interceptor, the area of possible approach is limited by the boundary of the zone of high G-loads. The equation for the case of approaching in an almost horizontal plane is:

$$D = \frac{V_{int} V_{tar}}{9.8 N^{*2} - 1} \sin q \quad (2)$$

q is the track crossing angle, which is the angle between the targets flight path and the interceptors flight path, as portrayed in Figure 1. N* is the maximum G-load the interceptor can pull and still fly the pursuit curve. An approach along a pursuit curve is not possible in all instances as the area of possible approaches depends on the speed and altitude of the target and interceptor.

For example, with an interceptor speed of 600 knots and a target speed of 485 knots, an altitude of 16,000 feet and with the beginning of the approach made at a range of 4.5 nautical miles, a pursuit curve is possible from any angle off the rear of the target. With an interceptor speed of 800 knots, a target speed of 700 knots and a range of 4.5 nautical miles, a pursuit curve is possible, with the angle q greater than 120, and from a range of 2.7 nautical miles with the angle q greater than 140°. With these same speeds

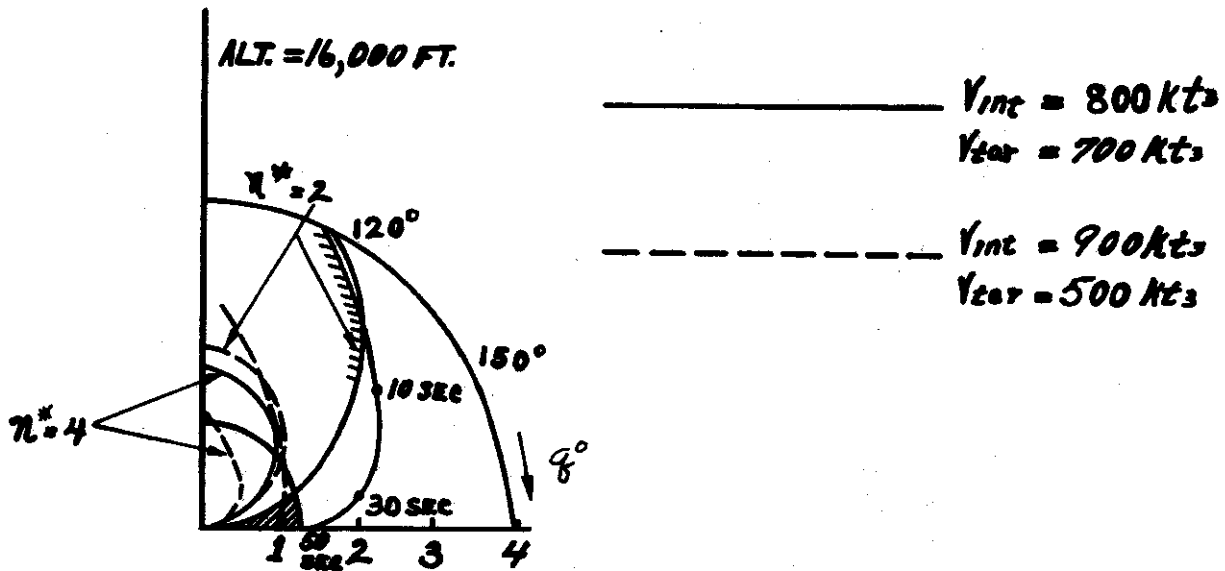

AREA OF POSSIBLE FIGHTER APPROACH ALONG A
 PURSUDE CURVE.

(N^* IS THE NECESSARY G-FORCE)

FIGURE I

[REDACTED]

at 50,000 feet, approach by pursuit curve is possible from a range of 2.7 NM with the angle q greater than 160° , and from a range of 4.5 NM with the angle q greater than 140° .

The amount of time spent on the pursuit curve depends mostly on the ratio of interceptor-to-target speed and the approach distance. By flying at a speed greater than that of the target, the interceptor can approach by use of a pursuit curve and rapidly penetrate into the rear hemisphere of the target with only a small angle-off, (practically at the tail of the target).

When the interceptors speed is equal to or only slightly in excess of that of the target, much time is lost during the approach. If the interceptor rolls out much behind the target, it normally cannot catch up in time to complete the intercept.

A characteristic feature of flight along the pursuit curve is the continuous change in angle of bank. For example, if the interceptor detects the target at a range of 4 NM with an aspect angle of 60° , with an interceptor speed of 595 knots and a target speed of 380 knots, the interceptor will change bank by 20° when approaching an angle-off of 15° . This change may be even greater at supersonic speeds. These large bank angles restrict the possibility of using the pursuit-curve method of approach at altitudes near the interceptor ceiling. When near the ceiling, the approach can only be started with small TCA's because the change in bank angle at these altitudes is only possible within a small range (maximum permissible bank not more than 20°). An increase in bank will lead to a loss in altitude.

In summary, target approach by pursuit curve is advisable when flying at low, medium and high altitudes with an initial TCA of 30° and with a considerable excess of speed over the target's speed (no less than 100 knots).

APPROACH BY PASSING-PARALLEL COURSES

In some cases, the MiG-21f-13 interceptor may be vectored so that it appears on a passing-parallel course with the target.

In making a target approach by the passing-parallel course method, the interceptor catches up by paralleling the target before beginning the attack. (Figure 2)

At the departure point for attack, which is determined by the side interval (I) and the sighting angle to the target (B), the

THM = POINT OF BEGINNING MANEUVER

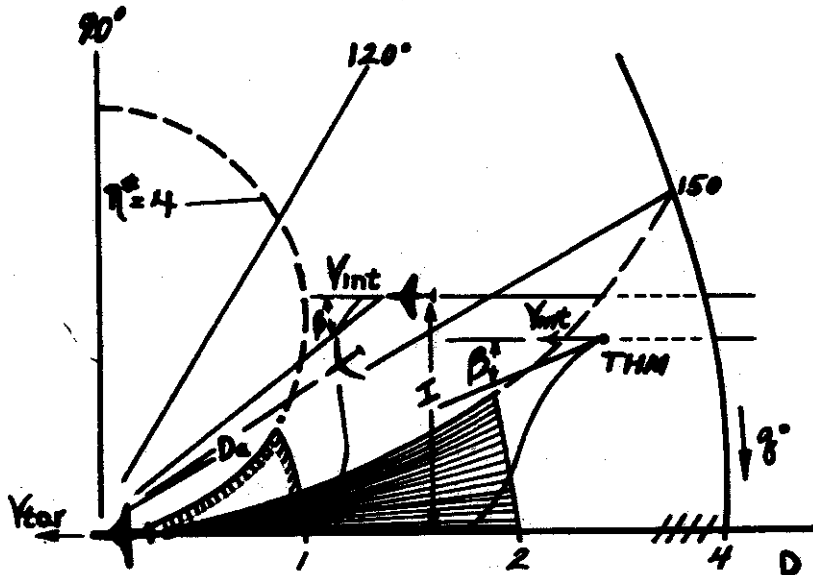

DISTANCE - N. M.

FIGHTER APPROACH OVER A PASSING
PARALLEL COURSE

FIGURE 2

interceptor initiates a turn toward the target. When the axis of the aircraft is in approximate alignment with the target (or with lead angle), a reverse banking maneuver is made and rough aiming is performed, after which the interceptor rolls out on the aiming curve and attacks the target.

A deficiency in the passing-parallel course method of attack is the necessity of initially turning toward the target. This reduces the possibility of using this method at high altitudes and speeds.

In Figure 2 are also shown the conditions for approach on parallel courses with subsequent pull-out onto a given aiming curve.

While making the approach, the actions of the pilot are reduced basically to determining the side interval and the moment for beginning the initial turn toward the target.

The side interval and the sighting angle are determined visually by the pilot. These can be calculated with the aid of the equations:

$$I = R(1 - \cos q_i) + (D_a + V_{int} t_b) \sin q_i; \tag{3}$$

$$\tan B = \frac{I}{D}$$

$$d = R \sin q_i + (D_a + V_{int} t_b) \cos q_i - V_{tar} (t_{tn} + t_b), \tag{4}$$

- where q_i - initial course angle of target
- D_a - initial range of attack
- V_{int} - interceptor speed
- V_{tar} - target speed
- t_b - time of transposing bank
- t_{tn} - time of turn toward target
- R - radius of interceptor turn

For the most probable MiG-21f-13 speed range when attacking B-47 or B-58 bombers at altitudes of up to 50,000 feet, the size of the side interval is normally 4900 feet, and at altitudes over 50,000 feet, 3300 feet is the interval.

When an interceptor reaches the rear hemisphere of a target and has a speed equal to or slightly above that of the target, then the most advisable method of approach is by the "wave downward" method.

(Figure 3)

The nature of the "wave downward" approach lies in the following. Having reached the same altitude as the target, the interceptor pilot puts the aircraft into a descent at a 3-5° dive angle thereby accelerating along an inclined straight line. He then pulls the aircraft into a climb of 5-10°, figuring to level off at the end of the "wave" at the same altitude as the target. In approaching by the "wave downward" method, the pilot uses less time than he would in approaching on a straight line without changing altitude.

It is evident from the graph given in Figure 4 that the approach by the "wave downward" method is especially suitable for instances when the difference between interceptor-target speed is small. (The graph is calculated for distances for beginning the approach at 5500 yards.) For example, pursuit with an overtake speed of 43 kts along a straight line requires 4 minutes, and by the "wave downward" method requires 1.5 minutes, i.e., less than half the time. If the interceptor and target fly at identical speeds, the only way to catch up with the target is by the "wave downward" method.

(Figure 4)

When at altitudes close to interceptor ceiling, the approach to the target should be made by the "wave downward" method with a descent to 6,000-7,000 feet lower than the target. This will allow the fighter to make maximum use of its speed capabilities.

Approach by the "wave downward" method at other altitudes can be adopted successfully by the pilot when he detects the target in front of him approximately on a passing or passing-parallel course. If the target is on a course considerably different from the course of the interceptor, the pilot must first execute a turn toward the heading of the target in order to come out on a passing or passing-parallel course with it, and then continue the approach by the "wave downward" method.

In the "wave downward" method, the angle of descent should not exceed 5-7° because at greater angles the aircraft rapidly loses altitude and during the subsequent climb the drag of the aircraft

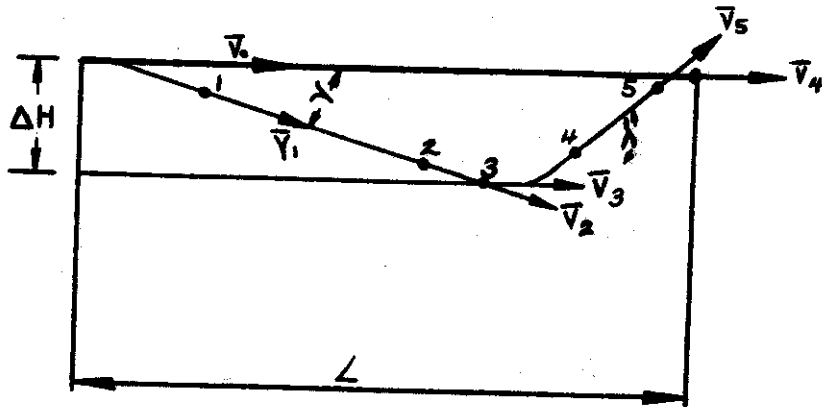

SCHEMATIC OF FIGHTER APPROACH BY THE "WAVE-DOWNWARD" METHOD

FIGURE 3

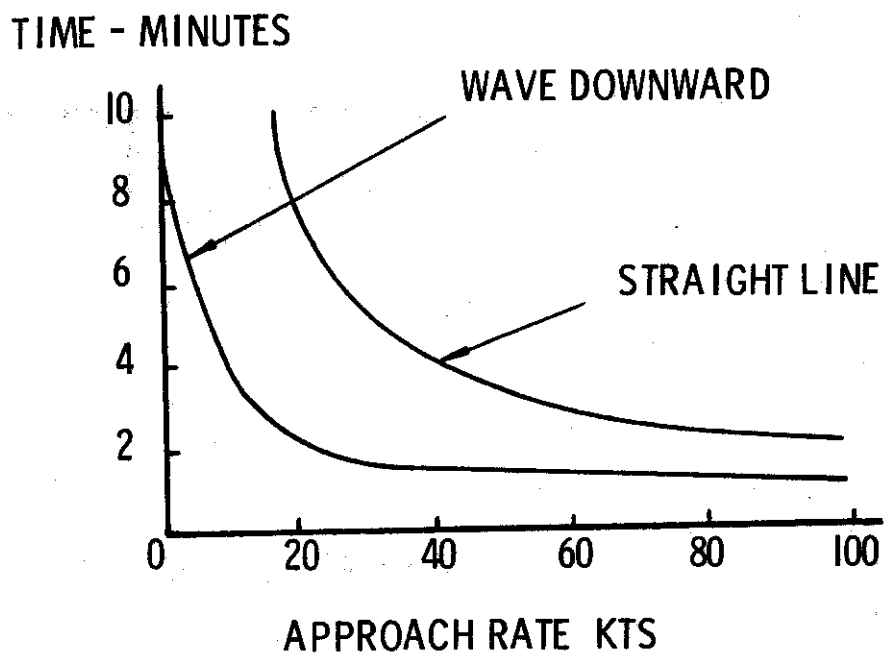

APPROACH TIME WHEN APPROACHING BY "WAVE DOWNWARD" AND BY A STRAIGHT LINE.

FIGURE 4

increases noticeably, reducing the speed. With descent angles of 3-5° and loss of 2300-3300 feet in altitude, sufficient acceleration is assured to climb and take up the initial attack position. An altitude loss of more than 3300 feet during descent is not advisable at lower altitudes because the interceptor may lose the target.

In Figure 5 the MiG-21f-13 characteristics are given for maneuvering by the "wave downward" method under various initial approach conditions (interceptor speed = 540-970 knots, altitude = 50,000 feet).

It may be seen from the graph that with a relatively small loss in altitude, the flight time of an interceptor with descent is less than that of one flying horizontally at initial altitude.

(Figure 5)

Knowing the "wave downward" maneuvering parameters of his aircraft under typical flight conditions, the pilot, depending on the distance, may employ various segments of the maneuver. By changing the duration of any segment, it is possible to change the altitude loss and general time duration of the "wave downward" maneuver.

APPROACH WITH LEAD ANGLE

The lead-angle method may be used by an interceptor to gain the pursuit curve or aiming curve, and can be executed in three ways:

- parallel approach;
- approach with positive angle of lead;
- approach with negative angle of lead.

The nature of the parallel approach lies in the following. Having detected the target, the pilot, by maneuvering his aircraft, maintains a constant cut-off angle to the target. The pilot observes only a reduction in range to the target. The interceptor continues until it takes up an initial attack position which is determined by the distance needed to begin the maneuver, ($D_{n.m.}$).

From the initial position, the pilot executes a maneuver for rolling out on the aiming curve. To do this, he begins turning toward the target until the axis of the interceptor is approximately directed toward the target (or ahead of the target by the lead angle). After this he rolls out and flies along a straight line for 2-3 seconds, and finally rolls on to the aiming curve.

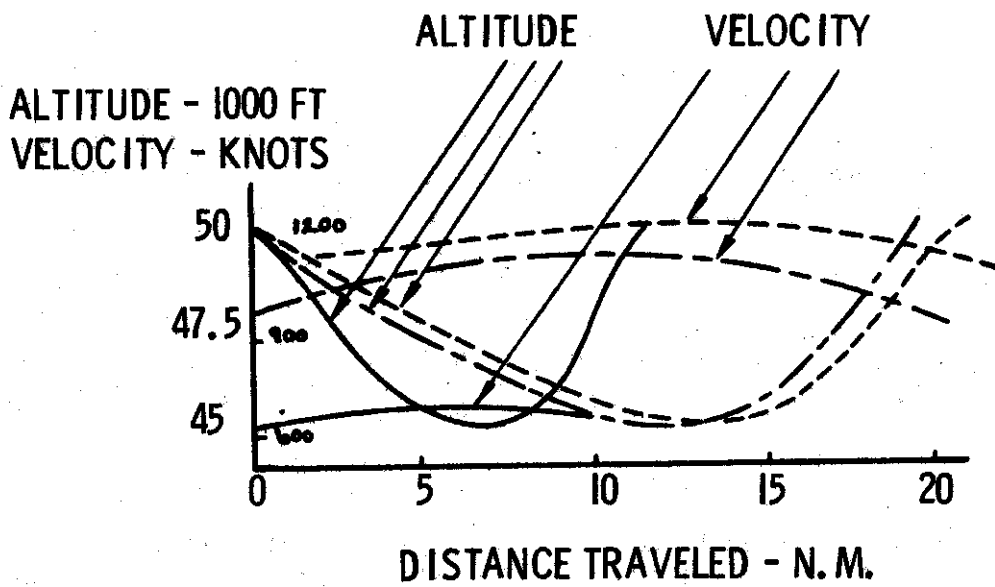

CHANGE IN ALTITUDE, SPEED, AND RANGE WHEN APPROACHING BY THE "WAVE-DOWNWARD" METHOD

- 550 KNOTS
- 975 KNOTS
- - - - - 850 KNOTS

FIGURE 5

(Figure 6)

For the successful execution of approach and attack, the pilot should know for various flight conditions the magnitude of the target drift angle (angular measurement between interceptor heading and bearing to the target) B^* , and also the distance at which to begin the maneuver, $D_{n.m.}$ (See Figure 6).

The magnitude of this angle B^* to the target can be determined on the basis of the main principle established during approach (angular velocity of initial distance line $\dot{\theta}_d = 0$), namely

$$\sin B^* = \frac{V_{tar}}{V_{int}} \sin q \quad (5)$$

For the MiG-21f-13 aircraft at altitudes up to 50,000 feet, the average values are $B^* \approx 10^\circ$, $D_{n.m.} \approx 3$ nautical miles.

The deficiencies of the lead-angle approach method are the necessity of determining visually the $D_{n.m.}$, making the correct turn to roll out onto the aiming curve, and the difficulty of rapidly establishing the necessary drift angle of the target and suitable approach condition. The positive aspects of this method are the minimum approach periods and the flight during the approach over a straight line without G-loads.

Attack from a given direction of approach along a straight line with a subsequent roll-out onto the aiming curve should begin with an aspect angle greater than the angle at the initial point of the aiming curve. This is because the execution of the turn for roll-out onto the aiming curve leads to an increase in angle-off, and consequently also to a reduction in angle-off during the attack.

The nature of interceptor-target approach with a positive lead angle consists in the fact that the pilot should direct the longitudinal axis of the aircraft ahead of the target by a certain angle, and during the flight, keep this angle approximately constant. This approach method is the principal one during the initial segment of approach because detection of targets at long range (2-1/2 to 4-1/2 nautical miles) is possible only through the side windows of the cockpit canopy. While watching the target through the side window, the pilot should hold the lead angle at approximately 20° until he arrives at a distance of reliable target observation through the forward windscreen. The pilot determines target visibility through the bulletproof windscreen by making slight turns toward the target

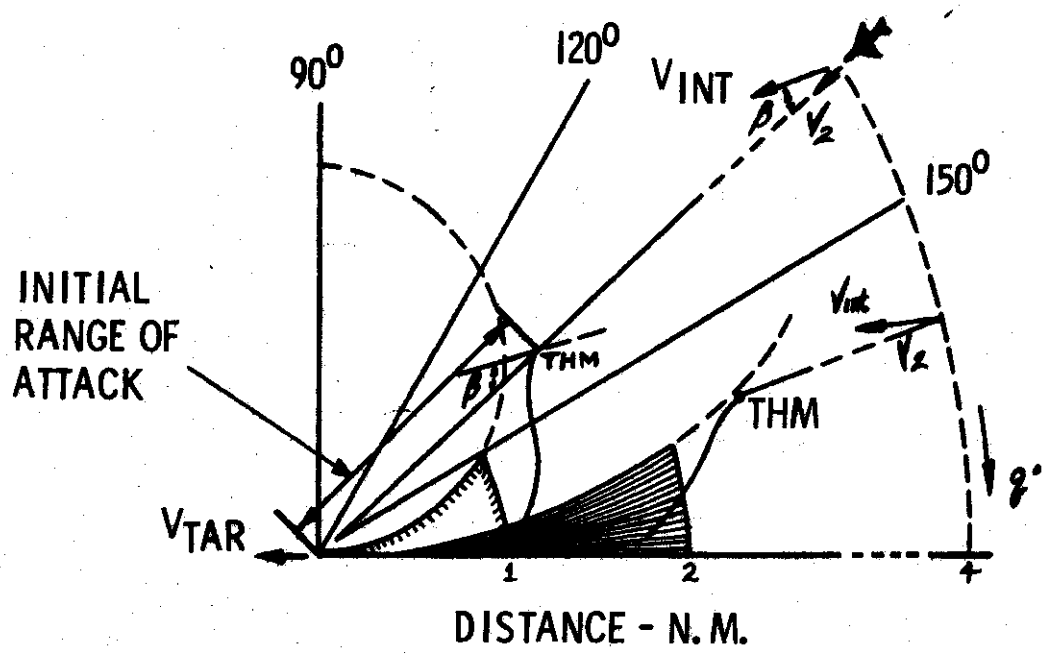

APPROACH WITH LEAD ANGLE (THM IS POINT OF BEGINNING MANEUVER)

FIGURE 6

~~SECRET~~

during the process of approaching. When the target is clearly visible through the bulletproof glass, the pilot should switch onto the aiming curve and hold the target in the ring of the sight reticle. The sighting device is set in the stationary position with a ring radius of 17.5 thousandths (for rocket launching). Flight experience has shown that stable visibility of a target through bulletproof glass begins at about 10,000 feet. The deficiencies and advantages of the positive leadangle method are about the same as those of the parallel-approach method.

The nature of the negative lead-angle approach is that the pilot directs the longitudinal axis of the aircraft toward a certain point at the rear of the target. This method is most effective when approaching a maneuvering target.

By re-examining the conditions of possible interceptor-target approach with lead angle (see Figures 2 and 6), it may be concluded that:

1. This method is effective at great target-detection distances and low rates of approach.
2. Approach at supersonic flight speeds is possible only from the rear hemisphere.
3. When flying at low, medium and high altitudes at subsonic speeds (interceptor speed - 660 knots, target speed - 540 knots), approach is possible with initial TCA's near 85° . When flying under the same conditions but at supersonic speeds, approach becomes difficult. For example, at interceptor speed, 970 knots and target speed, 860 knots, then the initial approach angles are $35-40^\circ$, and at interceptor speed, 1080 knots and target speed, 1025 knots, then the angles are $25-30^\circ$.
4. When approaching with a lead angle, the greatest gain in time in comparison with an approach by the pursuit curve, is obtained when approaching with an initial angle-off close to 90° . With angles of $0-10^\circ$ off the tail, the approach time by these methods is identical.
5. With an increase in speed and altitude, the area of possible approach decreases to the point where approach becomes possible only with an initial angle-off of about 10° . This is due to the limited possibilities of the interceptor to make a turn toward the target.

~~SECRET~~

In this way, when attacking a target at altitudes close to ceiling, all three discussed approach methods (pursuit curve, parallel heading and lead angle) fuse into one- that is, catching up with the target on passing courses.

CHARACTERISTICS OF APPROACHING A MANEUVERING TARGET

In a tactical situation, the enemy bomber will employ various defensive maneuvers, such as changing course, speed and altitude in an attempt to disrupt or hamper the interceptors approach and attack.

Figure 7

One of the bombers probable defensive maneuvers is a tight turn flown with a maximum G-load. The turn can be made either toward the interceptor or away from it and combined with either a descent or ascent. A turn toward the attacking interceptor increases the G-load necessary if the interceptor is to continue the approach and attack. In the process of approaching, the interceptor may then overshoot toward the boundary of the zone of high G-loads. While the interceptor is on the initial section of its trajectory, the target angle increases continuously (Figure 7, Curve 2). The approach and attack of the interceptor can be disrupted by a tight turn by the bomber because the final section of the interceptor trajectory at aiming and firing distances will then be in the zone of high G-loads. If the interceptor is vectored by the GCI controller to a position close to 0-15° off the bombers tail, the bomber maneuver does not complicate the approach and attack. This is because the relative angular velocity and G-load of the interceptor changes smoothly and will not exceed the limits. As a result of this, the trajectory of the interceptor will be close to the trajectory of the bomber with constant (although it can even be greater) bank, which facilitates following the target.

In this way, with a small angle-off, the bombers maneuver in the direction of the attacker is of little effect, and will not lead to disruption of the approach. If the bomber maneuvers by turning away from the attacking fighter, the latter gets away from the zone of high G-loads and the angle-off decreases rapidly. The fighter then intersects the line of bomber heading and eventually appears on its other side. The target angle first increases and then decreases and the interceptor draws close to the zone of high G-loads but will not enter into it (see Figure 7, Curve 3). During such a maneuver, the interceptor is compelled to change his bank which slightly complicates

~~SECRET~~

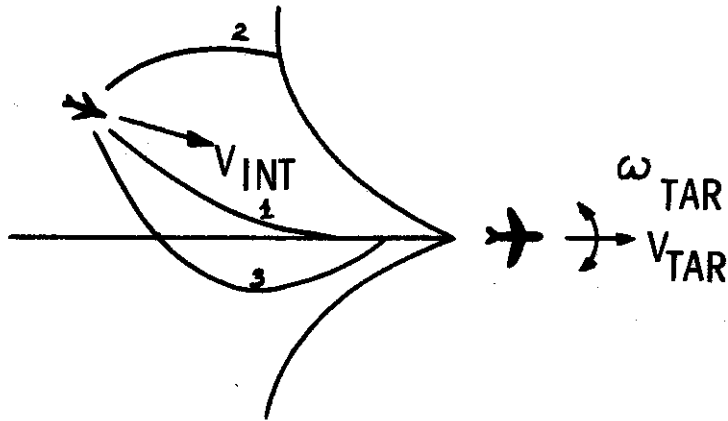

TRAJECTORY OF FIGHTER WHEN APPROACHING A
MANEUVERING TARGET

FIGURE 7

~~SECRET~~

~~SECRET~~

tracking the target, but there will be no disruption of the approach; (in Figure 7, Curve 1 is the trajectory of the interceptor when approaching a nonmaneuvering target and is shown for the purpose of comparison).

Since the turning away of the bomber from the interceptor does not lead to the disruption of the approach, this defensive maneuver has little effect and its application is not probable.

A bomber can intensify the effectiveness of a turning maneuver by combining it with changes of speed and altitude. The turn of the bomber, together with climb and deceleration, may reduce the interceptor attack time considerably which leads to a decrease in aiming accuracy. Furthermore, if the pilot does not notice the speed reduction of the bomber, he will overshoot into the bombers forward hemisphere and this will lead to the disruption of the attack.

The possibility of executing the approach to a maneuvering target by use of the pursuit curve is determined by the zone of effective target maneuvering, the boundaries of which are determined by the maximum pursuit curves.

The tangent point direction of the maximum pursuit curve is determined by the formula:

$$(6) \quad \cos q_k = \frac{K}{2 \pm \frac{K \sqrt{n_{tar}^2 - 1}}{\sqrt{n_{int}^*{}^2 - 1}}}$$

where K - ratio of fighter speed to target speed, n_{tar} - maximum permissible G-load of bomber, n_{int}^* - maximum permissible G-load of interceptor.

In the above formula, the "-" sign is taken when the target turns toward the interceptor, and the "+" sign when it turns away from the interceptor.

The basic factors affecting the dimensions of the effective maneuvering zone are the maximum permissible G-loads of the interceptor and bomber, and the ratio of their air speeds. An increase in maximum interceptor G-load reduces the bombers possibilities of interrupting the attack by employing an evasive maneuver because the zone of ineffective bomber maneuvering increases. For example, an increase of more than double the

[REDACTED]

maximum G-load of the interceptor leads to an expansion of the approach zone to the target from 10° to 60° (when the range at beginning the approach is around 3 NM).

Figure 8

The greater the permissible G-load of the bomber, the more successful will be its anti-fighter maneuver, since the area of ineffective maneuvering narrows considerably.

In Figure 8 is shown the change in area of ineffective bomber maneuvering, depending on the bombers maximum G-load. It is evident from the drawing, that an increase in maximum G-load brings the target point of the maximum pursuit curve closer to the bomber. This leads to a considerable reduction in the area of ineffective bomber maneuvering. Apparently, at a certain value of maximum G-load, the maximum pursuit curve and the area of ineffective bomber maneuvering turn into a point and fuse with the bomber. This maximum case means that the maneuver of the bomber at such a G-load will always be successful.

From Figure 8, it can be seen how strongly the maneuvering qualities of the bomber influence its defensive capabilities. With an increase in G-load from 1.6 to 2.5, the range of ineffective maneuvering decreases in distance from 4.3 to 1.8 nautical miles and decreases the angle-off the tail from 70° to 40° .

Special attention should be devoted to the execution of the approach maneuver in the stratosphere at altitudes of 50,000 - 62,000 feet. In this case the maneuverability of the interceptor as well as the bomber is extremely limited and imposes definite restrictions on aerial combat in the stratosphere. At these altitudes, the maneuverability of the B-58 bomber is limited to G-loads of 2.0 - 1.1, and the MiG-21f-13 is limited to 3.0 - 1.2.

In Figure 9, the areas of effective maneuvering in the stratosphere are shown for a B-58 bomber under attack by a MiG-21f-13. It may be seen from the drawing that a successful approach to the target is possible when the interceptor is guided to the rear of the target with a TCA of not more than 15° . For practical purposes the interceptor should be vectored by the GCI controller to the rear of the target at a range of 2.7 - 3.2 nautical miles. This will enable the interceptor to detect the target and to successfully execute the approach maneuver.

Figure 9

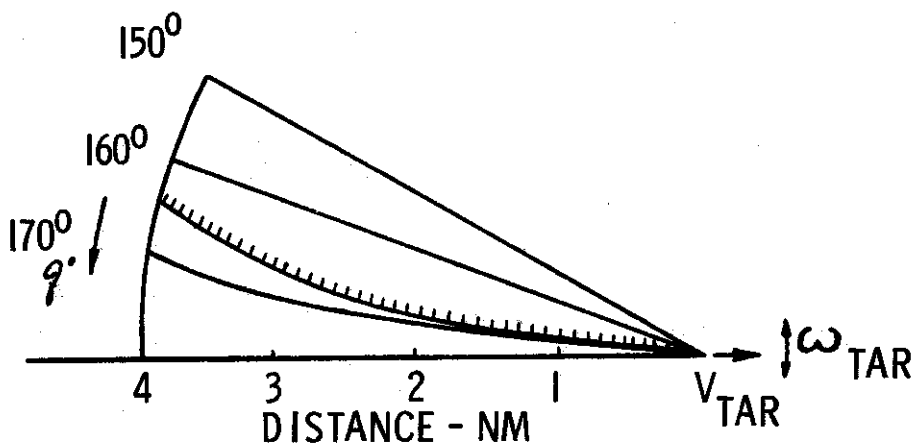

CHANGE IN AREA OF EFFECTIVE BOMBER
MANEUVERING

FIGURE 8

CURVE	N_{TAR}	K	N_{INT}^*
1	1.6	1.25	4
2	2	"	"
3	2.5	"	"

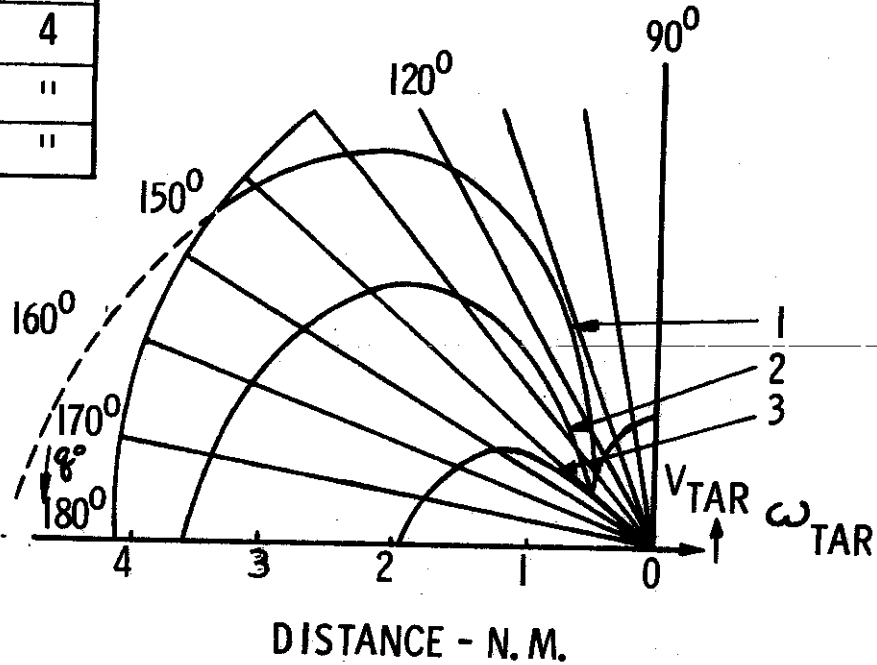

AREA OF EFFECTIVE BOMBER MANEUVERING

KEY:

- K - FIGHTER-BOMBER SPEED RATIO
- N_{INT}^* - NECESSARY G-LOAD FOR INTERCEPTOR
- N_{TAR} - TARGET G-LOAD

FIGURE 9

~~SECRET~~

The most effective countermaneuver against a maneuvering target is to approach with negative lead angle.

When selecting the size of the negative lead angle, it is necessary to consider two basic limitations:

- too large an angle may lead to the point where the interceptor will lag behind the target;
- at too small an angle, the interceptor will enter the zone of high G-loads during the final portion of the approach phase.

Examples of MiG-21f-13 approaches to the target with properly selected negative lead angle (ψ_1) and improperly selected angle (ψ_2) are given in Figure 10.

Figure 10

In practice, for a successful approach by this method, it is necessary to know the negative lead angles at which the interceptor can approach from what TCA's and from what ranges. When selecting these angles, it is also necessary to consider the capability of observing the target.

In Figure 11 are shown the optimum negative lead-angles for certain specific conditions of a MiG-21f-13 interceptor approaching a maneuvering target. For example, it is necessary to take a negative lead angle of $\psi = 0-20^\circ$ when the TCA is not more than 20° , the interceptor speed is 860 - 970 knots, and the target speed is 700 - 810 knots, (D = 2.5 nautical miles). For interceptor speeds of 1080 - 1190 knots and target speeds of 700 - 810 knots, it is necessary to take negative lead angles of $\psi = 0-15^\circ$ (range of detection = 2.5 nautical miles), when the TCA is not more than 5° .

Figure 11

It is necessary to keep in mind that the interceptor pilot will have difficulty in determining whether or not he is in the area of ineffective maneuvering since he cannot determine the target course angle from a detection range of 3 - 4 nautical miles.

The pilot can approximately determine his position by the magnitude of the angular velocity. If the approach has to be executed with a bank close to the maximum for a given altitude,

~~SECRET~~

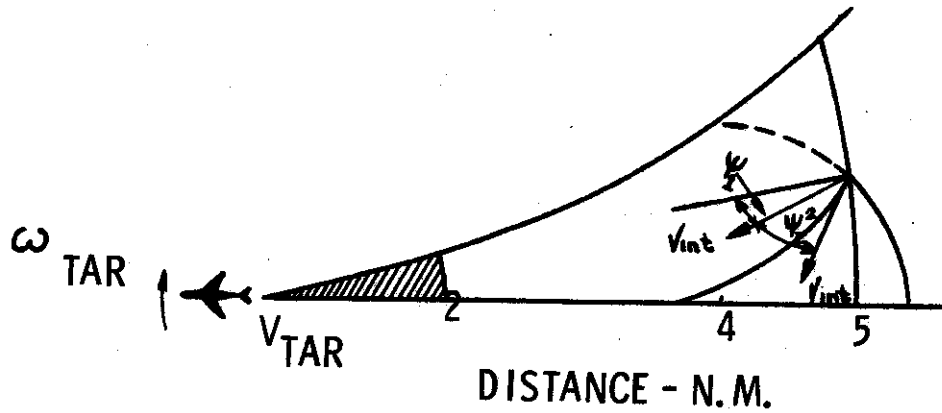

APPROACH WITH PROPERLY SELECTED NEGATIVE LEAD ANGLE. (ψ = NEGATIVE LEAD ANGLES)

FIGURE 10

~~SECRET~~

NEGATIVE LEAD ANGLE - ψ°

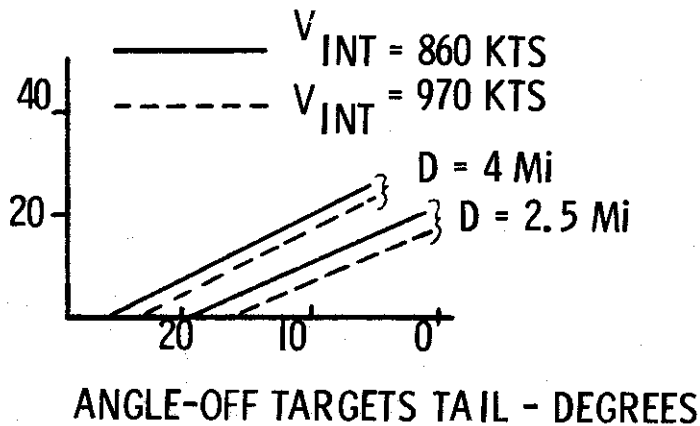

NEGATIVE LEAD ANGLE - ψ°

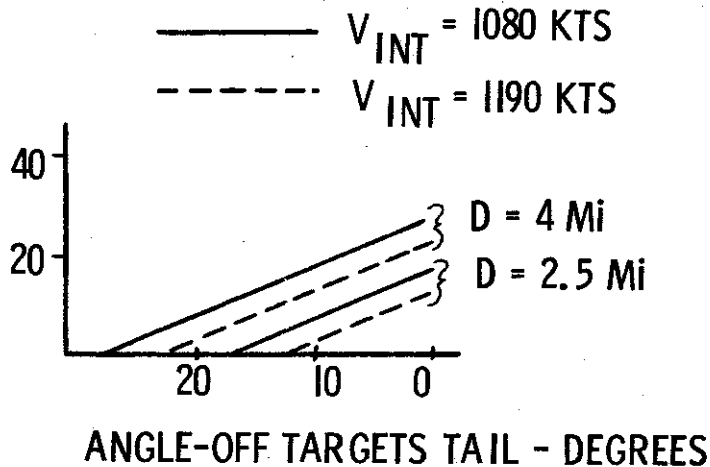

OPTIMUM NEGATIVE LEAD ANGLES FOR TARGET SPEEDS OF 700-810 KTS

FIGURE II

~~SECRET~~

~~SECRET~~

that means the angle-off will be large. To reduce this angle, it is necessary to apply the negative-lead-angle-approach until reaching a range of 1.3 - 2.0 nautical miles at the bombers four-thirty position and then changing to a pursuit curve, smoothly reducing the negative lead angle.

In aerial combat against a maneuvering target, the interceptor pilot should attentively study the nature of target movement in order not to miss the moment of beginning the countermaneuver, otherwise he may lose sight of the target and this will disrupt the attack.

During a parallel approach, the maneuvering of the target also complicates the approach conditions because the position of the meeting point changes. In this case, a successful approach is possible only after the interceptor executes a responsive maneuver. When approaching with a lead angle, the condition for successful execution of the approach is the constancy of the TCA and the angle (B^*). If the target maneuvers with angular velocity (ω_{tar}) then this leads to a change in the TCA with the very same angular velocity. To preserve the direction of motion to the meeting point, the interceptor should continuously be making a turn leading to a change in angle B^* , i.e., the interceptor should turn with a certain angular velocity. At an interceptor speed greater than that of the target, the angular velocity needed to counter the directional maneuver of the target will always be smaller than the angular velocity of the target turn.

A directional maneuver will have strongest effect when the interceptor is making its approach on a passing course, because here the interceptor's necessary angular velocity has maximum value.

Figure 12

Figure 12 is a graph showing the MiG-21f-13 G-loads (angular velocity) depending on the turning speed of a B-58 bomber, with consideration of various altitudes and interceptor-to-bomber speed ratios. The necessary interceptor G-loads for known maneuvering characteristics of the target may be determined from the graph.

An air speed change by the bomber will also lead to a change in the angle. To maintain the proper heading to arrive at the point of intersection, the interceptor pilot must establish a certain angular velocity and also change the speed of his aircraft.

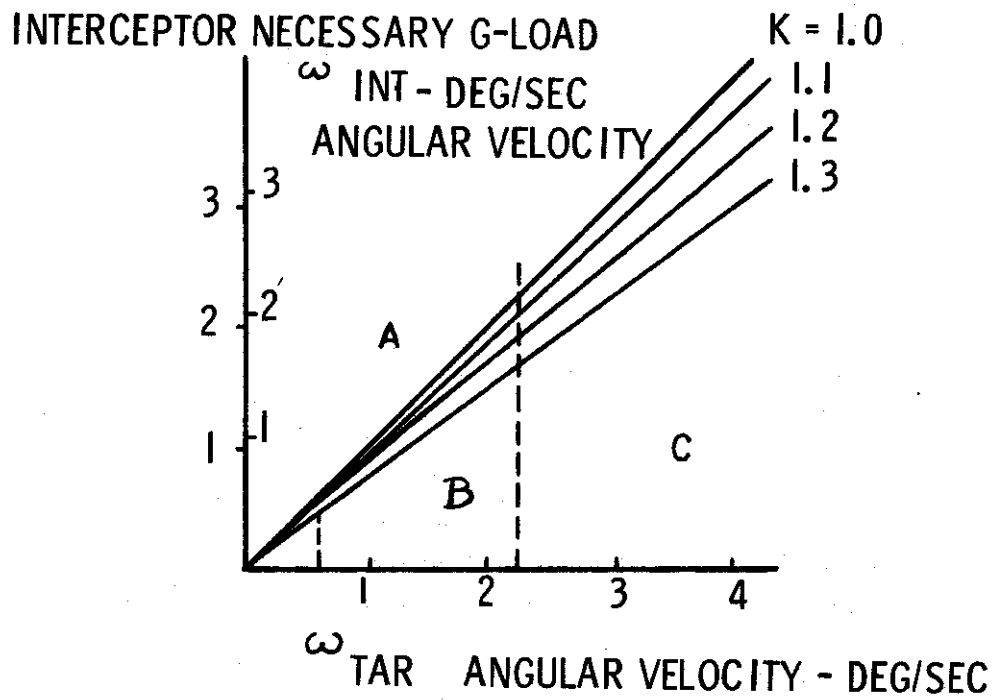

INTERCEPTOR G-LOAD AND ANGULAR VELOCITY VS TARGET ANGULAR VELOCITY FOR VARIOUS FIGHTER - BOMBER SPEED RATIOS, A) STRATOSPHERIC ALTITUDES; (B) HIGH ALTITUDES; AND C) MEDIUM ALTITUDES.

FIGURE 12

~~SECRET~~

In this case, the most unfavorable approach conditions will occur with intersecting courses of approximately 90° where the angular velocity of the interceptor will be greatest.

On detecting the maneuver of the target, the pilot should simultaneously begin his maneuver by turning in the same direction as the target and properly selecting the angular velocity by changing bank. When the pilot's view of the target has shifted toward the edge of the viewing zone of the faceplate of the helmet (indicating a surplus of angular velocity), the pilot must immediately reduce the bank until the target shifts back to the forward part of the canopy.

On reaching the range to begin the roll-out onto the aiming curve, it is necessary to turn toward the target and begin aiming (keeping the target in the center of the sighting ring). The approach is then continued to the range of rocket launching or cannon firing.

An approach with lead-angle to a maneuvering target is possible only with simultaneous and proper execution of the countermaneuver. During the approach, the interceptor should have sufficient speed over the target so as to have a minimum necessary G-load during the countermaneuver. The optimum approach speed of the interceptor will be 80 - 135 knots over that of the target.

Flight experience and theoretical investigations of the interceptor-target approach problem offer the basis for the following conclusions. For a MiG-21f-13 interceptor approaching a target, the maneuver should be executed by a combination of methods. From the moment the target is detected through the side glass of the canopy, usually a distance of 3-4 nautical miles, the approach should be made with a lead angle of about 20° . On reaching a distance of reliable target visibility through the armored glass (1.3 nautical miles), a switch should be made onto a pursuit curve, keeping the target in the ring of the sight reticle (set in the caged position with a radius of 17.5 thousandths).

ATTACKING AERIAL TARGETS WITH THE MiG-21f-13

Types of Attacks and Their Characteristics

The phase of the aerial battle carried out for the purpose of striking the target is called the attack.

~~SECRET~~

Depending on the number of interceptors participating in the engagement, there are two categories, "single" and "group" attacks. Group attacks in turn are sub-divided into "simultaneous" and "sequential."

Single attacks by MiG-21f-13 aircraft are employed mainly when intercepting single enemy aircraft under clear air mass conditions.

Group attacks by MiG-21f-13 fighters are employed when intercepting small groups and single enemy aircraft in daytime, clear air mass conditions.

The execution of group attacks at supersonic speeds is difficult and particularly so at altitudes above 50,000 feet, because the ability to maintain tactical formation is considerably diminished.

A pair or group of MiG-21f-13 aircraft can execute either simultaneous or sequential attacks. Of these two types, the most advantageous is the sequential attack as it best fulfills the flight and armament potential of the aircraft. The rockets are usually launched individually and the results ascertained before another is launched. However, when conditions demand a reduction in the duration of the battle, a pair of interceptors may execute a simultaneous attack with each plane launching its rockets one after another. Salvo firing of rockets from one aircraft is not recommended as the rockets may activate each other.

MiG-21f-13 aircraft can attack from various directions in the rear hemisphere of the target. Depending on the initial position, the following directions of attack are distinguished: from the side, side-above, above, side-below and below.

The attack consists of aiming and firing the rockets or cannons. To explain the possibilities of carrying out an attack, it is first necessary to determine the regions of possible rocket launching and cannon firing.

ROCKET LAUNCHING CONDITIONS

The area of rocket launching is that space relative to the target within the limits of which aimed launching of rockets is possible and which assures the striking of the target with no less than the given probability. The dimensions of the aimed-launching area depend on the characteristics of the interceptor

~~SECRET~~

armament system, the conditions under which the attack is executed, the maximum distances and angle-offs for launching at a given altitude, and on interceptor and target flight speeds.

A self-guided, heat-seeking, R-3S rocket proceeds toward the target by the proportional approach method (close to parallel approach), i.e., with a lead angle, the magnitude of which is determined by the self-guidance head (TGS) and is proportional to the angular velocity of the rocket-target line.

The rocket can be successful if the TGS locks on the target and the lock-on is not broken after the launching, and if the rocket reaches the target armed and at the velocity necessary for its activation.

The maximum ranges and angle-offs for rocket launching are determined in accordance with certain rocket characteristics.

Range of Rocket Launching - The possible launch range depends on the distance of the rocket's flight which is determined by the magnitude of the thrust and the duration of power plant operation as well as on the launch altitude and speed.

All these factors influence the flight range of the rocket by changing its velocity along its trajectory. The velocity of a rocket along its trajectory is composed of the speed of the aircraft at the moment of launching plus the velocity of the rocket, relative to the interceptor, which is derived from its own engine: $V_k = V_{int} + V_{r.rel}$. (7)

It should be pointed out that the rocket velocity relative to the interceptor after launch depends on the speed of the interceptor during launch (launch rate), because the launch rate, to a considerable extent, determines the air drag which affects the rocket at the moment of its launch and during its flight.

When the interceptor increases its speed at the moment of launch, the rocket velocity relative to the interceptor decreases. When launched at high altitudes, the rocket reaches greater total velocity because of lower drag. The effect of interceptor velocity at the moment of launch, in the broad range of its changes (up to ± 108 knots) is small and for tactical calculations can be disregarded. The dependence of $V_{r.rel}$ upon the launching altitude is more noticeable and cannot be disregarded.

~~SECRET~~

In conformity with the magnitude of relative rocket velocity, there is also a change in the distance of its flight relative to the interceptor. When an interceptor, attacking under a small TCA, continues aiming after the launching, the relative flight distance of the rocket is the same as the striking distance; i.e., it corresponds to interceptor-target distance when the rocket reaches the target.

Figure 13

Figure 13 shows the ballistic characteristics of the R-3S rocket (change in velocity and flight range) relative to the interceptor upon launching at various altitudes.

The range relative to the target from which the rocket can be successfully launched (D_1) for the given time of rocket flight (t) is determined by the formula:

$$D_1 = D_{r.rel} + V_{appr} t, \quad (8)$$

Where $D_{r.rel}$ = flight range of rocket relative to the interceptor during the time after launching.

This formula can be used with sufficient accuracy for all possible angles-off when launching the R-3S rocket from the MiG-21f-13.

In this way, the launching range for a given rocket flight time depends linearly upon the speed of interceptor-target approach, and increases with an increase in this speed ratio.

By substituting in formula (8) the minimum and maximum flight times of the rocket and the corresponding relative distances, it is possible to obtain values of minimum and maximum launching ranges. In order to detonate near the target, the rocket flight time should not be less than the time required to arm the proximity fuse.

The minimum launching range for the R-3S rocket is limited by the sum of the flight range of the rocket at the time of arming the proximity fuse (relative distance), and the reduction in interceptor-target distance during that time. At small approach speeds and during a lagging approach, the rocket has the possibility of firing from a minimum distance of around 3300 feet.

~~SECRET~~

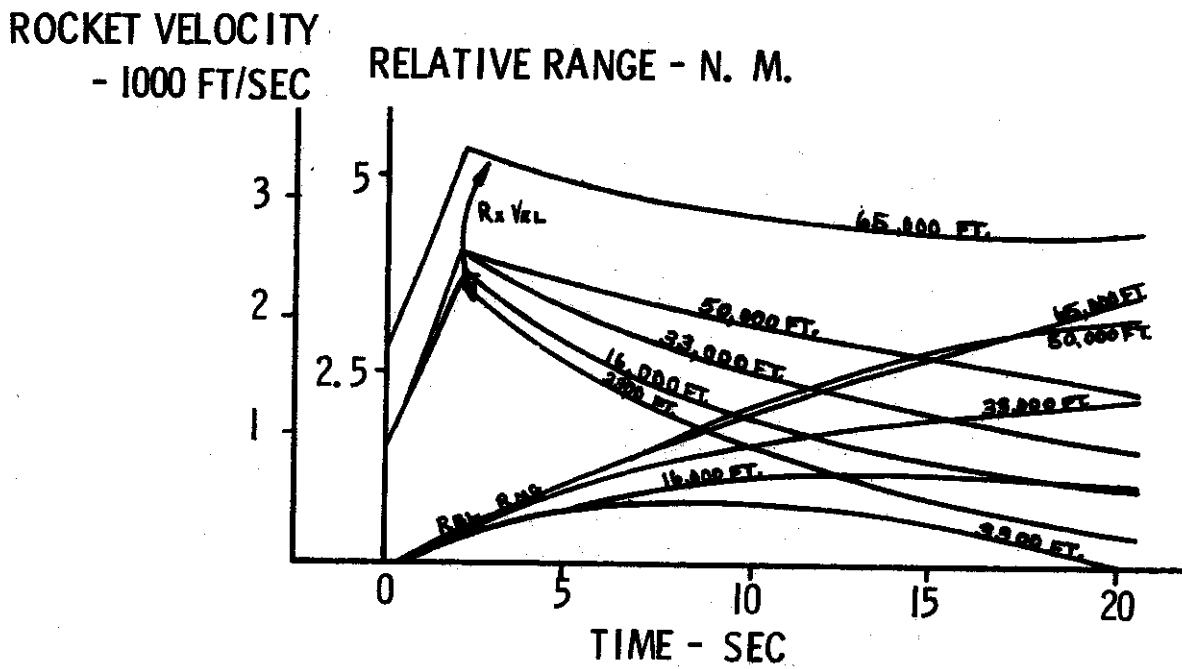

BALLISTIC CHARACTERISTICS OF R-3TYPE ROCKET

FIGURE 13

~~SECRET~~

~~SECRET~~

The time of rocket flight to the target should not exceed the working time of the rocket control system (21 seconds). But this flying time (and launching range) can be fully utilized only when the TGS has locked on the target and when the rocket, at the end of the controlled flight, has a target-meeting velocity sufficient for the activation of the proximity fuse.

In this way, the maximum range for launching the rocket is determined by the following:

-range of controlled rocket flight, derived from the power possibilities of the power plant and the working time of the control system;

- rate of interceptor-target approach;

- range of TGS lock-on;

- range radar lock-on or visual detection;

- rocket-target encounter velocity limitations determined by the condition of activation of the proximity fuse.

The shortest range established with consideration of the above factors, will be the maximum possible launching range.

As is evident from Figure 13, at low altitudes the rocket experiences a sharp retardation along the passive part of the trajectory. After 10-12 seconds of flight, the rocket speed becomes less than the interceptor speed and the available working time of the control system cannot be utilized. Hence, when launching at an altitude of 3300 feet, the flight range of the rocket relative to the interceptor at the 21st second of flight equals 0; i.e., the aircraft catches up with the rocket. At altitudes of 16,000 feet and above, the rocket loses speed at a slower rate and the working time of the control system can be utilized to the fullest extent.

Figures 14 and 15

The available range of launching distances, depending on the interceptor-target approach speed, can be determined on the basis of rocket flight ranges relative to the interceptor for each altitude (Figure 14). The linear minimum and maximum rocket launching ranges, in relation to the rate of approach, are shown schematically in the drawing by lines 1 and 2.

~~SECRET~~

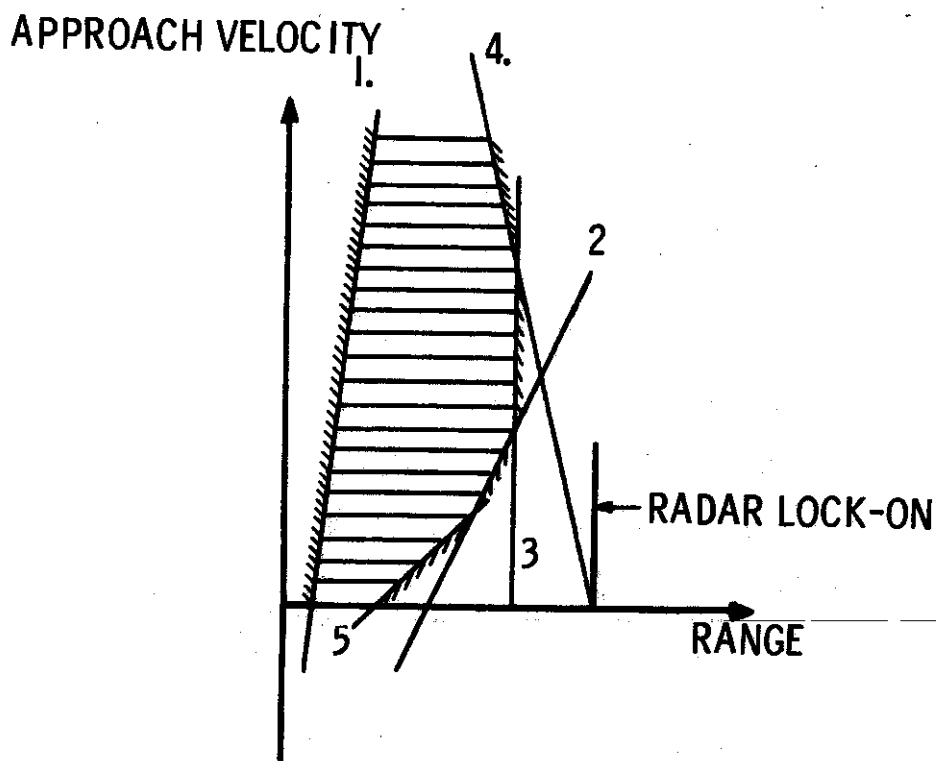

DETERMINING THE RANGE OF ROCKET LAUNCHING DISTANCES.
(THIS IS MERELY A SCHEMATIC AND WILL CHANGE WITH
APPROACH RATE).

LIMITATIONS

1. LINEAR MINIMUM ROCKET LAUNCHING RANGE.
2. LINEAR MAXIMUM ROCKET LAUNCHING RANGE.
3. TGS LOCK-ON RANGE
4. RADAR OR VISUAL TARGET DETECTION RANGE, CONSIDERING AIMING TIME.
5. LAUNCH RANGE LIMITATION DUE TO RELATION OF APPROACH RATE WITH FUSE ACTIVATION AT $V_{ENCOUNTER} = 500$ FT/SEC.

FIGURE 14

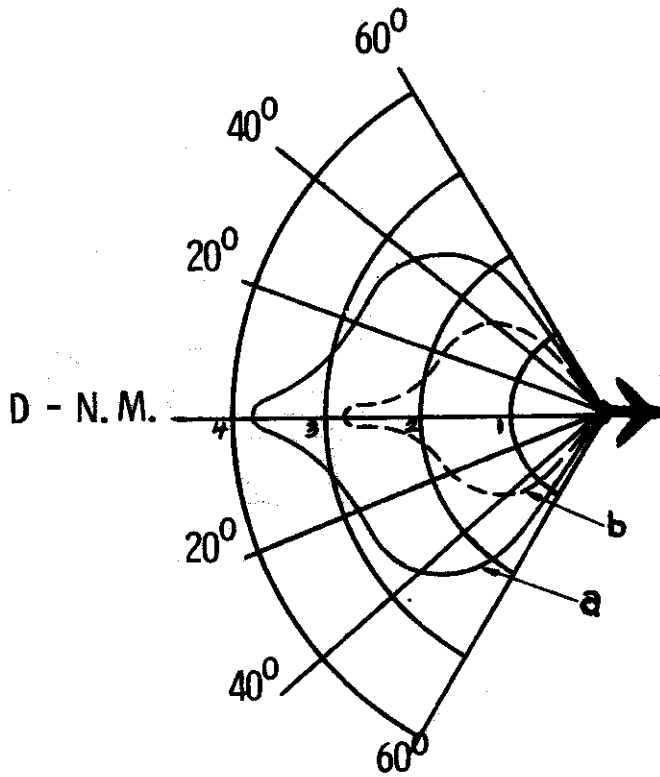

DIMENSIONS OF R-3S ROCKET TGS SEIZING AREA AT AN ALTITUDE OF 50,000 FT

- (a) LONG RANGE BOMBER
- (b) FRONT LINE FIGHTER

FIGURE 15

~~SECRET~~

With high interceptor-target overtake rates at high altitudes, the power of the rocket gives greater launching ranges, which, however, are limited in many instances by the range of TGS lock-on.

In Figure 15 are shown the dimensions of the R-3S TGS lock-on areas for front-line, fighter-type targets and long-range bombers at an altitude of 50,000 feet. Figure 16 shows the lock-on ranges in accordance with altitude. As is evident, even when an interceptor attacks directly from the rear, the TGS lock-on range is less than the maximum distance of rocket launching, beginning at altitudes of about 40,000 feet. Limitations of launching distances in accordance with TGS lock-on conditions will also be reflected at longer distances when attacking maneuvering targets, since in this case it is difficult to execute an attack directly from the rear. The limitations of rocket launching range by lock-on distance are shown in Figure 14 by line 3.

To utilize the maximum rocket launching range, it is necessary to begin aiming from rather long range. The maximum distance to start aiming is limited by the distance of target detection either by radar or visually.

Consequently, the ranges of radar and visual target detection can also limit the launching range, especially at high approach speeds. Depending on the weather conditions and type of target, the visual target-detection range can be greater or smaller than the TGS lock-on range. It is necessary to take into consideration that after detecting the target, the pilot requires a certain time (3-5 seconds) to perfect his aim and prepare to launch. During visual target detection, more time is added to eliminate heading errors, i.e., time to roll out on the aiming curve.

Limitation of rocket launching ranges by radar range or visual target detection with consideration of aiming time (t_{aim}) is shown in Figure 14 by line 4.

Limitations Imposed by Proximity Fuse - The fuse of the R-3S rocket is armed for a target encounter speed of no less than 500 feet per second.

When launching a rocket to catch up with the target, the rate of rocket-target encounter ($V_{encounter}$) is determined by the formula,

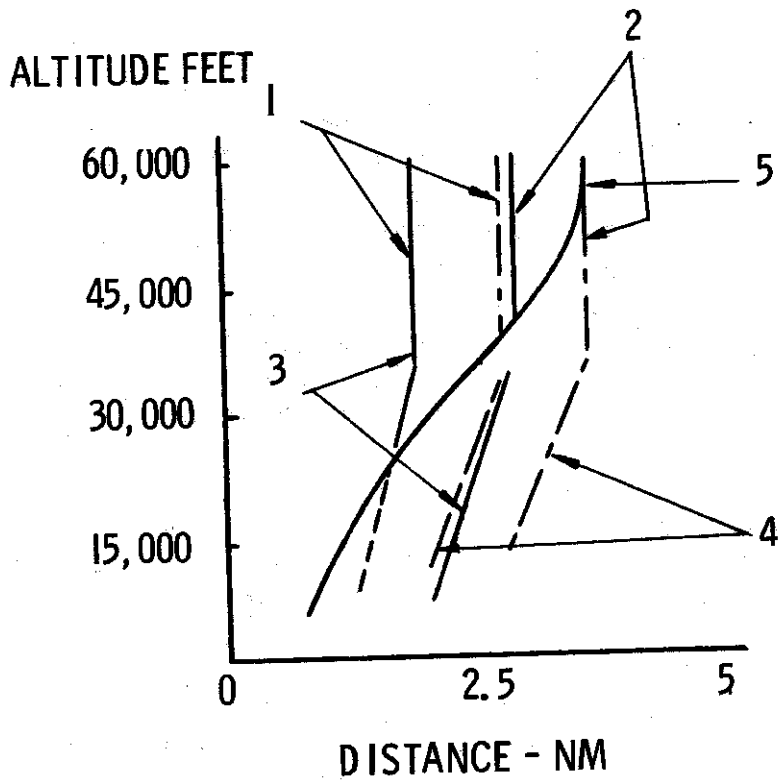

CHANGE IN R-3S ROCKET TGS TARGET SEIZING DISTANCE, RELATION TO ALTITUDE AND TARGET

KEY:

- (1) TARGET OF FRONTAL FIGHTER TYPE
- (2) TARGET OF BOMBER TYPE
- (3) AT TARGET COURSE ANGLE $\pm 15^\circ$
- (4) AT ZERO ANGLE OFF THE TARGET
- (5) MAXIMUM LAUNCHING RANGE, $VEL_{APPL} = 0$

FIGURE 16

~~SECRET~~

$$V_{\text{encounter}} = V_{\text{int}} + V_{\text{r.rel.}} - V_{\text{tar}} = V_{\text{appr.}} + V_{\text{r.rel.}}$$

where V_{int} - speed of interceptor;

$V_{\text{r.rel.}}$ - relative speed of rocket to interceptor;

V_{tar} - speed of target;

$V_{\text{appr.}}$ - speed of approach.

Therefore, the magnitude of interceptor-target approach and consequently the rocket launching range, are both limited by the characteristics of the fuse. The rate of approach should satisfy the inequality,

$$V_{\text{appr}} \geq 500 \text{ ft/sec} - V_{\text{r.rel.}} \quad (9)$$

Since the velocity of the rocket relative to the interceptor decreases in proportion to both a decrease in launch altitude and an increase in rocket flight time, the most significant limitations in the rate of interceptor-target approach are imposed by the fuse when the rocket is launched from maximum distance (at low altitude). Consequently, there is a limitation in maximum launching distance whereby the slower the rate of approach, the better it is to launch from shorter distances, i.e., the rocket flight-time should be shorter so that the value $V_{\text{r.rel.}}$ will be sufficiently great and the inequality (of formula 9) satisfied. Limitation of launching range in relation to rate of approach with fuse activation at $V_{\text{encounter}} = 500$ ft. per second is presented schematically in Figure 14 by line 5.

Figure 17 shows the change in R-3S rocket launching ranges at various altitudes, depending on the rate of interceptor-target approach with consideration of all limitations.

(Fig 17)

As may be seen from the figure, at low rates of approach (55-110 knots) at altitudes of 3300-10,000 feet, the rocket-launching ranges are from 1600 feet to 6500 feet. With an increase in launching altitude, there is also an increase in maximum launching range. In Table 1, the theoretical maximum rocket-launching ranges are given for various altitudes and overtake rates at interceptor speeds of 485-595 knots at altitudes up to 50,000 feet, and at interceptor speeds of 1080 knots at 65,000 feet. In Figure 18 are given the

~~SECRET~~

VELOCITY OF APPROACH - KNOTS

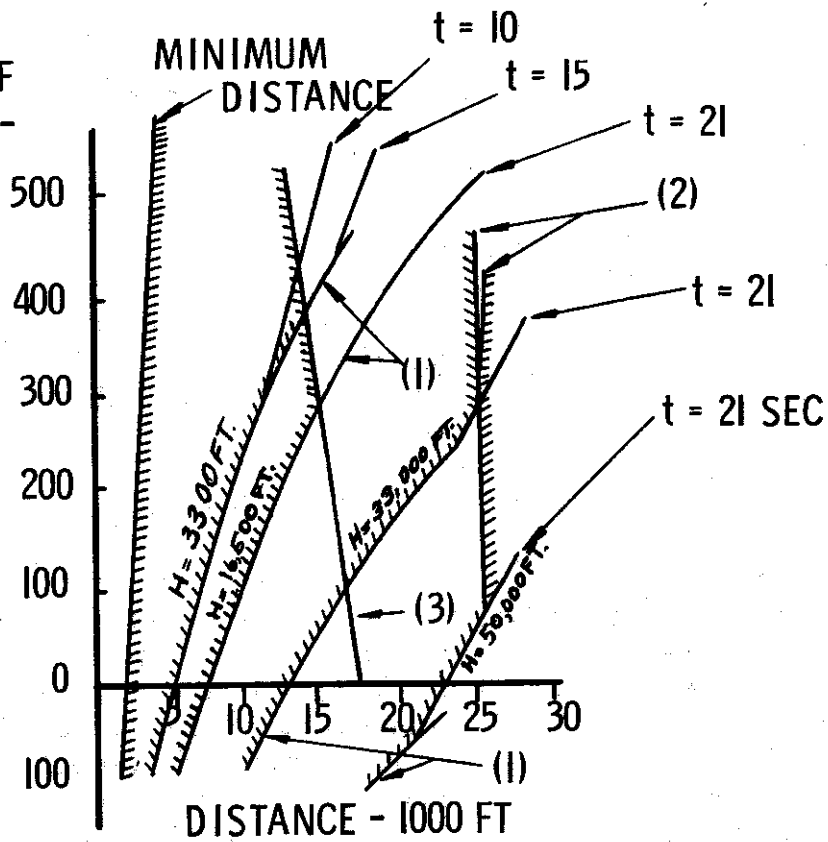

CHANGE IN R-3S ROCKET LAUNCHING DISTANCES AT VARIOUS ALTITUDES, IN RELATION TO APPROACH RATE

KEY:

- (1) 500 FT/SEC FIRING VELOCITY
- (2) MAXIMUM LOCK-ON RANGE BY IR ROCKET
- (3) DISTANCE OF LOCK-ON

FIGURE 17

~~SECRET~~

maximum permissible launching ranges as processed by the VRD-2, (permissible range computer), depending on the interceptor aircraft speed, altitude and rate of target approach.

(Fig 18)

On the right side of Figure 18 (in accordance with the interceptor speed and altitude) is determined the permissible range of rocket launching (D_0) when the rate of interceptor-target approach is zero.

On the left side of the graph (in accordance with the found value (D_0) and known rate of approach) is determined the permissible range of rocket launching (D_r) under specific conditions. In Figure 18, the arrows indicate the order of using the graph.

In Table 1 the underlined distances are those which exceed the distance from which aiming begins (by radar or visually) with respect to a single bomber. Distances below the lines (within the bottom frame) are those which exceed the maximum range of TGS lock-on. This means that at altitudes of more than 50,000 feet, with overtake rates of over 55 knots, the pilot can launch rockets against a visually-observed target immediately upon attaining TGS lock-on, regardless of whether he has radar lock-on.

As a result of analyzing Figures 17 and 18 and Table 1, it is possible to draw the following conclusions:

1. Conditions of launching R3-S rockets from the MiG-21f-13 fighter offer the possibility of approaching the target at all flight altitudes. Rocket launching is possible even from lagging positions.
2. At altitudes of up to 23,000 feet, the basic limitation of launching distances is the limitation of the minimum permissible rate of rocket-target encounter. The slower the rate of approach, the greater the limitation.
3. At high altitudes and in the stratosphere, particularly at high rates of approach, the launching distances are limited either by the range of TGS lock-on or by the distance of beginning to aim.

~~SECRET~~

PERMISSIBLE RANGE
WITH ZERO CLOSURE - 10^3 FT

APPROACH RATE - KTS

590 375 160

25

20

15

10

5

INTERCEPTOR
ALT - 10^3 FT

69

62

56

50

43

36

30

23

485

270

55

3.3

10

16

30

20

10

400

600

800

1000

1200

PERMISSIBLE LAUNCH RANGE - 10^3 FT

INTERCEPTOR VELOCITY - KTS

PERMISSIBLE DISTANCES FOR LAUNCHING R-3S ROCKETS.
(RIGHT SIDE FOR ZERO CLOSURE RATE)

FIGURE 18

TABLE I

THEORETICAL ROCKET-LAUNCHING RANGES

OVERTAKE RATE ~ Kts	55	110	100	215	270
	Minimum Theoretical Permissible Launching Ranges				
	1800	2000	2200	2400	2600
ALTITUDE (ft)	RANGES ~ FT.				
3,300	5,900	6,900	8,200	9,400	10,500
16,500	7,800	9,200	10,800	12,500	14,000
33,000	14,000	<u>16,400</u>	<u>19,000</u>	<u>22,000</u>	<u>24,000</u>
49,000	<u>24,000</u>	<u>26,000</u>	<u>28,000</u>	<u>30,000</u>	<u>32,000</u>
66,000	26,000	27,500	30,000	31,000	33,500

NOTE: The underlined distances are those which exceed the distance from which aiming begins, (radar or visually).
 Interceptor speed for altitude of 66,000 kts is 1080 kts, for the remaining altitudes, 485-595 kts.

~~SECRET~~

Possible Launching Angles - A larger TCA during the launch causes an increase in flight trajectory curvature and in the G-load of the rocket. Since the required rocket G-loads also depend on the speeds of the interceptor and target, and the available rocket G-loads depend on the altitude, the possible TCA's depend on the above factors.

The maximum available G-loads of the R-3S rocket are given in Table II.

During self-guided flight by the proportional approach method, the R-3S rocket, even with a large TCA, has only slight curvature of trajectory and slight G-loads, and so can be successfully guided to the target from an angle-off (50°) at altitudes up to 40,000 feet.

The high available G-loads also assure successful guidance of the rocket against maneuvering aircraft. Because, by the proportional approach method, the target maneuver causes only a slight increase in the necessary G-load of the rocket. However, for the rocket to be launched, it is necessary that the TGS be locked on the target. To accomplish this, the longitudinal axis of the rocket (longitudinal axis of the aircraft) must be directed toward the target as the lock-on angle of the TGS is small (35°). When aiming with the longitudinal axis of the aircraft, the rocket, after launching, must change from movement along a pursuit curve into movement along a trajectory close to parallel approach. This produces considerable rocket G-load and leads to a reduction in possible launching angles, because with the increase in TCA, the maneuvering ability of the rocket does not assure the transitional process.

(Figure 19)

That is why the interceptor G-load is limited to 2.0 during the rocket launching at altitudes up to 46,000 feet, and 1.6 at altitudes over 46,000 feet. With an increase in rocket launching distance, the possible TCA's increase. Consequently, beginning with a definite angle-off, a side boundary appears (Figure 19) which determines the minimum launching range in relation to the angle.

In some instances, at sufficiently long range, the angle during launching may be limited by the value of maximum lead angle worked out by the TGS. Maximum launching angles limited by the TGS can be determined from the formula:

~~SECRET~~

~~SECRET~~

TABLE II
MAXIMUM AVAILABLE G-LOAD OF R-3S ROCKETS

Altitude Feet	Velocity (Interceptor) Knots	
	595	1190
0	10	10
16,000	10	10
33,000	9	10
50,000	5.5	6.5
65,000	2.0	3.0

~~SECRET~~

~~SECRET~~

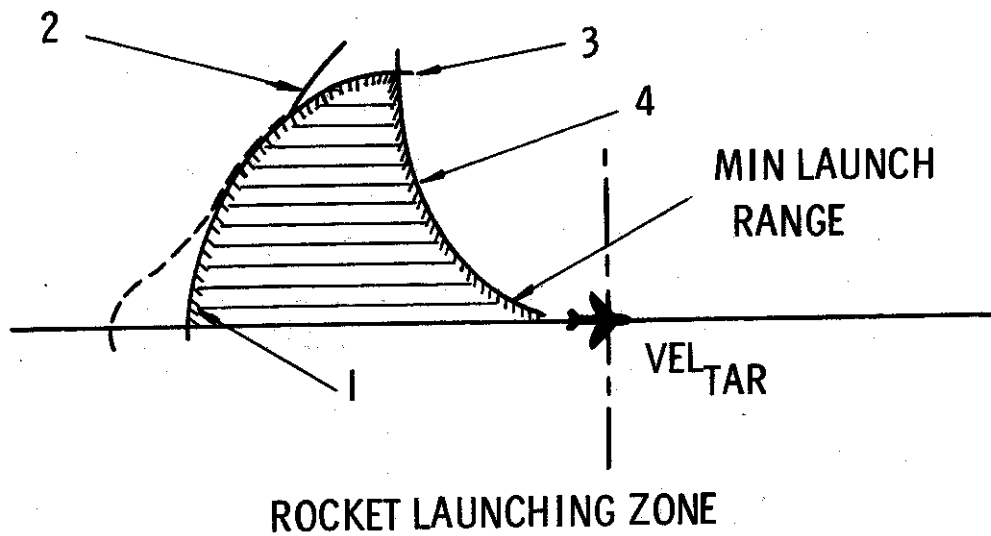

KEY

- (1) BOUNDARY DUE TO VELOCITY OF ENCOUNTER
- (2) BOUNDARY DUE TO LOCK-ON DISTANCE
- (3) BOUNDARY BY Ψ_{max}
- (4) BOUNDARY DUE TO G-FORCE LIMITATIONS

FIGURE 19

~~SECRET~~

~~SECRET~~

$$\sin q_{\text{pred}} \approx \frac{V_r}{V_{\text{tar}}} (\sin \psi_{\text{max}}) \quad (10)$$

where ψ_{max} = maximum angle of deviation of the optical axis of the TGS, accepted as 25° in the calculations; V_r = mean velocity of the rocket along the trajectory. Angle limitations when the rockets are launched by the TGS lead angle are observed only rarely during aerial engagements with strategic bombers at medium altitudes.

(Figure 20)

In all remaining instances, limitations come much sooner either in TGS target lock-on distance, or in distance of the controlled rocket flight (or by V_{enc}), which together with the boundary of maximum G-loads, determine the range of the launching (See Fig 19).

In Figure 20 are shown the zones for launching the R-3S rockets in the horizontal plane (symmetrical parts are discarded) for various altitudes and speeds of interceptor and target.

It can be seen from the drawing that the forward boundary of the restricted zone for launching is determined by the minimum distance of launching and the maneuvering possibilities of the interceptor. The rear zone is determined by the maximum launching range. At high altitudes, the latter is determined by the TGS target lock-on range. At low and medium altitudes, it is determined by the various factors mentioned for the calculation of maximum launching range. In the stratosphere, aiming conditions do not always permit the use of maximum launching range derived by the time needed to arm the fuse, because with consideration of the angle of attack at such a distance, a more than maximum interceptor G-load is needed.

The dimensions of the rocket launching zone depend substantially on the altitude and speed of the interceptor and the target. An increase in altitude and speed leads to a reduction of the possible launching angles as a result of the decrease of the available and the increase in the necessary G-loads of interceptor and rocket. At the same time, an increase in speed and altitude leads to an increase in launching distances and shifts the rear boundary of the launching area all the way back to the maximum lock-on distance.

For the most probable conditions of executing attacks on long range and strategic bombers, it can be considered that possible launching angles may reach 50° at altitudes up to 40,000 feet, and may decrease to 15° at altitudes of 65,000 feet.

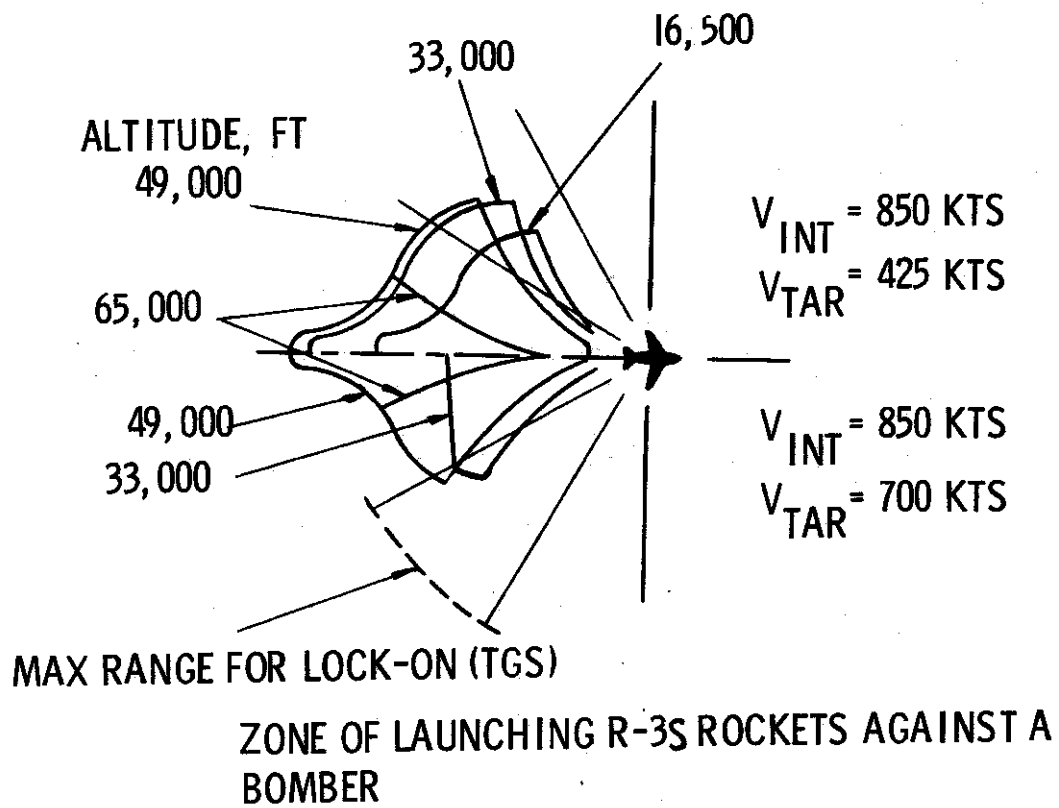

FIGURE 20

When firing in a vertical plane, the maximum G-loads of the interceptor decrease, especially when attacking from below. Consequently, there is a reduction in rocket launching angles determinable by the amount of maximum interceptor G-load while aiming. However, if brief aiming is carried out during a period of 4-6 seconds while flying the pursuit curve, it is possible to provide launching angles practically the same as those occurring during attack in a horizontal plane. This allows execution of the launch with a considerable descent (ascent) relative to the target.

ZONE OF POSSIBLE ATTACKS

The space relative to the target within the limits of which the target can be attacked is called the zone of possible attack (OVA). For an interceptor carrying guided rockets, the OVA is determined (under combined consideration) by the launching zone and by the zone in which movement of the interceptor is possible during the attack, i.e., aiming before launching. For the MiG-21f-13 interceptor, it is also necessary to consider the OVA for cannon firing.

In distance, OVA is restricted at one end by the distance of safe approach or minimum range for rocket launching, and at the other end (distance from the target) by the maximum distance for beginning to aim.

The distance of safe interceptor-target approach depends on the rate of approach and is determined by the formula:

$$D_{safe} = (V_{int.} + V_{tar.} \cos q_{p.o.}) (t_{p.o.} + t_{lag}) + \Delta D \quad (11)$$

where $q_{p.o.}$ = course angle when beginning the pull out from the attack;

$t_{p.o.}$ = minimum time required for safe pullout from attack;

t_{lag} = lag time in the action of the pilot (0.5-1.0 sec);

ΔD = error in measuring the distance to the target.

For the MiG-21f-13, it is possible to confine oneself to the calculation of safe approach distance when attacking with a zero angle-off as here:

$$t_{p.o.} = \sqrt{\frac{3d_{safe}}{5\Delta n_{av}}} \quad (12)$$

~~SECRET~~

where d_{safe} = safe approach interval, normally 160-330 feet;

n_{av} = average tempo of G-load change, which in calculations may be taken as 1 per second for altitudes up to 40,000 feet and 0.2-0.3 per second for attacks at altitudes close to interceptor ceiling.

Calculations have shown that the safe-approach distance values for the MiG-21f-13 are smaller than the minimum distances for rocket launching (with consideration of aiming possibilities) all the way up to approach rates of 380-485 knots. That is why the OVA is limited in a great majority of cases by the minimum distance for rocket launching. From this, the interceptor is also safeguarded against being hit by fragments of its own rockets. If the rockets have all been deployed and the attack is conducted with cannons, then the attack zone is limited by the safe approach distance.

The maximum distance for launching R-3S rockets is quite large but the MiG-21f-13 aiming capability has a relatively small range of action. Consequently, the distant boundary of the OVA is the distance of radar lock-on or the distance of visual sighting and aiming with the aid of the ASP-5nd sight set in caged position. When attacking with cannons, the distant boundary of the OVA is about 6500 feet, i.e., the boundary between beginning to aim (with analysis of angular errors) and actually firing the cannons.

Since the areas for launching R-3S rockets have already been given with consideration of the interceptor's aiming possibilities, the OVA, in accordance with the possible angles for the MiG-21f-13, coincides with the boundaries of the rocket launching zone.

To guarantee the execution of a successful attack and the elimination of the possibility of TGS break-lock after rocket launch, limitations are established by G-load: a maximum of 2 G's at altitudes above 46,000 feet. Upon the attainment of these G-loads, a warning light comes on.

Consequently, the OVA, with respect to angle-off is limited by the dimensions of the zone where the G-load of the interceptor is greater than the indicated maximum values. The boundaries of that zone are determined by formula (2) when attacking in horizontal plane, and by formula (13) when in vertical plane:

$$D = \frac{V_{\text{int}} V_{\text{tar}} \sin q}{9.81 (n_{\text{max}} \pm \cos q)} \quad (13)$$

~~SECRET~~

In Figures 21 and 22 are shown the OVA's limited by G-loads of 2.0 and 1.6 and by the distance of locking onto the target by radar or TGS for various altitudes and speeds of interceptor and target. Also shown are the launching zone boundaries limited by maximum interceptor G-load values at the time of aiming.

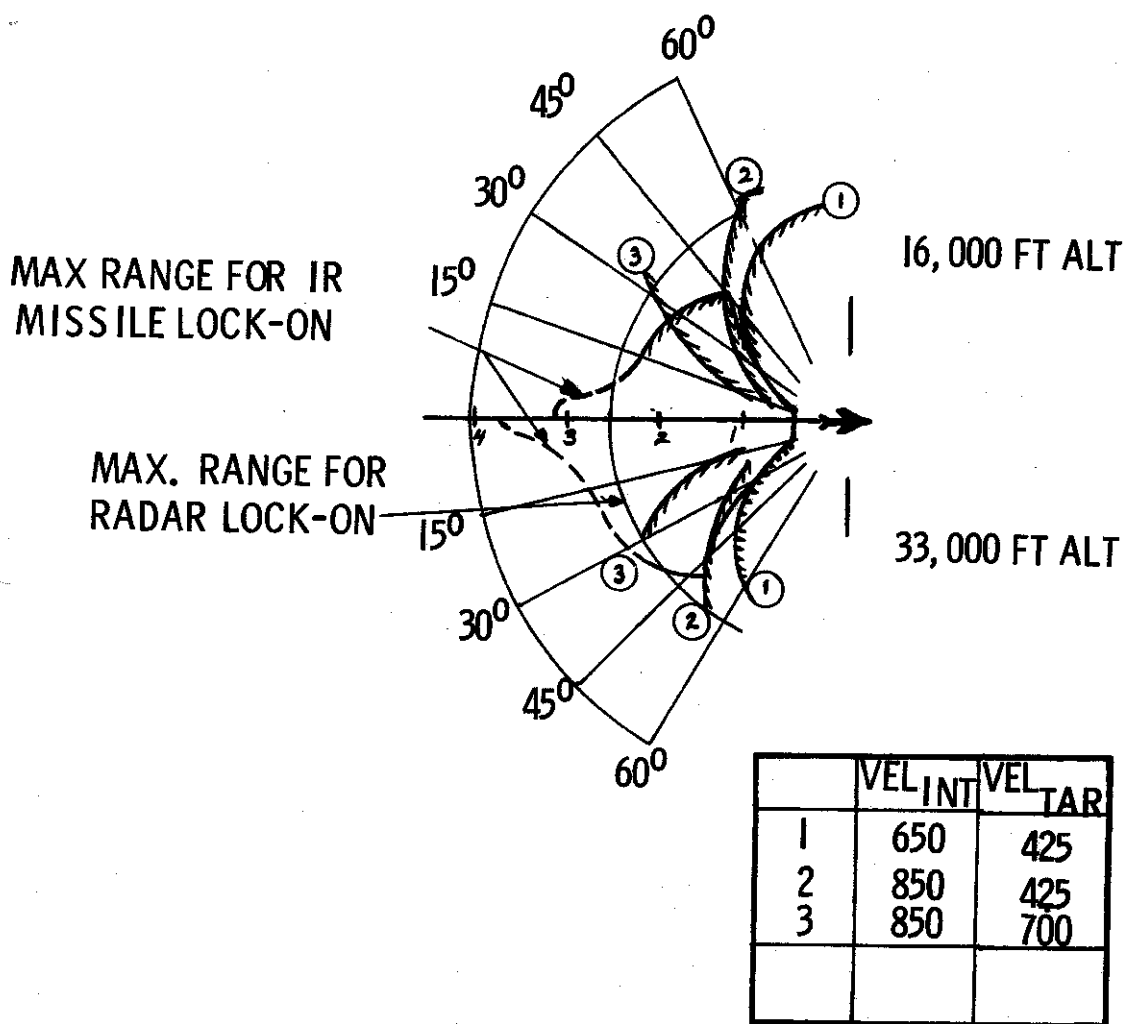

AREAS OF POSSIBLE ATTACK BY THE MIG 21f-13

FIGURE 21

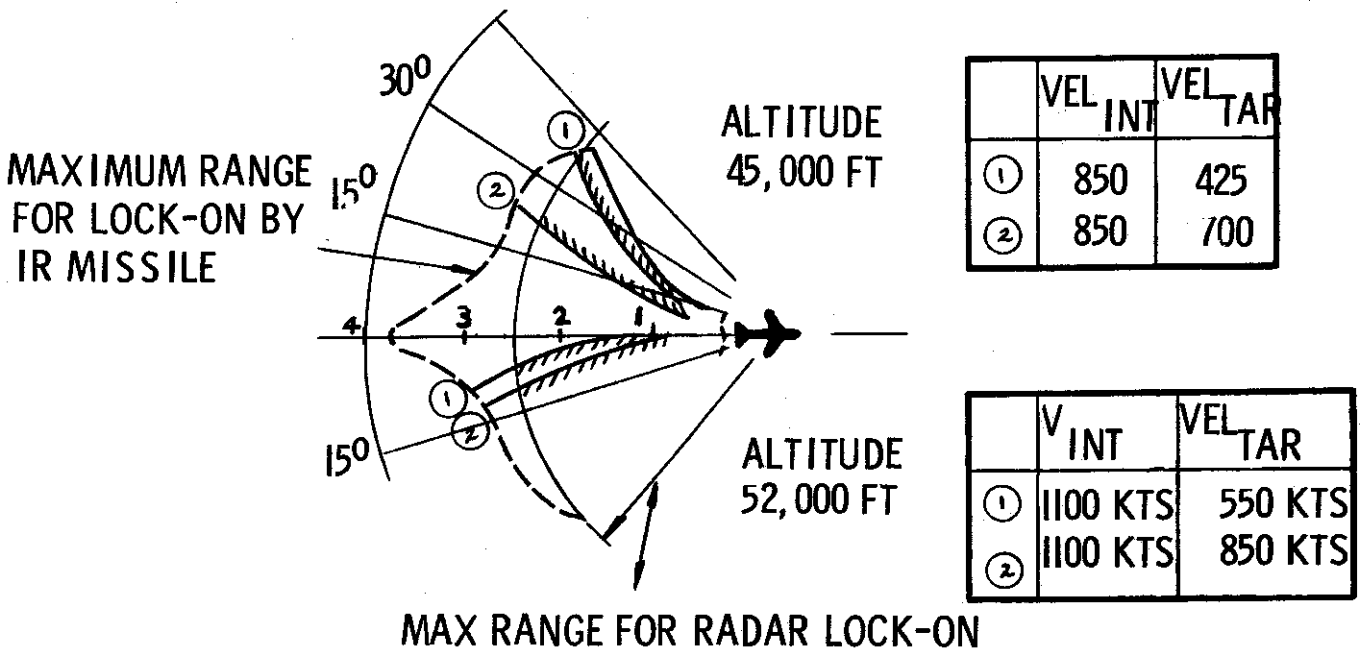

AREAS OF POSSIBLE ATTACKS BY MIG 21f-13

FIGURE 22

It can be seen from the drawings that the conditions for employing the R-3S rocket by the MiG-21f-13 allow only partial utilization of the rocket capabilities in regard to range and launch angles.

R-3S rockets can be employed throughout the entire range of altitudes and speeds of the interceptor. The range of rocket-launching distances depends on the launching altitudes and the interceptor-target approach rate. At altitudes up to 27,000 feet, the interceptor can use the entire range of launching distances with proper control of approach speed. At high altitudes, particularly above 40,000 feet, the launching range is limited by the distance at which the aiming begins. This distance, determined by visibility conditions, is approximately 3.2-4.3 nautical miles when attacking single bombers, and increases somewhat when attacking a group of targets. Keeping in mind that the radar lock-on

~~SECRET~~

range does not exceed 2.7 nautical miles (at which range the pilot receives a signal indicating permissible launch range), it must be assumed that at medium altitudes the launching range is limited by the radar lock-on range.

In an attack at altitudes above 50,000 feet, the maximum possible rocket launching range is limited by the TGS lock-on range. The rockets may be launched after receiving the TGS lock-on signal. It is not necessary to wait for the radar to lock-on the target, as the interceptor in these instances is within the limits of permissible launching range because of the greater power of the aircraft. In these cases, the maximum launching range, under sufficient visibility, will be limited by the TGS lock-on range, i.e., possible launching distances will be fully used.

As is evident from Figures 21 and 22, the possible target angles for launching the R-3S rocket by the MiG-21f-13 are considerably less than those allowed by the rocket. The reduction in possible launch angles becomes even more noticeable than the reduction in distances. This hampers interceptor-target approach, especially when the target is maneuvering.

When attacking with cannons and unguided rockets, the target angle is limited by the zone of greater-than-maximum G-loads and the zone of operation of the sighting mechanism. The area where interceptor G-load is greater than maximum is calculated by formulas (2) and (13).

Thus, the lateral boundaries of the MiG-21f-13 OVA, when attacking an aerial target by cannon fire, are in practical agreement with the boundaries of the area for launching R-3S rockets.

When flying at altitudes close to ceiling, the OVA narrows sharply. In these cases, it is limited in practice by the maximum pursuit curves touching on the area where the interceptor G-load is greater than maximum, whereby the target point during attack in a horizontal plane is determined by formulas (1) and (6).

When attacking by cannon fire and unguided rockets and at low and medium altitudes, the target angles (lateral boundaries of possible attack areas) may be limited by the working area of the sight.

The working area of the sight is the space relative to the target within the confines of which the sight can compute the necessary data for aiming and firing. The working area of the sight

~~SECRET~~

is determined by the magnitude of maximum angular correction which can be processed by the sight, and by the range of distances and approach rates for which they are intended.

The side boundaries of the working area of the sight are calculated by the formula:

$$\sin q_{av} \approx \frac{V_{ar}}{V_{tar}} (\sin \psi_{max}) \quad (14)$$

where q_{av} = average course angle determining the side boundary of the sight working area;

where V_{ar} = average velocity of the projectile under firing conditions;

ψ_{max} - maximum summary angular correction processed by the ASP-5 sight, equalling 13° .

When flying with the pressurized helmet, ψ_{max} does not exceed $7-8^\circ$ as the pilot cannot see a greater lead.

CHARACTERISTICS OF ATTACKING A MANEUVERING TARGET WITH R-3S ROCKETS

If the enemy target spots the attacking interceptor, he will usually begin maneuvering in order to hamper or break off the attack.

At low and medium altitudes, the target maneuvering may occur before the MiG-21f-13 comes within rocket launching range. At high altitudes and in the stratosphere, maneuvering will probably begin when the interceptor is already within possible launching range, since at these altitudes the maximum launching range usually exceeds the range of visual target visibility. The greatest difficulties are caused when the target turns toward the interceptor, since this leads to an increase in the G-load needed to fly along the attack curve. In many instances, it forces the interceptor out of the OVA, as was the case when approach methods were discussed. The target maneuver affects the nature of R-3S rocket movement in a similar manner. Figure 23 shows the effect of target maneuvers on the change of necessary rocket G-loads. It can be seen that the target maneuver does not sharply affect the increase in maximum value of the G-load needed by the R-3S rocket. Consequently, there is practically no change in the launching area. This is explained by the

~~SECRET~~

fact that the R-3S rocket is guided to the target by the proportional approach method and that the maximum G-load value is attained at the beginning of the trajectory.

The probability of the R-3S rocket striking the target is only slightly decreased by this target maneuver if the rocket is launched within the limits of the launching zone.

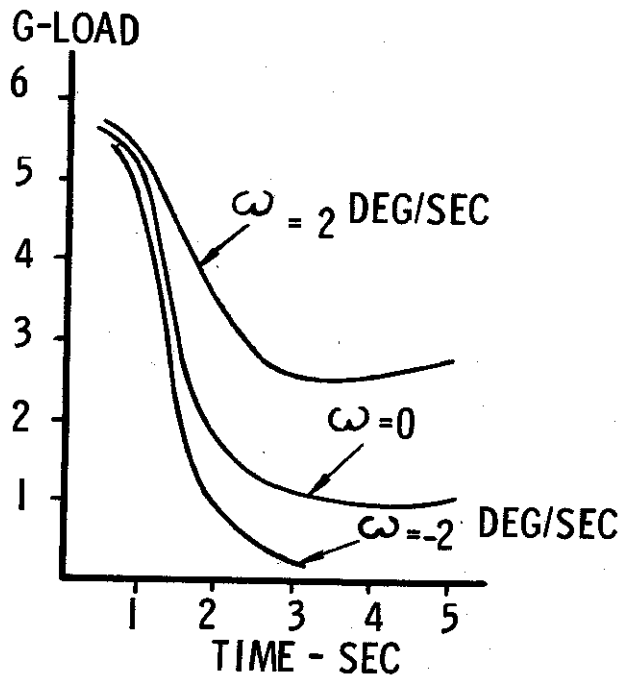

CHANGE IN NECESSARY G-LOAD OF R-3S ROCKETS

$$V_{INT} = 580 \text{ KTS}$$

$$V_{TAR} = 485 \text{ KTS}$$

FIGURE 23

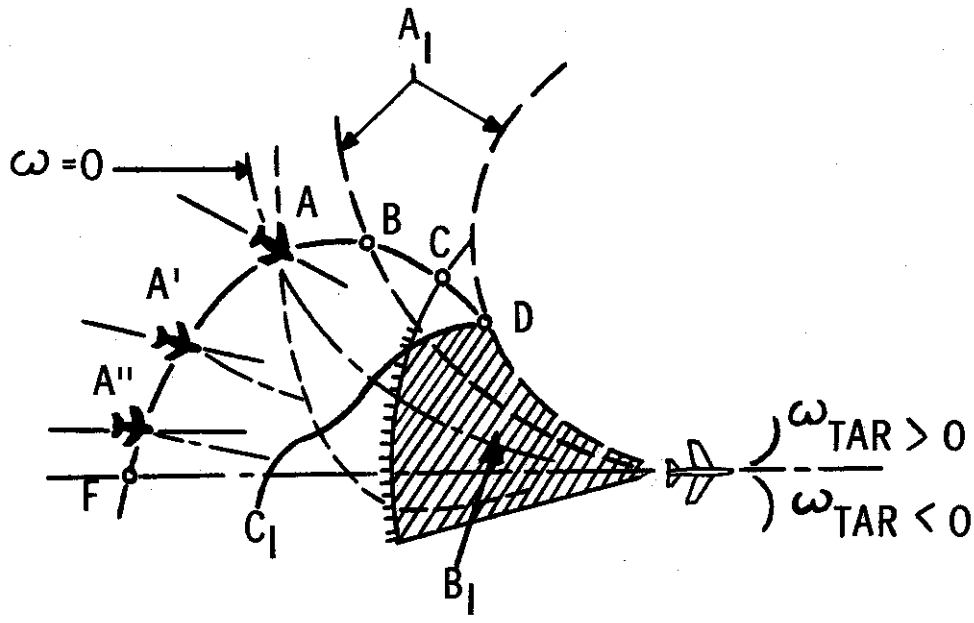

PURSUIT CURVES VS VARIOUS TARGET MANEUVERS

- (A₁) BOUNDARY OF ZONE WHERE INTERCEPTOR G-LOAD > 2., i.e., G-LOAD > MAX.
- (B₁) ROCKET LAUNCHING ZONE
- (C₁) IR MISSILE LOCK-ON RANGE

FIGURE 24

Consequently, the main task of the MiG-21f-13 pilot when attacking a target capable of maneuvering will be to roll out suddenly within rocket launching range and within the boundaries of the OVA.

In Figure 24 is shown the form of the interceptor pursuit curve when attacking maneuvering and nonmaneuvering targets. This drawing illustrates the effect of target maneuvers on the possibility of the interceptor entering the zone where rocket launching is of little effect or impossible. So, if the target does not maneuver, then an attack beginning from any point (A, A', etc.) in Section FB on Curve 2 will lead to entry into the rocket launching zone. But if the target does begin a maneuver toward the interceptor, then an attack from any point along line FB will lead to an entirely opposite

result; the interceptor will travel along a finite section along line BD, i.e., with an excess of permissible G-load during launch, and the launching of rockets after Point D (within limits of permissible range) will be unrealizable because of the impossibility of aiming to achieve lock-on by the TGS.

The TCA and consequently the necessary G-load with which the interceptor should execute its flight, change upon the attainment of the launching range in ratio to the distance at which the target begins maneuvering. At a sufficiently great initial distance, the pursuit curve of the interceptor attacking a maneuvering target will change into a spiral, twisted opposite to the direction of target turn. The MiG-21f-13 does not ordinarily encounter such a condition because the attack may usually only begin from distances of 2.5-3.3 nautical miles. However, it is entirely possible that the interceptor may pull out to beyond the limits of the zone of possible attack, which leads to a disruption of the attack. In this way, in order to successfully execute the attack within the limits of permissible target angle, the interceptor should approach to within the prescribed range before the target begins to maneuver.

If the interceptor is superior to the target in maneuverability and has a high surplus of speed, there is an area where the target defensive maneuvers cannot hinder the interceptor from flying along the pursuit curve up to any desired distance from the target (so called area of ineffective defensive maneuvers of the target). This area is limited by the pursuit curve touching the zone where the interceptor G-load is greater than maximum. The tangent course angle (q_{tan}) is determined during maneuvers in a horizontal plane by formula (15), derived from formula (6).

$$\cos q_{tan} = \frac{1}{\left[\frac{\sqrt{n_{tar}^2 - 1}}{\sqrt{n_{int}^2 - 1}} \right] \frac{-2 V_{tar}}{V_{int}}} \quad (15)$$

In Figure 25 are shown areas with various target G-loads originating during turns and limited by maximum pursuit curves emanating from points q_{tan} . The dimensions of these zones decrease in proportion to the increase of G-load (angular speed) of the target.

To create the best conditions for rocket launching when attacking a target capable of maneuvering, the MiG-21f-13 should appear at a rocket-launching range before the target begins to maneuver and with

~~SECRET~~

only a small angle-off the tail. Under these conditions, rockets may not be immediately launched if, by the attack conditions, launch from maximum range would be of little effect. The interceptor should continue the approach until the target defensive maneuver is noticed. To continue to aim, the bank will have to increase and approach maximum.

In cases where the target has begun maneuvering prior to the entry of the interceptor into the zone of possible rocket-launching, the attack should be executed from the portion of the rocket-launching zone situated beyond the OVA (Figure 26), i.e., rockets are launched at a G-load greater than normally permissible. The limitations in this case are the possibilities of aiming with lead and the corresponding maximum G-load of the interceptor since the rocket-launching zone is actually limited by the sighting conditions. But in these cases, disruption of the TGS lock-on is sometimes possible after the launching and there will also be a reduction in target striking possibility, i.e., the effectiveness of the aerial engagement with the target will be reduced.

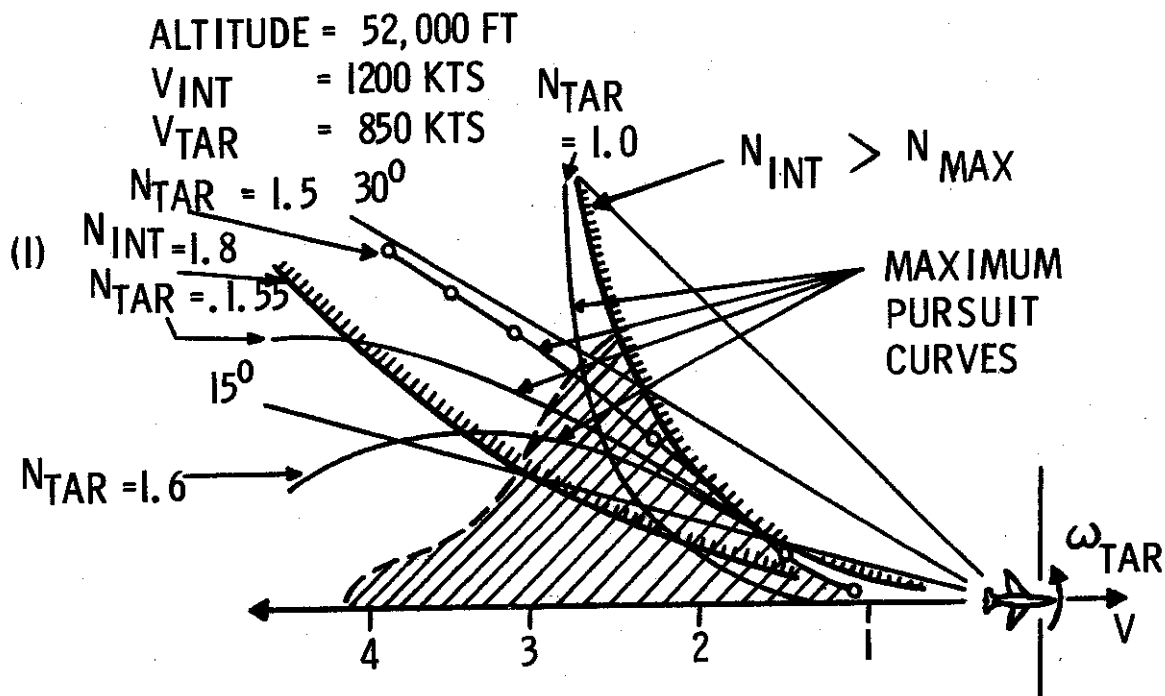

ZONES OF INEFFECTIVE DEFENSIVE TARGET MANEUVERS

FIGURE 25

~~SECRET~~

~~SECRET~~

When attacking bombers, if the conditions allow a small rate of approach to be maintained, it is possible to avoid the reduction in target striking probability and to launch the rockets under more convenient conditions. To achieve this, it is necessary to continue the approach while the G-load rises to maximum and then decreases again to the load permissible for launch (curve 1 in Figure 25). This can be done if the interceptor is in the zone of ineffective defensive maneuver at the moment the target begins maneuvering.

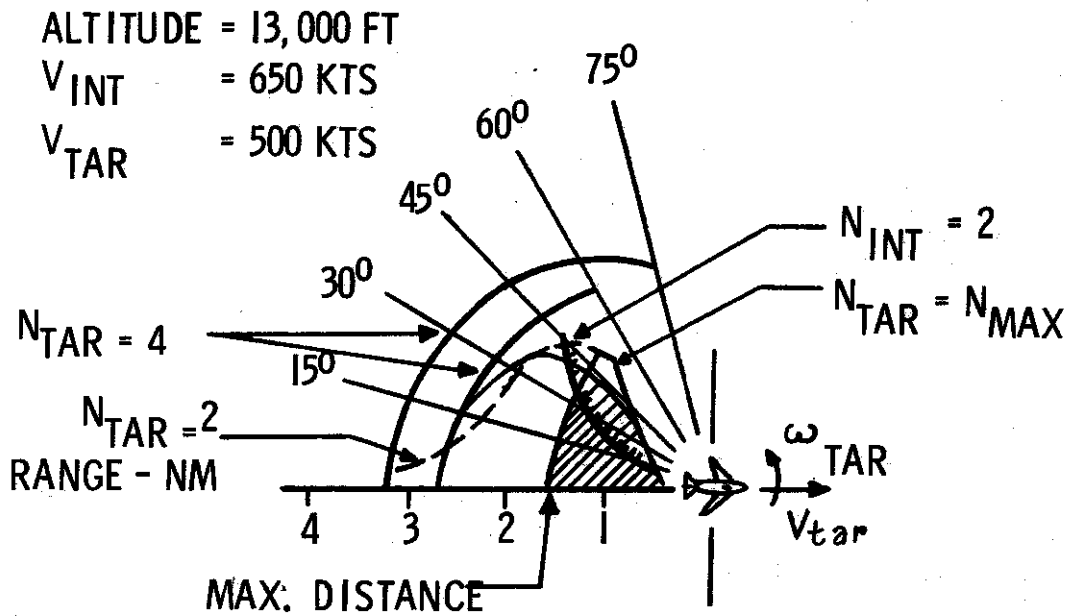

CONDITIONS FOR EXECUTING THE ATTACK AGAINST A
 MANEUVERING TARGET

FIGURE 26

~~SECRET~~

Since the range of target detection for the MiG-21f-13 is small, it can be concluded that if the attack on enemy bombers ($n_{tar} \ll n_{int}$) begins within limits of TCA's of 15° , then R-3S rockets can be launched under best conditions when the interceptor speed is raised somewhat above that of the target (not more than 50-110 knots). This is explained by the fact that the interceptor, at the onset of the attack, is within the limits of the ineffective target defensive area and can continue the approach to the necessary distance with a permissible G-load.

Since enemy fighters and fighter-bombers can maneuver with almost the same G-loads as the MiG-21f-13, it cannot be assumed that an interceptor beginning an attack with a zero angle-off the tail would be in the zone of ineffective target maneuver; because in a majority of cases, no such zone would exist, or if so, would be very small. For example, if an attack is made beginning with zero TCA from a range of more than 2.7 nautical miles, then a maneuvering target pulling a G-load of 4 would disrupt the attack. Consequently, when attacking highly maneuverable targets, R-3S rockets should be launched before the G-load reaches maximum value for sighting, if the interceptor can approach the target to a permissible launching range.

Of great importance is the interceptor-target speed ratio during attack. When the interceptor has a great speed advantage over the target, the zone of ineffective target maneuvering either decreases or disappears completely because the interceptor is not able to aim due to the origination of greater-than-maximum G-loads. But, if the MiG-21f-13 is attacking a highly-maneuverable target which has no zone of ineffective defensive maneuvering, then at the beginning of the attack from a small angle-off, it is advisable to have as great an advantage in speed as possible. This offers the possibility of extending the interception boundary back from the protected objective and increasing the probability of striking the target during the attack.

In Figure 27 is shown the nature of interceptor trajectory at various speed ratios with the target. It is evident from the drawing that during an attack which begins against a maneuvering target under small target angles, rockets can best be launched if the interceptor has an advantage in speed over the target. If the attack begins with large TCA's, then the interceptor should have a small speed excess over the target. This should be taken into consideration when vectoring the MiG-21f-13 toward a maneuvering target, then its speed can be regulated during the final section so as to assure the best condition for attack. In this case, the boundary at

~~SECRET~~

which the advisable change in interceptor speed occurs is the arc of the circumference with radius equaling one-half of the radius of the turn of the target (arc A in Figure 27). Taking into consideration the possible delay in reducing the speed, it is recommended that a high rate of approach (270-325 knots) be selected only in conditions where the interceptor emerges for attack outside the circumference of target turn.

In ratio to the increase in TCA, i.e., when located on the inside of the target turn and more so when within the zone limited by arc A, the interceptor's excess speed over the target should be reduced to 80-50 knots and below. When attacking a maneuvering target, changes in interceptor speed should be executed upon command of the GCI controller.

In this way, a MiG-21f-13 with R-3S rockets can successfully strike a target which is pulling 1.5-2.0G's at altitudes up to 50,000 feet without reducing the kill probability in comparison with a non-maneuvering target.

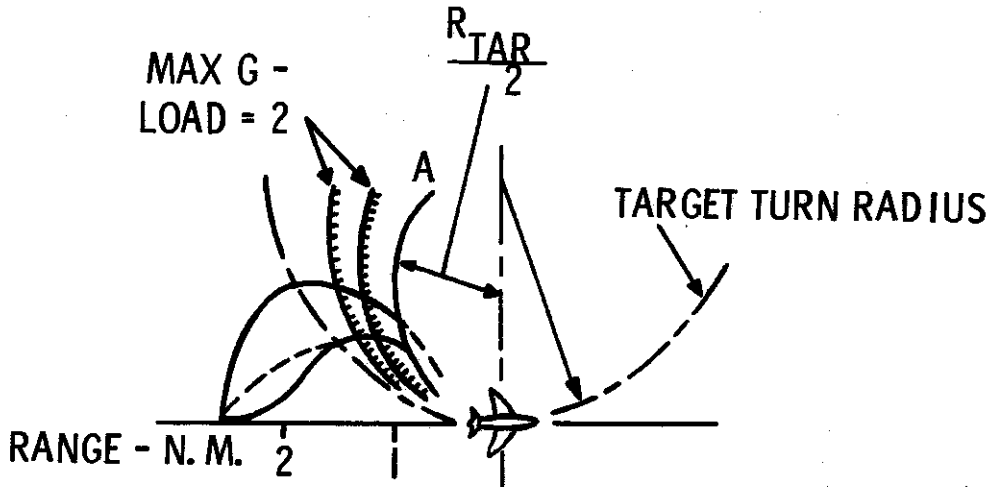

EFFECT OF SPEED RATIO ON CONDITIONS
WHEN ATTACKING A MANEUVERING TARGET

- TARGET ($V_{TAR} = 510$ KTS)
- MIG-21f-13 ($V_{INT} = 650$ KTS)
- MIG-21f-13 ($V_{INT} = 810$ KTS)

FIGURE 27

[REDACTED]

In summary, at high altitudes and when attacking highly maneuverable targets, the tactical capabilities of the MiG-21f-13 decrease because of the reduction in possibility of striking the target upon attack, or because of disruption of the attack. To execute a successful attack under these conditions, it is necessary to begin the attack with zero angle-off the tail with a considerable speed excess over the target.

DISENGAGEMENT OF THE MiG-21f-13 FROM ATTACK

The attack can be disrupted as a result of destruction of the target, expenditure of ammunition, impossibility of maintaining sighting conditions, and because of dangerous closeness with the target.

When pulling out from the attack, the interceptor approaches the target to the minimum distance which represents a definite danger due to the risk of colliding with the target, coming into contact with its fragments, being hit by the defensive fire of the target, or the possibility of colliding with its own rockets or their fragments.

Of all possible maneuvers for breaking off from after launching the rockets, it is most important to examine the conditions for pull-out after launch at less than minimum range from the target. Taking into consideration that the minimum range for rocket launching is considerably greater than for cannon firing, it should be assumed that the disengagement conditions for the MiG-21f-13, after having launched its rockets, are much safer than during cannon firing. Therefore, this will be discussed later in much greater detail when covering breaking off from attacks when using cannons and unguided rockets.

The safety of the MiG-21f-13, from being struck by fragments of its own rockets, is assured first of all by the fact that the rocket is armed only after launching and after having traveled a considerable distance. This distant fuzing of the rocket determines the minimum distance at which it may explode - at least 1640 feet from the launching aircraft. Detonation of the rocket at such a distance fully guarantees that the interceptor will not be struck by fragments during the rocket's rectilinear flight. The greatest danger of the interceptor encountering fragments of its own rockets occurs during a sharp turn away by the interceptor after rocket firing at close range and at low altitudes. However, calculations and gunnery practice with guided rockets show that in this case, the probability

~~SECRET~~

of the interceptor being hit by fragments of its own rockets is negligible. There is also very little probability of the interceptor encountering the rocket body.

To guarantee activation of the fuze and detonation of the rocket near the target when the time of arming the fuze is somewhat increased, and also to prevent instances of the interceptor aircraft being struck by its rockets or rocket fragments, the minimum distance for launching has been established as 3280 feet. A signal light comes on indicating to the pilot when this range is reached.

When cannons and unguided rockets are used in an aerial engagement, it is necessary to fire from as short a range as possible and with maximum fire duration in order to increase the fire effectiveness. Thus, the entire attack by MiG-21f-13 aircraft using cannons and unguided rockets takes place in the zone of defensive target fire.

Modern enemy bombers may carry from two to four cannons of the M-39 type (caliber 20 mm, cyclic rate of fire 1500 rounds per minute — aircraft B-47 and B-52) or one rapid-fire cannon of the "Vulcan" type (caliber 20 mm, cyclic rate of fire 6000 rounds per minute — B-58 aircraft). Based on the capabilities of the tail turrets and radar-aiming systems of the enemy aircraft, the zone of cannon-fire application is limited to an initial range of about 4900 feet and a side angle of 15-30°. In this way, the MiG-21f-13 can be fired upon both during the attack (up to 3 bursts) and while pulling away from the attack. Therefore, the possibilities of the interceptor being hit during the attack and while pulling away will be discussed separately.

The probability of the interceptor being hit during the attack at ranges of more than 3300 feet is relatively low (.05-.17). As the range decreases, the probability of being hit increases and reaches maximum when the interceptor ceases firing and pulls away from attack, not having destroyed the target.

The MiG-21f-13 may break off the attack at various distances and turn away from the bomber in any direction. The maneuver most frequently applied is a lateral turn with a descent as this gives the interceptor a chance to quickly get away from the zone of possible fire from the tail turret.

The time for pulling out of the firing zone of a B-47 or B-52 bomber depends to a large extent on the angular turning velocity of the interceptor.

~~SECRET~~

For example, when the turn begins at a distance of 2000 feet with an angular velocity of 3 degrees per second, the interceptor will be out of the firing zone of a B-47 bomber in 6 seconds, and with an angular turning velocity of 7 degrees per second, it will be out of the zone in 4.7 seconds; i.e., in the first case the interceptor remains in the zone of fire for 1.3 seconds longer.

As the MiG-21f-13 flies through the firing zone, the B-47 or B-52 will usually be able to fire at least a 1, but no more than a 2-second volley. The B-58 can fire only a 1-second burst (the B-58 firing zone is approximately 15° relative to the axis of the bomber).

The probability of an interceptor being hit by 1- or 2-second bursts while pulling out from attack is shown in Table III.

TABLE III
Probability of an Interceptor Being Hit During Pull-Out

Angular Velocity Interceptor ~ Deg/Sec	Distance When Pull-out from Attack Begins ~ (Feet)	N=50 rps B-47		N=100 rps B-52 or B-58	
		1 Volley	2 Volley	1 Volley	2 Volley
3	2000	0.25	0.43	0.40	0.64
4	2000	0.20	0.36	0.35	0.53
3	1500	0.30	0.51	0.45	0.70
4	1500	0.22	0.39	0.38	0.62

The table shows that the probability of hitting an interceptor pulling out from attack is sufficiently great; constituting .20-.30% when fired upon by a B-47, and .30-.40% when fired upon by a B-52 or B-58.

In order to reduce the effectiveness of enemy fire, it is necessary to increase the rate of target approach and to try to destroy the target before getting into close range (less than 1600-1900 feet). For this, it is necessary to make maximum use of the initial section of the attack, open fire immediately after acquiring a firing position ($D \approx 5,000$ feet), and continue firing in volleys of 1-1.5 seconds until the target is destroyed.

Additionally, the interceptor must execute the break-away maneuver energetically with a maximum increase in angular velocity, thus making it difficult for the bombers to conduct their fire.

Table IV illustrates the probabilities of the interceptor being hit during the period of one attack at various rates of approach and initial ranges of break-off from the attack.

TABLE IV
Probability of an Interceptor Being Hit During One Complete Attack

Pullout Distance ~ (ft)	Overtake Velocity ~ (kts) →	Fire from B-52 or B-58 type Aircraft				Fire from B-47 type Aircraft			
		55	80	110	160	55	80	110	160
2600		0.42	0.34	0.27	0.10	0.25	0.19	0.15	0.11
2000		0.54	0.44	0.36	0.26	0.34	0.26	0.21	0.16
1500		0.68	0.58	0.48	0.35	0.45	0.36	0.27	0.21

The data in the table shows that with the increase in rate of approach from 55 to 160 knots, the probability of being hit decreases by almost one-half.

AREA OF POSSIBLE COLLISIONS WITH TARGET

Table V gives the values of safe distances for breaking away from the target when attacking with cannons and unguided rockets. The table uses various target and interceptor speeds at the moment of beginning the break-away from the attack for two altitudes: near ceiling (top number) and at medium and low altitudes (bottom number).

TABLE V
Safe Pull-Out Distance (feet) to Avoid Collision

Velocity Interceptor ~ (kts)	Velocity (target) ~ (kts) →	550	660	750	860
660		<u>2300</u> 1970	Near Ceiling Alt		
860		<u>3440</u> 2960	<u>2300</u> 2140	<u>1180</u> 1150	
970		<u>5580</u> 3780	<u>3440</u> 2960	<u>2300</u> 2140	<u>1250</u> 1215
1080		<u>5640</u> 4600	<u>4600</u> 3930	<u>3440</u> 2960	<u>2140</u> 2100

It can be seen from the table that when the interceptor has a speed superiority of 215 knots over the target, the break-away ranges are from 1150-2300 feet, and at greater rates of approach they increase to 3300-5600 feet. Therefore, in order for the interceptor to have the possibility of firing at the target from effective ranges (4200-2000 feet), the rate of target approach at the time of attack should not exceed 160 knots.

RECOMMENDED PILOT ACTIONS FOR BREAKING AWAY FROM ATTACK

The break-away from the attack should be executed so as to pass through the zone of target fire as rapidly as possible.

In breaking away from the attack, the pilot should take into consideration the position of the sun in relation to the target.

Ordinarily when sighting through the ASP-5nd sight at the moment firing is completed, the angle-off the target is usually very small, and the interceptor draws closer to the target with no appreciable bank. In such cases, the break-away can be made in any direction.

If the break-away begins before the interceptor has come up directly on the tail of the target, it is advisable to maneuver without changing bank, i.e., to break-away in the same direction from which the attack began. In all instances, regardless of the direction of break-away from attack, the maneuver should be done rapidly with considerable angular velocity. In the process of maneuvering, it may be advisable to slip the aircraft in order to make enemy aiming more difficult.

If there is sufficient altitude, the break-away from an attack executed from behind and above should be made by passing under the target. This maneuver decreases the effectiveness of the defensive fire and enables the interceptor to make a repeated attack from below. If there is insufficient altitude for passing under the target, then the break-away should be made by turning away from the target.

In some instances, it may be advantageous for the interceptor to break-away by passing over the target. Although there is more danger of being hit at the beginning of the maneuver, the overall duration of defensive fire will be less, for the interceptor will have a very high angular velocity and should pass close over the target.

~~SECRET~~

The upward pull-out from attack can be used only with a sufficient surplus of speed and engine thrust, otherwise the interceptor risks losing speed before it leaves the zone of enemy defensive fire. Under equal basic conditions, a break-away upward will always take more time to complete than break-away downward.

The break-away from a climbing attack should be made by pulling the aircraft into an energetic zoom with bank of up to 90°.

The above mentioned recommendations are also applicable to group attacks. However, in a group attack, the break-away requires coordinated action from all pilots in the group. The group leader must warn his pilots in advance of the forthcoming maneuver. The break-aways are executed simultaneously at a command from the leader.

When conducting an attack on a horizontal plane close to ceiling altitude, the interceptor will emerge on the tail of the target and consequently in respect to safety, the break-away may be made either to the right or left. For making repeated attacks near ceiling altitude, the break-away maneuver of the interceptor can be made only with small banks of 15-20° and minimum speeds (270 knots). In favorable situations, which may allow repeated attacks on the target, the interceptor should never lose its speed surplus nor delay the beginning of the turn toward the target. If the interceptor has surplus speed at the end of the attack, in order not to overshoot the target, it should turn away at an angle of 15-20° with a gain in altitude.

In a horizontal attack against a defensively-armed bomber, the firing should be completed and the break-away begun within a range of 1500-2000 feet.

EVALUATION OF THE TACTICAL EFFECTIVENESS OF THE MiG-21f-13

In this section the expected results are given for certain frequent cases of aerial engagement by MiG-21f-13 aircraft employing R-3S rockets, cannons and unguided rockets against enemy bombers and tactical fighters.

The probability of a MiG-21f-13 being able to reach a rocket attack position depends on interceptor performance and the flight characteristics of its armament, the target maneuvers and the accuracy of the GCI system. The greater the GCI accuracy, the more probable is the entry to the attack position. The conditions

~~SECRET~~

for optimum GCI vectoring occur when the target flies in a straight line. The calculated vectored TCA, the flight altitude (its affect on the maneuverability of the interceptor), the ratio of interceptor-target speeds and the range of target detection by the pilot all have great effect on the interceptor reaching attack position.

Figure 28 shows the effect of the calculated TCA and range of target detection on the probability of reaching attack position employing GCI guidance. Assuming that the range of target detection does not depend on the angle of sighting the target, then the probability of reaching the attack position attains maximum value when the interceptor is guided directly onto the tail, and the probability increases with the increase in target detection (range of visual visibility). As may be seen in Figure 28, the probability of reaching attack position at a target detection range of 2.7 NM under the discussed conditions does not reach even 0.5. This is explained by the large excess of speed. When the speed superiority of the interceptor is reduced, the probability of entering attack increases.

PROBABILITY

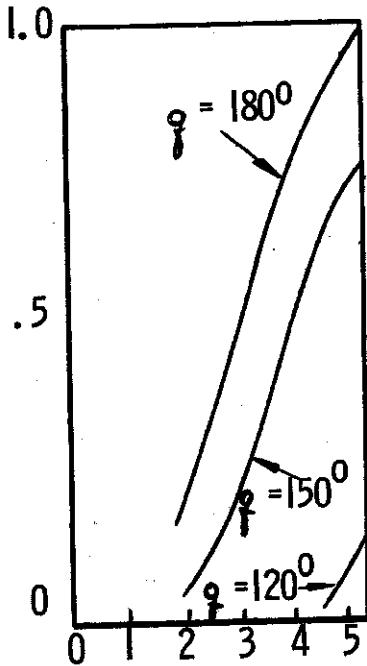

DETECTION RANGE - N. M.
PROBABILITY OF ENTERING INTO ATTACK.
ALT = 33,000 FT, INT VEL = 975 KTS, TAR VEL - 550 KTS,

$\sigma_v = 10^\circ$, $\phi =$ SIGHTING ANGLE TO THE TARGET

FIGURE 28

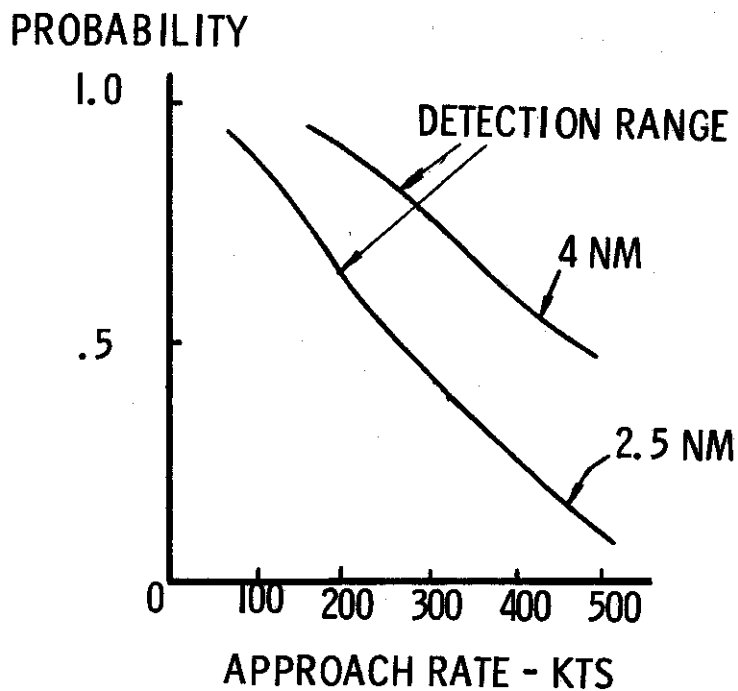

PROBABILITY OF ENTERING INTO
ATTACK ALT = 33,000 FT,
 $\sigma = 10^{\circ}$, $\phi = 150^{\circ}$

FIGURE 29

Figure 29 shows the probability of an interceptor reaching attack position. As may be seen, the probability exceeds 0.9 at an overtake rate of 55-160 knots and target-detection range of 2.7-3.3 NM. Hence, to increase the probability of a Mi G-21f-13 reaching attack position, the interceptor must be vectored directly into the target's tail with a speed excess of 100-160 knots. At medium altitudes under these conditions, an attack probability close to 1.0 can be achieved.

An important peculiarity of the MiG-21f-13 is the substantial reduction (by approximately 1-1/2 times) in target detection range when looking through the armored glass. In consideration of this, it is advisable that the interceptor be vectored so that the target detection will take place basically through the unarmored portion of the side glass.

~~SECRET~~

In this way, the MiG-21f-13 can be vectored toward maneuvering targets at altitudes where the zone of possible attack is sufficiently large (altitudes up to 40,000-43,000 feet), at approach rates up to 325-375 knots. When intercepting at altitudes above 46,000-49,000 feet, the necessity of vectoring at any angle-off the tail other than zero requires the guidance of the interceptor at an altitude lower than the target in order to increase its maneuverability during vectoring.

When the approach rate is over 375-430 knots, it is advisable that the vectoring be made with a zero TCA and from an increased range (up to 4.3-5.4 nautical miles). The conclusion of the vectoring must be made with accurate control and the direction of target search should be given continuously.

The arrival of the interceptor with any angle off the tail other than zero reduces the probability of making the attack if the target detects the interceptor at the time of approach and begins a maneuver toward the interceptor. The probability of making the attack decreases proportionately, the tighter the target makes the maneuver.

Figure 30 shows the effect of target maneuvering on the probability of the interceptor entering into attack, depending on the distance at which the target begins maneuvering. This maneuvering effect shows that the approach should be made unobserved in order to emerge at rocket launching distance before the target detects the interceptor and begins its defensive maneuver.

R-3S ATTACK EFFECTIVENESS

Attack effectiveness is evaluated by determining the probability of striking (destroying) the target. The probability of hitting a single target when firing R-3S rockets depends on the following basic factors:

- accuracy of guiding the rocket to the target;
- conditions of rocket-target encounter;
- zones of activation of the proximity fuze;
- type of target and nature of its mobility;
- reliability of rocket apparatus and control system under tactical conditions.

~~SECRET~~

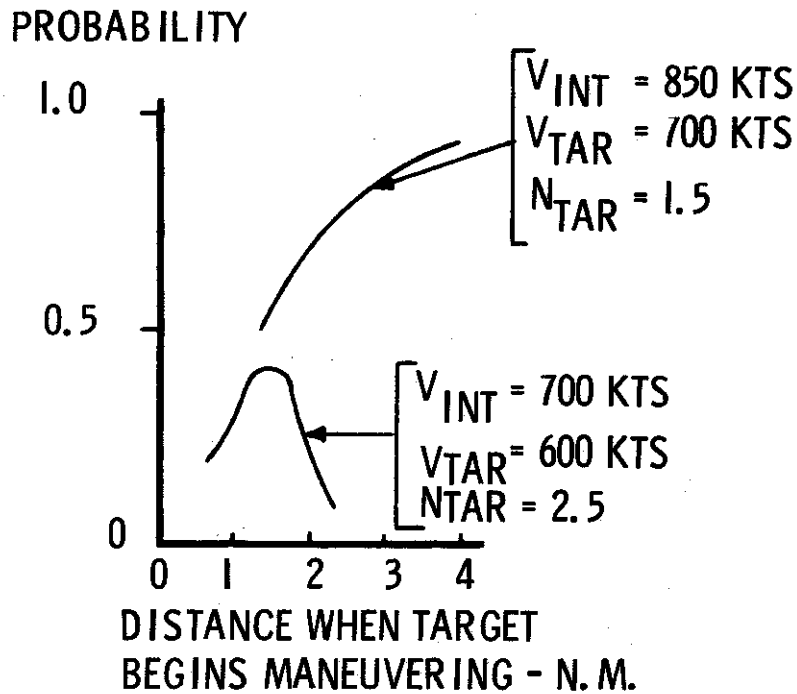

PROBABILITY OF ENTERING INTO ATTACK
AGAINST A MANEUVERING TARGET

FIGURE 30

It should be pointed out that self-guided rockets with TGS (heat-seeking, self guidance head), including the R-3S rocket, are noted for their high guidance accuracy. There are frequent cases of the rocket actually exploding in the tail pipe of the target. The guidance accuracy of the R-3S rocket does not depend on the target's dimensions.

The conditions of an R-3S rocket-target encounter and the zone of activation of the optical proximity fuze depend considerably on the magnitude and ratio of interceptor-target speeds, and on the altitude, range and angle-off during launching. The lower the rate of rocket-target encounter, the smaller the radius of activation of rocket-target encounter, the smaller the radius of activation of the proximity fuze. At the same time, there is an increase in miss rate due to deterioration of rocket controlability. Because of these two factors, with the reduction in rate of rocket-target encounter, the probability of hitting the target decreases.

The possibility of hitting the target when firing from a specific distance also decreases with a lowering of rocket launching altitude. Other conditions being equal, the probability of hitting the target decreases with an increase in launching distance. The effect of the TCA during rocket launching on the probability of hitting the target is insignificant when within the limits of the zone of possible attack.

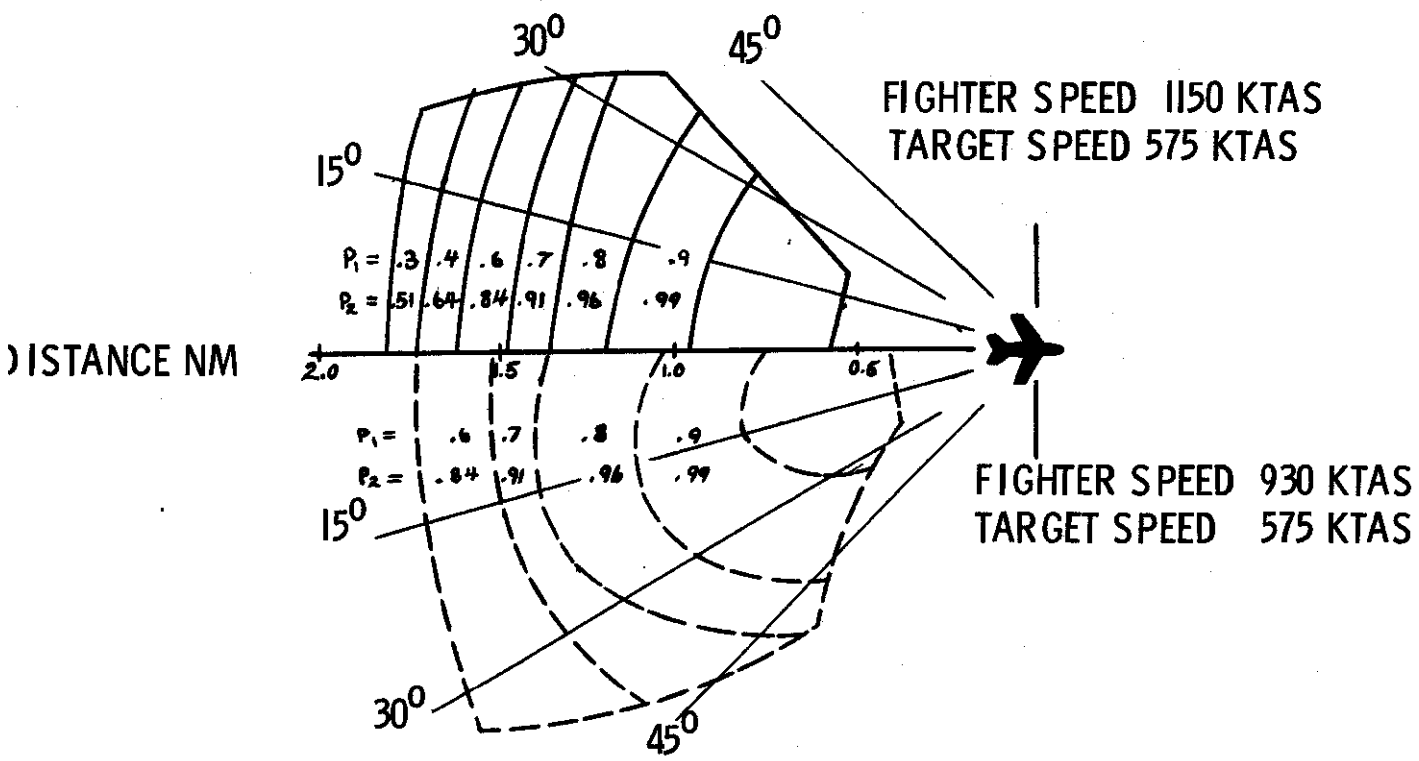

HIT PROBABILITY FOR VARIOUS LAUNCH CONDITIONS:
 ALTITUDE = 33,000 FT; P₁ = PROBABILITY WITH LAUNCH OF ONE R-3S ROCKET; P₂ = PROBABILITY WITH LAUNCH OF TWO R-3S ROCKETS

FIGURE 31

~~SECRET~~

In Figures 31 and 32 are shown the probabilities of striking a medium bomber with R-3S rockets when firing from various points at altitudes of 33,000 and 49,000 feet and at various interceptor-target speeds (P_1 - probability of striking the target with one rocket, P_2 - probability with two rockets, i.e., full complement of R-3S rockets on board the MiG-21f-13). The data in Figures 31 and 32 are given on the basis of calculations made by the rocket manufacturers.

An increase in rocket-launching altitude results in a smaller drop in rocket velocity and gives a reduction in the dependence of target-hitting probability on the launching distance.

At low altitudes, it is nearly useless to launch rockets at maximum range as the target-striking probability is substantially decreased. When launching at maximum range at altitudes of 13,000 feet down to 6000 feet, the probability of striking a medium bomber with one rocket is not more than 0.2. Consequently, at low altitudes, efforts should be made to launch the rocket from as short a range as possible. This reduced capability makes the destruction of F-104 and F-105 fighter-bombers and other high-speed targets difficult when they resort to afterburner flight.

To attain high target-striking probability at altitudes of 33,000-50,000 feet, rockets should be launched in the closest-to-target half of the available range of distances. At altitudes of more than 50,000 feet, the possible distance of rocket launching has no effect on the probability of striking the target because high probability is assured from any possible distance. This facilitates combat with high-altitude, low-speed targets.

The dependence of attack effectiveness on rocket-launching conditions must be taken into consideration when choosing a particular tactic for the execution of the attack, and the target approach must be based on this consideration.

An evaluation of the effectiveness of the MiG-21f-13 aircraft in tactical flight, armed with R-3S rockets, can be made and be based on the calculations of the probability of entering into attack plus the probability of striking the target during the attack (without consideration of the reliability coefficients). Therefore, the probability of intercepting a B-47 or B-52 type bomber flying at a speed of 485-540 knots at an altitude of 36,000-46,000 feet is 0.90-0.95. The probability of intercepting a B-58

bomber flying at a speed of 810-970 knots at an altitude of 52,000-59,000 feet is 0.75-0.85. The probability of intercepting a tactical fighter of the F-104 or F-105 type at a detection range of 2.7 nautical miles, depending on the maneuvers of the target and visibility conditions, is 0.6-0.8. At a detection range of 1.6 nautical miles, the probability is 0.5-0.7.

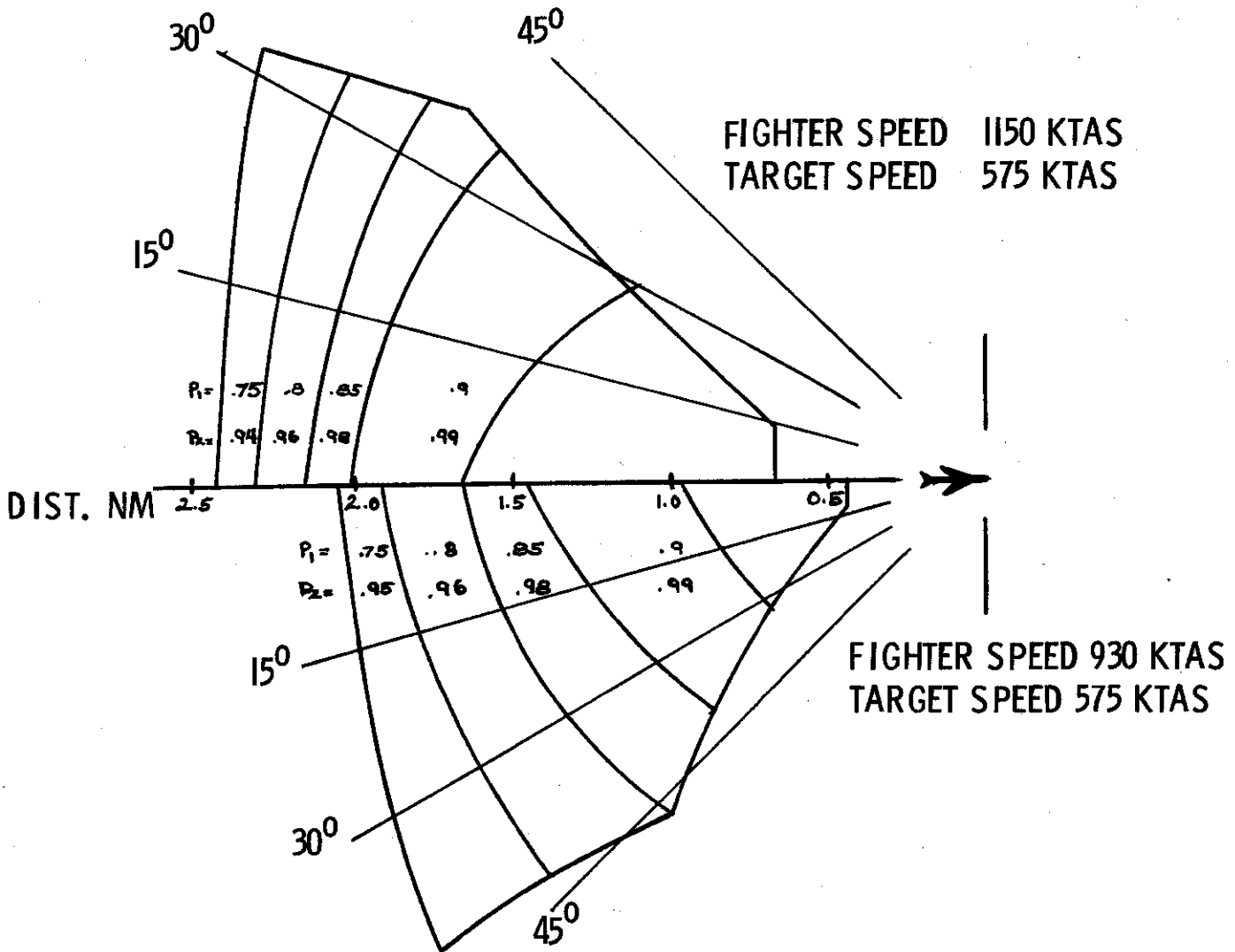

HIT PROBABILITY FOR VARIOUS LAUNCH CONDITIONS
 ALTITUDE = 49000 FT; P₁ = PROBABILITY WITH LAUNCH OF ONE (R-3S ROCKET); P₂ = PROBABILITY WITH LAUNCH OF TWO R-3S ROCKETS

FIGURE 32

In Table VI are given the MiG-21f-13 probability values for entering into attack against B-52 and B-58 bombers with a vectoring distance error, $E_d = 4100$ feet, TCA error $E_d = 3.5^\circ$ and course differential error $E_f = 7.5^\circ$.

TABLE VI

Probability of Entering into Attack Against
A B-52 or B-58 Type Aircraft

Altitude ~ (ft)	Target does not maneuver Calculated Vectoring Point ($q = 130^\circ$)	
	Detection Range 4.1 NM	Detection Range 2.7 NM
49,000	.93	.89
59,000	.72	.69
49,000	Target Maneuvers ($G = 1.5$) Calculated Vectoring Point ($q = 130^\circ$)	
	Detection Range 2.7 NM	Detection Range 3.8 NM
	.73	.82

It may be seen from the table that the probability of entering into attack is greater with proper vectoring, and that a maneuver by the target decreases this probability. The probability of entering into attack is also decreased at altitudes close to ceiling, especially if the vectoring is not quite accurate. To increase the probability of entering into attack, the interceptor should correct the vectoring errors by maneuvering as soon as the error becomes apparent.

PROBABILITY OF STRIKING THE TARGET IN ONE ATTACK

The probability of striking the target in one attack depends on the distance and angle of firing, duration of fire (number of volleys or rocket salvos), type of armament, sighting accuracy, rate of approach and other factors.

In Table VII are given the average probabilities of striking the target in one attack using 2 or 3 volleys, this is without consideration of return fire from the target.

TABLE VII
Probability of Striking a Target with Cannon Fire on one Attack
(No Consideration of Return Fire)

Open Fire Range ~ (ft)	Bomber, B-52 Type	
	Two Volleys	Three Volleys
5300	0.49	0.68
4000	0.60	0.75
2500	0.72	0.86
	Bomber, B-47 Type	
4000	0.63	0.76
2500	0.75	0.88

The table data indicates that the probability of striking the target in one attack can be sufficiently high, and even with defensive fire from the target, may reach 0.7.

The probable effectiveness of the unguided S-5m rocket is given in Table VIII.

Generalized data pertaining to the probability of entering into attack and striking the target on one attack (assuming the cannon and unguided rocket armament systems are completely reliable) show that the possibility of a MiG-21f-13 intercepting a nonmaneuvering medium bomber flying at an altitude of 50,000 feet is 0.65-0.75 when cannon fire is used from a range of 2600 feet. When the target maneuvers, the probability of interception drops to 0.5-0.6, i.e., the armament of the MiG-21f-13 is still sufficiently effective.

~~SECRET~~

TABLE VIII
Probable Effectiveness of Unguided S-5m Rockets

Open Fire Range (ft)	B-47 Type		B-52 Type	
	Number of Rockets on Interceptor			
	16	32	16	32
3300	.24	.34	.31	.43
2500	.30	.40	.33	.45

POSSIBILITIES OF EXECUTING GROUP ATTACKS

Under normal daylight conditions, an aerial group attack by MiG-21f-13 aircraft may be necessary in instances where:

- one aircraft is insufficient for the interception of the target;
- subsequent vectoring of several interceptors is impossible due to insufficient time or deficiency/overload of the GCI system;
- the enemy targets carry effective defensive armament or are protected by fighters.

Effective application of armament in a group attack is attained by proper employment of a tactical formation and its fluidity in an attack where each interceptor is able to conduct aimed fire without interfering with other aircraft.

When executing sequential attacks by units of a group of interceptors, different rocker-launching tactics may be employed, depending on the conditions of the battle.

The selection of a particular tactic depends on the amount of time the interceptor group has at its disposal to use for the attack. This time is determined by the depth of the launching zone and the

~~SECRET~~

rate of interceptor-target approach. In Figure 33 is shown the available time for launching R-3S rockets against fighter aircraft depending on the rate of approach, and in Figure 34, for the case of launching rockets against bombers.

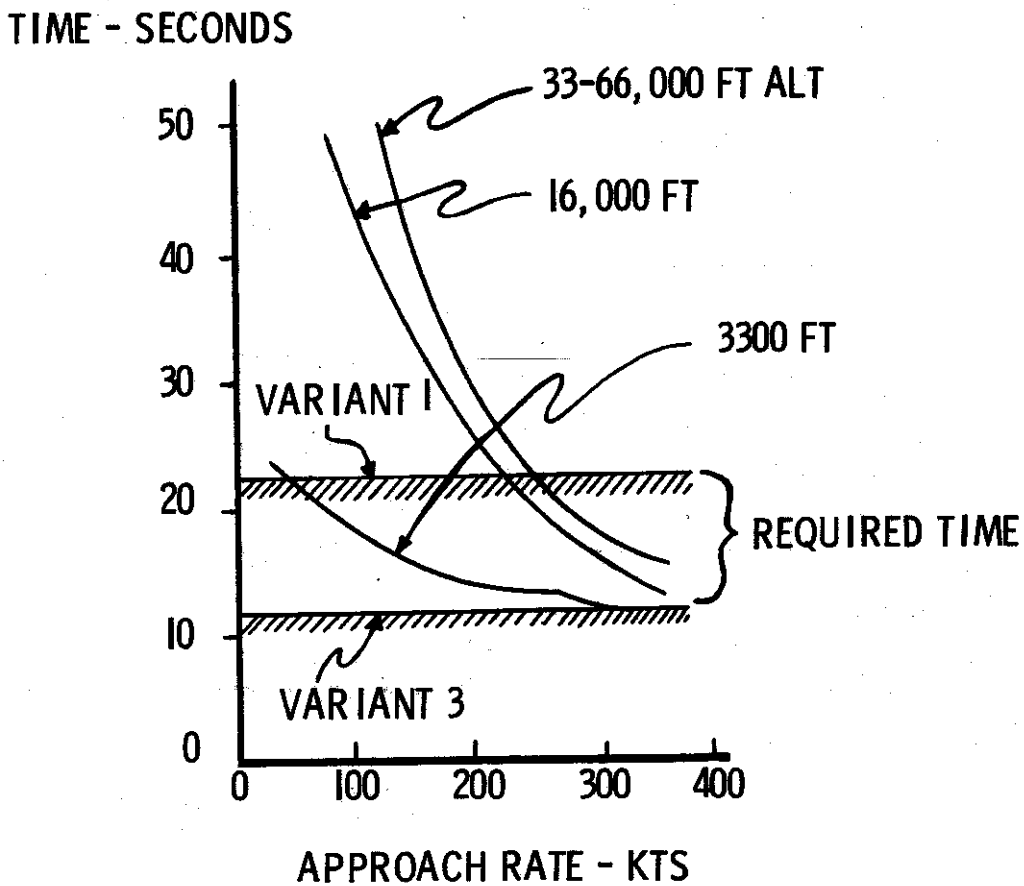

AVAILABLE TIME FOR LAUNCHING ROCKETS BY A PAIR OF FIGHTERS AGAINST FIGHTER TYPE AIRCRAFT. TCA = 15°

FIGURE 33

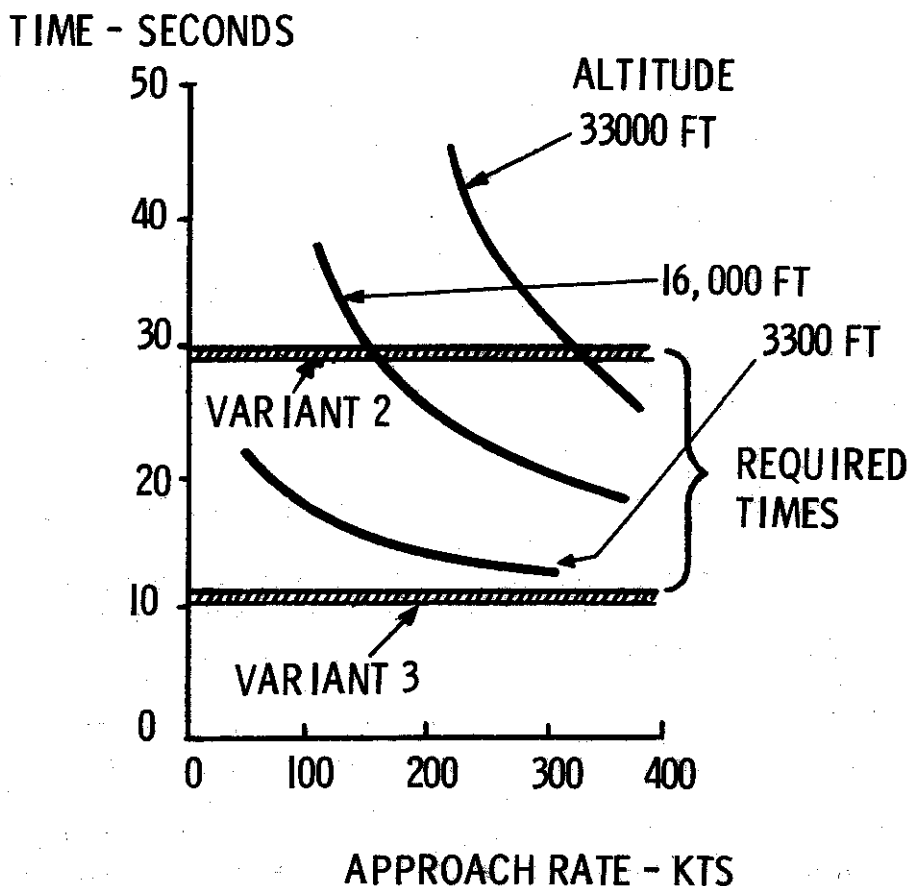

AVAILABLE TIME FOR LAUNCHING ROCKETS
BY A PAIR OF FIGHTERS AGAINST BOMBER TYPE
AIRCRAFT, TCA = 15°

FIGURE 34

In order to evaluate a specific tactic of group attack, it is necessary to determine the time needed for the rocket launching by the selected tactic and to compare it with the time available.

Given below are three typical variants of simultaneous attacks by a pair of MiG-21f-13 aircraft and the time necessary for the launching of rockets.

1. A pair of aircraft using controlled results, launching two rockets each at intervals of 5-6 seconds against an F-100 or F-104 type target, require a launching time of 22 seconds.

~~SECRET~~

2. Launching made analogously by a pair of aircraft against a B-47 type target require 30 seconds.

3. A pair of aircraft launching two rockets each, at intervals of 5-6 seconds without controlled results, require 11 seconds.

In calculating the required time for these variants, the following times were accepted:

- a. time of perfecting the aim - 3 seconds;
- b. time of rocket flight to the target from average distance at medium altitude, for a fighter 7-9 seconds, for a bomber 15-17 seconds;
- c. time of visual control of firing results - 3 seconds;
- d. time interval between each rocket launching - 5-6 seconds, (this eliminates interference by the lead rocket on the heat-seeking guidance head of the following rocket).

In Figures 33 and 34 are given comparisons of the required and available time for attack by the above-mentioned variants.

Such a comparison allows us to determine the possible rates of approach at various altitudes for a group attack. Attack by a pair of interceptors against F-100 or F-104 type aircraft at an altitude of 3300 feet, without controlled firing results, is possible at very high (practically unlimited) rates of approach. If the firing results are controlled, then the attack is possible only at approach rates not exceeding 55 knots, 225 knots, or 270 knots at altitudes of 3300 feet, 16,500 feet or 33,000-65,000 feet respectively.

The above-mentioned limitations in respect to the rate of interceptor target approach should be taken into consideration by pilots when carrying out group attack.

If the approach rates exceed the mentioned values, then when executing simultaneous attacks there may not be enough time for launching all the rockets. Knowing the necessary time for the execution of the attack, it is possible with the aid of graphs (see Figs 33 and 34), to determine the permissible approach rates for other conditions.

In this way, simultaneous attacks by a pair of MiG-21f-13 aircraft can be executed in a wide range of approach rates.

~~SECRET~~

When determining the position of the wingman in tactical pair formation for group attack, it is necessary to consider that the lead interceptor should not come into the beam of the heat-seeking guidance head of the wingman's rockets. Flying into this beam may cause the infrared radiation from the leading interceptor's engine to interfere with the lock-on of the rocket launched by the wingman.

To eliminate this interference, the necessary interval and distance between aircraft is established so that the sighting angle of the wingman to lead will be greater than the angle of deflection of the optical axis of the self-guidance-head, (greater than 28°).

If the conditions for observance of lead by the wingman are right, and under good flying-safety conditions in conjunction with maintaining tactical formation, the recommended formation for the execution of pair attack is the "bearing of the aircraft" formation with an interval between lead and the following aircraft of 650-1300 feet, and a sighting angle to the lead aircraft of 30°-40°.

It is evident from Figures 33 and 34 that with controlled firing results (especially at low altitude), the permissible approach rates are low.

To achieve suddenness of attack and effectiveness of strike, the pair attack should be executed at high approach speeds and with control of rocket-launching results. To accomplish this, it is advisable to execute the attacks in sequence.

When executing a sequential attack, two methods of launching R-3S rockets may take place:

1. Launching of rockets by all aircraft of the group from one distance, i.e., without dispersal in distance of the rocket-launching points;
2. Launching of rockets with dispersal of launching points.

When executing the first method, the necessary distance (D) between interceptors during launching is determined by the formula:
(necessary distance) $D = V(t_{aim} + t_k + t_{lag})$

where V = approach rate to the target;

t_{aim} = time for aiming (5 Sec);

~~SECRET~~

t_k = time of rocket flight and control of the launching results (against a fighter 10-12 sec., against a bomber 18-20 sec.);

t_{lag} = possible lag time in launching the rockets by the following aircraft (3 sec.).

In the second method, the distance between interceptors is determined by the formula:

$$D = V(t_{aim} + t_k + t_{lag}) - D$$

where D - distance of different launch points.

It is clear from the formulas that with an increase in approach rate, an increase will be required in the distance between the interceptors. At an approach rate of 110-160 knots, the required distances between interceptors in attacking a bomber without dispersal of launching points is 4900-8200 feet. When attacking with dispersal of launching points, an echelon-in-depth of interceptors is not needed.

Since it is inadvisable to increase the distance between interceptors to more than 6500-8200 feet, the attack with dispersal of launching points offers the possibility for considerably expanding the range of approach rates within which group attack is realizable.

DEPLOYMENT OF A PAIR OF INTERCEPTORS DURING THE INTERCEPTION OF A MANEUVERING TARGET

When previously discussing aerial engagements with maneuvering targets, it was pointed out that their defensive maneuvers considerably reduced the effectiveness of aerial combat. When an enemy fighter-bomber maneuvers with a G-load of 2-3, the probability of entry into attack does not exceed 0.4-0.5, even under conditions of sudden approach to a distance of 8200-9800 feet. Since enemy aircraft, using information from the ground and "tail protection" type armament, may begin maneuvering from greater distances, the probability of the interceptor entering into attack will be even further reduced.

The effectiveness of intercepting a maneuvering target increases against a maneuvering target, the following order of action is recommended.

The interceptors begin the mission in the "bearing of aircraft" tactical formation which is suitable for searching with the SRD mk radar range-finder in the scan mode. Vectoring commands are given by lead, and the wingman keeps his position in the tactical information.

When approaching the target, due to vectoring errors, the pair may appear either on the right or left of the target. To make it difficult for the enemy to make a proper maneuver against both interceptors, the pair should open up its formation so that one aircraft will be on each side of the target.

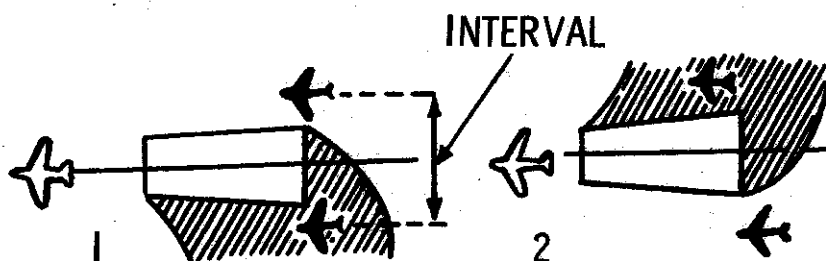

PAIR ATTACK AGAINST A MANEUVERING TARGET

- (1) TARGET MANEUVERS TO THE RIGHT, ATTACK FROM THE LEFT
- (2) TARGET MANEUVERS TO THE LEFT, ATTACK FROM THE RIGHT

FIGURE 35

With such a maneuver and with properly selected intervals, the target can be reliably attacked by one of the interceptors, regardless of the direction of its turn. The distance of the interval between the pair is determined in relation to the vectoring side-errors.

Calculations show that with an interval equal to three RMS (root-mean-square) vectoring errors, there is sufficient guarantee for the following interceptor to be able to cross over to the opposite side of the attack. In Figure 36 are shown the interval values which satisfy the above discussed condition. On the average, when an interceptor is 2.7-3.3 NM distance from the target at the conclusion of the spreading of the formation, the interval will be 5000-8000 feet.

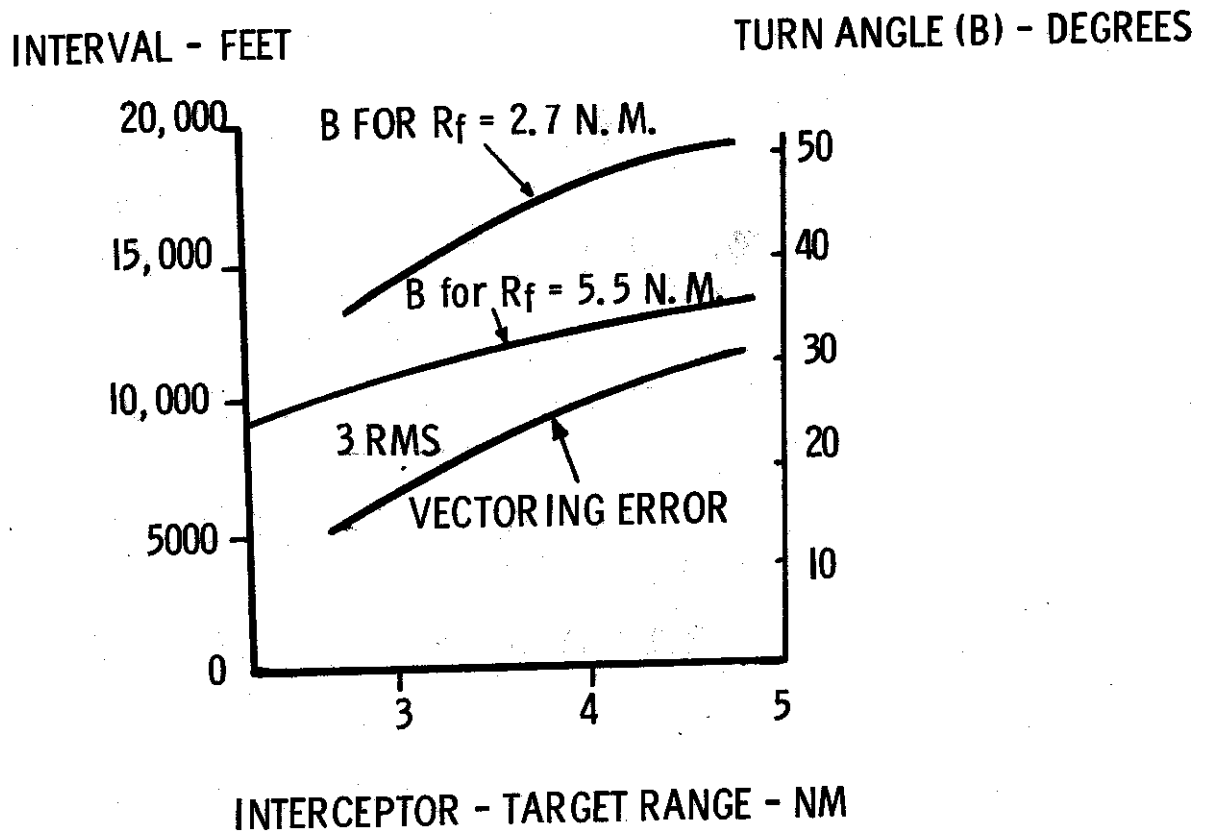

INTERVAL AND ANGLE OF TURN WHEN SPREADING THE FORMATION (R_f = INTERCEPTOR TURN RADIUS)

FIGURE 36

~~SECRET~~

Spreading out to such intervals represents a known difficulty for pilots, for after spreading, the interceptors will be in position similar to the formation known as "front of aircraft", in which mutual observation is hampered. It is advisable to spread out by a standard maneuver, (both interceptors turn in opposite directions using a fixed turn radius through a specific angle of turn, and then turn back the same amount. Figure 36 shows the values of the intervals and turn angles for the execution of this maneuver by the interceptor pair, depending on the distance to the target at the beginning of the maneuver. The graph is plotted by the formula:

$$\cos B = 1 - \frac{I}{2R_f}$$

where I - necessary interval;

R_f - interceptor turn radius during maneuver.

In the graph, the turn angle is determined by the distance and the radius of turn. With an interceptor-to-target range of 3.3 NM and a 5.5 NM radius of turn, the turn angle will be 30°. The pilot must know the turn angles for typical distances for beginning the approach. Commands to begin the maneuver should be given by the GCI controller with consideration of the amount of time needed for the execution of the standard turn.

[REDACTED]

CHAPTER II

TARGET SEARCH AND INTERCEPTION

Target interception can be made by interceptor aircraft from a "strip alert" position and also from a "combat patrol" position. A few generalized features of target interception by the MiG-21f-13 are mentioned below:

- After giving the interceptor the command to cut-in its afterburner, the GCI controller has only a limited capability to correct the flight speed. This is because the pilot has little control over the engine thrust while in afterburner.

- Maneuvering at altitudes of 52,000 - 62,000 feet and above is difficult because of the limiting G-loads.

- Differing from the MiG-17 and MiG-19 horizontal maneuvers for arriving at the rear of the target, which were made after the interceptor had reached an altitude equal to that of the target, the MiG-21f-13 horizontal maneuver should be made at an altitude below the target.

- When an interceptor is being vectored to a target flying at dynamic altitudes, the GCI controller must guide the interceptor into an accurate initial position for a zoom climb as it is often impossible to overtake a target at dynamic altitudes.

- Afterburner flight is extremely limited because of high fuel consumption.

- Since the R-3S rocket may be launched from a relatively long range (2.7 - 3.0 NM), there is less need for accuracy in vectoring the interceptor to the rear of the target and no extended approach time is required.

METHODS OF INTERCEPTION

The basic target-interception method for a front-line fighter with a relatively short flight-duration capability is the method of interception originating from a strip-alert position. This method is used when the interceptor on strip-alert has sufficient time to take off, find, and destroy the airborne target at a given boundary line.

[REDACTED]

Interception from the strip-alert position allows economy in the employment of available aircraft, but intercept possibilities are limited due to the relatively high amount of passive time required and the insufficient range of target detection. When organizing a plan of action for interception from the strip-alert position, special attention must be given to assuring that the aircraft are in a high state of readiness and that time losses are kept to a minimum during all stages of the interception.

To assure that target interception is made at maximum range when the interceptor aircraft are operating from a strip-alert position, it is necessary that:

- the alert aircraft be stationed close to the runways;
- the take-off command is given immediately upon target detection at the radar site;
- the interceptors climb on a direct heading for the intercept;
- the interceptors employ the most suitable maneuvers for appearing on a passing/overtaking course with the target.

Interception from the "combat patrol" position is employed in cases where a strip alert position would not assure timely interception of an aerial target. Combat patrol is the highest degree of interceptor readiness because it reduces to a minimum, both the passive time and the time needed to gain altitude.

Combat patrol is flown by interceptor aircraft in designated patrol zones. The disposition of these zones should assure that the target is intercepted within the zone boundaries. The patrol zones are selected by assuming the direction of possible enemy flights and by the range of radar coverage and GCI control.

The flight altitude in a patrol zone is derived from the anticipated altitude of the expected target. For the interception of low-flying targets under clear air mass conditions, an altitude of 5000 - 6500 feet is designated, and for the interception of targets flying at high altitudes and in the stratosphere, the most suitable altitude is 36,000 feet. This is the altitude (36,000 feet) at which minimum fuel consumption takes place.

An important segment of interceptor control is to vector the interceptor into a tactically suitable position, at a distance of target visibility, either by aircraft radar or visually.

[REDACTED]

Vectoring is done by giving the pilot the flight course, profile, and other instructions.

VECTERING AT MEDIUM, HIGH, AND STRATOSPHERIC ALTITUDES

When intercepting aerial targets at medium and high altitudes (up to 40,000 feet), the GCI controller vectors the interceptor after take-off (or from the patrol zone) on a climb heading to the point for beginning the turn into the rear hemisphere of the target. The interceptor is subsequently vectored to the rear of the target at a range of 1.6 - 2.2 NM. The turn can be flown with a bank of 40° - 45° while in a climb or when level, or if the target is proceeding at a lower altitude, with a descent.

When intercepting slower-flying targets (below 540 knots), after the turn, the afterburner is used to catch up rapidly with the target. When intercepting a high-speed target or one flying in the stratosphere (up to 52,000 feet), the GCI controller should give the command to cut in the afterburner prior to the turn, so the interceptor will have sufficient speed to eliminate having to overtake the target after the turn.

VECTERING WHEN NEAR INTERCEPTOR CEILING

The interception and destruction of targets at altitudes near interceptor ceiling and/or at dynamic altitudes is the most difficult type of MiG-21f-13 tactical maneuver. Attacks at these altitudes are possible only from very small angles off the tail of the target.

When intercepting targets at near-ceiling altitudes, it is necessary to adhere strictly to a pre-established flight program (flight profile, afterburner use, type of maneuver) which will allow the interceptors to fly supersonically to a given point at the target altitude.

The necessity for a definite flight profile is due to the fact that it is very difficult to determine an arbitrary initial point from which to turn in order to arrive in the given hemisphere of the target for each vectoring case. Also, with a definite flight profile, it is impossible to coordinate the climb to altitude with the appearance in a given hemisphere of the target at a given range.

Flight profiles for climbs to near ceiling altitudes can be quite varied as to the various amounts of fuel consumed and time

[REDACTED]

required for altitude gain. With respect to fuel consumption and climbing time there are three profiles which are preferred.

When flying these profiles, the take-off and climb to 33,000 - 36,000 feet can be made with afterburner (Condition I) and also with military power (Condition II).

Profile I (Figures 37 and 38)

- Climb to 33,000 feet at a true airspeed of 510 knots;
- 180° turn with simultaneous acceleration to Mach 1.8 - 1.85 and climb to 42,500 feet;
- Climb to ceiling at constant Mach number.

Profile II (Figures 39 and 40)

- Climb to 33,000 feet at a true airspeed of 510 knots;
- Acceleration to Mach 1.1 and climb to 36,000 feet;
- Acceleration to Mach 1.5 while in level flight;
- 180° turn with simultaneous acceleration to Mach 1.8 - 1.85 with climb to 46,000 feet;
- Climb to ceiling at constant Mach number.

Profile III (Figures 41 and 42)

- Climb to 33,000 feet at a true airspeed of 510 knots;
- Acceleration to Mach 1.1 with climb to 36,000 feet;
- Acceleration to Mach 1.5 in horizontal flight;
- Acceleration to Mach 1.8 - 1.85 with simultaneous climb to 39,000 feet;
- 180° turn at constant Mach 1.8 - 1.85 with climb to 49,000 feet;
- Climb to ceiling at constant Mach number.

Table IX shows the time for climbing to ceiling, the fuel remaining at the point, and the time available for horizontal flight.

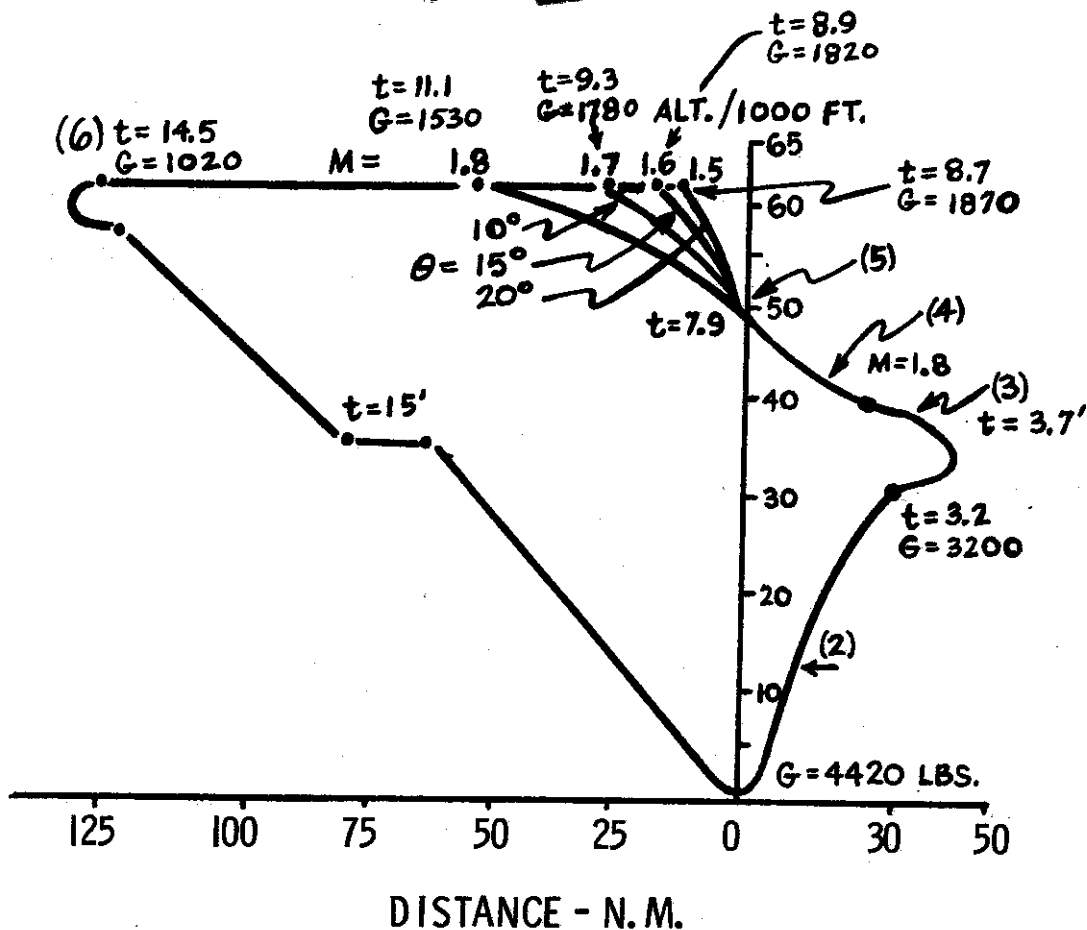

INTERCEPTION BY PROFILE I, FIRST CONDITION

1. CUT IN AFTERBURNER ON THE GROUND
2. CLIMB TO 33,000 FT WITH AFTERBURNER AT SPEED OF 510 KTS.
3. 180° TURN WITH ALTITUDE GAIN FROM 33,000 FT TO 42,000 FT AND ACCELERATION FROM $M=0.9$ TO $M = 1.8$
4. CLIMB AT $M = 1.8$ TO 50,000 FT
5. ZOOM FROM 50,000 FT TO 62,000 FT
6. CUT OFF AFTERBURNER

KEY: G = FUEL REMAINING, LBS

t = TIME, MIN.

θ = PITCH ANGLE, DEG

NOTE: IN THE CALCULATIONS WERE CONSIDERED 4 MIN OF FLIGHT FOR LANDING PATTERN

FIGURE 37

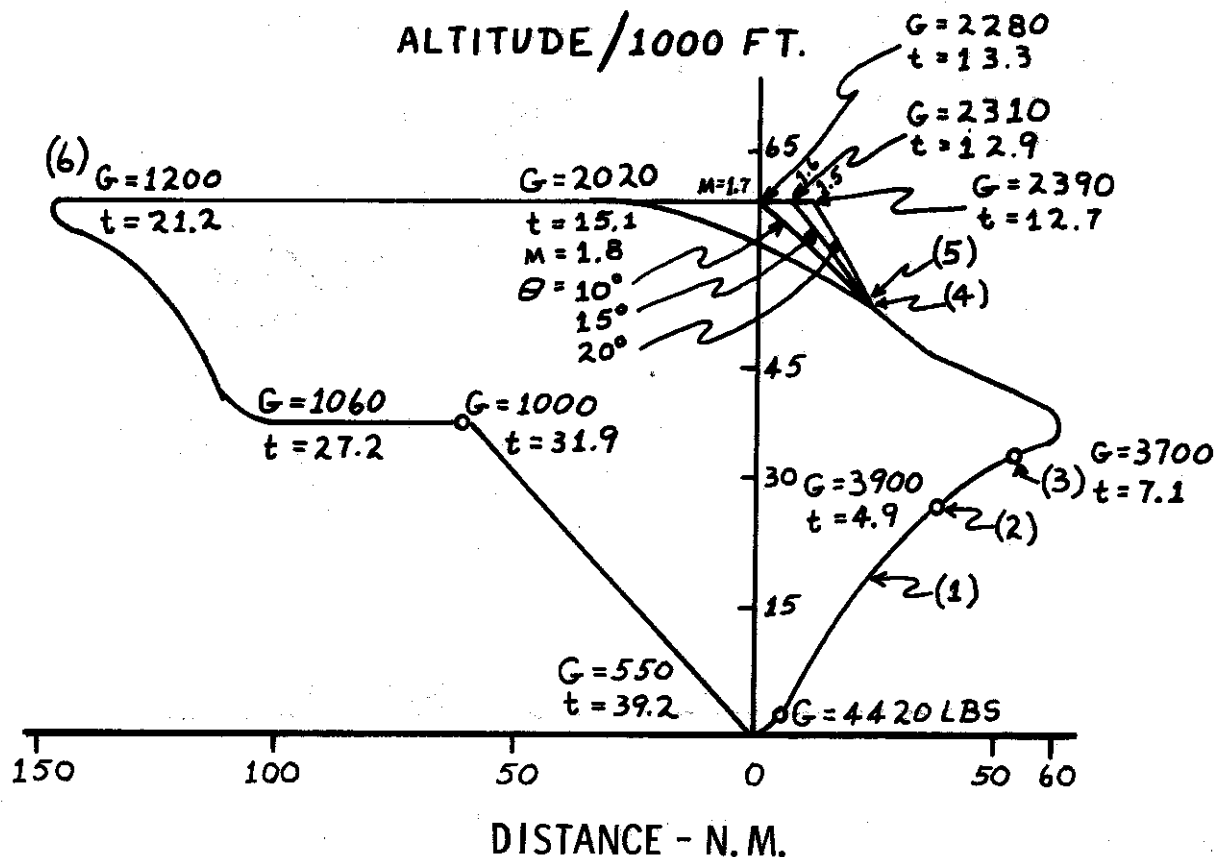

INTERCEPTION BY PROFILE I, SECOND CONDITION

- (1) CLIMB AT MILITARY POWER TO 33,000 FT at 510 KTS
- (2) CUT IN AFTERBURNER
- (3) 180° TURN WITH ALTITUDE GAIN FROM 33,000 TO 42,000 FT AND MACH FROM .0.9 TO 1.8
- (4) CLIMB TO 45,000 FT AT MACH OF 1.8
- (5) ZOOM FROM 45 TO 62,000 FT
- (6) CUT-OFF AFTERBURNER

KEY: G = FUEL REMAINING, LBS

t = TIME, MIN

θ = PITCH ANGLE, DEG

NOTE: IN THE CALCULATIONS 4 MIN OF FLIGHT WERE CONSIDERED FOR THE LANDING PATTERN.

FIGURE 38

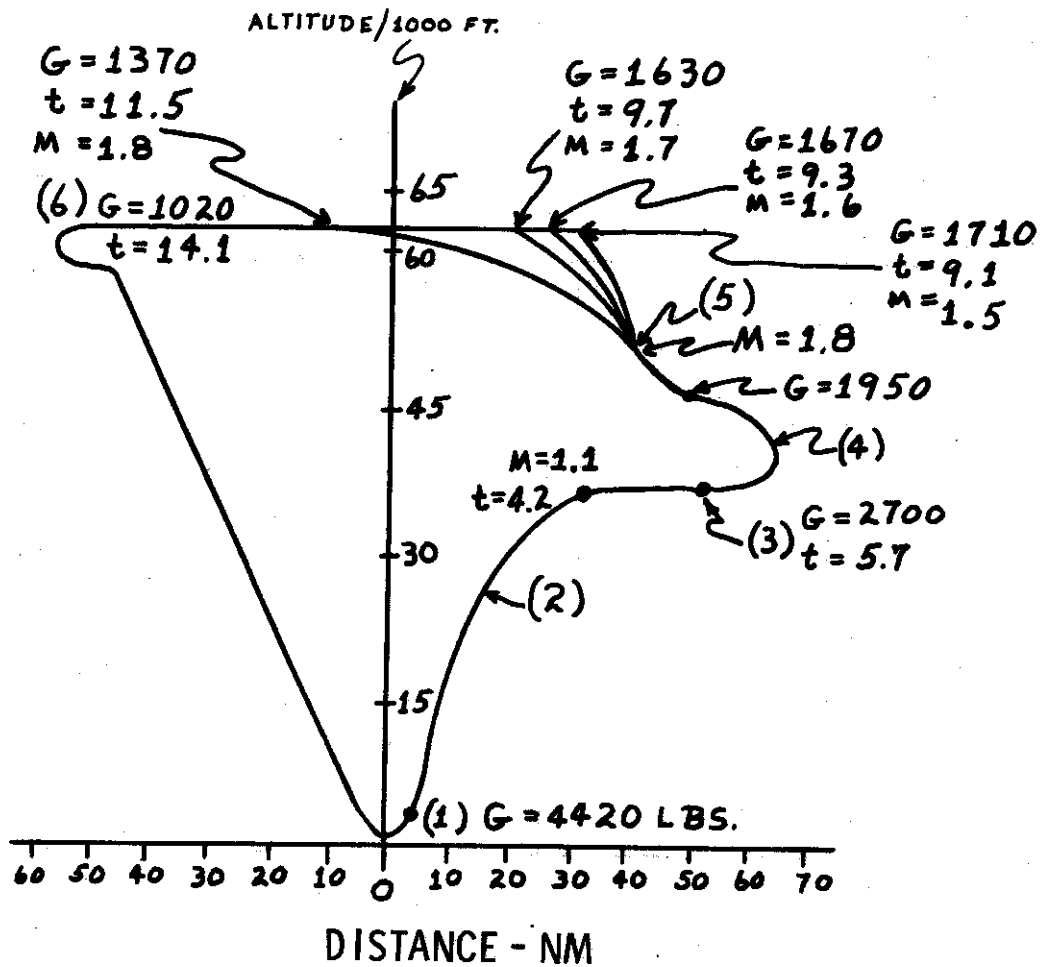

INTERCEPTION BY PROFILE II, FIRST CONDITION

- (1) CUT IN AFTERBURNER ON THE GROUND
- (2) CLIMB TO 33,000 FT WITH AB AT 510 KTS
- (3) 180° TURN WITH ALTITUDE GAIN FROM 33,000 TO 42,000 FT AND ACCELERATION FROM MACH 0.9 TO 1.8
- (4) CLIMB AT 1.8 TO 50,000 FT
- (5) ZOOM FROM 50 TO 62,000 FT
- (6) CUT-OFF AFTERBURNER

KEY: G = FUEL REMAINING, LBS

t = TIME, MIN

O = PITCH ANGLE, DEG'S

NOTE: IN THE CALCULATIONS, 4 MIN OF FLIGHT WERE CONSIDERED FOR THE LANDING PATTERN

FIGURE 39

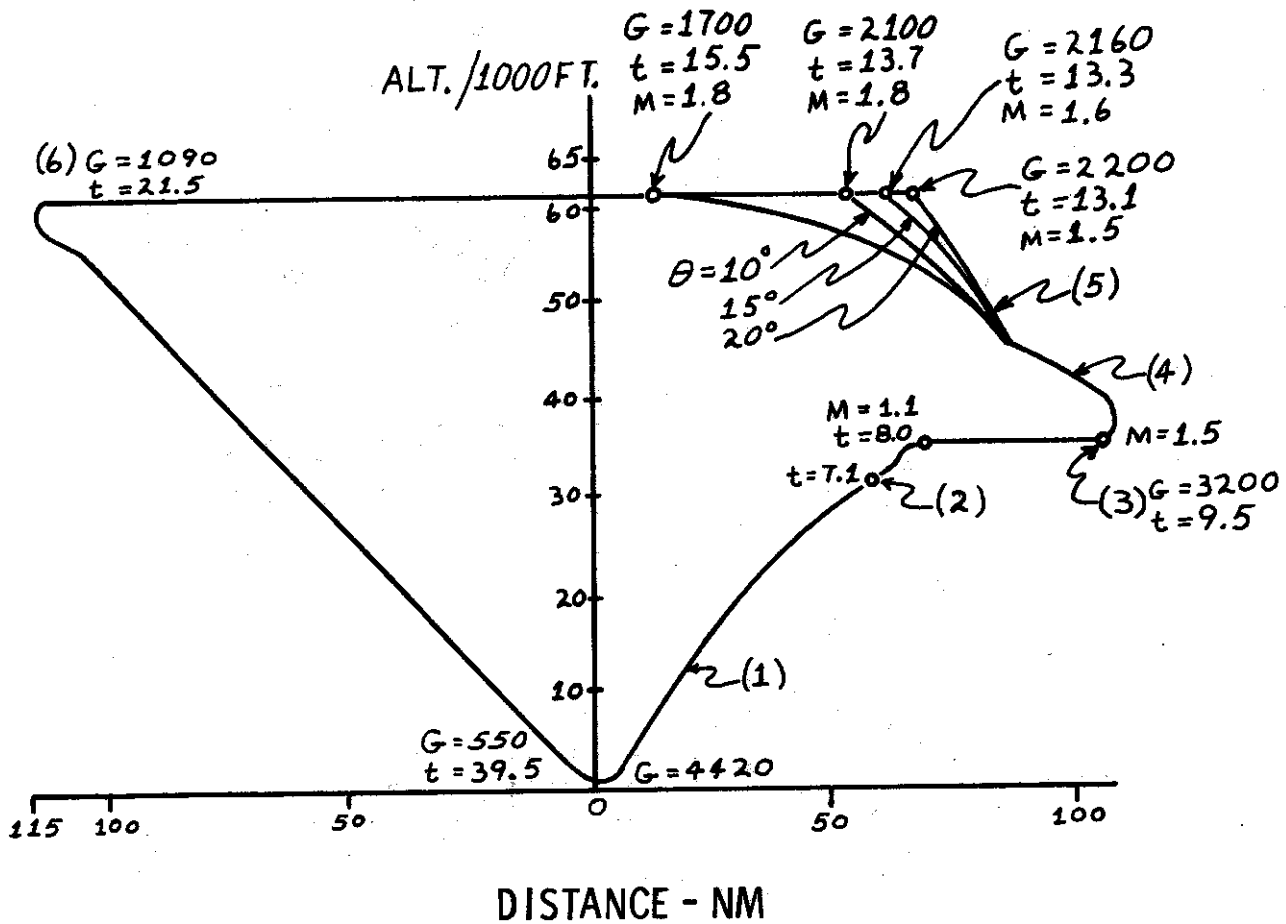

INTERCEPTION BY PROFILE II, SECOND CONDITION

- (1) CLIMB AT MILITARY POWER TO 33,000 FT AT 510 KTS
- (2) CUT IN AFTERBURNER
- (3) 180° TURN, ALTITUDE GAIN FROM 33 TO 42,000 FT, MACH FROM 0.9 TO 1.8
- (4) CLIMB TO 50,000 FT AT 1.8
- (5) ZOOM FROM 50 TO 62,000 FT
- (6) CUT-OFF AFTERBURNER

KEY: SAME AS FIGURE 39

NOTE: SAME AS FIGURE 39

FIGURE 40

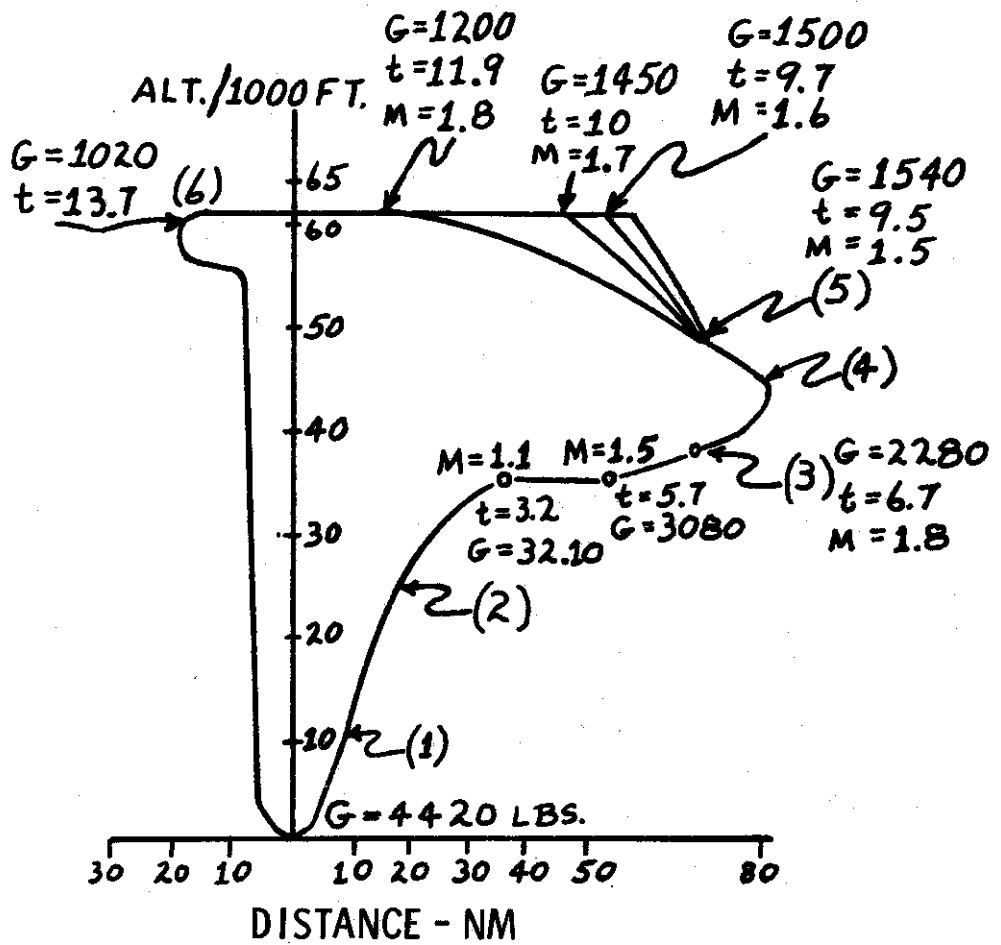

INTERCEPTION BY PROFILE III, FIRST CONDITION

- (1) CUT-IN AFTERBURNER FROM THE GROUND
- (2) CLIMB TO 33,000 FT WITH AB
- (3) 180° TURN, ALTITUDE GAIN TO 42,000, MACH FROM 0.9 TO 1.8
- (4) CLIMB AT 1.8 TO 50,000 FT
- (5) ZOOM TO 62,000 FT
- (6) CUT-OFF AFTERBURNER

KEY: SAME AS FIGURE 39

NOTE: SAME AS FIGURE 39

FIGURE 4I

~~SECRET~~

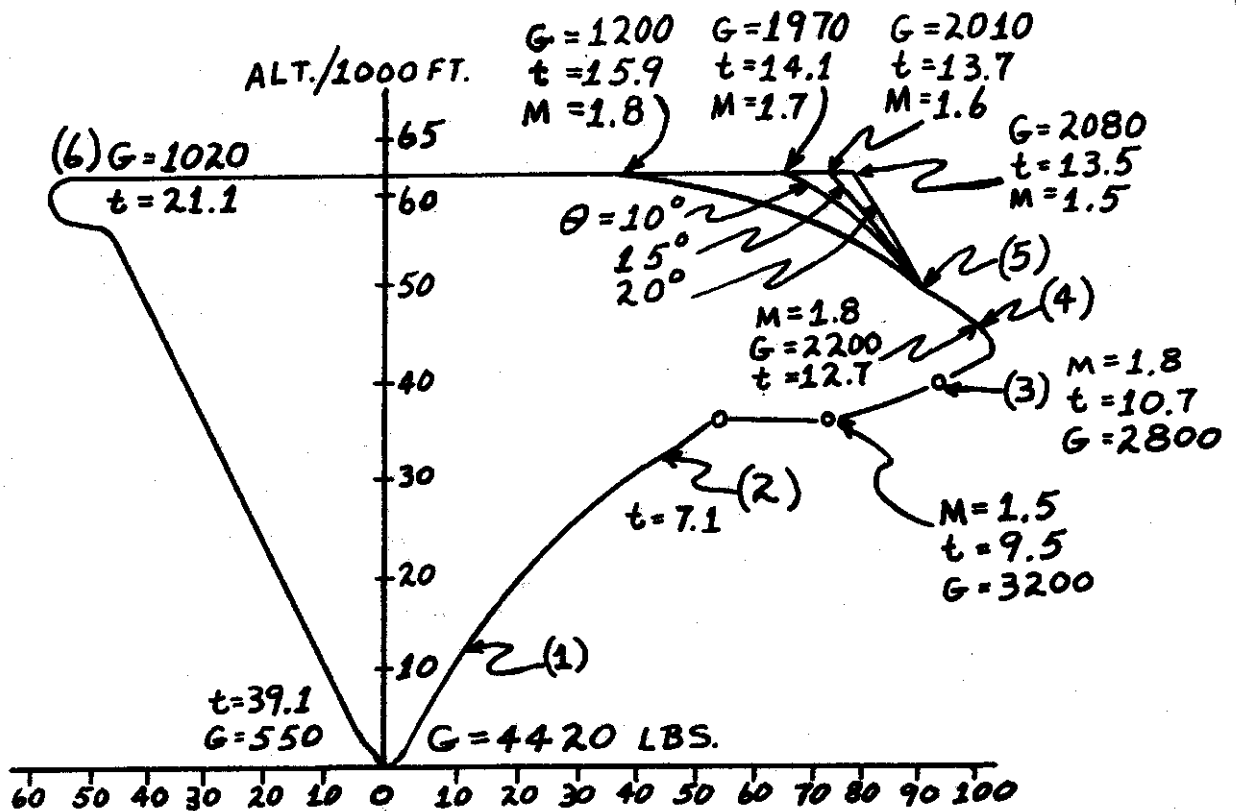

INTERCEPTION BY PROFILE III, SECOND CONDITION

- (1) CLIMB AT MILITARY POWER TO 33,000 AT 510 KTS
- (2) CUT-IN AFTERBURNER
- (3) 180° TURN, GAIN IN ALTITUDE FROM 33 TO 42,000 FT AND MACH FROM 0.9 TO 1.8
- (4) CLIMB AT 1.8 TO 50,000 FT
- (5) ZOOM FROM 50 TO 62,000 FT
- (6) CUT-OFF AB

KEY: SAME AS FIGURE 39

NOTE: SAME AS FIGURE 39

FIGURE 42

~~SECRET~~

~~SECRET~~

The slight differences in climbing time simplify the intercept calculations and allow them to be made by averaging. Additionally, in each of the three profiles, the climb from 50,000 feet after acceleration to Mach 1.8 - 1.85 can be made by zooming, i.e., with a reduction to Mach 1.7 - 1.5.

Table X shows the time required to climb to ceiling, the fuel remaining, and the available time for level flight at the ceiling when the zoom maneuver is used.

Climbing to 33,000 - 36,000 feet - To obtain the most suitable rate of climb, regardless of power setting or afterburner use, the true airspeed should be 510 knots. In the absence of orders from the GCI controller, the climb to 33,000 - 36,000 feet is executed at military power.

The cruise at 33,000 - 36,000 feet is executed at 510 knots until the order to cut-in the afterburner is received from the GCI controller.

At a given point and on a command from the GCI controller, the afterburner is cut in and the aircraft is either accelerated to a given speed or the necessary maneuver is executed.

When it is necessary to make the climb to 33,000 - 36,000 feet in minimum time, the GCI controller may order the take-off and climb to be made with afterburner. Depending on weather conditions, the take-off and initial portion of the climb can be made with military power and the afterburner cut in later on in the climb when ordered by the GCI controller.

Acceleration - The acceleration from Mach 0.9 to Mach 1.8, in relation to the selected flight profile, may be executed in various ways:

- by level flight at 33,000 - 36,000 feet with acceleration to Mach 1.5 and then with climb to 40,000 feet with simultaneous acceleration to Mach 1.8 - 1.85;

- by level flight with acceleration to Mach 1.5 and then a 180° turn with climb to 46,000 feet with acceleration to Mach 1.8 - 1.85;

- by making a 180° turn at 33,000 feet with climb to 43,000 feet and simultaneous acceleration to Mach 1.8.

TABLE IX

MIG-21f-13 CLIMB PROFILES

(Two R-3S Rockets, No External Fuel, Level Off At 62,000 Ft at Mach 1.8)

Profile	1st Condition (A/B During Climb)			2nd Condition (Military Power to 33,000 ft., A/B to Alt)		
	Time of Climb ~ Min.	Fuel Remaining ~ lbs.	Time of Horizontal Flight ~ Min.	Time of Climb ~ Min.	Fuel Remaining ~ lbs.	Horizontal Flight ~ Min.
I	11.1	1530	3.4	15.1	2020	6.1
II	11.5	1370	2.6	15.5	1760	6.0
III	11.9	1200	1.8	15.9	1700	5.2

TABLE X

CLIMB TO 62,000 FEET USING ZOOM MANEUVER

CONDITION	PROFILE	Reduction of Mach to 1.7			Reduction of Mach to 1.6			Reduction of Mach to 1.5		
		Climb Time, Min.	Fuel Remaining Lbs	Horizontal Flight Time, Min	Climb Time, Min	Fuel Remaining Lbs	Horizontal Flight Time, Min	Climb Time, Min.	Fuel Remaining Lbs	Horizontal Flight Time, Min
First	I	9.3	1780	5.3	8.9	1820	6.0	8.7	1870	6.7
	II	9.7	1630	5.3	9.3	1670	6.1	9.1	1710	7.3
	III	10.1	1450	3.4	9.7	1500	3.7	9.5	1540	4.1
Second	I	13.3	2280	8.8	12.9	2310	9.6	12.7	2396	10.8
	II	13.7	2110	8.7	13.3	2160	9.5	13.1	2260	10.5
	III	14.1	1970	8.2	13.7	2010	9.4	13.5	2080	9.8

~~SECRET~~

In addition to the acceleration methods indicated in the profiles, other methods may also be applied:

- by level flight at 33,000 - 36,000 feet with acceleration to Mach 1.8 - 1.85;

- at an altitude of 33,000 feet with gain or loss of altitude of 5,000 - 6,500 feet.

Selection of the acceleration method is made by the GCI controller after considering all circumstances; however, the most suitable method, with respect to acceleration tempo, is to accelerate to Mach 1.5 during level flight at 33,000 - 36,000 feet and then a turn and climb to 43,000 - 46,000 feet while accelerating to Mach 1.8 - 1.85 (Profile II).

Besides the high acceleration tempo in the given case, another advantage is the use of passive turning time for acceleration and altitude gain.

Acceleration in the range of the indicated altitudes is most suitable at the altitude at which the temperature of the outer air is the lowest.

Interceptor pilots should learn the techniques of accelerating the aircraft in a climbing turn during their training flights.

Having went into afterburner on command from the GCI controller, the pilot should report this fact so the controller will be further able to determine the flight profile for the interceptors.

Time, path, and fuel consumption during the acceleration are shown in Figures 43, 44 and 45.

Turns - Turns to arrive in the rear hemisphere of the target should be made at altitudes of not more than 50,000 feet. At higher altitudes there is a considerable increase in the radii and time of turning, plus, the possibility of correcting any vectoring errors decreases.

Turning the aircraft to a course toward the rear of the target should begin at an altitude between 26,000 - 39,000 feet, with the consideration that having completed a 180° turn, the interceptor will be at an altitude of 43,000 - 50,000 feet with a Mach of 1.8 - 1.85.

~~SECRET~~

TIME - SECONDS

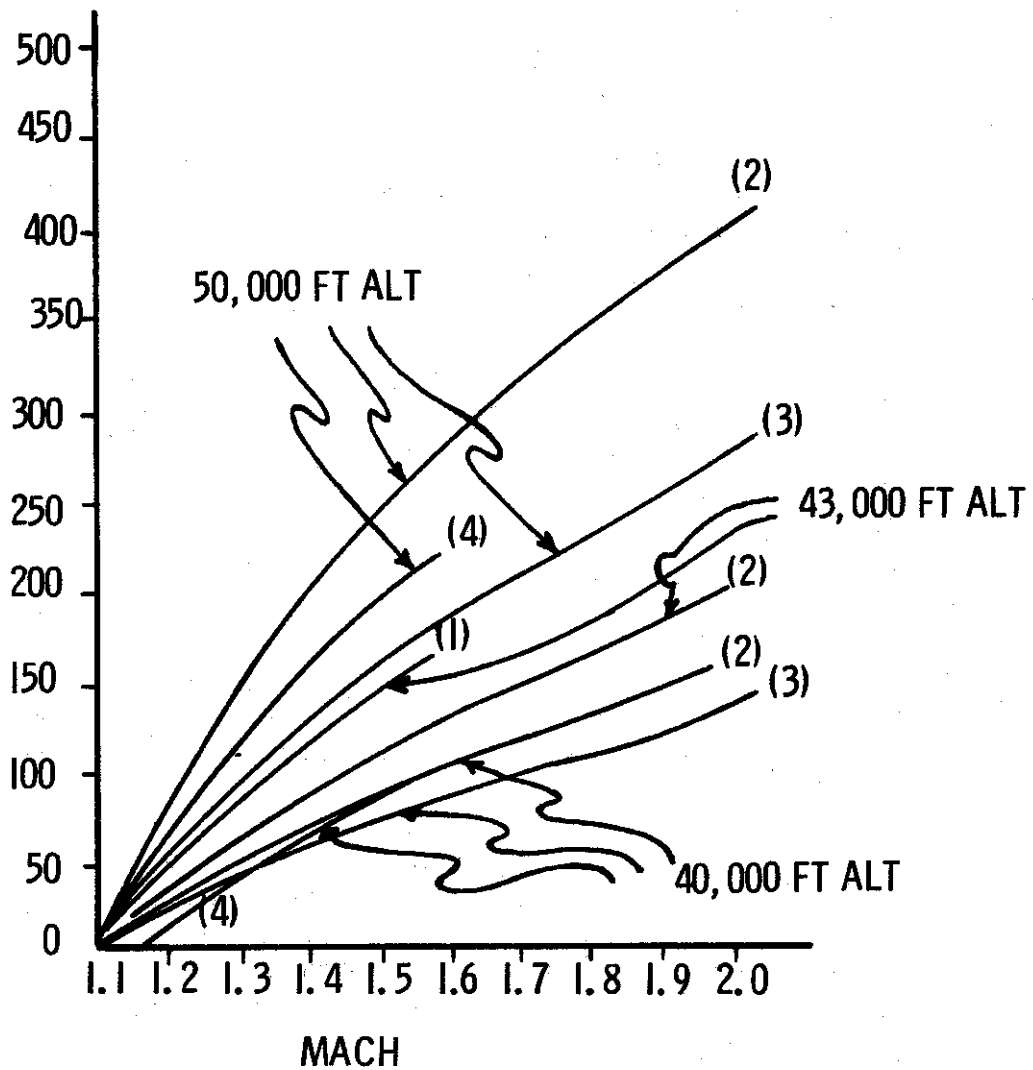

AIRCRAFT ACCELERATION - TIME GRAPH, WITH AFTERBURNER

KEY:

- (1) WITH R-35 ROCKETS AND DROP TANKS
- (2) ROCKETS ONLY
- (3) WITHOUT ROCKETS OR DROP TANKS
- (4) WITH DROP TANKS ONLY

FIGURE 43

DISTANCE - N. M.

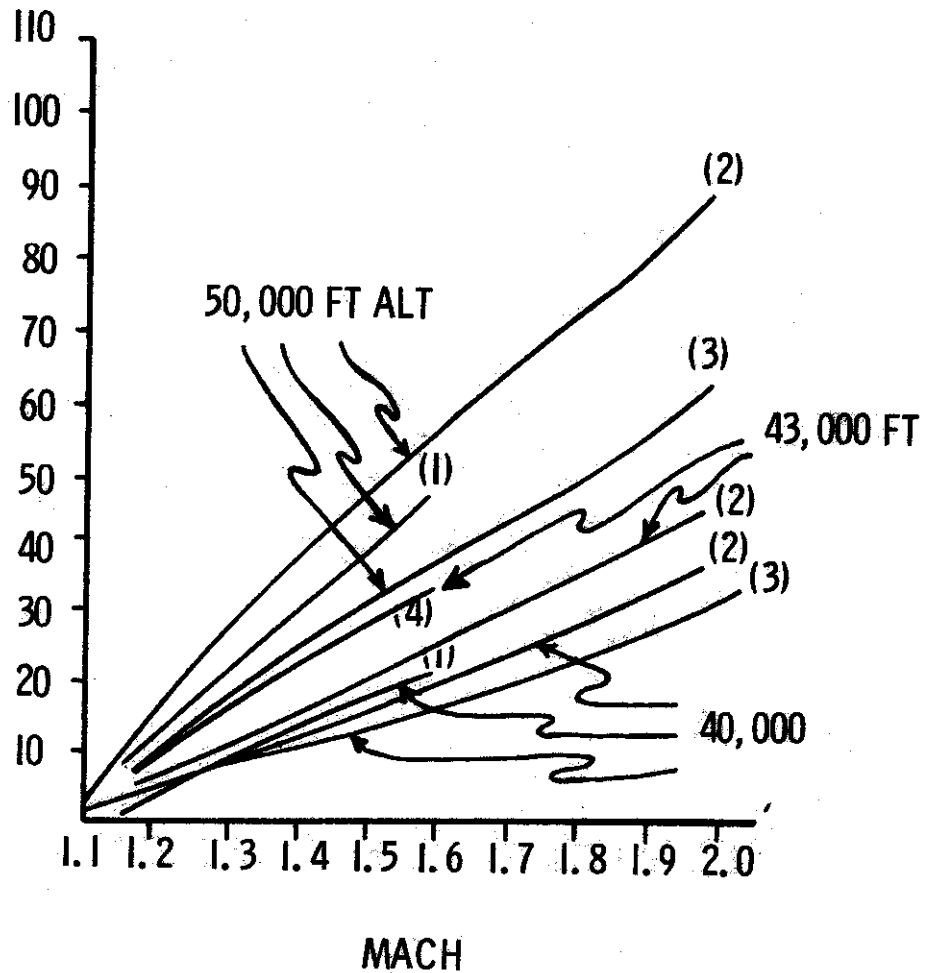

DISTANCE DURING ACCELERATION WITH FULL AFTERBURNER

KEY:

- (1) DROP TANKS ONLY
- (2) R-35 ROCKETS ONLY
- (3) WITHOUT ROCKETS OR DROP TANKS
- (4) WITH ROCKETS AND DROP TANKS

FIGURE 44

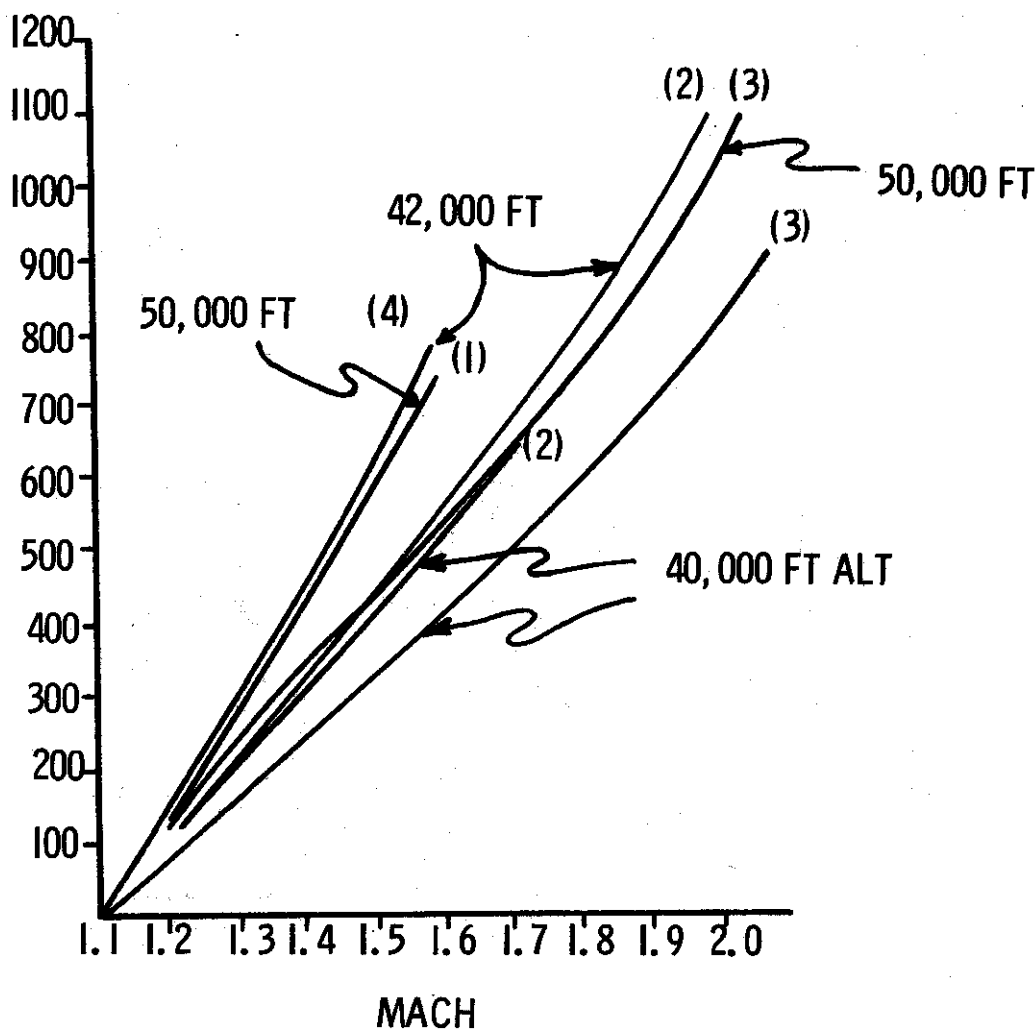

FUEL CONSUMPTION DURING ACCELERATION WITH FULL AFTERBURNER

- (1) WITH DROP TANKS ONLY
- (2) WITH R-35 ROCKETS ONLY
- (3) WITH ROCKETS OR DROP TANKS
- (4) WITH ROCKETS AND DROP TANKS

FIGURE 45

[REDACTED]

The climbing turn with simultaneous acceleration is a difficult maneuver that requires the pilot to adhere to two changing parameters - altitude and Mach number. To execute this maneuver accurately, the pilot must know the increase in Mach number in relation to altitude and the relation of the pitch angle to the speed at the onset of aircraft acceleration.

In Tables XI and XII are given the most pertinent Mach numbers at various altitudes when executing a climbing turn (in Table XI) from 26,000 to 41,000 feet, and (in Table XII) from 33,000 to 43,000 feet. In both instances, the bank during climb should be 30-40°.

When the turn begins at an altitude of 36,000 feet, the bank should be held at 40-50° with a rate of climb of 2700 - 4000 feet/minute. The change in Mach number by altitude is given in Table XIII.

Depending on the circumstances, the GCI controller may order a different profile in which no acceleration during the turn is needed. A climbing 180° turn from an altitude of 40,000 feet to an altitude of 50,000 feet, keeping a constant Mach number (profile III), is executed by maintaining Mach 1.8 and a bank of 50-60° with a G-load of 2. This maneuver presents no difficulty to the pilot. A condition may arise in which the aircraft has to additionally accelerate after making the 180° turn. The additional acceleration should then be made at an altitude of 46,000 feet; however, if the aircraft reaches an altitude of 50,000 feet after the turn, then the additional acceleration should be made with a loss of altitude down to 46,000 feet.

CLIMBING WHILE FOLLOWING THE TARGET

When climbing on a course following the target, the GCI controller and interceptor pilot must work out the problem of reaching the target altitude with an angle-off the target tail of no more than 15°, and when near ceiling altitude, an angle off the tail of no more than 7° when within rocket range.

The altitude gained while following the target can be realized either with constant Mach number (static climb) or with a reduction in Mach number (dynamic climb).

~~SECRET~~

TABLE XI

MACH NO. VS ALTITUDE FOR A CLIMBING TURN FROM 26,000 TO 41,000 FT.

Altitude (Ft)	26,000	30,000	33,000	36,000	39,000	41,000
Mach	0.85	1.10	1.40	1.60	1.75	1.80

NOTE: Bank Angle = 30-40°, Climb Angle on Gyro-Horizon 5-7°, Rate of Climb 4,000-6,000 Ft/Min.

TABLE XII

MACH NO. VS ALTITUDE FOR A CLIMBING TURN FROM 33,000 TO 43,000 FT.

Altitude (Ft)	33,000	34,000	36,000	38,000	39,000	43,000
Mach	0.9	1.1	1.35	1.5	1.7	1.8

NOTE: Angle of Bank = 30-40°, Climb Angle on Gyro-Horizon = 3-4°, Rate of Climb = 1800-2400 Ft/Min.

TABLE XIII

MACH VS ALTITUDE FOR CLIMBING TURN FROM 36,000 TO 46,000 FT.

Altitude (Ft)	36,000	39,000	43,000	46,000
Mach	1.5	1.65	1.75	1.80

NOTE: Angle of Bank = 40-50°, Rate of Climb = 2700-4000 Ft/Min.

[REDACTED]

The best method for gaining altitude with the least amount of fuel and time consumed is the dynamic climb with reduction in Mach number (zoom). During dynamic climb from 50,000 to 62,000 feet, the fuel consumption, in comparison with static climb is decreased by 40-50 gallons and the climbing time is reduced by 1.5 to 2 minutes.

The zoom climb also has several tactical advantages:

- The interceptor can reach target altitude without having to reduce the rate of approach (no need to use speed brakes, reduce rpm or cut out the afterburner);

- the interceptor-target approach and overtake times are reduced, allowing interception to take place at a more distant point;

- the initial distance for beginning the zoom is 4-6 nautical miles, which is equal to the maximum range of visual target detection. Hence, the pilot can detect the target visually prior to putting the aircraft into the zoom, facilitating the execution of the attack.

The speed at near ceiling altitudes must not be less than 240 knots indicated in order to avoid a flameout of the afterburner. The initial distance to the target from the start of the climb will be different for the dynamic and static methods. In the static climb, the time of climbing to 62,000 feet is constant for each initial altitude (Table XIV), and the distance will change in relation to the speed of the target.

Time of zoom climb from 49,000 - 62,000 feet at initial Mach of 1.8 is given in Table XV.

In Table XVI are given the interceptor-to-target distances at the beginning and end of the zoom climb, depending on the speed of the target and the Mach number at the completion of the climb. It is evident from the table that for target speeds in the range of 660 - 920 knots, the initial distance before the zoom can be considered as constant at about 5.5 nautical miles.

Table XVII offers calculated parameters for controlling the precision of the zoom maneuvers.105

T65-0593

[REDACTED]

TABLE XIV

STATIC CLIMB TIMES

Altitude When Climb Begins~(ft)	43,000	46,000	49,000
Time to Climb to 62,000 Ft~(Min)	4.5	3.5	3.0

TABLE XV

ZOOM CLIMB FROM 49,000-62,000 FT.

Mach No. At End of Zoom	Time of Executing Zoom ~ Sec.	Distance Covered During Climb ~ NM	Fuel Consumed ~ lbs.
1.5	46	12	215
1.6	60	16	260
1.7	82	23	300

TABLE XVI

INTERCEPTOR TO TARGET DISTANCES

Target Speed (Kts)	MACH NO. AT COMPLETION OF ZOOM					
	1.7		1.6		1.5	
	DISTANCE, ~NM		DISTANCE, ~NM		DISTANCE, ~NM	
	Begin	End	Begin	End	Begin	End
920-860	5.5	3.3-1.6	4.3	3.3-1.6	2.7	2.7-1.6
810-750	8	3.3-1.6	5.5	2.7-1.1	4.3	2.7-1.6
660-540	10.8	6.5-1.1	8	2.7-1.1	5.5	1.6-0.55

TABLE XVII

ZOOM PARAMETERS TO 62,000 FEET

Altitude ~ Ft Parameters →		49,000	53,000	56,000	59,000	62,000
V _Y =13,800-15,600 Ft/Min	M	1.8	1.76	1.75	1.74	1.72
	N _Y	1.4	1.0	0.8	0.8	1.0
	θ	10	10	8	6	6
V _Y =17,400-19,800 Ft/Min	M	1.8	1.72	1.7	1.68	1.62
	N _Y	1.6	1.0	0.8	0.7	1.0
	θ	13	15	10	7	7
V _Y =21,600-24,000 Ft/Min	M	1.8	1.68	1.63	1.58	1.52
	N _Y	1.8	1.0	0.7	0.6	1.0
	θ	18	20	15	12	8

NOTE: V_Y = Vertical Speed, N_Y = Normal G-Load, θ = Pitch Angle

[REDACTED]

For the execution of a zoom maneuver, the GCI controller informs the interceptor of the desired pitch angle and Mach number at the completion of the zoom. To intercept targets flying at 970 - 1025 knots, the zoom is executed with an initial Mach number of 1.9 - 2.0.

When beginning the zoom, the G-load should not exceed 1.8. A pitch angle of 10 - 15° should be maintained to an altitude of 52,500 - 56,000 feet, after which it is reduced to 5 - 6° and maintained to 62,000 feet as the speed drops to Mach 1.6 and lower.

When zoom climbing, the most serious pilot error is the premature reduction in Mach number. This sharply increases the interceptor-target approach time and may cause excessive fuel consumption and disruption of the attack.

The main cause for premature reduction in Mach number is the sharp introduction of the aircraft into the zoom altitude. If the pilot intends a Mach number reduction, he should obtain the angle of climb smoothly, figuring to arrive at the target altitude at a given Mach number.

If an aircraft arrives at the given altitude with surplus Mach number, it is necessary to continue climbing to reduce the Mach number to the desired amount and then fly the aircraft in horizontal flight.

CLIMBING TO DYNAMIC ALTITUDES

To intercept targets at altitudes exceeding the static ceiling of the interceptor (i.e., at dynamic altitudes) the profiles and flight conditions remain the same as during flight at static ceiling, but the climbing turn is executed only by zooming.

Depending on the altitude and speed of the target, additional acceleration of the interceptor may be needed. If the target is at 65,000 feet with a speed of less than 540 knots, there is no need to accelerate additionally and the execution of the zoom maneuver should begin with Mach 1.8 - 1.85. With a target speed up to 750 knots, it is necessary to accelerate up to Mach 1.9 - 2.0. At target speeds of more than 750 knots and when the target is flying at altitudes above 65,000 feet, additional acceleration should be made to Mach 2.0.

[REDACTED]

In view of the fact that at an altitude of 46,000 - 47,500 feet, the combination of the energy level and the available overloads is the most advantageous, additional acceleration should be made at that altitude. If the interceptor, after turning, arrives at an altitude of 49,000 feet (Profile III) or at 43,000 feet (Profile I), acceleration should be accomplished during the reduction or gain in altitude to 46,000 feet.

In calculating, it may be assumed that the acceleration of the aircraft from Mach 1.8 to Mach 1.9 will be made in a distance of 7.5 NM within 25 seconds, and to Mach 2.0 in 15 NM in 50 seconds.

At a speed of Mach 2.0 the radius of the trajectory when entering the zoom climb is quite high. Consequently the pitch angle is attained near the middle of the ascending branch of the zoom maneuver. Subsequently, the pitch angle begins to decrease, as the zoom climbing trajectory may not have a rectilinear section.

Table XVIII shows the change in Mach number, G-load and pitch angle for different altitudes during a zoom to 79,000 feet.

The speed at the peak of the zoom depends on the pitch angle held when entering the zoom. The greater the angle, the lower the speed and the greater the altitude gained.

MiG-21f-13 speeds for reaching an altitude of 72,000 feet are shown in Figure 46.

The possibility of piloting an aircraft at dynamic altitudes depends on the speed reserve with which it arrived at a given altitude. At dynamic altitudes, the Mach number decreases on an average of 0.15 per minute. The indicated airspeed at these altitudes should be no less than 243 knots because at lower speeds, the afterburner may flameout.

Table XIX shows the maximum time limits for level flight while losing airspeed.

During interception at dynamic altitudes, the GCI controller and the pilot must insure that the distance to the target after reaching the dynamic altitude will make an approach and attack possible without turning toward the target; and that no less than the minimum speed is maintained.

~~SECRET~~

TABLE XVIII

ZOOM PARAMETERS TO 79,000 FEET

Altitude ~ Ft	Mach	G-Load	Pitch Angle ~ Deg.
48,000	2.0	2.5	1
54,000	1.73	2	29
62,000	1.48	1.4	39
72,000	1.2	0.81	42
79,000	0.8	0.3	38

TABLE XIX

MAXIMUM AVAILABLE TIME AT ALTITUDE

ALTITUDE ~ FT. →	66,000					69,000	
Minimum Permissible Mach Number →	1.3					1.4	
Mach Initial	1.8	1.85	1.9	1.95	2.0	1.95	2.0
Mach Conclusion	1.46	1.52	1.57	1.64	1.66	1.54	1.58
Time ~ Sec.	64	88	108	136	144	56	72
Distance ~ NM	16	23	28	32	39	15	19

ALTITUDE 10³ FEET

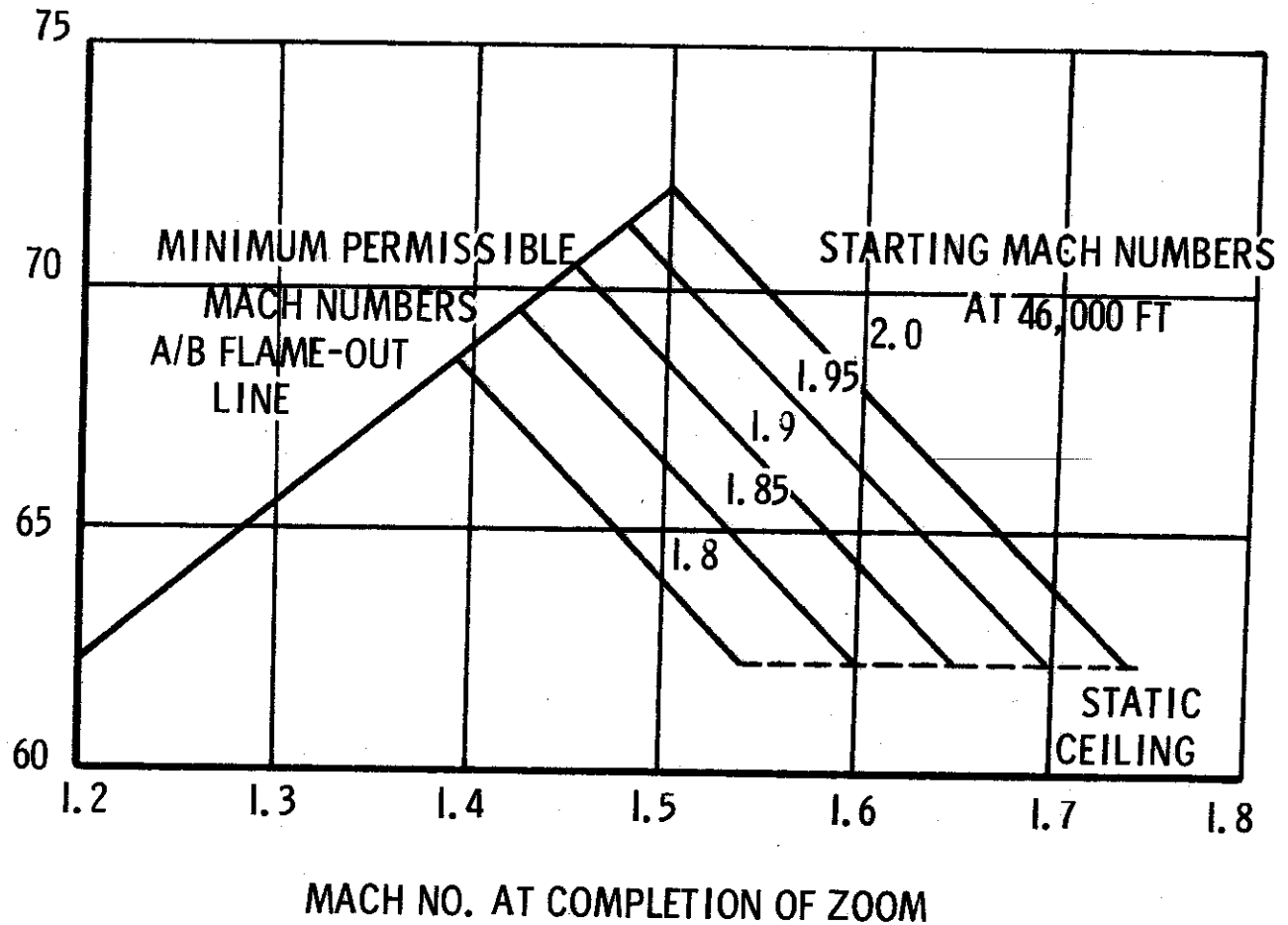

NOTE: THE DIFFERENCE BETWEEN VARIOUS MACH LINES AND FLAME-OUT LINES IS THE SPEED RESERVE

FIGURE 46

~~SECRET~~

The accuracy of the interceptor's arrival, at a given distance from the target during interception at dynamic altitudes, depends basically on the timely command for the zoom maneuver, i.e., accuracy of determining the initial distance.

Figures 47 and 48 show (in relation to target speed) the maximum permissible (solid line) and minimum desirable distances for an interceptor arriving at altitude behind the target.

The minimum permissible speed of the interceptor at an altitude of 69,000 - 72,000 feet is 755 - 810 knots, hence for a target flying at a speed of less than 590 knots at that altitude, an interceptor-target approach at speeds of 160 knots and under is impossible. Therefore, the distance for bringing the interceptor up to target altitude should be in the range from minimum to maximum. For example, if the target is flying at a speed of 700 knots at 66,000 feet and the interceptor arrives at this altitude at Mach 1.57, the maximum distance will be 3.8 NM and the minimum 1.1 NM. For calculations, the GCI controller should take 2.7 NM as the average amount of arrival distance.

Once in the process of climbing by means of the zoom maneuver, little regulating of the climb can be done. Consequently, the necessary arrival distance in the rear hemisphere of the target is regulated by a properly given distance for beginning the zoom. Figures 47 and 48 show the average initial distance for starting the zoom as determined for the following conditions:

- Zoom begins from an altitude of 46,000 feet with an initial pitch angle of 15°;
- time of executing the zoom to 66,000 feet is accepted as 90 seconds, and to 70,000 feet as 105 seconds;
- distance of arrival at target altitude, with a target speed of over 590 knots, is 3300 - 6600 feet less than the maximum permissible.

SELECTING THE CONDITIONS AND FLIGHT PROFILE

The selection of the intercept flight profile and conditions under which the flight is to be executed are made by the GCI controller on the basis of specific information regarding the aerial situation. The selection is basically determined by:

DISTANCE FROM TARGET - N. M.

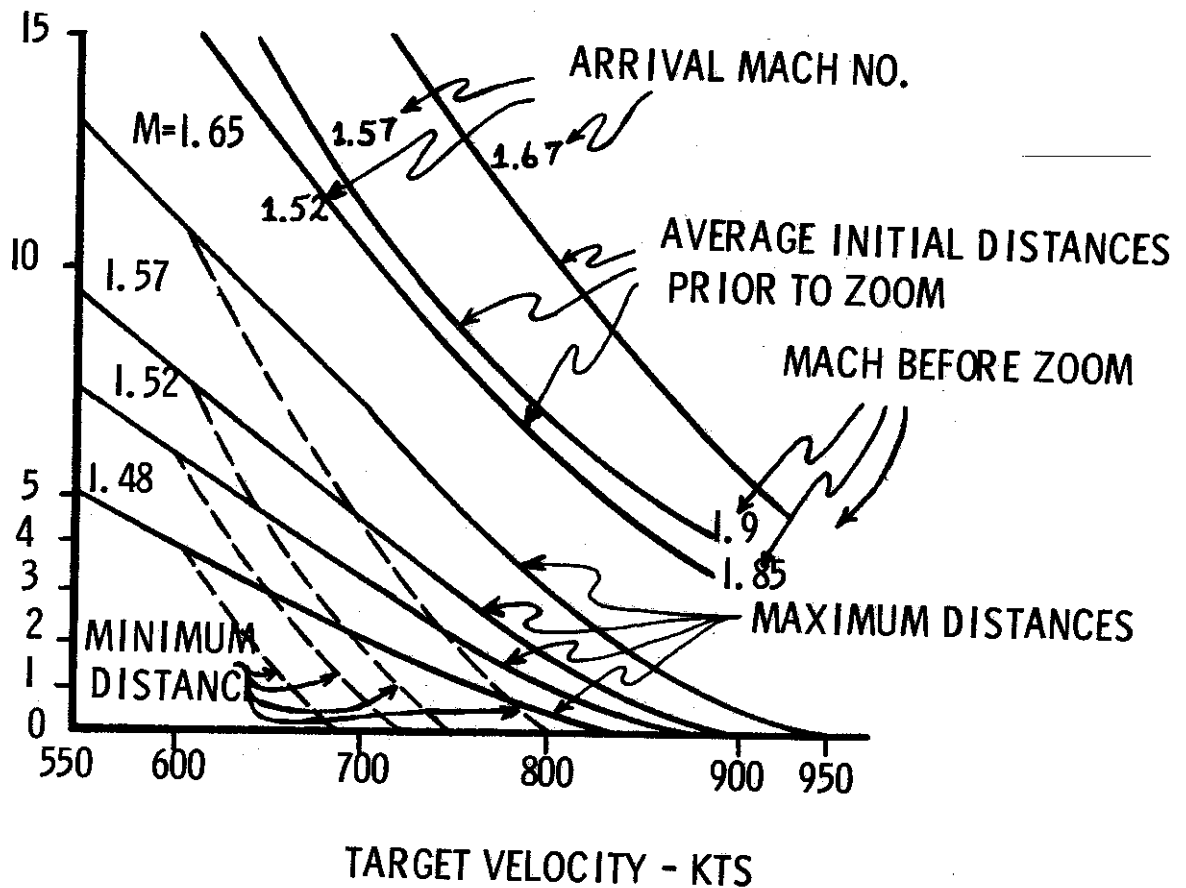

DISTANCES - PRIOR TO ZOOM AND AT CONCLUSION OF ZOOM - AT ALTITUDE OF 66,000 FT AND APPROACH RATE OF 160 KTS

FIGURE 47

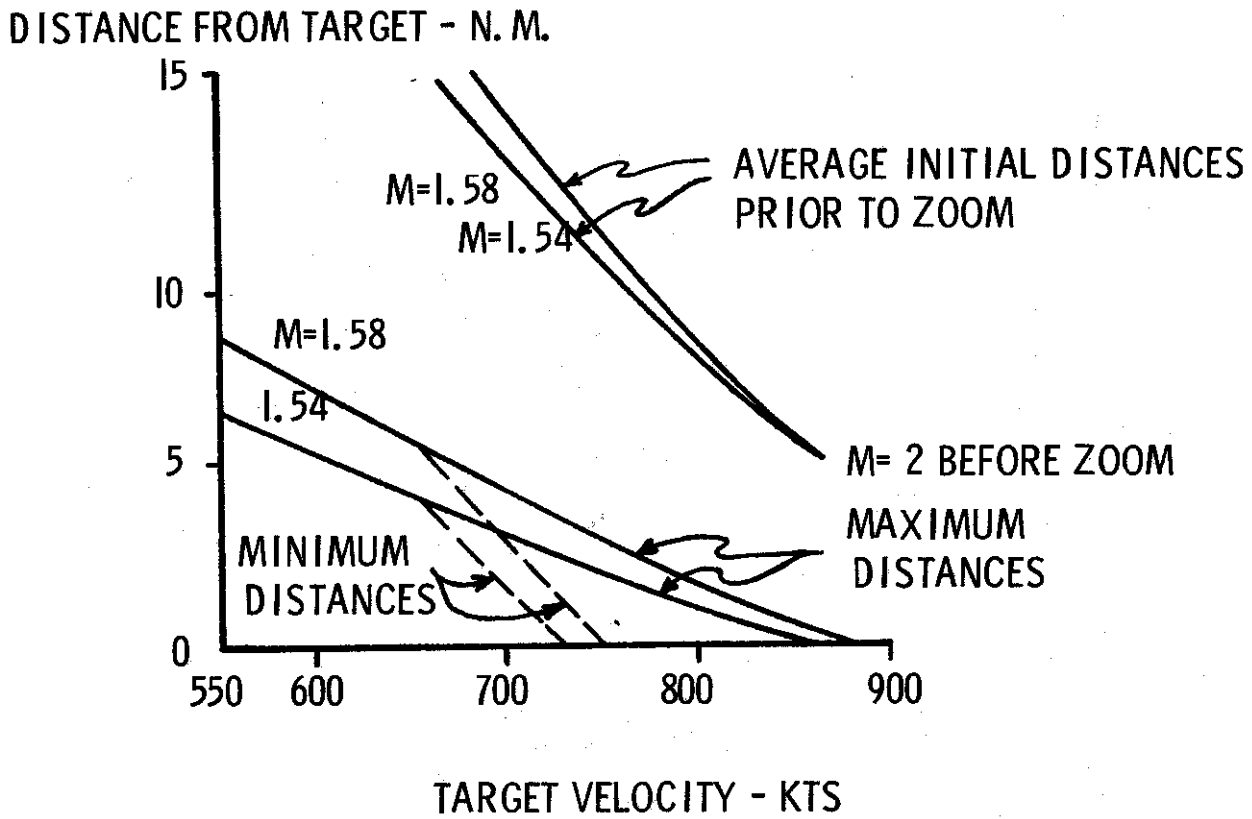

DISTANCES - PRIOR TO ZOOM AND AT COMPLETION OF ZOOM - AT 70,000 FT ALTITUDE

FIGURE 48

~~SECRET~~

- Range of target detection;
- target altitude, speed and course;
- state of interceptor readiness at the airfield or position in the combat patrol zone.

Table XX shows the possible flight profiles (with afterburner) in relation to target speed and altitude (range of detection - 190 nautical miles).

When beginning the interception from the combat patrol zone, it is generally necessary to use Profile III. For interception from the alert position (climb to 33,000 feet with military power) the possible profiles are shown in Table XXI.

Application of Condition II is advisable only when protecting objectives situated deep within tactical formations of friendly troops or when beginning the interception while the target is still at very long range (200 - 300 NM) and also when making interceptor training flights.

VECTERING AT LOW ALTITUDES

Flights against low-flying targets can be made from either the strip-alert position or from the combat-patrol zone. However, because of the short target-detection range at low altitudes and the relatively longer passive time required, take-off from the strip-alert position does not assure destruction of the target before it reaches the front line. Therefore, interception of low-altitude targets is usually made from the combat-patrol zone position.

Patrol zones should be laid out over friendly territory as close as possible to the front line. The best patrol altitude in regard to fuel consumption is 20,000 - 23,000 feet. At these altitudes, the interceptor aircraft are in good radar contact with the ground radar stations and the interceptions can be executed by descending maneuvers (roll-overs and half roll overs).

To assure interception of low-flying targets at maximum range, the patrol zone should be established at a distance of 8 - 11 nautical miles from the front line at an altitude of 5,000 - 6,500 feet. With external tanks and at 85% RPM, flight

~~SECRET~~

~~SECRET~~

TABLE XX

POSSIBLE FLIGHT PROFILES

Possible Profile	Target Speed ~ Kts	Target Altitude ~ Feet
I	970	59 - 62,000
	1025	56 - 62,000
II	700	56 - 62,000
	750-860	43 - 62,000
	970	43 - 59,000
	1025	43 - 56,000
III	485-660	43 - 62,000
	700	43 - 56,000

Note: With afterburner; detection range 190 NM.

TABLE XXI

POSSIBLE PROFILES FROM ALERT POSITION

Possible Profile	Target Speed ~ Kts	Target Altitude ~ Feet
I	700-1025	43 - 62,000
II	485-660	43 - 62,000

~~SECRET~~

at these altitudes can be maintained for 30 - 35 minutes with a subsequent 5 minutes for combat.

The lead into a roll-over type descent is made at an indicated airspeed of 215-325 knots. Figure 49 is a graph showing altitude loss (ΔH) in a roll-over executed at an indicated airspeed of 325 knots with a G-load of 4. For these conditions, the time of executing the roll-over from an altitude of 20,000 feet is 30 - 35 seconds, and the leveling-off altitude is 2,300 feet.

The GCI controller, having given the pilot the heading, guides the interceptor to the point where the maneuver is to begin. At this point, on command, the interceptor executes a roll-over with a pull-out on the course of the target. The moment for giving the command is determined by the distance of starting the maneuver (D_m). When target and interceptor courses are approximately head-on, this distance can be calculated by the formula:

$$D_m = V_{tar} t_{turn} + (V_{tar} + V_{int}) (t_{lag}) - (d)$$

where V_{tar} and V_{int} - target and interceptor velocities respectively;

t_{turn} - time of executing the turn;

t_{lag} - communications lag time (5-10 sec);

d - range of interceptor pull-out at the rear of the target (2.2 NM).

The point of beginning the roll-over is plotted on a line forward of the target and directly on a head-on course with it. Prior to making the roll-over, it is necessary to turn the interceptor approximately 15° to facilitate visual observation of the target.

A transparent overlay is used for determining the interceptor course to the point for beginning the roll-over maneuver (Figure 50). The overlay is plotted on a convenient scale for the all-around radar field of vision. The following values are used: interceptor indicated airspeed of 325 knots (true airspeed 445 knots), altitude of lead-in to the roll-over of 20,000 feet,

LOSS IN ALTITUDE 1000 FEET - (ΔH)

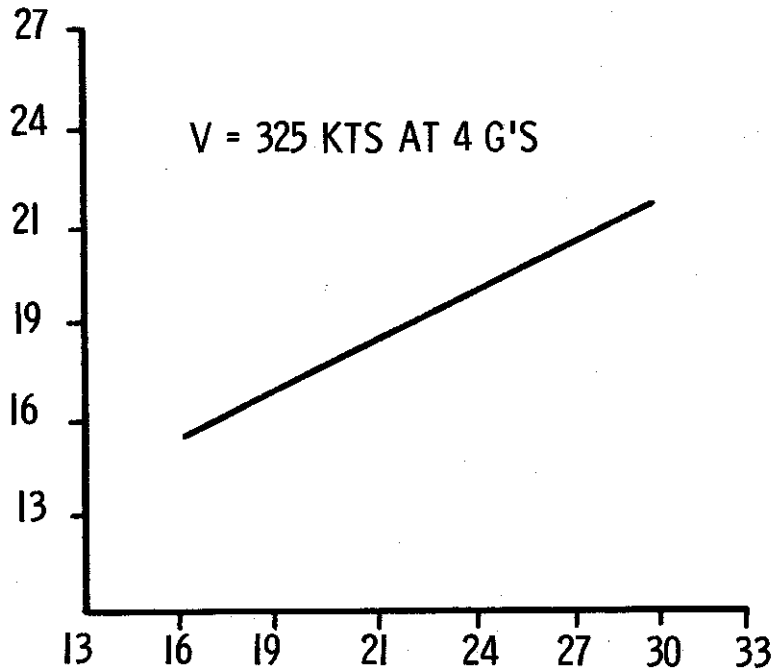

LEAD IN ALTITUDE - 1000 FEET

ALTITUDE LOSS DURING A TURNOVER

FIGURE 49

~~SECRET~~

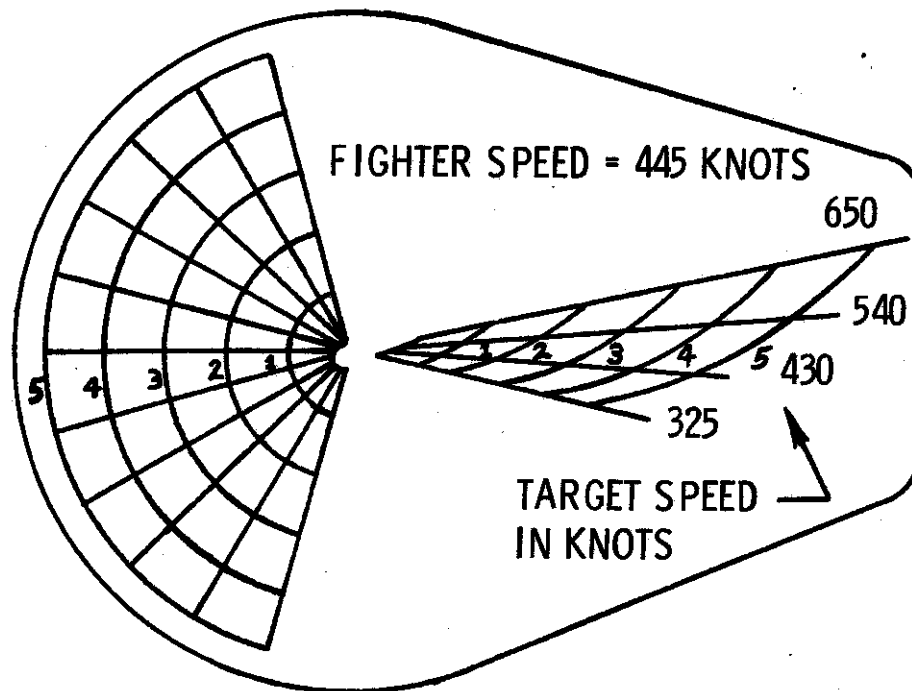

TRANSPARENT OVERLAY USED FOR VECTORING FIGHTERS
AT 20,000 FEET AGAINST LOW FLYING TARGETS

FIGURE 50

~~SECRET~~

[REDACTED]

and target speeds from 325 to 650 knots. On the right side of the figure are plotted lines indicating the target path, and on the left side, the interceptor path. The path lines are divided at one-minute intervals by lines which are numbered beginning with the point where the maneuver begins. These lines indicate the target and interceptor positions at the moment the command to commence the maneuver is to be given (with a communications lag time of 10 seconds).

Since the range of detecting low-flying targets is short and the rate of approach is very high, the GCI controller may not have time to use the overlay. Therefore, he should have sufficient knowledge and experience to be able to determine the vectoring conditions directly from the radar PPI.

When on patrol duty in a zone at an altitude of 5,000 - 6,500 feet, the flight from zone to intercept is executed at maximum speed and at patrol altitude. The turn onto a passing course with the target is also made at the altitude of 5000 - 6500 feet.

The anticipated distance to the point where the turn is begun is determined by considering that the distance to the target after pulling out from the turn should be 1.6 - 2.2 NM.

If the target is flying under the clouds and the patrol area is above (or in) the clouds, vectoring is begun at the patrol altitude (6,500 feet), and descent and cloud penetration is executed while following the target heading. This is the same as making a straight-in descent for landing in inclement weather.

From 6,500 feet down to 3,300 feet the pilot maintains a rate of descent of 3000 feet per minute from 3,300 feet to 2,000 feet, 1800 feet per minute, and from 2,000 feet to target altitude, 600 - 750 feet per minute. The speed should be approximately 485 knots.

To assure descent and pull-out at a given distance from the rear of the target after penetrating through the clouds, the pull-out distance from the turn at 6,500 feet should be established by considering the speed and altitude of the target. As evident from Figure 51, this distance is determined by formula:

$$D_{\text{pull-out}} = S_{\text{des}} + d - V_{\text{target}} t_{\text{des}}$$

where S_{des} and t_{des} are path and time of descent from 6,500 feet to target altitude.

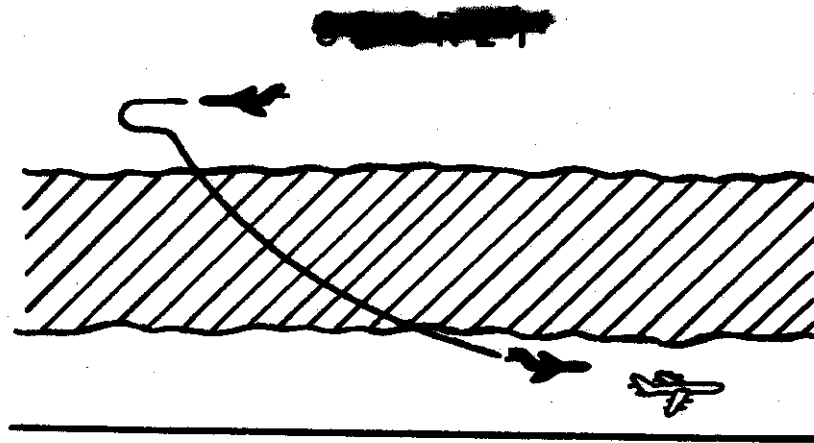

SCHEMATIC OF LOW-ALTITUDE INTERCEPT THROUGH THE CLOUDS

FIGURE 5I

Table XXII gives the values for time and descent path as well as distances of pulling out from the turn when the interceptor speed is 485 knots and $d = 2.2$ NM.

TABLE XXII

DESCENT PARAMETERS WHEN $V_{int} = 485$ Kts and $d = 2.2$ NM

Target Altitude ~ Feet	Time ~ Sec	Descent ~ NM	Pullout Distance (NM) When Target Velocity is:			
			325 Kts	430 Kts	540 Kts	660 Kts
650	207	28	11.6	6.5	-0.8	-9.8
1300	157	21	9.1	4.3	-0.3	-5.1
2000	107	14.5	7.1	3.9	0.7	-2.5
2600	87	12	6.2	3.6	1.0	-1.6
3300	67	9	4.8	3.3	1.3	-0.8

The negative values in the table correspond to instances where the interceptor, after pulling out from the turn, would appear in front of the target.

To vector by the described method, another overlay is used with the PPI of the radar. Figure 52 is an example of such an item with target altitude 1000 feet, interceptor turn at 6500 feet with 45° bank, interceptor speed 485 knots and target speeds of 325 to 655 knots.

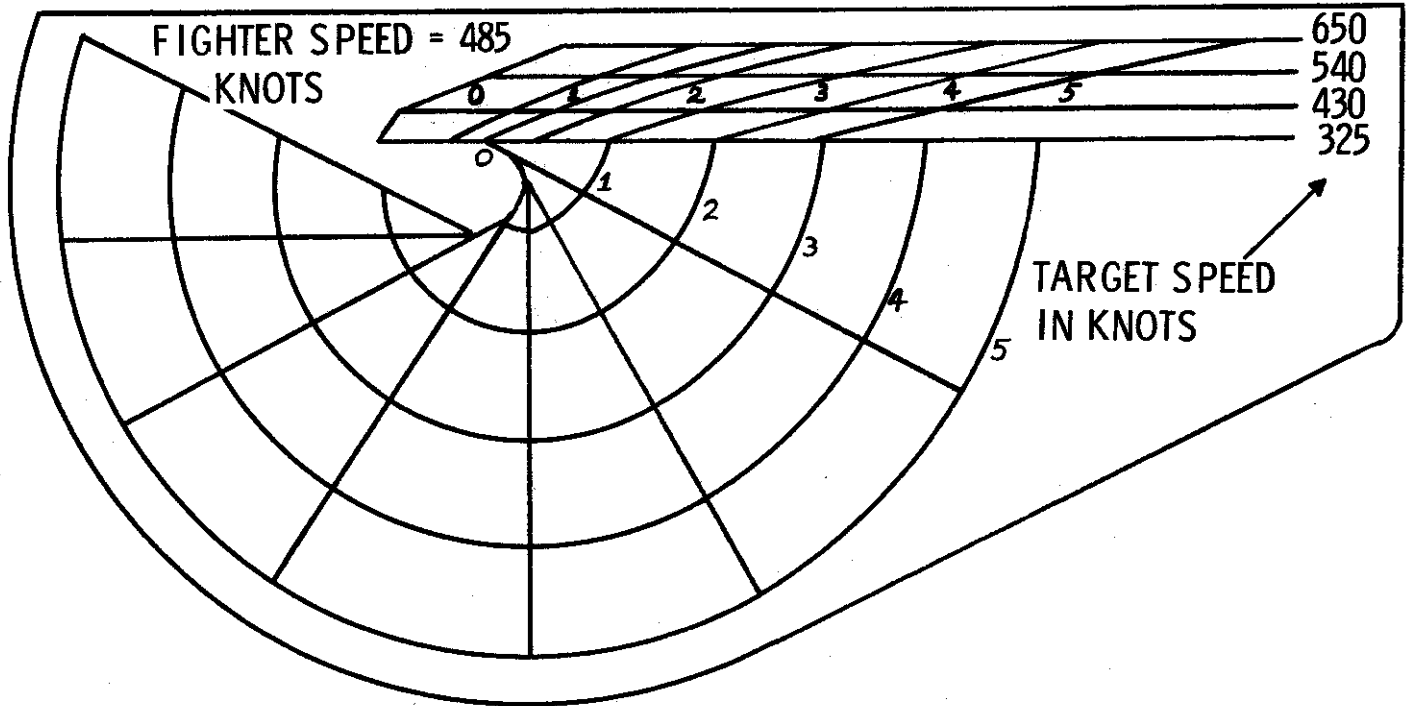

TRANSPARENT OVERLAY USED FOR VECTORING FIGHTERS
AT 6,000 FT AGAINST LOW FLYING TARGETS.

(TARGET ALT - 1000 FT)

FIGURE 52

Figure 53 is a graph of duty duration in the air by a single or a pair of MiG-21f-13 aircraft, depending on the distance of the duty patrol zone from the airfield.

TRANSFERRING INTERCEPTOR CONTROL TO A CO-OPERATING COMMAND POSITION

The transfer of control of an aircraft flying an intercept mission is done chiefly in cases where the interceptor has had to go beyond the technical (radio and radar) control limits of

~~SECRET~~

DURATION - MIN.

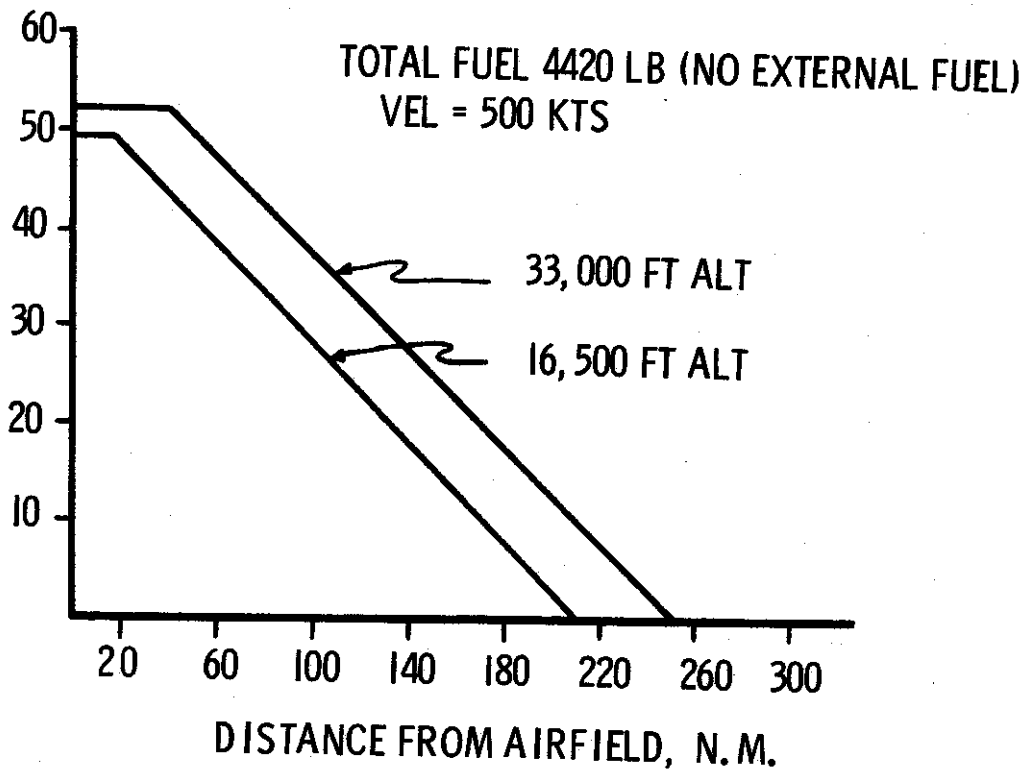

DURATION OF AIR DUTY IN THE PATROL ZONE IN RELATION TO THE DISTANCE OF THE ZONE FROM THE AIRFIELD

FIGURE 53

its own Command Post. This occurs when the range of technical control is smaller than the operating range of the interceptor. For example, at an altitude of 33,000 feet, the operating range of the MiG-21f-13 is approximately 275 nautical miles, while the MiG-21f-13 radio is reliable to only about 190 nautical miles.

The transfer of interceptor control data and target information from one CP to another is made in accordance with the method established for all interceptor units.

Cooperation between command posts entails a multitude of problems, but the more serious of these are the exchange of data about the combat situation and the actions of friendly fighters, the transferring of interceptor control, and the transfer of target data. Cooperating CP's must be in constant readiness to accept control over neighboring aircraft and also to assure their landing.

~~SECRET~~

[REDACTED]

The CP in the region where the target and interceptor are located bears the responsibility for the timely insurance of control orders to the next CP.

The order of transferring interceptor control and target information is as follows: prior to the interceptor exiting his area of control, the GCI controller should inform the neighboring command post of the radio call-sign of the interceptor, the raid number of the target against which the interceptor is reacting, the target aircraft type, the target grid-coordinate location, the time of interceptor take-off and the airfield where the interceptor is to land. The command post taking over control, must pick up the target and interceptor on radar (if it has not already done so) and establish communications with the interceptor. After establishing communications and plotting the positions of the target and interceptor on the surveillance board, the Command Post then informs the first Command Post that he is ready to assume full control. The first CP then informs the interceptor that he is now under control of the other CP. The interceptor pilot must confirm that he understands this.

The CP assuming control must inform the interceptor that he is assuming control and the interceptor must acknowledge. Only at this point can the first Command Post relinquish control of the interceptor. However, as far as possible, the first CP should continue to monitor the actions of the interceptor and target, and record the orders transmitted to the interceptor.

INTERCEPTION-AREA BOUNDARIES

The interception-area boundaries are determined by the distance the interceptor aircraft must cover when beginning its flight from the patrol zone or strip-alert positions.

The initial data for this are: range of detecting the target by ground radar, time lost in determining the target speed and course, time of transmitting this data to higher headquarters, time lost at higher headquarters in making the mission assignment, distance of interceptor airfields from the front lines, speed and rate of climb of the interceptor, speed and altitude of the target, direction to be taken for attack and time needed for approach and attack maneuvers.

In cases where the interceptor does not have time to reach target altitude before encountering the target, the distance

~~SECRET~~

from the take-off airfield to the interception-area boundary is determined by the formula:

$$S_{\text{area bound.}} = \frac{D - V_{\text{tar}} \cdot t + rS_n}{1 + r}$$

where D - distance between interceptor airfield and point of initial target detection;

V_{tar} - target speed, knots;

S_n - path (distance) of interceptor along a straight line while climbing to target altitude;

t - climbing time of interceptor, including time for making a 180° turn;

r - ratio of target speed to interceptor speed after acceleration ($r = \frac{V_{\text{tar}}}{V_{\text{int}}}$).

V_{int}

In cases where the interceptor does not have time to gain target altitude prior to making the attack, i.e., $(D - V_{\text{tar}} \cdot t) < S_n$, the distance to the interception area boundary is determined by a more simple formula:

$$S_{\text{area bound}} = D - V_{\text{tar}} \cdot t$$

The boundaries can be enlarged when the intercept flight is initiated from the duty patrol zone as the passive time is much less in this case. The distance from the duty patrol zone to the area boundary is determined by the formula:

$$S_{\text{area bound}} = \frac{D - V_{\text{tar}} \cdot t + V_{\text{app}} t_{\text{man}}}{1 + r}$$

where t - passive time plus time of climb or descent to target altitude from patrol zone;

t_{man} - time of maneuvering to arrive in the rear hemisphere of the target;

V_{app} - target speed plus interceptor speed.

To shift the interception area boundary in the direction of the enemy, it is advisable to shift the patrol zone forward.

~~SECRET~~

Shifting of the interception area boundary (Δ S area bound) is determined by the formula:

$$\Delta S_{\text{area bound}} = \frac{S_z}{1 + \frac{1}{r}}$$

where S_z - amount of shifting the duty patrol zone.

To intercept high-speed targets with the MiG-21f-13 from the strip-alert position, it is not advisable to shift the base airfield too far forward as there may not be sufficient space over friendly territory to gain the necessary altitude. When the interceptor is climbing to catch up with the target, the boundary shifts toward the interceptor of our territory.

Figure 54 shows the interception area boundaries for intercept from strip-alert position (solid lines) and from the patrol zone (dotted lines). The graph is calculated for target detection at a range of 162 NM at high altitudes and in the stratosphere, 90 NM at medium altitudes and 45 NM at an altitude of 3,000 feet. The interceptor airfield in the graph is located 55 NM from the front line, and the duty patrol zone and ground radar station are both 11 NM from the front line.

As may be seen from the graph, interception from the duty patrol zone allows the attack to be carried out to a greater range from the front line.

For example, from the strip-alert position, a target flying at 810 knots at 59,000 feet will be intercepted over friendly territory about 33 NM from the front line, while interception from the duty patrol zone will take place over enemy territory about 19 NM from the front line. A target flying at an altitude of 6,500 feet at a speed of 600 knots will be intercepted by a scrambled interceptor over friendly territory at a distance of about 27 NM from the front line.

However, maintaining combat patrols requires a greater, and not always justified, consumption of forces. Therefore, the patrolling intercept method is used only during periods of extreme readiness and while protecting ground troops when, as a rule, enemy air activity would be most active.

~~SECRET~~

~~SECRET~~

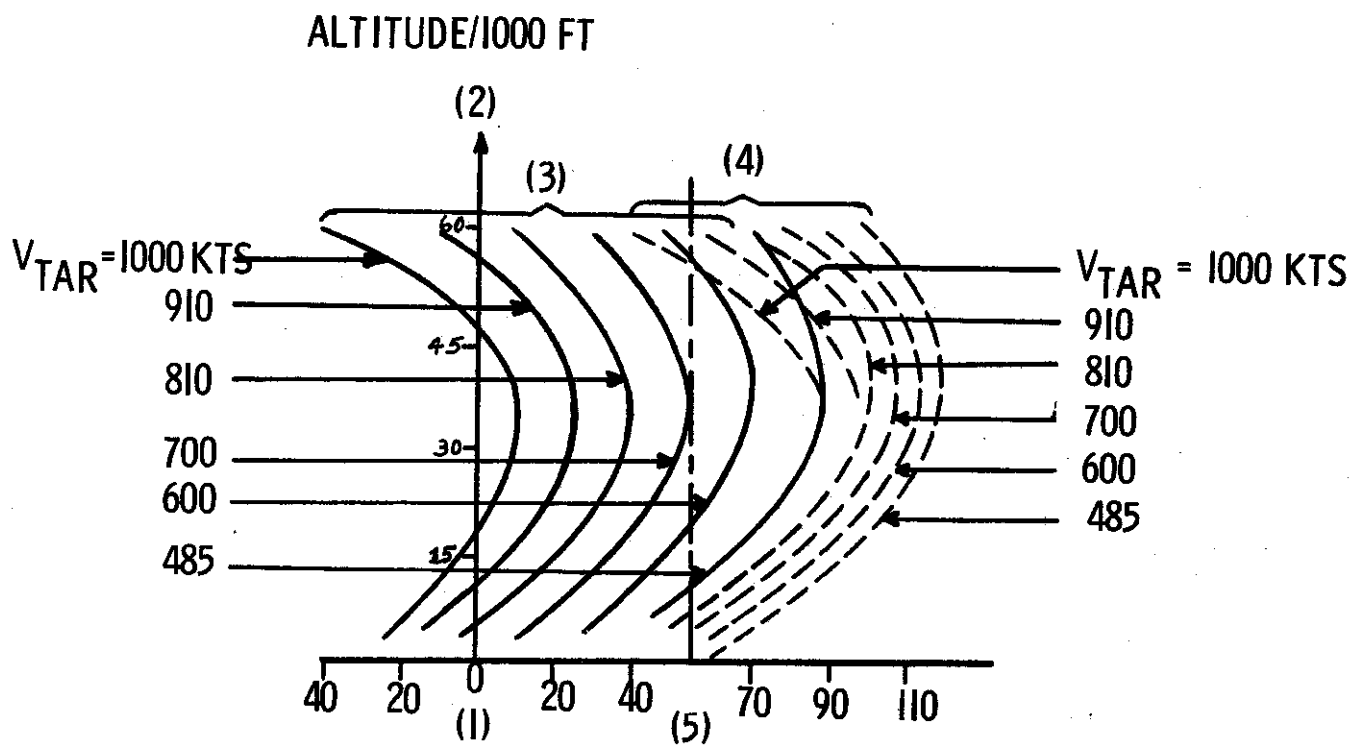

INTERCEPTION BOUNDARIES IN RELATION TO THE TARGET,
FROM STRIP ALERT AND PATROL ZONE POSITIONS

- KEY:
- (1) BASE AIRFIELD
 - (2) ALTITUDE
 - (3) FROM STRIP ALERT
 - (4) FROM PATROL ZONE
 - (5) FRONT LINE, 55 NM FROM AIRFIELD

FIGURE 54

127
~~SECRET~~

SEARCH FOR ENEMY AIRCRAFT

Searching for enemy aircraft is the most important element of all combat interceptor flights. To detect the enemy aircraft as early as possible greatly facilitates its destruction. Search is also made for the purpose of preventing any sudden enemy attacks on our interceptors, hence, it is of particular importance when anticipating an aerial engagement with enemy fighters as well as during an actual engagement.

Under present-day conditions, the basic type of search is that by ground radar. However, interceptors must often make flights beyond radar range and under conditions of radar and/or communications jamming where ground control will be either unreliable or completely absent. In these cases, the pilot must conduct the search independently.

The type of search conducted will be different and will depend on how the flight is executed. When carrying out a flight under GCI control, there is no need, and it is even inadvisable, for the pilot to continuously conduct an all-round search, for he is being constantly informed of the aerial situation by the Command Post.

The pilot should devote most of his attention to executing the orders of the Command Post. After receiving target indications from the CP, a visual search by the pilot then becomes more important. Because of the unavoidable errors in vectoring, the target indication will only be an approximate position of the target. Even with good visibility conditions, the pilot must devote much attention to the search and be skilled in rapidly detecting the enemy. When looking for the target, the pilot concentrates mainly on the directions of most probable appearance as given by the CP.

In the absence of reliable ground control and in complex tactical situations where a large number of aircraft may be in the air, the search must be continuous.

Depending on the nature of the flight, the tactical situation, and the weather conditions, the pilot's attention is concentrated on the most important sections -- usually where observation is somewhat hampered and where the enemy is most likely to appear. The directions facing the sun, clouds or haze are considered hazardous and the enemy will usually try to attack from these directions.

[REDACTED]

The most prevalent error in searching occurs when the pilot concentrates his attention on the narrow sector where he expects to spot the enemy. During such a search, there is danger of sudden attack by the enemy from an unexpected quarter.

All-round search is impossible for the MiG-21f-13 pilot when he is wearing the pressurized helmet.

Figure 55 shows a diagram of the viewing angles from the MiG-21f-13 aircraft. The shaded areas in the diagram are the areas not visible from the cockpit. These areas are relatively large, and are caused by the considerable limitations of the pilot's movements in the cockpit and the difficulty of turning his head while wearing the pressurized suit and helmet.

The downward view in the forward hemisphere is restricted by the nose section of the fuselage and the edges of the cockpit, and the viewing angle is only 10-11° below the horizontal. The view upwards in the forward hemisphere is limited by the upper section of the helmet and the difficulty of the pilot being able to raise his head within the helmet. The upper viewing angle in the forward hemisphere is approximately 45° above the horizon. The view in the rear hemisphere is limited by the ability of the pilot to turn his torso and head, and also by the side sections of the helmet. The rear viewing angle is 60° left and right. When flying with G-loads of 1.5 and above, the view is reduced and the rear viewing angle drops to 20-30°. With these overloads, the upward viewing angle also drops and is only 15-20°.

Even when within the limits of the above mentioned viewing angles, the pilot must exert considerable effort in order to search to the rear. Therefore, detection of enemy fighters is not assured, even when within cannon-firing range.

In order to make the task of detecting enemy fighters easier, it is advisable to make periodic 30-40° turns and check as far aft as possible while turning. Also, the interceptor flight can be flown in "squad column" formation; however, since the rear view is still incomplete, this does not preclude surprise attacks.

Searching should be done at long range which gives the possibility of first detecting the enemy and then gaining the necessary time to prepare for combat.

SECRET

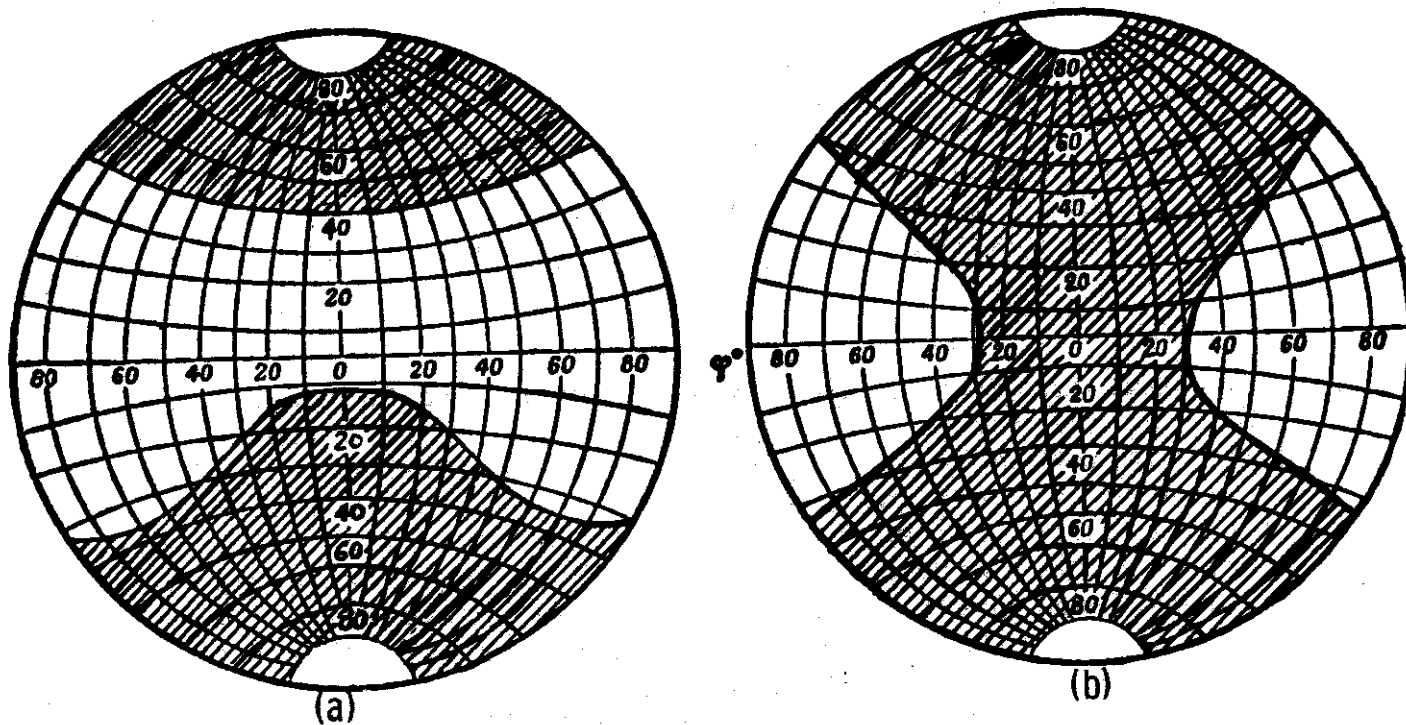

DIAGRAM OF VIEWING ANGLES FROM MIG 21f-13 AIRCRAFT

(a) FORWARD HEMISPHERE

(b) REAR HEMISPHERE

FIGURE 55

SECRET

[REDACTED]

The considerable number of window panels in the MiG-21f-13 reduces the visibility range. This range is especially reduced when looking through bulletproof glass. The range for detecting a single fighter when looking through the side canopy is approximately 2.7 NM; however, when looking through the bulletproof glass of the front windscreen, the range is reduced to 1.6 - 1.3 NM. Therefore, searching should be conducted through the side canopy.

The average range for detecting a pair of fighters is 3.3 NM. The average range for bombers is: single aircraft, 3.3 - 4.3 NM, pair of bombers, 4.3 - 5.4 NM, and group of aircraft, 6.5 NM.

The detection range depends to a large extent on the viewing angle of the target. When a fighter is spotted from directly astern, only the tailpipe may be seen. This will appear as a black dot and the wings may not be visible at all, therefore, the detection range in this case is minimum, (about 1.6 NM). When a fighter is detected from an angle of 15° and over and from either above or below, the wings and fuselage are visible and the detection range is maximum.

The GCI controller must take these viewing capabilities into consideration when vectoring the MiG-21f-13 during an interception. The aircraft must be vectored toward the target in such a manner that the target can be picked up at an angle through the side canopy.

When vectoring against an enemy fighter, the GCI controller must remember that since a fighter is a small-scale target, greater vectoring accuracy is required for reliable interception.

The SRD-5 mk radar should not be used for target searching as the target may detect the radar and, with proper maneuvering, break-off the attack. By not using his radar until the target has been spotted visually, the MiG-21f-13 pilot will have a better chance to approach to within firing range of the target.

If the target position or course is known, the interceptor can make his approach so that he will be approaching from out of the sun and thus remain hidden as long as possible. This will also enhance detecting the target, because of the reflected sun rays.

When lacking target information from the GCI controller, the pilot should conduct his target search so that the sun is not directly in front of him. When the search must be made in the direction of the sun, the sun visor must be used in order to

reduce the blinding effect of the direct sun rays. When there is no sun visor available, it is impossible to search in the direction of the sun because the multi-colored coating on the bulletproof glass causes specks and patches of light to appear on the helmet faceplate.

When flying in an inverted air layer, a reflection of the aircraft is created. It is important to avoid penetration into an inverted layer while searching for the target.

A target flying in a horizontal layer of haze has a certain degree of concealment, but can easily be seen from above or below. Therefore, when a layer of haze is present, the search is best conducted from either above or below.

When searching for a target in an area of broken cloud cover, it is best to fly above the clouds so that the target may be easily spotted against the cloud background.

When meeting a fighter on a counter heading, it is nearly impossible to execute a maneuver to attack the enemy and virtually impossible to visually detect the enemy because of the extreme closure rates. Flight experience has shown that search by a pair of interceptors is best carried out when flying in the "bearing of aircraft" tactical formation (Figure 56). This formation is made up by one aircraft flying 650 - 1300 feet back and 150 feet either above or below and with a sighting angle of 30 - 40° on the lead aircraft. The position of the wingman with respect to lead is determined mainly by pilot habit and can be flown either high or low. This formation gives good mutual coverage and allows the formation to have maximum maneuverability.

The "sharp bearing of aircraft" formation, in which the rear aircraft maintains a sighting angle of 15 - 20°, is adaptable for MiG-17 and MiG-19 aircraft, but unfit for the MiG-21f and MiG-21f-13. In this formation, the rear MiG-21f-13 sees lead through the forward bullet proof glass and the view is hampered. In this formation the wingman must devote full attention to watching the lead aircraft and is therefore unable to search. Also, if the wingman happens to lag behind by 2600 - 3300 feet and then is distracted momentarily, he is likely to lose the lead aircraft completely.

The "front of the aircraft" tactical formation is also unsuitable for the MiG-21f-13, because again, nearly all the

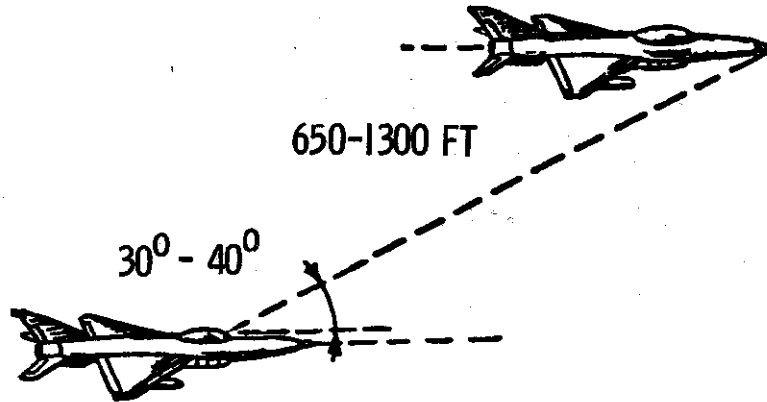

TACTICAL FORMATION OF A PAIR WHEN
SEARCHING FOR THE ENEMY, (BEARING
OF AIRCRAFT)

FIGURE 56

~~SECRET~~

attention of the wingman must be diverted to following the movements of the lead aircraft. When in this formation, the slightest delay in executing a maneuver will cause the wingman to drop behind and perhaps lose the flight leader.

Target search in formation is organized on the basis of distributing the sections to be searched between the first and second aircraft. Primary search sectors are assigned each pilot in an attempt to insure reliable coverage of the area to be searched. The pilot should be able to scan in one second an area of 140° horizontally and 7° vertically. Since the rate of approach to the target will often be below 150 - 200 knots, the basic sector can be scanned 4-5 times per minute.

As soon as the target has been spotted, the time factor becomes extremely important for even a slight delay may place the interceptor pair in a tactically unsuitable position or may lead to a loss of the initiative. The first pilot to detect the target should report, "I see the target", which will be a command for the other interceptor to follow him in making the approach or attack maneuver.

RECOVERING INTERCEPTORS AT THEIR OWN AIRFIELD

The recovery of the interceptors after the mission should be executed from a calculated boundary line, since the interceptor may be at a considerable distance from the airfield and low on fuel.

The recovery from a boundary line is made by vectoring the aircraft directly to a point where a straight in descent and landing can be made (See Figure 57). The interceptor is vectored by the GCI controller on the basis of radar data.

The GCI controller, using a transparent overlay on his PPI scope, determines the boundary line at which the interceptor will begin its descent (Figure 58). At the same time, he determines the best flight program for bringing in the aircraft by the shortest route and in minimum time.

The heading and rate of descent are given so that the aircraft will be at 6500 feet when at the turning point for final approach.

During the let-down, the pilot must follow the speed and descent commands as closely as possible. For the MiG-21f-13, the recommended penetration speed is 295 knots IAS. This speed,

[REDACTED]

with idle RPM, will give a rate of descent of approximately 10,000 ft/min, at altitudes below 39,000 feet. The controller may assign other speeds, however, depending on the circumstances.

When the airfield is equipped with precision approach radar, the GCI controller guides the returning interceptor to a hand-off point 20-25 miles from the airfield. There the GCA controller assumes control and brings the aircraft in for landing.

Having let down to 6500 feet and upon command from GCA, the pilot makes his turn onto final with a 30° bank. After leveling off and at a fixed distance from the runway (for the MiG-21f-13 this distance is 20.7 nautical miles) the pilot lowers the landing gear. The approach is then continued in accordance with the established procedure for a straight-in approach.

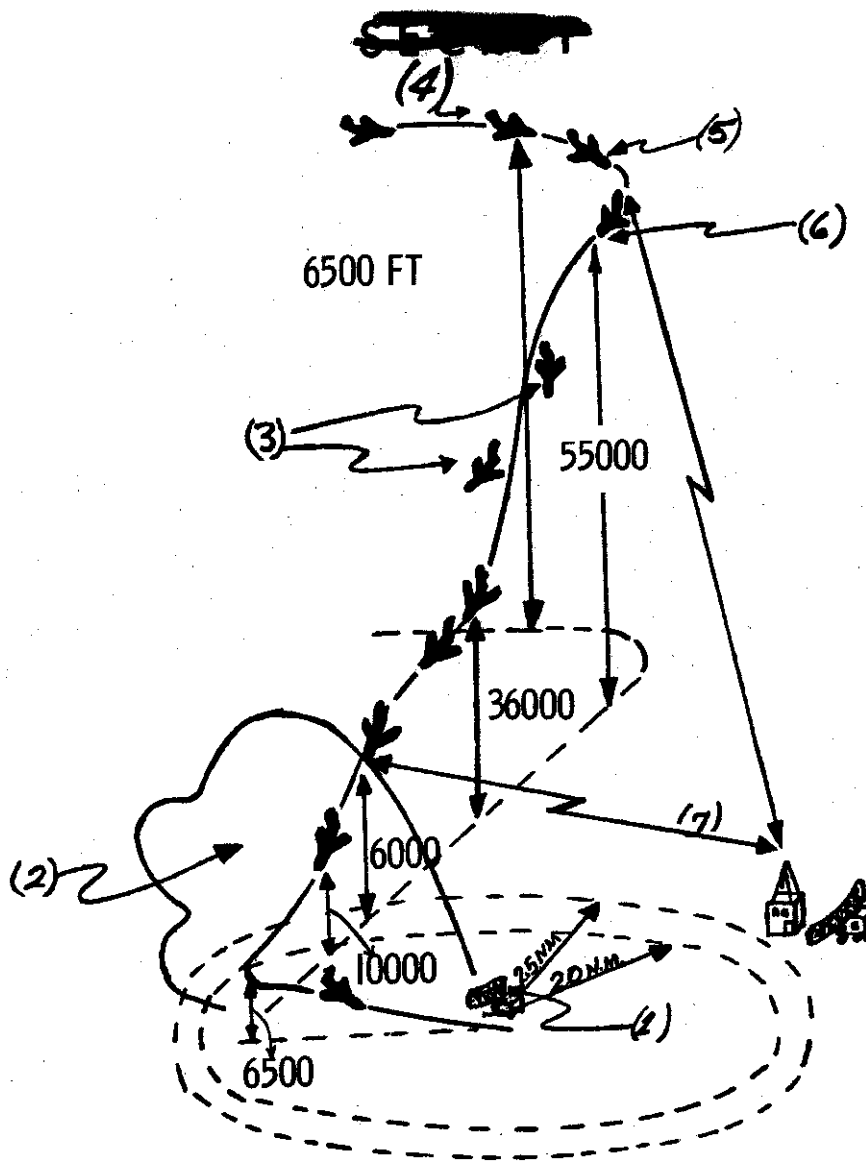

DESCENT DURING LANDING APPROACH FROM BOUNDARY

KEY:

- (1) CONTROL TRANSMISSION BOUNDARY
- (2) SECOND STAGE OF DESCENT ZONE OF VISABILITY AND CONTROLABILITY
- (3) CORRECTION OF HEADING ERRORS
- (4) PILOT COMPLETED MISSION
- (5) BEGINNING OF DESCENT TURN
- (6) AIRCRAFT REACHED GIVEN HEADING, DESCEND AT GIVEN CONDITIONS
- (7) FIRST STAGE OF DESCENT AND CONTROL FROM CP

FIGURE 57

~~SECRET~~

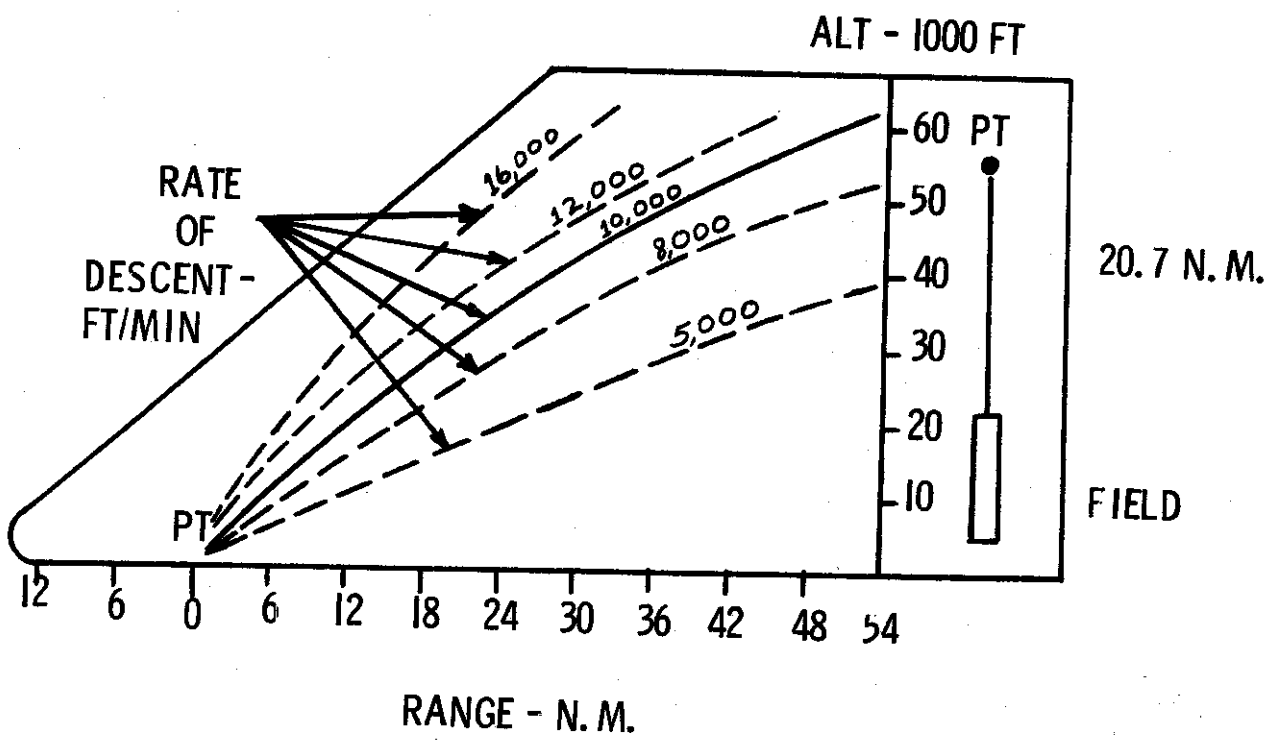

GRAPH FOR CALCULATING DESCENT FROM BOUNDARY TO POINT (PT) ON FINAL.

NOTE: PT IS AT 6500 FT and 20.7 N.M. FROM RUNWAY

FIGURE 58

~~SECRET~~

~~SECRET~~

(This page is blank.)

~~SECRET~~

~~SECRET~~

CHAPTER III

AERIAL ENGAGEMENT WITH BOMBERS

Interceptors are chiefly intended for the destruction of bombers, fighter-bombers and winged rockets. The high speed and rate-of-climb capabilities of the MiG-21f-13 allow it to be used successfully under clear air mass conditions.

SINGLE INTERCEPTOR AGAINST A SINGLE BOMBER

A single interceptor will normally be committed against a single bomber, especially when the bomber is flying at supersonic speeds. Each interceptor pilot must be familiar with the tactics for engaging a single bomber and be able to effectively use the tactical capabilities of his aircraft. In order to destroy the target, the pilot must visually observe the target and then decide upon the aerial engagement.

Approach

Having detected the target visually, the interceptor begins the approach to the rocket launching or cannon range. The interceptor should try to fly the approach and remain undetected in order to deny the bomber the chance to take evasive action or to escape.

Upon visual detection of the target, the interceptor can make an approximate estimate of the target range, speed and heading and thereby select a suitable approach method.

If the target is sighted from a position near rocket-launching range, the approach should be made by the pursuit curve. The pursuit curve approach is made by placing the sight piper on the target and keeping it there while approaching to launch range. It must be remembered however, that the target outline will be rather poor through the armoured glass of the windshield.

In cases where the target is sighted from a distance close to launching range but at a high angle-off, the pursuit curve approach will have to be made with high G-loads. Therefore, it is recommended that the approach be made differently. With a high rate of approach, the nose of the interceptor is pointed toward a point considerably to the rear of the target. As the distance decreases, the aircraft makes a tight turn toward the target and completes the approach by the pursuit curve. When

~~SECRET~~

slowly overtaking a bomber, the pilot should point the nose of the interceptor toward a point in front of the bomber in order to reduce the time used in a tail chase. Any approach should not be transformed into a pursuit curve if the G-load will exceed the maximum permissible for rocket launch.

When the target is detected at long range almost directly in front of the interceptor, the speed should be accelerated to maximum, and if necessary, the "wave downward" approach method used. After reaching a range near that necessary for launch, the pursuit curve is applied and the final attack begun.

When approaching a target, it is necessary to continue searching for other enemy aircraft that may be in the area, however, attention should not be diverted too much from the assigned target.

When making the approach, it is important that the speed advantage not be too high as excessive speed can reduce the probability of being able to roll out onto a final attack curve. When attacking with the R-3S rocket, the speed advantage should not be more than 150 - 200 knots. At such a speed, the pilot can aim well and monitor the results of the launching in case another rocket is needed.

Attack

The attack is the most critical phase of aerial combat. Having detected the interceptor attack, the bomber will usually attempt to escape by accelerating, changing course erratically, flying into clouds or heading into the sun. If the interceptor rolls out for his final attack within 4600 - 4900 feet of the bomber, it is within the zone of defensive bomber fire. All this hinders the attack and exerts a considerable influence on the pilot conducting the attack. As it is impossible to pre-determine and relate in detail all the tactics a pilot must employ in aerial combat, only the typical methods employing R-3S rockets and cannons will be discussed here.

R-3S ROCKET ATTACK

R-3S rockets can be launched outside the zone of bomber defensive fire and disengagement can be made immediately after launching. This greatly facilitates the conduct of an aerial engagement with a bomber, particularly when the attack is sudden and the target has not begun maneuvering.

~~SECRET~~

The R-3S rocket can be launched at a maximum G-load of 2 at altitudes below 47,500 feet, and 1.6 G's at altitudes over 47,500 feet.

A rocket attack against a non-maneuvering bomber at medium and high altitudes can be made with a speed advantage of up to 325 knots. This is explained by the fact that having visually detected the target at a range of 3.3 - 4.3 NM, the pilot has sufficient time to aim and launch the rockets at a range of 10,000 down to 6,500 feet as approaching the bomber.

The attack is executed in the following manner: the initial approach is made by any of the previously discussed methods, and at 10,000 - 13,000 feet, the pursuit curve is taken up. From here on, the center pipper of the sight is held on the target. To create favorable conditions for infrared lock-on, the aircraft must be piloted smoothly and accurately, because the rocket head field of vision prior to lock-on is only about 3.5 degrees. With infrared lock-on, an audio signal appears in the pilot's headset. When coming within permissible launching range (determined automatically by the Permissible Launch Zone Computer), a signal light flashes on. Having made sure that the audio signal in the headset is maximum, that the "permissible launch zone" light is on, and that the "breakaway" light is off, the pilot launches the rockets by pressing on the firing button (Figure 59).

At this point the pilot can either break away immediately or continue on and monitor the firing results. At a range of 3300 feet a "breakaway" light will flash on, and the pilot must then break-off the rocket attack.

The two rockets can be fired either separately or in salvo. When a single enemy bomber is close to its probable target or if a second rocket attack is clearly impossible, the rockets should be fired in salvo from the best launching position possible.

In an attack against a bomber with no tail defense, the recommended launch range is 4900 feet. When the bomber does have tail defense, the launch range should be no closer than 6500 feet.

ATTACKING A MANEUVERING BOMBER WITH R-3S ROCKETS

The attacking interceptor may be detected by the bomber either visually or by radar. If detection is made, the bomber will probably begin evasive maneuvers. In this case, it is advisable for

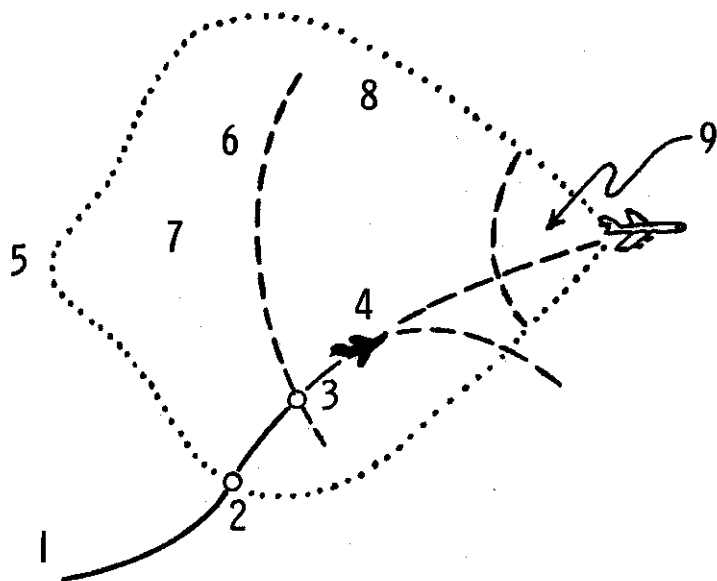

PRINCIPAL METHOD OF LAUNCHING ROCKETS

KEY:

- (1) APPROACH BY PURSUIT CURVE
- (2) AURAL TONE IN HEADSET INDICATING INFARED LOCK-ON
- (3) PERMISSIBLE LAUNCHING RANGE LIGHT COMES ON
- (4) BREAK AWAY LIGHT IS OFF, LAUNCH ROCKETS
- (5) 4-5 1/2 MILES
- (6) 3-3 1/2 MILES
- (7) ZONE OF INFARED LOCK-ON
- (8) PERMISSIBLE LAUNCHING AREA
- (9) DEFENSIVE FIRING ZONE OF BOMBER

FIGURE 59

~~SECRET~~

the single interceptor to employ the following tactics. When the target begins an evasive maneuver in the direction of the sun or clouds, the interceptor should make a tight turn toward the target, and attempt to obtain infrared lock-on. If all other launch conditions are met, the pilot determines if there is time to launch a rocket and have it catch up with the target before it enters the clouds or completes its turn into the sun.

The flight time of a rocket launched from maximum range with an interceptor speed advantage of 100 - 200 knots is: Altitude 10,000 feet - 9 seconds, 16,500 feet - 10 seconds, 33,000 feet - 12 seconds and 49,000 feet - 13 seconds.

In borderline cases, the attack is made with only one rocket, keeping the second rocket in reserve for another attack.

If the target completes its turn into the sun before the rocket is launched, the interceptor should quickly climb and attempt to make an attack from above, thereby excluding the acquisition of the sun by the rocket infrared guidance unit (TGS).

The most effective bomber evasive maneuver is a tight turn toward the attacking interceptor. If the target begins this maneuver, the interceptor should follow the turn even though the G-force may exceed the maximum permissible for launch. It is not likely that the bomber will complete the turn as it would divert the bomber from the basic mission course. It should be anticipated that the bomber will make several tight evasive turns while generally maintaining its basic heading. If the interceptor forces the bomber into continuing the turn, it has completed part of its mission, i.e., it stopped the enemy short of its target. (Figure 60)

Conditions may be such that the interceptor should immediately attack the target at the onset of the evasive maneuver, not waiting for it to turn back on its basic course. Here the interceptor must follow the target turn at maximum G-load, but in such a manner as to roll out with launch conditions. This can be done in two ways - by turning after the target with a lag angle or by turning after the target on an intersecting trajectory.

TURNING AFTER THE TARGET WITH A LAG ANGLE

This tactic is used when infrared lock-on has been acquired and the speed advantage is sufficiently high (at least 80 - 110 knots), but the target is outside maximum launch range. As

~~SECRET~~

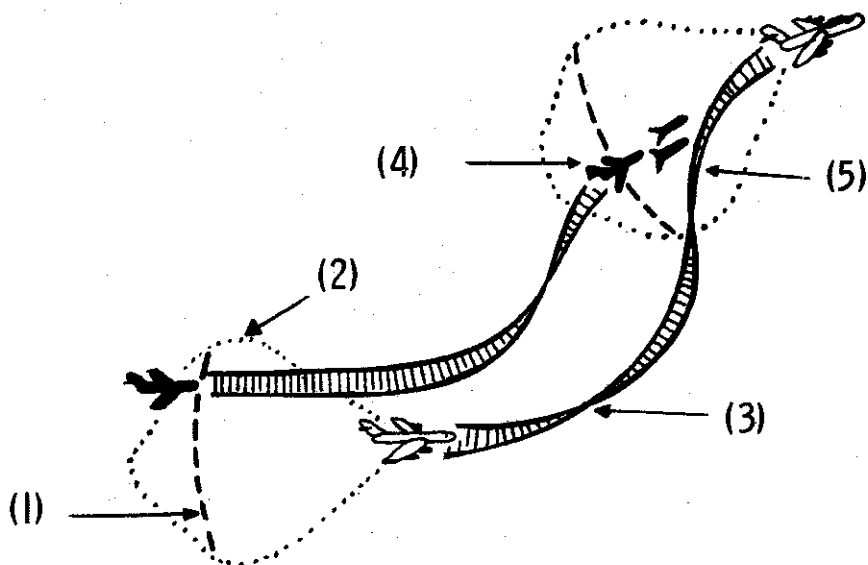

**AIMING AND LAUNCHING OF ROCKETS AT THE
MOMENT OF CHANGING DIRECTION**

KEY:

- (1) G-FORCE LESS THAN PERMISSIBLE, BUT NOT IN RANGE
- (2) ZONE OF TARGET LOCK-ON BY ROCKET HEAD
- (3) G-LOAD MORE THAN PERMISSIBLE
- (4) PERMISSIBLE DISTANCE FOR ROCKET LAUNCHING
- (5) CHANGE IN MANEUVERING DIRECTION OF ENEMY

FIGURE 60

~~SECRET~~

soon as the bomber begins to turn, the interceptor also turns and draws closer to the target, keeping it aligned in the center of the sight reticle. If the G-force is still too high when approaching launch range, the bank should be reduced by directing the nose to the rear of the target by an angle of 20 - 25°. When the interceptor nears the target's 6 o'clock position, a tight turn is made toward the target, infrared lock-on is re-acquired, and continuing the turn with less than maximum G-force, launching is done from a permissible range. The lag angle attack will be used mostly against comparatively slow targets such as the B-47 or B-52 type. (Figure 61)

TURNING INSIDE THE TARGET

If the bomber begins a tight turn at the moment the interceptor appears within launch range and if because of a high G-load, the interceptor cannot launch its rockets, then the interceptor should make a following turn while keeping the target near the center of the sight. The radius of the turn is then reduced by either increasing the G-load or decreasing the flight speed, and the center of the sight reticle is directed to a point approximately 20° ahead of the target. When in position, the pilot reduces the bank and G-load, aims the pipper on the target, receives indication of TGS lock-on, ascertains that permissible launching conditions exist and then fires the rockets. (Figure 62)

CANNON AND UNGUIDED ROCKET ATTACK

If the bomber is not destroyed by the R-3S rockets, the interceptor should attempt to destroy the target by cannon fire. In contrast to launching R-3S rockets, the attack with cannons and unguided rockets is executed within the range of defensive bomber fire. To increase the probability of hitting the bomber, fire should be conducted from short range and in long bursts. While tracking the target, the rate of interceptor/target approach should be in the range of 55 - 110 knots. This provides the opportunity to track for the necessary 2-3 seconds before firing. This is necessary when the sight is in the "gyro" position.

When the interceptor approaches to within a mile of the bomber, the pilot can identify the type of bomber and depending upon its defensive equipment, decide the effective range for opening fire. Cannon fire should begin from a range of 3900 - 3300 feet against a defensively armed bomber and at a range of 2500 - 2000 feet against a bomber with no defensive armament.

~~SECRET~~

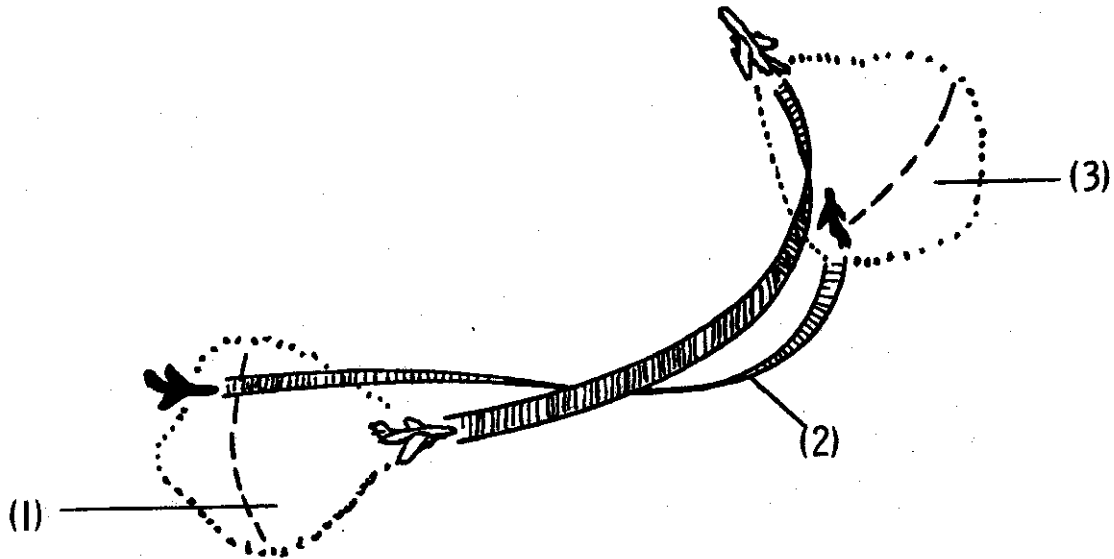

**AIMING AND LAUNCHING OF ROCKETS WHEN MANEUVERING
BEHIND THE TARGET**

KEY:

- (1) DISTANCE TO TARGET GREATER THAN LAUNCHING DISTANCE
- (2) DRAWING CLOSE TO THE TARGET WITH A LAGGING ANGLE
- (3) G-LOAD LOWER THAN PERMISSIBLE, LAUNCHING OR ROCKETS

FIGURE 61

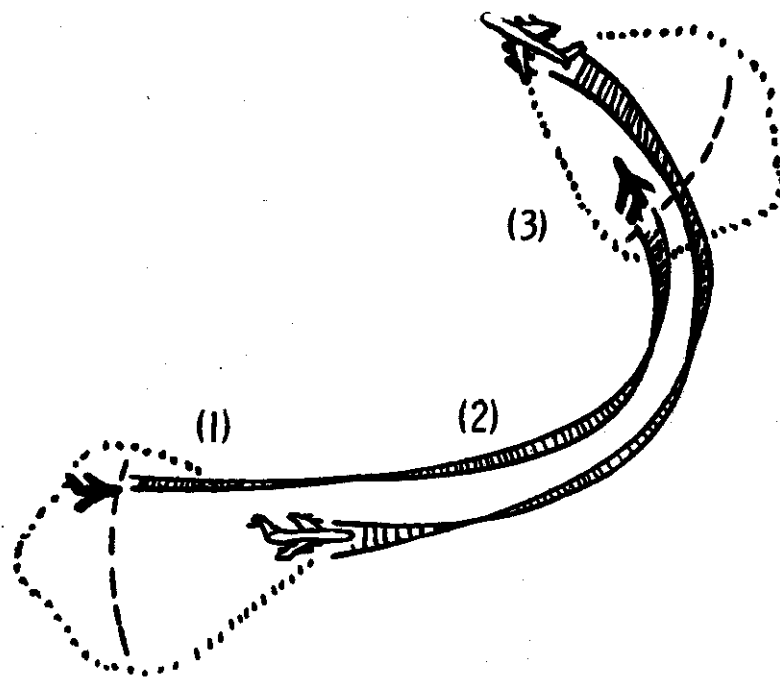

**AIMING AND ROCKET LAUNCHING WHEN
MANEUVERING AFTER A TARGET WITH
TRAJECTORY UNDERCUTTING**

- (1) TURN AFTER TARGET WITH G-LOAD GREATER THAN PERMISSIBLE
- (2) RANGE TO TARGET CLOSE TO LAUNCHING RANGE
- (3) REDUCTION IN G-LOAD AIMING AND LAUNCHING

FIGURE 62

~~SECRET~~

To attack from the side and to the rear of the target, the maneuver can be done either in a horizontal or inclined plane. Having determined the bomber type, the pilot adjusts his sight to conform with target dimensions, takes up an initial attack position, and checks his cannons for firing readiness. The attack scheme is illustrated in Figure 63.

From the initial (perch) position, holding the "Gyro Caging" button down, the pilot turns into the target with either a loss or gain of altitude, depending on the position of the target. As the target appears in the sight reflector, the bank is reversed and the pipper is pulled ahead of the target by two-three fuselage lengths. The pilot then releases the "Gyro Cage" button and continues the approach by smooth control movements and lets the pipper drift back to the target and starts tracking. He should track for 2-3 seconds, and then fire in bursts of 1 - 1.5 seconds. Open fire range is determined by the range indicator and visually by the pilot.

The attack from 6 o'clock high is done in the vertical plane or near to it. Such an attack is made in cases where the target is flying into the sun or when other conditions (haze) make visibility marginal for an attack in a horizontal plane. This attack scheme is illustrated in Figure 64.

The dive begins at the moment when the target is outlined low at 12 o'clock at an angle of 30 - 45°. Approaching this position, the interceptor may need to employ periodic banking maneuvers to keep the target in sight. From the initial position with the gyro caged button depressed, the aircraft dives at the target and the pipper is aimed 2-3 fuselage lengths in front of the target. To avoid negative G's, the aircraft may be inverted and the aircraft pulled down into a dive from which it is rolled back into an upright position. During the rolling and diving, only rough aiming is attempted. When the aircraft is upright, the cage button is released and the pipper laid on the target. During the process of aiming, the dive angle is decreasing and at the open fire range, the angle is less than the original 45°. The rate of approaching the target at this moment should not be permitted to be over 110-135 knots or the pilot will not have sufficient time to aim and track. The rise in speed can be countered with a power reduction or by extending the speed brakes.

After sufficient tracking, bursts of 1 - 1.5 seconds are fired from as short a range as possible.

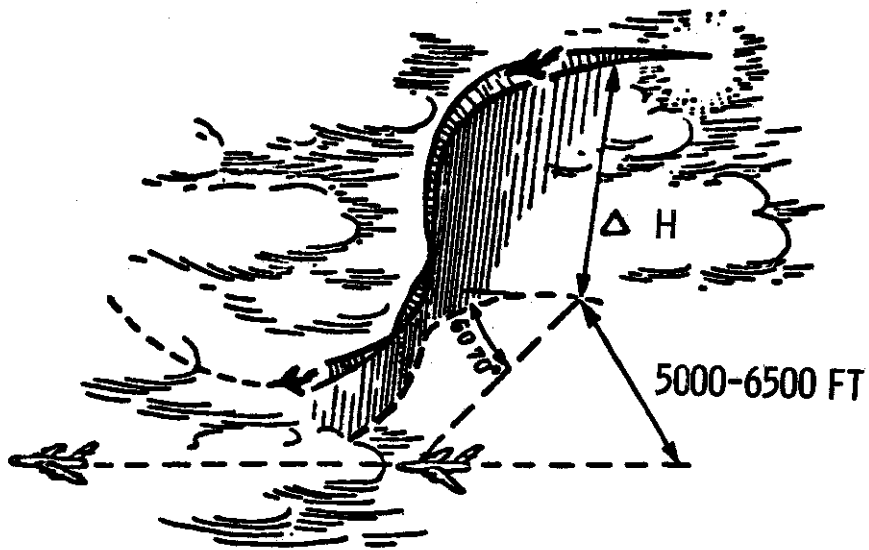

SIDEWAYS ATTACK FROM THE REAR

FIGURE 63

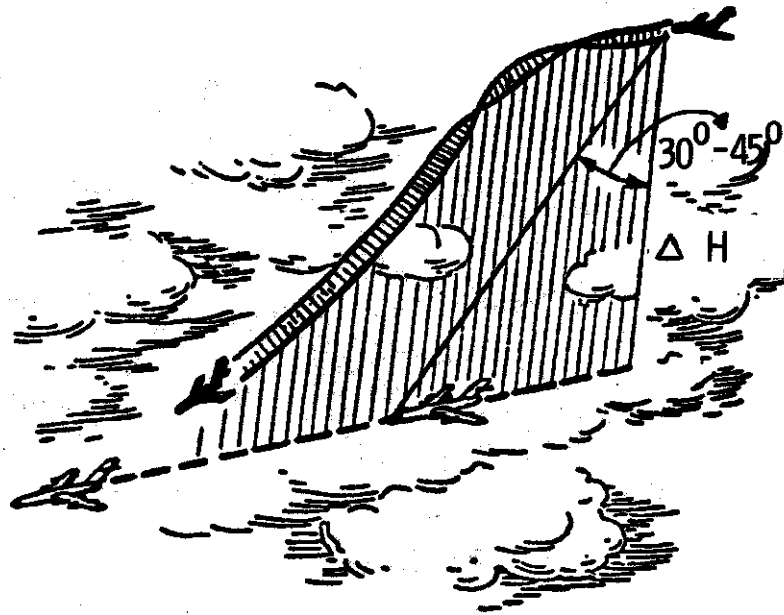

TOP REAR ATTACK

FIGURE 64

~~SECRET~~

An attack from 6 o'clock low is flown in a vertical plane or close to it and is done when the interceptor does not have time to obtain target altitude, or when the bomber has powerful protective armament, or as a continuation of attack after launching rockets. The attack scheme is shown in Figure 65.

The initial position to start the attack is determined by the speed of the interceptor, the distance below the bomber (ΔH), and the sighting angle up to the target (ω). The rate of approach at the moment of starting the climb should be 85 - 135 knots. With such an approach rate, the sighting angle at which to start the climb depends on altitude difference and it is selected to provide sufficient time for aiming, tracking and opening fire from a range of 2600 - 1800 feet. For an altitude difference of 5000 - 6500 feet, the angle should be 50 - 60°, for a 2500 - 3300 foot difference, the angle should be 30 - 40°.

Once the altitude difference has been determined, the interceptor approaches the bomber and keeps it in sight through the top of the cockpit canopy. When the target is aligned at the calculated angle, the gyro gage button is depressed and with full power, a 2 - 2.5 G climb is initiated. When a 30° pitch angle is attained, the caging button is released, aiming is perfected, tracking is accomplished for 2-3 seconds, and firing is commenced at a range of 2500 feet. Range is determined by the range indicator and visually.

When attacking with barrage fire, i.e., with a fixed sight, the target is moved through the sight by use of the rudders (smoothly) and firing is commenced when the target approaches the sight reticle and ceases when the target reaches the piper.

ATTACK DISENGAGEMENT

The break-off from an attack should be as tight as possible so as to eliminate entering the bomber defensive firing zone, or at least to hinder the bomber's aiming. The nature of this maneuver is partially determined by whether the interceptor has completed his engagement or if he has to make another attack.

If the engagement is completed, the attack is broken off by turning at maximum angular velocity and usually by pulling the maximum G-load. If the afterburner or speed brakes were used, they are cut-off or retracted as applicable. When the engagement is not over, and the pilot has the possibility for continuing the attack, the pull-out is flown in such a manner as to gain a new initial position in minimum time and to execute a repeated attack.

~~SECRET~~

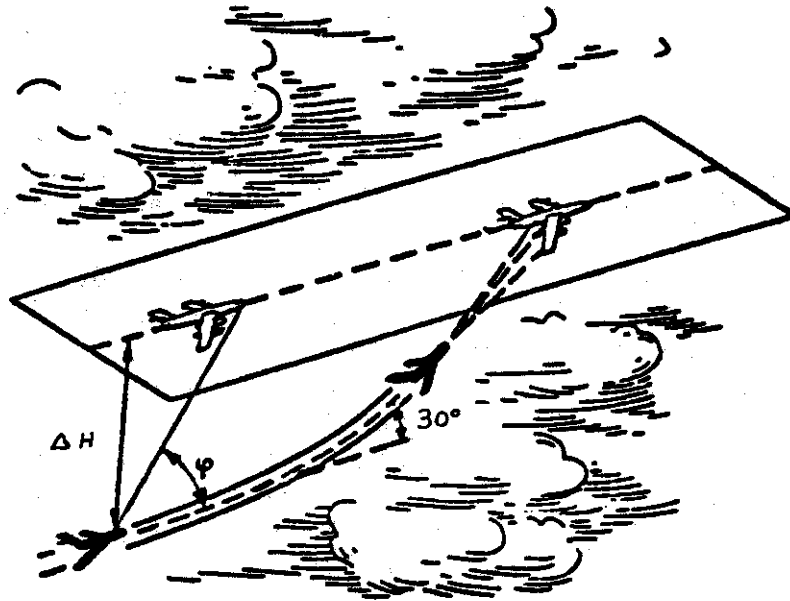

ATTACK FROM PITCHING

FIGURE 65

~~SECRET~~

When R-3S rockets are launched from outside the zone of bomber fire, the breakaway may be flown in any direction. When rockets are launched from shorter ranges, the breakaway should be more definite and should start immediately after launching or when the "breakaway" light comes on.

If the attack is flown with a high angle-off, the breakaway should be made in direction from which the attack began, i.e., without changing bank. A change in bank leads in a reduction of angular velocity and thus raises the probability of the interceptor being struck by bomber fire.

In cases where the overtake speed is sufficiently high, the pull-out from attack should be flown in an attempt to gain altitude. This altitude gain may be subsequently used to originate a new attack on the bomber. If possible the turn away from the bomber should be into the sun so the sun will not interfere with the TGS lock-on if another attack is to be made. If the turn away from the target is more than 45°, it is advisable to briefly reverse the bank so as not to lose sight of the target.

With a high rate of approach, to turn away without gaining altitude is not recommended because a high angle of turn will be needed or the interceptor will overshoot and outdistance the target. Either consequence may lead to losing the target.

If a low rate of approach exists and the target is not destroyed, the break-off should be executed downwards without changing bank. Speed will be gained which will later help to catch up with the target and a new attack from low and to the rear can be made.

Pulling out from an attack against a maneuvering bomber should always be made to the outside of the bombers' turn. All other conditions are the same as explained before.

ATTACKING A BOMBER AT LOW ALTITUDES

Combat with the MiG-21f-13 at low altitudes has a series of characteristics. The closeness of the ground restricts the actions of the pilot and limits its maneuverability in the horizontal and vertical planes. In contrast to high altitudes, at low altitudes the pilot is forced to reduce the G-load immediately when a stall occurs. To keep from exceeding the airspeed limitation of 600 knots, the pilot must devote a considerable amount of his attention to controlling his speed by monitoring his instruments, especially when using the after-burner. In view of the high fuel consumption under these conditions the pilot must also closely monitor his fuel supply.

When flying at low altitudes, it is recommended to have the aircraft trimmed slightly nose up so there is a small compressive force on the control stick.

The permissible distance for launching R-3S rockets at low altitudes is short. At an approach rate of 50 - 100 knots, the distance is only 5000 - 6500 feet. This hinders the maneuvers available for the acquisition of an initial attacking position. To launch the rockets, the interceptor will be very close to the zone of defensive bomber fire.

Combat at low altitudes is usually conducted with high angular velocities and it is necessary to maintain simultaneous observation of the horizon, earth, instruments, and bombers. The approach and attack is particularly difficult when under inclement weather conditions or at night, that is, whenever the natural horizon is invisible.

At altitudes of less than 1600 feet, the SRD-5 mk radar range finder does not assure the automatic determination of the range to the target. The range of rocket launching must be determined visually by the pilot using the method of comparing the image of the bomber in thousandths with the previously set in dimension of the range measuring ring (reticle).

A definite difficulty is encountered when searching for a target at low altitudes, especially if clouds are casting a shadow over the earth. The average ranges for visually detecting bombers at low altitudes are given in Table XXIII.

Table XXIII

AVERAGE RANGE FOR LOW ALTITUDE VISUAL DETECTION

Type of Target	RANGE OF DETECTION ~ NM	
	Counter Intersecting Course	Rear Intersecting Course
Tactical Bomber	2.2	2.7 - 3.3
Strategic Bomber	2.7 - 3.0	3.8 - 4.3

~~SECRET~~

LOW ALTITUDE APPROACH

Having detected a bomber, the interceptor executes the approach using the same methods used at medium altitudes. During the approach, the interceptor should enter the zone of possible rocket launching at a distance of 4900 - 6500 feet from the target with an angle-off of about 30°. While overtaking the bomber, the interceptor should be flying at the maximum speed possible. There is no difficulty in slowing down to a proper approach rate (50 - 100 knots) before commencing the attack.

LOW ALTITUDE ATTACK

An attack with R-3S rockets at low altitudes can be executed with an angle-off of not more than 30°. Permissible launching distances in relation to approach rates are given in Figure 18.

Prior to attack, the pilot should plan the direction of the attack, estimate the distance, select the launching method, and choose the necessary rate of approach. Depending on the specific flight conditions of the bomber - speed, altitude, location, visibility conditions and target detection conditions - attacks may be carried out from above or below. Under certain conditions, attacks from below are more advisable and most effective.

A low altitude attack from the side is flown in a horizontal plane with either a slight increase or very slight decrease in altitude. From the bombers 0430 or 0730 position and when at a range of 6500 - 10,000 feet, the interceptor makes a tight turn toward the target and then makes a turn reversal while placing the sight pipper on the target. Flight along a pursuit curve continues until the TGS locks on the bomber and the "permissible range" light comes on. At low altitudes, the radar ranging may not function, so the pilot can monitor the range by using the minimum ring of the sight rectile with the diameter equalling 22 thousandths. When entering the permissible range, the aiming is perfected and the rockets launched, provided the G-load is less than 2.

Depending on the combat conditions, R-3S rockets may be launched in a salvo or one at a time. Salvo firing should be done only in cases where the bomber must be destroyed within a minimum length of time, i.e., when it is approaching its probable target. During sequential rocket launching, the approach rate should be decreased after the first rocket is launched so there will be time to launch the remaining one before entering the zone of bomber defensive fire. This is usually done by opening the speed brakes.

~~SECRET~~

~~SECRET~~

A high side pass is executed in an inclined plane and preferably from out of the sun or from behind clouds. At a range of 10,000 - 13,000 feet, the pilot makes a tight descending turn toward the target and then reverses and rolls out on the aiming curve. The pipper is placed ahead of the bomber by 500 - 750 feet, which should assure a disengagement from the attack at an altitude no lower than that of the target. At first, the radar range finder will lock on the earth and the range indicator (UD-1) will show the distance to the earth. When the radar locks on the target, the arrow of the UD-1 will sharply change position and show the range to the target. Simultaneously, the rocket head should also lock on the target. If the approach rate exceeds 85 - 110 knots, it is necessary to reduce power or to use the speed brakes. The rockets are launched when the signal light "permissible range" comes on and if the G-load is within limits.

A side attack from below using R-3S rockets can be executed with a speed advantage or disadvantage while overtaking the target or even during lagging.

This method of attack, to a great extent, assures surprise and effectiveness. It offers the possibility of using the radar range finder to determine permissible rocket launching range and the current interceptor to target distance.

The initial position for this attack is below the target 1000 - 1600 feet and back at the target's 5 or 7 o'clock position. From this position, a turn is made toward the target and at the appropriate point a turn reversal is made. After the reversal, the TGS locks onto the target and the audio lock-on signal will be heard. The overload must not be more than 2 G's during launching and the break-away from the target is made by making a tight turn in the direction from which the attack began.

LOW ALTITUDE CANNON ATTACK

If the bomber was not destroyed by R-3S rockets, the interceptor should continue the attack using the cannon armament.

The initial attack position is 1000 - 1300 feet above or below the target at a range of 5000 - 6500 feet. The "Radar-Optics" switch is placed in the "Optic's" position and the sight is switched over to "Gyro". From an initial position with about a 60 - 70° angle-off, a tight turn is made toward the target and the turn is then reversed and the pipper laid ahead of the target about 500 - 650 feet. As the interceptor approaches the target, the pipper is aligned with the target and after tracking

~~SECRET~~

~~SECRET~~

for 2-3 seconds, firing commences. Open fire range is from 4000 down to 2500 feet.

COMBAT WITH BOMBERS AT ALTITUDES NEAR CEILING AND AT DYNAMIC ALTITUDES

The position of the interceptor relative to the target when the target is visually detected can vary by distance, angle, and altitude and depends greatly on the vectoring accuracy. When the interceptor has reached its altitude ceiling, it will have only a small amount of fuel remaining and the pilot cannot complete a lengthy pursuit of the bomber, especially if the flight goes in a direction away from the airfield. Because of this limitation, it is very important to select the best method of approaching in order to assure overtaking the bomber within a minimum length of time. Depending on the target position, the approach can be flown in a descent, level flight, or climb, and along parallel courses, intersecting courses or a pursuit curve.

If, at the moment of target detection, the interceptor has an altitude advantage, he should start a descent when at a range of 2 - 3.5 miles using a descent angle of 5 - 7°. When at the target altitude, the pilot should start to level off and end up 2500 - 3000 feet below the target at a range of 1.6 - 2.2 NM. In this way, the pilot enters the initial position to attack from below by zooming.

During the initial descent, there is the impression that the target is getting away. This is an apparent impression due to the fact that with the decrease in sighting angles, there is a decrease in the visible contours of the target.

This type approach can also be made in cases where the bomber first appeared at a co-altitude with the interceptor. In this case, the descent is very slight, merely at an angle of 3 - 5°. As the interceptor descends, he gently turns the aircraft toward the target, planning on arriving at a minimum range where the target can be observed through the side glass of the canopy. After attaining a range close to the permissible rocket launching range, the pilot perfects the initial position for attack and starts aiming while flying a zooming maneuver.

When flying descents at these high altitudes (60,000 - 63,000 feet) it is necessary to remember that to maintain level flight at 970 knots the gyro horizon will indicate a pitch angle (nose-up) of 6-7°. For an actual angle of descent of 3-5°, the gyro horizon indications should be 2-3° nose up. When approaching with maximum power, it is necessary to periodically monitor the

~~SECRET~~

~~SECRET~~

Mach number so the Mach limit of 2.05 is not exceeded. In combat situations, it is sometimes necessary to increase the speed beyond this established limitation. A descent of more than 5-7° causes a rapid loss in altitude and when an attempt is made to pull out, at least another 2500 - 3000 feet will be lost.

If at the moment of target detection, the interceptor is below the target, he should remain near this altitude or climb in such a manner so that at the moment of going into attack, he will be 3300 - 5000 feet below.

If the bomber is detected on a passing-parallel course with a small altitude advantage, and the interceptor has an approach rate of 150 - 200 knots, it is necessary not to change course to pursue the target until an initial attacking position is reached.

The shortcoming of the above approach methods is the necessity of turning towards the target, which with the small available G-loads at altitude, makes the entry into the pursuit curve nearly impossible. If it is impossible to make the approach and enter the zone of possible attack from the given side, it is necessary to execute a maximum bank turn and slide past the target but with an angle-off that should assure an attack.

Approach along a pursuit curve should always begin at a range of 2.2 - 2.7 NM. It is necessary to remember that the visibility through the front armoured glass is restricted and that this method is usually applied in combination with other approach methods.

When entering the initial attack position at altitudes of 59,000 - 62,500 feet, the approach rate is a critical element and should be from 85 - 160 knots. With such approach rates, there will be sufficient time for aiming, rocket launching or cannon firing.

By changing the climb angle, the pilot can select a suitable approach rate. The necessary approach rate when flying at maximum power can also be selected in level flight by executing small turns using 30° of bank. When selecting a given rate of approach, it is necessary to consider the sluggishness of the aircraft at altitude, and therefore the breaking action should be discontinued earlier, approximately by a Mach number of 0.1 more than normal.

~~SECRET~~

~~SECRET~~

ATTACK

The attack at altitudes near ceiling has a series of characteristics. Due to the sluggishness of the aircraft and the low available G-loads, it is difficult to aim and very difficult to track while firing the cannons. If the pilot is rough in making flight corrections, there will be a resultant loss in altitude and a rolling of the aircraft, either of which makes aiming even more difficult.

At altitudes near the ceiling of the interceptor, attacks are made only from below. An attack from above is nearly impossible. The zoom maneuver is the most effective method of attacking from below because it possesses the element of surprise, the possibility of launching rockets from a small angle-off, and the ability to reduce the effectiveness of bomber counter fire. In addition, flying the aircraft during an attack from below is much simpler.

To attack by maneuvering in a horizontal plane with speeds of more than 970 knots is possible with angles only up to 10° off the targets' tail. This limitation is determined by the low G-loads available.

When attacking smaller targets at altitudes of 59,000 - 62,000 feet, the signal indicating TGS lock-on normally occurs at a range of 2.7 - 3.2 nautical miles. SRD-5 mk radar lock-on occurs at 2.4 - 2.7 NM and the signal light illuminates which indicates permissible launching range.

The fuel remaining after reaching ceiling altitude with a MiG-21f-13 (fuel capacity 4420 lbs) allows two attacks under good vectoring conditions. Aircraft with only a 3700 lb capacity have only a one attack capability; however, if they carry one drop tank and drop it when it is empty, they can carry out two attacks.

ZOOMING ATTACK FROM BELOW

A zooming attack from below is the basic method of attacking a bomber flying near the interceptor's ceiling and the sole method of attacking when flying at dynamic altitudes. Figure 66 shows a schematic of a zooming attack. The necessary approach rates based on climb angle, zooming altitude and G-load when initiating the attack are listed in Table XXIV.

~~SECRET~~

TABLE XXIV

ZOOM PARAMETERS

Climb Angle at Zoom ~Degrees	Approach Rate ~Knots	G-Load When Going Into Zoom
10	50	1.5
15	110-80	1.5-2

TABLE XXV

INITIAL POSITION SIGHTING ANGLE VALUES

Altitude ~Feet	ρ_1 Degrees	ρ_2 Degrees	ρ_3 Degrees
33,000	15-20	10-13	30-35
49,000	25-30	15-20	40-45
65,000	30-35	20-25	50-55
82,000	35-40	25-30	55-60
98,000	40-45	30-35	60-65

NOTE: Zoom attack parameters are on the basis that the fighter enters the initial aiming point at a distance of 1.3 and 2.2 NM for rocket launching and 3300 feet for cannon firing. Angles ρ_1 , ρ_2 , ρ_3 are respective of these conditions.

If the pilot does not have visual contact with the bomber, the GCI controller, after considering distance and data from the graph and table, can give the command for executing the zoom maneuver. The initial zooming G-loads, target speeds, and climb angle are given in Table XXVI, (Table intended for conditions indicated in the remark to Table XXV).

~~SECRET~~

~~SECRET~~
TABLE XXVI

ZOOM PARAMETERS

Bomber Flight Speed ~ Kts	Fighter Climb Angle ~ Deg.	G-Load When Entering Zoom	Distance Necessary for Entering Initial Aiming Points of:		Distance Necessary for Aiming Point of 3300 Feet ~ Ft.
			2.2xNM Ft.	& 1.3 NM Ft.	
660-750	10-15	1.5	14,700	10,500	4600
		2.0	13,600	9,200	3900
860	10-15	1.5	16,400	11,500	8200
		2.0	14,700	9,800	4900
970	10-15	1.5	16,400	11,500	6500
		2.0	14,700	9,800	4200

A zooming attack can be flown, after the fighter turns on the target heading, from various altitudes up to ceiling (practical ceiling), but it is more advisable to begin the attack from altitudes at which the total energy of the aircraft will be maximum. It is necessary to keep in mind that at an altitude near the practical ceiling, the available G-load is small.

The altitude of the initial position for a zooming attack depends on the aerial situation. The most advisable altitudes are 56,000 - 59,000 feet with an altitude difference (less) of 3300 - 5000 feet to the target. From such an altitude it is easy to fly the aircraft into a zoom with a 10 - 15° pitch angle. The average vertical speed during zooming will be 200 - 230 feet/sec. The Mach number reduction during zooming is small and averages about 0.1 for a climb of 5000 feet.

The technique for flying a zooming attack against a bomber consists of the following procedures. As soon as the fighter obtains the initial attack position, pull smoothly into a climbing maneuver with the necessary climb angle. After the target appears on the sight reflector, perfect the lateral aiming and align the pipper on the target. Target tracking is executed with a smooth forward deflection of the stick. The aircraft reacts well to stabilizer deflection without lagging. Upon a stable signal indicating the target was picked up by the TGS, and a signal light indicating permissible launching range, and if the overload signal light is not on, the rocket is launched.

~~SECRET~~

Piloting the aircraft while firing the cannons during zooming is the same as during rocket launching, but it is necessary to approach the target to a range of 2600 - 3300 feet. The range is determined by the indicator of the radar range finder. Barrage fire is employed under these conditions.

ATTACK IN THE HORIZONTAL PLANE

The attack in the horizontal plane is used in cases where the fighter is only 800 - 1600 feet below the target. The interceptor is limited to banks of 20° - 30° during this maneuver. The area of possible attack by MiG-21f-13 aircraft in a horizontal plane at 66,000 feet is shown in Figure 22.

By studying the zone of possible attacks, it is evident that during an attack in a horizontal plane, the angle-off at a distance less than 3.3 NM with an interceptor speed of 1025 - 1075 knots is approximately 10°. This same attack at an altitude of 62,500 feet is possible only with an angle-off close to zero.

The pilot should turn in the direction of the target and then reverse, figuring to roll out on the aiming curve within rocket launching or cannon firing range. The point of beginning the maneuver is determined visually by the side interval and the sighting angle.

In Figure 67 is shown the dependence of target sighting angles (ω) and initial distances to the target (D_{in}) upon the intervals (I) at the beginning of the maneuver. Curves are plotted for altitudes of 62,500 feet and various approach rates. With a 3300 foot change in altitude, the magnitude of the sighting angle changes by 2 - 3°. With an increase in altitude, the angles decrease and with a reduction in altitude, they increase.

Dependence curves $\omega = f(I)$ show that with an increase in interval, there is an increase in the sighting angle from the initial position for the turn toward the aircraft. Making the turn toward the target and reversing the turn should begin on time because a delay in starting the turn will make it impossible to complete using only a 25 - 30° bank, and the interceptor will drift to the outside and as a result, there will be an increase in attack time.

When executing the roll-out on the sighting curve, it is necessary to consider the sluggishness of the aircraft and the difficulty of trying to increase the bank. In this connection, reversing the turn should not begin at the moment the nose of

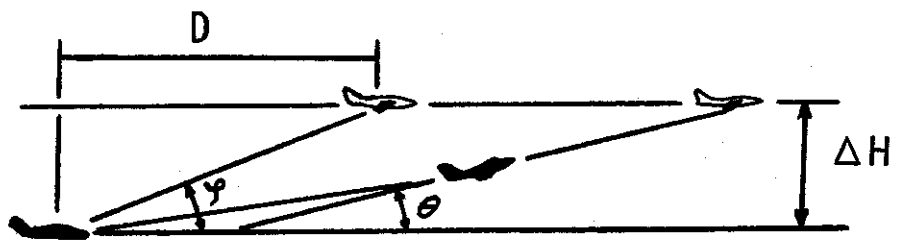

ZOOMING ATTACK

FIGURE 66

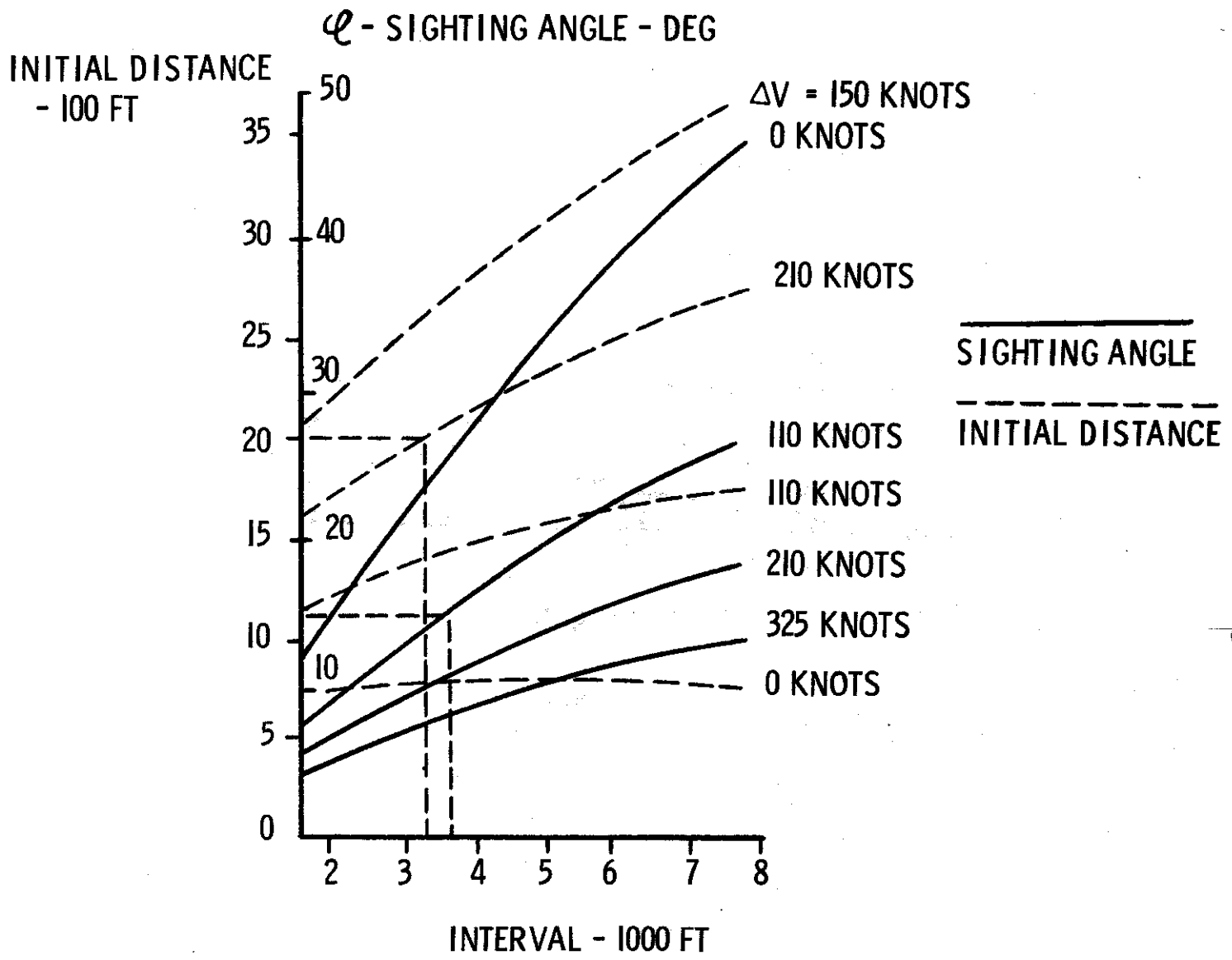

DEPENDANCE OF TARGET SIGHTING ANGLES AND INITIAL DISTANCE TO TARGET UPON INTERVAL AT THE BEGINNING OF THE MANEUVER. CURVES ARE PLOTTED FOR AN ALTITUDE OF 62,500 FEET

FIGURE 67

[REDACTED]

the interceptor will point at the target, but sooner, when the axis of the aircraft will be directed ahead of the target by a distance equal to one-half the initial interval between interceptor and target. After the turn reversal, target tracking begins when the pipper is still somewhat ahead of the target.

Experience has shown that frequently after executing the turn reversal, the interceptor may appear on the other side of the target. An attack in a horizontal plane should be executed with an approach rate of no more than 160 knots.

When attacking in a horizontal plane, the angular velocities of the interceptor while aiming are small, consequently cannon fire can be conducted with the gyroscope arrester switch in the "Gyro" position. Firing with the sight in the "Gyro" position can also be done when the target is executing a slight maneuver.

The maneuver for repeated attacks is executed by sliding off to the side after the attack. When rockets are launched from a distance of 8,000 - 10,000 feet, the pilot turns away from the target about 20 to 25° using a 25-30° bank. The turn is then reversed and the pilot turns back into an angle equal to double the angle of the first turn, i.e., by an angle of 40 - 45°. After this, he reverses once more and starts along a new pursuit curve.

The maneuver for repeating an attack by turning to the side at a speed of 1025 knots and with an approach rate of 110 knots takes about 2.5 minutes. If, during the maneuver for a repeated attack, the pilot loses the target, he must request immediate GCI vectoring.

With a low approach rate in a horizontal plane, the repeated attack can be executed by dropping 3300 - 5000 feet below the target and taking up an initial position for a zooming attack.

A repeated attack after one made by zooming can be done in the following manner. After rocket launching, continue climbing until reaching 325 - 650 feet above the target. While climbing, turn the minimum amount away from the target that will allow for keeping the target in sight through the side of the canopy. Then take up a initial position for an attack in the horizontal plane.

An attack using rockets must be broken off at 3300 feet to avoid rocket fragments. An attack by cannon firing must be completed at a distance of no less than 1900 feet.

Figure 68 shows a graph of minimum break-off distances to avoid a collision with the enemy bomber. The graph is intended for altitudes up to 59,000 feet when pulling out from the attack by a half loop (Split-S) and when passing within 650 feet of the target.

MINIMUM DISTANCES - FEET

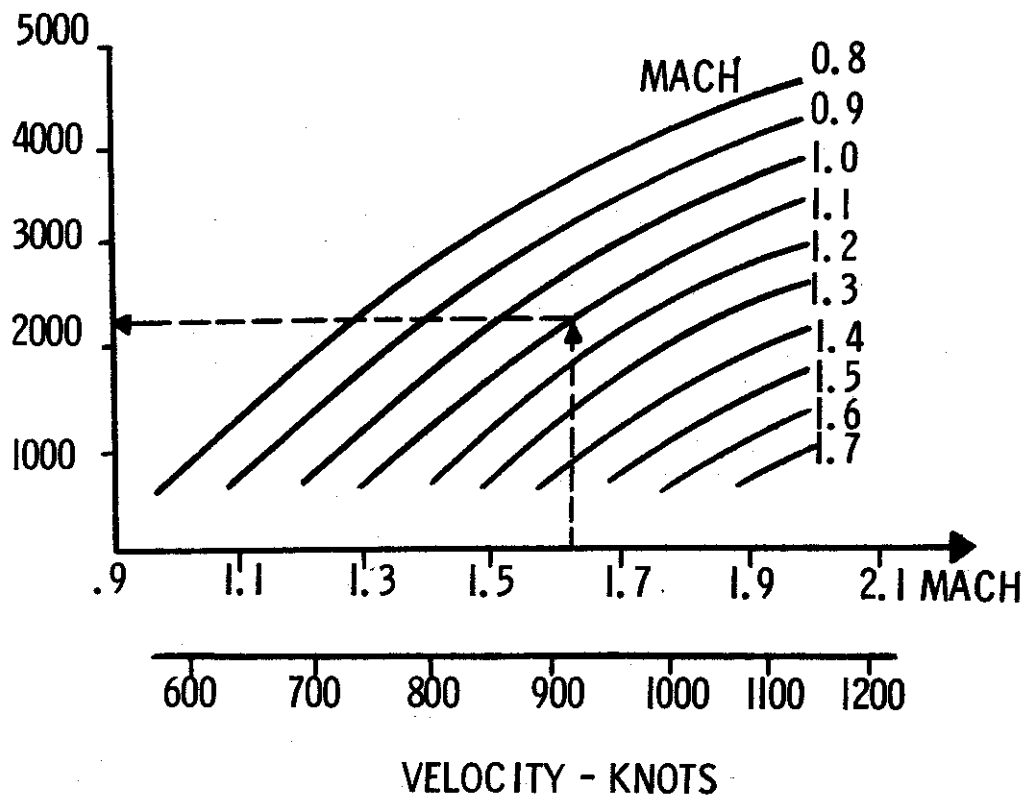

MINIMUM PULL OUT DISTANCE TO AVOID COLLISION WITH THE ENEMY AT ALTITUDES UP TO 59,000 FT

FIGURE 68

Pull-out from an attack in the horizontal plane is realized by rolling the aircraft and going into a half-loop (Split-S) and the subsequent dive. If at the moment of rocket launching, the interceptor is not in a bank he may roll either way, otherwise he rolls in the direction nearest to inverted flight.

When the interceptor has a high speed surplus over that of the target, the break-off can be made upwards with a turn away from the target at a 20-25° angle for a possible subsequent attack from the side.

ATTACK IN PAIRS

As a rule, a pair of interceptors attack sequentially. The attack can be executed from one or from different directions. The nature of pair attacks are essentially no different from single attacks. Sequential attacks by a pair of interceptors are executed according to the following procedures. The wingman remains behind lead at the maximum possible distance, depending on visibility. The lateral interval is usually a distance of 1600 - 2600 feet. Lead initiates the attack and the wingman continues the flight along a straight line and as soon as lead begins to pull out from the attack, the wingman, from a pre-calculated position, goes into attack. During his attack, the wingman must monitor the actions of the lead aircraft to make sure he does not launch his rockets before lead is beyond the zone of being picked up by the rocket heads.

When executing sequential attacks from various directions and after visual target detection, the interceptor closest to the target does over to the other side of the target and takes up an attack position from which he can simultaneously see the target and the other interceptor. The first interceptor to attack takes up an initial attack position, then having aimed and launched his rockets, pulls off to his side. The second fighter then does the same from his side. Sequential attacks from various directions make the evasive maneuvering of the bomber in a horizontal plane ineffective. For this reason, it is probable that a B-58 bomber attempting to escape attack will execute a vertical evasive maneuver, (rapid loss in altitude with subsequent horizontal flight). To attack the enemy, a pair in tactical formation should have a 3300 - 5000 foot altitude differential and be spread about 1600 - 2600 feet. In this case, the attack is initiated by the interceptor in the most convenient attacking position.

ATTACKING A SINGLE BOMBER AT DYNAMIC ALTITUDES

The MiG-21f-13 can attack enemy bombers at altitudes up to 72,500 feet. The success of an aerial engagement at dynamic altitudes depends basically on vectoring accuracy, visual target detection, and the available time the fighter can remain at these altitudes.

Since flight at dynamic altitudes is executed with large angles of attack, it is advisable to get the interceptor into an initial attacking position with a slight descent. For a distance of 1.3 - 5.4 nautical miles at a target sighting angle

~~SECRET~~

of 15 - 16°, the amount of descent is approximately 2600 - 10,000 feet. Consequently, the interceptor in relation to a target at 66,000 feet should be 3300 feet lower and for a target at 71,000 - 72,500 feet, he should be 10,000 feet lower. When below the target, the interceptor has better searching conditions, greater speed and better maneuvering possibilities and can attack a target flying at an altitude exceeding the interceptor altitude.

The initial attacking position is determined by the sighting angle toward the target aircraft. Table XXVII shows sighting angle values and altitude differences for interceptor to target distances equalling 1.6 - 1.9 NM.

TABLE XXVII

SIGHTING ANGLES AND ALTITUDE DIFFERENCES FOR INTERCEPTOR TO TARGET
DISTANCES OF 1.6 - 1.9 NM

Altitude, (AH) Feet	β Degrees
3300	20
4900	25
6500	30
8200	35
9900	40

The zooming attack is executed in the following manner. After visual detection of the target, the interceptor (when necessary) continues climbing and at an altitude designated by the GCI controller, he levels off. As he approaches the attacking position, he pulls the aircraft into a zoom with a 17 - 20° pitch angle as determined by the gyro horizon. Aiming and salvo launching of the rockets is done during the zooming maneuver. To carry out a repeated rocket attack or an attack with cannons is impossible at dynamic altitudes.

To execute an attack when overtaking a target, the speed advantage must be at least 55 knots. From small distances, attack is possible even with a slight speed disadvantage.

Determination of the initial position for climbing to dynamic altitudes becomes very difficult. To intercept targets at these altitudes, it is necessary to bring the interceptor to an altitude near the flight altitude of the target at a speed as close to minimum as possible in order to have an approach speed that will assure reliable aiming and rocket launching. The distance to the target in this case should be such that the sighting

[REDACTED]

angle is 2 - 3° greater than the angle of attack. This will allow an attack to be carried out with practically no change in flight trajectory. To create better conditions for target detection, the fighter should be brought to a position where the target is visible through the side of the canopy.

The zoom to gain altitude should be initiated from altitudes of 46,000 - 59,000 feet with a Mach number of 2 and with a 20 - 25° pitch angle. The altitude of 64,000 feet should be reached with a Mach number of 1.4 and at a 3.2 - 3.8 NM distance from the target. The target should be approached by executing the commands issued by the GCI controller. Having visually detected the target, the interceptor should get up to a position from where he can maneuver to emerge on the tail of the target, aim, and launch his rockets.

The overtake speed at the moment of visual detection should be from 270 - 325 knots. If the target is detected at a distance of 2.7 - 3.2 NM, the pilot has 20 to 25 seconds to correct vectoring errors and to execute the attack. During this time the interceptor will be closing to a distance of 5000 - 6500 feet.

After visual detection and when TGS lock-on is acquired, it is necessary to fire the rockets immediately. Attack disengagement is then done by banking the aircraft.

The interception of targets flying at dynamic altitudes requires special training for the pilots and the GCI controllers.

PAIR OF INTERCEPTORS VERSUS SINGLE BOMBER

A single interceptor cannot always fulfill the given mission of destroying a modern bomber because its fire power may be insufficient. To increase the fire power against the enemy and to increase the probability of destroying a single bomber, the interceptors can act in pairs or groups.

A two-ship or more flight of MiG-21f-13 aircraft, in comparison with the formation of old style aircraft, has certain undesirable features. The pilots view with the pressurized helmet is considerably reduced. Even in level flight, the pilot cannot scan the rear hemisphere or the space above him. When flying while pulling some G's, the view is even further limited. In such a flight, a pair of interceptors cannot maneuver freely and give mutual fire support as was the case when flying without pressurized helmets.

~~SECRET~~

Maneuvering at maximum G-loads in horizontal and vertical planes can be practically executed by a two-ship flight only when in extended tactical formation when the wingman repeats the maneuver behind the lead aircraft. But in such a formation, lead cannot see his wingman. All this leads to the fact that in a two-ship flight it is difficult to employ tactical methods based on deployment of aircraft.

In order to preserve the tactical formation of a pair, lead must fly at an altitude somewhat lower than maximum. Although this facilitates the wingman maintaining his position, it reduces the maneuvering qualities of the flight considerably.

When using the afterburner, the engine thrust is not well regulated. Even if the afterburners of two aircraft are switched on simultaneously, there is no guarantee that they will fire simultaneously and this too hinders formation flight. The afterburner must be cut in upon command of the leading aircraft. The wingman cuts his in immediately upon receiving the command and the lead, knowing the firing time of both aircraft, considers this and cuts in his afterburner. Lead should fly with incomplete afterburning, so as to offer the wingman the capability of keeping in formation.

It is not recommended to fly for extended periods, at Mach numbers close to 1.5 or 1.9, where extension or retraction of the inlet cone takes place. A change in the position of the inlet cone changes the flight situation with respect to speed. Because the extension and retraction of the cone on various aircraft is not simultaneous, formation flight when close to these Mach numbers represents a specific difficulty.

Very important factors when flying in formation are the legibility and timeliness of radio commands from lead and the reports from the wingman.

Two-ship tactical formation, up to the point of visual detection of the target, should be flown in such a way that the wingman could at any given altitude and at any airspeed, freely maneuver behind lead and not lose him. This condition is satisfied by the "bearing of aircraft" formation where the wingman is 650 - 1,300 feet out to the side and about 50 - 60° back from lead. When flying such a formation, the wingman can help conduct the search and still cover the lead's rear hemisphere. After visual bomber detection, the flight, during the process of approaching the target, takes up a tactical formation dependent upon the attacking method.

[REDACTED]

The flight should also be trained to fly close formation, so that flight integrity can be maintained during cloud penetrations. This eliminates the time needed to rejoin after breaking out of the clouds and increases the range and flight duration.

When destroying a single bomber, a pair should as a rule, execute sequential attacks and less frequently, simultaneous attacks.

SEQUENTIAL ATTACKS

The probability of a single MiG-21f-13 interceptor when striking an enemy bomber using R-3S rockets is 0.9. That is why a pair of interceptors should adopt sequential attacks against a single bomber. In case the bomber is destroyed by one interceptor, the second can utilize its rockets for the annihilation of another target. Table XXVIII gives the distances between aircraft when a two-ship flight is making sequential attacks with each interceptor having the same launch distance for his R-3S rockets. Flight experience has shown that this distance between interceptors in open tactical formation in depth should not exceed 5000 - 6500 feet.

TABLE XXVIII

DISTANCE BETWEEN AIRCRAFT FOR A 2-SHIP FLIGHT MAKING SEQUENTIAL
ATTACKS

Rate of Approach ~ Knots	Distance Between Aircraft ~ Feet
30-110	650-2600
110-215	2600-5000
215-325	5600-8000

Sequential attacks can be executed in close tactical formation, i.e., with smaller distances between the interceptors. In this case, lead fires both rockets from a maximum distance and the wingman salvos from the minimum distance. Such an attack with each interceptor emerging at various distances and from one or several directions, is possible with approach rates up to 160 - 215 knots. The more effective pair attack is when made from various directions and it is executed in the following manner. Having visual target detection, the pilots deploy during approach upon the command from lead. Aiming, i.e., TGS lock-on and approach to permissible launching range, is done by each pilot individually. If the target does not maneuver, the lead aircraft

~~SECRET~~

attacks first. If the sun interferes with the leaders attack, the wingman, with leads command, may attack first.

After the rockets are launched, the first attacker breaks off to his side so as not to interfere in the sequential attack of the second aircraft. The pilots inform each other about the rocket firing using a pre-arranged radio signal. In Figure 69 is shown a variant of a sequential attack by a pair of interceptors from various directions.



SEQUENTIAL ATTACK OF A PAIR FROM
DIFFERENT DIRECTIONS

FIGURE 69

If at the moment the interceptors begin attacking, the bomber starts a tight turn in lead's direction causing lead's "overload" signal light to come on, the rocket attack is then executed by the wingman. Lead gives the command to the wingman to attack while he reduces speed and continues turning after the target in an attempt to provide his wingman with favorable attack conditions. The wingman will have better conditions for attacking when the bomber changes direction. If the wingman's attack is unsuccessful, lead should be able to lock-on and launch his rockets from a permissible distance. In this way, sequential attacks from different directions offer favorable conditions for the annihilation of a bomber capable of evasive maneuvers.

~~SECRET~~

COMBAT WITH BOMBER FORMATIONS

Experience shows that the enemy pays serious attention not only to independent aircraft actions, but also to actions of small formations (3-4 aircraft). Bombers in general tactical formations should be considered as a rare phenomenon employed mostly when using conventional means of destruction. Timely destruction of such targets requires a definite detail of fighters. Among the basic units composed of MiG-21f-13 interceptors which can organize for group aerial combat, the pairs and groups are considered as the most maneuverable.

A bomber formation, depending on its composition and disposition, offers a chance to each pilot, pairs, or group of interceptors, to have an individual object of action or aiming point. This creates favorable rocket launching conditions. A bomber formation is limited in the effective defensive maneuvers it can fly and will usually be flown at subsonic speeds at medium or high altitudes where the MiG-21f-13 has high maneuverability and airspeed characteristics and can fully utilize its tactical possibilities.

A formation of interceptors, depending on the nature of the target, can apply sequential or simultaneous attacks. By simultaneous attack is meant the simultaneous launching of rockets from two or more interceptors, usually from various directions. A pair of interceptors engaged in combat with a bomber formation should attack simultaneously from one direction. This offers the possibility for an aimed launching of R-3S rockets from each interceptor against a picked target. With a simultaneous attack, the rockets are launched by a command from lead. If executed properly, both rockets may be aimed at the same formation and from the viewpoint of attack conditions, this differs very little from single interceptor attacks.

Simultaneous launching of two rockets by a pair of fighters should be done only when a sufficiently high probability of striking each bomber in the formation with one rocket is not fully assured. In this case, the remaining rockets can be utilized for the destruction of other bombers.

When executing a two-ship attack against a flight of bombers, with each interceptor picking out a separate target, it is important to take into consideration the tactical formation parameters of the opponent, the distribution of targets between lead and his wingman, and the type of rocket launching to employ.

~~SECRET~~

If the bombers are in a formation with intervals of about 300 feet, the distance between thermal sources (because of stacking up, down, or back) is usually about 400 - 450 feet. If lead aims at the lead bomber and number two aims at one of the following bombers, number two must launch from inside a range of 2.4 NM to make sure that his rocket does not seek out another bomber. This range decreases if the rocket was launched from some angle-off. At high altitudes, the range should be about 2.1 - 2.4 NM, at medium altitudes about 1.9 - 2.1 NM. In cases where the interceptors are compelled to launch their rockets at distances exceeding these ranges and/or the bombers are flying with side intervals of less than 300 feet, it is necessary to attack the following bombers first for reliable results, and the lead bomber only when necessary.

FLIGHT OF INTERCEPTORS VERSUS FLIGHT OF BOMBERS

A basic task of the interceptor flight commander after detecting a formation of bombers is proper distribution of targets between the pilots in his flight. Then each pilot independently executes the aiming and launching of rockets from distances which assure maximum kill probability.

If the bomber flight has less than four aircraft or if the formation is fairly tight, several bombers will appear in the R-3S IR detector unit field of vision. The interceptor flight should then execute sequential attacks in pairs.

Sequential attack in pairs appears to be the most convenient tactic to use in an aerial engagement with a group of bombers. It assures more favorable conditions for the aiming and launching of rockets by each interceptor against its own target. The time interval between pairs should not exceed 30 seconds, so this will have little effect on the interception boundary.

When searching for aerial targets, the recommended formation for the flight is "bearing of the pair", with a 1300 - 1600 foot distance between pairs, and the lead aircraft of the second pair should be back about 50 - 60° from the first pair.

When the flight is executing a sequential attack in pairs from a "bearing of the pair" formation and from one direction, the distance between pairs should be selected in conformity with the approach rate. The approach rate should not be more than 110 - 135 knots and for this rate, the distance should be 3300 - 5000 feet. When approaching at greater speeds, it is necessary to increase the distance between pairs or to launch the rockets without monitoring the results of the attack by the first pair.

~~SECRET~~

Rocket launching without knowing the results of previous launchings is advisable if the bombers are far enough apart so as to preclude a rocket homing on a neighboring bomber.

NIGHT COMBAT CHARACTERISTICS

When intercepting bombers at night, the pilot is vectored by ground control, but must detect the target visually or with the aid of the infrared sighting device, SIV-52. Visual target detection can take place at night by looking for the following signs:

- dark spots against the bright part of the horizon;
- shadows on a cloud background on a moonlit night;
- jet engine exhaust;
- missile traces from enemy bombers;
- contrails which can easily be observed at dusk and during bright nights in the form of rectilinear bands.

In spite of the many signs, there is still considerable difficulty connected with the search and timely detection of enemy bombers at night. Visual search during bright nights or at dusk (evening or morning) should be conducted after being vectored by ground commands to a distance of probable target detection. The GCI controller, in guiding the aircraft to a passing-intersecting course with the target, should take into consideration the characteristics of the night and the background of the sky in order to make it easier for the interceptor to detect the target. The possibility of visually detecting an enemy bomber at dusk and during bright nights depends upon the transparency of the air, degree of interceptor cockpit illumination, the presence of signs of the opponent's flight, and upon the position which the interceptor occupies with respect to the bomber, moon, or illuminated part of the horizon.

Searching for targets at twilight should be conducted against the background of the illuminated side of the sky and from an altitude of 1600 - 2000 feet below the supposed altitude of the bomber. At twilight, a bomber can be detected visually from about 2.2 nautical miles and at night from about 1.1 nautical miles.

~~SECRET~~

~~SECRET~~

Searching in moonlight conditions should be conducted so that the fighter, when in the low, rear hemisphere of the target, is between the moon and the target, i.e., the direction toward the target should not coincide with the direction toward the moon. The pilot first detects target reflections and then from a distance of 1 - 1.5 nautical miles should be able to see the target's shape.

When the target is between the moon and the interceptor, searching becomes complicated as the target silhouette can be spotted only when on the background of the moon or very close to it.

Visual target searching at twilight is flown at approach rates of not more than 50 - 80 knots and during bright nights at rates of only 10 - 15 knots.

When the interceptor reaches the range of probable target detection, the GCI controller controls the flight until the pilot reports, "I see the target;" next, he continually monitors the flight and when necessary, corrects same.

The target approach should begin immediately upon target detection as the execution of additional maneuvers in an attempt to obtain better position may lead to losing the target.

Aiming is done by using the fixed reticle of the sight and with minimum sight lighting.

Range is determined with the aid of the SRD-5mk radar range finder and in case the range finder is not functioning, with the aid of a mechanical range finder using the bomber silhouette, or by the illumination of the tailpipes of several engines.

When necessary, aiming against the bomber can be executed with the aid of the infrared sighting device, SIV-52.

Launching the R-3S rockets is done in salvo with an angle-off of not more than 15° immediately after the aiming is done. The attack should be broken off at a distance no less than 3300 feet.

When attacking with cannons, the approach rate should be only 10 - 15 knots in order to eliminate over-shooting the target. The attack can be made with an angle-off of not more than 15° and the open fire range is from 2600 - 2300 feet.

Searching for a target on a dark night can be done with the infrared sighting device (SIV-52) but as it is not too accurate, it is advisable to search under the close supervision of the GCI controller. Upon GCI commands, the interceptor is vectored into the rear hemisphere of the target at a distance of 2.7 - 3.3 NM and to an altitude about 1000 feet below the target. From here on, the pilot must systematically receive information about range, approach rate, and position of the target relative to the interceptor.

After detecting the target, the pilot with the aid of the infrared sighting device, should determine the distance to the target. The distance is determined by the doubling of the markers on the screen. The greater the distance between engines, the greater will be the distance of the marker from each engine.

In the process of approaching, the fighter may enter a zone where rocket launching is impossible because of the G-load or an absence of the audio-signal indicating TGS lock-on. Under these conditions, it is necessary to reduce bank, turn away from the target about 12°, and hold the target along the side edge of the SIV-52 screen until entering the zone of possible attack. Arrival at launching distance is determined with the aid of the SIV-52 and by information from the GCI controller.

For example, at ranges of 7000 and 5500 feet the visible position of the markers from the end engines of a B-47 is 13 and 17 thousandths respectively and from the engines of a B-58, 6 and 7 thousandths. The most suitable direction for attacking is from the rear in the same plane as the target or with a slight ascent and with an angle-off the tail of zero to 15°.

COMBAT UNDER ELECTRONIC AND INFRARED COUNTERMEASURES

The opponent may produce interferences to the operation of the radar range finder and to the R-3S rockets.

When radar jamming is being done the permissible range computer will function erroneously or may stop functioning entirely. When this occurs, the pilot should determine the rocket launching range manually by using the optical range finder of the ASP-5 mk sight or by commands from the GCI controller. This requires the pilot to know permissible rocket launching ranges for most altitudes and approach rates.

Determination of range using the optical range finder has a specific difficulty as the dimensions of a target in thousandths

~~SECRET~~

at long ranges is very small. Table XXIX gives values of target dimensions in thousandths in relation to distance.

TABLE XXIX

TARGET DIMENSIONS IN THOUSANDTHS

Target Wing Span (Ft)	Target Dimensions in Thousandths in Relation to Range				
	3300 Ft	6500 Ft	9800 Ft	13000 Ft	16400 Ft
114	35	18	12	9	7
183	56	28	18	14	11
60-65	18-20	10	6	5	4

The necessity for controlling the launch range by using the optical range finder originates in cases where the maximum launching range is less than the infrared lock-on range. This usually pertains to low and medium altitudes and when attacking a target at an approach rate of 55 - 215 knots.

When attacking targets at high altitudes and in the stratosphere, the range limits established by controlled flight time usually exceed the range of infrared lock-on. For example, when attacking heavy bombers up to an altitude of 33,000 feet, the TGS lock-on range is 2.7 - 3.8 NM and the maximum possible range of controlled rocket flight at approach rates of 55 - 215 knots changes with altitude as follows: 3300 foot altitude, .9 - 1.4 NM; 10,000 feet, 1.1 - 1.6 NM; 16,000 feet, 1.2 - 1.9 NM; 33,000 feet, 2.2 - 3.5 NM. Over 49,000 feet, the range of controlled rocket flight, considering minimum encounter velocity, usually exceeds 3.8 NM. This exceeds maximum TGS lock-on which is relatively constant at about 3.8 - 4.1 NM.

Consequently, the launching of R-3S rockets under ECM jamming at altitudes up to 33,000 feet should be carried out with the range being controlled by the audio signal announcing TGS lock-on and by determining the necessary time from the moment of receiving the signal to the arrival at launching distance, or by using the optical range finder. The approximate time (in seconds) to which the pilot has to adhere, from the moment of TGS lock-on to his entry into range of permissible rocket launching, is indicated in Table XXX.

~~SECRET~~

~~SECRET~~
TABLE XXX

TIME FROM TGS LOCK-ON TO PERMISSIBLE LAUNCH RANGE

Approach Rate ~ Knots Altitude ~ Feet	55	110	160
3,300	122 sec.	55 sec.	21 sec.
10,000	130 sec.	55 sec.	23 sec.
16,500	147 sec.	60 sec.	23 sec.
33,000	111 sec.	31 sec.	5 sec.

At altitudes of more than 49,000, the launching of R-3S rockets can be done as soon as the TGS is locked on, because in this case the fighter will be within permissible rocket launching distances. In practice, the range of rocket launching will usually be less because of the relatively short range of target detection.

To disrupt attacks, the opponent may release thermal sources or apply smoke screens for the purpose of creating a screen over the engines. In the latter case, the attack direction will depend upon the disposition of the smoke media. The greatest effect of the smoke screen will be produced when the target is attacked from directly astern at a co-altitude or slightly below.

In the role of interference media for thermally guided rockets, the opponent may drop slowly falling pyrotechnical thermal emitters. An emitter dropped from a bomber is detected with ease by the pilot and actually facilitates the orientation of the fighter with respect to the target. But if the countermeasure is dropped after the rocket is launched, it will attract the rocket away from the bomber. Attacking a target employing pyrotechnical countermeasures should be done with as high an angle-off as possible. This maneuver should be effective if the target will continue to fly in a straight line but it should be expected that an opponent to effectively utilize a pyrotechnical countermeasure will turn and descend away from the attacking interceptor. If the target makes a turn with 30 - 45° of bank at an airspeed of around 485 knots and continues to drop pyrotechnical countermeasures, the attack will be quite difficult to successfully execute. Under these conditions, it is advisable to execute a simultaneous attack with a pair of fighters from different directions.

~~SECRET~~

CHAPTER IV

AERIAL COMBAT BETWEEN MiG-21f-13's AND ENEMY FIGHTERS

Aerial combat between MiG-21f-13 fighters and enemy fighters has many characteristics similar to combat with old type fighters.

The presence of R-3S rockets and cannons on the MiG-21f-13 broadens considerably its possibilities in aerial engagements and allows it to carry on long range as well as short range battles. This offers the possibility of variegating the forms of fighter maneuvering and the tactical methods of aerial combat.

Aerial battle between fighters is the most frequently encountered aerial engagement. Each engagement has specific features which are determined first of all by the enemy's mission, and secondly by the conditions in which the battle is executed.

The typical effective altitudes of tactical fighters should be considered between 16,000 - 33,000 feet and at low altitudes.

The main task of fighter-bombers is to strike against ground targets; consequently, prior to the completion of their mission, they are in no position to accept aerial combat and will try to remain out of it. Once the mission is complete, the average fighter-bomber can engage in a battle which will be little different than combat with conventional fighters. The tactics of aerial combat are determined not only by the above mentioned characteristics, which are inherent to a wide variety of tactical fighters, but also by the unique flight qualities peculiar to a definite type of fighter.

MiG-21f-13 fighters, in contrast to previous types of fighters, are distinguished by much better flight qualities and more powerful armament. R-3S rockets, with which an adversary can be stricken with maximum probability from a range of 2.7 - 5.4 NM, are the basic armament of the MiG-21f-13. An adversary executing a maximum performance maneuver can be hit by R-3S rockets, only at ranges greater than 1.6 NM. At shorter distances, in view of the great angular velocity of the maneuvering enemy, a rocket attack cannot be carried out in the majority of instances because the G-load on the attacking interceptor becomes greater than permissible for rocket launching. Under these conditions, cannons are the most effective means of destroying the target.

Aerial engagements with earlier aircraft were distinguished by the frequency of attacks from various directions, greater

intensity, and were at the same time, of longer duration. Any enemy counter-maneuver was still in view of the interceptor and the latter could continue the attack without breaking away from the enemy. The battle tempo of supersonic fighters is much slower and because of the great speeds, a maneuver for a repeated attack often leads to the loss of the target by the pilot.

The presence of R-3S rockets with TGS allows the MiG-21f-13 to attack from a greater range of various approach rates. This is a highly important tactical quality as it requires no long lasting approach to the target and no complex maneuvering. It allows for the successful execution of the attack, provided the interceptor is vectored into the rear hemisphere of the target at a permissible rocket launching distance.

The pilot will be able to sustain superiority and initiative in battle only if he can simultaneously repeat the maneuvers of the enemy, particularly when the maneuvering qualities of the aircraft are relatively the same. The attacked aircraft will maneuver erratically in order to make tracking difficult; hence, the capture of initiative alone does not mean decisive victory, it still depends upon the expertness of the pilot and the enemy.

At contemporary fighter speeds, it became very difficult to stay oriented during an air battle and now because of greater airspeeds, there is a considerable increase in turning time and in the turning radius of all planes. Aerial battle now covers an enormous space and so in order not to lose the enemy from sight, the attacker as a rule, should try to repeat (follow) the maneuvers of the target. Execution of a maneuver in the opposite direction will unavoidably lead to a loss of the target and may make additional vectoring necessary.

The characteristics of aerial battle with the MiG-21f-13 are determined by the increasing role of flight speed. That is why speed is so important. For supersonic fighters, speed superiority is more important than altitude advantage because the presence of greater airspeed assures a rapid climb and without substantially reducing the airspeed.

Aerial battle with the MiG-21f-13, like never before, must be figured with a time factor. The pilot has less and less time for making a decision, and therefore, he must act within minimum time intervals. The slightest omission or inaccuracy may lead to incorrectible errors and may provide the enemy with the possibility of escaping.

~~SECRET~~

During air combat, there are considerable changes in altitude and airspeeds. Altitudes change from close to ceiling to medium or even to low, and airspeeds change from maximum permissible to near minimum. In these conditions, the enemy can fly a counter-maneuver and get away from the first attack and then as his speed increases, break away from the attacker and end the battle.

If a pilot succeeds in attaining a rapid approach, the nature of the maneuver is little different than the maneuver employed in battle with a bomber. The attacking pilot, using the element of surprise, may approach the target to the necessary distance at the 6 o'clock position and launch the rockets or use the cannon. To attain this element of surprise, the target should be pursued from out of the sun when possible. This aids in the approach and also facilitates the use of the R-3S rocket by firing away from the direction of the sun.

It is evident that if the interceptor has the possibility of attacking from the rear hemisphere, the fighter should adopt measures to stay on the target's tail through the distance needed to launch R-3S rockets or carrying out aimed cannon firing. If it was impossible to execute a sudden attack, the enemy, having detected the attacking fighter, will immediately adopt any maneuver to get away. Most frequently, he will break abruptly into the attacking fighter, thereby preventing rocket launching or cannon fire. Having executed this first defensive maneuver, the opponent will then begin flying maneuvers intended for gaining a tactical advantage or to get away from the attacking fighter.

APPROACH

The approach, as a phase of aerial combat, begins at the moment the target has been detected by the pilot and is concluded when the fighter arrives at the position for launching rockets or for firing the cannons. The approach should not be rated as only a simple overcoming of the distance which separates the interceptor from the target. In the process of approaching, the interceptor, by a pre-determined maneuver, should occupy the most convenient initial position which assures a successful attack.

Having detected the enemy, it is necessary to determine immediately whether there are additional enemy aircraft in the vicinity and also the number, type of formation, and flight direction of the detected aircraft. The nationality of the aircraft will, in a majority of the cases, be determined with the aid of the GCI controller and also by other direct signs

~~SECRET~~

(silhouettes, characteristic formations, flight direction, etc.). Unidentified aircraft are considered as enemy aircraft and their nationality is established during the approach.

With the airspeeds of the modern fighters, the slightest delay with the initial approach may lead to a disruption of the attack. That is why the approach should be flown carefully and be hidden from the enemy. The swiftness of the approach is attained through use of a high approach rate and by flying the shortest route.

Secrecy of the approach is attained first of all by trying to approach from directions and altitudes which are known to be poorly observed. The SRD-5 mk radar range-finder should be turned on only after the pilot has acquired an infrared lock-on. In the process of approaching, attention should be paid to the cloud disposition and the sun's position. To secretly approach a fighter the following basic methods are used:

- approach from the side of the sun along the edge of cloudiness or haze;

- approach from various directions.

The nature of the approach depends first of all upon the initial mutual positions of the fighters and upon how soon the target was visually detected. It also depends on the armament destined for employment.

When vectoring fighters, the encounter is usually from the rear hemisphere when solely our fighters were vectored, or at counter headings when vectoring was done by both sides. In the first case, the approach is usually relatively short because, at the moment of detection, our fighter will always have speed superiority. Depending on the speed differences and the type of weapon used, the approach time varies from 15 - 20 seconds to 5 minutes.

In the majority of cases, the approach is made by a pursuit curve or with lead angle. Approach by pursuit curve consists of keeping the nose of the interceptor on the target until reaching the point where aiming begins. This is the simplest method. When using such a method, the aiming curve tends to be a continuation of the approach curve and it is not required to fly any additional maneuvers in order to get on the aiming curve. This method can be applied at distances of not more than 1.6 NM because the view through the forward armored glass is difficult and does not assure reliable target observation.

The approaches are usually made with lead angle, but since the most suitable angle of lead is hard to determine visually, the approach takes place with a variable lead angle. It is obligatory that the target be well visible through the side glass of the canopy.

When fighters are detected at counter-headings, it is usually inadvisable to pursue the enemy because by the time our fighters make a 180° turn, the enemy covers a distance of 8 - 22 NM which requires repeated vectoring and takes too long a period of time. The GCI controller, as well as the pilot, must know the capabilities of the MiG-21f-13 with respect to overtaking an enemy aircraft in order to make the proper decision when encountering enemy fighters on counter courses. The basic maneuver in this situation is a tight horizontal turn. Calculations show that in spite of the minimum amount of turn time used in a maximum performance unstable turn with the resultant loss in speed, the total elapsed time needed to overtake the enemy is lower when a maximum performance stable turn without losing speed is used. In addition to a level turn, there may be instances where a more complex maneuver is called for such as a semi-loop, slanting half loop, tactical turn, or half turn, etc.

Maneuvers for a tactical turn and slanting half-loop are usually applied when on counter-courses and when at the same altitude or below. The start of the maneuver is determined by the distances to the target the moment the fighters go into a slanting half loop or into a tactical turn. (Figure 70)

LEAD DISTANCE - N. M.

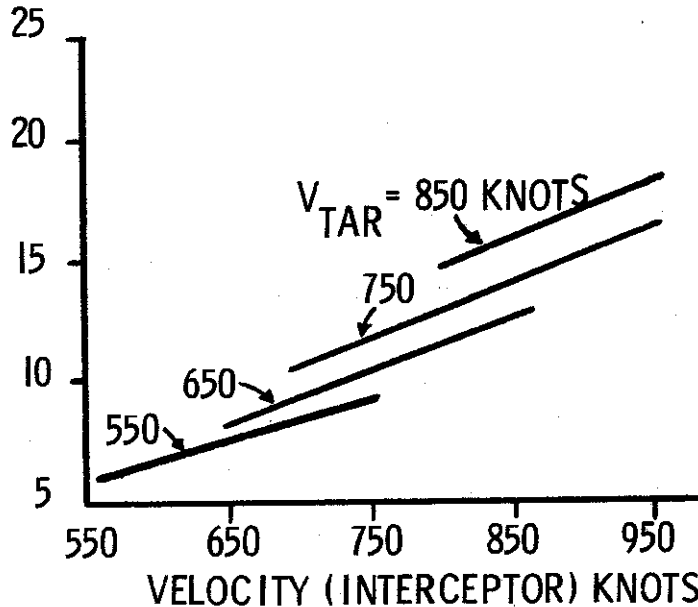

FIGURE 70 NECESSARY DISTANCE TO THE TARGET TO LEAD THE FIGHTER INTO A MANEUVER

~~SECRET~~

It is evident from the graph that the required distance may be considerable and can go beyond the limits of visual target detection. That is why a successful search and subsequent emerging at the target's tail is possible only with GCI vectors. The GCI controller using the graph data should guide the fighter to the point of beginning the maneuver and issue the command for starting. If the fighter is above the target on a counter-course, its emergence on the enemy's tail is executed with the employment of a descending maneuver, (split S). Since a half-roll provides a better view of the target during this maneuver, its parameters can be regulated according to the desired altitude loss and the maneuver can be flown when the interceptor altitude surpasses that of the target by nearly any amount.

Rapid target approach can be accomplished by use of an altitude advantage and if none exists, by the "wave down" maneuver. The nature of this maneuver consists of the following procedures. The pilot pushes over into a 5-7° angle descent and accelerates along a straight line, he then pulls into a climb of the same angle figuring to emerge at the end of the "wave" at the initial flight altitude. The advantage of this method lies in the fact that the average flight speed is greater than the initial speed, consequently the approach time is less than when overtaken in level flight. The descent, relative to the target, should not be more than 3000 - 5000 feet or the approach time is increased and the target can be lost from sight. There may be cases where a fighter must fly several such "waves" to overtake a target. The comparison of this method to a level approach is given in Figure 71 for various approach rates.

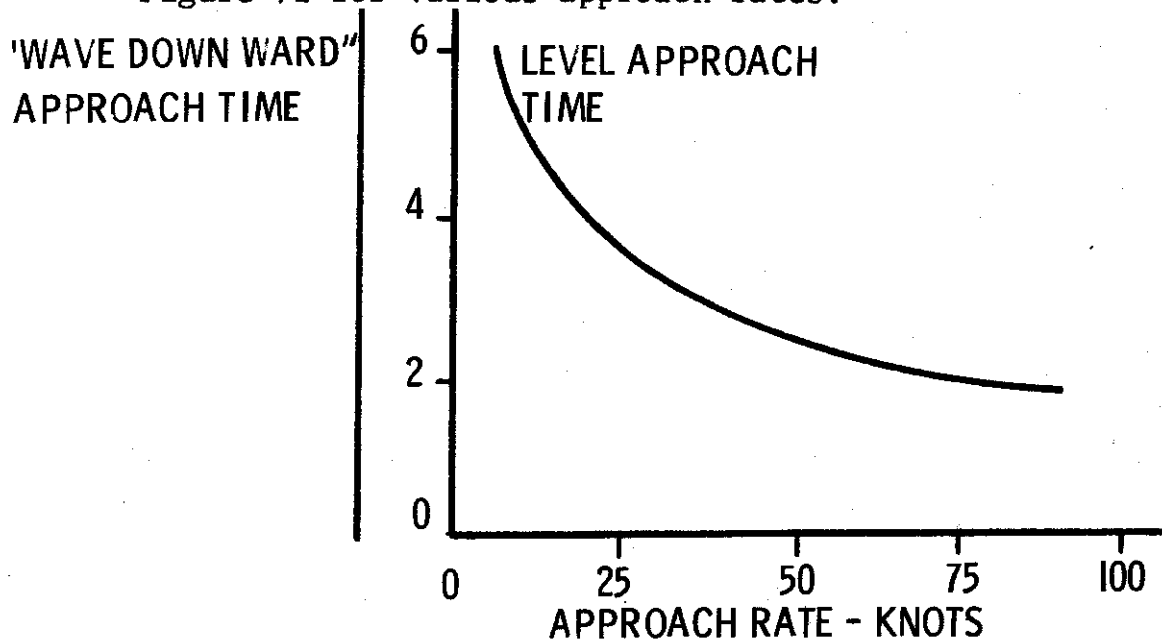

FIGURE 71 RATIO OF OVERTAKE TIMES

~~SECRET~~

[REDACTED]

The graph shows that the advantage of the "wave down" method lies in the dependence on the approach rate and is usually utilized at low rates of approach. For example, at an initial approach rate of 55 - 110 knots, the approach time by "wave down" is 2 to 2.5 times lower than by level flight, and at approach rates of less than 25 knots, the time is 4 - 6 times shorter.

The selection of the approach speed depends largely on the weapon used and it should assure the most favorable conditions for the attack. If R-3S rockets are used, the approach rate can be variable, for with normal GCI controlled vectoring and visual target detection at 2.5 - 3 NM, the pilot usually has time to aim and launch the rockets from a range of no less than 10,000 feet (1.6 NM).

If the attack is with cannon fire, the approach rate is limited to a large extent. When a fighter is vectored to the range of visual target detection, it is recommended the approach rate be not more than 270 knots, otherwise it is nearly impossible to slow down in the time remaining to the speed needed for attack. If the attack takes place at too great a speed, it seriously reduces the aiming accuracy and consequently the strike probability. Too low an approach rate (up to 25 knots) leads to a long approach time and may lead to the disruption of the attack. The most advisable approach rate is from 55 - 110 knots.

It should be pointed out that when a fighter emerges on the tail of the enemy with little or no angle-off, this hinders or practically excludes the possibility of the pilot determining the rate of approach. That is why the GCI controller must inform the pilot of his approach rate or at least give him the speed of his adversary. If a large angle-off exists, the pilot can determine the approach rate and by maneuvering, set up the necessary overtake rate that assures normal aiming.

One of the most widely employed and effective defensive maneuvers once the enemy detects a fighter drawing close to its rear hemisphere is a hard turn in the direction of the approaching interceptor. In this case, the interceptor usually does not succeed in adopting an approach with negative lead angle, which is normally considered a highly effective approach, because the fighters rapidly disappear beyond the limits of visual contact and repeated vectoring is required to carry out the attack. Consequently, if the enemy uses this maneuver, it is necessary to pursue the target persistently, approach it with positive lead, and try to remain in the target's rear hemisphere at rocket launching or cannon firing range. The tactics employed will in

~~SECRET~~

many cases depend on the formation and/or position of the fighters at the moment of detection.

Of the variety of possible instances, three of the most typical cases will be discussed here:

- battle begins with an attack by our fighter;
- battle begins with the enemy attacking our fighter;
- battle begins under equal conditions at counter, or counter-intersecting courses.

TACTICS WHEN THE MiG-21f-13 ATTACKS A FIGHTER

If the enemy detects an attacking fighter near a good position for firing R-3S rockets, it will try to disrupt the attack by our fighter. This will usually be followed by a speed acceleration along a straight line but the enemy will probably not do only this as his maximum speed is about equal or less than that of the MiG-21f-13. The attacker can easily launch his rockets at a rectilinearly flying target so the enemy will usually start maneuvering in the horizontal or vertical plane.

To successfully attack a maneuvering target, it is very important to select a suitable approach rate. Contrary to attacking a non-maneuvering target, where a greater approach rate had an advantage because it increased the launching range; when attacking a maneuvering target, a greater approach rate will generally eliminate the opportunity to launch rockets. Therefore, a pilot must select an approach rate which conforms with the position of the enemy fighters and the nature of their maneuvers. The best approach rate after visual target detection is 55 - 110 knots. With such a rate, the pilot has sufficient time to evaluate the nature of the enemies tactics and to execute a maneuver to attack the opponent. The attack should be made with a very small angle-off, because in this case, the enemy finds it difficult to execute a maneuver which will disrupt the attack.

To reliably strike the enemy fighter, it is sufficient if one R-3S rockets flies into the zone where the target is within the rocket's lethal radius. Since this probability is relatively high, especially when it is a group target or it maneuvers and the approach rate is slow, it is advantageous to launch single rockets. After the first rocket has been launched, continue the pass so that the results can be monitored and a second rocket fired if necessary.

~~SECRET~~

When the opponent first maneuvers, the attacker has a chance to aim for a short period of time and the G-load will usually not exceed the limit permissible for launching. The amount of time depends on the initial angle-off and range to the target, approach rate, and also the G-load used by the enemy in maneuvering.

In Figure 72^s a graph which shows the duration of target tracking when the target executes a turn toward the attacker at an altitude of less than 46,000 feet with a G-load of 3.

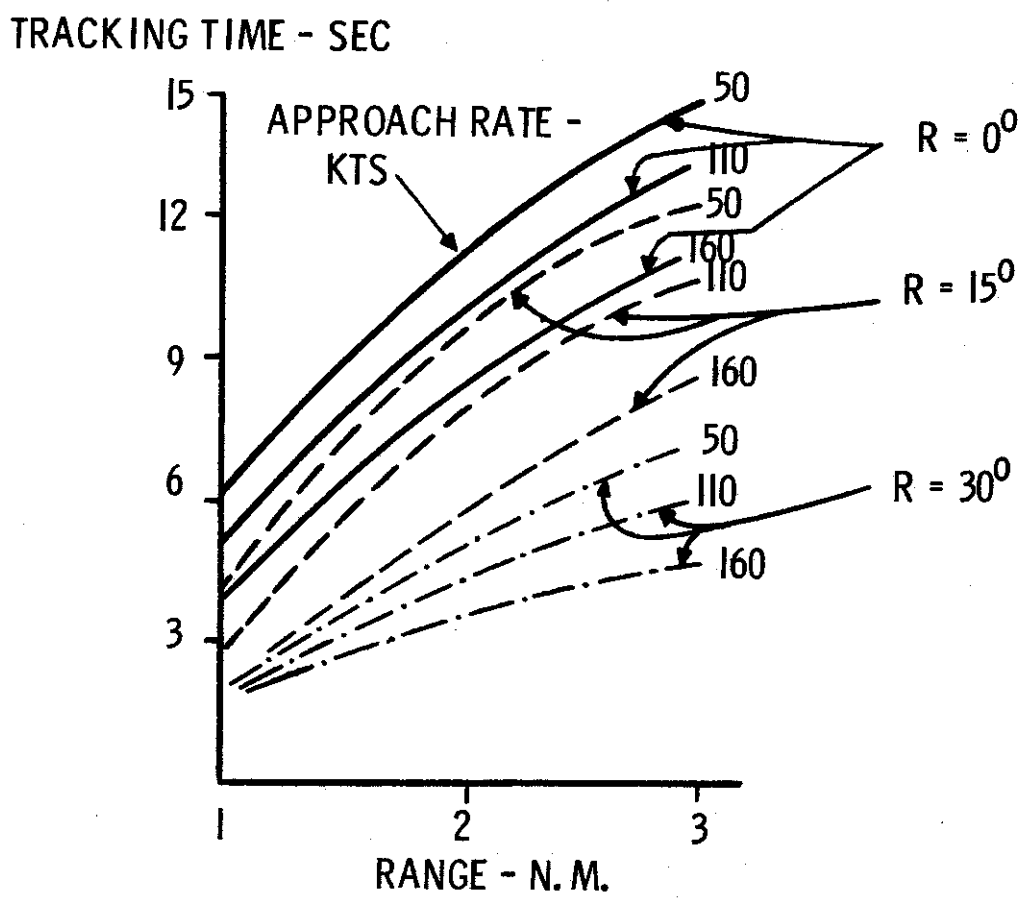

DURATION OF TRACKING IN A TURN. R IS THE ANGLE-OFF

NOTE: TARGET TURNS TOWARD THE ATTACKER AT AN ALTITUDE BELOW 46,000 FT AND PULLS 3-G's IN THE TURN

FIGURE 72

[REDACTED]

As is evident from the graph, the time depends largely upon the initial angle-off the target. If at a zero degree angle-off, the tracking time from a distance of 2.2 NM averages 11 seconds, and from 15°, same distance, 9 seconds, and from 30°, the time will only be 5 seconds. This means that the best possibilities exist when the R-3S rocket attack is made from as near the 6 o'clock position as possible, and consequently if distance allows, the rockets should be launched as soon as the target's maneuver is detected, otherwise it may become impossible.

Tracking time depends upon distance and approach rate. Naturally, the greater the distance to the enemy, the longer the attacker can track his opponent. At a distance of 1.1 NM the time for tracking is 2-4 seconds which is sufficient for aiming and launching of rockets.

In combat, at altitudes of more than 46,000 feet, the possibility of attacking a maneuvering opponent decreases because the permissible G-load for launching rockets decreases to 1.6. It can be assumed that when attacking a target at altitudes over 46,000 feet, the available tracking time will decrease by 1-2 seconds.

Figure 73 is a graph for the time of tracking when the target makes a hard, level turn with maximum G-load at an altitude of 33,000 feet. From the graph, if the level maximum G turn is made and the attacker was originally in the 6 o'clock position at 2.2 NM, the average tracking time is 6 seconds, i.e., about half what it was when a 3-G turn was made. From initial positions of 15 - 30° off the tail, the time is also half of that available from a 3-G turn.

If, at the moment of the enemies turn, the attacker is within permissible rocket launching range, he should turn toward the target and check to see if the "overload signal light" is on. If it is off, the rockets should be launched. If it is on and the pilot sees that to continue to track will take more G's rather than less, the rockets should not be launched. In these cases, continue the tight turn after the target, reduce the approach rate, and attempt to obtain enough lead so the G-load can be reduced to a permissible limit.

The enemy in an attempt to get away, may employ a maneuver with either a loss or gain of altitude. Experience shows that an effective defensive maneuver at a distance of 1.6 - 3.3 NM is a maneuver with a descent. Figure 74 is a graph showing the duration of tracking an enemy fighter which executed an evasive half-roll type maneuver. Altitude is less than 46,000 feet.

TRACKING TIME - SEC

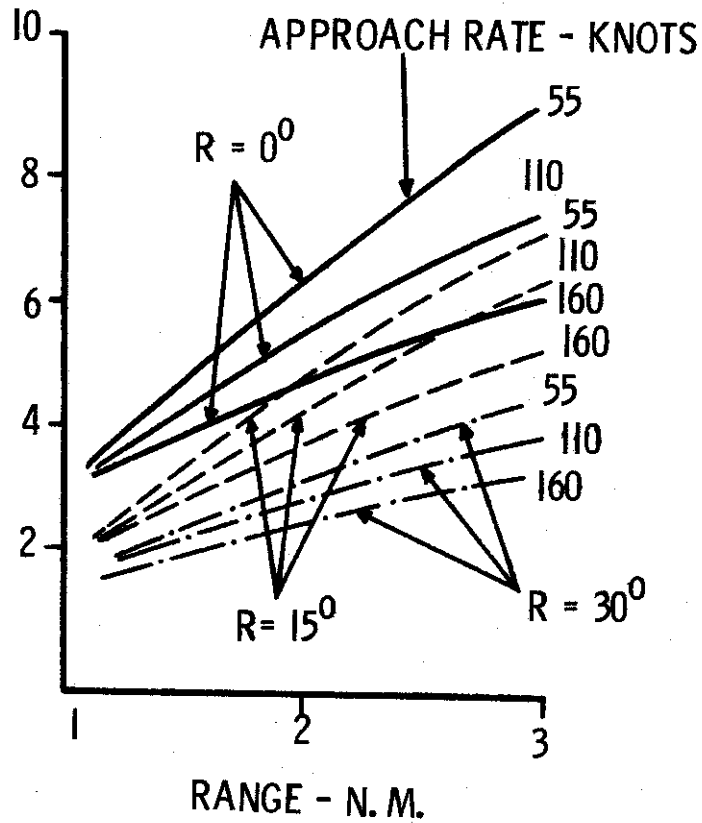

DURATION OF TRACKING TIME DURING A HARD TURN AT MAXIMUM G-LOAD AT AN ALTITUDE OF 33,000 FT

FIGURE 73

TRACKING TIME - SECONDS

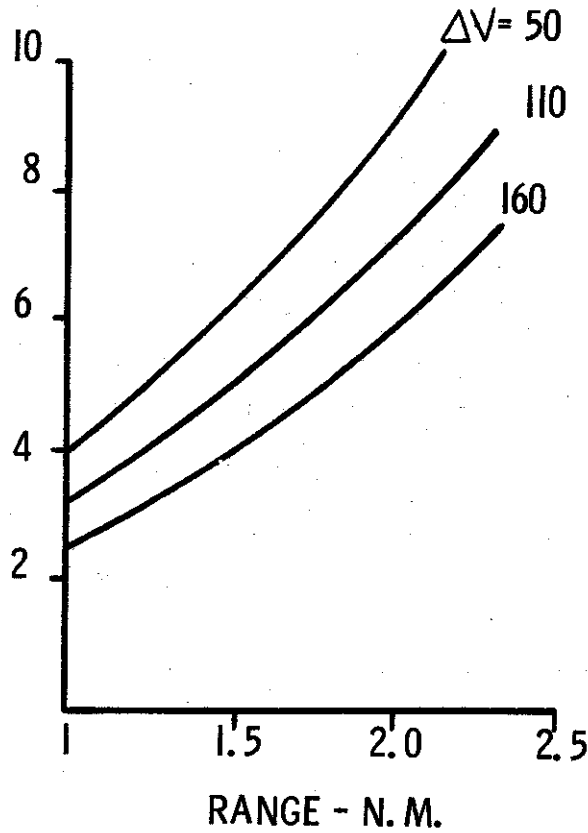

TRACKING DURATION DURING HALF ROLL
AT ALTITUDES LESS THAN 46,000 FT
 ΔV = APPROACH RATE - KTS

FIGURE 74

~~SECRET~~

If the approach rate is about 110 knots, then, depending on the distance, the tracking time will vary from 3 - 8 seconds. In this way, as in the case of horizontal maneuvering, rocket launching may be successful from a distance no less than 1.6 NM. At shorter distances, rocket launching is not recommended in the majority of cases because the G-load on the interceptor will be over two.

Against attacks by MiG-21f-13's carrying R-3S rockets, the enemy will often turn in the direction of the sun. If the turn in the sun's direction is accomplished so that the angle between the interceptor, target, and sun is less than 25 - 30°, no R-3S rocket attack is possible. In this case, the fighter will have to maneuver so as to attack from a greater angle. When it is impossible to attack with R-3S rockets, the cannons should be employed.

MANEUVERING AGAINST A LEVEL TURN

If the enemy fighter attempts to escape by making hard turns in the horizontal plane, our fighter, depending on the conditions under which the fight began, may employ various ways for completing the attack, but the ultimate purpose of all methods remains the same - stay behind the enemy and thus have the possibility of firing at him. The possibility of executing the attack depends largely on the maneuvering characteristics of both the MiG-21f-13 and the enemy fighters during turning maneuvers.

The basic parameters of a turn - radius and turning time - are determined by the flight speed and G-load. Figure 75 shows the maximum available G-loads during level turns for the MiG-21f-13 and for clean enemy aircraft. For all altitudes given on the graph, our aircraft can pull more G's per specific maneuver than the enemy aircraft. For example, at 36,000 feet, depending on Mach number, the enemy can pull between 2 - 3 G's, the MiG-21f-13, under the same conditions, can pull 2.5 - 4.2 G's. At altitudes from 42,000 - 49,000 feet our aircraft has an overall G advantage of 0.5 to 1.0.

Because of the available G-load advantage during turns, the MiG-21f-13 has considerably better horizontal turning qualities. Figure 76 shows a graph of minimum turning radii for stable horizontal turns in clean MiG-21f-13's and clean enemy aircraft.

At altitudes of 36,000 - 49,000 feet, at identical speeds, the radius of the horizontal turn of a MiG-21f-13 is approximately half that of the enemy aircraft. In combat, tight turns at maximum G-load and with a subsequent speed reduction are often

LOAD FACTOR $\sim "g"$

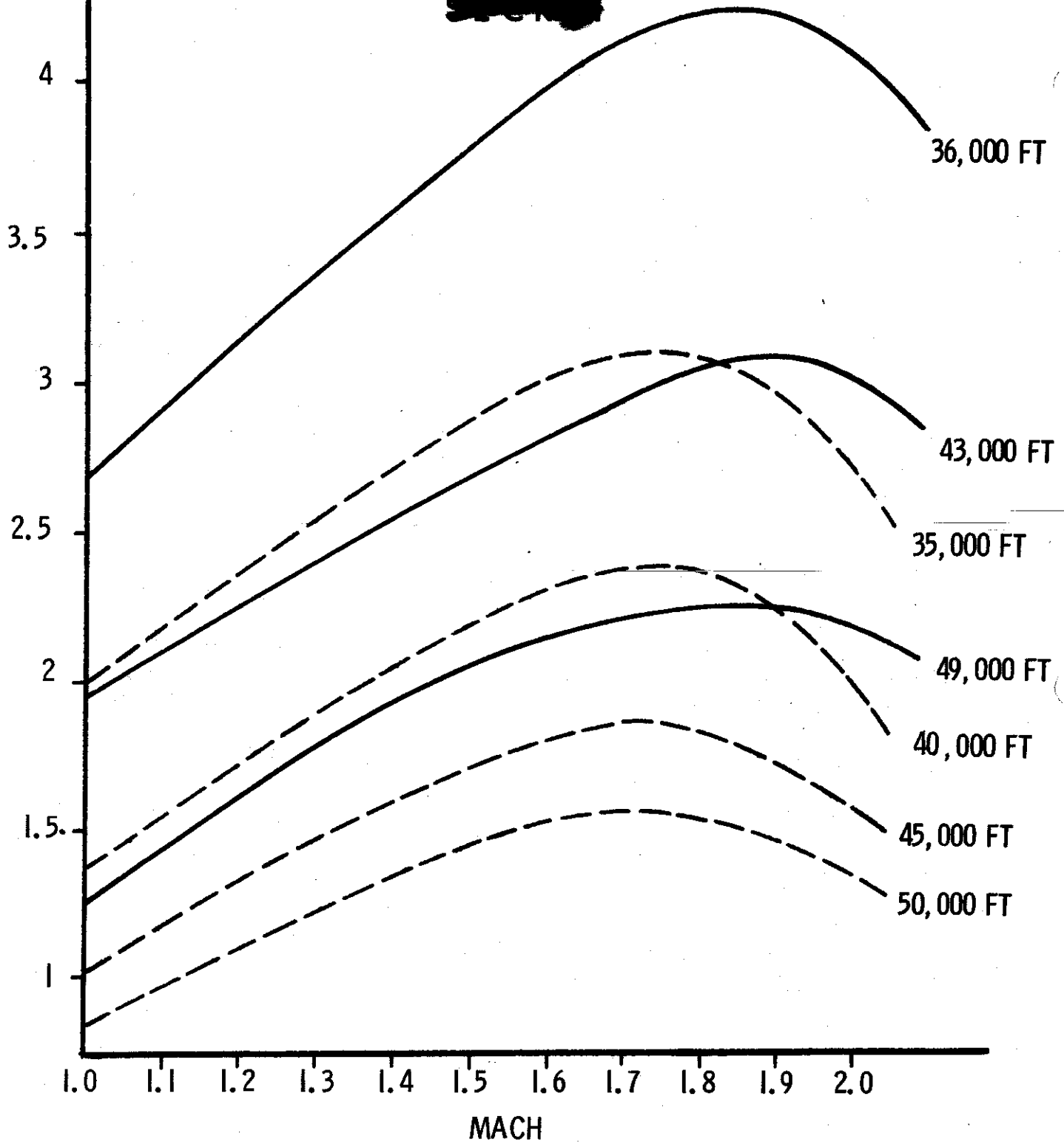

MAXIMUM AVAILABLE LOAD FACTOR IN STABLE LEVEL FLIGHT WITH MAX A/B POWER

— MIG-21f-13
- - - ENEMY FIGHTER

FIGURE 75
194

SECRET

TURN RADIUS - N.M.

~~SECRET~~

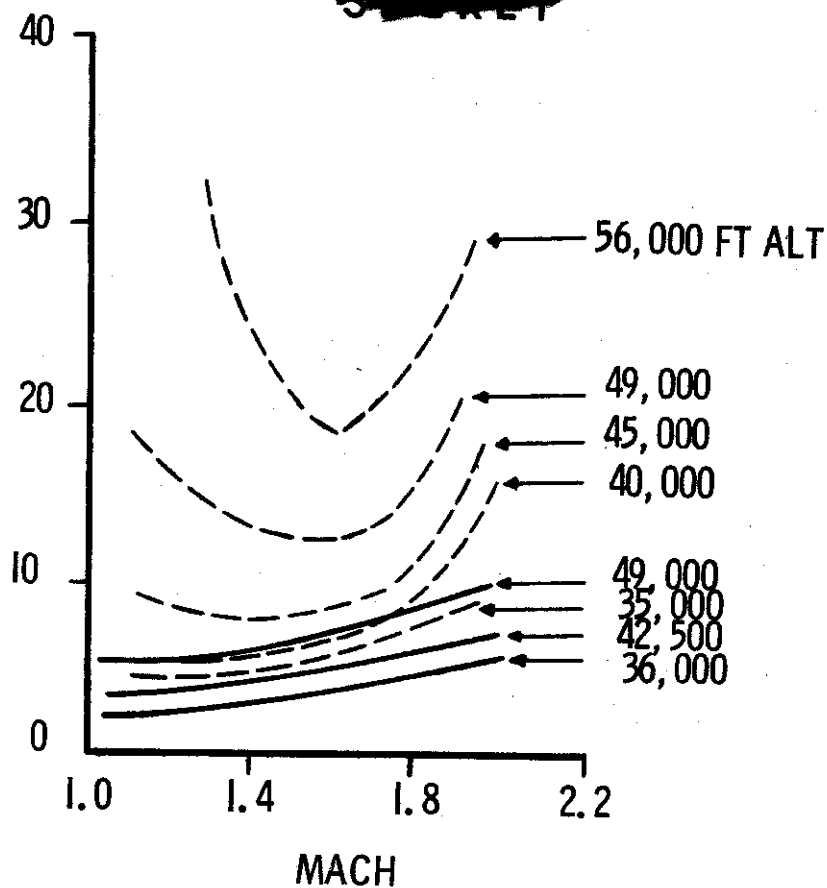

FIGURE 76 MINIMUM RADIUS OF STABLE HORIZONTAL
 TURNS OF MIG21f-13 AND ENEMY AIRCRAFT
 SOLID LINE — MIG-21f-13
 BROKEN LINE — ENEMY

flown and are characterized by the minimum time needed to complete the turn. Figure 77 shows diameter values and time needed for the tightest 180° turns of the MiG-21f-13 and the enemy aircraft executed at maximum non-afterburning engine conditions at an altitude of 33,000 feet with speed brakes extended.

From the graph, the time to turn the MiG-21f-13 180° is less than the enemies by 6 - 7 seconds and the diameter less by 3600 - 4900 feet, all conditions being equal.

In order to successfully attack an enemy, the attacker must persistently approach and fire as fast as possible from a minimum distance (Figure 78). As the range to the enemy decreases, the pilot adopts all necessary measures to keep the enemy in the sight, i.e., maximum G-loads and speed brakes if necessary.

~~SECRET~~

~~SECRET~~

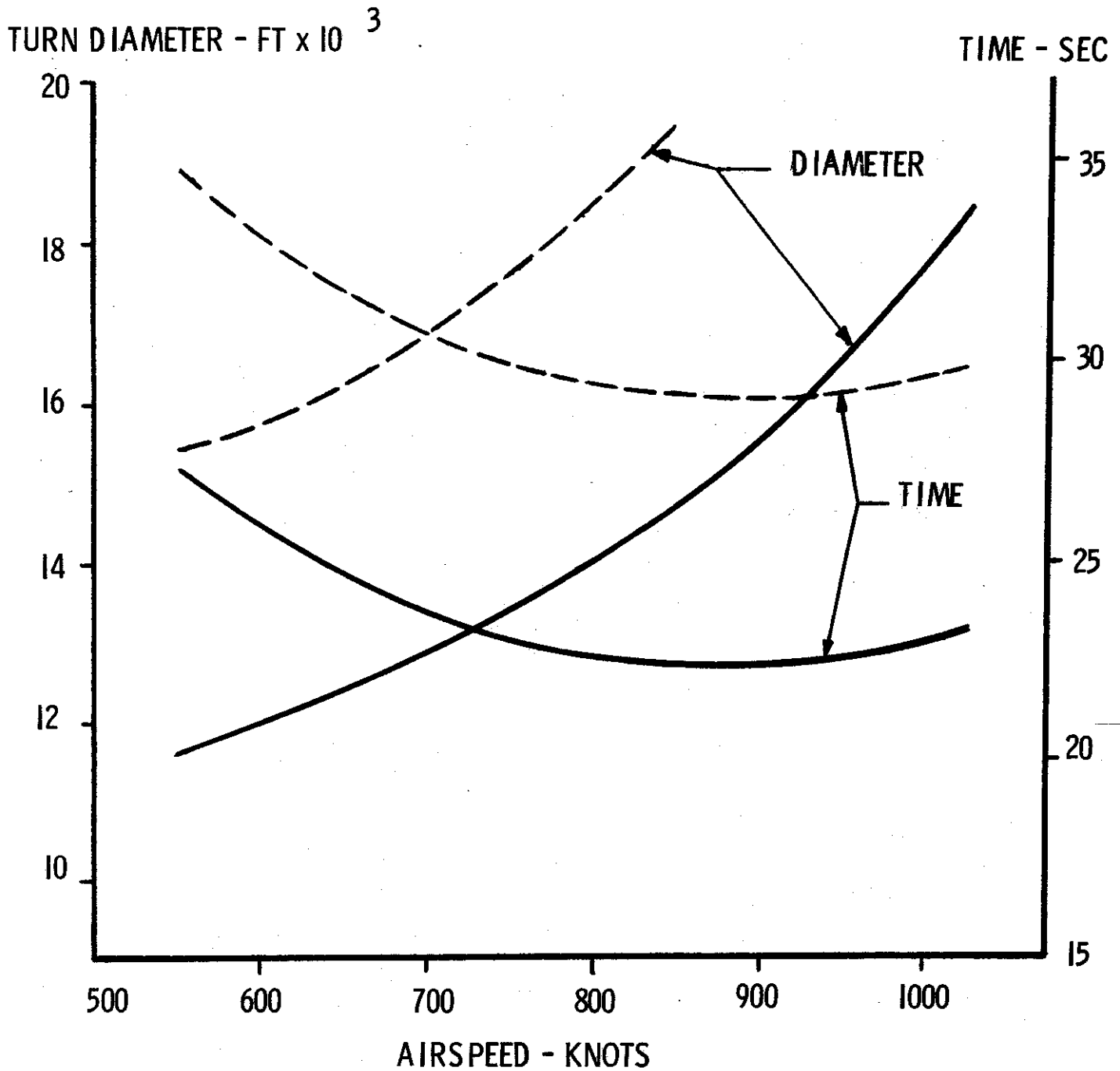

TURN DIAMETER AND TIME FOR MAXIMUM LOAD FACTOR, 180°
TURNS WITH MAXIMUM DRY POWER, SPEED BRAKES EXTENDED,
AND AT 33,000 FT ALTITUDE.

— MIG-21f-13
- - - ENEMY FIGHTER

FIGURE 77

~~SECRET~~

Table XXXI shows the turning angles of the enemy aircraft and firing distances when it is situated at points b and c (Figure 78), and also the average firing angles and duration of possible firing.

TABLE XXXI
TURNING ANGLES AND FIRING DISTANCES
TO BE USED IN CONNECTION WITH FIGURE 78

Initial Distance Between Aircraft ~ Feet	Difference In Air Speed ~ Knots	Lag Time (Sec)	Duration of Attack (Sec)	BEGINNING OF FIRE		END OF FIRE		Average Target Crossing Angle ~ Degrees
				Angle of Enemy Turn At Point b ~ Degrees	Range of Fire ~ Feet	Angle of Enemy Turn At Point c ~ Degrees	Range of Fire ~ Feet	
6600	55	0	3	135	3300	156	3000	30
		2	2	135	3300	150	3000	30
		4	1	135	3300	142	3000	30
	110	0	4	117	3300	143	2300	30
		2	3	115	3300	135	2600	30
		4	3	115	3300	135	2500	30
	160	0	6	85	3300	125	2000	22
		2	5	84	3300	118	2000	22
		4	6	70	3300	112	1600	22
3300	55	0	16	0	3300	135	1500	15
		2	14	0	3300	123	2000	15
		4	Firing Impossible					
	110	0	14	0	3300	123	1300	7
		2	13	0	3300	115	1500	7
		4	Firing Impossible					
	160	0	7	0	3300	60	1300	7
		2	6	0	3300	50	1600	7
		4	Firing Impossible					

~~SECRET~~

Table XXXI shows that the possibilities of executing an attack by cutting across the enemy's trajectory depends to a considerable degree upon the initial distance. The shorter the distance, the longer the time the attacker can remain on the enemy's tail and fire at it. For example, with a speed difference of 110 knots, lagging time of 2 seconds, and initial distance of 6500 feet, only a brief 3 second attack is possible. At the same approach rates and lagging time, but initial distance of 3300 feet, the attack is possible for 13 seconds.

The success of a strong attack largely depends on the lagging time in starting the maneuver. With a lag of 4 seconds or over, the attack from an initial distance of 3300 feet or less becomes impossible. The attack against an enemy fighter during a horizontal turn maneuver is in the majority of cases, successful. This attack is most effective at initial distances of less than 6500 feet, approach rates of 55 - 110 knots, and a lagging time of not more than 2 seconds. An increase in initial distance, approach rate, and lag time reduces the possibility of successfully executing the attack.

With a speed advantage of 160 knots and over, the above described method is not recommended, because the fighter, having executed a short attack, rapidly overshoots the enemy and may find itself in the position of being attacked.

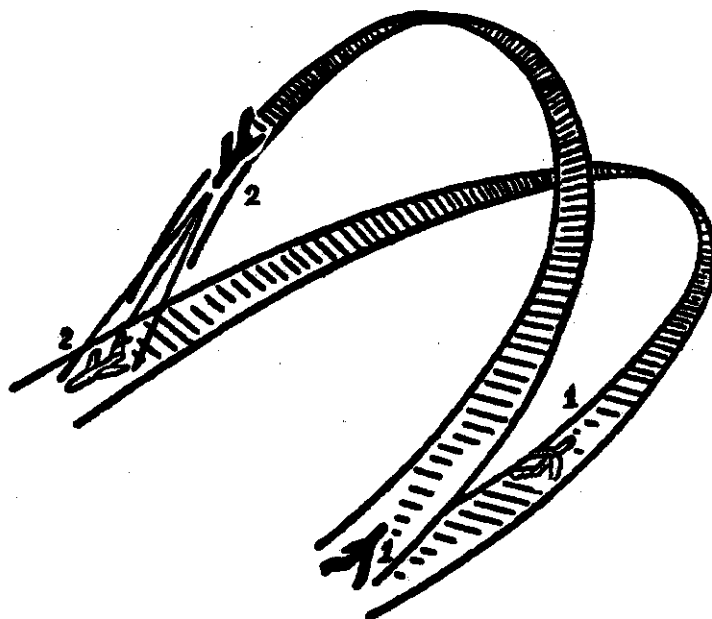

ATTACK WITH EMPLOYMENT OF ASCENDING
MANEUVER

FIGURE 79

~~SECRET~~

With a large speed advantage, an effective way of attacking an enemy fighter making a hard, level turn is to employ an ascending maneuver (Figure 79). The nature of this maneuver lies in the fact that the attacker, having perceived the enemy's turn, pulls up in a climbing turn with a bank of over 90° . This maneuver considerably reduces the turn radius and turn time and when properly executed, keeps the enemy in sight at all times. By proper bank selection, the attacker can emerge from this maneuver with a convenient firing position at a range of 2600 - 3300 feet. This method can be applied successfully even with small approach rates, at various distances, and at time lags of 3-4 seconds; however, it is most suitable when the speed surplus is over 160 knots.

When there is a considerable difference in speeds, the enemy quite often will turn back into the overshooting attacker. This is done by sharply reversing the turn the moment the attacker slides by his tail. If executed properly, the enemy may be in such a position as to fire at the attacker. The firing range will be 1000 - 1600 feet, and a firing time of only 1 - 2 seconds and the angle may approach 90° . To prevent over-shooting and hence not appear as the attacked, the MiG-21f-13 pilot should reduce the surplus speed by throttling back and extending the speed brakes, as well as by climbing with a gradual reduction in turn radius. The greater the approach rate, the greater the angle of climb should be. If the enemy's turn reversal is made with insufficient accuracy (too early or too late) the attacker usually ends up in better position than if the enemy would not have attempted the reversal. If the reversal was too early and the speed difference was less than 160 knots, the target will again fall under attack at a range of 1300 - 2600 feet and give a firing time of 2-4 seconds from an angle-off of $15 - 50^\circ$.

If the enemy fighter flies an ascending evasive maneuver, e.g., a tactical turn or half-loop, then the attacking fighter should adopt any measures needed to equalize the speed as it approaches the enemy. The possibilities of attacking the ascending opponent will depend on distance, approach rate, etc., plus it will depend to a large extent on the characteristics of the ascending maneuver of the target and the attacker. In Figure 80 are shown the characteristics of a slanting half-loop of the MiG-21f-13 and enemy fighters executed from altitudes of 26,000 - 33,000 feet with afterburner, without external tanks, and with maximum G-load.

~~SECRET~~

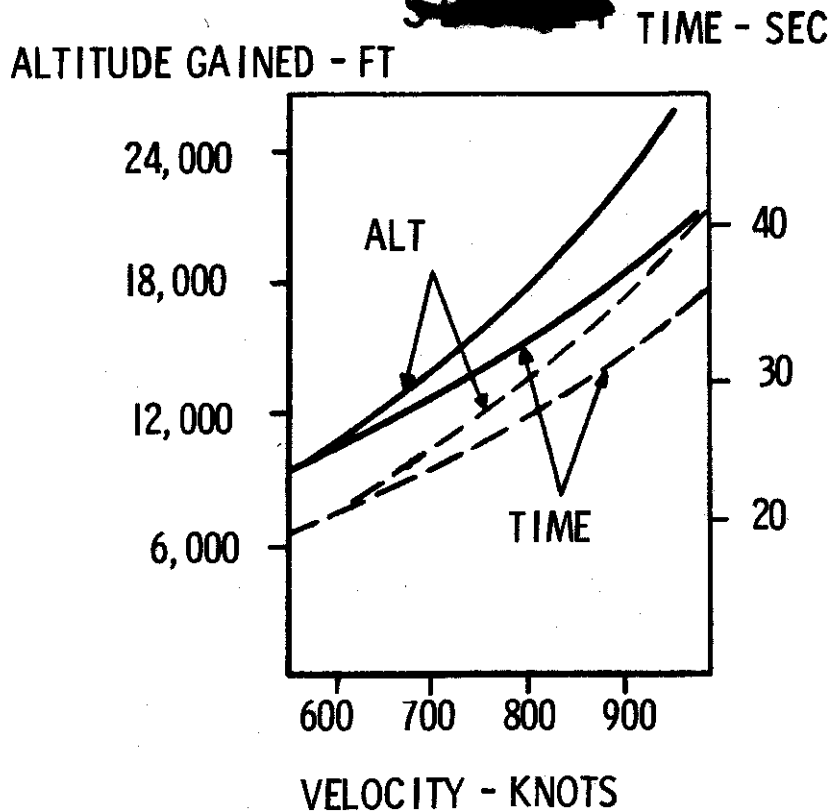

CHARACTERISTICS OF A SLANTING HALF-LOOP EXECUTED FROM AN ALTITUDE OF 26,000 - 33,000 FEET AT MAXIMUM G-LOAD, WITH A/B AND WITHOUT EXTERNAL TANKS.

————— MIG-21f-13
- - - - - ENEMY FIGHTER

FIGURE 80

The altitude gained by a slanting half-loop and the time of its execution is greater for the MiG-21f-13 than for the enemy fighter. The ratio of the altitude gained to the execution time is greater by 10% for the MiG-21f-13 over the enemy. This means that the MiG-21f-13 has a somewhat better maneuverability in the vertical plane, which should allow it to execute a successful attack against an enemy flying an ascending maneuver. As the attacker draws close to the target, he should be cutting his approach rate to 50 - 75 knots and continuously try to stay on the inside of the target's trajectory by pulling G's and the skillful use of throttle and speed brakes.

Table 32 gives values of attack durations, firing ranges, angle-off, angle of turn in the vertical plane of the enemy at the commencing and cessation of fire for various initial distances, and the lag time of attacker before beginning the maneuver.

~~SECRET~~

~~SECRET~~

In the upper part of the ascending maneuver, the attack is less probable as the aiming and firing would have to be done from an inverted position.

ALT. LOST
- 1000 FT

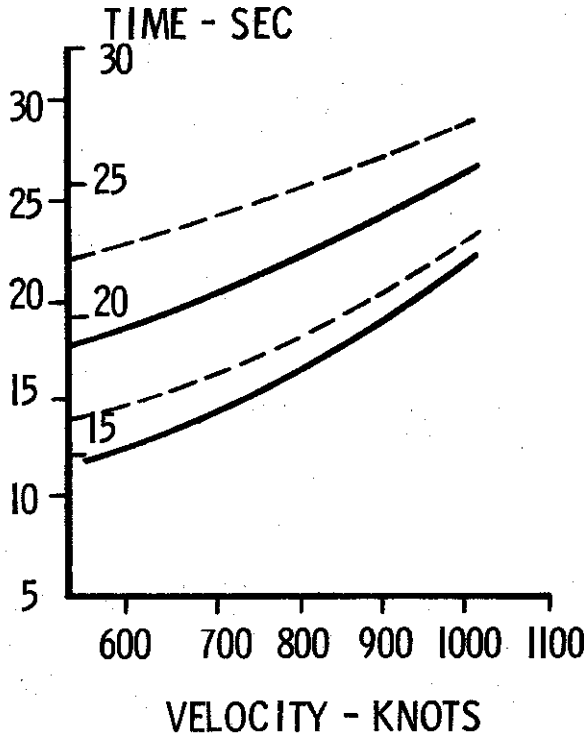

COMPARISON OF TURN CHARACTERISTICS OF MIG21f-13 AND ENEMY AIR CRAFT AT 30,000 FT IN A DESCENDING MANEUVER.

SOLID LINE ——— MIG21f-13
BROKEN LINE - - - - ENEMY

FIGURE 81

A descending evasive maneuver is sometimes employed and attack possibilities again depend on the maneuverability of the MiG-21f-13 and its opponents. Figure 81 gives the turning characteristics of the MiG-21f-13 and of an enemy aircraft when at 32,000 feet with extended speed brakes, reduced thrust, and maximum G-load. The maximum G-load is calculated from the magnitude of the lift coefficient when the aircraft begins to buffet. The drawing shows that at the same initial speeds, the enemy will lose more altitude and take longer to complete the turn than our fighter. This advantage over the enemy fighter allows a successful attack to be made against a descending, turning opponent. In order to attack the enemy, the pursuing MiG-21f-13 should follow the target's maneuver and be able to cut across the target's trajectory and approach to firing range. (Figure 82).

~~SECRET~~

~~SECRET~~

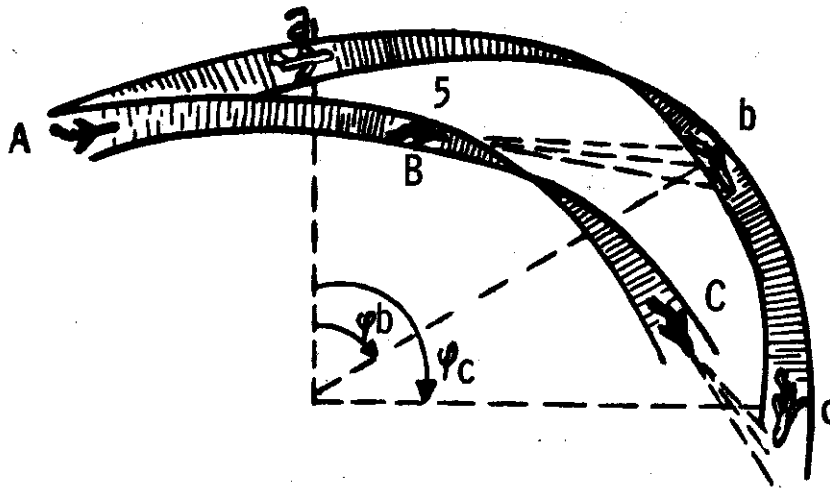

ATTACKING THE ENEMY DURING DESCENDING MANEUVER FIGURE 82

For all conditions of attacking in a descending turn, the attacker should use all available means to reduce his turn radius (even at the expense of speed), so he can work his way to the inner side of the enemy's maneuver. He should use speed brakes, reduce thrust, and pull maximum G's.

Table 33 shows the possibilities of attacking during a turn under various conditions. Data in the table are given for altitudes of 33,000 - 49,000 feet and Mach number at the beginning of the maneuver of 1.2 - 1.6. The speed brakes are assumed open and the power reduced on both aircraft.

From Table 33, attack is possible only at an initial distance of less than 6600 feet. If the initial distance is more, at the beginning of the attack, the firing range will exceed 3300 feet and as the range decreases, the attacker will unavoidably cross the target trajectory to the target's other side, from where aimed fire will be impossible. With a small lag time of not more than 2 seconds, the MiG-21f-13 can attack during the part of the turn limited by points B and C (See Figure 82). This section of trajectory increases with a decrease in either approach rate or lag time. For example, at an initial distance of 3300 feet and a lag time of 2 seconds, the attack duration may be 4 - 7 seconds; at the same distance with no lag time, 6 - 14 seconds; lag time of over 4 seconds, attack is impossible because of large distances and angles. At an approach rate of 160 knots, other conditions as above, the attack duration is 4 - 6 seconds as compared to 7 - 14 seconds with an approach rate of 55 knots. Thus, when attacking, it is advisable to equalize the speed and not have any delays in maneuvering of

~~SECRET~~

~~SECRET~~

The approach rate is from 75 - 110 knots and the data is given for the attack with the slanting loop executed from the altitude of 26,000 - 33,000 feet with afterburner and maximum G-load.

TABLE XXXII

MIG-21f-13 ATTACKING AN ENEMY FIGHTER CONDUCTING A SLANTING LOOP

Initial Distance (Ft)	Lag Time (Sec)	Duration of Attack (Sec)	Commence Fire		Cease Fire		
			Range of Fire (Ft)	Angle of Turn (Deg)	Range of Fire (Ft)	Angle of Turn (Deg)	Angle-Off
6600	4	2	3300	50	2500	70	68°
	6	3	3300	50	2000	70	68°
	76	Firing Impossible					
4900	2	6	3300	45	2000	100	45°
	4	Firing Impossible					

- NOTE: 1. Initial Altitude 26,000 - 33,000 Feet.
2. Afterburner Power
3. Maximum Load Factor
4. Approach Rate, 80 - 110 knots

As evident from Table XXXII, the possibilities of attacking by cutting the trajectory during an ascending maneuver depends basically on the initial distance between fighters. The shorter the distance, the better the attack conditions, i.e., a longer firing time. For example, at an initial distance of 6500 feet, only a brief 2-3 seconds of firing time is possible; at a distance of 4900 feet, firing is possible for 6 seconds. The lag time of the interceptor before beginning the maneuver affects the attack possibilities very little unless the time is extremely great.

During the ascending maneuver, experience has shown that in view of the greater curvature of the enemy's trajectory and the greater angle-off the target, firing can be conducted only with the sight in the caged position. The greater the angle-off, the less effective is the sight using this method.

If the attacker was lagging in starting the maneuver and was unable to attack the enemy, he will be on the outside of the enemy's trajectory and it is possible that he may be fired upon when in the upper part of the turn or slanting half-loop. If the attacker has an initial speed surplus of over 55 knots, he will rapidly overtake the target in less than 30 seconds.

~~SECRET~~

TABLE XXXIII

MiG-21f-13 ATTACKING AN ENEMY FIGHTER CONDUCTING A SPLIT-S

				Open Fire		Cease Fire		
Initial Distance (Ft)	Lag Time (Sec)	Approach Speed (Knots)	Duration of Attack (Sec)	Enemy Turn Angle (Deg)	Firing Range (Ft)	Enemy Turn Angle (Deg)	Firing Range (Ft)	Mean Angle-Off
3300	0	55	14	0	3300	130	1300	10°
		110	8	0	3300	85	1400	10°
		160	6	0	3300	80	1450	10°
	2	55	7	35	2600	90	1300	10°
		110	5	36	2400	75	1450	10°
		160	4	38	2300	72	1500	23°
	4	55			Attack Impossible			
		110			Attack Impossible			
		160			Attack Impossible			
6600	0-4	55		Attack Impossible				
		110		Attack Impossible				
		160		Attack Impossible				

NOTE: 33,000 - 50,000 Feet Altitude, Initial Mach Number of 1.2 - 1.6, Idle Power, Speed Brakes Extended.

over 2 seconds. If the attacker succeeds in reducing the approach rate during the turn to 0-55 knots and if the lag was about 2 seconds, he should be able to attack in the first half of turn plus when pulling out of the turn.

ATTACKING WHILE OVERTAKING

If the enemy detects the attacker at a distance considerably exceeding the firing range (2-3 NM), he may try to escape by accelerating along a straight line. The possibilities of our fighter overtaking an enemy depends upon the initial separation distance, the initial approach rate, and the acceleration qualities of the two aircraft. Figure 83 shows a graph depicting

~~SECRET~~

MiG-21f-13 and enemy aircraft acceleration times using after-burners at various altitudes and conditions.

ACCELERATION TIME - SEC

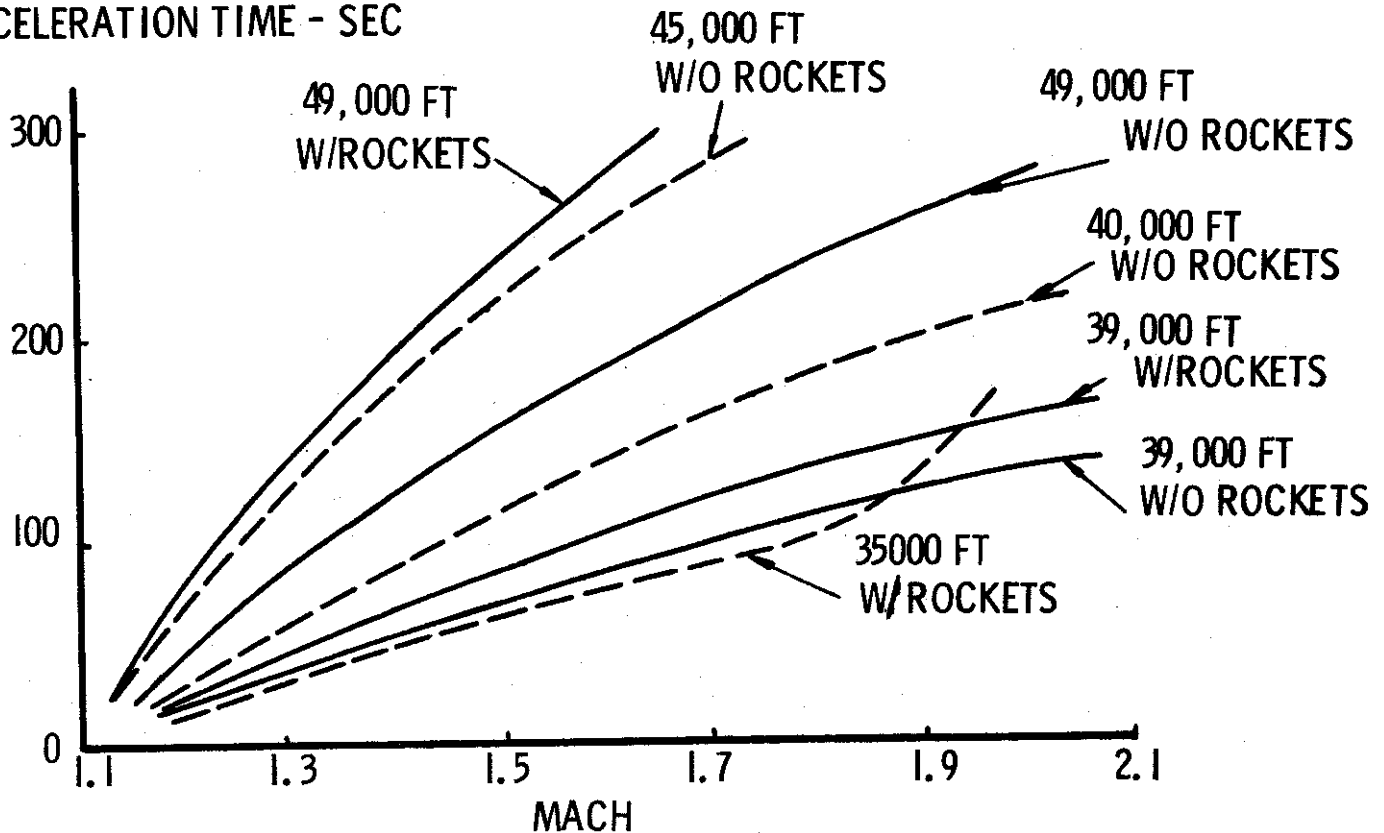

ACCELERATION TIME OF MIG-21f-13 AND ENEMY FIGHTER WITH MAX A/B

———— FISHBED C/E
----- ENEMY

FIGURE 83

The graph shows that the MiG-21f-13 has an acceleration advantage over the enemy aircraft. For example, at an altitude of 40,000 feet, the acceleration time of a clean MiG-21f-13 from Mach 1.1 to 1.9 is 2 minutes and that of the enemy aircraft, 3 minutes 10 seconds. At higher altitudes, this advantage becomes even greater. At 49,000 feet, the MiG-21f-13 can make this acceleration in 4 minutes 10 seconds and the enemy needs 5 minutes 20 seconds at the lower altitude of 45,000 feet. Acceleration of our aircraft with external tanks is also faster than that of the enemy

~~SECRET~~

Figure 84 depicts the changes in distance between aircraft when the clean MiG-21f-13 overtakes the enemy during acceleration in afterburner for various initial Mach number excesses at an altitude of 40,000 feet.

CHANGE IN INTERCEPTOR -
TARGET DISTANCE - NM

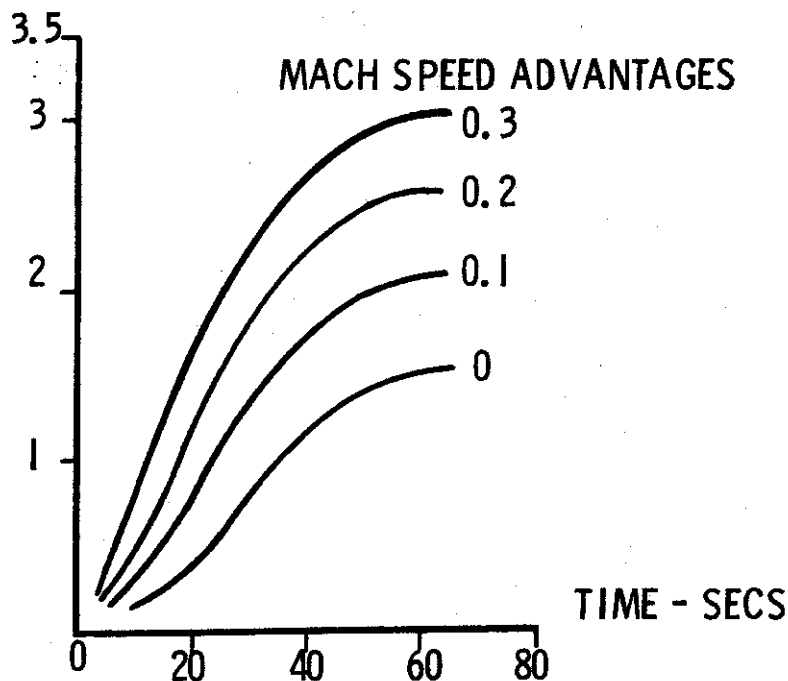

CHANGES IN DISTANCE WHEN A MIG-21f-13 OVERTAKES AN ENEMY FIGHTER AT 40,000 FT AT VARIOUS INITIAL MACH NUMBER SPEED ADVANTAGES WITH AFTERBURNER AND NO EXTERNAL FUEL TANKS

FIGURE 84

The maximum reduction in distance comes within 1 minute and the magnitude of it depends on the initial Mach number excess. With an excess of Mach equalling 0.3, the distance decreases by 2.7 NM, and at Mach = 0.1, by 2 NM. Even at equal initial Mach numbers, the distance decreases 1.4 NM in one minute. In this way, if the enemy is detected from a distance of not more than 2.7 NM and the difference in Mach numbers not less than 0.1, the MiG-21f-13 will have no difficulty in catching up. Within one minute, it will be within firing range of 3300 feet.

~~SECRET~~

PULLING AWAY FROM THE ATTACK

If the MiG-21f-13 finds itself being attacked, it should undertake a maneuver to get away and attempt to attack later on. The nature of the maneuver will largely depend on the speed and range of the enemy. If his speed is greater, he should turn in the enemy's direction and climb, if his speed is relatively low, he should turn, descend, and use full afterburner so he can accelerate and then climb. The evasive maneuvers for the MiG-21f-13 are the very same as those applied by the opponent when it was being attacked and have been explained previously. However, the possibilities of our aircraft escaping attack are somewhat better because it has better maneuverability in both the horizontal and vertical planes.

As shown before, our fighter has an acceleration advantage, and at altitudes over 40,000 feet, a speed advantage. Both of these superior characteristics should be utilized to get away from a pursuing opponent. Figure 85 is a graph of changes in distances between aircraft when the MiG-21f-13 is getting away by accelerating. The graph was plotted for altitudes of 42,000 - 49,000 feet and for various Mach number excesses.

If the initial Mach number excess is 0.3, while the MiG-21f-13 is accelerating to escape, the distance between fighters will decrease by a maximum of 7200 feet (point A on graph). At an initial Mach number excess of 0.1, the distance can reduce only 1,000 feet (point B).

If we use a distance of 2.7 NM for the enemy's rocket launching range, the MiG-21f-13 can get away under the following conditions - Mach excess of 0.3 at 3.8 NM, 0.2 at 3.3 NM, 0.1 at 3.0 NM.

In this way, a tactical flight is more appropriate at high speeds. When necessary to fly at slower speeds, the pilot must be provided with constant information from the ground control and he must intensify his search in the rear hemisphere in order to detect an adversary at maximum distance. If an enemy spots our fighter at low speed, it is impossible to get away with using straight line acceleration. In this case, it must adopt other evasive maneuvers.

When an enemy attacks from a rear side, our fighter must immediately turn into the enemy in order to make aimed firing more difficult. The turn can be flown horizontally or even better with a descent. If a hard turn (break) is required, the pilot should use speed brakes and pull maximum G's. Figure 86 shows a variant of this maneuver.

~~SECRET~~

CHANGE IN DISTANCE - FT X 10³

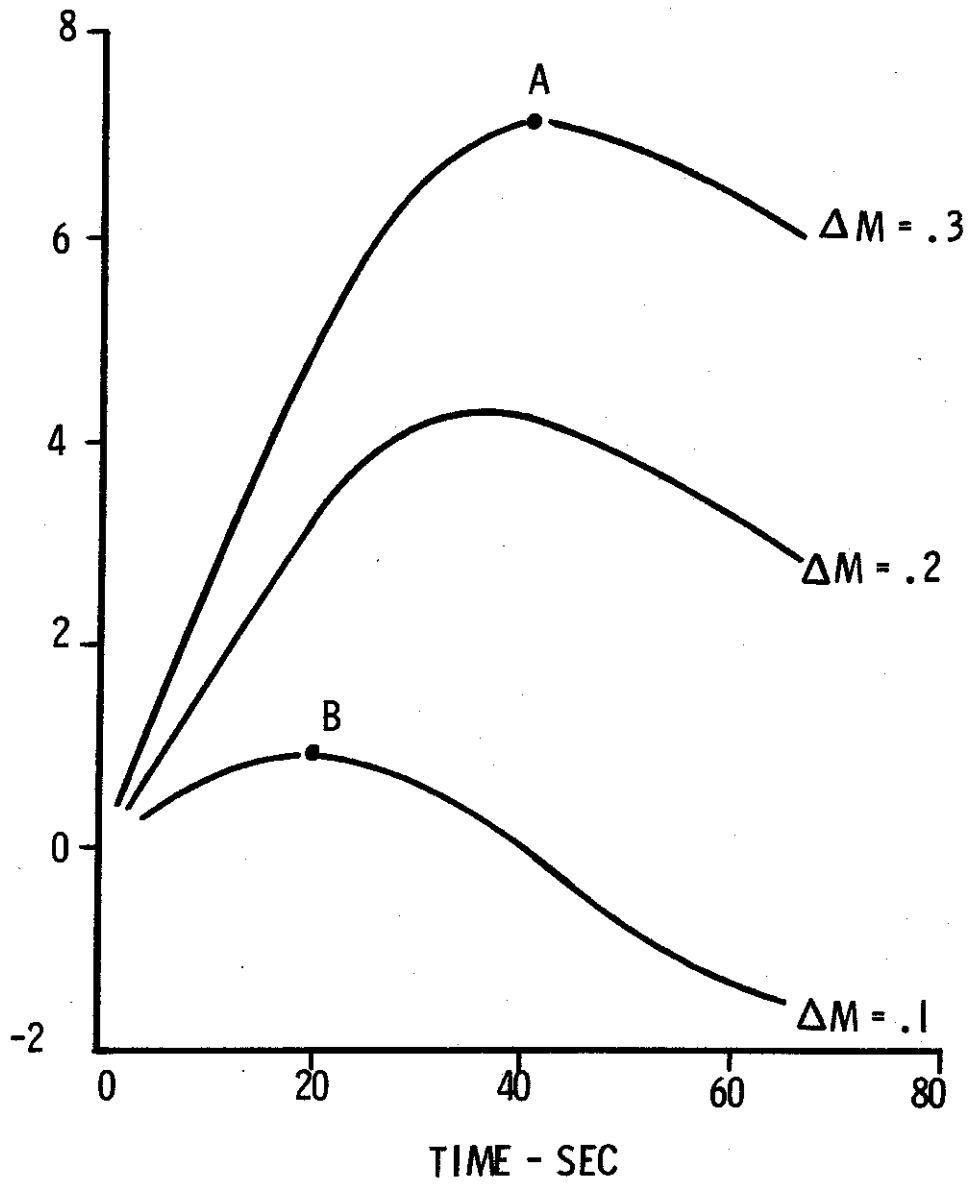

CHANGE IN DISTANCE WHEN A MIG-21f-13 EVADES AN ATTACKER IN LEVEL FLIGHT BY SPEED BUILDUP AT 43000-49000 FT ALTITUDE

NOTE: ΔM IS THE INITIAL MACH NUMBER ADVANTAGE OF THE ENEMY FIGHTER

FISHBED C/E CONFIGURATION: CLEAN + GUNS & AMMO

FIGURE 85

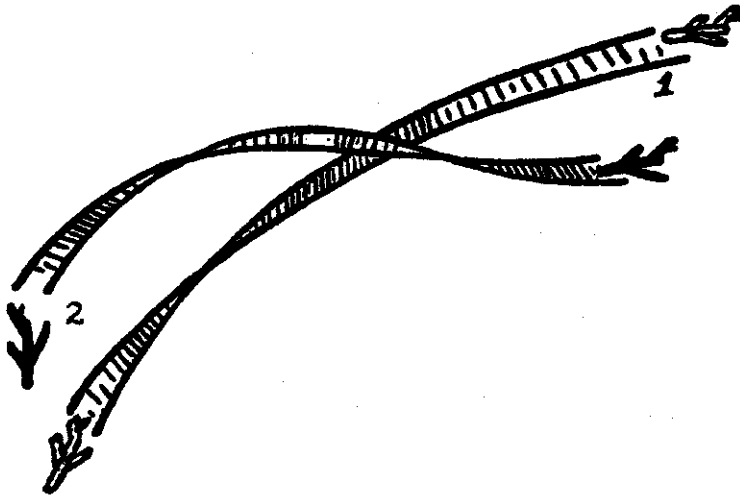

TURNING TOWARD ENEMY WITH SUBSEQUENT
ATTACK

FIGURE 86

~~SECRET~~

If the first turn was successful and conditions are right, it may be possible not only to evade the enemy's attack but to change over to being the attacker. The possibilities of subsequently attacking the enemy depend basically on the difference in fighter speeds, initial separation distance, and subsequent opponent maneuvering.

Calculations show that if the enemy overshoots our fighter and continues his slanting turn, the responsive attack of the MiG-21f-13 should come within 12 - 20 seconds after the maneuver began. The attack will be of short duration (1-2 seconds) with a large angle-off (50°) and at a distance of 1000 - 1600 feet. When the enemy gets farther away at a range more than 3300 feet, rockets may be launched. The turn toward the opponent has a better chance of success if the attacker has a speed excess over 110 knots. With the increase in speed excess, there is a better attack possibility after the enemy overshoots. This method works particularly well at distances between fighters of less than 3300 feet.

If the enemy turns into our fighter after the MiG-21f-13 reverses, then it cannot be attacked.

To escape from an enemy attack at short distances and with high approach rates and when the horizontal or vertical evasive maneuver doesn't bring success, another maneuver is to apply an irregular roll with either a loss or gain of altitude. This maneuver is intended to make firing conditions extremely difficult for the enemy, and should be flown with extended speed brakes and retracted throttle. Figure 87 shows the reduction in distance between fighters when the irregular roll maneuver is flown with extended speed brakes and reduced throttle for various initial approach rates. The enemy's Mach number is assumed to be 1.4 - 1.8.

The graph (Figure 87) shows that if the open fire range was 3300 feet and the cease fire range 1300 feet, then the time the enemy can fire at our fighter, which undertook an evasive maneuver, is 3 - 5 seconds. During this time, the firing effectiveness will be sharply reduced by the maneuver of our fighter.

REDUCTION IN DISTANCE - FT ~~SECRET~~

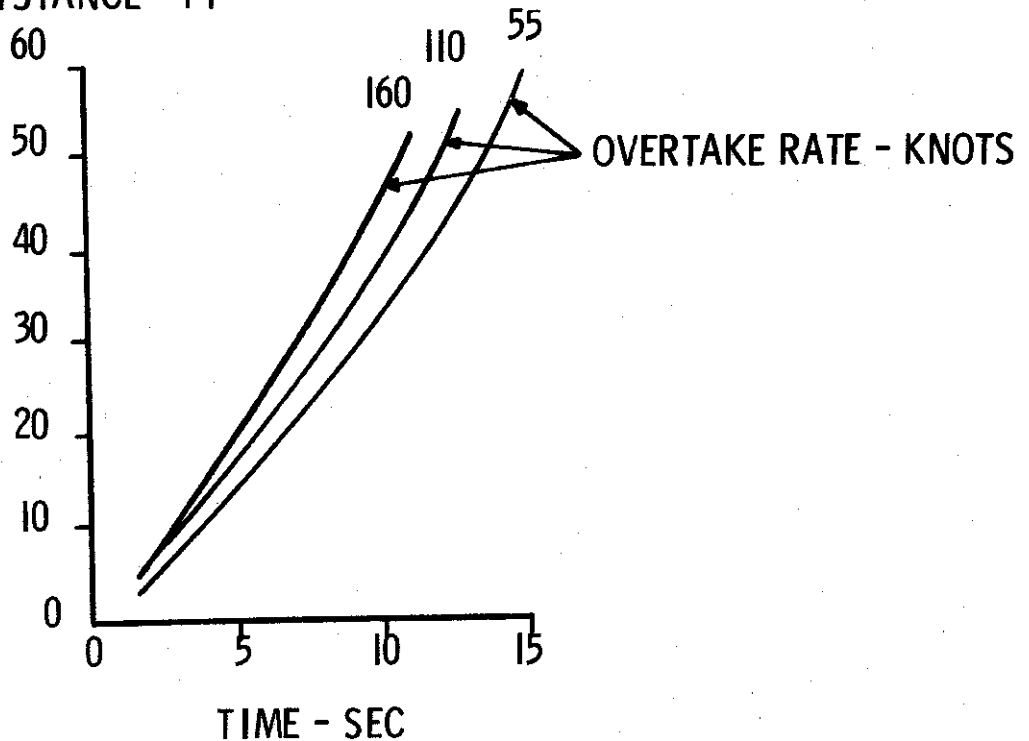

REDUCTION OF DISTANCE BETWEEN AIRCRAFT
WHEN EXECUTING AN IRREGULAR ROLL

FIGURE 87

FIGHTER COMBAT FROM COUNTER COURSES

As a result of vectoring from both sides, fighters often emerge on counter courses. The pilot may not visually detect the opponent, consequently the battle may begin only with the aid of control from the ground. One characteristic of this type of encounter is that if one fighter is ordered not to attack, he may avoid battle easily by continuing on his last heading. For example, assuming fighter speeds of 800 - 970 knots and that the time to make a 180° turn is 50 - 60 seconds, the non-turning aircraft will be 11 - 16 NM away before the other aircraft's turn is completed, which eliminates the possibility of overtaking him.

If both aircraft are to battle, and the opponent executes a hard, level turn attempting to get into the rear of the MiG-21f-13's hemisphere, our fighter should execute a slanting loop in the enemy's direction or zoom with a subsequent turn toward the enemy. It is more difficult if the enemy flies a vertical maneuver, because in this case our pilot should also fly a vertical maneuver and the aircraft will again appear at counter courses. Only this time, our fighter will have an altitude advantage of 1600 - 2000 feet and a speed advantage of about 25 knots. Further maneuvering can then be executed in either plane.

~~SECRET~~

GROUP AERIAL ENGAGEMENT

In spite of the fact that under modern conditions, group combat with fighters will be less frequent than during World War II, they will still take place because a group can execute some missions more successfully than a single fighter. The tactics of group aerial engagement are based on the previously discussed ways and means of conducting single fighter engagements. If in a group engagement, pairs/flight do not maneuver as a group, the tactics are similar to single engagements, but if the applications of tactical formations are employed and there is cooperation between flights and individual aircraft, the tactics have somewhat different characteristics.

The cooperation may consist of replacing one plane by another, executing sequential attacks, increasing the fire power directed at an opponent, mutual coverage, maneuvering the opponent so some other aircraft can attack it, plus many more characteristics that do not enter into single engagements. Experience has shown that considerable aid in group engagements can be furnished to the fighters from ground radars.

If a pair of MiG-21f-13 fighters spot a single enemy fighter from the rear at a suitable rocket launching range, they can attack in sequence and not resort to deployment. If rockets cannot be used, deployment is necessary for cannon firing. Deployment is convenient because individual aircraft are more maneuverable than a pair and it is harder to observe the separate activities of two aircraft than of one formation.

If the enemy, after detecting a pair of attacking MiG-21f-13's, executes a tight turn in the horizontal plane, the attacking pair should adopt the maneuver of deploying in both the horizontal and the vertical planes. The lead aircraft, for example, can continue after the enemy and the wingman, having flown a near vertical maneuver, can execute a climbing turn in the enemy's direction and attack it from 6 o'clock high. (Figure 88)

If the enemy fighter is escaping by using a full or half turn, then it is not feasible for both attacking aircraft to follow the maneuver. For best results, it is advisable to deploy the pair as follows: the leader follows the enemy and the wingman executes a descending maneuver in another plane, attempting at the completion of the maneuver to appear at a position above and behind the enemy. (Figure 89). Simultaneously with this, the wingman appears somewhat to the side of the opponent at a definite interval from it. The magnitude of the altitude difference and the interval depend on the angular difference of plane inclinations of the enemy and the wingman, and also

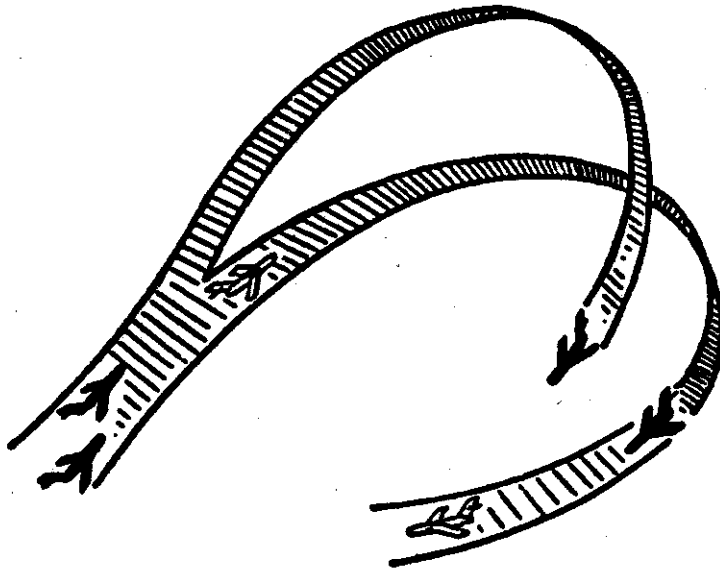

DEPLOYMENT OF PAIR IN HORIZONTAL AND VERTICAL PLANES

FIGURE 88

~~SECRET~~

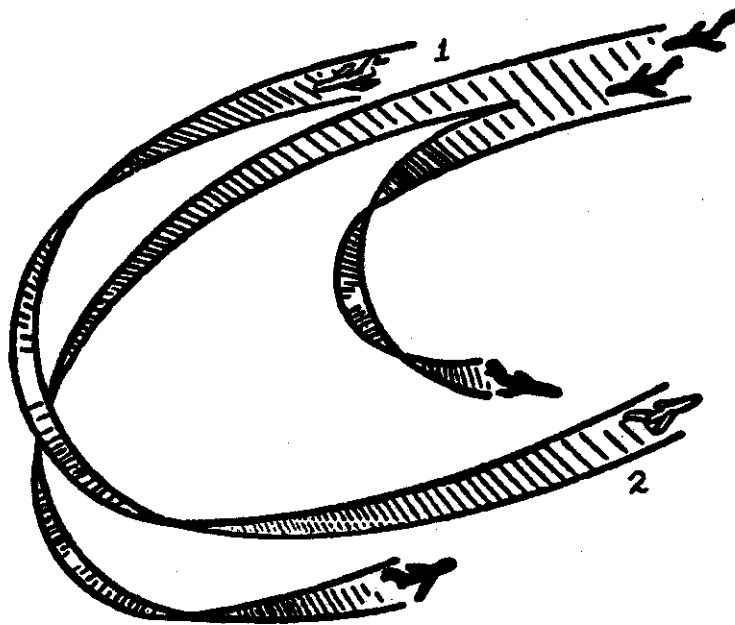

DEPLOYMENT OF PAIR IN ASCENDING
MANEUVER

FIGURE 89

~~SECRET~~

on the flight conditions during the maneuver - speed brakes, throttle, lead-in altitude, etc. Table 34 gives altitude and interval values which will result during an attack by a pair of MiG-21f-13's against an enemy executing turns (half turns). Flight conditions are: lead-in altitude of 33,000 - 50,000 feet, and speed brakes extended.

TABLE XXXIV

VALUES AT THE COMPLETION OF A DEPLOYMENT MANEUVER

Rate of Approach (Kts)	Angular Difference of Plane Inclination (Deg)	Elevation of Following Aircraft Above Enemy (ft)	Interval Between Following Aircraft and Enemy (ft)
55	20-30	2600 - 3000	3300 - 4000
110	20-30	1300 - 1600	4000 - 4600

The table shows that if the following aircraft (wingman) has a speed surplus of 55 - 110 knots, it has the possibility during the maneuver to take up a position above and to the enemy's side. The distance at the end of the maneuver depends basically on the time lag before executing the initial maneuver. If the wingman turns simultaneously with the target or with a slight delay (1-2 seconds), then at the end of the maneuver, he will appear ahead of the enemy fighter. With a delay of 5 seconds or over, he will appear at the rear of the enemy, but at a very great distance. The most feasible time lag is 3-4 seconds, from which the fighter will emerge in the enemy's rear hemisphere at a firing distance of 1600 - 4900 feet. From this maneuver, the wingman should appear above and behind the enemy and lead will be below and behind the target, hence the target will be bracketed and cannot get away.

If the enemy is escaping by using an ascending maneuver - half loop, slanting half loop, or tactical turn - the pair of attacking fighters should deploy as follows: the lead aircraft continues the attack, attempting to cut across the target's trajectory while his wingman, after appraising the maneuvers of the enemy and of the lead aircraft, executes a climbing turn in another plane and turns 45 - 60° toward the plane of the enemy's maneuver. This maneuver, if executed without delay, gives the

~~SECRET~~

wingman the possibility of attacking the enemy as it rolls out from his maneuver.

For example, if the enemy is escaping by flying a tight slanting half-loop, the leader pursues it and his wingman immediately starts a less tight, slanting half-loop in another plane from which he can observe the actions of his leader and the enemy. The time for executing the half-loop and the altitude gained is somewhat greater for the MiG-21f-13 than for the enemy but the difference will be small between lead and the enemy. The wingman will still be climbing when the enemy emerges from his maneuver and should emerge nearly right above the enemy or at least above and to the rear and side of the target. From this position, he should gain the possibility of initiating a new attack.

The conditions for successful execution of this maneuver are:

- immediate execution of the maneuver by the wingman once the enemy begins its maneuvering;
- continuous observation, by the wingman, of the actions of the enemy and the leader.

PAIR OF INTERCEPTORS ATTACKED BY AN ENEMY FIGHTER

Upon detection of an enemy fighter attacking from the rear, the formation should begin a maneuver designed to pull away from an attack. The maneuver selected is chosen after considering the distance, approach rate and other circumstances. If the enemy is not in firing range, the pair can accelerate and attempt to pull away. If this is impossible, a maneuver can be executed in either the horizontal or vertical plane. The formation should try to remain intact while evading, but this is not always possible. When necessary for preservation, the formation should be deployed.

Deployment of a pair in the horizontal plane in one direction is inadvisable because the enemy can easily attack at least one of the aircraft and deployment to opposite sides leads to a loss of sight of each other. A more feasible deployment is to obtain a spread in altitude while turning in the same direction. The lead makes a level turn while the wingman makes a climbing turn, keeping the enemy and lead in sight. If the enemy continues to attack the leader, the wingman will have good attack possibilities. If the enemy follows the wingman up the climbing turn, the lead will then be free to execute a vertical climbing maneuver and attempt to obtain a suitable attacking position.

~~SECRET~~

The most suitable maneuver appears to be when both aircraft maneuver vertically upwards or downwards, with a distance between them of 3300 - 5000 feet. Having executed slanting half-loops, or half-turns in one direction, with their angles of inclination differing by 20 - 30°, both aircraft will appear at the end of the maneuver at approximately the same altitude and separated by 3300 - 6000 feet. The enemy fighter pursuing one of the pair aircraft will, at the end of the ascending maneuver, be at the rear and above. When the enemy reaches the upper point of his maneuver, our aircraft will have already passed their upper point and can get away by diving.

When deploying by half-turns, (split-S type maneuver) as the enemy reaches the lower points of his maneuver, our pair will already have passed it, depending on initial approach rate, and they will be above the enemy by 1600 - 3300 feet. From this position, the pair can climb and obtain further separation between them and the enemy.

When impossible to break away from the enemy the attacked aircraft should turn away from the formation and allow the remaining aircraft the opportunity to attack or at least prevent the turning aircraft from being pursued.

COMBAT BETWEEN PAIRS

In cases where combat is between pairs, if the enemy does not deploy, it should be pursued by a pair and the tactics are in essence no different from those for a single engagement. If the enemy pair does deploy, our attacking aircraft should also deploy to create favorable conditions for launching R-3S rockets against both aircraft.

The enemy pair may deploy horizontally in what we term a "shear" (scissors) maneuver. This consists of periodic separation of and convergence of aircraft on intersecting headings. In this case, the attackers deploy immediately, continuing to pursue the enemy and adopt single engagement tactics.

When the enemy pair deploy by banking frequently in various directions, our pair also deploy if within range and good striking possibilities exist, otherwise our pair continue to pursue just one of the enemy.

When they maneuver with just one turn, they are planning on the aircraft that is not pursued to reach an attack position and attack our pair. However, if this appears too likely, our pair should also deploy, one behind each aircraft and attempt to

~~SECRET~~

tie up each enemy. Once we've deployed, the enemy may plan that our aircraft attacking their leader be attacked by their number two man. To avoid this, it is necessary to carefully observe both aircraft and when necessary to change to pair pursuit after just one enemy.

If an enemy pair undertake deployment by climbing or diving maneuvers, we should deploy and attack both aircraft. The enemy, when deploying, will try to organize cooperation between the pair. To disrupt this, it is necessary to persistently attack each aircraft, and especially if one is on the tail of one of our aircraft. Gunfire against this aircraft should be conducted at maximum distances in order to make it relinquish it's support to the other aircraft. Simultaneously, warning should be given to the first MiG under attack so he can employ evasive maneuvers.

If the enemy pair is detected considerably beyond cannon range in our fighters rear hemisphere, a turn in the enemy's direction should be executed immediately in order to hinder rocket launching.

Depending on the speed, the nature of the turn will differ. If the Mach number is relatively high (1.5 or greater), it is best to make a climbing turn in order to utilize the higher altitude for attacking the enemy. If the Mach number is low, the turn should be made with a descent to gain speed.

If the enemy was detected when near firing range, a hard turn (break) is made into the enemy. When the pair find it impossible to escape as a formation, it is necessary to deploy and attempt to draw the attackers under the fire of one of our fighters. The tactics are then relatively the same as discussed before for enemy fighters, but one must remember that to maneuver the MiG-21f-13 vertically is generally more feasible than to maneuver horizontally. A horizontal maneuver should be made only when it is impossible to execute a vertical maneuver because of meteorological conditions or tactical circumstances.

FIGHTERS VS FIGHTERS AT LOW ALTITUDES

Aerial combat with tactical enemy fighters at low altitudes possesses the following natural features: relatively poor visibility against the earth's background, which combined with a maneuvering target, may lead to the loss of visual contact. The R-3S rocket launching range does not exceed 1.1 NM and usually averages only 5000 - 6000 feet. For this reason, a rocket attack against a maneuvering fighter at low altitudes is extremely difficult because of the G-limitations.

The minimum altitude at which the MiG-21f-13 can fly (level), and not have the SRD-5 mk radar range finder lock-on the ground, is 1600 feet. When the target is at an altitude of 1600 feet or less, and if the background of the earth permits rocket launching, it is advisable to descend slightly and if possible, be a little below the target. The angle-off should be 10 - 20° off the tail, so the attacking aircraft won't be in the target's jet-wash.

Typical attacks at low altitudes when the fighter has been vectored to the rear of the target are from the side and above or from the side and below. An attack from above is executed in an inclined plane as shown in Figure 90.

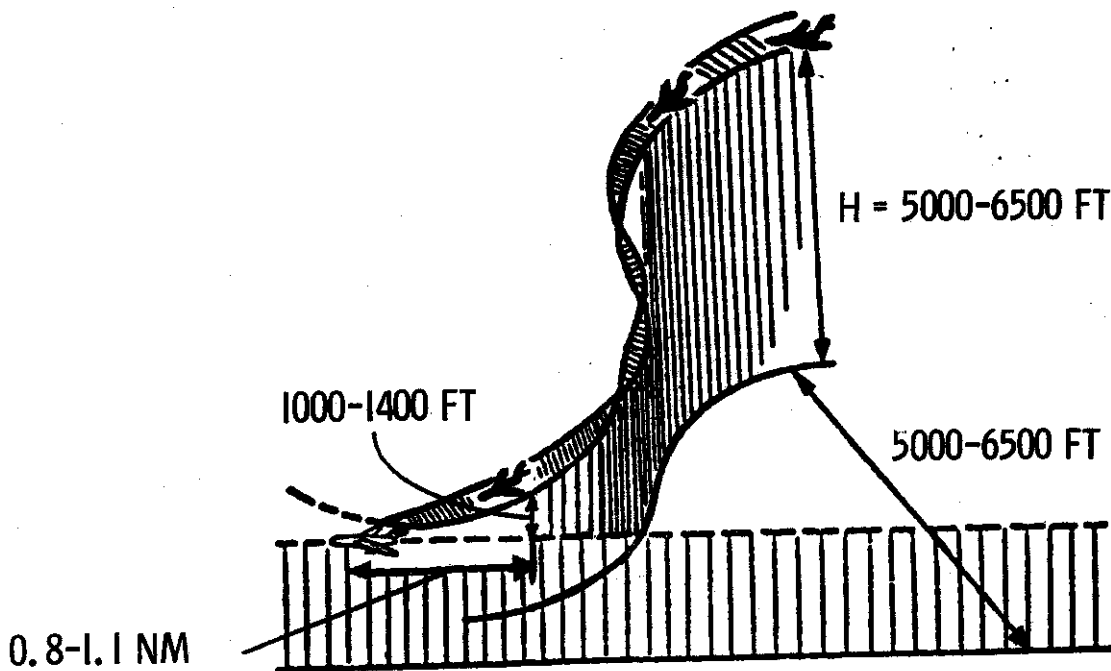

ATTACK FROM THE REAR UPPER SIDE

FIGURE 90

~~SECRET~~

From its initial position, the MiG-21f-13 executes a tight descending turn toward the target. A turn reversal is made when the nose of the aircraft is pointed roughly at the target. The attacker should emerge on the pursuit curve at a distance of 8000 - 10,000 feet, and the pilot should bring the sight piper in front of the target by 2 - 3 fuselage lengths. Attacking the target with a small positive lead angle guarantees an attack entry at an altitude no lower than the target's. At low altitudes, this is very important, because at the time of attacking the target it is difficult for the pilot to watch simultaneously the changes in altitude and target position.

The radar range-finder during the approach takes in the earth and the UD-1 will show a range of 2.7 - 3.2 NM, depending on the angle of descent. At rocket launching distance, the piper is put on the target and the radar should lock-on the target at this moment. The range dial of the UD-1 will sharply change its position and will show a reduced range. Simultaneously, with all this, the TGS rocket head emits a signal indicating lock-on.

If the approach rate exceeds 80 - 110 knots, it should be reduced by throttling back and extending the speed brakes. Rockets are launched when the "Permissible Distance" light comes on, the piper is on the target, the TGS is locked-on, and the G-load is within limits.

If the target was not hit by the rocket, it is necessary to increase the approach rate and continue the attack with the cannons. For this, the "Optics-Radar" switch is switched to "Optics," the sight is placed in the "Gyro" position and the sight is set to give a range indication of 1300 feet. For reliable scoring on small targets when using the cannons, the open fire range must not be more than 1600 - 2000 feet. To determine this range, the pilot must have considerable training because the target fits the sight ring only at a distance of 1150 feet.

At the open fire range, the target should occupy one-half the diameter of the sight reticle. Firing is done in short volleys with the aiming perfected at the range of 1150 feet, where the target will correspond to the diameter of the reticle.

When approaching the target prior to cannon firing, the same general aiming techniques are used as the piper is first placed 1-2 fuselage lengths in front of the target and allowed to slide back on the target simultaneously with arriving at the firing range.

~~SECRET~~

The most probable type of enemy evasive maneuvers at low altitudes is a tight turn with a subsequent turn back on course. Such a maneuver, with a G-load of 4, will usually disrupt a rocket attack because from the distance of possible rocket launching, the G-load on the MiG-21f-13 will exceed the permissible amount. As the distance to the target decreases and as its angular velocity increases, the attacker should use any measures necessary to keep the enemy aircraft in sight. While roughly tracking the target from near a possible rocket launching distance, the interceptor should increase the G-load and pull the sight ahead of the target, so that with a subsequent release of G's, the target will pass through the pipper and the rockets may be launched.

If the rockets cannot be launched, the pilot must decide whether to attack with cannons. If the G-load during tracking is not over 3, cannon fire can be conducted with the sight in the "Gyro" position. As the turn-in begins, the electrical cage button is depressed and the pipper is placed ahead of the target by 500 - 650 feet. After the turn is completed, the cage button is released, and the pipper should slide smoothly back to the target. When aligned and tracking, the pilot should open fire.

If the G-load is over 3, cannon fire should be conducted with either a electrically or manually caged sight.

If the target started a tight turn when the attacker was at a range of 6500 - 5000 feet, the attacking fighter, because of the simultaneous transition into a turn with an angle-off of 15° and the maximum G-load, should try to remain inside the turn and continue the attack. The MiG-21f-13 during this maneuver, will normally be pulling 0.4 - 0.6 more G's than his adversary if the approach rate was about 55 knots. The maneuverability of the MiG-21 will allow aimed firing nearly immediately after going into the turn. If the attacking fighter was late in starting the maneuver, the success of the attack depends on the possibility of pulling into the inside of the enemy's turn. This can be done by applying the maximum G-load from the beginning of the maneuver. (Figure 91)

If the enemy aircraft, in an attempt to get away, tries a climbing turn with maximum G-load, our attacking fighter with an angle-off of 15° , from a range of 5000 - 6500, can be increasing the G-load and utilizing his altitude advantage, and successfully attack with cannon fire during the ascending maneuver (Figure 92).

~~SECRET~~

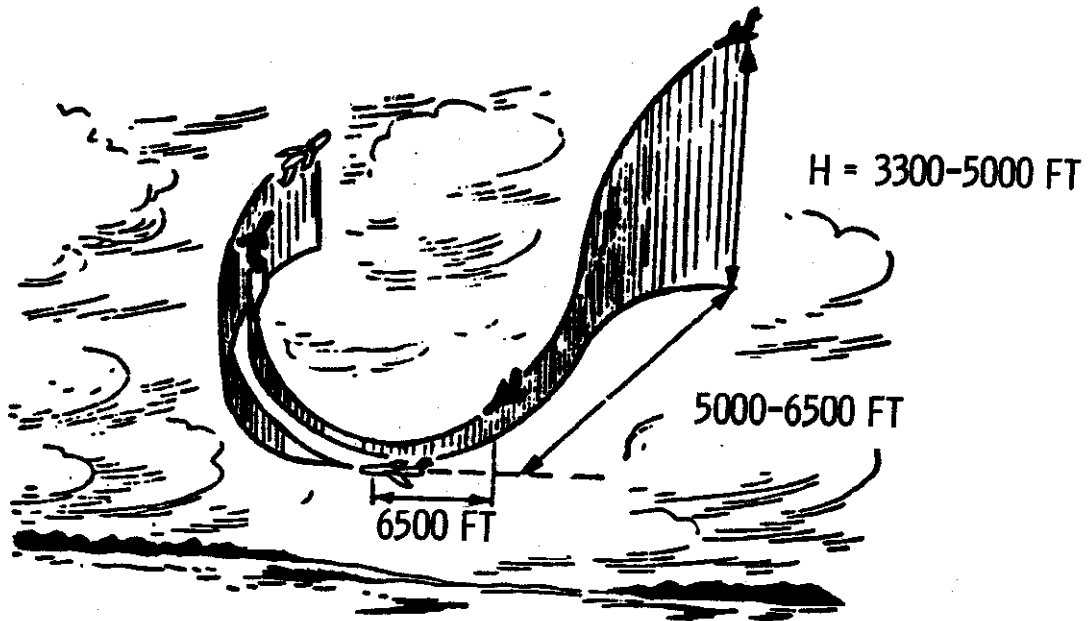

ATTACK DURING TURN. (ANGLE-OFF = 15°)

FIGURE 91

~~SECRET~~

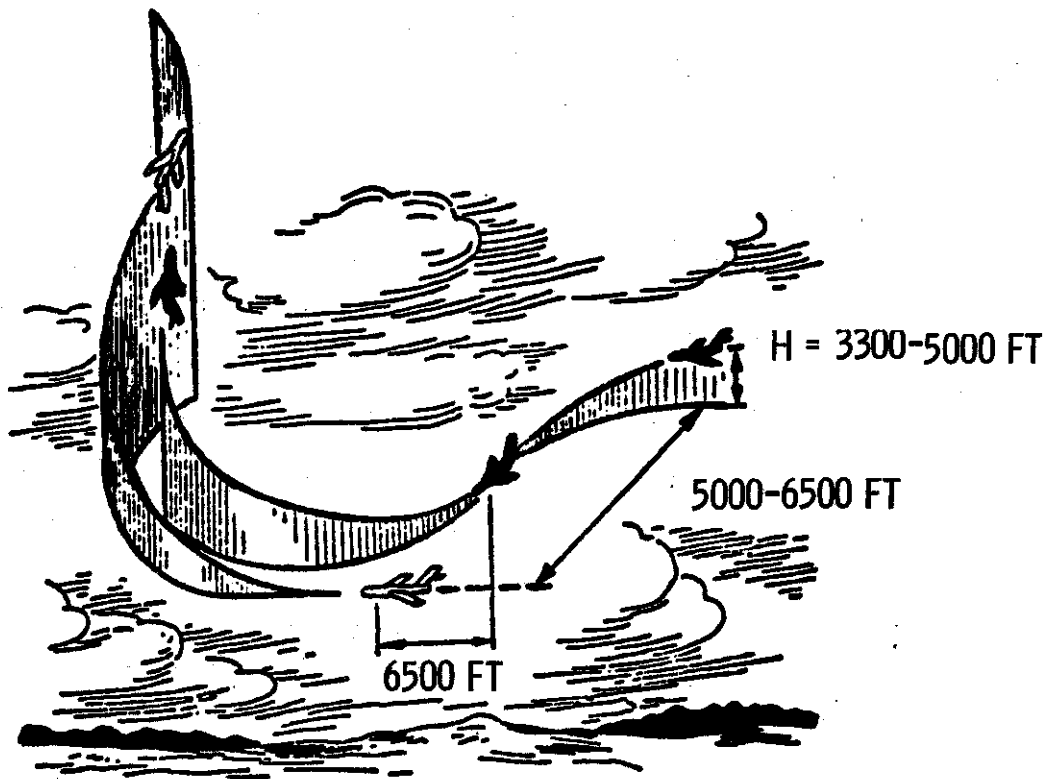

ATTACK DURING ASCENDING MANEUVER
(ANGLE-OFF = 15°)

FIGURE 92

~~SECRET~~

CHAPTER V

AERIAL COMBAT TRAINING

Aerial combat training instills in the pilots the firm habits necessary for successful target search and aerial combat. The tactical principles applied in combat, plus the maximum utilization of flight characteristics, are an essential part of this training.

Because of supersonic speeds, reduced visual area coverage by the pilots in their high altitude clothing, and the difficulties of handling a large formation at these speeds, it has become inadvisable to conduct aerial battle between large groups. Therefore, under modern conditions, the basic tactical unit, considered capable of conducting combat at all speeds and altitudes, is the two-ship formation. To increase the forces in a region of anticipated encounter, flights of fighters may be dispatched, but the actual engagements are considered the jobs of individual, independent pairs. To insure that a pair of pilots meet the tactical requirements imposed upon them in a modern engagement, each pilot must first be trained in single aerial engagements.

Aerial combat training should consist of a series of theoretical and practical instructions during ground training and during the execution and exhibition of training flights. During ground training, attention is paid to the study of the following basic problems:

- construction and exploitation of the armament system on the ground and in the air;

- technique of piloting and conducting combat in the stratosphere and at maximum and minimum altitudes;

- data about probable enemy aircraft and guided missiles, their tactics and limitations;

- possible tactical methods for combating the aerial adversary and the tactical possibilities of our own aircraft. When studying these problems, it is necessary to make wide use of textbooks which deal in the methodical tactical applications of the MiG-21f-13.

After studying theoretical problems, further training is done in the cockpit of the aircraft or in a ground training device (flight simulator). In this way, the pilot acquires

~~SECRET~~

experience in conducting a battle from the moment of take-off to the moment of pulling out from the attack.

Training pilots for single aerial engagements includes instruction in piloting techniques over the entire range of altitudes and speeds during horizontal and vertical maneuvers. In the process of training, the pilot adopts habits for controlling the engine during the execution of various evolutions and also the practice of executing any maneuver, depending on altitude and airspeed. After the individual aspects have been taught, the pilots work on group flying or tactical pair formations. They learn to change formation and to evaluate existing attack possibilities.

Because of the complexity of modern aerial engagements, the commanders at all levels must adhere strictly to the methodical training sequence of going from the simple elements of combat conditions to the more complex and difficult ones. The training sequence of the elements of combat should be orderly and feasible for the pilot during the entire training stage. This is attained by confronting the trainee only with tasks that he is capable of accomplishing at that stage of training. The commander must have an overall knowledge of the training level and possibilities of the pilot.

During preliminary training, the commander has to teach the pilots and bring them to the point where they are able to fulfill the training requirements. They must realize the errors that are possible in combat and the methods for eliminating these errors. Special attention should be paid to the analysis of tactical problems, the actions of pilots in battle, and the flying safety problems.

Training pilots in individual combat should follow this sequence:

- analysis of attacks recorded on film (against maneuvering and nonmaneuvering targets at medium and high altitudes at subsonic speeds);

- analysis of attacks against nonmaneuvering and maneuvering targets in the stratosphere at all speeds;

- processing of data concerning nonmaneuvering and maneuvering targets at low altitudes at subsonic speeds;

- processing of data concerning combat with a fighter at subsonic speeds at high altitudes;

- analyzing combat with a fighter at supersonic speeds in the stratosphere.

The first exercise is carried out with simulated attacks against bombers, the next one against fighters. The attacks are completed as if using R-3S rockets and then cannons. Demonstration flights should use this same sequence, as should the first solo flights.

When pilots are trained for combat, they must be given initiative and confidence so they can perform correctly, daringly and yet confidently. This teaches the pilot to properly evaluate the situation and to act accordingly.

COMBAT TRAINING, FIGHTER VS BOMBER

The main part of the training for combat against bombers is the training in interception and attack at all altitudes and air-speeds. To simulate targets, our bombers should be used as their tactical flight data is similar to the enemy's.

Each engagement should be flown with gun cameras or with some control-recording apparatus. Aerial training on the use of R-3S rockets should be done with training rockets which have an acting self-guidance head. Control of the launching conditions is done by the GCI controllers, and by a recorder, if a training rocket was carried along for this given flight. Gun camera results, as well as tape recordings from the self-recorder, should be thoroughly analyzed. This method uncovers errors and the pilot's progress can be determined.

The initial training for attacking bombers consists of acquiring the proper initial attack position for various distances and intervals. Next, the attack maneuver is developed. Depending on the target, and in accordance with GCI data, the pilot should learn to rapidly determine and fix the necessary approach rate which will allow him to aim and launch his rockets or to track and fire his cannons.

An important part of the training for aerial combat is the pull-out from the attack and the maneuvering for the execution of a repeated attack. In these cases, the trained pilot should estimate the displacement of the target relative to his own aircraft and also the possible maneuvers available, depending on his airspeed and altitude. When at medium and high altitudes and with a high approach rate, he should pull off in a climbing turn to the side, but when in the stratosphere, he should descend to get away.

~~SECRET~~

When all the elements of aerial combat have been mastered, the trainee must adopt the habits necessary for a successful target search. All detected aircraft are assumed as enemy aircraft and he must rapidly estimate the possibility of executing any type maneuver necessary for an attack. In case of improper analysis and action by the trainee, the instructor should relate what maneuver would have been feasible for an attack or for pulling out from an attack. The problem of maintaining a continual vigilance during a training flight is closely interwoven with the problem of searching under tactical conditions. Under modern conditions, especially when a fighter sortie is flown to intercept bombers, the searching should be done in a narrow sector. This sector will be indicated by the ground controller in conjunction with the vectoring instructions. The vectoring instructions are an attempt to assure that the fighters are guided directly to the initial attack position. When, because of unavoidable vectoring errors (especially when the opponent creates radio or radar interference), it is impossible to attain accurate vectoring, the fighter will be guided to a zone of possible visual target detection. Once the target has been visually detected, the pilot decides everything else, basically, on his own.

The next step in combat training against bombers is the training in pair formations. This includes training in mutual coverage during target searching and how to conduct subsequent and/or simultaneous attacks. These flights should have been preceded by a training flight to teach maneuvering in tactical formations at various altitudes and airspeeds. While training for group aerial combat, it is necessary to learn the R-3S rocket procedures for executing sequential attacks as well as simultaneous attacks, plus procedures for a subsequent attack using cannons. Training a pair to execute simultaneous attacks should be done against the densest groups of bombers. To simplify this by deploying the bomber formations, or by limiting their airspeed and altitude, is absolutely prohibited.

Serious attention should be devoted to teaching the pilots individual aiming and tracking. This training should begin with small approach rates and increase to the maximum rate possible.

The break-off from an attack should be handled just as attentively as the attack itself. The pilot should be trained to perform the proper maneuvers during the pull-out from an attack at various approach rates and at various altitudes. He should faultlessly determine the minimum distances for breaking off the attack assuring flight safety.

~~SECRET~~

At the beginning, control of the combat training should be done on one radio channel only. As the student progresses, control can be exercised over various channels. All mock attacks against bombers should be flown only in the presence of stable two-way radio communications.

NIGHT COMBAT TRAINING

With the optical sight (ASP-5nd), the MiG-21f-13 can make attacks at dusk or during nights which are bright enough to permit visual detection of targets at sufficient distances to permit an attack with rockets or cannons. That is why pilots must be trained in night combat against bombers. The moon offers an illuminosity which permits detection of targets at sufficient distances. The number of nights out of each month that the moonlight is bright enough is only seven or eight. In the half-moon period, visual target search is difficult and its success depends greatly on the GCI vectoring accuracy, direction of target flight, visibility conditions, and also on the position the fighter occupies with respect to the target and the moon.

Search for a target during the twilight period should be made against the illuminated side of the horizon at an altitude of 1500 - 3500 feet below the assumed altitude of the target. Under these conditions, bombers can be detected visually at distances up to 1.6 NM.

Search for a target under lunar illuminated conditions should be made from the rear hemisphere of the target and at a lower altitude. The pilot should try to be in a position where he can see the moon to one side, and so the target is on the other side and the interceptor's heading is within 20 - 50° of the target's. From such a position, the pilot will first detect the target's reflection, and then from around 6500 feet, the target contours. If the target is directly between the moon and the fighter, detection conditions become more difficult.

The possibility of detecting a target at twilight, or at night, depends considerably upon the visibility conditions (weather), the degree of cockpit illumination, and the presence of revealing aircraft signs. Some revealing signs are the glowing jet exhaust and contrails.

The pilot begins his visual search for the target in the sector of probable appearance the moment he receives current information from the GCI controller. This information should contain the target's heading and its relative position to the fighter. Having vectored the pilot into the rear hemisphere

~~SECRET~~

~~SECRET~~

of the target at a distance of 2.0 - 3.0 NM, with an approach rate of 80 - 110 knots and about 1500 - 3500 feet below the target, a command of "attention" is given to the pilot. From here on, the pilot must adhere strictly to the course, altitude, and air-speed. Approach rates should be: over 3 NM, 110 - 80 knots; over 2.2 NM, 80 - 55 knots; over 1 NM, 55 - 25 knots; under 1 NM, 10 - 15 knots until speeds are equal.

At this stage of visual target search, the pilot should not execute any sharp or long lasting evolutions as it distracts his attention from searching and it will require greater attention to monitor his instruments. Turns should be made with banks of not more than 45°. If at a distance of 1 mile, the pilot does not have visual contact, further approach is forbidden and the fighter is drawn away in a safe direction and vectoring is repeated. After detecting the target, the pilot must not lose it from sight while he approaches. He gradually reduces his approach rate so that it will be at a minimum where he opens fire.

Aiming is done with the stationary sight reticle. The sight lighting should be at a minimum. The pilot controls his own aircraft visually and by using the artificial horizon. The range is determined visually and with the aid of the radar range finder.

In view of the complexity of conducting night combat, night training should begin with demonstration flights to show the methods of searching for non-illuminated targets. These flights should be conducted under conditions of good visibility and where the bomber is flying in a straight line at a given altitude and airspeed, all of which are known to the fighter.

At first the pilot gets acquainted with the conditions of seeing a target at night. He should occupy a position relative to the target with an interval of 150 - 200 feet and at a distance of 500 - 600 feet back. The target then turns off their position lights. The trainee reduces his airspeed and draws back from the target, keeping it in sight and monitoring the range indicator. He should fix in his mind how the target looks at certain ranges. The moment the target is lost from sight, the trainee calls for the target to turn their position lights back on and he detects the target and flies back to the initial position. During subsequent flights, the trainee becomes acquainted with the conditions of detecting a non-illuminated target during the approach by performing the following procedures. At a distance of 1 - 1.6 NM, the pilot

[REDACTED]

gives the command, "Target lights out", and then with a small boost in speed, he begins to approach and search. Having detected the target, he assimilates aiming, rocket launching (camera firing), and at a distance of no less than 1300 feet, he enters the attack. The approach and attack are done with a zero angle-off. To determine the angle-off at night, even with the target's position lights on, is very difficult and with the lights out, it is nearly impossible to judge except by the relative displacement of the two aircraft.

After pulling out from the attack, a command is given to turn the position lights on and a new attack is originated. If the target cannot be detected, a command to turn on the landing lights is issued, and the pilot discontinues the approach and reports this to the controller. In all instances, the fighter trainees will have their position lights on.

In order to have safe, secure, night simulated attacks, it is necessary to have stable 2-way radio communications, clear execution of all the commands given by the controller, and to maintain all specified flight conditions. Controlling combat at night is done completely on one radio channel. Radio communications between the target and the interceptor crews is mandatory. The bomber crew, having detected the fighter, immediately reports to the controller, "I see the interceptor." The bomber crew attentively follows the flight of the fighter and orients itself by the fighter's position lights. If the fighter closes to less than 1300 feet, the target turns on all his lights and gives the trainee the command to break off the attack. The trainee must immediately obey all the commands issued by the target and the GCI controller.

COMBAT TRAINING AGAINST A FIGHTER

The principle of combat training when fighter versus fighter consists of mastering various tactics and techniques. Before the first solo fighter combat flights are allowed, the pilot must fly no less than two flights in a trainer aircraft with an experienced instructor who demonstrates the ways and means of preserving the initiative in combat and still observe the applicable safety measures. Exhibition flights should follow actual combat routine as closely as possible. They should be controlled by the ground and flown in a mock combat zone.

Once in the zone, upon a command from lead (target) the trainee pilot occupies an initial attack position at a distance of 1.6 - 2.2 NM and then the command "Attack" is given. Upon

~~SECRET~~

this command, the target aircraft takes evasive action, in accordance with a pre-arranged plan, in an attempt to disrupt the attack. The attacker tries to attain a more feasible position for rocket launching or cannon firing. The first mock battles are conducted at subsonic speeds with maximum engine operation at altitudes from 25,000 - 40,000 feet. The battle should begin with the target maneuvering in the horizontal plane and with subsequent complications. If the trainee stays on his tail, he should use full power and maximum banking.

After having flown some mock combat, the instructor demonstrates how to retain tactical superiority, the conditions for firing in a bank, the maximum and minimum firing ranges, and the action to take in case the target is lost. After the trainee has gained confidence from the horizontal maneuvers, the target, upon command from the instructor, begins vertical maneuvering with half turns, tactical turns, and slanting loops. From an altitude of 33,000 - 40,000 feet, the target goes into a 45° dive with a subsequent climbing turn. The maneuver is repeated with a dive angle of 60° and the turning time is reduced to a minimum (many G's during the maneuver). The trainee follows the target and attains a rocket launching position (aimed camera firing).

During the vertical maneuvering, the instructor should demonstrate the method of employing the speed brakes during descending maneuvers (to reduce the radius of the maneuver) and methods of emerging at open fire range (rocket or cannon).

During the entire battle, the target (leader) may not see the maneuvers of the trainee; that is why the responsibility of a safe mission rests on the instructor and the trainee.

On the second exhibition flight, combat is conducted at supersonic speeds at altitudes of 40,000 - 53,000 feet with use of the afterburner. The flight to the mock combat zone can be done separately or with the target and trainee in tactical formation. An attack with R-3S rockets and subsequent cannon firing (both during one attack) must be flown at an approach rate of no more than 165 knots, otherwise the pilot will not have enough time to get ready for cannon firing.

The trainee should pay special attention to his accuracy of executing the commands issued by the GCI controller. When informed that the target is ahead, the pilot must make 10° - 15° turns to either side in an attempt to gain a better view of the indicated area. However, the general flight direction must not be changed. After detecting the target, the instructor, if necessary, demonstrates the most advisable attack maneuver.

~~SECRET~~

If the target and the trainee arrive at the combat zone in open tactical formation at an altitude of 30,000 - 33,000 feet, both aircraft go into afterburner on a command from lead and start to climb when they reach Mach 1.5 - 1.6. Around 52,000 feet, lead (target) sets minimum afterburner power and upon a command from the trainee, he starts a turn with a gradual increase in G-load to the maximum. With a half-roll, he then goes into a 40° - 45° dive and accelerates to Mach 1.7 - 1.8 with subsequent execution of tactical turns and loops. The trainee, prior to starting the battle, should stay away from the leader (target) by a distance of 3500 - 4500 feet. He should prepare his gun-sight and gun camera for operation and test fire his gun camera in a safe direction. Upon the "Attack" command, the trainee can adjust his power within afterburner limitations and go after the target, figuring to approach to a rocket firing (photo firing) distance.

The instructor controls the actions of the trainee and when necessary, demonstrates the proper maneuvers needed to create conditions from which aimed firing is possible. If during the engagement, the trainee commits gross errors in piloting technique or rapidly loses his built-in tactical advantage, the flight is repeated or he is given other training for the purpose of developing his piloting skill. Upon successful completion of the maneuvers in a trainer, further training is permitted in a tactical aircraft. On the first flight, he executes only those maneuvers developed in the exhibition flights. As he gradually masters the features of aerial combat, the conditions become more complicated. The target begins employing more complex maneuvers at greater airspeeds and with higher G-loads.

After the trainee masters his combat training at medium and high altitudes, he is trained for single engagements at low altitudes. The training at low altitudes has some additional characteristics which are: maneuvering limitations in the vertical plane, difficulty of orientation, and the limitations of the radars for detection and vectoring. The vectoring and searching should be done from an altitude above the target about 3000 - 5000 feet. The attack should be made from above with an angle-off of no more than 30°.

For complete, universal combat training, the mock battles should not all be between the same type aircraft. Other fighter type aircraft, based at neighboring airfields, should be briefed on the tactical possibilities of enemy fighters and be flown as opponents during the training.

~~SECRET~~

Single engagement training should be carried out systematically, regardless of training level, thus continuously developing newer variants and methods of combat.

The analysis of a completed engagement is an essential form of training for the pilots. The analysis must be carefully prepared and done completely so that the pilots will derive maximum benefit from every analysis. During the mission analyzing (debriefing) the pilots relate the tactics they used, the difficulties they encountered during maneuvering and aiming, what made their camera gunnery easier, and information about the operational qualities of the aircraft, engine, sight and radar. Upon conclusions of the debriefing, the commander gives an evaluation and points out ways of eliminating errors and deficiencies in future flights.

Experience in combat training with MiG-21f-13 has shown that with good ground training, with thorough pre- and post-flight training, and with a thoughtful and detailed debriefing of each flight, successful mastering of combat tactics is assured.

Training in single aerial engagements is only the initial stage in combat training. The tactics the pilot will usually use will be carried out in a two-ship formation. For this reason, greater attention should be paid to the training of group combat tactics.

To master aerial combat in a group, the pilot must learn: to execute horizontal and vertical maneuvers without falling out of tactical formation; to carry out aimed firing from various positions when maneuvering in tactical formation and during different parts of the maneuvers; to give mutual protection in the formation; to adopt various tactical methods to assure a successful attack; to comprehend his leader's tactics and to execute his commands; to break-off from an attack on a signal from lead or from ground control; to show intelligent initiative for purposes of inflicting the heaviest blows on the enemy.

In order to fly formation during combat training, the pilots must have mastered single air engagements and tactical formation in pairs and flights. Group combat training can be done with tactical aircraft unless the results are unsatisfactory and if so, flights in a trainer will be scheduled for demonstration purposes.

Group combat is first flown by a pair against a single aircraft and then by pair against pair.

~~SECRET~~

During preliminary group combat training, the same problems inherent to single engagements are worked out, but special attention is paid to the flying safety aspects connected with formation flights. In connection with this, a more thorough investigation is made of tactical methods and possible formation positions. Because of the increase in number of aircraft, the number of tactical methods also increases.

As the pilots acquaint themselves with group combat, the battle conditions are gradually made more complicated by increasing the speed and by placing the attacking trainees in more difficult formation, the pilots may follow the targets to the combat zone in a general tactical formation. Subsequent sorties are executed with preliminary vectoring and interception.

Once in the training area, upon command from the formation leader, the leader of the pair (element leader) takes up a tactically convenient position and begins the attack. The attacked pair then begins evasive maneuvering first smoothly and then more rapidly, changing from basic horizontal maneuvers to complex combinations. With a sufficient fuel remainder, the pairs should swap roles and renew the engagements.

When the pairs are vectored together, mock R-3S attacks are flown with a subsequent change over to mock cannon attacks.

Pilots, having gained a thorough knowledge of two-ship combat, then train for combat under complex aerial and tactical circumstances with other aircraft who have been pre-briefed on what tactics to employ. The commander will control the engagement from the ground and will designate what target positions will be flown. Each one of the parties will adopt the formations and combat methods which they consider most feasible for themselves. Vectoring under these conditions may be done on various radio channels, but when the battle starts, all groups go to one channel. One of the leads is designated senior and upon his command the battle begins and ends. The commander monitoring the battle may order it to be stopped because of safety reasons.

The debriefing is very important for such flights. The reports submitted by the pairs, the GCI data, and the camera gunnery results, all are necessary to thoroughly analyze the battle. The commander will point out the errors committed, the false decisions made, the proper solutions and various methods and actions that might have been employed.

~~SECRET~~

~~SECRET~~

SAFETY MEASURES DURING COMBAT TRAINING

When engaged in combat training, the pilot should adhere to the following safety measures: to execute the mission only when stable two-way radio communications have been established with the GCI controller and the other involved aircraft; to stay within aircraft G and airspeed limitations; to closely monitor the fuel remaining and with 210 gallons left, discontinue the mission and go to the airfield; to stay VFR at all times; not to approach closer than pre-briefed distances; not to exceed pre-briefed approach rates; not to go supersonic below 36,000 feet; to avoid the jet wash of the target aircraft; when losing sight of the target or lead, discontinue the attack, and report it immediately; to discontinue the attack, if the attacking formation is broken up; to control the altitude loss during maneuvers; to check the gun camera switch in the safe position before attacking.

~~SECRET~~

~~SECRET~~

CHAPTER VI

GUNNERY TRAINING AGAINST AIR AND GROUND TARGETS

Training in the tactical application of the R-3S rocket includes both ground training in the aircraft cockpit and training flights made with practice rockets.

In the cockpit, the aircrew learns how to determine the aural tone in the headset which indicates that the missile has acquired the target. On training flights with practice rockets, the aircrew develops the tactics for launching the rockets against real targets.

The process of aerial gunnery training consists of the following stages: ground training, both in the gunnery trainer and in the aircraft cockpit; camera gunnery flights against air and ground targets; and live gunnery practice against air and ground targets.

The procedures necessary for handling the sight and fire control devices are acquired by the pilot when in the gunnery trainer or in the aircraft cockpit. The basic part of the gunnery training is the camera gunnery phase. Broad and proper utilization of the photo control instruments applicable to cannon or rocket firing, allow the pilots to work out single or group attacks against target aircraft of any type under conditions simulating actual combat. The basic purpose of the gunnery training is to train for attacks and to learn to handle the weapons control devices. It also builds the pilots confidence in the possibility of destroying aerial and ground targets.

To fly air-to-air gunnery with cannons against towed aerial targets takes a gunnery area (range) of 25-30 NM in length and 8 NM wide. On a range like this, fire can be directed in one direction only. If the range is 16 NM wide, fire can be directed when the two-ship is going in either direction.

EVALUATION OF FIRING RESULTS

Aerial firing of unguided S-5m and S-5k rockets from the MiG-21f-13 has certain aiming characteristics due to the increased mobility of the sight reticle. This mobility is caused by the calculation of the angle of attack and aircraft yaw which is done automatically by the angle of attack and yaw detector unit (DUAS).

Tactical firing of the cannons should be done at a true air-speed of no less than 370 knots. Firing of the S-5m and S-5k

~~SECRET~~

unguided rockets is permitted at any speed. The R-3S rockets should be launched at speeds of no less than Mach 0.8.

Depending on the distance to the air-to-air gunnery range, 3-5 aircraft should fire at the target per target sortie. If more fighters try to fire per target sortie, it leads to hurried firing and a reduction in firing quality, especially during the first flights.

To facilitate searching for the tow aircraft and to keep the tow on the given path, it is necessary that the GCI controller be included in the mission. Actual tactical gunnery flights should be permitted only for pilots who have shown satisfactory results during the camera gunnery phase.

AIR-TO-AIR GUNNERY (CANNONS AND UNGUIDED S-5m ROCKETS)

Cannon firing and the launching of unguided rockets is done only in specially designated zones (ranges), assuring total safety for the local population.

To obtain maximum target towing time, the tow aircraft should fly at an altitude of 13,000 - 16,000 feet at a true airspeed of 300 knots and the fighters should be vectored to the target by ground control. To facilitate searching for the tow, the fighter's should fly about 3000 feet lower than the target.

When approaching the firing zone, the fighter establishes radio contact with the commander of the tow aircraft and inquires about its position. When the target is visually detected, he requests permission to attack. Having obtained firing permission, the pilot arms the cannon and checks its firing readiness by checking that the red signal lights are on. He then takes up the initial attack position (perch).

With a fighter true airspeed of 380 - 400 knots, the initial attack position is 6500 - 8000 feet to one side, about 10 - 20° back from line abreast, and about 1300 - 1700 feet above the target. In case of other airspeed ratios between the two aircraft and the fighter, the initial attack position will vary and in each specific case will be determined in relation to the desired firing conditions.

From the initial position, the roll-in toward the target is made with a 50 - 60° bank and with the sight electrically caged. When the target appears near the edge of the sight, the

~~SECRET~~

turn is reversed and the piper is placed about 500 - 600 feet in front of the target, and the electrical gyro-caging button is released. After the radar has locked-on, the aiming is perfected and the target tracked for 2 - 3 seconds with the piper on the target's bullseye. Having done accurate aiming and having made sure the angle-off is no less than 15°, and that the distance is no more than 2600 feet, volleys of no more than 1 second duration are fired.

After completing the firing pass, a climb to 1300 - 1600 feet above the target is made and then a subsequent 50 - 60° turn is flown back in the direction of the perch. The aircraft is then flown on a parallel course with the target. If the pull-up is flown properly, the pilot will be close to a new initial attack position.

The most common firing errors are inaccurate aiming, firing out of range, and firing from too small an angle-off. These errors are caused mainly by a poor perch position and insufficient training in aiming with a movable sight reticle. To error in adhering to pre-determined firing conditions leads to a delayed execution of the necessary aircraft maneuvers. If the roll-in from the perch is slow and the turn reversal is late and slow, the consequences will be a high angle-off and not enough tracking time.

The firing of S-5m rockets against a tow target is done with the firing switch in the "salvo-1", or "salvo-2", or "automatic" position. It must be kept in mind that when the firing switch is in the "automatic" position, 16 rockets will fire and the probability of one rocket hitting the target is quite high, hence the target consumption will be greater (when a tow target is hit by one S-5m rocket, it is taken out of operation).

Firing conditions and the scheme of formulating the maneuver when using S-5m rockets are analogous to conditions for cannon firing. The maneuver is depicted in Figure 93.

When aiming to fire S-5m rockets against an aerial target, the following must be kept in mind. The MiG-21f-13 aircraft are equipped with ASP-5nd sights which are combined with the DUAS. When using this sight to fire unguided rockets, it isn't necessary to make angle of attack corrections. The DUAS switch, located to the left, on the bracket of the sight head, is placed in the "D" position and the angle of attack will be automatically taken in consideration, depending on the fighter's altitude and airspeed.

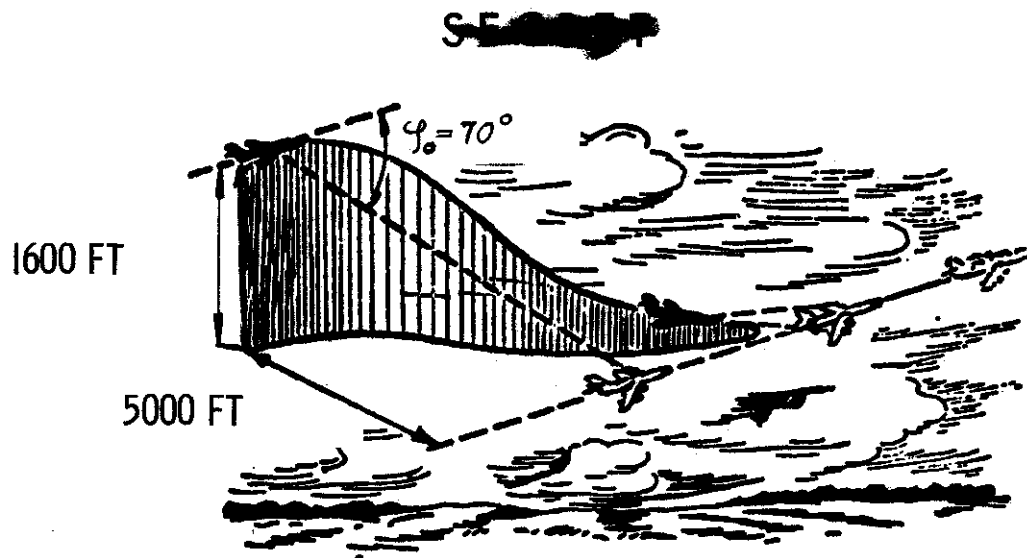

EXECUTION OF MANUEVER WHEN CANNONS AND ROCKETS ARE FIRED AGAINST AN AERIAL TARGET

FIGURE 93

AIR-TO-AIR GUNNERY (SELF-HOMING R-3S ROCKETS)

To train pilots for tactical readiness, training rockets are used. In contrast to a tactical rocket, the training rocket has only the actual heat seeking head and all remaining parts (warhead, proximity fuze, control section, power plant, etc.) are removed. In this way, the guidance head of the training rocket emits a realistic locked-on sound signal in the helmet of the pilot. To assure controlled results when making the attack, the training rocket is provided with a self-recorder. This recorder assures recording on a moving paper tape the following signals: seizing, launching, rocket consumption and time marker. After landing, the correctness of the pilot's tactics is determined by the tape recording. The evaluation is made in accordance with KBP standards.

READYING FOR FLIGHT

Prior to an R-3S rocket mission, the pilot should make a thorough inspection of the rockets and prepare the launch control system. Before getting into the cockpit, the pilot checks the reliability of the fastenings of the launching devices on the pylons, the correctness of the rocket suspension, the absence of mechanical damage on the rockets and the removal of the protective coverings from the heat seeking heads, the optical fuzes, and the reactive contacts of the contact fuzes.

██████████

Once in the cockpit and before starting the engine, it is necessary to fix in sequence - the radar range finder work switch "RS-cannon - SS" to the "S" position; the "B-S" switch to the "S" position; the "RS-NR-30" to the "NR-30" position; the mechanical caging handle on the sight head to the "Stationary" position; set the "base" handle (wing span lever) to 17.5 thousandths; the "Optics-Radar" switch to the "Radar" position; the switches for launching variants "Launching SS" to the "Single" position and the individual rocket launching "Left-Right" switch to the "Left" or "Right" position; and check that the AZS "Emergency Bomb Release," "RS", "Tanks", "APU", "Emergency launching of SS", "Cannon" "Bombs", "SS", and "FKP", are all switched on.

Upon a command from the pilot, the ground power source (APU) is connected.

The pilot then connects the AZS "Incandescence SS" and "Heating SS," and checks the emission of a sound signal indicating seizing by the TGS. The individual rocket launching switch is set to the "Left" position.

The pilot orders, "Lets start checking," and the technician or armaments mechanic directs the beam of light from a flashlight into the field of vision of the TGS on the left rocket. The flashlight is secured to a 6 foot long rod for safety's sake and is held about 3-6 feet from the rocket head. While the flashlight is shifted to the left, up, and down, the pilot with a correctly operating TGS, hears a signal indicating seizure and he selects the proper volume using the volume control. After checking the left rocket, the pilot sets the individual rocket launching switch to the "Right" position and runs through the same check-out procedures. If the sound signal in the helmet is satisfactory, it means the rocket TGS's are in good working order. After check-out, the AZS "Heating SS" and "Incandescence SS" are turned off.

After the engine is started, it is necessary to switch on: AZS converted; GIK; VRD; "Sight Heater;" "Sight;" "Radar Range Finder;" "FKP;" "Heating SS;" and "Incandescent SS". It is also necessary to check that the two signal lights, "Suspension SS," left and right are on, the two signal lights "Suspension of bombs," "RS," "APU," are on, and to check the signal light which indicates the readiness of the radar range finder, "Full Power," for action.

~~SECRET~~

When attacking and the fighter approaches the target along a straight line or along a pursuit curve attained by continuous alignment of the piper on the target, the rockets are oriented as necessary for seizing the target with the TGS. If the target does not go beyond the limits of the range finder ring (set at 17.5 thousandths), the TGS of the rockets will stick to the target at the time of seizing.

The radar range finder, starting from a distance of 3.8 - 2.7 NM (depending on target size), continuously determines the current distance to the target. The TGS, after seizing the target, will emit the characteristic sound signal into the pilot's helmet. The sound can be regulated by a volume control. The electrical TGS arrester of the R-3S rocket, after seizing the target, holds the optical axis of the head coordinator along the rocket axis. When aiming and seizing the target with the TGS, in order to obtain a maximum audio signal against a background of noise from extraneous sources of thermal radiation, the sight piper should not coincide with the center of the target, but should be displaced somewhat from the target center. Under no circumstances should the target be allowed to go beyond the limits of the range finder ring set at 17.5 thousandths, because the conditions for homing in after the launching will be less favorable.

The distance to the target at the time of attack is controlled by the pilot by monitoring the UD-1 distance indicator. The distance voltage, generated by the distance block of the radar range finder, and the permissible distance voltage generated by the permissible distance computer (VRD-2A), depending on altitude and airspeed, are fed into the comparison block. After the fighter attains maximum permissible distance for rocket launching, the voltage of the current distance becomes equal to the voltage from the VRD-2A and then becomes greater than the VRD-2A voltage. The comparison circuit then goes into action and connects the signal light, "Permissible Distance," which announces to the pilot the permissibility of launching rockets.

To assure reliable elimination of initial error in guiding the rocket after launching, a G-load sensor (sensing element, MP-28A) and a barometric sensor (VS-14500) assure connection of the "Signal Overload" light. The light comes on at G values of over 2 at altitudes up to 47,000 feet and at G's over 1.6 above 47,000 feet. This warns the pilot that launching the rocket is prohibited because of the G-forces.

From these indications, the necessary conditions for rocket launching are: the presence in the pilot's helmet of a sound

~~SECRET~~

~~SECRET~~

signal of definite tune, indicating the seizure of the target by the TGS of the rocket; the "Permissible Distance" signal light on; the "overload" light off.

The rockets are launched by pressing the tactical launching button. When pressure is applied to the launching button, voltage, through sliding contacts located in the catch of the APU-13U and in the forward guide of the rocket, is shot to a pyro-cartridge for the ignition of the powder igniter of the powder engine and to a powder cup for heating the battery of the noncontact optical rocket fuze. The igniters of the power pressure battery (PAD) and of the rocket power plant become activated. Simultaneously, the coordinator of the rocket TGS is released and acquires the properties of a follow-up gyroscope. The head then follows the target by the thermal radiation from the target. The rocket slides off the APU-13U guides and cuts the plug socket. The signal lights indicating "Suspension SS left, right" go off.

When the distance to the target coincides with the minimum permissible launching distance of 3300 feet, the comparison circuit cuts in the signal light, "Pull out from Attack." This warns the pilot to make a turn or he may be hit by warhead fragments from his own rocket or by the remains of the destroyed target.

When necessary to launch (jettison) rockets because of an emergency, the button under the cap labeled "Emergency launching SS" is pressed. After an emergency launching, the rockets will automatically explode within 21-26 seconds of flight. In addition, the rockets can be dumped with the APU-13U by pressing the "Emergency release of bombs, RS, APU" button.

To avoid harming the gyroscope of the TGS coordinator on both the tactical and training rockets, the take-off's and landings should be done with the AZS connected by having the switch in the "Incandescence SS" position.

R-3S rockets can be used at all speeds from Mach 0.8 to maximum and at all altitudes from 1600 feet to the fighter ceiling. Maximum rocket launching range depends on altitude, airspeed, and approach rate. The higher the altitude and the greater the approach rate, the greater the maximum launching range. A graph of permissible launching distances for the R-3S rocket is shown in Chapter I.

It is advisable to use this graph when determining the parameters for taking up the initial attack position and also when ECM is interfering with the operation of the radar range

~~SECRET~~

finder so that the moment of rocket launching has to be determined visually or on command from the GCI controller.

AIR-TO-GROUND GUNNERY (CANNONS AND UNGUIDED ROCKETS)

The basic task of frontline fighters is the destruction of aerial targets, but under favorable aerial situations (air superiority) and if it does not deter from the basic fighter task, they may also be employed against ground targets.

Taking into consideration, the fire power of the MiG-21f-13 (one NR-30 cannon and unguided S-5m and S-5k rockets), the greatest effect can be obtained in strikes against enemy aircraft on the ground, radio and radar stations, aviation control and vectoring points, automobiles, marching or concentrated troops, atomic cannons, surface-to-air missile sites, and anti-aircraft artillery.

Conditions for attacking ground targets are determined by the nature of the target, possibilities of detection and identification, weather conditions, ground vectoring possibilities, degree of target protection and available AAA defenses.

The necessity of overcoming the anti-aircraft defense of the enemy compels us to attack the objectives at greater speeds. Greater airspeeds cause the search for small scale targets to be quite difficult, especially under unfavorable visibility conditions or when flying at low altitudes where the view is limited and the objects in the field of vision flash by rapidly. Under these conditions, to see and immediately attack an approaching target is possible only if there is exact emergence on it. The MiG-21f-13 does not have a reliable means for arriving at an exact emerging point for a small scale target. That is why it is advisable to vector the fighters toward the target with the aid of ground radar stations. In cases where flight toward the target is advisable and possible, but the radar coverage doesn't extend to the target, the fighters are compelled to adopt different flight profiles. Under these profiles, as the distance from the radar station increases, so does the altitude, or when the aircraft emerges at a well defined reference point situated ahead of the target by a distance of 16 - 22 NM, he climbs to an altitude where radar can pick him up again. In the latter case, the emergence at the reference point should be exactly at a designated time.

Vectoring can be done with the use of the PPI or the vectoring plane table. The first method is more accurate and it is used for vectoring against small scale targets. Vectoring

~~SECRET~~

~~SECRET~~

with the aid of the plane table is used against moving targets. After instructions from the ground radar on the approximate location of the target relative to the pilots position, the pilot begins the search and after spotting the target, he makes an independent attack. If the target is not detected in the forward hemisphere by the pilot, a command from the controller will tell the pilot the moment he is above the target. After this command, the pilot should take notice of some prominent reference points, fly a maneuver calculated to help detect the target, and then attack.

When aircraft are vectored toward a moving target, the aircraft are flown toward a region (main roads) deduced from watching the standard operational movements of the target. It is necessary to keep in mind that moving targets can change direction of motion. If a target is not found on the basic routes, the search should continue over secondary roads, which will also be predetermined and considered by the ground controller. The search for a moving target is made in the same direction the target is moving, keeping the route and adjoining localities in sight and considering the possibility of deconcentration and camouflage.

The success of the attack is determined by detecting and identifying the target at a sufficient distance from which to attack without extra maneuvers. For this purpose, the pilot should first investigate the nature and form of noncamouflaged, camouflaged, and mock typical targets by use of photos. They must know the basic signs which give away a target, how targets may reflect the sun, and they must constantly train themselves in the development of search and detection habits during training flights. The vectoring of an aircraft toward a target should be done from various directions and if possible, from the direction of the sun.

During tactical and training flights against ground targets, experience has shown that the possible visual target detection distance depends on such factors as target dimensions, target contrast against the surrounding background, weather (visibility) conditions, and the physiological possibilities of the human eye. Table XXXV gives average distances for visual detection of certain ground targets under average visibility conditions.

The presence of limited visibility imposes definite limitations on the attack conditions; namely, the speed at which a search can be conducted and the type of weapons used. In all cases, the necessary detection distance should not be more than the visibility in the target area.

~~SECRET~~

~~SECRET~~

TABLE XXXV

AVERAGE VISUAL DETECTION RANGES FOR CERTAIN GROUND TARGETS
UNDER AVERAGE VISIBILITY CONDITIONS

<u>GROUND TARGET</u>	<u>VISUAL DETECTION Range in NM</u>
Freight Train (without smoke from locomotive)	2.4 - 2.7
Truck	0.8 - 1.1
Radio Station	0.8 - 1.1
Radar Station	1.3 - 1.6
Fuel Storage Tanks	2.2 - 2.4
Single Aircraft	2.4 - 2.7
Atomic Cannon (camouflaged)	0.5 - 1.1
Missile Launching Pad (camouflaged)	0.5 - 0.8
Artillery Position (camouflaged)	0.5 - 0.8

Firing of cannons and unguided S-5m and S-5k unguided rockets against ground targets can be done with dive angles of 5 - 15° and 20 - 30° respectively. The employment of these methods of firing in an actual situation is determined by specific tactical and meteorological conditions; namely, nature of the target, anti-aircraft defense, approach direction, striking means employed, group composition, visibility conditions, and cloud ceiling.

Firing from a steep dive angle in an individual aircraft or by groups is advisable under good weather conditions when against small scale ground targets. A steep dive at high speed and at low altitude assists in suddenly striking the target and reduces the probability of the aircraft being hit by enemy anti-aircraft fire. The shortcomings of steep dive are the difficulty of arriving right at the target and detecting it from low altitude, and the insufficient effectiveness of firing against small concealed targets. Dive angles of 20 - 30° are suggested for

~~SECRET~~

~~SECRET~~

small targets concealed in hollows and embankments if the ceiling is at least 4000 feet. If considerable altitude is needed prior to diving on the target, the probability of the fighter being hit increases. This can nearly be eliminated if the flight to the target is flown at low altitude and the aircraft pulls up into the attack position with a vertical maneuver (climbing turn, half-loop, etc.).

AIR-TO-GROUND GUNNERY (10-15° DIVE ANGLE)

When attacking ground targets from a steep descent, there is a definite relationship between the search rate, attack speed and the distance necessary for visual target detection. This distance is also affected by the speed and altitude when starting to dive. Figure 94 shows the dependence of the necessary target detection distance and altitude on airspeed when using dive angles of 10-15°. The cases are for when the attack is made nearly straight ahead or when a 30° or 60° turn must be made to execute the attack. It is evident from the graph that with an increase in flight speed and in the angle of turning on the firing pass, the needed visual target detection distance rises rapidly. It follows, that a reduction in necessary distance can be obtained by reducing airspeed and by emerging at the target with greater accuracy.

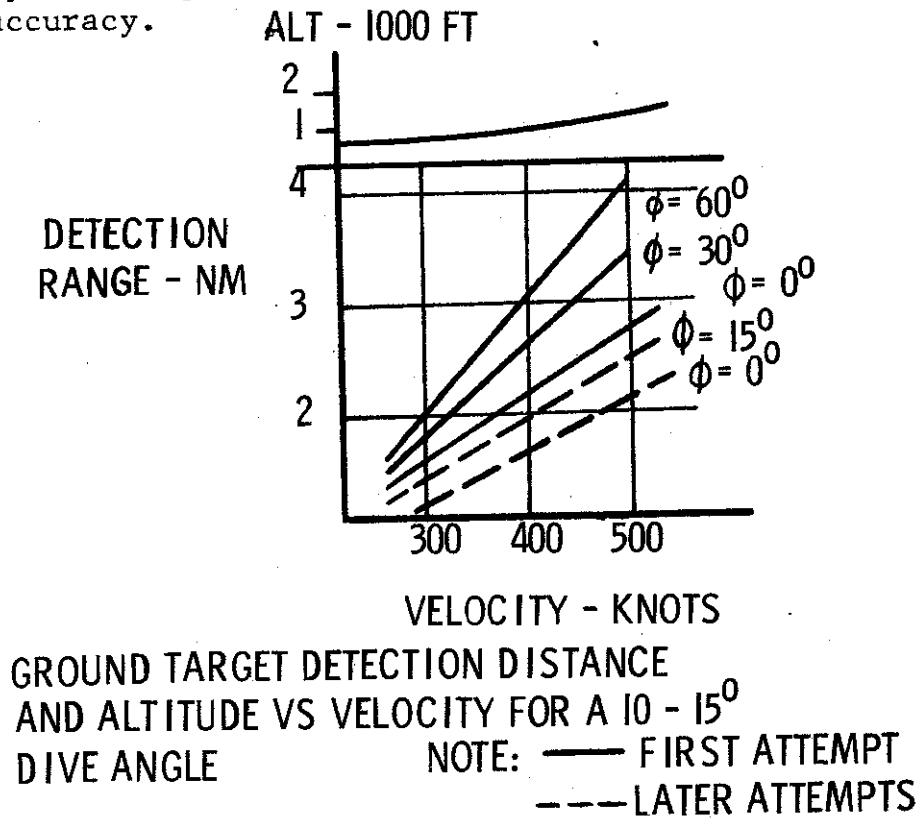

FIGURE 94

~~SECRET~~

~~SECRET~~

If the target is detected at a distance less than necessary, an immediate attack cannot be executed at the given speed and there is usually not enough time to reduce the speed to a permissible value, nor is it tactically convenient to do so. In this case, it is necessary to determine some visible reference points, make some turns and repeat the approach. After such a maneuver, the time needed for repeated searching and target recognition is reduced and the pilot should be able to approach on his final heading or near to it. Because of this, the distance for target recognition (on the second pass) decreases considerably even without reducing airspeed.

In Figure 94, the dotted lines show the dependence of the necessary detection distance when attacking on the second pass. They are calculated for conditions where the aircraft will roll out on the final heading ($\phi = 0$) or with an error where a turn into final of 15° is required. It is accepted that 3 seconds will be lost during target recognition.

Where the possible target detection distances under specific weather conditions are known, it is possible to determine the maximum airspeed for the approach. Considering the airspeed, attack method (first pass or after additional maneuvers), and accuracy of final approach (necessary angle of turn after target detection), it is possible to determine against what targets and under what minimum weather conditions it is possible to fire from a $10-15^\circ$ dive angle. Table XXXVI relates the dependency of these factors.

The dive is executed straight ahead by smoothly pushing over until the target appears in the sight reflector. The loss in altitude while building the airspeed to 490 knots is about 330 feet and to build up to 400 knots, the loss is about 200 feet. The time lost while gaining these speeds is from 2-3 seconds. The increase in speed from starting the dive until pull out is about 30 knots.

All the firing should be done with the sight gyroscope arrester in the "Gyro" position. The average time the aircraft remains in the rectilinear part of his dive is from 6-7 seconds. Depending on the target dimensions, the open fire range is determined by imposing the target in the ring of the sight reticle or by comparing the target dimensions to the dimensions of the sight pipper. With an airspeed of 490 knots, the average open fire slant range is from 3500 down to 2600 feet, with the pull-out being made at altitudes of 150 - 200 feet. With an airspeed of 400 knots, the open fire range is from 2600 - 2000 feet. On the first training firing pass, the pull-up altitude

~~SECRET~~

~~SECRET~~

TABLE XXXVI

10 - 15 DEGREE DIVE ANGLE ATTACK

Firing Conditions		Minimum Weather Conditions	
Velocity Knots	Initial Dive Altitude Feet	Cloud Ceiling Feet	Horizontal Visibility NM
ATTACK ON FIRST PASS			
to 400	1000 - 1400	No less than 1100 - 1600	No less than 2.5
400-500	2000 - 2400	No less than 2300 - 2600	No less than 3.5
500-600	2400 - 3100	No less than 2600 - 3300	No less than 4.5
ATTACK AFTER ADDITIONAL MANEUVERS			
400-425	1000 - 2000	No less than 1100 - 2100	No less than 2.5
425-500	2000 - 2400	No less than 2100 - 2600	No less than 2.5
500-600	2400 - 3100	No less than 2600 - 3300	No less than 3.5

should be no less than 300 feet, the open fire range should be from 5000 - 4000 feet with airspeeds of 490 knots and from 3300 - 2600 feet at speeds of 400 knots. The loss in altitude during the pull-out is less than half the altitude lost when initiating the dive because the pull-out is done with at least a G-load of two.

The accuracy of air-to-ground firing depends mainly on the pilot's skill in aiming and in determining the correct slant range for firing. The causes for scattered firing are errors in executing the necessary flying maneuvers and errors in aiming and firing. The erroneous execution of the necessary maneuvers before firing lead to aiming and firing errors. The prevalent errors committed during the approach are: inaccurate appearance at the target; nonadherence to calculated altitudes and airspeeds for entering the dive; failure to consider the wind when beginning the maneuver; inaccurate determination of the moment for starting

~~SECRET~~

~~SECRET~~

the dive. Inaccurate appearance at the target under conditions of limited visibility may lead to the impossibility of executing the attack on the first pass because the time for executing the necessary turn on to final may be insufficient. When airspeed and altitude are neglected, it reflects mainly on the accuracy of determining the moment to push over into the dive. Premature diving will lead to a low altitude from which to open fire and this in turn necessitates firing from greater distances. Starting the dive late leads to a steeper dive angle and consequently a reduction in the time available for aiming and firing. This leads to hurried pilot actions and the committing of more piloting errors. If the wind drift is not fully compensated for by the sight prior to arriving at open fire range, the firing will be less effective as the center of dispersion will be displaced in the direction of the wind.

AIR-TO-GROUND GUNNERY, INDIVIDUALLY AND IN FORMATION

Individual fighters, using a 10-15° dive angle, can be used with low ceilings (10,000 feet) and limited visibility for the destruction and damage of missile and rocket launching installations, R/R trains, enemy airfields in the forward area, radar stations, command posts, etc.

The training of single aircraft in the use of shallow dive angles against the ground targets in the gunnery ranges is done in the following manner. The flight to the range should be executed with an airspeed of 400 knots at an altitude of 600 - 1000 feet along a route with 2-3 check points. The flight along the route and the appearance at the gunnery range should be executed by using the compass plus detailed orientation. When approaching the gunnery range, obtain an altitude of 1800 feet and an airspeed of 400 knots at least 2.7 NM from the range. Attention should be devoted to target searching and the target should first appear through the forward armored windscreen. If the pilot has studied the approach line, and some area reference points, he will find the target rapidly. Having detected the target and determined the attack direction, he continues the approach along this direction and monitors the target in conjunction with the outline of his fuselage. When the target comes to within 4-6 inches of the upper edge of the forward fuselage, the dive is commenced and continued until the target appears in the sight reticle. Before diving, the sight is caged and when the pipper is on the target, the caging button is released and the pipper is held on the target until firing commences. Firing range is determined visually. If the target dimensions are known, it is necessary before the attack to

~~SECRET~~

~~SECRET~~

properly set up the range finder ring of the sight reticle and when the target fits the ring, the open fire range is determined. To determine the ring radius, use the formula:

$$R_{k.t} = 500 \frac{R_{tar}}{D}$$

Where $R_{k.t}$ = radius of the ring in thousandths, R_{tar} = dimensions of the target in feet, D = firing range in feet. When using the range finder ring to determine range, it is necessary to remember that the minimum radius is 11 thousandths.

If the target dimensions are small (less than 65 - 70 feet) and it is not possible to use the sight ring, the range is determined by comparing the target dimensions with the sight pipper. It is necessary to keep in mind that the angular dimension of the pipper equals 2.5 thousandths. For example, when firing from a slant range of 3300 feet at a target with dimensions of 36 feet, and since the minimum diameter of the range finder ring equals 22 thousandths, the pilot should commence firing when there is a gap of 5.5 thousandths between the ring edge and the edge of the target. This constitutes approximately 2 diameters of the pipper.

The best volley duration is 1 - 1.5 seconds and after firing the aircraft should be pulled up immediately. When training on a gunnery range and in the cases where a repeated attack is necessary, a climbing 180° turn must be initiated within 10 seconds after passing over the target. Banks of 50 - 60° are used and the altitude climbed to is 1000 feet during training and 300 - 700 feet under tactical conditions.

After the 180° turn the flight should continue for 25 - 50 seconds on a heading opposite of the firing pass. Another 180° turn is then made, and the aircraft should roll out on final at 1000 feet. At this moment, the range to the target will be from 10,000 - 11,500 feet. After completing the last turn, all attention should be concentrated on finding the target. When the target appears 4 - 6 inches from the upper edge of the forward fuselage, the attack is started in the same sequence as before. After completing a gunnery mission on the range, the return to the airfield should be flown in accordance with instructions given for that particular gunnery range. In a tactical situation, after the attack, the flight is at maximum speed at an altitude of 150 feet.

~~SECRET~~

~~SECRET~~

The technique of executing the maneuver and the necessary parameters when attacking in a two-ship formation are approximately the same as for a single aircraft. When training, however, the entry altitudes are raised 300 feet over those listed in Table 36. It should be pointed out that the turns toward the target must be flown smoothly in order not to disrupt the flight of the wingman. This leads to a certain increase in the time needed for turning toward the target, which in turn, leads to an increase in the minimum necessary range of target detection from which an attack on the first pass is possible.

The best tactical formation for flying to the target area and for searching is the "bearing of aircraft" formation with a distance of 700 - 1300 feet between aircraft and the wingman stacked back 50° - 60° from line abreast. Such a formation does not narrow the field of action of the wingman, even if the lead turns hard toward the target.

A two-ship formation attack against ground targets such as landed aircraft, equipment, troops in concentrated areas, assembly areas for missiles, etc., should be executed with individual aiming being done by each pilot at this own target. When attacking long, narrow targets, e.g., R/R trains, troops and equipment on a road, it should be done by approaching the line of the target from an angle of 20 - 30°. This gives the wingman better conditions for doing individual aiming and firing. The leader keeps the wingman informed about the target that lead is attacking, so he will not fly on an intersecting course with lead. Attacks against small scale targets should be done in sequence, by single aircraft, and the distance between aircraft should be no less than 3300 feet.

AIR-TO-GROUND GUNNERY (30° DIVE ANGLE)

A 30° dive angle against ground targets can be flown by the MiG-21f-13 with an entry speed of 490 - 515 knots indicated. Table XXXVII shows the conditions for cannon firing with a 30° dive angle. For these calculations it was assumed that the time of flying while in the dive is 6 - 7 seconds, the duration of the volley is 1 - 1.5 seconds, the pull-out from the dive is done with a G-load of 3.5 - 4, the minimum altitude during pull-out is 600 feet and the speed brakes are retracted.

To fire on a gunnery range using a 30° dive, attacks are flown at airspeeds of 330 knots and over. The gunnery pattern for this maneuver is shown in Figure 95. It is a quadrangular route with the first and second turns either made continuously or with an interval of 5-7 seconds. The third turn varies

~~SECRET~~

~~SECRET~~

TABLE XXXVII
30° DIVE ANGLE ATTACK PARAMETERS

IAS At Dive Initiation Knots	Initial Dive Altitude Feet	Loss of Altitude When Entering Dive Feet	Loss of Altitude on Rectilinear Section of Dive Feet	Pull-Out Initiation Altitude Feet	Loss of Altitude While Pulling Out Feet	Open-Fire Range Ft.	Angle of Sight to Target Before Third Turn Degrees
325	5000	800	2300	1900	1000	4000	125
380	6000	1300	2600	2100	1200	4300	120
430	7000	1700	2900	2400	1500	5000	120
490	8000	2000	3100	2900	1700	5600	115

1753

4000
 1.6

 6400
 2560

 8960

253
~~SECRET~~

~~SECRET~~

according to how much smaller the final turn is to be when leading into the dive.

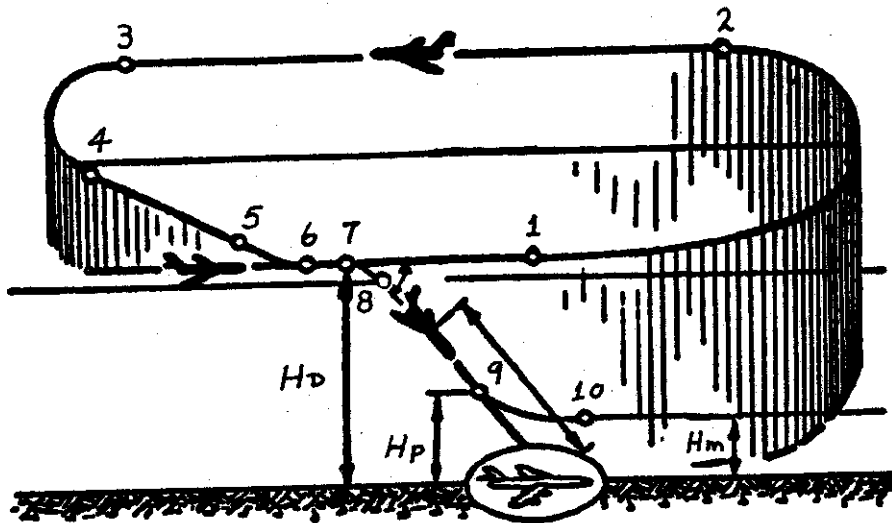

30° DIVE ANGLE GUNNERY PATTERN

1. ACTIVATE STOP WATCH, (5 SECONDS LATER, START 180° TURN)
2. COMPLETED 180° TURN, ACTIVATE STOP WATCH.
3. 20 SECONDS LATER, START 140° TURN
4. COMPLETED 140° TURN
5. CHECK ANGLE TO THE TARGET
6. START FINAL TURN
7. START DIVE
8. OPEN FIRE
 H_D = DIVE ALTITUDE
9. START PULL-OUT
 H_P = PULL-OUT ALTITUDE
10. COMPLETE PULL-OUT
 H_M = MINIMUM ALTITUDE

FIGURE 95

~~SECRET~~

~~SECRET~~

After the gunnery range is reached, the pilot obtains permission to fire, enters into a circling pattern over the range, recognizes the target and fixes its position relative to some reference points, readies his armament for firing, obtains his set flight conditions and passes over the target on his future firing heading. To facilitate the execution of this maneuver during the first training flights, use a stopwatch to determine when the first and second turns begin. At the moment of passing over the target, activate the stopwatch and within five seconds make a 180° turn using a 60° bank. For 20 seconds follow a course opposite that of the firing pass and then start a 140° turn back using the same bank. An additional reference point to aid in determining the moment of rolling into the third turn is the sighting angle toward the target. If speed brakes are to be used, they are opened simultaneously during this turn and enough power is added to maintain the given flight condition. After completing this turn, evaluate the distance to the target and the sighting angle. When necessary, make turning adjustments to perfect the calculation. When the route is properly flown, the turn onto final should start with a sighting angle to the target of 30° horizontally and 15° vertically. The lead into the dive is done with 60° bank at the moment the horizontal sighting angle to the target becomes equal to the given one. During the last part of the turn, reduce the power to idle and start pushing over into a dive. The aircraft should roll out on final completely lined up with the target. The bank is continually changing during the final turn. Before diving, the sight should be electrically caged, and when rolled out on final, superimpose the pipper on the target and release the electrical cage button. The open fire range is determined in the same manner as explained before. Firing should commence after being on the diving final approach for 6 - 7 seconds. Pull-out is done with a G-load of 3.5 - 4 G's. Small scale targets should be attacked in sequence by individual aircraft and the spacing between aircraft should be no less than 5000 feet. Simultaneous attacks in two-ship formations should be made against targets large enough to insure individual aiming with lateral separation 200 - 300 feet between aircraft. The roll into the dive is done in sequence by individual aircraft at time intervals of one second. The spacing between aircraft in a two-ship flight should not exceed 300 - 500 feet.

~~SECRET~~