

---

# DANISH OFFSHORE WIND Key Environmental Issues

---



DONG ENERGY  
VATTENFALL  
DANISH ENERGY AUTHORITY  
DANISH FOREST AND NATURE AGENCY

# DANISH OFFSHORE WIND Key Environmental Issues

DONG ENERGY

VATTENFALL

DANISH ENERGY AUTHORITY

DANISH FOREST AND NATURE AGENCY

## Danish Offshore Wind – Key Environmental Issues

Published by DONG Energy, Vattenfall, The Danish Energy Authority  
and The Danish Forest and Nature Agency

November 2006

### *Copy editor:*

Operate A/S

### *Advisors:*

#### *The Environmental Group consisting of:*

Jette Kjær, Vattenfall  
Jesper Kyed Larsen, Vattenfall  
Charlotte Boesen, DONG Energy  
Henriette Hassing Corlin, DONG Energy  
Steffen Andersen, DONG Energy  
Steffen Nielsen, The Danish Energy Authority  
Anne Grethe Ragborg, The Danish Forest and Nature Agency  
Karen M. Christensen, The Danish Forest and Nature Agency

Future activities suggested by the authors in this publication does not necessarily reflect the policy recommendations of the publishers.

### *Language review:*

Textwise

### *Layout:*

Operate A/S

### *Printed by:*

Prinfo Holbæk-Hedehusene

1st edition, 2000 copies

The publication can be ordered from the Danish Energy Authority's Internet bookstore <http://ens.netboghandel.dk>

The Background reports of the environmental monitoring programme can be downloaded from [www.ens.dk/offshorewind](http://www.ens.dk/offshorewind)

ISBN: 87-7844-625-2

ISBNwww: 87-7844-626-0

### *Photo credits:*

#### *Cover*

Wind Turbine: Nysted Offshore Wind Farm  
Cod: Jens Christensen  
Grey Seal: Svend Tougaard  
Hermit Crab: Maks Klausstrup  
Common Eider: Daniel Bergmann  
Horns Rev Offshore Wind Farm: Christian B. Hvidt

#### *Following page*

Horns Rev Offshore Wind Farm: Christian B. Hvidt

#### *Chapter 1 opening page*

Nysted Offshore Wind Farm: Christian B. Hvidt

#### *Chapter 2 opening page*

Nysted Offshore Wind Farm: Nysted Offshore Wind Farm

#### *Chapter 3 opening page*

Nysted Offshore Wind Farm: Nysted Offshore Wind Farm

#### *Chapter 4 opening page*

Common mussels: Maks Klausstrup

#### *Chapter 5 opening page*

Fishing by Nysted Offshore Wind Farm: Christian B. Hvidt

#### *Chapter 6 opening page*

Harbour porpoise: Jonas Teilmann

#### *Chapter 7 opening page*

Cormorants at fundament: Nysted Offshore Wind Farm

#### *Chapter 8 opening page*

Nysted Offshore Wind Farm: Christian B. Hvidt

#### *Chapter 9 opening page*

Nysted Offshore Wind Farm: Nysted Offshore Wind Farm

**DONG**  
energy

**VATTENFALL** 

DANISH  
**ENERGY**  
AUTHORITY

  
Danish Forest and  
Nature Agency



# PREFACE

## THE POWER SOURCE FOR THE FUTURE

Our future energy supply faces numerous challenges and has become subject to unstable international conditions. To meet these challenges offshore wind has a key role to play. Offshore windpower can contribute significantly to achieving the EU goals of a 21 per cent share of renewable electricity by 2010, halting global warming and reducing our dependence on coal, oil and gas.

We have come a long way since the 1980s, when most electricity production was based on coal and when the acidification of forests and lakes by acid rain was the predominant theme in the environmental debate. Today wind power provides 20% of Danish electricity consumption. Within a few years, the wind power industry has grown to become a significant industrial sector providing huge benefits for exports and employment. We are now talking about windpower generation plants rather than single turbines, and the Danish wind power industry is at the leading edge in an ever more competitive global market.

In the energy strategy for 2025 the Government expects to see a significant increase in the use of renewable energy in the years to come. The market-based expansion of this sector will be brought about through incentive schemes and investment in physical infrastructure as well as research-, development- and demonstration. With higher

oil prices and high CO<sub>2</sub> allowance prices we expect that a significant proportion of the renewable energy expansion will be delivered by large, offshore wind farms. At sea, wind resources are better and suitable sites are more readily available to enable these large projects to operate in harmony with the surrounding environment.

We are therefore very pleased that the Danish environmental monitoring programme on large scale offshore wind power has received a positive evaluation by the International Advisory Panel of Experts on Marine Ecology.

To sustain public acceptance and provide continued protection to vulnerable coastal and marine habitats, it is important to build upon the positive experience gained so far with the use of marine spatial planning instruments.

Offshore Wind farms impact on their natural surroundings and it is essential to ensure that conditions in unique marine areas are not detrimentally affected. Spatial planning when identifying potential locations for offshore wind farms – taking into account grid connection routes and other areas of interests – must ensure that future offshore wind farms are established in suitable areas in such a way that substantial adverse environmental impacts can be avoided or diminished. One of the challenges we face is to assess the cumula-

# READER'S GUIDE

tive effects from multiple offshore wind farms to arrive at optimal site selection.

Thus a committee on future offshore wind farms is currently updating the Danish action plan from 1997 to use the experience and learning gained to date in order to identify appropriate locations and at the same time to minimise visual disturbances and the effects on animal species such as marine birds and mammals.

This publication describes the Danish experiences with offshore wind power and discusses the challenges of environmental issues that Denmark has had to address in relation to the two large-scale demonstration offshore wind farms Horns Rev and Nysted since 1999.



Flemming Hansen  
MINISTER FOR TRANSPORT AND ENERGY



Connie Hedegaard  
MINISTER FOR THE ENVIRONMENT

The first three chapters contain an executive summary (chapter 1), an introduction to the Danish experiences with offshore wind farms and the environmental monitoring programme (chapter 2) and a description of the configuration and construction of Horns Rev Offshore Wind Farm and Nysted Offshore Wind Farm (chapter 3).

The following chapters deal with the key research findings of the environmental monitoring programme on benthic communities (chapter 4), fish (chapter 5), marine mammals (chapter 6), birds (chapter 7) and people's perceptions of offshore wind farms (chapter 8). Each of these chapters contains an introduction to key issues, a description of the research methods, a description of the results and a discussion of the results.

The book closes with a description of the Danish energy policy, the planning process and the public consultation process related to the establishment of offshore wind farms (chapter 9).

At the end of chapter 1 and 4-8 the International Advisory Panel of Experts on Marine Ecology (IAPEME) presents its viewpoints on the results of the environmental monitoring programme.

# CONTENTS

	<b>1: EXECUTIVE SUMMARY</b>	<b>08</b>
	<b>PROTECTING NATURE WHILE UTILISING ITS POWER</b>	
	Good experiences	09
	The environmental monitoring	09
	Horns Rev and Nysted	11
	Benthic fauna: Change in diversity and biomass	12
	Fish: Few effects on fish communities	13
	Marine mammals: Affected by piledriving	14
	Birds: Avoidance and displacement	14
	Socioeconomic effects: Positive attitudes	16
	Policy and planning	16
	General IAPEME viewpoints	18
	<b>2: INTRODUCTION</b>	<b>20</b>
<b>PREFACE</b>	<b>TOWARDS A COMMON SUSTAINABLE ENERGY FUTURE</b>	
04	Offshore in respect of nature	21
	Variable ecosystems	21
	Strong international commitments	23
	The technological development	25
	Positive lessons learned	26
	Horns Rev and Nysted wind farms	27
	Ambitious environmental programme	28
	<b>3: HORNS REV AND NYSTED</b>	<b>32</b>
	<b>152 WIND TURBINES AT SEA – 325 MW CAPACITY</b>	
	Configuration of a wind farm	33
	Horns Rev Offshore Wind Farm	35
	Nysted Offshore Wind Farm	38
	Environmental issues	43

<b>4: INFAUNA, EPIFAUNA AND VEGETATION</b>	<b>44</b>	<b>7: BIRDS</b>	<b>94</b>
<b>CHANGE IN DIVERSITY AND HIGHER BIOMASS</b>		<b>AVOIDANCE RESPONSES AND DISPLACEMENT</b>	
Introduction: Wind farms as new habitats	45	Introduction: Hazards to birds at sea	95
Methods: Seabed and hard bottom sampling	46	Methods: Radars, surveys and infra-red video	98
Results: Change in benthic communities	46	Results: Most birds show avoidance responses	102
Discussion: Indirect effects on benthic fauna	61	Discussion: Need for large scale assessment	109
IAPEME viewpoints	62	IAPEME viewpoints	111
<b>5: FISH</b>	<b>64</b>	<b>8: SOCIOECONOMIC EFFECTS</b>	<b>112</b>
<b>FEW EFFECTS ON THE FISH COMMUNITIES SO FAR</b>		<b>POSITIVE ATTITUDES IN LOCAL COMMUNITIES</b>	
Introduction: New habitat and sediment	65	Introduction: Attitudes and preferences	113
Methods: Fish abundance and distribution	66	Methods: Sociology and economics	113
Results: Similar effects at the two farms	69	Results: A generally positive attitude	116
Discussion: No effect on fish yet	76	Discussion: First study to address distance	122
IAPEME viewpoints	78	IAPEME viewpoints	123
<b>6: MARINE MAMMALS</b>	<b>80</b>	<b>9: PLANNING</b>	<b>124</b>
<b>SEALS AND PORPOISES REACT DIFFERENTLY</b>		<b>POLICY, PLANNING, PARTICIPATION AND PERMISSION</b>	
Introduction: Studies of seals and porpoises	81	Policy background	125
Methods: New methods developed	82	Approval of offshore wind power	128
Results: Pile driving gave reactions	84	Transmission grids	130
Discussion: No simple conclusion	90		
IAPEME viewpoints	92		
		<b>REFERENCES</b>	<b>134</b>
		<b>INDEX</b>	<b>140</b>



## EXECUTIVE SUMMARY

# PROTECTING NATURE WHILE UTILISING ITS POWER

Danish experience from the past 15 years shows that offshore wind farms, if placed right, can be engineered and operated without significant damage to the marine environment and vulnerable species.

The comprehensive environmental monitoring programmes of Horns Rev Offshore Wind Farm and Nysted Offshore Wind Farm confirm that, under the right conditions, even big wind farms pose low risks to birds, mammals and fish, even though there will be changes in the living conditions of some species by an increase in habitat heterogeneity.

The monitoring also shows that appropriate siting of offshore wind farms is an essential precondition for ensuring limited impact on nature and the environment, and that careful spatial planning is necessary to avoid damaging cumulative impacts.

Due consideration to limiting the impacts on nature together with positive attitudes towards offshore wind farms in local communities and challenging energy policy objectives at national and international levels mean that prospects look bright for future offshore expansion.

## CONTENTS

- Good experiences
- The environmental monitoring
- Horns Rev and Nysted
- Benthic fauna: Change in diversity and biomass
- Fish: Few effects on fish communities
- Marine mammals: Affected by piledriving
- Birds: Avoidance and displacement
- Socioeconomic effects: Positive attitudes
- Policy and planning
- General IAPEME viewpoints

## GOOD EXPERIENCES

At present wind energy is the most prominent form of renewable energy being developed, with significant growth envisaged for the coming years. So far Danish experience from offshore wind projects has led the way towards a promising energy future. Know-how from the past 15 years demonstrates how offshore wind power is possible to engineer. The framework for expansion of offshore wind farms in an environmentally sustainable manner now seems to be in place.

The European Union has committed itself to reach a 21% share of renewable electricity by the year 2010. To achieve this objective there is an important role for wind power, and in densely populated countries with extensive coastline like Denmark offshore wind power has a key part to play.

While offshore wind farms produce many benefits and the prospects for future expansion are promising, the technology also faces a number of challenges in terms of technological performance, competition for space with other marine users, compatibility with the European grid infrastructure and efficient integration in the energy system, as well as being fully competitive in the liberalised European electricity market.

Furthermore, all offshore wind farm projects impact on their natural surroundings and may only be

carried out on the basis of an assessment of the environmental consequences (an Environmental Impact Assessment, EIA). The establishment of the two large demonstration wind farms at Horns Rev and Nysted was not only planned on the basis of extensive EIAs, it was also followed up by an ambitious environmental monitoring programme from 2000 to 2006. This book deals with the results of this programme.



**FIGURE 1.1** *Wind power, as a renewable source of energy, produces no emissions and is an excellent alternative in environmental terms to conventional electricity production based on fuels such as oil, coal or natural gas.*

## THE ENVIRONMENTAL MONITORING

The environmental monitoring programme was established in order to chart the environmental conditions before, during and after the construction of the Horns Rev Offshore Wind Farm and the Nysted Offshore Wind Farm. The work has been co-ordinated by the Environ-

## ENVIRONMENTAL MONITORING PROGRAMME

The projects in the environmental monitoring programme adhere – where possible – to the “Before After Control Impact design” (BACI). BACI is a schematic method used to trace environmental effects from substantial man-made changes to the environment. The aim of the method is to estimate the state of the environment before and after any change and in particular to compare changes at reference sites (or control sites) with the actual area of impact.

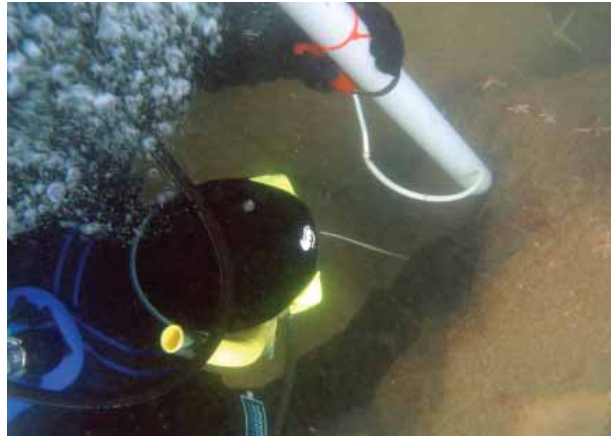
The studies and analyses have dealt with:

- Benthic fauna and flora, with particular focus on the consequences of the introduction of a hard-bottom habitat, which is the turbine foundation and scour protection, this also included a survey of the in-fauna community in the wind farms.
- The distribution of fish around the wind turbines and the scour protection, and the effect of electromagnetic fields on fish.
- Studies of the numbers and distribution of feeding and resting birds, performed by aerial surveys, and of the food choice of scoters.
- Migrating birds, including study of the risks of collision between birds and wind turbines.
- The behaviour of marine mammals – porpoises and seals – and their reaction to wind farms.
- The impact of electromagnetic fields on fish.
- Sociological and environmental-economic studies.
- Coastal morphology.

## VATTENFALL AND DONG ENERGY

Vattenfall was established in Denmark in 2006. The company took over parts of the Danish power companies Elsam and ENERGI E2 and presently supplies approx 25% of the Danish power production. As part of this process, Vattenfall took over the operation of the Horns Rev Offshore Wind Farm, with an ownership share of 60%, DONG Energy holds the remaining 40%.

PHOTO: MAKS KLAUSTRUP



**FIGURE 1.2** Scuba diver taking fauna samples at Horns Rev.

mental Group consisting of the Danish Forest and Nature Agency, the Danish Energy Authority, Vattenfall and DONG Energy and financed by electricity consumers as a public service obligation with a budget of DKK 84 million (approx EUR 11 million).

The results of the studies have been assessed by the International Advisory Panel of Experts on Marine Ecology (IAPEME) and the Environmental Group has also been in continuous dialogue with a “Green Group” consisting of representatives from the World Wide Fund for Nature (WWF), the Danish Society for Conservation of Nature, the Danish Outdoor Council, Greenpeace, the Danish Ornithological Society and the Danish Organisation for Renewable Energy.

In March 2006, the European Commission approved the merger of the Danish power companies DONG, Elsam, ENERGI E2 and Nesa as well as the electricity sections of Frederiksberg Forsyning and Københavns Energi. This means that from the autumn of 2006 80% of the Nysted Offshore Wind Farm is owned by DONG Energy with E.ON Sweden holding the remaining 20%. DONG Energy operates the wind farm. Before the merger, Energi E2 owned 50%, DONG 30% and E.ON Sweden 20%, and Energi E2 operated the wind farm.

## HORNS REV AND NYSTED

The construction of both the Horns Rev Offshore Wind Farm and the Nysted Offshore Wind Farm is a result of a governmental requirement to the utilities. In 1999, the Danish Energy Authority gave the green light to undertake preliminary surveys at the two sites. In the summer of 2000, the EIA for both sites was submitted to the authorities, and in 2001, the application to build both wind farms was approved by the authorities.

### HORNS REV OFFSHORE WIND FARM

During the summer of 2002, Elsam constructed the Horns Rev Offshore Wind Farm sited 14–20 km off the coast in the North Sea, west of Blåvands Huk. The wind farm consists of 80 turbines totalling 160 MW, equivalent to the electricity consumption in just over 150,000 Danish households.

### NYSTED OFFSHORE WIND FARM

The Nysted Offshore Wind Farm was constructed by Energi E2, DONG and E.ON Sweden in the period 2002–03 and consists of a total of 72 wind turbines placed in 8 rows of 9 turbines each, approx 10 km offshore. The 72 turbines have a total installed capacity of 165.5 MW.

### ENVIRONMENTAL ISSUES

Environmental management systems were established for both wind farms, including procedures for the handling of waste, noise and contingency plans in case of environmental accidents like oil spills. Requests were also made for both wind farms that in connection with short-term noisy activities, actions should be taken to scare off marine mammals likely to be affected by the noise. It was also specified that all transport to and from the wind farms should only take place in a special transportation corridor, and that access to the nature protection areas was forbidden without prior approval by the owner's environment coordinator.

FIGURE 1.3 HORNS REV AND NYSTED WIND FARMS



*The Horns Rev Offshore Wind Farm is located in the North Sea south of the actual reef, Horns Rev in the southwestern part of Denmark. The Nysted Offshore Wind Farm is located in the Baltic Sea south of Nysted in the southeastern part of Denmark.*

### ENVIRONMENTAL REQUIREMENTS FOR THE CONSTRUCTION PHASE

The regulatory environmental requirements for the construction phases at Horns Rev and Nysted vary, as the two areas are very different with different sensitivity issues. In general, the following points have been handled in the construction phase at both wind farms but in different orders of priority:

- Sediment spill monitoring
- Incidents, accidents and oil spill
- Waste handling
- Precautions regarding pile driving/vibration of sheet piles/monopiles
- Sediment depositing
- Marine archaeology
- Registration of navigation in the area

After the establishment of the two wind farms, the environmental monitoring programme focused on the effects on infauna, epifauna and vegetation, fish, marine mammals, birds and people's attitudes and preferences in local areas and nationally. The results of the studies are summarised below.

PHOTO: MAKS KLAUSTRUP



**FIGURE 1.4** Construction of wind turbine at Horns Rev.

## BENTHIC FAUNA CHANGE IN DIVERSITY AND BIOMASS

A total of six surveys of the seabed's infauna and vegetation community were performed at Horns Rev and Nysted during the pre- and post-construction phases. Sampling of benthic communities at turbine foundations was performed at six turbine sites at Horns Rev and at eight turbine sites at Nysted. Both types of surveys included collection of species, photo-sampling and video recordings.

The main effect from establishing the Horns Rev and Nysted wind farms was the introduction of hard bottom structures onto seabeds that almost exclusively consisted of sandy sediments. This has increased habitat heterogeneity and changed the benthic communities at the turbine sites from typical infauna communities to hard bottom communities. Abundance and biomass of the benthic communities increased at the position of the turbines compared to the native infauna communities. A consequence of the change in community structure was a local increase in biomass by 50 to 150 times, most of this as available food for fish and seabirds.

PHOTO: MAKS KLAUSTRUP



**FIGURE 1.5** Scour protection with common mussels at Nysted.



**FIGURE 1.6** Catch of cod at Nysted.

There were only negligible or no impacts detected from the changes in the hydrodynamic regimes on the native benthic communities, seabed sediment structure or established epifaunal communities. Similarities in the establishment, succession and distribution of epifaunal communities were found between Horns Rev and Nysted offshore wind farms. The differences in species composition were mainly attributable to differences in salinity between the two sites.

## FISH

### **FEW EFFECTS ON FISH COMMUNITIES**

The spatial and temporal distribution of fish at the Nysted Offshore Wind Farm and Horns Rev Offshore Wind Farm has been monitored by use of advanced hydroacoustic equipment with the aim of detecting any effects of the artificial reefs.

Data failed to provide significant statistical proof of the expectation of attracting fish to the artificial reef. At Horns Rev, one important reason for this could be that the studies and investigations were made during the early stages of colonisation of the turbine foundations

that constitute the artificial reefs. The colonisation of the foundations will probably progress over the coming years, which may lead to higher diversity and biomass of species. At Nysted, however, the colonisation of the epibenthic community may be well developed, but the monoculture of common mussel may not be attractive to fish

Investigations into the effects on fish and fish behaviour from electromagnetic fields were only made at Nysted. For this purpose, a specially designed setup and fishing gear were developed and applied to the area along the cable route connecting the wind farm with the shore.

Data have documented some effects from the cable route on fish behaviour indicating avoidance of the cable as well as attraction, depending on species. However, the observed phenomena were not significantly correlated with the assumed strength of the electromagnetic fields.

At Horns Rev, sandeel (*Ammodytidae spp.*) is one of the most abundant group of fish. Due to a known strong correlation between the distribution of sandeel and the composition of the sediments, the distribution of both sandeel and sediment composition was surveyed. The studies showed that the wind farm is unlikely to have a negative effect on the sandeel or any effect on sediment composition.

## MARINE MAMMALS

### AFFECTED BY PILEDIVING

---

Because of limited experience studying effects of offshore constructions on marine mammals, new methods had to be developed. The traditional visual surveys were thus supplemented or in some cases replaced by other methods, including acoustic monitoring by stationary dataloggers, remotely controlled video monitoring and tagging of animals with satellite transmitters. New statistical methods, including spatial modelling of survey data were also developed.

Seals were studied to evaluate their use of the wind farm and the surrounding areas, the effect of construction and operation on resting behaviour on land as well as the population development in the general area. Both wind farm areas were found to be part of much larger foraging areas. No general change in behaviour at sea or on land could be linked to the construction or operation of the wind farms. The only effect detected on land was a reduction in the number of seals on land during pile driving operations at Nysted.

Only a slight decrease in porpoise abundance was found at Horns Rev during construction, and no effect of operation of the wind farm was seen. At Nysted a clear decrease in the abundance of porpoises was observed during construction and operation of the wind farm. The effect has persisted during the first two years of operation of the wind farm, with indications of slow recovery. At both wind farms clear effects of pile driving operations were observed.

## BIRDS

### AVOIDANCE AND DISPLACEMENT

---

Hazards presented to birds by the construction of the Horns Rev and Nysted wind farms include barriers to movement, habitat loss and collision risks. Radar, infra-red video monitoring and visual observations confirmed that

PHOTO: SVEND TOUGAARD



FIGURE 1.7 *Harbour porpoise.*

PHOTO: JONAS TELMANN



FIGURE 1.8 *Harbour seal.*



**FIGURE 1.9** *Common scoter is one of the numerically important birds at Horns Rev.*

most of the more numerous species showed avoidance responses to both wind farms, although responses were highly species specific. Birds tended to avoid the vicinity of the turbines and there was considerable movement along the periphery of both wind farms.

Slightly extended migration distances are unlikely to have consequences for any species. Neither of the wind farms lies close to nesting areas to affect reproduction. Post-construction studies showed almost complete absence of divers and scoters within the Horns Rev Offshore Wind Farm and significant reductions in long-tailed duck densities within the Nysted Offshore Wind Farm. Other species showed no significant change or occurred in too few numbers to permit statistical analysis.

Although such bird displacement represents effective

habitat loss, it is important to assess the loss in terms of the proportion of potential habitat affected relative to the areas which remain available outside the wind farms. For most of the species studied, that proportion is relatively small and therefore of little biological consequence. However, the cumulative impacts of many other such wind farms may constitute a more significant effect in the future.

Of 235,000 common eiders passing Nysted each autumn, predicted modelled collision rates were 0.02% (45 birds). The low figure was confirmed by the fact that no collisions were observed by infra-red monitoring. Whilst unlikely to have major effects on the overall populations involved, assessing the cumulative effects of these and other developments remains a future challenge.





**FIGURE 1.10** *Nysted Offshore Wind Farm.*  
PHOTO: NYSTED OFFSHORE WIND FARM

## SOCIOECONOMIC EFFECTS

### **POSITIVE ATTITUDES**

---

A sociological and environmental economics study conducted in 2003/2004 revealed that both the local and national populations were, in general, positively inclined towards the Horns Rev and Nysted offshore wind farms. However, it was also clear that attitudes in the two local areas differed, whilst attitudes also differed between the local and national populations. Overall, inhabitants of the Nysted area were more critical towards offshore wind farms than inhabitants from the Horns Rev sample and the national sample. In terms of the preferences and willingness to pay for the future location of wind farms, the results showed a clear picture; people are willing to pay for future wind farms to be located at distances from the shore where their visual impact is significantly reduced.

However, the results also indicated that individual preferences varied depending on experience with visual intrusion from offshore wind farms. While the overall

willingness to pay to have the wind farms moved completely out of sight was limited, the respondents in the Nysted area had a higher willingness to pay for this than those from the Horns Rev area.

The sociological study was based on in-depth interviews to expose the attitudes towards the two local wind farms and was supplemented by an analysis of the local media coverage of the wind farms. The environmental economics study used a quantitative questionnaire based on the Choice Experiment method to elicit the preferences for different location strategies and included a Horns Rev, Nysted and national sample. This made it possible to compare the local findings with general national attitudes and preferences.

## **POLICY AND PLANNING**

---

The right to exploit wind energy within the Danish waters belongs to the Danish State. Permission to conduct preliminary studies and to exploit wind energy at sea is only granted by the Danish Energy Authority, either after



PHOTO: VATTENFALL

**FIGURE 1.11** *Horns Rev Offshore Wind Farm.*

applications have been requested in connection with a call for tenders or after an application has been made public and other interested parties have been given the opportunity to apply. Concessions for the establishment of two new offshore wind farms have already been awarded.

As a follow up to the Energy Strategy 2025, the Danish Government has decided that the Action Plan on Offshore Wind Power from 1997 is to be updated. The objective with the updating is to carry out a new assess-

ment of where future expansion of offshore wind power can take place. A committee has been set up dedicated to assessing the possibilities of future offshore expansion, and during 2006 this committee is supporting the Danish Energy Authority in drafting a new plan for siting of the next generation of offshore wind farms in the period from 2010 to 2025. This process builds on the experience from the Horns Rev and Nysted wind farms and the results of the environmental monitoring programme.

## **GENERAL VIEWPOINTS ON THE ENVIRONMENTAL MONITORING PROGRAMME FROM THE INTERNATIONAL ADVISORY PANEL OF EXPERTS ON MARINE ECOLOGY (IAPEME)**

The huge increase in the numbers of wind farm projects has required an enormous research effort to produce Environmental Impact Assessments (EIAs) for individual projects. Consequently, there is a substantial quantity of “grey” literature, of very variable quality, about the environmental impacts of wind farms; unfortunately, however, only little has been published in peer reviewed scientific journals or in books, and developers have tended to retain data as commercially confidential material.

We congratulate the Danish authorities with the open and transparent manner in which the monitoring has been carried out at Nysted and Horns Rev, and the presentation of detailed results of this work in highly accessible forms. Not only are there numerous, detailed, data-rich “Final Reports” that can be downloaded from the web, but this book summarizes the key research findings on topics from hydrography to top predators.

The research carried out at Nysted and Horns Rev has generally followed the ideal design for such work (a BACI – before-after-control-impact comparison), but has also required that several novel technologies should be developed. Such work is expensive, long-term and requires skilled and dedicated researchers. Denmark has invested heavily in this research, and as a consequence the work is very much at the forefront of research into the environmental effects of offshore wind farms, and will provide important information for those many countries where offshore wind farms are now being developed following the Danish example.

### **HIGHLIGHTS**

The studies have shown that the Nysted and Horns Rev offshore wind farms have had very little impact on the environment, neither during their construction nor during their operational phases.

There have been local effects on the benthic communities, particularly increases in faunal biomass and diversity associated with the introduction of hard substrates (towers, foundations and scour protection) onto a naturally sandy seabed. These structures and increases in food may well over time attract

higher numbers and a wider range of species of fish, although monitoring has not yet demonstrated any strong effect on fish communities at these two sites. Indeed, one conclusion from the work must be that demonstrating changes in fish populations at these local scales is very difficult when fluctuations in many fish stocks occur at much larger spatial scales.

The development of the T-POD system (deployed data loggers recording porpoise sound production underwater) to measure porpoise ultrasonic activity within the wind farm and in control areas has been one of the major achievements of this programme. During the construction phase, the number of porpoises at the farms decreased immediately when noisy activities commenced, alleviating fears that marine mammals would remain in the area and so might be hurt by the intense pressures generated by pile driving. At Horns Rev the porpoise numbers very quickly returned to “normal” once construction was completed, although data on porpoises at Nysted are different and more difficult to interpret. Seals also showed little response to the wind farms, except during the construction phase.

Development of a technology to measure collisions of birds, the “TADS” or “thermal animal detection system” has been another of the major achievements of this programme. The TADS provides empirical evidence that waterbird collisions are rare events. Collision risk modelling and bird tracking by radar as well as visual observations show that many waterbirds species tend to avoid the wind farm, changing flight direction some kilometres away to deflect their path around the site. Birds flying through the wind farm tend to alter altitude to avoid the risk of collision. Under adverse weather conditions, which were thought to be likely to increase collision risk, results show that waterbirds tend to avoid flying. The strong avoidance behaviour results in very low estimates of collision risk but of course increases habitat loss and increases costs of travel. The bird studies demonstrate strong differences between bird species in response to the marine wind farms, with some species of conservation concern such as divers and scoters showing particularly high aversion to these structures.

## APPLICATION OF FINDINGS AT NYSTED AND HORNS REV TO OTHER MARINE WIND FARMS

The technological tools developed in the Nysted and Horns Rev studies, especially for the study of behavioural responses of marine mammals and birds, will be very useful for researchers working on new offshore wind farms in other locations. These technologies can readily be transferred to estuarine or open sea sites and applied for study of a wide range of focal species.

The broad results from Nysted and Horns Rev also seem likely to apply more generally to other offshore wind farms, although it is important to appreciate that some differences have been found between Nysted and Horns Rev, and that responses are likely to vary among species and in relation to other environmental factors. It would not be sensible to generalise about impacts from a baseline of only the two studies we have available so far.

### FURTHER RESEARCH NEEDS

There is clearly a need to study a number of other offshore wind farms to compare results with those reported in this monitoring programme. A larger number of studies will be required if broad generalisations are to be made with confidence. And there are also a number of questions that arise from the results obtained at Nysted and Horns Rev:

- Does the opportunity that hard structures introduced on the seabed present for species such as crabs and cod result in these predators increasing and impacting the communities of the surrounding sandy substrate?
- Do fish increase at marine wind farms over a longer time scale than the studies reported here, or do their communities and numbers respond more to large scale processes than to local changes at the scale of individual wind farms?
- Can experiments be designed to test more critically the question of whether fish movements are affected by the electromagnetic field generated by cables carrying the electricity ashore?
- What characterizes important habitats for marine mammals and how tolerant are they of disturbance in such areas?
- Do some waterbirds species accommodate to marine wind farms and learn not to show such strong avoidance behaviour?

- Do marine mammals and waterbirds learn to forage within offshore wind farms if food abundances in these sites increase above normal levels?
- Even if the impact of a single wind farm on birds is apparently trivial at population level, can a paradigm be developed to assess cumulative impacts on bird populations of numerous offshore wind farms along their flight lines?

Current plans to extend the wind farms of Horns Rev and Nysted provide an ideal opportunity to determine the long-term impact of habitat loss thus testing rigorously the aversion to these structures shown by some species of marine birds as documented in the original studies.

### IAPEME

In 2000 the Danish Energy Authority appointed five international experts to the International Advisory Panel of Experts on Marine Ecology (IAPEME). The task of the panel has been to comment on the environmental monitoring programme before, during and after establishment of the wind farms and assess the methods used in the programme. The panel have also made statements on the observed impacts of the wind farms on birds, mammals, fish and benthos ecosystems.

The panel members are:

Professor Robert W. Furness, (chairman),  
UNIVERSITY OF GLASGOW, UNITED KINGDOM

Professor Rudi H. Drent,  
UNIVERSITY OF GRONINGEN, THE NETHERLANDS

Professor Klaus Lucke / Professor Ursula Siebert,  
UNIVERSITY OF KIEL, GERMANY

Professor Antony Jensen,  
UNIVERSITY OF SOUTHAMPTON, UNITED KINGDOM

Assistant Professor Peter Grønkjær,  
UNIVERSITY OF AARHUS, DENMARK

# INTRODUCTION **TOWARDS A COMMON SUSTAINABLE ENERGY FUTURE**

BY STEFFEN NIELSEN, DANISH ENERGY AUTHORITY

Wind power is one of the most important and promising forms of renewable energy, and significant growth is projected for the coming years. Experience has shown that offshore wind farms are an attractive alternative to onshore wind turbines, especially in densely populated countries like Denmark.

While there are significant benefits to be gained from offshore wind farms in mitigating climate change, diversifying energy supply, decoupling economic growth from resource use and creating jobs, wind farms also have an impact on the surroundings in terms of visual appearance, noise emission and direct impact on nature.

This book deals with the environmental planning and monitoring programmes of two of the biggest offshore wind farms in the world: the Horns Rev Offshore Wind Farm and the Nysted Offshore Wind Farm. The general conclusion from these programmes is that with the use of spatial planning it will be possible to construct offshore wind power facilities in many areas in an environmentally sustainable manner that does not lead to significant damage to nature.

## CONTENTS

- Offshore in respect of nature
- Variable ecosystems
- Strong international commitments
- The technological development
- Positive lessons learned
- Horns Rev and Nysted wind farms
- Ambitious environmental programme

## OFFSHORE IN RESPECT OF NATURE

The possibilities of utilizing shallow waters for offshore turbines in Denmark were evaluated a number of years ago.

So far Danish know-how from the past 15 years demonstrates how offshore wind power is possible to engineer. Likewise the framework for spatial planning of future large-scale projects in an environmentally sustainable manner seems now to be in place.

While expansion with offshore wind farms is an attractive energy alternative, activities at sea should take place according to an ecological approach and thereby respect the vulnerability of the marine environment.

## VARIABLE ECOSYSTEMS

Of Denmark's total area at sea of about 105,000 km<sup>2</sup>, 43,000 km<sup>2</sup> have a depth of less than 30 m. The Danish waters are in a zone of transition between the Baltic Sea, which comprises the world's largest bodies of brackish water, and the saltwater of the North Sea. The living conditions of plants and animals are thus much differentiated, eg by the fact that the salinity of the water can vary considerably over short distances.

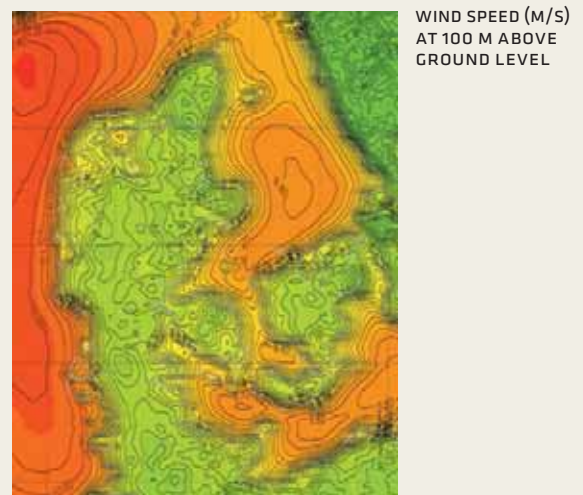
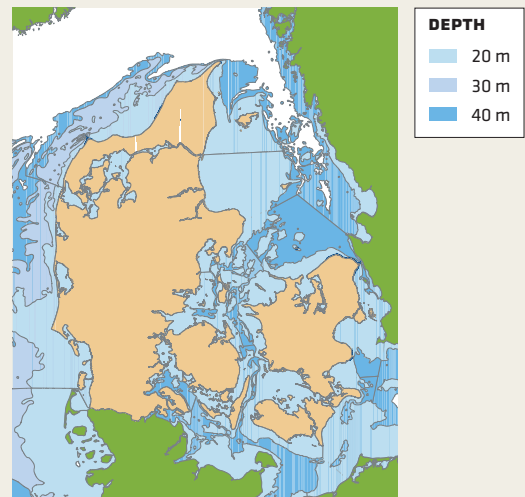
Thus the sea around Denmark consists of highly variable ecosystems. The seabed, for instance, is the habitat of a number of ecologically precious plant and animal communities that range from requiring brackish water of almost freshwater properties to communities requiring water with a high salinity. This variation is further

augmented by the great variation in the structure and dynamics of the seabed as well as the currents and the physical and chemical aspects of the sea.

## VULNERABLE SPECIES

The biodiversity of the Danish waters is vulnerable since many of the organisms in the sea live at or near the limit of the natural environmental factors that they can with-

FIGURE 2.1 DEPTH AND WIND SPEED IN DANISH WATERS



## FLORA AND FAUNA IN DANISH WATERS

PHOTO: MAKS KLAUSTRUP



### BENTHIC FLORA AND FAUNA

Especially the shallow waters are highly productive and form the basis of a "food chain" for an extremely rich assemblage of marine species. Algae comprise the predominant group of marine plants, including the large perennial algae which grow on rocks, hard, solid substrates and other materials on the seabed, and the microscopic algae that live as plankton in the free bodies of water. In shallow waters, eelgrass grows in silt or sand and forms the basis of various biological communities. Traditionally, the native fauna composition of Horns Rev has been associated with the sandy environment with a very variable and heterogeneous benthic fauna. The benthic fauna of Nysted is very homogeneous and the species found are typical indicators of brackish water.

PHOTO: CHRISTIAN B. HVIDT



### FISH

It is difficult to estimate the number of species of marine fish found in the Danish waters. Some are only rare guests and some are found in both freshwater and saltwater. However, it is estimated that up to 190 species can be found in the Danish waters of which approx. 106 species are native to saltwater and brackish water, including commercial species such as cod, herring, plaice and flounder. Of these native species only four are living solely in the pelagic environment whereas the rest is considered benthic – dependent on the seabed habitats.

PHOTO: SVEND TOUGAARD



### MAMMALS

Only three species of breeding marine mammals are found in the Danish waters, ie the harbour porpoise, the harbour seal and the grey seal. Various large whales, however, such as the sperm whale and killer whale, are regularly observed in Danish waters.

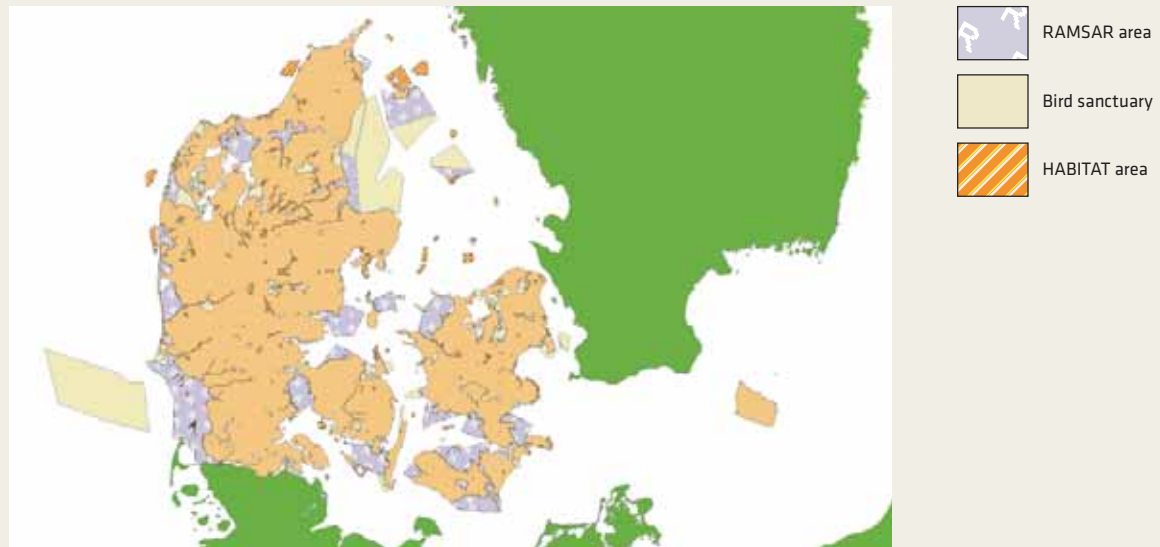
PHOTO: GREG DOWNING



### BIRDS

The Danish waters are of essential international significance as a winter refuge for several species of marine birds. Most of the marine species that appear in the Danish waters are migratory birds that spend the summer in the northern and northeastern parts of Europe. Many hundred thousand marine birds gather around Denmark, especially in the winter and some of them benefit from the large plant growths, benthic fauna and mussel beds in the shallow waters. Other birds spend most of their time on the open sea where they live on small fish, crustaceans, etc. The marine birds that are found in large numbers mainly count divers, grebes, cormorants, swans, ducks, gulls and terns. As regards some species, such as the brent goose from Svalbard, most of the population spends the winter in Denmark. Of other species, such as the common scoter and red throated diver, a large proportion of the northwestern European population spends the winter in Danish waters.

**FIGURE 2.2** INTERNATIONAL NATURE PROTECTION AREAS IN DANISH WATERS



stand. The effects of man's activities can thus become a factor which will be critical to the preservation of the biodiversity, especially at the local level.

Pursuant to the Bird Protection and Habitat Directives areas comprising a total of 13,000 km<sup>2</sup> have been designated in the Danish waters. These areas contribute to the coherent ecological network of the NATURA 2000 sites in Europe. The aim of the designation is to promote the maintenance or restoration of the natural habitat types and species concerned at a favourable conservation status in their natural environment.

## **STRONG INTERNATIONAL COMMITMENTS**

The governments in the European Union have agreed to European commitments in relation to the development of renewable energy resources. The EU member states have committed themselves to reach a 21% share of renewable electricity by 2010. To achieve this objective wind power will play an important role, and for several member states

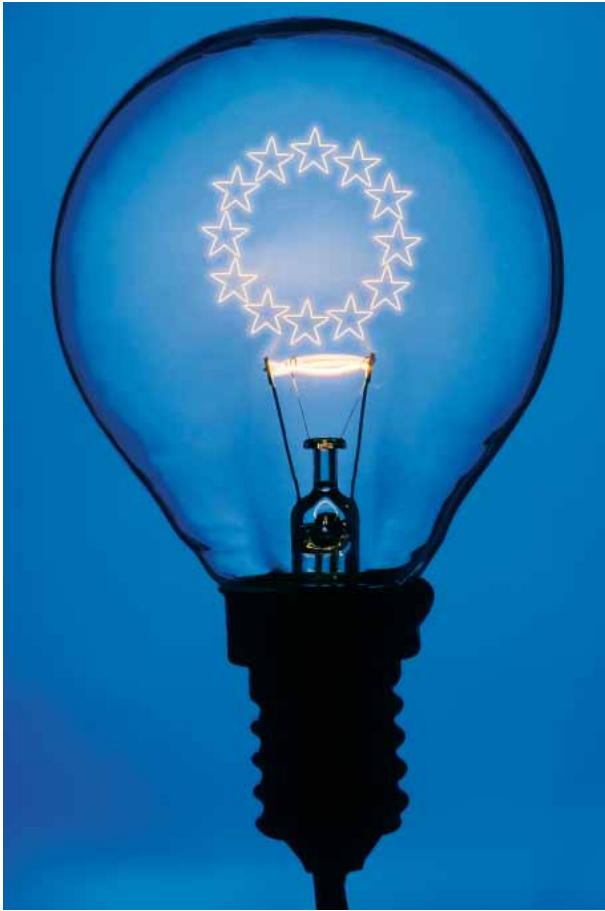
offshore wind power has a key part to play.

Although the long-term perspectives for offshore wind power are promising, the technology faces a number of challenges in terms of technological performance, competition for space with other users of the sea, compatibility with the European grid infrastructure and secure integration in the energy system, as well as full competitiveness in the liberalised European electricity market.

There is a huge potential for increasing the size and number of offshore wind farms, especially in the North Sea.

Since 2001, the British government has been inviting tender in two rounds encouraging interested developers to bid for potential projects in three strategic areas – in the northern part of the Irish Sea, ie the British west coast, in an area off the mouth of the Thames and an area off the northeastern coast. So far under round one, four wind farms with a total of 300 MW have been installed, while another project of 90 MW is under construction. Yet another 582 MW has been approved and is in the preconstruction phase. As of the second half of





**FIGURE 2.3** *EU member states have committed themselves to reach a 21% share of renewable electricity by 2010.*

2006 more than 3800 MW capacity has been applied for under round two.

Sweden has installed approx 21 MW divided onto four different projects. In addition, a 120 MW wind farm is under construction while approvals have been granted for more than 800 MW.

Ireland has installed one offshore wind farm of 25 MW and there are preinvestigation approvals for several projects.

The Netherlands will commission the country's first 108 MW offshore wind farm by the end of 2006, and one more project for 120 MW has been approved.

Germany also has ambitious offshore plans, and so far 15 pilot phases for offshore wind farms in the North Sea and in the Baltic Sea with nearly 5000 MW have been approved – though most grid connections within the 12 nautical miles zone are still pending.

Other European countries with offshore wind turbine plans count Spain, Belgium and France, and work is also performed on projects in the USA and Canada.

#### SEVERAL YEARS OF RESEARCH

Several member states have been conducting research into offshore wind energy for several years already. The environmental results acquired were summarised in the project “Concerted action for Off-shore wind energy Deployment (COD)” finalised in 2005. Other collections and databases with information on environmental aspects of offshore wind energy are eg the Oslo-Paris Convention (OSPAR) and the EU Communication & Information Resource Center Administrator (CIRCA).

Attention should also be given to the policy paper “Copenhagen Strategy 2005 on European Offshore Wind Power Deployment” that calls on the EU to launch an action plan that will address barriers affecting the market, the grid and the environment. As for the environment, the paper recommends, among others, the establishment and use of marine spatial planning instruments to reach the optimal site selection. Furthermore, the Copenhagen Strategy recognised the importance of more efficient consenting procedures which build on past experience and are in proportion to the scale of the project and the impact perceived. It also stressed the need to ensure assessments of a good quality, especially when dealing with sensitive areas, and to further develop methodologies for such assessments. The participants also recommended a continuation of a COD-like structure, in co-ordination with similar work done in OSPAR, in order to improve database transparency and allow for a higher degree of multilateral co-operation within environmental research.

**FIGURE 2.4** *Vindeby, west of Lolland, was the world's first offshore wind farm. Its 11 wind turbines of 450 kW each provided Danish utilities with invaluable experience.*

## THE TECHNOLOGICAL DEVELOPMENT

When the first energy crisis struck in the mid 1970s, exploitation of renewable energy as a replacement for fossil fuels to produce energy became very attractive. Ambitious wind power development programmes were therefore launched in several countries. In the USA, Japan, Germany and Sweden in particular, the aeronautical and turbine industries were encouraged by means of public research and development grants to come up with effective wind turbines in the MW range.

Denmark, on the other hand, adopted a double-edged development strategy. At the end of the 1970s the utilities focused on developing MW wind turbines. Simultaneously, in the beginning of the 1980s, support given to investments and advantageous feed-in tariffs for electricity produced by wind turbines led to the creation of a bottom-up market for small wind turbines.

A gradually growing demand in the domestic market made it possible for a number of relatively small companies – some of which originated from manufacturers producing agricultural tools and various types of machinery – to develop an industrial serial production. As wind turbines got increasingly larger the development drew on the technological competence acquired through the Danish Energy Research Programme. The synergy between the top-down and bottom-up approaches is an essential background to explain the Danish success with the development of wind turbines.

Since the industrial production of the first modern wind turbines there has been a tremendous growth in the technological development and turnover. As a result of up-scaling and technological advances today's Danish wind



PHOTO: JAN KOFOD WINTNER/SEAS

### INTERNATIONAL RESEARCH PROJECTS

A German-Danish Co-operation on Environmental Research for Offshore Wind Energy Deployment has been established in order to intensify co-operation in research on the impact of offshore wind power on the marine environment, to strengthen the transfer of know-how and exchange of information between the parties and to carry out joint research projects in relation to the associated monitoring of offshore wind farms.

The co-operation has so far comprised information exchange on national developments and various studies undertaken within the Horns Rev and Nysted wind farm areas, eg temperature measurements in sediments near cables, bird studies with focus on collision risks and studies of offshore wind farm effects on harbour porpoise. All data obtained from the joint research projects are shared among the parties, including raw data.

An ad hoc group has been set up by the European Commission (jointly by DG ENV and DG TREN) to assist the Commission services in producing a guidance document to help ensure – and clarify – that wind energy development projects are compatible with the nature conservation requirements of the EU and other relevant international nature legislation applicable in Europe. The development of guidelines must also be seen in the context of clear commitments and targets to increase the contribution of renewable energy sources to the overall energy consumption in the EU as part of the strategy to combat climate change.

turbines produce about 100 times as much electricity as wind turbines from 1980.

The most recent wind turbines have been given a higher and higher design which has meant that, for visual reasons and in consideration of any neighbours onshore, it has become attractive for the wind power industry to give a high priority to offshore location of the wind turbines. This development has become possible because the higher installation and operating costs for offshore wind farms are, to a determining extent, offset by increased production.

## POSITIVE LESSONS LEARNED

The possibilities of utilizing shallow waters for offshore turbines in Denmark were evaluated a number of years ago. The Danish government has supported several studies investigating the possibilities and the regulatory conditions for offshore wind power installations. In addition to selecting the sites for small pilot projects and large scale demonstration farms all interests in Danish waters have also been mapped and reported twice, in 1987 and in 1995.

Since 1991, eight wind farms have been established

offshore. The first three offshore wind farms, at Vindeby in 1991, Tunø Knob in 1995 and Middelgrunden in 2000, were pilot projects. Furthermore, the Danish Energy Authority has approved three nearshore projects at Rønland (2003), Frederikshavn (2003) and Samsø (2003). In each of the above mentioned projects, a series of specific requirements were made regarding the regulatory approvals in order to protect the marine environment.

### LARGE-SCALE DEMONSTRATION PROGRAMME

Meanwhile in 1997, a working group with representatives from the Danish Energy Authority, the Danish Forest and Nature Agency and the power utilities published an action plan outlining the conditions for large-scale expansion of wind power. The action plan underlined the need to concentrate wind power expansion in a few, relatively large areas at a distance of 7–40 km from the coast. On this basis, in 1998 the government obliged with the utilities to carry out a large-scale demonstration programme.

The objective of the programme was to investigate financial, technical and environmental issues to accelerate offshore development and to open up selected areas for future wind farms. The early establishment of

**FIGURE 2.5** EXISTING DANISH OFFSHORE WIND FARMS – STATUS AS OF AUTUMN 2006

NAME OF WIND FARM	YEAR OF COMMISSIONING	TURBINE CAPACITY	TOTAL CAPACITY	ESTIMATED ANNUAL PRODUCTION
Vindeby, Falster	1991	11 450 kW units	5 MW	approx 10 GWh
Tunø Knob, Odder	1995	10 500 kW units	5 MW	approx 15 GWh
Middelgrunden, Copenhagen	2001	20 2 MW units	40 MW	approx 95 GWh
Horns Rev 1	2002	80 2 MW units	160 MW	approx 600 GWh
Samsø	2003	10 2.3 MW units	23 MW	approx 80 GWh
Rønland, Harboøre	2003	4 2 MW units 4 2.3 MW units	17 MW	approx 70 GWh
Frederikshavn	2003	2 2.3 MW units 1 3 MW units	8 MW	approx 20 GWh
Nysted Offshore Wind Farm	2003	72 2.3 MW units	165 MW	approx 600 GWh



PHOTO: NOE

**FIGURE 2.6** *Rønland Offshore Wind Farm west of Jutland is one of the privately funded offshore wind power project in Denmark.*

a clear overview of restrictions and interests in the Danish waters proved wise. Besides government authorities also local authorities were involved in the process. This resulted in a framework for the formal part of the approval procedure.

## **HORNS REV AND NYSTED WIND FARMS**

The development of offshore wind farms at both Horns Rev and Nysted is a result of a governmental obligation to the utilities. In 1999, the Danish Energy Authority gave the green light to undertake preliminary surveys at the two sites. In the summer of 2000, Environmental Impact Assessments (EIAs) for both sites were submitted to the authorities and issued for public hearing. In 2002, the application to build both wind farms was approved by the authorities, under subject to certain conditions.

### **HORNS REV**

In the summer months of 2002, Elsam constructed the Horns Rev Offshore Wind Farm located 14–20 km off

the coast in the North Sea, west of Blåvands Huk. The Horns Rev Offshore Wind Farm consists of a total of 80 turbines totalling 160 MW. The production from the turbines is estimated to be equivalent to the electricity consumption of just over 150,000 Danish households. Elsam was responsible for the actual wind farm – installing and maintaining the turbines, the turbine foundations, the farm internal cabling, the accompanying remote control unit and auxiliary installations. In July 2006 Vattenfall took over 60% of the wind farm thus assuming the responsibility for operation and maintenance and all obligations. Energinet.dk is in charge of the installations designed to transmit the power ashore, ie the offshore transformer substation, the submarine cable leading to shore and the onshore cable leading to the general transmission grid.

### **NYSTED**

The Nysted Offshore Wind Farm commissioned 2002–03 consists of a total of 72 wind turbines standing in 8 rows of 9 turbines each, approx 10 km off the shore. The 72

### **AIMS OF THE ENVIRONMENTAL MONITORING PROGRAMME**

The monitoring programme was set up in order to chart the environmental conditions before, during and after the two farms were set up. The aim was to clarify:

- The risk of experiencing significant negative effects on the environment.
- The ecological fragility of the specific areas.
- The usefulness of the areas to investigate specific effects.
- The relevance of the effects in relation to decision-making regarding further development within the specific areas and the overall development of future offshore wind farms.
- The importance of the different effects in relation to the demand for action and the economic framework for the programme.

### **FOCUS OF THE ENVIRONMENTAL STUDIES**

The studies and analyses in the demonstration programme have dealt with:

- Benthic fauna and flora, with particular focus on the consequences of the introduction of a hard-bottom habitat; ie the turbine foundations and the scour protection. Also including a survey of the infauna community in the wind farms.
- The distribution of fish around the wind turbines and the scour protection.
- Studies of the numbers and the distribution of feeding and resting birds, performed by aerial surveys, and on the food choice of scoters.
- Migrating birds, including study of the risks of collision between birds and wind turbines.
- Marine mammals – porpoise and seal – behaviour and reaction to wind farms.
- The impact of electromagnetic fields on fish.
- Sociological and environmental economic studies.
- Coastal morphology.

turbines have a total installed capacity of approx 165.6 MW and generate sufficient electricity to supply equivalent to 145,000 single family houses with renewable energy. The farm is owned by a joint venture, where DONG Energy holds 80% and E.ON Sweden 20%. DONG Energy operates Nysted Offshore Wind Farm. SEAS Transmission is the owner of the grid connection, ie the offshore substation and the cabling from the substation and onshore.

### **AMBITIOUS ENVIRONMENTAL PROGRAMME**

Between 1999 and 2001, as part of the Environmental Impact Assessments (EIAs) and as the basis for the Horns Rev and Nysted environmental monitoring programmes, baseline studies were undertaken in order to establish a reference for later analyses to be able to compare the existing environmental conditions to the introduction

of a wind farm.

The environmental monitoring programme was launched following completion of the EIA. Thus the environmental studies carried out in the period 2000–2006 were obligatory as part of the consent to the utilities for wind farm construction at the two sites.

#### **BEFORE AFTER CONTROL IMPACT – BACI**

Where possible, the projects in the demonstration programme apply the BACI approach (BACI: “Before After Control Impact”). BACI is a schematic method used to trace environmental effects from substantial man-made changes to the environment. The aim of the method is to estimate the state of the environment *before* and *after* any changes and in particular to *control* changes at reference sites (or control sites) with the actual area of *impact*.

The monitoring programme is divided into three stages



**FIGURE 2.7** *Bottom fauna and flora at Horns Rev.*

PHOTO: MAKS KLAUSTRUP

consisting of three years of baseline monitoring, monitoring during construction and three years of monitoring during operation.

The EIA and baseline programmes provided large data sets for baseline studies in both the designated wind farm areas and in reference areas. For obvious reasons, some programmes had to await the actual construction of the wind farms. This included assessment of the risk of birds colliding with turbines as well as artificial reef effects due to the introduction of hard bottom substrates.

#### ADMINISTRATION OF THE PROGRAMME

The technical responsibility for the project descriptions and the implementation of the work rests with the Environmental Group. This group consists of representatives from the Danish Forest and Nature Agency, the Danish Energy Authority, Vattenfall (before July 2006 Elsam

represented Horns Rev) and DONG Energy. The Environmental Group thus coordinates the environmental monitoring programmes for both the Horns Rev Offshore Wind Farm and the Nysted Offshore Wind Farm.

The decision-making process relating to the environmental monitoring programmes is characterised by openness and continuous dialogue between all parties concerned.

The environmental studies between 1999 to 2006 have been financed with a budget of DKK 84 million (approx EUR 11 million) by Danish electricity consumers under the PSO funding scheme (PSO: Public Service Obligation). In practice the PSO funds are financed by electricity consumers as a public service obligation, earmarked for research and development projects. The Transmission System Operator, Energinet.dk, administers the financial part of the programme and submits projects for the Danish Energy Authority's approval.

**FIGURE 2.8** PROGRAMMES CARRIED OUT AT HORNS REV OFFSHORE WIND FARM

	1999	2000	2001	2002	2003	2004	2005	2006
Visualisation and socioeconomic investigations	●	●			●	●		
Hydrography	●							
Benthic fauna and flora in the farm area	●	●	●		●	●	●	
Fish in the farm area	●			●				
Fish, sand eel				●		●		
Monitoring of harbour porpoises	●	●	●	●	●	●	●	●
Monitoring of seals	●			●	●	●	●	
Monitoring of birds	●	●	●	●	●	●	●	
Development of new habitats					●	●	●	

**FIGURE 2.9** PROGRAMMES CARRIED OUT AT NYSTED OFFSHORE WIND FARM

	1999	2000	2001	2002	2003	2004	2005	2006
Visualisation and socioeconomic investigations	●	●			●	●		
Hydrography and coastal morphology	●	●		●	●	●		
Benthic fauna and flora along 132 kV cable	●	●	●	●	●	●		
Benthic fauna and flora in the farm area	●		●				●	
Fish in the farm area	●	●						
Electromagnetic fields and possible effect on fish			●	●	●	●		
Monitoring of harbour porpoises			●	●	●	●	●	
Monitoring of seals	●			●	●	●	●	
Monitoring of birds	●	●	●	●	●	●	●	●
Development of new habitats					●	●	●	

The work of the Environmental Group and the results of the studies are assessed by an international panel of independent experts, IAPEME (International Advisory Panel of Experts on Marine Ecology), consisting of experts with unique competence within the individual branches of the entire monitoring programme. These experts have evaluated the progress of the environmental monitoring programmes approximately once a year and made recommendations for future monitoring. On the basis of the

recommendations of the expert panel, the Environmental Group has set the priorities of future programmes.

To ensure that relevant stakeholders could influence the debate regarding the environmental monitoring of the Horns Rev Offshore Wind Farm and the Nysted Offshore Wind Farm, a number of organisations particularly committed to environmental issues have been offered the opportunity to participate in a “Green Group” which meets with the Environmental Group approximately once



PHOTO: NYSTED OFFSHORE WIND FARM

**FIGURE 2.10** *Cormorants on the foundations of Nysted Offshore Wind Farm.*

a year. The Green Group consists of representatives from the World Wide Fund for Nature (WWF), the Danish Society for Nature Conservation, the Danish Outdoor Council, Greenpeace, the Danish Ornithological Society and the Danish Organisation for Renewable Energy.

Status reports are published annually, including IA-PEME assessments and recommendations. All reports are publicly available and can be found at the Danish Energy Authority's website: [www.ens.dk](http://www.ens.dk).



## HORNS REV AND NYSTED **152 WIND TURBINES AT SEA** **– 325 MW CAPACITY**

BY CHARLOTTE BOESEN, DONG ENERGY AND  
HENRIETTE HASSING CORLIN, DONG ENERGY ON BEHALF OF VATTENFALL

The Horns Rev Offshore Wind Farm comprises 80 wind turbines erected in a grid pattern. Each wind turbine is of a nominal capacity of 2 megawatt (MW), ie the total installed capacity is 160 MW.

The wind farm is located in the North Sea south of the actual reef, Horns Rev, in the southwestern part of Denmark.

The Nysted Offshore Wind Farm consists of 72 turbines placed in eight north-south oriented rows. Each turbine is of a nominal capacity of 2.3 MW which gives a total installed capacity of 165.6 MW.

The wind farm is located in the Baltic Sea about 10 km south of the town of Nysted in the southeastern part of Denmark. About 2–4 km north of the wind farm the Rødsand formation is found which consists of two barrier spit systems bordering on the shallow lagoon of Rødsand.



## CONTENTS

- Configuration of a wind farm
- Horns Rev Offshore Wind Farm
- Nysted Offshore Wind Farm
- Environmental issues

## CONFIGURATION OF A WIND FARM

---

An offshore wind farm consists of the same components as an onshore wind farm; however, the sometimes harsh environment at sea calls for other demands to the design and construction methods than onshore. The construction, operation and maintenance of an offshore wind farm depend greatly on the weather conditions which – when unfavourable – will result in limited access to the turbines. Consequently, these activities become more time consuming and costly. The turbine technology and the actual construction of offshore wind farms are undergoing rapid progress as wind farms are planned to be erected in deeper waters and even further off the coast.

This chapter provides a brief presentation of the present technologies and methods used with the focus on the solutions employed at the Horns Rev Offshore Wind Farm and Nysted Offshore Wind Farm. This covers a description of the basic components of an offshore wind farm; the turbines, foundations, submarine cables and substation, including the primary environmental impacts from the various parts. Also the various environmental issues dealt with during the construction are discussed. The two wind farms, Horns Rev and Nysted, are described in terms of the specific areas and wind farm layouts.

### WIND TURBINES OF 2-2.3 MW

Basically a wind turbine consists of a turbine tower, which carries the nacelle, and the turbine rotor, consisting of rotor blades and hub. The turbine tower of offshore turbines is usually a tubular steel tower which is conical, ie the diameter increases downwards towards the base of

the turbine. This gives the tower a conical shape which increases the strength of the tower. The nacelle contains the key components of the wind turbine, eg the electrical generator, gearbox, mechanical brakes, control systems etc. To capture the wind, most modern wind turbines have three rotor blades usually placed upwind of the tower and the nacelle. On the outside the nacelle is usually equipped with anemometers and a wind vane to measure the wind speed and direction, as well as aviation lights.

At present the size range of offshore turbines in Denmark is approx 2–2.3 MW, with a tip height of approx 110 m, but the development within turbine technology is moving towards bigger turbines, which is ideal for offshore sites.

In terms of possible environmental impacts, an offshore wind turbine itself primarily constitutes a visual impact and is a source of noise. Furthermore, the turbines can present a barrier to the movement of migrating or feeding birds and marine mammals, and finally if birds do not show avoidance behaviours towards the turbines, there's a potential risk of collisions.

The visual impact is obvious due to the sheer size of the turbines although also equipment, such as aviation lights, contributes to the visual appearance of the turbines at night. Turbines higher than 100 m must be equipped with aviation lights, often on all turbines in a wind farm for the safety of the air traffic. Offshore turbines must also be equipped with navigation markings for the safety of the ship traffic. The Danish Civil Aviation Administration, which is responsible for air traffic marking, issued new marking requirements for both wind turbines with a total height between 100 m and 150 m and for wind turbines over 150 m in 2005. These new marking requirements are expected to reduce the overall negative visual impact.

The noise from the wind turbines originates from the rotating rotor blades and the mechanical units in the nacelle. The noise above water is rarely an environmental issue in connection with offshore wind farms since the

turbines are situated far from land and residential areas. The airborne noise from the rotating blades is reflected by the water surface and therefore does not contribute considerably to the underwater noise level. The underwater sound from the turbines mainly comes from the mechanical units, eg generator, gearbox, transformer cooling system etc, and the sound is transmitted through the tower to the water in the form of vibrations. Measurements carried out at the Utgrunden and Horns Rev offshore wind farms demonstrate that the turbines radiate sound at a few dominating frequencies from 30 Hz up to 800 Hz. The noise is therefore mainly of low frequencies.

#### FOUNDATIONS CREATE NEW HABITATS

The current offshore wind power technologies are based on foundation types most suitable for shallow water. These foundations are either concrete gravity caisson foundations, which is the first type of foundation ever used for an offshore wind turbine, or steel monopiles driven into the seabed, which can be used at greater depths. The choice of foundation also depends on the type of sediment in the proposed area. In waters with greater depths, tripod and quadropod foundations, of the kind used for small offshore oil and gas recovery installations, could presumably be used for future turbine foundation solutions.

The seabed around the base of the foundations will

often be protected against erosion or scouring by placing rocks and boulders around the foundation. The foundation and the scour protection will constitute a new substratum on the seabed, and mussels and algae will often colonise these new habitats.

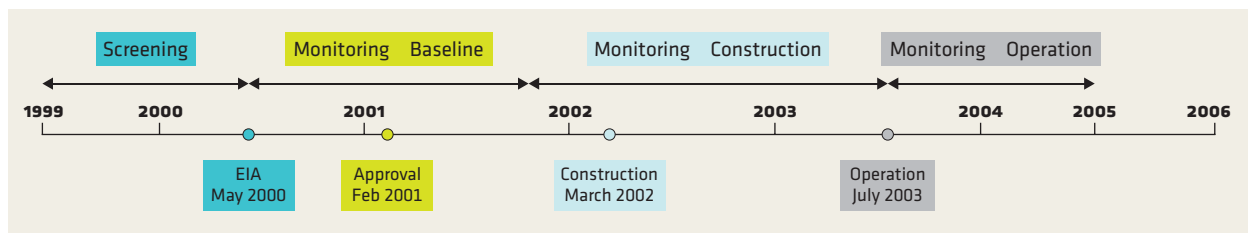
One of the main environmental impacts from the foundation itself is therefore considered to be the introduction of new habitats and the development of related vegetation and fauna, which again can serve as a food resource for eg birds and fish.

The short-term effects of installing monopile foundations are seen during the pile driving process as a result of the hydraulic offshore hammer used as this activity generates loud underwater noises. The noisy activity will have an effect on animals present in the area, and particular focus is paid to marine mammals. As mentioned in chapter 6, mitigation measures are taken to minimise this effect on both seals and harbour porpoises.

#### CABLE CONNECTION AND SUBSTATION

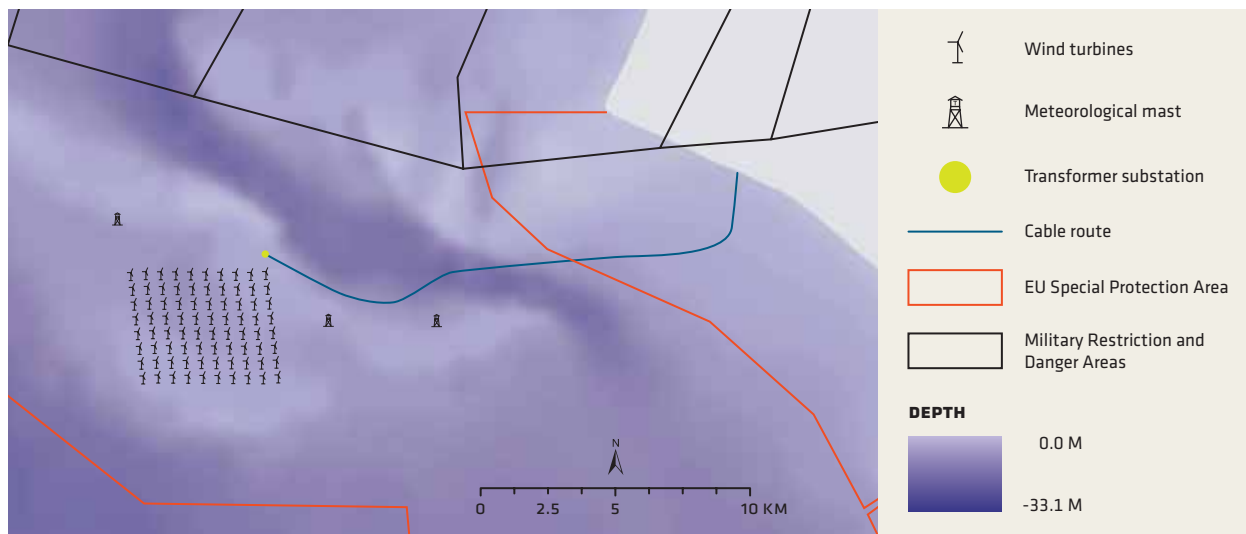
The power generated by the wind farm is collected in submarine cables buried in the seabed. The cables between the turbines are linked to a transformer substation. The power is transmitted to shore by an export cable connected to the public power transmission system. The submarine cables are typically three-phase alternating current (AC) cables protected by an outer steel armouring.

**FIGURE 3.1** THE TIME SCHEDULE FOR HORNS REV OFFSHORE WIND FARM



The time schedule is presented including the Environmental Impact Assessment (EIA), approval, construction, operation (the lower line) and the environmental monitoring phases (the upper line). The transformer platform was erected in October 2001 prior to the rest of the construction work. The wind farm has been operating successfully since December 2002.

**FIGURE 3.2** MAP OF THE WIND FARM AREA



Map of the wind farm area, showing the position of the 80 wind turbines, the transformer substation, the meteorology masts and the 150 kV cable to shore.

The function of the substation is to transform or convert the energy generated by the offshore wind farm from low voltage (eg 33 kV) to high voltage (eg 132 kV) thus reducing grid losses. At most wind farms the substation will be placed offshore due to the long distance to the shore, but for nearshore wind farms (5 km from the shore or less) it can be placed onshore.

The environmental impacts of the submarine cables in the construction phase include the risk of sediment spill from the seabed work, also during the operation phase issues such as electromagnetic fields and the effect on fish are considered.

The presence of submarine cables also constitutes an effect on the fishing industry as a Danish Executive Order on cabling provides for a 200 m protective zone around submarine cables against bottom-trawl fishing and raw materials extraction. These activities are therefore in general not possible within a wind farm area and along the cables from a wind farm to the shore. This might indirectly have a positive effect on the fish inside an offshore wind farm area since fishing activities are reduced here to a certain extent.

In Nysted Offshore Wind Farm, the wind farm area is open to sailing and fishing with net and line, whereas bottom-trawling methods are prohibited. In the Horns Rev area only fishing with line is allowed.

## **HORNS REV OFFSHORE WIND FARM**

### **TOTAL CAPACITY IS 160 MW**

The Horns Rev Offshore Wind Farm comprises 80 wind turbines erected in a grid pattern. Each wind turbine is of a nominal capacity of 2.0 MW which gives a total installed capacity of 160 MW. The distance between the individual wind turbines and the rows is 560 m.

Figure 3.2 shows the location of the offshore wind farm and shore-connecting cable.

The offshore wind farm is located south of the actual reef, Horns Rev. The distance from the northeasternmost wind turbine to Blåvands Huk is approx 14 km. The export cable from the wind farm is approx 19 km long, the inner 4 km runs through a designated area. The actual wind farm is located outside protected or designated areas.

The water depth in the wind farm area is between 6.5

m and 13.5 m (at mean sea level, MSL). In the entire wind farm area the seabed consists of sand.

The wind farm covers an area of approx 20 km<sup>2</sup>, and a 200 m wide exclusion zone is established around the wind farm resulting in an overall area of approx 24 km<sup>2</sup>.

#### HYDROGRAPHY – LOW WATER

Horns Rev is situated west of Denmark's westernmost point, Blåvands Huk. Horns Rev consists of two parts, outer Horns Rev and inner Horns Rev. These two parts are separated by the gulf Slugen. The water level at both parts of Horns Rev is low, approx 1–5 m. Geomorphologically speaking Horns Rev is a terminal moraine.

The North Sea has a complex tidal system, primarily controlled by tidal waves from the Atlantic Ocean. The average tide size at Horns Rev is approx 1.2 m.

Furthermore, the hydrography in the Horns Rev area is generally controlled by the wind and current regime in the North Sea and inflowing freshwater from the Elbe and other large rivers in Germany. Depending on the inflow of freshwater, the salinity varies between 30‰ and 34‰.

The average wave height is approx 1–1.5 m, and, according to the statistics, wave heights above 6 m are observed once a year.

The combination of low water levels, large and small seabed shapes (sand waves, sand banks, mega-ripples, etc) and the strong wave and tidal currents create a highly dynamic area in terms of morphology with very high natural concentrations of suspended sand in the water column. Thus the upper layers of the sand on and around the reef are constantly re-bedded.

#### METEOROLOGY MASTS COLLECT DATA

Adjacent to the wind farm area is a meteorology mast that has been collecting various data such as wind speed and direction since 1999.

Furthermore, two meteorology masts were erected in 2003, in connection with the wind farm. The masts

supply information for the operation of the farm and ensure the gathering of knowledge about the impact of the wind farm on the wind speed and turbulence outside the wind farm.

Within the wind farm a measuring device has been installed to monitor wave heights and wave periods. This is used to assess the possibility to access the wind turbines by boat.

#### 80 WIND TURBINES

The Horns Rev Offshore Wind Farm consists of 80 identical Vestas V80-2 MW wind turbines, with a hub height of 70 m and a total height to the blade tip of 110 m above mean sea level. The rotor diameter is 80 m. The main dimensions of the 80 wind turbines are shown in Figure 3.3 below.

The wind turbines can be accessed by boat and by helicopter. Access directly to the wind turbines by helicopter takes place in what is known as a “hoist operation”. For this purpose there is a 4×4 m platform on top of each wind turbine. The wind turbines are painted in a pale marine grey colour.

The standard V80-2 MW wind turbine has been customised to suit the offshore environment on the following points:

- Surface coating
- Navigational lighting (yellow beacons)
- Heli-hoist platform on nacelle roof
- Emergency accommodation equipment (sleeping bags, water and instant food)
- Communication system, including VHF radio
- Special maintenance equipment, eg add-on crane for heavy lifts and “sky climber” for blade inspection and repair
- Higher rotor speed due to less strict noise constraints

### FOUNDATIONS – MONOPILE CONCEPT

The foundations at Horns Rev is based on the monopile concept. The joint between turbine and foundation is placed 9 m above mean sea level where there is an access platform. For the design of the foundation, see to Figure 3.4.

The monopile foundation consists of two main components; the pile which is a steel pipe rammed into the seabed. The other component is the transition piece which is also a steel pipe but with a slightly larger diameter than the pile.

For the Horns Rev project, the monopile diameter is 4 m. The pile is driven down to a depth of up to approx 25 m. The advantage of the monopile concept is among other things that pile driving is a fast process, approx 20–90 minutes a pile.

At Horns Rev, scour protection was found necessary around the foundations. The scour protection consists of two different sizes of stones placed in two layers in an approx 10 m wide band around the foundation. The foundations and scour protections cover an area of approx 50,000 m<sup>2</sup>, corresponding to 0.2% of the wind farm area. The foundations increase the overall surface area by up to 10,000 m<sup>2</sup>.

### CABLE CONNECTION – 36 KV GRID

The wind turbines are interconnected in a 36 kV cable grid organised in north-south-bound rows. In the northeastern corner of the wind farm a substation connects the 36 kV cables and transforms the generated energy to 150 kV. The total length of the 36 kV cable is about 50 km. The 150 kV cable is connected to a transmission station at Hvidbjerg Strand, which is about 19 km from the wind farm. All cables are embedded 1 m in the seabed.

### AVIATION AND NAVIGATIONAL LIGHTING

All wind turbines positioned along the outer edges of the wind farm are equipped with two medium intensity synchronised flashing red beacons flashing with a

FIGURE 3.3 WIND TURBINE DIMENSIONS

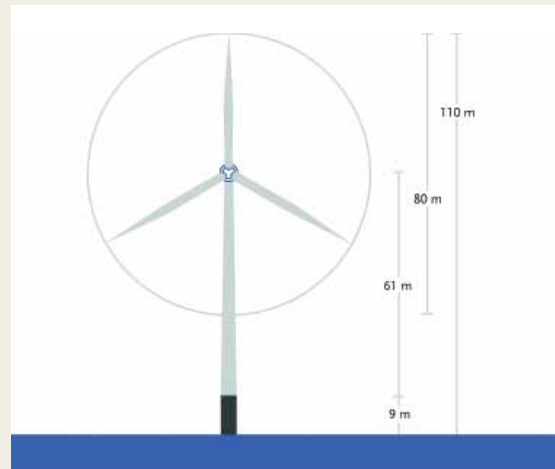
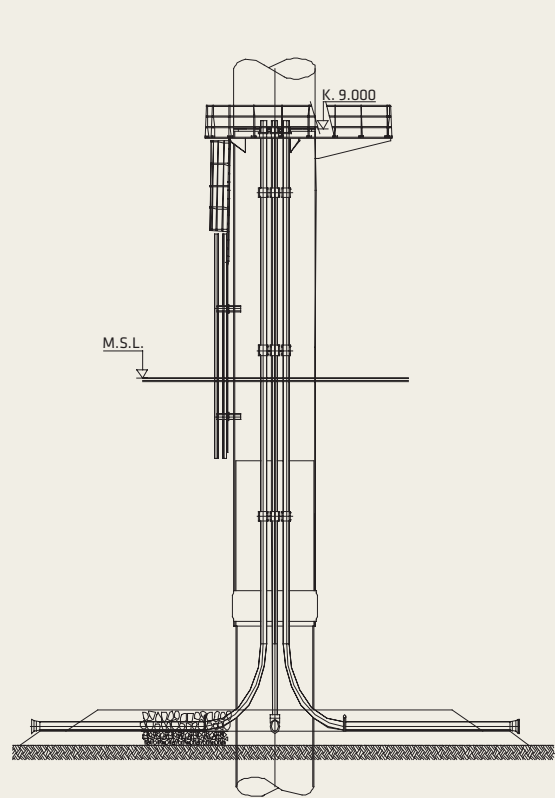


FIGURE 3.4 DESIGN OF MONOPILE FOUNDATION



frequency of 20–60 flashes a minute. The lights have a variable effective intensity of up to 2000 candela  $\pm$  25%. When visibility in the area exceeds 5 km, the intensity is automatically reduced to 200 candela. The visibility and intensity settings are remote controlled. All other wind turbines, ie the 48 turbines in the central part of the wind farm, are each equipped with two low intensity red lights with an intensity of 10 candela as a minimum.

Regarding navigational lighting, the corners and outer turbines are marked with either one or two beacons. All beacons will flash synchronously and will be of an effective light power of approx 5 nautical miles. The beacons have automatic control so that they are only in operation when it is dark.

#### CONSTRUCTION OF THE WIND FARM

All fully built foundations and wind turbine components were shipped from the Port of Esbjerg to the wind farm area.

The first step of the establishment of the foundations was the installation of the bottom layer scour protection, the filter layer, consisting of stones with a diameter of 30–200 mm. Then the monopiles arrived and were driven down through the filter layer. Ten monopiles at a time were transported to the wind farm area on a special-purpose jack-up vessel. Six transition pieces at a time, including premounted equipment such as boat landing and platform etc, were loaded onto a jack-up vessel and transported to the wind farm where they were mounted on the monopiles. The transition piece and the monopile were cast together. The final step was installation of the armour rock layer, which is also part of the scour protection.

The erection of the wind turbines was carried out from two special-purpose vessels, each provided with four hydraulically controlled jack-up legs and a lattice-mast mobile crane. Two complete wind turbines at a time were loaded onto each vessel and shipped to the wind farm.

#### FOUR STEPS OF TURBINE INSTALLATION

- 1 Installation of the two bottom tower sections
- 2 Installation of the top tower section
- 3 Installation of nacelle, complete with hub, spinner and two blades
- 4 Installation of the last blade

The actual installation of the four turbine parts took between one and seven days depending on the weather conditions. Under optimal conditions it is possible to erect one turbine a day with the vessels mentioned above.

#### NYSTED OFFSHORE WIND FARM

##### TOTAL CAPACITY IS 165.6 MW

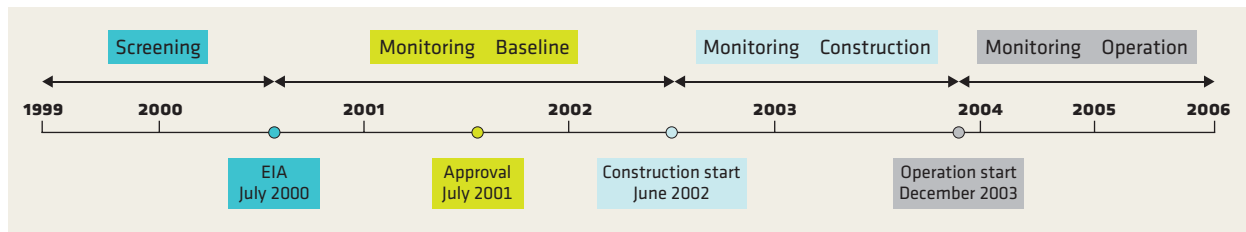
The wind farm consists of 72 turbines placed in 8 north-south oriented rows standing 850 m apart, see Figure 3.6. Each row consists of 9 turbines with an internal distance of 480 m. Each turbine is of a nominal capacity of 2.3 MW and hence the total installed capacity is 165.6 MW.

The Nysted Offshore Wind Farm at Rødsand is located approx 10 km south of the town of Nysted and 13 km west of the town of Gedser. About 2–4 km north of the wind farm lies the Rødsand formation which consists of two barrier spit systems bordering on the shallow lagoon of Rødsand. Close by lies Rødsand game reserve and Hyllekrog game reserve. The area north of the wind farm holds another two game reserves: Nysted Nor and Frejlev Vig.

The entire area north of the wind farm has been designated a Ramsar Site and an EU Bird Protection Area (SPA) to protect the requirements of specified wild birds and regularly occurring migratory birds and as a EU Habitat Area (SAC) to maintain and restore the marine habitats and wild fauna and flora.

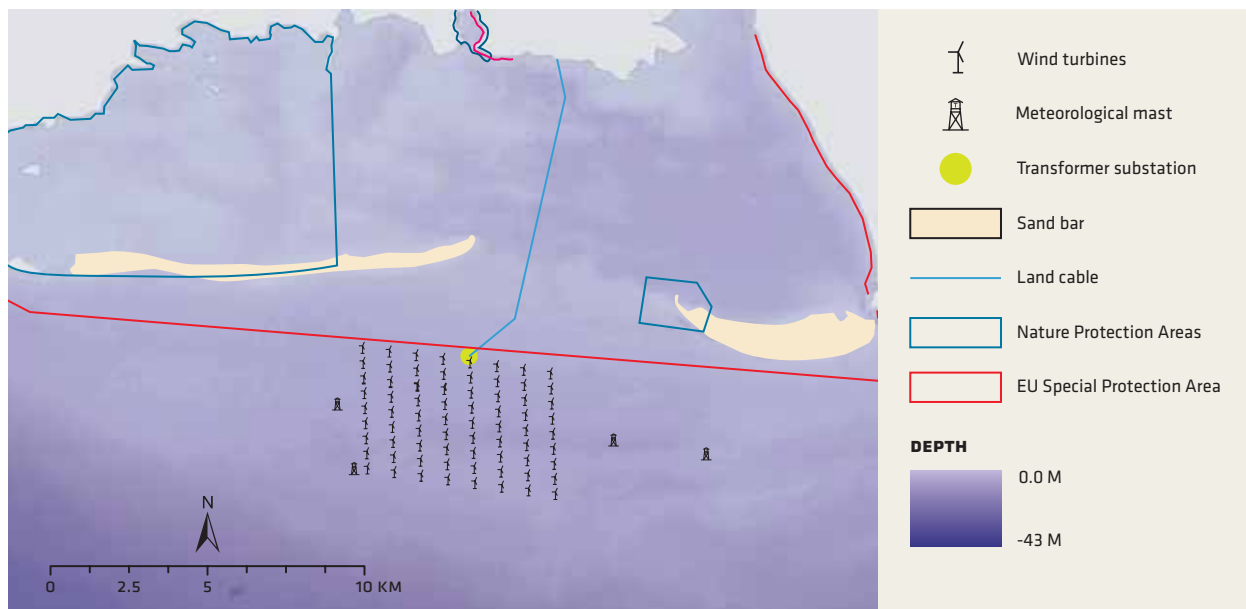
The wind farm is located on a gently sloping seabed consisting of glacial deposits covered by thin layers of sand. The water depth in the wind farm area is between 6 m and 9.5 m.

**FIGURE 3.5** THE TIME SCHEDULE FOR NYSTED OFFSHORE WIND FARM



The time schedule is presented including the EIA, approval, construction, operation (the lower line) and the environmental monitoring phases (the upper line). The wind farm has been operating successfully since December 2003.

**FIGURE 3.6** MAP OF THE NYSTED WIND FARM AREA



Map of the wind farm area, showing the position of the 72 wind turbines, the transformer substation, the meteorology masts and the 132 kV cable to shore.

The wind farm covers an area of approx 24 km<sup>2</sup>, in addition a 200 m wide exclusion zone is established around the wind farm resulting in an overall area of approx 28 km<sup>2</sup>.

#### HYDROGRAPHY – EXCHANGE OF WATER MASSES

The main currents in the Rødsand area are primarily ruled by the exchange of water between the Kattegat and the Baltic Sea flowing through the Great Belt, the Little Belt and Øresund, and by density and wave generating cur-

rents. The tidal currents in this area are insignificant.

In general, the water in the area is well mixed and not influenced by oxygen depletion. The salinity varies depending on the origin of the water masses exchanged horizontally between the Baltic Sea and the Kattegat, and vertically between the heavy salty bilge water from the deep areas of the Femern Belt and the more fresh surface water in the lagoon. Thus the salinity of the area generally varies between approx 9‰ and 13‰.

In terms of hydrography the area can be divided into





**FIGURE 3.7** Photos of the turbine foundations before they were positioned on the seabed.

the Rødsand lagoon with shallow water depths and dominating wave influence and the area outside the lagoon where the water depth quickly increases proportionally to the influence of the main current systems.

The Rødsand formation, which consists of two barrier spit systems (one going eastwards from Hyllekrog and another going westwards from Gedser Rev), is undoubtedly the most significant coastal morphological element in the area. Most of the water exchanged between Rødsand lagoon/Guldborg Sund and the Femern Belt passes through the gulf Østre Mærker, breaking the Rødsand formation immediately west of the barrier spit at Gedser.

The seabed in the area mainly consists of hard glacial moraine clay which locally is superposed by Holocene layers with a thickness of typically a few metres. These sediments can be found as filling of mud, organic silt and sand probably settled in meltwater channels eroded into the moraine clay. However, locally even very large

deviations from this overall pattern may occur.

The wave heights in the area are fairly low as a consequence of the relatively short, free beats in this part of the Baltic Sea. The combination of the fairly sparse presence of mobile sediments and the limited wave energy are grounds for a general limit to the sediment transportation in the area.

#### FIVE METEOROLOGY MASTS

In the period 1997 to 2005 a meteorology mast in the wind farm area has been collected information on wind speed and direction.

Furthermore, four meteorology masts were erected in 2003, in connection with the wind farm. The masts supply information about the operation of the farm and ensure the gathering of knowledge concerning the impact of the wind farm on the wind speed and turbulence upstream and downstream the wind farm.

## 72 WIND TURBINES

The Nysted Offshore Wind Farm consists of 72 identical Bonus 2.3 MW wind turbines, with a hub height of 69 m and a rotor diameter of 82.4 m. The total height is 110 m.

The wind turbines have been given a marine grey colour that blends in well and are equipped with warning lights for avoidance by sea and air traffic. The wind turbines can be accessed by boat.

## GRAVITY FOUNDATIONS

The turbine foundations are gravity foundations, of concrete with specially designed protection measures against ice (Figure 3.8). Erosion around the bottom plate of the foundations is prevented by a scour protection consisting of stone. The foundations take up an area of about 45,000 m<sup>2</sup>, corresponding to 0.2% of the total area of the wind farm. The foundations cause an increase of the overall surface area of up to 56,000 m<sup>2</sup>.

The foundation consists of a cylindrical shaft with a diameter of 4.2 m and a 3 m high and 16 m wide hexagonal basement divided into six chambers. The six chambers are filled with gravel and stones. The upper part of the shaft is conical and reaches a diameter of 8 m at the surface of the sea. The transformer substation is placed on a platform similar to the wind turbine foundations.

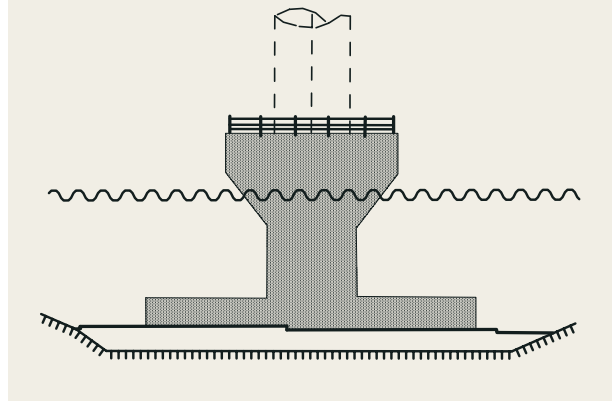
The outer diameter of the scour protections is about 25 m.

The base of the foundations is placed from 0 m to 5 m below the natural seabed. The surface of the stone fill in the basement chambers is in most cases 4.5 m to 7.5 m below the surface of the sea and up to almost 10 m below the surface at a few turbines.

## CABLE CONNECTION – 33 KV GRID

The turbines are interconnected with a 33 kV marine cable grid, which is embedded at a depth of 1 m. The total length of the 33 kV marine cable is about 48 km. The marine cable continues from the northernmost

**FIGURE 3.8** DESIGN OF THE GRAVITATION FOUNDATION



turbines to a 33/132 kV transformer substation 200 m north of these turbines.

A 132 kV marine cable buried 1 m into the seabed leads from the transformer substation in the wind farm to Vantore Strandhuse east of Nysted. The total length of the 132 kV cable connection to the shore is about 10 km. All the cables in the Nysted Offshore Wind Farm are three-phase AC (alternating current) cables.

## AVIATION AND NAVIGATIONAL LIGHTING

All wind turbines positioned along the outer edges of the wind farm, in total 30 turbines, are equipped with two medium intensity synchronised flashing red beacons. The lights have a variable effective intensity of up to 2000 candela. When visibility in the area exceeds 5 km, the intensity is automatically reduced to 200 candela. The visibility and intensity settings can be remote controlled. All other wind turbines, ie the 42 turbines in the central part of the wind farm, are each equipped with two low intensity red lights with an intensity of 10 candela as a minimum. These lights are not flashing.

The settings of the aviation lights will be adjusted in 2006 according to the new requirements from the Danish Civil Aviation Administration. The objective is to reduce the visible impression seen from the shore at night.



**FIGURE 3.9** *Construction of the first wind turbine at Nysted Offshore Wind Farm*  
PHOTO: NYSTED OFFSHORE WIND FARM

Yellow beacons are placed as navigation lighting on 10 outer turbines, and a sailing lane through the wind farm, from NE to SW, intended as a guide is marked with red and green markings.

#### CONSTRUCTION OF THE WIND FARM

The turbines were transported to the site by ship. The individual turbine consisted of four parts: a lower and upper tower section, the nacelle and the rotor. A special installation vessel fitted with a large crane was used for the erection of the turbines. The actual erection of the

four turbine parts took around an hour.

The concrete gravity foundations was built in a dry dock and sailed on barges to the construction site. Here they were lowered in place on the seabed which was prepared meticulously in advance with a bed of stone chippings allowing all the wind turbines to be aligned absolutely vertically. The foundations were then filled up with pebbles and gravel to give the foundation sufficient weight to withstand waves and ice pressure.

The cables were laid either by jetting or dredging the cable approx 1 m into the seabed.

## ENVIRONMENTAL ISSUES

---

The overall mapping of the environmental conditions of the two projects is described in the respective Environmental Impact Statements. The overall environmental conditions constituted the basis for regulatory requirements as specified in the approval of the projects.

To ensure that environmental demands and terms were an integral part of the projects these were incorporated into the requirement specifications to the suppliers. Environmental management systems were established for both wind farms. These systems included procedures and instructions for all personnel on the sites about the handling of environmental issues, such as waste handling, noise measurement, procedures for scaring off marine mammals, contingency plans in case of environmental accidents such as oil spill, etc.

The regulatory requirements for the construction phase at Horns Rev and Nysted, respectively, varied considerably since the two areas differ to a great extent and feature different sensitivity issues. Generally, the following points were addressed during the construction phase at both wind farms but in varying orders of priority:

- Sediment spill monitoring
- Incidents, accidents and oil spill
- Waste handling
- Precautions regarding pile driving/vibration of sheet piles/monopiles
- Sediment depositing
- Marine archaeology
- Registration of navigation in the area

After the construction phase, the total amount of sediment spill and removed amounts of sediment have been recorded, and it was concluded that the regulatory requirements were respected. Also the amount and types of waste generated during the construction period were registered and the

locations of interesting marine archaeological objects found during the construction period were recorded.

Of the above listed items the conditions for the driving of sheet piles and monopiles as well as registration of navigation in the area are described further as these two factors influence eg the disturbance of marine mammals during the construction period.

It was required of both wind farms that in connection with momentary noisy activities and similar, actions should be taken to scare off marine mammals potentially harmed by the construction noise. Pile driving was used for the establishment of the monopiles at Horns Rev, piling of sheet piles at a foundation and for erection of meteorology masts at the Nysted Offshore Wind Farm – all of these are activities which cause momentary noise. The requirement for measures warning off marine mammals beforehand was met by the application of soft-start/ramp-up, acoustic deterrent devices, so-called pingers, and seal scarers. The application of these devices was registered and monitored.

The Nysted Offshore Wind Farm is situated approx 2 km from a nature reserve and 4 km from Rødsand seal sanctuary. This has called for special consideration in connection with the construction work, including limitation and control of navigation in the area.

According to specific instructions to all persons involved at the construction site, all transport to and from the wind farm was to take place in a special transportation corridor only, and that access to the nature reserve was forbidden without prior special approval by the Owner's environmental coordinator.

To ensure compliance with the demands and for safety reasons all navigation to and from the wind farm was registered and reported. Thus the navigation to and from the wind farm has been controlled, and the impact of navigation on the sensitive areas, the nature reserve and the seal sanctuary, has been limited as much as possible.

## INFAUNA, EPIFAUNA AND VEGETATION CHANGE IN DIVERSITY AND HIGHER BIOMASS

BY SIMON LEONHARD, ORBICON AND  
JØRGEN BIRKLUND, DHI WATER AND ENVIRONMENT

The main effect from establishing the wind farms was the introduction of hard bottom structures onto seabeds that almost exclusively consisted of sandy sediments. This has increased habitat heterogeneity and changed the benthic communities at the turbine sites from typical infauna communities to hard bottom communities. Abundance and biomass of the benthic communities increased at the wind farm sites compared to the native infauna communities. A consequence from the change in community structure was a local increase in biomass at the wind turbine sites by 50 to 150 times, most of this as available food for fish and seabirds.

There were only negligible or no impacts detected from the changes in the hydrodynamic regimes on the native benthic communities, seabed sediment structure or established epifouling communities. Similarities in the establishment, succession and distribution of epifouling communities were found between the Horns Rev and Nysted Offshore Wind Farms. The differences in species composition were mainly attributable to differences in salinity between the two sites.



## CONTENTS

- Introduction: Wind farms as new habitats
- Methods: Seabed and hard bottom sampling
- Results: Change in benthic communities
- Discussion: Indirect effects on benthic fauna
- IAPEME viewpoints

## INTRODUCTION

### WIND FARMS AS NEW HABITATS

By establishing offshore wind farms, the sub-surface sections of the turbine towers and the scour protection will introduce new types of sub-littoral structures. These also increase the habitat heterogeneity in areas that previously consisted of relatively uniform sand. The introduced habitats will be colonised by a variety of marine animals and algae. The hard bottom structures may act both individually and collectively as an artificial reef and as sanctuary areas for threatened or vulnerable species.

Structural complexity appears to be characteristic of many productive environments. The size, diversity and density of organisms associated with an artificial reef are conditional on the number and size of niches. The growth of sessile invertebrates and macro algae on the reef further contributes to an increase in the heterogeneity of the ecosystem.

The presence of the artificial structures will lead to colonisation by epibenthic organisms that may not have inhabited the area previously. These structures may also provide substrates that are more usable to mobile fauna than the previous “pre-wind farm” seabed. The establishment of fouling communities on the hard substrates will increase the available food to fish, which again will lead to an increase in the available food to marine mammals and birds.

#### COLONISATION OF ARTIFICIAL SUBSTRATES

Colonisation of the artificial substrates will take place by

a combination of migration from the surrounding seabed and settling of larvae and juveniles. The recruitment will be governed by the tidal and residual currents carrying the larvae and juveniles to the foundation and by the location of the foundation with respect to factors such as depth and distance from recruitment source. Recruitment is seasonal in Danish waters and the composition of the fouling communities will also be dependent on the type and heterogeneity of the foundations.

The colonisation will often have a characteristic succession, starting with diatoms and filamentous algae, followed by barnacles and thereafter by a more diverse community. Fouling successions are highly dependent on the surrounding environment, the interaction between the different species and the predation or grazing on the fouling community by predatory or herbivorous species.

#### NEGLECTIBLE CHANGES TO NATIVE COMMUNITIES

Wind turbines are large structures and the physical presence of the turbine structures might induce changes in the hydrodynamic regimes which might have an impact on seabed sediment distribution and structure. Thereby, the turbine structure might have an effect on the benthic communities. However, modelling the hydrodynamic regime predicted that the changes in current velocity behind or between the foundations would be less than 1.5–2%. The modelling also demonstrated that changes in current velocity would be less than 15% within 5 m from the foundation.

Temporary impacts to the benthic communities might be attributable to sediment spill and an increase in turbidity from the cable jetting and excavation for gravitational foundations. The noise impact from pile driving activities is considered negligible to benthic communities.

There might also be an impact to the epifouling and the infauna communities from a combined effect of wind farms situated closely together. Other activities, such as maintenance and construction, might also contribute

to the impact. Effects attributable to ban of trawling activities and changes in foraging behaviour of birds are considered the most important.

The objective of the studies at Horns Rev and Nysted was to monitor the development in the native benthic communities *and* the development in the fouling communities on the hard bottom structures introduced to assess the impact of offshore wind farms, if any.

## METHODS

### SEABED AND HARD BOTTOM SAMPLING

---

There were differences in the methodology approaches between the two wind farm sites because two different operators and two different consultants performed the surveys. A total of six infaunal and vegetation community surveys were performed at the Horns Rev and Nysted offshore wind farms during the pre-construction and post-construction phases (Figure 4.1).

Quantitative samples of infauna and sediment were taken using a Van Veen grab and SCUBA diver operated hand cores and then analysed. The species were identified, counted and the biomass of the species was determined.

Common mussels (*Mytilus edulis*) were sampled at mussel bed sites by SCUBA divers. The seabed character and coverage of benthic communities were mapped and assessed using a photo-sampler methodology. The photo-sampler consisted of a conventional camera, a video camera and a flash light mounted on a steel frame, the sampler could cover a seabed area of 1–2 m<sup>2</sup>.

### SELECTION OF SAMPLING SITES

Sampling of benthic communities at turbine foundations and scour protection was performed at six turbine sites at Horns Rev and at eight turbine sites at Nysted from 2003 to 2005. Sampling was performed at both wind farms during the autumn with additional sampling being

performed at Horns Rev during the spring of each year. The sites were selected according to differences in depth regimes and turbine site locations.

SCUBA divers collected replicate quantitative samples of fouling organisms at individual stations placed at different depths and exposure regimes at the turbine foundations and scour protections (Figure 4.2).

At Horns Rev, a visual determination was performed of the fouling communities along transects. A semi-quantitative assessment was carried out for the frequency of each group of organism as well as an evaluation of the coverage of species and substrate. Certain groups of organisms were collected for species identification in the laboratory.

Underwater video recordings and photographs were also taken along transects for documentation purposes at each wind farm site. At Nysted, photographs using a frame mounted digital camera were taken at different length and depth intervals on the foundations for an assessment of the coverage of common mussels, barnacles and macro algae. Sediment and fauna samples were analysed in the laboratory.

## RESULTS

### CHANGE IN BENTHIC COMMUNITIES

---

The main effect of the establishment of the Horns Rev and Nysted wind farms was the introduction of the turbine foundations and the scour protection onto seabeds that previously consisted of relatively uniform sand. These hard bottom structures have increased habitat heterogeneity and changed the benthic communities from typical fauna communities with most aquatic animals living in the seabed to hard bottom communities with increased abundance and biomass.

### HETEROGENEOUS NATIVE FAUNA AT HORNS REV

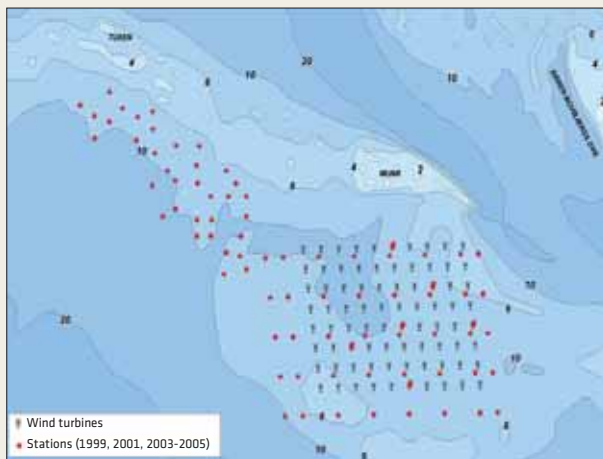
No vegetation was found at Horns Rev and therefore

**FIGURE 4.1** SEABED SAMPLING FROM 1999 TO 2005

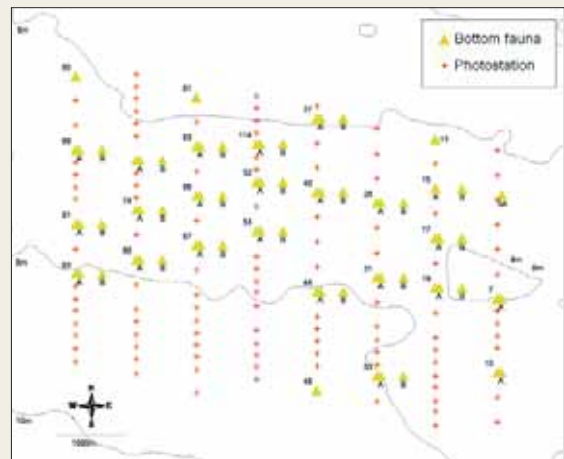
CAMPAIGN	YEAR	HORNS REV				NYSTED			
		WIND FARM AREA		REFERENCE AREAS		WIND FARM AREA		REFERENCE AREAS	
		SPRING	AUTUMN	SPRING	AUTUMN	SPRING	AUTUMN	SPRING	AUTUMN
EIA screening	1999	■		■		■	■	■	■
Baseline	2001	■				■	■	■	■
Monitoring	2003	■		■					
Monitoring	2004								
Monitoring	2005	■		■		■	■	■	■

■ Core samples     ■ Photo sampling     ■ Van Veen/mussels

*Surveys and methodology used for infauna and vegetation at Horns Rev and Nysted.*

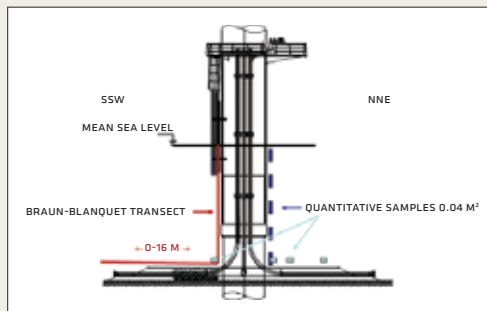


*Sampling locations at Horns Rev 1999-2005.*

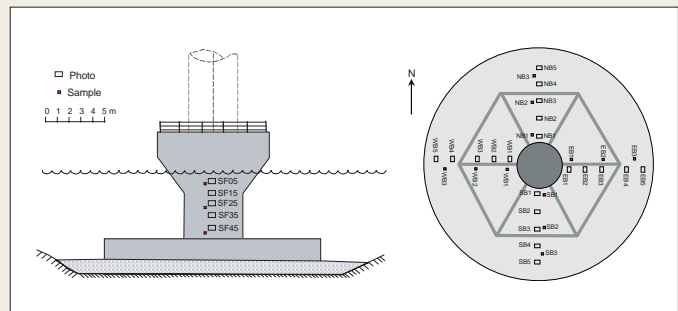


*Sampling locations at Nysted.*

**FIGURE 4.2** HARD BOTTOM SUBSTRATE SAMPLING FROM 2003 TO 2005



*Sampling locations at the turbine sites at Horns Rev.*



*Sampling locations at the turbine sites at Nysted.*



the native fauna composition at Horns Rev was closely associated with the sandy environment. The benthos community was similar in species composition with the communities in medium-coarse sand described for other shallow coastal waters of the North Sea. The community can be described as the *Ophelia borealis* community or the *Goniadella-Spisula* community named after the dominant and characteristic species. However, the fauna was very variable, heterogeneous and only slightly comparable in abundance and biomass with the fauna at other sandbanks.

The fauna in adjoining deeper areas was dominated by the *Venus* community.

In the sandbank community, characteristic species found included the bristle worm *Goniadella bobretzkii* and *Ophelia borealis* and the bivalve *Spisula solida* (thick trough shell) (Figure 4.3). The two last mentioned species were important contributors to the biomass of the community mainly due to their relatively large sizes (Figure 4.4). Indicators of environmental changes could be identified using dominance relations of different species.

**FIGURE 4.3**  
ABUNDANCE OF THE MOST DOMINANT SPECIES FOUND IN THE HORNS REV WIND FARM AREA FROM THE 1999 AND 2001 BASELINE SURVEYS

ABUNDANCE, NUMBER/M <sup>2</sup>		1999		2001			
		SPRING		SPRING		AUTUMN	
SPECIES	GROUP	MEAN	RELATIVE %	MEAN	RELATIVE %	MEAN	RELATIVE %
<i>Pisione remota</i>	Bristle worm	142	20.3	176	2.7	411	22.0
<i>Goodallia triangularis</i>	Bivalve	262	37.5	154	3.4	203	11.0
<i>Goniadella bobretzkii</i>	Bristle worm	114	16.3	129	5.1	190	10.0
<i>Ophelia borealis</i>	Bristle worm	29	4.1	47	13.8	72	4.0
<i>Spisula solida</i>	Bivalve	2	0.3	32	16.4	36	2.0
<i>Orbinia sertulata</i>	Bristle worm	12	1.7	25	18.8	0	0.0

**FIGURE 4.4**  
BIOMASS OF THE MOST DOMINANT SPECIES FOUND IN THE HORN REV WIND FARM AREA FROM THE 1999 AND 2001 BASELINE SURVEYS

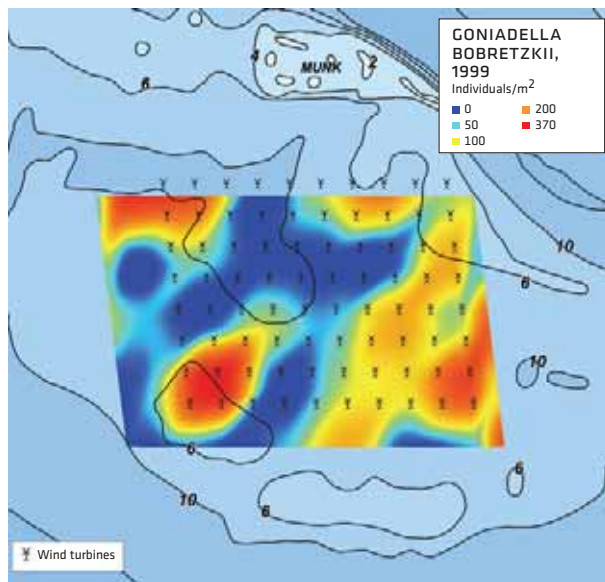
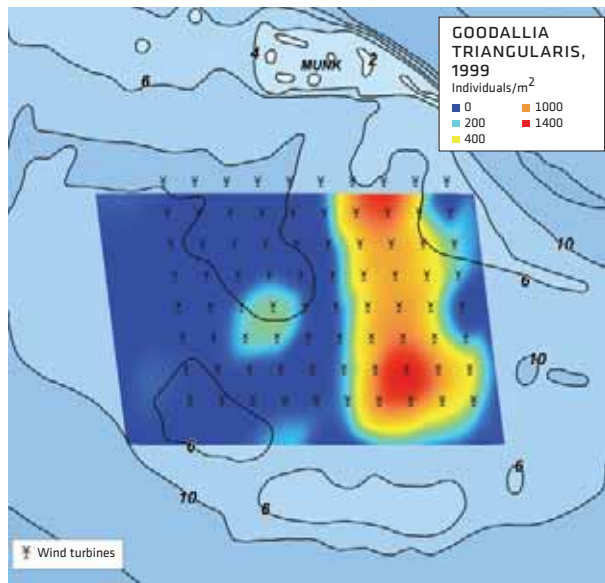
BIOMASS, WET WEIGHT G/M <sup>2</sup>		1999		2001			
		SPRING		SPRING		AUTUMN	
SPECIES	GROUP	MEAN	RELATIVE %	MEAN	RELATIVE %	MEAN	RELATIVE %
<i>Spisula solida</i>	Bivalve	15.413	7.3	42.109	64.7	231.883	77.4
<i>Ophelia borealis</i>	Bristle worm	27.560	13.0	6.505	10.0	7.405	2.5
<i>Goodallia triangularis</i>	Bivalve	0.904	0.4	0.400	0.6	0.542	0.2
<i>Goniadella bobretzkii</i>	Bristle worm	0.245	0.1	0.075	0.1	0.184	0.1
<i>Pisione remota</i>	Bristle worm	0.174	0.1	0.025	0.0	0.035	0.0
<i>Orbinia sertulata</i>	Bristle worm	1.415	4.9	2.788	4.3	0.000	0.0

#### INDICATORS OF ENVIRONMENTAL CHANGES

Bristle worms: *Ophelia borealis*, *Goniadella bobretzkii*, *Pisione remota*, *Orbinia sertulata*. Mussels: *Goodallia triangularis*, *Spisula solida*.

Due to natural variations in populations with respect to reproduction and body mass increase, considerable and significant differences were found in temporal and spatial distribution of the indicator species and other species in the community (Figure 4.5).

**FIGURE 4.5** DISTRIBUTION PATTERN OF SOME OF THE MOST ABUNDANT SPECIES IN THE WIND FARM AREA AT HORNS REV, 1999

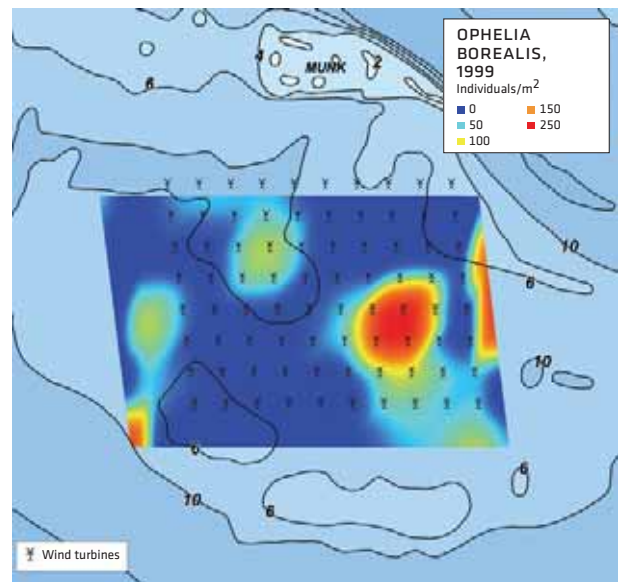


As at other sandbanks, the sediment at Horns Rev was characterised by a low organic content. The benthic community at Horns Rev was generally characterised by a lower degree of diversity, abundance and biomass compared to adjacent areas where the bottom conditions were more stable and the sediment had a higher content of fine sand and organic material. In comparison, the number of bivalves that are important food items for diving ducks, such as the common scoter (*Melanitta nigra*), was far lower in the Horns Rev area than in nearby areas of the North Sea characterised by the bivalve *Venus* community.

Mobile epifauna was often found on the seabed around Horns Rev. The brown shrimp (*Crangon crangon*), which

#### CHARACTERISTIC MOBILE EPIFAUNA ELEMENTS

The hermit crab (*Pagurus bernhardus*), the common shore crab (*Carcinus maenas*), the swimming crab (*Liocarcinus pusillus*, *L. holsatus* and *L. depurator*), the common whelk (*Buccinum undatum*), the brown shrimp (*Crangon crangon*), the common starfish (*Asterias rubens*), the Alder's necklace shell (*Polinices polianus*) and the edible crab (*Cancer pagurus*).



was often observed in the wind farm area, is an important prey species for both sea birds and fish.

#### HOMOGENEOUS NATIVE FAUNA AT NYSTED

At Nysted, the benthic infauna community was characterised as a shallow water bivalve *Macoma* community, named after the Baltic tellin (*Macoma balthica*). Some of the species found were typical indicators of brackish water.

#### BRACKISH WATER SPECIES

The bristle worm (*Fabricia stellata*) and (*Streblospio shrubsoli*) and the crustacean (*Cyathura carinata*).

The common mussel (*Mytilus edulis*) was scattered on the seabed surface, especially where stones were present, in high percentages (up to 80%) and large numbers and were mainly found in the southern part of the wind farm area (Figure 4.6). The bottom fauna was very homogeneous, however, subgroups of the *Macoma* community existed, which was mainly applicable to sites where common mussel biotopes were found (Figure 4.8). The crustacean *Gammarus* was often associated with the common mussel beds. The most important factor influencing species distribution and abundance was the organic content of the sediment, the similarity in abundance was about 50% between most stations.

#### SPECIES CHARACTERISTIC OF THE MACOMA COMMUNITY

The cockle (*Cerastoderma glaucum*), the sand gaper (*Mya arenaria*), the ragworm (*Nereis (Hediste) diversicolor*), the bristle worm (*Pygospio elegans*), the mud snail (*Hydrobia sp.*).

Common mussels were found locally in large numbers, up to 1,500 ind./m<sup>2</sup>, constituting more than 35% of the total biomass. Two or three generations were found but the mussel

FIGURE 4.6 COVERAGE OF COMMON MUSSELS AT NYSTED IN 1999

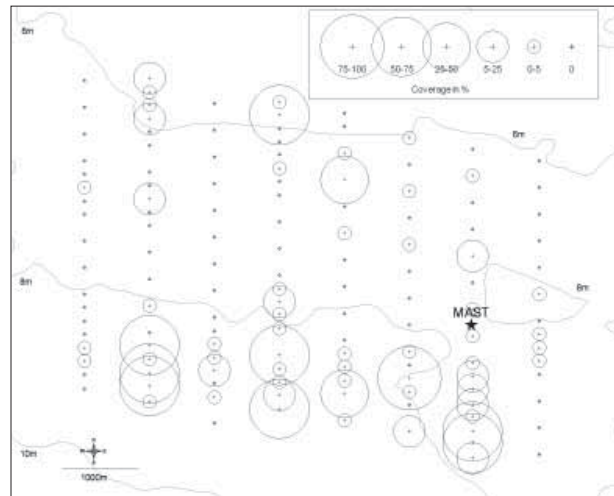


PHOTO: MAKS KLAUSTRUP



FIGURE 4.7 Common mussels with growth of hydrozoans at Nysted.

population was dominated by newly settled juveniles.

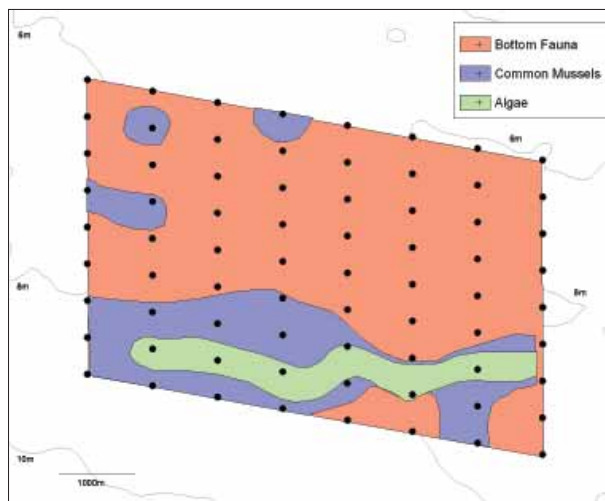
Attached algae communities were rare at Nysted but were dominated entirely by the annual filamentous brown algae *Pilayella/Ectocarpus*. The distribution of the algae was closely related to areas with suitable substrates and occurred in areas where stones and common mussels were observed (Figures 4.9 and 4.10). The coverage of algae was less than 5%.

#### DIFFERENCES IN SALINITY AND VEGETATION

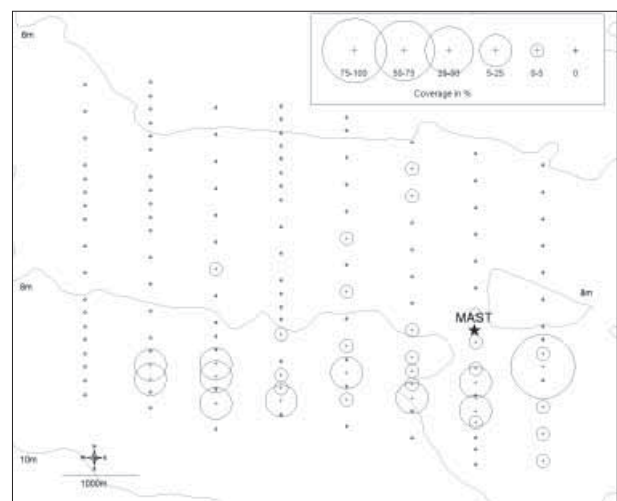
Although scattered stones were found at Nysted and the reworking and redistribution of sediment were considered

**FIGURE 4.8** MEAN ABUNDANCE (IND./M<sup>2</sup>) OF SPECIES CONTRIBUTING WITH 75% OF THE SIMILARITY IN THE THREE SUBGROUPS OF THE MACOMA COMMUNITY FOUND AT NYSTED IN THE 1999 BASELINE SURVEY

SPECIES	GROUP	FAUNA GROUP I	FAUNA GROUP II	FAUNA GROUP III
<i>Hydrobia sp.</i>	Snail	3,790	3,390	2,330
<i>Pygospio elegans</i>	Bristle worm	720	1,270	1,190
<i>Nereis diversicolor</i>	Bristle worm	50	125	95
<i>Mya arenaria</i>	Bivalve	70	27	28
<i>Macoma balthica</i>	Bivalve	30	30	35
<i>Mytilus edulis</i>	Bivalve	31	415	5



**FIGURE 4.9** DISTRIBUTION OF BENTHIC COMMUNITIES AT NYSTED 1999



**FIGURE 4.10** COVERAGE OF MACRO ALGAE ALONG TRANSECTS AT NYSTED 1999

to be considerably higher at Horns Rev due the higher waves and stronger currents than at Nysted, the seabed at the two wind farm sites consisted mainly of medium to coarse sand. The differences found in species composition and benthic communities were therefore mainly attributable to differences in salinity and vegetation cover between the two sites.

At Nysted, the benthic community was dominated by shallow water species characteristic of the inner Danish waters and brackish water species not recorded at Horns Rev. In general, very few species were commonly found at both Nysted and Horns Rev. The common mussel and

the mud snail (*Hydrobia spp.*) that dominated at Nysted were only found in small numbers at Horns Rev. They were found only as newly settled specimens and juveniles and were presumably limited in growth and controlled by the common starfish (*Asterias rubens*), which is a key predator not found at Nysted.

#### DIFFERENT EPIFOULING COMMUNITIES

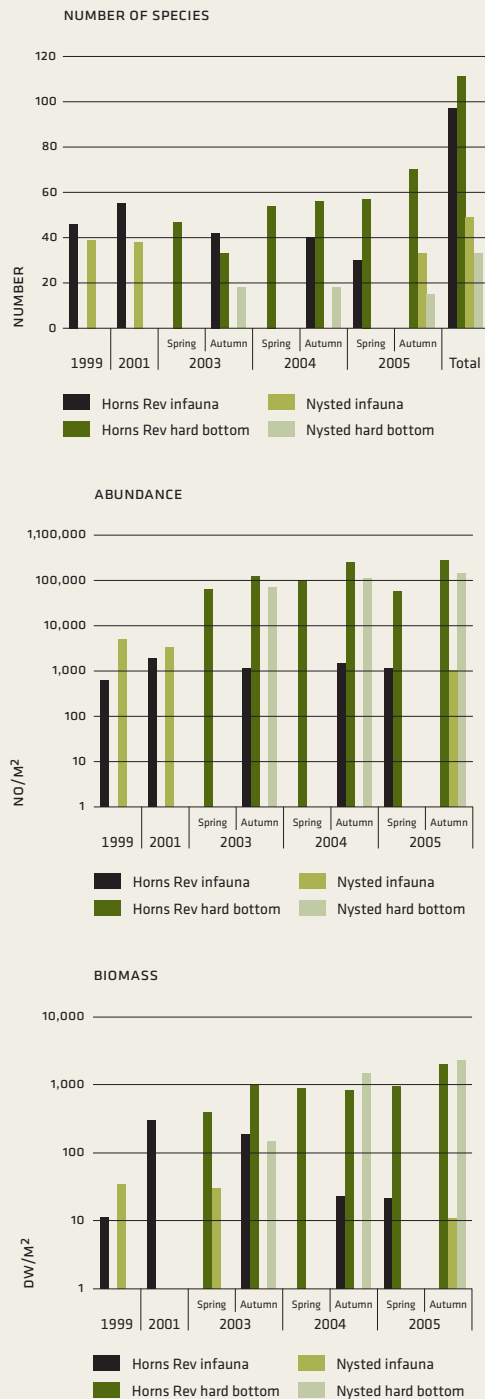
The epifouling community at Horns Rev was characterised by high species richness. The hard substrates were colonized mainly by species not previously recorded in the sandy seabed community, thereby increasing the spe-

cies richness in the area (Figure 4.11). At Nysted where more heterogeneous seabed structures were found, the colonizing communities were mainly composed of species previously recorded in the benthic mussel bed and algae communities. Almost a monoculture of common mussels had developed on the turbine structures at Nysted and the species richness at Nysted was far less pronounced than at Horns Rev. The differences in the characteristics of the epifaouling community were mainly attributable to the differences in salinity between the two sites.

No exact comparisons with a hard bottom reference site were made at Horns Rev. Similarities in the epifaouling communities were, however, found between the Horns Rev communities and the communities found in studies from other areas in the North Sea where hard bottom substrates were deployed. As in these studies, a continuous development in the succession of the epifaouling community was also found at Horns Rev. It was assessed that stability and maturity of the epifaouling communities will not be reached within 5–6 years after deployment of the hard bottom substrates. At Nysted, the species richness on the hard substrates deployed was comparable to the species richness at a nearby natural stone reef within three years after deployment.

Although most species in the epifaouling communities were found both on the vertical and the horizontal artificial structures, differences were found in community structure between different substrate types – shafts, monopiles and stones. The differences were attributable to differences in abundance and biomass of the most abundant and most important species. At Nysted, the dominance of the common mussel, the barnacle (*Balanus improvisus*) and the associated species of crustaceans (*Gammarus spp.*, *Corophium insidiosum* and *Microdeutopus gryllotalpa*) contributed to the differences between substrate types. At Horns Rev, these differences were mainly attributable to differences in dominance and biomass of the crustaceans (*Jassa marmorata* and *Caprella linearis* (*C. mutica*))

**FIGURE 4.11**  
DEVELOPMENT IN INFAUNA AND EPIFAUNA COMMUNITIES



together with the subdominant common mussel. Similar differences in community structure were found between individual turbine sites in the farm areas.

#### COLONISATION OF COMMON MUSSEL

An initial colonisation of high numbers of the common mussel was found at both wind farm sites. In 2003 densities ranging from 90,000 to 200,000 ind./m<sup>2</sup> could be found at the uppermost parts of the monopiles and the shafts of the turbines. Differences in growth rates and size, population structure and community development of the common mussel were attributable to the difference in salinities between the two farm sites. Mussel populations at the monopiles at Horns Rev grew faster and had reached a size exceeding the maximum size of mussels found at the reference site at Nysted within two–three years. The factor increase in biomass of 50–150 compared

to the biomass of the native infauna at the two wind farm sites was mainly attributable to the common mussel. The common mussel in the Baltic is generally accepted as a dwarf-form of its marine counterpart in the North Sea.

Comparable biomasses of mussels were found at the shafts at Nysted and at the monopiles at Horns Rev. Although, a more heterogeneous distribution of biomasses was found at Horns Rev.

The common mussel is a superior competitor for space compared to other sedentary species of invertebrates and macro algae, and at both farm sites the initial colonisation of the common mussel was massive. Due to a lack of efficient predators at Nysted, the common mussel was the numerically dominant species of the epifouling community. This has also been found in other studies of colonisation of deployed hard bottom structures in the Baltic area. The intra-specific competition from other mussels due to rapid



PHOTO: JENS CHRISTENSEN

**FIGURE 4.12** *Common mussel on turbine structures at Horns Rev.*



**FIGURE 4.13** Common starfish, a keystone predator at Horns Rev.



**FIGURE 4.14** Common shore crab, a predator at Nysted.

growth was attributable to the decline in the abundance of the common mussel at Nysted and it was shown that a climax in the epifaunal community was approached faster at the shafts than at the scour protection stones.

Predation is normally the main controlling factor of spatial distribution of the common mussels in the intertidal and subtidal environments. At Nysted, the predation pressure of the common shore crab (*Carcinus maenas*) was evidently too limited to affect the development and increasing dominance of common mussel. Physical disturbances and intra-specific competition were thus interpreted as the prevailing and potential limiting and structuring factors of the mussel-dominated community at the turbine structures at Nysted.

#### EFFICIENT PREDATORS AT HORNS REV

Higher salinity and the presence of more efficient predators were interpreted as the main reason for the reduced

dominance of the common mussel at Horns Rev. Spatial differences in distribution patterns of common mussels between and at the turbine sites were mainly controlled by the common starfish (*Asterias rubens*), a keystone predator at Horns Rev known to control the distribution of common mussels. As a consequence of predation by the starfish, no large specimens and only scattered aggregations of newly settled mussels were found on the scour protection. Larger mussels were only found at the uppermost parts of the monopiles. Although development in mussel community structure was found at Horn Rev, a climax community was not approached. Physical forces from wave exposure during storm events and ice scouring might be a potential limiting factor for expansion of the mussel layer both in space and thickness at the shafts and monopiles leaving space for re-colonisation by pioneering species.

The upper limit of common mussel populations is pri-



PHOTO: SIMON B. LEONHARD

**FIGURE 4.15**

Larvae tubes of the giant midge (green dots inside white spots) in the splash zone at a monopile foundation at Horns Rev.

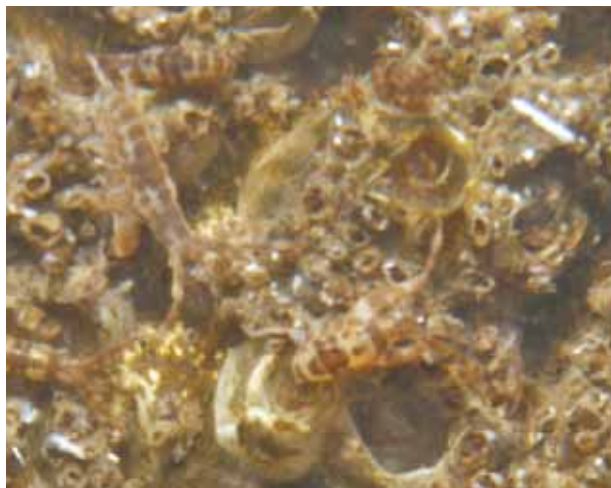


PHOTO: JENS CHRISTENSEN

**FIGURE 4.16** Colonisation of *Jassa marmorata* and barnacles at a monopile in 2003 at Horns Rev.



PHOTO: JENS CHRISTENSEN

**FIGURE 4.17**

Eddible crab at scour protection at Horns Rev in 2003.

**NEW SPECIES INTRODUCED AT HORNS REV NOT PREVIOUSLY RECORDED IN DENMARK**

The crustaceans *Jassa marmorata* and *Caprella mutica* and the midge *Telmatogeton japonicus*





**FIGURE 4.18** School of two-spotted gobies at scour protection at Nysted.

marily controlled by the synergistic effects of temperature and desiccation. Mussels at their upper limit in shallow water are replaced by more competitive species tolerant to desiccation. The barnacles known as early colonizers showed differences in species composition and distribution patterns between Nysted and Horns Rev.

At Nysted, the barnacle *Balanus improvisus* remained in the upper zone due to absence or scarcity of mussels whereas *Balanus crenatus*, known to be more intolerant to desiccation, decreased in abundance at Horns Rev shortly after colonisation. This might be a result of predation or competition for space by more competitive species. In the splash zone just above the mussel zone at the monopiles at Horns Rev, larvae of the desiccation resistant giant midge (*Telmatogeton japonicus*) were found grazing on the coating of microscopic green algae and diatoms that developed in this zone. This strictly marine insect rapidly colonised the monopiles and was found in increasing abundances from 2003 to 2005.

On the scour protection stones, increasing biomass of sea anemones and soft corals gradually reduced the relative importance of the most abundant species at Horns Rev, the tube building crustacean (*Jassa marmorata*). A dense layer of tube mats and very high abundances of

*Jassa marmorata* (nearly 1 mill. ind./m<sup>2</sup>) were found from the upper sublittoral zone on the monopiles down to the scour protection, which often covered all of the hard substrate surface completely. Due to the large abundance, *Jassa marmorata* might significantly contribute to the diet of a number of other invertebrates and vertebrates including crabs and fish.

#### IMPACT OF THE TURBINE FOUNDATION DESIGN

Although differences in species composition attributable to differences in salinity can be explained, differences in turbine foundation design between the two wind farm sites contributed to even higher differences in the scour protection communities. Although a high mobility in seabed sediments was found at Horns Rev, only slight evidences of current effects and sand scouring were found at the base of the monopiles and scour protection.

Unlike at Horns Rev, the seabed at Nysted was levelled before the foundations were deployed which resulted in a lowering of the scour protections below the surrounding seabed level at most turbine sites. In extreme cases, sand and silt intrusion at such sites buried stones and changed potentially hard bottom substrates to sandy seabeds with the potential for accumulating decaying macro algae and

so developing anoxic conditions.

The combined effects of smothering, sand intrusion and sand scouring have most likely contributed to the lower recruitment success of mussels on the scour protection below surrounding seabed levels at Nysted. However, the sedimentation of inorganic and organic matter was beneficial for settling of the tube building crustacean *Corophium insidiosum*.

Artificially deployed hard bottom substrates are generally considered beneficial to the reproduction and growth of some native mobile species, such as crabs by providing shelter and nursery grounds. This effect was only demonstrated at Horns Rev. Eggs and juveniles of different species of crab, bristle worm and sea slug were found at the turbine foundations during the survey period. The edible crab (*Cancer pagurus*) colonized the deployed hard substrates as adults and juveniles. A rapid growth of juveniles was found from 2003 to 2005.

At both wind farm sites, fish were often found swimming around the artificial reef structures apparently searching for food and shelter.

#### DEVELOPMENT IN ALGAE COMMUNITIES

On the deployed hard substrates, a succession in the development and distribution of attached algae was found. In the upper part of the monopiles at Horns Rev, a cover of algae was found shifting from an initial colonisation of filamentous green algae to a more diverse and permanent vegetation of green, brown and red algae. Some of the same species were also found colonizing the foundations at Nysted. Compared to Nysted, the macro algae community at Horns Rev was still attracting new species and increasing in depth distribution in 2005. The 2005 macro algae community at Nysted had decreased in species diversity and biomass at both shafts and scour protection since initial colonisation. Competition for space from common mussels was considered the most important factor controlling the distribution of macroalgae at Nysted.



PHOTO: JENS CHRISTENSEN

**FIGURE 4.19** Cod at Horns Rev.

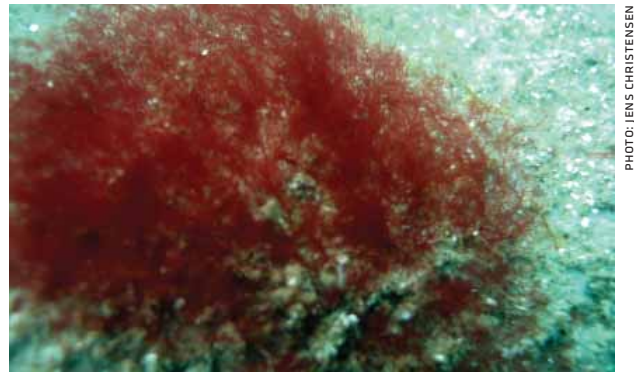
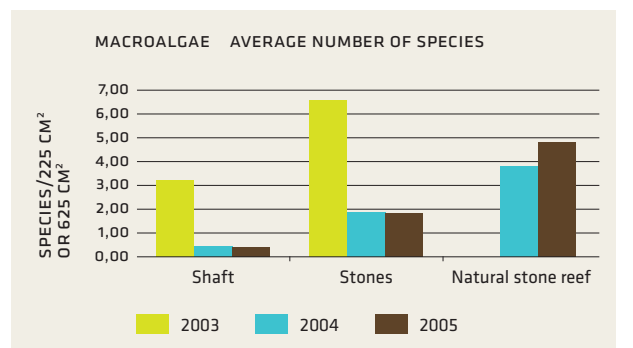


PHOTO: JENS CHRISTENSEN

**FIGURE 4.20** The red algae *Polysiphonia fibrillosa* found at foundations at Horns Rev and Nysted.



**FIGURE 4.21** Development in the number of species of macroalgae on shafts and stones of the turbines at Nysted and at a natural stone reef close to the wind farm.



**FIGURE 4.22** The white weed, a threatened species in the Wadden Sea, overgrown by *Jassa marmorata*.

#### POSSIBLE SANCTUARY AREA

The wind farm area at Horns Rev and the hard bottom structures introduced there might function as a sanctuary for species included on the Red List for threatened or vulnerable Wadden Sea species. Special attention should be given to the ross worm (*Sabellaria spinulosa*) and the white weed (*Sertularia cupressina*). These species and the native oyster (*Ostrea edulis*) that was also found around the turbine sites at Horns Rev, are regarded as threatened or red listed species in the Wadden Sea area as a result of habitat loss.

An increase in the abundance of the bristle worm (*Marenzelleria viridis*) was found since it appeared in the infauna at Nysted in 2001. This introduction was not attributable to the establishment of the wind farm as this species was found in abundant numbers elsewhere in the region.

#### NEGLIGIBLE EFFECTS ON SEABED

Results from other studies on the effect of changes in hydrodynamic regimes due to deployment of artificial reefs in the North Sea have only shown small effects on the infauna community very close to the reef. At Horns Rev, a general increase in sediment coarseness and changes in infaunal community structure was found from the pre-construction to the post-construction situation. The changes were not attributable to the presence of the wind farm because parallel changes were found at the reference sites.

The density of the most abundant bivalves and bristle worms was higher in the wind farm area than in the reference area. However, changes in the abundance and biomass of the character and dominant species, including the bristle worm (*Ophelia borealis*), were not statistically significant. The differences were mainly attributable to



PHOTO: MAXS KLAUSTRUP

**FIGURE 4.23** The American razor shell, an important food item for the common scooter at Horns Rev.

natural variations in spatial and temporal distribution and changes in sediment characteristics.

#### DECLINE OF SOME SPECIES

At Horns Rev, the most dramatic change in the benthic infauna community structure was the decline in abundance and biomass of the bristle worms (*Pisione remota* and *Goniadella bobretzkii*) from 2001 to 2004 and the decline in biomass of the bivalve thick trough shell (*Spisula solida*). In 2005, differences were found in the distribution patterns of the American razor shell (*Ensis americanus*) and another bivalve (*Thracia phaseolina*) between the wind farm area and a reference area. In the wind farm area, the American razor shell was observed in lower numbers than in the reference area whereas different observations were made for the bivalve *Thracia phaseolina*. Those observations showed differences in

abundance and biomass relations between the wind farm area and the reference area. This bivalve, although not found in very high numbers, seems to have increased in the wind farm area from 1999 to 2005 without a similar increase in the reference area.

A tendency was found towards an increase in sediment coarseness with increasing distance from the turbine foundations at Horns Rev but no significant distance-related effects on the benthic infauna community structure was detectable.

#### NO SIGNIFICANT CHANGES IN BIOMASS

At Nysted, the spatial variation and the temporal changes in sediment coarseness were generally insignificant. But average sediment coarseness was consistently lower in the wind farm area than at the reference transects. The organic content of the sediment in the wind farm area increased significantly from 2001 to 2005 and exceeded the level at the reference site in 2005. However, the differences were not attributable to the establishment of the wind farm.

A relationship was not found between sediment coarseness and the distance of the sampling stations from the cables between the turbines. The organic content was highest at the furthest distance from the cables between the turbines. Similar trends in sediment parameters were apparent in 1999 and in 2001 indicating that there was no impact from different hydrodynamic regimes related to the presence of the foundations.

Increased sedimentation of organic matter and/or decreased consumption on the seabed and turnover in the sediment could increase the accumulation of organic matter on the seabed sediment. This would have increased the abundance of deposit feeding benthic species. However, the abundance of deposit feeders had declined rapidly since 2001 in conjunction with an increase in organic matter in the sediment but a possible causal relationship is uncertain.



**FIGURE 4.24** Barnacles growing on common mussels filtering the water for plankton with their cirri.

Most of the characteristic shallow water species at Nysted declined between 1999 and 2005, including the formerly predominant species of the bristle worm (*Pygospio elegans*) and the mudsnail (*Hydrobia* sp.). Only the newly introduced species *Marenzelleria viridis* increased in numbers. The overall distribution of common mussels remained unchanged compared with 1999 but the coverage and biomass of mussels was reduced from 1999 to 2005 in the wind farm area. The changes in average biomass were not significant along the reference transects. An increase in the condition of the common mussels from 1999 to 2005 was most likely attributable to the decline in percentage cover of other species and reduction for food competition.

The causes of the decline in abundance and biomass of the benthic fauna and the coverage of common mussels in the wind farm area and along the reference transects were not obvious. The shallow water community at Nysted was not affected by imported oxygen deficiency from adjacent deeper waters or by decaying macro algae. The coverage of macro algae, mainly the dominating

detached filamentous brown algae, increased in the wind farm and reference areas from 1999 to 2005. However, the changes in coverage and distribution of macro algae were attributable to the combined effects of natural variations and weather induced changes in the transport and accumulation of macro algae. The changes were not attributable to changes in hydrodynamic regimes as an effect from the establishment of the wind farm.

#### NO SIGNIFICANT EFFECT ON EPIFOULING COMMUNITIES

Only insignificant differences were found in the epifouling communities at different directions and exposures of the turbine foundations. This indicates that there was only a negligible impact from the differences in current regimes and exposures on the community structure.

On the scour protections at Horns Rev, no statistically significant differences were found in fouling community structure between the leeward and current side of the monopiles. However, a statistically significant difference was found between the two sides in the zone near the bottom of the monopiles. This indicates an impact

from different hydrodynamic regimes on each side of the monopiles. Differences in community structure on the scour protections between overlapping zones on the leeward side of the monopiles might also reflect the effect of turbulence in the hydrodynamic regimes.

At Nysted, no statistically significant differences attributable to changes in current regimes were found in the structure of the benthic communities. However, the community on the scour protection stones was significantly different from the community on the shafts and the stones in foundations chambers.

#### IMPACTS OF SEDIMENT SPILL AND DREDGING

During the construction phase, impacts from sediment spillage on the benthic communities at Horns Rev were negligible due to the construction method applied, namely the monopile concept. Due to the character of the seabed, no monitoring studies were carried out on the impact to infauna. Modelling of different plume dispersion scenarios for cable jetting was not considered. Cable jetting activities might have resulted in limited release of sediment and spill with a temporary increase in water turbidity, but a worst-case spill scenario for gravitation foundations showed only very local and short-term impact. This impact was much lower than the natural variation in the redistribution and accumulation of re-suspended sediment in the area.

At Nysted, dredging activities in connection with the excavation of the gravitation foundations contributed to an increase in turbidity and sedimentation of spillage attributable to the methodology approach and the foundation design. The impacts on benthic communities were temporary and of limited spatial importance. However, detailed surveys along the cable trench from the wind farm to the coast revealed that eel grass, macro algae and benthic infauna were affected close to the trench. Eel grass had recovered but recovery of macro algae and benthic infauna was still in progress two years after the

major part of the earthwork was completed.

In the fouling communities at Nysted, sediment spill during seabed work and frequent re-suspension of the sediment due to heavy ship traffic might have contributed to a delayed settling and recruitment process of mussels on shafts and stones at the transformer platform in 2003.

#### DISCUSSION

### INDIRECT EFFECTS ON BENTHIC FAUNA

---

Differences and changes in abundance and biomass patterns observed in benthic faunal communities between the wind farm areas and reference sites might reflect indirect and secondary effects on the infauna community from the establishment of the wind farms. These indirect and secondary changes might be attributable to changes in feeding behaviour of sea birds and fish due to the presence of the wind turbine structures and a restriction in fishery activities inside the wind farm areas. On a regional scale, these effects might also contribute considerably to the cumulative impact on the benthic communities from more wind farms.

#### EFFECTS OF LESS FISHING ACTIVITIES

The benthic communities in the Horns Rev area outside the wind farm are influenced by bottom trawling for sandeels and brown shrimps and dredge-fishing for clams (*Spisula solida*). The benthic community inside the wind farm area might indirectly be affected by the termination of fishing activities. The exclusion of trawling activities might be beneficial to the benthic communities by increasing prey species populations and reducing disturbance by fishing gear. This would enable the species to mature to their natural sizes and allow very sensitive and long-lived species to establish populations. Constraints on fishing efficiency in areas between two or more wind farms might further be beneficial and contribute to a cumulative impact on the benthic communities.

## IAPEME VIEWPOINTS

The “artificial reef effect” was a prominent feature of the initial discussions relating to the environmental impact of scour protection around wind turbines. The information from the Horns Rev and Nysted wind farms allows the ongoing discussion of the ecological pros and cons of deploying scour protection to be based on data rather than suppositions. The use of industry standard methodology (photo and video transects, Van Veen grabs, diver hand cores, analytical software such as PRIMER) allows comparisons with previous and future work on soft and hard substrates.

### EPIBENTHOS

Epibenthic community structures at Nysted and Horns Rev wind farms differ in community composition. However, both sites showed, as hypothesised in the EIA, that the new, hard substrate (provided by the scour protection, gravity foundations and the steel tower) was colonised rapidly by both marine plants and animals. The differences in community structure between the wind farms reflect environmental differences between the areas, in this case most notably the salinity regimes as well as the supply of larvae and mobile adults. This colonisation recorded reflects the position found on most artificial reefs that colonisation of hard surfaces is rapid and community structure develops with time. Initial species composition reflects the season of deployment and the availability of species able to colonise, be they adults, juveniles or planktonic larvae, and so neither community can be considered as “typical” of all wind farms in either the North Sea or the Baltic Sea but representative of what is likely to happen under similar circumstances. What is obvious from these data is that both wind farms are

still developing their epibiotic communities, and data collected in 2005 cannot be taken to describe the final biological communities. There is a need for long-term monitoring of both wind farms to provide an appreciation of how the communities will develop and contribute to the ecology of the area, so providing a long-term dataset against which other wind farm developments can be judged. *Asterias rubens* as a predator of the Horns Rev *Mytilus* community is likely to have played a key role in preventing a “mussel monoculture” from developing by opening up space for other epibiota to settle, so increasing species diversity. This predator was absent from Nysted, presumably because of the low salinity, so allowing a *Mytilus* community to dominate.

In the case of Horns Rev, there is a particular need to understand the role of the scour protection in the ecology of the wind farm area. Whilst sedentary epifauna will be restricted to the hard surfaces, some mobile species, eg cryptic fish species such as gobies and blennies and invertebrates such as crabs, will move out onto the sandy areas between the scour protection to forage, possibly creating a feeding halo around each turbine. As wind farm numbers in the North Sea increase, so may the volume of scour protection, providing new habitats for these species.

It is also possible that the absence of trawling and dredging within a wind farm will promote increases in the abundance of the infauna. At Horns Rev this will always be influenced by the inherent mobility of the sandy sediment. In the case of exploited species, such as *Spisula*, densities may increase both as a result of a reduction in harvesting by humans and an

apparent reduction of predators such as the scoter entering the wind farm. The latter may change in time should these ducks become acclimatised to conditions around the wind farm.

The presence of commercial species such as cod and the edible crab *Cancer pagurus* at Horns Rev also gives rise to the question of how future wind farm expansions might influence the population of such commercially valuable mobile species through deposition of scour protection. Research into residence periods, shelter and food requirements for such species around wind farms would be the start of establishing the ecological links between the scour protection communities and potentially exploitable species leading to an assessment of how significant turbine scour protection could be to commercial species.

Speculation about crab and cod populations requires novel research in the future. However, the scientific effort that focused on the scour protection at Horns Rev has already provided dividends for science in identifying new species in Danish waters (*Telematogenton japonicus*, *Jassa marmorata* and *Caprella mutica*). In addition, researchers identified species on the Wadden Sea “red list” (*Sabellaria spinulosa*, *Serularia cupressina* and *Ostrea edulis*) utilising the scour protection habitat thus indicating the value of detailed study into the marine biota colonising newly deployed habitats.

The fragility and temporary nature of shallow water epibenthic communities in exposed locations must also be recognised. Whilst the Horns Rev epibiota appears to have been developing each year since deployment, a severe storm in 1999 removed all

fouling from a meteorological mast in the area. It is possible that a future storm might do the same to the biota on the scour protection, potentially reversing a substantial proportion of the community development.

#### INFAUNA

Infaunal data also show the strong influence of environmental factors on the sediment communities. The two wind farms differ in their biological composition, with the lower salinity sediments at Nysted supporting a *Macoma* community whilst the higher energy and salinity environment at Horn Rev revealed a *Goniadella-Spisula* community. The presence of internationally recognised infaunal communities will help when comparing the Danish data with potential new wind farm sites. Data collected show that whilst some changes in infaunal biology and sediment characteristics have taken place these do not seem to be focused within either wind farm area. A heterogeneous distribution within the sediment seems to be the norm at both sites and natural variability is to be expected, especially in the high energy environment of Horns Rev. Changes in the hydrographic character of the sites post wind farm deployment seem to be minimal, suggesting the spacing of the wind turbines is sufficient to minimise disruption to water flows.



## FISH FEW EFFECTS ON THE FISH COMMUNITIES SO FAR

BY MAKS KLAUSTRUP, ORBICON

Overall, the studies have so far found few effects on the fish fauna that could be attributed to the establishment and operation of the wind farms.

Fish abundance and diversity were not higher inside the wind farms than in the areas outside the wind farms. At Horns Rev, one important reason for this could be that the studies and investigations were made during the early stages of colonisation of the turbine foundations that constitute the artificial reefs. At Nysted, the effect was presumably weak because the benthic community consisted of a monoculture of large common mussels that are only moderately attractive to fish.

Investigations into the effects on fish and fish behaviour from electromagnetic fields were made at Nysted. Data have documented some effects from the cable route on fish behaviour indicating avoidance of the cable as well as attraction, depending on the species. However, only flounder showed correlation between the phenomena observed and the assumed strength of the electromagnetic fields.

## CONTENTS

- Introduction: New habitat and sediment
- Methods: Fish abundance and distribution
- Results: Similar effects at the two farms
- Discussion: No effect on fish yet
- IAPEME viewpoints

## INTRODUCTION

### NEW HABITAT AND SEDIMENT

Offshore wind farms may influence the fish fauna and the fish communities during four different stages of a wind farm's existence: pre-construction, construction, operation and decommissioning. In connection with the establishment of the offshore wind farms at both Nysted and Horns Rev, a number of surveys and investigations were carried out to document and assess the possible effects from the wind farms on the fish fauna community. The main effects associated with pre-construction surveys (seismic investigations) and the construction of the wind farm only took place during short transition phases and were not expected to have long-term effects on fish. However, two elements have long-term effects: the establishment of turbine foundations, which create new hard substrate habitats, and the transmission of the electric power to the shore, which generates a weak electromagnetic field along the cable that may be sensed by several species of fish. This chapter focuses on these two effects.

#### INCREASING HABITAT DIVERSITY

Fish communities reflect the habitats they live in and a change of habitat is expected to be reflected in the fish community. The establishment of an offshore wind farm in areas where the seabed is made up of sand leads to a loss of natural habitats by the introduction of foundations and the rocks and stones that serve as scour protection. This was the case at Nysted and Horns Rev.

The attraction of fish to the scour protection is spe-

cies specific and may take place for a number of reasons. Resident fish species are expected to be attracted to the scour protections and turbine foundations (artificial reefs) because they offer shelter against predators and strong water currents. In addition to this, some fish may visit the artificial reefs to feed, while others may use the reefs as spawning and nursery areas for juvenile fish. Further, the reefs may function as important sanctuaries for some species due to restrictions in commercial fishing within the wind farm areas.

The turbine foundations are typically constructed over a short period of time with the biological colonisation known to begin shortly after the construction. However, full development of the reef community is area specific and typically takes several years since not all species colonise the new habitats simultaneously and some species continue their growth. Thus, in most areas the full effect of the new habitat can be expected only after several years.

#### CHANGE OF WATER CURRENTS AND SEDIMENT

The introduction of artificial physical structures on the seabed invariably influences the direction and strength of the water currents, and these changes in the flow of water may change the composition of the sediments by moving sand and clay to new locations. This can have a large impact on fish, such as sandeel and flatfish that bury themselves in the sediment and rely on very specific sediment conditions (ie grain sizes) in order to do this.

#### NEW ELECTROMAGNETIC FIELD

The power from the offshore wind farms is transported to the shore through power cables surrounded by weak electromagnetic fields. As electromagnetic fields are sensed by some fish species, the power cables may influence the behaviour and migration of the fish fauna in areas traversed by the cables. In the extreme case the cable could act as a barrier to the migration of fish, especially for species that use the Earth's magnetic field for navigation and orientation.

The present investigations of the fish fauna around Nysted and Horns Rev aimed at evaluating 1) the effect of the introduced stone habitat on the abundance and composition of the fish fauna, 2) the effect of the wind farm on the abundance and distribution of sandeel and, finally, 3) the potential effect of the electromagnetic fields on the behaviour and migration of fish approaching the power cable.

## METHODS

### FISH ABUNDANCE AND DISTRIBUTION

The species and size composition of the fish fauna around Nysted and Horns Rev were investigated by fishing with conventional survey equipment (gill nets and trawls). The spatial and temporal distribution of fish at the Nysted Offshore Wind Farm and Horns Rev Offshore Wind Farm was furthermore monitored by use of advanced hydroacoustic equipment with the aim of detecting any effects produced by the wind turbines. The hydroacoustic method measured both the number of individuals and their biomass. While the method is capable of distinguishing between fish with and without a swim bladder it does not provide information in relation to species level.

The range of the horizontally positioned transducer of the hydroacoustic equipment was 0–100 m, resulting in a “window” of 15.7 m by 7.7 m (Figure 5.1). Surveys were typically made along transects at speeds of 1–3 knots. The hydroacoustic setup consisted of a SIMRAD EK60 echo sounder and a split-beam transducer mounted on a pan and tilt unit (Figure 5.2), all controlled by a laptop equipped with a GPS-receiver.

The methods and procedures of the two hydroacoustic surveys carried out at the Horns Rev Offshore Wind Farm and Nysted Offshore Wind Farm were identical. The surveys consisted of two transects across the areas (gradient transects) from east to west (E/W) and north to south (N/S) to detect possible upward or downward gradients

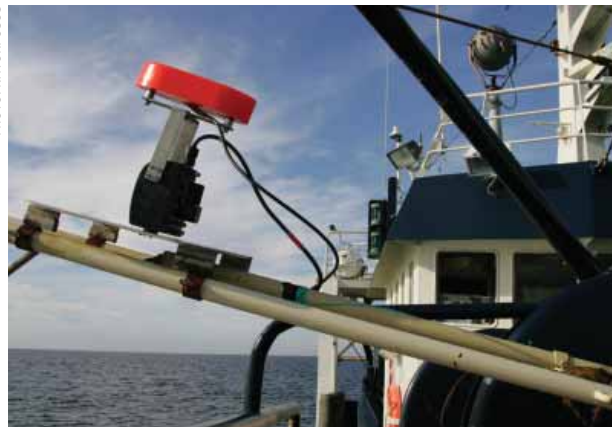
PHOTO: NATURFOCUS



**FIGURE 5.1** Illustration of the setup for the hydroacoustic surveys along transects.

**FIGURE 5.2**

PHOTO: NATURFOCUS



*Transducer mounted on the vessel.*

in fish density along a transect perpendicular to the wind farm area (Figure 5.4). In addition, a transect survey was carried out to detect differences between inside (Impact) and outside (Reference) the wind farm. Each location was sampled twice in both daylight and darkness.

## SURVEYS OF SEDIMENT AND SANDEEL

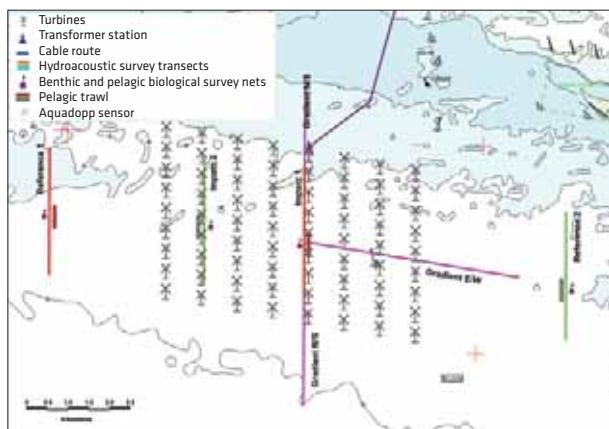
At Horns Rev, sandeel (*Ammodytidae spp.*) is one of the



PHOTO: MAKS KLAUSTRUP

**FIGURE 5.3** Sandeel at the scour protection.

**FIGURE 5.4** NYSTED OFFSHORE WIND FARM AND HORNS REV OFFSHORE WIND FARM



Maps of the Nysted Offshore Wind Farm (left) and the Horns Rev Offshore Wind Farm (right) showing layout of transects in the wind farm areas and the areas outside the wind farm.

most abundant groups of fish. Due to a known strong correlation between the distribution of sandeel and the composition of the sediments, the distribution of both sandeel and sediment composition was surveyed. A modified scallop dredge was used to sample sandeels. Five replicates were made at each location. Each haul lasted for 10 min. and covered an area between 815 and 1,111 m<sup>2</sup>. At each haul location, three replicates of sedi-

ment samples were taken with a Van Veen grab (0.2 m<sup>2</sup>). The sediment was dried and sieved through a standard Wentworth series to obtain information about grain size distribution.

#### FISH BEHAVIOUR AT THE POWER CABLE

Surveys and an assessment of the effect on fish by electromagnetic fields were exclusively carried out at Nysted.

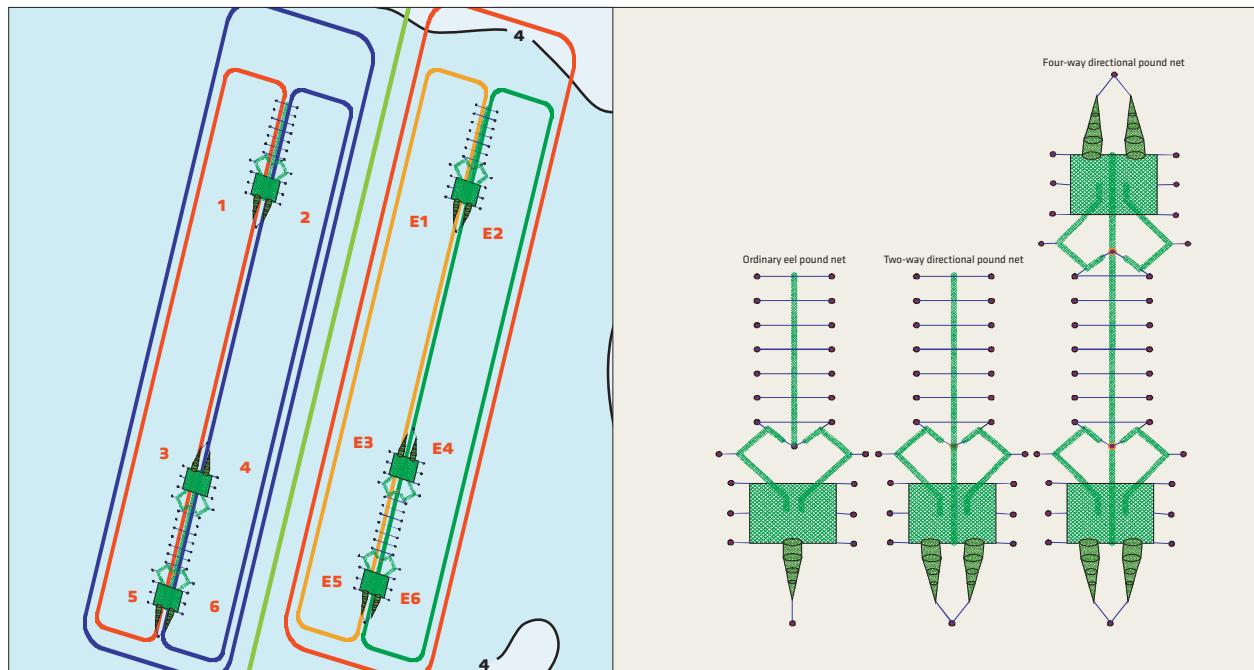
For this purpose, specially designed setup and fishing gear were developed and applied to the area along the cable route connecting the wind farm with the shore (Figure 5.5). Initially, ordinary pound nets were used simply to monitor the fish fauna on each side of the power cable. However, the setup underwent considerable improvements from 2001 to 2004. The final design of fishing gear included two types of pound nets, bi-directional and quadri-directional. One bi-directional and two quadri-directional pound nets were placed on each side of the cable. This setup made it possible to detect the migration direction of the fish and estimate the number of fish crossing the cable.

In order to relate behavioural patterns of the fish with local oceanographic conditions, a CT probe (Aquadopp™) with automatic and continuous logging was placed between

the pound nets. The probe measured the direction and velocity of water current together with water temperature and salinity (conductivity) every half hour during the sampling periods.

As part of the survey programme at Nysted, the migration direction for common eel (*Anguilla anguilla*) was investigated through a mark and recapture programme carried out in 2004. Eels caught in the pound nets were marked with individual numbers using Hallprint T-bar tags in a bright yellow colour making them easily recognizable. Before tagging, the length and weight of each individual was measured. After being tagged, the eels were released on the same side of the power cable as they were caught and at a distance of at least 400 m from the power cable. Fishermen then recaptured the tagged fish and reported the catches to the survey programme.

**FIGURE 5.5** MAP OF THE SURVEY SETUP



The green line illustrates the cable route and E1-E6 represent 6 fykes east of the cable and W1-W6 represent 6 fykes west of the cable (right) and the design of the pound nets, ordinary, two-way directional and four-way-directional (left).

## RESULTS

### SIMILAR EFFECTS AT THE TWO FARMS

The species composition, distribution and abundance of fish differed between the two wind farm sites. The differences were to a large extent attributable to a number of physical and biological factors. Generally, the fish communities at Nysted and Horns Rev differ primarily due to differences in salinity. Due to the position in the Baltic Sea, the water found at Nysted is more brackish (lower salinity) than the water found at Horns Rev, which is positioned in the North Sea.

#### HORNS REV – AN AREA IN THE NORTH SEA

At least 42 fish species are known to inhabit the ICES squares that cover the area around Horns Rev. The fish

Sandeel is one of the fish families that is most important to the fishing industry in the North Sea. Sandeel has a diel cycle, feeding in the pelagic during the day and remaining buried in the sand during the night. Besides light intensity, other physical and biological parameters have been found to influence the distribution of sandeels. The sandeel is found to inhabit turbulent and exposed sandy areas, such as the edges of sandbanks with strong tidal currents. However, the most important factor to the distribution and abundance is the texture (grain size distribution) of the sediment. The distribution of sandeel is correlated with a narrow range of sediment grain sizes, the preferred grain size being between 0.25 mm and 1.2 mm. Sandeels avoid both gravel (coarser sediments) and silt/clay (finer sediments).

fauna where the wind farm is situated (sandy habitat only) is probably less rich in species. A total of 18 species were caught prior to the establishment of the wind farm. The fish fauna at Horns Rev consists mainly of species adapted to strong currents, but other species may occasionally be found in the area (Figure 5.6).

Most of the fish caught during the survey in 2002 were benthic fish with a high affinity for a sandy bottom. The most abundant group of fish at Horns Rev was sandeel (*Ammodytidae spp.*). This group was represented by three species, ie lesser sandeel (*Ammodytes marinus*), small sandeel (*Ammodytes tobianus*) and great sandeel (*Hyperoplus lanceolatus*) with the last one being the most abundant species. Catches of sandeel in 2002, prior to the construction of the wind farm at Horns Rev, are listed in Figure 5.6 together with the other most abundant species.

**FIGURE 5.6** MEAN NUMBERS OF INDIVIDUALS OF SPECIES AT HORNS REV

SPECIES	MEAN NUMBER OF FISH
	IND/KM <sup>2</sup>
Scaldfish	461
Dragonet	2,777
Herring	512
European anchovy	103
Sandeel spp.	19,800
Atlantic cod	215
American plaice	1,208
Dab	2,306
Whiting	835
Short-spined sea scorpion	100
African armoured searobin	467
Butterfish	120
Plaice	3,682
Sand goby	6,057
Sprat	835
Broad-nosed pipefish	120

Mean numbers of individuals of species caught at Horns in 2002, before the establishment of Horns Rev Offshore Wind Farm.

## NYSTED – AN AREA IN THE BALTIC SEA

The fish fauna at Nysted along the cable route comprises a total of 43 species. The most abundant species caught was Baltic herring (*Clupea harengus*), Atlantic cod (*Gadus morhua*), short-spined sea scorpion (*Myoxocephalus scorpius*), flounder (*Platichthys flesus*), common eel and eelpout (*Zoarces viviparus*). The ten most abundant species are listed in Figure 5.7. Furthermore, the catches showed large temporal variations; common eel showed a special pattern with most of the eels being caught around new moon, all years.

In the expected wind farm area, 24 species were caught during the baseline survey in 2001. Sandeels and cod-like fish were found to be the two most abundant groups (Figure 5.8).

### ATTRACTION OF FISH SPECIES TO NEW HABITATS

During the fishery associated with the hydroacoustic survey at Horns Rev, 21 species were caught with sand goby (*Pomatoschistus minutus*), sandeel, plaice (*Pleuronectes platessa*) and dab (*Limanda limanda*) being the most numerous (Figure 5.10). At Nysted, 16 species, dominated

by small sandeel, atlantic cod, short-spined sea scorpion and flounder, were caught (Figure 5.12).

At both Horns Rev Offshore Wind Farm and Nysted Offshore Wind Farm, the fishing indicated that the species compositions were similar inside and outside the wind farm areas.

**FIGURE 5.8** THE TEN MOST ABUNDANT SPECIES AT NYSTED IN 2001 BASELINE SURVEY

SPECIES	2001
	NUMBER
Atlantic cod	758
Great sandeel	642
Whiting	428
Small sandeel	423
Eelpout	133
Fifteen-spined stickleback	118
Sand goby	99
Brisling	82
Short-spined sea scorpion	60
Baltic herring	32

*The ten most abundant species caught at Nysted before the establishment of the wind farm*

**FIGURE 5.7** THE TEN MOST ABUNDANT SPECIES AT NYSTED ALONG THE CABLE ROUTE

SPECIES	2001	2002	2003	2004
	NUMBER	NUMBER	NUMBER	NUMBER
Baltic herring	2815	342	4459	2180
Atlantic cod	2108	308	4772	1115
Flounder	1005	1289	1342	1363
Short-spined sea scorpion	1171	496	1078	1232
Common eel	678	77	391	231
Eelpout	67	517	293	154
Brisling	11	602	292	119
Black goby	24	73	580	120
Hornfish	148	52	365	64
Whiting	6	2	368	19
Total	8033	3758	13940	6597

*The ten most abundant species caught at Nysted along the cable route before the establishment of the wind farm (2001-2002) and after establishment of the wind farm (2003-2004)*

**FIGURE 5.09** *Catch from Nysted.*



PHOTO: CHRISTIAN B. HVIDT

**FIGURE 5.10** THE FISH FAUNA AT HORNS REV OFFSHORE WIND FARM

SPECIES	INSIDE THE WIND FARM	OUTSIDE THE WIND FARM
	NUMBER	NUMBER
Snake pipefish	1	0
Lesser pipefish	0	1
Saithe	1	0
Whiting	1	0
Atlantic cod	10	0
Atlantic horse mackerel	9	10
Striped mullet	6	1
Goldsinny wrasse	2	0
Corkwing wrasse	1	0
Lesser sandeel	6	111
Small sandeel	0	11
Great sandeel	5	8
Sand goby	295	57
Dragonet	2	4
Tub gurnard	1	0
Short-spined sea scorpion	1	0
Brill	1	0
Scaldfish	6	12
Dab	24	11
European plaice	56	8
Solenette	1	0

*The number of fish caught in biological sample nets and trawl in association to the acoustic survey.*

**FISH ABUNDANCE IN WIND FARM AREAS**

A total of 12,099 and 18,388 fish were registered during the hydroacoustic surveys at the Horns Rev Offshore Wind Farm and Nysted Offshore Wind Farm, respectively. Overall, a similar pattern in data of fish density inside and outside

**FIGURE 5.11** THE FISH FAUNA AT NYSTED OFFSHORE WIND FARM

SPECIES	INSIDE THE WIND FARM	OUTSIDE THE WIND FARM
	NUMBER	NUMBER
Herring	1	3
Sprat	2	1
Whiting	2	1
Atlantic cod	7	2
Small sandeel	0	10
Great sandeel	0	2
Sand goby	1	0
Rock gunnel	1	0
Eelpout	1	0
Short-spined sea scorpion	6	0
Longspined bullhead	3	0
Hooknose	4	0
Turbot	0	2
Dab	0	2
Flounder	2	4
Common sole	1	0

*The number of fish caught in biological sample nets and trawl in association to the acoustic survey.*



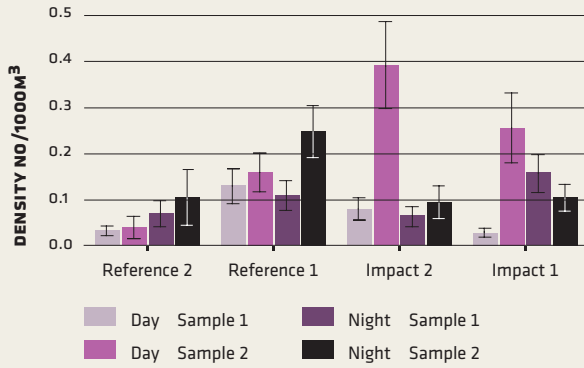
the wind farms was observed at both wind farms.

The overall distribution of fish from the transect surveys showed no clear patterns of variation between night and day in neither density nor biomass within any of the two wind farm areas (Figure 5.12–5.13). At Nysted, biomasses were statistically different between the individual transects, with transect Impact 1 having the lowest and transect Reference 1 having the highest value (Figure 5.13). In general, fish densities were higher

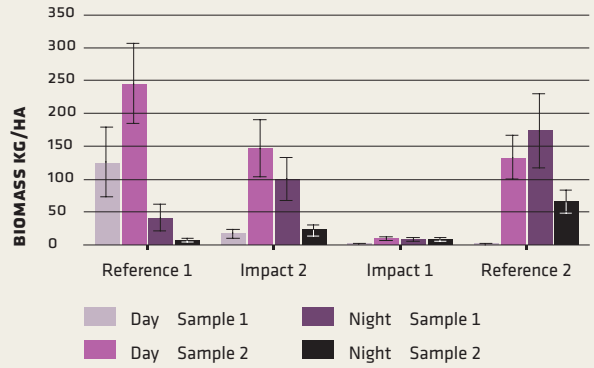
during the second sampling period showing a temporal variation in both areas.

The density of fish at the Nysted Offshore Wind Farm was found to have a patchy spatial distribution pattern, especially inside the wind farm area. Hence, the distance to the nearest neighbour (distance between two fish) outside the wind farm was higher during darkness than during daytime revealing that the fish were more aggregated during daytime. The opposite spatial distribution

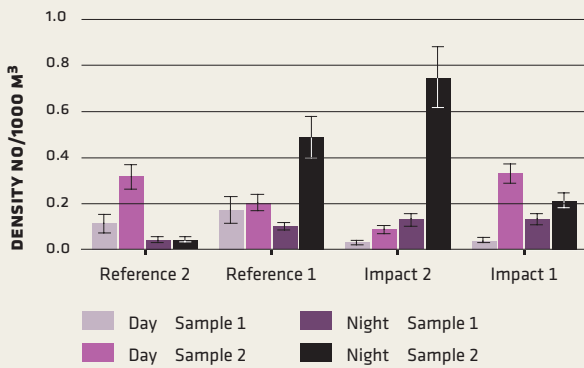
**FIGURE 5.12** MEAN FISH DENSITY AT HORNS REV



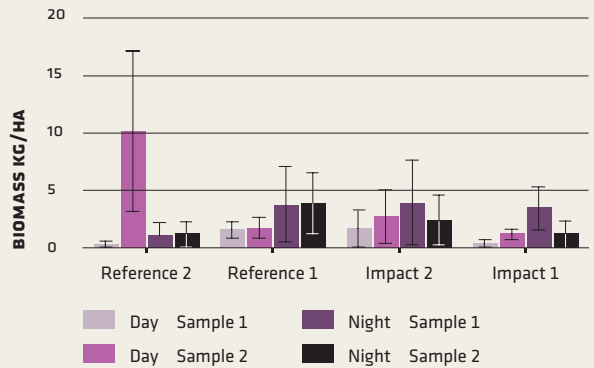
Mean fish density (ind./1,000 m<sup>3</sup>) at Horns Rev Offshore Wind Farm during daylight (day) and darkness (night) along two transects in the wind farm area and in the reference area.



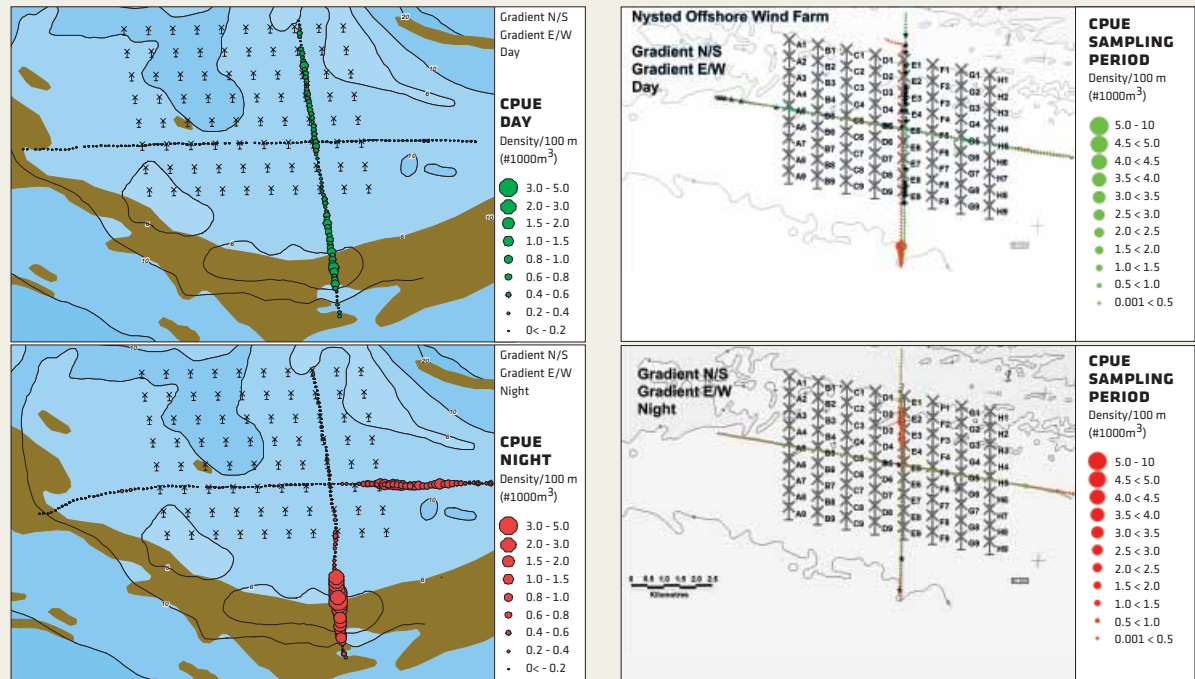
**FIGURE 5.13** MEAN FISH DENSITY AT NYSTED



Mean fish density in CPUE (ind./1,000 m<sup>3</sup>) at Nysted Offshore Wind Farm during daylight (day) and darkness (night) transecting the impact and reference areas at each sample.



**FIGURE 5.14 FISH DENSITY**



Fish density in CPUE (ind./1,000m<sup>3</sup>) along the gradient transects at Horns Rev (left) and Nysted (right) during day and night. The sizes of the circles are proportional to the fish density.

pattern was found inside the wind farm area. It remains unknown if this pattern is a result of the wind farm.

The abundance of fish along the two gradient transects showed similar patterns at both wind farms with no correlation being found between distances from the wind farm and densities of fish (Figure 5.14). However, a tendency for higher densities of fish around varying bathymetries and coarse sand was observed, indicating that the fish faunas in both areas are more influenced by these factors than by the wind farm.

**LOCAL EFFECT ON FISH**

At Nysted, local variations in the spatial distribution patterns were observed inside the wind farm although no significant statistical differences were found. However, the



**FIGURE 5.15** Trawling near Nysted Offshore Wind Farm.

importance of the hydrographical pattern to fish abundance was demonstrated at the Nysted Offshore Wind Farm. A diel variation was observed, ie densities at night were in general

PHOTO: CHRISTIAN B. HVIDT.

10 times the amount found during daytime. Furthermore, fish densities in the northern part of the wind farm were higher than in the southern part (Figure 5.16).

This distribution pattern was found to coincide with an observed east to west oriented current, dividing the wind farm area with a clear boundary. One third of the transect is situated to the south with a high current velocity and the remaining two thirds of the transect is situated to the north with less current velocity. Hence, patterns suggest that natural factors, such as the current regime, may over-shadow any effect from the wind farm.

#### SANDEEL NOT ADVERSELY AFFECTED

A total of 1,517 individuals of sandeel were caught at the Horns Rev Offshore Wind Farm, ie 540 individuals in 2002 and 977 individuals in 2004. The majority (59%) of the sandeels caught were great sandeels. The density of sandeels increased by approx 300% from 2002 to 2004 within the wind farm area and decreased by 20% in the control area during the same period (Figure 5.17).

The increase in sandeels inside the wind farm areas

FIGURE 5.18 THE CATCHES OF SANDEELS

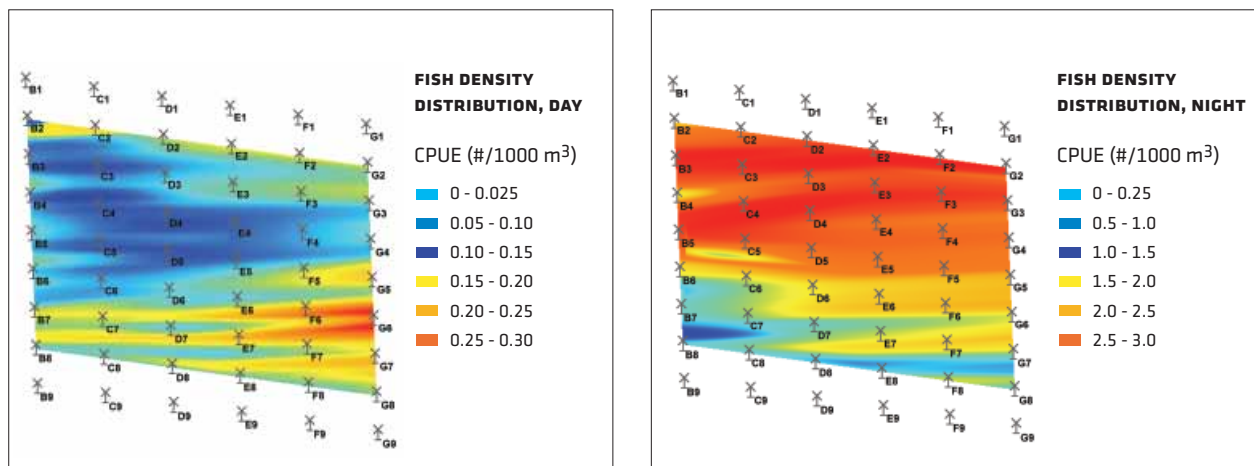
YEAR	SPECIES	INSIDE THE WIND FARM AREA	OUTSIDE THE WIND FARM AREA
2002	Lesser sandeel	2.5	3.3
	Small sandeel	1.1	1.6
	Great sandeel	5.6	5.1
	Sandeel ssp.	0.4	0.2
2004	Lesser sandeel	0.6	0.3
	Small sandeel	11.1	0.8
	Great sandeel	18.6	7.1
	Sandeel ssp.	0.0	0.1

was mainly caused by a large increase in specimens that were less than 8 cm in length. Furthermore, the density changes do not indicate that the construction of the wind farm had any effect on the sediment composition as no increase in clay/silt and fine sand from 2002 to 2004 was observed. Hence, it is unlikely that the wind farm has a negative effect on the sandeel.

#### NO PROVEN ELECTROMAGNETIC EFFECT

The investigations made at Nysted to detect any effects from the electromagnetic fields on migration and behaviour

FIGURE 5.16 MAP OF FISH DENSITY



Map of fish density based on CPUE values from the hydroacoustic data from the second sampling period in the wind farm area. An east-westward current boundary was visually observed between turbines B5 and B6. Please note the tenfold difference in legend values between day and night.

Sandeel is a short-living species that is strongly influenced by recruitment. The variation in recruitment is expected to be strongly dependent on environmental factors. Thus, the variation in sandeel abundance at Horns Rev is most likely a consequence of environmental factors influencing the recruitment. The dynamic abundance of sandeel at Horns Rev is expected to be controlled by several other factors such as predation by birds, piscivore fish, marine mammals, human impact and hydrographical parameters. Ecosystem modelling of the mortality dynamics reveals that predation by fish, especially by mackerel, whiting and haddock, exceeds the mortality induced by both industrial fishing and wildlife. At the Horns Rev Offshore Wind Farm, the main impact on sandeels is expected to be from piscivorous species, such as whiting and cod, since the foundations are suitable to attract these species.



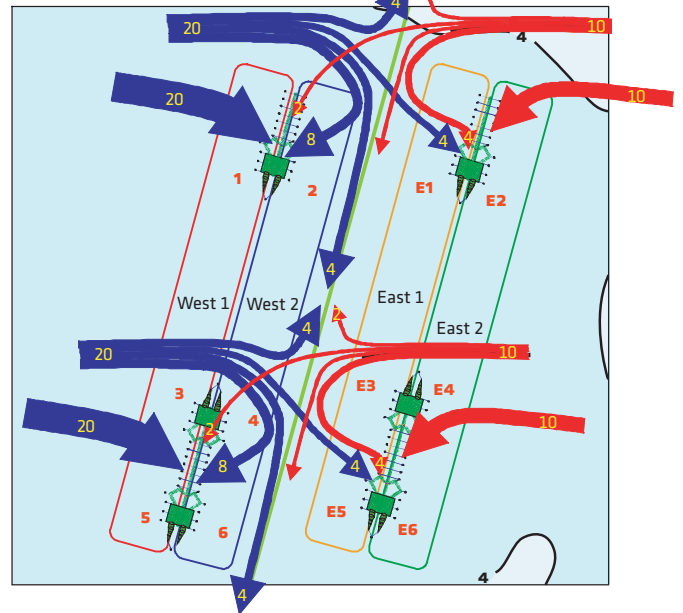
PHOTO: MAKS KLAUSTRUP

FIGURE 5.18 Short-spined sea scorpion eating a sandeel.

of fish were characterised by high complexity and many difficulties, both in the sampling phase and in the analysis phase. As a consequence, analysis including baseline data was not possible and the analysis includes only data from 2003 and 2004. As part of the data analysis, a conceptual model was formulated as depicted in Figure 5.19. The model represents an open system with bi-directional migration across and along the cable route.

Two effect measures were defined and subsequently used for the statistical test of possible effects on fish behaviour from the cable, here referred to as Effect1 and Effect2. Both measures were calculated from the catches in the inward and outward facing fykes on each side of the cable. Effect1 measures possible asymmetries in the catches across the cable route indicating an east-west/west-east migration, depicting a hindrance or blocking effect from the cable route. Effect2 measures the possible import or export of fish along either side of the cable route and also indicates effects on fish behaviour.

FIGURE 5.19 CONCEPTUAL MODEL



Conceptual model: open system with export, bidirectional movements. Numbers shown indicate a hypothetical distribution.

On the basis of the combined data from 2003 and 2004, significant impacts were found for Effect1 for four species: baltic herring, common eel, atlantic cod and flounder. These results suggest that migration of some species across the cable route may be impaired. On the other hand, the results do not suggest that the migration is completely blocked. Regarding Effect2, significant results were only obtained in two cases. The first case indicates that some of the common eels react by leaving the area along the cable route when analysing the combined data. In the second case, the 2003 data indicate that Atlantic cod accumulate close to the cable route.

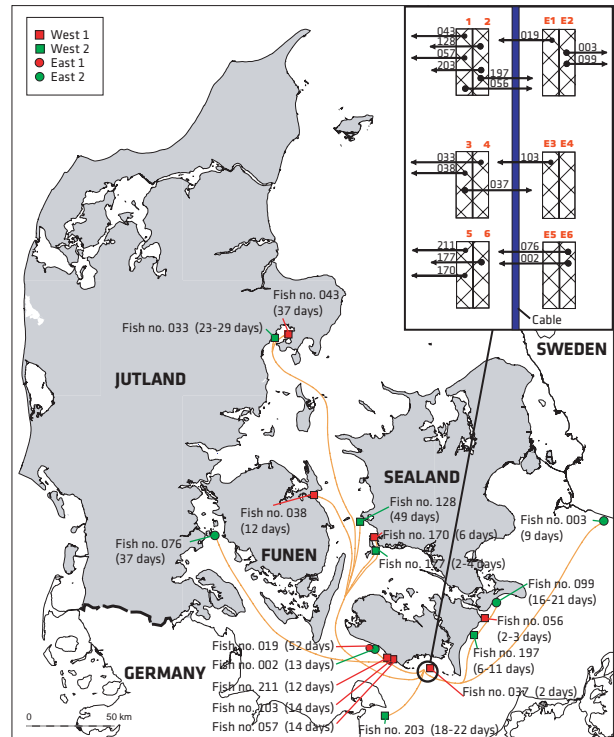
The electromagnetic field around the cable was not measured. However, assuming that the power production at the wind farm is proportional to the strength of the electromagnetic fields, possible correlations between Effect1 and Effect2 and the power production were examined. A significant correlation was found only for flounder. Flounder primarily crossed the cable when the strength of the electromagnetic fields was estimated to be low, ie during calm periods.

Altogether, the investigations along the cable route at Nysted show some effects from the cable route on fish behaviour. However, the analyses of data have only to a very limited extend proven a correlation between these impacts and the strength of the electromagnetic fields. One alternative explanation may be that fish reacted to the physical conditions along the cable route if the seabed was not fully re-established.

#### MIGRATION DIRECTION FOR COMMON EEL

In the mark-recapture study, 231 common eels were marked and 18 were recaptured. Of the recaptured eels, 13 (72%) migrated in a westerly direction and the remaining 5 (28%) migrated eastward. The results showed that 7 (39%) of the recaptured eels probably had passed the power cable during their migration. Furthermore, more than 50% of the eels probably changed direction after

**FIGURE 5.20** MIGRATION ROUTE



*Possible migration routes out of the Baltic Sea of 18 recaptured common eels tagged at Nysted.*

being captured (Figure 5.20).

In the literature, migration of eel from the Baltic Sea is predominantly believed to take place through Øresund. However, the results from the mark-recapture programme at Nysted strongly indicate that eels west of Øresund migrate through the Great Belt, ie the prevailing migration direction at Nysted is westward (Figure 5.20). Hence, there is no reason to assume any influence on the overall migration direction on common eel from the wind farm.

#### DISCUSSION

### **NO EFFECTS ON FISH YET**

Possible effects from the Horns Rev Offshore Wind Farm and Nysted Offshore Wind Farm on the fish fauna were

**FIGURE 5.21** *Catch at Nysted.*



investigated through extensive studies addressing different issues and covering a large range of spatial scales and methodologies. Overall, the studies showed few effects on the fish fauna that could be attributed to the establishment and operation of the wind farms.

The use of advanced techniques and intensive surveys did not document any clear effects on fish communities. Fish abundance and diversity were not higher inside the wind farms than in the areas outside the wind farms. A likely explanation is that the hard substrate habitats at Horns Rev were still young and biologically immature at the time of surveying. Therefore, the reef effect at Horns Rev may become more pronounced over the coming years as colonisation and development of the biological communities progress. At Nysted, the effect was weak presumably because the benthic community consisted of a monoculture of large common mussels that are only moderately attractive to most fish species.

#### **SANDEEL NOT AFFECTED**

At the time of sampling the wind farm at Horns Rev did not have any negative effect on the sandeel. The influence

of the environmental factors on recruitment may be a likely explanation to the increase in sandeel abundance inside the wind farm. Furthermore, future development in the sandeel populations may be influenced by the development of the biological community at the hard substrate, which may result in an increasing number of predators attracted to the area.

#### **FEW EFFECTS FROM CABLE ROUTE**

The surveys at Nysted found some effects on fish behaviour from the cable route. The results indicate that the migration of some species across the cable route was impaired, but not entirely blocked. Beforehand, the common eel was documented to be the species most sensitive to electromagnetic fields among the investigated species. The eel displayed significant behavioural responses to the cable route but the data failed to link these responses to the electromagnetic fields. However, a weakness in this context is that the electromagnetic fields around the cable were not measured directly. In conclusion, different behavioural responses of fish along the cable route were recorded but the cause-effect relationship remains unclear.

## IAPEME VIEWPOINTS

### IMPACT OF OFFSHORE WIND FARMS ON FISH POPULATIONS

#### THE PRESENT STUDIES

#### THE IMPACT OF OFFSHORE WIND FARMS ON FISH POPULATIONS

#### THE IMPACT OF OFFSHORE WIND FARMS ON FISH POPULATIONS

#### THE IMPACT OF OFFSHORE WIND FARMS ON FISH POPULATIONS

The present studies represent a first assessment of the impact of large offshore wind farms on fish populations, and a substantial amount of new data on fish abundance, distribution and behaviour around offshore wind farms has been collected. These data form a good basis for evaluation of the short-term effects of establishing and operating offshore wind farms on local fish communities.

#### NEW HABITATS AND THE ABUNDANCE OF FISH

The introduction of new complex structures, such as wind turbine foundations and scour protection, in sandy coastal areas generates new habitats and may attract fish and other fauna that are relying on these habitats for shelter, food or reproduction (Grossman et al 1997, Powers et al. 2003). Furthermore, the areas within and immediately around the wind farm effectively constitute a marine protected area in which fishing is restricted and other activities, such as gravel extraction, are banned. Consequently, a more diverse fish fauna in the wind farm area, compared to the surrounding sand habitats, is often anticipated. Unfortunately, the abundance and behaviour of fish populations is notoriously difficult to monitor, yet in order to assess the impact of offshore wind farms on the fish community, knowledge of changes in both abundance and behaviour is essential.

The investigations at Horns Rev and Nysted have not documented major changes in the fish fauna with regard to overall abundance or species composition following the construction

### IMPACT OF OFFSHORE WIND FARMS ON FISH POPULATIONS

#### THE PRESENT STUDIES

#### THE IMPACT OF OFFSHORE WIND FARMS ON FISH POPULATIONS

#### THE IMPACT OF OFFSHORE WIND FARMS ON FISH POPULATIONS

#### THE IMPACT OF OFFSHORE WIND FARMS ON FISH POPULATIONS

and operation of the wind farms. However, it is important to note that the surveys were carried out shortly after the introduction of the new habitats. It is therefore likely that the epifauna and the fish fauna will continue to develop, and it will be necessary to monitor the development of the fish fauna at later stages in order to determine the long-term effect on it. Sandeels are common in most shallow bare sand habitats and an important food source for larger fish, marine mammals and birds (Greenstreet et al. 2006). Concern has been expressed that offshore wind farms may adversely affect the sandeel habitats due to the changes to the sediment structure. The current studies do not suggest that this is the case. In short, the documented short-term effects on the fish abundance and composition in the wind farm area are few and not easily separated from larger scale changes in the fish communities. While this conclusion applies to both the North Sea and the Baltic Sea studies, the colonisation of the new habitats may be more rapid and more pronounced in other areas where natural reef structures in the vicinity of the wind farm area may enhance the supply of fish.

The studies have been conducted using a wide range of methodologies. The use of hydroacoustic surveys yields a cost-effective way of assessing the abundance of small pelagic fishes. However, the fish species most likely to benefit from the introduction of the new habitats are demersal or benthic; hence, there is a continued need to monitor the abundance and behaviour of these species using other technologies, including direct obser-

vations, video, tagging and fishing. Furthermore, knowledge of the habitat and resource use of individual fish within the wind farm and the extent to which they stay in this area for a longer period time may further enhance our understanding of the importance of these artificial habitats (Relini et al. 2002, Einbinder et al. 2006). These studies could be conducted using acoustic tagging of relevant fish species.

#### ELECTROMAGNETIC FIELDS AND THE MOVEMENT OF FISH ACROSS SUBMARINE CABLES

Many fish species are able to sense electromagnetic fields (Kalmijn 2000), such as the one originating from submarine power cables, and both attraction and avoidance reaction to the electromagnetic fields have been observed in laboratory experiments. There has therefore been a concern that the power cables connecting offshore wind farms to the land could influence the movements of fish in the wind farm area, and in the worst case act as a barrier to for instance seasonal migrations. This topic has been investigated using directional fyke nets and tagging of migrating eel at the cable route at Nysted. While these studies suggest in a few cases that the movement patterns may be influenced by the electromagnetic field from the cable, alternative explanations to these patterns exist and the studies cannot be viewed as conclusive. One problem has been that the directional fyke nets had to be deployed at a rather large distance from the cable, and there is no firm evidence that the fish caught in the fyke net facing the cable has actually crossed the cable. Similarly, the migration routes

of recaptured eels may not have led them across the cable route. Hence, there is a need for supplementary studies and new methodology should be considered in order to verify the movements across the cable and clarify the potential impact of the electromagnetic fields surrounding the submarine cables. For some fish species the best approach may be to attach acoustic tags to the fish and directly record their movement and behaviour as they approach the cable route. Another approach could be to use large enclosures (eg 100 m by 5 m) that traverse the cable. In these enclosures, several individually marked specimens of the species in focus could be released at specific locations and the distribution of the individuals within the enclosure recorded after a specified time. Both approaches will allow firm conclusions regarding the propensity of the fish to cross the cable and thereby show whether or not the electromagnetic fields from the cable influence the movements of fish in the wind farm area.

Despite the new knowledge of the effects of offshore wind farms on fish communities at local level obtained within the current programme, it will be difficult to extrapolate the impact to regional or population scale. However, the relatively small area expected to be occupied by offshore wind farms compared to the area covered by most marine fish populations does not suggest that the wind farms will significantly alter the population dynamics of fish on a larger scale.



## MARINE MAMMALS

# SEALS AND PORPOISES REACT DIFFERENTLY

BY JONAS TEILMANN, JAKOB TOUGAARD, JACOB CARSTENSEN, RUNE DIETZ, NATIONAL ENVIRONMENTAL RESEARCH INSTITUTE, ROSKILDE AND SVEND TOUGAARD, FISHERIES AND MARITIME MUSEUM, ESBJERG

Seals were studied to evaluate their use of the wind farms and the surrounding areas, the effect of construction and operation on resting behaviour and the population development in the area. Both wind farm areas were found to be part of much larger foraging areas used by the seals. No general change in behaviour at sea or on land could be linked to the construction or operation of the wind farms. The only effect detected on land was a reduction in the number of seals on land during pile driving operations at Nysted.

Only a slight decrease in porpoise abundance was found at Horns Rev during construction and no effect of the operation of the wind farm was seen. A clear decrease in the abundance of porpoises was found at Nysted during the construction and operation of the wind farm. The effect has persisted after two years of operation of the wind farm, with indications of a slow recovery. At both sites porpoises inside the wind farm and up to 15 km from the wind farm reacted to pile driving operations.

## CONTENTS

- Introduction: Studies of seals and porpoises
- Methods: New methods developed
- Results: Pile driving gave reactions
- Discussion: No simple conclusion
- IAPEME viewpoints

## INTRODUCTION

### STUDIES OF SEALS AND PORPOISES

Offshore wind farms may affect marine mammals in several ways. The physical presence of the turbines and the construction activities could cause animals to avoid the area, partly or completely. The most important factor in this respect is likely to be underwater noise. Construction activities are generally noisy, and especially pile driving operations generate very high sound pressures.

The operation of wind turbines also generates noise, but at considerably lower levels which are only audible in the vicinity of the wind farm. Construction of an offshore wind farm also creates permanent alterations to the local environment, especially on soft bottoms where the turbines, foundations and scour protections will be colonised by algae and animals new to the area thereby creating an artificial reef. This will cause subsequent changes in the fish fauna and possibly increase the productivity of the local area. Such changes to the fish fauna and productivity are likely to be neutral or even positive to opportunistic feeders like seal and porpoise.

The studies of the environmental monitoring programme were primarily directed at determining effects of construction and operation on abundance and distribution of porpoises and seals. The secondary aim was determination of mechanisms behind the observed effects.

#### LIMITED INFORMATION ON SEALS AT SEA

When the Environmental Impact Assessments (EIA) were made in 1999 there was only limited information avail-



PHOTO: SVEND TOUGAARD

FIGURE 6.1 *Grey seal.*



PHOTO: SVEND TOUGAARD

FIGURE 6.2 *Harbour seal.*

able on seals in the vicinity of Horns Rev and Nysted. It was well known that harbour seals (*Phoca vitulina*) were resting on land sites in the Wadden Sea, the closest being 20 km from Horns Rev. Four km north of the Nysted wind farm area at Rødsand and Vitten, land sites for both harbour seals and grey seals (*Halichoerus grypus*) are found. From previous studies with radio transmitters on harbour seals from the Wadden Sea, it was expected that the shallow areas of Horns Rev could play a central role in the foraging of the harbour seals.

The main objectives of the monitoring of harbour seals at Horns Rev were to assess the importance of the wind farm area and the reef as a whole to foraging harbour seals and to monitor changes in their habitat use. These



**FIGURE 6.3** *Two harbour porpoises.*

objectives were also part of the program at Nysted, with the important additional question of whether construction and operation of the wind farm influenced the haul out behaviour of harbour seals and grey seals on the important and nearby resting site in the Rødsand seal sanctuary.

Interpretation of results from both studies is influenced by the general increase in the Danish harbour seal population in recent years. Since 1976, when hunting was abolished, the population has increased by about 10% annually, only temporarily disrupted by outbreaks of phocine distemper virus disease in 1988 and 2002. The last outbreak was in 2002, the year before construction of the Nysted Offshore Wind Farm.

#### **PORPOISES PRESENT IN BOTH WIND FARM AREAS**

From ship and aircraft surveys it was known that harbour porpoises (*Phocoena phocoena*) were present in the two wind farm areas at the time of the EIAs. Movements of individual animals tagged with satellite transmitters were also available from the Western Baltic region. These data show that porpoises move over large distances and only occasionally stay within the same area for longer periods.

It was also found that porpoises in the two wind farm areas have no contact with each other and are part of two separate populations. From the surveys it was clear that the eastern part of the North Sea, and thus also Horns Rev, was home to a large number of porpoises, whereas densities in the Western Baltic and thus the area around Nysted were lower.

#### **METHODS**

##### **NEW METHODS DEVELOPED**

Dedicated marine mammal surveys from ship and aircraft in the Horns Rev and Nysted areas started in 1999 in connection with the EIAs (aerial surveys were primarily directed at birds). Marine mammals, however, are difficult to study at sea and thus also in offshore wind farms. Because of limited experience studying effects of offshore constructions on marine mammals, new methods had to be developed. The traditional visual surveys were thus supplemented or in some cases replaced by other methods, including acoustic monitoring by stationary dataloggers, remotely controlled video monitoring and tagging of animals with satellite transmitters. New statistical

methods, including spatial modelling of survey data, were also developed. A detailed description of these methods can be found in the final reports of the environmental impact studies from both wind farm sites.

The close vicinity of the Rødsand seal sanctuary to the wind farm and the fact that Rødsand is the only known breeding site for the grey seal in Denmark made Nysted a key site for the study of seals on land. Studies of movements and foraging behaviour by satellite telemetry were conducted at both sites.

The high density of porpoises at Horns Rev made it possible to conduct visual ship surveys to determine changes in spatial distribution of animals. The sounds produced by porpoises were continuously monitored at both sites by automatic detection systems.

#### CENSUS TECHNIQUES FOR SEALS

Seals are rarely observed in high numbers in visual surveys in the open sea. Therefore, to study the seals' use of the

wind farm area and surrounding sea individual seals were tagged with satellite transmitters. At Rødsand, close to Nysted, five harbour seals and six grey seals were tagged before the construction started and at Rømø, 50 km from Horns Rev, 21 harbour seals were tagged before, during and after the construction of the wind farm.

To monitor the behaviour of the seals on land visual observations were made from a bird observation tower during the baseline study. During construction and operation this was done by a remotely controlled camera system (Figure 6.4). In addition, to determine if seals were leaving the Nysted/Rødsand area due to construction and operation of the wind farm, seals at Rødsand and the alternative resting sites within the region were counted from an airplane on monthly surveys.

#### VISUAL AND ACOUSTIC STUDIES OF PORPOISES

Changes in the spatial distribution of porpoises were studied at Horns Rev by visual surveys primarily from ship

**FIGURE 6.4** RØDSAND SEAL SANCTUARY



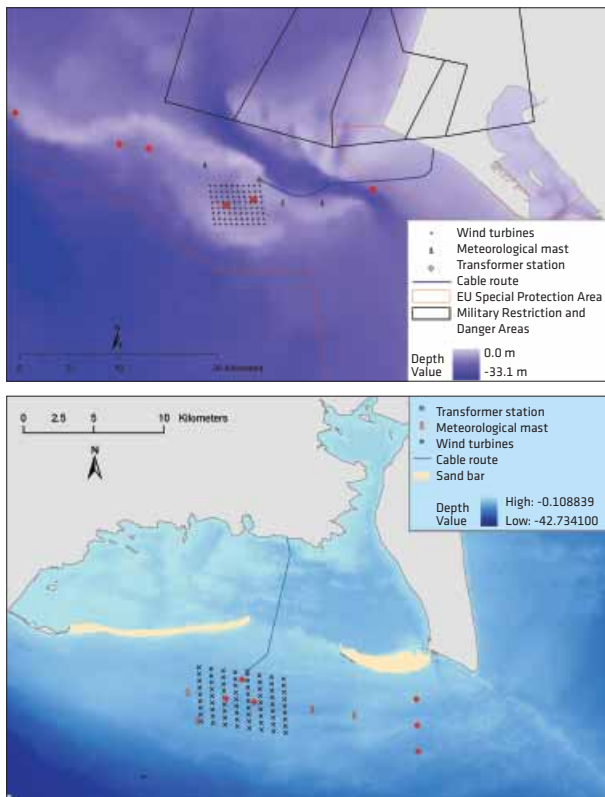
*The Rødsand seal sanctuary with the seal haulout site, bird tower and camera tower indicated. To the right a close up of the camera tower.*

PHOTOS: JONAS TEILMANN



**FIGURE 6.5** Deployment of acoustic datalogger (T-POD) outside the Horns Rev Wind Farm.

**FIGURE 6.6** MAP OF STUDY AREAS



Maps of Horns Rev (top) and Nysted (bottom), with positions of the T-POD stations indicated with red diamonds.

conducted before and during the construction and during normal operation of the wind farm. Porpoise abundance in the wind farm relative to one or more reference areas was studied at both sites by passive acoustic monitoring.

Thirty surveys of 1–3 days duration were conducted between 1999 and 2006 covering the wind farm and the rest of Horns Rev. Surveys were only carried out in light winds to make observation of porpoises possible. Data on porpoise observations, salinity, temperature, depth and tide were collected and used in the development of a spatial model of the distribution of porpoises on individual surveys. This way maps of porpoise density covering the entire survey area could be made. From the density maps a comparison of the relative density of porpoises inside the wind farm could be compared to three zones progressively more distant from the wind farm.

Porpoises produce high frequency echolocation click sounds almost continually to orient and catch fish. These sounds were recorded by dataloggers (T-PODs) moored using anchors and buoys (Figure 6.5) both inside the wind farm areas and in one or more reference areas outside. These T-PODs record echolocation sounds made by porpoises in a radius of 100–1200 m. Six T-PODs were deployed at Horns Rev and six T-PODs at Nysted. Two at Horns Rev and three at Nysted were placed inside the wind farm area and the rest were deployed 5–15 km away from the wind farm to serve as undisturbed or at least less disturbed references (Figure 6.6).

## RESULTS

### PILE DRIVING GAVE REACTIONS

#### SEALS ONLY AFFECTED DURING PILE DRIVING

Monthly aerial seal surveys were conducted from March 2002 to October 2005 in the Nysted region. Furthermore, aerial surveys from late August in the period 1990–2000 were included in the analysis as part of the baseline data. The Rødsand seal sanctuary and five other seal haulout

sites in the south-western Baltic area are believed to be home to a harbour seal population with limited exchange with other harbour seal populations.

Harbour seal counts were dominated by the general increase in the Danish population. In 2002, the year before the construction of Nysted Offshore Wind Farm, a seal epidemic killed about 20% of the harbour seals in the south-western part of the Baltic Sea. The population has recovered well from this and continues to increase (Figure 6.7).

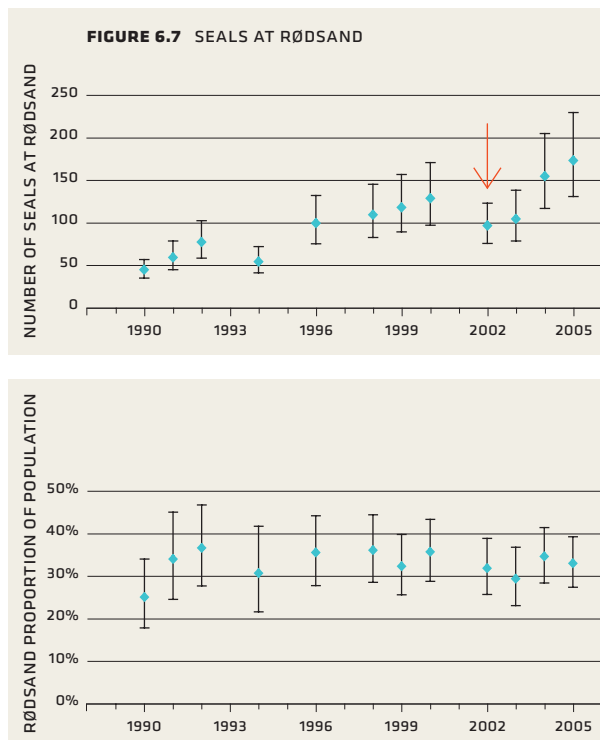
There was no statistically significant change in the importance of the Rødsand seal sanctuary to grey seals

and harbour seals, compared to the five other main seal localities in the south-western Baltic (Vitten, Avnø, Bøgestrømmen, Saltholm and Falsterbo). The relative number of seals on land at Rødsand decreased slightly (but not statistically significant) during construction in 2003 and increased again during operation of the wind farm in 2004 and 2005 (see Figure 6.7).

There was no change in the number of disturbances to the seals on Rødsand (seals fleeing into the water) between baseline, construction and operating periods, indicating that the increase in boat traffic due to the wind farm construction and operation did not disturb the seals on land and did not cause them to flee into the water more often than before construction was initiated.

The construction of the Nysted Wind Farm only 4 km away from the seal sanctuary had no overall measurable effect on the presence of seals on land. The only clear link to construction activities was during sheet piling operations that were carried out at a single foundation located approximately 10 km southwest of the seal sanctuary. This activity comprised piling of several individual sheet piles and took place intermittently throughout three months. A significant decrease in the number of seals on land during pile driving was seen. This effect was less pronounced during the moulting period in August when the seals are strongly attached to land, whereas the strongest effect was observed in November, when the seals show less affinity to being on land. During the pile drivings the seals may have stayed in the local area around the sand bank, or could have left Rødsand entirely in favour of other sites further away from Rødsand.

Observations from the bird tower in June–August 2001 (baseline) and video observations during June–August 2004 (operation) showed a significant increase in the number of both harbour seals and grey seals on land at Rødsand. This increase is consistent with the general increase in the Danish seal population as a whole. However, there were also significant changes in the distribution across the



In the top figure the mean number of seals counted at Rødsand during aerial surveys in August 1990–2005 is shown (the arrow indicates the time of the seal epidemic). In the bottom figure the proportion of seals at Rødsand relative to the other five localities in the southwestern part of the Baltic Sea (Avnø, Bøgestrømmen, Saltholm, Vitten and Falsterbo) is given. The black lines show the 95% confidence limits.

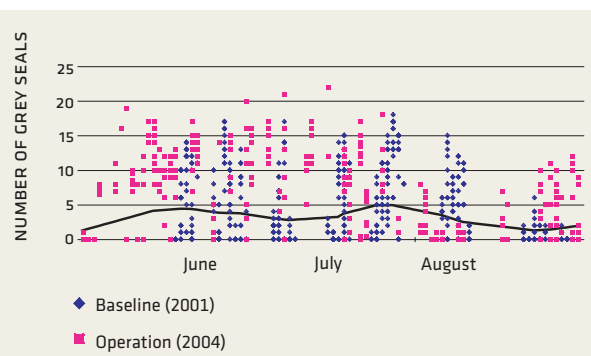
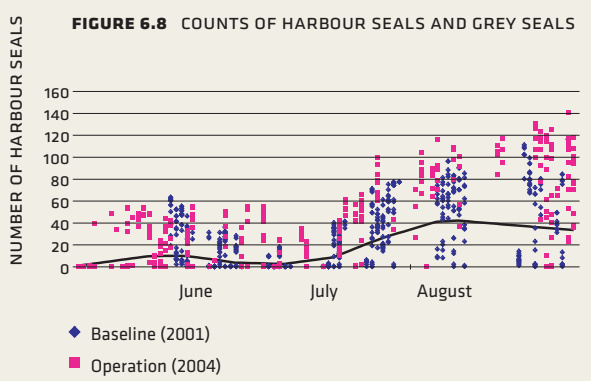
summer months. Fewer harbour seals hauled out in June, and more in July and August, when comparing operation to the baseline study. This could indicate relatively fewer seals breeding at Rødsand in June, while more seals used Rødsand for resting, mating and moulting in July–August during operation compared to the baseline period. More grey seals used Rødsand in June and July during operation compared to the baseline study, whereas the opposite was the case in August (Figure 6.8).

Newborn grey seal pups were observed in February–March during the construction period in 2003 and during operation in 2004 and 2005. This is the first time for about 100 years that grey seals have been observed breeding on a regular basis in Danish waters (Figure 6.9). This underlines the importance of the Rødsand seal sanctuary to grey seals in Denmark.

#### SATELLITE TAGGINGS

Five harbour seals and six grey seals were captured in the Rødsand seal sanctuary and a satellite tag was glued to the fur on top of the head. The tags stayed on until the seals moulted their fur during the following summer. Daily locations showed that the harbour seals remained within 50 km of the tagging site year-round, while the grey seals made extensive movements up to 850 km away from Rødsand to Sweden, Germany and Estonia (Figure 6.10). During the baseline period only few locations were obtained within the wind farm area planned at Nysted. However, most of both the harbour seals and grey seals used the general area of the wind farm and its surroundings, probably for feeding. All the tagged harbour seals stayed year-round in the Rødsand area, whereas individual grey seals on average only remained in the area for less than 20% of the time they were tracked.

21 harbour seals at Rømø, southeast of Horns Rev were tagged with satellite tags. The tracks show that the tagged seals used an area extending out to 50–100 km west of the coast and 50 km north of Horns Rev. Horns



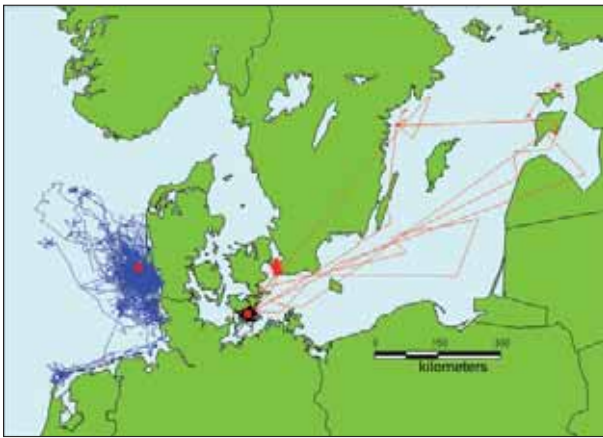
Counts of harbour seals and grey seals from the observation tower (baseline) and camera (operation) during the summers of 2001 and 2004 at Rødsand. Lines show the estimated mean count. Intercalibration showed that the two counting methods are directly comparable.



FIGURE 6.9 Grey seal pup at Rødsand on 25 February 2003.

Rev and the wind farm area thus lie in the middle of a large area of great importance to the seals for foraging. No particular areas within this region appeared to be significantly more important to the seals than the rest of the area and Horns Rev thus cannot be said to be neither more nor less important than the surrounding waters. Compared to the harbour seals from Rødsand/Nysted the seals from Rømø used a much larger area, whereas the grey seals used an even larger area (Figure 6.10).

**FIGURE 6.10** MAP OF TRACKS FROM HARBOUR AND GREY SEALS



Map of tracks from harbour seals tagged at Rømø (blue lines), harbour seals tagged at Rødsand (black lines) and grey seals tagged at Rødsand (red lines). Wind farms are indicated by red squares.

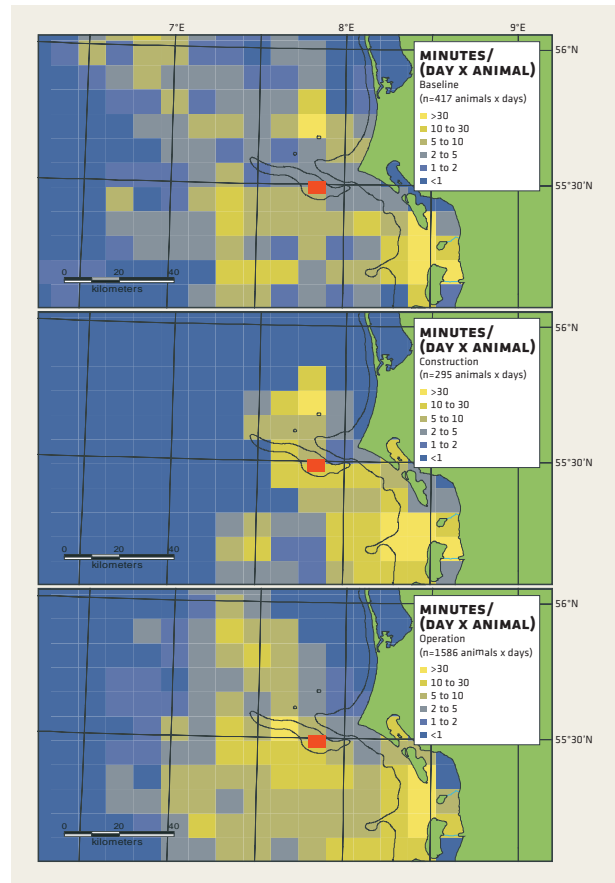


**FIGURE 6.11**

Harbour seal with satellite transmitter glued to the top of the head.

Construction was anticipated to cause a significant disturbance to the seals in the local area of the construction site. The time spent in the wind farm area during this period, however, shows no sign of a deterring effect of the construction at the scale of the satellite positioning (Figure 6.12). No effects of the wind farm could be observed after it was put into normal operation. However, due to limitations in the accuracy and limited number of locations received, only a very strong effect from the

**FIGURE 6.12** TIME SPENT BY THE TAGGED SEALS IN 10X10 KM SQUARES



Time spent by the tagged seals in 10x10 km squares, separated into baseline, construction and operating periods around Horns Rev. Each square is colour coded according to the average time (in minutes) spent per seal per day in the square. The wind farm is indicated with a red square.



wind farm would have been measurable. From the ship surveys, conducted mainly to count porpoises, seals were also observed. The survey data supports the satellite tracking data that Horns Rev is important to the seals and that they were seen inside the wind farm before, during and after construction, with the exception that no seals were observed inside the wind farm in surveys which took place on days with pile drivings.

### PORPOISES THROUGHOUT THE AREA

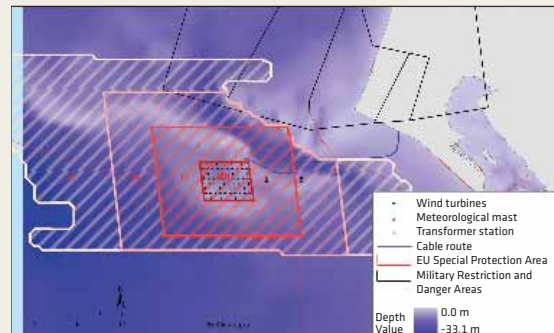
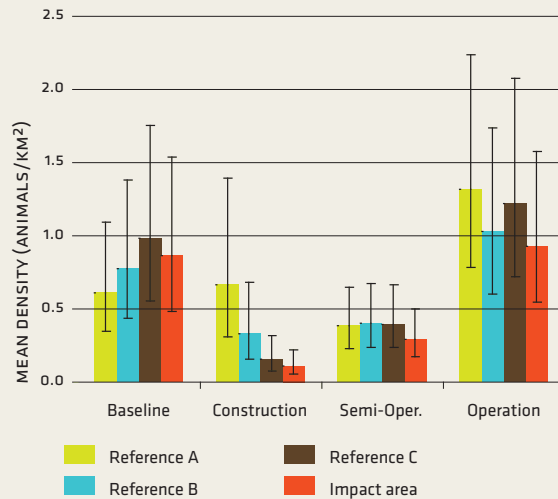
The ship surveys at Horns Rev showed that porpoises were found throughout the survey area, both before, during and after construction of the wind farm. The porpoises tended to concentrate on the reef and only few animals were observed in the deeper areas south of the reef. During construction few porpoises were observed in the wind farm. There was a substantial variation in the number of animals counted per survey, with a general pattern of few animals in the winter and the most stable presence of animals during the summer. Spatial modelling of the distribution of porpoises on individual surveys was used to calculate average densities of animals and compare the densities in the wind farm with surrounding reference areas (Figure 6.13).

This analysis showed a significant change in the distribution of porpoises from baseline to construction, from even density across areas to a situation with a gradient in density from low inside the wind farm to high in the surroundings. The average density decreased from baseline to construction and semi-operation (period following construction with intensive maintenance and service operation) and increased again during operation, but this change was only significant for the wind farm area during construction. There was thus a general but small effect of the construction of the wind farm on the distribution of porpoises (away from the wind farm). During operation the distribution returned to the baseline situation.

### ACOUSTIC MONITORING SUCCESSFUL

The acoustic monitoring started before construction in July 2001 at Horns Rev and in November 2001 at Nysted, and data were collected until December 2005 in both areas.

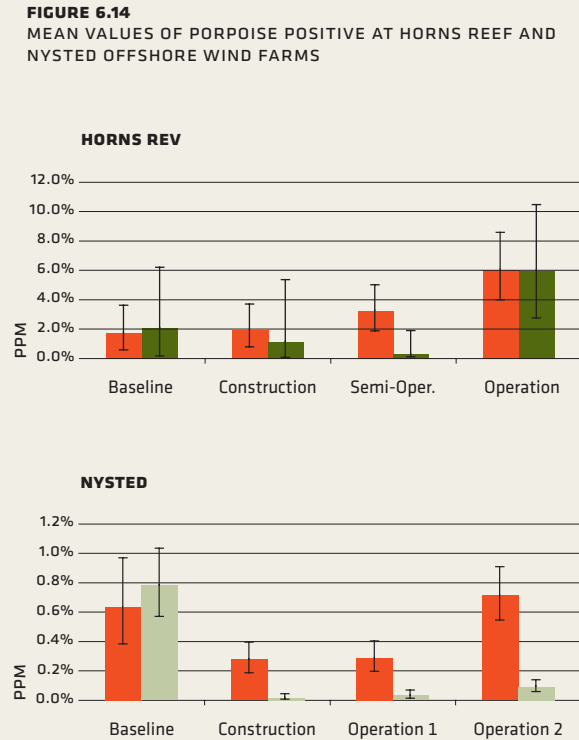
**FIGURE 6.13**  
MEAN DENSITY OF PORPOISES AND REFERENCE AREAS



*Estimated mean density of porpoises in the Horns Rev wind farm area and three reference areas, modelled from visual observations of animals in ship surveys. Black lines show the 95% confidence intervals. There was a significantly different distribution during construction, with a significantly lower density inside the wind farm area. The map shows the wind farm area and the three concentric reference areas.*

The acoustic activity of porpoises recorded during the baseline study inside the wind farm areas was similar to the activity recorded in the reference areas for both wind farms (Figure 6.14).

There was a significant change in the distribution of



Mean values of porpoise positive minutes (PPM, defined as minutes where porpoise sounds were recorded) at Horns Rev and Nysted. Data from the wind farm are shown with green bars and the reference area with brown bars. 95% confidence limits are shown with black lines. Note that the y-scales are different and that the levels from the two areas are not entirely comparable since different versions of T-PODs were used in the two areas. Semi-operation covers a period following construction when intensive maintenance and service operations occurred and thus the turbines were not operating at full capacity. Operation 1 and 2 are the first and second year after construction.

porpoises between the wind farm area and reference areas on Horns Rev, when assuming that acoustic activity is related to the number of porpoises. During construction and especially semi-operation the acoustic activity decreased in the wind farm relative to the reference areas at Horns Rev, followed by an increase during operation.

At Nysted the presence of porpoises decreased significantly in the wind farm area during construction and the first two years of operation. A decrease in acoustic activity was also seen at Nysted in the reference area during construction and the first year of operation. This was possibly a result of a general effect of the construction noise extending more than 10 km from the wind farm. As seen in Figure 6.14 the porpoises gradually returned, and during the second year of operation the level of acoustic activity in the reference area equalled the level during the baseline study. In the wind farm area the acoustic activity was still far from the baseline level two years after construction. The reason behind the slow recovery at Nysted is unknown.

T-POD recordings showed strong effects of pile driving operations on porpoises, both at Horns Rev and Nysted. At Horns Rev the steel monopile foundations were driven into the seabed with a large hydraulic hammer whereas steel sheet piles were used at a single foundation at Nysted.

To protect seals and porpoises from exposure to the excessive noise levels close to the foundations, the pile driving force was slowly intensified (ramped up) and underwater acoustic alarms (porpoise pingers and seal scarers) were deployed at both Horns Rev and Nysted prior to each operation, in order to deter animals to safe distances during pile driving. At both wind farms the porpoises disappeared following each pile driving operation, evidenced by a longer period without acoustic recordings. Porpoise acoustic activity returned to normal levels (for the construction period as a whole) within hours at Horns Rev and within a few days at Nysted.

The disappearance of porpoises during pile driving could be measured both on T-PODs inside the wind farm and in the reference areas up to 15 km away from the pile driving. Visual observations of porpoises at Horns Rev during ship surveys supported that porpoises changed behaviour during pile driving operations. On days without pile driving the predominant behaviour was non-directional swimming (presumably associated with feeding). This changed towards directional swimming on days with pile driving and was observed at distances up to 15 km from the construction site.

## DISCUSSION

### **NO SIMPLE CONCLUSION**

Seven years of monitoring seals and porpoises have documented effects from construction and operation of the two largest wind farms in the world. There is no simple conclusion, but in general studies showed smaller effects on seals than on porpoises and smaller effects at Horns Rev than at Nysted.

No statistically significant effects were seen on seals, except for a decrease in the number of seals resting on land at Rødsand during pile driving operations. Studies with seals tagged with satellite transmitters did not indicate differences in the seals' use of the wind farm area when compared to the surrounding areas at Horns Rev. However, the accuracy of the satellite positions does not allow for an analysis of the behaviour of the seals in the immediate vicinity of the wind turbines. They could be deterred from the foundations, but fish around the turbines may in fact attract the seals (artificial reef effect). The present studies do not suggest that operation of the two wind farms will have a generally negative effect on the seal populations in the two areas.

The effects on porpoises were mainly connected to the construction phase, and only for porpoises at Nysted did the negative effect persist through the first two years of



PHOTO: DMU

**FIGURE 6.15** *Harbour seal.*

operation. At Horns Rev, which is an important area to porpoises and with general high densities of animals, there was a weak negative effect of the construction period as a whole and strong – but short lived – reactions to pile driving operations. No effects were observed during normal operation at Horns Rev. At Nysted, an area with a lower abundance of porpoises, there were strong negative reactions to the construction, where animals left the wind farm area almost completely. Also the reference site 10 km away was affected. As on Horns Rev strong reactions were observed to pile driving operations and recovery from pile drivings took significantly longer than at Horns Rev. After two years of operation the porpoise activity in the reference area is back to baseline levels, but the activity in the Nysted Wind Farm is still lower than expected.

#### DIFFERENT SITUATIONS AT THE TWO SITES

Whereas the disturbance during construction was anticipated in the impact assessment, the slow recovery at Nysted was unexpected. The effect of constructing and operating the two wind farms on the porpoise populations in the two areas has not been assessed. In general, however, one can say that at Horns Rev a large number of animals was affected but for a limited period of time (construction period), and even more animals were affected for an even shorter period of time during pile driving operations when the effects extended beyond the outer edges of the study area.

At Nysted the situation is reversed. Although a comparatively low number of animals was affected the population of porpoises in the western part of the Baltic Sea is also smaller. Therefore the relative impact on the population was higher at Nysted, both because the response to the wind farm was stronger and because the duration of the disturbance has been considerably longer than at Horns Rev, as it extends into the operating period. Although effects of the wind farms on the population levels are unlikely to be very large it is not possible to estimate these.

#### SOURCES OF DISTURBANCE NOT DETERMINED

From the outset the monitoring programmes were designed to show whether the animals avoided the wind farm areas and whether the occurrence in the surrounding area was affected by the construction and operation of the wind farms. Conclusions on what specific factors like noise, turbine presence, boat traffic or change in prey availability are responsible for the observed effects are thus weak, as the studies were not designed to detect these. The only exception is pile driving operations, where significant reactions were found for porpoises and to a lesser degree for seals.

However, the negative effect on porpoises is probably due to the generally high level of disturbance from the construction activities, involving considerable boat traffic,

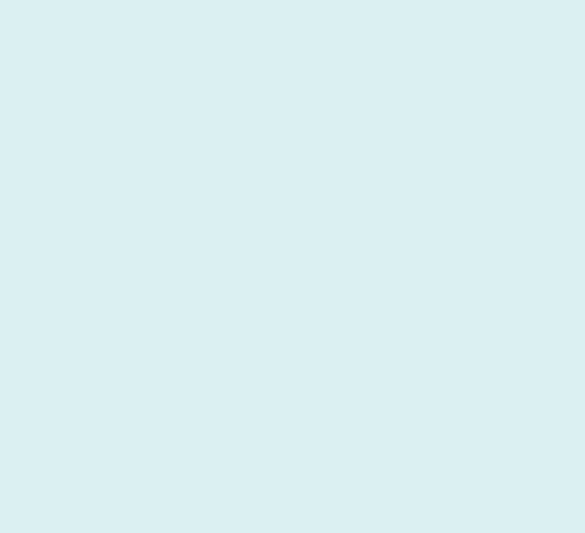
with associated underwater noise, as well as disturbance to the seabed with resuspension of sediment etc. Secondary effects where prey species of fish were deterred by the construction activities are also possible. There are no clear indications of the cause of the slow recovery at Nysted. Whether the difference in construction methods between the two wind farms (pile driving at Horns Rev and gravitation foundations at Nysted) affected the porpoises differently is also unknown.

#### DIFFERENT RESPONSE TO THE TWO WIND FARMS

We may speculate that the more pronounced response at Nysted may be because the area is of lesser importance to the porpoises than Horns Rev and that porpoises at Nysted thus are less motivated to remain in the area when disturbed. In other words, the porpoises at Horns Rev may be more inclined to ignore the disturbance, because the area is of great importance, whereas the porpoises around Nysted are not particularly interested in the area and will simply avoid it if disturbed, without any more severe consequences than the need to swim around the area. Another possibility is that the Nysted area is relatively sheltered, whereas Horns Rev is very exposed, with higher background noise. This means that the turbine noise from the wind farm at Nysted will be higher above the background noise than at Horns Rev and therefore the porpoises will be able to hear the turbines at greater distances at Nysted.

In general, it can be concluded that the construction of the wind farms had a measurable effect on porpoises, whereas the effects on seals were marginal. For porpoises there were differences in the magnitude of the response between the two wind farms, differences that are largely unexplained. With the exception of porpoises at Nysted which still two years after end of construction have not returned completely to the wind farm area, no indications of long term effects on the number of animals were found.

## IAPEME VIEWPOINTS



### IMPORTANT STEPS IN UNDERSTANDING THE BEHAVIOUR OF MARINE MAMMALS

Marine mammals such as harbour and grey seals or the harbour porpoise are difficult to study. Their predominantly submerged lifestyle makes it hard to assess any impacts of human activities on these species on a large scale and even more so on a small scale, as within the two wind farm sites in Danish waters. Nevertheless, the Danish studies on the effects of the wind farms on these species yielded comprehensive and valuable results.

Construction and operation of wind turbines create noises of varying intensities and durations, and marine mammals rely heavily on acoustic cues from their environment. So strong concern existed about the potential effect wind turbines might have on these animals. The effects discussed ranged from behavioural changes to habitat loss and even to physical injury due to pile driving. Within the Danish monitoring programme a focus was put on the potential changes in abundance and habitat use of seals and porpoises. Information on these parameters and their sensitivity to disturbances was very limited when the environmental impact studies started and few methods existed to study these issues. Therefore the Danish scientists had to improve the existing techniques to gather and to analyse the

data and also to develop new ones to answer the questions raised. The combination of established methods, such as line transect surveys at Horns Rev, and new methods, such as video monitoring at Rødsand, and the combination of satellite tags and data loggers on seals or the use of stationary acoustic data loggers (T-PODs) at both sites revealed important information on the effects of the wind farm related activities on the marine mammals both on land and at sea. Technical improvements of the devices used had to go along with a continuous development of new analytical methods for the resulting data. In close cooperation with the developers and research groups in Europe, the Danish scientists evolved their methods to a leading standard on an international level.

### FACTORS AFFECTING NUMBERS AND ACTIVITIES

The abundance of marine mammals and their habitat use is of course also influenced by a large number of factors that are unrelated to wind turbines. As an example a drastic reduction in the size of the seal population was monitored in 2002 due to an epidemic caused by the Phocine Distemper Virus (PDV), while the numbers steadily increased over the following years. Even though external factors like this have the potential to mask effects of wind farms, the aerial surveys conducted at Nysted and other haul-out sites allowed the conclusion that there is

no measurable effect of this particular wind farm. While the declarative strength of the tracking data from satellite tags at Horns Rev is limited these results nevertheless indicate that there was no strong effect on the seal behaviour with regard to the wind farm. Due to the complexity of cause-effect relationships between all natural and anthropogenic parameters with regard to marine mammals it is impossible at present to identify any effects of the wind farms at a population level. Nevertheless, the Danish studies revealed some clear effects on the harbour porpoises on a smaller scale which could be related to construction activities. A clear avoidance reaction was monitored during the construction at Horns Rev even at considerable distances. Equally important might be the fact that this effect was of short duration at Horns Rev as the habitat use returned to a normal level soon after construction and remains at this level during the ongoing operation of the wind turbines. However, it remains unclear whether the animals returning to the Horns Rev site were the same individuals, or animals which had not been exposed to construction sounds. A significant reduction in habitat use is still persistent at Nysted as a consequence of the construction activities even after two years of operation. The detected differences between reactions at Horns Rev and Nysted highlight the problem of a generic application of such results for other sites. With the

exception of the ramming activities at Nysted the reactions by seals were not as pronounced as those of porpoises. The underlying mechanism influencing the detected differences at the different sites and between species is not understood and merits further research.

#### FUTURE STUDIES

A focus in future research should be put on the telemetry of harbour porpoises as this might shed some light on the individual reactions of porpoises to acoustic disturbances. Another relevant issue is the behaviour of both harbour and grey seals at the wind farm sites. This issue might be addressed by the combined use of satellite tags and activity dataloggers. Even though the rapid technical development in these devices might soon provide some substantial improvements, this technique should be used at its current stage of technological development to address these important questions. Finally, the understanding of parameters defining a critical habitat for marine mammals, and the cumulative effect that numerous wind farms might have may be the most important research issues to solve in order to understand and assess effects of offshore wind farms on mammals.

## BIRDS

# AVOIDANCE RESPONSES AND DISPLACEMENT

BY TONY FOX, THOMAS KJÆR CHRISTENSEN, MARK DESHOLM, JOHNNY KAHLERT AND IB KRAG PETERSEN,  
DEPARTMENT OF WILDLIFE ECOLOGY AND BIODIVERSITY, NATIONAL ENVIRONMENTAL RESEARCH INSTITUTE

Hazards presented to birds by construction of the Horns Rev and Nysted wind farms include barriers to movement, habitat loss and collision risks. Radar, infra-red video monitoring and visual observations confirmed that most of the more numerous species showed avoidance responses to both wind farms.

Slightly extended migration distances are unlikely to have consequences for any species. Neither site lies close to nesting areas to affect reproduction. Post-construction studies showed almost complete absence of divers and scoters within the Horns Rev Offshore Wind Farm and significant reductions in long-tailed duck densities within the Nysted Offshore Wind Farm. Other species showed no significant change or occurred in too few numbers to permit statistical analysis.

Of 235,000 common eiders passing Nysted each autumn, predicted collision rates were 0.02% (45 birds). This low magnitude was confirmed by the fact that no collisions were observed by infra-red monitoring.

Whilst unlikely to have major effects on the overall populations involved, assessing the cumulative effects of these and other developments remains a future challenge.

## CONTENTS

- Introduction: Hazards to birds at sea
- Methods: Radars, surveys and infra-red video
- Results: Birds show avoidance responses
- Discussion: Need for large scale assessment
- IAPEME viewpoints

## INTRODUCTION

### HAZARDS TO BIRDS AT SEA

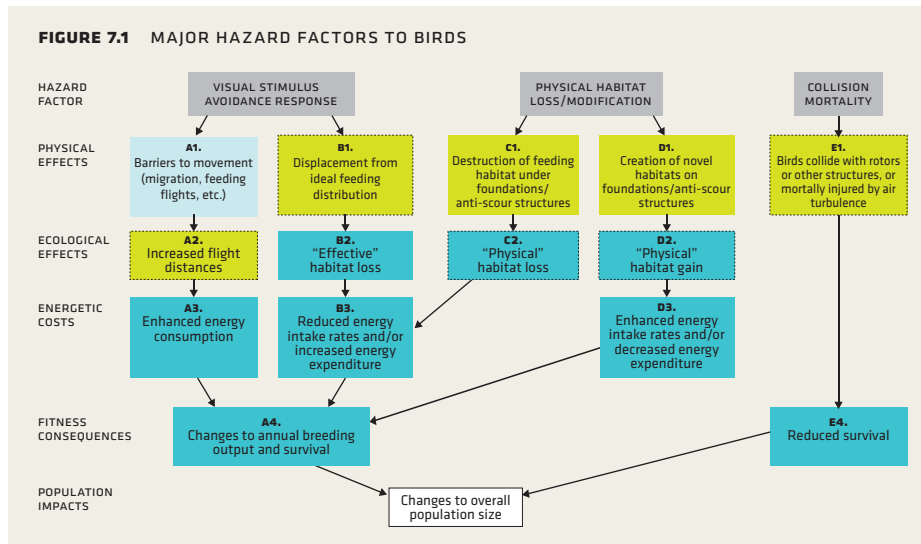
Offshore wind farms represent the single most extensive industrial infrastructural development in the marine environment to date, and the erection of tall towers supporting rotating turbine blades presents three types of hazard to birds at sea (see Figure 7.1).

First, they can present a barrier to movement of migrating or feeding birds. Many bird species avoid unfamiliar man-made objects, especially large moving structures, the erection of which may deflect prior migration routes or feeding movements, although some may be attracted to them. Displacement of migration routes will likely add little to energetic costs by slightly extending traditional routes to avoid turbines.

Displacement of feeding birds on a more frequent basis (eg birds commuting daily between a roost and feeding site, or parent birds flying between feeding areas and provisioning young at nests elsewhere), may incur heavier energetic costs, which may ultimately affect survival or breeding success. Behavioural avoidance of the vicinity of turbines could also potentially displace feeding birds from wind farms resulting in “effective” habitat loss. Even if the habitat and food resource remain intact, they are lost to the birds because of their reticence to approach the turbines.

Secondly, there may be physical habitat loss, as a food resource is buried under the foundations, or lost below anti-scour protection associated with the wind farm structures. These features may also create novel feeding opportunities, for instance where hard concrete substrates or anti-scour boulder protection are introduced to a formerly exclusively sandy seabed. Hence, a second potential impact may be the net change as a result of destruction and creation of habitats, the effects of which also need to be assessed on birds.

Finally, if birds do not show avoidance behaviours, there is a potential risk of collisions with the turbines. The latter is often considered to be the most important hazard because of its demographic effect on populations,



Flow chart describing the three major hazard factors (grey boxes) presented to birds by the construction of offshore wind farms, showing their physical and ecological effects on birds, the energetic costs and fitness consequences of these effects, and their ultimate impacts on the population level (white box). The light green boxes indicate potentially measurable effects, the dark blue boxes indicate processes that need to be modelled (see text for details).



### FOCUS ON CERTAIN SPECIES

From the start, it was impossible to address all hazards with respect to all bird species occurring in the vicinity of the wind farms. It was therefore necessary to focus upon those avian species:

- subject to special protection measures (eg under EU or domestic legislation),
- for which the two study areas have some significance at some stage in the annual life cycle (typically in numbers exceeding 1% of the flyway population),
- that are for some reason especially susceptible to habitat loss (eg highly specialised habitat) or collision (eg fly habitually at rotor height) or
- that are susceptible to even small increases in adult mortality (essentially long-lived birds with low annual reproductive output).

For these reasons, most emphasis was placed upon studies of long lived large bodied birds, essentially marine waterbirds.

adding directly to the death rate. The impact of this elevated mortality depends on the population dynamics of the species concerned. Long-lived species with naturally low reproductive output (such as divers *Gavia* species and common eider ducks *Somateria mollissima*) are slow to replace themselves and can suffer rapid declines in population size in response to relatively small increases in annual adult mortality rates, making such species much more vulnerable to collision mortality than, say small finches, that regularly experience high mortality (eg on migration), but exhibit higher reproductive potential to rapidly replace annual losses.

Equally, habitat loss/gain and deflection of flight trajectories should not be considered trivial. For species with highly restricted marine habitats, habitat loss may have population level effects, because displaced birds have poorer quality or little alternative habitat to which to resort. For now, considering the first two large offshore marine wind farms ever constructed, these effects are likely to

be small, as the area affected compared to the extent of similar shallow waters is miniscule, but the cumulative impacts of many more such developments distributed along the length of a species' migratory corridor could have impacts on survival and reproduction in the future. The challenge of addressing cumulative impacts of this and other human developments on populations of birds is critical to the future exploitation of offshore wind resources and is considered briefly at the end of this chapter, but needs to be the subject of continuing research.

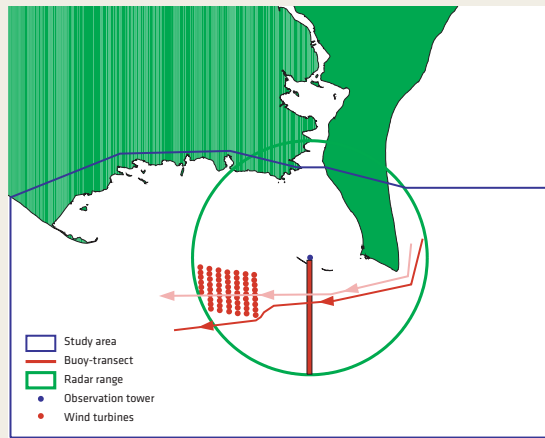
### EFFECTS OF KEY HAZARDS ON BIRDS

The focus of the present avian programme was to tackle each major issue identified as key hazards to birds: namely flight displacement (A in Figure 7.1), changes in distribution (B, C and D in Figure 7.1) and collision rate (E in Figure 7.1). For each hazard, we needed to assess the effects, based on observations of bird behaviour prior to turbine erection, using measures that would enable post-construction comparisons.

For flight displacement, the effects would be changes in flight orientations (lateral avoidance, see Figure 7.2) and potentially height (altitudinal avoidance) so the frequency of flight tracks in three dimensional space had to be described in a way that enabled assessment of effects (specifically the extension of flight) post construction (A1 and A2 in Figure 7.1).

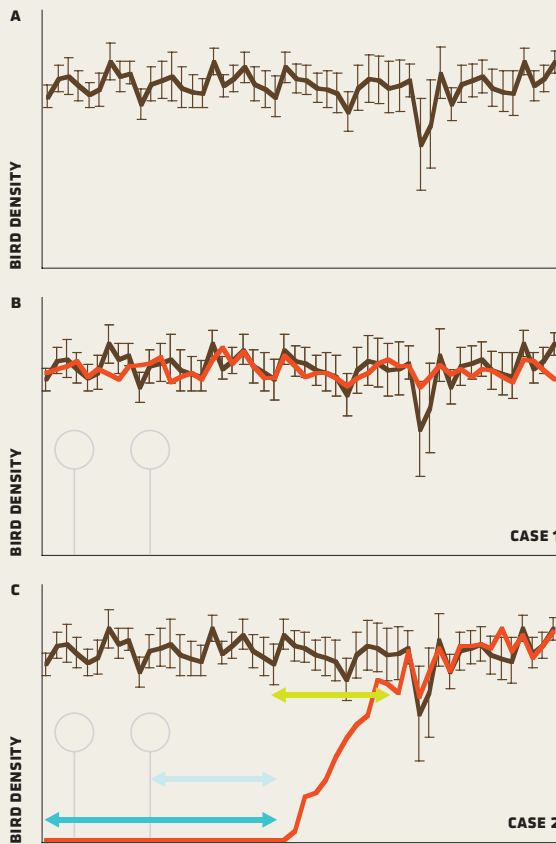
For changes in distribution, effective loss/gain of habitat needed to be compared by measuring bird densities at sea in and around the proposed wind farm area prior to and post construction (Figure 7.3), using bird densities as the currency to measure habitat gain, or loss through behavioural avoidance (B1 and B2 in Figure 7.1). The physical loss and gain of habitat (C1/C2 and D1/D2 in Figure 7.1) associated with turbine construction and other wind farm structures were considered trivial in proportional terms – even accounting for the anti-scour structures, these features equated to less than 1% of the

**FIGURE 7.2** AVOIDANCE BEHAVIOUR AT NYSTED



If birds show lateral avoidance behaviour (in this case at Nysted Offshore Wind Farm), it should be possible to show the difference between the pre-construction state (pink arrow showing the route taken by birds prior to construction) compared to the avoidance behaviour post construction (red arrow). Such effects can be detected statistically by sampling the headings of radar tracks of birds as they progress through the study area. The energetic costs of these avoidance flights can be derived by estimating the costs of flight per unit distance for a given species under the prevailing wind conditions and comparing the distances of the two trajectories.

**FIGURE 7.3** DISPLACEMENT FROM FEEDING DISTRIBUTION ASSOCIATED WITH WIND FARM CONSTRUCTION



Assume we fly an aerial transect through a stretch of sea, and over a series of flights, we gather mean densities (brown) and an assessment of the variation bird density (grey error bars) along this strip of sea (see A, top).

If birds show no avoidance behaviour to the turbines (Case 1), we would expect the subsequent observed mean densities gathered by aerial survey after the erection of turbines not to differ from those prior to construction (orange line see B middle graph).

If, however, birds will not approach a turbine within a distance (shown by the pale blue arrow in C lower graph) more than the gap between successive turbines (Case 2), then the area within the wind farm and an area beyond the outermost turbines will be lost as potential habitat (extent shown by dark blue arrow).

There may also be a further area lost where densities are reduced, but some birds are willing to tolerate approach (extent shown by the pale green arrow). The theoretical total habitat loss in this one dimensional scene equates to the area between the two curves.

total area of marine substrate enclosed within the total wind farm. Their effects would therefore be small and difficult to distinguish from other distributional effects described by monitoring changes in bird densities, except for the arrival of new species attracted to novel habitats post construction.

Finally, estimating bird collision rate (E1 in Figure 7.1) required an assessment of the rate of passage of birds through the area swept by the turbine blades prior to construction, and a modelling approach to assess the proportions of these that would impact or be mortally wounded by the turbines.

## METHODS

### **RADARS, SURVEYS AND INFRA-RED VIDEO**

The Horns Rev and Nysted study areas differed markedly in physical characteristics and bird species. Horns Rev's North Sea location is exposed to the prevailing south-westerly winds, experiences lunar tides and is far more "marine" than the more protected and enclosed brackish Baltic location of the Nysted site, where changes in water level result mainly from the effects of winds in the eastern Baltic Sea, Kattegat and Skagerrak.

Numerically important species at Horns Rev included divers (mostly red-throated *Gavia stellata* Figure 7.4), gannet *Morus bassanus*, common scoter *Melanitta nigra* (Figure 7.5), herring gull *Larus argentatus*, little gull *L. minutus*, kittiwake *Rissa tridactyla*, arctic/common tern *Sterna paradisaea/hirundo* and auks (guillemot *Uria aalge* and/or razorbill *Alca torda*), with few common eider which mostly associated with the coast.

At Nysted, cormorant *Phalacrocorax carbo* and mute swan *Cygnus olor* occurred in internationally important numbers (regularly >1% of the flyway population). Also numerically important were goldeneye *Bucephala clangula*, long-tailed duck *Clangula hyemalis* (Figure 7.6), common eider (Figure 7.7), red-breasted merganser *Mergus*



PHOTO: JAKOB SJÖGUBSSON  
**FIGURE 7.4** RED THROATED DIVER *GAVIA STELLATA*



PHOTO: DANIEL BERGMANN  
**FIGURE 7.5** COMMON SCOTER *MELANITTA NIGRA*



PHOTO: GREG DOWNING  
**FIGURE 7.6** LONG-TAILED DUCK *CLANGULA HYEMALIS*



PHOTO: DANIEL BERGMANN  
**FIGURE 7.7** COMMON EIDER *SOMATERIA MOLLISSIMA*

*serrator*, herring gull and great black-backed gull *Larus marinus*, with divers and scoters in much fewer numbers. Nysted also lies on the main migration route for many thousands of waterbirds, dominated by eiders, which occurred in internationally important numbers together with dark-bellied brent geese *Branta bernicla bernicla*. Regular counts suggest that barnacle goose *Branta leucopsis* and pintail *Anas acuta* could potentially occur in internationally important numbers.

#### DISPLACEMENT STUDIES

The study of bird flight trajectories was heavily reliant upon remote sensing techniques, with conventional azimuth ship navigation radar as the most important tool for recording the patterns of all bird movements in the vicinity of the wind farms. This provided two-dimensional tracks of all migrating birds within a radius of approx 11 km of the radar antenna and hence a plan view of how birds assort themselves in flight with regard to the wind turbines.

At Nysted, the radar antenna and observers were located on an observation tower placed in the sea 5 km northeast of the wind farm (Figure 7.8). From here, radar observations were gathered and as much as possible, the bird or flock of birds responsible for each radar screen track was visually verified to species and number of individuals, enabling the collation of three years baseline data prior to construction at this site.

At Horns Rev, the radar antenna, observation platform and accommodation block for the human observers were located on the transformer station, but since this logistic platform was only available post construction, no prior baseline exists for comparison with post-construction data here. At both sites, the radar traces were transferred to a geographical information system (GIS) for subsequent statistical analysis (Figure 7.9). Supplementary bird flight altitude distributions were derived by vertically mounted marine radar and infra-red surveillance (Figure 7.10).



PHOTO: JONAS TEILMANN

FIGURE 7.8 NYSTED OBSERVATION TOWER.

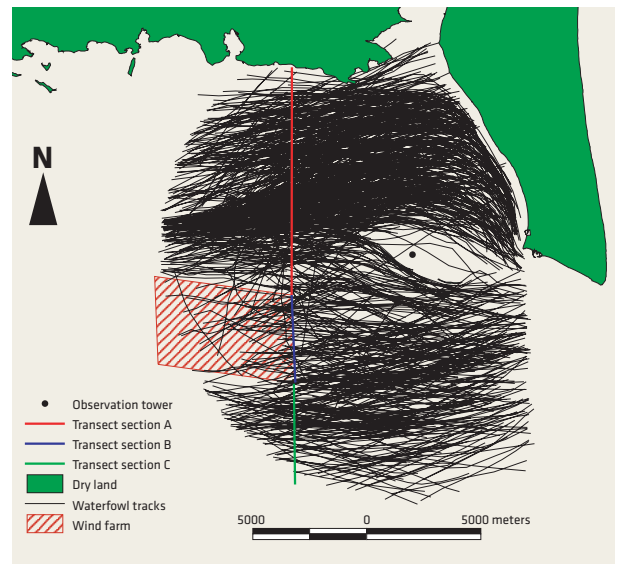


FIGURE 7.9 RADAR TRACKS DERIVED FROM NYSTED



PHOTO: MARK DESHOLM

FIGURE 7.10 Photograph of the Thermal Animal Detection System (TADS) in operational position, mounted on a turbine at Nysted, to vertically monitor warm-bodied objects approaching the rotating turbine blades.

## CHANGES IN DISTRIBUTION OF SPECIES

Aerial surveys were designed to describe numbers and distributions of the different species to assess their status and distribution throughout the year; later the objective became to assess the changes in these measures post construction. Aerial surveys were carried out at Horns Rev and Nysted to count birds using trained observers seated on either side of the high-winged aircraft.

Observers logged bird species, numbers and behaviour with the precise time of the observation on a dictaphone (Figure 7.11). The time associated with each bird/flock observation could be converted to position via the timed global positioning system (GPS) track recorded by computer throughout the flight. Positioned observations were then entered into the GIS for subsequent analysis. Cumulative positions of birds/flocks could then be used to undertake before/after construction comparisons of bird distributions for species recorded in sufficient numbers.

For both wind farms, aerial surveys covered an area of sea much larger than the impact area. At Horns Rev, 30 north-south parallel transects were flown at 2 km intervals from the coast westwards to a line 37 km off Blåvands Huk (Figure 7.12). Nysted was covered by 26 north-south orientated transects extending approx 25 km south from the mainland flown at 2 km intervals (Figure 7.13).

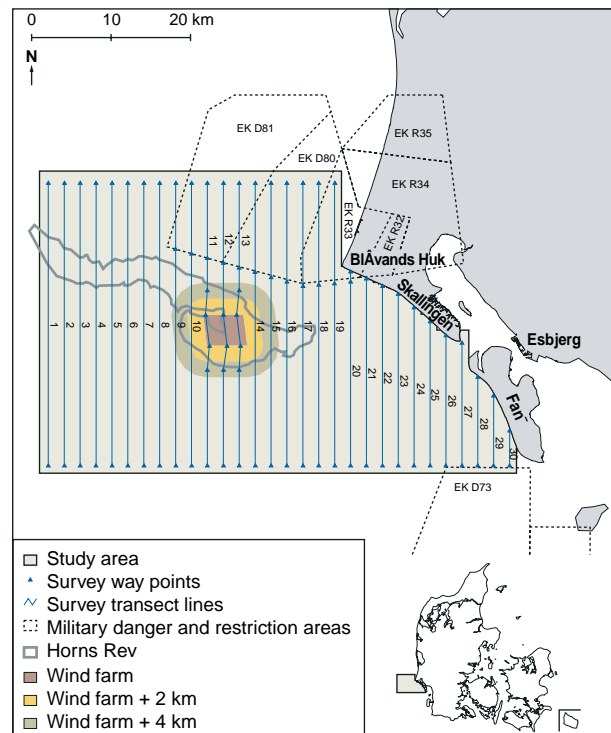
The aerial survey count data were analysed comparing bird encounter rates to test whether these were lower in the wind farm area, a strip 2 km outside, a strip 4 km outside and in the general area before and after turbine construction. This enabled an assessment of the level of attraction/avoidance shown by each species at both wind farms post construction. Furthermore, cumulative frequency distributions of species were compiled before and after construction (based on measured distances to the nearest turbines) to look for displacement effects.

## ESTIMATING AND MEASURING COLLISIONS

A stochastic predictive collision model was constructed

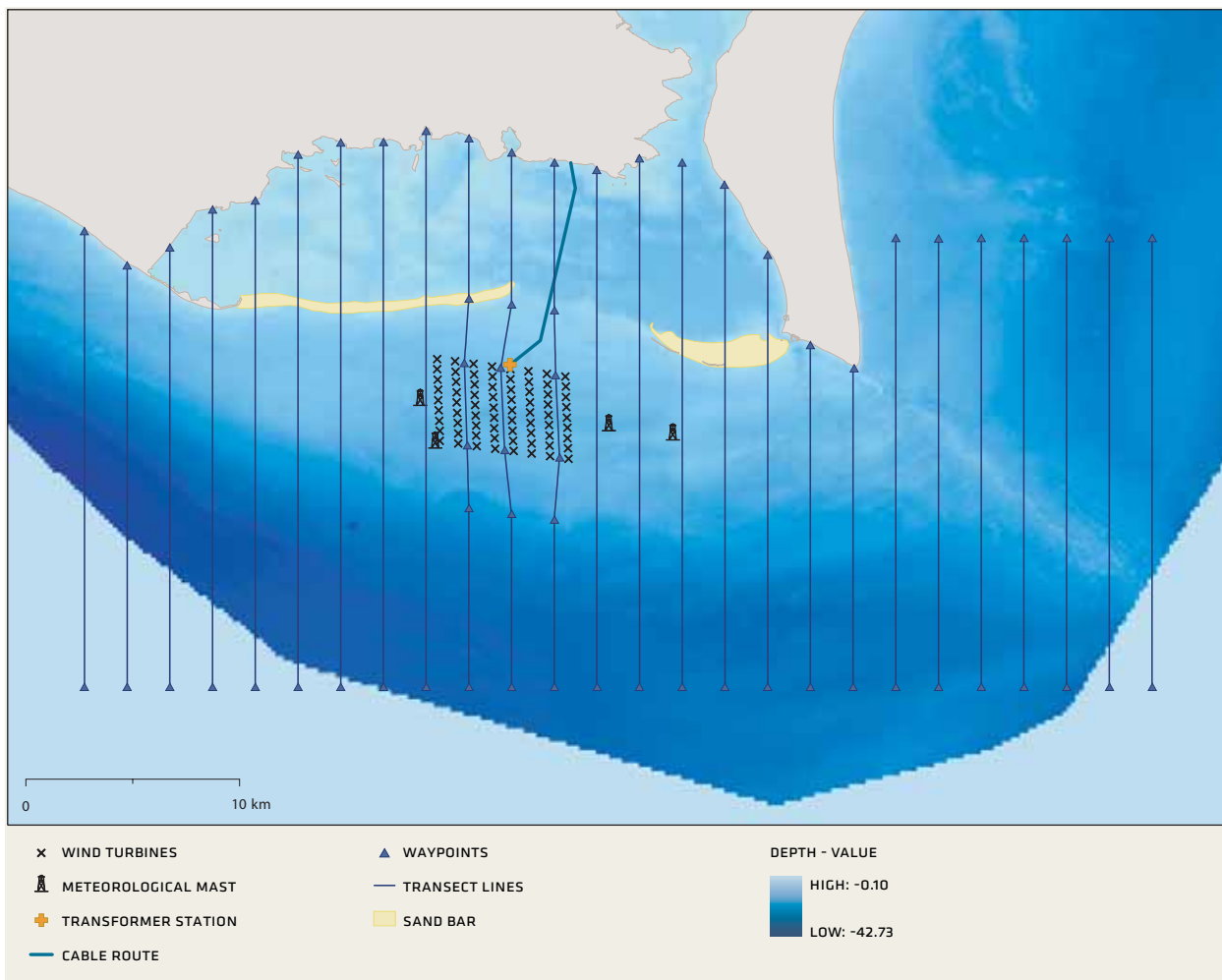


PHOTO: IB KRAG PETERSEN  
**FIGURE 7.11** COUNTING BIRDS FROM AIRCRAFT



**FIGURE 7.12** HORNS REV STUDY AREA

*The Horns Rev study area covered by the aerial surveys, showing the positions of the wind turbines, with areas 2 km and 4 km from the outermost turbines and the ideal survey transect lines and way points.*



**FIGURE 7.13** THE NYSTED STUDY AREA. *The Nysted study area covered by the aerial surveys, showing the positions of the wind turbines, the ideal survey transect lines and bathymetric profile.*

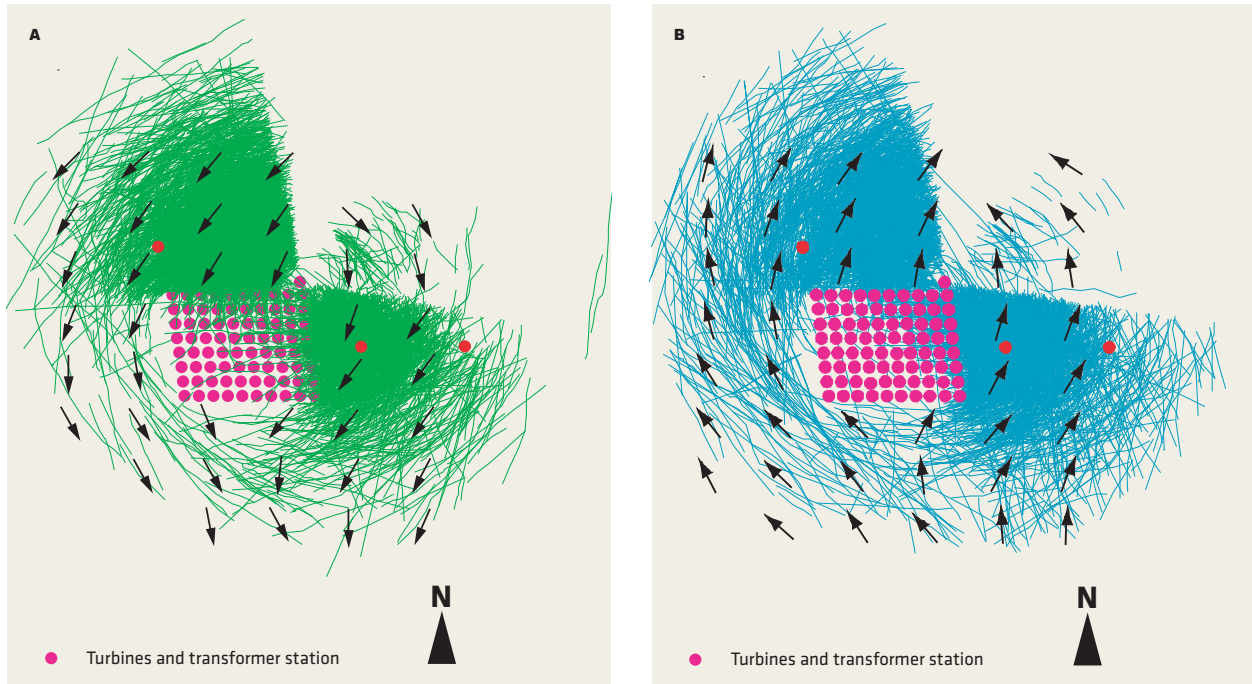
for autumn migrating waterbirds, specifically for common eiders at Nysted, for which parameter values were available. Collision risk is the proportion of birds/flocks exposing themselves to a collision by crossing the area swept by the rotor blades. This risk can be calculated pre construction by using the known intensity of birds/flocks passing this area gathered by the other studies reported below, adjusted for the evasion behaviour of the bird species involved. Because we know so very little about the “last minute” avoidance responses shown by birds close to rotating rotor blades,

published estimates were substituted.

The much improved model developed during this project incorporated measures of variance in the input parameters and provided confidence intervals for collision estimations. Birds avoiding collisions in initial encounters with outermost turbines were assumed to show avoidance at all subsequent rows they would encounter. For those birds passing through the first row without showing evasive action, the risk of collision in subsequent rows was recalculated.

Post-construction, remote controlled infra-red video

**FIGURE 7.14** RADAR TRACKS OF BIRDS



*Radar tracks of birds/bird flocks migrating southwards (A) and northwards (B) at Horns Rev during 2003–2005. Arrows show the average orientation in the flight direction of birds within each grid cell. The vertical heights of the migrating birds are not known. Note radar shadows to the north and east of the transformer station, where birds could not be detected because of the transformer station superstructure.*

surveillance equipment (the Thermal Animal Detection System, TADS) was mounted on one of the Nysted turbines, to monitor 30% of the sweep area of the turbine for large waterbird collisions (Figure 7.10). This provided data on both the specific nature and frequency of bird avoidance actions and a direct sampled measure of the number of collisions per unit time monitored.

## RESULTS

### **BIRDS SHOW AVOIDANCE RESPONSES**

Radar studies showed birds generally avoided Horns Rev and Nysted wind farms, although responses were highly species specific. At Horns Rev, radar tracks of birds show circular adjustments in northward and southward flight tracks around the periphery of the wind farm out to 5

km (Figure 7.14). Between 71 and 86% of all bird flock radar trajectories heading for the wind farm at 1.5–2 km distance ultimately avoided entering into the wind farm between the turbine rows. Patterns at Nysted confirm similar large scale avoidance patterns, predominantly amongst waterbirds there as well. There was considerable movement of birds along the periphery of both wind farms, as birds preferentially flew around rather than between the turbines (eg Figure 7.15).

Radar studies at Nysted showed that the proportion of autumn migrating birds (essentially large waterfowl and mostly common eider) rounding Gedser Odde that avoided passing through the wind farm area varied little between 91 and 92% after construction compared to 52–76% during the baseline period when no turbines were present in the area. The latter comparison offers

a more robust demonstration of bird avoidance, which contributed most to the overall reduction of 78% in the use of the wind farm airspace by birds post construction compared to that prior to construction.

#### CHANGES TO FLIGHT DIRECTIONS

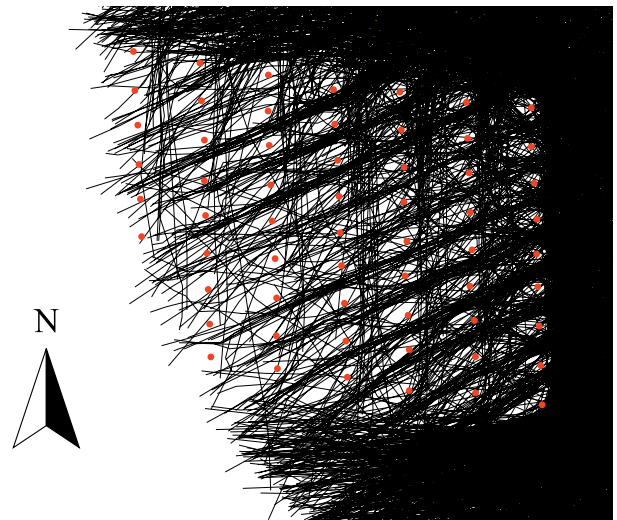
Deflection behaviour was readily visible amongst radar tracks, resulting from birds making gradual and systematic modification to their flight routes in response to the visual stimulus of the wind farm (1–2 km at Horns Rev and 1.5–5 km at Nysted), with more dramatic changes in flight deflection close to the outermost turbines (at 500 m or closer at both Horns Rev and Nysted, eg Figure 7.15).

For some species (notably common eiders rounding Gedser Odde in excellent visibility), it is not possible to exclude that birds react at 10–15 km by modifying their flight orientation. Such changes in flight route were not present in the baseline pre-construction data and hence could be interpreted as a direct consequence of the erection of the turbines. However, such avoidance represented an extension of only between 0.5% (night) and 0.7% (day) to the normal estimated 800 km common eider annual migration route.

At both Horns Rev and Nysted, changes in flight direction tended to occur closer to the wind farm at night (0.5 km) than by day (1.5 km or more). At Nysted, although there was still a remarkably high level of avoidance effect by night (6 out of 10 flocks, which crossed the eastern edge of the wind farm pre construction avoided it post construction), this was less pronounced than by daytime (9 out of 10).

Extended periods of infra-red monitoring at night using TADS at Nysted provided unexpected evidence that no movements of birds were detected below 120 m during the hours of darkness, even during periods of heavy migration. This confirms the results from night time vertical-mounted radar studies that night migrating birds below 1500 m generally flew at higher altitudes than those by day. The constraints of night time observation unfortunately mean that visual verification of the species involved was not

FIGURE 7.15 FLIGHT TRAJECTORIES OF BIRDS AT NYSTED



*The westerly orientated flight trajectories of birds tracked by radar at the Nysted Offshore Wind Farm during the initial operation of the wind turbines. Black lines indicate migrating waterbird flocks and the red dots indicate the wind turbines. Reproduced from Desholm & Kahlert (2005) with permission from Royal Society of London.*

possible, but at least some of these birds must be common eider flocks which are known to migrate under cover of darkness, although in lesser numbers than by day.

#### RESPONSES ARE HIGHLY SPECIES SPECIFIC

The studies were generally unable to gather data on avoidance responses during poor visibility (eg fog or precipitation) affecting the avoidance response, because too few observations of intense migration traffic occurred during periods of poor visibility to enable such assessments. Waterbird migration typically reduces substantially or ceases during periods of poor visibility and indeed during the observations reported here, the arrival of fog and active rain associated with frontal systems invariably resulted in the cessation of active migration that had been observed during previous periods of good visibility. The lack of observations during periods with <1 km visibility at either of the observation platforms therefore precludes provision of support for any major hypothesis that such



conditions modify the avoidance response.

We must stress that these responses are those shown by waterbirds generally (except where otherwise specified), and at Nysted by common eiders in particular because they are the most abundant species present. Nevertheless, it was clear that the avoidance responses are highly species specific, that individuals show different responses to wind farms and that all birds can potentially enter the wind farms. Some species were almost never witnessed flying between turbines despite their abundance outside (eg divers and gannets), others rarely did so (eg scoters) or generally avoided flying far into the wind farm (eg terns), whilst others (eg cormorant and gulls, especially greater black-backed and herring gulls) showed no sign of avoidance at all.

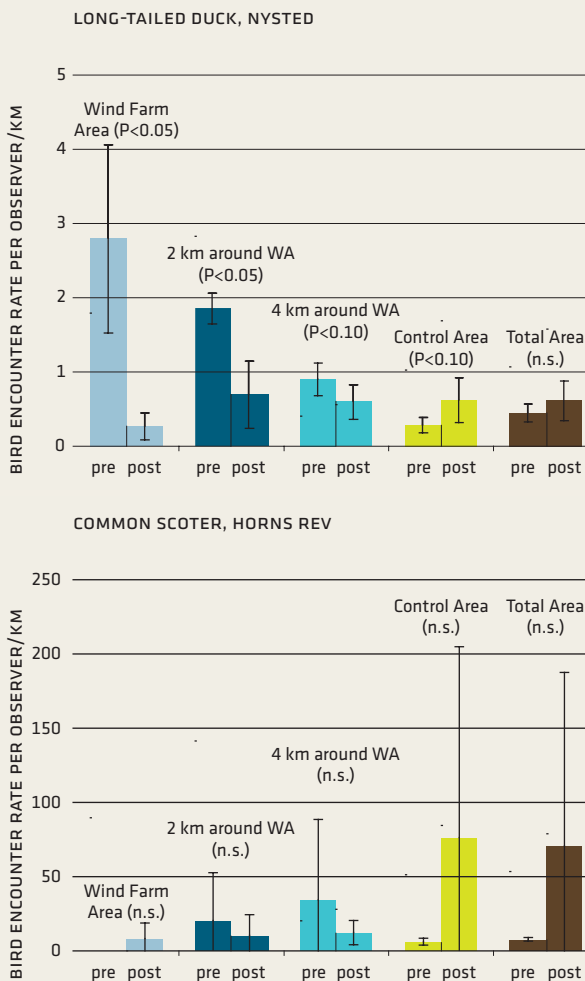
#### NO ATTRACTION RESPONSES

Observations did not support the alternative hypothesis that some flying birds of certain species show a lateral attraction response to the wind farm. Gulls (especially greater black-backed and herring gulls) and cormorant were undoubtedly attracted to the turbine foundations as loafing areas, but specific support for the hypothesis that these species show a gradual and systematic deflection towards the wind farm was hard to establish, and there was little evidence of changes in local abundance of these species in the vicinity of and within the wind farm based on the aerial survey data. There was no support at all for the hypothesis that large nocturnal migrating waterbirds were attracted to the wind farm (eg as a result of the illumination).

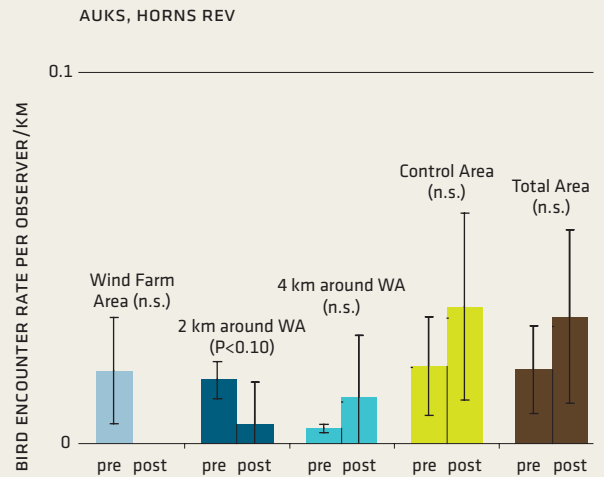
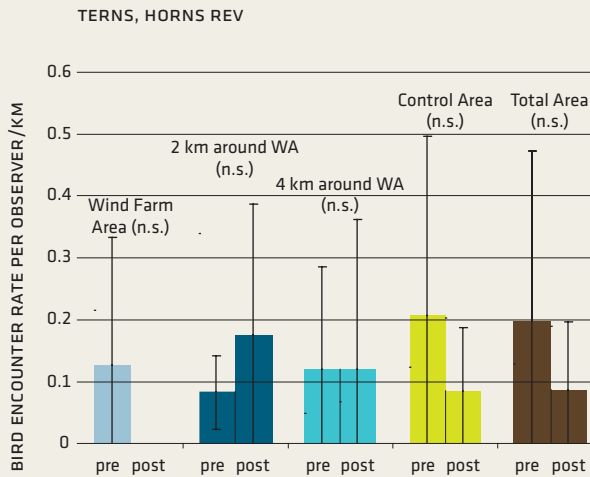
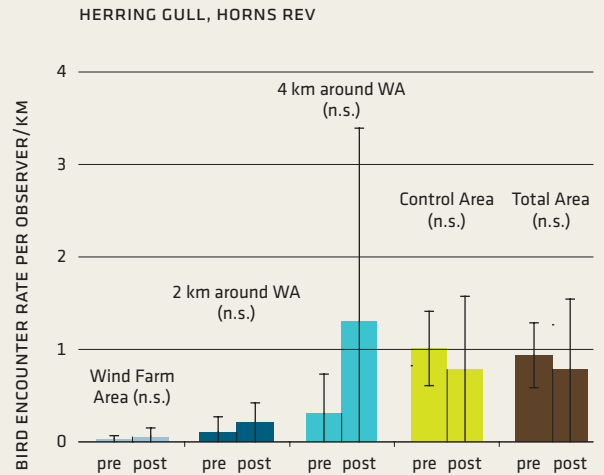
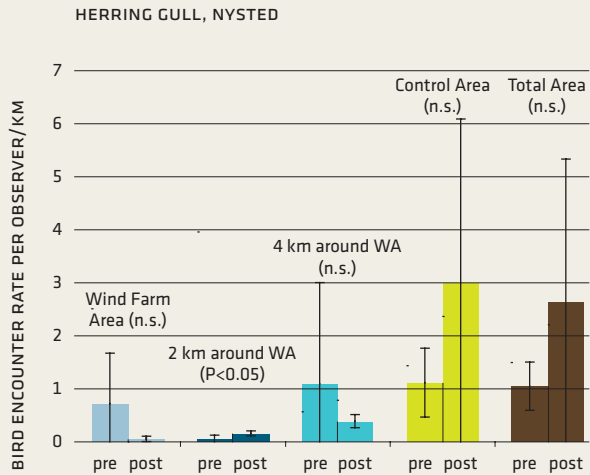
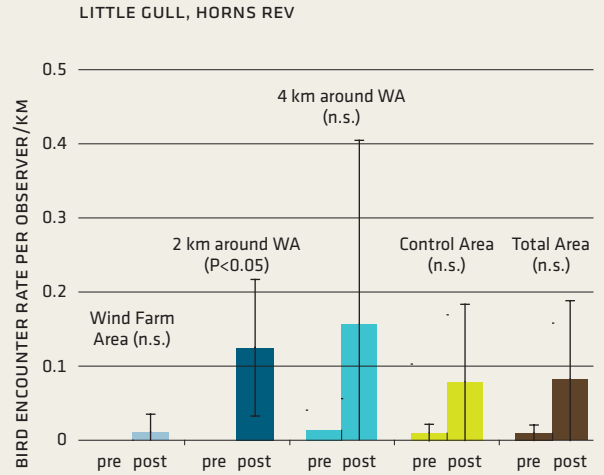
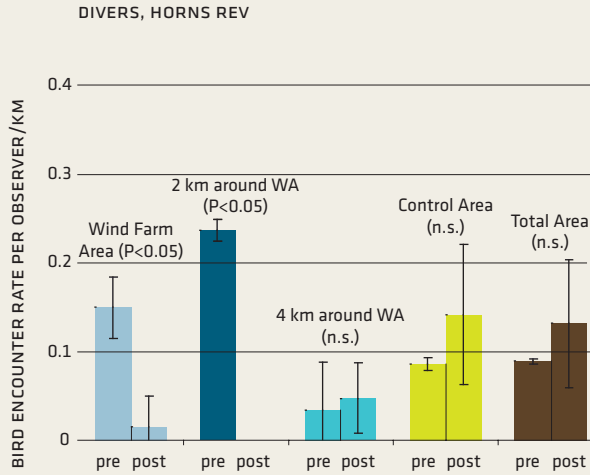
#### CHANGES IN FEEDING AND RESTING DISTRIBUTION

Comparison of pre- and post-construction aerial surveys of waterbird distributions generally showed they avoided both offshore wind farms, although responses were highly species specific. Divers at Horns Rev showed almost complete avoidance of the wind farm area post construction, despite being present in average densities prior to construction (Figure 7.16).

**FIGURE 7.16**  
COMPARISON OF BIRD DENSITIES PRE AND POST CONSTRUCTION



Comparisons of the bird densities inside the area of the wind farms (pale blue columns), an area 2 km outside of the outer edge of the turbines (dark blue) and 2–4 km outside of the outermost turbines (light blue) before and after construction of the turbines. Comparisons are given for the remainder of the area (green) and the total areas including all areas (brown). Values are the means for the pre- and post-construction periods for the month of the year with the highest counts for each species, March for divers, scoters, gulls and auks, January for long-tailed ducks and April and May for terns. The 95% confidence intervals are shown for each value, and the statistical probability level obtained from the results of students' *t*-tests for each comparison are given above the columns (n.s. represents no significant difference).



The interpretation of the use by common scoter of the Horns Rev Offshore Wind Farm is difficult, because of the birds' absence in the vicinity during the baseline study, compared with very large numbers post construction (potentially as a result of changes in food distribution). The extreme scarcity of visual observations of scoters flying in between turbines and the lack of observations during aerial surveys post construction (when up to 381,000 were present in the general area) confirm that this was also amongst the species that showed almost complete avoidance of flying or swimming between the rows of turbines, despite very large concentrations in the surrounding waters (Figure 7.17).

Long-tailed ducks showed statistically significant reductions in density post construction in the Nysted wind farm (and in sectors 2 km outside) where they had shown higher than average densities prior to construction. This strongly suggests major displacement of this species from formerly favoured feeding areas, although the absolute numbers were relatively small and therefore of no significance to the population overall (Figure 7.16). Terns and auks were almost never counted in the Horns Rev Offshore Wind Farm post construction, but were present in densities similar to the overall average prior to turbine erection, but because of high variance during the baseline, the differences were not statistically significant (Figure 7.16). Other species, such as little and herring gulls, showed no significant change in distribution. Comparing pre-construction distributions of birds with sufficient sample sizes with those post construction, no bird species convincingly demonstrated enhanced use of the waters within the two Danish offshore wind farms after the erection of turbines, but it was clear, for example amongst cormorants at Nysted, the wind farm area was used occasionally for social feeding by very large numbers of birds post construction.

Although bird displacement (as a result of behavioural avoidance of wind farms) represents effective habitat loss,

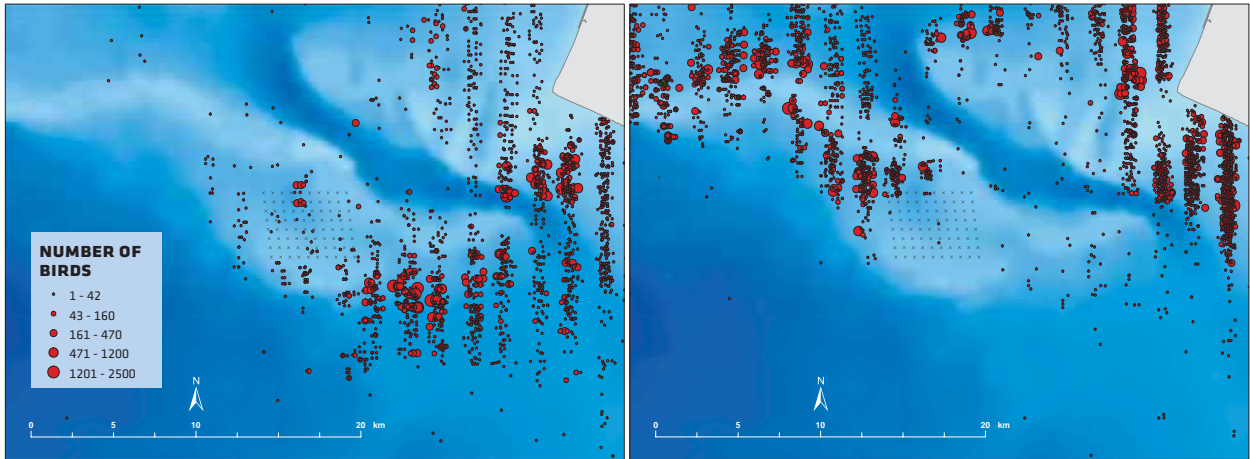
it is important to assess the relative loss in terms of the proportion of potential feeding habitat (and hence the proportion of birds) affected relative to the areas outside of the wind farm. For most of the species considered here, that proportion is relatively small and therefore likely to be of little biological consequence. However, the additional costs of many other such wind farm effects may constitute a more significant effect and represents a high priority when considering cumulative impacts of many such developments along an avian flyway.

#### LOW PROBABILITY OF WATERBIRD COLLISIONS

The avoidance responses documented above mean that although erecting turbines at sea does have a major effect on the local distribution, abundance and flight patterns of birds, the corollary is that many fewer birds come within the risk zone of the rotor blade sweep area. Radar study results demonstrated that many birds showed avoidance responses up to 5 km from the turbines, and that >50% of birds heading for the wind farm avoid passing within it. Radar studies at Horns Rev and Nysted also confirm that many birds entering the wind farms re-orientate to fly down between turbine rows, frequently equidistant between turbines (eg Figure 7.15), further minimising collision risk. The Nysted TADS study confirmed that waterbirds (mostly common eider) reduced their flight altitude within the wind farm, flying more often below rotor height than they did outside the wind farm.

The stochastic predictive collision model was used to estimate the numbers of common eiders, the most common species in the area, likely to collide with the sweeping turbine blades each autumn at the Nysted Offshore Wind Farm. Using parameters (including those described above) derived from radar investigations and TADS, and 1,000 iterations of the model, it was predicted with 95% certainty that out of 235,000 passing birds, 0.018–0.020% would collide with all turbines in a single autumn (41–48 individuals).

**FIGURE 7.17** DISTRIBUTION OF COMMON SCOTER AROUND HORNS REV



Distribution of common scoter, *Melanitta nigra*, around the Horns Rev Offshore Wind Farm based on 16 pre-construction aerial surveys (left plot), compared to 15 post-construction surveys (right). Observations are arranged around north-south oriented lines along the survey track lines, each point indicates an individual bird or flock, the point size being proportional to the number of birds. Small crosses indicate the positions of the turbines, the mainland is indicated in grey and the bathymetry of the area is indicated by the blue shading (darker colour representing deeper water). Changes in overall distribution may reflect changes in food distribution between the two periods, but it cannot be excluded that the absence of birds southeast of the wind farm post construction was at least partly due to maintenance traffic in this area.

With such a low level of probability of collision expected at any one turbine, it was predicted that the TADS monitoring system would fail to detect a single collision of a waterbird during more than 2,400 hours of monitoring that was undertaken at the site, and this proved to be the case, despite the effectiveness of TADS in detecting birds (Figure 7.18). This level of monitoring resulted in a mere 11 bird detections well away from the sweep area of the turbine blades, two passing bats, two passing objects that were either small birds or bats, a moth and one collision of a small bird/bat.

#### MAJOR CONSEQUENCES UNLIKELY

The objectives of the assessment undertaken here were to predict the potential effects of the construction of the first two large scale major offshore wind farms in Danish waters and then to measure the observed effects post construction. Because these two wind farms are the first of their size on the planet, for which we have only

**FIGURE 7.18** INFRA-RED IMAGE OF PASSING BIRD FLOCK



An infra-red image of a passing flock of common eiders, *Somateria mollissima*, captured by the Thermal Animal Detection System (TADS) during operation at the Nysted Offshore Wind Farm. This scene was captured whilst the camera was pointing away from the turbine rotors.

## **MODELLING COLLISION RISK AT OFFSHORE WIND FARMS**

The stochastic collision risk model is a mathematical means of estimating the likelihood of a bird colliding with a turbine, based on the product of an array of probabilities (each determined by different factors), drawn from observations, which includes an assessment of natural variability (see Petersen et al. 2006 for a full explanation). Few of these probabilities can be determined in advance of turbine construction, but many more can be obtained from comparisons between pre and post construction measurements.

For example, baseline mapping of radar tracks of flying individual birds or flocks enables a basic assessment of the proportion that entered the wind farm area prior to construction. Vertical and horizontal radar and infrared technology studies can measure the proportion of those birds entering the wind farm that would potentially fly within horizontal and vertical reach of the rotor blade sweep area. The combination of these parameters is crucial for a basic environmental impact assessment of the proportions of birds passing through a proposed wind farm area that are at potential risk from collision. However, if a species also tends to avoid travelling through the wind farm post construction, or flies at a lower altitude and equidistant between turbines when they do so (as was the case with eiders at Nysted), the probability of collision is further reduced compared with the original prediction. At present, only the Horns Rev and Nysted offshore studies have provided such information to parameterise such models.

Many of these probabilities are also affected by environmental conditions, such as wind strength and direction, or the specific local conditions that affect migration in the vicinity, which also need to be taken into account in modelling collision risk. Even those birds that do approach the rotor blade sweep area may avoid collision by pure chance (which can be mathematically estimated based on known factors such as bird size, flight speed and rotor speed) or by active avoidance (which is likely to be highly species specific and requires much greater study). These site- and species-specific probabilities require fresh empirical studies to generate robust risk probabilities at other offshore wind farm sites in the future in order to conclude on any generic effects.

3 years of post-construction data we should be cautious about drawing general inferences from the results at this stage.

Nevertheless, the broad conclusion is that at least the majority of the more numerous bird species at Horns Rev and Nysted show avoidance responses to both wind farms. Whilst this may add to energetic costs, neither site is so close to a nesting area of any of the species to affect reproduction, and the slight extension to flight distances (generally <10 km) is unlikely to have any major consequences for any of the species involved at this level. The responses were highly species- and site-specific and subject to influence by factors such as wind, so it is not possible to generalise, but general avoidance also extended, not just to flying between turbines, but also to not resting or foraging between them.

Aerial surveys showed almost complete displacement of divers at Horns Rev, where virtually no common scoters were encountered between the turbines, confirmed by visual and radar observations which showed the species was reticent to fly or swim between the turbines. There were significant reductions in long-tailed duck densities within the Nysted wind farm compared with pre construction and control areas. This implies that construction of wind farms in favoured feeding areas for these species, and potentially others, will cause habitat loss for at least three years after construction, even if the habitat and the feeding resource remained intact. This habitat loss for such benthic and pelagic feeders is a major consideration in any future environmental impact assessment, especially where there are high bird concentrations or where there is evidence of habitat limitation at the stage of the life cycle when the habitat is exploited.

Avian avoidance behaviour of turbines minimizes collision risk, and these early post-construction studies show that, despite very heavy common eider migration in the Nysted area, their avoidance of turbines at different spatial scales resulted in very low modelled collision risk. The

**FIGURE 7.19** *The collision risk with the wind turbines is very low. Of 235,000 common eiders passing Nysted each autumn, predicted collision rates were 0.02% (45 birds). The low figure was confirmed by the fact that no collisions were observed by infra-red monitoring of the turbine blades.*

model predictions of collision rates (confirmed by TADS monitoring) suggested that large waterbird collisions were extremely rare events, amounting at Nysted (with 95% confidence) to 40–50 common eiders on average per year, less than 0.05% of the annual hunt in Denmark (currently approx 70,000 birds). TADS monitoring of a single turbine is expensive in terms of equipment and analysis, but TADS deployment was invaluable for supporting collision model predictions and providing data on the frequency and nature of near turbine avoidance behaviours of birds (and indeed moths and bats), knowledge of which has been previously virtually non-existent.

#### DISCUSSION

### **NEED FOR LARGE SCALE ASSESSMENT**

The issues of flight displacement, habitat loss and collision are common to all wind farm developments, so the most effective first tier level of screening for potential locations for offshore wind farms throughout the world should be based upon large scale assessment of avian migration routes and of feeding distributions of birds in the marine environment. Aerial survey techniques enable large areas of offshore waters to be censused in relatively short periods and large scale radar to describe bird migration in relation to the geography of coastlines



PHOTO: NYSTED OFFSHORE WIND FARM

and the world's major avian flyways.

It is more feasible now than ever before to assess at international and regional scales, the relative sensitivity of particular areas to development by constructions because of collision or avoidance by birds. Our experience confirmed the need for pre- and post-construction monitoring to demonstrate effects and measure their magnitude and we strongly recommend this is undertaken at consented offshore wind farm locations to thoroughly document the abundance and distribution of all bird species pre construction, to investigate any residual effects after mitigation, to assess the effectiveness of mitigation measures and contribute to our gathering knowledge of the effects of offshore wind farm constructions on different species under a range of differing circumstances.

#### MEASURING CUMULATIVE EFFECTS

The European Union's Environmental Impact Assessment Directive requires some assessment of the cumulative effects and impacts arising from each wind farm development and from other projects (which may include both other wind farms and other relevant human development projects) that impact upon the same flyway populations. Such assessments are extremely difficult without a common currency. Human development pressures may enhance energy expenditure, destroy habitat, inhibit nesting or kill birds, none of which are directly comparable in terms of their impacts.

It is necessary to establish a common measure for comparison, and gauge the effects of individual developments to overall impacts at the population level. The opportunity to define the impact in terms of the contribution to changes in annual population size offers one of the few possibilities to compare very different effects overall and to make an assessment of their cumulative results. Such an approach is neither simple nor easy, but the framework described in Figure 7.1 offers some possibility of attaining this goal.

## IAPEME VIEWPOINTS

#### COLLISION RISK

Risk of bird mortality through collisions with turbines has long been one of the main environmental issues associated with wind farms. Collision risk can be estimated through models, but modelling requires a number of key parameters of bird behaviour to be measured or guessed (Band et al. in press). In the context of the present studies, we can have great confidence in the data on numbers of birds using the study areas, as there have been detailed and accurate surveys over many years. However, there is a shortage of data on the avoidance behaviour of birds approaching turbines and this is a key determinant of the collision rates computed from models (Chamberlain et al. 2006). For onshore wind farms, there is a possibility to obtain empirical data on collision rates by collecting carcasses, but that is not possible at marine wind farms. Study of bird behaviour in the vicinity of onshore wind farms can be done relatively easily by direct observation or radio tracking (Barrios & Rodriguez 2004; Drewitt & Langston 2006). This is less practical at sea, although observations can be made of flight altitudes, speeds and behaviours of seabirds that can provide data on species vulnerability and some of the parameters required for collision risk models (Garthe & Hüppop 2004). The research at Horns Rev and Nysted provides novel and critically important data on the behavioural responses of waterbirds to marine wind farms, obtained through the development of sophisticated methods such as the novel TADS (thermal animal detection system) and use of state of the art radar that can track individual birds over the sea. These studies have provided very strong evidence indicating that collision mortality of waterbirds during migratory passage at Horns Rev and Nysted is unlikely to have a significant impact on populations.

There has been a general concern world-wide that even if there are few collisions under normal conditions, bird populations may be affected by catastrophic mortality events on rare occasions when visibility is impaired by fog or other adverse weather conditions. The observations at Nysted that waterbirds tend not to fly in the area of the turbines at night, or under adverse weather conditions (as found elsewhere; Petterson 2005) suggest that collision risk is not likely to be high even under conditions when the turbines are less visible, although more work testing this hypothesis would be desirable.

#### **HABITAT LOSS AND INCREASED TRAVEL COSTS**

Although the strong tendency for waterbirds to avoid entering the wind farm seems to indicate that collision rates will be very low, the strong avoidance behaviour may lead to greater loss of habitat and energy costs of increased travel distances. Such travel costs may also be an issue for nocturnal migrant passerines where body reserves dictate migratory ability and survival prospects (Alerstam 1990; Ballasus & Hüppop 2006). The studies at Horns Rev and Nysted suggest that extra travel costs (and costs of habitat loss) for seabirds are likely to be trivial in the context of a single wind farm. But the development of numerous marine wind farms along the coasts of Europe leads to questions about cumulative effects. Marine wind farms tend to be sited in water depths that are the preferred habitat of bird species of conservation concern such as common scoters and red-throated divers, species that are already considered to be vulnerable to impacts of disturbance (Kaiser et al. 2006; Schwemmer & Garthe 2006). Assessing cumulative effects on bird populations is clearly an important topic for future research.

It seems likely that studies in other parts of the world will find similar bird behaviours in relation to offshore wind farms to those reported here, but there is a clear need to investigate how much the behaviour of birds varies between sites and species; it would be inappropriate to assume that data from Horns Rev and Nysted can necessarily be applied to offshore wind farms elsewhere.

#### **QUESTIONS ARISING FOR FUTURE STUDY**

The Danish research has developed valuable new tools for study of birds in relation to marine wind farms, and has provided insights into the flexibility of waterbird behavioural responses to the hazard of turbines suggesting that collision rates are likely to be less of a problem than often suggested, whereas habitat loss may potentially be a greater issue if numerous sites are developed along an avian flyway or key winter range. It is evident from the studies of benthic organisms and fish at Horns Rev and Nysted that ecological changes in the wind farm will probably take many years to reach equilibrium. Birds may respond to these changes; for example the wind farm may become more attractive if food stocks increase. Birds may also learn to adapt to the new structures, so that behavioural responses may differ after some years from those seen when the farm was new. The extent of adaptation by birds is yet to be seen, but given the long life-spans of seabirds such changes can be anticipated, and may influence parameters of collision risk models. These questions also merit research, but the greatest challenge for the future may be the development of paradigms to assess cumulative impacts of marine wind farms on bird populations at a landscape scale.



## SOCIOECONOMIC EFFECTS

# POSITIVE ATTITUDES IN LOCAL COMMUNITIES

BY JACOB LADENBURG, JESPER TRANBERG, ALEX DUBGAARD (INSTITUTE OF FOOD AND RESOURCE ECONOMICS, KVL)  
AND SUSANNE KUEHN

A sociological and environmental economic study reveals that both the local and national populations are positive towards the offshore wind farms. However, it is very clear that there is a difference in attitudes between the two local areas and also between the attitudes at local and national level.

In terms of the preferences and willingness to pay for the future placing of wind farms the results show a clear picture. People are willing to pay to place future offshore wind farms away from the shore to reduce their visual impact. However, the willingness to pay to have wind farms moved completely out of sight is limited. The results also indicate that the preferences vary with regard to the experience with visual intrusions of offshore wind farms.

## CONTENTS

- Introduction: Attitudes and preferences
- Methods: Sociology and economics
- Results: A generally positive attitude
- Discussion: First study to address distance
- IAPEME viewpoint

## INTRODUCTION

### ATTITUDES AND PREFERENCES

---

In Denmark the number of land-based wind turbines has increased significantly during the last decades. At the same time focus on the negative effects on the surroundings in terms of noise, reflections and visual intrusions have been the focus of much debate. Moving wind power offshore has been expected to reduce some of these negative effects but the attitudes and preferences actually found in the local communities have not been investigated so far.

An investigation of the perception of landscape effects was the aim of the socioeconomic study. The study was conducted as two separate studies, containing a sociological study examining the local attitudes and an environmental economic study investigating people's preferences for future locations of offshore wind farms.

When investigating the preferred locations several factors were expected to be important. The size of the individual wind turbines, distance from the shore, size of the wind farms and the number of wind farms are all characteristics which were expected to influence the individual perception of the visual intrusions of offshore wind farms.

From a policy point of view the different intrusion characteristics are very interesting as they entail important information on the welfare economic impacts of locating offshore wind farms within sight from the shore. To be able to estimate the preferences and willingness to pay for a reduction of the visual intrusions associated with the different characteristics of offshore wind farms, the

Choice Experiment valuation method was viewed as ideal for the purpose compared to other approaches.

## TWO LOCAL AREAS WITH DIFFERENT SET-UPS

This chapter will make it evident that there is a clear difference in the attitudes and preferences between the two local areas of Horns Rev and Nysted. A difference in preferences exists between the local population and the Danish population as well.

The Horns Rev Offshore Wind Farm is located 14 km west of the coast of the Blåvands Huk area. The area is predominated by recreational homes and 3260 people are permanent residents in the municipality. Only a few homes, both permanent and recreational, have a location with a view of the wind farm from their plot.

The wind farm at Nysted is located 10 km from the coastline and, contrary to Blåvands Huk, quite a few of the 4,285 citizens can actually see the wind farm from their houses. The wind farm can also be viewed from the town of Nysted and from the town harbour, which is a central meeting place for both locals and tourists.

The somewhat different local conditions of the two sites are important to keep in mind since they are expected to be the major reason for the differences in attitudes found in the sociological study, and in part the reason why different preferences for future locations are revealed. It is also important to keep in mind that the distance between the wind farm and the coastline differs for the two locations. This difference creates a dissimilar visual interference, which is expected to be the origin of much of the difference in attitudes.

## METHODS

### SOCIOLOGY AND ECONOMICS

---

Not surprisingly the two studies apply different approaches due to their different aims.

The sociological study takes a qualitative approach by

relying on in-depth interviews for its empirical work to expose the attitudes towards the two local wind farms. A total of 46 persons were interviewed, each interview lasted between one and two hours. The sociological study was supplemented with an analysis of the local media coverage of the wind farms. The study includes two local samples but also investigates the change in attitudes over time in interviews conducted before and after the construction of the wind farms.

The environmental economic study uses a quantitative questionnaire based on the Choice Experiment approach to elicit the preferences for different location strategies. As follow-up questions the questionnaire also included a series of attitudinal questions on wind farms in general. The environmental economic study includes a Horns Rev, Nysted and a national sample. This makes it possible to compare the local findings with the general national attitudes and preferences.

In spite of the different focuses and approaches the two studies were able to benefit from each other. The findings in the sociological survey supported the formulation of the attitudinal questions in the environmental economic questionnaire. Subsequently the responses to the attitudinal part of the questionnaire were used to validate the results of the sociological interviews.

#### ASSESSMENT OF LOCAL ATTITUDES

The sociological study was initiated in the spring of 2003 when the pre-construction interviews at Nysted were conducted. The study ended in the autumn of 2004 with follow-up interviews at Nysted. As mentioned these last interviews were conducted to monitor if there had been a change in attitudes.

During this period the interviews in the Horns Rev area (Blåvands Huk) were also conducted (no pre-construction interviews were conducted at Horns Rev). The analysis of the local media was also made during this period. It is worth noting that the people selected for these in-

depth interviews were chosen because they had shown an interest in the local project. Therefore, their opinion cannot be directly transferred to cover the opinion of the general local public.

The interviews were carried out on the basis of a guide containing themes on the decision-making process, general view and perception of wind energy and the general opinion about nature and environmental issues. In the second stage interviews, whose main purpose it was to detect whether a development in attitude had taken place, the interview guide was expanded. This expansion was based on relevant questions which had come up during the first interview sessions and in the questionnaire from the environmental economic study.

Part of the sociological study focused on the debate in two local newspapers in relation to the wind farms. The selected papers were Lolland-Falster Folketidende (Nysted) and Jyske Vestkysten (Horns Rev), relevant articles in the period of 1997 to 2004 were analysed. The analysis investigated what attitudes the papers presented and to what extent the public discussion and attitudes were influenced by the papers.

#### CHOICE EXPERIMENTS

The environmental economic study of preferences for the location of future wind farms in terms of the distance from the shore line was conducted as a mail survey in May 2004. The Choice Experiments valuation survey was based on 1400 randomly selected individuals and divided into three samples; a national sample of 700 respondents represented the Danish population and two samples of 350 respondents each represented the populations living close to the two wind farms at Nysted and Horns Rev.

In total 672 usable questionnaires were returned, distributed onto 362, 140 and 170 respondents from the national, Horns Rev and Nysted samples respectively. This is equal to an effective response rate of 48%, which can be considered as good in this type of research.

**FIGURE 8.1** VISUALISATIONS



DISTANCE 8 KM, TURBINES 100, WIND FARMS 7 AND COST PER HOUSEHOLD: 70€.



DISTANCE 18 KM, TURBINES 144, WIND FARMS 5 AND COST PER HOUSEHOLD: 140€.

PHOTOS: ELSAM ENGINEERING A/S

*Examples of the visualisations and attributes levels. The photos are reproduced in 1/3 of the size of the photos of the questionnaires.*

The methodology of Choice Experiments is to ask people to choose between different alternatives. In the study this is done by asking each respondent to evaluate three choice sets consisting of two alternative offshore wind farm layouts. The alternatives define the good in terms of the key attributes and different alternatives are described by varying levels of the attributes.

The Choice Experiments approach has a high degree of resemblance to real market situations, where consum-

ers are used to evaluate several products simultaneously, and subsequently choose between them. By examining the trade-offs between attributes/attribute levels that are implicit in the choices made by the respondents, it is possible to derive an estimate of the utility associated with the different attributes. If one of the attributes is measured in monetary units (ie price), it is possible to derive estimates of respondents' willingness to pay (WTP) for the other attributes from the marginal rate

of substitution between the monetary attribute and the other attributes.

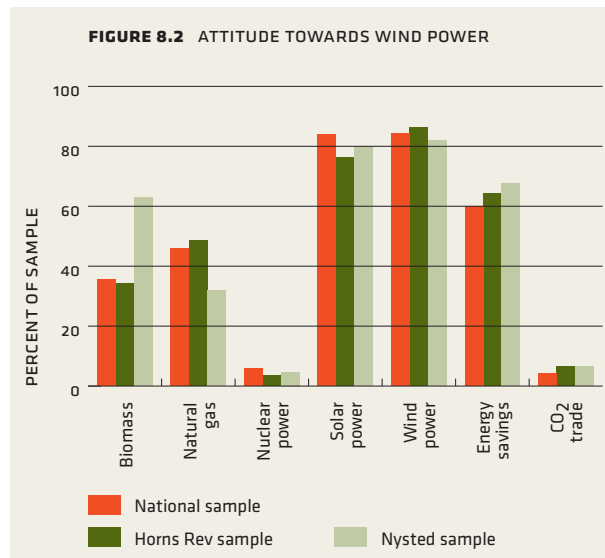
The attributes that form each alternative are the distance from the shore, the size of the wind farm and the price of electricity. The different levels of each attribute are combined using statistic methods, and 36 different alternatives were used to construct the choice sets. The price, here as an additional payment over the electricity bill, and the size of the wind farm (49, 100 or 144 turbines of 5 MW each) are relatively easy to relate to. However, the visual impact caused by different distances and sizes might be difficult to comprehend. To counter this each choice set was supplemented by a visualisation of the two choices.

## RESULTS

### A GENERALLY POSITIVE ATTITUDE

Both the sociological and the environmental economic studies showed a positive attitude towards wind power in general. Of the 46 individuals in the sociological study only two expressed a negative attitude towards the future use of wind power as a sound alternative to other types of renewable and non-renewable fuels. The same findings were made in the environmental economic study where both local and national respondents pointed to wind energy as their favoured choice of reducing CO<sub>2</sub> emissions. In comparison it was found that solar power and energy savings were among the second most preferred, whereas nuclear power and tradable CO<sub>2</sub>-quotas were among the less favoured.

There was a consensus between the three samples on the preferred source of energy but the respondents in the Nysted area stand out from the national and Horns Rev samples by placing more emphasis on biomass. Along the same lines the respondents at Nysted seem to value natural gas less. According to the sociological study the reason for these deviations in the Nysted sample might



Percentage of each sample who answered "to a great extent" when asked whether the energy source should be used "to a great extent", "to some extent" or "not at all" in the Danish effort to meet CO<sub>2</sub> reduction demands.

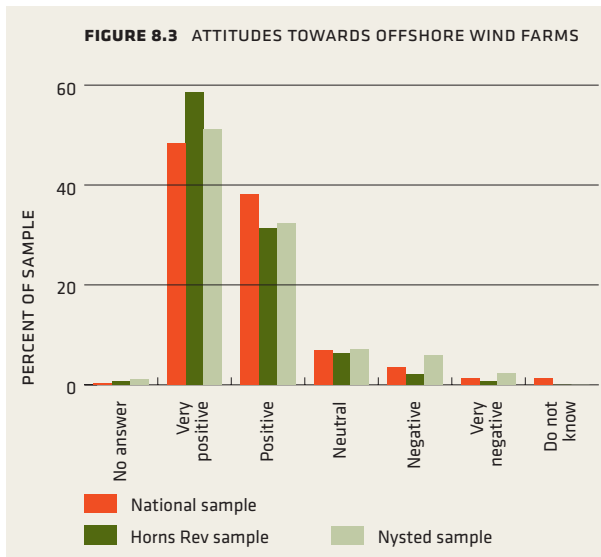
be due to positive local experience with biomass (see Figure 8.2).

#### ATTITUDE TOWARDS EXISTING WIND FARMS

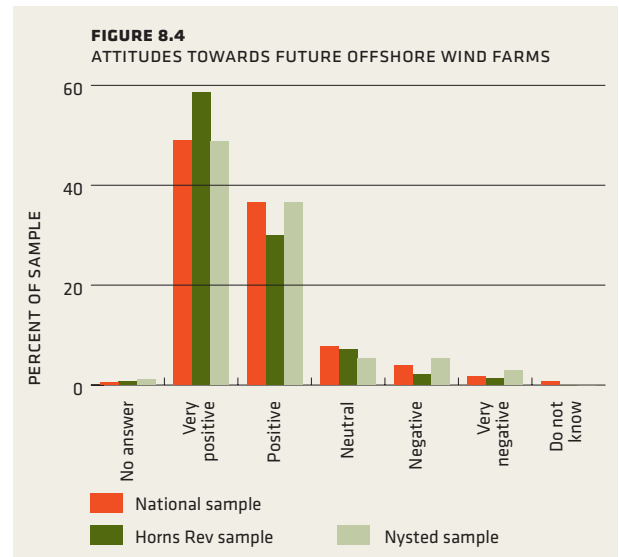
In both studies the respondents were asked to state their attitude towards existing and future offshore wind farms. In the environmental economic study it was found that people in the Horns Rev area are more positive towards existing offshore wind farms than respondents in the Nysted area. This is expressed by more respondents stating that they are "very positive" towards the existing offshore wind farms in the Horns Rev sample. At the same time a predominant part of the "negative" replies happens to be from Nysted (see Figure 8.3).

These findings are consistent with the findings in the sociological study. Here it was found that the people in the Horns Rev area accept the local wind farm to a higher extent than is the case in the Nysted area.

When looking into who is the most sceptical of the



The attitudes towards existing offshore wind farms divided onto each of the three samples, each sample sums to 100%.



The attitudes towards future offshore wind farms divided onto each of the three samples, each sample sums to 100%.

existing wind farms it is found that in general middle-aged to elderly men (above 56) exhibit a far more negative attitude than others. Not surprisingly the commercial fishermen at Horns Rev form another group of very negative respondents. During the interviews of the sociological study they stated that they would have preferred a different location of the wind farm to avoid affecting prime fishing locations. The latter statement may relate to the fact that compensation from the developer was to be negotiated.

#### ATTITUDES TOWARDS FUTURE WIND FARMS

When asked about future offshore wind farms, a very similar pattern in the answers as for the existing wind farms was observed. In the sociological study the respondents were asked what they preferred in terms of future location of the offshore wind farms.

The result showed that respondents who are already negative towards the existing wind farm would prefer that

new wind farms are made as extensions to the existing farms so as to protect other areas. Other respondents stated that the nuisance of wind farms should be a more collective one and therefore new offshore wind farms should be placed in other areas. Yet again another group argued that wind farms should be placed further out at sea making them less visible (see Figure 8.4). As we will see later this is very much in line with the results of the environmental economic study of people's preferences.

#### UNDERLYING REASONS FOR ATTITUDES

In the sociological study a number of underlying reasons for the respondents' positive or negative attitudes were registered. To a large extent the attitudes for Nysted and Horns Rev corresponded. Positive attitudes were motivated by environmental concerns, reliability of supply, exports and employment benefits.

The environmental concern was split in two groups; one who put emphasis on CO<sub>2</sub> emissions and one who

emphasised pollution by NO<sub>x</sub> and SO<sub>2</sub> as their main concern. The argument of exports and employment were stressed by almost all of the respondents with a positive stance, and it was the general opinion among the positive group that the nuisance of a local facility could be endured as long as it assured employment and a Danish leading position within wind power.

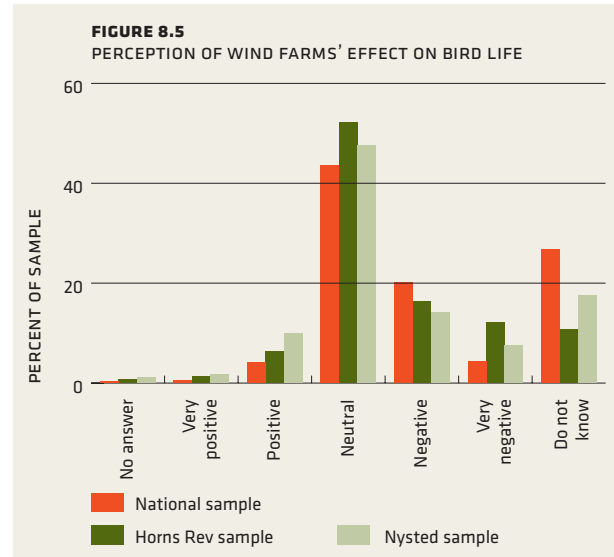
Among the respondents who expressed a negative attitude two things were in focus. Firstly, visual intrusions were a concern. Secondly, there was a concern that the wind farms would have a negative impact on nature. The loss of the undisturbed view of the coastline and the ocean is mentioned by several of the respondents as a major issue.

At both locations, respondents mentioned that they were highly surprised with the decision to place a wind farm in the area as they found that exactly this spot contained outstanding natural values. This observation points towards the fact that a decision made at a national level, including the pros and cons, often will conflict with local preferences. One possible explanation is that experiences with nature are closely connected to the individual formation of identity.

In this way the authority's management of landscapes becomes management of identity. This could explain the strong feelings and major protests that often arise when governmental decisions are made concerning local nature/identity. Another source of concern and negative attitude was the light markers for air traffic, which were seen as a major aesthetic and landscape disturbing factor.

#### PERCEPTION OF IMPACT ON WILDLIFE

As a follow-up question in the environmental economic questionnaire, the respondents were asked to what extent they perceived wind farms as a danger to birds and marine animals. The answer to this is interesting as it gives a hint of the informational level of the respondents and can be related to the scientific studies on birds and marine life.

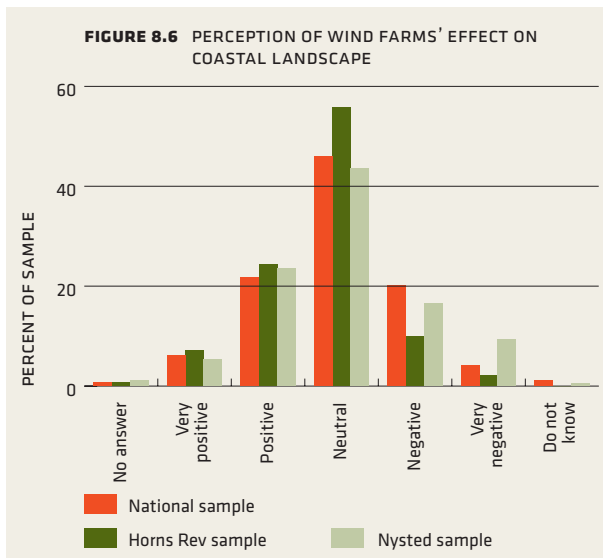


*Respondents' perception of the wind farms' effect on the bird life in the area, each sample sums to 100%.*

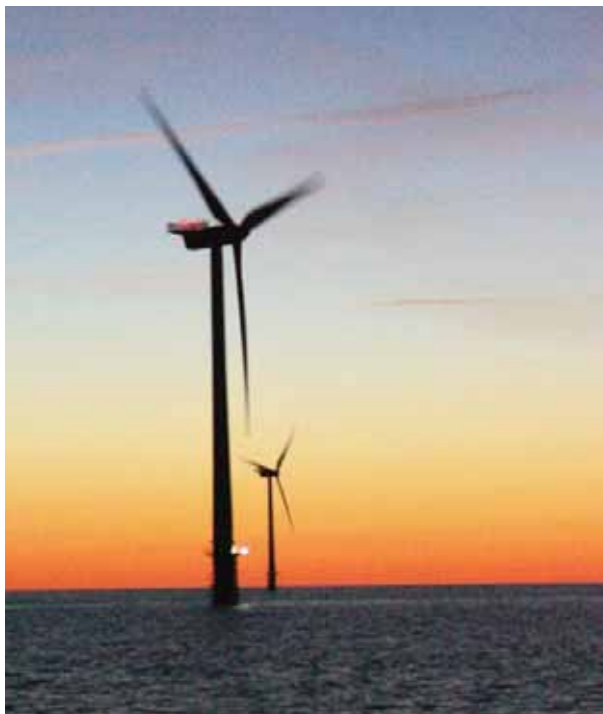
The prevailing attitude among both local and national respondents is that the impact on birds and marine life is neutral. However, between 22 and 29% of the respondents in the three samples stated that they believed the wind farm to have a negative or very negative effect on bird life. In comparison, only 12 to 19% answered that wind farms would have a negative or very negative effect on underwater marine wildlife.

A rather large proportion of the respondents answered "don't know" when asked about their opinion on the wind farms' effect on marine wildlife (see Figure 8.5). This is not surprising as the question requires prior knowledge of the subject. It is interesting to note that respondents in the two local samples have a significantly lower percentage of "don't knows" than the national sample. This indicates that the local populations have (or think they have) a much higher level of knowledge when it comes to the effects of wind farms than is the case of the Danish population as a whole.

Along the same lines it can be seen that the respond-



*Respondents' perception of the offshore wind farms' effect on the coastal landscape divided onto each of the three samples, each sample sums to 100%.*



**FIGURE 8.7** *Sunset over Horns Rev Wind Farm.*

ents of the Horns Rev sample feel even better informed than the Nysted respondents. This was not only the case in relation to the question on birds but also in several of the other questions. The second round of interviews made in the sociological study support this conclusion. Here the respondents in the local areas stated that the results of the environmental monitoring programme had convinced them that the effect on nature was less pronounced than they had expected.

#### ROLE OF EXPERIENCE AND MEDIA COVERAGE

One of the main goals of the sociological study was to identify whether people in the local areas of Horns Rev and Nysted changed their opinions on the local offshore wind farm. The study shows that the opposition against the wind farm at Horns Rev was the largest by far prior to the construction. This negative attitude gradually became less pronounced, and in 2004 the general attitude could be described as neutral or even slightly positive towards the offshore wind farm. This was also found to be the case in the environmental economic study where the respondents in the Horns Rev area were the least negative by far in their perception of an offshore wind farm.

The interviews reveal that there were two major concerns which caused the initial opposition. Firstly, the respondents pointed to the decision-making process which was seen as highly centralised and with no local “co-decision” when it came to placing the wind farm. Secondly, there was a major concern that the wind farm would cause extensive visual intrusions and thereby result in a radical reduction in the number of visiting tourists. As time has passed the discontent with the decision process has worn off and the negative effect on tourism has not occurred thus resulting in reduced opposition.

The sociological study did not encounter the same change in attitudes when conducting interviews in the Nysted area. It is concluded that the reason for this is the fact that the opposition in Nysted is mainly based on

PHOTO: CHRISTIAN B. HVIDT



visual externalities. As mentioned previously, the wind farm at Nysted has a much more visible appearance and is located close to residential areas. In line with this, one of the major reasons for the opposition according to the second round of interviews was the visibility of the light markings at night.

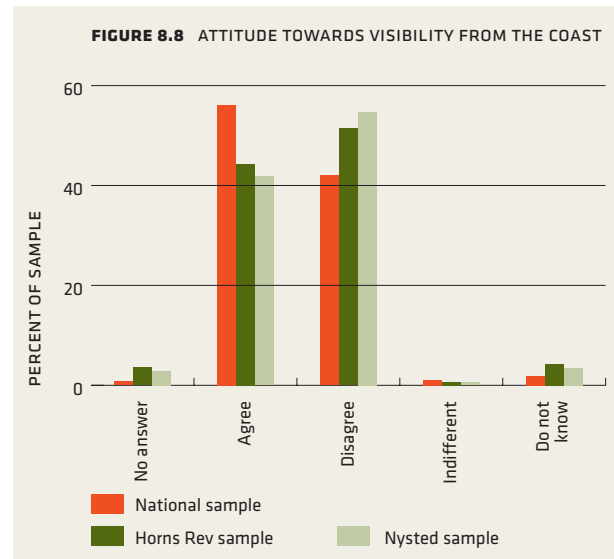
#### DISTANCE AND WILLINGNESS TO PAY

The main objective of the environmental economic study was to elicit people's preferences in relation to the placement of future wind farms and to calculate a willingness to pay to reduce the visual externalities.

Before looking at the willingness to pay, it is worth taking a look at a couple of the follow-up questions. One of the follow-up questions in the environmental economic study asked the respondents what influence a wind farm had on the coastal landscape. Surprisingly, 43 to 55% of the respondents stated that they found the impact on the landscape to be neutral. Among the respondents who stated that a wind farm had a negative impact, the respondents at the Horns Rev sample stood out as seeing wind farms to be much less negative to the coastal landscape. Only 12% of the Horns Rev sample stated the impact as being "negative" or "very negative". In comparison 24% of the national sample and 26% of the Nysted sample landed themselves in these categories.

Even though almost two thirds of the respondents stated that they found wind farms' effect on the landscape to be either neutral or even positive, the case is slightly different when asked about the preferred placement of future wind farms.

When asked about their preference to the hypothetical scenario of placing 720 wind turbines of 5 MW each offshore – close to 50% of the respondents in both the Horns Rev and the Nysted sample stated that they preferred the wind farms to be moved out of sight. In the national sample the preferences seemed to be a little different. Here more than half of the respondents stated



*Respondents' answers when asked if they preferred the offshore wind farms placed so that they are not visible from the coast, each sample sums to 100%.*

that they preferred wind farms to be moved out of sight. This result is surprising at two levels. Firstly, it is interesting that so many stated that they found the impact of wind farms neutral or positive and still expressed a preference for moving them out of sight. Secondly, the result contradicts a hypothesis that experience with wind farms causes stronger preferences to place future farms out of sight.

When it comes to the question of placing future wind farms in several small groups or fewer but larger groups there does not seem to be any doubt in regard to the preferences. When asked, a majority of both local and national respondents stated that they preferred larger and fewer farms. In fact more than 70% agree to this. This indicates that the recent decision to expand the Nysted and Horns Rev sites instead of building new farms makes sense.

As already mentioned the main purpose of the environmental economic study was to assign a monetary value to the preferences for diminishing the visual effects of

wind farms. Even though the follow-up questions reveal that far from all respondents found that wind farms had a negative effect on the landscape, a substantial willingness to pay to place wind farms more than 8 km from the shore was found.

#### THE NATIONAL SAMPLE

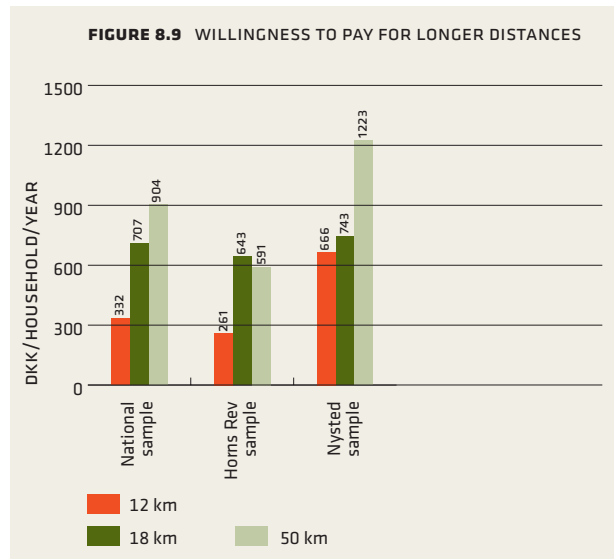
Taking the *national sample* as the “standard” case, the results show the following pattern: Willingness to pay (WTP) to extend the distance from 8 to 12 km is 332 DKK/household/year. WTP increases by more than 100% to extend the distance from 12 to 18 km where the visual intrusions are significantly reduced, and by approx 30% to have the distance extended from 18 to 50 km, ie virtually out of sight.

In other words, there is a significant willingness to pay to have wind farms located at distances where the visual intrusions are fairly modest, ie up to 18 km from the shore. There are not equally strong preferences – in terms of willingness to pay – to have wind farms moved further out to a distance of 50 km where they are virtually invisible from the shore.

#### THE LOCAL SAMPLES

Taking the two *local samples*, the results show a somewhat different WTP pattern. In the Horns Rev sample, respondents are willing to pay (only) 261 DKK/household/year to have the distance extended from 8 to 12 km. WTP increased by close to 150% to have the distance extended from 12 to 18 km, but surprisingly there is no extra WTP to have wind farms moved from 18 to 50 km from the shore. (The difference in the drop in WTP from 643 DKK to 591 DKK when going from 18 to 50 km is not statistically significant).

In the Nysted area, respondents are willing to pay nearly twice as much as in the national sample to have the distance of wind farms extended from 8 to 12 km from the shore. WTP for extending the distance to 18



Willingness to pay (WTP) to place wind farms at distances larger than 8 km from the shore.

km is not much higher than WTP for 12 km, but WTP increases by more than 160% for locating wind farms out of sight, ie at a distance equal to 50 km from the shore.

It seems obvious to seek the explanation to these WTP patterns in the different experience with offshore wind farms for the people in the two areas. The Horns Rev Offshore Wind Farm is located at a distance of 14 km from the coast. That is, at a distance where the visual intrusions are significantly reduced. The Nysted Offshore Wind Farm, on the other hand, is located at a distance of only 10 km from the shore. Furthermore, the visibility at Nysted is assumed to be better than at Horns Rev. This means that the visual intrusions are rather significant.

As noted previously, the Nysted sample did not have a much greater share of respondents expressing negative attitudes towards wind farms. However, when focussing on respondents expressing preferences to move wind farms out of sight, this subgroup had considerably *stronger* preferences for this alternative in the Nysted sample than the similar subgroups in the two other samples. As discussed earlier the sociological investigation in the



**FIGURE 8.10** Only 12 to 19% of the respondents answered that wind farms will have a negative effect on underwater marine wildlife.

Nysted area shows a similar pattern.

When examining the results to see if the respondents expressed preferences for either large or small wind farms, preferences differ somewhat. Some perceive fewer but larger wind farms to have less effect whereas others consider more but smaller farms as a means of reducing the visual effects. However, more than 70% of local and national respondents stated that they preferred larger and fewer farms.

#### WIND FARMS GENERATE LOCAL EMPLOYMENT

As an additional part of the environmental economic study an estimate was made of the employment effects of constructing and maintaining an offshore wind farm.

The employment effects were calculated using input-output model data. Using the Horns Rev Offshore Wind Farm as a model, the calculations show that the establishment of an offshore wind farm with 80 2 MW turbines creates a total of around 2,000 man years of domestic employment over the construction period. A tentative estimate indicates that up to one quarter of this will be at local level. Operation and maintenance over the 20-year life time of the facility will create an additional 1,700 man years of employment – or 85 man years on average on an annual basis. It is expected that three quarters of this will be at local level.

## DISCUSSION

### FIRST STUDY TO ADDRESS DISTANCE

Using an inter-disciplinary approach by combining a sociological and an environmental economic study turned out to be very beneficial. The detailed results of the sociological interviews and the quantitative approach of the economic questionnaire supplemented each other very well, both in terms of validation and basis of experience.

Investigations of people's placement preferences and their attitudes towards offshore wind farms have only been the subject of very few studies so far. The studies which come closest in terms of identifying preferences were undertaken in Sweden in 2002, in Spain in 2002 and in Norway in 2004. These studies confirm that wind turbine development is associated with negative environmental impacts and that the impacts depend strongly on the location of the wind turbines. Thus, the environmental impacts of wind power development can be reduced by selecting appropriate sites for this development.

The Swedish study is the only study addressing offshore location of wind turbines. Here it was established that the external costs of wind power generation can be reduced by locating wind turbines offshore. However, the Swedish study did not consider alternative locations of offshore wind farms with respect to the distance from the shore. To the best of our knowledge the present study of distance-dependent intrusions from Danish offshore wind farms is the first to address the distance aspect explicitly.

The willingness-to-pay estimates can be used in cost-benefit analyses of the optimal location and design of future offshore wind farms in Denmark – and possibly elsewhere in the world. At the time of writing it has not been possible to get access to project specific or generic data on the costs of placing offshore wind farms at different distances from the coast. Consequently, the present report does not contain any appraisals regarding the future policies in this context.

## IAPEME VIEWPOINTS

IAPEME was pleased to see the results of this survey of public attitudes, as we had suggested that this work should be carried out as part of the overall monitoring programme. The survey used standard methods of questioning the public but also developed a novel quantitative assessment of the willingness of people to pay for a reduced visual impact of the development. Many of the findings confirm attitudes that had been anticipated, and it is interesting to see in particular the willingness of local people to pay for lower visual intrusiveness of adjacent offshore wind farm developments. It is also clear that local opinions vary somewhat between communities; in this case the views of residents near the Nysted Offshore Wind Farm were more negative than those of a nationwide sample, whereas those of residents near the Horns Rev Offshore Wind Farm were more positive than the national sample. It is important to be aware of these local variations.

A strong local public attitude appears also to be seen in many other countries, where land-based or nearshore wind farms can be highly unpopular with local communities. In many countries

there is frequent local opposition to planning applications for wind farms, despite the general view among objectors that wind farms should be developed (somewhere else) as a means of reducing CO<sub>2</sub> emissions. In qualitative terms this is simply a “not in my back yard” attitude. The economic assessment of the willingness-to-pay for removal of the development to an acceptable distance represents an elegant step from qualitative to quantitative. These estimates also have the potential to be used in cost-benefit analyses of optimal locations and designs of offshore wind farms.

Most opposition to offshore wind farms in Denmark appears to be related to local visual impact, although there have been concerns about possible environmental impacts raised particularly by fishermen and ornithologists. It would be interesting to see whether public attitudes to offshore wind farms will become more positive in the light of evidence from studies at Horns Rev and Nysted, such as summarized in this book, indicating little or no adverse effects on the environment at these sites.

# PLANNING POLICY, PLANNING, PARTICIPATION AND PERMISSION

BY STEFFEN NIELSEN, DANISH ENERGY AUTHORITY

The promotion of wind energy has been part of Danish energy strategies for decades. The contract for the establishment of two new offshore wind farms have been awarded in 2005 and 2006 and Denmark is currently working on a new plan for siting of the next possible generation of offshore wind farms from 2010 to 2025.

The right to exploit wind energy within Danish waters belongs to the State and permission to conduct preliminary studies and to exploit wind energy at sea is granted by the Danish Energy Authority.

Offshore wind farm projects may only be carried out on the basis of a detailed Environmental Impact Assessment (EIA) and after the general public, the authorities and organisations concerned have had an opportunity to express their opinions. Once the EIA procedure has been completed, and the deadline for appeal has expired, the Danish Energy Authority grants the final approval.



## CONTENTS

- Policy background
- Approval of offshore wind power
- Transmission grids

## POLICY BACKGROUND

Denmark has a long tradition of implementing energy policies with broad political support and involving a wide range of stakeholders such as energy companies, industry, municipalities, research institutions, NGOs and consumers.

The present Danish energy policy is based on broad political compromise. These agreements have been implemented by the Danish Energy Authority through a number of strategies and action plans for production, distribution and consumption of energy taking into account reliability of supply, cost-efficiency and international commitments and environment.

### KICK-STARTING WIND ENERGY

Development and implementation of wind energy have been included in all Danish energy strategies. Policy instruments – such as taxation, production subsidies, local ownership, agreements with utilities, regulation on grid connection and spatial planning procedures – and technology-push policy instruments – such as R&D programmes, test station for wind turbines as well as approval and certification schemes – have been tools in the strategies.

The most important incentive to promote wind turbines were an obligation for the Danish Transmission System Operator (TSO) and the consumers to buy renewable electricity at a fixed price. This system – the fixed feed-in tariff – give the investor full security and proved to be an effective way to promote wind power. The obligation and fixed price scheme is not a very cost-efficient system, but an efficient way of “kick-starting” the production of renewable energy.

In the spring of 1999, an electricity reform was introduced that unbundled the utilities and laid down the principles for the future promotion of renewable energy. The current policy aims to strengthen the use of market-based instruments to increase competition in the energy sector and encourage cost-efficiency for renewables.



**FIGURE 9.1** Full-scale testing of a wind turbine blade at Risø National Laboratory. Risø's test station for wind turbines was established in 1978 with the aim of developing new opportunities for industry and society in the exploitation of wind power.

### NEW ENERGY POLICY AGREEMENTS

On 29 March 2004, the Government entered into energy-policy agreements with a large parliamentary majority. The objective was to promote the long-term reliability of the energy supply and a continued diversification of the supply to several sources of energy and to promote the continued development of wind power technology. The agreement introduced a market-oriented pricing system for wind power. The obligation to purchase wind power has been fully replaced with financial support in order to ensure an unchanged price subsidy for the owners of wind turbines. Likewise, the purchase obligation and subsidy to existing decentralised combined heat and power plants has been adjusted to ensure that these power plants react to price signals in the spot market for electricity.

## **RESEARCH, DEVELOPMENT AND TECHNICAL APPROVAL**

Denmark currently has a wide range of unique technological development environments in the wind power industry that combined with government-subsidised research environments give rise to optimistic expectations for further economic growth. This applies both to large wind turbine manufacturers and to Danish research institutions and universities. Danish wind power – onshore and offshore – provides valuable data and experience for the further development of the technology and energy supply solutions as well as export opportunities.

Currently an effort is made to find new suitable locations for test turbines onshore and offshore. A test site at Høvsøre on the northwestern coast of Jutland has given manufacturers the opportunity to lease test stands in order to test new prototypes for short periods since 2004. The test site consists of five test stands allowing turbines with heights of up to 165 m and a capacity of 5 MW each.

Among others things the parties agreed on a second re-powering scheme for the replacement of onshore wind turbines at unfavourable locations with new wind turbines in better locations, increased research and development and demonstration of advanced energy technologies as well as the future expansion of Denmark's offshore wind farms. The basis for the installation of two new offshore wind farms of 200 MW each was made. The two new farms will be capable of supplying electricity to 350,000–400,000 households, equivalent to approx 4% of the total Danish electricity consumption.

### **HORNS REV 2 AND RØDSAND 2**

After the screening of potential sites the Danish Energy Authority called for tenders for two offshore wind farms, one at Horns Rev 2 and one at Rødsand 2 in the summer

and autumn of 2004. The winners of the tender processes are given the right to undertake preliminary studies, establish a production facility and exploit offshore wind energy; however, the successful tenderer must adhere to the same planning process as applies to all offshore wind power projects, including environmental impact assessment (EIA) procedures.

In June 2005, DONG Energy, who had submitted the tender with the lowest feed-in price, was chosen as the winner of the tender for a 200 MW offshore wind farm at Horns Rev 2. The price has been set at approx EUR 0.069/kWh fixed for 50,000 full-load hours, which corresponds to approx twelve years' electricity production. The farm will be put into operation in 2009. The offshore wind farm is to be located about 10 km northwest of the existing wind farm at Horns Rev and will cover a total area of about 35 km<sup>2</sup>. Energinet.dk is responsible for extending the electricity grid to the wind farm. It is estimated that the offshore wind farm at Horns Rev 2 will be able to supply approx 200,000 households with electricity annually, corresponding to approx 2% of the Danish electricity consumption. The EIA was published for public consultation in October 2006.

A consortium consisting of DONG Energy and E.ON Sweden was appointed the winner of the tender at Rødsand on 6 April 2006. The tender submitted offered the lowest kWh price of approx EUR 0.066/kWh fixed for 50,000 full-load hours. This is equivalent to approx 14 years electricity production. The offshore wind farm at Rødsand will supply 200,000 households annually, which corresponds to approx 2% of the total Danish electricity consumption. The offshore wind farm will be situated three km west of the existing wind farm at Rødsand. It has been agreed to commission the wind farm in 2010. Energinet.dk is responsible for extending the electricity grid to the wind farm in cooperation with SEAS Transmission. The next step for the consortium will be to carry out preliminary studies and to prepare an EIA in order



PHOTO: FOLKETINGET

**FIGURE 9.2** *In 2004 a large majority in the Danish Parliament agreed on a new energy policy including expansion of offshore wind farms.*

to clarify all impacts on nature and the environment. The EIA will be subject to a public consultation.

#### ASSESSMENTS OF FUTURE OFFSHORE EXPANSIONS

If oil prices are high and international climate objectives result in higher CO<sub>2</sub> allowance prices, both wind energy and biomass will become competitive and the amount of renewable energy produced could increase significantly. Under such conditions wind power may be able to cover more than 50% of the Danish electricity consumption in 2025 out of which most is envisaged to be offshore.

As a follow-up to the Energy Strategy 2025, the Government has decided that the Action Plan on Offshore Wind Power from 1997 is to be updated by a committee. The objective is to carry out an assessment of where future expansions of offshore wind power can take place.

The committee will also consider possibilities for grid connection of even larger offshore wind farms and new technological possibilities for establishing wind turbines in deeper water. The possible introduction of offshore wind turbines in relation to other interests such as environmental protection, navigation, military, fishery and visual consequences, etc, are to be assessed. In order to maintain and further develop peak competencies in the wind power sector in Denmark, the committee will also assess where it might be possible to locate offshore test sites for wind turbines.

Thus in December 2005 the Danish Energy Authority started the work on a new plan addressing the issue of placing the next generation of offshore wind farms from 2010 to 2025. The process builds on the Action Plan from 1997 as well as on experience from the Horns Rev and



## EIA REPORT

The rules governing EIA reports are described in Executive Order no. 815 of 28 August 2000 on assessment of the environmental impact of offshore electricity producing installations. Any party applying to establish an offshore wind farm must prepare an environmental report in order to ensure;

- that the environmental conditions within the defined installation are described,
- that impact and reference areas are studied and described,
- that all known environmental impacts in connection with the establishment and operation of the wind turbine installation have been previously considered and assessed, and
- that the authorities and the general public have a basis for assessing and making a decision regarding the project.

Nysted demonstration offshore wind farms and on the results of the screenings carried out in relation to the two upcoming 200 MW wind farms.

## APPROVAL OF OFFSHORE WIND POWER

The conditions for offshore farms are laid down in the Danish Electricity Supply Act adopted by Parliament in May 1999 as a result of the liberalisation of the Danish electricity sector. It provides that the right to exploit energy from water and wind within the territorial waters and the exclusive economic zone (up to 200 nautical miles) around Denmark belongs to the Danish State.

The act also lays down the procedures for the approval of electricity production from water and wind and pre-investigation of this within the national territorial waters

and within the economic zone belonging to Denmark. Permission will be given for a specific area, and if a project is expected to have an environmental impact an EIA must be carried out.

## OPEN-DOOR PROCEDURE

According to the provisions of the Electricity Supply Act regarding electricity generating installations at sea, permission for preliminary studies and for exploitation of wind energy at sea may only be given either after applications have been requested in connection with a call for tenders or after an application has been made public and other interested parties have been given the opportunity to apply.

The latter procedure is known as an *open-door procedure*, since applicants may seek authorisation at any time to carry out preliminary studies, establish installations and exploit wind energy. On the basis of a specific application and according to objective criteria, the Danish Energy Authority may decide that expansion is to be carried out in a given area as requested. Other interests in the marine area concerned will be taken into consideration when the decision is made as to whether the area in question is to be expanded.

If the Danish Energy Authority decides that no major societal interests are compromised by the expansion of an offshore wind farm, it has the authority to invite other interested parties to apply to develop a given project, thus ensuring competition regarding the conditions. The Danish Energy Authority has not, however, yet carried out an open-door procedure for offshore wind farms. A new amendment to the Electricity Supply Act from the spring of 2006 exempts test turbines from the open-door procedure/tendering provision.

The procedure for establishing offshore wind farms has been gradually developed as experience has been gained during the first eight Danish offshore wind power projects. The Danish Energy Authority functions as a one



PHOTO: MAKS KLAUSTRUP

**FIGURE 9.3** *Hermit crab at the seabed of Horns Rev.*

stop shop in relationship to the many, often opposing, interests connected to the establishment of offshore wind power projects. This means that investors only need to receive authorisation from the Danish Energy Authority when an offshore wind power project is to be realized. Offshore wind power facilities are thus consented to and approved by the Danish Energy Authority in pursuance of the Electricity Supply Act, legislation concerning other authorities and in relation to the cause of EIA suggestions and objections.

#### ENVIRONMENTAL IMPACT ASSESSMENTS

According to regulations the Danish Energy Authority decides whether a special Environmental Impact Assessment (EIA) report must be prepared before an application to set up an offshore wind farm can be processed. An

EIA report must provide an exhaustive assessment of the project's environmental consequences and it must include a description of workable alternatives. Given the size and numbers of offshore wind farms all projects may only be carried out on the basis of an assessment of the environmental consequences (an EIA report) and after the general public and the authorities and organisations concerned have had an opportunity to express their opinions.

An applicant will not only be required to study the wind, current and bottom conditions that must be known in order to plan an offshore wind power installation, environmental studies must also demonstrate how the installation will affect the local nature. The description of the environmental consequences must assess fauna and flora, seabed, water and air, climatic conditions, any archaeological remains, impact on the landscape and coastal safety. The applicant

must also demonstrate how any damaging environmental impacts can be reduced or neutralised.

#### IMPORTANT INVOLVEMENT OF THE PUBLIC

According to the Danish Electricity Supply Act the establishment of offshore wind farms requires a permit as well as a license for the operation. The twofold approval process includes permission for preliminary surveys and later a final approval of the project – a building permit. Both of these permissions depend upon a process of public consultation in order to take into account the different interests. In relation to the last issue the applicant is called upon to do an EIA.

When, on the basis of these preliminary studies, an application (including an EIA report) has been submitted regarding an offshore wind power project, the Danish Energy Authority present this material for public consultation with a deadline of at least eight weeks.

Experience gained during the first EIA procedures for offshore wind farms has shown that the authorities concerned, interest organisations and citizens all use of the public consultation of EIA reports in order to present comments that contribute to the final definition of the projects.

Once the EIA procedure has been completed, the Danish Energy Authority prepares the final authorisation for the establishment of the offshore wind farm in question. This is done according to detailed conditions that reflect both the conclusions of the EIA report and consultation responses from the general public and the authorities concerned. Public consultation of the EIA report is an open and flexible process that makes it possible for the Danish Energy Authority to clarify and prioritise the various – and often opposing – interests associated with the establishment of an offshore wind farm.

#### AUTHORISATION IS MADE PUBLIC

The authorisation issued by the Danish Energy Authority is made public. Any party with a justified and individual

interest in the decision has the right to register a complaint with the Energy Appeal Board regarding the decision's environmental aspects. The authorisation may not be acted upon before the appeal deadline has expired. Once authorised to carry out a project, the developer must provide the Danish Energy Authority with documentation proving how the conditions in the permit issued will be fulfilled. This must be done in the form of a detailed project description of the construction/installation works. The developer may not begin to construct the offshore wind farm until the Danish Energy Authority has determined that the documentation submitted is sufficient.

When an installation is ready to produce electricity for the grid, the holder of the authorisation for the establishment applies to the Danish Energy Authority for a permit to exploit the wind energy. Electricity production may not begin before such a permit has been issued. The issuing of the permit to produce electricity is given upon documentation that all conditions in the permit issued have either been fulfilled or how fulfilment will be achieved.

In addition, the developer must also obtain a licence to produce electricity if the overall project has a capacity of more than 25 MW and if the developer does not already hold such a licence.

## TRANSMISSION GRIDS

---

Large offshore wind farms are usually located far from major centres of consumption and are connected to the transmission grid in sparsely populated areas. The transmission grid must therefore be able to transport the power from the offshore wind farms over long distances. Up to the present time, it has basically been sufficient to use the existing transmission grid, originally built to transport power in the opposite direction, from centralised power plants to consumers. It has therefore been possible to grid connect the first offshore wind farms

**FIGURE 9.4** HORNS REV VISUALISED AND PHOTOGRAPHED



PHOTO: VATTENFALL



PHOTO: VATTENFALL

*The EIA report for Horns Rev showed a number of visualisations of the wind farm appearance from various positions onshore. Here is the visualisation of the wind farm seen from Blåvands Huk (top) and a photo taken after construction (bottom).*



**FIGURE 9.5** *Transformer station at the Nysted Offshore Wind Farm.*

at Horns Rev and Nysted without major investments in grid reinforcement.

The two large offshore wind farms at Horns Rev and Nysted are technically prepared to provide various system services ie requirements of control capabilities, the output of reactive power, the ability to remain operational and to continue production when there is a grid outage, gradient limitation and the contents of operation agreements.

#### **BOTTLENECKS IN THE TRANSMISSION GRID**

It is envisaged that bottlenecks will be created if the transmission grid is not reinforced when the Horns Rev 2 and Rødsand 2 offshore wind farms are grid connected in these areas by 2009/2010. Such bottlenecks can limit the possibilities for fully exploiting wind power. Depending on the location, it is therefore to be expected that future Danish wind power expansions will necessitate a corresponding expansion of the transmission grid if it is to make full use of the wind power.

The Transmission System Operator (TSO), Energinet.dk, has been entrusted with the responsibility of the long-term general planning of the Danish electricity system. The investments in transmission lines have service lives of 30–40 years so it is important that the system responsibility can be planned from a very long-term perspective.

So far – within the framework for the existing and planned large scale offshore wind farms – the TSO assumes all costs for bringing the electricity production ashore whereas the owner is to finance the internal grid of the offshore wind farm up to the offshore transformer platform.

In addition – and this applies to the two upcoming wind farms Horns Rev 2 and Rødsand 2 – the investors receive a sales guarantee so that they will be paid for the production they could have made but which the TSO is not able to handle in a given situation. These terms enable the TSO to weigh the costs of grid reinforcement to handle extreme situations against the costs of compensating the wind farm owners.

## WIND POWER ECONOMICS

The economy of wind power operation depends partly on the total amount of electricity produced by the wind turbines and partly on the feed-in price and on installation and operating costs. Wind turbines generally feature high investment costs but have no fuel costs. Hence, the production costs are highly dependent on the investment costs and their financing.

### INVESTMENT COSTS

For onshore wind turbines, investment costs, including financing, typically account for 75–85% of the production costs while operational costs account for the remainder. For offshore wind turbines, investment costs make up 70% of the production costs and operational costs are somewhat higher than for onshore turbines, primarily because the load on wind turbines at sea is greater and maintenance is therefore more costly and more complicated.

In addition to the actual cost of the wind turbine itself, investment costs relate to the construction of the foundation, the internal collection grid, planning, etc. For offshore wind turbines, grid connection and the foundations generally account for a relatively higher percentage of the costs than for wind turbines onshore where the cost of the wind turbine itself accounts for considerably more than half of the total costs involved.

### ANNUAL PRODUCTION

Annual production is often declared as corresponding to a number of full-load hours. A full-load hour is an hour in which a wind turbine produces at full capacity. An annual number of full-load hours is the time it will take a given wind turbine to yield its annual production if it is able to produce with its installed capacity all of the time.

At sea, an annual production of approx 4000 full-load hours can be expected in the best areas in terms of wind, such as in the North Sea at Horns Rev. For a 2 MW wind turbine, this corresponds to the electricity consumed by approx 2000 single-family households. In the inner Danish waters, such as at

Nysted-Rødsand, the estimate is approx 3500 full-load hours. For a single 2.3 MW wind turbine at the Nysted Offshore Wind Farm, this corresponds to the electricity consumed by approx 1900 single-family households. In comparison, the corresponding production from wind turbines onshore varies between approx 1500 full-load hours and approx 3000 full-load hours at the best locations which, in Denmark, are on coasts facing westward.

### PRODUCTION COSTS

The production cost for wind generated electricity per kWh has decreased rapidly over the last two decades and the trend is that in a few years the production from large size turbines will be able to compete on equal terms with electricity production from conventional power stations. Consequently, the consumer price for wind generated electricity approaches the level of other electricity prices. For long periods of time, the difference has been as little as 0.03 DKK/kWh.

### AVAILABILITY

The technical availability of new on onshore wind turbines in Denmark is usually in the range of 98–100%. Offshore the availability of the small nearshore farms is also high, but in 2004 the availability for Horns Rev was low due to a comprehensive repair of the gears and transformers on all the Vestas turbines. However, in 2005 all turbines operated nearly 100% with an availability of 95%, where as the Siemens (Bonus) turbines at Nysted reached 97%.

### LIFE-CYCLE OUTPUT

A life-cycle analysis is a relevant tool to assess the net energy output from a wind turbine throughout its entire life. As an example, with an expected electricity production output of approx 12,000 MWh per year for a 3 MW offshore wind turbine, the wind turbine will generate the equivalent amount of energy needed for manufacture, transport and operation of the wind turbine in approx eight months.

# REFERENCES

*The Background reports of the environmental monitoring programme can be downloaded from*  
[www.ens.dk/offshorewind](http://www.ens.dk/offshorewind)

## 2: INTRODUCTION

### TOWARDS A COMMON SUSTAINABLE ENERGY FUTURE

---

CIRCA:

[forum.europa.eu.int/public/irc/env/Home/main](http://forum.europa.eu.int/public/irc/env/Home/main)

*Concerted action for Offshore wind energy Deployment (COD):*

See [www.offshorewindenergy.org/index\\_cod.php](http://www.offshorewindenergy.org/index_cod.php)

*Copenhagen Strategy:* [www.ens.dk/sw14310.asp](http://www.ens.dk/sw14310.asp)

OSPAR: [www.environmentalexchange.info](http://www.environmentalexchange.info)

## 3: HORNS REV AND NYSTED

### 152 WIND TURBINES AT SEA – 325 MW CAPACITY

---

*Betke, K. 2006.* Measurement of underwater noise emitted by an offshore wind turbine at Horns Rev. Report from ITAP – Institute für technische und angewandte Physik GmbH.

*Ingemansson Technology AB, 2003.* Utgrunden off-shore wind farm. Measurements of underwater noise. June 2003.

## 4: INFAUNA, EPIFAUNA AND VEGETATION

### CHANGE IN DIVERSITY AND HIGHER BIOMASS

---

*Birklund, J. 2006.* Surveys of the Benthic Communities in Nysted Offshore Wind Farm in 2005 and Changes in the Communities since 1999 and 2001. Commissioned by Energi E2.

*Birklund, J. 2006.* The Hard Bottom Communities on Foundations in Nysted Offshore Wind Farm and Schönheiders Pulle in 2005 and Development of the Communities in 2003–2005. Commissioned by Energi E2.

*Jensen, A.C., Collins, K.J. and Lockwood, A.P.M. (Eds.). 2000.* Artificial Reefs in European Seas. Kluwer Academic Publishers. Dordrecht.

*Leonhard, S.B. and Birklund J. 2006.* Benthic Communities and Offshore Wind Farms. Experiences from Horns Rev and Nysted Offshore Wind Farms. Reviewing and Concluding Summary Report. Commissioned by Vattenfall and Energy E2.

*Leonhard, S.B. and Pedersen, P. 2006.* Benthic Communities at Horns Rev Before, During and After Construction of Horns Rev Offshore Wind Farm. Commissioned by Vattenfall.

## 5: FISH

### FEW EFFECTS ON THE FISH COMMUNITIES SO FAR

---

*Jensen, A., K. Collins and P. Lockwood (Eds.). 2000.* Artificial Reefs in European Seas. Dordrecht: 1–508.

*Einbinder, S., Perelberg, A., Ben-Shaprut, O., Fouchart, M.H. and Shashar, N. 2006.* Effects of artificial reefs on fish grazing in their vicinity: evidence from algae presentation experiments. *Mar Envir Res* 61:110–119

*Greenstreet, S.P.R., Armstrong, E., Mosegaard, H., Jensen, H., Gibb, I.M., Fraser, H.M., Scott, B.E., Holland, G.J. and Sharples, J. 2006.* Variation in the abundance of sandeels *Ammodytes Marinus* off southeast Scotland: an evaluation of area-closure fisheries management and stock abundance assessment methods. *ICES Journal of Marine Science* 63: 1530–1550.

- Grossman, G.D., Jones, G.P. and Seaman, W.J. 1997. Do artificial reefs increase regional fish production? A review of existing data. *Fisheries* 22:17–23
- Kalmijn, A.J. 2000. Detection and processing of electromagnetic and nearfield acoustic signals in elasmobranch fishes. *Phil. Trans. Royal. Soc. B* 355:1135–1141
- Karlsson, L. 1985. Behavioural responses of European common eels (*Anguilla anguilla*) to the geomagnetic field. *Helgoländer Meeresuntersuchungen*, 39: 71–81.
- Løkkeborg, S., Humborstad, O-B, Jørgensen, T. and Soldal, A. V. 2002. Spatio-temporal variations in gillnet catch rates in the vicinity of North Sea oil platforms. *ICES Journal of Marine Science*, 59: 294–299.
- Magill, S.H and Sayer, M.D.J. 2002. Seasonal and interannual variation in fish assemblages of northern temperate rocky subtidal habitats. *Journal of fish biology*. 61: 1198–1216.
- Powers, S.P., Grabowski, J.H., Peterson, C.H. and Lindberg, W.J. 2003. Estimating enhancement of fish production by offshore artificial reefs: uncertainty exhibited by divergent scenarios. *Mar Ecol Prog Ser* 264:265–277
- Relini, G., Relini, G., Torchia, G. and De Angelis, G. 2002. Trophic relationships between fishes and an artificial reef. *ICES J Mar Sci* 59:S36–S42
- Soldal, A.V., Svelling, S., Jørgensen, T. and Løkkeborg, S. 2002. Rigs-to reefs in the North Sea: Hydroacoustic quantification of fish in the vicinity of a "Semi-Cold" platform. *ICES Journal of Marine Science*, 59: 281–287.
- Sjöberg, N.B. and Petersson, E. 2005. Blankålmärkning – Til for at hjælpe for forstå blankålens migration i Östersjön. Fiskeriverkets Sövattnerslaboratorium i Drottningholm, March 2005.
- Westerberg, 1994. Fiskeriundersøgninger ved havbaseret vindkraftverk 1990–1993. Fiskeriverkets Utredningskontoret Jønkøbing. Rapport 5-1994. Gøteborgfilialen.
- Westin, L. 2003. Migration failre in stocked eels *Anguilla anguilla*. *Marine Ecology Progress Series*, 254: 307–311, 2003.
- Wright, P.J., Jensen, H. and Tuck, I. 2000. The influence of sediment type on the distribution of the lesser sandeel, *Ammodytes marinus*. *Journal of Sea Research* 44: 243–256, 2000.
- FishBase – A Global Information System on Fishes.*  
www.fishbase.org

## 6: MARINE MAMMALS

### SEALS AND PORPOISES REACT DIFFERENTLY

- Carstensen, J., Henriksen, O.D. and Teilmann, J. 2006. Impacts on harbour porpoises from offshore wind farm construction: Acoustic monitoring of echolocation activity using porpoise detectors (T-PODs). *Mar. Ecol.Prog.Ser.* 321:295-308.
- Dietz, R., Teilmann, J., Henriksen, O.D. and Laidre, K. 2003. Movements of seals from Rødsand seal sanctuary monitored by satellite telemetry. Relative importance of the Nysted Offshore Wind Farm area to the seals. National Environmental Research Institute Technical Report No. 429: 44 pp.  
www.dmu.dk/1\_viden/2\_Publikationer/3\_fagrapporter/rapporter/FR429.pdf



- Edrén, S.M.C., Teilmann, J., Carstensen, J., Harders, P. and Dietz, R. 2005.* Effect of Nysted Offshore Wind Farm on seals in Rødsand seal sanctuary - based on remote video monitoring and visual observations. Final report commissioned by ENERGI E2 A/S. National Environmental Research Institute: 52 pp. [www.nystedhavmoellepark.dk/upload/pdf/SealsVideo\\_2004.pdf](http://www.nystedhavmoellepark.dk/upload/pdf/SealsVideo_2004.pdf)
- Härkönen, T., Dietz, R., Reijnders, P., Teilmann, J., Harding, K., Hall, A., Brasseur, S., Siebert, U, Goodman, S.J., Jepson, P.D., Rasmussen, T.D. and Thompson, P. 2006.* A review of the 1988 and 2002 phocine distemper virus epidemics in European harbour seals. *Diseases of Aquatic Organisms* 68: 115-130.
- Hammond, P.S., Berggren, P., Benke, H., Borchers, D.L., Collet, A., Heide-Jørgensen, M.-P., Heimlich, S., Hiby, A.R., Leopold, M.F. and Øien, N. 2002.* Abundance of harbour porpoise and other cetaceans in the North Sea and adjacent waters. – *Journal of Applied Ecology* 39:361-376.
- Madsen, P.T., Wahlberg, M., Tougaard, J., Lucke, K. and Tyack, P. 2005.* Wind turbine underwater noise and marine mammals: Implications of current knowledge and data needs. *Mar. Ecol. Prog. Ser.* 309, 279-295.
- Marine Mammal Commission. 2004.* Noise Exposure Criteria. Presentation at the Second Plenary Meeting of the Advisory Committee on Acoustic Impacts on Marine Mammals, April 28-30, 2004, Arlington, Virginia.
- National Research Council. 2005.* Marine Mammal Populations and Ocean Noise: Determining When Noise Causes Biologically Significant Effects. National Academy Press, Washington, D.C.
- Teilmann, J. and Lowry, N. 1996.* Status of the Harbour Porpoise (*Phocoena phocoena*) in Danish waters. – Report of the International Whaling Commission 46: 619-625.
- Teilmann, J., Dietz, R., Larsen, F., Desportes, G., Geertsen, B.M., Andersen, L.W., Aastrup, P.J., Hansen, J.R. and Buholzer, L. 2004.* Satellitssporing af marsvin i danske og tilstødende farvande. Danmarks Miljøundersøgelser. – Technical report from National Environmental Research Institute 484: 86 pp. Available at: [www2.dmu.dk/1\\_viden/2\\_Publikationer/3\\_fagrappporter/rappporter/FR484\\_samlet.PDF](http://www2.dmu.dk/1_viden/2_Publikationer/3_fagrappporter/rappporter/FR484_samlet.PDF)
- Teilmann, J., Carstensen, J., Dietz, R., Edrén, S.M.C. and Andersen, S.M. 2006.* Final report on aerial monitoring of seals near Nysted Offshore Wind Farm. Final report commissioned by Energi E2 A/S. Available at: [uk.nystedhavmoellepark.dk/](http://uk.nystedhavmoellepark.dk/)
- Teilmann, J., Tougaard, J., Carstensen, J., Dietz, R. and Tougaard, S. 2006.* Summary report on seal monitoring around Nysted and Horns Rev Offshore Wind Farms. Final report commissioned by Energi E2 A/S and Vattenfall A/S. Available at [www.hornsrev.dk](http://www.hornsrev.dk)
- Teilmann, J., Tougaard, J. and Carstensen, J. 2006.* Summary report on harbour porpoise monitoring around Nysted and Horns Rev Offshore Wind Farms. Final report commissioned by Energi E2 A/S and Vattenfall A/S. Available at [www.hornsrev.dk](http://www.hornsrev.dk)
- Tougaard, J., Carstensen, J., Bech, N.I. and Teilmann, J. 2006.* Final report on the effect of Nysted Offshore Wind Farm on harbour porpoises. Final report commissioned by Energi E2 A/S. Available at: [uk.nystedhavmoellepark.dk](http://uk.nystedhavmoellepark.dk)

- Tougaard, J., Carstensen, J., Wisz, M.S., Jespersen, M., Teilmann, J., Bech, N.I. and Skov, H. 2006.* Harbour Porpoises on Horns Reef Effects of the Horns Reef Wind Farm. Final report commissioned by Vattenfall A/S. Available at [www.hornsrev.dk](http://www.hornsrev.dk)
- Tougaard, J., Tougaard, S., Jensen, R.C., Jensen, T., Teilmann, J., Adelung, D., Liebsch, N. and Müller, G. 2006.* Harbour seals at Horns Reef before, during and after construction of Horns Rev Offshore Wind Farm. Final report commissioned by Vattenfall A/S. Available at [www.hornsrev.dk](http://www.hornsrev.dk)
- Trilateral Seal Expert Group. 2005.* Counting Harbour Seals in the Wadden Sea in 2004 and 2005 – Expected and unexpected results. *Wadden Sea Newsletter*, 1:26-27
- 7: BIRDS**
- AVOIDANCE RESPONSES AND DISPLACEMENT**
- 
- Alerstam, T. 1990.* Bird Migration. Cambridge University Press, Cambridge.
- Ballasus, H. and Hüppop, O. 2006.* Estimating the condition and flight range of short- and long- distance passerine migrants: Are additional flight costs caused by barrier-effects from offshore windfarms a problem? *J Ornithol* 147: S130-S131.
- Band, W., Madders, M. and Whitfield, D.P. in press.* Developing field and analytical methods to assess avian collision risk at wind farms. In: de Lucas, M., Janss, G. and Ferrer, M. (Eds.) *Birds and Wind Power*. Lynx Edicions, Barcelona.
- Barrios, L. and Rodriguez, A. 2004.* Behavioural and environmental correlates of soaring-bird mortality at on-shore wind turbines. *J Appl Ecol* 41: 72-81.
- Blew, J., Diederichs, A., Grünkorn, T., Hoffman, M. and Nehls, G. 2006.* Investigations of the bird collision risk and the response of harbour porpoises in the offshore wind farms Horns Rev, North Sea, and Nysted, Baltic Sea, in Denmark. Report from the University of Hamburg and BioConsult SH, 165pp.
- Chamberlain, D., Freeman, S., Rehfish, M., Fox, T. and Desholm, M. 2005.* Appraisal of Scottish Natural Heritage's Wind Farm Collision Risk Model and its Application. BTO Research Report 401. British Trust for Ornithology, Thetford.
- Chamberlain, D.E., Rehfish, M.R., Fox, A.D., Desholm, M. and Anthony, S. 2006.* The importance of determining avoidance rates in relation to the use of wind turbine collision risk models to predict bird mortality *Ibis* 148: S198-S202.
- Desholm, M. 2003.* Thermal Animal Detection System (TADS). Development of a method for estimating collision frequency of migrating birds at offshore wind turbines. National Environmental Research Institute Report 440. NERI, Rønde. Available at: [www2.dmu.dk/1\\_viden/2\\_Publikationer/3\\_fagrappporter/rapporter/FR440.pdf](http://www2.dmu.dk/1_viden/2_Publikationer/3_fagrappporter/rapporter/FR440.pdf)
- Desholm, M. and Kahlert, J. 2005.* Avian collision risk at an offshore wind farm. *Biology Letters* 1(3) 296-298.
- Desholm, M., Fox, A.D., Beasley, P. and Kahlert, J. 2006.* Remote techniques for counting and estimating the number of bird-wind turbine collisions at sea: a review *Ibis* 148: S76-S89.
- Drewitt, A.L. and Langston, R.H.W. 2006.* Assessing the impacts of wind farms on birds. *Ibis* 148: S29-S42.

- Fox, A.D., Desholm, M., Kahlert, Christensen, T.K. and Petersen, I.K. 2006. Information needs to support environmental impact assessment of the effects of European marine offshore wind farms on birds. *Ibis* 148: S129-S144.
- Garthe, S. and Hüppop, O. 2004. Scaling possible adverse effects of marine wind farms on seabirds: developing and applying a vulnerability index. *J Appl Ecol* 41: 724-734.
- Guillemette, M. and Larsen, J.K. 2002. Post-development Experiments to Detect Anthropogenic Disturbances: The Case of Sea Ducks and Wind Parks. *Ecological Applications* 12(3): 868-877.
- Hüppop, O., Dierschke, J. and Wendeln, H. 2004. Zugvögel und Offshore-Windkraftanlagen: Konflikte und Lösungen. *Berichte zum Vogelschutz* 41: 127-218.
- Kaiser, M.J., Galandini, M., Showler, D.A., Elliott, A.J., Caldow, R.W.G., Rees, E.I.S., Stillman, R.A. and Sutherland, W.J. 2006. Distribution and behaviour of common scoter *Melanitta nigra* relative to prey resources and environmental parameters. *Ibis* 148: S110-S128.
- Petersen, I.K., Christensen, T.K., Kahlert, J., Desholm, M. and Fox, A.D. 2006. Final results of bird studies at the offshore windfarms at Nysted and Horns Reef, Denmark. National Environmental Research Institute, Rønde.
- Petterson, J. 2005. The impact of offshore wind farms on bird life in Southern Kalmar Sound, Sweden. Report to Swedish Energy Agency, 124pp.
- Schwemmer, P. and Garthe, S. 2006. Sea ducks and impacts of ship traffic in the Baltic Sea. *J Ornithol* 147: S249.
- Tucker, V.A. 1996. A mathematical model of bird collisions with wind turbine rotors. *J Solar Energy Engineering* 188: 253-262.
- West, A.D and Caldow, R.W.G. 2006. The development and use of individuals-based models to predict the effects of habitat loss and disturbance on waders and waterfowl. *Ibis* 148: S158-S168.
- Whitfield, D.P. and Madders, M. 2005. A review of the impacts of wind farms on hen harriers *Circus cyaneus*. Natural Research Information Note 1. Natural Research Ltd, Banchory. Available at: [www.natural-research.org/documents/NRIN-1.pdf](http://www.natural-research.org/documents/NRIN-1.pdf)
- Winkelman, J.E. 1995. Bird/wind turbine investigations in Europe. pp. 110-140 In: Proc. Nat. Avian - Wind Power Planning Meeting, Denver, Colorado, July 1994.

## 8: SOCIOECONOMIC EFFECTS

### POSITIVE ATTITUDES IN LOCAL COMMUNITIES

---

- Alvarez-Farizo, B. and Hanley, N. 2002. Using conjoint analysis to quantify public preferences over the environmental impacts of wind farms. An example from Spain, *Energy Policy*, vol. 30, no. 2, pp. 107-116.
- Bruun, J. 2002. Den nationale identitets natur, i Agger et al: Naturens værdi. Vinkler på danskernes forhold til naturen. Gads Forlag, København.
- Ek, K. 2002. Valuing the Environmental Impacts of Wind Power, a Choice Experiments Approach. Licentiate Thesis, Luleå University, Sweden.

- Kuehn, S. 2005a.* Havvindmøller i lokalområdet – en undersøgelse ved Horns Rev Havmøllepark. Baggrundsrapport. Unpublished.
- Kuehn, S. 2005b.* Havvindmøller i lokalområdet – en undersøgelse ved Nysted Havmøllepark. Baggrundsrapport. Unpublished.
- Ladenburg, J., Dubgaard, A., Martinsen, L., and Tranberg, J. 2005.* Economic Valuation of the Visual Externalities of Offshore Wind Farms, Report from the Food and Resource Economic Institute, The Royal Veterinary and Agricultural University, Copenhagen, Report no. 179.
- Ladenburg, J. 2006.* Attitudes towards Wind Power Development in Denmark, The Royal Veterinary and Agricultural University, Food and Resource Economic Institute, Working Paper no. 3.
- Navrud, S. 2004.* Miljøkostnader av vindkraft i Norge. Institutt for Økonomi og Ressursforvaltning. Universitetet for Miljø- og Biovitenskap (UMB).

# SUBJECT INDEX

References indicate pages where a given subject is described in greater detail.

## A

Acoustic monitoring *82-84, 88*  
Aerial surveys *100*  
Algae communities *57*  
Anoxic *57*  
Approval procedures *128*  
Arctic/Common Tern *98*  
Artificial substrates *45*  
Auk *98, 106*  
Aviation lights *33*  
Avoidance *14-15, 96-97*

## B

BACI (Before After Control Impact) *28*  
Barnacle Goose *99*  
Benthic communities *44-63*  
Birds *94-111*  
Bird collision rate *98, 108-109*  
Brackish water *21, 50-51*

## C

Changes in distribution *96, 100*  
Choice experiment *114*  
Collision model *108*  
Collision risk *18, 100, 106-110*  
Colonisation *45, 53*  
Common Eider *98*  
Common Scoter *98*  
Cormorant *31*  
Cumulative impacts *15, 96*

## D

Danish Energy Authority *10, 29*  
Danish Nature and Forest Agency *10, 29*  
Dark-bellied Brent Geese *99*  
Deflection *103*  
Deposit feeding *59*  
Desiccation *56*  
Displacement *95*  
Divers *98-99*  
DONG Energy *10, 29*  
Dredging *61*

## E

Ecosystems *21*  
Ecosystem modelling *75*  
Electricity reform *125*  
Electricity supply act *129-130*  
Electromagnetic fields *74-76*  
Energy policy *125-128*  
Environmental Economic study *113*  
Environmental Impact Assessment (EIA) *129-130*  
Environmental management systems *43*  
Environmental monitoring programme *28-31*  
Epifauna *49*  
Epifouling communities *51-52, 60*  
EU Bird Protection area *38*  
European Union *23*

## F

Fish *64-79*  
Flight displacement *96*  
Foundations *34, 37-38, 41-42, 45-46, 56-57, 60-61, 65, 89*  
Frederikshavn *26*

## G

Gannet *98*  
Goldeneye *98*

Gravity foundations 34, 41  
Great Black-backed Gull 99  
Grey seal 81-83, 86, 92-93  
Gulls 104

## H

Habitat loss/gain 96  
Harbour porpoises 83, 88-90  
Harbour seal 81  
Hard bottom sampling 46  
Hazards to birds 95  
Herring Gull 99  
Horns Rev 2 126  
Horns Rev Offshore Wind Farm 27, 35-38  
Hub 33  
Hydrography 36, 39

## I

IAPEME 18-19, 62-63, 78-79, 92-93, 110-111, 123  
Infauna 46, 50, 63  
Intertidal 54

## K

Kittiwake 98

## L

Little Gull 98  
Long-tailed Duck 98

## M

Macro algae 57, 60  
Marine Mammals 80-93  
Meteorology mast 36, 40  
Middelgrunden 26  
Monocultures 52  
Monopile foundations 37  
Mussel beds 50  
Mute Swan 98

## N

Nacelle 33  
Native communities 45  
Natura 2000 23  
Navigational lighting 37-38  
Navigation markings 33  
Noise 33-34, 43, 81, 89, 91  
Nursery ground 57  
Nysted Offshore Wind Farm 27, 38-42

## O

Open-door procedure 128  
Oxygen deficiency 60

## P

Phocine distemper virus 82  
Physical habitat loss 95  
Pile driving 14, 18, 84-85, 89-92  
Pingers 43, 89  
Pintail 99  
Piscivore 75  
Predators 54, 62

## R

Radar 98-99  
Ramsar site 38  
Red-breasted Merganser 98  
Research projects 24-25  
Re-suspension 61  
Rotor blades 33  
Rødsand 38-40, 83-86  
Rødsand 2 126  
Rødsand seal sanctuary 83  
Rønland 26

## S

Sand scouring 56-57  
Satellite taggings 86

Satellite transmitters *82-83*  
Scoters *99*  
Scour protection *37*  
Seabed sampling *46*  
Seal scarers *43, 89*  
Sediment spill *61*  
Sediment coarseness *58-59*  
Sediment spill *35, 61*  
Ship surveys *83, 88*  
Socioeconomic effects *112-123*  
Sociological study *113*  
Sublittoral *56*  
Subtidal *54*

## T

TADS *99*  
Terns *104*  
The Baltic Sea *39-40, 70*  
The Environmental Group *29*  
The "Green Group" *29*  
The North Sea *36, 48-49, 69, 98*  
T-POD *84*  
Transformer substation *34, 41*  
Transmission grids *130*  
Transmission system operator *132*  
Trawling *61*  
Tunø Knob *26*  
Turbine rotor *33*  
Turbine tower *33*

## V

Vattenfall *10, 29*  
Video monitoring *82*  
Vindeby *26*  
Visual impact *33, 123*  
Visual intrusion *113*

## W

Willingness to pay *120-122*  
Wind power economics *133*



Large offshore wind farms can be constructed and operated without significant damage to the marine environment and vulnerable species. The general conclusion from the environmental monitoring programme of two of the largest offshore wind farms in the world – Horns Rev Offshore Wind Farm and Nysted Offshore Wind Farm – is that with the use of spatial planning it will be possible to construct offshore wind power facilities in many areas in an environmentally sustainable manner.

The environmental monitoring programmes of Horns Rev and Nysted were carried out from 1999 to 2006. This book summarises the key research findings on the impacts on benthic communities, fish, marine mammals, birds and people's perception of offshore wind farms.