

Features

- High Voltage Type (20V Rating)
- Encodes 10 Line to 4 Line BCD
- Active Low Inputs and Outputs
- 100% Tested for Quiescent Current at 20V
- 5V, 10V and 15V Parametric Ratings
- Maximum Input Current of 1 μ A at 18V Over Full Package Temperature Range; 100nA at 18V and +25 $^{\circ}$ C
- Noise Margin (Over Full Package/Temperature Range)
 - 1V at VDD = 5V
 - 2V at VDD = 10V
 - 2.5V at VDD = 15V
- Standardized Symmetrical Output Characteristics
- Meets All Requirements of JEDEC Tentative Standard No. 13B, "Standard Specifications for Description of 'B' Series CMOS Devices"

Applications

- Keyboard Encoding
- 10 Line to BCD Encoding
- Range Selection

Description

CD40147BMS CMOS encoder features priority encoding of the inputs to ensure that only the highest order data line is encoded. Ten data input lines (0-9) are encoded to four line (8, 4, 2, 1) BCD. The highest priority line is line 9. All four output lines are logic 1 (VSS) when all input lines are logic 0. All inputs and outputs are buffered, and each output can drive one TTL low power Schottky load. The CD40147BMS is functionally similar to the TTL 54/74147 if pin 15 is tied low.

The CD40147BMS is supplied in these 16-lead outline packages:

| | |
|------------------|-----|
| Braze Seal DIP | H4T |
| Frit Seal DIP | H1E |
| Ceramic Flatpack | H6W |

Pinout

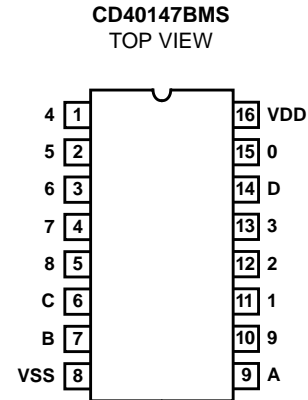

Functional Diagram

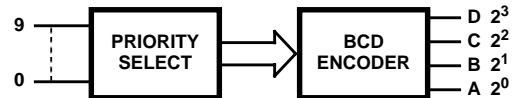

Specifications CD40147BMS

Absolute Maximum Ratings

| | |
|---|---|
| DC Supply Voltage Range, (VDD) | -0.5V to +20V (Voltage Referenced to VSS Terminals) |
| Input Voltage Range, All Inputs | -0.5V to VDD +0.5V |
| DC Input Current, Any One Input | ±10mA |
| Operating Temperature Range | -55°C to +125°C Package Types D, F, K, H |
| Storage Temperature Range (TSTG) | -65°C to +150°C |
| Lead Temperature (During Soldering) | +265°C At Distance 1/16 ± 1/32 Inch (1.59mm ± 0.79mm) from case for 10s Maximum |

Reliability Information

| | | |
|---|---|---------------|
| Thermal Resistance | θ_{ja} | θ_{jc} |
| Ceramic DIP and FRIT Package | 80°C/W | 20°C/W |
| Flatpack Package | 70°C/W | 20°C/W |
| Maximum Package Power Dissipation (PD) at +125°C | | |
| For T _A = -55°C to +100°C (Package Type D, F, K) | 500mW | |
| For T _A = +100°C to +125°C (Package Type D, F, K) | Derate Linearity at 12mW/°C to 200mW | |
| Device Dissipation per Output Transistor | 100mW | |
| For T _A = Full Package Temperature Range (All Package Types) | | |
| Junction Temperature | +175°C | |

TABLE 1. DC ELECTRICAL PERFORMANCE CHARACTERISTICS

| PARAMETER | SYMBOL | CONDITIONS (NOTE 1) | | GROUP A SUBGROUPS | TEMPERATURE | LIMITS | | UNITS |
|-----------------------------|--------|---------------------------------------|-----------|----------------------|----------------------|----------------|----------------|-------|
| | | | | | | MIN | MAX | |
| Supply Current | IDD | VDD = 20V, VIN = VDD or GND | | 1 | +25°C | - | 2 | μA |
| | | | | 2 | +125°C | - | 200 | μA |
| | | VDD = 18V, VIN = VDD or GND | | 3 | -55°C | - | 2 | μA |
| Input Leakage Current | IIL | VIN = VDD or GND | VDD = 20 | 1 | +25°C | -100 | - | nA |
| | | | | 2 | +125°C | -1000 | - | nA |
| | | | VDD = 18V | 3 | -55°C | -100 | - | nA |
| Input Leakage Current | IIH | VIN = VDD or GND | VDD = 20 | 1 | +25°C | - | 100 | nA |
| | | | | 2 | +125°C | - | 1000 | nA |
| | | | VDD = 18V | 3 | -55°C | - | 100 | nA |
| Output Voltage | VOL15 | VDD = 15V, No Load | | 1, 2, 3 | +25°C, +125°C, -55°C | - | 50 | mV |
| Output Voltage | VOH15 | VDD = 15V, No Load (Note 3) | | 1, 2, 3 | +25°C, +125°C, -55°C | 14.95 | - | V |
| Output Current (Sink) | IOL5 | VDD = 5V, VOUT = 0.4V | | 1 | +25°C | 0.53 | - | mA |
| Output Current (Sink) | IOL10 | VDD = 10V, VOUT = 0.5V | | 1 | +25°C | 1.4 | - | mA |
| Output Current (Sink) | IOL15 | VDD = 15V, VOUT = 1.5V | | 1 | +25°C | 3.5 | - | mA |
| Output Current (Source) | IOH5A | VDD = 5V, VOUT = 4.6V | | 1 | +25°C | - | -0.53 | mA |
| Output Current (Source) | IOH5B | VDD = 5V, VOUT = 2.5V | | 1 | +25°C | - | -1.8 | mA |
| Output Current (Source) | IOH10 | VDD = 10V, VOUT = 9.5V | | 1 | +25°C | - | -1.4 | mA |
| Output Current (Source) | IOH15 | VDD = 15V, VOUT = 13.5V | | 1 | +25°C | - | -3.5 | mA |
| N Threshold Voltage | VNTH | VDD = 10V, ISS = -10μA | | 1 | +25°C | -2.8 | -0.7 | V |
| P Threshold Voltage | VPTH | VSS = 0V, IDD = 10μA | | 1 | +25°C | 0.7 | 2.8 | V |
| Functional | F | VDD = 2.8V, VIN = VDD or GND | | 7 | +25°C | VOH > VDD/2 | VOL < VDD/2 | V |
| | | VDD = 20V, VIN = VDD or GND | | 7 | +25°C | | | |
| | | VDD = 18V, VIN = VDD or GND | | 8A | +125°C | | | |
| | | VDD = 3V, VIN = VDD or GND | | 8B | -55°C | | | |
| Input Voltage Low (Note 2) | VIL | VDD = 5V, VOH > 4.5V, VOL < 0.5V | | 1, 2, 3 | +25°C, +125°C, -55°C | - | 1.5 | V |
| Input Voltage High (Note 2) | VIH | VDD = 5V, VOH > 4.5V, VOL < 0.5V | | 1, 2, 3 | +25°C, +125°C, -55°C | 3.5 | - | V |
| Input Voltage Low (Note 2) | VIL | VDD = 15V, VOH > 13.5V, VOL < 1.5V | | 1, 2, 3 | +25°C, +125°C, -55°C | - | 4 | V |
| Input Voltage High (Note 2) | VIH | VDD = 15V, VOH > 13.5V, VOL < 1.5V | | 1, 2, 3 | +25°C, +125°C, -55°C | 11 | - | V |

NOTES: 1. All voltages referenced to device GND, 100% testing being implemented. 3. For accuracy, voltage is measured differentially to VDD. Limit is 0.050V max.
2. Go/No Go test with limits applied to inputs.

Specifications CD40147BMS

TABLE 2. AC ELECTRICAL PERFORMANCE CHARACTERISTICS

| PARAMETER | SYMBOL | CONDITIONS (NOTE 1, 2) | GROUP A SUBGROUPS | TEMPERATURE | LIMITS | | UNITS |
|--------------------------------------|----------------|----------------------------|----------------------|---------------|--------|------|-------|
| | | | | | MIN | MAX | |
| Propagation Delay In Phase Output | TPHL1 TPLH1 | VDD = 5V, VIN = VDD or GND | 9 | +25°C | - | 900 | ns |
| | | | 10, 11 | +125°C, -55°C | - | 1215 | ns |
| Transition Time | TTHL TTLH | VDD = 5V, VIN = VDD or GND | 9 | +25°C | - | 200 | ns |
| | | | 10, 11 | +125°C, -55°C | - | 270 | ns |

NOTES:

1. CL = 50pF, RL = 200K, Input TR, TF < 20ns.
2. -55°C and +125°C limits guaranteed, 100% testing being implemented.

TABLE 3. ELECTRICAL PERFORMANCE CHARACTERISTICS

| PARAMETER | SYMBOL | CONDITIONS | NOTES | TEMPERATURE | LIMITS | | UNITS |
|-------------------------|--------|-------------------------------|-------|-------------------------|--------|-------|-------|
| | | | | | MIN | MAX | |
| Supply Current | IDD | VDD = 5V, VIN = VDD or GND | 1, 2 | -55°C, +25°C | - | 1 | µA |
| | | | | +125°C | - | 30 | µA |
| | | VDD = 10V, VIN = VDD or GND | 1, 2 | -55°C, +25°C | - | 2 | µA |
| | | | | +125°C | - | 60 | µA |
| | | VDD = 15V, VIN = VDD or GND | 1, 2 | -55°C, +25°C | - | 2 | µA |
| | | | | +125°C | - | 120 | µA |
| Output Voltage | VOL | VDD = 5V, No Load | 1, 2 | +25°C, +125°C, -55°C | - | 50 | mV |
| Output Voltage | VOL | VDD = 10V, No Load | 1, 2 | +25°C, +125°C, -55°C | - | 50 | mV |
| Output Voltage | VOH | VDD = 5V, No Load | 1, 2 | +25°C, +125°C, -55°C | 4.95 | - | V |
| Output Voltage | VOH | VDD = 10V, No Load | 1, 2 | +25°C, +125°C, -55°C | 9.95 | - | V |
| Output Current (Sink) | IOL5 | VDD = 5V, VOUT = 0.4V | 1, 2 | +125°C | 0.36 | - | mA |
| | | | | -55°C | 0.64 | - | mA |
| Output Current (Sink) | IOL10 | VDD = 10V, VOUT = 0.5V | 1, 2 | +125°C | 0.9 | - | mA |
| | | | | -55°C | 1.6 | - | mA |
| Output Current (Sink) | IOL15 | VDD = 15V, VOUT = 1.5V | 1, 2 | +125°C | 2.4 | - | mA |
| | | | | -55°C | 4.2 | - | mA |
| Output Current (Source) | IOH5A | VDD = 5V, VOUT = 4.6V | 1, 2 | +125°C | - | -0.36 | mA |
| | | | | -55°C | - | -0.64 | mA |
| Output Current (Source) | IOH5B | VDD = 5V, VOUT = 2.5V | 1, 2 | +125°C | - | -1.15 | mA |
| | | | | -55°C | - | -2.0 | mA |
| Output Current (Source) | IOH10 | VDD = 10V, VOUT = 9.5V | 1, 2 | +125°C | - | -0.9 | mA |
| | | | | -55°C | - | -1.6 | mA |
| Output Current (Source) | IOH15 | VDD = 15V, VOUT = 13.5V | 1, 2 | +125°C | - | -2.4 | mA |
| | | | | -55°C | - | -4.2 | mA |
| Input Voltage Low | VIL | VDD = 10V, VOH > 9V, VOL < 1V | 1, 2 | +25°C, +125°C, -55°C | - | 3 | V |
| Input Voltage High | VIH | VDD = 10V, VOH > 9V, VOL < 1V | 1, 2 | +25°C, +125°C, -55°C | +7 | - | V |

Specifications CD40147BMS

TABLE 3. ELECTRICAL PERFORMANCE CHARACTERISTICS (Continued)

| PARAMETER | SYMBOL | CONDITIONS | NOTES | TEMPERATURE | LIMITS | | UNITS |
|--|--------------|------------|---------|-------------|--------|-----|-------|
| | | | | | MIN | MAX | |
| Propagation Delay In Phase Output | TPHL TPLH | VDD = 10V | 1, 2, 3 | +25°C | - | 400 | ns |
| | | VDD = 15V | 1, 2, 3 | +25°C | - | 300 | ns |
| Propagation Delay Out of Phase Output | TPHL TPLH | VDD = 5V | 1, 2, 3 | +25°C | - | 850 | ns |
| | | VDD = 10V | 1, 2, 3 | +25°C | - | 350 | ns |
| | | VDD = 15V | 1, 2, 3 | +25°C | - | 250 | ns |
| Transition Time | TTLH | VDD = 10V | 1, 2, 3 | +25°C | - | 100 | ns |
| | | VDD = 15V | 1, 2, 3 | +25°C | - | 80 | ns |
| Input Capacitance | CIN | Any Input | 1, 2 | +25°C | - | 7.5 | pF |

NOTES:

1. All voltages referenced to device GND.
2. The parameters listed on Table 3 are controlled via design or process and are not directly tested. These parameters are characterized on initial design release and upon design changes which would affect these characteristics.
3. CL = 50pF, RL = 200K, Input TR, TF < 20ns.

TABLE 4. POST IRRADIATION ELECTRICAL PERFORMANCE CHARACTERISTICS

| PARAMETER | SYMBOL | CONDITIONS | NOTES | TEMPERATURE | LIMITS | | UNITS |
|------------------------------|--------------|-----------------------------|------------|-------------|----------------|--------------------------|-------|
| | | | | | MIN | MAX | |
| Supply Current | IDD | VDD = 20V, VIN = VDD or GND | 1, 4 | +25°C | - | 7.5 | μA |
| N Threshold Voltage | VNTH | VDD = 10V, ISS = -10μA | 1, 4 | +25°C | -2.8 | -0.2 | V |
| N Threshold Voltage Delta | ΔVTN | VDD = 10V, ISS = -10μA | 1, 4 | +25°C | - | ±1 | V |
| P Threshold Voltage | VTP | VSS = 0V, IDD = 10μA | 1, 4 | +25°C | 0.2 | 2.8 | V |
| P Threshold Voltage Delta | ΔVTP | VSS = 0V, IDD = 10μA | 1, 4 | +25°C | - | ±1 | V |
| Functional | F | VDD = 18V, VIN = VDD or GND | 1 | +25°C | VOH > VDD/2 | VOL < VDD/2 | V |
| | | VDD = 3V, VIN = VDD or GND | | | | | |
| Propagation Delay Time | TPHL TPLH | VDD = 5V | 1, 2, 3, 4 | +25°C | - | 1.35 x +25°C Limit | ns |

- NOTES: 1. All voltages referenced to device GND. 2. CL = 50pF, RL = 200K, Input TR, TF < 20ns. 3. See Table 2 for +25°C limit. 4. Read and Record

TABLE 5. BURN-IN AND LIFE TEST DELTA PARAMETERS +25°C

| PARAMETER | SYMBOL | DELTA LIMIT |
|-------------------------|--------|--------------------------|
| Supply Current - MSI-1 | IDD | ± 0.2μA |
| Output Current (Sink) | IOL5 | ± 20% x Pre-Test Reading |
| Output Current (Source) | IOH5A | ± 20% x Pre-Test Reading |

TABLE 6. APPLICABLE SUBGROUPS

| CONFORMANCE GROUP | MIL-STD-883 METHOD | GROUP A SUBGROUPS | READ AND RECORD |
|-------------------------------|-----------------------|-------------------|------------------|
| Initial Test (Pre Burn-In) | 100% 5004 | 1, 7, 9 | IDD, IOL5, IOH5A |
| Interim Test 1 (Post Burn-In) | 100% 5004 | 1, 7, 9 | IDD, IOL5, IOH5A |
| Interim Test 2 (Post Burn-In) | 100% 5004 | 1, 7, 9 | IDD, IOL5, IOH5A |

Specifications CD40147BMS

TABLE 6. APPLICABLE SUBGROUPS (Continued)

| CONFORMANCE GROUP | | MIL-STD-883 METHOD | GROUP A SUBGROUPS | READ AND RECORD |
|-------------------------------|--------------|--------------------|---------------------------------------|------------------------------|
| PDA (Note 1) | | 100% 5004 | 1, 7, 9, Deltas | |
| Interim Test 3 (Post Burn-In) | | 100% 5004 | 1, 7, 9 | IDD, IOL5, IOH5A |
| PDA (Note 1) | | 100% 5004 | 1, 7, 9, Deltas | |
| Final Test | | 100% 5004 | 2, 3, 8A, 8B, 10, 11 | |
| Group A | | Sample 5005 | 1, 2, 3, 7, 8A, 8B, 9, 10, 11 | |
| Group B | Subgroup B-5 | Sample 5005 | 1, 2, 3, 7, 8A, 8B, 9, 10, 11, Deltas | Subgroups 1, 2, 3, 9, 10, 11 |
| | Subgroup B-6 | Sample 5005 | 1, 7, 9 | |
| Group D | | Sample 5005 | 1, 2, 3, 8A, 8B, 9 | Subgroups 1, 2 3 |

NOTE: 1. 5% Parametric, 3% Functional; Cumulative for Static 1 and 2.

TABLE 7. TOTAL DOSE IRRADIATION

| CONFORMANCE GROUPS | MIL-STD-883 METHOD | TEST | | READ AND RECORD | |
|--------------------|--------------------|-----------|------------|-----------------|------------|
| | | PRE-IRRAD | POST-IRRAD | PRE-IRRAD | POST-IRRAD |
| Group E Subgroup 2 | 5005 | 1, 7, 9 | Table 4 | 1, 9 | Table 4 |

TABLE 8. BURN-IN AND IRRADIATION TEST CONNECTIONS

| FUNCTION | OPEN | GROUND | VDD | 9V ± -0.5V | OSCILLATOR | |
|----------------------------|-------------|-------------------|--------------------|-------------|--------------|---------------------|
| | | | | | 50kHz | 25kHz |
| Static Burn-In 1 Note 1 | 6, 7, 9, 14 | 1-5, 8, 10-13, 15 | 16 | | | |
| Static Burn-In 2 Note 1 | 6, 7, 9, 14 | 8 | 1-5, 10-13, 15, 16 | | | |
| Dynamic Burn-In Note 1 | - | 8 | 16 | 6, 7, 9, 14 | 1, 3, 11, 13 | 2, 4, 5, 10, 12, 15 |
| Irradiation Note 2 | 6, 7, 9, 14 | 8 | 1-5, 10-13, 15, 16 | | | |

NOTE:

- Each pin except VDD and GND will have a series resistor of $10K \pm 5\%$, $VDD = 18V \pm 0.5V$
- Each pin except VDD and GND will have a series resistor of $47K \pm 5\%$; Group E, Subgroup 2, sample size is 4 dice/wafer, 0 failures, $VDD = 10V \pm 0.5V$

All Intersil semiconductor products are manufactured, assembled and tested under **ISO9000** quality systems certification.

Intersil products are sold by description only. Intersil Corporation reserves the right to make changes in circuit design and/or specifications at any time without notice. Accordingly, the reader is cautioned to verify that data sheets are current before placing orders. Information furnished by Intersil is believed to be accurate and reliable. However, no responsibility is assumed by Intersil or its subsidiaries for its use; nor for any infringements of patents or other rights of third parties which may result from its use. No license is granted by implication or otherwise under any patent or patent rights of Intersil or its subsidiaries.

For information regarding Intersil Corporation and its products, see web site <http://www.intersil.com>

Sales Office Headquarters

NORTH AMERICA

Intersil Corporation
P. O. Box 883, Mail Stop 53-204
Melbourne, FL 32902
TEL: (321) 724-7000
FAX: (321) 724-7240

EUROPE

Intersil SA
Mercure Center
100, Rue de la Fusee
1130 Brussels, Belgium
TEL: (32) 2.724.2111
FAX: (32) 2.724.22.05

ASIA

Intersil (Taiwan) Ltd.
Taiwan Limited
7F-6, No. 101 Fu Hsing North Road
Taipei, Taiwan
Republic of China
TEL: (886) 2 2716 9310
FAX: (886) 2 2715 3029

CD40147BMS

Logic Diagram

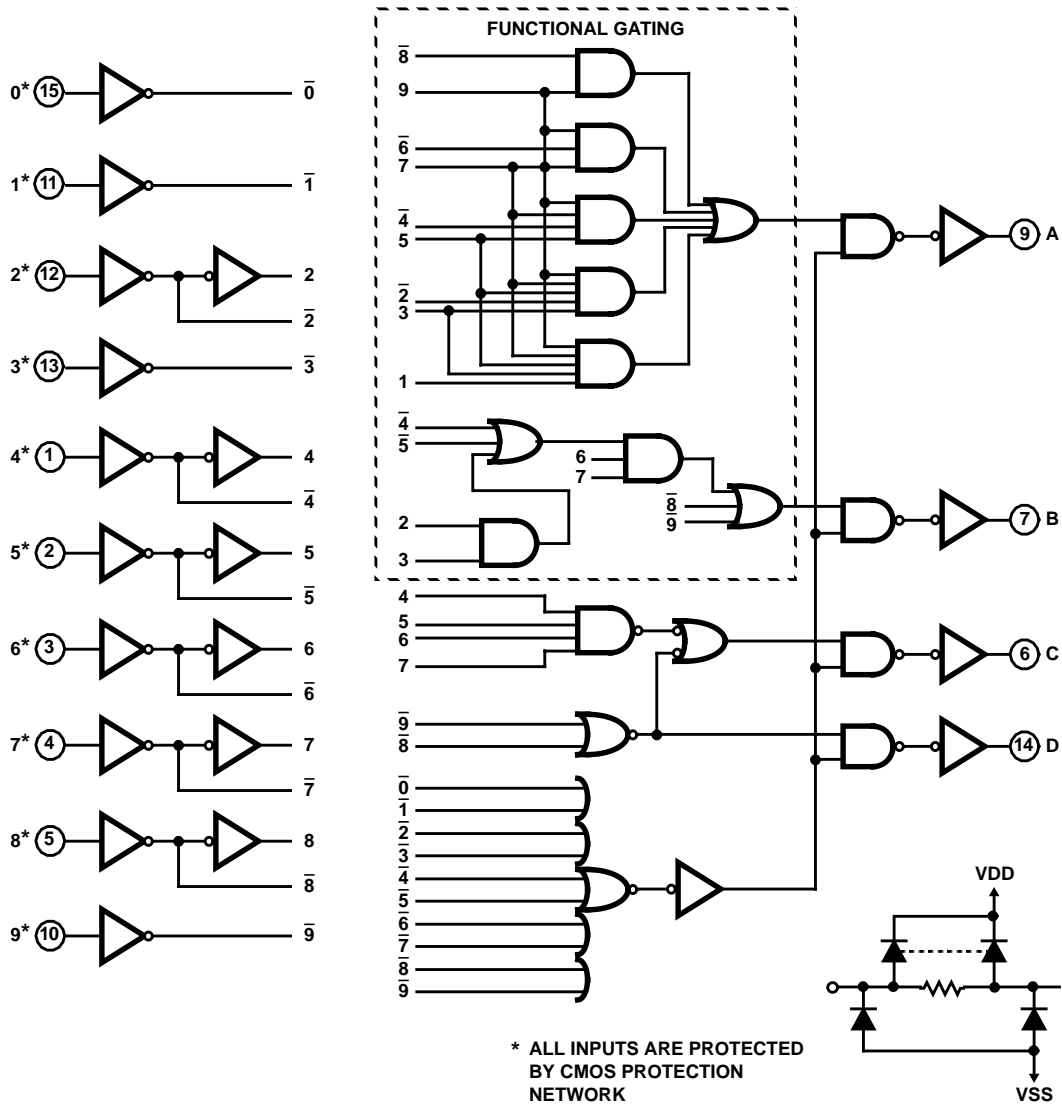

FIGURE 1.

TRUTH TABLE (Negative Logic)

| INPUTS | | | | | | | | | | OUTPUTS | | | |
|--------|---|---|---|---|---|---|---|---|---|---------|---|---|---|
| 0 | 1 | 2 | 3 | 4 | 5 | 6 | 7 | 8 | 9 | D | C | B | A |
| 0 | 0 | 0 | 0 | 0 | 0 | 0 | 0 | 0 | 0 | 1 | 1 | 1 | 1 |
| 1 | 0 | 0 | 0 | 0 | 0 | 0 | 0 | 0 | 0 | 0 | 0 | 0 | 0 |
| X | 1 | 0 | 0 | 0 | 0 | 0 | 0 | 0 | 0 | 0 | 0 | 0 | 1 |
| X | X | 1 | 0 | 0 | 0 | 0 | 0 | 0 | 0 | 0 | 0 | 1 | 0 |
| X | X | X | 1 | 0 | 0 | 0 | 0 | 0 | 0 | 0 | 0 | 1 | 1 |
| X | X | X | X | 1 | 0 | 0 | 0 | 0 | 0 | 0 | 1 | 0 | 0 |
| X | X | X | X | X | 1 | 0 | 0 | 0 | 0 | 0 | 1 | 0 | 1 |
| X | X | X | X | X | X | 1 | 0 | 0 | 0 | 0 | 1 | 1 | 0 |
| X | X | X | X | X | X | X | 1 | 0 | 0 | 0 | 1 | 1 | 1 |
| X | X | X | X | X | X | X | X | 1 | 0 | 1 | 0 | 0 | 0 |
| X | X | X | X | X | X | X | X | X | 1 | 1 | 0 | 0 | 1 |

0 = High level 1 = Low level X = Don't care

Typical Performance Characteristics

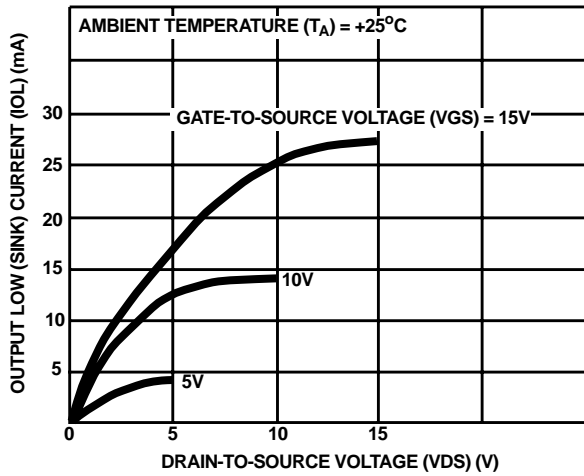

FIGURE 2. TYPICAL OUTPUT LOW (SINK) CURRENT CHARACTERISTICS

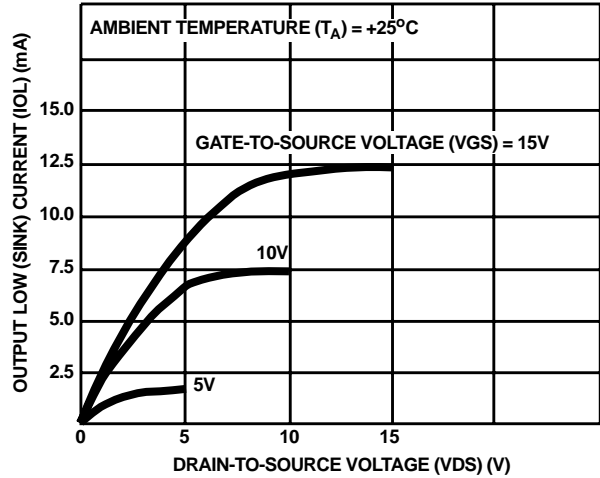

FIGURE 3. MINIMUM OUTPUT LOW (SINK) CURRENT CHARACTERISTICS

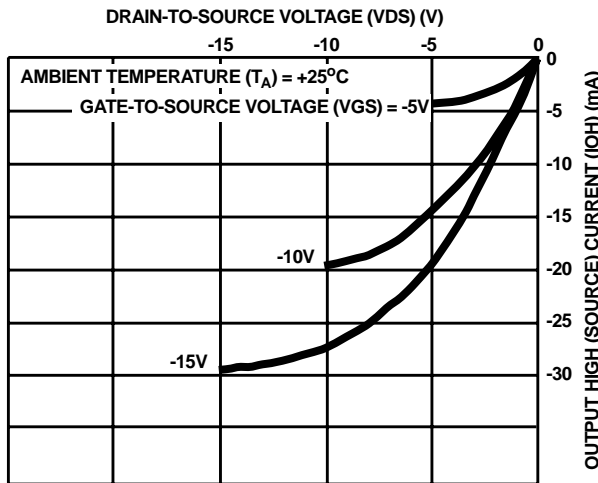

FIGURE 4. TYPICAL OUTPUT HIGH (SOURCE) CURRENT CHARACTERISTICS

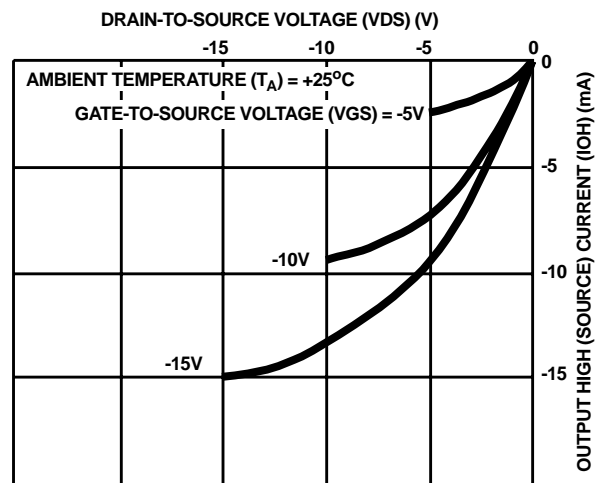

FIGURE 5. MINIMUM OUTPUT HIGH (SOURCE) CURRENT CHARACTERISTICS

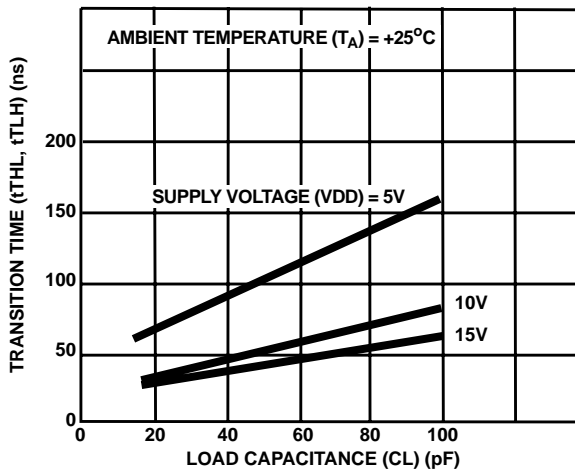

FIGURE 6. TYPICAL TRANSITION TIME AS A FUNCTION OF LOAD CAPACITANCE

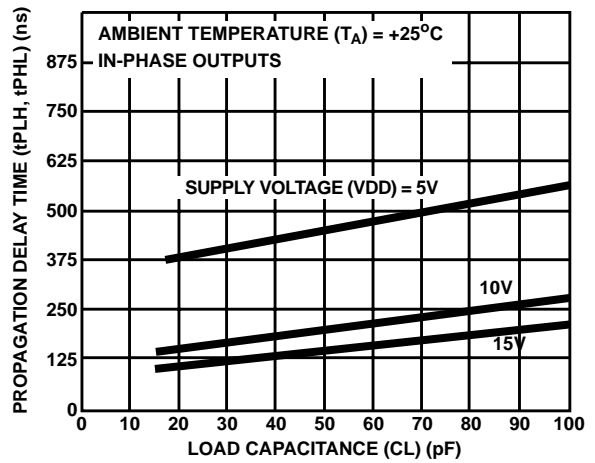

FIGURE 7. PROPAGATION DELAY TIME AS A FUNCTION OF LOAD CAPACITANCE

CD40147BMS

Typical Performance Characteristics (Continued)

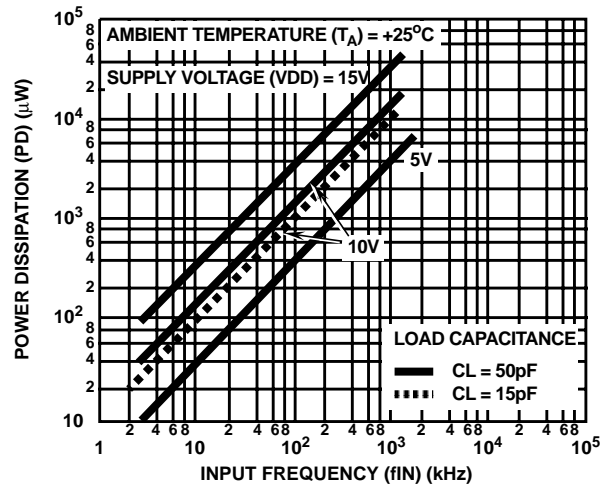
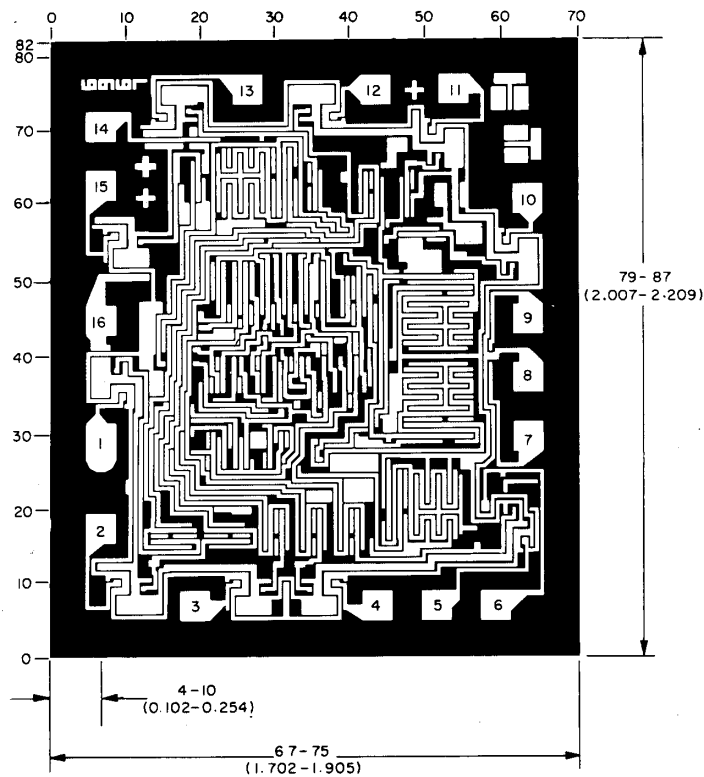

FIGURE 8. TYPICAL DYNAMIC POWER DISSIPATION AS A FUNCTION OF INPUT FREQUENCY

Chip Dimensions and Pad Layout



Dimensions in parenthesis are in millimeters and are derived from the basic inch dimensions as indicated. Grid graduations are in mils (10^{-3} inch).

METALLIZATION: Thickness: $11\text{k}\text{\AA} - 14\text{k}\text{\AA}$, AL.

PASSIVATION: $10.4\text{k}\text{\AA} - 15.6\text{k}\text{\AA}$, Silane

BOND PADS: 0.004 inches X 0.004 inches MIN

DIE THICKNESS: 0.0198 inches - 0.0218 inches

This datasheet has been downloaded from:

www.DatasheetCatalog.com

Datasheets for electronic components.