

Comprehensive Industry Documents Series (COINDS)
COINDS/73/2007

**DEVELOPMENT OF
NATIONAL EMISSION
STANDARDS FOR PESTICIDES
MANUFACTURING INDUSTRY**



**CENTRAL POLLUTION CONTROL BOARD
MINISTRY OF ENVIRONMENT & FORESTS**

e-mail : cpcb@nic.in Website : www.cpcb.nic.in

May 2007



केन्द्रीय प्रदूषण नियंत्रण बोर्ड

(भारत सरकार का संगठन)

पर्यावरण एवं वन मंत्रालय

Central Pollution Control Board

(A Govt. of India Organisation)

Ministry of Environment & Forests

Phone: 22304948 / 22307233

ज. मो. माऊसकर, भा.प्र.से.

अध्यक्ष

J. M. MAUSKAR, IAS

Chairman

FOREWORD

Pesticide Sector comprises many processing units which adopt different technologies, equipments, unit process and unit operations for manufacturing various products. The manufacturing processes lead to generation of a wide spectrum of air pollutants, mainly inorganic hazardous air pollutants. Some of these pollutants are toxic, responsible for damage of materials and creation of malodour. Besides these hazardous air pollutants, volatile organic compounds (VOCs) mainly solvents are generated as fugitive emissions. Volume of VOCs in Pesticide units are quite low in comparison to VOCs generation in petrochemical and oil refinery, however.

In order to reduce the air pollutants emissions to an acceptable level, it is necessary to adopt a comprehensive approach considering possible thermal destruction, recovery of chemicals, good engineering practices and end-of-pipe technology with due regard to techno-economical feasibility within the framework of National Environment Policy (NEP), 2006. The salient features of NEP with respect to standards are as below:

- (a) General availability of required technology and techno-economic feasibility;
- (b) Risk reduction related to health, ecosystem and manmade assets; and
- (c) Ensure to achieve the ambient air quality standard (location specific).

Within this backdrop, the Central Pollution Control Board in association with M/s Shriram Environment & Allied Services, Gurgaon, took up a study to develop National Emission Standards for the Pesticides Manufacturing Industry.

My colleagues Sh. G. Thirumurthy, Assistant Environmental Engineer, Dr. D. D. Basu, Senior Scientist were involved in preparation, evaluation and finalisation of this Report. Sh. N. K. Verma, former Additional Director coordinated the project. The preparation and finalisation of this Report has been done under the overall supervision of Sh. P. M. Ansari, Additional Director and Dr. B. Sengupta, Member Secretary. Necessary support and inputs provided by the representatives of the Pesticide industries and by various Experts during the finalisation of this Report need due acknowledgement. Secretarial assistance rendered by Sh. Atul Sharma is also appreciated.

I hope that the information contained in this Report will be useful to the Regulatory Authorities, the Pesticide Industry and all other concerned about pollution in this Sector.

(J. M. Mauskar)

May, 2007

Development of National Emission Standards For Pesticides Manufacturing Industry

CONTENTS

FOREWORD

1.0 Introduction

- 1.1 Pesticide Use**
- 1.2 Pesticide Production in India**

2.0 Manufacturing Process

- 2.1 Acephate**
 - 2.1.1 Associated air pollutants**
- 2.2 Aluminium Phosphide**
 - 2.2.1 Associated air pollutants**
- 2.3 Captafol**
 - 2.3.1 Associated air pollutants**
- 2.4 Captan**
 - 2.4.1 Associated air pollutants**
- 2.5 Cypermethrin**
 - 2.5.1 Associated air pollutants**
- 2.6 Dimethoate**
 - 2.6.1 Associated air pollutants**
- 2.7 2,4 – Dichlorophenoxy Acetic Acid (2,4-D)**
 - 2.7.1 Associated air pollutants**
- 2.8 Dichlorvos (D.D.V.P.)**
 - 2.8.1 Associated air pollutants**
- 2.9 Ethion**
 - 2.9.1 Associated air pollutants**
- 2.10 Endosulphan**
 - 2.10.1 Associated air pollutants**
- 2.11 Fenvalterate**
 - 2.11.1 Associated air pollutants**
- 2.12 Malathion**
 - 2.12.1 Associated air pollutants**
- 2.13 Methyl Bromide**
 - 2.13.1 Associated air pollutants**
- 2.14 Monocrotophos**
 - 2.14.1 Associated air pollutants**
- 2.15 Isoproturon**
 - 2.15.1 Associated air pollutants**
- 2.16 Phosalone**
 - 2.16.1 Associated air pollutants**
- 2.17 Phorate**
 - 2.17.1 Associated air pollutants**

- 2.18 Phosphamidon
 - 2.18.1 Associated air pollutants
 - 2.19 Zinc Phosphide
 - 2.19.1 Associated air pollutants
 - 3.0 **Air Pollutants from Pesticide Industry**
 - 3.1 Emissions Profile in Pesticide Industry
 - 3.2 Solvents
 - 3.3 Prioritisation of Air Pollutants for Control
 - 3.4 Toxicity and Health Impact of Priority Pollutants
 - 4.0 **Available Control Technology to Prevent and Control of Air Pollutants from Pesticide Industry**
 - 4.1 Principle of Air Pollution Control Technology
 - 4.1.1 Separation techniques
 - 4.1.2 Thermal destruction
 - 4.1.3 Conversion to harmless product
 - 4.1.4 Combination approach
 - 4.2 Control Technologies Adopted in Indian Industries
 - 4.3 Efficiency Evaluation of Existing Pollution Control Technology
 - 4.4 Description of Various Treatment Technique
 - 4.4.1 Absorption
 - 4.5 Condensation
 - 4.6 Chemical Reaction
 - 4.7 Incinerator Technology with Air Pollution Control Devices
 - 4.8 Adsorption
 - 5.0 **An Approach for Development of Emission Standards for Pesticide Industry**
 - 5.1 Introduction
 - 5.2 Best Practicable Approach (general availability to required technology and techno-economic feasibility)
 - 5.3 Emission Standards with respect to Location Specificity
 - 5.4 Emission Standards
 - 5.5 Guidelines for Fugitive Emission Control
 - 5.6 LDAR for Pesticide Industry
- Bibliography**

1.0 INTRODUCTION

The word pest comes from the Latin word “pestis” which includes an animal or plant that occurs in such abundance as to present a distinct threat, economically or medically to man or his interest. A pest may be insect, fungus, weed, rodent, bacteria, virus, nematodes, acarid / mite, parasite and even animal or bird. Worldwide, about 10,000 species of insects are important as pest, out of 750,000 identified species. Over 50,000 species of fungi are responsible for some 1,500 plant diseases; Over 1,800 species of weeds out of the known 30,000 cause serious economic loss. About 15,000 species of nematodes produce more than 1,500 serious deleterious effects on plants. Over 1,00,000 species of pests destroy food which could be food for 135 million people. The word pest has no biological meaning. Pests are organisms that diminish the value of resources in which we are interested.

In India, crops are affected by over 200 major pests, 100 plant diseases, hundreds of weeds and other pests like nematodes, harmful birds, rodents and the like. About 4,800 million rats cause havoc in India. Approximately, 30% of Indian crop yield potential is being lost due to insects, disease and weeds which in terms of quantity would mean 30 million tones of food grain. The value of total loss has been placed at Rs 50,000 million, represents about 18% of the gross national agriculture production. The pest wise losses are as follows:

Pest	Loss of Food Grains (%)
Weeds	28
Diseases	25
Insects	23
Storage	10
Rats	8
Others	6

Besides the agriculture, non – agriculture pests are carriers of malaria, filaria, encephalitis, typhus, plague and other dreadful diseases. About 30 household pests are worthy of attention, like flies, fleas, bedbugs, lice, cockroaches, mites, termites and moths. Man’s war against pests is perennial and almost eternal. No agriculture or forest crop can be grown in an insect and disease – free environment. Pests and disease are parts of natural processes that are going on since the beginning of the universe, and the biological process of evolution. Total extermination of pests is not possible and is no longer the aim of pesticide application. The control of pests is the objective and designated as plant protection. The efficient producer wants to keep loss due to pests to a minimum pest control is now the chemistry of human survival.

While pest control is one of the imperative prerequisite, it bears also higher degree of negative impacts on environment. Since the chemicals which control the pest commonly known as pesticides. Pesticides are basically toxics and persistence; it can enter in food chain and causes injury to human health. It also destroys the diversity and food web and causes ecological imbalance. Pest control therefore needs regulation on the interest of human health and environment.

1.1 Pesticide Use

Pesticides are defined as the substance or mixture of substances used to prevent, destroy, repel, attract, sterilise, stupefy or mitigate any insects. Generally pesticides are used in three sectors viz. agriculture, public health and consumer use. The consumption of pesticide in India is about 600 gms. / hectare, where as that of developed countries is touching 3000 gms. / hectare.

There is a wide range of pesticides found used in non-agriculture situations such as industries, public health and for a number of purposes in the home. Domestic use of pesticides is mainly as fly killer, ant killer, moth killer, repellants, rodenticides and fungicides etc. By and large industrial use of pesticide is of vital importance in the industries such as wood and carpet, wood preservation, paint industry, paper and board industry, leather industry, building industry, miscellaneous industrial application e.g. soluble cutting oils, industrial water systems, drilling fluids etc.

1.2 Pesticide Production in India

Pesticide is manufactured as technical grade products and consumable pesticides are then formulated The installed capacity of technical grade pesticide was 1,45,800 tonnes during March 2005, and the production in the financial year 2004-05 was 94,000 tonnes. The year wise actual production during year 2001 to 2005 was given at **Table 1**.

Table 1: Actual Production of Technical Grade Pesticides

S. No.	Financial Year	Production (Tonnes/Year)	Annual Growth (%)	Overall Annual Growth (2004-05) / (2001-02)
1.	2001-2002	81,800		14.9%
2.	2002 -2003	69,600	- 15	
3.	2003-2004	84,800	21.8	
4.	2004- 2005	94,000	10.8	

Source: Annual Report 2005-06 of Ministry of Chemicals & fertilizers, Department of Chemicals & Petrochemicals, page no – 54-55

The annual growth of pesticide production between the years 2001 to 2005 was 14.9%. The productions of various categories of technical grade pesticides against the installed capacity during the year 2004-05 in India are summarized in **Table 2**.

Table 2: Installed Vs Production Capacity of various pesticides

S.No.	Pesticides	Capacity (T/Y)		Production Vs Installation	Distribution of various pesticides
		Installed	Production		
1.	Insecticides	104200	63100	60.6%	67.13%
2.	Fungicides	26200	22800	87.0%	24.25%
3.	Herbicides	1700	400	23.6%	0.43%
4.	Weedicides	10100	5900	58.4%	6.27%
5.	Rodenticides	3200	1700	53.1%	1.81%
6.	Fumigants	400	100	2.5%	0.11%
Total		145800	94000		100%

Source: Annual Report 2005-06 of Ministry of Chemicals & fertilizers, Department of Chemicals & Petrochemicals

From above table, the percentage distribution of various categories of technical grade pesticides are insecticides (67%), Fungicides (24%), Weedicides (6%) and the others Herbicides, Rodenticides, Fumigants (3%). The table clearly indicates that in India the production of insecticides is very high compared to the other types of pesticides. The list of technical grade pesticides manufactured under various types in India during the year 2004-05 is given at **Table 3**. The technical-grade pesticides manufactured are registered under the Insecticides Act, 1968 in India.

Information compiled from the Monitoring and Evaluation Division, Department of Chemicals & Petrochemicals, Ministry of Chemicals and Fertilizers reveal that in the pesticide sector, Gujarat has in installed capacity of 77.68 MT but produces about 36.05 MT, followed by Maharashtra with installed capacity of 41.08 MT but producing about 32.16 MT, Andhra Pradesh produces 2.655 MT against an installed capacity of 3.4 MT, Kerala producing 2.407 MT against an installed capacity of 4.594 MT and Karnataka producing 0.911 MT against installed capacity of 3.9 MT. This is summarized in **Table 4**.

Table 3: Production of Technical Grade Pesticides

S.No.	Name of the Pesticide	Type	Capacity (000' MT)	
			Installed	Production
1.	D.D.T	Insecticides	6.3	4.0
2.	Malathion		11.9	4.7
3.	Parathion		4.0	1.0
4.	Dimethoate		3.2	0.9
5.	D.D.V.P		4.3	5.0
6.	Quinalphos		4.0	0.9
7.	Monocrotophos		13.9	9.5
8.	Phosphamidon		3.9	0.4
9.	Phorate		8.2	3.6
10.	Ethion		5.6	1.8
11.	Endosulphan		10.1	3.1
12.	Fenvalerate		2.7	0.6
13.	Cypermethrin		5.9	6.5
14.	Anilophos		1.1	0.4
15.	Acephate		6.1	6.1
16.	Chlorpyriphos		8.6	9.0
17.	Phosalone		1.0	0.5
18.	Metasystox		*	0.6
19.	Abate		*	0.0
20.	Fenthion		*	0.2
21.	Triazophos		*	2.9
22.	Lindane		1.4	0.4
23.	Temephos		0.2	0.3
24.	Deltamethrin		0.5	0.4
25.	Alphamethrin		1.3	0.3
26.	Captan & Captafol	Fungicides	1.8	0.9
27.	Ziram		0.5	0.3
28.	Carbendzim		1.5	0.7
29.	Calixin		0.2	0.1
30.	Mancozab		20.7	20.8
31.	Coppon – oxychloride	1.5	0.0	
32.	2,4- D	Herbicides	1.2	0.1
33.	Butachlor		0.5	0.3
34.	Isoproturon	Weedicides	5.4	4.7
35.	Glyphosate		3.9	1.0
36.	Paraquat		*	0.0
37.	Diuron		0.1	0.0
38.	Atrazine		0.5	0.0
39.	Fluchloralin		0.2	0.2
40.	Zinc Phosphide	Rodenticides	0.9	0.3
41.	Aluminium Phosphate		2.3	1.4
42.	Methyl Bromide	Fumigants	0.2	0.0
43.	Dicofol		0.2	0.1
Total			145.7	94.0

Source: Annual Report 2005-06 of Ministry of Chemicals & fertilizers, Department of Chemicals & Petrochemicals

Table 4: State wise Installed capacity Vs Production

S.No.	Name of the State	Installed capacity (MT/Year)	Actual Production (MT/Year)
1.	Gujarat	77.68	36.05
2.	Maharashtra	41.08	32.16
3.	Andhra Pradesh	3.4	2.665
4.	Kerala	4.594	2.407
5.	Karnataka	3.9	0.911

Source: Annual Report 2005-06 of Ministry of Chemicals & fertilizers, Department of Chemicals & Petrochemicals

2.0. MANUFACTURING PROCESS

Pesticides are produced by chemical reactions of organic materials, which seldom go to completion. The degree of completion of organic reaction is generally very much less than those involving inorganic reactions. The law of mass actions states that in order to transform one reactant fully, the other reactant must be present far in excess in weight than the stoichiometric requirement. This law is applied in practical field. As a result, the final mass of an organic reaction is associated with not only the desired product, but also untreated reactants and undesired products of side reactions or partially completed reactions. The manufactures of pesticide is hardly accomplished in one reaction, in most cases, it involves various unit processes and unit operations.

The important types of unit process (chemical reactions) are:

- Alkylation
- Carboxylation
- Acetylation
- Condensation
- Cyclization,
- Dehydration
- Halogenation
- Oxidation
- Sulfonation
- Nitration
- Amination

Also, the important types of unit operations (physical) are:

- Liquid / Liquid extraction
- Liquid / Liquid separation
- Liquid / Solid separation
- Gas / Solid separation
- Distillation
- Crystallization
- Gas absorption
- Drying
- Grinding
- Mixing

In each reaction, state some raw material remain un-reacted, and some unwanted product are formed which remain in the system. Desired products are carefully recovered in each step from the system. Unwanted products are discarded, but not carefully. These inevitably become pollutants in wastewater and solid waste. Some are vented out in the atmosphere. Although in some cases some recyclable materials are also profitably taken back in to the system. Impurities present in raw materials may also react with one another and in many cases show up as a scum, froth or tar or simply as un-reacted raw material. In order to understand generation of wastewater, solid waste and emission understanding of unit process and operation is required. The typical unit operation of chemical synthesis is depicted in **Fig. 1**. Within this backdrop the manufacturing process of some of the technical grade pesticides and associated air pollutants are discussed in the subsequent paragraphs.

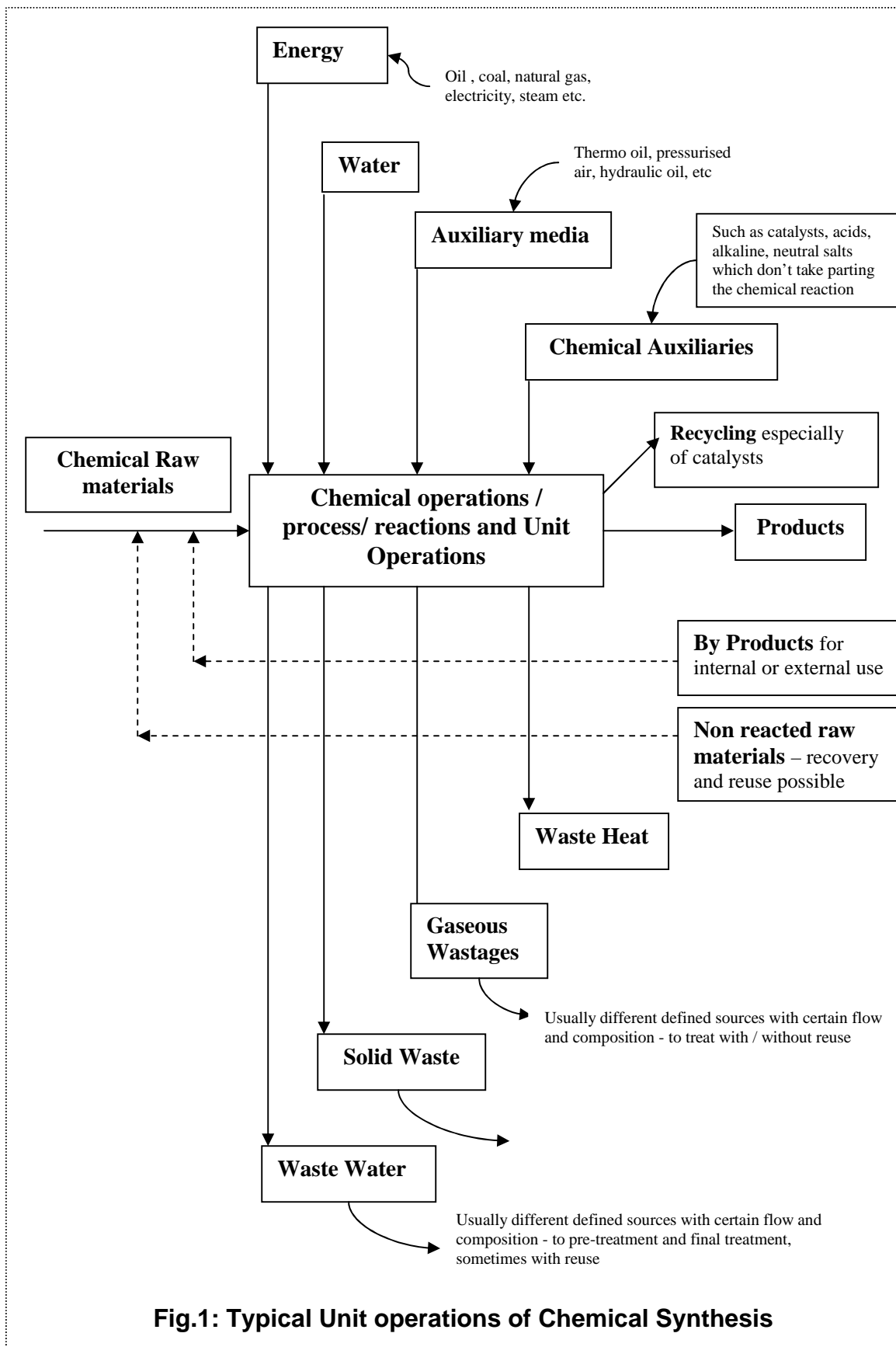

2.1. Acephate

Process starts with the addition of Dimethyl Sulphate to Dimethyl thio phosphoramidate (DMPAT) to give Methamodophos, which is acetylated with acetic Anhydride in presence of sulphuric acid to give crude acephate. Crude acephate is neutralised with ammonia solution and extracted in methylene chloride. The extracted acephate liquor is crystallised under chilled condition in presence of Ethyl acetate. Crystallised Acephate is then centrifuged and dried. The chemistry of Acephate production is stated below:

Step 1: Isomerisation

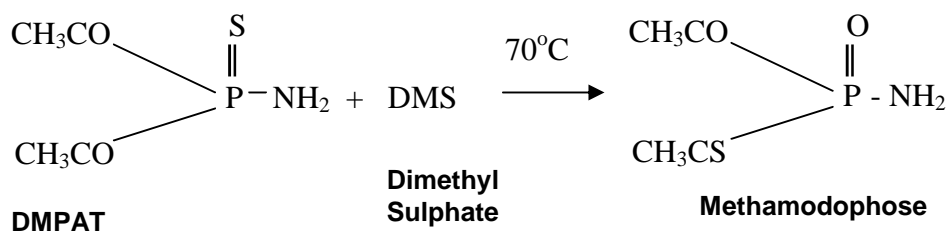

Step 2: Acetylation

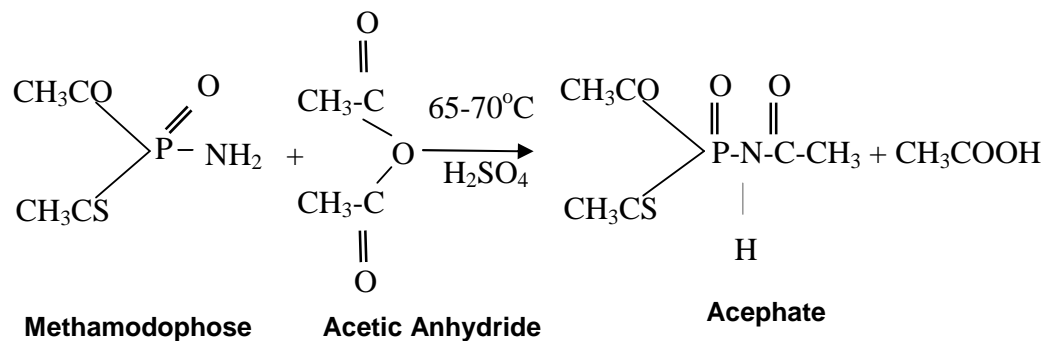

Step 3: Neutralisation & Extraction of Acephate

Liquor ammonia is slowly added under stirring to neutralize sulphuric acid and acetic acid. Liquor ammonia is added till pH is about 7. Layers are separated. Organic layer is washed with water. Aqueous layer is sent to effluent treatment plant.

Step 4: Crystallisation of Acephate Liquor

Organic layer is subjected to vacuum distillation to recover methylene chloride. After recovery of methylene chloride, mother liquor is taken in a crystallizer. Ethyl acetate is added, stirred and crystallized Acephate is allowed to settle. Acephate is filtered and mother liquor is taken for ethyl acetate recovery. Viscous organic mother liquor after ethyl acetate recovery is sent for incineration. The process flow diagram of Acephate is given in **Fig. 2**.

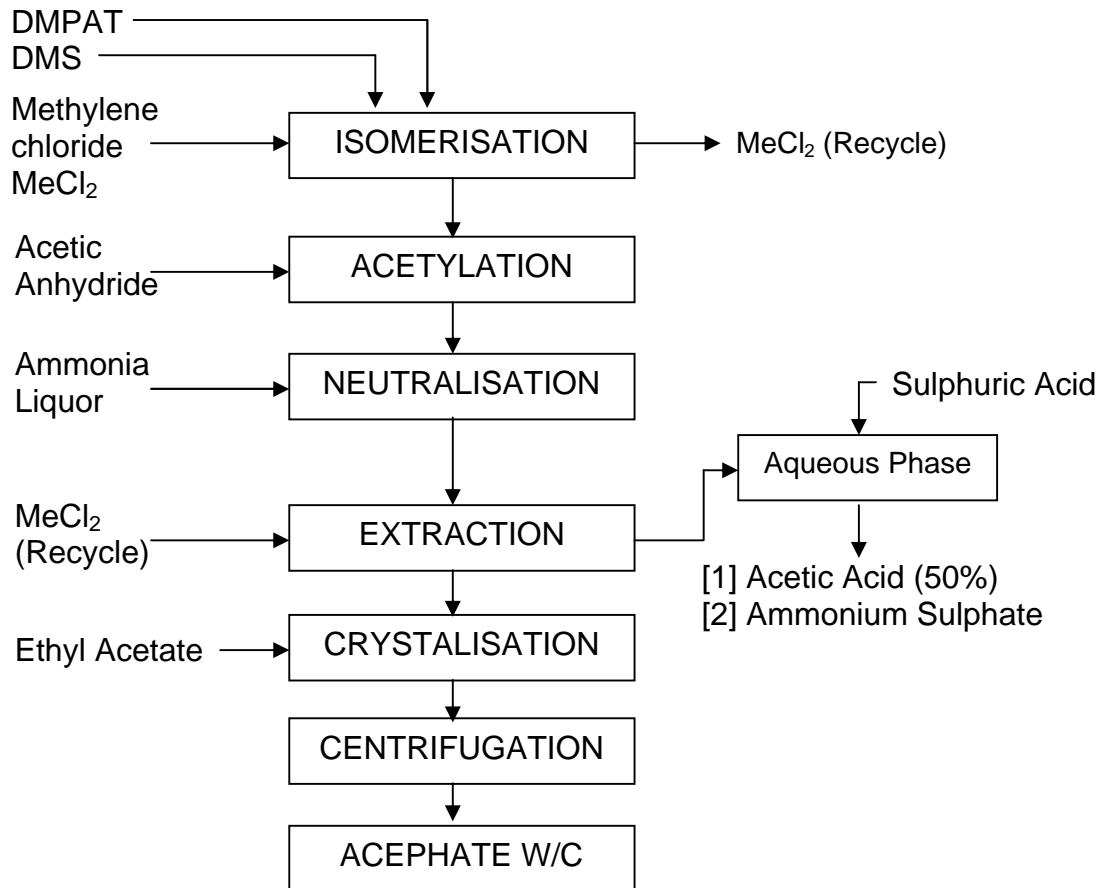

Fig. 2: Process Flow Diagram of Acephate Manufacturing

2.1.1 Associated Air Pollutants

There is no channelised emission observed in the process of Acephate manufacturing. Because, process steps for preparation of Dimethyl thio phosphoramidate (DMPAT) has been eliminated / stopped, which is the source of HCl emission as data received from the industrial units manufacturing Acephate.

2.2 Aluminium Phosphide

Aluminium phosphide is manufactured by reacting Aluminium and Phosphorus in a closed chamber. Aluminium phosphide is formed, instantaneously liberating heat of reaction. The Aluminium phosphide thus obtained, is reduced to required size, blended with inert ingredients and converted into various tablets and pouches.

The process flow diagram of Aluminium phosphide is shown in **Fig. 3**.

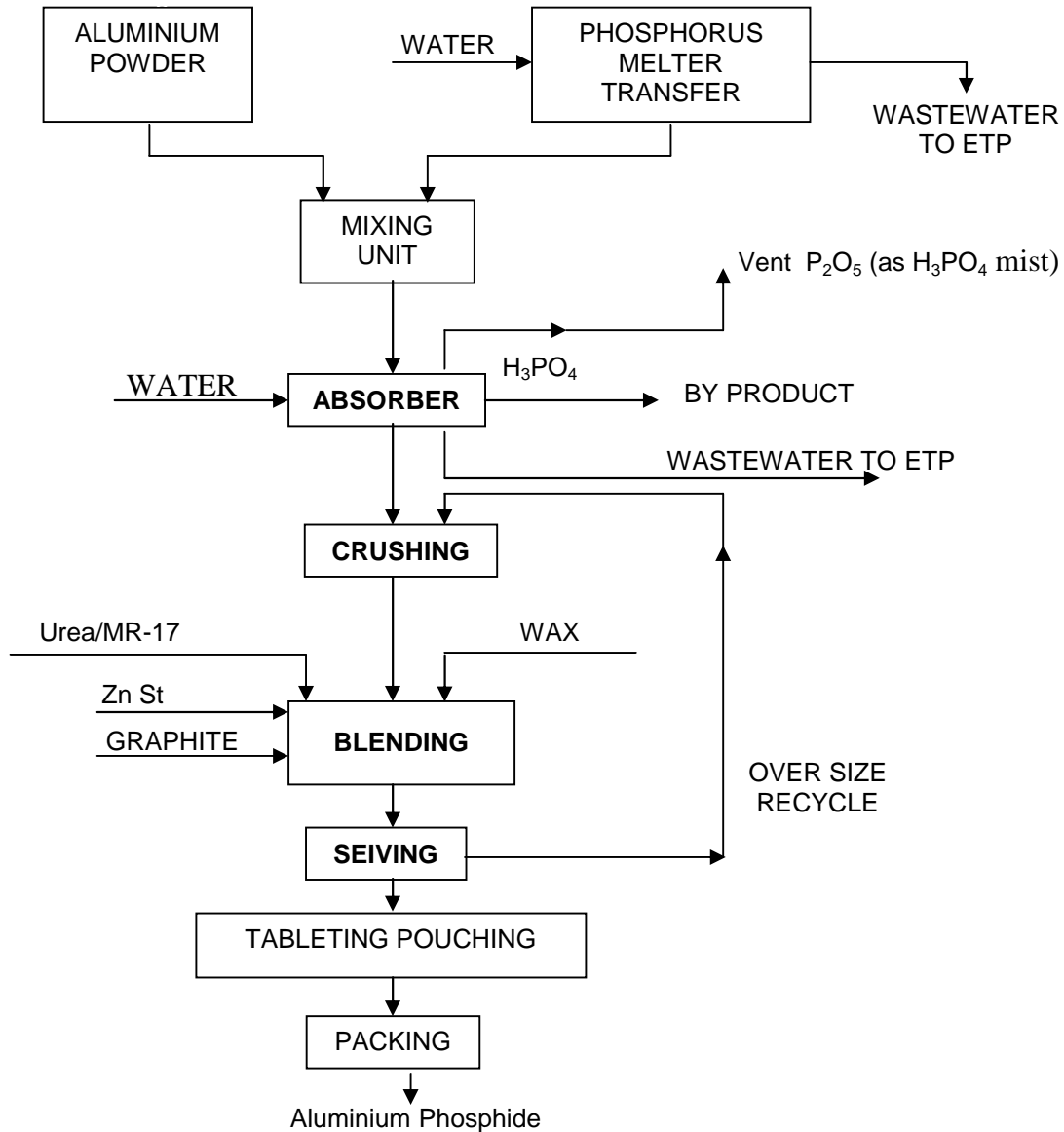

Fig 3. : Process Flow Diagram of Aluminium Phosphide Manufacturing

2.2.1. Associated Air Pollutants

During the course of reaction, P₂O₅ fumes (as H₃PO₄ mist) generated, which are pass through scrubber, followed with mist eliminator so as to control the emission of pollutants. Also, dilute phosphoric acid is generated as a by-product by the industrial units.

2.3 Captafol

Sulphur is charged in reactor then chlorine is slowly passed at controlled temperature (55° to 60°C) to form sulphur Mono Chloride. Again Chlorine is passed through Sulphur Mono Chloride to convert it to Sulphur Dichloride. Sulphur Dichloride is added to hot (86°C) Trichloro Ethylene & then Mixture is heated to 135°C to form Tetrachloro Ethyl Sulphonyl Chloride (TCESCL), which is then washed with water and diluted with Toluene. Finally TCESCL is condensed with Tetra hydro phthalic imide (THPI) in presence of NaOH to give Captafol, which is centrifuged & dried.

The steps of chemical reactions for Captafol manufacturing are as follows:

Step 1: Sulphur Mono Chloride Preparation

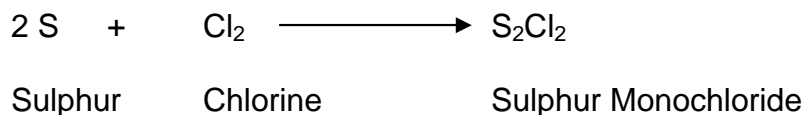

Step 2: Sulphur Dichloride Preparation

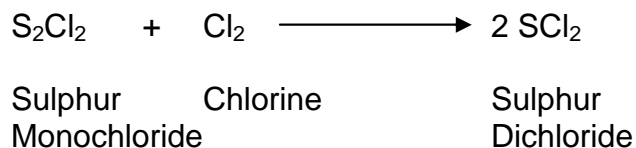

Step 3: Tetrachloro Ethyl Sulphonyl Chloride Preparation (TCESCL)

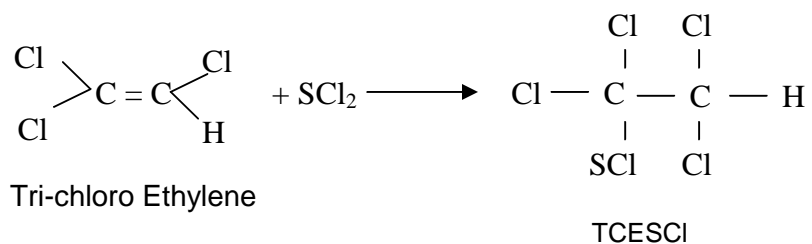

Step 4: Condensation

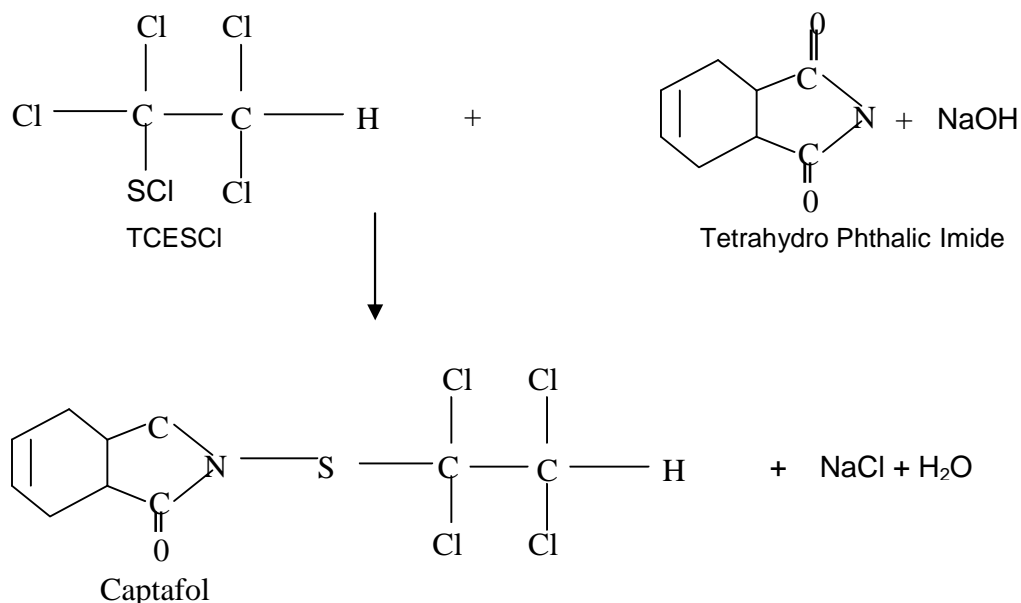

Step5: Filtration & Drying

2.3.1 Associated Air pollutants

In the manufacturing of Captafol pesticide, S₂Cl₂ & SCl₂ are formed during chlorination of sulphur and subsequent chlorination of sulphur monochloride. It is observed that there is no direct emission of S₂Cl₂ & SCl₂. But, only chlorine emission takes place during process, which is confirmed during in-depth study.

2.4 Captan

Manufacturing process starts with chlorination of Carbon Disulphide to form CCl₄, which is washed with water & diluted with Toluene prior to condensation. After dilution CCl₄ is condensed with Tetra Hydro Phthalic Amide (THPA) at temperature less than 10°C to form Captan. Toluene is added for slurry preparation. Then the crude mass is centrifuged and then dried in rotary drier.

The chemistry of Captan formation is given below:

Step 1: Chlorination of Carbon Disulphide

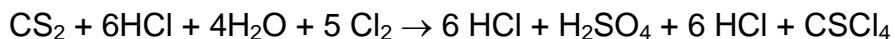

Step 2: Washing & Dilution of CCl₄

Step 3: Condensation

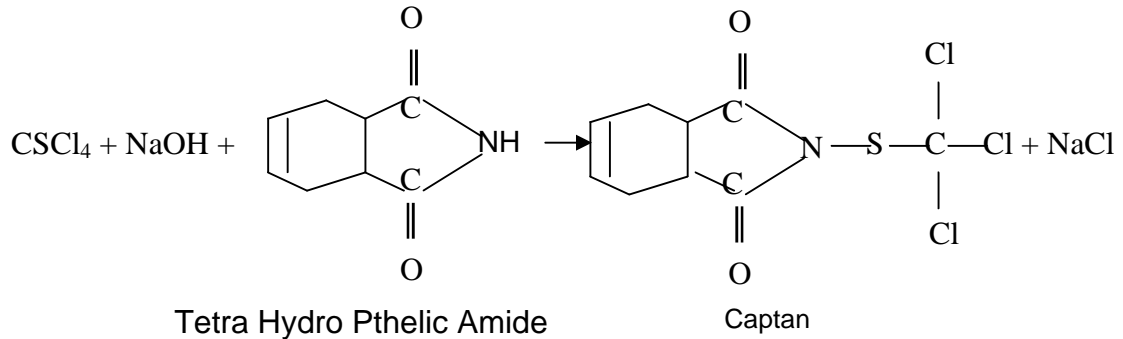

Step 4: Washing

Step 5: Filtration & Drying

Process flow diagram for manufacturing of Captan is given in **Fig. 4**

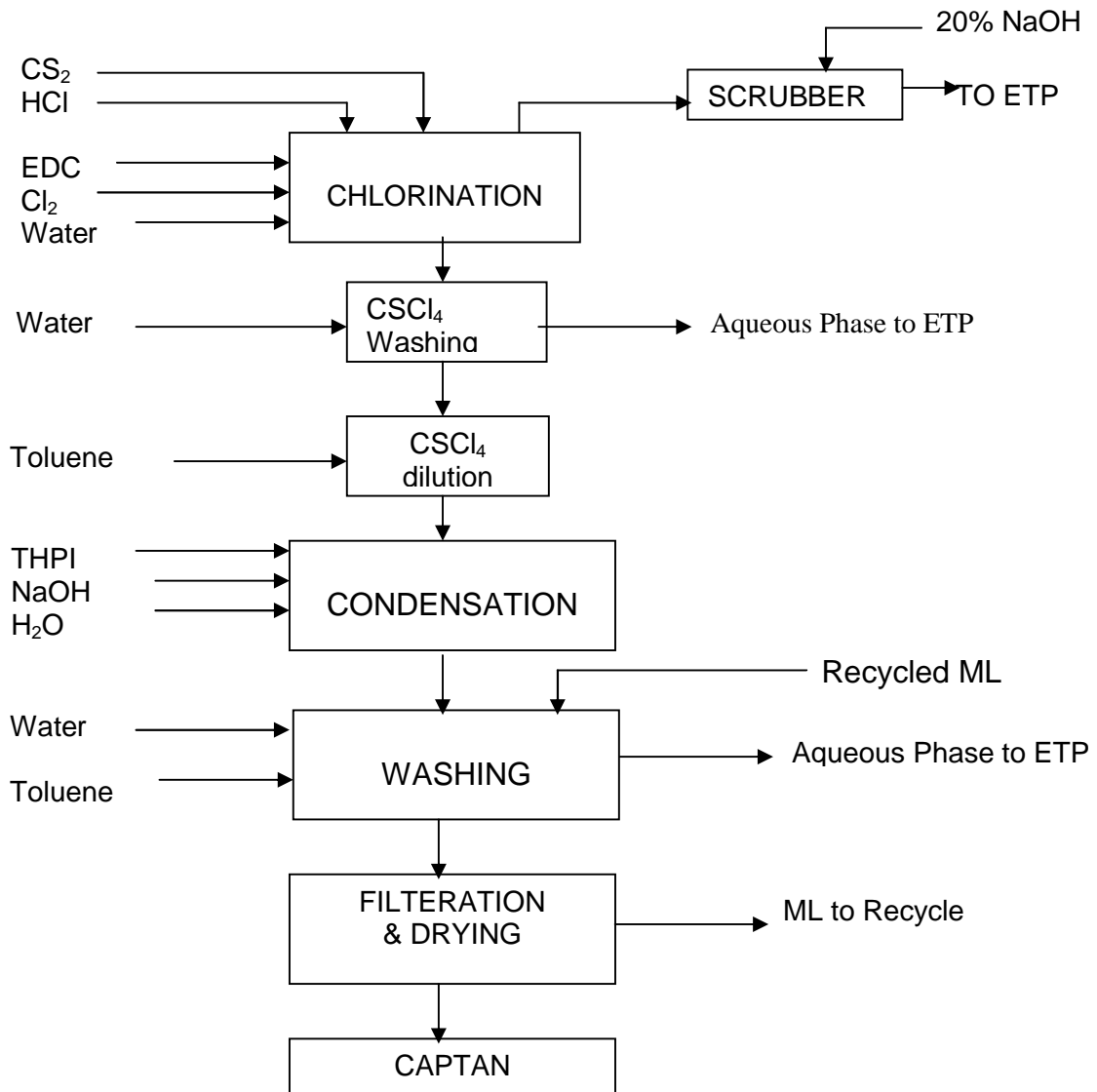

Fig. 4: Process Flow Diagram of Captan Manufacturing

2.4.1 Associated Air Pollutants

The air pollutants identified from the process of manufacturing of Captan are Hydrochloric Acid (HCl) and Chlorine (Cl₂).

2.5 Cypermethrin

Dichloro Vinyl Cyclo propane Carboxylic Acid Chloride (DVACl) also known as Cypermethric Acid Chloride (CMAC) and Meta Phenoxy Benzaldehyde (MPBAD) are taken in an agitator reactor, in a solvent (Hexane). Sodium cyanide and water are added to the mass. Mass is agitated in reactor for the required time. At the end of reaction, the reaction mass is separated into two phases, organic layer and aqueous layer.

Organic layer containing the product, Cypermethric technical with solvent is taken for distillation, where the solvent is removed and recycled. The final traces of solvent, which are around 3-4%, are removed under vacuum and recycled back. The process flow diagram is shown in **Fig. 5**.

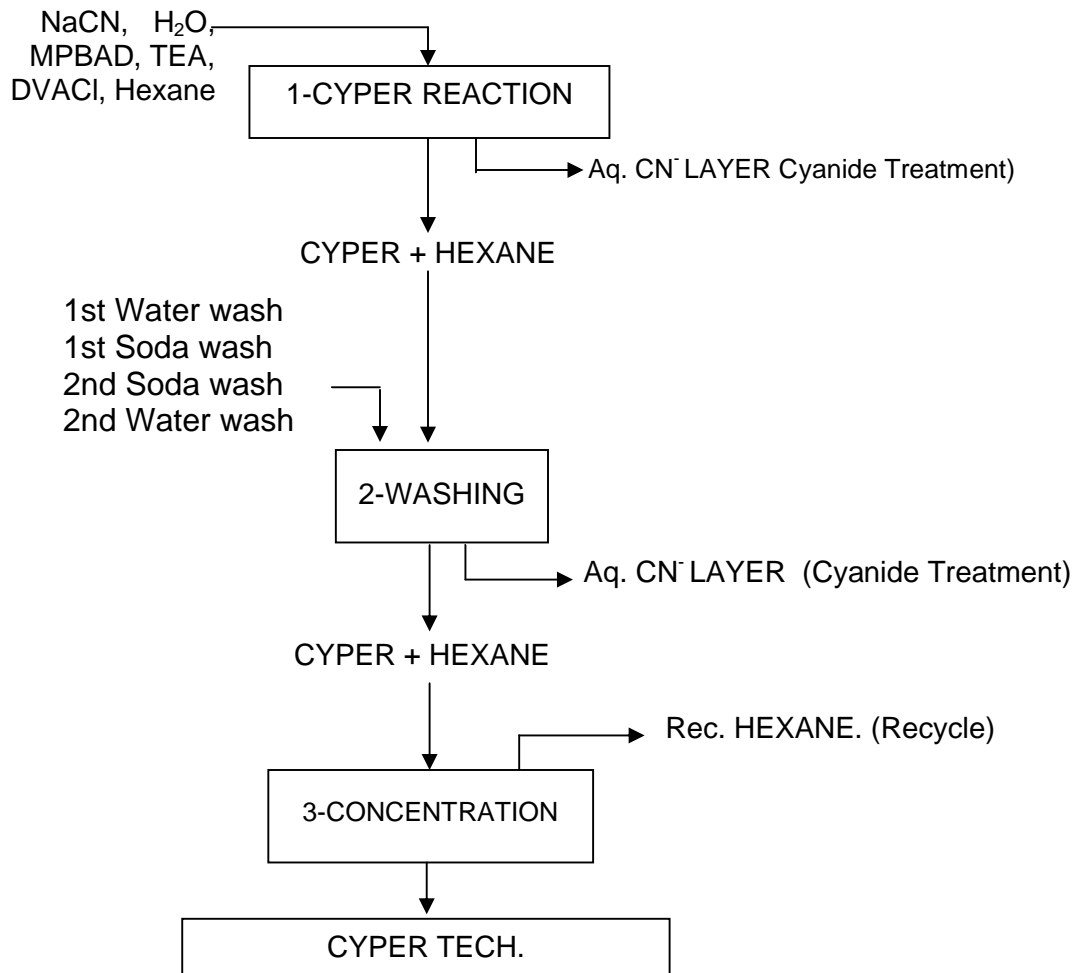

Fig. 5: Process Flow Diagram of Cypermethrin Manufacturing

DVA chloride

Acrylonitrile and Carbon tetrachloride are reacted in presence of catalyst to give Tetrachloro butyronitrile (TCBN) and the same is taken for distillation. Purified TCBN is hydrolysed with Sulphuric acid to form Tetra chloro butyric acid. The spent acid is separated, taken for despatch. TCB acid is reacted with Thionyl chloride to make TCB Acid chloride. The gases liberated are scrubbed with water to remove HCl and with Caustic to remove SO₂. TCBACl is taken for distillation.

Distilled TCBACl is reacted with Isobutylene in presence of Tri Ethyl Amine to make 2-Cyclobutanone (2-CB). After recovery of solvent, it is taken for filtration. Mother liquid is taken for recycle. 2-CB powder is isomerised in presence of catalyst to give the derivative of 4-Cyclobutanone (4-CB).

4-Cyclobutanone thus obtained is reacted with Caustic solution to form Sodium salt of DVA. DVANa is acidified with HCl to make DV Acid. DVA is further reacted with Thionyl chloride to obtain DVA chloride. The gases liberated are scrubbed with water to remove HCl and with Caustic to remove SO₂. DVA chloride thus obtained is taken for solvent recovery followed by distillation to make purified DVA chloride.

Metaphenoxy benzaldehyde (MPBAD)

Benzaldehyde is reacted with Bromine and chlorine in presence of EDC to form Meta Bromo Benzaldehyde (MBB). HCl generated during the course of reaction is scrubbed in water to form HCl, which is recycled. Reaction mass is washed with HCl (3-4%). AlCl₃ solution formed during the wash is sold after treatment. Organic portion from above wash is treated with thio sulphate and given a water wash. Organic layer containing MBB and EDC is taken for distillation. Crude MBB thus formed is then fractionally distilled to get distilled MBB. EDC and mid fractions recovered during the distillation are recycled. Distilled MBB is then reacted with Mono Ethylene Glycol in presence of catalyst to form Meta Bromo benzaldehyde acetal (MBBA).

MBBA is reacted with phenol in presence of catalyst, KOH and Toluene to form Meta Phenoxy benzaldehyde acetal (MPBA). MPBA is further treated with caustic lye in presence of water. Aqueous layer is separated from organic layer and treated with sulphuric acid. KBr solution formed during the course of treatment is then taken for Bromine recovery. Organic layer containing MPBA and toluene is taken for hydrolysis in next stage.

MPBA in toluene is heated with sulphuric acid (98%) to form Metaphenoxy Benzaldehyde (MPBAD). MEG generated during the reaction is taken for recovery and recycled. MPBAD + Toluene are fractionally distilled to get pure MPBAD. Toluene and mid fractions recovered during the distillation are recycled.

2.5.1 Associated Air Pollutants

The air pollutants identified from the process of manufacturing of Cypermethrin are Chlorine (Cl₂), Hydrochloric Acid (HCl) and Sulphur dioxide (SO₂).

2.6 Dimethoate

The process of manufacturing Dimethoate is furnished below alongwith process chemistry:

Step 1: DDPA preparation

Phosphorous penta Sulphide reacts with methanol to produce Dimethyl Dithio Phosphoric Acid, which is used in next step.

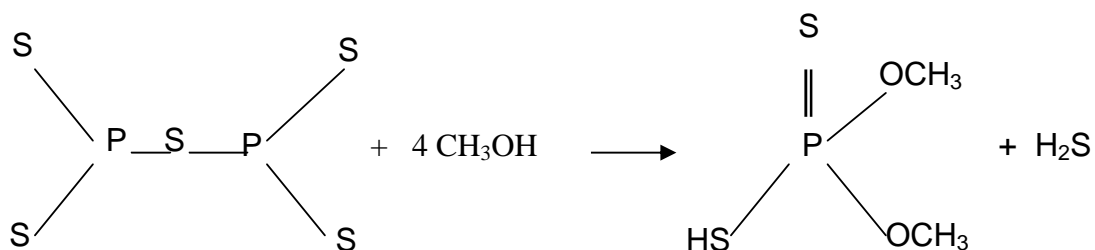

Phosphorous pentasulphide

Dimethyl Dithio Phosphoric Acid

Step 2: Na-DDPA preparation

20% Sodium carbonate is added to the DDPA solution prepared as above till pH 7.0. The layers are separated. The toluene layer goes for purification and the aqueous layer containing sodium salt of DDPA is taken for next step.

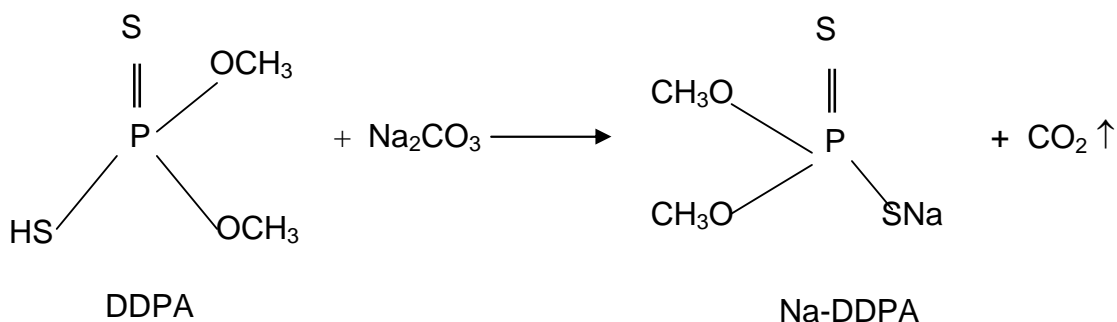

DDPA

Na-DDPA

Step 3: Methyl monochloro acetate (MMCA)

Monochloro Acetic Acid, Methanol and Catalytic amount of sulphuric acid are refluxed and MMCA formed is distilled out at 140°C and used for the next step.

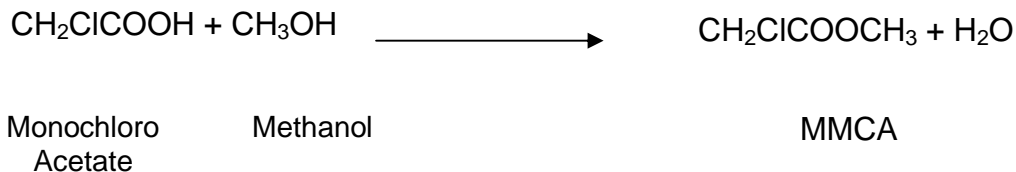

Step 4: Condensation

Na-DDPA prepared as in step 2 and MMCA prepared as in step 3 are mixed and heated for four hours at 60°C under stirring. After the reaction is over same is washed with water and carried out amidation reaction with MMA at -2°C. The reaction mass is neutralised to pH 5.5 – 6.0 with 10% sulphuric acid and the product is extracted with ethylene dichloride solvent. The solvent is then removed from the separated organic layer under vacuum at 70 -75°C and dimethoate is packed.

The process flow diagram is shown in **Fig.6**.

2.6.1 Associated Air Pollutants

The air pollutants identified from the process of manufacturing of demethoate are Hydrogen Sulphide (H₂S) and Methanol (CH₃OH). Methanol is not reported by the industrial units.

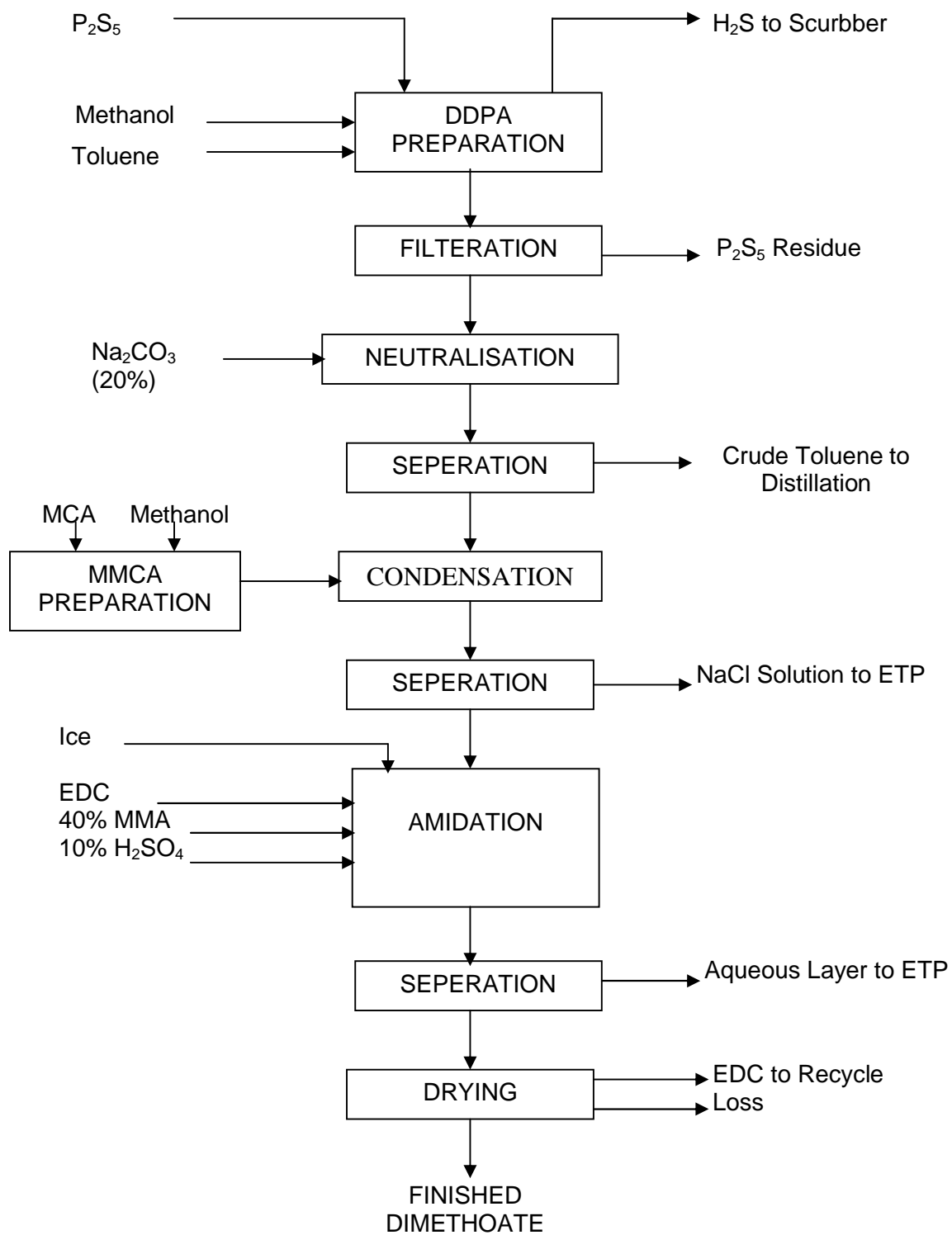

Fig. 6: Process Flow Diagram of Dimethoate Manufacturing

2.7 2,4 – Dichlorophenoxy acetic acid (2,4 – D)

Phenol is chlorinated to get Dichlorophenol, which is condensed with mono chloro Acetic Acid in presence of Alkaline solution to get 2,4-D Sodium. A stirrable slurry of 2,4-D Sodium is prepared and its pH adjusted to 1.0 – 1.2 by adding 98% Sulphuric acid. 2,4-D acid thus formed is filtered, dried & packed.

The process flow diagram is shown in **Fig. 7**.

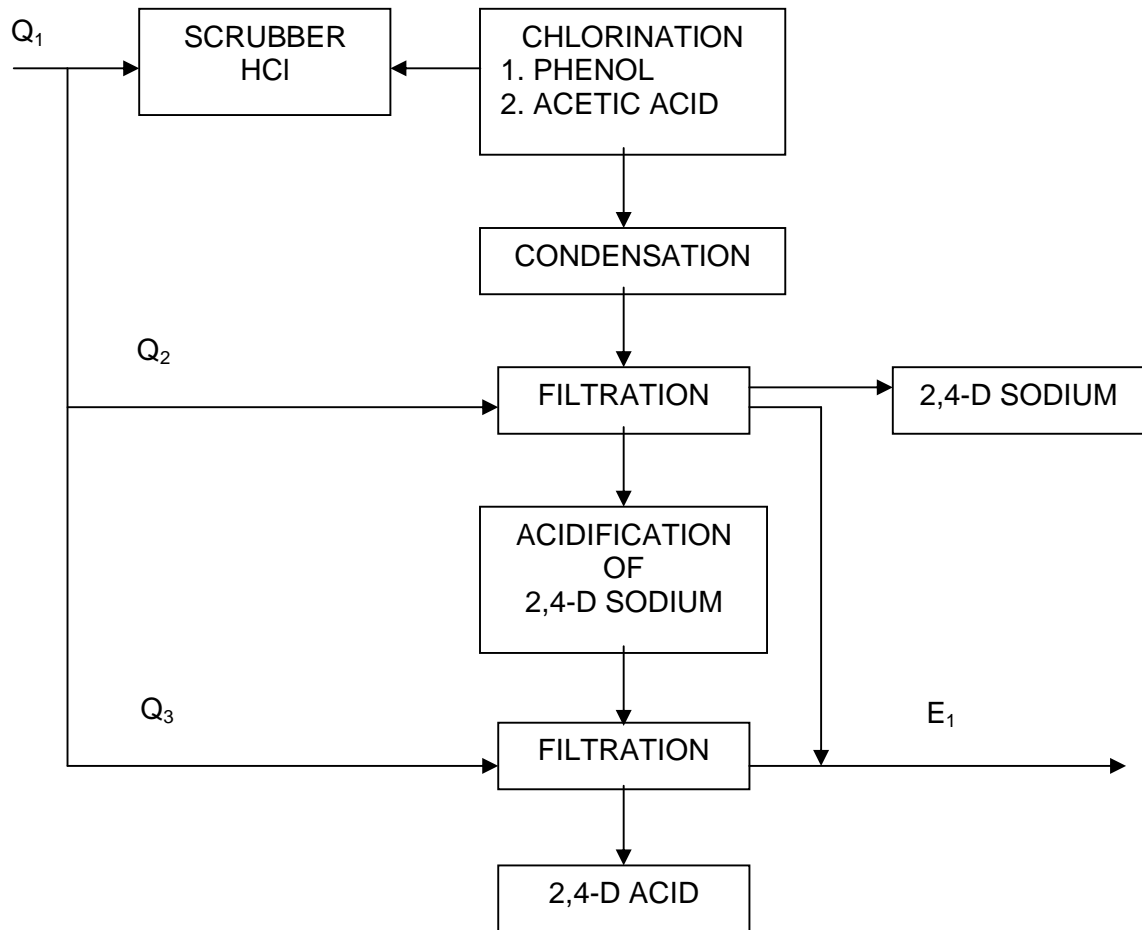

Fig. 7: Process Flow Diagram of 2, 4 – D Acid Manufacturing

2.7.1 Associated Air Pollutants

The air pollutants identified from the process of manufacturing of 2, 4 – D Acid are Hydrochloric Acid (HCl) and Chlorine (Cl₂).

2.8 Dichlorvos (D.D.V.P)

In the first step Tri-Methyl Phosphite (TMP) is slowly allowed to react chemically with tri chloro acetaldehyde at controlled conditions of temperature and at ambient pressure to produce crude DDVP.

Product obtained from step 1 is purified under vacuum by film evaporator to get final product having purity around 95%. The chemistry of DDVP manufacturing process is stated below:

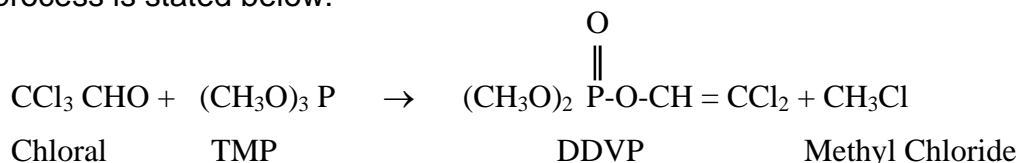

The process flow diagram for manufacture of DDVP is shown in **Fig. 8**.

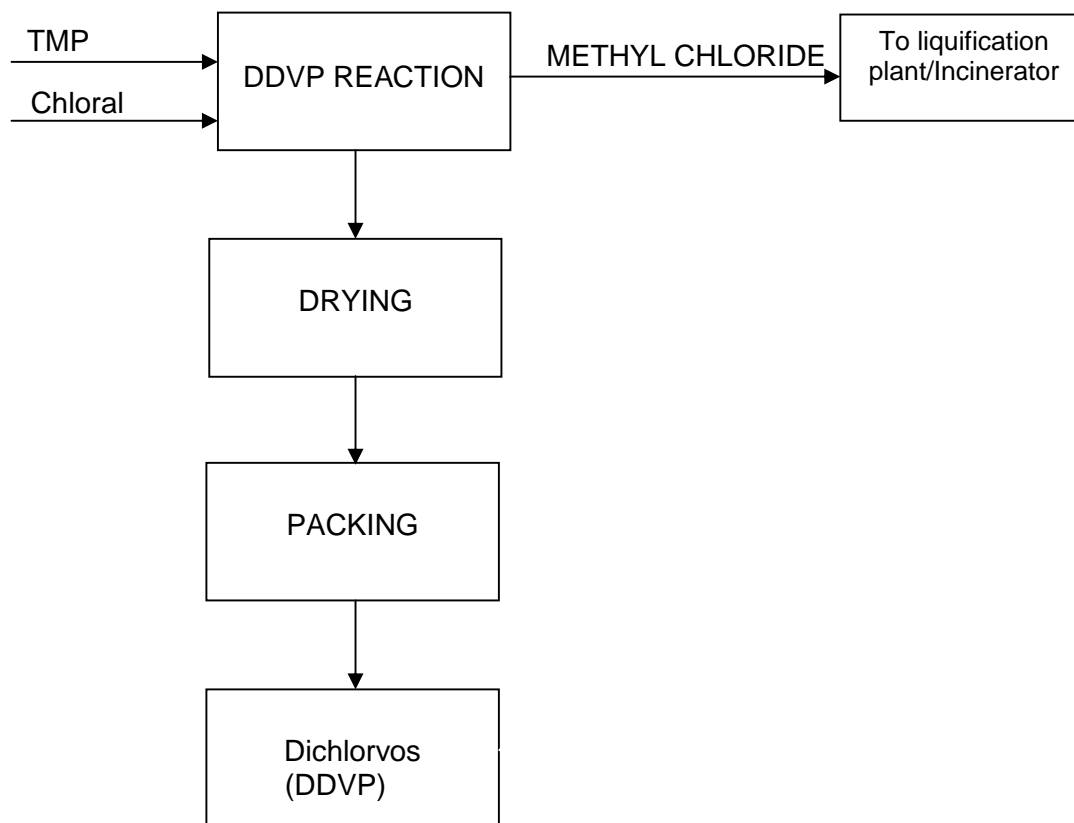

Fig. 8: Process Flow Diagram of D.D.V.P. Manufacturing

2.8.1 Associated Air Pollutants

Methyl chloride (CH_3Cl) is identified as an air pollutant from the manufacturing process of D.D.V.P.

2.9 Ethion

Phosphorus penta-sulphide and absolute alcohol are reacted to produce diethyl dithiophosphoric acid (DDPA), which is reacted with caustic to form sodium salt of DDPA. This salt and methylene dibromide are reacted together to produce Ethion. The manufacturing process step by step is given below alongwith process chemistry:

Step 1: Preparation of Dithioacid

Toluene is taken in the reactor and phosphorus pentasulfide is added under stirring. Temperature is raised and ethanol is slowly added under controlled temperature conditions. During the reaction, hydrogen sulphide gas is evolved. It is absorbed in dilute sodium hydroxide solution in a scrubber.

Step 2: Sodium salt preparation:

With Dithioacid formed in step No. 1, sodium hydroxide solution is added slowly and temperature is controlled by circulating cooling water in the jacket of reactor. At the end of reaction, two layers are separated. Aqueous layer is taken for next step and organic layer is sent for toluene recovery.

Step 3: Condensation

To the aqueous solution of sodium salt of dithioacid, methylene bromide is added, and temperature is raised under maintain condition. At the end of reaction, layers are separated. Aqueous layer contains sodium bromide and organic layer contain product is steam stripped to remove impurities.

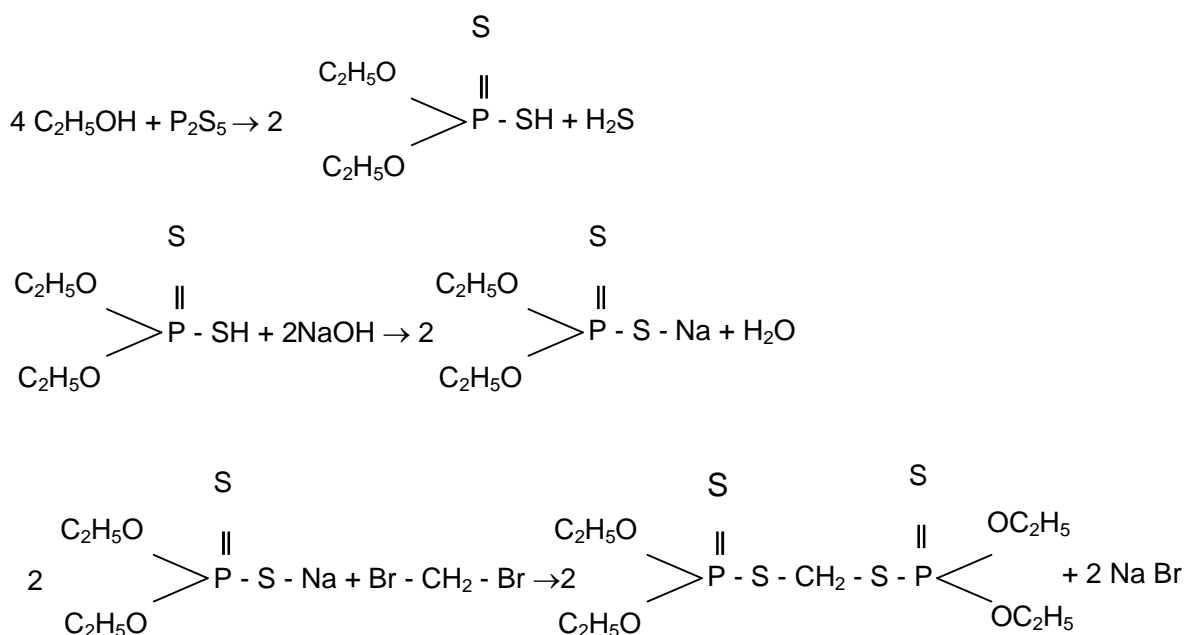

The process flow diagram of Ethion manufacturing is given at **Fig. 9**.

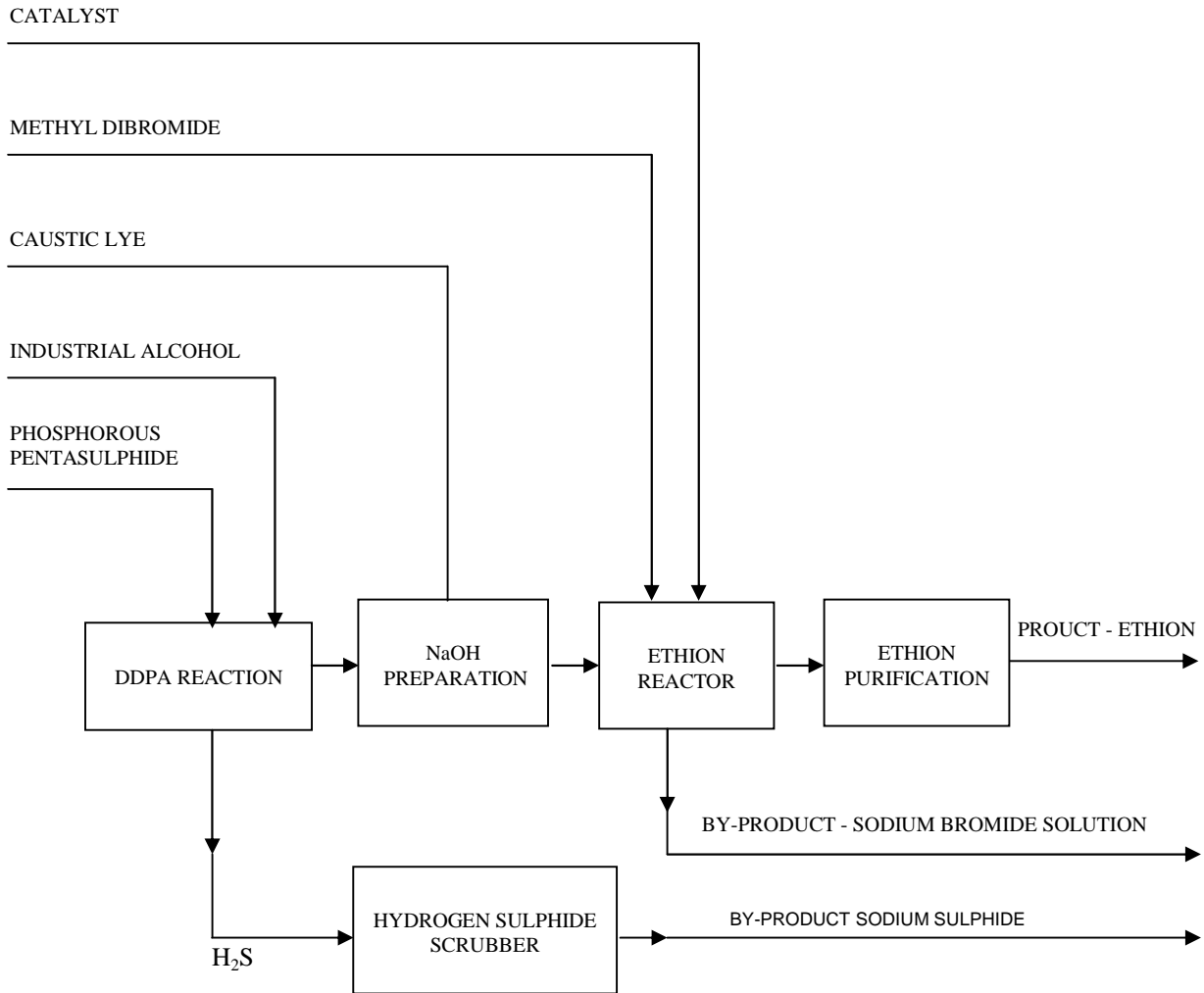

Fig. 9: Process Flow Diagram of Ethion Manufacturing

2.9.1 Associated Air Pollutants

Hydrogen Sulphide (H₂S) and Ethyl Mercaptan (C₂H₅SH) are identified air pollutants from the manufacturing process of Ethion.

2.10 Endosulphan

The manufacturing process for Endosulphan alongwith process chemistry in sequence is stated below:

Step 1: Hexa-chloro-cyclo-pentadiene (HCCP) is reacted with 2-Butene 1:4-Diol in presence of carbon tetra chloride as solvent to form Het Diol.

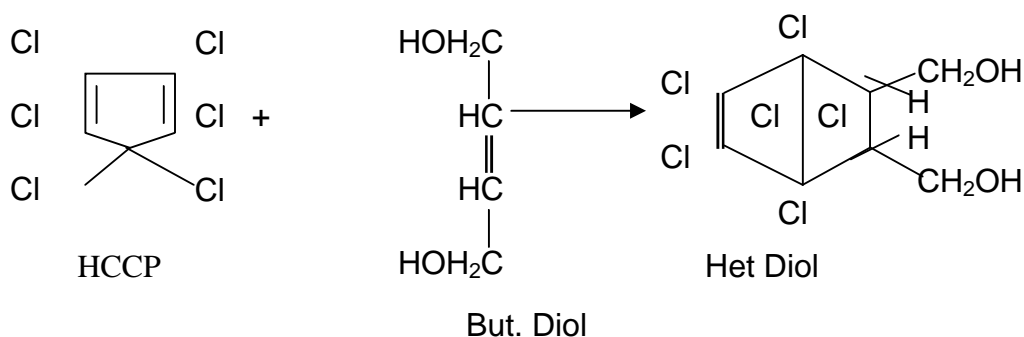

Step 2: Solid Het Diol is separated from mother liquor by centrifuge.

Step 3: Het Diol is then reacted with Thionyl chloride in Carbon tetrachloride solvent to give Endosulphan solution.

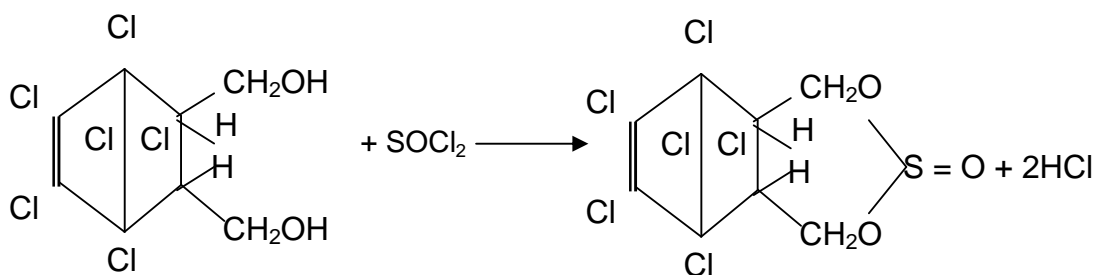

Step 4: Carbon tetrachloride is recovered by distillation to give molten Endosulphan, which is flaked and packed

The process flow diagram of Endosulphan manufacturing is given at **Fig. 10**.

2.10.1 Associated Air Pollutants

Hydrochloric Acid (HCl) is identified air pollutant from the manufacturing process of Endosulphan.

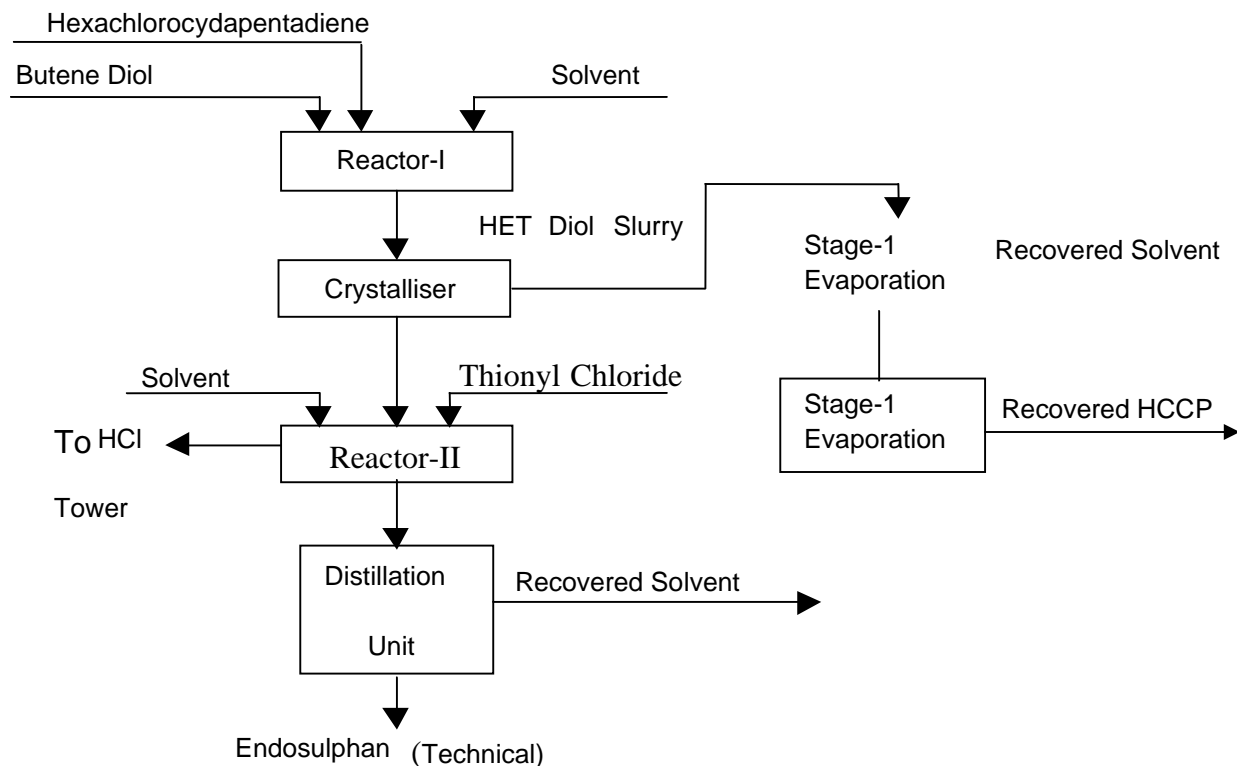

Fig. 10: Process Flow Diagram of Endosulphan Manufacturing

2.11 Fenvalerate

Para chloro toluene (PCT) is chlorinated to Para chloro benzyl chloride (PCBC). The HCl and Cl₂ gases liberated are scrubbed with water and caustic solution. The chlorinated mass is distilled to remove excess PCT. PCBC is reacted with Sodium cyanide to form PCCN. The aqueous layer is treated with Sodium hypochlorite to reduce cyanide content.

The para chloro benzyl cyanide is reacted with Isopropyl bromide in presence of caustic to form PCAN. The reaction mass is washed with water. Aqueous layer is taken for NaBr recovery. The organic layer is taken for fractional distillation. PCAN thus obtained is hydrolysed with sulphuric acid to form PCA.

PCA is further reacted with Thionyl chloride to obtain PCA chloride. The gases liberated are scrubbed with water to remove HCl and with caustic to remove SO₂. PCA chloride thus obtained is condensed with MPBAD, alongwith sodium cyanide and washed with water. Organic mass containing solvents is taken for solvent distillation. Fenvalerate (Tech) thus obtained is packed in drums.

The aqueous layer containing excess cyanide is treated with Sodium hypochlorite and is drained to ETP. The process flow diagram is given at **Fig. 11A to Fig. 11 E**

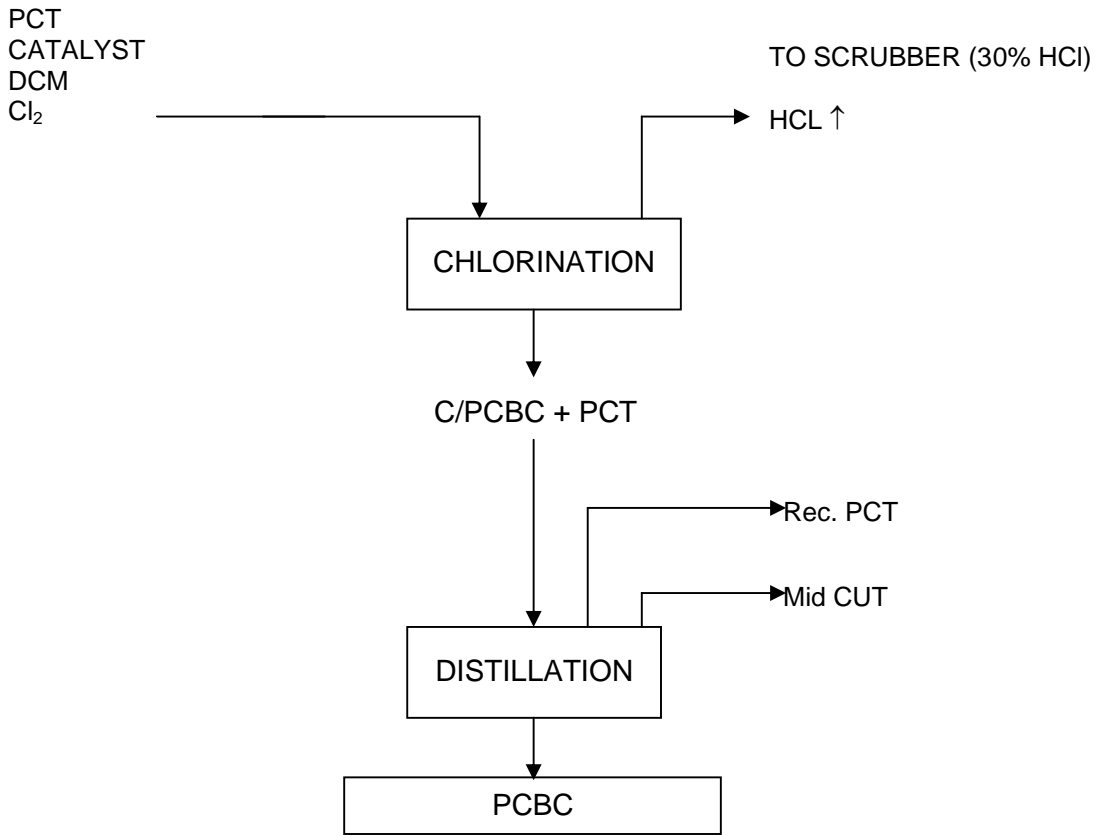

Fig. 11 A. Process Flow Diagram (step PCT to D/PCBC)

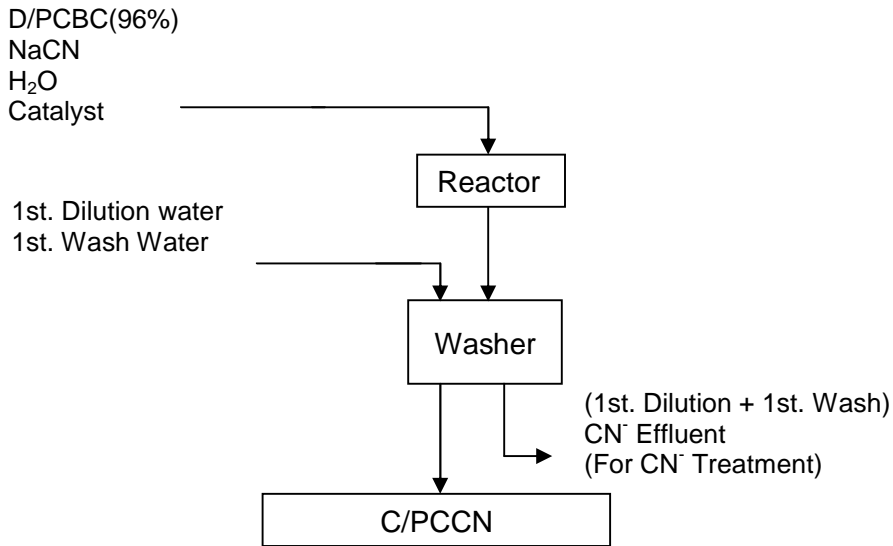

Fig. 11 B. Process Flow Diagram (step D/PCBC to C/PCCN)

C/PCCN (96%)
IPBr. (98% min.)
Catalyst
Caustic Lye (47%)

1st. Dilution water
1st. Wash water

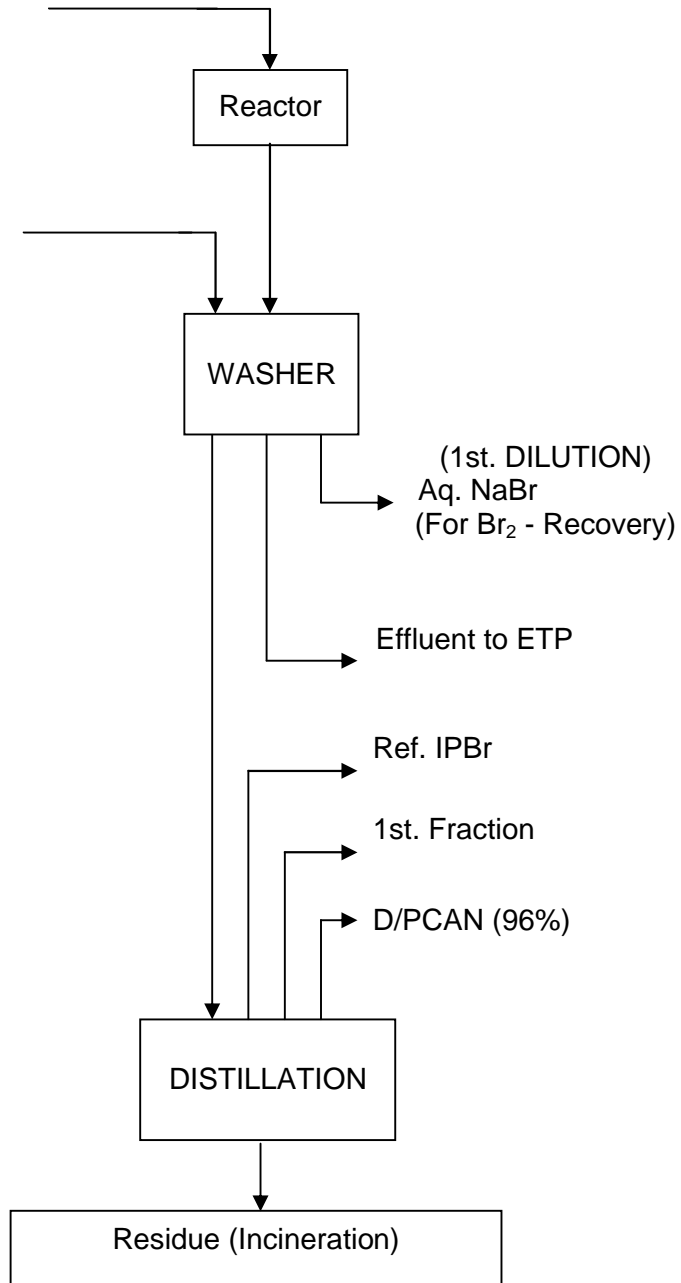

Fig. 11 C. Process Flow Diagram (step C/PCCN to D/PCAN)

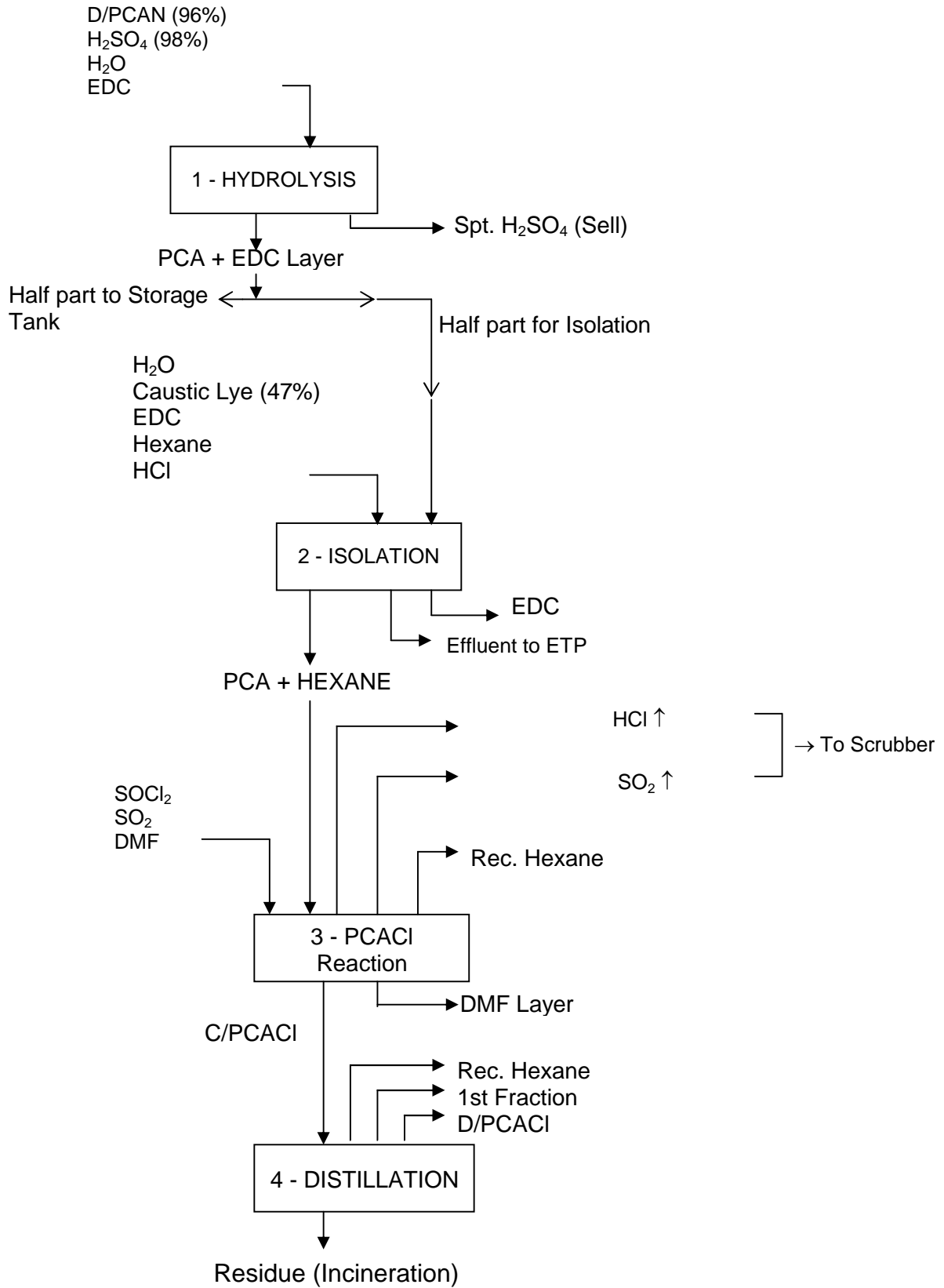

Fig. 11 D. Process Flow Diagram (step D/PCAN to D/PCACl)

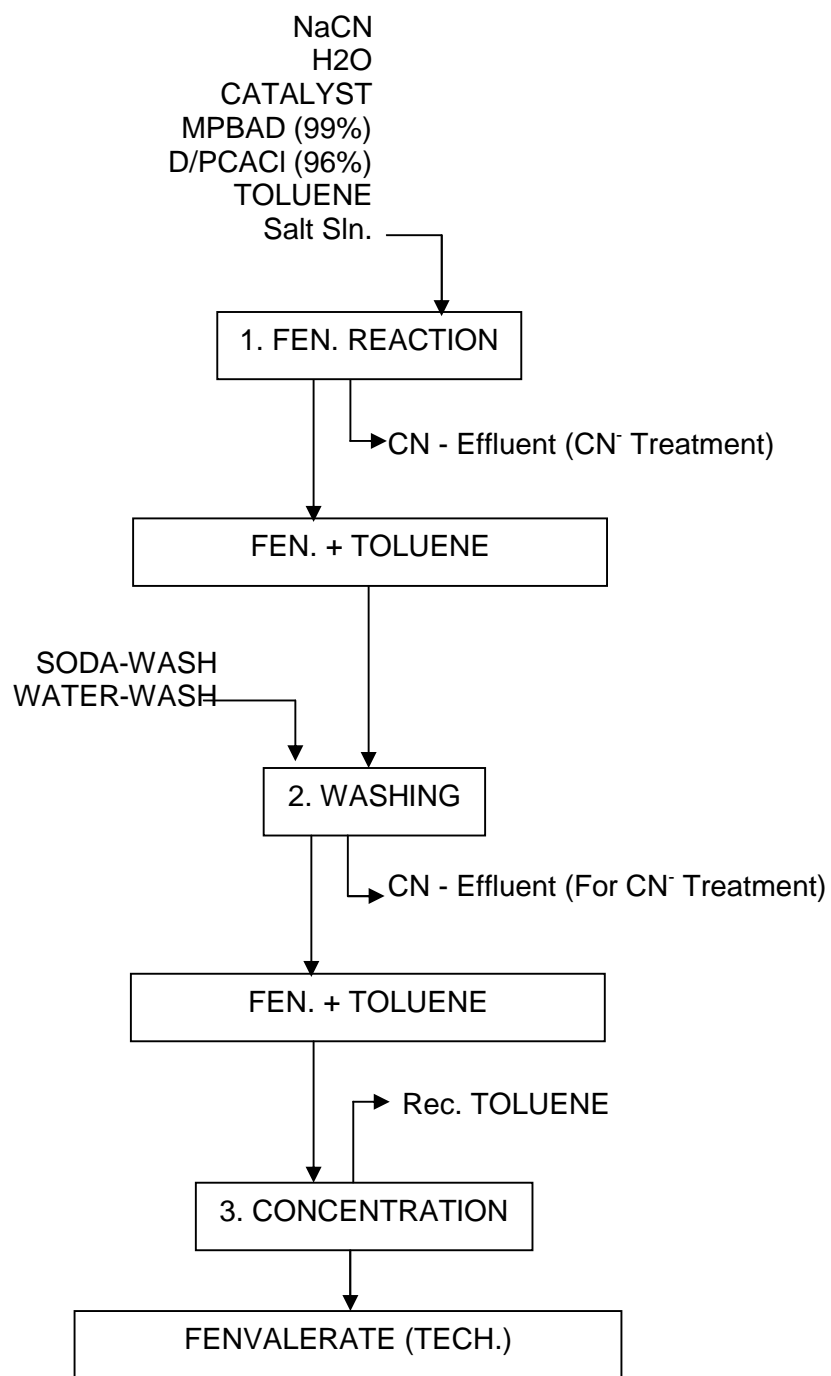
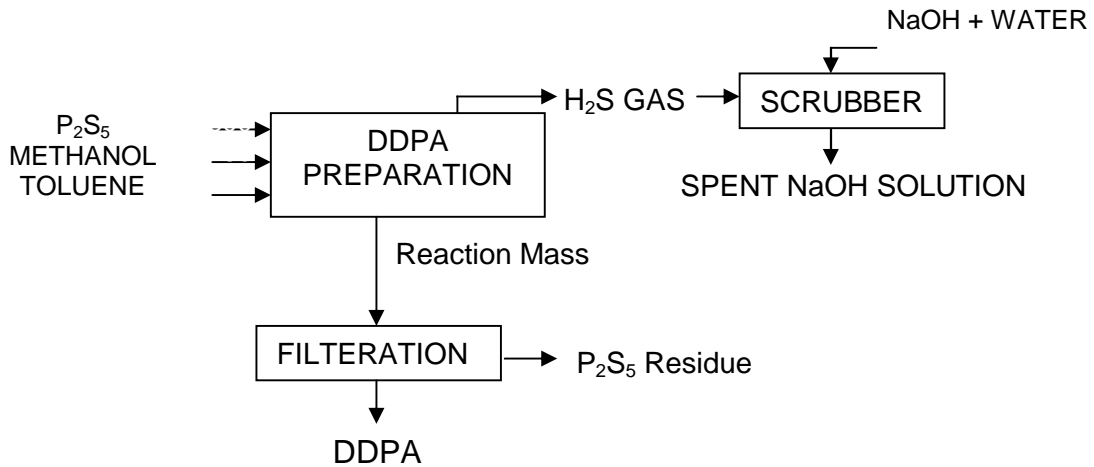
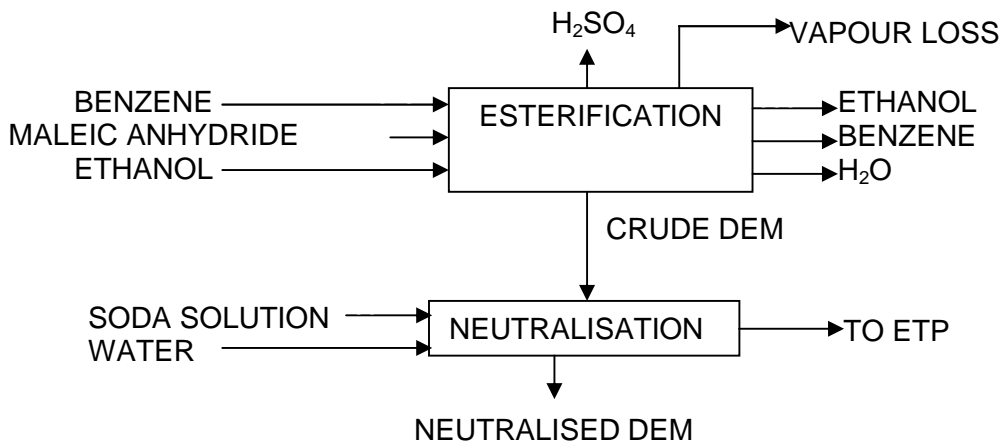

Fig. 11 E. Process Flow Diagram of Fenvalerate (step D/PCACI to Fenvalerate technical)

DDPA PREPARATION



DEM PREPARATION



MALATHION PREPARATION

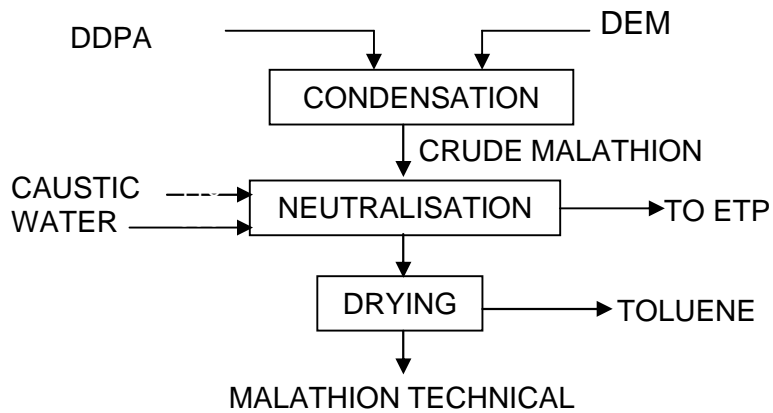

Fig. 12: Process Flow Diagram of Malathion manufacturing

2.12.1 Associated Air Pollutants

Hydrogen Sulphide (H₂S) is an identified air pollutant from the manufacturing process of Malathion.

2.13 Methyl Bromide

Methyl Alcohol and Bromine are reacted in a glass lined reactor. After completion of Bromination, distillation of Methyl Bromide is started. As the boiling point of Methyl Bromide is 4.5° C, chilled brine having temperature less than – 8° C is circulated in the Reflux condenser as well as Product condenser.



A dense ash (Na₂CO₃) column is used to prevent carry over of un-reacted bromine if any. When the colour of the vapour is colourless the reflux condenser chilled brine flow is controlled to allow the vapour to flow to product condenser. The Methyl Bromide vapour gets condensed in the product condenser and flows to the receiver tank. Chilled brine is circulated in the Jackets of the receiver tanks. The process flow diagram for manufacture of Methyl Bromide is shown in **Fig. 13**

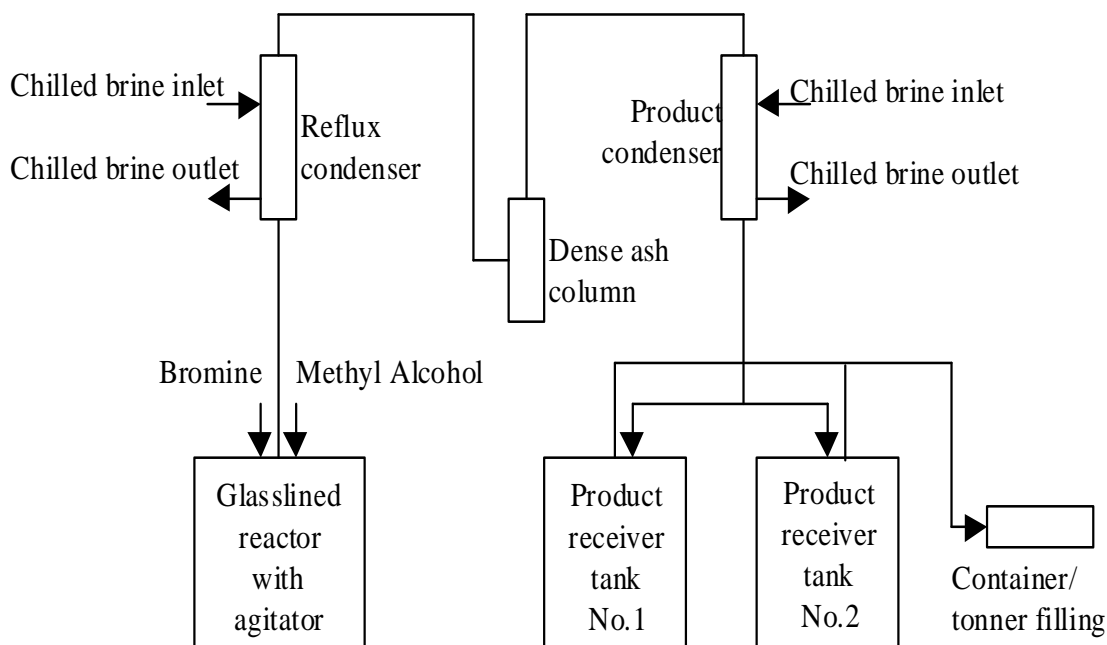

Fig.13. Process Flow Diagram of Methyl Bromide Manufacturing

2.13.1 Associated Air Pollutants

There is no reported emission from closed reaction of Methyl Bromide manufacturing.

2.14. Monocrotophos

Manufacturing of Monocrotophos, following steps are involved:

Step 1: Chlorination of MMAA:

Chlorination of Monomethyl acetoacetamide (MMAA), water and methanol are taken and cooled to 25°C to 30°C temperature then chlorine gas is passed. After the reaction is completed, the reaction mass is neutralised to pH 7.0 with 20% Sodium Carbonate solution. The solvents (methanol & some amount of water) and distilled out and chlorinated product is extracted with EDC. The water is removed by refluxing the chlorinated product in EDC with simultaneous water removal. The reaction mass is taken for the next step.

Step 2: Condensation

The chlorinated product (MMACI) is condensed with Trimethyl phosphite (TMP) to form Monocrotophos Technical.

The process flow diagram is shown in **Fig. 14**.

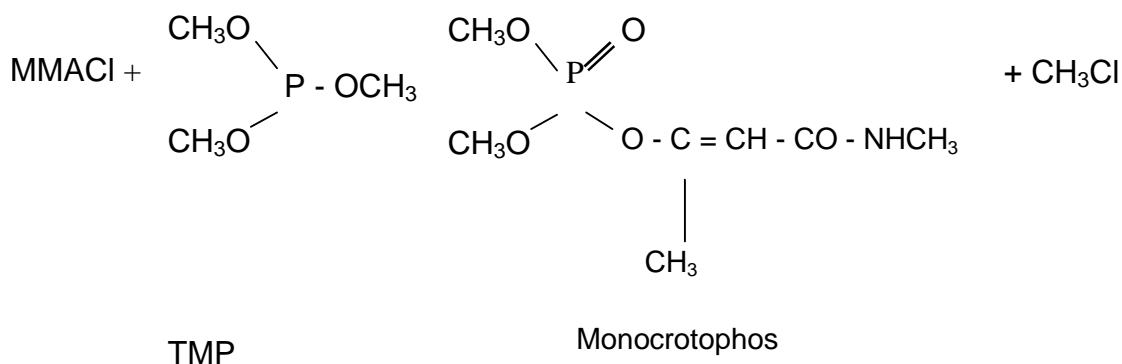
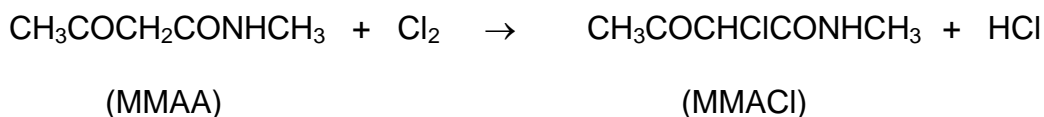

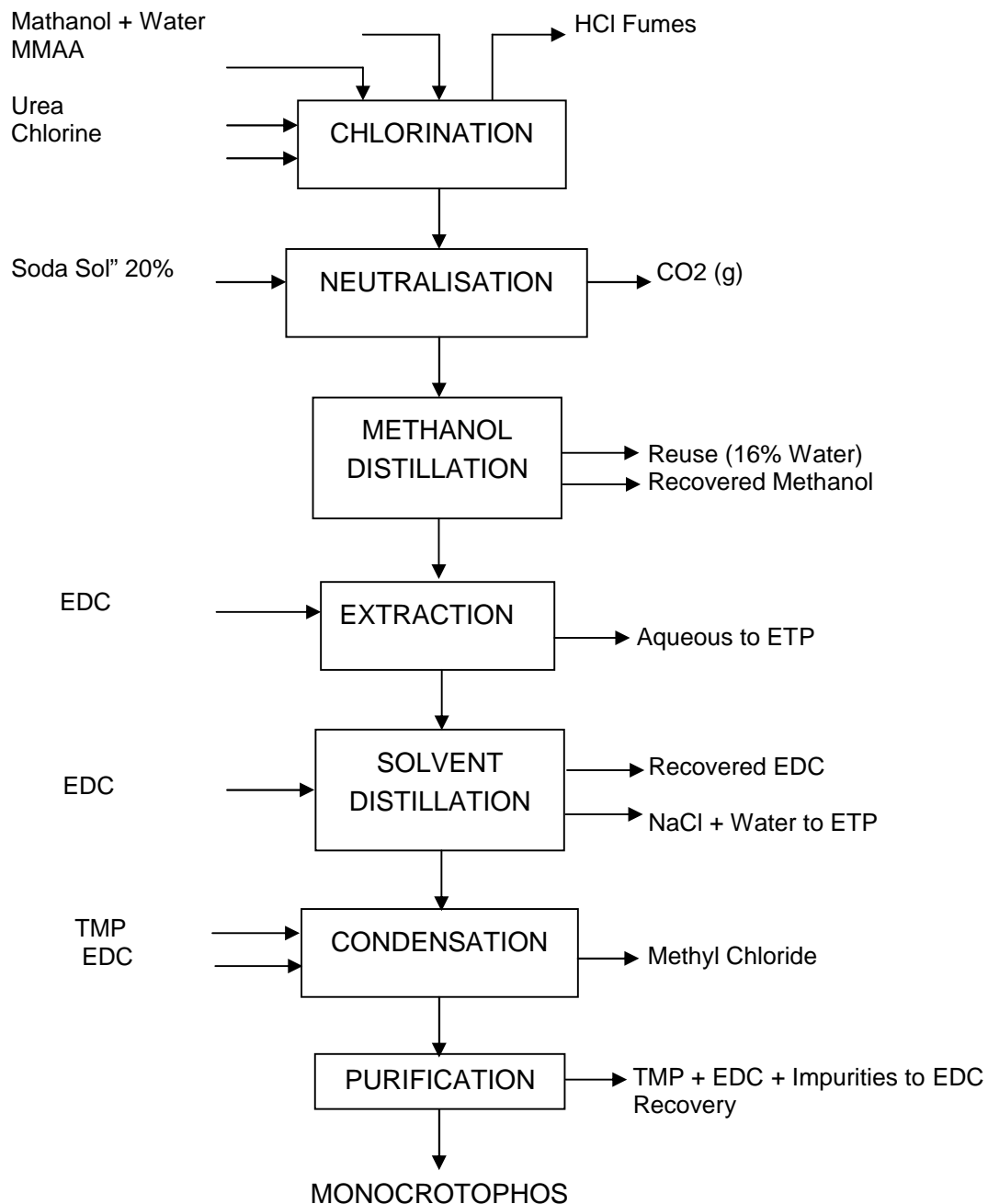

Fig. 14: Process Flow Diagram of Monocrotophos Manufacturing

2.14.1 Associated Air Pollutants

Hydrogen Chloride (HCL) and Methyl Chloride (CH₃Cl) are identified air pollutant from the manufacturing process of Monocrotophos.

2.15 Isoproturon

Cumene is nitrated with a mixture of nitric acid and sulphuric acid to produce nitrocumenes. Nitrocumenes are reacted with sulphur and caustic soda to give cumidine. Cumidine is reacted with urea and di-methyl amine in presence of solvent to produce isoproturon. Isoproturon is isolated by filtration and dried then pulverised and packed. The process flow diagram is given at **Fig. 15**

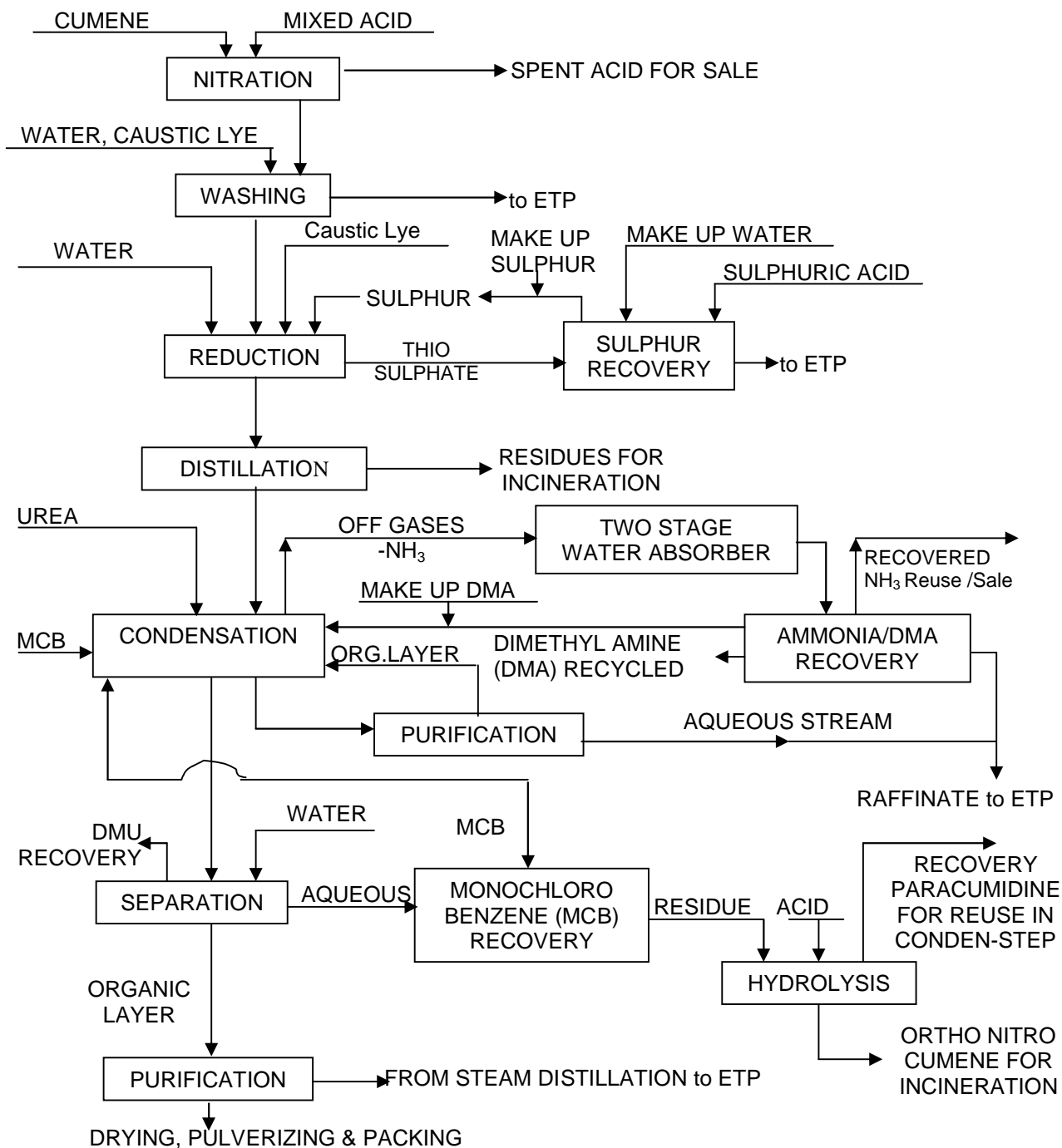

Fig 15: Process Flow Diagram of Isoproturon Manufacturing

2.15.1 Associated Air Pollutants

Ammonia (NH₃) is an identified air pollutant from the manufacturing process of Isoproturon.

2.16. Phosalone

Orthoaminophenol is reacted with urea in solvent medium to get benzoxazolone, which is then chlorinated in solvent medium, and formaldehyde is added to get hydroxy methychloro benzoxazolone (HMCB). HMCB is chlorinated using dry HCl gas to get chloromethyl chlorobenzoxazolone (CMCB) which is extracted in methylene chloride medium. P₂S₅ is reacted with ethyl alcohol to get diethyl dithiophosphoric acid (DDPA) which is neutralised with caustic soda to get sodium salt of DDPA. This sodium salt and CMCB are reacted to get crude phosalone.

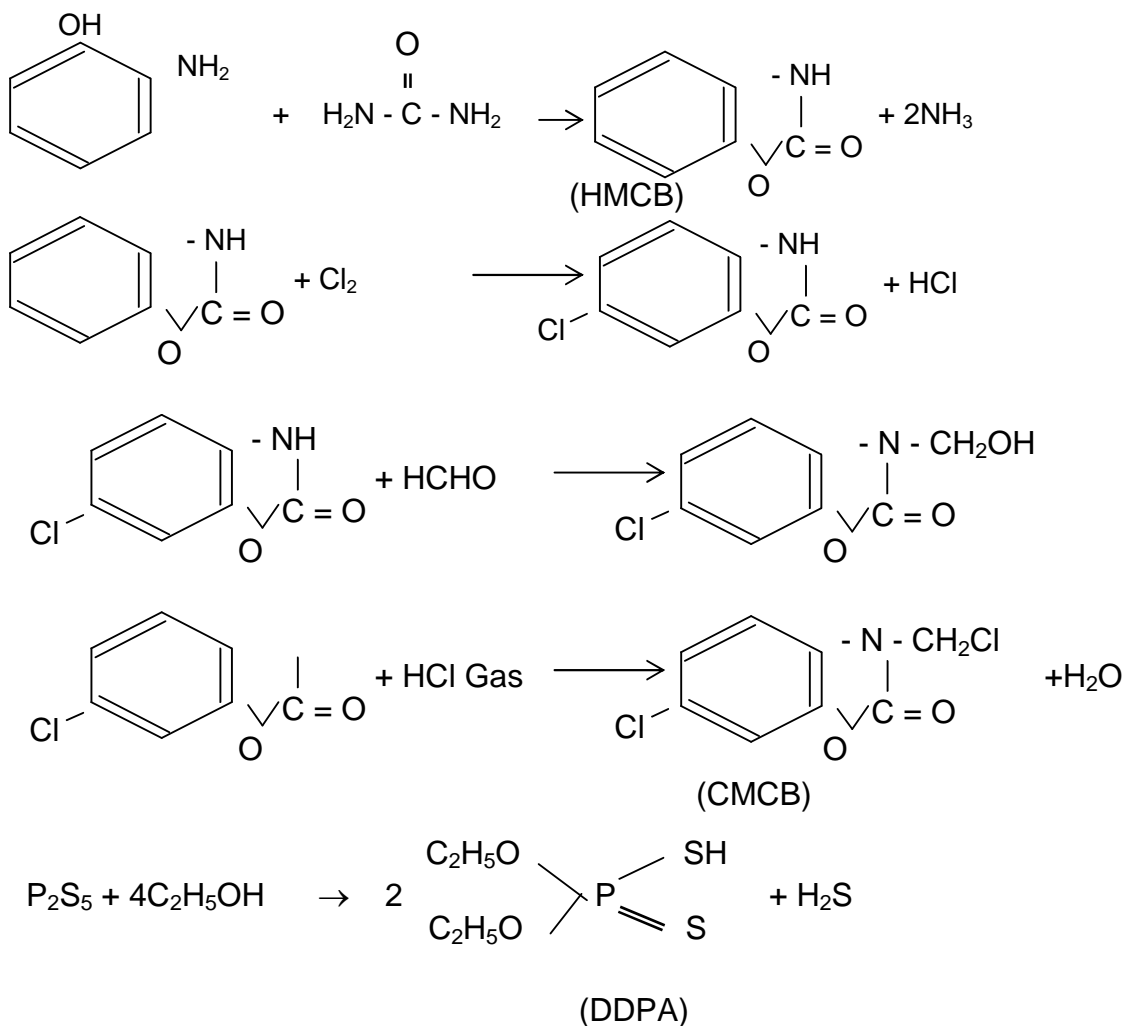

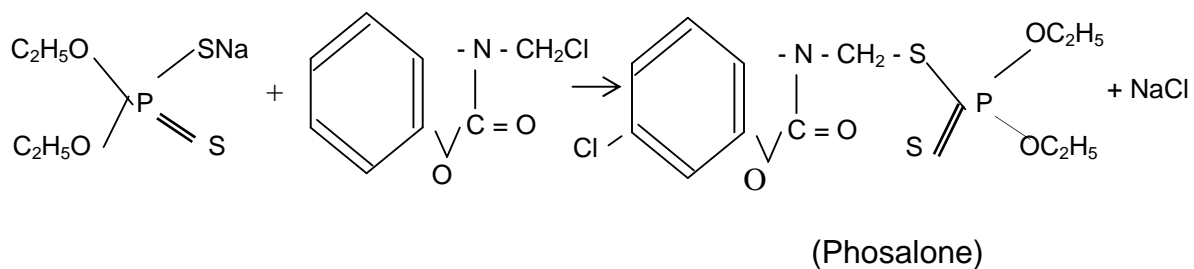
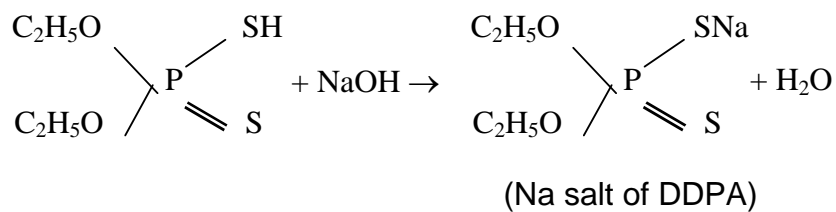

The process flow diagram for manufacture of Phosalone is shown in **Fig. 16**.

2.16.1 Associated Air Pollutants

Ammonia (NH₃), Hydrochloric Acid (HCl) and Hydrogen Sulphide (H₂S) are the identified air pollutants from the manufacturing process of Phosalone.

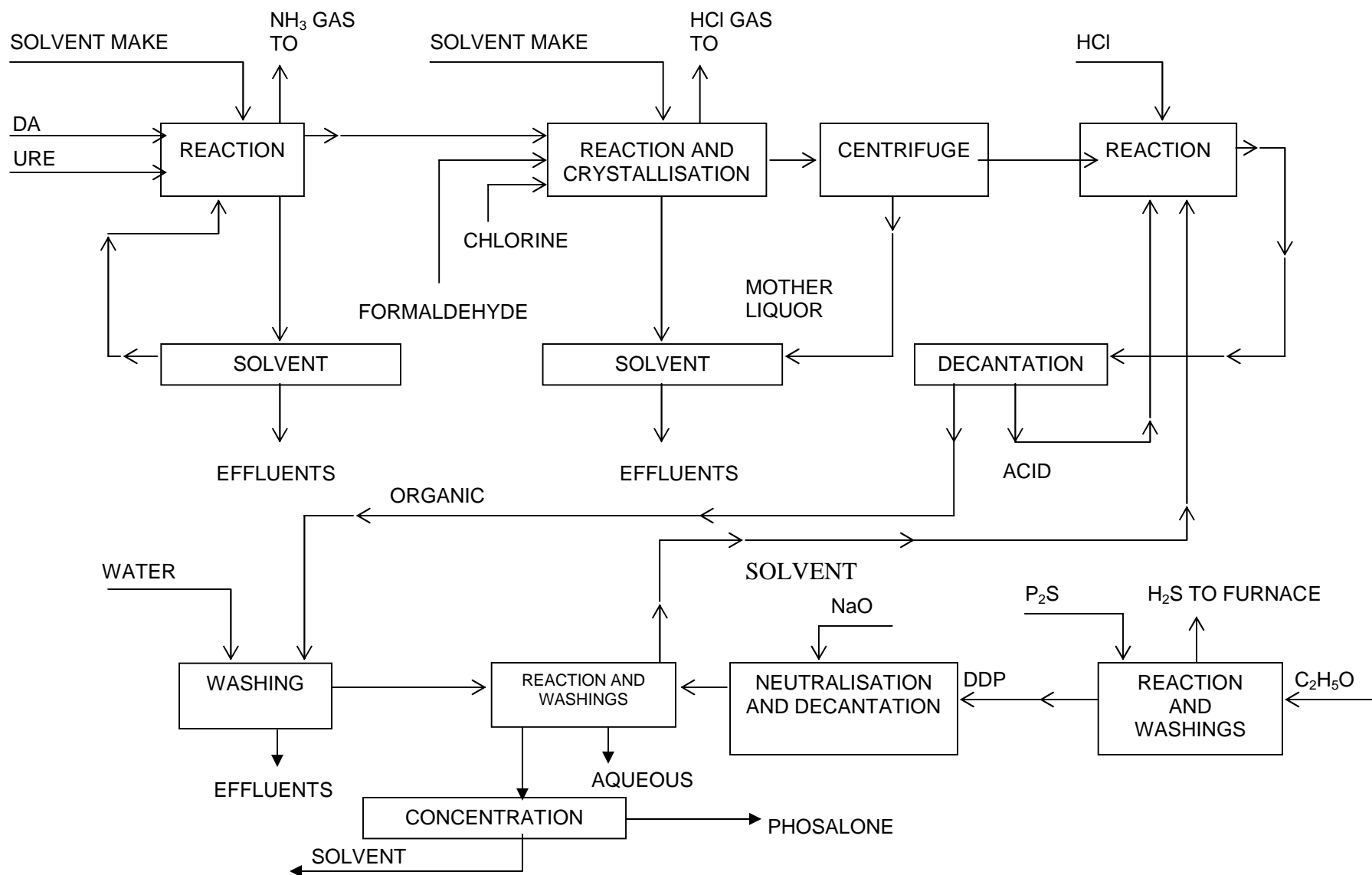

Fig. 16: Process Flow Diagram of Phosalone Manufacturing

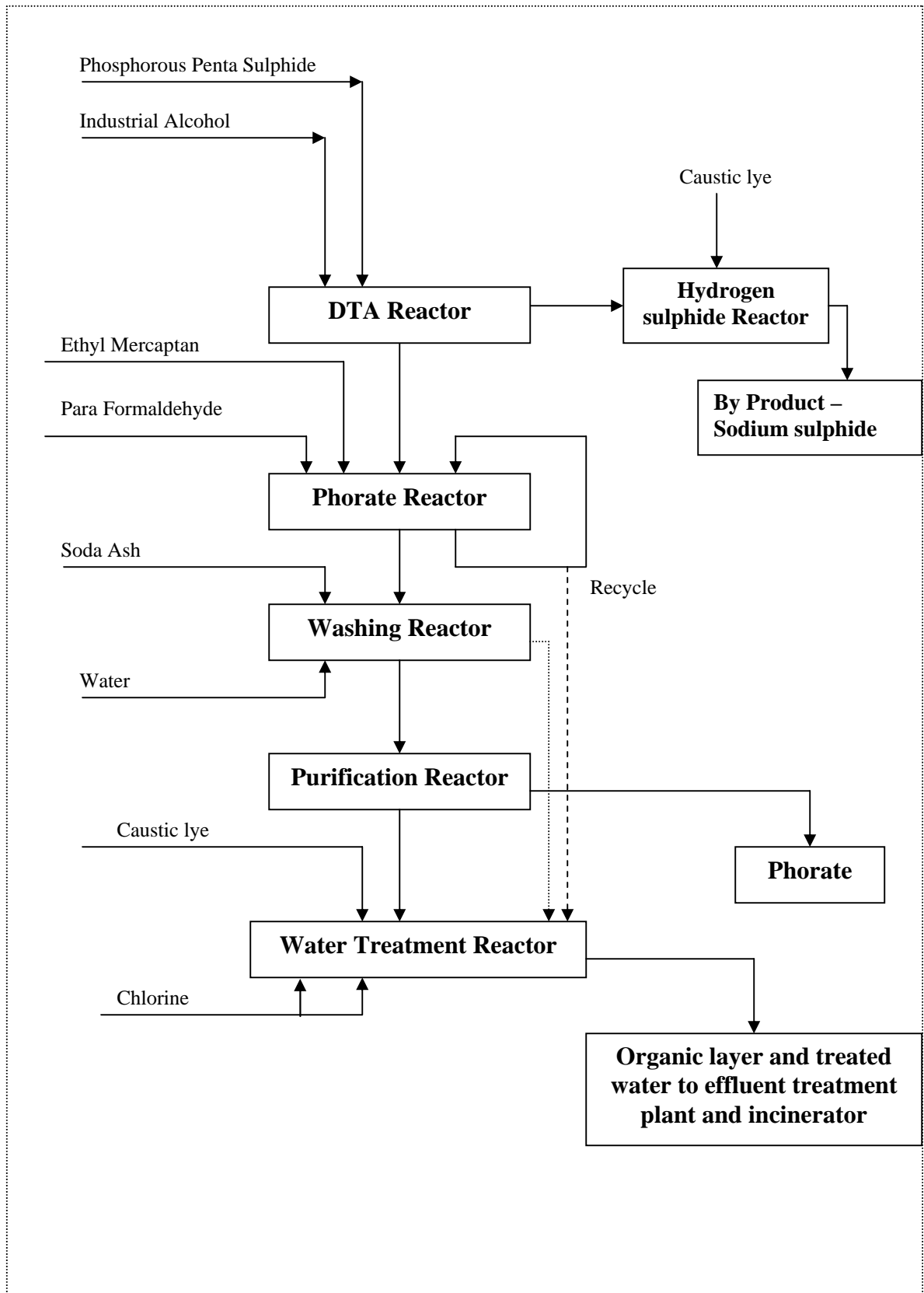
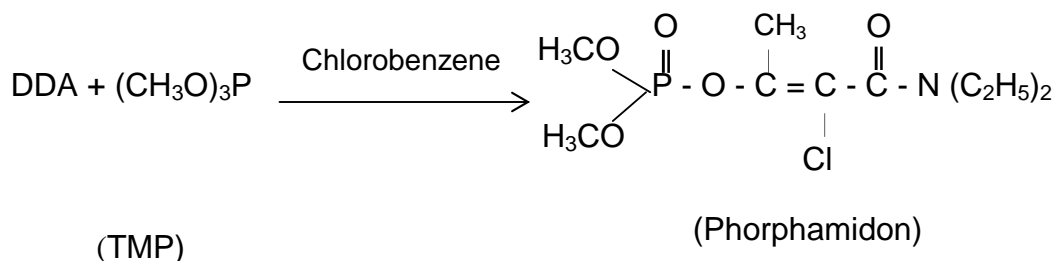
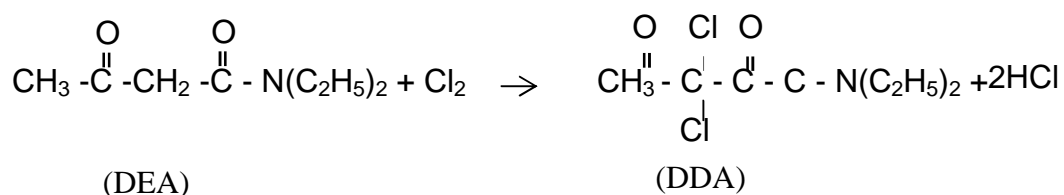

Fig. 17: Process Flow Diagram of Phorate Manufacturing

2.18. Phoshamidon

Diethylacetoacetamide (DEA) is chlorinated by using chlorine. HCl gas removed by degassing is scrubbed to obtain HCl as by-product. Reaction mass is neutralised using sodium carbonate and dichloro diethyl aceto acetamide (DDA) present in the organic layer is removed. DDA is diluted in solvent, heated to 100°C and Trimethyl phosphite (TMP) is added. From the reaction mass, methyl chloride gas is removed by degassing and phoshamidon technical is obtained.

The process flow diagram for manufacture of Phoshamidon is shown in **Fig.18**



2.18.1 Associated Air Pollutants

Hydrochloric Acid (HCl) and Methyl Chloride (CH₃Cl) are the identified air pollutants from the manufacturing process of Phoshamidon

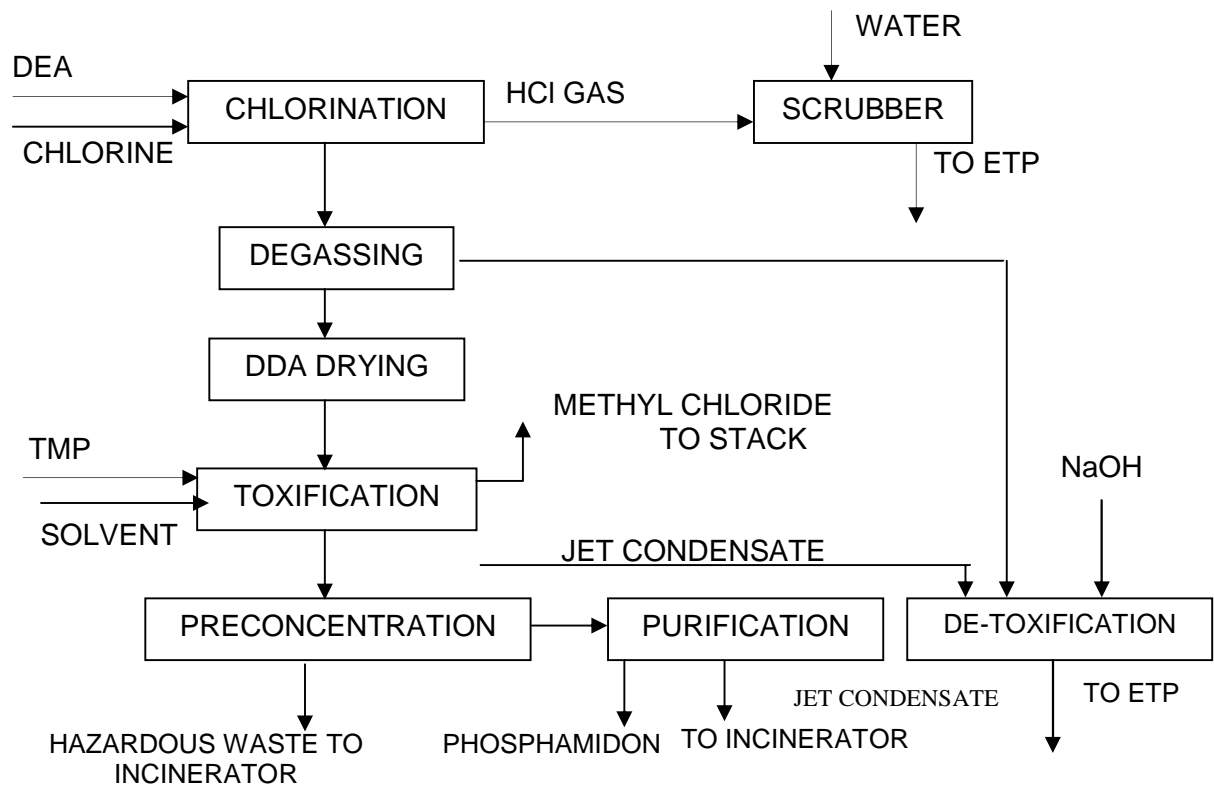

Fig.18: Process Flow Diagram of Phosphamidon Manufacturing

2.19 Zinc Phosphide

Zinc dust is charged in a reactor and heated. Phosphorous is added slowly in to the reactor. Once the reaction is completed, Zinc phosphide mass is crushed in ball mill and packed into desired containers. The process flow diagram for manufacture of Zinc phosphide is shown in **Fig. 19**

2.19.1 Associated Air Pollutants

Phosphorus Pentaoxide (P_2O_5 as H_3PO_4 mist) is identified air pollutants from the manufacturing process of Zinc Phosphide.

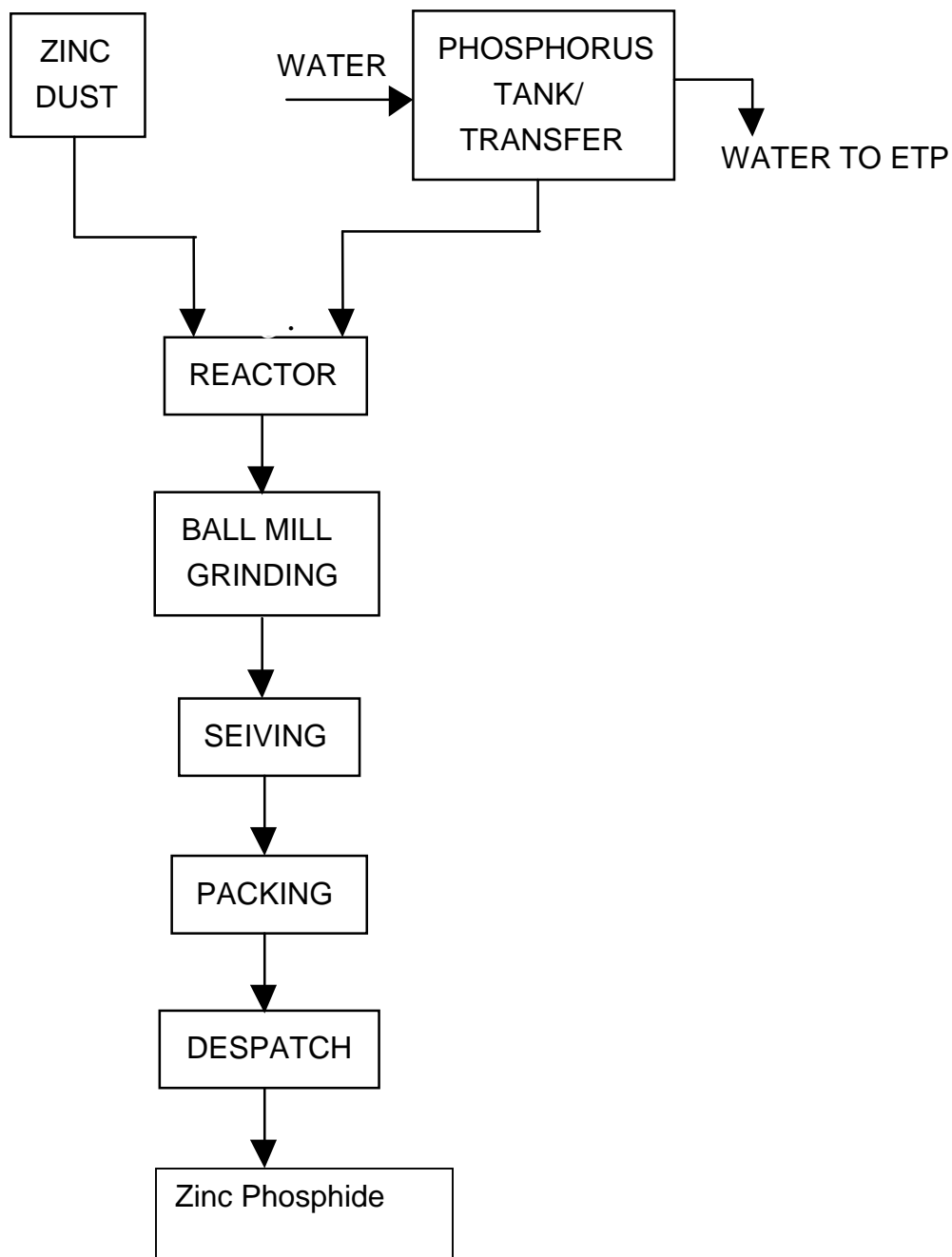

Fig. 19: Process Flow Diagram of Zinc Phosphide Manufacturing

3.0 AIR POLLUTANTS FROM PESTICIDE INDUSTRY

3.1 Emissions Profile in Pesticide Industries

In general, process emissions can be classified into channelised and fugitive emissions. The channelised emission is a point source emission from process operations and the fugitive emission is an uncontrolled emission from storage tanks/drums, spills, leaks, overflows etc. In order to identify the various sources of process emissions and their control systems in pesticide industries a questionnaire survey and in-depth study of some pesticide industries were conducted.

The manufacturing process for a product is a combination of various unit operations and unit process. The material balance of the reactants and products gives the characteristics and quantity of emissions. However, their quantity is constrained by the efficiency of conversion of the system. Chances of pure process emissions of only one gaseous pollutant are very less. The process emissions are contaminated by other vapours of raw materials, solvents and also some times product of the unit operations. Theoretical emission of pollutants is difficult to compute.

Very often during the unit operations wastewater and solid waste are separated, whereas waste gas is directly released from the reactions itself. It is observed that no process or production site is directly comparable to another. However, there are some forms of similarities with respect to air pollutants with product specific group such as organochlorine, organophosphate etc.

Based on the studies conducted on various pesticide manufacturing units, as the identified pollutants associated with products are given in **Table 5**.

Table 5: Product and associated priority pollutants

S. No.	Pesticide	Name of the Pollutants
1.	Acephate	HCl
2.	Aluminium phosphide	P ₂ O ₅ fumes (as H ₃ PO ₄ mist)
3.	Captafol	Cl ₂ and HCl
4.	Captan	Cl ₂ and HCl
5.	Cypermethrin	Cl ₂ , HCl and SO ₂
6.	Dimethoate	H ₂ S

S. No.	Pesticide	Name of the Pollutants
7.	2, 4 – D Acid	HCl and Cl ₂
8.	Dichlorvos (D.D.V.P)	CH ₃ Cl
9.	Ethion	H ₂ S and C ₂ H ₅ SH
10.	Endosulphan	HCl
11.	Fenvalerate	HCl, Cl ₂ and SO ₂
12.	Isoproturon	NH ₃
13.	Malathion	H ₂ S
14.	Monocrotophos	HCl and CH ₃ Cl
15.	Phosalone	NH ₃ , HCl and H ₂ S
16.	Phorate	H ₂ S and C ₂ H ₅ SH
17.	Phosphamidon	HCl and CH ₃ Cl
18.	Zinc Phosphide	P ₂ O ₅ as H ₃ PO ₄ mist

3.2. Solvents

Besides the air pollutant listed in Table 5, the pesticide manufacturing processes use various types of solvents for separation of desired product from other chemicals. The list of solvents for various pesticides manufacturing process is given in **Table 6**. Spent solvent are recovered either recycle in the same system or reuse for other purposes. The un-recovered solvents are generally incinerated in the pesticide industries in India. The loss of solvent is not so significant. A well designed LDAR programme can prevent loss due to fugitive emissions.

Table 6: List of Solvents used in manufacturing process of pesticides

S. No.	Name of the Solvents	Product list
1.	Acetone	Quinalphos, Acetamidrid, Triazophos, Pendimethalin
2.	Acetonitrile	Divenyl acid chloride, Acetamidrid, Imidachlorpid, Tetrachloro butyronitrile, Cypermethrin, Alphamethrin, Permethrin

S. No.	Name of the Solvents	Product list
3.	Acetic acid	Acephate, 2,4-D acid, Mancozeb
4.	Acetic anhydride	Acephate, 2,4-D acid
5.	Benzene	Malathion, Diethyl Aniline, Dimdethoate, Lindane
6.	Butanol	Aureofungin
7.	Carbon tetrachloride	Endosulfan, 2,6, Dichloro pyridine, Divenyl acid chloride, isoproturan, Tetrachloro butyronitrile, Cypermethrin, Alphamethrin, Permethrin
8.	Dioxane	Metconazole
9.	Diethyl Amine	Cypermethrin, Alphamethrin, Permethrin, Devrinol
10.	Di Methyl Formamide (DMF)	Fenvalerate, Hexaconazole, Propiconazole, Hexaconazole
11.	Ethanol	Malathion, Phorate, Ethion, Terbufos, Diethyl Aniline, Ethyl chloride, Phenthoate, Lindane
12.	Ethyl acetate	Acephate
13.	Ethylene Di Chloride	Captan, Dimethote, Monocrotophos, Meta Bromo Benzaldehyde, Fenvelerate, Cypermethrin, Phosphamidon
14.	Formaldehyde	Phorate, Tebufos
15.	Hexane	Cypermethrin, Alphamethrin, Permethrin, Deltamethrin, Fenvalerate, Cypermethrin, Divenyl acid chloride, Iso proturon
16.	Isopropyl alcohol	Delatamethrin, Phosphamidon, Imidachlorprid
17.	Methanol	Dimethote, Malathion, Methyl Bromide, hexaconazole, Quinalphos, Metamitron, Phenthoate, Methyl Parathion, Temephos
18.	Methylene Chloride	Acephate, Dichlorvos, Mepiquate chloride, Hexaconazole
19.	Methylene dichloride	Acephate, Deltamethrin, Propiconazole
20.	Piperidine	Mepiquate chloride
21.	Phenol	2,4-D acid, Meta Phenoxy Denzaldehyde
22.	Pyridine	D-Allethrin, Carbendazin
23.	Renine	For formulations,
24.	Toluene	Captafol, Captan, Cypermethrin, Ethion, Malathion, Dimethote, Fenvalerate, 5-Amino Salicylic acid, Andpa, Meta Phenoxy Denzaldehyde, Permethrin, Benfuresate, d-Allethrin, Penpropathrin, Tenephos, Metconazole
25.	Triethyl amine	Cypermethrin, Divenyl acid chloride, Benfuresate, Permethrin, Deltamethrin
26.	Xylene	Quinalphos, Triazophos, Cymoxanil, Melalxyl, Marcozeb, Anilofos, DMTA, Oxadiargyl, Benfuresate, Phosphamidon, Pendimethalin,

3.3 Prioritisation of air pollutants for control

Considering the health risk or damage to environment and effects on man made assets and the volume of discharge, a combinatory tree is evolved for prioritisation or selection of air pollutant for control, has been identified. This is stated below :

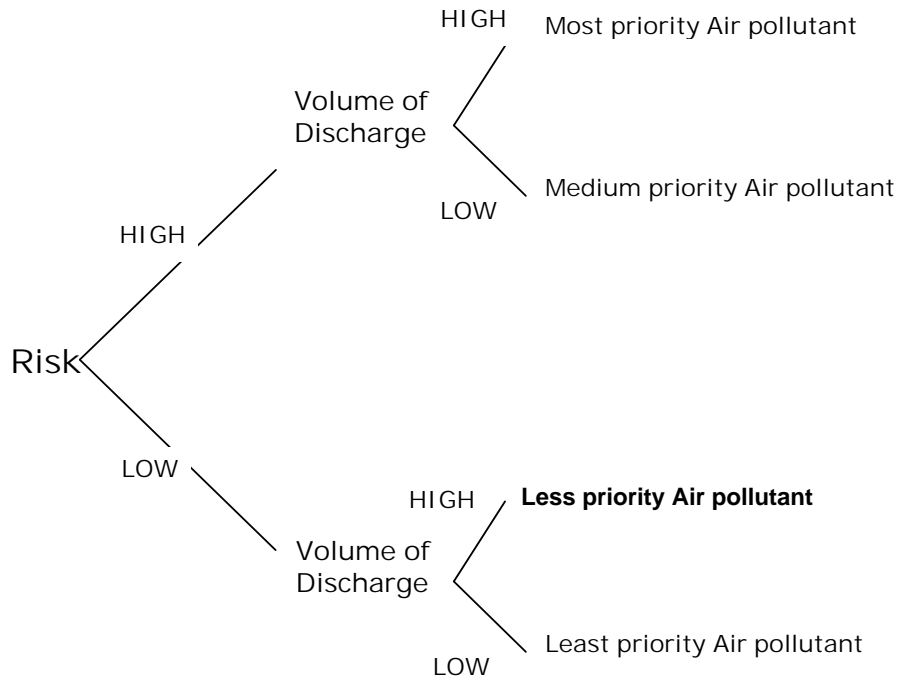

An exercise has been made with said combinatorial tree, accordingly the priority air pollutants identified are listed below:

- Ammonia (NH₃)
- Chlorine (Cl₂)
- Hydrogen Bromide (HBr)
- Hydro Chloric Acid (HCl)
- Hydrogne Sulphide (H₂S)
- Methanol (CH₃OH)
- Methyl Chloride (CH₃Cl)
- Phosphorous Pentoxide (P₂O₅ as H₃PO₄ mist)
- Sulphur Dioxide (SO₂)

3.4. Toxicity and Health Impact of Priority Pollutants

Summary of toxic properties of priority pollutants identified from the studied process are given in **Table 7**.

Table 7: Properties and Health impact of some priority pollutants

S. No.	Pollutants	Physical & Chemical Property	Exposure, odour and Corrosively	Health impact
1.	Ammonia (NH ₃)	Colourless, stable at room temp, Anhydrous ammonia will react exothermically with acids and water. Anhydrous ammonia decompose to hydrogen and nitrogen gases above 450° C. Decomposition temperature may be lowered by contact with certain metals.	TWA 50ppm, Ammoniacal strong, high corrosive in presence of Cu and its alloys. Slightly corrosive in presence of Al and Zn. Very slightly corrosive in presence of Mild Steel. Non Corrosive in presence of glass or Stainless steel (304 or 316)	Exposure can cause coughing, chest pains difficulty in breathing. Repeated significant overexposure can cause permanent lung function damage, edema and chemical pneumonitis. May cause serious damage to eyes
2.	Chlorine (Cl ₂)	Greenish yellow gas, extremely reactive can react violent with many combustible materials and other chemicals including water	TLV 0.5 ppm, pungent suffocating bleach like odour, strongly corrosive to most metals in the presence of moisture	Can cause itching and burning of the eyes, nose, throat. At high concentrations chlorine is respiratory poison.
3.	Hydrogen Bromide (HBr)	Colourless gas, stable incompatible with strong oxidising agents, strong bases. Hazardous decomposition products: Bromine and Hydrogen	TWA 3 ppm, Pungent suffocating odour, corrosive to most common metals and alloys	Toxic- causes serious burns
4.	Hydro Chloric Acid (HCl)	Colourless to slightly yellow gas, stable incompatible with alkalis	TLVTWA 5 ppm, irritating pungent odour, odour threshold 0.77 ppm, and dry gaseous hydrogen chloride can be handled in many metals and alloys, although at elevated temperature the corrosion rates increase. Commonly used metals are Carbon steel alloy 400, 300, series stainless steels, alloy 600 and Nickel 200	Toxic may be fatal if inhaled, severe irritant, very harmful by inhalation, ingestion or through skin contact.
5.	Hydrogne Sulphide (H ₂ S)	Colourless gas, stable, highly inflammable, may form explosive mixture with air incompatible with oxidising agents, oxides and metals	TWA 10 ppm, smell of rotten eggs, corrosive to most metals	High toxic may be fatal if inhaled. Skin contact may cause burns. Asphyxiant.
6.	Sulphur Dioxide (SO ₂)	Colourless gas, stable, incompatible with strong reducing or oxidising agents, moisture Zinc and its alloys	TWA 2ppm, irritating pungent odour, non corrosive to common materials except Zn when dry; corrosive when wet	Toxic-high concentrations are fatal
7.	Ethyl Mercaptan (C ₂ H ₅ SH)	Colourless gas, stable under normal storage condition, decomposition of chemical can emit carbon monoxide, hydrogen sulphide and sulphur dioxide	TWA 0.5ppm, extremely strong and repulsive smell. Odour threshold is 0.001 ppm	Highly toxic, affects the central nervous system

4.0 AVAILABLE CONTROL TECHNOLOGY TO PREVENT AND CONTROL OF AIR POLLUTANTS FROM PESTICIDE INDUSTRY

4.1 Principle of Air Pollution Control Technology

Principle of air pollution control technology can be broadly classified into following groups.

- ❖ Separation techniques
 - Gas solid separation
 - Liquid-liquid separation
 - Gas liquid separation
- ❖ Conversion to harmless end product
- ❖ Thermal destruction

These are illustrated below.

4.1.1 Separation techniques

In case of gas solid separation, the following techniques are employed:

- ⇒ Separator
- ⇒ Cyclone
- ⇒ Multiclone
- ⇒ Electrostatic precipitator
- ⇒ Wet dust scrubber
- ⇒ Fabric filter including ceramic filter

With respect to liquid-gas or liquid-liquid separation, the following techniques are considered:

- ⇒ Mist filter
- ⇒ Condensation
- ⇒ Adsorption
- ⇒ Wet scrubbing

4.1.2 Thermal destruction

Thermal destruction is generally used, when toxic and carcinogenic chemicals are emitting from the process. The thermal destruction technology generally used is stated below:

- ⇒ Thermal oxidation
- ⇒ Catalytic oxidation
- ⇒ Flaring

4.1.3 Conversion to harmless product

These techniques are used for organic pollutants; however, these techniques are not used in India. The techniques are:

- ⇒ Bio filtration
- ⇒ Bio scrubbing
- ⇒ Bio trickling

4.1.4 Combination approach

The technique for cleaning of flue gases can combine both recovery and abatement. The techniques are as follows:

- ⇒ Dry sorbent injection
- ⇒ Semi dry sorbent injection
- ⇒ Selective non-catalytic reduction (SNCR) of NO_x
- ⇒ Selective catalytic reduction (SCR) of NO_x

In order to provide an overview, all available techniques are compiled in **Fig. 20**. To this purpose it appears appropriate to distinguish between two sources of waste gases:

- ⇒ “Normal” temperature processes, such as production, handling or work-up processes, with the main contaminants:
 - Volatile organic compounds such as solvents
 - Inorganic gases, such as hydrogen halides, hydrogen sulphide, ammonia, carbon monoxide
 - Particulates in the form of dust
- ⇒ Incineration processes, with main contaminants:
 - Particulates in the form of ashes and dust, containing soot, metal oxides
 - Fuel gases such as carbon monoxide, hydrogen halides, sulphur-oxygen compounds (SO_x), nitrogen-oxygen compounds (NO_x)

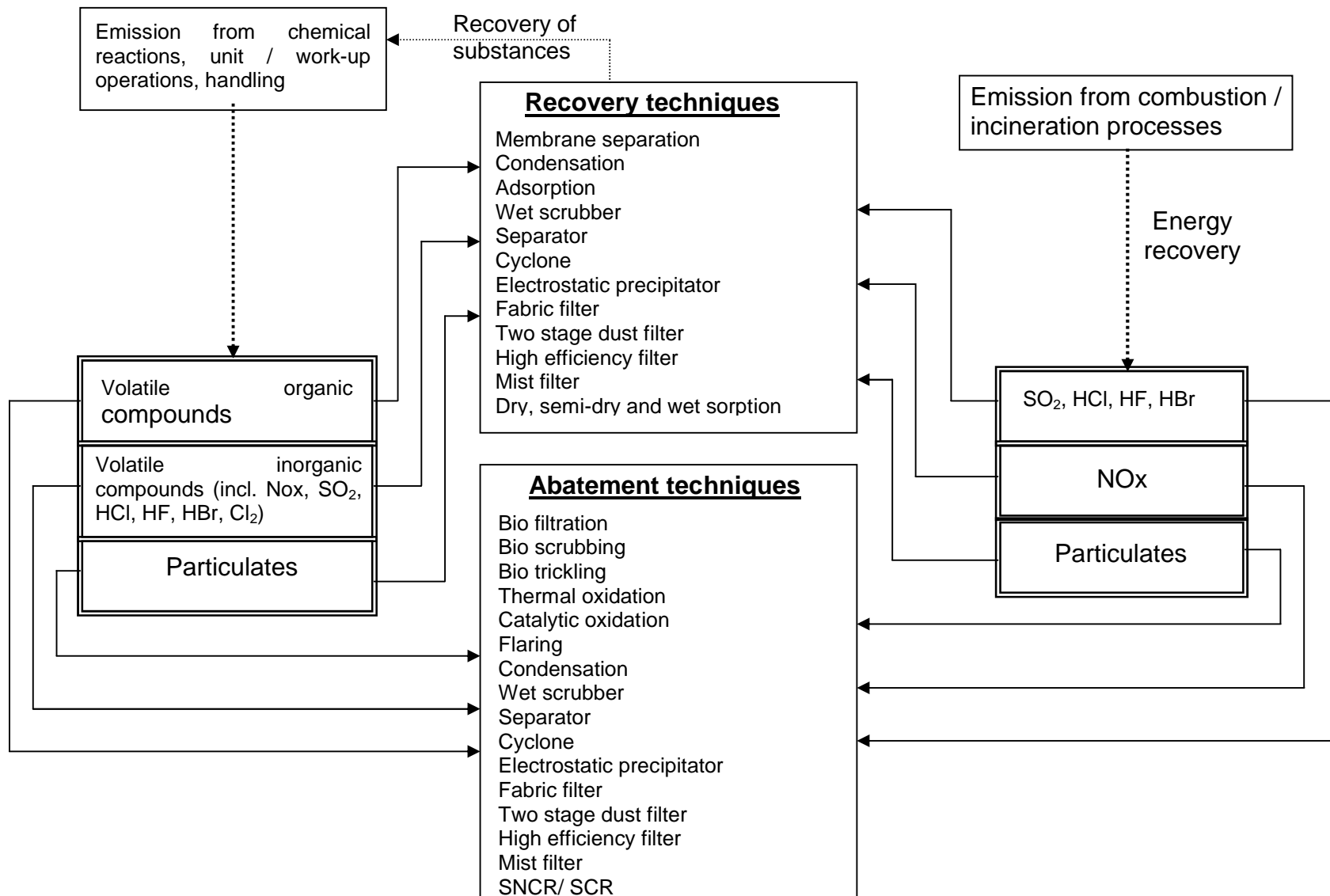

Fig. 20. Available techniques for end-of-pipe treatment of waste gases from chemical industries in relations to type of contaminants

Arising waste gases are treated by techniques where:

- ➔ The waste gas content is recovered and either recycled to the original process or used in another process as raw material or energy carrier
- ➔ The contaminants are abated.

Compounds normally worth to recover comprise:

- VOC, recovered from, solvent vapours or vapours of low-boiling products
- VOC used as energy carrier in incinerators or boilers
- Hydrogen chloride, transferred into hydrochloric acid
- Ammonia to recycle into the production process
- Sulphur dioxide, transferred into sulphuric acid, sulphur or gypsum
- Dust containing higher amounts of solid raw products or end products

4.2 Control Technologies Adopted in India

On the basis of information received from various industries either in questionnaire survey or collected during in-depth study of pesticides industries, the control technologies adopted to control the identified gaseous pollutants are given in **Table 8**.

Table 8: Control technologies adopted in Indian industries

S. No	Pollutants	Control System
1	HCl	<ul style="list-style-type: none"> ➤ Water Scrubber, ➤ Caustic Scrubber, ➤ Water / Caustic Scrubber
2	Cl ₂	<ul style="list-style-type: none"> ➤ Water Scrubber, ➤ Caustic Scrubber, ➤ Water / Caustic Scrubber
3	CH ₃ Cl	<ul style="list-style-type: none"> ➤ Charcoal Bed Scrubber, ➤ Liquification, filling and /or Combustion
4	H ₂ S	<ul style="list-style-type: none"> ➤ Scrubber with NaOCl media ➤ Scrubber with NaOH media ➤ Charcoal Bed Scrubber
5	SO ₂	<ul style="list-style-type: none"> ➤ Caustic Scrubber ➤ Water/Caustic Scrubber
6	P ₂ O ₅ (as H ₃ PO ₄)	<ul style="list-style-type: none"> ➤ Water Scrubber ➤ Water Scrubber (Ring jet scrubber) + Mist Eliminator + Demister ➤ Mist Eliminator
7	NH ₃	<ul style="list-style-type: none"> ➤ Two Stage Water Scrubber ➤ Recovery System

S. No	Pollutants	Control System
8	CH ₃ OH	➤ Channelised Emission was not observed, because this chemical (solvent) is used in less quantity in the manufacturing
9	HBr	➤ Caustic Scrubber
10	Odours compounds, non recovered solvents	➤ Incinerator / chemical reaction

4.3 Efficiency Evaluation of Existing Pollution Control Technologies

The concept of control efficiency is the limitation of emissions into the atmosphere by the use of air pollution control equipment systems. The efficiency of pollution control technology / system is defined as the ratio of the quantity of emissions prevented from entering to the atmosphere by the control device to the quantity of emissions that would have entered the atmosphere (quantity input to the control device); if there had been no control.

The efficiency of gas cleaning devices is expressed in a variety of ways, including control efficiency, penetration, and decontamination factor. The most common means for expressing the efficiency of performance is in terms of the control efficiency, which is defined as the ratio of the quantity of pollutant prevented from entering the atmosphere by the control device to the quantity that would have been emitted (inlet quantity to the gas cleaning device) to the atmosphere had there been no control device.

$$\begin{aligned} \text{Efficiency } (\eta) &= \text{Collected} / \text{Inlet} = C/I \\ &= (\text{Inlet} - \text{Outlet}) / \text{Inlet} = (I-O)/I \end{aligned}$$

Penetration is defined as the ratio of the amount of pollutant escaping (penetrating without control) the gas cleaning device to the amount entering.

$$\text{Penetration } (P) = \text{Outlet} / \text{Inlet}$$

Hence penetration focuses attention upon the quality of the emission stream, but in reality it is actually another way of looking at control efficiency. Since

$$\begin{aligned} \text{Efficiency } (\eta) &= 1 - [\text{outlet} / \text{inlet}] \quad , \text{ then} \\ &= 1 - P \end{aligned}$$

For a control efficiency of 99.999% (i.e., $E = 0.99999$), the penetration is 0.00001, or 10^{-5} . Alternatively, efficiency can be expressed as the decontamination factor (DF), which is defined as the ratio of the inlet amount to the outlet amount.

$$\begin{aligned} \text{Decontamination Factor} &= \text{Inlet} / \text{Outlet} \\ &= 1 / (1 - E) \end{aligned}$$

For a percentage control efficiency of 99.999%, *DF* is 10^5 . The logarithm to the base 10 of the decontamination factor is the decontamination index. In the numerical example above, this index is 5.0. These efficiency terms are used to represent the overall efficiency of control of a single device or any combination of control devices.

Based on the data obtained from the industry and also monitored / measured during the in-depth study, it is found that the control system as presented in the **Table 9** are suitable for identified priority pollutants on efficiency point of view.

Table 9: Suitable Control Systems for Priority Pollutants

S. No.	Pollutants	Control System
1.	HCl	Water/Caustic Scrubber
2.	Cl ₂	Water/Caustic Scrubber
3.	CH ₃ Cl	Liquification system and/or Incinerator
4.	H ₂ S	Scrubber with NaOH media
5.	SO ₂	Water/Caustic Scrubber
6.	P ₂ O ₅ (as H ₃ PO ₄)	Water Scrubber (Ring jet scrubber) + Mist Eliminator + Demister
7.	NH ₃	Two Stage Water Scrubber
8.	CH ₃ OH	Adsorption Bed (Charcoal or Molecular Sieve)
9.	HBr	Caustic Scrubber
10.	Mercaptan	Incinerator

After review of available and adopted control technologies for the control of identified gaseous pollutants, it is found that the technologies based on absorption and chemical reaction are being commonly used to control the gaseous pollutants e.g. HCl, H₂S, SO₂, P₂O₅ (as H₃PO₄), Cl₂, NH₃ and HBr. In case of H₂S, adsorption and incineration technology is also adopted by some pesticide industry. To control the emission of CH₃Cl, condensation (liquification) and incineration system is observed in one or two large scale industry.

4.4 Description of Various Treatment Techniques

In the previous paragraph, it is indicated that the absorption (scrubber) generally used as air pollution control devices in India for pesticides industry. However, incinerator is also used for destruction of odorous compounds or un-recovered solvents, in some occasion chemical oxidation is also used for abatement of odorous compounds. Condensation is used as an intermediate step for recovery of chemicals before using cleaning up technology such as incinerator. In this paragraph, an attempt is made to describe the most commonly used techniques such as absorption, condensation, chemical reaction and incinerator as air pollution control devices for controlling priority pollutants in pesticides manufacturing industries in brief.

There are various techniques available for recovery and abatement, however, concerning most important techniques for pesticide manufacturing industries to control priority (gaseous) pollutants emission are (i) absorption, (ii) adsorption, (iii) condensation, (iv) chemical reaction and (v) incineration.

4.4.1 Absorption

The identified priority pollutants from the pesticide process / operation can be efficiently removed using suitable scrubbing liquor in a mass transfer device. The liquor and gas can contact each other while both are flowing in the same direction (co-current flow), in opposite directions (counter current flow), or while are flows perpendicular to the other (cross flow). The scrubbing liquor used for the removal of gaseous pollutants can be by-product, in the form of slurry or a chemical solution. In chemical engineering terminology the alternate terms for scrubbing is absorption.

Absorption is a diffusion-controlled, gas-liquid mass transfer process. The efficiency of absorption in air pollution control is governed by the ease with which contaminants can be transferred through the interface into the liquid face. Absorption is enhanced by high diffusion rates, high solubility, large interfacial areas and turbulence. The gaseous containing vapours are scrubbed with water or liquid in which they are soluble. Scrubbing can be carried out in spray columns, packed bed columns, plate columns, floating-bed scrubbers and liquid-jet scrubber or venturi scrubbers. With the proper choice of operating conditions, almost complete removal of gaseous vapour is possible by this method.

Absorption is carried out in variously designed scrubbers. The various designs of scrubbers are based on the consideration to provide maximum contact between absorbent and the gas so as to achieve a high efficiency of gas removal.

An account of some common type of scrubbers is given below:

a) ***Packet Tower Scrubber***

The design of a packed tower scrubber is given in **Fig. 21**. It consists of a long tower packed with a suitable inert packing material such as polyethylene. The absorbent trickles down from the top to downward, while the gases pass in the opposite direction from downward to the top, thus allowing the maximum reaction time. The presence of packing material makes the absorbent to trickle down in thin films to provide maximum surface area for contact. The packed tower is usually more economic for corrosive gases and vapours in view of the lesser quantities of corrosion resistant materials required for its construction.

b) ***Plate Tower Scrubber***

The construction of a plate tower scrubber is shown in **Fig. 22**. It consists of a long vertical chamber fitted with perforated circular plates at equal spacing. The gases or vapours pass from downward to the top of the tower making a contact with the liquid present on the each perforated plate. The liquid do not fall through the pores on the plates as it is held by the pressure created by the velocity of the gases. Each plate is provided with a pipe to carry the excess absorbent downward from plate to plate. The plate towers are most suitable when a frequent cleaning is required particularly in case of the liquid which after absorption contains high quantities of particulates and relatively insoluble and offensive gases.

c) ***Spray Tower Scrubber***

The design and construction of these scrubbers is given in **Fig. 23a to Fig. 23c**. In these types of scrubbers, the liquid is sprayed on the pollutant gas that provides the turbulence to the gases for better absorption. The method is best suited for highly soluble and offensive gases. The design of the scrubber can be so made as to give a centrifugal force to both liquid spray and the gas to achieve maximum contact between the two for higher efficiency of removal. The spray tower scrubber can also be used for removal of both solid and liquid particulates.

d) ***Liquid Jet Scrubber***

The device is most suitable for the condensable gaseous pollutants. The scrubber is shown in **Fig. 24**, and consists of two vertical chambers. In one of the chambers, a liquid jet is sprayed which atomizes and produces small droplets of the absorbent. Gases are also introduced into the same chamber from the upper end. Non-condensable clean gases are removed from the other chamber.

e) **Agitated Tank Scrubber**

The effluent gases, in this type of scrubber, are agitated together with the absorbent in a tank against baffle plates fitted on the sides of the tank as shown in **Fig. 25**. The turbulence caused by stirring provides greater absorption efficiency when particulates are also present.

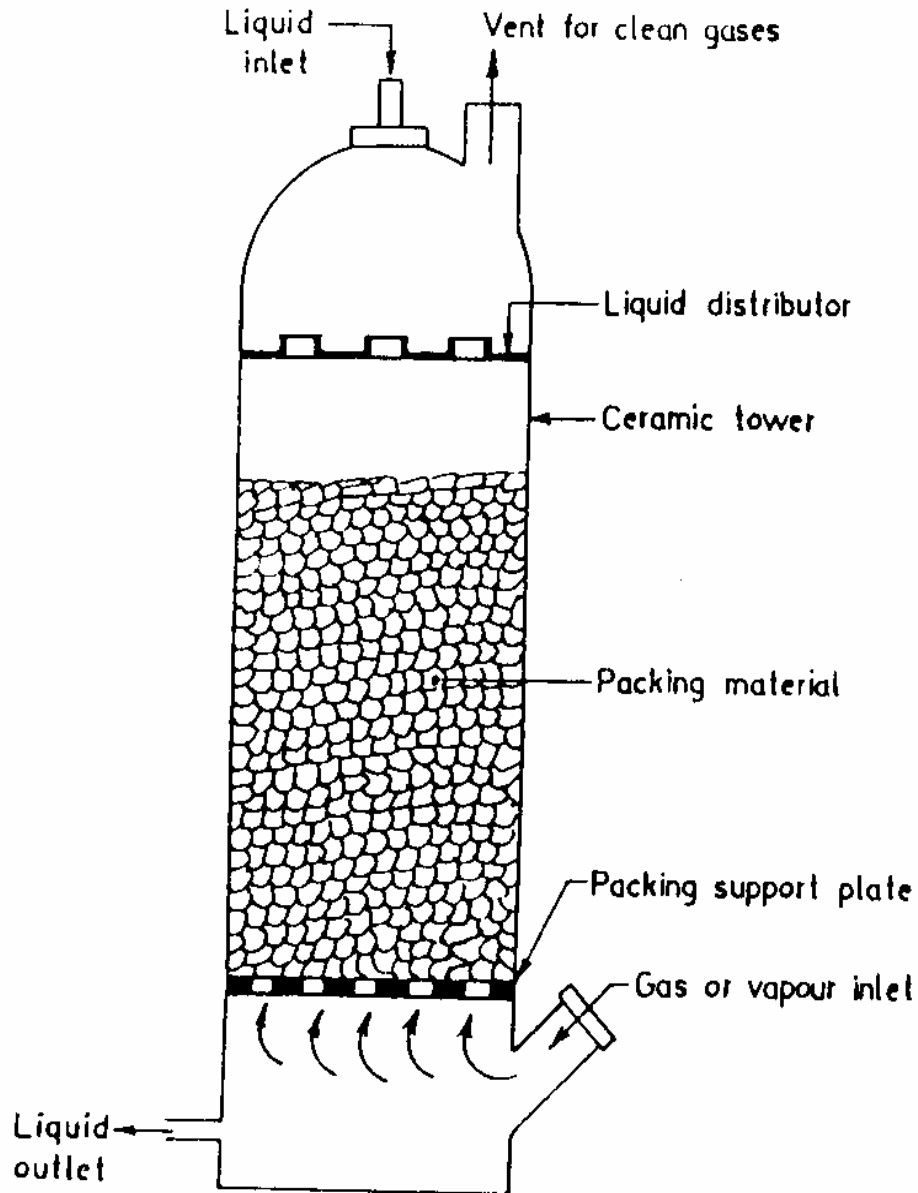

Fig. 21:- Packed Tower Gas Scrubber

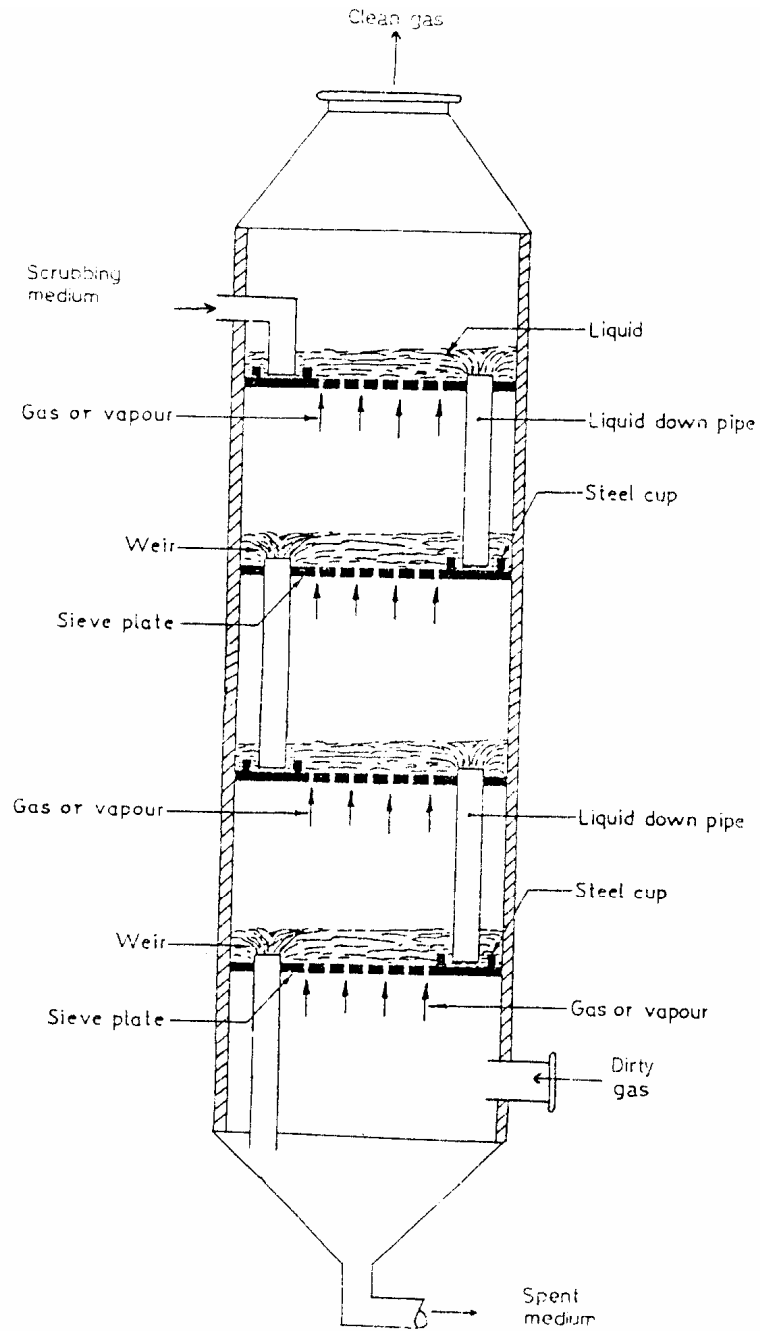

Fig. 22: Plate Tower Gas Scrubber

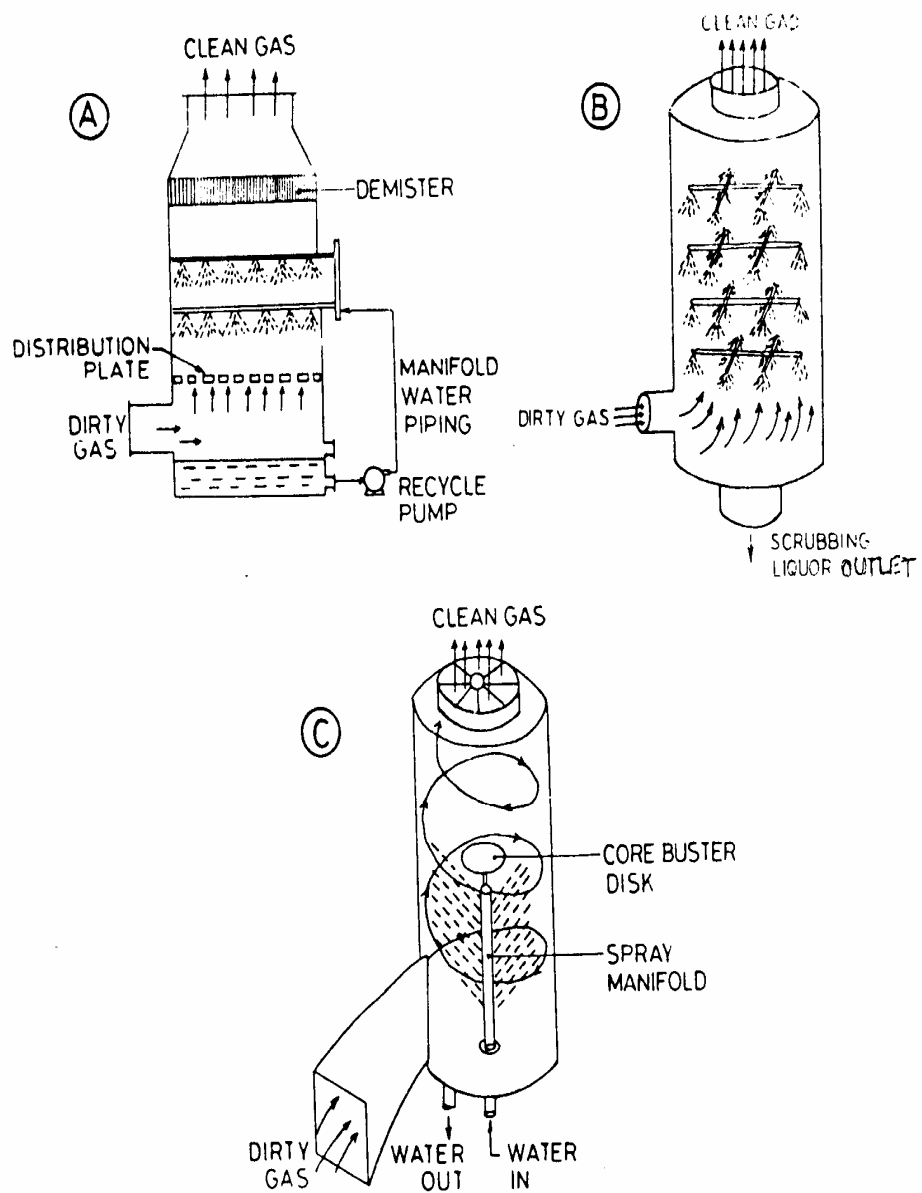

Fig. 23 (a) to (c) : - Spray Tower Gas Scrubbers

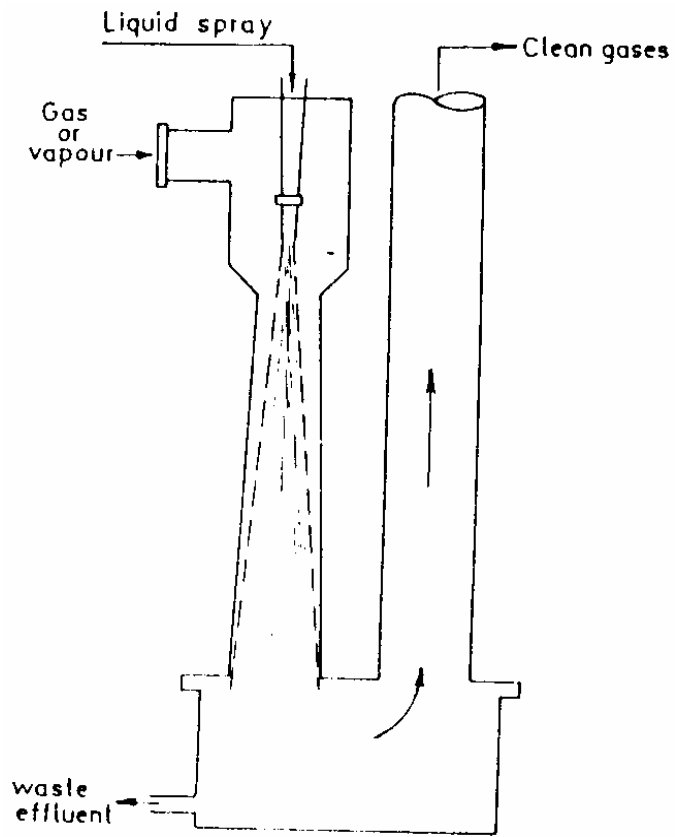

Fig. 24: Liquid Jet Scrubber

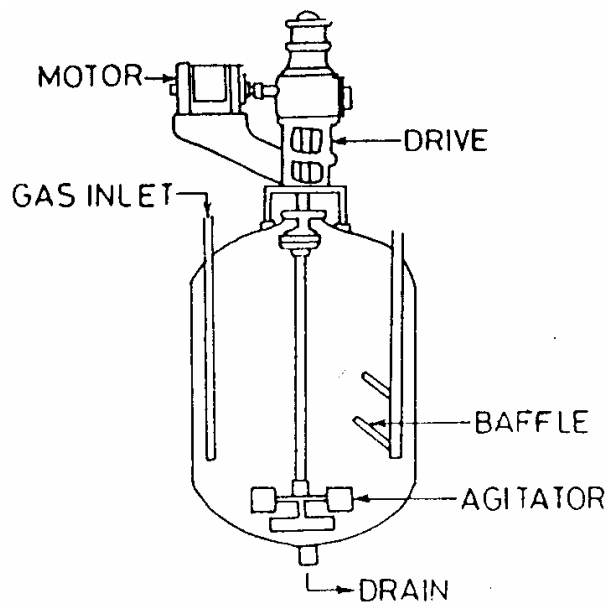

Fig. 25: Agitated Tank Gas Scrubber

All these scrubbers described above, operate efficiently at a temperature below 100°C that avoids the undue loss of the absorbent by evaporation, and keeps it in the liquid state. For this, the scrubbers are always preceded by some cooling devices to bring down the temperature of effluent gases to the desired level. The treated gases have always a lower temperature, and contain large quantities of water vapours and absorbent droplets. Demisters or some other suitable devices are installed in sequence after the scrubber to remove water vapours and the traces of the absorbent from the effluent gases. Reheating of the gases is also necessary in most cases to provide required buoyancy to the gases for their escape from the long stacks.

4.5 Condensation

Condensation is best for vapours with reasonable high vapour pressure. In these process volatiles gases and vapours are controlled. Condensation may be useful for primary recovery before final cleanup with another method such as adsorption and incineration of gas. In the condensation process gases were cooled to achieve adequate condensation. Fog occurs when the rate of heat transfer appreciably exceeds the rate of mass transfer. When fog formation is unavoidable, it may be removed by high efficiency moist collector designed for 0.5-5µg droplets. Condensation procedures were normally used in the organic chemical process.

4.6 Chemical Reaction

Odours of many organic compounds can be destroyed by strong oxidants such as KMnO_4 , HNO_3 , H_2O_2 , $\text{K}_2\text{Cr}_2\text{O}_7$ and hypochlorite solution. Conversion of HCl to NH_4Cl is an example of changing a gas to a particulate (as by-product). Use of alkaline scrubbing medium to collect acidic gases is a way of enhancing the collection of an absorption process. In general, gaseous pollutants were collected easily by chemical reactions.

4.7 Incineration Technology with Air Pollution Control Device

Incinerator is a versatile process. Organic materials are destroyed the organic molecular structure by oxidation or thermal degradation. Incineration provides the highest degree of destruction and control for a broad range of hazardous substances. Design and operating experience exists and a wide variety of commercial incineration system are available, which are stated below:

- (i) Liquid injection;
- (ii) Rotary kiln;
- (iii) Fixed hearth;
- (iv) Fluidised bed incinerator; and
- (v) Pyrolysis bases incineration

In India, it is observed that selection of incinerator technology mainly guided by physical state of hazardous waste generated by the pesticides industry. The incinerator technology adopted by pesticides industries is given in **Table 10**.

Table 10: Incinerator Technology adopted by Pesticides Industries

Physical state	Type	% share	Technology adopted
Only liquid waste	Only aqueous	100	Liquid injection (horizontal)
	Aqueous + Liquid organic	90 8	Fluidised bed combustion
	Aqueous + Liquid organic	40-50 40-50	Liquid injection
Predominantly liquid with some solid waste	Liquid	70-95	Liquid injection +
	Solid	5-30	Pyrolysis
Only solid waste (solid & semi solid)	Solid waste	100	Rotary kiln

Typical air pollution control devices for controlling different pollutants from an incinerator are given in **Table 11**.

Table 11: Air Pollution Control Devices for Controlling Different Pollutants

Air pollutant	Air pollution control devices (APCDs)
Acid gases, Mercury, Dioxin, and Furan Emission	Packed towers, spray dryers or dry injection (activated carbon, lime) scrubbers
Particulate and Heavy Metal Emission	Venturi scrubbers, wet or dry electrostatic precipitators (ESPs) or fabric filters
Oxide of Nitrogen Emission	Selective non-catalytic reduction (SNCR) and selective catalytic reduction (SCR)

4.8 Adsorption

Besides the techniques stated above on air pollution control system of pesticide, adsorption technique has a large potential too. Adsorption is a surface phenomenon by which gas or liquid molecules are captured by and adhere to the surface of the solid adsorbent. It is desirable for removal of

contaminant gases to extremely low levels (<1ppmv) and handling large volume of gases with quite dilute contaminants. It may be used alone or along with other methods, in combination, it is usually the last step of clearing the exhaust gases.

Adsorption is used to concentrate (30-50 folds) or store contaminants until they can be recovered or destroyed in the most economical manner. In the case of solvent recovery, studies have shown that the value of solvent recovered will often pay the total annualized cost of the adsorption system. Adsorption is also used to prevent the release of odorous or otherwise offensive organic gases associated with rendering, glue manufacturing, pesticide production, food processing etc.

The adsorbents used to adsorb gases and reduce odour should have large surface area and pore volume. The adsorption of the gases is also dependent on other factor e.g. temperature, molecular polarity and chemical nature of adsorbent surface. Some of the adsorbents commonly used in air pollution control are activated carbon, activated alumina, silica gel and molecular sieves. Typical data for adsorbent material and their uses are given in **Table-12**.

In adsorption, the adsorbate is recovered, with its chemical form un-changed. It is highly concentrated, and involves no potential of water pollution problem. The adsorbents were normally regenerated when the break through point is reached.

Table 12: Typical Data for Adsorbent Material and their Use

S. No.	Adsorbents	Specific surface area (m ² /g)	Bulk Density (g/cm ³)	Pore Volume (cm ³ /g)	Use
1	Activated Carbon	1000-1500	0.3 – 0.5	0.6 – 0.8	Removal of odours and traces of gaseous pollutants
2	Activated Alumina	175-250	0.7 – 0.8	0.4	Dehydration of gases and liquid.
3	Silica gel	250-850	0.4 – 0.8	0.3 – 0.45	Dehydration and purification of gases
4	Molecular sieves	500-1000	0.6 – 0.9	0.25 – 0.3	Selective adsorption of NH ₃ , H ₂ S, C ₂ H ₂ and SO ₂

5.0 AN APPROACH FOR DEVELOPMENT OF EMISSION STANDARDS FOR PESTICIDE INDUSTRY

5.1 Introduction

The National Environment Policy (NEP), 2006, with respect to emission standards i.e. permissible discharges of specified waste by different class of activities relates to risk reduction of health, sensitive and valuable ecosystem and manmade asset. The NEP further stated that standard for each class of activities need to be set on the basis of general availability of required technology, the feasibility of achieving the applicable environmental quality standards at the location (specific or category) concerned with the proposed emissions standards, and the likely unit costs of meeting the proposed standard. It is also important that the standard is specified in terms of quantities of pollutants that may be emitted, and not only by concentration levels, since the latter can often be easily met through dilution, with no actual improvement in ambient quality. National Environmental Policy also recommends to eschew the prescribed abatement technology. Keeping in view of above the approach for development of emission standard for Pesticide industries is given below:

- General availability of required technology and techno-economic feasibility
- Risk reduction related to health, ecosystem and manmade asset
- Ensure to achieve the ambient air quality standard (location specific)

5.2 Best Practicable Approach (general availability to required technology and techno-economic feasibility)

The emission standards for point source are often based on the best practicable means of control at source. The standard developed based on the best practicable means should in particular be uniform for the whole of the country for specific group of industries, in this case pesticide. An advantage of the technology –based approach is that within a specific group of industries the extent of pollution control measures are alike. In addition, these standards serve to preserve the environment quality in non-polluted areas without modification. The disadvantage of this approach is that these standards may become unnecessary burden on the industry where the recipient environment does not demand such control measures. This is because these standards do no related to the actual environmental of the specific site.

The methodology suggested for evolving stand on best practicable means is explained in Flow Chart (**Fig. 26**). The acceptability of development of standard on the basis of Best Practicable Technology is very much linked to the techno-economic acceptability of the suggested stage of treatment to the pollutant which is possible by linking the annual cost of pollution control measures (capital and capitalised operation, maintenance and repair cost converted into annual cost or annual burden) to the annual turnover of the industry. The stage of treatment

whose annual burden remains within the critical percentage of annual turnover is generally accepted as minimal stage of treatment and the concomitant emission standards is evolving standard of Best Practicable technology. There may be medium hard industry for whom the annual burden of the minimal stage of treatment should remain above the critical percentage of annual turnover but below the super critical percentage. The industry for whom the annual burden of the minimal state of treatment remains above supercritical percentage of annual turnover are obviously hard industry. 3% is generally considered, as critical and 5% is super critical.

- N - Total number of pollution control stage; annual burden of each stages of treatment is required to be evaluated
- J - Stage of pollution control under consideration $J = 1$, it indicates the best stage of treatment which obviously uses the best available technology of treatment
- C - Critical percentage of annual turnover of the industry to be ascertained by the industry committee
- SC - Super critical percentage of annual turnover of the industry to be ascertained by the industry committee
- EQ - Quality of treated emission corresponding to any stage of treatment
- AB - Annual burden of any stage of treatment
- AT - Annual turnover of the industry
- P - AB / AT
- LD - Location details of discharge of emissions; in the ambient
- AQL - Air quality criteria for the location

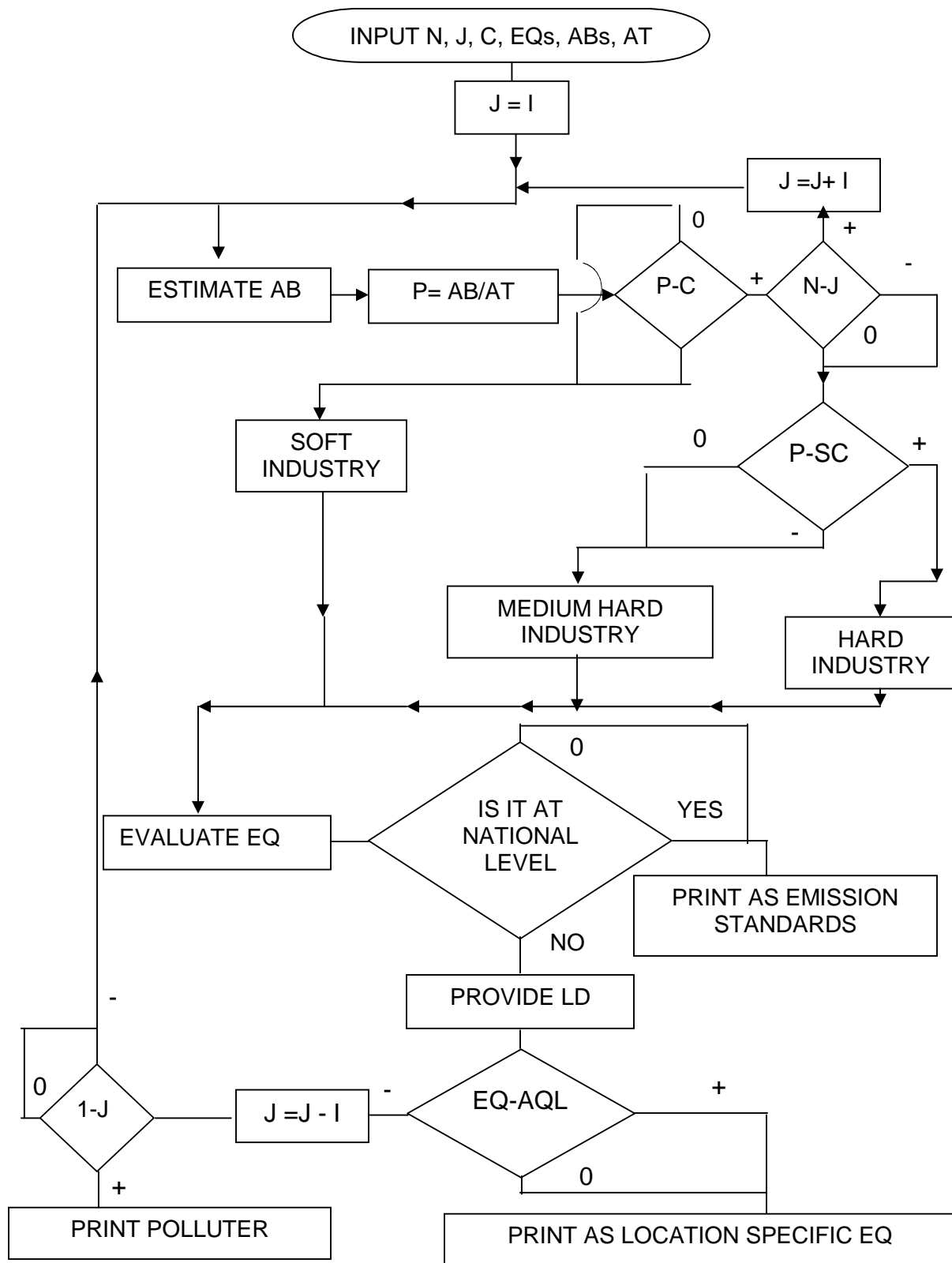

Fig. 26 Flow Chart depicting Methodology for Best Practicable Means

On the basis of questionnaire survey and in-depth studies carried out, industry-wise comparison of present available control technologies with respect to identified priority pollutants are given in **Table 13**.

Table 13: Comparison of Control System for Identified Pollutants

Industry	Product (or) Source of Pollution	Pollutant	Control System	Concentration after control system (mg/Nm ³)	
1	Captan	HCl	Caustic Scrubber	Nil - 37	
		Cl ₂		Nil - 3	
	Captafol	HCl	Caustic Scrubber	Nil - 35	
		Cl ₂		Nil - 0.3	
	Hexaconozole	HCl	Caustic Scrubber	13 - 63	
	Incinerator (Liquid)	SO ₂	Caustic Scrubber	Nil - 0.66	
		HCl		Nil	
	Incinerator (Solid)	SO ₂	Caustic Scrubber	---	
		HCl			
	2	Cypermethrin	HCl	Water/Caustic Scrubber	5 - 9
Cl ₂			Nil - 0.01		
SO ₂			1.2 - 16		
Fenvelearte		HCl	Water/Caustic Scrubber	9.5 - 15	
		Cl ₂		0.06 - 1.0	
		SO ₂		1.02 - 5	
MPBAD		HCl	Water Scrubber	6 - 290.35	
		Cl ₂		0.5	
DVACI - TBACI		HCl	Water/Caustic Scrubber	Nil	
		SO ₂		18.3	
DVACI - Final		HCl	Water/Caustic Scrubber	4.6 - 12.5	
		SO ₂		0.73 - 67	
Aluminium Phosphide		P ₂ O ₅	Water Scrubber + Mist Eliminator + Demister (German Technology)	0.98 - 24.3	
		PH ₃		0.3 - 0.7	
3		Zinc Phosphide	P ₂ O ₅	Mist Eliminator	0.072 - 2
			PH ₃		0.31 - 0.5
	Incinerator	SO ₂	Caustic Scrubber	Nil - 37	
		HCl		Nil - 6.9	

Industry	Product (or) Source of Pollution	Pollutant	Control System	Concentration after control system (mg/Nm ³)
4	Phorate	H ₂ S	Ventury Scrubber	7.55
		C ₂ H ₅ SH	Mercaptan Scrubber	Nil
			Wet Scrubber with NaOCl media	-
			Charcol bed Scrubber	-
	Ethion	H ₂ S	Wet Scrubber with NaOCl media + Charcol Scrubber	8.5
	Monocrotophos	CH ₃ Cl	Wet Scrubber with NaOCl media + Charcol Scrubber	N.A.
	DDVP	CH ₃ Cl	Wet Scrubber with NaOCl media + Charcol Scrubber	N.A.
	Incinerator	SO ₂	No Control System	3843.6
H ₂ S		219.55		
5	Phosphamidon/ Monocrotophos	CH ₃ Cl	Recovery + Liquification + Filling System or Incineration	Nil
		HCl	Water/Caustic Scrubber	
	DDVP	CH ₃ Cl	Recovery + Liquification + Filling System or Incineration	Nil
	Chemical Waste Incinerator	SO ₂	Quench + Water Scrubber + Caustic Scrubber + Ring Jet Scrubber	94.12
		CH ₃ Cl		Nil
	Solid Waste Incinerator	SO ₂	Caustic Scrubber	40.48
6	Isoproturon	NH ₃	Two Stage Primary & Secondary Scrubber with Water	12.7 - 39.7
	CMAC/ Cypermethrin	SO ₂	Caustic Scrubber	Nil - 72.2
		HCl		5.1 - 18.3
	Incinerator	SO ₂	Caustic Scrubber	Nil - 61
		HCl		11 - 70

Industry	Product (or) Source of Pollution	Pollutant	Control System	Concentration after control system (mg/Nm ³)
7	Malathion	H ₂ S	Caustic Scrubber	Nil - 0.85
	Dimethoate	H ₂ S	Caustic Scrubber	Nil - 0.85
	Monocrotophos	CH ₃ Cl	No Control System	
		HCl	Caustic Scrubber	5.00
		Cl ₂	Caustic Scrubber	0.35
	Incinerator	SO ₂	Caustic Scrubber	Nil - 32.01
		HCl		6.73
H ₂ S		12.5		
8	Fenvelerate (PCT Chlorination)	SO ₂	Water/Caustic Scrubber	0.32 - 21
		HCl		2.06 - 19.8
		Cl ₂		0.32 - 1.43
	Cypermethrin (Acid chloride preparation)	SO ₂	Water/Caustic Scrubber	0.24
		HCl		16.45
		Cl ₂		0.04
	MPBAD	SO ₂	Water/Caustic Scrubber & Bromine Recovery Unit	1.6 - 8.96
		HCl		4.73 - 14.3
		Cl ₂		Nil - 0.05
		Br ₂		Nil
	Bromine Rec. Unit	Br ₂	Caustic Scrubber	Nil
		HBr		11.7
	Incinerator	SO ₂	Ventury Caustic Scrubber	Nil - 17.8
		HCl		16.87 - 28.2
		Cl ₂		0.15
9	Chlorpyriphos	HCl	HCl recovery & Scrubber system	Nil
10	Monocrotophos	CH ₃ Cl	Incineration after distillation	Nil
		HCl	Two stage Water Scrubber	Traces
	Chlorpyriphos	HCl	Water Scrubber	Traces
	Incinerator	HCl	No Control System	Not Traceable
11	Methyl Bromide	No emission	Totally closed & Controlled System	

Industry	Product (or) Source of Pollution	Pollutant	Control System	Concentration after control system (mg/Nm ³)
12	Phosphamodon	CH ₃ Cl	To Incinerator	Nil
		HCl	Water Scrubber	N.A.
		Cl ₂		N.A.
	DDVP	CH ₃ Cl	To Incinerator	Nil
	Monocrotophos	CH ₃ Cl	To Incinerator	Nil
		HCl	Caustic Scrubber	Nil - 12
		Cl ₂		0.25 - 3.8
	Chlorpyriphos & Qunilophos	HCl	Caustic Scrubber	Nil - 5
		Cl ₂		Nil - 1.2
	Incinerator	SO ₂	Caustic Scrubber	Nil - 2
HCl		6		
13	DVACI	SO ₂	Packed column Alkali Scrubber	12.00
		HCl		3.2
	Incinerator	SO ₂	Water Jet Scrubber	32
		HCl		2.1
14	Malathion	H ₂ S	Packed column caustic Scrubber	32 - 40
	Chlorpyriphos	HCl	Water Scrubber	6.3 - 11
	Incinerator (solid/Liquid)	SO ₂	Water spray tower scrubber	2
	Incinerator (Liquid / Liquid & Vapour / Liquid)	SO ₂	Caustic Spray Tower	N.A.
15	Glyphosate	HCl	Two stage tail gas absorption System along with water scrubber for vent	Nil
16	Mercural Salt	Cl ₂	Caustic Scrubber	1.45 - 8.71
17	Phenoxy Herbicide (2,4 D Acid)	HCl	HCl Recovery system & Caustic Scrubber	Nil
		Cl ₂		Nil
	Urea Herbicide (Isoproturon)	HCl	HCl Recovery system & Caustic Scrubber	Nil

Industry	Product (or) Source of Pollution	Pollutant	Control System	Concentration after control system (mg/Nm ³)
18	Endosulfan	HCl	Absorption tower & Caustic scrubber	Nil
	Fanvelerate	NH ₃	Water scrubber	N.A.
		HCl	Caustic scrubber	N.A.
		Cl ₂		N.A.
		SO ₂		N.A.
	Cypermethrin/ Permethrin	HCl	Caustic scrubber	N.A.
	Phosphamidon/ Monocrotophos	HCl	Caustic Scrubber	N.A.
		CH ₃ Cl	Data not available	N.A.
	Incinerator	SO ₂	Caustic scrubber	N.A.
HCl		Nil		
19	Monocrotophos	HCl	Water scrubber	NA
	Phosphamidon	HCl	Water scrubber	N.A.
	Cypermethrin	HCN	Caustic Scrubber	N.A.
	Chlorpyriphos	HCl	Caustic Scrubber	N.A.
	Incinerator	P ₂ O ₅	Water/Caustic Scrubber	0 – 35
		HCl		Nil
20	Aluminium Phosphide	P ₂ O ₅	Water scrubber (Recovery as H ₃ PO ₄), Cyclone	N.A.
	Zinc Phosphide	P ₂ O ₅	Water scrubber (Recovery as H ₃ PO ₄)	N.A.
21	Endosulfan	HCl	Two Absorber (Water)/Alkali Scrubber	10 – 18
	Chlorpyriphos	HCl	Caustic Scrubber	10 – 18
	Incinerator for Hydrocarbon Waste	SO ₂	Multi Cyclone Blower	N.A.
	Incinerator for Chlorinated Hydrocarbon	SO ₂	Water/Caustic Scrubber	N.A.
		HCl		Nil
22	Isoproturon / Diuron	DMA	Water Scrubber	0.50
	Anilophos	HCl	Water Scrubber	1.95 - 9.2
		H ₂ S	Caustic Scrubber	0.40
		HCl	Water Scrubber	N.A.
	Deltamethrin	SO ₂	Water Scrubber	N.A.
		HCN	Caustic Scrubber	Nil
	Incinerator	SO ₂	Caustic Scrubber	N.A.
		HCl		Nil

Industry	Product (or) Source of Pollution	Pollutant	Control System	Concentration after control system (mg/Nm ³)
23	Phosalone	NH ₃	Plain Water Scrubber	N.A.
		HCl	Caustic Scrubber	N.A.
		H ₂ S	Caustic Scrubber	N.A.
	Phorate/Ethion	H ₂ S	Caustic Scrubber	N.A.
		C ₂ H ₅ SH	Hypo (NaOCl) Scrubber + Activated Carbon Filter	N.A.
	Monocrotophos	HCl	Caustic Scrubber	N.A.
		CH ₃ Cl	To Incinerator	N.A.
	Incinerator	SO ₂	Caustic Scrubber	N.A.
HCl		9.2		
24	Dimethoate	H ₂ S	To Flare Stack	1.10
		CH ₃ OH	No Control System	9.10
	Ethion	H ₂ S	To Flare Stack	1.1
		C ₂ H ₅ OH	No Control System	15.05
	Incinerator	SO ₂	Caustic Scrubber	N.A.
		H ₂ S		N.A.

Note: N.A. = Not Available.

In the light of above, general availability of technology in India for control of air pollution in pesticides industries, are given in **Table 14**.

Table 14: Comparison of Best Practicable Technology for pollutants

Pollutants	Control System	Recovery or by-product	Expected Efficiency	Achievable average Conc. (mg/Nm ³)
HCl	-Water Scrubber	Y	90 %	8.65
	-Caustic Scrubber	N	99 %	17.5
	-Water/Caustic Scrubber	Y	99%	7.0
Cl ₂	-Water Scrubber	Y	90 %	0.5
	-Caustic Scrubber	N	99 %	0.15
	-Water/Caustic Scrubber	Y	99 %	0.01
CH ₃ Cl	-Liquification & Recovery System	Y	99 %	Nil
	-Incineration after distillation	N	99 %	-

Pollutants	Control System	Recovery or by-product	Expected Efficiency	Achievable average Conc. (mg/Nm ³)
H ₂ S	-Scrubber with NaOCl media	N	96 %	8.5
	-Scrubber with NaOH media	Y	99 %	0.43
	-Charcoal Scrubber	N	97 %	5.6
SO ₂	-Caustic Scrubber	Y	99 %	0.33
	-Water/Caustic Scrubberr	Y	99 %	3.01
P ₂ O ₅ (as H ₃ PO ₄)	-Water Scrubber	Y	96 %	-
	-Water Scrubber (Ring jet scrubber) + Mist Eliminator + Demister	Y	98 %	12.64
	-Mist Eliminator	N	99 %	1.1
NH ₃	-Two Stage Water Scrubber	N	98 %	26.2
	-Recovery System	Y	99 %	-
HBr	Caustic Scrubber	N	98 %	11.7

With respect to various control systems to various pollutants, the annual burden to annual turn over ratio is summarised in **Table 15**. The table reveals that AB/AT ratios are below critical percentage.

Table 15: AB/AT ratio for various pollution control systems

Pollutants	Control System	AB / AT ratio
HCl and Cl ₂	➤ Water/Caustic Scrubber	0.02 – 0.7
CH ₃ Cl	➤ Liquification & filling system	0.54
H ₂ S	➤ Ventury Scrubber	0.15
	➤ Three stage caustic scrubber	0.61
P ₂ O ₅ and PH ₃	➤ Mist Eliminator	0.004
	➤ Water Scrubber + Mist Eliminator + Demister	0.10
NH ₃	➤ Two Stage Water Scrubber	0.13

Pollutants	Control System	AB / AT ratio
SO ₂ and HCl	➤ Caustic scrubber	0.10 – 0.18
	➤ Incinerator with caustic scrubber	0.41
	➤ Solid waste incinerator	0.13
	➤ Incinerator	0.47
SO ₂ , HCl and CH ₃ Cl	➤ Chemical waste Incinerator with quencher, water / caustic scrubber	2.11
	➤ Incinerator	1.37
C ₂ H ₅ SH	➤ Scrubber with NaOCl media	0.06
H ₂ S, C ₂ H ₅ SH and CH ₃ Cl	➤ Charcoal scrubber	0.09
	➤ Wet Scrubber	0.44

5.3 Emission Standards with respect to Location Specificity

Dispersion modelling is a very strong tool/best alternative to estimate the Ground Level Concentration (GLC) of the source emission pollutants in the ambient air. If the modelling results of emission from the industry indicate violation or likelihood of violation of ambient air quality standards (after accounting for background levels), the industry sector specific emission standards be made to ensure compliance with the ambient air quality standards. For this purpose, the PC based Gaussian model has been employed to calculate the maximum Ground Level Concentration (GLC) of priority pollutants. The modelling results are shown in **Table 16 and 17**. For the calculation of GLC of priority pollutants, worst-case source emission & weather conditions are taken into account:

- ⇒ Maximum volumetric flow rate as 5000 m³/hr (because it is varying from 1000 m³/hr to 5000 m³/hr in different pesticide units covered)
- ⇒ Wind velocity at stack height is 1 m/s
- ⇒ Plume rise = 0.5 m (Because the temperature and pressure of emission vents are observed as ambient temperature and atmospheric pressure respectively).
- ⇒ Ambient temperature = 25°C.
- ⇒ Stability condition - F = Stable (throughout 24 hours is constant)

Table 16: Control system + 20 m Stack height + Max. achievable concentration

Parameters	Concentration (mg/Nm ³)	Emission Rate (kg/sec)	Critical Distance (M)	Max. GLC (µg/m ³)
HCl	17.5	12.6 x 10 ⁻⁶	354	3.72
Cl ₂	0.5	0.36 x 10 ⁻⁶	354	0.11
H ₂ S	8.5	6.1 x 10 ⁻⁶	354	1.80
SO ₂	3.01	2.2 x 10 ⁻⁶	354	0.65
P ₂ O ₅ (as H ₃ PO ₄)	12.64	9.1 x 10 ⁻⁶	354	2.69
NH ₃	26.2	18.8 x 10 ⁻⁶	354	5.55
HBr	11.7	8.4 x 10 ⁻⁶	354	2.48

Table 17: Control system+ 30 m Stack height + Max. achievable concentration

Parameters	Concentration (mg/Nm ³)	Emission Rate (kg/sec)	Critical Distance (M)	Max. GLC (µg/m ³)
HCl	17.5	12.6 x 10 ⁻⁶	582	1.59
Cl ₂	0.5	0.36 x 10 ⁻⁶	582	0.045
H ₂ S	8.5	6.1 x 10 ⁻⁶	582	0.77
SO ₂	3.01	2.2 x 10 ⁻⁶	582	0.28
P ₂ O ₅ (as H ₃ PO ₄)	12.64	9.1 x 10 ⁻⁶	582	1.15
NH ₃	26.2	18.8 x 10 ⁻⁶	582	2.37
HBr	11.7	8.4 x 10 ⁻⁶	582	1.06

After going through the data obtained through questionnaire survey and during in-depth study, it was observed that the vent height of the process emission was varying from 10 m to 22 m, industry to industry and the maximum height of surrounding building was observed as 10 m.

5.4 Emission Standards

Considering the achievability of best practicable standards with the general availability of technology, the maximum ground level concentration with the help of modelling, threshold limit value and also considering standards prescribed by Central Pollution Control Board in other cases, the proposed standards for pesticide industry are summarised in **Table 18**.

Table 18: Proposed Emission Standards for Pesticides Manufacturing and Formulation Industry

Parameter	Max. GLC ($\mu\text{g}/\text{m}^3$)	Achievable average concentration (mg/Nm^3)	TLV (mg/m^3)	Proposed Emission Standards
HCl	1.59 – 3.72	7.0 – 17.5	8	20
Cl ₂	0.045 – 0.11	0.01 - 0.5	3	5
H ₂ S	0.77 – 1.80	0.43 – 8.5	14	5
P ₂ O ₅ (as H ₃ PO ₄)	1.15 – 2.69	1.1 – 12.64	1	10
NH ₃	2.37 – 5.55	26.2	18	30
CH ₃ Cl	--	Nil	105	20
HBr	1.06 – 2.48	11.7	10	5

The Central Pollution Control Board developed national emission standards for pesticides manufacturing industries, which were presented before eighteenth meeting of Peer and Core Committee held on April 20 & 21, 2004. Subsequently proposed standards were approved by the 132nd Board meeting held on January 04, 2005 and forwarded to MoEF for consideration and issuance of notification under the Environment (Protection) Act, 1986.

The Ministry of Environment and Forests; vide G.S.R. 46(E) dated 3rd February, 2006, notified the National Emission Standards for Pesticide Manufacturing and Formulation Industry. The notified standard is given in **Table 19**.

Table 19: National Emission Standards for Pesticide Manufacturing and Formulation Industry.

S. No.	Parameter	Not to exceed mg/Nm³
1.	HCl	20
2.	Cl ₂	05
3.	H ₂ S	05
4.	P ₂ O ₅ (as H ₃ PO ₄)	10
5.	NH ₃	30
6.	Particulate matter with pesticide compounds	20
7.	CH ₃ Cl	20
8.	HBr	05

5.5 Guidelines for Fugitive Emission Control

- i) Fugitive emissions over reactors, formulation areas, centrifuges, chemical loading, transfer areas etc., are yet to be collected through hoods and ducts by induced draft and controlled by scrubber / dust collector.
- ii) Usually scrubbers installed for channelised emissions are used for fugitive emissions to control also and some times dedicated scrubbers are provided. This practice may be permitted as long as tail gas concentrations are within the prescribed limit.
- iii) In addition, organic gaseous emissions (odorous and toxic) be routed to activated carbon beds (adsorption) or to thermal oxidiser, and for dust emissions cyclones / bag filters are to be provided.
- iv) Emphasis be given to solvent management / solvent loss prevention.
- v) Enclosures to chemical storage area, collection of emissions from loading of raw materials, in particular, solvents through hoods and ducts by induced draft, and control by scrubber / dust collector to be ensured.
- vi) Vapour balancing, nitrogen blanketing, ISO tanks etc. to be provided; special care needs to be taken for control in respect of odorous chemicals.

5.6 LDAR for Pesticide Industry

Pesticides are manufactured in multi-stages in batch mode. In the manufacture of technical grade pesticides, various types of solvents are being utilized by the industries. Some of the solvents used are low boiling solvents and when such solvents are used, emission of Volatile Organic Compounds can be high. In addition to this, from the manufacture of intermediate products or technical grade pesticides, emission of raw materials or by-products like Cl_2 and H_2S is possible.

The pesticide industries are using pipelines, pumps, valves and other fittings in the transfer of solvents / raw materials from storage to the reactors and other ancillary facilities. To reduce fugitive emissions from the plants, proper Leak Detection And Repair (LDAR) Program is required at industry level.

The major solvents, which need special attention, are Toluene, Benzene, Xylene, Ethyl Acetate, Methanol and Cyclohexane. The raw materials or by-products needing special attention during transfer are Cl_2 and H_2S .

Comparing with refineries and petrochemical sector, the quantity of solvents used by pesticide industries is very less. Typically, the quantity handled in a batch process pesticide unit will be only 2,000 liters of solvent per batch. However, for better control of fugitive emissions, a proper LDAR Program is required.

The proposed LDAR program is as follows:

- a) Identification of sources: Valves, pipes, joints, pump seals, flanges etc
- b) Monitoring Program: VOC monitoring should be carried out by the industry regularly. For low boiling solvents and toxic / hazardous chemicals, monitoring frequency of minimum once in a quarter is suggested. The suggested solvents / chemicals subjected to such monitoring is Benzene, Toluene, Ethyl Mercaptan and H_2S .
- c) The industries handling small quantities of Chlorine and Ethyl Mercaptan can use simpler monitoring methods. They can use lead acetate paper for checking the joints of pipes. For chlorine lines' leak detection, they can use dilute ammonia solution.
- d) Preventive Maintenance: Focus should be for prevention of fugitive emissions for which preventive maintenance of pumps, valves, pipelines are required. Proper maintenance of mechanical seals of pumps and valves are required. A preventive maintenance schedule should be prepared by each industry and adhered to.

- e) Repair Program: When monitoring results indicate VOC above permissible limits, repairing should be done immediately. The repairs should be conducted in such a way that there is no fugitive emission from the particular component.
- f) To make the LDAR program more effective, for critical gases like H₂S and Cl₂, continuous monitors should be installed.
- g) For Mercaptan lines, leak detection can be done with lead acetate solution, which is more reliable.

BIBLIOGRAPHY

1. Minimal National Standards: Pesticides Manufacturing and Formulation Industry (COINDS/15/1985-86), Central Pollution Control Board, Delhi
2. Revised MINAS Pesticides (COINDS/31/1988-89), Central Pollution Control Board, Delhi
3. Wastewater Management in Pesticide Industry (COINDS/47/1993-94), Central Pollution Control Board, Delhi.
4. Document on pesticides Industry (INDO/5/84/85), Rajasthan Pollution Control Board, Jaipur.
5. Environment Audit – NOCIL Agrochemicals (PROBES/49/1992-93), Central Pollution Control Board, Delhi.
6. Rationale in Evolution of Standards for Industrial Effluents and Emissions (PROBES/67/1996-97), Central Pollution Control Board, Delhi.
7. Chemical Industry News, August 1995.
8. Pesticides Information, Journal, January-March 1998.
9. Chemical Weekly Annual, Journal, September, 1998.
10. Manual for Pesticides User's: Pesticide Association of India, New Delhi Nov 1983
11. Audit and Reduction Manual for Industry Emissions and Wastes UNEP, 1991.
12. Air Pollution Control and Design for Industry Edited by Paul N. Cheremisinoff.
13. Environmental Engineers' Volume 2 Air Pollution Edited by Bela G. Liptak.
14. Air Pollution Control Engineering Edited by Noel de Nevers, University of Utah.
15. Pollution Control in Process Industries, Edited by S.P. Mahajan, IIT, Bombay.
16. An Introduction to Air Pollution, Edited by R. K. Trivedi & P. K. Goel, Department of Pollution Studies, Y.C. College of Science, Karad, Vidyanagar (Maharashtra)
17. Industrial Pollution Control Handbook, Edited by Herbert F. Lund, President, Leadership Plus, Inc.

18. Encyclopaedia of Environmental Pollution and Control, Vol. 1, Edited by R.K. Trivedi
19. Air Pollution Control Technology, An Engineering Analysis Point of View, Edited by Robert M. Bethea, P.E., Ph.D., Professor of Chemical Engineering, Texas Tech University, Lubbock, Texas.
20. Air Pollution Control Engineering, Basic Calculations for Particulate Collection, Second Edition, Edited by William Licht, Department of Chemical and Nuclear Engineering, University of Cincinnati, Cincinnati, Ohio.
21. Air Pollution, Third Edition, Volume IV, Engineering Control of Air Pollution Edited by Arthur C. Stern, Department of Environmental Sciences and Engineering, School of Public Health, University of North Carolina at Chapel Hill, Chapel Hill, North Carolina.
22. Threshold Limit Values (TLV) for Chemical Substances in the Work Environment Adopted by ACGIH for 1984-85.
23. Filled Questionnaires received from various Pesticide Industries.