

34390052
© 1985 APPLE
8603 CDP



Apple Service
Technical Procedures
Peripheral Interface Guide



 **Apple Technical Procedures**

Peripheral Interface Guide

P/N: 072-0213D

Copyright 1986 – 1989 by Apple Computer, Inc.
Revision: March 1989

Peripheral Interface Guide

Table of Contents

	viii	Preface
Section 1 –	1.3	Introduction
Computer Interfaces:	1.4	Apple II, II Plus, and IIe
Pin-outs	1.5	Composite Video Connector
	1.5	Auxiliary Video Connector
	1.5	Cassette Connector – Input
	1.5	Cassette Connector – Output
	1.6	Game Controller Connector
	1.7	Joystick/Hand Controller Connector – IIe
	1.8	Apple IIGs
	1.8	Sound Connector
	1.9	External Audio Connector
	1.9	Modem and Printer Connectors
	1.9	Joystick/Hand Controller Connector
	1.10	Disk Drive Connector
	1.10	RGB Video Connector
	1.11	Composite Video Connector
	1.11	Apple DeskTop Bus Connector
	1.12	Apple IIc and IIc Plus
	1.13	Joystick/Hand Controller/Mouse Connector
	1.13	Modem and Printer Connectors – IIc
	1.13	Modem and Printer Connectors – IIc Plus
	1.15	Video Expansion Connector
	1.16	Composite Video Connector
	1.16	External Disk Drive Connector
	1.16	External Power Connector – IIc
	1.17	Audio Connector – IIc
	1.18	Apple III and III Plus
	1.18	Audio Connector
	1.18	Monochrome Video Connector
	1.19	External Disk Drive Connector
	1.20	Joystick A Connector
	1.21	Joystick B Connector
	1.22	Color Video Connector
	1.23	RS-232-C Serial Connector

...Continued on next page

1.24	Macintosh 128K, 512K, and 512K Enhanced
1.24	Mouse Connector
1.25	External Disk Drive Connector
1.26	Modem and Printer Connectors
1.26	Audio Connector
1.27	Macintosh Plus
1.27	Audio Connector
1.28	Mouse Connector
1.28	External Disk Drive Connector
1.29	SCSI Connector
1.30	Modem and Printer Connectors
1.31	Macintosh SE and SE/30
1.31	Apple DeskTop Bus Connector
1.32	External Disk Drive Connector
1.33	SCSI Connector
1.34	Modem and Printer Connectors
1.34	Audio Connector
1.35	Macintosh II, IIx, and IIcx
1.36	Audio Connector
1.36	Apple DeskTop Bus Connector
1.37	Modem and Printer Connectors
1.38	SCSI Connector
1.39	Lisa/Macintosh XL
1.40	Serial A Connector
1.41	Serial B Connector
1.41	Mouse Connector
1.41	Composite Video Connector
1.42	Parallel Connector

**Section 2 –
Interface Cards:
Pin-outs and
Switch Functions**

2.2	Introduction
2.3	Apple II, II Plus, IIe, IIGs
2.3	Parallel Printer Interface and Centronics Printer Interface Pin-outs
2.4	Parallel Interface Card Pin-outs
2.4	Parallel Interface Card Switches
2.5	Graphics Tablet Interface – Tablet Pin-outs
2.5	Graphics Tablet Interface – Pen Pin-outs
2.5	Communications Interface Card Pin-outs
2.6	High Speed Serial Interface Card Pin-outs
2.6	High Speed Serial Interface Card Switches
2.7	IEEE-488 Interface Pin-outs

2.7	Super Serial Card Pin-outs
2.8	Super Serial Card Printer Mode Switch SW1
2.8	Super Serial Card Printer Mode Switch SW2
2.9	Super Serial Card Communication Mode Switch SW1
2.9	Super Serial Card Communication Mode Switch SW2
2.10	Apple II SCSI Card
2.11	Apple III and III Plus
2.11	Universal Parallel Interface Card (UPIC) Pin-outs
2.12	Serial Card III Pin-outs
2.13	Lisa/Macintosh XL
2.13	Two-Port Parallel Card Pin-outs
2.14	Macintosh II, IIx, IIcx
2.14	Video and Monochrome Card
2.14	Two-Page Monochrome Video Card
2.15	EtherTalk Interface Card

**Section 3 –
Peripheral Devices:
Pin-outs and
Switch Functions**

3.3	Introduction
3.4	Dot Matrix Printer
3.4	Pin-outs
3.5	Switch 1
3.6	Switch 2
3.7	Daisy Wheel Printer
3.7	Pin-outs
3.7	Front Panel DIP Switch
3.8	Rear Panel Switch 1
3.8	Rear Panel Switch 2
3.9	Scribe
3.9	Pin-outs
3.9	Switch 1
3.10	ImageWriter and ImageWriter 15-inch
3.10	Pin-outs
3.10	Switch 1
3.10	Switch 2
3.11	ImageWriter II
3.11	Pin-outs
3.11	Switch 1
3.12	Switch 2
3.13	ImageWriter LQ
3.13	Pin-outs
3.14	Switch 1
3.14	Switch 2
3.15	Switch 3

...Continued on next page

3.16	LaserWriter and LaserWriter Plus
3.16	AppleTalk
3.16	RS-232
3.17	LaserWriter II
3.17	Pin-outs
3.18	NT – Switch 1
3.18	NTX – Switch 1
3.19	Apple Scanner
3.19	Pin-outs
3.20	Modem 300/1200
3.20	Pin-outs
3.20	Modem 300
3.20	Modem 1200
3.21	Apple Personal Modem
3.21	Pin-outs
3.22	AppleFax Modem
3.22	Pin-outs
3.23	AppleLine
3.23	Pin-outs

**Section 4 –
Configurations:
Computers and
Peripherals**

4.4	Introduction
4.5	Dot Matrix Printer
4.5	Standard Switch Settings
4.5	Apple II, II Plus, IIe, and IIGS
4.6	Apple III and III Plus
4.6	Lisa/Macintosh XL
4.7	Daisy Wheel Printer
4.7	Standard Switch Settings
4.7	Apple II, II Plus, IIe, and IIGS
4.8	Apple IIGS and IIC Plus
4.8	Apple IIC
4.9	Apple III and III Plus
4.9	Lisa/Macintosh XL
4.10	Scribe
4.10	Standard Switch Settings
4.10	Apple II, II Plus, IIe, and IIGS
4.11	Apple IIGS and IIC Plus
4.11	Apple IIC
4.11	Apple III and III Plus
4.11	Lisa/Macintosh XL

- 4.12 ImageWriter and ImageWriter 15-Inch
- 4.12 Standard Switch Settings
- 4.12 Apple II, II Plus, IIe, and IIGs
- 4.13 Apple IIGs and IIc Plus
- 4.13 Apple IIc
- 4.14 Apple III and III Plus
- 4.14 Macintosh 128K, 512K, and 512K Enhanced
- 4.14 Macintosh Plus
- 4.14 Macintosh SE and SE/30
- 4.14 Macintosh II, IIx, and IIcx
- 4.14 Lisa/Macintosh XL
- 4.15 ImageWriter II
- 4.15 Standard Switch Settings
- 4.15 Apple II, II Plus, IIe, and IIGs
- 4.16 Apple IIGs and IIc Plus
- 4.16 Apple IIc
- 4.16 Apple III and III Plus
- 4.17 Macintosh 128K, 512K, and 512K Enhanced
- 4.17 Macintosh Plus
- 4.17 Macintosh SE and SE/30
- 4.17 Macintosh II, IIx, and IIcx
- 4.17 Lisa/Macintosh XL
- 4.18 ImageWriter LQ
- 4.18 Standard Switch Settings
- 4.19 Apple II, II Plus, IIe, and IIGs
- 4.19 Apple IIGs and IIc Plus
- 4.19 Apple IIc
- 4.20 Apple III and III Plus
- 4.20 Macintosh 128K, 512K, and 512K Enhanced
- 4.20 Macintosh Plus
- 4.20 Macintosh SE and SE/30
- 4.20 Macintosh II, IIx, and IIcx
- 4.20 Lisa/Macintosh XL
- 4.21 Modem 300/1200
- 4.21 Standard Switch Settings
- 4.21 Apple II, II Plus, IIe, and IIGs
- 4.23 Apple IIGs and IIc Plus
- 4.23 Apple IIc
- 4.23 Apple III and III Plus
- 4.23 Macintosh 128K, 512K, and 512K Enhanced
- 4.23 Macintosh Plus
- 4.23 Macintosh SE and SE/30
- 4.23 Macintosh II, IIx, and IIcx
- 4.23 Lisa/Macintosh XL

...Continued on next page

4.24	Apple Personal Modem
4.24	Standard Switch Settings
4.24	Apple II, II Plus, IIe, and IIGs
4.25	Apple IIGs and IIc Plus
4.25	Apple IIc
4.25	Apple III and III Plus
4.25	Macintosh 128K, 512K, and 512K Enhanced
4.25	Macintosh Plus
4.25	Macintosh SE and SE/30
4.25	Macintosh II, IIx, and IIcx
4.25	Lisa/Macintosh XL
4.26	Color Plotter
4.26	Standard Switch Settings
4.26	Apple II, II Plus, IIe, and IIGs
4.26	Apple IIGs and IIc Plus
4.26	Apple IIc
4.27	Apple III and III Plus
4.28	AppleLine
4.28	Standard Switch Settings
4.28	Apple III and III Plus
4.28	Lisa/Macintosh XL
4.28	Macintosh 128K, 512K, and 512K Enhanced
4.28	Macintosh Plus
4.28	Macintosh SE and SE/30
4.28	Macintosh II, IIx, and IIcx
4.29	AppleFax Modem
4.29	Standard Switch Settings
4.29	Macintosh Plus
4.29	Macintosh SE and SE/30
4.29	Macintosh II, IIx, and IIcx

**Section 5 –
Cable and
Connector
Specifications**

5.3	Introduction
5.4	Cable Specifications
5.4	Cable 590-0029
5.4	Cable 590-0036
5.5	Cable 590-0037
5.6	Cable 590-0042
5.6	Cable 590-0121
5.7	Cable 590-0166
5.8	Cable 590-0169
5.8	Cable 590-0191
5.9	Cable 590-0192
5.9	Cable 590-0197
5.10	Cables 590-0331 and 590-0555
5.10	Cables 590-0332 and 590-0551
5.11	Cables 590-0333 and 590-0554

5.11	Cables 590-0335 and 590-0556
5.11	Cables 590-0340 and 590-0552
5.12	Cables 590-0341, 590-0553, and 699-0430
5.13	Cable 590-0345
5.14	Cable 590-0346
5.14	Cable 590-0347
5.14	Cable 590-0550
5.15	Connector Specifications
5.15	DE-9 Connector
5.15	DA-15 Connector
5.15	DB-19 Connector
5.15	DB-25 Connector
5.15	Mini DIN-4 Connector
5.15	Mini DIN-8 Connector
5.15	DIN-5 Connector

©Apple Computer, Inc., 1986-1989. No portion of this document may be reproduced in any form without the written permission of Apple Computer, Inc.

Apple IIGs, AppleTalk, DuoDisk, ImageWriter, LaserWriter, Lisa, Macintosh, Silentype, Apple, and the Apple logo are registered trademarks of Apple Computer, Inc. AppleCD SC, Apple DeskTop Bus, AppleFax, AppleLine, EtherTalk, LocalTalk, and UniDisk are trademarks of Apple Computer, Inc.

Scribe is a registered trademark licensed to Apple Computer, Inc.

TRW is the name and mark of TRW, Inc.

LaserJet Plus is a trademark of Hewlett-Packard, Inc.

Ethernet is a registered trademark of Xerox Corporation. Diablo is a trademark of Xerox Corporation.

PostScript is a registered trademark of Adobe Systems Incorporated.

□ PREFACE

Welcome to the fifth edition of the Apple® Peripheral Interface Guide.

This guide contains interfacing information—pin-outs, switch settings, cabling requirements, and diagrams of interface ports—for Apple computers, interface cards, and peripherals. This information will help you in connecting both Apple and non-Apple peripheral devices to Apple computers. It will also be useful in troubleshooting situations where interface problems may be involved.

The following information is provided:

Section 1, Computer Interface Ports: Pin-outs

This section lists all the built-in interface ports on each Apple computer. Pin numbers, signal mnemonics, signal descriptions, and connector types are provided. Special information related to the interface is noted.

Section 2, Interface Cards: Pin-outs and Switch Functions

Similar in format to Section 1, this section covers interface cards for each type of Apple computer. For each card, pin numbers, signal mnemonics, signal descriptions, and connector types are listed. If the interface card contains any option switches, a table lists the functions of the switches and how they should be set to produce various operating characteristics.

Section 3, Peripheral Devices: Pin-outs and Switch Functions

This section covers Apple peripheral devices. Each device's pin numbers, signal mnemonics, signal descriptions, and connector types are listed. Option switch functions and settings are listed, with the default (factory) settings shown in bold type.

Section 4, Configurations: Computers and Peripherals

This section is a guide to connecting any Apple peripheral device to any Apple computer. The cables needed, option switch settings, and any special notes or requirements are all listed.

Section 5, Cable and Connector Specifications

Included here is a list of all the standard Apple peripheral cables, with their pin connections. Also included are diagrams of the various connectors used, with pin designations indicated.

Peripheral Interface Guide

Section 1 – Computer Interfaces: Pin-outs and Signal Descriptions

□ CONTENTS

1.3	Introduction
1.4	Apple II, II Plus, and IIe
1.5	Composite Video Connector
1.5	Auxiliary Video Connector
1.5	Cassette Connector – Input
1.5	Cassette Connector – Output
1.6	Game Controller Connector
1.7	Joystick/Hand Controller Connector – IIe
1.8	Apple IIGs
1.8	Sound Connector
1.9	External Audio Connector
1.9	Modem and Printer Connectors
1.9	Joystick/Hand Controller Connector
1.10	Disk Drive Connector
1.10	RGB Video Connector
1.11	Composite Video Connector
1.11	Apple DeskTop Bus Connector
1.12	Apple IIc and IIc Plus
1.13	Joystick/Hand Controller/Mouse Connector
1.13	Modem and Printer Connectors – IIc
1.13	Modem and Printer Connectors – IIc Plus
1.15	Video Expansion Connector
1.16	Composite Video Connector
1.16	External Disk Drive Connector
1.16	External Power Connector – IIc
1.17	Audio Connector – IIc
1.18	Apple III and III Plus
1.18	Audio Connector
1.18	Monochrome Video Connector
1.19	External Disk Drive Connector
1.20	Joystick A Connector
1.21	Joystick B Connector
1.22	Color Video Connector
1.23	RS-232-C Serial Connector

- 1.24 Macintosh 128K, 512K, and 512K Enhanced
 - 1.24 Mouse Connector
 - 1.25 External Disk Drive Connector
 - 1.26 Modem and Printer Connectors
 - 1.26 Audio Connector
- 1.27 Macintosh Plus
 - 1.27 Audio Connector
 - 1.28 Mouse Connector
 - 1.28 External Disk Drive Connector
 - 1.29 SCSI Connector
 - 1.30 Modem and Printer Connectors
- 1.31 Macintosh SE and SE/30
 - 1.31 Apple DeskTop Bus Connector
 - 1.32 External Disk Drive Connector
 - 1.33 SCSI Connector
 - 1.34 Modem and Printer Connectors
 - 1.34 Audio Connector
- 1.35 Macintosh II, IIX, and IICX
 - 1.36 Audio Connector
 - 1.36 Apple DeskTop Bus Connector
 - 1.37 Modem and Printer Connectors
 - 1.38 SCSI Connector
- 1.39 Lisa/Macintosh XL
 - 1.40 Serial A Connector
 - 1.41 Serial B Connector
 - 1.41 Mouse Connector
 - 1.41 Composite Video Connector
 - 1.42 Parallel Connector

□ INTRODUCTION

This section contains the specifications for all the built-in interface connectors on each type of Apple computer. The information is arranged by computer type. A drawing at the beginning of each section shows the locations of the interface connectors.

Notes:

A slash (/) after the signal name indicates that the signal is valid when the signal is low.

The connector type identified is that required for the mating connector.

□ APPLE II, II PLUS, IIe

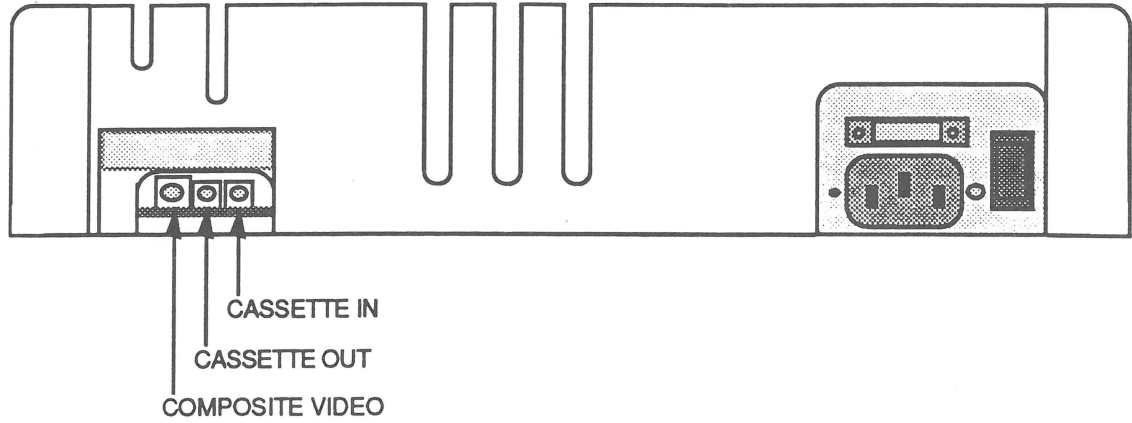

Apple II / II Plus

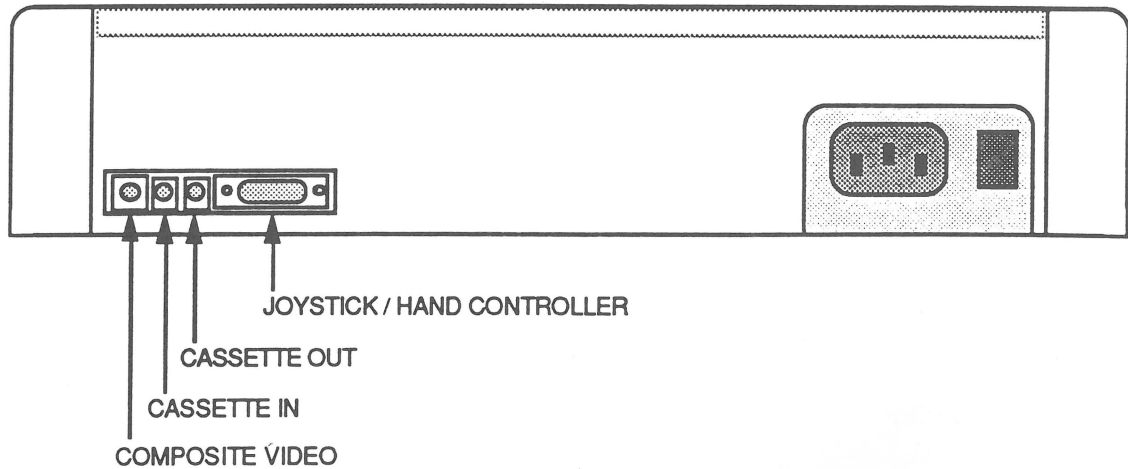

Apple IIe

**Composite
Video Connector**

<u>Pin No.</u>	<u>Signal Name</u>	<u>Signal Description</u>
(Sleeve)	GND	System common ground.
(Tip)	VIDEO	NTSC composite video.

Connector Type: RCA Phono Plug

Apple II and II Plus video level is adjustable from 0 to 1 volt by a 200-ohm potentiometer (not shown in the illustration) located on the logic board near the right rear of the computer. Apple IIe video level is not adjustable.

**Auxiliary
Video Connector**

This connector (not shown in the illustration) is located on the logic board near the right-rear side of the computer.

<u>Pin No.</u>	<u>Signal Name</u>	<u>Signal Description</u>
1	GND	System common ground.
2	VIDEO	NTSC positive composite video.
3	+12V	+12 volts.
4	+5V	+5 volts.

Connector Type: Molex KK100 Series

Video level is not adjustable. On the Apple II/II Plus, pin 1 is at the edge of the logic board. On the Apple IIe, pin 1 is toward the front of the logic board.

**Cassette Connector
- Input**

<u>Pin No.</u>	<u>Signal Name</u>	<u>Signal Description</u>
(Sleeve)	GND	System electrical ground.
(Tip)	DATA IN	Audio in. One volt peak-to-peak; impedance of 12K ohms.

Connector Type: Miniature Phono Plug

**Cassette Connector
- Output**

<u>Pin No.</u>	<u>Signal Name</u>	<u>Signal Description</u>
(Sleeve)	GND	System electrical ground.
(Tip)	DATA OUT	Audio out. 25 mV into a 100-ohm load.

Connector Type: Miniature Phono Plug

Game Controller Connector

This connector (not shown in the illustration) is located near the right-rear side of the computer on the logic board.

<u>Pin No.</u>	<u>Signal Name</u>	<u>Signal Description</u>
1	+5V	+5 volts, 100-ma maximum current drain.
2	PB0	Push-button input. Standard 74LS-Series
3	PB1	See Pin 2.
4	PB2	See Pin 2.
5	C040 STROBE/	General-purpose strobe output. Goes low during phase zero of a read or write cycle to any address from \$C040 to \$C04F.
6	GC0	Game controller input. Connected through a 150K-ohm variable resistor to +5V.
7	GC2	See Pin 6.
8	GND	System electrical ground.
9	NC	No connection.
10	GC1	See Pin 6.
11	GC3	See Pin 6.
12	AN3	Annunciator. Standard 74LS-Series TTL output. Must be buffered if used to drive other than TTL inputs.
13	AN2	See Pin 12.
14	AN1	See Pin 12.
15	AN0	See Pin 12.
16	NC	No connection.

Connector Type: 16-pin DIP header

**Joystick/
Hand Controller
Connector
Apple IIe Only**

This connector is present only on the Apple IIe.

<u>Pin No.</u>	<u>Signal Name</u>	<u>Signal Description</u>
1	PB1	Push-button input. Standard 74LS Series.
2	+5V	+5 volts, 100-ma maximum current drain.
3	GND	System electrical ground.
4	PDL2	Hand control input. Connected through a 150K-ohm variable resistor to +5V.
5	PDL0	See Pin 4.
6	PB2	See Pin 1.
7	PB0	See Pin 1.
8	PDL1	See Pin 4.
9	PDL3	See Pin 4.

Connector Type: DE-9 Male

□ APPLE IIGS

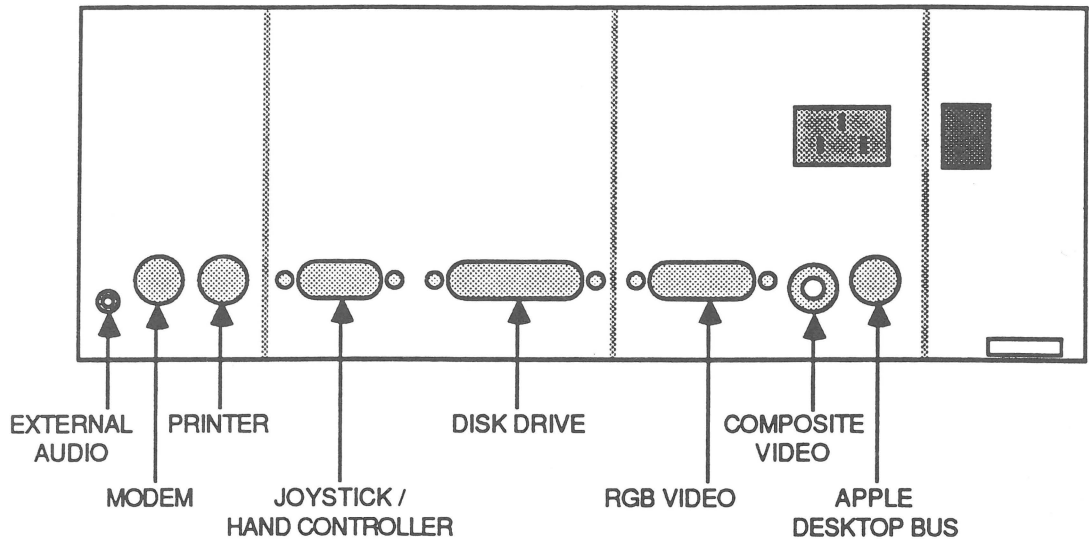

Sound Connector

This connector (J25) is located on the logic board, near the right-front side of the computer just below the memory expansion connector. (It is not shown in the illustration.) Pin 1 is located at the front of the logic board.

<u>Pin No.</u>	<u>Signal Description</u>	<u>Pin No.</u>	<u>Signal Description</u>
1	A/D converter input	5	Channel address 1
2	Analog ground	6	Channel strobe/
3	Analog output	7	Channel address 2
4	Channel address 0		

Connector Type: 7-pin Molex

External Audio Connector

<u>Pin No.</u>	<u>Signal Description</u>
1	Signal ground
2	Earphone 1
3	Earphone 2

Connector Type: Miniature Phono Plug

Modem and Printer Connectors

<u>Pin No.</u>	<u>Signal Description</u>	<u>Pin No.</u>	<u>Signal Description</u>
1	Data Terminal Ready	5	Receive Data -
2	Handshake In	6	Transmit Data +
3	Transmit Data -	7	General-Purpose Input
4	Signal Ground	8	Receive Data +

Connector Type: Mini DIN-8 Male

PRINTER port (slot 1) defaults to: 9600 baud, 8 bits, no parity, 1 stop bit, unlimited line length, LF after CR, DCD and DSR/DTR handshake, no echoing, and no buffering.

MODEM port (slot 2) defaults to: 1200 baud, 8 bits, no parity, 1 stop bit, unlimited line length, no LF after CR, DCD and DSR/DTR handshake, no echoing, and no buffering.

**Joystick/
Hand Controller
Connector**

<u>Pin No.</u>	<u>Signal Description</u>	<u>Pin No.</u>	<u>Signal Description</u>
1	Switch 1/Option key	6	Switch 2
2	+5 volts	7	Switch 0/Open
3	Signal ground	8	Paddle 1
4	Paddle 2	9	Paddle 3
5	Paddle 0		

Connector Type: DE-9 Male

These signals are also available on a 16-pin DIP socket labeled GAME I/O (J22) inside the case.

Disk Drive Connector

<u>Pin No.</u>	<u>Signal Description</u>	<u>Pin No.</u>	<u>Signal Description</u>
1	Signal ground	11	Motor phase 0
2	Signal ground	12	Motor phase 1
3	Signal ground	13	Motor phase 2
4	3.5-inch drive	14	Motor phase 3
5	-12 volts DC	15	Write request
6	+5 volts DC	16	Head select
7	+12 volts DC	17	Drive 1 select
8	+12 volts DC	18	Read data
9	Drive 2 select	19	Write data
10	Write-protect		

Connector Type: DB-19 Male

The Apple 5.25 Drive, UniDisk 5.25, DuoDisk, Apple 3.5 Drive, or UniDisk 3.5 may be connected to this connector.

RGB Video Connector

<u>Pin No.</u>	<u>Signal Description</u>	<u>Pin No.</u>	<u>Signal Description</u>
1	Signal ground (Red)	9	Analog Blue video
2	Analog Red video	10	No connection
3	Composite Sync	11	Sound (1 Volt peak-to-peak)
4	No connection	12	Composite video output
5	Analog Green video	13	Signal ground (Blue)
6	Signal ground (Green)	14	No connection
7	-5 volts DC	15	No connection
8	+12 volts DC	(Shield)	System ground

Connector Type: DA-15 Male

CAUTION: *The signals on this connector are not the same as those on the DA-15 of the Apple IIc, Apple III and III Plus, Macintosh II Video Cards, or the EtherTalk Interface Card. DO NOT connect an Apple IIc, III, III Plus, Macintosh II Video Card, or EtherTalk Interface Card device or cable to the IIGS.*

Composite Video Connector

<u>Pin No.</u>	<u>Signal Description</u>	<u>Pin No.</u>	<u>Signal Description</u>
(Sleeve)	System common ground	(Tip)	NTSC composite video

Connector Type: RCA Phono Plug

Apple DeskTop Bus Connector

<u>Pin No.</u>	<u>Signal Description</u>	<u>Pin No.</u>	<u>Signal Description</u>
1	Bidirectional data bus	3	Power (+5v)
2	Reserved	4	Ground

Connector Type: Mini DIN-4 Male

Total length of all cables should not exceed 16 feet (5 meters).

□ APPLE IIc AND IIc PLUS

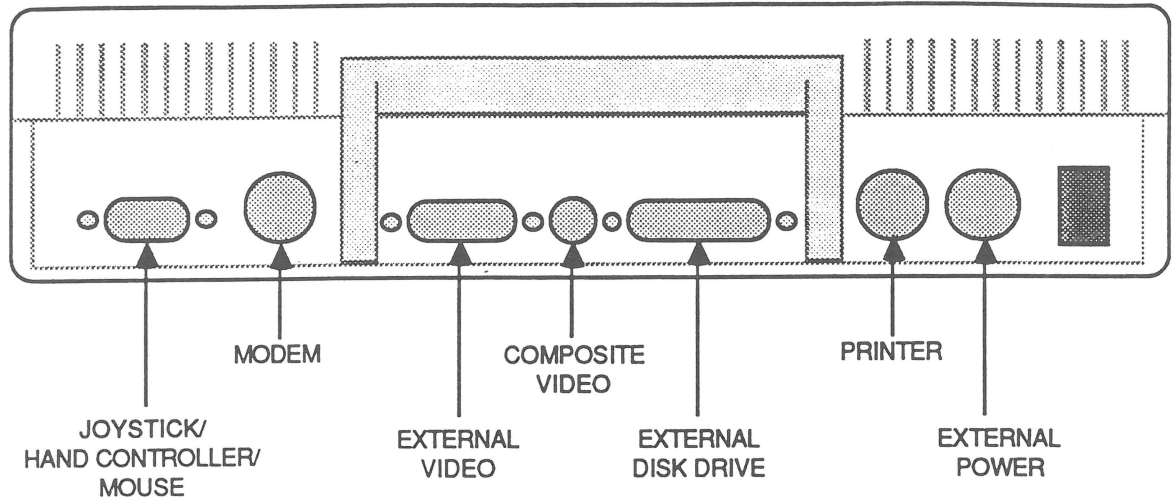

Apple IIc

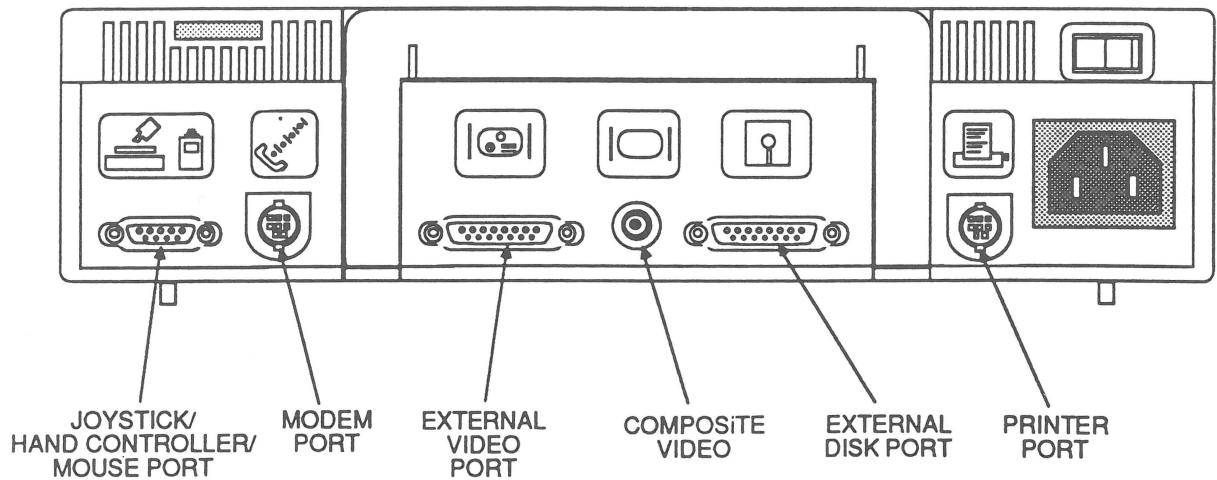

Apple IIc Plus

**Joystick/
Hand Controller/
Mouse Connector**

This port supports the connection of either a joystick, a hand controller, or a mouse.

**Mouse Connector
Signals**

The following table shows the signals when a mouse is in use.

<u>Pin No.</u>	<u>Signal Name</u>	<u>Signal Description</u>
1	MOUSEID/	Mouse identifier. When active, disables hand controller timer.
2	+5V	+5 volts, 100-ma maximum current drain.
3	GND	System ground.
4	XDIR	Mouse x-direction indicator.
5	XMOVE	Mouse x-movement interrupt.
6	NC	No connection.
7	MSW/	Mouse button.
8	YDIR	Mouse y-direction indicator.
9	YMOVE	Mouse y-movement interrupt.

Connector Type: DE-9 Male

**Joystick/
Hand Controller
Connector Signals**

The following table shows the signals when either a joystick or hand controller is in use.

<u>Pin No.</u>	<u>Signal Name</u>	<u>Signal Description</u>
1	GAMESW1	Switch input 1.
2	+5V	+5 volts, 100-ma maximum current drain.
3	GND	System ground.
4	NC	No connection.
5	PDL0	Hand controller input. Connected through a 150K-ohm variable resistor to +5V.
6	NC	No connection.
7	GAMESW0	Switch input 0.
8	PDL1	See Switch 5.
9	NC	No connection.

Connector Type: DE-9 Male

**Modem and
Printer Connectors
Apple IIc Only**

The Apple IIc uses 5-pin DIN connectors for the serial interfaces.

<u>Pin No.</u>	<u>Signal Name</u>	<u>Signal Description</u>
1	DTR	Data Terminal Ready
2	TD	Transmit Data
3	GND	Signal Ground
4	RD	Receive Data
5	DSR	Data Set Ready

Connector Type: 5-Pin Male DIN

PRINTER port (slot 1) defaults to: 9600 baud, 8 bits, no parity, 2 stop bits, 80 characters per line, LF after CR, hardware handshake.

MODEM port (slot 2) defaults to: 300 baud. DTR is an output. DSR is an input.

**Modem and
Printer Connectors
Apple IIc Plus Only**

The Apple IIc Plus uses Mini DIN-8 connectors for the serial interfaces.

<u>Pin No.</u>	<u>Signal Name</u>	<u>Signal Description</u>
1	HSKo	Handshake out
2	HSKi	Handshake in
3	TXD-	Transmit Data -
4	GND	Signal ground
5	RXD-	Receive Data
6	TXD+	Transmit Data +
7	NC	No connection
8	RXD+	Receive Data +

Connector Type: Mini DIN-8

PRINTER port (slot 1) defaults to: 9600 baud, 8 bits, no parity, 2 stop bits, 80 characters per line, LF after CR, hardware handshake.

MODEM port (slot 2) defaults to: 300 baud. DTR is an output. DSR is an input.

To connect DE-9 cables to the Mini DIN-8 port, use adapter cable 590-0341 (beige) or 590-0553/699-0430 (smoke).

Video Expansion Connector

The video expansion connector is used for connecting an RGB monitor, RF modulator, or Flat Panel Display.

<u>Pin No.</u>	<u>Signal Name</u>	<u>Signal Description</u>
1	VIDEO	Text signal from GLU.
2	14M	14-MHz timing signal from the system oscillator.
3	SYNC/	Display sync signal from IOU pin 39.
4	SEGB	Displays vertical counter bit from IOU pin 4.
5	1VSOUND	One-volt sound signal from AUD pin 5.
6	LDPS/	Video shift register load enable from TMG pin 12.
7	WNDW/	Active area display blanking.
8	+12V	+12 volts, 300-ma maximum.
9	PRAS/	RAM row-address strobe from TMG pin 19.
10	GR	Graphics-mode enable from IOU pin 2.
11	SEROUT/	Serialized character generator output from 74LS166 (UE6) pin 1.
12	NTSC	Composite NTSC video signal from VID.
13	GND	Signal ground.
14	VIDD7	Causes half-dot shift if high.
15	CREF	3.58-MHz color reference from TMG pin 3.

Connector Type: DA-15 Male

CAUTION: *The signals on this connector are not the same as on the DA-15 of the Apple IIGS, III and III Plus, Macintosh II Video Card, or EtherTalk Interface Card. DO NOT connect an Apple IIGS, III, III Plus, Macintosh II Video Card, or EtherTalk Interface Card device or cable to the Apple IIc.*

Composite Video Connector

<u>Pin No.</u>	<u>Signal Description</u>	<u>Pin No.</u>	<u>Signal Description</u>
(Sleeve)	System common ground	(Tip)	NTSC composite video

Connector Type: RCA Phono Plug

External Disk Drive Connector

<u>Pin No.</u>	<u>Signal Name</u>	<u>Signal Description</u>
1	GND	Ground reference
2	GND	Ground reference
3	GND	Ground reference
4	GND	Ground reference
5	-12V	-12 volts
6	+5V	+5 volts
7	+12V	+12 volts
8	+12V	+12 volts
9	EXTINT/	External interrupt
10	WRPROT	Write-protect input
11	PH0	Motor phase 0 output
12	PH1	See Pin 11
13	PH2	See Pin 11
14	PH3	See Pin 11
15	WRREQ/	Write request
16	NC	No connection
17	DR1/	Drive 1 select
18	RDDATA	Read data input
19	WRDATA	Write data input

Connector Type: DB-19 Male

The Disk IIc, Apple 5.25 Drive, UniDisk 5.25, DuoDisk, Apple 3.5 Drive, or UniDisk 3.5 may be connected to this port.

**External Power Connector
Apple IIc Only**

The external power connector is used to connect an external power supply to the Apple IIc. The Apple IIc Plus does not require an external power supply.

<u>Pin No.</u>	<u>Signal Name</u>	<u>Signal Description</u>
1	NC	No connection
2	GND	Signal ground
3	GND	Signal ground
4	SGND	Shield ground
5	+15V	+15 volts DC
6	+15V	+15 volts DC
7	NC	No connection

Connector Type: 7-Pin Male DIN

**Audio Connector
Apple IIc Only**

This connector (not shown in the illustration) is located on the left side of the case near the keyboard. It is not present on the Apple IIc Plus. Connecting to this connector disables the internal speaker.

<u>Pin No.</u>	<u>Signal Name</u>	<u>Signal Description</u>
(Tip)	AUDIO	Audio signal
(Sleeve)	GROUND	System electrical ground

Connector Type: Miniature phono plug

□ APPLE III AND III PLUS

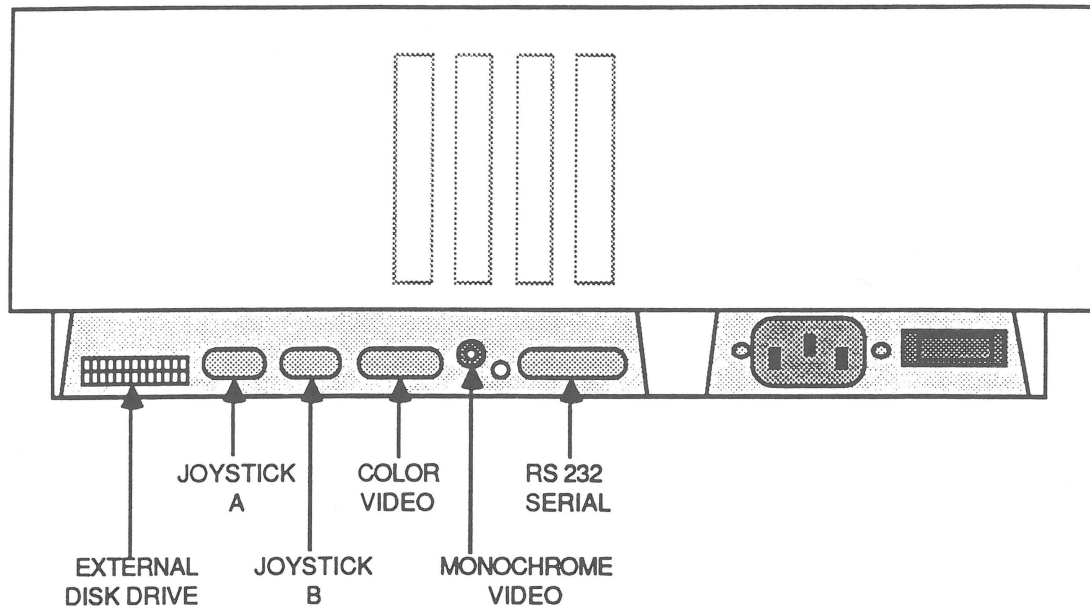

Audio Connector

<u>Pin No.</u>	<u>Signal Name</u>	<u>Signal Description</u>
(Sleeve)	GND	Signal ground.
(Tip)	AUDIO	.5-volt peak-to-peak audio signal.

Connector Type: Miniature Phono Plug

The internal speaker is disabled when this connector is in use.

Monochrome Video Connector

<u>Pin No.</u>	<u>Signal Name</u>	<u>Signal Description</u>
(Sleeve)	GND	Signal ground
(Tip)	BWVID	Monochrome video signal

Connector Type: RCA Phono Plug

**External Disk
Drive Connector**

<u>Pin No.</u>	<u>Signal Name</u>	<u>Signal Description</u>
1	SGND	Shield ground
2	DPH0	Motor phase 0
3	GND	Signal ground
4	DPH1	Motor phase 1
5	GND	Signal ground
6	DPH2	Motor phase 2
7	GND	Signal ground
8	DPH3	Motor phase 3
9	-12F	-12 volts
10	WRREQ	Write request
11	+5F	+5 volts
12	+5F	+5 volts
13	+12F	+12 volts
14	ENBL1E/	Drive select 1
15	+12F	+12 volts
16	RDDATA	Read data
17	+12F	+12 volts
18	WRDATA	Write data
19	+12F	+12 volts
20	WRPROT	Write protect
21	ENBL3E/	Drive select 3
22	ENBL2E/	Drive select 2
23	AII/	Apple II emulation mode active
24	SIDE2/1	Side select
25	NC	No connection
26	EXT/	External drive

Connector Type: 26-pin Male socket

**Joystick A
Connector**

<u>Pin No.</u>	<u>Signal Name</u>	<u>Signal Description</u>
1	GND	Shield ground.
2	+5V	+5 volts.
3	GND	Power and signal ground.
4	JS1-X	Horizontal analog input, read by PDL(2); in Emulation mode, equivalent to Apple II Paddle 0 (GC0) input, read by PDL(0).
5	JS1-B	Joystick switch input, read by button (2); in Emulation mode, equivalent to Apple II Paddle 0 button (PB1) input, read by PEEK(-16287).
6	+12V	+12 volts.
7	GND	Power and signal ground.
8	JS1-Y	Vertical analog input, read by PDL(3); in Emulation mode, equivalent to Apple II Paddle 2 (GC2) input, read by PDL(2).
9	JS1-SW	Joystick switch input, read by button (3); in Emulation mode, equivalent to Apple II Paddle 2 button (PB3) input, read by PEEK (-16285).

Connector Type: DE-9 Male

This port also supports the connection of a Silentyte III printer.

Circuitry is provided for two analog devices (potentiometers) and two digital devices (switches). The analog inputs accept input voltage in the range of 0 to 2.2 volts and can sink 3 μ a. The digital inputs are TTL.

**Joystick B
Connector**

<u>Pin No.</u>	<u>Signal Name</u>	<u>Signal Description</u>
1	GND	Shield ground.
2	+5V	+5 volts.
3	GND	Power and signal ground.
4	JS0-X	Horizontal analog input, read by PDL(0); in Emulation mode, equivalent to Apple II Paddle 1 (GC1) input, read by PDL(1).
5	JS0-B	Joystick switch input, read by Button (0); in Emulation mode, equivalent to Apple II Paddle 1 button (PB2) input, read by PEEK(-16286).
6	+12V	+12 volts.
7	GND	Power and signal ground.
8	JS0-Y	Vertical analog input, read by PDL(1); in Emulation mode, equivalent to Apple II Paddle 3 (GC3) input, read by PDL(3).
9	JS0-SW	Joystick switch input, read by Button (1); not used in Emulation mode.

Connector Type: DE-9 Male

Circuitry is provided for two analog devices (potentiometers) and two digital devices (switches). The analog inputs accept input voltage in the range of 0 to 2.2 volts and can sink 3 μ a. The digital inputs are TTL.

Color Video Connector

<u>Pin No.</u>	<u>Signal Name</u>	<u>Signal Description</u>
1	SG	Shield ground.
2	XRGB4	This is a TTL output with instantaneous color information. A linear-weighted sum of these four signals will form a true 16-color RGB video signal.
3	SYNCH	Composite sync signal (negative-going).
4	PDI	Not used.
5	XRGB1	See Pin 2.
6	GND	Power and signal ground.
7	-5V	-5 volts, 200-ma maximum current drain.
8	+12V	+12 volts, 500-ma maximum current drain.
9	XRGB2	See Pin 2.
10	XRGB8	See Pin 2.
11	BWVID	Black and white composite video. NTSC-compatible signal with negative-going sync. 1 volt peak-to-peak into a 75-ohm load.
12	NTSC	Color composite video. NTSC-compatible signal with negative-going sync. 1 volt peak-to-peak into a 75-ohm load.
13	GND	Power and signal ground.
14	-12V	-12 volts, 200-ma maximum current drain.
15	+5V	+5 volts, 1 amp maximum current drain.

Connector Type: DA-15 Male

This port supports the connection of any NTSC-compatible color or monochrome monitor. Additional circuitry is required to support an RGB monitor. Current ratings are with no peripheral cards installed.

CAUTION: *The signals on this connector are not the same as on the DA-15 of the Apple IIc, IIgs, Macintosh II Video Cards, or EtherTalk Interface Card. DO NOT connect an Apple IIc, IIgs, Macintosh II Video Cards, or EtherTalk Interface Card device or cable to the Apple III or III Plus.*

**RS-232-C
Serial Connector**

<u>Pin No.</u>	<u>Signal Name</u>	<u>Signal Description</u>
1	SGND	Shield ground
2	TXD	Transmit Data
3	RCD	Receive Data
4	RTS	Request To Send
5	CTS	Clear To Send
6	DSR	Data Set Ready
7	GND	Signal ground
8	DCD	Data Carrier Detect
9-19	NC	No connection
20	DTR	Data Terminal Ready
21-25	NC	No connection

Connector Type: DB-25 Male

□ MACINTOSH 128K, 512K, 512K ENHANCED

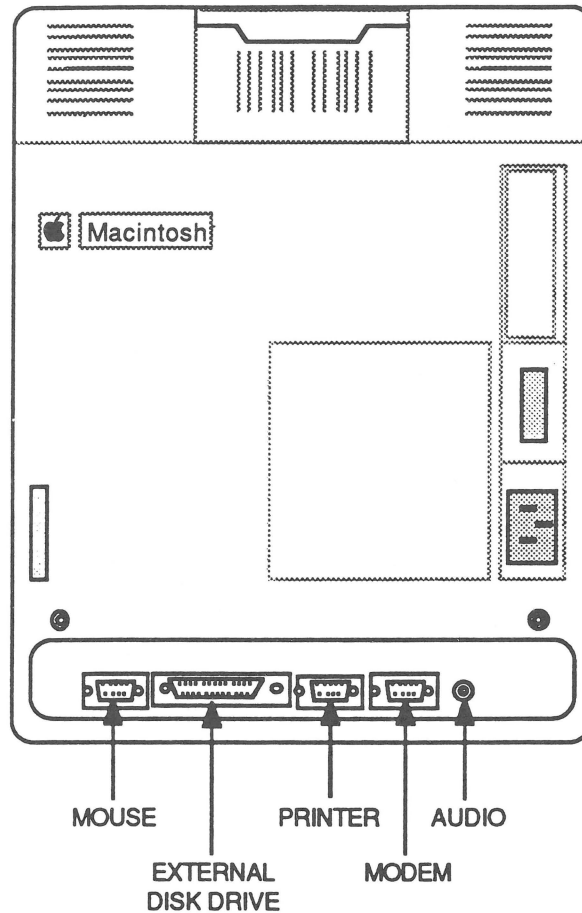

Mouse Connector

<u>Pin No.</u>	<u>Signal Name</u>	<u>Signal Description</u>
1	GND	Signal ground
2	+5V	+5 volts
3	GND	Signal ground
4	X2	Left-to-right motion indicator
5	X1	Interrupt line (left-to-right motion)
6	NC	No connection
7	SW	Mouse button
8	Y2	Up-down motion indicator
9	Y1	Interrupt line (up-down motion)

Connector Type: DE-9 Male

**External Disk
Drive Connector**

<u>Pin No.</u>	<u>Signal Name</u>	<u>Signal Description</u>
1	GND	Signal ground
2	GND	Signal ground
3	GND	Signal ground
4	GND	Signal ground
5	-12V	-12 volts DC
6	+5V	+5 volts DC
7	+12V	+12 volts DC
8	+12V	+12 volts DC
9	NC	No connection
10	PWM	Motor speed control
11	PH0	Command control line
12	PH1	Command control line
13	PH2	Command control line
14	PH3	Command control line
15	WRREQ/	Write request
16	HDSEL	Head select
17	ENBL2/	Read line enable
18	RD	Read data
19	WR	Write data

Connector Type: DB-19 Male

A **Macintosh 400K External Drive** can be connected to the **Macintosh 128K or 512K**.

A **Macintosh 400K or 800K External Drive** or an **Apple 3.5 Drive** can be connected to the **Macintosh 512K Enhanced**.

**Modem and
Printer Connectors**

	<u>Pin No.</u>	<u>Signal Name</u>	<u>Signal Description</u>
<i>Signal Name</i> <i>RS-422</i>	1	GND	Signal Ground
	2	+5V	+5 volts
	3	GND	Signal Ground
	4	TXD+	Transmit Data +
	5	TXD-	Transmit Data -
	6	+12V	+12 volts
	7	HSKi	Handshake Input
	8	RXD+	Receive Data +
	9	RXD-	Receive Data -

Signal Name
RS-232

1	FG	Frame Ground
2	NC	No connection
3	SG	Signal Ground
4	NC	No connection
5	TXD	Transmit Data
6	NC	No connection
7	DSR	Data Set Ready
8	NC	No connection
9	RXD	Receive Data

Connector Type: DE-9 Male

Audio Connector

	<u>Pin No.</u>	<u>Signal Name</u>	<u>Signal Description</u>
(Sleeve)		GND	Signal ground
(Tip)		AUDIO	.5-volt peak-to-peak audio signal

Connector Type: Miniature Phono Plug

The internal speaker is disabled when this connector is in use.

□ MACINTOSH PLUS

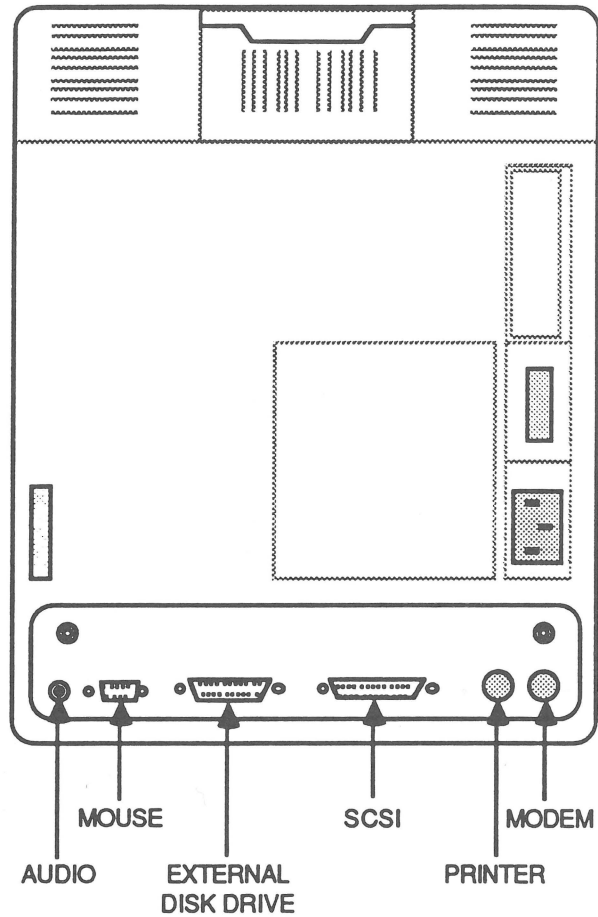

Audio Connector

<u>Pin No.</u>	<u>Signal Name</u>	<u>Signal Description</u>
(Sleeve)	GND	Signal ground.
(Tip)	AUDIO	.5-volt peak-to-peak audio signal.

Connector Type: Miniature Phono Plug

The internal speaker is disabled when this connector is in use.

Mouse Connector

<u>Pin No.</u>	<u>Signal Name</u>	<u>Signal Description</u>
1	GND	Signal ground
2	+5V	+5 volts DC
3	GND	Signal ground
4	X2	Left-to-right motion indicator
5	X1	Interrupt line (left-to-right motion)
6	NC	No connection
7	SW	Mouse switch
8	Y2	Up-down motion indicator
9	Y1	Interrupt line (up-down motion)

Connector Type: DE-9 Male

External Disk Drive Connector

<u>Pin No.</u>	<u>Signal Name</u>	<u>Signal Description</u>
1	GND	Signal ground
2	GND	Signal ground
3	GND	Signal ground
4	GND	Signal ground
5	-12V	-12 volts DC
6	+5V	+5 volts DC
7	+12V	+12 volts DC
8	+12V	+12 volts DC
9	NC	No connection
10	PWM	Motor speed control
11	PH0	Command control line
12	PH1	Command control line
13	PH2	Command control line
14	PH3	Command control line
15	WRREQ/	Write request
16	HDSEL	Head select
17	ENBL2/	Read line enable
18	RD	Read Data
19	WR	Write Data

Connector Type: DB-19 Male

A Macintosh 400K or 800K External Drive or an Apple 3.5 Drive can be connected to the Macintosh Plus.

SCSI Connector

<u>Pin No.</u>	<u>Signal Name</u>	<u>Signal Description</u>
1	REQ/	Request
2	MSG/	Message
3	I/O/	Input/output
4	RST/	Reset
5	ACK/	Acknowledge
6	BSY/	Busy
7	GND	Signal ground
8	DB0/	Data bit 0
9	GND	Signal ground
10	DB3/	Data bit 3
11	DB5/	Data bit 5
12	DB6/	Data bit 6
13	DB7/	Data bit 7
14	GND	Signal ground
15	C/D/	Control/data
16	GND	Signal ground
17	ATN/	Attention
18	GND	Signal ground
19	SEL/	Select
20	DBP/	Data parity
21	DB1/	Data bit 1
22	DB2/	Data bit 2
23	DB4/	Data bit 4
24	GND	Signal ground
25	NC	No connection

Connector Type: DB-25 Male

Total length of all cables should not exceed 20 feet (6 meters).

CAUTION: *This interface uses the same type of connector as a standard RS-232 serial interface, but is electrically very different. DO NOT connect any RS-232 device or cable to this connector. Doing so can result in damage to both the device and the Macintosh Plus.*

**Modem and
Printer Connectors**

<u>Pin No.</u>	<u>Signal Name</u>	<u>Signal Description</u>
1	HSKo	Handshake out
2	HSKi	Handshake in
3	TXD-	Transmit Data -
4	GND	Signal ground
5	RXD-	Receive Data
6	TXD+	Transmit Data +
7	NC	No connection
8	RXD+	Receive Data +

Connector Type: Mini DIN-8

To connect DE-9 cables to the Mini DIN-8 port, use adapter cable 590-0341 (beige) or 590-0553/699-0430 (smoke).

□ MACINTOSH SE AND SE/30

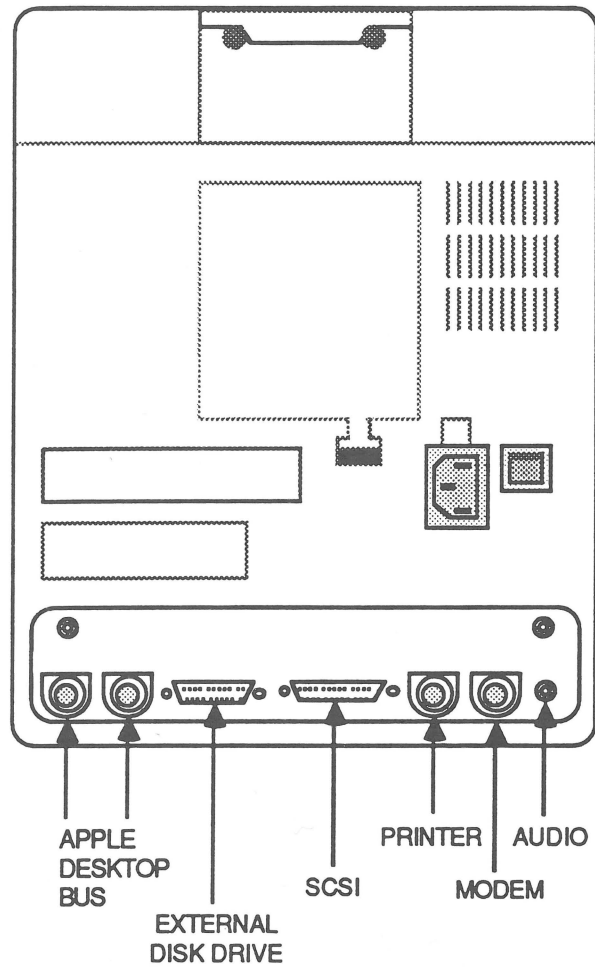

Apple DeskTop Bus Connector

<u>Pin No.</u>	<u>Signal Description</u>	<u>Pin No.</u>	<u>Signal Description</u>
1	Data	3	Power (+5v)
2	Reserved	4	Ground

Connector Type: Mini DIN-4 Male

Total length of all cables should not exceed 16 feet (5 meters)

**External Disk
Drive Connector**

<u>Pin No.</u>	<u>Signal Name</u>	<u>Signal Description</u>
1	GND	Signal ground
2	GND	Signal ground
3	GND	Signal ground
4	GND	Signal ground
5	-12v	-12 volts DC
6	+5v	+5 volts DC
7	+12v	+12 volts DC
8	+12v	+12 volts DC
9	NC	No connection
10	PWM	Motor speed control
11	PH0	Command control line
12	PH1	Command control line
13	PH2	Command control line
14	PH3	Command control line
15	WRREQ/	Write request
16	HDSEL	Head select
17	ENBL2/	Read line enable
18	RD	Read Data
19	WR	Write Data

Connector Type: DB-19 Male

A Macintosh 800K External Drive or an Apple 3.5 Drive can be connected to the Macintosh SE or SE/30.

SCSI Connector

<u>Pin No.</u>	<u>Signal Name</u>	<u>Signal Description</u>
1	REQ/	Request
2	MSG/	Message
3	I/O/	Input/output
4	RST/	Reset
5	ACK/	Acknowledge
6	BSY/	Busy
7	GND	Signal ground
8	DB0/	Data bit 0
9	GND	Signal ground
10	DB3/	Data bit 3
11	DB5/	Data bit 5
12	DB6/	Data bit 6
13	DB7/	Data bit 7
14	GND	Signal ground
15	C/D/	Control/data
16	GND	Signal ground
17	ATN/	Attention
18	GND	Signal ground
19	SEL/	Select
20	DBP/	Data parity
21	DB1/	Data bit 1
22	DB2/	Data bit 2
23	DB4/	Data bit 4
24	GND	Signal ground
25	NC	No connection

Connector Type: DB-25 Male

Total length of all cables should not exceed 20 feet (6 meters).

CAUTION: *This interface uses the same type of connector as a standard RS-232 serial interface, but is electrically very different. DO NOT connect any RS-232 device or cable to this connector. Doing so can result in damage to both the device and the Macintosh SE or SE/30.*

**Modem and
Printer Connectors**

<u>Pin No.</u>	<u>Signal Name</u>	<u>Signal Description</u>
1	HSKo	Handshake out
2	HSKi	Handshake in
3	TXD-	Transmit Data -
4	GND	Signal ground
5	RXD-	Receive Data
6	TXD+	Transmit Data +
7	NC	No connection
8	RXD+	Receive Data +

Connector Type: Mini DIN-8

To connect DE-9 cables to the Mini DIN-8 port, use adapter cable 590-0341 (beige) or 590-0553/699-0430 (smoke).

Audio Connector

<u>Pin No.</u>	<u>Signal Name</u>	<u>Signal Description</u>
(Sleeve)	GND	Signal ground
(Tip)	AUDIO	.5-volt peak-to-peak audio signal

Connector Type: Miniature Phone Plug

The internal speaker is disabled when this port is in use.

□ MACINTOSH II, IIx, IIcx

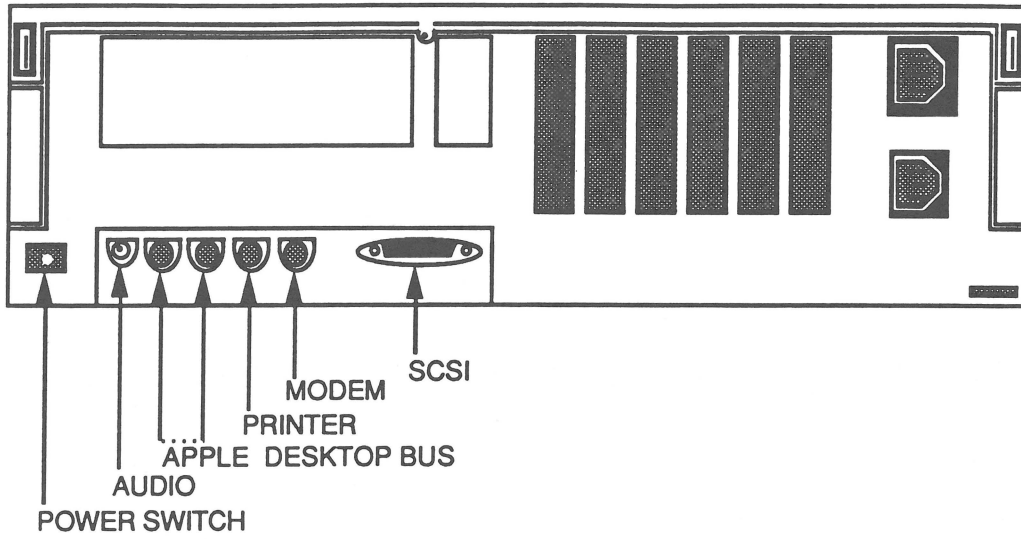

Macintosh II and IIx

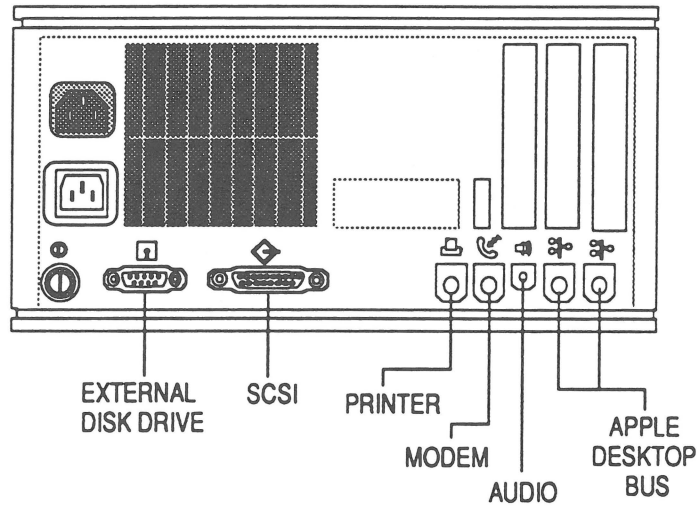

Macintosh IIcx

Audio Connector

<u>Pin No.</u>	<u>Signal Name</u>	<u>Signal Description</u>
(Sleeve) (Tip)	GND AUDIO	Signal ground. 1-volt peak-to-peak stereo audio signal with an impedance of 47 ohms.

Connector Type: Miniature Stereo Phono Plug

The internal speaker is disabled when this connector is in use.

**Apple DeskTop
Bus Connector**

<u>Pin No.</u>	<u>Signal Name</u>	<u>Signal Description</u>
1	Data	Bidirectional data bus Signal is momentarily grounded to pin 4 to begin power-up sequence in CPU.
2	Power On/	
3	Power	+5 volts
4	Ground	Signal Ground

Connector Type: Mini DIN-4 Male

Total length of all cables should not exceed 16 feet (5 meters).

**Modem and
Printer Connectors**

<u>Pin No.</u>	<u>Signal Name</u>	<u>Signal Description</u>
1	HSKo	Handshake output. Connected to SCC Data Terminal Ready.
2	KSKi	Handshake input. Connected to SCC Clear To Send and Transmit/Receive Clock.
3	TxD-	Transmit Data (inverted). Connected to SCC transmit Data. Tri-stated when Request To Send is deasserted.
4	SG	Signal Ground. Connected to logic and chassis ground.
5	RxD-	Receive Data (inverted). Connected to SCC Receive Data.
6	TxD+	Transmit Data. Connected to SCC Transmit Data. Tri-stated when Request To Send is deasserted.
7	GPI	General-Purpose input. Connected to SCC Data Carrier Detect. (See note.)
8	RxD+	Receive Data. Connected to the SCC Receive Data.

Connector Type: Mini DIN-8

Note: If the VIA1 SYNC signal is high, this input will be routed to the receive/transmit clock. This is true only for the Modem port and is used to support synchronous modems.

To connect DE-9 cables to the Mini DIN-8 port, use adapter cable 590-0341 (beige) or 590-0553/699-0430 (smoke).

SCSI Connector

<u>Pin No.</u>	<u>Signal Name</u>	<u>Signal Description</u>
1	REQ/	Request
2	MSG/	Message
3	I/O/	Input/output
4	RST/	Reset
5	ACK/	Acknowledge
6	BSY/	Busy
7	GND	Signal ground
8	DB0/	Data bit 0
9	GND	Signal ground
10	DB3/	Data bit 3
11	DB5/	Data bit 5
12	DB6/	Data bit 6
13	DB7/	Data bit 7
14	GND	Signal ground
15	C/D/	Control/data
16	GND	Signal ground
17	ATN/	Attention
18	GND	Signal ground
19	SEL/	Select
20	DBP/	Data parity
21	DB1/	Data bit 1
22	DB2/	Data bit 2
23	DB4/	Data bit 4
24	GND	Signal ground
25	TERMPWR	+5 volts

Connector Type: DB-25 Male

Total length of all cables should not exceed 20 feet (6 meters).

CAUTION: *This interface uses the same type of connector as a standard RS-232 serial interface, but is electrically very different. DO NOT connect any RS-232 device or cable to this connector. Doing so can result in damage to both the device and the Macintosh II.*

LISA 2.0 AND LISA 2/5

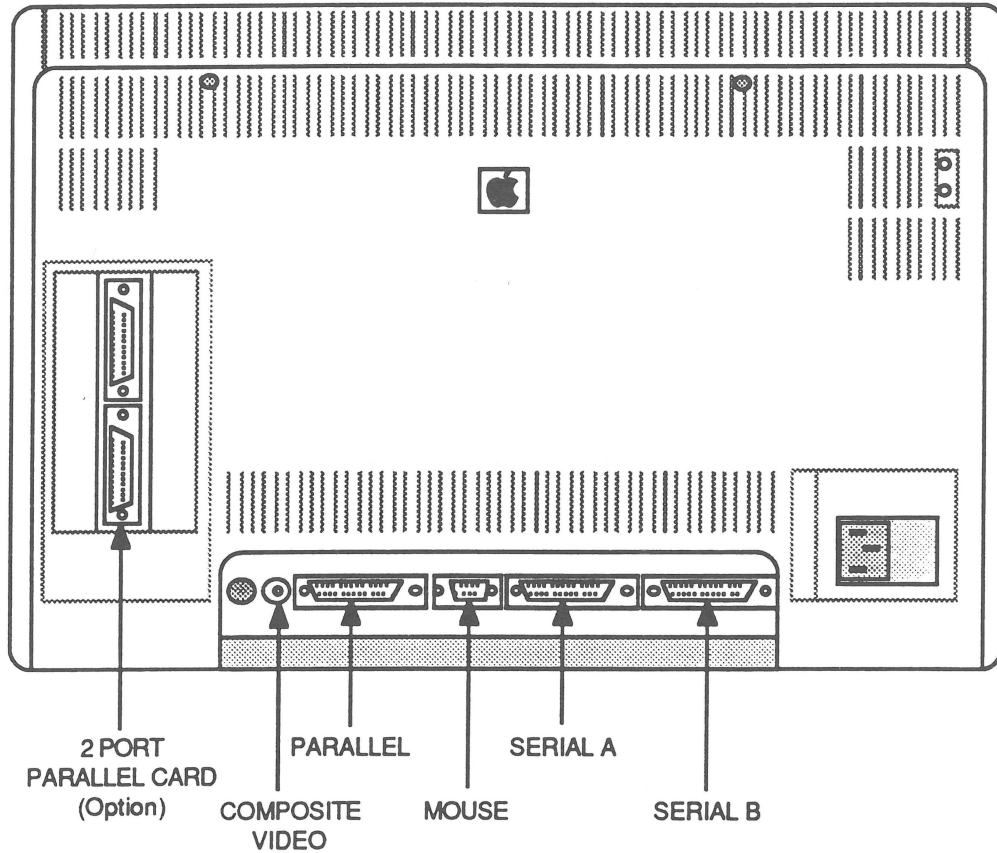

...Continued on next page

LISA 2/10 AND MACINTOSH XL

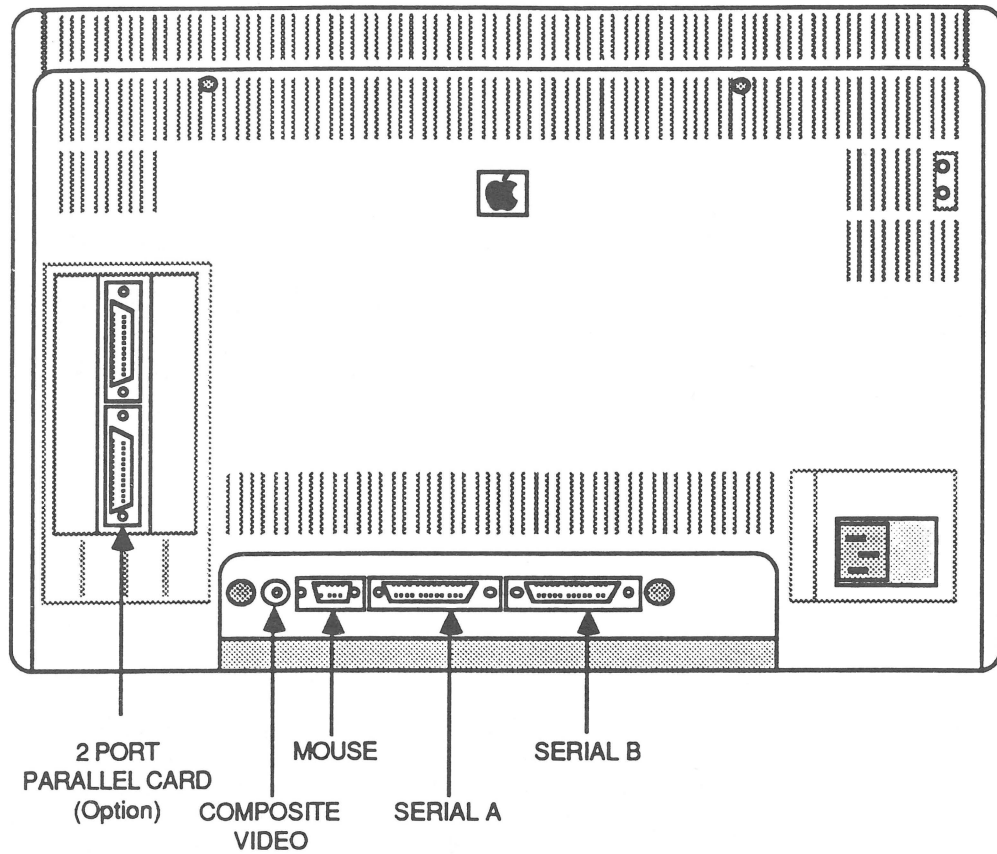

Serial A Connector

<u>Pin No.</u>	<u>Signal Name</u>	<u>Signal Description</u>
2	TXD	Transmit Data
3	RXD	Receive Data
4	RTS	Request To Send
5	CTS	Clear To Send
8	DCD	Data Carrier Detect
15	TXC	Transmit clock input
17	RXC	Receive clock input
20	DTR	Data Terminal Ready
24	TEXT	Transmit clock output

Serial B Connector	<u>Pin No.</u>	<u>Signal Name</u>	<u>Signal Description</u>
	2	TXD	Transmit Data
	3	RXD	Receive Data
	4	RTS	Request To Send
	6	DSR	Data Set Ready
	19	RXD	AppleTalk Receive Data
	20	DTR	Data Terminal Ready

Mouse Connector	<u>Pin No.</u>	<u>Signal Name</u>	<u>Signal Description</u>
	1	Switch 1	Mouse switch
	2	+5V	+5 Volts DC
	3	GND	System electrical ground
	4	LEFT	Mouse movement - left
	5	RIGHT	Mouse movement - right
	6	Switch 2	Connected to CHK on parallel port
	7	Button	Not used
	8	DOWN	Mouse movement - down
	9	UP	Mouse movement - up

Composite Video Connector	<u>Pin No.</u>	<u>Signal Name</u>	<u>Signal Description</u>
	(Tip)	VIDEO	Composite video output
	(Sleeve)	GND	System electrical ground

**Parallel Connector
(Lisa 2.0/2.5 Only)**

<u>Pin No.</u>	<u>Signal Name</u>	<u>Signal Description</u>
1	GND	System electrical ground
2	GND	System electrical ground
3	DRW/	Data direction
4	GND	System electrical ground
5	DD0	Data bit 0 (Bidirectional)
6	DD1	Data bit 1 (Bidirectional)
7	N/C	No connection - blocked
8	DD2	Data bit 2 (Bidirectional)
9	GND	System electrical ground
10	GND	System electrical ground
11	DD5	Data bit 5 (Bidirectional)
12	DD6	Data bit 6 (Bidirectional)
13	DD7	Data bit 7 (Bidirectional)
14	GND	System electrical ground
15	PSTRB/	Strobe (output)
16	BSY	Busy (input)
17	CMD/	Command
18	PARITY/	Parity (Bidirectional)
19	OCD	Device on-line status
20	GND	System electrical ground
21	CRES/	Reset (output)
22	DD3	Data bit 3 (Bidirectional)
23	DD4	Data bit 4 (Bidirectional)
24	GND	System electrical ground
25	CHK	Interrupt (input)

Peripheral Interface Guide

Section 2 – Interface Cards: Pin-outs and Switch Functions

□ CONTENTS

2.2	Introduction
2.3	Apple II, II Plus, IIe, IIGs
2.3	Parallel Printer Interface and Centronics Printer Interface Pin-outs
2.4	Parallel Interface Card Pin-outs
2.4	Parallel Interface Card Switches
2.5	Graphics Tablet Interface – Tablet Pin-outs
2.5	Graphics Tablet Interface – Pen Pin-outs
2.5	Communications Interface Card Pin-outs
2.6	High Speed Serial Interface Card Pin-outs
2.6	High Speed Serial Interface Card Switches
2.7	IEEE-488 Interface Pin-outs
2.7	Super Serial Card Pin-outs
2.8	Super Serial Card Printer Mode Switch SW1
2.8	Super Serial Card Printer Mode Switch SW2
2.9	Super Serial Card Communication Mode Switch SW1
2.9	Super Serial Card Communication Mode Switch SW2
2.10	Apple II SCSI Card
2.11	Apple III and III Plus
2.11	Universal Parallel Interface Card (UPIC) Pin-outs
2.12	Serial Card III Pin-outs
2.13	Lisa/Macintosh XL
2.13	Two-Port Parallel Card Pin-outs
2.14	Macintosh II, IIx, IIcx
2.14	Video and Monochrome Card
2.14	Two-Page Monochrome Video Card
2.15	EtherTalk Interface Card

□ INTRODUCTION

This section contains specifications for Apple interface cards. The information is arranged so that all the interface cards for a particular computer type are grouped together.

Notes:

This section refers to switches as either "ON" (closed) or "OFF" (open).

A slash (/) after the signal name indicates that the signal is valid when the signal is low.

The connector type identified is that required for the mating connector.

□ APPLE II, II PLUS, IIe, IIgs

Parallel Printer Interface and Centronics Printer Interface Pin-outs	Pin No.	Signal Name	Signal Description
	1	GND	System electrical ground
	2	ACK	Acknowledge input
	3	NC	No connection
	4	F	Not used
	5	NC	No connection
	6	NC	No connection
	7	NC	No connection
	8	STROBE	Strobe output
	9	NC	No connection
	10	DP0	Data bit 0
	11	DP1	Data bit 1
	12	DP2	Data bit 2
	13	DP3	Data bit 3
	14	DP4	Data bit 4
	15	DP5	Data bit 5
	16	DP6	Data bit 6
	17	DP7	Data bit 7
	18	NC	No connection
	19	NC	No connection
	20	GND	System electrical ground

Connector Type: Underterminated 20-pin flat cable

Parallel interface has the P1 (341-0005) PROM that provides a linefeed after carriage return. The jumper block is not wired.

Centronics interface has the P9 (341-0019) PROM that does not provide a linefeed after carriage return. The jumper block is prewired for negative strobe and positive acknowledge.

**Parallel Interface
Card Pin-outs**

<u>Pin No.</u>	<u>Signal Name</u>	<u>Signal Description</u>
1	DI0	Data In, bit 0
2	GND	Signal ground
3	DI2	Data In, bit 2
4	GND	Signal ground
5	DO0	Data Out, bit 0
6	DO1	Data Out, bit 1
7	NC	No connection - blocked
8	DO2	Data Out, bit 2
9	NC	No connection
10	NC	No connection
11	DO5	Data Out, bit 5
12	DO6	Data Out, bit 6
13	DO7	Data Out, bit 7
14	DI4	Data In, bit 4
15	STROBE	Strobe output
16	ACK	Acknowledge input
17	DI1	Data In, bit 1
18	DI7	Data In, bit 7
19	DI5	Data In, bit 5
20	GND	Signal ground
21	DI6	Data In, bit 6
22	DO3	Data Out, bit 3
23	DO4	Data Out, bit 4
24	GND	Signal ground
25	DI3	Data In, bit 3

Connector Type: DB-25 Male

**Parallel Interface
Card Switches**

	1	2	3	4	5	6	7
STROBE LENGTH							
1 microsecond	OFF	OFF	OFF				
3 microseconds	ON	OFF	OFF				
5 microseconds	OFF	ON	OFF				
7 microseconds	ON	ON	OFF				
9 microseconds	OFF	OFF	ON				
11 microseconds	ON	OFF	ON				
13 microseconds	OFF	ON	ON				
15 microseconds	ON	ON	ON				
STROBE POLARITY							
Positive					OFF		
Negative					ON		
ACKNOWLEDGE POLARITY							
Positive					OFF		
Negative					ON		
FIRMWARE SELECT							
Parallel Printer (No LF)						OFF	
Centronics						ON	
INTERRUPTS							
Disabled							OFF
Enabled							ON

**Graphics Tablet
Interface – Tablet
Pin-outs**

<u>Pin No.</u>	<u>Signal Name</u>	<u>Signal Description</u>
1	YDRIVE	Y-axis input
2	XDRIVE	X-axis input
3	NC	No connection
4	RESET	Reset signal
5	GND	System electrical ground
6	-12V	-12 volts DC

**Graphics Tablet
Interface – Pen
Pin-outs**

<u>Pin No.</u>	<u>Signal Name</u>	<u>Signal Description</u>
1	NC	No connection
2	GND	System electrical ground
3	PEN	Pen coil
4	PEN	Pen coil

**Communications
Interface Card
Pin-outs**

<u>Pin No.</u>	<u>Signal Name</u>	<u>Signal Description</u>
2	TXD	Transmit Data
3	RXD	Receive Data
4	RTS	Request To Send (jumpered to pin 8)
6	DSR	Data Set Ready (jumpered to pin 20)
7	SG	Signal Ground
8	DCD	Data Carrier Detect (jumpered to pin 4)
20	DTR	Data Terminal Ready (jumpered to pin 6)

Connector Type: DB-25 Male

The Communications Interface Card should be used only with low-speed devices (300 baud or below). No handshaking is available.

**High Speed Serial
Interface Card
Pin-outs**

<u>Pin No.</u>	<u>Signal Name</u>	<u>Signal Description</u>
2	RXD	Receive Data
3	TXD	Transmit Data
4	RTS	Request To Send (jumpered to pin 5)
5	CTS	Clear To Send (jumpered to pin 4)
6	DSR	Data Set Ready (jumpered to pins 8 & 20)
7	GND	Signal ground
8	DCD	Data Carrier Detect (jumpered to pins 6 & 20)
20	DTR	Data Terminal Ready (jumpered to pins 6 & 8)

Connector Type: DB-25 Male

1. This card should be used only with low-speed devices (300 baud or below).
2. PROM P8A should be used with Qume-compatible printers. When using this PROM, the function of Switch 4 is different and the switch must be OFF.

**High Speed Serial
Interface Card
Switches**

	<u>1</u>	<u>2</u>	<u>3</u>	<u>4</u>	<u>5</u>	<u>6</u>	<u>7</u>
BAUD RATE							
110	ON	ON	ON				
134.5	OFF	ON	ON				
300	ON	OFF	ON				
1200	OFF	OFF	ON				
2400	ON	ON	OFF				
4800	OFF	ON	OFF				
9600	ON	OFF	OFF				
19200	OFF	OFF	OFF				
CARRIAGE RETURN DELAY							
Disabled					ON		
1/4 Second Delay					OFF		
LINE WIDTH VIDEO							
40 Columns/Video On					ON	ON	
72 Columns/Video Off					OFF	ON	
80 Columns/Video Off					ON	OFF	
132 Columns/Video Off					OFF	OFF	
AUTO LF ON CR							
Disabled							ON
Enabled							OFF

**IEEE-488
Interface
Pin-outs**

<u>Pin No.</u>	<u>Signal Name</u>	<u>Signal Description</u>
1	DIO1	Data Input/Output, bit 1
2	DIO2	Data Input/Output, bit 2
3	DIO3	Data Input/Output, bit 3
4	DIO4	Data Input/Output, bit 4
5	EOI	End Or Identify
6	DAV	Data Valid
7	NRFD	Not Ready For Data
8	NDAC	Not Data Accepted
9	IFC	Interface Clear
10	SRQ	Service Request
11	ATN	Attention
12	SHIELD	Earth ground
13	DIO5	Data Input/Output, bit 5
14	DIO6	Data Input/Output, bit 6
15	DIO7	Data Input/Output, bit 7
16	DIO8	Data Input/Output, bit 8
17	REN	Remote Enable
18	GND	Logic ground
19	GND	Logic ground
20	GND	Logic ground
21	GND	Logic ground
22	GND	Logic ground
23	GND	Logic ground
24	GND	Logic ground

**Super Serial Card
Pin-outs**

<u>Pin No.</u>	<u>Signal Name</u>	<u>Signal Description</u>
1	FG	Frame Ground
2	TXD	Transmit Data
3	RXD	Receive Data
4	RTS	Request To Send
5	CTS	Clear To Send
6	DSR	Data Set Ready
7	SG	Signal Ground
8	DCD	Data Carrier Detect
9-18	NC	No connection
19	SCTS	Secondary Clear To Send
20	DTR	Data Terminal Ready
21-25	NC	No connection

Connector Type: DB-25 Male

When the jumper block is installed with the arrow pointing toward MODEM, the signals are as listed above. When the jumper block is pointing toward TERMINAL, the signals are the same as the signals produced when using a modem eliminator.

**Super Serial Card
Printer Mode
Switch SW1**

	1	2	3	4	5	6	7
BAUD RATE							
50	ON	ON	ON	OFF			
75	ON	ON	OFF	ON			
110	ON	ON	OFF	OFF			
135	ON	OFF	ON	ON			
150	ON	OFF	ON	OFF			
300	ON	OFF	OFF	ON			
600	ON	OFF	OFF	OFF			
1200	OFF	ON	ON	ON			
1800	OFF	ON	ON	OFF			
2400	OFF	ON	OFF	ON			
3600	OFF	ON	OFF	OFF			
4800	OFF	OFF	ON	ON			
7200	OFF	OFF	ON	OFF			
9600	OFF	OFF	OFF	ON			
19200	OFF	OFF	OFF	OFF			
MODE SELECT							
Printer						OFF	ON
SIC P8 Emulation						ON	OFF
SIC P8A Emulation						OFF	OFF
HANDSHAKING *							
Clear To Send (Pin 5)							ON
Secondary Clear To Send (Pin 19)							OFF

* Used with Switch 2, position 7.

**Super Serial Card
Printer Mode
Switch SW2**

	1	2	3	4	5	6	7
STOP BITS							
1	ON						
2	OFF						
DELAY AFTER CR							
32 ms.		ON					
Disabled		OFF					
LINE WIDTH/VIDEO							
40 Columns/Video On			ON	ON			
72 Columns/Video Off			ON	OFF			
80 Columns/Video Off			OFF	ON			
132 Columns/Video Off			OFF	OFF			
AUTO LF ON CR							
Enabled					ON		
Disabled					OFF		
INTERRUPTS							
Enabled						ON	
Disabled						OFF	
HANDSHAKING *							
Clear To Send (Pin 5)							OFF
Secondary Clear To Send (Pin 19)							ON

* Used with Switch 1, position 7.

**Super Serial Card
Communication
Mode
Switch SW1**

	1	2	3	4	5	6	7
BAUD RATE							
50	ON	ON	ON	OFF			
75	ON	ON	OFF	ON			
110	ON	ON	OFF	OFF			
135	ON	OFF	ON	ON			
150	ON	OFF	ON	OFF			
300	ON	OFF	OFF	ON			
600	ON	OFF	OFF	OFF			
1200	OFF	ON	ON	ON			
1800	OFF	ON	ON	OFF			
2400	OFF	ON	OFF	ON			
3600	OFF	ON	OFF	OFF			
4800	OFF	OFF	ON	ON			
7200	OFF	OFF	ON	OFF			
9600	OFF	OFF	OFF	ON			
19200	OFF	OFF	OFF	OFF			
MODE SELECT							
Communication						ON	ON
HANDSHAKING *							
Clear To Send							ON

* Used with Switch 2, position 7.

**Super Serial Card
Communication
Mode
Switch SW2**

	1	2	3	4	5	6	7
STOP BITS							
1	ON						
2	OFF						
DATA BITS							
8		ON					
7		OFF					
PARITY							
None			ON	ON			
Odd			ON	OFF			
Even			OFF	OFF			
AUTO LF ON CR							
Enabled					ON		
Disabled					OFF		
INTERRUPTS							
Enabled						ON	
Disabled						OFF	
HANDSHAKING *							
Clear To Send							OFF

Used with Switch 1, position 7.

Apple II SCSI Card

<u>Pin No.</u>	<u>Signal Name</u>	<u>Signal Description</u>
1	REQ/	Request
2	MSG/	Message
3	I/O/	Input/Output
4	RST/	Reset
5	ACK/	Acknowledge
6	BSY/	Busy
7	GND	Signal ground
8	DB0/	Data Bit 0
9	GND	Signal ground
10	DB3/	Data Bit 3
11	DB5/	Data Bit 5
12	DB6/	Data Bit 6
13	DB7/	Data Bit 7
14	GND	Signal ground
15	C/D/	Control/Data
16	GND	Signal ground
17	ATN/	Attention
18	GND	Signal ground
19	SEL/	Select
20	DBP/	Data Parity
21	DB1/	Data Bit 1
22	DB2/	Data Bit 2
23	DB4/	Data Bit 4
24	GND	Signal ground
25	NC	No connection

Connector Type: DB-25 Male

Not compatible with the original Apple II.

CAUTION: *This interface uses the same type of connector as a standard RS-232 serial interface, but it is electrically very different. DO NOT connect any RS-232 device or cable to this connector. Doing so can result in damage to both the device and the computer.*

□ APPLE III AND III PLUS

Universal Parallel Interface Card (UPIC) Pin-outs

<u>Pin No.</u>	<u>Signal Name</u>	<u>Signal Description</u>
1	DO0	Port B, Data Output, bit 0
2	DO1	Port B, Data Output, bit 1
3	DO2	Port B, Data Output, bit 2
4	DO3	Port B, Data Output, bit 3
5	DO4	Port B, Data Output, bit 4
6	DO5	Port B, Data Output, bit 5
7	DO6	Port B, Data Output, bit 6
8	DO7	Port B, Data Output, bit 7
9	NC	No connection
10	NC	No connection
11	GND	Signal Ground
12	ACK	Acknowledge input
13	DI0	Port B, Data Input, bit 0
14	DI1	Port B, Data Input, bit 1
15	DI2	Port B, Data Input, bit 2
16	DI3	Port B, Data Input, bit 3
17	DI4	Port B, Data Input, bit 4
18	STROBE	Strobe output
19	DI5	Port B, Data Input, bit 5
20	DO0	Port A, Data Output, bit 0
21	DO1	Port A, Data Output, bit 1
22	DO2	Port A, Data Output, bit 2
23	DO3	Port A, Data Output, bit 3
24	DO4	Port A, Data Output, bit 4
25	DO5	Port A, Data Output, bit 5
26	DO6	Port A, Data Output, bit 6
27	DO7	Port A, Data Output, bit 7
28	DI6	Port B, Data Input, bit 6
29	DI7	Port B, Data Input, bit 7
30	GND	Signal Ground
31	NC	No connection
32	NC	No connection
33	DRO	Data Ready Output
34	GND	Signal ground
35	GND	Signal ground
36	GND	Signal ground
37	GND	Signal ground
38	ACK	Acknowledge
39	GND	Signal ground
40	GND	Signal ground

Connector Type: 40-Pin Female socket

Pins 11-30 are used to support a parallel printer.

**Serial Card III
Pin-outs**

<u>Pin No.</u>	<u>Signal Name</u>	<u>Signal Description</u>
1	SGND	Shield ground
2	TXD	Transmit Data
3	RXD	Receive Data
4	RTS	Request To Send
5	CTS	Clear To Send
6	DSR	Data Set Ready
7	GND	Signal ground
8	DCD	Data Carrier Detect
9-19	NC	No connection
20	DTR	Data Terminal Ready
21-25	NC	No connection

Connector Type: DB-25 Male

The signals are as listed above when the modem eliminator button is pushed IN. When the modem eliminator button is in the OUT position, the Serial Card III signals are the same as the signals produced by a modem eliminator cable.

□ LISA/MACINTOSH XL**Two-Port
Parallel Card
Pin-outs**

<u>Pin No.</u>	<u>Signal Name</u>	<u>Signal Description</u>
1	GND	System electrical ground
2	GND	System electrical ground
3	DRW/	Data Direction
4	GND	System electrical ground
5	DD0	Data bit 0 (Bidirectional)
6	DD1	Data bit 1 (Bidirectional)
7	NC	No connection - blocked
8	DD2	Data bit 2 (Bidirectional)
9	GND	System electrical ground
10	GND	System electrical ground
11	DD5	Data bit 5 (Bidirectional)
12	DD6	Data bit 6 (Bidirectional)
13	DD7	Data bit 7 (Bidirectional)
14	GND	System electrical ground
15	PSTRB/	Strobe (output)
16	BSY	Busy (input)
17	CMD/	Command
18	PARITY/	Parity (Bidirectional)
19	OCD	Device on-line status
20	GND	System electrical ground
21	CRES/	Reset (output)
22	DD3	Data bit 3 (Bidirectional)
23	DD4	Data bit 4 (Bidirectional)
24	GND	System electrical ground
25	CHK	Interrupt (input)

Connector Type: DB-25 Male

□ MACINTOSH II, IIx, IIcx

Video and Monochrome Card

<u>Pin No.</u>	<u>Signal Description</u>	<u>Pin No.</u>	<u>Signal Description</u>
1	Signal ground (Red)	9	Analog blue video
2	Analog red video	10	No connection
3	Composite Sync	11	No connection
4	Signal ground (Sync)	12	No connection
5	Analog green video	13	Signal ground (Blue)
6	Signal ground (Green)	14	No connection
7	No connection	15	No connection
8	No connection	(Shield)	Shield ground

Connector Type: DA-15 Male

CAUTION: *The signals on this connector are not the same as on the DA-15 of the Apple IIc, IIgs, III and III Plus, or EtherTalk Interface Card. DO NOT connect an Apple IIc, IIgs, III, III Plus, or EtherTalk Interface Card device or cable to the Video Card.*

Two-Page Monochrome Video Card

<u>Pin No.</u>	<u>Signal Description</u>	<u>Pin No.</u>	<u>Signal Description</u>
A1	Red	6	HSYNC/
A2	Green	7	VSYNC/ ground return
A3	Blue	8	SENSE1
1	HSYNC/ ground return	9	SENSE0
2	VSYNC/	10	CSYNC/ ground return
3	SENSE2		
4	SENSE ground return		
5	CSYNC/		

Connector Type: 13-pin, mixed-contact, D-type

**EtherTalk
Interface Card**

<u>Pin No.</u>	<u>Signal Description</u>	<u>Pin No.</u>	<u>Signal Description</u>
1	Shield	9	Collision
2	Collision Presence +		Presence -
3	Transmit +	10	Transmit -
4	Reserved	11	Reserved
5	Receive +	12	Receive -
6	Power Return	13	Power
7	Reserved	14	Reserved
8	Reserved	15	Reserved

Connector Type: DA-15 Male

This connector supports thick coaxial cable with the use of an optional transceiver (not available from Apple).

CAUTION: *The signals on this connector are not the same as on the DA-15 of the Apple IIc, IIGS, III and III Plus, or Macintosh II Video Cards. DO NOT connect an Apple IIc, IIGS, III, III Plus, or Macintosh II Video Card device or cable to the EtherTalk Interface Card.*

Peripheral Interface Guide

Section 3 – Peripheral Devices: Pin-outs and Switch Functions

□ CONTENTS

3.3	Introduction
3.4	Dot Matrix Printer
3.4	Pin-outs
3.5	Switch 1
3.6	Switch 2
3.7	Daisy Wheel Printer
3.7	Pin-outs
3.7	Front Panel DIP Switch
3.8	Rear Panel Switch 1
3.8	Rear Panel Switch 2
3.9	Scribe
3.9	Pin-outs
3.9	Switch 1
3.10	ImageWriter and ImageWriter 15-inch
3.10	Pin-outs
3.10	Switch 1
3.10	Switch 2
3.11	ImageWriter II
3.11	Pin-outs
3.11	Switch 1
3.12	Switch 2
3.13	ImageWriter LQ
3.13	Pin-outs
3.14	Switch 1
3.14	Switch 2
3.15	Switch 3

- 3.16 LaserWriter and LaserWriter Plus
- 3.16 AppleTalk
- 3.16 RS-232
- 3.17 LaserWriter II
- 3.17 Pin-outs
- 3.18 NT – Switch 1
- 3.18 NTX – Switch 1
- 3.19 Apple Scanner
- 3.19 Pin-outs
- 3.20 Modem 300/1200
- 3.20 Pin-outs
- 3.20 Modem 300
- 3.20 Modem 1200
- 3.21 Apple Personal Modem
- 3.21 Pin-outs
- 3.22 AppleFax Modem
- 3.22 Pin-outs
- 3.23 AppleLine
- 3.23 Pin-outs

□ INTRODUCTION

This section contains interface specifications for Apple peripheral devices. The factory switch settings of each device are shown in **bold** type.

Notes:

This section refers to switches as either "ON" (closed) or "OFF" (open).

Switches marked "XX" are unused and can be set either ON or OFF.

A slash (/) after the signal name indicates that the signal is valid when the signal is low.

The connector type identified is that required for the mating connector.

□ DOT MATRIX PRINTER

<u>Pin-outs</u>	<u>Pin No.</u>	<u>Signal Name</u>	<u>Signal Description</u>
	1	DATA STB/	Data Strobe
	2	DATA1	Data bit 1
	3	DATA2	Data bit 2
	4	DATA3	Data bit 3
	5	DATA4	Data bit 4
	6	DATA5	Data bit 5
	7	DATA6	Data bit 6
	8	DATA7	Data bit 7
	9	DATA8	Data bit 8
	10	ACK/	Acknowledge
	11	INPUT-BUSY	Busy
	12	PE	Paper empty
	13	SELECT	On/Off-line status
	14	OV	Ground
	15	NC	No connection
	16	OV	Ground
	17	CGND	Chassis ground
	18	+5V	+5 volts DC
	19	GND	Twisted pair ground (pin 1)
	20	GND	Twisted pair ground (pin 2)
	21	GND	Twisted pair ground (pin 3)
	22	GND	Twisted pair ground (pin 4)
	23	GND	Twisted pair ground (pin 5)
	24	GND	Twisted pair ground (pin 6)
	25	GND	Twisted pair ground (pin 7)
	26	GND	Twisted pair ground (pin 8)
	27	GND	Twisted pair ground (pin 9)
	28	GND	Twisted pair ground (pin 10)
	29	GND	Twisted pair ground (pin 11)
	30	GND	Twisted pair ground (pin 31)

...Continued on next page

<u>Pin No.</u>	<u>Signal Name</u>	<u>Signal Description</u>
31	INPUT-PRIME/	Reset input to printer
32	FAULT/	Error condition
33	OV	Ground
34	NC	No connection
35	NC	No connection
36	INPUT-BUSY	Busy input

Connector Type: TRW CINCH 57-30360 or equivalent

Switch 1

	1	2	3	4	5	6	7	8
CHARACTER SET								
English (US)	OFF	OFF	OFF					
Italian	ON	OFF	OFF					
English (UK)	ON	ON	OFF					
German	OFF	OFF	ON					
Swedish	ON	OFF	ON					
French	OFF	ON	ON					
Spanish	ON	ON	ON					
LINES PER PAGE								
66 Lines					OFF			
72 Lines					ON			
REMOTE SELECT								
Disabled						ON		
Enabled						OFF		
CR/LF ON BUFFER FULL								
Enabled							ON	
Disabled							OFF	
PRINT UPON RECEIPT OF								
CR, LF, VT, US, or FF								ON
CR								OFF
AUTO LF ON CR								
Disabled								OFF
Enabled								ON

Switch 2

	1	2	3	4	5	6	7	8
ZERO								
Unslashed	OFF							
Slashed	ON							
BUFFER								
Single-Line		ON						
N-Line		OFF						
NOT USED			XXX					
NOT USED				XXX				
PRINTING								
10 CPI (Pica)					OFF			
Proportional (Elite)						ON		
WORD LENGTH								
7-Bit						ON		
8-Bit						OFF		
POWER-ON STATUS								
Selected							ON	
Deselected							OFF	
PRINTING DIRECTION								
Bidirectional								OFF
Unidirectional								ON

□ DAISY WHEEL PRINTER

Pin-outs	Pin No.	Signal Description	Pin No.	Signal Description
	1	Protective ground	7	Signal ground
	2	Transmit Data	8	Carrier Detect
	3	Receive Data	9-19	No connection
	4	Request To Send	20	Data Terminal Ready
	5	Clear To Send	21-25	No connection
	6	Data Set Ready		

Connector Type: DB-25 Male

Front Panel DIP Switch	1	2	3	4	5	6	7	8
TYPE PITCH								
10 CPI	OFF	OFF						
12 CPI	ON	OFF						
15 CPI	OFF	ON						
Proportional	ON	ON						
FORM LENGTH								
3 inches			OFF	OFF	OFF	OFF		
3.5 inches			ON	OFF	OFF	OFF		
4 inches			OFF	ON	OFF	OFF		
5 inches			OFF	OFF	ON	ON		
5.5 inches			ON	ON	OFF	OFF		
6 inches			OFF	OFF	ON	OFF		
7 inches			ON	OFF	ON	OFF		
8 inches			OFF	ON	ON	OFF		
8.5 inches			ON	ON	ON	OFF		
9 inches			ON	OFF	ON	ON		
10 inches			OFF	ON	ON	ON		
11 inches			OFF	OFF	OFF	ON		
11.66 inches			ON	OFF	OFF	ON		
12 inches			OFF	ON	OFF	ON		
14 inches			ON	ON	OFF	ON		
16 inches			ON	ON	ON	ON		
AUTO LF ON CR								
Disabled								OFF
Enabled								ON
LINES PER INCH								
6								OFF
8								ON

**Rear Panel
Switch 1**

	1	2	3	4	5	6	7	8
BAUD RATE								
110	OFF	OFF	OFF					
150	ON	OFF	OFF					
300	OFF	ON	OFF					
600	ON	ON	OFF					
1200	OFF	OFF	ON					
2400	ON	OFF	ON					
4800	OFF	ON	ON					
9600	ON	ON	ON					
HANDSHAKING								
ETX/ACK & DTR					OFF	OFF		
X-On/X-Off					ON	OFF		
DTR					OFF	ON		
MODEM								
No modem							ON	
Modem							OFF	
PARITY								
Space							ON	ON
Mark							OFF	ON
Even							ON	OFF
Odd							OFF	OFF

**Rear Panel
Switch 2**

	1	2	3	4	5	6	7	8
CHARACTER SET								
ASCII Standard	OFF	OFF	OFF	OFF				
USA WP	ON	OFF	OFF	OFF				
Italian	OFF	ON	OFF	OFF				
Swedish	ON	ON	OFF	OFF				
English (UK)	OFF	OFF	ON	OFF				
French	ON	OFF	ON	OFF				
German	OFF	ON	ON	OFF				
Spanish	ON	ON	ON	OFF				
PRINT DIRECTION								
Bidirectional					ON			
Unidirectional					OFF			
AUTO LF ON CR								
Disabled						OFF		
Enabled						ON		
DUPLEX								
Full							OFF	
Half							ON	
PAPER OUT CONDITION								
Stop printing								ON
Continue printing								OFF

SCRIBE

Pin-outs	Pin No.	Signal Name	Signal Description
	1	FG	Frame Ground
	2	SD	Send Data
	3	RD	Receive Data
	4	RTS	Request To Send
	7	SG	Signal Ground
	20	DTR	Data Terminal Ready

Connector Type: DB-25 Male

Switch 1

	1	2	3	4	5	6	7	8
CHARACTER SET								
American	OFF	OFF	OFF					
Italian	OFF	OFF	ON					
American	OFF	ON	OFF					
British	OFF	ON	ON					
German	ON	OFF	OFF					
Swedish	ON	OFF	ON					
French	ON	ON	OFF					
Spanish	ON	ON	ON					
AUTO LF ON CR								
Disabled					OFF			
Enabled					ON			
PRINT INTENSITY								
Darkest					OFF	OFF		
					OFF	ON		
					ON	OFF		
Lightest					ON	ON		
BAUD RATE								
9600							OFF	
1200							ON	
HANDSHAKING								
DTR								OFF
X-On/X-Off								ON

□ IMAGEWRITER AND IMAGEWRITER 15-INCH

Pin-outs	Pin No.	Signal Name	Signal Description
	1	FG	Frame Ground
	2	SD	Send Data (output)
	3	RD	Receive Data (input)
	4	RTS	Request To Send (output)
	7	SG	Signal Ground
	14	FAULT/	Fault
	20	DTR	Data Terminal Ready (output)

Connector Type: DB-25 Male

Switch 1

	1	2	3	4	5	6	7	8
CHARACTER SET								
American	OFF	OFF	OFF					
British	ON	ON	OFF					
German	OFF	OFF	ON					
French	OFF	ON	ON					
Swedish	ON	OFF	ON					
Italian	ON	OFF	OFF					
Spanish	ON	ON	ON					
PAGE LENGTH								
66 Lines					OFF			
72 Lines					ON			
EIGHTH DATA BIT								
Recognize						OFF		
Ignore						ON		
CHARACTER PITCH								
Pica						OFF	OFF	
Elite						ON	OFF	
Ultra Condensed						OFF	ON	
Elite Proportional						ON	ON	
AUTO LF ON CR								
Disabled								OFF
Enabled								ON

Switch 2

	1	2	3	4
BAUD RATE				
300	OFF	OFF		
1200	ON	OFF		
2400	OFF	ON		
9600	ON	ON		
HANDSHAKING				
DTR				OFF
X-On/X-Off				ON

□ IMAGEWRITER II

Pin-outs	Pin No.	Signal Name	Signal Description
	1	DTR	Data Terminal Ready (output)
	2	DSR	Data Set Ready (input)
	3	TXD-	Transmit Data
	4	SG	Signal Ground
	5	RXD-	Receive Data
	6	TXD+	Balanced transmit +
	7	NC	No connection
	8	RXD+	Balanced receive +
	(Shield)	PG	Protective Ground

Connector Type: Mini DIN-8 Male

Switch 1

	1	2	3	4	5	6	7	8
CHARACTER SET								
American	OFF	OFF	OFF					
Italian	ON	OFF	OFF					
Danish	OFF	ON	OFF					
British	ON	ON	OFF					
German	OFF	OFF	ON					
Swedish	ON	OFF	ON					
French	OFF	ON	ON					
Spanish	ON	ON	ON					
FORM LENGTH								
11 inches				OFF				
12 inches				ON				
PERFORATION SKIP								
Disabled					OFF			
Enabled					ON			
CHARACTERS PER INCH								
10						OFF	OFF	
12						ON	OFF	
17						OFF	ON	
Proportional						ON	ON	
AUTO LF ON CR								
Disabled								OFF
Enabled								ON

Switch 2

	1	2	3	4	5	6
BAUD RATE						
300	OFF	OFF				
1200	ON	OFF				
2400	OFF	ON				
9600	ON	ON				
HANDSHAKING						
Hardware (DTR)					OFF	
X-On/X-Off					ON	
OPTION CARD						
Not installed					OFF	
Installed					ON	
HAMMER FIRING						
Factory set					XXX	XXX
Factory set					XXX	XXX

Note: Refer to *ImageWriter II Technical Procedures* for information on the "Hammer Firing" adjustment.

□ IMAGEWRITER LQ

Pin-outs	Pin No.	Signal Name	Signal Description
<i>RS-422</i>	1	DTR	Data Terminal Ready (output)
	2	DSR	Data Set Ready (input)
	3	TXD-	Transmit Data
	4	SG	Signal Ground
	5	RXD-	Receive Data
	6	TXD+	Balanced Transmit +
	7	NC	No connection
	8 (Shield)	RXD+ PG	Balanced Receive + Protective Ground
<i>RS-232</i>	1	DSR	Data Set Ready
	2	DTR	Data Terminal Ready
	3	RxD	Received Data
	4	GND	Signal ground
	5	TxD	Transmitted Data
	6	NC	No connection
	7	NC	No connection
	8 (Shield)	GND Shield	Signal ground

Connector Type: Mini DIN-8 Male

Switch 1

	1	2	3	4	5	6	7	8
CHARACTER SET								
American	OFF	OFF	OFF					
Italian	ON	OFF	OFF					
Danish	OFF	ON	OFF					
British	ON	ON	OFF					
German	OFF	OFF	ON					
Swedish	ON	OFF	ON					
French	OFF	ON	ON					
Spanish	ON	ON	ON					
FORM LENGTH								
11 inches					OFF			
12 inches					ON			
PERFORATION SKIP*								
Disabled						OFF		
Enabled						ON		
CHARACTERS/DOTS PER INCH								
10 cpi						OFF	OFF	
12 cpi						ON	OFF	
17 cpi						OFF	ON	
160 dpi						ON	ON	
216 dpi						ON	ON	
AUTO LF ON CR								
Disabled								OFF
Enabled								ON

***Note:** This switch must always be set to ON.

Switch 2

	1	2	3	4	5	6	7	8
BAUD RATE								
1200	ON	OFF						
2400	OFF	ON						
9600	ON	ON						
19200	OFF	OFF						
HANDSHAKING								
Hardware (DTR)				OFF				
X-On/X-Off				ON				
OPTION CARD								
Not installed					OFF			
Installed					ON			
CUT-SHEET FEEDER BINS ATTACHED								
1					OFF	OFF	ON	
1 and 2					ON	OFF	ON	
1, 2, and 3					OFF	ON	ON	
1 and envelope					OFF	OFF	OFF	
1, 2, and envelope					ON	OFF	OFF	
1, 2, 3, and envelope					ON	ON	OFF	
AUTO PAPER LOAD POSITION								
To print line								OFF
To paper bail								ON

Switch 3

	1	2	3	4	5	6	7	8
COLOR RIBBON								
HOME POSITION								
Shift Ribbon Down								
.78125 mm				ON	ON	OFF		
.46875 mm				OFF	ON	OFF		
.15625 mm				ON	OFF	OFF		
Shift Ribbon Up								
.78125 mm				ON	ON	ON		
.46875 mm				OFF	ON	ON		
.15625 mm				ON	OFF	ON		
HORIZONTAL REGISTRATION								
Left Movement								
+0.159 mm						ON	ON	OFF
+0.106 mm						OFF	ON	OFF
+0.053 mm						ON	OFF	OFF
+0.000 mm						OFF	OFF	OFF
Left Movement								
-0.044 mm						ON	ON	OFF
-0.088 mm						OFF	ON	OFF
-0.132 mm						ON	OFF	OFF
-0.176 mm						OFF	OFF	OFF

Note: These switches modify adjustments critical to print quality. DO NOT change their settings until you refer to the *ImageWriter LQ Technical Procedures* for additional information.

□ LASERWRITER AND LASERWRITER PLUS

AppleTalk	<u>Pin No.</u>	<u>Signal Name</u>	<u>Signal Description</u>
	3	SG	Signal Ground
	4	TXD+	Transmit Data +
	5	TXD-	Transmit Data -
	8	RXD+	Receive Data +
	9	RXD-	Receive Data -

Connector Type: DB-9 Male

Mode switch set to "AppleTalk" selects this port.

RS-232	<u>Pin No.</u>	<u>Signal Name</u>	<u>Signal Description</u>
	2	TD	Transmit Data
	3	RD	Receive Data
	4	RTS	Request To Send
	7	SG	Signal Ground
	20	DTR	Data Terminal Ready

Connector Type: DB-25 Male

Mode switch set to "1200" or "9600" selects this port.

□ LASERWRITER II

<u>Pin-outs</u>	<u>Pin No.</u>	<u>Signal Name</u>	<u>Signal Description</u>
<i>SC</i>	1-12	GND	Signal Ground
	13	NC	No connection
	14-25	GND	Signal Ground
	26	DB0/	Data Bit 0
	27	DB1/	Data Bit 1
	28	DB2/	Data Bit 2
	29	DB3/	Data Bit 3
	30	DB4/	Data Bit 4
	31	DB5/	Data Bit 5
	32	DB6/	Data Bit 6
	33	DB7/	Data Bit 7
	34	DBP/	Data Parity
	35-37	GND	Signal Ground
	38	+5V	+5 volts
	39	GND	Signal Ground
	40	GND	Signal Ground
	41	ATN/	Attention
	42	GND	Signal Ground
	43	BSY/	Busy
	44	ACK/	Acknowledge
	45	RST/	Reset
	46	MSG/	Message
	47	SEL/	Select
	48	C/D/	Control/Data
	49	REQ/	Request
	50	I/O/	Input/Output
	<i>NT and NTX DB-25</i>	1	Shield
2		TxD	Transmitted Data
3		RxD	Received Data
4		RTS	Request To Send
5		CTS	Clear To Send
6		DSR	Data Set Ready
7		SG	Signal Ground
8		DCD	Data Carrier Detect
20		DTR	Data Terminal Ready
22		RI	Ring Indicator
<i>NT and NTX Mini DIN-8</i>	1	HSK _o	Handshake out
	2	HSK _i	Handshake in
	3	TxD-	Transmit Data -
	4	SG	Signal Ground
	5	RxD-	Receive Data-
	6	TxD+	Transmit Data +
	7	GPI	General Purpose in
	8	RxD+	Receive Data+

**NT
SWITCH 1**

	1	2
COMMUNICATION AND COMMAND MODE		
LocalTalk	OFF	OFF
Diablo 630 emulation	ON	OFF
9600 Baud RS-232 & RS-422	OFF	ON
1200 Baud RS-232 & RS-422	ON	ON

**NTX
SWITCH 1**

	1	2	3*	4*	5*	6*
COMMUNICATION MODE						
LocalTalk	OFF	OFF				
1200 Baud RS-232 & RS-422	ON	OFF				
9600 Baud RS-232 & RS-422	OFF	ON				
9600 Baud RS-232	ON	ON				
COMMAND MODE						
PostScript Batch			OFF	OFF		
Diablo 630			ON	OFF		
PostScript Interactive			ON	OFF		
HP LaserJet			ON	ON		
HANDSHAKING						
X-On/X-Off					OFF	OFF
X-On/X-Off					ON	OFF
ETX/ACK					OFF	ON
Data Set Ready					ON	ON

Note: If LocalTalk is selected, switches 3 through 6 are not used.

□ APPLE SCANNER

<u>Pin-outs</u>	<u>Pin No.</u>	<u>Signal Name</u>	<u>Signal Description</u>
	1-12	GND	Signal Ground
	13	NC	No connection
	14-25	GND	Signal Ground
	26	DB0/	Data Bit 0
	27	DB1/	Data Bit 1
	28	DB2/	Data Bit 2
	29	DB3/	Data Bit 3
	30	DB4/	Data Bit 4
	31	DB5/	Data Bit 5
	32	DB6/	Data Bit 6
	33	DB7/	Data Bit 7
	34	DBP/	Data Parity
	35-37	GND	Signal Ground
	38	+5V	+5 volts
	39	GND	Signal Ground
	40	GND	Signal Ground
	41	ATN/	Attention
	42	GND	Signal Ground
	43	BSY/	Busy
	44	ACK/	Acknowledge
	45	RST/	Reset
	46	MSG/	Message
	47	SEL/	Select
	48	C/D/	Control/Data
	49	REQ/	Request
	50	I/O/	Input/Output

Connector Type: DB-50 Male

MODEM 300/1200

<u>Pin-outs</u>	<u>Pin No.</u>	<u>Signal Name</u>	<u>Signal Description</u>
	2	DSR	Data Set Ready
	3	SGND	Signal Ground
	5	RCD	Receive Data
	6	DTR	Data Terminal Ready
	7	DCD	Data Carrier Detect
	8	GND	Chassis Ground
	9	TXD	Transmit Data

Connector Type: DB-9 Male

Modem 300	1	2	3	4	5	6	7	8
CARRIER DETECT								
Always high		ON						
Normal		OFF						
NOT USED			XXX					
DATA TERMINAL READY								
Computer supplies						OFF		
Modem supplies						ON		

Modem 1200	1	2	3	4	5	6	7	8
CARRIER DETECT								
Always high		ON						
Normal		OFF						
PBX/CBX								
Meets Bell standard						OFF		
Doesn't meet Bell standard					ON			
DATA TERMINAL READY								
Computer supplies						OFF		
Modem supplies						ON		

□ APPLE PERSONAL MODEM

Pin-outs	<u>Pin No.</u>	<u>Signal Name</u>	<u>Signal Description</u>
	1	DSR	Data Set Ready
	2	DTR	Data Terminal Ready
	3	RXD	Receive Data
	4	SG	Signal Ground
	5	TXD	Transmit Data
	6	SG	Signal Ground
	7	DCD	Data Carrier Detect
	8	NC	No connection

Connector Type: Mini DIN-8 Male

□ APPLEFAX MODEM

<u>Pin-outs</u>	<u>Pin No.</u>	<u>Signal Name</u>	<u>Signal Description</u>
	1	DSR	Data Set Ready
	2	DTR	Data Terminal Ready
	3	RXD	Receive Data
	4	SG	Signal Ground
	5	TXD	Transmit Data
	6	SG	Signal Ground
	7	DCD	Data Carrier Detect
	8	NC	No connection

Connector Type: Mini DIN-8 Male

□ APPLELINE

Pin-outs	<u>Pin No.</u>	<u>Signal Name</u>	<u>Signal Description</u>
	1	SNG	Shield Ground
	2	TXD	Transmit Data (output)
	3	RXD	Receive Data (input)
	4	RTS	Request To Send (output)
	5	CTS	Clear To Send (input)
	6	DSR	Data Set Ready (input)
	7	GND	Signal Ground
	8	DCD	Data Carrier Detect (input)
	12	CH	Data signal rate selector (input)
	20	DTR	Data Terminal Ready (output)
	22	CE	Ring Indicator (input)

Connector Type: DB-25 Male

Peripheral Interface Guide

Section 4 – Computer and Peripheral Configurations

□ CONTENTS

4.4	Introduction
4.5	Dot Matrix Printer
4.5	Standard Switch Settings
4.5	Apple II, II Plus, IIe, and IIGS
4.6	Apple III and III Plus
4.6	Lisa/Macintosh XL
4.7	Daisy Wheel Printer
4.7	Standard Switch Settings
4.7	Apple II, II Plus, IIe, and IIGS
4.8	Apple IIGS and IIc Plus
4.8	Apple IIc
4.9	Apple III and III Plus
4.9	Lisa/Macintosh XL
4.10	Scribe
4.10	Standard Switch Settings
4.10	Apple II, II Plus, IIe, and IIGS
4.11	Apple IIGS and IIc Plus
4.11	Apple IIc
4.11	Apple III and III Plus
4.11	Lisa/Macintosh XL
4.12	ImageWriter and ImageWriter 15-Inch
4.12	Standard Switch Settings
4.12	Apple II, II Plus, IIe, and IIGS
4.13	Apple IIGS and IIc Plus
4.13	Apple IIc
4.14	Apple III and III Plus
4.14	Macintosh 128K, 512K, and 512K Enhanced
4.14	Macintosh Plus
4.14	Macintosh SE and SE/30
4.14	Macintosh II, IIx, and IIcx
4.14	Lisa/Macintosh XL

- 4.15 ImageWriter II
 - 4.15 Standard Switch Settings
 - 4.15 Apple II, II Plus, IIe, and IIGS
 - 4.16 Apple IIGS and IIc Plus
 - 4.16 Apple IIc
 - 4.16 Apple III and III Plus
 - 4.17 Macintosh 128K, 512K, and 512K Enhanced
 - 4.17 Macintosh Plus
 - 4.17 Macintosh SE and SE/30
 - 4.17 Macintosh II, IIx, and IIcx
 - 4.17 Lisa/Macintosh XL
- 4.18 ImageWriter LQ
 - 4.18 Standard Switch Settings
 - 4.19 Apple II, II Plus, IIe, and IIGS
 - 4.19 Apple IIGS and IIc Plus
 - 4.19 Apple IIc
 - 4.20 Apple III and III Plus
 - 4.20 Macintosh 128K, 512K, and 512K Enhanced
 - 4.20 Macintosh Plus
 - 4.20 Macintosh SE and SE/30
 - 4.20 Macintosh II, IIx, and IIcx
 - 4.20 Lisa/Macintosh XL
- 4.21 Modem 300/1200
 - 4.21 Standard Switch Settings
 - 4.21 Apple II, II Plus, IIe, and IIGS
 - 4.23 Apple IIGS and IIc Plus
 - 4.23 Apple IIc
 - 4.23 Apple III and III Plus
 - 4.23 Macintosh 128K, 512K, and 512K Enhanced
 - 4.23 Macintosh Plus
 - 4.23 Macintosh SE and SE/30
 - 4.23 Macintosh II, IIx, and IIcx
 - 4.23 Lisa/Macintosh XL
- 4.24 Apple Personal Modem
 - 4.24 Standard Switch Settings
 - 4.24 Apple II, II Plus, IIe, and IIGS
 - 4.25 Apple IIGS and IIc Plus
 - 4.25 Apple IIc
 - 4.25 Apple III and III Plus
 - 4.25 Macintosh 128K, 512K, and 512K Enhanced
 - 4.25 Macintosh Plus
 - 4.25 Macintosh SE and SE/30
 - 4.25 Macintosh II, IIx, and IIcx
 - 4.25 Lisa/Macintosh XL

- 4.26 Color Plotter
 - 4.26 Standard Switch Settings
 - 4.26 Apple II, II Plus, IIe, and IIGS
 - 4.26 Apple IIGS and IIC Plus
 - 4.26 Apple IIC
 - 4.27 Apple III and III Plus
- 4.28 AppleLine
 - 4.28 Standard Switch Settings
 - 4.28 Apple III and III Plus
 - 4.28 Lisa/Macintosh XL
 - 4.28 Macintosh 128K, 512K, and 512K Enhanced
 - 4.28 Macintosh Plus
 - 4.28 Macintosh SE and SE/30
 - 4.28 Macintosh II, IIX, and IICX
- 4.29 AppleFax Modem
 - 4.29 Standard Switch Settings
 - 4.29 Macintosh Plus
 - 4.29 Macintosh SE and SE/30
 - 4.29 Macintosh II, IIX, and IICX

□ INTRODUCTION

This section contains the information necessary to connect any Apple peripheral device to any Apple computer. The cables are listed with both Service/Engineering and Marketing part numbers (the Marketing part numbers are given in parentheses). Option switch settings and any special notes or requirements are also listed.

Notes:

1. Accessory kit part numbers followed by an asterisk (*) include items in addition to the cable (software and/or manuals, for example).
2. Accessory kit part numbers followed by a dagger (†) include a modem eliminator cable (590-0166).
3. Switches marked "XX" are unused and can be set either ON or OFF.
4. All DIP switch settings are referred to as ON and OFF. Some DIP switches may not be marked ON and OFF. On those switches, the number marked on the package will be the ON position.
5. Cable part numbers indicated include **all possible** cables that can be used, including cables that may be aesthetically incorrect—using a beige-colored cable with a platinum Macintosh SE and ImageWriter LQ, for example. The Apple-recommended cable part number will be in **bold**.

□ DOT MATRIX PRINTER

Standard Switch Settings

Standard switch settings are:

SW1	1	2	3	4	5	6	7	8
	OFF	OFF	OFF	OFF	OFF	OFF	OFF	OFF
SW2	1	2	3	4	5	6	7	8
	OFF	OFF	XXX	XXX	OFF	ON	ON	OFF

These settings configure the printer as follows:

- US English character set
- 66 Lines/page
- Respond to select codes
- No line feed on buffer overflow
- Print on CR only
- No LF after CR
- Unslashed zero
- Single-line buffer
- 10 Chars/inch
- 7 Data bits
- Power-on select
- Bidirectional printing

Apple II, II Plus, IIe, and IIGS

With a **Parallel Interface Card**, use cable 590-0042. Set the DIP switches on the card as follows:

SW1	1	2	3	4	5	6	7
	OFF	OFF	OFF	ON	ON	OFF	OFF

With a **Centronics Printer Card**, use cable 590-0036.

Note: When using the Centronics Printer Card, set Dot Matrix Printer Switch 1 (SW1) position 8 to ON to provide a line feed on receipt of a carriage return.

Apple III and III Plus

With a **Universal Parallel Interface Card (UPIC)**, use cable 590-0036.

Driver Configuration Block - Printer Driver

0	1	2	3	4
0E	00	00	00	00

Set the auto line feed switch on the UPIC to AUTO.

Lisa/ Macintosh XL

Connect cable 590-0042 to either the internal parallel port or one of the two ports on the two-port parallel card (if installed).

□ DAISY WHEEL PRINTER

Standard Switch Settings

Standard switch settings are:

SW1	1	2	3	4	5	6	7	8
	ON	ON	ON	OFF	OFF	ON	ON	ON

SW2	1	2	3	4	5	6	7	8
	OFF	OFF	OFF	OFF	ON	OFF	OFF	ON

Front Panel Switch

	1	2	3	4	5	6	7	8
	ON	OFF	OFF	OFF	OFF	ON	OFF	OFF

These settings configure the printer as follows:

- 9600 Baud
- ETX/ACK and DTR handshaking
- No modem connected
- Space parity
- 12 Chars/inch
- 11-Inch form
- No LF after CR
- 6 Lines/inch
- ASCII standard character set
- Bidirectional printing
- No auto CR/LF
- Full duplex
- Stop printing on paper-out condition

Apple II, II Plus, IIe, and IIgs

With a **High Speed Serial Card**, use cable 590-0037. Set the DIP switches on the card as follows:

SW1	1	2	3	4	5	6	7
	OFF	OFF	ON	OFF	OFF	OFF	OFF

These settings configure the interface as follows:

- 1200 Baud
- No delay after CR
- 132 columns/video off
- Auto LF on CR

Note: You must use a P8A PROM in place of a P8 PROM on the High Speed Serial Card to avoid losing characters. Set Daisy Wheel Printer Switch 1 (SW1) position 2 to OFF for 1200 baud.

With a **Super Serial Card**, use cable 590-0037 (A2C0351*). Set the DIP switches on the card as follows:

SW1	1	2	3	4	5	6	7
	OFF	OFF	OFF	ON	OFF	ON	ON

SW2	1	2	3	4	5	6	7
	ON	ON	OFF	OFF	ON	OFF	OFF

These settings configure the interface as follows:

9600 Baud
Printer mode
Normal Clear To Send
8 Data bits, 1 stop bit
32 msec delay after CR
132 Columns/video off
Auto LF on CR
Interrupts OFF

Note: Install the jumper block on the card with the arrow pointing toward TERMINAL.

**Apple IIGS
and IIC Plus**

Connect cables 590-0037 (A2C0351*) and 590-0550 (A9M0333) to the PRINTER port.

Use the default port settings.

Apple IIC

Connect cable 590-0191 to the PRINTER port.

Use the default port settings.

Apple III and III Plus

Connect cables 590-0037 and 590-0166 (A3C0351*†) to the RS-232 serial port. Either the Printer driver or the RS232 driver may be used.

Driver Configuration Block - Printer Driver

0	1	2	3	4
08	22	00	00	00

Driver Configuration Block - RS232 Driver

0	1	2	3	4	5
0E	00	00	00	00	00
6	7	8	9	A	B
13	11	DF	84	50	80

Lisa/ Macintosh XL

Connect cables 590-0037 and 590-0029 (obsolete) or 590-0166 (A6C0351*†) to the SERIAL A port.

□ SCRIBE

Standard Switch Settings

Standard switch settings are:

SW1	1	2	3	4	5	6	7	8
	OFF	OFF	OFF	ON	OFF	OFF	OFF	OFF

These settings configure the printer as follows:

- American character set
- Auto LF on CR
- Low-intensity print
- 9600 baud
- DTR handshaking

Apple II, II Plus, Ile, and IIGS

With a **Super Serial Card**, use cable 590-0037 (A2C0355*). Set the DIP switches on the card as follows:

SW1	1	2	3	4	5	6	7
	OFF	OFF	OFF	ON	OFF	ON	ON

SW2	1	2	3	4	5	6	7
	ON	OFF	OFF	ON	ON	OFF	OFF

These settings configure the interface as follows:

- 9600 baud
- Printer mode
- Normal Clear To Send
- 8 data bits, 1 stop bit
- No delay on carriage return
- 80 columns/video off
- Auto LF on CR
- Interrupts off

Note: Install the jumper block on the card with the arrow pointing toward TERMINAL.

**Apple IIgs
and IIc Plus**

Connect cables 590-0037 (A2C0355*) and 590-0550 (A9M0333) to the PRINTER port.

Use the default port settings.

Apple IIc

Connect cable 590-0191 (A2C4520*) to the PRINTER port.

Use the default port settings.

Apple III and III Plus

Connect cables 590-0037 and 590-0029 (obsolete) or 590-0166 to the RS-232 Serial port. Either the Printer driver or the RS232 driver may be used.

Driver Configuration Block - Printer Driver

0	1	2	3	4
0E	00	00	00	00

Driver Configuration Block - RS232 Driver

0	1	2	3	4	5
0E	00	00	00	00	00
6	7	8	9	A	B
13	11	DF	84	50	80

**Lisa/
Macintosh XL**

Connect cables 590-0037 and 590-0029 (obsolete) 590-0166 (A6C0355*†) to the SERIAL A port.

□ IMAGEWRITER AND IMAGEWRITER 15-INCH

Standard Switch Settings

Standard switch settings are:

SW1	1	2	3	4	5	6	7	8
	OFF	OFF	OFF	OFF	ON	ON	OFF	OFF
SW2	1	2	3	4				
	ON	ON	OFF	XXX				

These settings configure the printer as follows:

- US character set
- 66 Lines/page
- Ignore eighth bit
- Elite character pitch
- No LF after CR
- 9600 baud
- DTR handshaking

Apple II, II Plus, IIe, and IIGS

With a **High Speed Serial Card**, use cable 590-0037. Set the DIP switches on the card as follows:

SW1	1	2	3	4	5	6	7
	ON	OFF	ON	ON	OFF	OFF	OFF

These settings configure the interface as follows:

- 300 baud
- Delay on CR
- 132 columns/video off
- Auto LF on CR

Note: You must use a P8 PROM (not a P8A PROM) on the High Speed Serial Card. Set ImageWriter Switch SW2 positions 1 and 2 to OFF (300 baud).

With a **Super Serial Card**, use cable 590-0037 (A2C0352*). Set the DIP switches on the card as follows:

SW1	1	2	3	4	5	6	7
	OFF	OFF	OFF	ON	OFF	ON	ON

SW2	1	2	3	4	5	6	7
	ON	OFF	OFF	OFF	ON	OFF	OFF

These settings configure the interface as follows:

9600 baud
Printer mode
Normal Clear To Send
8 data bits, 1 stop bit
No delay on CR
132 columns/video off
Auto LF on CR
Interrupts off

Note: Install the jumper block on the card with the arrow pointing toward TERMINAL.

**Apple IIcS
and IIc Plus**

Connect cables 590-0037 (A2C0352*) and 590-0550 (A9M0333) to the PRINTER port.

Use the default port settings.

Apple IIc

Connect cable 590-0191 (A2C4515*) to the PRINTER port.

Use the default port settings.

Apple III and III Plus

Connect cables 590-0037 and 590-0166 (A3C0352*†) to the RS-232 serial port. Either the Printer driver or the RS232 driver may be used.

Driver Configuration Block - Printer Driver

0	1	2	3	4
0E	00	00	00	00

Driver Configuration Block - RS232 Driver

0	1	2	3	4	5
0E	00	00	00	00	00
6	7	8	9	A	B
13	11	DF	84	50	80

**Macintosh 128K,
512K, and 512K
Enhanced**

Connect cable 590-0169 (M0150*) to the PRINTER port.

Macintosh Plus

Connect cables 590-0169 (M0150*) and 590-0341 (M0189) or 590-0553/699-0430 (M0199) to the PRINTER port.

**Macintosh SE
and SE/30**

Connect cables 590-0169 (M0150*) and 590-0341 (M0189) or 590-0553/699-0430 (M0199) to the PRINTER port.

**Macintosh II,
Iix, and Iicx**

Connect cables 590-0169 (M0150*) and 590-0341 (M0189) or 590-0553/699-0430 (M0199) to the PRINTER port.

**Lisa/
Macintosh XL**

Connect cables 590-0037 and 590-0029 (obsolete) or 590-0166 (A6C0352*†) to the SERIAL A port.

□ IMAGEWRITER II

Standard Switch Settings

The standard switch settings are:

SW1	1	2	3	4	5	6	7	8
	OFF	OFF	OFF	OFF	OFF	ON	OFF	OFF
SW2	1	2	3	4				
	ON	ON	OFF	OFF				

These settings configure the printer as follows:

- American character set
- 11-inch form
- Perforation skip inactive
- No LF on CR
- 12 chars/inch
- 9600 baud
- DTR handshaking
- No option card installed

Apple II, II Plus, Ile, and IIGS

With a **High Speed Serial Card**, use cable 590-0335. Set the DIP switches on the card as follows:

SW1	1	2	3	4	5	6	7
	ON	OFF	ON	OFF	OFF	OFF	OFF

These settings configure the interface as follows:

- 300 baud
- No delay on CR
- 132 columns/video off
- Auto LF on CR

Note: You must use a P8 PROM (not a P8A PROM) on the High Speed Serial Card. Set ImageWriter II Switch 2 (SW2) positions 1 and 2 to OFF (300 baud).

For a **Super Serial Card**, use either cable 590-0335 (A9C0313) or 590-0556 (A9C0314). Set the DIP switches on the card as follows:

SW1	1	2	3	4	5	6	7
	OFF	OFF	OFF	ON	OFF	ON	ON

SW2	1	2	3	4	5	6	7
	ON	OFF	OFF	OFF	ON	OFF	OFF

These settings configure the interface as follows:

9600 baud
Printer mode
Normal Clear To Send
8 data bits, 1 stop bit
No delay on CR
132 columns/video off
Auto LF on CR
Interrupts off

Note: Install the jumper block on the card with the arrow pointing toward TERMINAL.

**Apple IIcS
and IIc Plus**

Connect cable 590-0340 or 590-0552 (M0197) to the PRINTER port.

Use the default port settings.

Apple IIc

Connect cable 590-0333 (A2C4312) or 590-0554 (A2C4313) to the PRINTER port.

Use the default port settings.

Apple III and III Plus

Connect cable 590-0331 (A2C0311) or 590-0555 (A2C0312) to the RS-232 serial port. Either the Printer driver or the RS-232 driver may be used.

Driver Configuration Block - Printer Driver

0	1	2	3	4
0E	00	00	00	00

Driver Configuration Block - RS232 Driver

0	1	2	3	4	5
0E	00	00	00	00	00
6	7	8	9	A	B
13	11	DF	84	50	80

**Macintosh 128K,
512K, and 512K
Enhanced**

Connect cable 590-0332 (M0185) or 590-0551 (M0196)
to the PRINTER port.

Macintosh Plus

Connect cable 590-0340 (M0187) or 590-0552 (M0197)
to the PRINTER port.

**Macintosh SE
and SE/30**

Connect cable 590-0340 (M0187) or 590-0552 (M0197)
to the PRINTER port.

**Macintosh II,
IIx, and IIcx**

Connect cable 590-0340 (M0187) or 590-0552 (M0197)
to the PRINTER port.

**Lisa/
Macintosh XL**

Connect cable 590-0331 (A2C0311) or 590-0555
(A2C0312) to the SERIAL A port.

□ IMAGEWRITER LQ

Standard Switch Settings

The standard switch settings are:

SW1	1	2	3	4	5	6	7	8
	OFF	OFF	OFF	OFF	OFF	ON	OFF	OFF
SW2	1	2	3	4	5	6	7	8
	OFF	OFF	OFF	OFF	OFF	OFF	OFF	OFF

These settings configure the printer as follows:

- American character set
- 11-inch form
- Perforation skip inactive
- 12 characters/inch
- No LF on CR
- 19200 baud
- DTR handshaking
- No option card installed
- 1 cut-sheet feeder bin and envelope attachment
- Paper positioned to the print line

Note: When using the ImageWriter LQ with the Apple II, II Plus, IIe, IIGs , IIc, III, and III Plus, or Lisa/Macintosh XL, the printer should be set to 9600 baud. Set DIP switch 2, positions 1 and 2, to ON.

**Apple II, II Plus,
IIe, and IIgs**

With a **Super Serial Card**, use either cable 590-0335 (A9C0313) or 590-0556 (A9C0314). Set the DIP switches on the card as follows:

SW1	1	2	3	4	5	6	7
	OFF	OFF	OFF	ON	OFF	ON	ON

SW2	1	2	3	4	5	6	7
	ON	OFF	OFF	ON	ON	OFF	OFF

These settings configure the interface as follows:

- 9600 baud
- Printer mode
- Normal Clear To Send
- 8 data bits, 1 stop bit
- No delay on CR
- 80 columns/video off
- Auto LF on CR
- Interrupts off

Note: Install the jumper block on the card with the arrow pointing toward TERMINAL.

**Apple IIgs
and IIc Plus**

Connect cable 590-0340 or 590-0552 (M0197) to the PRINTER port.

Change the default printer port setting to 19200 baud.

Apple IIc

Connect cable 590-0333 (A2C4312) or 590-0554 (A2C4313) to the PRINTER port.

Use the default port settings.

Apple III and III Plus

Connect cable 590-0331 (A2C0311) or 590-0555 (A2C0312) to the RS-232 serial port. Either the Printer driver or the RS-232 driver may be used.

Driver Configuration Block - Printer Driver

0	1	2	3	4
0E	00	00	00	00

Driver Configuration Block - RS232 Driver

0	1	2	3	4	5
0E	00	00	00	00	00
6	7	8	9	A	B
13	11	DF	84	50	80

**Macintosh 128K,
512K, and 512K
Enhanced**

Connect cable 590-0332 (M0185) or 590-0551 (M0196) to the PRINTER port.

Macintosh Plus

Connect cable 590-0340 (M0187) or 590-0552 (M0197) to the PRINTER port.

**Macintosh SE
and SE/30**

Connect cable 590-0340 (M0187) or 590-0552 (M0197) to the PRINTER port.

**Macintosh II,
IIfx, and IIfx**

Connect cable 590-0340 (M0187) or 590-0552 (M0197) to the PRINTER port.

**Lisa/
Macintosh XL**

Connect cable 590-0331 (A2C0311) or 590-0555 (A2C0312) to the SERIAL A port.

□ MODEM 300/1200

Standard Switch Settings

For both the Modem 300 and Modem 1200, standard switch settings are:

SW1 1 2 3
ON OFF OFF

Note: ON is the same as DOWN; OFF is the same as UP.

Apple II, II Plus, IIe, and IIgs

With a **High Speed Serial Card**, use cable 590-0121. Set the DIP switches on the card as follows:

For the Modem 300:

SW1 1 2 3 4 5 6 7
ON OFF ON OFF OFF OFF ON

These settings configure the interface as follows:

300 baud
No delay after CR
132 columns/video off
No LF after CR

For the Modem 1200:

SW1 1 2 3 4 5 6 7
OFF OFF ON OFF OFF OFF ON

These settings configure the interface as follows:

1200 baud
No delay after CR
132 columns/video off
No LF after CR

...Continued on next page

With a **Super Serial Card**, use cable 590-0121 (A2C0354*). Set the DIP switches on the card as follows:

For the Modem 300:

SW1	1	2	3	4	5	6	7
	ON	OFF	OFF	ON	ON	ON	ON
SW2	1	2	3	4	5	6	7
	ON	ON	OFF	ON	OFF	OFF	OFF

These settings configure the interface as follows:

300 baud
Communications mode
Normal RS-232 signals
8 data bits, 1 stop bit
No parity
No LF after CR
Interrupts off

For the Modem 1200:

SW1	1	2	3	4	5	6	7
	OFF	ON	ON	ON	ON	ON	ON
SW2	1	2	3	4	5	6	7
	ON	ON	OFF	ON	OFF	OFF	OFF

These settings configure the interface as follows:

1200 baud
Communications mode
Normal RS-232 signals
8 data bits, 1 stop bit
No parity
No LF after CR
Interrupts off

Note: Install the jumper block on the card with the arrow pointing toward MODEM.

**Apple IIGS
and IIC Plus**

Connect cables 590-0121 (A2C0354*) and 590-0550 (A9M0333) to the MODEM port.

For the **Modem 300**, change the baud rate of the modem port to 300 baud.

For the **Modem 1200**, use the default port settings.

Apple IIc

Connect cable 590-0192 (A2C4505*) to the MODEM port.

For the **Modem 300**, use the default port settings.

For the **Modem 1200**, change the baud rate of the MODEM port to 1200 baud.

Apple III and III Plus

Connect cable 590-0121 (A3C0354*) to the RS-232 serial port.

**Macintosh 128K,
512K, and 512K
Enhanced**

Connect cable 590-0197 (M0170*) to the MODEM port.

Macintosh Plus

Connect cables 590-0197 (M0170*) and 590-0341 (M0189) or 590-0553 (M0199) to the MODEM port.

**Macintosh SE
and SE/30**

Connect cables 590-0197 (M0170*) and 590-0341 (M0189) or 590-0553 (M0199) to the MODEM port.

**Macintosh II,
IIX, and IICX**

Connect cables 590-0197 (M0170*) and 590-0341 (M0189) or 590-0553 (M0199) to the MODEM port.

**Lisa/
Macintosh XL**

Connect cable 590-0121 (A6C0354*) to the SERIAL A port.

□ APPLE PERSONAL MODEM

Standard Switch Settings

No switches.

Apple II, II Plus, IIe, and IIgs

With a **High Speed Serial Card**, use cable 590-0331 (A2C0311) or 590-0555 (A2C0312). Set the DIP switches on the card as follows:

SW1	1	2	3	4	5	6	7
	OFF	OFF	ON	OFF	OFF	OFF	ON

These settings configure the interface as follows:

- 1200 baud
- No delay after CR
- 132 columns/video off
- No LF after CR

With a **Super Serial Card**, use cable 590-0331 (A2C0311) or 590-0555 (A2C0311). Set the DIP switches on the card as follows:

SW1	1	2	3	4	5	6	7
	OFF	ON	ON	ON	ON	ON	ON
SW2	1	2	3	4	5	6	7
	ON	ON	OFF	ON	OFF	OFF	OFF

These settings configure the interface as follows:

- 1200 baud
- Communications mode
- Normal RS-232 signals
- 8 data bits, 1 stop bit
- No parity
- No LF after CR
- Interrupts off

Note: Install the jumper block on the card with the arrow pointing toward MODEM.

**Apple IIgs
and IIc Plus**

Connect cable 590-0340 or 590-0552 (M0197) to the MODEM port.

Use the default port settings.

Apple IIc

Connect cable 590-0333 (A2C4312) or 590-0554 (A2C4313) to the MODEM port.

Change the baud rate of the MODEM port to 1200 baud.

Apple III and III Plus

Connect cables 590-0331 and 590-0166 (A2C0311) or 590-0555 and 590-0166 (A2C0312) to the RS-232 serial port.

**Macintosh 128K,
512K, and 512K
Enhanced**

Connect cable 590-0332 (M0185) or 590-0551 (M0196) to the MODEM port.

Macintosh Plus

Connect cable 590-0340 (M0187) or 590-0552 (M0197) to the MODEM port.

**Macintosh SE
and SE/30**

Connect cable 590-0340 (M0187) or 590-0552 (M0197) to the MODEM port.

**Macintosh II,
IIx, and IIcx**

Connect cable 590-0340 (M0187) or 590-0552 (M0197) to the MODEM port.

**Lisa/
Macintosh XL**

Connect cable 590-0331 (A2C0311) or 590-0555 (A2C0312) to the SERIAL A port.

□ COLOR PLOTTER

Standard Switch Settings

Standard switch settings are:

SW1	1	2	3	4	5	6	7	8
	OFF	ON	ON	OFF	ON	ON	OFF	OFF

These settings configure the plotter as follows:

8 data bits
No parity
1 stop bit
1200 baud

Apple II, II Plus, Ile, and IIGS

With a **Super Serial Card**, use cable 590-0037 (A2C0302*). Set the DIP switches on the card as follows:

SW1	1	2	3	4	5	6	7
	OFF	ON	ON	ON	OFF	ON	ON

SW2	1	2	3	4	5	6	7
	ON	OFF	OFF	OFF	OFF	OFF	OFF

Note: Install the jumper block on the card with the arrow pointing toward TERMINAL.

Apple IIGS and IIC Plus

Connect cables 590-0037 (A2C0302*) and 590-0550 (A9M0333) to the PRINTER port.

Set the baud rate of the PRINTER port to 1200 baud.

Apple IIC

Connect cable 590-0191 (A2C4510*) to the PRINTER port.

Set the baud rate of the PRINTER port to 1200 baud.

Apple III and III Plus

Connect cables 590-0037 and 590-0166 (A2C0302*†) to the RS-232 serial port. Either the printer driver or the RS-232 driver may be used.

Note: Set Color Plotter Switch 1 (SW1) position 1 to ON and position 2 to OFF. These settings will configure the plotter for 7 data bits and odd parity.

Driver Configuration Block - Printer Driver

0	1	2	3	4
08	22	00	00	00

Driver Configuration Block - RS232 Driver

0	1	2	3	4	5
08	22	00	00	00	00
6	7	8	9	A	B
13	11	DF	84	50	80

APPLELINE

Standard Switch Settings

No switches.

Apple III and III Plus

Connect cables 590-0037 and 590-0166 (A2C0302*†) to the RS-232 serial port.

Lisa/Macintosh XL

Connect cables 590-0037 and 590-0166 to either the A or B (preferred) port of the Lisa or port B of the Macintosh XL.

Macintosh 128K, 512K, and 512K Enhanced

Connect cable 590-0169 to either the modem (preferred) or printer port.

Macintosh Plus

Connect cables 590-0169 and 590-0341 or 590-0553/699-0430 to either the modem (preferred) or printer port.

Macintosh SE and SE/30

Connect cables 590-0169 and 590-0341 or 590-0553/699-0430 to either the modem (preferred) or printer port.

Macintosh II, IIX, and IICX

Connect cables 590-0169 and 590-0341 or 590-0553/699-0430 to either the modem (preferred) or printer port.

APPLEFAX MODEM

Standard Switch Settings

No switches.

Macintosh Plus

Connect cable 590-0340 or 590-0552 (M0197) to the modem port.

Macintosh SE and SE/30

Connect cable 590-0340 or 590-0552 (M0197) to the modem port.

Macintosh II, Iix, and Iicx

Connect cable 590-0340 or 590-0552 (M0197) to the modem port.

Peripheral Interface Guide

Section 5 – Cable and Connector Specifications

□ CONTENTS

5.3	Introduction
5.4	Cable Specifications
5.4	Cable 590-0029
5.4	Cable 590-0036
5.5	Cable 590-0037
5.6	Cable 590-0042
5.6	Cable 590-0121
5.7	Cable 590-0166
5.8	Cable 590-0169
5.8	Cable 590-0191
5.9	Cable 590-0192
5.9	Cable 590-0197
5.10	Cables 590-0331 and 590-0555
5.10	Cables 590-0332 and 590-0551
5.11	Cables 590-0333 and 590-0554
5.11	Cables 590-0335 and 590-0556
5.11	Cables 590-0340 and 590-0552
5.12	Cables 590-0341, 590-0553, and 699-0430
5.13	Cable 590-0345
5.14	Cable 590-0346
5.14	Cable 590-0347
5.14	Cable 590-0550
5.15	Connector Specifications
5.15	DE-9 Connector
5.15	DA-15 Connector
5.15	DB-19 Connector
5.15	DB-25 Connector
5.15	Mini DIN-4 Connector
5.15	Mini DIN-8 Connector
5.15	DIN-5 Connector

□ INTRODUCTION

This section contains information about pin connections, colors, and connector types for Apple peripheral cables. A diagram at the end of the section shows the pin numbering of each connector.

□ CABLE SPECIFICATIONS

Cable	<u>DB-25 Male</u>	<u>DB-25 Female</u>
590-0029	1	1
	2	3
	3	2
	4 and 5	8
	6	20
	7	7
	8	4 and 5
	20	6

Color: light gray

This is a modem eliminator cable, used to connect the Apple III, III Plus, and Lisa/Macintosh XL to serial ports on devices other than modems.

This cable has been replaced by 590-0166.

Cable	<u>20-Pin Socket Connector</u>	<u>TRW Cinch 57-30360 Male</u>
590-0036	1	14
	2	10
	3	33
	4	32
	5	31
	6	17
	7	11
	8	1
	9	12
	10	2
	11	3
	12	4
	13	5
	14	6
	15	7
	16	8
	17	9
	18	13
	19	18
	20	16

Color: varies

Used to connect the following devices:

Apple II, II Plus, IIe, IIGs using the Centronics Printer Card to a Dot Matrix Printer.

Apple III, III Plus using the Universal Parallel Interface Card to a Dot Matrix Printer.

**Cable
590-0037**

DB-25 Male

1
2
3
4
5
6
7
8
20

DB-25 Male

1
2
3
4
5
6
7
8
20

Color: light gray

Used to connect the following devices:

Apple II, II Plus, IIe, IIGs using the High Speed Serial Card or Super Serial Card to a Daisy Wheel Printer or ImageWriter/ImageWriter 15-Inch.

Apple II, II Plus, IIe, IIGs using the Super Serial Card to a Scribe or Color Plotter.

Apple IIGs and IIc Plus to a Daisy Wheel Printer, Scribe, ImageWriter/ImageWriter 15-Inch, or Color Plotter (also requires cable 590-0550).

Apple III and III Plus to a Daisy Wheel Printer, Scribe, ImageWriter/ImageWriter 15-Inch, Color Plotter, or AppleLine (also requires cable 590-0029 (obsolete) or 590-0166).

Lisa/Macintosh XL to a Daisy Wheel Printer, Scribe, ImageWriter/ImageWriter 15-Inch, or AppleLine (also requires cable 590-0029 (obsolete) or 590-0166).

Cable
590-0042

DB-25 Male

AMP-36 Male

2	19
5	2
6	3
8	4
11	7
12	8
13	9
14	11
15	1
16	10
18	35
19	12
21	13
22	5
23	6
24	16
25	32

Color: light gray

Used to connect the following devices:

Apple II, II Plus, IIe, IIGS using the Parallel Interface Card to a Dot Matrix Printer.

Lisa/Macintosh XL using the internal parallel interface (Lisa 2.0 and 2/5 only) or the 2-Port Parallel Card to a Dot Matrix Printer.

Cable
590-0121

DE-9 Male

DB-25 Male

3	7
9	2
7	8 and 5
6	20
2	6
5	3
8	1

Color: beige

Used to connect the following devices:

Apple II, II Plus, IIe, IIGS using the High Speed Serial Card or Super Serial Card to a Modem 300 or Modem 1200.

Apple IIGs and IIc Plus to a Modem 300 or Modem 1200
(also requires cable 590-0550).

Apple III and III Plus to a Modem 300 or Modem 1200.

Lisa/Macintosh XL to a Modem 300 or Modem 1200.

Cable
590-0166

DB-25 Male

1
2
3
4 and 5
6
7
8
20

DB-25 Female

1
3
2
8
20
7
4 and 5
6

Color: gray

This is a modem eliminator cable, used to connect the Apple III, III Plus, and Lisa/Macintosh XL to serial ports on devices other than modems.

This cable replaces 590-0029.

**Cable
590-0169**

DE-9 Male

1
3 and 8
5
7
9

DB-25 Male

1
7
3
20
2

Color: medium brown

Used to connect the following devices:

Apple IIGs and IIC Plus to a Scribe, ImageWriter/
ImageWriter 15-Inch, or Color Plotter (also requires
cable 590-0341).

Macintosh 128K, 512K, 512K Enhanced to an
ImageWriter/ImageWriter 15-Inch or AppleLine.

Macintosh Plus, SE, SE 30, II, IIX, IICx to an
ImageWriter/ImageWriter 15-Inch or AppleLine (also
requires either cable 590-0341 or 590-0553/699-04390).

**Cable
590-0191**

DIN-5 Male

1
2
3
4
5

DB-25 Male

6
3
7
2
20

Color: beige

Used to connect the following devices:

Apple IIC to a Daisy Wheel Printer, Scribe,
ImageWriter/ImageWriter 15-Inch, or Color Plotter.

**Cable
590-0192**

DIN-5 Male

1
2
3
4
5
Case Shield

DE-9 Male

6
9
3
5
2
8

Color: beige

Used to connect the following devices:

Apple IIc to a Modem 300 or Modem 1200.

**Cable
590-0197**

DE-9 Male

3 and 8
5
6
7
9

DE-9 Male

3 and 8
9
6
7
5

Color: medium brown

Used to connect the following devices:

Macintosh 128K, 512K, 512K Enhanced to a Modem 300 or Modem 1200.

Macintosh Plus, SE, SE/30, II, IIX, IICx to a Modem 300 or 1200 (also requires cable 590-0341 or 590-0553).

Cables
590-0331
and 590-0555

<u>Mini</u> <u>DIN-8 Male</u>	<u>DB-25 Male</u>
1	6 and 8
2	20
3	3
4 and 8	7
5	2

Color: 590-0331—beige, 590-0555—smoke

Used to connect the following devices:

Apple II, II Plus, IIe, IIGS using High Speed Serial Card or Super Serial Card to an ImageWriter II, ImageWriter LQ, or Apple Personal Modem.

Apple III and III Plus to an ImageWriter II or ImageWriter LQ.

Apple III and III Plus to an Apple Personal Modem (also requires cable 590-0029 (obsolete) or 590-0166).

Lisa/Macintosh XL to an ImageWriter II, ImageWriter LQ, or Apple Personal Modem.

Cables
590-0332
and 590-0551

<u>Mini</u> <u>DIN-8 Male</u>	<u>DE-9 Male</u>
1 and 7	7
2	6
3	9
4	1
5	5
6	8
8	4

Color: 590-0332—beige, 590-0551—smoke

Used to connect the following devices:

Macintosh 128K, 512K, 512K Enhanced to an ImageWriter II, ImageWriter LQ, or Apple Personal Modem.

**Cables
590-0333
and 590-0554**

Mini DIN-8 Male	DIN-5 Male
2	1
3	4
4 and 8	3
5	2

Color: 590-0333—beige, 590-0554—smoke

Used to connect the following devices:

Apple IIc to an ImageWriter II, ImageWriter LQ, or
Apple Personal Modem.

**Cables
590-0335
and 590-0556**

Mini DIN-8 Male	DB-25 Male
1	20
2	6 and 8
3	2
4 and 8	7
5	3

Color: 590-0335—beige, 590-0556—smoke

Used to connect the following devices:

Apple II, II Plus, IIe, IIGS using High Speed Serial Card
or Super Serial Card to an ImageWriter II.

Apple II, II Plus, IIe, IIGS using Super Serial Card to an
ImageWriter LQ.

**Cables
590-0340
and 590-0552**

Mini DIN-8 Male	Mini DIN-8 Male
1	2
2	1
3	5
4	4
5	3
6	8
7	7
8	6

...Continued on next page

Color: 590-0340—beige, 590-0552—smoke

Used to connect the following devices:

Apple IIGs and IIC Plus to an ImageWriter II, ImageWriter LQ, or Apple Personal Modem.

Macintosh Plus, SE, SE/30, II IIX, IICX to an ImageWriter II, ImageWriter LQ, Apple Personal Modem, or AppleLine.

Cable
590-0341,
590-0553,
and 699-0430

Mini DIN-8 Male	Mini DE-9 Female
1	6
2	7
3	5
4	3 and 1
5	9
6	4
8	8

Color: 590-0341—beige, 590-0553 and 699-0430—smoke

This is an adapter cable used to connect DE-9 cables to devices with Mini DIN-8 ports.

Cables
590-0345

<u>BR-50 Male</u>	<u>DB-25 Male</u>
1, 2, and 3	14
4, 5, and 6	16
7, 8, 9, and 11	18
16, 18, and 19	7
20, 21, and 22	9
23, 24, and 25	24
26	8
27	21
28	22
29	10
30	23
31	11
32	12
33	13
34	20
38	25
41	17
43	6
44	5
45	4
46	2
47	19
48	15
49	1
50	3

Color: beige

Used to connect Apple II and Macintosh computers having a SCSI interface to SCSI peripherals.

Compatible computers:

- Apple IIe and IIgs with an Apple II SCSI Interface Card
- Macintosh Plus, SE, SE/30, II, IIx, or IIcx

Compatible peripherals:

- Hard Disk 20SC, 40SC, or 80SC
- TapeBackup 40SC
- AppleCD SC™
- LaserWriter II SC
- Apple Scanner

**Cable
590-0346**

This cable is wired straight through (1-to-1, 2-to-2, 3-to-3, etc.).

Color: beige

Used to daisy chain SCSI devices (male-to-male).

**Cable
590-0347**

This cable is wired straight through (1-to-1, 2-to-2, 3-to-3, etc.).

Color: beige

Used to daisy-chain SCSI cables (male-to-female).

**Cable
590-0550**

Mini DIN-8

DB-25 Female

1	6
2	20
3	3
4 and 8	7
5	2
7	4 and 5
Shield	Shield

Color: smoke

Apple IIGs and IIC Plus Peripheral Adapter Cable. Used to connect DB-25 cables to the Mini DIN-8 ports.

□ CONNECTOR SPECIFICATIONS

Note: The pin numbers shown are for the connector attached to the end of the cable, not on the device. They are viewed from the front of the connector (the side that plugs into the mating connector).

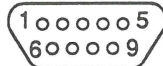

DE-9

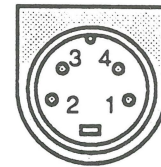

Mini DIN-4

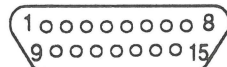

DA-15

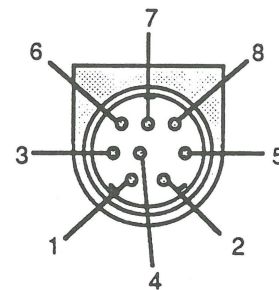

Mini DIN-8

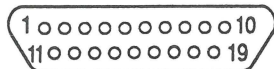

DB-19

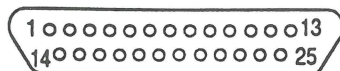

DB-25

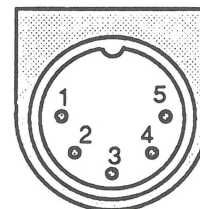

DIN-5

Apple Computer, Inc.
20525 Mariani Avenue
Cupertino, California 95014
(408) 996-1010
TLX 171-576