



Planning and Installation Manual

DeviceNet™ Cable System

Important User Information

Because of the variety of uses for the products described in this publication, those responsible for the application and use of this control equipment must satisfy themselves that all necessary steps have been taken to assure that each application and use meets all performance and safety requirements, including any applicable laws, regulations, codes and standards.

The illustrations, charts, sample programs and layout examples shown in this guide are intended solely for purposes of example. Since there are many variables and requirements associated with any particular installation, ODVA does not assume responsibility or liability (to include intellectual property liability) for actual use based upon the examples shown in this publication.

Reproduction of the contents of this copyrighted publication, in whole or part, without written permission of ODVA, is prohibited.

Throughout this manual we use notes to make you aware of safety considerations:



ATTENTION: Identifies information about practices or circumstances that can lead to personal injury or death, property damage or economic loss

Attention statements help you to:

- identify a hazard
- avoid a hazard
- recognize the consequences

Important: Identifies information that is critical for successful application and understanding of the product.

Using This Manual

What's in This Manual

Use this manual to plan and install a DeviceNet™ cable system. This manual describes the required components of the cable system and how to plan for and install these required components.

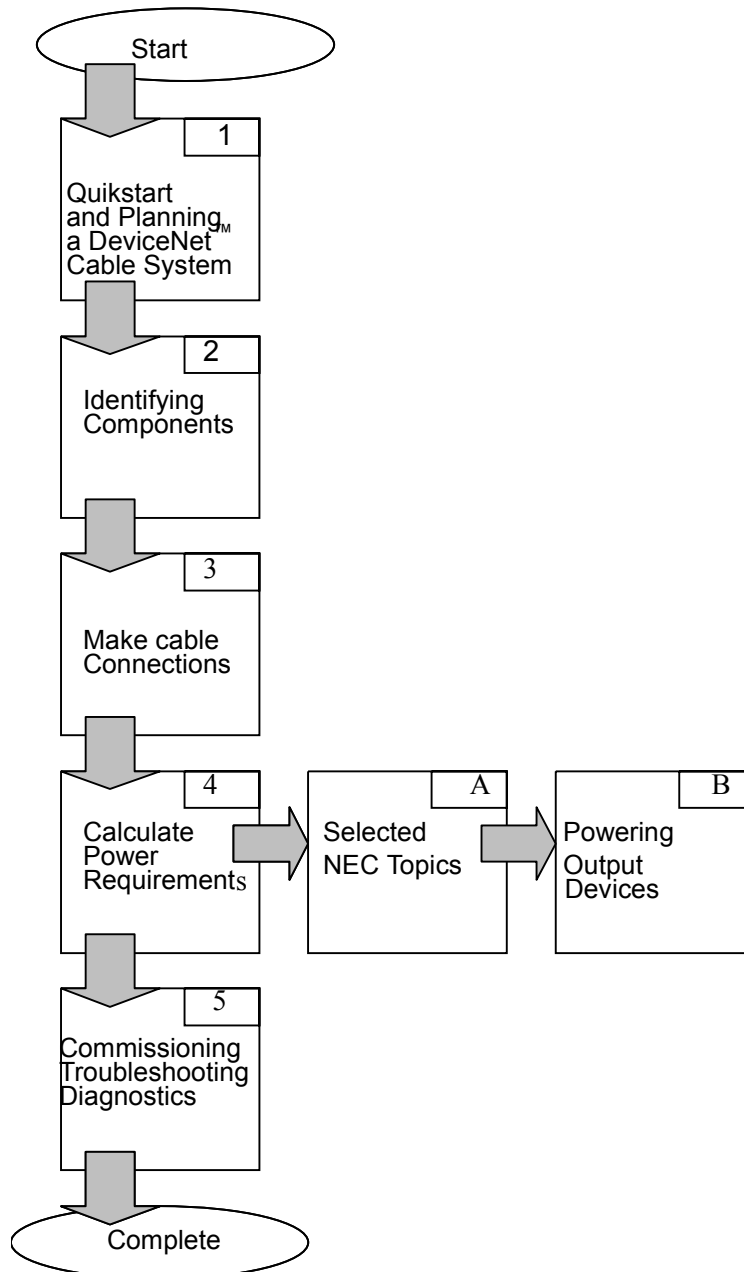

Who Should Read This Manual

We assume that you have a fundamental understanding of:

- electronics and electrical codes
- basic wiring techniques
- ac and dc power specifications
- load characteristics of the devices attached to the DeviceNet™ network

About the National Electric Code

Much of the information provided in this manual is representative of the capability of a DeviceNet™ network and its associated components. The National Electric Code (NEC), in the United States, and the Canadian Electric Code (CECode), in Canada, places limitations on configurations and the maximum allowable power/current that can be provided. Refer to Appendix A for details.

Important: Be sure that all national and local codes are thoroughly researched and adhered to during the planning and installation of your DeviceNet™ network.

Common Techniques Used in This Manual

The following conventions are used throughout this manual:

- Bulleted lists provide information, not procedural steps.
- Numbered lists provide sequential steps.
- Information in **bold** contained within text identifies menu options, screen names and areas of the screen, such as dialog boxes, status bars, radio buttons and parameters.
- Text in *this font* identifies node addresses and other values assigned to devices.
- Pictures of keys and/or screens represent the actual keys you press or the screens you use.



This symbol represents an information tip.



Table Of Contents

Get Started	1-1
What's in this chapter?	1-1
Set Up a DeviceNet™ Network	1-1
Basic DeviceNet™ Network	1-2
Understand the Topology.....	1-2
Understand the Media.....	1-2
Understand the Cable Options.....	1-2
Determine the Maximum Trunk Length Distance	1-3
Determine the Cumulative Drop Line Length.....	1-4
About the Direct Connection	1-5
Using Connectors	1-5
Terminate the Network	1-7
Guidelines for Supplying Power	1-9
Supplying Power	1-10
Identify Cable System Components	2-1
Round (Thick, Mid and Thin) Cable Network.....	2-1
About Thick Cable.....	2-2
About Mid Cable	2-3
About Thin Cable	2-3
About Flat Cable	2-4
Connecting to the Trunk Line	2-4
About the T-Port Tap.....	2-6
About the Multi Port Tap.....	2-7
About the Power Tap.....	2-7
About the Multi Port Tap.....	2-8
About the Direct Connection.	2-8
About the Open-Style Connector	2-9
About Flat Cable Insulation Displacement Connectors (IDCs)	2-10
Using Preterminated Cables	2-11
About Thick Cable.....	2-11
About Thin Cable.....	2-11
About Terminators	2-13
Make Cable Connections	3-1
Preparing Cables	3-1
How to Install Open-Style Connectors	3-2
How to Install Mini/Micro Sealed Field-Installable Connectors	3-3
How to Install Power taps and Multi Port Taps with Terminals	3-4
How to Install Multi Port Taps with Sealed Connectors.....	3-5
How to Connect Drop Lines	3-5



Table Of Contents

Flat Cable Installation Instructions	3-6
How to Install a Flat Cable Connector.....	3-6
End Cap Installation	3-10
Installing Auxiliary Power Cable.....	3-11
Connecting Power Supplies to Round Media.....	3-11
Determine Power Requirements	4-1
Use the Look-Up Method	4-1
One Power Supply (End-Connected).....	4-11
One Power Supply (Middle-Connected)	4-12
NEC/CE Code Current Boost Configuration.....	4-14
Two Power Supplies (End-Connected) in Parallel with No V+ Break	4-15
Two Power Supplies (Not End- Connected) in Parallel with No V+ Break.....	4-16
Use the Full-Calculation Method	4-18
Using the Equation.....	4-18
One Power Supply (End-Connected).....	4-20
One Power Supply (Middle-Connected).....	4-21
Commissioning Troubleshooting and Diagnostics.....	5-1
Network Measurement Tools	5-1
Verifying Network Installation.....	5-1
Confirming Media	5-2
Proper Network Maintenance.....	5-4
Common Mode Problems	5-4
Bus Errors	5-5
Bus Traffic Problems.....	5-5
Bus Power Problems.....	5-6
Shield Voltage Problems.....	5-6
Common Faults.....	5-7
Flat Cable Shorts	5-7
Understanding Select NEC Topics	A-1
What's in This Appendix	A-1
Class 1 (CL1) Cable	A-1
Class 2 (CL 2) Cable.....	A-1
Specifying Article 725 Topics.....	A-2
Round (Thick, Mid & Thin) and Class 2 Flat Media.....	A-2
Class 1 Round or Flat Media.....	A-2



Table Of Contents

Powering Output Devices..... B-1
 Wide Available Voltage Range..... B-1
 Noise or Transient Protection..... B-2

DeviceNet Baseline & Test Report..... C-1
 Baseline and Test Report..... C-1

Index



DeviceNet™

Get Started

What's in This Chapter?

This chapter introduces the DeviceNet™ cable system and provides a brief overview of how to set up a DeviceNet™ network efficiently. The steps in this chapter describe the basic tasks involved in setting up a network.

Set Up a DeviceNet Network

The following diagram illustrates the steps that you should follow to plan and install a DeviceNet™ network. The remainder of this chapter provides an overview and examples of each step, with references to other sections in this manual for more details.

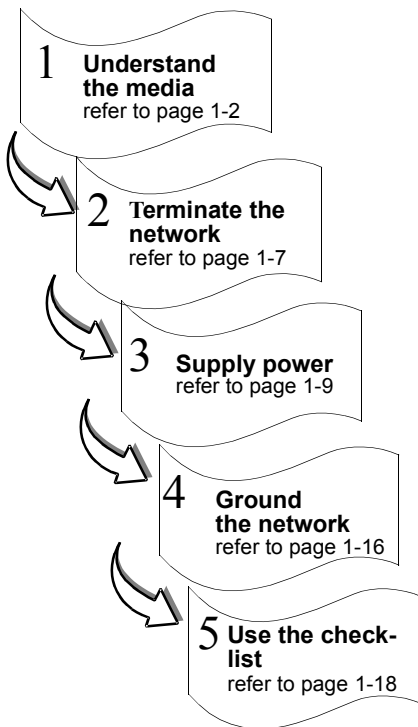

1 Understand the media	Refer to page 1-2
2 Terminate the network	Refer to page 1-7
3 Supply power	Refer to page 1-9
4 Ground the network	Refer to page 1-16
5 Use the checklist	Refer to page 1-18

Basic DeviceNet™ Network

This figure shows a basic DeviceNet™ network and calls out its basic components.

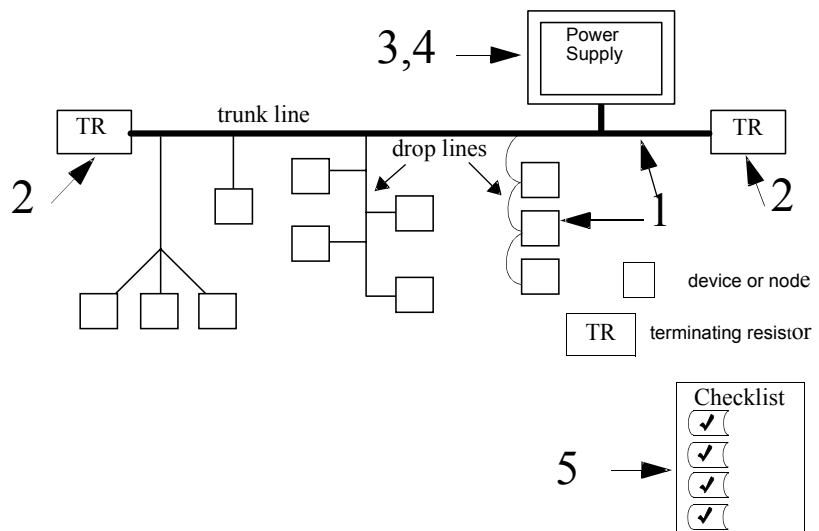

1 Understand the media

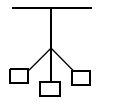

You must terminate the trunk line at both ends with 121 Ohms, 1%, 1/4W terminating resistors.

Understand the Topology

The DeviceNet cable system uses a trunk/drop line topology.

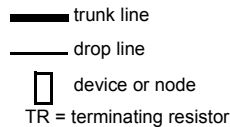
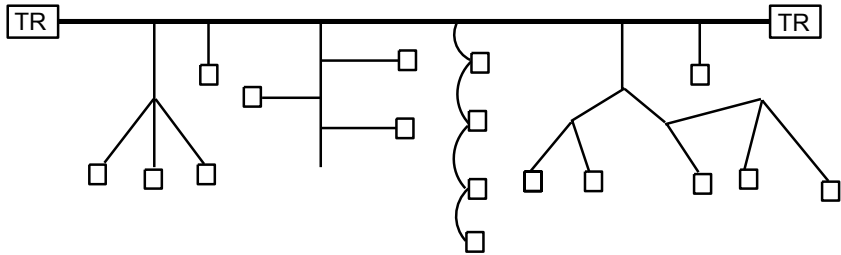

Use only DeviceNet™ media that meet or exceed ODVA specifications.

Understand the Cable Options

You can connect components using five cable options:

Wire Color	Wire Identity	Usage Round	Usage Flat
white	CAN_H	signal	signal
blue	CAN_L	signal	signal
bare	drain	shield	n/a
black	V-	power	power
red	V+	power	power

Use this cable	For
Round (thick)	The trunk line on the DeviceNet™ network with a nominal outside diameter of 12.2 mm (0.48 in.). You can also use this cable for drop lines.
Round (mid)	The trunk line on the DeviceNet™ network where smaller cable diameters and smaller bend radii are required. Its outside diameter is specified by the vendor. This cable can also be used for drop lines.
Round (thin)	The drop line connecting devices to the main line with an outside diameter of 6.9 mm (0.27 in.). This cable has a smaller diameter and is more flexible than thick cable. You can also use this cable for the trunk line.
Flat	The trunk line on the DeviceNet™ network, with dimensions of 19.3 mm x 5.3 mm (0.76 in. x 0.21 in.). This cable has no predetermined cord lengths, and you are free to put connections wherever you need them.
Unshielded drop cable	This is a non-shielded, 4 conductor, drop cable for use only in flat cable systems, with an outside diameter specified by the vendor.

NOTE: These generic cable types are available in a variety of different offerings such as FLEX, HAZ-DUTY, CLASS I (600V), UV RESISTANT, etc.



- ▶ All DeviceNet™ Cabling components selected shall be suitable for the environment in which they are installed and in particular; corrosion resistance, IP rating and Ultra Violet stabilisation.

Note: DeviceNet™ cables are available in a variety of different types including; High flexibility, Hazardous duty, Class 1 - 600 Volt, UV resistant.

Consideration must also be given to environmental protection of cable components when individual nodes are removed for maintenance and for testing.

- ▶ Excessive bending of DeviceNet™ cables can reduce their ability to meet the DeviceNet™ specification. Standard Thick cables shall have a bending radius of greater than 3" (75mm). Standard Thin cables shall have a bending radius of greater than 2" (50mm).

- ▶ Round shielded cable (thick, mid and thin) contains five wires: One twisted pair (red and black) for 24V dc power; one twisted pair (blue and white) for signal, and a drain wire (bare).

Flat cable contains four wires: One pair (red and black) for 24 dc power; one pair (blue and white) for signal.

Unshielded 4-wire drop cable is only designed for use with flat cable systems .

The maximum cable distance is not necessarily the trunk length only. It is the maximum distance between any two devices.

Determine the Maximum Trunk Line Distance

The distance between any two points must not exceed the maximum cable distance allowed for the data rate used.

Data rate	Maximum distance (flat cable)	Maximum distance (thick cable)	Maximum distance (mid cable)	Maximum distance (thin cable)
125k bit/s	420m (1378 ft)	500m (1640 ft)	300m (984 ft)	100m (328 ft)
250k bit/s	200m (656 ft)	250m (820 ft)	250m (820 ft)	100m (328 ft)
500k bit/s	75m (246 ft)	100m (328 ft)	100m (328 ft)	100m (328 ft)

For most cases, the maximum distance should be the measurement between terminating resistors. However, if the distance from a trunk line tap to the farthest device connected to the trunk line is greater than the distance from the tap to the nearest terminating resistor (TR), then you must include the drop line length as part of the cable length.

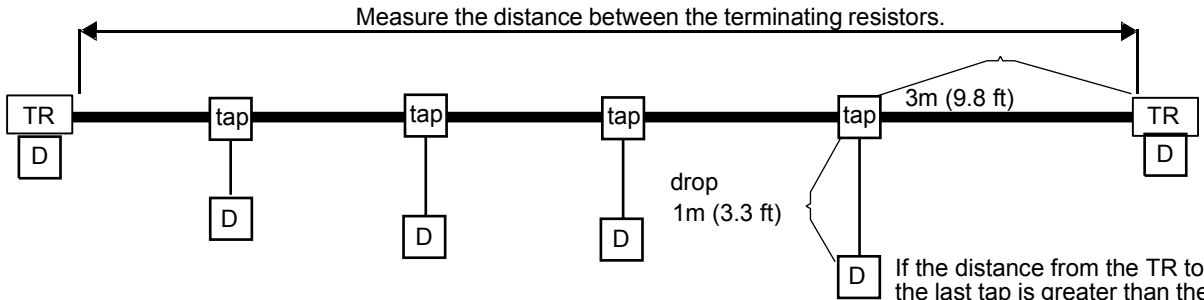

Always use the longest distance between any 2 nodes of the network.

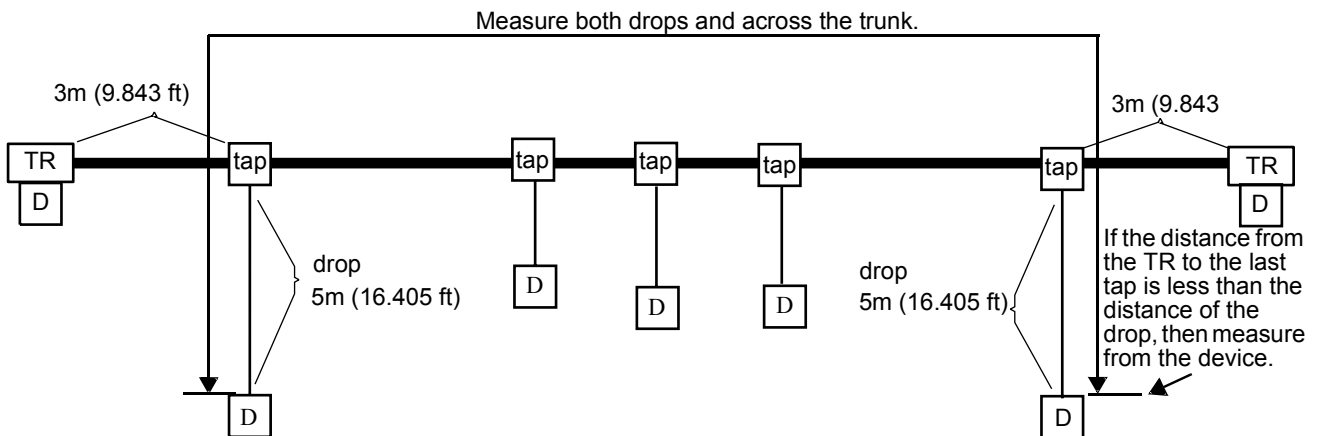

Determine the Cumulative Drop Line Length

The data rate you choose determines the maximum trunk line and the cumulative drop line lengths.

The cumulative drop line length refers to the sum of all drop lines, thick, thin, or mid cable, in the cable system. This sum cannot exceed the maximum cumulative length allowed for the data rate used.

The maximum cable distance from any device on a branching drop line to the trunk line is 6m (20 ft).

Data rate	Cumulative drop line length
125k bit/s	156m (512 ft)
250k bit/s	78m (256 ft)
500k bit/s	39m (128 ft)

The following example uses four T-Port (single-port) taps and two multi-port taps to attach 13 devices to the trunk line. The cumulative drop line length is 42m (139 ft) and no single node is more than 6m (20 ft) from the trunk line. This allows you to use a data rate of 250k bit/s or 125k bit/s. A data rate of 500k bit/s cannot be used in this example because the cumulative drop line length (42m) exceeds the total allowed (39m) for that data rate.

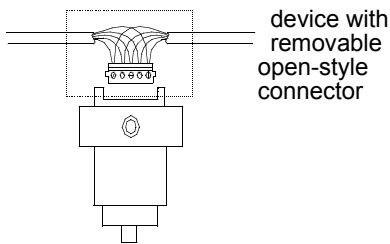
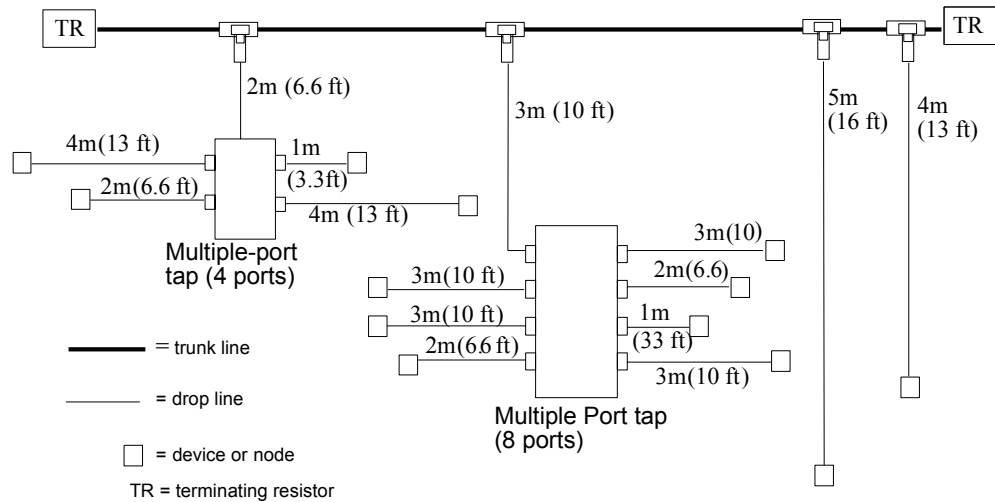

About the Direct Connection

Connect devices directly to the trunk line only if you can later remove the devices without disturbing communications on the cable system. This is called a “zero-length” drop, because it adds nothing (zero) when calculating cumulative drop line length.

Important: If a device provides only fixed-terminal blocks for its connection, you must connect it to the cable system by a drop line. Doing this allows you to remove the device at the tap without disturbing communications on the trunk line of the cable system.

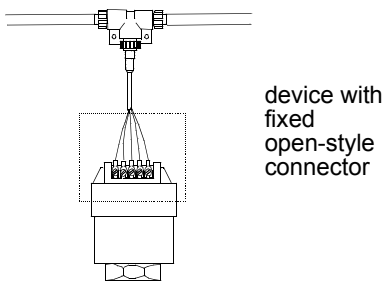

Using Connectors

Connectors attach cables to devices or other components of the DeviceNet™ cable system. Field-installable connections are made with either sealed or open connectors.

Wire Color	Wire Identity	Usage Round	Usage Flat
white	CAN_H	signal	signal
blue	CAN_L	signal	signal
bare	drain	shield	n/a
black	V-	power	power
red	V+	power	power

Connector	Description
Sealed	Mini-style: Attaches to taps and thick, thin, and mid cable. Micro-style: Attaches to thin cable only - has a reduced current rating.
Open	Plug-in: Cable wires attach to a removable connector. Fixed: Cable wires attach directly to non-removable screw terminals (or equivalent) on device.

Micro/Mini field-installable quick-disconnect (sealed) connectors (round media only).

Screw terminals connect the cable to the connector.

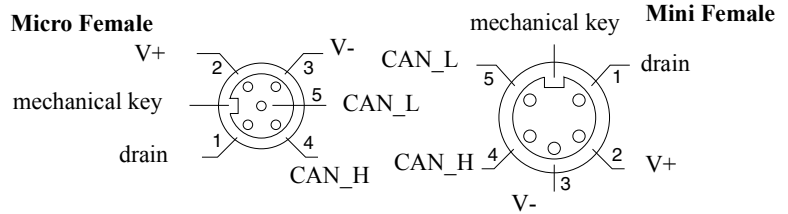

Plug-in field-installable (open) connectors

Most open-style devices ship with an open-style connector included.

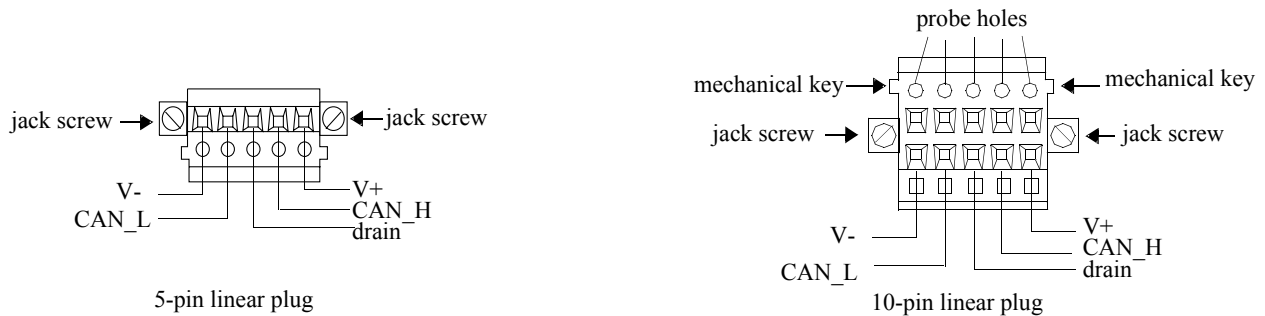

2 Terminate the network



The terminating resistor reduces reflections of the communication signals on the network. Choose your resistor based on the type of cable (round or flat) and connector (open or sealed) you use

- For round cable:
 - the resistor may be sealed when the end node uses a sealed T-port tap
 - the resistor may be open when the end node uses an open-style tap
- For flat cable:
 - the resistor is a snap-on cap for the flat cable connector base, available in sealed and unsealed versions

To verify the resistor connection, disconnect power and measure the resistance across the Can_H and Can_L lines (blue and white wires, respectively). This reading should be approximately 50-60 ohms.

Do not put a terminating resistor on a node with a non-removable connector. If you do so, you risk network failure if you remove the node. You must put the resistor at the end of the trunk line.

You must attach a terminating resistor equal to 121 ohms, 1%, 1/4W or greater wattage, to each end of the trunk cable. You must connect these resistors directly across the blue and white wires of the DeviceNet™ cable.



ATTENTION: If you do not use terminating resistors as described, the DeviceNet™ cable system will **not** operate properly.

The following terminating resistors provide connection to taps and the trunk line.

- sealed-style terminating resistors

Male or female connections attach to:

- trunk line ends
- T-Port taps

- open-style terminating resistors

121 ohms, 1%, 1/4W or greater wattage resistors connecting the white and blue conductors attach to:

- open-style T-Port taps
- trunk lines using terminator blocks

Wire Color	Wire Identity	Usage Round	Usage Flat
white	CAN_H	signal	signal
blue	CAN_L	signal	signal
bare	drain	shield	n/a
black	V-	power	power
red	V+	power	power

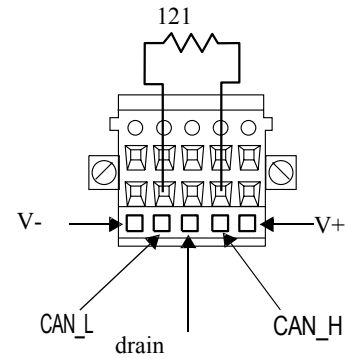

- Flat cable terminating resistors

The 121 ohm resistor is contained in the snap-on interface module:

- sealed terminator with an Insulation Displacement Connector (IDC) base (NEMA 6P, 13; IP67)
- unsealed terminator with IDC base (no gaskets) (NEMA 1; IP60)

Network endcaps should be included with each flat cable terminator; see Page 3-12 for complete installation instructions.

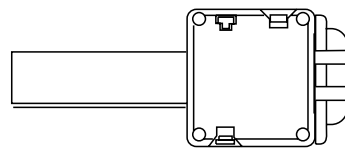

terminating resistor with end cap

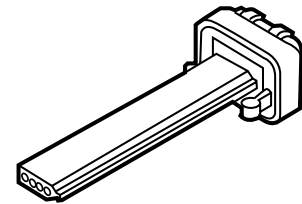

end cap

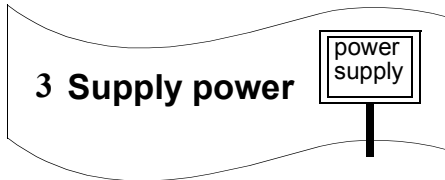

Guidelines for Supplying Power

The cable system requires the power supply to have a rise time of less than 250 milliseconds to within 5% of its rated output voltage. You should verify the following:



Use the power supply to power the DeviceNet™ cable system only. If a device requires a separate 24V power source other than the DeviceNet™ power source, you should use an additional 24V power source.

- the power supply has its own current limit protection
- fuse protection is provided for each segment of the cable system
 - any section leading away from a power supply must have protection
- the power supply is sized correctly to provide each device with its required power
- derate the supply for temperature using the manufacturer's guidelines

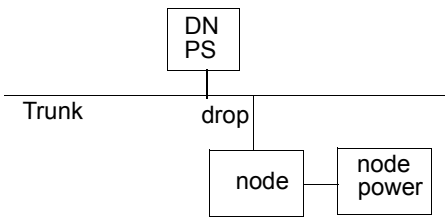

Important: For class 2 cables, your national and local codes may not permit the full use of the power system capacity when installed as building wire. For example, **in the United States and Canada, the power supplies that you use with class 2 cable must be Class 2 listed per the NEC and CECODE.** The total current allowable in any section of class 2 cable must not exceed 4A(100VA). Assume that a cable is class 2 unless the vendor describes it as class 1.

Class 1 power supplies allow for an 8A system, and the use of Class 1 flat cable. See Appendix A for more information about national and local codes.



Appendix B - Powering Output Devices provides valuable information to the installer.

Choosing a Power Supply

The total of all of the following factors must not exceed 3.25% of the nominal 24V needed for a DeviceNet™ cable system.

- initial power supply setting - 1.00%
- line regulation - 0.30%
- temperature drift - 0.60% (total)
- time drift - 1.05%
- load regulation - 0.30%



Use a power supply that has current limit protection as per national codes such as NEC, Article 725.

Important: The dc output of all supplies must be isolated from the ac side of the power supply and the power supply case.

To determine the required power supply current:

1. Add the current requirements of all devices drawing power from the network.
For example: 6.3A
2. Add an additional 10% to this total to allow for current surge.
e.g. $6.3A \times 10\% = 6.93A$
3. Make sure the total of 2 is less than the minimum name-plate current of the power supply you are using. e.g. $6.3A < 8A$ and NEC/CECode

If you use a single power supply, add the current requirements of all devices drawing power from the network. This is the minimum name-plate current rating that the power supply should have. For proper operation of your network, we recommend that you use a power supply that complies with the Open DeviceNet Vendor Association (ODVA) power supply specifications and NEC/CECode Class 2 characteristics (if applicable).

About Power Ratings

Although the round thick cable and Class 1 flat cable are both rated to 8A, the cable system can support a total load of more than 8A. For example, a 16A power supply located somewhere in the middle of the cable system can supply 8A to both sides of the power tap. It can handle very large loads as long as no more than 8A is drawn through any single segment of the trunk line. However, cable resistance may limit your application to less than 8A.

Drop lines, thick, mid or thin, are rated to a maximum of 3A, depending on length. The maximum current decreases as the drop line length increases.

Drop line length	Allowable current
1.5m (5 ft)	3A
2m (6.6 ft)	2A
3m (10 ft)	1.5A
4.5m (15 ft)	1A
6m (20 ft)	0.75A

You may also determine the maximum current in amps (I) by using:

$$I = 15/L, \text{ where } L \text{ is the drop line length in feet}$$

$$I = 4.57/L, \text{ where } L \text{ is the drop line length in meters}$$

The maximum allowable current applies to the sum of currents for all nodes on the drop line. As shown in the example on page Page 1-3, the drop line length refers to the maximum cable distance from any node to the trunk line, not the cumulative drop line length.

- The maximum allowable current may also be limited by high maximum common mode voltage drop on the V- and V+ conductors
 - the voltage difference between any two points on the V- conductor must not exceed the maximum common mode voltage of 4.65V
- voltage range between V- and V+ at each node within 11 to 25V

Sizing a Power Supply

Follow the example below to help determine the minimum continuous current rating of a power supply servicing a common section.

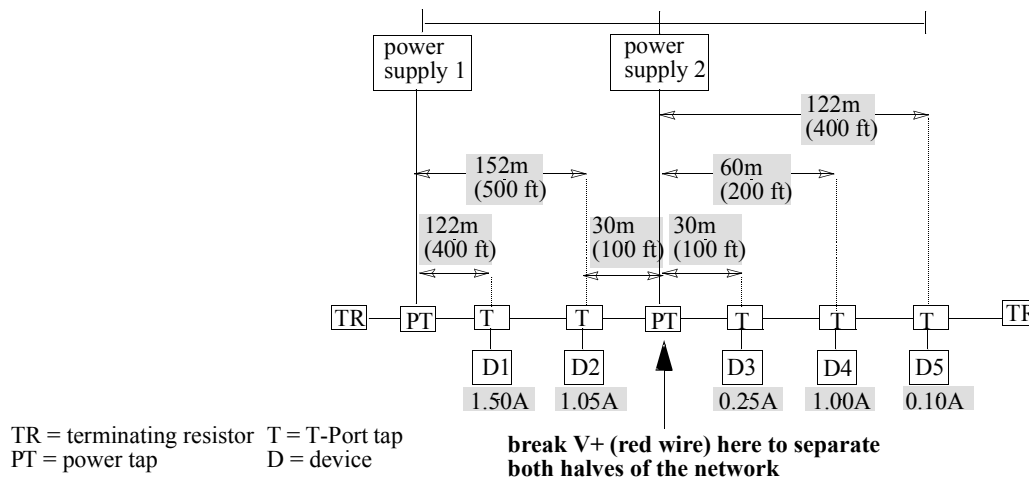

Power Supply 1

Add each device's (D1, D2) DeviceNet™ current draw together for power supply 1 ($1.50+1.05=2.55A$).

Results \Rightarrow 2.55A is the minimum name-plate current rating that power supply 1 should have. Remember to consider any temperature or environmental derating recommended by the manufacturer.

Important: This derating factor typically does not apply when you consider the maximum short circuit current allowed by the national and local codes.

Power Supply 2

Add each device's (D3, D4, D5) current together for power supply 2 ($0.25+1.00+0.10=1.35\text{A}$).

Results  1.35A is the minimum name-plate current rating that power supply 2 should have. Remember to consider any temperature or environmental derating recommended by the manufacturer.

Placing the Power Supply

DeviceNet™ networks with long trunk lines or with devices on them that draw large currents at a long distance sometimes experience difficulty with common mode voltage. If the voltage on the black V- conductor differs by more than 4.65 volts within the trunk line from one point on the network to another, communication problems can occur. Note: There is 0.35 volts reserved for the drop line. Moreover, if the voltage between the black V- conductor and the red V+ conductor ever falls below 15 volts, then common mode voltage could adversely affect network communication. To work around these difficulties, add an additional power supply or move an existing power supply closer to the heavier current loads.

To determine if you have adequate power for the devices in your cable system, use the look-up method which we describe more fully in Chapter 4. See the following example and figure (other examples follow in Chapter 4). You have enough power if the total load does not exceed the value shown by the curve or the table.

In a worst-case scenario, all of the nodes are together at one end of the cable and the power supply is at the opposite end, so all current flows over the longest distance.

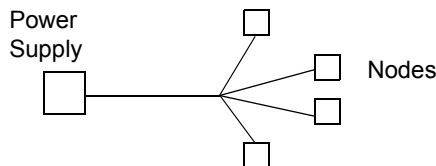

Important: This method may underestimate the capacity of your network by as much as 4 to 1. See Chapter 4 to use the full-calculation method if your supply does not fit under the curve.

A sample curve (reprinted from page 4-4) for a single, end-connected power supply is shown on the next page.

Figure 1.1 One Power Supply (End Segment) Flat Cable

Important: Assumes all nodes are at the opposite end of the cable from the power supply.

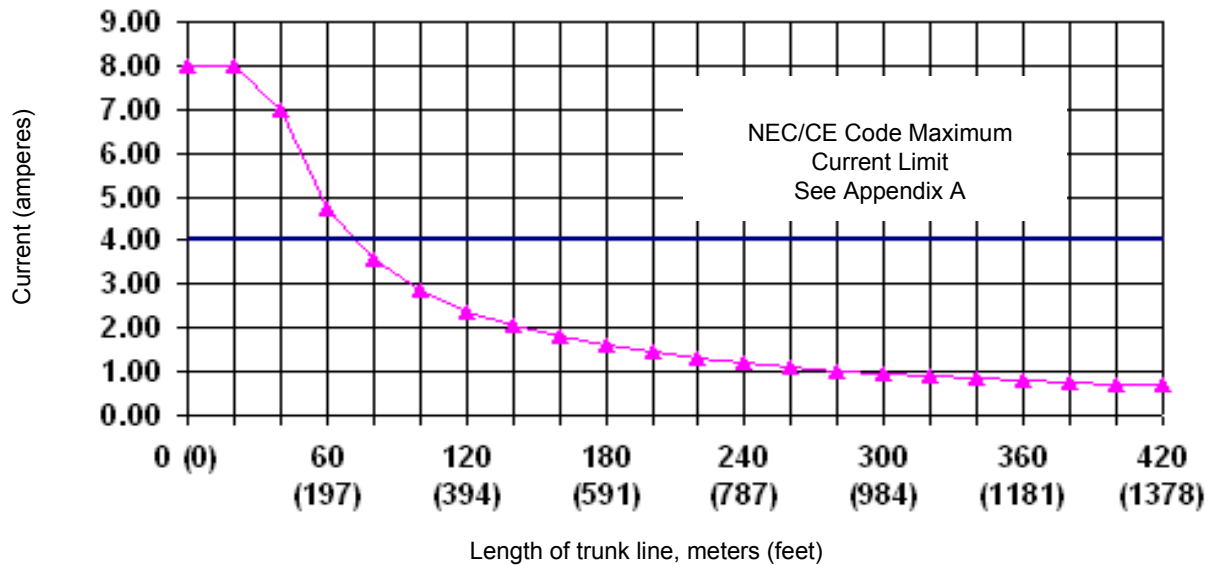

Network Length m (ft)	Maximum Current (A)	Network Length m (ft)	Maximum Current (A)
0 (0)	8.00*	220 (722)	1.31
20 (66)	8.00*	240 (787)	1.20
40 (131)	7.01*	260 (853)	1.11
60 (197)	4.72*	280 (919)	1.03
80 (262)	3.56	300 (984)	0.96
100 (328)	2.86	320 (1050)	0.90
120 (394)	2.39	340 (1115)	0.85
140 (459)	2.05	360 (1181)	0.80
160 (525)	1.79	380 (1247)	0.76
180 (591)	1.60	400 (1312)	0.72
200 (656)	1.44	420 (1378)	0.69

Exceeds NEC CL2/CECode 4A

The following example uses the look-up method to determine the configuration for one end-connected power supply. One end-connected power supply provides as much as 8A near the power supply.

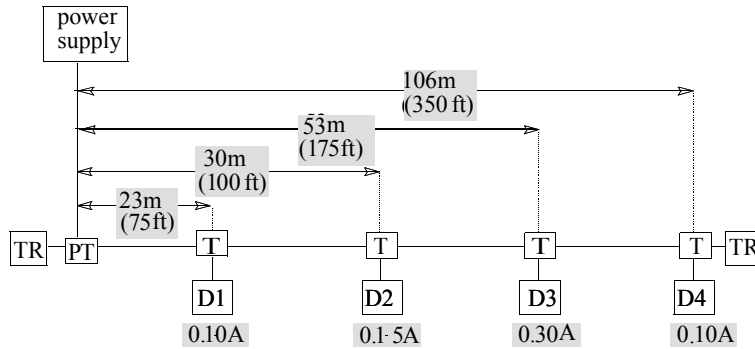

TR = terminating resistor T = T-Port tap
 PT = power tap D = device

1. Determine the total length of the network.

– **106m**

2. Add each device's current together to find the total current consumption.

– **0.10+0.15+0.30+0.10=0.65A**

Important: Make sure that the required power is less than the rating of the power supply. You may need to derate the supply if it is in an enclosure.

3. Find the next largest network length using the table on page 1-13 to determine the maximum current allowed for the system (approximately).

– **120m (2.47A)**

Results 

Since the total current does not exceed the maximum allowable current, the system will operate properly (0.65A is less than 2.47A).

Important: If your application doesn't fit "under the curve," you may either:

- Do the full-calculation method described in Chapter 4.
- Move the power supply to somewhere in the middle of the cable system and reevaluate per the previous section.



Connecting Power Supplies

To supply power you will need to install and ground the power supplies. To install a power supply:

Important: Make sure the ac power source remains off during installation.

1. Mount the power supply securely allowing for proper ventilation, connection to the ac power source, and protection from environmental conditions according to the specifications for the supply.
2. Connect the power supply using:
 - a cable that has one pair of 12 AWG (4 mm²)* conductors or the equivalent or two pairs of 15 AWG (2.5mm²) conductors
 - a maximum cable length of 3m (10 ft) to the power tap
 - the manufacturer's recommendations for connecting the cable to the supply

* **NOTE:** Metric wire sizes are for reference only - you should select a wire size big enough for the maximum possible current.

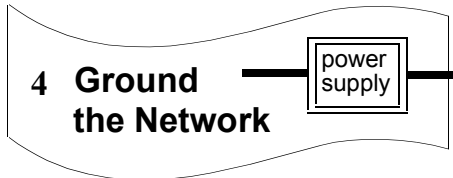

You must ground the DeviceNet™ network at only one location. Follow the guidelines described below.



ATTENTION: To prevent ground loops,

- **For Shielded Round media** - Ground the V- conductor, shield, and drain wire at **only one** place.
- **For Flat media** - Ground the V- conductor at **only one** place.

Do this at the power supply connection that is closest to the physical center of the network to maximize the performance and minimize the effect of outside noise.

Make this grounding connection using a 1 in (25mm) copper braid or a #8 AWG (10mm²) wire up to a maximum 3m (10 ft) in length. Where greater than 3M (10 ft) must be used due to installation constraints, adequate sized grounding cable shall be utilized to ensure effective grounding takes place and provides a low impedance path from the shield to ground for optimal shield performance.

If you use more than one power supply, the V- conductor of **only one** power supply should be attached to an earth ground.

If you connect multiple power supplies, V+ should be broken between the power supplies. Each power supply's chassis should be connected to the common earth ground. Verify that V- is isolated from the Power supply chassis.

To ground the network:

- Connect the network shield and drain wire to an good earth or building ground (such as an 8 foot stake driven into the ground, attached to building iron or the cold water plumbing) using a 25 mm (1 in.) copper braid or a #8 AWG (10 mm²) wire up to 3m (10 ft) maximum in length.
- Use the same ground for the V- conductor of the cable system and the chassis ground of the power supply. Do this at the power supply.

Important: For a non-isolated device, be certain that additional network grounding does not occur when you mount the device or make external connections to it. Check the device manufacturer's instructions carefully for grounding information.

Round media wiring terminal

One Power Supply

Flat media wiring terminal block open-style connector*

CAN_H
CAN_L
drain
V-
V+

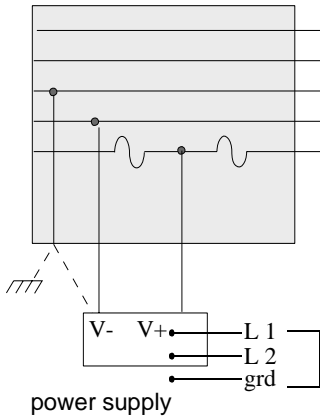

Wire Color	Wire Identity	Usage Round	Usage Flat
white	CAN_H	signal	signal
blue	CAN_L	signal	signal
bare	drain	shield	n/a
black	V-	power	power
red	V+	power	power

CAN_H
CAN_L
V-
V+

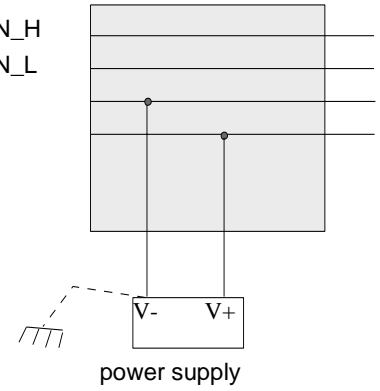

power supply

*A micro style connector may be used for power supply connections requiring less than 3A. Use a mini or open-style connectors for up to 8A.

Two or more Power Supplies for Round Media

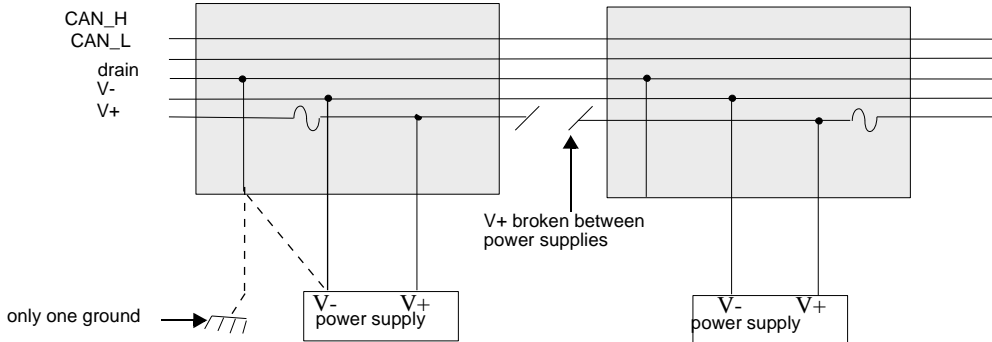

Two or more Power Supplies for Flat Media

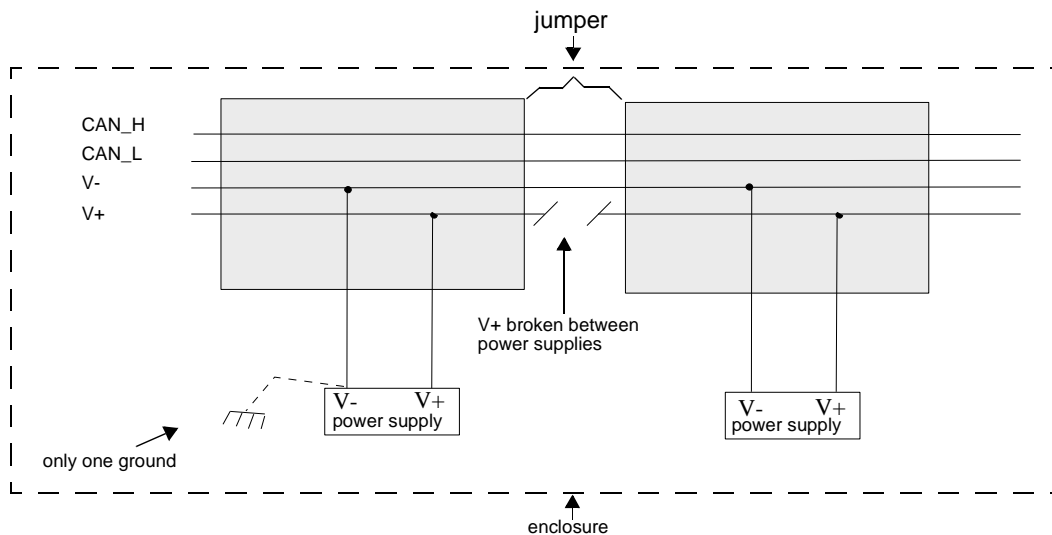

5 Use the checklist



Use this checklist when you install the DeviceNet™ network. You should complete this checklist prior to applying power to your network.

- Total device network current draw does not exceed power supply current limit.
- Common mode voltage drop does not exceed limit (as defined in Section 3, Chapter 1).
- Number of DeviceNet™ nodes does not exceed 64 on one network. The practical limit on DeviceNet™ nodes may be 61 slave nodes since you should allow one node each for the scanner, the computer interface module, and an open node at node 63.*
- No single drop over 6m (20 ft).
- Cumulative drop line budget does not exceed network baud rate limit.
- Total network trunk length does not exceed the maximum allowable per the network data rate and cable type.
- Terminating resistors are on each end of the trunk line and are proper.
- Ground, at only one location, preferably in the center of the network
 - V- for flat media
 - V- drain and shield for round media
- All connections are inspected for loose wires or coupling nuts.
- Check for opens and shorts.

Important: * Devices default to node 63. Leave node 63 open to avoid duplicate node addresses when adding devices. Change the default node address after installation.

Identify Cable System Components

Use this chapter to identify and become familiar with the basic DeviceNet cable system components.

Round (Thick, Mid and Thin) Cable Network

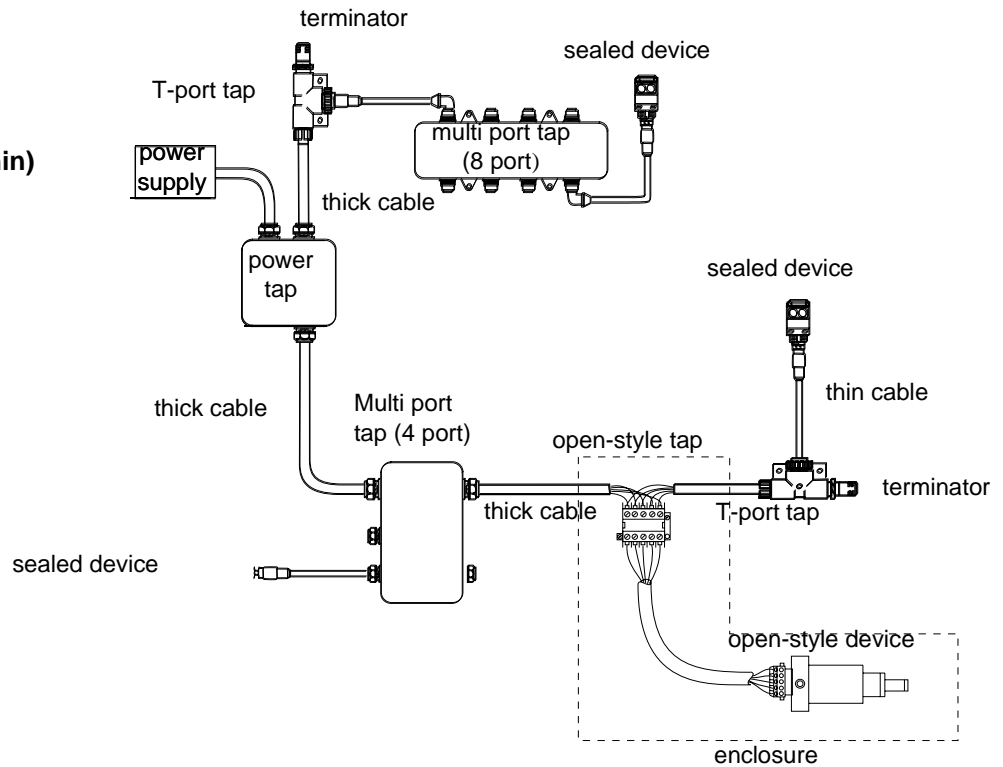

Flat Cable Network

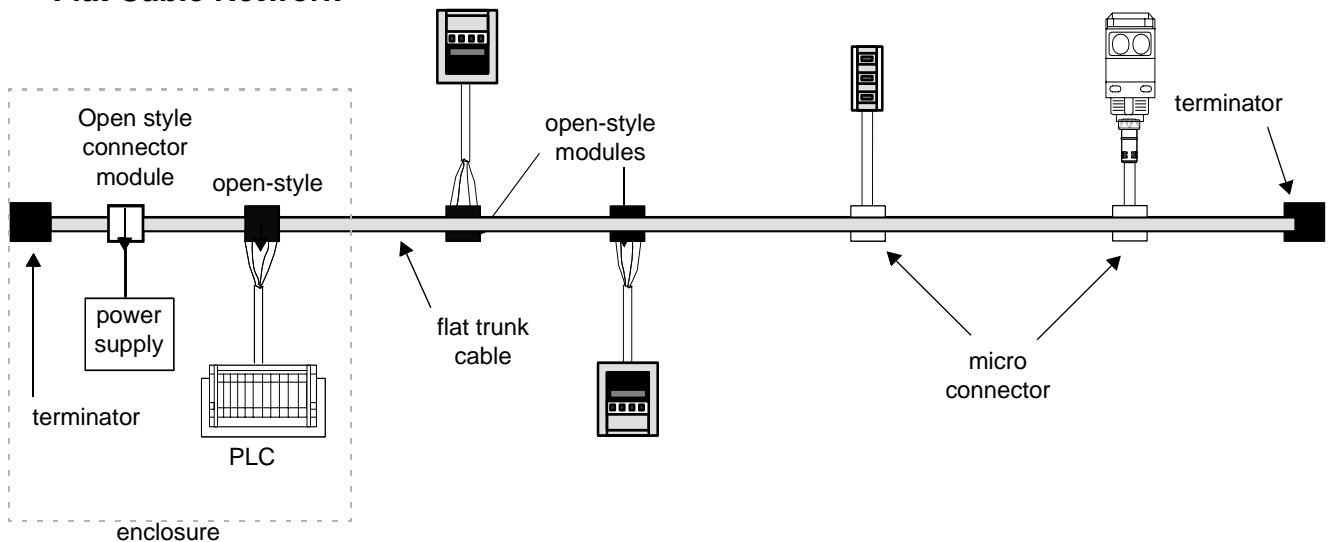

2-2 Identify Cable System Components

Component	Description	Component	Description
Trunk line	The cable path between terminators that represents the network backbone. - can be made of thick, mid, thin, or flat cable - connects to taps or directly to device.	Multi port tap	A junction box that allows multiple drop lines (typically 2, 4, or 8) to connect to the trunk line.
Drop line	The drop line is made up of thick or thin cable. - connects taps to nodes on the network.	Power tap	The physical connection between the power supply and the trunk line.
Node/device	An addressable device that contains the DeviceNet™ communication circuitry.	Open-style tap	Screw terminals that connect a drop line to the trunk line.
Terminating resistor	The resistor (121 Ohm, 1%, 1/4 W or larger) attaches only to the ends of the trunk line.	Flat cable micro tap	A single-port connection to flat cable available in both sealed and unsealed versions.
Open-style connector	Used with devices not exposed to harsh environments.	Flat cable Open-Style tap	A single terminal connection to flat cable available only in unsealed versions.
Sealed-style connector	Used with devices exposed to harsh environments.	Flat cable Terminator	A terminating resistor for use with flat cable, available in both sealed and unsealed versions.
T-Port tap	A single-port connection with sealed connector.		

About Thick Cable

Thick cable, with an outside diameter of 12.2 mm (0.48 in.), is generally used as the trunk line on the DeviceNet™ network. *Thick cable can be used for trunk lines and drop lines.*

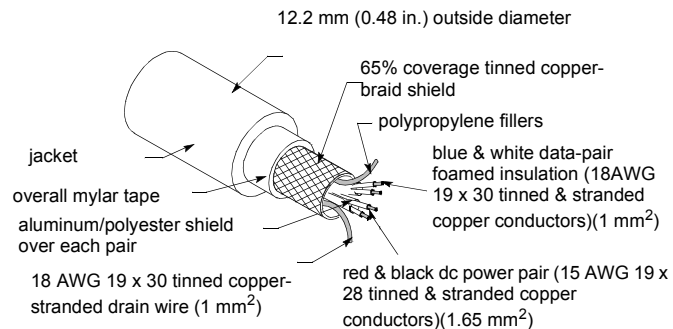

Note: The mm² wire sizes in this and similar drawings are for information only.. The wires are specified in AWG sizes.

About Mid Cable

Mid cable, with an outside diameter specified by the vendor, connects devices to the DeviceNet trunk line via taps. *Mid cable can be used for trunk lines and drop lines.*

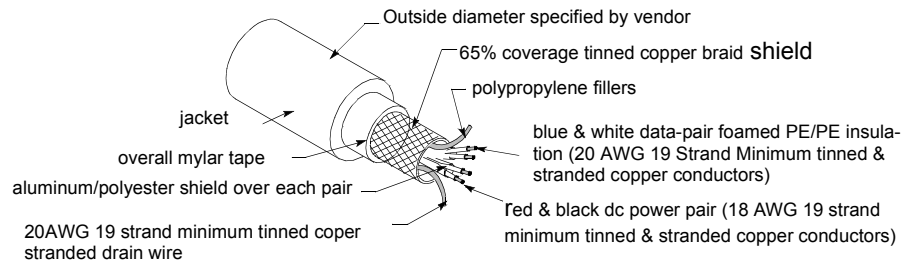

About Thin Cable

Thin cable, with an outside diameter of 6.9 mm (0.27 in.), connects devices to the DeviceNet trunk line via taps. *Thin cable can be used for trunk lines and drop lines.*

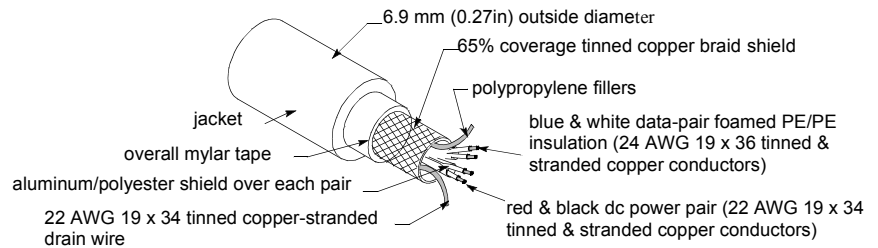

About Flat Cable

Flat cable is physically keyed to prevent wiring mishaps. Flat cable is unshielded and contains four conductors. *Flat cable is usually used only for the trunk line.*

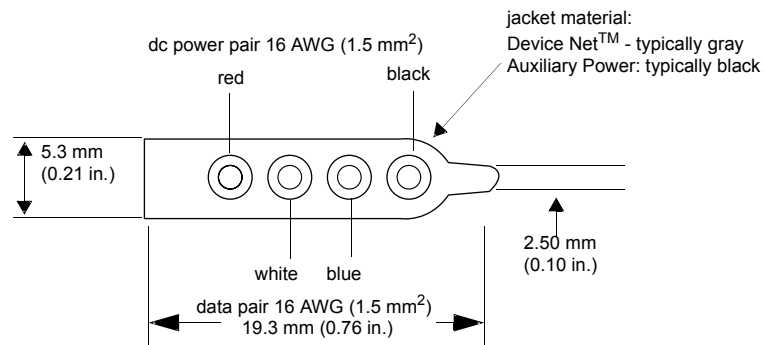

It is common practice to use a second flat cable to power outputs, e.g. valves, actuators or indicators. This is called the Auxiliary Power Cable. It is typically distinguished from the DeviceNet™ by jacket color: typically black for Auxiliary Power, typically gray for DeviceNet™.

Connecting to the Trunk Line

The cable system design allows you to replace a device without disturbing the cable system's operation.

Important: You must terminate the trunk line on each end with a 121 Ohm, 1%, 1/4W resistor.

You can connect to the trunk line through a:

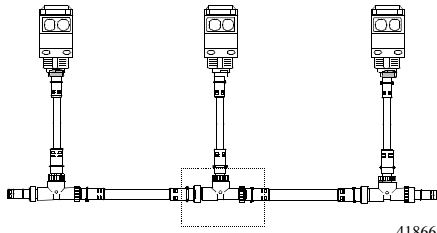
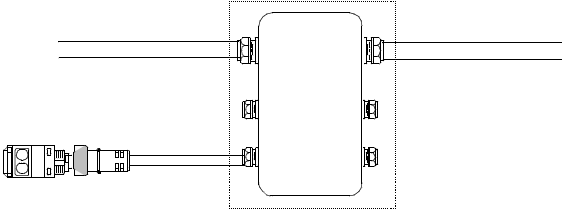
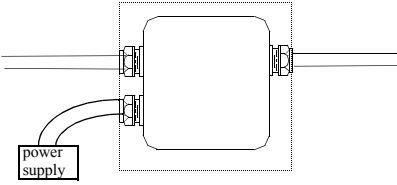
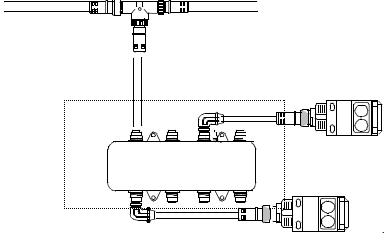
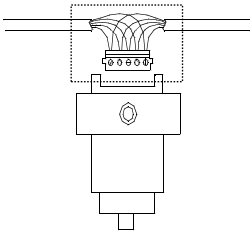
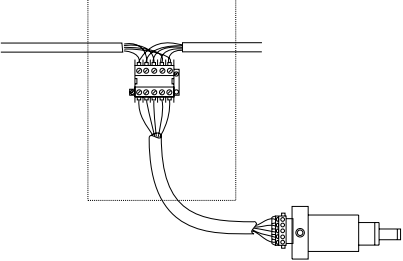
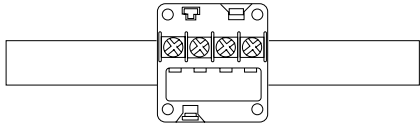
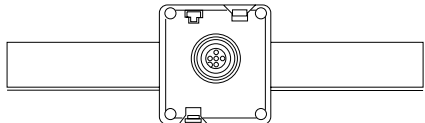
Trunk-line connection	See page	Trunk-line connection	See page
T-Port tap  <p style="text-align: right;">41866</p>	2-6	Multi port tap  <p style="text-align: right;">41867</p>	2-7
Power tap  <p style="text-align: right;">41868</p>	2-7	Multi port tap  <p style="text-align: right;">41869</p>	2-8
Open-style connector 	2-9	Open-style tap  <p style="text-align: right;">41679</p>	2-9
Flat cable open-style connector 	2-10	Flat cable micro connector 	2-10

About the T-Port Tap

The T-Port tap connects to the drop line with a mini or micro quick-disconnect style connector. Mini T-Port taps provide right or left keyway for positioning purposes. Mini T-Ports are also available with a micro (M12) drop connection .

Mini T-Port tap

Right keyway

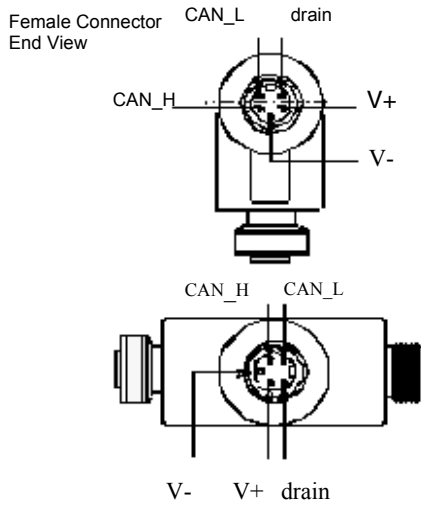

Keying Information

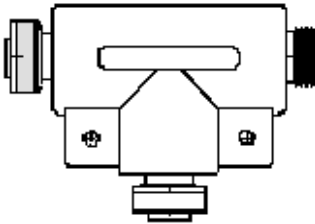

Left keyway

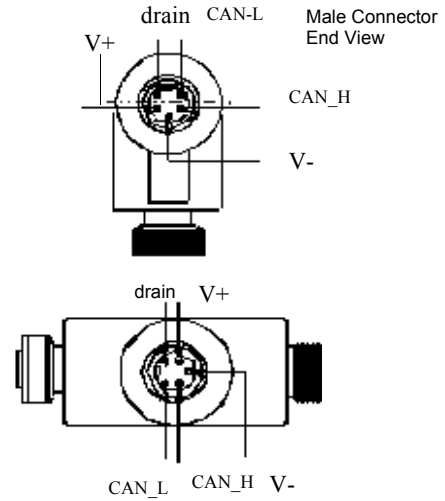

Micro T-Port tap

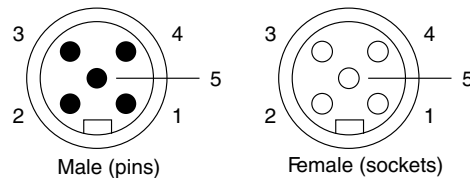

- 1 - Drain bare
- 2 - V+ red
- 3 - V- black
- 4 - CAN_H white
- 5 - CAN_L blue

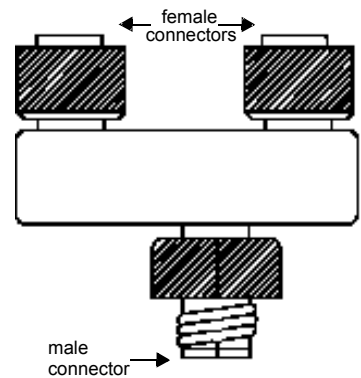

About the Multi Port Tap

Multi port taps use round media only for a direct connection to a trunk line. They provide terminal strip connections for as many as 8 nodes using thin-cable drop lines. Removable gasket covers and cable glands provide a tight, sealed box that you can mount on a machine. Order Multi port taps according to the trunk type (thick, mid or thin).

2-Port Multi port Tap

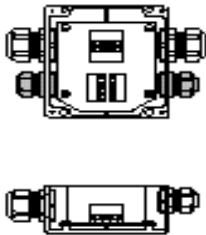

4-Port Multi port Tap

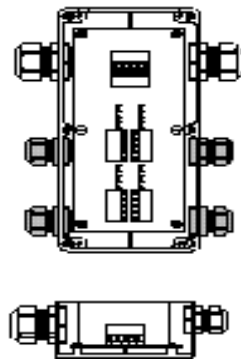

8-Port Multi port Tap

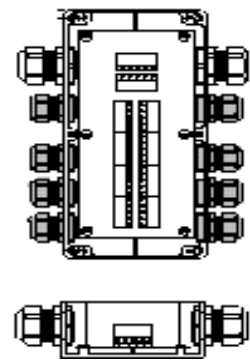

About the Power tap

The power tap can provide overcurrent protection to the cable, with fuses for each trunk. (Country and/or local codes may prohibit the use of the full capacity of the tap.) You can also use the power tap to connect multiple power supplies to the trunk line without back-feeding between supplies by removing one of the fuses. Power taps are only used with round media.

Power tap

sub-assembly PCB

cable grips
enclosure

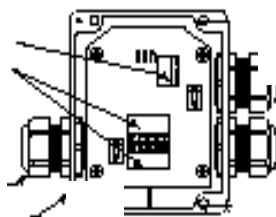

Schematic

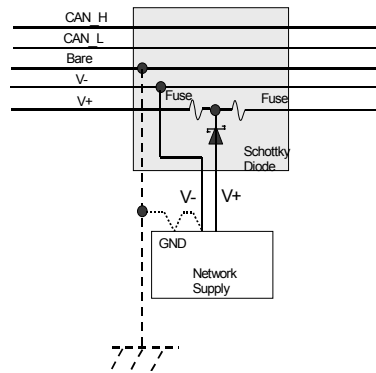

Wire Color	Wire identity	Use
white	CAN_H	signal
blue	CAN_L	signal
bare	drain	shield
black	V-	power
red	V+	power

In cases in which the power supply provides current limiting and inherent protection, you may not need fuses/overcurrent devices at the tap.

About the Multi Port Tap

Multi port taps connect to a round or flat media trunk line via drop lines. Multi ports connect multiple devices to the network through mini or micro quick disconnects. The ports of the multi port taps provide connectivity to the network for multiple nodes at one location.

Micro Version

All device connections are micro female receptacles; only micro male connectors with rotating coupling nuts can interface with each port.

Multi port Tap with 2m Drop Line

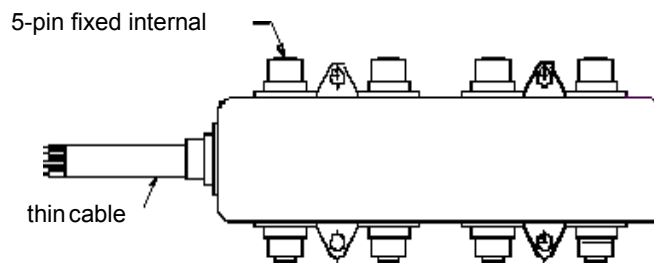

Mini multi port taps

All device connections in the multi port tap are mini female receptacles; only mini male connectors can interface with each port. Trunk connection is a mini male quick disconnect.

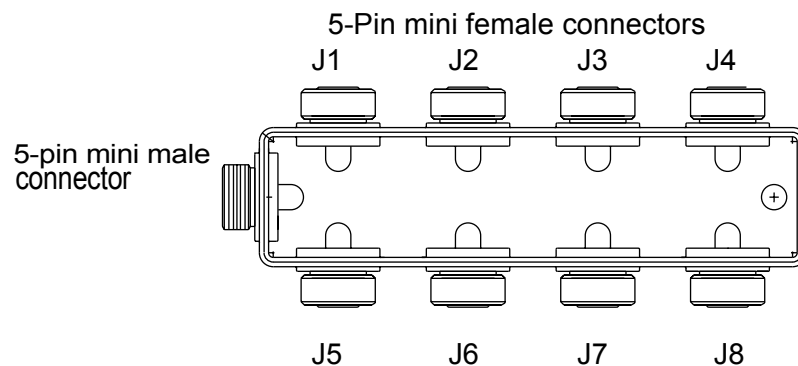

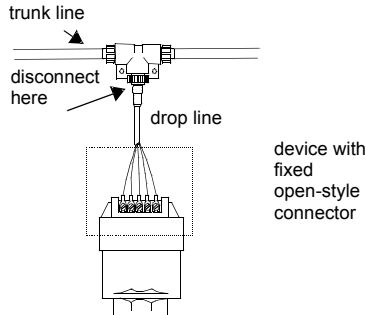

About the Direct Connection

Connect devices directly to the trunk line only if you can later remove the devices without disturbing communications on the cable system.

Important: If a device provides only fixed-terminal blocks for its connection, you must connect it to the cable system by a drop line. Doing this allows you to remove the device at the tap without disrupting communications on the cable system.

About the Open-Style Connector

Open-style connectors come in two primary varieties:

five-position (5-pin linear plug)

ten-position (10-pin linear plug)

Ten-position connectors provide easier daisy-chaining because there is an independent wire chamber for each wire (entering cable and exiting cable).

Wire Color	Wire Identity	Usage Round
white	CAN_H	signal
blue	CAN_L	signal
bare	drain	shield
black	V-	power
red	V+	power

open-style connectors

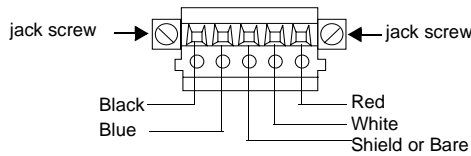

5-pin linear plug (open)

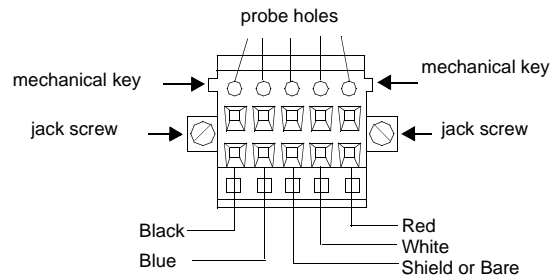

10-pin linear plug (open)

Some open-style connectors provide a temporary connection, for a PC or other configurable tool, using probe holes. For connection, insert the prongs of a probe cable into the probe holes of a connector. Mechanical keys on the connector prevent improper insertion.

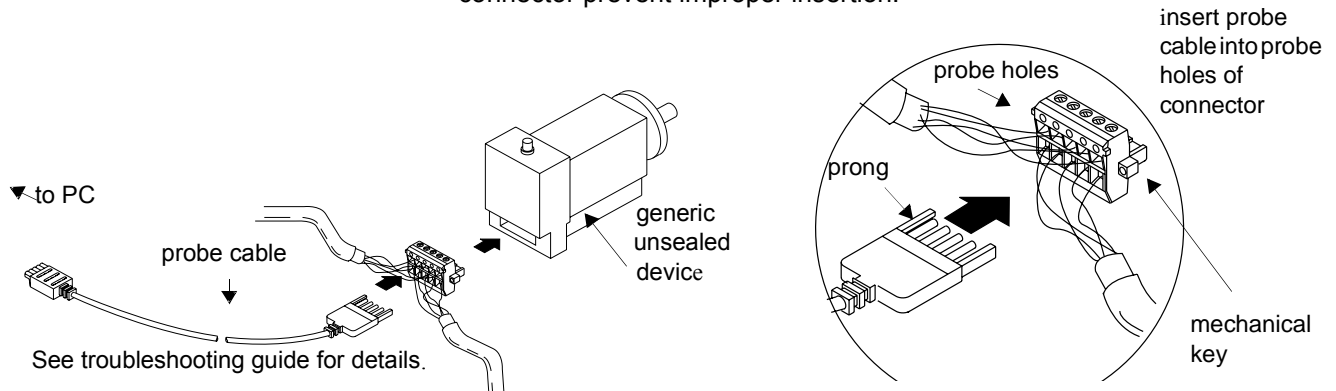

About Flat Cable Insulation Displacement Connectors (IDCs)

IDCs interface drop cables and devices to the flat cable trunkline. The hinged, two-piece base snaps around the flat cable at any point along the trunk. Contact is made with the cable conductors by tightening two screws that drive the contacts through the cable jacket and into the conductors. The snap-on interface provides the connection to the drop cable and is available with various connectors.

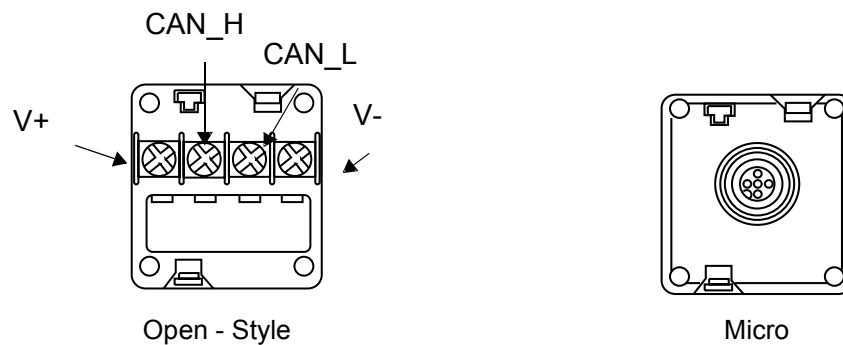

Using Preterminated Cables

Using preterminated cable assemblies saves you the effort of stripping and wiring connectors to the cable ends and also reduces wiring errors as these cable assemblies are normally factory tested.

About Thick Cable

You can order preterminated thick cable in several lengths with mini connectors at each end. Thick cable that is 6m (20ft) or shorter can also be used as drop lines.

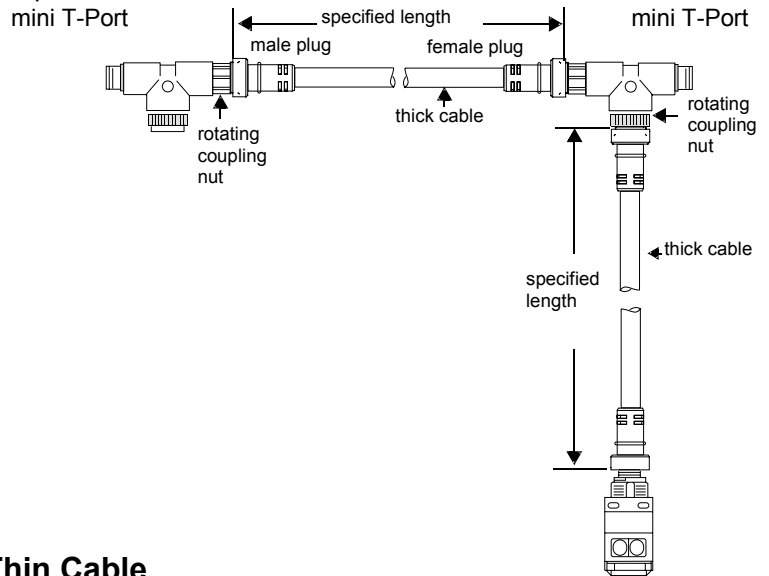

About Thin Cable

Preterminated thin cable assemblies for use as a drop line are available with various connectors in several lengths. Preterminated thin cable assemblies can also be used as trunk lines up to a total of 100 meters in a system.

Connecting to a T-port tap from a sealed device.

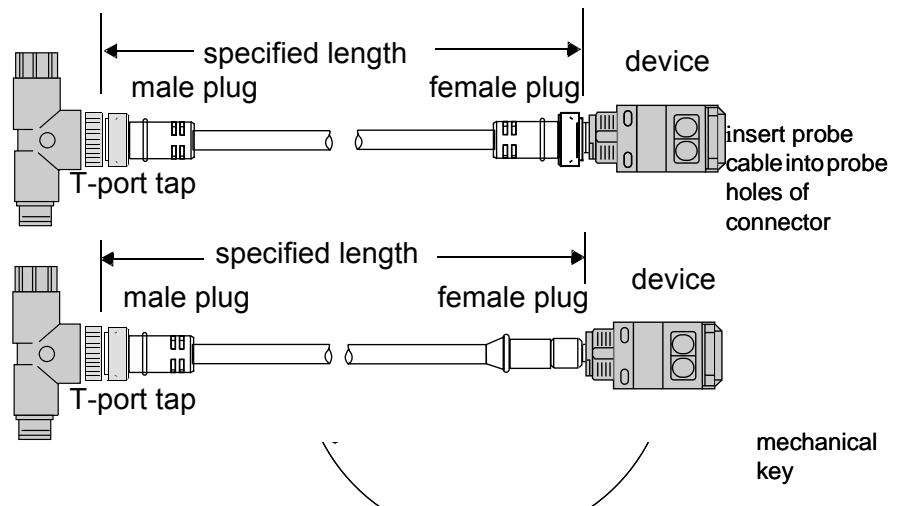

Connecting to a T-Port tap from an open device

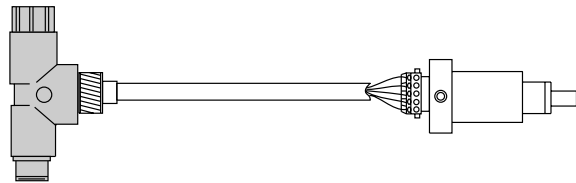

Connecting to a multi port tap or Micro T-Port tap from a sealed device

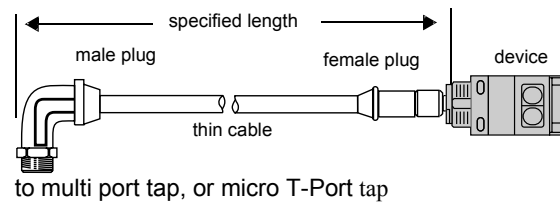
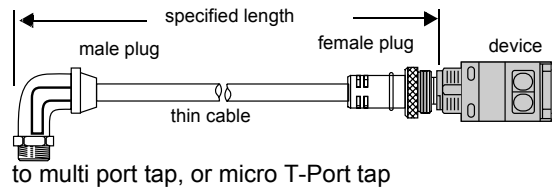

Connecting to a multi port tap or open-style tap from a sealed device

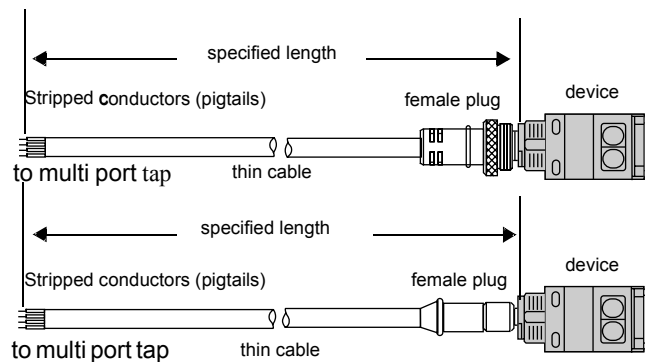

Connecting to micro T-Port taps

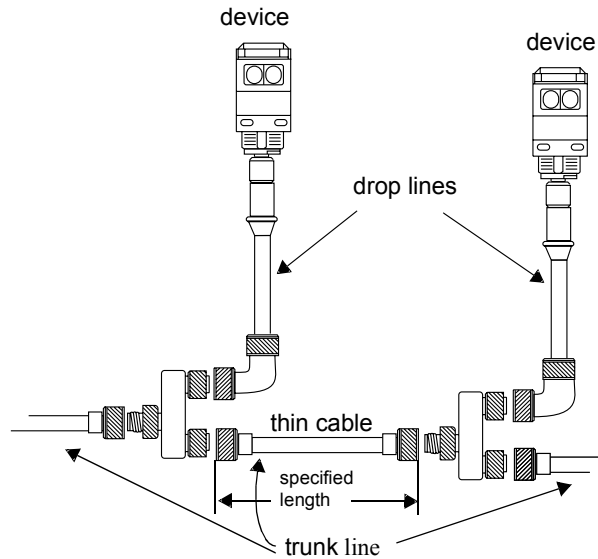

Connecting to a flat cable tap from a sealed device

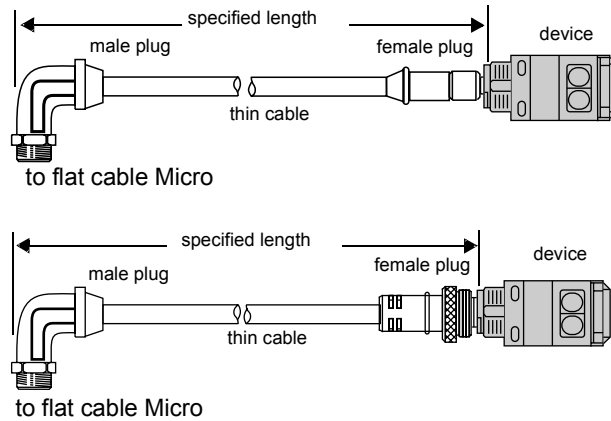

About Terminators

Electrically stabilize your DeviceNet™ communication with terminating resistors.

Important: You must terminate the trunk line on each end with a 121ohms, 1%, 1/4W resistor.

Wire Color	Wire Identity	Usage Round	Usage Flat
white	CAN_H	signal	signal
blue	CAN_L	signal	signal
bare	drain	shield	n/a
black	V-	power	power
red	V+	power	power

Sealed-style terminators (round media)

Male and female sealed terminators are available in mini and micro versions.

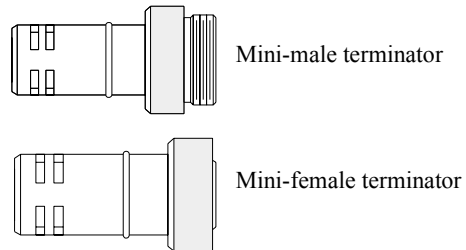

Unsealed-Style terminator (round and flat media)

Important: You must connect these resistors directly across the blue and white wires of the DeviceNet™ cable.

An open-style terminator is suitable for use with:

- Multi-port taps (open style taps only)
- open-style plugs or taps
- Flat cable open-style Insulation Displacement Connectors (IDC)

121ohms

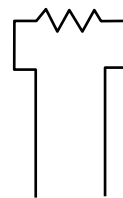

Flat cable IDC with open-style terminator

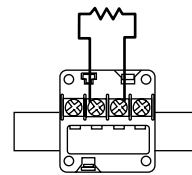

end cap

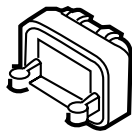

A means of sealing a flat cable connector.

Sealed and unsealed flat media terminators

These terminators have an IDC base and are shipped with an end cap. Unsealed terminators do not have gaskets.

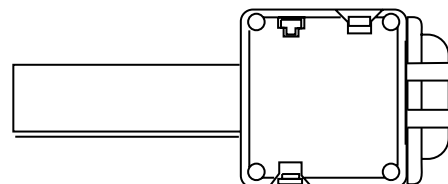

Make Cable Connections

Preparing Cables

In Chapter 1, you determined the required lengths of trunk line and drop line segments for your network. To cut these segments from reels of thick, thin, mid and flat cable, use a sharp cable cutter and provide sufficient length in each segment to reduce tension at the connector.



Select an end of the cable segment that has been cleanly cut. The positions of the color-coded conductors should match the positions at the face of the connector.

Important: Before beginning, make sure:
the DeviceNet cable system is inactive
all attached devices are turned off
any attached power supply is turned off
you follow the manufacturer's instructions for stripping,
crimping, and/or tightening

The dimensions and instructions in this chapter are typical for many connectors. Some connectors are different. Follow the connector manufacturer's instructions if they differ from those in this chapter.

How to Install Open-Style Connectors

To attach a plug-in open-style connector to a round media (thick, mid or thin) trunk line:

- Strip 65 mm (2.6 in.) to 75 mm (3 in.) of the outer jacket from the end of the cable, leaving no more than 6.4 mm (0.25 in.) of the braided shield exposed.

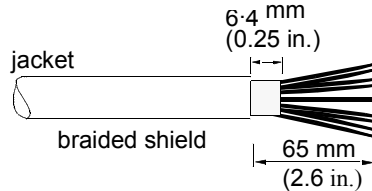

- Wrap the end of the cable with 38 mm (1.5 in.) of shrink wrap, covering part of the exposed conductors and part of the trunk line insulation.

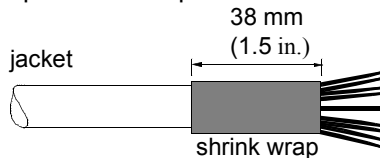

- Strip 8.1 mm (0.32 in.) of the insulation from the end of each of the insulated conductors.

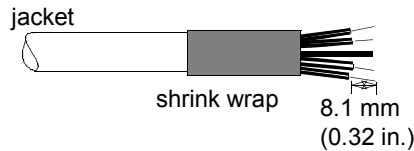

- Tin the last 6.5 mm (0.26 in.) of the bare conductors or crimp a suitable ferrule on the conductors.

- Insert each conductor into the appropriate clamping cavity of the open-style connector or the screw terminal on the device, according to the color of the cable insulation.

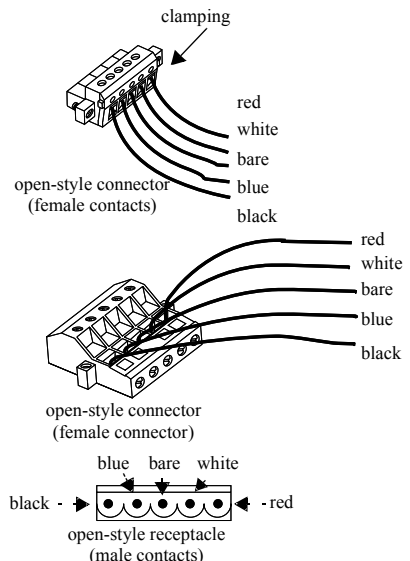

Wire Color	Wire Identity	Usage Round
white	CAN_H	signal
blue	CAN_L	signal
bare	drain	shield
black	V-	power
red	V+	power

- Tighten the clamping screws to secure each conductor. The male contacts of the device connector must match the female contacts of the connector.

How to Install Mini/Micro Sealed Field-Installable Connectors

To attach a mini/micro sealed-style connector to round media:

1. Prepare the cable jacket by cleaning loose particles from the jacket.

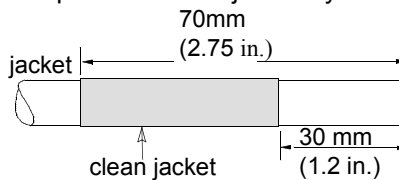

2. Strip 30 mm (1.2 in.) of the cable jacket from the end of the cable.

3. Cut the braided shield and the foil shields surrounding the power and signal conductors.

4. Trim the conductors to the same length.

5. Slide the connector hardware onto the cable in the order shown.

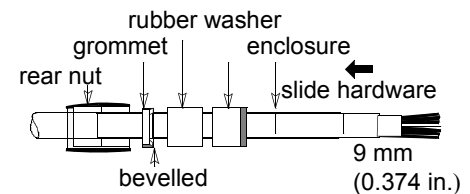

6. Strip 10 mm (0.4 in.) of insulation from the ends of all conductors except the bare drain wire.

Do not nick the conductor strands.

Wire Color	Wire Identity	Usage Round
white	CAN_H	signal
blue	CAN_L	signal
bare	drain	shield
black	V-	power
red	V+	power

Important: Do not twist or pull the cable while tightening the gland nut.

7. Attach wires to the connector using screw terminals as seen in the following diagram.

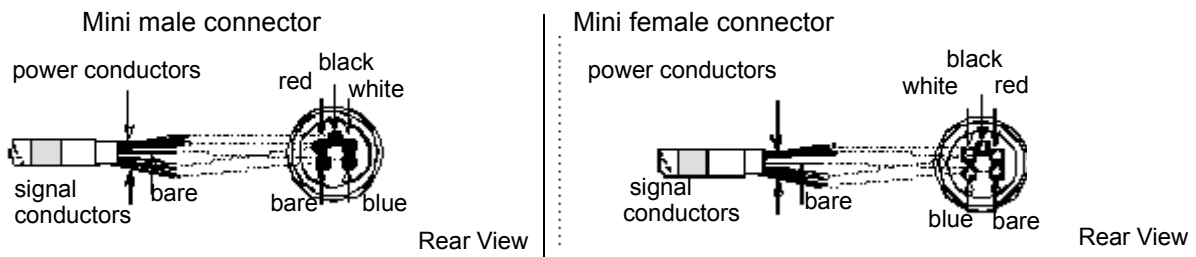

8. Screw the enclosure body to the connector.

9. Screw the rear nut into the connector enclosure.

Important: Do not twist or pull the cable while tightening the rear nut.

How to Install Power Taps and Multi Port Taps with Terminals

Cable preparation and attachment is the same for Power taps and Multi Port taps which use hard-wire connections of round media. To install your taps, perform the following steps and then proceed to the appropriate section for wiring the specific tap.

1. Remove the cover from the tap.
2. Prepare the ends of the cable sections.
 - A. Strip 65 mm (2.6 in.) to 76 mm (3 in.) of the outer jacket

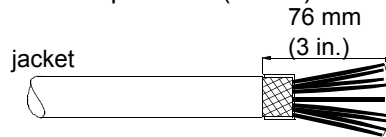

and braided shield from the end of the cable.

- Leave no more than 6.4 mm (0.25 in.) of the braided shield exposed.

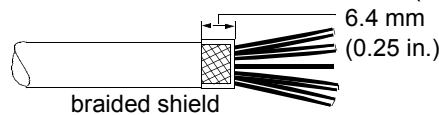

- B. Strip 8.1 mm (0.32 in.) of the insulation from the end of each of the insulated conductors.

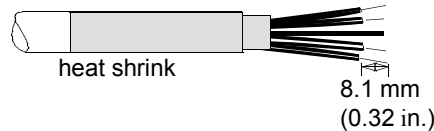

3. Attach cables to the enclosure.
4. Insert conductors into the terminal block clamping cavities, following the color coding specified for the terminal blocks.

thin cable terminal blocks

thick cable terminal blocks

Wire Color	Wire identity	Use
white	CAN_H	signal
blue	CAN_L	signal
bare	drain	shield
black	V-	power
red	V+	power

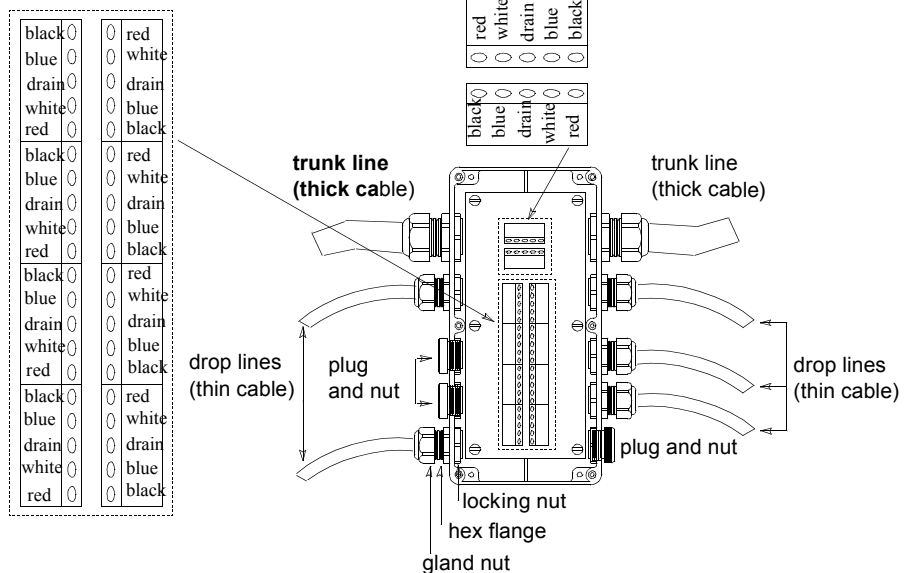

5. Tighten all clamping screws to secure conductors to the terminal blocks.
6. Seal unused ports.
7. Tightly secure the cover to the enclosure.

How to Install Multi Port Taps with Sealed Connectors

The Multi Port tap connects multiple quick-disconnect cables to the trunk line.

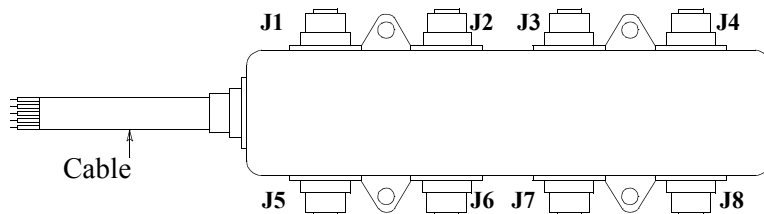

When installing Multi Port Taps or removing nodes for maintenance it is important to seal unused ports to maintain the integrity of the IP rating of the installation. Use suitable threaded plugs to seal unused connectors

To Connect Drop Lines

Drop lines, made up of thick, mid or thin cable, connect devices to taps. Connections at the device can be:

open-style

- pluggable screw connectors
- hard-wired screw terminals
- soldered

sealed-style

- mini quick-disconnect connectors
- micro quick-disconnect connectors

Important: It is best to connect drop lines when the cable system is inactive. If you must connect to an active cable system, make all other connections before the connection to the trunk line.



ATTENTION: Although it is possible to make a screw-terminal connection while the cable network is active, you should avoid this if at all possible.

To connect drop lines:

1. Attach contacts as described earlier in this section.
2. Connect the cable to the device.
3. Make any intermediate connections.
4. Make the connection to the trunk line last
5. Add and record measured drop length on cabling documentation.

Important: Follow the wiring diagrams for each connection, and make sure you do not exceed the maximum allowable length from the device connection to the trunk connection.

Flat Cable Installation Instructions

How to Install a Flat Cable Connector

Install flat cable with the wider flat edge of the cable on the bottom.

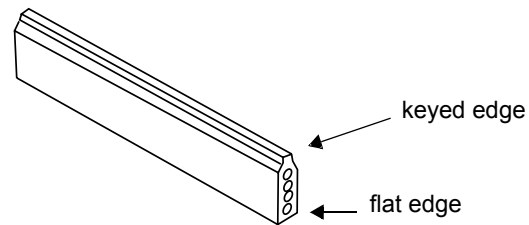

Follow these steps to properly install flat cable into a connector: (Note that the connector base is not mounted to the panel until sept 4.)

1. Lay the cable in the hinged base, paying attention to the keyed profile; the unkeyed edge is closer to the hinge, the keyed edge is toward the latch.

Important: Prior to closing the connector, make sure the IDC blades do not protrude from the housing. If the blades are exposed, gently push them back into the base. In the event that the blades do not retract easily (or retract only partially), verify that the IDC screws are not partially driven.

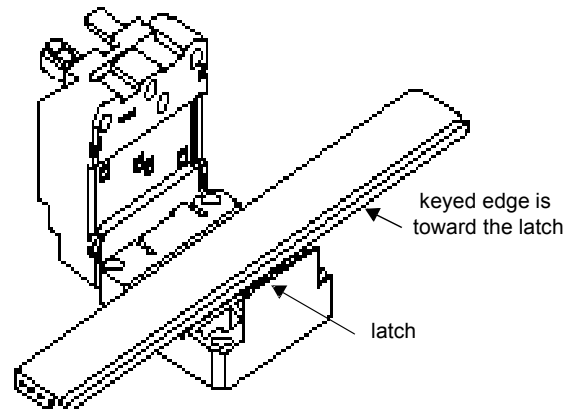

2. Close the hinged assembly, applying pressure until the latch locks into place. The latch has two catches. The first catch loosely holds the connector on the cable. The second catch needs more pressure applied to close the connector tightly. If the cable is not in the correct position, the connector will not close.

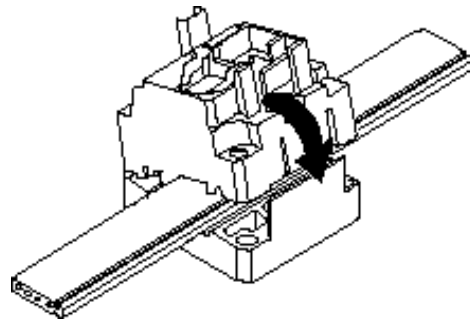

3. Make sure the cable is straight before moving on to step four.

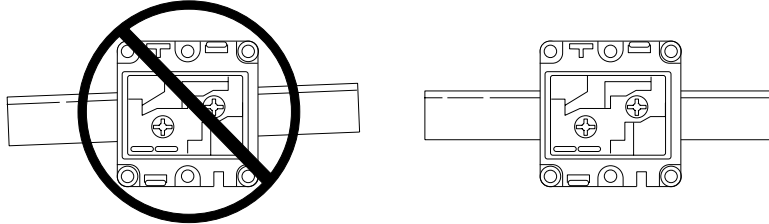

ATTENTION: You must make sure the cable is straight before tightening the screws. Improper seating of the cable may cause a weak seal and impede IP67 requirements for the life of the cable. A misaligned cable may also cause shorts due to mis-registration of the IDC contacts.

the metal inserts.

4. Tighten down the two screws at the center points of the hinge and latch sides of the base; tighten down the latch side first. Take care to avoid stripping, ample torque per manufacturers specifications. Mount the base to the panel by driving screws through the corner holes not containing the metal inserts.

Check the cable position prior to tightening the screws.

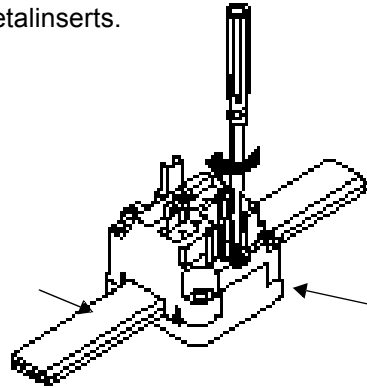

Tighten screws by the latch first

5. Drive the IDC contacts into the cable by tightening down the two screws in the center of the base assembly. Once again, be careful to avoid stripping, ample but not excessive torque should be used.

The module should not be removed after connection is made. Determine the exact placement of the connector **before** engaging the IDC contacts.

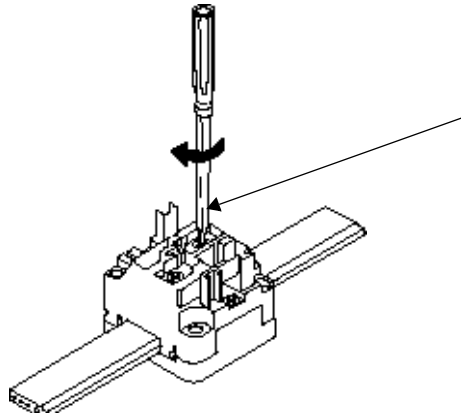

ATTENTION: Once the IDC contacts are driven into the cable, the module should not be removed. If the module is removed, it must be discarded and proper cable healing techniques must be used to protect the waterproofing to IP67.

- Line up the keyed rectangular holes of the micro/open/terminator/other connection interface with the matching posts on the base and snap the connection interface into place. **Optional:** Secure the micro/open/terminator module by driving screws through the two remaining mounting holes.

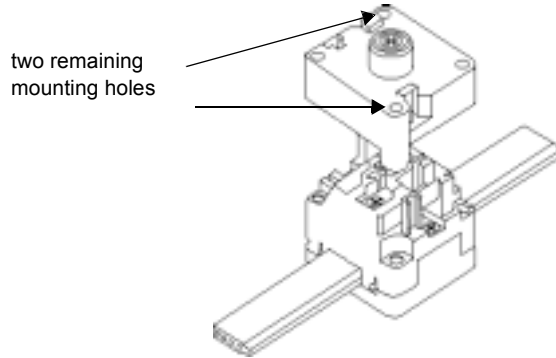

Additional considerations: When used in flexing applications, the cable must be secured to a solid reference with mounting hardware 10-15 cm (4-6 in.) from the connector.

Installation of connectors is recommended only at temperatures of 0°C - 75°C.

Make sure the cable is free of debris or scratches before attaching the connector to ensure a proper seal.

The recommended distance between cable mounts is 3-5 m (10-16 ft) . Special glands are available for running cable into an enclosure.

Installing a flat cable open-style connector to a drop cable

Install the flat cable open-style connector to the flat media using the directions starting on page 3-6. Prepare the drop cable following the directions on page 3-2 numbers 1 through 5. For flat media connections you can use shielded or unshielded drop cables

- You must cut or heat shrink the drain wire when you use shielded drop cable.

Wire Color	Wire identity	Use	Flat
white	CAN_H	signal	signal
blue	CAN_L	signal	signal
bare	drain	shield	n/a
black	V-	power	power
red	V+	power	power

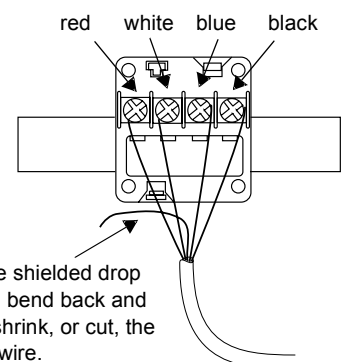
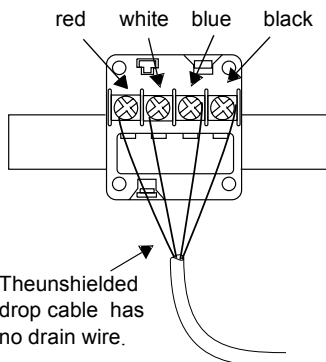

End Cap Installation

Each flat cable terminator module needs an end cap designed to cover the exposed end of the cable. To install the end cap:

1. Fit the end cap on the cable as keyed. Align the end cap posts with the receptacles in the lower IDC base and press down until the end cap is firmly seated (the upper surface of the posts will be flush with the upper surface of the base).

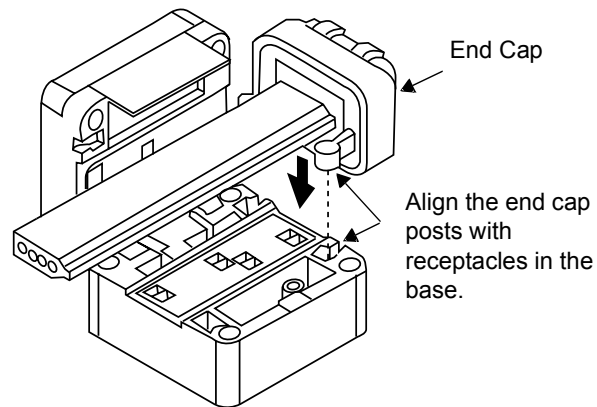

2. Close the IDC base and continue with the connection process..

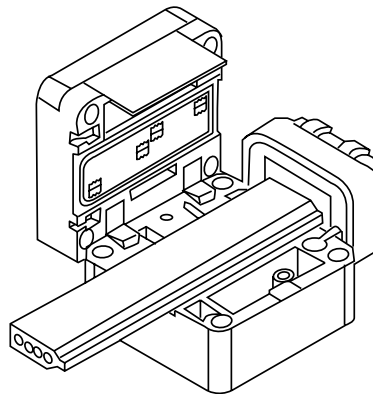

When installing an end cap on the other end of the cable, note that the guide receptacles are on the upper portion of the IDC base. Repeat the end cap installation process as outlined previously. Close the IDC base and continue with connection. .

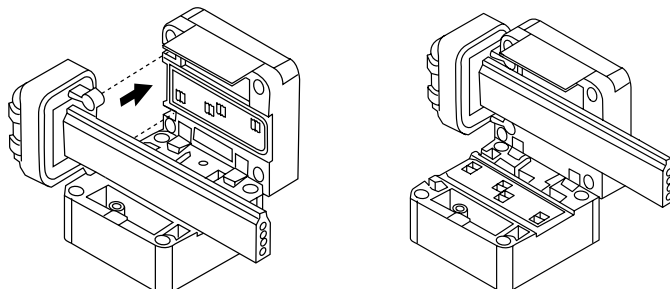

Auxiliary Power Cable

Wire Color	Wire Identity	Use
white	user defined	user defined
blue	user defined	user defined
black	V-	output power
red	V+	output power

Installing Auxiliary Power Cable

Install Auxiliary Power Cable as you would network cable. Refer to page 3-6 for installation instructions..

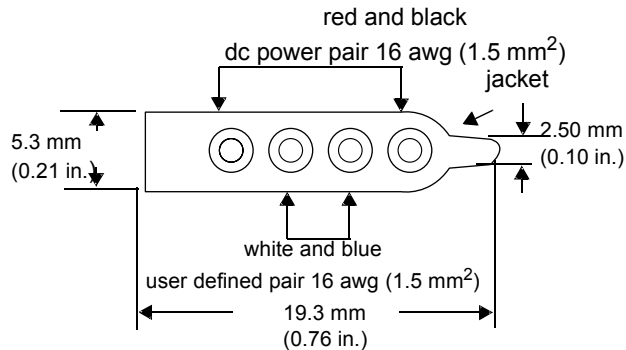

▶ When running cable into an enclosure, use a flat cable gland.

Pinout diagrams for micro and mini connections to the power cable are shown next.

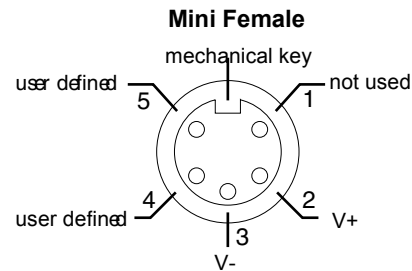
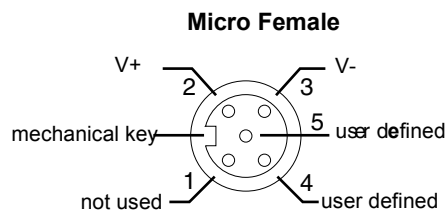

Connecting Power Supplies to Round Media

To supply power you will need to install and ground the power supplies as well as connect all Power taps. If you haven't determined power supply placement, see Chapter 4. To install a power supply:

Important: Make sure the ac power source remains off during installation.

1. Mount the power supply securely allowing for proper ventilation, connection to the ac power source, and protection from environmental conditions according to the specifications for the supply.

2. Connect the power supply using:

a cable that has one pair of 12 AWG (3.3mm²) conductors or the equivalent or two pairs of 15 AWG (1.7mm²) conductors

a maximum cable length of 3m (10 ft) to the Power tap

the manufacturer's recommendations for connecting the cable to the supply



Connecting Power Supplies to Flat Cable

Use a flat cable tap to connect power. Choose a tap that is suitable for the expected current.

Because these taps have no overcurrent protection, you must provide such protection (fuse or circuit breaker) externally or use a current-limited power supply.

Only connect V+ (red) and V- (black) unless the power supply is designed for use with DeviceNet™ and requires all conductors. If you use a molded connector that includes the other conductors CAN_H (white) and CAN_L (blue) ensure these are not connected at the power supply. Cut and insulate them. Their length must be included in the cumulative drop length calculation.

Determine Power Requirements

In this chapter, we describe two methods for determining your system's power requirements:

the look-up method

the full-calculation method

Try the look-up method first, then move on to the full-calculation method if you cannot meet your configuration requirements.

Important: You must consider two areas when powering output devices using the DeviceNet™ power supply:

- (1) Wide DeviceNet™ voltage range of 11-25V dc
- (2) Noise or transient protection at each device

You must calculate a worst-case situation, and maintain voltage within the 11-25V dc range on all segments. This can be accomplished using diodes or other similar techniques. See Appendix B, Powering Output Devices, for more information.

Use the Look-UP Method

To determine if you have adequate power for the devices in your cable system, see the following examples and figures. You have enough power if the total load does not exceed the value shown by the curve or the table.

In a worst-case scenario, all of the nodes are together at the opposite end of the cable from the power supply.

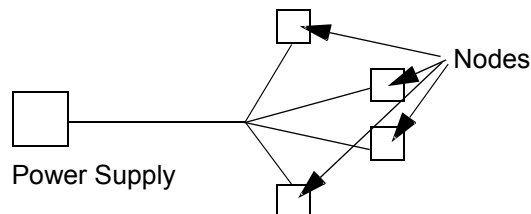

Important: This method may underestimate the capacity of your network by as much as 4 to 1. See the following section to use the full-calculation method if your supply does not fit under the curve.

For this configuration example	Flat cable uses figure	Thick cable uses figure	Mid cable uses figure	Thin cable uses figure
One power supply (end-connected)	Figure 4.2	Figure 4.1	Figure 4.7	Figure 4.8
One power supply (middle-connected)	Figure 4.2	Figure 4.1		Figure 4.8
NEC/CECode current boost configuration (V+ cut)	Figure 4.2	Figure 4.1		Figure 4.8
Two power supplies (end-connected)	Figure 4.6	Figure 4.5		*
Two power supplies (not end-connected)	Figure 4.4	Figure 4.3		*

* You can draw as much as 3A from a thin cable trunk line if the power supply separation is below 70m (230 ft).

Figure 4.1 One Power Supply (End Segment) Round Cable (Thick)

Important: Assumes all nodes are at the opposite end of the cable from the power supply.

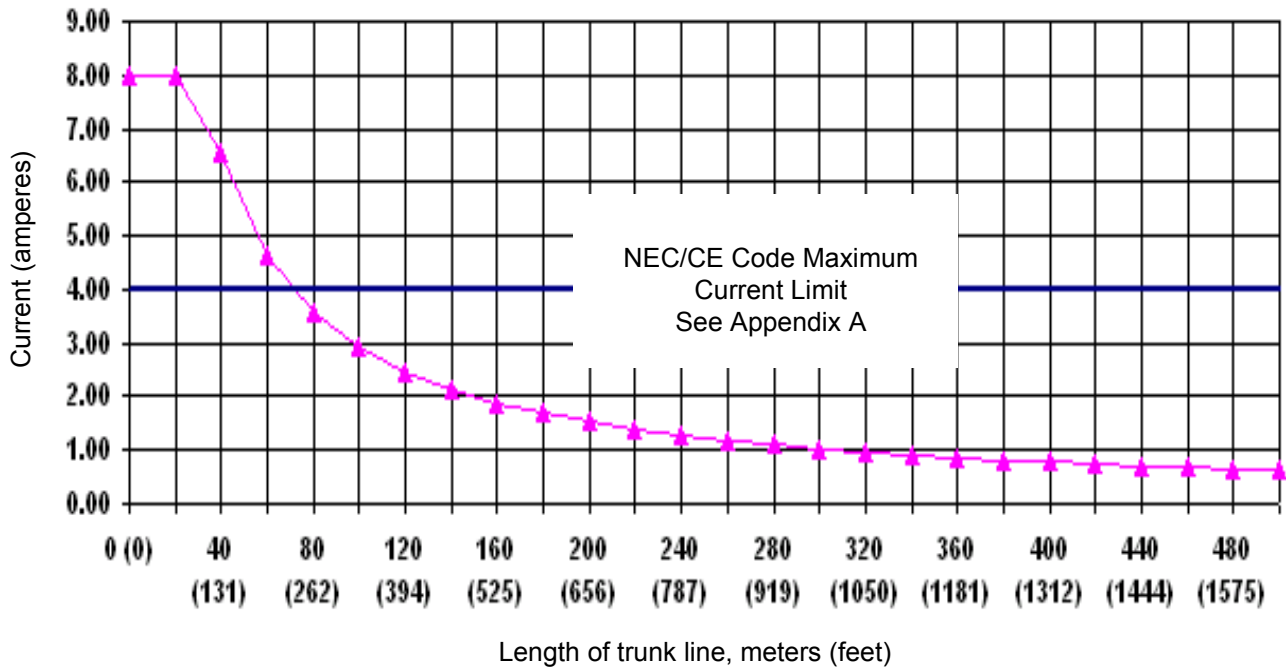

Network Length m (ft)	Maximum Current (A)	Network Length m (ft)	Maximum Current (A)
0 (0)	8.00*	240 (787)	1.28
20 (66)	8.00*	260 (853)	1.19
40 (131)	6.53*	280 (919)	1.10
60 (197)	4.63*	300 (984)	1.03
80 (262)	3.59	340 (1115)	0.91
100 (328)	2.93	360 (1181)	0.86
120 (394)	2.47	380 (1247)	0.82
140 (459)	2.14	420 (1378)	0.74
160 (525)	1.89	440 (1444)	0.71
180 (591)	1.69	460 (1509)	0.68
200 (656)	1.53	480 (1575)	0.65
220 (722)	1.39	500 (1640)	0.63

*Exceeds NEC CL2/CECode 4A limit.

Figure 4.2 One Power Supply (End Segment) Flat Cable

Important: Assumes all nodes are at the opposite end of the cable from the power supply.

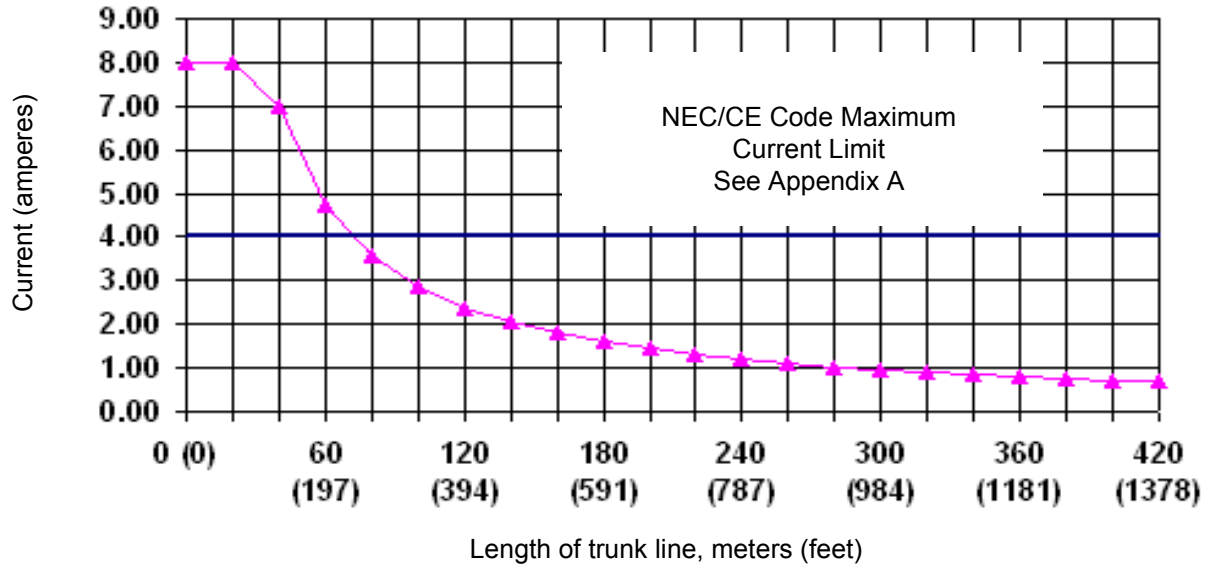

Network Length m (ft)	Maximum Current (A)
0 (0)	8.00*
20 (66)	8.00*
40 (131)	7.01*
60 (197)	4.72*
80 (262)	3.56
100 (328)	2.86
120 (394)	2.39
140 (459)	2.05
160 (525)	1.79
180 (591)	1.60
200 (656)	1.44

Network Length m (ft)	Maximum Current (A)
220 (722)	1.31
240 (787)	1.20
260 (853)	1.11
280 (919)	1.03
300 (984)	0.96
320 (1050)	0.90
340 (1115)	0.85
360 (1181)	0.80
380 (1247)	0.76
400 (1312)	0.72
420 (1378)	0.69

*Exceeds NEC CL2/CECode 4A limit.

Figure 4.3 Two Power Supplies, (one end connected, one middle connected) Two Cable Segments, Round Cable (Thick)

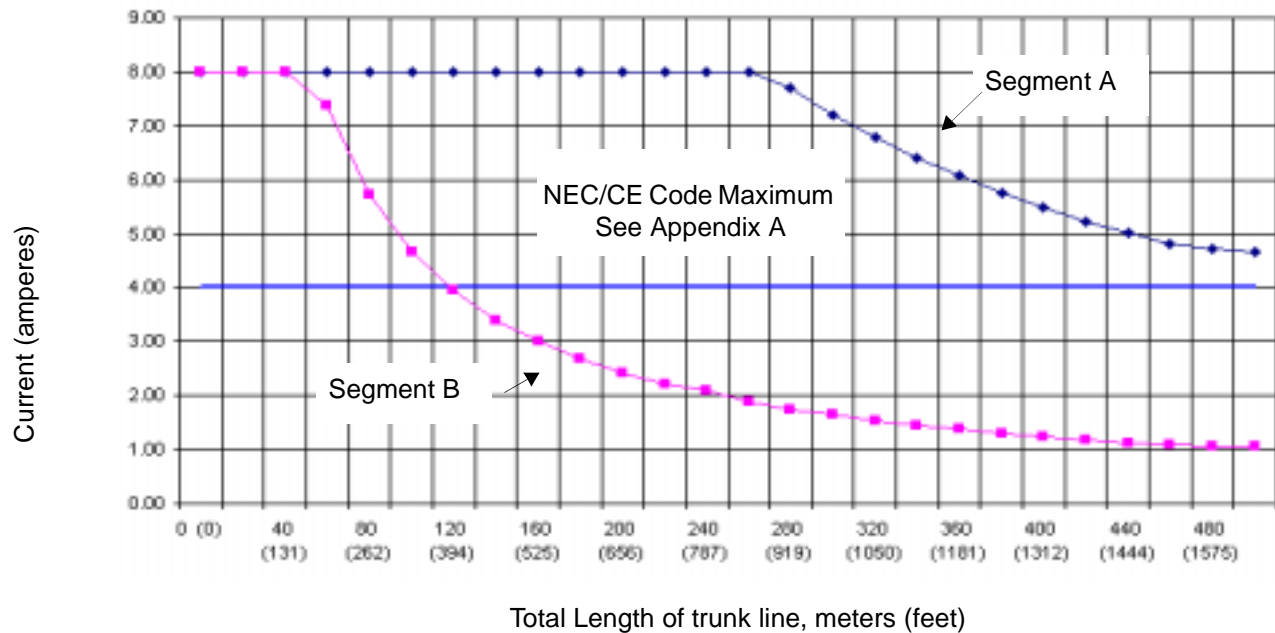

Power Supply A				Power Supply B			
Network Length m (ft)	Maximum Current (A)	Network Length m (ft)	Maximum Current (A)	Network Length m (ft)	Maximum Current (A)	Network Length m (ft)	Maximum Current (A)
0 (0)	8.00*	260 (853)	8.00*	0 (0)	8.00*	260 (853)	1.89
20 (66)	8.00*	280 (919)	7.69*	20 (66)	8.00*	280 (919)	1.76
40 (131)	8.00*	300 (984)	7.21*	40 (131)	8.00*	300 (984)	1.64
60 (197)	8.00*	320 (1050)	6.78*	60 (197)	7.38*	320 (1050)	1.54
80 (262)	8.00*	340 (1115)	6.41*	80 (262)	5.71*	340 (984)	1.46
100 (328)	8.00*	360 (1181)	6.07*	100 (328)	4.66*	360 (1050)	1.38
120 (394)	8.00*	380 (1247)	5.76*	120 (394)	3.94	380 (1247)	1.31
140 (459)	8.00*	400 (1312)	5.49*	140 (459)	3.40	400 (1312)	1.24
160 (525)	8.00*	420 (1378)	5.24*	160 (525)	3.00	420 (1378)	1.18
180 (591)	8.00*	440 (1444)	5.01*	180 (591)	2.68	440 (1444)	1.13
200 (656)	8.00*	460 (1509)	4.80*	200 (656)	2.43	460 (1509)	1.08
220 (722)	8.00*	480 (1575)	4.73*	220 (722)	2.22	480 (1575)	1.07
240 (787)	8.00*	500 (1640)	4.66*	240 (787)	2.08	500 (1640)	1.05

*Exceeds NEC CL2/CECode 4A limit.

*Exceeds NEC CL2/CECode 4A

Figure 4.4 Two Power Supplies, (one end connected, one middle connected) Two Cable Segments, Flat Cable

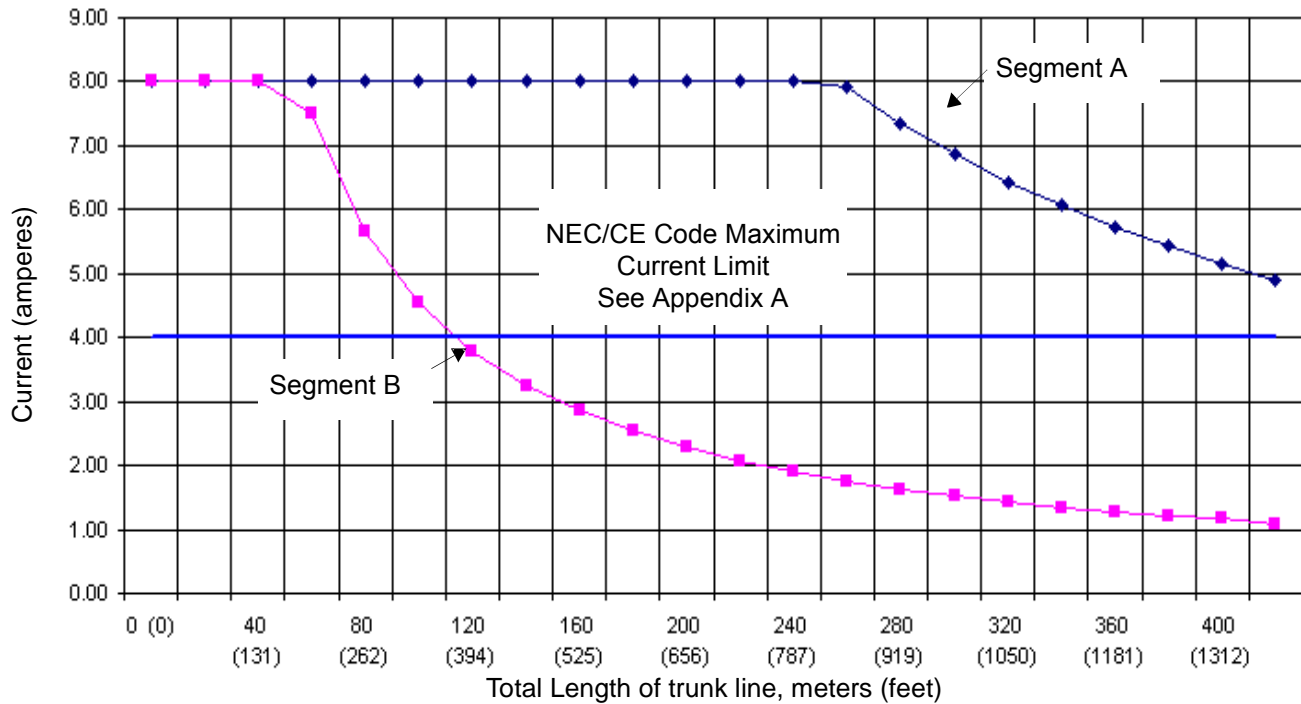

Segment Supply A

Segment Supply B

Network Length m (ft)	Maximum Current (A)	Network Length m (ft)	Maximum Current (A)
0 (0)	8.00*	220 (722)	8.00*
20 (66)	8.00*	240 (787)	8.00*
40 (131)	8.00*	260 (853)	7.91*
60 (197)	8.00*	280 (919)	7.35*
80 (262)	8.00*	300 (984)	6.86*
100 (328)	8.00*	320 (1050)	6.43*
120 (394)	8.00*	340 (1115)	6.06*
140 (459)	8.00*	360 (1181)	5.72*
160 (525)	8.00*	380 (1247)	5.43*
180 (591)	8.00*	400 (1312)	5.16*
		420 (1378)	4.91*

Network Length m (ft)	Maximum Current (A)	Network Length m (ft)	Maximum Current (A)
0 (0)	8.00*	220 (722)	2.08
20 (66)	8.00*	240 (787)	1.91
40 (131)	8.00*	260 (853)	1.76
60 (197)	7.52*	280 (919)	1.64
80 (262)	5.67*	300 (984)	1.53
100 (328)	4.55*	320 (1050)	1.43
120 (394)	3.80	340 (984)	1.35
140 (459)	3.26	360 (1050)	1.28
160 (525)	2.86	380 (1247)	1.21
180 (591)	2.54	400 (1312)	1.19
200 (656)	2.29	420 (1378)	1.09

*Exceeds NEC CL2/CECode 4A limit.

*Exceeds NEC CL2/CECode 4A limit.

Figure 4.5 Two End-Connected Power Supplies, Round Cable (Thick)

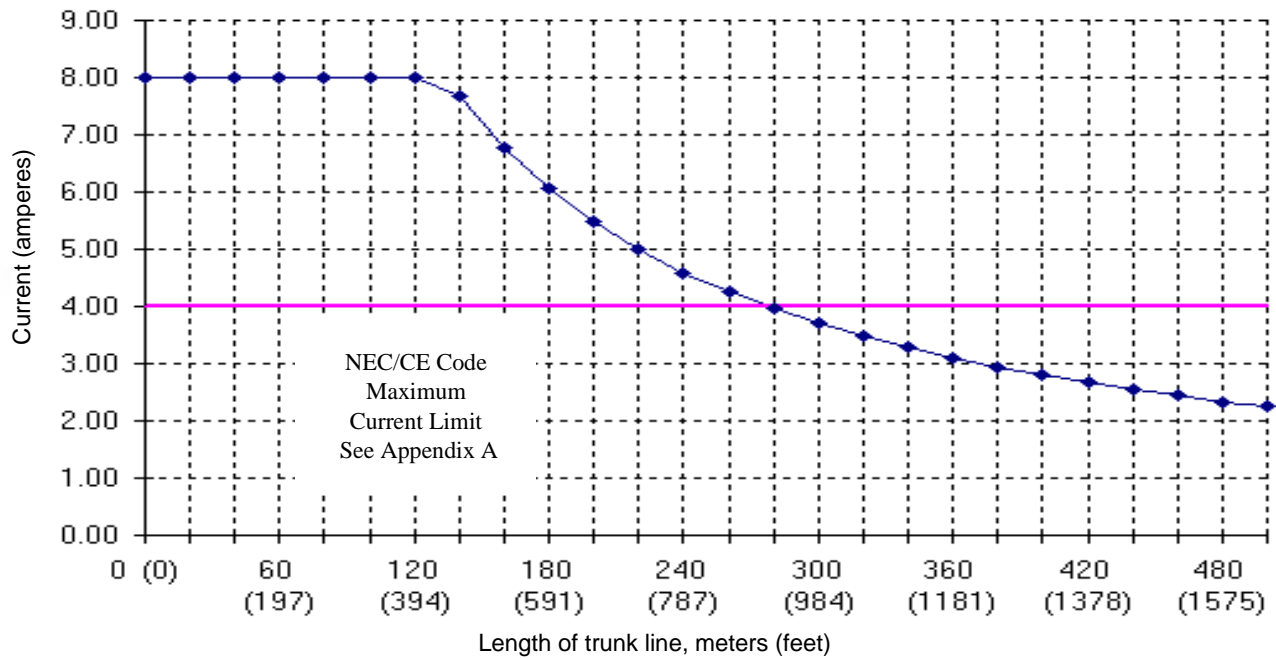

Network Length m (ft)	Maximum Current (A)
0 (0)	8.00*
20 (66)	8.00*
40 (131)	8.00*
60 (197)	8.00*
80 (262)	8.00*
100 (328)	8.00*
120 (394)	8.00*
140 (459)	7.68*
160 (525)	6.77*
180 (591)	6.05*
200 (656)	5.47*
220 (722)	4.99*
240 (787)	4.59*

Network Length m (ft)	Maximum Current (A)
260 (853)	4.25*
280 (919)	3.96
300 (984)	3.70
320 (1050)	3.48
340 (1115)	3.28
360 (1181)	3.10
380 (1247)	2.94
400 (1312)	2.79
420 (1378)	2.66
440 (1444)	2.55
460 (1509)	2.44
480 (1575)	2.34
500 (1640)	2.25

* Exceeds NEC CL2/CECode 4A

Figure 4.6 Two End-Connected Power Supplies, Flat Cable

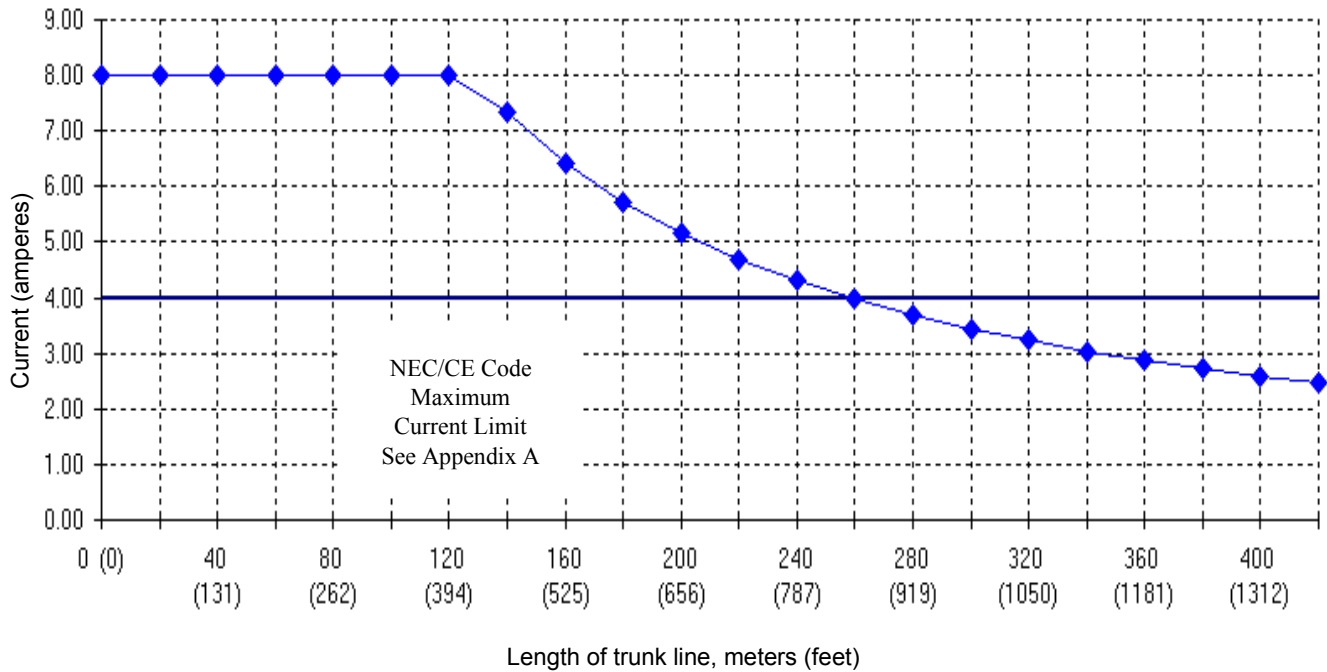

Network Length m (ft)	Maximum Current (A)	Network Length m (ft)	Maximum Current (A)
0 (0)	8.00*	220 (722)	4.69*
20 (66)	8.00*	240 (787)	4.30*
40 (131)	8.00*	260 (853)	3.97
60 (197)	8.00*	280 (919)	3.69
80 (262)	8.00*	300 (984)	3.44
100 (328)	8.00*	320 (1050)	3.23
120 (394)	8.00*	340 (1115)	3.04
140 (459)	7.35*	360 (1181)	2.87
160 (525)	6.43*	380 (1247)	2.72
180 (591)	5.72*	400 (1312)	2.59
200 (656)	5.16*	420 (1378)	2.46

*Exceeds NEC CL2/CECode 4A

Figure 4.7 One Power Supply (End Segment) Round Cable (Mid)

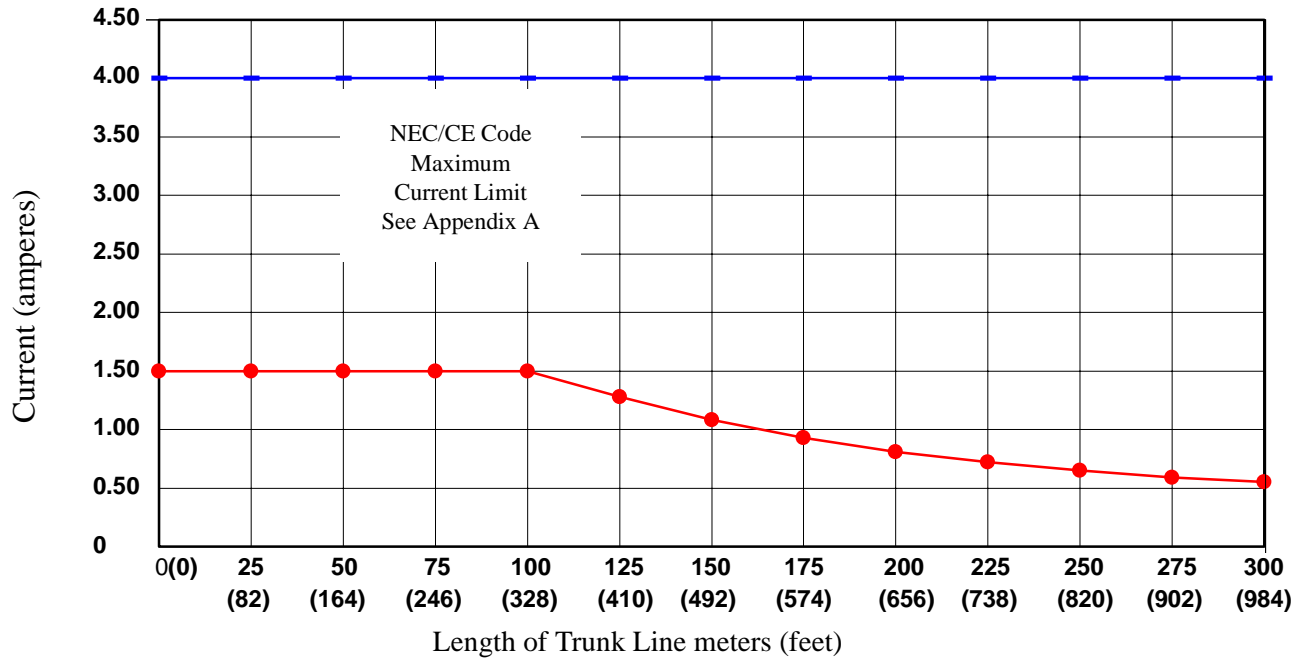

Network Length m (ft)	Maximum current (A)
0 (0)	1.50
25 (82)	1.50
50 (164)	1.50
75 (246)	1.50
100 (328)	1.50
125 (410)	1.28
150 (482)	1.08
175 (574)	0.93
200 (656)	0.81
225 (738)	0.72
250 (820)	0.65
275 (902)	0.59
300 (984)	0.55

Figure 4.8 One Power Supply (End Segment) Round Cable (Thin)

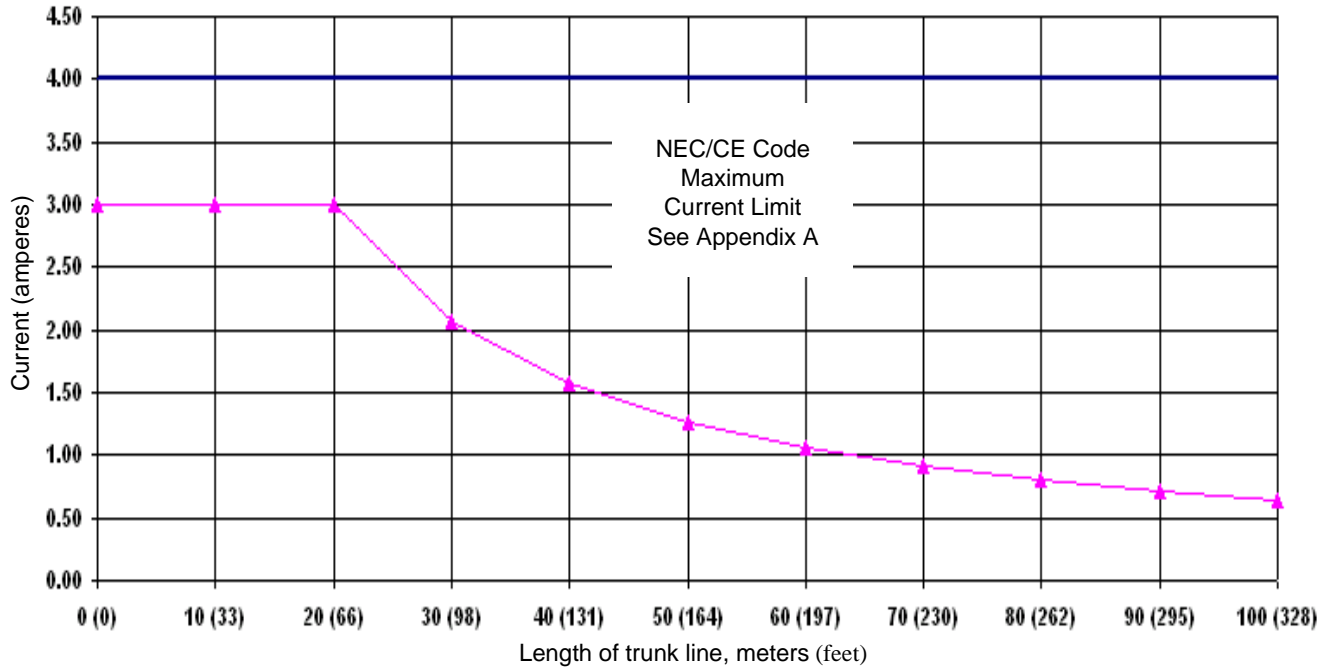

Network Length m (ft)	Maximum Current (A)
0 (0)	3.00
10 (33)	3.00
20 (66)	3.00
30 (98)	2.06
40 (131)	1.57
50 (164)	1.26
60 (197)	1.06
70 (230)	0.91
80 (262)	0.80
90 (295)	0.71
100 (328)	0.64

One Power Supply (End-Connected)

The following example uses the look-up method to determine the configuration for one end-connected power supply. One end-connected power supply provides as much as 8A near the power supply.

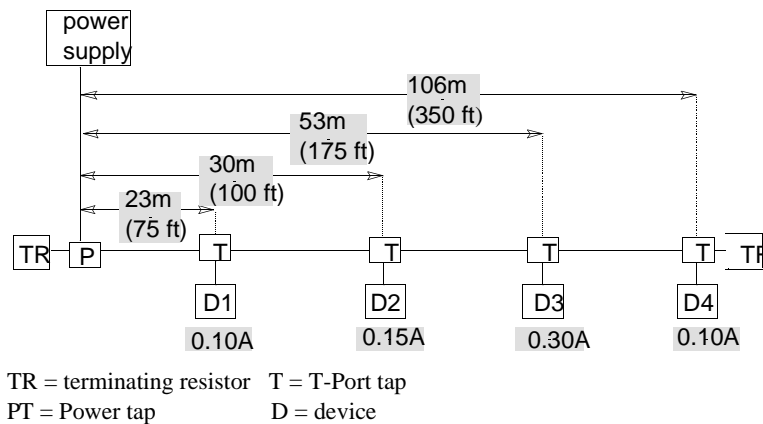

1. Determine the total length of the network.

– **106m**

2. Add each device's current together to find the total current.

– $0.10 + 0.15 + 0.30 + 0.10 = 0.65\text{A}$

Important: Make sure that the required power is less than the rating of the power supply. You may need to derate the supply if it is in an enclosure.

3. Find the value next largest to the network length using Figure 4.1 on page Page 4-3 to determine the maximum current allowed for the system (approximately).

– **120m (2.47A)**

Results



Since the total current does not exceed the maximum allowable current, the system will operate properly ($0.65\text{A} < 2.47\text{A}$).

Important: If your application doesn't fit "under the curve", you may either:

- do the full-calculation method described later in this chapter
- move the power supply to somewhere in the middle of the cable system and reevaluate per the following section

One Power Supply (Middle-Connected)

The following example uses the look-up method to determine the configuration for one middle-connected power supply. One middle-connected power supply provides the maximum current capability for a single supply.

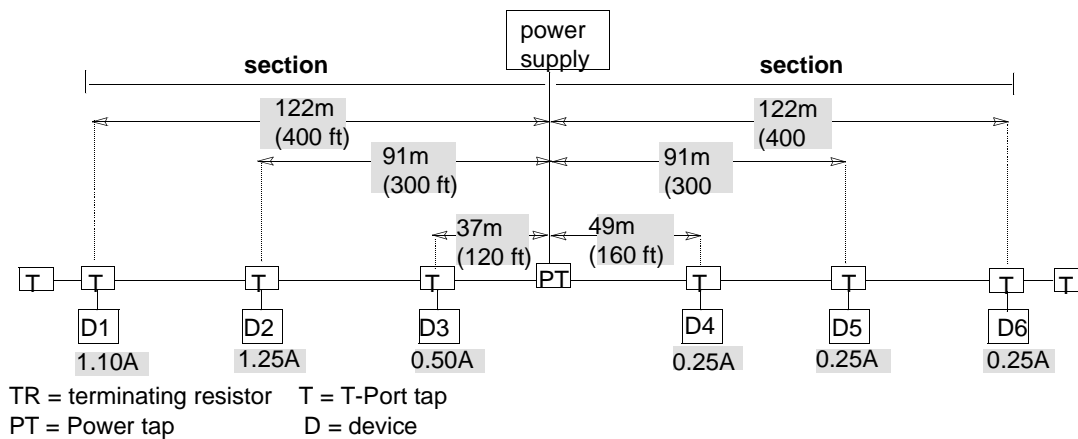

1. Add each device's current together in section 1.
 - $1.10+1.25+0.50 = 2.85A$
2. Add each device's current together in section 2.
 - $0.25+0.25+0.25 = 0.75A$
3. Find the value next largest to each section's length to determine the maximum current allowed for each section (approximately).
 - **Section 1 = 140m (2.14A)**
 - **Section 2 = 140m (2.14A)**

Important: Section 1 + Section 2 = 3.6A. This is $\leq 4A$ for NEC/CECode compliance.

Results  Section 1 is overloaded because the total current exceeds the maximum current ($2.85A > 2.14A$).

Section 2 is operational since the total current does not exceed the maximum current ($0.75A < 2.14A$).

Balance the system by moving the power supply toward the overloaded section (section 1). Then recalculate each section.

4-14 Determine Power Requirements

- add a second power supply to the cable system (do this as a last resort) as shown in the following three examples

NEC/CECode Current Boost Configuration

If the national or local codes limit the maximum rating of a power supply, use the following configuration to replace a single, higher current power supply.

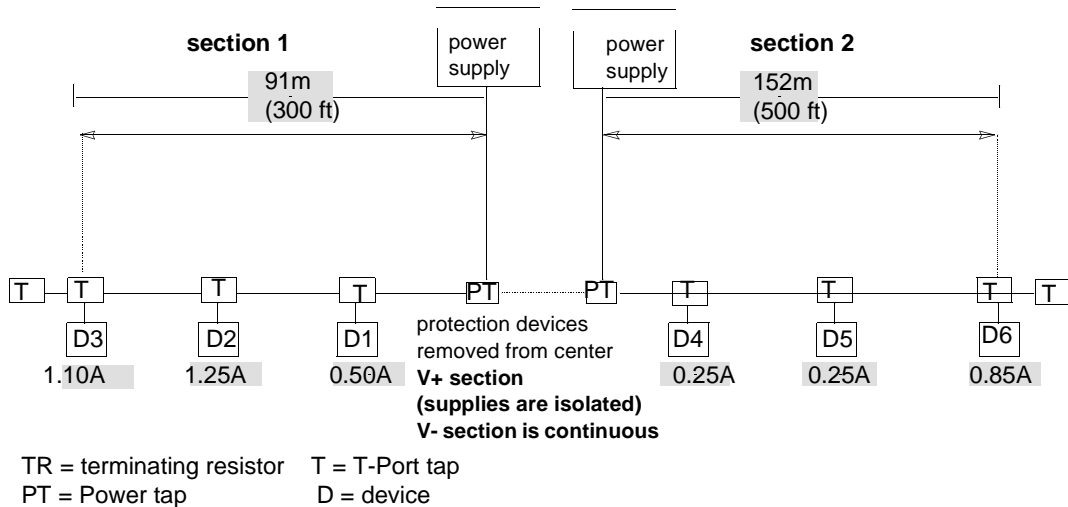

This configuration effectively doubles the available current. It has the following characteristics:

- no loads are allowed between the Power taps
- fuses between the two Power taps must be removed to segment the V+ conductor in the trunk line between the taps
 - also cut V+ (red) flush with cable jacket

These are the Power tap modifications.

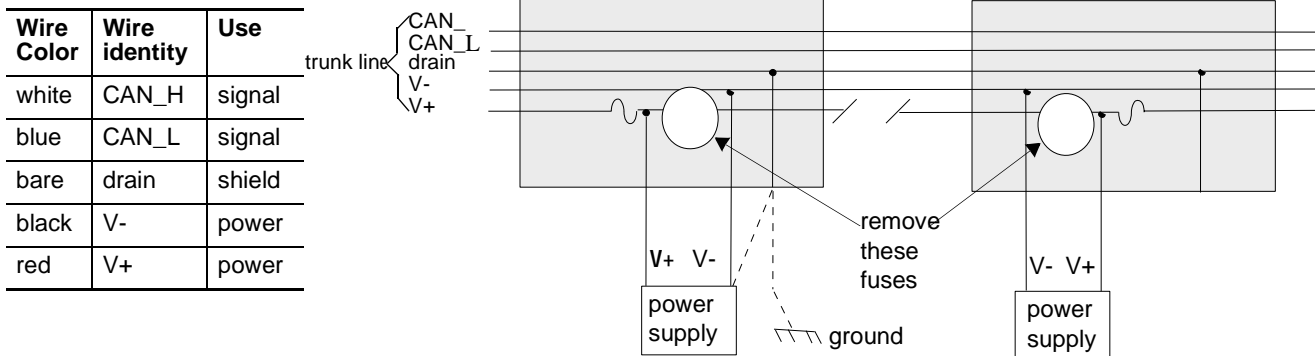

- essentially two independent segments, each of which is a “one power supply end-connected system”

- each power supply can be rated up to 4A and still meet NEC/CECode Class 2 current restrictions

Two Power Supplies (End-Connected) in Parallel with No V+ Break

The following example uses the look-up method to determine the configuration for two end-connected power supplies. You must use diodes at the power taps to prevent back-feeding of the power supplies. Check your national and local codes for any restrictions on the use of parallel power supplies. The NEC/CECode requires that the power supplies must be listed for parallel operation.

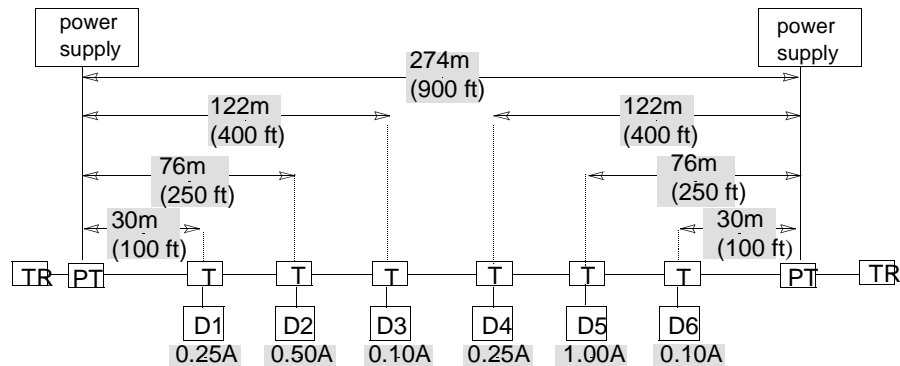

TR = terminating resistor T = T-Port tap
 PT = Power tap D = device

1. Determine the total length of the network.
 - **274m**
2. Add each device's current together to find the total current.
 - **0.25+0.50+0.10+0.25+1.00+0.10 = 2.20A**
3. Find the value next largest to each section's length using Figure 4.5 on page 4-7 to determine the maximum current allowed for each section (approximately).
 - **280m (3.96A)**

Results 

Since the total current does not exceed the maximum current, the system will operate properly (2.20A < 3.96A).

Two Power Supplies (Not End-Connected) in Parallel with No V+ Break

The following example uses the look-up method to determine the configuration for two power supplies that are not end-connected. This configuration provides the most power to the cable system. You must use diodes at the power taps to prevent back-feeding of the power supplies. Check your national and local codes for any restrictions on the use of parallel power supplies.

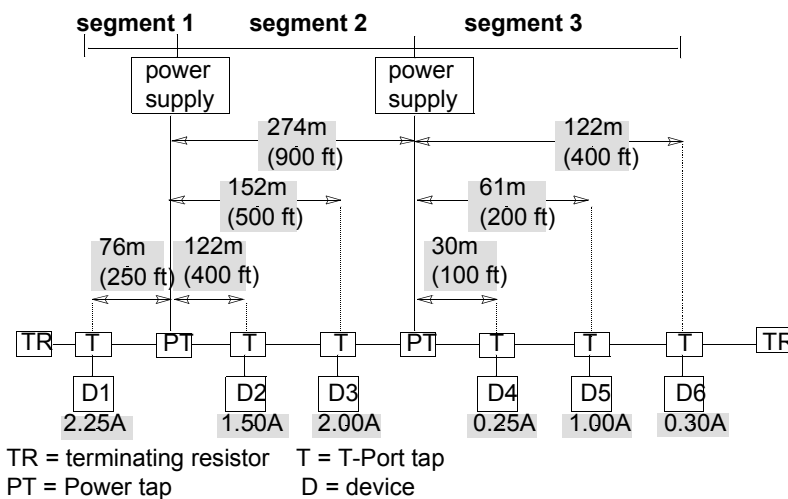

1. Determine the trunk line length of one end section (for this example we will use section 3).

– 122m

2. Add each device's current together in section 3.

– $0.25 + 1.00 + 0.30 = 1.55A$

3. Find the value next largest to the length of section 3 using Figure 4.3 on page 4-5 to determine the maximum current allowed (approximately).

– 140m (3.40A)

Important: If the total current in the section exceeds the maximum current, move the power supply closer to the end and repeat steps 1-3 until the total current in the section is less than the maximum allowable current.

Since the total current does not exceed the maximum current, section 3 will operate properly ($1.55A < 3.40A$).
Loading is 46% ($1.55/3.40$).

Results 

4. Determine the trunk line length of the other end section (section 1).
 - 76m
5. Add each device's current together in section 1.
 - 2.25A
6. Find the value next largest to the length of section 1 using Figure 4.1 on page 4-3 to determine the maximum current allowed (approximately).
 - 80m (3.59A)

Important: If the total current in the section exceeds the maximum current, move the power supply closer to the end and repeat steps 4-6 until the total current in the section is less than the maximum allowable current.

Results  Since the total current does not exceed the maximum current, section 1 will operate properly (2.25A < 3.59A).
Loading is 63% (2.25/3.59).

7. Determine the length of the middle section (section 2).
 - 274m
8. Add each device's current together in section 2.
 - 1.50+2.00 = 3.50A
9. Find the value next largest to the length of section 2 using Figure 4.3 on page 4-5 to determine the maximum current allowed (approximately).
 - 280m (7.69A)

Important: If the total current in the section exceeds the maximum current, move the power supplies closer together and repeat steps 7-9 until the total current in the section is less than the maximum allowable current.

Results  Since the total current does not exceed the maximum allowable current, section 2 will operate properly (3.50A < 7.69A).
Loading is 46% (3.50/7.69).

If the middle section is still overloaded after you move the power supplies closer together, add a third power supply. Then recalculate each segment.

Important: Section 1 + Section 2 + Section 3 = 7.3A. This is >4A and does not comply with the NEC/CECode for Class 2 installations.

Important: To determine spare capacity for future expansion, subtract the actual current from the maximum allowable current. To determine the percentage loading for each segment, divide the maximum allowable current into the actual current.

Segment	Maximum Current - Actual Current =	Spare Capacity	% Loading/ Segment
1	2.85A - 2.25A=	0.60A	79% (2.25A/ 2.85A)
2	3.83A - 3.50A=	0.33A	91% (3.50A/ 3.83A)
3	1.70A - 1.55A=	0.15A	91% (1.55A/ 1.70A)

Use the Full-calculation Method

Use the full-calculation method if your initial evaluation indicates that one section is overloaded or if the requirements of your configuration cannot be met by using the look-up method.

Important: Before constructing the cable system, repeat all calculations to avoid errors.

Using the Equation

A supply that is not end-connected creates two sections of trunk line. Evaluate each section independently.

$$\text{SUM } \{[(L_n \times (R_c)) + (N_t \times (0.005))] \times I_n\} \leq 4.65V$$



Term	Definition
L_n	<p>L = The distance (m or ft) between the device and the power supply, excluding the drop line distance.</p> <p>n = The number of a device being evaluated, starting with one for the device closest to the power supply and increasing by one for the next device. The equation sums the calculated drop for each device and compares it to 4.65V.</p>
R_c	<p>Thick cable Metric 0.015 Ohms/m English 0.0045 Ohms/ft</p> <p>Mid cable Metric 0.023 Ohms/m English 0.0069 Ohms/ft</p> <p>Thin cable Metric 0.069 Ohms/m English 0.021 Ohms/ft</p> <p>Flat Cable Metric 0.019 Ohms/m English 0.0058 Ohms/ft</p>
N_t	<p>The number of taps between the device being evaluated and the power supply. For example:</p> <ul style="list-style-type: none"> • when a device is the first one closest to the power supply, this number is 1 • when a device has one device between it and the power supply, this number is 2 • when 10 devices exist between the evaluated device and the power supply, this number is 11. <p>For devices attached to a multi port tap, treat the tap as one tap. The currents for all devices attached to one of these taps should be summed and used with the equation only once.</p> <p>For flat cable, $N_t = 1 +$ twice the number of intermediate splice kits.</p>
(0.005)	The nominal-contact resistance used for every connection to the trunk line.
I_n	<p>I = The current drawn from the cable system by the device. For currents within 90% of the maximum, use the nominal device current. Otherwise, use the maximum rated current of the device. For DeviceBox taps or DevicePort taps, sum the currents of all the attached devices, and count the tap as one tap.</p> <p>n = The number of a device being evaluated, starting with one for the device closest to the power supply and increasing by one for the next device.</p>
4.65V	The maximum voltage drop allowed on the DeviceNet trunk line. This is the total cable system voltage drop of 5.00V minus 0.35V reserved for drop line voltage drop.

One Power Supply (End-Connected)

Example of Thick Cable

The following example uses the full-calculation method to determine the configuration for one end-connected power supply on a thick cable trunk line.

Device 1 and Device 2 cause the same voltage drop but Device 2 is twice as far from the power supply and draws half as much current.

Device 4 draws the least amount of current but it is furthest from the power supply and causes the greatest incremental voltage drop.

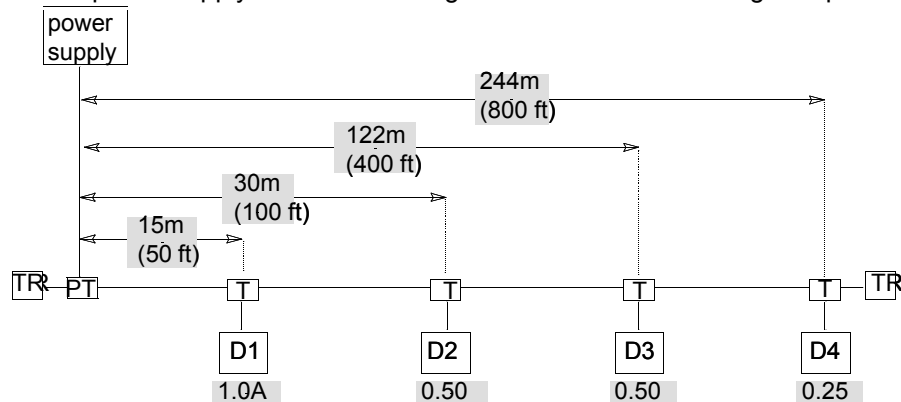

TR = terminating resistor T = T-Port tap
 PT = Power tap D = device

1. Find the voltages for each device using the equation for thick cable.

$$SUM \{[(L_n \times (0.0045)) + (N_t \times (0.005))] \times I_n\} \leq 4.65V.$$

D1
1.0A
D2
0.50A
D3
0.50A
D4
0.25A

A. $[(50 \times (0.0045)) + (1 \times (0.005))] \times 1.00 = 0.23V$

B. $[(100 \times (0.0045)) + (2 \times (0.005))] \times 0.50 = 0.23V$

C. $[(400 \times (0.0045)) + (3 \times (0.005))] \times 0.50 = 0.91V$

D. $[(800 \times (0.0045)) + (4 \times (0.005))] \times 0.25 = 0.91V$

1. Add each device's voltage together to find the total voltage.

$$0.23V + 0.23V + 0.91V + 0.91V = 2.28V$$

Results \Rightarrow Since the total voltage does not exceed 4.65V, the system will operate properly (2.28V < 4.65V).

The percent loading is found by dividing the total voltage by 4.65V.

$$\%Loading = 2.28/4.65 = 49\%$$

One Power Supply (Middle-Connected)

Example of Thick Cable

This example is used to check loading on both sides of a middle-connected supply on a thick cable trunk line. Keep the loads, especially the higher ones, close to the power supply. If the device location is fixed, put the power supply in the center of the highest current concentration.

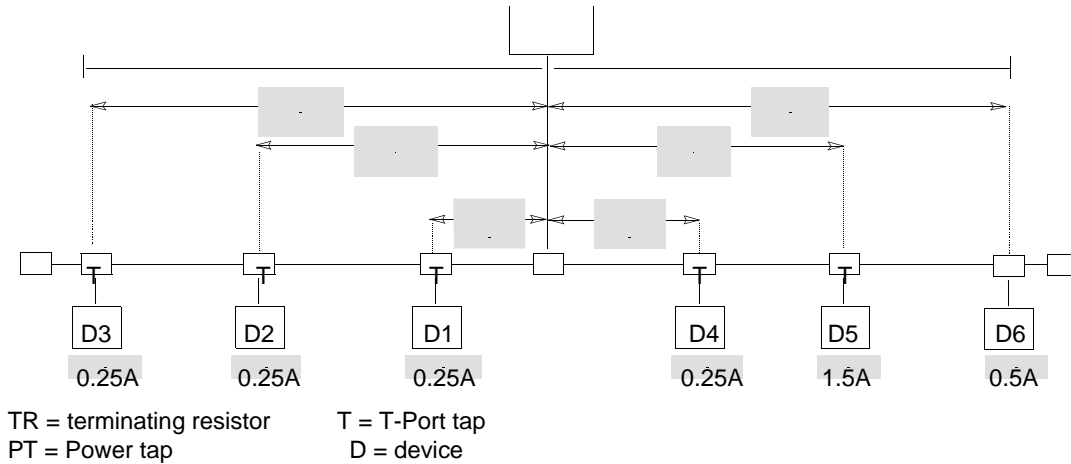

According to the look-up method, section 1 is operational while section 2 is overloaded.

Value of	Section 1	Section 2
Total maximum current	1.25A (approximately)	1.25A (approximately)
Total current required	0.75A	2.25A

- Find the voltages for each device in section 1 using the equation for thick cable.

$$SUM \{[(L_n \times (0.0045)) + (N_t \times (0.005))] \times I_n\} \leq 4.65V$$

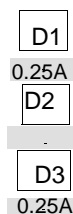

A. $[(100 \times (0.0045)) + (1 \times (0.005))] \times 0.25 = 0.12V$

B. $[(400 \times (0.0045)) + (2 \times (0.005))] \times 0.25 = 0.45V$

C. $[(800 \times (0.0045)) + (3 \times (0.005))] \times 0.25 = 0.90V$

- Add each device's voltage together to find the total voltage for section 1.

$$0.12V + 0.45V + 0.90V = 1.47V$$

- Find the voltages for each device in section 2 using the equation for thick cable.

$$SUM \{[(L_n \times (0.0045)) + (N_t \times (0.005))] \times I_n\} \leq 4.65V.$$

D1
0.25A

A. $[(200 \times (0.0045)) + (1 \times (0.005))] \times 0.25 = 0.23V$

D2
1.5 A

B. $[(400 \times (0.0045)) + (2 \times (0.005))] \times 1.5 = 2.72V$

D3
0.5A

C. $[(800 \times (0.0045)) + (3 \times (0.005))] \times 0.5 = 1.81V$

- Add each device's voltage together to find the total voltage for section 2.

$$0.23 + 2.72 + 1.81 = 4.76V$$

Results \Rightarrow Since the total voltage in section 2 exceeds 4.65V, the system will not operate properly (4.76V > 4.65V).

Attempt to correct this overload by moving the power supply 91m (300ft) toward the overloaded section. Now there are four devices in section 1 and two devices in section 2. Once you've moved the power supply, try the calculations again.

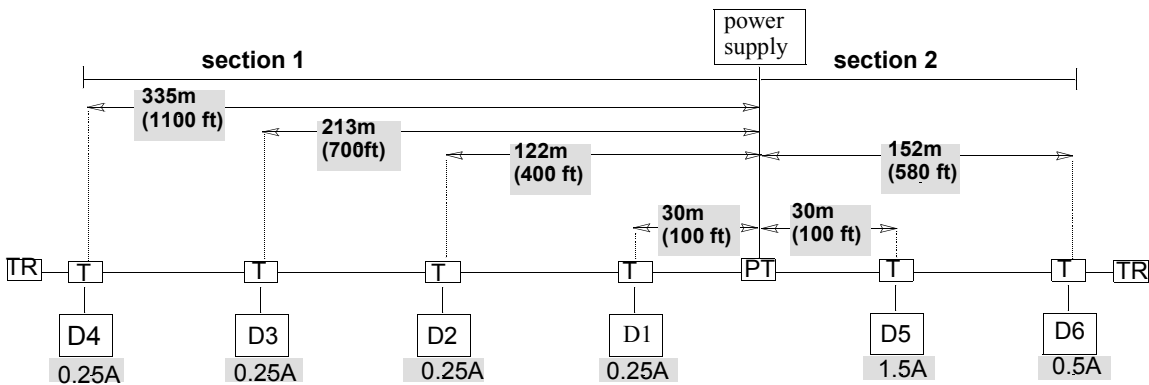

TR = terminating resistor
PT = Power tap

T = T-Port tap
D = device

- Find the voltages for each device in section 1 using the equation for thick cable.

$$SUM \{[(L_n \times (0.0045)) + (N_t \times (0.005))] \times I_n\} \leq 4.65V.$$

D1
0.25A

A. $[(100 \times (0.0045)) + (1 \times (0.005))] \times 0.25 = 0.11V$

D2
0.25A

B. $[(400 \times (0.0045)) + (2 \times (0.005))] \times 0.25 = 0.45V$

D3
0.25A

C. $[(700 \times (0.0045)) + (3 \times (0.005))] \times 0.25 = 0.79V$

D4
0.25A

D. $[(1100 \times (0.0045)) + (4 \times (0.005))] \times 0.25 = 1.24V$



2. Add each device's voltage together to find the total voltage for section 1.

$$0.11 + 0.45 + 0.79 + 1.24 = \mathbf{2.59V}$$

3. Find the voltages for each device in section 2 using the equation for thick cable.

$$SUM \{[(L_n \times (0.0045)) + (N_t \times (0.005))] \times I_n\} \leq 4.65V.$$

D5

1.5A

$$\mathbf{A. [(100 \times (0.0045)) + (1 \times (0.005))] \times 1.5 = 0.68V}$$

D6

0.5A

$$\mathbf{B. [(500 \times (0.0045)) + (2 \times (0.005))] \times 0.5 = 1.13V}$$

4. Add each device's voltage together to find the total voltage for section 2.

$$0.68 + 1.13 = \mathbf{1.81V}$$

Results  Since the total voltage does not exceed 4.65V in either section, the system will operate properly - section 1 (2.59V ≤ 4.65V) section 2 (1.81V ≤ 4.65V).

The percent loading is found by dividing the total voltage by 4.65V.

$$\text{Section 1\% Loading} = 2.59/4.65 = \mathbf{56\%}$$

$$\text{Section 2\% Loading} = 1.81/4.65 = \mathbf{39\%}$$



DeviceNet™



Commissioning, Troubleshooting and Diagnostics

Network Measurement Tools

There are several different type of diagnostic and troubleshooting tools available to aid you in the initial commissioning of the network, further troubleshooting during operation and as an ongoing means of monitoring its health. For a complete listing of the most recent diagnostic/troubleshooting tools available see www.odva/products/diagnostics . The broadest category of tools are those which are general purpose such as a voltmeter, oscilloscope, time domain reflectometer, etc. These analytical tools can confirm connections, verify cable lengths and the proper installation of terminations as well as being able to measure voltages and confirm signal levels. This category of tools requires a user with advanced knowledge of both the measuring tool and the DeviceNet specification.

The second category of tools are protocol-specific and include a variety of both passive and active hand-held meters. Passive instruments are designed to locate short circuits, opens, confirm terminations and cable lengths. Active handheld devices are designed to give "dial in" measurements of the physical layer voltages such as common mode voltage as well as data packet characteristics such as node error count or rate and bandwidth utilization. These protocol-aware measuring tools are more user friendly in that they typically use plug-play network connections.

Lastly there are a variety of software tools available to monitor network traffic which can aid in commissioning and diagnostics. For instance some configuration tools can monitor traffic and errors produced in the network. More sophisticated software tools such as protocol analyzers parse out and decode both CAN and DeviceNet messages to get into refined issues such as device communications and timing. These tools require a higher level of sophistication and are not designed specifically to address physical layer issues.

Verifying Network Installation

VERIFYING NETWORK INSTALLATION - Commissioning the Network

Prior to making any measurements use the quick check list below to verify that the physical media system has been installed and designed properly:

Total device network current draw does not exceed power supply current limit



- Number of DeviceNet™ nodes does not exceed 64 on one network. The practical limit of DeviceNet™ nodes may be 61 devices since you should allow one node each for the scanner, the computer interface module, and an open node at node 63.
- No drop should be greater than 6m in length (20 ft)
- Cumulative drop line budget does not exceed the maximum allowable per the network baud rate limit
- Total network trunk length does not exceed the maximum allowable per the network data rate and cable type
- Terminating resistors are on each end of the trunk line
- Ground V-, drain and (for round media) shield at only one location preferably in the center of the network
- Check the physical media prior to applying power
 - All connections are inspected for loose wires or coupling nuts
 - Check for opens or shorts
 - Check the proper value of the terminating resistors

Confirming Media

CONFIRMING MEDIA TOPOLOGY AND CONNECTIONS

The following measuring procedures are suggested PRIOR to commissioning your network:

1. Use a Time Domain Reflectometer, DVM or handheld network media checker to verify cable lengths, cable types, termination and connection integrity. These tests are to be conducted PRIOR to connection of devices and power on the network.
2. Insure that both termination resistors are connected to the network. Measure and record DC resistance between CAN_H and CAN_L at the middle and the ends of the network.



Measured Value	Action
<50 Ohms	Check for short circuit between CAN_H and CAN_L wiring Check for more than two terminating resistors Check nodes for faulty transceivers
50-70 Ohms	Normal
71-125 Ohms	Check for open circuits in CAN_H and CAN_L wiring Check for only one terminating resistor
>125 Ohms	Add termination resistors

3. Temporarily disconnect from ground and measure between ground and measure between ground and the disconnected grounding point.

Measured Value	Action
<1 Megaohm	Check for additional grounded V- or shield wires
>1 Megaohm	Normal

Record all of the above in the attached "Baseline and Test Report"

4. Measure the network's electrical characteristics with the following as the recommended minimum to make and record:

- A. Bus Power
- B. Shield Voltage
- C. Common Mode Voltage

Record all of the above in the attached "Baseline and Test Report"

5. After scanner(s) and any other connection originators have been configured and are operating normally, measure network protocol characteristics with the following the recommended minimum to make and record:

- A. Network Error Rate
- B. Error Counter
- C. % Network Bandwidth
- D. Network Message Rate/Sec

Record all of the above in the attached "Baseline and Test Report"



Proper Network Maintenance

PROPER NETWORK MAINTENANCE

Once the network has been installed and has been successfully commissioned and baseline measurements recorded, periodic measurements can improve network availability. The most obvious place to begin this checkup is by comparing the network's operating characteristics against the established baseline. Checkup frequency and thoroughness is the key to early detection of deteriorating network properties. A continuous monitoring of these baselined parameters is ideal, however, a quick protocol-aware checkup every few weeks would be adequate to detect any deteriorations of network performance.

ANALYZING SYMPTOMS

Use the following to analyze the most common symptoms and their likely sources.

Most devices have LEDs, some have alphanumeric or other displays. If any of these show error codes or messages, read the manufacturer's data sheets to interpret the codes.

Common Mode Problems

SYMPTOMS:

1. Nodes at the end of the trunk stop communicating after operating normally
2. The network communicates only when the number of nodes is decreased or the trunk length is reduced
3. Properly configured slaves are not detected by the scanner

CHECKS:

- Check the communications at the end of the network.
- Check the common mode voltage.

SUGGESTED ACTIONS:

- Move nodes from overloaded section to less overloaded section
- Shorten the overall length of the network cable
- Move power supply in direction of the overloaded section of the network
- Move high current nodes (e.g. valve banks) close to the power supply
- Add second power supply
- Break network into two (2) separate networks



Bus Errors

Bus Errors

SYMPTOMS:

1. Nodes intermittent-they drop off suddenly and unexpectedly
2. LEDs or other displays indicate “buss off” errors.

CHECKS:

- Use protocol-aware tool to measure bus error rate.

SUGGESTED ACTIONS:

- Node baud rate set incorrectly affects other nodes when it attempts to go online
- Replace suspected faulty device and re-check error rates
- Intermittent cables - check by shaking/bending/twisting the suspected cable or connection while looking at the error rates

Bus Traffic Problems

Bus Traffic Problems

SYMPTOMS:

1. Nodes stop communicating and devices time out. No communication from a device

CHECKS:

- Check bandwidth using protocol-aware device

SUGGESTED ACTION:

- Check scanner configuration as scan rate may be set incorrectly
- Inter-scan delay/scan interval too short can cause device timeouts
- Inter-scan delay/scan interval too long can reduce system performance and makes inefficient use of available bandwidth
- Check Change-of-State devices consuming excessive bandwidth -increase production inhibit time or change these devices to poll, strobe or cyclic communications.
- Look for nodes with excessive bandwidth or much higher than average MAX value



Bus Power Problems

Bus Power Problems

SYMPTOMS:

1. Nodes near end of trunk stop communicating after operating normally
2. Network communicates only when the number of nodes is reduced or the trunk length is reduced

CHECKS:

- Check network power voltage at the node and the common mode voltage at the ends of the network

SUGGESTED ACTIONS:

- Check for output devices (eg contactors) powered from the network
- Check for network cables routed too close to interferences from high voltage and RF lines
- Check power supply ripple increasing over time against the baseline
- Intermittant cables check by shaking/bending/twisting the suspected cable or conenctor while watching the peak-peak voltage changes

Shield Voltage Problems

Shield Voltage Problems

SYMPTOMS:

1. Nodes intermittantly dropping out.
2. properly configured slaves are not detected by the scanner.

CHECKS:

- Check shield voltage

SUGGESTED ACTIONS:

- Check for additional V- or shield wire connections.
- Check for loose connections, especially field attachable connections
- Make sure only shield and V- connected together at earth ground and the power supply



Common Faults

Common Faults

If you are having difficulty with the network make sure to check the following most common network problems :

- More or less than two (2) terminators
- Relaxed connector pin - especially those which use a soft brass contact on the female socket. The DeviceNet™ specification requires that connectors are good for at least 1000 insertions. Phosphor-Bronze contacts are more likely to meet this requirement.
- Excessive drop line cable length
- Too many drop cables - cumulative drop length
- Excessive trunk line length - especially with THIN cable
- Improper shield and ground connection at the power supply
- Shorts and opens in manually-wired connectors
- Failure to perform power distribution calculations for new installations and again when adding nodes i.e your power budget has been exceeded
- Using a typical device current rather than maximum current for power distribution calculations
- Scan interval configured faster than the network can handle

Flat Cable Shorts

Flat Cable Shorts

Badly installed flat cable taps can cause short circuits. These can be difficult to find because the taps are not designed to allow removal. A time domain reflectometer or handheld network media checker can indicate the approximate distance to a short. This may not be accurate enough if there are several taps within a short distance of each other. The following technique can be used to identify the shorted tap more precisely.

Disconnect all devices by removing all of the snap-on connection interfaces. Use two open-style connection interfaces for the test. Use one of these to inject about 100mA DC into the shorted pair of conductors. Use the other with a multimeter to measure mV across the shorted pair. Move the measurement point to different taps - the voltage should decrease as it gets nearer to the short. If you see no change, the short is probably on the other side of the current injection point. If you see no change on either side, the short is probably at the current injection point. Move the current injection point to another tap and repeat the test. The lowest voltage measured should be at the shorted tap.



The 100mA current can be generated by a low-voltage DC power supply and a resistor. Be careful if using the 24V DC network supply for this - the resistor (240 Ohms) would dissipate 2.4 watts and would get hot. It should have at least a 5 watt rating. It is better to use a 1.5V cell and a 15 Ohm resistor, which will only dissipate about 0.15 watts.

Once the shorted tap is identified, the flat cable must be cut on either side and the faulty tap removed. Use a splice kit to repair the cable. The splice kit consists of two taps with end caps for sealing, and two connection interfaces permanently joined by a short length of cable.

Never attempt to re-use a flat cable tap.



Understanding Select NEC Topics

What's in this Appendix

Be aware that the following topics from the National Electrical Code (NEC) 725 (revision 2002) impact the configuration and installation of DeviceNet systems in the United States. There also may be additional NEC sections and local codes that you must meet. Other codes exist outside of the United States that may also affect your installation.

Class 1 (CL1) Cable

Per NEC specifications for a Class 1 circuit (see NEC Article 725), the energy in the circuit anywhere is limited to 1000 VA. A Class 1 circuit requires that the cables used must have jacketing with 600V isolation and pass the CL1 burn test.

DeviceNet™ specifies the power source to be a regulated maximum of 24V dc and the power circuit is limited to 8A. Applying this to a Class 1 circuit running at 24V dc, a DeviceNet™ certified cable with a 600V jacket isolation rating meets all requirements to be used in a Class 1 circuit. So, based on DeviceNet™ specification, the cable's power carrying conductors are sized for an 8A maximum load.

Class 2 (CL2) Cable

Per NEC specifications for a Class 2 circuit (see NEC Article 725), the energy in the circuit anywhere is limited to 100 VA and the cable's jacketing used must have a 300V minimum isolation rating. Based on a 30V dc system your circuit would be limited to 3.3A.

DeviceNet™ specifies the power source to be a maximum of 24V dc. Applying this to a Class 2 circuit running at 24V dc, the maximum allowable current is 4A. A DeviceNet™ certified cable with a 300V jacket isolation rating meets all requirements to be used in a Class 2 circuit. So, based on the DeviceNet™ specification, the cable's power carrying conductors, are sized for a 8A maximum load.



Suppliers of DeviceNet™ physical components use the above information to provide components you can use to cable DeviceNet™ systems

The DeviceNet™ specifications provide for both “open and closed style” wiring terminations. You can engineer a wiring system for a DeviceNet™ installation that lays out a trunk line in accordance with the requirements of the Class 1 guidelines and uses drop lines in accordance with Class 2 guidelines. Care must be taken at the point where the two guidelines meet. At that point you must put in place a way to limit the energy on each wire to be in accordance with the NEC guidelines. In short, the energy in the drop line must be limited to no more than 100 VA. How you accomplish that is your decision. Most people resolve this issue by isolating the trunk from the drop line with different power sources. Other ways to limit energy may give you the same protection.

Specifying Article 725 Topics

Round (Thick, Mid & Thin) and Class 2 Flat Media

power limitations of Class 2 circuits

- The power source for Class 2 circuits must be either inherently limited, thus requiring no overcurrent protection, or limited by a combination of a power source and overcurrent protection.

marking

- Class 2 power supplies must be durably marked where plainly visible to indicate the class of the supply and its electrical ratings.

interconnection of power supplies

- Class 2 power supplies must not be paralleled or otherwise interconnected unless listed for such applications.

Class 1 Round or Flat Media

power limitations of Class 1 circuits

- The overcurrent protection shall not exceed 10 amperes per NEC article 725-23.
- Consult the product manufacturer to determine if the device is suitable for installation with a Class 1 power source.

Powering Output Devices

Wide Available Voltage Range

You can power some output devices on the DeviceNet™ network. The application must allow the voltage to remain within the DeviceNet™ specification limits of 11-25V dc. Most actuators need to be powered by a separate power supply. They usually require more power than is practically available from DeviceNet™. Also, the large voltage variation of 11-25V that DeviceNet™ allows is typically beyond the range that most available actuators or output devices can safely operate over.

You can use DeviceNet™ power to operate output devices such as hydraulic and pneumatic solenoid valves, pilot and stack lights, and motor starter coils with the following caution:



ATTENTION: Do not let DeviceNet™ voltage at the relevant node exceed the output device's acceptable voltage range. Output devices rated 24V dc rarely are specified to operate below 19.2V dc or -20% of their 24V dc rating. Many only operate down to 20.4V dc or -15% of the rated voltage. This means that the DeviceNet™ network design must not allow the available voltage to drop below 19.2 volts, for example, instead of the 11 volts that the DeviceNet™ specification allows. This higher lower voltage limit which is within the DeviceNet™ specification will actually restrict the distance of the DeviceNet™ network from what would be possible if actuators were not utilizing the DeviceNet™ power

Important: Design your network to make sure that sufficient voltage is available to operate the output device wherever it is installed. This is especially important when it is connected at the farthest location from the power supply.

The DeviceNet™ common mode drop voltage specification limit of 10 volts, 5 volts in each power supply V+ and V- conductor, will never be a concern. This is because in the design process we start with a 24V dc power supply and allow for the 4% stack-up tolerance which leaves 23V dc to work with. From here we consider the output device's minimum required operating voltage of 19.2 volts. This gives 23V dc-19.2V dc = 3.8V dc for the common mode voltage or 1.9V dc in each conductor. This is far more restrictive than the 5 volts of the DeviceNet™ specification and will result in shorter allowable distances for the installation.

Noise or Transient Protection

The typical actuators used in DeviceNet™ control systems utilize inductive coils that generate transients when de-energized. You must use appropriate protection to suppress transients during coil de-energization. Add a diode across the inductive coil to suppress transients on the actuator's dc coils. Use a MOV varistor module suppressor for a 24V dc coil if the added drop out time with the diode is unacceptable. This varistor module must clamp the transient voltage across the coil at 55 volts to prevent the output contact from arcing on switch separation. Read the output device's specifications. It may have more restrictive transient suppression requirements than stated herein (lower maximum voltage).

Typical actuators used in DeviceNet™ control systems use inductive coils and limit current transients on energization by their inherent L/R time constant. Any transients due to contact bounce on energization will be suppressed by the transient protection utilized for coil de-energization.



ATTENTION: Do not use DeviceNet™ power to actuate dc coils that use economizing coils to operate. These coils have high inrush currents.



DeviceNet Baseline & Test Report

Tested By:		Company
Phone		e-mail
Measurement Date	Measurement Time	Network Identification
Network Location (Company name & Address)		

Network Characteristics

- Single Master # ___ Multi Master # ___, ___, ___, ___ Single power supply Multiple power supplies (No. ___)
- 125 Kbaud 250 Kbaud 500 Kbaud Network uses Thick media
- Network uses Thin media Network uses Mid media Network uses Flat media

Media Testing

- Trunk checked for short circuit Trunk checked for opens Wiring of trunk checked Drops checked for short circuit
- Drops checked for opens Check termination values Shield and V- connected to ground at single point on network-at power supply

Node List (According to network administrator, or "Network Who" scan)

- 0 1 2 3 4 5 6 7 8 9 10 11 12 13 14 15
- 16 17 18 19 20 21 22 23 24 25 26 27 28 29 30 31
- 32 33 34 35 36 37 38 39 40 41 42 43 44 45 46 47
- 48 49 50 51 52 53 54 55 56 57 58 59 60 61 62 63

Basic Observations & Symptoms

Reported Symptoms

- No problems reported Intermittent problems (___ min, ___ hrs, ___ days) Constant problems
- All nodes affected Some nodes affected
- Error codes: Error codes per node

Node Network Status LEDs (LED indications refer to Network Status or Combined Module/Network Status LEDs)

- All nodes active (green) Some nodes active (green) Some nodes inactive (blink green)
- Some nodes faulted (red) All nodes occasionally inactive (green/ blink green) Some nodes occasionally inactive (green/ blink green)
- All nodes with no power (LED off) Some nodes with no power (LED off)



Physical Layer Measurements (☐ NetMeter™ ☐ DeviceNet Detective ☐ Multimeter ☐ Oscilloscope Connected to network in proximity to node # ____). Use NetMeter to take all of the following measurements (NetMeter switch positions are shown beside each measurement). You can also collect a limited number of measurements using other tools such as the DeviceNet Detective 📡, multimeter 📏 and/or oscilloscope 📡 (indicated by icons in the table).

Note: This document shows some measurements that are only practical with specific proprietary test instruments. All measurements are theoretically possible with general-purpose instrumentation such as oscilloscopes, but some would be very tedious. Proprietary instruments make it easy to perform the tests for which they are designed. This page indicates instruments that are believed to have such capabilities, but you should NOT assume that it is complete or accurate. Consult the instrument manufacturers for more information about each instrument's capabilities.

Autosearch Results (record measurements as indicated by NetMeter Autosearch function and check for ☺ and/or ☹ with each reported problem)

No faults found ☺

NetMeter gathered data for (H:M:S) ____:____:____ before

Measurement	Min	Max
[2] Bus error rate (/S)		☐☺ ☐☹ ☐☹☺
[4] Bus power, DC (V)	☐☺ ☐☹☺	☐☺ ☐☹☺
[5] Shield Voltage (V)	☐☺ ☐☹☺	☐☺ ☐☹☺
[7] CANH/L Recessive Diff.	☐☺ ☐☹☺	☐☺ ☐☹☺
[9] CANH Recessive (V)	☐☺ ☐☹☺	☐☺ ☐☹☺
[11] CANL Recessive (V)	☐☺ ☐☹☺	☐☺ ☐☹☺

Measurement	Min	Max
[3] Bus traffic, bandwidth	☐☺ ☐☹☺	☐☺ ☐☹☺
[4] Bus power, P-P (V)		☐☺ ☐☹☺
[6] Common Mode Voltage		☐☺ ☐☹☺
[8] CANH/L Dominant Diff.	☐☺ ☐☹☺	☐☺ ☐☹☺
[10] CANH Dominant (V)	☐☺ ☐☹☺	☐☺ ☐☹☺
[12] CANL Dominant (V)	☐☺ ☐☹☺	☐☺ ☐☹☺

Overall Subnet Measurements (only important for baseline performance, or for more detail if NetMeter Autosearch indicates problems)

Measurement	"Live"	Min	Max
[2] Bus error rate (/S)	📡		
[3] Bus traffic, bandwidth (%)	📡		
[4] Bus power, DC (V)	📡	📡	📡
[5] Shield Voltage (V)	📏📡		
[7] CANH/L Recessive Diff. (V)	📏📡		
[9] CANH Recessive (V)	📏📡		
[11] CANL Recessive (V)	📏📡		

Measurement	"Live"	Min	Max
[2] Bus error count			📡
[3] Bus traffic, message rate (/S)	📡		
[4] Bus power, P-P (V)	📏📡		
[6] Total Common Mode Voltage			
[8] CANH/L Dominant Diff. (V)	📏📡		
[10] CANH Dominant (V)	📏📡		
[12] CANL Dominant (V)	📏📡		

Measurement	Network idle	Network active (normal operation)
CAN_H average (V)	📏	📏
CAN_L average (V)	📏	📏

"Network idle" means all scanners and other connection originators inactive, disabled or disconnected. In this state the average voltages should be the same, about 2.5 – 3.5 volts. This will vary with position on the network. Repeated measurements should be taken at the same point for valid comparisons. With network active you are using a DC meter to measure a complex high frequency waveform, so these measurements are only approximate. Different meters may give different results. Repeated measurements should be taken with the same instrument at the same point for valid comparisons. CAN_H average should be about 0.5 – 1 volt higher than when idle. CAN_L average should be about the same amount lower than when idle. Because multimeters are not intended for this sort of waveform it is possible that they might cause errors on an active network. Experience suggests that this is rare with modern, high-impedance instruments, but if you experience this problem or are concerned about the possibility, construct a pair of probes with 100 kOhm resistors and heat-shrink sleeving. This is much higher than the network impedance (so it can't significantly affect the network) and much lower than the meter impedance (so it does not introduce a significant error).



DeviceNet™

Numerics

10-pin linear plug 1-6

5-pin linear plug 1-6

A

adequate power

worst case scenario 4-1

adjusting the configuration 4-13

auxiliary power cable

diagram 3-11

installation 3-11

C

cable installation

Flat cable 3-6

cable position

Flat cable 3-8

cable preparation 3-1

cables

maximum distance 1-3

determining 1-3

preterminated

thick 2-11

thin 2-11

CECode

current boost configuration

example 4-14

circuit

Class 2

limitations A-2

power source A-2

class 1

Flat cable

total allowable current 1-10

class 1 applications

Flat cable rating A-1

class 1 cable

maximum load A-1

NEC specifications A-1

class 2

total allowable current A-1

class 2 cable

maximum load A-1

NEC specifications A-1

common mode drop voltage

DeviceNet B-1

communication rate 1-3

determining 1-4

components

flat media network diagram 2-1

components diagram 2-1

conductors

V- 1-11

V+ 1-11, 4-14

configuration

adjusting 4-13

NEC/CECode current boost 4-14

one power supply end connected look-up method 4-11

middle connected 4-12

C (Con't)

connecting

drop lines 3-5

power supplies 3-11

to a Multi port tap preterminated thin cable

stripped conductors to micro female 2-12

stripped conductors to mini female 2-12

to a T-Port tap from open device preterminated thin cable

mini male to conductors 2-12

to a T-Port tap from sealed device preterminated thin cable

mini male to micro female 2-11

mini male to mini female 2-11

to the trunk line via direct connection 2-5

to the trunk line using connectors

open-style 3-2

sealed-style 3-3

to flat cable micro T-Port tap 2-10

connectors

Flat cable

IDC's 2-10

installation 3-6

open-style

attaching to trunk line 3-2

fixed 3-5

pinouts 3-11

sealed-style

attaching to trunk line 3-2

micro-style 1-6, 3-3

mini-style 1-6, 3-3

conventions used in manual P-2

current

boost example 4-14

cable system

maximum 4-18

maximum allowable

one power supply (end connected) example 4-11

one power supply (middle connected) example 4-12

segment between two power supplies figure 4-10

two power supply (end connected) example 4-15

two power supply (not end connected) example 4-15

maximum drop line 1-10

equation 1-10

name plate setting 1-12

thick cable 1-10

thin cable 1-10

current chart

end segment

two power supplies round cable thick 4-7

one power supply

end segment

flat cable 4-4

round cable mid 4-9

round cable thin 4-10

two power supplies

end segment flat cable 4-8

flat cable 4-6

round cable thick 4-5

D

definition

- open-style connector
 - fixed 1-5
 - plug-in 1-6
- sealed connector
 - micro-style 1-6
 - mini-style 1-6
- terminating resistor 1-7

definitions

- flat cable 1-2
- power supply formulas 4-18
- thick cable 1-2
- thin cable 1-2

determining adequate power

- power usage 4-3

DeviceNet common mode drop voltage B-1

DeviceNet power

- economizing coils B-2
- high inrush currents B-2

DeviceNet

- powering output devices 4-1

DeviceNet voltage limits

- output power B-1

diagram

- auxiliary power cable 3-11
- end cap installation
 - flat cable 3-12
- flat cable 3-6
- flat cable connector installation 3-6
- flat cable connectors 2-10

diagrams

- components 2-1
- multi port tap 2-7
- direct connection 2-9
- Power tap 2-5, 2-7,3-11
- preterminated
 - thick cable 2-11
 - thin cable 2-11
 - connecting to T-Port tap 2-11
- thick cable 2-2
- mid cable 2-3
- thin cable 2-3
- T-Port tap 2-5

diodes

- transient protection B-2

direct connection

- connecting to trunk line 2-4
- description 1-5, 2-9
- diagram 1-5, 2-9
- open-style 2-5, 2-9
- zero-length drop 1-5

distance

- maximum cable 1-4
- determining 1-4

D (Con't)

drift

- temperature 1-9
- time 1-9

drop cable

- flat cable installation
 - open-style 3-9

drop line

- allowable current 1-10

connection types

- open-style
 - hard-wire screw terminals 3-5
 - pluggable screw connectors 3-5
 - soldered 3-5
- sealed-style
 - quick disconnect connectors

cumulative length 1-4

- definition 1-4
- determining communication rate 1-4

current 1-10

equation 1-10

- including as part of cable length 1-4

rating 1-10

E

economizing coils

- DeviceNet power B-2

end cap installation 3-10

end segment current chart

- two power supplies
 - round cable (thick) 4-7

endcap

- flat cable
 - terminating resistor 1-8

equation

- current 1-10
- equation 1-10
- including as part of cable length 1-4
- rating 1-10

examples

- NEC/CECode current boost configuration 4-14
- power supply
 - one
 - end connected 4-11, 4-20
 - end segment 4-10
 - middle connected 4-12, 4-20
 - two
 - end connected 4-15
 - not end connected 4-16

F

figures

- power supply
 - two segment between 4-10
- fixed
 - connector open-style 1-5

F (Con't)

- flat cable
 - class 1
 - total allowable current 1-9
 - definition 1-2
 - size 1-2
 - total allowable current
 - class 2 1-9
 - use of connectors
 - flat cable 2-11
 - wire contents 1-3
- flat media
 - network diagram 2-1
- full-calculation method
 - description 4-18
 - equations 4-18
 - examples
 - power supplies - one
 - end connected 4-19
 - middle connected 4-20
- full-calculation method 4-18

G

- grounding 1-16, 4-14
- guidelines
 - supplying power 1-9

H

- hard wire taps
 - installing
 - multi port tap 3-4
 - Power tap 3-4
- high inrush currents
 - DeviceNet power B-2
- hydraulic solenoid valves
 - output power B-1

I

- IDC's
 - flat cable connectors 2-10
- installation
 - auxiliary power cable 3-11
 - flat cable
 - end cap 3-11
 - flat cable connector 3-6
 - flat cable open-style
 - drop cable 3-9
 - open-style connectors 3-2
 - pluggable screw-connector 3-2
- installing
 - multi port tap 3-5
 - hard wire taps
 - multi port tap 3-4
 - Power tap 3-4
 - power supplies 3-11
 - Power taps 3-4

K

- keying information
 - T-Port tap 2-6

L

- line regulation 1-9
- linear plug
 - 10-pin 1-6
 - 5-pin 1-6
- load regulation 1-9
- loading
 - percentages 4-23
- look-up method
 - configuration
 - one power supply end connected 4-12
 - examples
 - NEC/CECode current boost
 - configuration 4-14
 - power supply
 - one
 - end connected 4-11
 - middle connected 4-12
 - two
 - end connected 4-15
 - not end connected 4-16
 - figures
 - power supply
 - one
 - middle segment 4-12
 - making system operational 4-13

M

- maximum current
 - % loading/segments
 - table 4-18
 - network length
 - one power supply
 - flat cable 4-5
 - round cable
 - thin 4-10
 - two power supplies 4-6
 - end segment
 - flat cable 4-9
 - flat cable 4-7
- maximum load
 - class 1 cable A-1
 - class 2 cable A-1
- minimum name-plate current rating single power supply 1-9
- minimum required operating voltage output devices B-1
- motor starter coils output power B-1

N

- NEC
 - about P-2
 - Class 2 A-1
 - current boost configuration
 - example 4-14
 - section 725 A-1
 - NEC regulations power conductors A-1

N

- NEC specifications
 - class 1 cable A-1
 - class 2 cable A-1
- NEC/CECode current boost configuration 4-14
- NEMA rating
 - flat cable terminating resistor
 - sealed 1-7
 - unsealed 1-7
- network length
 - maximum current end segment
 - two power supplies round cable (thick) 4-7
 - one power supply flat cable end segment 4-4
 - round cable thin 4-10
 - two power supplies 4-6
 - flat cable 4-8, 4-9
- noise or transient protection
 - output power B-2
- noise protection
 - powering output devices 4-1
- O**
- one power supply
 - configuration
 - middle connected 4-12
 - current chart
 - end segment round cable thin 4-10
- open device
 - connecting to flat cable micro T-Port tap 2-12
- open-style
 - connector
 - attaching to trunk line 3-2
 - fixed 1-5, 2-5, 3-9
 - hard wire 3-9
 - plug-in 1-5, 2-5, 3-9
- open-style connectors
 - installation 3-2
- open-style flat cable
 - installation
 - drop cable 3-12
- output device
 - relevant node
 - voltage range B-1
- output devices
 - minimum required operating voltage B-1
 - powering B-1
- output power
 - hydraulic solenoid valves B-1
 - motor starter coils B-1
 - noise or transient protection B-2
 - pneumatic valves B-1

P

- parallel application
 - power supplies 1-9
- plu 10-pin 1-6
 - installation 3-2
- plug-in
 - connector
 - open-style 1-5
- pneumatic valves
 - output power B-1
- power
 - determining
 - using look-up method 1-12, 4-3
 - limitations A-1
- power cable
 - diagram
 - flat cable 3-11
 - flat cable
 - installation 3-11
- power conductors
 - NEC regulations 4-2
- power supplies
 - adjusting 4-13
 - choosing 1-8
 - Class 2 A-1
 - connecting 3-12
 - initial setting 1-8
 - marking A-2
 - multiple
 - parallel applications 1-9
- one
 - end connected
 - example 4-11, 4-19
 - rating 4-11
 - middle connected
 - example 4-12, 4-20
 - rating 4-12
- two
 - end connected
 - example 4-15
 - not end connected
 - example 4-16
 - segment between 4-10
- power supply
 - current chart
 - end segment
 - flat cable 4-5
 - rise time 1-9
- power usage
 - determining adequate power 4-1

P (Con't)

- powering output devices B-1
 - DeviceNet power supply 4-1
 - noise protection 4-1
 - transient protection 4-1
- Power tap
 - description 2-7
 - diagram 2-7, 3-6
 - installing 3-4
 - NEC/CECode current boost
 - configuration 4-14
 - schematic 2-7
- preparing cables 3-1
- preterminated cables
 - thick cable 2-11
 - thin cable 2-11
 - connecting to a multi port tap
 - stripped conductors to micro female 2-12
 - stripped conductors to mini female 2-12
 - connecting to a DevicePort tap
 - micro male (90) to micro female 2-12
 - micro male (90) to mini female 2-12
 - connecting to a T-Port tap
 - mini male to micro female 2-11
 - mini male to mini female 2-11

R

- rating
 - drop line 1-10
 - thick cable 1-10
- regulation
 - line 1-9
 - load 1-9
- relevant node
 - output device
 - voltage range B-1
- resistance
 - nominal contact 4-18
- resistor connection verification 1-5
- resistors
 - usage definition 1-4
- rise time
 - power supply 1-7
- round cable
 - wire contents 1-2

S

- sealed device
 - connecting to flat cable micro T-Port tap 2-13
- sealed-style
 - connector
 - attaching to trunk line 3-3
 - micro-style 1-5, 3-3
 - mini-style 1-5, 3-3

R (Con't)

- single power supply
 - minimum name-plate current 1-9
- spool size
 - thick cable 2-2
 - thin cable 2-3
- supplying power
 - gui
 - system
 - current 4-18
 - making operational 4-13
- T**
- table
 - maximum current
 - % loading/segments 4-18
- taps
 - multi port 2-7
 - diagram 3-5
 - installing 3-5
 - hard wire
 - multi port 3-4
 - installing 3-5
 - Power tap 3-4
 - PowerTap 2-6
 - diagram 3-4
 - installing 3-4
 - NEC/CECode current boost configuration 4-14
 - T-Port 2-6
 - connecting to 2-12
- temperature drift 1-9
- terminating
 - trunk line 1-3, 2-4
- terminating resistor
 - endcap flat cable 1-8
 - flat cable definition 1-7
 - round cable definition 1-7
 - usage definition 1-7
- terminating resistors
 - flat cable/encap 1-8
- thick cable
 - current 1-10
 - definition 1-2
 - description 2-2
 - diagram 2-2
 - preterminated
 - description 2-11
 - diagram 2-11
 - rating 1-10
 - size 1-2
 - spool size 2-2
 - total allowable current 1-10

T(Con't)

- thin cable
 - current 1-10
 - definition 1-2
 - description 2-3
 - diagram 2-3
 - preterminated
 - connecting to a multi port tap
 - stripped conductors to micro female 2-12
 - stripped conductors to mini male 2-12
 - connecting to a DevicePort tap
 - micro male (90) to micro female 2-12
 - micro male (90) to mini female 2-12
 - connecting to a T-Port tap
 - mini male to micro female 2-11
 - mini male to micro male (90) 2-11
 - mini male to mini female 2-11
 - description 2-11
 - diagram 2-11
 - size 1-2
 - spool size 2-3
- time drift 1-8
- total allowable current
 - class 1
 - flat cable 1-9
 - thick cable
 - class 2 flat cable 1-9
- T-Port tap
 - connecting to 2-12
 - description 2-5
 - diagram 2-5
 - keying information 2-5
- transient protection
 - diodes B-2
 - powering output devices 4-1
- trunk line
 - attaching
 - connectors
 - open-style 3-2
 - sealed-style 3-3
 - connecting to via direct connection 2-5
 - maximum cable distance 1-3
 - terminating 1-4, 2-4
- two power supplies
 - current chart
 - end segment
 - flat cable 4-8
 - round cable
 - thick 4-6

U

- unsealed terminating resistor
 - flat cable
 - NEMA rating 1-8

V

- voltage
 - maximum drop 1-11, 4-18
 - range 1-10
- voltage limits on DeviceNetTM
 - output power B-1
- voltage range
 - output device
 - relevant node B-1
 - wide DeviceNet 4-1

W

- wide DeviceNet voltage range 4-1
- wide range voltage B-1
- worst case scenario
 - adequate power 4-3

Z

- zero-length drop 1-5