

Flying Empires

Short 'C' class Empire flying boats

Written by Brian Cassidy
3 Queen's Parade BATH BA1 2NJ UK.

Originally typed on an Amstrad 8512 in Locoscript 10pt. LX Roman type and published as a book in 1996.
Transferred from Locoscript to Microsoft Word in 10pt. Times Roman.
Revised June 2011.
Copyright © Brian Cassidy 2009 All rights reserved.

British Library Cataloguing in Publication Data

ISBN 0 9529298 2 1

Universal Decimal Classification 629.135.5
Dewey Decimal Classification 20 629.133.347

Preface

It may even be too late now to record the full story of the forty-two, nearly forty-three, Empire flying boats. Time and history move on quickly. Although some small scraps of the flying boats exist, none of the aircraft themselves have survived. So much about them has already vanished. Most of those who flew and worked the 'boats are, sadly, no longer here. For all practical purposes, the Short Brothers drawings and most of the calculations have gone up in smoke and unless someone, somewhere, has a hitherto undiscovered hoard of prints, they too seem to have all disappeared.

The Empire flying boats had a highly respectable pedigree. They were designed and built by the world's first aircraft manufacturing company, led by one of the pioneers of metal construction for aircraft, Oswald Short, now seemingly forgotten. Oswald Short and Francis Webber designed the world's first metal-hulled flying boat, the minute Cockle. Arthur Gouge, with an apparently faultless eye for a flying boat hull, succeeded Webber as Chief Designer, to design the Singapore I and set the line of ancestry that led to the Empire hull. The Seaplane Works at Rochester built twenty-seven flying boats of eight different designs from the launch of the Singapore I in August 1926, to the roll-out of the first Empire 'boat ten years later.

The Empire 'boats were designed to carry the mail and for the first chapter of their history they did so. The sections of this book outlining the operations of the 'boats on the Empire Air Mail Programme, and later on the Horseshoe Route and their wartime exploits, are no more than notes. A fully expanded account is needed to complete this corner of aviation history.

The fact that an authentic general arrangement drawing of an Empire 'boat could not be found is a considerable drawback. None of the existing three-view drawings, and most of them are no more than small scale diagrams, are wholly accurate. Over the years, I have assembled – the correct word as the sources are many – a set of General Arrangement drawings. Until a print of an authentic Short Bros. GA can be found to check these drawings, they are probably the best available. The drawing number for the hull lines is Short Brothers S.23.C.1000.

To my certain knowledge, I have never seen an Empire 'boat. Without the help of those I have met, who knew the Empire 'boats inside and out, there would have been little to add to their story.

Most of the photographs have been provided by Short Brothers plc. as prints of Mr Galloway's magnificent photographs. My Maintenance Manual is a photocopy of Major Mayo's, now lodged as part of the Mayo papers at the Science Museum. The photocopied text of the Manual has been reunited with an original screw bound hard cover, a gift of Eddy Gosling acquired during his time in the Drawing Office at Rochester. Diagram 29 of the Manual, showing the construction of the tail of an Empire 'boat, is one of his drawings. Permission to publish the photographs and the diagrams from the Maintenance Manual has been granted by Short Brothers plc. and is acknowledged with thanks.

My thanks also goes to the following have contributed material, advice and assistance of all kinds:

Aerofilms Limited, Aéroport International Marseilles-Marignane, Air Historical branch Ministry of Defence, Captain M.J.R.Alderson, G.Angell, Air New Zealand, W.Appleton, Arms and Armour Society, J.Ashmead, C.H.Austin, Australian War Memorial., G.H.Aveil, J.Bagley, C.H.Barnes, Bath City Library, Birmingham Public and Reference Libraries, Bristol Industrial Museum, BritishAerospace, British Airways, British Library, G.Brown, G.Bruce, P.B.Buckley, Captain J.W.Burgess, Canopus Inn, Chatham News, Chatham, Rochester and Gillingham News, Mrs. Chorley, Civil Aviation Agency, Konedobu, Papua-New Guinea, G.Clements. Coley Metals Ltd. H.Conway, A.Cormack, A.Cowling, D.Crook, G.W.Cussans, D.Dean, Defence Research Agency, Department of Civil Aviation, Melbourne, Department of Defence (Air Force Office) Canberra, Director of Civil Aviation, New Delhi, L.R.Dougal, Dowty Aerospace, Captain L.A.Egglesfield. Evening Post Chatham A.Finch. Commander Finseth, J.Fisher, Flight Refuelling Limited, Foynes Flying Boat Museum, J.D.Froggat, Captain B.Frost, Captain H.L.Fry, R.Funnell, B.Gardner, GEL-Marconi, P.Gilbert, Gillingham Reference Library, J.Gnosspeilius, H.Gordon, E.L.Gosling, H.M.Coastguard. B.Halstead, P.Hammond, N.Harry, S.G.Hill, C.A.Hills, Hydrographic Department Ministry of Defence, Imperial War Museum, R.Jambon, Captain J.C.Kelly-Rogers, B.C.Kervell, J.Lamb, Kaptein B. Larsen, U.Larsstuvold, H.R.G.Lee, Mrs.P.Lowman, Lucas-CAV Ltd., W.H.Mares, J.W.McNeill, Ministre de l'Equipment du Logement de l'Amenagement du Territoire et des Transports, W.W.Morgan, H.Morris, R.W.Morris, D..Mack Muir, Museum of Transport and Technology, Auckland, National Film Archive, National Maritime Museum, Greenwich, New Guinea Mission, P.Newnham, Newport (IOW) Reference Library, R.Parsons, H.Penrose. B.Pettman, QANTAS Press Relations Sydney, S.Redman, Rhône-Poulenc, Rochester Museum, Rochester Public Library, R.Rodwell, H.Rolfe, N.F.Rose, Royal Aeronautical Society Library, Royal Air Force Museum Library, Royal Military Academy, Royal National Lifeboat Institution, Royal Naval Air Station, Yeovilton, Science Museum, Shell UK., Smiths Industries Ltd., Southampton Central Library and Record Office, Solent Sky Museum (formerly Southampton Hall of Aviation), Southern Evening Echo, Sperry Flight Systems., J.Tattershall, The Patent Office, Tropical Diving Adventures, Boroko, Papua-New Guinea, University of Bristol Queen's Library, D.Vincent, L.Wilson, H.J.Yea.

Brian Cassidy
Bath
June 2011

Terms

The Short Empire flying boats were primarily designed to carry the unsurcharged letter mail of the Empire Air Mail Scheme (EAMS) as it was originally known. From 1935 onwards, in the days of a flourishing British Empire, the Short S 23, S 30 and S.33 flying boats were usually known as Empire Flying Boats or Empire flying boats. They were described as such in a Short Bros.' letter dated 25 May 1935, more than a year before the launch of the first 'boat. Janes All the World's Aircraft of 1938, referring to the fleet of thirty-one flying boats, states that they were 'known as the Empire type' and known by Imperial Airways Limited (IAL) as the 'C' class'. Not only were they usually called Empire Flying Boats, but in the middle of 1938 it was Imperial Airways Limited's intention to prefix the names of individual aircraft with '*Imperial...*' - '*Imperial Canopus*', '*Imperial Caledonia*' and so forth. There is not much evidence that this cumbersome practice ever became widespread or indeed was ever used, although one of Imperial Airways Limited's promotional posters, titled 'AN IMPERIAL FLYING BOAT', shows a cut-away, and perhaps *Imperial* Calypso flying serenely over a sunlit archipelago. The names of the 'boats were also prefixed with the initials RMA (Royal Mail Aircraft) when they were carrying the Royal Mail. On 29 June 1937 the Empire Air Mail Scheme (EAMS) became the Empire Air Mail Programme (EAMP) until 10 June 1940. The RMA prefix was used until 1940, when its use was supposed to have been discontinued. IAL traditions died hard and there are instances of the prefix being used well into British Overseas Airways Corporation (BOAC) days.

The names of the individual Empire flying boats are given in the text in full capitals, prefixed with the last two letters of their registration. All the 'boats were originally taken on the British register. The QANTAS Empire Airways (QEA) and Tasman Empire Airways Limited (TEAL) aircraft were subsequently transferred to the respective Australian and New Zealand registers. During World War II nine of the 'boats were impressed in Royal Air Force and Royal Australian Air Force service and so carried military serials. Others were transferred from BOAC to QANTAS Empire Airways and vice versa, with consequent changes of registration.

Distances in the text relating to flights are given in nautical miles (n.m.) and kilometres (km.). Short distance are in nautical miles and kilometres (km.) or in feet (ft.) and metres (m.). Altitudes and heights above ground are given in feet (ft.). Horizontal speeds are in knots and kilometres per hour (km.per hr.). Vertical speeds are in feet per minute (ft. per mm.). Temperatures are in degrees Celcius (deg. C.). Dimensions of aircraft and buildings are in feet (ft.) and inches (ins.) and in metres or millimetres (m. or mm.) with some degree of rounding out. The Syst me Internationale des Unites (SI metric) measures 'weight' as a force in newtons (N.) and 'mass' in kilogrammes (kg.). Strictly speaking therefore, metric references to 'weight' should be in newtons, or referred to as the 'mass' in kilogrammes. The aircraft were designed using the imperial system of weights and measures with the pound (lb.) as a unit of mass and force. 'Weights' are therefore given here in pounds (lb.) and (usually) kilogrammes (kg.). Purists can (properly) mentally substitute the word 'mass' each time they read 'weight'. The capacities of fuel and oil tanks, and the transfers between aircraft in flight refuelling, are given in imperial gallons and litres. Weights (or masses) of payload, mail and freight are in kilogramme (kg.) as they were in 1936. Times are either Greenwich Mean Time (GMT) or British Summer Time (BST), or local time. Often it is not clear which standard is meant, so in these cases the time is given as it appears in the reference.

Following the usage of the day, and befitting their role as maritime aircraft, 'port' and 'starboard' were used to describe sides of the aircraft and are used here in place of the now usual 'left' and 'right'. The Empire 'boat engines were known as 'port outer', 'port inner', 'starboard inner' and 'starboard outer' rather than Nos. 1, 2, 3 and 4. Engine powers are given in horse power (hp.) and kilowatts (kW.). The contemporary term 'airscrew' has been used in place the now more usual 'propeller'. The word 'wireless' in 1936 was gradually giving way to 'radio'. The Maintenance Handbook refers to the radio installations on the Empire 'boats as 'wireless installations' and the company that supplied most of the equipment was Marconi's Wireless Telegraph Co). Ltd. The preferred mode of communication used by the 'boats was by W/T, - wireless telegraphy, in the International Morse Code although the man who operated the wireless sets was known as the Radio Officer.

To get a rough and ready sense of the relative value of money between the past and the present, the term Present Value (PV) is used to represent the difference between the purchasing power of a pound sterling then and when this was originally written 1996. Since then, the inflation rate has increased by about 16%. To arrive at the equivalent contemporary value, the prices of items and salaries mentioned in the text have been multiplied by a factor derived from the relative values of the index of purchasing power.using the Bank of England's Retail Prices Index and are approximate and are often rounded out. In 1936 the purchasing power of sterling was at approximately the same level as it had been twenty years before in 1916. Half the wage earners in the United Kingdom lived, or perhaps existed, on £ 1:0:0 (£1.00) or less per week, a PV of £ 21.25.. A man on the shop floor at the Seaplane Works at Rochester could earn £ 2:10:0 (£2.50) per week in 1936 (PV £ 53.00), so Short Bros'. employees were therefore comparatively well paid.

The following abbreviations appear in the text:

British Airways	BA
British Overseas Airways Corporation	BOAC
Empire Air Mail Service	EAMS
Empire Air Mail Programme	EAMP
Flight Refuelling Limited	FRL
Imperial Airways Limited	IAL
Marine Aircraft Experimental Establishment	MAEE
Pan American Airways	PAA
Present Value in £ sterling	PV
QANTAS Empire Airways	QEA
Royal Aeronautical Establishment	RAE
Royal Air Force	RAF
Royal Australian Air Force	RAAF
Royal Canadian Air Force	RCAF
Tasman Empire Airways Limited	TEAL
True Air Speed	TAS

Flying Empires

By the middle of 1936, British commercial aircraft were fast becoming something of a joke. Imperial Airways Limited (IAL) was Britain's major airline and although its aircraft were considered comfortable and safe, most of them were biplanes and they were slow. IAL's No. 1 European Operating Division had two Handley Page HP 42s, two Short L.17 landplane versions of the Kent flying boat, and seven de Havilland DH 86As - all biplanes. No. 2 Division had five Handley Page HP 42s, three de Havilland DH 86As and four flying boats, two Short Calcuttas and two Short Kents - all biplanes. Nos. 3 and 4 Operating Divisions had eight Armstrong Whitworth AW.XV Atalanta monoplanes between them and one de Havilland DH 86A. The fleet was completed with three other monoplanes, two Avro 652s and a single Westland Wessex.

Although cruising speeds are often quoted on the optimistic side, they are one rough-and-ready way of comparing performance and speed and that, for commercial operation, is important. The fastest passenger-carrying aircraft in the IAL fleet was the de Havilland DH.86A, with a cruising speed of 126 knots. The Atalantas cruised at 103 knots and the Short Kent flying boats and the two L.17s, both at 91 knots. The Handley Page HP 42s cruised at 83 knots and the Short Calcutta flying boats at 70 knots.

In the United States, the Boeing 247 - the world's first 'modern' airliner - had been flying for three years with a cruising speed of 135 knots. The Douglas DC-2 and the Lockheed L-10 Electra had cruising speeds of 172 knots - approaching twice that of the L.17s - and had been flying for two years. The incomparable Douglas DC-3 entered service with American Airlines on 25 June 1936 - with a cruising speed of 180 knots - just over a week before the flight of the first Empire 'boat' at Rochester. These three American airliners changed the shape of airline economics, bringing about the chance of profit by carrying passengers with some airmail supplement. Of the flying boats, the Sikorsky S.42 and the Martin 130 had cruising speeds of 148 and 136 knots and both had been flying for two years.

But changes were about to take place in the British aeronautical world. The advent of the Empire flying boats caused a sensation. Written in March 1936, some four months before the launch of the first 'boat', an article in Flight stated:

'Never in the history of flying has there been a parallel to the activity in civil flying boat construction, the beginnings of which are now to be seen at the Rochester works of Short Brothers.'

At that time, the hull of the first Empire 'boat' - G-ADHL CANOPUS - was out of the gantry and standing in No.3 shop, the main erection shop at Rochester, undergoing a trial fit of the mainplane spars. Later, a not-entirely-accurate Movietone newsreel commentator, taking to the air to view the first Empire 'boat' on the slipway at Rochester, said:

"Big developments are pending on the world's air routes and the new all-metal flying boats being built at Rochester are Britain's stake in the forthcoming struggle for commercial air supremacy. Twenty-nine of these huge air vessels are being constructed and the most advanced of them the Canopus, over which we are passing, is for experimental trans-Atlantic work. They dwarf any other air liner in operation."

On the day before the launch of G-ADUT CENTAURUS, the third Empire 'boat', the Editor of The Aeroplane (then a weekly publication) published an article under the heading of 'Our Empire Flying Boats'. In his inimitable style, C.G.Grey wrote:

'Our Empire Flying boats are collectively the biggest and boldest experiment; one might almost call it gamble, that has ever been taken in connection with British Civil Aviation. And yet when one has seen the way in which all the Short flying boats of the past years have come up to calculations, and have generally bettered them, one can hardly regard the 'boats themselves as an experiment, or call the use of them a gamble.'

Experiment or gamble, the urgency of the order for the new 'boats' did not allow for the customary prototype to be built and tested before the main production run was committed. Although G-ADHL, later named CANOPUS, the first Empire, it was always known by Short Bros. as the 'prototype' although it never was not strictly so in the normally accepted sense of the word. While G-ADHL was on the slipway outside Short Bros.' Seaplane Works at Rochester awaiting its engine runs and launch, the Empire 'boat' production run had been well and truly committed. More aircraft were inside No.3 main assembly shop in increasingly advanced stages of manufacture. The second 'boat', G-ADHM, was practically complete. The Board of IAL had already sanctioned the expenditure of £ 488 100 (Present Value £ 10.6 million) for an additional twelve 'boats'. The urgency implied a risk and Short Bros. found themselves carrying the major share. If the first flight had revealed that any significant design modifications were required, the consequences for Imperial Airways Limited and Short Bros. would have been most serious. On the

new Empire 'boats' depended a considerable share of the prestige and expectations of the whole of the British aircraft industry.

The same issue of *The Aeroplane* contained an article by Thurstan James (an ex-employee of Short Bros.) entitled *'Outside and inside the Empire boats'*. He described the 'boats' in some detail and his description well expresses the mood of the times. He wrote:

'No pictorial representation that one has seen really gives an idea of the size of the Empire Boat. To say that the inside is 17 ft. from the bottom of the hull to the top of the wing will probably not bring home the capacity of the hull much more. The vastness of the craft becomes more obvious when a wander about a smoking room as large as a room in a modern flat and rather higher than some, and then hear a member of the crew walking about above on the upper deck. Then, with that in your mind, consider the fact that there are three more cabins, two of them even bigger and both of them longer and that all of them are being pushed through the air at up to 200 m.p.h. Then you begin to see what Shorts have achieved.'



1. **Short Bros. photo H 902(d).** The then un-named G-ADHL, newly rolled-out and lashed down on the famous slipway outside No. 3 Erecting Shop at the Seaplane Works, Rochester awaiting its engine runs. The figure in the left foreground must surely be H.O.Short, admiring the company's handiwork.

And the roll-out of the first Empire 'boat' was indeed an achievement. The first of the forty-two 'boats' emerged from No. 3 Erecting Shop on 1 July 1936. It had been designed and constructed in response to the Imperial Airways Limited *'Outline specification for a 4-engined flying boat'*, almost certainly written by Major R.H.Mayo and issued sometime after January 1934. The IAL project was given the Short Bros. design index S.23, the Empire flying boat or 'C' class. The later versions of the Empire 'boats' were given design indices S.30 and S.33.

The first S. 23 - G-ADHL - was always known at Rochester as the 'Prototype'. The standard S.23 'boats' were known as Mark I aircraft, the two 'Bermuda' 'boats' as Mark IIs and the two first generation 'Atlantic' 'boats', as Mark IIIs. The first S.30 - a replacement for G-ADV C COURTIER - with Construction Number S.879 was also known as Mark I. The Mark II S.30s is listed as 'unspecified'. The four second generation 'Atlantic' 'boats' - Construction Numbers S.880 to 883 - were known as Mark IIIs and two 'New Zealand' 'boats' as Mark IVs. It seems that the 'unspecified' Mark II became the third 'New Zealand' 'boat' - on the British register as G-AFCZ AUSTRALIA.

Nothing like IAL's new flying boat had been seen in Britain before. Everything about the first of the Empire 'boats' seemed completely new. In reality, it was the culmination of more than a decade of continuous development. Design and construction at Rochester had advanced progressively and carefully over the years, step by step, led first by Oswald Short and then by Arthur Gouge. They were confident that the flying boat would perform to expectations and their confidence was well founded.

Slipping back nearly a generation from 1936 to 1913, the ages of the Short brothers were then respectively Horace 41, Eustace 38 and Oswald 30. The firm of Short Brothers had moved from the railway arches of Battersea in London in 1909, to a landlocked site at Eastchurch on the Isle of Sheppey, when the production of seaplanes started. Sometime in 1913 it became clear that a larger site with waterside access would be needed. A new site of about 8.4 acres (3.4 hectares) was chosen 14 nautical miles (26 km.) away - as the seaplane flies - at Rochester in Kent. The new Seaplane Works, a name it kept for the whole of its occupancy by Short Bros., were to the west of

the town, between the Pilgrim's Way and the Esplanade that ran alongside the Tower Reach of the River Medway. The old Medway Tower, after which this part of the river is named, had formerly been part of the local defensive fortifications. The transfer of the land - known as the Tower field - from the owner, Councillor Willis, to Short Bros. was done on an exchange of letters and a handshake - Oswald Short's preferred way of doing business - and work started on the construction of the new works. The move of the world's first aircraft manufacturer to Rochester was the beginning of Oswald Short's firm, but benevolent, control of the Seaplane Works, which continued for nearly thirty years.



2. Short Bros. photo 75675. An aerial shot of the Seaplane Works taken from the west. From top left to bottom right along the river bank are Nos. 1, 2, 3 and 4 Shops. No. 3 Erecting Shop is the largest of the four. The end of the chalk dump is seen on the far right, behind No.4 Shop. The tide is out showing the slipway spanning the Medway mud to the water's edge. The Medway Tower, soon to be demolished, is still in place between Nos.3 and 4 Shops.

By early 1915, No. 1 Erecting Shop had been completed and the steel framework for No. 2 Erecting Shop was up. Wartime production work filled the two new Shops to overflowing and the need for additional manufacturing and erecting space became increasingly urgent. It became even more so when Short Bros. secured a contract to build thirty-five Felixstowe-designed F.3 and fifteen F.5 flying boats. In October 1917, excavations in the chalk of the riverbank were started for a new building that was to become No. 3 Erecting Shop. By February 1918, some 37 700 cubic yards (29 600 cubic metres) of chalk had been excavated by steam shovel and dumped to the south of the new building, the site of the building cleared and the erection of the steel framework under way.

The new Erecting Shop was a nine bay structure, three bays wide by three deep. The frontage to Tower Reach measured 320 feet (97.5 m.). There were two bays of 100 feet (30.0 m.) flanking a centre bay of 120 feet (36.5 m.). The choice of the dimension for the centre bay was no doubt influenced by the span of the F boats – 103 ft. 8 ins. (31.6 m.) in the case of the F.5.'boat. The main door fronting on to Tower Reach was just under 120 feet (36.5 m.) wide. The six-part sliding door was boldly painted on the outside with SHORT BROS. AERONAUTICAL ENGINEERS. When the first Empire 'boat was pulled out of the Shop on its beaching chassis, the fin and rudder cleared the transome of the door by 6 ins. (150 mm.) and the tips of the mainplanes by less than 3 ft. (900) mm.) on either side.

At right angles to Tower Reach, No. 3 Shop had three bays each of 70 ft. (21.33 m.) span and a lean-to bay of 60 ft. (18 m) span along the rear of the building. The centre 70 ft. (21.33 m) bay was higher than the flanking bays and equipped with a Herbert Morris bridge crane that could travel from end to end of the Shop. The production floor space of the new building was 80 000 sq. feet (7 435 sq m.) more than doubling the total floor area of the other two Shops.

The horizontal distance between the high and low water marks of the River Medway alongside No. 3 Shop, was about 165 ft. (50 m.). A reinforced concrete slipway was built on the centreline of the main door of No. 3 Shop, to launch flying boats and other craft into the river. This slipway, some 27 ft.9ins. (8.5m)wide by 192 ft. (58.5 m.) long, spanned the Medway mud to a point below the low water mark so that launches could be made at any state of

the tide. It was designed, with considerable foresight, to carry loads of up to 20 tons, though when it was built, a fully laden F.5 weighed less than 6 tons. The slipway is still in existence although it is reported to be gradually slipping into the Medway. (2011).

Production work was progressively transferred from Eastchurch to Rochester as the various buildings of the new Seaplane Works were completed. The entire work force of about three hundred moved to Rochester. One of the woodworkers who transferred with the firm in 1915 was Arthur Gouge, then aged 23 years.

The first batches of F.3s and F.5s were followed by an additional order for fifty F.5s. Post-war austerity reduced this number to ten, the last of which was flown for the first time on 23 March 1920. The F.3 and F.5 flying boats were designed by John Porte of the Marine Aircraft Experimental Establishment (MAEE) at Felixstowe. Both were of all-timber construction with fabric-covered flight surfaces. The F.5 was slightly the larger, with a span of 103 ft. 8 ins (31.6 m.) The all-up weight of about 13 000 lb. (5 897 kg.) approaching the span dimension of an Empire 'boat but one third of its weight.

The flight performance and seaworthiness of the F 'boats encouraged Oswald Short to tender for the Admiralty specification N.3 for a long-range patrol flying boat capable of operating with fast surface cruisers. Short Bros. tendered the Cromarty and were awarded a contract for three aircraft. The design and construction of the Short Bros.' contenders, with RAF serials N 120 to N 122, closely followed that of the F.5.

The hulls were both constructed of plywood on spruce frames, conforming to the standard practice of the day. A mid-ship section through an F.5 hull showed the planing bottom to be vee-shaped, straight from keel to chine while the planing bottom of the Cromarty hull were concave-shaped rather than straight. An F.5. hull was somewhat 'dirty' on the water, throwing up considerable amounts of spray whilst taxiing and taking off. The Cromarty hull produced much less sideways spray and the concave underwater body resulted in less water resistance and less shock to the hull on alighting. At high alighting speeds, water can be as solid as concrete.

The first Cromarty hull N 120 was not ready for launching until 21 March 1921. The half-completed hull of N 121 was cancelled, a fate that was to befall the forty-third and last Empire 'boat nearly twenty years later. The third Cromarty was never started. N 120 did well on its service trials. It was wrecked in a storm in the Isles of Scilly, subsequently found to be beyond economic repair, and scrapped.

Short Bros. set up the airship factory at Cardington during World War I. They built two timber-framed Vickers-designed rigid airships, R.31 and R.32, based on German Schutte-Lanz craft. Following these came two duralumin-framed craft, R.37 and R.38, Copies of German Naval Zeppelins. The experience of working in timber and duralumin was to have a far-reaching effect on the future operations of Short Bros. and on the whole of the British aircraft industry. Before R.38 could be completed, the airship factory was taken over by the Air Ministry in April 1919, under the Defence of the Realm Act. This experience was repeated again during World War II, when the Rochester Seaplane Works were nationalised in 1943 under Reg. 78 of the Defence (General) Regulations 1939, presided over by Sir Stafford Cripps as Minister of Aircraft Production. The compensation to Short Bros. for the Cardington Works was £ 40 000.(PV £ 570 400)). The company, twenty-four years later, was valued at £447 324 (PV£7.2 million).

While the Seaplane Works were busy producing all-timber F.3s and F.5s, Oswald Short had been experimenting with aluminium alloys for the construction of aircraft. Most metallurgists at the time thought that these alloys had inherent defects and were unsuitable for the primary structures of aircraft - especially marine aircraft. Corrosion and fatigue were the two characteristics that particularly worried them - particularly 'sporadic inter crystalline corrosion'. Since 1916, Oswald Short had been testing light-alloy samples for the effects of corrosion. Samples were fixed to the jetty piling in the River Medway at Rochester, so that the ebb and flow of the tide alternatively exposed them to the water and the air. After thirty-six weeks it was found the mild steel control samples had virtually rusted away, whereas the alloy samples showed no significant signs of corrosion. Oswald Short's view was that any alleged defects in the light-alloys were due more to inadequate manufacturing practices, rather than to any inherent defects in the light-alloys themselves.

To prove the point, Short Bros. designed a small, elegant, single-seat, biplane of orthodox layout, powered by a 240 hp. (179 kW.) Siddeley Puma engine. The new landplane, Construction number S. 543, was based on the Shrimp Sporting Type Seaplane and originally named Swallow. Registration was applied for on 17 March 1920 as G-EARQ, though it was not used, as a Certificate of Airworthiness was never issued.

The Shrimp had a traditional, fabric-covered timber structure but the Swallow was built entirely of metal, with the exception of the timber airscrew. Oswald Short had also been evolving a system for the fabrication of metal aircraft components in aluminium alloys, covered by a series of patents in 1921 and 1922. The Short Brothers were all keen patentees, and the techniques covered by this series of patents were for monocoque construction in metal (185,992), wing rib construction (192,966 and 194,516), metal covering for flight surfaces (195,235) and a true monocoque wing without spars or ribs (206,998). Oswald Short asked for Air Ministry assistance in funding the first fully 'engineered' British aeroplane but when this was refused, he committed Short Bros. to building it as a private venture.



3. **Short Bros. photo H 23 (b).** The Silver Streak in original single seat form The lower case suffix attached to Short Bros. photographs. (b) in this case, usually indicated that the photograph formed part of a series taken for record purposes before, or sometimes during, the first flight of a newly completed aircraft.

The Swallow's wing spars were of steel tube with duralumin-plate ribs and built-up box ribs as compression struts between the spars. The covering was of sheet aluminium in flanged, chordwise strips joined at the ribs. The fuselage was a shell of duralumin plates riveted to L-section, oval shaped frames. The longitudinal stiffeners were cut and fixed between the frames, rather than notching the frames to allow the longerons to run through continuously. This established a principle of construction - the un-notched frame - that was maintained through to, and beyond, the Empire 'boats.

In September 1919, part of a fuselage shell was built and subjected to a water test. A section of the fuselage with both ends plugged, having the appearance of an old-fashioned milk churn, was filled with water. A pump, driven from the overhead machinery shafting, continued to pump in water until the pressure was 7 lb. per sq. in. (48 kPa.), causing the plating to pant at each stroke. A continuous test over 24 hours caused a few rivets to leak slightly.

The Swallow was exhibited on the Short Bros.' stand at the International Aero exhibition at Olympia, clad in its gleaming aluminium skin. It suffered a change of name, becoming known as the Silver Streak, attracted much interest but received no orders. It was modified as a two-seater, reluctantly bought by the Air Ministry for £4 500 (PV £62 600) and taken on charge on 23 December 1920 as J 6854. One of the first jobs for Short Bros.' newly employed test pilot, John Lankester Parker, was to take the Silver Streak on its first flight and then to RAE at Farnborough to be tested to destruction. RAF pilots had to protest to the Air Ministry before they were allowed to fly the Silver Streak and then only after they had been warned about the dangers of the form of construction.

It was inexplicably grounded after six flights and subjected to structural tests. The wings were loaded with sand bags, failing by the buckling of the forward spar, outboard of the outer struts, at just above the calculated ultimate stress. The tailplane was loaded to 57 lb. per sq. ft. (2.7 kPa.) and the fin and rudder to 63 lb. per sq. ft. (3.0 kPa.) - without ill effect. Applying a moment of 2 000~ lb.ft. (2 711 N.m.) to the fuselage produced no apparent distortion or permanent deflection except for a dent, which suddenly appeared with a bang in the top of the fuselage at the junction with the wing. The dent as quickly disappeared when the load was released. During the flight test programme, if these six flights could be called a programme, the only defect was some splitting of the trailing edge of the wing, due to vibration from the slipstream. Testing at the RAE ended with a 100 hour vibration test. When the tests were completed, corrosion was found to be negligible, there was no cracking of the skin and no loose rivets. Short Bros. were warned not to proceed with light-alloy structures because of their inherent dangers.

The building of the Silver Streak as a private venture had been a considerable commercial risk for Short Bros. But it demonstrated that an aircraft built of light-alloys could be built and flown with a performance comparable to a timber-framed aircraft. It was a personal triumph vindicating Oswald Short's theories on metal construction for aircraft and establishing Short Bros. as the leading aircraft manufacturer in Europe or the United States. No other

1. Ancestry

manufacturer had the technical expertise demonstrated by the building of the Silver Streak. As a pioneer of stressed-skin metal construction, Oswald Short now seems to have been almost completely forgotten in Britain. He proved that stressed-skin structures could be designed and built and that the cracking and corrosion of aluminium alloys was controllable, opening up the possibility of water-tight metal hulls for flying boats. It was also the first of many battles to come between Oswald Short and the Air Ministry. The Ministry refused Short Bros. access to the Silver Streak, and would not divulge details of the aircraft's flight performance and behaviour under test. It took questions in Parliament to extract the information, but access was never obtained.

The story moves forwards to 1924 when two almost simultaneous events resulted in the building of the first Short Bros.' aircraft to be assigned S. design index numbers. The S.1 was a tiny, single-seat flying boat and the S.2 was an updated version of the F.5. flying boat. This lucky coincidence enabled the S.1 hull to be built first as a pilot project for the much larger S.2 hull.

The S.1, construction number S.638, was designed by Oswald Short and the then Chief Designer, Francis Webber and named the Cockle. The little 'boat had been ordered by Julius Horden to ferry him about Botany Bay, New South Wales as he searched for suitable fishing grounds.

The wing span was 36ft. (10.95 m), the length 24ft. 8in. (7.5m.) and the original all-up weight 1 062 lb. (482 kg.). The structure was metal, with fabric covered flight surfaces. The hull was a monocoque, fabricated in duralumin with a flared concave underwater mid-section. A transverse main step and a second step at the end of the planing surface aft were built onto the hull, both considerably deeper than those on the conventional F.5 hull. The steps were built as appendages to the shell of the hull with the aftermost frames of the steps left open for drainage to prevent corrosion. The hull was launched and left moored out on the Medway to test its watertightness. Proving satisfactory, the hull was retrieved, the 'boat completed and finally re-launched on 18 September 1924.

The little 'boat was considerably under-powered and although the getting-off speed was only 23 knots, it resolutely refused to fly. The original engines were two 16 hp. (12 kW.) Blackburne Tomtit motor cycle engines, directly coupled to the airscrews, giving a total of 22 hp. (16.5 kW.) at the revolutions used.



4. Short Bros. photo.H 75 (c). The Cockle motoring along on the Medway with John Lankester Parker in charge, possibly on its first outing on 18 September 1924. JLP tried for thirty-three minutes to take-off without success.

The power loading - weight of the aircraft in lb.divided by available power in hp.- of the Cockle was 48.3, the contemporary Short S.2, 19.37 and the standard S.23 Empire boat, 11.13. Finally, with the wing at a revised incidence of 7 deg. and with John Lankester Parker wearing lighter-weight trousers and gym shoes, the Cockle was persuaded off the water and flew for ten minutes on 7 November - the first metal hulled flying boat in the world to do so. The maximum speed when it did finally get into the air, was a bare 50 knots. Mr Horden declined to take delivery of his 'boat.

Once, without jacket or shoes, John Parker succeed in getting the Cockle to 2 000 ft. but in his opinion, its service ceiling was minus 3 000 ft. Subsequently, the 'boat went to the MAEE at Felixtowe to test its resistance to

salt-water corrosion - as N 193. While at Felixstowe the Cockle was flown by RAF pilots, of heavier build than John Parker, wearing only bathing trunks. The little flying boat was returned to Rochester for re-engining with Bristol Cherubs, transfer back to Felixstowe and returned to Rochester for final scrapping in August 1926.

The S.2 design was a response to the Air Ministry's invitation to tender for two hulls 'of modern design' to suit the aerostructure of the F.5, still the standard flying boat in service with the RAF. Short Bros. tendered a developed Cromarty hull, built in duralumin. The lines of the hull differed considerably from those of the Cromarty, which was clearly of the same breed as the Felixstowe boats. Gone were the wide flat side 'blisters' of the F.5, the proposed hull was narrower in the beam and the planing bottom longitudinally fluted.

The Air Ministry initially rejected the tender, so before securing a contract, Oswald Short had to accept full financial responsibility for the whole of the contract sum of £ 10 000 (PV £ 176 500) should the hull show a leak. The patent document (244,898 28 November 1924), describing the construction of a hull, is in the name of Oswald Short. The somewhat opaque language of the patent reads:

'In the construction of sheet metal hulls for flying boats and sea planes, I have already constructed hulls with an arch, extending from one side of the underneath portion of a float or boat, and gradually disappearing out at the forward end where it merges into the inclined under portion of the said float or boat. I have also made floats for seaplanes with several arches horizontally arranged and parallel with each other. This form combines great strength with a minimum of resistance, and by involving the flexing of the sheet metal to form the arch ensures maintaining the said arch free from undulations and irregular portions, which are inseparable from boats constructed with flat or nearly flat under surfaces.'

Panel-beating of the skin plating was kept to the minimum as most of the plates were of single curvature. This became the recognised practice on future Short Bros. hulls, to minimise the work-hardening of the aluminium alloys to prevent the sheets becoming brittle and so liable to crack - a potential starting point for corrosion.

The S.2 duralumin hull - with RAF serial N 177 - was mated with a standard F.5 aerostructure, fitted with two Rolls-Royce Eagle VIII engines, launched on 31 December 1924 and first flown by John Lankester Parker on 5 January 1925. The S.2 had a span of 103 ft. 8 ins (31.6 m.), an all-up weight of 13 950 lb. (6 328 kg.) and a maximum speed of 81 knots. It was some 1 268 lb. (575kg.) heavier than a typical all-timber F.5 but it handled well and was 'cleaner' on the water than the standard 'boat'. Comparable timber flying boats could take up some two hundred pounds (about 100 kg.) of water by soakage in the course of a year, to the detriment of the performance and life of the structure. At the end of the tests, the hull of the S.2 had no water soakage and minimal amounts of small-scale corrosion. N 177 - known in the Service as the 'tin Five' - was delivered by John Parker to the MAEE at Felixstowe on 14 March. It was moored out for a year and, on one occasion, stalled into the water from a height of 30 ft., to test the strength of the fluted planing bottom. The first large all-metal hull confirmed the soundness of Oswald Short's theories and the manufacturing practices of the Rochester works.

As the S.2 neared completion, the Short Bros. private testing tank was under construction along the rear of No. 3 Shop. Testing of model hulls was essential to predict the behaviour of full-sized aircraft on the water. Flying boat hulls had been tested at the National Physical Laboratory (NPL) tank at Teddington, but there were significant differences between the testing of marine aircraft hulls and ship hulls. The William Froude tank at the NPL was designed to test ship hulls for their resistance and stability at a series of steady speeds. Flying boat hulls existed in a more complex regime and testing was required for a whole range of characteristics. Longitudinal, lateral and directional stability during take-off and alighting needed investigation through a range of speeds from zero to 70 or 80 knots.

The Rochester testing tank was commissioned in the last half of 1924 and is believed to be the first such tank built exclusively for use in the design of aircraft. The first model hull to be tested was the F 5 with the fluted hull. The tank was installed in the lean-to structure at the rear of No. 3 Erecting Shop, built up from the floor of the Shop with retaining walls of reinforced concrete, 300 ft. (91.44 m.) long, 6 ft. (1.83 m.) wide and 3 ft. 6 ins. (1.07 m.) in depth, with a capacity of 78 000 gal. (179 cu. m.) of water. Arthur Gouge stated that he would have preferred a tank width of 10 - 12 ft. (3.05 - 3.66 m.), no doubt to minimise the effects of interference from the walls of the tank, when testing hulls at higher speeds. Rough water testing was attempted, but it was difficult to generate standard waves of the correct pitch in the narrow tank. Goldfish and other marine life were later introduced into the Rochester tank to control the growth of algae in the water and evaporation losses were made good from the Works water supply system through a ball-valve. The RAE testing tank at Farnborough - commissioned four years later - was 360 ft. (109.73 m.) long X 9 ft. (2.74 m.) wide X 4 ft. 6 ins. (1.37 m.) deep.

The Test Department was originally staffed by Oscar Gnospelius, Arthur Gouge and Jack Lower, with Thurstan James as a junior - an extract from whose article was quoted earlier in this chapter. The timber-framed travelling carriage, designed by Oscar Gnospelius and Arthur Gouge, had two pairs of flanged wheels straddling the tank, driven by electric motors on the rear axle. Small horizontal stabilising wheels were fitted, certainly to the rear axle and probably to both. The carriage ran on rails laid on the top of the retaining walls. The controller of the test run

was seated at the rear of the carriage, with an open section in front of him over which was mounted the framework for the balances, with the model hull to be tested floating below.

Model hulls were normally made from solid mahogany, with a highly polished finish and in the early days of operations in the tank, often by Arthur Gouge. The Model Shop was included within the Test Department, so that the hulls could be made in privacy, undisturbed by the rush and bustle of No. 3 Shop. After he became Chief Designer, Arthur Gouge kept some of these models, including Empire boat hulls, in his office where they were destroyed in the bombing of the Seaplane Works in August 1940. A single float from the model of G-AAJY, the Valetta floatplane, was picked out of the rubble by an apprentice and he has it still.

At the start of a run, the model hull was suspended in the water immediately below the balance framework. It was fixed to the framework and balanced about its transverse axis through the point representing the centre of gravity of the full-sized aircraft. The displacement and trim of the model were adjusted by means of weights attached to light wires running over pulleys on the framework. When it had been correctly balanced, the model was attached to the central swinging frame on the platform. The frame swung on knife-edge pivots on the outer frame, which itself was ball-bearing mounted, and free to slide in fixed guides. A rigid, light-weight towing rod was attached vertically above the centre of gravity of the model, at the height and inclination of the thrust of the airscrews. The other end of the rod was attached to a lever and, through a mechanical amplifying link, the pull on the towing rod was continuously recorded on a revolving drum. The drum and timing mechanism were geared to the forward axle of the travelling carriage. As the carriage moved, an electrically controlled timing device accurately recorded the speed of travel and the pull on the towing rod representing the water resistance of the model.

A parallel linkage simultaneously recorded the attitude of the model hull in the water. The maximum speed of the carriage was 10.5 knots or 17.7 ft. per sec. (5.36 metres per sec.). The direction of travel while testing was left to right, seen with one's back to the main doors of No. 3 Shop. A typical test, taking a model to the maximum carriage speed, took about 35 seconds - about 7 seconds to accelerate to speed, with 20 seconds at speed and some 9 seconds for retardation.

Flying boat hulls are displacement vessels in the initial stages of the take-off run so the water resistance due to friction increases as the square of the speed. The total resistance to friction, the residual drag due to wave making, to spray thrown up by the movement of the aircraft and to changes in the attitude of the hull in the water, increases sharply at the lower end of the speed range until it peaks at the so called 'hump'. The 'hump' is the point of maximum resistance on a chart of the water resistance of a hull occurring at about 20% of the displacement and occurs at about 33% of the getting off speed. The 'hump' marks the transition from the displacement to the full planing condition. As the speed increases, and lift from the aerofoil makes itself felt, the hull starts to climb out of the water. As it does so the combined resistance due to the decreased wetted surface and the residual drag, fall away until the aircraft becomes airborne. The lift of the aerostructure was simulated in tank tests. As well as the hydrodynamic considerations, the spray patterns around the hull are extremely important for the flying boat designer, to minimise damage to airscrews, mainplanes and wing floats. Hulls and floats often needed to be tested, then modified and tested again, sometimes in short order.

Tank testing determined, to acceptable standards of accuracy, the resistance and attitude of a hull at varying speeds in the water, its longitudinal and lateral stability at all times and any tendencies to 'porpoise'.

Porpoising is the mysterious and alarming tendency of a flying boat hull to rock fore and aft about its centre of gravity when moving on the water, while at the same time moving up and down. The two movements have the same period but differ in phase and are complex enough to defy analysis. Depending on its form and loading, porpoising can occur at virtually any speed - but usually occurs at between 50% of getting-off speed when the hull finally leaves the water. At some point in the speed regime, at some angle of trim and under some condition of loading, any hull can be made to porpoise. Tail-down alightings could initially produce a bouncing effect akin to porpoising, leading to a full-blown porpoise as the hull settled down in the water. With the full-sized aircraft, porpoising could usually be controlled at slow speed. If it occurred at high speed, the results were often catastrophic, as the movements of the hull could be erratic and violent. Much work had been done in other testing tanks before 1920 to determine the effect of the variation of beam dimension, the ratio of the lengths of the fore and after planing bodies, and the effect of overloading typical hulls. Water pressure distribution on the bottom of flying boat hulls had been investigated since 1930. Maximum pressure of 15lb.per sq. in. occurred near the keel at the main step on alighting. 11lb.per sq in. was typical on take off in rough water with 8lb.per sq. in pressure almost anywhere on a hull bottom on alighting. Extreme vertical accelerations of 4.7g. could be experienced taking off in rough water.

Model hulls were first checked for their static stability before any movement took place. As a displacement vessel a hull obeyed Froude's Law of Comparison. The Law states: *'The resistances of similar ships (and in this case flying boat hulls) are in the ratio of the cubes of their linear dimensions, provided that their speeds are in the ratios of the square roots of their dimensions'*. Model scales for tank testing were normally 1/8th., 1/10th., 1/16th., 1/20th. and 1/24th. of full-size, depending on the dimensions of the full-sized aircraft, the width of the testing tank and the speed regime under investigation. Model hulls longer than the width of the testing tank led to interference

from the walls, which limited the model scale for an Empire 'boat to 1/16th scale in the Rochester tank. The scale depth of water for this sized model was 56 ft. or 17 metres.

Tank testing set the upper and lower trim angles within which the hull could be expected to plane in a stable condition. Between these limits there were an infinite number of trim angles that a hull could assume without porpoising but above and below these limits, porpoising could occur. The hull either took up its own trim angle, depending on speed and loading, or was affected by the actions of the pilot through the moment imparted by the elevators. Porpoising after a 'boat was through the 'hump' to the planing condition was potentially the most dangerous. High angle porpoising - above the upper limit - was mostly due to the interaction of the fore and aft planing bodies. If the first symptoms occurred in a full-sized 'boat - a series of unexpected movements of the hull - were not recognised and corrected by the pilot, it could lead to acute discomfort at one end of the scale and high structural loading and catastrophic impact damage at the other. Changes in fore and aft trim, when a hull was running fast on the water, produced marked changes in the immersed volumes of the hull, tending to amplify the instability. Porpoising below the lower limit was usually due to some defect in the design of the forebody of the hull. In both cases, entrained high-velocity air, rushing into the trough formed between the afterbody and the water, also influenced events.

The success of the S.1 and S.2 hulls finally persuaded the Air Ministry that the era of the duralumin hull, and even the all-metal flying boat, had arrived. All-metal, in the terminology of the day, meant a metal hull, metal-framed wings and tail unit, with the flight and control surfaces still covered with the familiar doped fabric. No further S.2 'boats were ordered. Instead, the Air Ministry ordered six metal hulled Supermarine Southampton 'boats with displacements of 14 300 lb. or 6 350 kg. Oswald Short had flown as a passenger in a Southampton at Felixstowe and was amazed to find that, owing to the cramped hull, he had to crawl on hands and knees through a tunnel on the starboard side to speak to the pilot. The S.2 hull was much larger. A bigger 'boat with a displacement of 21 000 lb. or 9 333 kg. was designed at Rochester and, when submitted to the Technical Department of the Air Ministry, was rejected in favour of the even larger Blackburn Iris II. This 'boat had a displacement of 27 400 lb. or 12 200 kg. Rather than lose out to the Blackburn 'boat, Short committed the company to build the new 'boat. Sir Geoffrey Salmon of the Air Council saw the drawings of the Short 'boat and gave a firm order for one aircraft. The project was defined in Specification 13/24, the Short Bros. design index number was S.5 and construction number S.677. The new 'boat was named Singapore I and given the RAF serial N 179. The contract sum was £20 000 (PV £347 600).

The Short Bros.' design team was led by Francis Webber. The first scheme for the hull of the new 'boat was based on the patented fluted form of the S.2 and was tested in the NPL ship testing tank at Teddington. When the Rochester testing tank was available, the tests were repeated with differing results. Part of the Complete Patent Specification for the fluted planing bottom stated:

'The formation of these arches which are of uniform width permits the relative travel of the boat through the water with a minimum disturbance thereof, the water which enters at the forward end of the arch being free to travel the length of the float (or hull) and to leave the aft end without being diverted or arrested by the change in cross sectional area of the arch or by the change in its direction.'

The instruments on the Rochester tank were more sensitive than those at the NPL and showed the fluted test hull to have increased resistance. Working over the weekend in the Test Department at the back of No.3 Shop, on tank models with fluted and plain underwater bodies, Arthur Gouge and Jack Lower concluded that this statement was incorrect. Interference between the multiple bow waves thrown up by the flutes was the source of the increased resistance. In the light of these test runs in the Rochester tank, Francis Webber was asked by Oswald Short - the originator of the idea of arching the planing surfaces - to re-design the hull with an unfluted planing bottom. Webber considered that his design authority had been overruled, took exception to this instruction and resigned shortly afterwards. Much to his surprise, Arthur Gouge was appointed Chief Designer in his place. The hull of the new 'boat was duly reshaped under his direction, without the flutes or 'arches'. When tested, the No. 1 model hull porpoised in the tank when it was loaded beyond its proposed displacement. The revised No. 2 model ran steadily, even when loaded to 32 000 lb. (14 515 kg.) displacement, but with greater resistance.

At the same time that the Singapore I hull was being developed in the testing tank, other tests were run to determine the optimum method of providing transverse stability for flying boat hulls. The test results were expressed in terms of the load that would have to be sacrificed to get a 'boat off the water using three different methods - wing tip floats, inboard floats and stub wings or sponsons. Compared to wing tip floats, the loss of load for the inboard floats was 9% and for the stub wings, 14%. Beside the static balance of the aircraft at rest on the water, there were the matters of the engine torque and turning on the water to be considered.

As an Empire 'boat moved through the hump, the reaction of the airscrews tended to yaw the hull to starboard, at the moment when the 'boat was not moving fast enough for the aerodynamic action of the rudder to fully counteract the torque. Cross winds and wave action, at speeds too low for the ailerons to become effective, were also potential dangers whilst taking off, alighting, taxiing or turning on the water. Flying boats with the stub

wings, or sponsons, were particularly 'tender' - in the nautical sense - when turning on the water in some conditions of wind. When BOAC got its Boeing 314s - stabilized with sponsons - the crews found them difficult to taxi downwind. A 314 could dip a wingtip if the wind shifted unexpectedly, or if too tight a turn was attempted, so Boeing thoughtfully provided them with watertight wing tips. Sponsons had some advantages, however. It was claimed that the Dornier Do X, also stabilised with sponsons, could take on freight and intrepid passengers while taxiing at 16 knots.

Short Bros. considered wing floats to be the safest, lightest and most economic method available. When the time came to consider the possible solutions for the Empire 'boats, Arthur Gouge considered the use of retractable floats. Although the Consolidated XP3Y flying boat had appeared in the US with retractable wing floats in 1933, he rejected them as impracticable, considering that the operating mechanism would have to be 100% reliable. In 1935, he thought that could not be guaranteed. The Singapore I wing tip floats were of a completely different form to those previously used on the Short flying boats - a form that was to be developed into the floats used on the Empire 'boats, 'HK Maia, the various Marks of Sunderland, the 'G' 'boats and the two Shetlands.



5. **Short Bros. photo. H.137(g).** Singapore I N 179 at the foot of the slipway on 17 August 1926. The public footpath running along side the River Medway enabled members of the public to watch the launching.

The Singapore I was probably the first Short Bros. aircraft to use a modified version of the Göttingen Gö 436 aerofoil profile for the mainplanes. A photograph of No. 1 Shop shows the fuselage of the Satellite - a contemporary land plane cousin of the Cockle - hanging from the roof trusses with the profile of the mainplane clearly visible. It appears very similar to a Gö 436 and has an apparent thickness to chord ratio of about 20%. The Gö 436 (tested 1921) is a thick high-lift aerofoil with low stalling speed intended for use by monoplanes, with a maximum coefficient of lift of 1.2. The maximum lift to drag ratio is 21, the zero lift incidence at minus 5 deg. and maximum lift incidence at 15 deg. The standard Gö 436 profile has a thickness to chord ratio of 11.% at the 30% chord position and a flat under-surface - the datum line - from 7.5% of the chord back to the trailing edge. Published coordinate tables of the standard profile differ slightly in detail. Some show the trailing edge lifted by 0.25% of the chord while the official Göttingen figures as shown in Riegel's Aerofoil Sections, put the trailing edge firmly on the datum line. The Rochester modification lifted the trailing edge higher to 0.87% of the chord - approaching that of a Clark YH. Reflexing the trailing edge tended to limit the movement of the profile's centre of pressure. The modified Gö 436 profile, known to Shorts as A.D.5, with varying thickness to chord ratios, became the standard at Rochester and was used for all subsequent aircraft until the Sealand amphibian in 1948, with the exception of the Mussel I (RAF 33 aerofoil) and II (NACA M 12) and the Short-Bristow Crusader float plane (RAF 27). Increasing the thickness to chord ratio seemed to have little effect on the aerodynamic characteristics of the profile - except for an increase in the drag but this was considered acceptable for commercial aircraft.

The Singapore I - RAF serial N 179 - was Short Bros' third duralumin hull and the first to be developed in the Rochester testing tank. The remainder of the Singapore I's aerostructure did not greatly influence the design of the Empire 'boats, except that it was metal-framed with Frise ailerons on set-back hinges, on the upper mainplanes for the first time. N 179 had a span of 93ft (28.35 m.), was fitted with two Rolls-Royce Condor IIIA engines of 705 hp. (525 kW.), had an all-up weight of 19 560 lb. (8 700 kg.) and a maximum speed of 111 knots. N 179 was launched on 17 August 1926, first flown by John Lankester Parker and subsequently delivered by him to the MAEE at Felixstowe for its service trials. At the time of the launch, the Singapore I was the largest metal hulled flying boat in the world. The aircraft underwent various modifications to its tailplane and engines, and with its up-rated Rolls-Royce Condor engines and modified form, set out on the RAF Scandanavian cruise starting on 12 August 1927. It was in company with the Blackburn Iris II N 185 - metal hull and timber aerostructure, the all-timber Saunders Valkyrie N 186 - with a 'Consuta' copper-stitched plywood hull - and Supermarine Southampton I N 218 with a timber hull. The metal-hulled boats completed the 4 378 n.m. (8 000 km.) circuit round the Scandanavian ports without major incident.

Sir Alan Cobham saw the Singapore I on one of his many visits to Rochester. Sir Alan had Short Bros.' metal floats on IAL's de Havilland DH.50 seaplane G-EBFO for his flight from England to Australia the previous year, so he knew Oswald Short well. They discussed the possibility of a flight to Singapore to demonstrate the capabilities of the flying boat, but finally settled on a tour round the coast of Africa. The Singapore I was to be loaned by the Air Council to Sir Alan for the journey. N 179 was stripped of its military equipment, cleaned up, repainted, fitted with high-compression Rolls-Royce Condor engines and registered as G-EBUP on 6 October 1927. It was insured for £ 25 000 (PV£ 444 000). The expenses of the expedition were covered partly by Short Bros. - £3 000 (PV £53 280) - and a contribution from Rolls-Royce - £ 1 000 (PV £ 17 760) - as the main sponsors, with many other smaller contributors. The deficit of £12 000 (PV £213 120) was made up by Sir Charles Wakefield. The Certificate of Airworthiness for the 'boat in its new form was issued on 7 November 1927 and the 'Sir Charles Wakefield Flight of Survey round Africa' commenced ten days later.

The survey flight was to circumnavigate most of the coast of Africa in a clockwise direction, starting from a landfall at Benghazi on the north coast. The outbound route was via Malta and it was here that the most convincing demonstration occurred of the sea keeping qualities and strength of the metal hull. During its stay, 'UP' lost both its wing floats in the swell with the sea breaking right over the upper mainplane. Finally beached, it was dragged up the concrete slipway, on keel and chine, to escape the waves. Finally, with three hundred RAF men pulling on ropes attached to all parts of the 'boat, and others levering the lower mainplanes up with steel joists and planks of wood, 'UP was dragged further up the slip. To get the 'boat to safety, the port lower mainplane had to be levered, wrenched and smashed to get it over the sea wall, an operation described by Sir Alan as '*... indescribably wet and cold and noisy and violent, ...*'. Arthur Gouge was sent out to Malta to survey the damage and found the hull to be virtually undamaged, only dented by the football-sized boulders that had been dredged up and swilled around in the swell. A new lower port mainplane, two new wing floats and new elevators were manufactured in two weeks and dispatched, accompanied by A.E. Bibby - Short Bros.' Works Manager - to superintend their fitting. The survey flight was resumed on 21 January 1928 and the remainder of the circular tour of the African continent was made without further serious structural or mechanical trouble. Part of the expedition's route southwards up the River Nile and onwards to Durban, was a preliminary route survey for the projected Imperial Airways Limited service to South Africa. The expedition arrived back at Rochester on 4 June, and almost immediately set out on a tour of British ports, ending on 11 June. The total distance flown was 20 000 n.m. (36 800 km.), covered in some sixty separate flights. The satisfactory completion of the survey confirmed the use of the flying boat for airline use.

G-EBUP reverted to N 179 in October and returned to the Seaplane Works at Rochester for modification. The hull was taken into No.2 Shop and cut through just forward of the main spar frame bay. A new slice, 17 ins. (437 mm.) wide, was inserted and the whole planing bottom re-faired to resemble the hull of the Calcutta flying boats, then in production next door in No.3 Shop. New engines - Rolls-Royce Buzzards - were installed and Handley Page auto-slats fitted to the upper mainplanes. Although not in flying condition, N 179 was exhibited at the 7th International Aero Exhibition at Olympia - eight years after the Silver Streak made its appearance in the same hall. When tested in the air, the modifications resulted in an increase of speed of 3 knots, for an addition to the all-up weight of 440 lb (196 kg.). N 179 returned to Felixstowe on 8 November to become the test vehicle for the Rolls-Royce Buzzard engines and the development aircraft for the new Singapore II.

Early in 1926, IAL's fleet was augmented with two new flying boats for the Mediterranean sectors. The new 'boat with design index S.8 and named Calcutta, generally followed the design of the Singapore I, to become the first metal-hulled British commercial aircraft with a metal-framed aero structure. The 'boat was in project form in the first quarter of 1926 and an order for two aircraft was placed by the middle of the year, at a price of £ 32 000 (PV £ 568 320) each.



6. Short bros. photo H 243 (j). Short Calcutta G-EBVG over the Medway. The lines of the hull and planing bottom are seen to advantage. 'VG capsized in a storm at Mirabella 28 December 1936.

The new hull was the fourth Short Bros.' metal hull. It was designed to accommodate passengers so was somewhat deeper than that of the Singapore I, and had increased beam. The forebody of the hull from the bow to the main step was lengthened to provide the extra buoyancy needed to counter the increased downward thrust of the three engines. The afterbody - aft of the main step - was re-designed so that the tail unit and afterbody were clear of the water at all speeds above the 'hump'. The rear step was faired into the afterbody as it swept up to the tailcone resulting in reduced water resistance and increased aerodynamic advantage. The wing structure was almost identical to the Singapore I, of the same span but increased in area by 102 sq. ft. (9.5 sq. m.). The engines chosen by IAL were Bristol Jupiter IX nine-cylinder air-cooled radials of 540 hp. (400 kW.) mounted in monocoque nacelles in the gap between the mainplanes, driving four-blade wooden airscrews. The choice of air-cooled Bristol engines was a precedent that carried through to the Empire 'boats. Fuel was carried in thickened sections of the upper mainplane, with gravity feed to the engines. As passengers were to be carried in the new 'boats, no fuel was stored in the hull - another precedent that was carried through to the standard passenger-carrying S.23 Empire 'boats.

The Captain and First Officer of a Calcutta sat side-by-side in an open, and somewhat cramped, cockpit with dual controls. A covered mooring hatch was in the bow, forward of the cockpit. A work station for the Radio Officer was provided on the starboard side immediately aft of the cockpit.

Passengers entered by a hatchway on the port side forward, with the hat and coat storage immediately opposite. The single cabin, with fifteen seats, was 17 ft.6ins. (5.33 m.) long by 6 ft.6 ins. (1.98 m.) wide by 6 ft. 3ins. (1.9 m.) high, trimmed in blue leather up to dado level, changing to buff-coloured felt up to the ceiling - to help absorb engine and airscrew noise. Hide was later used for trimming the walls and ceilings of the Empire 'boats. The seating, upholstered in blue leather, was arranged in four rows of three seats with the aisle offset to port, between the single seat on that side, and the double seat on the starboard side. An extra double seat was installed in the coat storage area and a single seat at the rear of the cabin. The toilet, pantry and steward's seat were aft. Cabin ventilation was provided by ram air ducted to punkah louvres. Some of the windows could be opened for additional ventilation and four of them could be used as emergency exits.

The first Calcutta - construction number S.712 - was launched on 13 February 1928, when the Singapore I was in the early stages of its tour of Africa and delivered to Imperial Airways Limited on 9 August. Six Short Rangoon 'boats were delivered to the RAF, virtually the same as the Calcutta except for increased fuel tankage and an enclosure over the pilot's position.

The Air Council specification R 5/27 for a naval reconnaissance flying boat was re-issued to manufacturers as R 32/27. This specification called for a three-engined long-range flying boat with either Rolls-Royce Kestrel or Bristol Jupiter engines. Short Bros. first offered a military version of the Calcutta but later an enlarged Singapore I, with four Kestrels in a double tandem tractor-pusher arrangement was offered. The Air Council ordered one prototype from each of the three other contenders and ignored the tender from Short Bros. Oswald Short successfully argued the case for the four-Kestrel 'boat and eventually secured a contract for one aircraft.

The new Short Bros.' 'boat was the S.12 Singapore II - construction number S. 749. The hull was developed from the Calcutta but with a deeper keel and forebody, giving an increase in the displacement of about 40 %. As originally launched, the hull had a transverse main step and was plated with stainless steel on the planing bottom and chines - corrosion resistant and stronger than aluminium alloy. The use of austenitic stainless steel for the

underwater bodies of flying boats was another Short Bros. pioneering development. The aerostructure of the S.12 was considerably cleaned up, with streamlined close-fitting monocoque nacelles for the four Kestrels, supported by massive struts. The launching - with RAF serial N 246 - took place on 27 March 1930. Various modifications were made to N 246, the most important of which, in the line of ancestry of the Empire 'boats, was the re-plating of the planing bottom and the revision of the main step. The original stainless steel underwater plating was found to cause bi-metallic corrosion at the junction with the duralumin topsides, and was replaced with duralumin plating. The 'boat was returned to Rochester for re-skinning and at the same time the underwater body shape was revised, as a result of model tests performed in the testing tank.

Larger models are more accurate, so revised hull forms were tried out by suspending 42 % scale models beneath a de Havilland DH. 60M Moth (K 2235), linked to the Moth as a central float. Dynamometers were incorporated in the linkage, to measure the resistance of the various hull forms at varying speeds on the water. The rig also included wing floats to scale. K 2235, with various appendages, was tested at the MAEE at Felixstowe during 1930 and 1931. The rig provided much needed data on the correlation between the resistances and behaviour of the small testing tank model and the nearer-to-full-sized hull.

It was comparatively easy to modify the form, the position and the depth of the step, and even the dead-rise angle of model hulls. The transverse main step of the model was altered to rake it forward from the keel to the chines - apparently another Short Bros.'first'. John Lankester Parker suggested that moving the point of the step forward might help handling on the water but moving it aft was better. A transverse step was theoretically efficient at only one speed so raking the step increased its effectiveness over a range of speeds. In conjunction with a parallel hull forward of the step, it brought a general improvement in the handling on the water and a reduction in the tendency to porpoise. The third version of the 42% model planing bottom was incorporated in the full-scale Singapore II, when the 'boat was having the planing bottom re-plated. Finally N 246, with its newly shaped and plated underwater body, was sent for testing at the MAEE. At the end of its career, the 'boat was stripped of equipment and tested by being dropped into the water from progressively increasing heights. Quick-release shackles were fitted to the upper mainplanes, the 'boat hoisted up by the Stothert and Pitt 50 ton Titan hammerhead crane and then dropped. The final drop was made from 14 ft. The acceleration of 9g. on this final drop produced some buckling of the wing spars and interior bulkheads. The planing bottom remained intact.

Once the Singapore II contract had been secured, work began on the design studies for a scaled-up version, with the design index S.14 - there was no S.13. The immense German Dornier Do.X was under construction at the time and when it made its first flight on 25 July 1928, it was the largest flying boat in the world with a maximum displacement of 105 820 lb. (48 000 kg.). The Short Bros.'boat was smaller, although it was to have double the displacement of the Singapore II. Oswald Short persuaded the Chief of the Air Staff, Sir Hugh Trenchard, of the feasibility of the project and managed to get an assurance of £ 60 000 (PV £1.22 million) towards the project. Specification R. 6/28 was issued to define the proposal and the detail design work started.

The S.14 Sarafand - with RAF serial S 1589 - was launched on 30 June 1931, the second largest 'boat in the world, with an all-up weight of 70 000 lb. (31 700 kg.) and flown the same evening for an hour by John Lankester Parker, with Oswald Short as co-pilot to help with the controls if needed. No one really knew how heavy the flight controls of such a large 'boat would be. The Sarafand took off in 20 seconds and trimmed, hands off, at 300 ft.

The hull - the sixth Short Bros. metal hull - was originally launched with a transverse main step and a stainless steel planing bottom. Alclad was extensively used for the other parts of the construction and all the aluminium alloy components were anodised. At the end of 1933, S 1589 was returned from the MAEE to Rochester for the fitting of a new planing bottom with a raked forward main step, similar to that of the modified Singapore II, and the stainless steel skin plating replaced with Alclad. After a successful career as a general flying testbed on the strength of the MAEE, this huge and stately aircraft - almost a galleon - was slowly dismantled and scrapped at Felixstowe in 1936.

In October 1930, Short Bros. started building the first of the three S.17 Kent flying boats, known in IAL service as the Scipio class. The S.17s were enlarged versions of the Calcutta, with the same passenger-carrying capacity but with an increased payload for mail. An extra Bristol Jupiter engine was included for increased reliability, arranged in line abreast with the other three in the gap between the mainplanes, well away from interference by spray. Maximum comfort was required for passengers and crew. The cost was £45 000 (PV £ 916 200), putting the cost of a Kent 'boat roughly equal to the notational cost of an Empire 'boat in 1936.



7. Short Bros. Photo. H.473(d). The second Short Kent G-ABFB , later named Sylvanus, over the Medway on 31 March 1931. 'FB was destroyed by fire at Brindisi on 9 November 1935.

The construction of the hull - the seventh Short Bros. metal hull - generally followed that of the Calcuttas. The planing bottom was in stainless steel in the manner of the Singapore II, with a transverse main step. Bi-metallic corrosion problems arising from the Singapore II hull had been solved, so Short Bros. became the first company to master the technique of building seaplane floats and flying boat hulls in this combination of metals.

The Kents had a greater beam than the Calcuttas. The passenger cabin was also wider - 8 ft. 6 ins. (2.59 metres) - and as the number of seats was the same, the cabin was shorter - 14 ft. (4.27 metres) long. The seating was arranged in four rows of facing pairs, with a centre aisle, Pullman style. A publicity photograph shows the tables laid for luncheon complete with linen serviettes, daffodils in cut glass vases and cruets. Special attention was paid to sound attenuation in the passenger cabin and crew's stations so the Bristol Jupiter engines were fitted with exhaust collector rings and long tail pipes, to reduce exhaust noise inside the hull. The steward's pantry was aft of the passenger cabin, with the toilet opposite. The mail and freight compartment was aft again. The cockpit was fully enclosed with a separate Radio Officer's station aft of the cockpit, an evolutionary step towards the Control Deck of the Empire 'boats. The Kents were fitted with a quick-release hook near the tail, controlled by the pilots. This simple device enabled the engines to be run up to full power on the tail mooring and later, when it was fitted to the Empire 'boats, proved to be critical in handling the aircraft on fast-flowing rivers, such as the Nile.

The first of the three Kent flying boats - construction number S.759 and named Scipio - was launched on 24 February 1931 and was in service in the Mediterranean in May.

1932 was an eventful year in the development of the Empire 'boats. The Bristol Aeroplane Co. Ltd. revealed details of their two new engines, the Pegasus and the Perseus, both nine-cylinder geared air-cooled radials and both later to power the Empire 'boats. The use of air-cooled engines for the Empire 'boats was an IAL requirement, following the successful use of the Bristol Jupiter engines on the Calcutta and Kent flying boats and the L.17 Scylla landplanes.

Pegasus poppet-valved engines were a direct descendant of the Jupiters, with the same cylinder bore, stroke and swept volume. Some 5 000 hrs. of testing had gone into the evolution of the Pegasus, resulting in an increase of power output per litre of cylinder capacity of 50%. The extra power was obtained from an increase in engine speed and advances in metallurgical technology, which enabled the resulting higher stress levels in the engines to be contained. The output of the series of Pegasus engines started at 400 hp. (298 kW.) and ended with 1010 hp. (753 kW.)

The Pegasus engine was manufactured in seven types of which two, the XC and the up-rated XXII, were used on the S.23s, one S.30 initially and the two S.33 Empire 'boats. The Bristol Aeroplane Co. was in a process of transition to accommodate the expansion of the RAF, so Imperial Airways Limited's initial order for one hundred

and fifty six engines was a big one. Some of the 'boats originally fitted with the XC version were re-engined with the more powerful XXII during World War II. The two engines were virtually identical except for the degree of supercharging which affected the output - a maximum of 1010 hp. (753 kW.) for the XXII as opposed to 920 hp. (686 kW.) maximum for the XC.

Sleeve-valve engine development started in 1926, to overcome the speed and load limitations of push-rod operated valve-gear, as engine performance increased. Compared to an equivalent engine with poppet-valves, sleeve-valves offered simplified installation, the virtual elimination of valve maintenance, reduced mechanical and exhaust noise and better fuel consumption. They could also tolerate higher compression ratios with consequently lower exhaust manifold temperatures. The new high octane rating fuels enabled the compression ratios of both engines to be increased to 1:6.75 in the case of the Perseus and to 1:6.54 for the Pegasus. The Perseus was the world's first sleeve-valve engine to go into series production when in 1938, after five years research and application by High Duty Alloys of Slough, Firth-Vickers of Sheffield and the Bristol Engine Company, urged on by A.H.R.Fedden, techniques were evolved to machine the new alloys for mass production. The Perseus was developed from an initial 515 hp. (384 kW.) to 900 hp. (671 kW.). The Mark XII C version of the Perseus engine used to power eight of the S.30 'boats developed 890 hp. (664 kW.) maximum take off power - 4% less than the Pegasus XC. The Perseus also had a slightly smaller overall diameter than the Pegasus, with 6% less frontal area.

Imperial Airways Limited issued the first of a series of flying boat specifications for the Empire routes in December 1932, proposing aircraft carrying twenty passengers and a payload of 2 040 kg. On 14 November 1933, a revised specification called for an all-up weight of 60 000 lb (27 216 kg.) with a payload of 3 630 kg. at 130 knots (240 km. per hr.) for 435 nautical miles (800 km.) against a 35 knot (64 km. per hr.) headwind. The first flights of the Boeing 247 - 8 February 1933 - and the Douglas DC 1 - 1 July 1933 - had already taken place. Nine days after Major Mayo's revised specification was written, the Air Ministry issued the now famous Specification R 2/33 for a 'Four Engined General Purpose Boat Seaplane'.

Airscrews were being developed away from the fixed pitch to being to vary the pitch in flight. de Havilland had obtained the Hamilton licence from the United States to manufacture a range of three bladed airscrews. The airscrews fitted initially to all the 'boats were de Havilland 5000 series variable pitch units of 12 ft. 9 ins. (3.886 metres) diameter with a pitch of approximately 14 ft. (4.63 m.). Pegasus engined 'boats had two position airscrews. The later Perseus engined 'boats were fitted with constant speed units. By 1943, the two TEAL 'A' 'boats had been fitted with fully-feathering de Havilland Hydromatic constant speed airscrews - the only Empire 'boats to be so equipped. Airscrews salvaged from crashed aircraft were reconditioned and fitted to aircraft in production. 'KZ CATHAY and the three S.33 'boats were all equipped, partially or completely, with reconditioned airscrews. Judging from the parts list, 'CV CABOT had a reconditioned airscrew on the starboard inner engine.

Sometime in the latter half of 1932, four consecutive Short Bros. construction numbers - S. 766 to 769 - were allotted to three types of aircraft that played significant parts in the development of the Empire 'boats. They were the S.16 Scion landplane, the S.18 Knuckleduster flying boat and the two L.17 landplane versions of the Kent flying boat - G-ACJJ Scylla and 'JK Syrinx.

The S.16 Scion was Short Bros.' contender for the low cost 5/6 seater commercial aircraft market opened up by the de Havilland DH.84 Dragon. The Scion - priced at £2 600 (PV £ 55 200) and therefore slightly cheaper than the Dragon - was the first Short Bros.' aircraft to use the Rochester-modified Göttingen Gö 436 aerofoil profile on a cantilever monoplane wing. The Scion wing was slightly tapered in plan, with rounded tips and inset ailerons. The mainplane spar consisted of two trussed booms, held apart by drag struts top and bottom, to form a box. The boom flanges were cruciform light-alloy extrusions, milled in both dimensions to progressively diminish their area towards the wing tips, corresponding to the spanwise loading on the wing. The spar boom compression members and drag struts were duralumin tubes. Arthur Gouge was a shrewd and thrifty designer. An identical structure was used for the main structural members of the tail plane and fin of the Empire 'boats. The principle of the constantly diminishing structural section was used again on the Empire 'boats, whose mainplane structure was finally patented (447,520 31 May 1935). A wing plan, similar to that of the Scion, was used on the S.18 Knuckleduster as the outer mainplane panels.

The spring of 1933 found IAL seriously short of aircraft on their European routes. They approached Handley Page Ltd. for two additional HP 42s. Handley Page responded with a quotation for a version of the HP 42 with Armstrong Whitworth Tiger II engines, at double the original price. IAL turned to Short Bros. for help, who offered a land version of the S.17 flying boat - to be known as the L.17 - using the aerostructure of the S.17s perched on a new fuselage. With their low wing loading of about 13 lb. per sq. ft. and high ground angle, they were highly susceptible to wind gusts while on the ground. The engine nacelles were designed to receive Bristol Jupiter, Pegasus or Perseus engines without modification, a most worthwhile provision, as the two inboard Jupiters of one of the L.17s were replaced later with Perseus II L sleeve valve engines, to test their performance in airline conditions. When one of the L17s - 'JK Syrinx - was re-built following the incident when it was overturned whilst taxiing at Brussels Airport, 'JK it was fitted with four Pegasus XC engines - the engines that had by then been specified for the S.23 Empire 'boats.

Time was short, so a heavier braced-frame structure was used for the fuselage of the L.17s in place of a lighter monocoque, which would have taken longer to design. The passenger accommodation was a forerunner, almost a prototype, of that used later for the S.23s. The cabin mock-up was ready by April 1933.

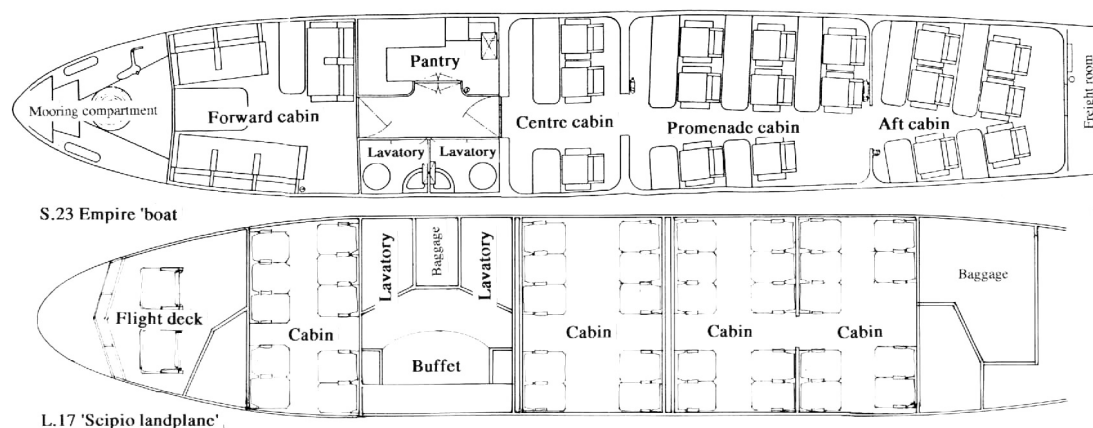

8. Accommodation plans of the L.17 and S.23 compared.

The accommodation in the L.17 was on a single deck with the Captain and First Officer in a fully enclosed control position in the nose of the aircraft. The Radio Officer sat behind the Captain, facing forward with the Marconi AD 41A/42A wireless sets on the bulkhead that separated them. The forward entrance vestibule led to a nine seat Smoking Cabin. A large pantry was on the port side, with two toilets and a baggage compartment opposite - all in the plane of the airscrew discs. Next came a cabin between the spars for ten passengers, then a rear cabin for nineteen passengers and a rear entrance vestibule. The freight compartment was aft.

The L.17s were noisy aircraft, much noisier than their flying boat cousins. The sound pressure levels recorded in the passenger cabins of the L.17s in flight were 75-83 dB., which compared unfavourably with the 65-72 dB. of the Handley Page HP 42s and the 60 dB. of the Empire 'boats'. The noisest part of the passenger accommodation in an Empire 'boat' was quieter than the quietest part in a Kent 'boat'. Noise levels in the L.17s were improved in service by cropping the inboard airscrews, by double glazing the windows and by increasing the thickness of the sound insulation of the cabins - stylishly panelled in polished walnut veneer. Ventilation was provided by a ram air system which delivered air to punkah louvre outlets in the cabins. A similar cabin ventilation system was used on the Empire 'boats'. G-ACJJ was the first L.17 to fly on 26 March 1934.

Short Bros. fitted Flettner servo aerofoils to aircraft with large rudders, to move them. Apart from their appearance and other minor idiosyncrasies, the L.17s had a marked tendency to wallow in flight. In an attempt to cure this habit, 'JJ' was fitted with a modified rudder early in 1935. The Flettner servo was removed and a long inset tab - half the height of the rudder - was built into the trailing edge in its place. In the event, it was discovered that a rearward shift of the centre of gravity was a more effective cure than the inset servo tab, so the original Flettner servo was replaced.

The Short Singapore II was developed into the Singapore III. The first - Construction number S. 770 with RAF serial K 3592 - was on the slipway outside No.3 Shop on 15 June 1934 and the last of batch was launched on 11 November. A further batch of nine production aircraft to Specification R14/34 was followed by an additional sixteen 'boats'. The production was completed in June 1937, with four more, these 'boats' sharing No. 3 Shop with the first fifteen Empire 'boats' off the line and the Sunderland prototype.



9. **Short Bros. photo H 668 (d).** A superb shot of a Short Singapore III, probably K 3592 taken in June 1934 on its first flight. K3592 was ferried by 210 Sqdn personnel to reinforce 205 Sqdn. at Singapore, arriving 5 March 1935.

A week after Specification R 2/33 for a Four Engine General Purpose Boat Seaplane was issued, the Short S.18 flying boat was launched at Rochester. The S.18 was Short Bros.' submission for Specification R 24/31 for a prototype general purpose twin-engined flying boat, capable of carrying out long-range patrol work. The S.18 - RAF serial K 3574 - was a monoplane, while the other two contenders for this Specification offered biplanes - the Saro London (K 3560) and the Supermarine Stranraer (K 3973), both were powered by Bristol Pegasus engines. These two aircraft were awarded production contracts. The Short Bros.'boat was not.

The S.18 was a gull-winged monoplane - the first Short Bros. monoplane flying boat since the S.1 Cackle - powered by two Rolls-Royce steam-cooled Goshawk engines. To gain tip clearance for the large diameter geared-down airscrews, the mainplanes were cranked upwards at a 30 deg. angle to the engines. The knuckle in the mainplane at the engines led inevitably to the nickname of Knuckleduster.

Following traditional shipbuilding practice, the lines of the underwater body and planing bottom of the hull of the new 'boat were developed from those of the previous seven metal hulls. The main step was raked forward from the centre line of the keel and the chine line curved up in a reverse curve as it swept forward producing a greater volume forwards and giving good performance in rough water. These lines produced a 'boat that ran clean on the water and was free from porpoising under normal conditions. The maximum beam - believed to have been 9ft. 0 in. (2.74 m.) - was slightly under that predicted by the so-called 'cube' law. The hull plating was not swept inboard above the chine line in the traditional way but was straight sided, with considerable tumblehome. The hull frames and plating were in Alclad, with stainless steel fittings used at points of high stress, characteristics of the hull (except the tumblehome) later to be incorporated in the design of the Empire 'boat hulls.



10. Short Bros. photo H 618 (b). The Short R 24/31 K 3574 Knuckleduster taxiing on the Medway, November 1933. The high set Rolls-Royce Goshawk engines are evident. The aircraft is in its original form with un-sprung wing tip floats and open tail gunner's position. K 3574 was retired in 1938 to become an instructional airframe at the RAF No. 2 School of Technical Training at Cosford.

The mainplane construction too, foreshadowed that used on the Empire 'boats. The modified Göttingen Gö 436 aerofoil profile had thickness chord ratios of 18.87% of chord at the hull and 13.36% for the outer mainplane panels. The wing spar trusses were high-tensile steel tubular booms, diminishing in gauge and diameter as the loads decreased towards the tips, with tubular lift and drag struts and braced with tie-rods. The squat cylindrical fuel tanks, forerunners of those used on the Empire 'boats, were located between the spar trusses. The wing floats were carried on vertical struts, which were sprung with oleo-dampers, to absorb sudden loads imposed while moving on the water. Lastly, the beaching chassis, and its method of attachment, was an ancestor of the gear used on the Empire 'boats - and the tail trolley appears to be identical. An engine and airscrew changing jib was included in the aircraft's equipment.

The primary function of the new Empire 'boat was to carry un-surcharged mail for the projected Empire Air Mail Scheme (EAMS). IAL's order (2 May 1935) '*for two Flying boats (one for Bermuda)*' sets out the guaranteed minimum performance required from them. They were to carry a payload of 8 200 lb. (3 720 kg.) for 435 n.m. (800 km.) at a speed of 113 knots (208 km. per hr.) True Air Speed against a head wind of 35 knots (64 km. per hr.), with a fuel consumption of not more than 130 gal. per hr. (585 litres per hr.) and were to alight at not more than 63 knots (116 km. per hr.).

A number of assumptions tipped the decision in favour of flying boats as the major partner on the EAMS. The Empire routes were subject to extremes of wind and weather. Existing airfields were subject to flooding by monsoon rain and damage by wind. The Handley Page HP. 42 class, with an all-up weight of 28 000 lb. (12 700 kg.), was thought to be the heaviest land aircraft able to operate from many of the small grass airfields along the routes. The 'A' class Armstrong Whitworth AW XV Atalantas, with an all-up weight of 12 000 lb. (9 525 kg.), flying in partnership with the HP. 42s, had been specially designed for the hot and high sectors of the South African route. The new aircraft for the EAMS would be considerably heavier than either. As they were expected to weigh over 40 000 lb. (18 100 kg.), many of the existing aerodromes would require costly improvements, such as hard surfaced runways, to bring them up to standard. The partners of the Empire 'boats on the EAMS, the Armstrong Whitworth Ensign landplanes, had all-up weights of up to 55 500 lb. (25 174 kg.). They were intended to operate over those parts of the routes which had airports with established facilities.

IAL had flying boat experience with the Short Calcutta and Kent 'boats on the Mediterranean and African sectors, so would be well placed to operate a maritime fleet. Sir Alan Cobham's successful tour of Africa in Short Singapore I G-EBUP, including some route-proving flying southwards up the Nile, was another factor in favour of the flying boat. The EAMS routes, although they crossed some difficult ground and were subject to extremes of the weather, were largely in existence. The establishment of marine airports, with sufficient alternative forced alighting areas, appeared to be feasible and low in capital cost. Some investment however, would be required in the way of port and radio facilities. Eight British Power Boat attendant surface craft had been delivered to IAL by October 1936 and thirty more were on order. The tenders were driven by two 100 hp (74.6 kW) motors at 24 knots, could accommodate 20 passengers and were crewed by a coxswain and deckhand. Most had Marconi and Hermes radios. The design of their hulls was based on the 37ft. 6ins. (11.4 metre) RAF 1931 seaplane tender. One of the RAF tenders - No. 206 - has recently been restored to navigable condition on Southampton Water.

Some smaller Sea Rover 22ft.(7 metre) launches were also on order. The survey flight by 'UV CAMBRIA (Captain L.A.Eggesfield) from Alexandria to Durban in May 1937 loaded Air Ministry radio equipment for the ground stations along the East African coastline at Lindi, Mosambique, Quilemane and Beira, with the equipment being installed as it went.

The routes were over friendly territory for most of their length and for the most part, over water. The four engines specified for the new flying boats would enable the aircraft to maintain height, should an engine fail while over land. If an emergency should occur over water, a flying boat had a good chance of alighting successfully and remaining afloat until help arrived. Lastly, the cost of fuel at ports on the seaboard was likely to be half that at inland airfields in the remoter parts of the world. The cost of aviation spirit in 1936 was 3/9 per gallon or 10p. per litre (PV £ 3.98 per gal. or 88p per litre) dropping to 2/- per gallon (PV £ 1.97) by 1938.

A chain of events in 1934 set the scene for the Empire 'boats. Short Bros. received the 'Outline Specification for 4 Engined Flying Boat' from Imperial Airways Limited on 1 March. The Short L.17 flew for the first time on 26 March. The first flight of the Sikorsky S.42 was three days later. In early May, the Douglas DC.2 was in service with TWA. The second L.17 flew on 17 May. Short Bros.' tender for the Empire 'boats was submitted to IAL on 29 June. The first RAF Expansion Scheme 'A' was published on 19 July. Short Bros.' patent (431 895) describing the spar construction for their new 'boat, was published on 28 July, so design work on the 'boats must have been reasonably well advanced. The Lockheed L.10 Electra entered service with Northwest Airlines on 11 August and the Sikorsky S.42 was in service with Pan American Airways by 16 August. The MacRobertson Air Race took place on 20 October and Igor Sikorsky read his lecture to the Royal Aeronautical Society on 15 November, describing the S.42 in detail. Two days earlier, the patent for IAL's 'adjustable chairs' was published. The Short-Mayo composite was '*... being built ...*' and on 20 December, the Empire Air Mail Scheme was announced in principle and followed by the order for twenty-eight Short flying boats. The Martin 130 Clipper flew for the first time on 30 December.

Oswald Short, Arthur Gouge and John Parker were at Mildenhall in Suffolk, to watch the start of the MacRobertson Air Race to Australia. Competitor No. 44, the first of KLM's Douglas DC.2s, PH-AJU named 'Uiver' (Stork) (Captain K.D.Parmentier) attracted their attention and confirmed their decision that the day of the biplane was well and truly over. The Scion had been flying for sixteen months and the Knuckleduster for eleven months - both monoplanes. The first sketches of the Short S. 22 - the Scion Senior - yet another monoplane - must have been on the drawing boards at Rochester. Competitor No. 34, Arthur Hagg's supremely elegant, but tricky to fly, de Havilland DH.88 with its tapered wing plan and split flaps must also have caught their eye. The DH. 88, registered as G-ACSS and named 'Grosvenor House', was flown by C.W.A.Scott and T.Campbell Black to win the race in 70 hrs. 54 min. - and the prize of £15 000 (PV £ 329 250.00). No. 44, the specially adapted airliner, carrying passengers who had paid 5 000 guilders (PV £ 9 000) each for the privilege of the return flight, finished second - nineteen hours and nine minutes after 'SS 'Grosvenor House'.

Igor.I.Sikorsky gave the 582nd. lecture before the Royal Aeronautical Society on 15 November 1934, describing the design and development of the Sikorsky S.42 flying boat in some detail. He also described the first flight - a short hop - was followed by the first test flight on the next day. Although no one knew it at the time, the first two flights of the S.42 foreshadowed those of the first Empire 'boat, just over two years later. Oswald Short and Arthur Gouge were in the audience and both commented on the lecture.

The inspiration for the design of the Empire 'boats undoubtedly came from Arthur Gouge, the General Manager and Chief Designer at Rochester. He was ably supported by the two Assistant Chief Designers - Messrs C.P.T.Lipscomb and W.C.Jackson and Mr W.Browning, the Head of Stress Office. At Short Bros.' Annual General Meeting in November 1936, Oswald Short paid a handsome tribute to Arthur Gouge, saying that he carried the greatest responsibility for the design of the new 'boat and that the greatest credit should go to him. The major decisions committing the company to the project were taken by Oswald Short but towards the end of his life he considered, with increasing bitterness, that his part in the design of the Empire 'boats had been overlooked.

Arthur Gouge read a paper before the Royal Society of Arts on 10 December 1936, entitled 'Recent Progress in the Design of Civil Flying boats'. Answering questions afterwards, he said that while Imperial Airways Limited were deciding on the specification for the Empire flying boat, he had built a half-scale model. Nothing predicted from this model, concerning the performance of the full-sized flying boat, had to be changed. And he had sold the half-scale model to somebody else and showed a profit.

The half-scale model was the S.22 Scion Senior, the first of which was registered G-ACZG only five days after the historic visit to Mildenhall and flew for the first time on 22 October 1935, almost exactly one year later. The handling and performance of the aircraft on its first flight was excellent. This must have been greeted with considerable relief at Rochester, as the Empire 'boat programme had by then been well and truly committed. Sheet 8 of the Type Record is dated 8 February 1935 showing the estimated wing characteristics of the S. 23. A small diagram on the Sheet establishes the setting out of the mainplane, which were never altered. On the date of the first flight of the S.22, the framed-up hulls of the first two Empire 'boats were in the gantries in No. 3 Shop, with the hull of 'HK Maia alongside. A photograph, dated 15 November 1935, shows the aft spar frame of the first Empire 'boat - Construction No.795 - being assembled from details on its table jig.

1. Ancestry

The Empire 'boats were designed to operate from the waters of sheltered harbours. The hull had to be of adequate strength to conform to the requirements of Air Publication AP 1208 - the Airworthiness Handbook for Civil Aircraft. The hull also had to be of adequate size and volume to ensure its stability at rest on the water. Ease of handling and control on the water, laterally and longitudinally, were obviously important.

AP 1208 required the minimum hull volume to be 4.5 times greater than the volume of the maximum displacement. The minimum required hull volumes for the Empire 'boats therefore, lay between 2 940 cu. ft. (83.25 cu. metres) and 3 847 cu. ft. (109 cu. metres), calculated on the extreme fresh water displacements of 40 500 lb. and 53 000 lb. The volume of an Empire hull was 9 800 cu. ft. (277.5 cubic metres) or about 2.5 times the minimum required by AP 1208. The minimum volume required per passenger was 120 cu. ft. or 2 880 cu. ft. (81 cu. metres) for a full load of twenty-four passengers. The block coefficient - the ratio of the actual volume to that derived from the extreme dimensions of the hull - was 0.675.

The maximum beam dimension of a flying boat was the equivalent of the mid-ship section of a ship, the starting point for the design of the hull. The accepted practice of the day for deciding the beam dimension, was governed by one of the two versions of the so-called 'cube law'. The Rochester version was quoted by Jack Lower in a paper entitled 'The hydrodynamics of marine aircraft', given before the Royal Aeronautical Society in May 1933. The 'law' states that the beam dimension (in feet) is equal to 0.36 multiplied by the cube root of the loaded weight of the aircraft on the water in lbs. Short Bros.' hulls generally followed the 'law' up to the advent of the Empire hull. One of Arthur Gouge's major objectives for the hull of the new 'boat was a significant decrease in the beam. Narrower hulls meant less aerodynamic drag and lower structural weight.

The maximum beam dimension of all Empire 'boats was 10 ft. (3.05 m.). Obeying the 'law', the beam of an S.23 should have been 12.36 ft. (3.77 m.). For an S.30, loaded to 48 000 lb. (21 772 kg.) it should have been 13.08 ft. (3.98 m.) and at the extreme displacement of 53 000 lb. (24 040 kg.), the beam should have been 13.52 ft. (4.12 m.). For comparison, a Felixstowe F.5. with a loaded weight of 12 700lb. (5 760 kg.) had a beam of 20 ft. 4 ins. (6.2 m.).

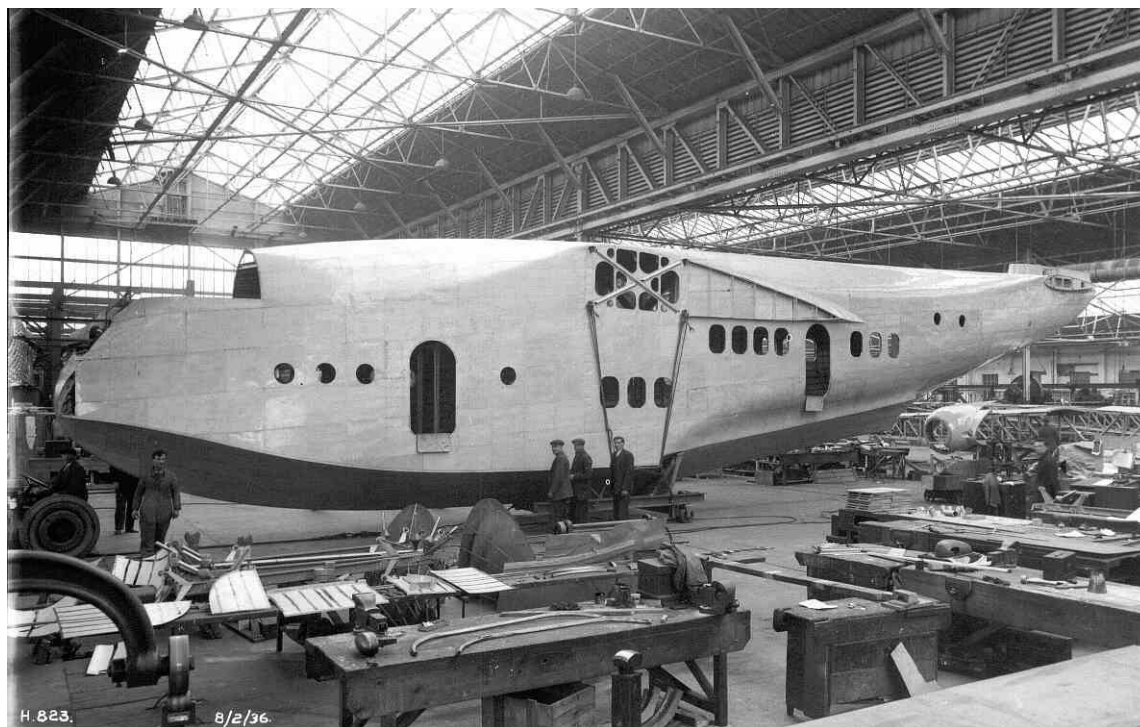

11. Short Bros. photo 832. 8 February 1936. The hull of the first Empire 'boat - minus the coupé, but mated with the tail aft of Frame 42 - newly withdrawn from the gantry, perched on the shop truck. The hull has been turned on to the centre line of the main doors of No. 3 Shop with the nose pointing towards the main doors, ready for eventual roll-out. The date is 8 February 1936 and the time, 16.15. The starboard half mainplane is evident to the right of the photo, beneath the tail.

Mr C.P.T.Lipscombe was responsible for the layout of the hull, developed from that of the Knuckleduster. One of the considerations preoccupying Arthur Gouge, when a change from a biplane to a monoplane layout was made, was the wing-to-hull junction. If a drawing of the front view of the hull of the Knuckleduster is amended to open out the tumblehome, so that the sides of the hull are vertical then increased in height to meet the straightend out mainplanes, one is looking at something very near to the body plan of a two-engined Empire 'boat. The Empire

'boat solution created a precedent which was followed by Douglas, Boeing, Grumman, the later Sikorsky and Consolidated 'boats, the Latecoere 523 and 611, the Saunders-Roe Lerwick and Princess, the Blohm und Voss Bv. 222 Wilking and Bv. 238, the Hughes HK-1 - the so-called Spruce Goose - the Kawanishi H8K1/4 (Emily) and subsequent Short Bros. 'boats.

The displacement of the new Short Bros.' 'boat was more than double that of the Knuckleduster. The beam was increased by a foot from 9.0 ft. to 10.0 ft (2.74 m. to 3.048 m.) and the hull deepened to meet the mainplanes. The height of the mainplane above the water was determined by the airscrew clearance above the water. 5 ft (1.52 m.) was considered to be a reasonable clearance to keep the airscrew discs clear of spray. This clearance, added to the semi-diameter of the airscrew of 6 ft. 4.5 ins. (1.943 m.), gives a minimum of 11 ft. 4.5 ins. (3.46 m.) to the centre of the lower engine. The actual dimension for a standard S.23 at a displacement of 40 500 lb (18 370 kg.) in fresh water was about 11 ft. 8 ins. (3.53 m.), with an inboard engine airscrew clearance of 5 ft. 5 ins. (1.62 m.). With the airscrew of the inner engine in the one-blade-up position, the airscrew clearance was 8 ft.6 ins. (2.6 m.) allowing tenders and refuelling barges ample headroom to pass freely round a 'boat.

The maximum depth of a hull at Frame 20, from the top of the frame to the keelson, was 16 ft. 6 in. (5.05 m.), enabling an upper deck to be inserted in the forward part of the hull, extending from Frame 3 aft to the forward spar frames at Frames 15/16. The flight crew's operating positions were on this fully enclosed upper deck. The passenger accommodation was on the lower deck, occupying about 1/3 of the total volume of the hull. The hull was unpressurised.

The Empire hulls differed from accepted practice, apart from their reduced beam, as they were considerably slimmer than their forbears. The beam:length ratios for three of the Short Bros. commercial hulls were 6.05 for the Calcutta, 6.39 for the Kent and 8.8 for the Empire hulls. Lengthening the hull tended to lighten it and reduce the shock on alighting. It also reduced the fore-and-aft trimming angles about the centre of buoyancy when moving on the water, thereby lessening tendencies to porpoise. The Empire hull was considered to be aerodynamically clean.

The forebody of a flying boat hull - forward of the main step - had to be long enough to prevent the hull wallowing in the water. It also had to have sufficient underwater volume, forward of the centre of buoyancy, to counter the downward thrust couple exerted by the airscrews. Arthur Gouge's rule of thumb was that the forebody and afterbody lengths should be equal, and that they should be the beam dimension multiplied by 2.75. The ratio between these two dimensions was vital to the maintenance of the fore-and-aft stability when the hull was running on the water, to avoid porpoising. He did not quite keep to the rule for the Calcutta and Kent hulls - the ratios were about 2.46 and 2.25 and 2.3 and 2.27 respectively. The Knuckleduster hull and Empire hulls diverged even further. The Knuckleduster ratios were 2.69 and 1.99 and for the Empire hull, the ratios were stretched to 3.5 and 2.33.

For purely aerodynamic considerations a flying boat hull would be better for the omission of steps and chines. The function of the main step was to break the suction that developed along the underside of the planing bottom, as a 'boat moved through the water. If the suction was not broken the 'boat could not, in theory at least, become airborne. As the speed built up, air was drawn in at the break of the chine behind the main step, forming a air bubble of ever increasing size. The step was the cause of much of the water resistance at higher speeds and it was aerodynamically 'dirty' and difficult to manufacture. When the Empire hull was tested in the RAE tank at Farnborough in May 1941, described as '*...a successful modern flying boat with a comparatively shallow main step....*', the conclusion was that deeper steps led to hydrodynamically stable hulls. The function of the rear step was to prevent the hull digging into the water, as the nose of a hull tended to rise as the speed built up. The extreme end of the afterbody on most hulls was curved downwards, to hold the hull on the water until getting-off speed was reached. Much work was done in the Rochester test tank to improve the form of the Empire 'boat's afterbody, resulting in a general improvement of the hydrodynamic and aerodynamic characteristics of the whole hull.

The Calcutta and Kent hulls had single 'humps' at about 17 knots (31 km. per hr.). Tank tests showed the Empire hulls to have a double 'hump' at 20 knots and again at 26 knots (37 and 48 km. per hr.). To compare the three hulls, the water resistance was calculated for a common take-off weight. The Empire hull had lower water resistance than the other two at the 'hump', but greater thereafter, showing the effect of the narrower hull. In later tank tests, the maximum water resistance of a standard S.23 hull at 40 500 lb. (18 370 kg.) displacement, free to trim with 8 deg. take-off flap, to be about 8 250 lb. (36.7 kN) at 22 knots (41 km. per hr.). The variable pitch airscrews of the Empire 'boats - in FINE pitch for take-off - developed a thrust of 13 280 lb. (59 kN) at 20 knots (37 km. per hr.). This compared with the thrusts of the fixed pitch airscrews of the Calcutta of 5 900 lb. (26.24 kN) and the Kent of 9 275 lb. (41.26 kN).

The line of the keel from Frame 10 aft to Frames 20/21 formed the hull datum line. The normal trim angle for a standard displacement Empire 'boat hull at rest in the water, was 4 deg. 15min.- nose-up. Flying boat hulls change their attitude as speed builds up during take-off. The tank tests at Rochester showed that as a standard displacement Empire 'boat began to move, the angle increased to 7 deg. at 15 knots, to 10 deg. at 25 knots, with a peak of 13 deg. at 30 knots, and then decreased to about 12 deg. until the 'boat left the water at about 78 knots (144 km. per hr.).

The following is a quotation from Chris Barnes' comprehensive book *Shorts Aircraft Since 1900* (Putnam 1967) giving the professional's technical assessment of the design.

“Confidence in the basic Empire Boat concept was fully justified by the first few flights of Canopus, and when Caledonia went to Felixstowe for C.of A tests on 15 September, 1936, the M.A.E.E pundits were considerably astonished to find that it could take off at 45,000 lb (30 lb/sq ft) in little more than 30 seconds ‘easily and gracefully’ as E.T.Jones put it in a report in which he estimated that it would also be able to take off in 60 seconds at an overload of 54,000 lb (36 lb/sq ft). He attributed this unexpected take-off efficiency to the combination of high slipstream lift at ‘hump’ speed, clean hydrodynamic design with low spray interference, smooth hull finish without highly flared chines and the effect of the Gouge flap in reducing take-off speed, time and distance. He noted that at the achieved top speed of nearly 200 mph there was a strong case for reducing parasitic air drag caused by wing-tip floats, steps and hard chines and urged a research programme to determine the magnitude of the separate drag contributions of these features, whose cumulative effect was to add some 40 per cent to the drag of a basic streamlined body, “.

The extract goes on to note that Arthur Gooze followed up the suggestions in the report to experiment with variously faired main and rear steps. The results were unfortunately not available in time for incorporation in the Empire hull. The full-sized Empire 'boat hull was remarkably stable on the water at all speeds and displacements - with few exceptions. If a take-off was attempted with FULL flap, especially if the water was dead calm, porpoising could set in at about 50 knots (93 km. per hr.). On occasions this porpoising could be controlled - but only just.

The construction of the mainplanes of the Scion Senior was similar to the Scion, a method that provided an exceedingly stiff structure, free from vibration and flutter. The wing plan of the Scion Senior, a cantilever monoplane, was more aerodynamically efficient than the Scion with greater taper and an elliptical tip, but without flaps. The geometry of the mainplane of the Empire 'boat was based on that of the Scion Senior. The span of an Empire 'boat was reduced from 127 ft. (38.7 m.) to 114 ft.(34.75 m.) at Oswald Short's insistence. This revised span was a little over double that of the Scion Senior, with a span of 55 ft. (16.76m.). The engines of the Scion Senior - Pobjoy Niagaras - were practically half the diameter of the Bristol Pegasus XC engines to be fitted to the Empire 'boats, and the direction of airscrew rotation was the same.

The Empire 'boat was the third Short Bros. design for a monoplane flying boat. The span of 114 ft. (34.75 m.) was constant for all types - S.23, S.30 and S.33. The gross area of the mainplanes for all types was 1 720 sq. ft. (160 sq. m.) with a nett area including the flaps, ailerons and nacelles of 1510 sq. ft. (140 sq. m.) - normally quoted as 1 500 sq. ft. (139 sq.m.). The aspect ratios were respectively 7.56 and 8.60. The datum chord measured 16 ft. 5.5 in. (5.018 m.), at a point 23 ft. 11.32 in. (7.298 m.) from the centre line of the aircraft at right angles to the plane of symmetry. The modified Gö 436 aerofoil used had a thickness to chord ratio of 18.78 % at the junction with the hull, diminishing to an hypothetical 9% thickness to chord ratio at the tip.

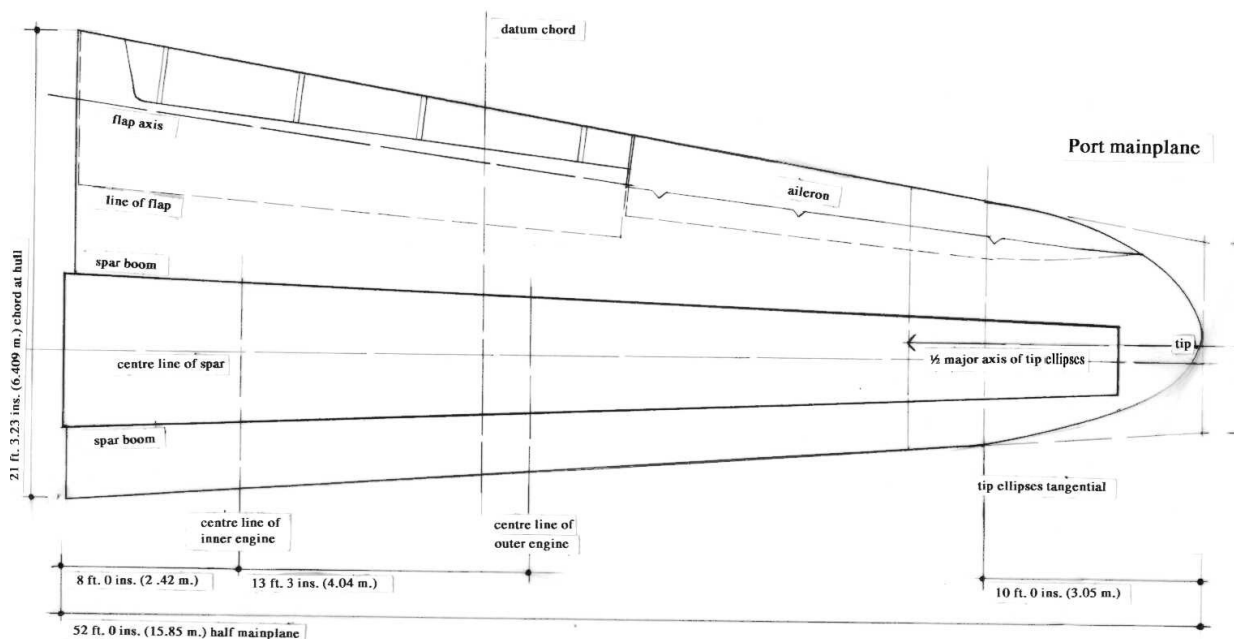

12. Diagram of mainplane geometry.

The mainplane had a medium taper in plan, with a ratio of 1:2.47. If drawn out, the leading and trailing edges and spar plan angles appear to originate from a common point on an extension of the spar centre line, distant some 92 ft. 4.7 ins. (28.161 m.) from the centre line of the hull. The leading edge was swept back at an angle of 4 deg. 16 min. and the trailing edge swept forward at 9 deg. 25min. 14 sec., joining with a double elliptical tip, 8.6 ins. (218 mm.) to the rear of the spar centre line. The ellipses were tangential to the lines of the leading and trailing edges 10 ft. (3.048 m.) inboard from the tip. The width of the mainplane at this point is 10 ft 10.909ins. (3.325 m). The common major axis of the ellipses stretched 26 ft. 8 ins. (8.128 m.) inboard from the tip.

The spar consisted of two massive trussed booms, leading and trailing. This form of construction was chosen as it was possible to stress the members accurately for 95% of the flying likely to be encountered and it was also the lightest structure. The aerofoil datum line was set at a positive incidence of 3 deg. to hull datum. The spar centre line was at right angles to the centre line of the hull, at 31% of the mainplane chord, coinciding with the centre of pressure of the aerofoil, with the leading and trailing spar booms toed in towards each other at angles of 2 deg 14 min. 24 sec. The hull datum point was the leading edge of the datum chord. The centre of gravity was 4.56 ft. (1.4 m.) aft of datum and the range measured 11.3 in. (287 mm.) for the standard S.23'boats, or 0.057% of the datum chord. The spar centre line was nearly in the centre of the range, 5.6 in. (141 mm.) forward of the rear limit. The special category, Mark III S.23 'Atlantic' 'boats had a much reduced centre of gravity range of only 3.7 in. (94 mm.).

The spar axis was a straight line through the mid-camber points of the aerofoil at 31% chord, set at a 3 deg. dihedral. The upper surface of the aerofoil had a nominal dihedral of 1 deg. on the spar centre line.



13. Short Bros. photo H 861. The completed hull of G-ADHL is in the left background, with its two half mainplanes on either side of the tail, sheeted and awaiting the installation of engines. The newly withdrawn hull of G-ADHM is in the centre background. The two half mainplanes in the centre of the photo, showing the spar truss, are for 'HM'. The mainplane spar boxes in the right foreground, ready for sheeting, are for the first Mark II 'boat, G-ADUT.

The modified profile increased the coefficient of lift over the standard Gö 436 profile. With a 'clean' wing, approaching the stall at an angle of attack of 17 deg., the respective coefficients were 1.65 and 1.48. Flaps increased the lift coefficient. At the same angle of attack, the modified profile had a coefficient of 1.85 with 12 deg. flap and 2.08 with 25 deg. flap.

Arthur Gouge quoted a minimum 9 deg. positive angle from datum as the trim angle of an Empire 'boat as it was about to leave the water rather than the 12 deg. angle of the tank tests, putting the mainplanes at an angle of attack of 12 deg. with the engine thrust line aligned with the aerodynamic chord line, a further 1 deg. 8 min. up. At take-off, the modified aerofoil gave a coefficient of lift of 1.4 with the 8 deg. flap setting compared to about 1.2 for the standard Gö 436.

The wing loading chosen for the S.23 'boats was 27 lb. per sq. ft., more than double that of the Kent 'boats, a matter of some concern when the choice of a monoplane layout was decided. The lift/drag ratio for the Empire was 30% better than the Kent. For comparison, the wing loading of the Knuckleduster was 16 lb. per sq. ft., the Sikorsky S.42 flying boat of a comparable size and weight to the Empire 'boats, 28.4 lb. per sq. ft. but later to be increased to 31.34 lb. per sq. ft. for the S.42B version. The Sunderland I had a wing loading of 33.7 lb. per sq. ft. The wing loading of the standard Empire 'boats gave them a cruising speed of 143 knots (265 km. per hr.). The later S.30 and S.33 'boats, with all-up weights of 53 000 lb. (24 040 kg.), had wing loadings of 35.33 lb. per sq. ft. As the power loading was constant, the theoretical cruising speed should have increased to 153 knots (284 km. per hr.).

Higher wing loadings could decrease structural weight. The structure of the Empire 'boats was more efficient than that of the Kent 'boats. The structure of a Kent 'boat was 40% of the loaded weight, the structure of an Empire 'boat was 37% of the loaded weight. The higher wing loading gave greater safety in the air in bad weather and at moorings. 'CX CLYDE rode out a hurricane at its moorings at Lisbon for eight hours on 15 February 1941, before the 'boat was capsized by a punctured wing float. The PAA station staff which had given all possible assistance to BOAC, stated that a Boeing 314 would not have lasted for more than an hour in similar conditions. Higher wing loadings also meant longer take-off runs and increased alighting speeds to be countered by the flaps which reduced the alighting speed and shortened the take-off run.

Any longer take-off runs were not generally an operational consideration, except occasionally in hot, and hot and high, ports such as Lake Victoria (altitude 3 720 ft.) - the highest port on either of the EAMS routes.

The ailerons, of Frise form, were carried on four set back hinges, mass balanced to prevent flutter, with a 21 lb. (9.5 kg.) weight placed 47 ft. 4 1/2 ins. (14.44 m.) out from the aircraft's centre line. They spanned 24 ft. 1.33 ins (7.35 m.) with an inboard chord of 4 ft. 8.3 ins (1.13 m.) and had an area of 67 sq. ft (6.23 sq. m.). When correctly rigged, they drooped slightly by 21/64 in. (8.5 mm.) and some had fixed trim tabs between ribs 13 and 15. The aileron volume was 0.0462.

The mainplane flaps, which were so essential for the operation of the new 'boats', were the subject of a patent taken out in the joint names of Short Bros. and Arthur Gouge. The patent (443 516) was applied for on 7 January 1936, when the hull of the first 'boat' was nearing completion in its gantry in No.3 Shop and the mainplane spar booms were being assembled. The flaps, referred to as 'controllers' in the patent Specification, were also called up in other places in the literature as 'control flaps', 'mainplane flaps', and 'flaps'. The switch operating the flaps on the Control Deck was labelled 'controller flaps'. They are referred to here as flaps. A description of the flaps reads, in the language typical of a patent specification, as follows:

'This invention relates to wings for aircraft and has for its object the provision of means for enabling the aerodynamic characteristics of wings to be altered during flight. The invention may be applied to any normal wing of a section deep enough to allow a recess to be formed in the underside of the trailing portion adapted to receive a controller section having an upper surface curved to a part-cylindrical or conical formation, whilst its under surface completes the normal contour of the wing section.'

As Arthur Gouge had limited experience in the design of flaps, he tried out the new device on the modified wing of the Short Scion II G-ADDR. The standard metal-framed and fabric covered wing was replaced with an all timber mainplane of tapered plan form, obviously foreshadowing the Empire mainplane. Photographs show the modified wing fitted with a pair of the new controller flaps. The modified mainplane is described as being '*...very heavily loaded...*' and '*...a scale model of an Empire 'boat wing...*'. The wing loadings of a standard Scion and a standard S.23 Empire 'boat' were respectively 12.5 lb. per sq.ft and 27 lb. per sq. ft. To load the modified wing of the Scion to that of a standard Empire 'boat' would have drastically reduced its area. It was possible to get a Scion weighing 2 400 lb. (1 088 kg.) into the air, with two crew and full fuel and oil. At an Empire 'boat' wing loading, the Scion's wing area would have had to have been reduced from 255 sq. ft. to 89 sq. ft. (21 sq. m. to 8.26 sq. m.). The newly designed flaps were tested by John Lankester Parker over a period of eight weeks, with 'DR' flying in 'B' condition markings as M.3. M.3 was passed to the RAE for assessment and it was generally agreed that the new flap was a success. When fitted to an Empire 'boat', the Gouge flaps reduced the alighting speed by some 10 knots.

The patent specification states that the controllers could be used differentially although the Gouge flaps fitted to the Empire 'boats' could not. On the one recorded occasion when an Empire 'boat' alighted with differential flap settings - a failure of the mechanism on the starboard flap allowed it to run out to the full extent while the port flap was at a lesser setting - the aircraft could just be held on the ailerons. M.3 was subsequently fitted with another experimental wing with full-span Gouge flaps and spoilers in place of ailerons - no doubt to test the differential action. The project turned out to be a near disaster, halting further development along these lines.

The upper surface of the flap used on an Empire 'boat' was a nearly true segment of a cone, slightly flattened towards the trailing edge, where the retracted flap formed part of the upper surface of the aerofoil. Let into the upper surface of each flap were the tracks, which enabled the flap to move out and down, turning on the axis of the cone with a vertex angle of 10 deg. 30 min. The under surface was slightly curved, conforming to the modified Gö 436 aerofoil profile. The flaps on standard S. 23 'boats' were moved by a single small electric motor, which took a full minute to wind them out to the full flap position of 25 deg. and a minute and a half to retract them. Each flap had a span of 26 ft. (7.92 m.), a chord of 33% of the mainplane chord and an area of 149 sq. ft. (7.67 m.). At a take-off flap setting of 8 deg. or 1/3 OUT, the mainplane area increased by 55 sq. ft. (5 sq. m.) and as the angle of incidence was about 7 deg. at the start of the take-off run, the flap increased the coefficient of lift from 0.9 to 1.0. Just before leaving the water, the angle of incidence had increased to about 12 deg. and the coefficient of lift from 1.3 to 1.4. With the flaps in the fully extended position for alighting, the mainplane area was increased by 130 sq. ft. (12 sq. m.) or 8.66% and the coefficient of lift approached 2.1 as the 'boat' rounded out with the points of both steps of the planing surface, touching simultaneously.

There was no change of trim to the aircraft as the flaps were moving OUT or IN, nor at the three most commonly used flap settings of 8 deg., 12 deg. and 25 deg. The extended flap at any setting did not interfere with the efficiency of the elevators and the drag was low.

The tail plane aerofoils used at Rochester were normally of RAF 30 symmetrical section. For the Empire 'boats' the thickness to chord ratio was increased from the standard 12.64% to 13.75%. The overall span of the tail plane was 32 ft. 1.3 in. (9.79 m.) and chord 9 ft. (2.74 m.). The combined area of each plane and elevator was 92.5 sq. ft. (8.6 sq. m.). The area of each elevator was 39.75 sq. ft. (3.7 sq. m.) with an inset trimming tab of 1.26 sq. ft. (0.12 sq.m.). The tailplane volume was 0.387.

The fin and rudder used the same profile and thickness to chord ratio as the tailplane, with a area of 122 sq. ft. (11.34 sq.m.). The chord was 12 ft. 6 ins, (3.81 m.). The rudder area was 52.46 sq. ft. (4.87 sq.m.) with two inset

tabs each of 0.86 sq. ft. area. The lower tab was a conventional trimming tab, while the upper tab acted as a servo to assist in turning the rudder - normal practice for Rochester 'boats with large rudders. The fin and rudder volume was 0.073.

The servo tab, probably developed from the experimental tab used on the rudder of 'JJ Scylla and referred to in the patent specification as a 'servo flap', was patented (463 184 by Short Bros. and Dudley Lloyd Parkes) on 7 August 1936. The patent states:

'This invention relates to control surfaces of aircraft of the type in which a servo flap (sic) is pivoted to the trailing end (sic) of the control surface, and the object of the invention is to provide means for automatically angularly adjusting the servo flap by the angular adjustment of the control surface itself, the mechanism for communicating adjustment to the servo flap being completely contained within the major control surface.'

The first Empire 'boat, 'HL CANOPUS, was launched and flown without the servo tab. A photograph of No.3 Shop, taken on 30 July 1936, shows 'HL minus its rudder, flaps and elevators so it seems likely that the servo tab was in process of being fitted.

The transverse stability of the 'boats was achieved by fitting wing floats of three types. Type 1, with a buoyancy of 6 000 lb. (26.7 kN), was fitted to the first generation S.23 'Atlantic' 'boats. Type 2, with a buoyancy of 5 000 lb. (22.2 kN), was fitted to the thirty-one S.23s and probably to the early marks of Sunderland. An untyped float, with a buoyancy of 6 000 lb. (26.7 kN), was fitted to the later S.30 and S.33 'boats. All the floats had a single step and pointed aft ends. The revised Type 1 was somewhat finer in the nose than original Type 1 and generally the more 'aerodynamic' in appearance with a very small step - more a discontinuity in the planing surface than a definite step. The block coefficients were almost the same, 0.49 for Type 1 and 0.47 for Type 2. The three types of float, and Sunderland floats, were interchangeable with each other.

The floats were carried on tubular light-alloy chassis struts, streamlined with light-alloy casings - patented in 1930. Springing the wing tip floats was first tried on the Knuckleduster. The sprung panel bracing of the Empire 'boats was taken an evolutionary step further. The first twenty-eight S.23 'boats were fitted with a patented sprung panel bracing arrangement, (463 008 on 11 February 1936) allowing some forward and backward movement of the float chassis, to absorb shock while moving on the water. It was discovered in service that most damage to the float chassis occurred from sideways and upward forces, rather than from shocks to the nose so the device was replaced by a much simpler un-sprung, X-shaped, wiring plate.

The Empire 'boats were ordered straight off the drawing board, a decision that caused many sleepless nights for the managements of Short Bros. and IAL. The flying boat standing on the slipway at Rochester on 1 July 1936, lashed down and chocked awaiting its engine runs, was the culmination of a process that began some twenty years before.

The development of the hull of the new 'boat started with the Cromarty, with its concave planing bottom. It continued through the Cockle - the world's first metal-hulled flying boat - the Singapore I and II, the Calcutta, the Singapore III with its raked forward main step, the stately Sarafand - the second largest flying boat of its day - the Kent 'boats and finally the Knuckleduster. Mainplane development started with the adoption and modification of the Göttingen Gö 436 aerofoil, probably on the Singapore I. The cantilevered monoplane wing was first used on the Scion, developed further for the Scion Senior and the Knuckleduster, and ultimately for the Empire, Sunderland and Stirling wings. The half-sized flying precursor of the Empire 'boats, the Scion Senior, had a wing plan that was doubled up for the Empires. The highly effective Gouge flaps were tried out on the modified mainplane of the 'DR Scion II, flying as M3.

The fuel tanks installed in the mainplanes of the Empire 'boats, first appeared on the Knuckleduster. The Frise ailerons were first used on the Singapore I, the Bristol air-cooled radial engines on the Calcutta, the quick-release hook on the Kents and the engine changing jib, the rudiments of the beaching chassis and the tail trolley, on the Knuckleduster. The rudder servo tab was tried on 'JJ Scylla. Like the L.17s, the Empire 'boats could carry a spare engine.

Short Bros. were not entirely consistent in the naming of the various compartments and cabins inside the hull of the Empire 'boats and the names differed from those used by IAL. The upper deck was sometimes referred to as the 'cockpit' - which it was not - and sometimes as the 'control cabin'. Besides the pilot's positions, this control cabin included the wireless station, the Flight Clerk's original working station and the mail room. As a compromise between 'control cabin' - the more accurate of the descriptions - and the contemporary 'flight deck', it is named here as the 'Control Deck'.

The cabin between the main spar frames for example, was usually called up by Short Bros. as the 'Centre Cabin' but is sometimes referred to as the 'mid cabin' but usually known as the 'spar cabin' by the IAL crews. 'Centre Cabin' is used here. The food preparation space on the lower deck is referred to in the Maintenance Manual as the 'buffet' in some places and as the 'pantry' in others. 'Pantry' has been chosen as the most frequently used, and most appropriate, name. The toilets were known as 'lavatories' in the Maintenance Manual and are called so here.

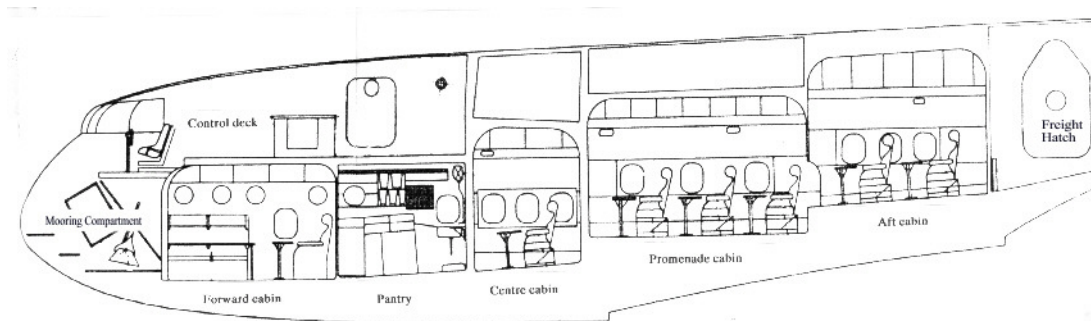

14. Section through an S.23 showing the accommodation on upper and lower decks. The pantry was on the starboard side, with the lavatories opposite on the port side. The passenger cabins show the seating on the starboard side.

The flight crew's operating positions were in the fully enclosed cabin on the upper deck. The Captain occupied the port side pilot's seat with the First Officer beside him to starboard. The wireless station was immediately behind the Captain. The Control Deck stretched from Frame 3 - the forward point of windscreen of the coupé, - aft to the forward spar frame at Frames 15/16 - a distance of about 23 ft. (7 metres). By the standards of the day, the Control Deck was considered to be 'luxurious'. It was certainly adequately roomy and not unduly noisy, although un-lined. Bare and workmanlike might be a reasonable description. The panels of the windscreen were well rounded in both dimensions and shed the rain without recourse to mechanical wipers. Despite the Bostick and the water test, the windscreens on some of the 'boats leaked in monsoon rain conditions. The visibility from the pilot's seats through the ample windscreen forwards and to the sides was extensive - 'excellent' - was Captain J.C.Kelly-Rogers' description. The noise levels on the Control Decks of Empire 'boats and the Boeing 314As were comparable although the level of vibration on the 314As was more noticeable. The Control Decks of the two 'A' 'boats were insulated when the cabin heating arrangements were changed in late 1944 or early 1945.

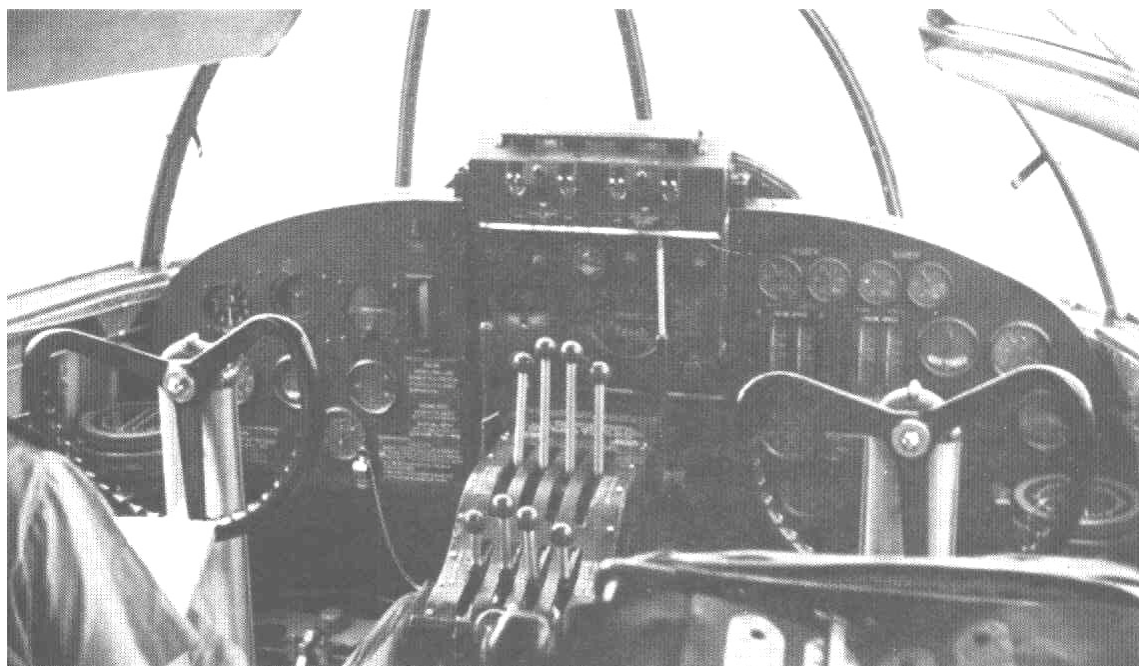

15. Captain Alderson photo. The Control Deck of 'UU CAVALIER in flight. 'UU is cruising on automatic pilot, somewhere over the Atlantic between Bermuda and the USA. The altimeter reads 9 500 ft., the oil pressures are 80 lb. per sq. in. and the engine speeds are 2 100 rev. per min. Note the whistle hung from the Captains dashboard. The unfurled blind on the port side might indicate that 'UU was on the way to Bermuda. The shoulder, on the left of the photo, belongs to Captain Alderson.

The Radio Officer sat immediately behind the Captain on the Control Deck, facing aft. The importance of close and instant communication between the pilots as the 'eyes' of the aircraft, and the Radio Officer as it's 'mouth and ears', was crucial. The Flight Clerk's original work station on the Control Deck was soon moved down to the Forward Cabin on the lower deck, doubling as a hold for mail and freight and providing a much more convenient working position.

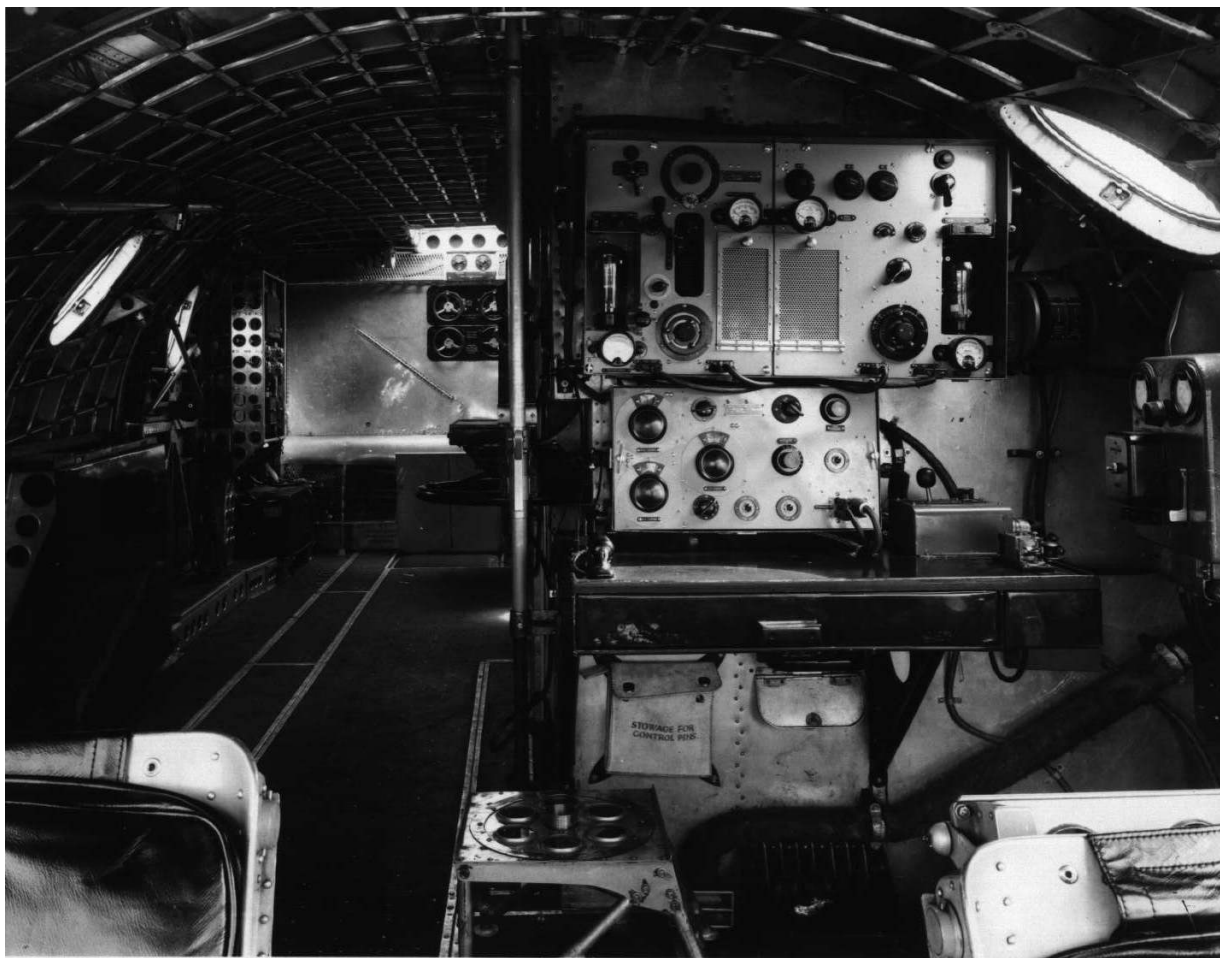

16. Short Bros. photo H 928. The Control Deck looking aft. The Radio Officer's station is on the right of the photo, showing the 1937 equipment for the normal range S.23 'boats. On the left of the photo, the Control Deck extends aft to the bulkhead at Frames 15/16. The escape hatch is OPEN. Reading down from the opening are: the Telelevel fuel tank contents gauges, the two carburettor air intake shutter control wheels and the fuel pump test cock control wheels. The fuel tank cock controls are roof mounted, to the left of the hatch opening. The main electrical switchboard and battery are to starboard, forward of the bulkhead, with the desk of the Flight Clerk's original working station, opposite. The two ports on the starboard side are in the mail loading hatch (rear most) and over the navigator's chart table (folded down).

'JK Syrinx, one of the L.17 landplane cousins of the Short Kent flying boats, susceptible as ever to wind gusts, was overturned whilst taxiing at Brussels Airport, crushing the nose and damaging the aircraft extensively. The passengers were unharmed but three of the crew were injured. The remains of the aircraft were returned from Belgium to Rochester by barge for re-building, their arrival coinciding with the construction of the Empire 'boat accommodation mock-up. It was decided to re-construct 'JK's cabins in the style and colours of the new Empire 'boats. 'JK Syrinx emerged from the re-building, a second generation hybrid, with Bristol Pegasus XC engines of the same ratings used for the Empire 'boats and an Empire 'boat interior, including the ventilation system. The chronic shortage of engines in the earlier days was such that 'JK's Pegasus engines were earmarked for the Empire 'boats, if the need should arise. The Empire 'boat specification called for Sperry automatic pilots to be fitted. During the re-building of 'JK it was originally intended to fit a Sperry automatic pilot but its installation had to be abandoned to speed up the reconstruction. Even so, 'JK was out of service for eleven months. It was test flown by John Lankester Parker on the same day as the work was completed, 12 September 1936. The first of the Empire 'boats, 'HL CANOPUS, had been launched with the passenger accommodation un-trimmed. The interior fittings and equipment were installed later, when the 'boat was overhauled before entering service. 'HL was launched again and flew, complete with its newly trimmed interior, on 17 September 1936. The photograph on the title page of this book shows 'HL on the slipway ready for launching, fully complete. So by a quirk of history, the first Empire 'boat passenger accommodation to take to the air was not in a flying boat but in 'JK Syrinx, an L.17 land plane.



17. Short Bros. Photo H 938 20 October 1936. The forward Smoking Cabin of 'HJ CANOPUS', looking forward. The entry hatch to the mooring compartment is in the bulkhead at the end of the table, with a double cold air punkah louve unit on either side. One of the two ceiling lights is visible. The pillars took the ends of the bunks. This cabin was later converted to a mail room and office for the Flight Clerk.

The entry and servicing arrangements on the lower deck were divided between the port and starboard sides of the aircraft. Passengers and crew entered through two passenger hatches on the port side, the forward hatch being the most used for loading and unloading. The servicing arrangements for mail, baggage, freight, pantry stores and refuelling were on the starboard side, except for the chemical toilets from the lavatories. These were serviced through the passenger entry hatches. The restricted circulation on the lower deck occasionally led to some slight confusion and delay at disembarkation. The control tenders, which were never designed to come alongside a flying boat, often had to be used to ferry passengers and other loads to and from the aircraft at moorings. On occasions on the Horseshoe route, the tender meeting a newly arrived boat would drop off the Traffic Officer through the open forward passenger hatch and then go forward to assist with the mooring. It had been known for some TOs, hurrying back to the tender, stepped through the hatch without looking. The forward passenger entry hatch on the port side was at the rear of the forward passenger cabin, with a step down to the floor. A curtain and track was arranged to form an entry lobby.

The Forward Cabin - originally the Smoking Cabin - occupied the lower deck from the bulkhead at Frame 6, aft to Frame 11. The dimensions were about 9 ft. 10 ins. (3.0 metres) long with an average height - the floor sloped - of 6 ft. 10 ins. (2.1 metres). Cigarettes were allowed in the Smoking Cabins, pipes and cigars were not. The airflow inside the passenger accommodation in flight was forward, confining the smoke to the Forward Cabin. When the cabin was taken over as the forward hold, including the Flight Clerk's office, smoking was confined to the Aft Cabin, distributing the smell of smoke throughout the 'boat.

In the original arrangement seven day passengers were seated - two two-seater and one three-seater. The one window was on the starboard side. Four bunks could be rigged for use by night. The six ports had pull-down blinds. The two bunk windows were fitted with flaps to close out the daylight. There were positions for a maximum of seven wall and bunk lights, with switches and Steward's call buttons incorporated, which could be interchanged for day and night use. All passenger cabins were fitted with light-weight hat racks and hold-alls. When the Forward Cabin was converted to the Flight Clerk's office, some cut-away diagrams show a ladder against the bulkhead at Frame 11, direct to the Control Deck above. Photographs of the interior of 'TY CLIO in process of conversion to military status clearly shows the ladder and its arrival on the Control Deck. There is no hatch as the opening is protected by a guard rail. The forward bulkhead at Frame 6 gave access to the mooring compartment.

At the rear of the Cabin, an outward opening door led to the Corridor. The Corridor was offset slightly to port between Frame 11 and the forward spar frame, giving access to the pantry and lavatories. The Pantry was on the starboard side, entered from the corridor. The exact disposition of the Pantry equipment is not known with accuracy. The stainless steel sink, draining board with plate draining rack over, plate stowage rack, cup rack and glass rack were all ranged along the starboard side of the aircraft. The detailed arrangement of the other equipment, the ice chest, hot box, syphon rack, tray rack, fruit rack, wine rack, cabinet and storage for the vacuum flasks is uncertain. A fixed and folding table was provided and a refuse bin. The water supply was from a 22.5 litre (5 gal.) cold water tank. A folding seat completed the equipment. The first aid box and the emergency ration pack were also in the pantry. Pantry stores were loaded through the window hatch above the sink. Two 12 watt ceiling lights were provided.

On 29 June 1939, a conference took place at Rochester to discuss a modified pantry arrangement for the three S.33 aircraft. The a revised layout was prepared and costed by Short Bros for the later 'boats. The revision must have been radical because although the extra weight was only 14 kg. (31 lb.), the cost was £595 (PV 12 000) per aircraft added to the cost of a standard pantry of £ 305 (PV£ 6 100), making a total of £ 900 (PV£ 18 000) for the new design. The proposal was retained for future consideration but never implemented. The original, and perhaps the only, ladder between the decks in normal use was in a recess in the pantry.

Continuing towards the rear of the aircraft, a door from the Corridor opened into the Centre Cabin, squeezed between the two main spar frames, about 6ft. 0ins. (1.8 metres) long, 9ft. 10 ins. (3.0 metres) wide and 8ft. 0ins. (2.5 metres) high. There were six windows and two bunk windows. All the windows and ports were fixed on aircraft up to the twelfth 'boat of the second batch - 'UG COOGEE. The windows were modified on the later 'boats so that all windows could be opened in emergencies. Instructions for use were fixed below each window explained that it could be opened with a sharp blow with the hand or foot towards an edge. The earlier aircraft were retro-fitted with the modified windows. Three IAL seats were fitted, two to starboard and one to port. Four bunks could be rigged. The concealed bullion locker was under the floor - approximately under the aircraft's centre of gravity. There were seven light positions with a maximum of four lights and one 36 watt ceiling light. The entry to the Promenade Cabin to the rear was one step up.



18. Short Bros. photo 8S126-3 An interior photo taken from the Centre Cabin, looking aft into the Promenade Cabin, showing the Promenade space. A combined wall and bunk light with Steward's call button is to the left of the opening. An escutcheon for the end of a bunk is to the right of the opening. The passenger entry hatch is in the centre of the photo. The Aft Cabin is in the background.

The Promenade Cabin stretched from Frame 20/21 aft to Frame 28 - about 19 ft. 8 ins. (6 metres) long, 9 ft. (2.7 metres) wide, with a height of about 7 ft. 9 ins. (2.36 metres). The six or eight adjustable seats, with tables, were arranged in three groups of two on the starboard side of the Cabin, with two doubtful single seats on the port side. The Maintenance Manual loading diagram shows these two seats but none of the interior

photographs - including Photo 18 on the facing page - show them. If these seats were fitted, the passengers in them could not see out of the higher level windows, nor could most of the promenade space be used. The promenade space was popular with passengers allowing them to stretch their legs during a flight and to stand and watch the unfolding panorama through the four windows. Being un-pressurised, the 'boats flew at heights anywhere between 500 ft. - and sometimes much lower - to a normal operational height of 10 000 ft., so there was often much to see, cloud conditions and the atmosphere permitting. A handrail below the windows enabled standing passengers to steady themselves, should a 'boat run into a patch of bumpy air. The four windows on the starboard side were at the normal height for seated passengers, with two bunk windows above. Four bunks could be rigged. An additional escape hatch was provided in the S. 30, and presumably, S.33 'boats. The aft passenger hatch between Frames 26 and 28, was on the port side of the aircraft, at the rear of the Promenade Cabin. The aircraft's registration plate was just inside the door. A step up through the doorway led to the Aft Cabin.

The Aft Cabin extended from Frame 28 to Frame 33 - a distance of about 9 ft. (2.8 metres). The Cabin was about 8ft. 6ins.(2.6 metres) wide and 8ft. 6ins. (2.6 metres) high. The daytime seating was for six passengers, two pairs in IAL seats on the starboard side with tables and two single seats on the port side, each with a table. There were six windows and two bunk windows. Four bunks could be rigged. There was access to the stowage room above the ceiling of the Promenade Cabin where the bunk fittings, mattresses, pillows, linen and blankets and top bunk access ladders were stowed. An escape hatch, with folding access ladder, was provided at the forward bulkhead. A door, offset to port in the aft bulkhead, led to the freight room in the tail. In the revised passenger seating arrangement, the Aft Cabin became the Smoking Cabin, a not altogether satisfactory arrangement as the forward airflow inside the aircraft in flight distributed the smoke through the Promenade and Centre Cabins. The Bermuda 'boat, 'UU CAVALIER, seems to have had two Smoking Cabins, fore and aft and the full complement of twenty-four passengers.

The freight room was not so much a room as a space to the rear of the Aft Cabin. The freight room was normally used for the stowage of freight, passenger's luggage and the occasional spare engine. Captain Alderson managed to get a sailing dinghy into the freight room of 'UU CAVALIER, in course of delivery to Bermuda. The flooring extended to Frame 39 - about 11 ft. (3.4 metres). Once in the freight room, it was possible to walk to the tail of the aircraft, as there was no rear bulkhead. The luggage and freight was secured by nets and straps to cleats on the frames. The two-part freight hatch was in the starboard side, between Frames 35 and 37. Also stowed in the freight room were the hull and float bilging pumps. The engineer's platforms and cradles, the engine, airscrew and seat covers and the engine transport beam and stay, the trolley and chain block were stowed aft of the floor, when they were carried.

From the start of the design of the Empire 'boats to the first flight took about one hundred and eight weeks. The estimated requirement for the Empire Air Mail Programme was for twenty-six aircraft, with two spares. The anticipated service life was ten years, with a replacement aircraft needed in service by 1944.

The design and construction of the new 'boats proceeded in secrecy. The two new aircraft for the Empire Air Mail Scheme - the Armstrong Whitworth Ensign and the Short flying boat were announced by the Chairman of IAL, Sir Eric Geddes at the annual general meeting of the company on 31 October 1935. The first public illustration of an Empire 'boat is believed to have been on the front cover of that year's annual report.

About a week before the first Empire 'boat took to the air, a contract was signed between Pan American Airways and the Boeing Airplane Company for the construction of the first six of the twelve Boeing 314 flying boats. The Boeing 'boat was designed under the leadership of Wellwood Beall and based on the already developed wing and tail of the XB-15 bomber. The take-off weight of the new 'boat was 82 500 lb. (37 420 kg.) or a little over twice that of a standard S.23 Empire 'boat. Like the S. 23s, the 314s were innovators in their time. But it took Boeing nearly thirty-six weeks to rectify the serious design defects of the first of their new 'boats. An early high-speed taxi run nearly ended in the loss of the 'boat when a gust of wind caused a wingtip to dip. Keeping the 'boat straight in the air was described by Eddie Allen, the test pilot, as akin to herding a reluctant buffalo. The sponsons and tail plane had to be modified before the first 314 could be granted its certificate of airworthiness and the step of the later version, the 314A, was moved aft to cure porpoising tendencies. The time from the first flight of NC 18601 Honolulu Clipper to delivery was eighty-five weeks. The first Empire 'boat flew its first commercial service less than sixteen weeks after launching.

The new Empire 'boat was launched on 2 July 1936, the twenty-eighth metal hulled 'boat down the Rochester slipway. It was just over twelve years since the Cockle had been launched on the Medway. The next day was Short Bros.' sports day so the Seaplane Works were practically deserted. John Lankester Parker had 'HL CANOPUS cleared for flight with the intention of trying some fast runs on the river, to get the 'feel' of the 'boat before the first flight. The 'boat handled so well that he took off and flew for fourteen minutes. Reluctant flaps were the only snag, so the first alighting was made without their help. 'HL CANOPUS (J.L.Parker) left the buoy for the first - official - flight on 4 July 1936, with all engines running and took off in 17 seconds at a weight of 37 140 lb. (16 846 kg.).



19. Short Bros. Photo H.907 (g). 'HL CANOPUS gathering speed for take off on 4 July 1936 before an assembled multitude of spectators. Note the original sprung float arrangement, the un-painted mahogany trim tab, the lack of the upper servo tab on the rudder and the original position for the owner and port of registration lettering.

Climbing steadily, John Parker turned 'HL CANOPUS and made for the open water of Gillingham Reach, in case a hasty alighting should become necessary. 'HL returned over the Seaplane Works, made a steep climbing turn to starboard and disappeared from sight up the Medway valley. Turning, 'HL reappeared over the Seaplane Works and finished the flight with a low pass down the middle of Tower Reach, to show the 'boat off to the invited audience and work force of Short Bros. It had also been arranged beforehand that a low pass would indicate to Oswald Short and Arthur Gouge that all was well. The flaps refused to go out again on the approach. So the second alighting was also made without their help, un-noticed by most of the spectators, the aeronautical press and luckily, the shareholders of Short Bros. There are believed to be few air-to-air photographs of this flight, as the new 'boat was too fast for the photographic chase aircraft. Certainly there was very thin photographic cover in the aeronautical journals of this, the first official flight. 'The Aeroplane' published a photograph of the flapless arrival and one ground-to-air shot. The second official flight on 6 July 1936 was photographed from G-ACHI, one of IAL's Westland Wessex G-ACHI (Captain H.G.Travers).

In contemporary terms the new flying boat was an advanced aircraft. The fact that there were only minor details requiring attention was a vindication of the care that went into its design and construction. The Certificate of Airworthiness trials for the standard S.23 Mark I aircraft and special category 'boats were carried out in October 1936 with 'HM CALEDONIA, a Mark III and the second 'boat off the line. At the end of the trials, the MAEE report made six recommendations. They were an indicator to signal that the flaps were in the FULL OUT position, a short ladder for access to the flap motor in case of malfunction, a modification of the engine starting handle, a modification to the maintenance platform for easier access to the engine nacelles and carburettors, a re-positioning of the fuel tank filters and some insulation to the top of the rear fixing strap of the main battery. The Type Certificate was granted on 4 December 1936.

There is a coda to the story. At the end of 1939, Major Mayo drew up a specification for a replacement 'boat for the Empire fleet when they came to the end of their working lives. The replacement was to be powered by four Rolls-Royce Merlin engines, breaking the traditional use of the air-cooled engine, and to carry fifteen day passengers and 3 175 kg. freight and mail, over a 652 nautical mile sector, against a 35 knot headwind, at a cruising speed of 152 knots. Surprisingly, in view of the experience of night flying on the Empire Air Mail Programme routes, ten passenger bunks were to be provided.

Arthur Gouge, who already had in mind flying boats with displacements of 180 000 lb. (81 600 kg.), was due to deliver a paper before the Institution of Mechanical Engineers in New York, in September 1939. He was thinking of flying boats of double the weight of anything then flying, making direct crossings of the Atlantic, possibly powered by compression-ignition engines buried in the wing. Neither he, nor Major Mayo, had an inkling of the revolution that was about to overwhelm the air transport world during World War II, leaving no place for the economic operation of marine aircraft.

In 1943 Oswald Short resigned as Chairman of the company, to become Honorary Life President. Arthur Gouge moved from Rochester to Cowes to become Vice-Chairman of Saunders-Roe Ltd. His main responsibility was to direct the design and construction of the R 14/40 'boat, with an all-up weight of 125 000 lb. (56 700 kg.). It was assembled in October 1944 at Rochester as the Shetland. The Brabazon committee met in the same year, to establish the shape of British commercial aircraft after the war. The committee were considering flying boats for

1. Ancestry

the South Atlantic and Pacific routes. Saunders-Roe had detailed proposals for large flying boats of 184 000 lb., 187 000, and 250 000 lb. displacements (83 500 kg., 84 800 kg. and 113 400 kg. respectively), with various engine arrangements. The last proposal, P 136/1 and 2, was the basis of the ultimate British marine aircraft, launched in 1952, as the Saunders-Roe SR 45 Princess. It had a displacement of 330 000 lb. (150 000 kg.) - nearly eight times that of a standard Empire 'boat and three times that of the Dornier DoX. The only Princess to fly - G-ALUN (G.A.V.Tyson and J.S.Booth with a crew of twelve) - was launched during the night of 20-21 August 1952. After twenty-eight minutes of taxiing, 'UN took off for the first time at 12.29 on 22 August 1952, for a flight of thirty-five minutes. The second and third Princesses never received engines. 'UO, the second 'boat was launched on 13 February 1953 and towed to Calshot to be cocooned and desiccated for storage. All three were finally scrapped at Cowes on the Isle of Wight in 1967.

3. Production

Names

Imperial Airways Limited started naming its aircraft in 1926, after cities in the Commonwealth and United Kingdom. The policy changed in 1931, matching the initial letter of the aircraft's name to that of the manufacturer. The two Avros 10s were named G-AASP Achillies and G-ABLU Apollo, to be followed in 1935 by the two Avro 652s, G-ACRM Avalon and 'RN Avatar (later Ava). The classical trend was followed by the Handley Page 42s. Whoever chose the names must have had a grounding in Greek and Roman history and mythology - G-AAGX Hannibal, 'UC Horsa, 'UD Hanno, 'UE Hadrian, 'XC Heracles, 'XD Horatius 'XE Hengist and 'XF Helena. The three Short S.17 Kent class flying boats maintained the tradition - G-ABFA was named Scipio, followed by 'FB Sylvanus and 'FC Satyrus. The well established precedent was maintained for the next batch of aircraft - the Armstrong Whitworth AW XV Atalanta fleet. The two Short L.17 landplane versions of the Kent flying boats - G-ACJJ Scylla and 'JK Syrinx - followed the Kent 'boats.

The choice of 'C' rather than 'S' as the class initial for the Empire 'boats was an accident of the alphabet. 'A' was occupied by the Armstrong Whitworth AW XV Atalantas and the Avros, 'B' by the Boulton and Paul P 71As 'OX Boadicea and 'OY Britomart, 'D' by the de Havilland DH 86A Diana class, 'H' by the Handley Page HP. 42s and 'S' by the Short S.17s and L.17s. 'C' was hitherto unused and therefore available for the Empire 'boats with 'E' reserved, and subsequently used, for their landplane partners, the AW 27 Ensigns.

The names of the forty-two Empire 'boats were chosen from a full list of one hundred and twenty five - a diverse mixture of the classical, the literary, the national, the regional, persons or just names beginning with the initial letter 'C'. All the 'boats were first entered on the UK registry and all originally given names starting with 'C'. The Qantas Empire Airways and two of the Tasman Empire Airways Limited 'boats were re-registered when taken on their national registers.

Eight of the 'boats had their originally chosen names subsequently changed and these are noted below. Three S.30 aircraft, S.884 to S.886, were re-named as 'A' 'boats when allotted to Tasman Empire Airways Limited and had their names changed from Captain Cook, Canterbury and Cumberland. S.884 was registered G-AFCY and launched as AO-TEA-ROA, with the New Zealand registration of ZK-AMA. The hyphenated name drew a protest from the New Zealand Government. Before delivery to TEAL, 'CY was re-registered ZK-AMC and re-named AWARUA. S.885 became G-AFCZ AUSTRALIA and never reached New Zealand, being retained by IAL and BOAC. After being out of service for three months to repair the damage inflicted by the grounding at Basra, 'CZ was re-named CLARE. S.886 was launched as G-AFDA AWARUA with the New Zealand registration of ZK-AMC. Re-named AOTEAROA, and re-registered as ZK-AMA, S.886 became the first of TEAL's 'boats..

In 1942, three BOAC 'boats - 'TV CORIOLANUS (acquired August 1942), 'UB CAMILLA (acquired August 1942) and 'PZ CLIFTON (acquired July 1943) - were re-registered in Australia as VH-ABG, VH-ADU and VH-ACD in exchange for two QEA 'boats - 'BA CARPENTARIA and 'BF COOEE, which were taken back on the British registry as G-AFBJ and G-AFBL. These aircraft appear in the text with both registrations, before and after 1942. 'BE COORONG reverted to its original British registration - G-AEUI - in 1939 after it was rebuilt. Nine of the 'boats subsequently found themselves in military service at some time during their careers, four in the RAF and five in the RAAF, and therefore carried military serials.

The S.23 Empire flying boats on the Empire Air Mail Programme were equipped with headed writing paper when first introduced into service, as befitted their station somewhere between an ocean going passenger liner and first class hotel. The notepaper was printed with the aircraft's badge and a literary quotation or allusion that gives some clue as to the choice of name. Post cards of the 'boats were also available.

The list below gives the construction numbers, the design index, registrations of the 'boats, their names and their military serials, where applicable. Some of the aircraft had badges and where these are known, they are described. Registration, Certificate of Airworthiness and delivery dates are given when known. There is some debate over some of the dates, delivery dates in particular. Where there is an IAL or BOAC listing, this is followed. The eventual fate of the aircraft is noted.

3. Production

S.795 S.23 G-ADHL CANOPUS. *'Canopus is a city distant by land from Alexandria 120 stadia (22 miles). It has its name from Canopus, the pilot of Menelaus, king of Sparta, who died there'*. The quotation is from Strabo the Geographer (64 BC-24 AD). Also the second brightest star (no.2326 apparent magnitude – 0.72 distance 300 light years).

The badge shows a Greek bireme under oar with sail furled and Canopus evident, aft.

Ordered 24 January 1935. Registered 17 June 1935. CoA 20 October 1936. Delivered 22 October 1936. Broken up Hythe. 23 October 1946.

S.804 S.23 G-ADHM CALEDONIA. The allusion is to Scotland and the notepaper had a two-line quotation from Lord Byron (1788-1824).

The badge shows a spray of thistle with two heads.

Ordered 27 May 1935. Registered 17 June 1935. CoA December 1936. Delivered 4 December 1936. Broken up Hythe. 23 March 1947.

S.811 S.23. G-ADUT CENTAURUS Impressed into RAAF as **A-10**. Some say the son of Apollo (Avro Ten G-ABLU) and father of the centaurs by the mares of Thessaly. Others say he was a hero with a serpent's tail.

The badge shows two centaurs being fed by a woman. Also the ninth brightest constellation.

Ordered 24 January 1935. Registered 7 October 1935. CoA 28 October 1936.

Delivered 7 December 1936. Transferred to QEA September 1939

Destroyed at moorings Broome WA. 3 March 1942.

S 812 S.23 G-ADUU CAVALIER A quotation from a poem by William Wordsworth (1770-1850) headed the notepaper *'The cavalier was eager to depart.'*

The badge shows a cavalier, hatted and booted.

Ordered 27 May 1935. Registered 7 October 1935. CoA 26 November 1936. Delivered 10 December 1936. Crashed North Atlantic. 21 January 1939.

S.813 S.23 G-ADUV CAMBRIA. The allusion is to Wales with another quotation from a poem by William Wordsworth (1770 – 1850).

Ordered 27 May 1935. Registered 7 October 1935. CoA 15 January 1937. Delivered 21 January 1937.

Broken up Hythe. January 1947.

S.814 S.23 G-ADUW CASTOR. One of the twin sons of Zeus and Leda. The quotation was from T.E.Lawrence (1888 - 1935). Also the twenty-sixth brightest star (no. 2890 apparent magnitude 1.58 distance 45 light years).

The badge shows Castor on horseback.

Ordered 27 May 1935. Registered 7 October 1935. CoA 23 December 1936. Delivered 2 January 1937. Broken up Hythe. 4 February 1947.

S.815 S.23 G-ADUX CASSIOPEIA. Mother of Andromeda (AW XV G-ABTH) and subsequently transformed into a star by Poseidon. Also the twenty-fifth biggest constellation in the northern sky..

The badge shows Cassiopeia, cloaked.

Ordered 27 May 1935. Registered 7 October 1935. CoA 25 January 1937. Delivered 1 February 1937. Crashed Sabang 29 December 1941.

S.816 S.23 G-ADUY CAPELLA. A she-goat transformed into a star as a reward for supplying milk to the infant Jupiter. Also the sixth brightest star (no. 1708 apparent magnitude 0.08 distance 45 light years).

The badge shows an eight-pointed star.

Ordered 27 May 1935. Registered 7 October 1935. CoA 16 February 1937. Delivered 16 February 1937. Holed in Batavia harbour. 12 March 1939.

3. Production

S.817 S.23 G-ADUZ CYGNUS. One of the many defenders of Troy killed by Achilles (Avro Ten G- AASP). His spirit was changed by Poseidon into a swan. Also the sixteenth brightest constellation. The badge shows a man-headed swan.
Ordered 27 May 1935. Registered 7 October 1935. CoA 1 March 1937. Delivered 3 March 1937.
Crashed Brindisi. 5 December 1937.

S.818 S.23 G-ADVA CAPRICORNUS. A sign of the zodiac. Also the 40th brightest constellation in the southern sky.
Ordered 27 May 1935. Registered 7 October 1935. CoA 14 March 1937. Delivered 16 March 1937.
Crashed Ouroux, France. 24 March 1937.

S.819 S.23 G-ADVB CORSAIR. A privateer of the Barbary coast. The quotation is from a poem by Lord Byron (1788 – 1824).
The badge shows a corsair, arms folded, legs astride.
Ordered 27 May 1935. Registered 7 October 1935. CoA 3 April 1937. Delivered 8 April 1937.
Broken up Hythe. 20 January 1947.

S.820 S.23 G-ADVC COURTIER.
Ordered 27 May 1935. Registered 7 October 1935. CoA 21 April 1937. Delivered 24 April 1937.
Crashed Athens. 1 October 1937.

S.821 S.23 G-ADVD CHALLENGER. The quotation is from a poem by William Wordsworth.
*“With staff in hand across the cleft
The challenger persued his march”*
The badge shows a medieval knight with drawn sword.
Ordered 27 May 1935. Registered 7 October 1935. CoA 8 May 1937. Delivered 6 May 1937.
Crashed Mosambique. 1 May 1939.

S.822 S.23 G-ADVE CENTURION. The quotation was from Julius Caesar (100-44 BC).
The badge shows a centurion with shield and drawn sword.
Ordered 27 May 1935. Registered 7 October 1935. CoA 29 May 1937. Delivered 29 May 1937.
Crashed Calcutta. 12 June 1939.

S.838 S.23 G-AETV CORIOLANUS VH-ABG. The hero of the play by William Shakespeare (1564 - 1616).
The badge shows Coriolanus, his wife Vergilia and their son, Marcius.
Ordered 2 September 1935. Registered 1 March 1937. CoA 17 June 1937. Delivered 17 June 1937.
Broken up Sydney. End of 1947.

S.839 S.23 G-AETW CALPURNIA. The daughter of Piso and wife of Julius Caesar. The quotation was from Plutach (c.46 - c.120 AD).
The badge shows a Roman matron.
Ordered 2 September 1935. Registered 1 March 1937. CoA 28 June 1937. Delivered 30 June 1937.
Crashed Lake Habbaniyah 27 November 1938.

S.840 S.23 G-AETX CERES. The quotation was from Ovid (43 BC-17 AD). Ceres was the giver of wheat to the world and the first law maker.
The badge shows Ceres, seated, holding a sheaf of corn in her right hand, outstretched.
Ordered 2 September 1935. Registered 1 March 1937. CoA 16 July 1937. Delivered 17 July 1937.
Destroyed by fire at Durban. 1 December 1942.

S.841 S.23 G-AETY CLIO Impressed into RAF as **AX 659.** One of the nine Muses, the proclaimer. The quotation was from Decius Magnus Ausonius (c.309-392).
The badge shows Clio declaiming from a scroll.
Ordered 2 September 1935. Registered 1 March 1937. CoA 26 July 1937. Delivered 30 July 1937.
Crashed Loch Indal. 22 August 1941.

3. Production

S.842 S.23 G-AETZ CIRCE. The sorceress in the Iliad who turned Odysseus' crew into swine during their return journey from the Trojan War.

The badge shows Circe with two swine at her feet.

Ordered 2 September 1935. Registered 1 March 1937. CoA 16 August 1937. Delivered 16 August 1937. Lost without trace between Broome and Tijilatjap. 28 February 1942.

S.843 S.23 G-AEUA CALYPSO Impressed into RAAF as **A18-11**. The daughter of Thetis and Oceanus who kept Odysseus captive for seven years on the mythical island of Ogygia on his way back to Ithaca from Trojan War.

The badge shows Calypso with left arm raised.

Ordered 2 September 1935. Registered 1 March 1937. CoA 26 August 1937. Delivered 27 August 1937. Transferred to QEA September 1939. .

Crashed in sea off Daru Papua-New Guinea, damaged & sank. 8 August 1942.

S.844 S.23 G-AEUB CAMILLA.VH-ADU. Daughter of Metabus King of the Volsci. Protected by the goddess Diana, Camilla could run through grain without trampling it and through the sea without wetting her feet. She died in battle at the head of her company of Amazons. The quotation was from Alexander Pope (1688-1744). The badge shows Camilla about to fire an arrow from a bow.

Ordered 2 September 1935. Registered 1 March 1937. CoA 13 September 1937.

Delivered 13 September 1937. To QANTAS August 1942.

Crashed Port Moresby 22 April 1943.

S.845 S.23 G-AEUC CORINNA. A Greek poetess of Tanagra, flourishing c. 500 BC. A contemporary of Pindar (c.522 - c.438 BC). The badge shows Corinna playing the harp.

Ordered 2 September 1935. Registered 1 March 1937. CoA 25 September 1937.

Delivered 29 September 1937.

Destroyed at moorings Broome WA 3 March 1942.

S.846 S.23 G-AEUD CORDELIA AX 660. Cordelia was a Duchess of Burgundy.

The badge shows the Duchess, arms outstretched.

Ordered 2 September 1935. Registered 1 March 1937. CoA 9 October 1937. Delivered 9 October 1937.

Broken up Hythe early April 1947.

S.847 S.23 G-AEUE CAMERONIAN. Allusions to Scotland. Originally named Cairngorm.

Ordered 2 September 1935. Registered 1 March 1937. CoA 23 October 1937. Delivered 23 October 1937.

Broken up Hythe. January 1947.

S.848 S.23 G-AEUF CORINTHIAN. A passing allusion, perhaps, to the Gulf of Corinth, well known to crews and passengers on the approach to, and departure from, Athens. Originally named Cotswold.

Ordered 2 September 1935. Registered 1 March 1937. CoA 9 November 1937. Delivered 6 November 1937.

Crashed Darwin. 22 March 1942.

S.849 S.23 G-AEUG COOGEE Transferred to QEA September 1939 as **VH-ABC** Impressed into RAAF as **A18-12**. Name 'means mist rising from water'

A suburb of Sydney NSW. Represented the State of New South Wales. Originally named Cheviot.

Ordered 2 September 1935. Registered 1 March 1937. CoA 8 January 1938. Delivered 3 January 1938.

Transferred to QEA September 1939. Impressed into RAAF. Crashed Townsville Qld. 1 March 1942.

S.850 S.23 G-AEUH CORIO Transferred to QEA as **VH-ABD**. Represented the State of Victoria.

Originally named Coolin.

Ordered 2 September 1935. Registered 1 March 1937. CoA 10 February 1938.

Delivered 10 February 1938. To QEA October 1938.

Shot down near Koepang. 30 January 1942.

3. Production

S.851 S.23 G-AEUI COORONG VH-ABE. A lake in South Australia.
Represented the State of South Australia. Originally named Calpe.
Ordered 2 September 1935. Registered 1 March 1937. CoA 26 February 1938.
Delivered 26 February 1938. To QEA September 1938.
Broken up Hythe. 10 February 1947.

.876 S.23-G-AFBJ CARPENTARIA VH-ABA. The Gulf of Carpentaria is a shallow inlet of the Arafura Sea in North Australia. Represented the Territory of Northern Australia.
Ordered 27 April 1937. Registered 26 August 1937. CoA .Delivered 3 December 1937.
To QEA June 1938.
Broken up Hythe. 19 January 1947.

S.877 S.23 G-AFBK COOLANGATTA Transferred to QEA. **VH-ABB**
Impressed into RAAF as **A18-13**. A town in Queensland.. Name means 'high land overlooking water' Represented the State of Queensland.
Ordered 22 June 1937. Registered 26 August 1937. CoA 19 April 1938. Delivered 18 December 1937.
To QEA 18 March 1938. Impressed into RAAF 8 November 1941. Returned to QEA 29 July 1943.
Crashed Rose Bay Sydney NSW. 11 October 1944.

S.878 S.23 G-AFBL COOEE VH-ABF. Transferred to QEA. . *Cooee* is the long-distance communication call of the Australian aboriginal in the bush. Represented the State of Tasmania.
Ordered 22 June 1937. Registered 26 August 1937. CoA 30 March 1938. Delivered 30 March 1938.
Broken up Hythe 2 February 1947.

S.879 S.30 G-AFCT CHAMPION.
Ordered 21 October 1937. Registered 15 November 1937. CoA 27 October 1938.
Delivered 28 October 1938.
Broken up Hythe. 16 March 1947.

S.880 S.30 G-AFCU CABOT V 3137. Sebastian Cabot (c1476- 1557) explorer, associated with Bristol, voyages across the North Atlantic and the discovery of Newfoundland.
Ordered 21 October 1937. Registered 15 November 1937. CoA 8 March 1939. Delivered March 1939.
Destroyed near Bodø. 5/6 May 1940.

S.881 S.30 G-AFCV CARIBOU Impressed into RAF as **V 3138**. The Canadian name for the wild reindeer.
Ordered 21 October 1937. Registered 15 November 1937. CoA .Delivered 7 or 13 July 1939.
Destroyed Bodø. 5 May 1940.

S.882 S.30 G-AFCW CONNEMARA. A part of County Galway in the Republic of Ireland, bordering on the Atlantic coast.
Ordered 21 October 1937. Registered 15 November 1937. CoA 25 March 1939.
Delivered 25 March 1939.
Destroyed by fire Southampton Water. 19 June 1939.

S.883 S.30 G-AFCX CLYDE. A river in the west of Scotland, flowing through Glasgow and once famous for its shipbuilding industry.
Ordered 21 October 1937. Registered 15 November 1937. CoA 29 March 1939.
Delivered 30 March 1939.
Wrecked Lisbon. 14 February 1941.

S.884 S.30 G-AFCY AWARUA ZK-AMC. Originally launched as **ZK-AMA AO-TEA-ROA**, re registered ZK-AMC & re-named **AWARUA**. Maori name for two arms of a harbour at the extremity of South Island used as a canoe landing. Originally named Captain Cook.
Ordered 21 October 1937. Registered 15 November 1937. CoA .Delivered 21 April 1939.
Broken up Auckland on 3:8:1948.

3. Production

S.885 S.30 G-AFCZ AUSTRALIA. Originally named Canterbury. Later re-named **CLARE**.
Ordered 21 October 1937. Registered 15 November 1937. CoA 6 April 1939. Delivered 24 April 1939.
Destroyed by fire in the air off Bathurst, West Africa 14 /15 September 1942.

S.886 S.30 G-AFDA AOTEAROA ZK-AMA. Originally launched as **ZK-AMC AWARUA**, re-registered **ZK-AMA** & re-named **AOTEAROA**. Transferred to QEA. Maori name for 'long white cloud'.
Originally named Cumberland. .
Ordered 21 October 1937. Registered 15 November 1937. CoA Delivered 25 May 1939.
Broken up Auckland. After October 1947.

S.1003 S.30 G-AFKZ CATHAY. The medieval European name for China.
Date of order not known. Registered 10 November 1938. CoA 26 February 1940. Delivered 8 March 1940.
Broken up Hythe 9 March 1947.

S.1025 S.33 G-AFPZ CLIFTON VH-ACD Leased to RAAF as **A18-14**.
A suburb of the City of Bristol.
Ordered 7 June 1939. Registered 27 January 1939. CoA Delivered 17 March 1940.
Leased to RAAF 12 March 1942. Released from RAAF 26 June 1943 & bought by QEA.
Crashed Rose Bay Sydney NSW during a training accident. 18 November 1944.

S. 1026 S.33 G-AFRA CLEOPATRA. Cleopatra VII (69-30 BC) Queen of Egypt.
Ordered 7 June 1939. Registered 27 January 1939. CoA 8 May 1940. Delivered 10 May 1940.
Broken up Hythe. 4 November 1946

S. 1027 S.33 G-AFRB. Never named.
Ordered 7 June 1939. Registered 27 January 1939. Hull stored 12 April 1940.
Scrapped 1943

Tasman Empire Airways Limited used the names 'Australia' and 'Aotearoa' for subsequent aircraft, the TEAL Short S.25 Sandringham IV ZK-AMD being named 'Australia' in 1946. 'Aotearoa' was handed on to the Short S.45 Solent ZK-AML (Aotearoa II in 1949), to Douglas DC. 6 ZK-BGA (Aotearoa III in 1954) and finally to Lockheed Electra L 188C ZK-TEA (Aotearoa in 1959). By the time the Boeing 377 Stratocruisers were delivered to BOAC in 1949, the surviving Empire 'boats had been scrapped, all except Aotearoa in Auckland. The BOAC 377s were given names picked from the 'C' class list, displaying a sad lack of originality and imagination in contrast to the compilers of the original list. The first 377 to arrive, G-AKGH, was named 'Caledonia' to be followed by 'GI 'Caribou', 'GJ 'Cambria', 'GK 'Canopus', 'GL 'Cabot', 'GM 'Castor', G-ALSA 'Cathay', 'SB 'Champion', G-ANTX 'Cleopatra', 'TY 'Coriolanus', 'TZ 'Cordelia', G-ANUA 'Cameronian', 'UB 'Calypso', 'UC 'Clio' and 'UM 'Clyde'.

In 1963 de Havilland Comet 4C XS 235, named 'Canopus', was delivered from the production line in Chester to the Aeroplane & Armament Experimental Establishment at Boscombe Down as a navigational trials aircraft. For the next three decades XS 235 did little flying, only clocking up a total of 8 2000 hours. The aircraft was threatened with auction until the National Air Pageant, supported by Lord Brabazon of Tara, petitioned the Secretary of Defence, Micheal Portillo MP to withdraw it from sale. He did as his last act in Government. XS 235 was sold to the de Havilland Aircraft Museum Trust but ownership was later acquired by the British Aviation Heritage Collection at Buntingthorpe. XS 235 departed Boscombe on 30 October 1998 on its last flight (Captain Sqn Ldr M.Leonczek, G.Delmege, C.Ware, N.Newton and N.Paull) for Bruntingthorpe where it now forms part of the Museum's collection.

Production

The design and production of the Empire 'boats took place against a rising tide of political tension in Europe. The disarmament talks in Geneva broke down completely on 28 June 1934. In less than three weeks the first RAF Expansion Scheme, Scheme 'A', was published, calling for an additional forty one RAF squadrons by 31 March 1939. Six of these squadrons were to be equipped with flying boats. This requirement for thirty-six flying boats remained unchanged in successive Schemes up to Scheme 'M' in April 1938.

The now-famous Air Ministry Specification No. R. 2/33 for a 'Four Engined General Purpose Boat Seaplane', issued to established flying boat constructors on 23 November 1933, was in Short Bros.' hands when the Imperial Airways Limited Empire 'boat specification arrived at Rochester. Surprisingly, the IAL project was considered by Short Bros. to be more urgent than the 'Military 'boat', as the original order for the IAL flying boats stipulated a first flight by 30 April 1936. The first Empire 'boats were given design index S.23 and the 'Four Engined General Purpose Boat Seaplane' became S.25, re-defined under the provisions of Specification No. 22/36 and later given the name of Sunderland. The prototype Sunderland, K 4774, was launched on 14 October 1938, the first of no less than three hundred and forty-one to be built at Rochester, out of a total of seven hundred and forty-nine of all types. Forty Sunderland Is had been delivered by the outbreak of war on 3 September 1939. The later versions of the Empire 'boats received design indices of S.30 and S.33.

Short Bros.' tender for the new Empire flying boat had been submitted to IAL at the end of June 1934, an *'instruction to proceed'* was received at Rochester on 24 January 1935 and a confirming order placed on 19 February for two aircraft - a 'prototype' and a 'Bermuda' 'boat, for delivery on 1 May and 1 June 1936 respectively. The original order for two S.23 aircraft contained a proviso that a further ten aircraft could be ordered not later than 31 May. During the construction of the first 'boat - the 'prototype' - time had slipped somewhat. It was launched two months after it should have been delivered.

Production started in the Drawing Office, stretched out along the back of the Seaplane Works, above and behind Nos. 11 and 13 Shops. The 12 000 drawings required for the production for the first S.23 'boat were produced in some 147 000 man-hours by more than seventy draughtsmen, under the direction of the Chief Draughtsman, A.G.Parkes. A photograph of the Drawing Office shows the draughtsmen packed in, board to board. Among the draughtsman was one of author Joseph Conrad's two sons.

The order for the first two 'boats included a stipulation that the principal drawings should be submitted to Imperial Airways Limited for approval and signature before being passed for production. The order from Imperial Airways Limited to Short Bros. required the drawings, together with *' all special tools, jigs and fixtures to be preserved by Short Bros. during the useful life of the aircraft, together with working drawings.* Drawings and prints of the Empire 'boats are now hard to find. Despite an extensive search in all the more obvious places, the only aircraft prints known to exist are those of Drawing Number S.23.C.29.013, forming part of the Type Record. It shows the interior layout of a Mark II S.23 - the 'Bermuda' 'boat. Tantalisingly, the numbers of some of the other drawings are mentioned on the documents forming the Type Record. The hull lines were shown on S.23.C.1000, the hull construction on S.23.C.1001, the planing bottom plating on S.23.C.1006 and the topside skin plating on S.23.C.1008 but to date, no copies of these drawings have been found. At the end of the production run, the drawing negatives were stored at Rochester until the Seaplane Works closed in 1948. They were transferred to Belfast as part of the general move to Northern Ireland. Storage space in Ireland became increasingly scarce and the negatives, as well as all remaining prints, were subsequently incinerated. Burnt too, were all the calculations from the Stress Office - almost everything went up in flames. Part of the Type Record documents miraculously survived the inferno, shut away in a cupboard. and have recently (1993) been discovered. The paper work of a complete Type Record, but sadly without any accompanying drawings, is now lodged at the RAF Museum at Hendon.

The only other drawing with an S.23 prefix known to exist is a print from an original issued by the Jig and Tool Drawing Office. The drawing number is S.23.C.30.012 and shows the shop truck used in No.3 Erecting Shop. When a hull had been completed in the gantry, the shop truck was wheeled in beneath it and jacked up to take the weight, enabling the hull to be withdrawn. The hull remained on the shop truck until the beaching chassis was attached, just before the aircraft was finally rolled out. The complete chassis weighed 1 897 lb. (825 kg.). The drawing shows a substantial eight-wheeled truck fabricated from mild steel channels and angles, with screw jacks at each corner. A shadowy line on the drawing shows part of

3. Production

the sheer plan of the aircraft, with the position of the main step indicated in relation to Frames 15/16 and 20/21 - the two spar frames. The shop truck picked up the weight of the hull on profiled cradles at the spar frames. An end elevation of the truck shows the hull sections at the spar frames, giving the profiles of the underwater planing body at these two points. A schedule of materials completes the drawing. No date is visible, but the drawing refers to differences between the first and second trucks and subsequent ones. The inference is, therefore, that the drawing was made while the first Empire hull was on the stocks in the gantry, probably in the later part of 1935. Photo 11 on Page 22 shows the shop truck beneath the hull of 'HL CANOPUS, newly emerged from the gantry.

Short Bros. Construction method shadowed traditional ship building. Once the design drawings had been completed, the lines of the hull were laid out, full size, on the Mould Loft floor. The lines could then be checked for truth and any necessary corrections made to the drawings. Offset tables for the keelson and frames were made from the corrected drawings, to enable the Jig and Tool Drawing Office to complete the drawings. The templates for the keelson and the top of hull, the scribe boards for the hull frames and the other jigs, could then be made up.

Before the production of the new aircraft began, the Drawing Office sent a copy of each component drawing and material schedule to the Planning Office of the Production Department. Here the drawings and materials schedules were examined and the materials requisition chits - red card and two flimsies - made out. The drawing and the requisition chit was then passed to the Rate Fixing Department to determine the tools and jigs needed to make each component. Decisions were made in consultation with the foremen concerned, and the necessary orders for tooling and jigs were passed to the Jig and Tool Drawing Office. When all the components had been considered in this way, an accurate assessment of the amount of time required for each stage of the construction was consolidated into a Production Chart, with individual Progress and Precedence Charts for each component. The Production Chart was duplicated and issued to the heads of all the Departments. As Sunderlands were going through the Shops at the same time as the Empire 'boats, the jigs for the two aircraft were distinguished by colour to prevent misunderstandings. The Empire 'boat jigs were painted RED and those for the Sunderlands, YELLOW.

The Empire 'boats were described as being of 'all metal' construction, a concept that had been changing over the years from a metal hulled 'boat with metal framed mainplanes to an almost completely metal aircraft. The Empire 'boats were 'all metal', except for the fabric covered parts of the fin, tail planes and the flight control surfaces, and the trim and servo tabs which were solid mahogany.

The construction of the first of the new 'boats did not go entirely to schedule. The order from IAL gives the delivery date as 1 May 1936, with the second 'boat to follow a month later. An early production photograph - 15 November 1935 - shows the two main spar frames well advanced in assembly on their table jigs. The after section of the hull - aft of Frame 42 - also well advanced - was in its own jig nearby.

The first hull was withdrawn on the shop truck at the end of the first week of February 1936. Once withdrawn, the hull was swung round through a right angle on to the centre line of the main doors of No. 3 Shop, with the nose pointing towards the slipway, ready to be rolled out at the end of Stage 18. The mainplane spar boxes were in the process of being sheeted. The first of the Pegasus engines was due from Bristol by the end of June 1935 but had not arrived. The remaining three engines were to have been delivered by the end of November 1935. The first engines - starboard inner and outer - were actually fitted to the mainplane on 19 May 1936. By the end of the month, the mainplanes had been erected on the hull - complete with engines. The fin and tail planes were in place - minus the rudder and elevators. The interior was nearing partial completion, as the passenger accommodation had not been trimmed. The first set of beaching gear was ready for fitting. The date of the scheduled first flight had slipped by eight weeks - something of an achievement for the first 'boat off the line.

The Production Chart was published in a copy of Aircraft Engineering, dated August 1939. The Production Chart appears to indicate a theoretical construction time of twenty-four weeks from start to The Production Chart finish. In fact, it seems that the Production Chart was not always rigidly followed. Indeed, it is possible that the Production Chart timing was never attained in actual practice. From the available data, thirty-seven weeks for S. 885 'CZ AUSTRALIA seems to have been the fastest production time achieved in reality. Production times are available for the last twelve 'boats of the complete production run of forty-three aircraft, from the first S.30 - S.879 'CT CHAMPION - onwards, counting G-AFRB as the forty-third 'boat.

The shortest recorded time in the gantry from the laying of the keelson in Production Stage 3, to the withdrawal of the completed hull from the gantry in Stage 13 is twenty-two weeks for S.885 'CZ AUSTRALIA. The longest time was thirty-five weeks for S.883 'CX CLYDE. The hull for the forty-third

3. Production

'boat - S.1027 G-AFRB - was withdrawn after seventeen weeks in the gantry, 90% complete. Although not strictly an Empire 'boat, the hull of 'HK Maia - the lower component of the Short-Mayo composite - was in its special gantry alongside the Empire hulls, for more than eighty weeks.

A detailed diary exists of the latter part of the construction of G-AFKZ CATHAY - Construction Number S.1003 - the single S.30 'boat ordered as a replacement. The assembly sequence for this aircraft was not quite as smooth and ordered as it should have been if the Production Chart had been followed. The 'boats were coming out of No. 3 Shop at the rate of one every two weeks in 1937. To achieve this rate of production, there must have been a much stricter adherence to the Chart. In order to maintain the impetus when the first and second production hatches were going through No. 3 Shop, it would seem that the average time in the gantry must have been in the order of twenty-four weeks.

It has been difficult on occasions to place a particular part or item in the correct Stage of the Production Chart. The construction diary of 'KZ CATHAY sometimes gives a clue to the placing of an item in the right sequence. Some items are elusive and their placing is conjectural.

The construction stages shown on the Production Chart were:

Stage 1 Making frames and keelson.

Stage 2 Erection of stocks.

Stage 3 Erection of hull frames, alignment of frames, fitting and rivetting of stiffeners.

Stage 4 Spar frames and centre section assembled to hull, complete with stiffeners.

Stage 5 Beaching chassis and tail trolley fittings on hull. Hull sheeted and rivetted.

Stage 6 Bottom floor structure, steps, entrance doors and escape hatches.

Stage 7 Control chassis and control columns. Throttle box and instrument panel fitted. Tail section fitted to hull.

Stage 8 Top and bottom floors and skirtings fitted. Retractable bollard fitted. Drogue eyes and boxes fitted. Flying and cock controls pulley banks, fairleads and brackets fitted.

Stage 9 Windows, roof brackets, bunk, parcel rack and table fittings. Electrical conduit and lamp brackets fitted.

Stage 10 Cabin furnishing grounds and ventilation ducts fitted. Pantry and lavatory partitions fitted.

Stage 11 Coupé, fitted to hull.

Stage 12 D/F loop, radio table, chart table and purser's tables fitted. Ventilation and control guards fitted. Sorting partitions and stowages fitted. Cabin interior trimmed.

Stage 13 Hull withdrawn from gantry. Erection of tail planes, tail elevator, fin and rudder.

Stage 14 Fitting of engines and engine controls completed.

Stage 15 Main planes erected on hull.

Stage 16 Beaching chassis erected on hull.

Stage 17 Wing tip floats fitted.

Stage 18 Controls completed. Aircraft assembly complete.

3. Production

Some component items were supplied to Short Bros. as embodiment loans for incorporation as 'free issue'. Quoting from the order, IAL undertook to supply the following:

(a) One Wireless installation for telephony, telegraphy, and direction finding.

(b) One complete electric generating and lighting installation.

(c) Four Bristol engines of 'Perseus' and 'Pegasus' types without airscrews, exhaust manifolds, tail pipes, air intakes, oil coolers, cowling (including inter-cylinder baffles), gas starters *sic* the engines of the Empire 'boats were electrically started), Tel Tachometers, but otherwise complete and ready for installation.'

The radio installations provided by IAL were on lease from Marconi's Wireless Telegraph Co. Ltd. It is not known if the Hermes radios fitted to some of the later aircraft were leased by IAL or BOAC, or bought outright.

All components, assemblies and sub-assemblies manufactured at Rochester were given part numbers. The main assemblies carried an SB prefix. Smaller components carried S.23 prefixes and, where they differed, presumably S.30 and S.33 prefixes.

The main assemblies of Construction Number S.881, the Mark III S.30 Empire 'boat 'CV CARIBOU, were as follows:

Hull SB 3509

Main planes SB 3493 (port) SB 3501 (starboard)

Engine nacelles SB 3207 (port outer) SB 3205 (port inner)

SB 3206 (starboard inner) SB 3208 (starboard outer)

Flaps SB 3785 (port) SB 3786 (starboard)

Ailerons SB 3112 (port) SB 3117 (starboard)

Floats SB 2905 (port) SB 2904 (starboard)

Fin SB 3167

Rudder SB 3176

Tail planes SB 3153 (port) SB 3154 (starboard)

Elevators SB 3128 (port) SB 3129 (starboard)

'Free issue' and bought-in items were called up by their manufacturer's own identification. 'CV CARIBOU was originally fitted with Bristol Perseus engines numbered 20505 to 20508 - port to starboard - which in turn were fitted with de Havilland 5000 series constant-speed airscrews numbered 55997, 55998, 50008 and 55996 - port to starboard.

The works inspectors of Short Bros.' Inspection Department were approved by the Air Ministry's Inspection Directorate (AID) and worked under the control of the Chief Inspector - a 'B' Licence holder. The airframes were inspected at each Stage during the construction and passed subject to AID approval.

Progress payments for the work were made on the presentation of certificates at the completion of each of ten manufacturing stages. These stages only occasionally coincided with the eighteen stages of the Empire 'boat Production Chart. Certificates for work carried out were presented by Short Bros. to Imperial Airways Limited, to be honoured within seven days. The final certificate, when the aircraft was handed over at delivery, was due for payment within 14 days.

3. Production

The staging of progress payments were:

Stage 1 Hull frames completed	10% of contract sum
Stage 2 Hull completed bare	12%
Stage 3 Hull complete, less cabin equipment	12%
Stage 4 Fuel tanks ready for installation	5%
Stage 5 Wing floats ready for assembly	5%
Stage 6 Main plane spars complete	7%
Stage 7 Main plane ribs complete	4%
Stage 8 Tail unit centre section complete	7%
Stage 9 Mainplanes sheeted	3%
Stage 10 Delivery and acceptance	33%

This breakdown of the contract sum values the hull at about 43% of the contract sum, the mainplanes at 24% and the period of the delivery and acceptance at 33%.

The first order was for one Mark I 'boat - the 'prototype' (Construction Number S 759) and one Mark III 'Atlantic' 'boat (S 804). The first production batch comprised one Mark II 'variation on the Bermuda' 'boat (S 811), the original 'Bermuda' 'boat (S 812), the second 'Atlantic' 'boat (S 813) and nine standard Mark Is (S 814 - 822), all fitted with Bristol Pegasus XC poppet-valved engines.

The second production batch of fourteen Mark I S.23 'boats (S 838 - 851) was covered by the third order, placed on 2 September 1935. This batch brought the total fleet to twenty-eight aircraft. They were registered on 1 March 1937.

The next order was for a single aircraft to replace G-ADVA CAPRICORNUS, which crashed on 24 March 1937. The order, dated 27 April 1937, was for a standard Mark I S.23 (S.876). The aircraft was named CARPENTARIA, originally taken on the British register on 26 August 1937 as G-AFBJ, and later transferred to the Australian register as VH-ABA. This was followed soon after by an order, dated 22 June 1937, for two more Mark I S.23s (S 877 and 878), making up a batch of three. Both of these aircraft were also registered on 26 August 1937.

The next batch of eight 'boats were S.30s, ordered on 21 October 1937. The first S.30 was a replacement for G-ADV C COURTIER - crashed 1 October 1937 - and known as Mark I. The next 'boat, a Mark II, was 'unspecified'. Then followed four second generation Mark III 'Atlantic' 'boats and two Mark IV 'New Zealand' 'boats. It seems that the 'unspecified' Mark II 'boat became the third 'New Zealand' 'boat - on the British register as G-AFCZ AUSTRALIA. The Construction Nos. for this batch ran from S.879 to S.886 and they were registered on 15 November 1937. The S.30 'boats were fitted with Bristol Perseus XIIC sleeve valve engines.

The date, and the reason for ordering the ninth S.30 'boat, (S.1003), is uncertain. As it was ordered as 'equal to G-AFCT CHAMPION' it seems likely that it was intended as a replacement. Two of the Empire fleet had crashed by 1 October 1937 and replacements for both these aircraft - Construction Nos. S.876 and S.879 - had been included in the orders to that date. The registration of the single 'boat took place on 10 November 1937, so the order must have been placed some time before. The third Empire 'boat to be lost crashed at Lake Habbaniyh on 5 December 1937, three weeks after S.1003 had been registered. The 'boat, 'KZ CATHAY was something of an oddity. Specified as 'equal to G-AFCT CHAMPION' - the Mark I S.30 'boat and therefore fitted with Bristol Perseus XIIC sleeve-valve engines, 'KZ was the only S.30 'boat with Bristol Pegasus XC poppet-valved engines.

3. Production

The last order - 7 June 1939 - was for three S.33 hybrid aircraft (S 1025 - 1027), with Bristol Pegasus XC engines, strengthened hulls and medium range wings. The 'boats were registered as G-AFPZ CLIFTON, G-AFRA CLEOPATRA and G-AFRB on 27 January 1939. Work on 'RB, the forty-third and last 'boat, was stopped when it was about 75% complete. On 18 August 1939, Short Bros. quoted for an additional four 'boats at a unit price of £ 42 500 (PV £ 853 400) each for delivery at the end of June 1940, providing the necessary light-alloy extrusion sets were available in November 1939. These 'boats were not ordered.

It is difficult to put a firm price on an Empire 'boat. The original order to Short Bros. for two flying boats - the 'prototype' and the 'one for Bermuda' - dated 19 February 1935, gives the price 'for the first flying boat' - 'HL CANOPUS' - as £37 860 (PV £823 000) and 'for the second' - 'UT CENTAURUS' - as £ 36 200 (PV £787 000). The price for the additional aircraft was not to exceed £ 35 856 (PV £ 780 000) each and IAL were hoping that the price could be pulled down the learning curve to a unit price of £ 33 127 (PV £ 720 180) each - a reduction of 12.5% on the price of 'HL CANOPUS'. In further calculations, IAL used a reduction of about 9% to arrive at the unit price of the additional 'boats. Between 1936 and 1938 there had been a 30% rise in the cost of materials and a 10% rise in the cost of labour. Short Bros.' price for the single Mark I S.30 'boat - 'equal to CHAMPION' - ordered on 7 June 1939, was £ 41 275 (PV £ 828 800). QANTAS Empire Airways valued their 'boats, complete with engines and 'free issues', at £A69 111 or £ 55 288 (PV £ 1.11 million). In August 1939, Short Bros.' quotation for the additional four 'boats priced them at £42 500 (PV £ 853 400) each.

In calculating the total unit price of an aircraft, IAL added the cost of the variable-pitch airscrews at £725 (PV £15 400) each and the Sperry automatic pilot at £750 (PV £16 000), both in 1936 prices. Why this was done is not clear as these items did not form part of the 'free issue' equipment mentioned in the order. Item (b) of the order, listing the 'free issue' items, costs the electrical generating and lighting equipment at £ 925 (PV £ 19 656) and included 'acceptance tests, etc.' The cost of the seats and bunks - 'free issue' items not mentioned above - were £ 500 (PV £10 600). With an allowance 'for extras' (a contingency sum, perhaps) of £ 250 (PV £ 5 300), the unit cost of an aircraft (1936 prices) was £ 40 675 (PV £ 864 344). No mention of the cost of the engines (item (a) of the 'free issue' list) appears in any of the orders but they cost in the neighbourhood of £2 000 (PV £ 42 500) each. If added to the unit price, the total cost to IAL was about £ 47 500 (PV £ 998 750).

In April 1935, the Board of IAL sanctioned the expenditure of a total of £ 488 100 (PV £10 611 million) for 12 additional 'boats. This expenditure was based on a unit price of £ 40 675 (PV £884 274), of which Short Bros.' content was £ 35 350 (PV £768 500).

A cost breakdown of one of the QEA 'boats gives a check on the total cost. The % breakdown gives 78.5% for the airframe, 15.4% for the engines, 4.8% for the airscrews and 1.3 % for the radios. Applying these figures to the 1936 price quoted above, the total notational cost would have been £ 48 830 (PV £ 1 04 million). The cost of a Sunderland (1938) was double that of an Empire 'boat, being in the neighbourhood of £ 100 000 (PV £ 1.965 million).

A comparison between the 1936 Empire flying boat and the 1991 Canadair CL 215T flying boat is interesting. The tare weights of the two 'boats are much the same - 12 630 kg. for the Empire and 12 333 kg. for the CL 215T. The notational price of PV £ 1 million for an Empire 'boat compares with the £9.69 million for a Canadair CL 215T.

Clause 11 of the order set out the grounds for the rejection of the aircraft. It could be rejected if it was delivered more than twenty weeks late, if it failed to perform in accordance with the specification and if the passenger cabins were noisier than the Kent 'boats - which they were not.

The delivery date in the order was 1 May 1936. 'HL CANOPUS was launched on 2 July 1936, but not delivered to Imperial Airways Limited for service until 22 October 1936. The launch date is, give or take a day, inside the eight week period. The final delivery date is not and therefore IAL would have been within their rights to reject the first 'boat. Imperial Airways Limited were only too glad to have the first of their Empire 'boats.

Clause 17 of the order specified that a mock-up be built. The order states: 'Shorts to complete full-scale mock-up of portion of hull containing crew and paying load compartments, of machinery, fuel and oil arrangements, including complete layout of such compartments and apparatus in mock-up form except that such portions of the paying-load accommodation as required by us shall be equipped and furnished in final form.'

This mock-up was not to cost more than £ 1 495 (PV £32 500), was to be approved by Imperial Airways Limited, paid for by them and to remain their property and to be retained for such modifications and improvements as might be necessary. It seems that the mock-up was in two parts. The main mock-up was

3. Production

in No. 15 Shop, adjacent to the Barge Yard. It comprised the hull to the rear step and part of one mainplane from the centre line to just beyond the outer engine position, demonstrating 'the machinery, fuel and oil arrangements'. The accommodation mock-up, showing the passenger cabins and possibly the Control Deck, demonstrated the '...portions of the paying-load accommodation as required by us equipped and furnished in final form.' was located under the Drawing Office. Both mock-ups were built of timber and were in existence within four months of the original order being given. There is a reference - 20 June 1934 - to the expenditure of £ 495 (PV £ 10 700) on the mock-up. Major Brackley, the Air Superintendent of Imperial Airways Limited, visited the mock-ups ten months later on 2 April 1935. The secrecy that surrounded the design and construction of the new 'boats dictated that any Short Bros.' employee requiring to visit a mock-up was accompanied by Mr. Bibby, the Works Manager, who kept them under lock and his personal key.

Representatives of the aeronautical Press were invited to view the mock-ups at the end of February 1936. Publicity photographs appeared shortly afterwards in the aeronautical periodicals and in IAL's own promotional material. These photographs show 'passengers' gazing at the passing scenery out of the Promenade Cabin windows and chatting over drinks in the Smoking Cabin - complete with the traditional daffodils in cut glass vases. Other photographs portrayed children playing on the floor of the Promenade Cabin supervised by Granny, and ladies reclining in their bunks in the Centre Cabin, all taken in the accommodation mock-up, on the ground, at Rochester. The mock-ups were still in existence on 4 October 1938, when Major Brackley made yet another visit to the Seaplane Works to inspect progress. He found that the hull of 'CT CHAMPION had just been withdrawn from its gantry in No. 3 Shop and the hulls of the other S.30 'boats were in the neighbouring gantries, in varying degrees of completion. A conference to investigate the layout of the upper deck of the S.30s took place at Rochester on 24 April 1939 and a revised pantry arrangement was submitted in October 1939, so it is possible that the mock-ups survived until the end of 1939.

Once the Production Chart had been agreed, the materials requisition chits were sent to the Stores. As each item on the chit was issued, the Stores entered the series number of the part or component and its weight, and returned the flimsies to the Production Department. The top flimsy was inspected to see if all the materials on the chit had been marked for issue. If not, additional red cards and flimsies were made out (issue 'A') for any remaining materials, and the process repeated. The top flimsy was then sent to the appropriate Shop to enable the materials to be drawn from Stores to start production. The second flimsy was sent to the Costing Department. Tools were drawn from the Tool Stores in No. 11 Shop.

Production in the Seaplane Works was in the capable hands of the Works Manager - the redoubtable Arthur E. Bibby. Oswald Short had managed to keep the work force of about fourteen thousand together through the lean years after World War I and during the depression that followed. The Seaplane Works had turned out children's pedal cars, prams, bus conductor's ticket punch machines, car bodies for Fiat and Salmson, motor boats and electric canoes, ship's lifeboats, sailing and motor barges and even domestic flat irons. Short Bros. were also famous for their light weight bus bodies - turning out one per day on Thornycroft chassis at the peak of the production. The production ended with a batch of 20 seater bodies for Leyland Cub chassis. These buses were for London Transport and known as Class C.

Inspections were made at each stage of the production process, including the jigs and templates. It was usual for details made from, or assembled on a jig, to have the jig proved by the production of the first component. If the component was satisfactory, the jig was passed and stamped by the inspector. The heat treatment baths and tanks were also periodically inspected for temperature. Fabric covered components were inspected and the bonding checked before being covered. The weight of the doping system was checked at intervals and also the temperature and humidity of the Paint Shop. The final inspection covered the airframe, the engines and their mountings, the flying controls, the electrical system and radio equipment, the instruments, the other controls for the engines and the fuel system. Finally the aircraft was weighed in the tare condition and the centre of gravity calculated. Then, with the aircraft lashed down to the slipway outside No. 3 Shop, the engines were run up and tested.

The Empire 'boats were the sixteenth aircraft type to be designed and produced at Rochester since the Calcutta was launched in 1928, five of them being completely new flying boats - and the Rangoon - approaching a new design each year. When expansion was required to meet the Imperial Airways Limited order for the Empire 'boats, with the requirements of the RAF expansion in the background, skilled tradesmen - especially metalworkers - were hard to come by. In February 1936, RAF Expansion Scheme 'F' set up the Shadow Factories and orders were in hand for 310 Supermarine Spitfires and 600 Hawker Hurricanes.

3. Production

The expansion had put the other aircraft construction companies in a similar position, requiring every skilled worker they could find. The Rochester workforce was augmented by un-skilled people, working with the 'old hands' and apprentices. They learnt on the job to carry out the work to the high standard of workmanship that had become the hallmark of a Short Bros.' aircraft. The 'new hands' worked under the watchful eyes of Mr Bibby, Mr W.(Bill) Newnham - the Foreman-in-Charge - the Shop Foremen, the Chargehands and the craftsmen. The work force expanded to twenty thousand on shift work during World War II.

Deliveries of the Empire 'boats - five in 1936, twenty-two in 1937, five in 1938, seven in 1939 and three and three quarters in 1940 - demonstrate the competence and capacity of the management and workforce. Photographs show No. 3 Erecting Shop to be crowded with hulls and mainplanes, when the various batches of the Empire 'boats were going through the Shop. Some shuffling of aircraft and major components was necessary, which sometimes caused minor damage and delays to production. For example, while 'HJ Mercury - the upper component of the Short-Mayo composite aircraft - was being assembled, it was moved to at least three different positions in No. 3 Shop.

The first two production batches of the Empire 'boats shared the floor space in No. 3 Shop, at one time or another, with sixteen Singapores, the two Short-Mayo composite aircraft 'HK Maia and 'HJ Mercury, the Sunderland I prototype K 4774, the first batch of Sunderland Is and the fuselages of the S.32 long range civil landplanes. The third batch of Empires - the Qantas Empire Airways' order and the S.30 'boats - shared the Shop with the three 'G' 'boats and at least some of the second production batch of Sunderland Is. King George VI and Queen Elizabeth visited the Seaplane works on 14 March 1939 and a photograph shows them leaving the completed hull of 'CZ AUSTRALIA. 'CY AO-TEA-ROA was about a month away from launching and 'MC AWARUA slightly less advanced. The stragglers, 'KZ CATHAY and the three S.33 'boats, were in No. 3 Shop while 'BE COORONG was being re-built, following its stranding at Darwin.

Some items salvaged from the crashed 'boats were intended for use in the aircraft during construction. A considerable amount of 'UZ CYGNUS - crashed at Brindisi, 5 December 1937 - was returned to Rochester as it was thought that much of the recovered material could be incorporated in the third S.33 - G-AFRB. The mainplanes were stored in the open but when the spar boom extrusions came to be tested by High Duty Alloys, they were found to be below strength and had to be scrapped. The tail unit, the engine nacelles, the rear section of the hull - presumably aft of Frame 42 - and a few other details were considered fit for reconditioning. Exactly how much of this material was actually incorporated in 'RB is open to speculation but as the hull was in the gantry for only seventeen weeks before it was withdrawn substantially complete, it is at least possible that parts of 'UZ were used.

'UY CAPELLA was salvaged almost entirely after the incident in Batavia Harbour on 12 March 1938, when the hull was holed while taxiing close to the shore. The hull, mainplanes, engines, airscrews and five cases of detail were shipped back to the United Kingdom. When they arrived at Rochester, the main components of the airframe were found to be beyond repair and scrapped. The total cost of the operation - dismantling, returning and scrapping - cost £2 100 (PV £ 41 265) and was not attempted again. However the wing floats, some of the control surfaces and the anchor, were re-used.

Corrosion was a particular problem during the salvage of 'VD CHALLENGER at Mosambique in May 1939. The mainplanes, tail unit and engines were salvaged, as were the airscrews, with their bent blades. After only three days immersion, a knife could be pushed through the magnesium alloy reduction gear casing of the engines.

'VE CENTURION crashed on the Hoogly river at Calcutta on 12 June 1939. The hull broke in two as the aircraft turned over on its back. The aft end of the hull, including the tail planes, the fin and rudder, three of the engines and airscrews and the fuel and oil tanks were salvaged. The starboard mainplane was wrecked and the port mainplane was damaged beyond repair. The port outer engine was swept away by the current. The remaining part of the hull was blown up to prevent it causing a hazard to shipping. It is not known how much of this salvaged material was re-used.

After the hurricane had died down at Lisbon on 19 February 1941, 'CX CLYDE was discovered on its back in a fathom (2 metres) of water. The four engines and airscrews, oil tanks, the two elevators, one aileron, the port wing float and the radio equipment were salvaged and brought ashore. The Relunit fuel tank valves were reconditioned and used in the tanks of the third S.33 - G-AFRB. The remainder of the aircraft was sold for scrap.

The mainplanes of 'TX CERES survived the fire at Durban on 1 December 1942. There was a suggestion that they should be mated with the hull of G-AFRB, still in its box in the Barge Yard at Rochester, but this

3. Production

was not done. Even 'HK Maia, bombed and sunk in Poole Harbour, 11 May 1942, yielded airscrews, some of the engines and some instruments for further service.

Some 'boats were successfully salvaged and rebuilt. 'BE COORONG was returned to Rochester from Darwin - where it became stranded on 12 December 1938 - to be rebuilt and returned to service after a gap of eleven months. Airscrews generally fared better than airframes and some of those salvaged were reconditioned and reused. The port inner airscrew of 'CV CARIBOU - 50008 - is out of sequence with the other three and would seem to have been a reconditioned unit. Salvaged engines, too, were rebuilt. The Bristol Perseus XIIC sleeve valve engines of 'CW CONNEMARA were brought up from the bottom of Southampton Water and stripped down to check for wear.

The Seaplane Works at the start of the Empire 'boat production were almost unchanged since the end of World War I. The various Shops were strung out, roughly north east to south west, along an 840 yard (770 metre) frontage to the River Medway. The site was about 110 yards (100 metres) deep at its widest. The Shops concerned with the production of the Empire 'boats were:

Nos. 1 and 2 Erecting Shops - Dope Shop and detail manufacture, with main stores under.

No. 3 Erecting Shop - the main erecting and finishing shop containing the gantries for the assembly of the hulls, the Spar Shop where the mainplane spars were assembled and the mainplanes were sheeted. The rear of No. 3 Shop contained the Panelbeater's and Coppersmith's Shop, the Shop Maintenance Fitter's Shop and the Engine Installation Section. On the south side were the Production Offices and Mould Loft. Anodic treatment and annealing baths were grouped round the periphery. The floor area of the Shop was about 80 000 sq. ft. (7 432 sq. metres). The hull and model Testing Tank was in the lean-to at the back of the Shop with an area of 2 500 sq. ft. (232 sq. metres).

No. 4 Float Shop - concerned with the assembly of floats and small details. Area about 6 600 sq. ft. (613 sq. metres).

No. 6 Shop - the Sawmill with a Coppersmith's Shop at the rear, Pattern Shop over and the main Boiler House behind.

No. 9 Shop - Machine Shop. Area about 6 500 sq. ft. (600 sq. metres)

No. 10 Shop - production and assembly of hull frames, tailplanes and formed components. Area about 10 500 sq. ft. (976 sq. metres).

Foundry - behind No. 10 Shop. The Foundry was moved to Strood in 1939.

Nos. 13 Press Shop and 14 Shop - production and assembly of tailplanes, fins, rudders and engine nacelles.

Drawing Office - behind Nos. 11 and 13 Shops.

No. 15 Shop - Mock-up Shop. Area about 7 780 sq. ft. (723 sq. metres).

No. 16 Shop - Erecting Shop for mainplanes for 'HK Maia.

The Office Block and S.23 Design Office was adjacent to the main entrance of the Works from Willis Avenue, at the northern end of the site. The Barge Yard and its slipway were beyond at the extremity of the site, adjacent to No. 15 Shop. Flying boats and other craft on the river were - quite literally - in the skilled hands of Ernie 'Sailor' Wadhams, the boatman. The incomparably detailed record photographs were taken by Mr V.E.Galloway, with plate camera and powder flash equipment.

The working hours for a normal week of 47 1/2 hours were:

Monday to Friday 7.30 am. to 5.00 pm. with a lunch break from 12 noon to 1.00 pm. Saturday 7.30 to 12 noon.

3. Production

Smoking in the Shops was allowed for two 10 minute periods during the day, in the morning and during the afternoon.

Weekday overtime was paid at 1 1/4, Saturday overtime at 1 1/2 and Sunday overtime at double rates. In 1936 a top rate fitter was paid 2 shillings and 4 pence (PV £2.80) per hour and un-skilled workers 1 shilling and 6 pence (PV £ 1.60) per hour. Apprentices were paid between 5 shillings (PV £5.31) per week in their first year plus a special bonus of 2/6 (PV £ 2.65), rising to £1 (PV £ 21.25) in their fourth year. No overtime was paid to apprentices but piecework bonuses could sometimes be earned. In 1938 foremen were earning £ 6:0:0 per week (PV £ 127.50) and works inspectors £ 5:0:0 (PV £ 106.25).

Materials

f

The airframe of a standard S.23 'boat' weighed about 15 100 lb. (6 850 kg.). A total of some 18 000 sq. ft. (1 673 sq. m.) of light-alloy sheet was used in its construction, weighing 9 700 lb. (4 400 kg.). The total length of the extrusions used was about 2 111 ft. (644 m.), with a weight of 3 200 lb. (1 450 kg.). 3 700 ft. (1 127 m.) of tubing, varying in diameter from 3 1/2ins. (89 mm.) to 3/16 in. (4.75 mm.), was used in the structure and as pipelines in the fuel, oil and hydraulic systems. The weight of the light-alloy tube was 600 lb. (272 kg.). There were approaching 600 000 rivets of all sizes in the completed 'boat', with a weight of 900 lb. (400 kg.). Some 600 lb. (272 kg.) of steel of various qualities and forms were used, and other materials such as spruce and miscellaneous light-alloy castings and forgings, accounted for another 100 lb. (45 kg.).

A list of the materials used in the construction of the 'boats' is given below. The two authorities controlling the standards used in the industry were the British Standards Institute, issuing British Standard Specifications (BSS) and the Director of Technical Development of the Air Ministry (DTD), who issued standards for materials. The DTD specifications were less formal than the BSS, as they had not gone through the full British Standards procedure. To avoid confusion during manufacture, the sheets, strips and bars were colour-coded with painted bands and discs, using seven colours.

British Standard Specifications (BSS)

L.1	Duralumin bar 386 MPa (25 ton)	Yellow
L.3.	Duralumin sheet and strip	Yellow, green
L 33.	Aluminium silicon casting alloy	
L 37.	Duralumin rivets	Yellow,black
L 40.	Aluminium alloy extrusions	Blue,white,blue
S 80.	High chrome steel bar 850 MPa(55 ton)	Black,yellow,brown
T.40.	Duralumin tube	

Director of Technical Development specifications (DTD)

DTD	60A High chrome steel sheet and strip Non-corrosive.	Blue,black,blue
DTD	111.'Alclad' sheet and strip	Yellow,blue
DTD	138 Carbon steel strip	Red,green,blue
DTD	176 Chrome nickel steel tubular rivets, non-corrodible	Red,black
DTD	206 Wrought alloy sheet and strip Hyduminium RR 56	
DTD	220 Wrought light-alloy tubes	Blue,white
DTD	265 Hard drawn phosphor bronze tube	Blue,black,white
DTD	275 Aluminium coated aluminium alloy	Black,red,green

3. Production

F DTD 275 Aluminium coated aluminium alloy sheet and strip. Black,red,green
Rivets Dural, anodised and plain aluminium

The sheet thicknesses and the rivet sizes used were:

Sheet thickness Rivets

SWG	ins.	mm.	diam. ins	diam. mm.
23	0.024	0.61	1/16	1.588
22	0.028	0.7112	1/16	1.588
20	0.036	0.9144	3/32	2.381
19	0.040	1.016	3/32	2.381
18	0.048	1.2192	1/8	3.175
16	0.064	1.626	5/32	3.969
14	0.80	2.032	3/16	4.763
13	0.092	2.34	3/16	4.763
12	0.104	2.642	3/16 or 1/4	6.35 or 7.938

Rivet holes were drilled or sub-punched and reamed to size.

The references to the various materials used in the following description of the construction of the 'boats, use the BSS or DTD notations where these are known. Sheet thicknesses in the following description of the production are given in SGW only.

The materials were received into store from the manufacturer, under the cover of a Release Note. The Release Note certified that the material complied with the requirements of the Air Navigation Directions, the specification and any relevant drawings. An internal Works Release Note was issued, quoting the original Note, and the material marked so that it could be identified. When the material from a batch was issued to the Shops, the Job Card recorded the details. When the detail, which had been fabricated from the material, was passed and stamped by the inspector, the Job Card could be filed for reference.

The higher the strength of a light alloy, the more susceptible it was to corrosion. The high-strength DTD 111 'Alclad' clad sheet and strip were protected by the elegantly simple means of hot-rolling on a thin coating of pure aluminium to both sides of a sheet or strip during the manufacturing process. All aluminium alloy details and components were anodised before they were finally fixed in position in the aircraft. Some material required heat treatment to enable it to be worked to shape. Details and components made from this material were anodised before final fixing.

Aluminium alloy material needing extensive working to shape in the Panelbeaters Shop was heat-treated to prevent the work-hardening of the material. Material that required annealing before heat-treatment was heated to 360 deg. C. and held at that temperature for between 3/4 to 4 hours. Heat-treatment consisted of immersing the material in a bath of molten salts at 525-535 deg. C. for up to two hours, quenching in water at 70 deg. C. and ageing at 170 deg. C for some 15-20 hours. The material was quenched again in water or air, ready for working. Sheets were worked to shape over hardwood or metal formers. Anodising augmented the thickness of the natural oxide film on the surface of the aluminium by depositing a dense layer of aluminium hydroxide, increasing the resistance of the surface to corrosion. Parts to be anodised were cleaned up, dipped in a de-greasing solvent bath - such as naphtha - washed in hot water, dried and then immersed in a tank of warm (40 deg. C.) dilute chromic acid for up to one hour. An electrical charge was passed through the tank using the part to be anodised as the anode, and a stainless steel rod or graphite plate as the cathode. After anodising, the part was washed and dried. In addition to its function in the anodising process, the chromic acid acted as a useful crack detector, staining dark any defects in the surface of a defective part. It was also possible to check whether a particular component or detail had been heat-treated, as they showed darker after anodising. A lanolin coating was applied to the aluminium surfaces as an extra protection against corrosion. Application was by hand, using pieces of scrap timber to scoop the lanolin from handy used condensed milk tins. The lanolin adhered tightly to the anodic film.

3. Production

The notations used for the electric cables mentioned in the description refer to the number of wires and their diameter in inches. A typical single core 14/0076 cable, for example, had fourteen wires each of 0.0076 inches diameter.

STAGE 1 Making frames and keelson.

There were fifty-one frame positions in the hull, starting with Frame 1 in the nose and numbering aft towards the tail. Key frame positions were at Frame 6 - the aft extent of the coupé, Frames 15/16 - the forward mainplane spar frame and Frames 20/21 - the aft mainplane spar frame. Frame 42 was the construction joint between the hull and the tail section and Frames 44/45 and 47/48 were the fore and aft attachments of the tailplane and fin. The point of the main step was aft of Frames 20/21, sweeping forward to the chines at Frame 19. The rear step was on Frame 34. The Frame positions are shown on Diagram 21 on page 61. The keelson stretched from the stem of the 'boat to Frame 36 - two frames aft of the rear step. From Frame 36 to Frame 48, two pressed Z sections acted in place of the keelson as supports for the frames and the keel buttstrap. All the material used in the keelson was fabricated from British Aluminium Co. Ltd. Alclad DTD 275 plate. The plates were cut to profile on the bench, the lightening holes fly cut, normalised and flanged, and the plates drilled to detail. The Z sections were pressed and formed to curvature. The component details of the keelson were then inspected and bolted up for checking against a full-sized template drawing - extreme tolerance + or - 1/16 in. (1.5 mm.) - before being anodised and assembled. Pressed plate angles were riveted on to form the bottom flange. The top flange angles were left temporarily bolted in position until all the hull frames had been fixed in position in the gantry. The temporary bolts were then removed and top flange angles finally riveted in place. The length of the keelson was about 62 ft. (19 metres) long, with a variable depth of between 4 ins. (100 mm.) and 5 ins. (125 mm.) along its length. The keelsons and frames for the hulls were made in No.10 Shop.

Forty-seven of the frames were 2 ins. (50 mm.) wide, machine-pressed or hand-flanged from plate. The frames were marked out from templates, rough cut with pneumatic hand shears and shaped with wooden mallets on metal formers. They were then drilled to detail on mild steel drilling templates. The members of each frame were inspected before being bolted together and checked for truth on a lay-out table. Tolerances were the same as for the keelson. They were then anodised and finally riveted up. Frames 10 to 34 were stiffened by doubling up the channels, back to back. The doubling extended from the chine line to just above the line of the upper deck for Frames 10 to 14 and 17 to 19, or its equivalent for Frames 22 to 34. Frames 6, 11, 25, 29 and 34 had water tight bulkheads up to floor level. The hull, as assembled in the gantry, ended at the construction joint at Frame 42. The two double main spar frames - Frames 15/16 and 20/21 - were assembled on flat table jigs. These frames were a sandwich of two plate frames substantially reinforced with angle and top-hat section pressings, kept apart with distance pieces. Both the main spar frames had watertight bulkheads up to floor level. The centre part of the mainplane spar trusses was built into the tops of the spar frames. The tail section, which was assembled in a jig near the spar frames, started at Frame 42. All the frames, including the two main spar frames, were assembled for drilling by clamping them on their respective jigs. When this operation was completed, the frames were taken apart for anodising before final assembly, liberally jointed with Duralac jointing compound and finally riveted.

STAGE 2. Erection of stocks in Main Erecting Shop. No.3 Shop

The hulls were assembled in gantries built along the north eastern wall of No. 3 Erecting Main Shop. The number of gantries varied according to the needs of production, with a maximum of nine. When nine gantries were in use, they were arranged in a group of six and a group of three, divided by the gangway from the side entrance doors of the Shop. The lefthand gantry - nearest the river - is referred to here as No. 1. Short Bros.' Photograph H 764, taken at the end of October 1935, shows the first three gantries. The framework of the hull of Construction No. 795 - later to become G-ADHL CANOPUS - is in No. 3 with the framework of the hull of Construction No. 804 - later 'HM CALEDONIA' - in No. 2. No.1 gantry was specially heightened to accommodate the swept-up tail of Construction No. 797 - later to become G-ADHK Maia - which occupied it until April 1937.

The hulls were assembled with the nose towards the side wall of the Shop. A typical gantry for an Empire 'boat was some 75 ft. long X 15 ft. 3 ins. (23 metres long X 4.33 metres) wide. The framework was

3. Production

constructed from mild steel channel section uprights, bolted to channel section cross members with angle cleats, so that the framework could easily be dismantled or changed. A mild steel angle ran the length of the gantry to brace the cross members. The uprights had triangular lightweight angle supports for access planking at two levels. The centreline of the aircraft - and gantry - was marked on a painted line on the floor and used for locating and plumbing the keel board and top profile board. The profile board had fixing brackets at each frame station and was fixed to the cross members of the gantry with angle brackets at each crossing. The positioning jig for Frame 42 - the last frame of the hull as built in the gantry - was braced off the supporting framework at the Shop end of the gantry. At various stages of the construction of a hull, tubular steel scaffolding was used inside the gantry structure, threaded transversely through the aircraft's frames, windows, ports (port holes) and hatches, to enable work to be carried out anywhere on the hull.

Compressed air for pneumatic hand tools - Broomwade one shot riveting tools, a few Broomwade drills up to 5/16 ins. diam. and dozens of Desoutter 'Mighty Atom' 3/16 ins. diameter drills - was supplied from galvanised steel tube compressed air lines, draped over the gantry framework, to outlet points around the gantry. The air compressors were at the back of No. 3 Shop and because the air driers took some time to become effective, the air pressure at the start of a shift on cold and foggy mornings, was often low.

Notices were hung on the gantries warning that only plimsoles - rubber-soled shoes or trainers - could be worn by anyone working on the hulls.

STAGE 3 Erecting hull frames, alignment of frames, fitting and riveting of stiffeners.

Completed keelsons were brought from No.10 Shop and placed in position on the keel board in the gantry. The two Z section members that acted as dual keelsons from Frame 36 to 42, were also put in place. After alignment, the keelson was clamped to the keel board either through the lightening holes or by the bottom flanges. Frame 42 - the aft end of the hull in the gantry - was then bolted to the jig at the end of the gantry. Frames 1 to 14 and 22 to 36 were lowered into position along the keelson at their respective frame stations and temporarily fixed. The temporary fixings were made to the angle brackets of the profile board, fixed along the top of the gantry and the keelson at the bottom. The main spar frames - Frames 15/16 and 20/21 - and the intermediate Frames, 17, 18 and 19 were positioned and fixed as part of Stage 4. Using the last frame in the gantry - Frame 42 - as the datum, the frames were aligned, trued up and plumbed to true vertical, working forward along the length of the hull.

After inspection, the frames were clamped longitudinally along the outside of the hull with 3/4 ins. (13 mm.) steel angle spacing bars to prevent the frames from moving while the final fixing was in progress and when the stiffeners and stringers were fitted. The frames were then riveted to the keelson. As successive frames were fixed, the top flange angles of the keelson were finally riveted in place between them.

The intercostal stiffeners were pressed from sheet to a Z section in the Press Shop, punched with flanged lightening holes and delivered to No.3 Shop in a series of standard rough lengths. About 3,000 stiffeners were used in a hull. Each stiffener was cut to length and the ends finished to the correct angle in a template. The stiffeners were drilled with pilot holes for the end-fixing brackets and along the outside flange for the skin plating. Hull stiffeners were intercostal between frames - following the standard Short Bros.' technique of leaving the hull frames un-notched - and were fitted to the pre-drilled fixing holes on the frame, by bolting through a pressed plate angle bracket at each end. The junction between a frame and the stiffeners on either side was reinforced with a pressed gusset plate, which was bolted in position through three pre-drilled locating holes in the gusset plate, the frame and the stiffeners. Four more holes were then drilled through the gusset to the frame and stiffeners. One or two lines of pressed V section stringers - to stabilise the flanges of the stiffeners - were fixed circumferentially between frame stations, to be finally fixed by a double rivet joint at each crossing with a stiffener. The stiffeners were progressively taken down, the intermediate skin fixing holes drilled, all holes de-burred and the parts anodised. The gusset plate holes were de-burred and anodised, as were the stringers. The hull framing was then progressively reassembled, with each joint being liberally coated with Duralac jointing compound and finally fixed by riveting.

3. Production

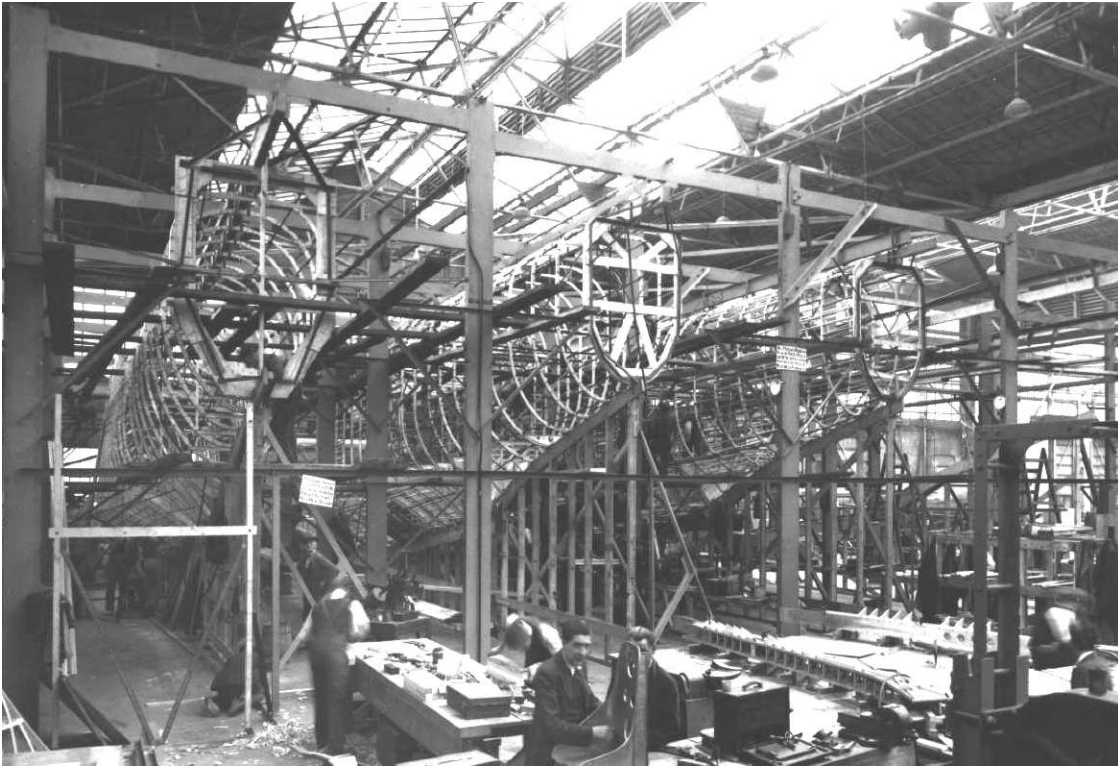

20. Short Bros. photo H 764. The first two S.23 hulls being assembled in Gantries Nos. 2 and 3. The hull in Gantry No. 1, on the left of the photo, is that of 'HK Maia. As the hull in Gantry No. 3 is the more advanced with the stiffeners in place, it is likely to be for 'HL CANOPUS. The hull in Gantry No. 2 is that of 'HM CALEDONIA. The Empire 'boat hulls ended at Frame 42, the construction joint between the hull and the tail unit. The profile board for the third S.23 hull can just be seen to the right of the photo.

Hulls were found to require strengthening when the 'boats were in service. The first four strengthening sets were ordered in June 1939, after the episode in the Atlantic when 'UU CAVALIER broke up and sank within 15 minutes of a forced alighting. Twenty-two sets were on order by October 1939 at a cost of £ 135: 4:6 (PV £ 2 715) each.

A typical strengthening set consisted of 46 skin plates, 1 490 omega-shaped stiffeners, 15 frames and one half frame and 32 lb. (14.5 kg.) of rivets, weighing in all 180 lb. (81.6 kg.). The strengthened frames were inserted between Frames 6 to 24, with the half-frame at the main step. The thickened skin plating extended from Frame 6 to Frames 20/21 - the aft spar frame. Possibly twenty S.23 hulls were subsequently strengthened while the S.30 and S.33 hulls had the strengthening measures incorporated during manufacture. Strengthening a hull took 900 man-hours and cost £ 67:10:0 (PV £ 1 355). The S.30 and S.33 hulls, and the rebuilt 'UI COORONG hull, had the bulkhead at Frame 33 - at the aft end of the passenger accommodation - strengthened to make it watertight, thus increasing the buoyancy of the hull. This modification increased the aircraft's weight by 35 lb. (16 kg.).

STAGE 4 Spar frames and centre section assembled to hull complete with stiffeners.

The two main spar frames, Frames 15/16 and 20/21, were slung into position on the keelson, ready for fixing. They were held in position by a jig while they were being fixed, to ensure that they would mate with the mainplanes, when these came to be fixed in Stage 15. The arrival of the spar frames seemed to have been fairly flexible, as one photograph shows a hull with the skin plating in place, forward to Frame 22 and with Frames 17, 18 and 19 lying loose on the keelson, apparently waiting the arrival of the spar frames. The main spar frames and the intermediates, Frames 17, 18 and 19 were aligned and plumbed.

3. Production

After inspection, the frames were then riveted in position. The stiffeners between the frames were fitted in the same way as for the remainder of the hull, taken down, anodised and then riveted in position.

Seven 'boats were fitted with 1B and M1 fuel systems, which had fuel tanks in the hull. Both these systems had two 280 gal. (1 273 litre) tanks between Frames 15/16 and 20/21, installed on bearers over the Centre Cabin. 'HM CALEDONIA and 'UV CAMBRIA - the two Mark III 'Atlantic' 'boats with 1B systems - had these two tanks only. The five S.30 aircraft with M1 fuel systems - the four S.30 flight refuelled 'boats 'CU CABOT, 'CV CARIBOU, 'CW CONNEMARA and 'CX CLYDE, and the rebuilt 'CZ AUSTRALIA as 'CZ CLARE - had the additional smaller top-up tank installed forward of the spar on the port side of the Control Deck. The feed pump for the top-up tank was a 24 volt Rotax C 1401, switched with a Rotax N5 HU switch through a 20 amp. Rotax N5 EB fuse.

No detailed information is available for the construction, staying, or means of attachment of the hull fuel tanks. They were fabricated from DTD 275 clad aluminium alloy sheet - as were all the tanks - and their construction must have generally followed that of the wing tanks. They were oval in section and each tank was fitted with a Relunits shut-off valve at the inlet and a single 38 mm. diam. outlet sump. Tank overflow arrangements and the securing arrangements of the hull tanks are not known. The tanks presumably rested on spruce grids and cradles, and were secured with bands.

Although the Production Chart does not show them, it is assumed that the interior bulkheads were fixed in position in the hull at this Stage.

STAGE 5 Beaching chassis and trolley fittings on hull. Hull sheeted and riveted, including water test.

Before the skin plating was fixed to the hull, the remaining detail fittings were fixed in position on the skeleton of the hull, including the coamings for the hatches, windows and ports.

The hatches for the Mark I standard S.23 'boats of the first production batch and the first eleven 'boats of the second batch to 'UF CORINTHIAN, were as follows:

Mooring hatch on the centreline, between Frames 1 and 2.

Navigation hatch on the starboard topside, between Frames 6 and 7.

Escape hatch from the upper deck to topside of the 'boat - starboard side between Frames 14 and 15/16.

Two passenger escape hatches on the top of the aircraft - between Frames 20/21 and 22 - port side and Frames 27 and 28 - starboard side.

Two passenger entry hatches - between Frames 10 and 11 and Frames 26 and 28, port side lower deck. Two recessed mooring cleats were let into the skin plating on either side of each hatch to allow surface craft to tie up alongside.

Mail loading hatch - between Frames 11 and 13, starboard side upper deck.

Pantry loading hatch - between Frames 14 and 15, lower deck.

Freight room hatch - between Frames 35 and 37, starboard side, lower deck aft. Mooring cleats were provided on either side of the hatch.

The two S.23 Mark III 'Atlantic' 'boats - 'HM CALEDONIA and 'UV CAMBRIA - were launched without the ports to the Forward Cabin, the pantry loading hatch, two windows each to the Centre and Aft Cabins, two windows to the Promenade Cabin on the port side, one lavatory port, the rear passenger hatch and the freight hatch. All these items were later fitted when the 'boats were converted from Mark III to standard Mark I. The flight refuelled S.30s, 'CU CABOT and 'CV CARIBOU, had the normal ports and windows cut in the skin plating but some of them blanked off. They had both the two passenger hatches.

The ports and windows on all 'boats were glazed with Rhodoid V.7 or V.13 cellulose acetate sheet. The S.30 'boats - except 'CT CHAMPION - omitted the navigation hatch and were fitted with a 21 ins. (530 mm.) diam. observation dome on the starboard side, between Frames 11 and 12 - at an extra cost of £ 11:6:0 (PV £ 227.00). The S.30 and S.33 'boats had a hatchet and hatch key in a recess on the top of the hull near the upper deck escape hatch, and an additional key in a recess on the outside of the aft passenger entry hatch.

3. Production

The other details bolted to the framing, before the skin plating was applied to the hull were:

- Framing for the retractable bow searchlight, the door of which was just above the chine between Frames 1 and 2.
- Refuelling cock recess, complete with door, on the starboard side of the hull, between Frames 13 and 14, above the pantry loading hatch.
- Electrical ground plug connection, immediately above the refuelling cock recess.
- Beaching chassis fittings in Frames 15/16 and 20/21.
- Tail beaching trolley securing eye in Frame 34 and the ring bolt fitting in Frame 37.
- Tail slip release hook assembly at Frame 44.
- Double upward curving members for the retractable bollard, between Frames 1 and 2.
- Storm pennant eye at the stem between the chine and the bollard.
- Fitting for the trailing aerial fairlead in the port side of the planing bottom, just forward of Frame 6.

Five thicknesses of DTD 275 sheet were used for plating the hull and planing bottom. Approximately 300 sheets, with an area of about 3 000 sq. ft. (280 sq. metres), were needed to plate a hull. The thickness of 22 plates of the strengthened 'boats was increased from 20 SWG. to 18 SWG.

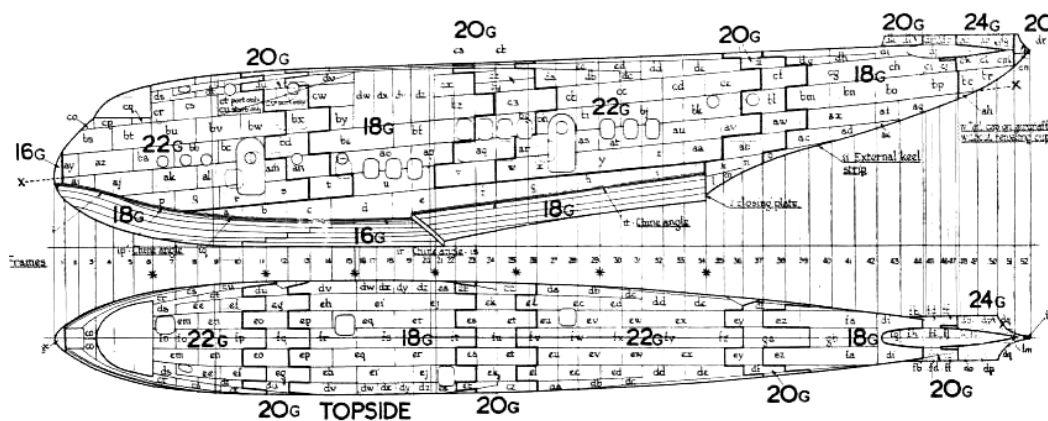

21. Maintenance Manual Diagram M 35. The hull plating and Frame positions.

The hull plating was arranged in strakes, laid across the frames at an angle approximately parallel to the waterline of the aircraft. Plating laps and seams were joggled. Watertight riveting extended from the planing bottom upwards to the upper seam of the strake that started in the nose with Plate 'ai' to Plate 'ah' in the tail. Most hull plates spanned two frames, with the occasional three- and four-frame plate. The planing bottom was plated with two thicknesses of sheet, 18 SWG. from the stem to Frame 10, tooting into 16 SWG. sheet to the main step. From the main to the rear step, the bottom was in 18 SWG. sheet.

Sheets from which the plates were to be cut were drawn from Stores in standard sizes and cut to approximate dimension in No.3 Shop. Each stiffener, already in position on the hull, had three location holes drilled in the outside flange. The plate was G-clamped in position on the outside of the hull and 3/32 ins. (2.3 mm.) pilot holes drilled back from inside the hull through the stiffeners or frames. The plate was marked in pencil with its location code - plates were marked port and starboard from 'a' to 'z' and 'aa' to 'im' - before being taken down.

The plate was joggled as required, cut to exact size, re-positioned on the hull and held with 3/32 ins. (2.3 mm.) temporary bolts, each with a 1/2 ins. (13 mm.) diam. red fibre washer against the plate to protect the anodising. The remainder of the rivet holes in the plate were drilled back through the stiffeners. Plates with thicknesses of 18 SWG. or thicker, were countersunk to take the rivet heads flush. The holes in

3. Production

thinner plates were dimpled with a special hand-lever tool, as were the corresponding holes in the stiffeners.

The plate was then taken down once more, the holes de-burred, buffed and the plate anodised. While the anodising was being carried out, the frame and stiffeners were painted with Duralac jointing compound. The newly anodised plate was put up to the frame and stiffeners, and temporarily bolted in position. Tack rivets were inserted between the bolts and closed down. The temporary bolts were removed, and the remaining rivets inserted in the holes and closed down, to complete the fixing of the plate. The S.30 flight-refuelled aircraft had small sheet acetate windows let into the skin plating on both sides of the aircraft, between Frames 40 and 41. When all the plates had been fixed and the rivets closed down, the inner chine angle, the external chine angle and the keel buttstrap were fitted and riveted, to complete the hull.

S.23, S.30 and S.33 'boats without flight refuelling had the tail light housing fitted and the tail cap Plates, 'dr' and 'cn' - port and starboard, fitted and fixed. On the S.23 and S.30 'boats equipped for flight refuelling, a tail cup was fitted to Frame 51 in place of the standard tail cap and a trap door immediately below it. All S.30s also had a hatch and wedge plate for fixing the KBB drift sight in the after body of the hull, aft of the stowage floor of the freight room.

Broomwade pneumatic one-shot riveting guns were used for most of the rivets, the remainder being hand-closed. If the rivets were hand closed, they were drawn up in the hole with one tool, and the tail snapped over inside to close the rivet down with another, so that the rivet head was flush with the surface of the plate. A flat metal 'dolly' was held up to the rivet head as it was being closed, usually by one of the many 'dolly' boys. All joints between plates were also treated with Duralac before being closed down. Most of the plates, by careful design, were either flat or of single curvature. Certain of the plates of more complex form required more extensive shaping on wheeling machines. The plates were then checked on timber jigs before being finally fixed.

The normal pitches for 1/8 in. (3 mm.) diam. rivets were: plates to single frames - 1 1/2 ins. (38 mm.) single seam, plates to double frames - 1 1/2 ins. (38 mm.) double reeled, plate laps to single and double frames double seam - 1 1/2 ins. (38 mm.) and 16 mm., plates to stiffeners - 1 1/2 ins. (38 mm.) single seam, plate laps to stiffeners double seam - 1 1/2 ins. (38 mm.) and 3/4 in. (19 mm.).

Riveting on the hull below the watertight line was substantially the same except that 5/32 in. (4mm.) diam. rivets were used and the pitches were altered in a few places.

The planing bottoms were originally riveted with a combination of 1/8 in. and 5/32 in. (3mm and 4 mm.) diam. rivets. Taking off and alighting on choppy water could produce accelerations of 3.0g., loosening the riveting with consequent intake of water into the bilges. All seams were double riveted to prevent this. On one service from Hythe to Alexandria before modification, the bilges gained 240 gals. (600 litres).

The top profile board was removed in sections as the sheeting on the top of the hull progressed. When sufficient plates had been fixed to make the hull stable, the keel board was removed and the hull transferred to a shop truck - the subject of Drawing S.23.C.30012 previously mentioned.

After an inspection, the hull was given a water test with a high pressure hose to test the skin plating joints. At the completion of the test, the hull was pumped out and allowed to dry. Any defective rivets were drilled out and re-riveted.

Two hull re-building operations took place away from No.3 Shop - one was the hull of 'VB CORSAIR on the banks of the Dangu river in Africa and the other to 'CZ AUSTRALIA at Basra. The original damage to 'VB CORSAIR involved tears to Frames 12 to 24, extensive damage to the keel, stringers and floor supports and the plating of the port side planing bottom. The forward and rear main spar frames - Frames 15/16 and 20/21 - were damaged below the Centre Cabin. The Short Bros. repair party estimated the time to re-build the damaged hull to be six weeks although the actual time was nearer fifteen weeks. The ill-fated attempt to take the aircraft off the Dangu ended with 'VB being holed again above and below the waterline - a tear in the starboard planing bottom, 10 ft. (3.3 metres) long between Frames 10 and 14 with water in Nos. 1, 2 and 3 bilges. The aircraft was pumped out and the hole patched, the patching being done half in and half out of the water. 'VB was beached and the damaged plates drilled off and replaced. The repair was completed with the fitting of the planing bottom and side plates and the chine angle replaced.

The damage to 'CZ AUSTRALIA was more serious. The nose was stove in back to Frame 8 and torn on the port side of the planing bottom. The keelson was broken at Frame 2, the port float was detached but serviceable and there was some minor damage to the flaps and ailerons. The nose was completely removed aft to Frame 6 and the side and bottom plating back to Frame 7. A keel board was set up and the nose re-built on it with the frames being made on site in an adjacent hangar. 'CZ was ferried back to the United Kingdom by Captain Oscar Garden. When the condition of the planing bottom was examined the

3. Production

considered opinion was that they were lucky to have made the journey at all. 'CZ AUSTRALIA returned to service on 1 October 1939 with a take-off weight of 53 000 lb.(24 040 kg.) but without in-flight refueling equipment. 'CZ, in the normal way with Imperial Airways Limited after an accident, kept its registration but was re-named as 'CZ CLARE.

STAGE 6 Bottom floor structure, steps and entrance doors and escape hatches fitted.

The lower deck floor was arranged in seven watertight compartments from the stem to the rear step with watertight bulkheads at Frames 6, 11, 15/16, 20/21, 25, 29 and 34. Datum brackets for levelling the aircraft for rigging purposes were fitted in the floors of the Centre and Promenade Cabins. Bullion lockers, covered with a trap door and secured with a padlock, were built into the floor of the Centre Cabin (at a extra cost of £ 49:0:0 (PV £ 1 040) each). The steps at the forward entrance door, between the Centre and Promenade Cabins and between the Promenade and Aft Cabins, were fixed in position.

The various hatches, and the observation dome for the S.30s and S.33s, were fitted to the coamings in the hull. The passenger entry hatches on the port side opened inwards and were fitted with locks and clamps, to clamp them shut against the rubber sealing gaskets. The mail and freight loading hatches on the starboard side were outward opening two-part hatches. For loading and unloading freight and passenger's baggage, the bottom half only of the hatch was used, propped open by stays on both sides of the opening. A pulley was attached to the inside of the hatch for hoisting freight and baggage into the freight room, from the tender moored alongside. The hatch could be fully opened up to ship a spare engine. The upper part of the hatch was opened upwards to allow the engine transport beam to be fitted to the diaphragm that formed the upper part of Frame 36. A port was provided in the lower half of the hatch. The mail loading hatch was similar. The pantry loading hatch had the appearance of a window and opened inwards. The escape hatches in upper surface of the hull were outward opening. The drift sight hatch for the S.30 'boats was water tight and secured with clamp handles.

The mooring hatches of the later S.30 aircraft were hung on leather straps which proved to be unsatisfactory in service. The straps were later removed and fitted with metal hinges. The floor of the mooring compartment was modified to increase the foothold.

An observation hatch was fitted to the S.23 'boats, between Frames 6 and 7, immediately behind the First Officer's seat. It was secured by clamps and opened inwards, hinging on the starboard side. The hatch was apparently intended for taking navigation sights in flight, as a small windscreen could be folded out into the slipstream, to partially protect the observer. It was only occasionally, if ever, used for this purpose but mostly by the Flight Clerks to mount the ensign staff in its socket on the starboard side of the aircraft. The ensign staff, 6 ft. (2.8 m.) long, was stowed aft of the observation hatch on the starboard side, above the temperature gauge panel. The S.30 - except 'CT CHAMPION - and S.33 'boats dispensed with the observation hatch and were fitted with an observation (astro) dome. The dome was offset from the centreline to starboard, just aft of Frame 10. The dome was 21 inches (540 mm.) in diameter and was alleged to be several inches too small for taking sights with a Mk. 12 sextant. The dome was too small to be used as an escape hatch. Opposite the direction finding loop on the starboard side was a folding chart table with port hole over. A 6 watt light was provided over the table.

The door in the bulkhead at Frame 33 in the S.30 'boats, and the rebuilt 'BE COORONG, was fitted with a lock and an emergency exit notice.

STAGE 7 Control chassis with control columns. Throttle box and dashboard. Tail section to hull.

The two complete rudder bar units, similar to those used on the Sarafand, were bolted in position on the substantial chassis which incorporated the Control Deck floor bearers. The rudder bars had a movement of 22 deg. each way and were adjustable 2 ins. (63.5 mm.) forward and 2 3/8 ins. (60 mm.) aft, by turning a star wheel between the pedals. The rudder bars were linked together with a tubular connecting rod under the floor.

3. Production

22. Short Bros. photo H 927. The Control Deck of 'HL CANOPUS on the slipway at Rochester, looking forward. The rounded top of the dashboard is evident with the engine starter buttons on the top of the centre panel with the magneto switches below. The Sperry automatic pilot panel is immediately below. The throttle box between the seats had the throttle levers forward and the mixture levers aft. The airscrew pitch control levers are near the floor with the Sperry engaging lever above. The tab controls are in the centre of the coupé, roof. The navigation hatch, with its windscreen, is top centre right. The alighting searchlight controls are on the port side, just below the framing of the open direct vision panel, with the Sperry automatic pilot speed valves below. The temperature gauge panel is to the extreme right of the photo. The carburettor test cock controls are beneath the panel (with ring-pull) between the pilots seats. Between the test cocks and the airscrew pitch controls is the hatch to the mooring compartment below.

The complete control column unit consisted of the hand wheel, the column and the base. The castings were similar to those used on the Knuckleduster and originated, perhaps, on the Singapore III. The hand wheel, which was devoid of switches, had a turn of 87 deg. each way and the column a fore-and-aft movement of 15 deg. 40 min. each way, the neutral position being vertical. Aileron movement was transmitted from the hand wheel to the base by a Reynolds Chainette roller chain, covered by a guard. For the aileron control, the two columns were coupled together by chain. For the elevator control, the two control columns were linked by torque tube. A lever arm below the port control column base was linked by a push rod to a bell crank, which connected to the elevator control lines.

The pilot's instrument panel - referred to in the Short Bros. Maintenance Handbook as the 'dashboard' - was made up of three panels. They were mounted clear of the airframe on Lord shock absorbers - just forward of Frame 4. The centre panel of the dashboard, immediately over the throttle box, contained the controls for the automatic pilots.

The port side panel of the dashboard on the Captain's side, contained the following instruments:

- 3 in. (82.5 mm.) K.B.B. Kollsman sensitive altimeter.
- 2 in. (63.5 mm.) Sperry gyro compass.
- 3.5 in. (89 mm.) Sperry artificial horizon.
- Smiths AV 875 fore and aft level.
- 3? in. (95.25 mm.) Smiths AV 549 air speed indicator (miles per hour).
- Turn and bank indicator.
- Rate of climb indicator.
- Trip clock.

The Type PL 4 compass was immediately aft of the panel, on the extreme left hand side. Compasses were Smith PL 4s, Hughes P/4/11s, or Kelvin Bottomly and Laird KBB 4s.

For 'boats with Smiths automatic pilots, the following additional instruments were included on the First Officer's dashboard. The Pegasus engine data plates were fixed on the port side panel below the fore and aft level. The information on the plates read:

	Maximum rpm	Boost.	Cylinder temp.	Oil temp. deg. C.
Take off	2475	+4 1/4	235 for 15 min.	
Climbing	2250	+ 2 1/2	235	80
Cruising	2250	+ 2	190	70
All out	2600	+ 2	235	90
Oil pressure	Maximum	80 lb./sq. in.	5 minutes	
	Minimum	5 lb./sq. in.		

The Sperry automatic pilot data plate was on the Captain's panel of the dashboard under the engine data plates. 'CX CLYDE and 'CZ CLARE were fitted with air speed indicators registering in knots, with an additional indicator, and an outside air thermometer, at the navigation table.

The starboard side panel of the dashboard on the First Officer's side, for 'boats with Sperry automatic pilot, contained the following instruments:

3. Production

Four 2.12 in. (54 mm.) oil pressure gauges (one for each engine).
Two Record Cirscale engine speed indicators (one for each pair of engines, port and starboard).
Smiths turn and bank indicator.
3 in. (95.25 mm.) Smiths AV 549 air speed indicator (miles per hour).
3 in. (95.25 mm.) Smiths AV 567 static altimeter.
Two boost gauges (port and starboard engine pairs) and two engine selector cocks. Later aircraft were fitted with a boost gauge for each individual engine.

The First Officer's compass was of a similar type and in a similar position to the Captain's compass.

The centre panel of the dashboard, immediately over the throttle box, contained the control panel for which ever type of automatic pilot was fitted to the 'boat - Sperry Gyropilots for all the 'boats with the exception of the three S.30 'A' 'boats, which were equipped with Smith Mark 1A automatic pilots.

The Sperry control unit comprised the directional gyro unit, the bank and climb gyro unit and the vacuum gauge. The engaging lever was a Bowden double pull lever, located above the airscrew pitch control levers on the rear of the throttle box. With the lever to port the system was OFF. Moved over to starboard, the system was ON. The Sperry speed valves and oil pressure gauge - graduated from 0 to 300 lb. per sq. in. (0 to 2.0 MPa.) - were mounted on the port side of the Control Deck, immediately forward of the bow searchlight controls. The three speed valves were graduated from 0 to 6. The valves sometimes sprang a leak, distributing Sperry oil down the Captain's left trouser leg. The Sperry servo unit under the Captain's seat was a three cylinder monoblock unit, connected directly to the control cables of the aircraft.

The differential pressure gauge, the course change cock Type II, the azimuth control cock, the 5C/543 ON/OFF cut-out switch and the 5C/540 push switch re-setting button of the Smith Mark 1A automatic pilot equipment, were mounted on the centre panel of the dashboard. The pitch control lever was fitted to the port side of the throttle box. The dial plate was marked in degrees - UP 0 to 5 DOWN 0 5 10 - and operated in the normal sense of the controls. The lateral trim lever was on the Captain's panel of the dashboard. The dial plate was marked RIGHT WING UP LATERAL TRIM LEFT WING UP - the lever operating in the normal sense of the controls. The safety catch lever, which was fitted to the throttle box on the starboard side, operated the safety catches on all three units, to provide a complete and instantaneous mechanical disconnection of the automatic pilot in cases of emergency. The lever had two positions, IN and OUT, with a ratchet to allow the catches to be left disengaged. The main control cock was a three position cock - OUT SPIN GYRO IN - controlled by a handle and mounted on the throttle box, probably in a similar position to the Sperry control lever. The remainder of the equipment, the test cock, the air filter and non-return valve, the air throttle Mk. 1, the oil reservoir and automatic valve Mk. IV were mounted on the starboard side of the Control Deck, possibly aft of the temperature gauge panel.

First Officer's Panel:

Sperry directional gyro.
Sperry artificial horizon.
Turn indicator.

The switches and pilot lights for the instrument heaters and pressure head heaters on the instrument lighting panel or sub-board on the Captain's side of the dashboard.

The airscrew pitch controls were at the aft end of the throttle box, below the Sperry automatic pilot lever, near the floor. For the 'boats with Pegasus engines, the airscrews were controlled by a two position lever - RED knobs for port engines and GREEN knobs for starboard engines - operating a cable and pulley arrangement. The lever position for COARSE was UP, FINE pitch was DOWN. For the S.30 'boats with Perseus engines, Exactor units were used for the pitch controls. The control operating positions were in a similar position as those on the Pegasus engined 'boats. The position to increase revolutions was UP and decrease was DOWN.

The two engine cut-out control levers were mounted either side of the throttle box. The two inner engines were controlled by the port side lever, while the starboard lever controlled the two outer engines. Pulling the levers operated spring-loaded valves which cut off the supply of fuel to the slow-running jets of the carburettors, stopping the engines dead when pulled.

3. Production

The carburettor test cock controls were located between the pilot's seats. A section of flooring between the seats, hinged along the aft edge, was lifted by a ring-pull let into the top surface, for access to the levers. Each engine had a lever - RED for port and GREEN for starboard - operating a pulley round which a 10 cwt. W2/5 stranded steel wire cable ran over pulleys to each carburettor. The controls for the retractable bow 'landing (sic) searchlight' were mounted just below the windscreen coaming on the Captain's side at Frame 5. The dual Teleflex remote control levers moved the light IN/OUT and UP/DOWN.

The temperature gauge panel was situated behind the First Officer's right shoulder, on the starboard side of the aircraft, between Frames 6 and 7. This panel carried the following instruments for Pegasus engined aircraft with Sperry automatic pilots:

Weston Pyrometer Model 602 HJ 509 engine cylinder-head temperature indicator - 0 to 350 deg. C - with a Weston four-way rotary switch. The twin copper-constantan cables ran from the four-way switch to the junction box in each engine nacelle, and from there to a Bristol thimble couple on the No. 1 cylinder of each engine. The total lengths were: starboard outer 58 ft.(17.68 metres), starboard inner 45 ft.(13.71 metres), port inner 63 ft. (19.2 metres) and port outer 76 ft. (23.16 metres).
Four 2.12 in. (54 mm.) oil temperature gauges - one for each engine.
Four 2.12 in. (54 mm.) carburettor air intake thermometers - one for each engine.
Vacuum distributor, gauge, adjuster and control cocks for the Sperry automatic pilot connected to the Romec vacuum pumps on the two starboard engines.

The arrangement of this panel for the Perseus engined S.30 aircraft with the Smith's automatic pilots - the 'A' 'boats - is assumed to have been similar. The main vacuum distributor was on the panel, receiving vacuum from the two Romec vacuum pumps on the inner engines and distributing to the directional gyros, artificial horizons and turn indicators.

The hydraulic system for the Sperry automatic pilots was driven by the Northern oil pump on the port inner engine. The tubing ran from the pressure regulator in the engine nacelle, via the Parker four-way plug valve adjacent to the Captain's seat, to the oil pressure gauge and manifold block behind the automatic pilot panel. Connections from the manifold block ran to the Sperry control unit, the Sperry servo unit under the Captain's seat and the drain tank in the mooring compartment. The Sperry control unit was connected by tubing to the speed control valves, fixed beneath the coaming of the Captain's direct vision panel, on his left hand side.

The compressed air system of the Smith Mk. 1A automatic pilot was connected to the RAE Type C compressor mounted on the port inner engine. The oil reservoir Mk. III, automatic valve Mk. IV, air throttle Mk. I, air filter and non-return valve and test cock, were all mounted on the port side, forward of the main spar frame. The connection to the main control cock on the throttle box and the main air line for the operating units was run in 3/8th. (9.5 mm.) diam. tubing. The tubing from the differential pressure gauge, the course change cock Type II and the azimuth control cock to the operating units, was run in 8 mm. diam. tubing.

Fitted above the automatic pilot panel were the engine ignition switches and the starter buttons. The four Rotax N5 CD engine starter buttons were on the top of the panel, protected by a flip-up cover. The starter solenoid circuit ran in 35/0.012 copper core cables from the connection box on the main switchboard, through the Tucker B 70 2-way switch and the Rotax SFS Type N5EB fuse, to the starter buttons. From the starter buttons, the cables ran to junction boxes in the wing-roots. The ignition switches were flush-mounted Lundberg twin knob switch units. Each of the two magnetos on an engine was controlled by a switch knob, yoked together in pairs for port and starboard. A short length of LT Unisheath plain cable connected the switches to the earthing clips. The connections from the switches to the 5C/441 connectors in the wing-roots ran in bonded LT Unisheath braided 7 cable.

The two outboard panels of the dashboard - port and starboard - carried the Captain's and First Officer's instruments respectively. The air speed indicators were connected to the electrically heated Kollsman Type 171B pressure heads on the aerial mast. The Maintenance Manual states that the Kollsman and Smiths altimeters and the rate of climb indicator were connected to a static pressure head on the starboard side of the hull - although it does not appear on any of the photographs. The turn indicators for both automatic pilots were connected to their respective vacuum systems in 5/16 in. OD (8 mm.) diam. aluminium tubing. The port and starboard instrument panels were heated by Berco Type BE 5630 electric resistance heaters, two to each side, wired in 35/012 cable from the battery and the main switchboard (Switch 3) through two

3. Production

ACL switches - labelled PRESSURE HEADS and DASHBOARD. Two indicator lights on the port instrument panel were wired into the switch circuit.

The mooring hatches became loose or damaged in service and would not always close tightly, particularly the hatches on the S.30 'boats hung on leather straps. Consequently, the instruments on the dashboard - to say nothing of the pilots - suffered from the effects of the incoming blasts of cold air. To protect the instruments, dashboard screens were made by Short Bros., for fitting to the back of the dashboards. Forty dashboard screens were manufactured in August 1939 for retrofitting to the fleet, at a total cost of £ 581:16:8 (PV £ 13 700). Short Bros. disclaimed all responsibility.

The throttle box, between the pilots, was a light alloy casting slotted for the levers of the throttle, mixture and airscrew pitch controls. Port control levers were topped with RED knobs and those for the starboard levers, GREEN knobs. The lettering, indicating the settings for the levers, was cast directly into the top surface of the box. The throttle and mixture levers were linked through cam levers. For the throttle, OPEN was forward and SHUT to the rear. For the mixture control, FULL WEAK was forward, NORMAL to the rear, then through the gate to RICH, in the full aft position. The throttle and mixture controls were fitted with a yokes, with adjusting screws for individual levers, enabling the levers to be set to the individual lever and to move all the levers together when required.

The throttle and mixture control for the Pegasus and Perseus-engined S.30 'boats, and the airscrew controls for the Perseus 'boats, were hydraulically operated by the Exactor controls. The throttle and mixture controls were linked together through cam levers. When the throttle was OPEN between 15 and 60 deg., the mixture was WEAK. Further OPEN with the throttle up to 80 deg., the mixture was at climbing boost. Fully OPEN throttles gave take off boost. Fully SHUT throttles allowed slow running. The use of rod linkage or wire and pulley arrangements for the engine controls had been ruled out on the grounds of friction and the structural distortion of the airframe. Cable and pulley systems were not considered precise enough for engine controls. Exactors were claimed - by the makers - to have no backlash, to be self-locking and to be extremely accurate to a fraction of a degree. The system for each control operated through a transmitter unit to a receiver unit, initially connected by a 3/16 in. diam. (4.8 mm.) copper pipeline. The Exactor transmitter units, operated by the controlling levers, were fitted inside the throttle box, with the receiver units fitted in the engine nacelles. Both units had pistons attached to a rocker arm, working in cylinders of the same bore. The open ends of the cylinders were connected by the pipe line. Since the cylinder bores were the same diameter, any movement of the transmitter piston imparted the same amount of movement to the receiver piston, which moved the control connected to it. The oil in the system was kept under pressure by springs in both units, acting on the other end of the rocker arms. This pressure caused a certain amount of friction in the system, making it practically self-locking. The system did not provide any mechanical advantage. The system needed priming from time to time in flight, due to variations of temperature or slight seepage. There was a small port in the transmitting cylinder reservoir which was normally closed by a spring-loaded valve. By moving the throttle or mixture levers an additional five degrees at the end of its travel past the FULL THROTTLE or EXTRA RICH MIXTURE position. The valve was opened by a simple mechanical link. The system and the reservoir were then open to each other and any variations in the volume of fluid was compensated for placing the transmitter and receiver units in full synchronisation. The side covers were detachable for access to the Exactor transmitter units inside, ganged together in fours. Each transmitter unit in the throttle box was connected to its receiver unit in the engine nacelles with a single 3/16 in. (5 mm.) OD copper tube. The tubing in the hull ran on the starboard side, over the top of the mail hatch, to unions in each wing-root.

The boats with Sperry automatic pilots had the engaging lever located in the aft end of the throttle box, below the mixture controls. The engaging lever was connected to the Sperry servo unit by a Bowden control, operated by a double pull lever. The 'A' 'boats, with Smith Mk. I A. automatic pilots, had the main cock mounted on the throttle box - position unknown - but probably in the same position as the Sperry control lever. The safety catch levers were mounted on the starboard side of the box and the pitch control on the opposite side. Both levers were operated by Bowden controls to the rudder, elevator and aileron units. The lateral trim control was on the instrument panel on the Captain's side below the rate of climb indicator.

The bulkhead forming the aft end of the Control Deck was the forward main spar frame - Frames 15/16. The fuel tank cocks were attached to the roof of the Control Deck at the aft end, just forward of the main spar frame bulkhead. The cocks for majority of the fuel systems were identified by letters, except for Systems IA, IB and the flight-refuelling systems. The various operating levers and wheels were colour coded - RED for port. GREEN for starboard and BLACK for the levelling or balance cocks. For simple

3. Production

systems. such as System 1/ID, only three cocks were needed - RED, BLACK and GREEN - one for the tank in each mainplane, with the BLACK levelling cock lever in the middle. System MI, the most complex, required nine cocks. A group of five - two RED, and three GREEN - served the outboard and centre port wing tanks and the three starboard wing tanks. A subsidiary group of four levers - one GREEN, one BLACK and two RED - controlled the two hull tanks, one mainplane tank and the levelling cock. The drain cock for the single tank systems, such as System 1/ID, was accessible inside the port mainplane root. The multi-tank systems had a separate lever-operated drain cock.

The fuel tank contents gauges, the hand wheels for the carburettor air intake shutter controls and fuel pump test cock controls were all mounted on the forward spar frame bulkhead, with the contents gauges at the top. Each fuel tank had its Telelevel or a Smith's Korect gauge. The two hand wheels of the air intake shutter controls were below the tank contents gauges. Coloured RED and GREEN for port and starboard, they operated the hot air supply to the carburettors. Each wheel had two positions - COLD and HOT. Turning the wheel from COLD to HOT compressed a spring return, which was released by a button on the wheel. When the wheel was in the HOT position, the return to COLD was a matter of pressing the button. The controls on 'CT CHAMPION, 'KZ CATHAY and 'RA CLEOPATRA were extended to a point beside the First Officer's seat, so that he could change carburettor heat without leaving his seat. It is probable that 'PZ CLIFTON was also modified in the same way.

The hand wheels for the engine fuel pump test cocks were similar in appearance to the shutter controls and mounted directly beneath them. The RED and GREEN wheels had two positions - OPEN and SHUT. Turning the wheels to SHUT closed Cock D, isolated the engines on one side from the common engine pump feed line. With Cock D closed, the fuel pumps of the two engines were drawing separately from the tank - in the case of System 1/ID - or tanks for the other fuel systems. A fuel pump malfunction could be detected by the faltering of its engine. An extra cock, to separate the supply between the mainplanes - Cock I - was located in the wing root and reached through a small door. The Ki-gas primers were mounted on either side of the aircraft, just forward of the forward spar frame bulkhead and beneath the access panel to the leading edge of the mainplane. Each primer had a pump and selector cock for the two engines on that side.

The handles for the adjustable engine cowl gills were on either side of the aircraft, just inside the access panels to the mainplanes. Cranking the handles opened or closed the gills. The gills opened to a 30 deg. angle with 2 1/2 turns of the driving sprockets. The normal OPEN position was 5 deg.

The refuelling cock was installed in its fuel proof box, complete with door, let into the outside of the starboard hull plating of the aircraft above the pantry loading hatch, just forward of the main spar frame. Refuelling through the cock was carried out under pressure of the pump on the refuelling barge. To withstand this pressure, the refuelling pip aircraft lines were run from the refuelling cock to the various tanks in duralumin tubing. In the flight-refuelling aircraft, the pipe line from the tail cup, where the fuel entered the receiver aircraft from the tanker, ran to the tanks in the same tubing. Almost any fuel tank, or the whole system if necessary, could be drained down through the refuelling cock. The one exception was the smaller of the three hull tanks in System MI. This tank on the Control Deck, was at a lower level than the two larger hull tanks and discharged its fuel through a Rotax C 1401 double feed pump up to the other hull tanks. The fuel systems were drained down through the refuelling cock via the drain line connecting the balance line that joined all the tanks together, to finally discharge through the refuelling line. The Callender 14/.0076 cables from the engine revolution counter generators ran to the dual 5C/430 junction boxes in the wing-roots and from there to the tachometers on the First Officer's panel of the dashboard.

STAGE 8 Top and bottom floors and skirtings fitted, retractable bollard fitted. Drogue eyes and boxes fitted. Flying and cock controls, pulley banks, fairleads and brackets fitted.

The upper deck flooring was formed of panels, cut from Venesta plywood sheet, reinforced at the edges with pressed alloy channels and screwed down to the extruded light-alloy cross bearers. Sections of the flooring were either hinged or removable for access to the various controls or control runs beneath. The Control Deck floors became soaked with oil in use - increasing the aircraft's weight and becoming slippery for the crew. An application of green Nobel paint, incorporating cork granules, was suggested to seal them.

The floors on the lower deck were also sheeted with plywood from Frame 6 to Frame 39. Floor plates for the chairs and tables were fixed to the flooring. The seven watertight compartments - at Frames 6, 11,

3. Production

15/16, 20/21, 25, 29 and 34 - had a bilging trap and two inspection traps let into the floor on either side of the aircraft's centreline. The freight room floor had the inspection traps aft of Frame 34. The datum brackets were set flush in the floor surfaces of the Centre Cabin and in the Promenade Cabin. During war-time operations the carpets were stripped from the passenger accommodation and the heavy loads that were carried damaged the flooring. Loose screws and bolts that dropped off the various loads were trodden into the floor, tearing the surface.

The Production Chart does not mention during which Stage the controls were run, so for convenience it is assumed that they were installed in this Stage. The various fairleads, brackets and pulley banks for the control runs in the hull were fitted. Movements of the flight controls were transmitted to their respective control surfaces by swaged tie rods, supported at intervals with fibre fairleads. Changes of direction in the control runs were made with Reynolds Chainette No. 110500 light roller chain running over sprockets or chain pulleys, fitted with sealed and factory-greased ball bearing races. The control lock, which also incorporated the limit stops for the controls, secured and immobilised the control runs to the rudder, elevators and ailerons. The lock was fitted on the W/T bulkhead above the floor level of the Control Deck, under the Radio Officer's desk. The locking handle was stored in a canvas bag when not in use, marked STOWAGE FOR CONTROL PINS. When the locking handle - with its locking pins in the form of a comb - was inserted in the lock, the covering flap could be screwed up to secure it. The flight controls were connected through dashpots installed at the extreme end of each control run to compensate for temperature differentials in the runs and to eliminate snatch. Dashpots were small diameter cylinders containing a spring-loaded piston and filled with DTD 201 anti-freeze. The cylinder of the dashpot was connected to the control lever on the flight surface and the piston to the end of the control run.

The controls from the port rudder bar unit were taken by two short tie rods, via chain connections, to the control lock and the Sperry servo unit. From the control lock, the controls ran in chain to the top of the hull and thence by tie rod along the inside of the top of the hull. At Frame 44/45, a short length of 30 cwt. cable connected to the lower rudder lever at Frame 47/48. A short length of vertical tube connected the lower lever to the upper lever. The connection from the upper lever to the lower rudder hinge lever was in tie rod, through the dashpots.

A torque tube extended aft from the base of the port side control column unit, with sprockets at both ends for the aileron controls. One sprocket took the coupling chain, the other took the first section of the control to the Sperry servo unit and thence to the control lock, with a bypass to the lock. From the control lock, the controls ran in chain and tie rod to the 90 deg. drive at Frames 15/16 for the connection at the mainplanes.

Elevator controls ran from the port control column, through a short push rod to a bell crank. The bell crank connected, by chain and tie rod, to the Sperry servo unit and thence to the control lock with the bypass in tie-rod and chain. From the control lock, the controls ran in chain and tie rod, parallel to the rudder controls, through dashpots to the levers on the elevator torque tube.

In the three S.30 'A' boats - 'MA AOTEAROA', 'CZ AUSTRALIA' and 'MC AWARUA' - fitted with Smith Mk. 1A automatic pilots, the connections were run from the pilot's controls to the dummy bars on the automatic pilot rudder, elevator and aileron units, and from there to the control lock. The remainder of the runs were similar to the 'boats with the Sperry automatic pilots.

3. Production

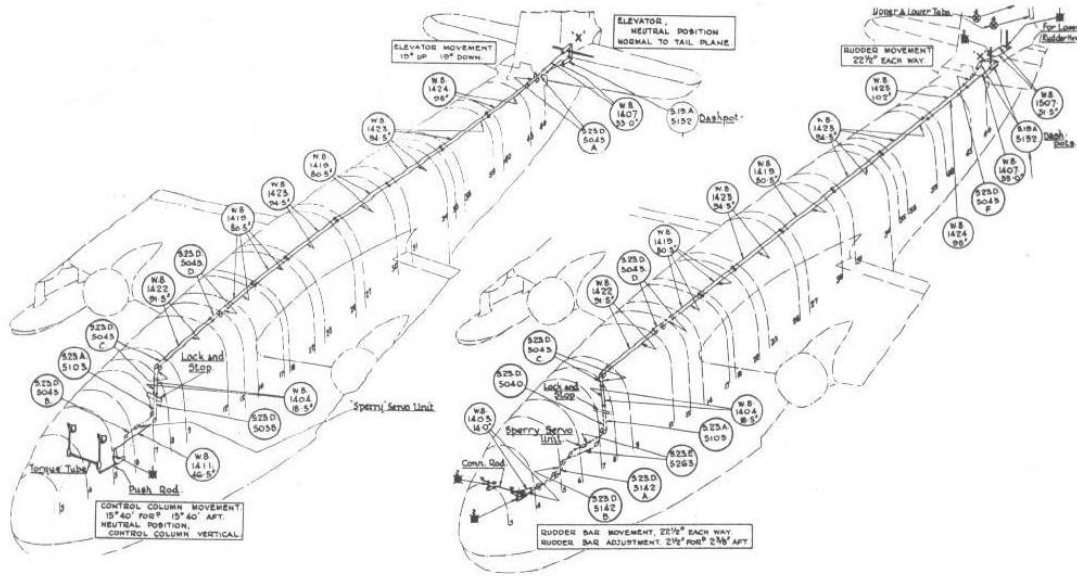

23. Parts of Maintenance Manual Diagrams 4 and 5 showing the rudder and elevator control runs.

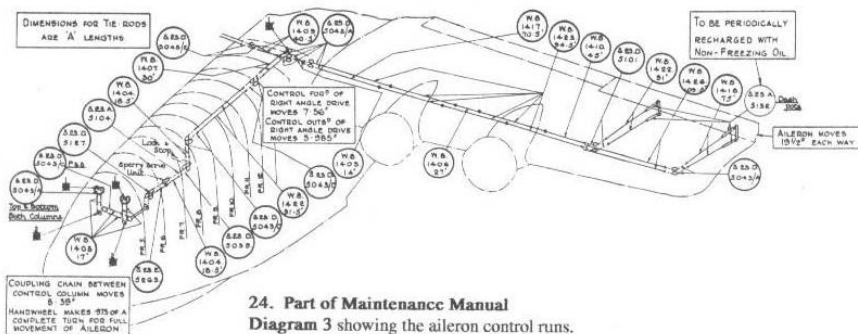

24. Part of Maintenance Manual Diagram 3 showing the aileron control runs.

The airscrew pitch control cables for the Pegasus engine 'boats, were run from the throttle box in 5 cwt. breaking strain stranded steel wire cable through fairleads, and over a series of pulleys, to each engine nacelle. There, a bell crank transferred the motion to a short length of Arens control cable at the fire wall. The Arens cable ran to the pitch change valve on the engine's reduction gear casing. Leaving the throttle box on the Control Deck, the cables ran under the floor, through two fairleads which they shared with the engine cut-off control, to the bulkhead at the front spar frame - Frame 15/16. Through the bulkhead, the cables ran along the forward spar truss to the engine nacelles.

The engine cut out control connections were made by a single 5 cwt. stranded steel wire cable, running through the same fairleads as the airscrew pitch controls, and over a series of pulleys along the forward spar truss to the engine nacelles. The cut-out valves at the engines were spring loaded and self-returning, requiring only a pull on the lever to be tripped.

The flap operating motor is not mentioned in the Production Chart, so for convenience the installation is described here. The standard equipment was a Rotax split-field MT 14-N3DZ series-wound 373 W.

(0.5 hp.) electric motor, directly coupled to a gearbox, geared down 12.5 to 1. The motor was mounted in the storage space over the forward end of the Promenade Cabin. The flaps could be operated manually by disengaging the clutch on the port side and winding the flap IN or OUT by means of a winding handle inserted in the starboard side of the gearbox. The first of the four torque tubes that drove the flaps, extended on either side of the gearbox to the wing roots. Some of the S.30 'boats were fitted with Delco-Remy flap motors and in January 1940, a modification to fit Rotax Y 150 1 kW.(1.5 hp.) motors was considered. As this entailed fitting a new jackscrew and motor gearbox with an extra weight of 6 lb. (2.7 kg.) and a probable additional battery, this modification was not carried out.

3. Production

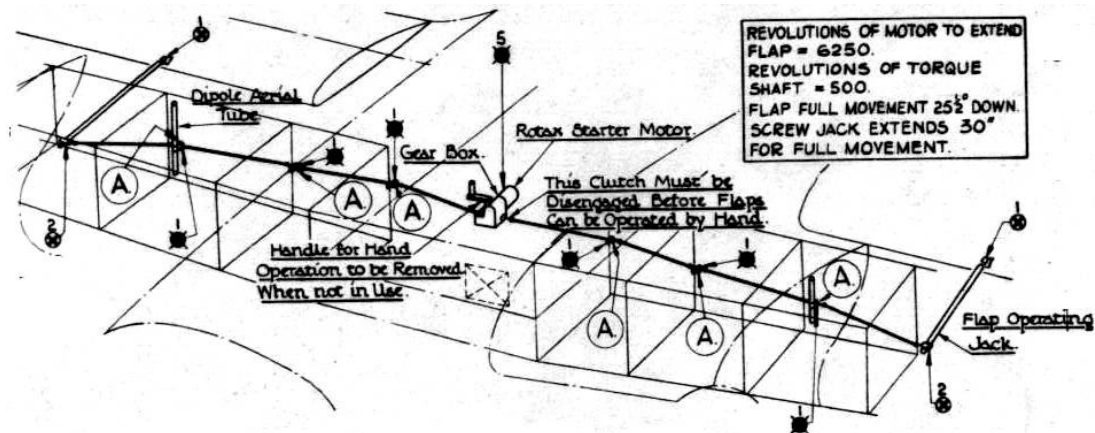

25. Part of Maintenance Manual Diagram 27 showing flap controls.

The retractable mooring bollard in the bow was the subject of Patent 451 809, applied for on 1 August 1935 in the names of Short Bros. and A.G.Parkes, the Chief Draughtsman. The bollard was fitted to the upward curving framing members in the stem. The other details around the nose were fitted, the drogue eyes and mooring cleats were cut into the skin sheeting on either side of the mooring hatch.

The switch for the System 33 heating system used on the S.23 'boats was on the main switchboard switchbox.

STAGE 9 Windows, roof brackets, bunk, parcel rack and table fittings. Electrical conduit and lamps.

The transparencies for the windows and ports were cut from Rhodoid cellulose acetate sheet. The ports (portholes), windows and bunk windows for the first twenty-five 'boats were fixed. From the twenty-sixth 'boat - S.849 'UG COOGEE January 1938 - onwards, all the windows in the passenger cabins could be pushed out as emergency exits, with instructions for use were attached to each window. The first twenty-five 'boats were retro-fitted with push-out windows. The brackets on the walls for the parcel racks and fittings for the bunks, and parcel rack straps on the ceilings, were all fixed in position.

The conduits were run for the electrical installation, the light fitting bases installed and the cables connected to the fittings.

The bow searchlight, between Frames 1 and 2, low down on the port side of the hull, was a 8 ins. (200 mm.) diam. 240 watt Smith-Harley unit on a retractable and adjustable mounting. The searchlights (bow and wing) were energised by a three-position switch, mounted on the port side of the aircraft - possibly on the dashboard. Moving the switch from the OFF position to the first ON position (F 1) brought the bow light in directly. Moving the switch to position F 2, energised a solenoid to complete the circuit to the wing light. Only one searchlight could be in used at a time. Both the hull and the wing searchlights were switched by a Rotax N5 EJ three-position switch mounted on the port side, energising a Rotax N5 CP solenoid to complete the circuit to the searchlights. The cables to the bow light were 140/0.010.

The lighting sub-board was probably on the starboard side of the Control Deck. The sub-board carried the switches for the steaming light, the identification light, the outlet for the signalling lamp and the dimmer switches for the two roof lights in the Control Deck.

The instrument lighting sub-board was on the port side of the aircraft, beside the Captain's seat. Each switch incorporated a dimmer.

3. Production

Switch No. Instruments

- 1 Captain's altimeter, directional gyro, artificial horizon.
- 2 Airspeed indicator, turn indicator, clock, fore and aft level, rate of climb indicator.
- 3 Static altimeter.
- 4 Engine speed indicators.
- 5 Oil pressure gauges, turn and bank indicator, airspeed indicator.
- 6 Boost gauges, static altimeter.
- 7 First Officer's compass.
- 8 Captain's compass.
- 9 Automatic pilot instruments.

The wiring for the instrument lighting was run in 14/0076 single-core cable.

Two Berco Type BE 5630 instrument heaters were fitted to the port and starboard dashboard panels. Two Kollsman Type 171B pressure heads were located at the top of the aerial mast. The pressure head and dashboard heaters were switched through ACL switches, either on the instrument lighting panel or on the instrument lighting sub-board, with pilot lights indicating PRESSURE HEADS and DASHBOARD on the Captain's dashboard panel. The wiring was run in 35/012 and 40/0076 cable.

Below, and on the same side of the aircraft aft of Frame 5, were the two electrical panels for the dimmers on the lighting circuits for the instruments and Control Deck lights. The switches for the instrument dimmer panel were:

Switch No.	Instruments
1	Captain's altimeter, directional gyro, artificial horizon.
2	Airspeed indicator, turn indicator, clock, fore and aft level, rate of climb indicator.
3	Static altimeter.
4	Engine speed indicators.
5	Oil pressure gauges, turn and bank indicator, air speed indicator.
6	Boost gauges, static altimeter.
7	First Officer's compass.
8	Captain's compass.
9	Automatic pilot instruments.

The lighting panel included switches for the Control Deck roof lights for the pilot's position and the Radio Officer's station, the steaming light and the identification light - located under the starboard mainplane. The plug for the signalling light and the instrument heater switches were also on this panel.

3. Production

The schedule of light fittings was as follows:

Mooring compt.	6 watt light.	1 off
Control Deck.	6 watt roof lights.	2 off
Mail room.	6 watt roof lights	3 off
Receiving space.	6 watt roof light.	1 off
Loading space.	6 watt roof light.	1 off
Chart table.	6 watt light.	1 off
Stowage room.	6 watt roof lights.	2 off
Forward Cabin.	6 watt wall and bunk lights. 6 watt ceiling lights. (1 with 6 watt pilot).	7 off 2 off
Corridor.	6 watt ceiling light.	1 off
Lavatories.	6 watt ceiling light each.	1 off
Pantry.	12 watt ceiling lights.	2 off
Centre Cabin.	6 watt wall and bunk lights. 36 watt ceiling lights. (1 with 6 watt pilot).	2 off 1 off
Promenade Cabin	6 watt wall and bunk lights. 36 watt ceiling lights. (1 with 6 watt pilot).	7 off 3 off
Aft Cabin.	6 watt wall and bunk lights. 36 watt ceiling lights (1 with 6 watt pilot).	5 off 2 off
Freight room.	6 watt ceiling light.	1 off

The wiring was run in 14/0076, 23/0076, 40/0076, 110/0076, 162/0076, 195/01 and 61/044 single-core cable, depending on the loading of the circuits. The terminal blocks were 5C/450 two-way blocks or 5C/432 three-way blocks.

The passenger cabin ceiling lights were 8 in. (200 mm.) diam. Taw 36 watt totally enclosed fittings. One light in each cabin was fitted with a 6 watt pilot light for use as a night light. The individual wall-light and bunk-light fittings were removable plug-in units, which could be moved about the cabins in the various positions to suit the seating and bunk arrangement. They incorporated the Steward's call button.

The Steward's call signal indicator was fitted to the wall of the pantry. The 'boats of the first two orders had a four-way relay unit with differing coloured indicator lights for each cabin - RED for the Forward Cabin, WHITE for the Centre Cabin, GREEN for the Promenade Cabin and AMBER for the Aft Cabin. The later 'boats, probably - S 1003 'FA CATHAY February 1940 -and the two S.33 'boats, were fitted with high-pitched buzzers on the indicator board, in place of lights. There were nine call button positions in the Forward Cabin, seven in the Centre Cabin, nine in the Promenade Cabin and seven in the Aft Cabin. The later 'boats also had a call button on the Control Deck. The wiring was run in 14/0076 single-core cable.

3. Production

The aircraft's electrical main switch board and battery were on the Control Deck between the mail hatch and Frames 15/16, on the starboard side. The main switchboard was a Rotax N5 EX switchbox incorporating the six main switches, the fuses, a voltmeter and an ammeter. The Desiderio emergency starting switch and change-over switch were also on the main switch board. The Desiderio Type 500 screw-action switch - usually known as the 'Dizzy' - was on the 12 volt circuit to the engine starter motors. The Dizzy had to be screwed right IN to bring it into operation and screwed a full 1 1/2 turns OUT, to break the circuit. The Tucker B 70 two-way change-over switch connected the starter button circuit either to the battery, or the Niphan NFAB ground plug. The battery was securely strapped down to its base with, no doubt, some insulation to the top of the rear fixing strap as recommended at the end of the C of A trials. The battery was a 24 volt 18 cell Nife alkaline battery with a capacity of 55 ampere hours. It was connected to the generators via two Rotax N5 FF voltage regulators on the main switchboard. The power for the electrical installation was supplied from the two Rotax N2 BW generators mounted as auxiliaries on the inner engines. The output from each generator was 1 000 watts at 24 volts.

The battery supplied:

24 volt circuits

- Navigation lights.
- Searchlights for alighting .
- Power supply for radio installation.
- Internal lighting.
- Steward's call signals.
- Flap motor.

12 volt circuits

- Instrument lighting.
- Engine starting for emergency use when ground battery was not available.

A Rotax N5 FY connection box was provided on the main switchboard immediately above the battery to simplify the connection of the various circuits. The following switches and fuses were incorporated in the switchbox:

Switch no.	Fuse no.	Fuse circuit	Watts amps.	Circuit amps.	Fuse
1		Voltmeter.			
2	1	Instrument lighting (12 V).	48	.4	8
	2	Instrument lighting (12 V).	48	4	8
	3	Anchor and steaming lights.	20	0.83	4
	4	Identification light.	12	0.5	4
	5	Steward's call signals.	24	1	4
3	6	Cockpit and wireless lights.	18	0.75	4
4	7	Corridor, Forw'd. and Centre. Cabins, bunks, Lavatory and Pantry lights.	108	4.5	8
	8	Prom. and Aft Cabin wall and bunk lights.	72	3	8
	9	Chart table, Mail rooms, Receiving table, Loading and Stowage lights.	48	2	4
5	10	Forw'd. and Centre Cabin and Mooring compartment roof- lights.	126	5.25	12
5	11	Prom. and Aft Cabins, Freight room roof lights.	204	8.5	12

3. Production

6	12	Port navigation light.	20	0.83	4
	13	Tail and stadbd. navigation lights.	30	1.25	4
	14	Signalling light.	30	2.5	4
	F	Dynamo fields.		4	

The following fuses were also fitted on the main switchboard:

Rotax N5 EB	15 amp.fuse for engine starting.
Rotax N5	4 amp.fuse for the flap indicator.
Rotax N5 EB	15 amp.fuse for flap motor changeover switch.
Rotax N5 DN	50 amp.fuse for flap motor.
Rotax N5 EB	20 amp.fuse for bow searchlight.
Rotax N5 EB	50 amp.fuse for wing searchlight.
Rotax N5 EB	15 amp.fuse for searchlight solenoid.
Rotax N5 EB	15 amp.fuse for instrument heaters.

STAGE 10 Cabin furnishing grounds and ventilation ducts fitted. Pantry and lavatory partitions fitted.

The three heating systems used on the 'boats are identified here by the diagram numbers used in the Maintenance Manual. System 33 was used on the Mark I standard S.23 'boats. System M33 was used on the S.30 'passenger aircraft' and the S.33 'boats and System M33A on the S.30 'mail aircraft'. System 33 used steam as the heating medium, the other two Systems used hot water.

'MA AOTEAROA and 'MC AWARUA, the two S. 30 New Zealand 'A' 'boats were initially fitted with M33 systems. The main cold air trunk for the three Systems entered the hull from the mainplane, high up on the port side of the hull, just forward of Frames 20/21 for System 33, and just aft for the other two systems. The main warm air trunk for Systems 33 and M 33A entered the hull from the mainplane on the starboard side, opposite the respective cold air trunk entries. The air heaters and associated equipment for both the systems were located inside the starboard mainplane. The air heater for System M 33 was inside the hull over the Promenade Cabin on the starboard side, with the main warm air trunk discharging aft.

Hot and cold air was distributed throughout the hull from the main trunk outlets, divided into three to serve the forward, centre and aft parts of the aircraft. The cold air system on the port side was extended to each of the punkah louvres in the passenger cabins, and the warm air system on the starboard side to the low level outlets.

The large air trunking was formed from light alloy sheeting. Much of the smaller diameter air trunking was made from fabric, impregnated with synthetic resin and moulded over foundry cores or inflated rubber tubes. This technique was especially effective in the manufacture of complicated junctions and bends. The larger sized ducts were made with double fabric walls, with stiffening wire wound between them. The manufacturing method was patented (Patent 455 110, dated 21 November 1935).

3. Production

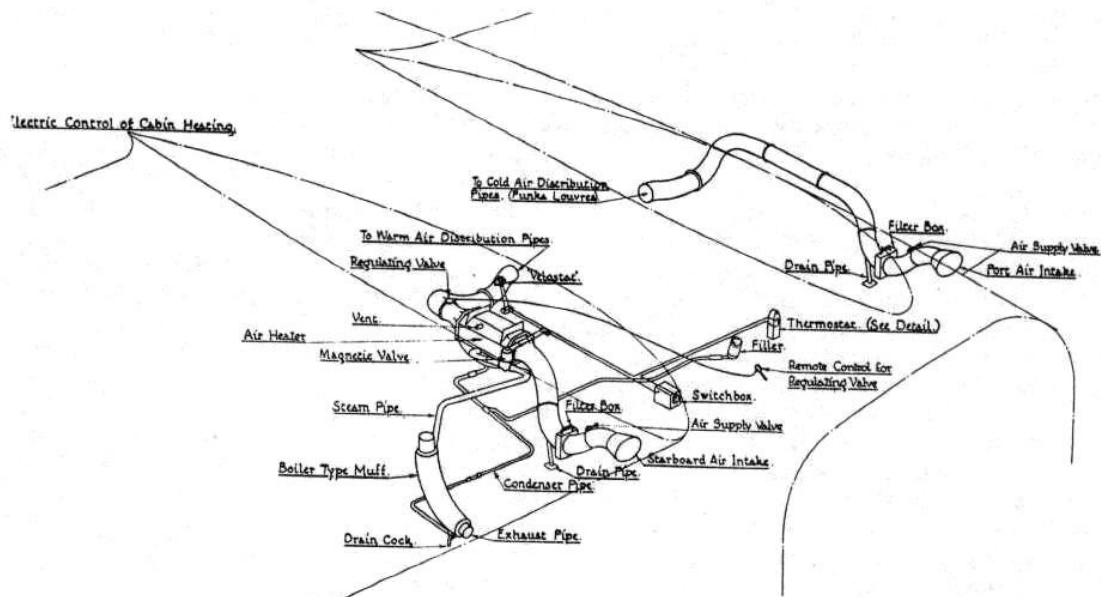

26. Part of Maintenance Manual Diagram 33 showing the heating and ventilating system used on the Mark I S.23 'boats.

The water tank and pump for cabin heating systems M 33 and M 33A was fixed to the aft bulkhead of the pantry. The filler for the heating system tank - which held about one gallon (4.5 litres) of softened or distilled water - was attached the forward spar frame bulkhead. The warm air regulating valve - downstream of the air heater - was moved by a Bowden cable and lever next to the filler. The hot water was circulated by a 250 watt Delco-Remy pump, controlled by a Rotax N5 HU switch with a RED Rotax H 1102 indicator light.

The ducts for the extract systems from the two lavatories and the pantry were run to positions in the low pressure zones of the mainplanes, just aft of the leading edges, ending with a grilled outlet. The duct from the lavatories was on the port side and the duct from the pantry on the starboard side.

Once the air trunking was in position the timber grounds for the cabin trimming were fixed to the frames. The pantry and lavatory bulkheads were fitted. The equipment in these spaces was installed in Stage 18, before the 'boat was rolled out. The waste water from the pantry sink and lavatory wash basins were discharged to the outside. Floor drains to the outside were provided in each compartment.

STAGE 11 Coupé, fitted to hull.

The roof, windscreen and sliding direct-vision windows of the Control Deck were built as a unit, known at Rochester as the coupé. The roof stiffeners were hand formed to profile, drilled for fixing holes and anodised. The roof sheets were cut to shape, formed to curvature, drilled back from the stiffeners and anodised. The windscreen was provided with sliding direct vision panels on both sides - handy exits for the pilots in crash conditions. The framing for the windscreen and sliding windows was formed from light-alloy extrusions. After drilling for riveting, the framing was anodised and the coupé assembled as a unit. The transparencies were fabricated from heat-formed Rhodoid cellulose acetate sheet (V.13B grade) and inserted into the frames with BLACK Bostick C adhesive and Bostick glazing compound. The coupé was water tested by hose after assembly, then lifted and fixed in position on the hull in the gantry. The controls for the flaps and the trim tabs were on the underside of the coupé, roof on the aircraft's centre line, and could be worked by either pilot. The elevator tab control handles were fitted to the sides of the same operating box with quadrants marked ELEVATOR TRIM NOSE UP NOSE DOWN. When the handle was turned forward, the nose of the aircraft went down and vice versa, 6.38 turns being required to move

3. Production

the trim tab through its full movement. A pointer moved along the cover to show the degree of nose UP or nose DOWN. The final connection was by chain to two worm-drive boxes, port and starboard, operating the respective tab through push-rods.

The rudder trim tab control was located on the centreline of the coupé, facing downwards. The operating box of the rudder tab control was mounted with the single handle facing downwards on the underside. The quadrant was marked RUDDER TRIM, TURN LEFT and TURN RIGHT. The handle turned a sprocket - considerably geared down - on which the first length of the control ran in Reynolds Chainette. The chain was connected to W2/5 flexible steel cables, which ran, with the other controls, along the inside of the hull to beyond Frame 43. At Frame 43 the controls changed again to chain, being taken down to the floor of the tail and then up to the aft side of a two-to-one countershaft. Chains then ran from sprockets on the forward side of the countershaft to a self-locking worm-drive operating box. The final connection to the tab - the lower of the two rudder tabs - was by a push-rod connected to the worm segment of the operating box. Trim was applied by turning the handle, 7.74 turns either way for the full extent of the tab. The handle operated in the natural sense, marked on the rudder trim plate. The degree of trim was indicated by a pointer that moved in a slot in the casing covering the chain mechanism.

The flap controls were mounted on the underside of the roof. The Rotax N5 EC three-position CONTROLLER FLAPS operating switch, the ON-OFF flap motor switch, the flap position indicator and the RED and BLUE indicator lights were grouped together. The wiring from the battery to the 5C/432 terminal block in the port wing-root was in 14/0076 cable. The wiring from the operating switch to the flap jack ran in 35/012 cable, via two 5C/430 terminal blocks in the wing-root.

The tail slip release hook operating handle was mounted on the underside of the coupé, roof, slightly to starboard of the centre line. The control was run in a single 10 cwt. flexible stranded wire cable from the coupé, to the slip release hook assembly at Frame 44. The first part of the cable, from the handle to mid-way between Frames 9 and 10, was in Trulay cable. A spring was attached to the cable at Frame 42, just before the cable dropped down from the roof of the hull to the hook at Frame 44.

Brackets were riveted in position to take roller sun blinds to cover the sides of the windscreen. The blinds originally covered the direct-vision panels only but were later modified to cover the whole of the side of the windscreen. A blind was also fitted across the Control Deck behind the pilot's seats, for use when flying at night. A roller blind was also fitted to the port which lit the Radio Officer's desk.

STAGE 12 D/F loop, W/T, chart table and purser's tables fitted. Ventilation and control guards fitted. Sorting partitions and stowages fitted. Cabin interior trimmed.

The frames for the pilots seats were fixed to the floor structure and the adjustable seats installed. Safety restraint harnesses were provided, which proved somewhat restricting in use. By means of a lever outboard of each seat, they could be adjusted up and down in five increments, each of 2 ins. (50 mm.). By lifting the cross tube below the front edge, the seat could be moved backwards or forwards in increments of 2 ins. (50 mm.). The seats were fitted with leather covered seat and back cushions and flip-up arm rests.

The transverse bulkheads for the mail hold and wireless equipment were installed on the Control Deck. The wireless bulkhead was located slightly aft of Frame 8, extending to the centre line of the aircraft. The fittings for stowage of mail and freight were fixed in the mail room on the upper deck and aft freight room on the lower deck, including the guards which protected the control runs and ventilation ducting. The tables for the Radio Officer's station, the chart table and the Flight Clerk's table were fabricated to detail from light-alloy sheet and installed in position. The Flight Clerk's position on the S.23 'boats was originally on the Control Deck, until moved down to the Forward Cabin on the lower deck. The fittings for the wireless equipment were fixed to the bulkheads ready for the installation in Stage 18, including the direction finding loop frames for the retractable loops of the S.23 'boats.

3. Production

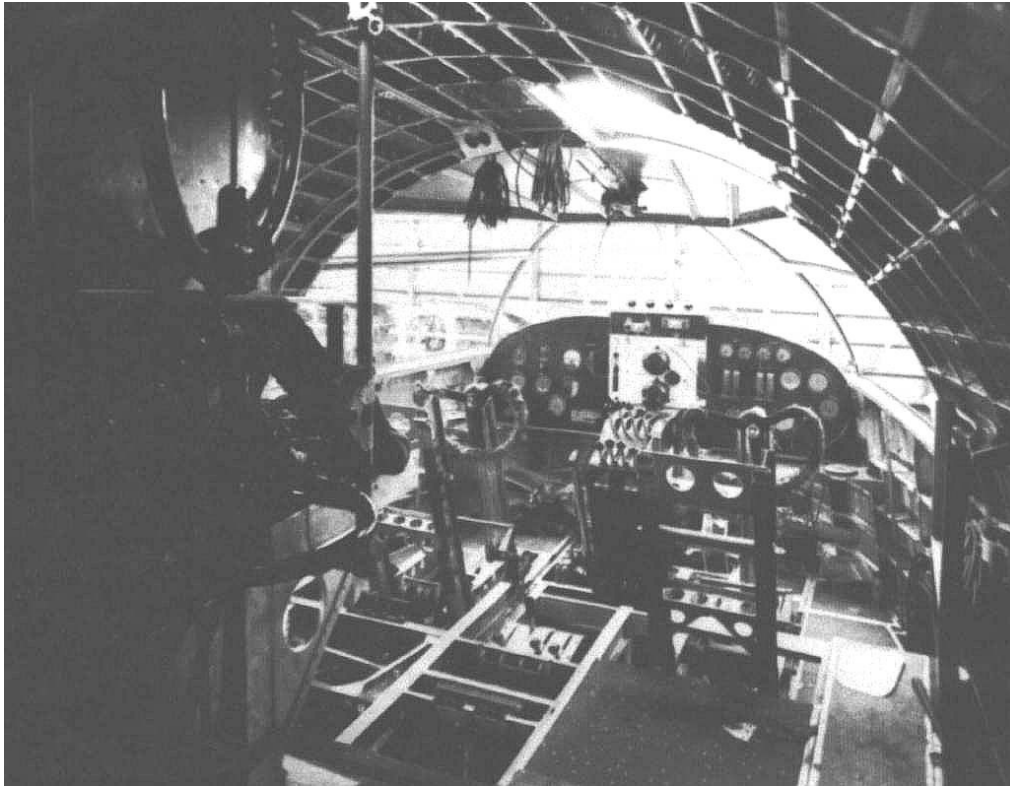

27. Short Bros. photo H 886. The uncompleted Control Deck of 'HL CANOPUS' showing the pilot's seats, the carburettor cocks between the seats and the trim tab controls on the roof of the coupé. The D/F loop is on the left of the photo. The observation hatch, behind the starboard pilot's seat, is without the cover with fold-out windscreen.

The supply and fixing of the interior trim of the passenger cabins was sub-contracted to L.A.Rumbold and Co. Ltd. and was carried out to the design of Brian O'Rourke ARIBA - architect. The precise details of the construction and finishes are now beyond recall, as Rumbold's archives for this period of their operations have long since been discarded. The walls and ceilings of the passenger cabins were finished in Connolly Bros. Vaumol hide. The colours are variously described. The wall surfaces are described as 'bottle green' or 'dark restful green' and the carpets as 'grey', or in some descriptions, as 'mottled green and black'. The Science Museum cut-away interior model shows the interior wall colour as grey-green, rather lighter in tone than the traditional bottle, with a dark green finish below the dado line in the Centre Cabin only. The ceilings were described as 'white' for the Forward Cabin, and 'dove grey' or 'very pale lime green' for the other passenger cabins. Photographs taken in the accommodation mock-up show the ceilings of the Forward and Promenade Cabins to be the same tone. The corridor between the pantry and the lavatories was finished in white paint for walls and ceiling. The jointing beads of the wall and ceiling finishes in the cabins, the grab rails and the escutcheons for the bunk fixings were in aluminium alloy, finished with a specially developed opalescent anodising by British Anodising Ltd. The trimming of the cabins was completed with the fixing of the 'NO SMOKING' signs over the heads of the appropriate internal cabin doors, the square clock and matching altimeter in the Centre Cabin, the small hold-alls let into the walls, the light luggage racks - light alloy tube frame with netting stretched between and suspended from the ceiling with leather straps - the draw curtains at the windows, the blinds at the ports and the carpets. The quoted cost of the trimming was £ 1 468 (PV £ 31 195) in 1936, rising to £ 1 891 (PV £ 37 970) in 1939.

The seats were supplied to Short Bros by Imperial Airways Limited as embodiment loan or 'free issue' items. IAL was very proud of its new seats - called in the Patent document an 'adjustable chair' - and by contemporary standards they were considered to be extremely comfortable. The framework was the subject of Patent 447 327 dated 13 November 1934, in the names of Imperial Airways Limited and Harold Burchall, the General Manager of IAL. It was made from light-gauge electron tubing and the fabrication licenced to Accles and Pollock Ltd. in Birmingham. Each complete seat weighed 21 lb.(9.54 kg.). The

3. Production

seats had five positions, from the upright to the virtual recline. As the seat was moved downwards, a rubber cord on either side was put in progressive tension, to help move the seat back to a more upright position. The seats and backs were Mosely "Float-on Air" pneumatic cushions, covered in green, all-wool, un-cut moquette with piped edges. The padded head and arm rests were provided with detachable, possibly fawn coloured, washable covers. The seat cushions doubled in duty as life preservers in the event of a ditching. The seats in the Smoking Cabins had ashtrays incorporated in the arm rests. The seats could fold down to 15 ins. (380 mm.) high to allow the bunks to be fitted over them. Bunk curtains and coverlets were green, to match the seat covering.



28. **Short Bros. photo H 939.** The photograph is taken in the Promenade Cabin looking forward, showing the Centre Cabin, the entry to the pantry and the Forward Cabin beyond.

3. Production

The actual number of seats supplied to the 'boats varied. The original specification called for twenty-four passenger seats. With this complement, the Mark I and Mark II S. 23 'boats were fitted with a total of seventeen adjustable seats in the centre, Promenade and Aft Cabins and seven fixed seats in the Forward Cabin. When the Forward Cabin of the Mark I 'boats was taken over for the Flight Clerk's office, the passenger seating was reduced to the seventeen adjustable seats - three in the Centre Cabin, eight in the Promenade Cabin and six in the Aft Cabin. This arrangement released another 1778 kg. for mail and freight. In order to make up the eight seats in the Promenade Cabin, there should have been two seats on the port side, occupying part of the promenade space. The two seats are shown in the Loading Distribution (Day) Diagram of the Maintenance Manual but do not appear in any of the photographs or in either of the cut-away models. Neither the model in the Science Museum nor the 1:72 scale plastic Frog 22P Kit cut-away model of the interior - available in 1938 - included these two seats. There is a photograph, taken in the accommodation mock-up, showing a single table on the port side of the Promenade Cabin, apparently laid as a serving table, without a seat. In any case, because of the higher sills of the windows on the port side of the Promenade Cabin, the two passengers in these seats would not have been able to see out. The drawing (S.23.C.29.013) accompanying the Type Record is of a Mark II S.23 'Bermuda' 'boat and shows a full complement of twenty-four passengers. The Bermuda - New York service was outside the EAMS and passengers were more commercially important than mail. It is probable that 'UU CAVALIER was the only 'boat to retain the original arrangement for the whole of its service life. It was the only 'boat to carry a junior Steward.

A poster advertising IAL services shows a 'boat with the modified arrangement, with six seats in the Promenade Cabin and quotes a seating capacity of fifteen. The Short Bros.' entry in the 1939 SBAC Directory confirms fifteen as the number of seats. The revised passenger load in the EAMS was therefore either seventeen or fifteen. 'KZ CATHAY, 'PZ CLIFTON, and presumably 'RA CLEOPATRA were fitted with seventeen seats. The two of the Mark III S.30 'boats - 'CW CONNEMARA and 'CX CLYDE - the QEA 'boats and the two TEAL "A" 'boats, had fifteen seats. 'CU CABOT and 'CV CARIBOU - November 1939 - were untrimmed at launching but later fitted with ten seats in the Centre and Promenade Cabin.

The tables in the passenger cabins were not mentioned in the 'free issue' list so were presumably made by Short Bros. The number of tables was also variable. There were two in the Forward Cabin, two in the Centre Cabin, three - or five - in the Promenade Cabin and two - or four - in the Aft Cabin - totals of nine or thirteen. The Type Record shows a Mark II S.23 aircraft with thirteen tables. In the revised accommodation, the two tables in the Forward Cabin were omitted. To confuse the issue, the equipment list for the S.30 'boat 'KZ CATHAY lists ten tables. Most of the tables were divided to fold longitudinally, either to act as a book rest or to enable the passenger to get in and out of the seat more easily. The tables were fitted with a fiddle round the edge, nautical fashion, to stop cutlery and crockery sliding off in bumpy conditions. Cuspidors were carried in place of the later airsickness bags - one for each seat.

The two Mark III S.23 'Atlantic' 'boats and two of the four Mark III S.30 'boats - 'CU CABOT and 'CV CARIBOU - were originally untrimmed. One lavatory was installed and the drinking water tank was in the area of the pantry. Timber slat flooring was supplied for carrying mail.

STAGE 13 Hull withdrawn from gantry. Erection of tailplanes, elevators, fin and rudder.

The hull aft of Frame 42, including the fin, rudder, tailplanes and the elevators, were made as sub-assemblies in Nos. 10, 11, 13 and 14 Shops for final assembly and mating with the major portion of the hull in No.3 Shop. The aft end of the hull was manufactured and assembled in a small gantry in No.10 Shop, in a similar way to the hulls. This part of the hull, starting at Frame 42, consisted of six single hull frames and the two double spar frames - Frames 44/46 and 47/48 - to connect to the fin and tailplanes. The single frames were made from channel section in DTD 275 sheet, in a similar way to the other hull frames, and assembled on a keelboard in a gantry. The tail plane and fin spar frames were cut from blanks and assembled on table jigs, with the forged and machined S 80 steel jointing lugs sandwiched between. The tail assembly was then sheeted in a similar way to the hull in 18 SWG., 20 SWG. and 24 SWG. sheet.

The 20 SWG. tail cone was formed to shape and riveted to Frame 51. The tail cone carried the Rotax A5C/498 phenolic moulding for the tail light. The tail light, WHITE in colour, doubled as an overtaking light while the 'boat was on the water and had an arc of visibility of 67 deg. on either side of the aircraft's centre line, making a total sweep of 135 deg. The flight-refuelled aircraft had a refuelling cup installed in

3. Production

place of the tail cone, with the tail light mounted above. The refuelling cup was similar to that shown in the Flight Refuelling Limited Patent (No. 491 953) in the names of Sir Allan Cobham, Hugh C. Johnson and P.R. Allison, dated 10 December 1936.

The fin and tailplanes were of similar construction and based on the constructional method evolved for the mainplane of the Scion. The fin post was a seven-panel Parker truss spar, 10 ft.10 ins. (3.30 metres) in height. Each half of the tailplane was a ten-panel truss of 11 ft. 8 ins. (3.56 metres) span. The fin post and tailplane spar booms were one-piece cruciform extrusions, machined on a Parkson horizontal milling machine with a 11 ft. (3.335 metre) travel. The booms were jiggged for the drilling and fitting of gussets, angle pieces and root-end fittings. Each fin and tail plane was then assembled in two separate jigs, top and bottom for the tailplanes and each side of the fin. A surface jig held the spar booms while the tubular drag members, stiffeners and sheeting were fitted and riveted. Pairs of surfaces from the jigs were assembled together in the three main assembly jigs to form the port and starboard tailplanes, and the fin. The whole truss was trued up and the tubular vertical and lift struts fitted and riveted. The elevator - or rudder - hinge plates were placed in the jig and the holes opened out for bolting and riveting. Steel rod cross-bracing completed the truss. The leading edges were jig-assembled from plate diaphragm ribs and formed sheets.

The plate ribs were formed to profile on timber formers. The lightening holes were formed and flanged on a fly-press. The after edges of the trusses were formed by rectangular plate ribs, made from blanks with flanged lightening holes.

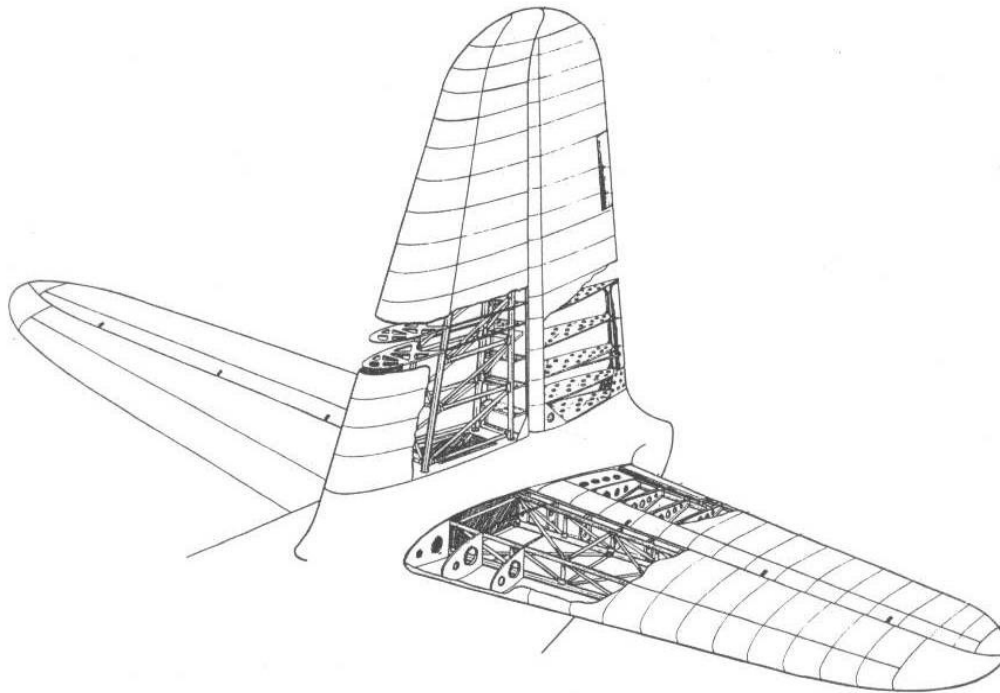

29. Maintenance Manual Diagram 50 showing the construction of the tail.

The elevators and rudder were similar in construction. The elevators were built round a spar formed from two channels, arranged back-to-back. The sixteen ribs forward of the spar were formed from flanged blanks, each with two flanged lightening holes. The leading edge was shaped from DTD 275 sheet over timber formers and anodised. The sheeting and the ribs were assembled in three jigs - port, starboard and rudder - with throw-over clamps acting as drilling jigs for the rivets. The flanges of the ribs aft of the spars were straight to ease production. Each rib had four flanged lightening holes. The whole elevator or rudder was then assembled in a jig, complete with hinge plates, brackets and the torque tube with its end collar. The elevators had solid mahogany trim tabs on brass hinges with stainless steel pins, extending from Rib 1 to between Ribs 3 and 4.

3. Production

The rudder had a lead mass balance weight of 16 lb. 10 oz. (7.5 kg.), situated in the leading edge, 7ft.2.76ins (2.356 m.) up from the junction with the hull. The rudder had two tabs in the trailing edge, the upper tab - between Ribs 8 and 11 - was a servo to help in moving the rudder. The lower tab, between Ribs 2 and 5, was a trim tab. Both these tabs were formed from solid mahogany on brass hinges.

The surfaces of the rudder and elevators, aft of the spar, were covered with 4 oz. per sq. yd. (134 gm. per sq. metre) linen cloth, made from long-fibred flax to BSS F.1. The method of attachment of the linen to metal was the subject of another Short Bros. patent. This Patent - 450 083 - shows the joggled edge of the metal sheeting of a control surface, with a fairing strip of fabric laid along the length, half in the joggled joint. A pocket was sewn along the length of the covering fabric, into which was slipped an aluminium alloy strip. The cover fabric was then bolted through the metal strip and the linen fairing strip lying in the joggle. The other half of the linen fairing strip was turned back over the bolted joint and finally doped in position to cover the joint and fair it in. The fabric covering was then sewn to the ribs with No. 1 Kite Cord to BSS F. 35. Ribs were covered with a strip of fabric, with the edges frayed for maximum adhesion. The trailing edges were turned in 1/2 in. (12 mm.) and lock-stitched together with 40 gauge linen thread. A doped-on, doubled-over, frayed-edge reinforcing strip finished the trailing edge, covering the stitching.

The fabric surfaces were finished with dope to tighten and preserve them. The dopes used were volatile solutions of cellulose nitrate - cotton dissolved in nitric acid - or acetone in solvents, with additional softeners, plasticizers and thinners. A typical doping system to conform to D.T.D. 83 consisted of a brush-applied first coat of red oxide dope, then the frayed edge-strips applied with clear dope as adhesive, then a second sun-resistant coat, followed by two pigmented finishing coats - SILVER in the case of the pre-war Empire 'boats. Any markings, such as part numbers and the W/T bonding symbol, were stencilled on in BLACK or DARK BLUE paint and protected with clear dope. Doping nearly doubled the original weight of the fabric and increased its tensile strength by a quarter.

The various components of the tail were brought together and assembled in No.3 Shop. The tail assembly to complete the hull, was lifted by the bridge crane, offered up to Frame 42 of the hull and bolted through to complete the construction joint. The skin plating was lapped and riveted over the joint from the outside to complete the hull. If the gantry could be reached by the bridge crane, this operation was usually carried out before the hull was withdrawn.

The weight of a standard S.23 bare hull was about 5 900 lb. (2 676 kg.) and contained about 8 000 sq. ft. (744 sq.m.) of all gauges of sheet, fixed with 250 000 rivets of varying size. The overall length, normally quoted as 88 ft 0 ins. was 88 ft. 3.115 ins. (26.90 metres) overall including the tail light for all Marks and types, except the flight refuelled 'boats. The receiving cup of the flight refuelled S.23 and S.30 'boats shortened the tail to an overall length of 87ft. 6.955 ins. (26.694 metres), giving them a docked appearance.

The keel board under the centre section of the hull was dismantled and the shop truck positioned under the completed hull. The hull was secured on the shop truck with strops from the lower spar fittings, protruding from the sides of the hull. The truck was jacked up to take the weight of the hull at the two spar frames (Frames 15/16 and 20/21). Once the hull was secure on the shop truck, the remainder of the keel board was removed. The hull was then free to be withdrawn from its gantry by tractor. It was then swung through a right angle onto the centre line of the main doors of the Shop, with the nose pointing towards the doors. Photograph 11 on page 22 shows the hull of 'HL CANOPUS on the shop truck. The fin and tailplanes were bolted in position to the lugs at Frames 44/45 and 47/48. The elevators could then be lifted and the three hinge bolts inserted and bolted up. The torque tube connection was bolted up and the chain drive for the trim tabs connected inside the hull. The three rudder hinge bolts and the torque tube at the bottom hinge position were fitted. The rudder was then fitted and the chain drive to the trim tab connected inside the hull. The weight of a Mark I S.23 hull ready for withdrawal complete with door framing and covering, controls, tail plane and fin and rudder complete, cabin trimming, heating and ventilation was 9 443 lb. (4 283 kg.).

The construction and fitting of the aerial mast is not mentioned on the Production Chart so for convenience, it is included here. The mast was on the centre line of the hull immediately aft of Frame 9, close to the wireless sets, to minimise interference. The fixed aerial, single or dual, extended from the mast to the fin. When the early dipole aerial arrangement was in use, two subsidiary masts were slotted into sockets attached to the rear mainplane spar, inboard of the inner engines. The aerial mast also carried the pressure heads and could be extended upwards for 3 ft. (900 mm.) as an ensign mast.

On 6 October 1939, the Air Ministry instructed Short Bros. not to complete G-AFRB, the last of the three S.33 'boats. On 27 October, a verbal instruction required completion with a strengthened hull. The hull was withdrawn early in December 1939, after seventeen weeks in the gantry, 90% complete. In April 1940,

3. Production

the hull was cleaned up, liberally coated with lanolin and prepared for storage. The hull was encased in a weatherproof case and stored in the Barge Yard. The weatherproof case could be entered by a small door and doubled as a store for light-alloy extrusions, slid in beside the hull. When he could, one 14 year-old shop boy liked to slip into 'RB's 'box' through the door, avoiding the lanolin on the hull, and climb up to the Captain's seat on the Control Deck to spend a few happy moments 'flying' 'RB about the world.

Short Bros.' estimate on 5 December 1940 was that 'RB was 77% complete. The parts of the 'boat remained in limbo until 15 January 1941, when Short Bros. quoted £ 11 752:0:0 (PV £ 236 000) to complete. Later that year, on 9 July, they asked the Air Ministry for a final decision on the fate of the aircraft. The hull, at least, was in existence at the end of March 1943. It was suggested that the mainplanes of 'TX CERES, salvaged from the hangar fire in Durban - 1 December 1942 - should be mated with 'RB's hull, still in its packing case in the Barge Yard. Nothing came of this suggestion. The hull was eventually scrapped.

STAGE 14 Fitting of engines and engine controls completed.

The engines installed during production were both air-cooled Bristol radial engines. The Pegasus XC was a 28.7 litre, civil-rated, medium supercharged, poppet-valved engine and equipped the S.23, S.33 'boats and one of the S.30 aircraft - 'KZ CATHAY. The Bristol Perseus XIIC was 24.9 litre, civil rated, medium supercharged, sleeve-valve engine and was fitted to the eight S.30 'boats. Both types of engine were geared down to turn the airscrew at half crankshaft speed, through Farman type reduction gearing. The engine nacelles were designed so that either engine, Pegasus or Perseus, could be accommodated without modification. Some of the S.23s and 'KZ CATHAY had their Pegasus XC engines exchanged for Pegasus XXII during their service on the Horseshoe route, during World War II. The XXII was rated at 753 kW. (1010 bhp.) at 2 600 rev. per min. with +6 lb. sq. in. for take off.

The engines were supplied by the Bristol Aeroplane Co. Ltd to Short Bros., bonded and screened. The bonding and screening conformed to DTD GEL 125 - Bonding of the Ignition System - up to the starting magneto and the primary short circuiting terminals of the main magnetos. The engines were delivered as 'free issue' complete with magnetos, carburettors and starters. The fitting of the engines and the supply and fitting of the airscrews was the responsibility of Short Bros. The exhaust collector rings, inter-cylinder cooling baffles, NACA long chord cowlings with attached cooling gills, Record engine speed indicators, Marconi screened ignition harnesses and the auxiliaries, were supply and fit items by Short Bros. The magnetos fitted to the engines were dual Rotax-Watford SP 9-6 magnetos with screened distributors, mounted on the rear casing and driven off the crankshaft at 9/8 of engine speed. The preferred spark plugs - two plugs per cylinder - for the Pegasus engines were 14 mm. diameter KLG RV 7/5 or RV 7/4. During World War II, Lodge RS 14/2R and Sphinx R2 14R plugs were sometimes substituted. The Perseus engines had 14 mm. spark plugs, specially made by KLG, with an extended metal sleeve to protect the body of the plug, deep in the junkhead.

The oil-and-water proof Marconi harness screened the main and starting magnetos, their switches and leads, the high tension leads to the spark plugs and the plugs themselves. The harness was fitted and the s screened and bonded. Bonding ensured that the whole aircraft remained at the same electrical potential, by good electrical contact between all metal parts of the airframe. Bonding was intended to prevent electrical interference to the wireless installation, especially if radio-telephone, short-wave and direction-finding equipment was used. The Marconi harness, as delivered with the engines of the first few 'boats off the Rochester line, needed some modification. 'UT CENTAURUS was kept for five weeks at Rochester - to the dismay and consternation of Captain Eggesfield who was to assume command - between the launching on 29 October 1936 and delivery to IAL on 7 December 1936. Different types of spark plugs and different arrangements of protected lead were tried out on the engines - "*....whistling in and out of the engines like corks in and out of a bottle....*" was Captain Eggesfield's comment . "*it made you dizzy to see it*" - until a satisfactory solution was found.

The carburettors were Claudel Hobson Duplex Type ATV 85E with CH XXXB automatic boost and mixture controls, and slow-running cut-out. The fuel pumps were Bristol vane-type Duplex pumps, driven at engine speed. The carburettor air intake temperatures could be controlled from the Control Deck. The air intake had three inlets, the centre admitting air at atmospheric temperature - the COLD air condition -

3. Production

while the two side inlets passed air to the carburettor that had been heated by Nos. 5 and 6 cylinders - the HOT air condition.

The starters were Rotax-Eclipse E 160R direct-cranking starters, capable of turning the crankshaft over at 25 to 30 rev. per min. A hand turning gear was also provided. Power for the starter motors came directly from the main battery or through the ground plug for external starts. They were energised by Rotax Type N5.CP solenoid switches, operated by the Rotax Type N5.EB starter buttons on the dashboard on the Control Deck. The Rotax Type N1.KA booster coils for the distributors were energised at the same time. The starter circuit was in circuit with the switches on the maintenance platforms, on either side of each engine. If the platform was not shut or screwed up tight, the circuit was not made and the engine, therefore, could not be started.



30. Short Bros. photo H 877 showing the starboard inner engine of 'HL CANOPUS' fixed in position on the nacelle, complete with collector ring and gills but without cowling or exhaust pipe.

Engine lubrication for both engines was by the dry sump principle. The pressure pump fed oil to the master connecting-rod, the big-end bearings, cam gear, rear cover and reduction gears. The remainder of the moving parts of the engine were lubricated by splash from the sump at the bottom of the crankcase, between cylinders Nos. 5 and 6. The oil was returned from the sump to the oil tank by the scavenge pump via the carburettor jacket, the oil filter and oil cooler.

The exhaust gases were taken forward from the cylinders to a collector ring, or exhaust manifold, on the leading edge of the cowling, built up from riveted sheet steel. The cowling was fixed on the engine nacelle with a three-point rubber anti-vibration mounting. The exhaust pipe was 6 ins.(160 mm.) in diameter and taken from the manifold between Nos. 3 and 4 cylinders, through the leading edge of the mainplane running in a steel duct with a 1 in. (25 mm.) clear annular air space to discharge over the upper surface. The exhaust pipe of the starboard inner engine was fitted with a muff-type water boiler for the aircraft's heating system.

3. Production

The exhaust pipes originally ended flush with the top surface of the mainplane. The Type Certificate of Airworthiness mentioned that exhaust gases impinging *'on the stressed metal covering of the upper surface of the main planes might in time effect the characteristics of the metal.* Extension stubs were fitted to divert the exhaust gases safely away.

The flow of cooling air through the engine was controlled by adjustable gills attached to the aft edge of the cowling - adjustable between 0 deg. and 30 deg. The cowlings of probably all the Perseus engined S.30 'boats, were fitted with a reverse flow cooling arrangement. A five-part pressed sheet aluminium shroud was fitted round the collector ring so that the cooling air entered at the back, inside the cowling. The shroud funnelled the cooling air round the back of the collector ring and discharged it forwards, over the outside of the ring. The more efficient cooling of the exhaust system more than compensated for the extra drag and weight.

Each engine had a 6 mm. flexible drive to a gearbox mounted on the fire wall of the nacelle to split the drive between the generator for the engine speed indicator and the Hasler Tel-tachometer. The engine speed generator was connected to the two 5C/430 junction-boxes in the wing-roots in 14/0076 cable. The Tel-tachometers provided a continuous record of engine speed on a removable paper disc.

Cylinder head temperature wiring was run in twin copper constantan cable from the thimble couple on the head of No. 1 cylinder of each engine, to the junction-box in the nacelle.

According to the Production Chart, the complete engine assembly was mounted on its nacelle while the half mainplane was on the Shop floor and the connections made before the half mainplane was lifted for attachment to the hull. This procedure was not always followed as Short Bros.' photograph - H 1087 26 July 1938 - shows 'CT CHAMPION being assembled in No. 3 Shop with the mainplanes in position but without the engines in place and photograph H 1111 - dated 31 January 1939 - shows a similar situation for one of the 'A' boats.

On arrival at Rochester, engines were delivered to No.3 Shop through the side entrance between the gantries and lifted by the bridge crane from the shipping cradles on the lorry. The crane took the engine right across the Shop to the Engine Installation Department in the north-east corner to be prepared for mounting and to have its auxiliaries attached.

The auxiliaries were driven off the tailshaft, their arrangement depending on the type of engine and automatic pilot fitted to the aircraft. The auxiliaries on the Pegasus engines were mounted on the backplate. The Perseus engines had a flexible drive to a gearbox which drove the auxiliaries, enabling them be left in place when an engine was changed. The electrical generators were common to both types, but the number and location of vacuum pumps, air compressors and oil pumps differed.

The auxiliaries on the Pegasus XC engines fitted to the S.23 'boats and on the gear boxes of the Perseus XIIC engines when fitted to S.23, S.30 and S.33 aircraft with Sperry automatic pilots were arranged as follows:

Port inner engine	Starboard inner engine	Starboard outer engine
Northern oil pump	Romec vacuum pump	Romec vacuum pump
Electrical generator	Electrical generator	

The auxiliaries on the gear boxes of the three S.30 'A' boats with Perseus XIIC engines and Smith automatic pilots were arranged as follows:

Port inner engine	Starboard inner engine
R.A.E Type C air compressor	Romec vacuum pump
Romec vacuum pump	
Electrical generator	Electrical generator

The vacuum pumps were Turner-Romec rotary-vane pumps, with relief valves incorporated. The air compressors were R.A.E. Type C compressors, complete with their own oil system and cooler. The oil pumps were Sperry-Northern PL 1335 rotary pumps. The electrical systems were supplied by Rotax Type N2.BW generators, each producing 1000 watt at 24 volts.

The prepared engine was slung and transferred by crane, back again across the Shop to its final fixing position on the mainplane. The nett dry weight of a Pegasus XC engine on the sling, was

3. Production

1081 lb. (490 kg.). A Perseus XX engine was slightly heavier.

The cooling gill ring was placed round the nacelle before the engine was offered up for fixing. Still on the sling, the engine was positioned by the crane so that the nine 3/8 in. (9.5 mm.) diameter fixing bolts could be inserted through the mounting holes in the nacelle mounting ring and tightened up. The engine was then bonded to the nacelle.

The cooling gill ring was then brought forward and fixed. The gills were opened and closed by a light roller chain that ran round the circumference of the ring, engaging in a sprocket at each gill plate. The whole mechanism was driven by another sprocket attached to a system of torque tubes and worm-drive gearboxes, ending with a flexible drive to gearboxes. Operating handles were in the wing roots on either side of the Control Deck. To save maintenance during wartime conditions, the adjusting mechanism and gills on some 'boats were removed altogether and on others the cowling was modified to the equivalent of 1/3 open gills. 'PZ CLIFTON was fitted with long chord gills.

With the engine in position, the exhaust collector ring was secured, the stub pipes fitted to the cylinders and the exhaust pipes passed through the steel ducts in the leading edges of the wings. The starboard inner engine tail-pipe was fitted with its muff boiler for the warm-air heating system.

The connections to a typical engine were:

- 16 mm Avioflexus fuel line to engine fuel pump.
- 16 mm Avioflexus pressure line through reducing valve to carburettor.
- 4 mm.(5/32 ins.) Avioflexus priming connection with copper to Avioflexus joint at the fire wall.
- Exactor throttle and mixture controls.
- 6 mm. flexible drive to the Hasler Tel Tachometer.
- Twin copper constantan cable from thimble couple on No. 1 cylinder head to the junction-box, for cylinder head temperature.
- Arens flexible connection, or Exactor connection for airscrew pitch controls.
- Engine cut-out control.
- Carburettor air shutter.
- Avery self-sealing couplings in nacelles.

The Perseus engines of 'CU CABOT and 'CV CARIBOU were fitted with Gravinier fire suppression equipment. Each engine was fitted with a RED banded copper bottle, filled with 2.72 kg. of methyl bromide, charged with nitrogen under pressure of 60 lb. per sq. in. (400 kPa.). Operation was by either a push button, an inertia switch - operating instantly at not less than 6g. - or a flame switch at 60 deg.C.. When actuated, an electrically-operated fuse in the head of the bottle opened the explosive discharge head, to empty the bottle in a few seconds, spraying the engine surface, especially the exhaust manifold and pipes, and the inside of the cowling. Initially, oil from the Sperry oil supply tanks, mounted just above the bottles, leaked onto the discharge heads, rendering them useless. ORANGE banded bottles with oil resistant heads were substituted. The cost of fitting the Gravinier equipment to the two aircraft was £ 299:11:6 (PV £ 6 000).

STAGE 15 Mainplanes erected on hull.

Although the Production Chart heads this Stage '*... Mainplanes erected ...*', the construction of the mainplanes is described here for convenience, putting it out of sequence with Stage 14 '*... fitting of the engines ...*'

The mainlanes were built in two halves, port and starboard, around a massive spar box. Each half plane was 52 ft. (15.85 metres) long, with a chord of 21ft. 0.327 in. (6.409 m.) at the junction with the hull. For constructional purposes each half plane was divided into six principal components - the spar box, the leading-edge ribs and covering, the trailing-edge ribs and covering, the engine nacelles, the flaps and the ailerons.

The Type Certificate trials for all Marks of the S.23 'boats were carried out by 'HM CALEDONIA, one of the Mark III special category 'Atlantic' 'boats with a long-range wing and a 1B fuel system. The surviving Type Record documents include the stress calculations for two spar loadings - 39 000 lb. and 40 500 lb.

3. Production

(17 690 kg. and 18 370 kg.) take-off weights. The Record documents also show a Mark II spar which could take the medium-range 1A and 1C fuel systems of the Mark II S.23s - 'UT CENTAURUS' and 'UU CAVALIER' and the three S.33 'boats'. Some of the short-range Mark I S.23 'boats' had their fuel systems modified to M1C systems when they were flying on the Horseshoe route. The tankage was increased from the maximum of 652 gals. (2 964 litres) of the 1/1D systems to M1C systems, which were equal to the 1A or 1C systems with capacities of 1 010 gals. (4 592 litres) but there is no mention of any modification of the spars.

The long-range S.23 and S.30 Mark III 'boats', the Mark II and Mark IV S.30 'boats' had 1B and M1 and M1A fuel systems, respectively with 1 770 gals. (8 047 litres) carried in the mainplanes. The spar design for 'HM CALEDONIA' would, in theory at least, cover all these eventualities. There is a quotation for fitting a 'long-range wing' to a standard hull for £ 1 468 (PV £ 37 700)', dated some nineteen weeks before the launch of 'HM CALEDONIA'. When it was agreed between IAL and Flight Refuelling Limited that one Empire 'boat' should be adapted for flight refuelling, FRL asked IAL to examine the feasibility of strengthening the mainplane structure of the Empire 'boat' to enable additional fuel to be taken on board. The extra fuel requirement was quoted as being between 500 to 1000 gals. (2 250 to 4540 litres), resulting in an increase in the all-up weight to between 45 000 to 50 000 lb. (20 400 to 22 700 kg.). The answer - presumably from Short Bros. via IAL - was that strengthening was impracticable. But Empire 'boats' were refuelled in flight to all-up weights of 53 000 lb. (24 040 kg.) and later took off at this weight. The hulls of the later 'boats' were strengthened but there is no mention of wing spar modification or strengthening in any of the records.

The spar box was formed by a forward and rear spar truss connected by drag struts and braced with incidence bracing wires. The box was completed by covering the top and bottom surfaces with stiffened sheet, riveted in position. The spar box was 48 ft. (14.63 metres) long, 6 ft. 7.064 ins. (2.008 m.) wide between spar boom centre lines at the root, and 3 ft. 10.8 ins (937 mm.) wide at the outboard end. The spar booms were toed in towards each other about the centre line, at an angle of 2 deg. 14 min. 24 sec.

The spar trusses were in the form of Parker girders, with extruded light-alloy tee-section top and bottom boom members. The booms were held apart by vertical light-alloy tubular struts and braced by diagonal tubular lift struts. The struts were joined by snap-riveted gusset and tie-plates. Each truss had sixteen panels of varying length, the engine nacelle centre lines occurred in the middle of the third and eighth panels, outboard from spar booms. The tee-sections were extruded by the Reynolds Tube Co. Ltd in L.40 alloy, 22 ft. (6.7 metre) in length. Three extrusions were joined to make up the flange of a spar boom. The first butt-strapped joint was made behind the centre line of the outer engine nacelle, with the second in the middle of the fourteenth panel. The first two lengths of a boom were full length extrusions, while the third was 4 ft.(1.219 m.) in length. The extrusions had constant angles between the flange and the web. This angle, between 2 and 15 deg. to the aircraft's horizontal datum, depended on the changing profile of the aerofoil along the span.

The sizes of the tee-sections differed for the top and bottom flanges and for the front and rear booms. The largest section on the top of the front boom was 4 ins. (102 mm.) wide X 5 ins. (127 mm.) deep with a flange thickness of 0.655in.(17 mm.). The smallest was 2 in. (51 mm.) X 1.53 in.(39 mm.) with a flange thickness of 0.17 in. (4 mm.). The corresponding flange sections for bottom boom were 4 in. (102 mm.) X 3.807 ins. (97 mm.) X 0.507 in. (13 mm.) and 2.07 ins. (53 mm.) X 1.45 ins (37 mm.) X 0.17 in. (4 mm.). The sections for the rear booms were slightly smaller.

The spar boom flange sections were machined to constant tapers in width, depth and thickness throughout their length. Short Bros. bought a horizontal milling machine for this operation and installed it in No. 9 Machine Shop. The machine was modified by extending the travelling table from 10 ft. 6 ins. (3.2 metres) to the full length of an extrusion, and the total length of the bed was extended to 45 ft. (13.7 metres). Photographs show a smiling Mr H.J.E.Piper in command of the machine. Other machines were bought and modified during World War II. At least one machine was transferred to the safety of the tunnels excavated in the chalk behind No. 18 Shop, so the production of Sunderland spar booms could continue undisturbed by air raids.

A typical boom flange machining operation proceeded as follows. An aluminium jig held the extrusion on the cutting table. When the thickness of the web was being milled, a screw and vernier on the jig enabled the position of the web to be adjusted to the correct slope to the cutter - a constant 1:800. Two roughing cuts and one finishing cut were made on one side with a face cutter, feeding at 11 ins. per min. (5 mm. per sec). The jig was then moved on the table, so that the other side of the web could be milled. The nominal machining tolerances were + 0.0005 in. (0.0127 mm.) - 0.00.

3. Production

The flanges were milled to a taper - in plan view to a constant 1:132 - for the length of a complete spar boom. The extrusion was turned in the jig, with the face of the web vertical. First one edge was milled and then the other, to tolerances of + 0.020 in. (0.5 mm.) - 0.00. For this operation the work was raised at one end, with adjusting screws along its length to prevent sag, and the flange machined to the correct thickness. The last operation was to adjust the depth of the web. The jig was lifted at one end and the three cuts made as before.

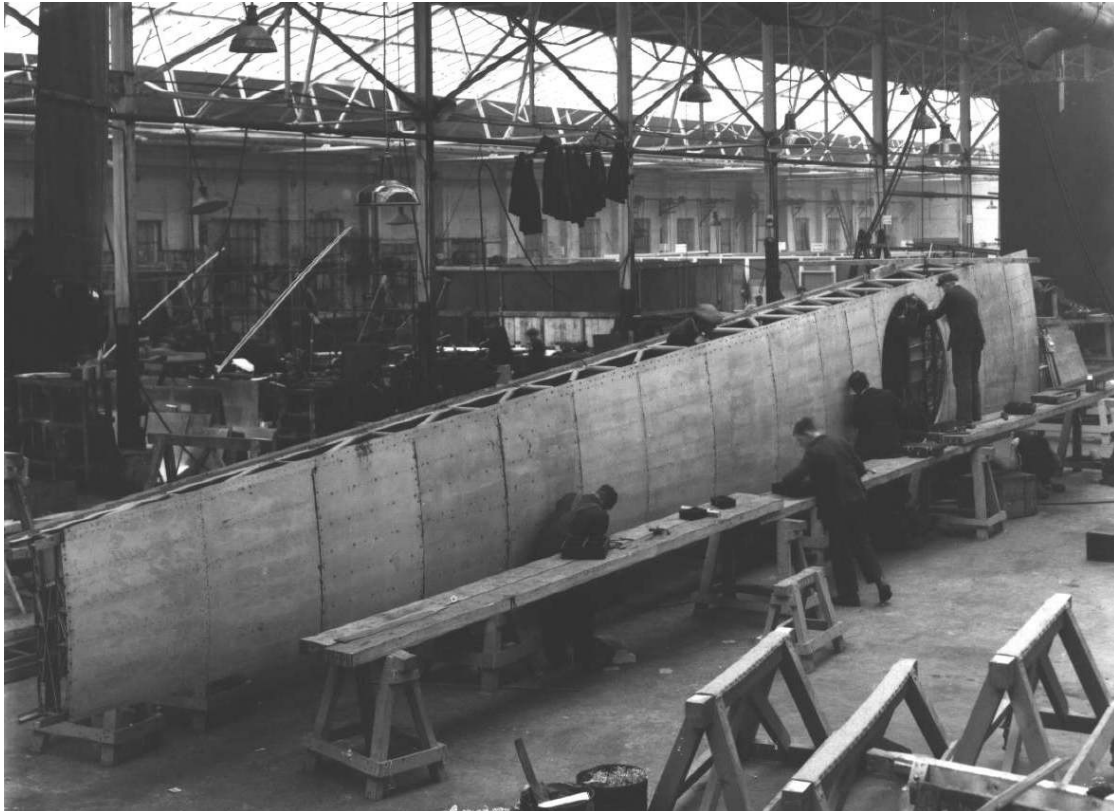

31. Short Bros. photo H 803 showing the starboard mainplane spar box of 'HL CANOPUS'. The assembly is tipped onto its leading edge as the sheeting between the spar booms is fixed. Most of the sheets are riveted, with three of them tack bolted. The rear spar boom is visible as are the top and bottom flanges protruding from the tip.

As the aerofoil profile altered along the span of the half plane, the flange angle changed by some 1 or 2 deg. in the length of an extrusion. For the first few 'boats, the boom flanges were clamped to steel templates and scraped by hand to produce the correct twist. Later, the flanges were clamped to the milling machine bed and twisted to the correct change of angle by means of cast iron pads beneath the section. It was then milled flat to the correct thickness and angle in one pass. The extrusions were then cut to length and the ends milled in the Machine Shop ready for fitting in the assembly jig in No. 3 Shop.

The sixteen lift struts and verticals were parted from DTD 220A alloy tubes and slotted to detail in the Machine Shop before going to the Spar Detail Shop at the rear of No.3 Shop. Here they were jig-drilled for fixing. The tubes ranked down from a maximum of 3.5 ins. (89 mm.) outside diameter X 13 SWG. to 1 in. X 20 SWG. The connections between the spar boom flanges and the lift struts were made with plug-ends extruded from L 40 alloy, parted and shaped in the Machine Shop. The plugs - Patent 447 517 in the names of Short Bros. and Arthur Gouge - dated 11 April 1936 - were squeeze-riveted to the struts and verticals with DTD 176A tubular stainless steel rivets, using pneumatic bench type machines. Some of these rivets subsequently worked loose in service, so Short Bros. evolved a special tool for re-fixing them, which they demonstrated to IAL on 26 July 1939. The spar biscuit plates, connecting the ends of the plugs to the flange webs, were machined from DTD 206 alloy.

3. Production

The drag struts, which joined both top and bottom boom flanges of a spar truss, were made up in the Spar Detail Shop. They were of two types. The majority were lighter intermediate struts, similar to ribs. A few were heavier, built-up box-section members. The lighter struts were built from L 40 extruded tee-section top and bottom flanges, the flanges being shaped to the aerofoil profile on rolling machines and checked against steel templates. The braces were pressed from DTD 265 sheet. The heavier box section struts were also built-up from DTD 265 sheet. The sides were hand-flanged to channel sections and riveted to the top and bottom strut flanges. The top flanges of the upper struts were shaped to the aerofoil, but the top flanges of the lower struts were carefully curved to accommodate the load distribution and laminated with doublers - and in some places treblers - on the top chord. The side members were likewise laminated at the end bearings on the spar booms.

The diagonal incidence bracing between the two spar trusses was by means of crossed, swaged streamline W 3 steel wires. The wires were in pairs, on either side of a lift strut - except in positions where this interfered with a fuel tank. The standard short-range wing had fifteen crosses of twin wires, with one pair omitted, to enable the mid-position fuel tank to be inserted. The wires varied in size from 5/16 in. (8 mm.) BSF at the first panel position outboard from the wing root, to 4 BA at the tip end of the spar. The wires ended with forked ends, pinned to shackles which were riveted to the spar boom webs.

The three lengths of extrusion were assembled, end to end, on the spar boom jig. The mating faces were scraped and filed to a maximum nominal clearance of 0.0015 in. (0.038 mm.) at any point on an adjacent face. They were then joined with DTD 138 steel gusset plates which were bolted through with S 80 nuts and bolts. The holes were drilled by a mobile F.J.Edwards motorised radial drill mounted on casters, which was brought into position and jacked up clear of the floor to steady it, before drilling.

The node points for each panel of the truss were marked on lines on the floor of the Shop. The nodes were transferred up to the boom flanges by plumb bobs and the positions centre-popped on the centre lines of the boom flanges. The positions of the rivet holes for the sheeting were marked along the boom flanges by centre-punching through metal template strips, laid along the booms. The boom extrusions were taken down from the jig and drilled under a fixed drilling machine. Returned to the jig, and with the gusset plates bolted up, the steel drilling plates for the lift strut attachment plates were placed at each panel position, and the holes drilled. The whole truss was then dismantled for anodising.

The final assembly of a spar truss started with the boom extrusions being lined and levelled up, bolted together, end to end. The lift and diagonal struts were progressively fitted to the boom webs by riveting through the attachment plates. The riveting was done by a de Bergue portable pneumatic machine, suspended over the work. The completed trusses of a half mainplane were bolted through their root end fittings to a jig that represented the centre section of a 'boat at Frames 15/16 and 20/21. The jig reminded someone on the shop floor of Westminster Bridge over the River Thames in London. The name stuck and thereafter the jig was thereafter generally known as the *Westminster Bridge*.

The trusses were supported on trestles along their length, checked for dihedral and trued up to the centre line on the floor. The drag struts were fitted and riveted to the truss webs. The streamlined incidence braces were fitted, and the pressed DTD 275 alloy Z section intercostals riveted in position between the drag struts. The top skin of the spar box in DTD 275 alloy was fitted, drilled, anodised and finally riveted, using the same procedure as for the hull plating. The thickness of the skin varied from 16 SWG. for the first two truss panels outboard from the root, to 24 SWG. at the tip end. Timber supporting members were then passed through the spar under the top booms, and trestles removed to allow the skin plating to be fixed on the under surface. The sheets - to the same gauges as the upper sheets - were slid in and riveted, after anodising. The openings for the fuel tanks were cut into the top surface and rebated to receive the tank covers.

The two half mainplanes were un-bolted from *Westminster Bridge* and moved forward on wheeled trestles, out of the Spar Detail Shop. Half mainplanes were then completed by the attachment of leading edges, trailing edges, flaps and ailerons. The remainder of the skin plating was completed and the fuel tanks installed. The nacelles were attached, the controls run and the other equipment installed.

3. Production

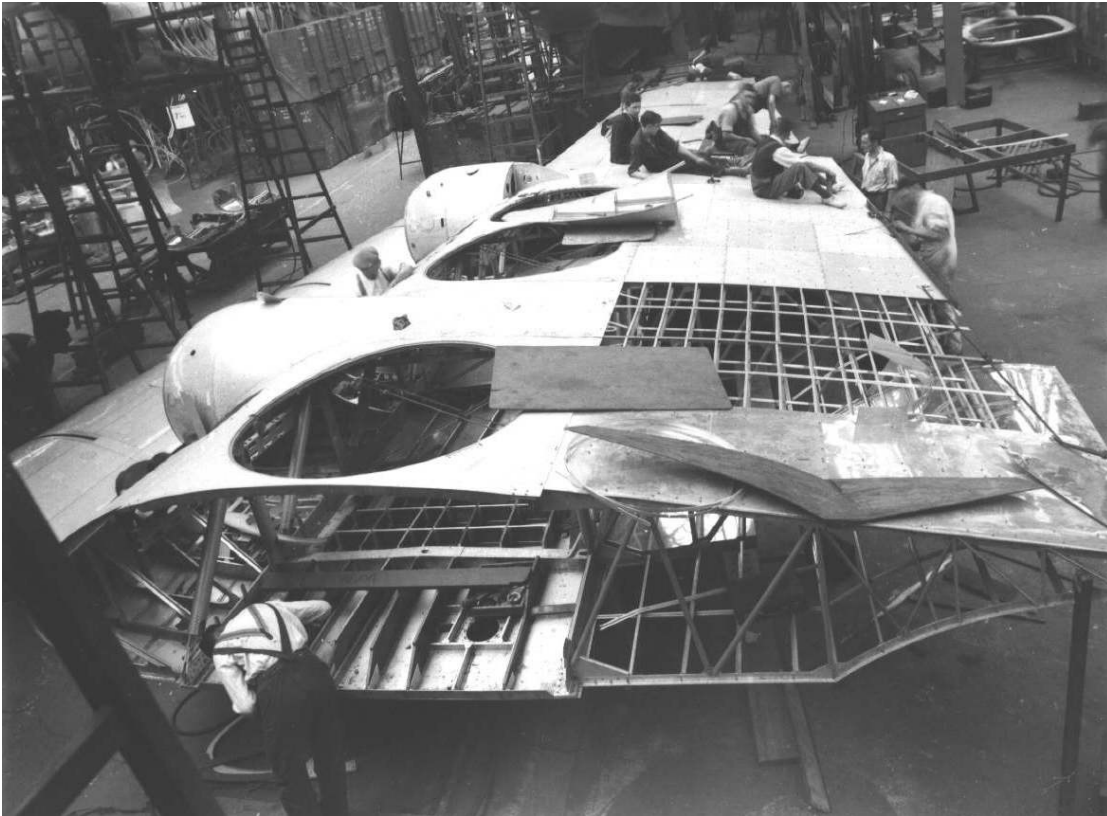

32. Short Bros. photo H 1086 showing work in progress on the starboard half mainplane of 'CV CARIBOU' - Part number SB 3501. A finished flap is evident below the leading edge.

The thirty-four leading-edge ribs were marked out on DTD 275 alloy sheet blanks and the assembly and tooling holes drilled from templates. The lightening holes in the larger ribs were fly cut from the tooling holes and flanged on a fly-press. The edges of the ribs were flanged, drilled for temporary assembly and anodised. The maintenance platforms were between mainplane leading edge Diaphragms 3 and 4, 5 and 6, 9 and 10, and 11 and 12. The ribs on either side of the maintenance platforms - Ribs 3, 4, 5, 6, 9 and 10 - were reinforced with a tubular brace. The leading edge sheeting was cut to shape from 22 SWG. Alclad sheet, beaten to profile on hardwood or Paxolin formers, drilled, anodised and flush riveted in position.

The framework for the trailing edge was formed from a series of drag members or ribs whose structure depended on their function. Working outboard from the hull, there were four flap-support ribs, interspaced by four skin-support ribs and a special junction rib between the flap and the aileron. The flap-support ribs carried the sealed ball-races which engaged in the channels on the top surface of the flap. Further sets of races were fixed at right angles to prevent the flaps from binding when they moved.

The spar root fittings were forged from S. 80 stainless steel. The forgings were squared up on a planing machine and then marked out in rough. They were rough-shaped on a planer, finally marked out, then shaped and profiled. The ends were cut to length, the fitting filed and polished, and the fixing holes jig-drilled and reamed.

The aileron was supported on four hinge-ribs, interspaced with four skin-support ribs. The aileron hinge-ribs had sealed ball-races to support the aileron hinges. The top boom of each rib was made from L 40 extruded alloy angle, doubled up for the flap and aileron-support ribs. The 4T4 alloy braces were attached to the top flanges with tubular gusset plates. The bottom flange of each rib was of extruded angle of a lighter section than the top member. The trailing edge of each rib was cut from a blank, holed and flanged for lightening and tooling, and cut to profile. The ribs were cut and drilled as details, anodised, and assembled. The inner end-rib was positioned first on the spar, followed by Flap Support Rib No.1. This rib was turned 6 deg. in plan, and once fixed, became the datum for setting out the remaining ribs for the trailing edge and aileron. The ribs were then set up and bolted to the spar webs - already drilled as details -

3. Production

using attachment lugs. The ribs were held rigidly during assembly with timber clamping strips, to prevent any displacement. The wing tip was attached to Aileron Hinge Rib No. 4 and the end of the spar.

The twenty-six trailing edge ribs were formed from blanks and flanged all round, with flanged lightening holes. The ribs were attached to the rear spar box and joined by a V-section trailing edge.

The upper and lower surface of each half-mainplane was then plated with DTD 275 sheets, cut to size, drilled, joggled, countersunk and anodised in the same way as the hull plates. Circular inspection covers were let into the skin plating at all control pulley positions. Covers were secured by a bridge-piece inside the inspection plate, screwed from the outside and attached to the aircraft by short lengths of 5 cwt. stranded steel cable, to prevent loss. A large rectangular inspection plate was let into Plate 'ab' on the underside of the mainplane, and secured with countersunk screws.

The port and starboard flaps were assembled in jigs from details in DTD 275 alloy. The four hinge ribs in L 1 alloy - strangely named as they were runners for the flap guides - the five normal ribs and the end ribs were assembled on the spar that ran in the centre of the flap. This assembly, and the flanking stiffeners, were put in the appropriate jig. The jig also contained the vee-shaped trailing edge, the stiffener channels and the bottom 24 SWG. skin plating. After drilling and riveting the part-completed flap was removed from the jig to trestles, for the attachment of the top plating. The lug for the flap operating jack was fixed to Hinge Rib No. 3, the other end of the jack being fitted to the lower rear spar boom. Drain holes were drilled in the trailing edges.

The torque tubes which operated the flap jacks were jointed with universal couplings, running in ball-races. There were four torque tubes each side, supported by the lift and vertical members of the rear spar trusses. The torque tube drive ended by engaging with a worm and worm-wheel drive on the end of the jack. The worm gear rotated the jack casing, which forced out the square-threaded spindle to move the flap. The maximum extension of the jack was 30 ins. (760 mm.), taking 6250 rev. of the standard flap motor to move the flap through an angle of 25 deg.

The port flap was fitted with the operating limit switches. A short length of Teleflex cable, attached to the end of the jack spindle, drove a small gearbox containing the Rotax N 5 FN limit switches for the flap motor. The switches operated for the OUT and IN flap position, switching the motor OFF six revs. before the mechanical stops were reached. The control wiring was in 35/012 copper single core cable. The flap position indicator and the BLUE indicator light were both on the underside of the coupé, roof of the Control Deck. The limit switch gearbox also drove both the potentiometer for the Smith flap-angle indicator and the 1/3 rd. extension indicator. A short length of Teleflex cable from the gearbox drove a small ramp as the flap moved. When the flap reached the 1/3 OUT position, the ramp switched the RED indicator light ON and kept it in circuit until the flap reached the same point as it retracted. Flaps were attached to the mainplane by removing the cover plates on the underside of the flap at each hinge rib. The flap was then lifted and slipped onto the ball-races on the ends of the flap-support ribs, after which the stopping blocks in the hinge rib channels were screwed home. The jack was inserted through the opening in the underside of the mainplane. It was anchored to the rear spar boom at one end and the flap at the other. The Teleflex controls were attached and the flap wound IN and OUT manually, to check the operation. The potentiometer, stop and indicator switches and operating ramp were fitted to the port flap only and tested for correct operation. The cover plates were then fitted over the access openings.

The ailerons were assembled on jigs from DTD 275 alloy details. Each aileron consisted of a built-up box spar with a channelled web and twenty-four nose diaphragms. The diaphragms were formed from flanged blanks, with two flanged lightening holes. The aileron box spar was sheeted with 22 SWG. sheet, beaten to shape over timber formers. A lead mass balance weight of 20 lb. 7 oz. (9.2 kg.) was bolted in position in the leading edge at Rib 19, 47ft. 4.56 ins (12 917 m.) out from the aircraft's centre line. The surfaces aft of the spar were fabric covered. The control levers were formed from L 3 alloy sheet. The completed ailerons were lifted into position and the hinge bolts bolted to the hinge ribs. The covers at the hinges were secured with anchor nuts and the tear-off fabric patches fitted. The aileron tie rods were 5/16 in. (8 mm.) diameter steel rods, passing through Tufnol blocks. The blocks were secured to light alloy fairlead brackets, bolted through the webs of the main spar extrusions. Changes in direction in the control runs were accommodated by 1/4 in. (6 mm.) Reynolds steel chains over stainless steel sprockets, with ball-bearing journals. The sprockets were supported on light alloy or stiffened plate brackets. The controls were then finally connected to the aileron levers through dashpots.

The engine nacelles were of monocoque construction. Each had seven frames cut from 16 SWG. DTD 275 alloy sheet, formed to curvature and flanged by hand. The covering was formed from 19 SWG. sheet, beaten by hand to curvature and finished on a wheeling machine. The engine mounting ring was a spinning

3. Production

in 16 SWG. sheet, with a cutout at the bottom to allow for the withdrawal of the carburettor. The detail parts of the nacelle were anodised. The frames were put into an assembly jig and connected by the skin stiffeners and secondary frames. The various holes for oil tank access, engine starter handle and fire extinguisher were cut and reinforced. The boundary frames were cut from 14 SWG. sheet and beaten to shape on formers. The skin plating was attached and the boundary angle at the junction of the nacelle and the aerofoil profile riveted in position. The nose spinning was then riveted in position and the work removed from the jig. The three-piece fire bulkhead and the Exactor control brackets were fitted. The top fairing was made ready for fixing, after the nacelle had been mounted on the half mainplane.

The oil tanks were mounted in the nacelles, aft of the fire wall. The engine lubrication system for each engine was completely self-contained. The oil tanks were made in the Tank Shop using DTD 275 clad aluminium alloy sheet and joined with de Bergue rivets in the same way as the fuel tanks. The top surfaces of the tanks were shaped to correspond with the contours of the engine nacelles, so a limited degree of interchangeability existed between tanks. The starboard inner engine tanks were interchangeable with the port outer tanks, and the port inner tanks with the starboard outer tanks. Each tank was fitted with a filler and a circulating chamber, a connection for the oil returning from the oil cooler, and a vent to the engine crankcase rear cover. An extra connection for the oil returning directly to the 'hot pot' was fitted for engines equipped with the Bristol High Initial Oil Pressure system. The outlet from the tank was at the bottom of the 'hot pot', through a Vokes filter. The tank was drained through a plug fitted below the filter.

The tanks were made in four capacities: 13 gals. (61 litres), 18 gals. (85 litres), 21 gals. (97 litres) and 22 gals. (99 litres). These capacities represented the amounts of cold oil held in the tank. Each tank had an extra airspace of about 15% of the contents, to allow for the expansion of the oil when the engine started. From the carburettor jacket, a 1 in. diam. (25 mm.) Superflexit return line carried the oil back to the tank through the oil cleaner and the oil cooler. The Tecalemit oil cleaner was fixed to a vertical member of the forward mainplane spar truss, in a position where it was readily accessible through one of the maintenance platforms on either side of an engine.

The Bristol Pegasus XC engines of the standard S.23 aircraft were fitted with Robertson Type RH5-29 oil coolers and single 13 gals (61 litres) oil tanks. An alternative type of oil cooler with a greater throughput - the Robertson Type RH5-43 - was fitted to some of the later boats and it is probable that all the S.30 'boats with the Perseus sleeve valve engines were fitted with these coolers.

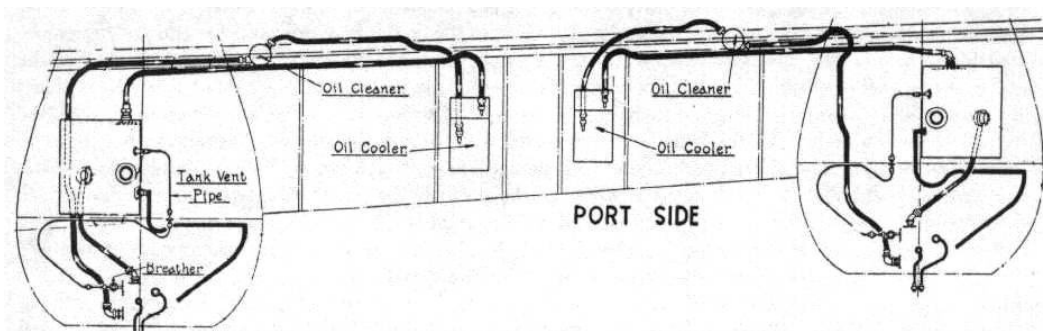

33. Part of Maintenance Manual Diagram 2 showing the oil system for a standard Mark I S.23 'boat perseus type oil coolers with the ducts similar to the starboard side of 'UI COORONG ...' - presumably RH5-43 coolers.

3. Production

The following oil systems were used:

System	Oil tank capacity	No. of tanks	Total capacity
Standard S.23	13 gals.(61 litres)	4	54gals.(244 litres)
'UT CENTAURUS and 'UU CAVALIER	22 gals. (99 litres)	4	88 gals.(396 l.)
Medium range	13 gals.(61 litres)	8	108 gals.(488 l.)
Long range	18 gals. (85 litres)	8	144 gals.(648 l.)
Long range	22 gals. (99 litres)	4	88 gals.(396 l.)
Perseus	21 gals.(97 litres)	4	86 gals.(387 l.)

The three types of wing fuel tanks were made in the Tank Shop. The mid-position and inboard tanks were cylindrical in plan, the outboard tank was approximately oval.

The construction of a mid-position wing tank was typical for all the wing tanks. 18 SWG. DTD 275 clad alloy sheet was used for the tops and bottoms, and 20 SWG. for the side shells. De Bergue patent rivets were used to join the sheets, with an interleaving of petrol-resisting tape in the joint. The holes for the rivets were drilled at fuel-tight pitch and the rivet inserted with the flat head on the outside of the tank. The bottom riveting tool, which also had a flat head, was then brought up in contact with the rivet head. The top riveting tool had a specially shaped face, and when forced down over the projecting shank of the rivet, pressed the flat head of the rivet into the sheets. At the same time it formed the shank into a snap head. The two sheets were thus forced by the rivet head into a cup shape round the shank of the rivet. The shear stress created in the joint was distributed over the surface of the sheets, with none left in the shank of the rivet.

The tank shells were cut to size, drilled on a template for the rivet holes, anodised and then rolled to curvature. Depending on size, a typical wing tank shell was made from two or three sheets. The shells were butt-joined, end-to-end on the flange of a light alloy angle stiffener, on the inside the tank. The tank tops and bottoms for the two larger wing tanks were made from two pieces of sheet. The smaller wing tank tops and bottoms were made from single sheets. The sheets were holed for inlet, overflow, fuel gauge and sump outlet. They were then cut to shape, joined, drilled for rivets, anodised, and flanged on a Selson flanging machine. The reinforcing patches on the outside of the tank tops and bottoms, to receive the ends of the 5/8 in. (16 mm.) stay-tubes, were coated with Heldtite jointing compound and riveted in position.

Mid-position wing tanks were fitted with a cruciform baffle in the centre of each tank, formed from two blades crossing at right-angles. Each half blade was lightened with six flanged holes and braced with a light alloy tube. The complete baffle could be slipped over the centre stay-tube and the ends of the blades slipped over four of the outer stay tubes. This left a gap between the end of the baffle and the shell of the tank, allowing fuel to slosh unimpeded round the perimeter of the tank. The Telelevel or KDG Korect fuel gauge and a Relunits valve were fitted to the top of the tank. The stay-tube plugs were inserted through the holes in the bottom of the tank, the faying surfaces coated with Heldtite, and the whole assembly bolted up.

The aviation spirit entered each tank through a Relunits float-operated cut-off valve, fitted inside the tank at the top. A vent line, which also acted as an overflow, ran from the top of each tank to the under surface of the mainplane. All tanks were originally fitted with a single 1 1/2 ins. (38 mm.) diam. L 33 cast light alloy outlet sump. For the mid-position 326 gal. (1428 litres) tank, the outlet was positioned 18.5 ins.(473 mm.) from the centre and protected with a low vertical baffle, fixed concentrically around the sump outlet on the bottom of the tank. The baffle was slotted to allow the fuel at the bottom of the tank to reach the sump. The enquiry into the near disaster to 'UV CAMBRIA at Kroosi Bay recommended that a second outlet should be fitted to each tank, with an additional horizontal baffle fixed 3 ins. (75 mm.) above the outlets. There is no evidence, however, that the modification was carried out.

Fuel tanks were assembled by fitting the top to the shell and then bolting both to a steel angle jig. The tank top and shell were temporarily bolted together, lifted, turned on edge and riveted. Once this had been done, the tank was turned over, with the top facing downwards, ready for fitting the T 4 alloy stay-tubes

3. Production

and baffle. The mid-position tank had twenty-eight stay-tubes and a larger diameter centre tube, through which ran the fixing spindle. The stay-tubes were arranged in three concentric rings about the centre stay-tube. The outer and middle rings had twelve tubes each and the inner ring, four tubes. Each of the twenty-eight stay-tubes was fitted with an S 80 stainless steel threaded plug at either end. The threaded part of a plug was inserted through the hole in the patches on the outside of the tank top, and bolted up tight. The faying surfaces of the fuel gauge, overflow, inlet and outlet sump fittings were also coated with Heldite before being bolted in position. Finally, the bottom of the tank was then riveted through the flange to close the tank. The completed tank was tested to a pressure of 1.5 lbf. per sq. in. (10 kPa.) and if satisfactory, washed out and painted inside with one coat of chromate and one of silver paint. The weight of the pair of mid-position tanks and associated pipework for a 1D system was 249 lb. (113 kg.) - 0.38 lb. per gallon contained, or 0.038 kg. per litre.

The fuel tank contents gauges were either Telelevel or KDG Korect gauges. The Telelevel equipment was mechanically operated and used on all the 'boats up to the 40th. - 'KZ CATHAY. At the request of Short Bros., 'KZ CATHAY was fitted with KDG Korect electrically-signalled floating-arm equipment. It is probable that 'PZ CLIFTON and 'RA CLEOPATRA, the two S.33 'boats that followed 'KZ, were also fitted with these gauges.

The Telelevel recording equipment was fitted inside each fuel tank. A small diameter tube, having a continuous slot cut in the wall, was fixed vertically from top to bottom of the tank. An annular float, floating on the top of the fuel, was threaded on the slotted tube. A small wheel, fixed to the top of the float, engaged in the slot. A conical pin inside the slotted tube was moved up and down by means of a winding cable, that entered the tube from the top of the tank. When the pin moved down the slotted tube to meet the float, it displaced the wheel on the top of the float, locking the wheel - and the float - in position. The winding cable ran inside a small-bore copper tube from the top of the tank to its Telelevel indicator gauge on the Control Deck. The cable was wound onto a drum inside the indicator casing. The drum was turned by the person reading the gauge, by means of a butterfly shaped winding handle. As the handle was turned, the pin moved up or down the slotted tube inside the tank. Turning the handle slowly in an anti-clockwise direction - moving the pin downwards inside the tank - turned a pointer on the dial. Once the pin locked on the float, the dial showed the contents of the tank in Imperial gallons. The pin could be freed by winding the handle clockwise, to pull it up.

The KDG Korect indicators were continuously-reading, electrically-signalled instruments. A pivoted float-arm was fitted to the inside of the tank top, with the float resting on the surface of the fuel. The fall - or rise - of the liquid in the tank caused a spindle, geared to the arm, to wipe a slider over a resistance, housed outside the tank. The movements of the arm in the tank were recorded by a pointer on the dial of the indicating instrument, showing the contents of the tank. The location of the indicating gauges is not known but they were probably on the forward spar frame bulkhead, in an equivalent position to the Telelevel gauges.

Fuel tanks rested on grids made of spruce, spanning between the lower boom members of the front and rear spar trusses. The ends of each spruce bearer were bolted to cleats, attached to the webs of the spar booms. The rubber-bushed anti-vibration bottom fitting of a tank was fixed to the substantial fore-and-aft spruce bearer that ran between the bottom members of the spar trusses.

The tank covers, assembled on jigs, were built with a channel section round the edge and stiffened laterally to support the skin plating. The plating of the covers was of the same gauge as the mainplane spar skin sheeting, as the tank covers formed part of the stressed skin of the spar box. Brackets on the underside of the boundary channel bore down on the top rim of the tank, to hold it securely in position. The tank covers were fitted into the recesses in the mainplane plating. The mid-position tank cover was secured with some seventy closely set machine screws. As the covers to the mid-position and inboard tanks were circular, a small projecting lug on the cover, fitting into a corresponding recess in the skin of the mainplane, ensured that it was replaced in the correct position.

The sizes and capacities of the tanks were:

Inboard	380 gals.	(1728 litres)	65.5 ins.diam.	X 31.5 ins.ht.*
Mid-position	326 gals.	(1482 litres)	64 ins.diam.	X 28 ins.ht.
Outboard	179 gals.	(814 litres)	56.5 ins. long	X 41.75ns. wide X19.5 ins ht.*

* Dimensions estimated from drawings.

3. Production

	Starboard wing			Port wing			Totals		
	Litres	814	1482	1728	1728	1482	814	Gallons	Litres
Gallons	179	326	380	380	326	179			
Type 1 and 1D <small>Type 1 on CANOPUS only, Type 1D on other S.23s.</small>							652		2 964
Type 1A CAVALIER							1 010		4 592
Type 1C CENTAURUS							1 010		4 592
Type M1C							1 010		4 592
Type M1D							1 010		4 592
Type M1B							1 412		6 419
Type M1A							1 770		8 047
Type 1B							2 330		10 592
Type M1							2 534		11 520

204 gal.(927 litre) Top-up tank on Control Deck

34. Diagram showing the fuel systems. M1 systems had an extra hull tank on the port side of the Control Deck. Systems M1A and M1 had jettison arrangements on the two inboard tanks. It is not known which aircraft was fitted with System M1D and for how long.

The tanks were slung for fitting and lifted into position in the mainplane. The projecting end of the centre stay tube was inserted in the anti-vibration bottom fitting and screwed up. The tank was connected up with its Telelevel winding cable - or KDG wiring - the bonding wires and fuel pipelines. To get it to bed down, a quantity of fuel had to be in the tank while it was being fitted. The top end of the centre stay tube, with distance piece and rubber ring, was screwed up. The tank cover was placed in position and screwed in place. The square cover plates were screwed in place on the upper and lower surfaces of the plane and the circular tank filler cover fitted. A mid-position tank weighed over 100 lb. (45 kg.).

The ability to fit this range of Systems must have affected the mainplane spars. There is reference in the Type Record to a Mark II spar fitted to the Mark II 'Bermuda' 'boat CAVALIER, with its modest increase in tankage. But there is nothing about the long range S. 30 'boats that came later.

The fuel supply to the engine fuel pumps was by gravity, the fuel leaving each tank from the sump in the bottom. The supply line from each tank was fitted with a shut-off cock - Cock C for the 1D fuel systems used on the standard S.23 'boats - enabling individual tanks to be isolated. The shut-off cocks were controlled by wire and pulley from the tank cock control levers on the roof of the Control Deck, just forward of the forward spar bulkhead.

The arrangement of the supply lines can be divided into two groups. One group consisted of Systems 1/1D and 1C, incorporating a swept tee in the system. The other group included all the other fuel systems, using a five-way distributor in place of the swept tee. The five-way distributor made it possible to connect up various combinations of fuel tanks.

3. Production

AGS fuel filters were originally installed in the supply lines, immediately upstream of the connection to the engine pumps, fixed to a convenient vertical member of the forward mainplane spar truss, accessible through the maintenance platforms in the leading edge. A shut-off cock was installed in the line, so that it could be closed off to clean the filter.

Pumped fuel was under pressure - a maximum of 10 lbf. per sq. in. (69 kPa.) - passed to a tee-junction with connections to the carburettor and to a common pump feed line connecting all the pumps. Should an engine pump fail for any reason, the common feed line ensured that the other three pumps could maintain an adequate, although somewhat reduced, fuel flow to all four engines. The supply lines to each engine were connected to the carburettor through an engine shut off cock and an Amal 192/102/046 fuel pressure reducing valve. The fuel pressure valve reduced the line pressure to a steady 2.5 lbf. per sq.in. (17 kPa.), relieving the carburettor of fluctuations of pressure.

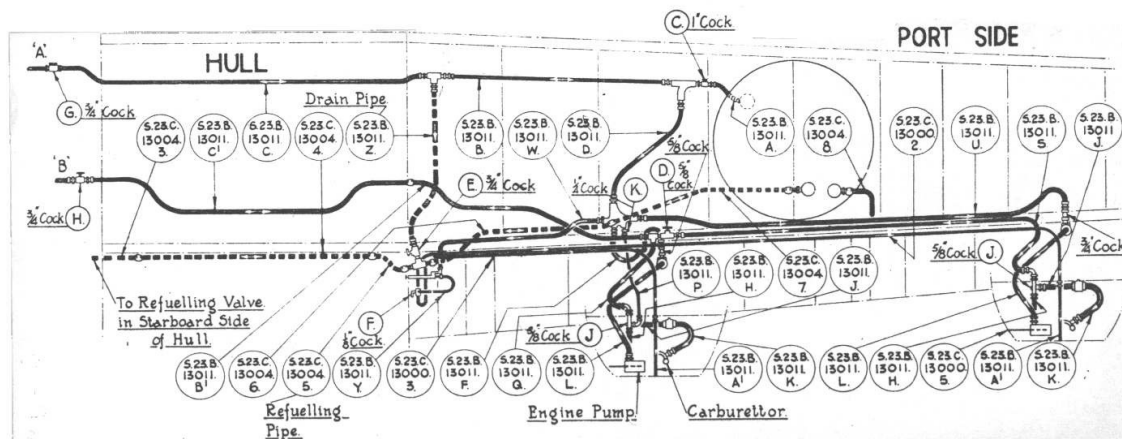

35. Part of Maintenance Manual Diagram 1 showing the fuel tank and associated pipework for a System 1/1D fuel system fitted to the standard Mark I S.23 'boats.

The fuel lines from the tank sumps to the carburettors were run in flexible, non-metallic Superflexit tubing, to protect the tanks from engine vibration. Superflexit tubing was formed by winding strips of petrol-resistant rubber round a wire helix, and bonding the whole together with adhesive as it was being wound. A continuous copper bonding wire ran in contact with the helix. The various unions, tee-junctions and distributors in the fuel system were of anodised aluminium alloy. As the anodic film is an electrical insulator, the holes for the locking wires were drilled in the nuts of the unions after assembly, to ensure electrical continuity and thus maintain a good electrical bond. Satisfactory electrical connections between the joints of the external bonding wire on the Superflexit tubing and an alloy fitting, were made by scraping away the anodising on the fitting.

Cocks were distributed throughout the fuel systems to control the flow of fuel, to test the operation of the fuel pumps, to enable the engines to be started and to isolate individual tanks. The controls for all the cocks were led to the operating position at the aft end of the Control Deck.

3. Production

The cocks were:

Systems	1/1D and 1C	Other systems
Tank cocks	C	D
Levelling cock	G	E
Carburettor cocksJ		M
Pump test cocks	D and H	G and H
Spring-loaded carburettor cocks	K	J
Drain cock	E	K
Engine priming cock	F	F
Hull tank cock	unlettered	L

The flight-refuelling main cock was unlettered. A Ki-gass primer was fitted on each side of the hull on the Control Deck to serve each pair of engines.

The Exactor tubes for the throttle and mixture controls for each engine were run from the engine nacelles to the junctions in the wing roots. The Unisheath braided cable for the ignition system ran from the 5C/441 connectors in the wing roots, to the 5C/439 connectors at the engine nacelle fire walls. The cables from the revolution-counter generators were run to the dual 5C/430 junction-boxes in the wing roots. The engine starting cables - 61/044 copper core for the main circuits and 35/012 for the control circuits - ran from the junction-boxes in the wing roots to the Rotax N5 CP solenoid switches and starter motors. The Uniplug screened cables from the Rotax N1 KA booster coils in the engine nacelles ran to the distributor on each engine. The twin copper-constantan cable for the engine pyrometer ran to the Weston four-way rotary switch on the temperature gauge panel on the Control Deck from the junction box in each nacelle. The three wire-operated controls for the engine cut-outs, the carburettor air shutters and the airscrew pitch controls ran over pullies and fairleads in 5 cwt. (2.5 kN) stranded steel wire to the Control Deck. The torque tubes for gills extended from the worm drive gear boxes at the rear of each nacelle to the flexible connection in the wing roots.

The circular 14 ins. (365 mm.) diameter air intakes for the heating and ventilation systems were in the leading edges of each half mainplane, close to the wing root, clear of the inner airscrew disc. Both were gridded to prevent the ingestion of large objects.

3. Production

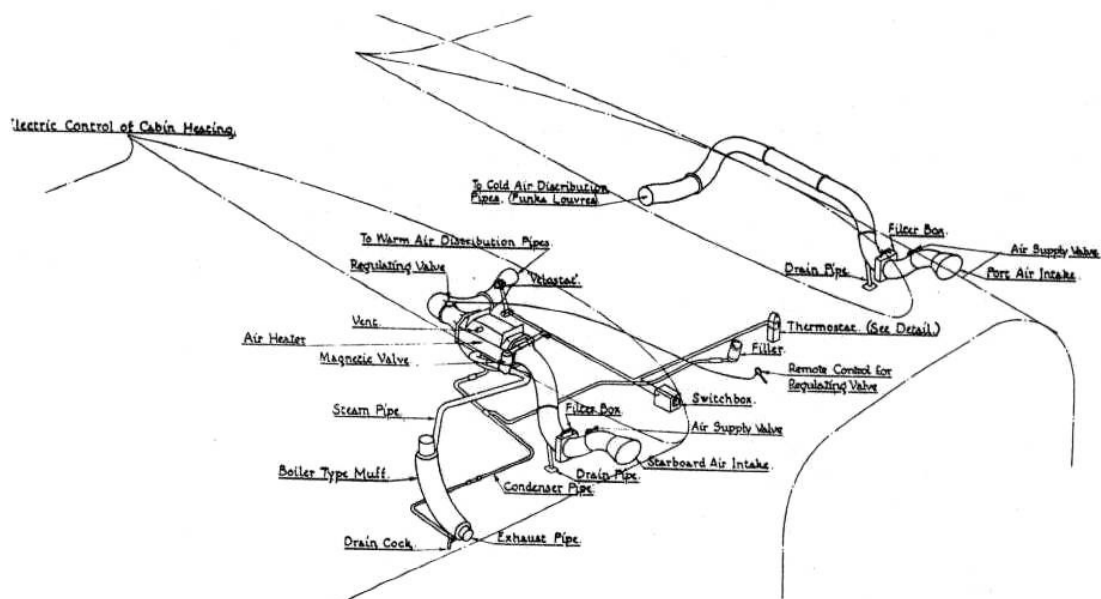

36. Part of Maintenance Manual Diagram 33 showing System 33 used the standard S.23 'boats.

In heating System 33 - used in the standard Mark I S.23 'boats - the air trunking in both half mainplanes ran from the 14 ins.(365 mm.) diam. intakes in the leading edge, through butterfly-action air supply valves to removable filters. The filters were accessible for removal and cleaning from the Control Deck. Rain traps, draining to the under surface of the mainplanes, were fitted to the filters and to the 'dip' in the trunking immediately behind the filter boxes. The cold-air system in the port half mainplane was distributed to punkah louvre outlets throughout the passenger accommodation. The trunking in the starboard half mainplane was taken from the filter through an air heater and a remotely controlled butterfly-action regulating valve, past the Velostat, to enter the hull aft of Frame 19. From here, the warm air was distributed to low-level outlets throughout the passenger accommodation and crew stations.

The steam for the air heater in the starboard wing root was generated by a Sangamo Weston boiler, fitted in the form of a muff round the exhaust pipe of the starboard inner engine. The 1 1/2 ins. (38 mm.) steam flow pipe from the boiler ran to a solenoid operated ON-OFF magnetic valve, which controlled entry to the heater. The condensate returned to the boiler by gravity through the 3/4 in. (19 mm.) pipe. The primary water system was filled with one gallon (4.5 litres) of distilled or softened water through a filler and sight glass mounted on the forward spar bulkhead on the Control Deck. The Velostat - Patent 498 069 in the names of Short Bros. and A.G. Parkes, dated 4 September 1937 - was a light metal vane arranged to hang in the main warm-air trunking, downstream of the air heater. When the vane was deflected by the moving air current, it closed an electrical circuit which operated the steam valve solenoid, opening the valve. The heating thermostat - mounted on the bulkhead of the centre passenger cabin - the Velostat and the magnetic valve were wired in series in 14/0076 copper cable. If either the thermostat or the Velostat were OFF, the solenoid of the magnetic valve was not energised, preventing steam from entering the heater. The original warm-air system was not very successful and twenty eight of the S.23 aircraft had their heating systems modified - at a cost of £ 4 872 (PV £ 97 830) each. Short Bros. Contributed £ 1 000 (PV £ 20 000) towards the cost.

3. Production

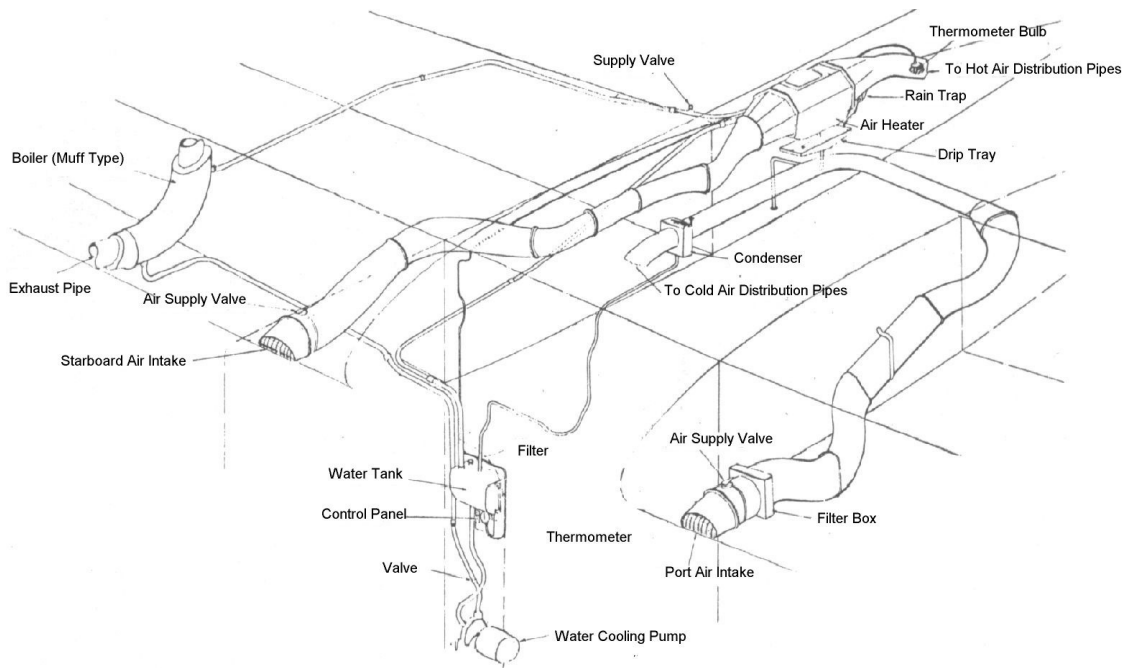

37. Part of Maintenance Manual Diagram M 33 showing System M33 used for the S.30 'passenger' boats - presumably all except 'CU CABOT and 'CV CARIBOU.

Heating System M33 - used in the S.30 'passenger aircraft' - and System M33A - used in the S.30 'mail aircraft' - were similar to each other, differing only in the disposition of the components. The port half mainplane contained the cold-air system, similar to System 33, excepting that there was an additional condenser in the trunking before it turned into the hull. The warm-air system in the starboard half mainplanes used hot water as the heating medium, heated by a muff boiler on the inner engine exhaust pipe. The hot water was pumped through the air heater and returned to the boiler. The air heater was in the bunk storage space over the Promenade Cabin in the S.30 'passenger aircraft' and S.33 'boats', and in the spar box behind the inner engine for the S.30 'mail aircraft'. A safety valve was included in the primary water circuit. These systems dispensed with the Velostat, the air temperature being controlled by a thermostat fitted in the trunking before it entered the hull, just forward of Frame 19. The modified systems were not entirely satisfactory either and modifications to these systems cost about £ 250 (PV £ 5 000) for each aircraft. A test carried out in 'CW CONNEMARA' showed that the modified system could maintain a cabin temperature of 22 deg.C. with an outside air temperature of minus 5 deg.C.

The two 'A' 'boats, 'MA AOTEAROA and 'MC AWARUA, fitted with 33M systems had them replaced with combustion heaters of US origin located at the aft end of the Control Deck in late 1944 or early 1945. The engine exhaust arrangements for these aircraft were revised to discharge over the top of the wing.

The navigation lights, RED for the port side and GREEN for starboard, were Rotax A5C/492 phenolic mouldings projecting from the leading edge of each half mainplane, just inboard of the end of the spar. The upper surface of the lamp housing was removable to enable the bulb to be replaced or the whole lamp unit withdrawn.

The 'boats were fitted with two searchlights for use during night operations in place of the Holt pyrotechnic wing tip flares used previously. The bow searchlight, between Frames 1 and 2 on the port side, was a 8 ins. (200 mm.) diam. 240 watt Smith-Harley unit on a retractable and adjustable mounting. The other, the wing searchlight was in the leading edge of the starboard half mainplane was a fixed 10 ins. (254 mm.) diam. 500 watt Smith-Harley unit, mounted behind an acetate transparency in the leading edge, between Diaphragms 14 and 15, outboard of the starboard outer engine. The cables of 266/012 lacquered tinned copper single wire, were run in the cable tray fixed to the forward spar truss and coiled ready for connection to the solenoid and battery at the main switchboard. The Rotax K 625 identification light was located below the starboard mainplane, just forward of the forward spar truss, 13 ft. (3.96 metres) out from

3. Production

the root of the half mainplane. The light was connected to a 5C 432 terminal block in the wing root. A drift sight was fitted in the starboard mainplane root, accessible from the Control Deck.



38 Short Bros photo H 917 showing the starboard half mainplane of 'HM CALEDONIA' practically ready for lifting for attachment to the hull. The starboard half mainplane of 'UT CENTAURUS' is next in the line, with the port half mainplane spar box of 'UT' behind it. In the gantries are, left to right, the hulls of the Sunderland prototype K 4774, 'UV CAMBRIA' and 'UZ CYGNUS'.

Approximately 4 000 sq. ft. (372 sq.m.) of light-alloy sheet was used in the construction of a half mainplanes and 62 500 L 37 light-alloy rivets. The total weight of a half mainplane, complete with engines and ready for lifting, was in the neighbourhood of 5 417 lb. (2 457 kg.) for a short-range wing and somewhat heavier for the long-range version, due to the extra fuel tanks.

To attach a half mainplane to the hull, still on its shop truck, the 'biscuits' or jointing plates were bedded down on the stub ends of the wing root forgings, which projected from the sides of the hull. The completed half mainplane was then ballasted with a quantity of lead shot at the root end to balance it, slung with a four strop sling and lifted by the bridge crane.

The root ends of the spar booms were temporarily secured with under-sized bolts. The half mainplane was jacked up to the correct dihedral - a little over 1 deg. on the upper surface of the spar centreline - by long steel adjustable jacking struts. The struts were attached to the spar booms at the positions where the wing floats were later to be fixed. Next the jig plates were fitted to the spar boom flanges. The fixing holes were drilled with a special cutter that opened the holes 0.005 ins. (0.12 mm.) under-size, ready for reaming. The holes were reamed, starting with the vertical holes. The jig-plates were removed, the biscuit plates re-fitted and reamed in position and the stainless steel attachment bolts fitted. The six countersunk screws on the upper and lower surfaces of the spar booms were screwed home and the detachable inboard nose bolted to the spar webs. The upper and lower light-alloy drag angles were bolted to the sides of the hull. The fabric strips at the leading-edge and the upper and lower surfaces of the trailing edges were doped on. The leading-edge fairing at the junction of the half plane and hull was screwed in place and the connections made for the various control functions inside the wing at the junction with the hull. The jacks supporting

3. Production

each half mainplane were then struck. The maximum allowable weight on the shop truck was 27 500 lb. (12 473 kg.).

The wing span of all types and Marks of Empire 'boat was 114 ft. (34.75 metres). Although not specifically mentioned in the Production Chart, it is assumed that the aerial mast was mounted on the centreline of the hull, just aft of Frame 9. The aerial mast, beside mounting the pitot head, contained the extending mast, on top of which was the anchor and steaming light housing.

STAGE 16 Beaching chassis erected on hull.

The beaching chassis, which could support a maximum all-up weight of 39,000 lb. (17 690 kg.), consisted of two main struts and a tail truck. The struts were fabricated from mild steel plate, welded up to form a box section strut. The top part of the strut was hinged, allowing a detachable castoring transport wheel to be attached to enable the strut to be wheeled about on land. The dual main wheels were mounted on a short pivoted axle, to accommodate uneven ground conditions. The wheels were fitted with 6 ins. X 20 ins. (150 mm. X 500 mm.) Dunlop pneumatic tyres, inflated to a pressure of 90 lb. per sq. in. (620 kPa.). Outriggers were fixed to the strut, each with an air ball at the end. Cylindrical cork floatation collars were built round the strut above and below the junction with the outrigger.

The tail truck was constructed mainly of timber, with two steerable solid rubber tyred wheels, and manoeuvred by a long timber tiller. The truck was made fast to the hull by stub fittings on either side, which engaged in receiving eyes in the hull, screwed in by hand wheels on the truck. When the truck was in position under the hull between Frames 33 and 34, the tiller could be lashed amidships to a ringbolt, inserted in a watertight screw fitting on the underside of the hull, at Frame 38. The cost of a complete chassis was £ 945 (PV £ 21 700).

The main chassis struts were secured under the main planes to fittings on the lower front spar-boom. The outriggers were locked into fittings built into the two main spar-frames.

The shop truck, which had been inserted under the hull in Stage 13 to enable the hull to be withdrawn from the gantry, was jacked up to allow the main beaching chassis struts to be fitted. The shop truck was then jacked down and removed from under the hull. The aircraft was then on the beaching chassis ready to be rolled out.

On the beaching chassis, the top of the fin and rudder was 27 ft. 9 ins.(8.46 metres) above the slipway.

STAGE 17 Wing tip floats fitted.

Three types of wing tip float were fitted to the 'boats. The Type 2 float, with a buoyancy of 5000 lb. (22kN.), was the most widely used and was fitted to the thirty-one S.23 'boats. The Type 1 float, with a buoyancy of 6 000 lb.(2 7kN.), was fitted to the S.23 'Atlantic' 'boats 'HM CALEDONIA and 'UV CAMBRIA. The third, and unnamed, type was a revised version of Type 1, with the same dimensions and buoyancy, and was used on the S.30 and S.33 'boats. Floats of all types were interchangeable with each

3. Production

other, and with Sunderland floats. The attachment centres were the same.

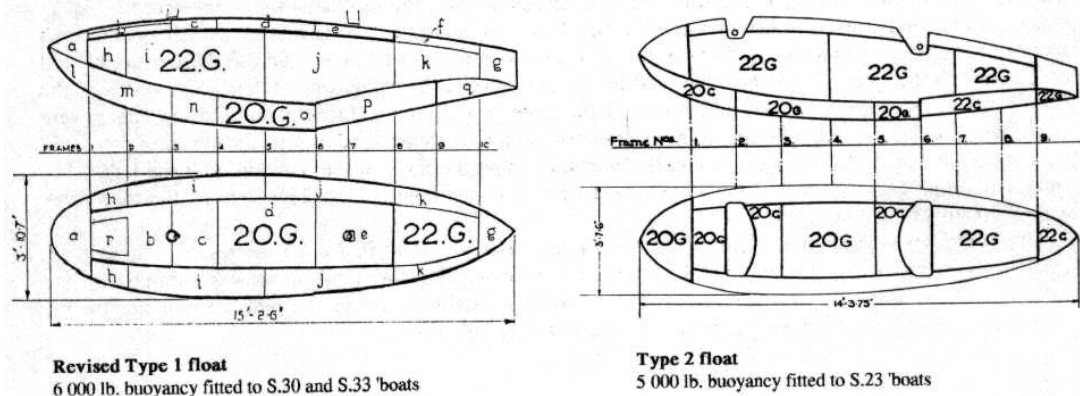

39. Parts of Maintenance Manual Diagrams 48 and M 48 showing the revised Type 1 and Type 2 floats.

The floats were assembled in No. 4 Shop from DTD 275 clad sheet. The frames and bulkheads were channelled and flanged from blanks. Five frames and four bulkheads were required for a Type 2 float and six frames and four bulkheads for both Type 1 floats. The bulkheads were reinforced with V, top-hat or Z pressed sheet stiffeners. The frames, bulkheads and keelsons were first assembled in a jig, upside down. The frames and bulkheads were lined up with a straight edge and height gauge, and clamped in position with 1/2 in. X 1/2 in. (13 mm.) steel angles. The keelson and bottom sheeting was fitted, anodised and riveted. The plating forward of the step was 20 SWG. and aft, 22 SWG., with the sheets overlapping at the step. Each compartment between bulkheads had a drain plug in the bottom plating. When the bottom plating and butt strap had been riveted, the float was transferred from the assembly jig to a cradle, and turned right side up. The alignment of the troughs for the strut connections, frames and bulkheads were checked again, and clamped. The rivet holes in the frames channels and bulkhead flanges were drilled from strip templates, and the side and top skin plating drilled back. A bilging tube was provided between each pair of bulkheads, extending down into the bilge from a bilge pump connection on the top of the float. The pressed sheet intercostals were fixed between the frames, and the skin plating anodised and riveted in position in two strakes. The cast light-alloy chassis attachment fittings were bolted in the troughs at Frame 2 - all types - and Frame 7 for Type 1 or Frame 6 for Type 2. Stainless steel lugs on the chassis fittings allowed the wing bracing and panel bracing wires to be attached. The floats were water-tested by filling alternate compartments to check for seepage. The structure was inspected at each stage during the assembly. A steadying eye, for use during beaching operations, was attached to the aft end of some floats.

The chassis consisted of two DTD 220 extruded light-alloy tubes, encased in folded light-alloy streamline casings. Some of the S.30 'boats had longer chassis tubes to lower the floats. The forward tube was 2 3/4 ins. (70 mm.) diam., the rear tube 3 ins. (75 mm.) diam. and both attached to lugs on the bottom booms of the main plane spars, forward and aft. The ends of the casings were faired in with Celastoid plastic cuffs, which cracked when the 'boats were in service. Light alloy replacement cuffs were suggested but as they were heavier than the plastic, they were not fitted. The floats were braced inboard and out with swaged steel wires, ending with eyebolts fitted to lugs on the bottom booms of the spars. The bracing wires were prone to pull out of the swaged ends in service, so they were re-designed.

The twenty-eight S. 23 'boats with Type 2 floats, were originally fitted with an ingenious patented sprung panel bracing, enclosed in a streamlined, transparent cellolose-acetate plastic housing. The mechanism proved unsatisfactory in service and was soon replaced with a much simpler, un-sprung X shaped wiring plate. The revised Type 1 float chassis was braced diagonally with longer crossed wires, held at the cross by an acorn assembly. The streamline wires were a source of trouble as they kept breaking in the air and were replaced with cables.

A typical float and chassis, with the patented sprung bracing, weighted about 260 lb. (116 kg.). To fit the floats, the chassis tubes were bolted to the fitting on the underside of the spar booms at the top, the float offered up and the lower bolts fitted, the bracing wires and panel bracing attached and the float trued up. The rigging angles for the forward chassis strut for the Type 2 float, was 90 deg. 4 min. to underside of the

3. Production

mainplane. The angles were 89 deg. 10 min. for the forward chassis strut of the revised Type 1 floats and 89 deg. 2 min. for the rear strut.

STAGE18 Controls completed. Aircraft assembly complete.

With the aircraft virtually complete, the final connections to the controls and pipe lines were made and the controls adjusted.

The aileron tie-rods in the mainplanes were connected to the chain cross-overs on the port and starboard sides.

The copper tubing for the Exactor controls for throttle and mixture controls was joined at the unions in the wing-roots. The Exactors were filled from the transmitter units in the throttle box on the Control Deck, with a mixture of one part of Vacuum Oil Co. Flowrex E to two parts of kerosine, and bled to exclude any air in the pipelines.

The paired and braided Unisheath cables for the engine ignition were connected at the 5C 441 connectors in the wing-roots.

The connection from the potentiometer on the port flap mechanism was made at the 5C 432 terminal block. The connection for the flap limit switches was made at the 5C 430 terminal block in the wing-root.

The torque tubes from the flap motor were connected, on either side of the hull, to the torque tubes in the mainplanes.

The leads from the engine speed indicator generators in the engine nacelles were connected through the 5C 420 terminal blocks in the wing roots.

The engine starter solenoid circuit wiring and the starter circuits, were connected through the junction boxes in the wing-roots in 35/012 copper core cable to the Rotax N5CP solenoid switches, which energised the starter motors. The Rotax Type N1. KA booster coils for the distributors operated at the same time. The pair of 266/012 lacquered cables for the landing searchlight was taken from the wing-root of the starboard mainplane, to the solenoid and battery on the main switchboard. The pair of 40/0076 cables from the identification light was connected through the terminal block in the starboard wing-root.

The twin copper-constantan cables for the engine pyrometer wiring were taken to the temperature gauge panel on the Control Deck and connected to the Weston 4-way rotary switch.

The 10 cwt. flexible wire cabling for the carburettor test cocks, engine fuel pump test cocks, carburettor test cocks, engine fuel pump and cock D were connected in the mainplanes on either side.

The vacuum pipelines for the Sperry automatic pilot were run from the Romec vacuum pumps on the starboard engines to the vacuum distributor on the temperature gauge panel. The oil hydraulic pipelines from the Northern oil pump, on the port inner engine were run from the oil supply tank to the Parker 4-way plug valve on the Control Deck. The vacuum pipelines from the Romec vacuum pump on each inner engine for the Smiths automatic pilot, were run to the distributor on the temperature gauge panel.

The Telelevel tubes and winding cables for the fuel tank contents gauges were run from the tanks to their respective gauges at the aft end of the Control Deck. The wiring from the KDG Korrekt tank contents indicators were run from the tanks to the gauges.

For the Pegasus engined 'boats, the flexible wire cables for the airscrew pitch controls were completed by wiring through the pulleys to the engine nacelles. For the Perseus engined S.30 'boats, the connections for the Exactor controls were made at the unions in the wing-roots and the systems filled and bled.

The control runs for the Pegasus and Perseus engine cut-out controls were run from the throttle box to the engine nacelles in 5 cwt. flexible wire cables.

The carburettor air shutter controls from the hand wheels on the spar bulkhead were run to the engine nacelles in flexible cables.

The balance line, and the engine pump feed lines of the fuel system were connected across the hull. The refuelling and drain lines from the refuelling cock in the starboard side of the hull were connected across to the fuel systems in the mainplanes.

For the aircraft with flight refuelling systems, the distribution pipe connecting the starboard inner wing tank was connected to the hull tanks.

The flexible wire cables for the fuel tank cock controls were run from the tank cock levers in the hull, to the tank cocks in the mainplanes and the balance line cock.

The connections for the heating and ventilating systems were made from the ducts in the mainplanes to the distribution trunking in the hull.

3. Production

The prepared and balanced airscrews, each weighing 365 lb. (166 kg.), were slung and brought to their respective engine by crane. The airscrews were offered up to the splined engine shaft, which had been coated with anti-seizing compound, slid onto the shaft and the airscrew piston screwed up - with a torque of 800 lb.ft (1 kN.m) - and the split pins inserted in the piston locking ring. The cylinder cover was then screwed on and the sling removed.

Although not specifically mentioned on the Production Chart, it is assumed that the aircraft was painted during this Stage. In Imperial Airways Limited livery, no coatings were applied to the external Alclad surfaces of the 'boat. The fabric covering of the flight control surfaces were doped SILVER. The registration lettering, which followed the style of the 1930 Convention relating to the Regulation of Aerial Navigation was 7 ft. (2.13 metres) high for the upper and lower surfaces of the mainplanes and 3ft.6ins. (1.067 metres) high on either side of the hull. The aircraft's name was applied, in capitals, 12 ins. (305 mm.) high on either side of the nose, immediately below the windscreen side panels. The Maximum Permissible and Tare weights - 40 500 lb. and 27 000 lb. respectively for a standard S. 23 - were painted on the hull in 3 ins. (76 mm.) high lettering, below the starboard tail plane. There is some controversy concerning the colour of the lettering. The Convention requires it only to be of contrasting colour to that of the aircraft. For the IAL Empire 'boats the majority opinion is that it was DARK BLUE. Photographs of Empire 'boats are invariably black-and white. Colour photographs of Empire 'boats are very rare. There are however are two Imperial Airways colour postcards of paintings showing the registration lettering of a moored-up Empire 'boat and a Handley Page HP 42 in flight. The Empire 'boat painting by A.Brenet shows the lettering to be medium blue but too light to appear in photographs as very dark blue or black, although the lettering for the aircraft's name - CANOPUS - seems to be black. The HP 42 painting by W.H.A.Constable has much darker blue lettering which could just possibly show in photographs as black. The minority opinion is that it all the lettering was BLACK. The colour of the lettering for the QANTAS and TEAL 'boats is not known but likely to be BLACK.

The operator's name and the aircraft's port of registry were added to the hull on both sides. The size and location of the lettering differed but for the majority of 'boats it was in 10 ins. (250 mm.) high capitals reading IMPERIAL AIRWAYS LONDON or QANTAS EMPIRE AIRWAYS BRISBANE low down on the hull, between Frames 10 and 15. Some of the S.23s had reduced height lettering higher up on the hull. 'VD CHALLENGER and 'TY CLIO, and two S.30 'A' TEAL 'boats had 6 ins. (150 mm.) high capitals centred on Frame 12. The TEAL 'boats were lettered TASMAN EMPIRE AIRWAYS WELLINGTON. The S.23 'Atlantic' 'boats were lettered IMPERIAL AIRWAYS (ATLANTIC) Ltd high up on the hull - at an extra cost of £ 3:1:3 (PV £ 71.00).

The style of the lettering was unique both to Short Bros. - and the Empire 'boats. A connoisseur of lettering would have had considerable difficulties with the heightened initial capitals, the somewhat erratic spacing of the letters and the variation of stroke thicknesses in the individual letters. The pre-war livery was completed with the W/T bonding symbol stencilled on the movable flight surfaces in the Dope Shop and on the corresponding adjacent fixed surfaces on the aircraft. The paintwork was DARK BLUE or BLACK.

After the incorporation of Imperial Airways into the British Overseas Airways Corporation, the original operator's name and port of registration was stripped from the hull. The Speedbird logo was added to most of the aircraft beneath the name, and the words BRITISH AIRWAYS, in 6 ins. (150 mm.) high lettering, added below. The paintwork was DARK BLUE or BLACK.

The outbreak of the war brought the underlining of the registration lettering on the hull and mainplanes with RED, WHITE and BLUE bands, 12 ins. (305 mm.) wide. The 'boats sported a fin or rudder flash, most of which were 3ft.6ins. (1.066 metres) high. Some 'boats - 'TY CLIO was one - had rudder flashes that extended more than half way up. Some of the 'boats were put into full camouflage. The last two S.33 'boats - 'PZ CLIFTON and 'RA CLEOPATRA - were delivered in camouflage at an extra cost of £ 82:2:1 (PV £1 760) each with a weight penalty of 41 kg.each. The Horseshoe 'boats retained the underlining and their registration lettering when they were put into camouflage and some of them had the colour stripes on the elevators. The TEAL 'boats were not camouflaged but had the upper surface of the outer mainplane panels painted orange and carried union flags (2ft.6ins.X 5ft. - 762 mm. X 1.5 metre), painted between Frames 6 and 8, on both sides of the hull. Un-camouflaged 'boats in Horseshoe service had a line of lettering on the fin and rudder - perhaps the Corporation's name.

The 'boats impressed for war service, both British and Australian, were also fully camouflaged. If the schemes complied with Air Ministry Order A 926/40 - and it is thought generally that they did - they would have been finished in standard Coastal Command Temperate Sea Scheme camouflage, with the upper

3. Production

surfaces and hull finished in Pattern 1 format in EXTRA DARK SEA GREY and DARK SLATE GREY with Sky Type 'S' DUCK EGG BLUE undersurfaces. National 1 roundels (equal RED and BLUE) - 7ft. (2.13 metres) in diameter - were on the upper surfaces of the mainplanes. The hull had National 3 (RED, WHITE, BLUE and YELLOW) roundels - 4 ft. 6 ins.(1.37 metres) diameter. No markings were carried on the under surfaces of the mainplanes. Three colour fin flashes - 27 ins. high X 24 ins. wide (686mm. X 610mm.) - and serial numbers 'B' in LIGHT SLATE GREY completed the scheme. A painting of AX 659 CLIO in this camouflage is shown on the inside back cover of the Profile Publication No. 84. A black and white photograph of the remains of '38 CARIBOU in Bodø Harbour, taken by Oddvar Tonaas, shows no YELLOW surrounding the roundels on the hull. Because of confusion with the markings of Japanese aircraft the RED centre of the roundel was omitted in later Australian service, A-18 CLIFTON had DULL BLUE and WHITE roundels and fin flashes.

Before delivery each aircraft was completed with its full complement of equipment items.

The Control Deck equipment list included:

- 1 Aldis signalling lamp with RED and GREEN filter glasses.
- 1 Webley and Scott signalling pistol.
- 1 Rack for signalling pistol with three WHITE, three GREEN, three RED cartridges.
- 1 Engine starting handle.
- 4 Engine starting handle extensions.
- 1 Handle for manual operation of flaps, in stowage.
- 1 Night flying screen.
- 1 Axe in stowage.
- 2 Door keys in stowage.
- 1 set of bunting (Civil Air Ensign, IAL or BOAC house flag, Royal Mail pendant, National flags, International Code Flags and Semaphore flags).
- 1 Brown's signal book.
- 5 Auliffe lifebelts - later equipment at crew stations.
- 1 Set keys for hatches.
- 1 Aircraft log book.
- 1 Set of engine log books.
- 1 Instrument log.
- 1 Voyage report book.

'CU CABOT and 'CV CARIBOU were each equipped with KBB air sights for their Atlantic flights. Some of the S.30 'boats were fitted with voice-pipes between the Captain's seat and the Navigator's position. The extra cost for fitting was £ 42:10:0 (PV£ 1000 .00).

Pyrene fire extinguishers were located on both decks:

Upper deck

- Starboard side near deck at Frame 7
- Starboard side on roof between Frames 13 and 14.

Lower deck

- Forward Cabin on left hand side of entry hatch.
- Pantry on right hand side of ladder to upper deck.
- Promenade Cabin on left hand side of entry from corridor and on left hand side of bulkhead at entry to Aft Cabin.
- Aft Cabin on right hand side of entry from Promenade Cabin.

There were at least four different standard wireless equipments used on the Empire 'boats. The 1937 equipments were used by the standard Mark I S.23 boats. The two Mark III long range 'Atlantic' boats - 'HM CALEDONIA and 'UV CAMBRIA - were used for survey work in connection with the Atlantic crossing, so these 'boats had special sets to deal with short range approach work on the eastern seaboard of the United States. The same set operated in the R/T mode for working with the American east coast

3. Production

stations and in the W/T mode for the journey back to the United Kingdom. The Mark II 'Bermuda' 'boat' 'UU CAVALIER, had similar equipment. The later 'Atlantic' aircraft - the S.30 'boats' - also carried additional receivers to cope with direction finding and radio telephony work with the US stations.

Initially all the radio equipment used by the 'boats' on line service, main sets and ancillary equipment, were leased from Marconi's Wireless Telegraph Co. Ltd. on an hourly basis. Captain L.A.Eggesfield, First Officer Upton, Radio Officers T.C.Jones and H.F.Jones and Flight Engineers F.J.Crowson and Green were on board 'UV CAMBRIA' on the African route survey flight from Alexandria to Durban in May 1937. For the journey, 'UV' was equipped with Marconi and Standard radio equipment, no doubt to assess the relative merits of the equipments in 'African' conditions. The fact that both Radio Operators had the same family name, and both were required by IAL etiquette to be addressed as "Mr Jones", together with keen rivalry between them to work their respective sets to the best advantage, caused some amusing moments on the Control Deck, much relished by their Captain. Hermes transceivers were installed on some of the later boats, notably the TEAL 'A' 'boats' used on the trans-Tasman sector, in addition to the normal 1938 version Marconi sets.

The various known equipments are listed below. All equipment items are Marconi manufacture or supply, unless otherwise shown. The (HD 1****) references are to the Marconi internal connection diagram number for each item. The Hermes radios were 1050/51 60 watt crystal controlled transceivers, originally developed by Hermes Ltd. of Surbiton for use with the Imperial Airways Limited control tenders on Southampton Water but fitted to the flying boats as stand-by sets. Some control tenders were fitted with a full set of Marconi AD 57a/5872a equipment, included a direction finding (D/F) loop, in place of the Hermes sets. The main wireless equipment was fixed to a transverse bulkhead located slightly aft of Frame 8, extending to the centre line of the aircraft. The work station had its own port hole, with roller blind. A shielded light was on the left-hand end of the desk, with the Morse key at the right-hand end. When fitted, the stand-by Hermes set was below the D/F loop on the left hand end of the desk. The top of the set was level with the desk making it somewhat difficult to use, as the knobs were small and the position awkward.

The D/F aerial used on the S.23 'boats' was a retractable 13 in. (325 mm.) diameter circular, rotatable, screened loop aerial linked to the receiver, or both receivers if a stand-by set was carried. A Short Bros. patent (No. 455164 'Improvements connected with directional wireless apparatus for aircraft' of 1 August 1935) describes an elliptical D/F loop aerial, with an end plate attached to the top of the loop. The whole apparatus is arranged to slide vertically upwards from the body of the aircraft into the airstream on the two guide tubes, clear of the screening effects of the metal hull. A modified form of this patent was used on the 'boats'. In this version, a hinged sealing plate was attached to the hull rather than perched on top of the loop as in the patent, but otherwise the aerial and its supporting mechanism was much as shown in the patent drawing. The later S.30 and S.33 aircraft were fitted with the larger, non-retractable 18 in. (450 mm.) diameter loops and some of the S.23 'boats' on the Horseshoe route were also fitted with fixed loops.

The power supply for the radio equipment ran in screened cables from the generators on the inner engines, to the motor generator set. The power for the transmitter was supplied by the motor generator set, which was switched ON each time before a transmission was made. The motor generator charging switchboard, which controlled the operation of the generator set, was fixed to the side of the aircraft between Frames 7 and 8, immediately under the port hole. The motor generator set consisted of a Stanley Type SM 5M 0.74 kW (1 hp.) two-stroke petrol engine, a 24 volt FB/M1 electric motor normally powered by the aircraft's electrical system - and a Type FB/G1 double output generator, arranged in that order and coupled together. In normal conditions on the water and in flight, the FB/G1 generator was powered by the electric motor. The generator supplied HT power at 1200 volt 200 milli-amp DC and LT power at 12.5 volt 6 amp. DC. For emergency use on the water, the petrol engine could be engaged through a hand-operated clutch, to drive the generator through the electric motor. The whole of the petrol engine, its fuel tank and exhaust pipe, were enclosed in a 'fireproof' box, kept tightly closed while the aircraft was in flight. The petrol motor's starting handle was in a canvas case attached to the side of the aircraft, over the 'fireproof' box. If the petrol engine was required for use, the box was opened up and the exhaust pipe fitted, leading to the outside of the aircraft through the direct vision panel of the windscreen on the Captain's side. Very noisy in operation, the set provided enough power for effective communication. The fuel tank was drained after each operation. It was also possible for the petrol motor to charge the aircraft's battery.

The trailing aerial winch was on the port side of the aircraft, between the Radio Officer's station and the Captain's seat. The trailing aerial itself was a 7/26 stranded, phosphor bronze wire some 280 ft. (85 m.) in length, wound onto the storage drum of a hand operated winch. When the lever on the winch was set to FREE, the aerial was free to run out, under the control of a centrifugal brake. To wind in, the lever was set

3. Production

to FIXED and aerial wound in by hand against a ratchet mechanism. The wire ended with a string of small lead weights - weighing 700 g.- to stabilise the end of the aerial wire, preventing it from whipping about in the air. The aerial wire left the aircraft through a retractable Paxolin fairlead. In the DOWN position, the fairlead projected 600 mm.(24 in.) vertically downwards clear of the planing bottom on the port side, just aft of Frame 6. In the UP position, the fairlead aperture was closed off by a watertight rubber flap. A 6 watt roof light, back to back with the pilot's roof light, gave general illumination for the Radio Officer's working position.

The aircraft of the first two production orders had a single longitudinal fixed T aerial, that extended from the aerial mast to the fin. There was also a dipole aerial arrangement from the aerial mast to two subsidiary masts, slotted into sockets let into the plating and attached to the rear mainplane spar, inboard of the inner engines. The di-pole arrangement did not seem to have been very effective, for it not last for very much longer than the end of 1937. It was certainly fitted to the sixteenth S.23 boat - 'TW CALPURNIA - the second boat of the second production batch, which was launched on 27 June 1937 - and was probably installed on all the S.23 'boats. However, by August the next year, 'TW CALPURNIA had the revised aerial arrangement in place. This replaced the horizontal V di-pole and the single fixed aerials with a double longitudinal T fixed aerial, fitted with spreaders at both ends. The port aerial was for transmission and the starboard for reception.

Each 'boat was equipped with a copy each of Indicatif d' Appel (call signs), a list of aeronautical stations, a list of coast stations and the W/T logbooks.

The various equipments were:

Normal range S.23 boats - 1937 equipment:

This equipment was fitted to 'HL CANOPUS and the Mark I aircraft of the first and second production batches of S.23 standard 'boats, up to Construction No. S.851 'UI COORONG.

Transmitter	AD 57A (HD 1011) Short wave AD 57A (HD 1012) Medium wave
Receiver	AD 5782 A (HD 1016) Short wave and Medium wave
Anode converter	(HD 1005)
Visual D/F attachment	Type 626C (HD 1032)
Aerial switch Type 190	(HD 1044)
Earthing relay Type 190	(HD 1044)
Charging switchboard	Type H 230A (HD 1041)
Fixed aerial (single aerial in early aircraft, replaced by dual aerial with spreaders)	
Fixed di-pole aerial (on early aircraft only)	
D/F loop	
Double pole on-off switch	

The Mark II 'boats - 'UT CENTAURUS and 'UU CAVALIER - had extra equipment for the survey flight to Australasia and for the North American service. For North American service a radio telephone set, AD 37K Medium and long range R/T was fitted.

Long range Mark III S.23 Atlantic boats - 1937 equipment:

'HM CALEDONIA and 'UV CAMBRIA

Transmitter	AD 73A (HD 1011) Short wave A.1 wave AD 73A (HD 1017) Medium wave A. 2 wave
Receiver	AD 5872 B (HD 1019)
Stand-by Receiver	AD 5062B (HD 1007) Medium wave D/F in USA
Anode converter	(HD 1009)
Barrater Unit	Filament heater (HD 1030)
Visual D/F attachment	Type 626B (HD 1023)
D/F reversing hand switch	(HD 1010)
Aerial switch	
Earthing relay	Type 190 (HD 1044)

3. Production

Charging switchboard Type H 230A (HD 1041)
Fixed single aerial
Fixed di-pole aerial
D/F loop
Double pole on-off switch

For North American service a radio telephone set, AD 37K Medium and long range R/T was fitted.

Normal range boats - 1938 equipment:

This equipment was used on the S.30 and the S.33 'boats, except for the four Mark III long-range 'boats.

Transmitter AD 67A Ed. A (HD 1083) Short and Medium wave
Receiver AD 6872B Ed. H (HD 1138)
Transceiver (some aircraft) Hermes 1050A/1051A D/F
ML converter Type C (modified)
D/F reversing hand switch Type 180A (HD 1010)
Voltage control unit Type 580A
Aerial switch Type H 130B
Charging switchboard Type H 230A (HD 1041)
Fixed aerial
D/F loop Type 823/18
On-off switch Type H 240A

Long range boats - 1938 equipment:

This equipment was used on the four S.30 Mark III long-range 'boats, 'CU CABOT, 'CV CARIBOU, 'CW CONNEMARA and 'CX CLYDE.

Transmitter AD 67A Ed. A (HD 1083) Short and Medium wave
Receiver AD 6872B Ed. H (HD 1138)
D/F receiver AD 5062E Ed. H (HD 1145)
Telephone control unit
ML converter Type C (modified)
ML converter Type C (with relay)
D/F reversing hand switch Type 180A (HD 1010)
Voltage control unit Type 580A
Aerial switch Type H 130B (spec)
Charging switchboard Type H 230A (HD 1041)
Fixed dual aerial
D/F loop Type 823/18
On-off switch Type 240A

The following equipment was common to all 'boats:

Transmitting key
Head phones
Microphone
Motor generator set.
Trailing aerial winch

Wartime additions included assorted standard RAE Type 1154 transmitters, Bendix and Marconator direction finders, Air/Surface Vessel ASV Mark 2b, 1.5 metre band radars with range scales of 3 n.m, 12 n.m, 30 n.m and 120 n.m.on board 'TY CLIO as AX 659 and 'UD CORDELIA as AX 660. Some unknown radar equipment was installed in 'MA AOTEAROA and 'MC AWARUA. IFF Identification Friend or Foe equipment - and, towards the end of the war, BABS - Blind Approach Beacon System secondary radar was installed. Under the heading of "'C" class Alterations and Modifications in Air Publication A.P. 2206A Z1 - W dated 10 September 1941', Modification 10141 referred to the installation of ' *the fixed fittings of a complete Lorenz equipment but the actual installation of receiver 1125A only.*' The only Empire 'boat in RAF service at the time was AX 660 CORDELIA, to be sold back to BOAC nine days later

3. Production

to resume its previous existence as 'UD CORDELIA, so it doubtful if the mod. was carried out. Many of the 'boats originally fitted with the 1937 standard equipment, were re-equipped with 1939 sets sometime during their service lives.

The marine equipment in the mooring compartment included:

- 1 Taylor's patent ploughshare XII anchor with 20 fathoms (36.6 metres) of 3 in. circ. manila rope c/w with shackle.
- 2 36 in. (914 mm.) diameter canvas drogues and pennants for tandem use stowed in the bins on either side.
- 2 5 fathom (10 metre) 2 in. Circ. manila warp lines for the drogues.
- 2 65 ft. (19.8 metre) 1 in. Circ. triplines for drogues.
- 1 30 ft.(10 metre) 7/8 in. diam. steel towing and mooring cable c/w shackle.
- 1 Slip release.
- 1 "Grabbit" boat hook c/w with haft and rope in stowage.
- 1 16 ft. (4.9 metre) 3 in. Circ.slip line.
- 1 50 ft. (15.24 metre) 1 in. Circ. manila heaving line.
- 1 5 fathom (9 metre) 5 in. Circ. bass mooring rope c/w shackle.
- 2 Linatex fenders for passenger hatches.

On survey flights or flights to non-scheduled stations, an extra 30 ft. (9 metre) slipline was carried.

The drogues were stowed in bins, to port and starboard, with the warp and trip lines nearby. The anchor light switch was at the bow, to be operated by the bowman when he was mooring up or casting off in darkness.

The passenger cabin equipment included:

S.23 original accommodation including the Forward Smoking Cabin and bunk mattresses, blankets, pillows, bunk ladders and curtains

- 15 or 17 Single adjustable IAL 'chairs'.
- 7 Fixed 'chairs' for Forward Cabin.
- 1 Set of bunk mattresses.
- 1 Set of blankets and pillows.
- 4 Bunk ladders (4 rung) for top bunks.
- Sets of bunk curtains for Forward, Centre, Promenade and Aft Cabins.
- 15 or 17 Single adjustable IAL 'chairs'.
- 15, 17 or 24 Lifebelts. CAVALIER on Bermuda –New York sector was probably the only Empire 'boat to carry full compliment of 24 passengers.

S.23 revised accommodation and S.30 and S.33 aircraft after Forward Cabin had been converted to Flight Clerk's office and sleeping onboard had been abandoned.

All passenger aircraft:

- 1 Registration plate.
- 1 Set of light luggage racks.
- 1 Set of carpets.
- 10 or 13 Tables.
- 12 Jewel cases (hold-alls ?).

The pantry equipment for a standard S.23 aircraft included:

- 1 Ice chest c/w with racks and trays.
- 1 Hot box.
- 1 Syphon rack.
- 1 Tray rack.
- 1 Plate draining rack - over the draining board.
- 1 Plate stowage rack.

The pantry equipment for a standard S.23 aircraft continued:

3. Production

1	Cup rack.
1	Glass rack.
1	Fruit rack.
1	Wine rack cabinet c/w with drawers and cupboard storage for vacuum flasks.
1	Stainless steel sink and waste - waste discharged to outside..
1	Draining board.
1	First Aid kit.
1	Steward's folding seat.
1	Folding table.
1	Fixed table.
1	Refuse bin.
30	Large plates, small plates, deepwell plates, tea cups, saucers, large knives, small knives, large forks, small forks, dessert spoons and tea spoons.
1	Bread knife.
1	Carving knife.
1	Carving fork.
4	Cruets.
4	Sugar tongs.
4	Sugar casters.
2	Trays.
1	Spirit measure.
30	Sherry glasses.
30	Tumblers.
4	Milk jugs.
4	Sugar basins.
1	Tea pot.
1	Coffee pot.

Two minor modifications to the equipment were made. An electric liquid food immersion heater was fitted to 'KZ CATHAY and an experimental hot box to 'CT CHAMPION - at an extra cost of £11:9:5 (PV£ 230).

The Steward's call signal indicator was fitted to the aft wall of the pantry. The ladder for access to the Control Deck was in the pantry, in a recess on the right hand side of the entry from the corridor.

The two lavatories for men and women were located side by side on the port side, opposite the pantry - the women's lavatory forward. The equipment list for the two lavatories included:

2	Blake chemical toilets c/w with Elsanol chemical charge.
2	Beresford or Starkie Gardner stainless steel wash basins c/w taps and waste.
2	Towel cupboards c/w mirror.
1	Shaving shelf in men's lavatory.
2	Toilet paper holders.
2	Soiled towel baskets.

A shared 22.5 litre (5 gals.) tank provided cold water for hand washing. Each lavatory had a 6 watt ceiling light and switch. The S.33 'boats were fitted with Starkie Gardner wash basins at an extra cost of £14:2:0 (PV£ 280.00) each.

The freight room equipment included but not necessarily all carried:

1	Saunders 3 ins. portable bilge pump, hose with adaptor for the floor connection, chart and dipstick.
1	Enots portable float bilge pump.
1	Beaching leg key.
1	Set of engine, airscrew and seat covers.
1	Set of engineer's platforms and cradles.
1	Spare engine H section steel lifting beam and struts, Buck and Hickman epicyclic Cat. No. 4285 chain block, spare engine trolley and engine sling.
1	Set of cargo nets and tie-down webbing straps.

3. Production

When carried, covers for the engines, airscrews and seats were stowed aft of the flooring towards the tail, as were the maintenance platforms and cradles. The flight refuelling equipment for the S.30 Atlantic 'boats was installed aft of the freight room at about Frame 42. The equipment included:

- 1 Refuelling platform.
- 1 Windlass complete with hauling line and brake.
- 1 Receiver cup and guide tube.
- 1 Main cock and cock controlling lever.
- 1 Tail refuelling signal box.
- 1 Hydraulic pump, pressure control valve, pressure release unit and pressure gauge.
- 1 Special crook for releasing pipeline weight.
- 1 Set of signalling flags (RED, GREEN, ORANGE and BLACK and WHITE chequered).

The flight refuelling equipment items fitted to the S.23 Mark III 'Atlantic aircraft is not known but must have been similar to the list given above. Some 'boats carried additional miscellaneous equipment during their wartime service. 'CU CABOT - and presumably 'CV CARIBOU - were equipped with five parachutes - 18 July 1939. S.30 aircraft on the West African route carried four life rafts, two parachute flares and eight RAE aluminium sea markers.

The Type Record gives the weight of a complete set of equipment items for a typical standard S.23 Empire 'boat on Empire Air Mail Programme (including the wireless equipment) to be about 2 995 lb. (1 360 kg.).

The aircraft were weighed to comply with their Certificate of Airworthiness. The Short 'boats were handmade products and their tare weights varied somewhat. The specific gravity of the aviation spirit was variously given as 0.745 or 0.76 - depending on the origin of the refinery feed stock. The latter figure is used here. The specific gravity of the lubricating oil is given as 0.9.

The weights recorded in the literature are also at variance. The Type Record gives the following breakdown:

Airframe	16 718 lb.	(7 583 kg.)
Engines	7 496 lb.	(3 400 kg.)
Fuel tanks	249 lb.	(113 kg.)
Fuel and oil	4 960 lb.	(2 250 kg.)
Equipment	2 995 lb.	(1 359 kg.)
Paying load	8 082 lb.	(3 666 kg.)
Total	<hr/> 40 500 lb.	(18 370 kg.)

The maximum authorised weights allowed by the Certificate of Airworthiness increased in service. Typical figures are given below for a standard weight Mark I S.23 'boat - 'HL CANOPUS, a medium weight strengthened S.30 'boat - 'KZ CATHAY - and a heavy weight long-range Mark III S.30 'boat - 'CV CARIBOU.

S.23 G-ADHL CANOPUS		
Weight empty	23 055 lb.	(10 458 kg.)
Weight of fuel 600 gals.	4 560 lb.	(2 068 kg.)
Weight of oil 44 gals.	396 lb.	(180 kg.)
Weight of aircraft ready to receive paying load plus crew	28 011 lb.	(12 056 kg.)
Paying load plus crew	12 489 lb.	(6 893 kg.)
Maximum weight authorised	<hr/> 40 500 lb.	(18 370 kg.)

3. Production

S.30 G-AFKZ CATHAY		
Weight empty	30 070 lb.	(13 640 kg.)
Weight of fuel 1 000 gals	7 600 lb.	(3 447 kg.)
Weight of oil	792 lb.	(359 kg.)
Weight of aircraft ready to receive paying load plus crew		
	38 462 lb.	(17 446 kg.)
Paying load plus crew	4 038 lb.	(1 832 kg.)
Maximum weight authorised	42 500 lb.	(19 278 kg.)
S.30 G-AFCV CARIBOU		
Weight empty	28 668 lb.	(13 004 kg.)
Weight of fuel 2 474 gals	18 804 lb.	(8 529 kg.)
Weight of oil 174 gals.	1 566 lb.	(710 kg.)
Weight of aircraft ready to receive paying load plus crew		
	49 470 lb.	(22 441 kg.)
Paying load plus crew	3 530 lb.	(1 601 kg.)
Maximum weight authorised	53 000 lb.	(24 040 kg.)

The original Order for the 'boats, dated 19 February 1935, placed the aircraft under guarantee. *'Defective parts within one year of acceptance or within first thousand hours of flight (whichever is the longer) to be replaced (by Short Bros.) at Croydon (sic) free of charge and carriage paid, unless due to fair wear and tear or racing (sic), neglect. etc...'* Disagreements between IAL and Short Bros. were subject to arbitration by the Air Ministry.

The Type Certificate cost £300:0:0 (PV£6 700.00) with a fee of £5:5:0 (PV£ 121) for each subsequent aircraft. The annual renewal fee was £ 5:0:0 (PV£ 115.00).

The engines were then run for a ground test. The completed aircraft was inspected for its Safety for Flight certificate, issued by an AID inspector, and a test flight flown. The 'boat was swung and the compass corrections made.

It was then ready for delivery.

Operations

Captains and First Officers

With the advent of the Empire Air Mail Programme (EAMP), Imperial Airways Limited changed its policy of stationing aircraft crews along the routes. In July 1936, the four Operating Divisions were operated by about eighty-five pilots, Captains and First Officers. No.1 Operating Division, the European Division, had thirty pilots and No.2 Operating Division, which covered the Mediterranean and Africa as far east as Karachi and south as far as Kisumu, thirty pilots. No.3 Operating Division, from Karachi eastwards to Singapore and Hong Kong had twenty and No.4 Operating Division, south of Kisumu, ten pilots

Flight crews for the new 'boats were recalled to the United Kingdom to be based at Hythe. At the start of the EAMS, as the Empire 'boats were progressively brought into service in No.5 Operating Division, a permanent crew was allotted to an aircraft and stayed with it. This excellent arrangement could not be sustained for much longer than the first six months of the service. Crews were then made up from the pool of available personnel, as and when they were required. Some IAL Captains had a well founded reputation for idiosyncrasy and were individuals, in all senses of the word. The other members of their crews adjusted accordingly.

A normal EAMS crew consisted of the Captain and First Officer as the pilots, a Radio Officer, a Flight Clerk and one Steward. The Bermuda-New York service was the exception. It was flown without a Flight Clerk and carried instead an additional Steward. On the Horseshoe route, the Steward was often dispensed with, as the standard of cuisine no longer required his skilled administration. On these services the Flight Clerk, by then translated into a Purser, stood in for the Steward when required. Some Horseshoe services were flown without either Pursers or Stewards.

Crew uniforms for the European and temperate climate sectors were navy blue in colour, with white shirt and dark tie. Jackets were changed on 1 September 1938 from a belted army officer style with patch pockets, to a more fitting naval type with a double row of four buttons. Rank was indicated by sleeve rings. Captains wore three rings, First Officers two and Supernumerary First Officers, one. All pilots wore brevets on the left breast. Matching greatcoats and raincoats completed the uniform. Shoes or boots were black. Khaki drill uniforms and topees were issued for the hot weather sectors with the rank indicators worn on the epaulettes. First Officers were additionally issued with two white boiler suits, laundered at the Company's expense, which had to be worn when working around the aircraft. Uniform was not worn off duty in clubs, bars or hotels.

All uniforms were to be kept clean and well pressed. Likewise, white cap covers, shirts and shirt collars were to be clean and boots or shoes well polished. Wire cap stiffeners, or grommets, were not to be removed. A high standard of smartness and personal cleanliness was required at all times. Some Captains lined their crews up for inspection before a flight, to make sure that they passed their own exacting standards of neatness. Jewellery, except watches and a ring, was forbidden.

Judging from the published transcripts of recent conversations on the flight deck, etiquette has changed somewhat since 1936. According to IAL's operating procedures, the etiquette of the day required all other crew members to address their Captain as 'Sir' or 'Captain'. First Officers were addressed as 'Mister' by the Captain and 'Sir' by the Radio Officer, the Flight Clerk and the Steward. These last three crew members were addressed as 'Mister' by everybody, at least in the hearing of the passengers and the more autocratic Commanders. However, most crews were on first name terms unless the Commander was not on the best of terms with his crew. Orders given by the Captain or First Officer were repeated back, nautical fashion. Cabin staff addressed passengers either by name, which they were expected to know for the more important passengers, or as 'Sir' or 'Madam', and when wearing a uniform cap, to salute when addressing them or when reporting to a senior officer.

Captains and First Officers were members of Imperial Airways Limited's Air Department, under the control of the Air Superintendent, initially Major H.G Brackley. The Air Superintendent, chosen by the pilots, was responsible to the Management of IAL for the selection, training and supervision of all pilots. He was also responsible for testing new aircraft before they were accepted by the Company, and for all matters affecting the testing and development of navigational equipment, especially Direction Finding equipment and any other aids to flying operations. Major Brackley - known as 'Brackles' to his friends, was described by Captain D.C.T.Bennett as *'calm, immaculate and extremely proper in all his conduct'*.

4 Operations

He established the prestige and authority of the Captain of an IAL aircraft. As far as he was concerned, the Captain had the absolute and final word regarding the safety of a flight. The function of the Air Superintendent was subsequently taken over by the Manager of Operations.

Captains for the new Empire 'boats were recruited from the four existing Operating Divisions of IAL and posted to the newly formed No.5 Operating Division. As commander of the aircraft, the Captain was legally responsible for all aspects of the conduct and safety of the crew and passengers whilst they were on board and for the safety of the aircraft on the water and in the air. Outbound wireless communication was under his direct authority, except for signals relating to the radio service itself. The Captain signed the load sheet, previously made out and signed by the Flight Clerk. Captains were also responsible for the navigation log, the instrument log, the daily certificate, the radio log, the emergency drill log book, and that all the other documents were kept in accordance with the Company's regulations. Captains held current 'B' Licences, First Class Navigators Licence ('First N'), 'A' and 'C' Engineers Licences and, most of them, Wireless Operators Licences. Since 1 January 1928, it had been a requirement that a navigator with at least a Second Class Navigators Licence ('Second N') should be on board any aircraft carrying more than ten passengers. Selected Captains took a nine month course in celestial navigation at IAL's school at Croydon in preparation for the trans-Atlantic survey flights.

Master Air Pilots Certificates had been instituted in 1929 for pilots of civil aircraft. The requirements for this certificate were a current 'B' licence, 1 000 hours as pilot of a civil aircraft during the five years prior to the Certificate, twenty night flights over land or sea beginning and ending in the dark and a 'Second N' held for five years. Eighteen Master Certificates had been issued by August 1936 - all to IAL Captains.

In preparation for the new service, IAL approached the Air Ministry in 1935 to allow volunteers to transfer from the Royal Air Force. Pilots agreeing to transfer, some of whom had been flying Short Rangoon and Singapore III flying boats, were signed up by IAL's Staff Manager, Sir Tom Webb-Bowen.

An agreement was signed in November 1936 between IAL and Air Pilots Training Ltd. for the training of one hundred Captains and First Officers for the EAMS. By the beginning of 1938, IAL had about seventy Captains in the new No.5 Operating Division. Some Captains had transferred from the Mediterranean where they had been flying the Short flying boats of No.2 Division. Many others transferred from the Handley Page HP 42s of Nos.1 and 2 Divisions and the Armstrong Whitworth Atalantas XV of Nos.3 and 4 Divisions. Pilots who had transferred from the RAF were sent to the IAL 'school' near the London Terminal Airport at Croydon, to qualify for their 'A' and 'C' Licences and for the Wireless Operator's licence. They emerged, some twelve to fifteen months later, as acting First Officers. The training operation was later taken over by Air Pilots Training Ltd, a company specially formed for the purpose..

The conversion courses took place at Hamble, conveniently placed across Southampton Water from the new IAL base at Hythe. The three month course taught aspiring flying boat Captains and First Officers seamanship in a course of seventeen lectures. This was followed by 12 hours, solo and dual, in one of the two Saunders-Roe Cutty Sark amphibians, finishing with 20 hours, solo and dual, in one of the Short Calcutta 'boats, G-AATZ, the ex City of Salonica/City of Swanage, or the Short Rangoon, G-AEIM. Land lubbers, three or four at a time, were given a two week course on practical seamanship on a 10 ton ketch, skippered by a retired sea captain. No weeding out took place and some senior Captains, bred up as they were on land aircraft, never managed to acquire a full grasp of the essentials of maritime operations.

When the newly transferred crew members finally arrived at the controls of an Empire 'boat, they revealed differences in approach and alighting technique, depending on the previous aircraft to which they had been accustomed. The tendency of ex-HP 42 pilots was to glide in to alight slowly, with very little engine and full flap. Turning on to the final approach was often made at low level, with consequent loss of height. Realising that the wing float on the inside of the turn was in danger, they tended to pull up sharply to level off, alighting tail down, splashing in heavily with the risk of porpoising. Ex-Atalanta crews tended to approach straight in at a flat gliding angle, with a small amount of engine and a modicum of flap. This resulted in a flat, fast alighting with the 'boat running out for a considerable distance on the water. The curved top of the dashboard on the Empire 'boats caused some problems during training, as it did not give a clear horizontal reference. Pilots converting to the Empire 'boats tended to make their approach and alighting with the wing on their side down, with a potentially high mortality rate for wing floats. This tendency was corrected by rigging a wire between the blind brackets on either side of the coupé, straight across the pilot's field of vision, to establish a clear horizontal reference.

After training, Captains and First Officers were posted to No.5 Division to fly the routes as Supernumeraries under the supervision of selected Captains. Captain F.R.Bailey (then a veteran of some twenty years on

4 Operations

marine aircraft) was the first IAL Captain to gain command of 'HL CANOPUS on 22 October 1936. He was followed by Captains F.D.Travers, J.Spafford, E.J.Alcock, A.B.H.Youell, F.V.W.Foy, W.Armstrong, O.P.Jones, H.H.Penny, A.S.Wilcockson, H.W.C.Alger, F.Dismore, R.P.Mollard, J.S.Sheppard, G.J.Powell and A.C.Lorraine - all with Master Air Pilot's Certificates. In the early days of the Empire Air Mail Scheme most Captains were checked out by Captain Bailey or Major Brackley, before being given command.

As the senior member of the aircrew, the Captain flew the aircraft in collaboration with his First Officer. In rough weather it was often necessary, for the comfort and equilibrium of the passengers, to disconnect the automatic pilot and for them both to fly a 'boat manually, together. At the start of the EAMS, the operation of an aircraft depended largely on the individuality of the Commander but standard operating procedures soon emerged. An Empire 'boat Captain exercised a degree of autonomy over the conduct of the flight that is unknown today. He decided the route that he would fly and at what height, so his position was more akin to that of the Master of an ocean-going vessel. The 'boats often deviated to show passengers points of interest along the routes, waterfalls, elephant herds and pagodas being among them sometimes at alarmingly low heights.

The particular route to be flown was decided by the Captain after he had seen the weather forecast. He had absolute say as to whether he would make the flight if he considered the weather conditions were not to his liking at the point of take-off, over the sector or at the destination. As the blind alighting aids then in use were considered impractical for flying boats, the weather conditions at the end of a flight were of vital importance. Alternative alighting areas were not readily available at many ports. Weather conditions also included the state of the water at the terminals, as the 'boats could operate in sea states that the attendant servicing vessels could not tolerate. In the case of sand and dust storms, the visibility at the alighting area decided whether a departure was made.

A Captain's basic salary was about £ 475 (PW £ 9 540) per annum (1939) augmented by the service pay, which could bring the total to £ 1 300 (PW 26 100) per annum. As the service pay depended on the hours flown, Captain's duties were rostered to share out the flying hours as equally as possible. The number of flying hours was controlled by law. Pilots of passenger carrying aircraft were allowed to fly for a maximum of 125 hours in any 30 day period, a theoretical yearly total of 1 520 hours compared to the current (1 May 1990) Civil Aviation Authority maxima of 100 hours per month and 900 hours per year.

First Officers, like Captains, were members of IAL's Air Department and were posted to No.5 Operating Division after training. A First Officer was required to be over 23 years of age, to hold a current 'B' Licence with more than 1 000 hours solo, to have more than 500 flying hrs. on twin engined aircraft, experience of night flying, a 2nd. Class Navigators Licence ('Second N'), an 'A' Licence (authority to issue a Daily Flight Certificate for aircraft), a 'C' Licence (authority to issue a Daily Flight Certificate for the engines) and a 'X' Licence (covering the repair of instruments and magnetos). Some First Officers also had a Wireless Operator's Licence. The aircraft carried a tool kit enabling him to change spark plugs and engine cylinders, and other items such as starter motor booster coils, if the need should arise, and it did at the start of operations. Captains and First Officers had to pass a six monthly medical to re-validate their 'B' Licences and pass an instrument rating test.

The First Officer was second in command to the Captain and was required to take command at any time should the Captain become unable to act for any reason. He flew the aircraft as and when required and took on all the Captain's responsibilities in his absence. He was responsible to the Captain for the internal organization of the aircraft, for the supervision of the duties of the other members of the crew and for the aircraft being in a fit state to fly. At stations without a resident Station Engineer he would also be responsible for the Daily Check, including the engines, and would superintend the refuelling. On the flight refuelled 'boats, he acted as winchman.

During flight he was required to know the full details of the aircraft's position, its speed, fuel state, course, ETA, weather reports, air space restrictions and prohibited areas, and any warnings. As instrument meteorological conditions hardly applied, most flying was done in what would now be called visual flight rules. Most navigation on service, with the short sector distances, was generally by dead reckoning. If the weather was clear, the sector between ports was flown by dead reckoning, with the position confirmed by known landmarks from a hand-held map. Drift could be checked with the drift sight in the starboard wing root. On sectors over oceans, position 'fixes' were obtained by sun, moon and star sights by sextant. If the ground was obscured by cloud or when flying at night, the dead reckoning position was confirmed by radio direction finding 'fixes' as necessary.

4 Operations

The First Officer was restricted to the same number of annual flying hours as a Captain. On appointment with two licences, he was entitled to full basic pay and half service, or flying, pay. On obtaining his third licence, he received full service pay. His basic annual salary was between £312 and £416 per annum (PV£ 6 265 .8 353), augmented by the service pay which could bring the total up to about £ 990 (PV£ 20 000). On the Bermuda station the allowance for quarters was £ 150 (PV£ 300) per annum. The cost of obtaining a 'B' Licence from scratch was about £300 (PV£ 6 000). After three or four years as a First Officer, he might expect promotion to Captain.

From 29 June 1937, the Empire Air Mail Scheme (EAMS) became the Empire Air Mail Programme (EAMP). A typical Empire Air Mail Programme service of an eighteen day round trip to Singapore involved about forty-two sectors in 115 flying hours. Depending on the weather, this could involve some strenuous manual flying. Captains could expect a period of between eight to ten days before being rostered for the next service. The interval between trips was occupied in reporting at Hythe, possibly another one or two days reporting in London and the odd test flight after maintenance and resting as flying the EAMS could be physically demanding.

Radio Officers

The Empire flying boats flew in a serene radio world, largely uncluttered by incessant traffic. At the start of the Empire Air Mail Programme (EAMP), the number of aircraft in the air at any one time in the skies of Europe was small, but increasing. By the end of 1938, Croydon Airport was averaging 100 movements a day. On the EAMP operating out of Southampton, the traffic density was much sparser, with a maximum of perhaps four or five aircraft on some days of the week. On other sectors of the EAMP south and east of Alexandria, the traffic density varied between an aircraft movement every other day, down to twice a week. Besides its primary role of communication between an aircraft and ground stations, radio also played a vital part in the navigation of aircraft by providing radio direction finding (D/F) services to pinpoint an aircraft's position. In 1932 32 000 radio bearings had been given to aircraft by the British ground stations. On the European sectors of the EAMP the D/F services were adequate but on other sectors D/F was not available at all. The intermittent nature of the D/F services was one of the adverse factors that affected the scheduled operation of the 'boats. The Lorenz radio-assisted approach system was in use at European airports, including Croydon and Heston. No doubt due to the small volume of traffic and to difficulties with the location of the marker beacons over the water, the Lorenz system was not used on the EAMS, so the Empire 'boats in commercial service were not equipped to operate it.

The radio service was split into three broad divisions. The traffic division comprised point to point communications between aerodromes and included landlines and teleprinters as well as radio. The aircraft division included all communications between aircraft, and between aircraft and ground stations. These communications included departure and position reports, special reports and distress calls. The third division covered the transmission of weather information, actual or forecast.

The International Telecommunications Convention established the following radio wave length and frequency bands:

Long wave	more than 3000 metres (100 kc/s. or kHz.)
Medium wave	200 metres (1500 kc/s.) to 3000 metres (100 kc/s.)
Intermediate	50 metres (6000 kc/s.) to 200 metres (1500 kc/s.)
Short wave	10 metres (30 000 kc/s.) to 50 metres (6000 kc/s.)
Ultra short wave	below 10 metres (more than 30 000 kc/s.)

Three types of radio wave form were in common use. Type A1 was the continuous unmodulated key-controlled form for use on the medium band for wireless telegraphy (W/T). Type A2 was a continuous wave modulated key-controlled form for use on the short wave band - also known as interrupted continuous wave (I.C.W), and used for W/T. The Type A3 waves were of complex form and used for radio telephony (R/T).

4 Operations

Radio telephony was used by some internal airlines in the UK and was particularly well developed in the USA, where international boundaries and different languages did not present the problems that could arise over the continent of Europe. Contemporary R/T receivers were however, subject to interference. All the various radio equipments carried by the Empire 'boats could receive and transmit R/T - all the transmitting sets had microphones and jacks - but telephony was not much used on the Empire routes. With a trailing aerial, the range for R/T transmissions was between 250 and 300 miles (400 to 480 km.) and with the fixed aerial between 80 and 100 miles (130 to 160 km.).

Most of the communication between the Empire 'boats and ground stations was by wireless telegraphy in the International Morse code, using A1 and A2 wave forms. W/T was superior to R/T for long range work and was less liable to interference. It also used a narrower bandwidth than R/T, a distinct advantage when all aviation radio traffic had to be squeezed into the 822 to 938 metre band. On the Empire routes over Africa and India, interference from intense sand and electrical storms, and from the monsoons, could blot out all medium wave radio communication for hours. In these conditions short wave W/T was the most reliable form of radio communication, as it was virtually free of atmospheric disturbance.

The trailing aerial was normally used in the air and was best for long distance work with the medium wave sets. A switch was included in the aerial circuit to isolate the trailing aerial in the event of a sudden electrical storm appearing before it could be wound in. When a reasonable height had been gained after take-off, the Radio Officer extended the fairlead tube, set the lever to FREE and allowed the trailing aerial to wind out. The aerials could then be switched from FIXED to TRAILING by the change-over switch. If, for one reason or another, the aerial was not wound in at the end of a flight, the impact with the surface of the water would usually whip the weights straight off the end of the aerial.

The range of W/T transmission was impressive. The normal range over water on Type A1 waves was over 500 nautical miles (960 km.) and over 800 n.m. (1 400 km.) on short waves. Messages could be received over distances of more than 3 250 n.m. (6 000 km.) and up to 4 400 n.m. (8 000 km.) on occasions. Working up to 2 000 n.m. (4 000 km.) was not unusual, with 'boats in touch with each other in the air. There were occasions when contact was made by an Empire 'boat in the air over Southampton Water with ground stations at Alexandria and in India. 'Boats at Basra and Khartoum could be heard at Hythe. Communications from 'UU CAVALIER on the inaugural flight from New York to Bermuda were heard in London. The broadcast Coronation service of King George VI on 12 May 1937 was picked up by 'UW CASTOR and 'VC COURTIER over the Mediterranean and by 'UX CASSIOPEIA near Marseilles. The service was relayed to the passenger Cabins. The reception was good.

The Radio Officer's station on the Empire 'boats was on the port side of the Control Deck facing aft, literally back-to-back with the Captain, so that communication between them could be immediate. The amount of traffic in W/T, on an aircraft of the size of an Empire 'boat, required the full attention of the Radio Officer. When R/T was used, communications were still handled by him rather than directly by either pilot.

After he had signed on and opened his station, the Radio Officer would be on watch for the duration of the flight. When he was not actually transmitting a message, he would be 'listening out' on the international calling frequency - a continual period of concentration that started at take-off and lasted throughout the flight to just before alighting at the end. Before starting his watch at the radio sets, he had to attend to casting off the moorings. There were two means of entry to the mooring compartment on the lower deck. The longest, but most often used, was via the ladder in the pantry to the lower deck to enter the mooring compartment through the door in the dividing bulkhead of the Forward Cabin on the lower deck, at Frame 6. The other was directly from the Control Deck overhead, by means of a hatch between the pilot's seats. A ladder attached to the back of the bulkhead door allowed the Radio Officer to climb down into the compartment. Radio Officers also were issued with overalls for use when attending to the marine tackle. At the end of a flight, when he had signed off in the radio log, he was once again in the mooring compartment to handle the drogues, to see to the tow if there was one, and to moor up.

A W/T operator could achieve transmitting speeds of between twenty to twenty five words per minute, the rate being partly influenced by reception conditions at the ground station and partly by atmospheric conditions. Rain, sand and electrical storms could drastically reduce the speed and clarity of exchanges, as could interference from other radio stations. Even for the swiftest and most experienced operator, communicating by Morse code is a somewhat lengthy business if a message is spelt out in full, letter by letter. In any event, the International Telecommunications Convention limited any one message on the international calling frequency to a maximum of five minutes.

4 Operations

The Q code was already in use by the shipping fraternity and an aeronautical section was devised to cover aircraft operations. Commonly used messages, covering practically every eventuality, were assigned three letter code groups, all starting with the letter Q. Each three letter group had a specific meaning which remained the same, irrespective of the languages spoken by either party to an exchange of messages. The Q code speeded up radio traffic and neatly sidestepped the language problem at the same time.

Each Code group is either a question, an answer, an instruction or an intention depending on the direction of the communication. 'QAA' is the first Q code group. As a question 'QAA' means 'At what time do you expect to arrive?'. As an answer, or as a statement of intention, 'QAA 1500' means 'I expect to arrive at 15.00 hrs'.

Meteorological information in the form of words, letter and numeral groups could be attached to Q Code groups to amplify them. Although the Code is now practically obsolete, vestiges remain in use today. QAM 'Can you give me the latest meteorological weather report for', QDM 'What is the magnetic course to steer, with zero wind, to reach you?', QFE 'Can you give me the present barometric pressure, not reduced to sea level, at the surface of .. aerodrome', QFZ 'Can you give me a weather forecast for the region of..', QGH 'May I land using the procedure of descent through cloud?', QNH 'What is the barometric pressure at sea level?', and 'QTE' 'What is my true bearing in relation to ?' are still used.

The handling of the message itself had it's own code groups, chosen for their ease of transmission in Morse code. The most used groups were CT run together as one letter when sent, but not much used by aircraft) - 'start of transmission', CQ - 'all stations', DE - 'from', AR run together as one letter and written in the log as '+' - 'end of message', K - 'invitation to transmit (or reply)', R - 'acknowledgement of receipt' and VA (run together as one letter) - 'end of work'.

There were additional two and three letter code groups that dealt with such operational matters as heights in feet FT or metres MTR, miles and kilometres, ML and KM; speeds, MPH and KPH and whether the aircraft was climbing or descending, ASC and DES. There were other less formal and unofficial code groups in common use such as WX 'weather', GM 'Good morning', TU 'Thank you', OM 'Old man' and BJ 'Bon jour'.

The strength of signals for W/T and R/T reception was coded by numbers.

- 1 hardly perceptible, unreadable.
- 2 weak, readable now and then.
- 3 fairly good, readable but with difficulty.
- 4 good, readable.
- 5 very good, perfectly readable.

International communications in W/T between aircraft and ground stations used a common calling frequency of 333 kc/s. (Hz.) (900 metres).

Ships used four letter call signs. Aircraft used the five letter group of their registration markings as their call sign. Given in full (but without the hyphen) at the start of an exchange of messages, they were normally abbreviated to a three letter combination once communication was established. The Empire 'boat' HL CANOPUS - registration G-ADHL - on making contact with a station for the first time for example, would call as 'GADHL'. Once contact had been made, the call sign could be shortened to G, plus the last two registration letters 'GHL'. To avoid any possibility of confusion between three letter aircraft call signs and those of ground stations, the Air Convention of 1930 required the registration authorities of signatories to proscribe certain letter groups in the registration of aircraft. Banned are any groups starting with the letter Q and such groups as SOS, PAN, TTT, XXX REF, and RPT.

Radio ground control stations had three letter call signs, the initial letters of the sign (usually) identifying the country of origin. Most British ground stations had call signs starting with GE+. The ground station at Portsmouth - call sign GEN on a frequency of 363 kc/s. - was the area station for Empire 'boats' on their way through the Portsmouth Communication Area from Hythe to the French coast. The boundaries of the Portsmouth Communication Area ran from Guildford westwards through Andover to Bridgewater, turning south across the Channel to 50N 003W, eastwards to 50N 002W and south to Cap de la Hauge. The eastern boundary ran from Guildford to Shoreham and thence across the Channel to Cap de la Heve. There were no established reporting points as such, but when an aircraft was approximately mid-way between control centres or crossing an international boundary, the Radio Officer would sign off from the original controlling ground area station and contact the next forward control station, to signal destination and by inference, the route.

4 Operations

The first and last sectors of the Empire Air Mail Programme service were across mainland France, so for this part of the Service the 'boats were operating in the European Continent Airway. The Continent Airway was more an arrangement of control areas and zones rather than the defined track of a contemporary airway. Le Bourget was the control station for northern France, operating with a number of satellite stations for position finding purposes. For central and southern France, Lyon Bron was the control station, with various co-operating satellites. For the Atlantic services, direction finding facilities were available at Foynes, Botwood, New York, Bermuda and the Azores.

Southampton was in the Portsmouth Communication Area, so an Empire 'boat departing Hythe would work *GEN* (Portsmouth on 363 kc/s.) by W/T until it was in a position approximately halfway across the Channel. It would then send *GEN* the end of work signal *VA*, change to the international calling frequency of 333 kc/s. and call forward to the next station *FNB* (Paris-Le Bourget). Depending on the route selected for the flight across France, a 'boat might have worked *FND* (Dijon), *FNX* (Bordeaux), *FNT* (Toulouse) or *FNL* (Lyon Bron) on it's way to *FNM* (Marseilles- Marignane).

Three direction finding and position fixing services were available to aircraft from ground stations. Firstly, an aircraft could ask for a bearing from a single ground station by calling *QTE* - 'What is my true bearing in relation to you?'. The ground station would respond with *QTG* - 'Will you send your call sign for fifty seconds followed by a dash of ten seconds on 377 kc/s (frequency) in order that I may take your bearing?'. If the bearing was, say 045 degrees, the ground station would reply with *QTE 045*.

The second service was to give a position 'fix' from two or more ground stations. More accurate than from a single station, it required three to get really reliable results. Ground stations that gave D/F bearings normally worked with two satellite stations which were alerted either by the control station by landline or radio - if they had not already heard the initial exchange - to take bearings on the aircraft and relay them back to the aircraft, either directly or through the control station.

An illustration of the working of both services is given during the inaugural flight of the ill-fated 'VA CAPRICORNUS (Captain A. Paterson, First Officer G.E.Klein, Radio Officer J.L.Cooper, Flight Clerk D.R.O'Brien and Steward F.A.E.Jeffcoate) which ended by the aircraft flying into the ground near Ouroux in France. 'VA departed Hythe at 11.30 on 24 March 1937, in clear weather. As 'VA climbed steadily, radio traffic became bad and the weather deteriorated. At 13.04, 'VA obtained a position fix (*QTE*) to confirm its estimated position. The fix was obtained from Tours (*FEW*), Beauvais and Auxerre (*FNO*) and relayed to 'VA from Le Bourget (*FNB*). The estimated position was 11 n.m. (20 km.) north west of Chateau while the fix put the 'boat south of Toussus-Le-Noble, about 22 n.m. (40 km.) from Le Bourget. 'VA CAPRICORNUS was then flying on a course of 145 deg. at a height of 8 000 ft. The air speed was 125 knots, the engine 2150 rev per min. and 400 gals. (1800 litres) of fuel remained.

At 13.33 'VA CAPRICORNUS - calling as *GVA* - asked the radio stations at Tours and Dijon (*FND*) for another position fix. Tours responded with '*QTG*' 'Send your call for fifty seconds followed by a dash of ten seconds in order that I may take your bearing.' Dijon was busy, so the first *QTE* came in to 'VA at 13.35 from Tours - '*QTE 92 DEG*'. Mr Cooper mistook the *QTE* of 212 deg. from the station at Auxerre as the *QTE* from Dijon. Auxerre had been listening in to 'VA's requests for a position fix and gave its own *QTE*. The deteriorating weather conditions led to *FNO* (Auxerre) being mistaken for *FND* (Dijon) - the last two dashes of 0 (--) were confused for the last two dots of the letter D. The mistake was corrected. The *QTE* from Dijon was received via Auxerre - '*QTE 276 DEG. DOUTEUX. QSA. 1*' (signal strength 1). This fix took five minutes to obtain and put 'VA CAPRICORNUS about 11 n.m. (20 km.) east of Cosne - considerably off the usual track. The aircraft's height was then about 5 000 ft.

In normal conditions, the *QTE* - *QTG* - *QTE* procedure took up to a minute in time. A first class bearing was accurate to 2 deg. so at a distance of 100 miles, the area of doubt was 12 square miles. A second class bearing was accurate to 5 deg. and with a third class bearing of more than 5 deg., the area of doubt increased to 300 square miles. Due to the time difference, when two or more stations were giving a position fix, the position lines did not close exactly when plotted on a chart. For a three station fix the position lines enclosed a small triangular space - the area of doubt or 'the cocked hat' - with the exact position of the aircraft being somewhere within the space.

At 13.37, some thirty five minutes before the crash, the radio station at Dijon was reporting the transmissions from 'VA CAPRICORNUS as very faint - strength 1. At 13.52 'VA was in contact with Le Bourget to say that the aircraft was flying in cloud and descending. Lyon (*FNL*) heard the call and noted that the reception was *QSA 1 to 2* - 'hardly perceptible or unreadable' to 'weak, readable now and then'. At 14.08 'VA called forward to Lyon asking for a bearing. The message was '*QAB FNM QTE QTG*' - 'I am making for Marignane - what is my true bearing in relation to you - I will send my call sign for fifty

4 Operations

seconds followed by a dash of ten seconds'. Lyon responded with '*QTE 339 DEG*'. Two minutes later 'VA called Lyon again for a bearing. FNL replied with '*QTE 340 DEG*'.

Sometime after this last bearing from Lyon at 14.11, 'VA CAPRICORNUS, descending in a snowstorm on a course of 145 deg., with the engines throttled back to 1 500 rev. per min., flew into the snow covered ground about 1.85 km. N.N.E. of Ouroux (Rhône), at an altitude of about 540 metres above sea level. The aircraft was in a normal flying attitude at the moment of impact, striking the ground lightly on the centre line of the keel and with the port wing float. The impact wrenched off the port float and chassis. 'VA turned 45 deg. to port and bounded into the air for 200 m., crashed through a dry stone wall and ploughed along the ground. It finally came to rest in a wood of pine trees. No one saw the crash or heard it. Lyon repeated the QTE at 14.12. Receiving no acknowledgement, Lyon sent '*QRU*' *'Have you anything for me ?'* at 14.19 and again at 14.24. There was no reply. Three of the crew were killed by the impact. The single passenger and the Flight Clerk were badly injured and died later from their injuries. The Radio Officer survived the crash and although injured, waded through deep snow for a kilometre to give the alarm.

The third service was to provide a course to steer to a ground station. The request from the aircraft was *QDM* - '*What is the magnetic course to steer, with zero wind to reach you?'*. The reply from the ground station was the reciprocal of the magnetic bearing of the aircraft from the ground station, with no allowance for wind. In the final stages of an approach, QDMs could be given at the rate of four to six per minute, with the ground station serving one aircraft at a time. 'HM CALEDONIA was guided in to Botwood at the end of the Foynes-Botwood sector of the first Atlantic flight on 6 July 1937. Captain A.S. Wilkcockson's log reads 'At 09.40 to 09.55, I received a succession of QDMs and went to Botwood on them, arriving there at 10.02 GMT or two minutes behind my ETA.' 'HM alighted at 10.08 and was moored up at 10.13. Some ground control stations could also give aircraft a 'distance away' or a 'distance to go' as well as a bearing. Using its onboard D/F equipment, an aircraft could take its own bearings on known ground stations or radio beacons.

The S.23 'boats had retractable D/F loops which required them to be pushed up into the airstream clear of the hull, before a bearing could be taken. The S.30 and S.33 'boats, and some of the S.23s on the Horseshoe route, had loops fixed in position above the hull.

To obtain a position fix, the aircraft's receiver was switched to D/F and tuned to the frequency of a suitable ground station. The loop, acting as an aerial to feed the receiver with signals from the ground station, was swung back and forth by the hand wheel, conveniently located at the end of the Radio Officer's desk. The strength of the signal received depended on the angle of the plane of the loop, relative to the line that joined the aircraft to the ground station. The loop received the signal at all angles, except at right angles to the great circle line joining the loop to the ground station - the position line. When the plane of the loop was along the position line, the signal was strong. When the plane of the loop was at right angles to the position line nothing was heard from the station. The exact angle of the 'zero' was not difficult to determine aurally, although all the boats were also equipped with a Marconi Type 626 C Visual D/F Attachment which indicated any left-right deviation visually on the Captain's side of the dashboard. The hand wheel of the D/F loop carried a drum graduated in degrees, so that the relative angle between the aircraft's direction of flight and the plane of the loop, could be read off by the Radio Officer as a relative bearing. A position fix could be obtained actively by the aircraft taking its own bearings on two or three ground station or beacons, whose whereabouts were known, and then plotting the position lines.

It was also possible to 'home' on a ground station or radio beacon. The receiver was tuned to the station and the signal picked up by the loop. The loop was set at right angles to the aircraft's centreline and the aircraft turned to fly down the position line towards the ground station, with a continual 'zero' from the D/F receiver. The visual indicator enabled the Captain to fly an accurate leg towards the ground station. This facility was particularly useful on the Empire routes outside of Europe, as the ground based D/F services were sparse, or non-existent, and the radio stations mostly ahead of the line of flight of the aircraft. The procedure worked as long as the station continued to transmit. But as no signal was heard in the aircraft, it was not always certain that the aircraft was on the correct course and, if there was no visual ground contact, it was also possible to 'over fly' a station without knowing it - flying away from the ground station rather than towards it. As the direction - the 'sense' - of the signal was of such vital importance in direction finding, techniques were evolved to deal with the problem. All the radio equipments used on the 'boats (except the 1937 standard equipment) include a D/F reversing hand switch to enable the sense of the signal to be determined.

Two sets of errors affected the accuracy of the D/F process - errors due to the radio waves and errors due to the installation of the equipment in the aircraft. Radio wave errors were usually variations of the night

4 Operations

effect, relating to the difference in time between the arrival of a direct ray from the ground station and the indirect ray reflected off the ionised layers in the atmosphere. If the indirect ray was strong, and it became stronger at night, its arrival at the D/F loop later than the direct ray, caused the loop to register a signal when a 'zero' should be obtained. In the early days, night effect caused problems for accurate D/F work after sunset at ranges of over 45 n.m. (80 km.) with errors of up to 30 deg. This situation was solved by the installation of Marconi-Adcock stations. A similar effect occurred with transmissions from an aircraft's trailing aerial - the so-called 'aeroplane error' - depending on the height of the aircraft, its distance from the ground station, its direction of flight and the angle of the trailing aerial. The ground station's D/F equipment indicated the aircraft to be in a position where the extension of the trailing aerial met the ground rather, than its correct position in the air. This effect was most marked at short ranges and when the aircraft was flying on a track at right angles to the position line.

Equipment errors were caused by the aircraft itself acting as a loop aerial - the quadrantal errors. To establish the error, the D/F loop was set at 000 deg., and the aircraft aligned on a radio source whose bearing was known accurately. On the water, the aircraft was then turned a few degrees and a bearing taken with the loop. The difference between the D/F bearing and the correct bearing represented the error. These errors were plotted as the 'boat was turned through each of the quadrants in a full circle of 360 deg. - sixteen measurements were usually taken. Unless the water was dead calm, it was sometimes difficult to hold the 'boat steady while the bearings was taken. The errors increased to a maximum at 45 deg., back to zero at 90 deg., to a minimum at 135 deg., to zero at 180 deg., to a maximum at 225 deg., back to a minimum at 315 deg. and to zero again at 360 deg. Tests to determine the quadrantal errors produced marked variations between aircraft. Five S.23 aircraft were tested in November 1937 and the variation in the quadrantal error curves between individual 'boats was found to be in the order of 3 to 4 deg. Plus and minus 16 deg. was considered to be an acceptable quadrantal error range. The strengthened S.30 and S.33 boats were heavier than the S.23s and had greater quadrantal errors. 'CW CONNEMARA had errors of plus 18 deg - minus 19 deg. and 'CT CHAMPION, plus 26 deg. - minus 27 deg. These errors of calibration were corrected by reference to a previously prepared table or by a variable mechanical adjustment of the loop itself. Beam bearings were often viewed with some scepticism, due to quadrantal error.

A wrongly wired receiver or a faulty reversing switch were possible factors that were instrumental in the forced alighting by 'VD CORSAIR (Captain E.J.Alcock) on the River Dangu on 14 March 1939. Receiver H 908 was removed from 'VE CENTURION and tried in 'VB. When tested, it was discovered that 'VB CORSAIR's original set caused the D/F loop to sense wrongly. The epic struggle with the river, the heat, disease and the other, often appalling, difficulties experienced by both parties in rebuilding part of the planing bottom in the mud of the river bank, is documented elsewhere.

Flight Clerk

The post of Flight Clerk was a innovation for Imperial Airways Limited. A new department was set up in 1936 to manage the recruitment and training of the newest member of an Empire 'boat crew. In October 1936 four hundred Imperial Airways staff were guests of Short Bros. for the day, traveling to Rochester by special train & bus. Here they were divided into groups to be shown round the Seaplane Works & the new flying boats by future Captains. Time was short, so of the original forty Flight Clerks at the start of the Empire Air Mail Service, eleven were 'converted' from IAL Stewards working the Short Mediterranean flying boats and the Handley Page HP. 42s, two were transferred from the Traffic Department and the rest recruited from outside the company. The position was advertised in the Press, asking for young men between the ages of twenty and thirty-five. Two thousand six hundred applicants responded including a bank manager, an ex-policeman, an ex-RAF pilot with 2 000 hours in his log book and some pursers already working on ocean going ships. Working hours were up to eighteen hours per day with four days off at each end of a flight.

At the start of theEAMS, Mr J.Latty, the Commercial Assistant to the Traffic Manager, was responsible for the administration and training of Flight Clerks. The duties of this new crew member were many and varied, 'boiler-suited jacks-of-all-trades' is how they described themselves. His function was to attend to the official business of the aircraft and in recognition of this, his title was changed from Flight Clerk to Purser at the beginning of World War II.

4 Operations

His prime responsibility was to deal with the increasingly formidable amount of paper work associated with the Empire Air Mail Service. He could attend to much of this work while the aircraft was air borne and so reduce the time spent on the water at the many stops along the routes. At least one stop in 1938 was cleared in 10 minutes, including the dropping and picking up of passengers, freight and mail.

The Conditions of Employment were set out in the Empire Services Agreement (14/10/37). It required him to work at such times as the exigencies of operations dictated, including night shifts, Sundays, holidays and time outside normal working hours. His basic pay at the start of the EAMS in January 1937, was £2:10:0 per week (PV £51.60) plus 10/- (PV £10.30) for every day outside the UK west of Alexandria and 11/- (PV £ 11.35) for every day east and south of Alexandria. When out of the UK, Flight Clerks were provided with food and accommodation free of charge and were required to stay at the hotel or rest house indicated by the Company. Trip times were the same as for the pilots. Flight Clerks were rostered so that their earnings, dependent as they were on the days away from the UK, were approximately equal over the year. No overtime was paid.

Trainees were considered to be supernumery to an experienced Flight Clerk until they knew the routes. In the early days of the EAMS, Flight Clerks learnt on their feet as they went, expediency and improvisation were often the order of the day. The performance and potential of the trainee was carefully watched by his tutor and the aircraft's Commander. Two long flights were part of the training to assess the trainee's ability to cope with air-sickness. A few of the experienced marine purser trainees found that the unpredictable motions of a flying boat, and the atmosphere of a somewhat temperamental heating and ventilating system, was too much for them.

The Flight Clerk prepared all the aircraft's 'papers' - the aircraft journey log book, the daily certificate of safety - the 'snag sheet' - the authorization of operations of the wireless, the load sheet, the passenger list, manifests, bills of health, inoculation and vaccination cards, precious cargo transit check sheets, six copies of the consignment notes, mail way bills, passenger tickets, passports, the standard forms required at all ports and the special forms required at some ports. Health, Customs and Immigration regulations and requirements changed so often that Flight Clerks needed to de-brief at the Head Office at Victoria at the end of each service. The current state of the documents could then be handed on to succeeding Flight Clerks.

He supervised and controlled the loading of all the 'dead load', the bullion, diplomatic mail, letter and parcel mail, freight, company stores, and baggage for the passengers and crew, sometimes loading it himself - hence the boiler suit. He was personally accountable for 'over' or 'under carries' on his flights.

The freight and mail 'first off' was loaded into the aircraft 'last on'. The loading of the aircraft was his responsibility, including the calculation of the position of the aircraft's centre of gravity, which was required to lie between the limits defined by the Certificate of Airworthiness. Some Captains liked their aircraft a little nose heavy, some a bit down by the tail so Flight Clerks got to know their Captain's preferences, and aimed to stow the load accordingly. The centre of gravity calculation was done initially from the Short Bros. loading diagram, a long and tedious operation calculating the lever arms fore and aft of the aircraft's datum point and fraught with opportunities for unintentional error under pressure of time. The Traffic Department devised a loading slide rule, and some loading charts, which quickened the operation and reduced the possibilities of mistakes. When the slide rule became available it was normally used, with or without the loading charts in conjunction.

After the Foynes station had been reopened in 1941 for the West African service, an ingenious loading rule was devised by Mr. L.R.Dougal, the resident Traffic Officer. The 'boats were staging through Foynes on their way to and from Lisbon and did not normally carry a Flight Clerk. The first 'boat through from Poole had to be night-stopped as no one at Foynes was prepared to carry out the loading calculations for the onward sector to Lisbon. This dire state of affairs was resolved by Mr. Dougal's invention which was assembled by the local blacksmith and attached to the wall of the Station Manager's office. Three brass curtain tracks, about 1.4 metres long, projected from each side of the centre plate. The whole was balanced about an upturned Rolls Razor blade as the central knife-edge and levelled with a spirit level. Once the Captain's preferred centre of gravity was known weights, representing the various elements of the load, were attached to curtain track end stops, and adjusted along the arms to get the rule to balance about the centre of gravity setting. The whole operation was speedy and foolproof, enabling the 'boats to be turned round smartly as activity at Foynes was of considerable interest to the Luftwaffe operating from Brest.

For an EAMS, the Flight Clerk obtained from the Air and Catering Departments the names of the crew and the details of the mail, freight and stores to be flown. A telephone call to the Station Superintendent at Hythe supplied him with details of the fuel and oil uplift. With this information, he was able to make a trial

4 Operations

run of the load distribution. A passenger and baggage was taken to weigh 100 kilogrammes - 75 kilogrammes for the person and 25 kilogrammes for the baggage. Passengers over 85 kilogrammes in weight were limited to 15 kilogrammes of baggage. The actual weights of passengers and their baggage were checked at Waterloo Station before they boarded the special train to Southampton.

The Flight Clerk's working station on the aircraft was originally at the aft end of the Control Deck, opposite the mail hatch on the starboard side and near the ladder to the escape hatch topsides. When the 'boat was on the water both these hatches were normally open, making it impossible for him to carry on with his paperwork. When the 'boat was in the air, if a direct vision panel of the coupé was opened by the Captain or First Officer, a strong forward moving current of air could whip all his loose papers up in the air, to flutter down the length of the Control Deck, and occasionally out through the open panel. Early in the EAMS operations, the Forward passenger Cabin on the lower deck was taken over as an office for the Flight Clerk and to stow additional mail and freight. The cut-away diagrams show a ladder at the bulkhead at Frame 11, directly from the Forward Cabin up to the Control Deck overhead. This arrangement would have required a hatch in the floor of the Control Deck above. However, no one who worked on the 'boats can remember it. There is one diagram which shows the hatch in the floor of the Control Deck of COOLANGATTA with the head of the ladder below. COOLANGATTA became A-13 when impressed into the RAAF and the 'boat was modified in 1941 to carry engines in the Promenade and Aft Cabins shown on RAAF drawing A3164, dated January 1942. However, when 'TX CLIO and 'UD CORDELIA were in process of conversion to military status a series of photographs of the interior were taken at various stages in the work. These show a different ladder in place between the decks on the starboard side with the opening on the Control Deck protected by a guard rail. It is not known if the original ladder in the pantry between the decks was kept in place or removed.

The Flight Clerk's kit comprised a lightweight Baby Empire (sic) portable typewriter - cleaned and complete with spare ribbon for each service - and the 'papers' in his leather document case together with a loading slide rule and set of loading charts when available, an electric torch, a bullion locker padlock and key, a key for the hatches, a mail waybill book, a concertina folder for IAL mail and a cash float and currency coupons. The currency coupons, valued at 5/- each, sold in books of ten at £2 :11:0 (PV £52.00). They were used for small purchases during the flight and could be exchanged for local currency at IAL offices out of the UK. Flight Clerks soon evolved a special technique of typing while in the air, to counteract the effects of bumpy weather. The Baby Empire was held down firmly on the desk with one hand, while typing with the other.

The Flight Clerk was responsible for crew and passenger's passports, publicity material, maps and guide booklets for night stops, timetables, stationery, currency coupons, quarantine forms, currency declarations and aliens cards. The Airmail Waybill Book, devised by Mr. Dolby - IAL's Airmail Manager, kept track of the mail.

Many countries had restricted areas and if the 'boats were flying anywhere near them, the passenger's cameras were impounded by the Flight Clerk and kept in a sealed camera box for the duration of that sector. He was also responsible for ensuring that the periodicals and newspapers were up-to-date and that the first aid kit in the pantry was complete. Working with the Steward, he was required to maintain the interior of the aircraft in a scrupulously clean condition and if needed, to help the Steward with the preparation of meals and attending to the passenger's needs.

It was originally intended that the EAMS should be flown by day and night, so accommodation for sixteen bunks was provided in the passenger cabins. Passenger seats folded down to a height of 15 ins. (381 mm.) allowing the bunks were to be rigged over them. The bunk frames, mattresses, pillows, sheets and blankets were stowed in the space over the Promenade Cabin, accessible from the Aft Cabin. The bunk frames were designed with bolts at either end which fitted into recesses in the walls of the cabins, spanning between the bulkheads or between a vertical pillar and a bulkhead. Tolerances were tight. While it was possible to mount the bunks when the aircraft was on the water, trying the same operation in the air was another matter. The airframe flexed to a considerable degree in the air, especially in rough weather. It proved to be practically impossible to assemble the bunks in an acceptable time in flight, even with the Flight Clerk and Steward working together. Other operational considerations precluded night flying on the EAMS except in exceptional circumstances to make up schedules, so the idea of passengers sleeping on board the 'boats while on normal services, was abandoned. The compliment of bunks, mattresses, bunk frames and mattresses weighed 600 kg.

4 Operations

As flying boats were considered to be ships while they were on the water, they were required to fly the recognised flags, pennants and ensigns, collectively known as the 'bunting'. The duty of managing the bunting fell to the Flight Clerk. The full complement carried by an Empire 'boat' was:

Civil Air Ensign

Imperial Airways House Flag - later BOAC House Flag

Royal Mail Pennant (or Pendant)

National Flags or maritime Ensign Code Flags – 26 letter flags A to Z, 1st, 2nd, and 3rd substitutes, 10 numeral pennants and 3 substitutes 0 to 9 and an answering pennant and a set of semaphore flags.

A full set of bunting comprised some fifty items. The Ground Services Steward at Hythe was responsible for the supply and management of the bunting for the whole fleet. The correct use of the bunting was set out in the IAL company handbook, published on 1 January 1936. There were two positions on the S.23 Empire 'boats from which bunting could be flown - either from the extended aerial mast on the centreline of the aircraft, or from the demountable staff, mounted just aft of Frame 6 on the starboard side. For use as an ensign staff, the aerial mast could be extended to twice its height, to a total height of about 6 ft. (1.8 metres) by an extension tube that nested inside the aerial mast. The extension ended in a streamlined fitting that incorporated the steaming and anchor lights with an eye at the aft end for bending on the hoist of the ensign. To extend the mast, the top fitting was simply pulled upwards to its full height.

The demountable staff was stowed on the underside of the roof of the Control Deck on the starboard side and stepped in a socket let into the skin plating specially for that purpose. On the S.23 aircraft, the bunting was bent on the staff before it was manoeuvred out through the observation hatch in the top of the hull.

The procedure for signalling with International Code flags is elaborate and more suited for use by ships than aircraft. Signals are coded in hoists (or groups) of one, two, three, four or five flags, in rough order of urgency. Suitable code groups for practically any situation can be selected from Brown's Signalling, a copy of which was carried on each aircraft. Alternatively, words can be spelt out in plain language if no suitable code group exists. Two flag hoists were possible on the aircraft but without a cross tree and halyards that could be easily manipulated from inside the aircraft, it is difficult to see how flying boats could have managed to comply with all the conventions of communication by flag signal. The only positively known International Code flags used by the 'boats were both single flag hoists. P (in harbour) - *'All persons are to repair on board as the vessel is about to proceed to sea'* - was flown at moorings until all was ready for the passengers to embark and Q - *'My vessel is healthy and I request free pratique'* - was made in Sydney Harbour by the trans-Tasman 'boats as they arrived from New Zealand, requesting immigration clearance.

There is a possibility that a two flag hoist was made by 'UV CAMBRIA when aground in Kroosi Bay. Flags AT indicated that the 'boat was aground and required immediate assistance. Both signals could be made by lamp after dark. There were also a series of thirteen single flag hoists, adapted from the international code that related to the towing of a flying boat on the water by another vessel. These signals, which could also be given by lamp, were published late in the operational lives of the Empire 'boats - 12 September 1946 - so it is not known if any were used. It is not known either if the semaphore flags, carried as part of the bunting, were often used. A brief newsreel film clip shows someone on an Empire 'boat vigorously semaphoring an adjacent 'boat. There was a relaxation for British flying boats covering the *'Not under command'* lights and for fog sound signals such as whistles and bells although the Boeing 314s carried both..

Precedence in the display of bunting determines that the right hand takes precedence over the left, so the starboard staff was considered to be superior to the extended aerial mast on the centre line. Bunting was only flown when the flying boat was on the water, between the hours of 08.00 and sunset. No flags or ensigns were hoist when the aircraft was beached. National maritime ensigns were flown as a courtesy from the starboard staff 'close up' with the flag hoisted to the top of the staff, except in cases of national mourning when the Civil Air Ensign and national ensigns were broken to half mast. The correct national flag or maritime ensign was, or was supposed to have been, flown when the aircraft was at moorings in foreign ports as a courtesy. In the early days of the EAMS there were not always enough national ensigns to go round. In July 1937, Flight Clerk Burr was reporting that 'UT CENTAURUS was deficient in national ensigns for Sudan, Portuguese East Africa and the Union of South Africa. In January 1938, 'VE CENTURION staged through Lake Bracciano three or four times without an Italian national flag on board. To fill the gap, the French national tricolour was used instead. Later in the same year in March, Flight Clerk Tear reported that 'HL CANOPUS - carrying India Eastbound (IE 630) mail - had no national ensigns for use east of Iraq.

At the request of IAL, the Civil Air Ensign was introduced on 11 August 1931. At first restricted to airports, airships in flight and stationary aircraft on foreign soil. Its use was extended in 1937 to flying boat bases, aircraft and civil aviation related sites, such as offices in London which, prior to this would have

4 Operations

flown a union flag. The Ensign has an air force blue ground, charged with a dark blue cross, lined in white. A union (union flag) appears in the upper hoist canton - the upper quarter of the flag nearest the hoist. The Ensign was flown at airports, and whenever the aircraft was on the water during the hours of daylight. It was hoisted at the end of the alighting run and lowered when leaving moorings - the first bunting to be hoisted and the last to be lowered. In ports where no national flag was flown, the Civil Air Ensign was hoisted on the starboard staff. In foreign ports when the national flag occupied the starboard staff, the Civil Air Ensign was hoisted on the central extended aerial mast.

The Royal Mail pennant was flown when mail was on board and always in conjunction with the Civil Air Ensign. The pennant, flown for the first time on 26 May 1934 from Handley Page HP. 42W 'XE Hengist (Captain Horsey), was triangular in format and air mail blue in colour, with the defacements - a crown over the words 'ROYAL MAIL' and a hunting horn beneath - all in gold.

The following hoists were used:

In United Kingdom ports (no mail on board):

Starboard staff: Civil Air Ensign.

In United Kingdom ports with mail on board:

Starboard staff: Civil Air Ensign with Royal Mail Pennant below.

In foreign ports (no mail on board):

Starboard staff: National flag or maritime ensign as a courtesy.

Extended aerial mast: Civil Air Ensign.

In foreign ports with mail on board:

Starboard staff: National flag or maritime ensign with Royal Mail Pennant below.

Extended aerial mast: Civil Air Ensign.

Aircraft could 'dress ship' on appropriate occasions in peacetime - between the hours of 08.00 and sunset - taking their example from any of His Majesty's ships in the vicinity. In addition to the correct flag and ensign hoist, signal flags were grouped as two hoists and strung from the aerial mast to the ends of the tailplanes on either side and kept taut to prevent the flags trailing in the water. A suggested arrangement was:

Port side

A. Y. V. numeral 2. R. S. numeral 1. Z. H. numeral 5. X. F. numeral 6. W. Q. numeral 4. P.U. 1st. substitute.

Starboard side

A. T. G. numeral 8. J. O. numeral 3. I. C. numeral 0. N. L. numeral 9. D. E. numeral 7. M. K. B.

The occasions for dressing ship were:

Birthdays of Duke of Gloucester, Princess Elizabeth (now Queen Elizabeth II), Princess Royal, the Queen (the late Queen Mother) and Princess Margaret Rose (the Queen's late sister).

H.M. the King's wedding day	26 April
Coronation day	12 May
Empire day	24 May
Queen Mother's (Queen Mary) birthday	26 May
Armistice day	11 November
H.M. the King's accession	11 December
H.M. the King's birthday	14 December
Any other dates when British naval vessels were dressed over-all.	

Steward

Stewards were members of the Catering Department and their prime responsibility was for the safety and comfort of passengers. One Steward looked after the full load of passengers - somewhere between a possible intended maximum of twenty-four in the early days of the EAMS, and seventeen or fifteen later. On the single-sector New York-Bermuda service on 'UU CAVALIER, could carry a full complement of twenty-four passengers, an Assistant Steward was carried in place of the Flight Clerk.

The Steward was responsible for the condition and cleanliness of the passenger cabins. On first boarding at the start of a service, he would make a thorough inspection of the cabins and lavatories. If night flying was take place, as originally intended, he was also responsible for mounting the bunks with the help of the Flight Clerk and making them up. At stops he was also expected to help make fast any of the servicing craft if required and to tidy up the cabins. Gratuities were not allowed to be accepted by IAL staff.

Stewards were responsible for ordering the catering supplies and beverages for a flight and for their reception and stowage in the pantry. Stores for a sector which included a meal could weigh 140 kg., loaded in hampers through the inward-opening loading hatch above the pantry sink on the starboard side. The total electrical generating capacity of 2.0 kW. did not normally allow for heating food or for refrigeration. The Short Calcutta and Kent flying boats were equipped with twin-burner oil stoves on which IAL Stewards, and the valets of valued passengers, could cook meals in flight. No cooking was done on the Empire 'boats. Meals were prepared and cooked by high quality caterers and the cuisine varied, depending on the port at which they were loaded. The varieties of cuisine offered were English, French, Italian, African, Indian, Malayan and Netherlands East Indian. All the hot and cold food and beverages were loaded in vacuum flasks and stowed for service in the pantry in the hot box, or the ice chest. Notwithstanding this, the range of catering offered to the passengers on the peacetime services was impressive by any standard, and was considered by Imperial Airways Limited to be better than that offered by the competition. IAL claimed to be the first airline to offer 'restaurant' quality meals in flight and this was considered to be of great importance for the passengers.

The passenger cabins sported Christmas trees in the festive season and traditional Christmas dinners were served on board the 'boats in 1937 and 1938. The Thanksgiving dinners served on board 'UU CAVALIER in 1938 included the traditional turkey, cranberry sauce and pumpkin pie. Special diets were catered for and the Steward was also responsible for looking after the culinary needs of the other members of the crew.

After stowing the consumable stores, the Steward would check that the pantry water tank was full, that the first aid kit and the emergency rations were in place in the pantry, and that the lights on the indicator board for the passenger's call system were all OUT. After take-off, he changed into his white patrol jacket before visiting the passenger cabins to distribute magazines, national daily newspapers, the aircraft's headed notepaper and picture postcards of the 'boat. The standard of cabin service required him to be continually on the move between the pantry and the passenger cabins. On sectors when a meal was served, he would wash and stow the cutlery and dishes before the 'boat alighted.

The menus for the flight were typed by the Flight Clerk, one for each passenger cabin. The Steward took the menus through to the cabins and then saw to the needs of the crew. Then he returned to the passengers and took their orders, cabin by cabin. The small Centre Cabin was often kept clear of passengers so that the Captain and First Officer could have their meals on the lower deck if they decided to have a full meal. The Captain was also at liberty to invite passengers to take their meal or a drink with him. The Radio Officer was unable to leave his working station and so his meals were brought to him on a tray by the Steward, up the ladder from the pantry to the Control Deck. The Captain and First Officer, if either was on watch on the Control Deck, would be served in the same way.

The preparations in the pantry depended on the meal being served. Most menus started with fruit, so this would be prepared first. Fruit juices were decanted from the vacuum flasks into serving jugs and the bread rolls and RyVita placed in baskets. Preserves and butter were put on plates and covered with doilies. Hot food was served either from the hot box or from vacuum jars positioned ready for serving. The vacuum jugs for tea and coffee were positioned ready for use.

Stewards soon mastered the techniques needed to get items of food, hot or cold, out of the vacuum flasks intact. Poached eggs required a special knack. On one occasion the soup - potage St. Germain - was the only liquid able to quell a fire in the port inner engine nacelle of 'HL CANOPUS at Lake Bracciano. The Sperry automatic pilot oil supply tank was burning and defied the combined effect of all the fire extinguishers on board the aircraft and all the water scooped up from the lake in vacuum flasks and poured

4 Operations

over the burning nacelle. As a last resort a flask of the potage was emptied on the flames. Pea soup was too much for the fire, which was extinguished.

White linen table cloths and serviettes, cutlery, side plates and cruets for the number of covers were assembled on trays, taken through to the cabins, and the tables laid up for the meal. Food was served on ceramic plates. Drinks were served in glass. Cutlery was metal. Condiments such as O.K and Worcester sauces, mayonnaise, and pickles were available. Doses of a mixture of chlorotone and caffeine were available to ward off air sickness.

The Imperial Airways Gazette for September 1937 gives three typical British menus:.

BREAKFAST (typical)

Fresh Grape Fruit
Various Fruit Juices Cereals
Omelettes and Bacon
Cold York Ham and Boiled Egg
Ryvita Rolls and Butter
Marmalade and Honey
Tea and Coffee

LUNCH 'VD CHALLENGER (date unknown)

Iced Melon
Roast Chicken, York ham, Veal Galantine
Tomatoes and Asparagus Tips
Fresh Fruit Salad and Cream
Cheese - Cheshire, Cheddar, Cream Cheese
Toast Imperial Assorted Biscuits
Crystallised Fruit
Coffee and Liqueurs

DINNER 30.8.38 (Aircraft unknown)

Grapefruit or Consomme Princess
Roast Pheasant and Watercress
Lamb Cutlets and Mint Sauce
Roast Chicken, York ham
Green Salad Beetroot and Apple Salad
Fresh Fruit Salad and Cream
Cheese Cheddar, Gorgonzola, Gruyere
Toast Imperial Assorted Biscuits Coffee

DINNER 'VB CORSAIR (Date unknown)

Pate de Fois Gras or Grapefruit
Roast Chicken, Ox Tongue, York Ham
Russian Salad
Peaches Melba, Golden Figs
Cheese - Cheshire, Camembert, Kraft
Toast imperial Assorted biscuits Coffee

Although the cost of meals was included in the price of the ticket, a dinner was costed on the menu at 5/- (PV £ 5.00) and passengers were asked to obtain a receipt.

A comprehensive wine list was carried, together with the usual range of spirits. Cocktails were available, including the famous 'Airways Special' (composition unknown).

4 Operations

On sale were Idris soft drinks and cigarettes - Virginian, Turkish and Egyptian. Free of charge items included such drinks as tea, cocoa, coffee, chocolate, Bovril, OXO, Horlicks and such items as sandwiches, cocktail snacks, biscuits, fresh fruit, aspirin, smelling salts, eau de Cologne, Enos fruit salts, cotton wool for the ears, barley sugar, saccharine, Glucose-D, air-sickness tablets, soap and towels, pencils, notepaper headed with the aircraft's name, badge and quotation, postcards and descriptive booklets of the route and night stops. On loan for the flight were playing cards, crossword puzzles, jigsaw puzzles, books, children's magazines, games and sun glasses.

This standard of cabin service was maintained until the entry of Italy to World War II in 1940. The start of the Horseshoe Route brought many changes to the interior accommodation of the 'boats and to the service. Many Horseshoe services were flown without a Steward, the Flight Clerk (or Purser as he had then become) standing in for him to dispense a much reduced culinary service.

Empire Services

From March 1938, the Empire 'boats took over the eastern route as far as Singapore. The point of departure was switched some three kilometres upstream from Hythe, to the newly completed Ocean Docks. Flying boats were previously serviced by tenders from Berth 5 in the old Southampton docks, making the long trip to the 'boats moored off Hythe. The new docks stretched for a nautical mile from Berth 101, near the Royal Pier, to Berth 108 at the entrance of the King George V graving dock. From May 1938 the new IAL Braby pontoon for loading and discharging a single flying boat was moored to the east of Berth 101 and until gangways were fitted from the dockside, it was also served by tender from Berth 5. Later in the year, pontoons for two 'boats were moved to the other end of the Ocean Docks at Berth 108. Once the pontoons were in use, cargo could be taken by a railway spur line right to the berth and transferred by dockside crane, making the loading process immeasurably easier. Braby pontoons were also eventually installed at Auckland, New Zealand.

For a typical EAMS service, a 'boat was given a routine end-of-service turn-round by the engineering staff, any snags were rectified, a Daily Check carried out and the aircraft fuelled and oiled in readiness for an early morning departure - as early as 04.00. It was then towed up the Water, warped into the pontoon tail first and secured ready for departure.

The outbound passengers also started their preparations for the journey on the previous evening as most of them travelled by train from Southern Railway's London Waterloo main-line terminus to Southampton station. Coupled to the rear of the 19.30 Southampton to Portsmouth train - departing from Platforms 9 or 11 - were two Pullman coaches and a brake van for the exclusive use of the Imperial Airways Limited passengers. The coaches carried running boards lettered 'EMPIRE SERVICE IMPERIAL AIRWAYS'.

Passengers were met at Southampton station by a member of IAL's Traffic staff and transferred by bus to the South Western Hotel for the first night stop of the journey. The Captain and First Officer called in to the IAL Operations Office at Southampton on the evening before departure to see the weather report and forecast. On the basis of the forecast and any other factors affecting the flight, the Captain would then decide which of the four routes across the mainland of France to Marseilles-Marignane would be flown the next day.

Thirty minutes before departure time on the following morning, the 'boat's crew, less the Captain, assembled at the IAL Operations Office near Dockyard Gate No.8, before walking to the pontoon to board the aircraft. All, except the Steward, would be wearing their white IAL issue boiler suits over their uniforms and their raincoats or greatcoats if required. The First Officer had his personal tool kit - screwdriver, pliers, torch and cotton waste - the Radio Officer his radio bag and the Flight Clerk his typewriter and document case.

The most obvious differences between the operations of an EAMS crew and a contemporary flight crew is their mobility and multiplicity of tasks. An EAMS First Officer was responsible to the Captain for the condition of the aircraft, so before take-off this entailed a thorough inspection of the 'boat. Refuelling stops at small ports without a permanent engineering staff required him to supervise the refuelling and on some occasions to carry out the Daily Check himself. The Radio Officer, in addition to keeping a continuous watch for the duration of the flight, was in the mooring compartment at the beginning and end of a flight, attending to casting off and mooring up. The Flight Clerk was everywhere, acting as loadmaster for the

4 Operations

mail, freight and baggage on the upper and lower decks, fore and aft. He was in the square of the topside hatch, looking across the top of the wing so that he could see the engines as they were started, ready with a fire extinguisher, should an engine catch fire on starting. It was his duty to get to it to extinguish the fire. He had his paperwork to do in his office and if required, he helped the Steward with the passengers. He managed the bunting at both ends of a daylight flight. Other than the Radio Officer who remained at his post throughout the flight after attending to his activities as bow man, the Captain took his seat when all was ready to go.

At the start of a typical EAMS from Southampton, a Mark I S.23 Empire 'boat was moored at the pontoon, in the hands of the engineering staff with the aircraft's head secured by the main hawser to the buoy anchored off the pontoon. The tail line was hooked into the slip release hook under the tail, with the locking nut removed. Breast ropes from bollards on the starboard side of the pontoon secured the 'boat from the cleats at Frames 11 and 38. The electrical shore connection was connected to the ground plug on the starboard side. If the departure was early in the morning, as they usually were, the navigation lights, the anchor light and tail light and all the interior lights would be ON. The forward and aft mail and freight hatches and the pantry loading hatch on the starboard side would be OPEN, as were the forward and aft passenger hatches on the port side.

The First Officer, approaching the aircraft, checked that the tail line locking nut had been removed from the slip release hook and that the tail line was secure. He boarded through the aft passenger hatch to make his inspection of the lower deck, before going up to the Control Deck via the ladder in the pantry or forward freight hold. At the notice board at the head of the ladder, he paused to read the last flight notes. Although the Daily Check had been completed by the engineering staff, the First Officer often made his own inspection of the engines by way of the ladder from the Control Deck, through the hatch on the top of the hull, complete with his tool kit. He checked that the anchor light was ON - for an early start - that the pitot head covers had been removed and if Kilfrost paste was required, that it had been applied to the leading edge of the aerial mast, the leading edges of the mainplanes and the fin and tail planes. He checked that the maintenance platforms on either side of each engine were closed and locked, and that the rain plugs had been removed from the exhaust pipes. The airscrew hub cylinders should have been inboard - for FINE PITCH - and the engine cowling gills CLOSED. He might open up the oil tank circulating chamber and dipstick door on an engine nacelle, unscrew the cap and dip the tank. He checked that the oil tank filler cap doors on the nacelles were secured. Making certain that nothing had been left lying loose on the upper surface of the mainplane, that the navigation lights were ON and that the fuel tank filler caps were screwed down tight, he returned to the Control Deck, leaving the topside hatch OPEN.

Returning from topsides, the First Officer could 'dip' the tanks with the Telelevel fuel tank contents dials to check contents. The carburettor air intake controls were below the Telelevels, checked by turning each control wheel to the HOT position until it locked, releasing it by pushing the button to operate the spring return to the COLD position, and then back to HOT. The engine cooling gill handles were on either side of the hull at the spar bulkhead and were cranked a few turns to open the gills, and then back to the CLOSED position. If the cabin heating system was to be used, he checked that the cabin heating system water level was up to RED line on the tank and that the air supply valve on the starboard side was ON. Just behind him were the fuel cocks mounted on the roof - all OFF. On the main switchboard to his left he checked that the voltage switch was DOWN, the Disiderio (Dizzy) emergency starting switch was screwed OUT and the change-over switch was over to ground plug. Going forward to his seat, he removed his boiler suit and stowed it. Taking his seat, he adjusted the height and rudder bar length. The Station Engineer brought him the aircraft's technical log, which he completed. He signed the daily certificate and the fuel record - checking this against supply company's fuel uplift chit. He checked that the navigation log, instrument log, daily folio and emergency drill book, were in the pocket at the side of his seat and the signalling pistol and cartridges were stowed to the right hand side of his seat.

Settled in his seat, he continued his pre-flight check. He plugged the signalling lamp in to the switch panel, checked that the RED and GREEN glasses are available and switched the lamp ON - OFF. For departures in the dark he could use the lamp to make a quick visual inspection of aircraft's engines to port and starboard and if the Kilfrost was in use for the sector, that it had been applied to the noses of the floats and leading edges of the chassis struts. He turned the instrument heaters and instrument lights ON. Moving across to the Captain's seat, he checked the operation of the bow searchlight, turning it OUT - UP - DOWN, leaving it central. He turned the F switch to F.1 - bow searchlight ON - then to F.2 - bow searchlight OFF and the starboard wing searchlight ON - and back to OFF. He set QFF on the Captain's altimeter and the initial course on the Captain's compass - turning the compass lights ON, if required. He

4 Operations

opened the main Sperry automatic pilot oil valve, set the speed valves to 6 and screwed the other valves OPEN. Finally, he checked that the trip clock has been wound and looked round to see if the aerial fairlead was in the UP position. Back in his own seat, he set QFF on his altimeter and the initial course on his own compass.

The Radio Officer went straight up to his station on the Control Deck on boarding to leave his radio bag containing the aircraft's wireless log book and two spares, the code books and his own pencils. Taking the covers off the wireless sets, if not already done by the engineering staff, he checked the desk light - ON - OFF, that the aircraft's control lock was in position on the bulkhead beneath his desk - in front of his left knee - that the trailing aerial fairlead was in UP position, and that the aerial change-over switch was in the FIXED NORMAL and TRAILING EARTHED positions. He then returned to the lower deck, via the ladder and through the forward mail hold to the mooring compartment in the bow. Here he checked that the marine gear in the mooring compartment was properly stowed - anchor, drogues in their bins, spare wire rope storm pennant, boat hook and fenders, handy. He checked that the slip line was under the mooring cable, ready to slip and returned to the radio station on the Control Deck.

The Flight Clerk boarded the aircraft through the forward passenger hatch and went immediately to his office in the forward freight hold to leave his typewriter and document case. He checked that the aircraft's documents, camera box, passport container and key and hasp for the bullion locker were all present. He then went aft through the passenger cabins to the rear freight room, to check the freight nets, webbing straps and duck boards. At Southampton, the mail, freight and baggage was delivered to the pontoon by dockside crane. IAL and the Transport and General Workers Union had agreed in early 1938 to the employment of a team of stevedores - a chargehand and three men - to load the baggage.

The Steward boarded the aircraft through the aft passenger hatch and made his own thorough inspection of the passenger cabins and lavatories before returning to the pantry to supervise the loading of the pantry stores, brought in through the pantry loading hatch. He then set about unpacking and stowing the pantry stores.

The maximum authorised take-off weight of a standard Mark I S.23 was 40 500 lb. (18 370 kg.). With a full load of fuel and oil, the permissible payload was about 3 500 kg - individual 'boats varied slightly. The dead load could be stowed in five positions in the aircraft. The freight hold aft could stow 925 kg., the space over the Centre Cabin 816 kg., the upper mail room on the Control Deck could take 1 361 kg. and when the forward passenger cabin on the lower deck became the Flight Clerk's office, an additional dead load of 508 kg. became available. A bullion locker in the floor of the Centre Cabin held 600 kg. The total dead load available in the various positions throughout the 'boat was 2 849 kg. The maximum floor loading in the dead load areas was 65 kg. per sq. ft. so any exceptionally heavy loads, such as a spare engine, required duck boards under them to distribute the load. Freight and stores were usually stowed aft, baggage and intermediate mail in the forward hold, and the main mail load in the upper mail room and in the space over the Centre Cabin. The loads were secured by webbing straps and nets, fixed to cleats on the hull frames. The correct stowage and securing of the freight and baggage was of the greatest importance. The 'boats were un-pressurised, flying in the weather and frequently in turbulent air. Accelerometers fitted in 'CT CHAMPION on one occasion registered 'bumps' of 3g. and fifty-one 2g. movements in the space of twenty minutes, flying in a patch of rough weather. In monsoons, bumps of 6g. were recorded on alighting. Loads needed to be well lashed down.

A typical EAMS load was taken by 'VD CHALLENGER on its maiden flight on 15 May 1937. 'VD CHALLENGER (Captain F.J.Bailey) departed Southampton with nine passengers, mail and freight. The permissible payload was 3 518 kg. Deductions for the pantry - 148 kg. - and special equipment - 10 kg. - brought the nett payload to 3 360 kg. The passengers weighed 625 kg. and their baggage - free and excess - 170 kg. The IE 448 mail amounted to 792 kg. The freight weighed 178 kg., IAL stores 150 kg. and company mail, 22 kg. The weight of the crew was 349 kg. and their baggage, 96 kg. The total load was 2 382 kg. or 71% of the total permissible payload - and the passenger load factor was 53%. Six passengers were seated in the Promenade Cabin and three in the Aft Cabin. The Centre Cabin was empty. The dead load was distributed between the forward freight hold on the lower deck - 425 kg., the mail room on the Control Deck - 529 kg., over the Centre Cabin - 39 kg. and in the aft freight room - 434 kg. The Australasian and Far East mail was loaded first, with the rest of the mail being stowed 'first on - last off'.

This batch of mail, the freight and baggage was delivered to the pontoon on the starboard side. The freight and baggage was sorted for destination by the Flight Clerk and then stowed in the freight room by the dockers, heavy items below. When the load had been netted and strapped down to his satisfaction, the Flight Clerk closed and secured the freight hatch. He moved to the forward freight room to load and secure

4 Operations

the other batch of 350 kg. of letter mail, all the Government mail and IAL company correspondence, delivered by crane on the port side of the pontoon. When secured, he went up to load the remainder of the mail into the mail room on the Control Deck, hoisted up by means of the pulley on the underside of the mail loading hatch. The mail bags were hauled across the square of the hatch and stowed in the mail room. When the load was stowed, he closed and secured the hatch.

The limits of the centre of gravity for the Mark I S.23s were between 55.5 ins. and 66.8 ins. (1409.7 to 1696.72 mm.) aft of datum. Using the special IAL slide rule, the Flight Clerk calculated the centre of gravity at 58.7 ins. (1491 mm.) aft of datum. 'VD CHALLENGER would have been slightly nose-heavy.

The Captain boarded the aircraft about fifteen minutes before departure and went straight up to the Control Deck, checking the last flight notes on the notice board, on the way. He took his seat on the port side and adjusted the seat height and rudder bar length. The First Officer, coming to the end of his checks was priming throttle and mixture controls. Asking the Radio Officer to remove the control lock and with the controls free, the Captain tried the ailerons, elevators and rudder for full movement each way. The First Officer opened the flap between the pilots seats to turn the carburettor cocks to the OPEN position, completed the check report and reported "*Check Report complete*" to the Captain.

The Flight Clerk signed Section III of the load sheet '*certifying that the load distribution was in accordance with the written instructions approved by the Secretary of State*' and then started on the remainder of the aircraft's papers - the passenger list, baggage list, mail way bill and the aircraft's manifest.

The Radio Officer made his own inspection topsides, checking that the aerial spreader, insulators and fairleads were secure and, if Kilfrost was in use, clean and free from the paste. Returning to his station on the Control Deck, he lifted the direction finding loop up to the OUTBOARD position and locked it in position. He filled in the service details in the wireless log and, with code books handy, signed on. He then switched the receivers ON. Switching the motor generator ON and adjusting the voltage on the indicator, he switched the transmitter ON to make the check call to Eastleigh - call sign GJX on 348 kcs. (348 kHz.).

He sent in the international Morse code:

Eastleigh from G-ADHL - Good morning - testing - do you receive me well? - are my signals good? - what is the strength of my signals? - please reply....

GJX GJX GJX DE GADHL GADHL GADHL GM TEST QRK QSA K

He received

G-ADHL from Eastleigh - Good morning - receiving you well - the strength of your signal is 5 - reply....

GHL GHL GHL DE GJX GM QRK QSA 5 K

He sent:

G-ADHL received - thanks - please send your call sign for 50 secs. followed by a dash of 10 secs. to check my direction finder - reply....

GHL R TKS QTG CK DF K

He received:

GJX GJX GJX..... for 10 secs. followed by ----- for 50 secs.

He turned the D/F loop aerial back and forth until he found the null, noted the bearing - 180 deg. - turned the set OFF and turned the motor generator OFF. If Eastleigh was busy, the D/F loop could be checked on the BBC Daventry transmitter. If all the equipment was in order, he reported "*All radio checks OK, Sir*" to the First Officer, retracted the D/F loop, closed the roof plate and signed off the radio log.

After stowing the mail on the Control Deck, the Flight Clerk checked that a full complement of ensigns and flags were on board, before returning to his working position on the lower deck. If the departure was in the early morning in the dark, no bunting was flying, otherwise the Civil Air Ensign and Royal Mail Pennant would be flying on the extended aerial mast. Back in his office, he removed his boiler suit, explained the passenger seating arrangements to the Steward and received from him the breakfast menu for typing.

The passengers arrived at Berth 108 by bus from the hotel, escorted by the Traffic Officer. He checked that the 'boat was ready to receive the passengers, returned to the bus and directed the passengers to the aircraft's aft passenger hatch. As the arrival of the passengers was imminent, the Radio Officer moved down to the mooring compartment, via the ladder. When the passengers were about to board, the Flight Clerk went up to the Control Deck to report to the Captain and First Officer and to present the load sheet to the Captain for signature. The Captain checked it through and signed the 'Pilots Certificate of General Fitness of Aircraft'.

4 Operations

The passengers boarded the aircraft, to be greeted by the Steward and shown to their seats, the Flight Clerk checking their names against the passenger list. He completed and then signed Form 818 Statement of Uplift, and got the Station Officer's signature on the load sheet. Any cameras were collected from the passengers by the Flight Clerk, placed in the camera box and sealed.

In the passenger cabins, Steward explained the reclining mechanism of the seats and operation of the seat belts. Although the first sector of the service from Southampton was predominantly overland, he explained the emergency procedures in event of ditching, the location and fitting of the lifebelts and how the windows could be opened if required. He explained, too, that an emergency drill would be required on one of the five sectors before the boat reached Alexandria. He warned passengers about the high-pitched whine of the flap motor when the flaps were moved for take-off and alighting. For departures in the dark, he reassured the nervous that the flames shooting across the top of the mainplanes as the engines started, were quite normal.

The Steward then set about making his passengers comfortable. On cold weather sectors he checked that the cold air punkah louvres were CLOSED and until the heating made itself felt, distributed foot muffs and rugs. If the heating system was to be used on the sector, the thermostat was set at 20 deg.C. and the heating switch turned ON. The cabin heating did not come into operation until the starboard inner engine had started and the heating system took about thirty minutes to warm the cabins up to a comfortable temperature. The passengers on these sectors needed to keep well wrapped up until the heating made itself felt.

The Flight Clerk then made his final check that all members of the engineering staff had left the aircraft. Starting with the aft passenger hatch, he withdrew the fender and made fast the hatch, made his way forward to the pantry to check that the loading hatch was secured, checked each lavatory - for stowaways - and moved to the forward passenger hatch. He reported all in order to the Traffic Officer, withdrew the fender, and secured the hatch. Before reporting "*All passengers seated and hatches fast, Sir*" to the First Officer, he stowed the fenders in the mooring compartment. All hatches on the lower deck were secured although the escape hatch in the top of the hull and the mooring hatch forward were still OPEN.

Starting engines

If the flying boat was moored in a pontoon, it was warped forward before starting engines. Engine starting was a two man operation involving the Captain and the First Officer. The starting procedures for Bristol Pegasus and Perseus engines was similar. Cold Bristol Pegasus engines were considered to be easy to start. Hot engines were more temperamental and could be difficult on occasions. Before starting engines, a check was made to see that all attendant barges and tenders were clear of the airscrews. The direct vision sliding panels on either side of the coupé, allowed the pilots to lean out to see the area immediately below the engines. For a normal start, the Captain would move the four throttle levers forward about one inch (25 mm.), check that mixture controls were in NORMAL and that the airscrews were in FINE pitch.

He would then give the starting order to the First Officer. The outer engines were usually started first to gain maximum control of the aircraft on the water. A typical order might have been port outer, starboard outer, port inner followed by starboard inner. This would bring the buoy round to the Captain's side, if the aircraft was on a mooring.

The First Officer left his seat and moved aft to the forward spar frame bulkhead at Frames 15/16 to prime (or dope) the engines. For internal engine starts using the aircraft's own battery, the Desiderio (Dizzy) was screwed IN and the change-over switch to battery. For engine starts using external batteries or power, the Dizzy was screwed OUT and the change-over switch to ground plug. The Flight Clerk donned his life jacket, took the Pyrene fire extinguisher in hand from its position on the roof of the Control Deck near the escape hatch and made his way up the ladder to the escape hatch in the top of the hull. From there he had a clear view of the engines across the top of the mainplanes and if one of the engines should catch fire on starting, he was required to extinguish it. To do this he had to get to the engine, insert the nozzle of the extinguisher into the port in the side of the nacelle and douse the fire, not the easiest of jobs on a slippery mainplane with no hand holds, perhaps with some of the other engines running, sometimes in the dark and often in the rain.

With the First Officer at forward spar frame at the aft end of the Control Deck, the engine cooling gills were wound to the full OPEN positions at the two operating positions on either side of the Control Deck,

4 Operations

just forward of the bulkhead. The two carburettor air intake shutter control wheels were checked at HOT AIR. The Mark I S.23s had 1D fuel systems, with a tank in each mainplane. He opened the fuel tank cocks, mounted on the roof, - GREEN, BLACK and RED, - and confirmed "*All Fuel cocks OPEN, connected to common supply, Sir*" to the Captain. The BLACK headed lever controlled the cock on the balance line, connecting the wing tanks together in common supply.

The Ki-gass primers were on either side of the Control Deck, just forward of the spar bulkhead, near the engine cooling gill handles. Each primer consisted of a pump and a cock, which was turned to select one or other of the engines on that side. The priming operation started by operating the plunger of the primer, until the suction pipe and pump were primed full of aviation spirit. The cock was turned to the first engine to be primed - say the port outer - and the pump given six full pumping strokes in normal temperature conditions. An extra stroke was given in winter conditions for the outboard engines but only four strokes were necessary for high summer temperatures. Inboard engines required four pumping strokes for normal conditions, an extra stroke for winter and only three for high summer. The spring loaded cock K - for Systems 1/1D or J for the other systems - was released momentarily to allow the spirit to flood the carburettor of the engine. Hot engines required only two strokes of the priming pump for the outers and one for the inners.

Once primed, the First Officer confirmed "*Port outer primed, Sir*". The Captain then pulled the ganged double Lundberg ignition switch upwards for ON. The four starter buttons were grouped on the top of the dashboard under a flip-up cover. Although engraved with the two messages "*Are all hatches closed ?*" and "*Are all boats clear ?*", at the time the engines were being started, two of the hatches were always open. The escape hatch on the top of the hull was OPEN, with the Flight Clerk standing in the square of the hatch in his role of fireman, watching the engines as they started, and the mooring hatch with the Radio Officer as bowman standing in the hatchway, ready to cast off.

Pushing the starter button energised a solenoid switch, which connected the starter motor directly, either to the 12 volt side of the main battery - for an internal start on the battery with the Dizzy screwed IN - or to the ground plug - with the Dizzy screwed OUT - for an external start. At the same time, the starter button activated the booster coil, direct to the distributor on the engine. The button was held down until the engine fired, when it was immediately released. If the engine did not fire within 10 seconds, the button was released and a wait of 30 seconds was recommended before a second try. A reluctant engine could be tried several times on the starter button before it required re-priming. The solenoid switch circuit was connected through two contact switches, one on each of the engine maintenance platforms either side of the engine. When the platforms were closed and screwed up tight, the contact switches made the circuit and the engine could therefore be started.

Once the engine had fired and was running, the throttle lever was advanced to give between 400 and 600 rev. per min. The other three engines were then started in turn. The First Officer, back in his seat after priming the engines, was responsible for watching the engine speeds, the oil temperatures and the oil pressures. As the engine speed moved through the 500 rev. per min. mark, the Record Cirscale engine speed indicators - 500 to 3 000 rev. per min. - started to register, enabling the First Officer to call the speeds. Once all the airscrews were turning, the Flight Clerk could retreat down the ladder, closing and securing the hatch behind him and reporting "*Hatch closed, Sir*" to the Captain. After all the engines had been running for a minute, the Captain moved the throttle levers forward to open the engines up to about 700 or 800 rev. per min., and after a further minute, to 1 000 rev. per min., providing the oil temperatures were above 15 deg. C. and the pressures had settled down. The oil pressure gauges were on the starboard panel of the dashboard in front of the First Officer and the temperature gauges on the panel behind his right shoulder. Typical oil pressures when starting from cold were 200 to 150 lb. per sq. in. (1 380 to 1 030 kPa.) - stabilising at about 80 lb. per sq. in. (550 kPa.). The engines would be left at that speed for a further minute before being increased to 1 200 rev. per min., ready for taxiing.

For emergency use, an engine could also be started by a hand crank through the side of the nacelle. The original arrangements for hand starting were criticized in Part II of the Certificate of Airworthiness as taking an inordinate length of time - 10 to 15 minutes is quoted - to fit the parts of the starting handle together. The starting handle and extensions were inserted through a hole in the starboard side of the engine nacelle, to engage with the starter's fly wheel. Hand starting was not particularly strenuous. The fly wheel was started slowly, without great effort. Turning the crank handle was speeded up as the fly wheel speed built up. After 30 to 45 seconds, the sound of the fly wheel indicated that it was turning at between 75 to 80 rev. per min., the correct speed for the throw-in lever to engage the starter jaw with the engine jaw, and was held in until the engine fired. It was often convenient to lower the starboard

4 Operations

maintenance platform to get a sure footing when hand-cranking. In this case, the maintenance platform microswitches had to be held in the engaged position with a screwdriver, to complete the engine starting circuit, so that the engine could start.

Back in his seat, the First Officer would call engine speeds, temperatures and pressures before leaving his seat to go aft again to the forward spar bulkhead to screw the Dizzy IN - so that the engines could be started on the battery if necessary - and to switch the changeover switch to battery. He pushed the buttons on the carburettor air shutter control wheels to return them to COLD AIR and returned to his seat to report to the Captain "*Dizzy IN, Carburettor Air to COLD, Sir*". The air intake setting would remain at COLD for the rest of the flight, unless the aircraft encountered snow, rain clouds or damp atmosphere.

On the water

That the flying boat is a hybrid is evident from its handling characteristics at low speed on the water, especially when leaving or taking up moorings. Water movement is the dominant factor controlling low speed handling of surface craft but for a flying boat, both the tide and the wind play their parts, depending on their relative strengths.

The Empire 'boats handled well on the water. Taxiing presented no particular difficulties even in cross winds, rough water, or adverse tides or currents. The normal engine speed for taxiing was 1 000 – 1 200 rev. per min. with a little more on the up-wind engines in cross wind conditions. Lower engine speeds could cause the spark plugs to oil up, a condition sometimes cured by running the faltering engine up to 2 000 rev. per min. in RICH mixture for a while. Often when taxiing on rough water, the inner engines were throttled back to prevent spray being thrown up onto the airscrew discs. A fully loaded 'boat had a tendency to swing into the wind on the starboard side when taxiing due to airscrew rotation, and the down wind float could become submerged in rough conditions, making it necessary to ease-up into the wind to prevent it being 'lost'. With no brakes, other than the drogues - which could only slow a 'boat down but not stop it - the crew had to anticipate continually to avoid difficult situations. Taxiing away from a 'tight' mooring was done with the two outer engines to gain maximum control with the least way, bringing in a third engine if necessary for a turn.

Turning on the water was one of the considerations that led Arthur Gouge to select wing floats rather than sponsons for the transverse stability of the Empire 'boats. Floats could be 'lost' turning in rough water - and very occasionally were - but at least the 'boat would not capsize, provided enough crew members and even passengers were out through the escape hatch topsides onto the mainplane of the 'good' side quickly enough to balance the 'boat. If there was any wind, the 'boat had to be turned with the 'good' side away from the wind to prevent the aircraft turning over - a fate that finally overcame 'CX CLYDE on the River Tagus. Turning into the wind was normally done with the outer engine, helped by the inner if required, with same-side rudder and opposite aileron. Turning down wind was done with the appropriate engine, or engines, with opposite rudder and same-side aileron. To turn 180 deg. across a strong wind, it was necessary to swing the 'boat in the opposite direction to the turn with the engines, at the same time applying opposite aileron and rudder, as the engines on the outside of the turn were opened up. The swing had to be checked, as the 'boats had a tendency to turn back into the wind. Drogues could also be streamed from the mooring hatch in the nose of the aircraft, to assist a turn or to slow a 'boat.

Surface vessels at moorings normally lie to the tide or current, whereas flying boats usually lie to the wind. In certain restricted anchorages, such as a river, the situation could be difficult. The south to north current of the River Nile could be up to five knots, with a twenty knot wind in the opposite direction. In these conditions, the tendency of the 'boats was to lie across the stream, making it impossible to get a tender alongside. A large drogue attached to the 'boat's tail release hook to act as a sea anchor, steadying the aircraft. Before moving off the mooring, the aircraft's tail release lever was pulled and the drogue slipped, to be recovered by the tender. The use of this simple device completely revolutionised operations on the river.

Lamp signals for '*cleared to taxi*' was a flashing GREEN light. A steady RED light indicated '*stop*' - difficult or impossible for a flying boat and a flashing RED light - '*move clear of alighting area*'. A flashing WHITE light signalled '*return to the starting point*'. Inside the 'boat, the signal for '*Let go forward*' was given by the Captain, by whistle, with the letter 'L' in Morse. The Radio Officer, acting as bowman, would be standing by in the open mooring hatch, ready to let go the main hawser from the buoy. On the Captain's order to slip, he would free the hawser from the bollard with the slip line, raise his hand to

4 Operations

indicate that the hawser had been slipped, retract the bollard, close the mooring hatch, stow the slip line and return to his station on the Control Deck. Letting go aft was by means of the lever on the roof of the coupé to release the hook under the tail, normally the job of the First Officer. He confirmed the slip to the Captain, "*All gone aft, Sir*".

Empire 'boats could be towed, with the tow rope made fast to the retractable mooring bollard. 'Boats were sometimes towed by control tenders to and from taking off and alighting areas, especially on the Horseshoe service when the engine cooling gills had been modified or removed altogether, to prevent the engines overheating. On one Horseshoe service, 'CZ CLARE was taxiing for one hour and forty-three minutes before taking off, with the cylinder head temperature reaching 170-180 deg. C. and the oil temperature 55 deg. C. Quite long tows were undertaken on occasions. 'UV CAMBRIA was towed 26 n.m. (48 km.) to Mosambique by an IAL control tender, after being stranded on a reef at Kroosi Bay in March 1939.

The drafts at the main step for a standard S.23 'boat at 40 500 lb.(18 409 kg.) were 4.1813 ft. (1.274 m.) in salt water. The draft at the rear step was approximately half that of the main step. The maximum draft for some of the S.30 'boats with displacements of 53 000 lb. (24 040 kg.) was 4.62 ft. (1.408 m.) in fresh water.

Grounding therefore, was not normally of great concern to 'boats moving normally about their business on the water although 'UY CAPELLA (Captain H.B.Hussey) came to grief in Batavia Harbour on 12 March 1939 snagged, it was thought, by an underwater obstruction rather than the bottom. 'UY was manoeuvring near the shore - the port wingtip was seven metres from the shore - when the disaster occurred. The crew were ordered ashore and the aircraft settled down, partly submerged, to a line midway between the forward lower and upper main spar booms, in a tail-down position. The hull was severed at Frame 41 and there was major damage to the hull bottom in the vicinity of the main step, between Frames 18 to 21. The engines were dismantled to stop the corrosion, particularly of the lower cylinders and the carburettors. 'UY CAPELLA was the sixth Empire 'boat to be written off.

All flying boats were at risk while on the water from a catalogue of hazards, natural and man-made. The catalogue is extensive. Following the long established maritime tradition, one 'boat on the Horseshoe route shipped an African rat. The rodent had to be captured with a cage baited with the traditional cheese before the aircraft could be cleared to depart for the UK.

Some rivers used by the 'boats were subject to exceptionally strong currents, making handling on the water difficult. At Allahabad, the alighting area was at the confluence of the Jumna and Ganges rivers, with the river current normally running at 7 knots but increasing to 14 knots on occasions. The alighting area at Calcutta was the Hoogly river near the Howrah bridge. The river was full of eddies and undercurrents, so cautious taxiing was indicated.

On its delivery flight to the Mediterranean in October 1936 - 'HL CANOPUS (Major H.G.Brackley, Captain F.J.Bailey, First Officer S.Long, Radio Officer Bell, Flight Clerk Adams and Steward Doyle) - was in danger of being overwhelmed by the Seine bore at Caudebec in Northern France. 'HL departed Rochester on what became Route 3 across France at 14.35 for Bordeaux - presumably Hourtin - and Marignane. The flight ran into bad weather and an alighting was made at Caudebec at 15.35. This was the first occasion that an Empire 'boat had met a river bore. Captain Bailey was uncertain whether to breast the advancing wave while taxiing to meet it, or to moor up and take the necessary precautions to prevent the aircraft charging the mooring buoy, as the tail was lifted by the passing wave front. The aircraft remained moored and the bore passed off without difficulty.

'BE COORONG was driven ashore while at moorings on the Harbour on 12 December 1938. A squall blew up, gusting to 48 knots, building up the biggest sea ever seen in the harbour. The 3 in. (75 mm.) manila line securing the 'boat broke at 21.03. The storm pennant shackle, which was secured to a ring on the buoy worked loose, although it was screwed right home and secured with wire in the normal way for a night stop. 'BE, with four engineers and a watchman on board, became adrift and was driven ashore, fetching up with the hull fast across a timber jetty, with the starboard mainplane overhanging a low cliff. Those on board escaped along the starboard wing to dry land. The planing bottom was gashed on the starboard side between Frames 5 and 8. During the storm, the seas were breaking over the coupé, and under the mainplanes. The rear freight hatch burst open. The rescue party worked to hold the aircraft, securing it with ropes to a nearby lamp post. They earthed up under the starboard mainplane, and then lay on the top of the starboard wing to weigh it down to stop the pounding. Later, baulks of timber and steel roofing sheet were piled on the mainplane to hold it in position. To prevent the jetty collapsing under the weight of the aircraft, extra steelwork was welded in position before the next high tide. The aircraft was dismantled and returned to Rochester for re-building, starting in May 1939. 'BE was delivered back for service on 14 November 1939 - having being out of service for almost exactly eleven months.

4 Operations

In February 1941, 'CX CLYDE was employed on the Poole-Lagos service. 'CX was at moorings on the River Tagus at Lisbon, ready for the expected service to the UK. At 05.00, the flight was cancelled due to the weather. At 09.00, the wind had reached Force 8 and by 10.00, the aircraft was adrift. Attempts to anchor the aircraft succeeded when the anchor finally held, about 100 metres north east of Sacor Pier. Although the locking pin of the bolt of the mooring shackle was secured, the bolt - made of normalised BSS 3.S.6 40 ton steel - fractured and the aircraft slipped its moorings. The storm, which was the worst experienced since 1854, continued unabated. At 15.30, Captain F.D.Travers attempted to board 'CX with the intention of taxiing back to the original mooring, but was prevented by the sea that was then running. At 16.45, the port wing float was punctured by debris and the port mainplane gradually submerged. The seas were breaking right over the aircraft and at 17.00 a gust under the starboard main plane capsized the 'boat. It hovered for a minute upright in the water, before settling on its back at an angle of 50 deg. After firing two RED signal lights, two of the three men on board jumped clear. One preferred to stay with the 'boat and was unfortunately drowned. The BOAC staff were assisted by PAA personnel, who considered that a Boeing 314 would not have been able to withstand the weather conditions for more than an hour. By 18.00, all that could be seen was the aft part of the hull, forward to the freight compartment port hole. The hull was lying inverted, at an angle of 25 deg. On this occasion some parts of the aircraft were salvaged and the remains written off. 'CX CLYDE was the fourth S.30 and twelfth Empire 'boat to be written off.

The 'boats also had to contend with the 'suds' of the Nile - floating islands of papyrus and elephant grass weighing tons, floating ice, semi-submerged hippopotami in Lake Victoria, and miscellaneous flotsam of varying size up to whole trees. One nearly sank 'BL COOEE (Captain F.J.Bailey) on the River Congo at Leopoldville on the flight out from the UK to reinforce the Horseshoe route. During the night, a WHITE round fired from the signal pistol brought the launch out to the 'boat in the pouring rain. A twenty metre long tree lay across 'BF's mooring line. Either, the mooring line would break and the 'boat whirled away down river in the darkness, or the tree would break loose and stove in the hull. Captain Bailey started the engines while the launch party tried to drag the tree away. At each attempt, the towing line round the tree broke. A steam tug was called but it could not move the tree either. At dawn, the mooring line was cut, hoping that the 'boat would drift away faster than the tree. Captain Bailey managed to swing the 'boat clear as the tree swept by. Crocodiles could swallow the rubber mooring buoys - invented by Eustace Short - and did. Metal buoys had to be substituted.

'UV CAMBRIA (Captain G.J.Powell) was disabled at Toronto on 28 August 1937 before thousands of spectators who were watching the alighting, when the port wing float struck a semi-submerged log on the lake surface. The log tore jagged holes in the float and 'UV took a list to port as crew and passengers scrambled up the upper surface of the starboard mainplane to balance the aircraft. A spare float and fittings were dispatched from Rochester and brought across the Atlantic on RMS *Berengaria*. 'UV was out of action for a month, arriving back at Foynes on 28 September at 08.14 BST after a flight of 10 hr. 36 min. - the shortest of the five survey flights at an average speed of 165 knots (304 km. per hr.). Some Horseshoe Captains considered that they had proprietary rights to certain buoys, a hazard for other 'boat crews who ignored the frantic gesticulations of the crews of the control tenders, and moored up to them - regardless of the wrath to come.

The most common man-made incidents were collisions with the array of attendant surface craft - particularly refuelling barges. The hulls of some of the S.23s, all the S.30s and S.33s had some of the hull plating increased in gauge when their hulls were strengthened.

'Boats were rammed by a control tenders. 'CT CHAMPION was hit by a felucca on the Nile, cast adrift by young boys and Sunderland JM 722 broke loose during a gale, to collide with 'UI COORONG's port mainplane and tail plane. A submarine was encountered by a 'boat while taxiing in Naples Harbour. The hull plating on another 'boat - 'UD CORDELIA - was torn while a beaching leg was being attached, as the 'boat swung in the choppy water.

The 'boats themselves sometimes caused collisions. One broke away from its moorings on Southampton Water and collided with a yacht, ending up with the tail plane entangled in the rigging. On another occasion, 'CT CHAMPION collided with an hospital ship while taxiing in Durban Harbour, grazing the hull with a wing tip and carrying away some staging being used to paint the ship's hull. 'BA CARPENTARIA met Peng Am 46 a two-masted junk head on, stoving in the nose of the starboard float, bending the starboard outer airscrew and tearing out part of the leading edge of the mainplane.

Several collisions were caused when 'boats approached mooring buoys too fast. 'UD CORDELIA overran a mooring buoy at Kisumu when a drogue failed to open, holing the hull. Tail lines could part.

4 Operations

'UW CASTOR was moored fore and aft, with the tail line made fast to a launch, itself moored to a buoy. When the port inner engine was run up, 'UW suddenly lurched forward, wrenching the mooring bollard 20 deg. to port and distorting the hull at Frame 1. On another occasion when a port inner engine was being tested, the line broke and 'HL CANOPUS ran round the buoy. Once a sticking starter solenoid on 'BL COOEE's starboard inner engine was being investigated while the 'boat was being refuelled. The refuelling barge was moored in the usual position on the starboard side of the aircraft, immediately beneath the inner engine. The Dizzy on the main switchboard had not been screwed out sufficiently, and as the solenoid finally unstuck, the engine started to turn on the battery. Luckily it did not fire and was stopped before it could cause real damage to the barge.

On 10 August 1939, 'CZ AUSTRALIA ran aground at Basra prior to taking off, bound for Singapore. 'CZ, with twelve passengers on board, was turning in the narrow channel when it was allowed to run hard aground on Coal Island at considerable speed. The bow was stove in, the skin plating buckled back to Frame 9 on the port side and the keelson fractured at Frame 2. The port float became detached, the extreme edge of the port flap was damaged and the port aileron slightly damaged. The 'boat became submerged to the underside of the mainplanes to be lifted clear of the water by barge crane. The damage was repaired by re-building the forward part of the 'boat on site, before the aircraft was flown back to the UK. The aircraft was unserviceable for two months before being renamed CLARE and put back in service.

World War II brought other hazards due to military action. 'CZ CLARE was nearly set on fire by an incendiary bomb at moorings in Kalafrana Harbour, Malta, some seven months before succumbing to an engine fire over the Atlantic between Bathurst and Lisbon. The bomb penetrated the top of the hull and set alight some of the seats before being extinguished.

Four of the 'boats were caught by enemy action while they were moored up on the water. Late in April 1940, V 3137 CABOT and V 3138 CARIBOU were stripped of the ASV radar and converted as transport aircraft for special missions to Norway. The 'boats were to transport radar equipment to Norway and remain for ten days to assist the RAF in the search for possible airfield sites. '37 CABOT (Captain A.G.Store, First Officers T.Allitt and B.C.Frost, Radio Officers A.J.Watson and J.H.B.Tiplady) departed Hythe for Invergordon on 3 May 1940 with Flt. Lt. Milsom, Flg. Offs. Clarke and Jukes and Cpl. Loveday as passengers.. Lt. B.J.Nilsen (Royal Norwegian Navy) was picked up and the aircraft loaded with rations, blankets, rifles, ammunition, kerosene heaters and Arctic clothing. At 00.00 BST V 3137 CABOT (Captain A.G.Store, crew and passengers) took off for Harstad - the main Allied naval base - on the northern tip of the island of Hinnoy in the Lofoten Islands. The landfall was made at the southern end of the Islands, and as the flight proceeded, a visual survey was made of possible landing areas. On arrival at 08.21 hrs.all personnel slept on board.. The remainder of the day was spent in obtaining 600 gal. (2700 litres) of aviation spirit The next morning, '37 CABOT (Captain A.G. Store and crew) departed for the of Bodø, 135 n.m. (248 km.) to the south and arrived in the middle of an air raid alert. From force of habit, and impeccable flag etiquette, the Norwegian national flag was run up as the aircraft alighted. '37 moored up near some Norwegian float planes and fishing boats and started to unload. On 4 May '38 CARIBOU (Captain S.G.Long, First Officers G.H.Bowes and R.G.Buck, Radio Officers J.Howard and D.F.Mayrick, Flight Engineer LAC Dupe, and Gunner LAC Williams RAF) departed Hythe for Invergordon, arriving at 20.05 . They loaded three RAF gunners to augment the crew, Admiral Lumley Lyster, (Flag Officer - Narvik) and four of his staff, and the RAF radar party of Flt. Lt. Carter, Cpl. West, an LAC and Mr Johansen, a Norwegian translator. '38 CARIBOU departed Invergordon to arrive at Harstad at 08.30 here the passengers disembarked. At 09.30, '38 departed for Bodø, arriving at 09.10 It is possible that '38 CARIBOU was followed in by a German aircraft.

The church bells of Bodø rang yet another air raid alert. The crew members ashore raced for their dinghies and pulled for the flying boats. The attack by a Heinkel He 115 float plane from Trondheim came within an hour of the 'boats alighting. '37 CABOT's engines were started, the mooring slipped and Captain Store started to taxi the 'boat out towards the harbour entrance. Captain Long attempted to get '38 CARIBOU moving, but the engines were reluctant to start and it was some time before he could follow '37 CABOT. The first attack came as '37 CABOT was passing the Nyholmen lighthouse at the entrance to the harbour. First Officer Frost acted as Fire Controller from his position in the astrodome. As each attack came in, '37 CABOT was turned away at 090 deg. to the line of flight of the German aircraft and was given full throttle. The gunners on board '37 CABOT were registering hits as the attacking aircraft made each pass. As the two 'boats turned for the eighth time, a last pass made by the German aircraft wounded four members of the crew of '38 CARIBOU. First Officer Bowes was hit in the thigh, First Officer Buck in the calf, LAC Dupe was drilled across his back and LAC Williams in the arm. Captain Store had been

4 Operations

wounded in the left foot and First Officer Frost had his steel helmet dented by a passing round. The starboard outer engine of '37 CABOT was out of action, the hull was holed, the mooring hatch shattered and the roots of the main planes, smoking. The fuel tanks in hull were punctured and fuel was pouring into the bilges. It was decided to beach both aircraft on the mud at the north end of the harbour to prevent them sinking. The IFF equipment was removed from the 'boats and sunk. As the tide went out, work started to salvage all loose equipment items and armament from the 'boats. The Vickers guns were handed over to the commander of the Norwegian troops in Bodø. The removal of equipment from '37 CABOT was completed when another alert was sounded, and an attack developed with bombs and machine gun fire. A Dornier Do 17 bomber dropped two bombs, one 300 metres from '37 CABOT and the other, 15 metres from the port side of '38 CARIBOU, set fuel alight and the aircraft became a total loss. '78 CARIBOU was the second S.30 and the tenth Empire 'boat to be written off.

'37 CABOT was moved away from Bodø by M.V.Sissy and another motor boat. Between them they towed '37 CABOT, in the twilight of the northern night and floating on the night tide, out of the harbour and northwards up the coast, supervised by Captain Long and First Officers Allitt and Frost. A safer position was found, about 6.5 km. north of Bodø, between the high cliffs at Geitvagen and the rocky island of Mauren. '37 CABOT was anchored by the head with considerable difficulty because of the steeply shelving sea bed with its own, and some borrowed, anchors. The tail line was secured to the cliff. The roundels on the main planes were covered with blankets and the aircraft camouflaged with bushes. The RAF crew and the Norwegian seamen returned to Bodø, hoping that the aircraft would be invisible to searching German aircraft, except from directly overhead. Ground mountings were to be made for the aircraft's Vickers K guns so that they could be deployed on the surrounding cliff tops to protect '37 CABOT whilst the electrical system was being repaired. Before any of this work could be started, '37 was discovered the next day and destroyed by incendiary bullets from a Junkers Ju 88 bomber before anyone could reach the 'boat. '37 CABOT was the third S.30 and eleventh Empire 'boat to be written off.

Uninjured crew members were evacuated by destroyer, loaded with some 100 women and children, to Harstad and from thence to the United Kingdom in two other destroyers. Injured crew members remained in hospital in Bodø for a further three weeks before being returned to the UK, listening to the progress of the German invasion of Northern Europe on a radio salvaged from '37 CABOT, watching Ju 37s stuka dive bombers machine gunning the streets of the town.

A similar incident occurred nearly two years later. Flying boats were spotted on the harbour at Broome, Western Australia by a Japanese reconnaissance aircraft on 2 March 1942. Three flying boats were moored in the harbour. At dusk, four more 'boats arrived and during the night, nine more.

By next morning, A18-10 CENTAURUS (Flt. Lt. K.Caldwell), 'UC CORINNA (Captain Ambrose), two US Navy Consolidated Catalinas, four Dutch Marine Luchvaart Dienst Catalinas, two RAF Catalinas and five Dutch licence-built Dornier Do.24s were on the water in the harbour and roadsteads. Most of the Dutch 'boats had flown in from Java, and were waiting to refuel before departing to safer destinations, loaded with some 100 women and children of the families of the crews. Captain L.J.Brain, in charge of operations at Broome, thought that a raid by Japanese aircraft a distinct possibility and arranged to disperse the 'boats as soon as possible at daybreak.

Before dispersal could be arranged, the anticipated raid took place. At 09.20, nine Japanese Zero A6M2 fighters from the 23rd. Air Flotilla, led by Lt. Miyano, swept in over the town. Three Zeros circled above keeping top cover while the remaining six, in line astern, shot up the flying boats at anchor.

A18-10 CENTAURUS was the first to be attacked with incendiary bullets. The Captain, Flt. Lt. Caldwell RAAF, was ashore at the time and the crew on board managed to get the inflatable life raft overside and escape before the aircraft caught fire. The RAAF men made their way towards the shore picking up survivors from the Dutch 'boats as they went, finally packing thirteen people into their five man raft.

'UC CORINNA, in the process of refuelling from the lighter *Nichol Bay*, was the next 'boat to be attacked. The lighter's master, Captain Mathison, cast off immediately and although loaded with 180 drums of aviation spirit, began searching for survivors in the water. The QEA crew on 'UC CORINNA jumped for their lives, before the aircraft went up in flames. They found a dinghy floating nearby and joined in the search for survivors. Captain Ambrose was ashore making final arrangements for 'UC CORINNA's coming departure and the twenty-five passengers were waiting on the jetty, ready to embark. The Japanese pilots made no attempt to strafe survivors in the water or the group of passengers on the jetty. Beside some rifle fire, the only effective defence against the attack came from a single machine gun, belonging to one of the Dutch 'boats. It was out of the aircraft being checked ashore for a fault. The gunner had a full pan of ammunition beside him. He fired at the attacking Zeros by resting the barrel of the gun on his forearm,

4 Operations

ignoring the fact that his arm was being burnt almost down to the bone, and succeeded in bringing down one of them - probably that of Chief Air Sergeant Kudo. A18-10 CENTAURUS was the eighteenth, and 'UC CORINNA, the nineteenth Empire 'boats to be written off. In 2001, archaeologists from the Western Australian Maritime museum searched the harbour with side scan sonar, discovering many underwater wrecks, two of which were believed to be the Empire boats.

After destroying all fifteen flying boats at anchor, the Zeros shot up the neighbouring airfield. They destroyed two Boeing B.17 Flying Fortresses and two Consolidated B.24 Liberators of the USAAC, an RAAF Lockheed Hudson, a Dutch Lockheed Lodestar and a Douglas DC.3, all on the ground. One B. 24s took off but was shot down into the sea. The attack was over by 09.40. Returning to base, about 54 n.m. or 100 km. north of Broome, the Zeros came across the last Allied aircraft out of Java - a Dutch DC.3 loaded with diamonds - which they also shot down, but the pilot managed to land on the beach.

Seven Zeros returned to base of which six had one or more bullet holes. One Japanese airman was killed, one slightly injured and one rescued after crashing into the sea. The exact total of casualties amongst the aircrews and families of the Allied flying boats on the water and those on the airfield is unknown but is believed to be about seventy dead, including the thirty-three US personnel killed in the B.24 brought down in the sea. Twenty-nine unidentified bodies are buried in a communal grave in the Broome war cemetery. None of the QEA aircrews or ground staff were killed or injured. 'DU CAMILLA (Captain Sims) arrived at Broome about an hour after the attack. All the moorings had sunk with the aircraft, so 'DU was anchored off the end of the jetty. A follow-up bombing raid on the jetty was expected at any moment, so 'DU CAMILLA was removed by Captain Sims 'to a place of comparative safety', away from Broome for the night.

Taking off

Four final systems checks were made before taking off - the airscrew pitch controls, the engine fuel pumps, the magnetos and the engine boost and they were often done while the 'boat taxied for take-off. The airscrews were in FINE pitch for engine starting, so the First Officer moved each of the four pitch levers in turn from FINE to COARSE, noting the drop in engine speed as the pitch coarsened and then moved the levers back to FINE. On one occasion on the West African Service at Lisbon, the airscrews of 'KZ CATHAY (Captain J.C. Harrington) jammed in COARSE pitch when taking off, promoting heavy porpoising and an abandoned take-off. The airscrew pitch controls on the Pegasus engined 'boats could be primed by holding the levers fully DOWN for ten seconds. The fuel pump check was done by the First Officer, leaving his seat to move aft to the forward spar bulkhead. He turned the port and starboard engine fuel pump test cock control wheels inboard, and cock H in the starboard wing root to the CLOSED position - listening for any change in the engines. If all the fuel pumps were working satisfactorily, each supplying its own engine, there would be no change in engine note. All being well, he returned all the test cocks and the balance line cock to the OPEN position and returned to his seat to report to the Captain. The engine magneto check was done by the Captain and First Officer working together. As the Captain moved the two outer engine throttle levers through to FULL and held them there, the First Officer turned first one and then the other ignition switches OFF and then ON. As each magneto was switched OFF, they noted the drop in engine speed. They repeated the procedure for the inner engines and returned the throttle levers to their original positions. The mixture control check was normally done by the First Officer. For each engine in turn, he moved the mixture control lever back from NORMAL to RICH -. + 1 lb. sq. in, then through the gate to +3 lb. sq. in. and back to NORMAL. At night, this process could be confirmed by the change in colour of the exhaust flames from a solid BLUE-WHITE to the long, narrow BLUE flames of the RICH and then back to the Bunsen flame of the NORMAL boost. WEAK mixtures produced a narrow, transparent, dull GREEN flame. FULL RICH mixtures had a characteristic long, narrow, smoky BLUE flame.

Flaps were something of a novelty to most of the IAL pilots transferring to the newly formed No. 5 Division. The controls for the flaps were on the underside of the coupé, roof between the two pilots, and could be worked from either side, although the First Officer was normally responsible for lowering and raising the flaps. In emergencies, flap settings could be put on manually. The motor and gearbox were in the compartment over the Centre Cabin, between the spar booms. To manually operate the flaps, the operator had to clamber into the compartment, de-clutch the motor and insert the winding handle into the gearbox, to move the flaps IN or OUT.

4 Operations

For normal operation, before switching the flap motor ON, the position of the flaps operating switch – (described as CONTROLLER FLAPS OPERATING SWITCH on the switch) – was checked in the OFF position. To lower the flaps, the flap motor switch was pulled ON – illuminating a BLUE pilot light – and the controller flaps operating switch turned DOWN to flaps OUT. This energised the OUT split field of the motor, through the solenoid. As the flaps moved, the indicator showed their position by a pointer. The take-off position was 1/3 OUT, a setting which took the standard flap motor 20 seconds to complete.

In the early days of the EAMS there were occasions when the flaps were extended past the 1/3 position – with potentially disastrous results. While it was possible to take-off with the flaps extended beyond the 1/3 OUT position, conditions had to be just right to do so. When Captain J.W.Burgess was being checked out by Captain F.J.Bailey, he made his first take-off from Lake Bracciano in 'HL CANOPUS. Captain Burgess called for flaps OUT, waited for them to move, put the mixture levers through the gate to FULL RICH and pushed the throttle levers forward. The flaps were not stopped at the take-off setting and went out to the full OUT position. After accelerating across the lake for some 30 seconds, 'HL suddenly leapt 50 ft. into the air and dived for the surface. Luckily Captain Burgess had flown Short Rangoon flying boats of 203 Squadron during his RAF service. He had experienced 'boats trying to take-off from the tops of long Indian Ocean swells before they had reached flying speed. He managed to gain control of 'HL after kangaroo-hopping across the Lake while Captain Bailey, who had been standing behind him, was being hurled about the Control Deck shouting "*Stop her, boy, stop her*".

A RED pilot light – located beside the BLUE indicator light – switched ON when the flaps reached and exceeded the 1/3rd. OUT position, warning pilots that the flaps were at – or beyond – the take-off position. When the correct flap extension was indicated, the controller flaps operating switch was turned OFF and the flap motor switch pushed OFF – switching the BLUE and RED indicator lights OFF. To retract an extended flap, the procedure was reversed. From the fully extended flaps OUT position it took 90 sec. for the standard flap motor to wind the flaps IN. Once IN, the flap motor switch was pushed OFF – switching the BLUE and RED indicator lights OFF.

A much more serious incident than that on Lake Bracciano occurred later in the same year in Brindisi harbour, when 'UZ CYGNUS crashed in the harbour during take-off. The aircraft was westbound at the time of the accident, carrying passengers – including Air Marshal Sir John Salmond (a director of IAL) and Robert Lutyens, the architect son of Sir Edwin – and mail. During take-off, 'UZ porpoised out of control. Again it appeared that the call for "Flaps" had been misunderstood, and as on Lake Bracciano, were allowed to run to the fully OUT position. During the ensuing porpoise, the forward planing bottom gave way and the hull stove in to the forward spar frame. The port outer airscrew was lost. The Captain and First Officer were unhurt but the Radio Officer and five of the passengers, including Sir John and Robert Lutyens, were injured and one passenger and the Steward, killed. The First Officer, with considerable skill and courage, managed to rescue three passengers trapped in the after cabin. The aircraft was salvaged and 1700 kg. of mail dried out and forwarded to London. 'UZ was not fully loaded at the time of the accident and it was generally considered that the 'boat should have been controllable, even if the flaps were in the fully OUT position. This was subsequently proved to be so at Rochester by John Lankester Parker, depending on conditions. 'BE COOEE was loaded to simulate the condition of 'UZ CYGNUS at the time of the accident. John Parker demonstrated that a take-off, with flaps in the full FLAPS OUT position, could be made safely from choppy waters of the Medway. When the performance was repeated with representatives of Imperial Airways Limited, the Air Ministry and insurance companies on board, on an absolutely still and glassy river, porpoising developed at alarming speed, although John Parker retained control. Repeated once more, porpoising started almost immediately and that time John Parker was only just able to hold the 'boat. Space permitting, the surface of glassy water could be broken up by 'boats taxiing in a figure-of-eight, while warming up the engines before taking-off. 'UZ CYGNUS was the third S. 23 Empire 'boat to be written off.

The rudder and elevator trim tab controls were on the underside of the coupé, roof near the flap controls and accessible to both pilots. The operating mechanism was enclosed in a casing, with the tab settings shown by pointers running along numbered scales on the bottom and sides of the casing. The rudder trim control was mounted with the operating handle vertical. Turning the handle clockwise wound on a turn to port, and vice versa. A typical take-off setting would have been 2 to port, to counteract the swing to starboard induced by the airscrew rotation. The elevator trim control was mounted just forward of the rudder trim handle. Nose up trim was put on clockwise, nose down trim, anti-clockwise. Tab settings depended on the position of the centre of gravity. With the centre of gravity forward at the

4 Operations

55.6 ins (1 412 mm.) position, the setting for take-off was NEUTRAL. With the centre of gravity in the optimum position of 59 ins. (1 500 mm.), the tabs were set at 5 1/2 NOSE DOWN. In the extreme aft position at 66.9 ins. (1 699 mm.), the setting was 8 NOSE DOWN.

Directly the checks were completed, and oil and cylinder head temperatures were past their minima - oil temperature 15 deg. C. minimum, cylinder head temperature 100 deg. C. minimum and oil pressure 70 lb. per sq. in. (480 kPa.) minimum for Pegasus XC - the 'boat was ready to take-off.

The Captain then asked the First Officer to request take-off permission from the control tender at the far end of the take-off area or flare path. The request - 'OKTO' - was made with the signalling lamp in Morse Code, in WHITE light. A steady WHITE light from the tender gave permission to take-off. A steady RED light indicated 'stay where you are'.

On the steady WHITE light, the Captain would then call for "Override IN, Mister". This was confirmed by the First Officer, who moved the mixture controls back through the gate to the FULL BOOST position. On Lake Tiberias, being 800 ft. below sea level, no extra boost was required. The Captain took control, moving the control column fully back and opening the throttles slowly and smoothly. The Exactor controls for the throttles and mixture controls generally had an easy 'feel' and were smooth in operation. Sometimes they could be quite stiff due to an adhesive film forming in the system when left at rest. If the Exactor throttle controls were easy, the Captain moved all the levers together - little by little. If the Exactors were stiff, they were opened in pairs, first the outer engines, followed by the inners. Due to airscrew rotation, the 'boats had a marked tenancy to swing to starboard in the early stages of the take-off run, until they were through the hump. The swing was counteracted by retarding the port outer engine - or both engines. Once rudder control became positive at about 42 knots, the throttle levers for the retarded engine - or engines - could be pushed forward to the full OPEN position and the 'boat kept straight with the rudder.

Pegasus engines could be run at a maximum speed of 2 475 rev. per min. with +3 3/4 lb.sq. in. boost, for not more than two minutes. Moving on the water at speed was potentially dangerous, so the shorter the take-off run, the better. Whenever circumstances allowed the Empire 'boats made their take-off run directly into the wind. In a cross wind take-off, the outer engines were opened up first and adjusted to get the aircraft to run straight, then the inner engines were fully opened up. Once aileron control became effective at about 40 knots, the ailerons were used to keep the 'boat steady as the speed increased. In a 10 knot cross wind, full aileron was required and with a lightly loaded aircraft, it was sometimes difficult to hold the windward wing down during the early stages of the take-off. Getting off with a full load at high temperatures was a lengthy process, especially if the water surface was glassy. The control column was held hard back as the 'boat gathered speed and then progressively eased forward to the neutral position as the 'boat rose in the water. The nose was kept slightly up to prevent any tendency to loose control. Allowing the nose to dig in produced a 'water loop', with consequent damage if allowed to build up. The aircraft, still accelerating, was gradually eased up out of the water until it was skimming the surface, with just the point of the main step in contact. It could then be flown off the water with a gentle backward pressure on control column at about 75 knots (138 km. per hr.). The minimum take-off speed was 68 knots (125 km. per hr.). The S.30 'boats with Perseus engines generally, and 'CT CHAMPION in particular, took slightly longer to get off than the aircraft with Pegasus engines.

Once off the water, the 'boat was held down close to the surface, allowing the air speed to build up to about 95 knots before being pulled up to climb away. The take-off and climb out was considered satisfactory at all ports, except for some on the upper reaches of the River Nile where the proximity of the banks there caused some anxious moments. As the 'boat climbed away from Southampton Water at the start of an Empire Air Mail Programme, the Radio Officer got off the departure signal. Putting the trailing aerial fairlead to the DOWN position, allowing the trailing aerial to wind out, switching the aerial selector to TRAILING NORMAL FIXED TO EARTH, he made his call. The motor generator was turned ON - for the first of many times during a flight - the voltage adjusted and checked, the frequency of 363 kcs. selected and the departure message sent to Portsmouth control.

He sent:

Portsmouth from G-ADHL - departed Hythe at 04.24 - making for Marseilles - expect to arrive at 08.30 - climbing to 10,000 ft - reply....

GEN GEN GEN DE GADHL GADHL GADHL - QAD HY 0424 - QAB FNM - QAA 0830 - ASC 10000 - K

He received:

G-ADHL from Portsmouth - received.

GHL DE GEN - R

4 Operations

At the end of the transmission he switched the motor generator OFF, changed the frequency to 333 kcs. - the international control frequency - and continued to listen out. Listening to the transmissions of other aircraft, he could get an impression of other aircraft in the air, and their approximate whereabouts.

The Certificate of Airworthiness allowed the Mark I S.23s to take-off loaded to 40 500 lb. (18 370 kg.). The loaded weights of the S.30 and S.33 'boats at take-off were increased first to 46 000 lb. (20 865 kg.), then 48 000 lb. (21 772 kg.), 49 000 lb. (22 226 kg.), 50 500 lb. (22 906 kg.) and finally 53 000 lb. (24 040 kg.).

The corrective drill for an engine out of action on take-off took about 20 seconds. Three engine take-offs were possible in certain circumstances. If an engine failed during the take-off run after rudder control speed had been reached, the 'boat was kept straight with the rudder and the failed engine carburettor cock and the ignition both turned OFF. A 'boat could take off and be kept straight with the rudder until it gained a safe height. The rudder was then trimmed to take the strain off the rudder bar. If there was a full load on board, there was no chance of climbing away.

'HL CANOPUS (Captain F.J.Bailey) experienced failure of the port inner engine while over the Mediterranean between Mirabella and Athens on 23 June 1937. The aircraft was put down on the sea and taxied back to Mirabella. The defective engine was removed and the nacelle blanked off with a faired nosing. The port wing float was filled with 5 gals. (25 litres) of water to balance the 'boat and it took off with the three operational engines. 'HL was escorted on its journey back to Rochester by 'UV CAMBRIA, which had difficulty keeping station with the lightly loaded 'HL CANOPUS, flying on its three engines.

'UT CENTAURUS was taken off Lake Tiberias by Captain J.W.Burgess with a dead port outer engine, the main engine bearing having seized. The nearest replacement engine was at Alexandria and as he wished to get back to the UK as soon as possible, Captain Burgess decided not to wait for it. There were no passengers on board as the aircraft was returning from the survey flight to New Zealand. The first attempts to take-off with three engines failed, as the starboard outer engine could not be fully opened up. The lake was mirror calm and the dead engine's windmilling airscrew engine generated too much drag, so it was unshipped over night and stowed in the passenger accommodation. Captain Burgess tried an operational procedure learnt during his days on the Rangoon 'boats. He mustered the crew forward on the lower deck with instructions to proceed - run - aft as quickly as possible on the word of command. Alone on the upper deck, he opened the throttles. As the 'boat came up onto the step, the crew rushed aft at their Captain's shout of command. 'UT came off the surface *'like a bird'*.

Taking off at night was normally assisted by a flare path, to indicate the direction of run. A 'water aerodrome' was incorporated in the Southampton Harbour Act (July 1939) and the area off Netley licenced for use by flying boats. A contemporary Ordnance Survey map shows this area of Southampton Water for *'Aircraft night landing (sic) marked by movable lights'*. Six AMBER coloured electric battery-operated 'flares' formed the flare path - strung out in single line as near as possible in the direction of the wind - about 140 metres apart with a width marker at the far end.

The licence for the water aerodrome was withdrawn in 1958, after Aquila Airways ceased operations. A similar arrangement existed at Singapore. Where the path was not permanent, it was laid from a control tender by dropping lighted kerosene flares over the side at regular intervals, to make a path 750 yards (686 metres) long - usually with six flares but sometimes with four.

Depending on the port, the 'boat was either guided or towed out to the start of the flare path by a control tender, or found its own way there. The aircraft was brought up to the threshold of the path about 100 metres short of the first flare, and lined up with the path.

Flying boats were considered to be surface vessels while on the water and as surface vessels measuring under 150 ft.(45.7 metres) in length, they were required to carry an anchor, or riding, light and a steaming light, and an overtaking light - all WHITE as well as their RED and GREEN navigation lights.

The anchor light was required by international law to be visible all round for a distance of 2 miles (3.2 kilometres). The steaming light was required to have a visibility, from the front of the aircraft, of 3 miles (4.8 kilometres), in an arc that extended 112deg. on either side, making a total of 225 deg. On the Empire 'boats both lights were in a combined fitting at the top of the ensign mast, nested inside the aerial mast. The tail light doubled as an overtaking light while on the 'boat was on the water. This light had an arc of visibility of 67deg. on either side of the aircraft's centre line, making a total sweep of 135 deg. The navigation lights had the same arc of visibility as the steaming light.

'CX CLYDE (Captains A.C.Loraine and W.S.May, Radio Officer Cheesman, Engineer Officer Rogers) was at Lisbon on 6 August 1940, en route for French Equatorial Africa. On board was a party of eight Free

4 Operations

French officers, led by Colonel - later General - de Larminat, whose mission it was to persuade the French army in Africa to switch sides from Vichy France to Free France. 'CX CLYDE was the first British flying boat to transit through Lisbon and the Portuguese authorities caused some difficulties regarding the passengers - all of whom were in civilian dress. Once the difficulties were resolved, Captain Loraine decided to depart as soon as possible, so a flare path was laid for a night take-off at the maximum all-up weight of 53 000 lb. (24 040 kg.). The control tender had not succeeded in clearing all shipping from the take-off area. 'CX was just airborne and building up speed close to the water when Captain May, in the starboard seat watching the engine instruments, saw a thin horizontal line slightly to starboard, extending into the flight path. He realised that it was the furled sail of a fishing boat shining in the light of the bow searchlight. He shouted a warning to Captain Loraine who had control and was fully occupied in handling the heavily laden 'boat. Captain May then shouted another warning and putting his hands on the control wheel, both pilots banked the 'boat hard to port and managing to clear the vessel's mast with the starboard wing and climb away into the night. At daybreak Captain May was on the lower deck chatting to the passengers when he noticed a vee-shaped tear in the starboard aileron, just outboard of the outer engine. 'CX had not entirely avoided the fishing boat's mast. The aileron was repaired at Bathurst with alloy sheet left behind by Deutsche Lufthansa, when they abandoned the airfield at the outbreak of war.

Take off runs and times for Pegasus XC engined aircraft, at sea level in temperate climatic conditions, were quoted as follows:

Weight in lb.	40 500	41 500	42 500	43 500
Take off in still air	520 yds. 475 metres	555 507	625 572	690 631
Take off in 9 knot wind	400 yds. 366 metres	485 443	520 475	550 503
Time in seconds, still	25	27.5	29	31.5
9 knot wind	22	24	26	28

Lake Victoria was the highest port on the South African route at an altitude of 3 720 ft. Take-off times at this height could be as much as 100% longer than the standard sea level condition. At sea level in tropical conditions, the take-off runs were often extended by between 50% to 100% and the take-off times by 50% or more. Typical times at Bathurst, for example, were 107 seconds.

'VB CORSAIR (Captain E.J. Alcock, First Officer W.L. Garner, Radio Officer G.W. Cussans, Flight Clerk Parsons and Steward Riddock) northbound from Durban, departed Port Bell for Juba at 06.15 on 14 March 1939, with DN 178 mail and passengers. At 10.00, 'VB made a forced alighting on the River Dangu in the north east corner of the Belgian Congo, about 130 n.m. (240 km.) south west of Juba. The aircraft was holed by rocks in the river on alighting and the 'boat settled in the shallow water. The port wing float was damaged. A search was instituted using 'TY CLIO and a RAF Wellesley and 'VB was found. The passengers and crew had been rescued by the Belgian Resident Officer and driven to Aba, from where the passengers, salvaged mail and baggage were picked up by 'VE CENTURION (Captain F.V.W. Foy). This forced alighting on the Dangu was the start of an epic salvage operation involving recovery teams from Short Bros. and IAL. After the Short Bros.' team had repaired the damage, an attempt was made to take the lightly loaded 'boat off a short length of the river. While the repairs were in progress, a series of trials involving Captains Bailey and Alcock, were made to get a 'boat with a similar load off Southampton Water to assess the probability of success on the Dangu.

The actual attempt to get 'VB off the River Dangu was made in the early morning of 14 July 1939 by Captain Alcock and First Officer Garner and one other crew member. The 'boat was loaded to 31 116 lb. (14 114 kg.), the fuel limited to 360 gals. (1 620 litres) and the oil to 9 gals. (39 litres) per engine. Two lots of ballast were stowed - 454 kg. in the Centre Cabin and 136 kg. in the aft freight compartment, to bring the Centre of Gravity to 57.5" (1 461 mm.) aft of datum. The speed of the river current was estimated at 2.5 knots. The conditions were far from ideal as the water level was low. Markers were strung across the river, between which the 'boat had to go to avoid the rock. When the engines were opened up to full power for take-off, the port side engines responded while those on the starboard side failed to react. The 'boat started

4 Operations

its take-off run but as it gathered way the nose came up so far that Captain Alcock could not see the markers. The starboard wing float hit the water and 'VB swung out of control, colliding with yet another rock on the right hand side of the river. 'VB came to rest on the rock and then slipped off back into the river, there to remain for two months.

While 'VB languished in the river, 'CZ AUSTRALIA ran aground at Basra on 9 August, prior to taking off with twelve passengers on board. The crew and passengers all escaped uninjured but the hull of the 'boat was extensively damaged. 'CZ was unserviceable for two months.

The IAL survey team of G.Halliday, R.Sissons, H.Hawkins, C.Burl and A.Cowling arrived on the Dangu in September to assess the possibilities of salvaging 'VB CORSAIR. It was decided to repair the aircraft. The rip in the planing bottom was patched and the 'boat floated again on the river. Beaching took three days aided by a 60 tonne winch, 40 planks and 75 convicts to haul the aircraft out.

By the middle of November, 'VB was ready to launch, an operation that took six days. Captain J.Burgess had tried another eight experimental take-offs from Southampton Water with a 'boat loaded to various weights between 28 300 lb. (12 837 kg.) and 29 622 lb. (13 436 kg.), with the centre of gravity in various positions between the forward limit of 55.5 ins. to 66 ins. aft of datum. He found that the 'boat would come off in 125 yards (114 m.). The newly repaired 'VB CORSAIR was finally flown off the Dangu by Captain J.C.Kelly-Rogers, First Officer Garner and Radio Officer Dangerfield, early in the morning of 6 January 1940, returning the 'boat to civilization with a short flight to Juba. After a two day overhaul at Alexandria, 'VB was flown back to the UK to resume service.

'UX CASSIOPEIA (Captain C.E.Madge, First Officer N.A.Blount, Radio Officer J.MacPherson, Purser Evans), one of the Horseshoe 'boats, departed Singapore on service XWS 150 westbound to Karachi, on 29 December 1941. The 'boat was loaded with five passengers, 1 265 kg. of aircraft parts and spares and 800 kg. of diplomatic mail from Batavia. 'UX departed Sabang at 23.28 GMT on the next sector of the flight at a weight of 42 275 lb. (19 266 kg.) with the centre of gravity 62.5 ins. aft of datum. The take-off run had reached the 1 500 ft. (460 metres) mark, with the aircraft well up on the step and just about to unstick at a speed of 78 knots, when it ran into the first line of a swell. At the second line of swell, 'UX lost acceleration smoothly and rapidly, and started to sink. The planing bottom had collapsed at Frame 13 and had been torn back to Frame 27 - about half way between the steps. Within three minutes, the aircraft was full of water. Captain Madge escaped through the port Control Deck direct vision window and Messers Blount, MacPherson and Evans through the escape hatch in the top of the hull. Mr Blount immediately opened the Promenade Cabin escape hatch and climbed down to search the Promenade and Centre Cabins for the four women passengers and a very young baby - seventeen days old. He found no one and swam out through the rent in the bottom of the hull. Mr. Evans tried to open the escape hatch of the Aft Cabin without success, and returned to the mainplane. 'UX broke in two between Frames 26 and 27. The forward section sank quickly, nose first. A launch, with Engineer Cooper on board, arrived to take off Captain Madge, Messrs Blount, Evans and MacPherson and the one surviving passenger. The tail section became vertical in the water and it was thought that another of the passengers was trapped inside. Blount and Cooper went into the water to right it before it sank but without success. After a search, the bodies of two passengers were recovered but they failed to respond to artificial respiration. After landing Mr MacPherson and the passenger at the jetty, the launch returned to the site of the accident with Captain Madge and Messers Blount and Cooper, to salvage freight and equipment. Little was found beyond a few suitcases and some wreckage. Three tugs searched the area for a further seventy-five minutes without finding the missing passenger or baby. 'UX CASSIOPEIA was the fourteenth Empire 'boat to be written off.

Aviation spirit is highly volatile and problems arose with the 'locking' of the fuel supply lines to the engines by air or vapour. Under conditions of extreme heat, fuel could vaporise in the fuel lines. During Horseshoe route operations in Africa and India, ambient air temperatures of over 50 deg.C at sea level were fairly common - Allahabad and Pointe Noire are mentioned - resulting in engines choking, missing, fading or refusing to start altogether, due to the phenomenon of vapour locking. Outer engines were normally affected first, but in the more extreme cases, all four engines could fade at the crucial moment, resulting in an abandoned take-off. Vapour locking occurred sufficiently often to be a nuisance and various counter measures were suggested, the most obvious being to avoid taking-off during the hottest part of the day. The temperature of the fuel supplied to the aircraft during refuelling was crucial and everything was done to keep this as low as possible. It was also suggested that the fuel filters should be lowered to eliminate any inverted U bend effect on the suction side of the fuel pump, where the fuel could vaporise to form a gas pocket, effectively blocking off the line to the flow of fuel. It is not known if this remedial work was carried out.

4 Operations

A typical incident occurred at Mosambique on 2 April 1944, when the starboard outer engine of 'UW CASTOR (Captain Glover) faded on take-off. The engine suddenly opened up again and 'UW veered off track, to collide with the second flare of the path.

There were other, seemingly impossible, hazards at the moment of becoming airborne. The port outer maintenance platform opened immediately after take-off - 'UX CASSIOPEIA on 13 August 1941 - seemingly impossible, as the engines could not have been started if the platforms were not closed and screwed up tight. The autopilot suddenly engaged itself during the take-off run, swinging 'BJ CARPENTARIA to starboard, on 17 August 1945. The engaging lever of the Sperry automatic pilot required a full 180 deg. movement of the lever to engage.

There is one occasion when an Empire 'boat took off and flew for a considerable distance with a crew of only two. Japanese aircraft from the 1st. Air Fleet carrier striking force carried out the first wave of the daylight raid on the port and town of Darwin on 19 February 1942. 'DU CAMILLA was at moorings in the harbour having arrived the night before, and was held there pending movement orders from the Department of Civil Aviation. Several QEA crews were also in Darwin in preparation for the start of the Broome - Tijilatjap shuttle service. The defences were overwhelmed by the raid. After the bombing had died down, besides the damage done to the town, it appeared that every ship in the harbour had either sunk or was sinking. Two large vessels were tied up at the wharf, both on fire. Black smoke from the burning ships - one of which was loaded with explosives was billowing over 'DU CAMILLA, afloat and undamaged, except for two small holes in the elevator fabric. It was decided to move 'UB somewhere safer. After the Department of Civil Aviation launch had finished picking up survivors in the harbour, it took Captains W.H.Crowther and H.B Hussey out to 'UB. They circled the aircraft in the launch to assess the damage and, finding nothing of any significance, boarded and prepared to take-off. Captain Crowther taxied the 'boat towards the East Arm of the harbour, with Captain Hussey keeping a look out for floating debris from the observation hatch in the top of the hull. Once in the air, they headed south and then east to Groote Eylandt. It must have been the first, and possibly the only time, in the entire history of the Empire 'boats that an empty 'boat was manned and flown by two Captains as the complete crew. The burning ship loaded with explosives blew up minutes after 'UB had departed. Had the aircraft still been at its moorings, it would have been destroyed. 'UB arrived at Groote Eylandt at 12.00. to take on a full load of fuel. 'DU CAMILLA, as the seventh aircraft in the second production batch of Mark I S.23 'boats had a 652 gal. (2 964 litre) fuel system. Sometime later it had been converted - either by QEA or at Durban - by the addition of two inboard tanks, giving a total possible uplift of 1 412 gals. (6 419 litres). 'DU CAMILLA (Captains Crowther and Hussey) departed Groote Eylandt at 16.00 for Darwin, to evacuate the remaining QEA crews and Captain Koch, staff and passengers. Captain Koch was in hospital recovering from wounds received three weeks before when 'BD CORIO was shot down.

In the air

Once in the air, the Empire 'boats were a delight to fly. Individual 'boats differed slightly from each other in their handling and performance but the three types, the S.23s, the S.30s and the S.33s responded in much the same way to the controls and had no recorded vices. Some aircraft were a little slower than the norm, some a little nose heavy - 'BD CORIO was one and 'KZ CATHAY another - and some more reluctant to leave the water than others.

The Certificate of Airworthiness states that:

The seaplane handles well in the air. The elevator control is light and effective over the whole speed range. The aileron control is moderately light and effective at normal speeds but becomes heavier as the speed increases, being quite heavy at top speed. The rudder control is heavy but effective at all speeds. There is ample rudder control with either outer engine throttled.'

The elevator and aileron controls for all types of Empire 'boat were well harmonised and considering the size of the aircraft, gentle. The elevators were not quite fast enough in rough weather, requiring constant

4 Operations

elevator trim tab work. In unstable weather the ailerons could stall. The maximum force needed on the ailerons was 40 lb. (180 N), which was not considered to be excessive.

In calm air the Empire 'boats were very stable, especially laterally and could be easily trimmed hands and feet off. The acceptance trials required the 'boat to fly straight and level *'in normal weather conditions'*, hands and feet off, for at least ten minutes at cruising speed, with a full load on all four engines. When trimmed, the trial was repeated with any one of the engines *'switched off'*.

The rudder was not much used in calm air turns and banks. The single leg force on the rudder bar was in the order of 30 - 50 lb. (130 - 225 N) which was considered to be inside the limits for short periods. The rudder was used, however, in conjunction with the ailerons in rough weather to prevent distortion of the airframe. Flat turns could be made with full flap at 91 knots and with $\frac{3}{4}$ flap at 99 knots. In rough weather, the automatic pilot was disengaged and both pilots flew the aircraft together, using combined maximum force. This afforded some relief to the passengers in the Aft Cabin, as the continual angular motion in pitch, bank and yaw with the automatic pilot engaged, tended to upset the most hardened of travellers.

The controls reacted more slowly at heights over 10 000 ft. and at 20 000ft. - the service ceiling - they were definitely sluggish.

Although they were approaching the upper limit of size for an aircraft with manual controls, they could be flown manually for long periods. Captain F.D. Travers flew one manually for ten hours. Captains Loraine and May brought 'CX CLYDE back to the UK from West Africa with an unserviceable automatic pilot, flying manually for more than 3 000 nautical miles (5 500 km.) - more than twenty hours flying. The normal arrangement when flying manually was for each pilot to fly a twenty to thirty minute spell, before handing over.

Once airborne after taking off, the 'boats were held down close to the water until the speed reached 95 knots, before the aircraft was set to climb. The effective maximum rate for the first segment climb to 1 000ft. was 725 ft. per min. For a fully loaded Mark I S.23 'boat, climbing at 104 knots the more usual rate of climb with passengers on board, was 400 ft. per min. The maximum rate of climb from 1 000 ft. to 10 000 ft. was 920 ft. per min. for a laden S.23, with airscrews in COARSE pitch, at an engine speed of 2 000 rev. per min., with $+1\frac{1}{4}$ lb. sq. in.. By the time a 'boat had reached this height, the rate of climb had dropped to 600 ft. per min. A height of 10 000 ft. could be reached in 12 $\frac{1}{2}$ minutes. Increasing the all-up weight to 43 000 lb. (19 500 kg.), decreased the rate of first segment climb to 575 ft. per min. and the maximum rate of climb to 775 ft. per min. The 'boats had a quirk by which, if the throttles were opened to increase speed during the climb, the 'boat would level off until the increased speed was reached, and then resume its climb.

At a height of 400 ft and climbing, the override was taken OUT and the mixture control levers moved forward through the gate to the NORMAL position and the flaps brought IN. After checking the oil temperatures and pressures, the engines would be throttled back to 2200 rev. per min. As the engines changed from the FULL throttle - FULL boost condition to NORMAL boost, the engine note dropped to more normal sound levels. The airscrews were then changed from FINE to COARSE pitch, the aircraft dropping away 50 ft. in height as it did so, before resuming its climb. The First Officer adjusted the throttle levers to reduce the engine speed to 2 100 rev. per min. and moved the mixture levers to a boost of $+ 1\frac{1}{4}$ lb. per sq. in. The two inner engines were synchronised by ear and the outer engines by eye on either side, adjusting the outer engine speed until the patterns on the airscrew discs coincided. At night the signalling lamp was used to synchronise the engine speeds by shining the beam across the two airscrew discs and adjusting the throttles until the patterns were similar.

The service ceiling is quoted as 20 000 ft. There was one occasion, in the early days of the EAMS, when Captain L.A.Eggesfield decided to find out how high an Empire 'boat would go. The 'boat was over the Mediterranean between Marseilles and Lake Bracciano, carrying mail only. Captain Eggesfield put the automatic pilot to climb. The 'boat climbed steadily to the quoted service ceiling of 20 000ft. If the crew members sat quite still, they experienced no ill-effects from the lack of oxygen. The 'boat was still climbing as it reached its service ceiling, so it was allowed to have its head, gaining 25 000 ft. and still climbing slowly. Captain Eggesfield decided that it was high enough for an unpressurised aircraft, and turned the elevator knob to descend. The quoted service ceilings were revised when the 'boats were in line service. At the standard all-up weight of 40 500 lb. (18 370 kg.) on four engines, the ceiling was 15 500 ft., at 41 500lb. (18 824 kg.) the ceiling was 14 300 ft., at 42 500 lb. (19 278 kg.), 13 400 ft. and at 43 500 lb. (19 730 kg.), 12 300 ft. With three engines the respective figures were 8 000 ft., 7 000 ft., 6 400 ft. and 5 700 ft.

4 Operations

If an engine went out of action in hot weather at heights over 5 000 ft., it became difficult to maintain height and plenty of control was needed. If the two starboard engines failed, the flutter of the rudder could not be controlled at speeds approaching 130 knots and the loss of height was very rapid. A straight course could be kept without rudder flutter if the two port engines were lost but the loss of height was more than 300 ft. per min.

The 'boats would dive without vibration or instability up to 200 miles per hr. indicated (174 knots or 320 km. per hr.) or about 183 knots true (336 km. per hr.), with the throttles $\frac{2}{3}$ open and would pull out easily and quickly. The maximum speed in level flight at 5 500 ft. was 172 knots (316 km. per hr.). The maximum permitted speed for 'boats weighing up to 48 000lb. (21 772 kg.) was 209 knots (385 km. per hr.) and for weights over 48 000 lb.(21 772 kg.), 165 knots (304 km. per hr.). The maximum speed with an automatic pilot engaged was 170 knots (313 km. per hr.). The flaps were not fully extended over 100 knots (184 km. per hr.).

The normally quoted cruising speed was 143 knots (263 km. per hr.) at 510 bhp. (380 kW.) per engine, dropping to an economic cruising speed of 128 knots (237 km. per hr.) at 10 000 ft. The optimum cruising speed for maximum range in still air was 114 knots (211 km. per hr.). Against the standard 35 knot head wind, the optimum speed was 120 knots (223 km. per hr.).

Stalling speed with the flaps unextended was 63 knots (116 km. per hr.). With $\frac{1}{4}$ flap, the stalling speed was 77 knots (142 km. per hr.). With $\frac{1}{2}$ flap, the stall was at 71 knots (131 km. per hr.). With $\frac{3}{4}$ flap, the stall occurred at 70 knots (129 km. per hr.) and with FULL flap, the stalling speed was a little over that of the 'clean' condition, at 65 knots (120 km. per hr.). The minimum flying speed was 61 knots (112 km. per hr.) and the lowest possible alighting speed 59 knots (109 km. per hr.).

Three engine performance with a heavily laden 'boat was not satisfactory with a full fuel load, until a sufficient quantity had been burned off. A 'boat loaded to 48 000 lb. (21 772 kg.) could not maintain height on three engines. It was for this reason that the long-range 'boats that the original Mark III S.23 'Atlantic' 'boats, the second generation Mark III S.30 long-range 'boats and the two Mark IV TEAL S.30 'A' 'boats and possibly the third 'A' 'boat, were fitted with fuel jettison pipes to dump fuel from the inboard mainplane tanks.

The trim tabs for the elevators and rudder were satisfactory. Climbing out at 104 knots, the tab was set to 1 DOWN, 7 DOWN for full throttle level flight and 5 DOWN in the level cruise. At the other extreme of the centre of gravity range, the take off and initial climb was made with 8 DOWN for full throttle level flight, $9\frac{3}{4}$ DOWN and $8\frac{3}{4}$ DOWN in the cruise.

The Empire 'boats were among the first British commercial aircraft to fly with automatic pilots. Most of the 'boats were fitted with Sperry equipment of US origin except the three 'A' 'boats, which were fitted with British RAE automatic pilots.

The Sperry Gyropilot automatic pilot was the development of the Sperry Aeroplane Stabiliser which won the Grand Prix in Paris in 1914 for its contribution to safety in flight. The Sperry Company had continued development work on the automatic control of aircraft, in parallel with the design and manufacture of the gyro horizon and the directional gyro. The Sperry Gyropilot had two gyroscopes, one for direction and one for bank-and-climb. The directional gyroscope was free to move about three axes and had a compass card attached. The gyroscope could be caged and set to the same course as the aircraft's magnetic compass. As the gyroscope remained fixed - except for a tendency to wander an average of not more than 3 deg. per hour - the directional gyro provided a steering indicator and directional control reference. The bank-and-climb gyroscope, which had its spinning axis vertical, acted as the reference for longitudinal and lateral control. The miniature 'aircraft' of the bank-and-climb gyro instrument indicated the aircraft's degree of bank with reference to the horizon bar. The operation of the automatic pilot was by air pick-offs which worked air relays, which in turn controlled the oil hydraulic servo pistons connected into the control lines to the flight surfaces. The gyros were spun by suction supplied by the Romec vacuum pumps on the two starboard engines. The pressure for the oil system to work the servos was provided by the Northern pump on the port inner engine. The oil pressure gauge was graduated from 0 to 300 lb. per sq. in. (0 to 2.0 MPa).

The Sperry directional gyro was the directional reference for both manual and automatic steering control. The directional gyro unit contained the course indicator, the air pick-offs, the follow-up mechanism and the means to cage the gyro and set the required course. The bank-and-climb gyro unit contained the gyro, the air pick-offs, the follow-up mechanism and the control and caging knobs. The aileron knob controlled one set of pick-offs, allowing adjustments of lateral attitude. The elevator knob controlled the pick-offs for longitudinal attitude. The vacuum gauge was graduated in inches of water - from 0 to 10 ins.

4 Operations

(0. to 2.5 kPa). The engaging lever was on the rear of the throttle and mixture controls, accessible to both pilots, with the OFF position to port and the ON position to starboard.

The speed valves controlled the flow of oil from the servo units and could be adjusted to suit the speed with which the rudder, the ailerons and the elevators reacted to the prevailing weather conditions. To speed the reaction, the knob was turned anti-clockwise and to slow the control reactions in rough weather, clockwise. The servo unit under the Captain's seat was a three cylinder monoblock unit, the pistons of which were connected directly to the control cables of the aircraft. The unit was controlled by the follow-up cables from the directional and bank-and-climb gyro units. Spring-loaded relief valves allowed the automatic control to be overpowered by the pilot in emergencies, by the application of about twice the normal manual force.

Before engaging the automatic pilot in the air, the aircraft was trimmed straight and level, the vacuum was checked - 4 inches of mercury - (14.4 kPa.) and the oil pressure (150 lb. per sq. in. or 1 034 kPa). The speed valves were OPEN. The bank-and-climb gyro was uncaged by turning the caging knob counter clockwise to its full extent and the directional gyro by pushing the caging knob IN, turning it to set the lower card to the course, and then pulling the caging knob OUT. The rudder knob on directional gyro control was turned to align the upper and lower cards, and the aileron and elevator knobs turned until the respective follow-up indices matched their indicators. The level control was checked as OFF, then the engaging lever slowly turned over to ON, the pilot becoming aware of the automatic pilot taking control of the aircraft. The rudder knob was adjusted to bring the aircraft exactly on to the course already set. Any climb was set by the elevator knob. Turns could be made flat with the rudder knob, or banked with the aileron knob. The automatic pilot could also be disengaged, the turn made manually, and then re-engaged.

The automatic pilot fitted to the three Marks II and IV S.30 'A' boats was invented by P.A.Cooke and F.Meredith of the Air Ministry with the patents transferred from the RAE to Smiths Industries for manufacture. The Mk. 1A was an all air device, using air at a pressure up to 35 lb. per sq. in. (241 kPa.) provided by an RAE Type C compressor on the port inner engine. The Empire boats were equipped for three axis control, with control units for the rudder and the ailerons. The elevator servo motor was controlled by the gyro on the rudder unit.

When the automatic pilot was in operation, deviations as small as 1/10 th. deg. in the attitude of the aircraft in pitch and roll, caused the small air valves in the control units to react. The air valves acted on a push-pull basis to operate the servo motors, which in turn moved the aircraft's control surfaces to correct the deviation. Typical course deviations were in the order of 4 or 5 deg. maximum per hour.

The Mk. 1A equipment consisted of the test cock, main control cock, differential pressure gauge, course change cock Type II, azimuth control cock, cut-out switch and the re-setting button. The test cock had two positions, FLYING or TEST. When set to FLYING, the normal position in service, air from the compressor passed to the main control cock. In the TEST position, the air compressor was isolated and an external source of compressed air was connected for testing. The test cock was mounted on the port side of the Control Deck, together with the air filter and non-return valve, the air throttle Mk. 1, the oil reservoir and the automatic valve Mk. IV, possibly just forward of the forward spar frame bulkhead.

The three position main control cock was mounted somewhere on the throttle box. When the handle was rotated anti-clockwise to OUT - with the handle down - the compressed air used to operate the control units was vented to atmosphere. This was the position for take-off or alighting. In the SPIN GYRO position - with the handle to the right - compressed air passed to the gyros in the aileron and rudder control units. A safety device prevented the air from reaching the control units unless the main control cock handle had first been turned to the SPIN GYRO position. The gyros took about five minutes to spin up to their operating speed of 11 000 rev. per min. The IN position - handle vertically up - the compressed air passed to the three control units with their servo motors, thereby putting the automatic pilot in control.

The differential pressure gauge, course change cock Type II, azimuth control cock, cut-out switch and re-setting button were mounted on the centre panel of the dashboard. The differential pressure gauge was divided vertically, the right hand half of the dial registering the system pressure - 0 to 70 lb. per sq. in. (0 to 480 kPa.) and the left hand half indicating the load on the elevators. The course change cock had two interlinked cocks. The lower cock had two positions. With the handle moved to the right to the HAND position, the aileron control unit was by-passed and the pilot was able to put on the bank required for a turn. Moving the handle to the left to the AUTO position, put the aileron control unit back in circuit. The upper cock had three positions, PORT, STRAIGHT and STBD. When the lower cock was in the HAND position, the aircraft could be turned to port or starboard by turning the upper cock in the appropriate direction. This directed air to the course change cylinder on the rudder unit of the automatic

4 Operations

FFpilot which, in turn, turned the rudder. When the turn had been completed, the upper cock had to be turned to STRAIGHT before the lower cock could be moved to AUTO, giving the control of the aircraft back to the automatic pilot.

The azimuth control cock was a two way adjustable reducing valve, allowing air pressure to be applied to either side of the piston in the course change cylinder of the rudder unit. Using the cock, the pilot could make precise adjustments of a few degrees, without using the course change cock. The cut-out switch and re-set button was designed to disconnect the automatic pilot instantaneously in the event of excessive elevator movement. The cut-out unit was installed on, and operated by, the elevator servo motor. It was normally set to allow a 5 deg. UP or DOWN movement from the datum position determined by the aircraft's trim. If excessive movement took place, the cut-out operated to break an electrical circuit to the quick release unit. When the circuit was broken, the air valve on the quick release unit vented the compressed air to atmosphere, cutting out the automatic pilot and reverting the aircraft to manual control. The re-set button remade the electrical circuit after it had been tripped by the cut-out.

The pitch control lever was fitted to the port side of the throttle box, operating an endless Bowden cable attached to the rudder unit. The dial plate was marked in degrees UP 0 to 5 and DOWN 0 5 10, operating in the normal sense of the controls. The pitch control operated directly on the gyro of the rudder unit, causing it to precess to a new datum. The aircraft moved smoothly, even if the lever was jerked from one extreme to the other.

The lateral trim lever was on the Captain's panel of the dashboard. The lever operated an endless Bowden cable similar to the pitch control but attached to the aileron unit. The dial plate was marked _ RIGHT WING UP LATERAL TRIM LEFT WING UP. The lever operated in the normal sense of the controls and was used for small adjustments to the roll attitude or trim.

The safety catch lever was fitted to the throttle box on the starboard side, operating the safety catches on all three units, providing a complete and instantaneous mechanical disconnection of the automatic pilot in cases of emergency. The lever had two positions, IN and OUT, with a ratchet to allow the catches to be left disengaged. If the automatic pilot was to be used on a flight, the safety catch had to be engaged before taking off by releasing the lever, and moving the aircraft's control surfaces to their full extent to ensure full engagement. Before alighting the main control cock had to be turned to OUT before the safety catch lever withdrew the catches.

The IAL route survey from Singapore to Sydney was carried out by a Short Singapore III of No. 205 Squadron RAF, between 7 to 25 May 1936. A record of the flight, written by Hudson Fysh of QANTAS and published in *The Aeroplane*, mentions the eleventh member of the crew - the Smith automatic pilot. Mr Fysh evidently knew his Homer well and Homer, apparently, had some inkling of what was to come. In the Alexander Pope (1688 -1744) translation of the *Odyssey* of 1726 the lines read:

*So shalt thou instant reach the realm assign'd,
In wondrous ships, self-moved, instinct with mind;
No helm secures their course, no pilot guides;
Like man intelligent, they plough the tides,
Conscious of every coast, and every bay,
That lies beneath the sun's all-seeing ray;
Though clouds and darkness veil the encumber'd sky,
Fearless through darkness and through clouds they fly;*

Flown manually, Empire 'boats could be surprisingly agile when circumstances allowed or demanded. 'TW CALPURNIA appeared at the Royal Aeronautical Society's annual garden party, held at Fairey's Great West aerodrome in May 1938. Captain Eggesfield was in command and brought the 'boat in over the aerodrome in a very low, high speed pass. A photograph shows 'TW at perhaps 100 ft., flying over a line-up of parked de Havilland aircraft including the DH.91 Albatross prototype, a DH.86B, a DH.90 Dragonfly, a DH.89 Dragon Rapide and an Avro Anson. Captain Eggesfield returned low and slow, with the flaps fully extended. The Editor of *The Aeroplane* was not amused. 'Alarmingly low' wrote C.G.Grey, who was watching. Captain Eggesfield finished his display with a series of vertically banked turns. Empire 'boats could also be made to sideslip, with a wing down at 45 deg.

There is an account by Gerald Brown of 'MA AOTEAROA beating up the town of Mackay, Queensland during the delivery flight to Auckland on 26 August 1939. 'MA had on board a nucleus of the future staff of TEAL. The crew was Captain J.Burgess, First Officer W.J.Craig, Supernumery First Officer Kerr (as far

4 Operations

as Singapore), Radio Officer G.W.Cussans, and Steward R.Phillips. The complement was made up with Flight Engineers R.S.Peek and R.MacNamara, Bert Knee (TEAL Chief Engine Inspector), S J Bradshaw (TEAL Instrument Engineer) and G.W.Brown (Smiths Aircraft Industries representative to deal with the automatic pilot). Mackay was celebrating the opening of a new harbour facility and requested 'MA to 'look in' on its way south. Captain Burgess was unwell and resting below, so First Officer Craig was in charge as 'MA proceeded southwards, following the Queensland coast, cruising at 130 knots on automatic pilot. When Mackay was sighted, Bill Craig disengaged the autopilot and took 'MA down to 1 000 ft. to make a tight circuit of the airfield and town. A ship in the centre of the harbour was dressed overall for the occasion. Bill Craig put the nose down and made for the ship, with the air speed indicator moving through the 200 mile per hour mark. 'MA shot across the ship's masts with Paddy Cussans winding in the trailing aerial as fast as he could - missing the bunting stretched between the masts - to be pulled up in a steep turn and lined up along the main street of Mackay. Bill Craig took the 'boat up the street at 148 knots with the wing tips just clearing the roofs of the houses on either side. Hearing the noise a cyclist turned his head to see, as in a nightmare, a flying boat following him up the street. He swerved and fell off as the 'boat swept over him. Mr Craig finished his run, climbed away to 2 000 ft. and continued the flight southwards to Brisbane.

Other occasions were much more serious and much more dangerous. On 30 January 1942, 'BD CORIO (Captain A.A.Koch, First Officer V.Lyne, Radio Officer A.S.Patterson, Purser G.W.Cruickshank and Steward Elphick) was on special service XWS 160 to evacuate women and children from Sourabaya. 'BD departed Darwin at dawn. The weather conditions were marginal with low cloud and rain. It was arranged that Koepang radio would broadcast a report every 30 minutes to let Mr Patterson know the situation regarding the latest Japanese air raids. 'BD was approaching Koepang over the sea in clear weather, at a height of 400 ft. Radio Officer Patterson was listening out for the half hourly report, which he missed. He had just sent off a message asking for the latest state in Koepang - heard by 'UF CORINTHIAN (Captain H.B.Hussey) as they were south of Bima - when the aircraft was attacked from above and behind by Japanese Zero fighters. Captain Koch opened the throttles and dived to sea level, making for the coast 13 n.m. (24 km.) away. He tried turning and zig-zagging to avoid the bursts of tracer, incendiary bullets and cannon fire from the fighters. The 'boat was flying at maximum speed with the main step a foot above the water and the wing floats dipping the surface alternatively, each time the aircraft twisted and turned. As the first rounds of each volley hit the aircraft, Aub Koch turned 'BD hard towards the stream of bullets, directing the fire away from the aircraft. The speed dropped off as two of the engines caught fire. The planing bottom was so badly holed that 'BD practically stood on its nose as it hit the water, going in opposite the mouth of the Noelmini river, about 3 n.m. (6 km.) off shore. Of the eighteen passengers and crew board only Captain Koch (wounded in the left forearm and knee), Mr Lyne (injured in the foot), Radio Officer Patterson (badly wounded) and four passengers survived the attack and subsequent crash. The Zeros circled overhead for some minutes before making off. Captain Koch and Mr F.A.Moore - one of the surviving passengers - stripped off and set out to swim ashore. It took them three hours to reach the shoreline. Mr Moore helped Captain Koch, who found that he could no longer stand, up the beach to safety. They were joined by Mr B.L.Westbrook, another passenger, three hours later and in the afternoon by First Officer Lyne and Mr J.C.B.Fisher, the last of the surviving passengers, who was also injured. Mr Patterson and a passenger, who managed to get out of the cabin before the blazing aircraft broke in half and sank, failed to reach the shore. The survivors were discovered by Dutch Dornier Do. 24 searching the shoreline. The Dornier alighted on the open sea and a rescue party - a doctor and two crew - put ashore in the dark in an inflatable boat. Dr Hekking was able to attend to Captain Koch and Mr Fisher and the next day attempts were made to get the patients on board the Dornier. Each of the injured men were put aboard the inflatable and two men tried to paddle it out through the surf. The boat was repeatedly swamped and had to be returned to the beach to be emptied. It was not until a man waded right out into the surf to hold the bow of the boat that the two patients could be taken out to the flying boat. Within 30 minutes the whole party was in Koepang. Eastbound services between Darwin and Batavia were temporarily suspended. After this episode the Department of Civil Aviation instructed QEA to cease using the normal route through Koepang and Bima and organise a service between Java and the west coast of Australia. Sourabaya was originally selected as the port on Java but the Japanese advance prevented this and Tjilatjap was chosen instead. Captain Koch was later transferred to Darwin Hospital. 'UH CORIO was the fifteenth Empire 'boat 'boat to be written off with the first fatal accident, if it can be called an accident, for Qantas Empire Airways.

4 Operations

The throttles required priming in flight. They were primed at the top of the climb and thereafter every half hour into the flight. The throttle levers were moved forward to the FULL OPEN position, held there for a few seconds and then moved back to the original position. At the top of the climb, the aircraft was levelled off and the engines were adjusted for economic cruise. The mixture controls were advanced from the NORMAL to the FULL WEAK position, waiting for the engine speed to drop to 2130 rev. per min., then slowly opening the throttles to bring the engine speeds back to 2200 rev. per min. The directional gyro had to be checked every 15 minutes to find it, typically, 3 deg. off course. The 'boat was brought back on course by turning the rudder knob, until the bottom card of the directional gyro matched the course previously set on the top card.

When a 'boat reached cruising height, the fuel cocks were changed to cruising positions. This entailed the First Officer leaving his seat and moving to the fuel cocks mounted at roof level, just forward of the spar bulkhead. For the System 1/1D fuel tanks fitted to the Mark I S.23 'boats, this involved closing the BLACK fuel cock sandwiched between the port and starboard tank cocks. This shut cock G on the balance line that connected the fuel tanks in each mainplane. The engines on each side then drew their fuel from the tank on that side. The carburettor air controls - port and starboard - were left at COLD. The cylinder head temperatures were adjusted to about 180 deg. C. by cranking the port and starboard engine cowl gill handles, to open or close the gills. The state of the fuel supply was checked every half hour by 'dipping' the tanks with the Telelevel fuel gauges - another journey for the First Officer from his seat to the forward spar bulkhead. He could read the battery voltage from the main switchboard at the same time.

The First Officer was responsible for the half hourly instrument report on Form D. 96. A typical, but considerably simplified, entry might have been:

Time:	05.00.
Trip clock	1 hr. 30 min.
A.S.I. (speed)	155 m. per hr.
Altimeter (height)	10 000 ft.
Engine Speed Ind.	2200 rev. per min.
Boost Gauge	-1½ lb. per sq. in.
Oil Pressure Gauge	80 lb. per sq. in.
Oil temp Gauge	62 deg. C.
Cylinder Head temp.	160 deg. C.
Outside air temp.	+ 3 deg. C.
Sperry oil pressure	130 lbf. per sq. in.
Battery voltage	30 volts

Returning his seat, he would report the fuel state and the total consumption per hour to the Captain. The division of the control functions between the forward and aft extremities of the Control Deck of the Empire 'boats has never been explained. The arrangement meant that one of the pilots, usually the First Officer, was involved in a considerable amount of walking. He had to leave his seat and walk the 16 ft.(5 metres) to the other end of the Control Deck to attend to the priming of the engines, the operation of the fuel cocks, 'dipping' the fuel tanks and reading the tank contents gauges, testing the fuel pumps, adjusting the engine cowling and for most of the 'boats, changing the carburettor heat.

There were some problems in the operation of the Exactor controls. Any failure of the Exactor hydraulic system, such as a broken pipe line or a connection coming adrift, caused the spring in the operating cylinder to move the control to the extreme position - as a fail-safe mechanism. This was not dangerous when the throttles were set in the fully OPEN position but if an engine suddenly opened to FULL throttle during the last stages of the approach for an alighting, especially asymmetrically, the result could have been testing for the pilot. A steel nipple, brazed to the copper tubing which served the starboard outer engine throttle control of 'BJ CARPENTARIA, came adrift while the 'boat was making an alighting approach to the River Nile at Luxor - difficult enough at any time - slamming one of the engines to full power. The runaway engine could then only be controlled by switching it OFF.. Exactors would lock solid if closed too quickly. The joints in the Exactor pipe lines were subject to leaking - some reports mention incessant leaking - and the leather cylinder cup washers tended to harden. This problem was overcome on the QANTAS 'boats by the substitution of neoprene for the leather washers.

4 Operations

'UV CAMBRIA (Captain L.A.Eggesfield, First Officer Upton, Radio Officers T.C.Jones and H.F.Jones and Flight Engineers F.J.Crowson and Green) departed Alexandria for Cairo on 9 May 1937, the first Empire 'boat to fly over Africa. 'UV was on the first sector of the Nile survey flight and the extreme heat caused the hydraulic fluid in the Exactor systems to expand faster than the relief valves could cope with the expansion. The effect was the same as a break in the pipeline, suddenly opening the throttles to full power. Larger diameter pipework was fabricated and flown out to Africa, solving the problem. The other 'boats were retro-fitted.

The breakage of throttle levers was an additional hazard. The force needed to break a lever - 75 lb. (333 N.) - was calculated to be five or six times the normal control force. While the phenomenon occurred sufficiently often to be mentioned on the IAL modifications file - levers had fractured on six occasions by May 1939 and it was still happening in 1944 - no explanation was advanced as to why this should have occurred.

The 'boats were un-pressurised so consequently flew in the weather. With limited ability to fly round or over it, they were frequently in the thick of it. Airframe and airscrew icing caused some difficulties in winter, especially on the overland sectors across France. During the first winter of operation with IAL, the Empire 'boats had no external protection from icing. The leading edges of the flight surfaces were particularly vulnerable to super-cooled droplets, freezing immediately on contact to form glassy ice. The build-up proceeded rapidly by the evaporative cooling effect of the lowered pressure and speed of the air flow over the leading edges. Accretion rates of up to 2 ins. (50 mm.) per minute were possible.

Warm front conditions were especially dangerous. Often thunder clouds formed behind the line of flight, making it impossible to turn back. Climbing to get over the clouds also had its problems, as fast moving cumulus could out-climb a 'boat, especially as the 'boat's rate of climb dropped off with altitude. It was not uncommon for the 'boats, unpressurised and with marginally effective heating systems and no oxygen available, to be taken to 18 500 ft. over France in the early days of the service to avoid turbulence and ice. Captains Burgess and Caspareuthus were reputed to hold the joint height record of 22 000 ft. - with passengers on board. IAL's passengers comatose, well wrapped up, uncomplaining and ignorant of anoxia, accepted high altitude flying as one of the hazards of the journey. Experience with the route brought increasing confidence and more comfortable flight levels, so it became less common to climb to those heights. To descend in cloud to get into the warmer air below the cloud base was potentially dangerous. 'VA CAPRICORNUS, first Empire 'boat to be written off, crashed near Maçon in France on 24 March 1937, descending in thick cloud and snow, en route for Marseilles. Kilfrost paste, originally developed for the use in refrigerated cold rooms, was brought into use for de-icing. The paste was applied by brush or palette knife to the leading edges of various vital parts of the airframe - the mainplanes, float struts, aerial mast, fin and tailplanes and the noses of the wing tip floats. Kilfrost was only partially effective due to difficulties with adhesion, its tendency to corrode metal and to be abraded by heavy rain and hail. It was also possible for ice to form on the surface of the Kilfrost itself. As Kilfrost melted at higher temperatures, a 'boat at moorings in warm weather, say at Alexandria having flown across a much colder France, presented a dreadful sight covered with running Kilfrost.

From 1 November 1938, all British transport aircraft were required to have some means of airframe de-icing. It was intended to fit Goodrich pulsating rubber 'overshoe' equipment - removing another 108 kg. from the payload - to the leading edges of the wing and tail surfaces of 'CX CLYDE - one of the S.30 'boats. Ice formation in the airways of a carburettor was not fully understood at the start of EAMS operations. Although the choke tube of the carburettor was heated by circulating hot engine oil round the jacket, and heat could be applied to the carburettor air intake, the heating arrangements were often not very effective. In certain cloud conditions, the engines faded as the edge of the cloud touched them and the 'boat had to climb to avoid the carburettors becoming iced up. A 'boat could be chased up to over 20 000 ft. in this fashion over the Massif Central, on the Southampton to Marignane sector. 'UU CAVALIER was lost on 21 January 1939 over the North Atlantic, about half way between Bermuda and Baltimore, due to loss of power from carburettor icing. 'UU CAVALIER was the fifth Empire 'boat to be written off.

Storms over sectors of the African, Middle East and Indian routes could be sudden and violent. In rough weather the 'boats were quite stable, tending to pitch in a not unpleasant way. In patches of rough weather 'bumps' of 3g. occurred, 2g. were common and occasionally 'bumps' of 6g. were recorded in monsoon conditions.

The Forward and Centre Cabins were considered to be the most uncomfortable for passengers in bumpy conditions. airsickness among passengers and crew was not uncommon in rough weather and the 'boats

4 Operations

carried cuspidors, rather than air sickness bags, for the passengers. Flown manually in bad weather, they were subject to wide fluctuations of air speed.

The only significant air strikes recorded were an encounter with a vulture and a flock of fifty geese. 'MA AOTEAROA' encountered a vulture over India on its delivery flight to New Zealand on 19 August 1939. The bird hit the windscreen at a closing speed of 170 knots - without damage to the aircraft. On another occasion a flock of fifty geese damaged the leading edge of the mainplane of another 'boat. 'HL CANOPUS' was struck by lightning while flying near Corfu and 'MA AOTEAROA' was struck while over the Tasman Sea in June 1941, causing a fire on the Control Deck.

The descent from cruising altitude was normally between 300 and 400 ft. per min. If conditions were likely to be bumpy, the descent was quickened to 400 ft. per min., to save the passengers from discomfort. At that rate, the descent from a cruising height of 10 000 ft. to the circuit height took just over twenty minutes, which for most passengers was not sufficient time for them to become airsick.

The engines originally fitted to all the Mark I S.23 'boats, one of the S.30s and both the S.33 'boats were poppet valved Bristol Pegasus XCs. The engines developed 820/900 bhp. (589/611 kW.) at 2 250 rev. per min., at the rated altitude of 3 500 ft. At sea level, the maximum power was 885/920 bhp. (660/686 kW.) at 2 250 rev. per min. The maximum economy cruise power was 510 bhp. (380 kW.). The maximum engine speed for the climb - with the airscrews in COARSE pitch - was 2 250 rev. per min. with +1 1/4 lb. sq. in. boost. For continuous cruising the speed was 2 500 rev. per min. up to 5 000 ft. and 2 100 rev. per min. over 5 000 ft. Maximum engine speed - all out - was 2 600 rev. per min. with +2 1/2 lb. sq. in. boost for 5 minutes in level flight.

Bristol Perseus XIIC sleeve valve engines were fitted to the remaining S.30 'boats. They developed 715/745 bhp. (533/556 kW.) at the rated altitude of 6 500 ft. The sea level maximum power for take off was 815 bhp. (608 kW.) at 2 650 rev. per min. with +2 1/2 lb. sq. in. boost. For the climb, the speed was 2 400 rev. per min. with +1 1/4 lb. sq. in. boost. The maximum economy cruise power was 510 bhp. (380 kW.). Maximum power was 890 bhp. (664 kW.) at 2 750 rev. per min. with +2 1/2 lb. sq. in. boost for 5 minutes level flight.

For climbing, the oil temperature was 70 deg. C. maximum (emergency maximum 90 deg. C. for continuous climb) and the cylinder head temperature 210 deg. C. maximum. For cruising, the oil temperature was between 50 to 60 deg. C., the cylinder head temperatures 170 to 180 deg. C. and the oil pressure 80 lb. per sq. in. at 70 deg. C. The emergency maximum oil temperature was 100 deg. C. for not more than 5 minutes. The emergency (low) oil pressure was 60 lb. per sq. in.

Both the Pegasus and the Perseus engines had their troubles in service. Mishaps to the Pegasus engines were mostly due to sticking valves and in the early days of the EAMS, metal particles in the oil filters caused much concern. On one occasion a piston came right through the cylinder head and lodged in the cowling. An inlet valve on one engine broke and punched through the crown of the piston, causing the engine to seize and the cylinder to blow off. Valve seats vibrated loose and some valves broke. Cylinder barrels split, connecting rods broke and airscrew reduction gears sheared. The junk head of a cylinder of one of the Perseus engined TEAL 'boats came off over the Tasman Sea, opening out the cowling like an umbrella, causing a return to Sydney at wave top height. Connecting rods of another Perseus broke, four hours out from Auckland. The 'boat was escorted back to New Zealand by a RNZAF Lockheed Hudson, whose crew could see the whole engine nacelle vibrating as the airscrew windmilled. When the engine was dismantled, six connecting rods were found to have been fractured. Perhaps this incident promoted the fitting of the fully-feathering constant speed airscrews to the two 'A' 'boats in 1943.

There were at least nine different fuel systems used by the Empire 'boats, involving from two to nine tanks. Combinations of the tanks made up six total capacities. Diagrams outlining the systems appear in both editions of the Maintenance Manuals, those with an M prefix being from the later 1939 edition. Other fuel systems were also used, most of which appear to be temporary modifications made in response to war-time conditions. 'UF CORINTHIAN (Captain I.C. Harrington), 'UX CASSIOPEIA (Captain J. Davys) and 'BL COOEE (Captain F.J. Bailey) were all fitted with extra tanks 'in the cabin' - presumably the Centre Cabin - for their journeys to join the Horseshoe Route in 1940. They were followed by 'CT CHAMPION and 'KZ CATHAY with three extra 121 gals. (540 litres) tanks in the Centre Cabin, plumbed in with domestic stop valves and with sight glasses to register the contents,

'BB COOLANGATTA, then chartered by the RAAF as A18-13, had an arrangement of 'several' Wirraway tanks in the Centre Cabin strapped down to rails on the floor - normally used for the transport of spare engines. Another boat used Lockheed (?) fuel tanks, believed to have been stowed away somewhere in the wing roots. There are also total fuel capacities recorded in the literature that are impossible to reach

4 Operations

by any combination of the standard tanks, and remain something of a mystery. Recorded tank capacities were subject to variation by a few gallons, which might account for some of the discrepancies.

Fuel consumptions varied between individual aircraft. In practice, 'normal' four engine fuel consumptions ranged from as little as 107.5 gal. per hr. (484 litres per hr.), to 120 gal. per hr. (540 litre per hr.). A good average consumption was considered to be 115 gal. per hr. (518 litre per hr.). A consumption test carried out on 'KZ CATHAY showed a gauge consumption of 97 gal. (437 litre per hour) when the actual consumption was 107.5 gal per hour (484 litre per hour).

The upper limit of acceptable consumption was set at 141 gal. per hr. (631) litre per hr.), and anything over this amount was considered to be excessive. These consumption figures appear to be better than the manufacturer's figure of a maximum of 0,67 pints (0.38 litres) per bhp. per hour. Oil consumptions varied between the Pegasus and the Perseus engines. The poppet-valved Pegasus had a reputation - at least on the Empire 'boats - of leaky engines distributing oil copiously inside and outside the wing. The sleeve-valved Perseus were more economic with their oil. Consumptions varied from 8 pints to 3½ gal. per hour, (2,25 to 15.75 litres per hour) for a typical Pegasus down to 2 to 3 pints (0.5 to 0,84 litres per hr.) for hour for a Perseus.

The ranges for the different fuel systems were:

Systems 1 and ID. System 1 was fitted to 'HL CANOPUS only. The other Mark I S.23 short-range aircraft had ID systems. Duration 5 hours. Range (still air) 684 nautical miles (1 270 km.). Range against 35 knot head wind 517 n.m. (960 km.).

The following four medium-range systems had the same capacities:

System IA was fitted to 'UU CAVALIER, System 1C to 'UT CENTAURUS and System MIC was fitted to the three S.33 'boats. It is possible that some of the other 'boats operating the Horseshoe route were converted to MI C. System MID was the same as MI A but with the inboard tanks locked off.

Durations for Systems 1A, 1C, MIC, and MID were 7 hours 30 minutes.

Range (still air) 1 078 n.m. (2 (XX) km.). Range against head wind 814 n.m. (1 510km.).

System MIB. When the two Mark III S.23 long-range Atlantic boats 'HM CALEDONIA and 'UV CAMBRIA were converted to Mark I S.23 aircraft, the original I B fuel systems were modified to ID.

Subsequently, both aircraft are recorded with MIB systems. It is also possible that the other aircraft cited in the literature with non-standard capacities had MIB fuel systems. Duration 10 hours 40 minutes.

Range (still air) 1 520 n.m. (2 820 km.). Range against head wind 1148 n.m. (2 130 km.).

System MIA is classed here as long-range. It was fitted to the two Mark IV S.30 'A' boats for the Trans-Tasman sector, possibly to 'CZ AUSTRALIA, and 'KZ CATHAY. Duration 13 hours 23 minutes. Range (still air) 1 914 n.m. (3 551 km.) Range against head wind 1 446 n.m. (2 682 km.).

System IB was the long-range flight-refuelled system fitted to the two original Mark III S.23 'Atlantic' 'boats HM CALEDONIA and 'UV CAMBRIA. Duration 17 hours 41 minutes.

Range (still air) 2 530 n.m. (4 694 km.). Range against head wind 1 911 n.m. (3 545 km.).

System MI was the long-range system flight-refuelled system fitted to the Mark III S.30 second generation 'Atlantic' aircraft 'UC CABOT, 'CV CARIBOU, 'CW CONNEMARA, 'CX CLYDE but not 'CZ CLARE (ex 'CZ AUSTRALIA). Duration 19 hours 16 minutes.

Range (still air) 2 754 n.m. (5 110 km.). Range against head wind 2 080 n.m. (3 859 km.).

The ranges are calculated assuming a fuel consumption of 130 gal. per hr. (585 litres per hr.), a cruising speed of 143 knots (265 km. per hr.) with an allowance of 30 gal. (135 litres) deducted for taxiing and take off. The standard head wind used in the IAL specifications was 35 knots (64 km. per hr.).

The fuel systems had cocks in the balance line that divided the system in two so that the engines on either side of the aircraft drew their fuel from the tank or tanks on that side. The 'boats normally flew with the balance line cock CLOSED. If one of the tanks in a multi-tank system had to be closed off in flight for any reason, the balance cock was opened to balance up the levels in the remaining tanks. After the incident when 'UV CAMBRIA suffered a air lock in the fuel system in March 1939, it was recommended that the levelling cock should be left OPEN at all times. The MI system had a small tank on the Control Deck at a

4 Operations

lower level that could not feed the engine fuel pumps by gravity, as with all the other tanks. The tank was used to top up the two larger hull tanks by electric pump, switched ON and OFF manually.

Bumpy weather could also cause airlocking of the fuel system. Captain S.G.Long reported two engines fading in bumpy weather between Alexandria and Lake Bracciano on Service KN 74 on 27 November 1938 and Captain Davys experienced a similar situation over Crete. On 8 March 1939 'UT CAMBRIA (Captain E.J.Alcock) was forced down on the ocean when all four engines faded and then cut out altogether following a normal turn was made to port. On this occasion, air entered the supply piping from the starboard wing tank. The fuel level in this tank had dropped to 30 gal. (135 litres) a depth of about 65 mm. in the bottom of the tank. The turn to port was sufficient to force this small quantity of fuel away from the sump outlet of the tank, allowing air to enter the supply line. As all four engines faded simultaneously, they must have all been drawing their fuel from the starboard tank. The levelling cock must have been OPEN.

Alighting

A lefthand circuit was normally flown over the alighting area at a speed of 120 knots (221 km. per hr.) and at a height of between 800 to 1 000 ft. This gave the Captain time to view the alighting area, the First Officer to prime the throttles and mixture controls in pairs and for the Radio Officer to wind in the trailing aerial, if he had not already done so during the descent. The aerial selector was changed to FIXED - TRAILING EARTHED, the trailing aerial wound in and the aerial fairlead retracted to the UP position. If the direction finding loop on a S.23 'boat was outside the hull, it was brought inboard and the sealing plate closed. The Radio Officer continued to listen out until he closed down the station and signed off, just prior to alighting. The Flight Clerk went up to the Control Deck to start moving the mail from the mail room into the square of the hatch, ready for off-loading. Returning to his station on the lower deck, he made the rounds of the passenger cabins with the Steward. The passengers put their seats in the fully upright position and secured their seat belts. The Flight Clerk collected the passenger's passports, tickets, quarantine cards, currency cards and alien's cards and returned to his office in the forward mail room. The passports were placed in the passport container. On the water below, the control tender on the alighting area turned to point its bow into the wind. A steady GREEN or WHITE light from the surface was the lamp signal for 'clear to alight'. A flashing RED lamp signal indicated 'do not alight'. A steady RED light was the signal to give way to another aircraft, while continuing to circle. A gentle turn to port started the approach, to alight as near as possible into the wind. Although the approach could be made as low as 76 knots (140 km. per hr.), the usual speed was about the 100 knot mark in good visibility or 90 knots (184 or 166 km. per hr.) in marginal conditions, with a minimum of throttle work. The aim was to alight at the lowest possible speed.

Once the 'boat had been turned and lined up, the airscrews were changed from COARSE to FINE pitch and the engines throttled back. The flaps could be put out early in the approach, as no change of trim was required while they were moving or when they were in the extended position. The Captain called the flap setting and the First Officer reached up to pull the flap motor switch - BLUE light ON - and moved the controller flaps operating switch down to FLAPS OUT. As the flaps start to move, he confirmed "Flaps going OUT, Sir" while watching the flap position indicator move round the dial - the RED light coming ON as the flaps moved past the 1/3 OUT position. Flap settings were 1/2 3/4 and FULL for heavy swell conditions with a maximum speed of 102 knots (188 km.per hr.) for FULL flap. The elevator tab settings were between 1 to 6 DOWN - depending on the position of the centre of gravity - and 1 to 2 turns to port was wound on the rudder tab if needed.

The 'boat - sinking at between 300 to 400 ft. per min. - was kept level with the ailerons. The Captain normally had control and eased back slightly on the control column to monetarily check the descent and increased the engine speed to 2 300 rev. per min. to keep the 'boat's speed up. At 20 ft. above the surface, he checked the 'boat by moving the control column back and then to the neutral position, at the same time moving the throttle levers practically to the CLOSED position. In a normal alighting, the aircraft rounded out above the water in a planing attitude and touched down with the point of the main step, followed almost immediately by the point of the aft step. The tail continued to dig into the water and with the control column hard back, some power was applied to ease it as the way came off and the aircraft came off the step. As the speed dropped off the 'boat settled down into the water, the bow wave increasing until it was washing up the sides of the hull. If the nose rose too high, the inner engines were opened up momentarily to check it. As the 'boat came off the plane, there was a sensation of 'falling through' the water surface.

4 Operations

With the flaps at the $\frac{3}{4}$ setting, the bow wave often streamed back to beat on the flaps before they could be brought IN, to be countered by opening up the inner engines.

The 'boats could stall during the approach. On one occasion - 30 July 1939 - 'DU CAMILLA (Captain R.P.Mollard, First Officer J.H.Jones, Radio Officer J.M.Owers, Flight Clerk A.H.Tyler and Steward G.E.Martin), eastbound with DS 218 mail and eleven passengers on board, stalled into Alexandria Harbour from a height of 10 ft. The circuit was flown at 95 knots (175 km. per hr.). The approach was made normally with the airscrews in FINE pitch and the flaps half OUT. The flare was made at 20 ft., with the control column fully back, when the aircraft stalled and hit the water tail down at 82 knots (151 km. per hr.), damaging the port float and part of the mainplane structure. There were no injuries.

'VE CENTURION (Captain A.C.Loraine, First Officer E.A.T.Murray, Radio Officer E.B.Brown, Flight Clerk L.R.Smith and Steward A.Carter) westbound from Sydney on 12 June 1939, lightly loaded and carrying four passengers, was involved in a freak accident at Calcutta while alighting on the Hoogly river. The approach was made with FULL flap. The 'boat touched down near the Bally Bridge at about 90-95 knots (166 - 175 km. per hr.), and after running for some four or five seconds, the tail came up and 'VE slewed violently to port. The skin plating forward collapsed, causing the bow to dig into the water. The aircraft started to sink. Captain Loraine and Messers Murray and Carter were injured and one of the four passengers broke a leg. 'VE turned on its back and finally sank, becoming the eighth Empire 'boat to be written off.

Alighting into a 5 knot wind with FULL flap, a typical arrival took about 18 to 20 seconds with a run of some 350 metres. Directly the aircraft was on the water, the flaps were brought IN - flap motor switched ON - BLUE and RED lights ON if the flaps were more than 1/3rd. OUT and the operating switch turned upwards to FLAPS IN. When the flaps were inboard - it took the motor 90 sec. to wind them in from the FULL flap position - the First Officer reached up to turn the operating switch up to OFF and pull the flap motor switch OFF - RED and BLUE lights OFF - and confirmed 'Flaps IN and motor off'. As the way came off, the Captain brought the inboard throttle levers towards the CLOSED position.

The Radio Officer had donned his overalls and moved through the forward freight hold to the mooring compartment in the bow. He opened the mooring hatch, clipped it back, swung the retractable mooring bollard out, locked it and put the slip line in position on the bollard. He then prepared the port and starboard drogues and their lines ready for use.

The drogues were conical canvas sea anchors with a trip line attached to the apex of the cone by a swivel and spring hook. A short drogue line ran from the bridle at the mouth of the drogue, ending with a swivel eye. The pennant line was connected to this swivel eye with a spring hook at one end and to the retractable eye on the side of the 'boat at the other. The trip line - from the apex of the drogue - was permanently connected to the cleat on the inside of the retractable eye, so that the drogue could not be lost overboard. The folded drogues were kept in containers in the mooring compartment, to port and starboard. They could be used either singly on one side of a 'boat, or on either side at the same time, or with both drogues in tandem on one side or the other. To stream a drogue, the retractable eye was wound out and the drogue removed from its container. The pennant line was then attached to the retractable eye at one end and the drogue swivel at the other, the drogue opened out and dropped overboard. Whistle signals from the Captain indicated which drogue was required. When used in tandem, the forward drogue was hooked up in the same way as for a single drop but with the drogue line of the rear drogue was attached to apex swivel of the forward drogue. The trip line for both drogues was hooked to the apex swivel of the rear drogue. When the drogues were ready, the Radio Officer stood in square of the mooring hatch and signalled to the Captain - thumbs up - that the drogues were ready for use. Drogues were intended for low speed manoeuvring up to a maximum of ten knots and therefore streamed towards the end of the alighting run. Streaming a drogue at too high a speed could cause it to skip ineffectually on the surface of the water. On some occasions they were streamed at 50 knots (92 km. per hr.), with consequent damage to the drogue and its lines. At £ 35 (PV £ 700) a set, drogues were expensive items. To retrieve a drogue, the bowman hauled on the trip line until the drogue was within his reach. It was impossible to haul a drogue in by means of the pennant line.

Taxiing in to a mooring or pontoon was either done with the two outer engines idling at 200 rev. per min. or the aircraft took a tow. The trip clock was stopped. The Flight Clerk went up to the Control Deck to unship the ensign staff and prepare the appropriate bunting.

The approach to the mooring was made as slowly as possible to give the bowman the best chance to pick it up first time and to prevent damage to the mooring bollard. If the wind and the tide were in the same direction, the approach to a mooring was made in the usual way without difficulty, up-tide and up-wind. In this situation, the mooring buoy is streaming towards the aircraft and could be easily picked up. The way

4 Operations

on the 'boats dropped off slowly, so speed was reduced well away from the mooring. Drogues could cut down the speed still further and to help in turning onto a mooring.

When the wind and tide were against each other, a decision had to be made depending on the relative strengths of the two elements and the physical circumstances of the waterway. Normally, a flying boat would be worked to the stronger of the two. If the approach to the mooring was made up-tide, the control of the aircraft was as good as it would have been if moving into the wind but the drogues would be less effective. The pick-up buoy on the mooring however, would be fully extended on the sinker chain by the tide, and therefore difficult to pick up.

In the reverse situation, when approaching down wind and up-tide, the control of the aircraft was more difficult. Any increase in engine speed to change direction, increased the speed on the water but the drogues were effective. If sufficient room existed, the best method was to overshoot the buoy and turn 180 deg. on the drogues and engines, and finally approach the buoy up-wind.

When the wind and tide were in opposition and the approach had to be made across them, the situation was even more difficult. It was virtually impossible to hold the head of the flying boat to the buoy, so a quick pick-up as the bow of the flying boat was allowed to drift across the buoy, was the best that could be arranged. Getting away in this situation was as difficult as mooring, and often the cable had to be cut. This particular combination of the elements also made things difficult - and sometimes impossible - for the coxswains of the various service barges and tenders as they approached the flying boat. The 'boats could operate safely in water conditions that were too rough for the attendant surface craft.

When he had finished with the engines, the Captain switched the ignition OFF for all engines and pulled the inboard and outboard engine cut-out levers. The First Officer turned each airscrew with the starter motor, by working the starter button, until one blade was vertical. The rudder bar was centralised, the control wheel levelled and the control column pushed fully forward, depressing the elevators to their fullest extent. The First Officer unshipped the control lock from its stowage and inserted it, before moving aft to the forward spar bulkhead to close all the fuel cocks and screw the Dizzy OUT. While at the bulkhead, he checked the remaining fuel in the tanks with the Telelevel gauges. Returning to his seat, he primed the throttle levers by pushing them fully forward and leaving in FULL OPEN position and then the mixture controls by moving the levers back and leaving them there - if the Captain had not already done so. The carburettor test cocks between the pilot's seats were turned OFF and the flap closed.

In certain weather conditions it was difficult to judge the height of the aircraft above the surface with accuracy. Without any movement apparent on the surface of the water, as in a mirror calm, the situation could become hazardous. On 1 October 1937, 'VC COURTIER (Captain E.Poole, First Officer Hall, Radio Officer Dunk, Flight Clerk Boughton and Steward McQuarrie) arrived over Phaleron Bay, Athens, westbound from Alexandria at 10.35, with nine passengers on board. There was no wind and the sea was glassy. The sky was covered with white cloud. No circuit was flown and the aircraft failed to check its descent at 20 ft. to flare in the normal way before alighting. It is not entirely clear who was the pilot flying on the approach and alighting. Who ever it was, not realising how close he was to the water thought that he had sufficient height to climb away safely, to go round. At the precise moment of opening the throttles to climb away, 'VC hit the surface and flew into the sea at high speed. Three of the passengers were killed and three passengers and First Officer Hall, injured. Rescue attempts were hampered by the airscrews as they continued to turn in the water. After this accident the windows of all the Empire 'boats were modified to enable them to be pushed out and additional exits were provided on the top of the hull. The best approach in these conditions was made over the land rather than straight in from the sea, with the crew looking for anything that could give an indication of the water level, such as shoreline waves, small boats or flotsam. 'VC COURTIER was the second Empire 'boat to be written off.

Alighting in the direction of a swell, with no wind, could also be hazardous as the resulting high alighting speed led to a longer run on the water. 'UU CAVALIER (Captain M.J.R.Alderson, First Officer N.Richardson, Radio Officer W.P.Chapman, Steward D.H.Williams and Assistant Steward R.Spence) departed Port Washington for Bermuda on the 290th service flight on 21 January 1939. The weather was poor at the time of departure, but not unduly so, with a forecast for sleet near the American coast. Two hours out and climbing through high cumulus at a height of 12 000 ft., loss of power occurred due to carburettor icing. All four engines faded simultaneously - the inner engines completely and the outer engines partially. As the aircraft was turned through 180 deg. to clear the weather, the two outer engines opened up again. Unable to maintain height, and while he still had control of the aircraft, Captain Alderson alighted on a lumpy sea with a long swell. The time was 18.15. Captain Powell in Bermuda estimated the probable position of the alighting as N 37 17 W 069 45, about 248 n.m. (436 km.) south east of Port

4 Operations

Washington. The alighting on the open ocean stove in the planing bottom of 'UU, just aft of the main step. The passenger cabins filled with water. All eight passengers - one of whom injured himself at the moment of impact - and five crew members escaped to a makeshift raft formed of inflated seat cushions, as 'UU was not equipped with life rafts. 'UU CAVALIER finally sank at 18.35. Five ships answered the S.O.S. call and NC 16735, the PAA Sikorsky S.42 Bermuda Clipper was called out and departed to search the route within 45 minutes. The survivors spent ten hours in the water and it was lucky for them that the water temperature in the Gulf Stream in January is 18 deg.C. They were finally rescued by the tanker Esso Baytown. The Master of the tanker, with great skill, took his ship to the exact position given, arriving at about 04.30 the next morning. He stopped the ship's engine and in the ensuing silence heard the shouts of the survivors in the darkness. By the time they were picked up, two of the passengers had died of exposure, and Assistant Steward Spence, of shock. The survivors were transferred to a US naval vessel. The Enquiry recommended that passengers should be strapped in their seats at take off and alighting. 'UU CAVALIER was the fifth Empire 'boat to be written off.

On 1 May 1939, 'VD CHALLENGER (Acting Captain F.D.Smith, First Officer Saunders, Supernumery First Officer Gavshon, Radio Officer F.C.Webb, Flight Clerk Knight and Steward Milland) crashed on alighting at Mosambique harbour. The southbound service had been delayed by bad weather between Southampton and Athens. The crew had taken over at Kisumu and had night stopped at Dar-es-Salaam, departing for Mosambique early, arriving at 06.30. No circuit was flown and an alighting was attempted on the narrowest part of the harbour, to bring the 'boat up to the mooring buoy at the end of its run. The flaps were run out to the « OUT position and the airscrews changed to FINE pitch. Later in the approach, the flaps were ordered to the FULL OUT position. The Captain, realising that he did not have sufficient length of water to avoid the pier, and a dinghy that had drifted into the path of the aircraft, ordered flaps IN and opened the throttles to full power. 'VD touched the water about 200 metres to the north of the pier, bounced 10 ft. into the air, and hit the water again striking the bottom, porpoised twice and came to rest with the remains of the keel on the bottom in just over 4 ft. (1.2 metres) of water, with the engines at full power. The planing bottom was completely destroyed by the impact, from the nose back to the rear step. The nose was crushed back to Frame 9 or 10, trapping Mr Knight in the rear of the Control Deck and Mr Webb, who was in the forward mail room at the time of impact. Both these officers lost their lives. The pilots were thrown clear through the roof of the coupé, and such was the damage to the hull, it is a miracle that they survived. The main spar frame at Frames 15/16 was fractured. The reduction gear was torn away from the port outer engine and the airscrews bent. The three passengers survived and were taken out of the aircraft through the gaping hole in the bottom of the Promenade Cabin, assisted by Mr Milland. The mail and freight was salvaged and forwarded. Some of the engines, the mainplanes and the tail unit were salvaged. 'VD CHALLENGER was the seventh Empire 'boat to be written off.

Night alightings were made by setting up the aircraft on the approach in the planing attitude, controlling the rate of descent to 200 ft. per min. with the engines. The flare path or searchlight of the control tender gave direction and an indication of the surface level. Only when the aircraft was firmly on the surface was the power reduced. In the early days of the service, training Captains noticed a reluctance of their trainees to use the flaps at night, which resulted in higher approach speeds and consequently a tendency to overshoot. In an attempt to correct, the engines were cut earlier than desirable, steepening the approach angle. Because the position of the pilot was higher in the new Empire 'boats, the tendency was to round out too late, resulting in a heavy alighting. The searchlight in the starboard mainplane was used for alighting in the dark.

'UF CORINTHIAN (Captain Ambrose) broke up and sank after a normal night alighting on Darwin harbour during the night of 21/22 March 1942, in good weather. The 'boat was on charter to the US Army and was carrying personnel and stores, some of which were very heavy and may have shifted at the time of alighting. Captain Ambrose was seriously injured, two passengers were killed and two seriously injured. It is thought that 'UF struck floating wreckage, as the accident occurred just a month after the bombing attack by Japanese aircraft on the harbour. 'UF CORINTHIAN was the twentieth Empire 'boat to be written off.

Alightings sometimes had to be made in sandstorms. Major Brackley suggested two methods of approaching an alighting area in a sand storm, depending on the visibility. One method was to fly on course by dead reckoning and then lose height to 600 ft. as the alighting area approached. When the ground was in sight, the Captain followed features on the ground to the alighting area. The second method - with the visibility of more than 800 metres - was to fly directly over the alighting area on a radio bearing and then descend to make visual contact with the ground. In both these cases, the Captain needed detailed knowledge of surrounding features - particularly obstructions - on the approaches to the alighting areas.

4 Operations

Aircraft in dust and sandstorms become highly charged, so radio communication was notoriously difficult. Taking off was not recommended if the visibility at the alighting area was less than 300 metres.

On 26 November 1938, 'TW CALPURNIA (Captain E.H.Attwood, First Officer A.N.Spottiswoode, Radio Officer B.Bayne-Rees, Flight Clerk F.G.Ubee and Steward D.E.Anderson) was eastbound for Karachi with Christmas mail - 65 bags for Australia, 60 bags for New Zealand, 5 bags for Iraq, 2 bags for Iran and 1 bag for Portuguese India. Station Officer D.B.Harrison was the only passenger. 'TW encountered a severe sandstorm on the sector from Lake Tiberias to Lake Habbaniyah and ended flying low, with the crew trying to pick up landmarks. It was very dark and strong atmospheric conditions made radio contact impossible. The aircraft's engines were heard over Lake Ramadi. Obviously unsure of its position, 'TW circled the village of Ramadi twice - very low. During a turn to port, the crew had a glimpse of the ground, immediately below the wing tip. Captain Attwood pulled 'TW up sharply and straightened up. There was another momentary sight of water beneath the aircraft as it struck the lake on an even keel, with the engines at normal cruising power, some 19 km. north of the normal alighting area. Captain Attwood and Mr Spottiswoode were killed instantly. The other members of the crew and the passenger escaped to shelter on the port mainplane, where Radio Officer Bayne-Rees died during the night. Steward Anderson and Station Officer Harrison were injured. The aircraft impacted at 15.32 and was reported missing at 17.00. The search for the aircraft had to be abandoned due to the weather and the wreck was not located until the next day, stranded in 10 ft. (3 metres) of water. The injured were rescued by an RAF party and the mail salvaged and forwarded. This service was Captain Attwood's last for IAL before taking up an appointment as Deputy Director of Civil Aviation in India. Captain Eggesfield replaced him. 'TW CALPURNIA was the fourth Empire 'boat to be written off.

One of the reasons for the choice of flying boats for the EAMS was the assumption that they could put down on the open sea in times of emergency, with some degree of safety. On the occasions when forced alightings were made on the open ocean, some were successful and some were not. Captain F.J.Bailey, in command of 'HL CANOPUS, experienced a failure of the port inner engine between Athens and Mirabella, put 'HL down on the Mediterranean and taxied back to Mirabella.

'UV CAMBRIA (Captain E.J.Alcock, First Officer Shakespeare, Radio Officer G.Cussans, Flight Clerk Parsons and Steward Riddock) was forced down on the ocean (8 March 1939) by a vapour lock in the fuel lines, some 13 n.m. (24 km.) north of Mosambique on service DS 176 with six passengers. 'UV was being flown at a height of 1 000 ft., following the coastline southwards, just east of Kroosi Bay. Mr Shakespeare, who was the pilot flying the aircraft, made a normal banked turn to port when all four engines faded. 'UV was heavily laden and he just had time to straighten up and alight down wind on a rough sea with a long swell. The 'boat was anchored and signal lights fired. The ebb tide started to carry 'UV out to sea so the drogues were used as sea anchors to slow the movement. The 'boat grounded on soft coral during the night and took up a list to port. The distress call was heard by SS Columbus, the Nord-Deutsch liner, and a searching Junkers Ju.52 found 'UV. An IAL control tender was directed to the scene of the accident, arriving early the next morning to embark the crew and passengers. 'UV was taken in tow to Mosambique.

A18-12 COOGEE (Flg. off. R.Love) sank whilst alighting off Townsville, Queensland on 27 February 1942, killing the Captain and seven other RAAF personnel on board. A18-12 COOGEE was the sixteenth Empire 'boat to be written off.

A18-11 CALYPSO (Flt. Lt. M.Mather) departed on 8 August 1942 in search of survivors of the ship Mamutu which had been attacked and sunk by a Japanese submarine in the Great North East Channel off Daru in Papua-New Guinea. A ship's life boat was sighted with eight survivors on board. The weather was bad with a heavy swell running but A18-11 CALYPSO was put down to attempt a rescue. The swell stove in the nose of the aircraft on alighting and the next wave ripped off part of the planing bottom. The 'boat sank in two minutes, taking with it a member of the crew. The remainder of the crew boarded two inflatable life rafts and were joined by one of the survivors from the ship's lifeboat - which had disappeared. The party in the two rafts made a landfall two days later, in the early hours of 10 August, near the Fly River. They made their way overland on foot to Kikiri, arriving on 18 August, finally arriving back in Port Moresby by lugger ten days later. A18-11 CALYPSO was the twenty-first Empire 'boat to be written off.

On 22 April 1943, 'DU CAMILLA (Captain A.A.Koch, First Officer Peak, Radio Officer Phillips and Purser Bartley) was in serious trouble over Port Moresby. 'DU had departed Townsville for Port Moresby with twenty-six military passengers. The weather deteriorated *en route*, with the Port Moresby weather reported as low cloud at 600 ft. to 1 000 ft. and heavy rain with visibility limited to 1 000 metres. Approaching Port Moresby, the weather was given as cloud base 1 000 ft. - visibility 2 Km. The cloud

4 Operations

forced 'DU down to 500 ft. and the harbour was obscured by the driving rain. Captain Koch considered the potentially risky procedure of alighting outside the harbour, near the Basilisk Light which marked the way through the reef some 7 km and taxiing in. The area of the Basilisk Passage was un-patrolled and strewn with uncharted reefs. Port Moresby advised that a flare path would be put out in the harbour, so Captain Koch decided to explore the possibilities on both sides of the town, to see if he could find break in the clouds. Conditions did not improve and Mr Phillips discovered that the D/F set was not working in the heavy rain showers. Port Moresby was asked to switch the radio beacon on, so that 'DU could home on it. Visibility was reported as nil and as 'DU had by that time been flying for seven hours, only 90 gal. (400 litres) of fuel remained. At 19.55, with the D/F loop back in operation, 'DU was flown directly over the beacon and turned due south. The stopwatch was started and the aircraft set to lose height to 1 500 ft. At the end of 10 minutes, 'DU was turned on the reciprocal course towards Port Moresby, the stopwatch restarted and the descent set at 200 ft. per min for minutes. The rate of descent was reduced to 100 ft. per min. and when the altimeter showed 100 ft 'DU was still in cloud, with the water visible immediately below. Captain Koch disengaged the automatic pilot and flared for alighting. Suddenly, the surface was seen to be some distance below the 'boat and, as the Captain opened the throttles, 'DU stalled and crashed into the water. Captain, First Officer and fifteen of the passengers survived the crash. Captain Koch, Mr Peak and two passengers were rescued after they had been in the water for some eighteen hours and taken to Port Moresby. The other passengers were picked up by crash boats. 'DU CAMILLA was the twenty-fourth Empire 'boat to be written off.

Late on in the operational lives of the 'boats, Standing Orders were issued for forced alightings over the ocean. When it became clear that a forced alighting was imminent and inevitable, the Orders stated that the aircraft's course was to be altered to the nearest sheltered water, ship or shipping lane. A distress signal was to be sent and radio transmission continued for as long as possible. After the last position report had been given, the radio transmitting key was to be clamped down to transmit continuously. Fuel was to be jettisoned for those 'boats with jettison equipment - the S.30 flight-refuelled 'boats and the two "A" 'boats - and also freight, if the loss of weight would mitigate the circumstances.

Life rafts or dinghies were not part of the equipment of the original IAL 'boats. They were included later so if an emergency alighting was to be made, they were prepared along with emergency rations and water, a signal pistol and cartridges, navigating equipment and a chart with the last known position marked. The S.30 'boats on the West African Service carried life rafts. One of these liferafts, unopened in its container, formed part of the wreckage found floating in the Atlantic after the disappearance of 'CZ CLARE on 14 September 1942 - some 30 n.m. (55 km.) west of the aircraft's estimated track off the West African coast. With the liferaft was a bellows, a pair of paddles, a drogue and a water container. The liferaft opened as it was being hauled aboard the un-named naval vessel, or possibly RAF Search and Rescue launch, that found it.

If possible the 'boat was to be flown low over the alighting area, well ahead of any ship and the alighting made parallel to any swell or line of waves. Passengers were required to remove collars and ties, put on their life jackets and fasten their seat belts. At the moment of impact they were to brace themselves, with their heads down and their knees up slightly. After alighting, the aircraft was to be brought round, head to the waves, using the engines and drogues as necessary. The Radio Officer was to try to establish communication. If the 'boat had alighted on the open sea and two-way communication was possible, he was to confirm the position and reason for the emergency and whether the 'boat was in danger of sinking or could take off again. If a ship was standing-by, he was to give the name and nationality, and if the 'boat was able to taxi, the speed and direction.

There were also forced alightings on inland waters. On an EAMP flight on 12 June 1938, 'TX CERES (Captain E.M.Gurney) made a forced alighting on Lake Dingari, between Karachi and Gwalior- said to be the hottest place in India. The aircraft became bogged. The crew and passengers remained on board and sat down for a five course dinner before retiring for the night. Lake Dingari was infested with crocodiles which scraped their backs along the planing bottom of the aircraft. Next day the passengers were transferred to Gwalior and picked up by the spare aircraft from Karachi. At first it was thought that the 'boat would have to be dismantled. However, 'TX was towed off the mud bank by the crew, assisted by a score of local inhabitants, wading into the lake on the end of a tow line, crocodiles notwithstanding. When they could walk no longer, they resorted to swimming. 'TX was flown off the lake on 20 June. One account states that in the mean time, the crew who stayed with the 'boat waiting for a suitable wind, were supplied with food and water (from Gwalior?), dropped from passing 'boats, apparently by parachute. Finally 'BB COOLANGATTA and 'CD CLIFTON were both lost in alighting accidents on Sydney harbour

4 Operations

within five weeks of each other, in October and November 1944, the twenty-fifth and twenty-sixth - and last - Empire 'boats to be written off.

Refuelling

The Empire 'boats were the first British commercial aircraft to use 87 octane aviation spirit to the DTD 230 specification. The crude oil came mostly from Mexico and the spirit derived from petroleum with added aromatics and/or tetra-ethyl-lead. The specific gravity was about 0.76, depending on the exact origin of the base stock but often shown on the aircraft weight schedules as 0.74. The boiling point of the spirit was between 50 to 180 deg. C.- which caused some problems with vapour locks in the fuel systems in hot weather. The calorific value was between 18 750 - 18 600 BThu. per lb. (43.7 - 43.3 kJ. per kg.). The price at the start of EAMS operations was 2/- per gal. (PV £ 2.06 per gal. or 46p. per litre).

Two main methods used for refuelling the 'boats on the water, 'through the side' or 'over the top', depending on the type of anchorage and the facilities available at the port. In sheltered harbours where a powered refuelling barge was available, the refuelling was normally carried out through the side, via the refuelling cock on the starboard side of the aircraft. In less sheltered harbours and the fast flowing rivers of Africa, the refuelling was usually done 'over the top' delivering the spirit directly to each tank through the individual filler cap, either by hose from a barge, or from cans and drums.

Lubricating oil used for the engines was DTD 109 mineral oil, usually AeroShell 100. The oil was always dispensed over the top through the filler cap of each oil tank by pipeline from the refuelling barge or by measures from cans.

Early in 1937, the Shell Company ordered twenty-seven self-propelled steel refuelling barges for the Empire routes. The barges were all named MEXSHELL - followed by a number - a reminder of the contribution from the Mexican oil fields. The barges were 50 ft. 0 ins. (15.25 metres) long X 10 ft. 0 ins. (3.048 metres) wide X 3 ft. 6 ins. (1.07 metres) draft with a freeboard of 4 ft. 9 ins. (1.45 metres). The barges displaced 15.5 tonnes empty, 27.6 tonnes fully laden and had a speed of 7 knots. A full load of aviation spirit was 2 500 gal. (11 250 litres) carried in four tanks - two 500 gal. (2 250 litres) tanks and two 750 gal. (3 375 litres) tanks. 200 gal. (900 litres) of lubricating oil was carried in two tanks. A single barge carried enough spirit and oil to service 'boats with any fuel system except System M1. The aviation spirit pump on the barge was a Stothert and Pitt rotary displacement pump, delivering 120 gal. per min. (9 litre per sec.) at a pressure of 25 lb. per sq. in. (172 kPa.) through a Kent indicating meter. The lubricating oil was delivered by compressed air through a flexible hose at between 7 gal. to 10 gal. per min. (0.5 and 0.75 litre per sec.), depending on the viscosity of the oil.

The normal complement of a refuelling barge was a Coxswain - in charge of the barge and responsible for seamanship - a Pumpman responsible for the refuelling operation - and a Deckhand whose duties included mooring the barge, casting off and generally assisting with the refuelling.

Powered Shell barges were stationed at Hythe, Cairo, Luxor, Karachi, Allahabad and Calcutta and the exact distribution of the remainder along the Empire routes is not known with certainty. In Australia, Shell designed and built refuelling barges to be stationed at Darwin, Groote Eylandt, Townsville, Bowen, Brisbane and Sydney. They had a capacity of 1 080 gal. (4 860 litres) of spirit and 50 gal (225 litres) of oil

The Basra barge was not standard as it is described as 'extra long' and later in the Horseshoe operation, the 'boats refuelled from RAF barges at Pamanzi and Diego Suarez. Unpowered barges were stationed at Raj Samand and Gwalior.

Refuelling was a potentially hazardous operation, especially in rough weather. Heavily laden refuelling barges, even when they were powered, were not the sprightliest of vessels. Away from the main bases, the seamanship of the barge coxswains was not always up to the standards of Southampton Water. Although the barges were well provided with fenders, when a collision occurred between a barge and an aircraft, it was inevitably the 'boat that was damaged. Mishandling of the mooring or casting off operation could also cause the retractable bollard at the aircraft's mooring hatch to be wrenched out of position. Starboard wing floats were also at risk, as approaching or departing refuelling barges swung in the current.

The more important ports along the routes had resident British Station Officers who supervised the refuelling operation. At other ports, it was the First Officer who took the responsibility for supervision and at Mosambique, the Station Officer required the First Officer to attend the refuelling operation. Passengers were not allowed to remain on board while 'boat was being refuelled. At the start of the first service of the day, the aircraft would have been fuelled before the passengers boarded. At intermediate stops, passengers

4 Operations

were either taken ashore, or weather and circumstances permitting, treated to a sightseeing trip in an Imperial Airways Limited tender, until the refuelling had been completed.

The amount of fuel required for the sector about to be flown was established, the contents of the tanks checked by the aircraft's gauges, or by dipping the tanks, and the total fuel uplift was calculated. Aircraft that had recently flown through sand or dust storms were highly charged with static electricity, so extra care was required during the refuelling.

If the refuelling was to be through the side, the supervisor would open up the mail loading hatch on the starboard side of the Control Deck. From this position, he had a good view of the refuelling barge as it was tied up immediately below him. The aircraft's main electrical switchboard, the fuel gauges and tank cocks were all within his easy reach. The supervising officer - the Station Officer or First Officer - checked that the Dizzy was screwed right OUT, that all switches on the main switchboard were OFF, that the tank cocks were CLOSED and that the fire extinguishers on the Control Deck were ready for action. The ladder leading to the escape hatch in the top of the hull was also close by.

To refuel through the side, the barge would approach the aircraft's starboard bow and stand off. The signal that all was ready on the aircraft was a long blast on the whistle. Assuming a sheltered anchorage, a powered refuelling barge would come alongside the 'boat and tie up on its starboard side. A mooring line from the bowman on the barge would be taken to the aircraft's bow mooring hatch and made fast to the retractable bollard. If the tide was running at more than two knots, an additional line would be secured to the storm pennant. The line aft would be made fast to the mooring cleats let into the side of the aircraft. The barge was then immediately below the mail loading hatch, in a position to make the connection to the refuelling cock in the starboard side of the aircraft.

When the wind and the tide are from the same direction it is not difficult for the barge to approach and close with the moored aircraft. In this situation, the refuelling barge would circle round the starboard mainplane of the aircraft and approach from aft, up wind and up tide, to tie up alongside the starboard side of the flying boat. When the wind and tide were in opposite directions the situation was more difficult. The barge could either approach the flying boat from aft down tide, anchor and warp back to it, or approach up tide from the aircraft's head - a decision that depended on the strength of the tide and the skill of the coxswain. When the wind and tide were across each other the situation was even more difficult, and sometimes impossible. In these cases, the approach, if it could be made at all, required the greatest possible skill on the part of the coxswain.

Before connecting to the refuelling cock, the spirit in the barge's tanks was checked for water. The first two litres of spirit from each of the barge's tanks were pumped through a chamois leather into a bucket, any water from the tanks being retained by the leather. The door in the side of the aircraft was opened and the connection made to the refuelling cock on the aircraft by a 1 1/2 in. (38 mm.) diam. rubber hose from the delivery side of the barge's delivery pump. The cock had a four position body and an operating handle which could be turned to select STARBOARD, BOTH SIDES, PORT or ALL OFF - allowing fuel to be pumped to the tank - or tanks - on either side of the aircraft, or to both sides simultaneously. The ALL OFF position was selected when refuelling had been completed and after the system had been drained down. The refuelling cock was turned from the ALL OFF position to either STARBOARD, PORT or BOTH SIDES and pumping could begin. The Pumpman watched the Kent meter to monitor the flow. The rate of pumping was reduced towards the end of the operation so that the last 20 gal. (90 litres) were pumped slowly into the tank. The Relunit valves inside the tanks were designed to close off when the tanks were full. In fact, they could often be heard to close - with an audible 'clunk' - before the tank was absolutely full. When this happened, the Pumpman would be watching the connecting hose, ready to disengage the clutch on the delivery pump motor at the first sign of bulging - before the pump pressure could do any damage. By turning the refuelling cock first to STARBOARD and then to PORT and pumping very slowly, the last 10 gal. (45 litres) of spirit could be 'squeezed' past the Relunit valves to fill the tanks. The tank vents acted as overflows, discharging surplus fuel through the under surface of the mainplanes.

When the fuel tanks were full, the system was drained by turning the refuelling cock to the BOTH SIDES position and opening the drain cock on the aircraft, allowing the residual spirit in the refuelling lines - about 2 gal. (9 litres) in the 1/1D fuel system - to run back through the cock to clear the lines. The hose from the barge was disconnected, the refuelling cock turned to ALL OFF and the door to the recess in the side of the aircraft closed. The barge cast off and the operation was complete.

While the fuel tanks were being filled, the oil tank, or tanks, in each engine nacelle were topped up, using the lubricating oil line from the barge. The flaps in the nacelles over the filler and circulating chamber caps were unfastened, the caps unscrewed and the levels in the oil tanks checked with the dipstick in the

4 Operations

circulating chamber. If additional oil was required, this was added through the tank filler. When completed, the caps were screwed back on. The tightness of the caps was crucial, as they had a tendency to seize solid if screwed up too tight. When all the caps were on, the flaps in the nacelles were fastened with a half turn of the fastener.

When refuelling over the top, the fuel was delivered to the tank fillers, either through a hose from the refuelling barge or directly through funnels from drums. If hoses were used, the barge was either tied up alongside the 'boat on either side or streamed out fore or aft. On swiftly flowing rivers such as the Nile and the Congo, the barges were often made fast to the 'boat's mooring bollard or the tail release hook. When the barge was attached forward, the hoses were brought up onto the mainplanes over the leading edge. With the barge aft, the hoses were brought aboard over the tailplane and along the top of the hull, with the fabric covered elevators depressed out of harm's way.

Refuelling from drums was a last resort as they had to be manhandled up onto the mainplanes. Allowing for the state of the wind and tide, the refuelling barge would be moored in the best position to get the drums on board the aircraft without damage. At Broome, West Australia, the barge was a lugger with the masts removed. The 'boats were refuelled from drums by pump and hose, with the barge anchored off the mooring hatch. Refuelling could be carried out in any weather.

The preparations inside the aircraft for refuelling over the top were the same as those for refuelling through the side but with the tank filler covers removed and the filler caps unscrewed. When filling over the top by hose or drums, funnels with chamois leather linings were used to filter out any water present in the spirit. The funnels were earthed with static lines to the aircraft. Rain during refuelling was an additional hazard.

On 5 August 1940, 'CX CLYDE (Captains Loraine and May) found itself at Freetown, having departed Poole for Lagos and Leopoldville. On board was Colonel de Larminat and his staff of eight Free French officers whose job it was to persuade the army of French Equatorial Africa to change sides from Vichy to Free France. The capitals of the Belgian Congo and French Equatorial Africa, Leopoldville and Brazzaville, faced each other across the River Congo. The Governor of the French colony, General Husson, was a supporter of Vichy France. Many of the other colonial officials were ignorant of the Free French movement and suspicious of it. Plans existed for a landing at the end of the month at Duala to consolidate the Cameroons, Equatorial Africa and Chad, to prevent another tragedy like Dakar. If the French command could not be persuaded to change sides then the French African colonies would have to be taken by force, at a time when the mounting of such an operation would have been extremely difficult. 'CX finally alighted on the Congo on the Belgian side. The commander of the Air Force in French Equatorial Africa, Colonel Carretier, was invited to inspect the 'boat. When he arrived, Colonel de Larminat was waiting for him, and between them they worked out the coup de that that brought Brazzaville over to the Free French side a few days later.

At Freetown, Captain Loraine had to wave off an enormous barge, stacked high with drums of spirit, which bore down on the flying boat and threatened to sink it. The next day, 'CX was towed to a quiet bay and moored to an old buoy. In continuous torrential rain, with Captain Loraine's raincoat held over the funnel, 1 000 gal. (4 500 litres) of spirit from small drums were brought to the aircraft in canoes, manhandled on board and poured into the tanks - enough to enable the flight to continue to Lagos and finally Brazzaville. Refuelling took all day.

In contrast, A18-12 COOGEE was refuelled on one occasion, over the top, with three hundred 4 gal. (18 litre) cans in less than fifteen minutes. At least once during World War II, a 'boat refuelled itself from extra tanks installed in the interior of the aircraft. On 12 February 1942, A18-13 COOLANGATTA put down on the sea to the north of Australia at dusk, to refuel from Wirraway fuel tanks strapped down to the engine transport rails in the cabins. The refuelling was over the top, using a hand pump.

When fuelling over the top, tanks were dipped to establish their contents and at intervals during refuelling. The filler caps and covers were replaced and a last check was made to make sure that nothing had been left lying on the wings and the operation was complete.

Refuelling could be potentially dangerous. 'CW CONNEMARA was lost by fire late in the evening of 19 June 1939. 'CW CONNEMARA, as an S.30 aircraft was fitted with Bristol Perseus XIIC sleeve-valve engines and equipped for flight-refuelling with an M1 fuel system. The aircraft was on a 400 hour flight test programme to prove the Perseus sleeve-valved engines for commercial operation. The aircraft was flown in shifts round the clock, to accumulate hours as quickly as possible. By the beginning of June 150 hours had been clocked up and 280 at the time of the accident. The tests were being run with four of the six wing tanks - probably the middle and inboard tanks. 'CW (Captain A.G.Store) alighted on

4 Operations

Southampton Water at 21.00 BST to refuel and change crews. The programme was to resume at 22.00 with the aircraft under the command of Captain D.C.T.Bennett. Engine endurance tests were being run in addition to the 400 hr. test, so the amounts of fuel in the respective tanks had to be known with as accurately as possible so 'CW' was refuelled over the top. Dipping the tanks to record the fuel uplift was considerably more accurate than reliance on the Telelevel tank gauges.

The aircraft was made fast to No. 6 mooring on Southampton Water off the Hythe base and the crew went ashore by IAL tender. At the same time, a Shell-Mex and BP refuelling barge left the Hamble depot and made for 'CW'. Coxswain G. Summers was in charge, with Relief Pumpman H. Vincent - working on a barge for the first time - and Deckhand Barker on board. The IAL tender returned to the aircraft with a refuelling crew on board - Inspector D.Munro, Ground Engineer J.Marsden and Refueller H.Fosse.

The refuelling barge arrived at 'CW CONNEMARA' at 21.25 and tied up alongside on the starboard side, with the barge engine left running. The aviation spirit tanks on the barge were vented to atmosphere and in this instance were so full, that the motion of the barge caused the spirit to slop out through the vents into the gunwales. The test for water in the barge tanks was made, in the usual way, by pumping a small quantity of spirit from each of the four tanks through a chamois leather into a bucket. Up on the mainplane of the aircraft, Deckhand Barker had undone the tank filler covers and unscrewed the filler caps. Mr Marsden, of the IAL refuelling crew, had two fuel lines up onto the wing and the nozzle of one in the filler of the starboard middle tank - immediately above the barge. No spirit had yet entered the tank but the refuelling pump was engaged and the fuel line was full, as the 'hammer' of the pump could be felt against the nozzle. The hoseline for the lubricating oil had been taken from the barge, through the mail loading hatch, across the Control Deck and out through the escape hatch in the top of the hull, to the engine nacelles.

The bucket that had been used to test the tanks was in the cockpit of the barge. It overturned and the spirit caught fire. There was a mild explosion as the aft end of the barge caught alight - possibly caused by a backfire - as vapour was sucked into the barge's engine. The spirit in the gunwales ignited almost immediately and the barge was soon afire from end to end. Pumpman Vincent was blown overboard. The heat from the flames on the barge vaporised the residual fuel in the aircraft's starboard middle tank which exploded, sending a jet of flame vertically upwards through the filler. Although Inspector Munro tried to extinguish the fire, the centre of the aircraft was engulfed in flame. Mr Fosse and Deckhand Barker were picked up from the port wing tip by a passing vessel. A pilot cutter was fortunately near at hand and was able to rescue Coxswain Summers and Pumpman Vincent - who was nearly drowning - from the water. Before he abandoned 'CW CONNEMARA', Mr Munro tried to free the aircraft from the barge, effectively lashed together as they were, by the oil hoseline.

The flames spread quickly. The centre of the aircraft burst open and the both mainplanes dropped. The starboard mainplane fell across the barge and disintegrated. Within ten minutes, the aircraft had sunk. As the barge continued to burn and was in danger of drifting, 'MC AWARUA' was moved from an adjacent mooring to a more distant buoy by First Officer Garden.

The refuelling barge, still on fire, was beached some 2 hours later. When the fire was finally put out, 1 784 gal. (8 110 litres) of spirit and 190 gal. (864 litres) of oil remained in the burnt-out hulk. Marker lights were placed over 'CW' where it lay on the bottom of Southampton Water. When the remains of 'CW' were subsequently hauled out at the IAL base, the hull was in two sections - from the nose back to Frame 14 and the aft part from the rear step to the tail. The engines were salvaged and stripped for inspection, so at least some benefit was gained from this unfortunate episode. All that remained of the mainplanes was a tangled mass of wreckage which was reduced to scrap, together with the remains of the barge. Coxswain Summers and Pumpman Vincent were both injured by the explosion. Mr Summers recovered after a long period in hospital, but Mr Vincent died eight days later from his injuries and the effect of near drowning. 'CW CONNEMARA' was the first S. 30 and the ninth Empire 'boat to be written off.

Flight refuelling

Experiments in flight refuelling were started by the Royal Aeronautical Establishment (RAE) in the UK in 1924 with military applications in view. Sir Alan Cobham started his own investigations later but with civil applications in mind, forming Flight Refuelling Limited (FRL) in October 1934. Imperial Airways Limited joined him as a partner, and the company set about developing fuelling techniques for use with the S.23 and

4 Operations

S.30 Empire 'Atlantic' flying boats. Later still in 1937, Shell replaced IAL as Sir Alan's partner as more workable arrangement.

Various methods were tried to establish contact between the two aircraft in a flight refuelling exchange. The RAE method (Patent 460 843 February 1937 in the names of R.L.R. Atcherly and Interair), the receiver aircraft, quaintly named in the patent as the 'calf', streamed a 100 metre long line behind it, ending with a small grapnel. The tanker - or 'cow' - trailing a similar line behind it, flew a track at an angle across the rear of the receiver, and slightly above it. The two lines made contact by crossing, then sliding over each other until the two grapnels hooked together, establishing contact between the two aircraft. The lines could then be hauled aboard the tanker by a winch. The grapnel on the end of the line from the 'calf' was disconnected and the line hooked on to nozzle of the tanker's hose. The refuelling hose was then paid out from the tanker, as it was hauled aboard the receiver and connected to the receiver's fuel system. The transfer of fuel was then made by gravity. When the transfer was complete, the hose was disconnected from the 'calf' and wound back into the 'cow'.

This method was demonstrated at the 15th. RAF Display at Hendon in 1934, when Vickers Virginia J 7275 (Flt.Lt. E.A. Healy) refuelled Westland Wapiti K 1142 (Flt. Lt. S.R. Ubee). The same method was also tried out by Sir Alan Cobham's team but they considered it to be potentially dangerous. At the vital moment of contact between the two lines, the tanker pilot was unable to see the receiver aircraft, which was behind and slightly below him. As the two aircraft were close together, the risk of a collision in bumpy weather was high.

Alan Cobham's team evolved and patented an alternative method which they considered to be safer. The patent (432 908 in the name of Cobham Aviation Ltd.) was applied for in February 1934. The receiver approached the tanker from below and stayed in that position, immediately below and slightly astern, during the whole time of the contact and transfer. The pilot of the receiver aircraft had the tanker in his full view above him during the vital moments of the operation and was first tried out using two de Havilland DH 9s.

When the Air Ministry reviewed the development of flight fuelling by the rival organizations, it concluded that the RAE flight team at Farnborough should give way to FRL. It was agreed that Service aircraft should be made available to FRL for use as tankers, starting with the handover of two Vickers Virginias. Various aircraft were suggested as tankers, a Boulton and Paul Sidstrand was one, followed by a Fairey Hendon and a Handley Page Heyford III (K 5184), both of which proved to be quite useless as tankers. The pair of ancient 'Ginnys' were eventually replaced by two of the contenders offered for the C26/31 bomber-transport specification. The Armstrong Whitworth A.W.23 K 3585 (Whitley prototype) and the Handley Page HP.51 J 9833 (Harrow prototype) were fitted out for flight refuelling. The Harrow was to become FRL's preferred tanker aircraft.

FRL's technique for establishing contact between the receiver and the tanker aircraft is described in detail in Patent 508 220 - applied for on 5 January 1938 - reversing the previously developed procedure. The receiver proceeded steadily on course at the rendezvous, while the more complex flying was done by the tanker. This arrangement was better suited to regular airline service as the crews of the receiver aircraft required little training and the tanker crews could be specially trained for their part in the refuelling work. The refuelling hose originated on the underside of the tanker at its approximate centre of gravity. When the contact had been made, as the tanker was above and to one side of the receiver, the hose was connected to the extreme tail of the receiver, so that the refuelling hose never passed over either aircraft.

For the tests, the A.W.23 was hermaphroditically equipped to operate both as tanker and receiver. It was modified, as a tanker, by installing a transfer tank with a capacity of 900 gal. (4 050 litres) in the fuselage, a hose drum - mounted on the port side of the bomb bay - and a hauling line winch for the contact line. The hose drum projected about half way into the airstream and was wound with 150 ft. (46 meters) of 1 1/2 in. (38 mm.) diam. rubber hose, arranged to unwind forwards. The hose was wire wound externally, bonded at one end to the tanker's drum and at the other end to the nozzle. Forward of the hose drum, and on either side of the centreline, were two openings in the floor of the tanker's fuselage. The smaller, on the port side was for the steel wire contact line, with a bracket fixed immediately below to secure the hose nozzle. The larger, on the starboard side, allowed the winch operator to reach out to remove the weight from the receiver's hauling line, when it came up to the tanker's contact line opening.

The tanker's contact line ended with a latched hook fixed at the tip of the leading edge of the tanker's port mainplane. The patent drawing shows the line being led back from the wingtip to a quick-release on the centre line of the underside of the fuselage, at a point about mid-way between the trailing edge of the mainplane and the leading edge of the tailplane. This arrangement ensured that the contact line did not foul

4 Operations

either the airscrews or landing gear of the tanker. From the quick-release, the line was led forward again to the opening in the floor of the fuselage, and passed over a roller to the winch inside the aircraft. The HP. 51 was equipped for tanker operations only.

The equipment fitted in the Short Empire 'boats was somewhat simpler. The extreme end of the tail cone, aft of Frame 51, was modified to take the refuelling cup (Patent 491 953 10 December 1936) with spring-loaded locking claws around the periphery of the cup. The locking mechanism on the Empire 'boats was hydraulic operated by a manual pump, connected through a pressure release unit. The hydraulic system was designed to break the locking arrangement if the force on the hose exceeded a pull of 1 000 lbf. (4.4kN). Transfers in bumpy or gusty weather could cause the hose nozzle to momentarily break clear of the receiver cup. Methyl bromide fire extinguishers were provided. Nitrogen gas bottles were included in the equipment to flush the hose through the claw holes in the refuelling cup. The total weight of the refuelling equipment was about 100 lb. (45 kg.).

300 ft. (91 m.) of 10 cwt. (5 kN) steel wire hauling line was wound onto the drum of the receiver's winch. The first 75 ft. (23 metres) of line on the drum was of lighter gauge than the hauling line to act as a weak link. The winch was geared with a ratio of 1:5 for easy operation and fitted with a brake lever. The whole assembly was mounted inside the flying boat's hull on the refuelling platform, just forward of Frame 41. The lead weight (7.25 kg.) and grapnel attached to the end of the hauling line were housed in the refuelling cup until streamed to make contact with the tanker. As the weight could become jammed in the refuelling cup, the S.30 'boats were fitted with a small hatch cut into the underside of the hull, immediately below the cup, to allow the winch operator - normally the First Officer - to lean out to dislodge it with a special crook. Look-out windows were fitted in place of hull plating in the top of the hull, between Frames 40 and 41 on the starboard side and between Frames 42 and 43 to port. Light signals communicated between the winch operator and the pilot. A switchbox with three switches, numbered '1' WHITE - *'Tanker in sight'*, '2' GREEN *'Ready to receive'* and '3' RED *'Emergency'*. The pilot had a similar switchbox on the Control Deck, switching OFF to acknowledge.

The first series of contacts were over Southampton Water. The Empire 'boat took off, climbed to the agreed height and was flown straight and level at speeds of between 104 knots and 140 knots, depending on wind and weather. The winch operator paid out the weighted hauling line from the winch, so that the line streamed out behind the 'boat in a catenary, curving down under the influence of the weight and grapnel. The A.W.23 tanker, having made the rendezvous, closed up behind and below the 'boat, manoeuvring to bring the leading edge of its port mainplane in contact with the hauling line. Once contact had been made, a slight turn to starboard by the tanker caused the hauling line to slide outwards along the leading edge, to the latched hook at the wing tip. As the turn continued, the line latched in the hook and at the same time caused the hook to pull free off the wing, with the two lines now engaged.

Sparking from static electricity was a potential danger. The electrical potential of the two aircraft was continually changing and differences of up to 40 000 volts had been recorded by Cobham's team during their experiments. If any sparking took place as the lines came into contact, it was better that it occurred in mid air, well away from either aircraft and before any fuel was transferred. As both the lines were of steel wire, the contact effectively bonded them, and the two aircraft, together before any fuel was flowing.

Contact made, the tanker climbed to the transfer position, about 75 ft. above the Empire 'boat and a wing span to starboard. When the tanker was in the correct position, the quick-release was operated by the tanker pilot, freeing the tanker's contact line for the tanker's winch operator to start hauling in the engaged lines. When the weight on the end of the receiver's hauling line was within reach of the tanker's winch operator, he reached through the opening in the floor of the fuselage, detached the weight and grapnel and re-attached the receiver's hauling line to the hose nozzle by means of a bayonet fitting. At a signal, the winch operator in the Empire 'boat would start to wind in, the brake on the tanker's winch was released and the hose drum in the A.W.23 tanker allowed to unwind. The weight of the hose and about 75% of the drag - between 100 lb. to 400 lb. or 445 N to 1 800 N - was taken by the tanker.

The two first generation long-range Mark III S.23 'Atlantic' aircraft - 'HM CALEDONIA and 'UV CAMBRIA - were intended for flight refuelling, although only 'HM CAMBRIA seems to have been so equipped. During the trials that started in January 1938, UV CAMBRIA (Captain A.S. Wilcockson) was refuelled by the A.W.23 (Flight Lt. G.A.V. Tyson of FRL) in daily contacts over the Southampton area. The contacts were made in fair weather and foul, in storm, rain and cloud and at all heights between 200 ft. to 4 500 ft. The A.W.23, from the FRL base at Ford - still in its RAF livery - arrived at the rendez-vous every day, to meet 'UV CAMBRIA from the IAL base at Hythe. Fourteen tests were flown, the first being a 'dry' run when no fuel was transferred. The amounts of fuel passed between the aircraft varied between a

4 Operations

minimum of 60 gal. (270 litres) to a maximum of 440 gal. (1 980 litres). On two occasions, 'UV' was ballasted up to the normal maximum take-off weight of 40 500 lb (18 370 kg.), with 2 000 kg. of sand in sacks. The test transferred 450 gal. (2 025 litres) of fuel in the air, bringing the Empire 'boat's weight up to the overload condition of 44 800 lb. or 19 910 kg. This was above the safe alighting weight, so the 2 000 kg. of sand ballast had to be laboriously dumped out of one of the passenger hatches, sack by sack, before alighting. The extra fuel was jettisoned. Later in the same year, a contact was made between the same two aircraft at 11.00 every morning through the month of June, to demonstrate that regular working to time was feasible.

The A.W.23 proved to be too slow for the Empire 'boats. When looped together by the hose, the speed of the two aircraft dropped as low as 80 knots, causing the flying boat to wallow. Other tankers were proposed. 'HK Maia' was suggested for the Azores-Bermuda sector. Handley Page HP. 42s - also too slow - Armstrong Whitworth Atalantas and the S.23s themselves, were all suggested. In the opinion of the FRL pilots, another Empire 'boat would have made the best tanker although exactly how this was to be done was not explained.

However, it was not until the first of the Handley Page Harrows (K 7027) was delivered to FRL - registered by FRL as G-AFRL on 6 March 39 - that a really effective tanker aircraft became available. FRL's fleet of Harrows grew to three, before the outbreak of World War II put an end to flight refuelling operations for the Atlantic air mail service. One aircraft was stationed at Shannon, the others in Newfoundland.

The normal operating crew of a Harrow tanker was one pilot and two winch operators. As with the A.W.23, the hose reel, with its 175 ft (53 m.) of 2 in. (50 mm.) diam. hose, was fitted in the floor of the fuselage, slightly ahead of the centre of gravity. The hose was led forward over a guide roller to its stowed position, immediately under the pilot's seat. The contact winch was just forward of the guide roller. The fuel carried for transfer was 960 gal. (4 320 litres). Two 125 gal. (563 litre) transfer tanks were fitted in the fuselage and the balance of the transfer fuel was held in five 142 gal. (639 litres) wing tanks, arranged along the plane of the aircraft's centre of gravity. An additional 150 gal. (675 litres) fuselage tank provided fuel for the tanker. A tank holding 500 litres of nitrogen gas was available for purging the system.

A considerable part of the skin plating on the port side of the Harrow's fuselage was replaced with transparent sheeting in the vicinity of the transfer apparatus - with apertures for the line throwing gun aft of the wing and for the signalling flags near the winches. Surprisingly, radio contact between tanker and receiver was not possible, as the tankers did not carry full radio equipment although they were fitted with direction finding loops, so that they could home onto the Empire 'boat to establish contact in marginal weather conditions. Communication between the tanker and the receiver during the refuelling operation was by flags, carried by both aircraft. A RED flag indicated 'Emergency', ORANGE 'Transfer of fuel completed', GREEN 'Ready for transfer' and a chequered BLACK and WHITE 'Break-away'. Flags were flown by rolling them up on the staff, pushing them out into the airstream and releasing them with a twist.

The method of contact was changed from the wing tip hook, to one by which the tanker's hauling line was fired across the receiver's hauling line by a hand-held line-throwing gun. The Greener cavalry gun - designed in 1880 - was adapted to fire a grapnel attached to the end of the Harrow's hauling line, coiled on a Schermuly rocket cable drum. Sir Alan Cobham in his book 'A Time to Fly' records '*That the recoil of this ancient gun practically threw its operator overboard when we tried it in a Virginia, but a little practice soon made this a very reliable technique.*'

The Empire 'boat flew on course to the rendezvous at the agreed height, straight and level. As the Harrow approached, the winch operator alerted the pilot - Switch '1' ON WHITE 'Tanker in sight' and started to stream the hauling line. The tanker took station slightly behind and below the Empire 'boat, on its starboard quarter. When the 'boat's hauling line had been fully streamed, the Harrow would adjust its height so that it was just above the weight on the end of the line. The Greener line-throwing gun was then discharged, so that the contact line shot ahead and across the right in the Empire 'boat's hauling line and as it was blown back, the lines came in contact with each other. The grapnels at the end of the lines engaged, establishing contact. The connected lines were then hauled in to the Harrow, the Empire 'boat's hauling line transferred to the hose nozzle and the hose allowed to unwind as before. The hose was then wound in by the First Officer, acting as winchman in the Empire 'boat. The nozzle was hydraulically locked home in the refuelling cup, the main cock turned ON, Switch '2' GREEN 'Ready to receive' turned ON and the GREEN flag flown - acknowledged by a GREEN flag from the Harrow. Purging of the system with nitrogen gas began. The fuel systems in the Harrow, the refuelling hose and the receiving system in the Empire 'boat were completely flushed through with nitrogen gas to prevent risk of fire caused by a spark generated by

4 Operations

the spirit, as it flowed through the hose. The nitrogen purge was followed by the fuel, flowing by gravity at about 110 gal. per min.(8.25 litre per sec.). If the hose was pulled away from the tail fitting during the transfer, the break was immediately signalled by the chequered BLACK and WHITE flag - usually by the Empire 'boat first and acknowledged by the Harrow. Once the hose was re-connected by hauling the nozzle back in position and locking it home, a GREEN flag from the 'boat would be acknowledged by the Harrow's own GREEN flag.

When the transfer had been completed, the main cocks in both aircraft were turned OFF - signalled by the ORANGE flag. The nozzle was released from the Empire 'boat by operating the handle on the hydraulic pressure release unit. The receiver cup was flushed with methyl bromide gas and the hauling line allowed to unwind to its full extent as the winch operator in the Harrow wound in the hose. The final break was made by the Harrow turning away to break the connection at the weak link on the Empire 'boat's hauling line, well away from any petrol vapour and, should there be any sparking from static it would be harmless. In all the refuelling operations carried out by FRL and IAL, no sparks were ever seen.

The average time for the contact and transfer was about fifteen minutes - three to seven minutes for making contact, five minutes to haul down the hose and seven to eight minutes for the transfer of the fuel, averaging about 800 gal. (3 600 litres).

The S.30 'boats 'CU CABOT, 'CV CARIBOU, 'CW CONNEMARA and 'CX CLYDE were fitted with M1 fuel systems with durations of some 19 hrs. 16 min. but only 'CU CABOT and 'CV CARIBOU were fully equipped for flight refuelling. The North Atlantic series of eight double crossings by these latter S.30 'Atlantic' 'boats, starting on 5 August 1939, gave the crews valuable experience in handling the aircraft and equipment. The estimated cost of a single transfer was £ 460 (PV £ 9 240) for the first year of operation, dropping to £ 270 (PV £ 5 420) for the second year.

As in all pioneering ventures, a number of problems arose. The jettison pipe projected below the hull near the main step. Taking off vibrated the pipe and broke the support, causing the pipe to trail and on one occasion to fracture one of the plates in the planing bottom. The jettison valve was initially troublesome and, until the correct combination of pipe and valve was perfected, the spray of jettisoned fuel was eddying at the main step and washing up the rear of the aircraft as far as the elevators and rudder. On 3 July 1939 the problems were solved when a test on 'CV CARIBOU worked perfectly. The three fuel tanks on the Empire 'boats involved in the flight refuelling operation - the two 280 gal. (1 273 litre) hull tanks and the starboard 380 gal. (1 728 litre) tank - did not fill at equal rates and the fuel from the starboard wing tank syphoned back into the hull tanks. To cure this unforeseen eventuality, sliding valves were fitted to the tank inlets. The hydraulic system to lock the nozzle in the refuelling cup gave trouble and break-aways were not uncommon. The first Atlantic air mail service - North Atlantic Westbound 1 -.was flown by 'CV CARIBOU (Captain J.C.Kelly-Rogers) on 5 August 1939 with 454 kg. of mail. 'CV was refuelled at Foynes by the Harrow tanker at 1 000 ft. in full view of the assembled Press. To keep the proceedings in view to allow photographs, the two aircraft were flown on a left hand circular track and, as the Harrow was on the outside, it had difficulty keeping up with the Empire 'boat. Contact was made on the second attempt and there was a break-away when some fuel was lost during the transfer. It was completed in 16 minutes. Of the fifteen transfers during the 1939 North Atlantic trials - NAE 1 was not flight refuelled - nine were 'good' or 'satisfactory' although fuel got into the hull of the receiver in varying amounts on five occasions. IAL thought that the tankers tended to get too high, perhaps to increase the pressure head and shorten the time for the transfer of fuel but FRL considered that any problems that arose were due to the 'boats not being properly handled. At least one contact and transfer was made with the Empire 'boat on automatic pilot

Maintenance

No. 5 Division grew in strength as the Empire 'boats were progressively delivered to Imperial Airways Limited. Their maintenance and overhaul then became the responsibility of the Engineering Department, overseen by the Engineering Superintendent. Overall control was in the hands of IAL's Chief Engineer.

IAL's main engineering base was the former Vickers Supermarine Works at Hythe, 4.4km. south of Southampton, on the south west shore of Southampton Water. The Supermarine Works were bought by the Air Ministry in 1938 as a temporary home but, like so many temporary arrangements, it was neither temporary nor satisfactory. The Works served first IAL and later the British Overseas Airways Corporation, until it closed on 31 March 1948 - after the dismemberment of thirteen of the surviving BOAC Empire 'boats.

The hangars were of World War I vintage, the largest being 500 ft (152 m.) long X 155 ft. (47 m.) wide with 33 ft. (10 m.) headroom. This proved inadequate, so an additional hangar, 200 ft. (61 m.) long X width unknown, was built opposite in 1939. The general inadequacy of the working and hangarage arrangements meant that maintenance of the 'boats took longer than necessary. The maintenance staff worked two shifts from 06.15 to 14.15 and 14.30 to 20.30. A Meteo. Station was formed at Hythe in 1937 to serve the Empire Air Mail Programme with full observation and charting services, staffed by three Technical Officers and two assistants with the information broadcast through Portsmouth (GEN) radio. Finally Hythe was classed as a Public Customs Seaplane Station.

Other IAL maintenance bases were established at Alexandria, Kisumu, Durban, Karachi, Calcutta and Singapore. QEA built a maintenance base at Rose Bay on Sydney Harbour and TEAL's base was at Mission Bay, Auckland. Durban later became the main base for the Horseshoe route. By the time it closed at the end of Horseshoe operations, the base was extensive and covered passenger handling and the whole range of workshop activities.

The Captain's Daily Report noted details of the trim of the aircraft, the functioning of the instruments, and the operation of each of the engines. The Radio Officer's page of the Report noted any shortcomings of the sets, the D/F loop and the motor generator. The four engine Tel-Tachometer discs accompanied the Report. The aircraft was inspected by an AID inspector who made his own observations on the Daily Report before passing it to Foreman-in-charge of the Running Shift, which was to carry out any repairs and adjustments. As each item requiring attention was completed, it was checked off.

The Daily Check was carried out on the water by an 'A' Licenced inspector. The hull was checked for cuts, scrapes, corrosion and 'flats' between frames from a dinghy or tender. Cuts and scrapes in the skin plating up to 30% depth were acceptable but if deeper, the plate was marked for replacement. The windows, ports and hatches were checked for security and watertightness. The undersurface of each mainplane and tailplane were checked visually. Floats were visited and examined for damage - especially around the nose. The bilges were dipped, pumped out with the Enots portable bilging pump if required. The handhole covers on the top of the floats, the chassis struts and stays were visually checked.

The interior was inspected from nose to tail on both decks. In the mooring compartment the inspection included the mooring hatch, the retractable mooring bollard with mooring cable secured on the slip line, the anchor stowed, the eyelet on the end of the rope anchor cable ready to slip over the bollard, the drogues and drogue lines stowed in their containers, the spare wire rope storm pennant in it's stowed position, and the boat hook and fenders ready for use.

The visible internal structure of the hull in the mooring compartment and aft of the passenger accommodation was inspected for the general condition of the frames, plating and intercostals. Any work carried out on the frames and intercostals required a 'B' or AID licence.

The passenger cabins were inspected in turn for general cleanliness. Lap straps and seat upholstery, curtains and carpets were checked for condition, the cold air punkah louvres closed, the correct time on the bulkhead clock, the heating thermostat set at 20 deg.C. and the heating switch turned ON, if required for the next forward sector. The emergency ladders, lighting and call systems checked for correct operation. Hull bilges were dipped and pumped out with the Saunders bilging pump if necessary. 5 to 10 gals. (22 to 45 litres) of water was considered admissible but when the volume of bilgewater approached 50 gals. (225 litres), remedial work to the planing bottom was indicated. In any case, the inspection traps to the bilges were opened up at least once per week.

Doors and hatches were checked for proper working and locking. Windows and ports in the cabins checked from inside and the push-out windows to see if they were easy to operate and clearly marked.

5. Maintenance

The lavatories were checked for cleanliness, that the toilet paper packs were full (with a spare), that the lavatory floor drains were clear and that the shared water tank between the lavatories was full (5 gals. or 22.5 litres). The pantry was checked to see that the water tank was full (5 gals. or 22.5 litres), that the first aid kit was complete, that the emergency rations were in place and that the push buttons for the Steward's call system were working and that the indicator lights on the indicator board were all OUT. The stowage and operation of the fire extinguishers throughout the 'boat were checked.

The freight nets, webbing straps and duck boards in the rear freight room were checked. The general condition of the exposed parts of hull - frames, plating and intercostals - was examined and any damage marked for replacement. Where visible, the control cables were lubricated (or greased), especially the thrust race at base of rudder. Control cables with not more than two broken strands were passed.

On the upper deck, the previous Daily Report was read and noted. The filler for the heating system was checked - the distilled water was up to the RED line, the handles of the air supply valves were in line with the ducts and the removable filters in the air ducts, clean. If fuelling had been completed, the contents of the fuel tanks could be read off from the Telelevels (or Korect) gauges.

The windscreen and the direct vision panels of the coupé, and the ports were examined for defects, operation and cleanliness. The instruments on the dashboard were checked for operation and security. The pilot's seats and lap straps were inspected, the control lock removed and the flight controls tried hard over each way, and the lock replaced - ailerons and rudder NEUTRAL and the elevators fully DOWN.

The oil levels of the Exactor transmitter controls for the throttle and mixture controls in the throttle box were checked on the sight gauges and topped up, as required, through the plug on the transmitter unit. The hydraulic fluid mixture was one part DTD 44/C Flowex E or Shell No 1 anti-freezing oil to two parts of kerosene. 'Spongy' operation at the end of a stroke indicated air in the pipeline which required bleeding. The pipe at the receiver was disconnected and, using the transmitter as a pump, the oil was pumped through until it was free of air bubbles. The bow and wing searchlights were turned ON-OFF and the bow searchlight moved OUT - UP and DOWN - IN. The flaps were run to the FULL OUT position for inspection from the mainplanes. The elevator and rudder trimming tabs were tried in both directions. The bunting was checked for a full complement.

The engine and airscrew check was carried out from the mainplanes. The inspector gained access via the ladder on the Control Deck and through the escape hatch to the top of the hull, complete with a small tool kit. The pitot head covers should have been off and the heads, clean. The mainplanes were examined for damage, that the inspection covers over the control runs were in place and screwed up and that the navigation lights covers and attachments were secure. The ailerons and flap guides were inspected for condition and the flap runners on the extended flaps greased if required. The metal and fabric surfaces of the rudder and elevator were examined and checked for excessive play and damage. Any signs of corrosion to the aileron levers, hinges and controls was noted and the trim tab hinges lubricated as required. The flaps were brought inboard.

To open the maintenance platforms on either side of an engine, the centre screw of the cover was unscrewed to free it - circular covers for the S.23 'boats and Sunderland type for the S.30 and S.33 'boats. The hand wheels, visible inside the mainplane, were unscrewed and pushed backwards to free the retaining hooks to allow the platform to be opened forwards. For access to the lower cylinders of the engines, and for the removal of the airscrews, extension ladders - interchangeable between platforms - were fitted into castings on the edges of the platforms. Planks were then placed between the ladders, allowing full access to the engine and airscrew. Safety belts and harnesses were provided for use when un-shipping an airscrew, secured to eyebolts screwed into threaded inserts in the nacelles.

Obvious fuel and oil leaks were noted. In turn, the engine cowling panels were removed - a 'C' licence was required for engine inspections - to check the throttle and mixture controls and the operation of the air intake shutter, the fuel filters cleaned and the tightness of all the main nuts and bolts checked. The spring loaded slow running cut-out controls were operated from the Control Deck to see that the weights were free. The valve springs on each piston of the Pegasus engines were examined to ensure that they were all intact and the spark plugs to cylinders 4, 5, 6 and 7 were removed, cleaned and replaced. The H.T. leads were checked over and the connections to the spark plugs secured. If not already done, the new Tel-tachometer discs were inserted. Engine maintenance was more difficult on the medium and long range 'boats with the double oil tank arrangement as it meant that the engine had to be swung out to replace or repair an oil tank.

The engine cowlings were replaced and the blades of the airscrews checked for scratches and dents, slight damage being removed by scraping or filing and polishing. Airscrews were checked for tightness on the

5. Maintenance

hub and the hub itself tight on the shaft and correctly locked. The maintenance platforms were then closed. Each platform was fitted with two micro switches, connected into the engine starting electrical circuit so maintenance platforms had to be screwed up tight - engaging the switches - before the adjacent engine could be started.

With the gills OPEN and airscrews in FINE pitch, the engines were started in turn. When the oil temperature was up to 15 deg.C. and with the mixture in NORMAL, the throttles were opened up fully for not more than ten seconds and the boost checked by moving the mixture levers to RICH and back to NORMAL. Throttling back to 1 500 rev. per min., the magnetos were checked and the airscrews changed from FINE to COARSE and back to FINE, out-of-balance airscrews producing a characteristic rhythmic beat. Engine acceleration was checked for flat spots and the engines for rough running and then throttled back to 500 rev. per min. to check the slow running. The maker's instructions for the pre-flight checks on the automatic pilot were carried out while the engines were running. Before shutting an engine down, it was throttled back, the magnetos turned OFF and the cut-off levers pulled OFF. The cowling gills were CLOSED. The engines were checked again for fuel and oil leaks, the airscrews for tightness and the oil filters examined for metal particles.

The oil tank filler cap doors on the nacelles were secured and the oil tank circulating chamber and dipstick doors on other side of the nacelles opened up, the caps unscrewed and the tanks dipped. The fuel tank filler cap covers were checked for security and the rain plugs fitted to the exhaust pipes.

If required for a service, Kilfrost anti-icing paste was applied by brush or palette knife to the leading edges of the mainplanes, aerial mast, tailplanes and fin. Kilfrost was also smeared on the joints of the servo and trim tabs on the rudder and the trim tabs on the elevators, the noses of the floats and the leading edges of the float chassis struts. The Daily Certificate for flight could then be signed.

There is some variation in the literature in the intervals between in-service checks and the type of check but they were of the following order and mostly apply to the Pegasus engined 'boats:

10 hour engine check. A normal Pegasus engine check included a compression check, spark plug check, fuel filters cleaned, valve clearances checked and re-set, engine sump filters removed, cleaned and replaced and exhaust system checked, magnetos examined and contact breakers cleaned. With airscrews in COARSE, the airscrew hub nipples were lubricated with Mobile No. 2 oil, the exposed cylinder greased, the counterweight bearing caps were removed and the bearings greased and hubs checked for oil leaks. S.30 'boats with Bristol Perseus sleeve valve engines avoided this part of the maintenance work.

20 hours engine and airframe check. A 10 hour check and in addition, Pegasus engine cylinder rockers, brackets and upper ends of push rods were inspected and rocker adjusting screws lubricated. The spark plugs were removed, cleaned and replaced, the compression was checked, the magneto contact breakers examined and gaps re-set. The fuel system was flushed out, the pipes replaced and wire locked and the controls adjusted. The passenger and freight compartments were inspected.

The 20 hour and subsequent checks required the 'boat to be beached. It was towed to the end of the slipway and moored by the head until conditions were right for beaching. On Southampton Water the best time was at high water. The Hythe slipway, part concrete and part timber, 725 ft.(221 m.) long X 198 ft. (60 m.) wide was long enough, and the area dredged sufficiently, for an aircraft to be beached at any time, except dead low water and one hour either side of the spring tide highs. The slipway mooring was out of the run of the tide, which made handling easier but a watchful eye had to be kept for the movements of the larger ocean liners, as their wash could cause difficulties at crucial moments during the beaching. Winter conditions, strong winds at any time of the year and night time operations were added complications.

A beaching crew normally consisted of a chargehand and six seamen. The beaching chassis was attached whilst the 'boat was on the slipway mooring. The two beaching legs were run down the slipway into the water, running on their main wheels and the transport wheel, main wheels first. The transport wheel was removed and a line hitched to the strut for towing out to the aircraft. In the water, the struts floated in a wheels-down attitude with the strut at an angle of 60 deg. When brought up to the hull of a 'boat, the wheels were under the hull. The strut was taken alongside and the attachment pins on the outriggers inserted in the holes in the hull at the spar frames - Frames 15/16 and 20/21. These holes were normally sealed with watertight plungers which could be withdrawn from inside the 'boat. The withdrawal of the plungers and the insertion of the pins were arranged to coincide, to prevent any water being shipped. The forward outrigger strut was attached to its pin first, followed by the rear outrigger strut to its pin. A ring

5. Maintenance

bolt was screwed home in its socket in the hull and a 10 cwt. differential chain block and tackle hooked onto the ring. The other end of the tackle was hooked onto the beaching strut and the load was taken up on the chain. One of the beaching crew stood on the top flotation cork of the strut to work the block and tackle bringing the strut upright. As the strut was brought up to the underside of the mainplane by the block and tackle, he inserted the fitting on the underside of the forward truss of the mainplane spar where it was held by two hinged stub pins and locked by a quarter turn. The chain block was removed and the other beaching strut connected in the same way. The average time to beach a 'boat was from fifteen to twenty minutes depending on the weather - particularly the wind - the state of the tide and passing ships.

The hauling-out line was attached to the quick-release hook under the tail, and the 'boat brought round until it was floating in calm water over the slipway, stern towards the land. The tail trolley was floated out and forced under the rear step. The adjustable stub fittings on the trolley were inserted into the receiving eyes in the hull and screwed up by the hand screws. The trolley handle was lashed to the ring bolt on the centreline of the hull and the aircraft was ready to slip.

The 'boat was hauled out by tractor or winch, and directly it was clear of the water, it was hosed down to remove any deposits of salt. The security of the beaching chassis was checked and the 'boat hauled right up the slipway. The maximum allowable weight of a 'boat on the beaching chassis was 39 000 lb. (17 700 kg.). At the top of the slip, a tractor took over to tow the aircraft either directly into one of the hangars, or to park it on the hardstanding outside. With the tail trolley handle freed, a 'boat on the beaching chassis was surprisingly manoeuvrable and could be turned in its own length. The inspection then began.

40 hours engine and airframe check. A 20 hour check and in addition, the control wires and chains, levers. Bearings and pulleys in the mainplanes and hull were examined, cleaned and lubricated. In the cabins, the carpets were taken up and the flooring on the lower deck removed to examine and clean the bilges and re-coat with lanolin. The inspection patches on the rudder and elevators were removed for internal inspection. The ailerons and flaps were inspected, especially the ballraces to the flap guides. The wing float inspection covers were removed and the interior examined, cleaned and re-lanolin. The float attachments, top and bottom, and the bracing wires were checked. The maker's instructions covering the electrical system, generators, bow and wing searchlights were carried out. The heating and ventilating systems were examined throughout, with special attention to the bonding. The engine oil system was drained down and flushed out. The oil filters were checked for metal particles. The oil coolers were drained and flushed. The magnetos were oiled and the distributors cleaned. The carburettor float chambers were drained and cleaned. The Pegasus engine valve spring felt pads were lubricated with DTD 109 oil. The fuel pump bearings were lubricated. The engine boost gauges were inspected and calibrated.

120 hours engine and airframe check. The airframe was checked for alignment - plus or minus 3/4 in. (19 mm.) on diagonals was allowed. All inspection openings and patches on the mainplanes, elevators and rudder were opened up to examine all control runs for wear and corrosion. The solid mahogany servo and trim tabs were examined for oil and water soakage and checked for twist - 1/4 in. (6 mm.) allowable. The fuel and oil pipe lines were checked for chafing and corrosion and fuel tanks were examined from inside the mainplane for fuel leaks and water penetration from the tank cover. The underwater surfaces of the hull and floats were re-coated with lanolin as required. The Pegasus engine cylinder head rockers and felt pads were greased and the Tecalemit oil filter element replaced.

210 hours engine and airframe check. A 120 hour check and in addition a detailed inspection of the hull interior and floats. Spark plugs were changed, the oil system drained and oil tanks inspected. The flying and engine controls were checked for operation.

250 hours engine check. Pegasus engines from EAMS 'boats were removed in rotation and sent to Croydon by road for overhaul. Engines from Horseshoe 'boats were overhauled in Durban and Sydney and the Tasman 'boats in Auckland. The engines were completely stripped, parts cleaned and replaced as required. Crankshafts, airscrew shafts, gear wheels and pump and auxiliary drives were checked for cracks. Early Pegasus engines with floating crankcase bushes could overheat if taxiing was prolonged. With fixed bushes the time between engine overhauls was progressively increased up to 600 hours. The booster coils in the engine starting systems also gave trouble initially and were difficult to service. There were not enough spare engines to distribute along the routes to deal with unserviceability and were initially in such

5. Maintenance

short supply that the four Pegasus XCs engines installed in 'JK Syrinx, rebuilt after its inversion at Brussels, were earmarked for use in the Empire 'boats in cases of dire emergency.

270 hours airscrew check. Airscrews were removed from the aircraft and completely stripped. Blades were examined under magnification for scratches, the hubs dismantled, steel parts subjected to crack detection (iron filings in kerosene on the magnetised part), re-assembled dry, balanced and the blades checked for angle. After balancing, airscrews were stripped down, greased and reassembled. Engines and airscrews could be changed on the aircraft with a lifting derrick fixed to a three point fixing on the top of an engine nacelle screwed into sockets let into the upper flange of the spar boom. An extension beam extended the reach, enabling an airscrew to be removed. The engineer stood on the plank spanning between the maintenance platform extension ladders - a definitely precarious situation - so a safety belt was provided with a harness hooked to eyebolts screwed into sockets on the nacelles.

312 hours engine and airframe check. General hull inspection, cleaning, full and detailed check of the whole of the airframe, engines and electrical equipment.

After inspection, the 'boat was rolled out from the hangar for engine runs, compass swinging and launching. The beaching gear was removed, the 'boat ballasted to take-off weight and moored ready for the test flight.

Spare engines could be carried in the aft freight room. To ship an engine, the freight hatch was fully opened up and the engine transport beam bolted to the underside of the diaphragm of Frame 37, on the centreline of the freight hatch. The beam was braced by a vertical strut on the inboard end, inserted in eye plates in the floor and flange of the beam. Two inclined struts were fitted into eye plates in the beam and screwed to socket bolts in the sides of the hatch coaming. The beam projected beyond the side of the hull enabling the spare engine to be taken inboard from a pontoon or tender moored alongside. The engine was lifted by a Buck and Hickman chain block that ran, attached to a trolley, along the bottom flange of the beam. The engine was secured - airscrew boss pointing aft - in a standard Bristol wooden engine cradle, modified to suit the width of the aircraft's hull, bolted down to the floor with four 5/8 ins. (16 mm.) diam. bolts.

Other inspections were carried out in addition to those mentioned. One of these occurred on 1 December 1942, when two Horseshoe 'boats were sharing the hangar at Congella airport, Durban. 'TX CERES, the third 'boat of the second batch of S.23s and originally equipped with a 1D fuel system - one 326 gal. (482 litre) tank in each mainplane - was on beaching gear and tail trolley undergoing a six monthly fuel tank inspection. Some Horseshoe 'boats had been modified to a M1C system by the addition of two outboard tanks and it seems likely that 'TX was one of them. During the inspection, one of the tanks in the starboard mainplane had the tank cock turned off and the supply line disconnected. Normally, the tank cock was wired in the CLOSED position to prevent accidental discharge of residual fuel in the tank. In this instance, the cock was not wired and fuel escaped into the hull after the supply line had been disconnected. An estimated 34 gal. (150 litres) of spirit escaped into the interior and some 5 gal. (22 litres) got into the bilges beneath the pantry. An inspection lamp on a long electrical lead was in use in the starboard mainplane. There was an explosion in the bilge at 09.00, injuring three of the engineers working on the aircraft. Leading Hand Wiseman and Ground Engineer Vincent were severely burned and Ground Engineer Hornagold, working on the Control Deck above, injured. Mr Vincent subsequently died. The windows of the hangar were damaged by the explosion but 'UE CAMERONIAN, the other 'boat in the hangar was, surprisingly, not affected.

Although the hull of was badly damaged by the explosion and on fire, 'TX CERES was towed out of the hangar by a tractor driven by Charge Hand Speigal, guided by Assistant Foreman A.E.Head on the tail trolley. The nose was crumpled, the aft bulkhead at Frame 33 blown out and the hull wrecked back to Frame 42 - the construction joint with the tail. The mainplanes, complete with flaps were salvaged, sprayed with paint to prevent corrosion, and stored. On 19 February 1943 it was decided to reduce the remains of the hull to produce and sell it for scrap. Later that year, on 31 March, it was suggested that the stored mainplanes could be mated with the hull of G-AFRB - still presumably in its weatherproof crate at Rochester - to complete the 43rd. 'boat but nothing came of this suggestion. 'TX CERES was the twenty-third Empire 'boat to be written off.

7. The Horseshoe Route

The British Government announced its approval of the Empire Air Mail Scheme (EAMS) on 20 December 1934. The EAMS was intended to improve and expand communications by carrying all letter mail within the Empire and the Dominions without surcharge.

The Imperial Airways Limited were to operate the service, flying a partnership of new aircraft, Short 'C' class four-engined flying boats and the Armstrong Whitworth AW.27 'E' class land planes. The 'E' class was intended for IAL's European sectors and the better developed eastern route as far as Calcutta. The flying boats were to fly the remainder of the routes. The partnership was considerably compromised by the late delivery of the AW.27s, victims of the re-armament programme and a constant stream of modifications from IAL. 'SR Ensign, the first of the AW.27s to fly on 24 January 1938, was delivered some two years late. The service lives of the 'E' class were fraught with difficulties. They had to be twice recalled for up-rated engines to be installed and this put a considerable strain on the whole of IAL'S operations. The Empire 'boats, which were delivered more or less on time, took practically the whole strain of flying the EAMS.

The primary function of the Empire 'boats was to carry EAMS and Government mail. Payload not required for mail was available for freight and passengers. Standard Mark I S.23 'boats were intended to carry 1 500 kg. of mail and freight and twenty-four passengers, at a cruising speed of 130 knots for 435 n.m. (800 km.) against a headwind of 35 knots. The seemingly short range requirement was based on the assumption that alternative alighting areas were available on the Southampton to Marseilles sector, and that the 'boats could break the Athens-Alexandria sector at Crete, if necessary. The alternative alighting areas in France were the result of Major Brackley's careful and extensive survey before the EAMS began. The specified range was found to be insufficient in some weather conditions over India in monsoon conditions, and if Lake Bracciano, the port for Rome, was shrouded in cloud. In the case of Lake Bracciano, the Mark I S.23 'boats did not have enough range to return to Marseilles. An alternative alighting area was later arranged on Lake Paola, between Rome and Naples.

At the time of their conception in 1934, the Empire 'boats were expected to have an operational life of no more than ten years with replacements needed by the end of the decade. At the end of 1944, there were sixteen Empire 'boats still flying - eleven S.23s, four S.30s and one S.33, some of them slightly battered and worn but still giving good service. By the end of 1946 there were only fourteen survivors.

IAL's operations on the European and Empire routes were divided into Areas and the aircraft allotted to the four numbered Operating Divisions. A new Division - No. 5 Division - was formed to operate the Empire 'boats and presumably the Ensigns as well. The Division grew in size as the 'boats were progressively delivered to IAL from Rochester, until it finally absorbed Nos. 2, 3, and 4 Divisions. When it had its full complement of Empire 'boats, No. 5 Division was named the Empire Division.

The two main Empire routes were already in existence. Outbound from the United Kingdom, the routes were common to the Kingdom of Egypt, where they branched. One route stretched southwards to terminate at Durban in the Dominion of South Africa. The other lay eastwards from Egypt across the Middle East, Palestine, India, Burma and the Malaysia Straits Settlements and the Dutch East Indies to Australia. The antipodean service was later extended from Brisbane to Sydney and finally across the Tasman Sea to Auckland, New Zealand. The EAMS route distance from Southampton to Durban was 6 348 n.m. (11 680 km.) and 11 113 n.m. (20 448 km.) for the antipodean route to Sydney. Both routes were about 19% longer than their respective great circle distances. A trans-Atlantic mail service was also contemplated and a potentially lucrative subsidiary service, between Bermuda and New York, was to be flown in pool with Pan American Airways. The New York terminal was at Port Washington on the east end of Long Island, alighting on Long Island Sound.

Early in 1935, an Air Mail Division was formed in the Foreign Section of the General Post Office (GPO) in London to handle the outbound mail from all origins in the United Kingdom. More than half the air mail originated in London, where it was collected by 'streamlined' air-mail blue painted Morris Commercial vans from special air-mail blue letter boxes. The one surviving air mail letter box stands on the corner of High Street and St. Albans Street, Windsor, UK, painted a darker blue than the original. As the original specification is still available, the next re-paint of this box should return it to the original, and lighter, colour.

Outbound mail was divided into 'roads', each road representing a destination - a country or group of countries - rather than a route. The mail was sorted at the GPO for road - 68% for the EAMS, 26% for European destinations and 6% for other countries, and then made up into mails. Outbound EAMS mail was dispatched to Southampton by train, to begin its journey to the Empire and Dominions. Each mail was identified by the road and direction. The roads were A - Africa and I - India, which extended to Singapore, and eventually, S - Sydney. The direction of the service was indicated by W for westbound mails, inbound to the UK, E for eastbound to India and beyond, and S and N for the southbound and northbound services to and from Africa. The North Atlantic services were coded NAW or NAE, depending on direction. Each mail carried a serial number.

The GPO contract required IAL to deliver the mail within 24 hours of the scheduled arrival time for full payment. A delivery within 48 hours of the scheduled time, was paid at half rate and if the mail was later than 48 hours, IAL carried the mail for nothing. The rate was 1 penny (p) per ounce (oz) for letters and packets or the equivalent of about 10p. per 10 grammes compared to the present rate of 41 p. per 10 g. in 1995. The rate for postcards was one penny, or 10 p. compared to 35 p. today.

7. The Horseshoe Route

The first EAMS mail was flown by 'HL CANOPUS (Captain F.C.Bailey), then IAL's one and only Empire 'boat, on 30 October 1936, less than two years after the announcement of the Scheme. 'HL CANOPUS lifted the 490th India Westbound mail (IW 490) from Alexandria to Brindisi, from where it went by train to Paris and forward by air, to London.

Langstone Harbour to the east of Portsmouth was to be the EAMS base. The Air Ministry declined to contribute more than 40% of the cost, and as the Portsmouth City Council decided that it could not afford to invest more than its original share, or develop the base alone, the matter was dropped. The use of Southampton Water as a flying boat base was discussed by the Air Ministry and the Southampton Harbour Board in August 1936 and its use sanctioned. An area of Southampton Water, one mile long by 400 yards wide (1.6 km. by 366 m.) off the Royal Victoria Hospital was declared to be the Empire Air Scheme Terminal. Mooring trots were established to the east of the Netley Buoy, on the north side of the main shipping channel. Notwithstanding the marked terminal area, the 'boats usually took off in daylight, where and when they could. This caused some dismay and consternation to the Pilots and Masters of the ocean-going liners and other shipping plying the Water, who considered the flying boats to be trespassing on their exclusive domain. The maintenance base was the former Vickers Supermarine Works at Hythe.

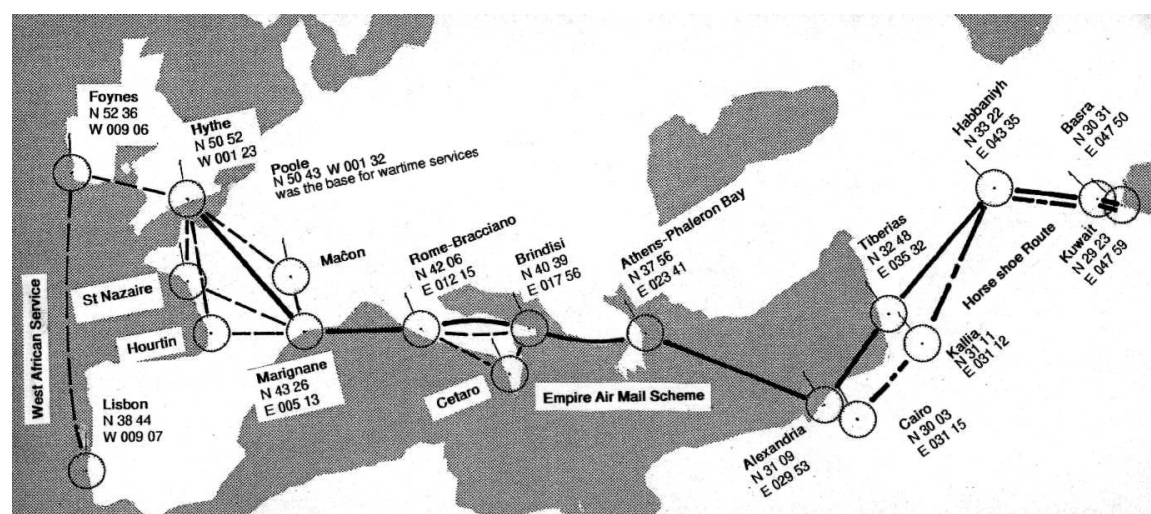

40. The Empire Air Mail Programme from the UK to Egypt.

The EAMS route started from Southampton Water, either at moorings off Hythe or from Berths 101 or 108 at the new Southampton docks. Four routes were used across France for the Southampton-Marignane sector depending on the weather conditions, actual or forecast.

Route 1, the most direct, although not the most frequently used, lay down the eastern arm of the Solent, turning over the Nab Tower to cross the Channel, crossing the French coast to the west of Le Harvre and then down the valley of the River Cher, over the River Allier to the Velay mountains and on to Avignon and Marignane - a distance of 522 n.m. (960 km.).

Route 2, the most easterly route, from the Nab Tower the French coast was crossed at F,camp, thence via Caudebec, Louviers, the forest of Rambouillet, Etampes, Malesherbes, Montargis, Clamency and Maçon for a refuelling stop if required. From Maçon the route turned south to Lyon, down the Rhine valley to Marignane - a distance of 544 n.m. (1 0001km.).

Route 3, one of the two western routes, turning westwards at Calshot over the western arm of the Solent, turning again over the Needles southwards over the Channel. The French coast was crossed between Cherbourg and the lighthouse on Pointe de Barfleur, to the east of the airspace restriction over Cherbourg. The route continued southwards to Avranches, crossing the River Loire near Ancenis, over the Vend,e to pass between Isle de Re, and La Rochelle and over the Isle d' Oleron to the Etang de Hourtin-Carcans for a possible refuelling stop and turning point. The route turned eastwards to Blaye and thence to Libourne, Villefranche de Rouergue and Millau on the River Tarn, over the delta of the Rhine at St. Gilles and then to Marignane - a distance of 641 n.m. (1 180 km.).

7. The Horseshoe Route

Route 4, the most westerly of the four routes started as for Route 3, but the southward leg was flown over Jersey to the west of the airspace restriction around Cherbourg, crossing the French coast at Dinard. The route proceeded south to St. Nazaire - a possible refuelling stop and turning point - and from there direct to Marignane - a distance of 614 n.m. (1 130 km.).

The alighting area at Marignane was the eastern arm of l'Etang de Berre to the north of the land aerodrome, 20 km. north west of Marseilles. Marignane was a normal refuelling stop.

Departure from Marignane was by two routes to avoid the airspace restriction over the Marseilles - Toulon area. One was due south to the limit of the restriction and then eastwards over the Golfe du Lion. The other was due east overland from Marignane to avoid the northern limit of the restriction, crossing the French coast at St. Raphael and when direct for Lake Bracciano. The route crossed the northern tip of Corsica over Bastia and made a landfall on the Italian coast at the estuary of the River Marta - a distance of 303 n.m. (557 km.). Low cloud often made the approach to Lake Bracciano hazardous. When used as a night stop, the passengers and crew were taken by bus to the Grande Hotel de Russie in Rome.

The onward sector from Rome-Bracciano to Brindisi could be flown by three routes.

Route 1, the most direct, departed to the north of the airspace restriction over the city of Rome, climbed to 10 000 ft. over the Monte Simbruini range to pick up the valley of upper reaches of the Sangro river and then to the south of Campobasso. From there the route was direct to Brindisi, avoiding the prohibited zone around the city - a distance of 269 n.m. (495 km.).

Route 2, skirted the restriction over Rome, the 'boats climbing to 4 000 ft. to follow the valley of the River Sacco over Monte Cassino and then in an arc over the Matese mountains to Melfi on Mt. Volture and thence to Brindisi - a distance of 270 n.m. (497 km.).

Route 3, the most southerly and longest, departed to the north of Rome, swung south over Frascati, the Pontine Marches to Formia and Naples for a refuelling stop if required. From the Bay of Naples, the route continued over the headland to Amalfi and out over the Golfo di Salerno to follow the coast to the turning point at Cetaro. From Cetaro the route turned north-east over the waist of Calabria and the Golfo di Taranto to Brindisi - a distance 349 n.m. (642 km.).

The sector from Brindisi to Athens followed two routes.

Route 1, slightly the longer route, proceeded direct to the eastern end of the Gulf of Corinth at the entrance to the Corinth Canal and then turned slightly eastwards to Athens - a distance of 319 n.m. (586 km.).

Route 2, diverged before the island of Corfu to fly down the western coast and swung in an arc to the south across the island of Levkas and the north coast of the Peloponnese to the Corinth Canal and Athens - a distance of 310 n.m. (571 km.).

The alighting area for Athens was on Phaleron Bay with an alternative at Megalo Pefko. The first normal outbound night stop was made at the Hotel Grande Bretagne on Constitution Square. The route from Athens to Alexandria was across the islands of the Cyclades direct to Alexandria. The 'boats sometimes diverted to, either to Cape Ayios Ioannis to the north of Mirabella Bay for a refuelling stop if required, and occasionally at Suda Bay in the west of the island - distance 196 n.m. (361 km.). The IAL depot ship the MV *Imperia*, commanded by Captain Francis Grant Poole, had been anchored in Mirabella Bay since 1929 to act as a radio and meteo. station. The water in the Bay had a reputation for being exceptionally clear, making it difficult to judge heights when alighting.

From Crete the route lay direct to Alexandria. Departing Mirabella, the route was across the narrow neck of land between the Sitia and Dhikti mountains - the legendary birth place of Zeus where he was suckled by the she-goat, Capella. The departure from Suda Bay was eastwards to round Cape Dhrapanon, then south over the island between the mountains and out over the Mediterranean to Alexandria - a distance of 315 n.m. (580 km.). The 'boats alighted on the East Harbour, sharing the anchorage with the Royal Navy Mediterranean fleet. After Customs formalities, the passengers were night stopped at the Hotel Cecil.

'HL CANOPUS (Captain F.C.Bailey) departed Alexandria on 30 October 1936 for Brindisi, via Mirabella and Athens with IW 490 mail on board, returning on 2 November 1936, with the first eastbound service and remained in the Mediterranean to fly the Alexandria - Brindisi sectors until January 1937.

'HM CALEDONIA, the first Mark III S.23 'Atlantic' 'boat, was the next to be launched at Rochester, followed by the two Mark II 'Bermuda' 'boats, 'UT CENTAURUS and 'UU CAVALIER, both with medium range fuel systems

7. The Horseshoe Route

suitable for the New York - Bermuda sector. 'UU CAVALIER was chosen in place of 'UT CENTAURUS, the original 'Bermuda' boat, to be dispatched to Bermuda on board SS *Loch Katrine*, dismantled in a score of packing cases, arriving on 30 December 1936.

IAL's flying boat operations on Southampton Water started on 13 December 1936, when 'UT CENTAURUS departed with India Eastbound (IE 505) mail for Alexandria. 'UT then joined 'HL CANOPUS in the Mediterranean, as IAL's second revenue earning Empire 'boat. 'HM CALEDONIA joined in the effort to move the Christmas mails, and demonstrated its long-range performance by taking 5 588 kg. of mail from the UK to Alexandria, via Marseilles and Brindisi. The fifth delivery from Rochester, 'UW CASTOR, was launched and delivered before the end of 1936, bringing the fleet at the end of the year to two Mark Is and one Mark II on the UK - Alexandria route, one Mark III 'Atlantic' boat and the other Mark II in Bermuda. The introduction of the EAMS proceeded apace. In January 1937, the rail terminal was diverted from Brindisi to Marseilles. On 1 January, 'UT CENTAURUS arrived at Marseilles from Alexandria with AN 407 mail, inaugurating the Marseilles - Alexandria sectors of the route. The three S.23 'boats maintained the Mediterranean service until the beginning of February, when a scheduled two-day service from Hythe to Alexandria started.

The schedule for a typical flight to Alexandria was:

London (Waterloo)	dep. 19 30 (all times local)
Southampton	arr. 21 28 (night stop)
Southampton	dep. 06 00
Marseilles	dep. 12 25
Rome	arr. 16 15 (night stop)
Rome	dep. 07 15
Brindisi	dep. 10 00
Athens	dep. 14 10
Alexandria	arr. 19 00 (night stop).

The first through service from Southampton to Alexandria was flown by 'UX CASSIOPEIA (Captain G.J.Powell) on 26 January 1937, taking thirteen passengers and 762 kg. of AS 417 mail. The cross flight was made by 'UW CASTOR bringing in AN 416 mail on 4 February 1937. The regular service had begun with four S.23 'boats. 'UW CASTOR (Captain H.W.C.Alger) inaugurated the eastbound service on 6 February 1937, taking off at 11.47 with eight passengers and 1 250 kg. of IE 521 mail - some of which was to go forward to Australia - only to return with oiled spark plugs at 12.11. Hundreds of spectators, some of whom had been brought in by four special trains from London, witnessed the event that demonstrated some of the difficulties with which the IAL crews had to contend. Surprisingly, neither KLG nor Lodge admitted to supplying the plugs. 'Castor oiled' was the headline in one newspaper. Bad weather set in, so 'UW did not get away until 8 February 1937.

An agreement between Great Britain and Australia, lasting fifteen years, consented to the use of the Empire 'boats. Either side had the right to terminate the agreement within two years and withdraw, should the aircraft prove unsatisfactory.

On 18 February 1937, 'HM CALEDONIA flew direct from Hythe to Alexandria in 13 hrs. 44 min. at an average speed of 148 knots (272 km. per hr.). 'UU CAVALIER was test flown on the next day in Bermuda. Regular two-day services between the UK and Egypt began on 24 February 1937. The last westbound Empire service to be flown by a land aircraft arrived at Croydon Airport from Africa at 11.45 on 4 March 1937. The next day, Friday 5 March 1937, IAL opened the base at Hythe on Southampton Water. 'UY CAPELLA departed with IE 528 mail and from that day onwards, all the EAMS mail outbound and inbound to Southampton, was flown by the Empire 'boats. The mail was trans-shipped at Cairo into land aircraft for the remainder of its journey, eastwards or southwards.

Once the UK - Egyptian service was established, the EAMS expanded in three phases. The first opened the route to South Africa. The initial sector of the southbound route from Alexandria to Cairo lay across the delta of the Nile, a short 96 n.m. or 177 km. sector, alighting on the River Nile at Rod el Farag. Hot, dry winds, the Khamsin, occurred when low pressure approached the North African coast with a region of high pressure centred over Middle Egypt. The next short sectors over the lower reaches of the Nile followed the course of the river to Juba, the first being to Luxor - a distance of 313 n.m. or 576 km.

The next sector was to Wadi Halfa - a distance of 261 n.m. or 480 km. This was followed by an overland sector to Khartoum, bisected by the River Nile at the 4th.cataract (431 n.m. or 793 km.). Khartoum was the junction with the IAL service to Lagos via Fort Lamy. Night stops were made at the Grand Hotel. Between Khartoum and Lake Victoria, when a strong southerly was blowing at lower levels, a moderate north-easterly wind was available above 7 000 ft. If a strong northerly wind was blowing at low level, comparative calm existed above 8 000 ft. The distance from Khartoum to Malakal was 356 n.m. or 655 km. The next sector was to Juba, a distance of 274 n.m. or 504 km.

7. The Horseshoe Route

From Juba, boats flying to Port Bell diverted, if conditions permitted, for a low pass over the Murchison Falls where the Victoria Nile thunders through a gorge six metres wide with spectacular results, on its way south to Lake Albert. Violent storms occurred during the rainy season on the sectors from the north of Khartoum to Juba and at any time between Juba and Lake Victoria. The sector distance from Juba to Port Bell was 280 n.m. or 515 km.

Passengers crossing the equator for the first time, on the African service over Lake Victoria (E 030 deg.) and on the eastern route over the Lingga Archipelago (E 105 deg.) south of Singapore, were given a certificate signed by the Commander of the aircraft. The passenger's name was written in to certify that

'... has flown over the equator in the Empire flying boat the thus becoming one of the progressive band of travellers who cross the line by air. Over the waters of Lake Victoria, the Lingge Archipelago, the Empire flying boats pass in a moment from hemisphere to hemisphere, beyond the zone whose dwellers recognise no alteration in the length of night and day.

*'Born with the sun they travelled a short
Way towards the sun,
And left the vivid air signed with their honour'
Stephen Spender
Longitude 193. ...
Latitude zero. Commander'*

The Port Bell alighting area was on Lake Victoria (height 3 717 ft.), the highest port on the route. Passengers left the aircraft and were taken by bus to Kampala for the night stop. The next sector was flown round the northern shore of the Lake to Kisumu - a distance of 129 n.m. or 237 km.

7. The Horseshoe Route

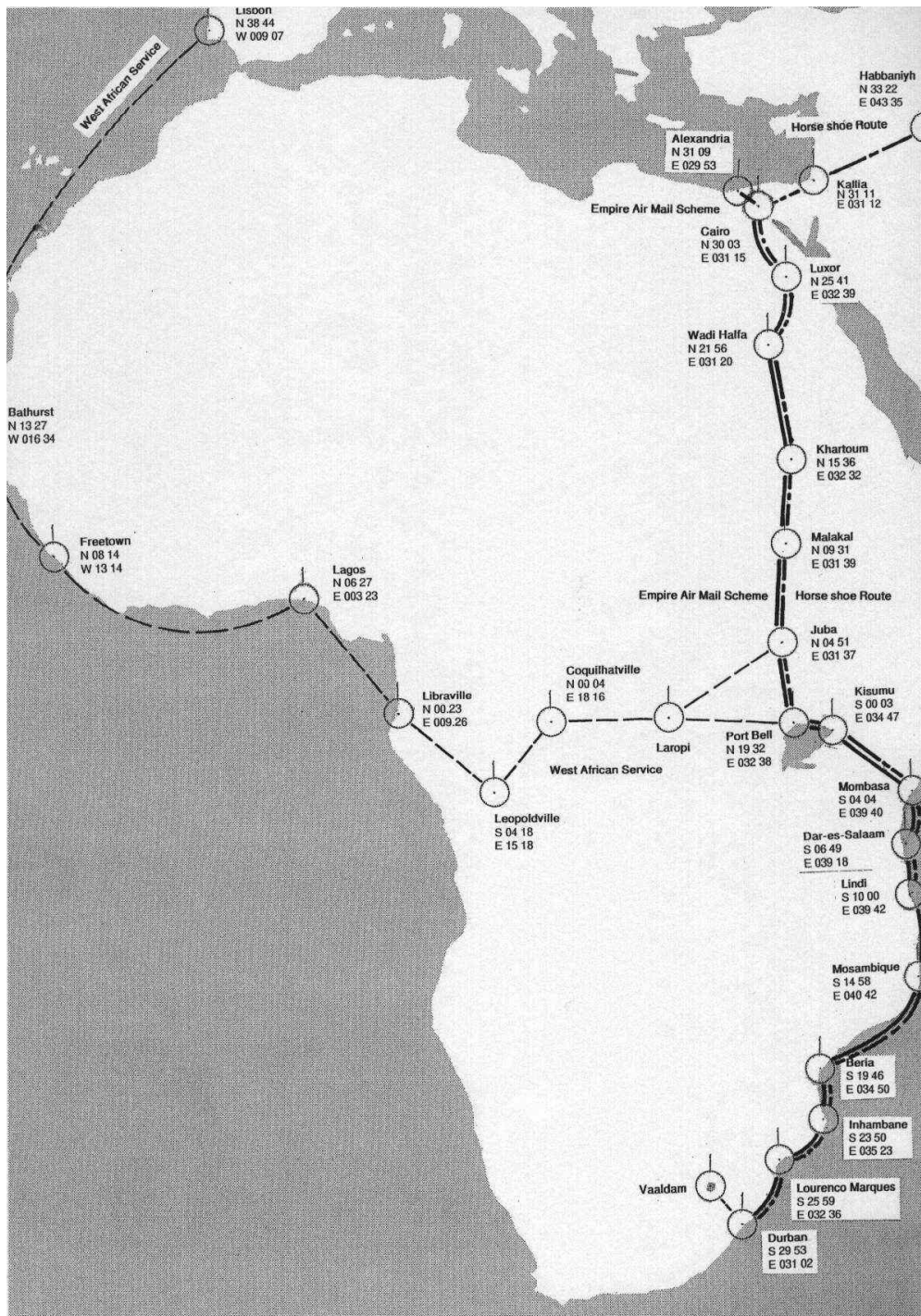

41. The Empire Air Mail Programme, the Horseshoe Route and the West African Service.

7. The Horseshoe Route

The 380 n.m. (699 km.) sector from Kisumu to the ocean at Mombasa was overland, climbing over the mountains of Kenya, some of which were over 10 000 ft. in height. Depending on weather conditions, Mount Kenya (17 058 ft.) was visible 65 n.m. (120 km.) to port and the twin snow capped peaks of Mount Kilimanjaro (19 340 ft.), rising from its double wreath of white cloud, were to be seen some 38 n.m. (70 km.) off the track to starboard, 150 n.m. out from Mombasa. 'Boats called at Lake Navivasha if inducement by way of passengers or freight offered and circumstances permitted, on southbound services only.

From Mombasa to the end of the line at Durban, the route was flown over the Indian Ocean. The next two sectors were from Mombasa to Dar es Salaam - a distance of 174 n.m. or 320 km. and from there to Lindi, a further 193 n.m. (355 km.).

The next sector was from Lindi to Mosambique - a distance of 304 n.m. (560 km.) - where passengers night stopped at the Hotel do Lumbo in the village. The cyclone season for this part of the coast was from November to mid-May. Southwards from Mosambique to Durban, the route staged through optional refuelling stops at Beria, (466 n.m. or 821 km.), Inhambane and Lourenco Marques. The distance from Biera to Lourenco Marques was 449 n.m. or 827 km. The final sector of the service was to the terminus at Durban - a distance of 249 n.m. or 458 km. The alighting area was at Congella airport on the substantially land locked harbour of Durban. Total distance of this branch of the EAMS to Durban was 6 348 nautical miles or 11 680 km. The sector distances are worth recording. Four were under 200 nautical miles, five between 200 and 300 n.m., four between 300 and 400 n.m. and two between 300 and 400 n.m.

The second phase in February 1938, extended the EAMS to India, Burma and Malaya. From Alexandria, the eastern route turned north-eastwards across the eastern end of the Mediterranean Sea, dropping down to a refuelling stop on Lake Tiberias, 689 ft. below sea level, the lowest point on the route, crossing the coast of Palestine (Israel) south of Haifa. The route turned for a cross country sector of 398 n.m. or 733 km. over the Syrian desert to the Euphrates-Tigris basin, to alight on Lake Habbaniya. Weather had a distinct influence on this part of the route for seven months of the year and as the 'boats flew right in the weather, an influence on the operations of the EAMS. The desert sectors were normally flown high to avoid turbulence from the heat. Sand and dust storms occurred from June to September, extending up to 12 000 ft. Thunderstorms, in May and June and again in October and November, occurred up to 35 000 ft. and both these storms could blot out all communication from ground to air. From Habbaniya the route turned southwards down the river to Basra - a distance of 276 n.m. or 508 km. This sector was subject to storms appearing instantly without any warning.

The night stop was made at the Iraq Railway guest house at the combined land and marine airport on the west bank of the Shatt el Arab, 2km. north of the city of Basra. The Basra to Kuwait sector was the shortest on the route - a distance of 70 n.m. or 130 km. The normal route from Kuwait was direct to Dubai down the Persian Gulf - a distance of 458 n.m. (843 km.). Some 'boats called at Bahrein on their way to Dubai. Distances from Kuwait to Bahrein - 234 n.m. or 430 km. and from Bahrain to Dubai - 261 n.m. or 480 km. Low level flying over the Gulf was hot and bumpy.

The alighting area at Dubai was on a reach of the creek. The alighting charge, including an overnight stay was 5 rupees, with an additional 4 rupees for the night watchman. Passengers and crew were ferried 10 miles (16 km.) from the creek in two Ford utilities, to sleep overnight at the combined Sharjah Fort and hotel, complete with its steel entrance door, loopholes for rifles and encircling belt of barbed wire. Departing Dubai, the route was eastwards across the desert, climbing to a safe height of 8 000 ft. to cross the mountain range.

The sector from Dubai to Karachi direct was flown over the Gulf of Oman, following the southern coast of Persia, to Karachi - a distance of 630 n.m. or 1 160 km. This part of the route was subject to monsoon conditions from June to August with much turbulence and upward convection currents. Tropical storms were also frequent in May and June and again in October and November. From the windows of the Promenade Cabin (flying eastbound) passengers could see some of the most extraordinary and fantastic rock formations of the Makran coast range of mountains. 'Boats sometimes put down at Jiwani, a fishing village on a sheltered inlets. The sector distance was 377 n.m. or 694 km.

The third night stop was made at Karachi, after the 'boats had alighted on the Karangi Creek. Monsoons affected the flying from Karachi to Singapore. Upper air reports were available from most of the meteo. stations along the route, giving wind speeds and directions.

The dust storms that occurred over the Sind desert were not of the same density as those over the Middle East, with visibility rarely dropping below 1 000 m. Before and after the south-west monsoon, the ground temperatures could reach 46 deg. C. Strong, to very strong, west and south-west winds increased in speed with height. Captains flying sectors across India often had two options to consider. Either they could fly very low, sometimes between 200 and 300 ft. in the very hot, disturbed air and risk upsetting the passengers or they could climb higher into cooler and calmer air, to face head winds of between 40 to 50 knots. During the south-west monsoon, the route was covered in dense cloud with intervals of heavy rain. High ground was cloud covered and wind direction and strength were difficult to forecast. Cumulus clouds over high ground, with their strong vertical air currents, could reach 15 000 ft. Meteo. balloons could not be tracked through the overcast, so wind speed and direction had to be

7. The Horseshoe Route

estimated from the synoptic chart - often incorrectly. Dead reckoning positions could not always be confirmed by radio D/F 'fixes' in heavy tropical storms making course holding, even on the comparatively short sector distances, difficult. In these trying conditions the higher the altitude, the calmer the weather. Even in the worst of the south-west monsoon, the 'boats could be flying in sunshine above the clouds at 10 000 to 15 000 ft. The sector from Karachi to Raj Samand was overland and often flown at between 500 and 1 000 ft. An unconfirmed reference states that 11/2 kW. revolving beacons were, or were to be, installed on the ground at intervals of between 26 and 43 n.m. (48 to 80 km.) between Karachi and Rangoon to assist night time flying.

An ancient reservoir complete with palace, temple and dam was used as the alighting area at Raj Samand. The water level here and at Gwalior varied considerably and the 'boats had to radio ahead for alighting clearance. From Raj Samand the route continued overland to Gwalior - a distance of 234 n.m. or 433 km. The Gwalior alighting area was on the lake of Madho Saga to the west of the city.

Another overland sector brought the route to Allahabad. Due to headwinds this sector was also often flown very low - 200 to 300 ft. - with accompanying turbulence from the ground - a distance of 213 n.m. or 392 km. The 'boats alighted at the confluence of the Jumna and Ganges rivers where the river current was normally 7 knots but up to 14 knots on occasions. The route continued overland to Calcutta - a distance of 396 n.m. or 728 km.

The fourth night stop at Calcutta was made at the Great Eastern Hotel, considered by many as the best hotel on the route. The alighting was made on the Hoogly river near the Howrah bridge. Taxiing was sometimes difficult as the river was full of eddies and undercurrents. The route continued across the delta of the Ganges and the Sundarbans to cross the north east of the Bay of Bengal. This part of the route was subject to tropical storms from April to November and as the 'boats flew southwards they re-entered the monsoon area. Revolving storms, with torrential rain, developed over the Bay of Bengal at any season and the 'boats had to find a way around them. Akyab, for example, could have as much as 6 300 mm. (250 in.) of rain during the monsoons in May and June, with cumulo-nimbus cloud to 60 000ft. The Calcutta to Akyab sector distance was 296 n.m. or 544 km.

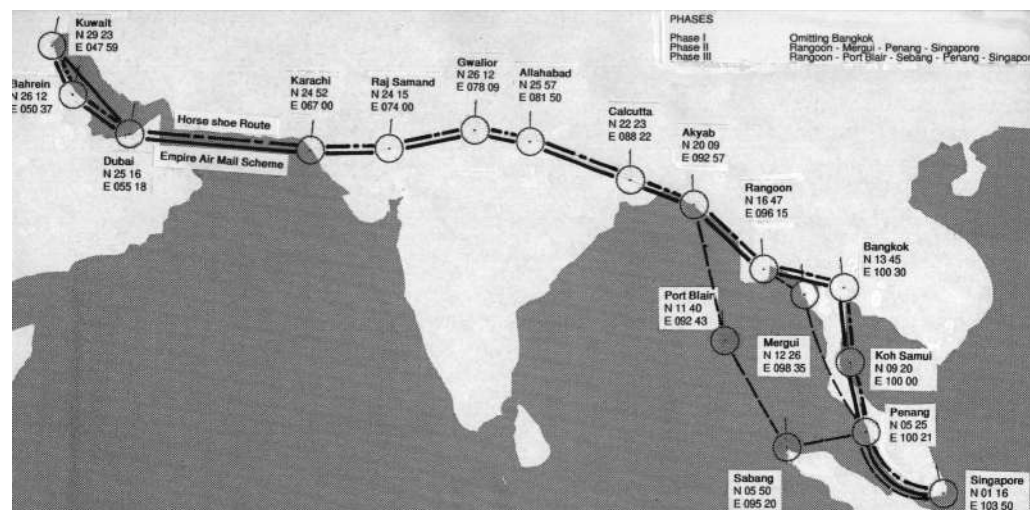

42. The Empire Air Mail Programme and Horseshoe Route

Akyab was an optional refuelling point. IAL passengers used the shallow-draught vessel *Tanko* as a lounge while the aircraft was refuelled. The sector to Rangoon was flown down the west coast of Burma and thence across land and the Dawna mountain range to the alighting area 16 km. north of the city - a distance of 274 n.m. or 504 km. The giant Shwe-Dagon pagoda, covered with gold leaf, was clearly visible 16 n.m. (30 km.) away and the 'boats flew low over the pagoda to give the passengers a good view.

The Rangoon to Bangkok sector was partly across the Gulf of Martaban to cross the coast of Burma and over the border to Thailand, alighting on the river Menam at Bangkok - a distance of 317 n.m. or 584 km. Bangkok was the base for the IAL de Havilland DH 86s that flew the spur service to Hong Kong.

The EAMS route turned almost due south over the Gulf of Siam to the island of Koh Samui - a distance of 272 n.m. or 500 km. Continuing southwards, the route continued down the 100 deg. meridian, across the Malay peninsular to Penang - a distance of 231 n.m. or 425 km. The alighting area at Glugor was 6 n.m. (10 km.) from Bayan Lepas airport. Depending on the service, the alighting was often at midnight, departing again at 03.00 to arrive at Singapore for breakfast at the Raffles Hotel. Mr Mansfield, IAL's Penang agent, gave passengers tea ashore while the 'boat was refuelled. The route followed the west coastline of Malaya to Singapore - a distance of about 324 n.m. (597 km.). Early in 1937, the mile-long channel that served as the alighting area at Singapore was marked and kept clear of surface vessels.

7. The Horseshoe Route

On the EAMS, the IAL crews slipped at Singapore to take the next return westbound service from Australia. After July 1938 on some services, the aircraft continued onwards with a QEA crew, while on others the eastbound service was flown in a QEA 'boat to Brisbane and Sydney. The night stop was made at the Raffles Hotel.

Finally in the third phase in 1939, the EAMS was completed to Hong Kong, Australia and New Zealand. Departing Singapore to the south, the route lay over the Riau islands and the Straits of Malacca to pick up the eastern coast of Sumatra, over the channel between the mainland and Banka island, to turn southwards to make a cautious approach to a heavily defended Batavia (Djakarta), hedged around with prohibited areas. The equator was crossed over the Lingga archipelago an hour out from Singapore, with certificates for first time passengers - a distance of about 513 n.m. or 944 km.

The Batavia - Sourabaya sector was flown along the north coast of Java - a distance of 378 n.m. or 696 km. Sourabaya was the seventh night stop, made at the Orange Hotel. From Sourabaya the route followed the north coasts of the islands of Bali and Lombok of the Dutch East Indies (Indonesia) to Bima on Sumbawa Island - a sector distance of 367 n.m. or 675 km. The route continued on to cross the Sumba Strait, skirting the northern coast of Sumba island and then across the Savu Sea to Koepang - a distance of 321 n.m. or 591 km.

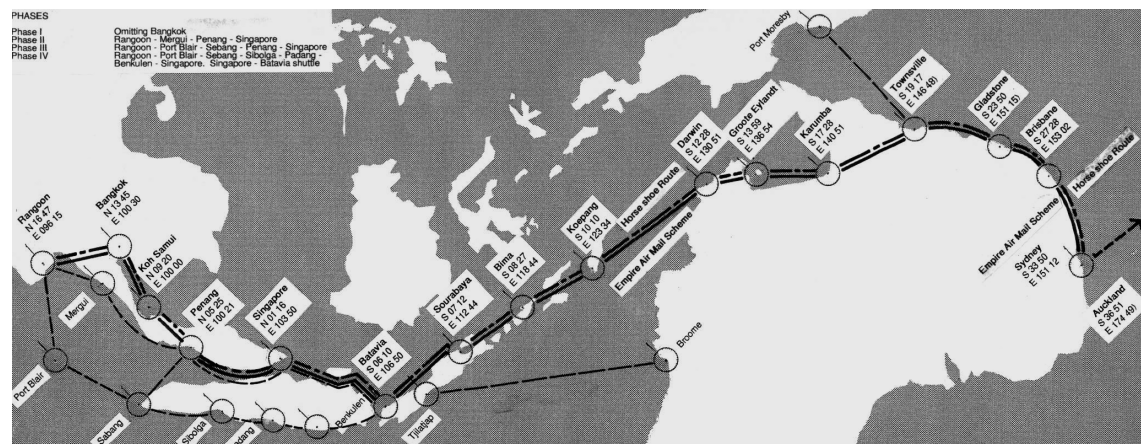

43. The Empire Air Mail Programme and the Horseshoe Route

The next 494 n.m. or 909 km. sector across the Sea to Darwin was flown at 10 000 ft to avoid the south-east prevailing winds in winter, to alight on the harbour with its tidal range of 8 metres. The cyclone season was from December to March. British Power Boats built a special patrol and rescue launch for this sector capable of 27 knots at full throttle, to be stationed at Darwin. The launch could rescue up to 50 persons unlucky enough to ditch in the 'shark infested' Timor Sea. The eighth night stop was spent at Darwin Cottage.

The first Australian sector of the route lay across the middle of Arnhem Land, crossing the coast of the Gulf of Carpentaria near Bickerton Island, to Groote Eylandt - a distance of 359 n.m. or 660 km. The base on Groote Eylandt was on the hitherto uncharted Princess Elizabeth Bay with refuelling facilities that included a 140 000 gal. (630 000 litre) storage tank and 450 metre long submarine pipeline to the jetty. The next forward sector was over the Gulf of Carpentaria to the Queensland shoreline at Karumba - a distance of 308 n.m. or 567 km.

From Karumba the route was overland, crossing the northern part of Queensland and the Great Dividing Range to drop down to Townsville for the ninth night stop, alighting on the harbour - a distance of 343 n.m. or 631 km. The route continued southwards along the Queensland coastline to Gladstone, flying over the Cumberland Islands and the Capricorn Channel - a distance of 370 n.m. or 681 km.

The Gladstone - Brisbane sector also followed the coastline to Brisbane, over the southern tip of Frazer Island to Double Island Point and thence to Brisbane, to alight on the Pinkenbar Reach of the Brisbane River - a distance of 245 n.m. or 451 km. The final sector of the route continued southwards along the New South Wales coast to the terminus of the EAMS at Sydney, to alight at Rose Bay on the harbour - a distance of about 245 n.m. or 451 km. The total distance was 11 332 n.m. (20 851 km.) An analysis of sector distances from Southampton to Brisbane shows fourteen to be between 200 and 300 nautical miles, seventeen between 300 and 400 n.m., two between 300 and 400 n.m., one between 500 and 600 n.m. and one over 600 n.m.

Before the services came the survey flights. During 1937, IAL flying boats flew southwards from Alexandria to Durban, eastwards to Singapore and later to New Zealand, westwards across the Atlantic and southwards to the Azores. Two African survey flights were made. The first, by the Short Kent 'FC Satyrus' (Captain L.A.Eggesfield), was from Cairo as far south as Lindi. It was followed soon after by the second Mark III 'Atlantic' 'boat' 'UV CAMBRIA' (Captain L.A.Eggesfield) - the first Empire 'boat to fly over Africa - which completed the journey to Durban.

7. The Horseshoe Route

Mail and passenger services started almost immediately. At first the route terminated at Kisumu. The first to fly in was 'UY CAPELLA with AS 448 mail - and then the whole distance to and from Durban was opened for service. The 1 000th EAMS departure from the United Kingdom was flown on 21 May 1937. 'HL CANOPUS flew the first service into Durban on 2 June 1937, to be followed by 'VE CENTURION on 29 June 1937, with the inaugural all-air service. 'VE was carrying 1 583 kg. of un-surcharged mail with no air mail stickers. Eleven standard S.23s were in service on the EAMS at this date. A total of six services were flown each week, two to Durban - departing Southampton on Tuesdays and Fridays - with an additional service to Kisumu on Thursdays. The return flights from Durban arrived at Southampton on Sundays and Tuesdays, and from Kisumu on Fridays. The journey time was six days.

'UU CAVALIER, the 'Bermuda' 'boat, began a leisurely twice weekly service on 16 June 1937, between Bermuda and New York. The base in Bermuda was on Darrel's Island while the New York terminus was at Port Washington with an alternative for winter operations at Baltimore. The hurricane season lasted from June to November with the maximum frequency of storms occurring from August to October. The 659 n.m. (1 213 km.) sector was flown in pool with the PAA Sikorsky S.42 NC 16735 Bermuda Clipper. The initial IAL service departed Bermuda for New York at 10.30 on Wednesdays, arriving at 15.30 and returning the next day. The schedule was doubled in frequency in August 1937, the IAL service departing Bermuda on Mondays and Fridays. The single fare was £ 20 (PV £ 413). The service continued until 21 January 1939, when 'UU CAVALIER was forced down on the Atlantic on the 290th service.

'FC Satyrus (Captain H.W.C.Alger) was used again to survey the route from Alexandria to Singapore. As before, the survey flight was quickly followed by Empire 'boat services, first to Karachi - 'UA CALYPSO in October 1937 - and then to Singapore. The Singapore to Sydney route was surveyed by Major Brackley and a RAF crew in a Short Singapore III flying boat of 205 Squadron RAF. The navigator was Sergeant C.E.Elder, later to join IAL. Mr Hudson Fysh, one of the founders of QANTAS was also on board.

Five return survey flights across the North Atlantic were made by the two long-range Mark III S.23 'Atlantic' 'boats, 'HM CALEDONIA and 'UV CAMBRIA. One return flight was made by 'HM CALEDONIA to Horta in the Azores, to investigate a possible South Atlantic route, an option that was not pursued by IAL.

Spurs from the main routes served the British West African colonies and Hong Kong. Imperial Airways Limited, as the British Government's 'chosen instrument', flew the EAMS route to Singapore. Eastwards from Singapore, the newly formed QANTAS Empire Airways (QEA) operated to Brisbane and finally, Sydney. From Sydney, the last link to Auckland would be flown by Tasman Empire Airways Limited (TEAL). The route to Durban was the sole responsibility of IAL.

When IAL got their new Empire 'boats, they were more than satisfied with them, considering them to be the most successful marine aircraft ever produced. The 'boats were very popular with their crews and the passengers. The passenger seats, which had been developed by IAL, were acknowledged to be the best and most comfortable available and the noise levels in the cabins were satisfactory. Passengers could move relatively freely about the cabins although too much movement could be felt on the Control Deck in the matter of tail trim.

There was one reservation, the matter of payload. A kilogramme of payload was worth £ 27 per annum (PV £ 620 per kg. per annum). Payloads of the standard Mark I S.23 'boats varied but were about 3 700 kg. They could carry 1 500 kg. of mail and freight with sixteen passengers or twenty-four passengers and 750 kg. of mail and freight, but could not lift 1 500 kg. of mail and freight, and twenty-four passengers. There was an argument current at that time as to whether passengers and mail would not be better completely separated and carried in different aircraft. The upper component of the Short-Mayo composite aircraft 'HJ Mercury, for example, was designed to carry only mail and freight. The three Short 'G' class 'boats, which succeeded the Empires, were intended to carry only mail across the Atlantic, although they were impressed by the RAF before they could do so. The weight of trimming the passenger cabins of an Empire 'boat - including seats, bedding, an additional lavatory and the pantry equipment and stores - was between 900 and 1 000 kg. The low passenger load factors on the EAMS meant that the comfortable appointments of the passenger accommodation and the provision of hotel-quality catering, were not sold up to their full capacity.

The intended scheduled journey speed of the 'boats on the EAMS, in day and night service, terminal to terminal, was to be 87 knots (160 km. per hr.). There were thirty-two ports on the route to Sydney and twenty-one to Durban. Too many were of minor importance to the EAMS and their inadequate facilities caused delay and occasionally tempted some Captains to overfly them, with the possibility of fuel shortages occurring in flight. Flying time was usually between five and six hours per day and the total number of hours flown by a 'boat on the EAMS averaged 700 hrs. per year.

The actual scheduled speeds, terminal to terminal, achieved on the accelerated services were about 60 knots (110 km.per hr.) for the South African route and about 52 knots (95 km. per hr.) to Brisbane. When intermediate ports were omitted, ground speeds increased significantly. 'HM CALEDONIA flew Alexandria to Marseilles direct on 21 December 1936, at an average speed of 128 knots. The fastest Atlantic crossing - west to east - during the 1937 survey flights was made by 'UV CAMBRIA on 27/28 September, at an average ground speed of 166 knots. The single sector Bermuda-New York service was scheduled for 132 knots (243 km. per hr.) and usually maintained it.

7. The Horseshoe Route

For comparison, the de Havilland Comet G-ACSS 'Grosvenor House' (C.W.A.Scott and T.Campbell Black), which Messers Short, Gouge and Parker had watched setting out from Mildenhall, won the 1934 Mac Robertson air race over 9 855 n.m. (11 333 km.) to the Flemington Racecourse in Melbourne at an average speed of 138 knots (254 km. per hr).

There were a number of reasons for the shortfall in achieved speeds along the routes. The direction finding services, which were so vital to navigation, were inaccurate and intermittent over some sectors and on others, practically non-existent. Meteorology was becoming established on a more scientific basis and weather forecasting was becoming accepted with increasing confidence by the air crews. Bad weather was found to have a more serious effect on the operation of marine aircraft than on land aircraft. Many of the alighting areas, including Southampton Water, were poorly developed or unsuitable. Blind alighting facilities were not available. The standard Mark I S.23 'boats, which flew the majority of EAMS flights, lacked the range to deal with occasional adverse weather conditions. The Bristol Pegasus engines of the S.23 'boats were not very reliable at the start of the EAMS, with short lives between overhauls. The booster coils in the engine starting systems also gave trouble and were difficult to service. There were not enough spare engines to distribute along the routes to deal with any unserviceability. Lastly, the inability to maintain services at night.

The EAMS was intended to operate by night as well as day. Other than the occasional night flight to make up schedules, regular night operations could not be flown. The 'boats were originally equipped with sixteen bunks for night sectors. The method of mounting the bunks in the cabins was ingenious but subject to close tolerances. So close indeed, that it was discovered that often the bunks could not be fitted while the aircraft was in the air, due to the flexing of the hull structure. To mount a single bunk, yet alone sixteen, was a lengthy process if it could be done at all, and took the combined efforts of the Steward and the Flight Clerk working together. When it became clear that no sleeping passengers were to be carried, the mattresses, sheets, blankets and pillows were withdrawn.

The two Mark III S.23 'Atlantic' 'boats,'HM CALEDONIA and 'UV CAMBRIA, were originally fitted with fuel systems for flight refuelling giving flight durations of nearly 18 hours. Weather conditions over the North Atlantic at that time were virtually unknown. Few flights had ever been made over the Atlantic either by airship or by aircraft. Prior to the IAL - PAA survey flights there had only ever been thirty-five crossings of the Atlantic by aircraft and thirty-one by airship. The upper air over the Atlantic was almost completely unexplored. Information on the weather at the ocean surface was available from ships, but mostly confined to the recognized shipping lanes. Wind directions and strengths, cloud conditions, temperature variations, humidity and precipitation at the levels to be flown by aircraft, were unknown. Early in the 1930s, a group of University graduates in mathematics and physics, led by Air Ministry meteorologist C.F.Peters, assembled at Croydon airport to begin a survey of Atlantic weather conditions. They started work by drawing weather charts of the area, month by month, stretching back over the previous twelve years. An uncoordinated mass of material was available, mostly weather logs of ships but also from meteorological stations on both sides of the ocean and from inland continental stations in Europe and North America. The information was analysed and transferred to monthly weather charts, which gradually filled up with the increasing detail. The charts also showed areas of sparse information.

The object of the survey was to discover the timing and extent of the best and worst weather conditions likely to be met by an aircraft flying the various routes across the North Atlantic. Theoretical schedules were prepared using information from the charts, indicating the limits within which flight durations might fall. Allowance was made for head and tail winds, and deviations to fly over, under or round storm centres. The schedule for the Foynes-Botwood sector showed a worst case flight duration of 23 hrs. 30 min. and a best case flight of 10 hrs., based on a theoretical average speed of 130 knots (240km. per hr.). During the most favourable months - April to September - the east-to-west crossing time was calculated to be 14 hr. 30 min. increased, between October and January, by an hour. The five-year average case showed that there could be periods in December, January and March when crossings of between 10 hr. and 10 hr. 30 min. would be possible. IAL had three aircraft already stationed in Newfoundland, two de Havilland Fox Moths - VO-ABC and VO-ADE - and a Fairchild 71 - VO-AFG - and they were used to investigate upper air conditions over Newfoundland. Fog was a persistent problem in the St.John's area but less so at Botwood.

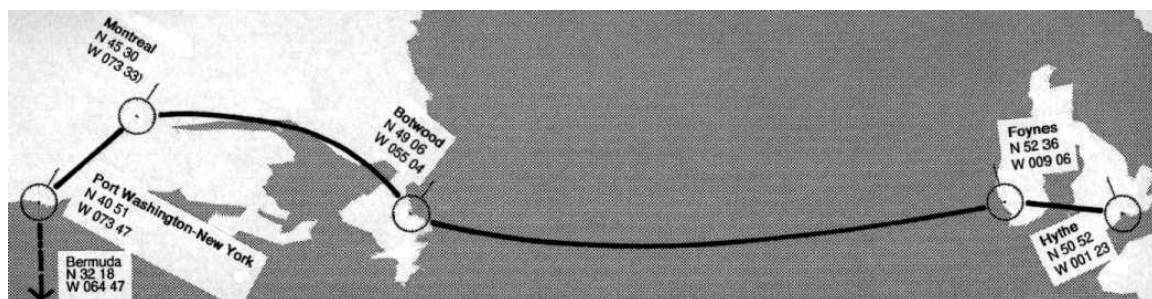

44. The Trans-Atlantic Service.

7. The Horseshoe Route

The actual durations for the five Atlantic survey flights of the 1937 summer season were:

'HM CALEDONIA	Foynes - Botwood	15hr. 26 min.
'HM CALEDONIA	Botwood - Foynes	12hr. 13 min.
'UV CAMBRIA	Foynes - Botwood	17hr. 45 min.
'UV CAMBRIA	Botwood - Foynes	12hr. 06 min.
'HM CALEDONIA	Foynes - Botwood	16hr. 44 min.
'HM CALEDONIA	Botwood - Foynes	11hr. 33 min.
'UV CAMBRIA	Foynes - Botwood	14hr. 23 min.
'UV CAMBRIA	Botwood - Foynes	10hr. 36 min.
'HM CALEDONIA	Foynes - Botwood	15hr. 35min.
'HM CALEDONIA	Botwood - Foynes	11hr. 38min.

C.F.Peters and his two assistants moved to the hotel at Foynes to maintain radio contact with the Atlantic survey 'boats and to continue gathering information to augment the predictions of the survey. Movements of the upper air were obtained by Air Ministry meteorologists who lived on board a vessel plying between Manchester and St John's, Newfoundland. This floating meteo. station recorded air temperature, humidity, barometric pressure, wind force and wind direction at sea level and the upper air. The data were radioed back to the Foynes station. The meteorological data from all sources were collated on a daily weather chart, up to a height of 10 000 ft., from which the following day's weather could be predicted. The commander of a survey flight would decide the time for departure 24 hours in advance, allowing the weather chart to be drawn and from it the wind strength and direction, the location and movement of storm centres and the general weather conditions for the flight to be forecast. The flight plan could then be drawn up, the track to be flown decided and an estimate of the flight duration made.

The payload that the two Mark III S.23 'Atlantic' 'boats could carry over this sector was strictly limited. 'CV CARIBOU, a Mark III S.30 'boat, carried 434 kg. of mail on its first Atlantic crossing. If the Atlantic service was to become a commercial reality, means had to be found of getting heavily loaded flying boats into the air with commercially respectable payloads. One of the means investigated by IAL led them into collaboration with Sir Alan Cobham's company, Flight Refuelling Limited (FRL). Their equipment was fitted to the 'boats but the flight refuelling techniques used were considered, rightly, to be too dangerous except for 'boats carrying mail and freight.

At the end of the year, 'UT CENTAURUS was taken by Captain Burgess and his crew on a route survey flight to Australia and New Zealand. Departing on 3 December 1937, they arrived at Singapore on 11 December. Captain Lester Brain, the senior pilot of QEA, joined the crew - *'to show them the way to Darwin'* - and made the first alighting there on 17 December. The first trans-Tasman flight was made on 27 December by 'UT CENTAURUS (Captain J.W.Burgess and crew) departing Rose Bay at 04.00 for Auckland. 'UT carried letters of greeting addressed to the New Zealand Herald newspaper from the Lord Mayor of London, the New Zealand High Commissioner in London, Jean Batten (who had, the previous year, made the first flight from the UK to New Zealand) and Flying Officer A.E.Clouston. The landfall was made after a flight of 9 hours 15 minutes, tying up to a 40 gal. drum as the mooring buoy. The drum had taken more than two years talking to get it in opposition.. Most of the citizens of Auckland, (50 000 estimated) lined up in some places four and six deep, witnessed the arrival. 'UT returned to Sydney on 10 January 1938, finally departing Rose Bay on Sydney Harbour on 27 January, arriving back at Hythe at the end of the route survey on 23 February 1938, coinciding with the first departure of EAMS mail to India, Burma and Malaya. 'VE CENTURION (Captain G.U.Allen) took the load to Singapore. During the year, twenty-two Mark I S.23s had been delivered and three written off, leaving a total of twenty-four 'boats in service.

'The Report of the Committee of Inquiry into Civil Aviation' (Cmd. 5685) was published in February 1937. It reported the findings of the committee, under the chairmanship of Lord Cadman, which had been set up after a series of questions had been asked in the House of Commons. IAL had sacked two of their pilots, who happened to be the Chairman and Vice-Chairman of the newly formed British Air Line Pilots' Association. The Cadman Committee was dissatisfied with IAL's relations with the Air Ministry and its own staff and found the management to be *'...intolerant of suggestion and unyielding in negotiation'*. The Managing Director G.E.Woods Humphery

7. The Horseshoe Route

and the Air Superintendent Major Brackley left the company, considered by many to be scapegoats, without an opportunity to defend themselves. The Air Minister, Lord Swinton, was replaced by Sir Kingsley Wood, a move that was to open the way to the eventual amalgamation of Imperial Airways Limited and British Airways.

Mail still continued to be carried, partly by sea and partly by air, until the PandO liner *Strathnaver* departed India on 26 February 1938, with the last batch of westbound seaborne letters. On Tuesday 12 April 1938, 'UT CENTAURUS (Captain J.S.Sheppard) with all-up India Eastbound 643 mail on board, flew the first of the accelerated Empire Air Mail Programmes from Southampton, bound for Brisbane. The flying boats for Australia were then turned round at Singapore, the passengers and mail continuing on to Brisbane by QANTAS de Havilland DH 86 landplanes. The Australian end of the EAMS was extended to Sydney later in the year when 'UD CORDELIA (Captain C.E.Madge) and 'UB CAMILLA (Captain E.S.Alcock) departed Southampton on Sunday 26 June 1938, with the first Sydney Eastbound (SE 1) mail on board. The new timetable allowed journey times of 4 days 10 hrs.to Durban and 8 days 23 hrs. to Brisbane compared to the previously scheduled times of 10 1/2 and 6 days respectively.

The thirty-first and last Mark I S.23 - 'BF COOEE, a QEA 'boat - was delivered on 30 March 1938. The combined fleet totals of IAL and QEA then numbered twenty-eight 'boats, of which twenty-five were available for EAMS line service - one more than the predicted operational fleet requirement. 'UU CAVALIER was employed on the Bermuda-New York run and the two long-range 'Atlantic' 'boats, 'HM CALEDONIA and 'UV CAMBRIA, were in process of conversion from Mark III to standard Mark I S.23s at Hamble.

The final link in the EAMS, the trans-Tasman Sea sector from Australia to New Zealand, was to be flown by the three Tasman Empire Airways Limited (TEAL) S.30 Empire 'A' 'boats, starting in 1940. The second 'boat of the trio, 'CZ AUSTRALIA, was never delivered to TEAL so the trans-Tasman link was initiated, and maintained, with two S.30s.

By the end of June 1938, the EAMS it was in full operation. An IAL flight crew departing Southampton for Singapore would slip at Karachi on the third day, the aircraft being taken on by a waiting crew. The slipped crew become a waiting crew, ready to take next service through to Singapore. Returning from Singapore, the slip would be made at Alexandria, after four and half days flying. As a waiting crew, they would take the next service westbound to Southampton. A typical Singapore return journey took eighteen days, with 115 flying hours. The other journeys were Karachi return, Kisumu return and Durban return. The Singapore to Sydney sectors were flown by QEA crews.

The aircraft movements to and from Southampton for the first phase of the Empire Air Mail Programme were:

Sunday	Departure: India Eastbound	Arrivals India Westbound
Monday		Arrivals: India W, Kisumu Northbound
Tuesday		Arrival: Africa Northbound
Wednesday	Departures: India E, Africa S	Arrival: India W
Thursday	Departure: India E	Arrival: India W
Friday	Departures: India E, Africa S	Arrival: Africa N
Saturday	Departures: India E, Africa S	Arrival: India W

There were eight services per week to Egypt, three to Africa (Kisumu) - two of which continued through to Durban, five to Karachi - three of which continued through to Singapore. On a typical day at the end of June 1938, there would have been between seven and ten 'boats at Hythe - three or four 'boats moored up, one or two 'boats on the ramp and three or four in the hangars undergoing overhaul and checks. Between thirteen and fifteen 'boats would have been on service in the air. Stand-by 'boats were stationed at Alexandria, Kisumu, Durban, Singapore and Sydney. At the end of 1938 the combined IAL and QEA fleet consisted of twenty-seven S.23s and one S.30.

An analysis of passengers on the EAMS showed 40% to be business men, 35% to be Government servants, 20% to be on pleasure and 5% to be undertaking urgent journeys, usually of a compassionate nature. Government servants were mostly travelling on leave and were offered special fare rates. The number of passengers flown between the UK and Australia in 1938 were 14 732 eastbound and 15 041 westbound. The ton-mileage figure for 1936 was 4.8 million, rising to 8.4 million by 1938. The operating cost per ton-mile had dropped by 16 % over the same period.

The gross traffic receipts amounted to 68% of IAL's income, with the balancing 32% made up from subsidy. Of the outgoings, salaries and wages took 22%, fuel and oil 18%, replacement of flying stock 14%, materials for maintenance and repairs 7%, rents and subcontracted services 17%, passenger accommodation and ground transfers 6%, advertising 4%, agents commission, development expenditure and dividends each 2% and UK income tax 1%.

7. The Horseshoe Route

Typical fares (October 1938) from London were:

Cairo	£42 (PV £ 825) single	£ 75 (PV £ 1 474) return
Calcutta	£108 (PV £ 2 122) single	£ 194 (PV £ 3 812) return
Singapore	£156 (PV £ 3 065) single	£ 234 (PV £ 4 598) return
Sydney	£160 (PV £ 3 144) single	£ 274 (PV £ 5 384) return
Durban	£125 (PV £ 2 456) single	£ 225 (PV £ 4 421) return

There was only one class of accommodation on the Empire 'boats. The fare included hotel accommodation at night stops, all meals in flight and meals and transfers on the ground. If a return ticket was booked in advance, a reduction equivalent to 20% of the single fare was allowed. Children up to three years old, accompanied by an adult and not requiring a seat, were carried at 10% of full fare and children from three to seven years at 50% of full fare. The full baggage allowance was 20 kilogrammes.

After a gap of sixty years, it is increasingly difficult to grasp the magnitude and multiplicity of the problems that beset the EAMS. Unfortunately, IAL discovered to their cost that the initial assumptions made in favour of the flying boat were not all valid when the 'boats came into service. The handling of passengers, mail and freight on the water, in the increased volume generated by the new service, proved more difficult than on dry land. Southampton was initially the only port with a pontoon for loading and discharging the 'boats, firstly at Berth 101 and later at Berth 108. It was not always easy to warp a 'boat into the pontoon, except in a dead calm. At most of the other ports, all servicing had to be done on the open water by surface craft. It was found too, that the flying boats could operate on the water in sea states that the attendant servicing craft and barges could not tolerate, and this disrupted services. Carrying out essential maintenance and minor repairs was more difficult on water than on land. Early morning and late evening fogs and mist, often associated with stretches of water, could also interfere with services. On one occasion - 13 March 1939 - 'BB COOLANGATTA (Captain H.L.M.Glover), unable to alight at its next port of call in the Gulf due to an early morning mist, alighted short near Bahrain in a patch of clear weather. The 'boat was anchored to enable the passengers and crew to enjoy a leisurely breakfast, waiting for the mist to clear, before resuming the service. The alteration of schedules from these many causes was a source of irritation to passengers and of disruption to the mail service, for which there were penalties for IAL. The Shell Company, which supplied the aviation spirit, undertook to supply fuel at inland stations at marine rates.

The assumption that a 'boat could alight on the water if it ran into trouble, proved to be true on at least two other occasions when IAL 'boats were successfully put down on the open sea in an emergency, and one which ended in disaster. On 23 June 1937 'HL CANOPUS experienced a failure of the port inner engine, alighted on the Mediterranean and taxied to Mirabella. 'UA CALYPSO ran into severe icing conditions and deteriorating weather 13 n.m. north of Alderney at 15.43 in the afternoon of 5 January 1939, put down on the English Channel and set out to taxi the 35 n.m. to Cherbourg. It was taken in tow, finally arriving at Cherbourg the following morning. Two weeks later, on 21 January 1939, carburettor icing forced 'UU CAVALIER down onto a moderate Atlantic swell, half way between Bermuda and Baltimore. The planing bottom was stove in by the impact of alighting and the 'boat broke in half and sank in fifteen minutes.

In August 1939, IAL announced that passenger bookings had been curtailed. The EAMS had been too successful, generating a bigger volume of mail than had been predicted and there was a shortage of aircraft to move it. For some time before the announcement, IAL had been operating with increasing difficulty. The causes of delay - weather, engine trouble, wireless and miscellaneous - were shown on the service record charts in colour, a different colour for each kind of delay. The record charts, which showed the progress of the individual services, took on the aspect of rainbows. Night flying was an occasional event to catch up a schedule rather than a regular part of the service, as had been intended. The partners of the Empire 'boats, the re-engined Armstrong Whitworth AW.27 'E' class, were only gradually coming back into service. It is interesting to speculate what would have happened to the whole EAMS operation if it other events had not intervened. Poland was invaded by German forces on 1 September 1939.

The EAMS was summarily revoked the next day, a day before the declaration of war by France and Great Britain on Germany. The Empire Air Mail Programme had run for two years, forty-three weeks and five days from start to finish but only for about eighteen months of full operation. The EAMS was replaced by an air fee service carrying letters at 1/3 per 1 1/2 oz. (PV £ 1.03 per 10g.).

Although the EAMS was suspended, the outbreak of World War II on Sunday 3 September 1939 did not have a marked effect on the running of services from the United Kingdom. The 'boats sported RED, WHITE and BLUE stripes on the upper and lower mainplane surfaces and on the hull, underlining the registration markings. A fin or rudder flash in the three colours completed the identification markings. The operational base was moved to Poole Harbour to avoid the barrage balloons and anti-aircraft artillery defending Southampton Water. The 'boats were still serviced at the engineering base at Hythe and ran the risk of being fired on as they flew in for maintenance.

Three 'boats had been requisitioned by the Australian Government immediately war broke out. A18-1 to 9 had been reserved for the Sunderlands of 10 Sqdn. RAAF, so 'UT CENTAURUS became A18-10 and 'UA CALYPSO,

7. The Horseshoe Route

A18-11. A18-11 was exchanged for 'BE COORONG, and 'UC CORINNA placed on Government charter. A total of five 'boats were to serve with the RAAF at one time or another with 11, 20, 33 and 41 Squadrons, mostly in the transport and medical-evacuation roles. In Sydney 'BC COOGEE and 'BB COOLANGATTA were impressed into the RAAF as A18-12 and A18-13.

Aircraft in RAF and RAAF service were armed. The impressed 'boats serving with 11 Squadron RAAF had four underwing bomb racks, two for 250 lb. and two for 500 lb. bombs. Two 0.303 in. Lewis machine guns were fitted in the freight room, aft. A18-10 CENTAURUS, probably late in 1939, was bristling with machine guns. There were two Scarff mountings on top of the hull for 0.5 in. guns, two mountings on either side of rear freight compartment for 0.30in. guns, one 0.5 in. gun on a swivel mounting in the mooring compartment, two 0.30in. guns in the navigation hatch and two 0.5 in. guns on either side of the Control Deck. Later in 1940, A18-10 CENTAURUS carried one 0.5 in. machine gun on a swivel mounting in the mooring compartment, two 0.30in. machine guns in the navigation hatch and one 0.5 in. machine gun in new positions on either side of the Control Deck. A18-11 CALYPSO and A18-12 COOGEE were fitted with transparent plastic bombing cupolas in place of the mooring hatch, to accommodate No.4 course setting bomb sights. The bomb sights were removed for the maritime operations of casting off and mooring up. A18-14 CLIFTON, when serving with 33 Squadron RAAF in 1942, had the Vickers and Lewis machine guns replaced with US calibre weapons - 0.5 in. (12.7 mm.) and 0.30in. (8.46 mm.). The two TEAL 'boats were also armed for a period during the war, making them the only Empire 'boats to operate alternatively in dual civil and military capacities. Their military equipment was similar to the RAAF 'boats and included at least six Lewis guns - one on a Scarff ring on the top of the hull round the aft passenger escape hatch - and under-wing bomb carriers with electrical fusing and release. The guns and bomb carriers were removed when the 'boats were engaged in their civil capacity - flying the trans-Tasman service and special charters to Noumea, Samoa and Honolulu. Replacing the bomb carriers and bombing-up took about twenty minutes. One of the 'boats was on the buoy at Mechanics Bay, Auckland at readiness for reconnaissance duties.

The fact that few passengers had been killed and injured in accidents up to the end of 1939 was due mostly to low load factors and good luck. Accidents resulted in three 'boats being written off in 1937, one in 1938 and five in 1939 - a total of eight S.23s and one S.30 - leaving a fleet of thirty at the end of 1939 - twenty-three S.23s and seven S.30s. The high attrition rate had shaken confidence in IAL's operating abilities and resulted in a shortage of aircraft. Ten crew and seven passengers had been killed and four crew and twelve passengers injured. One crew member of a refuelling barge had died in hospital and one had been seriously injured. Although forty-two Empire 'boats were completed, the year-end totals of the Empire 'boat fleet never exceeded thirty-one aircraft in service and that was at the end of 1940.

After sixteen years of operation, the name of Imperial Airways Limited disappeared when the amalgamation with British Airways became effective. George Woods Humphery had named IAL and it fell to the Chairman of the new company, Sir John Reith, to find a name for the new organization. As no one could think of a better name, the combined forces of IAL and BA became the British Overseas Airways Corporation (BOAC). Sir John had been a reluctant Chairman of IAL and, as soon as his task to amalgamate the two companies was accomplished, he departed to the Ministry of Information. He was succeeded by Hon. Clive Pearson, his deputy in the early days of BOAC and the former Chairman of British Airways (BA). The 'Appointed Day' for the integration of the two airlines was 1 April 1940, when the aircraft, assets and staff of both companies were transferred to BOAC.

Besides 1 April, the first half of the new Corporation's first year was dominated by three other dates, 9 April, 10 May and 10 June. After an initial pause following the outbreak of war, the Empire 'boats continued their services from Poole across France to Marignane. From there they flew across a neutral Italy to a peaceful Greece and onwards across the eastern end of the Mediterranean to Durban and Sydney, via Cairo or Alexandria. The two S.30 'A' 'boats for Tasman Empire Airways Limited were worked out to New Zealand to start the scheduled service across the Tasman Sea, between Auckland and Sydney. This service was continued right through the war years until October 1947, when it ended with the 442nd. Crossing. The frequency of the trans-Tasman service started as a weekly service, increasing in August 1940 to three flights per fortnight.

The two long-range S.30 'boats, 'CU CABOT and 'CV CARIBOU, started their charter to the Air Ministry and were taken on the strength of Coastal Command RAF as long-range reconnaissance aircraft. They were armed with seven Vickers .303" (7.69 mm.) K guns each with 45 drums each of 100 rounds. A dummy gun - believed to be a length of broom stick painted matt BLACK - was installed in the refuelling cup in the tail. BOAC were expecting to receive the 'boats back from RAF service in time for the summer Atlantic season. The two 'boats became involved in a dispute as to their ownership when they were sent to Hythe for their first 200 hr. Check. BOAC assumed that the 'boats had been handed back in preparation for the trans-Atlantic mail service. The situation was only resolved by a memo from the War Cabinet - 'CU and 'CV were to remain with the RAF as V3137 and V3138. To clinch the matter, the Air Ministry announced that there would be no Atlantic mail service in 1940, a decision that was changed later in the year, when a series of trans-Atlantic flights were flown in September 1940.

7. The Horseshoe Route

Early in the morning of 6 January 1940 the second attempt to get 'VB CORSAIR off the River Dangu was successful. Captain J.C.Kelly-Rogers took off and flew to Juba, returning the 'boat to service after its enforced stay of nearly ten months on - and in - the River Dangu.

On 9 April, German armed forces invaded Denmark and Norway. Within the month both V3137 CABOT and V3138 CARIBOU had been destroyed by the Luftwaffe at the little Norwegian port of Bodø, while delivering radar equipment for the RAF - the first of the six Empire 'boats destroyed during the war.

The German assault on the Low Countries began just over a month later on 10 May. The eight month stretch of the 'phony' war was over. A weary, dispirited and ailing Mr Chamberlain resigned as Prime Minister and Mr Churchill took his place. Soon the fighting had spread to northern France, involving the 'E' class aircraft in ferrying supplies to the RAF fighter squadrons in France - with the loss of one Captain killed and one aircraft set on fire. Yet in spite of the fighting in France, the Empire services were maintained. On 30 May, for example, the brand new S.33 'boat, 'RA CLEOPATRA, departed Poole for India. Ten days later the entry of Italy into the War brought the service to an end. The intermediate period from the ending of the EAMS to the start of the Horseshoe route lasted for forty-one weeks and a day.

During the year the last of the S.30 'boats, the replacement aircraft 'KZ CATHAY and the two completed S.33 'boats, 'PZ CLIFTON and 'RA CLEOPATRA, were launched and delivered - in camouflage - to BOAC. The nearly completed hull of G-AFRB, the forty-third and un-named Empire 'boat, was taken out of No. 3 Erecting Shop at Rochester and stored in the barge yard. It survived there in its weatherproof crate until sometime after May 1943 when the side of the crate was pulled off by tractor, the case burnt and the hull, scrapped.

7. The Horseshoe Route

Italy entered World War II on 10 June, a month to the day after the invasion of the Low Countries by the German Army. On that day 'CX CLYDE and 'KZ CATHAY were westbound at Malta and Ajaccio, and 'HM CALEDONIA was eastbound at Corfu. All went on to complete their journeys. Sixteen 'boats were east or south of Alexandria. The IAL staff now found themselves in enemy territory. The staff in Rome were granted diplomatic status and departed with the diplomats. The staff in Malta were withdrawn to Algeria.

The Italian entry to the war had been expected. Planning was well advanced to set up the service between Durban and Sydney flying over what became known as the Horseshoe Route. If the track of the service is traced on a map of the world it describes an inverted horseshoe – hence the name. This chapter in the history of the Empire 'boats lasted for more than twice as long as the EAMS with the Horseshoe 'boats pounding up and down the route for six years.

The Horseshoe Route connected forty-three ports between the terminals, generally following the peacetime EAMS routes from Durban to Cairo and thence to Sydney. An operations control room was established at Cairo, the approximate centre of the route. The Horseshoe was connected to the UK initially by a route surveyed by Major Brackley, after he relinquished his post of Air Superintendent of IAL. When he made his survey, no one contemplated the collapse of French resistance. The link, which was to be flown by a collection of ex-Imperial Airways Limited and ex-British Airways aircraft lay across France, the western Mediterranean and the Sahara to Fort Lamy, and from there to join the Horseshoe Route at Khartoum. 'F' class de Havilland 91 Albatross and Lockheed Electras and Super Electras were to be used. One flight departed the UK on 15 June 1940 - flown by a Lockheed Electra - to join the Horseshoe via Gao and Fort Lamy. At least one return service was flown via Kano and Lisbon. The Franco-German Armistice was signed on 22 June 1940, denying the over-flying of mainland France. On 28 June, the overflying of French colonial territory was also banned.

Less than a fortnight after the Italian entry into the war, the first weekly Horseshoe Route services began from either end. The Poole-Lisbon flying boat service was in operation within the month and the first West African service arrived at Lagos on 6 August 1940. The first outbound sector of the West African service from Poole to Foynes was a short one - 287 n.m or 528 km. The next sector to Lisbon - a distance of about 890 n.m. (1 638 km.) - was often flown at night unless there was sufficient cloud cover over the Bay of Biscay to avoid marauding German fighters. From Lisbon a twelve hour flight over the ocean, parallel to the African coast, took the route to Bathurst, giving Vichy-controlled Dakar a wide berth. This segment of the sector was normally flown as a tangent to a 20 n.m. circle round Dakar. The next onward port was Freetown - a distance of 390 n.m. (720 km.), followed by a long sector parallel to the coast to Lagos - a further 1 109 n.m. (2 040 km.).

From Lagos, a direct ocean sector over the Bights of Benin and Biafra brought the service to Librville - a distance of 528 n.m. (972 km.). The route continued from Librville to Leopoldville - an overland sector of 457 n.m. (840 km.), to an alighting on the River Congo. The Leopoldville-Coquilhatville sector followed the approximate line of the river for 320 n.m. (588 km.). From Coquilhatville to Stanleyville, the route lay directly cross-country almost on the line of the Equator, cutting off the loop in the Congo River - about 411 n.m. (756 km.). The last sector of the West African service to join the Horseshoe Route was to Laropi (south of Juba) - a distance of about 404 n.m. (744 km.) or to Kisumu on Lake Victoria - about 567 n.m. (1 044 km.).

To link up with the resumed PAA service across the Atlantic to Lisbon, 'CT CHAMPION and 'KZ CATHAY were used on a twice weekly Poole-Lisbon shuttle service. To celebrate the inaugural flight, 'ZK CATHAY was fired on by a British merchant ship as it approached the UK - thirty bullet holes were counted but no other damage was done. 'ZK CATHAY was attacked and damaged by enemy fighters on another occasion when returning from Lisbon. 'ZK CATHAY was involved in the evacuation of General Sikorski, Commander of Polish forces, and his staff from Biscarosse during the last days of French resistance. 'ZK spent the night beached to avoid the bombing and the forward elements of German armour, before lifting the General and his entourage to safety on the following morning. The PAA trans-Pacific service opened between San Francisco and Auckland, completing the link with the USA at the other end of the Horseshoe.

Contrary to previously declared Air Ministry policy, 'CX CLYDE and 'CZ CLARE - in camouflage and with a Certificate of Airworthiness allowing a take-off at 53 000 lbs. (24 040 kg.), flew a series of five return trans-Atlantic flights in August 1940, carrying mail and a few passengers. The inaugural service carried the first three westbound passengers across the Atlantic in a British aircraft. Atlantic ferry pilots made up the return load. The second service, departing 14 August, took the Under-secretary for Air, Captain Harold Balfour, across to the USA to sign the purchasing contract for BOAC's Boeing 314s. Flight refuelling was not used for these flights. When the Atlantic season closed due to ice at Botwood, the two 'boats were switched to the West African service, to be joined by 'CT CHAMPION early in 1941.

In September 1940, at the height of the Battle of Britain, the Horseshoe was reinforced by 'UF CORINTHIAN (Captain J.C.Harrington), 'UX CASSIOPEIA and 'BF COOEE (Captain F.J.Bailey), flown out from the UK via the West African route to join the Horseshoe Route at Lake Victoria. 'UX CASSIOPEIA, and presumably the other two 'boats, had their Certificates of Airworthiness revised for the delivery flight for a take-off at 45 000 lbs. (20 410 kg.). The three extra 'boats enabled the Horseshoe service frequency to be doubled to two flights per week.

7. The Horseshoe Route

One S.30 and two S.33 'boats were delivered in 1940, two S.30s had been written off, leaving twenty-three standard S.23s, six S.30s and two S.33s in service - the largest combined fleet in the history of the 'boats.

For the whole of the Horseshoe operation, political events dominated to a much greater extent than with the EAMS as the tide of war in Africa, the Mediterranean and the Pacific shifted back and forth. In 1941 it was the Mediterranean and, later the Pacific theatres, that influenced Horseshoe operations. British forces pushed along the North African coast into Cyrenaica, with Benghazi being entered on 7 February 1941. At the same time, the operation to clear Italian forces from Abyssinia and Italian Somaliland was proceeding. Addis Ababa was occupied on 4 April 1941 and the campaign virtually over soon after. The first offensive by the Axis forces in North Africa, with the Italian army reinforced by German armoured units of the Afrika Corps under the command of Field Marshal E.Rommel, pushed the depleted British army back to the Egyptian frontier. British troops had been withdrawn from the Desert Army and sent to Greece, in the forlorn hope of stemming the German invasion of Greece and Yugoslavia. By 20 April 1941, the German army was at Thermopylai and in Athens a week later. The British and Greek forces were evacuated to Crete and North Africa from Kalamata, Nauplia, Rafina and Monemvasia.

In 1941, the 'boats on the Horseshoe Route had their passenger load increased to thirty. Five passengers and the Flight Clerk, by then translated to Purser, were in the Forward Cabin, seven in the Centre Cabin - two on seats and five on a lower bunk, ten passengers in the Promenade Cabin - eight on seats and two on bunks and eight in the Aft Cabin - six on seats and two on bunks. With this liveload on board, the centre of gravity of the aircraft could be affected if there was any movement of passengers. Once seated, passengers had to stay put. The Mark I S.23 QEA 'boats in wartime service were stripped to the bone by removing the cabin trimming, heating and pantry, enabling them to carry an average of thirty-one passengers, with the take-off weight increased to 43 500 lb. (19 730 kg.).

On April 1941, two of the Horseshoe 'boats, 'UV CAMBRIA (6 round trips) and 'UI COORONG (7 round trips), were detached for a three week period to help with the evacuation of the Allied forces from Crete. The 'boats operated from Alexandria, departing in the late afternoon to arrive at Suda Bay at last light for a 'night stop', departing at daybreak with RAF personnel. Crews were formed from a pool of five Captains, five First Officers, five Radio Officers and three Flight Engineers. Once made up the crews were shuttled backwards and forwards by car from Cairo to the 'boats at Alexandria.

The sorties were flown at wave top height, usually making a landfall near Selia, climbing to clear the White Mountains across the twenty kilometre waist of the island, rounding Cape Dhrapanon to Suda. Sometimes the 'boats were escorted by Sunderlands, sometimes they flew together and sometimes singly. Typical loads were thirty-five RAF men. No one worried about load sheets or load distribution. When the passenger hatch threshold was about to ship water, loading was halted. Once, 'UI COORONG (Captain J.M.L.Davys) and a crew of five took out forty-seven passengers. 'UI was then fitted with seats for twenty passengers. The thirteen round trips, the last on 5 May, carried a total of four hundred and sixty-nine passengers, most of whom had been rescued from Greece by Sunderlands. The extra flights to and from Suda Bay were made with the minimum disturbance to regular Horseshoe services and the operation was completed without mishap.

Two weeks later the German air borne invasion of Crete - Operation Mercury - started at first light on 20 May 1941 and was completed in some ten days. The ultimately disastrous German attack on the Soviet Union - Operation Barbarossa - rolled across the border of a partitioned Poland on 22 June. Syria was occupied by the Allies in the face of Vichy French resistance and British and Russian troops took over Persia. In November, the first offensive by the Eighth Army opened, relieving Tobruk by the end of the year. In December, the Germans had been fought to a standstill by the Red Army outside Moscow and the Japanese brought themselves, and the United States of America, into the war.

The Horseshoe Route continued in operation through the year with increasing difficulty due a shortage of aircraft and crews. Besides carrying personnel, the 'boats were flying mail to and from the UK, the majority for the Forces. Most of the mail was in the form of aerogrammes priced at three pence (3d.) (20p.) for the Services, six pence (6d.) (PV 40p.) for civilians and a special rate of two pence (2d.) (PV 17p.) for prisoners of war. The civilian rate was to remain fixed for twenty-five years.

Airgraphs were introduced into the Middle East when the first Kodak microfilm camera was flown out to Cairo. For the same price as an aerogramme - three pence - a hand written message was reduced to microfilm at the rate of 1 700 messages per 100 ft. of film which weighed 154 g. Films were flown back to the UK where they were processed, folded, placed in window envelopes and passed to the GPO's London Postal Region for delivery. The originals were kept until the microfilms were safely in the UK. 'CZ CLARE was carrying twenty-nine of these films when it disappeared over the Atlantic. The 50 000 airgraphs on board were re-processed and delivered within the fortnight. The first airgraphs left Cairo on 21 April 1941 and the reciprocal service from the UK started in August 1941. By the time the service closed on 31 July 1945 some 350 million airgraphs had been delivered.

For a period of about three weeks, the normal stops on the Horseshoe route were disrupted at Lake Habbaniyah by an insurrection in Iraq. The RAF station on the shores of Lake Habbaniyah was attacked and the BOAC resthouse looted. The Mark I S.23 'boats were in the process of having their fuel system capacities modified from 652 gal.

7. The Horseshoe Route

(2 964 litres) to 1 412 gal. (6 419 litres). The 'boats with increased tankage could overfly Iraq, so a shuttle service between Cairo and Bahrain direct was maintained with these aircraft, until the situation returned to normal. The former IAL base ship from Mirabella, the M.V. *Imperia*, was stationed in the Gulf of Akaba in case it became necessary for the Horseshoe route to be diverted eastwards to avoid Cairo and Akaba used for a short time as a refuelling stop.

Towards the end of the year, QEA crews took over the sectors from Singapore to Karachi to help the hardpressed BOAC crews, increasing QEA's segment of the route to 7 011 n.m. or 12 900 km. To counter the expected entry of the Japanese into World War II, diversions from the eastern end of the main Horseshoe route - known as 'Phases' - had been planned. Phase I omitted Bangkok as a night stop. Phase II diverted the route to omit Thailand, operating from Rangoon through Mergui and then to Singapore via Penang. Phase III omitted the Burma coast, from Rangoon to Port Blair in the Andaman Islands, to Sabang on Weh Island to the north of Sumatra and then as Phase II to Singapore via Penang. Phase IV omitted Malaya, operating down the west coast of Sumatra from Rangoon through Port Blair to Sabang and Padang to Batavia, with refuelling stops at Sibolga and Benkulen. A shuttle service was to be run between Batavia and Singapore. The 'boats were switched to the reserve routes on 8 December 1941.

The Poole-Foynes-Lisbon shuttle service was maintained by the three S.30 'boats, 'CT CHAMPION, 'PZ CATHAY and 'CZ CLARE. 'CX CLYDE was wrecked by a hurricane while at anchor on the Tagus river, Lisbon in February 1941. In the autumn of 1941, the military situation in the Mediterranean allowed a direct weekly Gibraltar to Cairo service to be operated by the West African 'boats, via Malta. The first Mediterranean sector on the Malta service, flown by 'CZ CLARE, was a nine hour night flight, flown in complete radio silence. Good navigation was required for the first 780 n.m. (1 440 km.) as the aircraft was flying parallel to the Vichy-controlled coast line of North Africa. The 'boats turned at the Cape Bon lighthouse (luckily still operating) to negotiate the 50 n.m. (96 km.) wide corridor between Tunis and the fortified Italian island of Pantelleria. A turn eastwards brought them to an alighting at the RAF base at Kalafrana on Malta, just before first light. The flare path was two lights, one on a wreck and the other on the control dinghy. A nine hour onward flight to Cairo to complete the service started in the dark. The return service often terminated on the calmer waters of the River Tagus at Lisbon rather than the more dangerous ocean swell off Gibraltar. The military situation in March 1942 brought this operation to a halt.

'TY CLIO and 'UD CORDELIA were purchased by the Air Ministry from BOAC in July 1940 as replacements for the two S.30 'boats lost at Bodø in Norway. The 'boats were flown to Queen's Island, Belfast, in September 1940 for a much more extensive conversion. They were equipped with two Bolton and Paul Type A four-gun power-operated turrets, one amidships on the starboard side - probably between Frames 23 and 25 - and the other in the tail. The fitting of the tail turret required considerable re-shaping of the hull aft of Frame 38. The turret fairing required the rudder to be cropped and the trim tab moved up. Some armour plating was installed. Both 'boats were modified to carry six 430 lb. (195 kg.) internally stowed depth charges inboard. ASV radar completed the conversion. They emerged in March 1941 as S.23Ms with RAF serials AX 659 and AX 660. The 'boats were delivered to 119 Squadron RAF at Bowmore on Islay, off the west coast of Scotland for convoy protection and transport. AX 659 CLIO flew its first convoy protection patrol - Convoy OG0.60 - on 27 April for 8 hr. 14 min. and its brief service of five months with the RAF ended when the aircraft crashed on a test flight near Bowmore - the unlucky thirteenth Empire 'boat to be written off. An eye witness account of the crash by one of the crew, W/Op Harry Pain, exists and is briefly summarised here. AX 659 had arrived back from a convoy protection sortie with a 'dead' starboard outer engine. The engine was changed with the 'boat on the water - no mean task. After taxiing trials, it was decided to carry out an air test. AX 659 (Captain Flying Officer S.J.Rawlins) took off climbed to 500 ft. when the replacement engine failed. The starboard inner engine then stopped due to contaminated fuel, leaving no power on the starboard side. High ground to port and ahead required an unavoidable turn to starboard for alighting. With the aircraft flying on only two engines, flying speed was lost during the turn. The aircraft stalled and crashed in a peat bog on rising ground near Bruichladdich, about 130 metres from the road. There was no fire. Harry Pain suffered a badly injured back, Flying Officer Rawlins was thrown forward through the coupé, nearly losing an ear, and another crew member had a deep gash to his arm. The injured were helped by peat cutters who were passing in their lorry. They used the tail gate as a stretcher to carry Harry Pain, face down, to the road to be picked up by ambulance on their way to the Sick Bay.

No. 119 Squadron RAF was disbanded and AX 660 CORDELIA spent six weeks with No. 413 Squadron RCAF before being sold back to BOAC, to be converted back to a standard war-time S.23.

Before the year was out, British troops on the Malayan peninsula were at the second degree of readiness, awaiting the Japanese invasion. On 26 November 1941, the Japanese First Air Fleet, embarked on six aircraft carriers and escorted by two battleships and a dozen other warships, sailed from Hitokappu Bay in the Kurile Islands, eastwards towards the Hawaiian Islands. By dawn on 7 December 1941, the carrier group was 200 n.m. (370 km.) north of Oahu and at 07.55 the attack on Pearl Harbour began. Japan had entered the war. At the same time, other Japanese aircraft were attacking RAF airfields in Malaya as convoys of Japanese ships landed their troops along the eastern

7. The Horseshoe Route

beaches. Singapore and Penang were also bombed. By 30 December, the situation was so dire that all flying boat operations south of Rangoon were suspended and Phase III brought in to service.

'UW CASTOR (Captain R.B. Tapp) was at Rangoon, eastbound and 'TX CERES (Captain A.A. Koch) at Mergui, westbound. Phase III, the reserve route from Rangoon to Singapore via Port Blair, Sabang and Penang, came into operation immediately. On 29 December 'UX CASSIOPEIA (Captain C. Madge) crashed on take off at Sabang, after re-fuelling there for the first time. Spare engines, some stores and personnel were moved from Singapore to Batavia on 14 February 1942, two days before the surrender of Singapore island.

In Auckland, the two TEAL 'boats were flying a series of reconnaissance flights. Thirteen flights were made – RF 1 to RF 13. A typical RF, RF 3, on 21 August 1940 flown by 'MC AWARUA lasted 12 hrs. 58 min.

Two S.23s and one S.30 were written off during 1941, leaving twenty-one S.23s, five S.30s and two S.33s in service.

In the Western Desert, the British 8th. Army was fighting a series of rearguard actions along the coast of Cyrenaica until at the end of June 1942, when it took up a defensive position at El Alamein. The El Alamein position, which stretched from the Mediterranean in the north to the impassable Qattra depression in the south, was 110 n.m. or 200 km. from Cairo and the Horseshoe route. M.V. *Imperia* was still at its station in the Gulf of Akaba in case it became necessary for the Horseshoe route to be diverted eastwards to avoid Cairo should the German and Italian forces break through. The military situation in the desert remained virtually static whilst the 8th. Army was reinforced and made ready for the Battle of Alamein in October 1942. The retreat of the German and Italian forces from Alamein started on 2 November 1942 and the threat to the Horseshoe route, from this quarter at least, was removed for ever.

1942 was a disastrous year for the Horseshoe fleet. Operations by the Japanese forces dominated the situation at the eastern end of the route. The Japanese invasion of the Malayan peninsula ended with the surrender of Singapore on 13 February 1942 and the Horseshoe broken. Captain W.H.Crowther took the last service out of Singapore in darkness, without a flare path, lifting forty-three women and children in either 'DU CAMILLA or 'UC CORINNA. The flight was mentioned on Tokio radio the same afternoon. The Horseshoe was to remain broken for three and three quarter years until 'BG CORIOLANUS (Captain K.G.Caldwell) flew in on 8 October 1945 - the first civil aircraft to do so. The Empire 'boats to the west of the break were turned round at Calcutta.

By the end of the month, a series of landings were made on either side of the erstwhile Horseshoe route. The Japanese Western Force invaded Sumatra and Java. Units of the Japanese Central Force landed on southern Borneo, Celebes, Timor, Bali and the eastern end of Java. The defenders were overwhelmed and by 8 March 1942, the whole of the Dutch East Indies was in Japanese hands.

Fifteen 'boats were in British registration and working on the Horseshoe or West African routes, eleven were either on charter to the RAAF or in QEA ownership and two belonged to TEAL. The Empire 'boats isolated in Australia to the east of the break in the Horseshoe were in the thick of the action. The nine aircraft destroyed or written off during the year left a total of nineteen in operation. 'BD CORIO (Captain A.A. Koch) was shot down by Japanese fighters on 29 January. On 27 February, A18-12 COOGEE was lost after a mishandled alighting at Townsville. 'TZ CIRCE (Captain W.B. Purton, First Officer M.W.Bateman, Radio Officer H.G.A.Oates, Pursers L.J.Hogan and W.R.Bartley and sixteen passengers including the Netherlands Consul General, his wife and daughter) was lost without trace about 160 n.m. or 300 km. out from Tjilatjap on the last of the shuttle services to Broome on 28 February. CIRCE gave a position report at 10.25 on 28 January 1942, about 130 n.m. (240 km.) out from Tjilatjap on the last Tjilatjap - Broome shuttle, the last message ever received. After the position report, nothing more was ever heard or seen of CIRCE. 'BG CORIOLANUS (Captain Howard) was flying a few minutes ahead and heard 'TZ give a last position report at 10.25. Nothing else was heard so the 'boat was presumably shot down by Japanese fighters. A search by 'UC CORINNA found no trace.

Within the week two more 'boats were caught on the water at Broome and destroyed - A18-10 CENTAURUS and 'UC CORINNA. Two weeks later 'UF CORINTHIAN sank in Darwin harbour, alighting at night, bringing the total of flying boats destroyed in the first three months of the year to six. Leading an apparently charmed existence 'DU CAMILLA, at its mooring in Darwin Harbour, rode out the Japanese air raid unharmed except for a few minor perforations. The other casualties were A18-11 CALYPSO, a rescue attempt that went wrong off Daru, New Guinea on 9 August and 'CZ CLARE destroyed by fire in the air between Bathurst and Lisbon on 14 September. 'CZ CLARE departed Lagos at daybreak for Bathurst, refuelling at Freetown. At Bathurst 'CZ was refuelled and a new crew (Captain Musson, First Officer A.D.C.Jenkins, Second Officer A.O.Cundy, and Radio Officers E.F.G.Brent and J.A.Wycherly) took over for the sector to Lisbon. Captain Musson always flew his tangents round Dakar on a 60 n.m.circle rather than the accepted 20 n.m. One hour out of Bathurst the Captain decided to return, having lost an engine. Minutes later a request for "Flares" was followed by "SOS Fire". 'CZ CLARE crashed in the dark some 30 minutes flying time from Bathurst. The next day all available aircraft searched without success. On 16 September a BOAC Catalina (Captain J.C.Parker, Second Officer Talbot and Navigator D.McGregor) searched to the west of the assumed track - McGregor had flown with Captain Musson – finding six bodies and wreckage. 'TX CERES was written off after a fire at Durban on 1 December.

7. The Horseshoe Route

Passenger loads of forty or more were flown by the 'boats in RAAF service, mostly on evacuation flights. A18-11 CALYPSO (Flt. Lt. M.Mather) and A18-12 COOGEE (Flt. Lt. L.Grey) between them rescued eighty-six RAAF personnel from boats at a rendezvous on the open sea, 35 n.m., south of Rabaul. The next day, 24 January 1942, A18-12 COOGEE (Flt. Lt. L.Grey) flew a sortie with forty-nine passengers. The (unconfirmed) record passenger load is believed to have been sixty women, children and wounded, evacuated from Ambon to Darwin by one of the RAAF 'boats.

Eight S.23s and one S.30 were lost during 1942, leaving thirteen S.23s, four S.30s and two S.33s in service.

In 1943, QEA established a weekly service connecting Perth, West Australia to Ceylon. The five Consolidated Catalina 'boats of the Western Operations Division flew the 3 055 n.m. (5 621 km.) from Nedlands, a suburb of Perth, direct to Lake Koggala in Ceylon, non-stop. The first service, with Captain Tapp in command, took 28 hrs. 19 minutes. The total of nine hundred passengers carried were each issued with a certificate indicating their membership of the exclusive Secret Order of the Double Sunrise. The service continued to Karachi.

Of the nineteen 'C' and 'A' 'boats remaining in service at the beginning of 1943, thirteen were engaged on the Horseshoe and African routes, four in Australia - two on charter to the RAAF and two under the control of the Australian Government - and the two TEAL 'boats on the Auckland-Sydney service.

After the seizure of Madagascar by British forces, 'CT CHAMPION flew the newly opened spur service from Lindi to Diego Suarez, via Pamanzi. The figures for the Horseshoe route for the year ending March 1943, with two months estimated, show that the services from Durban to Calcutta, the UK to West Africa and Lagos to Port Bell were operating with a 91% passenger load factor. The total hours flown was 23 767 and the total distance, 2 760 106 n.m. (5 078 595 km.) at an average flying speed of 116 knots.

At the other end of the Horseshoe route, the war had moved from Papua to New Guinea in a series of actions along the north coast. By the middle of the year, the United States 5th Air Force had gained superiority in the air and in September 1943, both Salamaua and Lae had been captured. The two Empire 'boats on charter with the RAAF continued to serve with 41 Squadron RAAF, delivering personnel and stores to Port Moresby and the newly captured Merauke. Both aircraft were handed back to QEA in the middle of the year, so ending their wartime service. The return of 'BB COOLANGATTA and 'CD CLIFTON brought QEA's Empire 'boat fleet back to three aircraft. At the end of 1943 the fleet total stood at eighteen - twelve S.23s, four S.30s and two S.33s. One 'boat was lost during the year - 'DU CAMILLA (Captain A.A. Koch) off Port Moresby after battling with a storm for more than six hours. Thirteen 'boats were flying on the Horseshoe and spur services, three were flying with QEA on charter to the Australian Government and the two TEAL 'boats were engaged on the trans-Tasman service.

Warfare had a diminishing influence on Horseshoe operations. The campaign to dislodge the Japanese forces from the islands to the north of Australia cleared New Britain, New Ireland and the Admiralty Islands, by-passing the bases at Rabaul and Kavieng, which remained in Japanese hands until the surrender. The QEA 'boats had made 765 flights into Papua and New Guinea and had carried 24 167 service personnel. The number of hours flown by the QEA 'boats had increased from some 700 hrs. per year in 1938 to more than 2 800 hrs. In the last year of the Horseshoe operation at the western end, the BOAC 'boats were flying between 1 765 and 2 000 hrs. each year.

Two of QEA's 'boats, 'BB COOLANGATTA and 'CD CLIFTON, were lost during 1944, both by alighting accidents and both in Sydney Harbour. 'CD CLIFTON was the twenty-sixth, and last, of the original forty-two 'boats to be written off.

The combined fleet at the beginning of 1945 was down to sixteen aircraft - eleven S.23s, four S.30s and one S.33. Thirteen were owned by BOAC, one by QEA and two by TEAL. At the end of January 1945, it was decided that the Empire 'boats would not be converted back to the pre-war standard passenger accommodation. The time limit on the Empire 'boat mainplane spars was set at 13 250 flying hrs. It is not clear if this figure was decided when the 'boats were designed, as a limit to their operational lives or whether it imposed at a later date. By 31 May 1945, 'HL CANOPUS had 12 794 hrs. on the log book and there were four more of the surviving 'boats with similar hours. In the final reckoning when they came to be scrapped, four of the BOAC 'boats had exceeded the limit with more than 15 000 hrs., and one had 14 989 hrs.

In February 1945, the postal arrangements were revised to give a 1 penny per ounce (PV 10 p. per 10 g.) outbound mail service from the UK. For the Armed Services, mail to the UK was carried without charge. This service undercut the aerogramme and airgraph services, both of which closed by the end of the year. The war in Europe came to an end on 29 April 1945 when German envoys signed the terms of unconditional surrender and all hostilities in Europe ceased on 7 May. By the end of the month, BOAC and QANTAS had instituted a joint weekly service from Hurnin the UK to Sydney - using Avro Lancastrian aircraft.

The Japanese domination of China, Burma, Borneo and the Philippine Islands was ended and the war brought to Japan. Boeing B.29 bombers of the 21st. Bomber Command of the USAAF based in the Mariana Islands, started a systematic bombing campaign to paralyse industry and bring city life to a standstill. The incendiary bomb raids were halted to assess the effect of first, and then the second, atomic bombs. Ten days later, on 19 August 1945, Japanese envoys arrived on the island of Ie Shima near Okinawa to arrange an unconditional surrender. The surrender documents were signed, under the watchful eye of General MacArthur, on the deck of the battleship USS Missouri anchored in Tokyo Bay on 2 September. After six years and a day, World War II was at an end.

7. The Horseshoe Route

The Horseshoe route continued with the surviving aircraft suffering an increasing number of minor accidents and incidents. The Johannesburg (Vaaldam) to Durban spur service ended with the 151st flight. At the end of September 1945, John Lankester Parker took Sunderland V TX 293 off the Medway at Rochester on a test flight for the last time as Chief Test Pilot of Short Bros., ending a remarkable career spanning twenty-nine years. The trans-Tasman route continued and QEA opened a service to Suva.

The fleet composition at the end of 1945 was unchanged, and for the first year since 1936, no 'boats were written off during the year.

A BOAC memo stated that flying boats would continue in service for *'two or three years'* until landplanes could meet the demand. It was also suggested that some flying boats should be kept in service for possible new routes and to enable the techniques of flying and handling to be kept alive. BOAC ceased to use the facilities at Foynes in April 1946 and a month later opened a service to Sydney, in co-operation with QANTAS, using Short Hythe flying boats. In June, PAA flew the first direct trans-Atlantic service flight from New York to London Heathrow.

However, all sixteen Empire 'boats that survived World War II had been taken out of service by the end of 1947, and all but one, scrapped. Thirteen were reduced to produce at Hythe, one at Sydney and two at Auckland.

On 17 October 1946, 'HL CANOPUS (Captain H.L.Fry) arrived back in the United Kingdom for the last time. A week and a day later 'HL was handed over for scrapping - after a service life of ten years with 15 026 hrs. on the log. The first was followed by the last. By the end of the month, the last of the Empire 'boats to be launched, 'RA CLEOPATRA (10 513 hrs.) had arrived back and was scrapped on 4 November 1946.

The memorandum setting out the schedule for the return of the surviving Empire 'boats to the UK for scrapping, has a pencil note in the margin - *'the end of an era'*. The melancholy procession to the scrapyards continued in the New Year. 'UE CAMERONIAN (15 652 hrs. on 13 January 1947) was next, followed by 'UV CAMBRIA (13 892 hrs. on 15 January 1947), 'BJ CARPENTARIA (14 989 hrs. on 19 January 1947), 'VB CORSAIR (13 262 hrs. on 20 January 1947), 'BL COOEE (10 628 hrs. on 2 February 1947), 'UW CASTOR (15 789 hrs. on 4 February 1947), 'UD CORDELIA (11 665 hrs. on 5 February 1947), 'UI COORONG (12 472 hrs. on 10 February 1947), 'KZ CATHAY (6 683 hrs. on 9 March 1947), 'CT CHAMPION (12 013 hrs. on 16 March 1947) and finally, 'HM CALEDONIA (15 143 hrs. on 23 March 1947). The Horseshoe route closed on 12 March 1947 when 'HM CALEDONIA departed Durban for Southampton.

In New Zealand, 'MA AOTEAROA and 'MC AWARUA were withdrawn from service in October 1946 to be scrapped, 'MC almost immediately and 'MA, probably sometime in 1954. The longest serving Empire 'boat, 'BG CORIOLANUS, was withdrawn from service in December 1947 and scrapped at Sydney.

The Horseshoe route had lasted 6 years, 37 weeks and about 5 days - more than twice as long as the Empire Air Mail Programme.

The Empire 'boats scrapped at Hythe were beached, hauled out and their engines and re-usable equipment removed. The spars were cut with oxy-acetylene torches and the hull hacked to pieces with axes, as they stood on their beaching chassis. The produce was trimmed to a convenient size to fit into a lorry on the way to the melting-down furnaces. At the same time as they were reducing Empire 'boats to produce, R.J.Coley and Son were scrapping Avro Lancasters bought for £ 30 (PV £ 450) each - less armament and presumably, engines. The residual value of an Empire 'boat for scrap is not known.

'MC AWARUA was scrapped and 'MA AOTEAROA was hauled out in Auckland on its beaching chassis for the last time on 28 July 1948, witnessed by a considerable crowd. Photographs of this sad occasion show no signs of the modifications that turned 'MA into a radar-equipped reconnaissance bomber in 1941. The 'boat was towed inland and settled to rest on a lot in a suburban street, as a static display. 'MA was surrounded with a rail fence and as an added attraction, a miniature golf course was laid out round the aircraft. A rockery, with flowers, completed the scene. A charge was made for a round of golf and admission to view the aircraft. Photographs show the aerial mast extended and some unidentifiable flag flying, in defiance of the etiquette that no bunting should fly from a beached flying boat. One photo shows the bunting broken - no doubt as an unintentional sign of distress - to the half mast position.

The advertising board at the entrance to the site read:

'A unique opportunity to inspect The Pioneer Flying Boat of the Tasman Service. See the passenger accommodation. Inspect the flight deck, the engineer's room, the observer's chart room with the chart still on the table after the last Tasman crossing. Sit in the pilot's cockpit and actually handle the controls of this GIANT AIRCRAFT! You will enjoy inspecting the intricate machinery of this masterpiece of engineering. An experience you'll never forget! A chance you'll never have again!'

Timber access steps were rigged to allow entry to the forward passenger hatch on the port side and to the starboard mail hatch on the Control Deck. Visitors entering the aircraft started a recorded description of the 'boat and its service. Although one account described 'MA *'as shiny and new as the day she took the water many years ago'*, another and perhaps later, visitor gave a different account of a visit to the old 'boat. His visit was a distinctly dispiriting experience. 'MA was then in a poor state and the interior not even properly cleaned out. 'MA remained landlocked in its distressed and undignified state, until sometime in 1954 when it too, as the very last remaining Empire 'boat, was scrapped.

7. The Horseshoe Route

The operational history of the Empire 'boats spanned eleven and a half years. The total distance flown by the forty-two 'boats during their service lives exceeded 33.26 million nautical miles or 61.2 million kilometres. Some 30.2 million nautical miles, or 55.6 million kilometres, had been flown by the IAL and BOAC 'boats. The two TEAL aircraft between them flew 17 240 hours - 2.5 million nautical miles or 4.5 million kilometres - before they were withdrawn from service. The total number of hours flown in QEA, RAF and RAAF service is not known accurately. The aircraft with the highest time on the IAL/BOAC records was 'UW CASTOR with 15 789 hours - representing a distance of about 2.2 million nautical miles or 4 million kilometres. The 'boat with the highest recorded time, 'BG CORIOLANUS, logged some 18 500 hrs. The 'boat with the lowest time was the ill-fated 'VA CAPRICORNUS, with 10 hours.

Designed as mail carriers for the Empire Air Mail Scheme with a service life of a decade, they flew from 68 deg. north to 30 deg. south and from 74 deg. west, across the International Date Line, to 158 deg. west. With their crews, the 'boats established the Empire Air Mail Programme, a most ambitious project for its time, and maintained it in the face of increasing difficulties for nearly three years. They pioneered the British end of the Atlantic crossing, with and without flight refuelling. In the second chapter of their history during World War II, they flew the Horseshoe Route and the connecting services from the UK. They played a vital part in communications between the UK, Africa, the Middle East and Australasia. Some 'boats were impressed into military service and armed. Others flew their wartime services through hostile air space completely unprotected - and paid for it. The 'boats were in action in Norway and over the waters to the north of Australia. The two TEAL 'boats, when they were not engaged on military duties, provided the only passenger link between New Zealand and Australia during the dangerous years of the war.

An announcement was made in Parliament, on 12 June 1946, that the Seaplane Works and the Rochester airport factory would have to close, as both were considered to be inadequate for the needs of the day. The last aircraft launched down the slipway at Rochester was G-AHIL, a S.45 Solent Mk. 3 - Construction number S.1300 - on 8 April 1948. The Seaplane Works at Rochester were finally closed in July 1948. It was almost thirty years since N 4000, the first Short-built flying boat, was lifted by crane into the Medway - the slipway not then being ready.

The Works changed when they were re-built after the bombing of August 1940. Nos.1 and 2 Shops were rebuilt and swallowed Nos.11, 13 and 14 Shops in the process. Nos.6 Shop - the sawmill, 9 Shop - machine shop and 10 Shop - where the hull frames and tailplanes for the Empires were made - survived. No.3 Shop - where the 'boats were assembled - was undamaged. No.15 Shop - where one of the mock-ups was built - remained, along with No. 16 Shop - where the mainplanes for 'HK Maia were built - to be re-named S Shop. The float shop - No.4 Shop, with traces of many rivets trodden into the floor and No.5 Shop - the Sunderland hull shop - survived the destruction then. But now the Works have almost entirely disappeared. A plaque has been erected at the former entrance to the Works by the Short Brothers Commemoration Society in 2008. It reads *The Horace, Eustace and Oswald aviation pioneers and their workforce founded Britain's aircraft seaplane and flying boat industry Isle of Sheppy 1908 Rochester 1914-1948*. Some of the roads of the housing development now occupying the site are named after Shorts' aircraft built at Rochester: *Valetta Way, Sealand, Sunderland and Seaford Court, Stirling and Sunderland Close* and finally *Shorts Way*. The slipway down which all the Empires went at their launching is slowly slipping into the Medway.

The Tower Reach of the River Medway was bridged in 1963 to the west of the Works by an elegant prestressed concrete structure by Freeman, Fox and Partners carrying the M 2 motorway and not even John Lankester Parker could take a 'boat off the Reach now. Many of the names, well-known around the Seaplane Works when the Empire 'boats were being designed and built, died more than a generation ago. It is more than sixty years since Oswald Short and Sir Arthur Gouge, as he later became, left Rochester.

Few, if any, of the Imperial Airways 'barons' are still with us. A rapidly diminishing number of their crews are however, and their memories of events, and their Captains, remain as sharp as ever after a span of over sixty years.

No complete 'boat has survived. Rather than being scrapped, 'KZ CATHAY was offered to the Science Museum in London, for preservation as part of the National Aeronautical Collection. The offer had to be regretfully declined. The Museum had suffered the loss of about one third of its display accommodation due to bombing during World War II and had no space available to house the proffered 'boat. 'KZ was scrapped on 9 March 1947, seven years and a month after it had been launched.

Fragments of a cylinder and the data plate of one of the engines of V 3138 CARIBOU, rescued by divers from the wreckage on the seabed, are in the Luftfahrtshistoriske Museum at Bodø, Norway. A compass housing and an airscrew boss - with part of one of the blades - are also in the Museum.

Parts of 'HL CANOPUS still exist. One of the control wheels and a 15 ins. (380 mm.) length of the control column is mounted on a display plaque, hanging in the Public Bar of the Canopus Inn at Borstal - up the road from the Seaplane Works. An accompanying photograph shows Captain H.W.C. Alger presenting the plaque to Mr H.H.Green, the licensee, on 4 July 1947 - the eleventh anniversary of the first - official - flight. Nearby on the wall is a brass plate giving the permission of IAL and Short Bros. to the naming of the Inn in 1938.

7. The Horseshoe Route

Mr G.E.Woods Humphery, the Managing Director of IAL who left the Company in the aftermath of the Cadman report, was presented with an double inkwell made from part of the mainplane spar boom extrusion of 'HL CANOPUS.

'BJ CARPENTARIA was one of the QEA 'boats that came back on the British register and was scrapped at Hythe on 19 January 1947. They were demolished by R.J.Coley and Son – scrap merchants. Before Mr Coley's men got to the 'boat with their axes, Purser W.W.Morgan removed the registration plate and some of the bunting where they remains today in the possession of his family. . The produce from 'boats scrapped at Hythe was melted down. The metal from the furnaces had many uses. Some was used to make crankcase covers for cars and some of the metal found its way into domestic kitchenware. A small amount of the melt-down was cast into acommemorative ashtrays, weighing 300g. each. The words '*BOAC IMPERIAL AIRWAYS SHORT C CLASS 1936 - 1946*' and the Speedbird logo are moulded inside.

The registration plate and logbooks of 'BG CORIOLANUS are in the QANTAS Museum in Sydney New South Wales.

The remains of 'UU CAVALIER are at N 37 17 W 069 45, about 248 n.m. (436 km.) south east of Port Washington, on the seabed of the Atlantic.

Some of the radio equipment used by the ground station to communicate with the 'boats on the Atlantic and West African services, is in the Foynes Air Museum.

The Science Museum in London have at least three model Empire 'boats. There is one 1:24 scale model (accession number 587/37), one purporting to be a solid wind tunnel test model (643/38) and the third, a cut-away model of 'HL CANOPUS shows the original interior accommodation in colour – the nearest match to the original available. Museums rotate their displays so not all are on display.

In 1938 International Model Aircraft Limited issued their Frog 1:72 scale acetate plastic model of the Empire 'boats. . Model kit 21P was for a '*Short 'Empire' ocean-going liner*' was on sale at a cost of 15 shillings (PV £ 14.74). An undated Frog drawing (No. P.7103/D and G) exists showing the general arrangement of the cut-away version Kit 22P (17/6 or PV £ 17.00). This was the '*de luxe*' model which showed most of the port side is removed to show the interior. It is described as '*fitted with transparent windows, scuttles and bridge (sic); internally fitted exactly as full-sized boat, this includes decks, chairs, bunks, carpets, marine gear, control panels, wireless room, kitchen (sic), etc., etc.*'. The drawing is of 'UU CAVALIER, the 'boat used on the Bermuda - New York service. There is reason to believe that 'UU was the only 'boat to keep the 24 place passenger seating yet the drawing clearly shows the modification where the Forward Cabin was taken over for use as the Purser's office. The Promenade is shown clear of seats or table. The starboard side elevation shows the port window and entry arrangement superimposed on it. Frog quaintly described the 'boats as if they were surface vessels as '*quadruple-screwed monoplane boat seaplanes with a gross register of 18.375 tons*' with the '*quadruple Pegasus machinery*' quoted in shaft horse-power The acetate material from which the model parts were moulded was not particularly stable, so any surviving models could by now have twisted out of shape, despite the plywood mainplane spar and transverse bulkhead ('spar frame') that Frog provided as part of the kit. The individual steel moulding dies for the models survived until 1946. When the 'boats were scrapped, they too were scrapped. The last known sale of a mint condition Frog 21P kit was for £ 5 000. One thousand models were made up by Frog for distribution to travel agents throughout the world. One was present in Auckland at the inauguration of the trans-Tasman service in the hands of the Hon. F F. Jones, Minister for Air. Some of the models exist although the acetate has twisted out shape. Skilful people with hair driers have been able to un-twist these survivors and bring them back to their rightful shape.

In 2008 Czech Master Resins produced their 1:72 Empire resin kit CMR-200 for the 'boats – closing a gap of seventy years after the Frog model of 1938.

Dinky Toys produced their own version of the Empire 'boat as a small diecast model,(No 60r), priced at 1 shilling (PV £1.00) These models are now collector's items worth between £100 to £300. One of them, registered as G-ADHM CALEDONIA, is in its original box in a showcase in the Sky Solent Museum (formerly Southampton 'Hall of Aviation) together with other memorabilia of the 'boats and their connection with Southampton Water.

Nearby in the Museum is a beautifully made model of 'UY CAPELLA undergoing a Daily Check on the port inner engine.

One of the full-colour posters, originally published in 1936, has been re-published by Plaistow Pictorial. It shows a not-entirely-accurate 'HL CANOPUS in flight at night, in its original passenger arrangement. The poster mentions twenty-four passengers, including eight in the Promenade Cabin, but shows only six seats. Unaware of future problems with the mounting of the bunks in the air, it shows three passengers, either in their bunks or about to go to bed.

The National Film Archive holds two of the three IAL promotional films as part of their collection. The films were made circa. 1937 by the Strand Film Company for IAL on 35 mm. highly flammable, and increasingly fragile, acetate stock with sound track. The titles, '*Watch and ward in the air*', '*Air outpost*' and '*The future is in the air*' were made under the supervision of Paul Rotha and directed by Alexander Shaw and Ralph Keene. The music was composed by William Alwyn and Raymond Bennell. The commentaries were written by Graham Greene and

7. The Horseshoe Route

spoken by Stuart Legg and Ivan Scott. The third film is potentially the most interesting but unhappily is not in the NAB collection. It was specially made for the inauguration of the EAMS, describing a journey from Southampton along the eastern route to Sydney. Acetate film stock has to be refrigerated to preserve it, so it seems unlikely that other copies have survived. *'Watch and ward in the air'* has been issued by the British Airways Archive Collection as a VHS format video.

The remains of at least ten 'boats lie beneath the water around the world and with them some of their crews and passengers.

'UU CAVALIER lies in deep water in the Atlantic at N 37 17 W 069 45.

Divers report that parts of V 3137 CABOT are still on the seabed in fairly shallow water off the Island of Mauren to the north of Bodø, inside the Arctic Circle.

'UX CASSIOPEIA, its hull broken in two pieces, is just outside the entrance to Sabang Harbour. The bodies of one of the passengers and the baby were never found.

'BD CORIO, on a flight from Darwin to Sourabaya to evacuate women and children, was shot down on fire into the water off the mouth of the Noelmini river, near Koepang. Three crew and fifteen passengers did not survive.

'TZ CIRCE, complete with its crew of four and thirty passengers, is somewhere in the deep water between Tijlatjap and Broome, believed to have been shot down by Japanese fighters while on the last of the shuttle flights on

28 February 1942. 'TZ gave a position report at 10.25, about 130 n.m. (240 km.) out from Tijlatjap, the last message ever received.

'UF CORINTHIAN is believed to be still in Darwin harbour although its whereabouts are not known. 'UF broke up and sank after a normal night alighting on Darwin harbour during the night of 21/22 March 1942, in good weather. Captain Ambrose was seriously injured, two passengers were killed and two seriously injured. It is thought that 'UF struck floating wreckage, as the accident occurred just a month after the bombing attack by Japanese aircraft on the harbour.

The shattered remains of A18-10 CENTAURUS and 'UC CORINNA lie under the water off Broome, West Australia. An underwater side scan sonar survey of the harbour by archaeologists from the Western Australian Maritime Museum in 2001 revealed evidence of many of the wrecks. One of these is one of the two Empire 'boats is at E 122deg. 15min. 12sec. S 18deg 00min. 48 sec. Anecdotal evidence indicates that it is probably A18-10. The Empire 'boats were moored close together and with luck, they will be both identified in 2003. Underwater photographs show what seems to be an engine - the cooling gills are evident - and the blade of an airscrew.

There is a remote possibility that A18-11 CALYPSO was salvaged as it does not appear on the list of crashed aircraft. If it was not salvaged, it lies with its nose stove in and the planing bottom ripped out in the shallow water to the north of Australia, with a member of its crew.

The wreckage of 'CZ CLARE is in the Atlantic, brought down by fire at night, somewhere off Bathurst. The bodies of one of the crew and five of the passengers are buried at Bathurst but the other four crew members and eight passengers were never recovered.

'DU CAMILLA is listed as crash No. 366, located 5 miles west of Port Moresby. The water in this area is shallow and a search of the area revealed nothing. It more probable that the remains of 'DU are on the ocean side of Nateara Reef, to the south of the Basilisk Light with two of the crew and eleven passengers. The bottom in the area is some 100 fathoms (180 m.), shelving down to 400 fathoms (730 m.). The positions of many of the hundreds of other aircraft wrecks in the waters around the coasts of Papua New Guinea are known and have been visited by divers but so far 'DU has eluded all efforts at discovery.

Without stretching the point too far, some aircraft have distinct 'personalities' and some do not. The forty-two Empire 'boats were individual in their manufacture, their handling and personalities. Some were 'good' 'boats which seem to have had more than their fair share - and others not quite so good. They were designed for a role and they fulfilled it. During the war years, the 'boats and their crews performed duties with great distinction, of a kind that the compilers of the original specification in 1934 never dreamed of, in places around the world they had never heard of.

The Empire flying boat era started when 'HL CANOPUS was wheeled out onto the slipway at Rochester. It ended twelve years later when 'MA AOTEAROA was hauled off its suburban lot in Auckland, New Zealand, on the way to the scrapyards.

Everyone who had anything to do with the Empire 'boats, those who designed and built them, who flew them, maintained them, flew in them had, or who are just interested in them had, and still have, an apparently indelible and abiding impression of affection for them.

Their passing was, indeed, the end of an era.

Bibliography

- Aero Engineering Vols. I, II and III, Newnes Technical Advisory Service. London, undated.
- Aeroplane. A New Trailing-edge Flap .Gouge flaps, 8 Apr. 1936.
Imperial Pilotage, p.245 19 Aug. 1936.
Returned from internment ('VB CORSAIR on River Dangu), p. 118, 26 Jan. 1940.
- Aeroplane Monthly, BOAC's Boeing Clippers (Boeing 314s), reprint of Feb. 1942, p. 508. Oct. 1985.
- Aircraft Engineer, The Construction of the Empire Boats. p.24, Oct. 1936.
- Aircraft Engineering. Large Flying boat in series, Aug. 1939.
- Appleton, J. The Civil Aircraft Registers of Great Britain 1919-1985, The Aviation Hobby Shop, ISBN 0 907178 12 X, 1986.
- Baker, CB., Tank tests on a model of the 'Empire flying boat. Report B.A. 1678, May 1941. R.A.E., Farnborough.
- Barnes, C.H., Shorts Aircraft since 1900, Putnam, London, 1967.
- Beaumont, R.A., Aeronautical Engineering, Odhams Press Limited, London. Undated.
- Bennett, Captain (later Air Vice Marshal) D.C.T., Pathfinder, Goodall Publishing Co. ISBN 0907579 05 1,1958.
- Bennett-Bremner, E, Front Line Airline, Paul Elek (publishing) Ltd., London, 1945.
- BOAC Training School, Notes for First Officers 'C' class aircraft. Vaaldam, South Africa, 1943.
- Brackley, F.H., Brackles, Putnam, 1952
- Bristol Aeroplane Co. Ltd., Pegasus X-C Fight Operational Notes for Imperial Airways Empire Boat Aircraft, undated.
- C.G.G. (C.G.Grey), Our Empire Flying boats, The Aeroplane, 28 Oct. 1936.
- Chant, C. Early Airliners, Phoebus Publishing Co., 1980.
Piston-Engined Airliners, Phoebus Publishing Co. 1980.
Early Airliners, Phoebus Publishing Co., 1980.
- Cobham. Sir A. The history and progress of refuelling in flight, Royal Aeronautical Soc. J, Apr. 1940.
Twenty Thousand Miles in a Flying Boat, G. Harrap and Co. 1930.
A Time to Fly, Shephard-Walwyn (Publishers) Ltd. ISBN 0 85683 0372 1978.
- Coombes, L.P.. Research in the R.A.E. tank, Royal Aeronautical Soc. J.. 22 Feb. 1935.
- Donne, M, Pioneers of the Skies, Nicholson and Bass for Short Brothers PLC, ISBN 0900903295, 1987
- Duval, G.R., British Flying boats and Amphibians. Putnam, London, 1966.
- Engineer. Refuelling in flight. Aug. 4 1939.
- Flight. Editorial Comment - Imperial Airways operations, Oct. 3 1931).
Comfort on the Empire Routes, p.258. 5 Mar. 1936.
The Short Empire Flying Boats, p.430 Oct. 29 1936.
- Fysh, H., The Singapore-Sydney Flying boat Survey - 1, The Aeroplane, 16 Sept. 1936.
- Gadja, S., Air-Raid on Broome, After the Battle No. 28 .Battle of Britain Prints International Ltd. 1980.
- Gardner, B., Skytanker, The story of air-to-air refuelling, Air Extra No.49 July 1985.
- Gouge, A. Flying boats and their possible developments, North East Coast Institution of Engineers and Shipbuilders, Mar. 1935.
Transatlantic air transport with particular reference to flying boats, Institution of Mechanical Engineers
Progress in civil flying boats, Aeronautical Engineering. The Aeroplane. 16 Dec. 1936.
Some Aspects of the Design of Sea-going Aircraft, Royal Aeronautical Soc. J.. May 1931.
- Hamilton, Sir J..Aerial Wonders of our Time vols I and II, Waverly Book Company Ltd, London, undated.
- Handbook of Aeronautics ,Vols. I and II, Pitman, London, 1934.
- Hannah, D, Shorts. FlyPast Reference Library, Key Publishing Ltd. Stamford, ISBN 0 946219 03 6, 1983
deHavilland, Flypast Reference Library, Key Publishing Ltd. Stamford, ISBN 1 946219 00 1. 1983.
- Heffenan. T. and Lumsden, A., Per Mare Probare, Short-Mayo Composite, Aeroplane Monthly, p 712, Dec. 1988.
- Hill, FT., Materials of Aircraft Construction, Pitman, London, 1937.
- His Majestys Stationery Office
Cmd. 5254 Agreement for IAL services, Bermuda-New York, 1936.
Cmd. 5325 Agreement for an air service between UK and USA., 1936.
Cmd. 5414 Agreement for services to India, Australia and South Africa, 1937.
Cmd. 5497 Supplement to cover service to Sydney, 1937.
Cmd. 5676 EAMS to India and Malaya, 1938.
Cmd. 5685 Committee of inquiry into Civil Aviation, Lord Cadman, Chairman, 1938.
Cmd. 5813 EAMS agreement Singapore-Sydney, IAL and QEA. 1938.
- Hudson, K. and Pettifer, J., Diamonds in the Sky: A Social History of Air Travel, Bodley Head, London, 1979.
- Imperial Airways, A Survey of its Organization, IAL, 1938.
- Imperial Airways Limited/British Overseas Airways Corporation, Reference AW I Empire flying boat files 794--821,1831 .1906, 1922, 1926, 1994-5, 337-8, 412, 490, 547, 556, 580, 1174, 1454, 2904, 2905-6.
- British Airways Archives and Museum Collection, 1939 -1947.

Imperial Airways Gazette, A Detailed Description of the *EMPIRE* Flying boats, Dec. 1936.

Imperial Airways Gazettes, Jan. 1927 -Sept. 1939.

James, T Outside and Inside the Empire Boat, p.541, *The Aeroplane* 28 Oct. 1936.

Janes All the Worlds Aircraft, Grey, C.G. and Bridgeman, L., Short Bros'entry, p.(67c), 1938.

Kelly-Rogers, Captain J.C., Two years of Empire flying boat operations, Royal Aeronautical Soc. Rochester Branch, Jan 1939.

King, H.F. Empire Return journey to Sydney 1938, Propliner No. 21 p. 24, 1984.

Kinloch, E., By Empire boat to India (April 1941), *Aeroplane Monthly*, p.423. Aug. 1986.

Kinsey. G., Seaplanes-Felixstowe, Terence Dalton Ltd., ISBN 0 900963 89 1, 1978.

Langley, M. Seaplane float and hull design, Pitman, 1935.

Metal Aircraft Construction, Pitman, 1941.

Lower, J.H. Some Notes on Flying Boats and Seaplanes, Royal Aeronautical Soc. J., June 1931.

The Hydrodynamics of Marine Aircraft. Royal Aeronautical Soc. J.. May 1933.

Marine Aircraft Experimental Establishment, Felixstowe, Certificate of Airworthiness trials of "Empire" flying boat "Caledonia" G-A.D.H.M.,Report F/144, Oct. 1936.

Mayo. Major R.H. Trans-Atlantic Air Services. British Association. Engineers New York. Sept 1939.

Mayo papers. Memo. Review of the Empire Mail Service consequent upon demands for higher speeds as a result of the Melbourne Air Race, undated.

Report on replacement of the fleet under the EAMS. 16 Sept. 1939, (lodged at Science Museum, London).

McGregor. DB., BOAC Flying boats at War, *Air Enthusiast* No.43, p19.

Merchant Airman. HMSO, 1946.

Middleton, D., Test pilots, Guild Publishing. 1985.

Mullett,.G.W., Light Alloys in Large Flying boat Construction, p.2. *Light Metals*, Jan. 1944).

TheDetailedConstruction of Empire Flying boats, p.5. *Light Metals* Feb. 1941).

Munson, K., Pictorial History of BOAC and Imperial Airways. Ian Allen. 197)).

Ministry of Information, Merchant Airmen- British Civil Aviation 1939 -1944, HMSO,London, 1946.

National Film Archive, 'Watch and ward in the air', Strand Film Co., 1937.

Narracott, A.H., *Unsung Heros of the Air*, Frederick Muller, London, 1943.

Norris, G., *The Short Empire Boats*, Profile Publications No. 84, 1966.

Patent Specifications.

443,516, Short Brothers and A. Gouge. Improvements in or connected with Wings for Aircraft, (controller flaps), 1935.

147,327, Imperial Airways Limited and H. Burchall, Improvements in Adjustable Chairs (passenger seats). 1935.

447,521), Short Brothers and A. Gouge, Improvements in or relating to Spars for Aircraft Wings, (spar Construction), 1936.

463,1)4)8, Short Brothers and G.I.Robinson, Improvements in means for Absorbing Vibration in Aircraft, (sprung wing tip floats)1937.

464,184, Short Brothers and D.L.Parkes. Improvements in or connected with Control Surfaces of Aircraft, (servo tabs), 1937.

483,423, Short Brothers and A. Gouge, Improvements in or connected with Flying Boats, (hull construction), 1935.

Powell. Captain (later Air Commodore) G.J.. *Ferryman*. Airline Publishing Ltd., ISBN 0 906393 24 8 1982.

Preston, J.M. *A Short History*, North Kent Books, ISBN 0950573 3 1, 1978.

Pudney, J., *Seven Skies: A Study of B.O.A.C. and its Forerunners since 1919*, Putnam, London, 1959.

Public Record Office,

AIR 2/838 14082.Spec. No. R. 2/33 Four Engined General Purpose Boat Seaplane, 23 Nov. 1933.

AIR 2/838.144)82 Spec. No. 22/36 For the Manufacture of (Short R2/33) (S.25 Sunderland). 17 Nov. 1936

AIR 2/421)5 Borrowing of Atlantic Type Imperial Airways Flying Boats.

AIR 2/4234) Diversion of Civil Flying Boats for Military Duties.

AIR 15/116 Defensive Armament of Civil Flying Boats, AIR 27/910 Operations Record Book (RAF Form 541)119 Squadron RAF.

AIR 27/181)7 Operations Record Book (RAF Form 541) 413 Squadron RCAF.

AVIA 15 116 Defensive armament for civil flying boats.

AVIA 15 798 Arming of Short 'G' and 'C' class flying boats.

Rance, A.B., *Seaplanes and Flying Boats of the Solent*, Southampton University Industrial Archaeology Group and Southampton City Museums. ISBN 091)52801)3 2, July 1981.

Reith, J.C.W., *Into the Wind*, Hodder and Stoughton, 1949.

Q Code, Civil Air Publication 1, Air Publication 1529, ,3rd. Ed. Nov. 1945, Ministry of Civil Aviation. 1945.

Riegels. F.W., *Aerofoil Sections*. trans. Randall, D.G., Butterworths, 1961.

Short, H.O., Gouge, A.. Bibby. A.E.. Parker, IL., *Empire Flying boats*, p.533, *The Aeroplane* 28 Oct 1936.

Short, H.O., Aircraft with stressed skin metal construction, Royal Aeronautical Soc. I. Mar. 1968.
Short Bros. Type Record S.23 Empire flying boat, incomplete parts only 1936. (lodged at RAF Museum. Hendon).
Short Bros. Maintenance Manual 'C' Class Aircraft, Rochester, 1937.
Sikorsky, I., The development and characteristics of a long-range flying boat (the S-42), Royal Aeronautical Soc. J. Apr. 1935.
Sims, P.E Adventurous Empires, Airlife 2000 ISBN 1 84037 130 7
Smith, L., Work in an experimental seaplane tank -paper on Rochester test tank, Royal Aeronautical Soc. J. Sept. 1943.
Souvenir of Royal Visit to Rochester, March 1939.
Stroud, J. Wings of Peace Armstrong Whitworth A.W. XV Atalanta, Aeroplane Monthly, p.321, June 1986.
 Wings of Peace Short S.8 Calcutta and Short S.17 Kent, Aeroplane Monthly, p.⁹⁷. Feb. 1987.
 Wings of Peace Short Scion and Scion Senior, Aeroplane Monthly, p.36⁹. June 1989.
 Wings of Peace Short Empire Flying boats, Aeroplane Monthly, p. 763, Dec. 1989.
Vincent, D., C-Class 'Boats at War, Air Enthusiast, p.33, No. 15 Apr/July 1981.
Webb, G., A Short Tribute. AWE News, June 1989.
Williamson, Group Captain G.W., Aeroplane Production Year Book and Manual, Paul Elek (Publishers), London, 1943.
Wixey, K. The Empire Flying boats, Wingspan No.33, p.28. July/August 1986 Spanning the Empire.
Air Enthusiast No. 60
Yates, R.J., Fifty Years of Australian International Civil Aviation since Kingsford-Smith's Pacific Crossing, Royal Aeronautical Soc., Sydney. 1978