



TIR



Lors des premiers Jeux olympiques modernes (Athènes 1896) huit pays participaient aux trois épreuves de tir. A Mexico le programme comportait sept compétitions et réunissait 450 concurrents de soixante-six nationalités différentes, ce qui démontre clairement la popularité sans cesse croissante de ce sport. De construction récente, le Polygone de tir olympique constituait une attraction supplémentaire pour les amateurs qui s'attendaient à de très brillants résultats, encore facilités par des installations ultramodernes. En effet, quatre records olympiques tombèrent: petite carabine, position couchée (Jan Kurka, Tchécoslovaquie); pistolet libre (Grigory Kosykh, URSS); tir de vitesse aux silhouettes (Jozef Zapadzki, Pologne) et arme libre (Gary Anderson, Etats-Unis) tandis qu'un record était établi en skeet, épreuve nouvellement inscrite au programme. Par ailleurs, les titres mondiaux furent améliorés en skeet (Evgeny Petrov, URSS) et en arme libre (Anderson). L'événement le plus inattendu fut sans aucun doute l'échec de l'équipe américaine, incapable de renouveler son exploit de Tokyo où elle avait été citée sept fois. A Mexico elle ne remporta que trois médailles, tandis que les Soviétiques en trustaient cinq. Par contre, l'américain Anderson fut le seul concurrent à conserver son titre de champion olympique.

SHOOTING



At the first of the modern Olympic Games, held in Athens in 1896, eight countries participated in the three events of the shooting competition. In the Mexico City Games, more than 450 marksmen from sixty-six countries were entered in seven events—an indication of the greatly increased contemporary interest in this sport. Capacity crowds turned out on each of the six days of competition. The newly-constructed Olympic Shooting Range was itself an attraction for sportsmen, and it was expected that its ultra-modern facilities would contribute to improved shooting. In fact, no less than four Olympic records were broken—in small-bore rifle prone (by Jan Kurka of Czechoslovakia), free pistol (Grigory Kosykh of the U.S.S.R.), rapid-fire pistol (Josef Zapadzki of Poland) and free rifle (Gary Anderson of the U.S.)—and a record was established in skeet, a new event. World records were bettered in skeet (by Soviet Evgeny Petrov) and free rifle (Anderson). The most surprising aspect of the competition was the failure of the U.S. team to match the seven medals it had taken in Tokyo. In Mexico City, Americans took only three medals, while Soviet marksmen returned supremacy in the sport to Europe by winning five. The American Anderson, however, was the only Tokyo gold-medalist in the entire competition to repeat as Olympic champion.







PETIT CARABINE - POSITION COUCHE — SMALL BORE RIFLE - PRONE POSITION

			Total Points
1	84	Kurka, Jan.....	CHE 598
2	195	Hammerl, Laszlo.....	HUN 598
3	256	Ballinger, Roy.....	NZL 597
4	301	Rotaru, Nicolae.....	RUM 597
5	168	Palin, John.....	GBR 596
6	156	Loret, Jean.....	FRA 596

De nombreux spectateurs se pressent au Polygone de tir olympique pour assister au match de barrage entre Jan Kurka et Laszlo Hammerl, médaille d'or à Tokyo, qui avaient obtenu un score identique de 598. La place d'honneur fut cette fois occupée par Kurka. La Péruvienne Gladys de Seminario (en bas, à gauche), l'une des deux femmes inscrites, se classa 31e sur 86 concurrents.

A capacity crowd is on hand at the Olympic Shooting Range as Jan Kurka and Tokyo gold-medalist Laszlo Hammerl engage in a shoot-off after tying in the regular competition with a record 598. This time it is Kurka who takes the champion's place on the awards stand. Peru's de Seminario (right), one of two women in the event, finished 31st in a field of 86.





PETITE CARABINE - TROIS POSITIONS — SMALL BORE RIFLE - THREE POSITIONS

			Total Points
1	3	Klingner, Bernd.....	ALE 1157
2	134	Writer, John.....	EUA 1156
3	357	Parkhimovich, Vitaly.....	URS 1154
4	124	Foster, John.....	EUA 1153
5	238	González, José.....	MEX 1152
6	55	Ouellette, Gerald.....	CAN 1151

Bien qu'en position debout le score de Klingner (ci-contre) ait été inférieur à celui de Writer (en haut) – 367 contre 370 – ce dernier manqua pourtant d'un point la première place au classement général. Un excellent 393 en position à genoux permet à Parkhimovich de se classer troisième.

Klingner (left) compiles 367 points standing to edge out Writer (top), whose 370 from the same position still left him one point short in the overall point-total. Parkhimovich scores an excellent 393 in the kneeling position on his way to third place in the final standings.



ARME LIBRE — FREE RIFLE

			Total Points
1	123	Anderson, Gary.....	EUA 1157
2	353	Kornev, Valentin	URS 1151
3	318	Müller, Kurt	SUI 1148
4	355	Kveliashvili, Shota	URS 1142
5	325	Vogt, Erwin	SUI 1140
6	20	Sommer, Hartmut	ADE 1140

Après avoir défendu son titre de Tokyo et établi un nouveau record du monde, Anderson monte sur le podium en compagnie de Müller, médaille de bronze. Le Norvégien Overgard (en haut) et Kornev — médaille d'argent — rivalisèrent longtemps avec Anderson, mais perdirent du terrain en position debout.

Gary Anderson, Tokyo champion, mounts the awards platform with Muller, the bronze-medal winner, after setting a new world record in successfully defending his title. Norway's Overgard (top) and second-place Kornev stayed with Anderson most of the way, but lost ground in the standing position.

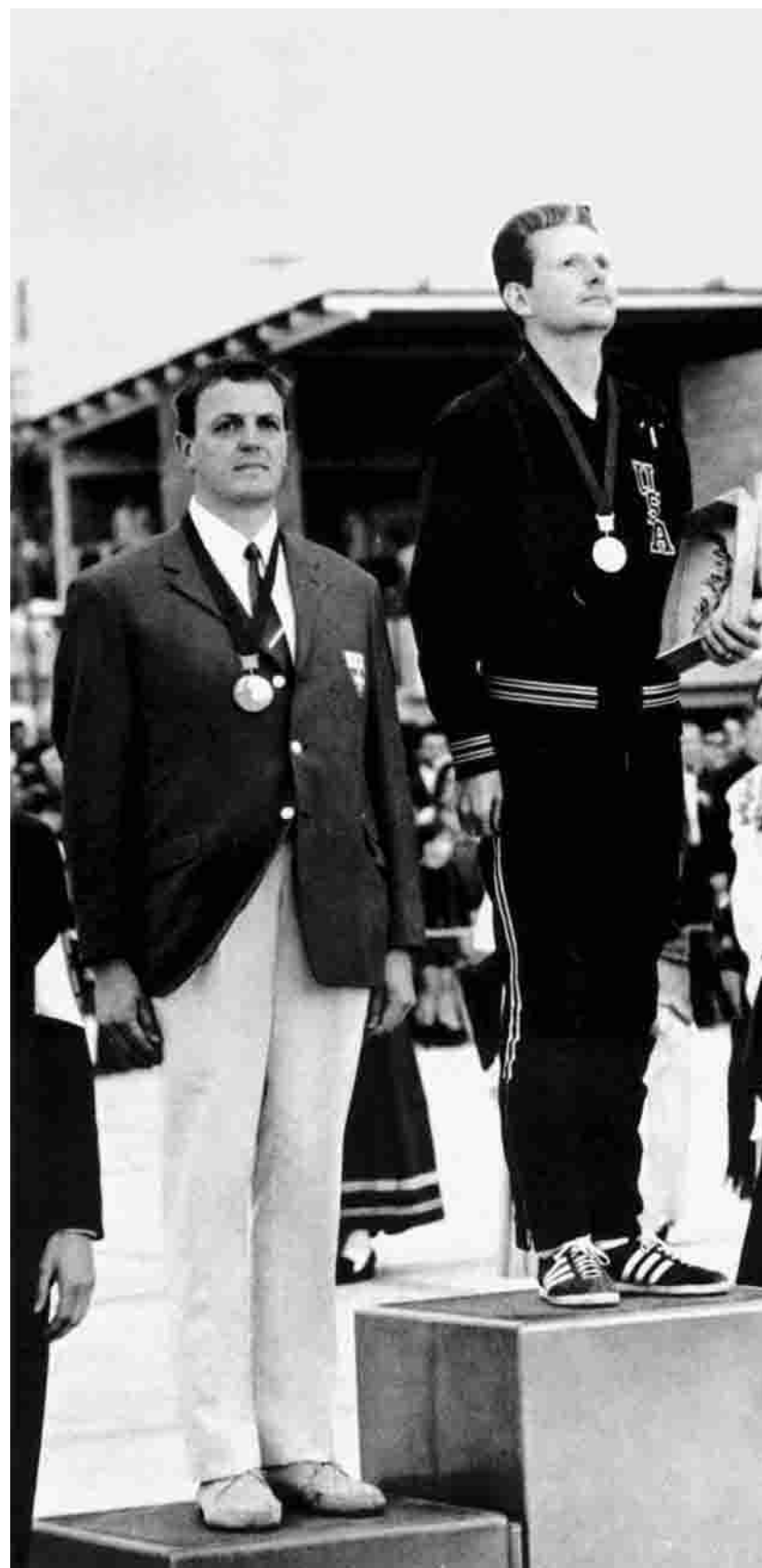

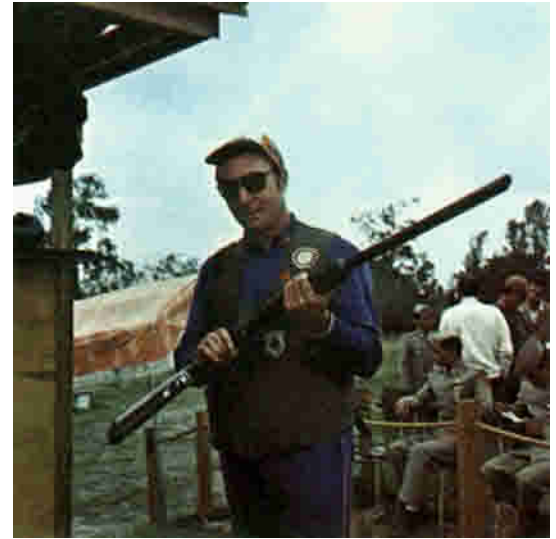
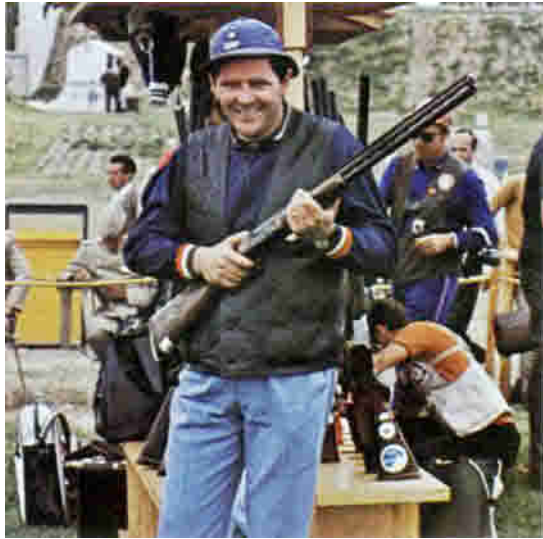

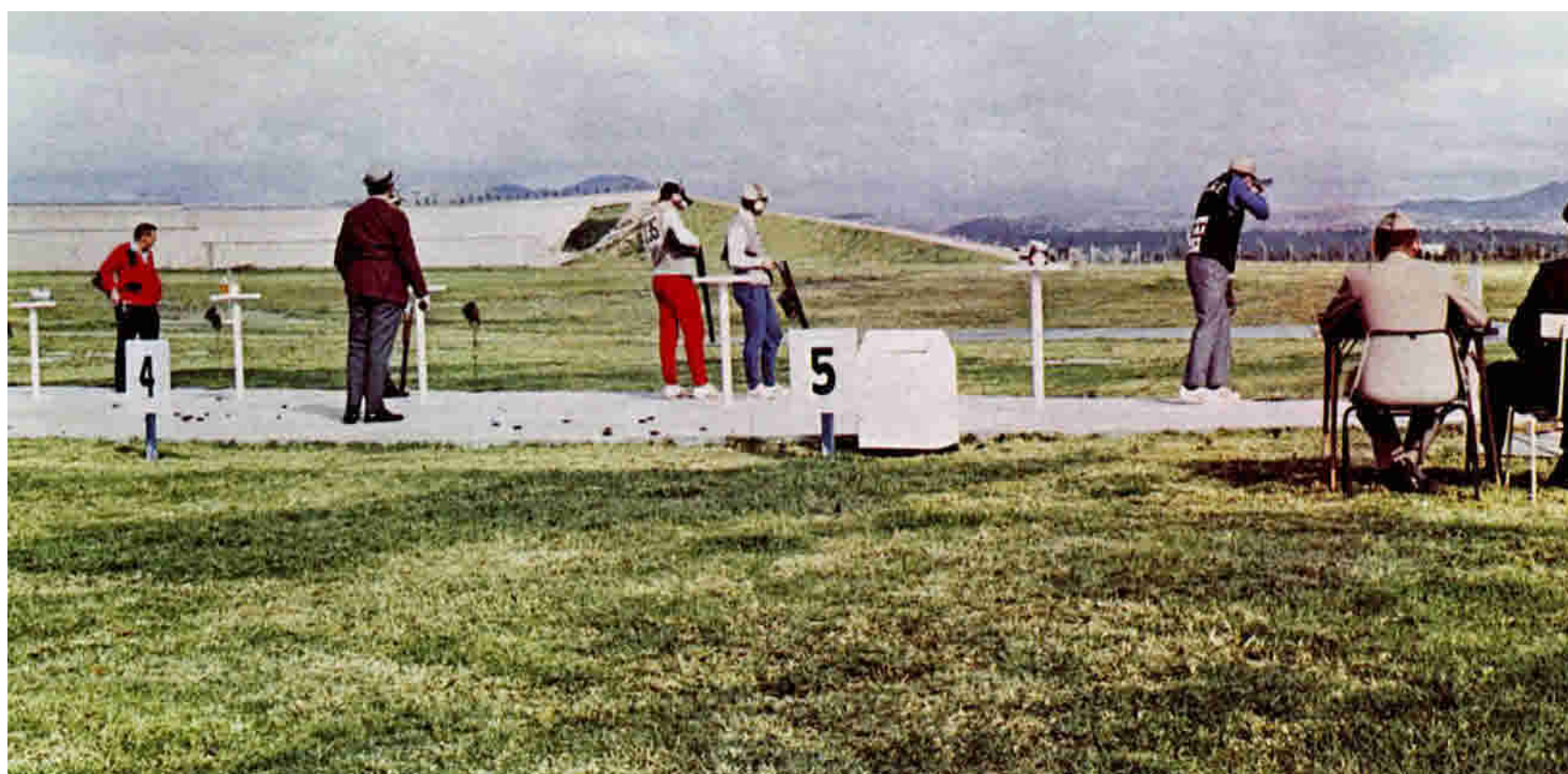

FOSSE OLYMPIQUE — OLYMPIC TRAP SHOOTING

			Total Points
1	163	Braithwaite, John	GBR 198
2	125	Garrigus, Thomas	EUA 196
3	14	Czekalla, Kurt	ADE 196
4	359	Senichev, Pavel	URS 196
5	153	Candelo, Pierre	FRA 195
6	270	Smelczynski, Adam	POL 195

Sur le pas de tir de la fosse olympique, les concurrents (page de gauche) s'accordent un moment de détente entre deux séries de 25 coups. John Braithwaite (ci-contre, en rouge) en profite pour bavarder avec Candelo et Senichev, deuxième à Tokyo; il allait un peu plus tard obtenir le score maximum pour la septième fois consécutive et remporter le championnat.

Olympic trap shooters (opposite) relax for a moment as they move from station to station along the firing line, between series of twenty-five clay targets. John Braithwaite (right, red jacket) pauses to chat with fellow competitors Candelo and Tokyo runner-up Senichev. Braithwaite then went on to fire his seventh consecutive perfect series and win the championship.



428

SKEET

			Total Points
1	358	Petrov, Evgeny	URS 198
2	213	Garagnani, Romano	ITA 198
3	11	Wirnhier, Konrad	ALE 198
4	362	Tsuranov, Yuri	URS 196
5	258	Gianella, Pedro	PER 194
6	91	Atalah, Nicolas	CHI 194

Romano Garagnani ne cache pas sa satisfaction d'avoir établi un record du monde de 198, score également obtenu par Wirnhier et Petrov. Dans la première épreuve supplémentaire, Petrov (page de droite) abat d'une main sûre ses 25 cibles et s'empare de la médaille d'or. Toujours ex-aequo avec Garagnani, Wirnhier (au centre) manque deux pigeons en seconde série de barrage, tandis que les 25 points de l'Italien lui donnent la première place. Martinez (ci-contre, en haut) tire une série de coups pendant que Rodale attend son tour. La Mexicaine Nuria Ortiz fit sensation en se classant onzième.

Romano Garagnani smiles with satisfaction after firing a world-record 198 in the new Olympic skeet event to end deadlocked with Wirnhier and Petrov. In the first shoot-off series, Petrov (opposite) steadies his shotgun as he scores a perfect 25 to take the gold medal. Wirnhier (right, center), still tied with Garagnani after the series, shatters only 23 disks in a second shoot-off, while the Italian broke all 25 to win the silver medal. Spain's Martínez (above, right) fires a series as Rodale of the U.S. awaits his turn. The surprise of the event was Mexico's 24-year-old Nuria Ortiz (below, right) who placed 11th.

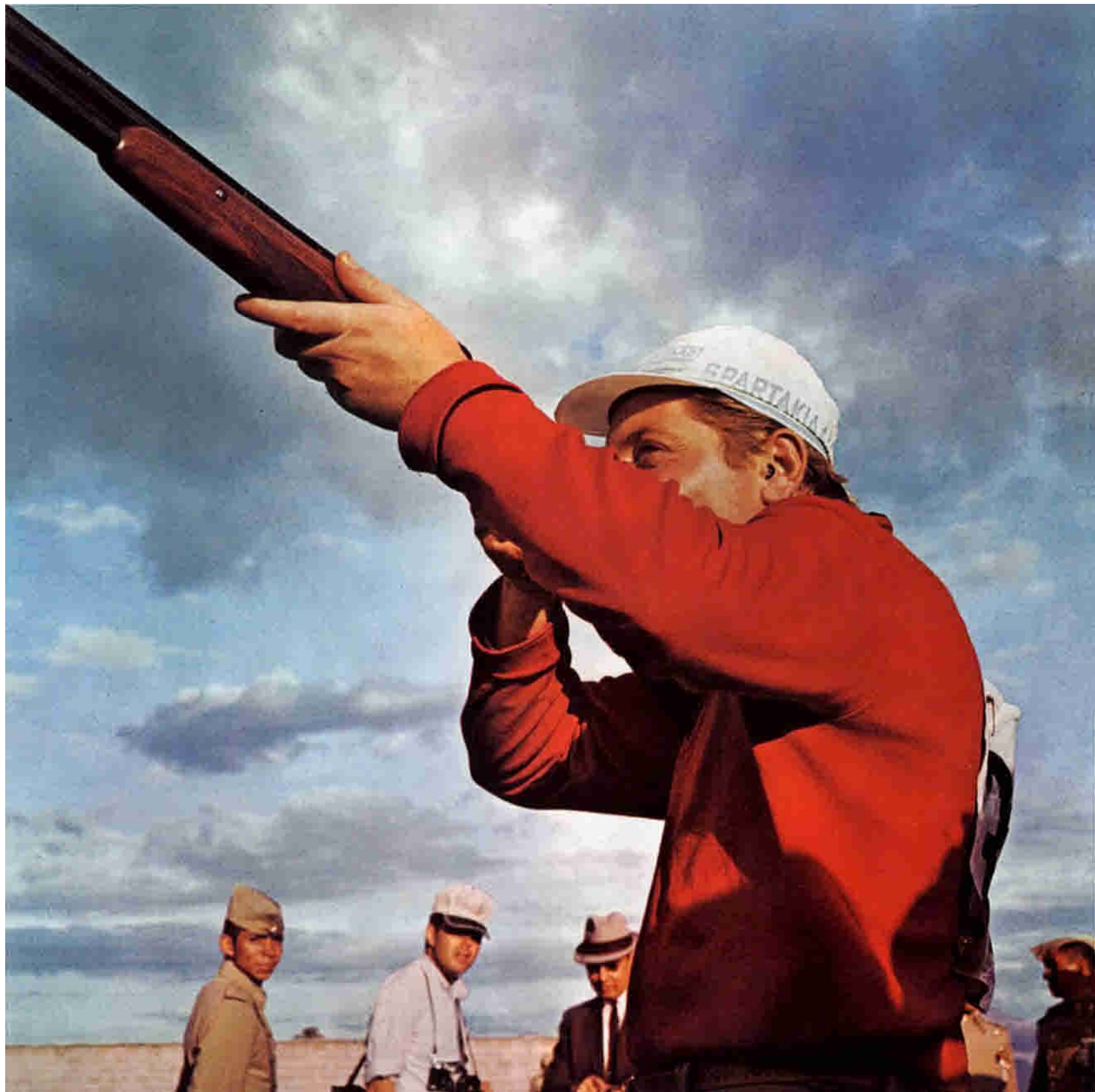



430

PISTOLET LIBRE — FREE PISTOL

				Total Points
1	354	Kosykh, Grigory	URS	562
2	6	Mertel, Heinz	ALE	562
3	21	Vollmar, Harald	ADE	560
4	132	Vítarbo, Arnold	EUA	559
5	367	Malek, Pawel	POL	556
6	13	Artelt, Helmut	ADE	555

Armés de leur pistolet favori, les concurrents tirent sur des cibles installées à 50 mètres de distance; des protège-tympan éliminant tout bruit extérieur leur permettent de mieux se concentrer. Ex-aequo avec Mertel (562 points – nouvelle marque olympique), le Soviétique Grigory Kosykh (ci-contre) sera proclamé vainqueur pour avoir fait mouche plus souvent.

Employing a wide variety of individually modified pistols, competitors along the firing line take aim at targets 50 metres away. Earphones are worn to eliminate the distracting sound of sharp reports. Grigory Kosykh shows the steady hand that brought him a new Olympic record and the gold medal—on the basis of a superior target pattern—after tying at 562 with Mertel.



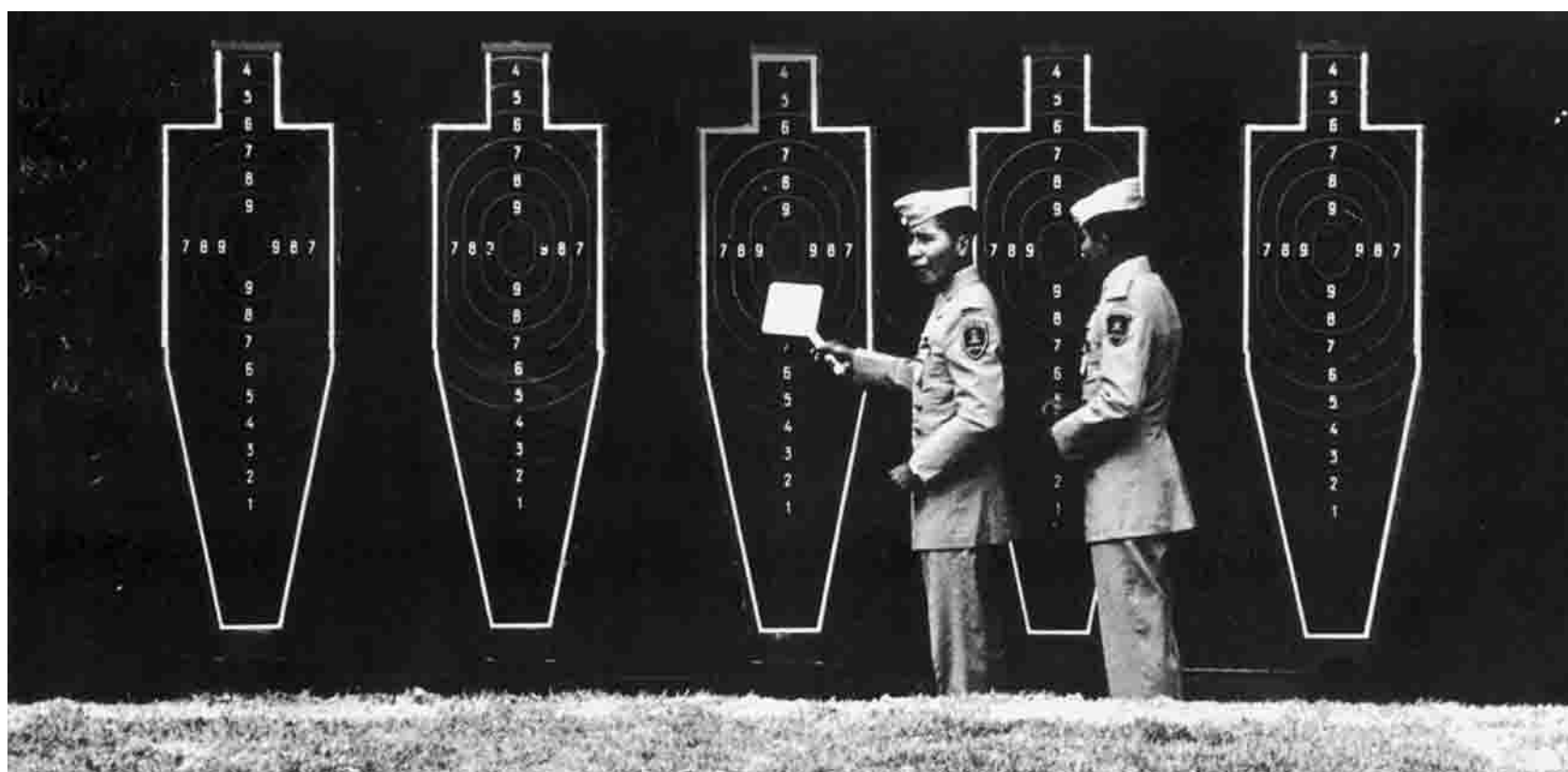

TIR DE VITESSE AUX SILHOUETTES — RAPID FIRE PISTOL

			Total Points
1	272	Zapedzki, Jozef	POL 593
2	300	Rosca, Marcel	RUM 591
3	361	Suleimanov, Renart	URS 591
4	16	During, Christian	ADE 591
5	5	Masurat, Erich	ALE 590
6	15	Domrich, Gerhard	ADE 589

Les officiels signalent les impacts sur les silhouettes aux juges placés derrière le pas de tir. A l'issue de la compétition, le vainqueur Josef Zapedzki, titulaire d'un nouveau record olympique, reçoit, outre sa médaille et son rameau d'olivier, une pyramide de Teotihuacan en miniature.

Assistants signal rapid-fire hits on silhouettes to judges who tabulate scores behind the firing line. The result: a new Olympic record and first place for Jozef Zapedzki. After the competition, the winner receives a replica of the pyramid of Teotihuacan along with his medallion and olive branch.





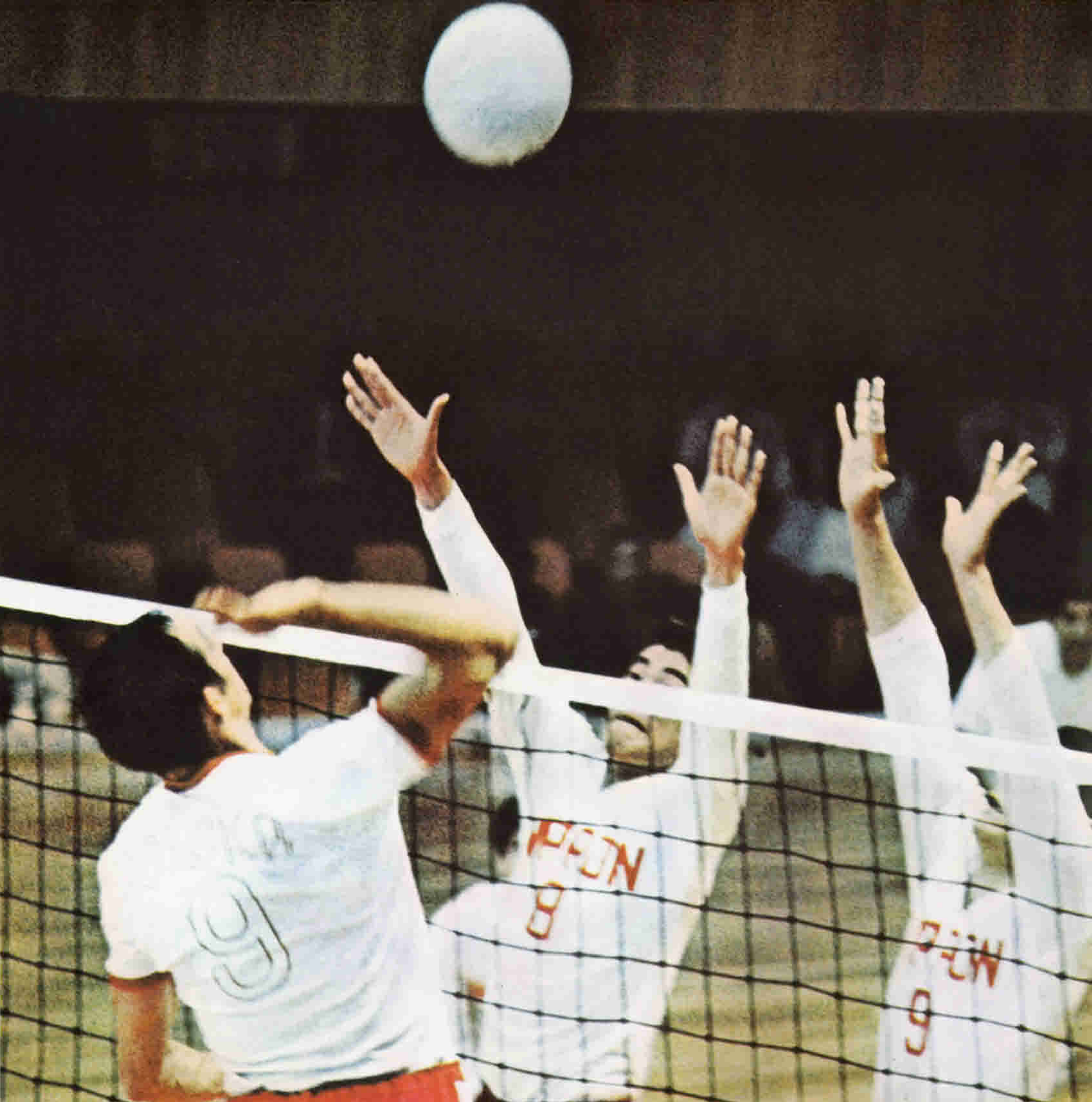

VOLLEY-BALL



Ce sport n'a été inscrit au programme olympique qu'en 1964, à Tokyo. Pourtant le volley-ball jouissait depuis longtemps d'une grande popularité dans le monde et, à Mexico, les matchs disputés tant à la patinoire Revolución qu'au Gymnase olympique ont attiré un public nombreux. Que ce soit dans la division masculine ou féminine, chaque équipe devait rencontrer toutes les autres en poule unique. Dix pays disputèrent le tournoi masculin dont la rencontre la plus intéressante fut celle qui opposa la Tchécoslovaquie à la fulgurante formation japonaise. L'entraîneur tchèque recommanda à ses joueurs de ne pas forcer dans les premières manches et d'attendre que les Nippons se soient essoufflés. Les Européens s'économisèrent donc pendant les deux premiers sets qu'ils perdirent par 15-2 et 15-3 respectivement mais, à la moitié du troisième, ils se donnèrent à fond et enlevèrent les deux manches suivantes et la partie. Mais ils furent battus dans deux autres matchs tandis que les Soviétiques n'en perdirent qu'un et remportèrent le tournoi. A la surprise générale, l'équipe des Etats-Unis — qui au classement général se retrouvait dans les dernières places — infligea sa seule défaite à l'Union Soviétique. Dans les compétitions féminines, elle ne perdit aucun de ses matchs, apportant ainsi une seconde médaille d'or de volley-ball à son pays.

VOLLEYBALL



Volleyball is a very recent addition to the list of official Olympic sports, having been introduced in the 1964 Games in Tokyo. But the game has long been popular all over the world, and during the tournament in Mexico City the stands and temporary seats of the Revolución Ice Rink and the Olympic Gymnasium were usually well filled. In both the men's and women's divisions, each team played every other in a single-pool round robin. Ten nations competed in the men's tournament, in which perhaps the most interesting match pitted Czechoslovakia against the lightning-fast Japanese. The Czech coach's strategy was to let his players conserve their energy while their opponents wore themselves out. His men therefore relaxed and lost the first set 15-2. They hardly increased their efforts in the second set, and lost 15-3. Then halfway through the third set they suddenly sprang into action, came from behind, and won—and kept on chalking up points to win two more sets and the match. But they lost two other matches, while the U.S.S.R. lost only one, to take the championship. Strangely enough, it was the U.S. team—which finished the tournament near the bottom of the list—that handed the Soviets their sole defeat. In the women's competition, the Russians breezed through their matches without a loss to give the Soviets twin gold medals in volleyball.





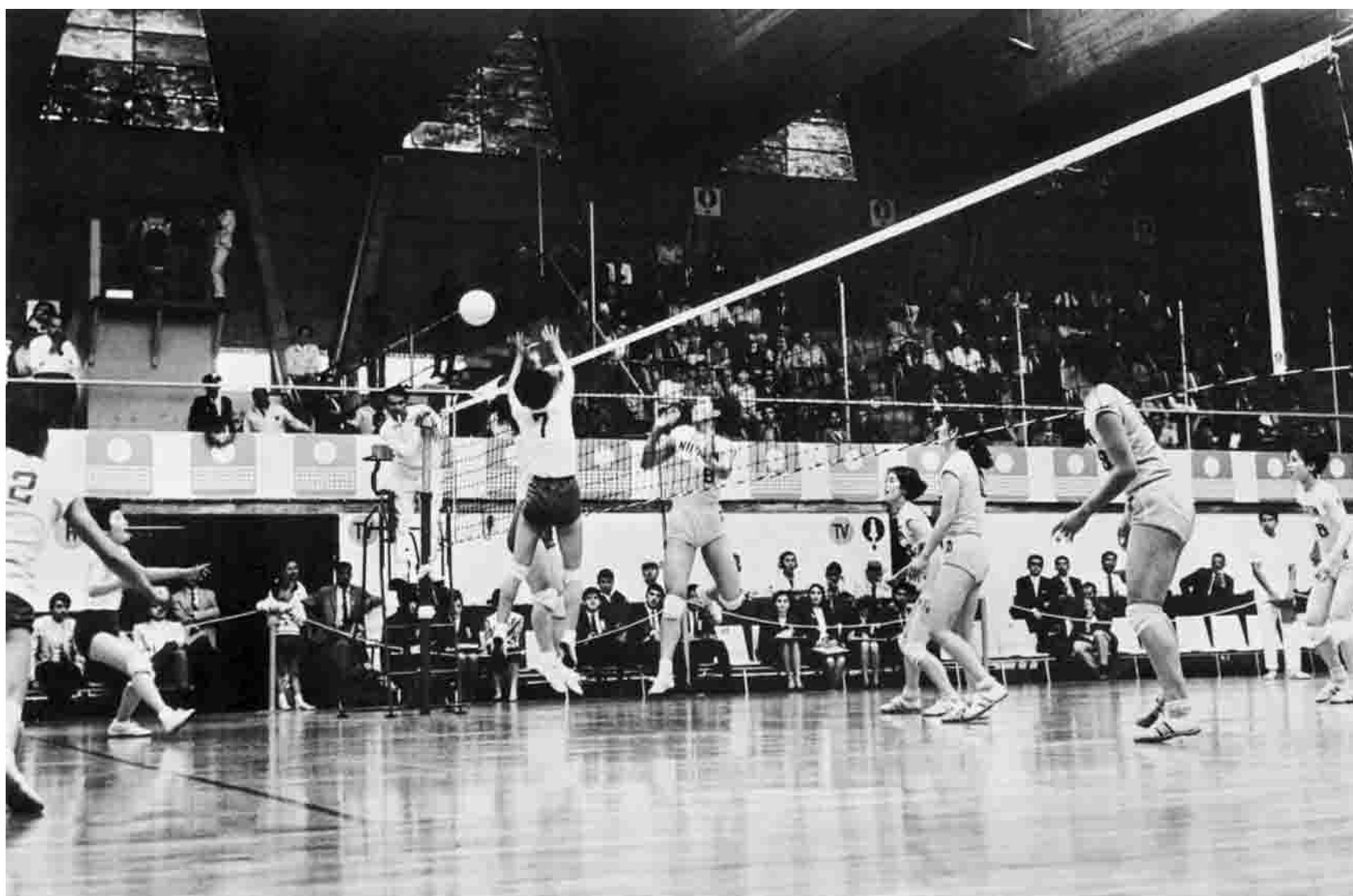

La rencontre féminine Corée-Japon fut, de part et d'autre, une brillante exhibition de rapidité et d'adresse. Les Japonaises, tenantes du titre, devaient remporter six de leurs matchs. Trois équipes de l'hémisphère occidental (page de droite) se relaxent avant le jeu. Les Péruviennes allaient faire sensation en se classant 4es. Face au Mexique (extrême droite), les Tchèques déployèrent une technique qui leur valut une victoire en trois sets.

In one of Japan's six victories in the round-robin tournament, Korea and the defending champion demonstrate the speed and agility basic to the oriental style of play. Three teams from the Western Hemisphere (opposite, top to bottom) relax before game-time. A surprise of the competition, the Peruvian girls placed fourth in the final standings. In a match against Mexico, the Czechs show great form at the net (far right) as they win impressively in straight sets.

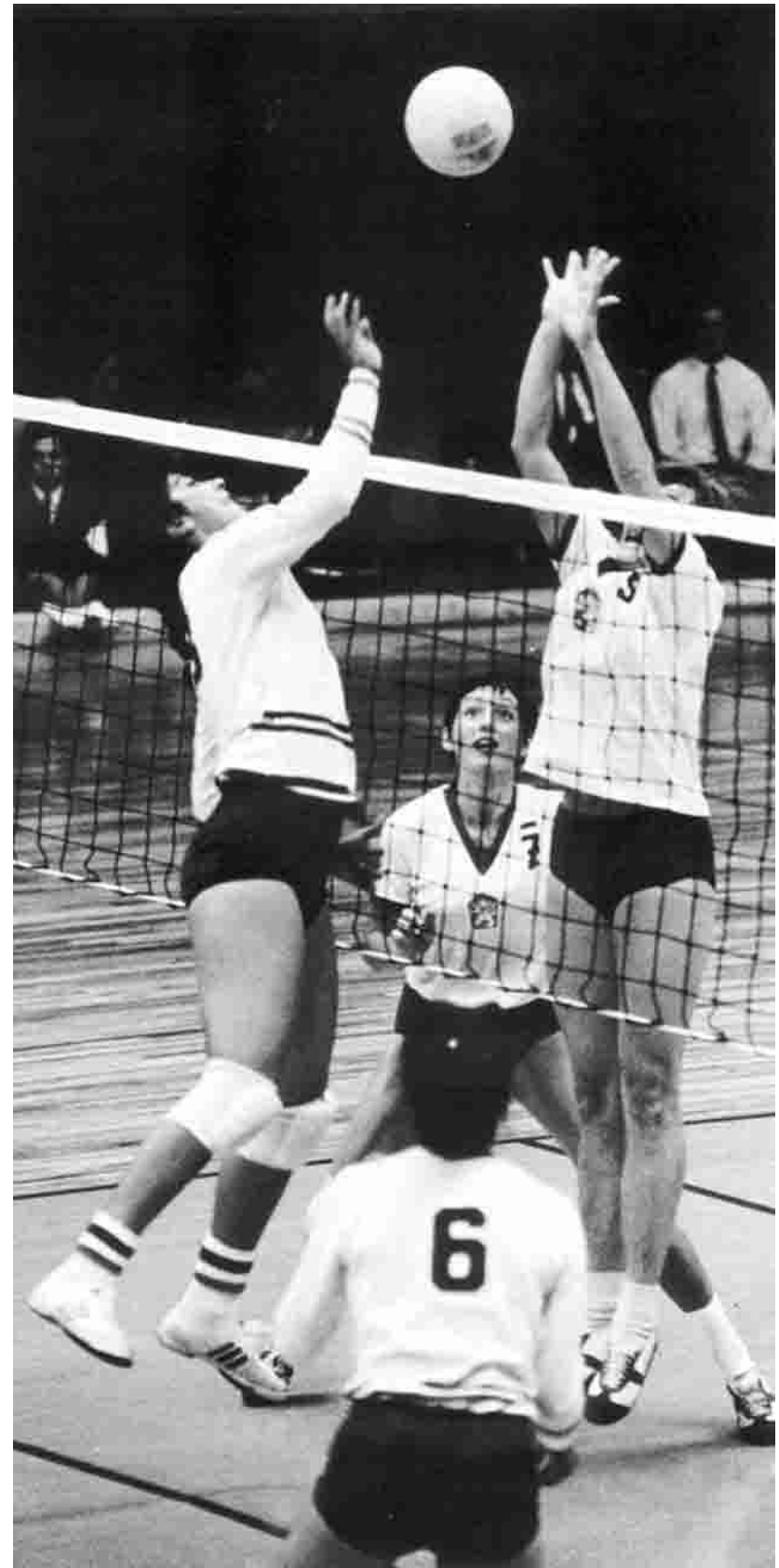

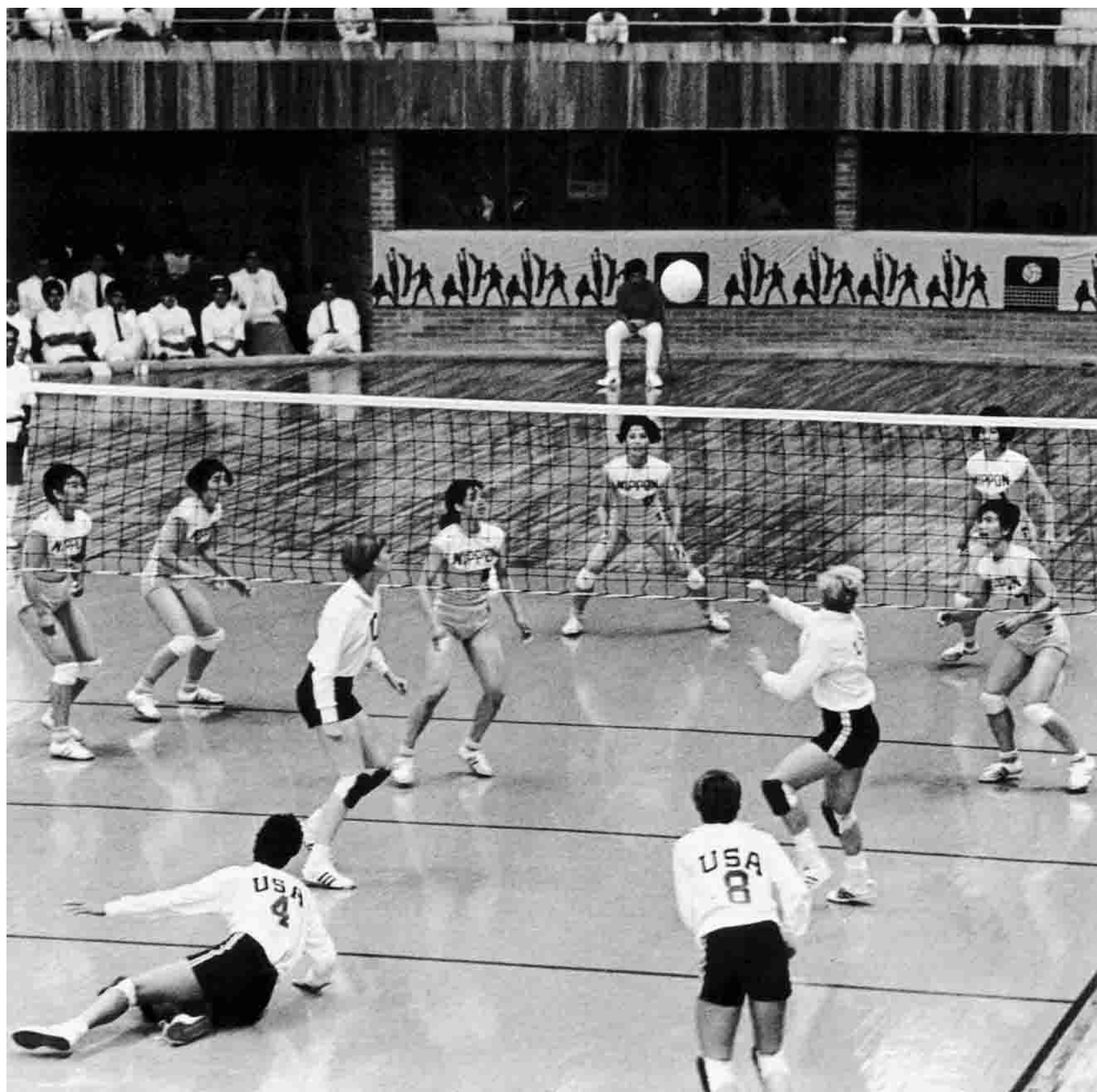



Résolues à défendre leur titre, les Japonaises (page de gauche) s'adjugent une facile victoire sur l'équipe américaine. La Pologne, troisième au classement, bat successivement la Tchécoslovaquie (ci-dessus) et le Pérou (ci-contre, en haut). La Corée, pour sa part, eut raison par 3-1 des Etats-Unis.

On its way to a confrontation with the Soviet Union for the gold medal, Japan (opposite) rolls over the United States 3-0. Poland—which placed third in the final standings—downs Czechoslovakia (above) and then Peru (above, right). Korea (right) also had little difficulty with the U.S. team, winning 3-1.



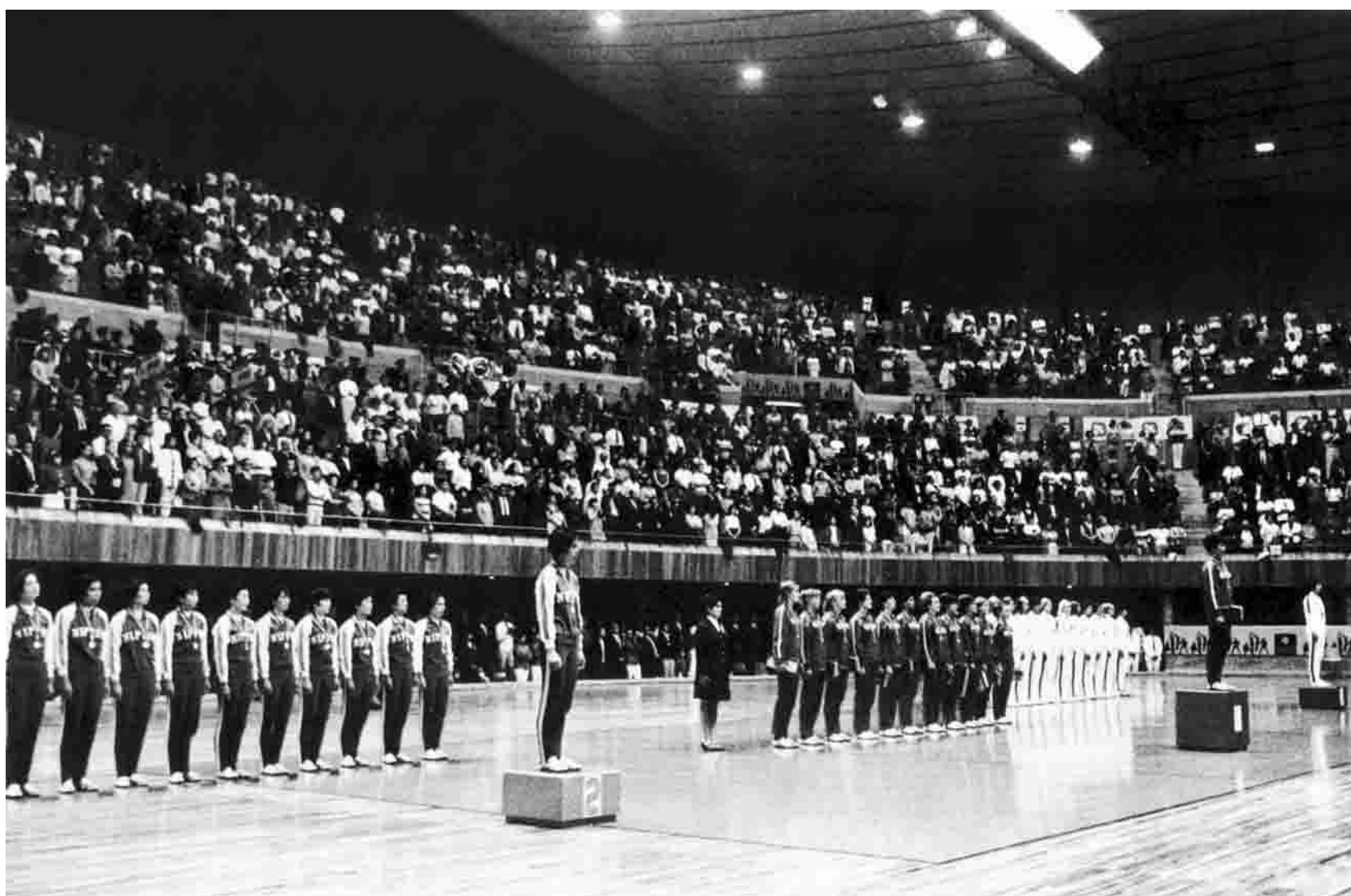

CATEGORIE FEMININE — WOMEN

1	URS	14
2	JPN	13
3	POL	12
4	PER	10
5	COR	10
6	CHE	10

Soviétiques et Japonaises – les seules équipes invaincues – s'affrontent dans la finale (page de gauche) pour la conquête du titre. Quatre sets âprement disputés, et les Européennes détrônaient leurs adversaires.

In the last game of the tournament (opposite), Japan and the U.S.S.R.—the only undefeated teams—clash in a dramatic showdown for the title. After four arduous set the Soviets emerge victorious, reversing the 1964 results at Tokyo.



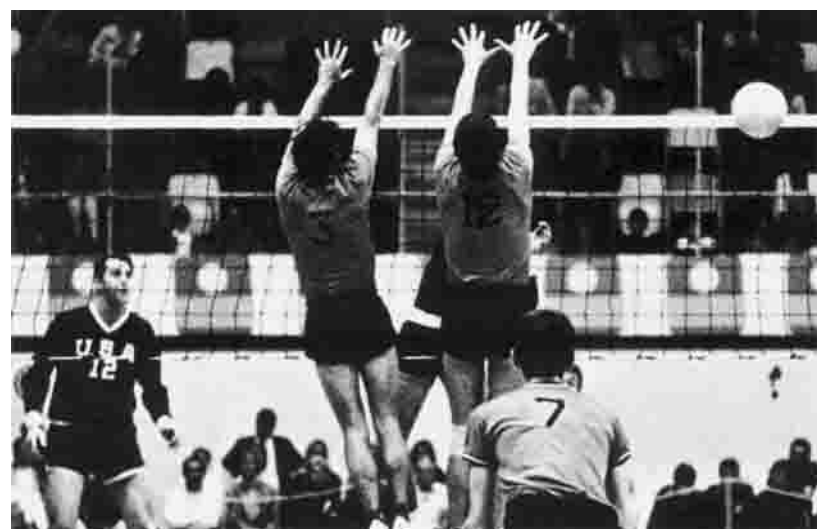

Aucune acrobatie ne semble rebuter les joueurs d'Allemagne de l'Est (page de gauche) et de Pologne (ci-dessus), deux teams redoutables. D'autres rencontres (ci-contre, de haut en bas) se terminèrent en faveur de la Tchécoslovaquie sur le Brésil, des Etats-Unis sur la Belgique et des Soviétiques sur le Mexique.

In the men's tournament, spectacular play on the part of the East Germans (opposite) and the Poles (above) keeps their teams in contention. Other round-robin matches (right, top to bottom) found Brazil defeating Czechoslovakia 3-2; the U.S. downing Belgium 3-0; and Mexico losing to the Soviets 1-3.

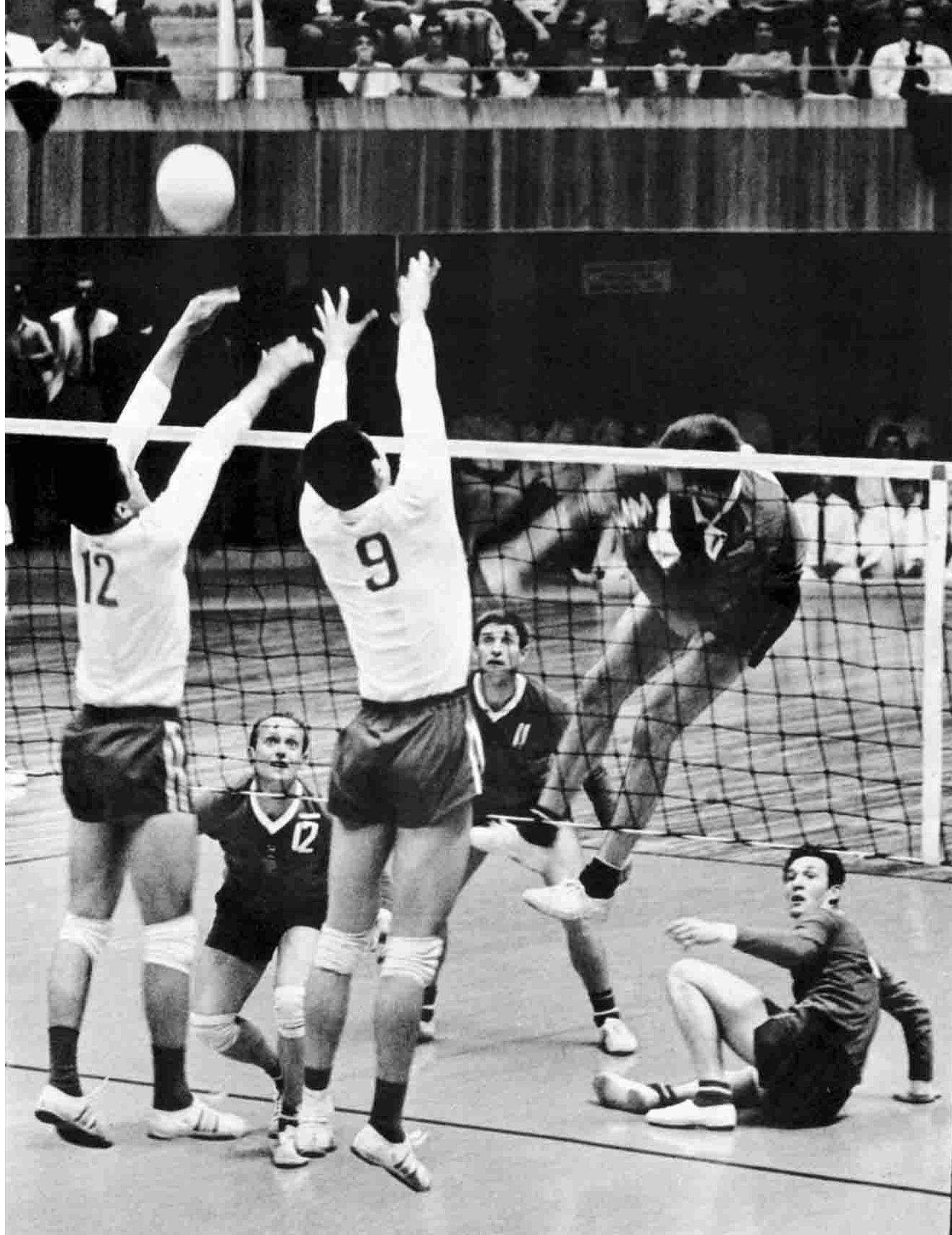



447

CATEGORIE MASCULINE — MEN

1	URS	17
2	JPN	16
3	CHE	16
4	ADE	15
5	POL	15
6	BUL	13

Un smash japonais déjoue le contre de deux Soviétiques au cours de l'un des matchs les plus importants du tournoi, gagné en quatre sets par les Européens qui ne devaient s'incliner que devant les Etats-Unis. En finale (ci-dessus), l'équipe russe, à égalité avec les Tchécoslovaques — sept victoires, une défaite — écrasa ses adversaires et s'empara de la médaille d'or.

A net-skimming Japanese smash passes through four outstretched Russian hands during one of the tournaments most decisive encounters. The Soviets, who had lost only to the U.S.A., went on to win in four sets. On the final day, the tall Russian squad—now tied with Czechoslovakia at 7-1 in matches—rolled over the Czechs (above) to a straight-set victory and the gold medal.

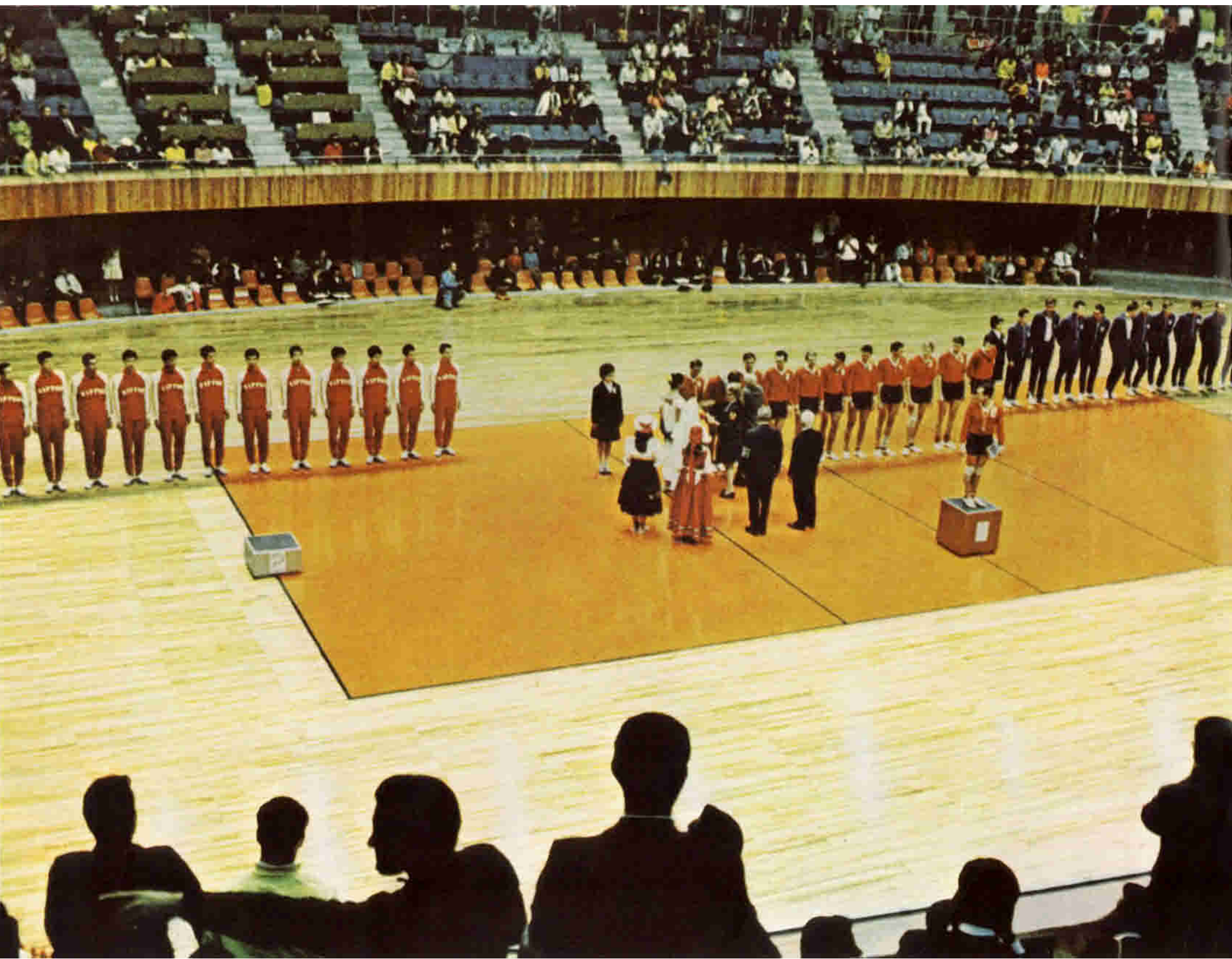





WATER-POLO



La Hongrie s'est classée pour la première fois parmi l'élite du water-polo en 1928, année où elle remporta une médaille d'argent. Lors des huit Olympiades suivantes, les Magyars s'adjugèrent toujours un trophée, accumulant ainsi 5 médailles d'or, 2 d'argent et une de bronze. Moins titrés que les Hongrois, les Yougoslaves gagnèrent 3 médailles d'argent au cours des dernières années. Quant à la URSS, depuis 1956 elle a remporté une 2^e ou une 3^e place à chacun des rendez-vous olympiques. A la fin des poules éliminatoires du tournoi de Mexico, les "trois grands" restaient en piste à côté d'une équipe italienne résolue. En demi-finale, les Soviétiques battirent les Italiens tandis que la Yougoslavie dominait la Hongrie. Les deux perdants se rencontrèrent alors dans la finale pour la 3^e place — lutte acharnée jusqu'à ce que les Magyars marquent 6 buts successifs. Puis vint la finale Union Soviétique-Yougoslavie. La partie fut dure, les deux équipes adoptant la même stratégie: shooter souvent et impitoyablement. A la fin du temps réglementaire, le score était de 11-11 et ce sont deux formations épuisées qui s'affrontèrent pour la prolongation de quatre minutes. Marquant coup sur coup deux buts, la Yougoslavie s'adjugea sa première médaille d'or dans les compétitions olympiques de water-polo.

WATER POLO



Hungary first entered the ranks of Olympic water-polo powers in 1928, when it won the silver medal behind Germany. Since then, in eight successive Olympic Games, the Magyars never failed to take home a medal of some kind—accumulating five gold, two silver and a bronze. Yugoslavia, although it could not match that record, won three silver medals in recent years. And the U.S.S.R., beginning in 1956, took either a silver or a bronze at each Olympiad. At the end of round-robin play in the Mexico City tournament, these "Big Three" teams, plus Italy, prepared to battle it out for the honors. In the semi-finals, the U.S.S.R. defeated Italy and Yugoslavia bested Hungary. The two losers then met in the final for third place—a bitter contest for half its length, until Hungary broke it open with six straight goals to run its string of water-polo medals through nine consecutive Olympiads. Then came the confrontation between the Soviet Union and Yugoslavia to determine possession of the gold. It was a rough, free-swinging game, with both teams employing the same simple strategy: shoot often and give no quarter. At the end of regulation time, the score was tied 11-11. Both teams were thoroughly exhausted when the four-minute overtime began, but Yugoslavia pushed in two goals during the period to capture its first gold medal in water polo.

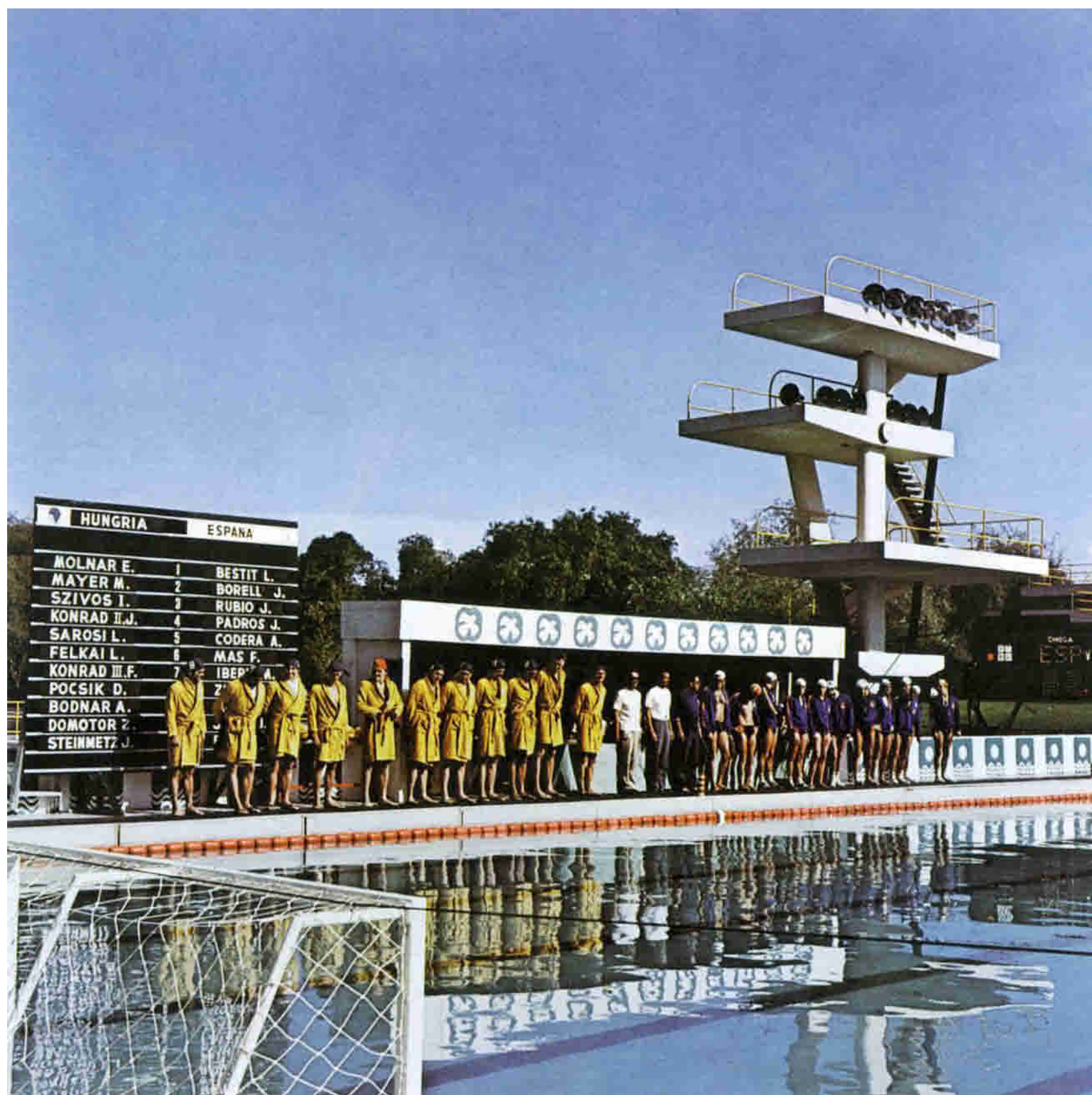



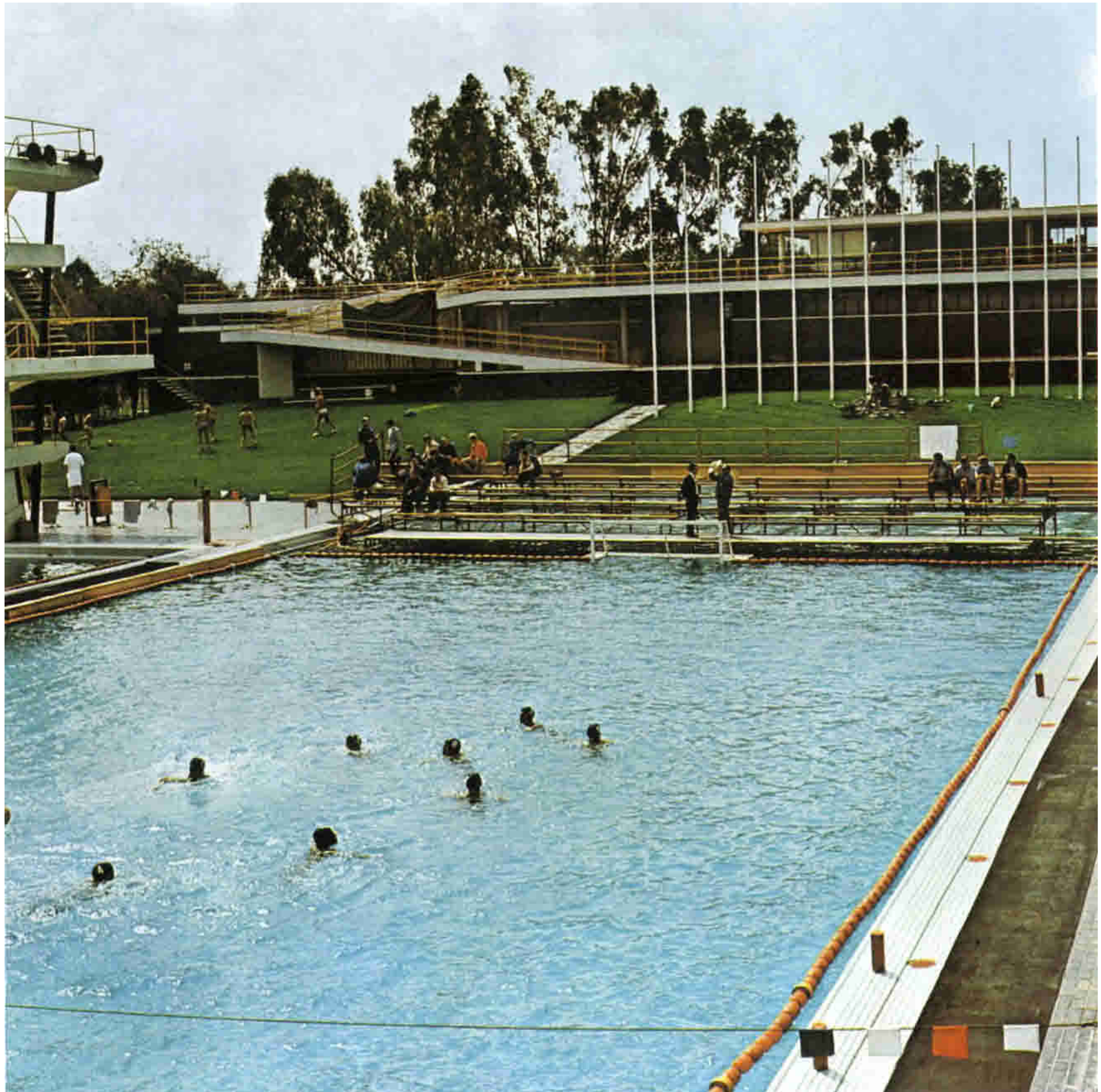

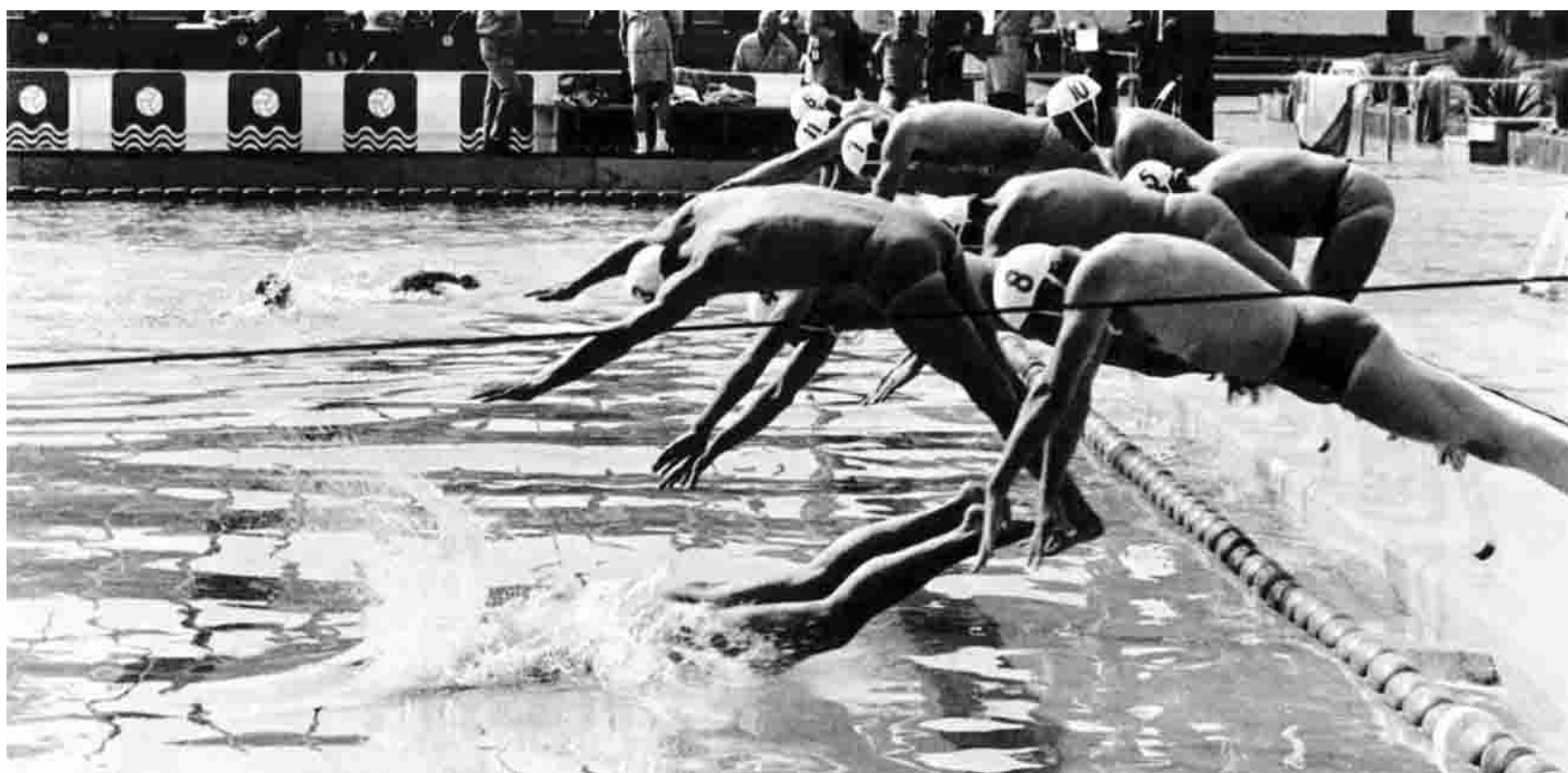

Avant le début des compétitions, les joueurs de water-polo s'échauffent dans la piscine de la Cité universitaire. Départ en plongée de l'équipe allemande, tandis que d'autres athlètes se dorant au soleil en attendant leur tour. Quatorze pays allaient s'opposer à l'Italie et à la Hongrie, tous bien décidés à leur enlever la suprématie qu'elles détenaient depuis trente-six ans en water-polo.

At the University City Swimming Pool, players go through their final drills prior to the start of competition. The German team takes to the water while other athletes, enjoying the Mexican sunshine, await their turn in the tank. Along with thirteen other teams, the Germans were out to break Italy and Hungary's 36-year domination of Olympic water polo.





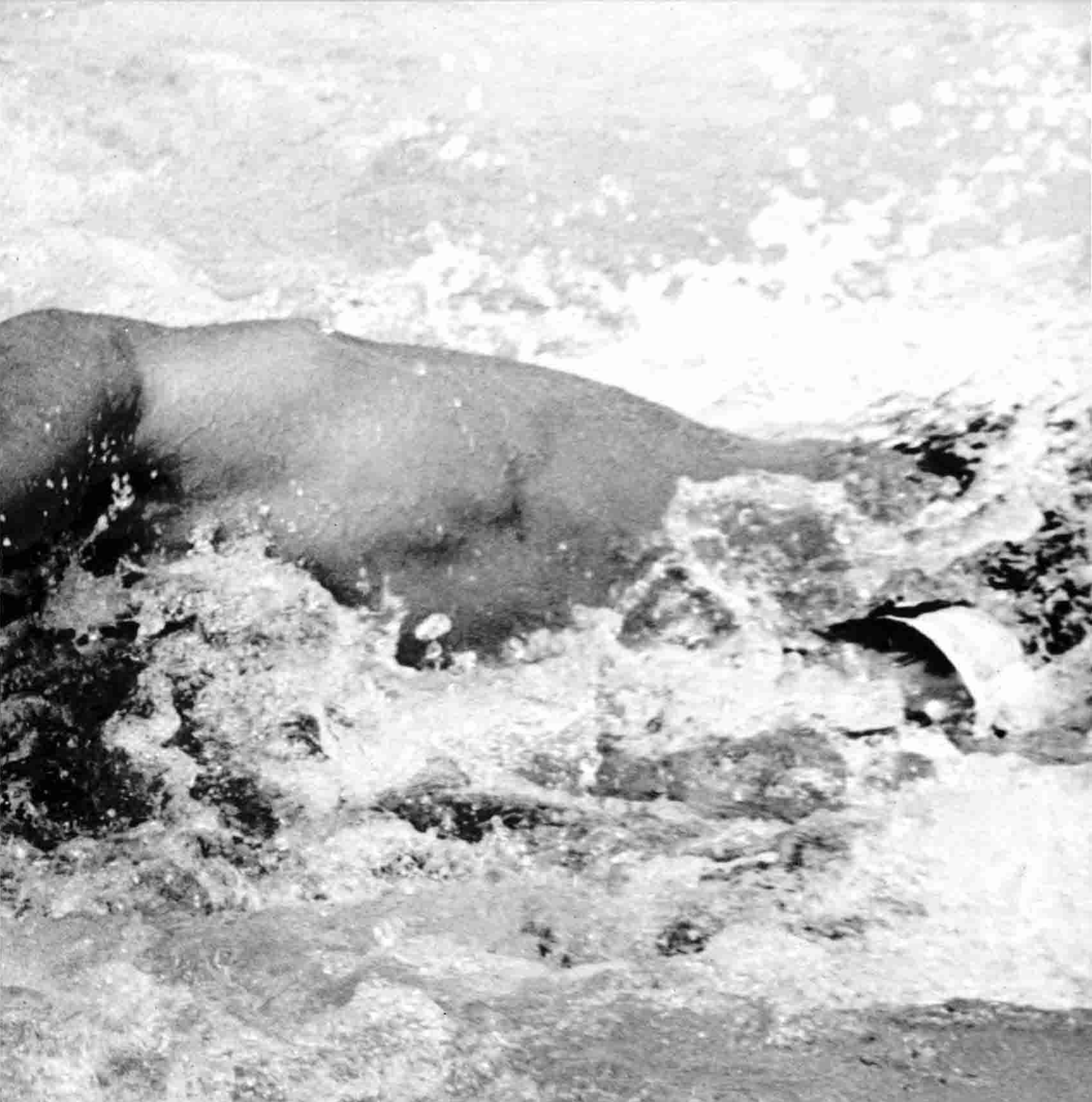



460



L'Italien Ghibellini (N° 8) contre Herzog, de l'Allemagne de l'Est, au cours d'un match âprement disputé et gagné par les Italiens, leaders invaincus du groupe B. Kuwabara va tenter d'intercepter une passe de Van Dorp. Après une victoire sur les Japonais et un match nul avec la puissante équipe transalpine, les Hollandais, menés tambour battant par Parrel (page de droite), battent la RAU.

Italy's Ghibellini (8) intercepts Herzog of East Germany as the Italians, undefeated in Group B, earn a sharply-contested victory. Van Dorp of Holland sets to pass, with Japan's Kuwabara closing in. After dunking the Japanese and tying powerful Italy, the Dutch—helped along by Parrel's heads-up play (opposite)—splash to a win over the United Arab Republic.

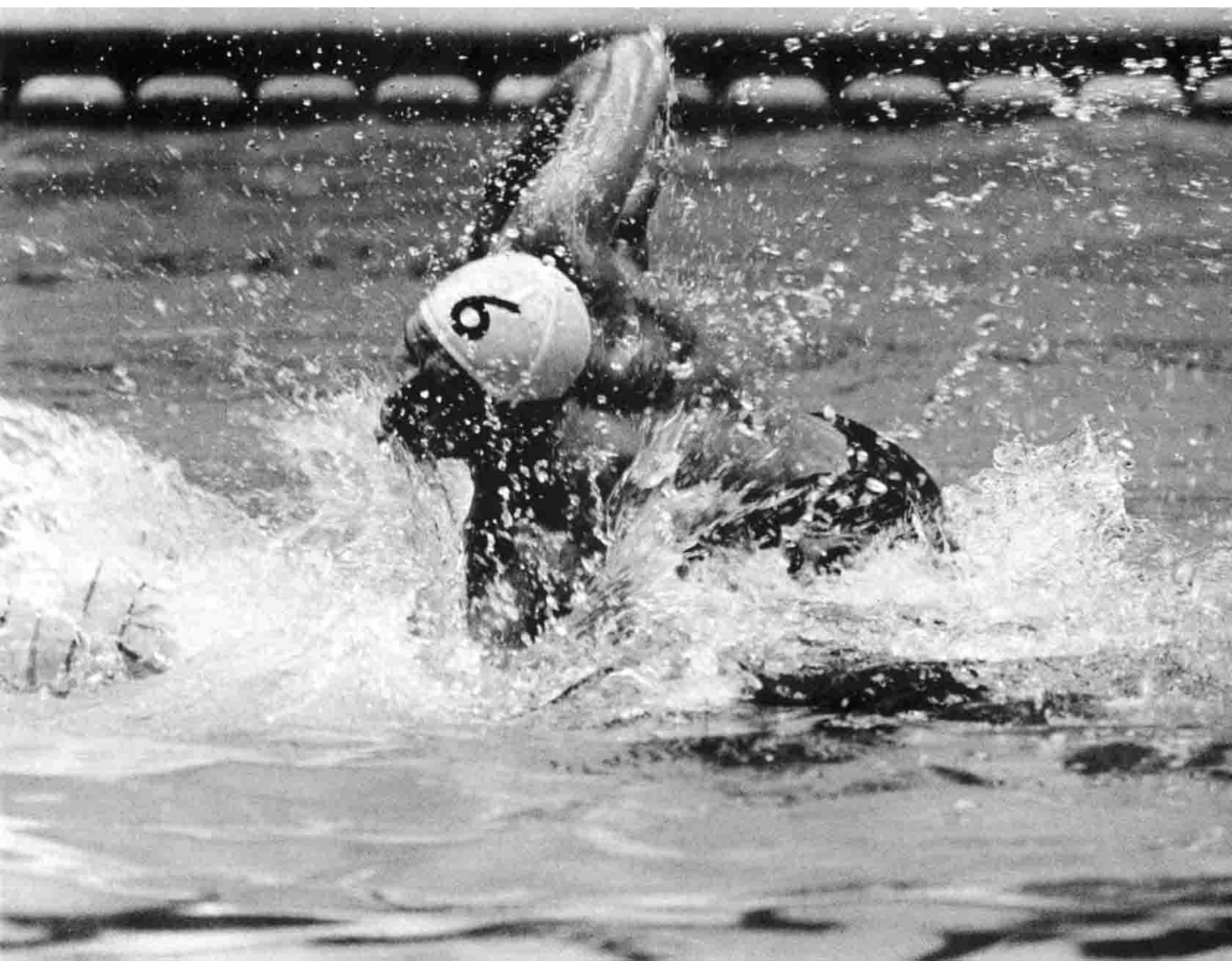

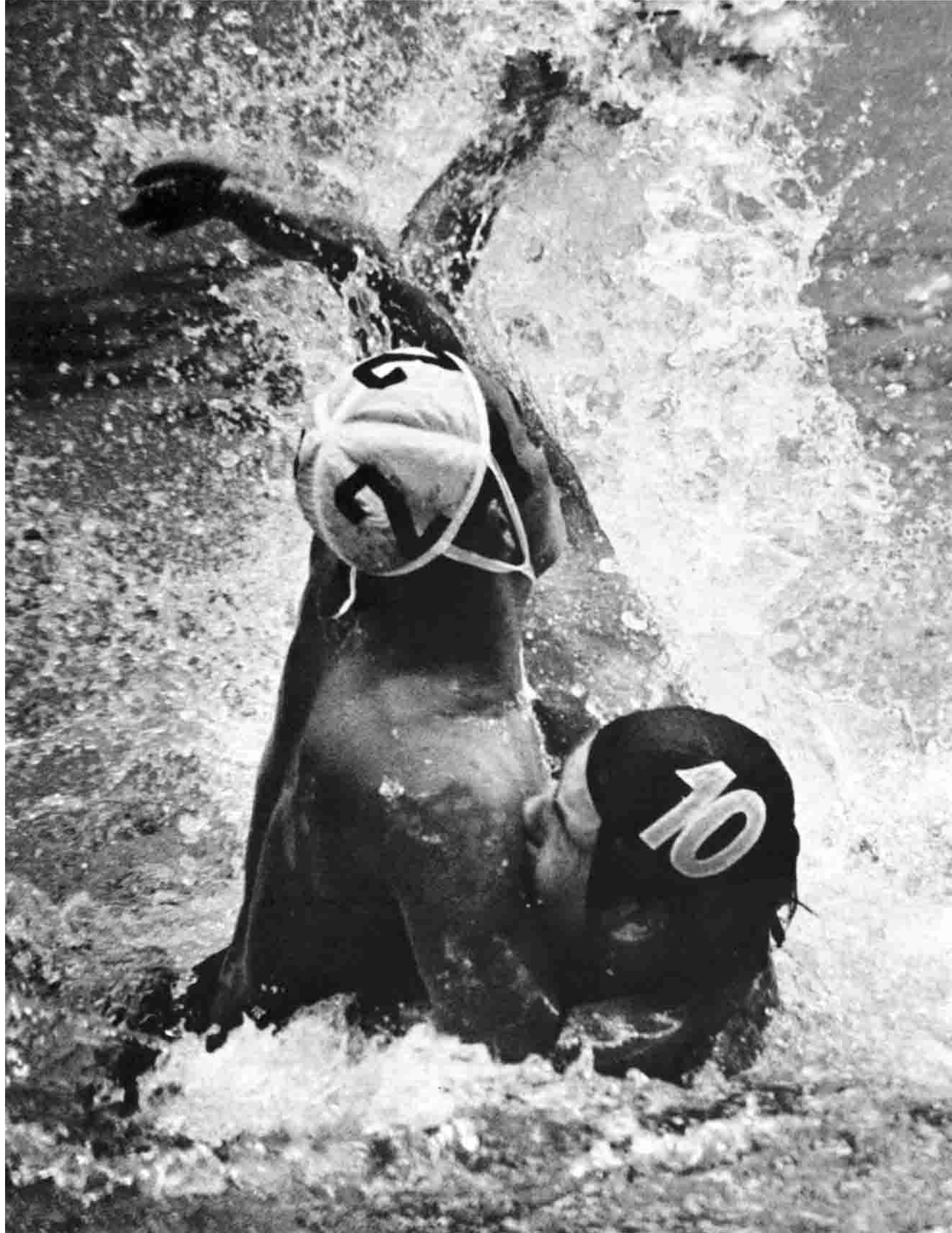



463

Plaquage de Sandic par le Japonais Kuwayama (N° 2) au cours de la dernière rencontre préliminaire. Pour pouvoir supplanter l'Allemagne de l'Est et participer à la finale, les Slaves avaient besoin de battre le Japon avec 13 points d'avance. Résultat largement atteint puisqu'ils gagnèrent par 17 à 2. Poursuivi par Borell, le Hongrois Sarosi dribble vers le but espagnol. Les détenteurs du titre n'eurent aucun mal à remporter ce match, pas plus d'ailleurs que ceux les opposant aux autres équipes du groupe A. Seuls les Soviétiques, deuxièmes au classement final, se défendirent farouchement avant de perdre 5-6.

Japan's Kuwayama (2) and Yugoslavia's Sandic clash in the last round-robin contest, which the Slavs had to win by an improbable 13-point margin to beat out East Germany for a place along with Italy in the finals for the medals. They made it with goals to spare, thrashing to a 17-2 victory. With Spain's Borell in hot pursuit (above), Sarosi of Hungary moves the ball toward the enemy goal. The defending champions had little trouble routing Spain in this contest and vanquishing all their other Group-A foes. Only the second-place Soviets made a close game of it before succumbing 5-6.



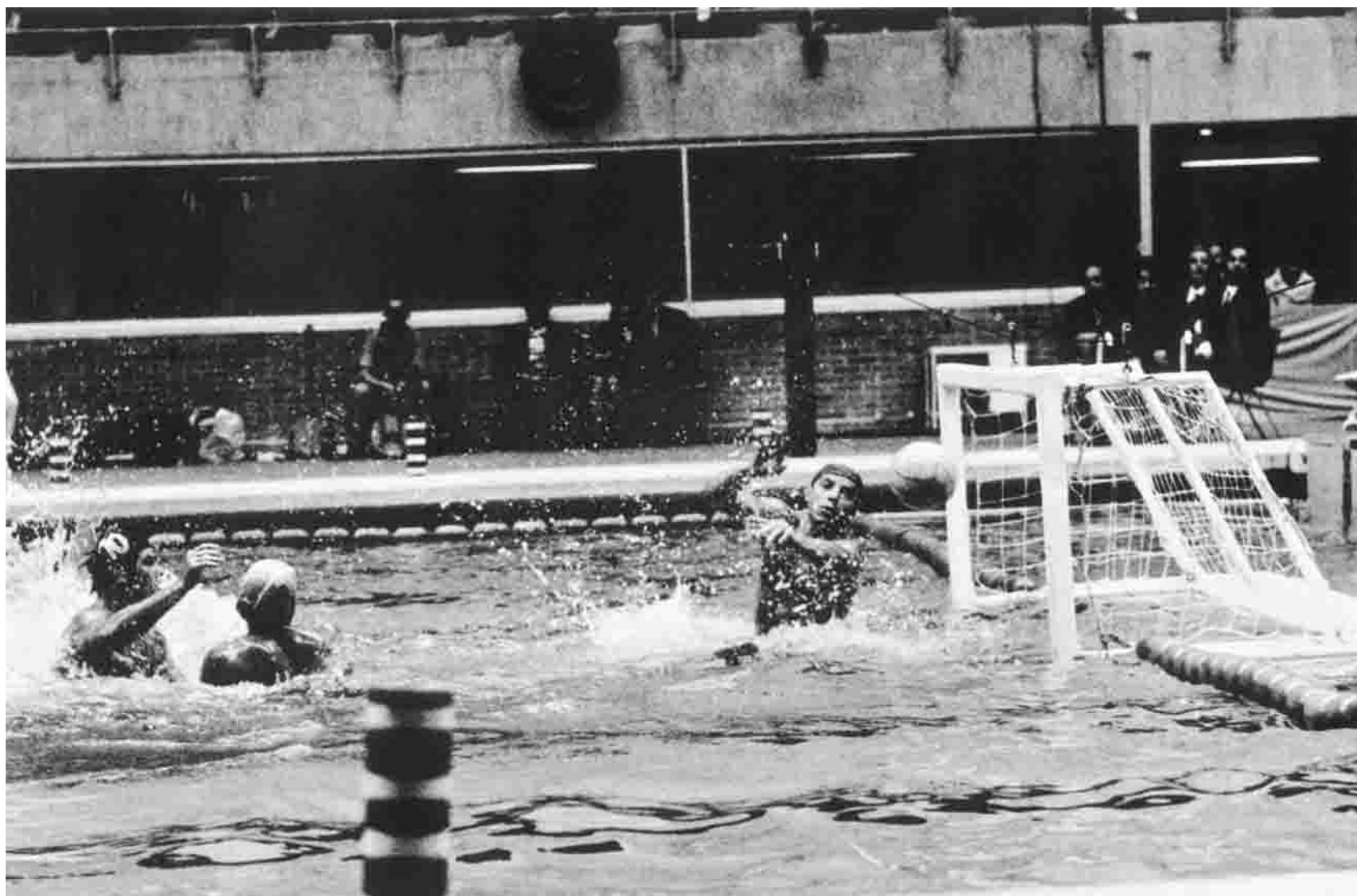

465

La Hongrie (bonnets foncés) dispute la médaille de bronze à l'Italie (page de gauche) après avoir été tenue en échec en demi-finale par la Yougoslavie. Les Italiens, déjà vaincus dans l'autre demi-finale par l'URSS, durent s'incliner de nouveau, et leurs adversaires remportèrent leur neuvième médaille de water-polo. Le gardien de but soviétique semble pris au dépourvu par un tir de Sandic (N° 10). Ce match de finale fut particulièrement rude puisque 20 buts sur 24 furent marqués à la suite d'un penalty. Enfin, après deux buts en prolongation, la Yougoslavie remportait sa première médaille d'or de water-polo.

Hungary (dark caps) tangles with Italy for the bronze medal (opposite) after being upset by Yugoslavia in one of the semi-final matches. The Italians, downed by the U.S.S.R. in the other semi-final, again went under as Hungary won to extend its streak of Olympic water-polo medals to nine. A shot by Sandic (10) at the Russian goal goes wide of the mark (above). In a rough and thrill-packed final—in which all but 4 of the 24 goals scored came on penalties—Yugoslavia took its first water-polo gold medal with two overtime tallies, after the regular contest ended in an 11-11 deadlock.







YACHTING



Le samedi 12 octobre le flambeau olympique arrivait à Acapulco, dont les équipements avaient été entièrement rénovés depuis deux ans pour faire de la station un véritable port olympique. Quarante-et-une nations avaient envoyé 247 yachtsmen pour disputer les régates, qui commencèrent le lundi suivant et, une semaine plus tard, 33 concurrents montaient sur le podium lors d'une cérémonie organisée au crépuscule sous les palmiers. Les détenteurs des médailles d'argent et de bronze se suivaient de près au total des points, mais il en allait tout autrement pour les cinq lauréats: trois fois champion du monde en catégorie Star, Lowell North (EUA) termina 1er, 3e, 3e, 1er, 2e, 1er, lors de ses six meilleures courses. "J'ai marché bon train", dit-il simplement. Les autres aussi! Dans la catégorie Finn, Valentin Mankin (URS) finit 3e, 1er, 1er, 2e, 2e, 1er, tandis que Rodney Pattison (GBR) mena son Flying Dutchman à un train aussi prodigieux que son nom, le "Supercalifragilisticexpialidocious": 1er, 1er, 1er, 1er, 1er, 2e, terminant souvent avec plus de 2 min. d'avance. George Friedrichs (EUA) montra à plusieurs reprises aux barreaux des Dragons comment on remonte ses adversaires (2e, 1er, 1er, 2e, 1er, 1er). Autre surprise: les trois frères Sundelin (SUE) sur leur 5.5 finirent, en dépit de leur jeunesse, 4es, 1ers, 1ers, 1ers, 1ers, 1ers.

YACHTING



On Saturday, October 12, the Olympic Flame arrived in Acapulco, where the sailing facilities had been transformed by new construction over the past two years into truly Olympic proportions. Forty-one nations had sent 247 yachtsmen to the regatta, and on Monday the races began. A week later, thirty-three men received their honors at a twilight awards ceremony under tropical palms. Point totals were close for silver and bronze medalists, but the case was different for the five Olympic champions. All of them had won decisively. Three-time world champion Lowell North of the U.S. finished 1, 3, 3, 1, 2, 1 in his six best races in the Star class. He simply "went the right way," he said. The others "went the right way," too. The U.S.S.R.'s Valentin Mankin, winner in the Finns, placed 3, 1, 1, 2, 2, 1. Britain's Rodney Pattison skippered his Flying Dutchman to a lead as long as its name (the "Supercalifragilisticexpialidocious"): 1, 1, 1, 1, 1, 2, often finishing more than two minutes ahead. George Friedrichs of the U.S. showed Dragon helmsmen how to come "the right way" from behind, doing so a number of times in compiling a record of 2, 1, 1, 2, 1, 1. Sweden's three Sundelin brothers were so young that some people thought they might not even find the right way to the 5.5 course. But they did—and finished 4, 1, 1, 1, 1, 1.









473

Les aménagements (page de gauche, en haut) spécialement construits pour les compétitions olympiques de yachting abritent plus de 200 yachts de course et embarcations auxiliaires. Pour la première fois dans l'histoire des Jeux (en bas), la flamme olympique est apportée par des skieurs nautiques au Yacht-Club d'Acapulco, où un groupe d'officiels et de personnalités attend son arrivée. Les yachtsmen (ci-dessus) procèdent aux derniers préparatifs.

The facilities (opposite, above), specially constructed for the yachting competition, harbor more than two hundred racing boats and auxiliary craft. Setting an Olympic precedent, water skiers (opposite, left) carry the Olympic Flame across the bay to the Acapulco Club de Yates, where officials and dignitaries await its arrival. Then, as the Flame blazes in its Aztec urn (above), yachtsmen make final preparations for the offshore races.





475

CATEGORIE — CLASS 5.5 M

	Voile Sail		Points
1	S Sundelin, Ulf.....	Sundelin, Jörgen..... SUE	8.0
		Sundelin, Peter.....	
2	z Noverraz, Louis.....	Stern, Marcel..... SUI	32.0
		Dunand, Bernard.....	
3	K Aisher, Robin.....	Jardine, Adrian..... GBR	39.8
		Anderson, Paul.....	
4	G Harmstorf, Rudolf.....	Stolze, Karl-August..... ALE	47.4
		Stein, Harald.....	
5	I Zucchini, Giuseppe.....	Carattino, Antonio..... ITA	51.1
		Carattino, Domenico.....	
6	KC Leibel, Stanley.....	Weiss, Ernest..... CAN	68.0
		Hasen, Jack.....	

Extrême gauche: Des membres de la Marine mexicaine placent les bouées; les résultats sont vérifiés par des officiels et un groupe d'experts procède au mesurage des coques. Page de gauche, à droite: M. Heredia, maire d'Acapulco, l'amiral Otal Briseño et M. González Karg; l'équipage suisse de 5.5 et son capitaine, M. Noverraz, âgé de 66 ans; de charmantes jeunes filles renseignent les visiteurs. Toutes voiles dehors, les 5.5 (ci-dessus) profitent d'un bon vent.

Scenes at Acapulco 68. Opposite, left column: Mexican Navy personnel signal buoy placement; results are checked and recorded at the tabulation center; officials verify boat measurements. Right column: Acapulco Mayor Heredia, Adm. Otal Briseño and Sergio González Karg, Committee Delegate; the Swiss 5.5 crew, headed by veteran yachtsman Noverraz; girls at information desk. Spinnakers billowing, the 5.5s (above) make good use of a quartering wind.



476

CATEGORIE — CLASS DRAGON

	Voile Sail			Points
1	US	Friedrichs, George.....	Jahncke, Barton.....	EUA 6.0
2	D	Birch, Aage.....	Schreck, Gerald.....	DIN 26.4
			Jensen, Poul.....	
			Markussen, Niels.....	
3	GO	Borowski, Paul.....	Thun, Karl-Heinz.....	ADE 32.7
			Weichert, Konrad.....	
4	KC	Tupper, Stephen.....	Miller, David.....	CAN 64.1
			Irwin, Timothy.....	
5	KA	Cuneo, Bruce.....	Anderson, Thomas.....	AUS 65.0
			Ferguson, John.....	
6	S	Broberg, Gunnar.....	Eisner, Lennart.....	SUE 71.4
			Hanson, Sven.....	

Le capitaine des Bermudes (ci-dessus) s'apprête à larguer ses amarres. Menant dès le début de la course (à droite, en haut), les Américains boivent un peu plus tard à leur victoire (ci-contre). Bien qu'arrivés en tête dans l'une des sept régates, les Danois (D 174) se montreront pourtant incapables de surpasser les Américains, qui terminèrent quatre fois en première position.

The Bermuda skipper (above), ready to cast off before the competition. The U.S. boat (above, right) takes an early lead in one of the races, and later its crew (right) celebrates the victory. In another of the seven races (opposite), the Danes (D 174) sail home first, but are unable to overcome the commanding lead of the Americans, who posted four first-place finishes.

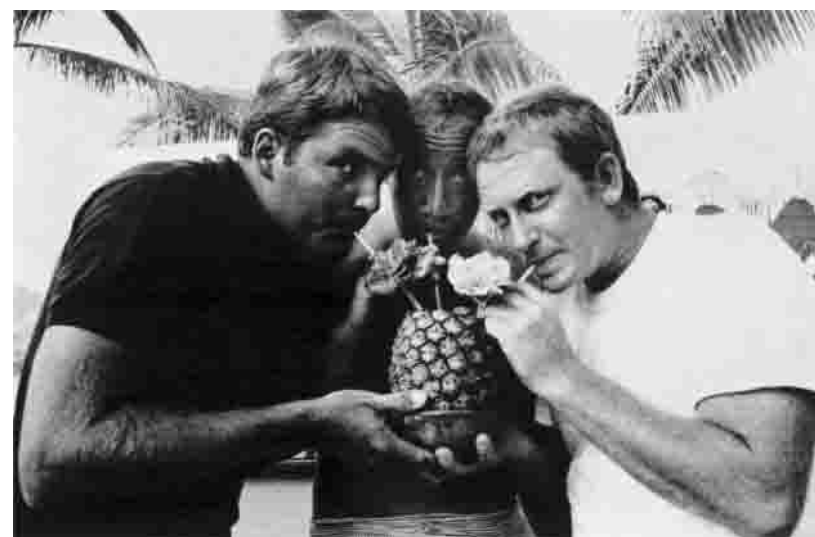





Des membres du comité de course (ci-contre) attendent le départ d'une régata. La Marine apporte son concours pour la mise à l'eau des bateaux (au centre) et des bouées (en bas). Séduits par la mode tropicale, Naumann et Libor posent sous la vasque olympique. Page de droite: Des Dragons en pleine course.

Members of the race committee (left) await the start of a regatta. The Navy assists in lowering a racing boat into the water (left, center) and in placing buoys (left, below). Germany's Naumann and Libor pose Acapulco-style beneath the Olympic Flame. Opposite: Dragons on course.









CATEGORIE - CLASS FLYING DUTCHMAN

	Voile Sail		Points
1	K	Pattisson, Rodne MacDonald, Lain GBR.	3.0
2	G	Libor, Ullrich Naumann, Peter ALE.	43.7
3	BL	Conrad, Ralph Cordes, Burkhard BRA.	48.4
4	KA	Ryves, Carl Sargeant, James AUS.	49.1
5	N	Lofterod, Bjorn Lofterod, Odd NOR.	52.4
6	F	Trouble, Bruno Cheret, Bertrand FRA.	68.0

Aux accents du "God Save the Queen" joué par un orchestre militaire, Pattisson et MacDonald (page de gauche) saluent le drapeau britannique après avoir reçu la médaille d'or. Souvent seul en tête, leur "Supercalifragilisticexpialidocious" (ci-contre) arriva cinq fois premier, donnant à la Grande-Bretagne une victoire indiscutée en catégorie Flying Dutchman.

As the military band plays "God Save the Queen," Pattisson and MacDonald (opposite) salute the British flag after receiving their gold medals. Their "Supercalifragilisticexpialidocious", (right) outdistances the field on its way to one of five first-place finishes that gave world-champion Great Britain an overwhelming victory in the Flying Dutchman competition.





CATEGORIE - CLASS STAR

	Voile Sail			Points
1	US North, Lowell	Barrett, Peter	EUA	14.4
2	N Lunde, Peder	Miken, Per Olav	NOR	43.7
3	I Cavallo, Franco	Gargano, Camillo	ITA	44.7
4	D Elvstrom, Paul	Mik-Meyer, Poul	DIN	50.4
5	BA Knowles, Durward	Knowles, Percival	BAH	63.4
6	KA Forbes, David	Williamson, Richard	AUS	68.7

Agés de 8 à 14 ans, les "mousses", interprètes et assistants des concurrents, s'accordent quelques instants de repos. L'embarcation norvégienne (ci-dessus) file tout droit vers une médaille d'argent, après être arrivée en deuxième position dans la dernière course. La place d'honneur revint aux Américains (extrême droite), ici à bord de leur "North Star", qu'ils menèrent brillamment à la victoire. Des pancartes indiquaient les divers mouillages.

"Grumetes" (left), 8-to-14-year-old interpreters and helpers, take time out from their nautical chores. The Norwegian boat (above) slices through choppy water to win the silver medal after taking second in the last race. The U.S. pair (far right) aboard their "North Star," which they sailed to a decisive victory and top place on the awards platform. Signs are used to designate each country's berth at the Club de Yates.





A la fin de chaque régate, les "mousses" (page de gauche) s'empresent d'amar-
rer et de briquer "leur" bateau. Tandis que des ballons olympiques (ci-contre)
vont être lâchés, les Danois partent faire un tour sur leur Star, "Scandale"

Between races the well-trained "grumetes" (opposite) keep busy berthing and
washing down boats. Olympic balloons (right) are readied for launching, and
Denmark's Star class crew (below) takes "Scandale" out for a trial run.



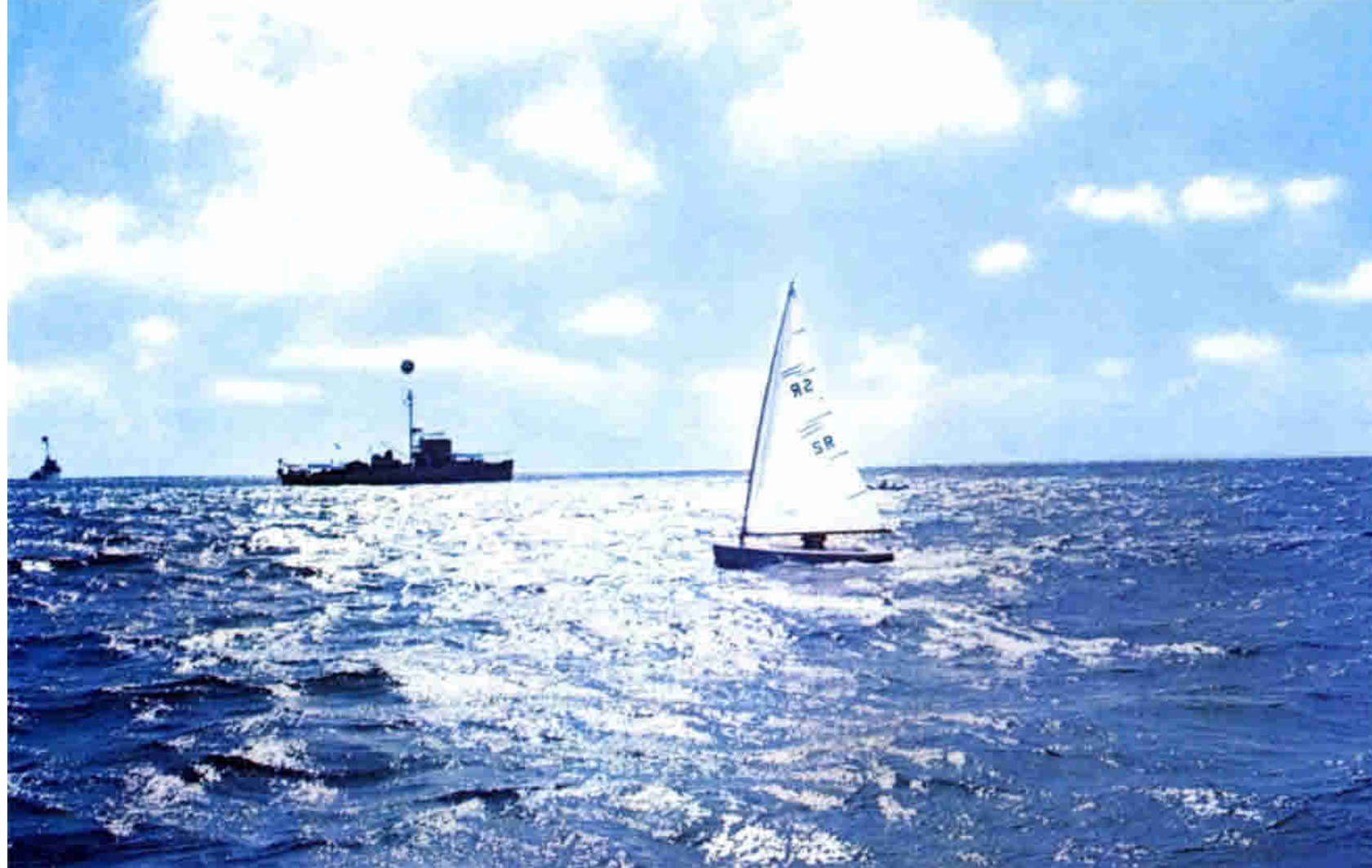

CATEGORIE - CLASS FINN

	Voile Sail		Points
1	SR	Mankin, Valentin	URS 11.7
2	OE	Raudaschl, Hubert	AUT 53.4
3	I	Albarelli, Fabio	ITA 55.1
4	KA	Jenyns, Ronald	AUS 67.0
5	GR	Kouligas, Panagiotis	GRE 71.0
6	L	Winquist, Jan	FIN 72.0

Sous la surveillance d'un bateau-jury, Mankin glisse en solitaire vers l'une des trois victoires qui lui donneront la médaille d'or. Les résultats complets de la journée sont affichés au Yacht-Club (page de gauche, en bas). Le Norvégien Werenskiold (ci-contre) sourit d'aise à l'issue de la première course, où il fut 2^e. Kouligas (GRE) en position de rappel durant un bord au près.

In full view of a committee boat, Mankin takes his Finn the right way to one of three victories that gave him the gold medal. Complete results are posted daily outside the Club de Yates (opposite, below). Norway's Werenskiold (right) unrigs his Finn after finishing second in the first race. Greece's Kouligas goes over the side on a windward tack.





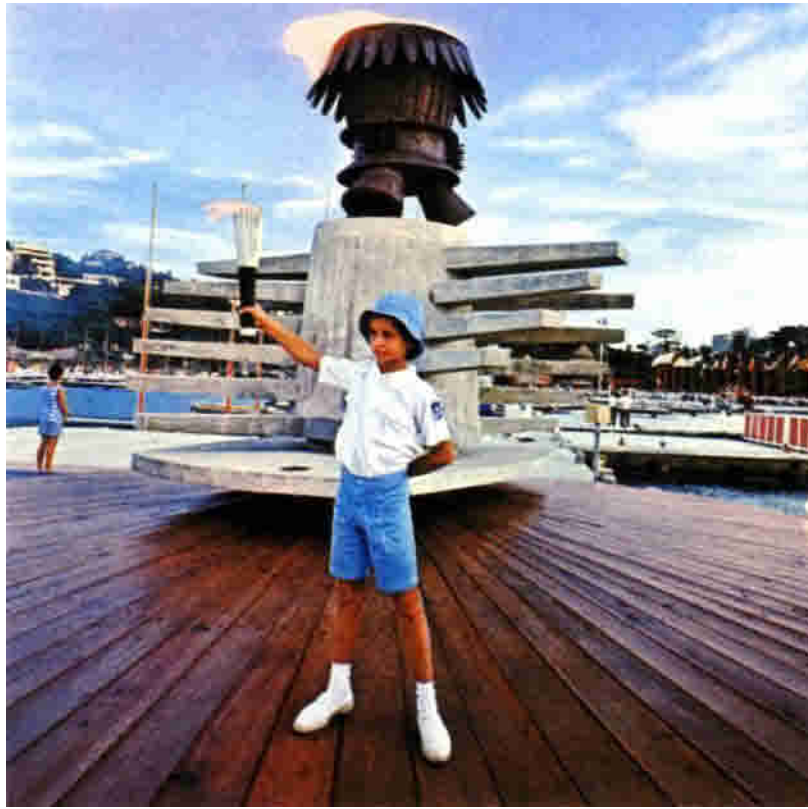

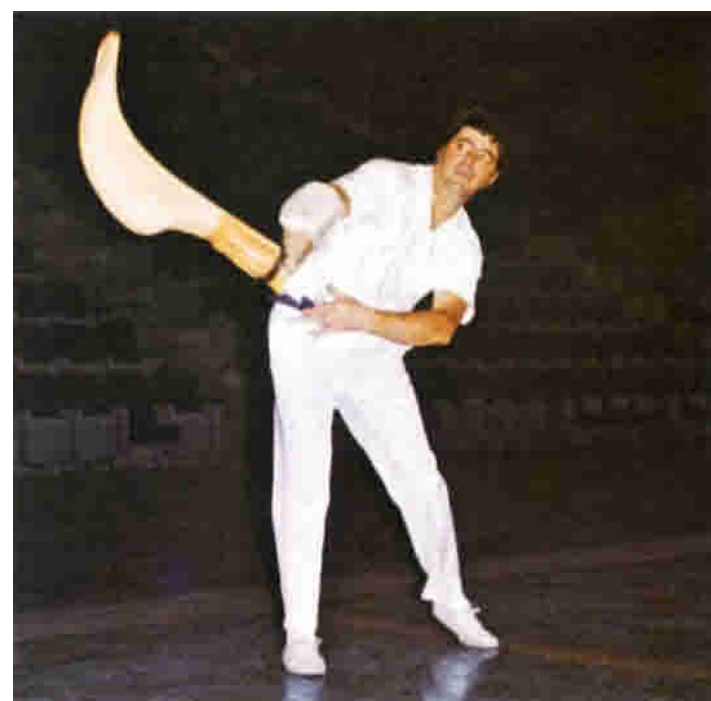
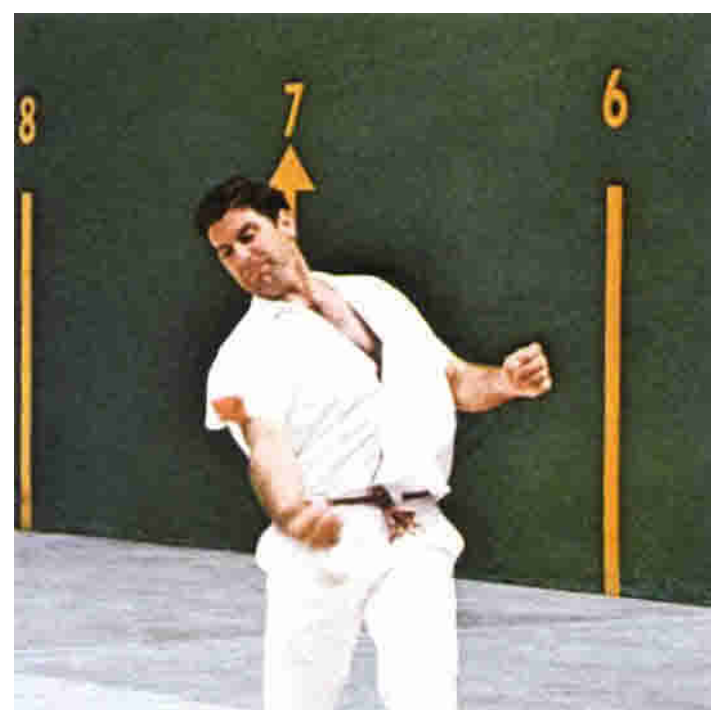
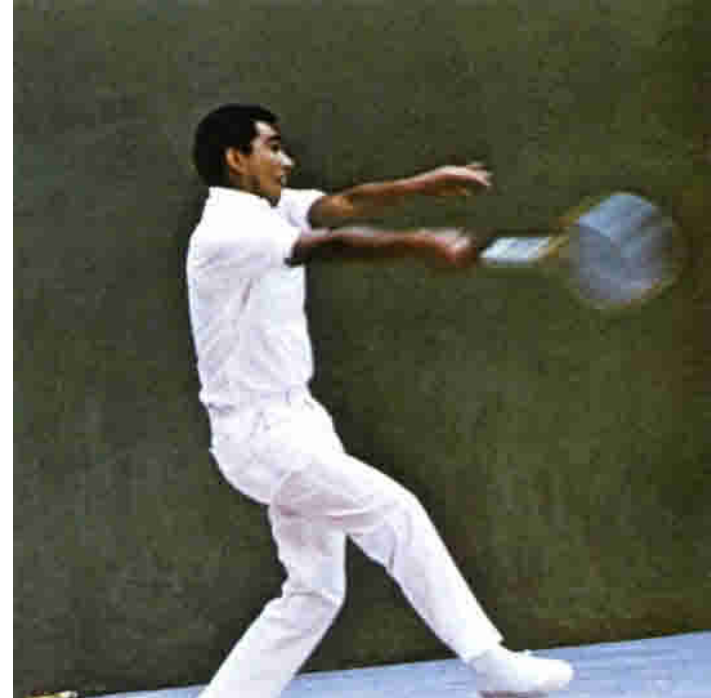

TENNIS ET PELOTE BASQUE



Après plus de quarante ans, le tennis a été inscrit à nouveau en tant que sport d'exhibition au programme des Jeux Olympiques. Quarante-six concurrents en provenance de quinze pays ont disputé des matchs simples et doubles à Mexico et à Guadalajara, pour la plus grande joie des spectateurs. Par ailleurs, cinq versions d'un jeu basque très ancien ont été présentées en exhibition à Mexico et Acapulco. Le principe de ces jeux, qui se disputent sur des terrains délimités par trois murs, est de lancer la balle sur l'une des parois — "frontis", "mur d'aide" et "rebot" respectivement situés face aux joueurs, sur leur gauche et derrière eux — de façon à ce que l'adversaire (ou les adversaires dans les doubles) ne puissent la renvoyer avant le deuxième rebond. Le plus rapide de ces sports est le jai-alai pour lequel on utilise une petite balle très dure qui, catapultée à une vitesse foudroyante, doit être cueillie et immédiatement renvoyée par le chistera, un long panier d'osier attaché au poignet. Sept équipes participaient au tournoi qui dura deux semaines. L'Espagne, la France et le Mexique s'imposèrent à l'Argentine, l'Uruguay, les Philippines et les Etats-Unis, donnant une excellente démonstration aux spectateurs qui, dans bien des cas, assistaient pour la première fois à une rencontre de pelote basque.

TENNIS AND FRONTON



After a lapse of more than four decades, tennis was re-introduced to Olympic Games spectators as one of two demonstration sports. Forty-six competitors from fifteen nations displayed their skill in singles and doubles matches on courts in the capital and in Guadalajara, and the tournament was received with enthusiasm by both players and fans. In addition, five versions of an old Basque game were presented in Mexico City and Acapulco as the second demonstration sport. In all these games, which are played on three-sided courts, the basic idea is to have the ball strike the short front wall—making use also of the long left or "helping" wall and the back or "rebound" wall—in such a way that the opposing player (or players in doubles) cannot make a fair return before the ball hits the floor twice. The fastest of these games is jai-alai, in which the small, hard ball, rebounding at terrific speed, is caught in—and in the same motion hurled out of—a long wicker basket strapped tightly to the wrist. Teams from seven nations participated in the two-week-long tournament, with Spain, France and Mexico generally winning over Argentina, Uruguay, the Philippines and the U.S. The fast-moving action and intense competitiveness of these games held a great appeal for the many spectators who were seeing them for the first time.





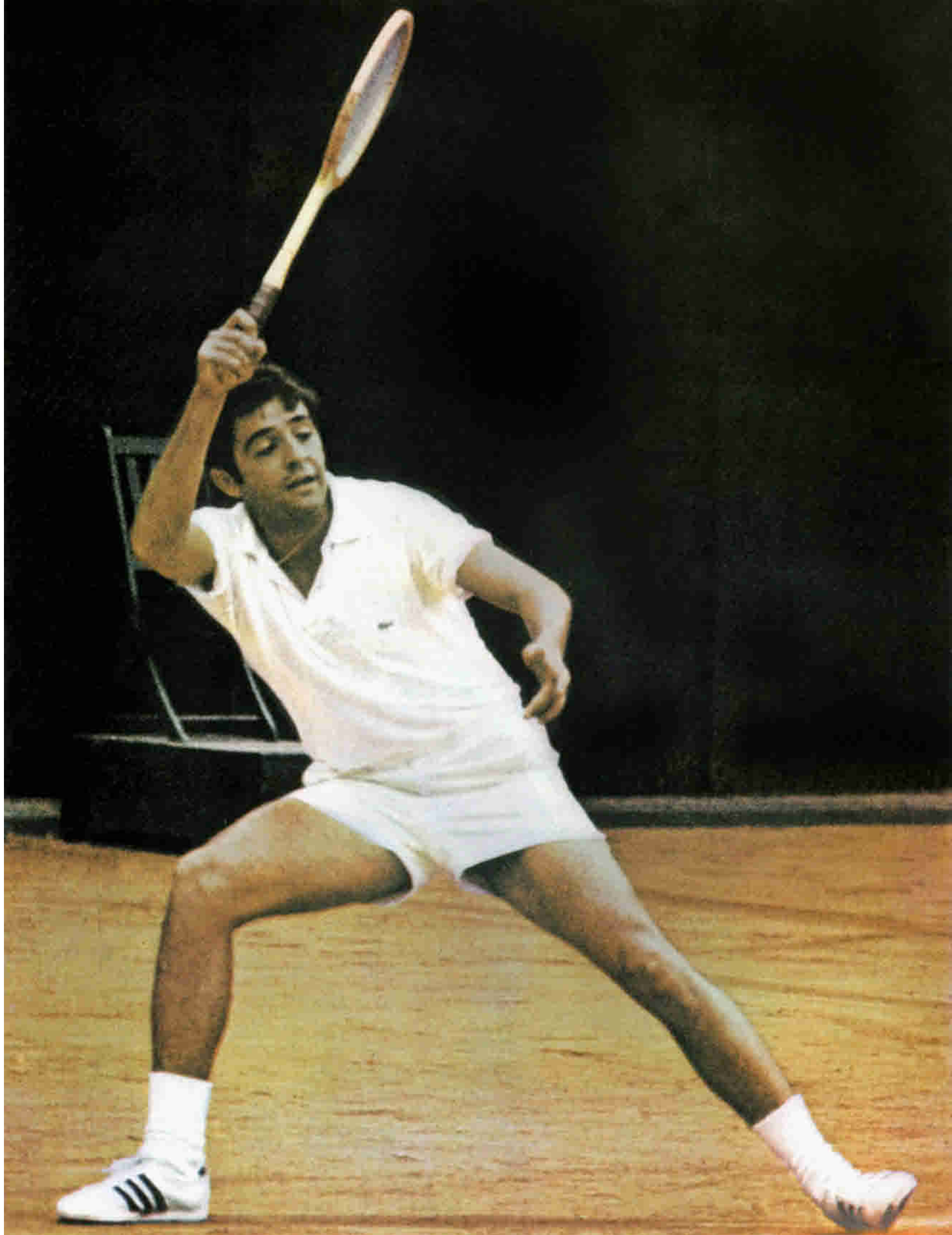



Quarante-six joueurs en provenance de quinze pays ont participé aux tournois olympiques d'exhibition de Mexico et de Guadalajara. Le Mexicain Osuna (p. de gauche) gagna le simple messieurs dans la capitale. Ci-dessus en haut, de gauche à droite: Pietrangeli (ITA); Santana et Gisbert (ESP) au fond du court contre Loyo (MEX) et Darmon (FRA); Orantes (ESP). En bas: L. Góngora (MEX); M. Santana (ESP), champion des simples à Guadalajara; E. Buding et H. Niessen (ALE), gagnantes des doubles dames de Guadalajara.

Forty-six players from fifteen nations took part in the Olympic demonstration tennis tournaments at Guadalajara and Mexico City. Mexico's Rafael Osuna (opposite), winning the Mexico City singles tournament. Above, top row, left to right: Pietrangeli (ITA); Santana and Gisbert (ESP), far court, play Loyo (MEX) and Darmon (FRA); and Orantes (ESP). Bottom row: Góngora (MEX); Santana (ESP), singles champion in Guadalajara; Buding and Niessen (ALE), winners of the Guadalajara women's doubles tournament.



496



Au filet, l'Espagnol Santana (ci-dessus) renvoie à la volée. Korotkov (ci-contre) était l'une des trois raquettes soviétiques participant aux simples messieurs. Sur les courts de frontennis du Centro Deportivo Libanés de Mexico (p. de droite), les parties avec balle de caoutchouc et pelote de cuir furent un spectacle nouveau pour beaucoup de spectateurs. Nous voyons ici l'Argentin Sehter (en haut) et l'Uruguayen Bernal (extrême droite).

At the net, Spain's Santana (above) makes a sharp backhand return. Korotkov (left) was one of three entrants representing the Soviet Union in men's singles. On the frontenis courts of Mexico City's Centro Deportivo Libanés (opposite), games of rubber-ball and leather-ball paddle fronton provide an exciting novelty for many spectators. Expertly demonstrating their smashing returns are Argentina's Sehter (above) and Uruguay's Bernai (far right).

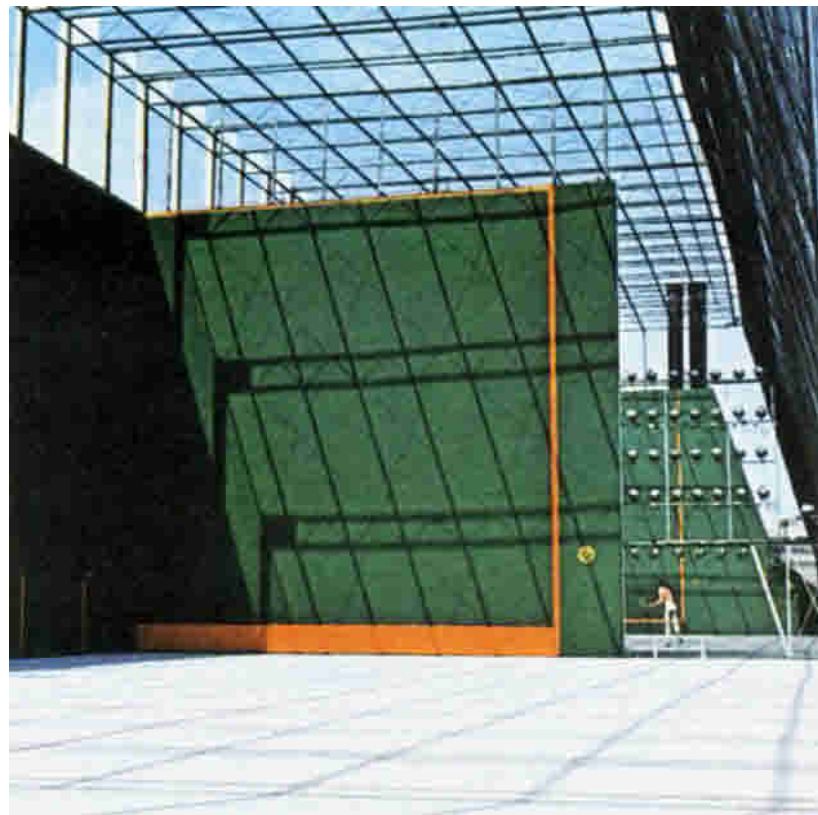







CEREMONIE DE CLOTURE



Salué par une salve de vingt et un coups de canon, le président du Mexique, M. Gustavo Díaz Ordaz, prit place dans la loge d'honneur située au milieu des gradins. C'était le 27 octobre et le soir tombait tandis que l'on s'affairait sur la pelouse du Stade olympique pour enlever les obstacles, après la remise des médailles aux gagnants du Grand Prix des Nations, l'élégante épreuve qui avait mis fin, comme le veut la tradition, aux compétitions sportives des Jeux de la XIX Olympiade. Un groupe de gymnastes danois vint alors distraire le public tandis que les drapeaux grec, mexicain et allemand flottaient au-dessus de l'immense tableau de marquage. Puis une petite brise s'éleva, à la plus grande satisfaction des 100 000 spectateurs qui, en manches de chemise, s'épongeaient le front depuis le début de cette chaude journée. Les drapeaux et les oriflammes olympiques se mirent à claquer dans le vent. La foule, habituée à la fraîcheur des nuits de Mexico, commença à enfiler manteaux et pull-overs: le crépuscule fit peu à peu place à la nuit et le stade s'illumina.

Quelques instants plus tard, la foule immense lança son cri de bienvenue aux athlètes qui avaient réalisé tant d'exploits au cours des deux semaines passées. Élégamment vêtus, les porte-drapeaux des 113

CLOSING CEREMONY



An echoing twenty-one howitzer salute announced the arrival of Mexico's chief of state, President Gustavo Díaz Ordaz, in the midfield dignitaries' box. It was early evening of Sunday, October 27, and the obstacles were being removed from the Olympic Stadium's green infield after the presentation of the awards for the Team Jumping Grand Prix—the colorful and elegant final sports event of the Games of the XIX Olympiad. A group of Danish gymnasts came out to entertain the crowd. The flags of Greece, Mexico and Germany were flying from staffs atop the huge scoreboard as dusk settled over the scene. Soon a light breeze arose—very welcome to the hundred thousand shirtsleeved spectators after the long sun-drenched day—and set flags and Olympic pennants fluttering. The crowd, well prepared for Mexico City's cool nights, slipped into sweaters and coats, as the gymnasts completed their program and retired. Twilight quickly turned to night, and the stadium suddenly came ablaze with daylight brightness as banks of floodlights were turned on.

A moment later the huge crowd erupted in a roar of welcome, giving vent to its feelings for the men and women who had performed with such outstanding success over the past two weeks. The smartly-clad

nations firent leur entrée dans le stade en file indienne, au son de la joyeuse fanfare de l'orchestre olympique. De même qu'à la cérémonie d'Ouverture, le point de mire était l'haltérophile soviétique qui, dédaignant la courroie de cuir dont se servaient ses compagnons, soutint à nouveau d'un seul bras les couleurs de son pays. Puis les athlètes s'avancèrent en rangs de huit ou dix: six représentants pour chaque nation, sauf pour le Mexique dont la délégation au grand complet ferma le défilé. Marchant d'une allure souple et non au pas, échangeant sourires et saluts dans toutes les langues, ils pénétrèrent en masse sur le stade, toute distinction de nationalité abolie. Les applaudissements durèrent jusqu'au moment où ils se rangèrent sur la pelouse centrale, encadrés par l'équipe mexicaine vêtue de blanc pour symboliser la fraternité exprimée en ces termes par le président Díaz Ordaz, sous le haut patronage duquel étaient placés les Jeux: "Nous offrons notre amitié à tous les peuples de la terre et souhaitons la leur en retour".

Le silence se fit de nouveau lorsque, debout au milieu du stade, M. Avery Brundage, président du Comité international olympique, prononça en espagnol ces mots solennels: "Je déclare terminés les Jeux de la XIX Olympiade et invite la jeunesse du monde entier à se réunir dans quatre ans à Munich, où seront célébrés les Jeux de la XX Olympiade".

Une salve de coups de canon retentit soudain, les lumières du stade s'éteignirent et des projecteurs illuminèrent le drapeau olympique qui flottait toujours au sommet du mât dominant les gradins. Lentement, le pavillon orné des cinq anneaux fut amené et reçu par un groupe de cadets de la Marine mexicaine en uniforme bleu et blanc, qui se retirèrent en le portant au-dessus de leur tête. Le stade n'était plus maintenant éclairé que par une seule lueur: tous les yeux se tournèrent alors vers la Flamme olympique qui brûlait constamment depuis le 12 octobre. Le silence se fit tandis qu'elle s'éteignait progressivement. Puis soudain, les énormes lettres "MEXICO 68" inscrites sur le tableau électronique firent place à "MUNICH 72". Les fusées du feu d'artifice éclatèrent dans le ciel pendant un bon quart d'heure et tandis que, dans l'obscurité irradiée par un pluie d'étoiles, les athlètes rangés derrière les drapeaux amorçaient leur dernier tour de piste, une vive émotion s'empara de l'assistance. Debout, les 100 000 spectateurs — dont la plupart avaient les larmes aux yeux — applaudissaient et laissaient éclater leur enthousiasme: "Magnifique! Bravo! Au revoir! Adieu!" Des fleurs, des chapeaux de paille, des foulards volèrent depuis les

standard bearers of all the 113 competing nations were entering the stadium, marching in single file to the gay, spirited music of the Olympic band. As on opening day, one of the many highlights of the march-past was the Soviet weightlifter who once again held his country's colors straight out in front of him in one mighty fist without benefit of the leather hip-rest needed by the other flag bearers. Then, not marching but walking easily, eight and ten abreast, the Olympic athletes followed: six representatives from each national contingent—except for the host country, which entered last and in full strength. No longer separated by nations, the young men and women moved in a solid phalanx, smiling and exchanging greetings in scores of languages. The roar from the stands never let up until all the athletes had assembled on the central grass, surrounded by the Mexican team, which was dressed all in white to reflect the fraternal concept expressed by President Díaz Ordaz as Patron of the Games: "We offer and desire friendship with all the peoples of the world."

The crowd gradually became quiet again, and then Avery Brundage, President of the International Olympic Committee, speaking in Spanish from the middle of the field, made this solemn pronouncement: "I declare the Games of the XIX Olympiad closed and call upon the youth of all nations to assemble four years hence at Munich, there to celebrate with us the Games of the XX Olympiad." With that, a volley of howitzers boomed, the floodlights that illuminated the stadium went out, and through the darkness spotlights were trained on the Olympic flag, which still waved atop its mast at the edge of the field. Slowly, the five-ringed banner came down, into the hands of a group of blue-and-white-uniformed Mexican naval cadets, who moved out of the arena carrying it aloft. Now there was only one source of light left in Olympic Stadium. Everyone turned his eyes on it—the Olympic Flame that had burned so steadily and proudly since October 12. The stands fell silent as it was slowly extinguished. Then, in an instant, the huge letters on the scoreboard changed from MEXICO 68 to MUNICH 72. Fireworks blasted off in a massive display—which would continue without letup for a quarter of an hour—and, while the black sky burst open with a rain of exploding stars and the athletes started off behind the flags on a final circuit of the track, the stadium came alive in a spontaneous show of emotion. The spectators—the entire hundred thousand of them—rose to their feet, shouting, applauding, trying to express what they felt in their hearts: Well done! Bravo!

tribunes et des milliers de mouchoirs s'agitèrent lentement dans la nuit en guise d'adieu. Touchés par l'accueil chaleureux et triomphal que leur avait réservé le peuple mexicain, les concurrents — dont beaucoup emportaient en souvenir un chapeau de "charro" à larges bords — répondaient gaiement aux ovations.

Le thème de la "Cinquième Symphonie" de Beethoven, qui avait accompagné la remise des médailles gagnées par la République fédérale d'Allemagne et la République démocratique allemande, fut joué en l'honneur des prochains Jeux. Puis un orchestre composé d'un millier de "mariachis" entonna un air plein d'allégresse, "La Negra", suivi de la triomphale "Guadalajara" et finalement du traditionnel et mélancolique chant d'adieu mexicain, "Las Golondrinas".

Mais la cérémonie ne devait pas se terminer là. Après avoir effectué un dernier tour, les porte-drapeaux avaient disparu comme prévu, mais les athlètes, au lieu de les suivre, continuèrent à célébrer l'événement et bientôt, le public descendit des tribunes pour les rejoindre sur la piste. Concurrents et spectateurs, délégués et assistants, hommes et femmes de tous les continents, désireux de prolonger la cérémonie de Clôture des Jeux de la XIX Olympiade, chantèrent et dansèrent durant des heures au son ininterrompu des trompettes des mariachis, faisant de cette dernière soirée une gigantesque "fiesta".

Bientôt tout Mexico fut en liesse. Ceux qui n'avaient pas eu la chance d'obtenir des billets pour assister à la cérémonie, mais l'avaient suivie à la télévision ou à la radio, s'élancèrent dans les rues pour se joindre à la foule en délire. D'interminables files de voitures se dirigèrent vers l'élégante "zone rose" ou le centre de la ville et pendant des heures, les conducteurs scandèrent de leur klaxon les trois syllabes qui n'avaient pas cessé de résonner dans l'air durant deux semaines: "ME-XI-CO! MEXICO!" Fièvre et heureuse, la capitale toute entière était dehors, manifestant un enthousiasme débordant, qui surpassait peut-être encore celui qui avait accompagné tous les événements des Jeux Olympiques, et ce fut seulement au petit matin que l'on dut se résoudre à l'évidence: l'Olympiade était terminée.

Hail... and farewell! There were tears in many eyes. Flowers, straw hats and scarves flew into the arena from the stands as the Olympians walked by, and the dark background rippled white with handkerchiefs being waved in an emotional good-bye. The athletes waved back—many of them with the sombreros or wide-brimmed "charro" hats they carried as souvenirs of Mexico—saying good-bye to a people who had opened their arms wide to them in admiration and affection.

In honor of the next celebration of the Games, the theme from Beethoven's Ninth Symphony was played—the same theme that had been used at the awards ceremonies whenever Germany or East Germany won a sports event. Then a thousand "mariachis" took over, sounding the gay notes of "La Negra," the bold ones of "Guadalajara," the slow, sad ones of "Las Golondrinas"—Mexico's traditional song of farewell. The celebration, however, refused to end. The flag bearers, after their tour of the arena, had exited as scheduled, but the athletes, instead of following them out of the stadium, stayed on to keep the festivity going, and the crowd flowed down from the stands onto the field to join them. Athletes and spectators, officials and aides, men and women, Europeans and Americans and Africans and Asians, unwilling to see this last ceremony come to an end, began what turned into a huge fiesta—singing and dancing and laughing together under the open sky for hours, while the "mariachis" played on and on.

The fiesta spread quickly outside the stadium into all parts of Mexico City. People who had not been fortunate enough to have closing-day tickets—and had watched the ceremony on television or listened to it over the radio—poured out of their homes and joined their neighbors in the streets. Caravans of cars set out toward the city's elegant "Pink Zone" and the downtown area, and for hours drivers kept sounding their horns in unison, over and over again, with the accented triple notes that had filled the air constantly during the past two weeks: "ME-XI-CO! ME-XI-CO!" The proud and happy city was wide awake and friendly, thrilled beyond anything it had ever known by the spectacular success of its Olympic Games—and it was many hours before everyone was ready to accept the fact that this Olympiad had finally ended.

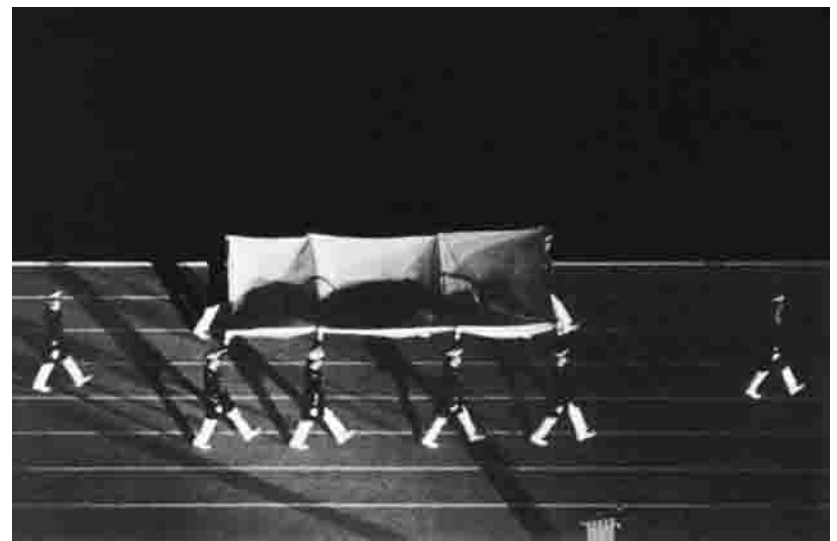
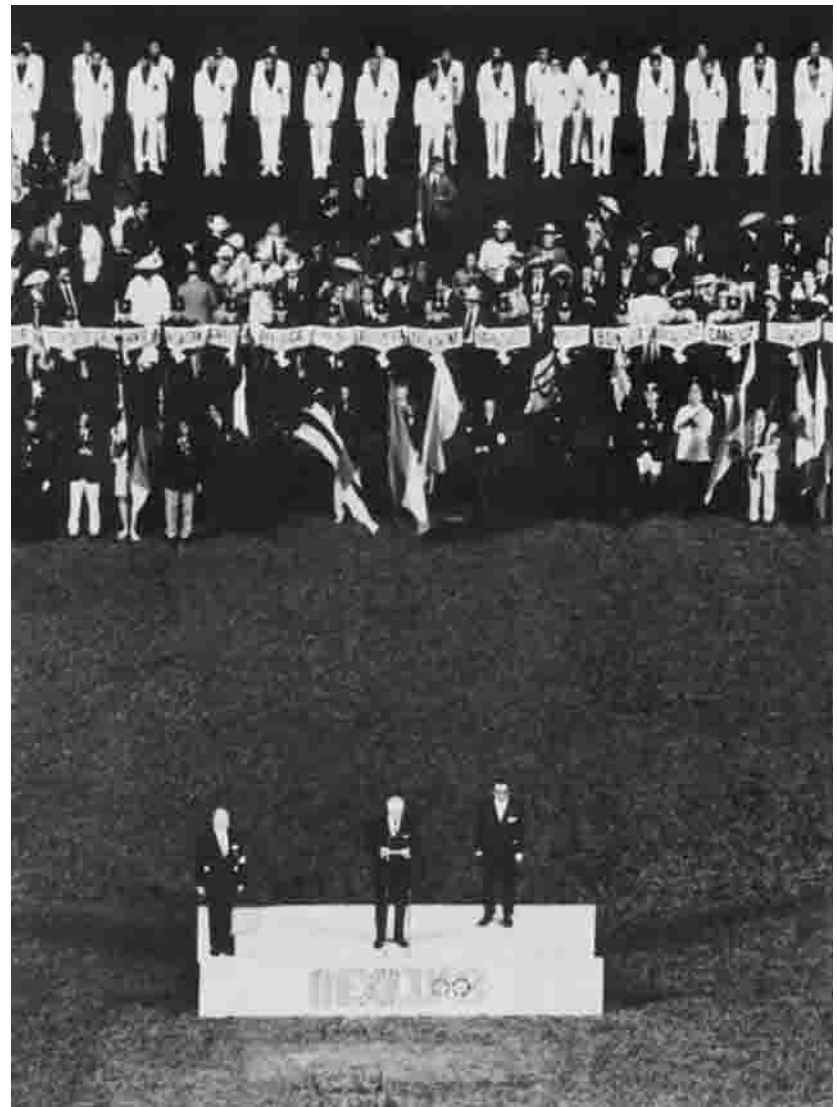

















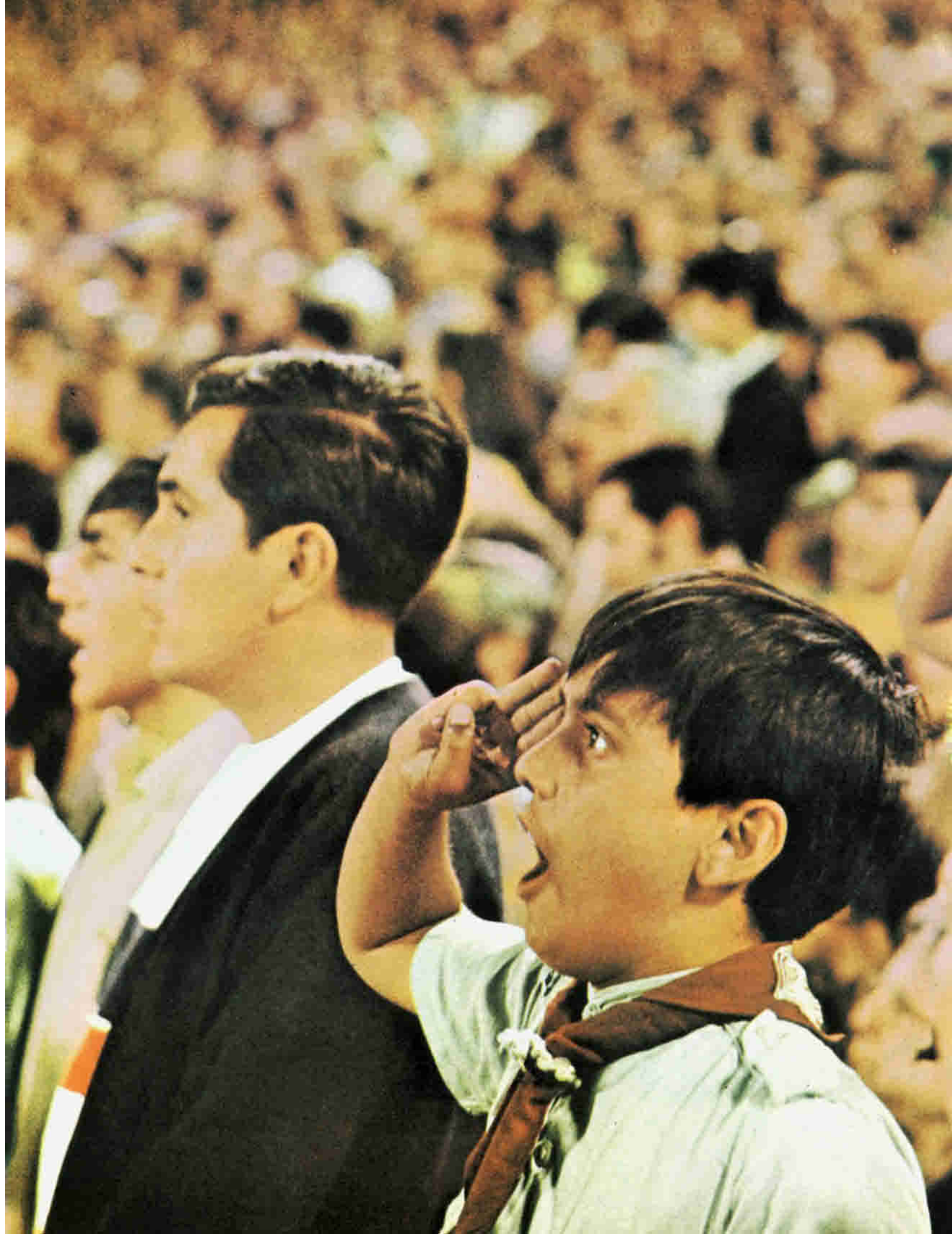



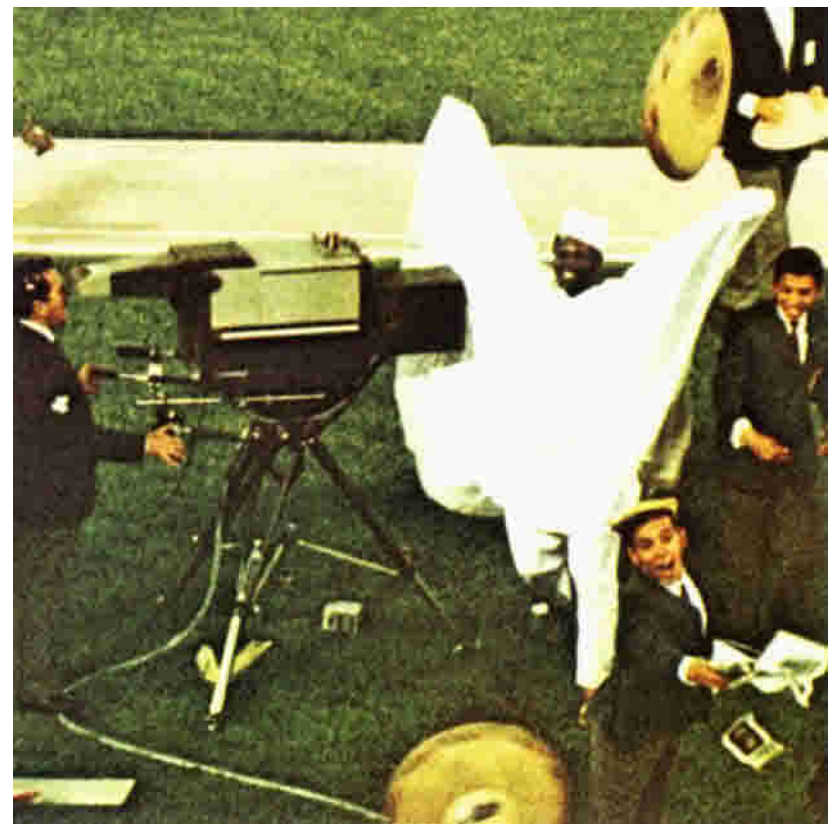
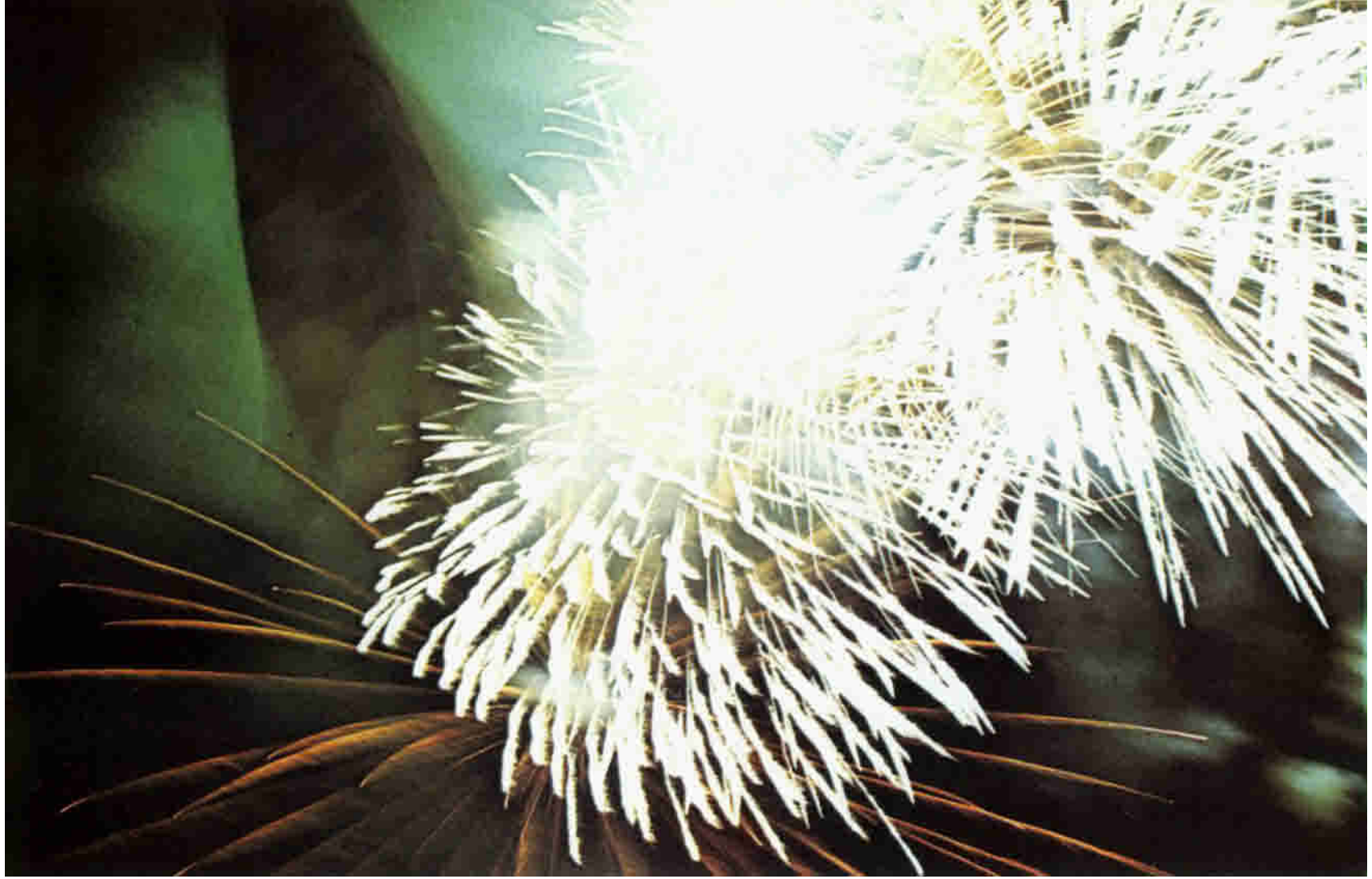







**FEDERATION INTERNATIONALE
D'ATHLETISME AMATEUR IAAF**

**INTERNATIONAL AMATEUR
ATHLETIC FEDERATION IAAF**

PRESIDENT
Le marquis d'Exeter GBR

**SECRETARE-TRESORIER HONORAIRE
HONORARY SECRETARY-TREASURER**
Donald T.P. Pain GBR

518

**FEDERATION MEXICAINE
D'ATHLETISME AMATEUR FMA**

**MEXICAN AMATEUR ATHLETIC
FEDERATION FMA**

PRESIDENT
Carlos de Anda Domínguez MEX

**SECRETARE
SECRETARY**
Salvador Pérez Trejo MEX

**SECTION ATHLETISME DU C.O.O.
O.O.C. ATHLETIC SECTION**
César Moreno Bravo MEX

José J. Medrano MEX
Jesús Mere Groth MEX
Mario Argumosa MEX
Roque Sagardoy MEX
Leopoldo González MEX
Francisco Lechón MEX

**CONSEILLER DE L'IAAF
CONSULTANT TO THE IAAF**
Artur Takac YUG

**OFFICIELS DE LA COMPETITION
COMPETITION OFFICIALS**

**JURY D'APPEL
JURY OF APPEAL**
Le marquis d'Exeter GBR

Max Danz ALE
Joao da Costa BRA
Daniel J. Ferris EUA
Toimi Tulikoura FIN
Donald T.P. Pain GBR
Adrian Paulen HOL
George Oberwerger JPN
Kinichi Asano ITA
Jacob Lindahl SUE
Leonid Khomenkov URS

**DIRECTEUR
DIRECTOR**
César Moreno Bravo MEX

**JUGES INTERNATIONAUX
DE MARCHE
INTERNATIONAL WALKING
JUDGES**
Max Weber ADE
Hans Stahl ALE
Victor Sharp AUS
Palle Lassen DIN
Joseph Tigerman EUA
Walter Batson GBR
Bela Fehervari HUN
H. Eriksson NOR
Hans Ekenmyr SUE
Armand Libotte SUI

**JUGE ARBITRE POUR LES COURSES
REFEREE FOR TRACK EVENTS**
Braulio Alvarez MEX

**ARBITRES POUR LES SUATS
REFEREES FOR JUMPING EVENTS**
Manuel Martínez MEX
Gustavo Pontvianne MEX

**ARBITRES POUR LES LANCEMENTS
REFEREES FOR THROWING EVENTS**
Omar Rendón MEX
Santiago Nakasawa MEX

**ARBITRES POUR LE MARATHON
REFEREES FOR MARATHON**
Lucas Nájera MEX
Ignacio Torres MEX

**ABITRE POUR LE MARCHE
REFEREE FOR WALKING**
Jorge Muñoz Murillo MEX

**OFFICIELS DU CONTROLE DES
ATHLETES
CONTROL OF ATHLETES**
Hermilo Arce, Teresa Talamantes, Elsa de la Garza, Monique Valery, Romeo Gomez Poncet, Héctor Chávez, Natalia Ventura, Angélica López, Rosa María Vivanco, Juan Barrera, Alfredo Isita, Jesús A. Mercado, Santa Suárez, Palmira Serrano, Teresa Cuevas, Alfredo Barrera, Carmen Magaña, Victoria Medrano, María de la Paz Ramírez, María Elena Flores, José Navarro, Juan Alegría, Raúl Alegría, Jorge Suárez.

**STARTERS ET STARTERS DE RAPPEL
STARTING JUDGES**
Abrahám Ferreira, Javier Souza, Enrique Esquivel, Pedro Torres, Sergio Ortiz, Juan Godínez, Alfonso Millán, Javier Mejía, Rogelio Bustos, Jesús Moraña, Mario Bello, David Rodríguez, Jesús Mere, Manuel Retta, Benito Pérez, Roberto Lavín, José Sandoval.

**JUGES D'ARRIVEE
FINISH LINE JUDGES**
Horacio Contreras, Isidro Marmolejo, Susana Flores, Carlos Jiménez, Zenaida Verduzco, Dora Miranda, Mercedes Pimentel, Fernando Riestra, Esteban Zúñiga, Ana Ma. del Olvido, Víctor Hernández, Elda Belio, Rosa Covarrubias, Laura Parrao, Elidia de la Rosa, Manuel Retta, Hilda Macías, Margarita Díaz, Silvia González, Nohemí Coronado, Evelina Muñoz, Socorro Madrid, Azucena Arroyo, Ruth Coronado, José Reyes, Aída Pineda, José Salas, Mercedes Espejel, Ma. de Jesús Flores.

**COMPTEURS DE TOURS
LAP SCORERS**
Irma Elorriaga, Elfega Cisneros, Griselda Montero, Gloria Colina, Guadalupe García, Gloria Vivanco, Socorro Castillo, Lucila Castillo, Rosalba Celis, Blanca Mejía, Rosario Vargas.

**CHRONOMETREURS
TIMEKEEPERS**
Alfonso Lara, Rodolfo Díaz, Juan Figueroa, José Torres, Roberto Osegueira, Ignacio Díaz, Rodolfo López, Mario Lugo, Luis Trucios, Rafael Medina, Enrique Ortiz, Efraín Pérez, Miguel Caviedes, Emma Carrera, Hilda Saro, Ariel González, Alfonso Nolasco, Francisco Gómez, Esperanza Olvera, Eduardo Kammermayer, Natividad Sandoval, Mario Victoria, Valentín Gallardo, Omar Luján, Amparo Ortega, Agripino Flores, Norma Godoy, Leonor Montes, Aarón Arcos, Julián Arellanos Suárez, Carmen Martínez, Antonio Soto, Luis Guzmán, Hilda Contreras Sánchez, Luis López, Graciela Martínez, Ma. del Refugio Suárez, Laura Guzmán, Rafael

Orozco, Dora Luz Díaz, León Mota, Alfredo Carrillo, Claudio Galicia, Rocio Gomez, Elia Rico, Ma. del Socorro Ibarra, Celia Mota, Gilberto Lozada, Irma Morales, Rosalba Velasco, Irma Gómez, Ana Zamora.

**JUGES DU TEMPS PARTIEL
LAP TIMEKEEPERS**
Arturo Plácido, Leonardo Antúnez, Miguel Espinoza, Alfredo Tejeda, Lucina Rojas, Olivia Sandoval, Delia Pérez, Ma. de Lourdes Garza, José Romero, Mario Monroy, Carmen Hebe, Ma. Antonieta Eckerle, Ma. Elena Linares, Gloria Delgado, Esaúl Serrano, Ma. Luisa Peralta.

**INSPECTEURS DE PISTE
TRACK INSPECTORS**
Lucila Monroy, Antonio Flores, Verónica Molina, Omar Abrego, Noehmí Quiroz, José L. Loyola, Juana Vissuet, Miguel Pozas, Patricia Vargas, Yolanda Reyes, Guadalupe Magaña, Maximino Buenrostro, Fernando Martínez, Socorro Fregoso, Alma Chávez, Joaquín Velasco, Blanca Bermúdez, Daniel Luna, Delfino Benitez, Rodrigo Santoyo, Ana Luna, Alfonso Cabrer, Víctor Way, Estela Avendaño, Ignacio Flores, Guadalupe Cervantes, Dolores Girón, Plácido Hernández, Manglio López, Gertrudis González, Santiago Baeza, Enriqueta Aguirre, Silvia Espinosa, Ciro Hernández, Ederne García, Nohemí Luna, Dulce Ma. Pineda, Yolanda González, Berta Ponce, Virginia Martínez, Clara Varela, Olga Navarrete, Margarita Vázquez, Eugenia Magaña, Guillermo Arcos, Guillermo Valdés, Clara Muñoz, Francisco Meneses, Marina Martínez, Eduardo Rojas, Ma. Eugenia Fernández, Ma. del Refugio Sánchez, Irma Lemus, Concepción Hernández, Jorge Ramírez Vargas.

**JUGES DU TRIPLE SAUT
TRIPLE JUMP JUDGES**
Sara León, Jesús Silva, Roberto Ochoa, Lourdes Navarro, Patricia Tlaseca, Laura Sandoval, Atenea Ramírez, Angel Rangel, Rosa Cervantes, Esperanza Bravo, Marco Sandoval, Manuel Guerrero, Benjamín Espinoza, Emma Mendoza, Georgina Costarrica.

**JUGES DU SAUT EN
LONGUEUR
LONG JUMP JUDGES**
Rafaela Acosta, Salvador Pliego, Fernando Cerón, Salvador González, Esther Caballero, Patricia Muñoz, Virginia Gómez, Ruth Molina, Silvia Escalante, Carlos Rodríguez, Dora Cuervo, Rosalba Huarte, José García, Eladio González, Alfredo Pacheco, Lilia Argaez, Ma. del Carmen Fregoso, Ernesto Calderón.

**JUGES DU SAUT A LA PERCHE
POLE VAULT JUDGES**

Rigoberto Magallo, Víctor Urquieta, Martín Durán, Felipe Hernández, Emma Sáinz, Francisco Gómez, Sara Bautista, Isabel Lobera, Leticia Merino, Ma. Eugenia del Río, Manuel Meléndez, Verónica Rojas.

**JUGES DU LANCEMENT DU POIDS
SHOT PUT-JUDGES**

Francisco José Argumosa, Ma. Teresa Hurtado, Araceli Pastrana, Juan Flores, Arturo Gómez, Gabriel Ramos, Ma. Araceli Sandoval, Jesús Zertuche, Isabel Contreras, Beatriz Valle, Sergio Velázquez, Gustavo Gómez, América Carabantes, Javier Torrecillas, Georgina Hernández, Carolina Ayala.

**JUGES DU LANCEMENT DU
DISQUE ET DU MARTEAU
DISCUS AND HAMMER THROW
JUDGES**

Ma. del Rayo Quintanar, Enrique Lara, Silvia Ramos, Pedro Flores, Lourdes Esparragoza, Francisco Castillo, Sandalio Sáenz, Roberto Munive, Daniel Vite, Quintín Castillo, Guillermo Sánchez, Elvira Ruiz, Eleanore García, Delia Jácome, Reyna Lozada, Librado de la Torre, Alfredo Guendulain, Celia Mejía, Graciela Morales.

**JUGES DU LANCEMENT DU JAVELOT
JAVELIN THROW JUDGES**

Dolores López, César Guerrero, Gloria Elorriaga, Martha D'Beístegui, Roberto Rodríguez, Roberto Cano, Carlos Bado, César Sáinz, León Torres, Miguel Espinoza, Ernesto de la Fuente, Yolanda Espinoza, Emilia Martha, Martha Lara, Concepción Navarrete, Francisco González, Javier Ruiz, Martha Best, Ma. Teresa Báez.

**AUXILIAIRES DE PISTE
TRACK ASSISTANTS**

Antonio Morales, Alfredo Alvarez, Manuel Amezcua, Luis Alanís, César Rogelio, René Cano, Alfredo Maubert, Mario Pedral, Jorge Saltijeral, Eduardo González, Angel García, Gabriel Lonngi, Gilberto Ibarra, Gustavo Alvarez, René Avila, Alfonso Lara, Juan Orellana, Rubén Núñez, Alejandro Sánchez, Carlos Sánchez, Juan López, Francisco López, J. Francisco Rosas, José López, Alfredo Pérez.

**COMMISSAIRES DU TERRAIN
SECURITY SERVICE**

Alfonso Pineda, Samuel Soto, Eva Visuet, Guillermo Núñez, Marcelo Moreno, Georgina González, Salvador Canciola, Pablo Santamaría, Ma. Teresa Molina, Ana Ma. García, Gilberto Rodríguez, Adela Galicia, Marina Galicia,

Manola Sánchez, Roberto Ramírez, Isabel Torres, Agustín Avilés, Antonio García, Ma. de los Angeles Reyes, Antonieta Marín, Alicia Pineda, Rosa Medina, Alejandro Marváez, Francisco Hernández, Ma. Esther García, Ana Ma. Morales, Leticia Lohera, Consuelo Cárdenas, Lourdes Hernández.

**JUGES DU DECATHLON ET DU
PENTATHLON
DECATHLON AND PENTATHLON
JUDGES**

Alberto Nájera, Carlos Arroyo, Magdalena Ramos, Margarita Alvarez, Angel Vargas, Elizabeth Garnett, Héctor Palafox, Virginia Hurtado, Clara Rivera, Jaime Mijares, Adelina Isabel López, Benito Gil, Salvador Padilla, Cristina Espejel, Esther Narváez, Francisco Mijares, Emilio Morales.

**SERVICES ADJOINTS A LA
DIRECTION
AUXILIARY SERVICES OF THE
MANAGEMENT**

Anastasio Serrano, Jesús Magaga, Javier Jerónimo Macías, Francisco Rosenzweig, Jorge González Hernández, Luis Carbajo, Fernando Alonso, Víctor Flores, Charles Allport, Bernard Lucquiaud, Heberto Sein, Ernesto Araiza, Luis González, Irma López, Ma. Luisa Terrazas, Adela Ducker, Mario García, Rafael Salgado, Jorge Lozano, Miguel Márquez, Jesús Castilla, Ramiro de León, Javier Juárez, José López, Lupe Aguilar, Lucía Pérez.

SECRETARIAT

Juan Ponce, Eduardo Endo, Cristina Blizzard Soto, Lourdes Staffon, Mercedes Anzures, Fernanda Ramírez, Juan Ponce, Eugenio García, Estela Herrera, Oralia Pimentel, Vicente Tenorio, Rebeca Lozano, Julio Guerrero, Silvia Nava, Aurora Ortiz, Rosario Mendoza, Ma. Elena Rodríguez, Enrique Martínez, Rosario Ortiz, Pedro Gutiérrez, José Ayllon, José Antonio Vega, Victoria Acitores, Pedro Aguayo, Miguel Mere, Rodolfo Suárez, Juan Solorio, Pablo Ibarra, Roberto Alvarez, Antonio Godines, Cristina Haquet, Jorge Alvarez, Elsa González, Ma. del Carmen Urías, Alejandra Rodríguez, Ana Ma. Rock.

**OFFICIELS DU SECRETARIAT DES
JUGES ET ARBITRES
SECRETARIAT FOR JUDGES**

Jorge Molina, Jesús Ulíbarri, Carlos Esacelra, Juan Hernández, Raul Tenorio, Salvador Luna, Ernesto Andonegui, Natividad Parra, Gregorio Flores, Salvador Araujo, Rogelio Elizondo, Ramon Wolfer, Silvia Hernández, Javier Rodríguez, Jorge Álvarez, Camilo Velásquez, Ramón Barrera, Arnulfo García, Jesús Soltero, Fernando Palacios, Guadalupe Nava.

**OFFICIELS DU SERVICE
METEOROLOGIQUE
METEOROLOGICAL SERVICE**

Juan Valera, Ramón A. Ríos Recamier, Carlos Garmendia, Gustavo Amparán, Francisco Benítez, José Antonio Juan Rebollo, Rodolfo Buendía, Gonzalo Blanco, Javier Solana, Bartolo Ramírez, Mario García, Inocencio Gallegos, Irma Campos, Román García, Sergio Delgado, Rafael Gascón.

**OFFICIELS DU PROTOCOLE
PROTOCOOL OFFICIALS**

José Rodríguez del Río, Pedro Jouanen D'Oleire, Humberto Rodríguez García, Enrique Luis, Jouanen Johnstone, Alfredo Tinoco Alanis, Manuel Muñoz de Cote, Jorge Alejandro de Anda Zetina, José Rodríguez Iglesias, José Luis Herrera, Rutilia Carrillo, Cecilia Jiménez, Elvia Soto, Ma. Teresa Espihosa J., Gabriela Nava, Charlotte Bradley Reus.

**OFFICIELS DE LA DIRECTION
TECHNIQUE**

TECHNICAL DIRECTION
Marcelo Save, Miguel Alba, Francisco Bello, Maximiliano Wong, Juan Gpe. Tovar, Eleuterio Becerra, Leopoldo Pérez, Roberto Ortiz, Mario González.

**JUGES POUR LES EPREUVES DE ROUTE
ROAD RACING OFFICIALS**

Roque Sagardoy, Francisco Lechón, Eloy Rangel, Raymundo Reyes, Aurelio Archundia, José Leranca, Zenón Badillo, Alicia Libreros, José Méndez, Juan Ortiz, Constantino Ramírez, José Huerta, Rodolfo Martínez, Enrique Méndez, Inés Santana, José Arce, Esmeralda Escobar, José Guerrero, Vicente Gil, Adán Gámez, Andrés López, Jorge Negrete, Julián Sánchez, René Castañeda, Saúl Cholula. Rosa Escalante, Mario Penagos, Diodoro Manzano, Feliciano Maranchel, Zoilo Fernando Lima, Carlos Córdoba, José Leal, Jorge Vera, Antonio Martínez, David Brito, Miguel Landero, Virginia Luna, Armando Velasco, Manuel Reyes, Martha Mendoza, Arturo Meza, Daniel Corro, José L. González, Gabriel Muñoz, Gabriel Jiménez, Jesús Muñoz, Alvaro Velasco, Ricardo Libreros, Josefina Aguilar, Natalia Bolaños, Javier Orozco, Roberto Ortiz, Enrique Motolinía, Guadalupe Flores, José Herrera, Alberto Mariscal, Raymundo Zárate, Edmundo Tapia, Rodolfo Vázquez, José Zarco, Enrique Bolaños, Daniel Díaz, Ignacio Schaffini, Armando Juárez, Rodolfo Núñez, Agustín Tlaczani, José C. Quintero, Maximino Madrid, Alvaro Rosales, Ramiro Sánchez, Jorge Osio, Vidal Serrano, Janet Escobar, Luisa López, Juan Delfino, Ascención Lara, Daniel Huesca, Manuel Flores, Ali Romano, Gonzalo Hernández, Estela Ramírez, Salomón

García, Ma. del Carmen Viñuela, Oscar Hernández, León Bautista, Alberto Colorado, Ernesto Esquivel, Luis Sánchez, Guillermo González, Cándido García, Arturo Dinorin, Jesús Lozano, Guillermo Cuenca, Agustín Flores, Salvador García, José Ublado, Eugenio Pérez, Manuel López, José Villegas, Pedro González, Ventura Rivas, Javier Hernández, David Díaz, Fernando Cortés, Abraham Fidel, Pedro González, Leoncio Elizur, José Inocencio, Jaime Zúñiga, José Vera, Roberto Oliva, Eneida Morán, Mario Balbuena, Victor Negrete, Maximino Fuentes, Mario Américo, Isaías Flores, Alberto Apango, Antonio Morales, Catalina Macip, Virgilio Díaz, Arturo Jimares, Miguel Angel Paz, Netzula Real, José Rodríguez, Alfonso Animas, Delsar Pinto, Fermín Galván, Trinidad Rosete, Eunice Real, Mario Méndez, Alejandro Avilés, Luis Barrosa, Felipe Guzmán, Sara Acosta, Edith Sánchez, Otilio Tehuítzil, René Balbuena, David Mitzi, Manuel Aquino, Antonio Sánchez, Olaf Páez, René Pérez, Josefina Hernández, Jesús Vargas, Consuelo Flores, Rosalba Cano, Ma. Cristina Avelard, Felisa Gamboa, Teresa Díaz, Araceli Real, José Uribe, Joaquín Carranza, José Caudillo, Carlos Mendieta, Luis González, Araceli Saavedra, Leticia Márquez, Francisca Gonzaga, Hermelinda Ortega, Armando Herrera, Tomás Herrera, José Contreras, José Pérez, Emiliano Sánchez, Armando Mujica, José Flores, Raymundo Hernández, Floritulia Martínez, Gloria Montealegre, Dolores Rojas, Humberto Mier, Sebastián Cortés, Blanca Montealegre, Enrique Espinoza, Amada Flores, Natalia Flores, Donato Ramírez, Rafael Morales, Ma. Elena Montealegre, Brisia Martínez, Otga Ortiz, Jorge Muñoz, Ma. de Lourdes Maceda, Gloria Pérez, Beatriz Espinoza, Lourdes Meneses, Blanca Alonso, Lázaro Pérez, Beatriz Mendoza, Ricardo García, Roberto Ruiz, Felipe Herrera, Perfecto Ramírez, Diego Hernández, José Montes, Carlos Cuevas, Oscar M. Hernández, Angel Torres, Egberto Bonilla, Sergio Santa Cruz, Rubén Palacios, Camelia Hernández, Leticia Pérez, Oscar Calixto, David Zafra, Victor Rosas, Agustín Bolaños, Salvador García, David Aguayo, Raúl Onofre, Carlos Argüello, Clara Esquivel, José Castiño, Alfredo Liaca, Tomás Vergel, José Mendieta, Manuel Herrera, José Varela, Antonio Gutiérrez, Darío Nava, Servando Pérez, Oswaldo Hernández. Federico Juárez, Virgilio Zarauth, Edith Pérez, Carolina Caporal, Martha Gutiérrez, Teresa González, Oscar Córdoba, Victor Garduño, Eduardo Esparrajosa, Armando Pérez, Samuel García, Victor Ramírez, José Zenteno, Joel Hernández, Efrén Quiñones, Andrés Rosales, Emilio Amaro, Fabio Rodríguez, Ismael Rodríguez, Moisés Rojas, Rodrigo Ruiz, Rodolfo Alvarado del Castillo, Constantino Paleta, Faustino González, Simón Moreno, Miguel Sarmiento, Félix Carrillo, Jorge Luyando, Agustín López, Ruperto Rojas, José

Tobón, Salvador Hernández, Miguel Rojas, Jesús Martínez, Jorge Morales, César Luna, Bartolomé Barbosa, Ma. de Lourdes Robles, Carmen Cabrera, Irma Contreras, Teresa Aguirre, Ma. Teresa Figueroa, Silvia Núñez, Eva Núñez, Mariano Cano, Narciso Antonio González, Oscar González, Delfino Pacheco, Jovita Rolón, Moisés Lozada, Andrés Marquez, Fermín Mata, Joaquín Porras, Marco Jiménez, Guillermo Tapia, Armando Ortega, Facundo García, Raúl Rivera, Leovigildo León, Claudio Ramírez, Luis Nefake, Leobardo Vázquez, Ma. Estela Ramírez, Sergio Morales, Gaudencio Tlecuítl, Enrique Hernández, Josefa Bravo, Esther Aragón, Silvestre Guzmán, Roberto Gallardo, Ubaldo Gómez, José Durán, Jorge Díaz, Yolanda Bedolla, Cliseria Gamboa, Aura Morán, Esteban Gregorio, Rogaciano Aca, José Orta, Alejandro Aguilar, Benjamín Barbosa, Gustavo López, Joaquín Cordero, Rogelio Mendoza, Carlos Ramos, Javier Romero, Alejandro Oropeza, Gilberto Montiel, Taurino Arrazola, Luis Sánchez, José Sánchez, Víctor Díaz, Centulio Pérez, Jaime López, Alejandro Ramírez, Ricardo Castañeda, José Carrasco, Otilio Méndez, Ignacio Espinosa, Jorge Lara, Jaime Mora, Flavio Solís, Guillermo Cerezo, Eduardo Zacarías, José Angel, Mario Martínez, Olinda Conde, Roberto Osorio, Porfirio Torres, Ma. Cristina Rosas, Guadalupe Melgarejo, América Guevara, Ignacio Contreras, Manuel Hernández, Ricardo Reyes, Basilio Saucedo, Roberto Avila, Alejandro Romero, Rafael Corona, Valente Quintana, Marcos Palacios, Francisco Bravo, Paulino Chino, Leodegario Cotzomi, Ruperto López, Javier Vera, Roberto Escobar, Jorge Espinal, Leopoldo Rivera, Francisco Vallejo, Ambrosio Carro, Roberto Salmorán, Juan Cruz, Heriberto Ramírez, Blas Juárez, Julio Vázquez, Silvestre Salazar, José Serrano, Elías Villanueva, Norberto González, Agustín González, Guillermo Rodríguez, Miguel Yáñez, Carlos Ríos Carpio, Jaime González, Luis de Regil, Alfonso de Regil, Eduardo Gómez, Rubén Baena, Carlos Garzón, Rodolfo Mercado de la Torre, José Mercado, Rodolfo Pimenta, Adolfo Mercado, Rosa Ma. Villanueva.

SIGNES EMPLOYES

SYMBOLOGY

VF	— VENT FAVORABLE	WIND IN FAVOR
VC	— VENT CONTRAIRE	WIND AGAINST
*	— QUALIFIE (REGLE 309-2)	QUALIFIED (RULE 309-2)
⊙	— REUSSE	CLEARED
x	— MANQUE	FAILED
—	— NON ESSAYE	PASSED
I	— NOMBRE D'ESSAIS	NUMBER OF ATTEMPTS
F	— NOMBRE D'ECHECS	NUMBER OF FAILURES
NSP	— NE S'EST PAS PRESENTE	FAILED TO APPEAR
NPM	— MINIMUM NON PASSE	FAILED TO CLEAR MINIMUM
V	— VENT	WIND
ST	— SANS TEMPS	NO TIME
PENTATHLON		
I	— 80 m HAIES	80 m HURDLES
II	— LANCEMENT DU POIDS	SHOT PUT
III	— SAUT EN HAUTEUR	HIGH JUMP
IV	— SAUT EN LONGUEUR	LONG JUMP
V	— 200 m	200 m
DECATHLON		
I	— 100 m	100 m
II	— SAUT EN LONGUEUR	LONG JUMP
III	— LANCEMENT DU POIDS	SHOT PUT
IV	— SAUT EN HAUTEUR	HIGH JUMP
V	— 400 m	400 m
VI	— 110 m HAIES	110 m HURDLES
VII	— LANCEMENT DU DISQUE	DISCUS THROW
VIII	— SAUT A LA PERCHE	POLE VAULT
IX	— LANCEMENT DU JAVELOT	JAVELIN THROW
X	— 1 500 m	1,500 m
—	— TEMPS INTERMEDIAIRES	INTERMEDIATE TIMES
C	— QUALIFIE	QUALIFIED
DES	— DISQUALIFIE	DISQUALIFIED
MRM	— RECORD MONDIAL AMELIORE	BETTERED WORLD RECORD
MRO	— RECORD OLYMPIQUE AMELIORE	BETTERED OLYMPIC RECORD
ERM	— RECORD MONDIAL EGALE	TIED WORLD RECORD
ERO	— RECORD OLYMPIQUE EGALE	TIED OLYMPIC RECORD
	— MEILLEURE PERFORMANCE MONDIALE	BEST WORLD PERFORMANCE
	— MEILLEURE PERFORMANCE OLYMPIQUE	BEST OLYMPIC PERFORMANCE
	— RECORD OLYMPIQUE: ETABLI A MEXICO	OLYMPIC RECORD: SET IN MEXICO

DEMI-FINALE
SEMI-FINAL

1	Stewart, Errol (mrm) (mro)	JAM	38.3
	Fray, Michael Forbes, Clifton Miller, Lennox		
2	Erbstösser, Heinz (mro)	ADE	38.7
	Schelter, Hartmut Haase, Peter Eggers, Harald		
3	Schmidtke, Karl-Peter (mro)	ALE	38.9
	Metz, Gert Wucherer, Gerhard Eigenherr, Joachim		
4	Maniak, Wieslaw (mro)	POL	38.9
	Romanowski, Edward Nowosz, Zenon		
1	Dudziak, Marian	GBR	39.4
5	Speake, Joseph		
	Jones, Ronald Banthorpe, Ralph Kelly, Barrie		
6	Fabien, Raymond	TRT	39.5
	Short, Winston Archer, Carl Roberts, Edwin		
7	Kouaukou, Atta	CML	39.6
	Kouame, N'Dri Diby, Boy Kone, Gaoussou		
8	Jegathesan, Manikavasagam	MAL	40.8
	Thambusamy, Krishnan Rajalingam, Gunaratnam Hock Lim, Jai		
1	Ramírez, Hermes (erm) (mro)	CUB	38.6
	Morales, Juan Montes, Pablo Figueroa, Enrique		
2	Greene, Charles (erm) (mro)	EUA	38.6
	Pender, Mel Smith, Ronald Hines, James		
3	Fenouil, Gerard (mro)	FRA	38.8
	Delecour, Josselyn Piquemal, Claude Bambuck, Roger		
4	Ottolina, Sergio	ITA	39.4
	Pretoni, Ennio Squazzero, Angelo Berruti, Livio		
5	Owusu, Edward	GHA	39.9
	Ahey, Micheal Quaye, William Aday, James		
LES EQUIPES DE URS NIG ET BAH ONT ETE DISQUALIFIEES. URS, NIG, AND BAH TEAMS DISQUALIFIED.			

FINALE
FINAL

OCT 20

1	Greene, Charles (mrm) (mro)	EUA	38.2
	Pender, Mel Smith, Ronald Hines, James		
2	Ramírez, Hermes (mrm) (mro)	CUB	38.3
	Morales, Juan Montes, Pablo Figueroa, Enrique		
3	Fenouil, Gerard (mrm) (mro)	FRA	38.4
	Delecour, Josselyn Piquemal, Claude Bambuck, Roger		
4	Stewart, Errol (mrm) (mro)	JAM	38.4
	Fray, Michael Forbes, Clifton Miller, Lennox		
5	Erbstösser, Heinz (erm) (mro)	ADE	38.6
	Schelter, Hartmut Haase, Peter Eggers, Harald		
6	Schmidtke, Karl-Peter (mro)	ALE	38.7
	Metz, Gert Wucherer, Gerhard Eigenherr, Joachim		
7	Ottolina, Sergio	ITA	39.2
	Pretoni, Ennio Squazzero, Angelo Berruti, Livio		
8	Maniak, Wieslaw	POL	39.2
	Romanowski, Edward Nowosz, Zenon Dudziak, Marian		

(RM) McCullough, Ed EUA 38.6 1967, EUA
Kuller, Fred
Simpson, O. John
Miller, Lennox

(RO) Drayton, Otis-Paul EUA 39.0 1964, JPN
Ashworth, Gerard
Stebbins, Richard
Hayes, Robert

4x400m RELAIS HOMMES
4x400m RELAY MEN

ELIMINATOIRES
ELIMINATION HEATS

OCT 19

1	Matthews, Vincent (ero)	EUA	3:00.7
	Freeman, Ronald James, Larry Evans, Lee		
2	Rudisna, Daniel	KEN	3:00.8
	Nyamau, Munyoro Bon, Naftali Asati, Charles		
3	Ottolina, Sergio	ITA	3:04.8
1	Puosi, Giacomo		
	Fusi, Furio Bello, Sergio		
4	Schwabe, Hartmut	ADE	3:06.9
	Fromm, Dieter Müller, Wolfgang Zerbes, Michael		
5	Gómez, Rolando	DOM	3:19.4
	L'Oficial, Jose Mora, Radhames Soriano, David		
		NSP	
1	Gredzinski, Stanislaw	POL	3:03.0
	Balachowski, Jan Werner, Jan Badenski, Andrzej		
2	Winbolt-Lewis, Martin	GBR	3:03.6
	Campbell, Colin Hemery, David Sherwood, John		
2	Makama, Mamman	NGR	3:05.7
	Ejoke, David Dogon Yaro, Musa Egwunyenga, Anthony		
4	Gakou, Amadou	SEN	3:06.9
	M'Baye, Daour N'Diaye, Papa Sarr, Mamadou		
		NSP	
1	Müller, Helmar	ALE	3:03.8
	Kinder, Manfred Hennige, Gerhard Jellinghaus, Martin		
2	Simon, George	TRT	3:04.5
	Bobb, Euric Cayenne, Benedict Roberts, Edwin		
3	Nallet, Jean	FRA	3:04.6
	Carette, Jacques Bertould, Gilles Nicolau, Christian		
4	Martínez, Carlos	CUB	3:05.2
3	Tellez, Eddy		
	Olivera, Miguel Díaz, Rodobaldo		
5	Patínez, Víctor	VEN	3:07.6
	Dome, Raúl Maldonado, Víctor Hidalgo, José		
6	Piña, Melesio	MEX	3:08.1
	Medina, Salvador Castro, Carlos Sardo, Francisco		
7	MacKenzie, Ross	CAN	3:09.6
	MacLaren, Brian Crothers, William Brooker, Wesley		

FINALE
FINAL

OCT 20

1	Matthews, V. (mrm) (mro)	EUA	2:56.1
	Freeman, Ronald James, Larry Evans, Lee		
2	Rudisna, Daniel (erm) (mro)	KEN	2:59.6
	Nyamau, Munyoro Bon, Naftali Asati, Charles		
3	Müller, Helmar (mro)	ALE	3:00.5
	Kinder, Manfred Hennige, Gerhard Jellinghaus, Martin		
4	Gredzinski, Stanislaw (mro)	POL	3:00.5
	Balachowski, Jan Werner, Jan Badenski, Andrzej		
5	Winbolt-Lewis, Martin	GBR	3:01.2
	Campbell, Colin Hemery, David Sherwood, John		
6	Simon, George	TRT	3:04.5
	Bobb, Euric Cayenne, Benedict Roberts, Edwin		
7	Ottolina, Sergio	ITA	3:04.6
	Puosi, Giacomo Fusi, Furio Bello, Sergio		
8	Nallet, Jean	FRA	3:07.5
	Carette, Jacques Bertould, Gilles Boccardo, Jean		

(RM) Frey, Bob EUA 2:59.6 1966, EUA
Smith, Tommie
Evans, Lee
Lewis, Theron

(RO) Cassel, Ollan EUA 3:00.7 1964, JPN
Williams, Ulis
Larrabee, Michael
Carr, Henry

SAUT EN HAUTEUR HOMMES
HIGH JUMP MEN

EPREUVE DE QUALIFICATION
QUALIFICATION

OCT 19

NORME DE QUALIFICATION: 2.14 m
QUALIFYING MARK: 2.14 m

Meilleur essai
Best performance

		1.80	1.85	1.90	1.95	2.00	2.03	2.06	2.09	2.12	2.14	I	F		
A	Alexa Jaroslav	CHE	---	---	---	0	---	0	xx0	xxx		8	5	2.09 m	
	Todosijevic, Miodrag	YUG	---	---	---	0	---	0	0	0	xxx	7	3	2.12 m*	
	Brown, Reynaldo	EUA	---	---	---	---	---	x0	---	0	xxx	6	4	2.12 m*	
	Spielvogel, Günther	ALE	---	---	---	0	0	0	0	x0	xxx	9	4	2.12 m*	
	Zacharias, Thomas	ALE	---	---	---	---	---	0	0	xxx		5	3	2.09 m	
	Boyce, Peter	AUS	---	---	---	0	x0	---	x0	xxx		8	5	2.06 m	
	Milek, Polde	YUG	---	---	---	---	0	---	xxx			4	3	2.00 m	
	Sneazwell, Anthony	AUS	---	---	---	0	0	---	0	xxx		6	3	2.06 m	
	Hubner, Rudolf	CHE	---	---	---	---	0	0	0	xxx		6	3	2.06 m	
	Elliott, Junior	FRA	---	---	---	---	0	---	0	xxx		8	5	2.09 m	
	Peckham, Lawrence	AUS	---	---	0	0	0	---	0	0	x0	7	1	2.14 m	
	Skvortsov, Valery	URS	---	---	---	0	0	---	0	x0	0	6	1	2.14 m	
	Sainte-Rose, Robert	FRA	---	---	---	0	---	---	0	x0	xxx	8	4	2.12 m*	
	Gavrilov, Valentin	URS	---	---	---	0	---	x0	0	0	xxx	9	4	2.12 m*	
	Lundmark, Kenneth	SUE	---	---	---	0	0	0	---	xxx		6	3	2.06 m	
	Fosbury, Richard	EUA	---	---	---	---	0	0	---	0		3	0	2.14 m	
	Jonsson, Bo-Sven	SUE	NSP	---	---	---	---	---	---	---					
	Blshov, Victor	URS	---	---	---	0	---	---	x0	x0	---	8	5	2.09 m	
	Caruthers, Edward	EUA	---	---	---	---	---	0	0	---	0	4	0	2.14 m	
Dahlgren, Jan-Erik	SUE	NSP	---	---	---	---	---	---	---	---					
B	Balfour, Anthony	BAH	---	0	0	0	xxx	---	---	---	---	6	3	1.95 m	
	Koussoulas, Ioannis	GRE	---	---	---	---	0	x0	0	xx0	xxx	10	6	2.09 m	
	Candan, Nurullab	TUR	xx0	0	xx0	0	xxx	---	---	---	---	11	7	1.95 m	
	Idriss, Mohamed	CHE	---	---	---	---	---	0	---	xxx		4	3	2.06 m	
	Portmann, Michel	SUI	---	---	---	0	---	xx0	xxx			7	5	2.06 m	
	Abugattas, Roberto	PER	---	---	---	---	x0	---	xxx			5	4	2.00 m	
	Palacios, Teodoro	GUA	---	---	---	0	---	0	0	xxx		6	3	2.06 m	
	Crosa, Giacomo	ITA	---	---	---	0	---	0	0	0	x0	6	1	2.14 m	
	Olafsson, Jon	ISL	---	---	---	0	x0	xx0	x0	xxx		11	7	2.06 m	
	Sennussi, Ahmed	CHA	---	---	---	---	---	---	0	0	x0	5	1	2.14 m	
	Sieghart, Ingomar	ALE	---	---	---	0	0	0	0	0	xxx	8	3	2.12 m*	
	Dosza, Csaba	RUM	---	0	0	0	xx0	xx0	xxx	---	---	12	7	2.03 m	
	Tovondray, Fernand	MAD	---	---	0	0	xx0	0	xxx	---	---	8	5	2.03 m	
	Hong, Son-Long	TWN	0	0	xx0	0	xxx	---	---	---	---	9	5	1.95 m	
	Wiesfr, Thomas	SUI	---	---	---	0	---	x0	xxx	---	---	7	4	2.03 m	
	Sugioka, Kuniyoshi	JPN	---	---	---	0	0	---	0	0	xxx	7	3	2.09 m	
	Ly, Ababacar	SEN	NSP	---	---	---	---	---	---	---	---				
	Garriga, Luis	ESP	---	---	---	x0	---	0	x0	0	xxx	10	5	2.12 m*	
	Wedmann, Wilfriedt	CAN	---	---	---	---	0	---	xxx	---	---	4	3	2.00 m	
	Herbrandt, Freddy	BEL	NSP	---	---	---	---	---	---	---	---				
Singh, Bhim	IND	---	---	---	0	0	x0	0	x0	xxx	10	5	2.09 m		
Abugattas, Fernando	PER	---	---	---	---	x0	0	xxx	---	---	6	4	2.03 m		
Igun, Samuel	NGR	NSP	---	---	---	---	---	---	---	---					
Turay, Marconi	SLA	0	0	xx0	xxx	---	---	---	---	---	8	5	1.90 m		

526

FINALE
FINAL **OCT 20**

		2.00	2.03	2.06	2.09	2.12	2.14	2.16	2.18	2.20	2.22	2.24	2.29	I	F	Résultat Result
Fosbury, Richard (mro)	EUA	---	0	---	0	---	0	---	0	0	0	xx0	xxx	12	5	2.24 m
Caruthers, Edward (mro)	EUA	---	---	---	0	---	xx0	---	xx0	0	x0	xxx		13	8	2.22 m
Gavrilov, Valentin (mro)	URS	0	0	0	0	0	0	0	---	0	xxx		11	3	2.20 m	
Skvortsov, Valery	URS	---	0	x0	0	xx0	0	xx0	xxx				14	8	2.16 m	
Brown, Reynaldo	EUA	---	0	---	0	---	0	---	xxx				6	3	2.14 m	
Crosa, Giacomo	ITA	0	---	x0	0	0	0	xxx					9	4	2.14 m	
Spielvogel, Günther	ALE	---	---	0	0	xx0	x0	xxx					10	6	2.14 m	
Peckham, Lawrence	AUS	---	0	0	0	x0	xxx						8	4	2.12 m	
Sainte-Rose, Robert	FRA	0	---	0	0	xxx							6	3	2.09 m	
Sieghart, Ingomar	ALE	---	0	0	0	xxx							6	3	2.09 m	
Garriga, Luis	ESP	0	---	x0	0	xxx							7	4	2.09 m	
Sennusi, Ahmed	CHA	---	---	x0	xx0	xxx							8	6	2.09 m	
Todosijevic, Miodrag	YUG	0	---	0	xxx	---	---	---	---	---	---		5	3	2.06 m	

(RM) 2.28 m Brumel, Valery URS 1964, URS

(RO) 2.18 m Brumel, Valery URS 1964, JPN

SAUT A LA PERCHE
POLE VAULT

EPREUVE DE QUALIFICATION **OCT 14**
QUALIFICATION

NORME DE QUALIFICATION: 4.90 m
QUALIFYING MARK: 4.90 m

		4.20	4.30	4.40	4.50	4.60	4.70	4.75	4.80	4.85	4.90			Résultat Result
						o					xxx			
							o				o	4	3	4.60 m
											o	2	0	4.90 m
											o	1	0	4.90 m
									o		o	2	0	4.90 m
A		NSP												NSP
						o					o	2	0	4.90 m
									o		o	2	0	4.90 m
						o			o		xxx	5	2	4.90 m
											xo	2	1	4.90 m
											o	1	0	4.90 m
						o					o	2	0	4.90 m
							o				xo	3	1	4.90 m
									o		o	2	0	4.90 m
				o		o			o		xxx	6		4.80 m
		NSP												NSP
		NSP												NSP
						o			o		o	3	0	4.90 m
			xo		o		xxx					6	4	4.50 m
		NSP												NSP
B				o		o		o		xxx		6	3	4.75 m
						xxx						3	3	NPM
		o	o		xo	o	xxo		o		xxx	12	6	4.80 m
						o		xxo			xxx	7	5	4.75 m
		o	o		o	xxx						6	3	4.50 m
						o			o		o	3	0	4.90 m
						o			o		o	3	0	4.90 m
				xxo	o		o		xxo		o	9	4	4.90 m

FINALE **OCT 16**
FINAL

527

		4.40	4.60	4.80	4.90	5.00	5.05	5.10	5.15	5.20	5.25	5.30	5.35	5.40	5.45	I	F	Résultat Result
							o			xo		o		xo	xxx	9	5	5.40 m
					o	o		o			xo	o	xo	xo	xxx	14	6	5.40 m
						xo				o		o	o	xxx	xxx	11	6	5.40 m
				o		o			o		xo	xo	o	xxx	xxx	11	5	5.35 m
							o			xo		xo	xxo	xxx	xxx	11	7	5.35 m
			o		o			o		o		o	xxx	xxx	xxx	9	4	5.30 m
						o			xo		o		xxx	xxx	xxx	7	4	5.25 m
				o		xxx		xo		o	xxx					10	6	5.20 m
						o		xo	o	xxo	xxx					12	7	5.20 m
					o		xo		o	xxx	xxx					7	4	5.15 m
				o	o	o		o	xo		xxx					9	4	5.15 m
			o		o	o		xxx								6	3	5.00 m
				xo	o	xo		xxx								8	5	5.00 m
						xxo										3	2	5.00 m
				xxx												3	3	NPM

(RM) 5.38 m Wilson, Peter EUA 1968, EUA

(RO) 5.10 m Hansen, Fred EUA 1964, JPN

SAUT EN LONGUEUR HOMMES
LONG JUMP MEN

EPREUVE DE QUALIFICATION
QUALIFICATION

OCT 17

NORME DE QUALIFICATION: 7.65 m
QUALIFYING MARK: 7.65 m

		1	2	3	Meilleur essai Best performance	
Borkowsky, Leonid	URS	7.25	7.70	—	7.70	m
Wisdom, Gerald	BHA	x	x	6.99	6.99	m
Chen, Ming-Chih	TWVN	6.62	x	6.71	6.71	m
Chen, Chuan-Show	TWVN	NSP	—	—	—	—
Kalocsai, Henrik	HUN	NSP	—	—	—	—
Stalmach, Andrzej	POL	7.60	7.48	7.70	7.70	m
May, Philip	AUS	NSP	—	—	—	—
Sagna, Clement	SEN	7.26	7.17	7.31	7.31	m
Lerwill, Alan	GBR	7.57	7.62	7.60	7.62	m
Reed, Peter	GBR	NPM	—	—	—	—
A Pani, Jack	FRA	7.91	—	—	7.91	m
Meighan, Owen	HBR	x	6.06	6.06	6.06	m
Beamon, Robert (mro)	EUA	x	x	8.19	8.19	m
Ogura, Shinji	JPN	7.57	x	7.28	7.57	m
Housiaux, Philippe	BEL	7.30	7.44	7.40	7.44	m
Boston, Ralph (mro)	EUA	8.27	—	—	8.27	m
Gentile, Giuseppe	ITA	NSP	—	—	—	—
Lepik, Tynu	URS	7.91	—	—	7.91	m
Yamada, Hiroomi	JPN	7.67	—	—	7.67	m
Brooks, Victor	JAM	x	7.54	7.72	7.72	m
Ahey, Michael	GHA	7.18	7.77	—	7.77	m
Flores, Galdino	MEX	7.38	7.59	x	7.59	m
Charland, Michel	CAN	7.15	7.35	7.35	7.35	m
Pousi, Pertti	FIN	7.46	7.63	x	7.63	m
Mays, Charles	EUA	7.85	—	—	7.85	m
Cochard, Jean	FRA	6.11	—	x	6.11	m
Ugolini, Gerard	FRA	7.75	—	—	7.75	m
Boschert, Renhold	ALE	x	7.79	—	7.79	m
Velez, Donald	NIC	x	6.63	x	6.63	m
Sarr, Laurent	SEN	7.27	7.50	7.61	7.61	m
Abe, Naoki	JPN	7.44	x	7.58	7.58	m
B Su, Wen-Ho	TWVN	7.30	x	7.14	7.30	m
B Amoa, Johnson	GHA	NSP	—	—	—	—
Clayton, Wellesly	JAM	7.54	7.57	x	7.57	m
Crawley, Allen	AUS	x	7.71	—	7.71	m
Singh, Labh	IND	NSP	—	—	—	—
Nyak Voon, A. Chong	MAL	7.09	x	7.29	7.29	m
Hook, Lars-Olof	SUE	7.77	—	—	7.77	m
Davies, Lynn	GBR	x	x	7.94	7.94	m
Cziffra, Zoltan	HUN	NSP	—	—	—	—
Ter-Ovanesian, Igor	URS	7.74	—	—	7.74	m
Beer, Klaus	ADE	7.77	—	—	7.77	m

FINALE
FINAL

OCT 18

		1	2	3	4	5	6	
Beamon, Robert (mro) (mrm)	EUA	8.90	8.04	—	—	—	—	8.90 m
Beer, Klaus (mro)	ADE	7.97	8.19	x	7.62	x	x	8.19 m
Boston, Ralph (mro)	EUA	8.16	8.05	7.91	x	x	7.97	8.16 m
Ter-Ovanesian, Igor (ero)	URS	8.12	8.09	x	x	8.10	8.08	8.12 m
Lepik, Tynu	URS	7.82	8.09	7.63	7.36	7.84	7.75	8.09 m
Crawley, Allen	AUS	x	8.01	x	7.80	x	8.02	8.02 m
Pani, Jack	FRA	7.94	7.97	7.69	7.58	7.61	x	7.97 m
Stalmach, Andrzej	POL	7.71	7.94	7.88	7.75	7.75	7.84	7.94 m
Davies, Lynn	GBR	6.43	7.94	x	—	—	—	7.94 m
Yamada, Hiroomi	JPN	x	7.93	x	—	—	—	7.93 m
Borkowsky, Leonid	URS	7.90	7.82	x	—	—	—	7.90 m
Boschert, Renhold	ALE	x	7.54	7.89	—	—	—	7.89 m
Ahey, Michael	GHA	7.71	7.57	7.40	—	—	—	7.71 m
Hook, Lars-Olof	SUE	7.66	x	x	—	—	—	7.66 m
Brooks, Victor	JAM	x	x	7.51	—	—	—	7.51 m
Ugolini, Gerard	FRA	7.44	7.02	x	—	—	—	7.44 m
Beamon, Robert	EUA	2.0 m/sec	VF	—	—	—	—	
Beer, Klaus	ADE	0.0 m/sec	V	—	—	—	—	
Boston, Ralph	EUA	0.0 m/sec	V	—	—	—	—	
Ter-Ovanesian, Igor	URS	0.0 m/sec	V	—	—	—	—	

(RM) 8.35 Boston, Ralph EUA 1965, EUA

(RO) 8.12 Boston, Ralph EUA 1960, ITA

TRIPLE SAUT
TRIPLE JUMP

EPREUVE DE QUALIFICATION
QUALIFICATION

OCT 16

NORME DE QUALIFICATION: 16.10 m
QUALIFYING MARK: 16.10 m

		1	2	3	Meilleur essai Best performance	
Ciochina, Serban	RUM	15.93	16.07	16.21	16.21	m
Vlassis, Evangelos	GRE	15.47	15.52	15.71	15.71	m
Singh, Labh	IND	NSP	—	—	—	—
Boosey, Derek	GBR	15.07	15.99	16.01	16.01	m
Sauer, Michael	ALE	15.61	16.02	15.84	15.84	m
Neumann, Klaus	ADE	15.16	x	—	15.16	m
May, Philip	AUS	16.32	—	—	16.32	m
Muraki, Yukito	JPN	x	15.37	15.83	15.83	m
A Tate, Norman	EUA	13.43	15.84	15.83	15.84	m
Smith, David	EUA	x	x	15.75	15.75	m
Schmidt, Jozef	POL	x	16.19	—	16.19	m
Barrett, Timothy	BAH	x	15.06	15.79	15.79	m
Zolotarev, Alexander	URS	15.41	14.72	x	15.41	m
Igun, Samuel	NGR	15.40	13.86	15.46	15.46	m
Cziffra, Zoltan	HUN	15.04	x	—	15.04	m
Chen, Ming-Chin	TWVN	15.29	15.04	14.76	15.29	m
Gentile, Giuseppe (mrm) (mro)	ITA	x	17.10	—	17.10	m
Areta, Luis	ESP	15.94	16.20	—	16.20	m
Tuna, Askin	TUR	15.65	x	15.43	15.65	m
Pousi, Pertti	FIN	x	15.84	15.74	15.84	m
Saneev, Victor	URS	16.22	—	—	16.22	m
Burgher, Lennox	JAM	15.20	15.29	15.14	15.29	m
Jaskolski, Jan	POL	15.88	15.83	16.04	16.04	m
Prudencio, Nelson	BRA	15.79	16.46	—	16.46	m
Dudkin, Nikolay	URS	15.81	16.15	—	16.15	m
B Amoa, Johnson	GHA	15.65	15.28	15.65	15.65	m
Kalocsai, Henrik	HUN	15.44	16.16	—	16.16	m
Stoykovski, Gueorgui	BUL	15.26	x	16.24	16.24	m
Ivanov, Dragan	HUN	15.61	x	14.42	15.61	m
Kugler Joachim	ALE	15.79	16.20	—	16.20	m
Schenk, Heinz-Günter	ADE	x	14.72	15.61	15.61	m
Serrate, Hector	PRO	15.09	15.05	14.89	15.09	m
Alsop, Frederick	GBR	12.93	15.71	15.50	15.71	m
Walker, Arthur	EUA	16.49	—	—	16.49	m
Dia, Mamadou	SEN	16.58	—	—	16.58	m

FINALE
FINAL

OCT 17

		1	2	3	4	5	6	
Saneev, Victor (mrm) (mro)	URS	16.49	16.84	17.23	17.02	16.81	17.39	17.39 m
Prudencio, Nelson (mrm) (mro)	BRA	16.33	17.05	16.75	x	17.27	17.15	17.27 m
Gentile, Giuseppe (mrm) (mro)	ITA	17.22	x	x	x	16.54	x	17.22 m
Walker, Arthur	EUA	15.43	16.45	16.77	16.48	x	17.12	17.12 m
Dudkin, Nicolay	URS	16.15	16.70	16.37	16.73	17.09	16.53	17.09 m
May, Philip (mro)	AUS	15.48	16.58	16.51	17.02	x	—	17.02 m
Schmidt Jozef (mro)	POL	16.06	16.77	x	16.66	x	16.89	16.89 m
Dia, Mamadou	SEN	16.71	16.48	15.44	16.73	16.64	15.83	16.73 m
Stoykovski, Gueorgui	BUL	16.28	16.46	16.19	—	—	—	16.46 m
Kalocsai, Henrik	HUN	16.45	16.39	16.20	—	—	—	16.45 m
Kugler, Joachim	ALE	12.87	x	15.90	—	—	—	15.90 m
Areta, Luis	ESP	15.72	15.75	14.80	—	—	—	15.75 m
Ciochina, Serban	RUM	x	x	15.62	—	—	—	15.62 m
Saneev, Victor	URS	2.0 m/sec	VF	—	—	—	—	
Prudencio, Nelson	BRA	2.0 m/sec	VF	—	—	—	—	
Gentile, Giuseppe	ITA	0.0 m/sec	V	—	—	—	—	
Walker, Arthur	EUA	2.5 m/sec	VF	—	—	—	—	
Dudkin, Nickolay	URS	3.0 m/sec	VF	—	—	—	—	
May, Philip	AUS	2.0 m/sec	VF	—	—	—	—	
Schmidt, Jozef	POL	1.8 m/sec	VF	—	—	—	—	

(RM) 17.03 m Schmidt, Jozef POL 1960, POL

(RO) 16.85 m Schmidt, Jozef POL 1964, JPN

LANCEMENT DU POIDS HOMMES
SHOT PUT MEN

EPREUVE DE QUALIFICATION
QUALIFICATION

OCT 13

NORME DE QUALIFICATION: 18.90 m
QUALIFYING MARK: 18.90 m

		1	2	3	Meilleur essai Best performance	
A	Hoffmann, Dieter	ADE	18.30	19.75	—	19.75 m
	Prolius, Dieter	ADE	NSP	—	—	—
	Gushchin, Eduard	URS	19.88	—	—	19.88 m
	Woods, George	EUA	19.79	—	—	19.79 m
	Komar, Wladyslaw	POL	19.09	—	—	19.09 m
	Birlenbach, Heinfried	ALE	19.43	—	—	19.43 m
	Varju, Vilmos	HUN	18.69	x	18.86	18.86 m
	Maggard, David	EUA	18.73	19.26	—	19.26 m
	Glockler, Traugott	ALE	18.89	19.08	—	19.08 m
	Puce, George	CAN	NSP	—	—	—
	Grabe, Uwe	ADE	18.08	18.59	19.15	19.15 m
	Matson, Randy (mro)	EUA	20.68	—	—	20.68 m
B	Lemonis, Georgios	GRE	16.43	x	x	16.43 m
	Teale, Jeffrey	GBR	18.76	x	18.87	18.87 m
	Akka, Samsam	MAR	NSP	—	—	—
	Keshmiri, Jalal	IRN	NSP	—	—	—
	Beer, Arnljot	FRA	18.72	x	x	18.72 m
	Colnard, Pierre	FRA	19.57	—	—	19.57 m
	Hubacher, Edy	SUI	18.54	18.38	x	18.54 m
	Hermannsson, Gudmundur	ISL	16.24	16.77	17.35	17.35 m
	Bruch, Bjorn	SUE	NSP	—	—	—
	Mendoza, Rolando	NIC	11.39	13.33	13.32	13.33 m
	Jubis, Mauricio	SAL	12.04	12.46	12.92	12.92 m
	Mills, Leslie	NZL	18.56	19.00	—	19.00 m

FINALE
FINAL

OCT 14

		1	2	3	4	5	6
Matson, Randy (mro)	EUA	20.54	20.09	18.67	20.15	20.02	20.18
Woods, George	EUA	20.12	x	x	—	19.19	x
Gushchin, Eduard	URS	20.09	19.45	19.69	x	x	19.41
Hoffmann, Dieter	ADE	20.00	19.33	19.75	19.68	19.85	19.86
Maggard, David	EUA	19.43	19.33	18.46	18.90	19.15	x
Komar, Wladyslaw	POL	18.66	19.28	18.54	x	x	19.21
Grabe, Uwe	ADE	18.20	18.74	19.03	17.43	17.66	18.34
Birlenbach, Heinfried	ALE	18.80	18.48	x	18.13	18.67	x
Colnard, Pierre	FRA	18.62	x	18.79	—	—	—
Teale, Jeffrey	GBR	18.65	18.57	18.60	—	—	—
Mills, Leslie	NZL	18.18	18.01	17.95	—	—	—
Glockler, Traugott	ALE	x	17.20	18.14	—	—	—

(CRM) 21.78 m Matson, Randy EUA 1967, EUA

(RO) 20.33 m Long, Dallas EUA 1964, JPN

LANCEMENT DU DISQUE HOMMES
DISCUS THROW MEN

EPREUVE DE QUALIFICATION
QUALIFICATION

OCT 14

NORME DE QUALIFICATION: 58.00 m
QUALIFYING MARK: 58.00 m

		1	2	3	Meilleur essai Best performance	
A	Neu, Hein-Direk	ALE	x	55.26	58.56	58.56 m
	Schaumburg, Günter	ADE	60.14	—	—	60.14 m
	Danek, Ludvik	CHE	59.34	58.10	56.42	59.34 m
	Gudashvili, Guram	URS	57.48	55.84	x	57.48 m
	Piatkowski, Edmund	POL	58.24	—	—	58.24 m
	Reimers, Jens	ALE	53.18	x	54.02	54.02 m
	Carlsen, Gary	EUA	60.36	—	—	60.36 m
	Oerter, Alfred	EUA	59.36	—	—	59.36 m
	Milde, Lothar	ADE	60.36	—	—	60.36 m
	Puce, George	CAN	57.34	x	x	57.34 m
	Bruch, Bjorn	SUE	59.08	—	—	59.08 m
	Losch, Manfred	ADE	60.40	—	—	60.40 m
B	Tegla, Ferenc	HUN	57.18	58.50	—	58.50 m
	Simeon, Silvano	ITA	NSP	—	—	—
	Silvester, Jay (mro)	EUA	63.34	—	—	63.34 m
	Akka, Samsam	MAR	NSP	—	—	—
	Niare, Namakoro	MLI	x	54.92	56.60	56.60 m
	Keshmiri, Jalal	IRN	53.00	53.96	53.30	53.96 m
	Hennig, Klaus-Peter	ALE	53.80	x	x	53.80 m
	Hubacher, Edy	SUI	x	49.80	51.70	51.70 m
	Tancred, William	GBR	x	48.86	51.74	51.74 m
	Mederos, Modesto	CUB	52.30	x	49.42	52.30 m
	Kumar, Praveen	IND	NSP	—	—	—
	Tait, Robin	NZL	58.88	—	—	58.88 m
Kragbe, Segui	CML	55.24	54.24	x	55.24 m	
Jubis, Mauricio	SAL	33.62	35.94	36.18	36.18 m	
Mendoza, Rolando	NIC	39.62	36.46	38.78	39.62 m	
Farago, Janos	HUN	54.98	56.00	x	56.00 m	
Gajdzinski, Lech	POL	54.92	x	x	54.92 m	
Reinitzer, Heimo	AUT	51.90	52.00	53.52	53.52 m	
Nashatar, Sidhu	MAL	NSP	—	—	—	

FINALE
FINAL

OCT 15

		1	2	3	4	5	6
Oerter, Alfred (mro)	EUA	61.78	x	64.78	62.42	64.74	64.04
Milde, Lothar (mro)	ADE	62.44	63.08	62.58	59.98	60.24	58.00
Danek, Ludvik (mro)	CHE	60.62	x	62.92	x	61.28	61.34
Losch, Manfred (mro)	ADE	62.12	61.68	60.34	59.48	58.94	59.50
Silvester, Jay (mro)	EUA	61.10	61.78	x	x	x	60.44
Carlsen, Gary	EUA	58.62	59.26	59.46	59.30	52.60	58.54
Piatkowski, Edmund	POL	59.40	58.46	57.66	57.52	x	58.72
Bruch, Bjorn	SUE	58.94	58.02	58.12	59.28	58.50	58.34
Neu, Hein-Direk	ALE	55.96	x	58.66	—	—	—
Schaumburg, Günter	ADE	56.64	57.70	58.62	—	—	—
Tegla, Ferenc	HUN	56.74	58.36	57.78	—	—	—
Tait, Robin	NZL	56.52	57.68	56.84	—	—	—

(RM) 66.54 m Silvester, Jay EUA 1968, EUA

(RO) 61.00 m Oerter, Alfred EUA 1964, JPN

LANCEMENT DU JAVELOT HOMMES
JAVELIN THROW MEN

EPREUVE DE QUALIFICATION
QUALIFICATION

OCT 15

NORME DE QUALIFICATION: 80.00 m
QUALIFYING MARK: 80.00 m

		1	2	3	Meilleur essai Best performance
A	Stolle, Manfred	ADE 81.88	—	—	81.88 m
	Murro, Mark	EUA 74.14	81.14	—	81.14 m
	Kulcsar, Gergely	HUN 81.56	—	—	81.56 m
	Paama, Mart	URS 74.18	77.26	74.64	77.26 m
	Kinnunen, Jorma	FIN x	74.16	83.16	83.16 m
	Nevala, Pauli	FIN x	77.90	x	77.90 m
	Herings, Rolf	ALE 79.08	77.00	78.70	79.08 m
	Nilsson, Karl-Ake	SUE x	x	84.74	84.74 m
	Lusis, Yanis	URS 83.68	—	—	83.68 m
	Sidlo, Janusz	POL 74.90	80.12	—	80.12 m
	Salomon, Hermann	ALE 79.48	x	76.50	79.48 m*
	Covelli, Frank	EUA 70.30	x	73.04	73.04 m
	Von Wartburg, Urs	SUI 76.58	80.66	—	80.66 m
	Nikiciuk, Wladyslaw	POL 74.16	78.22	81.00	81.00 m
	Nemeth, Miklos	HUN 74.56	74.82	75.50	75.50 m
	Heikila, William	CAN 70.10	71.20	70.78	71.20 m
	Buhler, Rolf	SUI 61.06	x	x	61.06 m
	Velez, Donald	NIC 48.92	x	61.32	61.32 m
	Akka, Samsam	MAR NSP	—	—	—
	Hoppe, Rolf	CHI 68.32	65.82	65.86	68.32 m
	Nashatar, Sidhu	MAL x	63.58	70.70	70.70 m
B	Pierrakos, Panagiotis	GRE NSP	—	—	—
	Pektor, Walter	AUT 82.16	—	—	82.16 m
	Wyns, Lode	BEL 73.68	x	x	73.68 m
	Stenlud, Gary	EUA 73.52	68.88	71.44	73.52 m
	Janet, Aurelio	CUB 80.10	—	—	80.10 m
	Wolfermann, Klaus	ALE 75.78	71.40	75.02	75.78 m
	Travis, David	GBR 74.24	74.36	70.84	74.36 m
	Liga, Viliame	FJI x	61.62	62.32	62.32 m

FINALE
FINAL **OCT 16**

		1	2	3	4	5	6
	Lusis Yanis (mro)	URS 81.74	86.34	82.66	84.40	x	90.10 90.10 m
	Kinnunen, Jorma (mro)	FIN 86.30	x	x	79.00	85.82	88.58 88.58 m
	Kulcsar, Gergely (mro)	HUN 83.10	x	83.82	87.06	85.14	83.40 87.06 m
	Nikiciuk, Wladyslaw	POL x	85.70	82.24	x	82.32	80.44 85.70 m
	Stolle, Manfred	ADE x	76.86	81.52	84.42	x	79.72 84.42 m
	Nilsson, Karl-Ake	SUE 83.48	x	x	x	76.74	79.76 83.48 m
	Sidlo, Janusz	POL 80.00	76.36	80.58	75.50	77.86	76.46 80.58 m
	Von Wartburg, Urs	SUI 80.56	77.06	77.22	x	x	x 80.56 m
	Murro, Mark	EUA 80.06	80.08	x	—	—	80.08 m
	Pektor, Walter	AUT 75.64	77.40	x	—	—	77.40 m
	Janet, Aurelio	CUB x	74.88	x	—	—	74.88 m
	Salomon, Hermann	ALE x	71.64	73.50	—	—	73.50 m

(RM) 91.72 m Pedersen, Terje NOR 1964, NOR

(RO) 85.71 m Danielsen, Egil NOR 1956, AUS

LANCEMENT DU MARTEAU
HAMMER THROW

EPREUVE DE QUALIFICATION
QUALIFICATION

OCT 16

NORME DE QUALIFICATION: 66.00 m
QUALIFYING MARK: 66.00 m

		1	2	3	Meilleur essai Best performance
A	Kondrashov, Gennadiy	URS 67.56	—	—	67.56 m
	Lovasz, Lazar	HUN 68.96	—	—	68.96 m
	Baumann, Helmut	ADE 68.24	—	—	68.24 m
	Klim, Romuald	URS 66.82	—	—	66.82 m
	Beyer, Uwe	ALE 65.02	64.88	65.44	65.44 m
	Sugawara, Takeo	JPN 67.76	—	—	67.76 m
	Shchupliakov, Anatoly	URS 64.78	66.56	—	66.56 m
	Burke, Edward	EUA 67.36	—	—	67.36 m
	Fahsl, Hans	ALE 65.80	67.90	—	67.90 m
	Theimer, Reinhard	ADE 65.78	68.12	—	68.12 m
	Zsivotzky, Gyula (mro)	HUN 72.60	—	—	72.60 m
	Ammann, Ernst	SUI x	61.48	62.40	62.40 m
	Martinez, José	ESP 60.60	63.40	62.84	63.40 m
	Caspers, Lutz	ALE x	65.54	64.70	65.54 m
	Morales, Gustavo	NIC x	43.88	45.76	45.76 m
	Connolly, Harold	EUA x	x	65.00	65.00 m
B	Politis, Frangiskos	GRE NSP	—	—	—
	Hasbun, Carlos	SAL x	37.02	37.46	37.46 m
	Eckschmide, Sandor	HUN 68.60	—	—	68.60 m
	Kumar, Praveen	IND x	59.80	60.84	60.84 m
	Payne, Andrew	GBR 65.52	64.80	68.06	68.06 m
	Hall, Albert	EUA x	65.70	58.28	65.70 m
	Ishida, Yoshihisa	JPN 67.16	—	—	67.16 m

FINALE
FINAL **OCT 17**

		1	2	3	4	5	6
	Zsivotzky, Gyula (mro)	HUN 72.26	72.46	72.54	x	73.36	72.22 73.36 m
	Klim, Romuald (mro)	URS 72.24	68.96	72.82	73.28	71.16	71.64 73.28 m
	Lovasz, Lazar (mro)	HUN 64.76	x	69.78	x	69.38	x 69.78 m
	Sugawara, Takeo (mro)	JPN 67.24	68.12	x	69.06	69.78	61.40 69.78 m
	Eckschmide, Sandor	HUN 67.84	68.50	69.46	x	67.64	68.08 69.46 m
	Kondrashov, Gennadiy	URS 69.08	67.00	68.64	67.10	67.98	67.70 69.08 m
	Theimer, Reinhard	ADE 68.82	x	66.16	68.84	67.86	63.54 68.84 m
	Baumann, Helmut	ADE 65.94	66.98	68.26	x	63.76	x 68.26 m
	Shchupliakov, Anatoly	URS 67.58	67.74	66.90	—	—	67.74 m
	Payne, Andrew	GBR 65.98	67.62	66.58	—	—	67.62 m
	Fahsl, Hans	ALE x	64.00	66.36	—	—	66.36 m
	Burke, Edward	EUA x	65.72	65.46	—	—	65.72 m
	Ishida, Yoshihisa	JPN 65.04	63.72	x	—	—	65.04 m

(RM) 73.76 m Zsivotzky, Gyula HUN 1968, HUN

(RO) 69.74 m Klim, Romuald URS 1964, JPN

DECATHLON
DECATHLON

FINALE **OCT 18, 19**
FINAL

		I	II	III	IV	V	VI	VII	VIII	IX	X	TOTAL
1	Toomey, William (mro) EUA	10.4	7.87	13.75	1.95	45.6	14.9	43.68	4.20	62.80	4:57.10	
		959	712	813	1021	859	757	859	795	424		8193
2	Walde, Hans-Joachim (mro) ALE	10.9	7.64	15.13	2.01	49.0	14.8	43.54	4.30	71.62	4:58.50	
		828	949	796	865	852	870	754	884	897	416	8111
3	Bendlin, Kurt (mro) ALE	10.7	7.56	14.74	1.80	48.3	15.0	46.78	4.60	75.42	5:09.80	
		879	933	773	680	884	848	814	957	940	356	8064
4	Avilov, Nickolay URS	10.9	7.64	13.41	2.07	49.9	14.5	46.64	4.10	60.12	5:00.80	
		828	949	691	917	810	903	812	832	763	404	7909
5	Kirst, Joachim ADE	10.5	7.61	16.43	1.98	50.2	15.6	46.89	4.15	57.02	5:20.10	
		932	943	872	840	797	787	816	845	724	305	7861
6	Wadell, Thomas EUA	11.3	7.47	14.45	2.01	51.2	15.3	43.73	4.50	63.70	5:04.50	
		733	915	757	865	753	817	758	932	806	384	7720
7	Sloan, Richard EUA	11.2	6.72	14.07	2.10	51.0	15.5	45.58	4.85	49.90	4:44.00	
		756	761	733	942	762	797	792	1017	632	500	7692
8	Smidt-Jensen, Steen DIN	10.9	7.17	13.03	1.95	50.2	14.9	41.07	4.85	46.80	4:41.30	
		828	855	667	813	797	859	706	1017	589	517	7648
9	De Noorlander, Eduard HOL	11.1	6.90	13.89	1.95	50.5	14.5	41.70	4.20	50.22	4:37.80	
		780	800	721	813	784	903	719	859	636	539	7554
10	Tiedtke, Manfred ADE	10.9	7.46	15.77	1.95	50.0	14.7	40.31	4.30	51.84	5:33.40	
		828	913	834	813	805	881	692	884	657	244	7551
11	Hedmark, Lennart SUE	11.1	7.29	14.08	1.89	51.3	14.9	42.96	4.10	62.90	5:11.00	
		780	879	733	760	749	859	743	832	796	350	7481
12	Diessl, Walter AUT	10.7	7.42	14.32	1.83	51.6	14.7	42.23	4.25	55.38	5:19.70	
		879	905	747	707	736	881	729	871	703	307	7465
13	Longe, Clive GBR	10.9	6.86	15.10	1.70	49.3	15.5	47.60	4.00	59.30	5:18.80	
		828	791	795	588	838	797	829	807	753	312	7338
14	Wu, A-Min TWN	11.3	7.40	12.08	1.80	52.2	14.8	40.25	4.35	60.10	5:08.90	
		733	901	604	680	712	870	690	896	762	361	7209
15	Djourov, Spas BUL	10.9	7.40	13.99	1.89	50.2	15.1	40.90	3.60	47.04	5:15.50	
		828	901	727	760	797	837	703	700	592	328	7173
16	Lespagnard, Roger BEL	11.1	6.94	12.59	1.95	50.2	15.8	37.74	4.20	47.46	4:57.00	
		780	808	638	813	797	767	640	859	598	425	7125
17	Trautmann, Urs SUI	11.2	6.96	15.16	1.95	50.9	14.9	46.20	4.10	56.32	5:13.60	
		756	812	798	813	318	859	804	832	715	337	7044
18	Biedermann, Franz LIE	11.5	6.30	10.94	1.70	51.4	15.5	30.67	3.90	44.92	4:47.90	
		687	671	528	588	744	797	489	780	563	476	6323
19	Vélez, Donald NIC	11.5	6.63	10.60	1.65	53.1	16.2	36.43	3.40	48.94	5:46.10	
		687	742	504	540	675	730	613	644	618	190	5943
	Lanka, Yanis URS	10.9	7.15	15.31	1.80	49.9	14.8	49.90	3.80	59.76	NSP	
		828	850	807	680	810	870	870	754	758	0	

(RM) 8319 Bendlin, Kurt ALE 1967, ALE

(RO) 8001 Johnson, Rafer EUA 1960, ITA

I	100 m PLATS	100 m
II	SAUT EN LONGUEUR	LONG JUMP
III	LANCEMENT DU POIDS	SHOT PUT
IV	SAUT EN HAUTEUR	HIGH JUMP
V	400 m PLATS	400 m
VI	110 m HAIES	110 m HURDLES
VII	LANCEMENT DU DISQUE	DISCUS THROW
VIII	SAUT A LA PERCHE	POLE VAULT
IX	LANCEMENT DU JAVELOT	JAVELIN THROW
X	1 500 PLATS	1,500 m

**SAUT EN HAUTEUR FEMMES
HIGH JUMP WOMEN**

EPREUVE DE QUALIFICATION
QUALIFICATION

OCT 16

NORME DE QUALIFICATION: 1.74 m
QUALIFYING MARK: 1.74 m

		1.50	1.55	1.60	1.65	1.68	1.71	1.74			Résultat Result
									I	F	
A	Rezkova, Miloslava	CHE	---	---	o	o	o	xo	6	1	1.74 m
	Schulze, Karin	ADE	---	---	---	o	o	o	4	0	1.74 m
	Schmidt, Rita	ADE	---	---	---	o	o	o	4	0	1.74 m
	Gusenbauer, Maria	AUT	---	---	---	o	o	o	4	0	1.74 m
	Grushkina, Vera	URS	---	---	o	o	o	xo	6	1	1.74 m
	Montgomery, Eleanor	EUA	---	---	---	xxx	o	xxx	7	5	1.68 m
	Bonci, Virginia	RUM	---	o	o	o	xxx	xxx	6	3	1.65 m
	Kozyr, Valentina	URS	---	---	o	o	o	o	5	0	1.74 m
	Callender, Patricia	BAR	NSP	---	---	---	---	---			
	Valentova, Jaroslava	CHE	---	---	---	o	---	o	3	0	1.74 m
	Faithova, Maria	CHE	---	---	o	o	o	xo	6	1	1.74 m
	Okorokova, Antonina	URS	---	---	---	o	---	o	4	1	1.74 m
	Iordanka, Blagoeva	BUL	---	---	o	xo	o	xxx	7	4	1.68 m
B	Reid, Audrey	JAM	o	o	o	o	xxo	xo	12	6	1.71 m
	Shirley, Dorothy	GBR	---	o	o	o	xxo	xxx	9	5	1.68 m
	Johnson, Sandra	CRC	NSP	---	---	---	---	---			
	Csabi, Magda	HUN	---	---	o	o	xo	o	8	3	1.74 m
	Denise, Nicole	FRA	---	---	---	o	o	xxx	5	3	1.68 m
	Inkpen, Barbara	GBR	---	---	---	xo	o	xo	6	2	1.74 m
	Cypriano, Maria	BRA	---	---	o	o	o	o	6	1	1.74 m
	Barnay, Ghislaine	FRA	---	---	---	o	o	xxo	7	3	1.74 m
	Waerness, Anne	NOR	o	o	xo	xxx	---	---	7	4	1.60 m
	Lagrosas, Lolita	FIL	NSP	---	---	---	---	---			
	Callahan, Sharon	EUA	o	xo	o	xxx	---	---	7	4	1.60 m
	Hrepevnik, Snezana	YUG	---	---	o	o	xo	o	8	3	1.74 m
	Baskerville, Estelle	EUA	---	---	xxx	---	---	---	3	3	NPM
Lazova, Katia	BUL	---	o	o	xo	o	xxx	8	4	1.68 m	

536

FINALE
FINAL

OCT 17

		1.55	1.60	1.65	1.68	1.71	1.74	1.76	1.78	1.80	1.82	1.84	I	F	
	Rezkova, Miloslava	CHE	---	---	o	---	xo	xo	o	o	xxo	xxx	15	8	1.82 m
	Okorokova, Antonina	URS	---	---	---	o	---	o	xo	o	xxx	---	8	4	1.80 m
	Kozyr, Valentina	URS	---	---	o	o	o	o	xo	xxo	xxx	---	13	6	1.80 m
	Valentova, Jaroslava	CHE	---	---	o	---	o	---	xo	o	xxx	---	8	4	1.78 m
	Schmidt, Rita	ADE	---	---	o	---	o	xxo	o	xo	xxx	---	11	6	1.78 m
	Faithova, Maria	CHE	---	---	xo	---	o	xo	o	xxo	xxx	---	12	7	1.78 m
	Schulze, Karin	ADE	---	---	o	---	xo	o	o	xxx	---	---	8	4	1.76 m
	Gusenbauer, Maria	AUT	---	---	---	o	xo	o	xo	xxx	---	---	9	5	1.76 m
	Csabi, Magda	HUN	---	---	o	o	o	xxx	---	---	---	---	6	3	1.71 m
	Barnay, Ghislaine	FRA	---	---	o	o	o	xxx	---	---	---	---	6	3	1.71 m
	Cypriano, Maria	BRA	---	o	o	o	xxo	xxx	---	---	---	---	9	5	1.71 m
	Grushkina, Vera	URS	---	---	o	xo	xxo	xxx	---	---	---	---	9	6	1.71 m
	Inkpen, Barbara	GBR	---	---	o	o	xxx	---	---	---	---	---	5	3	1.68 m
	Hrepevnik, Snezana	YUG	---	---	xo	xo	xxx	---	---	---	---	---	7	5	1.68 m

(RM) 1.91 m Balas, Iolanda RUM 1961, BUL

(RO) 1.90 m Balas, Iolanda RUM 1964, JPN

**SAUT EN LONGUEUR FEMMES
LONG JUMP WOMEN**

EPREUVE DE QUALIFICATION
QUALIFICATION

OCT 13

		1	2	3	Meilleur essai Best performance	
A	Kirszenstein, Irena	POL	x	6.19	x	6.19 m
	Lohnert, Barbel	ADE	6.35	—	—	6.35 m
	Kispal, Eta	HUN	5.98	5.93	x	5.98 m
	Odogwu, Violet	NGR	6.45	6.09	—	6.45 m
	Robotham, Jean	CRC	4.75	4.55	4.40	4.75 m
	Watson, Martha	EUA	6.30	6.18	5.99	6.30 m*
	Rosendahl, Heidemarie	ALE	x	6.54	—	6.54 m
	Cederstrom, Eva	SUE	x	5.57	5.72	5.72 m
	Barton, Maureen	GBR	6.27	x	6.34	6.34 m*
	Talysheva, Tatjana	URS	6.34	6.30	6.28	6.34 m*
	Ammann, Sieglinde	SUI	x	x	x	NPM
	Sherwood, Sheila	GBR	6.42	—	—	6.42 m
	Anum, Alice	GHA	5.57	5.43	5.61	5.61 m
	Hansen, Nina	DIN	NSP	—	—	NSP
	Roman, Mercedes	MEX	5.75	x	5.72	5.75 m
B	Wilson, Ann	GBR	6.10	5.85	6.30	6.30 m*
	Viscopoleanu, Viiorica	RUM	6.48	—	—	6.48 m
	Sosa, Cecilia	SAL	x	x	x	NPM
	Rings, Elena	URS	x	5.84	x	5.84 m
	Garbey, Marcia	CUB	5.55	6.14	x	6.14 m
	Wieczorek, Burghild	ADE	6.28	6.30	6.15	6.30 m*
	Berthelsen, Berit	NOR	6.32	6.48	—	6.48 m
	Kaufmanas, Alicia	ARG	NSP	—	—	NSP
	Sarna, Mirosława	POL	6.32	6.44	—	6.44 m
	Becker, Ingrid	ALE	6.25	6.40	—	6.40 m
	White, Willye	EUA	6.17	6.42	—	6.42 m
	Bornholdt, Manon	ALE	6.27	6.09	x	6.27 m
	Trio, Maria	ITA	NSP	—	—	NSP
	Hendry, Joan	CAN	x	x	x	NPM
	Lin, Chun-Yue	TWN	5.23	x	5.59	5.59 m

FINALE
FINAL

OCT 14

		1	2	3	4	5	6
Viscopoleanu, Viiorica (mrm) (mro)	RUM	6.82	x	6.64	6.54	6.52	6.57
Sherwood, Sheila	GBR	6.60	x	6.50	6.59	6.68	6.61
Talysheva, Tatjana	URS	6.55	6.66	5.38	6.38	4.49	x
Wieczorek, Burghild	ADE	x	6.48	6.45	6.33	6.42	6.25
Sarna, Mirosława	POL	6.47	x	4.98	6.44	6.31	6.45
Becker, Ingrid	ALE	x	6.32	x	6.43	x	6.27
Berthelsen, Berit	NOR	6.38	6.40	6.27	6.22	x	6.32
Rosendahl, Heidemarie	ALE	x	x	6.24	6.05	6.37	6.40
Odogwu, Violet	NGR	6.23	5.89	6.15	—	—	—
Watson, Martha	EUA	6.20	x	6.06	—	—	—
White, Willye	EUA	6.01	5.44	6.08	—	—	—
Barton, Maureen	GBR	5.93	x	5.95	—	—	—
Wilson, Ann	GBR	x	5.90	5.59	—	—	—
Lohnert, Barbel	ADE	x	x	4.49	—	—	—

V: 0.0. m/sec

(RM) 6.76 m Rand, Mary GBR 1964, JPN

(RO) 6.76 m Rand, Mary GBR 1964, JPN

**LANCEMENT DU POIDS FEMMES
SHOT PUT WOMEN**

FINALE
FINAL

OCT 20

		Meilleur essai Best performance					
		1	2	3	4	5	6
1	Gummel, Margitta (mrm) (mro)	ADE	18.53	17.88	19.07	18.30	19.61
2	Lange, Marita (mrm) (mro)	ADE	18.78	x	18.17	18.47	18.20
3	Chizhova, Nadezhda (mro)	URS	18.19	x	18.03	17.62	17.49
4	Lendvai, Judit	HUN	17.14	17.30	17.21	17.78	17.75
5	Boy, Renate	ADE	17.67	17.15	17.68	17.49	17.72
6	Chrisotva, Ivanka	BUL	16.65	17.25	16.85	x	x
7	Fuchs, Marlene	ALE	17.11	16.56	x	x	x
8	Van Noorduy, Elsemia	HOL	15.89	15.71	14.97	15.54	16.23
9	Solontsova, Irina	URS	x	15.88	15.76	—	—
10	Schäfer, Gertrud	ALE	14.70	15.26	15.10	—	—
11	Seidler, Maren	EUA	14.38	14.86	x	—	—
12	Molina, Rosa	CHI	12.85	11.89	11.94	—	—
13	Paik, Ok-Ja	COR	12.67	12.08	11.97	—	—
14	Martinez, Rosario	SAL	9.58	x	10.18	—	—

(RM) 18.67 m Chizhova, Nadezhda URS 1968, URS

(RO) 18.14 m Press, Tamara URS 1964, JPN

**LANCEMENT DU DISQUE FEMMES
DISCUS THROW WOMEN**

FINALE
FINAL

OCT 18

		Meilleur essai Best performance					
		1	2	3	4	5	6
1	Manoliu, Lia (mro)	RUM	58.28	x	—	x	46.82
2	Westermann, Liesel (mro)	ALE	54.02	57.76	x	55.78	x
3	Kleiber, Jolan	HUN	54.90	54.24	x	x	x
4	Otto, Anita	ADE	54.40	54.10	53.88	x	51.16
5	Popova, Antonina	URS	53.42	53.12	51.40	52.60	52.86
6	Connolly, Olga	EUA	x	52.96	50.74	x	x
7	Spielberg, Christine	ADE	52.86	x	52.86	x	52.62
8	Berendonk, Brigitte	ALE	52.80	49.66	46.90	x	x
9	Muravjeva, Liudmila	URS	51.80	52.26	50.20	—	—
10	Ilgen, Karin	ADE	50.40	x	52.18	—	—
11	Stugner, Judit	HUN	42.12	51.38	52.08	—	—
12	Dashzeveg, Namjilmaa	MGL	50.76	x	49.00	—	—
	Catarama, Olimpia	RUM	x	47.50	50.20	—	—
	Moseke, Carol	EUA	48.28	44.78	44.04	—	—
	Roberts, Jean	AUS	36.58	46.26	x	—	—
	Lendvai, Judit	HUN	—	—	—	—	NSP
	De la Viña, Josephine	FIL	—	—	—	—	NSP
	McNeil, Mary	JAM	—	—	—	—	NSP

(RM) 62.54 m Westermann, Liesel ALE 1968, ALE

(RO) 57.27 m Press, Tamara URS 1964, JPN

LANCEMENT DU JAVELOT FEMMES
JAVELIN THROW WOMEN

FINALE **OCT 14**
FINAL

		1	2	3	4	5	Meilleur essai Best performance	
1	Nemeth, Angela	HUN	57.66	60.36	55.56	57.54	x	53.30 60.36 m
2	Penes, Mihaela	RUM	59.92	54.68	x	51.40	58.36	x 59.92 m
3	Janko, Eva	AUT	54.60	x	x	46.44	46.24	58.04 58.04 m
4	Rudas, Marta	HUN	56.38	x	x	51.60	x	52.68 56.38 m
5	Jaworska, Daniela	POL	55.78	56.06	52.34	51.88	x	53.20 56.06 m
6	Urbancic, Natasa	YUG	53.80	x	55.42	x	x	55.42 m
7	Koloska, Ameli	ALE	53.54	54.08	x	54.00	55.20	x 55.20 m
8	Launela, Kaisa	FIN	53.96	51.44	x	x	x	53.96 m
9	Friedrich, Barbara	EUA	53.44	51.00	52.16	x	x	53.44 m
10	Tsimozh, Lidia	URS	x	x	53.40	x	x	53.40 m
11	Bair, Ranae	EUA	49.54	48.08	53.14	x	x	53.14 m
12	Krawcewicz, Lucyna	POL	51.54	x	x	x	x	51.54 m
13	Dahlgren, Jay	CAN	51.34	51.10	48.04	x	x	51.34 m
14	Evert, Valentina	URS	x	51.16	x	x	x	51.16 m
15	Platt, Susan	GBR	x	44.94	48.52	x	x	48.52 m
	Strasser, Erika	AUT	x	x	x	x	x	NPM

(RM) 62.40 m Gorchakova, Elena URS 1964, JPN

(RO) 62.40 m Gorchakova, Elena URS 1964, JPN

PENTATHLON
PENTATHLON

FINALE **OCT 16**
FINAL

		I	II	III	IV	V	TOTAL
1	Becker, Ingrid	ALE	10.9	11.48	1.71	6.43	23.5
		1061	819	1057	1084	1077	5098
2	Prokop, Liese	AUT	11.2	14.61	1.68	5.97	25.1
3	Toth, Annamaria	HUN	1011	1023	1027	982	923
4	Tikhomirova, Valentina	URS	10.9	12.69	1.59	6.12	23.8
		1061	901	934	1016	1047	4959
5	Bornholdt, Mandn	ALE	11.2	14.12	1.65	5.99	24.9
		1011	993	996	986	941	4927
6	Winslow, Pat	EUA	11.0	12.37	1.59	6.42	24.8
		1044	880	934	1082	950	4890
7	Bauer, Ingeborg	ADE	11.4	13.33	1.65	5.97	24.5
		979	943	996	982	977	4877
8	Antenen, Meta	SUI	11.4	13.00	1.59	6.22	24.5
		979	921	934	1038	977	4849
9	Peters, Mary	GBR	10.7	11.06	1.62	6.30	24.9
		1096	790	965	1056	941	4848
10	Scott, Susan	GBR	11.0	15.09	1.53	5.60	24.9
		1044	1052	869	897	941	4803
11	Meldrum, Jennifer	CAN	11.0	11.33	1.56	6.20	24.3
		1044	809	902	1034	997	4786
12	Lubej, Marijana	YUG	11.0	12.41	1.59	5.89	24.8
		1044	882	934	964	950	4774
13	Hansen, Nina	DIN	10.9	10.38	1.59	6.01	23.9
		1061	741	934	991	1037	4764
14	Youroukova, Snejana	BUL	10.9	10.92	1.59	6.19	25.0
		1061	780	934	1031	932	4738
15	Bantegny, Monique	FRA	11.0	11.83	1.59	5.98	25.1
		1044	843	934	984	923	4728
16	Wilson, Ann	FRA	11.5	12.18	1.65	5.90	25.3
		963	867	996	966	905	4697
17	Ackermans, Marianne	GBR	11.1	10.58	1.62	6.01	24.8
		1027	755	965	991	950	4688
18	Berthelsen, Berit	HOL	11.5	12.62	1.65	5.65	25.5
		963	896	996	908	887	4650
19	Uhlemann, Gerda	NOR	11.6	10.80	1.56	6.28	24.5
		948	771	902	1051	977	4649
20	Dos Santos, Aida	ADE	11.3	12.00	1.53	6.02	25.0
		995	855	869	993	932	4644
21	Vettorazzo, Magali	BRA	11.6	12.41	1.59	5.50	24.9
		948	882	934	873	941	4578
22	Popescu, Cornelia	ITA	11.1	10.34	1.45	5.84	24.2
		1027	738	780	952	1007	4504
23	Ammann, Sieglinde	RUM	12.1	11.25	1.62	5.89	26.2
		876	803	965	964	827	4435
24	Hamblin, Cathy	SUI	11.7	10.35	1.53	6.07	25.7
		933	739	869	1004	869	4414
25	Lagrosas, Lolita	EUA	11.9	10.66	1.50	5.72	25.3
		904	761	836	924	905	4330
26	Lin, Chun-Yue	FIL	11.8	9.93	1.53	5.50	27.0
		918	708	869	873	763	4131
27	Tien, A-Mei	TWN	11.6	9.82	1.48	5.36	26.5
		948	700	814	839	803	4104
28	Sofjina, Galina	TWN	11.8	9.04	1.35	5.06	25.2
		918	640	660	767	914	3899
29	Focic, Djurdja	URS	11.6	14.43	1.59	5.76	—
		948	1012	934	934	0	3828
30	Emonts-Gast, Roswitha	YUG	11.1	11.80	1.62	5.90	41.8
		1027	841	965	966	15	3814
31	Román, Mercedes	BEL	11.5	12.33	NPM	5.81	25.7
		963	877	0	945	869	3654
32	Robotham, Jean	MEX	11.3	10.08	NPM	5.71	24.6
		995	719	0	922	968	3604
		712	615	0	686	896	2909
	Cederstrom, Eva	CRC	13.4	8.73	NPM	4.74	25.4
		948	740	869	—	—	2557

(RM) 5246 Press, Irina URS 1964, JPN

(RO) 5246 Press, Irina URS 1964, JPN

RECORDS OLYMPIQUES ETABLIS A MEXICO EN 1968 DURANT LES JEUX DE LA XIX OLYMPIADE

OLYMPIC RECORDS ESTABLISHED IN 1968 IN MEXICO DURING THE GAMES OF THE XIX OLYMPIAD

ATHLETISME HOMMES ATHLETICS MEN

100 m	-	100 m	J. Hines	EUA	9.9"
200 m	-	200 m	T. Smith	EUA	19.8"
400 m	-	400 m	L. Evans	EUA	43.8"
800 m	-	800 m	R. Doubell	AUS	1'44.3"
1500 m	-	1500 m	H. Keino	KEN	3'34.9"
110 m Haies	-	110 m Hurdles	W. Davenport	EUA	13.3"
400 m Haies	-	400 m Hurdles	D. Hemery	GBR	48.1"
4 x 100 m Relais	-	4 x 100 m Relay	EUA	38.2"	
4 x 400 m Relais	-	4 x 400 m Relay	EUA	2'56.1"	
Saut en Hauteur	-	High Jump	R. Fosbury	EUA	2.24 m
Saut a la Perche	-	Pole Vault	B. Seagren	EUA	5.40 m
Saut en Longueur	-	Long Jump	R. Beamon	EUA	8.90 m
Triple Saut	-	Triple Jump	V. Saneev	URS	17.39 m
Lancement du Poids	-	Shot Put	R. Matson	EUA	20.68 m
Lancement du Disque	-	Discus Throw	A. Oerter	EUA	64.78 m
Lancement du Javelot	-	Javelin Throw	Y. Lusia	URS	90.10 m
Lancement du Marteau	-	Hammer Throw	G. Zsivotzky	HUN	73.36 m
Décathlon	-	Decathlon	W. Toomey	EUA	8193P

ATHLETISME FEMMES ATHLETICS WOMEN

100 m	-	100 m	W. Tyus	EUA	11.0"
200 m	-	200 m	I. Kirszenstein	POL	22.5"
800 m	-	800 m	M. Manning	EUA	2'00.9"
80 m Haies	-	80 m Hurdles	M. Caird	AUS	10.3"
4 x 100 m Relais	-	4 x 100 m Relay	EUA	42.8"	
Saut en Longueur	-	Long Jump	V. Viscopoleanu	RUM	6.82 m
Lancement du Poids	-	Shot Put	M. Gummel	ADE	19.61 m
Lancement du Disque	-	Discus Throw	L. Manoliu	RUM	58.28 m

CYCLISME CYCLING

Km contre la montre	-	1000 m Time Trial	P. Trentin	FRA	1'03.91"
4000 m Poursuite individuelle	-	4000 m Individual Pursuit	F. Jensen	DIN	4'37.54"
4000 m Poursuite par Equipe	-	4000 m Team Pursuit	Alemania	ALE	4'15.76"

HALTEROPHILIE WEIGHTLIFTING

		TOTAL				
Poids Coq	-	Bantamweight	M. Nasiri	IRN	(J) 150.0	367.5 Kg.
Poids Léger	-	Lightweight	I. Foldi	HUN	(P) 122.5	
Poids Moyen	-	Middleweight	W. Baszanowski	POL	(J) 167.5	437.5 Kg.
			V. Kurenstov	URS	(J) 187.5	475.0 Kg.
			M. Ohuchi	JPN	(S) 140.0	
Poids Moyen Lourd	-	Light Heavyweight	B. Selitsky	URS	(P) 172.5	485.0 Kg.
			V. Belyaev	URS	(S) 147.5	
Poids Mi-Lourd	-	Middle Heavyweight	K. Kangasniemi	FIN	(P) 152.5	
					(S) 158.0	517.5 Kg.
			Y. Talts	URS	(J) 197.5	
Poids Lourd	-	Heavyweight	L. Zhabotinsky	URS	(P) 200.0	
					(S) 170.0	

(P) Développé Press
(S) Arraché Snatch
(J) Epaulé-jeté Jerk

NATATION HOMMES SWIMMING MEN

100 m Nage libre	-	100 m Freestyle	M. Wenden	AUS	52.2"
200 m Nage libre	-	200 m Freestyle	M. Wenden	AUS	1'55.2"
400 m Nage libre	-	400 m Freestyle	M. Burton	EUA	4'09.0"
1500 m Nage libre	-	1500 m Freestyle	M. Burton	EUA	16'38.9"
100 m Brasse	-	100 m Breaststroke	D. Mackenzie	EUA	1'07.7"
100 m Dos	-	100 m Backstroke	R. Mathes	ADE	58.0"
200 m Dos	-	200 m Backstroke	R. Mathes	ADE	2'09.6"
100 m Papillon	-	100 m Butterfly	D. Russell	EUA	55.9"
200 m 4 Nages	-	200 m Medley	C. Hickox	EUA	2'12.0"
4 x 100 m Relais Nage libre	-	4 x 100 m Freestyle Relay	EUA	EUA	3'31.7"
4 x 100 m Relais 4 Nages	-	4 x 100 m Medley Relay	EUA	EUA	3'54.9"

NATATION FEMMES SWIMMING WOMEN

200 m Nage libre	-	200 m Freestyle	D. Meyer	EUA	2'10.5"
400 m Nage libre	-	400 m Freestyle	D. Meyer	EUA	4'31.8"
800 m Nage libre	-	800 m Freestyle	D. Meyer	EUA	9'24.0"
100 m Brasse	-	100 m Breaststroke	D. Bjedov	YUG	1'15.8"
200 m Brasse	-	200 m Breaststroke	S. Wichman	EUA	2'44.4"
100 m Dos	-	100 m Backstroke	K. Hall	EUA	1'06.2"
200 m Dos	-	200 m Backstroke	P. Watson	EUA	2'24.8"
200 m Papillon	-	200 m Butterfly	A. Kok	HOL	2'24.7"
200 m 4 Nages	-	200 m Medley	C. Kolb	EUA	2'24.7"
400 m 4 Nages	-	400 m Medley	C. Kolb	EUA	5'08.5"
4 x 100 m Relais Nage	-	4 x 100 m Freestyle Relay	EUA	EUA	4'02.5"
4 x 100 m Relais 4 Nages	-	4 x 100 m Medley Relay	EUA	EUA	4'28.3"

TIR SHOOTING

Pet. Car. Pos. couchée	-	Small Bore R. Prone Pos.	J. Kurka	CHE	598 P
Pistolet libre	-	Free Pistol	G. Kosykh	URS	562 P
Vitesse aux Silhouettes	-	Rapid Fire Pistol	J. Zapadzki	POL	593 P
Carabine Libre	-	Free Rifle	G. Anderson	EUA	1157 P
Skeet	-	Skeet	E. Petrov	URS	198 P



540

FEDERATION INTERNATIONALE
DES SOCIETES D'AVIRON FISA

INTERNATIONAL FEDERATION OF
ROWING SOCIETIES FISA

PRESIDENT
Thomas Keller

SUI

SECRETAIRE
SECRETARY
Charles Riolo

SUI

FEDERATION MEXICAINE
D'AVIRON FMR

MEXICAN ROWING
FEDERATION FMR

PRESIDENT
José Ma. Alverde

MEX

SECRETAIRE
SECRETARY
Pablo Span

MEX

SECTION D'AVIRON DU C.O.O.
O.O.C. ROWING SECTION
Edmundo Rostan

MEX

Pedro Castro
Manuel Jolly

MEX
MEX

OFFICIELS DE LA COMPETITION
COMPETITION OFFICIALS

JUGES
JUDGES
Hans Jacob
Eberhard Rappaport

ADE
ALE

Karl Aletter ALE
Walter Wülfing ALE
Alexander McLiesh AUS
Jim Rogers AUS
Phillip Cayzer AUS
Helmut Hasenöhrl AUT
Eugene Jacob BEL
Stanieslas Fonteyn BEL
A. Nelson CAN
Charles Adams CAN
Claude Saunders CAN
Craig Swayze CAN
Russel Wood CAN
Theodore Norris CAN
Leopoldo Vives ESP
Albridge Smith EUA
Ernest Bayer EUA
John Carlin EUA
John Sulger EUA
Thomas Kerr EUA
William Knecht EUA
E. Fouch FRA
Louis Patricot FRA
Raymond Bourgeois FRA
David Cazes GBR
Harold Rickett GBR
John Garton GBR
Thanos Coutsikpoulos GRE
Chris Van Der Ploeg HOL
F. Aa. Hansen HOL
Johannes Meyjes HOL
Simon De Wit HOL
Udo Suermondt HOL
Enrico Chiaperotti ITA
Diodato Lanni ITA
Paolo Cappabianca ITA
Sergio Orsi ITA
Kunio Ikeda JPN
José Alverde MEX
Patrick O'Hea MEX
Vicente Mayo MEX
Charles Saunders NZL
Frederick Strachan NZL
T. Croot NZL
Jerzy Borkowski POL
Aref Fahmy RAU
Cornel Florescu RUM
Franz Starkl SUI
Charles Riolo SUI
Thomas Keller SUI
Eugene Kabanov URS
Bozo Benedik YUG
Mario Lucic YUG

SIGNES EMPLOYES

SYMBOLGY

*	— QUALIFIE POUR DEMI-FINALES LES AUTRES PASSENT AUX REPECHAGES	QUALIFIED FOR SEMI-FINALS; OTHERS TO REPECHAGES
**	— QUALIFIE POUR FINALE LES AUTRES PASSENT AUX REPECHAGES	QUALIFIED FOR FINAL; OTHERS TO REPECHAGES
+	— QUALIFIE POUR DEMI-FINALES LES AUTRES SONT ELIMINES	QUALIFIED FOR SEMI-FINALS; OTHERS ELIMINATED
⊙	— QUALIFIE POUR PETITE FINALE	QUALIFIED FOR SMALL FINAL
□	— QUALIFIE POUR FINALE	QUALIFIED FOR FINAL
ST	— SANS TEMPS	NO TIME
NTS	— N'A PAS PRIS LE DEPART	FAILED TO DEPART
NCM	— N'A PAS PASSE LA LIGNE	FAILED TO CROSS FINISH LINE
DES	— DISQUALIFIE	DISQUALIFIED

**QUATRE REMEURS EN POINTE AVEC BARREUR
COXED FOUR**

ELIMINATOIRES
ELIMINATION HEATS **OCT 13**

COURSE RACE 1



Couloir Lane	VENT (NO)	WIND (NW)	0.6 m/sec	Temps Time	
	500m	1000m	1500m	2000m	
1 * ADE	Kremtz, Peter Göhler, Roland Jacob, Klaus Gelpke, Manfred Semetzky, Dieter	1:40.72	3:26.40	5:15.63	7:03.60
4 * HOL	Rouwe, Herman Hartsuiker, Frederik Brummelman, Berend Dronkert, Tom Weekhout, Otto	1:39.15	3:27.22	5:18.06	7:08.15
5 URS	Nemtyrev, Anatoly Surov, Nikolai Mishin, Alexey Duiunov, Boris Mikheev, Victor	1:41.51	3:39.39	5:20.29	7:10.18
3 ARG	Aberastegui, Hugo Robledo, José Gómez, Juan Segurado, Guillermo Locatelli, Rolando	1:39.40	3:28.80	5:21.00	7:11.52
2 MEX	Castillo, Jorge Chávez, Daniel Soberón, Avelino Blasco, Gregorio Velasco, Rafael	1:48.41	3:49.45	5:51.04	7:51.39

COURSE RACE 2



Couloir Lane	VENT (NO)	WIND (NW)	0.5 m/sec	Temps Time	
	500m	1000m	1500m	2000m	
3 * NZL	Joyce, Richard Storey, Dudley Collinge, Ross Cole, Warren Dickie, Simon	1:38.48	3:24.15	5:17.55	7:12.19
4 * RUM	Batschi, Reinhold Ceapura, Petre Tudor, Stefan Papp, Francisco Lovrensky, Ladislau	1:40.44	3:29.52	5:25.71	7:16.50
2 * EUA	Jones, Luther Purdy, William Martin, Anthony Cadwalader, Gardner Hartigan, John	1:42.00	3:33.96	5:28.33	7:21.39
1 CUB	Rivero, Lázaro Cuesta, Santiago Luperón, Ramón López, Jorge Ojeda, Roberto	1:47.91	3:47.88	5:46.13	7:41.11

COURSE RACE 3



Couloir Lane	VENT (NO)	WIND (NW)	2.0 m/sec	Temps Time	
	500m	1000m	1500m	2000m	
2 * ITA	Sgheiz, Romano Trivini, Emilio Galante, Giuseppe Sgheiz, Luciano Gottifredi, Mariano	1:39.08	3:29.03	5:20.61	7:08.60

Couloir Lane	500m	1000m	1500m	2000m	Temps Time
1 * SUI	Oswald, Denis Waser, Hugo Bolliger, Peter Grob, Jakob Wirz, Beat	1:41.24	3:31.54	5:23.38	7:10.39
3 3 * ALE	Ott, Nikolaus Berger, Peter Brecht, Udo Färber, Hans-Johann Armbruster, Stefan	1:40.68	3:30.89	5:23.10	7:12.04
4 FRA	Le Goff, Jean Sloth, André Freslon, Jean Grimaud, Jean-Pierre Jouy, Roger	1:43.34	3:32.69	5:25.55	7:13.47

REPECHAGE

OCT 15

COURSE RACE 20



Couloir Lane	VENT (O)	WIND (W)	1.5 m/sec	Temps Time	
	500m	1000m	1500m	2000m	
1 + ARG	Aberastegui, Hugo Robledo, José Gómez, Juan Segurado, Guillermo Locatelli, Rolando	1:36.57	3:20.06	5:06.41	6:55.55
4 + FRA	Le Goff, Jean Sloth, André Freslon, Jean Grimaud, Jean-Pierre Jouy, Roger	1:35.80	3:20.98	5:12.97	7:05.48
3 + CUB	Rivero, Lázaro Cuesta, Santiago Luperón, Ramón Lopez, Jorge Ojeda, Roberto	1:37.50	3:25.92	5:22.09	7:13.43
2 MEX	Castillo, Jorge Chávez, Daniel Soberón, Avelino Blasco, Gregorio Velasco, Rafael	1:42.55	3:39.01	5:38.20	7:36.29

DEMI-FINALES
SEMI-FINALS

OCT 17

COURSE RACE 32



Couloir Lane	VENT (O)	WIND (W)	0.2 m/sec	Temps Time	
	500m	1000m	1500m	2000m	
6 □ NZL	Joyce, Richard Storey, Dudley Collinge, Ross Cole, Warren Dickie, Simon	1:34.15	3:16.49	5:02.61	6:48.65
3 □ EUA	Jones, Luther Purdy, William Martin, Anthony Cadwalader, Gardner Hartigan, John	1:35.25	3:21.34	5:10.23	6:54.22
5 □ ITA	Sgheiz, Romano Trivini, Emilio Galante, Giuseppe Sgheiz, Luciano Gottifredi, Mariano	1:34.79	3:20.74	5:09.65	6:58.24
4 ○ ARG	Aberastegui, Hugo Robledo, José Gómez, Juan Segurado, Guillermo Locatelli, Rolando	1:37.00	3:23.57	5:13.47	7:02.25
1 ○ ALE	Ott, Nikolaus Berger, Peter Brecht, Udo Färber, Hans-Johann Armbruster, Stefan	1:36.31	3:24.60	5:16.42	7:06.45
2 ○ HOL	Rouwe, Herman Hartsuiker, Frederik Dronkert, Tom Brummelman, Berend Weekhout, Otto	1:39.09	3:26.93	5:18.03	7:08.68

Couloir Lane	500m	1000m	1500m	2000m	Temps Time
--------------	------	-------	-------	-------	------------

COURSE RACE 33



VENT (N) WIND (N) 1.0 m/sec

1	□ ADE	Kremtz, Peter Göhler, Roland Jacob, Klaus Gelpke, Manfred Semetzky, Dieter	1:38.83	3:21.96	5:06.91	6:46.23
2	□ URS	Surov, Nikolai Mishin, Alexey Nemtyrev, Anatoly Kudinov, Arkady Mikheen, Victor	1:37.24	3:18.63	5:04.76	6:48.16
4	□ SUI	Oswald, Denis Waser, Hugo Bolliger, Peter Grob, Jakob Frohlich, Gottlieb	1:36.30	3:18.12	5:04.29	6:48.54
2	⊙ RUM	Batschi, Reinhold Ceapura, Petre Tudor, Stefan Papp, Francisco Lovrensky, Ladislau	1:36.79	3:20.97	5:07.31	6:52.67
5	⊙ FRA	Le Goff, Jean Sloth, André Freslon, Jean Grimaud, Jean-Pierre Jouy, Roger	1:37.70	3:24.66	5:21.32	7:14.05
6	⊙ CUB	Luperón, Ramón Cuesta, Santiago López, Jorge Rivero, Lázaro Ojeda, Roberto	1:40.44	3:32.53	ST	7:26.62

542

PETITE FINALE (7e à 12e places)
SMALL FINAL (For 7th to 12th places)

OCT 18

COURSE RACE 42



VENT (O) WIND (W) 1.9 m/sec

4	RUM (7)	Batschi, Reinhold Ceapura, Petre Tudor, Stefan Papp, Francisco Lovrensky, Ladislau	1:36.24	3:20.50	5:05.95	6:46.68
5	ARG (8)	Aberastegui, Hugo Robledo, José Gómez, Juan Segurado, Guillermo Locatelli, Rolando	1:34.99	3:18.07	5:04.04	6:50.54
6	HOL (9)	Rouwe, Herman Hartsuiker, Frederik Brummelman, Berend Dronkert, Tom Weekhout, Otto	1:35.97	3:21.53	5:06.77	6:51.77
2	FRA (10)	Le Goff, Jean Sloth, André Freslon, Jean Grimaud, Jean-Pierre Jouy, Roger	1:37.40	3:24.47	5:10.88	6:52.86
1	CUB (11)	Luperón, Ramón Cuesta, Santiago López, Jorge Rivero, Lázaro Ojeda, Roberto	1:40.33	3:29.86	5:20.09	7:07.07
3	ALE (12)	Ott, Nikolaus Berger, Peter Brecht, Udo Färber, Hans-Johann Armbruster, Stefan	NTS			

Couloir Lane	500m	1000m	1500m	2000m	Temps Time
--------------	------	-------	-------	-------	------------

FINALE FINAL OCT 19

COURSE RACE 49



VENT (O) WIND (W) 1.6 m/sec

4	NZL	Joyce, Richard Storey, Dudley Collinge, Ross Cole, Warren Dickie, Simon	1:37.19	3:16.96	5:00.69	6:45.62
2	ADE	Kremtz, Peter Göhler, Roland Jacob, Klaus Gelpke, Manfred Semetzky, Dieter	1:37.81	3:20.07	5:05.51	6:48.20
1	SUI	Oswald, Denis Waser, Hugo Bolliger, Peter Grob, Jakob Frohlich, Gottlieb	1:39.60	3:23.38	5:08.12	6:49.04
3	ITA	Sgheiz, Romano Trivini, Emilio Galante, Giuseppe Sgheiz, Luciano Gottifredi, Mariano	1:38.40	3:23.67	5:08.50	6:49.54
5	EUA	Jones, Luther Purdy, William Martin, Anthony Cadwalader, Gardner Hartigan, John	1:40.59	3:21.41	5:07.70	6:51.41
6	URS	Nemtyrev, Anatoly Surov, Nikolai Mishin, Alexey Duiunov, Boris Mikheev, Victor	1:41.14	3:24.31	5:11.01	7:00.00

JUGE DE DEPART ARBITRE ARBITRE SUPPLEANT STARTING JUDGE: REFEREE: ASSISTANT REFEREE: Rappaport, Eberhard De Wit, Simon Garton, John HOL ALE GBR

DEUX RAMEURS EN POINTE SANS BARREUR
COXLESS PAIR

ELIMINATOIRES
ELIMINATION HEATS OCT 13

COURSE RACE 4



VENT (O) WIND (W) 2.0 m/sec

5	* HOL	Luynenburg, Roelof Stokvis, Rudolf	1:45.56	3:36.02	5:26.68	7:14.50
1	* DIN	Christiansen, Peter Larsen, Ivan	1:44.70	3:35.52	5:28.67	7:23.51
2	ADE	Lucke, Jörg Bothe, Heinz-Jürgen	1:44.78	3:37.16	5:32.25	7:30.08
1	6 SUI	Rüssli, Fred Zwimpfer, Werner	2:00.58	3:39.59	5:36.84	7:36.91
4	ITA	Fermo, Ennio Specia, Marino	1:47.65	3:46.06	5:47.88	7:42.81
3	ALE	Karl, Günter Held, Franz	1:48.11	3:45.28	5:46.33	7:45.49

Couloir Lane		500m	1000m	1500m	2000m	Temps Time
COURSE RACE 5			VENT (NO)	WIND (NW)	2.8	m/sec
6 * AUT	Ebner, Dieter Losert, Dieter	1:41.45	3:34.43	5:33.55	7:31.29	
5 * FRA	Chatelain, Roger Drivet, Jean	1:44.04	3:35.46	5:32.88	7:34.42	
4 POL	Slusarski, Alfons Broniec, Jerzy	1:43.36	3:37.98	5:39.48	7:45.51	
2 MEX	Scheffler, Fernando Friedrich, Roberto	1:45.69	3:40.74	5:45.76	7:48.28	
3 CUB	Cabrera, Eralio Marrero, Norge	1:48.76	3:43.93	5:50.59	7:51.94	
1 CAN	Ulinder, John Gatley, Lyle	1:46.44	3:41.11	5:47.95	7:55.10	

COURSE RACE 6			VENT (NO)	WIND (NW)	1.6	m/sec
1 * EUA	Hough, Lawrence Johnson, Philip	1:41.06	3:29.08	5:20.30	7:19.92	
2 * AUS	Ramage, David Guest, Paul	1:42.48	3:32.41	5:25.60	7:24.66	
6 HUN	Romvari, Laszlo Palyi, Andras	1:44.31	3:36.81	5:33.42	7:33.31	
3 URS	Grigas, Apolinaras Rikkanen, Vladimir	1:43.32	3:36.74	5:34.37	7:35.61	
5 FIN	Sylvander, Pekka Hanninen, Kauko	1:48.13	3:37.23	5:39.17	7:37.34	
4 URG	Sigot, José Masseilot, Esteban	1:50.02	3:43.55	5:44.60	7:42.35	

REPECHAGES

OCT 15

COURSE RACE 21			VENT (O)	WIND (W)	1.7	m/sec
2 + ADE	Lucke, Jörg Bothe, Heinz-Jürgen	1:41.15	3:32.00	5:27.35	7:21.92	
1 + ITA	Fermo, Ennio Specia, Marino	1:41.88	3:35.00	5:29.55	7:23.77	
5 + HUN	Romvari, Laszlo Palyi, Andras	1:42.40	3:32.56	5:30.04	7:26.39	
3 CAN	Ulinder, John Gatley, Lyle	1:47.42	3:42.06	5:36.45	7:33.46	
4 FIN	Sylvander, Pekka Hanninen, Kauko	1:46.21	3:38.96	5:38.33	7:40.50	
6 MEX	Scheffler, Fernando Friedrich, Roberto	1:43.55	3:39.51	5:42.15	7:43.38	

COURSE RACE 22



			VENT (NO)	WIND (NW)	1.7	m/sec
4 + SUI	Rüssli, Fred Zwimpfer, Werner	1:42.25	3:36.58	5:32.96	7:26.33	
5 + ALE	Karl, Günther Held, Franz	1:42.97	3:39.92	5:35.06	7:31.91	

Couloir Lane		500m	1000m	1500m	2000m	Temps Time
6 + POL	Slusarski, Alfons Broniec, Jerzy	1:41.66	3:37.10	5:33.56	7:35.81	
1 URG	Sigot, José Masseilot, Esteban	1:44.65	3:42.46	5:41.79	7:37.95	
2 CUB	Cabrera, Eralio Marrero, Norge	1:45.81	3:44.04	5:44.28	7:50.88	
3 URS	Grigas, Apolinaras Rikkanen, Vladimir	1:43.69	3:38.36	5:32.60	NCM	

DEMI-FINALES
SEMI-FINALS

OCT 17

COURSE RACE 34



			VENT (N)	WIND (N)	1.7	m/sec
1 □ HOL	Luynenburg, Roelof Stokvis, Rudolf	1:42.82	3:33.26	5:26.00	7:15.51	
5 □ AUT	Ebner, Dieter Losert, Dieter	1:40.56	3:32.09	5:25.57	7:15.53	
6 □ SUI	Rüssli, Fred Zwimpfer, Werner	1:44.43	3:34.62	5:29.11	7:16.09	
2 ⊙ AUS	Ramage, David Guest, Paul	1:39.59	3:30.93	5:23.13	7:17.09	
3 ⊙ ITA	Fermo, Ennio Specia, Marino	1:42.31	3:33.75	5:28.82	7:29.75	
4 ⊙ POL	Slusarski, Alfons Broniec, Jerzy	1:43.38	3:39.38	5:36.42	7:40.10	

COURSE RACE 35



			VENT (NNE)	WIND (NNE)	1.4	m/sec
4 □ EUA	Hough, Lawrence Johnson, Philip	1:46.52	3:38.56	5:31.58	7:21.50	
5 □ DIN	Christiansen, Peter Larsen, Ivan	1:45.12	3:36.96	5:30.74	7:24.98	
3 □ ADE	Lucke, Jörg Bothe, Heinz-Jürgen	1:46.82	3:39.05	5:34.32	7:32.16	
1 ⊙ FRA	Chatelain, Roger Drivet, Jean	1:47.76	3:43.82	5:42.82	7:43.79	
6 ⊙ HUN	Romvari, Laszlo Palyi, Andras	1:46.04	3:43.49	5:40.72	7:45.73	
2 ⊙ ALE	Karl, Günther Held, Franz	1:49.30	3:47.27	5:48.58	7:53.06	

PETITE FINALE (7e à 12e places)
SMALL FINAL (For 7th to 12th places)

OCT 18

COURSE RACE 43



			VENT (O)	WIND (W)	2.6	m/sec
2 AUS (7)	Ramage, David Guest, Paul	1:43.20	3:34.91	5:29.33	7:19.49	
3 POL (8)	Slusarski, Alfons Broniec, Jerzy	1:43.88	3:38.20	5:32.23	7:22.89	
1 HUN (9)	Romvari, Laszlo Palyi, Andras	1:43.57	3:34.08	5:31.06	7:26.00	
5 ITA (10)	Fermo, Ennio Specia, Marino	1:41.88	3:33.39	5:33.92	7:32.50	
4 FRA (11)	Chatelain, Roger Drivet, Jean	1:44.51	3:37.26	5:34.64	7:37.64	
6 ALE (12)	Karl, Günther Held, Franz	1:45.29	3:42.85	5:44.81	7:40.88	

Couloir Lane	500m	1000m	1500m	2000m	Temps Time
--------------	------	-------	-------	-------	------------

FINALE
FINAL

COURSE RACE 50



VENT (ONO) WIND (WNW) 1.2 m/sec

1	ADE	Lucke, Jörg Bothe, Heinz-Jürgen	1:49.28	3:44.55	5:39.90	7:26.56
4	EUA	Hough, Lawrence Johnson, Philip	1:50.00	3:45.45	5:39.05	7:26.71
2	DIN	Christiansen, Peter Larsen, Ivan	1:48.96	3:45.17	5:41.84	7:31.84
5	AUT	Ebner, Dieter Losert, Dieter	1:48.20	3:43.62	5:41.31	7:41.80
6	SUI	Rüssli, Fred Zwimpfer, Werner	1:51.87	3:49.29	5:47.30	7:46.79
3	HOL	Luyneburg, Roelof Stokvis, Rudolf	1:50.30	3:46.28	5:40.41	ST

JUGE DE DEPART ARBITRE
ARBITRE SUPPLEANT

STARTING JUDGE:
REFEREE:
ASSISTANT REFEREE:

Rappaport, Eberhard
Aletter, Karl
Saunders, Charles

ALE
ALE
NZL

UN RAMEUR
SKIFF SINGLE SCULLS

ELIMINATOIRES
ELIMINATION HEATS

OCT 19

COURSE RACE 7



VENT (NO) WIND (NW) 2.2 m/sec

1	* ALE	Meissner, Jochen	1:45.17	3:42.10	5:44.00	7:45.80	
5	* ARG	Demiddi, Alberto	1:50.54	3:52.12	5:54.03	7:49.78	
1	3	AUT	Krausbar, Manfred	1:47.47	3:48.31	5:53.13	7:55.70
4	CHE	Kozak, Vaclav	1:55.57	3:57.63	6:00.31	7:59.93	
2	POL	Bromek, Zdzislaw	1:52.51	3:56.05	6:03.40	8:06.61	
6	JPN	Ito, Tsugio	1:49.96	3:50.64	5:59.79	8:10.00	

COURSE RACE 8



VENT (NO) WIND (NW) 2.0 m/sec

2	* DIN	Secher, Niels	1:44.54	3:44.17	5:49.33	7:51.45	
6	CAN	Jackson, Roger	1:50.89	3:49.92	5:52.33	7:55.88	
2	4	URS	Melnikov, Victor	1:52.35	3:50.85	5:54.11	8:03.29
1	RUM	Petrache, Eugen	1:47.59	3:49.31	5:58.61	8:05.33	
3	SUI	Ruckstuhl, Hans	1:46.68	3:45.02	5:50.96	8:08.90	
5	CUB	Martínez, Heriberto	1:55.02	3:55.50	6:03.37	8:14.20	

Couloir Lane

COURSE RACE 9



VENT (O) WIND (W) 1.7 m/sec

5	* HOL	Wienese, Henri	1:50.55	3:50.06	5:44.79	7:44.92	
3	* ADE	Hill, Achim	1:52.84	3:52.10	5:50.19	7:47.23	
3	2	EUA	Van Blom, John	1:51.78	3:51.23	5:52.07	7:54.79
4	GBR	Dwan, Kenneth	1:51.16	3:52.39	5:56.85	8:03.95	
1	BEL	Dehombreux, Claude	1:54.17	4:00.18	6:09.49	8:19.41	

REPECHAGES

OCT 15

COURSE RACE 23



VENT (ONO) WIND (WNW) 1.7 m/sec

1	+ EUA	Van Blom, John	1:45.66	3:38.07	5:37.54	7:43.00	
2	+ AUT	Krausbar, Manfred	1:44.68	3:40.24	5:42.06	7:46.65	
1	5	+ POL	Bromek, Zdzislaw	1:47.49	3:42.16	5:39.28	7:48.68
3	BEL	Dehombreux, Claude	1:48.92	3:48.21	5:49.86	7:54.98	
6	RUM	Petrache, Eugen	1:45.29	3:43.79	5:54.65	8:02.94	
4	CUB	Martínez, Heriberto	1:55.15	3:55.71	6:04.17	8:20.92	

COURSE RACE 24



VENT WIND 0.0 m/sec

3	+ GBR	Dwan, Kenneth	1:45.52	3:41.68	5:41.52	7:41.98	
2	2	+ URS	Melnikov, Victor	1:47.29	3:46.01	5:46.25	7:46.86
4	+ CHE	Kozak, Vaclav	1:48.69	3:48.04	5:47.46	7:49.93	
1	JPN	Ito, Tsugio	1:50.88	3:49.94	5:50.83	7:58.08	

DEMI-FINALES
SEMI-FINALS

OCT 17

COURSE RACE 36



VENT (N) WIND (N) 1.9 m/sec

3	□ ADE	Hill, Achim	1:50.80	3:46.65	5:49.86	7:48.56	
2	□ ALE	Meissner, Jochen	1:46.66	3:43.84	5:48.50	7:51.26	
1	4	□ GBR	Dwan, Kenneth	1:52.18	3:52.92	5:56.17	7:55.90
5	○ CHE	Kozak, Vaclav	1:55.29	3:53.98	5:57.91	8:01.81	
6	○ DIN	Secher, Niels	1:49.05	3:49.68	5:55.37	8:17.64	
1	○ AUT	Krausbar, Manfred	1:49.84	3:51.07	6:03.72	8:19.41	

Couloir Lane	500m	1000m	1500m	Temps Time 2000m
-----------------	------	-------	-------	------------------------

COURSE RACE **37**



VENT (E) WIND (E) 0.3 m/sec

4	□	HOL	Wienese, Henri	1:49.62	3:51.82	5:48.45	7:45.48	
6	□	ARG	Demiddi, Alberto	1:48.42	3:51.48	5:52.17	7:47.98	
2	5	□	EUA	Van Blom, John	1:51.60	3:55.46	5:57.43	7:49.85
1	○	URS	Melnikov, Victor	1:51.91	3:55.75	5:56.91	7:50.30	
2	○	CAN	Jackson, Roger	1:54.30	4:00.20	6:02.06	8:10.64	
3	○	POL	Bromek, Zdzislaw	1:54.59	4:00.46	6:07.42	8:13.92	

PETITE FINALE (7e à 12e places)
SMALL FINAL (For 7th to 12th places)

OCT 18

COURSE RACE **44**

VENT (O) WIND (W) 2.5 m/sec

3	POL	(7)	Bromek, Zdzislaw	1:44.99	3:44.08	5:45.33	7:38.88
2	DIN	(8)	Secher, Niels	1:42.86	3:43.69	5:50.64	7:43.47
1	CHE	(9)	Kozak, Vaclav	1:50.69	3:50.75	5:51.51	7:45.81
6	AUT	(10)	Krausbar, Manfred	1:42.18	3:42.63	5:47.15	7:46.19
4	CAN	(11)	Jackson, Roger	1:48.28	3:50.01	5:51.18	7:48.05
5	URS	(12)	Melnikov, Victor	NTS			

FINALE
FINAL

OCT 19

COURSE RACE **51**



VENT (NNE) WIND (NNE) 1.9 m/sec

4	HOL	Wienese, Henri	1:53.98	3:55.55	5:53.20	7:47.80
1	ALE	Meissner, Jochen	1:52.78	3:54.47	5:54.81	7:52.00
2	ARG	Demiddi, Alberto	1:56.67	3:59.70	6:00.06	7:57.19
6	EUA	Van Blom, John	1:57.72	4:02.43	6:05.76	8:00.51
3	ADE	Hill, Achim	1:56.26	3:57.86	6:01.28	8:06.09
5	GBR	Dwan, Kenneth	1:58.08	4:06.30	6:13.41	8:13.76

JUGE DE DEPART
ARBITRE
ARBITRE SUPPLEANT

STARTING JUDGE:
REFEREE:
ASSISTANT REFEREE:

Fonteyn, Stanislas
Kabanov, Eugene
Coolidge, L

FRA
URS
EUA

**DEUX RAMEURS EN POINTE AVEC BARREUR
COXED PAIR**

ELIMINATOIRES
ELIMINATION HEATS

OCT 13

COURSE RACE **10**



VENT (NO) WIND (NW) 0.2 m/sec

Couloir Lane	500m	1000m	1500m	Temps Time 2000m		
2	* RUM	Moldoveanu, Gheorghe Tarasov, Stefan Lovrensky, Ladislau	2:01.06	4:06.18	6:07.67	8:13.31
4	* ALE	Hiesinger, Bernhard Hartung, Rolf Benter, Lutz	1:56.61	4:02.29	6:07.29	8:19.78
5	ESP	Urrutia, Angel Solano, Miguel Marco, Filiberto	1:56.14	4:04.50	6:14.93	8:33.45
1	CHE	Kolesa, Karel Miluska, Ivan Kovar, Karel	2:02.45	4:11.22	6:22.45	9:02.98
3	URG	Ahlers, José Ahlers, Emilio Colman, Luis	1:57.58	4:05.68	ST	ST
6	URS	Drachevsky, Leonid Helma, Tit Rudakov, Igor	1:59.55	ST	ST	ST

COURSE RACE **11**



VENT (ONO) WIND (WNW) 1.5 m/sec

2	* BUL	Atanassov, Gueorgui Nikolov, Gueorgui Staevsky, Wesseline	1:59.90	4:03.95	6:08.45	8:11.13	
1	* EUA	Hobbs, William Edmunds, Richard MacDonald, Stewart	1:51.28	4:01.22	6:08.69	8:12.48	
5	FRA	Fraisse, Yves Szostak, Joseph Lippi, Richard	1:53.14	4:03.03	6:12.34	8:12.88	
2	6	ARG	Peterka, Rostislav Nedelcu, Diego Otero, Carlos	1:52.10	4:02.37	6:12.75	8:20.38
4	CUB	Lores, Teófilo Tabio, Mario Roselló, Jesús	1:49.82	4:00.55	6:12.05	8:23.39	
3	SUI	Fankhauser, Urs Bitterli, Urs Wirz, Beat	1:56.00	4:08.64	6:17.83	8:29.98	

COURSE RACE **12**



VENT (NE) WIND (NE) 2.0 m/sec

6	* ADE	Wollmann, Helmut Gunkel, Wolfgang Neubert, Klaus-Dieter	1:50.11	3:51.95	5:57.57	8:01.82	
3	5	* ITA	Baran, Primo Sambo, Renzo Cipolla, Bruno	1:51.23	3:51.08	5:55.80	8:03.00
4	HOL	Suselbeek, Herman Van Nes, Hadriaan Rijnders, Roderick	1:52.83	3:52.40	5:58.15	8:18.78	

545

Couloir Lane			500m	1000m	1500m	2000m	Temps Time
2	DIN	Krab, Jom Jorgensen, Harry Krab, Preben	1:49.37	3:50.22	6:04.74	8:21.42	
1	MEX	Alvarez, José Sáinz, Juan Castro, Armando	1:55.80	4:05.86	6:19.48	8:28.41	
3	PER	Pacussich, Lauro Menacho, Héctor López, Juan	2:02.48	4:15.60	6:31.31	8:49.26	

REPECHAGES OCT 25

COURSE RACE 25



VENT (NNO) WIND (NNW) 1.6 m/sec

5	+	HOL	Suselbeek, Herman Van Nes, Hadriaan Rijnders, Roderick	1:50.73	3:49.27	5:49.90	7:52.43
4	+	SUI	Fankhauser, Urs Bitterli, Urs Wirz, Beat	1:51.54	3:52.09	5:58.25	8:01.57
2	+	ARG	Peterka, Rostislav Nedelcu, Diego Otero, Carlos	1:53.21	3:55.88	6:00.65	8:03.62
1	6	MEX	Alvarez, José Sáinz, Juan Castro, Armando	1:54.82	4:02.22	6:07.48	8:08.05
3		URG	Ahlers, José Ahlers, Emilio Colman, Luis	2:01.73	4:05.64	6:12.03	8:11.88
1		ESP	Urrutia, Angel Solano, Miguel Marco, Filiberto	1:54.41	3:58.26	6:05.22	8:24.17

COURSE RACE 26



VENT (NO) WIND (NW) 1.9 m/sec

1	+	DIN	Krab, Jom Jorgensen, Harry Krab, Preben	1:53.32	3:54.72	5:56.64	7:52.83
3	+	CUB	Lores, Teófilo Tabío, Mario Roselló, Jesús	1:55.06	3:56.24	5:59.37	7:57.01
2	+	URS	Drachevsky, Leonid Helma, Tit Rudakov, Igor	1:52.29	3:53.68	5:57.30	8:06.14
2	6	PER	Pacussich, Lauro Menacho, Héctor López, Juan	1:58.83	4:07.88	6:27.74	8:25.90
5		FRA	Fraisse, Yves Szostak, Joseph Lippi, Richard	1:51.43	3:55.22	6:12.03	ST
4		CHE	Kolesa, Karel Miluska, Ivan Kovar, Karel	1:56.18	4:00.14	6:05.00	ST

DEMI-FINALES SEMI-FINALS OCT 17

COURSE RACE 38



VENT (NO) WIND (NW) 2.1 m/sec

5	□	ADE	Wollmann, Helmut Gunkel, Wolfgang Neubert, Klaus-Dieter	1:51.84	3:55.76	5:59.62	8:00.75	
6	□	HOL	Suselbeek, Herman Van Nes, Hadriaan Rijnders, Roderick	1:54.11	3:55.42	5:58.61	8:01.19	
4	□	EUA	Hobbs, William Edmunds, Richard MacDonald, Stewart	1:55.16	3:57.97	6:00.91	8:03.74	
1	3	⊙	RUM	Moldoveanu, Gheorghe Tarasov, Stefan Lovrensky, Ladislau	1:56.43	3:59.86	6:03.30	8:05.52
1	1	⊙	ARG	Peterka, Rostislav Nedelcu, Diego Otero, Carlos	1:52.20	3:59.02	6:05.74	8:09.75
2	2	⊙	CUB	Tabío, Mario Lores, Teófilo Roselló, Jesús	1:54.57	3:58.75	6:06.00	8:11.82

COURSE RACE 39



VENT (NE) WIND (NE) 0.3 m/sec

2	□	ITA	Baran, Primo Sambo, Renzo Cipolla, Bruno	1:52.98	3:55.78	5:59.53	7:59.95	
1	□	DIN	Krab, Jom Jorgensen, Harry Krab, Preben	1:55.34	3:58.76	6:03.99	8:02.78	
3	□	ALE	Heisinger, Bernhard Hartung, Rolf Benter, Lutz	1:54.84	4:00.68	6:04.57	8:05.49	
2	4	⊙	URS	Drachevsky, Leonid Helma, Tit Rudakov, Igor	1:56.15	4:01.11	6:05.89	8:06.39
6	⊙	BUL	Atanassov, Gueorgui Nikolov, Gueorgui Staevsky, Wesseline	1:59.95	4:03.68	6:07.95	8:06.41	
5	⊙	SUI	Fankhauser, Urs Bitterli, Urs Wirz, Beat	1:54.18	4:02.80	6:15.40	8:55.81	

PETITE FINALE (7e à 12e places) SMALL FINAL (For 7th to 12th places)

OCT 18

COURSE RACE 45



VENT (NO) WIND (NW) 2.2 m/sec

6	SUI	(7)	Fankhauser, Urs Bitterli, Urs Wirz, Beat	1:53.09	3:55.42	6:00.28	7:57.21
2	BUL	(8)	Atanassov, Gueorgui Nikolov, Gueorgui Staevsky, Wesseline	1:52.80	3:55.82	5:59.63	7:58.10
1	RUM	(9)	Moldoveanu, Gheorghe Tarasov, Stefan Lovrensky, Ladislau	1:51.36	3:56.56	6:03.55	8:04.38

Couloir Lane			500m	1000m	1500m	2000m	Temps Time
5	CUB (10)	Tabio, Mario Lores, Teófilo Roselló, Jesús	1:55.68	3:59.58	6:05.17	8:04.90	
3	ARG (11)	Peterka, Rostislav Nedelcu, Diego Otero, Carlos	1:50.72	3:56.24	6:05.88	8:06.91	
4	URS	Drachevsky, Leonid Helma, Tit Rudakov, Igor	NTS				

FINALE FINAL OCT 19

COURSE RACE			VENT (NO)	WIND (NW)	2.6	m/sec
3	ITA	Baran, Primo Sambo, Renzo Cipolla, Bruno	1:57.49	4:00.22	6:06.51	8:04.81
4	HOL	Suselbeek, Herman Van Nes, Hadriaan Rijnders, Roderick	1:58.49	3:59.77	6:04.50	8:06.80
5	DIN	Krab, Jom Jorgensen, Harry Krab, Preben	1:59.09	4:04.73	6:09.77	8:08.07
2	ADE	Wollmann, Helmut Gunkel, Wolfgang Neubert, Klaus-Dieter	1:56.54	4:01.63	6:07.33	8:08.22
6	EUA	Hobbs, William Edmunds, Richard MacDonald, Stewart	1:59.56	4:05.40	6:12.32	8:12.60
1	ALE	Hiesinger, Bernhard Hartung, Rolf Benter, Lutz	1:59.58	4:10.32	6:26.82	8:41.51

JUGE DE DEPART ARBITRE ARBITRE SUPPLEANT
STARTING REFEREE: ASSISTANT REFEREE:
JUDGE: REFEREE:
Fonteyn, Stanieslas Alverde, José Franz, Starkl FRA MEX SUI

QUATRE RAMEURS EN POINTE SANS BARREUR COXLESS FOUR

ELIMINATOIRES ELIMINATION HEATS OCT 13

COURSE RACE			VENT (N)	WIND (N)	1.7	m/sec	
5	** ADE	Forberger, Frank Grahm, Dieter Ruhle, Frank Schubert, Dieter	1:37.06	3:23.01	5:09.21	6:54.62	
6	EUA	Raymond, Peter Wright, Raymond Hamlin, Charles Terry, Lawrence	1:39.42	3:25.85	5:12.97	6:57.68	
1	URS	Barkans, Vitolds Rubins, Elmar Ilijnsky, Pavel Niedra, Guntis	1:40.93	3:29.89	5:17.57	7:08.82	
1	3	ALE	Hitzbleck, Thomas Weinreich, Manfred Buchter, Volkart Heck, Jochen	1:38.36	3:27.41	5:19.40	7:14.44

Couloir Lane			500m	1000m	1500m	2000m	Temps Time
4	SUI	Altenburger, Roland Gobet, Nicolas Meister, Alfred Rentsch, Franz	1:40.37	3:30.20	5:22.22	7:14.74	
2	RUM	Cichi, Pavel Ivanov, Dumitru Stratan, Emanoil Chirlacopsch, Anton	1:42.09	3:34.43	5:27.78	7:21.84	

COURSE RACE 14 VENT (N) WIND (N) 1.6 m/sec

4	** HUN	Melis, Zoltan Sarios, Gyorgy Csermely, Jozsef Melis, Antal	1:34.77	3:13.95	4:57.91	6:44.72	
3	ITA	Bosatta, Renato Baraglia, Tullio Conti, Pier Albini, Abramo	1:35.36	3:18.13	5:05.05	6:53.11	
2	1	DIN	Nielsen, Gunner Jensen, John Pedersen, Johnny Pedersen, Mogens	1:36.88	3:23.26	5:12.30	6:58.02
2	FRA	Sellier, Patrick Van Den Brouck, Patrick Beissiere, Michel Fave, Yannick	1:35.85	3:20.81	5:08.97	7:00.05	
5	MEX	Trejo, David Toscano, Jesús Padilla, Arcadio Retolaza, Roberto	1:38.57	3:26.41	5:19.06	7:15.18	

REPECHAGES OCT 15

COURSE RACE			VENT (O)	WIND (W)	1.0	m/sec	
4	□ ITA	Bosatta, Renato Baraglia, Tullio Conti, Pier Albini, Abramo	1:32.20	3:12.74	4:54.36	6:31.98	
3	□ ALE	Hitzbleck, Thomas Weinreich, Manfred Buchter, Volkart Heck, Jochen	1:33.69	3:14.81	4:55.21	6:32.56	
1	2	○ URS	Barkans, Vitolds Rubins, Elmar Ilijnsky, Pavel Niedra, Guntis	1:33.29	3:14.17	4:55.54	6:33.35
1	○ MEX	Trejo, David Toscano, Jesús Padilla, Arcadio Retolaza, Roberto	1:34.68	3:20.17	5:00.35	7:02.92	

COURSE RACE			VENT (O)	WIND (W)	2.0	m/sec	
1	□ EUA	Raymond, Peter Wright, Raymond Hamlin, Charles Terry, Lawrence	1:33.55	3:13.93	4:57.49	6:39.78	
5	□ SUI	Altenburger, Roland Gobet, Nicolas Meister, Alfred Rentsch, Franz	1:34.26	3:12.85	4:55.25	6:40.75	
2	4	○ FRA	Sellier, Patrick Petit, Yvon Beissiere, Michel Fave, Yannick	1:35.07	3:17.37	5:03.98	6:44.06

Couloir Lane		500m	1000m	1500m	2000m	Temps Time
3	⊙ RUM	Cichi, Pavel Ivanov, Dumitru Stratan, Emanoil Chirlacopschi, Anton	1:35.75	3:15.34	5:00.40	6:44.71
2	⊙ DIN	Nielsen, Gunner Jensen, John Petersen, Johnny Pedersen, Mogens	1:33.98	ST	ST	ST

PETITE FINALE (7e à 12e places)
SMALL FINAL (For 7th to 12th places)

OCT 18

COURSE RACE	46		VENT (N)	WIND (N)	1.6 m/sec	
3	RUM (7)	Cichi, Pavel Ivanov, Dumitru Stratan, Emanoil Chirlacopschi, Anton	1:34.32	3:15.39	5:04.55	6:50.13
4	MEX (8)	Retolaza, Roberto Padilla, Arcadio Toscano, Jesus Trejo, David	1:35.53	3:18.14	5:07.46	6:53.21
2	FRA (9)	Sellier, Patrick Petit, Yvon Beissiere, Michel Fave, Yannick	1:35.82	3:19.99	5:07.52	6:53.71
5	DIN (10)	Nielsen, Gunner Jensen, John Petersen, Johnny Pedersen, Mogens	1:36.45	3:25.70	5:13.27	7:20.31
1	URS	Barkans, Vitolds Rubins, Elmar Ilijinsky, Pavel Niedra, Guntis	NTS			

548

FINALE
FINAL **OCT 19**

COURSE RACE	53		VENT (N)	WIND (N)	1.8 m/sec	
4	ADE	Forberger, Frank Grahm, Dieter Ruhle, Frank Schubert, Dieter	1:33.51	3:14.72	4:59.77	6:39.18
3	HUN	Melis, Zoltan Sarios, Gyorgy Csermely, Jozsef Melis, Antal	1:33.20	3:15.20	5:01.04	6:41.64
2	ITA	Bosatta, Renato Baraglia, Tullio Conti, Pier Albini, Abramo	1:34.50	3:17.75	5:04.76	6:44.01
5	SUI	Rentsch, Franz Gobet, Nicolas Meister, Alfred Altenburger, Roland	1:36.33	3:19.33	5:05.63	6:45.78
6	EUA	Raymond, Peter Wright, Raymond Hamlin, Charles Terry, Lawrence	1:37.82	3:22.91	5:09.31	6:47.70
1	ALE	Hitzbleck, Thomas Weinreich, Manfred Bucher, Volkart Heck, Jochen	1:37.30	3:24.00	5:17.24	7:08.22

JUGE DE DEPART	STARTING JUDGE:	O'Hea, Patrick	MEX
ARBITRE	REFEREE:	Bourgeois, Raymond	FRA
ARBITRE SUPPLEANT	ASSISTANT REFEREE:	Jacobs, Eugene	BEL

**DEUX RAMEURS EN COUPLE
DOUBLE SCULLS**

ELIMINATOIRES
ELIMINATION HEATS **OCT 13**

COURSE RACE	15		VENT (ONO)	WIND (WNW)	0.3 m/sec	Temps Time
Lane Couloir			500m	1000m	1500m	2000m
4	* EUA	Mahe, William Nunn, John	1:38.63	3:24.26	5:11.05	6:56.96
1	* RUM	Aposteanu, Alexandru Pavelescu, Octavian	1:42.12	3:25.97	5:16.06	6:58.88
1 2	* ALE	Hild, Udo Glock, Wolfgang	1:39.15	3:25.24	5:14.80	6:59.70
5	MEX	Plettner, Otto Scheffler, Ricardo	1:38.00	3:23.79	5:13.76	7:02.18
3	BRA	Klein, Harri Gijssen, Edgard	1:35.36	3:25.15	5:20.00	7:16.70

COURSE RACE	16		VENT (N)	WIND (N)	0.5 m/sec	
3	* BUL	Jelev, Atanass Valtchev, Iordan	1:37.76	3:20.71	5:09.21	6:54.16
4	* HOL	Van Dis, Leendert Droog, Henricus	1:36.66	3:19.51	5:10.56	6:56.09
2	* ADE	Schmied, Hans-Ulrich Haake, Manfred	1:37.39	3:21.07	5:13.20	6:59.32
2	SUI	Burgin, Melchoir Studach, Martin	1:36.60	3:20.21	5:10.00	6:59.52

COURSE RACE	17		VENT (N)	WIND (N)	0.9 m/sec	
3	* URS	Sass, Anatoly Timoshinin, Alexander	1:36.46	3:22.90	5:13.25	7:07.46
2	* CHE	Hellebrand, Jaroslav Kratky, Petr	1:38.96	3:26.64	5:17.58	7:10.35
3	* FRA	Porte, Jean Vallanchon, Gilbert	1:38.46	3:27.72	5:18.74	7:10.72
4	CAN	Sturdy, Daryl Stubbs, Robert	1:42.48	3:39.00	5:37.05	7:36.52

REPECHAGE **OCT 15**

COURSE RACE	29		VENT (NNO)	WIND (NNW)	1.0 m/sec	
2	+ SUI	Burgin, Melchoir Ruckstuhl, Hans	1:37.93	3:25.92	5:17.62	7:07.09
3	+ BRA	Klein, Harri Gijssen, Edgard	1:36.63	3:26.46	5:20.00	7:08.46
1	+ MEX	Plettner, Otto Scheffler, Ricardo	1:41.95	3:29.86	5:21.13	7:11.43
4	CAN	Sturdy, Daryl Stubbs, Robert	1:42.76	3:34.55	5:27.84	7:22.87

Couloir Lane	500m	1000m	1500m	Temps Time 2000m
-----------------	------	-------	-------	------------------------

DEMI-FINALES
SEMI-FINALS

OCT 17

COURSE
RACE 40



VENT (NE) WIND (NE) 2.6 m/sec

1	□ ADE	Schmied, Hans-Ulrich Haake, Manfred	1:40.16	3:25.43	5:13.69	7:07.86
5	□ BUL	Jelev, Atanass Valtchev, Iordan	1:39.72	3:23.76	5:12.68	7:12.08
6	□ URS	Sass, Anatoly Timoshinin, Alexander	1:38.30	3:21.05	5:09.93	7:12.41
1	⊙ SUI	Burgin, Melchoir Ruckstuhl, Hans	1:37.47	3:24.25	5:19.17	7:14.74
4	⊙ FRA	Porte, Jean Vallanchon, Gilbert	1:37.93	3:25.76	5:21.35	9:54.48
2	⊙ RUM	Aposteanu, Alexandru Pavelescu, Octavian	1:44.37	ST	ST	10:53.17

COURSE
RACE 41



VENT (NE) WIND (NE) 0.8 m/sec

5	□ EUA	Maher, William Nunn, John	1:43.18	3:32.48	5:22.21	7:10.05
1	□ ALE	Hild, Udo Glock, Wolfgang	1:41.54	3:31.74	5:20.65	7:11.56
3	□ HOL	Van Dis, Leendert Droog, Henricus	1:43.88	3:36.85	5:21.24	7:13.74
2	⊙ MEX	Plettner, Otto Scheffler, Ricardo	1:42.10	3:33.01	5:24.40	7:15.20
6	⊙ BRA	Klein, Harri Gijsen, Edgard	1:40.41	3:33.44	5:25.48	7:17.08
4	⊙ CHE	Hellebrand, Jaroslav Kratky, Petr	1:39.69	3:26.19	ST	ST

PETITE FINALE (7e à 12e places)
SMALL FINAL (For 7th to 12th places)

OCT 18

COURSE
RACE 47



VENT (N) WIND (N) 1.5 m/sec

3	BRA (7)	Klein, Harri Gijsen, Edgard	1:42.90	3:26.83	5:17.32	7:04.13
5	RUM (8)	Aposteanu, Alexandru Pavelescu, Octavian	1:42.85	3:28.65	5:21.99	7:08.27
1	FRA (9)	Porte, Jean Vallanchon, Gilbert	1:39.22	3:28.26	5:21.69	7:08.49
6	MEX (10)	Plettner, Otto Scheffler, Ricardo	1:39.56	3:24.28	5:19.35	7:09.90
2	SUI (11)	Burgin, Melchoir Ruckstuhl, Hans	1:38.34	3:25.01	5:20.29	7:12.72
4	CHE (12)	Hellebrand, Jaroslav Kratky, Petr	1:37.87	3:23.32	5:16.82	7:25.14

FINALE
FINAL

OCT 19

COURSE
RACE 54



VENT (O) WIND (W) 1.5 m/sec

6	URS	Sass, Anatoly Timoshinin, Alexander	1:40.99	3:25.14	5:11.34	6:51.82
4	HOL	Van Dis, Leendert Droog, Henricus	1:39.11	3:23.33	5:07.08	6:52.80
2	EUA	Maher, William Nunn, John	1:40.20	3:27.53	5:13.52	6:54.21
1	BUL	Jelev, Atanass Valtchev, Iordan	1:39.45	3:24.88	5:10.89	6:58.48
3	ADE	Schmied, Hans-Ulrich Haake, Manfred	1:39.76	3:27.33	5:15.64	7:04.92
5	ALE	Hild, Udo Glock, Wolfgang	1:38.72	3:26.85	5:17.78	7:12.20

JUGE DE DEPART
ARBITRE
ARBITRE SUPPLEANT

STARTING JUDGE:
REFEREE:
ASSISTANT REFEREE:

O'Hea, Patrick
Strachan, Frederick
Cayser, Phillip

MEX
NZL
AUS

**HUIT RAMEURS EN POINTE AVEC BARREUR
COXED EIGHT**

ELIMINATOIRES
ELIMINATION HEATS

OCT 13

COURSE
RACE **18**



VENT (ESE) WIND (ESE) 0.2 m/sec

Couloir
Lane

4 ** ALE

Meyer, Horst
Schreyer, Dirk
Henning, Rüdiger
Ulbricht, Lutz
Hottenrott, Wolfgang
Hirshfelder, Egbert
Siebert, Joerg
Böse, Roland
Thiersch, Günther

500m

1000m

1500m

Temps
Time

2000m

1:26.48 2:57.05 4:30.75 6:04.22

3 AUS

Duval, Alfred
Morgan, Michael
Fazio, Joseph
Dickson, Peter
Douglas, David
Ranch, John
Pearce, Gary
Shirlaw, Robert
Grover, Alan

1:27.24 2:58.64 4:34.20 6:06.87

1 CHE

Cermak, Petr
Hurtala, Milan
Janos, Vladimir
Kuba, Zdenek
Marecek, Otakar
Svojanovsky, Oldrich
Svojanovsky, Pavel
Wallisch, Jan
Ptak, Jiri

1:27.65 3:00.53 4:35.58 6:13.30

1

5 CAN

Campbell, Neil
Ross, John
Brown, Clayton
Crooker, Richard
Richardson, John
Symyk, Richard
McIntyre, John
MacDonald, Daryl
Finlay, Joel

1:26.90 3:01.03 4:40.18 6:21.22

2 MEX

Fuentes, Miguel
Medina, Amado
Arce, Federico
Morales, Edgar
Páramo, Antonio
Cervantes, Victor
Vázquez, Sergio
Leal, Emilio
Santillán, Rodolfo

1:31.46 3:12.88 4:55.84 6:32.66

6 JPN

Shimizu, Masatoshi
Murai, Tomio
Kato, Tadamaša
Miyagawa, Shigeru
Nakata, Fumio
Tanaka, Jujiro
Fukumasu, Toshi
Arai, Yoshinori
Yamamoto, Katsumi

1:31.07 3:10.70 4:52.84 6:34.79

COURSE
RACE **19**



VENT (NO) WIND (NW) 0.2 m/sec

3 ** NZL

Webster, Alan
Veldman, Gerard
Dryden, Alistair
Hunter, John
Brownlee, Mark
Gibbons, John
Just, Thomas
Cawood, Gilbert
Page, Robert

1:25.48 2:57.81 4:31.86 6:05.62

1 ADE

Hein, Peter
Bähr, Klaus-Dieter
Wilke, Claus
Bergau, Günter
Gorny, Peter
Zerfowsky, Reinhard
Schneider, Manfred
Prompe, Peter
Danielowski, Karl-Heinz

1:27.68 3:00.69 4:37.36 6:09.48

Couloir
Lane

4 URS

Jukna, Zugmas
Bagdonavichus, Antanas
Sterlik, Vladimir
Yagelavichus, Iozapas
Matryshkin, Alexander
Briedis, Vitautas
Kravchuck, Valentin
Suslin, Victor
Lorentsson, Yury

500m

1000m

1500m

Temps
Time

2000m

1:29.71 3:01.12 4:35.07 6:09.65

6 HOL

Kloosterman, Maarten
Wesdorp, Izak
Van Laarhoven, Jan
Steinhauser, Jan
Niehe, Eric
Van Enst, Gerard
Reesink, Jaap
Bon, Pieter
Koning, Arthur

1:28.42 3:01.83 4:38.15 6:12.23

2

5 EUA

Evans, Arthur
Canning, Curtis
Larkin, Andrew
Steketee, Scott
Hobbs, Franklin
Brooks, Stephen
Livingston, Michael
Higgins, David
Hoffman, Paul

1:26.17 2:58.45 4:37.02 6:15.42

2 GBR

Thomas, Peter
Bayles, Andrew
Wright, Patrick
Knapp, Peter
Malpass, Malcolm
Yarrow, Robin
Carter, Bruce
Cooper, Michael
Kirk, Timothy

1:27.26 3:04.57 4:44.41 6:22.20

REPECHAGES

OCT 15

COURSE
RACE **30**



VENT (N) WIND (N) 1.2 m/sec

4 ☐ CHE

Cermak, Petr
Hurtala, Milan
Janos, Vladimir
Kuba, Zdenek
Marecek, Otakar
Svoianovsky, Oldrich
Svojanovsky, Pavel
Wallisch, Jan
Ptak, Jiri

1:28.67 3:04.28 4:43.17 6:19.34

2 ☐ EUA

Brooks, Stephen
Canning, Curtis
Larkin, Andrew
Steketee, Scott
Hobbs, Franklin
Fiechter, Jacques
Evans, Arthur
Higgins, David
Hoffman, Paul

1:31.70 3:08.65 4:47.30 6:19.81

5 ⊙ ADE

Hein, Peter
Bähr, Klaus-Dieter
Wilke, Claus
Bergau, Günter
Gorny, Peter
Zerfowski, Reinhard
Schneider, Manfred
Prompe, Peter
Danielowski, Karl-Heinz

1:30.92 3:05.69 4:43.24 6:21.71

1

1 ⊙ CAN

Campbell, Neil
Ross, John
Brown, Clayton
Crooker, Richard
Richardson, John
Symyk, Richard
McIntyre, John
MacDonald, Daryl
Finlay, Joel

1:29.93 3:07.65 4:45.48 6:31.14

3 ⊙ GBR

Thomas, Peter
Bayles, Andrew
Wright, Patrick
Knapp, Peter
Malpass, Malcolm
Yarrow, Robin
Carter, Bruce
Cooper, Michael
Kirk, Timothy

1:28.83 3:06.51 4:47.70 6:43.55

550

Couloir Lane	500m	1000m	1500m	2000m	Temps Time
--------------	------	-------	-------	-------	------------

COURSE RACE 31



VENT (NNO) WIND (NNW) 1.6 m/sec

1	□ AUS	Duval, Alfred Morgan, Michael Fazio, Joseph Dickson, Peter Douglas, David Ranch, John Pearce, Gary Shirlaw, Robert Grover, Alan	1:26.97	2:59.64	4:35.92	6:10.80
5	□ URS	Jukna, Zugmas Bagdonavichus, Antanas Sterlik, Vladimir Yagelavichus, Iozapas Matryshkin, Alexander Briedis, Vitautas Kravchuck, Valentin Suslin, Victor Lorentsson, Yury	1:25.40	2:58.25	4:37.53	6:12.12
2	⊙ HOL	Kloosterman, Maarten Wesdorp, Izak Van Laarhoven, Jan Steinhauser, Jan Niehe, Eric Van Enst, Gerard Reesink, Jaap Bon, Pieter Koning, Arthur	1:26.65	3:00.11	4:39.86	6:12.90
4	⊙ MEX	Fuentes, Miguel Medina, Amado Arce, Federico Morales, Edgar Páramo, Antonio Cervantes, Victor Vázquez, Sergio Leal, Emilio Santillán, Rodolfo	1:29.77	3:12.93	5:03.01	6:43.13
3	⊙ JPN	Shimizu, Masatoshi Murai, Tomio Kato, Tadamasa Miyagawa, Shigeru Nakata, Fumio Tanaka, Juiiro Fukumasu, Toshi Arai, Yoshinori Yamamoto, Katsumi	1:29.95	3:09.67	5:01.22	6:44.37

PETITE FINALE (7e á 12e places)
SMALL FINAL (For 7th to 12th places)

OCT 18

COURSE RACE 48



VENT (E) WIND (E) 0.8 m/sec

3	ADE (7)	Bergau, Günter Bähr, Klaus-Dieter Wilke, Claus Gorny, Peter Zerfowski, Reinhard Hein, Peter Schneider, Manfred Prompe, Peter Danielowski, Karl-Heinz	1:27.69	3:01.87	4:40.68	6:11.69
1	HOL (8)	Kloosterman, Maarten Bon, Pieter Nieche, Eric Reesink, Jaap Van Enst, Gerard Steinhauser, Jan Wesdrop, Izak Van Laarhoven, Jan Koning, Arthur	1:26.72	3:02.41	4:41.08	6:14.18
2	CAN (9)	Campbell, Neil Boss, John Brown, Clayton Crooker, Richard Sturdy, Daryl Symyky, Richard McIntyre, John MacDonald, Daryl Finlay, Joel	1:27.44	3:05.86	4:44.84	6:18.65

Couloir Lane	500m	1000m	1500m	2000m	Temps Time
--------------	------	-------	-------	-------	------------

5	GBR (10)	Thomas, Peter Bayles, Andrew Wright, Patrick Knapp, Peter Mullard, John Yarrow, Robin Carter, Bruce Cooper, Michael Kirk, Timothy	1:28.07	3:06.38	4:51.82	6:29.23
6	MEX (11)	Morales, Edgar Cervantes, Victor Leal, Emilio Vázquez, Sergio Fuentes, Miguel Páramo, Antonio Arce, Federico Medina, Amado Santillán, Rodolfo	1:30.95	3:15.22	5:01.34	6:41.62
4	JPN (12)	Shimizu, Masatoshi Murai, Tomio Kato, Tadamasa Miyagawa, Shigeru Nakata, Fumio Tanaka, Juiiro Fukumasu, Toshi Arai, Yoshinori Yamamoto, Katsumi	1:28.51	3:11.64	5:02.92	6:52.02

FINALE FINAL OCT 19

COURSE RACE 55



VENT (NO) WIND (NW) 0.9 m/sec

3	ALE	Meyer, Horst Schreyer, Dirk Henning, Rüdiger Ulbricht, Lutz Hottenrott, Wolfgang Hirschfelder, Egbert Siebert, Joerg Ott, Nikolas Thiersch, Günther	1:29.24	2:58.96	4:32.89	6:07.00
4	AUS	Duval, Alfred Morgan, Michael Fazio, Joseph Dickson, Peter Douglas, David Ranch, John Pearce, Gary Shirlaw, Robert Grover, Alan	1:29.60	3:00.29	4:36.56	6:07.98
1	URS	Jukna, Zugmas Bagdonavichus, Antanas Sterlik, Vladimir Yagelavichus, Iozapas Matryshkin, Alexander Briedis, Vitautas Kravchuck, Valentin Suslin, Victor Lorentsson, Yury	1:29.92	3:00.26	4:34.52	6:09.11
6	NZL	Webster, Alan Veldman, Gerard Dryden, Alistair Hunter, John Brownlee, Mark Gibbons, John Just, Thomas Cawood, Gilbert Page, Robert	1:27.66	2:57.74	4:33.35	6:10.43
5	CHE	Janos, Vladimir Kuba, Zdenek Svojanovsky, Oldrich Kolesa, Karel Svojanovsky, Pavel Vallisch, Jan Marecek, Otakar Cermak, Petr Ptak, Jiri	1:28.30	3:02.07	4:40.00	6:12.17
2	EUA	Brooks, Stephen Canning, Curtis Larkin, Andrew Stekete, Scott Hobbs, Franklin Fiechter, Jacques Livingston, Michael Higgins, David Hoffman, Paul	1:28.90	3:00.18	4:39.01	6:14.34

JUGE DE DEPART ARBITRE ARBITRE SUPPLEANT STARTING JUDGE: REFEREE: ASSISTANT REFEREE: Knecht, William Cappabianca, Paolo Florescu, Cornel EUA ITA RUM

551



FEDERATION INTERNATIONALE
DE BASKETBALL AMATEUR FIBA

INTERNATIONAL AMATEUR
BASKETBALL FEDERATION FIBA

PRESIDENT
Antonio Dos Reis BRA

SECRETAIRE GENERAL
GENERAL SECRETARY
William Jones ALE

FEDERATION MEXICAINE DE
BASKETBALL AMATEUR FMBA

MEXICAN AMATEUR
BASKETBALL FEDERATION FMBA

PRESIDENT
Juan Manzo MEX

SECRETAIRE GENERAL
GENERAL SECRETARY
Alberto Lara MEX

SECTION BASKETBALL DU C.O.O.
O.O.C. BASKETBALL SECTION
Juan Manzo MEX
Francisco Ugartechea MEX
Alberto Lara MEX

OFFICIELS DE LA COMPETITION
COMPETITION OFFICIALS

COMITE TECHNIQUE
TECHNICAL COMMITTEE
William Jones ALE
Francisco Ugartechea MEX
Borislav Stankovic URS

MEMBRES
MEMBERS
Haas J. Otto ADE
Manfred Sroehler ALE
Josef Andrie CHE
Russel Lyons EUA
Dionisio Calvo FIL
Robert Busnel FRA
Ferenc Hepp HUN
Yoshimi Ueda JPN
Abdel Azim RAU
Pedro Damiani URG

JURY D'APPEL
JURY OF APPEAL

PRESIDENT
Antonio Dos Reis BRA

MEMBRES
MEMBERS
Clifford Buck EUA
Ambrosio Padilla FIL
Alberto Guzmán MEX
Nikolai Semashko URS

ARBITRES
REFEREES
Theodor Shober ALE
Leslie Gough AUS
Helio Louzada BRA
Renato Righetto BRA
Borislav Stoytchev BUL
Allen Rae CAN
Mario Quintero CUB
Santiago Fernández ESP
Wyne Lichty EUA
Z. G. Mihalik EUA
Amadeo Quintos FIL
Erwin Kassai HUN
Elio Luglini ITA
Ryoichi Kanaka JPN
Abderrahmane Bouanane MAR

Arnulfo Saldívar MEX
Ernesto Alvarez MEX
Eugenio Ugalde MEX
Martín Ramos MEX
Rodolfo Díaz MEX
Czeslaw Raczynski POL
Augustus Kam PAN
Calvin Pacheco PRO
Mario Hopenhaym URG
Anatoli Kokorev URS
Obrad Belosevic YUG

SIGNES EMPLOYES SYMBOLOGY

+	—	MARQUE	SCORED
-	—	MANQUE	FAILED
JJ	—	MATCHS JOUES	GAMES PLAYED
JG	—	MATCHS GAGNES	GAMES WON
JP	—	MATCHS PERDUS	GAMES LOST
PS	—	POINTS	POINTS
TJ	—	TOTAL MATCHS	TOTAL GAMES

GROUPE A MATCH 1
GROUP GAME OCT 13

BRA-MAR 98-52 (48-17, 50-35)

BRA	Temps de jeu Time Played	Paniers Baskets			%	Coups francs Free Throws			Total	Fautes Fouls
		+	-			+	-			
4 Machado, Sergio	15	2	7	22.2	1	1	50.0	5	3	
5 Marques, Wlamir	22	8	8	50.0	3	1	75.0	19	3	
6 Maciel, Ubiratan	20	8	0	100.0	2	8	20.0	18	1	
7 Scarpini, Celso	7	1	1	50.0	3	1	75.0	5	3	
8 Garcia, Helio	22	4	1	80.0	0	0	00.0	8	2	
9 De Souza, Carmo	22	2	7	22.2	0	0	00.0	4	2	
10 Dos Santos, José	15	2	1	66.6	0	0	00.0	4	0	
11 Menon, Luiz	19	3	6	33.3	2	0	100.0	8	4	
12 Succar, Antonio	19	8	9	47.0	0	0	00.0	16	3	
13 Simoes, José	18	4	5	44.0	0	0	00.0	8	5	
14 De Castro, José	7	0	2	00.0	3	1	75.0	3	0	
15 Massoni, Carlos	14	0	2	00.0	0	0	00.0	—	1	
TOTAL		42	49	46.1	14	12	53.8	98	27	

MAR

4 Bensiamar, Abdelwahed	35	3	9	25.0	4	2	66.6	10	3
5 Laghrissi, Abderraouf	—	—	—	—	—	—	—	—	—
6 Alaoui, Mohamed	31	4	12	25.0	0	0	00.0	8	4
7 Seyad, Mokhtar	33	5	8	38.4	5	3	62.5	15	4
8 Bouazzaoui, Fathallah	—	—	—	—	—	—	—	—	—
9 Belgnaoui, Abdeljebbar	7	1	2	33.3	0	0	00.0	2	4
10 El Yamani, Khalil	32	4	13	23.5	2	2	50.0	10	5
11 Cherradi, Noureddine	6	0	1	00.0	0	0	00.0	0	3
12 Riad, Moulay	6	0	3	00.0	0	0	00.0	0	2
13 Bel Caid, Allal	31	1	1	50.0	0	1	00.0	2	3
14 Sebbar, Abderrahmane	11	1	2	33.3	1	0	50.0	3	2
15 Dioury, Farouk	8	0	1	00.0	2	0	100.0	2	3
TOTAL		19	52	26.7	14	8	63.6	52	33

ARBITRES REFEREES Kam, Augustus PAN Belosevic, Obrad YUG

553

GROUPE A MATCH 2
GROUP GAME

EUA-ESP 81-46 (39-16, 42-30)

EUA	Temps de jeu Time Played	Paniers Baskets			%	Coups francs Free Throws			Total	Fautes Fouls
		+	-			+	-			
4 Clawson, John	9	2	0	100.0	0	0	00.0	4	0	
5 Spain, Ken	17	3	0	100.0	1	1	50.0	7	2	
6 White, Joseph	25	4	3	57.1	2	0	100.0	10	2	
7 Barrett, Michael	25	0	2	00.0	0	0	00.0	0	1	
8 Haywood, Spencer	23	6	3	66.6	0	0	00.0	12	2	
9 Scott, Charles	17	4	1	80.0	2	2	50.0	10	1	
10 Hosket, Bill	20	5	4	55.5	0	0	00.0	10	2	
11 Fowler, Calvin	17	3	2	60.0	3	1	75.0	9	1	
12 Silliman, Michael	20	3	5	37.5	0	0	00.0	6	2	
13 Saulters, Glynn	14	2	6	25.0	6	0	100.0	10	0	
14 King, James	14	0	1	00.0	0	0	00.0	0	2	
15 Dee, Donald	9	1	6	14.8	1	3	25.0	3	4	
TOTAL		33	33	50.0	15	7	68.1	81	19	

ESP

4 Martínez, Juan	—	—	—	—	—	—	—	—	—
5 Ramos, Vicente	12	1	2	33.3	0	0	00.0	2	0
6 Santiago, Luis	25	2	3	40.0	0	0	00.0	4	0
7 Codina, Jesús	29	4	3	57.1	0	0	00.0	8	2
8 Margall, Enrique	34	2	1	66.6	0	0	00.0	4	4
9 Nava, Antonio	26	3	8	27.2	2	0	100.0	8	5
10 Rodríguez, Emiliano	—	—	—	—	—	—	—	—	—
11 Luyk, Clifford	—	—	—	—	—	—	—	—	—
12 Sagi Vela, José	28	5	8	38.4	0	2	00.0	10	5
13 Buscato, Francisco	—	—	—	—	—	—	—	—	—
14 Alocen, Lorenzo	23	0	6	00.0	0	2	00.0	0	3
15 Martínez, Alfonso	23	4	8	33.3	2	2	50.0	10	2
TOTAL		21	39	35.0	4	6	40.0	46	21

ARBITRES REFEREES Kokorev, Anatoly URS Quintos, Amadeo FIL

GROUPE B MATCH 3
GROUP B GAME 3

URS-POL 91-50 (47-30, 44-20)

URS	Temps de jeu Time Played	Paniers Baskets			Coups francs Free Throws			Total	Fautes Fouls
		+	-	%	+	-	%		
4 Krikun, Anatoly	14	1	3	25.0	4	0	100.0	6	1
5 Paulauskas, Modest	16	5	6	45.5	6	0	100.0	16	1
6 Sakandelidze, Zurab	13	3	2	60.0	3	1	75.0	9	1
7 Kapranov, Vadim	15	2	3	40.0	2	0	100.0	6	3
8 Selikhov, Yuri	15	2	1	66.8	2	0	100.0	6	2
9 Polivoda, Anatoly	16	2	0	100.0	3	1	75.0	7	1
10 Belov, Sergei	21	4	4	50.0	0	0	0.0	8	1
11 Tomson, Priit	13	1	0	100.0	2	0	100.0	4	0
12 Kovalenko, Sergei	12	1	0	100.0	0	2	0.0	2	2
13 Volnov, Gennady	24	4	7	36.3	0	0	0.0	8	2
14 Lipsu, Yaak	17	4	0	100.0	1	1	50.0	9	4
15 Andreev, Vladimir	24	4	3	57.1	2	0	100.0	10	2
TOTAL		33	29	53.2	25	5	83.3	91	20

POL

4 Korcz, Grzegorz	6	1	2	33.3	2	0	100.0	4	1
5 Trams, Wlodzimierz	28	3	6	33.3	0	0	0.0	6	1
6 Malec, Czeslaw	14	0	3	0.0	0	0	0.0	0	0
7 Cegielski, Henryk	15	1	1	50.0	0	0	0.0	2	3
8 Kasprzak, Andrzej	14	0	2	0.0	0	2	0.0	0	3
9 Jurkiewicz, Edward	32	3	6	33.3	0	0	0.0	6	4
10 Niemiec, Adam	3	0	0	0.0	0	0	0.0	0	0
11 Likszo, Bogdan	22	10	2	83.3	0	2	0.0	20	2
12 Lopatka, Mieczyslaw	18	1	6	14.2	2	0	100.0	4	5
13 Frelkiewicz, Kazimierz	25	4	3	57.1	0	0	0.0	8	5
14 Kwiatkowski, Boleslaw	9	0	3	0.0	0	0	0.0	0	4
15 Pasiorowsky, Andrzej	14	0	0	0.0	0	0	0.0	0	2
TOTAL		23	38	36.0	4	4	50.0	50	30

ARBITRES REFEREES Schober Thedor ALE Luglini, Elio ITA

554

GROUPE A MATCH 4
GROUP A GAME 4

ITA-FIL 91-66 (35-39, 56-27)

77ITA	Temps de jeu Time Played	Paniers Baskets			Coups francs Free Throws			Total	Fautes Fouls
		+	-	%	+	-	%		
4 Recalcati, Carlo	24	7	8	42.8	0	0	0.0	14	3
5 Pellanera, Giusto	23	1	3	25.0	0	2	0.0	2	4
6 Lombardi, Gianfranco	12	2	3	40.0	1	1	50.0	5	0
7 Bovone, Enrico	4	0	1	0.0	0	0	0.0	0	1
8 Masini, Massimo	22	11	4	75.0	2	0	100.0	24	1
9 Vittori, Paolo	27	3	2	60.0	4	2	66.6	10	4
10 Vianello, Gabriele	20	3	5	37.5	2	0	100.0	8	2
11 Gatti, Guido	4	0	1	0.0	0	0	0.0	0	0
12 Flaborea, Ottorino	27	7	3	70.0	4	0	100.0	18	2
13 Bufalini, Sauro	7	1	2	33.3	0	0	0.0	2	3
14 Cosmelli, Massimo	16	4	5	44.4	0	0	0.0	8	1
15 Jessi, Gianluigi	14	0	3	0.0	0	0	0.0	0	2
TOTAL		39	40	49.3	13	5	72.2	91	23

FIL

4 Reynoso, Alberto	27	4	5	44.4	0	3	0.0	8	4
5 Mariano, Jaime	16	8	9	47.0	0	0	0.0	16	5
6 Tolentino, Elias	14	0	3	0.0	0	0	0.0	0	0
7 Reyes, Renato	9	3	3	50.0	2	2	50.0	8	4
8 Ocampo, Edgardo	15	3	2	60.0	0	0	0.0	6	4
9 Bauzon, Orlando	32	3	3	50.0	0	0	0.0	6	5
10 Rojas, Joaquín	20	1	0	100.0	0	0	0.0	2	1
11 Melencio, Rogelio	6	0	0	0.0	0	0	0.0	0	1
12 Florencio, Danilo	16	0	0	0.0	0	0	0.0	0	2
13 Papa, Adriano	15	5	12	29.4	5	3	62.5	15	5
14 Márquez, Alfonso	9	0	6	0.0	1	1	50.0	1	5
15 Jaworski, Robert	21	1	10	9.0	2	0	100.0	4	2
TOTAL		28	53	34.5	10	9	52.4	66	38

ARBITRES REFEREES Hopenhaym, Mario URG Díaz, Rodolfo MEX

GRUPE A MATCH 5
GROUP GAME

PRO-SEN 69-26 (31-18, 38-8)

PRO	Temps de jeu Time Played	Paniers Baskets			Coups francs Free Throws			Total	Fautes Fouls
		+	-	%	+	-	%		
4 McCadney, Bill	18	1	6	14.2	2	0	100.0	4	4
5 Hatton, Joe	—	—	—	—	—	—	00.0	—	—
6 Porrata, Adolfo	24	0	8	00.0	0	0	50.0	0	1
7 Cancel, Angel	24	3	8	27.2	2	2	50.0	8	2
8 Adorno, Rubén	30	3	10	23.0	2	0	100.0	8	4
9 Zamot, Alberto	5	0	0	00.0	0	0	00.0	0	0
10 Dalmau, Raymond	10	5	5	50.0	2	2	50.0	12	4
11 Frontera, Jaime	22	5	9	36.0	2	0	100.0	12	1
12 Córdova, Francisco	11	3	3	50.0	1	1	50.0	7	4
13 Cruz, Teófilo	16	2	2	50.0	0	0	00.0	4	4
14 Gutiérrez, Tomás	15	1	5	17.0	0	0	00.0	2	0
15 Ortiz, Mariano	25	4	9	30.9	4	0	100.0	12	3
TOTAL		27	65	29.0	15	5	75.0	69	27

SEN

4 Fall, Cheikh	27	1	3	25.0	0	0	00.0	2	1
5 Diop, Papa	5	0	6	00.0	0	2	00.0	0	4
6 N'Diaye, Mousse	18	2	1	66.6	0	0	00.0	4	3
7 Camara, Doudou	15	0	3	00.0	0	0	00.0	0	4
8 Dia Babacar	19	2	2	50.0	0	0	00.0	4	5
9 Traore, Babacar	31	1	12	07.6	0	0	00.0	2	2
10 Seck, Babacar	23	2	7	22.2	1	1	50.0	5	2
11 Diagne, Mansour	7	2	2	50.0	0	2	00.0	4	2
12 Sadio, Claude	13	0	2	00.0	0	0	00.0	0	5
13 Constantino, Claude	21	0	6	00.0	1	3	25.0	1	3
14 Sene, Moussa	13	1	4	20.0	2	0	100.0	4	5
15 Gueye, Alioune	8	0	1	00.0	0	0	00.0	0	4
TOTAL		11	49	18.3	4	8	33.3	26	40

ARBITRES REFEREES Ugalde, Eugenio MEX Raczynski, Czeslaw

555

GRUPE B MATCH 6
GROUP GAME

MEX-COR 75-62 (39-27, 36-35)

MEX	Temps de jeu Time Played	Paniers Baskets			Coups francs Free Throws			Total	Fautes Fouls
		+	-	%	+	-	%		
4 Heredia, Rafael	8	0	0	00.0	0	0	00.0	0	4
5 Guerrero, Arturo	27	6	8	42.8	2	2	50.0	14	4
6 Tiscareño, Fernando	14	1	2	33.3	0	2	00.0	2	2
7 Arellano, Miguel	6	0	0	00.0	0	0	00.0	0	1
8 Ayala, Antonio	18	2	2	50.0	0	0	00.0	4	4
9 Asiain, Oscar	0	—	—	—	—	—	—	—	—
10 Grajeda, Luis	20	2	6	25.0	0	0	00.0	4	5
11 Guzmán, Alejandro	22	4	4	50.0	4	2	66.6	12	0
12 Quintanar, Carlos	18	1	3	25.0	0	0	00.0	2	1
13 Pontvianne, Ricardo	30	7	1	87.5	2	1	66.6	16	1
14 Hatch, John	6	1	1	50.0	0	0	00.0	2	2
15 Raga, Manuel	31	9	5	64.2	1	1	50.0	19	5
TOTAL		33	32	50.7	9	8	50.0	75	29

COR

4 Ha, Ui-Kon	5	0	0	00.0	0	0	00.0	0	2
5 Lee, Byung-Goo	2	0	0	00.0	0	0	00.0	0	1
6 Kwak, Hyun-Chae	14	2	3	40.0	0	0	00.0	4	3
7 Shin, Dong-Pa	35	10	3	55.5	4	2	66.6	24	4
8 Yoo, Hi-Hyung	24	0	6	00.0	4	0	100.0	4	4
9 Kim, Mu-Hyun	17	0	4	00.0	2	0	50.0	2	2
10 Park, Han	5	0	0	00.0	1	1	00.0	1	1
11 Choi, Jong-Kyu	15	1	0	100.0	0	0	100.0	2	5
12 Kim, In-Kon	26	1	2	33.3	2	0	00.0	4	5
13 Kim, Young-Il	20	1	2	33.3	0	0	00.0	2	3
14 Lee, In-Pyo	37	6	8	42.8	7	3	70.0	19	2
15 Lee, Kyung-Jae	—	—	—	—	—	—	76.9	—	—
TOTAL		21	33	38.8	20	6	76.9	62	32

ARBITRES REFEREES Kassai, Erwin HUN Rae, Allen CAN

GRUPE B MATCH 7
GROUP GAME

BUL-CUB 70-61 (19-27, 51-34)

BUL	Temps de jeu Time Played	Paniers Baskets			%	Coups francs Free Throws			Total	Fautes Fouls
		+	-			+	-			
4 Mihailov, Emil	—	—	—	—	—	—	—	—	—	—
5 Boiadjev, Stanislav	10	1	2	33.3	0	0	00.0	2	2	
6 Pandov, Pando	33	4	4	50.0	2	5	28.5	10	4	
7 Doitchinov, Khristo	19	0	1	00.0	4	0	100.0	4	4	
8 Spassov, Valentin	9	0	2	00.0	0	2	00.0	0	4	
9 Philipov, Stefan	33	4	3	57.1	1	5	16.6	9	3	
10 Dimov, Mintcho	30	5	7	41.6	3	1	75.0	13	2	
11 Kirov, Ivailo	4	0	1	00.0	0	0	00.0	0	1	
12 Sakhanikov, Dimitar	—	—	—	—	—	—	—	—	—	
13 Branzov, Boitcho	24	3	3	50.0	9	5	64.2	15	4	
14 Raitchev, Slavey	21	3	2	60.0	3	1	75.0	9	5	
15 Khristov, Gueorgui	17	2	0	100.0	4	0	100.0	8	4	
TOTAL		22	25	46.8	26	19	57.7	70	33	

CUB

4 Cuesta, Inocente	30	2	6	25.0	0	0	00.0	4	4
5 Herrera, Ruperto	39	9	12	42.8	1	1	50.0	19	5
6 González, Jacinto	14	2	2	50.0	0	0	00.0	4	3
7 Chappe, Pedro	19	5	3	62.5	2	0	100.0	12	5
8 Montalvo, Miguel	6	0	0	00.0	0	0	00.0	0	0
9 Cañizares, Rafael	16	2	2	50.0	1	2	33.3	5	5
10 Pérez, Conrado	22	1	1	50.0	0	0	00.0	2	5
11 Calderón, Miguel	7	1	0	100.0	0	2	00.0	2	5
12 Valdés, César	5	1	0	100.0	0	0	00.0	2	2
13 García, Pablo	27	1	9	10.0	2	0	100.0	4	3
14 Del Pozo, Carlos	14	3	0	100.0	1	3	25.0	7	5
15 Standard, Franklin	1	0	1	00.0	0	0	00.0	0	1
TOTAL		27	36	42.8	7	8	43.7	61	43

ARBITRES REFEREES Lichty, Wayne EJA Fernández, Santiago ESP

556

GRUPE A MATCH 8
GROUP GAME

YUG-PAN 96-85 (51-45, 45-40)

YUG	Temps de jeu Time Played	Paniers Baskets			%	Coups francs Free Throws			Total	Fautes Fouls
		+	-			+	-			
4 Zorga, Aljosa	—	—	—	—	—	—	—	—	—	
5 Korak, Radivoj	38	8	6	57.1	6	4	60.0	22	4	
6 Maroevic, Zoran	7	0	0	00.0	1	1	50.0	1	3	
7 Rajkovic, Trajko	16	4	5	44.4	5	1	83.3	13	5	
8 Cvetkovic, Vladimir	7	0	2	00.0	1	1	50.0	1	2	
9 Raznatovic, Dragoslav	18	4	2	66.6	2	0	100.0	10	2	
10 Daneu, Ivo	40	8	3	72.7	4	0	100.0	20	2	
11 Cosic, Kresimir	16	4	5	44.4	2	0	100.0	10	3	
12 Solman, Damir	5	0	1	00.0	0	0	00.0	0	3	
13 Plecas, Nicola	—	—	—	—	—	—	—	—	—	
14 Cermak, Dragutin	22	5	4	55.5	0	0	00.0	10	5	
15 Skansi, Petar	31	3	7	30.0	3	1	75.0	9	5	
TOTAL		36	35	50.7	24	8	75.0	96	34	

PAN

4 Checa, Francisco	7	0	1	00.0	0	0	00.0	0	0
5 Osorio, Julio	20	1	3	25.0	1	5	16.6	3	3
6 Blades, Percibal	23	5	2	71.4	0	0	00.0	10	1
7 Malcon, Calixto	4	0	2	00.0	0	0	00.0	0	4
8 Alvarado, Nicolas	6	1	1	50.0	0	0	00.0	2	3
9 Agard, Ernesto	22	2	3	40.0	2	2	50.0	6	4
10 Reyes, Ramón	11	1	0	100.0	0	0	00.0	2	4
11 Peralta, Davis	36	11	13	45.8	6	0	100.0	28	3
12 Webb, Norris	—	—	—	—	—	—	—	—	—
13 Sinclair, Luis	14	3	3	50.0	1	1	50.0	7	5
14 Rivas, Pedro	33	9	17	34.6	3	1	75.0	21	3
15 Ellis, Eliecer	24	3	3	50.0	0	0	00.0	6	3
TOTAL		36	48	42.8	13	9	59.0	85	33

ARBITRES REFEREES Righetto, Renato BRA Kanaka, Ryoichi JPN

GRUPE A MATCH
GROUP GAME 9

OCT 14

EUA-SEN 93-36 (44-15, 49-21)

EUA	Temps de jeu Time Played	Paniers Baskets		%	Coups francs Free Throws		%	Total	Fautes Fouls
		+	-		+	-			
4 Clawson, John	16	3	4	42.8	0	0	00.0	6	2
5 Spain, Ken	16	4	1	80.0	0	0	00.0	8	0
6 White, Joseph	18	2	7	22.2	0	0	00.0	4	1
7 Barrett, Michael	15	2	1	66.6	2	0	100.0	6	2
8 Haywood, Spencer	25	7	3	70.0	2	2	50.0	16	3
9 Scott, Charles	21	4	4	50.0	4	0	100.0	12	1
10 Hosket, Bill	15	6	2	75.0	2	2	50.0	14	2
11 Fowler, Calvin	19	4	2	66.6	1	1	50.0	9	4
12 Silliman, Michael	19	1	9	10.0	2	0	100.0	4	0
13 Saulters, Glynn	12	3	3	50.0	0	0	00.0	6	1
14 King, James	15	1	1	50.0	0	0	00.0	2	0
15 Dee, Donald	10	3	3	50.0	0	0	00.0	6	2
TOTAL		40	40	50.0	13	5	72.2	93	18

SEN

4 Fall, Cheikh	17	1	0	100.0	2	0	100.0	4	2
5 Diop, Papa	18	0	5	00.0	0	0	00.0	0	2
6 N'Diaye, Mousse	11	0	0	00.0	0	0	00.0	0	2
7 Camara, Doudou	12	2	3	40.0	0	0	00.0	4	1
8 Dia, Babacar	9	0	1	00.0	0	2	00.0	0	2
9 Traore, Babacar	35	3	12	20.0	1	1	50.0	7	3
10 Seck, Babacar	19	0	2	00.0	0	0	00.0	0	4
11 Diagne, Mansour	10	2	5	28.5	0	0	00.0	4	2
12 Sadio, Claude	15	2	2	50.0	1	1	50.0	5	2
13 Constantino, Claude	24	0	0	00.0	0	0	00.0	0	4
14 Sene, Moussa	21	3	10	23.0	2	2	50.0	8	2
15 Gueye, Alioune	9	2	2	50.0	0	0	00.0	4	1
TOTAL		15	42	26.3	6	6	50.0	36	27

ARBITRES REFEREES Díaz, Rodolfo MEX Quintero, Mario CUB

557

GRUPE B MATCH
GROUP GAME 10

URS-MAR 123-51 (51-30, 72-21)

URS	Temps de jeu Time Played	Paniers Baskets		%	Coups francs Free Throws		%	Total	Fautes Fouls
		+	-		+	-			
4 Krikun, Anatoly	18	4	0	100.0	2	2	50.0	10	1
5 Paulauskas, Mgest	17	5	4	55.5	2	0	100.0	12	2
6 Sakandelidze, Zurab	14	4	4	50.0	0	0	00.0	8	2
7 Kapranov, Vadim	24	4	8	33.3	6	2	75.0	14	0
8 Salikhov, Yuri	16	2	2	50.0	1	1	50.0	5	2
9 Polivoda, Anatoly	22	7	5	58.3	7	1	87.5	21	2
10 Belov, Sergei	8	1	3	25.0	2	0	100.0	4	0
11 Tomson, Priit	14	2	1	66.6	0	2	00.0	4	0
12 Kovalenko, Sergei	23	5	2	71.4	2	0	100.0	12	2
13 Volnov, Gennady	9	4	1	80.0	2	0	100.0	10	0
14 Lipso, Yaak	20	8	2	80.0	1	3	25.0	17	1
15 Andreev, Vladimir	15	2	0	100.0	2	0	100.0	6	0
TOTAL		48	32	60.0	27	11	71.0	123	12

MAR

4 Bensiamar, Abdelwahed	32	3	14	17.6	1	1	50.0	7	4
5 Laghrissi, Abderraouf	10	2	1	66.6	0	0	00.0	4	1
6 Alaoui, Mohamed	23	0	7	00.0	0	2	00.0	0	5
7 Seyad, Mokhtar	40	11	11	50.0	1	1	50.0	23	1
8 Bouazzaoui, Fathallah	—	—	—	—	—	—	—	—	—
9 Belgnaoui, Abdeljebbar	6	0	1	00.0	0	0	00.0	0	2
10 El Yamani, Khalil	35	5	12	29.4	2	0	100.0	12	4
11 Cherradi, Nouredine	3	0	1	00.0	1	1	50.0	1	4
12 Riad, Moulay	5	0	1	00.0	0	0	00.0	0	4
13 Bel Caid, Allal	29	2	5	28.5	0	0	00.0	4	5
14 Sebbar, Abderrahmane	8	0	1	00.0	0	0	00.0	0	2
15 Dioury, Farouk	9	0	5	00.0	0	0	00.0	0	3
TOTAL		23	59	28.0	5	5	50.0	51	35

ARBITRES REFEREES Fernández, Santiago ESP Gough, Leslie AUS

GROUPE B MATCH 11
GROUP B GAME

POL-COR 77-67 (38-27, 39-40)

POL	Temps de jeu Time Played	Paniers Baskets			%	Coups francs Free Throws			Total	Fautes Fouls
		+	-			+	-			
4	Korcz, Grzegorz	—	—	—	—	—	—	—	—	—
5	Trams, Włodzimierz	31	6	6	50.0	0	0	00.0	12	5
6	Malec, Czesław	19	3	0	100.0	1	1	50.0	7	3
7	Cegielski, Henryk	14	2	2	50.0	0	0	00.0	4	0
8	Kasprzak, Andrzej	—	—	—	—	—	—	—	—	—
9	Jurkiewicz, Edward	17	4	2	66.6	2	0	100.0	10	3
10	Niemiec, Adam	—	—	—	—	—	—	—	—	—
11	Likszo, Bogdan	26	3	7	30.0	0	0	00.0	6	5
12	Lopatka, Mieczysław	37	17	9	65.3	1	3	25.0	35	4
13	Frelkiewicz, Kazimierz	31	1	1	50.0	1	1	50.0	3	4
14	Kwiatkowski, Bolesław	25	0	5	00.0	0	2	00.0	0	5
15	Pasiorowski, Andrzej	—	—	—	—	—	—	—	—	—
	TOTAL		36	32	52.9	5	7	41.6	77	29

COR

4	Ha, Ui-Kon	9	0	2	00.0	0	0	00.0	0	4
5	Lee, Byung-Goo	—	—	—	—	—	—	—	—	—
6	Kwak, Hyun-Chae	29	5	9	35.7	1	1	50.0	11	4
7	Shin, Dong-Pa	37	11	6	64.7	5	1	83.3	27	3
8	Yoo, Hi-Hyung	15	4	0	100.0	0	0	00.0	8	5
9	Kim, Mu-Hyun	14	3	5	37.5	1	3	25.0	7	4
10	Park, Han	4	0	2	00.0	1	1	50.0	1	0
11	Choi, Jong-Kyu	7	0	0	00.0	0	0	00.0	0	1
12	Kim, In-Kon	22	0	4	00.0	1	1	50.0	1	0
13	Kim, Young-Il	29	2	5	28.5	0	0	00.0	4	2
14	Lee, In-Pyo	34	3	7	30.0	2	2	50.0	8	4
15	Lee, Kyung-Jae	—	—	—	—	—	—	—	—	—
	TOTAL		28	40	41.0	11	9	55.0	67	27

ARBITRES REFEREES Lichy, Wayne EUA Belosevic, Obrad YUG

558

GROUPE B MATCH 12
GROUP B GAME

BRA-BUL 75-59 (42-29, 33-30)

BRA	Temps de jeu Time Played	Paniers Baskets			%	Coups francs Free Throws			Total	Fautes Fouls
		+	-			+	-			
4	Machado, Sergio	10	0	1	00.0	0	0	00.0	0	3
5	Márques, Wlamir	36	11	6	64.7	1	1	50.0	23	1
6	Maciel, Ubiratan	24	3	4	42.8	1	3	25.0	7	3
7	Scarpini, Celso	37	0	0	00.0	2	0	100.0	2	1
8	Garcia, Helio	6	1	1	50.0	0	0	00.0	2	5
9	De Souza, Carmo	21	2	3	40.0	2	0	100.0	6	2
10	Dos Santos, José	—	—	—	—	—	—	—	—	—
11	Menon, Luiz	7	1	9	10.0	1	1	50.0	3	1
12	Succar, Antonio	16	2	1	66.6	0	0	00.0	4	4
13	Simoes, José	31	6	4	60.0	0	0	00.0	12	5
14	De Castro, José	2	0	0	00.0	0	0	00.0	0	1
15	Massoni, Carlos	31	5	2	71.4	6	2	75.0	16	4
	TOTAL		31	31	50.0	13	7	65.0	75	30

BUL

4	Mihailov, Emil	17	1	1	50.0	5	3	62.5	7	4
5	Boiadjev, Stanislav	5	1	0	100.0	0	0	00.0	2	0
6	Pandov, Pando	22	5	3	62.5	0	0	00.0	10	2
7	Doitchinov, Khristo	20	1	3	25.0	2	0	100.0	4	5
8	Spasov, Valentin	21	4	4	50.0	0	2	00.0	8	4
9	Philipov, Stefan	23	0	3	00.0	1	3	25.0	1	2
10	Dimov, Mintcho	18	1	5	16.6	0	0	00.0	2	3
11	Kirov, Ivailo	19	0	0	00.0	0	0	00.0	0	1
12	Sakhanikov, Dimitar	7	0	2	00.0	0	2	00.0	0	0
13	Branzov, Boitcho	23	4	4	50.0	0	0	00.0	8	3
14	Raitchev, Slavey	25	5	2	71.4	3	3	50.0	13	3
15	Khristov, Gueorgui	15	2	3	40.0	0	0	00.0	4	3
	TOTAL		24	30	44.4	11	13	45.8	59	30

ARBITRES REFEREES Pacheco, Calvin PRO Mihalik, Z. G. EUA

GROUPE A MATCH 13
GROUP GAME

ESP-FIL 108-79 (46-34, 62-45)

ESP	Temps de jeu Time Played	Paniers Baskets			Coups francs Free Throws			Total	Fautes Fouls
		+	-	%	+	-	%		
4 Martínez, Juan	—	—	—	—	—	—	—	—	—
5 Ramos, Vicente	13	1	4	20.0	1	1	50.0	3	4
6 Santiago, Luis	1	0	1	00.0	0	0	00.0	0	0
7 Codina, Jesús	29	5	0	100.0	3	3	50.0	13	4
8 Margall, Enrique	7	0	1	00.0	0	0	00.0	0	5
9 Nava, Antonio	8	3	2	60.0	0	0	00.0	6	4
10 Rodríguez, Emiliano	32	7	7	50.0	2	0	100.0	16	4
11 Luyk, Clifford	26	12	10	54.5	5	5	50.0	29	4
12 Sagi Vela, José	22	6	3	66.6	2	0	100.0	14	4
13 Buscato, Francisco	35	6	4	60.0	6	2	75.0	18	0
14 Alcen, Lorenzo	8	—	—	—	—	—	—	—	—
15 Martínez, Alfonso	17	4	1	80.0	1	1	50.0	9	2
TOTAL		44	33	57.1	20	12	62.5	108	31

FIL

4 Reynoso, Alberto	18	2	2	50.0	1	1	50.0	5	5
5 Mariano, Jaime	20	0	3	00.0	0	0	00.0	0	4
6 Tolentino, Elias	1	0	0	00.0	0	0	00.0	0	1
7 Reyes, Renato	15	2	2	50.0	0	0	00.0	4	5
8 Ocampo, Edgardo	13	0	2	00.0	0	0	00.0	0	5
9 Bauzon, Orlando	20	3	2	60.0	0	0	00.0	6	5
10 Rojas, Joaquín	15	2	3	40.0	0	0	00.0	4	3
11 Melencio, Rogelio	14	3	2	60.0	0	0	00.0	6	5
12 Florencio, Danilo	20	4	7	36.3	3	1	75.0	11	4
13 Papa, Adriano	29	5	9	35.7	3	1	75.0	13	1
14 Márquez, Alfonso	27	9	7	56.2	0	0	00.0	18	3
15 Jaworski, Robert	8	—	—	—	0	0	00.0	12	5
TOTAL		33	43	43.4	13	7	65.0	79	46

ARBITRES REFEREES Righetto, Renato BRA Stoytchev, Borislav BUL

559

GROUPE A MATCH 14
GROUP GAME

YUG-PRO 93-72 (41-32, 52-40)

YUG	Temps de jeu Time Played	Paniers Baskets			Coups francs Free Throws			Total	Fautes Fouls
		+	-	%	+	-	%		
4 Zorga, Aljosa	—	—	—	—	—	—	—	—	—
5 Korac, Radivoj	29	0	7	00.0	10	0	100.0	10	2
6 Maroevic, Zoran	7	1	2	33.3	0	0	00.0	2	3
7 Rajkovic, Trajko	12	3	1	75.0	1	1	50.0	7	1
8 Cvetkovic, Vladimir	32	12	4	75.0	3	1	75.0	27	4
9 Raznatovic, Dragoslav	5	3	5	37.5	6	0	100.0	12	3
10 Daneu, Ivo	37	5	5	50.0	2	0	100.0	12	3
11 Cosic, Kresimir	12	0	0	00.0	2	0	100.0	2	5
12 Solman, Damir	8	1	0	100.0	0	0	00.0	2	1
13 Plecas, Nicola	—	—	—	—	—	—	—	—	—
14 Cermak, Dragutin	38	3	5	37.5	9	1	90.0	15	4
15 Skansi, Petar	20	2	4	33.3	0	0	00.0	4	4
TOTAL		30	33	47.6	33	3	91.6	93	30

PRO

4 McCadney, Bill	20	2	1	66.6	0	0	00.0	4	3
5 Hatton, Joe	—	—	—	—	—	—	—	—	—
6 Porrata, Adolfo	37	6	6	50.0	3	7	75.0	15	3
7 Cancel, Angel	8	0	0	00.0	0	0	00.0	0	5
8 Adorno, Rubén	2	1	0	100.0	0	0	00.0	2	5
9 Zamot, Alberto	12	0	0	00.0	1	1	50.0	1	1
10 Dalmau, Raymond	22	5	7	41.6	1	3	25.0	11	4
11 Frontera, Jaime	12	1	3	25.0	2	2	50.0	4	5
12 Córdova, Francisco	13	1	4	20.0	0	0	00.0	2	5
13 Cruz, Teófilo	28	2	7	22.2	5	1	83.3	9	5
14 Gutiérrez, Tomás	8	2	4	33.3	1	1	50.0	5	2
15 Ortiz, Mariano	38	7	8	46.6	5	3	62.5	19	5
TOTAL		27	40	40.3	18	12	60.0	72	43

ARBITRES REFEREES Rae, Allen CAN Kokorev, Anatoly URS

GRUPE A MATCH 15
GROUP GAME

ITA-PAN 94-87 (49-42, 45-45)

ITA	Temps de jeu Time Played	Paniers Baskets		%	Coups francs Free Throws		%	Total	Fautes Fouls
		+	-		+	-			
4 Recalcati, Carlo	20	2	9	18.1	0	2	00.0	4	1
5 Pellanera, Giusto	28	3	2	60.0	2	0	100.0	8	5
6 Lombardi, Gianfranco	11	1	0	100.0	0	2	00.0	2	1
7 Bovone, Enrico	9	1	1	50.0	2	2	50.0	4	3
8 Masini, Massimo	22	9	7	56.2	2	0	100.0	20	5
9 Vittori, Paolo	16	1	1	50.0	3	1	75.0	5	1
10 Vianello, Gabriele	28	4	8	33.3	5	3	62.5	13	5
11 Gatti, Guido	—	—	—	—	—	—	—	—	—
12 Flaborea, Ottorino	14	3	0	100.0	2	0	100.0	8	5
13 Bufalini, Sauro	20	7	2	77.7	0	2	00.0	14	3
14 Cosmelli, Massimo	14	3	2	60.0	8	0	100.0	14	4
15 Jessi, Gianluigi	18	1	5	16.6	0	0	00.0	2	2
TOTAL		35	37	48.6	24	12	66.6	94	35

PAN	Temps de jeu Time Played	Paniers Baskets		%	Coups francs Free Throws		%	Total	Fautes Fouls
		+	-		+	-			
4 Checa, Francisco	10	0	0	00.0	0	0	00.0	0	2
5 Osorio, Julio	8	2	0	100.0	0	0	00.0	4	5
6 Blades, Percibal	32	1	2	33.3	4	2	66.6	6	5
7 Malcon, Calixto	27	2	2	50.0	2	0	100.0	6	3
8 Alvarado, Nicolás	8	0	0	100.0	0	0	00.0	0	5
9 Agard, Ernesto	16	6	5	54.5	1	3	25.0	13	5
10 Reyes, Ramón	18	1	3	25.0	3	3	50.0	5	4
11 Peralta, Davis	36	6	7	46.1	8	0	100.0	20	2
12 Webb, Norris	—	—	—	—	—	—	—	—	—
13 Sinclair, Luis	7	3	6	33.3	0	0	00.0	6	5
14 Rivas, Pedro	38	11	13	43.4	5	3	62.5	27	3
15 Ellis, Eliecer	—	—	—	—	—	—	—	—	—
TOTAL		32	38	45.7	23	11	67.7	87	39

ARBITRES REFEREES Kassai, Erwin HUN Louzada, Helio BRA

560

GRUPE B MATCH 16
GROUP GAME

MEX-CUB 76-75 (35-29, 41-46)

MEX	Temps de jeu Time Played	Paniers Baskets		%	Coups francs Free Throws		%	Total	Fautes Fouls
		+	-		+	-			
4 Heredia, Rafael	9	0	2	00.0	0	0	00.0	0	2
5 Guerrero, Arturo	36	8	14	36.3	7	3	70.0	23	3
6 Tiscareño, Fernando	—	—	—	—	—	—	—	—	—
7 Arellano, Miguel	9	0	0	00.0	0	0	00.0	0	2
8 Ayala, Antonio	23	3	0	100.0	0	0	00.0	6	3
9 Asaín, Oscar	7	0	0	00.0	0	0	00.0	0	0
10 Grajeda, Luis	11	0	2	00.0	0	0	00.0	0	0
11 Guzmán, Alejandro	14	1	2	33.3	1	1	50.0	3	4
12 Quintanar, Carlos	27	2	1	66.6	0	0	00.0	4	5
13 Pontvianne, Ricardo	26	2	3	40.0	3	1	75.0	7	2
14 Hatch, John	3	0	1	00.0	0	0	00.0	0	3
15 Raga, Manuel	35	13	11	54.1	7	1	87.5	33	4
TOTAL		29	36	44.6	18	6	75.0	76	28

CUB	Temps de jeu Time Played	Paniers Baskets		%	Coups francs Free Throws		%	Total	Fautes Fouls
		+	-		+	-			
4 Cuesta, Inocente	26	3	1	75.0	1	1	50.0	7	4
5 Herrera, Ruperto	34	4	6	40.0	0	0	00.0	8	4
6 González, Jacinto	14	3	3	50.0	1	1	50.0	7	1
7 Chappe, Pedro	29	5	3	62.5	0	4	00.0	10	4
8 Montalvo, Miguel	—	—	—	—	—	—	—	—	—
9 Cañizares, Rafael	17	5	2	71.4	0	0	00.0	10	5
10 Pérez, Conrado	22	0	0	00.0	0	0	00.0	0	2
11 Calderón, Miguel	15	2	1	66.6	2	0	100.0	6	5
12 Valdés, César	—	—	—	—	—	—	—	—	—
13 García, Pablo	26	9	6	60.0	3	1	75.0	21	1
14 Del Pozo, Carlos	17	3	3	50.0	0	2	00.0	6	2
15 Standard, Franklin	—	—	—	—	—	—	—	—	—
TOTAL		34	25	57.7	7	9	43.7	75	28

ARBITRES REFEREES Hopenhaym, Mario URG Schober, Theodor ALE

GRUPE B MATCH 17 OCT 15
GROUP GAME

BUL-MAR 77-59 (35-25, 42-34)

BUL	Temps de jeu Time Played	Paniers Baskets		%	Coups francs Free Throws		%	Total	Fautes Fouls	
		+	-		+	-				
4	Mihailov, Emil	22	6	2	75.0	1	1	50.0	13	5
5	Boiadjev, Stanislav	12	1	4	20.0	1	1	50.0	3	2
6	Pandov, Pando	24	2	5	28.5	2	2	50.0	6	2
7	Dortchinov, Khristo	9	1	0	100.0	0	0	00.0	2	3
8	Spasov, Valentin	16	1	3	25.0	2	0	100.0	4	2
9	Philipov, Stefan	22	4	2	66.6	1	1	50.0	9	0
10	Dimov, Mintcho	18	4	3	57.1	0	0	00.0	8	1
11	Kirov, Ivailo	14	1	7	12.5	0	0	00.0	2	0
12	Sakhanikov, Dimitar	18	4	5	44.4	0	0	00.0	8	2
13	Branzov, Boitcho	9	2	0	100.0	4	0	100.0	8	3
14	Raitchev, Slavey	14	3	3	50.0	0	0	00.0	6	2
15	Khristov, Gueorgui	22	4	2	66.6	0	0	00.0	8	1
	TOTAL		33	36	47.8	11	5	68.7	77	23

MAR

4	Bensiamar, Abdelwahed	25	2	5	28.5	0	0	00.0	4	4
5	Laghrissi, Abderraouf	15	2	1	66.6	0	0	00.0	4	5
6	Alaoui, Mohamed	26	3	4	42.8	0	2	00.0	6	2
7	Seyad, Mokhtar	40	8	16	33.3	6	2	75.0	22	3
8	Bouazzaoui, Fathallah	—	—	—	—	—	—	—	—	—
9	Belgnaoui, Abdeljebbar	—	—	—	—	—	—	—	—	—
10	El Yamani, Khalil	21	5	6	45.5	0	0	00.0	10	4
11	Cherradi, Nouredine	14	0	2	00.0	0	0	00.0	0	1
12	Riad, Moulay	—	—	—	—	—	—	—	—	—
13	Bel Caid, Allal	39	4	2	66.6	1	1	50.0	9	5
14	Sebbar, Abderrahmane	20	1	3	25.0	2	0	100.0	4	0
15	Dioury, Farouk	—	—	—	—	—	—	—	—	—
	TOTAL		25	39	39.0	9	5	64.2	59	24

ARBITRES REFEREES Gough, Leslie AUS Quintos, Amadeo FIL

561

GRUPE A MATCH 18
GROUP GAME

YUG-SEN 84-65 (40-33, 44-32)

YUG	Temps de jeu Time Played	Paniers Baskets		%	Coups francs Free Throws		%	Total	Fautes Fouls	
		+	-		+	-				
4	Zorga, Aljosa	40	7	7	50.0	5	3	62.5	19	3
5	Korac, Radivoj	30	7	7	50.0	6	2	75.0	20	0
6	Maroevic, Zoran	—	—	—	—	—	—	—	—	—
7	Rajkovic, Trajko	17	6	3	66.6	6	0	100.0	18	2
8	Cvetkovic, Vladimir	7	3	2	60.0	1	1	50.0	7	0
9	Raznatovic, Dragoslav	—	—	—	—	—	—	—	—	—
10	Daneu, Ivo	—	—	—	—	—	—	—	—	—
11	Cosic, Kresimir	25	0	8	00.0	3	3	50.0	3	5
12	Solman, Damir	40	3	9	25.0	4	0	100.0	10	3
13	Plecas, Nicola	40	2	7	22.2	3	1	75.0	7	2
14	Cermak, Dragutin	—	—	—	—	—	—	—	—	—
15	Skansi, Petar	1	0	0	00.0	0	0	00.0	0	0
	TOTAL		28	43	39.4	28	10	73.1	84	15

SEN

4	Fall, Cheikh	22	7	2	77.7	0	0	00.0	14	3
5	Diop, Papa	15	4	5	44.4	0	0	00.0	8	2
6	N'Diaye, Mousse	12	1	3	25.0	2	0	100.0	4	1
7	Camara, Doudou	16	0	6	00.0	0	0	00.0	0	4
8	Dia, Babacar	11	1	4	20.0	0	0	00.0	2	4
9	Traore, Babacar	32	1	12	07.6	2	0	100.0	4	3
10	Seek, Babacar	16	1	2	33.3	0	0	00.0	2	3
11	Diagne, Mansour	8	1	4	20.0	2	0	100.0	4	5
12	Sadio, Claude	10	5	2	71.4	0	0	00.0	10	2
13	Constantino, Claude	40	6	6	50.0	0	0	00.0	12	4
14	Sene, Moussa	—	—	—	—	—	—	—	—	—
15	Gueye, Alioune	18	1	3	25.0	3	3	50.0	5	4
	TOTAL		28	49	36.3	9	3	75.0	65	35

ARBITRES REFEREES Bouanane, Abderrahmane MAR Stoytchev, Borislav BUL

GROUPE A MATCH 19
GROUP GAME

ESP-PAN 88-82 (37-45, 51-37)

ESP	Temps de jeu Time Played	Paniers Baskets			Coups francs Free Throws			Total	Fautes Fouls
		+	-	%	+	-	%		
4 Martínez, Juan	—	—	—	—	—	—	—	—	—
5 Ramos, Vicente	10	0	0	00.0	0	2	00.0	0	1
6 Santiago, Luis	—	—	—	—	—	—	—	—	—
7 Codina, Jesús	30	2	3	40.0	2	0	100.0	6	1
8 Margall, Enrique	25	3	2	60.0	0	0	00.0	6	3
9 Nava, Antonio	4	0	0	00.0	0	0	00.0	0	0
10 Rodríguez, Emiliano	27	6	10	37.5	4	2	66.6	16	2
11 Luyk, Clifford	34	8	9	47.0	4	2	66.6	20	3
12 Sagi Vela, José	21	7	6	53.8	0	0	00.0	14	2
13 Buscato, Francisco	28	5	6	45.5	5	1	83.3	15	3
14 Alocen, Lorenzo	—	—	—	—	—	—	—	—	—
15 Martínez, Alfonso	21	5	2	71.4	1	3	25.0	11	2
TOTAL		36	40	47.3	16	10	61.5	88	17

PAN

4 Checa, Francisco	29	0	4	00.0	0	0	00.0	0	4
5 Osorio, Julio	24	4	1	80.0	2	4	33.3	10	5
6 Blades, Percibal	18	1	3	25.0	0	0	00.0	2	1
7 Malcon, Calixto	3	0	2	00.0	0	0	00.0	0	2
8 Alvarado, Nicolás	—	—	—	—	—	—	—	—	—
9 Agard, Ernesto	36	4	3	57.1	0	0	00.0	8	5
10 Reyes, Ramón	5	0	0	00.0	0	0	00.0	0	0
11 Peralta, Davis	33	14	9	60.8	2	0	100.0	30	2
12 Webb, Norris	—	—	—	—	—	—	—	—	—
13 Sinclair, Luis	2	1	1	50.0	0	2	00.0	2	1
14 Rivas, Pedro	22	6	11	35.1	0	0	00.0	12	4
15 Ellis, Eliecer	28	9	6	60.0	0	0	00.0	18	2
TOTAL		39	40	49.3	4	6	40.0	82	26

ARBITRES REFEREES Raczymski, Czeslaw POL Hopennaym, Mario URG

562

GROUPE B MATCH 20
GROUP GAME

POL-CUB 78-75 (36-41, 42-34)

POL	Temps de jeu Time Played	Paniers Baskets			Coups francs Free Throws			Total	Fautes Fouls
		+	-	%	+	-	%		
4 Korcz, Grzegorz	—	—	—	—	—	—	—	—	—
5 Trams, Wlodzimierz	40	9	3	75.0	2	0	100.0	20	2
6 Malec, Czeslaw	22	0	2	00.0	0	0	00.0	0	2
7 Cegielski, Henryk	—	—	—	—	—	—	—	—	—
8 Kasprzak, Andrzej	—	—	—	—	—	—	—	—	—
9 Jurkiewicz, Edward	37	9	6	60.0	3	1	75.0	21	3
10 Niemiec, Adam	—	—	—	—	—	—	—	—	—
11 Likso, Bogdan	39	7	8	46.6	5	3	62.5	19	3
12 Lopatka, Mieczyslaw	22	6	4	60.0	0	2	00.0	12	5
13 Frelkiewicz, Kazimierz	27	1	2	33.3	4	2	66.6	6	4
14 Kwiatkowski, Boleslaw	13	0	0	00.0	0	0	00.0	0	1
15 Pasiorowski, Andrzej	—	—	—	—	—	—	—	—	—
TOTAL		32	25	56.1	14	8	63.6	78	20

CUB

4 Cuesta, Inocente	21	1	2	33.3	0	0	00.0	2	3
5 Herrera, Ruperto	28	4	6	40.0	2	0	100.0	10	4
6 González, Jacinto	15	4	4	50.0	3	1	75.0	11	2
7 Chappe, Pedro	29	5	6	45.5	2	0	100.0	12	5
8 Montalvo, Miguel	—	—	—	—	—	—	—	—	—
9 Cañizares, Rafael	19	4	4	50.0	1	3	25.0	9	1
10 Pérez, Conrado	31	2	4	33.3	1	1	50.0	5	1
11 Calderón, Miguel	9	1	2	33.3	0	0	00.0	2	5
12 Valdés, César	—	—	—	—	—	—	—	—	—
13 Garcia, Pablo	26	6	8	42.8	8	4	66.6	20	2
14 Del Pozo, Carlos	17	2	3	40.0	0	0	00.0	4	5
15 Standard, Franklin	5	0	1	00.0	0	0	00.0	0	0
TOTAL		29	40	42.0	17	9	65.3	75	28

ARBITRES REFEREES Rae, Allen CAN Kassai, Erwin HUN

GRUPE A MATCH 21
GROUP GAME

EUA-FIL 96-75 (48-26, 48-49)

EUA	Temps de jeu Time Played	Paniers Baskets		%	Coups francs Free Throws		%	Total	Fautes Fouls
		+	-		+	-			
4 Clawson, John	18	2	2	50.0	0	0	00.0	4	2
5 Spain, Ken	10	7	0	100.0	0	0	00.0	14	1
6 White, Joseph	10	3	3	50.0	3	1	75.0	9	1
7 Barrett, Michael	23	2	5	28.5	1	1	50.0	5	2
8 Haywood, Spencer	15	2	3	40.0	2	2	50.0	6	0
9 Scott, Charles	23	1	2	33.3	3	1	75.0	5	2
10 Hosket, Bill	23	7	4	63.6	2	0	100.0	16	4
11 Fowler, Calvin	17	3	2	60.0	1	1	50.0	7	1
12 Silliman, Michael	21	6	1	85.7	1	1	50.0	13	4
13 Saulters, Glynn	12	1	1	50.0	0	0	00.0	2	1
14 King, James	12	0	1	00.0	0	0	00.0	0	2
15 Dee, Donald	16	5	4	55.5	5	1	83.3	15	5
TOTAL		39	28	58.2	18	8	69.2	96	25

FIL

4 Reynoso, Alberto	—	—	—	—	—	—	—	—	—
5 Mariano, Jaime	6	0	3	00.0	0	0	00.0	0	0
6 Tolentino, Elias	10	1	3	25.0	0	0	00.0	2	3
7 Reyes, Renato	8	2	3	40.0	2	0	100.0	6	0
8 Ocampo, Edgardo	31	0	4	00.0	1	1	50.0	1	3
9 Bauzón, Orlando	31	2	4	33.3	0	0	00.0	4	5
10 Rojas, Joaquín	21	3	4	42.8	1	1	50.0	7	2
11 Melencio, Rogelio	4	0	0	00.0	0	0	00.0	0	2
12 Florencio, Danilo	23	5	2	71.4	7	1	87.5	17	4
13 Papa, Adriano	23	7	10	41.1	6	2	75.0	20	3
14 Márquez, Alfonso	22	2	5	28.5	2	0	100.0	6	5
15 Jaworski, Robert	21	5	5	50.0	2	2	50.0	12	5
TOTAL		27	43	38.5	21	7	75.0	75	32

ARBITRES REFEREES Alvarez, Ernesto MEX Luglini, Elio ITA

563

GRUPE B MATCH 22
GROUP GAME

ITA-PRO 68-65 (30-33, 38-32)

ITA	Temps de jeu Time Played	Paniers Baskets		%	Coups francs Free Throws		%	Total	Fautes Fouls
		+	-		+	-			
4 Recalcati, Carlo	11	1	1	50.0	0	0	00.0	2	3
5 Pellanera, Giusto	26	2	5	28.5	5	3	62.5	9	2
6 Lombardi, Gianfranco	12	0	0	00.0	2	2	50.0	2	1
7 Bovone, Enrico	18	3	2	60.0	2	0	100.0	8	4
8 Masini, Massimo	33	6	7	46.1	4	2	66.6	16	1
9 Vittori, Paolo	14	0	1	00.0	0	0	00.0	0	1
10 Vianello, Gabriele	10	1	2	33.3	2	0	100.0	4	2
11 Gatti, Guido	18	4	3	57.1	1	1	50.0	9	4
12 Flaborea, Ottorino	21	5	1	83.3	1	1	50.0	11	1
13 Bufalini, Sauro	8	0	0	00.0	0	0	00.0	0	1
14 Cosmelli, Massimo	29	1	5	16.6	5	1	83.3	7	5
15 Jessi, Gianluigi	—	—	—	—	—	—	—	—	—
TOTAL		23	27	46.0	22	10	68.7	68	25

PRO

4 McCadney, Bill	16	2	2	50.0	0	0	00.0	4	2
5 Hatton, Joe	9	1	0	100.0	1	1	50.0	3	2
6 Porrata, Adolfo	24	3	3	50.0	2	0	100.0	8	5
7 Cancel, Angel	26	0	0	00.0	3	3	50.0	3	4
8 Adorno, Ruben	6	0	0	00.0	0	0	00.0	0	3
9 Zamot, Alberto	—	—	—	—	—	—	—	—	—
10 Dalmau, Raymond	11	3	2	60.0	0	0	00.0	6	1
11 Frontera, Jaime	18	2	3	40.0	4	0	100.0	8	4
12 Córdova, Francisco	20	0	2	00.0	0	0	00.0	0	5
13 Cruz, Teófilo	38	9	13	40.9	7	1	87.5	25	4
14 Gutiérrez, Tomas	1	0	0	00.0	0	0	00.0	0	1
15 Ortiz, Mariano	31	4	10	28.5	0	0	00.0	8	4
TOTAL		24	35	40.5	17	5	77.2	65	35

ARBITRES REFEREES Schober, Theodor ALE Righetto, Renato BRA

GRUPE B MATCH 23
GROUP GAME

URS-COR 89-58 (44-34, 45-24)

URS	Temps de jeu Time Played	Paniers Baskets		%	Coups francs Free Throws		%	Total	Fautes Fouls	
		+	-		+	-				
4 Krikun, Anatoly	15	4	1	80.0	2	0	100.0	10	3	
5 Paulauskas, Modest	15	4	4	50.0	0	0	00.0	8	1	
6 Sakandelidze, Zurab	14	1	1	50.0	0	0	00.0	2	0	
7 Kapranov, Vadim	17	1	2	33.3	0	0	00.0	2	2	
8 Selikhov, Yuri	20	2	1	66.6	0	0	00.0	4	2	
9 Polivoda, Anatoly	21	6	0	100.0	0	0	00.0	12	0	
10 Belov, Sergei	16	4	2	66.6	1	3	25.0	9	1	
11 Tomson, Priit	20	4	1	80.0	2	0	100.0	10	2	
12 Kovalenko, Sergei	11	1	3	25.0	1	1	50.0	3	0	
13 Volnov, Gennady	23	6	3	66.6	2	0	100.0	14	2	
14 Lipso, Yaak	15	4	2	66.6	1	5	16.6	9	2	
15 Andreev, Vladimir	13	3	1	75.0	0	0	00.0	6	0	
TOTAL		40	21	65.5	9	9	50.0	89	15	
COR										
4 Ha, Ui-Kon	—	—	—	—	—	—	—	—	—	
5 Lee, Byung-Goo	2	0	0	00.0	0	0	00.0	0	0	
6 Kwak, Hyun-Chae	10	0	0	00.0	0	0	00.0	0	4	
7 Shin, Dong-Pa	40	9	9	50.0	4	0	100.0	22	2	
8 Yoo, Hi-Hyung	18	1	1	50.0	0	0	00.0	2	5	
9 Kim, Mu-Hyun	9	0	3	00.0	2	0	100.0	2	2	
10 Park, Han	—	—	—	—	—	—	—	—	—	
11 Choi, Jong-Kyu	13	0	1	00.0	0	0	00.0	0	3	
12 Kim, In-Kon	40	4	2	66.6	0	0	00.0	8	4	
13 Kim, Young-Il	28	4	4	50.0	0	0	00.0	8	5	
14 Lee, In-Pyo	40	8	4	66.6	0	0	00.0	16	4	
15 Lee, Kyung-Jae	—	—	—	—	—	—	—	—	—	
TOTAL		26	24	52.0	6	0	100.0	58	29	
ARBITRES	REFEREES	Pacheco, Calvin	PRO	Mihalik, Z. G	EUA					

564

GRUPE B MATCH 24
GROUP GAME

BRA-MEX 60-53 (30-29, 30-24)

BRA	Temps de jeu Time Played	Paniers Baskets		%	Coups francs Free Throws		%	Total	Fautes Fouls	
		+	-		+	-				
4 Machado, Sergio	13	2	2	50.0	0	0	00.0	4	1	
5 Márques, Wlamir	38	6	9	40.0	0	0	00.0	12	1	
6 Maciel, Ubiratan	35	8	4	66.6	5	3	62.5	21	3	
7 Scarpini, Celso	—	—	—	—	—	—	—	—	—	
8 Garcia, Helio	8	0	1	00.0	0	0	00.0	0	2	
9 De Souza, Carmo	15	1	7	12.5	0	0	00.0	2	2	
10 Dos Santos, José	—	—	—	—	—	—	—	—	—	
11 Menon, Luiz	23	7	5	58.3	0	0	00.0	14	4	
12 Succar, Antonio	7	0	0	00.0	1	1	50.0	1	1	
13 Simoes, José	31	1	4	20.0	2	2	50.0	4	2	
14 De Castro, José	—	—	—	—	—	—	—	—	—	
15 Massoni, Carlos	30	0	3	00.0	2	4	33.3	2	4	
TOTAL		25	35	41.6	10	10	50.0	60	20	
MEX										
4 Heredia, Rafael	22	2	3	40.0	0	0	00.0	4	3	
5 Guerrero, Arturo	21	1	10	09.0	1	1	50.0	3	1	
6 Tiscareño, Fernando	6	0	1	00.0	0	0	00.0	0	1	
7 Arellano, Miguel	—	—	—	—	—	—	—	—	—	
8 Ayala, Antonio	30	6	4	60.0	3	1	75.0	15	2	
9 Asiain, Oscar	—	—	—	—	—	—	—	—	—	
10 Grajeda, Luis	6	0	1	00.0	0	0	00.0	0	1	
11 Guzmán, Alejandro	10	0	1	00.0	0	0	00.0	0	1	
12 Quintanar, Carlos	29	4	3	57.1	0	0	00.0	8	4	
13 Pontvianne, Ricardo	36	6	8	42.8	2	0	100.0	14	4	
14 Hatch, John	—	—	—	—	—	—	—	—	—	
15 Raga, Manuel	40	4	14	22.2	1	3	25.0	9	2	
TOTAL		23	45	33.8	7	5	58.3	53	19	
ARBITRES	REFEREES	Kanaka, Ryoichi	JPN	Lichty, Wayne	EUA					

GRUPE A MATCH 25 OCT 16
GROUP GAME

PAN-FIL 95-92 (38-48, 57-44)

PAN	Temps de jeu Time Played	Paniers Baskets			%	Coups francs Free Throws			Total	Fautes Fouls
		+	-	%		+	-	%		
4 Checa, Francisco	8	0	0	00.0	0	0	00.0	0	2	
5 Osorio, Julio	37	5	3	62.5	8	2	80.0	18	3	
6 Blades, Percibal	9	1	1	50.0	2	0	100.0	4	0	
7 Malcon, Calixto	23	4	5	44.4	1	1	50.0	9	4	
8 Alvarado, Nicolás	—	—	—	—	—	—	—	—	—	
9 Agard, Ernesto	21	3	6	33.3	0	0	00.0	6	5	
10 Reyes, Ramón	3	0	0	00.0	0	0	00.0	0	0	
11 Peralta, Davis	40	11	10	52.3	8	0	100.0	30	3	
12 Webb, Norris	—	—	—	—	—	—	—	—	—	
13 Sinclair, Luis	15	0	3	00.0	0	0	00.0	0	4	
14 Rivas, Pedro	28	9	7	56.2	5	5	50.0	23	4	
15 Ellis, Eliecer	16	2	2	50.0	1	1	50.0	5	5	
TOTAL		35	37	48.6	25	9	73.5	95	30	

FIL

4 Reynoso, Alberto	31	5	1	83.3	0	0	00.0	10	4
5 Mariano, Jaime	4	0	0	00.0	0	0	00.0	0	0
6 Tolentino, Elias	5	0	1	00.0	1	3	25.0	1	1
7 Reyes, Renato	—	—	—	—	—	—	—	—	—
8 Ocampo, Edgardo	30	5	1	83.3	0	0	00.0	10	5
9 Bauzón, Orlando	22	0	4	00.0	0	0	00.0	0	5
10 Rojas, Joaquín	4	2	2	50.0	0	0	00.0	4	2
11 Melencio, Rogelio	10	0	1	00.0	1	1	50.0	1	3
12 Florencio, Danilo	32	9	9	50.0	4	2	66.6	22	5
13 Papa, Adriano	27	11	13	45.8	3	1	75.0	25	3
14 Márquez, Alfonso	17	2	3	40.0	0	0	00.0	4	4
15 Jaworski, Robert	18	6	2	75.0	3	1	75.0	15	5
TOTAL		40	37	51.9	12	8	60.0	92	37

ARBITRES REFEREES Shober, Theodor ALE Ugalde, Eugenio MEX

565

GRUPE A MATCH 26
GROUP GAME

ESP-PRO 86-62 (40-23, 46-39)

ESP	Temps de jeu Time Played	Paniers Baskets			%	Coups francs Free Throws			Total	Fautes Fouls
		+	-	%		+	-	%		
4 Martínez, Juan	3	0	0	00.0	0	0	00.0	0	2	
5 Ramos, Vicente	—	—	—	—	—	—	—	—	—	
6 Santiago, Luis	—	—	—	—	—	—	—	—	—	
7 Codina, Jesús	37	3	3	50.0	0	0	00.0	6	3	
8 Margall, Enrique	17	1	0	100.0	0	0	00.0	2	5	
9 Nava, Antonio	8	2	1	66.6	3	1	75.0	7	2	
10 Rodríguez, Emiliano	36	8	9	47.0	9	0	100.0	25	4	
11 Luyk, Clifford	25	5	3	62.5	3	5	37.5	13	5	
12 Sagi Vela, José	24	4	2	66.6	2	2	50.0	10	3	
13 Buscato, Francisco	21	4	6	40.0	4	0	100.0	12	3	
14 Alocen, Lorenzo	9	2	0	100.0	1	1	50.0	5	5	
15 Martínez, Alfonso	20	2	0	100.0	2	0	100.0	6	5	
TOTAL		31	24	56.3	24	9	72.7	86	37	

PRO

4 McCadney, Bill	11	1	2	33.3	0	0	00.0	2	4
5 Hatton, Joe	18	4	8	33.3	2	2	50.0	10	2
6 Porrata, Adolfo	10	0	3	00.0	2	0	100.0	2	4
7 Cancel, Angel	16	2	3	40.0	0	0	00.0	4	5
8 Adorno, Ruben	15	2	4	33.3	3	1	75.0	7	4
9 Zamot, Alberto	—	—	—	—	—	—	—	—	—
10 Dalmau, Raymond	24	7	9	43.7	2	2	50.0	16	4
11 Frontera, Jaime	7	0	2	00.0	0	0	00.0	0	0
12 Córdova, Francisco	22	3	1	75.0	1	1	50.0	7	3
13 Cruz, Teófilo	22	0	0	00.0	1	1	50.0	1	5
14 Gutiérrez, Tomás	24	1	9	10.0	0	0	00.0	2	2
15 Ortiz, Mariano	31	4	8	33.3	3	1	75.0	11	3
TOTAL		24	49	31.8	14	8	63.6	62	36

ARBITRES REFEREES Hopenhaym, Mario URG Raczynski, Czeslaw POL

GROUPE B MATCH
GROUP GAME 27

URS-BUL 81-56 (40-23, 41-33)

URS	Temps de jeu Time Played	Paniers Baskets			%	Coups francs Free Throws			Total	Fautes Fouls
		+	-			+	-			
4 Krikun, Anatoly	28	6	4	60.0	0	0	00.0	12	1	
5 Paulauskas, Modest	18	9	4	69.2	4	0	100.0	22	2	
6 Sakandelidze, Zurab	20	0	2	00.0	0	0	00.0	0	5	
7 Kapranov, Vadim	—	—	—	—	—	—	—	—	—	
8 Selikhov, Yuri	25	1	4	20.0	0	0	00.0	2	2	
9 Polivoda, Anatoly	19	3	2	60.0	2	0	100.0	8	4	
10 Belov, Sergei	16	8	1	88.8	0	2	00.0	16	3	
11 Tomson, Priit	16	1	5	16.6	0	0	00.0	2	0	
12 Kovalenko, Sergei	10	0	1	00.0	1	1	50.0	1	4	
13 Volnov, Gennady	18	2	4	33.3	2	2	50.0	6	5	
14 Lips, Yaak	15	4	0	100.0	2	0	100.0	10	1	
15 Andreev, Vladimir	15	1	1	50.0	0	0	00.0	2	0	
TOTAL		35	28	55.5	11	5	68.7	81	27	

BUL

4 Michailov, Emil	16	2	5	28.5	5	2	66.6	9	5
5 Boiadjev, Stanislav	—	—	—	—	—	—	—	—	—
6 Pandov, Pando	35	2	6	40.0	0	0	00.0	4	4
7 Doitchinov, Christo	10	4	1	80.0	0	0	00.0	8	5
8 Spassov, Valentin	11	2	4	20.0	0	0	00.0	4	2
9 Philipov, Stefan	21	1	2	33.3	0	0	00.0	2	2
10 Dimov, Mintcho	25	2	4	33.3	0	0	00.0	4	0
11 Kirov, Ivailo	19	3	3	50.0	3	2	50.0	9	4
12 Sakhanikov, Dimitar	8	0	1	00.0	0	0	00.0	0	1
13 Branzov, Boitcho	15	3	8	27.2	2	2	50.0	8	1
14 Raitchev, Slavey	14	1	3	25.0	0	0	00.0	2	4
15 Khristov, Gueorgui	26	3	4	42.8	0	0	00.0	6	5
TOTAL		23	41	38.0	10	6	57.1	56	33

ARBITRES REFEREES Lichty, Wayne EUA Rae, Allen CAN

566

GROUPE A MATCH
GROUP GAME 28

ITA-SEN 81-55 (41-24, 40-31)

ITA	Temps de jeu Time Played	Paniers Baskets			%	Coups francs Free Throws			Total	Fautes Fouls
		+	-			+	-			
4 Recalcati, Carlo	29	3	11	21.4	3	1	75.0	9	2	
5 Pellanera, Giusto	5	1	0	100.0	0	2	00.0	2	0	
6 Lombardi, Gianfranco	17	0	2	00.0	0	2	00.0	0	3	
7 Bovone, Enrico	12	0	3	00.0	4	0	100.0	4	3	
8 Masini, Massimo	9	1	3	25.0	2	0	100.0	4	0	
9 Vittori, Paolo	11	2	1	66.6	0	0	00.0	4	2	
10 Vianello, Gabriele	15	5	1	83.3	0	0	00.0	10	0	
11 Gatti, Guido	29	8	5	61.5	0	0	00.0	16	1	
12 Flaborea, Ottorino	8	3	1	75.0	2	0	100.0	8	0	
13 Bufalini, Sauro	19	2	4	33.3	1	1	50.0	5	2	
14 Cosmelli, Massimo	15	3	1	75.0	3	1	75.0	9	2	
15 Jessi, Gianluigi	31	5	5	50.0	0	0	00.0	10	1	
TOTAL		33	37	47.1	15	7	68.1	81	16	

SEN

4 Fall, Cheikh	20	4	4	50.0	0	0	00.0	8	1
5 Diop, Papa	14	2	3	40.0	0	0	00.0	4	0
6 N'diaye, Mousse	6	0	1	00.0	0	0	00.0	0	1
7 Camara, Doudou	11	3	1	75.0	0	0	00.0	6	4
8 Dia, Babacar	18	2	5	28.5	0	0	00.0	4	0
9 Traore, Babacar	38	5	13	27.5	1	1	50.0	11	3
10 Seck, Babacar	19	5	5	50.0	1	1	50.0	11	3
11 Diagne, Mansour	7	1	2	33.3	0	0	00.0	2	2
12 Sadio, Claude	14	1	6	14.2	3	1	25.0	5	5
13 Constantino, Claude	32	1	3	25.0	0	0	00.0	2	3
14 Sene, Moussa	—	—	—	—	—	—	—	—	—
15 Gueye, Alioune	21	0	6	00.0	2	2	50.0	2	5
TOTAL		24	49	32.3	7	5	58.3	55	27

ARBITRES REFEREES Kanaka, Ryoichi JPN Zaldivar, Arnulfo MEX

GRUPE B MATCH 29
GROUP B GAME 29

MEX-MAR 86-38 (42-15, 44-23)

MEX	Temps de jeu Time Played	Paniers Baskets		%	Coups francs Free Throws		%	Total	Fautes Fouls
		+	-		+	-			
4 Heredia, Rafael	31	6	7	46.1	0	0	00.0	12	2
5 Guerrero, Arturo	28	10	8	55.5	5	1	83.3	25	3
6 Tiscareño, Fernando	20	1	4	20.0	0	0	00.0	2	4
7 Arellano, Miguel	20	1	5	16.6	0	0	00.0	2	2
8 Ayala, Antonio	—	—	—	—	—	—	—	—	—
9 Asiain, Oscar	37	1	7	12.5	1	1	50.0	3	4
10 Grajeda, Luis	19	4	3	57.1	0	0	00.0	8	5
11 Guzmán, Alejandro	23	8	4	66.6	0	0	00.0	16	3
12 Quintanar, Carlos	—	—	—	—	—	—	—	—	—
13 Pontvianne, Ricardo	—	—	—	—	—	—	—	—	—
14 Hatch, John	22	7	10	41.1	4	2	66.6	18	1
15 Raga, Manuel	—	—	—	—	—	—	—	—	—
TOTAL		38	48	44.1	10	4	71.4	86	24

MAR

4 Bensiamar, Abdelwahed	31	5	9	35.7	4	2	66.6	14	2
5 Laghrissi, Abderraouf	16	1	3	25.0	0	4	00.0	2	1
6 Alaoui, Mohamed	22	0	6	00.0	0	0	00.0	0	4
7 Seyad, Mokhtar	21	2	6	25.0	2	2	50.0	6	4
8 Bouazzaoui, Fathallah	7	0	0	00.0	0	0	00.0	0	3
9 Belgnaoui, Abdeljebbar	—	—	—	—	—	—	—	—	—
10 El Yamani, Khalil	25	4	12	25.0	0	0	00.0	8	3
11 Cherradi, Nouredine	30	1	4	20.0	0	0	00.0	2	2
12 Riad, Moulay	—	—	—	—	—	—	—	—	—
13 Bel Caid, Allal	23	0	3	00.0	2	0	100.0	2	2
14 Sebbar, Abderrahmane	20	1	5	16.6	1	1	50.0	3	2
15 Dioury, Farouk	5	0	2	00.0	1	1	50.0	1	1
TOTAL		14	50	21.8	10	10	50.0	38	24

ARBITRES REFEREES Pacheco, Calvin PRO Luglini, Elio ITA

567

GRUPE B MATCH 30
GROUP B GAME 30

BRA-POL 88-51 (35-26, 53-25)

BRA	Temps de jeu Time Played	Paniers Baskets		%	Coups francs Free Throws		%	Total	Fautes Fouls
		+	-		+	-			
4 Machado, Sergio	17	3	7	30.0	3	3	50.0	9	2
5 Márquez, Wlamiir	28	9	2	81.8	0	0	00.0	18	4
6 Maciel, Ubiratan	27	10	3	76.9	0	0	00.0	20	1
7 Scarpini, Celso	11	0	0	00.0	4	0	100.0	4	2
8 Garcia, Hello	15	3	1	75.0	1	1	50.0	7	2
9 De Souza, Carmo	29	5	10	33.3	0	0	00.0	10	3
10 Dos Santos, José	5	1	0	100.0	4	4	50.0	6	4
11 Menon, Luiz	23	5	4	55.5	2	4	33.3	12	1
12 Succar, Antonio	10	0	0	00.0	0	0	00.0	0	3
13 Simoes, José	—	—	—	—	—	—	—	—	—
14 De Castro, José	4	0	0	00.0	0	0	00.0	0	0
15 Massoni, Carlos	31	1	1	50.0	0	0	00.0	2	3
TOTAL		37	28	56.9	14	12	53.8	88	25

POL

4 Korcz, Grzegorz	9	1	1	50.0	0	0	00.0	2	0
5 Trams, Wlodzimierz	25	3	8	27.2	0	0	00.0	6	1
6 Mlalec, Czeslaw	—	—	—	—	—	—	—	—	—
7 Cegielski, Henryk	19	1	1	50.0	2	0	100.0	4	1
8 Kasprzak, Andrzej	24	1	3	25.0	2	0	100.0	4	4
9 Jurkiewicz, Edward	9	0	1	00.0	0	0	00.0	0	4
10 Niemiec, Adam	11	0	3	00.0	0	0	00.0	0	2
11 Likso, Bogdan	30	5	5	50.0	2	0	100.0	12	1
12 Lopatka, Mieczyslaw	18	4	3	57.1	2	2	50.0	10	5
13 Frelkiewicz, Kazimierz	21	2	3	40.0	0	0	00.0	4	3
14 Kwiatkowski, Boleslaw	26	3	8	27.2	0	2	00.0	6	2
15 Pasiorowski, Andrzej	8	0	0	00.0	3	5	37.5	3	4
TOTAL		20	36	35.7	11	9	55.0	51	27

ARBITRES REFEREES Mihalik, Z. G. EUA Fernández, Santiago ESP

GRUPE B MATCH 31
GROUP GAME

CUB-COR 80-71 (34-29, 46-42)

CUB		Temps de jeu Time Played	Paniers Baskets		%	Coups francs Free Throws		%	Total	Fautes Fouls
			+	-		+	-			
4	Cuesta, Inocente	—	—	—	—	—	—	—	—	—
5	Herrera, Ruperto	40	9	11	45.0	4	2	66.6	22	1
6	González, Jacinto	40	11	4	73.3	2	2	50.0	24	1
7	Chappe, Pedro	36	6	10	37.5	3	5	37.5	15	2
8	Montalvo, Miguel	—	—	—	—	—	—	—	—	—
9	Cañizares, Rafael	6	1	2	33.3	0	0	00.0	2	4
10	Pérez, Conrado	40	3	7	30.0	0	4	00.0	6	4
11	Calderón, Miguel	30	3	3	50.0	2	4	33.3	8	4
12	Valdés, César	4	0	2	00.0	0	0	00.0	0	1
13	García, Pablo	—	—	—	—	—	—	—	—	—
14	Del Pozo, Carlos	4	1	1	50.0	1	1	50.0	3	1
15	Standard, Franklin	—	—	—	—	—	—	—	—	—
TOTAL			34	40	45.9	12	18	40.0	80	18
COR										
4	Ha, Ui-Kon	7	2	1	66.6	0	0	00.0	4	2
5	Lee, Byung-Goo	—	—	—	—	—	—	—	—	—
6	Kwak, Hyun-Chae	19	5	2	71.4	0	0	00.0	10	4
7	Shin, Dong	34	13	12	52.0	0	0	00.0	26	2
8	Yoo, Hi-Hyung	24	2	2	50.0	0	0	00.0	4	4
9	Kim, Mu-Hyun	11	0	3	00.0	2	0	100.0	2	2
10	Park, Han	10	0	1	00.0	0	0	00.0	0	2
11	Choi, Jong-Kyu	4	0	0	00.0	2	0	100.0	2	0
12	Kim, In-Kon	26	2	0	100.0	1	1	50.0	5	5
13	Kim, Young-Il	26	1	3	25.0	0	0	00.0	2	2
14	Lee, In-Pyo	38	7	8	46.6	2	0	100.0	16	5
15	Lee, Kyung-Jae	—	—	—	—	—	—	—	—	—
TOTAL			32	32	50.0	7	1	87.5	71	28
ARBITRES	REFEREES	Righetto, Renato	BRA	Belosevic, Obrad	YUG					

568

GRUPE A MATCH 32
GROUP GAME

EUA-YUG 73-58 (36-28, 37-30)

EUA		Temps de jeu Time Played	Paniers Baskets		%	Coups francs Free Throws		%	Total	Fautes Fouls
			+	-		+	-			
4	Clawson, John	—	—	—	—	—	—	—	—	—
5	Spain, Ken	10	0	1	00.0	1	3	25.0	1	0
6	White, Joseph	39	12	4	75.0	0	0	00.0	24	2
7	Barrett, Michael	19	2	3	40.0	1	1	50.0	5	3
8	Haywood, Spencer	30	3	1	75.0	0	2	00.0	6	4
9	Scott, Charles	30	3	2	60.0	3	3	50.0	9	3
10	Hosket, Bill	8	1	1	50.0	2	6	25.0	4	3
11	Fowler, Calvin	22	4	0	100.0	0	0	00.0	8	4
12	Silliman, Michael	32	6	4	60.0	2	0	100.0	14	3
13	Saulters, Glynn	—	—	—	—	—	—	—	—	—
14	King, James	—	1	1	50.0	0	0	00.0	2	4
15	Dee, Donald	—	—	—	—	—	—	—	—	—
TOTAL			32	17	65.3	9	15	37.5	73	26
YUG										
4	Zorga, Aljosa	—	—	—	—	—	—	—	—	—
5	Korac, Radivoj	21	2	3	40.0	0	0	00.0	4	4
6	Maroevic, Zoran	10	0	1	00.0	0	0	00.0	0	4
7	Rajkovic, Trajko	28	4	1	80.0	1	1	50.0	9	3
8	Cvetkovic, Dragoslav	16	1	4	20.0	2	0	100.0	4	2
9	Raznatovic, Dragoslav	16	0	3	00.0	3	1	75.0	3	2
10	Daneu, Ivo	40	6	9	40.0	3	1	75.0	15	3
11	Cosic, Kresimir	31	5	5	50.0	3	1	75.0	13	3
12	Solman, Damir	10	2	1	66.6	0	0	00.0	4	2
13	Plecas, Nicola	—	—	—	—	—	—	—	—	—
14	Cermak, Dragutin	24	2	6	25.0	0	0	00.0	4	3
15	Skansi, Petar	9	1	1	50.0	0	2	00.0	2	3
TOTAL			23	34	40.3	12	6	66.6	58	29
ARBITRES	REFEREES	Kassai, Erwin	HUN	Díaz, Rodolfo	MEX					

GRUPE B MATCH 33 OCT 18
GROUP GAME

POL-MAR 85-48 (46-25, 39-23)

POL	Temps de jeu Time Played	Paniers Baskets		%	Coups francs Free Throws		%	Total	Fautes Fouls
		+	-		+	-			
4 Korcz, Grzegorz	9	0	1	00.0	0	0	00.0	0	0
5 Trams, Włodzimierz	12	6	3	66.6	0	0	00.0	12	1
6 Malec, Czesław	12	2	3	40.0	4	0	100.0	8	0
7 Cegielski, Henryk	15	0	3	00.0	0	0	00.0	0	2
8 Kasprzak, Andrzej	20	2	2	50.0	0	0	00.0	4	3
9 Jurkiewicz, Edward	23	5	5	50.0	3	1	75.0	13	2
10 Niemiec, Adam	13	2	1	66.6	0	0	00.0	4	3
11 Likszo, Bogdan	16	3	1	75.0	0	0	00.0	6	1
12 Lopatka, Mieczysław	31	6	5	54.5	4	2	66.6	16	1
13 Frelkiewicz, Kazimierz	20	2	4	33.3	1	1	50.0	5	0
14 Kwiatkowski, Bolesław	20	3	6	33.3	2	0	100.0	8	3
15 Pasiorowski, Andrzej	9	4	1	80.0	1	1	50.0	9	0
TOTAL		35	35	50.0	15	5	75.0	85	16

MAR

4 Bensiamar, Abdelwahed	26	1	6	14.2	0	0	00.0	2	2
5 Laghrissi, Abderraouf	7	0	1	00.0	0	0	00.0	0	3
6 Alaoui, Mohamed	31	0	9	00.0	0	0	00.0	0	1
7 Seyad, Mokhtar	40	13	14	48.1	7	3	70.0	33	3
8 Bouazzaoui, Fathallah	—	—	—	—	—	—	—	—	—
9 Belgnaoui, Abdeljebbar	—	—	—	—	—	—	—	—	—
10 El Yamani, Khalil	22	3	7	30.0	0	0	00.0	6	4
11 Cherradi, Nouredine	16	0	3	00.0	0	0	00.0	0	4
12 Riad, Moulay	3	0	0	00.0	0	0	00.0	0	3
13 Bel Caid, Allai	24	2	0	100.0	0	0	00.0	4	1
14 Sebbar, Abderrahmane	22	0	2	00.0	1	1	50.0	1	3
15 Dioury, Farouk	9	1	3	25.0	0	0	00.0	2	3
TOTAL		20	45	30.7	8	4	66.6	48	27

ARBITRES REFEREES Belocevic, Obrad YUG Kam, Augustus PAN

569

GRUPE A MATCH 34
GROUP GAME

EUA-PAN 95-60 (51-33, 44-27)

EUA	Temps de jeu Time Played	Paniers Baskets		%	Coups francs Free Throws		%	Total	Fautes Fouls
		+	-		+	-			
4 Clawson, John	6	2	1	66.6	2	0	100.0	6	3
5 Spain, Ken	8	0	0	00.0	0	0	00.0	0	2
6 White, Joseph	25	5	7	41.6	3	1	75.0	13	2
7 Barrett, Michael	21	4	2	66.6	0	0	00.0	8	0
8 Haywood, Spencer	32	1	3	78.5	3	5	37.5	27	1
9 Scott, Charles	27	4	5	44.4	4	0	100.0	12	2
10 Hosket, Bill	13	1	2	33.3	0	0	00.0	2	1
11 Fowler, Calvin	19	0	5	16.6	0	0	00.0	0	2
12 Silliman, Michael	25	6	5	54.5	2	0	100.0	14	1
13 Saulters, Glynn	11	3	2	60.0	2	0	100.0	8	2
14 King, James	—	—	—	—	—	—	—	—	—
15 Dee, Donald	13	2	4	33.3	1	1	50.0	5	0
TOTAL		39	36	52.0	17	7	70.8	95	16

PAN

4 Checa, Francisco	8	0	0	00.0	0	0	00.0	0	2
5 Osorio, Julio	23	1	4	20.0	0	0	00.0	2	3
6 Blades, Percibal	7	2	0	100.0	0	0	00.0	4	0
7 Malcon, Calixto	4	0	0	00.0	0	0	00.0	0	0
8 Alvarado, Nicolás	14	1	1	50.0	0	4	00.0	2	1
9 Agard, Ernesto	35	8	5	61.5	1	1	50.0	17	4
10 Reyes, Ramón	15	1	0	100.0	0	0	00.0	2	1
11 Peralta, Davis	25	3	11	21.4	0	0	00.0	6	1
12 Webb, Norris	15	3	1	75.0	0	0	00.0	6	5
13 Sinclair, Luis	10	1	1	50.0	1	1	50.0	3	3
14 Rivas, Pedro	27	3	8	27.2	1	1	50.0	7	2
15 Ellis, Eliecer	17	5	3	62.5	1	1	50.0	11	2
TOTAL		28	34	45.1	4	8	33.3	60	24

ARBITRES REFEREES Kanaka, Ryoichi JPN Louzada, Helio BRA

GROUPE A MATCH 35
GROUP GAME

ESP-SEN 64-54 (30-24, 34-30)

ESP	Temps de jeu Time Played	Paniers Baskets			Coups francs Free Throws			Total	Fautes Fouls
		+	-	%	+	-	%		
4 Martínez, Juan	8	1	2	33.3	0	0	00.0	2	1
5 Ramos, Vicente	—	—	—	—	—	—	—	—	—
6 Santiago, Luis	22	0	5	00.0	0	0	00.0	0	5
7 Codina, Jesús	32	3	3	50.0	0	0	00.0	6	2
8 Margall, Enrique	30	5	6	45.5	1	1	50.0	11	3
9 Nava, Antonio	26	6	12	33.3	0	0	00.0	12	2
10 Rodríguez, Emiliano	4	1	0	100.0	4	0	100.0	6	0
11 Luik, Clifford	—	—	—	—	—	—	—	—	—
12 Sagi Vela, José	33	6	10	37.5	0	0	00.0	12	5
13 Buscato, Francisco	5	1	0	100.0	0	0	100.0	2	1
14 Alocen, Lorenzo	18	0	3	00.0	7	3	70.0	7	1
15 Martínez, Alfonso	22	3	5	37.5	0	0	00.0	6	4
TOTAL		26	46	36.1	12	4	75.0	64	24

SEN	Temps de jeu Time Played	Paniers Baskets			Coups francs Free Throws			Total	Fautes Fouls
		+	-	%	+	-	%		
4 Fall, Cheikh	11	0	3	00.0	2	0	100.0	2	1
5 Diop, Papa	18	1	7	12.5	0	0	00.0	2	2
6 N'diaye, Mousse	16	0	1	00.0	0	0	00.0	0	1
7 Camara, Doudou	4	0	1	00.0	0	0	00.0	0	2
8 Dia, Babacar	11	0	0	00.0	1	1	50.0	1	2
9 Traore, Babacar	34	1	14	06.6	3	1	75.0	5	3
10 Seck, Babacar	25	7	4	63.6	1	1	50.0	15	2
11 Diagne, Mansour	19	4	7	41.6	2	0	100.0	10	4
12 Sadio, Claude	20	5	5	44.4	2	2	50.0	12	3
13 Constantino, Claude	27	1	3	25.0	3	1	75.0	5	4
14 Sene, Moussa	—	—	—	—	—	—	—	—	—
15 Gueye, Alioune	15	0	2	00.0	2	0	100.0	2	4
TOTAL		19	47	28.7	16	6	72.7	54	28

ARBITRES REFEREES Ramos, Martín MEX Quintero, Mario CUB

570

GROUPE B MATCH 36
GROUP GAME

URS-CUB 100-66 (52-35, 48-31)

URS	Temps de jeu Time Played	Paniers Baskets			Coups francs Free Throws			Total	Fautes Fouls
		+	-	%	+	-	%		
4 Krikun, Anatoly	14	2	1	66.6	0	0	00.0	4	1
5 Paulauskas, Modest	17	3	4	42.8	4	2	66.6	10	1
6 Sakandelidze, Zurab	14	3	2	60.0	3	1	75.0	9	1
7 Kapranov, Vadim	14	2	1	66.6	0	0	00.0	4	0
8 Selikhov, Yuri	17	2	2	50.0	0	0	00.0	4	4
9 Polivoda, Anatoly	21	3	3	50.0	1	1	50.0	7	3
10 Belov, Sergei	16	2	1	66.6	6	0	100.0	10	2
11 Tomson, Priit	19	0	3	00.0	6	0	100.0	6	2
12 Kovalenko, Sergei	23	7	0	100.0	1	1	50.0	15	4
13 Volnov, Gennady	19	4	5	44.4	4	2	66.6	12	4
14 Lipso, Yaak	12	5	3	62.5	1	1	50.0	11	1
15 Andreev, Vladimir	14	3	4	42.8	1	0	100.0	8	0
TOTAL		36	29	53.7	28	8	77.7	100	23

CUB	Temps de jeu Time Played	Paniers Baskets			Coups francs Free Throws			Total	Fautes Fouls
		+	-	%	+	-	%		
4 Cuesta, Inocencio	—	—	—	—	—	—	—	—	—
5 Herrera, Ruperto	32	1	7	12.5	3	5	37.5	5	3
6 González, Jacinto	31	11	2	84.6	0	0	00.0	22	5
7 Chappe, Pedro	18	2	6	33.3	5	1	83.3	9	5
8 Montalvo, Miguel	7	1	3	25.0	0	0	00.0	2	1
9 Cañizares, Rafael	17	4	3	57.1	0	0	00.0	8	2
10 Pérez, Conrado	22	2	3	40.0	0	0	00.0	4	3
11 Calderón, Miguel	25	1	2	33.3	1	3	25.0	3	4
12 Valdés, César	16	2	4	33.3	0	0	00.0	4	5
13 García, Pablo	—	—	—	—	—	—	—	—	—
14 Del Pozo, Carlos	15	2	9	18.1	1	1	50.0	5	5
15 Standard, Franklin	17	2	0	100.0	0	0	00.0	4	4
TOTAL		28	39	42.6	10	10	50.0	66	37

ARBITRES REFEREES Pacheco, Calvin PRO Fernández, Santiago ESP

GROUPE B MATCH 37
GROUP GAME

BRA-COR 91-59 (42-32, 49-27)

BRA	Temps de jeu Time Played	Paniers Baskets		%	Coups francs Free Throws		%	Total	Fautes Fouls
		+	-		+	-			
4 Machado, Sergio	—	—	—	—	—	—	—	—	—
5 Márques, Wlamir	32	9	8	52.9	3	1	75.0	21	4
6 Maciel, Ubiratan	37	13	3	81.2	0	0	00.0	26	4
7 Scarpini, Celso	—	—	—	—	—	—	—	—	—
8 Garcia, Helio	8	0	1	00.0	0	0	00.0	0	1
9 De Souza, Carmo	14	3	5	37.5	0	0	00.0	6	2
10 Dos Santos, José	—	—	—	—	—	—	—	—	—
11 Menon, Luiz	34	10	5	66.6	0	0	00.0	20	3
12 Succar, Antonio	9	0	0	00.0	0	0	00.0	0	1
13 Simoes, José	36	7	5	58.3	4	0	100.0	18	4
14 De Castro, José	—	—	—	—	—	—	—	—	—
15 Massoni, Carlos	30	0	1	00.0	0	0	00.0	0	3
TOTAL	—	42	28	60.0	7	1	87.5	91	22

COR

4 Ha, Ui-Kon	11	1	2	33.3	1	3	25.0	3	3
5 Lee, Byung-Goo	20	1	5	16.6	3	1	75.0	5	3
6 Kwak, Hyun-Chae	33	6	3	66.6	0	0	00.0	12	3
7 Shin, Dong-Pa	20	4	6	40.0	1	1	50.0	9	0
8 Yoo, Hi-Hyung	24	4	5	44.4	1	1	50.0	9	4
9 Kim, Mu-Hyun	10	1	1	50.0	1	1	50.0	3	1
10 Park, Han	3	0	0	00.0	0	0	00.0	0	0
11 Choi, Jong-Kyu	10	1	0	100.0	0	0	00.0	2	4
12 Kim, In-Kon	21	2	4	33.3	2	0	100.0	6	0
13 Kim, Young-II	27	2	4	33.3	1	1	50.0	5	1
14 Lee, In-Pyo	21	1	6	14.2	3	1	75.0	5	2
15 Lee, Kyung-Jae	—	—	—	—	—	—	—	—	—
TOTAL	—	23	36	38.9	13	9	59.0	59	21

ARBITRES REFEREES Luglini, Elio ITA Schober, Theodor ALE

571

GROUPE B MATCH 38
GROUP GAME

MEX-BUL 73-63 (33-36, 40-27)

MEX	Temps de jeu Time Played	Paniers Baskets		%	Coups francs Free Throws		%	Total	Fautes Fouls
		+	-		+	-			
4 Heredia, Rafael	16	1	4	20.0	0	0	00.0	2	2
5 Guerrero, Arturo	36	5	12	29.4	0	0	00.0	10	3
6 Tiscareño, Fernando	—	—	—	—	—	—	—	—	—
7 Arellano, Miguel	10	0	0	00.0	0	0	00.0	0	1
8 Ayala, Antonio	24	3	5	37.5	0	0	00.0	6	3
9 Asiain, Oscar	6	1	0	100.0	0	0	00.0	2	2
10 Grajeda, Luis	2	0	0	00.0	1	1	50.0	1	0
11 Guzmán, Alejandro	13	2	3	40.0	2	0	100.0	6	5
12 Quintanar, Carlos	25	3	4	42.8	0	0	00.0	6	5
13 Pontvianne, Ricardo	27	4	3	57.1	2	0	100.0	10	1
14 Hatch, John	3	0	0	00.0	0	0	00.0	0	3
15 Raga, Manuel	38	12	9	57.1	6	4	60.0	30	1
TOTAL	—	31	40	43.6	11	5	68.7	73	26

BUL

4 Mihailov, Emil	14	0	2	00.0	3	1	75.0	3	0
5 Boiadjev, Stanislav	7	1	2	00.0	0	0	00.0	2	0
6 Pandov, Pando	31	0	2	00.0	4	0	100.0	4	3
7 Doitchinov, Khristo	9	4	0	100.0	2	0	100.0	10	2
8 Spassov, Valentin	7	0	1	00.0	0	2	00.0	0	2
9 Philipov, Stefan	33	3	2	60.0	0	0	00.0	6	1
10 Dimov, Mintcho	38	8	10	44.0	4	0	100.0	20	1
11 Kirov, Ivailo	10	0	0	00.0	0	0	00.0	0	2
12 Sakhnikov, Dimitar	—	—	—	—	—	—	—	—	—
13 Branzov, Boitcho	24	4	2	66.6	4	4	50.0	12	2
14 Raitchev, Slavey	18	2	2	50.0	0	0	00.0	4	3
15 Khristov, Gueorgui	9	1	0	100.0	0	0	00.0	2	2
TOTAL	—	23	23	50.0	17	7	70.8	63	18

ARBITRES REFEREES Mihalik, Z. G. EUA Hopenhaym, Mario URG

GRUPE A MATCH 39
GROUP GAME

PRO-FIL 89-65 (45-33, 44-32)

PRO	Temps de jeu Time Played	Paniers Baskets			Coups francs Free Throws			Total	Fautes Fouls
		+	-	%	+	-	%		
4 McCadney, Bill	5	0	0	00.0	0	0	00.0	0	1
5 Hatton, Joe	16	3	2	60.0	1	5	16.6	7	5
6 Porrata, Adolfo	22	3	5	37.5	0	0	00.0	6	3
7 Cancel, Angel	23	1	3	25.0	2	4	33.3	4	4
8 Adorno, Rubén	11	2	3	40.0	1	3	25.0	5	0
9 Zamot, Alberto	5	2	0	100.0	1	1	50.0	5	2
10 Dalmau, Raymond	23	5	5	50.0	3	1	75.0	13	5
11 Frontera, Jaime	14	4	2	66.6	3	1	75.0	11	0
12 Córdova, Francisco	1	0	1	00.0	0	0	00.0	0	0
13 Cruz, Teófilo	24	7	2	77.7	4	0	100.0	18	3
14 Gutiérrez, Tomás	23	0	6	00.0	0	2	00.0	0	4
15 Ortiz, Mariano	33	8	6	57.1	4	2	66.6	20	2
TOTAL		35	35	50.0	19	19	50.0	89	29
FIL									
4 Reynoso, Alberto	31	1	3	25.0	4	0	100.0	6	4
5 Mariano, Jaime	7	2	2	50.0	0	0	00.0	4	2
6 Tolentino, Elias	—	—	—	—	—	—	—	—	—
7 Reyes, Renato	17	1	3	25.0	1	3	25.0	3	3
8 Ocampo, Edgardo	9	1	0	100.0	0	0	00.0	2	2
9 Bauzón, Orlando	20	3	2	60.0	0	0	00.0	6	5
10 Rojas, Joaquín	22	2	9	18.1	2	0	100.0	6	5
11 Melencio, Rogelio	9	1	3	25.0	0	0	00.0	2	5
12 Florencio, Danilo	27	9	6	60.0	2	0	100.0	20	4
13 Papa, Adriano	21	2	7	22.2	1	1	50.0	5	3
14 Márquez, Alfonso	22	3	6	33.3	0	0	00.0	6	4
15 Jaworski, Robert	15	1	1	50.0	3	3	50.0	5	2
TOTAL		26	42	38.2	13	7	65.0	65	39
ARBITRES	REFEREES	Kassai, Erwin	HUN	Stoytchev, Borislav	BUL				

572

GRUPE A MATCH 40
GROUP GAME

YUG-ITA 80-69 (29-29, 36-36) PROLONGATION-OVERTIME (15-4)

YUG	Temps de jeu Time Played	Paniers Baskets			Coups francs Free Throws			Total	Fautes Fouls
		+	-	%	+	-	%		
4 Zorga, Aljosa	—	—	—	—	—	—	—	—	—
5 Korac, Radivoj	45	1	8	11.1	16	2	88.8	18	4
6 Maroevic, Zoran	11	0	0	00.0	0	0	00.0	0	4
7 Rajkovic, Trajko	22	3	6	33.3	4	0	100.0	10	5
8 Cvetkovic, Vladimir	5	0	1	00.0	0	0	00.0	0	2
9 Raznatovic, Dragoslav	16	1	4	20.0	0	0	00.0	2	4
10 Daneu, Ivo	43	6	13	31.5	7	1	87.5	19	1
11 Cosic, Kresimir	18	5	3	62.5	6	2	75.0	16	1
12 Solman, Damir	3	0	0	00.0	0	0	00.0	0	1
13 Plecas, Nicola	—	—	—	—	—	—	—	—	—
14 Cermak, Dragutin	28	3	4	42.8	3	1	75.0	9	5
15 Skansi, Petar	34	3	5	37.5	0	0	00.0	6	5
TOTAL		22	44	33.3	36	6	85.3	80	32
ITA									
4 Recalcati, Carlo	5	0	1	00.0	0	0	00.0	0	2
5 Pellanera, Giusto	24	2	3	40.0	4	0	100.0	8	3
6 Lombardi, Gianfranco	17	4	7	36.3	1	1	50.0	9	4
7 Bovone, Enrico	28	1	10	09.0	4	4	50.0	6	4
8 Masini, Massimo	29	3	6	33.3	0	0	00.0	6	5
9 Vittori, Paolo	14	2	3	40.0	4	0	100.0	8	3
10 Vianello, Gabriele	28	3	5	37.5	4	0	100.0	10	5
11 Gatti, Guido	13	2	4	33.3	3	1	75.0	7	5
12 Flaborea, Ottorino	24	5	6	45.5	0	0	00.0	10	4
13 Bufalini, Sauro	27	1	5	16.6	1	1	50.0	3	5
14 Cosmelli, Massimo	16	0	1	00.0	2	0	100.0	2	5
15 Jessi, Gianluigi	—	—	—	—	—	—	—	—	—
TOTAL		23	51	31.0	23	7	76.6	69	45
ARBITRES	REFEREES	Righetto, Renato	BRA	Kokorev, Anatoli	URS				

GRUPE B MATCH 41 OCT 19
GROUP GAME

COR-MAR 76-54 (38-17, 38-37)

COR	Temps de jeu Time Played	Paniers Baskets			%	Coups francs Free Throws			Total	Fautes Fouls
		+	-			+	-			
4	Ha, Ui-Kon	5	0	2	00.0	0	0	00.0	0	0
5	Lee, Byung-Goo	9	0	3	00.0	0	2	00.0	0	1
6	Kwak, Hyun-Chae	14	1	2	33.3	1	1	50.0	3	4
7	Shin, Dong-Pa	32	9	6	60.0	3	1	75.0	21	5
8	Yoo, Hi-Hyung	17	0	0	00.0	4	0	100.0	4	4
9	Kim, Mu-Hyun	28	7	4	63.6	0	0	00.0	14	4
10	Park, Han	1	0	1	00.0	0	0	00.0	0	0
11	Choi, Jong-Kyu	3	0	0	00.0	0	0	00.0	0	1
12	Kim, In-Kon	26	3	3	50.0	1	1	50.0	7	3
13	Kim, Young-II	26	3	7	30.0	4	0	100.0	10	2
14	Lee, In-Pyo	29	5	1	83.3	7	3	70.0	17	5
15	Lee, Kyung-Jae									
	TOTAL		28	29	49.1	20	8	71.4	76	29

MAR

4	Bensiamar, Abdelwahed	28	1	6	14.2	4	0	100.0	6	2
5	Laghrissi, Abderraouf	4	0	1	00.0	0	0	00.0	0	5
6	Alaoui, Mohamed	40	6	12	33.3	0	0	00.0	12	3
7	Seyad, Mokhtar	40	9	14	39.1	6	2	75.0	24	3
8	Bouazzaoui, Fathallah	2	0	0	00.0	0	0	00.0	0	2
9	Belgnaoui, Abdeljebbar									
10	El Yamani, Khalil	24	3	6	33.3	2	2	50.0	8	5
11	Cherradi, Noureddine	7	0	1	00.0	0	0	00.0	0	2
12	Riad, Moulay	5	0	2	00.0	0	0	00.0	0	1
13	Bel Caid, Allal	20	1	2	33.3	0	0	00.0	2	4
14	Sebbar, Abderrahmane	29	1	4	20.0	0	2	00.0	2	3
15	Dioury, Farouk	1	0	0	00.0	0	0	00.0	0	1
	TOTAL		21	48	30.4	12	6	66.6	54	31

ARBITRES REFEREES Fernández, Santiago ESP Quintos, Amadeo FIL

573

GRUPE B MATCH 42
GROUP GAME

POL-BUL 69-67 (35-34, 34-33)

POL	Temps de jeu Time Played	Paniers Baskets			%	Coups francs Free Throws			Total	Fautes Fouls
		+	-			+	-			
4	Korcz, Grzegorz									
5	Trams, Wlodzimierz	16	1	5	16.6	0	0	00.0	2	5
6	Malec, Czeslaw									
7	Cegielski, Henryk	12	1	0	100.0	0	0	00.0	2	1
8	Kasprzak, Andrzej									
9	Jurkiewicz, Edward	30	7	6	53.8	0	2	00.0	14	4
10	Niemiec, Adam									
11	Likszo, Bogdan	40	4	9	30.7	3	1	75.0	11	3
12	Lopatka, Mieczyslaw	38	13	8	61.4	4	2	66.6	30	3
13	Frelkiewicz, Kazimierz	34	0	3	00.0	2	0	100.0	2	4
14	Kwiatkowski, Boleslaw	30	4	4	50.0	0	0	00.0	8	2
15	Pasiorowski, Andrzej									
	TOTAL		30	35	46.1	9	5	64.2	69	22

BUL

4	Miihailov, Emil	3	0	0	00.0	0	0	00.0	0	2
5	Boiadjev, Stanislav									
6	Pandov, Pando	29	4	2	66.6	0	0	00.0	8	2
7	Doitchinov, Khristo	34	4	0	100.0	7	1	87.5	15	2
8	Spassov, Valentin	11	0	2	00.0	0	0	00.0	0	3
9	Philipov, Stefan	21	3	2	60.0	0	0	00.0	6	2
10	Dimov, Mintcho	26	7	4	63.6	0	0	00.0	14	1
11	Kirov, Ivailo	9	0	1	00.0	1	1	50.0	1	2
12	Sakhanikov, Dimitar	4	0	0	00.0	0	0	00.0	0	0
13	Branzov, Boitcho	36	6	8	42.8	4	0	100.0	16	3
14	Raitchev, Slavec	3	0	0	00.0	0	0	00.0	0	0
15	Khristov, Gueorgui	24	3	2	60.0	1	3	25.0	7	2
	TOTAL		27	21	56.2	13	5	72.2	67	19

ARBITRES REFEREES Lichty, Wayne EUA Pacheco, Calvin PRO

GRUPE A MATCH
GROUP GAME 43

FIL-SEN 80-68 (33-29, 47-39)

FIL	Temps de jeu Time Played	Paniers Baskets		%	Coups francs Free Throws		%	Total	Fautes Fouls
		+	-		+	-			
4 Reynoso, Alberto	19	1	1	50.0	0	0	00.0	2	3
5 Mariano, Jaime	8	3	3	50.0	0	0	00.0	6	2
6 Tolentino, Elias	29	4	3	57.1	2	2	50.0	10	3
7 Reyes, Renato	7	3	4	42.8	0	0	00.0	6	2
8 Ocampo, Edgardo	5	0	0	00.0	0	0	00.0	0	1
9 Bauzón, Orlando	22	1	5	16.6	2	0	100.0	4	4
10 Rojas, Joaquín	5	1	0	100.0	0	0	00.0	2	1
11 Melencio, Rogelio	16	2	0	100.0	0	0	00.0	4	2
12 Florencio, Danilo	12	4	3	57.1	0	0	00.0	8	4
13 Papa, Adriano	29	9	7	56.2	2	0	100.0	20	1
14 Márquez, Alfonso	28	3	2	60.0	0	0	00.0	6	2
15 Jaworski, Robert	20	5	2	71.4	2	0	100.0	12	4
TOTAL		36	30	54.5	8	2	80.0	80	29

SEN										
SEN	Temps de jeu Time Played	Paniers Baskets		%	Coups francs Free Throws		%	Total	Fautes Fouls	
		+	-		+	-				
4 Fall, Cheikh	18	1	6	14.2	0	0	00.0	2	1	
5 Diop, Papa	13	2	3	40.0	1	1	50.0	5	3	
6 N'Diaye, Mousse	6	0	1	00.0	0	0	00.0	0	3	
7 Camara, Doudou	19	2	1	66.6	1	3	25.0	5	4	
8 Dia, Babacar	17	5	4	55.5	3	1	75.0	13	0	
9 Traore, Babacar	40	8	10	44.0	3	3	50.0	19	1	
10 Seck, Babacar	23	5	5	50.0	3	3	50.0	13	4	
11 Diagne, Mansour	10	3	4	42.8	0	0	00.0	6	5	
12 Sadio, Claude	12	1	5	16.6	1	1	50.0	3	4	
13 Constantino, Claude	30	0	3	00.0	0	0	00.0	0	4	
14 Sene, Moussa	12	1	0	100.0	0	2	00.0	2	4	
15 Gueye, Alioune	12	1	0	100.0	0	2	00.0	2	4	
TOTAL		28	42	40.0	12	14	46.1	68	33	

ARBITRES	REFEREES	Ugalde, Eugenio	MEX	Raczynski, Czeslaw	POL
----------	----------	-----------------	-----	--------------------	-----

574

GRUPE A MATCH
GROUP GAME 44

PRO-PAN 80-69 (42-36, 38-33)

PRO	Temps de jeu Time Played	Paniers Baskets		%	Coups francs Free Throws		%	Total	Fautes Fouls
		+	-		+	-			
4 McCadney, Bill	5	0	1	00.0	0	0	00.0	0	0
5 Hatton, Joe	1	0	0	00.0	0	0	00.0	0	0
6 Porrata, Adolfo	24	1	5	16.6	0	0	00.0	2	2
7 Cancel, Angel	4	1	0	100.0	0	0	00.0	2	1
8 Adorno, Rubén	31	9	7	56.2	5	3	62.5	23	3
9 Zamot, Alberto	—	—	—	—	—	—	—	—	—
10 Dalmau, Raymond	17	5	9	35.7	0	0	00.0	10	0
11 Frontera, Jaime	19	2	6	25.0	4	4	50.0	8	0
12 Córdova, Francisco	8	0	0	00.0	1	1	50.0	1	4
13 Cruz, Teófilo	36	5	4	55.5	3	1	75.0	13	5
14 Gutiérrez, Tomás	18	2	5	28.5	2	2	50.0	6	2
15 Ortiz, Mariano	37	5	7	41.6	5	5	50.0	15	4
TOTAL		30	44	40.5	20	16	55.5	80	21

PAN										
PAN	Temps de jeu Time Played	Paniers Baskets		%	Coups francs Free Throws		%	Total	Fautes Fouls	
		+	-		+	-				
4 Checa, Francisco	9	0	1	00.0	0	0	00.0	0	1	
5 Osorio, Julio	31	0	6	00.0	2	2	50.0	2	3	
6 Blades, Percibal	21	3	1	75.0	0	0	00.0	6	5	
7 Malcon, Calixto	—	—	—	—	—	—	—	—	—	
8 Alvarado, Nicolás	—	—	—	—	—	—	—	—	—	
9 Agard, Ernesto	18	0	2	00.0	0	0	00.0	0	2	
10 Reyes, Ramón	9	1	4	20.0	0	0	00.0	2	3	
11 Peralta, Davis	40	10	17	37.0	7	1	87.5	27	0	
12 Webb, Norris	11	1	2	33.3	0	0	00.0	2	4	
13 Sinclair, Luis	14	4	3	57.1	0	0	00.0	8	5	
14 Rivas, Pedro	23	5	11	31.2	6	4	60.0	16	2	
15 Ellis, Eliecer	24	3	5	37.5	0	2	00.0	6	4	
TOTAL		27	52	34.1	15	9	62.5	69	29	

ARBITRES	REFEREES	Kokorev, Anatoli	URS	Quintero, Mario	CUB
----------	----------	------------------	-----	-----------------	-----

GRUPE B MATCH 45
GROUP GAME

BRA-CUB 84-68 (47-37, 37-31)

BRA	Temps de jeu Time Played	Paniers Baskets		%	Coups francs Free Throws		%	Total	Fautes Fouls
		+	-		+	-			
4 Machado, Sergio	10	0	2	00.0	0	0	00.0	0	5
5 Marques, Wlamir	27	5	8	38.4	3	1	75.0	13	4
6 Maciel, Ubiratan	29	5	4	55.5	2	2	50.0	12	3
7 Scarpini, Celso	10	1	0	100.0	2	2	50.0	4	3
8 Garcia, Helio	13	2	1	66.6	0	0	00.0	4	3
9 De Souza, Carmo	19	8	6	57.1	1	1	50.0	17	1
10 Dos Santos, José	6	1	0	100.0	1	1	50.0	3	0
11 Menon, Luiz	16	8	3	72.7	1	1	50.0	17	1
12 Succar, Antonio	17	0	1	00.0	0	0	00.0	0	4
13 Simoes, José	25	6	1	85.7	0	0	00.0	12	2
14 De Castro, José	2	0	1	00.0	0	0	00.0	0	1
15 Massoni, Carlos	26	1	3	25.0	0	0	00.0	2	1
TOTAL		37	30	55.2	10	8	55.5	84	28

CUB

4 Cuesta, Inocente	—	—	—	—	—	—	—	—	—
5 Herrera, Ruperto	36	4	7	36.3	3	1	75.0	11	3
6 González, Jacinto	24	3	5	37.5	0	0	00.0	6	5
7 Chappe, Pedro	21	6	3	66.6	1	1	50.0	13	5
8 Montalvo, Miguel	10	0	0	00.0	0	0	00.0	0	1
9 Cañizares, Rafael	19	2	5	28.5	2	0	100.0	6	5
10 Pérez, Conrado	24	2	5	28.5	2	0	100.0	6	2
11 Calderón, Miguel	16	4	2	66.6	0	0	00.0	8	3
12 Valdés, César	16	1	1	50.0	0	0	00.0	2	3
13 García, Pablo	21	5	5	50.0	3	3	50.0	13	0
14 Del Pozo, Carlos	9	0	1	00.0	0	0	00.0	0	2
15 Standard, Franklin	4	1	0	100.0	1	1	50.0	3	0
TOTAL		28	34	45.0	12	6	66.6	68	29

ARBITRES REFEREES Mihalik, Z. G. EUA Belosevic, Obrad YUG

575

GRUPE A MATCH 46
GROUP GAME

YUG-ESP 92-79 (52-35, 40-44)

YUG	Temps de jeu Time Played	Paniers Baskets		%	Coups francs Free Throws		%	Total	Fautes Fouls
		+	-		+	-			
4 Zorga, Aljosa	1	0	0	00.0	2	0	100.0	2	0
5 Korac, Radivoj	20	6	4	60.0	2	2	50.0	14	2
6 Maroevic, Zoran	4	0	0	00.0	0	0	00.0	0	4
7 Rajkovic, Trajko	10	0	0	00.0	2	0	100.0	2	4
8 Cvetkovic, Vladimir	26	10	0	100.0	3	1	75.0	23	4
9 Rasnatovic, Dragoslav	14	0	4	00.0	0	0	00.0	0	2
10 Daneu, Ivo	36	4	4	50.0	0	0	00.0	8	2
11 Cosic, Kresimir	15	5	2	71.4	5	1	83.3	15	1
12 Solman, Damir	17	3	5	37.5	1	1	50.0	7	1
13 Plecas, Nicola	4	1	0	100.0	0	0	00.0	2	2
14 Cermak, Dragutin	25	5	5	50.0	0	0	00.0	10	4
15 Skansi, Petar	28	4	6	40.0	1	1	50.0	9	1
TOTAL		38	30	55.8	16	6	72.7	92	27

ESP

4 Martínez, Juan	4	0	0	00.0	0	0	00.0	0	0
5 Ramos, Vicente	18	1	6	14.2	0	0	00.0	2	2
6 Santiago, Luis	—	—	—	—	—	—	—	—	—
7 Codina, Jesús	18	1	6	14.2	0	0	00.0	2	3
8 Margall, Enrique	18	6	2	75.0	2	0	100.0	14	4
9 Nava, Antonio	1	1	0	100.0	0	0	00.0	2	0
10 Rodríguez, Emiliano	28	9	8	52.9	4	2	66.6	22	3
11 Luyk, Clifford	17	0	3	00.0	2	2	50.0	2	4
12 Sagi Vela, José	27	6	7	46.1	0	0	00.0	12	4
13 Buscato, Francisco	31	4	5	44.4	2	4	33.3	10	0
14 Alocen, Lorenzo	16	0	4	00.0	2	2	50.0	2	1
15 Martínez, Alfonso	22	4	2	66.6	3	3	50.0	11	3
TOTAL		32	43	42.6	15	13	53.5	79	24

ARBITRES REFEREES Kanaka, Ryoichi JPN Stoytchev, Borislav BUL

GRUPE **A** MATCH **47**
GROUP **A** GAME

EUA-ITA **100-61** (48-27, 52-34)

EUA	Temps de jeu Time Played	Paniers Baskets		%	Coups francs Free Throws		%	Total	Fautes Fouls
		+	-		+	-			
4 Clawson, John	9	2	0	100.0	1	1	50.0	5	2
5 Spain, Ken	12	1	0	100.0	1	3	25.0	3	2
6 White, Joseph	17	6	7	46.1	1	1	50.0	13	1
7 Barrett, Michael	16	6	3	66.6	0	0	00.0	12	5
8 Haywood, Spencer	13	11	3	78.5	4	2	66.6	26	2
9 Scott, Charles	23	2	4	33.3	0	0	00.0	4	2
10 Hosket, Bill	12	3	1	75.0	0	0	00.0	6	5
11 Fowler, Calvin	19	3	3	50.0	0	0	00.0	6	3
12 Silliman, Michael	34	3	5	37.5	2	0	100.0	8	3
13 Saulters, Glynn	9	4	1	80.0	2	0	100.0	10	1
14 King, James	14	2	0	100.0	1	1	50.0	5	2
15 Dee, Donald	22	1	0	100.0	0	0	00.0	2	2
TOTAL		44	27	61.9	12	8	60.0	100	30

ITA

4 Recalcati, Carlo	21	0	5	00.0	4	0	100.0	4	5
5 Pellanera, Giusto	15	1	2	33.3	0	0	00.0	2	4
6 Lombardi, Gianfranco	11	1	1	50.0	0	0	00.0	2	3
7 Bovone, Enrico	23	4	7	36.3	1	1	50.0	9	1
8 Masini, Massimo	17	2	5	28.5	2	2	50.0	6	2
9 Vittori, Paolo	12	0	2	00.0	2	0	100.0	2	2
10 Vianello, Gabriele	19	0	3	00.0	0	0	00.0	0	1
11 Gatti, Guido	18	4	2	66.6	4	0	100.0	12	3
12 Flaborea, Ottorino	25	4	3	57.1	5	1	83.3	13	1
13 Bufalini, Sauro	15	3	3	50.0	1	1	50.0	7	5
14 Cosmelli, Massimo	15	1	1	50.0	0	0	00.0	2	3
15 Jessi, Gianluigi	9	1	0	50.0	0	0	00.0	2	0
TOTAL		21	35	37.5	19	5	79.1	61	30

ARBITRES REFEREES Rae, Allen CAN Schober, Theodor ALE

576

GRUPE **B** MATCH **48**
GROUP **B** GAME

URS-MEX **82-62** (45-25, 37-37)

URS	Temps de jeu Time Played	Paniers Baskets		%	Coups francs Free Throws		%	Total	Fautes Fouls
		+	-		+	-			
4 Krikun, Anatoly	16	2	0	100.0	0	0	00.0	4	4
5 Paulauskas, Modest	22	7	6	53.8	3	1	75.0	17	3
6 Sakandelidze, Zurab	19	7	2	77.7	1	1	50.0	15	3
7 Kapranov, Vadim	19	0	6	00.0	2	0	100.0	2	3
8 Selikhov, Yuri	11	0	1	00.0	1	1	50.0	1	3
9 Polivoda, Anatoly	17	3	0	100.0	1	3	25.0	7	2
10 Belov, Sergei	20	3	2	60.0	2	0	100.0	8	2
11 Tomson, Prit	22	3	1	75.0	0	0	00.0	6	4
12 Kovalenko, Sergei	14	0	2	00.0	4	0	100.0	4	2
13 Volnov, Gennady	16	3	2	60.0	2	0	100.0	8	4
14 Lipsa, Yaak	15	4	1	80.0	0	2	00.0	8	2
15 Andreev, Vladimir	9	1	0	100.0	0	0	00.0	2	1
TOTAL		33	23	58.9	16	8	66.6	82	33

MEX

4 Heredia, Rafael	15	0	2	00.0	2	0	100.0	2	2
5 Guerrero, Arturo	27	4	10	28.5	2	0	100.0	10	3
6 Tiscareño, Fernando	16	0	2	00.0	0	0	00.0	0	1
7 Arellano, Miguel	1	0	0	00.0	0	0	00.0	0	4
8 Ayala, Antonio	16	2	3	40.0	0	0	00.0	4	3
9 Asiain, Oscar	5	1	0	100.0	1	1	50.0	3	0
10 Grajeda, Luis	15	2	4	33.3	0	0	00.0	4	2
11 Guzmán, Alejandro	24	9	9	50.0	2	2	50.0	20	3
12 Quintanar, Carlos	12	0	2	00.0	0	0	00.0	0	5
13 Pontvianne, Ricardo	28	1	4	20.0	4	0	100.0	6	4
14 Hatch, John	4	0	2	00.0	0	0	00.0	0	0
15 Raga, Manuel	37	6	6	50.0	1	3	25.0	13	1
TOTAL		25	44	36.2	12	6	66.6	62	28

ARBITRES REFEREES Righetto, Renato BRA Kassai, Erwin HUN

GROUP A MATCH 49
GROUP GAME

OCT 20

PAN-SEN 94-79 (48-29, 46-50)

PAN	Temps de jeu Time Played	Paniers Baskets		%	Coups francs Free Throws		%	Total	Fautes Fouls	
		+	-		+	-				
4	Checa, Francisco	9	1	1	50.0	0	2	00.0	2	0
5	Osorio, Julio	20	5	2	71.4	3	1	75.0	13	0
6	Blades, Percibal	15	1	4	20.0	0	0	00.0	2	3
7	Malcon, Calixto	—	—	—	—	—	—	—	—	—
8	Alvarado, Nicolás	20	5	6	45.5	1	2	00.0	11	5
9	Agard, Ernesto	21	3	5	37.5	0	0	00.0	6	4
10	Reyes, Ramón	9	0	1	00.0	0	0	00.0	0	5
11	Peralta, Davis	31	13	10	56.5	0	0	00.0	26	0
12	Webb, Norris	10	1	1	50.0	1	3	25.0	3	4
13	Sinclair, Luis	16	2	3	40.0	2	0	100.0	6	2
14	Rivas, Pedro	33	10	6	62.5	3	2	66.6	23	2
15	Ellis, Eliecer	16	1	3	25.0	0	0	00.0	2	2
	TOTAL	42	42	42	50.0	10	10	50.0	94	27
SEN										
4	Fall, Cheikh	10	5	3	62.5	0	0	00.0	10	0
5	Diop, Papa	15	0	1	00.0	0	0	00.0	0	1
6	N'diaye, Mousse	12	1	1	50.0	1	1	50.0	3	1
7	Camara, Doudou	13	4	3	57.1	2	2	50.0	10	4
8	Dia, Babacar	18	5	1	83.3	2	0	100.0	12	4
9	Traore, Babacar	40	2	7	22.2	0	0	00.0	4	2
10	Seck, Babacar	13	8	5	61.5	10	4	71.4	26	4
11	Diagne, Mansour	12	1	7	12.5	2	0	100.0	4	2
12	Sadio, Claude	15	3	0	100.0	0	0	00.0	6	2
13	Constantino, Claude	25	0	0	00.0	4	0	100.0	4	3
14	Sene, Moussa	—	—	—	—	—	—	—	—	—
15	Gueye, Alioune	27	0	1	00.0	0	2	00.0	0	3
	TOTAL	29	29	29	50.0	21	9	70.0	79	26
ARBITRES	REFEREES	Saldivar, Arnulfo	MEX	Stoytchev, Borislav	BUL					

577

GROUP B MATCH 50
GROUP GAME

CUB-MAR 89-53 (48-22, 41-31)

CUB	Temps de jeu Time Played	Paniers Baskets		%	Coups francs Free Throws		%	Total	Fautes Fouls	
		+	-		+	-				
4	Cuesta, Inocente	—	—	—	—	—	—	—	—	
5	Herrera, Ruperto	19	6	3	66.6	0	0	00.0	12	1
6	González, Jacinto	14	5	1	83.3	2	0	100.0	12	1
7	Chappe, Pedro	12	3	3	50.0	0	0	00.0	6	0
8	Montalvo, Miguel	12	4	1	80.0	0	0	00.0	8	4
9	Cañizares, Rafael	13	1	3	25.0	0	0	00.0	2	3
10	Pérez, Conrado	13	1	5	16.6	0	0	00.0	2	0
11	Calderón, Miguel	27	5	4	55.5	0	0	00.0	10	2
12	Valdés, César	27	3	5	37.5	1	1	50.0	7	4
13	García, Pablo	26	9	5	64.2	3	1	75.0	21	1
14	Del Pozo, Carlos	13	0	1	00.0	1	1	50.0	1	2
15	Standard, Franklin	21	4	2	66.6	0	0	00.0	8	2
	TOTAL	41	33	33	55.4	7	3	70.0	89	20
MAR										
4	Bensiamar, Abdelwahed	10	0	3	00.0	2	0	100.0	2	0
5	Laghrissi, Abderraouf	—	—	—	—	—	—	—	—	—
6	Alaoui, Mohamed	40	4	10	28.5	0	0	00.0	8	3
7	Seyad, Mokhtar	40	13	15	46.4	6	4	60.0	32	1
8	Bouazzaoui, Fathallah	—	—	—	—	—	—	—	—	—
9	Belgnaoui, Abdeljebbar	7	0	3	00.0	0	0	00.0	0	1
10	El Yamani, Khalil	14	1	8	11.1	0	0	00.0	2	3
11	Cherradi, Noureddine	—	—	—	—	—	—	—	—	—
12	Riad, Moulay	16	0	4	00.0	0	0	00.0	0	4
13	Bel Caid, Allai	40	2	1	66.6	0	0	00.0	4	1
14	Sebbar, Abderrahmane	33	2	3	40.0	1	1	50.0	5	3
15	Dioury, Farouk	—	—	—	—	—	—	—	—	—
	TOTAL	22	47	47	31.8	9	5	64.2	53	16
ARBITRES	REFEREES	Pacheco, Calvin	PRO	Schober, Theodor	ALE					

GRUPE B MATCH 51
GROUP B GAME

BUL-COR 64-60 (32-33, 32-27)

BUL	Temps de jeu Time Played	Paniers Baskets			%	Coups francs Free Throws			Total	Fautes Fouls
		+	-	%		+	-	%		
4 Mihailov, Emil	—	—	—	—	—	—	—	—	—	—
5 Boiadjev, Stanislav	9	0	3	00.0	0	0	00.0	0	1	
6 Pandov, Pando	22	1	3	25.0	2	0	100.0	4	3	
7 Doitchinov, Khristo	18	3	1	75.0	1	1	50.0	7	1	
8 Spassov, Valentin	12	0	2	00.0	2	0	100.0	2	2	
9 Philipov, Stefan	13	1	2	33.3	0	0	00.0	2	3	
10 Dimov, Mintcho	27	2	5	28.5	0	0	00.0	4	2	
11 Kirov, Ivailo	19	4	0	100.0	2	0	100.0	10	1	
12 Sakhanikov, Dimitar	17	2	2	50.0	0	0	00.0	4	5	
13 Branzov, Boitcho	24	7	3	70.0	7	1	87.5	21	2	
14 Raitchev, Slavey	16	2	3	40.0	0	0	00.0	4	3	
15 Khristov, Gueorgui	23	0	0	00.0	6	0	100.0	6	4	
TOTAL		22	24	47.8	20	2	90.9	64	27	

COR

4 Ha, Ui-Kon	—	—	—	—	—	—	—	—	—
5 Lee, Byung-Go	—	—	—	—	—	—	—	—	—
6 Kwak, Hyun-Chae	20	6	5	54.5	0	0	00.0	12	2
7 Shin, Dong-Pa	40	7	5	58.3	4	2	66.6	18	4
8 Yoo, Hyung	27	2	1	66.6	3	1	75.0	7	4
9 Kim, Mu-Hyun	9	0	4	00.0	0	0	00.0	0	2
10 Park, Han	3	0	0	00.0	0	0	00.0	0	1
11 Choi, Jong-Kyu	9	0	1	00.0	0	0	00.0	0	4
12 Kim, In-Kon	31	1	2	33.3	0	0	00.0	2	5
13 Kim, Young-Il	28	1	1	50.0	1	1	50.0	3	5
14 Lee, In Pyo	28	2	1	66.6	2	2	50.0	18	4
TOTAL		25	20	55.5	10	6	62.5	60	31

ARBITRES REFEREES Bolsevic, Obrad YUG Gough, Leslie AUS

578

GRUPE A MATCH 52
GROUP A GAME

ITA-ESP 98-86 (53-40, 45-46)

ITA	Temps de jeu Time Played	Paniers Baskets			%	Coups francs Free Throws			Total	Fautes Fouls
		+	-	%		+	-	%		
4 Recalcati, Carlo	11	1	2	33.3	0	0	00.0	2	2	
5 Pellanera, Giusto	14	3	3	50.0	0	2	00.0	6	2	
6 Lombardi, Gianfranco	—	—	—	—	—	—	—	—	—	
7 Bovone, Enrico	—	—	—	—	—	—	—	—	—	
8 Masini, Massimo	38	15	5	75.0	2	0	100.0	32	3	
9 Vittori, Paolo	—	—	—	—	—	—	—	—	—	
10 Vianello, Gabriele	29	5	6	45.5	2	0	100.0	12	0	
11 Gatti, Guido	11	3	2	60.0	2	2	50.0	8	1	
12 Flaborea, Ottorino	27	5	3	62.5	4	2	66.6	14	4	
13 Bufalini, Sauro	15	0	0	00.0	0	0	00.0	0	3	
14 Cosmelli, Massimo	31	5	1	83.3	2	0	100.0	12	3	
15 Jessi, Gianluigi	24	6	3	66.6	0	0	00.0	12	2	
TOTAL		43	25	63.2	12	6	66.6	98	20	

ESP

4 Martínez, Juan	—	—	—	—	—	—	—	—	—
5 Ramos, Vicente	16	1	1	50.0	0	0	00.0	2	2
6 Santiago, Luis	1	0	0	00.0	0	0	00.0	0	1
7 Codina, Jesús	27	5	3	62.5	0	0	00.0	10	2
8 Margall, Enrique	30	8	6	57.1	2	0	100.0	18	5
9 Nava, Antonio	5	2	1	66.6	4	0	100.0	8	2
10 Rodríguez, Emiliano	31	4	7	36.3	2	0	100.0	10	0
11 Luyk, Clifford	—	—	—	—	—	—	—	—	—
12 Sagi Vela, José	20	4	6	40.0	0	0	00.0	8	5
13 Buscato, Francisco	24	2	5	28.5	0	0	00.0	4	3
14 Allocen, Lorenzo	24	7	5	58.3	0	2	00.0	14	5
15 Martínez, Alfonso	22	6	8	42.8	0	0	00.0	12	2
TOTAL		39	42	48.1	8	2	80.0	86	27

ARBITRES REFEREES Righetto, Renato BRA Mihalik, Z.G. EUA

GRUPE A MATCH 53
GROUP GAME

YUG-FIL 89-68 (46-30, 43-38)

YUG	Temps de jeu Time Played	Paniers Baskets		%	Coups francs Free Throws		%	Total	Fautes Fouls
		+	-		+	-			
4 Zorga, Aljosa	25	5	2	71.4	0	0	00.0	10	5
5 Korak, Radivoj	—	—	—	—	—	—	—	—	—
6 Maroevic, Zoran	38	9	2	81.8	0	2	00.0	18	2
7 Rajkovic, Trajko	—	—	—	—	—	—	—	—	—
8 Cvetkovic, Vladimir	6	4	2	66.6	2	0	100.0	10	0
9 Raznatovic, Dragoslav	22	4	7	36.3	0	0	00.0	8	5
10 Daneu, Ivo	—	—	—	—	—	—	—	—	—
11 Cosic, Kresimir	2	0	0	00.0	0	0	00.0	0	0
12 Solman, Damir	40	4	8	33.3	1	1	50.0	9	4
13 Plecas, Nicola	32	4	6	40.0	9	1	90.0	17	2
14 Cermak, Dragutin	20	3	4	42.8	2	0	100.0	8	3
15 Skansi, Petar	15	4	4	50.0	1	1	50.0	9	3
TOTAL		37	35	51.3	15	5	75.0	89	24

FIL

4 Reynoso, Alberto	8	1	0	100.0	1	1	50.0	3	5
5 Mariano, Jaime	4	0	0	00.0	0	0	00.0	0	1
6 Tolentino, Elias	7	1	2	33.3	0	0	00.0	2	0
7 Reyes, Renato	24	6	8	42.8	0	0	00.0	12	3
8 Ocampo, Edgardo	7	0	1	00.0	0	0	00.0	0	4
9 Bauzón, Oriando	27	2	7	22.2	1	1	50.0	5	2
10 Rojas, Joaquin	24	1	6	14.2	0	0	00.0	2	4
11 Melencio, Rogelio	32	3	6	33.3	4	0	100.0	10	4
12 Florencio, Danilo	21	2	5	28.5	2	2	50.0	6	2
13 Papa, Adriano	—	—	—	—	—	—	—	—	—
14 Márquez, Alfonso	25	5	4	55.5	2	0	100.0	12	4
15 Jaworski, Robert	21	7	6	53.8	2	0	100.0	16	4
TOTAL		28	45	38.3	12	4	75.0	68	33

ARBITRES REFEREES Rae, Allen CAN Díaz, Rodolfo MEX

579

GRUPE B MATCH 54
GROUP GAME

MEX-POL 68-63 (40-28, 28-35)

MEX	Temps de jeu Time Played	Paniers Baskets		%	Coups francs Free Throws		%	Total	Fautes Fouls
		+	-		+	-			
4 Heredia, Rafael	13	3	2	60.0	0	0	00.0	6	2
5 Guerrero, Arturo	32	7	4	63.6	6	0	100.0	20	0
6 Tiscareño, Fernando	—	—	—	—	—	—	—	—	—
7 Arellano, Miguel	27	1	2	33.3	0	0	00.0	2	2
8 Ayala, Antonio	20	1	5	16.6	2	2	50.0	4	2
9 Asiain, Oscar	—	—	—	—	—	—	—	—	—
10 Grajeda, Luis	10	3	1	75.0	0	0	00.0	6	2
11 Guzmán, Alejandro	20	0	3	00.0	0	0	00.0	0	4
12 Quintanar, Carlos	17	1	2	33.3	0	0	00.0	2	4
13 Pontvianne, Ricardo	23	5	4	55.5	2	0	100.0	12	3
14 Hatch, John	—	—	—	—	—	—	—	—	—
15 Raga, Manuel	38	5	8	38.4	6	0	100.0	16	0
TOTAL		26	31	45.6	16	2	88.8	68	19

POL

4 Korcz, Grzegorz	—	—	—	—	—	—	—	—	—
5 Trams, Wlodzimierz	22	6	3	66.6	0	0	00.0	12	0
6 Malec, Czeslaw	8	0	2	00.0	0	0	00.0	0	1
7 Cegielski, Henryk	19	0	4	00.0	0	2	00.0	0	4
8 Kasprzak, Andrzej	—	—	—	—	—	—	—	—	—
9 Jurkiewicz, Edward	9	0	3	00.0	2	0	100.0	2	1
10 Niemiec, Adam	9	0	2	00.0	0	0	00.0	0	3
11 Likszo, Bogdan	33	2	3	40.0	2	2	50.0	6	3
12 Lopatka, Mieczyslaw	38	14	8	63.6	3	3	50.0	31	3
13 Frelkiewicz, Kazimierz	40	4	3	57.1	0	0	00.0	8	0
14 Kwiatkowski, Boleslaw	22	2	5	28.5	0	0	00.0	4	5
15 Pasiorowski, Andrzej	—	—	—	—	—	—	—	—	—
TOTAL		28	33	45.9	7	7	50.0	63	20

ARBITRES REFEREES Kanaka, Ryoichi JPN Fernández, Santiago ESP

GROUPE A MATCH 55
GROUP GAME

EUA-PRO 61-56 (30-29, 31-27)

EUA	Temps de jeu Time Played	Paniers Baskets		%	Coups francs Free Throws		%	Total	Fautes Fouls
		+	-		+	-			
4 Clawson, John	5	1	2	33.3	0	0	00.0	2	0
5 Spain, Ken	—	—	—	—	—	—	—	—	—
6 White, Joseph	36	1	8	11.1	0	0	00.0	2	4
7 Barrett, Michael	8	2	2	50.0	0	2	00.0	4	1
8 Haywood, Spencer	40	8	2	80.0	5	3	62.5	21	2
9 Scott, Charles	35	3	1	75.0	5	3	62.5	11	3
10 Hosket, Bill	—	—	—	—	—	—	—	—	—
11 Fowler, Calvin	24	3	0	100.0	1	1	50.0	7	3
12 Silliman, Michael	35	5	6	45.5	2	0	100.0	12	2
13 Saulters, Glynn	7	0	0	00.0	0	0	00.0	0	3
14 King, James	10	0	0	00.0	2	0	100.0	2	1
15 Dee, Donald	—	—	—	—	—	—	—	—	—
TOTAL		23	21	52.2	15	9	62.5	61	19

PRO

4 McCadney, Bill	15	0	2	00.0	1	1	50.0	1	2
5 Hatton, Joe	3	1	0	100.0	0	0	00.0	2	1
6 Porrata, Adolfo	30	3	3	50.0	6	0	100.0	12	5
7 Cancel, Angel	7	0	1	00.0	1	1	50.0	1	4
8 Adorno, Ruben	25	3	3	50.0	0	2	00.0	6	4
9 Zamot, Alberto	—	—	—	—	—	—	—	—	—
10 Dalmau, Raymond	16	1	3	25.0	0	0	00.0	2	4
11 Frontera, Jaime	23	4	5	44.4	0	0	00.0	8	2
12 Córdoba, Francisco	—	—	—	—	—	—	—	—	—
13 Cruz, Teófilo	40	5	5	50.0	0	0	00.0	10	4
14 Gutiérrez, Tomás	1	0	0	00.0	0	0	00.0	0	1
15 Ortiz, Mariano	40	5	4	55.5	4	2	66.6	14	2
TOTAL		22	26	45.8	12	6	66.6	56	29

ARBITRES REFEREES Ugalde, Eugenio MEX Louzada, Helio BRA

580

GROUPE B MATCH 56
GROUP GAME

URS-BRA 76-65 (39-38, 37-27)

URS	Temps de jeu Time Played	Paniers Baskets		%	Coups francs Free Throws		%	Total	Fautes Fouls
		+	-		+	-			
4 Krikun, Anatoly	4	0	0	00.0	0	0	00.0	0	2
5 Paulauskas, Modest	31	9	5	64.2	12	2	85.7	30	4
6 Sakandelidze, Zurab	16	2	1	66.6	1	1	50.0	5	2
7 Kapranov, Vadim	6	0	0	00.0	0	0	00.0	0	1
8 Selikhov, Yuri	9	0	1	00.0	0	0	00.0	0	3
9 Polivoda, Anatoly	25	4	2	66.6	8	0	100.0	16	4
10 Belov, Sergei	22	2	6	25.0	0	0	00.0	4	3
11 Tomson, Prijit	21	1	1	50.0	2	0	100.0	4	0
12 Kovalenko, Sergei	—	—	—	—	—	—	—	—	—
13 Volnov, Gennady	21	1	9	10.0	7	3	70.0	9	5
14 Lipso, Yaak	24	2	3	40.0	1	1	50.0	5	2
15 Andreev, Vladimir	21	1	2	33.3	1	1	50.0	3	3
TOTAL		22	30	42.3	32	8	80.0	76	29

BRA

4 Machado, Sergio	8	0	0	00.0	0	2	00.0	0	5
5 Márques, Wlami	37	7	5	58.3	0	0	00.0	14	3
6 Maciel, Ubiratan	24	3	5	37.5	4	2	66.6	10	5
7 Scarpini, Celso	5	1	0	100.0	0	0	00.0	2	5
8 Garcia, Helio	—	—	—	—	—	—	—	—	—
9 De Souza, Carmo	12	1	2	33.3	0	0	00.0	2	3
10 Dos Santos, José	3	0	0	00.0	0	0	00.0	0	0
11 Menon, Luiz	40	5	11	31.2	4	0	100.0	14	4
12 Succar, Antonio	11	0	2	00.0	0	0	00.0	0	5
13 Simoes, José	20	4	3	57.1	0	0	00.0	8	5
14 De Castro, José	—	—	—	—	—	—	—	—	—
15 Massoni, Carlos	40	4	3	57.1	7	1	87.5	15	3
TOTAL		25	31	44.6	15	5	75.0	65	38

ARBITRES REFEREES Luglini, Elio ITA Hopenhaym, Mario URG

RESUME
SUMMARY

GROUPE A
GROUP

							EUA	PRO	ITA	PAN	YUG	FIL	SEN	ESP
1	EUA	7	7	0	599—392	14	EUA *	61—56	100—61	95—60	73—58	96—75	93—36	81—46
2	YUG	7	6	1	592—511	13	PRO	56—61	*	65—68	80—69	72—93	89—65	69—26
3	ITA	7	5	2	562—539	12	ITA	61—100	68—65	*	94—87	69—80	91—66	81—55
4	ESP	7	4	3	557—548	11	PAN	60—95	69—80	87—94	*	85—96	95—92	94—79
5	PRO	7	3	4	493—468	10	YUG	58—73	93—72	80—69	96—85	*	89—68	84—65
6	PAN	7	2	5	572—624	9	FIL	75—96	65—89	66—91	92—95	68—89	*	80—68
7	FIL	7	1	6	525—636	8	SEN	36—93	26—69	55—81	79—94	65—84	68—80	*
8	SEN	7	0	7	383—565	7	ESP	46—81	86—62	86—98	88—82	79—92	108—79	64—54

GROUPE B
GROUP

							URS	BRA	MEX	CUB	BUL	COR	MAR	POL
1	URS	7	7	0	642—408	14	URS *	76—65	82—62	100—66	81—56	89—58	123—51	91—50
2	BRA	7	6	1	558—418	13	BRA	65—76	*	60—53	81—68	75—59	91—59	98—52
3	MEX	7	5	2	493—443	12	MEX	62—82	53—60	*	76—75	73—63	75—62	86—38
4	POL	7	4	3	473—504	11	CUB	66—100	68—81	75—76	*	61—70	80—71	89—53
5	BUL	7	3	4	456—478	10	BUL	56—81	59—75	63—73	70—61	*	64—60	77—59
6	CUB	7	2	5	514—529	9	COR	58—89	59—91	62—75	71—80	60—64	*	76—54
7	COR	7	1	6	453—530	8	MAR	51—123	52—98	38—86	53—89	59—77	54—76	*
8	MAR	7	0	7	355—634	7	POL	50—91	51—88	63—68	78—75	69—67	77—67	85—48

581

DEMI-FINALES MATCH 57
SEMI-FINALS GAME
POUR LES PLACES 13e à 16e
FOR PLACES 13th to 16th

OCT 22

COR-SEN 76-59 (37-28, 39-31)

		Temps de jeu Time Played		Paniers Baskets		Coups francs Free Throws			Total	Fautes Fouls
				+	-		+	-	%	
COR										
4	Ha, Ui-Kon	9		1	0	100.0	0	0	00.0	2
5	Lee, Byung-Goo	7		1	1	50.0	0	0	00.0	2
6	Kwak, Hyun-Chae	13		1	0	100.0	2	0	100.0	4
7	Shin, Dong-Pa	40		17	4	80.9	0	0	00.0	34
8	Yoo, Hi-Hyung	25		6	1	85.7	0	0	00.0	12
9	Kim, Mu-Hyun	9		0	1	00.0	0	0	00.0	0
10	Park, Han	2		1	1	50.0	0	0	00.0	2
11	Choi, Jong-Kyu	7		1	1	50.0	0	0	00.0	2
12	Kim, In-Kon	31		1	2	33.3	2	0	100.0	4
13	Kim, Young-Il	31		2	3	40.0	3	1	75.0	7
14	Lee, In-Pyo	26		3	2	60.0	1	1	50.0	7
	TOTAL			34	16	68.0	8	2	80.0	76
SEN										
4	Fall, Cheikh	14		1	1	66.6	0	0	00.0	2
5	Diop, Papa	16		0	4	00.0	0	0	00.0	0
6	N'diaye, Mousse	10		0	1	00.0	0	0	00.0	0
7	Camara, Doudou	11		1	1	50.0	0	0	00.0	2
8	Dia, Babacar	27		6	2	71.4	1	1	50.0	13
9	Traore, Babacar	40		7	4	63.6	0	0	00.0	14
10	Seck, Babacar	19		3	4	42.8	0	0	00.0	6
11	Diagne, Mansour	14		5	10	33.3	0	0	00.0	10
12	Sadio, Claude	14		3	4	42.8	0	0	00.0	6
13	Constantino, Claude	24		1	4	20.0	0	0	00.0	2
14	Sene, Moussa									
15	Gueye, Alioune	21		0	5	00.0	4	0	100.0	4
	TOTAL			27	40	40.2	5	1	83.3	59
ARBITRES	REFEREES	Kassai, Erwin	HUN	Louzada, Helio	BRA					

DEMI-FINALES MATCH **58**
SEMI-FINALS GAME
POUR LES PLACES 13e à 16e
FOR PLACES 13th to 16th

FIL-MAR **86-57** (36-26, 50-31)

FIL	Temps de jeu Time Played	Paniers Baskets		%	Coups francs Free Throws		%	Total	Fautes Fouls	
		+	-		+	-				
4	Reynoso, Alberto	20	0	2	00.0	0	0	00.0	0	1
5	Mariano, Jaime	11	1	5	16.6	0	2	00.0	2	0
6	Tolentino, Elias	18	3	5	37.5	2	0	100.0	8	1
7	Reyes, Renato	21	6	7	46.1	0	0	00.0	12	2
8	Ocampo, Edgardo	9	1	2	33.3	0	0	00.0	2	0
9	Bauzón, Orlando	7	0	2	00.0	0	0	00.0	0	0
10	Rojas, Joaquín	29	6	4	60.0	0	0	00.0	12	3
11	Melencio, Rogelio	10	2	2	50.0	0	0	00.0	4	4
12	Florencio, Danilo	10	5	2	71.4	2	0	100.0	12	1
13	Papa, Adriano	22	8	9	47.0	0	0	00.0	16	2
14	Márquez, Alfonso	12	1	0	100.0	0	0	00.0	2	2
15	Jaworski, Robert	21	7	4	63.6	2	0	100.0	16	1
	TOTAL		40	44	47.6	6	2	75.0	86	17

MAR

4	Bensiamar, Abdelwahed	34	3	11	21.4	5	1	83.3	11	3
5	Laghrissi, Abderraouf	2	0	3	00.0	0	0	00.0	0	2
6	Alaoui, Mohamed	28	2	10	16.6	3	1	75.0	7	2
7	Seyad, Mokhtar	38	4	15	21.1	5	1	83.3	13	3
8	Bouazzaoui, Fathallah	—	—	—	—	—	—	—	—	—
9	Belgnaoui, Abdeljebbar	11	2	1	66.6	0	0	00.0	4	2
10	El Yamani, Khalil	33	6	11	35.2	2	2	50.0	14	1
11	Cherradi, Nouredine	13	2	0	100.0	0	0	00.0	4	1
12	Riad, Moulay	—	—	—	—	—	—	—	—	—
13	Bel Caid, Allal	31	2	1	66.6	0	0	00.0	4	0
14	Sebbar, Abderrahmane	10	0	2	00.0	0	0	00.0	0	2
15	Dioury, Farouk	—	—	—	—	—	—	—	—	—
	TOTAL		21	54	28.0	15	5	75.0	57	16

ARBITRES REFEREES Kanaka, Ryoichi JPN Quintero, Mario CUB

582

DEMI-FINALES MATCH **59**
SEMI-FINALS GAME
POUR LES PLACES 9e à 12e
FOR PLACES 9th to 12th

BUL-PAN **83-79** (42-35, 41-44)

BUL	Temps de jeu Time Played	Paniers Baskets		%	Coups francs Free Throws		%	Total	Fautes Fouls	
		+	-		+	-				
4	Mihailov, Emil	—	—	—	—	—	—	—	—	
5	Boiadjiev, Stanislav	12	0	2	00.0	0	0	00.0	0	3
6	Pandov, Pando	26	4	1	80.0	0	0	00.0	8	4
7	Doitchinov, Khristo	29	7	1	87.5	4	0	100.0	18	5
8	Spassov, Valentin	14	2	3	40.0	0	0	00.0	4	4
9	Philipov, Stefan	7	1	0	100.0	2	0	100.0	4	2
10	Dimov, Mintcho	40	8	8	50.0	3	1	75.0	19	4
11	Kirov, Ivailo	—	—	—	—	—	—	—	—	—
12	Sakhanikov, Dimitar	—	—	—	—	—	—	—	—	—
13	Branzov, Boitcho	11	3	3	50.0	6	2	75.0	12	2
14	Raitchev, Slavey	28	2	4	33.3	2	0	100.0	6	3
15	Khristov, Gueorgui	33	4	5	44.4	4	0	100.0	12	2
	TOTAL		31	27	53.4	21	3	87.7	83	29

PAN

4	Checa, Francisco	13	1	0	100.0	0	0	00.0	2	2
5	Osorio, Julio	35	3	1	75.0	0	0	00.0	6	4
6	Blades, Percibal	18	4	1	80.0	0	0	00.0	8	3
7	Malcon, Calixto	—	—	—	—	—	—	—	—	—
8	Alvarado, Nicolás	9	2	4	33.3	0	0	00.0	4	1
9	Agard, Ernesto	13	3	3	50.0	0	0	100.0	8	4
10	Reyes, Ramón	7	0	1	00.0	0	0	00.0	0	2
11	Peralta, Davis	36	7	13	35.0	3	1	75.0	17	4
12	Webb, Norris	—	—	—	—	—	—	—	—	—
13	Sinclair, Luis	15	4	2	66.6	0	0	00.0	8	4
14	Rivas, Pedro	28	4	4	50.0	6	7	50.0	14	4
15	Ellis, Eliecer	26	5	5	50.0	2	1	50.0	12	3
	TOTAL		33	34	49.2	13	9	59.0	79	31

ARBITRES REFEREES Díaz, Rodolfo MEX Luglini, Elio ITA

DEMI-FINALES MATCH **60**
SEMI-FINALS GAME
POUR LES PLACES 9e à 12e
FOR PLACES 9th to 12th

PRO-CUB 71-65 (33-34, 38-31)

PRO	Temps de jeu Time Played	Paniers Baskets		%	Coups francs Free Throws		%	Total	Fautes Fouls
		+	-		+	-			
4 McCadney, Bill	18	4	3	57.1	0	0	00.0	8	5
5 Hatton, Joe	2	0	0	00.0	0	0	00.0	0	0
6 Porrata, Adolfo	20	2	4	33.3	5	1	83.3	9	1
7 Cancel, Angel	23	1	2	33.3	1	1	50.0	3	5
8 Adorno, Rubén	—	—	—	—	—	—	—	—	—
9 Zamot, Alberto	—	—	—	—	—	—	—	—	—
10 Dalmau, Raymond	20	10	5	66.6	4	0	100.0	24	1
11 Frontera, Jaime	5	0	0	00.0	0	0	00.0	0	0
12 Córdova, Francisco	33	1	2	33.3	1	1	50.0	3	4
13 Cruz, Teófilo	21	4	5	44.4	1	1	50.0	9	5
14 Gutiérrez, Tomás	22	3	7	30.0	1	1	50.0	7	1
15 Ortiz, Mariano	36	4	7	36.3	0	0	00.0	8	5
TOTAL		29	35	45.3	13	5	72.2	71	27

CUB

4 Cuesta, Inocente	—	—	—	—	—	—	—	—	—
5 Herrera, Ruperto	40	6	9	40.0	1	1	50.0	13	4
6 González, Jacinto	15	1	4	20.0	1	1	50.0	3	1
7 Chappe, Pedro	40	7	1	87.5	3	1	75.0	17	2
8 Montalvo, Miguel	—	—	—	—	—	—	—	—	—
9 Cañizares, Rafael	11	0	2	00.0	0	0	00.0	0	0
10 Pérez, Conrado	8	1	4	20.0	0	0	00.0	2	2
11 Calderón, Miguel	23	1	2	33.3	2	2	50.0	4	5
12 Valdés, César	37	6	6	50.0	2	0	100.0	14	5
13 García, Pablo	26	4	2	66.6	4	0	100.0	12	2
14 Del Pozo, Carlos	—	—	—	—	—	—	—	—	—
15 Standard, Franklin	—	—	—	—	—	—	—	—	—
TOTAL		26	30	46.4	13	5	72.2	65	21

ARBITRES REFEREES Righetto, Renato BRA Schober, Theodor ALE

583

DEMI-FINALES MATCH **61**
SEMI-FINALS GAME
POUR LES PLACES 5e à 8e
FOR PLACES 5th to 8th

POL-ITA 66-52 (28-31, 38-21)

POL	Temps de jeu Time Played	Paniers Baskets		%	Coups francs Free Throws		%	Total	Fautes Fouls
		+	-		+	-			
4 Korcz, Grzegorz	—	—	—	—	—	—	—	—	—
5 Trams, Włodzimierz	27	4	5	44.4	3	1	75.0	11	4
6 Malec, Czesław	12	1	1	50.0	0	0	00.0	2	4
7 Cegielski, Henryk	14	2	3	40.0	1	3	25.0	5	2
8 Kasprzak, Andrzej	5	1	3	25.0	0	0	00.0	2	2
9 Jurkiewicz, Edward	22	2	2	50.0	1	1	50.0	5	4
10 Niemiec, Adam	31	1	3	25.0	6	2	75.0	8	0
12 Lopatka, Mieczysław	35	9	1	90.0	3	1	75.0	21	3
13 Frelkiewicz, Kazimierz	26	0	2	00.0	0	0	00.0	0	4
14 Kwiatkowski, Bolesław	28	5	5	50.0	2	0	100.0	12	2
15 Pasiorowski, Andrzej	—	—	—	—	—	—	—	—	—
TOTAL		25	25	50.0	16	8	66.6	66	25

ITA

4 Recalcati, Carlo	—	—	—	—	—	—	—	—	—
5 Pellanera, Giusto	12	0	2	00.0	0	0	00.0	0	2
6 Lombardi, Gianfranco	9	0	2	00.0	0	0	00.0	0	1
7 Bovone, Enrico	5	0	2	00.0	0	0	00.0	0	1
8 Masini, Massimo	31	3	8	27.2	3	3	50.0	9	0
9 Vittori, Paolo	4	0	0	00.0	0	0	00.0	0	1
10 Vianello, Gabriele	18	1	4	20.0	1	1	50.0	3	4
11 Gatti, Guido	15	1	0	100.0	0	0	00.0	2	5
12 Flaborea, Ottorino	34	5	4	55.5	6	4	60.0	16	4
13 Bufalini, Sauro	10	0	3	00.0	0	0	00.0	0	3
14 Cosmelli, Massimo	25	5	6	45.5	0	0	00.0	10	4
15 Jessi, Gianluigi	37	5	3	62.5	2	2	50.0	12	4
TOTAL		20	34	37.0	12	10	54.5	52	29

ARBITRES REFEREES Mihalik, Z.G. EUA Belosevic, Obrad YUG

DEMI-FINALES MATCH **62**
SEMI-FINALS GAME
POUR LES PLACES 5e à 8e
FOR PLACES 5th to 8th

MEX-ESP 73-72 (31-31, 42-41)

MEX	Temps de jeu Time Played	Paniers Baskets		%	Coups francs Free Throws		%	Total	Fautes Fouls
		+	-		+	-			
4 Heredia, Rafael	7	0	3	00.0	0	0	00.0	0	0
5 Guerrero, Arturo	37	9	12	42.8	6	0	100.0	24	0
6 Tiscareño, Fernando	—	—	—	—	—	—	—	—	—
7 Arellano, Miguel	11	0	0	00.0	1	1	50.0	1	3
8 Ayala, Antonio	25	4	6	40.0	2	0	100.0	10	4
9 Asiain, Oscar	—	—	—	—	—	—	—	—	—
10 Grajeda, Luis	8	2	3	40.0	0	0	00.0	4	1
11 Guzmán, Alejandro	15	3	5	37.5	3	1	75.0	9	2
12 Quintanar, Carlos	29	3	5	37.5	0	0	00.0	6	2
13 Pontvianne, Ricardo	30	4	5	44.4	1	1	50.0	9	4
14 Hatch, John	—	—	—	—	—	—	—	—	—
15 Raga, Manuel	38	4	4	50.0	2	0	100.0	10	4
TOTAL		29	43	40.2	15	3	83.3	73	20
ESP									
4 Martínez, Juan	9	1	1	50.0	0	0	00.0	2	2
5 Ramos, Vicente	18	1	2	33.3	0	0	00.0	2	3
6 Santiago, Luis	—	—	—	—	—	—	—	—	—
7 Codina, Jesús	13	1	4	20.0	0	0	00.0	2	2
8 Margall, Enrique	20	1	5	16.6	0	0	00.0	2	3
9 Nava, Antonio	—	—	—	—	—	—	—	—	—
10 Rodríguez, Emiliano	33	7	6	53.8	2	4	33.3	16	2
11 Luyk, Clifford	40	13	11	54.1	6	2	75.0	32	2
12 Sagi Vela, José	23	5	7	41.6	0	0	00.0	10	2
13 Buscato, Francisco	25	0	4	00.0	1	1	50.0	1	3
14 Alocen, Lorenzo	7	0	3	00.0	0	0	00.0	0	0
15 Martínez, Alfonso	12	2	3	40.0	1	1	50.0	5	0
TOTAL		31	46	40.2	10	8	55.5	72	19

ARBITRES REFEREES Lichy, Wayne EJA — Kokorev, Anatoli URS

584

DEMI-FINALES MATCH **63**
SEMI-FINALS GAME
POUR LES PLACES 1ère à 4e
FOR PLACES 1st to 4th

YUG-URS 63-62 (31-27, 32-35)

YUG	Temps de jeu Time Played	Paniers Baskets		%	Coups francs Free Throws		%	Total	Fautes Fouls
		+	-		+	-			
4 Zorga, Aljosa	—	—	—	—	—	—	—	—	—
5 Korac, Radivoj	26	5	3	62.5	2	2	50.0	12	5
6 Maroevic, Zoran	7	1	0	100.0	0	0	00.0	2	5
7 Rajkovic, Trajko	19	3	4	42.8	0	0	00.0	6	4
8 Cvetkovic, Vladimir	13	1	1	50.0	3	1	75.0	5	3
9 Raznatovic, Dragoslav	5	0	0	00.0	0	0	00.0	0	0
10 Daneu, Ivo	36	4	5	44.4	1	1	50.0	9	4
11 Cosic, Kresimir	21	1	4	20.0	4	0	100.0	6	4
12 Solman, Damir	—	—	—	—	—	—	—	—	—
13 Plecas, Nicola	—	—	—	—	—	—	—	—	—
14 Cermak, Dragutin	40	2	3	40.0	4	0	100.0	8	4
15 Skansi, Petar	33	5	4	55.5	5	1	83.3	15	3
TOTAL		22	24	47.8	19	5	79.1	63	32
URS									
4 Krikun, Anatoly	9	1	1	50.0	0	0	00.0	2	4
5 Paulauskas, Modest	19	3	5	37.5	6	2	75.0	12	5
6 Sakandelidze, Zurab	19	1	4	20.0	0	2	00.0	2	3
7 Kapranov, Vadim	—	—	—	—	—	—	—	—	—
8 Selikhov, Yuri	20	0	1	00.0	0	0	00.0	0	4
9 Polivoda, Anatoly	24	0	3	00.0	9	5	64.2	9	4
10 Belov, Sergei	23	7	9	43.7	0	0	00.0	14	0
11 Tomson, Priit	27	5	10	33.3	0	0	00.0	10	3
12 Kovalenko, Sergei	8	1	0	100.0	1	1	50.0	3	3
13 Volnov, Gennady	7	0	1	00.0	0	0	00.0	0	2
14 Lipso, Yaak	18	3	6	33.3	0	0	00.0	6	4
15 Andreev, Vladimir	26	1	1	50.0	2	2	50.0	4	5
TOTAL		22	41	34.9	18	12	60.0	62	37

ARBITRES REFEREES Ugalde, Eugenio MEX Fernández, Santiago ESP

DEMI-FINALES MATCH 64
SEMI-FINALS GAME
POUR LES PLACES 1ère a 4e
FOR PLACES 1st to 4th

EUA-BRA 75-63 (42-26, 33-37)

EUA		Temps de jeu Time Played	Paniers Baskets		%	Coups francs Free Throws		%	Total	Fautes Fouls
			+	-		+	-			
4	Clawson, John	4	1	1	50.0	0	0	00.0	2	0
5	Spain, Ken	3	0	1	00.0	1	1	50.0	1	2
6	White, Joseph	22	7	7	50.0	2	0	100.0	16	2
7	Barrett, Michael	25	5	6	45.5	0	0	00.0	10	2
8	Haywood, Spencer	37	6	3	66.6	0	4	00.0	12	1
9	Scott, Charles	15	2	2	50.0	0	0	00.0	4	4
10	Hosket, Bill	20	7	2	77.7	0	0	00.0	14	3
11	Fowler, Calvin	28	3	2	60.0	0	0	00.0	6	4
12	Silliman, Michael	20	2	2	50.0	0	0	00.0	4	2
13	Saulters, Glynn	1	1	0	100.0	0	0	00.0	2	1
14	King, James	22	1	0	100.0	0	0	00.0	2	5
15	Dee, Donald	3	1	1	50.0	0	0	00.0	2	0
TOTAL			36	27	57.1	3	5	37.5	75	26

BRA

4	Machado, Sergio	17	1	1	50.0	1	1	50.0	3	1
5	Márques, Wlamir	22	4	4	50.0	5	1	83.3	13	3
6	Maciel, Ubiratan	33	5	2	71.4	3	1	75.0	13	5
7	Scarpini, Celso	—	—	—	—	—	—	—	—	—
8	Garcia, Helio	—	—	—	—	—	—	—	—	—
9	De Souza, Carmo	14	2	4	33.3	0	0	00.0	4	5
10	Dos Santos, José	—	—	—	—	—	—	—	—	—
11	Menon, Luiz	40	11	8	57.8	2	0	100.0	24	3
12	Succar, Antonio	15	0	2	00.0	0	0	00.0	0	3
13	Simoes, José	27	1	4	20.0	2	0	100.0	4	4
14	De Castro, José	—	—	—	—	—	—	—	—	—
15	Massoni, Carlos	32	1	3	25.0	0	0	00.0	2	3
TOTAL			25	28	47.1	13	3	81.2	63	27

ARBITRES REFEREES Rae, Allen CAN Pacheco, Calvin PRO

585

FINALES MATCH 65 OCT 23
FINALS GAME
POUR LES 15e et 16e PLACES
FOR PLACES 15 and 16

SEN-MAR 42-38 (24-18, 18-20)

SEN		Temps de jeu Time Played	Paniers Baskets		%	Coups francs Free Throws		%	Total	Fautes Fouls
			+	-		+	-			
4	Fall, Cheikn	15	2	5	28.5	0	0	00.0	4	2
5	Diop, Papa	3	0	1	00.0	0	0	00.0	0	0
6	N'Diaye, Mousse	8	0	2	00.0	0	0	00.0	0	1
7	Camara, Doudou	18	4	2	66.6	1	3	25.0	9	2
8	Dia, Babacar	12	0	4	00.0	0	0	00.0	0	1
9	Traore, Babacar	35	4	8	33.3	0	2	00.0	8	0
10	Seck, Babacar	25	3	5	37.5	2	0	100.0	8	2
11	Diagne, Mansour	15	1	5	16.6	4	0	100.0	6	0
12	Sadio, Claude	18	2	6	25.0	1	3	25.0	5	4
13	Constantino, Claude	36	1	3	25.0	0	0	00.0	2	2
14	Sene, Moussa	—	—	—	—	—	—	—	—	—
15	Gueye, Alioune	15	0	2	00.0	0	0	00.0	0	1
TOTAL			17	43	28.3	8	8	50.0	42	15

MAR

4	Bensiamar, Abdelwahed	25	3	9	25.0	2	0	100.0	8	2
5	Laghrissi, Abderraouf	—	—	—	—	—	—	—	—	—
6	Alaoui, Mohamed	30	2	8	20.0	0	0	100.0	4	5
7	Seyad, Mokhtar	40	8	15	34.7	2	0	00.0	18	2
8	Bouazzaoui, Fathallah	—	—	—	—	—	—	—	—	—
9	Belgnaoui, Abdeljebbar	6	0	3	00.0	0	0	00.0	0	1
10	El Yamani, Khalil	27	1	13	7.1	0	2	00.0	2	2
11	Cherradi, Nouredine	13	0	2	00.0	2	0	100.0	2	1
12	Riad, Moulay	20	0	2	00.0	0	0	00.0	0	1
13	Bel Caid, Allal	29	2	1	66.6	0	0	00.0	4	4
14	Sebbar, Abderrahmane	10	0	3	00.0	0	0	00.0	0	0
15	Dioury, Farouk	—	—	—	—	—	—	—	—	—
TOTAL			16	56	22.2	6	2	75.0	38	18

ARBITRES REFEREES Kokorev, Anatoli URS Ramos, Martín MEX

FINALES MATCH **66**
 FINALS GAME
 POUR LES 13e et 14e PLACES
 FOR PLACES 13 and 14

FIL-COR **66-63** (31-34, 35-29)

FIL	Temps de jeu Time Played	Paniers Baskets		%	Coups francs Free Throws		%	Total	Fautes Fouls
		+	-		+	-			
4 Reynoso, Alberto	15	1	1	50.0	0	2	00.0	2	3
5 Mariano, Jaime	12	2	5	28.5	1	1	50.0	5	3
6 Tolentino, Elias	8	1	3	25.0	0	0	00.0	2	3
7 Reyes, Renato	4	1	3	25.0	0	0	00.0	2	0
8 Ocampo, Edgardo	26	2	3	40.0	0	0	00.0	4	4
9 Bauzón, Orlando	22	0	2	00.0	0	0	00.0	0	5
10 Rojas, Joaquin	30	7	7	50.0	1	1	50.0	15	2
11 Melencio, Rogelio	22	4	3	57.1	1	1	50.0	9	4
12 Florencio, Danilo	12	2	2	50.0	1	1	50.0	5	3
13 Papa, Adriano	17	2	8	20.0	2	4	33.3	6	2
14 Márquez, Alfonso	23	6	8	42.8	0	0	00.0	12	2
15 Jaworski, Robert	9	1	2	33.3	2	0	100.0	4	4
TOTAL		29	47	38.1	8	10	44.0	66	35

COR

4 Ha, Ui-Kon	7	0	0	00.0	0	0	00.0	0	0
5 Lee, Byung-Goo	—	—	—	—	—	—	—	—	—
6 Kwak, Hyun-Chae	23	3	1	75.0	2	2	50.0	8	3
7 Shin, Dong-Pa	24	5	11	31.2	4	0	100.0	14	1
8 Yoo, Hi-Hyung	21	2	2	50.0	0	0	00.0	4	5
9 Kim, Mu-Hyun	14	1	2	33.3	2	0	100.0	4	3
10 Park, Han	—	—	—	—	—	—	—	—	—
11 Choi, Jong-Kyu	11	1	1	50.0	1	1	50.0	3	2
12 Kim, In-Kon	31	4	7	36.3	0	0	00.0	8	4
13 Kim, Young-II	29	2	8	20.0	3	1	75.0	7	0
14 Lee, In-Pyo	40	6	7	46.1	3	1	75.0	15	3
TOTAL		24	39	38.0	15	5	75.0	63	21

ARBITRES REFEREES Saldívar, Arnulfo MEX Lichty, Wayne EUA

586

FINALES MATCH **67**
 FINALS GAME
 POUR LES 11e et 12e PLACES
 FOR PLACES 11 and 12

CUB-PAN **91-88** (47-43,44-45)

CUB	Temps de jeu Time Played	Paniers Baskets		%	Coups francs Free Throws		%	Total	Fautes Fouls
		+	-		+	-			
4 Cuesta, Inocente	—	—	—	—	—	—	—	—	—
5 Herrera, Ruperto	38	11	11	50.0	6	4	60.0	28	4
6 González, Jacinto	12	2	2	50.0	1	1	50.0	5	0
7 Chappe, Pedro	35	7	4	63.6	5	3	62.5	19	4
8 Montalvo, Miguel	—	—	—	—	—	—	—	—	—
9 Cañizares, Rafael	25	4	6	40.0	1	1	50.0	9	3
10 Pérez, Conrado	8	2	1	66.6	0	0	00.0	4	1
11 Calderón, Miguel	38	3	2	60.0	1	3	25.0	7	4
12 Valdés, César	9	1	1	50.0	0	0	00.0	2	1
13 García, Pablo	30	6	13	31.5	2	4	33.3	14	4
14 Del Pozo, Carlos	5	1	1	50.0	1	1	50.0	3	3
15 Standard, Franklin	—	—	—	—	—	—	—	—	—
TOTAL		37	41	47.4	17	17	50.0	91	24

PAN

4 Checa, Francisco	18	1	3	25.0	0	2	00.0	2	4
5 Osorio, Julio	28	4	4	50.0	2	0	100.0	10	4
6 Blades, Percibal	12	0	1	00.0	0	0	00.0	0	2
7 Malcon, Calixto	—	—	—	—	—	—	—	—	—
8 Alvarado, Nicolás	2	0	1	00.0	0	0	00.0	0	1
9 Agard, Ernesto	25	3	7	30.0	4	0	100.0	10	5
10 Reyes, Ramón	3	0	0	00.0	0	0	00.0	0	0
11 Peralta, Davis	40	10	12	45.4	10	0	100.0	30	3
12 Webb, Norris	7	1	0	100.0	0	0	00.0	2	3
13 Sinclair, Luis	6	0	1	00.0	0	0	00.0	0	5
14 Rivas, Pedro	23	2	13	13.3	3	3	50.0	7	5
15 Ellis, Eliecer	36	13	8	61.4	1	3	25.0	27	5
TOTAL		34	50	40.4	20	8	71.4	88	37

ARBITRES REFEREES Rae, Allen CAN Gough, Leslie AUS

FINALES MATCH **68**
 FINALS GAME
 POUR LES 9e et 10e PLACES
 FOR PLACES 9 and 10

PRO-BUL **67-57** (35-31, 32-26)

PRO	Temps de jeu Time Played	Paniers Baskets		%	Coups francs Free Throws		%	Total	Fautes Fouls
		+	-		+	-			
4 McCadney, Bill	18	2	1	66.6	0	0	00.0	4	5
5 Hatton, Joe	9	0	0	00.0	0	0	00.0	0	0
6 Porrata, Adolfo	36	7	4	63.6	0	0	00.0	14	2
7 Cancel, Angel	12	0	0	00.0	1	1	50.0	1	3
8 Adorno, Rubén	—	—	—	—	—	—	—	—	—
9 Zamot, Alberto	—	—	—	—	—	—	—	—	—
10 Dalmau, Raymond	25	5	5	50.0	0	2	00.0	10	2
11 Frontera, Jaime	3	0	2	00.0	1	1	50.0	1	1
12 Córdova, Francisco	26	1	1	50.0	0	2	00.0	2	4
13 Cruz, Teófilo	36	8	4	66.6	7	1	87.5	23	1
14 Gutiérrez, Tomás	4	1	1	50.0	0	0	00.0	2	2
15 Ortiz, Mariano	31	5	11	31.2	0	4	00.0	10	1
TOTAL		29	29	50.0	9	11	45.0	67	21

BUL

4 Mihailov, Emil	16	2	1	66.6	5	3	62.5	9	2
5 Boiadjiev, Stanislav	9	0	1	00.0	0	0	00.0	0	1
6 Pandov, Pando	31	4	4	50.0	0	0	00.0	8	1
7 Doitchinov, Khristo	19	3	1	75.0	1	1	50.0	7	3
8 Spassov, Valentin	—	—	—	—	—	—	—	—	—
9 Philipov, Stefan	26	2	3	40.0	0	0	00.0	4	3
10 Dimov, Mintcho	31	6	4	60.0	1	1	50.0	13	1
11 Kirov, Ivailo	3	1	1	50.0	0	0	00.0	2	1
12 Sakhanikov, Dimitar	—	—	—	—	—	—	—	—	—
13 Branzov, Boitcho	25	4	2	66.6	1	1	50.0	9	4
14 Raitchev, Slavey	17	1	1	50.0	1	1	50.0	3	1
15 Khristov, Georgui	23	1	6	14.2	0	0	00.0	2	0
TOTAL		24	24	50.0	9	7	56.2	57	17

ARBITRES REFEREES Hopenhaym, Mario URG Kanaka, Ryoichi JPN

587

FINALES MATCH **69** **OCT 25**
 FINALS GAME
 POUR LES 7e et 8e PLACES
 FOR PLACES 7 and 8

ESP-ITA **88-72** (40-31, 48-41)

ESP	Temps de jeu Time Played	Paniers Baskets		%	Coups francs Free Throws		%	Total	Fautes Fouls
		+	-		+	-			
4 Martínez, Juan	22	3	1	75.0	0	0	00.0	6	4
5 Ramos, Vicente	—	—	—	—	—	—	—	—	—
6 Santiago, Luis	—	—	—	—	—	—	—	—	—
7 Codina, Jesús	18	1	2	33.3	0	0	00.0	2	3
8 Margall, Enrique	6	0	0	00.0	0	0	00.0	0	4
9 Nava, Antonio	—	—	—	—	—	—	—	—	—
10 Rodríguez, Emiliano	33	9	2	81.8	5	1	83.3	23	3
11 Luyk, Clifford	34	12	10	54.5	1	1	50.0	25	4
12 Sagi Vela, José	15	3	5	37.5	0	2	00.0	6	2
13 Buscato, Francisco	32	9	3	75.0	1	1	50.0	19	4
14 Alocen, Lorenzo	12	1	2	33.3	0	2	00.0	2	1
15 Martínez, Alfonso	28	2	2	50.0	1	1	50.0	5	5
TOTAL		40	27	59.7	8	8	50.0	88	30

ITA

4 Recalcati, Carlo	—	—	—	—	—	—	—	—	—
5 Pellanera, Giusto	32	4	5	44.4	3	7	30.0	11	2
6 Lombardi, Gianfranco	6	1	1	50.0	0	0	00.0	2	0
7 Bovone, Enrico	16	3	5	37.5	3	5	37.5	9	1
8 Masini, Massimo	21	1	6	14.2	2	0	100.0	4	2
9 Vittori, Paolo	14	1	3	25.0	0	0	00.0	2	3
10 Vianello, Gabriele	20	3	3	50.0	0	0	00.0	6	0
11 Gatti, Guido	8	2	0	100.0	0	0	00.0	4	4
12 Flaborea, Ottorino	20	10	1	90.9	0	0	00.0	20	4
13 Fufalini, Sauro	9	1	1	50.0	0	0	00.0	2	0
14 Cosmelli, Massimo	38	5	8	38.4	0	0	00.0	10	1
15 Jessi, Gianluigi	16	1	9	10.0	0	0	00.0	2	1
TOTAL		32	42	43.2	8	12	40.0	72	18

ARBITRES REFEREES Hopenhaym, Mario URG Kanaka, Ryoichi JPN

FINALES MATCH 70
 FINALS GAME
 POUR LES 5e et 6e PLACES
 FOR PLACES 5 and 6

MEX-POL 75-65 (43-23, 32-42)

MEX	Temps de jeu Time Played	Paniers Baskets		%	Coups francs Free Throws		%	Total	Fautes Fouls
		+	-		+	-			
4 Heredia, Rafael	5	0	0	00.0	1	1	50.0	1	2
5 Guerrero, Arturo	17	9	5	64.2	1	1	50.0	19	1
6 Tiscareño, Fernando	10	1	1	50.0	0	0	00.0	2	2
7 Arellano, Miguel	9	0	0	00.0	0	0	00.0	0	4
8 Ayala, Antonio	14	3	4	42.8	0	0	00.0	6	3
9 Asiaín, Oscar	7	1	1	50.0	1	1	50.0	3	4
10 Grajeda, Luis	24	3	4	42.8	0	0	00.0	6	1
11 Guzmán, Alejandro	7	3	0	100.0	0	0	00.0	6	4
12 Quintanar, Carlos	17	1	3	25.0	0	0	00.0	2	4
13 Pontvianne, Ricardo	22	2	3	40.0	2	0	100.0	6	3
14 Hatch, John	15	3	4	42.8	0	0	00.0	6	2
15 Raga, Manuel	35	7	5	58.3	4	2	66.6	18	1
TOTAL		33	30	52.3	9	5	64.2	75	31

POL

4 Korcz, Grzegorz	—	—	—	—	—	—	—	—	—
5 Trams, Włodzimierz	28	7	4	63.6	5	1	83.3	19	3
6 Malec, Czesław	17	1	2	33.3	0	0	00.0	2	0
7 Cegielski, Henryk	9	0	1	00.0	0	0	00.0	0	3
8 Kasprzak, Andrzej	7	0	0	00.0	0	0	00.0	0	0
9 Jurkiewicz, Edward	11	5	2	71.4	2	0	100.0	12	1
10 Niemiec, Adam	11	0	1	00.0	0	0	00.0	0	1
11 Likszo, Bogdan	31	6	2	75.0	2	4	33.3	14	1
12 Lopatka, Mieczysław	33	7	4	63.6	0	0	00.0	14	3
13 Frelkiewicz, Kazimierz	31	1	4	20.0	0	0	00.0	2	1
14 Kwiatkowski, Bolesław	2	1	3	25.0	0	0	00.0	2	1
15 Pasiorowski, Andrzej	—	—	—	—	—	—	—	—	—
TOTAL		28	23	54.9	9	5	64.2	65	14

ARBITRES REFEREES Rae, Allen CAN Kokorev, Anatoli URS

588

FINALES MATCH 71
 FINALS GAME
 POUR LES 3e et 4e PLACES
 FOR PLACES 3 and 4

URS-BRA 70-53 (38-25, 32-28)

URS	Temps de jeu Time Played	Paniers Baskets		%	Coups francs Free Throws		%	Total	Fautes Fouls
		+	-		+	-			
4 Krikun, Anatoly	8	0	2	00.0	0	0	00.0	0	1
5 Paulauskas, Modest	22	6	3	66.6	5	1	83.3	17	4
6 Sakandelidze, Zurab	32	6	5	54.5	2	2	50.0	14	3
7 Kapranov, Vadim	4	1	0	100.0	0	0	00.0	2	3
8 Selikhov, Yuri	17	0	0	00.0	0	0	00.0	0	5
9 Polivoda, Anatoly	25	5	3	62.5	4	4	50.0	14	4
10 Belov, Sergei	18	2	4	33.3	0	0	00.0	4	2
11 Tomson, Priit	15	1	4	20.0	2	0	100.0	4	2
12 Kovalenko, Sergei	8	0	1	00.0	2	0	100.0	2	0
13 Volnov, Gennady	4	0	1	00.0	0	0	00.0	0	1
14 Lips, Yaak	15	3	3	50.0	0	0	00.0	6	2
15 Andreev, Vladimir	32	3	3	50.0	1	1	50.0	7	1
TOTAL		27	29	48.2	16	8	66.6	70	28

BRA

4 Machado, Sergio	20	3	4	42.8	2	0	100.0	8	2
5 Márques, Wlamiir	22	4	6	40.0	1	1	50.0	9	3
6 Maciel, Ubiratan	40	3	11	21.4	0	4	00.0	6	4
7 Scarpini, Celso	—	—	—	—	—	—	—	—	—
8 García, Helio	9	1	1	50.0	0	0	00.0	2	1
9 De Souza, Carmo	12	2	5	28.5	0	0	00.0	4	1
10 Dos Santos, José	—	—	—	—	—	—	—	—	—
11 Menon, Luiz	30	4	10	28.5	0	0	00.0	8	4
12 Succar, Antonio	7	0	1	00.0	0	0	00.0	0	4
13 Simoes, José	25	1	5	16.6	1	1	50.0	3	3
14 De Castro, José	—	—	—	—	—	—	—	—	—
15 Massoni, Carlos	35	5	0	100.0	3	0	100.0	13	3
TOTAL		23	43	34.8	7	6	53.8	53	25

ARBITRES REFEREES Mihalik, Z.G. EUA Belosevic, Obrad YUG

FINALES MATCH **72**
 FINALS GAME
 POUR LES 1ère et 2e PLACES
 FOR PLACES 1 and 2

EUA-YUG 65-50 (32-29, 33-21)

EUA	Temps de jeu Time Played	Paniers Baskets			%	Coups francs Free Throws			Total	Fautes Fouls
		+	-	%		+	-	%		
4 Clawson, John	3	0	1	00.0	0	0	00.0	0	0	
5 Spain, Ken	2	0	0	00.0	1	1	50.0	1	1	
6 White, Joseph	30	6	6	50.0	2	0	100.0	14	1	
7 Barrett, Michael	22	3	6	33.3	0	0	00.0	6	2	
8 Haywood, Spencer	37	10	4	71.4	1	1	50.0	21	2	
9 Scott, Charles	20	2	3	40.0	1	1	50.0	5	2	
10 Hosket, Bill	14	1	2	33.3	1	1	50.0	3	2	
11 Fowler, Calvin	22	2	2	50.0	0	0	00.0	4	1	
12 Silliman, Michael	24	3	6	33.3	0	0	00.0	6	2	
13 Saulters, Glynn	3	2	1	66.6	0	0	00.0	4	1	
14 King, James	21	0	1	00.0	1	1	50.0	1	4	
15 Dee, Donald	2	0	2	00.0	0	0	00.0	0	0	
TOTAL		29	34	46.0	7	5	58.3	65	18	

YUG

4 Zorga, Aljosa	—	—	—	—	—	—	—	—	—
5 Korac, Radivoj	15	0	1	00.0	1	3	25.0	1	3
6 Maroevic, Zoran	8	1	0	100.0	0	0	00.0	2	1
7 Rajkovic, Trajko	21	2	6	25.0	0	0	00.0	4	1
8 Cvetkovic, Vladimir	11	0	2	00.0	3	1	75.0	3	3
9 Rznatovic, Dragoslav	13	1	2	33.3	0	0	00.0	2	2
10 Daneu, Ivo	38	6	6	50.0	4	0	100.0	16	2
11 Cosic, Kresimir	13	1	2	33.3	2	0	100.0	4	2
12 Solman, Damir	14	1	1	50.0	3	1	75.0	5	2
13 Plecas, Nicola	—	—	—	—	—	—	—	—	—
14 Cermak, Dragutin	29	4	5	44.4	0	0	00.0	8	3
15 Skansi, Petar	38	2	7	22.2	1	1	50.0	5	2
TOTAL		18	32	36.0	14	6	70.0	50	21

ARBITRES REFEREES Righetto, Renato BRA Kassai, Erwin HUN

589

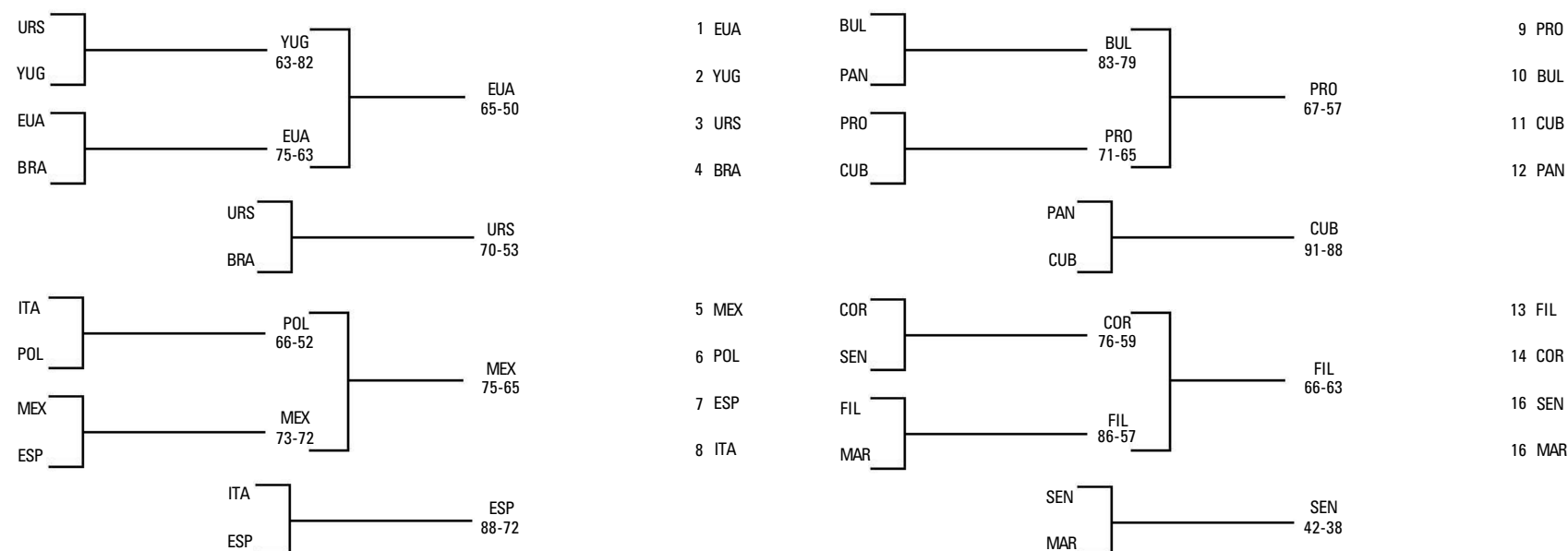

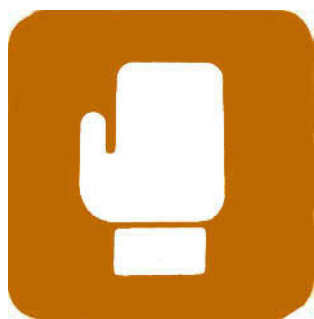

ASSOCIATION INTERNATIONALE
DE BOXE AMATEUR AIBA

INTERNATIONAL ASSOCIATION
OF AMATEUR BOXING AIBA

PRESIDENT
Rudyard H. Russell GBR

SECRETARE
SECRETARY
Harry R. Banks GBR

FEDERATION MEXICAINE
DE BOXE AMATEUR FMB A

MEXICAN FEDERATION O F
AMATEUR BOXING FMBA

PRESIDENT
Francisco Martínez MEX

SECRETARE
SECRETARY
Moisés Saldivar MEX

SECTION BOXE DU C.O.O.
O.O.C. BOXING SECTION
Marco Marín MEX

José Rodriguez Islas MEX

OFFICIELS DE LA COMPETITION
COMPETITION OFFICIALS

JUGES-ARBITRES
JUDGES-REFEREES
Hans Müller ADE
Horst Hertel ADE

Juan Pepe ARG
Archie Tanner AUS
G. Abrachart AUS
Emil Jetchev BUL
Bert Lowes CAN
In-Yang Pak COR
Waldo Santiago CUB
Jaroslav Hruska CHE
Juan Rial ESP
Roland Schwartz EUA
John Common FIJ
Alex Villacampa FIL
Kaleva Sampila FIN
Georges Gondre FRA
Godfrey Amarteifio GHA
Archibald Rankin GBR
James England GBR
Richard Gittins GBR
Ben Brill HOL
Imre Keleman HUN
Khoorshed Kuka IND
Edwin Thompson IRL
Petros Nazarbekian IRN
Gualtiero Checchi ITA
Hozumi Tanaka JPN
Yunes Mabruk LBA
Ernesto Arcos MEX
Fidel Ortiz MEX
Luis Martínez MEX
Daniel Pérez Garcia MEX
Olu Oguntokun NGR
Abdul Aslam PAK
Boleslaw Idziak POL
Mustafa Ezz RAU
C. Chiriak RUM
Siripai Swang TAI
George Zybalov URS
Danilo Ivanovic YUG

SIGNES EMPLOYES

SYMBOLY

*	— POINTS FAVORABLES	POINTS IN FAVOR
D	— DECISION	DECISION
PS	— POINTS	POINTS
RSC	— COMBAT SUSPENDU PAR ARBITRE	REFEREE STOPPED MATCH
DES	— DISQUALIFIE	DISQUALIFIED
□	— PESEE	WEIGHT
**	— ABSENCE	ABSENCE
†	— EXEMPTÉ	BYE
△	— A ABANDONNE	ABANDONED
○	— WALK-OVER	WALKOVER

**POIDS MOUCHE LEGER JUSQU'A 48 kg
LIGHT FLYWEIGHT UP TO 48 kgs**

1e TOUR ELIMINATOIRE **OCT 13**
1st ELIMINATION ROUND

GAGNANT WINNER	PERDANT LOSER	RESULTAT RESULT	ARBITRE - JUGES REFEREE - JUDGES
1 Aziz, Tahar (MAR)	Nata, David (ZAM)	DPS (4 - 1)	Arcos, Ernesto MEX
		58 - 60* *58 - 57 *58 - 57 *58 - 58 *60 - 56	Aslam, Abdul PAK Common, John FIJ Kuka, Khoorshed IND Lowes, Bert CAN Pepe, Juan ARG
2 Skrzypczak, Hubert (POL)	Sohem, Mohamed (RAU)	DPS (5 - 0)	Checchi, Gualtiero ITA
		*59 - 58 *59 - 58 *60 - 58 *60 - 58 *59 - 58	Bril, Ben HOL England, James GBR Thompson, Edwin IRL Swang, Siripai TAI Santiago, Waldo CUB
3 Donovan, Joseph (AUS)	Gedo, Gyorgy (HUN)	RSC 2do RD	Gittins, Richard GBR
			Amarteifio, Godfrey GHA Gondre, Georges FRA Pak, In-Yang COR Rankin, Archibald GBR Sampila, Kaleva FIN
4 Urretavizcaya, Robert (ARG)	Espinal, Ignacio (DOM)	D** □	Kiriak, Constantin RUM
			Jetchev, Emil BUL Keleman, Imre HUN Malik, N. NIG Thompson, Edwin IRL Zybalov, Georgi URS
13 Englmeier, Bernd (ADE)	Vicera, Manolo (FIL)	DPS (5 - 0)	Schwartz, Roland EUA
		*60 - 57 *60 - 58 *59 - 58 *60 - 57 *60 - 57	Pepe, Juan ARG González, Luis MEX Aslam, Abdul PAK Chuu, Sang-Jum COR Hruska, Jaroslav CHE
14 Morales, Alberto (MEX)	Udella, Franco (ITA)	DPS (3 - 2)	Zybalov, Georgi URS
		58 - 59* *60 - 58 *60 - 58 *60 - 58 *60 - 58 58 - 59*	Gradopolov, K. URS Pepe, Juan ARG Aslam, Abdul PAK Chuu, Sang-Jum COR Santiago, Waldo CUB
15 Zaporozhets, Victor (URS)	Watanabe, Junji (JPN)	DPS (5 - 0)	Schwartz, Roland EUA
		*60 - 58 *60 - 57 *59 - 58 *60 - 56 *59 - 57	Pepe, Juan ARG Aslam, Abdul PAK Abrahart, G. AUS Checchi, Gualtiero ITA Arcos, Ernesto MEX

GAGNANT WINNER	PERDANT LOSER	RESULTAT RESULT	ARBITRE - JUGES REFEREE - JUDGES
16 Jee, Yong-Ju (COR)	Ogada, Douglas (UGA)	RSC 2do RD 2.40	Sampila, Kaleva FIN
			Hruska, Jaroslav CHE Schwartz, Roland EUA Müller, Hans ADE Hertel, Horst ADE Santiago, Waldo CUB

HUITIEMES DE FINALE **OCT 18**
EIGHTH-FINALS

129 Ogun, Gabriel (NGR)	Alexandrov, Stepan (BUL)	DPS (4 - 1)	Bril, Ben HOL
		58 - 60* *60 - 57 *60 - 58 *60 - 57 *59 - 58	Swang, Siripai TAI England, James GBR Gondre, Georges FRA Gittins, Richard GBR Schwartz, Roland EUA
130 Marbley, Harlan (EUA)	Temel, Fuat (TUR)	DPS (5 - 0)	Rial, José ESP
		*60 - 57 *60 - 57 *60 - 58 *60 - 57 *60 - 57	Thompson, Edwin IRL Pak, In-Yang COR Rankin, Archibald GBR Gittins, Richard GBR Amarteifio, Godfrey GHA
131 Karunaratne, Hatha (CEI)	Thet, Lay (BIR)	DPS (5 - 0)	Amarteifio, Godfrey GHA
		*60 - 57 *60 - 58 *60 - 58 *59 - 58 *60 - 57	González, Luis MEX Hertel, Horst ADE Ivanovic, Danilo YUG Keleman, Imre HUN Müller, Hans ADE
132 Rodríguez, Francisco (VEN)	Carbonell, Rafael (CUB)	DPS (5 - 0)	Lowes, Bert CAN
		*59 - 57 *59 - 58 *59 - 58 *60 - 57 *59 - 58	Kiriak, Constantin RUM Hruska, Jaroslav CHE Zybalov, Georgi URS Oguntokun, Olu NGR Bril, Ben HOL
143 Skrzypczak, Hubert (POL)	Aziz, Tahar (MAR)	DPS (4 - 1)	Gondre, Georges FRA
		*60 - 57 *59 - 58 *59 - 58 *59 - 58 58 - 59*	Common, John FIJ Oguntokun, Olu NGR Bril, Ben HOL Tanaka, Hozumi JPN Tanner, Archie AUS
144 Donovan, Joseph (AUS)	Urretavizcaya, Robert (ARG)	DPS (5 - 0)	Hertel, Horst ADE
		*60 - 57 *59 - 58 *59 - 58 *59 - 57 *60 - 57	Amarteifio, Godfrey GHA England, James GBR Idziak, Boleslaw POL Pak, In-Yang COR Ivanovic, Danilo YUG
145 Morales, Alberto (MEX)	Englmeier, Bernd (ADE)	RSC 1er RD	Rankin, Archibald GBR
			Gittins, Richard GBR Gondre, Georges FRA Sampila, Kaleva FIN Checchi, Gualtiero ITA Amarteifio, Godfrey GHA

GAGNANT WINNER	PERDANT LOSER	RESULTAT RESULT	ARBITRE - JUGES REFEREE JUDGES
146 Jee, Yong-Ju (COR)	Zaporozhets, Victor (URS)	DPS (3 - 2)	Müller, Hans ADE
		60 - 58 Aslam, Abdul PAK 58 - 59 Lowes, Bert CAN 59 - 59* Rial, José ESP *59 - 58 Kuka, Khoorshed IND *59 - 58 Tanaka, Hozumi JPN	

QUARTS DE FINALE QUARTER-FINALS OCT 20

185 Marbley Harlan (EUA)	Ogun, Gabriel (NGR)	DPS (5 - 0)	Pak, In-Yang COR
		*60 - 58 Jetchev, Emil BUL *60 - 57 Villacampa, Alex FIL *60 - 57 Kiriak, Constantin RUM *60 - 57 Pepe, Juan ARG *60 - 59 Tanaka, Hozumi JPN	

186 Rodríguez, Francisco (VEN)	Karunaratne, Hatha (CEI)	RSC 2do RD	Kuka, Khoorshed IND
		Yunes, Mabruk LBA Keleman, Imre HUN Pak, In-Yang COR Swang, Siripai TAI Jetchev, Emil BUL	

195 Skrzypczak, Hubert (POL)	Donovan, Joseph (AUS)	DPS (3 - 2)	Jetchev, Emil BUL
		58 - 60* Yunes, Mabruk LBA *59 - 59 Santiago, Waldo CUB *59 - 59 Pepe, Juan ARG 59 - 60* Swang, Siripai TAI *59 - 59 Ivanovic, Danilo YUG	

196 Jee, Yong-Ju (COR)	Morales, Alberto (MEX)	DPS (3 - 2)	Idziak, Boleslaw POL
		59 - 58 Jetchev, Emil BUL 58 - 59 Pepe, Juan ARG 58 - 59* Bril, Ben HOL *59 - 58 Swang, Siripai TAI *59 - 58 Tanaka, Hozumi JPN	

DEMI-FINALES SEMI-FINALS OCT 24

279 Rodríguez, Francisco (VEN)	Marbley, Harlan (EUA)	DPS (4 - 1)	Müller, Hans ADE
		*59 - 58 Rankin, Archibald GBR *58 - 58 England, James GBR *60 - 56 Aslam, Abdul PAK 58 - 59* Tanner, Archie AUS *60 - 57 Swang, Siripai TAI	

280 Jee, Yong-Ju (COR)	Skrzypczak, Hubert (POL)	DPS (4 - 1)	Schwartz, Roland EUA
		59 - 59* Bril, Ben HOL *60 - 58 Gittins, Richard GBR *60 - 58 Santiago, Waldo CUB *60 - 57 Villacampa, Alex FIL *60 - 57 Pepe, Juan ARG	

GAGNANT WINNER	PERDANT LOSER	RESULTAT RESULT	ARBITRE - JUGES REFEREE JUDGES
-------------------	------------------	--------------------	-----------------------------------

FINALE FINAL OCT 26

291 Rodríguez, Francisco (VEN)	Jee, Yong-Ju (COR)	DPS (3 - 2)	Idziak, Boleslaw POL
--------------------------------	--------------------	-------------	----------------------

*59 - 58 Gittins, Richard GBR
58 - 59* Müller, Hans ADE
59 - 59* Aslam, Abdul PAK
*60 - 58 Pepe, Juan ARG
*60 - 58 Oguntokun, Olu NGR

1 Ogun, Gabriel NGR	2	P(5-0)	4	P(4-1)
2 Marbley, Harlan EUA	2			
3 Karunaratne, Hatha CEI	4	RSC 2do Rd	8	P(3-2)
4 Rodríguez, Francisco VEN	4			
5 Skrzypczak, Hubert POL	5	P(3-2)	8	P(3-2)
6 Donovan, Joseph AUS	6			
7 Morales, Alberto MEX	7	P(3-2)	8	P(3-2)
8 Jee, Yong-Ju COR	8			

1º Rodríguez, Francisco VEN
2º Jee, Yong-Ju COR
3º Skrzypczak, Hubert POL
3º Marbley, Harlan EUA

592

POIDS MOUCHE JUSQU'A 51 kg FLYWEIGHT UP TO 51 kgs

1e TOUR ELIMINATOIRE 1st ELIMINATION ROUND OCT 14

29 Pereyra, Tito (ARG)	Carney, Robert (AUS)	DPS (4 - 1)	González, Luis MEX
		58 - 59* Aslam, Abdul PAK *59 - 58 Thompson, Edwin IRL *60 - 55 Gondre, Georges FRA *60 - 57 Oguntokun, Olu NGR *60 - 56 Gittins, Richard GBR	

30 Nakamura, Tetsuaki (JPN)	McGonigle, Johnny (GBR)	DPS (4 - 1)	Zybalov, Georgi URS
		*58 - 57 Rial, José ESP *59 - 57 González, Luis MEX *60 - 59 Sampila, Kaleva FIN 59 - 59* Villacampa, Alex FIL *60 - 57 Checchi, Gualtiero ITA	

GAGNANT WINNER	PERDANT LOSER	RESULTAT RESULT	ARBITRE - JUGES REFEREE - JUDGES	
31 Ciuca, Constantin (RUM)	Hilmann, Boujemaa (MAR)	DPS (4 - 1)	Santiago, Waldo CUB	
		59 - 59*	Amarteifio, Godfrey GHA	
		*60 - 58	Pepe, Juan ARG	
		*60 - 54	Pak, In-Yang COR	
		*60 - 56	Thompson, Edwin IRL	
		*60 - 58	Tanaka, Hozumi JPN	
32 Olech, Artur (POL)	Cintrón, Heriberto (PRO)	DES	Gittins, Richard GBR	
			Tanner, Archie AUS	
			Rankin, Archibald GBR	
			Kiriak, Constantin RUM	
			Common, John FIJ	
			Gondre, Georges FRA	
33 Mwansa, Kenny (ZAM)	Díaz, Rodolfo (FIL)	DPS (4 - 1)	Schwartz, Roland EUA	
		*59 - 57	Bril, Ben HOL	
		*60 - 56	Hertel, Horst ADE	
		*59 - 55	Aslam, Abdul PAK	
		58 - 59*	Swang, Siripai TAI	
		*59 - 57	Hruska, Jaroslav CHE	
39 Novikov, Nicolai (URS)	Márquez, Félix (VEN)	DPS (5 - 0)	Rankin, Archibald GBR	
		*60 - 57	Amarteifio, Godfrey GHA	
		*60 - 59	Swang, Siripai TAI	
		*60 - 59	Aslam, Abdul PAK	
		*59 - 57	Müller, Hans ADE	
		*60 - 59	Rial, José ESP	
40 Vásquez, David (EUA)	Grasso, Filippo (ITA)	DPS (3 - 2)	Müller, Hans ADE	
		*57 - 57	England, James GBR	
		*58 - 57	Tanaka, Hozumi JPN	
		*57 - 56	Gittins, Richard GBR	
		57 - 58*	Pepe, Juan ARG	
		58 - 59*	Bril, Ben HOL	
41 Rwabwogo, Leo (UGA)	Sou, Sang-Young (COR)	DPS (5 - 0)	Checchi, Gualtiero ITA	
		*59 - 56	Aslam, Abdul PAK	
		*59 - 58	Zybalov, Georgi URS	
		*60 - 56	González, Luis MEX	
		*60 - 56	Jetchev, Emil BUL	
		*59 - 57	Ivanovic, Danilo YUG	
42 Badari, Tibor (HUN)	Martínez, Orlando (CUB)	DPS (4 - 1)	Amarteifio, Godfrey GHA	
		58 - 59*	Swang, Siripai TAI	
		*59 - 57	Schwartz, Roland EUA	
		*58 - 57	Yunes, Mabruk LBA	
		*60 - 58	Idziak, Boleslaw POL	
		*59 - 58	Sampila, Kaleva FIN	
43 Duangcha-Oom, Prapan (TAI)	Chan, Wa-Jen (TWN)	DPS (5 - 0)	Gondre, Georges FRA	
		*59 - 58	Checchi, Gualtiero ITA	
		*60 - 57	Thompson, Edwin IRL	
		*60 - 58	Idziak, Boleslaw POL	
		*60 - 58	Kiriak, Constantin RUM	
		*60 - 55	Lowes, Bert CAN	

GAGNANT WINNER	PERDANT LOSER	RESULTAT RESULT	ARBITRE - JUGES REFEREE - JUDGES	
----------------	---------------	-----------------	----------------------------------	--

HUITIEMES DE FINALE OCT 17 EIGHTH-FINALS

97 Destimo, Joseph (GHA)	Henry, Walter (CAN)	RSC 3er RD	Hruska, Jaroslav CHE	
			England, James GBR	
			Idziak, Boleslaw POL	
			Bril, Ben HOL	
			Kuka, Khoorshed IND	
			Ivanovic, Danilo YUG	
98 De Oliveira, Servilio (BRA)	Yadigar, Engin (TUR)	DPS (3 - 2)	Amarteifio, Godfrey GHA	
		*59 - 58	Aslam, Abdul PAK	
		*60 - 57	Common, John FIJ	
		59 - 59*	Gondre, Georges FRA	
		*59 - 59	Yunes, Mabruk LBA	
		57 - 59*	Oguntokun, Olu NGR	
111 Delgado, Ricardo (MEX)	McCarthy, Brendan (IRL)	DPS (5 - 0)	Jetchev, Emil BUL	
		*60 - 57	Gittins, Richard GBR	
		*60 - 56	Pepe, Juan ARG	
		*60 - 58	Rial, José ESP	
		*60 - 56	Oguntokun, Olu NGR	
		*60 - 57	Hruska, Jaroslav CHE	
112 Nakamura, Tetsuaki (JPN)	Pereyra, Tito (ARG)	DPS (5 - 0)	Keleman, Imre HUN	
		*60 - 58	Swang, Siripai TAI	
		*60 - 56	Common, John FIJ	
		*60 - 57	Santiago, Waldo CUB	
		*60 - 57	Müller, Hans ADE	
		*59 - 58	Hertel, Horst ADE	
113 Olech, Artur (POL)	Ciuca, Constantin (RUM)	DPS (3 - 2)	Villacampa, Alex FIL	
		*59 - 58	Rankin, Archibald GBR	
		*59 - 58	England, James GBR	
		*59 - 59	Amarteifio, Godfrey GHA	
		57 - 60*	Thompson, Edwin IRL	
		59 - 60*	Pak, In-Yang COR	
114 Novikov, Nicolai (URS)	Mwansa, Kenny (ZAM)	DPS (4 - 1)	Rankin, Archibald GBR	
		57 - 60*	Arcos, Ernesto MEX	
		*60 - 58	Müller, Hans ADE	
		*60 - 59	Kiriak, Constantin RUM	
		*60 - 57	Gondre, Georges FRA	
		*60 - 57	Kuka, Khoorshed IND	
115 Rwabwogo, Leo (UGA)	Vásquez, David (EUA)	DPS (3 - 2)	Zybalov, Georgi URS	
		*58 - 58	Pak, In-Yang COR	
		*60 - 57	Pepe, Juan ARG	
		58 - 59*	Idziak, Boleslaw POL	
		*59 - 58	Jetchev, Emil BUL	
		57 - 60*	England, James GBR	
116 Badari, Tibor (HUN)	Duangcha-Oom, Prapan (TAI)	DPS (4 - 1)	Müller, Hans ADE	
		*59 - 58	Rankin, Archibald GBR	
		*60 - 59	Tanaka, Hozumi JPN	
		*60 - 58	Villacampa, Alex FIL	
		*60 - 58	Schwartz, Roland EUA	
		59 - 59*	Checchi, Gualtiero ITA	

GAGNANT
WINNERPERDANT
LOSERRESULTAT
RESULTARBITRE - JUGES
REFEREE - JUDGESQUARTS DE FINALE
QUARTER-FINALS **OCT 21**

205 De Oliveira, Servilio (BRA) Destimo, Joseph (GHA) DPS (5 - 0) Gittins, Richard GBR

*60 - 59 Gondre, Georges FRA
*59 - 57 Tanaka, Hozumi JPN
*59 - 58 Hertel, Horst ADE
*58 - 57 Pak, In-Yang COR
*58 - 57 Tanner, Archie AUS

206 Delgado, Ricardo (MEX) Nakamura, Tetsuaki (JPN) DPS (5 - 0) Checchi, Gualtiero ITA

*60 - 59 Villacampa, Alex FIL
*60 - 58 Lowes, Bert CAN
*60 - 59 Oguntokun, Olu NGR
*60 - 58 Kuka, Khoorshed IND
*59 - 58 Gittins, Richard GBR

215 Olech, Artur (POL) Novikov, Nicolai (URS) RSC 2do RD Arcos, Ernesto MEX

Aslam, Abdul PAK
Checchi, Gualtiero ITA
Gondre, Georges FRA
Lowes, Bert CAN
Kuka, Khoorshed IND

216 Rwabwogo, Leo (UGA) Badari, Tibor (HUN) DPS (3 - 2) England, James GBR

57 - 58* Tanner, Archie AUS
58 - 59* Swang, Siripai TAI
*59 - 58 Gittins, Richard GBR
*58 - 58 Bril, Ben HOL
*60 - 58 Oguntokun, Olu NGR

1 Destimo, Joseph GHA

2 De Oliveira, Servilio BRA

3 Delgado, Ricardo MEX

4 Nakamura, Tetsuaki JPN

5 Olech, Artur POL

6 Novikov, Nicola URS

7 Rwabwogo, Leo UGA

8 Badari, Tibor HUN

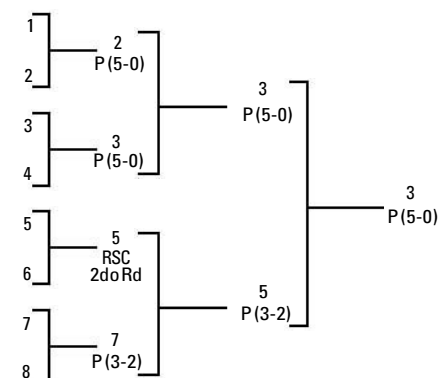
1^o Delgado, Ricardo MEX
2^o Olech, Arturo POL
3^o Rwabwogo, Leo UGA
3^o De Oliveira, Servilio BRA

594

**POIDS COQ JUSQU'A 54 kg
BANTAMWEIGHT UP TO 54 kgs**1e TOUR ELIMINATOIRE
1st ELIMINATION ROUND **OCT 13**GAGNANT WINNER PERDANT LOSER RESULTAT RESULT ARBITRE - JUGES REFEREE - JUDGES
5 Chang, Kyou-Chull (COR) Mendoza, Mario (GUA) DPS (5 - 0) Gondre, Georges FRA*60 - 55 Checchi, Gualtiero ITA
*60 - 55 Kiriak, Constantin RUM
*60 - 55 Amarteifio, Godfrey GHA
*60 - 56 Kuka, Khoorshed IND
*60 - 56 Aslam, Abdul PAK

269 Delgado, Ricardo (MEX) De Oliveira, Servilio (BRA) DPS (5 - 0) Gondre, Georges FRA

*60 - 57 England, James GBR
*60 - 56 Lowes, Bert CAN
*60 - 57 Müller, Hans ADE
*60 - 59 Rial, José ESP
*59 - 57 Tanner, Archie AUS

270 Olech, Artur (POL) Rwabwogo, Leo (UGA) DPS (3 - 2) Swang, Siripai TAI

*60 - 58 Rial, José ESP
*59 - 58 Gondre, Georges FRA
58 - 59* Amarteifio, Godfrey GHA
57 - 60* Oguntokun, Olu NGR
59 - 58 Santiago, Waldo CUB

6 Espinosa, Fermin (CUB) Udompachitkul, Ch. (TAI) DPS (4 - 1) Hertel, Horst ADE

58 - 59* Gittins, Richard GBR
*59 - 58 Idziak, Boleslaw POL
*58 - 57 Tanaka, Hozumi JPN
*59 - 58 Rial, José ESP
*59 - 57 Pepe, Juan ARG

17 Savov, Nikola (BUL) Mwamba, Godfrey (ZAM) RSC 2do RD 2.42 Villacampa, Alex FIL

Thompson, Edwin IRL
Tanaka, Hozumi JPN
Sampila, Kaleva FIN
Rankin, Archibald GBR
Pak, In-Yang CORFINALE
FINAL **OCT 26**

292 Delgado, Ricardo (MEX) Olech, Artur (POL) DPS (5 - 0) Müller, Hans ADE

*60 - 58 Rial, José ESP
*60 - 59 Gondre, Georges FRA
*59 - 58 Schwartz, Roland EUA
*60 - 58 Pepe, Juan ARG
*60 - 57 Villacampa, Alex FIL

GAGNANT WINNER	PERDANT LOSER	RESULTAT RESULT	ARBITRE - JUGES REFEREE - JUDGES	GAGNANT WINNER	PERDANT LOSER	RESULTAT RESULT	ARBITRE - JUGES REFEREE - JUDGES	
18 Shittu, Sulley (GHA)	Dasuda, Dary (NIG)	DPS (4 - 1)	Müller, Hans ADE	77 Rakowski, John (AUS)	Theotokatos, Angelos (GRE)	DPS (3 - 2)	Gondre, Georges FRA	
		*60 - 57 *59 - 58 *59 - 58 58 - 59* *59 - 58	Common, John Hruska, Jaroslav Ivanovic, Danilo Gondre, Georges Kiriak, Constantin	FIJ CHE YUG FRA RUM		58 - 59* *59 - 58 *60 - 56 *59 - 59 58 - 59*	Gittins, Richard Aslam, Abdul Pak, In-Yang Hruska, Jaroslav Kiriak, Constantin	GBR PAK COR CHE RUM
19 Szabo, Gyula (HUN)	Velásquez, Guillermo (CHI)	DPS (3 - 2)	Yunes, Mabruk LBA	78 Dowling, Michael (IRL)	Juterzenka, Bernd (ADE)	RSC 1er RD	Tanaka, Hozumi JPN	
		57 - 59* *59 - 58 58 - 59* *59 - 58 *59 - 58	Aslam, Abdul Amarteifio, Godfrey Arcos, Ernesto Checchi, Gualtiero Lowes, Bert	PAK GHA MEX ITA CAN			Lowes, Bert Santiago, Waldo Ivanovic, Danilo Amarteifio, Godfrey Schwartz, Roland	CAN CUB YUG GHA EUA
20 Rascher, Horst (ALE)	Dadigi, John (NGR)	RSC 1er RD 1.58	Tanaka, Hozumi JPN	83 Morioka, Eiji (JPN)	Calumarde, Dominador (FIL)	DPS (4 - 1)	Hertel, Horst ADE	
			Yunes, Mabruk Thompson, Edwin Common, John Villacampa, Alex Schwartz, Roland	LBA IRL FIJ FIL EUA		*59 - 58 58 - 59* *59 - 57 *59 - 58 *59 - 58	Ivanovic, Danilo Pérez, Daniel Sampila, Kaleva Idziak, Boleslaw Kiriak, Constantin	YUG MEX FIN POL RUM
				84 Cosentino, Aldo (FRA)	Fredriksson, Kjell (SUE)	DPS (5 - 0)	Santiago, Waldo CUB	
						*60 - 55 *60 - 57 *60 - 56 *60 - 57 *60 - 54	Kuka, Khoorshed Amarteifio, Godfrey Common, John Jetchev, Emil Pak, In-Yang	IND GHA FIJ BUL COR
21 Campbell, Kenneth (JAM)	Silva, Hermes (NIC)	DPS (5 - 0)	Tanner, Archie AUS	85 Giju, Nicolae (RUM)	Goss, Samuel (EUA)	DPS (5 - 0)	Pak, In-Yang COR	
		*60 - 55 *60 - 56 *60 - 57 *60 - 55 *60 - 54	Sampila, Kaleva Oguntokun, Olu Keleman, Imre Idziak, Boleslaw Zybalov, Georgi	FIN NGR HUN POL URS		*60 - 55 *60 - 56 *60 - 57 *60 - 56 *59 - 58	Rankin, Archibald Tanaka, Hozumi Swang, Siripai Yunes, Mabruk Pepe, Juan	GBR JPN TAI LBA ARG
73 Sokolov, Valery (URS)	Anchundia, Rafael (ECU)	DPS (3 - 2)	Swang, Siripai TAI	86 Mukwanga, Eridadi (UGA)	Suárez, Ramiro (ESP)	KO 2do RD 2.35	Bril, Ben HOL	
		57 - 60* *59 - 59 *59 - 58 58 - 60* *59 - 57	Yunes, Mabruk Müller, Hans Pepe, Juan Aslam, Abdul Rial, José	LBA ADE ARG PAK ESP			Hertel, Horst Lowes, Bert Checchi, Gualtiero Hruska, Jaroslav Schwartz, Roland	ADE CAN ITA CHE EUA
74 Carter, Michael (GBR)	Lindbergh, Jouko (FIN)	DPS (5 - 0)	Amarteifio, Godfrey GHA	87 Cervantes, Roberto (MEX)	Galazka, Jan (POL)	DPS (5 - 0)	Keleman, Imre HUN	
		*60 - 56 *60 - 56 *60 - 55 *60 - 56 *60 - 53	Checchi, Gualtiero Tanaka, Hozumi Bril, Ben Villacampa, Alex Pak, In-Yang	ITA JPN HOL FIL COR		*59 - 59 *58 - 58 *59 - 59 *59 - 57 *59 - 58	Thompson, Edwin England, James Gittins, Richard Bril, Ben Rankin, Archibald	IRL GBR GBR HOL GBR
75 Mbugua, Samuel (KEN)	Singh, Dhanraj (GUY)	DPS (5 - 0)	England, James GBR	88 Casco, Domingo (ARG)	Ladjili, Mahmoud (TUN)	DPS (3 - 2)	Sampila, Kaleva FIN	
		*60 - 55 *60 - 52 *60 - 54 *60 - 56 *60 - 55	Kuka, Khoorshed Gittins, Richard Ivanovic, Danilo Pérez, Daniel Swang, Siripai	IND GBR YUG MEX TAI		59 - 60* 59 - 59* *60 - 57 *59 - 58 *59 - 58	Gondre, Georges Oguntokun, Olu Tanner, Archie Keleman, Imre Müller, Hans	FRA NGR AUS HUN ADE
76 Mura, Guiseppe (ITA)	Torres, Andrés (PRO)	DPS (5 - 0)	Schwartz, Roland EUA	89 Chang, Kyou-Chull (COR)	Wang, Chee-Yen (TWN)	DPS (3 - 2)	Oguntokun, Olu NGR	
		*60 - 55 *60 - 52 *60 - 56 *60 - 52 *60 - 56	Zybalov, Georgi England, James Tanaka, Hozumi Rankin, Archibald Oguntokun, Olu	URS GBR JPN GBR NGR		*60 - 59 *59 - 58 58 - 59* *58 - 57 56 - 60*	Zybalov, Georgi Keleman, Imre Schwartz, Roland Tanaka, Hozumi Yunes, Mabruk	URS HUN EUA JPN LBA

2e TOUR ELIMINATOIRE
2nd ELIMINATION ROUND

OCT 16

GAGNANT WINNER	PERDANT LOSER	RESULTAT RESULT	ARBITRE - JUGES REFEREE - JUDGES	GAGNANT WINNER	PERDANT LOSER	RESULTAT RESULT	ARBITRE - JUGES REFEREE - JUDGES
90 Savov, Nikola (BUL)	Espinosa, Fermín (CUB)	RSC 2do RD	Zybalov, Georgi URS Aslam, Abdul Gondre, Georges Yunes, Mabruk Rial, José Hertel, Horst PAK FRA LBA ESP ADE	218 Cervantes, Roberto (MEX)	Casco, Domingo (ARG)	DES 2do RD	Kiriak, Constantin RUM Oguntokun, Olu Hertel, Horst Villacampa, Alex Rial, José England, James NGR ADE FIL ESP GBR
91 Shittu, Sulley (GHA)	Szabo, Gyula (HUN)	DPS (5 - 0)	Tanner, Archie AUS *60 - 56 Lowes, Bert CAN *60 - 57 Santiago, Waldo CUB *60 - 57 Sampila, Kaleva FIN *60 - 55 Pak, In-Yang COR *60 - 55 Villacampa, Alex FIL	219 Chang, Kyou-Chull (COR)	Savov, Nikola (BUL)	RSC 3er RD	Lowes, Bert CAN Tanaka, Hozumi JPN Checchi, Gualtiero ITA Kuka, Khoorshed IND Amarteifio, Godfrey GHA Thompson, Edwin IRL
92 Rascher, Horst (ALE)	Campbell, Kenneth (JAM)	DPS (4 - 1)	Kiriak, Constantin RUM *60 - 58 Idziak, Boleslaw POL *59 - 60* Checchi, Gualtiero ITA *60 - 58 Amarteifio, Godfrey GHA *60 - 57 Kuka, Khoorshed IND *60 - 58 Swang, Siripai TAI	220 Rascher, Horst (ALE)	Shittu, Sulley (GHA)	DPS (3 - 2)	Zybalov, Georgi URS *59 - 60* Swang, Siripai TAI *58 - 59* Arcos, Ernesto MEX *60 - 59 Kiriak, Constantin RUM *60 - 57 Gittins, Richard GBR *59 - 58 Santiago, Waldo CUB

HUITIEMES DE FINALE OCT 21

QUARTS DE FINALE OCT 23

596

207 Sokolov, Valery (URS)	Carter, Michael (GBR)	RSC 1er RD	Tanaka, Hozumi JPN Thompson, Edwin IRL Santiago, Waldo CUB Arcos, Ernesto MEX Schwartz, Roland EJA Gondre, Georges FRA	249 Sokolov, Valery (URS)	Mbugua, Samuel (KEN)	DPS (5 - 0)	Checchi, Gualtiero ITA *60 - 58 Gondre, Georges FRA *60 - 58 Ivanovic, Danilo YUG *60 - 58 Schwartz, Roland EJA *60 - 56 Lowes, Bert CAN *60 - 58 Villacampa, Alex FIL
208 Mbugua, Samuel (KEN)	Mura, Giuseppe (ITA)	DPS (3 - 2)	Pak, In-Yang COR *59 - 59 Amarteifio, Godfrey GHA *59 - 57 Arcos, Ernesto MEX *59 - 59* Tanaka, Hozumi JPN *59 - 59* Tanner, Archie AUS *59 - 59 Gittins, Richard GBR	250 Morioka, Eiji (JPN)	Dowling, Michael (IRL)	DPS (4 - 1)	Tanner, Archie AUS *60 - 56 Kuka, Khoorshed IND *58 - 59* Amarteifio, Godfrey GHA *60 - 58 Hruska, Jaroslav CHE *59 - 57 Idziak, Boleslaw POL *60 - 56 Santiago, Waldo CUB
209 Dowling, Michael (IRL)	Rakowski, John (AUS)	DES 2do RD	Schwartz, Roland EJA Lowes, Bert CAN Hertel, Horst ADE Gondre, Georges FRA Santiago, Waldo CUB Villacampa, Alex FIL	259 Mukwanga, Eridadi (UGA)	Cervantes, Roberto (MEX)	DPS (4 - 1)	Gondre, Georges FRA *60 - 59 Pak, In-Yang COR *60 - 57 Sampila, Kaleva FIN *59 - 57* Tanner, Archie AUS *59 - 59* Idziak, Boleslaw POL *60 - 58 Amarteifio, Godfrey GHA
210 Morioka, Eiji (JPN)	Cosentino, Aldo (FRA)	DPS (4 - 1)	England, James GBR *60 - 56 Schwartz, Roland EJA *59 - 58 Bril, Ben HOL *58 - 58 Lowes, Bert CAN *58 - 59* Aslam, Abdul PAK *59 - 58 Kiriak, Constantin RUM	260 Chang, Kyou-Chull (COR)	Rascher, Horst (ALE)	DPS (5 - 0)	Kiriak, Constantin RUM *59 - 58 Swang, Siripai TAI *60 - 58 Aslam, Abdul PAK *59 - 58 Keleman, Imre HUN *60 - 57 Pepe, Juan ARG *59 - 59 Gittins, Richard GBR
217 Mukwanga, Eridadi (UGA)	Giju, Nicolae (RUM)	RSC 2do RD	Gondre, Georges FRA Hertel, Horst ADE Müller, Hans ADE Lowes, Bert CAN Santiago, Waldo CUB Amarteifio, Godfrey GHA				

GAGNANT
WINNER

PERDANT
LOSER

RESULTAT
RESULT

ARBITRE - JUGES
REFEREE - JUDGES

**POIDS PLUME JUSQU'A 57 kg
FEATHERWEIGHT UP TO 57 kgs**

DEMI-FINALES
SEMI-FINALS **OCT 24**

281 Sokolov, Valery (URS) Morioka, Eiji (JPN) DPS (5 - 0) Bril, Ben HOL
*60 - 58 Kuka, Khoorshed IND
*60 - 58 Santiago, Waldo CUB
*59 - 58 Tanner, Archie AUS
*59 - 59 Gondre, Georges FRA
*59 - 58 Lowes, Bert CAN

282 Mukwanga, Eridadi (UGA) Chang, Kyou-Chull (COR) DPS (4 - 1) Rial, José ESP
58 - 59* Tanaka, Hozumi JPN
*59 - 58 Schwartz, Roland EUA
*60 - 58 Aslam, Abdul PAK
*59 - 58 Tanner, Archie AUS
*59 - 58 Bril, Ben HOL

FINALE
FINAL **OCT 26**

293 Sokolov, Valery (URS) Mukwanga, Eridadi (UGA) RSC2doRD Gittins, Richard GBR
Müller, Hans ADE
Oguntokun, Olu NGR
Tanaka, Hozumi JPN
Pepe, Juan ARG
Swang, Siripai TAI

1 Sokolov, Valery URS
2 Mbugua, Samuel KEN
3 Dowling, Michael IRL
4 Morioka, Eiji JPN
5 Mukwanga, Eridadi UGA
6 Cervantes, Roberto MEX
7 Chang, Kyou-Chull COR
8 Rascher, Horst ALE

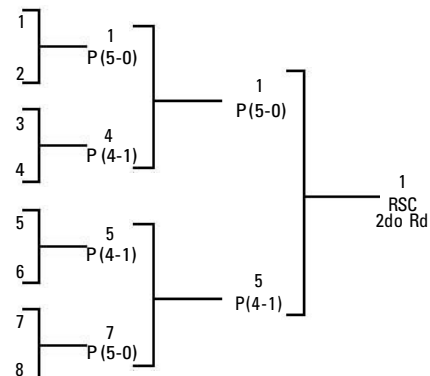

19 Sokolov, Valery URS
29 Mukwanga, Eridadi UGA
39 Morioka, Eiji JPN
39 Chang, Kyou-Chull COR

1e TOUR ELIMINATOIRE
1st ELIMINATION ROUND **OCT 15**

GAGNANT
WINNER 50 Garcia, Miguel (ARG) PERDANT
LOSER Oduardo, Francisco (CUB) RESULTAT
RESULT DPS (3 - 2) ARBITRE - JUGES
REFEREE - JUDGES Kiriak, Constantin RUM

59 - 59* Idziak, Boleslaw POL
*59 - 58 Aslam, Abdul PAK
58 - 59* Amarteifio, Godfrey GHA
*60 - 57 Kuka, Khoorshed IND
*59 - 58 Thompson, Edwin IRL

51 Simion, Aurel (RUM) Santamaria, Mario (NIC) DPS (5 - 0) Hertel, Horst ADE

*59 - 58 Gittins, Richard GBR
*59 - 58 Bril, Ben HOL
*60 - 56 Lowes, Bert CAN
*60 - 57 England, James GBR
*59 - 56 Checchi, Gualtiero ITA

52 Waruingi, Philip (KEN) Anton, Jean-Paul (FRA) DPS (5 - 0) Keleman, Imre HUN

*60 - 55 Ortiz, Fidel MEX
*59 - 58 Pepe, Juan ARG
*60 - 56 Yunes, Mabruk LBA
*60 - 55 Sampila, Kaleva FIN
*60 - 58 Zybalov, Georgi URS

53 Sourour, Mohamed (MAR) Mebarki, Ali (AGL) DPS (4 - 1) Gittins, Richard GBR

*59 - 57 Tanner, Archie AUS
58 - 59* Hruska, Jaroslav CHE
*59 - 57 Rankin, Archibald GBR
*60 - 57 Schwartz, Roland EUA
*59 - 57 Tanaka, Hozumi JPN

54 Cotena, Elio (ITA) Palm, Cari-Axel (SUE) DPS (5 - 0) Schwartz, Roland EUA

*59 - 58 Pak, In-Yang COR
*60 - 58 Kiriak, Constantin RUM
*60 - 57 Aslam, Abdul PAK
*60 - 58 Villacampa, Alex FIL
*59 - 58 Bril, Ben HOL

55 Plotnikov, Valery (URS) Meronen, Risto (FIN) DPS (5 - 0) Tanaka, Hozumi JPN

*60 - 54 Kuka, Khoorshed IND
*60 - 56 Santiago, Waldo CUB
*60 - 56 Oguntokun, Olu NGR
*60 - 55 Müller, Hans ADE
*60 - 58 Jetchev, Emil BUL

56 Tracey, Edward (IRL) West, Errol (JAM) DPS (4 - 1) Lowes, Bert CAN

*59 - 59 Zybalov, Georgi URS
57 - 58* Yunes, Mabruk LBA
*60 - 58 Idziak, Boleslaw POL
*60 - 58 Oguntokun, Olu NGR
*60 - 58 Sampila, Kaleva FIN

GAGNANT WINNER	PERDANT LOSER	RESULTAT RESULT	ARBITRE - JUGES REFEREE - JUDGES
57 Roldán, Antonio (MEX)	Abdel, Hwad (SUD)	DPS (5 - 0)	Zybalov, Georgi URS

*60 - 55	Hertel, Horst	ADE
*60 - 56	Tanner, Archie	AUS
*59 - 56	Keleman, Imre	HUN
*60 - 55	Gondre, Georges	FRA
*60 - 51	Schwartz, Roland	EUA

61 Pelegrino, Teogenes (FIL)	Seifu, Fantahun (ETI)	KO 2do RD 0.50	Jetchev, Emil BUL
------------------------------	-----------------------	-------------------	-------------------

Gittins, Richard	GBR
Hruska, Jaroslav	CHE
Kuka, Khoorshed	IND
Lowes, Bert	CAN
Hertel, Horst	ADE

62 Robinson, Albert (EUA)	Cheshire, John (GBR)	RSC 2do RD	Checchi, Gualtiero ITA
---------------------------	----------------------	------------	------------------------

Sampila, Kaleva	FIN
Pak, In-Yang	COR
Gondre, Georges	FRA
Pepe, Juan	ARG
Idziak, Boleslaw	POL

63 Jovan, Pajkovic (YUG)	Mercado, Reinaldo (PRO)	DPS (5 - 0)	Amarteifio, Godfrey GHA
--------------------------	-------------------------	-------------	-------------------------

*60 - 56	Aslam, Abdul	PAK
*60 - 58	Müller, Hans	ADE
*60 - 56	Oguntokun, Olu	NGR
*60 - 57	Ortiz, Fidel	MEX
*60 - 57	Rial, José	ESP

598

64 Khallaf, Abdel (RAU)	Manai, Mouldi (TUN)	DPS (4 - 1)	Ivanovic, Danilo YUG
-------------------------	---------------------	-------------	----------------------

*60 - 57	Pepe, Juan	ARG
*60 - 59	Jetchev, Emil	BUL
*60 - 57	Villacampa, Alex	FIL
59 - 59*	Aslam, Abdul	PAK
*59 - 58	Hruska, Jaroslav	CHE

65 Tatar, Seyfi (TUR)	Martín, Andrés (ESP)	DPS (5 - 0)	Oguntokun, Olu NGR
-----------------------	----------------------	-------------	--------------------

*60 - 58	England, James	GBR
*60 - 57	Rankin, Archibald	GBR
*60 - 58	Checchi, Gualtiero	ITA
*60 - 57	Zybalov, Georgi	URS
*60 - 55	Bril, Ben	HOL

66 Kim, Sung-Eun (COR)	Okamoto, Tadashi (JPN)	DPS (3 - 2)	Müller, Hans ADE
------------------------	------------------------	-------------	------------------

*60 - 57	Swang, Siripai	TAI
*59 - 58	Schwartz, Roland	EUA
58 - 60*	Sampila, Kaleva	FIN
*60 - 58	Checchi, Gualtiero	ITA
58 - 58*	Tanner, Archie	AUS

67 Michailov, Ivan (BUL)	Wadas, Jan (POL)	DPS (4 - 1)	Bril, Ben HOL
--------------------------	------------------	-------------	---------------

*59 - 58	Tanaka, Hozumi	JPN
*60 - 57	Ortiz, Fidel	MEX
59 - 59*	Amarteifio, Godfrey	GHA
*60 - 57	Yunes, Mabruk	LBA
*60 - 58	Santiago, Waldo	CUB

68 Stromme, Nils-Dag (NOR)	Ruzicka, Werner (ALE)	DPS (3 - 2)	Rankin, Archibald GBR
----------------------------	-----------------------	-------------	-----------------------

*60 - 58	Santiago, Waldo	CUB
*59 - 58	Thompson, Edwin	IRL
*60 - 58	Keleman, Imre	HUN
57 - 60*	Pepe, Juan	ARG
58 - 59*	Pak, In-Yang	COR

GAGNANT WINNER	PERDANT LOSER	RESULTAT RESULT	ARBITRE - JUGES REFEREE - JUDGES
----------------	---------------	-----------------	----------------------------------

HUITIEMES DE FINALE OCT 17
EIGHTH-FINALS

161 García, Miguel (ARG)	Simion, Aurel (RUM)	DPS (5 - 0)	Idziak, Boleslaw POL
--------------------------	---------------------	-------------	----------------------

*60 - 57	Swang, Siripai	TAI
*60 - 58	Schwartz, Roland	EUA
*60 - 56	Lowes, Bert	CAN
*59 - 58	Ortiz, Fidel	MEX
*60 - 57	Santiago, Waldo	CUB

162 Waruingi, Philip (KEN)	Sourour, Mohamed (MAR)	DPS (5 - 0)	Lowes, Bert CAN
----------------------------	------------------------	-------------	-----------------

*60 - 55	Kuka, Khoorshed	IND
*59 - 56	Keleman, Imre	HUN
*59 - 55	Schwartz, Roland	EUA
*59 - 56	Gondre, Georges	FRA
*60 - 56	Gittins, Richard	GBR

171 Plotnikov, Valery (URS)	Cotena, Elio (ITA)	DPS (3 - 2)	England, James GBR
-----------------------------	--------------------	-------------	--------------------

59 - 60*	Common, John	FIJ
58 - 59*	Pepe, Juan	ARG
*59 - 59	Oguntokun, Olu	NGR
*60 - 58	Tanaka, Hozumi	JPN
*60 - 59	Pak, In-Yang	COR

172 Roldán, Antonio (MEX)	Tracey, Edward (IRL)	DPS (4 - 1)	Hruska, Jaroslav CHE
---------------------------	----------------------	-------------	----------------------

*59 - 57	Lowes, Bert	CAN
59 - 59*	Ivanovic, Danilo	YUG
*60 - 57	Rial, José	ESP
*59 - 58	Hertel, Horst	ADE
*59 - 58	Keleman, Imre	HUN

173 Robinson, Albert (EUA)	Pelegrino, Teogenes (FIL)	KO 2do RD	Zybalov, Georgi URS
----------------------------	---------------------------	-----------	---------------------

Sampila, Kaleva	FIN
Gittins, Richard	GBR
Kiriak, Constantin	RUM
Checchi, Gualtiero	ITA
Kuka, Khoorshed	IND

174 Khallaf, Abdel (RAU)	Jovan, Pajkovic (YUG)	DES 3er RD	Lowes, Bert CAN
--------------------------	-----------------------	------------	-----------------

Müller, Hans	ADE
Amarteifio, Godfrey	GHA
Ortiz, Fidel	MEX
Villacampa, Alex	FIL
Tanner, Archie	AUS

175 Tatar, Seyfi (TUR)	Kim, Sung-Eun (COR)	DPS (3 - 2)	Ivanovic, Danilo YUG
------------------------	---------------------	-------------	----------------------

59 - 60*	Hruska, Jaroslav	CHE
*59 - 58	Amarteifio, Godfrey	GHA
*59 - 58	England, James	GBR
*60 - 58	Gondre, Georges	FRA
59 - 59*	Idziak, Boleslaw	POL

176 Michailov, Ivan (BUL)	Stromme, Nils-Dag (NOR)	DPS (5 - 0)	Santiago, Waldo CUB
---------------------------	-------------------------	-------------	---------------------

*60 - 58	Swang, Siripai	TAI
*60 - 57	Ortiz, Fidel	MEX
*60 - 58	Villacampa, Alex	FIL
*60 - 59	Oguntokun, Olu	NGR
*60 - 58	Schwartz, Roland	EUA

GAGNANT
WINNERPERDANT
LOSERRESULTAT
RESULTARBITRE - JUGES
REFEREE - JUDGESQUARTS DE FINALE
QUARTER-FINALS

OCT 22

225	Waruingi, Philip (KEN)	García, Miguel (ARG)	DPS (4 - 1)	Bril, Ben	HOL	*60 - 57 *60 - 56 59 - 59* *60 - 58 *60 - 56	Aslam, Abdul England, James Santiago, Waldo Idziak, Boleslaw Tanner, Archie	PAK GBR CUB POL AUS
226	Roldán, Antonio (MEX)	Plotnikov, Valery (URS)	DPS (4 - 1)	England, James	GBR	*59 - 58 *59 - 58 57 - 59* *59 - 57 *60 - 58	Ivanovic, Danilo Oguntokun, Olu Kuka, Khoorsed Lowe, Bert Gondre, Georges	YUG NGR IND CAN FRA
237	Robinson, Albert (EUA)	Khallaf, Abdel (RAU)	DPS (5 - 0)	Swang, Siripai	TAI	*60 - 58 *60 - 57 *60 - 56 *60 - 59 *60 - 57	Müllers, Hans Rial, José González, Luis Villacampa, Alex Oguntokun, Olu	ADE ESP MEX FIL NGR
238	Michailov, Ivan (BUL)	Tatar, Seyfi (TUR)	DPS (3 - 2)	Oguntokun, Olu	NGR	*59 - 59 *59 - 58 58 - 59* 57 - 58* *59 - 59	Keleman, Imre Checchi, Gualtiero Santiago, Waldo Lowe, Bert Pak, In-Yang	HUN ITA CUB CAN COR

DEMI-FINALES
SEMI-FINALS

OCT 24

271	Roldán, Antonio (MEX)	Waruingi, Philip (KEN)	DPS (3 - 2)	Pak, In-Yang	COR	58 - 59* *60 - 59 57 - 60* *60 - 59 *58 - 58	Idziak, Boleslaw Villacampa, Alex Kuka, Khoorsed Hertel, Horst Schwartz, Roland	POL FIL IND ADE EUA
272	Robinson, Albert (EUA)	Michailov, Ivan (BUL)	DPS (4 - 1)	Idziak, Boleslaw	POL	*59 - 58 *59 - 58 *59 - 58 *60 - 59 58 - 59*	Swang, Siripai Thompson, Edwin Gittins, Richard Aslam, Abdul Pérez, Daniel	TAI IRL GBR PAK MEX

FINALE
FINAL

OCT 26

294	Roldán, Antonio (MEX)	Robinson, Albert (EUA)	DES2do RD	Zybalov, Georgi	URS		Idziak, Boleslaw Tanner, Archie Villacampa, Alex Rankin, Archibald Tanaka, Hozumi	POL AUS FIL GBR JPN
-----	-----------------------	------------------------	-----------	-----------------	-----	--	-----------------------------------------------------------------------------------------------	---------------------------------

1	García, Miguel	ARG
2	Waruingi, Philip	KEN
3	Plotnikov, Valery	URS
4	Roldán, Antonio	MEX
5	Robinson, Albert	EUA
6	Khallaf, Abdel	RAU
7	Tatar, Seyfi	TUR
8	Michailov, Ivan	BUL

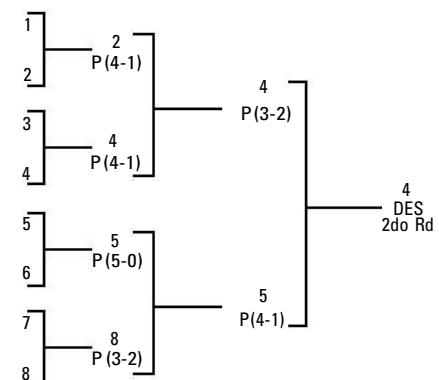

1º Roldan, Antonio
2º Robinson, Albert
3º Michailov, Ivan
3º Waruingi, Philip

MEX
EUA
BUL
KEN

POIDS LEGER JUSQU'A 60 kg
LIGHTWEIGHT UP TO 60 kgs1e TOUR ELIMINATOIRE
1st ELIMINATION ROUND

OCT 13

GAGNANT WINNER	PERDANT LOSER	RESULTAT RESULT	ARBITRE - JUGES REFEREE - JUDGES					
7	Grudzien, Josef (POL)	Ho, Ssu-Long (TWN)	DPS (5 - 0)	Amarteifio, Godfrey	GHA	*60 - 56 *60 - 52 *60 - 56 *60 - 53 *60 - 55	Oguntokun, Olu Müller, Hans Yunes, Mabruk Keleman, Imre Villacampa, Alex	NGR ADE LBA HUN FIL
8	Jonathan, Dele (NGR)	Chinae, Marcos (ESP)	DPS (5 - 0)	Pak, In-Yang	COR	*60 - 56 *60 - 56 *60 - 57 *59 - 58 *60 - 58	Tanner, Archie Schwartz, Roland Zybalov, Georgi Santiago, Waldo Thompson, Edwin	AUS EUA URS CUB IRL
22	Petriglia, Enzo (ITA)	Martey, Joe (GHA)	DPS (3 - 2)	Zybalov, Georgi	URS	*59 - 57 59 - 59* 58 - 59* *60 - 57 *59 - 57	Hertel, Horst Gittins, Richard Hruska, Jaroslav Swang, Siripai Arcos, Ernesto	ADE GBR CHE TAI MEX
23	Sheed, Abdel (SUD)	Febus, Eugenio (PRO)	DPS (5 - 0)	Ivanovic, Danilo	YUG	*60 - 58 *58 - 57 *60 - 58 *60 - 57 *60 - 57	Jetchev, Emil Gondre, Georges Tanaka, Hozumi Tanner, Archie Villacampa, Alex	BUL FRA JPN AUS FIL

GAGNANT WINNER	PERDANT LOSER	RESULTAT RESULT	ARBITRE - JUGES REFEREE - JUDGES	GAGNANT WINNER	PERDANT LOSER	RESULTAT RESULT	ARBITRE - JUGES REFEREE - JUDGES
24 Agüero, Pedro (ARG)	Arpón, Rodolfo (FIL)	DPS (3 - 2)	Jetchev, Emil BUL	106 Mendoza, Armando (VEN)	Puello, Martín (DOM)	RSC 3er RD	England, James GBR
		*60 - 59 *59 - 58 *59 - 58 58 - 60* 58 - 59*	Müllers, Hans ADE Pak, In-Yang COR Amarteifio, Godfrey GHA Gittins, Richard GBR Hertel, Horst ADE				Amarteifio, Godfrey GHA Schwartz, Rolando EUA Kiriak, Constantin RUM Swang, Siripai TAI Checchi, Gualtiero ITA
2e TOUR ELIMINATOIRE 2nd ELIMINATION ROUND				OCT 17			
99 Pilitchev, Stciane (BUL)	Ayele, Bayu (ETI)	DPS (5 - 0)	Swang, Siripai TAI	117 Minami, Luis (PER)	Tin, Tun (BIR)	KO 2do RD 0.33	Lowes, Bert CAN
		*60 - 55 *60 - 55 *60 - 54 *60 - 55	Gittins, Richard GBR Thompson, Edwin IRL Keleman, Imre HUN Hertel, Horst ADE Tanaka, Hozumi JPN				Amarteifio, Godfrey GHA Pak, In-Yang COR Rankin, Archibald GBR Oguntokun, Olu NGR Zybalov, Georgi URS
100 Durán, Antonio (MEX)	Azzaro, Dominique (FRA)	RSC 1er RD	Pak, In-Yang COR	118 Sevimli, Yeter (TUR)	Rivero, Juan (URG)	DES 3er RD	Tanaka, Hozumi JPN
			Rial, José ESP Tanner, Archie AUS Rankin, Archibald GBR Aslam, Abdul PAK Ivanovic, Danilo YUG				Idziak, Boleslaw POL Gondre, Georges FRA Villacampa, Alex FIL Keleman, Imre HUN Swang, Siripai TAI
101 Cutov, Calistrat (RUM)	Nikkinen, Karl-Erik (FIN)	DPS (5 - 0)	Santiago, Waldo CUB	119 Belousov, Valery (URS)	Gula, Laszlo (HUN)	RSC 1er RD	Gittins, Richard GBR
		*60 - 56 *60 - 56 *60 - 55 *60 - 54 *60 - 57	Thompson, Edwin IRL Yunes, Mabruk LBA Pepe, Juan ARG Arcos, Ernesto MEX Bril, Ben HOL				England, James GBR Oguntokun, Olu NGR Pepe, Juan ARG Arcos, Ernesto MEX Rial, José ESP
102 Lahdhili, Mongi (TUN)	Molina, Alfonso (NIC)	DPS (5 - 0)	Hertel, Horst ADE	120 Zvonimir, Vujin (YUG)	Rieger, Peter (ADE)	DPS (3 - 2)	Arcos, Ernesto MEX
		*59 - 57 *59 - 58 *60 - 56 *59 - 57 *59 - 57	Zybalov, Georgi URS Villacampa, Alex FIL Tanner, Archie AUS Lowes, Bert CAN Idziak, Boleslaw POL			59 - 59* *60 - 58 58 - 59* *59 - 59 *60 - 57	Santiago, Waldo CUB Schwartz, Roland EUA Bril, Ben HOL England, James GBR Aslam, Abdul PAK
103 Harris, Ronnie (EUA)	Lee, Chang-Kyi (COR)	DPS (5 - 0)	Checchi, Gualtiero ITA	121 Quinn, Anthony (IRL)	Bodio, Inoua (CMR)	KO 1er RD	Tanner, Archie AUS
		*60 - 58 *60 - 57 *59 - 57 *60 - 58 *59 - 57	Jetchev, Emil BUL Aslam, Abdul PAK Santiago, Waldo CUB Müller, Hans ADE Pepe, Juan ARG				Ivanovic, Danilo YUG Gittins, Richard GBR Hruska, Jaroslav CHE Lowes, Bert CAN Sampila, Kaleva FIN
104 Stracey, John (GBR)	Arneson, Marvin (CAN)	DPS (3 - 2)	Idziak, Boleslaw POL	122 Grudzien, Jozef (POL)	Caminero, Roberto (CUB)	DPS (5 - 0)	Bril, Ben HOL
		59 - 58 58 - 59 56 - 59* *58 - 56 *59 - 57	Sampila, Kaleva FIN Kuka, Khoorshed IND Villacampa, Alex FIL Yunes, Mabruk LBA Gondre, Georges FRA			*60 - 57 *60 - 58 *60 - 58 *60 - 59 *60 - 59	Rankin, Archibald GBR Kuka, Khoorshed IND Müller, Hans ADE Ivanovic, Danilo YUG Common, John FIJ
105 Muruli, Mohamed (UGA)	Muñoz, Luis (CHI)	DPS (5 - 0)	Ivanovic, Danilo YUG	123 Petriglia, Enzo (ITA)	Jonathan, Dele (NGR)	DPS (5 - 0)	Kiriak, Constantin RUM
		*60 - 56 *60 - 54 *60 - 57 *60 - 57 *60 - 56	Keleman, Imre HUN Lowes, Bert CAN Hruska, Jaroslav CHE Rial, José ESP Jetchev, Emil BUL			*60 - 58 *60 - 56 *60 - 57 *59 - 56 *60 - 58	Jetchev, Emil BUL Tanner, Archie AUS Santiago, Waldo CUB Idziak, Boleslaw POL Rial, José ESP

GAGNANT WINNER	PERDANT LOSER	RESULTAT RESULT	ARBITRE - JUGES REFEREE - JUDGES
124 Agüero, Pedro (ARG)	Sheed, Abdel (SUD)	DPS (5 - 0)	Rial, José ESP
		*60 - 57	Pak, In-Yang COR
		*60 - 57	Kiriak, Constantin RUM
		*60 - 58	Thompson, Edwin IRL
		*59 - 57	Villacampa, Alex FIL
		*59 - 58	Santiago, Waldo CUB

GAGNANT WINNER	PERDANT LOSER	RESULTAT RESULT	ARBITRE - JUGES REFEREE - JUDGES
200 Petriglia, Enzo (ITA)	Agüero, Pedro (ARG)	DPS (3 - 2)	Tanaka, Hozumi JPN
		*60 - 59	Hertel, Horst ADE
		*60 - 59	Aslam, Abdul PAK
		*60 - 58	Idziak, Boleslaw POL
		58 - 60*	Oguntokun, Olu NGR
		57 - 60*	Kuka, Khoorshed IND

HUITIEMES DE FINALE EIGHTH-FINALS OCT 20

187 Pilitchev, Stoiane (BUL)	Durán, Antonio (MEX)	DPS (4 - 1)	Amarteifio, Godfrey GHA
		*59 - 58	Müller, Hans ADE
		*59 - 58	Idziak, Boleslaw POL
		*59 - 59	Oguntokun, Olu NGR
		59 - 60*	Swang, Siripai TAI
		*60 - 59	Aslam, Abdul PAK

188 Cutov, Calistrat (RUM)	Lahdhili, Mongi (TUN)	DPS (5 - 0)	Tanaka, Hozumi JPN
		*60 - 59	Müller, Hans ADE
		*60 - 58	Pepe, Juan ARG
		*60 - 57	Pérez, Daniel MEX
		*60 - 58	Rial, José ESP
		*60 - 57	Kuka, Khoorshed IND

189 Harris, Ronnie (EUA)	Tracey, John (GBR)	DPS (4 - 1)	Idziak, Boleslaw POL
		*60 - 57	Aslam, Abdul PAK
		*60 - 57	Tanaka, Hozumi JPN
		*60 - 58	Amarteifio, Godfrey GHA
		58 - 60*	Oguntokun, Olu NGR
		*60 - 57	Sampila, Kaleva FIN

190 Muruli, Mohamed (UGA)	Mendoza, Armando (VEN)	DPS (4 - 1)	Ivanovic, Danilo YUG
		*60 - 59	Pak, In-Yang COR
		*59 - 58	Müller, Hans ADE
		*59 - 58	Amarteifio, Godfrey GHA
		58 - 60*	Pepe, Juan ARG
		*59 - 57	Yunes, Mabruk LBA

197 Minami, Luis (PER)	Sevimli, Yeter (TUR)	DPS (3 - 2)	Hertel, Horst ADE
		*60 - 59	Aslam, Abdul PAK
		*60 - 58	Pak, In-Yang COR
		*59 - 58	Amarteifio, Godfrey GHA
		58 - 59*	Bril, Ben HOL
		59 - 59*	Checchi, Gualtiero ITA

198 Zvonimir, Vujin (YUG)	Belousov, Valery (URS)	DPS (5 - 0)	Santiago, Waldo CUB
		*60 - 58	Villacampa, Alex FIL
		*60 - 57	Ortiz, Fidel MEX
		*60 - 54	Amarteifio, Godfrey GHA
		*60 - 57	Pepe, Juan ARG
		*60 - 57	Bril, Ben HOL

199 Grudzien, Jozef (POL)	Quinn, Anthony (IRL)	DPS (4 - 1)	Checchi, Gualtiero ITA
		*60 - 58	Ivanovic, Danilo YUG
		*59 - 58	Oguntokun, Olu NGR
		*60 - 57	Sampila, Kaleva FIN
		*60 - 59	Tanaka, Hozumi JPN
		57 - 59*	Yunes, Mabruk LBA

QUARTS DE FINALE QUARTER-FINALS OCT 23

251 Cutov, Calistrat (RUM)	Pilitchev, Stoiane (BUL)	DPS (4 - 1)	Müller, Hans ADE
		*60 - 57	Pepe, Juan ARG
		*60 - 59	Aslam, Abdul PAK
		*58 - 58	Oguntokun, Olu NGR
		*59 - 57	Lowes, Bert CAN
		57 - 59*	Thompson, Edwin IRL

252 Harris, Ronnie (EUA)	Muruli, Mohamed (UGA)	DPS (5 - 0)	Swang, Siripai TAI
		*60 - 56	Kuka, Khoorshed IND
		*60 - 56	Ortiz, Fidel MEX
		*60 - 57	Rial, José ESP
		*60 - 55	Tanaka, Hozumi JPN
		*60 - 56	Tanner, Archie AUS

261 Zvonimir, Vujin (YUG)	Minami, Luis (PER)	DPS (5 - 0)	Schwartz, Roland EUA
		*60 - 57	Ortiz, Fidel MEX
		*60 - 56	England, James GBR
		*60 - 57	Idziak, Boleslaw POL
		*60 - 56	Santiago, Waldo CUB
		*60 - 56	Tanaka, Hozumi JPN

262 Grudzien, Jozef (POL)	Petriglia, Enzo (ITA)	DPS (5 - 0)	Bril, Ben HOL
		*60 - 56	Keleman, Imre HUN
		*60 - 56	Schwartz, Roland EUA
		*60 - 59	Tanaka, Hozumi JPN
		*60 - 57	Villacampa, Alex FIL
		*60 - 57	Ortiz, Fidel MEX

DEMI-FINALES SEMI-FINALS OCT 24

283 Harris, Ronnie (EUA)	Cutov, Calistrat (RUM)	DPS (5 - 0)	Amarteifio, Godfrey GHA
		*59 - 59	Pepe, Juan ARG
		*60 - 57	England, James GBR
		*59 - 58	Gittins, Richard GBR
		*60 - 59	Tanaka, Hozumi JPN
		*60 - 59	Kuka, Khoorshed IND

284 Grudzien, Jozef (POL)	Zvonimir, Vujin (YUG)	DPS (5 - 0)	Sampila, Kaleva FIN
		*60 - 58	Bril, Ben HOL
		*59 - 58	Müller, Hans ADE
		*60 - 57	Tanner, Archie AUS
		*59 - 59	Pak, In-Yang COR
		*59 - 58	Pérez, Daniel MEX

GAGNANT
WINNER

PERDANT
LOSER

RESULTAT
RESULT

ARBITRE - JUGES
REFEREE - JUDGES

GAGNANT
WINNER

PERDANT
LOSER

RESULTAT
RESULT

ARBITRE - JUGES
REFEREE - JUDGES

FINALE FINAL OCT 26

295 Harris, Ronnie (EUA) Grudzien, Jozef (POL) DPS (5 - 0) Rial, José ESP

*60 - 59 Gondre, Georges FRA
*59 - 58 Gittins, Richard GBR
*60 - 57 Swang, Siripai TAI
*60 - 58 Oguntokun, Olu NGR
*60 - 58 Pak, In-Yang COR

1 Pilitchev, Stoiane BUL
2 Cutov, Calistrat RUM
3 Harris, Ronnie EUA
4 Muruli, Mohamed UGA
5 Minami, Luis PER
6 Zvonimir, Vujin YUG
7 Grudzien, Jozef POL
8 Petriglia, Enzo ITA

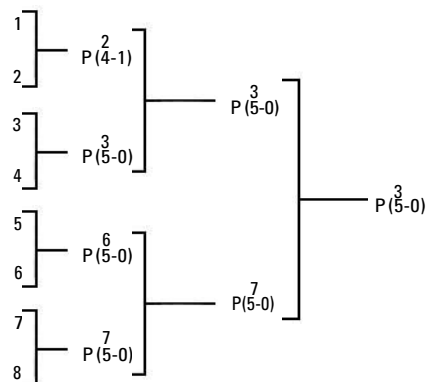

1^o Harris, Ronnie EUA
2^o Grudzien, Jozef POL
3^o Cutov, Calistrat RUM
3^o Zvonimir, Vujin YUG

25 Capretti, Gianbattista (ITA) Findlay, Richard (CAN) RSC 2do RD 2.05

Zybalov, Georgi ARG
Pepe, Juan ARG
Tanner, Archie AUS
Villacampa, Alex FIL
Malik, N. NIG

26 Regueiferos, Enrique (CUB) Waller, Terence (GBR) RSC 1er RD 2.59

Schwartz, Roland EUA
Sampila, Kaleva FIN
Ivanovic, Danilo YUG
Common, John FIJ
Jetchev, Emil BUL

2e TOUR ELIMINATOIRE 2nd ELIMINATION ROUND OCT 18

133 Kulej, Jerzy (POL) Kadji, Janos (HUN) DPS (3 - 2) Gittins, Richard GBR

59 - 60* Santiago, Waldo CUB
*59 - 58 Rankin, Archibald GBR
*59 - 58 Pepe, Juan ARG
*59 - 58 Villacampa, Alex FIL
58 - 59* Tanner, Archie AUS

SUR VERDICT MEDICAL, LE COMBAT No. 134 A ETE MODIFIE. L'ARGENTIN GONZALEZ, RAFAEL AYANT ETE ELIMINE A LA PESEE, L'ITALIEN CAPRETTI, GIANBATTISTA LE REMPLACA DANS LE MATCH CONTRE CASAL, CARLOS (URG). LE CUBAIN REGUEIFEROS, ENRIQUE, QUI DEVAIT RENCONTRER CAPRETTI, GIANBATTISTA, FUT EXEMPTÉ AU TOUR SUIVANT.

BECAUSE OF MEDICAL DISABILITY, THERE WAS A CHANGE IN FIGHT 134. GONZALEZ, RAFAEL OF ARGENTINA, ORIGINALLY SCHEDULED TO FIGHT CASAL, CARLOS OF URUGUAY, WAS ELIMINATED DURING THE WEIGH-IN AND WAS REPLACED BY CAPRETTI, GIANBATTISTA OF ITALY. REGUEIFEROS, ENRIQUE OF CUBA, SCHEDULED TO FIGHT CAPRETTI, GIANBATTISTA DREW A BYE.

135 Lozano, Jaime (MEX) Lawson, Emmanuel (GHA) DPS (5 - 0) Sampila, Kaleva FIN

*59 - 58 Tanner, Archie AUS
*60 - 59 Common, John FIJ
*59 - 58 Hertel, Horst ADE
*59 - 57 Lowes, Bert CAN
*59 - 58 Rankin, Archibald GBR

136 Tiepold, Peter (ADE) Kucera, Vladimir (CHE) DPS (5 - 0) Schwartz, Roland EUA

*60 - 57 Gittins, Richard GBR
*60 - 57 Oguntokun, Olu NGR
*60 - 59 Jetchev, Emil BUL
*60 - 57 Tanaka, Hozumi JPN
*60 - 58 Pepe, Juan ARG

POIDS WELTER LEGER JUSQU'A 63.5 kg LIGHT-WELTERWEIGHT UP TO 63.5 kgs

1e TOUR ELIMINATOIRE 1st ELIMINATION ROUND OCT 13

9 Galhia, Habib (TUN) Siebens, Adalberto (PRO) DPS (5 - 0) Hruska, Jaroslav CHE

*60 - 56 Lowes, Bert CAN
*60 - 57 Hertel, Horst ADE
*60 - 56 Rial, José ESP
*60 - 56 Bril, Ben HOL
*59 - 57 Checchi, Gualtiero ITA

137 Ljubinko, Veselinovic (YUG) Valencia, Samuel (ECU) DPS (3 - 2) Swang, Siripai TAI

58 - 60* Aslam, Abdul PAK
*60 - 57 Idziak, Boleslaw POL
*60 - 57 Pepe, Juan ARG
*60 - 57 Bril, Ben HOL
59 - 60* Common, John FIJ

10 Vasile, Antoniu (RUM) Dong, Ernest (CMR) KO 1er RD 2.50

Tanaka, Hozumi JPN
Rankin, Archibald GBR
Pak, In-Yang COR
Common, John FIJ
England, James GBR

138 Stoitchev, Petar (BUL) Kilicoglu, Ali (TUR) DPS (5 - 0) Santiago, Waldo CUB

*60 - 56 Rial, José ESP
*60 - 56 Sampila, Kaleva FIN
*60 - 56 Gondre, Georges FRA
*60 - 56 Pak, In-Yang COR
*60 - 55 Tanaka, Hozumi JPN

GAGNANT WINNER	PERDANT LOSER	RESULTAT RESULT	ARBITRE - JUGES REFEREE - JUDGES	
139 Puzicha, Gert (ALE)	McCourt, James (IRL)	DPS (5 - 0)	England, James	GBR
		*60 - 57	Zybalov, Georgi	URS
		*60 - 59	González, Luis	MEX
		*60 - 57	Schwartz, Roland	EUA
		*59 - 59	Oguntokun, Olu	NGR
		*60 - 58	Swang, Siripai	TAI

140 Nilsson, Arto (FIN)	Olulu, John (KEN)	DPS (3 - 2)	Idziak, Boleslaw	POL
		57 - 60*	Aslam, Abdul	PAK
		*60 - 58	Ivanovic, Danilo	YUG
		57 - 60*	Kuka, Khoorshed	IND
		*60 - 58	Schwartz, Roland	EUA
		*59 - 59	Kiriak, Constantin	RUM

147 Ruiz, Nelson (VEN)	Prasertsom, Niyom (TAI)	DPS (3 - 2)	Tanner, Archie	AUS
		58 - 59*	Tanaka, Hozumi	JPN
		*59 - 58	Idziak, Boleslaw	POL
		*59 - 59	Hertel, Horst	ADE
		*58 - 57	Keleman, Imre	HUN
		58 - 60*	Thompson, Edwin	IRL

148 Kim, Sa-Yong (COR)	González, Enrique (CHI)	DPS (3 - 2)	Checchi, Gualtiero	ITA
		*60 - 58	Jetchev, Emil	BUL
		58 - 59*	Hruska, Jaroslav	CHE
		*60 - 58	Kuka, Khoorshed	IND
		57 - 60*	Common, John	FIJ
		*59 - 58	Santiago, Waldo	CUB

149 Wallington, James (EUA)	Cartagena, Donato (DOM)	RSC 1er RD	Ivanovic, Danilo	YUG
			England, James	GBR
			Müller, Hans	ADE
			Aslam, Abdul	PAK
			Checchi, Gualtiero	ITA
			Swang, Siripai	TAI

150 Odhiambo, Alex (UGA)	Pérez, Mariano (ESP)	RSC 1er RD	Zybalov, Georgi	URS
			Pepe, Juan	ARG
			Schwartz, Roland	EUA
			Swang, Siripai	TAI
			Villacampa, Alex	FIL
			Kuka, Khoorshed	IND

151 Dabore, Issaka (NIG)	Marín, José (CRC)	DPS (5 - 0)	Hruska, Jaroslav	CHE
		*60 - 57	Bril, Ben	HOL
		*60 - 57	Hertel, Horst	ADE
		*60 - 58	Oguntokun, Olu	NGR
		*60 - 57	Lowes, Bert	CAN
		*60 - 57	Amarteifio, Godfrey	GHA

152 Frolov, Evgeny (URS)	Maguire, Raymond (AUS)	DPS (5 - 0)	Oguntokun, Olu	NGR
		*59 - 57	Bril, Ben	HOL
		*59 - 57	Rankin, Archibald	GBR
		*60 - 56	Tanaka, Hozumi	JPN
		*60 - 58	Pak, In-Yang	COR
		*59 - 58	Thompson, Edwin	IRL

153 Vasile, Antoniu (RUM)	Galhia, Habib (TUN)	D ⊙	Oguntokun, Olu	NGR
			Bril, Ben	HOL
			Rankin, Archibald	GBR
			Tanaka, Hozumi	JPN
			Pak, In-Yang	COR
			Thompson, Edwin	IRL

GAGNANT WINNER	PERDANT LOSER	RESULTAT RESULT	ARBITRE - JUGES REFEREE - JUDGES	
154 Capretti, Gianbattista (ITA)	Casal, Carlos (URG)	DPS (5 - 0)	Villacampa, Alex	FIL

*60 - 58	Kuka, Khoorshed	IND
*60 - 58	Jetchev, Emil	BUL
*59 - 58	Aslam, Abdul	PAK
*60 - 57	Tanner, Archie	AUS
*59 - 58	Amarteifio, Godfrey	GHA

HUITIEMES DE FINALE EIGHTH-FINALS

OCT 21

211 Kulej, Jerzy (POL)	Capretti, Gianbattista (ITA)	DPS (4 - 1)	Swang, Siripai	TAI
------------------------	------------------------------	-------------	----------------	-----

58 - 60*	Lowes, Bert	CAN
*60 - 58	Thompson, Edwin	IRL
*60 - 56	Aslam, Abdul	PAK
*60 - 58	Oguntokun, Olu	NGR
*60 - 58	Bril, Ben	HOL

212 Tiepold, Peter (ADE)	Lozano, Jaime (MEX)	DPS (5 - 0)	Zybalov, Georgi	URS
--------------------------	---------------------	-------------	-----------------	-----

*59 - 58	Lowes, Bert	CAN
*59 - 58	Thompson, Edwin	IRL
*59 - 58	Aslam, Abdul	PAK
*59 - 58	Oguntokun, Olu	NGR
*58 - 57	Bril, Ben	HOL

213 Stoitchev, Petar (BUL)	Ljubinko, Veselinovic (YUG)	DPS (4 - 1)	Oguntokun, Olu	NGR
----------------------------	-----------------------------	-------------	----------------	-----

58 - 60*	Gondre, Georges	FRA
*60 - 57	Thompson, Edwin	IRL
*60 - 57	Hertel, Horst	ADE
*60 - 58	Schwartz, Roland	EUA
*60 - 58	Arcos, Ernesto	MEX

214 Nilsson, Arto (FIN)	Puzicha, Gert (ALE)	DPS (3 - 2)	Amarteifio, Godfrey	GHA
-------------------------	---------------------	-------------	---------------------	-----

58 - 59*	Swang, Siripai	TAI
*59 - 58	Gittins, Richard	GBR
*60 - 59	Santiago, Waldo	CUB
57 - 60*	Kuka, Khoorshed	IND
*60 - 59	Villacampa, Alex	FIL

221 Kim, Sa-Yong (COR)	Ruiz, Nelson (VEN)	DPS (4 - 1)	Gittins, Richard	GBR
------------------------	--------------------	-------------	------------------	-----

*59 - 58	Oguntokun, Olu	NGR
*60 - 58	Lowes, Bert	CAN
*59 - 58	Rial, José	ESP
*60 - 59	Swang, Siripai	TAI
59 - 60*	Tanaka, Hozumi	JPN

222 Wallington, James (EUA)	Odhiambo, Alex (UGA)	DPS (5 - 0)	Pak, In-Yang	COR
-----------------------------	----------------------	-------------	--------------	-----

*60 - 57	England, James	GBR
*60 - 56	Thompson, Edwin	IRL
*60 - 59	Oguntokun, Olu	NGR
*60 - 55	Zybalov, Georgi	URS
*60 - 59	Amarteifio, Godfrey	GHA

223 Frolov, Evgeny (URS)	Dabore, Issaka (NIG)	DPS (4 - 1)	Müller, Hans	ADE
--------------------------	----------------------	-------------	--------------	-----

*59 - 57	Tanner, Archie	AUS
*60 - 56	Bril, Ben	HOL
*60 - 56	Checchi, Gualtiero	ITA
*60 - 56	Santiago, Waldo	CUB
59 - 60*	Amarteifio, Godfrey	GHA

GAGNANT WINNER	PERDANT LOSER	RESULTAT RESULT	ARBITRE - JUGES REFEREE - JUDGES
224 Regueiferos, Enrique (CUB)	Vasile, Antoniu (RUM)	RSC 2do RD	Tanaka, Hozumi JPN

Müller, Hans	ADE
Bril, Ben	HOL
Lowes, Bert	CAN
Aslam, Abdul	PAK
Arcos, Ernesto	MEX

GAGNANT WINNER	PERDANT LOSER	RESULTAT RESULT	ARBITRE - JUGES REFEREE - JUDGES
-------------------	------------------	--------------------	-------------------------------------

FINALE FINAL OCT 26

296 Kulej, Jerzy (POL)	Regueiferos, Enrique (CUB)	DPS (3 - 2)	Gondre, Georges	FRA
------------------------	----------------------------	-------------	-----------------	-----

*59 - 58	England, James	GBR
*60 - 59	Ivanovic, Danilo	YUG
*60 - 59	Tanaka, Hozumi	JPN
59 - 60*	Villacampa, Alex	FIL
58 - 60*	Arcos, Ernesto	MEX

QUARTS DE FINALE QUARTER-FINALS OCT 23

253 Kulej, Jerzy (POL)	Tiepold, Peter (ADE)	DPS (3 - 2)	Ivanovic, Danilo	YUG
------------------------	----------------------	-------------	------------------	-----

*59 - 58	Bril, Ben	HOL
*59 - 58	Rankin, Archibald	GBR
*60 - 58	Oguntokun, Olu	NGR
58 - 59*	Amarteifio, Godfrey	GHA
58 - 59*	Santiago, Waldo	CUB

254 Nilsson, Arto (FIN)	Stoitchev, Petar (BUL)	RSC 2do RD	Oguntokun, Olu	NGR
-------------------------	------------------------	------------	----------------	-----

Pak, In-Yang	COR
Pepe, Juan	ARG
Gittins, Richard	GBR
Tanaka, Hozumi	JPN
Hruska, Jaroslav	CHE

263 Wallington, James (EUA)	Kim, Sa-Yong (COR)	DPS (5 - 0)	Rial, José	ESP
-----------------------------	--------------------	-------------	------------	-----

*60 - 57	Idziak, Boleslaw	POL
*60 - 57	Thompson, Edwin	IRL
*60 - 57	Tanner, Archie	AUS
*60 - 56	Swang, Siripai	TAI
*60 - 58	Pepe, Juan	ARG

264 Regueiferos, Enrique (CUB)	Frolov, Evgeny (URS)	DPS (3 - 2)	Hertel, Horst	ADE
--------------------------------	----------------------	-------------	---------------	-----

58 - 59*	Gittins, Richard	GBR
*59 - 58	Ivanovic, Danilo	YUG
*60 - 59	Tanaka, Hozumi	JPN
*59 - 58	Pak, In-Yang	COR
58 - 59*	Tanner, Archie	AUS

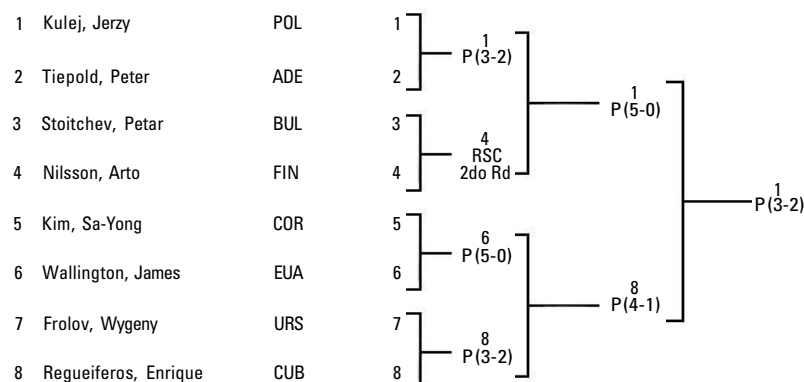

1 ^o	Kulej, Jerzy	POL
2 ^o	Regueiferos, Enrique	CUB
3 ^o	Nilsson, Arto	FIN
3 ^o	Wallington, James	EUA

604

DEMI-FINALES SEMI-FINALS OCT 24

273 Kulej, Jerzy (POL)	Nilsson, Arto (FIN)	DPS (5 - 0)	Ivanovic, Danilo	YUG
------------------------	---------------------	-------------	------------------	-----

*60 - 58	Müller, Hans	ADE
*60 - 57	Bril, Ben	HOL
*59 - 58	Amarteifio, Godfrey	GHA
*60 - 58	Tanaka, Hozumi	JPN
*60 - 58	Swang, Siripai	TAI

274 Regueiferos, Enrique (CUB)	Wallington, James (EUA)	DPS (4 - 1)	Checchi, Gualtiero	ITA
--------------------------------	-------------------------	-------------	--------------------	-----

*60 - 59	Oguntokun, Olu	NGR
*60 - 59	Aslam, Abdul	PAK
59 - 60*	Pak, In-Yang	COR
*60 - 59	Zybalov, Georgi	URS
*59 - 59	Thompson, Edwin	IRL

POIDS WELTER JUSQU'A 67 kg WELTERWEIGHT UP TO 67 kg

1e TOUR ELIMINATOIRE 1st ELIMINATION ROUND OCT 13

27 Kottysch, Dieter (ALE)	Saarivainio, Mauri (FIN)	RSC 2do RD 1.54	Malik, N.	NIG
---------------------------	--------------------------	--------------------	-----------	-----

Lowes, Bert	CAN
Yunes, Mabruk	LBA
Kuka, Khoorshed	IND
Keleman, Imre	HUN
Aslam, Abdul	PAK

28 Luipa, Julius (ZAM)	Labioud, Rabah (AGL)	DPS (4 - 1)	Rankin, Archibald	GBR
------------------------	----------------------	-------------	-------------------	-----

*59 - 58	Rial, José	ESP
59 - 59*	Hruska, Jaroslav	CHE
*59 - 58	Müller, Hans	ADE
*59 - 58	Idziak, Boleslaw	POL
*60 - 59	Ivanovic, Danilo	YUG

GAGNANT WINNER	PERDANT LOSER	RESULTAT RESULT	ARBITRE - JUGES REFEREE - JUDGES	GAGNANT WINNER	PERDANT LOSER	RESULTAT RESULT	ARBITRE - JUGES REFEREE - JUDGES
2e TOUR ELIMINATOIRE 2nd ELIMINATION ROUND				OCT 19			
163 Sandal, Celal (TUR)	Popoola, Aaron (GHA)	DPS (3 - 2)	Müller, Hans ADE	170 Durán, José (ESP)	Park, Koo-II (COR)	DPS (3 - 2)	Rankin, Archibald GBR
		58 - 59* *59 - 58 58 - 59* *59 - 58 *59 - 59	Pepe, Juan ARG Thompson, Edwin IRL Sampila, Kaleva FIN Hertel, Horst ADE Idziak, Boleslaw POL	177 Muñiz, Armando (EUA)	Kasprzyk, Marian (POL)	DPS (4 - 1)	Rial, José ESP
						58 - 59 *59 - 58 *60 - 58 58 - 60* *59 - 58	Gittins, Richard GBR Schwartz, Roland EUA Thompson, Edwin IRL Yunes, Mabruk LBA Zybalov, Georgi URS
164 Kiriakov, Ivan (BUL)	Nemecek, Bohumil (CHE)	DES 3er RD	Schwartz, Roland EUA	178 Hebeisen, Max (SUI)	Bouchara, M'hamed (MAR)	DPS (4 - 1)	Keleman, Imre HUN
			Yunes, Mabruk LBA Oguntokun, Olu NGR Pak, In-Yang COR Ortiz, Fidel MEX Rial, José ESP			*60 - 58 59 - 59* *59 - 58 *59 - 58 *59 - 57	Tanner, Archie AUS Keleman, Imre HUN Amarteifio, Godfrey GHA Tanaka, Hozumi JPN Thompson, Edwin IRL
165 Wolke, Manfred (ADE)	Molina, Andrés (CUB)	DPS (4 - 1)	Oguntokun, Olu NGR	179 Paduano, Donato (CAN)	Onye, Fidelis (NGR)	DPS (4 - 1)	Sampila, Kaleva FIN
		59 - 60* *59 - 57 *60 - 57 *59 - 58 *59 - 59	Common, John FIJ Kuka, Khoorshed IND Rankin, Archibald GBR Gondre, Georges FRA Schwartz, Roland EUA			*59 - 57 *59 - 57 *60 - 57 58 - 59* *58 - 57	Rankin, Archibald GBR Pepe, Juan ARG Santiago, Waldo CUB Amarteifio, Godfrey GHA Müller, Hans ADE
166 Arrais, Expedito (BRA)	Gebregiorgis, Tadesse (ETI)	RSC 3er RD	Pak, In-Yang COR	180 Guilloti, Mario (ARG)	Kajjo, Andrew (UGA)	DPS (4 - 1)	Swang, Siripai TAI
			Amarteifio, Godfrey GHA Müller, Hans ADE Ivanovic, Danilo YUG Sampila, Kaleva FIN Hertel, Horst ADE			58 - 59* *59 - 58 *59 - 57 *60 - 59 *59 - 58	Oguntokun, Olu NGR Idziak, Boleslaw POL Ortiz, Fidel MEX Hertel, Horst ADE England, James GBR
167 Ramírez, Alfonso (MEX)	Scano, Marco (ITA)	DPS (3 - 2)	Zybalov, Georgi URS	181 Zilberman, Victor (RUM)	Hansen, Jorgen (DIN)	RSC 3er RD	Gittins, Richard GBR
		*60 - 58 *60 - 57 *60 - 59 58 - 59* 59 - 59*	Villacampa, Alex FIL Tanaka, Hozumi JPN Rial, José ESP Amarteifio, Godfrey GHA Jetchev, Emil BUL				Pepe, Juan ARG Pak, In-Yang COR Common, John FIJ Santiago, Waldo CUB Gondre, Georges FRA
168 Ekonomakos, Evangelos (GRE)	Tottoh, Alan (GBR)	DPS (3 - 2)	Tanaka, Hozumi JPN	182 Gali, Istvan (HUN)	Mariolle, Yvon (FRA)	RSC 2do RD	Rankin, Archibald GBR
		60 - 56 56 - 58 *59 - 58 58 - 59* *59 - 58	Pepe, Juan ARG Yunes, Mabruk LBA Rial, José ESP Kiriak, Constantin RUM Idziak, Boleslaw POL				Schwartz, Roland EUA Villacampa, Alex FIL Lowe, Bert CAN Yunes, Mabruk LBA Oguntokun, Olu NGR
169 Musalinov, Vladimir (URS)	Kottysch, Dieter (ALE)	DPS (5 - 0)	Oguntokun, Olu NGR	183 Bessala, Joseph (CMR)	González, Luis (CHI)	DPS (5 - 0)	Hertel, Horst ADE
		*60 - 56 *60 - 55 *60 - 56 *60 - 56 *60 - 56 *59 - 57	Jetchev, Emil BUL Swang, Siripai TAI Santiago, Waldo CUB Tanner, Archie AUS Pak, In-Yang COR			*59 - 57 *60 - 57 *60 - 57 *60 - 55 *60 - 58	Zybalov, Georgi URS Sampila, Kaleva FIN Schwartz, Roland EUA Swang, Siripai TAI Santiago, Waldo CUB

KOTTYSCH, DIETER (ALE) AYANT ETE ECARTE POUR RAISONS MEDICALES. LE COMBAT 184 FUT ANNULE ET LUIPA, JULIUS (ZAM) PASSA EN HUITIEMES DE FINALE.

KOTTYSCH, DIETER OF GERMANY DID NOT SHOW UP FOR FIGHT 184 BECAUSE OF PHYSICAL DISABILITY. LUIPA, JULIUS OF ZAMBIA DREW A BYE, PASSING ON TO THE NEXT PHASE.

GAGNANT
WINNERPERDANT
LOSERRESULTAT
RESULTARBITRE - JUGES
REFEREE - JUDGESGAGNANT
WINNERPERDANT
LOSERRESULTAT
RESULTARBITRE - JUGES
REFEREE - JUDGESHUITIEMES DE FINALE
EIGHTH-FINALS

OCT 22

227	Sandal, Celal (TUR)	Kiriakov, Ivan (BUL)	RSC 2do RD	Lowes, Bert	CAN	Bril, Ben Gittins, Richard Swang, Siripai Santiago, Waldo González, Luis	HOL GBR TAI CUB MEX	
228	Wolke, Manfred (ADE)	Arrais, Expedito (BRA)	DPS (5 - 0)	Gondre, Georges	FRA	*60 - 58 *60 - 57 *59 - 57 *60 - 57 *60 - 57	Thompson, Edwin England, James Schwartz, Roland Villacampa, Alex Aslam, Abdul	IRL GBR EUA FIL PAK
229	Ramírez, Alfonso (MEX)	Ekonomakos, Evangelos (GRE)	DPS (4 - 1)	Zybalov, Georgi	URS	*60 - 58 *60 - 58 *60 - 58 58 - 59* *60 - 58	Swang, Siripai Gittins, Richard Hertel, Horst Oguntokun, Olu Pepe, Juan	TAI GBR ADE NGR ARG
230	Musalinov, Vladimir (URS)	Durán, José (ESP)	DPS (5 - 0)	Gittins, Richard	GBR	*59 - 56 *58 - 57 *59 - 57 *59 - 58 *59 - 57	Schwartz, Roland González, Luis Ivanovic, Danilo Oguntokun, Olu Pepe, Juan	EUA MEX YUG NGR ARG
239	Muñiz, Armando (EUA)	Hebeisen, Max (SUI)	DPS (4 - 1)	Sampila, Kaleva	FIN	*60 - 58 *60 - 57 59 - 59* *60 - 58 *60 - 57	Aslam, Abdul England, James Hruska, Jaroslav Villacampa, Alex Pepe, Juan	PAK GBR CHE FIL ARG
240	Guilloti, Mario (ARG)	Paduano, Donato (CAN)	DPS (5 - 0)	Keleman, Imre	HUN	*59 - 58 *60 - 58 *60 - 57 *60 - 58 *59 - 57	Hruska, Jaroslav Idziak, Boleslaw Oguntokun, Olu Kuka, Khoorshed Tanner, Archie	CHE POL NGR IND AUS
241	Zilberman, Victor (RUM)	Gali, Istvan (HUN)	DPS (5 - 0)	Hertel, Horst	ADE	*60 - 59 *59 - 58 *60 - 58 *60 - 57 *60 - 56	Santiago, Waldo Gittins, Richard Schwartz, Roland Rial, José Lowes, Bert	CUB GBR EUA ESP CAN
242	Bessala, Joseph (CMR)	Luipa, Julius (ZAM)	RSC 2do RD	Ivanovic, Danilo	YUG	Swang, Siripai Sampila, Kaleva Keleman, Imre Pepe, Juan Tanner, Archie	TAI FIN HUN ARG AUS	

QUARTS DE FINALE
QUARTER-FINALS

OCT 23

255	Wolke, Manfred (ADE)	Sandal, Celal (TUR)	DPS (4 - 1)	Amarteifio, Godfrey	GHA	*59 - 57 58 - 59* *60 - 58 *59 - 58 *59 - 57	England, James Sampila, Kaleva Schwartz, Roland Kuka, Khoorshed Swang, Siripai	GBR FIN EUA IND TAI
256	Musalinov, Vladimir (URS)	Ramírez, Alfonso (MEX)	DPS (5 - 0)	Gittins, Richard	GBR	*60 - 58 *59 - 58 *59 - 58 *59 - 58 *59 - 57	Rankin, Archibald Pepe, Juan Hertel, Horst Santiago, Waldo Tanner, Archie	GBR ARG ADE CUB AUS
265	Guilloti, Mario (ARG)	Muñiz, Armando (EUA)	DPS (4 - 1)	Sampila, Kaleva	FIN	*60 - 58 58 - 59* *59 - 58 *60 - 59 *59 - 58	Rankin, Archibald England, James Amarteifio, Godfrey Villacampa, Alex Swang, Siripai	GBR GBR GHA FIL TAI
266	Bessala, Joseph (CMR)	Zilberman, Victor (RUM)	RSC 3er RD	Pak, In-Yang	COR		Rial, José Aslam, Abdul Kuka, Khoorshed Thompson, Edwin Pepe, Juan	ESP PAK IND IRL ARG

DEMI-FINALES
SEMI-FINALS

OCT 24

285	Wolke, Manfred (ADE)	Musalinov, Vladimir (URS)	DPS (3 - 2)	Oguntokun, Olu	NGR	*59 - 58 57 - 59* *59 - 57 *59 - 58 59 - 60*	Thompson, Edwin Rial, José Lowes, Bert Schwartz, Roland Tanaka, Hozumi	IRL ESP CAN EUA JPN
286	Bessala, Joseph (CMR)	Guilloti, Mario (ARG)	DPS (5 - 0)	Zybalov, Georgi	URS	*60 - 57 *60 - 57 *59 - 58 *60 - 58 *60 - 58	Hertel, Horst Villacampa, Alex Swang, Siripai Idziak, Boleslaw Amarteifio, Godfrey	ADE FIL TAI POL GHA

FINALE
FINAL

OCT 26

297	Wolke, Manfred (ADE)	Bessala, Joseph (CMR)	DPS (4 - 1)	Schwartz, Roland	EUA	*60 - 57 *59 - 58 59 - 59* *59 - 58 *60 - 57	Bril, Ben Sampila, Kaleva Amarteifio, Godfrey Lowes, Bert Zybalov, Georgi	HOL FIN GHA CAN URS
-----	----------------------	-----------------------	-------------	------------------	-----	----------------------------------------------------------	---------------------------------------------------------------------------------------	---------------------------------

1	Sandal, Celal	TUR
2	Wolke, Manfred	ADE
3	Ramírez, Alfonso	MEX
4	Musalinov, Vladimir	URS
5	Muñiz, Armando	EUA
6	Guilloti, Mario	ARG
7	Zilberman, Victor	RUM
8	Bessala, Joseph	CMR

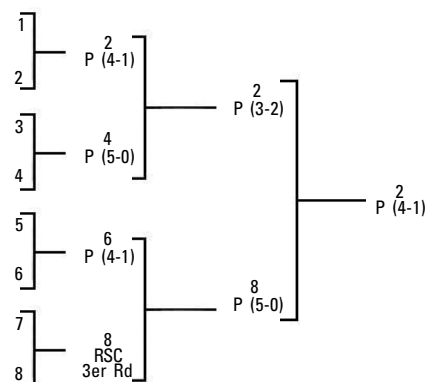

1^o Wolke, Manfred ADE
 2^o Bessala, Joseph CMR
 3^o Guilloti, Mario ARG
 3^o Musalinov, Vladimir URS

POIDS MOYEN LEGER JUSQU'A 71 kg LIGHT-MIDDLEWEIGHT UP TO 71 kgs

1e TOUR ELIMINATOIRE
 1st ELIMINATION ROUND

OCT 14

GAGNANT WINNER	PERDANT LOSER	RESULTAT RESULT	ARBITRE - JUGES REFEREE - JUDGES
34 Garbey, Rolando (CUB)	McCusker, Eamon (IRL)	RSC 1er RD 1.11	Pak, In-Yang COR
35 Blake, Eric (GBR)	Alemu, Bekele (ETI)	RSC 1er RD 2.57	Idziak, Boleslaw POL Jetchev, Emil Kuka, Khoorshed Zybalov, Georgi Tanner, Archie Schwartz, Roland BUL IND URS AUS EUA
36 Amartey, Prince (GHA)	Abdel, Abdalla (SUD)	DPS (4 - 1)	England, James GBR 59 - 60* *59 - 56 Müller, Hans *59 - 57 Lowes, Bert *60 - 57 Bril, Ben *59 - 58 Villacampa, Alex *59 - 58 González, Luis ADE CAN HOL FIL MEX

GAGNANT WINNER	PERDANT LOSER	RESULTAT RESULT	ARBITRE - JUGES REFEREE - JUDGES
37 Bentini, Aldo (ITA)	Galindez, Víctor (ARG)	DPS (5 - 0)	Jetchev, Emil BUL *59 - 59 Hertel, Horst *60 - 56 Schwartz, Roland *60 - 58 Oguntokun, Olu *59 - 58 England, James *60 - 58 Idziak, Boleslaw ADE EUA NGR GBR POL
38 Kovacs, Ianos (RUM)	Stachurski, Witold (POL)	DPS (3 - 2)	Tanner, Archie AUS 58 - 59* 59 - 60* Santiago, Waldo *60 - 53 Müller, Hans *60 - 53 Pak, In-Yang *60 - 57 Aslam, Abdul *59 - 58 Rankin, Archibald CUB ADE COR PAK GBR
44 El Nahas, Sayed (RAU)	Cebreros, José (MEX)	KO 2do RD 2.27	Ivanovic, Danilo YUG Amarteifio, Godfrey Swang, Siripai Oguntokun, Olu Pepe, Juan Kuka, Khoorshed GHA TAI NGR ARG IND
45 Lagutin, Boris (URS)	Fajardo, Moisés (ESP)	RSC 2do RD 1.00	Tanaka, Hozumi JPN Pak, In-Yang Gittins, Richard Villacampa, Alex Oguntokun, Olu Müller, Hans COR GBR FIL NGR ADE
46 Meier, Günther (ALE)	Borquez, Honorio (CHI)	DPS (5 - 0)	Villacampa, Alex FIL *60 - 57 Keleman, Imre *59 - 57 Rial, José *60 - 56 Sampila, Kaleva *59 - 58 Oguntokun, Olu *60 - 56 Santiago, Waldo HUN ESP FIN NGR CUB
47 Thega, Stephen (KEN)	Campos, Walter (CRC)	DPS (5 - 0)	Bril, Ben HOL *60 - 57 Ivanovic, Danilo *60 - 56 Santiago, Waldo *60 - 56 González, Luis *60 - 57 Lowes, Bert *60 - 57 Checchi, Gualtiero YUG CUB MEX CAN ITA
48 Larsen, Niels (DIN)	Menduni, Albert (FRA)	DPS (5 - 0)	Thompson, Edwin IRL *60 - 54 Rankin, Archibald *60 - 54 Pak, In-Yang *60 - 56 Kiriak, Constantín *59 - 58 Idziak, Boleslaw *59 - 58 Hruska, Jaroslav GBR COR RUM POL CHE
49 Jackson, David (UGA)	Salzburger, Rainer (AUT)	KO 2do RD 2.13	Rial, José ESP Zybalov, Georgi Kuka, Khoorshed Lowes, Bert Santiago, Waldo Aslam, Abdul URS IND CAN CUB PAK

GAGNANT WINNER PERDANT LOSER RESULTAT RESULT ARBITRE - JUGES REFEREE - JUDGES

GAGNANT WINNER PERDANT LOSER RESULTAT RESULT ARBITRE - JUGES REFEREE - JUDGES

HUITIEMES DE FINALES EIGHTH-FINALS **OCT 20**

QUARTS DE FINALE QUARTER-FINALS **OCT 23**

191 Benítez, Mario (URG) Boch, Eugenio (GUA) DPS (5 - 0) Checchi, Gualtiero ITA
 *60 - 54 Kuka, Khoorshed IND
 *60 - 55 Hruska, Jaroslav CHE
 *60 - 55 Hertel, Horst ADE
 *60 - 56 Swang, Siripai TAI
 *60 - 56 Oguntokun, Olu NGR

257 Baldwin, John (EUA) Benítez, Mario (URG) DPS (5 - 0) Zybalov, Georgi URS
 *60 - 58 Pak, In-Yang COR
 *60 - 58 Thompson, Edwin IRL
 *60 - 57 Gittins, Richard GBR
 *60 - 55 Aslam, Abdul PAK
 *60 - 56 Amarteifio, Godfrey GHA

192 Baldwin, John (EUA) Stantien, Vojtech (CHE) DPS (5 - 0) Oguntokun, Olu NGR
 *60 - 59 Aslam, Abdul PAK
 *60 - 59 Tanaka, Hozumi JPN
 *60 - 58 Sampila, Kaleva FIN
 *60 - 58 Pepe, Juan ARG
 *59 - 58 Checchi, Gualtiero ITA

258 Garbey, Rolando (CUB) Blake, Eric (GBR) RSC 1er RD Idziak, Boleslaw POL
 Ortiz, Fidel MEX
 Oguntokun, Olu NGR
 Zybalov, Georgi URS
 Sampila, Kaleva FIN
 Schwartz, Roland EUA

193 Garbey, Rolando (CUB) Dahn, Detlef (ADE) DPS (3 - 2) Villacampa, Alex FIL
 58 - 59* Jetchev, Emil BUL
 58 - 59* Ivanovic, Danilo YUG
 *59 - 58 Pak, In-Yang COR
 *58 - 58 Zybalov, Georgi URS
 *59 - 57 Yunes, Mabruk LBA

267 Lagutin, Boris (URS) Kovacs, Ianos (RUM) DPS (5 - 0) Villacampa, Alex FIL
 *60 - 54 Santiago, Waldo CUB
 *60 - 56 Rial, José ESP
 *60 - 56 Müller, Hans ADE
 *60 - 56 Swang, Siripai TAI
 *60 - 56 Lowes, Bert CAN

194 Blake, Eric (GBR) Amartey, Prince (GHA) DPS (4 - 1) Zybalov, Georgi URS
 *59 - 59 Idziak, Boleslaw POL
 *60 - 59 Hruska, Jaroslav CHE
 *60 - 58 Swang, Siripai TAI
 58 - 60* Aslam, Abdul PAK
 *60 - 58 Bril, Ben HOL

268 Meier, Günther (ALE) Jackson, David (UGA) DPS (5 - 0) Tanaka, Hozumi JPN
 *60 - 56 Zybalov, Georgi URS
 *60 - 58 Pak, In-Yang COR
 *60 - 57 Kuka, Khoorshed IND
 *60 - 57 Schwartz, Roland EUA
 *60 - 57 Gondre, Georges FRA

201 Kovacs, Ianos (RUM) Bentini, Aldo (ITA) DPS (5 - 0) Villacampa, Alex FIL
 *60 - 57 Pak, In-Yang COR
 *60 - 58 Swang, Siripai TAI
 *60 - 56 Müller, Hans ADE
 *60 - 58 Oguntokun, Olu NGR
 *60 - 57 Pepe, Juan ARG

DEMI-FINALES SEMI-FINALS **OCT 24**

275 Garbey, Rolando (CUB) Baldwin, John (EUA) DPS (4 - 1) Tanner, Archie AUS
 *59 - 59 Gondre, Georges FRA
 *59 - 58 Rankin, Archibald GBR
 *60 - 57 Pepe, Juan ARG
 *60 - 59 Pak, In-Yang COR
 58 - 60* Amarteifio, Godfrey GHA

202 Lagutin, Boris (URS) El Nahas, Sayed (RAU) RSC 2do RD Müller, Hans ADE
 Amarteifio, Godfrey GHA
 Checchi, Gualtiero ITA
 Oguntokun, Olu NGR
 Pérez, Daniel MEX
 Jetchev, Emil BUL

276 Lagutin, Boris (URS) Meier, Günther (ALE) DPS (4 - 1) Jetchev, Emil BUL

203 Meier, Günther (ALE) Thega, Stephen (KEN) DPS (5 - 0) Pak, In-Yang COR
 *59 - 57 Tanaka, Hozumi JPN
 *59 - 57 Pérez, Daniel MEX
 *57 - 54 Yunes, Mabruk LBA
 *60 - 56 Villacampa, Alex FIL
 *59 - 57 Kiriak, Constantin RUM

*60 - 58 Kuka, Khoorshed IND
 *59 - 58 England, James GBR
 *60 - 58 Oguntokun, Olu NGR
 58 - 59* Schwartz, Roland EUA
 *60 - 59 Santiago, Waldo CUB

204 Jackson, David (UGA) Larsen, Niels (DIN) DPS (3 - 2) Bril, Ben HOL
 58 - 59* Zybalov, Georgi URS
 *59 - 58 Kuka, Khoorshed IND
 58 - 59* Swang, Siripai TAI
 *59 - 59 Ivanovic, Danilo YUG
 *59 - 59 Pepe, Juan ARG

FINALE FINAL **OCT 26**

298 Lagutin, Boris (URS) Garbey, Rolando (CUB) DPS (5 - 0) Pak, In-Yang COR
 *59 - 57 Thompson, Edwin IRL
 *60 - 54 England, James GBR
 *60 - 57 Lowes, Bert CAN
 *59 - 56 Villacampa, Alex FIL
 *60 - 55 Tanner, Archie AUS

1	Benítez, Mario	URG
2	Baldwin, John	EUA
3	Garbey, Rolando	CUB
4	Blake, Eric	GBR
5	Kovacs, Ianos	RUM
6	Lagutin, Boris	URS
7	Meier, Günther	ALE
8	Jackson, David	UGA

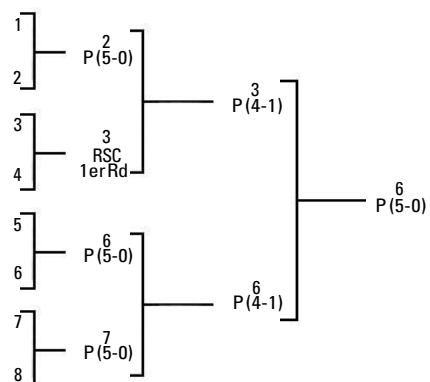

1^o Lagutin, Boris URS
2^o Garbey, Rolando CUB
3^o Meier, Günther ALE
3^o Baldwin, John EUA

GAGNANT WINNER	PERDANT LOSER	RESULTAT RESULT	ARBITRE - JUGES REFEREE - JUDGES
70 Mate, Parlov (YUG)	Ahidous, Lahcen (MAR)	DPS (5 - 0)	Gondre, Georges FRA
		*60 - 56 Oguntokun, Olu NGR	
		*60 - 53 Lowes, Bert CAN	
		*60 - 56 Idziak, Boleslaw POL	
		*60 - 55 Schwartz, Roland EUA	
		*60 - 55 Hertel, Horst ADE	
71 Kiselev, Aleksey (URS)	Abang, Antoine (CMR)	DPS (5 - 0)	Swang, Siripai TAI
		*60 - 56 Yunes, Mabruk LBA	
		*60 - 58 Pak, In-Yang COR	
		*60 - 56 Ivanovic, Danilo YUG	
		*60 - 57 Villacampa, Alex FIL	
		*60 - 55 Tanaka, Hozumi JPN	
72 Van Ispelen, Jan (HOL)	Vilugron, Misael (CHI)	RSC 3er RD	Thompson, Edwin IRL
			Lowes, Bert CAN
			Kiriak, Constantin RUM
			Amarteifio, Godfrey GHA
			Rankin, Archibald GBR
			Sampila, Kaleva FIN

HUITIEMES DE FINALE
EIGHTH-FINALS

OCT 17

**POIDS MOYEN JUSQU'A 75 kg
MIDDLEWEIGHT UP TO 75 kg**

1e TOUR ELIMINATOIRE
1st ELIMINATION ROUND **OCT 15**

GAGNANT WINNER	PERDANT LOSER	RESULTAT RESULT	ARBITRE - JUGES REFEREE - JUDGES
58 Marrero, Raúl (CUB)	Hernández, Saulo (PRO)	DES 3er RD	Villacampa, Alex FIL
			Ivanovic, Danilo YUG
			Swang, Siripai TAI
			Ortiz, Fidel MEX
			Amarteifio, Godfrey GHA
			Gittins, Richard GBR
59 Finnegan, Christopher (GBR)	Simba, Titos (TAN)	DPS (5 - 0)	Idziak, Boleslaw POL
		*60 - 55 Gondre, Georges FRA	
		*60 - 54 Thompson, Edwin IRL	
		*60 - 55 Tanaka, Hozumi JPN	
		*60 - 57 Amarteifio, Godfrey GHA	
		*60 - 57 Checchi, Gualtiero ITA	
60 Georgiev, Simeone (BUL)	Casati, Mario (ITA)	DPS (4 - 1)	England, James GBR
		*59 - 57 Santiago, Waldo CUB	
		59 - 60* Swang, Siripai TAI	
		*59 - 57 Rankin, Archibald GBR	
		*59 - 57 Pepe, Juan ARG	
		*60 - 54 Pak, In-Yang COR	
69 Jones, Alfred (EUA)	Quiñones, Marcelo (PER)	DPS (5 - 0)	Pak, In-Yang COR
		*60 - 56 Kuka, Khoorshed IND	
		*60 - 57 England, James GBR	
		*60 - 58 Ivanovic, Danilo YUG	
		*60 - 58 Aslam, Abdul PAK	
		*59 - 57 Tanner, Archie AUS	

107 Zaragoza, Agustín (MEX)	Wright, Dinsdale (JAM)	DPS (5 - 0)	Sampila, Kaleva FIN
		*60 - 58 Müller, Hans ADE	
		*60 - 56 Bril, Ben HOL	
		*60 - 57 Checchi, Gualtiero ITA	
		*60 - 57 Hertel, Horst ADE	
		*60 - 57 Gittins, Richard GBR	
108 Hejduk, Jan (CHE)	Freitas, Nolberto (URG)	RSC 1er RD	Oguntokun, Olu NGR
			Arcos, Ernesto MEX
			Sampila, Kaleva FIN
			Tanaka, Hozumi JPN
			Amarteifio, Godfrey GHA
			Schwartz, Roland EUA
109 Kiselev, Aleksey (URS)	Ouma, George (UGA)	DPS (4 - 1)	Schwartz, Roland EUA
		*59 - 58 Kuka, Khoorshed IND	
		*60 - 59 Aslam, Abdul PAK	
		*60 - 58 Hertel, Horst ADE	
		*60 - 57 Tanner, Archie AUS	
		59 - 60* Amarteifio, Godfrey GHA	
110 Rudkowski, Wieslaw (POL)	Amos, Charles (GUY)	RSC 2do RD	Gondre, Georges FRA
			Checchi, Gualtiero ITA
			Common, John FIJ
			Oguntokun, Olu NGR
			Lowes, Bert CAN
			Aslam, Abdul PAK
125 Finnegan, Christopher (GBR)	Wichert, Ewald (ALE)	DPS (3 - 2)	Swang, Siripai TAI
		*59 - 58 Sampila, Kaleva FIN	
		59 - 60* Aslam, Abdul PAK	
		*59 - 59 Oguntokun, Olu NGR	
		*59 - 58 Kiriak, Constantin RUM	
		58 - 60* Tanner, Archie AUS	

GAGNANT WINNER	PERDANT LOSER	RESULTAT RESULT	ARBITRE - JUGES REFEREE - JUDGES
126 Mate, Parlov (YUG)	Van Ispelen, Jan (HOL)	DPS (4 - 1)	Amarteifio, Godfrey GHA
		58 - 58*	Arcos, Ernesto MEX
		*59 - 56	Lowes, Bert CAN
		*60 - 58	Santiago, Waldo CUB
		*59 - 58	Oguntokun, Olu NGR
		*60 - 55	Tanner, Archie AUS

127 Jones, Alfred (EUA)	Marrero, Raúl (CUB)	DPS (5 - 0)	Pak, In-Yang COR
		*60 - 57	Gittins, Richard GBR
		*59 - 58	Swang, Siripai TAI
		*59 - 57	England, James GBR
		*59 - 57	Oguntokun, Olu NGR
		*59 - 58	Rankin, Archibald GBR

SON ADVERSAIRE GHANEEN AIDOO, GEORGE AYANT ETE ECARTE POUR RAISONS MEDICALES.
GEORGIEV SIMEONE (BUL) FUT EXEMPTÉ PAR UN NOUVEAU TIRAGE AU SORT ET PASSA EN QUARTS
DE FINALE.

BECAUSE OF THE PHYSICAL DISABILITY OF AIDOO, GEORGE OF GHANA, A NEW DRAWING HELD.
GEORGIEV SIMEONE OF BULGARIA DREW A BYE PASSING ON TO THE QUARTER FINALS.

QUARTS DE FINALE QUARTER- FINALS

OCT 22

231 Zaragoza, Agustín (MEX)	Hejduk, Jan (CHE)	DPS (4 - 1)	Tanner, Archie AUS
		59 - 59*	Gondre, Georges FRA
		*58 - 57	Pak, In-Yang COR
		*59 - 58	Checchi, Gualtiero ITA
		*60 - 57	Ivanovic, Danilo YUG
		*59 - 58	Pepe, Juan ARG

232 Kiselev, Aleksey (URS)	Rudkowski, Wieslaw (POL)	DPS (5 - 0)	Schwartz, Roland EUA
		*60 - 59	Pak, In-Yang COR
		*58 - 58	Gittins, Richard GBR
		*60 - 58	Tanner, Archie AUS
		*59 - 58	Thompson, Edwin IRL
		*59 - 58	Swang, Siripai TAI

243 Finnegan, Christopher (GBR)	Mate, Parlov (YUG)	DPS (5 - 0)	Müller, Hans ADE
		*59 - 58	Zybalov, Georgi URS
		*59 - 59	Idziak, Boleslaw POL
		*60 - 59	Villacampa, Alex FIL
		*59 - 58	Swang, Siripai TAI
		*59 - 57	Santiago, Waldo CUB

244 Jones, Alfred (EUA)	Georgiev, Simeone (BUL)	DPS (4 - 1)	Rial, José ESP
		*59 - 57	Gittins, Richard GBR
		*58 - 58	Thompson, Edwin IRL
		58 - 59*	Aslam, Abdul PAK
		*60 - 57	Kuka, Khoorshed IND
		*57 - 57	Pepe, Juan ARG

DEMI-FINALES SEMI-FINALS

OCT 24

287 Kiselev, Aleksey (URS)	Zaragoza, Agustín (MEX)	RSC 1er RD	Gittins, Richard GBR
			Santiago, Waldo CUB
			Gondre, Georges FRA
			Rial, José ESP
			Pepe, Juan ARG
			Oguntokun, Olu NGR

GAGNANT WINNER	PERDANT LOSER	RESULTAT RESULT	ARBITRE - JUGES REFEREE - JUDGES
288 Finnegan, Christopher (GBR)	Jones, Alfred (EUA)	DPS (4 - 1)	Tanaka, Hozumi JPN

*59 - 58	Aslam, Abdul	PAK
*59 - 57	Zybalov, Georgi	URS
*60 - 59	Thompson, Edwin	IRL
*60 - 59	Kuka, Khoorshed	IND
58 - 60*	Pérez, Daniel	MEX

FINALE FINAL

OCT 26

299 Finnegan, Christopher (GBR)	Kiselev, Aleksey (URS)	DPS (3 - 2)	Tanaka, Hozumi JPN
---------------------------------	------------------------	-------------	--------------------

*59 - 58	Arcos, Ernesto	MEX
*59 - 58	Rial, José	ESP
*59 - 58	Santiago, Waldo	CUB
58 - 59*	Swang, Siripai	TAI
58 - 59*	Kuka, Khoorshed	IND

1 Zaragoza, Agustín	MEX
2 Hejduk, Jan	CHE
3 Kiselev, Aleksey	URS
4 Rudkowski, Wieslaw	POL
5 Finnegan, Christopher	GBR
6 Mate, Parlov	YUG
7 Georgiev, Simeone	BUL
8 Jones, Alfred	EUA

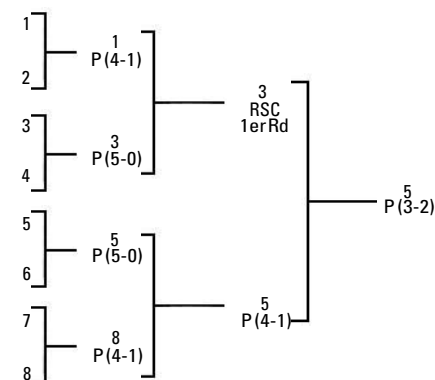

1 ^o	Finnegan, Christopher	GBR
2 ^o	Kiselev, Aleksey	URS
3 ^o	Zaragoza, Agustín	MEX
3 ^o	Jones, Alfred	EUA

POIDS MI-LOURD JUSQU'A 81 kg LIGHT-HEAVYWEIGHT UP TC 81 kgs

1e TOUR ELIMINATOIRE 1st ELIMINATION ROUND

OCT 13

11 Baumgartner, Kurt (AUT)	Bagayogo, Soungalo (MLI)	DPS (3 - 2)	Lowes, Bert CAN
----------------------------	--------------------------	-------------	-----------------

58 - 60*	Kuka, Khoorshed	IND
*59 - 58	Gondre, Georges	FRA
*60 - 58	Arcos, Ernesto	MEX
58 - 59*	Pepe, Juan	ARG
*58 - 58	Yunes, Mabruk	LBA

GAGNANT WINNER	PERDANT LOSER	RESULTAT RESULT	ARBITRE - JUGES REFEREE - JUDGES
12 Facchinetti, Walter (ITA)	Kapin, Josef (CHE)	DPS (5 - 0)	Bril, Ben HOL
		*59 - 58	Gittins, Richard GBR
		*59 - 57	England, James GBR
		*60 - 57	Oguntokun, Olu NGR
		*59 - 58	Swang, Siripai TAI
		*58 - 57	Tanner, Archie AUS

GAGNANT WINNER	PERDANT LOSER	RESULTAT RESULT	ARBITRE - JUGES REFEREE - JUDGES
160 Facchinetti, Walter (ITA)	Baumgartner, Kurt (AUT)	DES 3er RD	Schwartz, Roland EUA
			Rankin, Archibald GBR
			Villacampa, Alex FIL
			González, Luis MEX
			Zybalov, Georgi URS
			Swang, Siripai TAI

HUITIEMES DE FINALE
EIGHTH-FINALS

OCT 18

141 Stankov, Gueorgui (BUL)	Redden, Arthur (EUA)	DPS (4 - 1)	Tanaka, Hozumi JPN
		*59 - 58	Amarteifio, Godfrey GHA
		57 - 59*	Gittins, Richard GBR
		*59 - 58	Tanner, Archie AUS
		*60 - 58	Pak, In-Yang COR
		*60 - 59	Villacampa, Alex FIL

142 Malherbe, Bernard (FRA)	Alexopoulos, Estathios(GRE)	DPS (4 - 1)	Pak, In-Yang COR
		*59 - 59	Idziak, Boleslaw POL
		*59 - 59	England, James GBR
		58 - 59*	Santiago, Waldo CUB
		*59 - 59	Hruska, Jaroslav CHE
		*59 - 57	Zybalov, Georgi URS

155 Pozdniak, Dan (URS)	Aldama, Gregorio (CUB)	KO 2do RD 2.12	England, James GBR
			Aslam, Abdul PAK
			Common, John FIJ
			Oguntokun, Olu NGR
			Pepe, Juan ARG
			Gondre, Georges FRA

156 Schlegel, Jürgen (ADE)	Aman, Hassan (RAU)	DPS (4 - 1)	Amarteifio, Godfrey GHA
		*60 - 58	Tanaka, Hozumi JPN
		*60 - 57	Gittins, Richard GBR
		*59 - 58	Sampila, Kaleva FIN
		58 - 60*	González, Luis MEX
		*60 - 57	Zybalov, Georgi URS

157 Monea, Ion (RUM)	Reimers, Raymar (ALE)	DPS (5 - 0)	González, Luis MEX
		*60 - 57	Amarteifio, Godfrey GHA
		*60 - 54	Kuka, Khoorshed IND
		*60 - 56	Thompson, Edwin IRL
		*60 - 56	Tanner, Archie AUS
		*60 - 54	Lowes, Bert CAN

158 Ayinla, Fatai (NGR)	Villarreal, Enrique (MEX)	RSC 2do RD	Keleman, Imre HUN
			Müller, Hans ADE
			Schwartz, Roland EUA
			Idziak, Boleslaw POL
			Rial, José ESP
			England, James GBR

159 Dragan, Stanislaw (POL)	Clemente, Jorge (PRO)	D 3er RD	Jetchev, Emil BUL
			Gittins, Richard GBR
			Checchi, Gualtiero ITA
			Amarteifio, Godfrey GHA
			Pepe, Juan ARG
			Müller, Hans ADE

QUARTS DE FINALE
QUARTER-FINALS

OCT 22

233 Stankov, Gueorgui (BUL)	Malherbe, Bernard (FRA)	DPS (5 - 0)	Idziak, Boleslaw POL
		*60 - 57	Aslam, Abdul PAK
		*60 - 57	Pak, In-Yang COR
		*60 - 57	Schwartz, Roland EUA
		*60 - 58	Zybalov, Georgi URS
		*60 - 57	Gittins, Richard GBR

234 Pozdniak, Dan (URS)	Schlegel, Jürgen (ADE)	DPS (5 - 0)	Checchi, Gualtiero ITA
		*60 - 57	Pepe, Juan ARG
		*60 - 58	González, Luis MEX
		*60 - 57	Tanner, Archie AUS
		*60 - 57	Gondre, Georges FRA
		*59 - 59	Oguntokun, Olu NGR

245 Monea, Ion (RUM)	Ayinla, Fatai (NGR)	DPS (3 - 2)	Pak, In-Yang COR
		*60 - 59	Müller, Hans ADE
		57 - 60*	González, Luis MEX
		*60 - 58	Lowes, Bert CAN
		58 - 60*	Thompson, Edwin IRL
		*60 - 59	Villacampa, Alex FIL

246 Dragan, Stanislaw (POL)	Facchinetti, Walter (ITA)	DPS (4 - 1)	Swang, Siripai TAI
		*60 - 57	González, Luis MEX
		59 - 60*	Jetchev, Emil BUL
		*60 - 58	Sampila, Kaleva FIN
		*60 - 59	Santiago, Waldo CUB
		*60 - 58	Pepe, Juan ARG

DEMI-FINALES
SEMI-FINALS

OCT 24

277 Pozdniak, Dan (URS)	Stankov, Gueorgui (BUL)	DPS (5 - 0)	Tanaka, Hozumi JPN
		*60 - 57	Oguntokun, Olu NGR
		*60 - 57	Aslam, Abdul PAK
		*60 - 58	Rial, José ESP
		*60 - 57	Pepe, Juan ARG
		*60 - 57	Villacampa, Alex FIL

278 Monea, Ion (RUM)	Dragan, Stanislaw (POL)	DPS (4 - 1)	Gittins, Richard GBR
		*59 - 58	Rankin, Archibald GBR
		*60 - 57	Swang, Siripai TAI
		*60 - 58	Sampila, Kaleva FIN
		58 - 59*	Villacampa, Alex FIL
		*60 - 57	Oguntokun, Olu NGR

GAGNANT
WINNER

PERDANT
LOSER

RESULTAT
RESULT

ARBITRE - JUGES
REFEREE - JUDGES

GAGNANT
WINNER

PERDANT
LOSER

RESULTAT
RESULT

ARBITRE - JUGES
REFEREE - JUDGES

FINALE
FINAL **OCT 26**

300	Pozdniak, Dan (URS)	Monea, Ion (RUM)	Tanaka, Hozumi	JPN
			England, James	GBR
			Arcos, Ernesto	MEX
			Santiago, Waldo	CUB
			Swang, Siripai	TAI
			Rankin, Archibald	GBR

1	Stankov, Gueorgui	BUL
2	Malherbe, Bernard	FRA
3	Pozdniak, Dan	URS
4	Schlegel, Jürgen	ADE
5	Monea, Ion	RUM
6	Ayinla, Fatai	NGR
7	Dragan, Stanislaw	POL
8	Facchinetti, Walter	ITA

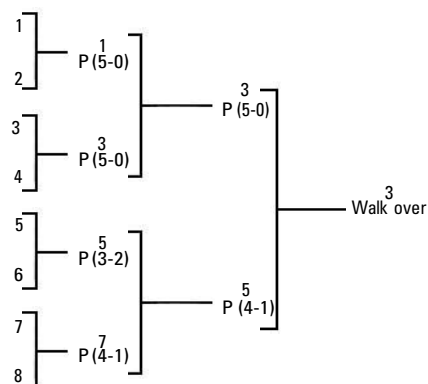

1^o Pozdniak, Dan URS
2^o Monea, Ion RUM
3^o Stankov, Gueorgui BUL
3^o Dragan, Stanislaw POL

81	Pandov, Kiril (BUL)	Petar, Milos (YUG)	DPS (3 - 2)	Swang, Siripai	TAI
----	---------------------	--------------------	-------------	----------------	-----

*59 - 58 Hertel, Horst ADE
59 - 60* Villacampa, Alex FIL
*59 - 58 Gondre, Georges FRA
59 - 60* Common, John FIJ
*60 - 58 Sampila, Kaleva FIN

82	Bambini, Giorgio (ITA)	Renz, Dieter (ALE)	DPS (5 - 0)	Idziak, Boleslaw	POL
----	------------------------	--------------------	-------------	------------------	-----

*60 - 59 Jetchev, Emil BUL
*59 - 57 Tanner, Archie AUS
*59 - 58 Thompson, Edwin IRL
*60 - 58 Oguntokun, Olu NGR
*60 - 58 Pepe, Juan ARG

93	Lubbers, Rudolfus (HOL)	Dahchan, Talaat (RAU)	DES 3er RD	Ivanovic, Danilo	YUG
----	-------------------------	-----------------------	------------	------------------	-----

Pérez, Daniel MEX
Aslam, Abdul PAK
Jetchev, Emil BUL
Oguntokun, Olu NGR
Pepe, Juan ARG

94	Rocha, Joaquín (MEX)	Ray, Adonis (GHA)	DPS (4 - 1)	Rankin, Archibald	GBR
----	----------------------	-------------------	-------------	-------------------	-----

*58 - 58 Kuka, Koorshed IND
*59 - 57 Zybalov, Georgi URS
*60 - 56 Thompson, Edwin IRL
*59 - 58 Common, John FIJ
57 - 59* Aslam, Abdul PAK

95	Anders, Bernd (ADE)	Carrillo, Nancio (CUB)	RSC 1er RD	Rial, José	ESP
----	---------------------	------------------------	------------	------------	-----

Tanner, Archie AUS
Kiriak, Constantin RUM
Sampila, Kaleva FIN
Checchi, Gualtiero ITA
Kuka, Koorshed IND

96	Chepulis, Iones (URS)	Wells, William (GBR)	RSC 2do RD	Müller, Hans	ADE
----	-----------------------	----------------------	------------	--------------	-----

Gondre, Georges FRA
Tanaka, Hozumi JPN
Common, John FIJ
Bril, Ben HOL
Amarteifio, Godfrey GHA

**POIDS LOURD 81 kg OU PLUS
HEAVYWEIGHT 81 kgs OR MORE**

HUITIEMES DE FINALE
EIGHTH-FINALS **OCT 16**

79	Foreman, George (EUA)	Trela, Lucjan (POL)	DPS (4 - 1)	Checchi, Gualtiero	ITA
----	-----------------------	---------------------	-------------	--------------------	-----

*60 - 58 Rial, José ESP
59 - 60* Keleman, Imre HUN
*59 - 58 England, James GBR
*59 - 58 Bril, Ben HOL
*60 - 57 Kuka, Koorshed IND

80	Alexe, Ion (RUM)	Coker, John (SLA)	DPS (5 - 0)	Gittins, Richard	GBR
----	------------------	-------------------	-------------	------------------	-----

*59 - 56 Yunes, Mabruk LBA
*60 - 57 Aslam, Abdul PAK
*60 - 57 Müller, Hans ADE
*60 - 56 Rankin, Archibald GBR
*60 - 57 Idziak, Boleslaw POL

QUARTS DE FINALE
QUARTER-FINALS

OCT 22

235	Foreman, George (EUA)	Alexe, Ion (RUM)	RSC 3er RD	Villacampa, Alex	FIL
-----	-----------------------	------------------	------------	------------------	-----

Rial, José ESP
Santiago, Waldo CUB
Kuka, Koorshed IND
Gittins, Richard GBR
Swang, Siripai TAI

236	Bambini, Giorgio (ITA)	Pandov, Kiril (BUL)	DPS (5 - 0)	González, Luis	MEX
-----	------------------------	---------------------	-------------	----------------	-----

*60 - 58 Aslam, Abdul PAK
*59 - 59 Hertel, Horst ADE
*60 - 58 Oguntokun, Olu NGR
*60 - 58 Schwartz, Roland EUA
*60 - 57 Rial, José ESP

GAGNANT WINNER	PERDANT LOSER	RESULTAT RESULT	ARBITRE - JUGES REFEREE - JUDGES
247 Rocha, Joaquín (MEX)	Lubbers, Rudolfus (HOL)	DPS (3 - 2)	Tanner, Archie AUS
		59 - 58 59 - 59 *59 - 58 *60 - 58 59 - 60*	Hruska, Jaroslav CHE Zybalov, Georgi URS Lowes, Bert CAN Kuka, Khoorshed IND Oguntokun, Olu NGR
248 Chepulis, Iones (URS)	Anders, Bernd (ADE)	RSC 3er RD	Jetchev, Emil BUL
			Checchi, Gualtiero ITA Schwartz, Roland EUA Lowes, Bert CAN Rial, José ESP Tanner, Archie AUS

1 Foreman, George	EUA
2 Alexe, Ion	RUM
3 Pandov, Kiril	BUL
4 Bambini, Giorgio	ITA
5 Lubbers, Rudolfus	HOL
6 Rocha, Joaquín	MEX
7 Anders, Bernd	ADE
8 Chepulis, Iones	URS

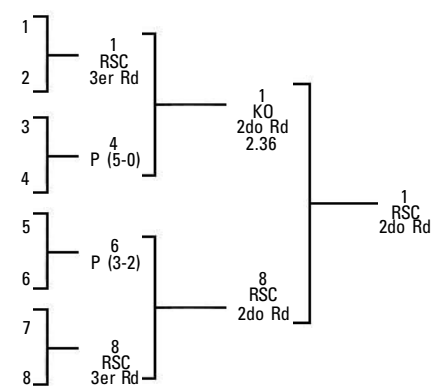

DEMI-FINALES SEMI-FINALS OCT 24

289 Foreman, George (EUA)	Bambini, Giorgio (ITA)	KO 2do RD 2.36	Hruska, Jaroslav CHE
			Oguntokun, Olu NGR Pepe, Juan ARG Villacampa, Alex FIL Müller, Hans ADE Rial, José ESP
290 Chepulis, Iones (URS)	Rocha, Joaquín (MEX)	RSC 2do RD	Gondre, Georges FRA
			Bril, Ben HOL Rankin, Archibald GBR Oguntokun, Olu NGR Tanaka, Hozumi JPN Lowes, Bert CAN

FINALE FINAL OCT 26

301 Foreman, George (EUA)	Chepulis, Iones (URS)	RSC 2do RD	Amarteifio, Godfrey GHA
			Gittins, Richard GBR Hertel, Horst ADE Villacampa, Alex FIL Tanner, Archie AUS Pepe, Juan ARG

1º Foreman, George EUA
2º Chepulis, Iones URS
3º Rocha, Joaquín MEX
3º Bambini, Giorgio ITA



OFFICIELS DE LA COMPETITION COMPETITION OFFICIALS

JURY
Charles de Coquereaumont FRA

Karel Popel CHE
John Dudderidge GBR
Otto Bonn HUN
Kurt Howeg MEX
Olov Verner SUE
Viktor Lukatin URS

COMITE DE LA COMPETITION COMPETITION COMMITTEE

**CHEF DE CABINET
CHIEF OFFICIAL**
Sergio Orsi ITA

**ORGANISATEUR DE LA COMPETITION
COMPETITION ORGANIZER**
Pablo Stock MEX

**SECRETAIRE DE LA COMPETITION
COMPETITION SECRETARY**
Edgar Ubbelohde MEX

**JUGES ET OFFICIELS
JUDGES AND OFFICIALS**
Hans Degebrodt ADE
Hans Wittig ADE
Ernst Müller ALE
Hans E. Vesper ALE
Peter Maassen ALE
Werner Böhle ALE
Fritz Gangl AUT
Manfred Falkner AUT
Max Raub AUT
Jaak Holemans BEL
Vaclav Vacek CHE
Hernando Calleja ESP
Chirich Veljar EUA
John Sulger EUA
Robert Sleeth EUA
Roger Wilkinson EUA
Thomas Johnson EUA
Erik Wolvalin FIN
Robert Vautrin FRA
Henry Thelen GBR
Ronald Emes GBR
Johannes De Jongste HOL
Istvan Granek HUN
Luigi Borelli ITA
Kasuo Yoshikawa JPN
Alex Deeke MEX
Guillermo Magnus MEX
José Reja MEX
Peter Henningsen MEX
Waclaw Kwassniewski POL
Nicolae Navassart RUM
Otto Tomiuc RUM
Lars Bennback SUE
Alexander Silajev URS
Boris Radulovic URS
Caslav Veljic YUG

CHEFS DE COMMISSION COMMISSION DIRECTORS

Gustav Schmidt ALE
Frank Clement CAN
Reginald Cooper EUA
Martine Zepeda FRA
Carlos Camacho MEX
Carlos Durán MEX
Carlos Soberanes MEX
Edgar Tams MEX
Edmundo Ameneiro MEX
Guillermo L. Portillo MEX
Homero Delgado MEX
Ignacio Escamilla MEX
Jaqueline Cooper MEX
José M. Acosta MEX
Juan Valera MEX
Julio Scheffler MEX
Kurt Howeg MEX
Leonardo Fonseca MEX
Manuel de la Peña MEX
Manuel Huerta MEX
Miguel Ruiz MEX
Miguel Turanzas MEX
Otto Sartorius MEX
Pedro Castro MEX
Rainer Zawadzki MEX
Ricardo Obert MEX
Roberto Wenning MEX
Susana Hahn MEX
Walter Schreiber MEX

JEUNES FILLES APPORTANT LES MEDAILLES

**GIRL ATTENDANTS AT AWARD
CEREMONIES**
Hortensia Niebla MEX
Lynn Praire MEX
Ma. del Rocio Suárez MEX
Riita Hakala MEX
Teresa Amézcua MEX
Yolica Sáenz MEX

ASSISTANTS
Ana I. Reja MEX
Angel Díaz MEX
Armando Salinas MEX
Barbara Adler MEX
Catherine Adler MEX
Cecilia Amtmann MEX
Concepción Torres MEX
Concepción Velasco MEX
Erika Silbermann MEX
Ernesto Raeder MEX
Evelyn Bodenstedt MEX
Evelyn Stock MEX
Hans Niederstrasser MEX
Herbert Görner MEX
Ingrid Christensen MEX
Jaime Rodríguez MEX
Javier Bragado MEX
Jorge Palma MEX
Lotti Deeke MEX
Luis Alcaraz Flores MEX
Manuel Valero MEX
Ma. Eugenia Villarreal MEX
Otto Schürenkämper MEX
Pablo Vargas MEX
Raúl Quintanilla MEX
Rosa Ma. Aréchiga MEX
Rosalia Perezzyera MEX
Rosina Rubio MEX
Silvestre Velázquez MEX
Silvia Ramírez MEX
Silvia Rodríguez MEX
Ursula Hahn MEX
Ursula Schreiber MEX
Wolfgang Hinze MEX
Yolanda Aréchiga MEX

FEDERATION INTERNATIONALE DE CANOE-KAYAK FIC

INTERNATIONAL CANOEING FEDERATION ICF

**PRESIDENT HONORAIRE
HONORARY PRESIDENT**
Karel Popel CHE

PRESIDENT
Charles de Coquereaumont FRA

**SECRETAIRE-TRESORIER
SECRETARY TREASURER**
Olov Verner SUE

FEDERATION MEXICAINE DE CANOE-KAYAK FMC

MEXICAN CANOEING FEDERATION FMC

PRESIDENT
Pablo Stock MEX

**SECRETAIRE
SECRETARY**
René Espino MEX

**SECTION DE CANOE-KAYAK
DU C.O.O.
O.O.C. CANOEING SECTION**
René Espino MEX
Edgar Ubbelohde MEX
Julio Scheffler, Jr. MEX

SIGNES EMPLOYES

SYMBOLGY

*	— QUALIFIE POUR DEMI-FINALES LES AUTRES PASSENT AUX REPECHAGES	QUALIFIED FOR SEMI-FINALS; OTHERS TO REPECHAGES
**	— QUALIFIE POUR-DEMI-FINALES LES AUTRES SONT ELIMINES	QUALIFIED FOR SEMI-FINALS; OTHERS ELIMINATED
□	— QUALIFIE POUR FINALES LES AUTRES PASSENT EN DEMI-FINALES	QUALIFIED FOR FINALS; OTHERS TO SEMI-FINALS
□□	— QUALIFIE POUR FINALES LES AUTRES SONT ELIMINES	QUALIFIED FOR FINALS; OTHERS ELIMINATED
ST	— S'EST RETOURNE SANS TEMPS	CAPSIZED NO TIME
NTS	— N'A PAS PRIS LE DEPART	FAILED TO DEPART
DES	— DISQUALIFIE	DISQUALIFIED
NCM	— N'A PAS PASSE LA LIGNE DE ARRIVE	FAILED TO CROSS FINISH LINE

KAYAK K-1 MESSIEURS 1000 m
KAYAK K-1 MEN 1000 m.

ELIMINATOIRES
HEATS

OCT 22

COURSE RACE 1



Coulair Lane		500 m.		1000 m.	
		Pos	Temps Time	Pos	Temps Time
6	*SUE			1	4:02.6
7	*RUM			2	4:03.7
4	*HUN			4	4:04.7
2	HOL	6	2:02.0	4	4:05.7
1	AUS	3	1:58.5	5	4:07.3
3	EUA			5	4:13.5
8	BOL				SV
1	AUT				NTS

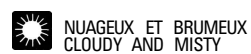
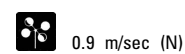

COURSE RACE 2



Coulair Lane		500 m.		1000 m.	
		Pos	Temps Time	Pos	Temps Time
7	*DIN			2	2:00.2
1	*NOR			1	4:05.6
3	*ALE			1	1:59.9
2	BEL	5	2:05.1	2	4:08.0
6	ESP	3	2:00.2	3	4:09.5
4	GBR	6	2:05.5	4	4:09.6
5	MEX	4	2:04.6	5	4:16.5
		7	2:09.7	6	4:16.7
				7	4:28.8

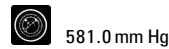
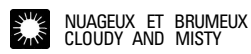

COURSE RACE 3



Coulair Lane		500 m.		1000 m.	
		Pos	Temps Time	Pos	Temps Time
4	*POL			2	1:59.2
1	*URS			3	2:00.5
6	*ADE			1	1:58.4
3	CHE	5	2:01.5	2	4:04.6
5	CAN	4	2:01.2	3	4:05.3
7	FIN	6	2:04.3	4	4:05.4
2	CML	7	2:06.9	5	4:11.8
				6	4:22.2
				7	4:31.2

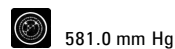
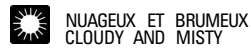

REPECHAGES
REPECHAGES

OCT 23

COURSE RACE 18



Coulair Lane		500 m.		1000 m.	
		Pos	Temps Time	Pos	Temps Time
8	**ESP			1	2:08.36
9	**HOL			2	2:10.43
7	**FIN			3	2:12.29

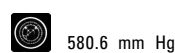
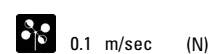

COURSE RACE 19



Coulair Lane		500 m.		1000 m.	
		Pos	Temps Time	Pos	Temps Time
9	**BEL			3	2:10.97
6	**CAN			1	2:09.40
8	**EUA			2	2:10.21
7	MEX			4	2:11.32

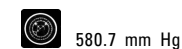
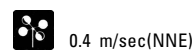

COURSE RACE 20



Coulair Lane		500 m.		1000 m.	
		Pos	Temps Time	Pos	Temps Time
6	**AUS			1	2:00.11
8	**GBR			2	2:01.34
9	**CHE			3	2:06.30
7	CML			4	2:10.96

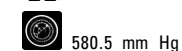

SEMI-FINALS
DEMI-FINALES

OCT 24

COURSE RACE 25



Coulair Lane		500 m.		1000 m.	
		Pos	Temps Time	Pos	Temps Time
7	□SUE			1	1:57.24
8	□CHE			4	1:59.58
6	□ADE			3	1:58.89
5	NOR			2	1:57.93
9	ESP			5	2:02.33
4	CAN			6	2:06.83

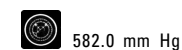
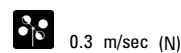

COURSE RACE 26



Coulair Lane		500 m.		1000 m.	
		Pos	Temps Time	Pos	Temps Time
8	□DIN			1	1:55.97
6	□URS			2	1:57.69
9	□HUN			3	1:57.76
7	BEL			4	1:59.44
4	GBR			5	2:00.34
5	FIN			6	2:02.02

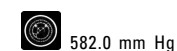
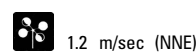

615

KAYAK K-1 DAMES 500 m
KAYAK K-1 WOMEN 500 m.

ELIMINATOIRES
HEATS

OCT 22

COURSE
RACE 6

Couloir
Lane

Pos	500 m. Temps Time
2	2:07.1
1	2:08.6
7	2:09.1
6	2:09.6
3	2:12.1
4	2:13.6
5	2:18.2

□URS	Pinaeva, Ludmila	1	2:07.1
□HUN	Pfeffer, Anna	2	2:08.6
□CHE	Vavrova, Iva	3	2:09.1
EUA	Smoke, Marcia	4	2:09.6
POL	Szydlowska, Stanislawa	5	2:12.1
GBR	Jackson, Sylvia	6	2:13.6
MEX	Henningsen, Ann	7	2:18.2

☀️	0.1 m/sec (NO) (NW)	☁️	BRUME MISTY	🌊	19.5°C	📊	581.0 mm Hg.
🌡️	16.5°C	📈	95%				

COURSE
RACE 7

Couloir
Lane

Pos	500 m. Temps Time
5	2:10.0
4	2:10.3
6	2:10.9
3	2:12.2
2	2:17.0
1	2:18.5

□RUM	Dumitru, Viorica	1	2:10.0
□ALE	Breuer, Renate	2	2:10.3
□HOL	Jaapias, Mieke	3	2:10.9
SUE	Svensson, Ing.-Marie	4	2:12.2
ADE	Nübner, Anita	5	2:17.0
CAN	Homer-Dixon, Marjorie	6	2:18.5

☀️	0.4 m/sec (NE)	☀️	SOLEIL BRILLANT BRIGHT SUN	🌊	21.0°C	📊	581.5 mm Hg
🌡️	17.8°C	📈	88%				

DEMI-FINALE
SEMI-FINAL

OCT 24

COURSE
RACE 29

Couloir
Lane

Pos	500 m. Temps Time
6	2:12.67
9	2:13.42
5	2:14.55
8	2:15.32
3	2:17.98
4	2:20.84
7	2:21.39

□EUA	Smoke, Marcia	1	2:12.67
□ADE	Nübner, Anita	2	2:13.42
□SUE	Svensson, Ing.-Marie	3	2:14.55
POL	Szydlowska, Stanislawa	4	2:15.32
GBR	Jackson, Sylvia	5	2:17.98
CAN	Homer-Dixon, Marjorie	6	2:20.84
MEX	Henningsen, Ann	7	2:21.39

☁️	0.3 m/sec (ONO) (WNW)	☁️	NUAGEUX CLOUDY	🌡️	20.2°C	📊	582.1 mm Hg
🌡️	16.0°C	📈	74%				

FINALE
FINAL **OCT 25**

COURSE
RACE 40

Couloir
Lane

Pos	500 m. Temps Time
6	2:11.09
7	2:12.71
1	2:13.22
2	2:14.68
5	2:14.78
3	2:16.02
4	2:16.04
9	2:18.38
8	SV

☁️	1.9 m/sec (NNO) (NNW)	☁️	NUAGEUX CLOUDY	🌡️	18.8°C	📊	583.8 mm/Hg
🌡️	14.3°C	📈	77%				

JUGE DE DEPART
ARBITRE
ARBITRE SUPPLEANT
CHEF DES JUGES DE LIGNE

STARTING JUDGE
REFEREE
ASSISTANT REFEREE
CHIEF FINISH-LINE JUDGE

Navassart, Nicolae
Magnus, Guillermo
Borelli, Luigi
Böhle, Werner

RUM
MEX
ITA
ALE

KAYAK K-2 MESSIEURS 1000 m
KAYAK K-2 MEN 1000 m.

ELIMINATOIRES
HEATS

OCT 22

COURSE
RACE 8

Couloir
Lane

Pos	500 m. Temps Time	1000 m. Temps Time	
5	1:43.6	1	3:36.5
7	1:45.1	2	3:37.9
4	1:46.7	3	3:40.9
1	1:48.5	4	3:42.6
3	1:46.2	5	3:42.8
2	1:47.6	6	3:49.5
6	1:50.5	7	4:15.0

☀️	0.7 m/sec (NNE)	☀️	SOLEIL BRILLANT BRIGHT SUN	🌡️	21.5°C	📊	581.4 mm Hg
🌡️	20.0°C	📈	85%				

COURSE
RACE 9

Couloir
Lane

Pos	500 m. Temps Time	1000 m. Temps Time	
4	1:44.2	1	3:38.9
6	1:49.6	2	3:42.0
7	1:47.3	3	3:44.1
2	1:46.3	4	3:50.8
1	1:54.4	5	4:09.8
5	1:59.4	6	4:14.5
3			NTS

☀️	1.3 m/sec (NE)	☀️	SOLEIL BRILLANT BRIGHT SUN	🌡️	22.0°C	📊	581.4 mm Hg
🌡️	20.0°C	📈	85%				

CANOE C-2 MESSIEURS 1000 m
CANADIAN C-2 MEN 1000 m.

ELIMINATOIRES
HEATS **OCT 22**

COURSE
RACE **11**

Couloir Lane				500 m. Pos Temps	1000 m. Pos Temps
2	<input type="checkbox"/> URS	Prokupets, Naum	Zamotin, Mikhail	1 2:01.5	1 4:09.9
6	<input type="checkbox"/> SUE	Lindelof, Bernd	Zeidlitz, Erik	4 2:03.5	2 4:10.5
1	<input type="checkbox"/> ALE	Kapf, Roland	Lewandowsky, Klaus	6 2:04.1	3 4:11.4
3	<input type="checkbox"/> MEX	Martínez, Juan	Altamirano, Félix	2 2:01.8	4 4:11.9
4	<input type="checkbox"/> FRA	Bouffinier, Bernard	Millot, Jean-François	5 2:04.1	5 4:13.1
5	<input type="checkbox"/> CHE	Penkava, Rudolf	Skarupski, Svatopluk	3 2:02.7	6 4:31.3
7	<input type="checkbox"/> EUA	Gates, William	Hickox, Malcolm	7 2:12.3	7 4:37.0

0.5 m/sec (O) (W)
 SOLEIL BRILLANT BRIGHT SUN
 20.5°C
 580.5 mm Hg
 22.0°C
 65%

COURSE
RACE **12**

Couloir Lane				Pos Temps	Pos Temps
2	<input type="checkbox"/> RUM	Patzaichin, Ivan	Covaliov, Serghei	1 1:58.52	1 4:03.4
1	<input type="checkbox"/> HUN	Wichmann, Tamas	Petrikovics, Gyula	2 1:58.85	2 4:04.4
6	<input type="checkbox"/> ADE	Harpke, Jürgen	Wagner, Helmut	4 2:07.84	3 4:21.8
4	<input type="checkbox"/> BUL	Valev, Ivan	Damianov, Alexandre	3 2:07.54	4 4:26.1
3	<input type="checkbox"/> JPN	Yamaguchi, Tetsumasa	Yoshino, Nobuatsu	6 2:10.70	5 4:30.9
5	<input type="checkbox"/> CAN	Wood, John	Lee, Scott	5 2:09.07	DES

1.9 m/sec (NO) (NW)
 SOLEIL BRILLANT BRIGHT SUN
 22.5°C
 580.4 mm Hg
 21.6°C
 60%

DEMI-FINALE
SEMI-FINAL **OCT 24**

COURSE
RACE **33**

Couloir Lane				Pos Temps	Pos Temps
4	<input type="checkbox"/> MEX	Martínez, Juan	Altamirano, Félix	1 2:07.01	1 4:15.01
8	<input type="checkbox"/> CHE	Penkava, Rudolf	Skarupski, Svatopluk	2 2:08.17	2 4:20.19
9	<input type="checkbox"/> BUL	Valev, Ivan	Damianov, Alexandre	5 2:10.96	3 4:22.17
5	<input type="checkbox"/> FRA	Bouffinier, Bernard	Millot, Jean-François	3 2:09.16	4 4:22.76
7	<input type="checkbox"/> JPN	Yamaguchi, Tetsumasa	Yoshino, Nobuatsu	4 2:09.95	5 4:29.54
6	<input type="checkbox"/> EUA	Gates, William	Hickox, Malcolm	6 2:14.56	6 4:33.49

2.2 m/sec (NO) (NW)
 SOLEIL BRILLANT BRIGHT SUN
 20.2°C
 582.0 mm Hg
 17.0°C
 64%

FINALE
FINAL **OCT 25**

COURSE
RACE **42**

Couloir Lane				500 m. Pos Temps	1000 m. Pos Temps
4	<input type="checkbox"/> RUM	Patzaichin, Ivan	Covaliov, Serghei	1 1:57.74	1 4:07.18
2	<input type="checkbox"/> HUN	Wichmann, Tamas	Petrikovics, Gyula	2 1:59.34	2 4:08.77
5	<input type="checkbox"/> URS	Prokupets, Naum	Zamotin, Mikhail	3 2:00.35	3 4:11.30
3	<input type="checkbox"/> MEX	Martínez, Juan	Altamirano, Félix	4 2:01.84	4 4:15.24
7	<input type="checkbox"/> SUE	Lindelof, Bernd	Zeidlitz, Erik	5 2:02.72	5 4:16.60
8	<input type="checkbox"/> ADE	Harpke, Jürgen	Wagner, Helmut	7 2:04.96	6 4:22.53
1	<input type="checkbox"/> ALE	Kapf, Roland	Lewandowsky, Klaus	8 2:06.27	7 4:26.36
9	<input type="checkbox"/> BUL	Valev, Ivan	Damianov, Alexandre	9 2:09.55	8 4:26.74
6	<input type="checkbox"/> CHE	Penkava, Rudolf	Skarupski, Svatopluk	6 2:03.95	DES

1.3 m/sec (NNO) (NNW)
 NUAGEUX CLOUDY
 19.5°C
 583.0 mm Hg
 17.0°C
 66%

JUGE DE DEPART
ARBITRE
ARBITRE SUPPLEANT
CHEF DES JUGES DE LIGNE

STARTING JUDGE
REFEREE
ASSISTANT REFEREE
CHIEF FINISH-LINE JUDGE

Navassart, Nicolae RUM
Granek, Istvan HUN
Falkner, Manfred AUT
Böhle, Werner ALE

KAYAK K-2 DAMAS 500 m
KAYAK K-2 WOMEN 500 m.

ELIMINATOIRES
HEATS **OCT 22**

COURSE
RACE **13**

Couloir Lane				500 m. Pos Temps
6	<input type="checkbox"/> ALE	Zimmermann, Anne	Esser, Roswitha	1 1:59.5
1	<input type="checkbox"/> RUM	Serghei, Valentina	Dumitru, Viorica	2 1:59.6
3	<input type="checkbox"/> URS	Pinaeva, Ludmila	Seredina, Antonina	3 1:59.9
2	<input type="checkbox"/> EUA	Rademaker, Sperry	Smoke, Marcia	4 2:08.9
5	<input type="checkbox"/> CAN	Hunt, Claudia	Gowans, Betty	5 2:12.1
4	<input type="checkbox"/> MEX	Henningsen, Ann	Zawadzki, Angelica	6 2:15.3

2.3 m/sec (N)
 SOLEIL BRILLANT BRIGHT SUN
 22.8°C
 580.2 mm Hg
 22.5°C
 59%

COURSE
RACE **14**

Couloir Lane				Pos Temps
4	<input type="checkbox"/> HUN	Pfeffer, Anna	Sagi, Katalin	1 2:01.0
3	<input type="checkbox"/> ADE	Kobuss, Anita	Haftenberger, Karin	2 2:02.8
5	<input type="checkbox"/> HOL	Jaapies, Mieke	Bergers-Duij, Tjeertje	3 2:03.4
2	<input type="checkbox"/> GBR	Oliver, Lesley	Mean, Barbara	4 2:06.5
1	<input type="checkbox"/> POL	Antonowicz, Izabella	Doering, Jadwiga	5 2:06.8

1.5 m/sec (N)
 SOLEIL BRILLANT BRIGHT SUN
 23.0°C
 579.0 mm Hg
 17.0°C
 52%

COURSE RACE 24

Coulair Lane		500 m.		1000 m.	
		Pos	Temps Time	Pos	Temps Time
9	**GBR			2	1:39.15
7	**ALE			1	3:26.01
2	**DIN	1	1:38.56	2	3:30.58
		8		3	3:30.92
6	ESP	3	1:39.68	3	3:30.92
5	EUA	4	1:40.89	4	3:30.93
		5	1:42.74	5	3:32.21



0.7 m/sec (NE)

 SOLEIL BRILLANT
BRIGHT SUN

22.5°C



19.9°C



66%



580.0 mm Hg

DEMI-FINALES SEMI-FINALS OCT 24
COURSE RACE 35

Coulair Lane		500 m.		1000 m.	
		Pos	Temps Time	Pos	Temps Time
5	□□RUM	1	1:36.37	1	3:19.88
9	□□SUE	3	1:37.56	2	3:20.18
1	□□DIN	4	1:38.33	3	3:21.27
		7		2	3:21.60
8	URS	2	1:37.20	4	3:21.60
			ST		ST



1.5 m/sec (NO) (NW)

 NUAGEUX
CLOUDY

20.8°C



17.0°C



62%



581.8 mm Hg

COURSE RACE 36

Coulair Lane		500 m.		1000 m.	
		Pos	Temps Time	Pos	Temps Time
8	□□HUN	2	1:37.12	1	3:20.03
6	□□FIN	3	1:37.44	2	3:21.70
2	□□ADE	1	1:36.82	3	3:23.30
		9		5	3:24.79
5	GBR	5	1:38.95	4	3:24.79
		4	1:38.47	5	3:25.48



1.6 m/sec (NNO) (NNW)

 NUAGEUX
CLOUDY

21.0°C



19.0°C



60%



581.5 mm Hg

COURSE RACE 37

Coulair Lane		500 m.		1000 m.	
		Pos	Temps Time	Pos	Temps Time
6	□□NOR	1	1:34.50	1	3:18.29
7	□□AUT	2	1:35.69	2	3:20.47
3	□□POL	5	1:38.45	3	3:21.29
		8		3	3:23.51
9	ALE	4	1:37.56	5	3:26.12



0.4 m/sec (N)

 SOLEIL
SUN

21.0°C



19.0°C



60%



581.0 mm Hg

FINALE FINAL OCT 25
COURSE RACE 44

Coulair Lane		500 m.		1000 m.	
		Pos	Temps Time	Pos	Temps Time
6	NOR	2	1:33.74	1	3:14.38
8	RUM	1	1:33.66	2	3:14.81
2	HUN	5	1:37.42	3	3:15.10
7	SUE	4	1:37.17	4	3:16.68
9	FIN	6	1:37.72	5	3:17.28
3	ADE	7	1:39.18	6	3:18.03
5	AUT	3	1:36.09	7	3:18.95
4	POL	8	1:39.50	8	3:22.10
1	DIN	9	1:40.38	9	3:25.64



1.4 m/sec (NO) (NW)

 NUAGEUX
CLOUDY

19.2°C



18.9°C



60%



582.0 mm Hg

 JUGE DE DEPART
ARBITRE
ARBITRE SUPPLEANT
CHEF DES JUGES DE LIGNE

 STARTING JUDGE
REFEREE
ASSISTANT REFEREE
CHIEF FINISH-LINE JUDGE

 Navassart, Nicolae RUM
Silajew, Alexander URS
Sulger, John EUA
Böhle, Werner ALE



FEDERATION INTERNATIONALE
DE CYCLISME AMATEUR FIAC

DEPART ET ARRIVEE
START AND FINISH
Hector Dekeersschieter BEL

INTERNATIONAL AMATEUR
CYCLING FEDERATION FIAC

COMMISSAIRES INTERNATIONAUX
INTERNATIONAL COMMISSIONERS
Jürgen Gallinge ALE
Domenico Mennillo ITA
Claude Jacquat SUI

PRESIDENT
Adriano Rodoni ITA

SECRETAIRE GENERAL
GENERAL SECRETARY
René Chesal ITA

JUGES NATIONAUX
NATIONAL JUDGES
Adolfo Cervantes MEX
Agustín Vázquez MEX
Anastacio González MEX
Angel Miranda MEX
Antelmo Arteaga MEX
Antonio Pérez MEX
Apolinar Barrera MEX
Bartolomé Miranda MEX
Benito Rivera MEX
Blas Martínez MEX
Daniel Espíndola MEX
David García MEX
Felipe Meléndez MEX
Francisco López MEX
Francisco Martínez MEX
Gerardo Rodea MEX
Gonzalo Cerón MEX
Higinio Lozada MEX
Humberto Martínez MEX
Jacinto Facio MEX
Javier Bravo MEX
Jerónimo Molina MEX
Jesús Cervantes MEX
Jesús Zavala MEX
Jorge Delgadillo MEX
José Castillo MEX
José González F. MEX
José González L. MEX
Juan Gutiérrez MEX
Juan Rojas MEX
Manuel García MEX
Manuel Morton MEX
Manuel Velasco MEX
Moisés Martínez MEX
Miguel Jiménez MEX
Noé Ramírez MEX
Pablo Xilótl MEX
Pedro Contreras MEX
Pedro Delgado MEX
Raúl Elías MEX
Rogelio Alejos MEX
Salvador Sánchez MEX
Sergio Fuentes MEX

FEDERATION MEXICAINE DE
CYCLISME AMATEUR FMCA

MEXICAN AMATEUR
CYCLING FEDERATION FMCA

PRESIDENT
Ernesto Grobet MEX

SECRETAIRE
SECRETARY
Alfonso Candelas MEX

SECTION CYCLISME DU C.O.O.
O.O.C. CYCLING SECTION
Arturo Camacho MEX

José Peña MEX
Juan Chino MEX

OFFICIELS DE LA COMPETITION
COMPETITION OFFICIALS

JURY D'APPEL
JURY OF APPEAL
Heinz Dietrich BEL
Maurice Moyson BEL
René Chesal FRA
Giuliano Pacciarelli ITA
Włodzimiers Golebiewski POL

622

SIGNES EMPLOYES

SYMBOLOLOGY

NSP	— NE S'EST PAS PRESENTE	FAILED TO APPEAR
□	— QUALIFIE POUR QUARTS DE FINALE	PASSED TO QUARTER-FINALS
□ □	— QUALIFIE POUR DEMI-FINALES	PASSED TO SEMI-FINALS
†	— QUALIFIE POUR FINALE: 1 ^e ET 2 ^e PLACES	PASSED TO FINAL FOR 1 st AND 2 nd PLACES
⊙	— PAR DECISION ULTERIEURE DE LA F I C A L'ALLEMAGNE EST CLASSEE 2 ^e POUR VIOLATION DES REGLEMENTS	GERMANY PENALIZED FOR VIOLATION DROPPING TO 2 nd PLACE, ACCORDING TO RULING HANDED DOWN LATER BY F I C A
NTS	— N'A PAS PRIS LE DEPART	FAILED TO DEPART
*	— ELIMINE PARCE QUE RATTRAPE	ELIMINATED WHEN OVERLAPPED
X	— QUALIFIE POUR LE 2 ^e TOUR ELIMINATOIRE LES AUTRES PASSENT AUX REPECHAGES	PASSED TO 2 nd ELIMINATION ROUND; OTHERS TO REPECHAGES
*	— QUALIFIE POUR LE 2 ^e TOUR ELIMINATOIRE	PASSED TO 2 nd ELIMINATION ROUND
XX	— QUALIFIE POUR HUITIEMES DE FINALE. LES AUTRES PASSENT AUX REPECHAGES DU 2 ^e TOUR ELIMINATOIRE	PASSED TO EIGHTH-FINALS; OTHERS TO REPECHAGES IN 2 nd ELIMINATION ROUND
**	— QUALIFIE POUR HUITIEMES DE FINALE	PASSED TO EIGHTH-FINALS
DES	— DISQUALIFIE	DISQUALIFIED
Δ	— QUALIFIE POUR QUARTS DE FINALE. LES AUTRES PASSENT AUX REPECHAGES DES HUITIEMES DE FINALE	PASSED TO QUARTER-FINALS; OTHERS TO EIGHTH-FINALS REPECHAGES
Δ Δ	— QUALIFIE POUR FINALE DES REPECHAGES DE HUITIEMES DE FINALE	PASSED TO FINAL REPECHAGES IN EIGHTH-FINALS
⊙	— DISQUALIFIE POUR FAUTE (1 ^{ere} PLACE: PKHAKADZE, OMAR URS No 334)	DISQUALIFIED FOR COMMITTING FOUL (1 st PLACE: PKHAKADZE, OMAR URS No 334)

Course Race	Temps Time	Course Race	Temps Time
2e TOUR ELIMINATOIRE 2nd ELIMINATION ROUND			
1 XX 1 FRA 182 Morelon, Daniel 2 EUA 153 Mountford, Tim	10.94		
2 XX 1 FRA 184 Trentin, Pierre 2 JPN 260 Inoue, Sanji 3 TRT 327 King, Leslie	10.91		
3 XX 1 ITA 242 Turrini, Giordano 2 ARG 32 Pittaro, José 3 CAN 70 Lovell, Jocelyn	11.47		
4 XX 1 URS 334 Pkhakadze, Omar 2 CHE 76 Jelinek, Milos 3 GBR 200 Alsop, Ian	11.26		
5 XX 1 TRT 326 Gibbon, Roger 2 DIN 119 Pedersen, Peder 3 HUN 231 Baranyecz, Andras	10.70		
6 XX 1 EUA 154 Simes, Jack 2 BEL 54 Van Lancker, Robert 3 URS 333 Kravtsov, Sergei	10.72		
7 XX 1 CHE 75 Kucirek, Ivan 2 GBR 199 Barnett, Reginald 3 MEX 266 Mercado, José	11.38		
8 XX 1 AUS 41 Johnson, Gordon 2 HOL 218 Jansen, Johannes 3 ARG 31 Roqueiro, Carlos	11.06		
9 XX 1 ALE 1 Barth, Jürgen 2 ITA 243 Verzini, Dino 3 AUS 40 Nicholson, John	10.95		
10 XX 1 DIN 120 Fredborg, Niels 2 HOL 219 Loevesijn, Leijn 3 BEL 53 Goens, Daniel	11.09		

Course Race	Temps Time	Course Race	Temps Time
2 1 FRA 184 Trentin, Pierre 2 URS 333 Kravtsov, Sergei 3 BEL 54 Van Lancker, Robert	10.96		
3 1 ITA 242 Turrini, Giordano 2 ALE 1 Barth, Jürgen 3 HOL 219 Loevesijn, Leijn	10.96		
4 1 URS 334 Pkhakadze, Omar 2 EUA 153 Mountford, Tim 3 DIN 120 Fredborg, Niels	10.94		
5 1 HOL 218 Jansen, Johannes 2 TRT 326 Gibbon, Roger 3 AUS 41 Johnson, Gordon	11.06		
6 1 ITA 243 Verzini, Dino 2 EUA 154 Simes, Jack 3 CHE 75 Kucirek, Ivan	10.81		

EPREUVE DE BARRAGE DES QUARTS DE FINALE
TIE-BREAKING RUNOFF IN QUARTER-FINALS

3 □ 1 ITA 242 Turrini, Giordano 2 HOL 218 Jansen, Johannes	11.12
4 □ 1 URS 334 Pkhakadze, Omar 2 ITA 243 Verzini, Dino	10.86

DEMI-FINALE 1e ET 2e SERIES
SEMI-FINALS 1st AND 2nd SERIES

1 1 URS 334 Pkhakadze, Omar 2 FRA 182 Morelon, Daniel	10.69
2 1 ITA 242 Turrini, Giordano 2 FRA 184 Trentin, Pierre	11.76
1 1 FRA 182 Morelon, Daniel 2 URS 334 Pkhakadze, Omar	10.76
2 1 ITA 242 Turrini, Giordano 2 FRA 184 Trentin, Pierre	11.24

EPREUVE DE BARRAGE DES DEMI-FINALES
TIE-BREAKING RUNOFF IN SEMI-FINALS

1 1 FRA 182 Morelon, Daniel 2 URS 334 Pkhakadze, Omar	10.69
----------------------------------------------------------	-------

REPECHAGES

1 1 ALE 1 Barth, Jürgen 2 BEL 54 Van Lancker, Robert 3 GBR 199 Barnett, Reginald	10.98
2 1 HOL 219 Loevesijn, Leijn 2 TRT 326 Gibbon, Roger 3 URS 333 Kravtsov, Sergei	10.66
3 1 EUA 154 Simes, Jack 2 DIN 120 Fredborg, Niels 3 TRT 327 King, Leslie	10.92
4 1 EUA 153 Mountford, Tim 2 AUS 41 Johnson, Gordon 3 CHE 75 Kucirek, Ivan	10.79

FINALE DES REPECHAGES
FINAL REPECHAGES

1 □ 1 ALE 1 Barth, Jürgen 2 EUA 154 Simes, Jack	11.30
2 □ 1 HOL 219 Loevesijn, Leijn 2 EUA 153 Mountford, Tim	11.09

FINALE POUR LA 3e PLACE 1e ET 2e SERIES
THIRD PLACE FINAL 1st AND 2nd SERIES

1 1 FRA 184 Trentin, Pierre 2 URS 334 Pkhakadze, Omar	11.57
1 1 URS 334 Pkhakadze, Omar 2 FRA 184 Trentin, Pierre	11.53

QUARTS DE FINALE 1e ET 2e SERIES
QUARTER-FINALS 1st AND 2nd SERIES OCT 19

1 1 182 Morelon, Daniel 2 219 Loevesijn, Leijn	11.09
2 1 184 Trentin, Pierre 2 1 Barth, Jürgen	11.49
3 1 218 Jansen, Johannes 2 242 Turrini, Giordano	10.85
4 1 243 Verzini, Dino 2 334 Pkhakadze, Omar	11.14
1 □ 1 FRA 182 Morelon, Daniel 2 HOL 219 Loevesijn, Leijn	11.26
2 □ 1 FRA 184 Trentin, Pierre 2 ALE 1 Barth, Jürgen	12.09
3 1 ITA 242 Turrini, Giordano 2 HOL 218 Jansen, Johannes	10.97
4 1 URS 334 Pkhakadze, Omar 2 ITA 243 Verzini, Dino	11.35

EPREUVE DE BARRAGE EN FINALE POUR LA 3e PLACE
TIE-BREAKING RUNOFF FOR THIRD PLACE FINALS

1 1 FRA 184 Trentin, Pierre 2 URS 334 Pkhakadze, Omar	10.92
----------------------------------------------------------	-------

FINALE POUR 1e ET 2e PLACES 1e ET 2e SERIES
FINAL FOR 1st AND 2nd PLACES 1st AND 2nd SERIES

2 1 FRA 182 Morelon, Daniel ITA 242 Turrini, Giordano	11.27
2 1 FRA 182 Morelon, Daniel ITA 242 Turrini, Giordano	10.68

REPECHAGES

1 ** 1 URS 333 Kravtsov, Sergei 2 JPN 260 Inoue, Sanji CHE 76 Jelinek, Milos	10.87
2 ** 1 TRT 327 King, Leslie 2 MEX 266 Mercado, José 3 GBR 200 Alsop, Ian	11.16
3 ** 1 DIN 119 Pedersen, Peder 2 EUA 153 Mountford, Tim	11.31
4 ** 1 BEL 54 Van Lancker, Robert 2 HUN 231 Baranyecz, Andras	10.99
5 ** 1 GBR 199 Barnett, Reginald 2 AUS 40 Nicholson, John	11.01
6 ** 1 HOL 218 Jansen, Johannes 2 BEL 53 Goens, Daniel 3 ARG 32 Pittaro, José	11.13
7 ** 1 ITA 243 Verzini, Dino 2 ARG 31 Roqueiro, Carlos	11.04
8 ** 1 HOL 219 Loevesijn, Leijn 2 CAN 70 Lovell, Jocelyn	11.91

HUITIEMES DE FINALE
EIGHTH-FINALS

1 1 FRA 182 Morelon, Daniel 2 TRT 327 King, Leslie 3 GBR 199 Barnett, Reginald	11.00
--------------------------------------------------------------------------------------	-------

Course Race	Temps Time	Course Race	Temps Time	Course Race	Temps Time
CLASSEMENT FINAL		2	DIN 127	Jensen, Jorgen	
FINAL CLASSIFICATION		3	1 AUS 41	Johnson, Gordon	10.26
1	FRA 182	Morelon, Daniel	10.68		
2	ITA 242	Turrini, Giordano			
3	FRA 184	Trentin, Pierre	10.92		
4	URS 334	Pkhakadze, Omar			

FINALE DES REPECHAGES
REPECHAGES FINAL

TANDEM

ELIMINATOIRES
HEATS

OCT 20

Course Race	Temps Time	Course Race	Temps Time
1	1 ITA 250	Gorini, Walter	10.29
	251	Borghetti, Luigi	
	2 CUB 113	Reyes, Juan	
	118	Valdés, Ulises	
2	1 FRA 182	Morelon, Daniel	10.39
	184	Trentin, Pierre	
	2 MEX 273	Munguía, Julio	
	274	Mendoza, Guillermo	
3	1 BEL 53	Goens, Daniel	10.40
	54	Van Lancker, Robert	
	2 EUA 152	Disney, Jack	
	160	Pranke, Charles	
4	1 CHE 75	Kucirek, Ivan	10.14
	76	Jelinek, Milos	
	2 URS 339	Tselovalnikov, Igor	
	340	Bodnieks, Inant	
5	1 ADE 24	Otto, Werner	10.32
	25	Geschke, Jürgen	
	2 HUN 231	Baranyecz, Andras	
	232	Lendvai, Tibor	
6	1 HOL 218	Jansen, Johannes	9.96
	219	Loevesijn, Leijn	
	2 DIN 126	Jorgensen, Per	
	127	Jensen, Jorgen	
7	1 ALE 9	Kobusch, Klaus	10.27
	10	Stenzel, Martin	
	2 AUS 41	Johnson, Gordon	
	42	Clarke, Hilton	

REPECHAGES

1	1 URS 339	Tselovalnikov, Igor	10.33
	340	Bodnieks, Inant	
	2 CUB 113	Reyes, Juan	
	118	Valdés, Ulises	
	3 MEX 273	Munguía, Julio	
	274	Mendoza, Guillermo	
2	1 HUN 231	Baranyecz, Andras	10.23
	232	Lendvai, Tibor	

QUARTS DE FINALE 1e ET 2e SERIES
QUARTER-FINALS 1st AND 2nd SERIES

1	1 ITA 250	Gorini, Walter	10.03
	251	Borghetti, Luigi	
	2 URS 339	Tselovalnikov, Igor	
	340	Bodnieks, Inant	
2	1 FRA 182	Morelon, Daniel	10.01
	184	Trentin, Pierre	
	2 ALE 9	Kobusch, Klaus	
	10	Stenzel, Martin	
3	1 CHE 75	Kucirek, Ivan	10.63
	76	Jelinek, Milos	
	2 HOL 218	Jansen, Johannes	
	219	Loevesijn, Leijn	
4	1 BEL 53	Goens, Daniel	10.25
	54	Van Lancker, Robert	
	2 ADE 24	Otto, Werner	
	25	Geschke, Jürgen	
1	□□1 ITA 250	Gorini, Walter	10.21
	251	Borghetti, Luigi	
	2 URS 339	Tselovalnikov, Igor	
	340	Bodnieks, Inant	
2	□□1 FRA 182	Morelon, Daniel	9.93
	184	Trentin, Pierre	
	2 ALE 9	Kobusch, Klaus	
	10	Stenzel, Martin	
3	1 HOL 218	Jansen, Johannes	9.88
	219	Loevesijn, Leijn	
	2 CHE 75	Kucirek, Ivan	
	76	Jelinek, Milos	
4	1 ADE 24	Otto, Werner	10.17
	25	Geschke, Jürgen	
	2 BEL 53	Goens, Daniel	
	54	Van Lancker, Robert	

BARRAGE DES QUARTS DE FINALE
RUNOFF IN QUARTER-FINALS

3	□□1 HOL 218	Jansen, Johannes	10.03
	219	Loevesijn, Leijn	
	2 CHE 75	Kucirek, Ivan	
	76	Jelinek, Milos	
4	□□1 BEL 53	Goens, Daniel	10.06
	54	Van Lancker, Robert	
	2 ADE 24	Otto, Werner	
	25	Geschke, Jürgen	

DEMI-FINALES 1e ET 2e SERIES
SEMI-FINALS 1st AND 2nd SERIES

OCT 21

1	1 ITA 250	Gorini, Walter	9.96
	251	Borghetti, Luigi	
	2 HOL 218	Jansen, Johannes	
	219	Loevesijn, Leijn	
2	1 FRA 182	Morelon, Daniel	10.24
	184	Trentin, Pierre	
	2 BEL 53	Goens, Daniel	
	54	Van Lancker, Robert	
1	1 HOL 218	Jansen, Johannes	10.10
	219	Loevesijn, Leijn	
	2 ITA 250	Gorini, Walter	
	251	Borghetti, Luigi	
2	□□1 FRA 182	Morelon, Daniel	10.60
	184	Trentin, Pierre	
	2 BEL 53	Goens, Daniel	
	54	Van Lancker, Robert	

BARRAGE DES DEMI-FINALES
RUNOFF IN SEMI-FINALS

1	t1 HOL 218	Jansen, Johannes	10.34
	219	Loevesijn, Leijn	
	2 ITA 250	Gorini, Walter	
	251	Borghetti, Luigi	

FINALE POUR LA 3e PLACE 1e ET 2e SERIES
THIRD PLACE FINALS 1st AND 2nd SERIES

1	1 BEL 53	Goens, Daniel	10.60
	54	Van Lancker, Robert	
	2 ITA 250	Gorini, Walter	
	251	Borghetti, Luigi	
1	1 BEL 53	Goens, Daniel	11.20
	54	Van Lancker, Robert	
	○ 2 ITA 250	Gorini, Walter	
	251	Borghetti, Luigi	

Course Race Temps Time

FINALE POUR 1e ET 2e PLACES 1e ET 2e SERIES
FINAL FOR 1st AND 2nd PLACES 1st SERIES 2nd SERIES

1	1	FRA	182	Morelon, Daniel	10.03
			184	Trentin, Pierre	
	2	HOL	218	Jansen, Johannes	
			219	Loevesijn, Leijn	
2	1	FRA	182	Morelon, Daniel	9.83
			184	Trentin, Pierre	
	2	HOL	218	Jansen, Johannes	
			219	Loevesijn, Leijn	

CLASSEMENT FINAL
FINAL CLASSIFICATION

1		FRA	182	Morelon, Daniel	9.83
			184	Trentin, Pierre	
2		HOL	218	Jansen, Johannes	
			219	Loevesijn, Leijn	
3		BEL	53	Goens, Daniel	11.20
			54	Van Lancker, Robert	
4		ITA	250	Gorini, Walter	
			251	Borghetti, Luigi	

4000 METRES POURSUITE INDIVIDUELLE
4000 METRES INDIVIDUAL PURSUIT

EPREUVE DE CLASSEMENT
CLASSIFICATION TRIAL

OCT 17

Course Race	Temps Time	KM/H
1	□ 314	Kurmann, Xaver (mrm) (mro) SUI 4:40.41 51.353
2	□ 43	Bylsma, John (mrm) (mro) AUS 4:41.10 51.225
3	□ 192	Rebillard, Daniel (mrm) (mro) FRA 4:42.15 51.036
4	□ 121	Jensen, Mogens (mrm) (mro) DIN 4:42.30 51.009
5	□ 245	Chemello, Cipriano (mrm) (mro) ITA 4:43.58 50.779
6	□ 4	Kratzer, Rupert (mrm) (mro) ALE 4:43.84 50.732
7	□ 268	Treviño, Radamés (mrm) (mro) MEX 4:44.12 50.682
8	□ 56	Crapez, Paul (mrm) (mro) BEL 4:44.93 50.538
9	92	Rodriguez, Martín (mrm) (mro) COL 4:45.38 50.459
10	299	Zielinski, Rajmund (mro) POL 4:46.03 50.344
11	280	Knudsen, Knut (mro) NOR 4:46.70 50.226
12	33	Merlos, Juan (mro) ARG 4:47.81 50.031
13	143	Yuste, Daniel (mro) ESP 4:50.36 49.593
14	77	Daler, Jiri (mro) CHE 4:50.50 49.569
15	202	Hallam, Ian (mro) GBR 4:50.62 49.549
16	179	Wackstrom, Ole (mro) FIN 4:50.76 49.525
17	308	Pettersson, Gosta (mro) SUE 4:51.37 49.421
18	155	Brink, David (mro) EUA 4:55.40 48.747
19	328	Stauble, Vernon
20	176	Evangelista, Benjamin
21	261	Abou-Zahab, Tarek
22	50	Forde, Colin
	115	Lizano, Inocente (mro) CUB 4:51.09 49.469
	221	Den Hertog, Fedor (mro) HOL 4:54.32 48.926
	304	Rusu, Emil
	107	Kwon, Jung-Hyun
	323	Boriharnvanakhet, Pakanit
	230	McNab, Denfield
	303	Torres, Edwin
	263	Razafinarivo, Solo
	264	Joo, Pong-Ng
	171	Ogbamichiel, Mahari
	103	Ombanzi, Francois
		ETI NTS
		COK NTS

QUARTS DE FINALE
QUARTER-FINALS

1	□□1	314	Kurmann, Xaver (erm) (mro)	SUI	4:45.94	50.360
	2	56	Crapez, Paul (mro)	BEL	4:49.99	49.657
2	□□1	43	Bylsma, John (mrm) (mro)	AUS	4:41.66	51.123
	2	268	Treviño, Radamés (mrm) (mro)	MEX	4:42.40	50.991
3	□□1	192	Rebillard, Daniel (mrm) (mro)	FRA	4:39.87	51.452
	2	4	Kratzer, Rupert (mrm) (mro)	ALE	4:41.43	51.183
4	□□1	121	Jensen, Mogens (mrm) (mro)	DIN	4:37.54	51.884
	2	245	Chemello, Cipriano (mrm) (mro)	ITA	4:42.29	51.011

DEMI-FINALE
SEMI-FINAL

OCT 18

1	† 1	121	Jensen, Mogens (mrm) (mro)	DIN	4:42.05	51.054
	2	314	Kurmann, Xaver (mrm) (mro)	SUI	4:44.26	50.657
2	† 1	192	Rebillard, Daniel (mrm) (mro)	FRA	4:41.80	51.098
	2	43	Bylsma, John (mro)	AUS	4:48.73	49.871

FINALE POUR 3e PLACE
THIRD PLACE FINAL

1	1	314	Kurmann, Xaver (mrm) (mro)	SUI	4:39.42	51.535
	2	43	Bylsma, John (mrm) (mro)	AUS	4:41.60	51.134

FINALE POUR 1e ET 2e PLACES
FINAL FOR 1st AND 2nd PLACES

2	1	192	Rebillard, Daniel (mrm) (mro)	FRA	4:41.71	51.114
	2	121	Jensen, Mogens (mrm) (mro)	DIN	4:42.43	50.986

CLASSEMENT FINAL
FINAL CLASSIFICATION

1		192	Rebillard, Daniel (mrm) (mro)	FRA	4:41.71	51.114
2		121	Jensen, Mogens (mrm) (mro)	DIN	4:42.43	50.986
3		314	Kurmann, Xaver (mrm) (mro)	SUI	4:39.42	51.535
4		43	Bylsma, John (mrm) (mro)	AUS	4:41.60	51.134

(RM) 4:45.94 Daler, Jiri CHE 1967, MEX
(RO) 4:56.07 Ursi, Giorgio ITA 1964, JPN

4000 METRES POURSUITE PAR EQUIPE
4000 METRES TEAM PURSUIT

EPREUVE DE QUALIFICATION
QUALIFYING ROUND

OCT 19

Course Race						Temps Time	KM/H
1	1	TAI	323 322	Boriharnvanakhet, Pakanit Prasongquamdee, Boontom	324 319	Chantrasamrit, Somchai Soponpong, Chainarong	4:56.80 48.515
	2	TWN	85 87	Deng, Chuen-Hwai Liu, Cheng-Tao	86 88	Shue, Ming-Shu Jiang, Guang-Nan	NSP
2	1	CUB	116 114	Martinez, Sergio Vázquez, Marcelo	117 115	Menéndez, Roberto Lizano, Inocente	4:34.96 52.366
	2	COK	101 103	Kabemba, Constantin Ombanzi, Francois	102 104	Mandjambi, Ignace Barnabe, Jean	NSP
3	1	EUA	161 163	Chauner, David Maaranen, Steven	162 164	Cutting, Harry Vande Velde, John	4:32.87 52.770
	2	COL	94 93	Saldarriaga, Luis Vanegas, Mario	95 92	Hernández, Severo Rodríguez, Martín	4:31.98 52.944
4	1	SUE	308 312	Pettersson, Gosta Pettersson, Erik	311 313	Pettersson, Sture Pettersson, Tomas	4:30.03 53.327
	2	TRT	329 331	Farrell, Robert Mohammed, Salim	330 332	Richardson, Phillip Lucas, Noel	4:48.64 49.887
5	□1	BEL	61 63	Bens, Ernest (mro) Debosscher, Willy	62 56	Vanmarcke, Ronny Crapez, Paul	4:26.14 54.106
	2	ARG	39 37	Contreras, Ernesto (mro) Breppe, Roberto	33 34	Merlos, Juan Alvarez, Carlos	4:26.22 54.090
6	□1	DIN	129 128	Asmussen, Gunar (mro) Olsen, Reno	361 121	Lyngemark, Pedersen Jensen, Mogens	4:23.58 54.632
	2	MEX	270 276	Díaz, Heriberto Belmonte, Adolfo	275 268	Alcántara, Agustín Treviño, Radamés	4:30.78 53.179
7	1	ADE	19 27	Richter, Heinz (mro) Franz, Rudolf	26 29	Schmelzer, Wolfgang Ulbricht, Manfred	4:26.61 54.011
	2	HOL	227 225	Hoekstra, Pieter (mro) Balk, Klaas	226 220	Nieuwkamp, Henricus Zoetemelk, Gerardes	4:27.17 53.808
8	□1	CHE	77 82	Daler, Jiri (mro) Puzrla, Milan	78 83	Kondr, Pavel Rezac, Frantisek	4:21.88 54.987
	2	POL	296 298	Matusiak, Wojciech (mro) Latocha, Wacław	291 299	Kierzkowski, Janusz Zielinski, Rajmund	4:23.77 54.593
9	□1	ALE	2 12	Hempel, Udo (mrm) (mro) Henrichs, Karl-Heinz	11 13	Link, Karl Podlesch, Rainer	4:19.90 55.405
	2	SUI	316 315	Richard, Walter (mro) Hubschmid, Bruno	317 314	Schneider, Jurg Kurmann, Xaver	4:28.71 53.589
10	□1	ITA	254 252	Bosisio, Lorenzo (mrm) (mro) Roncaglia, Luigi	253 245	Morbato, Giorgio Chemello, Cipriano	4:16.10 56.228
	2	GBR	200 202	Alsop, Ian (mro) Hallam, Ian	201 208	Jackson, Harry Keeble, Ronald	4:28.49 53.633
11	□2	FRA	185 193	Darmet, Bernard (mro) Mourioux, Jack	192 194	Rebillard, Daniel Van Lancker, Alain	4:24.45 54.452
	□1	URS	347 343	Koliushev, Mikhail (mrm) (mro) Kuznetsov, Vladimir	342 344	Moskvin, Stanislav Bykov, Victor	4:19.29 55.536

QUARTS DE FINALE
QUARTER-FINALS

1	□1	ITA	254 252	Bosisio, Lorenzo (mro) Roncaglia, Luigi	253 245	Morbato, Giorgio Chemello, Cipriano	4:22.48 54.861
	2	BEL	61 63	Bens, Ernest (mro) Debosscher, Willy	62 56	Vanmarcke, Ronny Crapez, Paul	4:26.05 54.125
2		URS	347 343	Koliushev, Mikhail (mro) Kuznetsov, Vladimir	342 344	Moskvin, Stanislav Bykov, Victor	4:26.63 54.007

Course Race						Temps Time	KM/H
	2	FRA	185 193	Darmet, Bernard Mourioux, Jack	192 194	Rebillard, Daniel Van Lancker, Alain	4:30.10 53.313
3	□1	ALE	2 12	Hempel, Udo (mro) Henrichs, Karl-Heinz	11 13	Link, Karl Podlesch, Rainer	4:27.14 53.904
	2	POL	296 298	Matusiak, Wojciech Latocha, Wacław	291 299	Kierzkowski, Janusz Zielinski, Rajmund	4:38.91 51.627
4	□1	DIN	129 128	Asmussen, Gunnar (mro) Olsen, Reno	361 121	Lyngemark, Pedersen Jensen, Mogens	4:27.02 53.928
	2	CHE	77 82	Daler, Jiri Puzrla, Milan	78 83	Kondr, Pavel Rezac, Frantisek	4:30.76 53.183

DEMI-FINALE
SEMI-FINAL

OCT 20

1	t1	ALE	2 12	Hempel, Udo (mrm) (mro) Henrichs, Karl-Heinz	11 14	Link, Karl Kissner, Jürgen	4:15.76 56.302
	2	ITA	254 252	Bosisio, Lorenzo (mrm) (mro) Roncaglia, Luigi	245 255	Chemello, Cipriano Pancino, Gino	4:16.21 56.204
2	t1	DIN	129 128	Asmussen, Gunnar (mrm) (mro) Olsen, Reno	119 121	Pedersen, Peder Jensen, Mogens	4:19.87 55.412
	2	URS	341 343	Latsis, Dzintars (mrm) (mro) Kuznetsov, Vladimir	342 344	Moskvin, Stanislav Bykov, Victor	4:20.39 55.301

FINALE POUR 3e PLACE
THIRD PLACE FINAL

OCT 21

1	1	ITA	254 252	Bosisio, Lorenzo (mrm) (mro) Roncaglia, Luigi	245 253	Chemello, Cipriano Morbato, Giorgio	4:18.35 55.738
	2	URS	341 343	Latsis, Dzintars Kuznetsov, Vladimir	342 347	Moskvin, Stanislav Koliushev, Mikhail	4:33.39 52.671

627

FINALE POUR 1e ET 2e PLACES
FINAL FOR 1st AND 2nd PLACES

2	1	ALE	2 12	Hempel, Udo (mrm) (mro) Henrichs, Karl-Heinz	11 14	Link, Karl Kissner, Jürgen	4:18.94 55.611
	2	DIN	129 128	Asmussen, Gunnar (mro) Olsen, Reno	361 121	Lyngemark, Pedersen Jensen, Mogens	4:22.44 54.869

CLASSEMENT FINAL
FINAL CLASSIFICATION

1		DIN	129 128	Asmussen, Gunnar (mro) Olsen, Reno	361 121	Lyngemark, Pedersen Jensen, Mogens	4:22.44 54.869
2	*ALE	2 12	Hempel, Udo (mrm) (mro) Henrichs, Karl-Heinz	11 14	Link, Karl Kissner, Jürgen	4:18.94 55.611	
3		ITA	254 252	Bosisio, Lorenzo (mrm) (mro) Roncaglia, Luigi	245 253	Chemello, Cipriano Morbato, Giorgio	4:18.35 55.738
4		URS	341 343	Latsis, Dzintars Kuznetsov, Vladimir	342 347	Moskvin, Stanislav Koliushev, Mikhail	4:33.39 52.671

(RM) 4:20.64 ITA 1966
(RO) 4:28.88 ITA 1960

				1e Tour	2e Tour	Temps Total					1e Tour	2e Tour	Temps Total		
				1st Lap	2nd Lap	Total Time	KM/H				1st Lap	2nd Lap	Total Time	KM/H	
6	POL	293 294 295 302	Magiera, Jan Czechowski, Zenon Kegel, Marian Blawdzin, Andrzej	1h05:50.05	1h08:50.93	2h14:40.98	44.556	27	CRC	108 109 110 111	Sánchez, José Soto, Manuel Sánchez, Miguel Solano, Adrián	1h14:41.52	1h21:44.27	2h36:25.79	38.554
7	ARG	33 34 37 39	Merlos, Juan Alvarez, Carlos Breppe, Roberto Contreras, Ernesto	1h06:42.57	1h08:51.67	2h15:34.24	44.259	28	SAL	137 139 141 142	Molina, Juan Bolaños, Mauricio Funes, Francisco García, Roberto	1h16:48.82	1h22:49.57	2h39:38.39	38.216
8	ALE	5 15 16 17	Ebert, Burkhard Tshan, Jürgen Czarnowski, Ortwin Koslar, Dieter	1h06:13.51	1h09:23.74	2h15:37.25	44.242	29	TWN	85 86 87 88	Deng, Chuen-Hwai Shue, Ming-Shu Liu, Cheng-Tao Jiang, Guang-Nan	1h18:02.53	1h24:11.35	2h42:13.88	37.033
9	URS	337 338 345 346	Shukhov, Boris Dokhlyakov, Alexander Dmitriev, Yury Yardy, Valery	1h06:09.02	1h09:30.56	2h15:39.58	44.231	30	COK	101 103 104 105	Kabemba, Constantin Ombanzi, Francois Barnabe, Jean Kibamba, Samuel	1h19:20.00	1h23:37.58	2h42:57.58	37.000
10 *	MEX	275 276 278 268	Alcántara, Agustín Belmonte, Adolfo Brito, Roberto Treviño, Radamés	1h05:12.65	1h08:55.79	2h16:08.44	44.732								
11	GBR	209 210 211 212	Bettinson, John Cromack, Roy Smith, Peter Watson, John	1h07:09.72	1h09:28.88	2h16:38.60	43.894								
12	ESP	144 145 148 149	Gomez, Lucas Lasa, Miguel Gonzalez, José Jiménez, Nemesio	1h06:59.45	1h09:39.45	2h16:38.90	43.894								
13	ADE	20 21 22 30	Ampler, Klaus Hoffmann, Gunter Grabe, Dieter Peschel, Axel	1h06:55.39	1h10:55.90	2h17:51.29	43.530								
14	AUS	45 44 47 48	McDermott, Peter Wilson, Donald Watson, David Morgan, Kevin	1h08:00.31	1h10:08.78	2h18:09.09	43.426								
15	FRA	195 196 197 198	Boulard, Jean-Pierre Bouloux, Robert Danguillaume, Jean-Pierre Lechatellier, Claude	1h06:49.52	1h11:46.30	2h18:35.82	43.270								
16	YUG	357 358 359 360	Skerlj, Franc Valencic, Rudi Kuvajica, Tanasija Bilic, Cvetko	1h07:32.11	1h11:20.09	2h18:52.20	43.218								
17	HUN	234 235 236 237	Magyar, Tibor Takacs, Andras Gera, Imre Meszaros, Andras	1h08:05.39	1h12:24.97	2h20:30.36	42.707								
18	BEL	65 66 67 68	Coulon, Michel Mintjens, Frans Grifnee, Marcel Opdebeeck, Englebert	1h08:14.78	1h12:38.15	2h20:52.93	42.609								
19	FIN	178 179 180 181	Suikkanen, Raimo Wackstrom, Ole Honkanen, Raimo Uusivirta, Mauno	1h08:08.92	1h12:46.55	2h20:55.47	42.440								
20	EUA	157 158 165 167	Howard, John Martin, Oliver Allis, John Van Boven, James	1h11:16.13	1h12:57.37	2h24:13.50	41.619								
21	GUA	213 214 215 216	Cuqué, Francisco Rustrian, Saturnino Inés Nulio, Jorge Oliva, Evaristo	1h11:07.55	1h13:13.22	2h24:20.77	41.571								
22	ECU	133 134 135 136	Morales, Victor Medina, Noé Pozo, Hipólito Pozo, Arnulfo	1h11:22.91	1h13:52.35	2h25:15.26	41.250								
23	NZL	287 288 289 290	Dean, John Thomson, Douglas Thomson, Ronald Lyster, Neil	1h10:13.99	1h15:32.48	2h25:46.47	41.189								
24	URG	351 352 353 354	Sosa, Luis Garre, Walter Jukich, Jorge Deceja, Rene	1h11:03.84	1h14:43.36	2h25:47.20	41.187								
25	CAN	71 72 73 74	Beland, Jules Jones, Joe Landry, Yves Roy, Marcel	1h12:28.31	1h14:49.83	2h27:18.14	40.724								
26	ETI	170 172 173 174	Ghebreyesus, Fessazien Saglimbeni, Mikael Woldu, Tekeste Negassi, Jemane	1h13:56.02	1h16:40.77	2h30:36.79	39.880								



**FEDERATION INTERNATIONALE
DE SPORTS EQUESTRES**

**INTERNATIONAL EQUESTRIAN
FEDERATION**

PRESIDENT
S.A.R. le prince Philip, duc
d'Edimbourg GBR

**SECRETAIRE GENERAL
GENERAL SECRETARY**
Chevalier H. de Menten de Home BEL

**FEDERATION MEXICAINE
DE SPORTS EQUESTRES**

**MEXICAN EQUESTRIAN
FEDERATION**

PRESIDENT
José Gómez Huerta MEX

**SECRETAIRE
SECRETARY**
Eduardo Baz MEX

**SECTION DES SPORTS EQUESTRES
DU C.O.O.
O.O.C. EQUESTRIAN SECTION**
Rubén Uriza C. MEX

Jaime Lara MEX
Antonio Eguiza MEX
Joaquín Hermida MEX

**OFFICIELS DE LA COMPETITION
COMPETITION OFFICIALS**

**JURY D'APPEL
JURY OF APPEAL**
S.A.R. le prince Philip, duc
d'Edimbourg GBR
S.A.R. le prince Bernard
des Pays-Bas HOL
Pedro Mayorga ARG
Vladimir Stoytchev BUL
José Gómez Huerta MEX

**JURY DU TERRAIN DU CONCOURS
COMPLET
GROUND JURY OF THE
THREE-DAY EVENT**

PRESIDENT
E. A. Serasin SUI

**JUGES
JUDGES**
Comte-Hertha E. Rothkirch ALE
Gustav Nyblaeus SUE

**JURY DU TERRAIN DU
GRAND PRIX OLYMPIQUE
DE SAUTS D'OBSTACLES
GROUND JURY OF THE OLYMPIC
JUMPING GRAND PRIX**

PRESIDENT
Bruno Bruni ITA

**JUGES
JUDGES**
Pierre Clave FRA
Eduardo Baz MEX

**JURY DU TERRAIN DU
GRAND PRIX OLYMPIQUE
DE DRESSAGE
GROUND JURY OF THE OLYMPIC
DRESSAGE GRAND PRIX**

PRESIDENT
G. Margot FRA

**JUGES II, III
JUDGES II, III**
Vigil Simpson EUA
A. J. Pot HOL

**JUGE OBSERVATEUR
OBSERVER JUDGE**
José I. Lepe MEX

**JUGES
JUDGES**
Germán Campero
Sergio Acevedo
Eduardo Baz
Ramiro Rodríguez
Carlos Aguirre
Abraham García
Horacio Ramírez
Carlos Jiménez
Manuel Garduño
José Tinajero
Oscar Caso
Kinardo Hamilton
Quirino Castillo
José L. García
Gabriel G. Nicanor
Manuel Cervello
Luis Cervello
Javier Salcedo
Roberto Osoyo E.
Héctor Rodríguez O.
Francisco Zambrano
Virgilio Morales
David Jiménez
Abel Cruz
Benjamín Ramos
José Ma. Alvarez
Salvador López
Juan Morales
Armando Morales
Tomás D. Arroyo
Isaías Reyna
J. Javier Barrera
Ramón Márquez
Juan Lozano
Nicolás R. Espinobarros
Guillermo Ferrer
Mauricio Sánchez
Benjamín M. Sánchez
Ricardo Martínez
Jesús Collazo
Cristóbal Menchaca G.
Salvador Rodríguez O.
Oscar Ayón
Federico Juárez
Jesús Flores R.
Francisco J. Chávez
Raúl Ruiz
Moisés Montoya
José L. Durán
Sofío Vargas
Leonardo Martínez
Víctor Faugier
José M. Beltrán
Luis F. Luna
Angel Moreno
Sergio Gamard

**CHRONOMETREURS ET
ANNOTEURS
TIMEKEEPERS AND
SCOREKEEPERS**
Alberto Valdez
Juan A. Noguera
Jaime L. Mercado
Jorge Rodríguez
Pablo Jean
José A. Greaves Jr.
Rafael Jiménez
Aurelio Miranda
Luis Jiménez
José I. Cortés
Aarón Sáenz
Antonio Galván
Vicente Rodríguez
Rubén Uriza Cerda
Arturo Ruiz
Patricio Chavarin
Alfredo Sánchez
José A. Vargas
Gerardo Pérez
David Alvarez
Genaro Arzave
Vicente Gámez
José L. J. Moreno
Raúl Eguarte
Alejandro Bello
Miguel A. González
Seúl Hernández
Noé Ezqueda
Sebastián Luna
Jesús Martínez
Arturo Meléndez
Fernando J. Ponce
Joaquín Ramos
Reynaldo Reynaga
Nelson Montes
Francisco J. Ramírez
Elías Reyes
Guillermo Rosillo
Juan Mendoza
José Vázquez
Rodolfo Martínez
Jaime Tafoya
Santiago Moto
Mateo Reyes
Raúl Sánchez
Moisés Torres
Aurelio Uribe
Alberto Espinosa
Jesús Pinto
Roberto Rendón
Agustín Vázquez
Adolfo Lecuona M.
Miguel Ramírez
Carlos Sánchez

Raúl Montoya
Efrén Pulido
Armando Gómez
José L. Romero
Rubén Arigoznaga
José E. Ibarra
Pablo Hoffman
Jaime Castañeda

**AUXILIAIRES
AUXILIARIES**
Jacques Porteny
Manuel Jiménez
R. Alberto García
Miguel Ramírez
Juan F. González
Pedro L. de la Vega
Ernesto Mocoroa
Francisco L. del Valle
Alfonso Hernández
Jaime Castañeda
Benjamín Marín
Edgard Perdomo
José Vázquez
José L. Méndez
Javier Márquez
Miguel Méndez
Felipe Corona

SIGNES EMPLOYES

SYMBOLY

I	— PREMIERE EPREUVE	FIRST TRIAL
II	— EPREUVE POUR FINALISTES	TRIAL FOR FINALISTS
PZ	— PENALITE	PENALTY
DES	— DISQUALIFIE	DISQUALIFIED
TE	— TOTAL PAR EQUIPE	TEAM TOTAL
⊙	— PLACE SELON RESULTATS DES 1er ET 2e JOURS	POSITION ACCORDING TO 1st AND 2nd DAY RESULTS
○	— PLACE SELON RESULTATS DES 1er, 2e ET 3e JOURS	POSITION ACCORDING TO 1st, 2nd AND 3rd DAY RESULTS
ST	— STEEPLE-CHASE	STEEPLECHASE
CC	— CROSS-COUNTRY	CROSS-COUNTRY
D	— DRESSAGE	DRESSAGE
F	— EPREUVE DE FOND	ENDURANCE TEST
S	— EPREUVE DE SAUTS D'OBSTACLES	JUMPING TEST
()	— BARRAGE	JUMP OFF

**GRAND PRIX OLYMPIQUE DE DRESSAGE
OLYMPIC DRESSAGE GRAND PRIX**

**FINALE INDIVIDUELLE
INDIVIDUAL FINAL** **OCT 25**

		Cheval Horse	I	II	Total Points	
1	URS	Kizimov, Ivan	Ijor	908	664	1572
2	ALE	Neckermann, Josef	Mariano	948	598	1546
3	ALE	Klimke, Rainer	Dux	896	641	1537
4	URS	Kalita, Ivan	Absent	879	640	1519
5	ADE	Köhler, Horst	Neuschnee	875	600	1475
6	URS	Petuchkova, Elena	Pepel	870	601	1471
7	SUI	Fischer, Gustav	Wald	866	599	1465
8	ALE	Linsenhoff, Liselott	Piaff	855	855	855
9	SUI	Chammartin, Henri	Wolfdietrich	845	845	845
10	SUI	Gossweller, Marianne	Stephan	836	836	836
11	GBR	Lawrence, Margaret	San Fernando	793	793	793
12	ADE	Brockmüller, Gerhard	Tristan	789	789	789
13	GBR	Johnstone, Hilda	El Guapo	777	777	777
14	GBR	Hall, Johanna	Conversano Caprice	762	762	762
15	CAN	Fischer-Credo, Inez	Marius	732	732	732
16	CHI	Squella, Guillermo	Colchaguino	693	693	693
16	ADE	Müller, Wolfgang	Marios	693	693	693
18	MEX	Serrano, Federico	Marko	689	689	689
19	CAN	Hanson, Christilot	Bonheur	677	677	677
20	CHI	Piraino, Antonio	Ciclón	672	672	672
21	EUA	Downton, Kyra	Cadet	657	657	657
22	CHI	Escudero, Patricio	Prete	650	650	650
23	EUA	Master, Edith	Helios	646	646	646
24	EUA	Plumb, Donnan	Attache	616	616	616
25	CAN	Sztehlo, Zoltan	Virtuose	603	603	603
26	MEX	Herrera, Julio	Otard	537	537	537

**FINALE PAR EQUIPE
TEAM FINAL** **OCT 24**

				Points
1	ALE	Neckermann, Josef	Mariano	948
		Linsenhoff, Liselott	Piaff	855
		Klimke, Rainer	Dux	896
				TE 2699
2	URS	Petuchkova, Elena	Pepel	870
		Kizimov, Ivan	Ijor	908
		Kalita, Ivan	Absent	879
				TE 2657
3	SUI	Chammartin, Henri	Wolfdietrich	845
		Gossweller, Marianne	Stephan	836
		Fischer, Gustav	Wald	866
				TE 2547
4	ADE	Müller, Wolfgang	Marios	693
		Brockmüller, Gerhard	Tristan	789
		Köhler, Horst	Neuschnee	875
				TE 2375
5	GBR	Johnstone, Hilda	El Guapo	777
		Hall, Johanna	Conversano Caprice	762
		Lawrence, Margaret	San Fernando	793
				TE 2332
6	CHI	Squella, Guillermo	Colchaguino	693
		Escudero, Patricio	Prete	650
		Piraino, Antonio	Ciclón	672
				TE 2015
7	CAN	Sztehlo, Zoltan	Virtuose	603
		Hanson, Christilot	Bonheur	677
		Fischer-Credo, Inez	Marius	732
				TE 2012
8	EUA	Downton, Kyra	Cadet	657
		Master, Edith	Helios	646
		Plumb, Donnan	Attache	616
				TE 1919

**CONCOURS COMPLET D'EQUITATION
THREE DAY EVENT**

**1er JOUR DRESSAGE INDIVIDUEL
1st DAY INDIVIDUAL DRESSAGE** **OCT 18**

		Cheval Horse	Temps Time	PZ
1	URS	Evdokimov, Alexander	Fat	5.53 - 48.00
2	URS	Gazumov, German	Fugas	6.21 - 49.50
3	ADE	Vite, Ulrich	Hubertus	6.23 - 53.01
4	URS	Deev, Pavel	Paket	6.06 - 59.51
5	EUA	Plumb, Michael	Plain Sailing	6.17 - 63.00
6	ARG	Moratorio, Carlos	Hijo Manso	6.21 - 68.01
6	ALE	Mehrdorf, Jochen	Lapislazuli	6.06 - 68.01
8	GBR	Jones, Reuben	The Poacher	6.20 - 68.51
9	ADE	Fuhrmann, Karl-Heinz	Saturn	6.19 - 70.50
10	IRL	Jobling-Purser, Juliet	Jenny	5.41 - 72.51
11	FRA	Guyon, Jean-Jacques	Pitou	6.06 - 73.01
12	IRL	Moreton, Penelope	Loughlin	6.28 - 74.01
12	ALE	Karsten, Horst	Adagio	6.21 - 74.01
14	EUA	Freeman, Kevin	Chalan	6.22 - 77.01
15	ADE	Plank, Uwe	Kranich	6.27 - 79.01
16	FRA	Sarrazin, Jean	Joburg	5.50 - 80.51
17	ITA	Checconi, Mauro	Surbeam	6.17 - 82.01
18	FRA	Le Goupil, André	Olivette	5.59 - 83.01
19	ITA	Argenton, Alessandro	Diambo de Nora	6.30 - 83.51
20	AUS	Roycroft, William	Warrathoola	6.18 - 84.00
21	GBR	Allhusen, Derek	Lochinvar	5.58 - 85.01
22	URS	Gluchkov, Svetozar	Balerina	5.53 - 86.51
22	GBR	Bullen, Jane	Our Nobby	6.13 - 86.51
24	FRA	Martin, Jean-Louis	Quel Feu	6.08 - 87.51
25	ARG	Pistarini, Roberto	Warti	6.21 - 90.00
26	ARG	Bedoya, Jorge	Naranjo	7.00 - 91.50
27	ALE	Goessing, Ludwig	Arved	5.59 - 94.01
28	CAN	Hahn, Robin	Taffy	6.10 - 97.01
28	GBR	Meade, Richard	Cornishman V	5.46 - 97.01
28	IRL	Brennan, Thomas	March Hawk	6.01 - 97.01
31	MEX	Avalos, Evaristo	Ludmilla II	6.53 - 98.01
32	CAN	Ehrlick, Allan	The Nomad	6.08 - 99.00
33	ADE	Hartmann, Helmut	Ingwer	6.39 - 101.01
34	EUA	Wofford, James	Kilkenny	6.24 - 101.51
35	ALE	Wagner, Klaus	Abdulla	6.39 - 102.00
36	CAN	Sonshine, Barry	Durlas Eile	6.12 - 103.01
37	AUS	Roycroft, Wayne	Zhivago	6.31 - 103.50
38	CAN	Elder, Norman	Questionnaire	5.49 - 106.01
38	ITA	Angioni, Paolo	King	6.37 - 106.01
40	EUA	Page, Michael	Foster	6.25 - 107.51
41	ARG	Acosta, José	Oligarca	6.37 - 110.01
42	ITA	Ravano, Giuseppe	Lord Jim	6.47 - 111.00
43	MEX	Mejia, Ramón	Centinela	7.10 - 112.50
44	AUS	Cobcroft, Brian	Depeche	6.39 - 115.01
45	MEX	Del Castillo, Ernesto	Codicioso	7.09 - 117.00
46	AUS	Scanlon, James	The Furtive	6.00 - 122.01
47	IRL	Willson, Diana	Chianti Rosso	5.59 - 122.51
48	JPN	Chiba, Mikio	Josephine	7.05 - 128.01
	MEX	Higareda, Eduardo	Samuray Azteca	DES

**1er JOUR DRESSAGE PAR EQUIPE
1st DAY TEAM DRESSAGE** **OCT 19**

			Temps Time	PZ
1	URS	Evdokimov, Alexander	Fat	5.53 - 48.00
		Gazumov, German	Fugas	6.21 - 49.50
		Deev, Pavel	Paket	6.06 - 59.51
				TE -157.01
2	ADE	Vite, Ulrich	Hubertus	6.23 - 53.01
		Fuhrmann, Karl-Heinz	Saturn	6.19 - 70.50
		Plank, Uwe	Kranich	6.27 - 79.01
				TE -202.52
3	ALE	Mehrdorf, Jochen	Lapislazuli	6.06 - 68.01
		Karsten, Horst	Adagio	6.21 - 74.01
		Goessing, Ludwig	Arved	5.59 - 94.01
				TE -236.03
4	FRA	Guyon, Jean-Jacques	Pitou	6.06 - 73.01
		Sarrazin, Jean	Joburg	5.50 - 80.51
		Le Goupil, André	Olivette	5.59 - 83.01
				TE -236.53
5	GBR	Jones, Reuben	The Poacher	6.20 - 68.51
		Allhusen, Derek	Lochinvar	5.58 - 85.01
		Bullen, Jane	Our Nobby	6.13 - 86.51
				TE -240.03

		Cheval Horse	Temps Time	PZ	
6	EUA	Plumb, Michael Freeman, Kevin Wofford, James	Plain Sailing Chalan Kilkenny	6.17 - 63.00 6.22 - 77.01 6.24 -101.51	
					TE -241.52
7	IRL	Jobling-Purser, Juliet Moreton, Penelope Brennan, Thomas	Jenny Loughlin March Hawk	5.41 - 72.51 6.28 - 74.01 6.01 - 97.01	
					TE -243.53
8	ARG	Moratorio, Carlos Pistarini, Roberto Bedoya, Jorge	Hijo Manso Warti Naranjo	6.21 - 68.01 6.21 - 90.00 7.00 - 91.50	
					TE -249.51
9	ITA	Checconi, Mauro Argenton, Alessandro Angioni, Paolo	Surbeam Diambo de Nora King	6.17 - 82.01 6.30 - 83.51 6.37 -106.01	
					TE -271.53
10	CAN	Hahn, Robin Ehrlick, Allan Sonshine, Barry	Taffy The Nomad Durlas Eile	6.10 - 97.01 6.08 - 99.00 6.12 -103.01	
					TE -299.02
11	AUS	Roycroft, William Roycroft, Wayne Cobcroft, Brien	Warrathoola Zhivago Depeche	6.18 - 84.00 6.31 -103.50 6.39 -115.01	
					TE -302.51
12	MEX	Avalos, Evaristo Mejia, Ramon Del Castillo, Ernesto	Ludmilla II Centinela Codicioso	6.53 - 98.01 7.10 -112.50 7.09 -117.00	
					TE -327.51

⊙2e JOUR EPREUVE DE FOND INDIVIDUELLE
⊙2nd DAY INDIVIDUAL ENDURANCE TEST

OCT 20

			Phase B ST	Phase D CC	Total Points
1	FRA	Guyon, Jean-Jacques	27.2	17.2	44.4
2	EUA	Wofford, James	37.6	33.6	71.2
3	URS	Deev, Pavel	27.2	- 5.6	21.6
4	GBR	Allhusen, Derek	35.2	9.2	44.4
5	GBR	Meade, Richard	37.6	17.2	54.8
6	EUA	Page, Michael	28.8	30.4	59.2
7	GBR	Jones, Reuben	11.2	- 6.8	4.4
8	URS	Gazumov, German	29.6	- 56.8	- 27.2
9	IRL	Jobling-Purser, Juliet	37.6	- 43.2	- 5.6
10	AUS	Roycroft, Wayne	23.2	- 2.0	21.2
11	CAN	Hahn, Robin	16.0	- 4.4	11.6
12	AUS	Cobcroft, Brien	19.2	- 2.8	22.0
13	FRA	Le Goupil, André	18.4	- 32.4	- 14.0
14	ALE	Karsten, Horst	20.0	- 43.2	- 23.2
15	EUA	Plumb, Michael	29.6	- 83.6	- 54.0
16	AUS	Roycroft, William	24.0	- 84.8	- 40.8
17	MEX	Del Castillo, Ernesto	36.0	- 55.6	- 19.6
18	GBR	Bullen, Jane	37.6	- 89.6	- 52.0
19	AUS	Scanlon, James	23.2	- 42.4	- 19.2
20	ITA	Argenton, Alessandro	36.0	-112.4	- 76.4
21	URS	Evdokimov, Alexander	2.4	-120.0	-117.6
22	MEX	Mejia, Ramon	17.6	- 78.0	- 60.4
23	ADE	Fuhrmann, Karl-Heinz	- 3.2	-100.8	-104.0
24	ALE	Mehrdorf, Jochen	32.0	-140.4	-108.4
25	ITA	Ravano, Giuseppe	18.4	- 94.0	- 75.6
26	ITA	Angioni, Paolo	37.6	-121.6	- 84.0
27	ALE	Wagner, Klaus	28.0	-127.6	- 99.6
28	ADE	Plank, Uwe	-55.2	- 76.8	-132.0
29	ADE	Hartmann, Helmut	27.2	-144.4	-117.2
30	IRL	Willson, Diana	8.0	-114.4	-106.4
31	ARG	Pistarini, Roberto	37.6	-187.6	-150.0
32	MEX	Avalos, Evaristo	4.8	-153.6	-148.8
33	ARG	Acosta, José	34.4	-189.6	-155.2
34	CAN	Elder, Norman	-47.2	-156.0	-203.2
35	CAN	Sonshine, Barry	27.2	-274.0	-246.8
36	FRA	Sarrazin, Jean	37.6	-316.8	-279.2
37	ARG	Moratorio, Carlos	21.6	-315.6	-294.0
38	CAN	Ehrlick, Allan	-60.0	-231.6	-291.6
39	ALE	Goessing, Ludwig	3.2	-127.2	-124.0
	JPN	Chiba, Mikio	37.6	DES	DES
	IRL	Moreton, Penelope	37.6	DES	DES
	FRA	Martin, Jean-Louis	36.8	DES	DES
	EUA	Freeman, Kevin	37.6	DES	DES
	ITA	Checconi, Mauro	23.2	DES	DES
	ADE	Vite, Ulrich	23.2	DES	DES
	ARG	Bedoya, Jorge	23.2	DES	DES
	IRL	Brennan, Thomas	28.8	DES	DES
	URS	Gluchkov, Svetozar	37.6	DES	DES

⊙2e JOUR EPREUVE DE FOND PAR EQUIPE
⊙2nd DAY TEAM ENDURANCE TEST

		Cheval Horse	Phase B ST	Phase D CC	Total Points
1	GBR	Allhusen, Derek Meade, Richard Jones, Reuben	35.2 37.6 11.2	9.2 17.2 6.8	44.4 54.8 4.4
					TE 103.6
2	EUA	Wofford, James Page, Michael Plumb, Michael	37.6 28.8 29.6	33.6 30.4 83.6	71.2 59.2 54.0
					TE 76.4
3	URS	Gazumov, German Deev, Pavel Evdokimov, Alexander	29.6 27.2 2.4	- 56.8 - 5.6 -120.0	27.2 21.6 -117.6
					TE -123.2
4	AUS	Cobcroft, Brien Roycroft, Wayne Roycroft, William	19.2 23.2 24.0	2.8 - 2.0 - 64.8	22.0 21.2 - 40.8
					TE 2.4
5	FRA	Le Goupil, André Guyon, Jean-Jacques Sarrazin, Jean	18.4 27.2 37.6	- 32.4 - 17.2 -316.8	- 14.0 44.4 -279.2
					TE -248.8
6	ALE	Wagner, Klaus Mehrdorf, Jochen Karsten, Horst	28.0 32.0 20.0	-127.6 -140.4 - 43.2	- 99.6 -108.4 - 23.2
					TE -231.2
7	ITA	Argenton, Alessandro Angioni, Paolo Ravano, Giuseppe	36.0 37.6 18.4	-112.4 -121.6 - 94.0	- 76.4 - 84.0 - 75.6
					TE -236.0
8	MEX	Del Castillo, Ernesto Mejia, Ramon Avalos, Evaristo	36.0 17.6 4.8	- 55.6 - 78.0 -153.6	- 19.6 - 60.4 -148.8
					TE -228.8
9	ADE	Hartmann, Helmut Plank, Uwe Fuhrmann, Karl-Heinz	27.2 -55.2 - 3.2	-144.4 - 76.8 -100.8	-117.2 -132.0 -104.0
					TE -353.2
10	CAN	Elder, Norman Hahn, Robin Sonshine, Barry	-47.2 16.0 27.2	-156.0 - 4.4 -274.0	-203.2 11.6 -246.8
					TE -438.4
11	ARG	Pistarini, Roberto Moratorio, Carlos Acosta, José	37.6 21.6 34.4	-187.6 -315.6 -189.6	-150.0 -294.0 -155.2
					TE -599.2

			Phase B ST	Phase D CC	Total Points
PHASE A ET PHASE C PAS DE PENALITE					
PHASE A AND PHASE C, NO PENALTY					

⊙3e JOUR EPREUVE DE SAUTS D'OBSTACLES INDIVIDUELLE
⊙3rd DAY INDIVIDUAL JUMPING TEST

OCT 21

			Obstacles	Temps Time	Total
			PZ		
1	FRA	Guyon, Jean-Jacques	-10	-0.25	-10.25
2	GBR	Allhusen, Derek	—	-1.00	- 1.00
3	EUA	Page, Michael	—	-4.00	- 4.00
4	GBR	Meade, Richard	-20	-2.25	-22.25
5	GBR	Jones, Reuben	—	-5.75	- 5.75
6	EUA	Wofford, James	-40	-3.75	-43.75
7	IRL	Jobling-Purser, Juliet	—	-1.00	- 1.00
8	AUS	Roycroft, Wayne	-10	-2.75	-12.75
9	CAN	Hahn, Robin	-10	—	-10.00
10	URS	Gazumov, German	-10	-9.00	-19.00
11	ALE	Karsten, Horst	—	-5.75	- 5.75

		Cheval Horse	D	F	S		
6	MEX	Del Castillo, Ernesto Mejia, Ramón Avalos, Evaristo	Codicioso Centinela Ludmilla II	-117.00 -112.50 -98.01	-19.6 -60.4 -148.8	-34.00 -10.00 -31.25	-170.60 -182.90 -278.06
TE -631.56							
7	ADE	Hartmann, Helmut Plank, Uwe Fuhrmann, Karl-Heinz	Ingwer Kranich Saturn	-101.01 -79.01 -70.50	-117.2 -132.0 -104.0	-23.25 -20.00 -43.75	-241.46 -231.01 -218.25
TE -690.72							
8	CAN	Elder, Norman Hahn, Robin Sonshine, Barry	Questionnaire Taffy Durlas Eile	-106.01 -97.01 -103.01	-203.2 11.6 -246.8	-23.25 -10.00 -10.00	-332.46 -95.41 -359.81
TE -787.68							

GRAND PRIX OLYMPIQUE DE SAUTS D'OBSTACLES OLYMPIC JUMPING GRAND PRIX

FINALE INDIVIDUELLE INDIVIDUAL FINAL

OCT 23

			I PZ	II PZ	Temps Time ()	PZ	Total PZ
1	EUA	Steinkraus, William	Snowbound	0.00	4.00		4.00
2	GBR	Coakes, Marion	Stroller	0.00	8.00		8.00
3	GBR	Broome, David	Mr. Softee	4.00	8.00	(35.3)	(0) 12.00
4	EUA	Chapot, Frank	San Lucas	4.00	8.00	(36.8)	(0) 12.00
5	ALE	Winkler, Hans	Enigk	8.00	4.00	(37.5)	(0) 12.00
6	CAN	Elder, James	The Immigrant	8.00	4.00	(39.2)	(0) 12.00
7	ALE	Schockemöhle, Alwin	Donald Rex	8.00	8.00		16.00
7	ARG	Molinuevo, Argentino	Don Gustavo	8.00	8.00		16.00
7	ITA	D'Inzeo, Piero	Fidux	4.00	12.00		16.00
7	SUI	Bachmann, Monika	Erbach	8.00	8.00		16.00
11	GBR	Smith, Harvey	Madison Time	8.00	8.25		16.25
12	BRA	Faria, Lucia	Rush du Camp	7.25	12.00		19.25
13	ARG	Delia, Carlos	Scandale	8.00	12.00		20.00
13	SUI	Blickenstorfer, Arthur	Marianka	8.00	12.00		20.00
13	CAN	Day, James	Canadian Club	4.00	16.00		20.00
16	BRA	Pessoa, Nelson	Pass-Op	8.00	16.00		24.00
17	FRA	D'Orliola, Pierre	Nagir	8.00	20.50		28.50
18	AUS	Bacon, Kevin	Chichester	4.00	24.75		28.75
19	MEX	Hernández, Fernando	Churintzio	10.75	10.75		10.75
20	FRA	Rozier, Jean	Quo Vadis	11.00	11.00		11.00
21	SUI	Weier, Paul	Wildfeuer	12.00	12.00		12.00
21	EUA	Kusner, Kathy	Untouchable	12.00	12.00		12.00
21	ITA	Mancinelli, Graziano	Doneraile	12.00	12.00		12.00
21	MEX	Guasch, Ricardo	Mixteco	12.00	12.00		12.00
21	AUS	Fahey, John	Bon Vale	12.00	12.00		12.00
26	JPN	Fukushima, Tadashi	Queen	16.00	16.00		16.00
26	ALE	Steeken, Hartwig	Simona	16.00	16.00		16.00
26	ITA	D'Inzeo, Raimondo	Bellevue	16.00	16.00		16.00
26	URS	Matveev, Victor	Krojtnyi	16.00	16.00		16.00
26	AUS	Campbell, Samuel	April Love	16.00	16.00		16.00
26	JPN	Sugitani, Masayasu	Ringo	16.00	16.00		16.00
32	FRA	Lefebvre, Jane	Rocket	20.00	20.00		20.00
33	BRA	Reynoso, José	Cantal	23.25	23.25		23.25
34	BOL	Nielsen, Roberto	Ukamau	24.00	24.00		24.00
35	POL	Kozicki, Marian	Braz	28.00	28.00		28.00
36	CAN	Miller, Terrance	Beefeater	31.50	31.50		31.50
37	MEX	Pérez de las H., Joaquín	Romeo	36.50	36.50		36.50
38	POL	Pacynski, Antoni	Cirrus	37.25	37.25		37.25
39	POL	Wawryniuk, Piotr	Farys	52.75	52.75		52.75
ARG	Amaya, Jorge	Gemelo	DES				
URS	Kuzin, Evgeny	Figlar	DES				
JPN	Araki, Yugo	Far East	DES				

FINALE PAR EQUIPE TEAM FINAL

OCT 27

		Cheval Horse	Obstacles PZ	1 Temps Time PZ	Obstacles PZ	2 Temps Time PZ	Total PZ
1	CAN	Gayford, Thomas Day, James Elder, James	Big Dee Canadian Club The Immigrant	20 16 8	2.25 2.00 1.25	16 16 16	39.50 36.00 27.25
TE 102.75							
2	FRA	Rozier, Jean Lefebvre, Jane D'Orliola, Pierre	Quo Vadis Rocket Nagir	20 16 16	1.50 1.25 1.75	12 12 28	33.50 29.75 47.00
TE 110.25							
3	ALE	Schridde, Hermann Schockemöhle, Alwin Winkler, Hans	Dozent Donald Rex Enigk	32 12 8	1.75 1.00 3.50	36 4 12	70.25 18.75 28.25
TE 117.25							
4	EUA	Chapot, Mary Kusner, Kathy Chapot, Frank	White Lightning Untouchable San Lucas	24 20 8	3.00 5.00 3.00	20 16 12	48.00 44.50 25.00
TE 117.50							
5	ITA	Mancinelli, Graziano D'Inzeo, Raimondo D'Inzeo, Piero	Doneraile Bellevue Fidux	20 12 24	3.50 0.00 4.50	32 12 16	57.50 24.25 47.50
TE 129.25							
6	SUI	Blickenstorfer, Arthur Bachmann, Monika Weier, Paul	Marianka Erbach Satan	20 15 19	1.75 8.00 4.50	28 24 12	50.50 49.50 36.75
TE 136.75							
7	BRA	Faria, Lucia Reynoso, José Pessoa, Nelson	Rush du Camp Cantal Pass-Op	20 24 24	4.75 3.75 4.50	16 24 8	44.75 54.50 38.75
TE 138.00							
8	GBR	Coakes, Marion Smith, Harvey Broome, David	Stroller Madison Time Mr. Softee	15 16 8	6.75 2.25 0.00	DES 24 12	72.75 45.00 20.00
TE 159.50							
9	AUS	Fahey, John Campbell, Samuel Bacon, Kevin	Bon Vale April Love Chichester	20 20 24	1.25 3.75 1.50	20 24 27	42.75 50.50 73.25
TE 166.50							
10	MEX	Pérez de las H., Joaquín Hernández, Fernando Guasch, Ricardo	Nancel Churintzio Mixteco	28 20 41	3.00 7.50 15.00	28 28 28	63.00 59.75 86.75
TE 209.50							
11	POL	Pacynski, Antoni Wawryniuk, Piotr Kowalczyk, Jan	Cirrus Poprad Braz	36 32 44	5.25 5.00 1.25	37 20 20	15.75 60.25 69.00
TE 223.25							
12	URS	Matveev, Victor Kuzin, Evgeny Samosedenko, Gennady	Krojtnyi Figlar Aeron	20 DES 15	3.75 76.00 10.25	16 39 40	1.75 121.00 68.00
TE 230.50							
13	ARG	Molinuevo, Argentino Tagle, Roberto Delia, Carlos	Don Gustavo Ojo Chico Scandale	28 43 24	3.75 11.50 3.25	DES 40 35	72.75 102.00 68.50
TE 275.00							
14	JPN	Fukushima, Tadashi Sugitani, Masayasu Araki, Yugo	Queen Ringo Fokker	36 20 DES	2.50 1.50	36 31 76	1.25 58.75 148.75
TE 283.25							

**CHAMPIONS OLYMPIQUES
OLYMPIC CHAMPIONS**

**GRAND PRIX OLYMPIQUE DE DRESSAGE
OLYMPIC DRESSAGE GRAND PRIX**

**INDIVIDUELLE
INDIVIDUAL**

1912	C. Bonde	SUE
1920	J. Lundblad	SUE
1924	E. Von Linder	SUE
1928	C. Von Langen	ALE
1932	F. Lesage	FRA
1936	H. Pollay	ALE
1948	H. Moser	SUI
1952	H. Saint Cyr	SUE
1956	H. Saint Cyr	SUE
1960	S. Filatov	URS
1964	H. Chammartin	SUI
1968	I. Kizimov	URS

**PAR EQUIPE
BY TEAM**

1928	ALE
1932	FRA
1936	ALE
1948	FRA
1952	SUE
1956	SUE
1960	ALE
1964	ALE
1968	ALE

**CONCOURS COMPLET D'EQUITATION
THREE-DAY EVENT**

**INDIVIDUELLE
INDIVIDUAL**

1912	A. Nordlander	SUE
1920	H. Morner	SUE
1924	A. Van Der Vort Van Zijp	HOL
1928	F. De Mortanges	HOL
1932	F. De Mortanges	HOL
1936	L. Stubbendorff	ALE
1948	B. Chevallier	FRA
1952	E. Von Blixen-Finecke	SUE
1956	P. Kastenman	SUE
1960	L. L. Morgan	AUS
1964	M. Chelloli	ITA
1968	J. Guyon	FRA

**PAR EQUIPE
BY TEAM**

1912	SUE
1920	SUE
1924	HOL
1928	HOL
1932	EUA
1936	ALE
1948	EUA
1952	SUE
1956	GBR
1960	AUS
1964	ITA
1968	GBR

**GRAND PRIX OLYMPIQUE DE SAUTS D'OBSTACLES
OLYMPIC JUMPING GRAND PRIX**

**INDIVIDUELLE
INDIVIDUAL**

1912	J. Cariou	FRA
1920	T. Leguio	ITA
1924	A. Gemuseus	SUI
1928	F. Ventura	CHE
1932	T. Nishi	JPN
1936	K. Hasse	ALE
1948	H. Mariles Cortés	MEX
1952	P. J. D'Oriola	FRA
1956	H. G. Winkler	ALE
1960	R. D'Inzeo	ITA
1964	P. J. D'Oriola	FRA
1968	W. Steinkrauss	EUA

**PAR EQUIPE
BY TEAM**

1912	SUE
1920	SUE
1924	SUE
1928	ESP
1932	ALE
1936	MEX
1948	GBR
1952	ALE
1956	ALE
1960	ALE
1964	ALE
1968	CAN



FEDERATION INTERNATIONALE
D'ESCRIME FIE

INTERNATIONAL FENCING
FEDERATION FIE

PRESIDENT
Pierre Ferri FRA

SECRETARE GENERAL
GENERAL SECRETARY
Henri Dulieux FRA

FEDERATION MEXICAINE
D'ESCRIME FME

MEXICAN FENCING
FEDERATION FME

PRESIDENT
David Romero MEX

SECRETARE
SECRETARY
Victoria Velasco MEX

SECTION ESCRIME DU C.O.O.
O.O.C. FENCING SECTION
David Romero MEX

Enriqueta Mayora MEX
Jorge Rizzo MEX
Héctor Cueto MEX
Luis Berlanga MEX
Abraham Pacheco MEX
Manuel Torres MEX

OFFICIELS DE LA COMPETITION
COMPETITION OFFICIALS

LISTE DES PRESIDENTS ET
DIRECTEURS DE COMBATS
INTERNATIONAUX

LIST OF PRESIDENTS AND
DIRECTORS OF INTERNATIONAL
COMPETITION

Werner Beuys	ADE
D. Guseklaus	ADE
S. Kaldschmidt	ADE
Hans Kniess	ADE
Kurt Noe	ADE
Anton Rehlinger	ADE
A. Ouadah	AGL
Charles H. Boutmy	AHO
Elmar Waterlon	ALE
Erich Burisch	ALE
Wilhelm Blumenthal	ALE
N. R. H. Gabel	ALE
Herst Melzig	ALE
George Müller	ALE
Hebert Paarman	ALE
Alberto Lanteri	ARG
Evaristo Prendes	ARG
Félix Galimi	ARG
Fernando Taboada	ARG
Fernando Petrella	ARG
Guglielmo Saucedo	ARG
Guglielmo Obeid	ARG
José Quintana	ARG
Rolando Mannini	ARG
Norberto Mattiazzo	ARG
Omar Vergara	ARG
B. P. Cowage Me.	AUS
Endre Szakall	AUS
Hans Hocke	AUT
Paul Kerb	AUT
Hubert Loisel	AUT
Lutz Maurer	AUT
Walter Misof	AUT
Peter Ulrich	AUT
Guenter Ulrich	AUT
Hugo Weczerek	AUT
Gustave Balister	BEL
Alex Bourgeois	BEL
G. De Bourguignon	BEL
Charles Debeur	BEL
Julien Eggermont	BEL
A. Henriët	BEL
François Jassogne	BEL
Léon Hellmann	BEL
Marcel Meinen	BEL
André Van de Verve	BEL
Pierre Van Houdt	BEL
Carl Viatour	BEL
Vieira Aruyo	BRA

Stevan Molnar	BRA
J. Simoes	BRA
Assen Diakovski	BUL
Nicolai Genof	BUL
V. Katerinska	BUL
John Andrew	CAN
Peter Samek	CAN
Carl Schwende	CAN
Imre Szabo	CAN
Magdy Conyd	CAN
Cestnir Civrny	CHE
Joseph Jungmann	CHE
Alois Sokol	CHE
Isze Goldstein	CHI
Robert Lowy	CHI
Sergio Vergara	CHI
Gabriel Blando	COL
Ene Echeverri	COL
B. Cardos	CUB
José Antonio Díaz	CUB
Luis Morales	CUB
Vitorio Ruiz	CUB
L. Eigenfeld	DIN
Francisco Carbonell	ESP
Antonio Cervantes	ESP
Antonio J. Delas	ESP
Pinillos Diez	ESP
Francisco Félix	ESP
Juan Ferrer	ESP
Enz Arias García	ESP
Ernesto Diez García	ESP
Amadeo Lloris	ESP
Miguel Manrique	ESP
Juan Martinez	ESP
C. Quintana	ESP
J. L. Villaverde	ESP
Fernando Vizcaino	ESP
Roland Asselin	EUA
Albert Axelrod	EUA
Robert Blum	EUA
Daniel Bukantz	EUA
José De Capriles	EUA
Miguel De Capriles	EUA
Michael Desaro	EUA
Walter Farber	EUA
John Farrell	EUA
Chaba Gall	EUA
John Geraci	EUA
Gene Glazer	EUA
Harnold Goldsmith	EUA
Ralph Goldstein	EUA
Marwin Grafton	EUA
Eugene Hamori	EUA
Jack Keane	EUA
William Latzko	EUA
Norman Lewis	EUA
Daniel Magay	EUA
Tibor Nylas	EUA
D. Orban	EUA
Thomas Orley	EUA
Chaba Pallyghy	EUA
Laszlo Pongo	EUA
Joel Wolf	EUA
George Worth	EUA
M. Mitchell	EUA
Lucien Alphonse	FRA
Roland Boitelle	FRA
Jean Brousse	FRA
E. Cazaban	FRA
René Coicaud	FRA
Yves Dreyfus	FRA
William Gauthier	FRA
F. Hattu	FRA
Jean Heymann	FRA
Jeanne Francois	FRA
Jacques Lefevre	FRA
René Levy	FRA
Claude Magnna	FRA

Edgard Mercier	FRA
René Mercier	FRA
Pierre Milan	FRA
Roger Nigrón	FRA
Christian d'Oriola	FRA
Serge Panizza	FRA
Marcel Parent	FRA
Pierre Rodocanachi	FRA
G. Sagot	FRA
Jean Tournon	FRA
Brigitte Gapais	FRA
Gérard Dellocque	FRA
Raoul Marques	FRA
Charles de Beaumont	GBR
D. Eden	GBR
Robert Foxcroft	GBR
J. D. Glaswell	GBR
H. Hobson	GBR
B. H. Hoskyns	GBR
M. Kallepitis	GBR
P. J. Kirby	GBR
P. Jacobs	GBR
A. Jays	GBR
A. M. Leckie	GBR
R. Oldcorn	GBR
I. Turquet	GBR
Y. Dwinger	HOL
J. Makk	HOL
F. Mosman Jr.	HOL
Weer Ter	HOL
O. Vanoosten	HOL
H. Vincent	HOL
P. Wolthuis	HOL
Lajos Balthazar	HUN
Ferenc Czvikovski	HUN
Rudolf Karpati	HUN
Istvan Tabor	HUN
Hayes Bouchier	IRL
Amnon Carmi	ISR
Mario Favia	ITA
Roberto Ferrari	ITA
Carlo Filogamo	ITA
Attilio Fimi	ITA
Renaldo Giusti	ITA
Nicola Granieri	ITA
Vittorio Guercia	ITA
Pasquale La Ragione	ITA
Cesare Lazzarini	ITA
Vittorio Lucarelli	ITA
Giuseppe Lipari	ITA
Guido Malacarne	ITA
Eduardo Mangiarotti	ITA
Mario Mangiarotti	ITA
Aldo Montano	ITA
Renzo Nostini	ITA
Domenico Pace	ITA
Alfonso Parravicini	ITA
Carlo Pavesi	ITA
Alberto Pellegrino	ITA
Carlo Picchi	ITA
Vincenzo Pinton	ITA
Mauro Racca	ITA
Saverio Ragno	ITA
Umberto Romani	ITA
Aldo Stefanini	ITA
Giorgi Tosti	ITA
Liro Verratti	ITA
Aristide Vilari	ITA
Bruna Colombetti	ITA
Antonella Ragno	ITA
Yamaguchi Yoshio	JPN
Nobrado Yamamoto	JPN
Hideo Kobagashi	JPN
L. Morita	JPN
K. Leischen	LUX
Roger Bousser	MAR
M. Degrandgeneuve	MAR
Abderraouf El Fassi	MAR

Abdelamed El Khomri	MAR	Dionisie Tepsan	RUM
Michel Holeman	MAR	Andrei Vilcea	RUM
Carlo Agostoni	MEX	Hans Drakenberg	SUE
Carlos Calderón	MEX	André Borle	SUI
Gustavo Chapela	MEX	Jacques Hochstaetter	SUI
Raúl Cicero	MEX	Claude Nigon	SUI
Hugo Fajardo	MEX	Fernand Thiebaud	SUI
William Fajardo	MEX	Z. Annabi	TUN
Miguel Guevara	MEX	Abderrazak Benzakour	TUN
Jesús Guevara	MEX	L. Arseven	TUR
Abraham Pacheco	MEX	Nefi Guven	TUR
José Paiz	MEX	José Luis Barano	URG
Benito Ramos	MEX	Adolfo Golindi	URG
Angel Roldán	MEX	Guillermo Gómez	URG
Conrado Schlaepfer	MEX	Juan Paladono	URG
N. Orengo	MON	Alberto Varela	URG
Raoul Heide	NOR	Vadim Andrevsky	URS
Egill Knutzen	NOR	Valerian Bazarewitch	URS
Zbig Czajkowski	POL	Sandor Baty	URS
Raffaele Harris	PAN	German Bokoun	URS
Boleslaw Banas	POL	Grigori Chvarts	URS
Ryszad Fisher	POL	David Douchman	URS
Zygmunt Fokt	POL	Vladimir Ganson	URS
T. Friendrich	POL	Anatoli Golianitski	URS
Stanilas Krucinski	POL	Victor Jdanovitch	URS
Boleslem Morasky	POL	Valeri Jitny	URS
Jan Navrocki	POL	Witatouas Kalmantas	URS
Henryk Nielaba	POL	Michael Kogout	URS
Ademar Papee	POL	Vitali Kolesnikov	URS
Zygmunt Pawlas	POL	David Kourbanov	URS
Jergy Pawlowsky	POL	Grigori Kriss	URS
Julubz Pekacki	POL	Issaak Leous	URS
Henryk Piatkowski	POL	Leonid Leytman	URS
Z. Przedziecki	POL	Vladimir Loukoyanov	URS
Wojeiek Rydz	POL	A. Chakanazarov Melik	URS
Jersy Sobol	POL	Trifon Meskhy	URS
W. Suskieszek	POL	Mark Midler	URS
Bohdan Szreider	POL	Oleg Mouradian	URS
Czeslaw Wardzynski	POL	losas Oudras	URS
Q. Zub	POL	Youlen Ouralov	URS
M. Fernández	POR	Alexandre Ovsiannkin	URS
Rahman Abdel	RAU	Mark Rakita	URS
Hassan Tawfik	RAU	Alguis Pajaouis	URS
Mahmoud Younes	RAU	Eres Pourliery	URS
Vasile Cheraliu	RUM	Vladimir Sierys	URS
Ion Drimba	RUM	Ev. Tcherepovski	URS
Julián Falb	RUM	David Tychler	URS
M. Ionescu	RUM	Vladimir Vichpolski	URS
Atanase Muresan	RUM	Rigoberto García	VEN

FLEURET INDIVIDUEL-MESSIEURS INDIVIDUAL FOIL-MEN

1er TOUR
1st ROUND OCT 15

POS	V	TR	TD	1	2	3	4	5	6	
1	Paul, Rene	GBR	4*	12	20	*	V	V	V	V
2	Wellmann, Dieter	ALE	3*	10	18	D	*	V	V	V
3	Putiatin, Victor	URS	2*	12	17	D	D	*	V	V
4	Jennings, Graeme	AUS	1*	17	8	D	D	D	*	V
5	Prenedes, Evaristo	ARG	0	20	8	D	D	D	D	*
PRESIDENT: Rodocanachi, Pierre FRA										
1	Anastasi, Lawrence	EUA	3*	10	17	*	V	D	V	V
2	Kamuti, Jeno	HUN	3*	13	19	D	*	V	V	V
3	Shimizu, Fujio	JPN	3*	13	18	V	D	*	V	V
4	Borges, Dagoberto	CUB	1*	19	13	D	D	D	*	V
5	Ryan, Michael	IRL	0	20	8	D	D	D	D	*
PRESIDENT: Wardzynski, Czeslaw POL										
1	Woyda, Witold	POL	5*	9	25	*	V	V	V	V
2	Sveshnikov, German	URS	4*	10	22	D	*	V	V	V
3	Wiedel, Gerry	CAN	3*	14	17	D	D	*	V	V
4	Sohem, Moustapha	RAU	2*	17	15	D	D	D	*	V
5	Varela, Alberto	URG	1	21	9	D	D	D	D	*
6	Pérez, José	PRO	0	25	8	D	D	D	D	*
PRESIDENT: Czvikovsky, Ferenc HUN										
1	Tiu, Mihai	RUM	4*	10	22	*	D	V	V	V
2	Magnan, Jean Claude	FRA	4*	12	24	V	*	V	D	V
3	El Hussein, Ahmed	RAU	3*	19	19	D	D	*	V	V
4	Ruiz, Victorio	CUB	2*	21	20	D	V	D	*	V
5	Barua, Enrique	PER	1	22	11	D	D	D	D	*
6	Nannini, Orlando	ARG	1	23	11	D	D	D	V	D
PRESIDENT: Ouralov, Youlen URS										
1	Parulski, Ryszard	POL	4*	10	20	*	V	V	V	V
2	Trost, Rudolf	AUT	2*	12	12	D	D	V	D	V
3	La Razione, Pasquale	ITA	2*	14	14	D	D	*	V	V
4	Calderón, Carlos	MEX	1*	15	14	D	V	D	*	D
5	Salazar, Freddy	VEN	1	19	10	D	D	D	V	*
PRESIDENT: Tepsan, Dionisie RUM										
1	Kamuti, Laszlo	HUN	5*	13	25	*	V	V	V	V
2	Granieri, Nicola	ITA	4*	11	23	D	D	V	V	V
3	Constandt, Michel	BEL	3*	16	18	D	D	*	V	V
4	Abaunza, Héctor	MEX	2*	22	18	D	D	D	*	V
5	Bouchier-Hayes, John	IRL	1	23	14	D	D	D	D	*
6	Pinero, Félix	VEN	0	25	12	D	D	D	D	*
PRESIDENT: Morales, Luis A. CUB										
1	Saucedo, Guillermo	ARG	3*	8	17	*	V	D	V	V
2	Szabo, Sandor	HUN	3*	13	16	D	*	V	V	V
3	Wessel, Friedrich	ALE	3*	14	17	V	D	*	V	V
4	Gómez, Román	MEX	1*	17	12	D	D	D	*	V
5	Farrell, Thomas	IRL	0	20	12	D	D	D	D	*
PRESIDENT: Stefanini, Aldo ITA										
1	Losert, Roland	AUT	5*	7	25	*	V	V	V	V
2	Revenu, Daniel	FRA	4*	9	23	D	*	V	V	V
3	Hobby, Russell	AUS	3*	16	17	D	D	*	V	V
4	Checkes, Jeffrey	EUA	2*	20	12	D	D	D	*	V
5	Ayoub, Souheil	LIB	1	21	10	D	D	D	D	*
6	Daponte, Rodolfo	PAR	0	25	11	D	D	D	D	*
PRESIDENT: Vilcea, Andrei RUM										
1	Drimba, Ion	RUM	4*	9	20	*	V	V	V	V
2	El Kalioubi, Gamil	RAU	3*	9	17	D	*	V	V	V
3	Hoskyns, Henry	GBR	2*	13	15	D	D	*	V	V
4	Cohen, Herbert	EUA	1*	19	7	D	D	D	*	V
5	Ronald, William	AUS	0	20	11	D	D	D	D	*
PRESIDENT: Nigrón, Roger FRA										

SIGNES EMPLOYES

V	— VICTOIRE
D	— DEFAITE
VE	— VICTOIRES PAR EQUIPE
TRE	— TOUCHES RECUES PAR EQUIPE
*	— PASSENT EN FINALE POUR LES 1ère ET 2e PLACES. LES PERDANTS PASSENT EN FINALE POUR LES 3e ET 4e PLACES
**	— PASSENT EN FINALE POUR LES 5e ET 6e PLACES
VI	— VICTOIRES INDIVIDUELLES
TDE	— TOUCHES MARQUEES PAR EQUIPE
TRE	— EGALITE DECIDEE POUR MOINS DE TRE
*	— QUALIFIE POUR LE TOUR SUIVANT
TR	— TOUCHES RECUES
TD	— TOUCHES MARQUEES
□	— QUALIFIE POUR FINALE
○	— IRL ABSENT POUR RAISONS MEDICALES
()	— BARRAGE

SYMBOLOGY

VICTORY
DEFEAT
TEAM VICTORIES
TEAM TOUCHES RECEIVED
PASSED TO FINALS FOR 1st AND 2nd PLACES. LOSERS PASSED TO FINALS FOR 3rd AND 4th PLACES
PASSED TO FINALS FOR 5th AND 6th PLACES
INDIVIDUAL VICTORIES
TOUCHES BY TEAM
TIE BASED ON FEWER TRE
QUALIFIED FOR FOLLOWING ROUND
TOUCHES RECEIVED
TOUCHES SCORED
QUALIFIED FOR FINAL
IRL WITHDREW AT 6th ASSAULT BECAUSE OF ILLNESS
BARRAGE

POS		V	TR	TD	1	2	3	4	5	6
1	Muresan, Tanase	RUM	4*	13	20	*	V	V	V	V
2	Pinelli, Arcangelo	ITA	2*	14	15	D	*	D	V	V
3	Gerresheim, Tim	ALE	2*	15	17	D	V	*	V	D
4	Bessemans, Florent	BEL	1*	17	15	D	D	D	*	V
5	Conyd, Magdy	CAN	1	19	11	D	D	V	D	*

PRESIDENT: Guerman, Bokun URS

1	Lisewski, Adam	POL	3*	13	18	*	D	V	V	V
2	Noel, Christian	FRA	3*	14	19	V	*	V	D	V
3	Mano, Kazuo	JPN	2*	14	18	D	D	*	V	V
4	Bimbaum, Udo	AUT	2*	16	15	D	V	D	*	V
5	Bakonyi, Peter	CAN	0	20	7	D	D	D	D	*

PRESIDENT: Tabor, Istvan HUN

1	Stankovich, Vasily	URS	4*	10	20	*	V	V	V	V
2	Ohkawa, Heizaburo	JPN	3*	10	19	D	D	*	V	V
3	Gil, Jesús	CUB	1*	16	7	D	D	D	D	V
4	Breckin, Michael	GBR	1*	17	16	D	D	V	*	D
5	Fernández, Silvio	VEN	1	18	9	D	D	D	V	*

PRESIDENT: Axelrod, Albert EUA

2e TOUR 2nd ROUND

1	Revenu, Daniel	FRA	4*	14	21	*	V	V	V	D
2	Paul, Rene	GBR	3*	15	23	D	*	D	V	V
3	Gerresheim, Tim	ALE	3*	17	20	D	V	*	V	D
4	Hobby, Russell	AUS	2*	19	15	D	D	D	*	V
5	Borges, Dagoberto	CUB	2	21	18	D	D	V	D	*
6	El Kalioubi, Gamil	RAU	1	21	10	V	D	D	D	*

PRESIDENT: Malacarne, Guido ITA

1	Pinelli, Arcangelo	ITA	4*	15	24	*	D	V	V	V
2	Hoskyns, Henry	GBR	4*	15	23	V	*	D	V	V
3	Wessel, Friedrich	ALE	3*	20	21	D	V	*	D	V
4	Szabo, Sandor	HUN	2*	20	17	D	D	V	*	D
5	Anastasi, Lawrence	EUA	2	21	19	D	D	D	V	*
6	Jennings, Graeme	AUS	0	25	12	D	D	D	V	D

PRESIDENT: Pawlas, Zygmunt POL

1	Granieri, Nicola	ITA	4*	20	24	*	V	V	V	D
2	Noel, Christian	FRA	3*	15	22	D	*	V	D	V
3	Woyda, Witold	POL	3*	18	23	D	D	*	V	V
4	Mano, Kazuo	JPN	3*	18	21	D	V	D	*	V
5	Constandt, Michel	BEL	1	21	14	D	D	D	D	*
6	Ruiz, Victorio	CUB	1	24	12	V	D	D	D	*

PRESIDENT: Jitny, Valery URS

1	Tiu, Mihai	RUM	4*	8	23	*	V	D	V	V
2	Ohkawa, Heizaburo	JPN	4*	14	20	D	*	V	V	V
3	La Ragione, Pasquale	ITA	3*	18	23	V	D	*	V	D
4	Trost, Rudolf	AUT	2*	18	15	D	D	D	*	V
5	Gil, Jesús	CUB	1	23	11	D	D	D	D	*
6	Sohem, Moustapha	RAU	1	24	13	D	D	V	D	*

PRESIDENT: Karpati, Rudolf HUN

1	Parulski, Ryszard	POL	5*	12	25	*	V	V	V	V
2	Stankovich, Vasily	URS	4*	16	23	D	*	V	V	V
3	Magnan, Jean Claude	FRA	3*	15	22	D	D	*	V	V
4	Breckin, Michael	GBR	2*	18	15	D	D	D	*	V
5	El Hussein, Ahmed	RAU	1	20	16	D	D	D	D	*
6	Calderón, Carlos	MEX	0	25	5	D	D	D	D	*

PRESIDENT: Czvikovsky, Ferenc HUN

1	Sveshnikov, German	URS	5*	10	25	*	V	V	V	V
2	Abaunza, Héctor	MEX	3*	16	19	D	*	D	V	V
3	Lisewski, Adam	POL	3*	16	18	D	V	*	V	D
4	Birnbaum, Udo	AUT	2*	21	14	D	D	D	*	V
5	Kamuti, Laszlo	HUN	1	21	19	D	D	D	D	*
6	Wiedel, Gerry	CAN	1	22	11	D	D	V	D	*

PRESIDENT: Bukantz, Daniel EUA

POS		V	TR	TD	1	2	3	4	5	6
1	Shimizu, Fujio	JPN	5*	13	25	*	V	V	V	V
2	Saucedo, Guillermo	ARG	4*	15	24	D	*	V	V	V
3	Muresan, Tanase	RUM	2*	17	16	D	D	*	V	V
4	Kamuti, Jeno	HUN	2*	20	17	D	D	V	D	*
5	Checkes, Jeffrey	EUA	1	21	13	D	D	D	V	D
6	Bessemans, Florent	BEL	1	23	14	D	D	D	D	*

PRESIDENT: Alphonse, Lucien FRA

1	Drimba, Ion	RUM	5*	10	25	*	V	V	V	V
2	Losert, Roland	AUT	3*	14	18	D	*	D	V	V
3	Putiatin, Victor	URS	3*	18	21	D	V	D	D	V
4	Wellmann, Dieter	ALE	3*	19	19	D	V	*	D	V
5	Cohen, Herbert	EUA	1	22	17	D	D	D	D	*
6	Gómez, Roman	MEX	0	25	8	D	D	D	D	*

PRESIDENT: Filogamo, Carlo ITA

FLEURET INDIVIDUEL - DAMES
INDIVIDUAL FOIL-WOMEN

1er TOUR
1st ROUND

OCT 1

POS		V	TR	TD	1	2	3	4	5	6
A	1 Zabelina, Alexandra	URS	4*	12	19	*	V	D	V	V
	2 Colombetti, Bruna	ITA	3*	13	16	D	*	V	D	V
	3 Tack-Fang, Milady	CUB	3*	15	15	V	D	*	D	V
	4 Romary, Janice-Lee	EUA	3*	17	17	D	V	V	*	D
	5 Cymerman, Elzbieta	POL	2	14	16	D	D	D	V	*
	6 Bain, Judith	GBR	0	20	8	D	D	D	D	*

PRESIDENT: Rodocanachi, Pierre FRA

B	1 Ragno, Antonella	ITA	5*	10	20	*	V	V	V	V
	2 Sakovics, Lidia	HUN	3*	14	17	D	*	V	V	D
	3 Depetris, Marie	FRA	2*	13	15	D	D	*	V	D
	4 Wardell, Janet	GBR	2*	15	11	D	D	D	*	V
	5 Skladanowska, Kamilla	POL	2	16	15	D	D	V	D	*
	6 Witteveen, Ivonne	AHO	1	19	9	D	V	D	D	*

PRESIDENT: Worth, George EUA

C	1 Palm, Kerstin	SUE	4*	9	19	*	V	D	V	V
	2 King, Harriet	EUA	3*	11	16	D	*	V	V	D
	3 Drimba, Ileana	RUM	3*	14	17	V	D	*	D	V
	4 Pulch, Monika	ALE	3*	14	15	D	D	V	*	V
	5 Farkasinszky, Ildiko	HUN	2	13	12	D	V	D	D	*
	6 Roldán, Lourdes	MEX	0	20	2	D	D	D	D	*

PRESIDENT: Guerman, Bokun URS

D	1 Novikova, Elena	URS	5*	5	20	*	V	V	V	V
	2 Szabo, Olga	RUM	4*	7	18	D	*	V	V	V
	3 Ceretti, Catherine	FRA	3*	14	14	D	D	*	V	V
	4 Volz Nee Mees, Helga	ALE	1*	16	10	D	D	D	*	V
	5 Green, Susan	GBR	1	17	9	D	D	D	D	*
	6 Del Moral, Rosa	MEX	1	19	7	D	D	D	V	*

PRESIDENT: Wardzynski, Czeslaw POL

E	1 Stahl-lencic, Clara	RUM	6*	12	24	*	V	V	V	V
	2 Roldán, Pilar	MEX	5*	16	22	D	*	V	V	V
	3 Gorokhova, Galina	URS	4*	11	22	D	D	*	V	V
	4 Schmid, Heidi	ALE	2*	17	15	D	D	D	*	V
	5 Flesch, Colette	LUX	2	19	16	D	D	D	V	*
	6 Anselma, Myrna	AHO	1	22	10	D	D	D	D	*
	7 San Martín, Sylvia	ARG	1	22	10	D	D	D	D	*

PRESIDENT: Montano, Aldo ITA

F	1 Rejto, Ildiko	HUN	5*	10	23	*	D	V	V	V
	2 Gapais, Brigitte	FRA	4*	14	22	V	*	V	D	V
	3 Masciotta, Giovanna	ITA	3*	15	17	D	D	*	D	V
	4 Chatel, Sigrid	CAN	3*	18	19	D	V	V	*	D
	5 Rodríguez, Margarita	CUB	3	18	15	D	D	D	V	*
	6 Balon, Halina	POL	2	20	14	D	V	D	V	*
	7 Smith, Veronica	EUA	1	21	6	D	D	D	D	*

PRESIDENT: Tepsan, Dionisie RUM

2e TOUR
2nd ROUND

A	1 Szabo, Olga	RUM	3*	12	18	*	V	V	D	D
	2 Roldán, Pilar	MEX	3*	12	16	D	*	V	D	V
	3 Ceretti, Catherine	FRA	3*	12	16	D	D	*	V	V
	4 Masciotta, Giovanna	ITA	3*	15	16	V	V	D	*	V
	5 Romary, Janice-Lee	EUA	2	15	11	V	D	D	D	*
	6 Zabelina, Alexandra	URS	1	19	8	D	D	D	V	*

PRESIDENT: Wardzynski, Czeslaw POL

POS		V	TR	TD	1	2	3	4	5	6
B	1 Drimba, Ileana	RUM	4*	12	18	*	D	V	V	V
	2 Ragno, Antonella	ITA	3*	11	18	V	*	D	D	V
	3 Gapais, Brigitte	FRA	3*	12	16	D	V	*	D	V
	4 Gorokhova, Galina	URS	3*	14	18	D	V	V	*	D
	5 King, Harriet	EUA	2	17	11	D	D	D	V	*
	6 Volz Nee Mees, Helga	ALE	0	20	5	D	D	D	D	*

PRESIDENT: Tabor, Istvan HUN

C	1 Rejto, Ildiko	HUN	5*	10	20	*	V	V	V	V
	2 Palm, Kerstin	SUE	4*	10	18	D	*	V	V	V
	3 Colombetti, Bruna	ITA	2*	15	16	D	D	*	D	V
	4 Depetris, Marie	FRA	2*	18	13	D	D	V	*	D
	5 Chatel, Sigrid	CAN	1	17	9	D	D	D	V	*
	6 Pulch, Monika	ALE	1	18	12	D	D	D	V	*

PRESIDENT: Jytny, Valeri URS

D	1 Novikova, Elena	URS	4*	10	16	*	V	D	V	V
	2 Stahl-lencic, Clara	RUM	3*	12	14	D	*	V	V	D
	3 Sakovics, Lidia	HUN	3*	14	16	V	D	*	V	V
	4 Schmid, Heidi	ALE	2*	15	15	D	D	D	*	V
	5 Wardell, Janet	GBR	2	16	12	D	V	D	D	*
	6 Tack-Fang, Milady	CUB	1	18	12	D	D	V	D	*

PRESIDENT: Malacarne, Guido ITA

DOUBLE ELIMINATOIRE

OCT 20

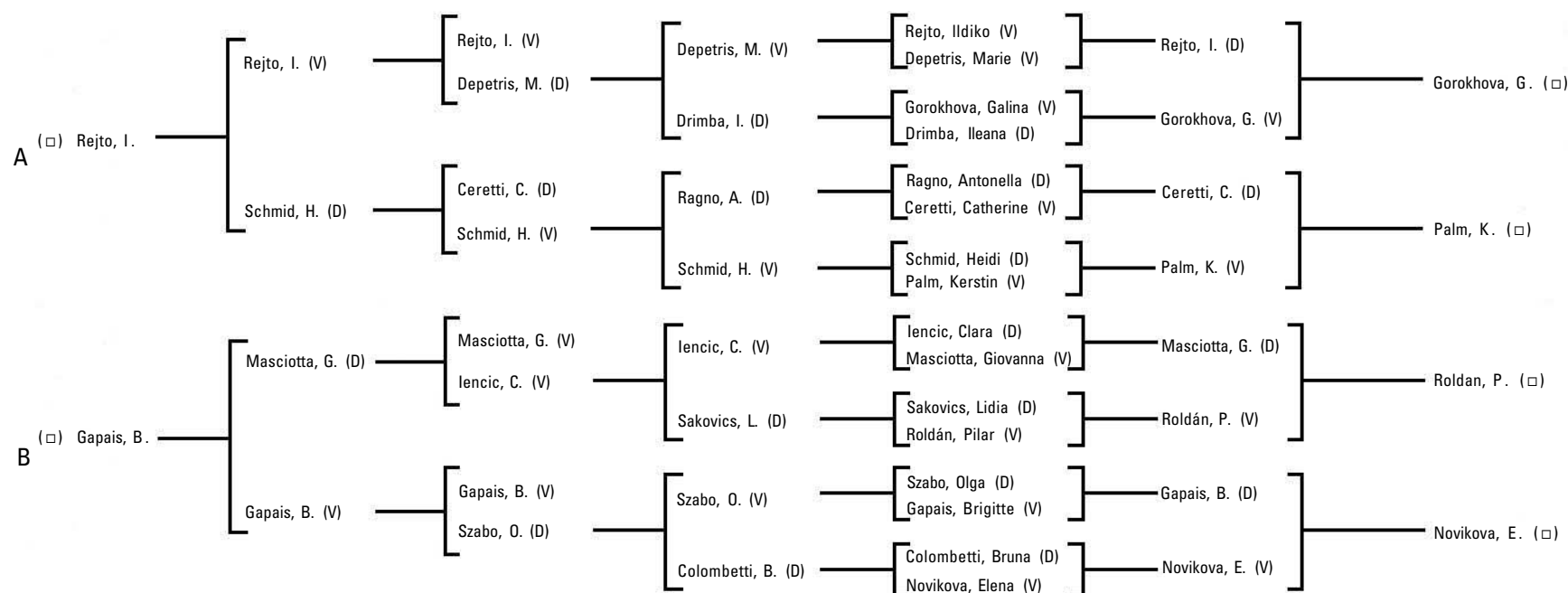

FINALE
FINAL

1	Novikova, Elena	URS	4	11	19	*	V	V	V	V	D
2	Roldán, Pilar	MEX	3	14	17	D	*	D	V	V	V
3	Rejto, Ildiko	HUN	3	16	14	D	V	*	D	V	V
4	Gapais, Brigitte	FRA	2	15	15	D	D	V	*	D	V
5	Palm, Kerstin	SUE	2	17	17	D	D	D	V	*	V
6	Gorokhova, Galina	URS	1	19	10	V	D	D	D	D	*

PRESIDENT: Bukantz, Daniel EUA

EPEE INDIVIDUELLE
INDIVIDUAL EPEE

641

1er TOUR
1st ROUND OCT 21

POS		V	TR	TD	1	2	3	4	5	6
1	Nikanchikov, Aleksey	URS	5*	9	25	*	V	V	V	V
2	Polzhuber, Herbert	AUT	4*	17	24	D	*	V	V	V
3	Fernández, Ernesto	MEX	2*	18	15	D	D	*	V	D
4	Dumke, Klaus	ADE	2*	21	19	D	D	D	*	V
5	Zein, Ahmed	RAU	2	21	17	D	D	V	D	*
6	Ryan, Michael	IRL	0	25	11	D	D	D	D	*

PRESIDENT: Andrew, John CAN

1	Rompza, Franz	ALE	5*	15	25	*	V	V	V	V
2	Micahnik, David	EUA	3*	16	19	D	*	D	V	V
3	Kriss, Grigory	URS	3*	18	20	D	D	*	V	D
4	Bakonyi, Peter	CAN	2*	19	21	D	D	D	*	V
5	Cheker, Ali	LIB	1	21	14	D	D	D	D	*
6	Díaz, Antonio	CUB	1	23	13	D	D	V	D	*

PRESIDENT: Schlaepfer, Conrado MEX

1	Losert, Roland	AUT	5*	10	25	*	V	V	V	V
2	Vergara, Alejandro	ARG	3*	17	20	D	*	V	D	V
3	Ladegaillerie, Jacques	FRA	2*	18	16	D	D	*	V	D
4	Fernández, Silvio	VEN	2*	19	16	D	V	D	*	V
5	Manso, José	POR	2	23	15	D	D	D	V	*
6	Amaral, Dario	BRA	1	22	17	D	D	V	D	*

PRESIDENT: Wardzynski, Czeslaw POL

DOUBLE ELIMINATOIRE
DOUBLE ELIMINATION

OCT 22

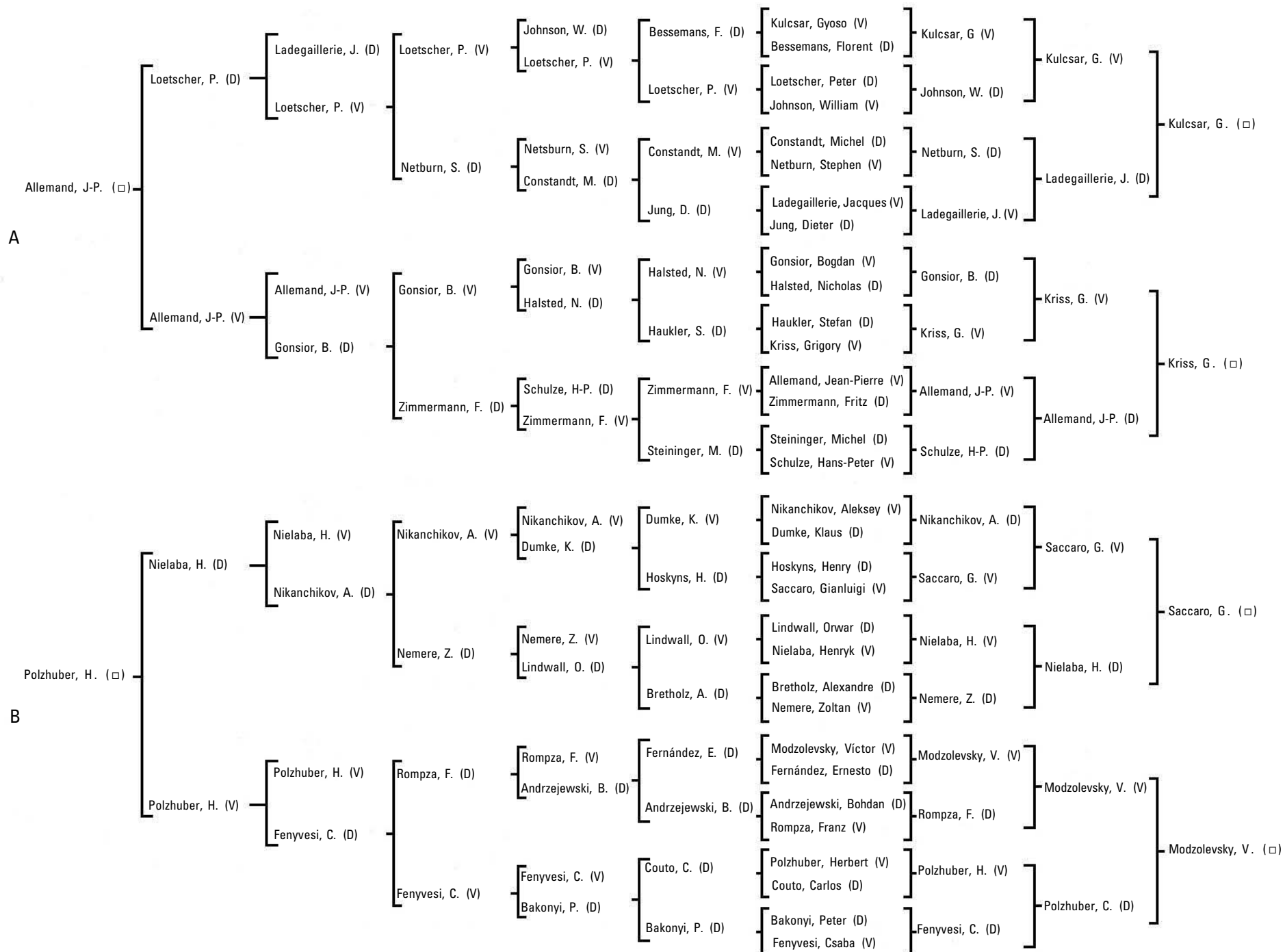

643

FINALE
FINAL

(1)	Kulcsar, Gyoso	HUN	4	14	24	*	D	V	V	V	V
(2)	Kriss, Grigory	URS	4	19	25	V	*	D	V	V	V
(3)	Saccaro, Gianluigi	ITA	4	19	21	D	V	*	V	V	V
4	Modzolevsky, Víctor	URS	2	23	20	D	D	D	*	V	V
5	Polzhuber, Herbert	AUT	1	24	17	D	D	D	D	*	V
6	Allemand, Jean-Pierre	FRA	0	25	17	D	D	D	D	D	*

PRESIDENT: Pawlas, Zygmunt POL

BARRAGE
BARRAGE

1	Kulcsar, Gyoso	HUN	2	5	10	*	V	V
2	Kriss, Grigory	URS	0	10	8	D	*	D
3	Saccaro, Gianluigi	ITA	0	10	7	D	D	*

DOUBLE ELIMINATOIRE
DOUBLE ELIMINATION

OCT 17

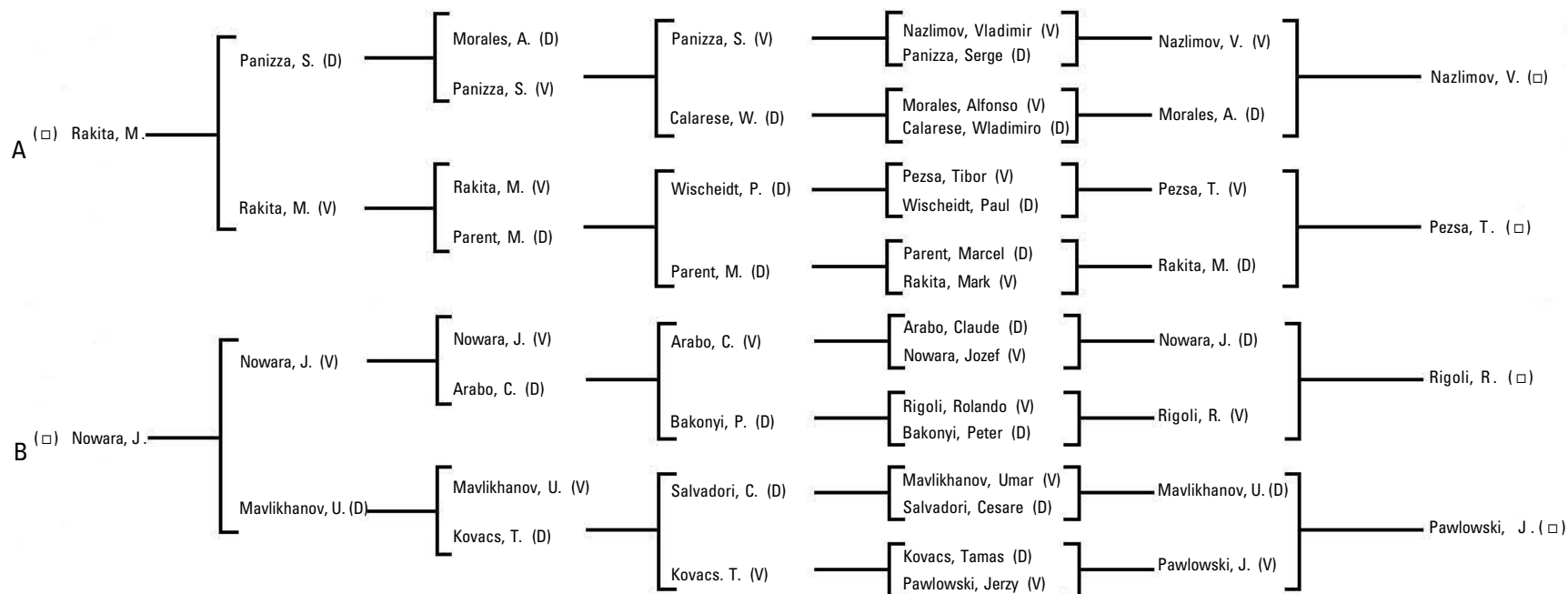

FINALE
FINAL

1	Pawlowski, Jerzy	POL	4 ()	18	22	*	V	D	V	V	V
2	Rakita, Mark	URS	4 ()	16	24	D	*	V	V	V	V
3	Pezsa, Tibor	HUN	3	16	20	V	D	*	V	V	V
4	Nazlimov, Vladimir	URS	3	17	21	D	D	V	*	V	V
5	Rigoli, Rolando	ITA	1	21	11	D	D	D	D	*	V
6	Nowara, Jozef	POL	0	25	15	D	D	D	D	D	*

PRESIDENT: Brousse, Jean FRA

BARRAGE
BARRAGE

1	Pawlowski, Jerzy	POL	1	4	5	*	V
2	Rakita, Mark	URS	0	5	4	D	*

FLEURET PAR EQUIPE - MESSIEURS
TEAM FOIL-MEN

645

1er TOUR
1st ROUND OCT 18

		Nº	V	1	2	3	4	5	6	7	8	Total	
		VE	TRE										
* CUB	Jons, Eduardo	1	3	—	—	—	—	V	D	V	V	9	65
	Ruiz, Victorio	2	3	—	—	—	—	D	V	V	V		
	Gil, Jesús	3	2	—	—	—	—	D	V	V	D		
	Borges, Dagoberto	4	1	—	—	—	—	D	D	D	V		
A MEX	Calderón, Vicente	5	3	D	V	V	V	—	—	—	—	7	67
	Gómez, Román	6	2	V	D	V	D	—	—	—	—		
	Calderón, Carlos	7	1	D	D	D	V	—	—	—	—		
	Chapela, Gustavo	8	1	D	D	V	D	—	—	—	—		
PRESIDENT: Karpati, Rudolf HUN													
* GBR	Jay, Allan	1	3	—	—	—	—	D	V	V	V	9	55
	Paul, Graham	2	3	—	—	—	—	D	V	V	V		
	Halsted, Nicholas	3	2	—	—	—	—	V	D	D	D		
	Hoskyns, Henry	4	1	—	—	—	—	D	D	V	V		
B EUA	Cohen, Herbert	5	3	V	V	D	V	—	—	—	—	7	62
	Axelrod, Albert	6	2	D	D	V	V	—	—	—	—		
	Jones, Uriah	7	1	D	D	D	V	—	—	—	—		
	Anastasi, Lawrence	8	1	D	D	V	D	—	—	—	—		
PRESIDENT: Nigrón, Roger FRA													



FEDERATION INTERNATIONALE
DE FOOTBALL ASSOCIATION FIFA

INTERNATIONAL FEDERATION
OF FOOTBALL ASSOCIATION FIFA

PRESIDENT
Sir Stanley Rous GBR

SECRETARE GENERAL
GENERAL SECRETARY
Helmut Käser ALE

FEDERATION MEXICAINE DE
FOOTBALL ASSOCIATION FMFA

MEXICAN FEDERATION OF
FOOTBALL ASSOCIATION FMFA

PRESIDENT
Guillermo Cañedo MEX

SECRETARE
SECRETARY
José Ortiz MEX

SECTION DE FOOTBALL DU C.O.O.
O.O.C. FOOTBALL SECTION
Héctor Ortiz MEX

Octavio Barreda MEX

OFFICIELS DE LA COMPETITION
COMPETITION OFFICIALS

ARBITRES
REFEREES
Romualdo Arp BRA
Todor Betchirov BUL

Guillermo Velásquez
Karol Galba
Ramón Mármol
Mariano Medina
Seyoum Tarekegn
Michel Kitabdji
George Lamptey
Augusto Robles
Jean-Louis Faber
Istvan Zsolt
Abraham Klein
Yoshiyuki Murayama
Abel Aguilar
Alfonso González
Arturo Yamasaki
Diego de Leo
Felipe Buergo
Javier Galindo
Raúl Osorio
Shakibudeen Thompson
Erwin Hieger
Wanchi Suvaree
Milivoje Gugulovic

COL
CHE
SAL
ESP
ETI
FRA
GHA
GUA
GUI
HUN
ISR
JPN
MEX
MEX
MEX
MEX
MEX
MEX
MEX
NGR
PER
TAI
YUG

656

SIGNES EMPLOYES

SYMBOLY

*	— CAPITAINE D'EQUIPE	TEAM CAPTAIN
G	— GAGNE	WON
P	— PERDU	LOST
()	— EGALITE	TIED
GLF	— GOALS POUR	GOALS FOR
GLC	— GOALS CONTRE	GOALS AGAINST
PS	— POINTS	POINTS
POS	— POSITION	POSITION
EX	— EXPULSE	EXPULSED
⊙	— BUL VICTOIRE PAR TIRAGE AU SORT	BUL WON BY TOSS OF COIN
MIN	— MINUTES	MINUTES
A	— AUTO GOAL	OWNGOAL

GRUPE A MATCH 1
GROUP MATCH 1 OCT 13

AZTECA

GRUPE C MATCH 3
GROUP MATCH 3

GUADALAJARA

MEX-COL 1-0 (1-0, 0-0)

MEX	G	COL	G
1 Vargas, Javier	0	1 Quintana, Otoniel	0
2 Alejandro, Manuel	0	2 Hernández, Gabriel	0
* 3 Medina, Humberto	0	* 3 Soto, Luis	0
4 Sanabria, Héctor	0	4 Muñoz, Oscar	0
5 Pérez, Mario	0	5 López, Dario	0
6 Regueiro, Luis	0	6 Pardo, Joaquin	0
7 Pulido, Héctor	0	8 Gonzalez, Germán	0
8 Bustos, Fernando	0	9 Arango, Alfredo	0
9 Estrada, Luis	1	10 Ortiz, Norman	0
10 Pereda, Vicente	0	11 Santa, Gustavo	0
11 Victorino, Cesáreo	0	14 Berdugo, Gabriel	0
TOTAL	1	TOTAL	0

ARBITRE REFEREE: Zsolt, Itsvan HUN

JUGES DE LIGNE LINESMEN: Rumentchev, Dimitar BUL Lamptey, George GHA

CHANGEMENT DE JOUEURS SUBSTITUTION

	ENTRE	IN	
Arango, Alfredo	COL	Tamayo, Javier	64 min
Pulido, Héctor	MEX	Basaguren, Ignacio	70

BUTS MARQUES	SCORER		
1 — 0	Estrada, Luis	MEX	6 min

GRUPE A MATCH 2
GROUP MATCH 2

PUEBLA

FRA-GUI 3-1 (0-0, 3-1)

FRA	G	GUI	G
4 Lempereur, Jean	0	1 Camara, Mamadouba	0
* 5 Zix, Freddy	0	* 2 Bangoura, Pierre	0
6 Verhoeve, Michel	0	3 Fofana, Ibrahima	0
7 Plante, Gilbert	0	4 Conde, Sekou	0
9 Larque, Jean-Michel	0	5 Sankon, Amadou	0
11 Hodoul, Jean-Louis	0	7 Camara, Morlaye	0
12 Perrigaud, Daniel	1	8 Diallo, Ibrahima	0
14 Horlavielle, Daniel	1	10 Cherif, Soulegmane	0
15 Case, Marc	0	11 Camara, Mamadou	1
18 Hallet, Gerard	1	14 Keita, Ibrahima	0
19 Ribul, Henri	0	18 Soumah, Soriba	0
TOTAL	3	TOTAL	1

ARBITRE REFEREE: Gugulovic, Milivoje YUG

JUGES DE LIGNE LINESMEN: Tarekegn, Seyoum ETI Galba, Karol CHE

CHANGEMENT DE JOUEURS SUBSTITUTION

	ENTRE	IN	
Camara, Mamadouba	GUI	Camara, Bouya	74 min
Case, Marc	FRA	Tamboueou, Charles	74

BUTS MARQUES	SCORER		
1 — 0	Hallet, Gérard	FRA	61 min
2 — 0	Horlavielle, Daniel	FRA	64
3 — 0	Perrigaud, Daniel	FRA	70
3 — 1	Camara, Mamadou	GUI	79

HUN-SAL 4-0 (1-0, 3-0)

HUN	G	SAL	G
1 Fater, Karoly	0	1 Martínez, Ricardo	0
* 2 Novak, Dezzo	0	2 Rivas, Roberto	0
4 Pancsics, Miklos	0	4 Morales, Edgar	0
5 Menczel, Ivan	1	5 Vázquez, Jorge	0
6 Szucs, Lajos	0	7 Flamenco, Salvador	0
7 Fazekas, Laszlo	1	8 Villalta, Alberto	0
10 Dunai, Antal	1	9 Quintanilla, José	0
11 Nagy, Laszlo	0	* 10 Rodriguez, Mauricio	0
14 Nosko, Erno	0	11 Acevedo, Elmer	0
15 Juhasz, Istvan	0	13 González, Mauricio	0
17 Sarkozi, Gabor	1	16 Méndez, Sergio	0
TOTAL	4	TOTAL	0

ARBITRE REFEREE: De Leo, Diego MEX

JUGES DE LIGNE LINESMEN: Galindo, Javier MEX Buergo, Felipe MEX

CHANGEMENT DE JOUEURS SUBSTITUTION

	ENTRE	IN	
Fazekas, Laszlo	HUN	Kocsis, Lajos	54 min
Martínez, Ricardo	SAL	Fernandez, Juan	55
Sarkozi, Gabor	HUN	Bastj, Istvan	70
Flamenco, Salvador	SAL	Martínez, Juan	72

BUTS MARQUES	SCORER		
1 — 0	Menczel, Ivan	HUN	19 min
2 — 0	Dunai, Antal	HUN	47
3 — 0	Fazekas, Laszlo	HUN	51
4 — 0	Sarkozi, Gabor	HUN	68

GRUPE C MATCH 4
GROUP MATCH 4

LEON

ISR-GHA 5-3 (3-2, 2-1)

ISR	G	GHA	G
2 Bar, Feiwei	0	4 Eshun, John	0
3 Bello, Menachem	0	* 5 Addo, Charles	0
4 Rosen, Zvi	0	6 Sunday, Ibrahim	0
5 Shwager, Shaia	0	8 Atuquayefio, Jones	0
6 Rosenthal, Shmuel	0	9 Alhassan, George	0
7 Talbi, Rachamim	0	10 Amusa, Gbadamosi	1
8 Shpigel, Giora	2	13 Naawu, John	0
9 Faygenbaum, Jehoshua	3	15 Malik, Jabir	2
* 10 Shpiegler, Mordechai	0	16 Acquah, Olive	0
13 Borba, George	0	17 Kpakpo, Jonathan	0
19 Malika-Aharon, Shmuel	0	18 Foley, Robert	0
TOTAL	5	TOTAL	3

ARBITRE REFEREE: Kitabdjian, Michel FRA

JUGES DE LIGNE LINESMEN: Velázquez, Guillermo COL Medina, Mariano ESP

CHANGEMENT DE JOUEURS SUBSTITUTION

	ENTRE	IN	
Foley, Robert	GHA	Abukari, Gariba	46 min
Atuquayefio, Jone EX	GHA		60
Alhassan, George EX	GHA		89

BUTS MARQUES	SCORER		
1 — 0	Shpigel, Giora	ISR	11 min
2 — 0	Faygenbaum, Jehoshua	ISR	16
2 — 1	Malik, Jabir	GHA	18
3 — 1	Faygenbaum, Jehoshua	ISR	30
3 — 2	Amusa, Gbadamosi	GHA	35
4 — 2	Faygenbaum, Jehoshua	ISR	70
5 — 2	Shpigel, Giora	ISR	75
5 — 3	Malik, Jabir	GHA	79

GRUPE B MATCH 5
GROUP MATCH 5
OCT 14

AZTECA

GRUPE D MATCH 7
GROUP MATCH 7

GUADALAJARA

ESP-BRA 1-0 (0-0, 1-0)

ESP	G	BRA	G
2 Mora, Pedro	0	1 Cruz, Pedro	0
3 Benito, Gregorio	0	2 Pereira, Miguel	0
4 Espildora, Francisco	0	* 3 De Almeida, Joao	0
6 Ochoa, Miguel	0	4 Alves, Jorge	0
* 7 Sala, Isidro	0	5 Silva, Sebastiao	0
* 8 Asensi, Juan	0	6 Dutra, José	0
11 Jaen, Rafael	0	7 Barbosa, Manuel	0
15 Fernández, Juan	1	8 Ueta, Ademir	0
16 Garzón, José	0	9 Ferreti, Fernando	0
17 Grande, José	0	10 Moreno, Daniel	0
19 Ortuno, Fernando	0	11 De Jesús, Antonio	0
TOTAL	1	TOTAL	0

ARBITRE REFEREE: Klein, Abraham ISR

JUGES DE LIGNE LINESMEN: Suvaree, Wanchai TAI Lamptey, George GHA

CHANGEMENT DE JOUEURS SUBSTITUTION

SORT	OUT	ENTRE	IN
	Barbosa, Manuel EX	BRA	44 min
	Ueta, Ademir	BRA	56
	Grande, José	ESP	68

BUTS MARQUES	SCORER		
1 — 0	Fernández, Juan	ESP	77 min

GUA-CHE 1-0 (1-0, 0-0)

GUA	G	CHE	G
2 López, Alberto	0	1 Kramerius, Antonin	0
3 León, Lijon	0	2 Vecerek, Jiri	0
4 Camposeco, Roberto	0	3 Jarabek, Stanislav	0
7 Montoya, Hugo	0	4 Mutkovic, Peter	0
* 8 Melgar, R. Armando	0	5 Bouska, Josef	0
* 9 Roldán, Jorge	0	6 Linhart, Josef	0
10 Torres, Hugo	0	7 Strunc, Stanislav	0
13 Valdez, Carlos	0	8 Petras, Ladislav	0
15 Peña, Hugo	0	9 Bartovic, Dusan	0
16 Stokes, David	1	10 Stratil, Pavel	0
19 García, Julio	0	14 Kral, Miroslav	0
TOTAL	1	TOTAL	0

ARBITRE REFEREE: Arp, Romualdo BRA

JUGES DE LIGNE LINESMEN: De Leo, Diego MEX Aguilar, Abel MEX

CHANGEMENT DE JOUEURS SUBSTITUTION

SORT	OUT	ENTRE	IN
	Stokes, David	GUA	46 min
	Stratil, Pavel	CHE	55
	Bartovic, Dusan	CHE	72
	Peña, Hugo EX	GUA	82
	Pajerchin, Ladislav EX	CHE	88
	Torres, Hugo EX	GUA	89

BUTS MARQUES	SCORER		
1 — 0	Stokes, David	GUA	28 min

GRUPE B MATCH 6
GROUP MATCH 6

PUEBLA

GRUPE D MATCH 8
GROUP MATCH 8

LEON

658

JPN-NGR 3-1 (1-1, 2-0)

JPN	G	NGR	G
1 Yokoyama, Kenzo	0	1 Fregene, Peter	0
2 Katayama, Hiroshi	0	2 Igwe, Anthony	0
3 Miyamoto Masakatsu	0	4 Okoye, Samuel	1
5 Kamata, Mitsuo	0	* 5 Olumodeji, Olusegun	0
8 Mori, Takaji	0	* 6 Opone, Samuel	0
9 Ogi, Aritatsu	0	8 Hamilton, Paul	0
* 11 Yaegashi, Shigeo	0	10 Anieke, Peter	0
12 Miyamoto, Teruki	0	11 Lawal, Mohammed	0
15 Kamamoto, Kunishige	3	14 Brodrick, Sebastian	0
16 Matsumoto, Ikuo	0	15 Obojememe, Clement	0
17 Sugiyama, Ryuichi	0	18 Aghoghovbia, Joseph	0
TOTAL	3	TOTAL	1

ARBITRE REFEREE: Mármol, Ramón SAL

JUGES DE LIGNE LINESMEN: Robles, Augusto GUA Hieger, Erwin PER

CHANGEMENT DE JOUEURS SUBSTITUTION

SORT	OUT	ENTRE	IN
	Hamilton, Paul	NGR	38 min
	Yaegashi, Shigeo	JPN	78

BUTS MARQUES	SCORER		
1 — 0	Kamamoto, Kunishige	JPN	24 min
1 — 1	Okoye, Samuel	NGR	33
2 — 1	Kamamoto, Kunishige	JPN	72
3 — 1	Kamamoto, Kunishige	JPN	89

BUL-TAI 7-0 (1-0, 6-0)

BUL	G	TAI	G
1 Yordanov, Stoyan	0	2 Pathipakornchai, Saravuth	0
2 Guerov, Atanasse	0	3 Sangkasuvan, Narong	0
3 Christakiev, Gueorgui	0	4 Sangkagovrit, Yongyouth	0
4 Gaidarski, Milko	0	6 Pimpawatjn, Chirawat	0
5 Ivkov, Kiril	1	8 Unyapo, Paiboon	0
6 Gueorguiev, Ivailo	0	9 Paholpat, Chatchai	0
* 9 Jekov, Petar	1	11 Sornbutnark, Udomsilp	0
10 Christov, Atanasse	2	13 Sesawasdi, Niwatana	0
11 Vassilev, Gueorgui	0	* 14 Panich, Suphot	0
13 Donev, Asparoukh	1	15 Nilpirom, Boonlert	0
14 Guionine, Mikhail	1	18 Nukulompratana, Kriengsak	0
TOTAL	7	TOTAL	0

ARBITRE REFEREE: Velázquez, Guillermo COL

JUGES DE LIGNE LINESMEN: Faber, Jean-Louis GUI Osorio, Raúl MEX

CHANGEMENT DE JOUEURS SUBSTITUTION

SORT	OUT	ENTRE	IN
	Panich, Suphot	TAI	46 min
	Sesawasdi, Niwatana	TAI	70
	Jekov, Petar	BUL	70
	Christov, Atanasse	BUL	77

BUTS MARQUES	SCORER		
1 — 0	Guionine, Mikhail	BUL	25 min
2 — 0	Jekov, Petar	BUL	55
3 — 0	Christov, Atanasse	BUL	58
4 — 0	Christov, Atanasse	BUL	61
5 — 0	Zafirov, Ivan	BUL	73
6 — 0	Donev, Asparoukh	BUL	85
			88

GRUPE A MATCH 9 OCT 15

AZTECA

GRUPE C MATCH 11

GUADALAJARA

FRA-MEX 4-1 (3-1, 1-0)

FRA	G	MEX	G
4 Lempereur, Jean	0	1 Vargas, Javier	0
* 5 Zix, Freddy	0	2 Alejándrez, Manuel	0
6 Verhoeve, Michel	0	* 3 Medina, Humberto	0
7 Planite, Gilbert	0	4 Sanabria, Héctor	0
9 Larque, Jean-Michel	0	5 Pérez, Mario	0
11 Hodoul, Jean-Louis	1	6 Regueiro, Luis	0
14 Horlaville, Daniel	0	7 Pulido, Héctor	0
15 Case, Marc	2	8 Bustos, Fernando	0
16 Tamboueou, Charles	1	9 Estrada, Luis	0
18 Hallet, Gerard	0	10 Pereda, Vicente	1
19 Ribul, Henri	0	11 Victorino, Cesáreo	1
TOTAL	4	TOTAL	1

ARBITRE REFEREE: Hieger, Erwin PER

JUGES DE LIGNE LINESMEN: Galba, Karol CHE Gugulovic, Miliwoje YUG

CHANGEMENT DE JOUEURS SUBSTITUTION

	ENTRE	IN	
	Estrada, Luis	MEX	Muñoz, Elías 37 min
BUTS MARQUES	SCORER		
1 — 0	Case, Marc	FRA	20 min
1 — 1	Victorino, Cesáreo	MEX	26
2 — 1	Tamboueou, Charles	FRA	30
3 — 1	Medina, Humberto	MEX	36
4 — 1	Case, Marc	FRA	69

HUN-GHA 2-2 (2-2, 0-0)

HUN	G	GHA	G
1 Fater, Karoly	0	* 4 Eshun, John	0
4 Pancsics, Miklos	0	6 Sunday, Ibrahim	1
* 5 Menczel, Ivan	1	7 Osei, Kofi	0
6 Szucs, Lajos	0	10 Amusa, Gbadamosi	0
7 Fazekas, Laszlo	0	11 Sampene, Sammy	1
10 Dunai, Antal	1	13 Naawu, John	0
11 Nagy, Laszlo	0	14 Wilson, Joseph	0
12 Keglovich, Laszlo	0	15 Malik, Jabir	0
14 Nosko, Erno	0	16 Acquah, Olive	0
15 Juhasz, Istvan	0	17 Kpakpo, Jonathan	0
17 Sarkozi, Gabor	0	18 Foley, Robert	0
TOTAL	2	TOTAL	2

ARBITRE REFEREE: Murayama, Yoshiyuki JPN

JUGES DE LIGNE LINESMEN: Galindo, Javier MEX Yamasaki, Arturo MEX

CHANGEMENT DE JOUEURS SUBSTITUTION

	ENTRE	IN	
	Sarkozi, Gabor	HUN	Kocsis, Lajos 46 min
	Fazekas, Laszlo	HUN	Basti, Istvan 69
BUTS MARQUES	SCORER		
1 — 0	Sunday, Ibrahim	GHA	12 min
1 — 1	Dunai, Antal	HUN	15
2 — 1	Menczel, Ivan	HUN	17
2 — 2	Sampene, Sammy	GHA	33

GRUPE A MATCH 10

PUEBLA

GRUPE C MATCH 12

LEON

659

GUI-COL 3-2 (1-0, 2-2)

GUI	G	COL	G
* 2 Bangoura, Pierre	0	1 Quintana, Otoniel	0
3 Fofana, Ibrahima	0	2 Hernández, Gabriel	0
4 Conde, Sekou	0	* 3 Soto, Luis	0
5 Sankon, Amadou	0	4 Muñoz, Oscar	0
6 Soumah, Mamadouba	0	5 López, Dario	0
7 Camara, Morlaye	1	8 González Germán	0
9 Camara, Bouya	2	9 Arango, Alfredo	0
10 Cherif, Soulegmane	0	10 Ortiz, Norman	1
11 Camara, Mamadou	0	11 Santa, Gustavo	0
14 Keita, Ibrahima	0	14 Berdugo, Gabriel	0
19 Sano, Mamadi	0	17 Mosquera, Fabio	1
TOTAL	3	TOTAL	2

ARBITRE REFEREE: Rumentchev, Dimiter BUL

JUGES DE LIGNE LINESMEN: Klein, Abraham ISR Zsolt, Itsvan HUN

CHANGEMENT DE JOUEURS SUBSTITUTION

	ENTRE	IN	
	González, Germán	COL	Pardo, Joaquín 62 min
	Sano, Mamadi	GUI	Camara, Mamadouba 87
BUTS MARQUES	SCORER		
1 — 0	Camara, Morlaye	GUI	26 min
1 — 1	Santa, Gustavo	COL	49
2 — 1	Camara, Bouya	GUI	58
2 — 2	Mosquera, Fabio	COL	66
3 — 2	Camara, Bouya	GUI	84

ISR-SAL 3-1 (2-1, 1-0)

ISR	G	SAL	G
1 Levin, Haim	0	2 Rivas, Roberto	0
3 Bello, Menachem	0	3 Castro, Guillermo	0
4 Rosen, Zvi	0	5 Vázquez, Jorge	0
5 Shwager, Shaia	0	6 Ruano, José	0
6 Rosenthal, Shmuel	0	* 8 Villalta, Alberto	0
7 Talbi, Rachamim	1	9 Quintanilla, José	0
8 Shpiegel, Giora	0	10 Rodríguez, Mauricio	0
* 9 Faygenbaum, Jehoshua	0	12 Flores, Mario	0
* 10 Shpiegler, Mordechai	1	13 González, Mauricio	0
12 Druker, Itzhak	0	16 Méndez, Sergio	0
13 Borba, George	0	19 Fernández, Juan	0
TOTAL	3	TOTAL	1

ARBITRE REFEREE: Thompson, Shakibudeen NGR

JUGES DE LIGNE LINESMEN: Medina, Mariano ESP Kitabdjian, Michel FRA

CHANGEMENT DE JOUEURS SUBSTITUTION

	ENTRE	IN	
	Flores, Mario	SAL	Martínez, Juan 32 min
	Shwager, Shaia	ISR	Bar, Feiwel 67
	Villalta, Alberto EX	SAL	67
	Rodríguez, Mauricio	SAL	Azúcar, Víctor 75
BUTS MARQUES	SCORER		
1 — 0	Talbi, Rachamim	ISR	20 min
1 — 1	Martínez, Juan	SAL	35
2 — 1	Shpiegler, Mordechai	ISR	44
3 — 1	Bar, Feiwel	ISR	85

GRUPE B MATCH 13 OCT 16

AZTECA

GRUPE D MATCH 15

GUADALAJARA

ESP-NGR 3-0 (1-0, 2-0)

CHE-BUL 2-2 (2-1, 0-1)

ESP	G	NGR	G
2 Mora, Pedro	0	1 Fregene, Peter	0
3 Benito, Gregorio	0	2 Igwe, Anthony	0
4 Espildora, Francisco	0	3 Ofookwu, Augustine	0
6 Ochoa, Miguel	0	4 Okoye, Samuel	0
7 Sala, Isidro	0	5 Olumodeji, Olusegun	0
* 8 Asensi, Juan	0	* 6 Opone, Samuel	0
11 Jaen, Rafael	0	10 Anieke, Peter	0
15 Fernández, Juan	0	11 Lawal, Mohammed	0
16 Garzón, José	0	14 Brodrick, Sebastian	0
17 Grande, José	2	15 Obojememe, Clement	0
19 Ortuno, Fernando	1	16 Salami, Abdul	0
TOTAL	3	TOTAL	0

CHE	G	BUL	G
1 Kramerius, Antonin	0	1 Yordanov, Stoyan	0
* 2 Vecerek, Jiri	0	2 Guerov, Atanasse	0
4 Mutkovic, Peter	0	3 Christakiev, Gueorgui	0
5 Bouska, Josef	0	5 Ivkov, Kiril	0
6 Linhart, Josef	0	6 Gueorguiev, Ivailo	1
8 Petras, Ladislav	1	* 9 Jekov, Petar	1
11 Boros, Jaroslav	0	10 Christov, Atanasse	0
12 Findejs, Jaroslav	0	12 Christov, Kiril	0
13 Pajerchin, Ladislav	0	14 Guionine, Mikhail	0
14 Kral, Miroslav	0	15 Dimitrov, Yantcho	0
16 Jarabinsky, Jozef	1	17 Zafirov, Ivan	0
TOTAL	2	TOTAL	2

ARBITRE REFEREE: Robles, Augusto GUA

ARBITRE REFEREE: Aguilar, Abel MEX

JUGES DE LIGNE LINESMEN: Hieger, Erwin PER Klein, Abraham ISR

JUGES DE LIGNE LINESMEN: González, Alfonso MEX Buergo, Felipe MEX

CHANGEMENT DE JOUEURS SUBSTITUTION

CHANGEMENT DE JOUEURS SUBSTITUTION

ESP	OUT	ENTRE	IN	min
Fernández, Juan	66 min	Ortega, Gerardo		
Asensi, Juan	73	Alcaide, Rafael		
1 — 0	Ortuno, Fernando			27 min
2 — 0	Grande, José			52
3 — 0	Grande, José			69

BUL	OUT	ENTRE	IN	min
Dimitrov, Yantcho	46 min	Donev, Asparoukh		
Findejs, Jaroslav	57	Bartovic, Dusan		
Kramerius, Antonin	72	Holes, Julius		
1 — 0	Jarabinsky, Josef			25 min
2 — 0	Petras, Ladislav			42
2 — 1	Gueorguiev, Ivailo			44
2 — 2	Jekov, Petar			77

660

GRUPE B MATCH 14

PUEBLA

GRUPE D MATCH 16

LEON

BRA-JPN 1-1 (1-0, 0-1)

GUA-TAI 4-1 (1-1, 3-0)

BRA	G	JPN	G
1 Cruz, Pedro	0	1 Yokoyama, Kenzo	0
2 Pereira, Miguel	0	2 Katayama, Hiroshi	0
* 3 De Almeida, Joao	0	4 Yamaguchi, Yoshitada	0
5 Silva, Sebastiao	0	* 5 Kamata, Mitsuo	0
6 Dutra, José	0	8 Mori, Takaji	0
9 Ferreti, Fernando	1	9 Ogi, Aritatsu	0
10 Moreno, Daniel	0	12 Miyamoto, Teruki	0
11 De Jesús, Antonio	0	14 Kuwahara, Yasuyuki	0
13 Deodato, Claudio	0	15 Kamamoto, Kunishige	0
14 De Godoy, José	0	16 Matsumoto, Ikuo	0
16 Mello, Luis	0	17 Sugiyama, Ryuichi	0
TOTAL	1	TOTAL	1

GUA	G	TAI	G
1 González, Ignacio	0	1 On-lam, Chao	0
2 López, Alberto	1	3 Sangkasuwan, Narong	0
3 León, Llijon	0	4 Sangkagowit, Yongyouth	0
5 Hasse, Horacio	0	6 Pimpawatit, Chirawat	0
6 Villavicencio, Luis	0	8 Unyapo, Paiboon	0
7 Montoya, Hugo	0	9 Paholpat, Chatchai	0
* 9 Roldán, Jorge	1	11 Sornbutnark, Udomsilp	1
12 García, Antonio	0	13 Sesawasdi, Niwatana	0
13 Valdés, Carlos	0	* 14 Panich, Suphot	0
14 Melgar, N. Armando	2	15 Nilpirom, Boonlert	0
18 Chacón, Edgar	0	18 Nukulsompratana, Kriengsak	0
TOTAL	4	TOTAL	1

ARBITRE REFEREE: Lamptey, George GHA

ARBITRE REFEREE: Faber, Jean-Louis GUI

JUGES DE LIGNE LINESMEN: Tarekegn, Seyoum ETI Rumentchev, Dimitir BUL

JUGES DE LIGNE LINESMEN: Velázquez, Guillermo COL Osorio, Raúl MEX

CHANGEMENT DE JOUEURS SUBSTITUTION

CHANGEMENT DE JOUEURS SUBSTITUTION

BRA	OUT	ENTRE	IN	min
Kuwahara, Yasuyuki	46 min	Miyamoto, Masakatsu		
Matsumoto, Ikuo	81	Watanabe, Masashi		
Ferreti, Fernando	84	De Mattos, Arnaldo		
1 — 0	Ferreti, Fernando			9 min
1 — 1	Watanabe, Masashi			83

GUA	OUT	ENTRE	IN	min
García, Antonio	46 min	Slusher, Jeron		
Sangkagowit, Yongyouth	46	Sangdhamkichakul, Vichai		
Chacón, Edgar	51	Clarck, Ricardo		
Paholpat, Chatchai EX	52			
Hasse, Horacio EX	60			
Sesawasdi, Niwatana	67	Chaiyong, Snong		
1 — 0	Melgar, N. Armando			23 min
1 — 1	Sornbutnark, Udomsilp			44
2 — 1	Roldán, Jorge			55
3 — 1	López, Alberto			67
4 — 1	Melgar, N. Armando			85

GRUPE A MATCH 17 OCT 17

AZTECA

MEX-GUI 4-0 (0-0, 4-0)

MEX	G	GUI	G
1 Vargas, Javier	0	* 2 Bangoura, Pierre	0
2 Alejándrez, Manuel	0	3 Fofana, Ibrahima	0
* 3 Medina, Humberto	0	4 Conde, Sekou	0
4 Sanabria, Héctor	0	5 Sankon, Amadou	0
5 Pérez, Mario	0	6 Soumah, Mamadouba	0
6 Requeiro, Luis	0	7 Camara, Morlaye	0
7 Pulido, Héctor	2	9 Camara, Bouya	0
8 Bustos, Fernando	0	10 Cherif, Soulegmane	0
9 Estrada, Luis	0	11 Camara, Mamadou	0
10 Pereda, Vicente	2	14 Keita, Ibrahima	0
11 Victorino, Cesáreo	0	19 Sano, Mamadi	0
TOTAL	4	TOTAL	0

ARBITRE REFEREE: Suvaree, Wanchai TAI

JUGES DE LIGNE LINESMEN: Robles, Augusto GUA Lamptey, George GHA

CHANGEMENT DE JOUEURS SUBSTITUTION

SORT	OUT	ENTRE	IN
Bustos, Fernando	MEX	Muñoz, Elías	35 min
Estrada, Luis	MEX	Morales, Albino	35
Soumah, Mamadouba	GUI	Dia, Badara	46
Camara, Bouya	GUI	Diallo, Ibrahima	69
Conde, Sekou EX	GUI		72

BUTS MARQUES SCORER

1 — 0	Pereda, Vicente	MEX	70 min
2 — 0	Pereda, Vicente	MEX	85
3 — 0	Pulido, Héctor	MEX	86
4 — 0	Pulido, Héctor	MEX	88

GRUPE A MATCH 18

PUEBLA

COL-FRA 2-1 (2-0, 0-1)

COL	G	FRA	G
1 Quintana, Otoniel	0	1 Delhumeau, Guy	0
2 Hernández, Gabriel	0	2 Grava, Dario	0
* 3 Soto, Luis	0	3 Goueffic, Bernard	0
6 Pardo, Joaquín	0	* 7 Plante, Gilbert	0
7 Ospina, Pedro	0	8 Delafosse, Michel	0
12 Viafara, Ramiro	0	10 Laurier, Alain	0
13 Escobar, Alberto	0	11 Hodoul, Jean-Louis	0
14 Berdugo, Gabriel	0	14 Horlavielle, Daniel	0
15 Tamayo, Javier	1	15 Case, Marc	0
16 Jaramillo, Alfonso	1	16 Tamboueon, Charles	1
17 Mosquera, Fabio	0	17 Parmentier, Michel	0
TOTAL	2	TOTAL	1

ARBITRE REFEREE: Galba, Karol CHE

JUGES DE LIGNE LINESMEN: Rumentchev, Dimiter BUL Gugulovic, Milivoje YUG

CHANGEMENT DE JOUEURS SUBSTITUTION

SORT	OUT	ENTRE	IN
Tamayo, Javier	COL	Ortiz, Norman	33 min
Jaramillo, Alfonso	COL	Arango, Alfredo	46
Laurier, Alain	FRA	Larque, Michel	46
Parmentier, Michel	FRA	Hallet, Gérard	49

BUTS MARQUES SCORER

1 — 0	Tamayo, Javier	COL	14 min
2 — 0	Jaramillo, Alfonso	COL	35
2 — 1	Tamboueon, Charles	FRA	59

GRUPE C MATCH 19

GUADALAJARA

HUN-ISR 2-0 (1-0, 1-0)

HUN	G	ISR	G
1 Fater, Karoly	0	1 Levin, Haim	0
* 2 Novak, Dezzo	0	2 Bar, Feiwei	0
3 Drestyak, Lajos	0	3 Bello, Menachem	0
4 Pancsics, Miklos	0	4 Rosen, Zvi	0
5 Menczel, Ivan	0	7 Talbi, Rachamim	0
6 Szucs, Lajos	0	8 Shpigel, Giora	0
7 Fazekas, Laszlo	0	9 Faygenbaum, Jehoshua	0
10 Dunai, Antal	2	* 10 Shpiegler, Mordechai	0
14 Nosko, Erno	0	12 Druker, Itzhak	0
15 Juhasz, Istvan	0	13 Borba, George	0
18 Basti, Istvan	0	16 Karako, David	0
TOTAL	2	TOTAL	0

ARBITRE REFEREE: Yamasaki, Arturo MEX

JUGES DE LIGNE LINESMEN: Arp, Romualdo BRA González, Alfonso MEX

CHANGEMENT DE JOUEURS SUBSTITUTION

SORT	OUT	ENTRE	IN
Juhasz, Istvan	HUN	Szalai, Miklos	46 min
Borba, George	ISR	Young, Reuben	46
Talbi, Rachamim EX	ISR		58
Karako, David	ISR	Kastro, Nachman	70

BUTS MARQUES SCORER

1 — 0	Dunai, Antal	HUN	40 min
2 — 0	Dunai, Antal	HUN	75

GRUPE C MATCH 20

LEON 661

SAL-GHA 1-1 (1-0, 0-1)

SAL	G	GHA	G
2 Rivas, Roberto	0	* 4 Eshun, John	0
3 Castro, Guillermo	0	6 Sunday, Ibrahim	0
5 Vázquez, Jorge	0	7 Osei, Kofi	1
6 Ruano, José	0	10 Amusa, Gbadamosi	0
7 Flamenco, Salvador	0	11 Sampene, Sammy	0
9 Quintanilla, José	0	13 Naawu, John	0
* 10 Rodríguez, Mauricio	1	14 Wilson, Joseph	0
13 González, Mauricio	0	15 Malik, Jabir	0
14 Martínez, Juan	0	16 Acquah, Olive	0
16 Méndez, Sergio	0	17 Kpakpo, Jonathan	0
19 Fernández, Juan	0	18 Foley, Robert	0
TOTAL	1	TOTAL	1

ARBITRE REFEREE: Medina, Mariano ESP

JUGES DE LIGNE LINESMEN: Faber, Jean-Louis GUI Thompson, Shakibudeen NGR

CHANGEMENT DE JOUEURS SUBSTITUTION

SORT	OUT	ENTRE	IN
Sampene, Sammy	GHA	Kusi, Bernard	46 min
Ruano, José	SAL	Angel, José	65
Martínez, Juan	SAL	Azúcar, Victor	75

BUTS MARQUES SCORER

1 — 0	Rodríguez, Mauricio	SAL	42 min
1 — 1	Osei, Kofi	GHA	55

GRUPE B MATCH 21 OCT 18
GROUP MATCH

AZTECA

GRUPE D MATCH 23
GROUP MATCH

GUADALAJARA

ESP-JPN 0-0 (0-0, 0-0)

ESP	G	JPN	G
1 Mendietta, Andrés	0	1 Yokoyama, Kenzo	0
*3 Benito, Gregorio	0	2 Katayama, Hiroshi	0
4 Espíldora, Francisco	0	3 Miyamoto, Masakatsu	0
6 Ochoa, Miguel	0	* 4 Yamaguchi, Yoshitada	0
9 Ciaurriz, Javier	0	* 5 Kamata, Mitsuo	0
10 Igartúa, José	0	8 Mori, Takaji	0
12 Alfonseda, Ramón	0	9 Ogi, Aritatsu	0
13 Alcaide, Rafael	0	12 Miyamoto, Teruki	0
14 Barrios, José	0	13 Watanabe, Masashi	0
17 Grande, José	0	15 Kamamoto, Kunishige	0
18 Ortega, Gerardo	0	17 Sugiyama, Ryuichi	0
TOTAL	0	TOTAL	0

ARBITRE REFEREE: Hieger, Erwin PER

JUGES DE LIGNE LINESMEN: Gugulovic, Milivoje YUG Zsolt, Itsvan HUN

CHANGEMENT DE JOUEURS SUBSTITUTION

ESP	JPN	ENTRE	IN
Benito, Gregorio	ESP	Sala, Isidro	73 min
Miyamoto, Teruki	JPN	Yuguchi, Eizo	73

GRUPE B MATCH 22
GROUP MATCH

PUEBLA

BRA-NGR 3-3 (0-3, 3-0)

BRA	G	NGR	G
1 Cruz, Pedro	0	1 Fregene, Peter	0
2 Pereira, Miguel	0	2 Igwe, Anthony	0
* 3 De Almeida, Joao	0	5 Olumodeji, Olusegun	0
5 Silva, Sebastiao	2	* 6 Opone, Samuel	0
6 Dutra, José	0	7 Oshode, Olumuyiwa	0
9 Ferreti, Fernando	1	9 Olayombo, Kenneth	2
11 De Jesús, Antonio	0	10 Anieke, Peter	1
13 Deodato, Norberto	0	11 Lawal, Mohammed	0
14 De Godoy, Plinio	0	14 Brodrick, Sebastian	0
16 Mello, Luis	0	15 Obojememe, Clement	0
18 Rubio, Hamilton	0	17 Aryee, Fred	0
TOTAL	3	TOTAL	3

ARBITRE REFEREE: Tarekegn, Seyoum ETI

JUGES DE LIGNE LINESMEN: Klein, Abraham ISR Suvaree, Wanchai TAI

CHANGEMENT DE JOUEURS SUBSTITUTION

BRA	NGR	ENTRE	IN
De Almeida, Joao	BRA	De Mattos, Arnaldo	46 min
Ferreti, Fernando EX	BRA		55
Olumodeji, Olusegun	NGR	Ofookwu, Augustine	75
Oshode, Olumuyiwa	NGR	Salami, Abdul	80

BRA	NGR	ENTRE	IN
1 — 0	Olayombo, Kenneth	NGR	10 min
2 — 0	Anieke, Peter	NGR	19
3 — 0	Olayombo, Kenneth	NGR	41
3 — 1	Ferreti, Fernando	BRA	50
3 — 2	Silva, Sebastiao	BRA	59
3 — 3	Silva, Sebastiao	BRA	65

CHE-TAI 8-0 (6-0, 2-0)

CHE	G	TAI	G
1 Kramerius, Antonin	0	2 Pathipakornchai, Saravuth	0
2 Vecerek, Jiri	1	3 Sangkasuwan, Narong	0
* 3 Jarabek, Stanislav	0	4 Sangkagowit, Yongyouth	0
4 Mutkovic, Peter	0	6 Pimpawatini, Chirawat	0
5 Bouska, Josef	0	8 Unyapo, Paiboon	0
6 Linhart, Josef	0	11 Sornbutnark, Udomsilp	0
8 Petras, Ladislav	3	12 Thongpleow, Narong	0
10 Stratil, Pavel	2	* 14 Panich, Suphot	0
13 Pajerchin, Ladislav	0	15 Nilpirom, Boonlert	0
14 Kral, Miroslav	0	17 Sangdhamkitchakul, Vichai	0
17 Herbst, Milos	1	18 Nukulsonpratrana, Kriengsak	0
TOTAL	8	TOTAL	0

ARBITRE REFEREE: Buergo, Felipe MEX

JUGES DE LIGNE LINESMEN: Yamasaki, Arturo MEX Murayama, Yoshiyuki JPN

CHANGEMENT DE JOUEURS SUBSTITUTION

CHE	TAI	ENTRE	IN
Sornbutnark, Udomsilp	TAI	Vimolsate, Kriengsak	36 min
Herbst, Milos	CHE	Strunc, Stanislav	42
Stratil, Pavel	CHE	Krnac, Mikulas	63

CHE	TAI	ENTRE	IN
1 — 0	Herbst, Milos	CHE	12 min
2 — 0	Petras, Ladislav	CHE	17
3 — 0	Petras, Ladislav	CHE	18
4 — 0	Stratil, Pavel	CHE	28
5 — 0	Stratil, Pavel	CHE	34
6 — 0	Vecerek, Jiri	CHE	38
7 — 0	Petras, Ladislav	CHE	67
8 — 0	Krnac, Mikulas	CHE	83

662

GRUPE D MATCH 24
GROUP MATCH

LEON

BUL-GUA 2-1 (0-0, 2-1)

BUL	G	GUA	G
1 Yordanov, Stoyan	0	2 López, Alberto	1
2 Guerov, Atanasse	0	3 León, Lijon	0
3 Christakiev, Gueorgui	0	4 Camposeco, Roberto	0
4 Gaidarski, Milko	0	6 Villavicencio, Luis	0
5 Ivkov, Kiril	0	7 Montoya, Hugo	0
* 6 Gueorguiev, Ivailo	0	* 9 Roldán, Jorge	0
10 Christov, Atanasse	0	10 Torres, Hugo	0
11 Vassilev, Gueorgui	0	11 Slusher, Jeron	0
13 Donev, Asparoukh	1	13 Valdez, Carlos	0
14 Guionine, Mikhail	0	15 Peña, Hugo	0
16 Ivanov, Gueorgui	0	19 García, Julio	0
TOTAL	2	TOTAL	1

ARBITRE REFEREE: Osorio, Raúl MEX

JUGES DE LIGNE LINESMEN: Kitabdjian, Michel FRA Thompson, Shakibudeen NGR

CHANGEMENT DE JOUEURS SUBSTITUTION

BUL	GUA	ENTRE	IN
García, Julio	GUA	González, Ignacio	35 min
Vassilev, Gueorgui	BUL	Dimitrov, Tzvetan	50
Ivanov, Gueorgui	BUL	Jekov, Petar	52

BUL	GUA	ENTRE	IN
1 — 0	Donev, Asparoukh	BUL	50 min
2 — 0	Jekov, Petar	BUL	84
2 — 1	López, Alberto	GUA	88

RESULTAT FINAL HUITIEMES DE FINALE
RESULTS ELIMINATION ROUND

GRUPE A
GROUP

	FRA	MEX	COL	GUI	J	GAN	PER	EMP	GF	GC	P	POS
FRA	*	4 — 1	1 — 2	3 — 1	3	2	1	0	8	4	4	1
MEX	1 — 4	*	1 — 0	4 — 0	3	2	1	0	6	4	4	2
COL	2 — 1	0 — 1	*	2 — 3	3	1	2	0	4	5	2	3
GUI	1 — 3	0 — 4	3 — 2	*	3	1	2	0	4	9	2	4

GRUPE B
GROUP

	ESP	JPN	BRA	NGR	J	GAN	PER	EMP	GF	GC	P	POS
ESP	*	0 — 0	1 — 0	3 — 0	3	2	0	1	4	0	5	1
JPN	0 — 0	*	1 — 1	3 — 1	3	1	0	2	4	2	4	2
BRA	0 — 1	1 — 1	*	3 — 3	3	0	1	2	4	5	2	3
NGR	0 — 3	1 — 3	3 — 3	*	3	0	2	1	4	9	1	4

GRUPE C
GROUP

	HUN	ISR	GHA	SAL	J	GAN	PER	EMP	GF	GC	P	POS
HUN	*	2 — 0	2 — 2	4 — 0	3	2	0	1	8	2	5	1
ISR	0 — 2	*	5 — 3	3 — 1	3	2	1	0	8	6	4	2
GHA	2 — 2	3 — 5	*	1 — 1	3	0	1	2	6	6	2	3
SAL	0 — 4	1 — 3	1 — 1	*	3	0	2	1	2	6	1	4

GRUPE D
GROUP

	BUL	GUA	CHE	TAI	J	GAN	PER	EMP	GF	GC	P	POS
BUL	*	2 — 1	2 — 2	7 — 0	3	2	0	1	11	3	5	1
GUA	1 — 2	*	0 — 1	4 — 1	3	2	1	0	6	3	4	2
CHE	2 — 2	1 — 0	*	8 — 0	3	1	1	1	10	3	3	3
TAI	0 — 7	1 — 4	0 — 8	*	3	0	3	0	1	19	0	4

QUARTS DE FINALE MATCH 25
QUARTER-FINAL MATCH OCT 20 AZTECA

JPN-FRA 3-1 (1-1, 2-0)

JPN	G	FRA	G
1 Yokoyama, Kenzo	0	4 Lempereur, Jean	0
2 Katayama, Hiroshi	0	* 5 Zix, Freddy	0
3 Miyamoto, Masakatsu	0	6 Verhoeve, Michel	0
4 Yamaguchi, Yoshitada	0	7 Plante, Gilbert	0
* 5 Kamata, Mitsuo	0	9 Largue, Jean-Michel	0
8 Mori, Takaji	0	11 Hodoul, Jean-Louis	0
9 Ogi, Aritatsu	0	14 Horlville, Daniel	0
12 Miyamoto, Teruki	0	15 Case, Marc	0
13 Watanabe, Masashi	1	16 Tamboueon, Charles	1
15 Kamamoto, Kunishige	2	18 Hallet, Gerard	0
17 Sugiyama, Ryuichi	0	19 Ribul, Henri	0
TOTAL	3	TOTAL	1

ARBITRE REFEREE: Tarekegn, Seyoum ETI

JUGES DE LIGNE LINESMEN: Klein, Abraham ISR Hieger, Erwin PER

CHANGEMENT DE JOUEURS SUBSTITUTION

SORT	OUT	ENTRE	IN
Plante, Gilbert	FRA	Goueffic, Bernard	59 min
Sugiyama, Ryuichi	JPN	Matsumoto, Ikuo	70

BUTS	MARQUES	SCORER
1 — 0	Kamamoto, Kunishige	JPN
1 — 1	Tamboueon, Charles	FRA
2 — 1	Kamamoto, Kunishige	JPN
3 — 1	Watanabe, Masashi	JPN

QUARTS DE FINALE MATCH 26
QUARTER-FINAL MATCH

PUEBLA 663

MEX-ESP 2-0 (1-0, 1-0)

MEX	G	ESP	G
1 Vargas, Javier	0	2 Mora, Pedro	0
2 Alejándrez, Manuel	0	3 Benito, Gregorio	0
4 Sanabria, Héctor	0	4 Espildora, Francisco	0
5 Pérez, Mario	0	6 Ochoa, Miguel	0
* 6 Regueiro, Luis	0	7 Sala, Isidro	0
7 Pulido, Héctor	0	* 8 Asensi, Juan	0
10 Pereda, Vicente	1	11 Jaen, Rafael	0
11 Victorino, Cesáreo	0	15 Fernández, Juan	0
14 Sánchez, Javier	0	16 Garzón, José	0
15 Muñoz, Elías	0	17 Grande, José	0
18 Morales, Albino	1	19 Ortuno, Fernando	0
TOTAL	2	TOTAL	0

ARBITRE REFEREE: Gugulovic, Milivoje YUG

JUGES DE LIGNE LINESMEN: Rumentchev, Dimitar BUL Lamptey, George GHA

CHANGEMENT DE JOUEURS SUBSTITUTION

SORT	OUT	ENTRE	IN
Jaen, Rafael	ESP	Alcaide, Rafael	49 min
Garzón, José	ESP	Ortega, Gerardo	51
Victorino, Cesáreo	MEX	Bustos, Fernando	62

BUTS	MARQUES	SCORER
1 — 0	Morales, Albino	MEX
2 — 0	Pereda, Vicente	MEX

QUARTS DE FINALE MATCH 27
QUARTER-FINAL MATCH

GUADALAJARA

DEMI-FINALE MATCH 29
SEMI-FINAL MATCH

OCT 22

AZTECA

HUN-GUA 1-0 (0-0, 1-0)

HUN		GUA	
	G		G
1 Fater, Karoly	0	1 González, Ignacio	0
* 2 Novak, Dezso	0	2 López, Alberto	0
3 Drestyak, Lajos	0	3 León, Llijón	0
4 Pancsics, Miklos	0	6 Villavicencio, Luis	0
5 Menczel, Ivan	0	7 Montoya, Hugo	0
6 Szucs, Lajos	1	* 9 Roldán, Jorge	0
7 Fazekas, Laszlo	0	10 Torres, Hugo	0
10 Dunai, Antal	0	11 Slusher, Jeron	0
14 Nosko, Erno	0	14 Melgar, N: Armando	0
15 Juhasz, Istvan	0	15 Peña, Hugo	0
18 Basti, Istvan	0	16 Stokes, David	0
TOTAL	1	TOTAL	0

ARBITRE REFEREE: Yamasaki, Arturo MEX

JUGES DE LIGNE LINESMEN: Arp, Romualdo BRA González, Alfonso MEX

CHANGEMENT DE JOUEURS SUBSTITUTION

SORT		OUT		ENTRE		IN	
	Menczel, Ivan	HUN	60 min		Kocsis, Lajos		
	López, Alberto	GUA	69		Melgar, R: Armando		
	Basti, Istvan	HUN	72		Szalai, Miklos		
	Peña, Hugo	GUA	76		Valdez, Carlos		

BUTS MARQUES	SCORER		
1 — 0	Szucs, Lajos	HUN	69 min

HUN-JPN 5-0 (1-0, 4-0)

HUN		JPN	
	G		G
1 Fater, Karoly	0	1 Yokoyama, Kenzo	0
* 2 Novak, Dezso	2	2 Katayama, Hiroshi	0
3 Drestyak, Lajos	0	3 Miyamoto, Masakatsu	0
4 Pancsics, Miklos	0	4 Yamaguchi, Yoshitada	0
6 Szucs, Lajos	3	* 5 Kamata, Mitsuo	0
7 Fazekas, Laszlo	0	8 Mori, Takaji	0
9 Kocsis, Lajos	0	9 Ogi, Aritatsu	0
10 Dunai, Antal	0	12 Miyamoto, Teruki	0
11 Nagy, Laszlo	0	13 Watanabe, Masashi	0
14 Nosko, Erno	0	15 Kamamoto, Kunishigue	0
15 Juhasz, Istvan	0	17 Sugiyama, Ryuichi	0
TOTAL	5	TOTAL	0

ARBITRE REFEREE: Arp, Romualdo BRA

JUGES DE LIGNE LINESMEN: Hieger, Edwin PER Velázquez, Guillermo COL

CHANGEMENT DE JOUEURS SUBSTITUTION

SORT		OUT		ENTRE		IN	
	Kocsis, Lajos	HUN	56 min		Menczel, Ivan		
	Miyamoto, Teruki	JPN	60		Yaegashi, Shigeo		
	Miyamoto, Masakatsu	JPN	67		Tomizawa, Kiyoshi		
	Fater, Karoly	HUN	77		Szarka, Zoltan		

BUTS MARQUES	SCORER		
1 — 0	Szucs, Lajos	HUN	30 min
2 — 0	Novak, Dezso	HUN	53
3 — 0	Szucs, Lajos	HUN	60
4 — 0	Novak, Dezso	HUN	65
5 — 0	Szucs, Lajos	HUN	75

664

QUARTS DE FINALE MATCH 28
QUARTER-FINAL MATCH

LEON

DEMI-FINALE MATCH 30
SEMI-FINAL MATCH

GUADALAJARA

BUL-ISR 1-1 (1-0, 0-1)

BUL		ISR	
	G		G
1 Yordanov, Stoyan	0	1 Levin, Haim	0
3 Christakiev, Gueorgui	1	2 Bar, Feiwei	0
* 4 Gaidarski, Milko	0	3 Belló, Menachem	0
5 Ivkov, Kiril	0	4 Rosen, Zvi	0
8 Yantchovski, Evgueni	0	5 Shwager, Shaia	0
10 Christov, Atanasse	0	6 Rosenthal, Shmuel	0
13 Donev, Asparoukh	0	8 Shpigel, Giora	0
14 Guionine, Mikhail	0	9 Faygenbaum, Jehoshua	1
15 Dimitrov, Yantcho	0	* 10 Shpiegler, Mordechai	0
16 Ivanov, Gueorgui	0	11 Young, Reuben	0
17 Zafirov, Ivan	0	12 Druker, Itzhak	0
TOTAL	1	TOTAL	1

ARBITRE REFEREE: Kitabdjiam, Michel FRA

JUGES DE LIGNE LINESMEN: Velázquez, Guillermo COL Thompson, Shakibudeen NGR

CHANGEMENT DE JOUEURS SUBSTITUTION

SORT		OUT		ENTRE		IN	
	Shwager, Shaia	ISR	39 min		Borba, George		
	Guionine, Mikhail	BUL	60		Jekov, Petar		
	Young, Reuben	ISR	75		Englander, Yizhak		
	Christov, Atanasse	BUL	75		Gueorguiev, Ivailo		

BUTS MARQUES	SCORER		
1 — 0	Christakiev, Gueorgui	BUL	5 min
1 — 1	Faygenbaum, Jehoshua	ISR	89

BUL-MEX 3-2 (2-1, 1-1)

BUL		MEX	
	G		G
2 Guerov, Atanasse	0	1 Vargas, Javier	0
3 Christakiev, Gueorgui	0	2 Alejándrez, Manuel	0
4 Gaidarski, Milko	0	4 Sanabria, Héctor	0
6 Gueorguiev, Ivailo	0	5 Pérez, Mario	0
7 Dimitrov, Tzvetan	1	* 6 Regueiro, Luis	0
8 Yantchovski, Evgueni	0	7 Pulido, Héctor	1
* 9 Jekov, Petar	1	10 Pereda, Vicente	0
10 Christov, Atanasse	1	11 Victorino, Cesáreo	0
12 Christov, Kiril	0	14 Sánchez, Javier	0
13 Donev, Asparoukh	0	15 Muñoz, Elías	0
19 Nikolov, Todor	0	18 Morales, Albino	1
TOTAL	3	TOTAL	2

ARBITRE REFEREE: Tarekegn, Seyoum ETI

JUGES DE LIGNE LINESMEN: Suvaree, Wanchai TAI Lamptey, George GHA

CHANGEMENT DE JOUEURS SUBSTITUTION

SORT		OUT		ENTRE		IN	
	Gueorguiev, Ivailo	BUL	60 min		Dimitrov, Yantcho		
	Muñoz, Elías	MEX	65		Alvarez, José		
	Dimitrov, Tzvetan	BUL	68		Zafirov, Ivan		
	Regueiro, Luis	MEX	73		Basaguren, Ignacio		

BUTS MARQUES	SCORER		
1 — 0	Jekov, Petar	BUL	8 min
2 — 0	Christov, Atanasse	BUL	9
2 — 1	Morales, Albino	MEX	39
2 — 2	Pulido, Héctor	MEX	48
3 — 2	Dimitrov, Tzvetan	BUL	58

POUR 3^e ET 4^e PLACES MATCH **31** OCT 24 AZTECA

JPN-MEX 2-0 (2-0, 0-0)

JPN		G		MEX		G	
1	Yokoyama, Kenzo	0		1	Vargas, Javier	0	
2	Katayama, Hiroshi	0		2	Alejandroz, Manuel	0	
4	Yamaguchi, Yoshitada	0		4	Sanabria, Héctor	0	
* 5	Kamata, Mitsuo	0		5	Pérez, Mario	0	
8	Mori, Takaji	0		* 6	Regueiro, Luis	0	
9	Ogi, Aritatsu	0		9	Estrada, Luis	0	
12	Miyamoto, Teruki	0		10	Pereda, Vicente	0	
13	Watanabe, Masashi	0		11	Victorino, Cesáreo	0	
15	Kamamoto, Kunishige	2		14	Sanchez, Javier	0	
16	Matsumoto, Ikuo	0		16	Basaguren, Ignacio	0	
17	Sugiyama, Ryuichi	0		18	Morales, Albino	0	
TOTAL		2		TOTAL		0	

ARBITRE REFEREE: Klein, Abraham ISR

JUGES DE LIGNE LINESMEN: Robles, Augusto GUA Thompson, Shakibudeen NGR

CHANGEMENT DE JOUEURS SUBSTITUTION

SORT		OUT		ENTRE		IN	
	Victorino, Cesáreo	MEX			Muñoz, Elías		37 min
	Estrada, Luis	MEX			Hernández, Bernardo		37

BUTS MARQUES SCORER

1 — 0	Kamamoto, Kunishige	JPN	20 min
2 — 0	Kamamoto, Kunishige	JPN	40

TOURS FINALES
FINAL ROUNDS

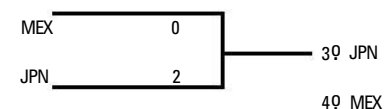
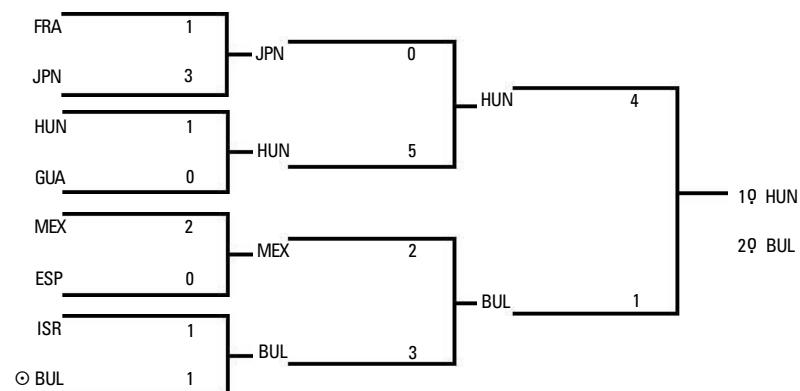

POUR 1^{ère} ET 2^e PLACES MATCH **32** OCT 26 AZTECA

HUN-BUL 4-1 (2-1, 2-0)

HUN		G		BUL		G	
1	Fater, Karoly	0		1	Yordanov, Stoyan	0	
* 2	Novak, Dezso	0		2	Guevov, Atanasse	0	
3	Drestyak, Lajos	0		3	Christakiev, Gueorgui	0	
4	Pancsics, Miklos	0		4	Gaidarski, Milko	0	
5	Menczel, Ivan	1		5	Ivkov, Kiril	0	
6	Szucs, Lajos	0		6	Gueorguiev, Ivailo	0	
7	Fazekas, Laszlo	0		7	Dimitrov, Tzvetan	1	
10	Dunai, Antal	2		8	Yantchovski, Evgueni	0	
11	Nagy, Laszlo	0		* 9	Jekov, Petar	0	
14	Noško, Erno	0		10	Christov, Atanasse	0	
15	Juhasz, Istvan	1		13	Donev, Asparoukh	0	
TOTAL		4		TOTAL		1	

ARBITRE REFEREE: De Leo, Diego MEX

JUGES DE LIGNE LINESMEN: Yamasaki, Arturo MEX González, Alfonso MEX

CHANGEMENT DE JOUEURS SUBSTITUTION

SORT		OUT		ENTRE		IN	
	Dimitrov, Tzvetan EX	BUL					43 min
	Ivkov, Kiril EX	HUN					44
	Christov, Atanasse EX	BUL					44
	Yantchovski, Evgueni	BUL			Christov, Kiril		54
	Donev, Asparoukh	BUL			Ivanov, Gueorgui		62
	Juhasz, Istvan EX	BUL					85

BUTS MARQUES SCORER

1 — 0	Dimitrov, Tzvetan	BUL	20 min
1 — 1	Menczel, Ivan	HUN	41
2 — 1	Dunai, Antal	HUN	42
3 — 1	Juhasz, Istvan	HUN	49
4 — 1	Dunai, Antal	HUN	62

+ VICTOIRE PAR TIRAGE AU SORT APRES EX-AEQUO LORS DES PROLONGATIONS.
WON ON TOSS OF COIN AFTER TIE IN EXTRA PERIODS.

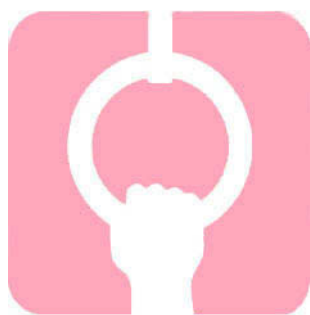

FEDERATION INTERNATIONALE
DE GYMNASTIQUE FIG

INTERNATIONAL GYMNASSTICS
FEDERATION FIG

PRESIDENT
Arthur Gander SUI

SECRETARE
SECRETARY
Max Bangerter SUI

PRESIDENT
Arthur Gander SUI

VICE-PRESIDENT
Ivan Ivancevic YUG

SECRETARE
SECRETARY
Pierre Hentges LUX

MEMBRES
MEMBERS
Nicolai Popov URS
José Saviñón MEX

JURY DES EPREUVES
COMPETITION JURY

EXERCICES IMPOSES ET
LIBRES - DAMES
COMPULSORY AND VOLUNTARY
EXERCISES - WOMEN

JUGE-ARBITRES
JUDGE-REFEREES

CHEVAL-SAUTOIR
HORSE VAULT
Andreina Gotta ITA

BARRES ASYMETRIQUES
ASYMMETRICAL BARS
Käthe Wiesenberger AUT

POUTRE
BALANCE BEAM
Valerie Nagy-Herpich HUN

EXERCICES AU SOL
FLOOR EXERCISES
Taissia Demidenko URS

EXERCICES IMPOSES
ET LIBRES - MESSIEURS
COMPULSORY AND VOLUNTARY
EXERCISES - MEN

JUGE-ARBITRES
JUDGE-REFEREES

EXERCICES AU SOL
FLOOR EXERCISES
Valentin Mouratov URS

OFFICIELS DE LA COMPETITION
COMPETITION OFFICIALS

JURY D'APPEL
JURY OF APPEAL

CHEVAL-ARCONS
POMMELLED HORSE
Alexander Lylo CHE
Heinz Neumann ADE

ANNEAUX
RINGS
George Gulack EUA

CHEVAL-SAUTOIR
HORSE VAULT
Pierre Hentges LUX

BARRES PARALLELES
PARALLEL BARS
Rudolf Spieth ALE

BARRE FIXE
HORIZONTAL BAR
Tuomo Jalantie FIN

JUGES - DAMES
JUDGES - WOMEN
Ingeborg Herrmann ADE
Sylvia Hlavacek ADE

Irma Walther ALE
Käthe Wiesenberger ALE
Meinhild Hierling ALE
Radka Pentscheva BUL
Fay Weiler CAN
Maria Medveczky CAN
Lilia Wong CUB
Teresa Oliva CUB
Alena Tinterova CHE
Hanna Vlacilova CHE
Dale Flansaas EUA
Jacqueline Uphues EUA
Berthe Villancher FRA
Michele Thiébault FRA
Annette Stapleton GBR
Eva Romak HUN
Valerie Nagy-Herpich HUN
Andreina Gotta ITA
Ginko Chiba JPN
Natsu Yoshida JPN
Ligia Gamboa MEX
Socorro Nieto MEX

Janina Skirlinska POL
Carin Delden SUE
Anna Anikina URS
Larissa Latynina URS
Taissia Demidenko URS

JUGES - MESSIEURS
JUDGES - MEN

Hans Pollich ADE
Heinz Neumann ADE
Rolf Bauch ADE
Alfred Schmidt ALE
Rudolph Spieth ALE
Nicolay Kouliy BUL
Albert Dippong CAN
Jacques Chouinard CAN
Angel Franco CUB
Luis de Pablo CUB
Alexander Lylo CHE
Miloslav Kolečka CHE
Zdenek Ruzicka CHE
Armando Vega EUA
Eugene Wettstone EUA
George Gulack EUA
Jerry Hardy EUA
Sotero Tejada FIL
Esa Seeste FIN
Tuomo Jalantie FIN
Georges André FRA
Istvan Sarkany HUN
Fabio Bonacina ITA
Gianfranco Marzolla ITA
Akitomo Kaneko JPN
Masao Takemoto JPN
Pierre Hentges LUX
Pierre Hentges, Jr. LUX
Enrique Sánchez MEX
Jorge Tirado MEX
Mario Sánchez MEX
Nicanor Villarreal MEX
Pedro Ortega MEX
Raúl Oliveros MEX
Tomás Vivian MEX
Victor Perea MEX
Tadeusz Bettyna POL
Zbigniew Noskiewicz POL
Arthur Gander SUI
Fritz Feuz SUI
Marcel Adatte SUI
Boris Chakline URS
Konstantin Darakachians URS
Valentin Mouratov URS
Ivan Ivancevic YUG
Milos Stergar YUG

SIGNES EMPLOYES

SYMBOLGY

MESSIEURS	MEN
I — EXERCICES AU SOL	FLOOR EXERCISES
II — CHEVAL-ARCONS	POMMELLED HORSE
III — ANNEAUX	RINGS
IV — CHEVAL-SAUTOIR	HORSE VAULT
V — BARRES PARALLELES	PARALLEL BARS
VI — BARRE FIXE	HORIZONTAL BAR
DAMES	WOMEN
I — EXERCICES AU SOL	FLOOR EXERCISES
II — BARRES ASYMETRIQUES	ASYMMETRICAL BARS
III — POUTRE	BALANCE BEAM
IV — CHEVAL-SAUTOIR	HORSE VAULT
TE — TOTAL EQUIPE	TEAM TOTAL
PI — POINTS INDIVIDUELS	INDIVIDUAL POINTS
O — EXERCICES IMPOSES	COMPULSORY EXERCISES
L — EXERCICES LIBRES	VOLUNTARY EXERCISES
C — CLASSEMENT	CLASSIFICATION
T — FIL ET CDN - EQUIPES AYANT ABANDONNE	FIL AND CDN TEAMS WITHDREW

			Exercices imposés Compulsory exercises	Exercices libres Voluntary exercises	Total points
90	Mitruk, Stephen	CAN	8.70	8.75	17.45
92	Larose, Gilbert	CAN	8.80	8.60	17.40
92	Pumpido, Roberto	CUB	8.65	8.75	17.40
94	Johannesson, Finn	SUE	7.95	9.40	17.35
95	Valles, Armando	MEX	9.30	8.00	17.30
95	Nielsen, Hans	DIN	8.30	9.00	17.30
97	Wild, Stanley	GBR	8.50	8.75	17.25
98	Lai, Chu-Long	TVN	8.70	8.40	17.10
99	Abreu, José	POR	8.40	8.50	16.90
100	Gabrovsky, Roumene	BUL	9.10	7.75	16.85
101	Valles, Fernando	MEX	8.35	8.40	16.75
101	Netusil, Miloslav	CHE	7.50	9.25	16.75
101	Ramírez, Luis	CUB	7.80	8.95	16.75
104	Suárez, Octavio	CUB	7.50	9.20	16.70
105	Ivanov, Bojidar	BUL	7.50	9.15	16.65
106	Luna, Sergio	ECU	8.05	8.55	16.60
107	Mori, Vincenzo	ITA	8.45	8.10	16.55
108	Zagdvazar, Niamdavaa	MGL	8.50	8.00	16.50
109	Brooker, Barry	CAN	8.65	7.80	16.45
110	Chessell, Murray	AUS	8.05	8.25	16.30
111	Navarrete, Luis	CUB	8.25	7.00	15.25
112	Nájera, Eduardo	ECU	8.05	4.70	12.75
113	Cheng, Fu	TVN	8.10	4.00	12.10
114	Menichelli, Franco	ITA	9.60	0.00	9.60
115	Rendón, Pedro	ECU	4.65	3.50	8.15

CLASSEMENT FINAL FINAL CLASSIFICATION

EXERCICES AU SOL FLOOR EXERCISES

OCT 26

			Exercices imposés Compulsory exercises	Exercices libres Voluntary exercises	Total points
1	Kato, Sawao	JPN	9.825	9.650	19.475
2	Nakayama, Akinori	JPN	9.700	9.700	19.400
3	Kato, Takeshi	JPN	9.675	9.600	19.275
4	Tsukahara, Mitsuo	JPN	9.550	9.500	19.050
5	Karasev, Valery	URS	9.550	9.400	18.950
6	Kenmotsu, Eizo	JPN	9.625	9.300	18.925

CHEVAL - ARCONS POMMELLED HORSE

1	Cerar, Miroslav	YUG	9.675	9.650	19.325
2	Laiho, Olli	FIN	9.575	9.650	19.225
3	Voronin, Michail	URS	9.600	9.600	19.200
4	Kubica, Wilhelm	POL	9.550	9.600	19.150
5	Kenmotsu, Eizo	JPN	9.550	9.500	19.050
6	Klimenko, Vladimir	URS	9.550	9.400	18.950

ANNEAUX RINGS

1	Nakayama, Akinori	JPN	9.750	9.700	19.450
2	Voronin, Michail	URS	9.725	9.600	19.325
3	Kato, Sawao	JPN	9.775	9.450	19.225
4	Tsukahara, Mitsuo	JPN	9.625	9.500	19.125
5	Kato, Takeshi	JPN	9.700	9.350	19.050
6	Diomidov, Sergey	URS	9.525	9.450	18.975

CHEVAL-SAUTOIR HORSE VAULT

1	Voronin, Michail	URS	9.500	9.500	19.000
2	Endo, Yukio	JPN	9.500	9.450	18.950
3	Diomidov, Sergey	URS	9.450	9.475	18.925
4	Kato, Takeshi	JPN	9.525	9.250	18.775
5	Nakayama, Akinori	JPN	9.425	9.300	18.725
6	Kenmotsu, Eizo	JPN	9.475	9.175	18.650

BARRES PARALLELES PARALLEL BARS

1	Nakayama, Akinori	JPN	9.775	9.700	19.475
2	Voronin, Michail	URS	9.725	9.700	19.425
3	Klimenko, Vladimir	URS	9.625	9.600	19.225
4	Kato, Takeshi	JPN	9.650	9.550	19.200
5	Kenmotsu, Eizo	JPN	9.625	9.550	19.175
6	Kubica, Wilhelm	POL	9.575	9.350	18.925

BARRE FIXE HORIZONTAL BAR

1	Voronin, Michail	URS	9.750	9.800	19.550
1	Nakayama, Akinori	JPN	9.750	9.800	19.550
3	Kenmotsu, Eizo	JPN	9.675	9.700	19.375
4	Köste, Klaus	ADE	9.725	9.500	19.225
5	Diomidov, Sergey	URS	9.650	9.500	19.150
6	Endo, Yukio	JPN	9.625	9.400	19.025

**EXERCICES IMPOSES
COMPULSORY EXERCISES**

1er TOUR OCT 22
1st ROUND

	I	PI	II	PI	III	PI	IV	PI	V	PI	VI	PI
A	SUI Berchtold, Meinrad	8.95	MEX Valles, Armando	9.05	ITA Carminucci, Giovanni	8.75	POL Kubica, Wilhelm	9.25	AUS Chessell, Murray	7.55	EUA Allen, Kanati	8.80
	Ettlin, Hans	8.60	González, José	8.20	Carminucci, Pasquale	8.70	Kubica, Mikolaj	9.30	FIL Beren, Ernesto	6.65	Cohen, Steven	8.90
	Greutmann, Edwin	8.75	García, Enrique	7.55	Cimnaghi, Luigi	9.05	Kubica, Sylwester	8.75	Henson, Norman	4.95	Freudenstein, Sidney	8.95
	Hurzeler, Roland	8.80	Mendoza, Rogelio	8.15	Franceschetti, Bruno	8.80	Kruza, Jerzy	9.00	POR Abreu, José	8.65	Hug, Steve	9.25
	Müller, Paul	8.65	Vilchis, José	7.80	Menichelli, Franco	9.60	Gonera, Andrzej	8.90			Roethlisberger, Fred	9.10
	Rohner, Peter	9.05	Valles, Fernando	8.90	Mori, Vincenzo	8.50	Rokosa, Aleksander	9.20			Thor, David	9.05
	TE	44.20	TE	42.10	TE	44.90	TE	45.65			TE	45.25

2e TOUR
2nd ROUND

A	EUA Allen, Kanati	9.10	SUI Berchtold, Meinrad	8.90	MEX Valles, Armando	9.05	ITA Carminucci, Giovanni	9.05	POL Kubica, Wilhelm	9.50	FIL Beren, Ernesto	NSP
	Cohen, Steven	8.85	Ettlin, Hans	8.95	González, José	7.45	Carminucci, Pasquale	8.75	Kubica, Mikolaj	9.45	Henson, Norman	NSP
	Freudenstein, Sidney	9.15	Greutmann, Edwin	8.60	García, Enrique	7.60	Cimnaghi, Luigi	9.15	Kubica, Sylwester	9.30	POR Abreu, José	8.40
	Hug, Steve	9.00	Hurzeler, Roland	9.30	Mendoza, Rogelio	8.15	Franceschetti, Bruno	8.80	Kruza, Jerzy	8.95	AUS Chessell, Murray	8.05
	Roethlisberger, Fred	8.95	Müller, Paul	9.25	Vilchis, José	8.55	Menichelli, Franco	9.30	Gonera, Andrzej	9.05		
	Thor, David	9.15	Rohner, Peter	9.10	Valles, Fernando	7.75	Mori, Vincenzo	9.15	Rokosa, Aleksander	9.15		
	TE	45.35	TE	45.50	TE	41.10	TE	45.45	TE	46.45		

3e TOUR
3rd ROUND

A	POR Abreu, José	8.80	EUA Allen, Kanati	9.00	SUI Berchtold, Meinrad	8.95	MEX Valles, Armando	9.15	ITA Carminucci, Giovanni	9.45	POL Kubica, Wilhelm	9.50
	AUS Chessell, Murray	7.95	Cohen, Steven	9.00	Ettlin, Hans	9.20	González, José	9.00	Carminucci, Pasquale	9.20	Kubica, Mikolaj	9.20
	FIL Beren, Ernesto	6.10	Freudenstein, Sidney	8.75	Greutmann, Edwin	8.70	García, Enrique	8.10	Cimnaghi, Luigi	9.30	Kubica, Sylwester	9.40
	Henson, Norman	7.70	Hug, Steve	9.30	Hurzeler, Roland	8.50	Mendoza, Rogelio	8.20	Franceschetti, Bruno	9.15	Kruza, Jerzy	8.90
			Roethlisberger, Fred	8.85	Müller, Paul	8.85	Vilchis, José	8.60	Menichelli, Franco	9.60	Gonera, Andrzej	9.15
			Thor, David	9.50	Rohner, Peter	8.90	Valles, Fernando	8.85	Mori, Vincenzo	8.95	Rokosa, Aleksander	8.80
			TE	45.65	TE	44.60	TE	43.80	TE	46.70	TE	46.15

4e TOUR
4th ROUND

A	POL Kubica, Wilhelm	9.25	AUS Chessell, Murray	8.40	EUA Allen, Kanati	7.80	SUI Berchtold, Meinrad	9.20	MEX Valles, Armando	8.70	ITA Carminucci, Giovanni	9.30
	Kubica, Mikolaj	9.20	FIL Beren, Ernesto	NSP	Cohen, Steven	9.30	Ettlin, Hans	9.10	González, José	9.00	Carminucci, Pasquale	8.80
	Kubica, Sylwester	9.30	Henson, Norman	NSP	Freudenstein, Sidney	8.90	Greutmann, Edwin	8.65	García, Enrique	8.00	Cimnaghi, Luigi	9.35
	Kruza, Jerzy	8.90	POR Abreu, José	8.40	Hug, Steve	8.80	Hurzeler, Roland	8.80	Mendoza, Rogelio	8.90	Franceschetti, Bruno	8.70
	Gonera, Andrzej	8.75			Roethlisberger, Fred	9.15	Müller, Paul	8.45	Vilchis, José	8.00	Menichelli, Franco	9.60
	Rokosa, Aleksander	8.80			Thor, David	9.00	Rohner, Peter	8.75	Valles, Fernando	7.20	Mori, Vincenzo	8.45
	TE	45.45			TE	45.15	TE	44.50	TE	42.60	TE	45.75

5e TOUR
5th ROUND

A	ITA Carminucci, Giovanni	8.75	POL Kubica, Wilhelm	9.60	FIL Beren, Ernesto	6.25	EUA Allen, Kanati	9.00	SUI Berchtold, Meinrad	9.45	MEX Valles, Armando	9.30
	Carminucci, Pasquale	7.65	Kubica, Mikolaj	9.45	Henson, Norman	6.60	Cohen, Steven	8.95	Ettlin, Hans	9.55	González, José	8.85
	Cimnaghi, Luigi	9.10	Kubica, Sylwester	9.00	POR Abreu, José	8.95	Freudenstein, Sidney	9.10	Greutmann, Edwin	9.10	García, Enrique	8.65
	Franceschetti, Bruno	7.75	Kruza, Jerzy	9.00	AUS Chessell, Murray	8.20	Hug, Steve	8.75	Hurzeler, Roland	9.50	Mendoza, Rogelio	8.80
	Menichelli, Franco	9.30	Gonera, Andrzej	8.85			Roethlisberger, Fred	9.25	Müller, Paul	9.30	Vilchis, José	8.85
	Mori, Vincenzo	8.20	Rokosa, Aleksander	8.55			Thor, David	9.10	Rohner, Peter	9.30	Valles, Fernando	8.35
	TE	43.10	TE	45.90			TE	45.40	TE	47.10	TE	44.45

6e TOUR
6th ROUND

I		II		III		IV		V		VI													
MEX	Valles, Armando	PI	8.00	ITA	Carminucci, Giovanni	PI	8.95	POL	Kubica, Wilhelm	PI	9.30	POR	Abreu, José	PI	9.25	EUA	Allen, Kanati	PI	7.70	SUI	Berchtold, Meinrad	PI	9.40
	González, José		8.85		Carminucci, Pasquale		8.70		Kubica, Mikolaj		9.30	AUS	Chessel, Murray		8.40		Cohen, Steven		9.10		Ettlin, Hans		9.40
A	García, Enrique		8.10		Gimnaghi, Luigi		9.10		Kubica, Sylwester		8.75	FIL	Beren, Ernesto		0.00		Freudenstein, Sidney		8.85		Greutmann, Edwin		9.05
	Mendoza, Rogelio		8.30		Franceschetti, Bruno		9.00		Kruza, Jerzy		8.90		Henson, Norman		8.40		Hug, Steve		9.05		Hurzeler, Roland		8.40
	Vilchis, José		8.00		Menichelli, Franco	NSP			Gonera, Andrzej		9.00						Roethlisberger, Fred		9.10		Müller, Paul		9.00
	Valles, Fernando		7.35		Mori, Vincenzo		8.70		Rokosa, Aleksander		9.05						Thor, David		8.70		Rohner, Peter		9.25
		TE	41.25			TE	44.45			TE	45.55							TE	44.80			TE	46.10

7e TOUR
7th ROUND

B	ECU	Luna, Sergio	6.60	CAN	Larose, Gilbert	8.90	HUN	Aranyos, Istvan	8.70	CUB	Suárez, Octavio	8.40	CHE	Bocko, Frantisek	9.30	ADE	Fülle, Siegfried	9.55	
		Nájera, Eduardo	7.35		Jensen, Sidney	8.70		Tihanyi, Endre	8.80		Pumpido, Roberto	8.70		Fejtek, Jiri	8.60		Köste, Klaus	9.75	
		Rendón, Pedro	6.25		Dion, Roger	8.55		Mentsik, Konrad	8.35		Navarrete, Luis	8.40		Kubicka, Vaclav	9.60		Brehme, Matthias	9.55	
		Campos, Jorge	NSP		Brooker, Barry	7.30		Kiss, Sandor	6.90		Ramírez, Héctor	8.85		Mudrik, Bohumil	9.35		Dietrich, Gerhard	9.30	
					Mitruk, Stephen	8.75		Herczegh, Bela	7.20		Rodríguez, Jorge	8.95		Netusil, Miloslav	9.45		Weber, Peter	9.40	
								Bordan, Dezso	7.95		Ramírez, Luis	8.60		Skoumal, Vaclav	9.30		Beier, Günter	9.40	
						TE	42.20		TE	41.00		TE	43.50		TE	47.00		TE	47.65

8e TOUR
8th ROUND

678	B	ADE	Fülle, Siegfried	9.15	ECU	Luna, Sergio	5.50	CAN	Larose, Gilbert	9.00	HUN	Aranyos, Istvan	9.05	CUB	Suárez, Octavio	8.00	CHE	Bocko, Frantisek	9.25
			Köste, Klaus	9.20		Nájera, Eduardo	4.00		Jensen, Sidney	9.05		Tihanyi, Endre	9.15		Pumpido, Roberto	8.70		Fejtek, Jiri	9.15
			Brehme, Matthias	9.10		Rendón, Pedro	3.50		Dion, Roger	6.15		Mentsik, Konrad	8.15		Navarrete, Luis	7.40		Kubicka, Vaclav	9.15
			Dietrich, Gerhard	8.80		Campos, Jorge	NSP		Brooker, Barry	7.90		Kiss, Sandor	9.05		Ramírez, Héctor	8.00		Mudrik, Bohumil	9.05
			Weber, Peter	8.85					Mitruk, Stephen	8.10		Herczegh, Bela	8.80		Rodríguez, Jorge	8.95		Netusil, Miloslav	7.50
			Beier, Günter	9.00								Bordan, Dezso	9.05		Ramírez, Luis	8.55		Skoumal, Vaclav	9.45
				TE	45.30				TE	40.20		TE	45.10		TE	42.20		TE	46.05

9e TOUR
9th ROUND

B	CHE	Bocko, Frantisek	9.20	ADE	Fülle, Siegfried	9.05	ECU	Luna, Sergio	8.10	CAN	Larose, Gilbert	9.10	HUN	Aranyos, Istvan	9.25	CUB	Suárez, Octavio	7.50
		Fejtek, Jiri	9.15		Köste, Klaus	9.25		Nájera, Eduardo	6.70		Jensen, Sidney	8.85		Tihanyi, Endre	9.10		Pumpido, Roberto	8.65
		Kubicka, Vaclav	9.40		Brehme, Matthias	9.50		Rendón, Pedro	5.50		Dion, Roger	8.55		Mentsik, Konrad	9.35		Navarrete, Luis	8.25
		Mudrik, Bohumil	9.10		Dietrich, Gerhard	9.15		Campos, Jorge	NSP		Brooker, Barry	8.90		Kiss, Sandor	9.40		Ramírez, Héctor	9.15
		Netusil, Miloslav	9.40		Weber, Peter	8.75					Herczegh, Bela	8.95		Rodríguez, Jorge	8.75		Rodríguez, Jorge	8.75
		Skoumal, Vaclav	9.25		Beier, Günter	8.75					Mitruk, Stephen	8.95		Bordan, Dezso	9.30		Ramírez, Luis	7.80
			TE	46.40		TE	45.70				TE	44.35		TE	46.55		TE	42.60

10e TOUR
10th ROUND

B	CUB	Suárez, Octavio	8.05	CHE	Bocko, Frantisek	8.90	ADE	Fülle, Siegfried	9.05	ECU	Luna, Sergio	8.35	CAN	Larose, Gilbert	8.20	HUN	Aranyos, Istvan	8.90
		Pumpido, Roberto	8.85		Fejtek, Jiri	9.40		Köste, Klaus	9.40		Nájera, Eduardo	0.00		Jensen, Sidney	9.05		Tihanyi, Endre	8.80
		Navarrete, Luis	7.00		Kubicka, Vaclav	8.90		Brehme, Matthias	9.30		Rendón, Pedro	6.75		Dion, Roger	7.70		Mentsik, Konrad	9.30
		Ramírez, Héctor	9.05		Mudrik, Bohumil	9.10		Dietrich, Gerhard	8.85		Campos, Jorge	NSP		Brooker, Barry	7.20		Kiss, Sandor	8.60
		Rodríguez, Jorge	9.05		Netusil, Miloslav	9.30		Weber, Peter	9.00					Ramírez, Héctor	8.35		Herczegh, Bela	9.15
		Ramírez, Luis	8.30		Skoumal, Vaclav	7.90		Beier, Günter	8.45					Mitruk, Stephen			Rodríguez, Jorge	9.05
			TE	43.30		TE	45.60		TE	45.60				TE	40.50		Bordan, Dezso	9.25
																	TE	45.20

11e TOUR
11th ROUND

		I		II		III		IV		V		VI							
		PI		PI		PI		PI		PI		PI							
B	HUN	Aranyos, Istvan	8.35	CUB	Suárez, Octavio	8.65	CHE	Bocko, Frantisek	8.95	ADE	Fülle, Siegfried	9.35	ECU	Luna, Sergio	7.70	CAN	Larose, Gilbert	8.80	
		Tihanyi, Endre	9.10		Pumpido, Roberto	6.85		Fejtek, Jiri	9.35		Köste, Klaus	9.15		Nájera, Eduardo	5.50		Jensen, Sidney	8.80	
		Mentsik, Konrad	8.05		Navarrete, Luis	7.90		Kubicka, Vaclav	9.00		Brehme, Matthias	9.20		Rendón, Pedro	5.70		Dion, Roger	8.95	
		Kiss, Sandor	8.65		Ramirez, Héctor	8.30		Mudrik, Bohumil	8.25		Dietrich, Gerhard	9.00		Campos, Jorge	NSP		Brooker, Barry	8.65	
		Herczegh, Bela	8.45		Rodríguez, Jorge	7.70		Netusil, Miloslav	9.10		Weber, Peter	9.20						Mitruk, Stephen	8.70
		Bordan, Dezso	7.90		Ramírez, Luis	6.75		Skoumal, Vaclav	8.95		Beier, Günter	9.30							
		TE	42.60			TE	39.40			TE	45.35							TE	43.90

12e TOUR
12th ROUND

B	CAN	Larose, Gilbert	8.60	HUN	Aranyos, Istvan	8.65	CUB	Suárez, Octavio	8.80	CHE	Bocko, Frantisek	9.25	ADE	Fülle, Siegfried	9.40	ECU	Luna, Sergio	8.05	
		Jensen, Sidney	8.10		Tihanyi, Endre	8.65		Pumpido, Roberto	7.85		Fejtek, Jiri	9.10		Köste, Klaus	9.45		Nájera, Eduardo	8.05	
		Dion, Roger	7.60		Mentsik, Konrad	7.50		Navarrete, Luis	6.50		Kubicka, Vaclav	9.30		Brehme, Matthias	9.60		Rendón, Pedro	4.65	
		Brooker, Barry	7.60		Kiss, Sandor	8.75		Ramirez, Héctor	7.85		Mudrik, Bohumil	9.25		Dietrich, Gerhard	8.70		Campos, Jorge	NSP	
		Mitruk, Stephen	7.00		Herczegh, Bela	8.75		Rodríguez, Jorge	8.25		Netusil, Miloslav	8.95		Weber, Peter	9.50				
			TE	38.90		Bordan, Dezso	8.80		Ramírez, Luis	8.55		Skoumal, Vaclav	9.20		Beier, Günter	9.10			TE
						TE	43.60			TE	41.30								

13e TOUR
13th ROUND

C	ALE	Haussler, Heinz	9.00	FIN	Nissinen, Mauno	9.40	YUG	Cerar, Miroslav	9.30	COR	Kim, Choong-Tai	9.00	CDN	Jung, Ryul-Jo	NSP	SUE	Johannesson, Finn	7.95	
		Hess, Erich	9.00		Rahikainen, Keijo	9.00		Brodnik, Janez	9.20	GBR	Booth, Michael	8.90		Heung, Do-Sin	NSP		Jonsson, Christer	9.50	
		Hopfner, Hermann	9.00		Rantakari, Hannu	8.35		Kersnic, Milenko	9.05		Wild, Stanley	9.10		Byung, Suk-Kim	NSP		Lindgren, Evert	8.70	
		Jaschek, Willi	9.15		Sappinen, Heikki	8.60		Srot, Martin	9.20					Joon, Han	NSP				
		Reinemer, Heiko	9.25		Heino, Reino	8.80		Vratic, Milko	8.75					Song, Sub-Ri	NSP				
		Tepasse, Helmut	9.00		Laiho, Olli	9.45		Anic, Damir	8.25					Sung, Il-Kim	NSP				
		TE	45.40			TE	45.25			TE	45.50								

14e TOUR
14th ROUND

C	SUE	Johannesson, Finn	8.75	ALE	Haussler, Heinz	9.30	FIN	Nissinen, Mauno	9.30	YUG	Cerar, Miroslav	9.20	GBR	Booth, Michael	8.70	CDN	Jung, Ryul-Jo	NSP	
		Jonsson, Christer	8.90		Hess, Erich	8.85		Rahikainen, Keijo	8.95		Brodnik, Janez	9.25		Wild, Stanley	9.10		Heung, Do-Sin	NSP	
		Lindgren, Evert	7.55		Hopfner, Hermann	8.80		Rantakari, Hannu	9.10		Kersnic, Milenko	9.10		Kim, Choong-Tai	9.05		Byung, Suk-Kim	NSP	
					Jaschek, Willi	9.25		Sappinen, Heikki	9.20		Srot, Martin	9.05					Joon, Han	NSP	
					Reinemer, Heiko	7.00		Heino, Reino	9.00		Vratic, Milko	9.20					Song, Sub-Ri	NSP	
					Tepasse, Helmut	7.70		Laiho, Olli	8.00		Anic, Damir	8.85					Sung, Il-Kim	NSP	
					TE	43.90			TE	45.55								TE	45.80

15e TOUR
15th ROUND

C	CDN	Jung, Ryul-Jo	NSP	SUE	Johannesson, Finn	8.55	ALE	Haussler, Heinz	8.65	FIN	Nissinen, Mauno	8.95	YUG	Cerar, Miroslav	9.60	COR	Kim, Choong-Tai	8.20	
		Heung, Do-Sin	NSP		Jonsson, Christer	8.85		Hess, Erich	8.90		Rahikainen, Keijo	9.00		Brodnik, Janez	9.30	GBR	Booth, Michael	8.75	
		Byung, Suk-Kim	NSP		Lindgren, Evert	8.75		Hopfner, Hermann	8.45		Rantakari, Hannu	9.05		Kersnic, Milenko	9.50		Wild, Stanley	8.50	
		Joon, Han	NSP					Jaschek, Willi	9.10		Sappinen, Heikki	8.90		Srot, Martin	8.20				
		Song, Sub-Ri	NSP					Reinemer, Heiko	8.85		Heino, Reino	8.90		Vratic, Milko	8.90				
		Sung, Il-Kim	NSP					Tepasse, Helmut	8.45		Laiho, Olli	9.15		Anic, Damir	8.85				
		NSP						TE	43.95			TE	45.05					TE	45.15

16e TOUR
16th ROUND

I			II			III			IV			V			VI				
C	GBR	Booth, Michael	PI	CDN	Jung, Ryul-Jo	PI	SUE	Johannesson, Finn	PI	ALE	Hauszler, Heinz	PI	FIN	Nissinen, Mauno	PI	YUG	Cerar, Miroslav	PI	
		Wild, Stanley	8.90		Heung, Do-Sin	NSP		Jonsson, Christer	9.10		Hess, Erich	8.85		Rahikainen, Keijo	9.40		Brodnik, Janez	9.55	
	COR	Kim, Choong-Tai	8.85		Byung, Suk-Kim	NSP		Lindgren, Evert	7.85		Hopfner, Hermann	9.00		Rantakari, Hannu	9.30		Kersnic, Milenko	9.45	
					Joon, Han	NSP					Jaschek, Willi	8.95		Sappinen, Heikki	9.15		Srot, Martin	9.05	
				Song, Sub-Ri	NSP					Reinemer, Heiko	9.10		Heino, Reino	9.05		Vratic, Milko	9.20		
				Sung, Il-Kim	NSP					Tepasse, Helmut	9.05		Laiho, Olli	9.50		Anic, Damir	8.80		
				Sung, Joo-Kim	NSP														
										TE	45.10			TE	46.40			TE	46.05

17e TOUR
17th ROUND

C	YUG	Cerar, Miroslav	9.25	COR	Kim, Choong-Tai	9.15	CDN	Jung, Ryul-Jo	NSP	SUE	Johannesson, Finn	9.05	ALE	Hauszler, Heinz	9.20	FIN	Nissinen, Mauno	9.45	
		Brodnik, Janez	9.05	GBR	Booth, Michael	8.40		Heung, Do-Sin	NSP		Jonsson, Christer	9.10		Hess, Erich	8.85		Rahikainen, Keijo	8.95	
		Kersnic, Milenko	9.20		Wild, Stanley	8.70		Byung, Suk-Kim	NSP		Lindgren, Evert	9.15		Hopfner, Hermann	9.10		Rantakari, Hannu	9.25	
		Srot, Martin	7.40					Joon, Han	NSP					Jaschek, Willi	9.35		Sappinen, Heikki	8.90	
	Vratic, Milko	8.75					Song, Sub-Ri	NSP					Reinemer, Heiko	9.20		Heino, Reino	8.40		
	Anic, Damir	8.50					Sung, Il-Kim	NSP					Tepasse, Helmut	9.45		Laiho, Olli	8.65		
							Sung, Joo-Kim	NSP											
										TE	44.75			TE	46.30			TE	45.20

18e TOUR
18th ROUND

680 C	FIN	Nissinen, Mauno	9.20	YUG	Cerar, Miroslav	9.65	GBR	Booth, Michael	7.85	CDN	Jung, Ryul-Jo	NSP	SUE	Johannesson, Finn	8.95	ALE	Hauszler, Heinz	9.05	
		Rahikainen, Keijo	8.80		Brodnik, Janez	8.85		Wild, Stanley	8.45		Heung, Do-Sin	NSP		Jonsson, Christer	9.20		Hess, Erich	9.55	
		Rantakari, Hannu	8.60		Kersnic, Milenko	8.85	COR	Kim, Choong-Tai	8.85		Byung, Suk-Kim	NSP		Lindgren, Evert	8.75		Hopfner, Hermann	9.20	
		Sappinen, Heikki	9.15		Srot, Martin	8.60					Joon, Han	NSP					Jaschek, Willi	9.30	
	Heino, Reino	8.85		Vratic, Milko	8.95					Song, Sub-Ri	NSP						Reinemer, Heiko	9.20	
	Laiho, Olli	8.60		Anic, Damir	8.35					Sung, Il-Kim	NSP						Tepasse, Helmut	9.35	
										Sung, Joo-Kim	NSP								
										TE	44.60								
																		TE	46.60

19e TOUR
19th ROUND

D	TWN	Lai, Chu-Long	8.30	URS	Voronin, Michail	9.70	JPN	Endo, Yukio	9.45	DIN	Thomsen, Arne	9.00	BUL	Adamov, Guerogui	9.35	FRA	Bouchonnet, Michel	9.20
		Cheng, Fu	7.70		Diomidov, Sergey	9.50		Kato, Takeshi	9.70		Nielsen, Hans	8.95		Zoev, Stefan	9.10		Deuza, Christian	9.20
	AGL	Lazhari, Larbi	8.45		Lisitsky, Victor	9.30		Nakayama, Akinori	9.75	MGL	Zagdvazar, Niamdavava	8.75		Khristov, Raitcho	8.50		Guiffroy, Christian	9.50
					Karasev, Valery	9.35		Kato, Sawao	9.70					Kondev, Ivan	8.85			
				Klimenko, Vladimir	9.50		Tsukahara, Mitsuo	9.65						Gabrovsky, Roumene	8.95			
				Ilijnykh, Valery	9.05		Kenmotsu, Eizo	9.55						Ivanov, Bojidar	9.10			
					TE	47.35			TE	48.35					TE	45.35		

20e TOUR
20th ROUND

D	FRA	Bouchonnet, Michel	9.15	AGL	Lazhari, Larbi	6.65	URS	Voronin, Michail	9.75	JPN	Endo, Yukio	9.35	MGL	Zagdvazar, Niamdavava	8.50	BUL	Adamov, Guerogui	9.50	
		Deuza, Christian	8.30	TWN	Lai, Chu-Long	4.50		Diomidov, Sergey	9.60		Kato, Takeshi	9.45	DIN	Thomsen, Arne	9.15		Zoev, Stefan	9.25	
		Guiffroy, Christian	9.00		Cheng, Fu	3.50		Lisitsky, Victor	9.40		Nakayama, Akinori	9.45		Nielsen, Hans	9.00		Khristov, Raitcho	9.50	
								Karasev, Valery	9.45		Kato, Sawao	9.35					Kondev, Ivan	8.75	
							Klimenko, Vladimir	9.40		Tsukahara, Mitsuo	9.05						Gabrovsky, Roumene	9.10	
							Ilijnykh, Valery	9.30		Kenmotsu, Eizo	9.40						Ivanov, Bojidar	7.50	
								TE	47.60			TE	47.00					TE	46.10

21e TOUR
21st ROUND

I			II			III			IV			V			VI			
D	BUL	Adamov, Guerogui	PI 8.20	FRA	Bouchonnet, Michel	PI 9.10	TWN	Lai, Chu-Long	PI 7.65	URS	Voronin, Michail	PI 9.45	JPN	Endo, Yukio	PI 9.65	DIN	Thomsen, Arne	PI 8.20
		Zoev, Stefan	8.65		Deuza, Christian	9.00		Cheng, Fu	6.65		Diomidov, Sergey	9.40		Kato, Takeshi	9.60		Nielsen, Hans	8.30
		Khristov, Raitcho	9.35		Guiffroy, Christian	9.05	AGL	Lazhari, Larbi	6.15		Lisitsky, Victor	9.40		Nakayama, Akinori	9.70	MGL	Zagdvazar, Niamdavaa	9.00
		Kondev, Ivan	9.10								Karasev, Valery	9.45		Kato, Sawao	9.65			
		Gabrovsky, Roumene	8.90								Klimenko, Vladimir	9.45		Tsukahara, Mitsuo	8.35			
		Ivanov, Bojidar	8.25								Ilijnykh, Valery	9.30	TE	Kenmotsu, Eizo	9.60	TE		
		TE 44.25									TE 47.15			TE 48.20				

22e TOUR
22nd ROUND

D	MGL	Zagdvazar, Niamdavaa	8.30	BUL	Adamov, Guerogui	9.05	FRA	Bouchonnet, Michel	8.65	AGL	Lazhari, Larbi	8.55	URS	Voronin, Michail	9.75	JPN	Endo, Yukio	9.55
	DIN	Thomsen, Arne	9.10		Zoev, Stefan	9.35		Deuza, Christian	8.90	TWN	Lai, Chu-Long	8.60		Diomidov, Sergey	9.45		Kato, Takeshi	9.55
		Nielsen, Hans	8.50		Khristov, Raitcho	8.40		Guiffroy, Christian	8.60		Cheng, Fu	8.60		Lisitsky, Victor	9.60		Nakayama, Akinori	9.70
					Kondev, Ivan	8.80								Karasev, Valery	9.55		Kato, Sawao	9.60
					Gabrovsky, Roumene	8.40								Klimenko, Vladimir	9.60		Tsukahara, Mitsuo	9.60
					Ivanov, Bojidar	7.70								Ilijnykh, Valery	9.50		Kenmotsu, Eizo	9.55
					TE 44.00									TE 48.00			TE 47.95	

23e TOUR
23rd ROUND

D	JPN	Endo, Yukio	9.15	DIN	Thomsen, Arne	7.70	BUL	Adamov, Guerogui	8.80	FRA	Bouchonnet, Michel	8.80	TWN	Lai, Chu-Long	8.70	URS	Voronin, Michail	9.70
		Kato, Takeshi	9.60		Nielsen, Hans	9.00		Zoev, Stefan	8.65		Deuza, Christian	8.75		Cheng, Fu	8.55		Diomidov, Sergey	9.60
		Nakayama, Akinori	9.60	MGL	Zagdvazar, Niamdavaa	8.45		Khristov, Raitcho	8.10		Guiffroy, Christian	9.10	AGL	Lazhari, Larbi	9.00		Lisitsky, Victor	9.35
		Kato, Sawao	9.75					Kondev, Ivan	8.60								Karasev, Valery	9.40
		Tsukahara, Mitsuo	9.50					Gabrovsky, Roumene	8.60								Klimenko, Vladimir	9.50
		Kenmotsu, Eizo	9.55					Ivanov, Bojidar	8.65								Ilijnykh, Valery	9.50
		TE 48.00						TE 43.30									TE 47.70	

24e TOUR
24th ROUND

D	URS	Voronin, Michail	9.55	JPN	Endo, Yukio	9.20	MGL	Zagdvazar, Niamdavaa	8.90	BUL	Adamov, Guerogui	9.20	FRA	Bouchonnet, Michel	8.55	AGL	Lazhari, Larbi	8.70
		Diomidov, Sergey	9.50		Kato, Takeshi	9.20	DIN	Thomsen, Arne	8.10		Zoev, Stefan	9.10		Deuza, Christian	9.30	TWN	Lai, Chu-Long	8.70
		Lisitsky, Victor	9.50		Nakayama, Akinori	9.40		Nielsen, Hans	8.80		Khristov, Raitcho	8.95		Guiffroy, Christian	9.55		Cheng, Fu	8.10
		Karasev, Valery	9.55		Kato, Sawao	9.45					Kondev, Ivan	9.15						
		Klimenko, Vladimir	9.25		Tsukahara, Mitsuo	9.40					Gabrovsky, Roumene	9.10						
		Ilijnykh, Valery	9.10		Kenmotsu, Eizo	9.45					Ivanov, Bojidar	8.80	TE					
		TE 47.35			TE 46.90						TE 45.50							

EXERCICES LIBRES
VOLUNTARY EXERCISES

1er TOUR **OCT 24**
1st ROUND

	I	PI	II	PI	III	PI	IV	PI	V	PI	VI	PI
A	CDN Jung, Ryul-Jo Heung, Do-Sin Byung, Suk-Kim Joon, Han Song, Sub-Ri Sung, Il-Kim Sung, Joo-Kim	**	BUL Adamov, Guerogui Zoev, Stefan Khristov, Raitcho Kondev, Ivan Gabrovsky, Roumene Ivanov, Bojidar	8.20 8.00 8.80 8.85 8.00 8.70	ITA Carminucci, Giovanni Carminucci, Pasquale Cimnaghi, Luigi Franceschetti, Bruno Menichelli, Franco Mori, Vincenzo	8.90 8.55 9.05 9.00 8.00	AUS Chessell, Murray GBR Booth, Michael Wild, Stanley	8.75 8.95 9.15	MEX Valles, Armando González, José García, Enrique Mendoza, Rogelio Vilchis, José Valles, Fernando	8.85 8.70 8.90 8.75 8.70 8.45	MGL Zagdvazar, Niamdavaa TWN Lai, Chu-Long Cheng, Fu	8.00 8.40 4.00
			TE 42.55		TE 43.50				TE 43.90			

2e TOUR
2nd ROUND

A	MGL Zagdvazar, Niamdavaa TWN Lai, Chu-Long Cheng, Fu	8.20 7.90 8.05	CDN Jung, Ryul-Jo Heung, Do-Sin Byung, Suk-Kim Joon, Han Song, Sub-Ri Sung, Il-Kim Sung, Joo-Kim	**	BUL Adamov, Guerogui Zoev, Stefan Khristov, Raitcho Kondev, Ivan Gabrovsky, Roumene Ivanov, Bojidar	8.85 8.70 8.60 8.15 8.95 8.45	ITA Carminucci, Giovanni Carminucci, Pasquale Cimnaghi, Luigi Franceschetti, Bruno Menichelli, Franco Mori, Vincenzo	8.70 8.60 8.95 8.95 9.05	AUS Chessell, Murray GBR Booth, Michael Wild, Stanley	8.90 8.95 8.70	MEX Valles, Armando González, José García, Enrique Mendoza, Rogelio Vilchis, José Valles, Fernando	8.00 8.75 9.05 9.00 8.80 8.40
					TE 44.25		TE 43.55				TE 44.00	

682

3e TOUR
3rd ROUND

A	MEX Valles, Armando González, José García, Enrique Mendoza, Rogelio Vilchis, José Valles, Fernando	8.80 8.80 8.65 9.10 8.40 8.45	MGL Zagdvazar, Niamdavaa TWN Lai, Chu-Long Cheng, Fu	8.25 7.80 6.95	CDN Jung, Ryul-Jo Heung, Do-Sin Byung, Suk-Kim Joon, Han Song, Sub-Ri Sung, Il-Kim Sung, Joo-Kim	**	BUL Adamov, Guerogui Zoev, Stefan Khristov, Raitcho Kondev, Ivan Gabrovsky, Roumene Ivanov, Bojidar	9.20 9.15 9.20 9.10 9.05 8.90	ITA Carminucci, Giovanni Carminucci, Pasquale Cimnaghi, Luigi Franceschetti, Bruno Menichelli, Franco Mori, Vincenzo	9.40 9.20 9.15 9.15 9.15 8.40	AUS Chessell, Murray GBR Booth, Michael Wild, Stanley	8.25 9.00 8.75
		TE 43.80					TE 45.70		TE 45.30			

4e TOUR
4th ROUND

A	AUS Chessell, Murray GBR Booth, Michael Wild, Stanley	8.65 9.15 9.15	MEX Valles, Armando González, José García, Enrique Mendoza, Rogelio Vilchis, José Valles, Fernando	9.10 6.45 8.40 9.05 7.70 8.35	MGL Zagdvazar, Niamdavaa TWN Lai, Chu-Long Cheng, Fu	8.15 7.65 7.10	CDN Jung, Ryul-Jo Heung, Do-Sin Byung, Suk-Kim Joon, Han Song, Sub-Ri Sung, Il-Kim Sung, Joo-Kim	**	BUL Adamov, Guerogui Zoev, Stefan Khristov, Raitcho Kondev, Ivan Gabrovsky, Roumene Ivanov, Bojidar	9.45 8.85 9.15 9.00 9.00 9.25	ITA Carminucci, Giovanni Carminucci, Pasquale Cimnaghi, Luigi Franceschetti, Bruno Menichelli, Franco Mori, Vincenzo	8.45 8.95 9.40 9.10 8.10 8.10
			TE 42.60				TE 45.85		TE 45.85		TE 44.00	

5e TOUR
5th ROUND

A	ITA Carminucci, Giovanni Carminucci, Pasquale Cimnaghi, Luigi Franceschetti, Bruno Menichelli, Franco Mori, Vincenzo	9.00 8.65 9.30 8.65 8.70	AUS Chessell, Murray GBR Booth, Michael Wild, Stanley	8.25 8.40 9.10	MEX Valles, Armando González, José García, Enrique Mendoza, Rogelio Vilchis, José Valles, Fernando	9.20 8.10 8.35 8.70 9.00 7.85	MGL Zagdvazar, Niamdavaa TWN Lai, Chu-Long Cheng, Fu	8.65 8.40 8.00	CDN Jung, Ryul-Jo Heung, Do-Sin Byung, Suk-Kim Joon, Han Song, Sub-Ri Sung, Il-Kim Sung, Joo-Kim	**	BUL Adamov, Guerogui Zoev, Stefan Khristov, Raitcho Kondev, Ivan Gabrovsky, Roumene Ivanov, Bojidar	9.15 8.90 9.40 9.00 7.75 9.15
		TE 44.30			TE 43.35						TE 45.60	

6e TOUR
6th ROUND

I		II		III		IV		V		VI							
BUL	Adamov, Guerogui	8.90	ITA	Carminucci, Giovanni	9.35	AUS	Chessell, Murray	8.55	MEX	Valles, Armando	9.20	MGL	Zagdvazar, Niamdavaa	8.50	CDN	Jung, Ryul-Jo	PI
	Zoev, Stefan	9.15		Carminucci, Pasquale	9.05	GBR	Booth, Michael	7.70		González, José	8.85	TWN	Lai, Chu-Long	7.70		Heung, Do-Sin	**
A	Khrstov, Raitcho	9.60		Cimnaghi, Luigi	8.85		Wild, Sidney	8.20		García, Enrique	8.65		Cheng, Fu	8.05		Byung, Suk-Kim	
	Kondev, Ivan	9.50		Franceschetti, Bruno	9.25					Mendoza, Rogelio	9.30					Joon, Han	
	Gabrovsky, Roumene	9.10		Menichelli, Franco	—					Vilchis, José	8.80					Song, Sub-Ri	
	Ivanov, Bojidar	9.05		Mori, Vincenzo	8.85					Valles, Fernando	9.15					Sung, Il-Kim	
	TE	46.40		TE	45.35					TE	45.30						

7e TOUR
7th ROUND

B	ALE	Hausssler, Heinz	9.15	SUE	Johannesson, Finn	8.60	CUB	Suárez, Octavio	8.85	ECU	Luna, Sergio	8.70	CAN	Larose, Gilbert	9.20	FIL	Beren, Ernesto	**
		Hess, Erich	9.05		Jonsson, Christer	7.90		Pumpido, Roberto	8.40		Nájera, Eduardo	8.05		Jensen, Sidney	8.35		Henson, Norman	
		Hopfner, Hermann	9.05		Lindgren, Evert	9.35		Navarrete, Luis	7.15	AGL	Rendón, Pedro	7.15		Dion, Roger	9.10			
		Jaschek, Willi	2.00					Ramírez, Héctor	8.60		Lazhari, Larbi	8.90		Brooker, Barry	8.05			
		Reinemer, Heiko	9.40					Rodríguez, Jorge	8.90					Mitruk, Stephen	8.80			
		Tepasse, Helmut	9.00					Ramírez, Luis	8.95									
		TE	45.65					TE	43.70					TE	43.50			

8e TOUR
8th ROUND

B	FIL	Beren Ernesto	**	ALE	Hausssler, Heinz	9.50	SUE	Johannesson, Finn	9.15	CUB	Suárez, Octavio	9.15	ECU	Luna, Sergio	8.95	CAN	Larose, Gilbert	8.60	
		Henson, Norman			Hess, Erich	8.25		Jonsson, Christer	9.05		Pumpido, Roberto	9.00		Nájera, Eduardo	7.20		Jensen, Sidney	9.20	
					Hopfner, Hermann	9.00		Lindgren, Evert	8.80		Navarrete, Luis	9.20		Rendón, Pedro	7.55		Dion, Roger	8.85	
					Jaschek, Willi	9.55					Ramírez, Héctor	8.85	AGL	Lazhari, Larbi	7.75		Brooker, Barry	7.80	
					Reinemer, Heiko	8.80					Rodríguez, Jorge	9.10					Mitruk, Stephen	8.75	
					Tepasse, Helmut	9.10					Ramírez, Luis	8.85							
					TE	45.95					TE	45.30						TE	43.20

683

9e TOUR
9th ROUND

B	CAN	Larose, Gilbert	9.30	FIL	Beren, Ernesto	**	ALE	Hausssler, Heinz	8.90	SUE	Johannesson, Finn	9.10	CUB	Suárez, Octavio	9.20	ECU	Luna, Sergio	8.55
		Jensen, Sidney	8.95		Henson, Norman			Hess, Erich	9.25		Jonsson, Christer	9.30		Pumpido, Roberto	9.00		Nájera, Eduardo	4.70
		Dion, Roger	8.25					Hopfner, Hermann	9.10		Lindgren, Evert	9.20		Navarrete, Luis	8.60		Rendón, Pedro	3.50
		Brooker, Barry	8.30					Jaschek, Willi	9.30					Ramírez, Héctor	8.55	AGL	Lazhari, Larbi	9.25
		Mitruk, Stephen	8.35					Reinemer, Heiko	9.40					Rodríguez, Jorge	8.15			
		TE	43.15					Tepasse, Helmut	9.30					Ramírez, Luis	8.65			
								TE	46.35					TE	44.00			

10e TOUR
10th ROUND

B	ECU	Luna, Sergio	8.45	CAN	Larose, Gilbert	9.05	FIL	Beren, Ernesto	**	ALE	Hausssler, Heinz	8.95	SUE	Johannesson, Finn	9.00	CUB	Suárez, Octavio	9.20
		Nájera, Eduardo	7.85		Jensen, Sidney	8.00		Henson, Norman			Hess, Erich	9.25		Jonsson, Christer	9.45		Pumpido, Roberto	8.75
		Rendón, Pedro	7.50		Dion, Roger	8.45					Hopfner, Hermann	9.15		Lindgren, Evert	9.45		Navarrete, Luis	7.00
		AGL	Lazhari, Larbi		Brooker, Barry	7.70					Jaschek, Willi	0.00					Ramírez, Héctor	9.05
					Mitruk, Stephen	8.75					Reinemer, Heiko	9.35					Rodríguez, Jorge	9.20
					TE	41.95					Tepasse, Helmut	9.40					Ramírez, Luis	8.95
											TE	46.10					TE	45.15

11e TOUR
11th ROUND

	I	PI	II	PI	III	PI	IV	PI	V	PI	VI	PI
B	CUB Suárez, Octavio	8.80	ECU Luna, Sergio	5.75	CAN Larose, Gilbert	9.30	FIL Beren, Ernesto	PI**	ALE Haussler, Heinz	9.10	SUE Johannesson, Finn	9.40
	Pumpido, Roberto	9.10	Nájera, Eduardo	3.50	Jensen, Sidney	9.20	Henson, Norman		Hess, Erich	8.45	Jonsson, Christer	9.40
	Navarrete, Luis	8.80	Rendón, Pedro	5.80	Dion, Roger	8.25			Hopfner, Hermann	9.20	Lindgren, Evert	9.35
	Ramírez, Héctor	—	AGL Lazhari, Larbi	7.00	Broocker, Barry	8.55			Jaschek, Willi	9.50		
	Rodríguez, Jorge	9.35			Mitruk, Stephen	8.40			Reinemer, Heiko	9.30		
	Ramírez, Luis	9.20							Tepasse, Helmut	9.45		
	TE	45.25			TE	43.70			TE	46.55		

12e TOUR
12th ROUND

B	SUE Johannesson, Finn	8.80	CUB Suárez, Octavio	8.90	ECU Luna, Sergio	8.60	CAN Larose, Gilbert	9.20	FIL Beren, Ernesto	**	ALE Haussler, Heinz	9.15
	Jonsson, Christer	9.15	Pumpido, Roberto	7.80	Nájera, Eduardo	7.15	Jensen, Sidney	9.35	Henson, Norman		Hess, Erich	9.35
	Lindgren, Evert	8.75	Navarrete, Luis	8.25	Rendón, Pedro	6.95	Dion, Roger	9.05			Hopfner, Hermann	9.10
			Ramírez, Héctor	4.50	AGL Lazhari, Larbi	8.10	Brooker, Barry	8.75			Jaschek, Willi	9.45
			Rodríguez, Jorge	8.40			Mitruk, Stephen	8.50			Reinemer, Heiko	9.45
			Ramírez, Luis	7.80							Tepasse, Helmut	9.10
			TE	41.15			TE	44.85			TE	46.50

13e TOUR
13th ROUND

684

C	COR Kim, Choong-Tai	8.90	HUN Aranyos, Istvan	8.70	DIN Thomsen, Arne	8.90	FIN Nissinen, Mauno	9.00	SUI Berchtold, Meinrad	9.45	EUA Allen, Kanati	9.40
	FRA Bouchonnet, Michel	9.05	Tihanyi, Endre	8.55	Nielsen, Hans	9.05	Rahikainen, Keijo	9.20	Ettlin, Hans	9.50	Cohen, Steven	9.45
	Deuza, Christian	8.95	Mentsik, Konrad	8.60	POR Abreu, José	9.05	Rantakari, Hannu	8.80	Greutmann, Edwin	9.25	Freudenstein, Sidney	9.50
	Guiffroy, Christian	9.20	Kiss, Sandor	8.55			Sappinen, Heikki	9.15	Hurzeler, Roland	9.60	Hug, Steve	9.35
			Herczegh, Bela	7.60			Heino, Reino	8.80	Müller, Paul	9.25	Roethlisberger, Fred	9.35
			Bordan, Dezso	8.65			Laiho, Olli	9.00	Rohner, Peter	9.40	Thor, David	9.50
			TE	43.05			TE	45.15	TE	47.20	TE	47.20

14e TOUR
14th ROUND

C	EUA Allen, Kanati	9.20	COR Kim, Choong-Tai	9.35	HUN Aranyos, Istvan	9.00	DIN Thomsen, Arne	7.00	FIN Nissinen, Mauno	9.60	SUI Berchtold, Meinrad	9.35
	Cohen, Steven	8.75	FRA Bouchonnet, Michel	9.25	Tihanyi, Endre	9.20	Nielsen, Hans	9.00	Rahikainen, Keijo	9.25	Ettlin, Hans	9.45
	Freudenstein, Sidney	9.50	Deuza, Christian	8.35	Mentsik, Konrad	8.75	POR Abreu, José	8.70	Rantakari, Hannu	9.20	Greutmann, Edwin	9.10
	Hug, Steve	9.15	Guiffroy, Christian	8.60	Kiss, Sandor	8.95			Sappinen, Heikki	9.10	Hurzeler, Roland	9.45
	Roethlisberger, Fred	9.40			Herczegh, Bela	8.85		Heino, Reino	9.10	Müller, Paul	8.80	
	Thor, David	9.30			Bordan, Dezso	7.80		Laiho, Olli	9.55	Rohner, Peter	9.35	
	TE	46.55			TE	44.75		TE	46.70	TE	46.70	

15e TOUR
15th ROUND

C	SUI Berchtold, Meinrad	8.95	EUA Allen, Kanati	8.85	COR Kim, Choong-Tai	9.00	HUN Aranyos, Istvan	9.20	DIN Thomsen, Arne	8.75	FIN Nissinen, Mauno	9.50
	Ettlin, Hans	9.05	Cohen, Steven	8.35	FRA Bouchonnet, Michel	8.60	Tihanyi, Endre	9.05	Nielsen, Hans	9.20	Rahikainen, Keijo	9.20
	Greutmann, Edwin	8.95	Freudenstein, Sidney	7.85	Deuza, Christian	8.60	Mentsik, Konrad	8.90	POR Abreu, José	8.95	Rantakari, Hannu	9.50
	Hurzeler, Roland	8.90	Hug, Steve	9.40	Guiffroy, Christian	8.95	Kiss, Sandor	9.15			Sappinen, Heikki	9.35
	Müller, Paul	8.80	Roethlisberger, Fred	8.70			Herczegh, Bela	9.05			Heino, Reino	9.30
	Rohner, Peter	9.15	Thor, David	9.60			Bordan, Dezso	8.85			Laiho, Olli	9.40
	TE	45.00	TE	44.60			TE	45.35			TE	47.05

16e TOUR
16th ROUND

I		II		III		IV		V		VI		
	PI		PI		PI		PI		PI		PI	
C	FIN Nissinen, Mauno	9.10	SUI Berchtold, Meinrad	9.35	EUA Allen, Kanati	8.50	COR Kim, Choong-Tai	8.65	HUN Aranyos, Istvan	9.20	DIN Thomsen, Arne	9.20
	Rahikainen, Keijo	9.00	Ettlin, Hans	8.50	Cohen, Steven	9.60	FRA Bouchonnet, Michel	9.15	Tihanyi, Endre	9.05	Nielsen, Hans	9.00
	Rantakari, Hannu	8.80	Greutmann, Edwin	8.60	Freudenstein, Sidney	9.15	Deuza, Christian	9.10	Mentsik, Konrad	9.50	POR Abreu, José	8.50
	Sappinen, Heikki	9.20	Hurzeler, Roland	9.05	Hug, Steve	9.10	Guiffroy, Christian	9.30	Kiss, Sandor	9.35		
	Heino, Reino	8.80	Müller, Paul	9.35	Roethlisberger, Fred	9.20			Herczegh, Bela	9.30		
	Laiho, Olli	8.75	Rohner, Peter	9.30	Thor, David	9.00			Bordan, Dezso	9.50		
	TE 44.90		TE 45.65		TE 46.85				TE 46.85			

17e TOUR
17th ROUND

C	DIN Thomsen, Arne	9.10	FIN Nissinen, Mauno	9.45	SUI Berchtold, Meinrad	9.20	EUA Allen, Kanati	9.15	COR Kim, Choong-Tai	9.45	HUN Aranyos, Istvan	9.30
	Nielsen, Hans	9.25	Rahikainen, Keijo	8.90	Ettlin, Hans	9.35	Cohen, Steven	9.05	FRA Bouchonnet, Michel	9.25	Tihanyi, Endre	9.15
	POR Abreu, José	9.20	Rantakari, Hannu	8.35	Greutmann, Edwin	8.90	Freudenstein, Sidney	8.95	Deuza, Christian	9.40	Mentsik, Konrad	9.50
			Sappinen, Heikki	9.20	Hurzeler, Roland	9.05	Hug, Steve	9.05	Guiffroy, Christian	9.65	Kiss, Sandor	9.10
			Heino, Reino	8.80	Müller, Paul	9.00	Roethlisberger, Fred	9.15			Herczegh, Bela	9.40
			Laiho, Olli	9.70	Rohner, Peter	8.95	Thor, David	9.40			Bordan, Dezso	9.40
			TE 46.05		TE 46.05		TE 45.80				TE 46.75	

18e TOUR
18th ROUND

C	HUN Aranyos, Istvan	8.70	DIN Thomsen, Arne	9.05	FIN Nissinen, Mauno	9.25	SUI Berchtold, Meinrad	9.35	EUA Allen, Kanati	9.05	COR Kim, Choong-Tai	9.45
	Tihanyi, Endre	9.00	Nielsen, Hans	9.30	Rahikainen, Keijo	9.05	Ettlin, Hans	9.25	Cohen, Steven	9.50	FRA Bouchonnet, Michel	9.40
	Mentsik, Konrad	8.75	POR Abreu, José	8.10	Rantakari, Hannu	9.15	Greutmann, Edwin	9.05	Freudenstein, Sidney	9.40	Deuza, Christian	9.30
	Kiss, Sandor	9.15			Sappinen, Heikki	9.25	Hurzeler, Roland	9.10	Hug, Steve	9.40	Guiffroy, Christian	9.50
	Herczegh, Bela	8.75			Heino, Reino	9.15	Müller, Paul	9.10	Roethlisberger, Fred	9.50		
	Bordan, Dezso	8.80			Laiho, Olli	9.20	Rohner, Peter	9.30	Thor, David	9.30		
	TE 44.45				TE 46.10		TE 47.10		TE 46.00			

19e TOUR
19th ROUND

D	POL Kubica, Wilhelm	9.30	JPN Endo, Yukio	9.20	URS Voronin, Michail	9.70	ADE Fülle, Siegfried	9.45	CHE Bocko, Frantisek	9.40	YUG Cerar, Miroslav	9.05
	Kubica, Mikolaj	9.30	Kato, Takeshi	9.45	Diomidov, Sergey	9.45	Köste, Klaus	9.25	Fejtek, Jiri	9.50	Brodnik, Janez	9.30
	Kubica, Sylwester	9.15	Nakayama, Akinori	9.45	Lisitsky, Victor	9.40	Brehme, Matthias	9.45	Kubicka, Vaclav	9.60	Kersnic, Milenko	9.00
	Kruza, Jerzy	8.95	Kato, Sawao	9.55	Karasev, Valery	9.15	Dietrich, Gerhard	9.00	Mudrik, Bohumil	9.50	Srot, Martin	9.35
	Gonera, Andrzej	9.05	Tsukahara, Mitsuo	8.25	Klimenko, Vladimir	9.50	Weber, Peter	9.30	Netusil, Miloslav	9.60	Vratic, Milko	9.30
	Rokosa, Aleksander	9.20	Kenmotsu, Eizo	9.65	Ilijnykh, Valery	9.30	Beier, Günter	9.30	Skoumal, Vaclav	9.30	Anic, Damir	9.50
	TE 46.00		TE 47.30		TE 47.35		TE 46.75		TE 47.60		TE 46.50	

20e TOUR
20th ROUND

D	YUG Cerar, Miroslav	9.40	POL Kubica, Wilhelm	9.50	JPN Endo, Yukio	9.50	URS Voronin, Michail	9.55	ADE Fülle, Siegfried	9.45	CHE Bocko, Frantisek	9.40
	Brodnik, Janez	9.00	Kubica, Mikolaj	9.55	Kato, Takeshi	9.70	Diomidov, Sergey	9.45	Köste, Klaus	9.30	Fejtek, Jiri	9.30
	Kersnic, Milenko	9.10	Kubica, Sylwester	9.40	Nakayama, Akinori	9.75	Lisitsky, Victor	9.40	Brehme, Matthias	9.50	Kubicka, Vaclav	9.40
	Srot, Martin	8.60	Kruza, Jerzy	9.10	Kato, Sawao	9.85	Karasev, Valery	9.45	Dietrich, Gerhard	9.35	Mudrik, Bohumil	9.40
	Vratic, Milko	8.90	Gonera, Andrzej	9.10	Tsukahara, Mitsuo	9.60	Klimenko, Vladimir	9.40	Weber, Peter	9.45	Netusil, Miloslav	9.25
	Anic, Damir	9.10	Rokosa, Aleksander	9.00	Kenmotsu, Eizo	9.45	Ilijnykh, Valery	9.45	Beier, Günter	9.35	Skoumal, Vaclav	9.55
	TE 45.50		TE 46.65		TE 48.40		TE 47.30		TE 47.10		TE 47.05	

21e TOUR
21st ROUND

	I	PI	II	PI	III	PI	IV	PI	V	PI	VI	PI
D	CHE Bocko, Frantisek	9.45	YUG Cerar, Miroslav	9.70	POL Kubica, Wilhelm	9.30	JPN Endo, Yukio	9.65	URS Voronin, Michail	9.70	ADE Fülle, Siegfried	9.55
	Fejtek, Jiri	9.25	Brodnik, Janez	9.15	Kubica, Mikolaj	9.45	Kato, Takeshi	9.60	Diomidov, Sergey	9.45	Köste, Klaus	9.70
	Kubicka, Vaclav	9.40	Kersnic, Milenko	8.80	Kubica, Sylwester	9.05	Nakayama, Akinori	9.40	Lisitsky, Victor	9.00	Brehme, Matthias	9.60
	Mudrik, Bohumil	9.30	Srot, Martin	8.65	Kruza, Jerzy	8.80	Kato, Sawao	9.55	Karasev, Valery	9.60	Dietrich, Gerhard	9.55
	Netusil, Miloslav	9.20	Vratic, Milko	9.40	Gonera, Andrzej	9.30	Tsukahara, Mitsuo	9.40	Klimenko, Vladimir	9.65	Weber, Peter	9.40
	Skoumal, Vaclav	9.30	Anic, Damir	9.15	Rokosa, Aleksander	9.20	Kenmotsu, Eizo	9.55	Iljinykh, Valery	9.45	Beier, Günter	9.25
	TE	46.70	TE	46.20	TE	46.30	TE	47.75	TE	47.85	TE	47.80

22e TOUR
22nd ROUND

D	ADE Fülle, Siegfried	9.45	CHE Bocko, Frantisek	9.40	YUG Cerar, Miroslav	9.40	POL Kubica, Wilhelm	9.30	JPN Endo, Yukio	9.50	URS Voronin, Michail	9.80
	Köste, Klaus	9.35	Fejtek, Jiri	9.60	Brodnik, Janez	9.30	Kubica, Mikolaj	9.40	Kato, Takeshi	9.70	Diomidov, Sergey	9.70
	Brehme, Matthias	9.40	Kubicka, Vaclav	9.00	Kersnic, Milenko	9.10	Kubica, Sylwester	9.30	Nakayama, Akinori	9.85	Lisitsky, Victor	9.45
	Dietrich, Gerhard	9.30	Mudrik, Bohumil	9.25	Srot, Martin	9.20	Kruza, Jerzy	9.15	Kato, Sawao	9.70	Karasev, Valery	9.30
	Weber, Peter	9.05	Netusil, Miloslav	9.55	Vratic, Milko	8.90	Gonera, Andrzej	9.35	Tsukahara, Mitsuo	9.60	Klimenko, Vladimir	9.60
	Beier, Günter	9.20	Skoumal, Vaclav	8.85	Anic, Damir	8.90	Rokosa, Aleksander	9.20	Kenmotsu, Eizo	9.65	Iljinykh, Valery	9.70
	TE	46.70	TE	46.80	TE	45.90	TE	46.55	TE	48.50	TE	48.25

23e TOUR
23rd ROUND

686

D	URS Voronin, Michail	9.70	ADE Fülle, Siegfried	8.25	CHE Bocko, Frantisek	9.20	YUG Cerar, Miroslav	9.40	POL Kubica, Wilhelm	9.65	JPN Endo, Yukio	9.70
	Diomidov, Sergey	9.45	Köste, Klaus	8.65	Fejtek, Jiri	9.40	Brodnik, Janez	9.35	Kubica, Mikolaj	9.60	Kato, Takeshi	9.55
	Lisitsky, Victor	9.50	Brehme, Matthias	9.25	Kubicka, Vaclav	9.30	Kersnic, Milenko	9.30	Kubica, Sylwester	9.40	Nakayama, Akinori	9.80
	Karasev, Valery	9.55	Dietrich, Gerhard	9.50	Mudrik, Bohumil	9.10	Srot, Martin	9.25	Kruza, Jerzy	9.15	Kato, Sawao	9.85
	Klimenko, Vladimir	9.50	Weber, Peter	8.95	Netusil, Miloslav	8.95	Vratic, Milko	9.30	Gonera, Andrzej	9.50	Tsukahara, Mitsuo	9.60
	Iljinykh, Valery	8.85	Beier, Günter	8.00	Skoumal, Vaclav	8.95	Anic, Damir	9.05	Rokosa, Aleksander	9.25	Kenmotsu, Eizo	9.80
	TE	47.70	TE	44.60	TE	45.95	TE	46.60	TE	47.40	TE	48.75

24e TOUR
24th ROUND

D	JPN Endo, Yukio	9.65	URS Voronin, Michail	9.50	ADE Fülle, Siegfried	9.40	CHE Bocko, Frantisek	9.30	YUG Cerar, Miroslav	9.50	POL Kubica, Wilhelm	9.70
	Kato, Takeshi	9.75	Diomidov, Sergey	9.50	Köste, Klaus	9.40	Fejtek, Jiri	9.40	Brodnik, Janez	9.35	Kubica, Mikolaj	9.60
	Nakayama, Akinori	9.80	Lisitsky, Victor	9.30	Brehme, Matthias	9.40	Kubicka, Vaclav	9.25	Kersnic, Milenko	9.50	Kubica, Sylwester	9.00
	Kato, Sawao	9.90	Karasev, Valery	9.50	Dietrich, Gerhard	9.20	Mudrik, Bohumil	9.30	Srot, Martin	9.20	Kruza, Jerzy	9.35
	Tsukahara, Mitsuo	9.60	Klimenko, Vladimir	9.60	Weber, Peter	9.30	Netusil, Miloslav	9.15	Vratic, Milko	9.35	Gonera, Andrzej	9.25
	Kenmotsu, Eizo	9.70	Iljinykh, Valery	9.40	Beier, Günter	9.10	Skoumal, Vaclav	9.25	Anic, Damir	9.00	Rokosa, Aleksander	9.45
	TE	48.80	TE	47.50	TE	46.70	TE	46.50	TE	46.90	TE	47.35

			Exercices imposés Compulsory exercises	Exercices libres Voluntary exercises	Total points
85	Bell, Margaret	GBR	8.10	8.20	16.30
87	Bautá, Nereida	CUB	8.40	7.80	16.20
87	Blanco, Suzette	CUB	7.90	8.30	16.20
89	Aldama, Nancy	CUB	8.15	8.00	16.15
90	Saenz, Julieta	MEX	7.95	8.00	15.95
91	Briones, Rosario	MEX	7.90	7.90	15.80
92	Ramírez, Elena	MEX	7.85	7.85	15.70
93	Bregado, Zulema	CUB	8.00	7.60	15.60
94	Morales, Luisa	MEX	7.85	7.35	15.20
95	Iadamsurengiin, Tuiaa	MGL	6.80	7.80	14.60
96	Vega, Yolanda	CUB	7.50	6.60	14.10
97	Dorj, Norlkhoo	MGL	6.90	6.80	13.70
98	Yu, Mai-Lee	TWN	6.50	7.10	13.60
99	Puente, Rosalinda	MEX	6.70	6.65	13.35
100	Rivera, Laura	MEX	6.70	5.75	12.45
101	Hong,Tan-Kuee	TWN	6.35	5.75	12.10

CHEVAL-SAUTOIR HORSE VAULT

1	Caslavska, Vera	CHE	9.875	9.900	19.775
2	Zuchold, Erika	ADE	9.825	9.800	19.625
3	Voronina, Zinaida	URS	9.700	9.800	19.500
4	Krajcirova, Mariana	CHE	9.725	9.750	19.475
5	Kuchinskaya, Natalia	URS	9.725	9.650	19.375
6	Sklenickova, Miroslava	CHE	9.675	9.650	19.325

CLASSEMENT FINAL FINAL CLASSIFICATION

EXERCICES AU SOL FLOOR EXERCISES

OCT 25

			Exercices imposés Compulsory exercises	Exercices libres Voluntary exercises	Total points
1	Petrik, Larissa	URS	9.775	9.900	19.675
1	Caslavska, Vera	CHE	9.775	9.900	19.675
3	Kuchinskaya, Natalia	URS	9.800	9.850	19.650
4	Voronina, Zinaida	URS	9.700	9.850	19.550
5	Karaseva, Olga	URS	9.575	9.750	19.325
5	Rimnacova, Bohumila	CHE	9.575	9.750	19.325

693

BARRES ASYMETRIQUES ASYMMETRICAL BARS

1	Caslavska, Vera	CHE	9.750	9.900	19.650
2	Janz, Karin	ADE	9.650	9.850	19.500
3	Voronina, Zinaida	URS	9.625	9.800	19.425
4	Rimnacova, Bohumila	CHE	9.650	9.700	19.350
5	Zuchold, Erika	ADE	9.525	9.800	19.325
6	Sklenickova, Miroslava	CHE	9.550	8.650	18.200

POUTRE BALANCE BEAM

1	Kuchinskaya, Natalia	URS	9.800	9.850	19.650
2	Caslavska, Vera	CHE	9.725	9.850	19.575
3	Petrik, Larissa	URS	9.500	9.750	19.250
4	Metheny, Linda	EJA	9.575	9.650	19.225
4	Janz, Karin	ADE	9.525	9.700	19.225
6	Zuchold, Erika	ADE	9.500	9.650	19.150

**EXERCICES IMPOSES
COMPULSORY EXERCISES**

1er TOUR
1st ROUND **OCT 21**

	I	PI	II	PI	III	PI	IV	PI
A	CUB Vega, Yolanda	7.50	MEX Briones, Rosario	6.30	POL Ochmanska, Lucja	8.75	GBR Bell, Margaret	8.40
	Aldama, Nancy	8.15	Sáenz, Julieta	7.70	Lech, Wieslawa	9.15	Prestidge, Mary	8.55
	Blanco, Suzette	7.90	Morales, Luisa	7.05	Witkowska, Grazyna	9.15	AUS Norris, Valerie	8.55
	Villacian, Miriam	8.40	Ramírez, Elena	7.75	Daniec, Halina	8.80	BEL Goethals, Christiane	8.75
	Bregado, Zulema	8.00	Rivera, Laura	7.85	Zieba, Barbara	9.05	Van Hoya, Horta	8.65
	Bauta, Nereida	8.40	Puente, Rosalinda	6.90	Chojnacka, Malgorzata	8.50		
	TE	40.85	TE	37.25	TE	44.90		

2e TOUR
2nd ROUND

A	DIN Trangbaek, Else	8.25	POL Ochmanska, Lucja	8.80	CUB Vega, Yolanda	6.90	MEX Briones, Rosario	8.40
	SUE Andersson, Solveig	9.10	Lech, Wieslawa	9.05	Aldama, Nancy	8.40	Sáenz, Julieta	8.40
	Holm, Rose-Marie	8.85	Witkowska, Grazyna	8.75	Blanco, Suzette	5.80	Morales, Luisa	8.25
	Lundquist, Marie	9.10	Daniec, Halina	8.50	Villacian, Miriam	8.65	Ramírez, Elena	8.30
			Zieba, Barbara	8.45	Bregado, Zulema	8.55	Rivera, Laura	8.55
			Chojnacka, Malgorzata	8.45	Bauta, Nereida	4.75	Puente, Rosalinda	8.20
			TE	43.55	TE	38.30	TE	41.90

694

3e TOUR
3rd ROUND

A	GBR Bell, Margaret	8.10	CUB Vega, Yolanda	8.20	SUE Andersson, Solveig	8.90	POL Ochmanska, Lucja	8.95
	AUS Prestidge, Mary	8.25	Aldama, Nancy	8.70	Holm, Rose-Marie	8.75	Lech, Wieslawa	8.90
	BEL Norris, Valerie	8.85	Blanco, Suzette	8.25	Lundquist, Marie	8.70	Witkowska, Grazyna	8.95
	Goethals, Christiane	8.50	Villacian, Miriam	8.00	DIN Trangbaek, Else	7.30	Daniec, Halina	8.60
	Van Hoya, Horta	9.00	Bregado, Zulema	8.70			Zieba, Barbara	8.70
			Bauta, Nereida	8.00			Chojnacka, Malgorzata	8.65
			TE	41.85			TE	44.15

4e TOUR
4th ROUND

A	MEX Briones, Rosario	7.90	SUE Andersson, Solveig	8.30	AUS Norris, Valerie	8.00	CUB Vega, Yolanda	8.05
	Sáenz, Julieta	7.95	Holm, Rose-Marie	8.85	BEL Goethals, Christiane	8.30	Aldama, Nancy	8.30
	Morales, Luisa	7.85	Lundquist, Marie	8.60	Van Hoya, Horta	7.60	Blanco, Suzette	8.20
	Ramírez, Elena	7.85	DIN Trangbaek, Else	8.25	GBR Bell, Margaret	8.60	Villacian, Miriam	8.20
	Rivera, Laura	6.70			Prestidge, Mary	7.95	Bregado, Zulema	8.95
	Puente, Rosalinda	6.70					Bauta, Nereida	8.45
	TE	38.25					TE	42.10

5e TOUR
5th ROUND

A	POL Ochmanska, Lucja	9.35	BEL Goethals, Christiane	8.45	MEX Briones, Rosario	7.25	SUE Andersson, Solveig	8.70
	Lech, Wieslawa	8.95	Van Hoya, Horta	8.70	Sáenz, Julieta	8.25	Holm, Rose-Marie	8.80
	Witkowska, Grazyna	8.75	GBR Bell, Margaret	8.55	Morales, Luisa	8.40	Lundquist, Marie	8.80
	Daniec, Halina	8.80	Prestidge, Mary	8.25	Ramírez, Elena	5.95	DIN Trangbaek, Else	8.70
	Zieba, Barbara	9.05	AUS Norris, Valerie	8.05	Rivera, Laura	7.80		
	Chojnacka, Malgorzata	8.35			Puente, Rosalinda	7.35		
	TE	44.90			TE	39.05		

6e TOUR
6th ROUND

	I	PI	II	PI	III	PI	IV	PI
B	NOR Holmen, Unni	8.95	ADE Starke, Ute	9.20	BUL Karachka, Maria	9.35	URS Kuchinskaya, Natalia	9.75
	Isberg, Torunn	8.65	Zuchold, Erika	9.45	Stoianova, Nelli	9.00	Voronina, Zinaida	9.65
	Kvamme, Jill	8.75	Bauerschmidt, Maritta	9.50	Mikhailova, Vania	8.90	Petrik, Larissa	9.70
	Sjong, Wenche	8.80	Janz, Karin	9.45	Atanassova, Raina	7.95	Karaseva, Olga	9.50
	Hvaal, Ann-Mari	8.90	Schmidt, Magdalena	9.10	Pacheva, Vessela	8.55	Turischeva, Liudmila	9.50
	Braathen, Helga	8.80	Noack, Marianne	9.45			Burda, Ljubov	9.35
	TE 44.20		TE 47.05		TE 43.75		TE 48.10	

7e TOUR
7th ROUND

B	CHE Caslavaska, Vera	9.90	BUL Karachka, Maria	8.80	NOR Holmen, Unni	7.60	ADE Starke, Ute	9.25
	Krajcirova, Mariana	9.75	Stoianova, Nelli	8.95	Isberg, Torunn	7.90	Zuchold, Erika	9.50
	Kubickova, Jana	9.60	Mikhailova, Vania	7.35	Kvamme, Jill	8.30	Bauerschmidt, Maritta	9.40
	Liskova, Hana	9.60	Sjong, Wenche	8.60	Sjong, Wenche	7.75	Janz, Karin	9.50
	Rimnacova, Bohumila	9.55	Hvaal, Ann-Mari	8.75	Hvaal, Ann-Mari	6.90	Schmidt, Magdalena	9.25
	Sklenickova, Miroslava	9.70	Pacheva, Vessela		Braathen, Helga	8.10	Noack, Marianne	9.35
	TE 48.55	TE 42.45		TE 39.65		TE 47.00		

8e TOUR
8th ROUND

B	URS Kuchinskaya, Natalia	9.75	NOR Holmen, Unni	8.05	CHE Caslavaska, Vera	9.60	BUL Karachka, Maria	8.80
	Voronina, Zinaida	9.75	Isberg, Torunn	7.90	Krajcirova, Mariana	8.90	Stoianova, Nelli	8.80
	Petrik, Larissa	9.70	Kvamme, Jill	8.20	Kubickova, Jana	8.85	Mikhailova, Vania	9.00
	Karaseva, Olga	9.65	Sjong, Wenche	8.45	Liskova, Hana	9.35	Atanassova, Raina	8.90
	Turischeva, Liudmila	9.60	Hvaal, Ann-Mari	7.40	Rimnacova, Bohumila	9.50	Pacheva, Vessela	8.75
	Burda, Ljubov	9.60	Braathen, Helga	8.35	Sklenickova, Miroslava	9.45		
	TE 48.45	TE 40.95		TE 46.80		TE 44.25		

695

9e TOUR
9th ROUND

B	ADE Starke, Ute	9.60	CHE Caslavaska, Vera	9.65	URS Kuchinskaya, Natalia	8.45	NOR Holmen, Unni	8.55
	Zuchold, Erika	9.80	Krajcirova, Mariana	9.35	Voronina, Zinaida	9.55	Isberg, Torunn	8.65
	Bauerschmidt, Maritta	9.45	Kubickova, Jana	9.30	Petrik, Larissa	9.45	Kvamme, Jill	8.55
	Janz, Karin	9.70	Liskova, Hana	9.45	Karaseva, Olga	9.40	Sjong, Wenche	8.40
	Schmidt, Magdalena	9.65	Rimnacova, Bohumila	9.45	Turischeva, Liudmila	9.40	Hvaal, Ann-Mari	7.95
	Noack, Marianne	9.50	Sklenickova, Miroslava	9.30	Burda, Ljubov	9.30	Braathen, Helga	8.55
	TE 48.25	TE 47.20		TE 47.10		TE 42.70		

10e TOUR
10th ROUND

B	BUL Karachka, Maria	9.45	URS Kuchinskaya, Natalia	9.80	ADE Starke, Ute	9.35	CHE Caslavaska, Vera	9.70
	Stoianova, Nelli	8.90	Voronina, Zinaida	9.40	Zuchold, Erika	9.45	Krajcirova, Mariana	9.55
	Mikhailova, Vania	9.10	Petrik, Larissa	9.50	Bauerschmidt, Maritta	9.30	Kubickova, Jana	9.50
	Atanassova, Raina	9.00	Karaseva, Olga	9.30	Janz, Karin	9.60	Liskova, Hana	9.40
	Pacheva, Vessela	8.90	Turischeva, Liudmila	9.30	Schmidt, Magdalena	9.40	Rimnacova, Bohumila	9.50
			Burda, Ljubov	9.50	Noack, Marianne	8.20	Sklenickova, Miroslava	9.40
	TE 45.35	TE 47.50		TE 47.10		TE 47.65		

11e TOUR
11th ROUND

	I	PI	II	PI	III	PI	IV	PI							
C	EUA	Cluff, Wendy	9.05	JPN	Mitsukuri, Taniko	9.35	HUN	Banfai, Agnes	9.30	ALE	Jebram, Petra	8.70			
		Gleason, Kathy	9.30		Kandori, Mitsuko	9.35		Schmitt, Katalin	9.45		Kern, Angelika	8.75			
		Metheny, Linda	9.35		Hashiguchi, Kayoko	9.35		Janosi, Aniko	9.15		Krauser, Irm	8.80			
		Mulvihill, Colleen	8.95		Bekesi, Ilona	9.50		Bekesi, Ilona	8.50		Matschkur, Helga	8.60			
		Rigby, Cathy	9.20		Oda, Chieko	9.25		Erdosi, Marta	8.25		Stegemann, Marie	8.90			
		Tanac, Joyce	9.25		Hanyu, Kazue	9.35		Szall, Katalin	8.20		Stein, Anna	8.70			
		TE	46.15			TE	46.90			TE	44.65			TE	43.85

12e TOUR
12th ROUND

C	ALE	Jebram, Petra	9.05	HUN	Banfai, Agnes	9.50	EUA	Cluff, Wendy	8.75	JPN	Mitsukuri, Taniko	9.40			
		Kern, Angelika	9.10		Schmitt, Katalin	9.25		Gleason, Kathy	9.00		Kandori, Mitsuko	9.25			
		Krauser, Irm	9.30		Janosi, Aniko	9.50		Metheny, Linda	9.40		Hashiguchi, Kayoko	9.30			
		Matschkur, Helga	9.15		Bekesi, Ilona	9.20		Mulvihill, Colleen	9.20		Matsuhisa, Miyuki	9.40			
		Stegemann, Marie	9.40		Erdosi, Marta	9.10		Rigby, Cathy	9.40		Oda, Chieko	9.45			
		Stein, Anna	9.20		Szall, Katalin	9.45		Tanac, Joyce	9.20		Hanyu, Kazue	9.35			
		TE	46.15			TE	46.90			TE	46.20			TE	46.90

13e TOUR
13th ROUND

696 C	JPN	Mitsukuri, Taniko	9.55	EUA	Cluff, Wendy	9.20	ALE	Jebram, Petra	8.85	HUN	Banfai, Agnes	9.45			
		Kandori, Mitsuko	9.35		Gleason, Kathy	9.15		Kern, Angelika	8.90		Schmitt, Katalin	9.10			
		Hashiguchi, Kayoko	9.35		Metheny, Linda	9.60		Krauser, Irm	9.10		Janosi, Aniko	9.50			
		Matsuhisa, Miyuki	9.55		Mulvihill, Colleen	9.40		Matschkur, Helga	8.90		Bekesi, Ilona	9.05			
		Oda, Chieko	9.40		Rigby, Cathy	9.55		Stegemann, Marie	9.00		Erdosi, Marta	9.15			
		Hanyu, Kazue	9.50		Tanac, Joyce	9.25		Stein, Anna	8.85		Szall, Katalin	9.35			
		TE	47.35			TE	47.00			TE	44.75			TE	46.55

14e TOUR
14th ROUND

C	HUN	Banfai, Agnes	9.30	ALE	Jebram, Petra	8.80	JPN	Mitsukuri, Taniko	9.45	EUA	Cluff, Wendy	9.10			
		Schmitt, Katalin	9.35		Kern, Angelika	8.50		Kandori, Mitsuko	9.30		Gleason, Kathy	9.20			
		Janosi, Aniko	9.50		Krauser, Irm	8.50		Hashiguchi, Kayoko	7.85		Metheny, Linda	9.30			
		Bekesi, Ilona	9.25		Matschkur, Helga	8.75		Matsuhisa, Miyuki	8.65		Mulvihill, Colleen	9.15			
		Erdosi, Marta	9.20		Stegemann, Marie	8.65		Oda, Chieko	9.25		Rigby, Cathy	9.45			
		Szall, Katalin	9.25		Stein, Anna	8.50		Hanyu, Kazue	9.30		Tanac, Joyce	9.25			
		TE	46.65			TE	43.20			TE	45.95			TE	46.35

15e TOUR
15th ROUND

D	POR	Fonseca, Esbela	8.95	ITA	Biagiotti, Adriana	9.00	CAN	Hartley, Sandra	7.75	FRA	Nourry, Françoise	9.05	
	TWN	Hong, Tan-Kuee	6.35		Maccelli, Daniela	8.70		Diachun, Jennifer	8.70		Letourneur, Évelyne	9.30	
		Yu, Mai-Lee	6.50		Pozzuolo, Gabriella	8.95		Cloutier, Suzanne	8.40		Lauvard, Dominique	9.15	
		Sljepica, Natalija	9.15		Iadamsurengiin, Tuiaa	8.60		Minaker, Marilyn	8.15		Cayre, Mireille	9.05	
					Dorj, Norlkho	8.40		McDonnell, Theresa	8.15		Brisepierre, Jacqueline	9.00	
					Tsagaandorj, Gundegmaa	8.85					Bourdiau, Nicole	9.00	
								TE	41.15			TE	45.55

16e TOUR
16th ROUND

	I	PI	II	PI	III	PI	IV	PI
D	FRA Nourry, Françoise	8.75	CAN Hartley, Sandra	8.95	TWN Hong, Tan-Kuee	6.10	MGL Iadamsurengiin, Tuiaa	8.60
	Letourneur, Evelyne	9.40	Diachun, Jennifer	8.90	Yu, Mai-Lee	6.15	Dorj, Norlkho	8.60
	Lauvard, Dominique	8.85	Cloutier, Suzanne	8.25	YUG Sljepica, Natalija	9.20	Tsagaandorj, Gundegmaa	8.60
	Cayre, Mireille	9.40	Minaker, Marilyn	8.35	POR Fonseca, Esbela	8.40	ITA Biagiotti, Adriana	8.60
	Brisepierre, Jacqueline	9.25	McDonnell, Theresa	7.95			Maccelli, Daniela	8.65
	Bourdiau, Nicole	8.75					Pozzuolo, Gabriella	8.80
	TE 45.65		TE 42.40					

17e TOUR
17th ROUND

D	ITA Biagiotti, Adriana	9.15	YUG Sljepica, Natalija	8.55	FRA Nourry, Françoise	8.65	CAN Hartley, Sandra	8.90
	Maccelli, Daniela	9.05	POR Fonseca, Esbela	7.55	Letourneur, Evelyne	9.50	Diachun, Jennifer	8.65
	Pozzuolo, Gabriella	8.95	TWN Hong, Tan-Kuee	8.05	Lauvard, Dominique	9.10	Cloutier, Suzanne	8.65
	MGL Iadamsurengiin, Tuiaa	6.80	Yu, Mai-Lee	7.10	Cayre, Mireille	9.10	Minaker, Marilyn	8.55
	Dorj, Norlkho	6.90			Brisepierre, Jacqueline	9.15	McDonnell, Theresa	8.80
	Tsagaandorj, Gundegmaa	8.55			Bourdiau, Nicole	8.95		
				TE 45.80		TE 43.55		

18e TOUR
18th ROUND

D	CAN Hartley, Sandra	9.10	FRA Nourry, Françoise	9.15	MGL Iadamsurengiin, Tuiaa	8.45	POR Fonseca, Esbela	8.40
	Diachun, Jennifer	9.20	Letourneur, Evelyne	9.50	Dorj, Norlkho	4.00	TWN Hong, Tan-Kuee	7.75
	Cloutier, Suzanne	8.90	Lauvard, Dominique	9.05	Tsagaandorj, Gundegmaa	8.75	Yu, Mai-Lee	7.75
	Minaker, Marilyn	8.60	Cayre, Mireille	8.95	ITA Biagiotti, Adriana	8.70	YUG Sljepica, Natalija	8.85
	McDonnell, Theresa	8.85	Brisepierre, Jacqueline	9.20	Maccelli, Daniela	8.45		
			Bourdiau, Nicole	8.75	Pozzuolo, Gabriella	8.60		
	TE 44.65		TE 45.85					

EXERCICES LIBRES
VOLUNTARY EXERCISES

1er TOUR
1st ROUND

OCT 23

A	POL Ochmanska, Lucja	8.70	MEX Briones, Rosario	6.40	BUL Karachka, Maria	9.30	NOR Holmen, Unni	8.30
	Lech, Wieslawa	8.60	Sáenz, Julieta	6.75	Stoianova, Nelli	7.70	Isberg, Torunn	8.90
	Witkowska, Grazyna	8.65	Morales, Luisa	6.85	Mikhailova, Vania	9.25	Kvamme, Jill	8.55
	Daniec, Halina	8.90	Ramirez, Elena	7.10	Atanassova, Raina	8.90	Sjong, Wenche	8.45
	Zieba, Barbara	8.85	Rivera, Laura	6.05	Pacheva, Vessela	8.75	Hvaal, Ann-Mari	8.35
	Chojnacka, Malgorzata	8.40	Puente, Rosalinda	5.90			Braathen, Helga	8.65
	TE 43.70		TE 33.15		TE 43.90		TE 42.90	

2e TOUR
2nd ROUND

	I	PI	II	PI	III	PI	IV	PI
A	CUB Vega, Yolanda	6.60	BUL Karachka, Maria	9.25	POL Ochmanska, Lucja	9.15	MEX Briones, Rosario	8.30
	Aldama, Nancy	8.00	Stoianova, Nelli	9.25	Lech, Wieslawa	8.90	Sáenz, Julieta	8.25
	Blanco, Suzette	8.30	Mikhailova, Vania	9.30	Witkowska, Grazyna	8.95	Morales, Luisa	8.40
	Villacian, Miriam	8.45	Atanassova, Raina	8.40	Daniec, Halina	9.00	Ramírez, Elena	8.25
	Bregado, Zulema	7.60	Pacheva, Vessela	8.95	Zieba, Barbara	8.60	Rivera, Laura	8.15
	Bauta, Nereida	7.80			Chojnacka, Malgorzata	8.85	Puente, Rosalinda	8.25
	TE	40.15		TE	45.15		TE	41.45

3e TOUR
3rd ROUND

A	NOR Holmen, Unni	8.45	POL Ochmanska, Lucja	9.00	CUB Vega, Yolanda	8.75	BUL Karachka, Maria	9.10
	Isberg, Torunn	8.35	Lech, Wieslawa	8.95	Aldama, Nancy	7.60	Stoianova, Nelli	8.90
	Kvamme, Jill	8.50	Witkowska, Grazyna	8.05	Blanco, Suzette	7.10	Mikhailova, Vania	9.25
	Sjong, Wenche	8.30	Daniec, Halina	7.45	Villacian, Miriam	8.85	Atanassova, Raina	9.00
	Hvaal, Ann-Mari	8.60	Zieba, Barbara	9.10	Bregado, Zulema	8.80	Pacheva, Vessela	8.95
	Braathen, Helga	8.65	Chojnacka, Malgorzata	7.20	Bauta, Nereida	8.00		
	TE	42.55		TE	42.55		TE	45.20

4e TOUR
4th ROUND

698 A	MEX Briones, Rosario	7.90	CUB Vega, Yolanda	6.65	NOR Holmen, Unni	8.10	POL Ochmanska, Lucja	9.05
	Sáenz, Julieta	8.00	Aldama, Nancy	8.80	Isberg, Torunn	8.10	Lech, Wieslawa	9.05
	Morales, Luisa	7.35	Blanco, Suzette	8.55	Kvamme, Jill	7.90	Witkowska, Grazyna	9.05
	Ramírez, Elena	7.85	Villacian, Miriam	8.75	Sjong, Wenche	7.35	Daniec, Halina	9.15
	Rivera, Laura	5.75	Bregado, Zulema	8.30	Hvaal, Ann-Mari	8.20	Zieba, Barbara	8.95
	Puente, Rosalinda	6.65	Bauta, Nereida	8.55	Braathen, Helga	8.90	Chojnacka, Malgorzata	8.95
	TE	37.75		TE	42.95		TE	42.25

5e TOUR
5th ROUND

A	BUL Karachka, Maria	9.25	NOR Holmen, Unni	7.70	MEX Briones, Rosario	8.40	CUB Vega, Yolanda	8.55
	Stoianova, Nelli	8.95	Isberg, Torunn	9.10	Sáenz, Julieta	8.45	Aldama, Nancy	9.05
	Mikhailova, Vania	9.15	Kvamme, Jill	9.05	Morales, Luisa	8.55	Blanco, Suzette	8.75
	Atanassova, Raina	8.85	Sjong, Wenche	8.95	Ramírez, Elena	8.50	Villacian, Miriam	8.80
	Pacheva, Vessela	8.85	Hvaal, Ann-Mari	7.50	Rivera, Laura	8.50	Bregado, Zulema	9.15
			Braathen, Helga	9.20	Puente, Rosalinda	8.45	Bauta, Nereida	8.90
	TE	45.05		TE	44.00		TE	44.65

6e TOUR
6th ROUND

B	CAN Hartley, Sandra	8.65	DIN Trangbaek, Else	8.75	TWN Hong, Tan-Kuee	6.30	AUS Norris, Valerie	8.90
	Diachun, Jennifer	8.85	SUE Andersson, Solveig	8.40	Yu, Mai-Lee	4.25	GBR Bell, Margaret	8.65
	Cloutier, Suzanne	8.45	Holm, Rose-Marie	8.15	YUG Sijepica, Natalija	9.00	Prestidge, Mary	8.75
	Minaker, Marilyn	8.60	Lundquist, Marie	8.75	POR Fonseca, Esbela	8.55	BEL Goethals, Christiane	8.95
	McDonnell, Theresa	8.55					Van Hoye, Horta	8.80
		TE	43.10					

7e TOUR
7th ROUND

	I	PI	II	PI	III	PI	IV	PI
B	MGL Iadamsurengiin, Tuiiaa	7.80	YUG Sljepica, Natalija	7.70	CAN Hartley, Sandra	8.50	SUE Andersson, Solveig	8.80
	Dorj, Norlkhoo	6.80	POR Fonseca, Esbela	7.90	Diachun, Jennifer	9.00	Holm, Rose-Marie	8.75
	Tsagaandorj, Gundegmaa	8.60	TWN Hong, Tan-Kuee	4.65	Cloutier, Suzanne	8.95	Lundquist, Marie	8.95
	ITA Biagiotti, Adriana	9.05	Yu, Mai-Lee	6.65	Minaker, Marilyn	7.70	DIN Trangbaek, Else	8.95
	Maccelli, Daniela	8.90			McDonnell, Theresa	7.90		
	Pozzuolo, Gabriella	8.80				TE 42.05		

8e TOUR
8th ROUND

B	AUS Norris, Valerie	8.95	CAN Hartley, Sandra	8.90	ITA Biagiotti, Adriana	9.00	POR Fonseca, Esbela	8.55
	GBR Bell, Margaret	8.20	Diachun, Jennifer	8.10	Maccelli, Daniela	8.40	Duarte, Maria	
	Prestidge, Mary	8.05	Cloutier, Suzanne	7.25	Pozzuolo, Gabriella	8.85	TWN Hong, Tan-Kuee	7.70
	BEL Goethals, Christiane	8.40	Minaker, Marilyn	9.05	MGL Iadamsurengiin, Tuiiaa	8.80	Yu, Mai-Lee	7.80
	Van Hoya, Horta	8.85	McDonnell, Theresa	9.05	Dorj, Norlkhoo	7.95	YUG Sljepica, Natalija	9.05
			TE 42.35	Tsagaandorj, Gundegmaa	8.75			

9e TOUR
9th ROUND

	DIN Trangbaek, Else	8.95	MGL Iadamsurengiin, Tuiiaa	9.00	GBR Bell, Margaret	8.50	CAN Hartley, Sandra	9.00
	SUE Andersson, Solveig	9.00	Dorj, Norlkhoo	8.35	Prestidge, Mary	7.30	Diachun, Jennifer	9.05
	Holm, Rose-Marie	9.15	Tsagaandorj, Gundegmaa	9.25	BEL Goethals, Christiane	7.40	Cloutier, Suzanne	8.55
	Lundquist, Marie	8.85	ITA Biagiotti, Adriana	8.05	Van Hoya, Horta	8.80	Minaker, Marilyn	8.60
			Maccelli, Daniela	7.10	AUS Norris, Valerie	8.60	McDonnell, Theresa	8.95
		Pozzuolo, Gabriella	8.15				TE 44.15	

10e TOUR
10th ROUND

	POR Fonseca, Esbela	8.40	BEL Goethals, Christiane	9.10	SUE Andersson, Solveig	8.80	ITA Biagiotti, Adriana	8.55
	TWN Hong, Tan-Kuee	5.75	Van Hoya, Horta	9.00	Holm, Rose-Marie	9.20	Maccelli, Daniela	8.55
	Yu, Mai-Lee	7.10	AUS Norris, Valerie	8.70	Lundquist, Marie	8.80	Pozzuolo, Gabriella	8.55
	YUG Sljepica, Natalija	8.85	GBR Bell, Margaret	8.95	DIN Trangbaek, Else	8.70	MGL Iadamsurengiin, Tuiiaa	8.85
			Prestidge, Mary	8.50			Dorj, Norlkhoo	8.50
						Tsagaandorj, Gundegmaa	8.65	

11e TOUR
11th ROUND

C	ADE Starke, Ute	9.55	FRA Nourry, Françoise	8.60	JPN Mitsukuri, Taniko	9.55	EUA Cluff, Wendy	8.95
	Zuchold, Erika	9.85	Letourneur, Evelyne	9.25	Kandori, Mitsuko	9.40	Gleason, Kathy	9.05
	Bauerschmidt, Maritta	9.45	Lauvard, Dominique	7.95	Hashiguchi, Kayoko	9.35	Metheny, Linda	9.00
	Janz, Karin	9.50	Cayre, Mireille	8.80	Matsuhisa, Miyuki	9.40	Mulvihill, Colleen	8.85
	Schmidt, Magdalena	9.65	Brisepierre, Jacqueline	8.75	Oda, Chieko	9.50	Rigby, Cathy	9.30
Noack, Marianne	9.50	Bourdiau, Nicole	6.80	Hanyu, Kazue	9.70	Tanac, Joyce	9.10	
	TE 48.05		TE 43.35		TE 47.55		TE 45.40	

12e TOUR
12th ROUND

	I	PI	II	PI	III	PI	IV	PI												
C	EUA	Cluff, Wendy Gleason, Kathy Metheny, Linda Mulvihill, Colleen Rigby, Cathy Tanac, Joyce	8.75 9.30 9.05 8.90 9.10 9.20	JPN	Mitsukuri, Taniko Kandori, Mitsuko Hashiguchi, Kayoko Matsuhisa, Miyuki Oda, Chieko Hanyu, Kazue	9.25 9.25 9.25 9.40 9.05 9.40	ADE	Starke, Ute Zuchold, Erika Bauerschmidt, Maritta Janz, Karin Schmidt, Magdalena Noack, Marianne	9.45 9.60 9.50 9.70 9.45 9.40	FPA	Nourry, Françoise Letourneur, Evelyne Lauvard, Dominique Cayre, Mireille Brisepierre, Jacqueline Bourdiau, Nicole	9.20 9.45 9.25 9.10 8.85 8.95	TE	45.55	TE	46.55	TE	47.70	TE	45.95

13e TOUR
13th ROUND

C	FRA	Nourry, Françoise Letourneur, Evelyne Lauvard, Dominique Cayre, Mireille Brisepierre, Jacqueline Bourdiau, Nicole	8.40 8.95 8.45 9.35 8.95 8.60	ADE	Starke, Ute Zuchold, Erika Bauerschmidt, Maritta Janz, Karin Schmidt, Magdalena Noack, Marianne	9.00 9.55 9.45 9.60 8.20 9.40	EUA	Cluff, Wendy Gleason, Kathy Metheny, Linda Mulvihill, Colleen Rigby, Cathy Tanac, Joyce	9.00 9.30 8.75 9.30 9.50 9.20	JPN	Mitsukuri, Taniko Kandori, Mitsuko Hashiguchi, Kayoko Matsuhisa, Miyuki Oda, Chieko Hanyu, Kazue	9.45 9.25 9.50 9.45 9.40 9.30	TE	44.30	TE	47.00	TE	46.30	TE	47.10
---	-----	----------------------------------------------------------------------------------------------------------------------------------	----------------------------------------------	-----	----------------------------------------------------------------------------------------------------------------	----------------------------------------------	-----	--------------------------------------------------------------------------------------------------------	----------------------------------------------	-----	-----------------------------------------------------------------------------------------------------------------	----------------------------------------------	----	-------	----	-------	----	-------	----	-------

14e TOUR
14th ROUND

700

C	JPN	Mitsukuri, Taniko Kandori, Mitsuko Hashiguchi, Kayoko Matsuhisa, Miyuki Oda, Chieko Hanyu, Kazue	8.85 9.50 9.20 9.55 9.50 9.40	EUA	Cluff, Wendy Gleason, Kathy Metheny, Linda Mulvihill, Colleen Rigby, Cathy Tanac, Joyce	9.00 9.30 9.55 9.30 9.45 9.20	FRA	Nourry, Françoise Letourneur, Evelyne Lauvard, Dominique Cayre, Mireille Brisepierre, Jacqueline Bourdiau, Nicole	8.95 9.45 8.35 8.00 9.30 9.25	ADE	Starke, Ute Zuchold, Erika Bauerschmidt, Maritta Janz, Karin Schmidt, Magdalena Noack, Marianne	9.25 9.50 9.40 9.50 9.25 9.30	TE	47.15	TE	46.80	TE	45.30	TE	46.95
---	-----	-----------------------------------------------------------------------------------------------------------------	----------------------------------------------	-----	--------------------------------------------------------------------------------------------------------	----------------------------------------------	-----	----------------------------------------------------------------------------------------------------------------------------------	----------------------------------------------	-----	----------------------------------------------------------------------------------------------------------------	----------------------------------------------	----	-------	----	-------	----	-------	----	-------

15e TOUR
15th ROUND

C	ALE	Jebam, Petra Kern, Angelika Krauser, Irmi Matschkur, Helga Stegemann, Marie Stein, Anna	8.85 8.90 9.00 8.50 9.00 8.65	CHE	Caslavska, Vera Krajcirova, Mariana Kubickova, Jana Liskova, Hana Rimnacova, Bohumila Sklenickova, Miroslava	9.80 9.30 9.40 9.40 9.40 9.30	HUN	Banfai, Agnes Schmitt, Katalin Janosi, Aniko Bekesi, Ilona Erdoesi, Marta Szall, Katalin	9.50 9.45 9.15 8.85 9.25 9.40	URS	Kuchinskaya, Natalia Voronina, Zinaida Petrik, Larissa Karaseva, Olga Turischeva, Liudmila Burda, Ljubov	9.85 9.75 9.85 9.65 9.50 9.40	TE	44.40	TE	47.30	TE	46.75	TE	48.60
---	-----	--------------------------------------------------------------------------------------------------------	----------------------------------------------	-----	-----------------------------------------------------------------------------------------------------------------------------	----------------------------------------------	-----	---------------------------------------------------------------------------------------------------------	----------------------------------------------	-----	-------------------------------------------------------------------------------------------------------------------------	----------------------------------------------	----	-------	----	-------	----	-------	----	-------

16e TOUR
16th ROUND

D	URS	Kuchinskaya, Natalia Voronina, Zinaida Petrik, Larissa Karaseva, Olga Turischeva, Liudmila Burda, Ljubov	9.70 9.65 9.50 9.50 9.25 9.35	HUN	Banfai, Agnes Schmitt, Katalin Janosi, Aniko Bekesi, Ilona Erdoesi, Marta Szall, Katalin	9.35 9.10 9.20 9.05 9.20 8.35	ALE	Jebam, Petra Kern, Angelika Krauser, Irmi Matschkur, Helga Stegemann, Marie Stein, Anna	9.30 9.15 9.40 9.15 8.35 9.35	CHE	Caslavska, Vera Krajcirova, Mariana Kubickova, Jana Liskova, Hana Rimnacova, Bohumila Sklenickova, Miroslava	9.85 9.55 9.50 9.50 9.65 9.40	TE	47.70	TE	45.30	TE	46.35	TE	48.05
---	-----	-------------------------------------------------------------------------------------------------------------------------	----------------------------------------------	-----	---------------------------------------------------------------------------------------------------------	----------------------------------------------	-----	--------------------------------------------------------------------------------------------------------	----------------------------------------------	-----	-----------------------------------------------------------------------------------------------------------------------------	----------------------------------------------	----	-------	----	-------	----	-------	----	-------

17e TOUR
17th ROUND

	I		II		III		IV						
D	CHE	Caslavska, Vera	PI	ALE	Jebram, Petra	PI	URS	Kuchinskaya, Natalia	PI	HUN	Banfai, Agnes	PI	
		Krajcirova, Mariana	9.85		Kern, Angelika	7.65		Voronina, Zinaida	9.65		Schmitt, Katalin	9.30	
		Kubickova, Jana	9.70		Krauser, Irmi	9.00		Petrik, Larissa	9.70		Janosi, Aniko	9.15	
		Liskova, Hana	9.40		Matschkur, Helga	7.90		Karaseva, Olga	9.50		Bekesi, Ilona	9.45	
		Rimnacova, Bohumila	9.40		Stegemann, Marie	7.70		Turischeva, Liudmila	9.60		Erdosi, Marta	9.10	
		Sklenickova, Miroslava	9.15		Stein, Anna	8.05		Burda, Ljubov	9.50		Szall, Katalin	9.20	
		9.65	TE	48.00		TE	40.35		TE	47.95		TE	46.20

18e TOUR
18th ROUND

D	HUN	Banfai, Agnes	9.40	URS	Kuchinskaya, Natalia	9.80	CHE	Caslavska, Vera	9.90	ALE	Jebram, Petra	9.10
		Schmitt, Katalin	9.30		Voronina, Zinaida	9.40		Krajcirova, Mariana	9.75		Kern, Angelika	9.05
		Janosi, Aniko	9.35		Petrik, Larissa	9.50		Kubickova, Jana	9.50		Krauser, Irmi	9.20
		Bekesi, Ilona	8.85		Karaseva, Olga	9.40		Liskova, Hana	9.55		Matschkur, Helga	9.00
		Erdosi, Marta	9.20		Turischeva, Liudmila	8.45		Rimnacova, Bohumila	9.80		Stegemann, Marie	9.20
		Szall, Katalin	8.95		Burda, Ljubov	9.35		Sklenickova, Miroslava	9.65		Stein, Anna	9.05
		TE	46.20		TE	47.45		TE	48.65		TE	45.60

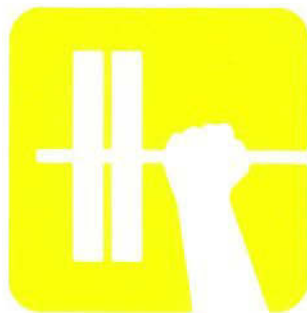

FEDERATION INTERNATIONALE
HALTEROPHILE ET CULTURISTE
FIHC

INTERNATIONAL FEDERATION OF
WEIGHTLIFTING AND PHYSICAL
CULTURE FIHC

PRESIDENT
Clarence H. Johnson EUA

SECRETAIRE
SECRETARY
Oscar State GBR

FEDERATION MEXICAINE
D'HALTEROPHILIE FMLP

MEXICAN WEIGHTLIFTING
FEDERATION FMLP

PRESIDENT
Gastón Barahona MEX

SECRETAIRE
SECRETARY
David Domínguez MEX

SECTION D'HALTEROPHILIE
DU C.O.O.
O.O.C. WEIGHTLIFTING SECTION
René de la Cerda MEX

OFFICIELS DE LA COMPETITION
COMPETITION OFFICIALS

JURY D'APPEL
JURY OF APPEAL

PRESIDENT
Clarence H. Johnson EUA

MEMBRES
MEMBERS
Jean Dame FRA
Walter Holland GBR
Philip Guenov BUL
Leopoldo de León PAN

CHEF DE PLATEAU
HEAD REFEREES
Gottfried Schodl
Bedrich Poula
Robert Hoffman
Gastón Barahona
Alexander Chapman
Konstantin Artemyev

AUT
CHE
EUA
MEX
TRT
URS

ARBITRES DE COTE
SIDE REFEREES
Helmut Atzrodt
Hans Kestler
Kim Jip
Elpidio Dorotheo
George Kerkley
David Abraham
Awanis Yessaian
Renato Gallo
Keith Shervington
Yukio Iguchi
Jack Azus
Jean Witucki
Nestor Figarella
Benito Seijas

ADE
ALE
COR
FIL
GBR
IND
IRK
ITA
JAM
JPN
PER
POL
PRO
VEN

SUPPLEANTS
RESERVES
Simeon Kolev
Jean-Yves Dionne
David Matlin
Alan Hool

BUL
CAN
EUA
MEX

702

SIGNES EMPLOYES SYMBOLOGY

DES — DISQUALIFIE	DISQUALIFIED
SRT — A ABANDONNE	WITHDREW

RECORDS OLYMPIQUES ETABLIS A TOKIO EN 1964 DURANT LES JEUX DE LA XVIII OLYMPIADE

OLYMPIC RECORDS ESTABLISHED IN 1964 IN TOKIO DURING THE GAMES OF THE XVIII OLYMPIAD

ATHLETISME HOMMES ATHLETICS MEN

100 m	-	100 m	R. Hayes	EUA	10.0"
200 m	-	200 m	H. Carr	EUA	20.3"
800 m	-	800 m	P. Snell	NZL	1'45.1"
10000 m	-	10000 m	W. Mills	EUA	28'24.4"
4 x 400 m Relais	-	4 x 100 m Relay	EUA	EUA	39.0"
4 x 100 m Relais	-	4 x 400 m Relay	EUA	EUA	3'00.7"
3000 m Steeplechase	-	3000 m Steeplechase	G. Roelants	BEL	8'30.8"
20 Km marche	-	20 km Walk	K. Mathews	GBR	1 ^o 29'34.0"
50 Km marche	-	50 km Walk	A. Pamich	ITA	4 ^o 11'12.4"
Marathon	-	Marathon	A. Bikila	ETI	2 ^o 12'11.2"
Saut en Hauteur	-	High Jump	V. Brumel	URS	2.18m
Triple Saut	-	Triple Jump	Schmidt	POL	16.85m
Saut à la Perche	-	Pole Vault	Hansen	EUA	5.10m
Lancement du Poids	-	Shot Put	Long	EUA	20.33m
Lancement du Disque	-	Discus Throw	A. Oerter	EUA	61.00m
Lancement du Marteau	-	Hammer Throw	Zsivotzky	HUN	73.74m
Décathlon	-	Decathlon	Toomey	EUA	8193P

ATHLETISME FEMMES ATHLETICS WOMEN

100 m	-	100 m	W. Tyus	EUA	11.2"
200 m	-	200 m	E. McGuier	EUA	23.0"
400 m	-	400 m	B. Cuthbert	AUS	52.0"
800 m	-	800 m	A. Packer	GBR	2'01.1"
80 m Haies	-	80 m Hurdles	K. Baltzer	ALE	10.5"
4 x 100 m Relais	-	4 x 100 m Relay	EUA	EUA	43.9"
Saut en Longueur	-	Long Jump	M. Rand	GBR	6.76m
Saut en Hauteur	-	High Jump	Y. Balas	RUM	1.90m
Lancement du Poids	-	Shot Put	T. Press	URS	18.14m
Lancement du Disque	-	Discus Throw	T. Press	URS	57.27m
Lancement du Javelot	-	Javelin Throw	E. Gorchakova	URS	62.40m
Pentathlon	-	Pentathlon	I. Press	URS	5246P

CYCLISME CYCLING

4000 m Poursuite individuelle	-	4000 m Individual Pursuit	Ursi	ITA	4'56.07"
-------------------------------	---	---------------------------	------	-----	----------

HALTEROPHILIE WEIGHTLIFTING

				TOTAL		
Poids Coq	-	Bantamweight	H. Vakhonin	URS (J)	142.5	357.5 Kg
			S. Ichinoseki	JPN (S)	110	
			I. Foldi	HUN (P)	115	
Poids Plume	-	Featherweight	Y. Miyake	JPN (P)	122.5	
			(S)	122.5	397.5 Kg	
			I. Berger	EUA (J)	152.5	
Poids Léger	-	Lightweight	W. Baszanowski	POL (S)	135	432.5 Kg
			V. Kaplunov	URS (P)	140	
			(J)	165.0		
Poids Moyen	-	Middleweight	H. Zdravila	CHE (S)	137.5	
			(J)	177.5	445.0 Kg	
			T. Kono	EUA (P)	140.0	
Poids Moyen Lourd	-	Light Heavyweight	R. Plyukfelder	URS (S)	142.5	475.0 Kg
			G. Veres	HUN (P)	155	
			(J)	185		
Poids Mi-Lourd	-	Middle Heavyweight	V. Golovanov	URS (P)	165.0	487.5 Kg
			A. Vorobyev	URS (S)	142.5	
			I. Palinski	POL (J)	182.5	
Poids Lourd	-	Heavy weight	L. Zhabotinsky	URS (S)	167.5	
			(J)	217.5	572.5 Kg	
			Y. Vlasov	URS (P)	197.5	

(P) Développé	-	Press
(S) Arraché	-	Snatch
(J) Epaulé-jeté	-	Jerk

NATATION HOMMES SWIMMING MEN

100 m Nage libre	-	100 m Freestyle	D. Schollander	EUA	53.4"
400 m Nage libre	-	400 m Freestyle	D. Schollander	EUA	4'12.2"
1500 m Nage libre	-	1500 m Freestyle	Windle	AUS	17'01.7"
200 m Brasse	-	200 m Breaststroke	O'Brien	AUS	2'27.8"
200 m Dos	-	200 m Backstroke	Graef	EUA	2'10.3"
200 m Papillon	-	200 m Butterfly	Berry	AUS	2'06.6"
400 m 4 Nages	-	400 m Medley	Roth	EUA	4'45.4"
4 x 100 m Relais Libre	-	4 x 100 m Freestyle Relay	EUA	EUA	3'32.2"
4 x 200 m Relais Libre	-	4 x 200 m Freestyle Relay	EUA	EUA	7'52.1"
4 x 100 m 4 Nages R.	-	4 x 100 m Medley Relay	EUA	EUA	3'58.4"

NATATION FEMMES SWIMMING WOMEN

100 m Nage libre	-	100 m Freestyle	D. Fraser	AUS	59.5"
400 m Nage libre	-	400 m Freestyle	V. Duenkel	EUA	4'43.4"
100 m Dos	-	100 m Backstroke	C. Ferguson	EUA	1'07.7"
200 m Brasse	-	200 m Breaststroke	G. Prozumenshikova	URS	2'46.4"
100 m Papillon	-	100 m Butterfly	S. Stouder	EUA	1'04.7"
400 m 4 Nages	-	400 m Medley	D. de Varona	EUA	5'18.7"
4 x 100 m Relais Libre	-	4 x 100 m Freestyle Relay	EUA	EUA	4'03.8"
4 x 100 m 4 Nages R.	-	4 x 100 m Medley Relay	EUA	EUA	4'33.9"

TIR SHOOTING

Pet. Car. Pos. couchée	-	Small Bore R. Prone Pos.	Hammerl	HUN	597P
Pet. Car. 3 Pos.	-	Small Bore Rifle 3 Pos.	L. Wigger	EUA	1164P
Carabine libre	-	Free Rifle	G. Anderson	EUA	1153P
Vitesse aux Silhouettes	-	Rapid Fire Pistol	P. Linnosvuo	FIN	592P
Skeet	-	Skeet	E. Mattarelli	ITA	198P



FEDERATION INTERNATIONALE
DE HOCKEY FIH

PRESIDENT
René G. Frank BEL

DELEGUES TECHNIQUES
TECHNICAL DELEGATES
Etienne Glichitch FRA
Dara Ali Iqtidar PAK

INTERNATIONAL HOCKEY
FEDERATION FIH

PRESIDENT
René G. Frank BEL

MEMBRES
MEMBERS
Josef Strecha CHE
Pablo Negre ESP
Alain Danet FRA
Bergman Van Zinnicq HOL
Ashwini Kumar IND
Jamsheed Nagarvala IND
Antonio Triglia ITA
Sakae Kubota JPN
Yoji Kitamura JPN
Carlos Hernández MEX
Ernesto Zubieta MEX
Leoncio Armijo MEX
Miguel Palet MEX
Sergio Delgadillo MEX
Abdul Hameed PAK
Mohamed Raafat RAU

ASSISTANTS
Leandro Jover ESP
Stewart MacIldowie GBR
Muneyoshi Ueda JPN
Albert Demarex SUI

SECRETAIRE GENERAL
GENERAL SECRETARY
Etienne Glichitch FRA

JUGES
JUDGES
Dieter Weiskopf ADE
Heinrich Lichtenfeld ALE
John Yeend AUS
Norman Porritt CAN
Jack Newblod EUA
Frank Levy GBR
Garnett Cowlshaw GBR
Jan Pelkman GBR
Roger Tattersall GBR
Patrick Ryan GBR
Emilius Engelberts HOL
Saleh Sait IND
Lombardo Festa ITA
Alejandro Schmidt MEX
Alfonso Martínez MEX
Francisco Detrell MEX
José Luis Manrique MEX
Manuel Cruz MEX

FEDERATION MEXICAINE
DE HOCKEY

MEXICAN HOCKEY
FEDERATION

PRESIDENT
Miguel Palet MEX

ARBITRES
REFEREES
Karl Trapper ALE
Kurt Dorzbach ALE
Walter Schinner ALE
James MacDowell AUS
Thomas Bedells AUS
Jacques Manneback BEL
Roger Wouters BEL
Jaime Salvatella ESP
Bernard Valette FRA
Archibald Young GBR
Gerald Eaves GBR
John Balmer GBR
John Handley GBR
Krishan Lall GBR
August Lathouwers HOL
Henri Herrebrugh HOL
John Jameson IND
Nemi Agarwal IND
Sarosh Nagarvala IND
Luigi Tinti ITA
Takashi Matsunawa JPN
Hardial Singh KEN
Peter Barboza KEN
Abdul Sami PAK
Abrar Ahmad PAK
Iqbal Hussain PAK
Shahzadi Khurram PAK
Sheikh Khurshid Ahmad PAK
Veeramuttu Ramalingam SIN

SECRETAIRE
SECRETARY
Andrés Padrós MEX

SECTION HOCKEY DU C.O.O.
O.O.C. HOCKEY SECTION
Ernesto Zubieta MEX
Leoncio Armijo MEX

OFFICIELS DE LA COMPETITION
COMPETITION OFFICIALS

JURY D'APPEL
JURY OF APPEAL

SIGNES EMPLOYES SYMBOLOGY

JJ	— MATCHS JOUES	GAMES PLAYED
G	— GAGNE	WON
()	— EX-AEQUO	TIE
P	— PERDU	LOST
GS	— GOALS	GOALS
PS	— POINTS	POINTS

GRUPE A MATCH 1
GROUP A GAME 1 OCT 13

NZL-IND 2 - 1 (2 - 0, 0 - 1)

NZL	IND
8 McPherson, Ross	1 Christy, Rajendra
3 Capey, Roger	2 Singh, Gurbux
13 Patterson, Alan	3 Singh, Prithipal
15 Thomson, Keith	6 Singh, Balbir I
10 Maister, Selwyn	5 Singh, Ajitpal
1 Anslow, John	14 Singh, Harmik
6 Judge, Bruce	16 Singh, Balbir III
4 Christensen, John	8 Peter, Jhon
7 McIntyre, Alan	9 Singh, Harbinder
9 Maister, Barry	10 Singh, Inder
2 Borren, Jan	11 Singh, Tarsem

ARBITRES REFEREES: Lathouwers, August HOL
Herrebrugh, Henri HOL

BUTS SCORE	1-0	Thomson, Keith	NZL	28 min
	2-0	Maister, Selwyn	NZL	35
	2-1	Singh, Prithipal	IND	49

GRUPE A MATCH 2
GROUP A GAME 2

ALE - BEL 2 - 0 (0 - 0, 2 - 0)

ALE	BEL
1 Rott, Wolfgang	1 Buisset, Jean-Marie
2 Krauss, Günter	3 Legros, Marc
3 Aichinger, Utz	7 Deville, Michel
13 Michel, Dirk	4 Vanderhulst, Georges
5 Greinert, Klaus	5 Leclerc, Jean-Louis
6 Vos, Ulrich	6 Bernaert, Yves
7 Kittstein, Detlef	8 Ravinet, Claude
8 Shuler, Norbert	9 Miserque, Guy
9 Schmidt, Fritz	15 Solie, Armand
10 Keller, Carsten	10 Roersch, Jean-Louis
15 Sloma, Ulrich	11 Gilles, Jean-François

ARBITRES REFEREES: Balmer, John GBR
Eaves, Gerald GBR

BUTS SCORE	1-0	Krauss, Günter	ALE	43 min
	2-0	Krauss, Günter	ALE	51

GRUPE B MATCH 3
GROUP B GAME 3

AUS - KEN 2 - 0 (2 - 0, 0 - 0)

AUS	KEN
4 Dearing, Paul	1 Simonion, John
2 Glencross, Brian	2 Bhardwaj, Kirpal
13 Piper, Desmond	3 Sohal, Avtar
11 Pearce, Gordon	14 Marwa, Harvinder
12 Pearce, Julian	5 Panesar, Surjeet
6 Haigh, Robert	6 Fernandes, Silvester
5 Evans, Raymond	7 Fernandes, Leo
15 Riley, Ronald	10 Matharu, Santokh
9 Nilan, Patrick	9 Deegan, Davinder
16 Smart, Donald	8 Fernandes, Hillary
10 Pearce, Eric	11 Mendonca, Aloysius

ARBITRES REFEREES: Schinner, Walter ALE
Dorzbach, Kurt ALE

BUTS SCORE	1-0	Glencross, Brian	AUS	15 min
	2-0	Riley, Ronald	AUS	32

GRUPE A MATCH 4
GROUP A GAME 4

JPN - MEX 2 - 1 (2 - 0, 0 - 1)

JPN	MEX
1 Matsumoto, Norihiko	1 Prud'Homme, Antonio
2 Yuzaki, Katsuhiko	2 Sevilla, David
3 Takashima, Akio	3 Varela, Javier
4 Kaoku, Shigeo	4 Maycseil, Adrian
5 Yuzaki, Tsuneya	5 Fernández, Zeno
6 Kudo, Akio	6 Ventura, Orlando
7 Nagaya, Kyoichi	7 Bustamante, Héctor
8 Tanaka, Hiroshi	8 Ventura, Héctor
9 Nishimura, Shozo	9 Huacuja, Oscar
10 Onda, Masashi	10 Calderón, Juan
11 Yoshimura, Minoru	11 Gutiérrez, Humberto

ARBITRES REFEREES: McDowell, James AUS
Bedells, Thomas AUS

BUTS SCORE	1-0	Tanaka, Hiroshi	JPN	12 min
	2-0	Takashima, Akio	JPN	34
	2-1	Fernández, Zeno	MEX	64

GRUPE A MATCH 5
GROUP A GAME 5

ESP - ADE 1 - 1 (1 - 0, 0 - 1)

ESP	ADE
1 Del Coso, Carlos	1 Stephan, Rainer
13 Colomer, José	2 Thieme, Axel
3 De Solaun, Julio	3 Wallossek, Eckhard
6 Ventallo, Narciso	4 Bahner, Klaus
5 Dinares, José	13 Thieme, Rolf
14 Amat, Juan	6 Brennecke, Horst
16 Alvear, Juan	7 Klaus, Dieter
9 Amat, Francisco	8 Lippert, Lothar
10 Fábregas, Jorge	9 Ehrlich, Dieter
18 Amat, Pedro	10 Freiberger, Karl-Heinz
7 Masana, Agustín	11 Sasse, Reinhart

ARBITRES REFEREES: Iqbal, Hussain PAK
Khurshid, Ahmed PAK

BUTS SCORE	1-0	Alvear, Juan	ESP	5 min
	1-1	Freiberger, Karl-Heinz	ADE	63

GRUPE B MATCH 6
GROUP B GAME 6

FRA - MAL 0 - 0 (0 - 0, 0 - 0)

FRA	MAL
2 Merkes, Jean-Claude	1 Koh-Chye, Ho
3 Burtschell, Patrick	2 Belavantheran, A.
5 Chapon, Marc	3 Srishanmuganathan, N.
6 Corbel, Georges	4 Arulraj, Michael
7 Windal, Claude	9 Savinder, Singh
10 Dodrieux, Richard	5 Alagaratnam Kunaratnam
11 Capelle, Jean-Paul	17 Kuldip, Singh
13 Grain, Georges	11 Siow-Ming, Yang
15 Vanpouille, Albert	12 Hock-Seng, Koh
17 Petit, Jean-Paul	13 Harnahal, Sewa
16 Arlin, Bernard	15 Jeevajothy, S.

ARBITRES REFEREES: Wouters, Roger BEL
Manneback, Jacques BEL

GRUPE B MATCH 7
GROUP B GAME 7

PAK - HOL 6 - 0 (3 - 0, 3 - 0)

PAK	HOL
1 Hussain, Zakir	2 Boks, Joost
2 Dar, Tanvir	15 Locker, Heiko
3 Aziz, Tariq	16 Terlingen, Theodoras
4 Anwar, Saëed	12 De Lanoy, Charles
5 Ahmed, Riaz	7 Fokker, Johan
6 Akhtar, Gulrez	6 Efficers, John
7 Hussain, Khalid	14 Spits, Frans
8 Ashfaq, Mohammad	17 Thole, Charles
17 Rashid, Abdul	9 Hijikema, Gerardus
10 Malik, Asad	18 Van Vroonhoven, Theo
11 Butt, Jehangir	10 De Keyzer, Arie

ARBITRES REFEREES: Trapper, Karl ALE
Ramalingam, Veeramuttu SIN

BUTS SCORE	1-0	Dar, Tanvir	PAK	6 min
	2-0	Malik, Asad	PAK	13
	3-0	Ashfaq, Mohammad	PAK	15
	4-0	Rashid, Abdul	PAK	50
	5-0	Rashid, Abdul	PAK	58
	6-0	Dar, Tanvir	PAK	63

GRUPE B MATCH 8
GROUP B GAME 8

GBR - ARG 2 - 0 (1 - 0, 1 - 0)

GBR	ARG
1 Cahill, Harold	18 Suárez, Jorge
3 Neill, John	12 Sabbione, Jorge
5 Oliver, Richard	3 Piccioli, Jorge
8 Ekins, Anthony	4 Monti, Osvaldo
10 Trentnam, Andrew	5 Calp, Fernando
7 Carr, Gerald	6 Tanuscio, Jorge
14 Lawson, Timothy	14 Portugés, Daniel
12 Christensen, Basil	8 Marinoni, Héctor
17 Campell, Colin	11 Monti, Rodolfo
13 Donald, Charles	15 Quacquareni, Alfredo
11 Barham, Jeremy	9 Lorenzo, Gerardo

ARBITRES REFEREES: Jameson, John IND
Agarwal, Nemi IND

BUTS SCORE	1-0	Lawson, Timothy	GBR	20 min
	2-0	Campbell, Colin	GBR	47

GRUPE A MATCH 9
GROUP A GAME 9 OCT 14

BEL - ADE 4 - 0 (1 - 0, 3 - 0)

BEL	ADE
1 Buisset, Jean-Marie	1 Stephan, Rainer
2 Muschs, André	2 Thieme, Axel
3 Legros, Marc	3 Wallossek, Eckhard
7 Deville, Michel	4 Bahner, Klaus
5 Leclerc, Jean-Louis	13 Thieme, Rolf
6 Bernaert, Yves	6 Brennecke, Horst
8 Ravinet, Claude	7 Klaus, Dieter
9 Miserque, Guy	8 Lippert, Lothar
12 Dupont, Daniel	9 Ehrlich, Dieter
15 Solie, Armand	10 Freiberger, Karl-Heinz
11 Gilles, Jean-François	11 Sasse, Reinhart

ARBITRES REFEREES: Lathouwers, August HOL
Herrebrugh, Henri HOL

BUTS SCORE	1-0	Ravinet, Claude	BEL	32 min
	2-0	Ravinet, Claude	BEL	53
	3-0	Ravinet, Claude	BEL	56
	4-0	Solie, Armand	BEL	63

GRUPE B MATCH 10
GROUP B GAME

PAK - FRA 1 - 0 (0 - 0, 1 - 0)

PAK	FRA
1 Hussain, Zakir	1 Sauthier, Jean-Paul
2 Dar, Tanvir	4 Verrier, Gilles
3 Aziz, Tariq	3 Burtschell, Patrick
4 Anwar, Saeed	9 Pous, Charles
5 Ahmed, Riaz	18 Windal, Claude
6 Akhtar, Gulrez	8 Joinau, Stephane
7 Hussain, Khalid	5 Chapon, Marc
8 Ashfaq, Mohammad	6 Corbel, Georges
17 Rashid, Abdul	15 Vanpouille, Albert
10 Malik, Asad	16 Arlin, Bernard
11 Butt, Jehangir	10 Dodrieux, Richard

ARBITRES REFEREES: Salvatella, Jaime ESP
Tinti, Luigi ITA

BUTS SCORE 1-0 Rashid, Abdul PAK 52 min

GRUPE A MATCH 11
GROUP A GAME

ESP - JPN 0 - 0 (0 - 0, 0 - 0)

ESP	JPN
1 Del Coso, Carlos	1 Matsumoto, Norihiko
2 Nagues, Antonio	2 Yuzaki, Katsuhiko
3 De Solaun, Julio	3 Takashima, Akio
4 Salles, José	4 Kaoku, Shigeo
10 Fábregas, Jorge	5 Yuzaki, Tsuneya
6 Ventallo, Narciso	6 Kudo, Akio
7 Masana, Agustín	16 Kamimura, Yukio
16 Alvear, Juan	8 Tanaka, Hiroshi
9 Amat, Francisco	9 Nishimura, Shozo
18 Amat, Pedro	10 Onda, Masashi
11 Vidal, Jorge	11 Yoshimura, Minoru

ARBITRES REFEREES: Valette, Bernard FRA
Barboza, Peter KEN

GRUPE B MATCH 12
GROUP B GAME

KEN - MAL 1 - 1 (0 - 1, 1 - 0)

KEN	MAL
1 Simonion, John	1 Koh-Chye, Ho
2 Bhardwaj, Kirpal	2 Belavantheran, A.
3 Sohal, Avtar	3 Srishanmuganathan, N.
4 Malik, Mohamed	4 Arulraj, Michael
5 Panesar, Surjeet	9 Savinder, Singh
6 Fernandes, Silvester	7 Johnson, Joseph
7 Fernandes, Leo	17 Kuldip, Singh
8 Fernandes, Hillary	11 Siow-Ming, Yang
9 Deegan, Davinder	12 Hock-Seng, Koh
10 Matharu, Santokh	13 Harnahal, Sewa
16 Fernandes, Egbert	15 Jeevajoathy, S.

ARBITRES REFEREES: Trapper, Karl ALE
Dorzbach, Kurt ALE

BUTS SCORE 1-0 Belavantheran, A. MAL 5 min
1-1 Fernandes, Egbert KEN 51

GRUPE A MATCH 13
GROUP A GAME

NZL - MEX 2 - 0 (0 - 0, 2 - 0)

NZL	MEX
8 McPherson, Ross	1 Prud'Homme, Antonio
3 Capey, Roger	2 Sevilla, David
13 Patterson, Alan	3 Varela, Javier
15 Thomson, Keith	13 Villaseñor, Roberto
10 Maister, Sekwyn	5 Fernández, Zeno
1 Anslow, John	14 Filoteo, Enrique
6 Judge, Bruce	16 Fernández, Manuel
4 Christensen, John	4 Maycseil, Adrián
7 McIntyre, Alan	7 Bustamante, Héctor
9 Maister, Barry	11 Gutiérrez, Humberto
2 Borren, Jan	8 Ventura, Héctor

ARBITRES REFEREES: Sami, Muhammad PAK
Khurram, Shahzadi PAK

BUTS SCORE 1-0 Borren, Jan NZL 42 min
2-0 Christensen, John NZL 53

GRUPE B MATCH 14
GROUP B GAME

HOL - ARG 7 - 0 (1 - 0, 6 - 0)

HOL	ARG
2 Boks, Joost	18 Suárez, Jorge
15 Locker, Heiko	12 Sabbione, Jorge
16 Terlingen, Theodoros	3 Piccioli, Jorge
12 De Lanoy, Charles	4 Monti, Osvaldo
7 Fokker, Johan	17 Kenny, Carlos
6 Elffers, John	6 Tanuscio, Jorge
14 Spits, Frans	14 Portugués, Daniel
8 Ter-Haar, Otto	8 Marinoni, Héctor
17 Thole, Charles	10 Disera, Alberto
18 Van Vroonhoven, Theo	13 Scally, Gabriel
10 De Keyzer, Arie	9 Lorenzo, Gerardo

ARBITRES REFEREES: Matsunawa, Takashi JPN
Krishan, Lal HOK

BUTS SCORE 1-0 De Keyzer, Arie HOL 34 min
2-0 De Keyzer, Arie HOL 45
3-0 Terlingen, Theodoros HOL 54
4-0 De Keyzer, Arie HOL 55
5-0 Thole, Charles HOL 60
6-0 Van Vroonhoven, Theo HOL 62
7-0 Fokker, Johan HOL 65

GRUPE B MATCH 15
GROUP B GAME

AUS - GBR 0 - 0 (0 - 0, 0 - 0)

AUS	GBR
4 Dearing, Paul	1 Cahill, Harold
2 Glencross, Brian	3 Neill, John
13 Piper, Desmond	5 Oliver, Richard
11 Pearce, Gordon	8 Ekins, Anthony
12 Pearce, Julian	10 Trentham, Andrew
6 Haigh, Robert	4 Deegan, James
10 Pearce, Eric	14 Lawson, Timothy
5 Evans, Raymond	12 Christensen, Basil
15 Riley, Ronald	18 Wilson, Peter
9 Nilan, Patrick	13 Donald, Charles
16 Smart, Donald	11 Barham, Jeremy

ARBITRES REFEREES: Nagarvala, Sarosh IND
Gursewak, Singh IND

GRUPE A MATCH 16
GROUP A GAME

IND - ALE 2 - 1 (1 - 1, 1 - 0)

IND	ALE
12 Sait, Munir	1 Rott, Wolfgang
2 Singh, Gurbux	2 Krauss, Günter
3 Singh, Prithipal	3 Aichinger, Utz
7 Singh, Balbir II	13 Michel, Dirk
5 Singh, Ajitpal	5 Greinert, Klaus
14 Singh, Harmik	6 Vos, Ulrich
16 Singh, Balbir III	7 Kittstein, Detlef
8 Peter, Jhon	8 Schuler, Norbert
9 Singh, Harbinder	9 Schmidt, Fritz
10 Singh, Inder	10 Keller, Carsten
11 Singh, Tarsem	15 Sloma, Ulrich

ARBITRES REFEREES: Young, Archibald GBR
Handley, John GBR

BUTS SCORE 1-0 Keller, Carsten ALE 27 min
1-1 Singh, Harbinder IND 34
2-1 Singh, Balbir II IND 39

GRUPE A MATCH 17 OCT 15
GROUP A GAME

ESP - BEL 2 - 0 (2 - 0, 0 - 0)

ESP	BEL
1 Del Coso, Carlos	1 Buisset, Jean-Marie
13 Colomer, José	2 Muschs, André
3 De Solaun, Julio	3 Legros, Marc
14 Amat, Juan	4 Vanderhulst, Georges
5 Dinares, José	5 Leclerc, Jean-Louis
6 Ventallo, Narciso	17 Bouvy, Charly
7 Masana, Agustín	9 Miserque, Guy
4 Salles, José	7 Deville, Michel
9 Amat, Francisco	16 Hansen, William
10 Fábregas, Jorge	15 Solie, Armand
11 Vidal, Jorge	8 Ravinet, Claude

ARBITRES REFEREES: McDowell, James AUS
Valette, Bernard FRA

BUTS SCORE 1-0 Fábregas, Jorge ESP 25 min
2-0 Amat, Francisco ESP 27

GRUPE A MATCH 18
GROUP A GAME

IND - MEX 8 - 0 (2 - 0, 6 - 0)

IND	MEX
12 Sait, Munir	1 Prud'Homme, Antonio
2 Singh, Gurbux	2 Sevilla, David
3 Singh, Prithipal	5 Fernández, Zeno
7 Singh, Balbir II	4 Maycseil, Adrián
5 Singh, Ajitpal	14 Filoteo, Enrique
14 Singh, Harmik	13 Villaseñor, Roberto
16 Singh, Balbir III	16 Fernández, Manuel
8 Peter, Jhon	9 Huacuja, Oscar
9 Singh, Harbinder	7 Bustamante, Héctor
10 Singh, Inder	15 Bada, Jorge
11 Singh, Tarsem	11 Gutiérrez, Humberto

ARBITRES REFEREES: Bedells, Thomas AUS
Barboza, Peter KEN

BUTS SCORE 1-0 Singh, Harbinder IND 1 min
2-0 Singh, Balbir II IND 29
3-0 Singh, Prithipal IND 44
4-0 Singh, Harbinder IND 48
5-0 Singh, Prithipal IND 54
6-0 Singh, Harbinder IND 55
7-0 Singh, Ajitpal IND 58
8-0 Singh, Inder IND 68

GRUPE A MATCH 19
GROUP A GAME

ADE - NZL 1 - 1 (0 - 0, 1 - 1)

ADE	NZL
12 Sasse, Hans-Dietrich	8 McPherson, Ross
2 Thieme, Axel	3 Capey, Roger
6 Brennecke, Horst	13 Patterson, Alan
4 Bahner, Klaus	15 Thomson, Keith
3 Wallossek, Eckhard	10 Maister, Selwyn
8 Lippert, Lothar	1 Anslow, John
7 Klaus, Dieter	6 Judge, Bruce
18 Rabis, Helmut	4 Christensen, John
9 Ehrlich, Dieter	7 McIntyre, Alan
10 Freiberger, Karl-Heinz	9 Maister, Barry
11 Sasse, Reinhart	2 Borren, Jan

ARBITRES REFEREES: Iqbal, Hussain PAK
Sami, Muhammad PAK

BUTS SCORE 1-0 Thieme, Axel ADE 50 min
1-1 Thomson, Kejth NZL 63

GRUPE A MATCH 20
GROUP A GAME

ALE - JPN 2 - 0 (0 - 0, 2 - 0)

ALE	JPN
1 Rott, Wolfgang	1 Matsumoto, Norihiko
2 Krauss, Günter	2 Yazaki, Katsuhiko
3 Aichinger, Utz	3 Takashima, Akio
4 Wein, Jürgen	4 Kaoku, Shigeo
5 Greinert, Klaus	5 Yuzaki, Tsuneya
6 Vos, Ulrich	6 Kudo, Akio
16 End, Hermann	16 Kamimura, Yukio
8 Schuler, Norbert	8 Tanaka, Hiroshi
9 Schmidt, Fritz	9 Nishimura, Shozo
10 Keller, Carsten	10 Onda, Masashi
11 Krause, Michael	11 Yoshimura, Minoru

ARBITRES REFEREES: Balmer, John GBR
Eaves, Gerald GBR

BUTS SCORE 1-0 Schuler, Norbert ALE 56 min
2-0 Greinert, Klaus ALE 61

GRUPE B MATCH 21 OCT 16
GROUP B GAME

HOL - GBR 2 - 1 (0 - 1, 2 - 0)

HOL	GBR
3 Brederode, Aemout	1 Cahill, Harold
16 Terlingen, Theodorus	3 Neill, John
15 Locker, Heiko	5 Oliver, Richard
12 De Lanoy, Charles	8 Ekins, Anthony
7 Fokker, Johan	10 Trentham, Andrew
6 Elffers, John	4 Deegan, James
14 Spits, Frans	14 Lawson, Timothy
8 Ter-Haar, Otto	15 Millner, James
4 Buma, Edo	18 Wilson, Peter
18 Van Vroonhoven, Theo	13 Donald, Charles
10 De Keyzer, Arie	11 Barham, Jeremy

ARBITRES REFEREES: Nagarvala, Sarosh IND
Agarwal, Nemi IND

BUTS SCORE 1-0 Neill, John GBR 32 min
1-1 Van Vroonhoven, Theo HOL 54
2-1 Buma, Edo HOL 63

GRUPE B MATCH 22
GROUP B GAME

KEN - FRA 2 - 0 (0 - 0, 2 - 0)

KEN	FRA
1 Simonion, John	2 Merkes, Jean
2 Bhardwaj, Kirpal	4 Verrier, Gilles
5 Panesar, Surjeet	3 Burtschell, Patrick
4 Malik, Mohamed	9 Pous, Charles
14 Marwa, Harvinder	18 Windal, Claude
6 Fernandes, Silvester	19 Petit, Jean-Paul
7 Fernandes, Leo	5 Chapon, Marc
8 Fernandes, Hillary	13 Grain, Georges
9 Deegan, Davinder	15 Vanpouille, Albert
10 Matharu, Santokh	16 Arlin, Bernard
16 Fernandes, Egbert	12 Vignon, Philippe

ARBITRES REFEREES: Salvatella, Jaime ESP
Ramalingam, Veeramuttu SIN

BUTS SCORE 1-0 Fernandes, Egbert KEN 53 min
2-0 Fernandes, Leo KEN 55

GRUPE B MATCH 23
GROUP B GAME

MAL - ARG 1 - 1 (1 - 1, 0 - 0)

MAL	ARG
1 Koh-Chye, Ho	1 Guelfand, Eduardo
2 Belavantheran, A.	2 Cigognini, Armando
3 Srishanmuganathan, N.	3 Piccioli, Jorge
4 Arulraj, Michael	6 Tanuscio, Jorge
9 Savinder, Singh	5 Calp, Fernando
5 Alaga, Kunaratnam	15 Quacquareni, Alfredo
17 Kuldip, Singh	7 Anderson, Eduardo
12 Hock-Seng, Koh	16 Giannini, Jorge
11 Siow-Ming, Yang	12 Sabbione, Jorge
13 Hamahal, Sewa	8 Marinoni, Héctor
15 Jeevajothy, S.	14 Portugués, Daniel

ARBITRES REFEREES: Schinner, Walter ALE
Trapper, Karl ALE

BUTS SCORE 1-0 Siow, Ming-Yang MAL 8 min
1-1 Cigognini, Armando ARG 25

GRUPE B MATCH 24
GROUP B GAME

PAK - AUS 3 - 2 (1 - 2, 2 - 0)

PAK	AUS
1 Hussain, Zakir	4 Dearing, Paul
2 Dar, Tanvir	2 Glencross, Brian
3 Aziz, Tariq	13 Piper, Desmond
4 Anwar, Saeed	11 Pearce, Gordon
5 Ahmed, Riaz	12 Pearce, Julian
6 Akhtar, Gulrez	6 Haigh, Robert
7 Hussain, Khalid	7 Martin, Donald
8 Ashfaq, Mohammad	5 Evans, Raymond
17 Rashid, Abdul	15 Riley, Ronald
10 Malik, Asad	9 Nilan, Patrick
11 Butt, Jehangir	16 Smart, Donald

ARBITRES REFEREES: Wouters, Roger BEL
Matsunawa, Takashi JPN

BUTS SCORE 1-0 Rashid, Abdul PAK 2 min
1-1 Glencross, Brian AUS 23
2-1 Riley, Ronald AUS 33
2-2 Aziz, Tariq PAK 40
3-2 Aziz, Tariq PAK 54

GRUPE A MATCH 25 OCT 17
GROUP A GAME

ALE - ADE 3 - 2 (1 - 1, 2 - 1)

ALE	ADE
1 Rott, Wolfgang	12 Sasse, Hans-Dietrich
2 Krauss, Günter	2 Thieme, Axel
3 Aichinger, Utz	14 Träumer, Klaus
4 Wein, Jürgen	4 Bahner, Klaus
5 Greinert, Klaus	3 Wallossek, Eckhard
6 Vos, Ulrich	6 Brennecke, Horst
14 Suhl, Eckart	7 Klaus, Dieter
8 Schuler, Norbert	8 Lippert, Lothar
9 Schmidt, Fritz	9 Ehrlich, Dieter
10 Keller, Carsten	10 Freiberger, Karl-Heinz
11 Krause, Michael	11 Sasse, Reinhart

ARBITRES REFEREES: Lathouwers, August HOL
Iqbal, Hussain PAK

BUTS SCORE 1-0 Krauss, Günter ALE 8 min
1-1 Lippert, Lothar ADE 11
2-1 Krauss, Günter ALE 42
3-1 Krauss, Günter ALE 47
3-2 Freiberger, Karl-Heinz ADE 68

GRUPE B MATCH 26
GROUP B GAME

FRA - GBR 1 - 0 (0 - 0, 1 - 0)

FRA	GBR
2 Merkes, Jean	2 Flood, Roger
4 Verrier, Gilles	6 Wilman, David
3 Burtschell, Patrick	5 Oliver, Richard
9 Pous, Charles	8 Ekins, Anthony
7 Windal, Claude	10 Trentham, Andrew
17 Petit, Jean-Paul	7 Carr, Gerald
5 Chapon, Marc	16 Fitzwalter, Malcolm
14 Pascarel, Alain	15 Millner, James
6 Corbel, Georges	17 Campbell, Colin
18 Windal, Michel	13 Donald, Charles
11 Capelle, Jean-Paul	14 Lawson, Timothy

ARBITRES REFEREES: Nagarvala, Sarosh IND
Jameson, John IND

BUTS SCORE 1-0 Pascarel, Alain FRA 47 min

GRUPE A MATCH 27
GROUP A GAME

BEL - MEX 4 - 0 (1 - 0, 3 - 0)

BEL	MEX
1 Buisset, Jean-Marie	1 Prud'Homme, Antonio
2 Muschs, André	2 Sevilla, David
3 Legros, Marc	5 Fernández, Zeno
4 Vanderhulst, Georges	4 Maycseil, Adrián
5 Leclerc, Jean-Louis	14 Filoteo, Enrique
6 Bernaert, Yves	6 Ventura, Orlando
8 Ravinet, Claude	17 Gutiérrez, Noel
9 Miserque, Guy	8 Ventura, Héctor
12 Dupont, Daniel	18 Noriega, Adán
15 Solie, Armand	7 Bustamante, Héctor
11 Gilles, Jean-François	11 Gutiérrez, Humberto

ARBITRES REFEREES: Khurram, Shahzadi PAK
Kurshid, Ahmed PAK

BUTS SCORE 1-0 Muschs, André BEL 18 min
2-0 Bernaert, Yves BEL 54
3-0 Bernaert, Yves BEL 63
4-0 Gilles, Jean-François BEL 69

GRUPE B MATCH 28
GROUP B GAME

PAK - ARG 5 - 0 (4 - 0, 1 - 0)

PAK		ARG	
1	Hussain, Zakir	1	Guelfand, Eduardo
2	Dar, Tanvir	2	Cigognini, Armando
13	Ud Din, Riaz	3	Piccioli, Jorge
4	Anwar, Saeed	6	Tanuscio, Jorge
5	Ahmed, Riaz	5	Calp, Fernando
6	Akhtar, Gulrez	15	Quacquareni, Alfredo
7	Hussain, Khalid	7	Anderson, Eduardo
8	Ashfaq, Mohammad	8	Marinoni, Héctor
17	Rashid, Abdul	10	Diserá, Alberto
10	Malik, Asad	9	Lorenzo, Gerardo
11	Butt, Jehangir	11	Monti, Rodolfo

ARBITRES REFEREES: Matsunawa, Takashi JPN
Wouters, Roger BEL

BUTS SCORE 1-0 Dar, Tanvir PAK 3 min
2-0 Malik, Asad PAK 12
3-0 Rashid, Abdul PAK 15
4-0 Rashid, Abdul PAK 29
5-0 Dar, Tanvir PAK 52

GRUPE A MATCH 29
GROUP A GAME

NZL - JPN 1 - 0 (0 - 0, 1 - 0)

NZL		JPN	
8	McPherson, Ross	1	Matsumoto, Norihiko
3	Capey, Roger	2	Yuzaki, Katsuhiro
13	Patterson, Alan	3	Takashima, Akio
15	Thomson, Keith	9	Nishimura, Shozo
10	Maister, Selwyn	5	Yuzaki, Tsuneya
1	Anslow, John	6	Kudo, Akio
6	Judge, Bruce	8	Tanaka, Hiroshi
4	Christensen, John	16	Kamimura, Yukio
7	McIntyre, Alan	4	Kaoku, Shigeo
9	Maister, Barry	10	Onda, Masashi
2	Borren, Ian	17	Kawamura, Kazuo

ARBITRES REFEREES: Valette, Bernard FRA
Sami, Muhammad PAK

BUTS SCORE 1-0 McIntyre, Alan NZL 42 min

GRUPE A MATCH 30
GROUP A GAME

IND - ESP 1 - 0 (1 - 0, 0 - 0)

IND		ESP	
12	Sait, Munir	1	Del Coso, Carlos
2	Singh, Gurbux	13	Colomer, José
3	Singh, Prithipal	3	De Solaun, Julio
7	Singh, Balbir II	4	Salles, José
5	Singh, Ajitpal	5	Dinares, José
14	Singh, Harmik	6	Ventallo, Narciso
16	Singh, Balbir III	16	Alvear, Juan
8	Peter, Jhon	18	Amat, Pedro
9	Singh, Harbinder	9	Amat, Francisco
10	Singh, Inder	10	Fábregas Jorge
11	Singh, Tarsem	11	Vidal, Jorge

ARBITRES REFEREES: McDowell, James AUS
Ramalingam, Veeramattu SIN

BUTS SCORE 1-0 Singh, Prithipal IND 6 min

GRUPE B MATCH 31
GROUP B GAME

AUS - MAL 3 - 0 (2 - 0, 1 - 0)

AUS		MAL	
4	Dearing, Paul	1	Koh-Chye, Ho
8	Mason, James	2	Belavantheran, A.
2	Glencross, Brian	3	Srishanmuganathan, N.
11	Pearce, Gordon	4	Arulraj, Michael
12	Pearce, Julian	9	Savinder, Singh
13	Piper, Desmond	5	Alagaratnam, Kunaratnam
7	Martin, Donald	10	Sabapathy, Arumugam
14	Quine, Frederick	12	Hock-Seng, Koh
10	Pearce, Eric	11	Siow-Ming, Yang
9	Nilan, Patrick	13	Harnahal, Seva
16	Smart, Donald	15	Jeevajothy, S.

ARBITRES REFEREES: Shinner, Walter ALE
Agarwal, Nemi IND

BUTS SCORE 1-0 Glencross, Brian AUS 7 min
2-0 Martin, Donald AUS 25
3-0 Quine, Frederick AUS 39

GRUPE B MATCH 32
GROUP B GAME

KEN - HOL 2 - 0 (1 - 0, 1 - 0)

KEN		HOL	
1	Simonion, John	3	Brederode, Aernout
2	Bhardwaj, Kirpal	16	Terlingen, Theodorus
5	Panesar, Surjeet	15	Locker, Heiko
4	Malik, Mohamed	12	De Lanoy, Charles
14	Marwa, Harvinder	7	Fokker, Johan
6	Fernandes, Silvester	6	Elffers, John
7	Fernandes, Leo	14	Spits, Frans
8	Fernandes, Hillary	8	Ter Haar, Otto
9	Deegan, Davinder	4	Buma, Edo
10	Matharu, Santokh	18	Van Vroonhoven, Theo
16	Fernandes, Egbert	10	De Keyzer, Arie

ARBITRES REFEREES: Manneback, Jacques BEL
Tinti, Luigi ITA

BUTS SCORE 1-0 Fernandes, Hillary KEN 13 min
2-0 Panesar, Surjeet KEN 44

GRUPE A MATCH 33 OCT 18
GROUP A GAME

IND-BEL 2 - 1 (0 - 1, 2 - 0)

IND		BEL	
12	Sait, Munir	1	Buisset, Jean-Marie
2	Singh, Gurbux	2	Muschs, André
3	Singh, Prithipal	3	Legros, Marc
7	Singh, Balbir II	4	Vanderhulst, Georges
5	Singh, Ajitpal	5	Leclerc, Jean-Louis
14	Singh, Harmik	6	Bernaert, Yves
16	Singh, Balbir III	8	Ravinet, Claude
8	Peter, Jhon	9	Miserque, Guy
9	Singh, Harbinder	12	Dupont, Daniel
10	Singh, Inder	15	Solie, Armand
11	Singh, Tarsem	11	Gilles, Jean-François

ARBITRES REFEREES: Valette, Bernard FRA
Ramalingam, Veeramattu SIN

BUTS SCORE 1-0 Solie, Armand BEL 11 min
1-1 Singh, Prithipal IND 41
2-1 Singh, Harbinder IND 52

GRUPE A MATCH 34
GROUP A GAME

ALE - NZL 0 - 0 (0 - 0, 0 - 0)

ALE		NZL	
1	Rott, Wolfgang	8	McPherson, Ross
2	Krauss, Günter	3	Capey, Roger
3	Aichinger, Utz	13	Patterson, Alan
13	Michel, Dirk	15	Thomson, Keith
5	Greinert, Klaus	10	Maister, Selwyn
6	Vos, Ulrich	1	Anslow, John
18	Baumgart, Wolfgang	6	Judge, Bruce
8	Schuler, Norbert	4	Christensen, John
9	Schmidt, Fritz	7	McIntyre, Alan
10	Keller, Carsten	9	Maister, Barry
11	Krause, Michael	2	Borren, Jan

ARBITRES REFEREES: MacDowell, James AUS
Lathouwers, August HOL

GRUPE A MATCH 35
GROUP A GAME

ESP - MEX 3 - 0 (1 - 0, 2 - 0)

ESP		MEX	
1	Del Coso, Carlos	1	Prud'Homme, Antonio
2	Nogues, Antonio	2	Sevilla, David
3	De Solaun, Julio	13	Villaseñor, Roberto
15	Fábregas, Francisco	4	Maycseñ, Adrián
5	Dinares, José	5	Fernández, Zeno
6	Ventallo, Narciso	15	Bada, Jorge
7	Masana, Agustín	17	Gutiérrez, Noel
4	Salles, José	18	Noriega, Adán
9	Amat, Francisco	9	Huacuja, Oscar
18	Amat, Pedro	10	Calderón, Juan
11	Vidal, Jorge	11	Gutiérrez, Humberto

ARBITRES REFEREES: Young, Archibald GBR
Handley, John GBR

BUTS SCORE 1-0 Amat, Francisco ESP 3 min
2-0 Dinares, José ESP 53
3-0 Dinares, José ESP 54

GRUPE A MATCH 36
GROUP A GAME

ADE-JPN 1 - 0 (0 - 0, 1 - 0)

ADE		JPN	
12	Sasse, Hans-Dietrich	1	Matsumoto, Norihiko
2	Thieme, Axel	2	Yuzaki, Katsuhiro
14	Träumer, Klaus	3	Takashima, Akio
4	Bahner, Klaus	9	Nishimura, Shozo
3	Wallossek, Eckhard	5	Yuzaki, Tsuneya
6	Brennecke, Horst	6	Kudo, Akio
7	Klaus, Dieter	15	Wada, Akihito
8	Lippert, Lothar	16	Kamimura, Yukio
9	Ehrlich, Dieter	4	Kaoku, Shigeo
10	Freiberger, Karl-Heinz	10	Onda, Masashi
11	Sasse, Reinhart	11	Yoshimura, Minoru

ARBITRES REFEREES: Iqbal, Hussain PAK
Khurram, Shahzadi PAK

BUTS SCORE 1-0 Thieme, Axel ADE 60 min

GRUPE B MATCH 37 OCT 19
GROUP B GAME

PAK - GBR 2 - 1 (1 - 0, 1 - 1)

PAK		GBR	
1 Hussain, Zakir		2 Flood, Roger	
2 Dar, Tanvir		3 Neill, John	
3 Aziz, Tariq		5 Oliver, Richard	
4 Anwar, Saeed		6 Wilman, David	
5 Ahmed, Riaz		8 Ekins, Anthony	
6 Akhtar, Gulrez		7 Carr, Gerald	
7 Hussain, Khalid		15 Millner, James	
8 Ashfaq, Mohammad		14 Lawson, Timothy	
17 Rashid, Abdul		17 Campbell, Colin	
10 Malik, Asad		13 Donald, Charles	
11 Butt, Jehangir		11 Barham, Jeremy	

ARBITRES REFEREES: Ramalingam, Veeramuttu SIN
Schinner, Walter ALE

BUTS SCORE 1-0 Dar, Tanvir PAK 10 min
2-0 Ashfaq, Mohammad PAK 53
2-1 Neill, John GBR 60

GRUPE B MATCH 38
GROUP B GAME

KEN - ARG 2 - 1 (2 - 1, 0 - 0)

KEN		ARG	
1 Simonion, John		18 Suárez, Jorge	
2 Bhardwaj, Kirpal		2 Cigognini, Armando	
5 Panesar, Surjeet		3 Piccioli, Jorge	
4 Malik, Mohamed		6 Tanuscio, Jorge	
14 Marwa, Harvinder		15 Quacquareni, Alfredo	
6 Fernandes, Silvester		13 Scally, Gabriel	
7 Fernandes, Leo		7 Anderson, Eduardo	
8 Fernandes, Hillary		8 Marinoni, Héctor	
9 Deegan, Davinder		12 Sabbione, Jorge	
10 Matharu, Santokh		9 Lorenzo, Gerardo	
16 Fernandes, Egbert		14 Portugés, Daniel	

ARBITRES REFEREES: Manneback, Jacques BEL
Nagarvala, Sarosh IND

BUTS SCORE 1-0 Deegan, Davinder KEN 2 min
2-0 Panesar, Surjeet KEN 4
2-1 Anderson, Eduardo ARG 28

GRUPE A MATCH 39
GROUP A GAME

FRA-AUS 1 - 0 (0 - 0, 1 - 0)

FRA		AUS	
1 Sauthier, Jean-Paul		4 Dearing, Paul	
4 Verrier, Gilles		8 Mason, James	
3 Burtschell, Patrick		2 Glencross, Brian	
10 Dodrieux, Richard		11 Pearce, Gordon	
7 Windal, Claude		12 Pearce, Julian	
8 Joinau, Stephane		16 Smart, Donald	
5 Chapon, Marc		7 Martin, Donald	
15 Vanpouille, Albert		14 Quine, Frederick	
6 Corbel, Georges		10 Pearce, Eric	
18 Windal, Michel		9 Nilan, Patrick	
17 Petit, Jean-Paul		5 Evans, Raymond	

ARBITRES REFEREES: Gursewak, Singh IND
Tinti, Luigi ITA

BUTS SCORE 1-0 Vanpouille, Albert FRA 54 min

GRUPE B MATCH 40
GROUP B GAME

HOL - MAL 1 - 0 (1 - 0, 0 - 0)

HOL		MAL	
2 Boks, Joost		1 Koh-Chye, Ho	
16 Terlingen, Theodorus		2 Belavantheran, A.	
15 Locker, Heiko		3 Srishanmuganathan, N.	
12 De Lanoy, Charles		4 Arulraj, Michael	
7 Fokker, Johan		9 Savinder, Singh	
19 Weemers, Petrus		7 Johnson, Joseph	
17 Thole, Charles		10 Sabapathy, Arumugam	
8 Ter-Haar, Otto		12 Hock-Seng, Koh	
9 Hijlkema, Gerardus		11 Stow-Ming, Yang	
18 Van Vroonhoven, Theo		13 Harnahal, Sewa	
10 De Keyzer, Arie		15 Jeevajothy, S.	

ARBITRES REFEREES: Jameson, John IND
Salvatella, Jaime ESP

BUTS SCORE 1-0 Weemers, Petrus HOL 25 min

GRUPE B MATCH 41 OCT 20
GROUP B GAME

HOL - FRA 1 - 0 (0 - 0, 1 - 0)

HOL		FRA	
2 Boks, Joost		2 Merkes, Jean-Claude	
16 Terlingen, Theodorus		4 Verrier, Gilles	
15 Locker, Heiko		3 Burtschell, Patrick	
12 De Lanoy, Charles		9 Pous, Charles	
19 Weemers, Petrus		7 Windal, Claude	
11 Kist, Ewaldus		10 Dodrieux, Richard	
14 Spits, Frans		5 Chapon, Marc	
4 Buma, Edo		14 Pascarel, Alain	
9 Hijlkema, Gerardus		6 Corbel, Georges	
18 Van Vroonhoven, Theo		13 Grain, Georges	
17 Thole, Charles		17 Petit, Jean-Paul	

ARBITRES REFEREES: Manneback, Jacques BEL
Salvatella, Jaime ESP

BUTS SCORE 1-0 Hijlkema, Gerardus HOL 60 min

GRUPE A MATCH 42
GROUP A GAME

ADE-MEX 2 - 0 (0 - 0, 2 - 0)

ADE		MEX	
12 Sasse, Hans-Dietrich		1 Prud'Homme, Antonio	
2 Thieme, Axel		2 Sevilla, David	
14 Träumer, Klaus		3 Varela, Javier	
4 Bahner, Klaus		4 Maycsell, Adrián	
3 Wallossek, Eckhard		5 Fernández, Zeno	
8 Lippert, Lothar		15 Bada, Jorge	
6 Brennecke, Horst		7 Bustamante, Héctor	
18 Rabis, Helmut		17 Gutiérrez, Noel	
9 Ehrlich, Dieter		14 Filoteo, Enrique	
10 Freiburger, Karl-Heinz		10 Calderón, Juan	
11 Sasse, Reinhart		11 Gutiérrez, Humberto	

ARBITRES REFEREES: Barboza, Peter KEN
Herrebrugh, Henri HOL

BUTS SCORE 1-0 Lippert, Lothar ADE 41 min
2-0 Ehrlich, Dieter ADE 55

GRUPE B MATCH 43
GROUP B GAME

KEN - GBR 3 - 0 (2 - 0, 1 - 0)

KEN		GBR	
1 Simonion, John		2 Flood, Roger	
2 Bhardwaj, Kirpal		3 Neill, John	
5 Panesar, Surjeet		5 Oliver, Richard	
4 Malik, Mohamed		6 Wilman, David	
12 Marwa, Harvinder		8 Ekins, Anthony	
6 Fernandes, Silvester		7 Carr, Gerald	
7 Fernandes, Leo		15 Millner, James	
8 Fernandes, Hillary		14 Lawson, Timothy	
9 Deegan, Davinder		17 Campbell, Colin	
10 Matharu, Santokh		13 Donald, Charles	
16 Fernandes, Egbert		11 Barham, Jeremy	

ARBITRES REFEREES: Dorzbach, Kurt ALE
Gursewak, Singh IND

BUTS SCORE 1-0 Matharu, Santokh KEN 1 min
2-0 Deegan, Davinder KEN 9
3-0 Deegan, Davinder KEN 69

GRUPE B MATCH 44
GROUP B GAME

AUS - ARG 3 - 1 (1 - 1, 2 - 0)

AUS		ARG	
4 Dearing, Paul		18 Suárez, Jorge	
2 Glencross, Brian		2 Cigognini, Armando	
8 Mason, James		3 Piccioli, Jorge	
11 Pearce, Gordon		4 Monti, Osvaldo	
12 Pearce, Julian		5 Calp, Fernando	
6 Haigh, Robert		13 Scally, Gabriel	
7 Martin, Donald		7 Anderson, Eduardo	
5 Evans, Raymond		8 Marinoni, Héctor	
15 Riley, Ronald		12 Sabbione, Jorge	
9 Nilan, Patrick		9 Lorenzo, Gerardo	
16 Smart, Donald		11 Monti, Rodolfo	

ARBITRES REFEREES: Krishan, Lal HOK
Agarwal, Nemi IND

BUTS SCORE 1-0 Marinoni, Héctor ARG 21 min
1-1 Riley, Ronald AUS 35
2-1 Smart, Donald AUS 63
3-1 Evans, Raymond AUS 69

GRUPE A MATCH 45
GROUP A GAME

IND - JPN 5 - 0 (5 - 0)

*IND		JPN	
12 Sait, Munir		1 Matsumoto, Norihiko	
2 Singh, Gurbux		2 Yuzaki, Katsuhiko	
3 Singh, Prithipal		9 Nishimura, Shozo	
7 Singh, Balbir II		4 Kaoku, Shigeo	
5 Singh, Ajitpal		5 Yuzaki, Tsuneya	
14 Singh, Harmik		6 Kudo, Akio	
16 Singh, Balbir III		15 Wada, Akihito	
8 Peter, Jhon		7 Nagaya, Kyoichi	
9 Singh, Harbinder		10 Onda, Masashi	
18 Rehman, Inamur		16 Kamimura, Yukio	
11 Singh, Tarsem		11 Yoshimura, Minoru	

ARBITRES REFEREES: Young, Archibald GBR
Handley, John GBR

* L'INDE A GAGNE 5 - 0 PAR INDIA WON BY FORFEIT 5 - 0
FORFAIT A 20:30 DE LA DEU- AT 20:30 IN SECOND HALF
XIEME PERIODE

MATCH
GAME 61

POUR 13e ET 14e PLACES
FOR 13th AND 14th PLACES

JPN - ARG 2 - 0 (1 - 0, 1 - 0)

JPN		ARG	
1	Matsumoto, Norihiko	18	Suárez, Jorge
2	Yuzaki, Katsuhiko	2	Cigognini, Armando
3	Takashima, Akio	3	Piccioli, Jorge
4	Kaoku, Shigeo	4	Monti, Osvaldo
5	Yuzaki, Tsuneya	5	Calp, Fernando
6	Kudo, Akio	15	Quacquareni, Alfredo
15	Wada, Akihito	7	Anderson, Eduardo
16	Kamimura, Yukio	8	Marinoni, Héctor
10	Onda, Masashi	12	Sabbione, Jorge
11	Yoshimura, Minoru	9	Lorenzo, Gerardo
8	Tanaka, Hiroshi	11	Monti, Rodolfo

ARBITRES REFEREES: Khurram, Shahzadi PAK
Khurshid, Ahmed PAK

BUTS SCORE 1-0 Onda, Masashi JPN 15 min
2-0 Tanaka, Hiroshi JPN 67

MATCH
GAME 62

POUR 15e ET 16e PLACES
FOR 15th AND 16th PLACES

MAL - MEX 1 - 0 (0 - 0, 0 - 0)
PROLONGATION-OVERTIME (1 - 0, 0 - 0)

MAL		MEX	
1	Koh-Chye, Ho	1	Prud'Homme, Antonio
2	Belavantheran, A.	2	Sevilla, David
3	Srishanmuganathan, N.	3	Varela, Javier
4	Arulraj, Michael	4	Maycell, Adrián
9	Savinder, Singh	5	Fernández, Zeno
6	Ameenuddin, Ibrahim	15	Bada, Jorge
10	Sabapathy, Arumugam	7	Bustamante, Héctor
14	Chong, Jim-Koe	17	Gutiérrez, Noel
11	Siow-Ming Yang	9	Huacuja, Oscar
13	Harnahal, Sewa	10	Calderón, Juan
17	Kuldip, Singh	11	Gutiérrez, Humberto

ARBITRES REFEREES: Gursewak, Singh IND
Khirshan, Lal HOK

BUTS SCORE 1-0 Harnahal, Sewa MAL 6 min

MATCH
GAME 63 OCT 24

AUS - IND 2 - 1 (0 - 1, 1 - 0)
PROLONGATION - OVERTIME (0 - 0, 1 - 0)

AUS		IND	
4	Dearing, Paul	12	Sait, Munir
8	Mason, James	2	Singh, Gurbux
2	Glencross, Brian	3	Singh, Prithipal
11	Pearce, Gordon	7	Singh, Balbir II
12	Pearce, Julian	5	Singh, Ajitpal
6	Haigh, Robert	14	Singh, Harmik
7	Martin, Donald	16	Singh, Balbir III
5	Evans, Raymond	8	Peter, Jhon
15	Riley, Ronald	9	Singh, Harbinder
9	Nilan, Patrick	10	Singh, Inder
16	Smart, Donald	11	Singh, Tarsem

ARBITRES REFEREES: Manneback, Jacques BEL
Tinti, Luigi ITA

BUTS SCORE 1-0 Singh, Balbir II IND 14 min
1-1 Glencross, Brian AUS 53
2-1 Glencross, Brian AUS 12

MATCH
GAME 64

PAK - ALE 1 - 0 (0 - 0, 0 - 0)
PROLONGATION-OVERTIME (0 - 0, 0 - 0, 1 - 0)

PAK		ALE	
1	Hussain, Zakir	1	Rott, Wolfgang
2	Dar, Tanvir	2	Krauss, Günter
3	Aziz, Tariq	3	Aichinger, Utz
4	Anwar, Saeed	13	Michel, Dirk
5	Ahmed, Riaz	5	Greinert, Klaus
6	Akhtar, Gulrez	6	Vos, Ulrich
7	Hussain, Khalid	7	Kittstein, Detlef
8	Ashfaq, Mohammad	18	Baumgart, Wolfgang
17	Rashid, Abdul	9	Schmidt, Fritz
10	Malik, Asad	10	Keller, Carsten
11	Butt, Jehangir	15	Sloma, Ulrich

ARBITRES REFEREES: Lathouwers, August HOL
Ramalingam, Veeramuttu SIN

BUTS SCORE 1-0 Hussain, Khalid PAK 16 min

MATCH
GAME 65

POUR 7e ET 8e PLACES
FOR 7th AND 8th PLACES

NZL - KEN 2 - 0 (1 - 0, 1 - 0)

NZL		KEN	
8	McPherson, Ross	1	Simonion, John
3	Capey, Roger	2	Bhardwaj, Kirpal
13	Patterson, Alan	5	Panesar, Surjeet
1	Anslow, John	6	Fernandes, Silvester
10	Maister, Selwyn	12	Manya, Harvinder
5	Hicks, John	4	Malik, Mohamed
6	Judge, Bruce	7	Fernandes, Leo
7	McIntyre, Alan	8	Fernandes, Hillary
9	Maister, Barry	9	Deegan, Davinder
2	Borren, Jan	10	Matharu, Santokh
14	Salmon, Edwin	16	Fernandes, Egbert

ARBITRES REFEREES: Eaves, Gerald GBR
Jameson, John IND

BUTS SCORE 1-0 Borren, Jan NZL 24 min
2-0 Capey, Roger NZL 65

MATCH
GAME 66

POUR 5e ET 6e PLACES
FOR 5th AND 6th PLACES

HOL - ESP 1 - 0 (0 - 0, 0 - 0)
PROLONGATION-OVERTIME (0 - 0, 0 - 0, 1 - 0)

HOL		ESP	
2	Boks, Joost	1	Del Coso, Carlos
16	Terlingen, Theodorus	2	Nogues, Antonio
15	Locker, Heiko	3	De Solaun, Julio
12	De Lanoy, Charles	15	Fábregas, Francisco
7	Fokker, Johan	5	Dinares, José
6	Elffers, John	14	Amat, Juan
14	Spits, Frans	8	Quintana, Juan
8	Ter-Haar, Otto	4	Salles, José
17	Thole, Charles	9	Amat, Francisco
19	Weemers, Petrus	18	Amat, Pedro
10	De Keyzer, Arie	7	Masana, Agustín

ARBITRES REFEREES: Nagarvala, Sarosh IND
Iqbal, Hussain PAK

BUTS SCORE 1-0 Thole, Charles HOL 74 min

FINALE
FINAL OCT 26

MATCH
GAME 67

POUR 3e ET 4e PLACES
FOR 3rd AND 4th PLACES

IND - ALE 2 - 1 (0 - 1, 2 - 0)

IND		ALE	
1	Christy, Rajendra	1	Rott, Wolfgang
2	Singh, Gurbux	2	Krauss, Günter
3	Singh, Prithipal	3	Aichinger, Utz
7	Singh, Balbir II	13	Michel, Dirk
5	Singh, Ajitpal	5	Greinert, Klaus
13	Krishnamurthy, Perumal	6	Vos, Ulrich
16	Singh, Balbir III	11	Krause, Michael
6	Singh, Balbir I	8	Schuler, Norbert
9	Singh, Harbinder	9	Schmidt, Fritz
18	Rehman, Inamur	10	Keller, Carsten
10	Singh, Inder	15	Sloma, Ulrich

ARBITRES REFEREES: Ramalingam, Veeramuttu SIN
Manneback, Jacques BEL

BUTS SCORE 1-0 Schuler, Norbert ALE 34 min
1-1 Singh, Prithipal IND 55
2-1 Singh, Balbir III IND 63

MATCH
GAME 68

POUR 1ère ET 2e PLACES
FOR 1st AND 2nd PLACES

PAK - AUS 2 - 1 (1 - 0, 1 - 1)

PAK		AUS	
1	Hussain, Zakir	4	Dearing, Paul
2	Dar, Tanvir	8	Mason, James
3	Aziz, Tariq	2	Glencross, Brian
4	Anwar, Saeed	11	Pearce, Gordon
5	Ahmed, Riaz	12	Pearce, Julian
6	Akhtar, Gulrez	6	Haigh, Robert
7	Hussain, Khalid	7	Martin, Donald
8	Ashfaq, Mohammad	5	Evans, Raymond
17	Rashid, Abdul	15	Riley, Ronald
10	Malik, Asad	9	Nilan, Patrick
11	Butt, Jehangir	16	Smart, Donald

ARBITRES REFEREES: Lathouwers, August HOL
Tinti, Luigi ITA

BUTS SCORE 1-0 Rashid, Abdul PAK 15 min
1-1 Glencross, Brian AUS 46
2-1 Malik, Asad PAK 56

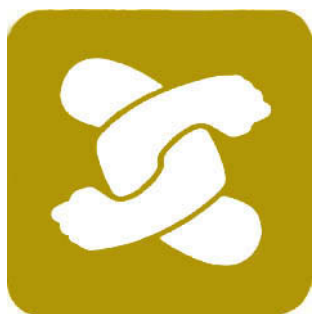

FEDERATION INTERNATIONALE
DE LUTTE AMATEUR

INTERNATIONAL AMATEUR
WRESTLING FEDERATION

PRESIDENT
Roger Coulon FRA

SECRETAIRE GENERAL
GENERAL SECRETARY
Milan Ercegan YUG

FEDERATION MEXICAINE
DE LUTTE FML

MEXICAN WRESTLING
FEDERATION FML

PRESIDENT
Victor Faugier MEX

SECRETAIRE
SECRETARY
Carlos Gamas MEX

SECTION DE LUTTE DU C.O.O.
O.O.C. WRESTLING SECTION
Manuel Andrade MEX

Felipe Ríos MEX
Leobardo Martínez MEX

OFFICIELS DE LA COMPETITION
COMPETITION OFFICIALS

JURY
Richard Garrad AUS
Gueirguiev Tzenov BUL
Kim Keuk Hwan COR
Albert De Ferrari EUA
Jacob Herbert GBR
Basile Fikiotis GRE
Mihaly Matura HUN
Majithia Sing IND
Izad Panah IRN
Ioan Hatta JPN
Dragan Corneanu RUM
Moustapha Sene SEN
Per Stromback SUE
Denis Perret SUI
Vehbi Emre TUR
Aleksy Katulin URS

JUGES - ARBITRES
JUDGES - REFEREES

Günter Czeck ADE
Robert Samzow ADE
Hans Heubach ALE
Matthias Berger AUT
J. Teunen BEL
Mikhayl Borisov BUL
Tzamko Zakhariev BUL
Ladislav Mihok CHE
Guhn Yung Kim COR
Sang Kym Lee COR
Dominick Torio EUA
Edward Garber EUA
Harold Rosenberg EUA
Josiah Henson EUA
Joseph Scalzo EUA
Stephen Evanoff EUA
Vicent Zauro EUA
Rauno Makinen FIN
C. Delmas FRA
L. Leclanché FRA
René Aurine FRA
A. W. D. Allpress GBR
Byron Caragiannis GRE
Bela Lukacs HUN
Istvan Balogh HUN
A. Hamidi IRN
A. Mandegori IRN
Naser Guiventchri IRN

Napoleone Meinardi ITA
Valentino Borgia ITA
Takeshi Nishide JPN
El Mir Taninos LIB
Felipe Ríos MEX
Luis Obregón MEX
I. Tchenderagyao MON
Odvar Svendsen NOR
Stanislaw Lis POL
Ion Crasnic RUM
Ioan Popovici RUM
Valentin Bati RUM
Egon Hallstrom SUE
L. Lundell SUE
Sven Blomqvist SUE
Jimmy Martinetti SUI
N. Grossenbacher SUI
A. Karabiber TUR
Ali Merdogan TUR
Kemal Erkmen TUR
Tok Adnan TUR
Umit Demirag TUR
Alexander Novikov URS
Ivan Maslennikov URS
Leonid Kravtsov URS
Vakhtang Balavadze URS
Rados Jovanovic YUG

SIGNES EMPLOYES

SYMBOLY

PM	— POINTS NEGATIFS	BAD POINTS
PA	— POINTS ACCUMULES	POINTS ACCUMULATED
TQ	— TOMBER	FALL
DC	— DECISION	DECISION
DES	— DISQUALIFIE	DISQUALIFIED
SE	— SUPERIORITE EVIDENTE	OBVIOUS SUPERIORITY
SR	— TIRAGE AU SORT	DRAWING
SRT	— A ABANDONNE	WITHDREW
()	— BARRAGE	TIE
*	— CHUTE POUR BLESSURE	FALL WON THROUGH INJURY
Δ	— ELIMINE	ELIMINATED
⊙	— A ABANDONNE POUR BLESSURE	WITHDREW BECAUSE OF INJURY
NSP	— NE S'EST PAS PRESENTE	FAILED TO APPEAR

LUTTE LIBRE
FREE STYLE

POIDS MOUCHE JUSQU'A 52 Kg
FLYWEIGHT UP TO 52 Kgs

1er TOUR
1st ROUND **OCT 17**

Tapis Mat			Résultat Result	PM	PA		
A	2	Ghorbani, Mohammad	IRN	TQ	1:55	0	
	1	Defran, José	DOM			4	
A	4	Triantafyllidis, Petros	GRE	DES	0:08	0	
	3	Solari, César	ECU			4	
A	5	Oh, Jung-Yong	COR	DC		1	
	6	Gaudinot, André	FRA			3	
A	7	Nakata, Shigeo	JPN	DC		1	
	8	Baev, Bajo	BUL			3	
A	10	Albarian, Nazar	URS	DC		1	
	9	Stoiciu, Gheorghe	RUM			3	
A	12	Grassi, Vincenzo	ITA	TQ	10:50	0	
	11	Kinsela, John	AUS			4	
A	14	Sukhbaatar, Surenjav	MGL	DC		1	
	13	Mongued, Mohamed	RAU			3	
A	15	Esenceli, Mehmet	TUR	()		2.5	
	16	Neff, Paul	ALE			2.5	
A	18	Erdos, Marton	HUN	DC		1	
	17	Martinez, Florentino	MEX			3	
A	19	Castillo, Wanelge	PAN	TQ	8:15	0	
	20	Ramirez, Gustavo	GUA			4	
A	21	Kumar, Sudesh	IND	SE		0.5	
	22	Dimovski, Boris	YUG			3.5	
	23	Sanders, Richard	EUA	SR			

2e TOUR
2nd ROUND **OCT 18**

A	23	Sanders, Richard	EUA	TQ	1:11	0	0
	1	Defran, José	DOM			4	8 *
A	2	Ghorbani, Mohammad	IRN	TQ	5:00	0	0
	3	Solari, César	ECU			4	8 *
A	5	Oh, Jung-Yong	COR	DC		1	2
	4	Triantafyllidis, Petros	GRE			3	3
A	7	Nakata, Shigeo	JPN	SE		0.5	1.5
	6	Gaudinot, André	FRA			3.5	6.5*
A	8	Baev, Bajo	BUL	TQ	5:30	0	3
	9	Stoiciu, Gheorghe	RUM			4	7 *
A	10	Albarian, Nazar	URS	SE		0.5	1.5
	11	Kinsela, John	AUS			3.5	7.5*
A	12	Grassi, Vincenzo	ITA	SE		0.5	0.5
	13	Mongued, Mohamed	RAU			3.5	6.5*
A	14	Sukhbaatar, Surenjav	MGL	TQ	10:14	0	1
	15	Esenceli, Mehmet	TUR			4	6.5*
A	16	Neff, Paul	ALE	TQ	6:40	0	2.5
	17	Martinez, Florentino	MEX			4	7 *
A	18	Erdos, Marton	HUN	DC		1	2
	19	Castillo, Wanelge	PAN			3	3
A	21	Kumar, Sudesh	IND	TQ	5:32	0	0.5
	20	Ramirez, Gustavo	GUA			4	8 *
	22	Dimovski, Boris	YUG	SR			3.5

Tapis
Mat

Résultat
Result

3e TOUR
3rd ROUND **OCT 19**

A	23	Sanders, Richard	EUA	TQ	8:41	0	0
	22	Dimovski, Boris	YUG			4	7.5*
A	2	Ghorbani, Mohammad	IRN	TQ	8:43	0	0
	4	Triantafyllidis, Petros	GRE			4	7 *
A	7	Nakata, Shigeo	JPN	DC		1	2.5
	5	Oh, Jung-Yong	COR			3	5
A	10	Albarian, Nazar	URS	DC		1	2.5
	8	Baev, Bajo	BUL			3	6 *
A	12	Grassi, Vincenzo	ITA	DES		0	0.5
	14	Sukhbaatar, Surenjav	MGL			4	5
A	16	Neff, Paul	ALE	DC		1	3.5
	18	Erdos, Marton	HUN			3	5
A	19	Castillo, Wanelge	PAN	DC		1	4
	21	Kumar, Sudesh	IND			3	3.5

4e TOUR
4th ROUND

A	23	Sanders, Richard	EUA	TQ	2:48	0	0
	2	Ghorbani, Mohammad	IRN			4	4
A	5	Oh, Jung-Yong	COR	DC		1	6 *
	10	Albarian, Nazar	URS			3	5.5
A	7	Nakata, Shigeo	JPN	DC		1	3.5
	12	Grassi, Vincenzo	ITA			3	3.5
A	14	Sukhbaatar, Surenjav	MGL	TQ	5:44	0	5
	18	Erdos, Marton	HUN			4	9 *
A	16	Neff, Paul	ALE	SE		0.5	4
	19	Castillo, Wanelge	PAN			3.5	7.5*
	21	Kumar, Sudesh	IND	SR			3.5

5e TOUR
5th ROUND **OCT 20**

B	23	Sanders, Richard	EUA	TQ	1:34	0	0
	21	Kumar, Sudesh	IND			4	7.5*
B	7	Nakata, Shigeo	JPN	TQ	6:32	0	3.5
	2	Ghorbani, Mohammad	IRN			4	8 *
A	10	Albarian, Nazar	URS	DC		1	6.5*
	12	Grassi, Vincenzo	ITA			3	6.5*
A	14	Sukhbaatar, Surenjav	MGL	SRT		0	5
	16	Neff, Paul	ALE			4	8 *

6e TOUR **1er MATCH DE POULE**
6th ROUND **1st ROUND ROBIN BOUT**

B	7	Nakata, Shigeo	JPN	DC		1	1
	23	Sanders, Richard	EUA			3	3

Tapis Mat	Résultat Result	PM	PA
-----------	-----------------	----	----

7e TOUR 2e MATCH DE POULE
7th ROUND 2nd ROUND ROBIN BOUT

A	23 14	Sanders, Richard Sukhbaatar, Surenjav	EUA MGL	DC		1 3	4 3
---	----------	------------------------------------------	------------	----	--	--------	--------

TOUR FINAL 3e MATCH DE POULE
FINAL ROUND 3rd ROUND ROBIN BOUT

B	7 14	Nakata, Shigeo Sukhbaatar, Surenjav	JPN MGL	TQ	5:07	0 4	1 7
---	---------	----------------------------------------	------------	----	------	--------	--------

CLASSEMENT FINAL
FINAL STANDING

1	7	Nakata, Shigeo	JPN
2	23	Sanders, Richard	EUA
3	14	Sukhbaatar, Surenjav	MGL
4	10	Albarian, Nazar	URS
5	12	Grassi, Vincenzo	ITA
6	21	Kumar, Sudesh	IND

Tapis Mat	Résultat Result	PM	PA
-----------	-----------------	----	----

2e TOUR OCT 18
2nd ROUND

C	21 1	Singh, Bishamber Singerman, Herbert	IND CAN	SE		0.5 3.5	0.5 3.5
C	3 5	Sevnic, Hasan Chang, Kyung-Mu	TUR COR	DC		1 3	2 6 *
C	6 4	Chavov, Ivan Simeon, Sutev	BUL YUG	TQ	9:00	0 4	1 7 *
C	9 7	Zedzicki, Zbigniew Terán, Marco	POL ECU	TQ	2:10	0 4	1 8 *
C	8 10	Uetake, Yojiro Mayer, Horst	JPN ADE	TQ	1:43	0 4	0 7 *
C	13 11	López, Moisés Alanen, Pekka	MEX FIN	SE		0.5 3.5	4.5 4.5
C	14 12	Aliev, Alí Cristes, Nicolae	URS RUM	DC		1 3	1 6 *
C	17 15	Gorgori, Abutaleb Ahmad, Jan	IRN AFG	DC		1 3	1.5 6 *
C	19 16	Sardar, Mohammad Bazaryn, Sukhbaatar	PAK MGL	DC		1 3	4 4
C	20 18	Behm, Donald Raxon, Javier	EUA GUA	TQ	6:20	0 4	1 7.5*
	2	Famatid, Rogelio	FIL				

3e TOUR OCT 19
3rd ROUND

B	21 3	Singh, Bishamber Sevnic, Hasan	IND TUR	DC		1 3	1.5 5
B	6 1	Chavov, Ivan Singerman, Herbert	BUL CAN	TQ	1:08	0 4	1 7.5*
B	8 9	Uetake, Yojiro Zedzicki, Zbigniew	JPN POL	DC		1 3	1 4
B	14 11	Aliev, Alí Alanen, Pekka	URS FIN	SE		0.5 3.5	1.5 8 *
B	16 13	Bazaryn, Sukhbaatar López, Moisés	MGL MEX	TQ	9:52	0 4	4 8.5*
B	17 19	Gorgori, Abutaleb Sardar, Mohammad	IRN PAK	DC		1 3	2.5 7 *
	20	Behm, Donald	EUA	SR			

4e TOUR
4th ROUND

B	20 21	Behm, Donald Singh, Bishamber	EUA IND	SE		0.5 3.5	1.5 5
B	3 6	Sevnic, Hasan Chavov, Ivan	TUR BUL	()		2.5 2.5	7.5* 3.5
B	8 14	Uetake, Yojiro Aliev, Alí	JPN URS	()		2 2	3 3.5
B	9 16	Zedzicki, Zbigniew Bazaryn, Sukhbaatar	POL MGL	DC		1 3	5 7 *
	17	Gorgori, Abutaleb	IRN	SR			

718

POIDS COQ JUSQU'A 57 Kg
BANTAMWEIGHT UP TO 57 Kgs

1er TOUR OCT 17
1st ROUND

B	1 2	Singerman, Herbert Famatid, Rogelio	CAN FIL	TQ	5:02	0 4
B	3 4	Sevnic, Hasan Simeon, Sutev	TUR YUG	DC		1 3
B	6 5	Chavov, Ivan Chang, Kyung-Mu	BUL COR	DC		1 3
B	8 7	Uetake, Yojiro Terán, Marco	JPN ECU	TQ	2:47	0 4
B	9 10	Zedzicki, Zbigniew Mayer, Horst	POL ADE	DC		1 3
B	11 12	Alanen, Pekka Cristes, Nicolae	FIN RUM	DC		1 3
B	14 13	Aliev, Alí López, Moisés	URS MEX	DES		0 4
B	16 15	Bazaryn, Sukhbaatar Ahmad, Jan	MGL AFG	DC		1 3
B	17 18	Gorgori, Abutaleb Raxon, Javier	IRN GUA	SE		0.5 3.5
B	20 19	Behm, Donald Sardar, Mohammad	EUA PAK	DC		1 3
	21	Singh, Bishamber	IND	SR		

Tapis Mat	Résultat Result	PM	PA
5e TOUR			
5th ROUND			
OCT 20			
B 17	Gorgori, Abutaleb	IRN	DC
20	Behm, Donald	EUA	DC
B 8	Uetake, Yojiro	JPN	SE
21	Singh, Bishamber	IND	SE
B 6	Chavov, Ivan	BUL	DC
9	Zedzicki, Zbigniew	POL	DC
14	Aliev, Ali	URS	SR

Tapis Mat	Résultat Result	PM	PA
6e TOUR			
6th ROUND			
C 14	Aliev, Ali	URS	()
17	Gorgori, Abutaleb	IRN	()
C 20	Behm, Donald	EUA	DC
6	Chavov, Ivan	BUL	DC
8	Uetake, Yojiro	JPN	SR

Tapis Mat	Résultat Result	PM	PA
TOUR FINAL			
FINAL ROUND			
A 8	Uetake, Yojiro	JPN	()
17	Gorgori, Abutaleb	IRN	()
A 20	Behm, Donald	EUA	DC
14	Aliev, Ali	URS	DC

Rank	Tapis Mat	Résultat Result	PM	PA
CLASSEMENT FINAL				
FINAL STANDING				
1	8	Uetake, Yojiro	JPN	()
2	20	Behm, Donald	EUA	DC
3	17	Gorgori, Abutaleb	IRN	()
4	14	Aliev, Ali	URS	DC
5	6	Chavov, Ivan	BUL	DC
6	9	Zedzicki, Zbigniew	POL	DC

POIDS PLUME JUSQU'A 63 Kg
FEATHERWEIGHT UP TO 63 Kgs

Tapis Mat	Résultat Result	PM	PA
1er TOUR			
1st ROUND			
OCT 17			
C 1	Akdag, Vehbi	TUR	DC
2	Luczak, Hans-Jürgen	ADE	DC
C 4	Seyed-Abbassi, Shamseddin	IRN	DC
3	Douglas, Bobby	EUA	DC
C 5	Tedeev, Elkan	URS	DC
6	Ibrahim, Mohammed	AFG	DC

Tapis Mat	Résultat Result	PM	PA
C 8	Teedendambaa, Natsagdorj	MGL	DC
7	Godyn, Tadeusz	POL	DC
C 10	Kaneko, Masaaki	JPN	TQ
9	Ruz, Gabriel	MEX	TQ
C 11	Choi, Jung-Heuk	COR	TQ
12	Rufino, Onésimo	DOM	TQ
C 13	Coman, Petre	RUM	SE
14	McCourtney, John	GBR	SE
C 16	Rusznayak, Jozsef	HUN	DC
15	Bolger, Patrick	CAN	DC
C 17	Enio, Todorov	BUL	TQ
18	Ramos, José	CUB	TQ
C 19	Al Karaghoul, Ismail	IRK	TQ
20	García, José	GUA	TQ
C 22	Karypidis, Nikolaos	GRE	TQ
21	Senosa, Antonio	FIL	TQ
23	Engel, Josef	CHE	SR

Tapis Mat	Résultat Result	PM	PA
2e TOUR			
2nd ROUND			
OCT 18			
A 1	Akdag, Vehbi	TUR	DC
23	Engel, Josef	CHE	DC
A 4	Seyed-Abbassi, Shamseddin	IRN	SE
2	Luczak, Hans-Jürgen	ADE	SE
A 5	Tedeev, Elkan	URS	TQ
7	Godyn, Tadeusz	POL	TQ
A 6	Ibrahim, Mohammed	AFG	()
8	Teedendambaa, Natsagdorj	MGL	()
A 10	Kaneko, Masaaki	JPN	TQ
12	Rufino, Onésimo	DOM	TQ
B 11	Choi, Jung-Heuk	COR	DC
9	Ruz, Gabriel	MEX	DC
B 13	Coman, Petre	RUM	SE
15	Bolger, Patrick	CAN	SE
B 16	Rusznayak, Jozsef	HUN	TQ
14	McCourtney, John	GBR	TQ
C 17	Enio, Todorov	BUL	SE
19	Al Karaghoul, Ismail	IRK	SE
C 18	Ramos, José	CUB	TQ
21	Senosa, Antonio	FIL	TQ
C 22	Karypidis, Nikolaos	GRE	TQ
20	García, José	GUA	TQ
3	Douglas, Bobby	EUA	NSP

Tapis Mat	Résultat Result	PM	PA
3e TOUR			
3rd ROUND			
OCT 19			
C 4	Seyed-Abbassi, Shamseddin	IRN	TQ
23	Engel, Josef	CHE	TQ
C 1	Akdag, Vehbi	TUR	()
5	Tedeev, Elkan	URS	()
C 10	Kaneko, Masaaki	JPN	SE
8	Teedendambaa, Natsagdorj	MGL	SE
C 13	Coman, Petre	RUM	DC
11	Choi, Jung-Heuk	COR	DC
C 17	Enio, Todorov	BUL	SE
16	Rusznayak, Jozsef	HUN	SE
C 18	Ramos, José	CUB	()
19	Al Karaghoul, Ismail	IRK	()
22	Karypidis, Nikolaos	GRE	SR
6	Ibrahim, Mohammed	AFG	NSP

Tapis
MatRésultat
Result

PM PA

POIDS LEGERS JUSQU'A 70 Kg
LIGHTWEIGHT UP TO 70 Kgs**4e TOUR**
4th ROUND

C	22	Karypidis, Nikolaos	GRE	()	2.5	2.5
	1	Akdag, Vehbi	TUR	()	2.5	6.5 *
C	4	Seyed-Abbassi, Shamseddin	IRN	DC	1	2.5
	5	Tedeev, Elkan	URS		3	6 *
C	10	Kaneko, Masaaki	JPN	TQ	0	0.5
	11	Choi, Jung-Heuk	COR		4	8 *
C	17	Enio, Todorov	BUL	DC	1	2
	13	Coman, Petre	RUM		3	5
C	19	Al Karaghoulis, Ismail	IRK	DC	1	6.5 *
	16	Rusznayak, Jozsef	HUN		3	7.5 *

5e TOUR
5th ROUND**OCT 20**

C	4	Seyed-Abbassi, Shamseddin	IRN	TQ	1:39	0	2.5
	22	Karypidis, Nikolaos	GRE			4	6.5 *
C	10	Kaneko, Masaaki	JPN	DC		1	1.5
	13	Coman, Petre	RUM			3	8 *
	17	Enio, Todorov	BUL	SR			2

6e TOUR
6th ROUND**1er MATCH DE POULE**
1st ROUND ROBIN BOUT

A	17	Enio, Todorov	BUL	()	2	2
	4	Seyed-Abbassi, Shamseddin	IRN		2	2
	10	Kaneko, Masaaki	JPN	SR		

7e TOUR
7th ROUND**2e MATCH DE POULE**
2nd ROUND ROBIN BOUT

B	17	Enio, Todorov	BUL	()	2.5	4.5
	10	Kaneko, Masaaki	JPN		2.5	2.5
	4	Seyed-Abbassi, Shamseddin	IRN	SR		2

TOUR FINAL
FINAL ROUND**3e MATCH DE POULE**
3rd ROUND ROBIN BOUT

B	10	Kaneko, Masaaki	JPN	DC	1	3.5
	4	Seyed-Abbassi, Shamseddin	IRN		3	5

CLASSEMENT FINAL
FINAL STANDING

1	10	Kaneko, Masaaki	JPN
2	17	Enio, Todorov	BUL
3	4	Seyed-Abbassi, Shamseddin	IRN
4	22	Karypidis, Nikolaos	GRE
5	13	Coman, Petre	RUM
6	5	Tedeev, Elkan	URS

1er TOUR
1st ROUND**OCT 17**

Tapis Mat	Résultat Result	PM	PA
A	1	Chand, Udey	IND
	2	Aldama, Angel	GUA
A	3	Rost, Klaus	ALE
	4	Till, Rodger	GBR
A	6	Lebequer, Francisco	CUB
	5	Vario, Carlos	ARG
A	7	Movahed, Abdollah	IRN
	8	Garvie, Gordon	CAN
B	9	Marchand, Guy	FRA
	10	Salugta, Eliseo	FIL
B	12	Danzandarjaa, Sereeter	MGL
	11	Marsh, Sidney	AUS
B	13	Agrali, Seyit	TUR
	14	Vargas, Israel	MEX
B	15	Taj, Mohammad	PAK
	16	Ioannidis, Stefanos	GRE
B	18	Enio, Valtchev	BUL
	17	Karlsson, Jan	SUE
C	19	Wells, Wayne	EUA
	20	Beriashvili, Zarbeg	URS
C	22	Enache, Ion	RUM
	21	Aguilar, Severino	PAN
C	23	Pajak, Janusz	POL
	24	Dastagir, Akha	AFG
C	25	Horiuchi, Iwao	JPN
	26	Buzas, Karoly	HUN

2e TOUR
2nd ROUND**OCT 18**

B	3	Rost, Klaus	ALE
	1	Chand, Udey	IND
B	4	Till, Rodger	GBR
	2	Aldama, Angel	GUA
B	7	Movahed, Abdollah	IRN
	5	Vario, Carlos	ARG
B	6	Lebequer, Francisco	CUB
	8	Garvie, Gordon	CAN
B	9	Marchand, Guy	FRA
	11	Marsh, Sidney	AUS
B	12	Danzandarjaa, Sereeter	MGL
	10	Salugta, Eliseo	FIL
B	13	Agrali, Seyit	TUR
	15	Taj, Mohammad	PAK
B	16	Ioannidis, Stefanos	GRE
	14	Vargas, Israel	MEX
B	19	Wells, Wayne	EUA
	17	Karlsson, Jan	SUE
B	18	Enio, Valtchev	BUL
	20	Beriashvili, Zarbeg	URS
B	23	Pajak, Janusz	POL
	21	Aguilar, Severino	PAN
B	25	Horiuchi, Iwao	JPN
	22	Enache, Ion	RUM
B	24	Dastagir, Akha	AFG
	26	Buzas, Karoly	HUN

Tapis
Mat

3e TOUR
3rd ROUND

OCT 19

				Résultat Result	PM	PA
A	1	Chand, Udey	IND	TQ	2:07	0 3
	4	Till, Rodger	GBR			4 8 *
A	3	Rost, Klaus	ALE	DC		1 2
	6	Lebequer, Francisco	CUB			3 4
A	7	Movahed, Abdollah	IRN	SE		0.5 1.5
	9	Marchand, Guy	FRA			3.5 4.5
A	12	Danzandarjaa, Sereeter	MGL	DC		1 1.5
	13	Agrali, Seyit	TUR			3 4.5
A	18	Enio, Valtchev	BUL	TQ	1:38	0 3
	15	Taj, Mohammad	PAK			4 8 *
A	19	Wells, Wayne	EUA	TQ	8:15	0 3
	16	Ioannidis, Stefanos	GRE			4 8 *
A	20	Beriashvili, Zarbeg	URS	TQ	2:10	0 4
	22	Enache, Ion	RUM			4 8 *
A	25	Horiuchi, Iwao	JPN	DC		1 2
	23	Pajak, Janusz	POL			3 4

4e TOUR
4th ROUND

A	1	Chand, Udey	IND	TQ	6:49	0 3
	6	Lebequer, Francisco	CUB			4 8 *
A	7	Movahed, Abdollah	IRN	SE		0.5 2
	3	Rost, Klaus	ALE			3.5 5.5
A	12	Danzandarjaa, Sereeter	MGL	TQ	1:52	0 1.5
	9	Marchand, Guy	FRA			4 8.5 *
A	18	Enio, Valtchev	BUL	TQ	10:28	0 3
	13	Agrali, Seyit	TUR			4 8.5 *
A	19	Wells, Wayne	EUA	DC		1 4
	23	Pajak, Janusz	POL			3 7 *
A	20	Beriashvili, Zarbeg	URS	DC		1 5
	25	Horiuchi, Iwao	JPN			3 5

5e TOUR
5th ROUND

OCT 20

C	7	Movahed, Abdollah	IRN	DC		1 3
	1	Chand, Udey	IND			3 6 *
C	18	Enio, Valtchev	BUL	TQ	10:38	0 3
	3	Rost, Klaus	ALE			4 9.5 *
C	20	Beriashvili, Zarbeg	URS	DC		1 6 *
	12	Danzandarjaa, Sereeter	MGL			3 4.5
C	19	Wells, Wayne	EUA	DC		1 5
	25	Horiuchi, Iwao	JPN			3 8 *

6e TOUR
6th ROUND

A	7	Movahed, Abdollah	IRN	DC		1 4
	12	Danzandarjaa, Sereeter	MGL			3 7.5 *
A	18	Enio, Valtchev	BUL	DC		1 4
	19	Wells, Wayne	EUA			3 8 *

Tapis
Mat

TOUR FINAL
FINAL ROUND

B	7	Movahed, Abdollah	IRN	DC		1 5
	18	Enio, Valtchev	BUL			3 7

CLASSEMENT FINAL
FINAL STANDING

1	7	Movahed, Abdollah	IRN
2	18	Enio, Valtchev	BUL
3	12	Danzandarjaa, Sereeter	MGL
4	19	Wells, Wayne	EUA
5	20	Beriashvili, Zarbeg	URS
6	1	Chand, Udey	IND

POIDS WELTERS JUSQU'A 78 Kg
WELTERWEIGHT UP TO 78 Kgs

1er TOUR
1st ROUND

OCT 17

A	2	Shakhmuradov, Yury	URS	TQ	0:37	0 4
	1	Singh, Mukhtiar	IND			4 4
A	3	Heffel, Brian	CAN	TQ	9:14	0 4
	4	O'Brien, Wesley	AUS			4 4
A	5	Sotirov, Anguele	BUL	DC		1 1
	6	Purev, Dagvasuren	MGL			3 3
A	8	Bajko, Karoly	HUN	DC		1 1
	7	Shacklady, Anthony	GBR			3 3
A	9	Momeni, Ali-Mohammad	IRN	SE		0.5 0.5
	10	Ayub, Kayum	AFG			3.5 3.5
A	11	Heinze, Martin	ALE	DC		1 1
	12	Romero, Carlos	MEX			3 3
A	13	Suh, Young-Suk	COR	DC		1 1
	14	Ferrari, Osvaldo	ITA			3 3
A	15	Atalay, Mahmut	TUR	DC		1 1
	16	Combs, Steven	EUA			3 3
A	18	Robin, Daniel	FRA	DC		1 1
	17	Martinetti, Jimmy	SUI			3 3
A	19	Sasaki, Tatsuo	JPN	SR		

2e TOUR
2nd ROUND

OCT 18

A	19	Sasaki, Tatsuo	JPN	TQ	10:10	0 0
	1	Singh, Mukhtiar	IND			4 8 *
A	2	Shakhmuradov, Yury	URS	SE		0.5 0.5
	3	Heffel, Brian	CAN			3.5 3.5
A	5	Sotirov, Anguele	BUL	TQ	1:03	0 1
	4	O'Brien, Wesley	AUS			4 8 *
A	6	Purev, Dagvasuren	MGL	TQ	4:51	0 3
	7	Shacklady, Anthony	GBR			4 7 *

Tapis Mat			Résultat Result	PM	PA
A	9	Momeni, Ali-Mohammad	IRN	DC	1 1.5
	8	Bajko, Karoly	HUN		3 4
A	11	Heinze, Martin	ALE	DES	0 1
	10	Ayub, Kayum	AFG		4 7.5*
A	13	Suh, Young-Suk	COR	TQ	0 1
	12	Romero, Carlos	MEX		4 7 *
A	15	Atalay, Mahmut	TUR	SE	0.5 1.5
	14	Ferrari, Osvaldo	ITA		3.5 6.5*
A	16	Combs, Steven	EUA	DC	1 4
	17	Martinetti, Jimmy	SUI		3 6 *
	18	Robin, Daniel	FRA	SR	

Tapis Mat			Résultat Result	PM	PA
TOUR FINAL					
FINAL ROUND					
B	15	Atalay, Mahmut	TUR	DC	1 5.5
	18	Robin, Daniel	FRA		3 8
CLASSEMENT FINAL					
FINAL STANDING					

3e TOUR 3rd ROUND

OCT 19

B	19	Sasaki, Tatsuo	JPN	DC	1 1
	18	Robin, Daniel	FRA		3 4
B	2	Shakhmuradov, Yury	URS	DC	1 1.5
	5	Sotirov, Anguele	BUL		3 4
B	6	Purev, Dagvasuren	MGL	TQ	0 3
	3	Heffel, Brian	CAN		4 7.5*
B	8	Bajko, Karoly	HUN	DC	1 5
	11	Heinze, Martin	ALE		3 4
B	15	Atalay, Mahmut	TUR	DC	1 2.5
	9	Momeni, Ali-Mohammad	IRN		3 4.5
B	16	Combs, Steven	EUA	DC	1 5
	13	Suh, Young-Suk	COR		3 4

1	15	Atalay, Mahmut	TUR
2	18	Robin, Daniel	FRA
3	6	Purev, Dagvasuren	MGL
4	9	Momeni, Ali-Mohammad	IRN
5	19	Sasaki, Tatsuo	JPN
6	2	Shakhmuradov, Yury	URS

POIDS MOYENS JUSQU'A 87 Kg MIDDLEWEIGHT UP TO 87 Kgs

1er TOUR 1st ROUND

OCT 17

4e TOUR 4th ROUND

B	18	Robin, Daniel	FRA	DES	0 4
	2	Shakhmuradov, Yury	URS		4 5.5
B	5	Sotirov, Anguele	BUL	DC	1 5
	19	Sasaki, Tatsuo	JPN		3 4
B	6	Purev, Dagvasuren	MGL	DC	1 4
	8	Bajko, Karoly	HUN		3 8 *
B	9	Momeni, Ali-Mohammad	IRN	DC	1 5.5
	11	Heinze, Martin	ALE		3 7 *
B	15	Atalay, Mahmut	TUR	TQ	0 2.5
	13	Suh, Young-Suk	COR		4 8 *
	16	Combs, Steven	EUA	SR	

B	2	Graffigna, Julio	ARG	DC	1
	1	Dastagir, Gulam	AFG		3
B	3	Gardjev, Prodane	BUL	()	2
	4	Peckham, Thomas	EUA		2
B	5	Ballo, Francisc	RUM	DES	0
	6	Mehdizadeh, Mansour	IRN		4
B	7	Hellosi, Geza	HUN	DC	1
	8	Marcheggiani, Umberto	ITA		3
B	10	Grinstead, Ronald	GBR	DC	1
	9	Chamberot, Robert	CAN		3
B	12	Gurevitch, Boris	URS	TQ	0
	11	Ninon, Robert	BAH		4
B	13	Wypiorczyk, Jan	POL	()	2.5
	14	Endo, Shigeru	JPN		2.5
B	16	Lara, Lupe	CUB	DC	1
	15	Knoll, Ernst	ALE		3
B	17	Chardonens, Jean-Marie	SUI	()	2
	18	García, Raul	MEX		2
B	19	Jigjid, Munkhbat	MGL	DC	1
	20	Doring, Peter	ADE		3
B	21	Gursoy, Huseyin	TUR	TQ	0
	22	Hernández, José	GUA		4

5e TOUR 5th ROUND

OCT 20

B	18	Robin, Daniel	FRA	DC	1 5
	16	Combs, Steven	EUA		3 8 *
B	19	Sasaki, Tatsuo	JPN	()	2.5 6.5 *
	2	Shakhmuradov, Yury	URS		2.5 8 *
B	9	Momeni, Ali-Mohammad	IRN	DC	1 6.5 *
	5	Sotirov, Anguele	BUL		3 8 *
B	6	Purev, Dagvasuren	MGL	()	2 6 *
	15	Atalay, Mahmut	TUR		2 4.5

2e TOUR 2nd ROUND

OCT 18

B	3	Gardjev, Prodane	BUL	TQ	0 2
	1	Dastagir, Gulam	AFG		4 7 *
B	4	Peckham, Thomas	EUA	DC	1 3
	2	Graffigna, Julio	ARG		3 4

Tapis Mat			Résultat Result	PM	PA
B	5	Ballo, Francisc	RUM	DES	4 4
	7	Hollosi, Geza	HUN		4 5 *
B	8	Marcheggiani, Umberto	ITA	SE	0.5 3.5
	9	Chamberot, Robert	CAN		3.5 6.5 *
B	10	Grinstead, Ronald	GBR	TQ	4:33 0 1
	11	Nihon, Robert	BAH		8 *
B	12	Gurevitch, Boris	URS	TQ	10:36 0 0
	13	Wypiorczyk, Jan	POL		4 6.5 *
B	14	Endo, Shigeru	JPN	DC	1 3.5
	15	Knoll, Ernst	ALE		3 6 *
B	16	Lara, Lupe	CUB	DC	1 2
	17	Chardonners, Jean-Marie	SUI		3 5
B	19	Jigjid, Munkhbat	MGL	TQ	1:17 0 1
	18	García, Raul	MEX		4 6 *
B	20	Doring, Peter	ADE	TQ	0:37 0 3
	21	Hernández, José	GUA		4 8 *
	22	Gursoy, Huseyin	TUR	SR	
	6	Mehdizadeh, Mansour	IRN	NSP	

3e TOUR
3rd ROUND

OCT 19

C	22	Gursoy, Huseyin	TUR	DC	1 1
	2	Graffigna, Julio	ARG		3 7 *
C	3	Gardjev, Prodane	BUL	TQ	6:54 0 2
	5	Ballo, Francisc	RUM		4 8 *
C	4	Peckham, Thomas	EUA	TQ	1:39 0 3
	8	Marcheggiani, Umberto	ITA		4 7.5 *
C	12	Gurevitch, Boris	URS	SE	0.5 0.5
	10	Grinstead, Ronald	GBR		3.5 4.5
C	14	Endo, Shigeru	JPN	DC	1 4.5
	16	Lara, Lupe	CUB		3 5
C	19	Jigjid, Munkhbat	MGL	SE	0.5 1.5
	17	Chardonners, Jean-Marie	SUI		3.5 8.5 *
	20	Doring, Peter	ADE	SR	

4e TOUR
4th ROUND

C	22	Gursoy, Huseyin	TUR	DC	1 2
	20	Doring, Peter	ADE		3 6 *
C	3	Gardjev, Prodane	BUL	SE	0.5 2.5
	10	Grinstead, Ronald	GBR		3.5 8 *
C	4	Peckham, Thomas	EUA	TQ	1:19 0 3
	14	Endo, Shigeru	JPN		4 8.5 *
C	12	Gurevitch, Boris	URS	TQ	0:49 0 0.5
	16	Lara, Lupe	CUB		4 9 *
	19	Jigjid, Munkhbat	MGL	SR	

5e TOUR
5th ROUND

OCT 20

B	19	Jigjid, Munkhbat	MGL	()	2 3.5
	3	Gardjev, Prodane	BUL		2 4.5
B	22	Gursoy, Huseyin	TUR	()	2 4
	4	Peckham, Thomas	EUA		2 5
	12	Gurevitch, Boris	URS	SR	

Tapis Mat			Résultat Result	PM	PA
--------------	--	--	--------------------	----	----

6e TOUR
6th ROUND

B	12	Gurevitch, Boris	URS	()	2 2.5
	19	Jigjid, Munkhbat	MGL		2 5.5
B	3	Gardjev, Prodane	BUL	DC	1 5.5
	22	Gursoy, Huseyin	TUR		3 7 *
	4	Peckham, Thomas	EUA	SR	

TOUR FINAL
FINAL ROUND

C	19	Jigjid, Munkhbat	MGL	DC	1 6.5
	4	Peckham, Thomas	EUA		3 8
C	3	Gardjev, Prodane	BUL	()	2 7.5
	12	Gurevitch, Boris	URS		2 4.5

CLASSEMENT FINAL
FINAL STANDING

1	12	Gurevitch, Boris	URS
2	19	Jigjid, Munkhbat	MGL
3	3	Gardjev, Prodane	BUL
4	4	Peckham, Thomas	EUA
5	22	Gursoy, Huseyin	TUR
6	20	Doring, Peter	ADE

723

POIDS MI-LOURDS JUSQU'A 97 Kg
LIGHT HEAVYWEIGHT UP TO 97 Kgs

1er TOUR
1st ROUND

OCT 17

C	1	Lewis, Jess	EUA	DC	1
	2	Bachmann, Gerd	ADE		3
C	3	Kawano, Zhunichi	JPN	DC	1
	4	Negut, Nicolae	RUM		3
C	5	Dlugosz, Ryszard	POL	TQ	1:33 0
	6	Nihon, Alexis, Jr.	BAH		4
C	8	Khorloogyn, Biiannmunkh	MGL	SE	0.5
	7	Millard, Edward	CAN		3.5
C	9	Csatari, Jozsef	HUN	DC	1
	10	Jutzeler, Peter	SUI		3
C	12	Lomidze, Shota	URS	SE	0.5
	11	Kiehl, Heinz	ALE		3.5
C	13	Eskandar, Moslem	IRN	SE	0.5
	14	Vernik, Victor	ARG		3.5
C	16	Ayik, Ahmet	TUR	DC	1
	15	Moustafov, Said	BUL		3

Tapis
MatRésultat
Result PM PA2e TOUR
2nd ROUND

OCT 18

C	1	Lewis, Jess	EUA	DC	1	2
	3	Kawano, Zhunichi	JPN		3	4
C	2	Bachmann, Gerd	ADE	()	2	5
	4	Negut, Nicolae	RUM		2	5
C	7	Millard, Edward	CAN	DC	1	4.5
	5	Dlugosz, Ryszard	POL		3	3
C	8	Khorloogyn, Biianmunkh	MGL	TQ	1:17	0 0.5
	6	Ninon, Alexis, Jr.	BAH		4	8 *
C	10	Jutzeler, Peter	SUI	DC	1	4
	13	Eskandar, Moslem	IRN		3	3.5
C	12	Lomidze, Shota	URS	DC	1	1.5
	9	Csatari, Jozsef	HUN		3	4
C	15	Moustafov, Said	BUL	TQ	5:16	0 3
	14	Vernik, Victor	ARG		4	7.5 *
	16	Ayik, Ahmet	TUR	SR		
	11	Kiehl, Heinz	ALE	NSP		

6e TOUR
6th ROUND 1er MATCH DE POULE
1st ROUND ROBIN BOUT

C	12	Lomidze, Shota	URS	DC	1	1
	9	Csatari, Jozsef	HUN		3	3
C	16	Ayik, Ahmet	TUR	SR		

7e TOUR
7th ROUND 2e MATCH DE POULE
2nd ROUND ROBIN BOUT

C	16	Ayik, Ahmet	TUR	TQ	10:12	0 0
	9	Csatari, Jozsef	HUN		4	7
C	12	Lomidze, Shota	URS	SR		

TOUR FINAL
FINAL ROUND 3e MATCH DE POULE
3rd ROUND ROBIN BOUT

B	12	Lomidze, Shota	URS	()	2	3
	16	Ayik, Ahmet	TUR		2	2

CLASSEMENT FINAL
FINAL STANDING

1	16	Ayik, Ahmet	TUR
2	12	Lomidze, Shota	URS
3	9	Csatari, Jozsef	HUN
4	15	Moustafov, Said	BUL
5	8	Khorloogyn, Biianmunkh	MGL
6	1	Lewis, Jess	EUA

3e TOUR
3rd ROUND

OCT 19

A	16	Ayik, Ahmet	TUR	()	2	3
	1	Lewis, Jess	EUA		2	4
A	2	Bachmann, Gerd	ADE	DC	1	6 *
	3	Kawano, Zhunichi	JPN		3	7 *
A	5	Dlugosz, Ryszard	POL	DC	1	4
	4	Negut, Nicolae	RUM		3	8 *
A	9	Csatari, Jozsef	HUN	TQ	9:02	0 4
	7	Millard, Edward	CAN		4	8.5 *
A	8	Khorloogyn, Biianmunkh	MGL	DC	1	1.5
	10	Jutzeler, Peter	SUI		3	7 *
A	12	Lomidze, Shota	URS	DC	1	2.5
	13	Eskandar, Moslem	IRN		3	6.5 *
	15	Moustafov, Said	BUL	SR		

4e TOUR
4th ROUND

C	15	Moustafov, Said	BUL	DC	1	4
	1	Lewis, Jess	EUA		3	7 *
C	16	Ayik, Ahmet	TUR	DC	1	4
	5	Dlugosz, Ryszard	POL		3	7 *
C	9	Csatari, Jozsef	HUN	DC	1	5
	8	Khorloogyn, Biianmunkh	MGL		3	4.5
	12	Lomidze, Shota	URS	SR		

5e TOUR
5th ROUND

OCT 20

A	16	Ayik, Ahmet	TUR	TQ	1:02	0 4
	8	Khorloogyn, Biianmunkh	MGL		4	8.5 *
A	12	Lomidze, Shota	URS	()	2.5	5
	15	Moustafov, Said	BUL		2.5	6.5 *
	9	Csatari, Jozsef	HUN	SR		

POIDS LOURDS 97 Kg ET PLUS
HEAVYWEIGHT 97 Kgs OR MORE1er TOUR
1st ROUND OCT 17

A	1	Douraliev, Osman	BUL	TQ	2:00	0
	2	Isogai, Yorihide	JPN			4
A	4	Medved, Alexander	URS	TQ	6:29	0
	3	Yilmaz, Giyasettin	TUR			4
A	6	Anvari, Abolfazl	IRN	DC		1
	5	Nyers, Laszlo	HUN			3
B	7	Kristoff, Larry	EUA	DES		0
	8	Robertsson, Arne	SUE			4
B	9	Dietrich, Wilfried	ALE	TQ	2:10	0
	10	Geris, Harry	CAN			4
B	12	Elziisaikhan, Erdeneotchir	MGL	DC		1
	11	Bochenski, Wieslaw	POL			3
C	14	Stingu, Stefan	RUM	TQ	8:45	0
	13	Uytterhaegue, Raymond	FRA			4
	15	Nihon, Alexis	BAH	SR		

Tapis
Mat

Résultat
Result

PM PA

2e TOUR
2nd ROUND

OCT 18

A	1	Douraliev, Osman	BUL	Δ	8:34	0	0
	3	Yilmaz, Giyasettin	TUR			4	8 *
A	4	Medved, Alexander	URS	TQ	0:46	0	0
	2	Isogai, Yorihide	JPN			4	8 *
B	6	Anvari, Abolfazl	IRN	DC		1	2
	8	Robertsson, Arne	SUE			3	7 *
A	7	Kristoff, Larry	EUA	DC		1	1
	5	Nyers, Laszlo	HUN			3	6 *
B	9	Dietrich, Wilfried	ALE	DES		0	0
	11	Bochenski, Wieslaw	POL			4	7 *
C	13	Uytterhaeghe, Raymond	FRA	DC		1	5
	10	Geris, Harry	CAN			3	7 *
C	14	Stingu, Stefan	RUM	TQ	1:42	0	0
	12	Elziisaikhan, Erdeneotchir	MGL			4	5
	15	Nihon, Alexis	BAH	NSP			

CLASSEMENT FINAL
FINAL STANDING

1	4	Medved, Alexander	URS
2	1	Douraliev, Osman	BUL
3	9	Dietrich, Wilfried	ALE
4	14	Stingu, Stefan	RUM
5	7	Kristoff, Larry	EUA
6	6	Anvari, Abolfazl	IRN

LUTTE GRECO-ROMAINE
GRECO-ROMAN STYLE

POIDS MOUCHE JUSQU'A 52 Kg
FLYWEIGHT UP TO 52 Kgs

3e TOUR
3rd ROUND

OCT 19

B	4	Medved, Alexander	URS	DC		1	1
	1	Douraliev, Osman	BUL			3	3
B	7	Kristoff, Larry	EUA	DC		1	2
	6	Anvari, Abolfazl	IRN			3	5
B	9	Dietrich, Wilfried	ALE	DC		1	1
	14	Stingu, Stefan	RUM			3	3
B	12	Elziisaikhan, Erdeneotchir	MGL	TQ	2:18	0	5
	13	Uytterhaeghe, Raymond	FRA			4	9 *

1er TOUR
1st ROUND

OCT 23

A	1	Chahrour, Ahmed	SIR	()		2	
	2	Mongued, Mohamed	RAU			2	
A	4	Zeman, Miroslav	CHE	TQ	5:20	0	
	3	Duarte, Leonel	POR			4	
A	6	Shin, Sang-Sik	COR	DC		1	
	5	Borger, Alex	DIN			3	
A	7	Jiménez, Enrique	MEX	TQ	1:25	0	
	8	Ramírez Gustavo	GUA			4	
A	9	Alker, Imre	HUN	()		2.5	
	10	Lacour, Rolf	ALE			2.5	
A	11	Kumar, Sudesh	IND	()		2	
	12	Karmous, Mohamed	MAR			2	
A	14	Marinko, Bosko	YUG	DC		1	
	13	Gaudinot, André	FRA			3	
A	15	Stoiciu, Gheorghe	RUM	DC		1	
	16	Michalik, Jan	POL			3	
A	17	Vesterinen, Jussi	FIN	DES	9:45	0	
	18	Ishiguro, Shuichi	JPN			4	
A	20	Ganotis, Vassilios	GRE	DC		1	
	19	Centurioni, Domenico	ITA			3	
A	21	Kirov, Petar	BUL	DC		1	
	22	Cikmaz, Metin	TUR			3	
A	24	Bakulin, Vladimir	URS	DC		1	
	23	Tamble, Richard	EUA			3	

725

4e TOUR
4th ROUND

B	1	Douraliev, Osman	BUL	TQ	6:39	0	3
	6	Anvari, Abolfazl	IRN			4	9 *
B	4	Medved, Alexander	URS	DES		0	1
	7	Kristoff, Larry	EUA			4	6 *
B	9	Dietrich, Wilfried	ALE	TQ	4:35	0	1
	12	Elziisaikhan, Erdeneotchir	MGL			4	9 *
	14	Stingu, Stefan	RUM	SR			

5e TOUR
5th ROUND

OCT 20

B	1	Douraliev, Osman	BUL	DC		1	4
	14	Stingu, Stefan	RUM			3	6 *
B	4	Medved, Alexander	URS			0	1
	9	Dietrich, Wilfried	ALE			4	5

2e TOUR
2nd ROUND

OCT 24

A	1	Chahrour, Ahmed	SIR	SE		0.5	2.5
	3	Duarte, Leonel	POR			3.5	7.5 *
A	4	Zeman, Miroslav	CHE	DC		1	1
	2	Mongued, Mohamed	RAU			3	5
A	5	Borger, Alex	DIN	()		2	5
	7	Jiménez, Enrique	MEX			2	2
A	6	Shin, Sang-Sik	COR	TQ	0:56	0	1
	8	Ramírez Gustavo	GUA			4	8 *

TOUR FINAL
FINAL ROUND

B	1	Douraliev, Osman	BUL			0	4
	9	Dietrich, Wilfried	ALE			4	9

Tapis Mat		Résultat Result	PM	PA
A	9 Alker, Imre	HUN		
	11 Kumar, Sudesh	IND	TQ 2:57	0 2.5 4 6 *
A	10 Lacour, Rolf	ALE		0 2.5
	12 Karmous, Mohamed	MAR	DES	4 6 *
A	14 Marinko, Bosko	YUG		2.5 3.5
	15 Stoiciu, Gheorghe	RUM	()	2.5 3.5
A	17 Vesterinen, Jussi	FIN		1 1
	16 Michalik, Jan	POL	DC	3 6 *
A	19 Centurioni, Domenico	ITA		0 3
	18 Ishiguro, Shuichi	JPN	TQ 2:01	4 8 *
A	21 Kirov, Petar	BUL		1 2
	20 Ganotis, Vassilios	GRE	DC	3 4
A	22 Cikmaz, Metin	TUR		1 4
	23 Tamble, Richard	EUA	DC	3 6 *
	24 Bakulin, Vladimir	URS	SR	
	13 Gaudinot, André	FRA	NSP	

3e TOUR 3rd ROUND

OCT 25

A	24 Bakulin, Vladimir	URS		0 1
	1 Chahrour, Ahmed	SIR	DES	4 6.5 *
A	4 Zeman, Miroslav	CHE		0 1
	5 Borger, Alex	DIN	TQ 1:55	4 9 *
A	7 Jiménez, Enrique	MEX		1 3
	6 Shin, Sang-Sik	COR	DC	3 4
A	9 Alker, Imre	HUN		1 3.5
	14 Marinko, Bosko	HUN	DC	3 6.5 *
A	10 Lacour, Rolf	ALE		0 2.5
	15 Stoiciu, Gheorghe	RUM	TQ 1:52	4 7.5 *
A	17 Vesterinen, Jussi	FIN		1 2
	20 Ganotis, Vassilios	GRE	DC	3 7 *
A	21 Kirov, Petar	BUL		1 3
	19 Centurioni, Domenico	ITA	DC	
	22 Cikmaz, Metin	TUR	SR	3 6 *
	2 Mongued, Mohamed	RAU	NSP	

4e TOUR 4th ROUND

A	24 Bakulin, Vladimir	URS		1 2
	22 Cikmaz, Metin	TUR	DC	3 7 *
A	4 Zeman, Miroslav	CHE		1 2
	6 Shin, Sang-Sik	COR	DC	3 7 *
A	9 Alker, Imre	HUN		1 4.5
	7 Jiménez, Enrique	MEX	DC	3 6 *
A	10 Lacour, Rolf	ALE		2.5 5
	17 Vesterinen, Jussi	FIN	()	2.5 4.5
	21 Kirov, Petar	BUL	SR	

5e TOUR 5th ROUND

OCT 26

A	21 Kirov, Petar	BUL		1 4
	24 Bakulin, Vladimir	URS	DC	3 5
A	10 Lacour, Rolf	ALE		1 6 *
	4 Zeman, Miroslav	CHE	DC	3 5
A	9 Alker, Imre	HUN		1 5.5
	17 Vesterinen, Jussi	FIN	DC	3 7.5 *

Tapis Mat		Résultat Result	PM	PA
TOUR FINAL FINAL ROUND				
B	21 Kirov, Petar	BUL		1 5
	4 Zeman, Miroslav	CHE	DC	3 8
B	24 Bakulin, Vladimir	URS		1 6
	9 Alker, Imre	HUN	DC	3 8.5

CLASSEMENT FINAL FINAL STANDING

1	21 Kirov, Petar	BUL
2	24 Bakulin, Vladimir	URS
3	4 Zeman, Miroslav	CHE
4	9 Alker, Imre	HUN
5	10 Lacour, Rolf	ALE
6	17 Vesterinen, Jussi	FIN

POIDS COQ JUSQU'A 57 Kg BANTAMWEIGHT UP TO 57 Kgs

1er TOUR 1st ROUND

OCT 23

B	2 Baciu, Ion	RUM		1
	1 Hazewinkel, David	EUA	DC	3
B	4 Traikov, Hristo	BUL		0
	3 Nielsen, Johnny	DIN	DES	4
B	5 Ibrahim, El Sayed	RAU		1
	6 Guerra, Rodolfo	MEX	DC	3
B	8 Nakouzi, Jean	LIB		0
	7 Singerman, Herbert	CAN	TQ 10:51	4
B	10 Sakurama, Kouji	JPN		1
	9 Svensson, Roland	SUE	DC	3
B	11 Spaenhoven, Arthur	BEL		2.5
	12 Puls, Hartmut	ADE	()	2.5
B	14 Kochergin, Ivan	URS		0
	13 Stange, Friedrich	ALE	TQ 9:08	4
B	16 Varga, Janos	HUN		0
	15 Grilo, Luis	POR	TQ 2:47	4
B	18 Moschidis, Othon	GRE		1
	17 Covic, Karlo	YUG	DC	3
B	19 Bjorlin, Risto	FIN		0
	20 Raxon, Javier	GUA	TQ 4:38	4
B	22 An, Chun-Young	COR		1
	21 Karouane, Khalifa	MAR	DC	3
B	23 Ozcan, Kaya	TUR		1
	24 Lipien, Jozef	POL	DC	3

Tapis
Mat

2e TOUR
2nd ROUND

OCT 24

			Résultat Result		PM	PA
B	1	Hazewinkel, David	EUA	TQ	8:28	0 3
	3	Nielsen, Johnny	DIN			4 8 *
B	2	Baciu, Ion	RUM	DC		1 2
	4	Traikov, Hristo	BUL			3 3
B	5	Ibrahim, El Sayed	RAU	TQ	1:30	0 1
	7	Singerman, Herbert	CAN			4 8 *
B	6	Guerra, Rodolfo	MEX	DC		1 4
	8	Nakouzi, Jean	LIB			3 3
B	11	Spaenhoven, Arthur	BEL	DC		1 3.5
	9	Svensson, Roland	SUE			3 6 *
B	10	Sakurama, Kouji	JPN	TQ	10:45	0 1
	12	Puls, Hartmut	ADE			4 6.5 *
B	13	Stange, Friedrich	ALE	DC		1 5
	15	Grilo, Luis	POR			3 7 *
B	16	Varga, Janos	HUN	DC		1 1
	14	Kochergin, Ivan	URS			3 3
B	17	Covic, Karlo	YUG	DC		1 4
	19	Bjorlin, Risto	FIN			3 3
B	18	Moschidis, Othon	GRE	TQ	1:23	0 1
	20	Raxon, Javier	GUA			4 8 *
B	23	Ozcan, Kaya	TUR	DC		1 2
	21	Karouane, Khalifa	MAR			3 6 *
B	22	An, Chun-Young	COR	()		2 3
	24	Lipien, Jozef	POL			2 5

3e TOUR
3rd ROUND

OCT 25

B	1	Hazewinkel, David	EUA	DES		0 3
	4	Traikov, Hristo	BUL			4 7 *
B	2	Baciu, Ion	RUM	DC		1 3
	5	Ibrahim, El Sayed	RAU			3 4
B	10	Sakurama, Kouji	JPN	TQ	2:44	0 1
	6	Guerra, Rodolfo	MEX			4 8 *
B	11	Spaenhoven, Arthur	BEL	DC		1 4.5
	8	Nakouzi, Jean	LIB			3 6
B	14	Kochergin, Ivan	URS	DC		1 4
	17	Covic, Karlo	YUG			3 7
B	16	Varga, Janos	HUN	DC		1 2
	18	Moschidis, Othon	GRE			3 4
B	19	Bjorlin, Risto	FIN	TQ	9:00	0 3
	24	Lipien, Jozef	POL			4 9 *
B	22	An, Chun-Young	COR	DC		1 4
	23	Ozcan, Kaya	TUR			3 5
	13	Stange, Friedrich	ALE			

4e TOUR
4th ROUND

B	5	Ibrahim, El Sayed	RAU	DC		1 5
	1	Hazewinkel, David	EUA			3 6 *
B	2	Baciu, Ion	RUM	()		2.5 5.5
	10	Sakurama, Kouji	JPN			2.5 3.5

Tapis
Mat

B	14	Kochergin, Ivan	URS	DC		1 5
	11	Spaenhoven, Arthur	BEL			3 7.5 *
B	16	Varga, Janos	HUN	DC		1 3
	19	Bjorlin, Risto	FIN			3 6 *
B	18	Moschidis, Othon	GRE	DC		1 5
	22	An, Chun-Young	COR			3 7 *
	23	Ozcan, Kaya	TUR	SR		

5e TOUR
5th ROUND

OCT 26

B	2	Baciu, Ion	RUM	TQ	6:13	0 5.5
	23	Ozcan, Kaya	TUR			4 9 *
B	14	Kochergin, Ivan	URS	TQ	10:49	0 5
	5	Ibrahim, El Sayed	RAU			4 9 *
B	16	Varga, Janos	HUN	DC		1 4
	10	Sakurama, Kouji	JPN			3 6.5 *
	18	Moschidis, Othon	GRE	SR		

6e TOUR
6th ROUND

B	18	Moschidis, Othon	GRE	()		2.5 7.5
	14	Kochergin, Ivan	URS			2.5 7.5
B	2	Baciu, Ion	RUM	()		2 7.5
	16	Varga, Janos	HUN			2 6

727

7e TOUR 1er MATCH DE POULE
7th ROUND 1st ROUND ROBIN BOUT

B	2	Baciu, Ion	RUM	TQ	2:32	0 0
	18	Moschidis, Othon	GRE			4 4

TOUR FINAL 2e MATCH DE POULE
FINAL ROUND 2nd ROUND ROBIN BOUT

B	2	Baciu, Ion	RUM	DES		4
	14	Kochergin, Ivan	URS			4

CLASSEMENT FINAL
FINAL STANDING

1	16	Varga, Janos	HUN
2	2	Baciu, Ion	RUM
3	14	Kochergin, Ivan	URS
4	18	Moschidis, Othon	GRE
5	10	Sakurama, Kouji	JPN
6	23	Ozcan, Kaya	TUR
6	5	Ibrahim, El Sayed	RAU

POIDS PLUME JUSQU'A 63 Kg
FEATHERWEIGHT UP TO 63 Kgs

1er TOUR
1st ROUND **OCT 23**

Tapis Mat		Résultat Result	PM	PA
C	2 Svec, Jiri	CHE	TQ 1:21	0
	1 Garcia, José	GUA		4
C	3 Lazarou, Nikolaos	GRE	DC	1
	4 Godyn, Tadeusz	POL		3
C	6 Alakoc, Hizir	TUR	DES	0
	5 Morais, Adriano	POR		4
C	7 Moareb, Seyed-Hossein	IRN	8.00	0
	8 Hassanein, Yehya	RAU		4
C	9 Gualintchev, Dimitar	BUL	DES	0
	10 Mahassine, Rahal	MAR		4
C	11 Kim, Ik-Jong	COR	()	2.5
	12 Damnjanovic, Sreten	YUG		2.5
C	14 Hazewinkel, James	EUA	DC	1
	13 Ruznyak, Jozsef	HUN		3
C	15 Rurua, Roman	URS	TQ 5:28	0
	16 Al Karaghoul, Ismail	IRK		4
C	18 Popescu, Simion	RUM	SE	0.5
	17 Contreras, Ponciano	MEX		3.5
C	19 Laakso, Martti	FIN	()	2
	20 Schneider, Lothar	ADE		2
C	22 Dutz, Leonard	BEL	TQ 2:49	0
	21 Tumas, Tortillano	FIL		4
	23 Fujimoto, Hideo	JPN	SR	

2e TOUR
2nd ROUND **OCT 24**

C	23 Fujimoto, Hideo	JPN	TQ 0:20	0	0
	1 Garcia, José	GUA		4	8 *
C	2 Svec, Jiri	CHE	DES	4	4
	3 Lazarou, Nikolaos	GRE		4	5
C	4 Godyn, Tadeusz	POL	DES	4	7 *
	5 Morais, Adriano	POR		4	8 *
C	6 Alakoc, Hizir	TUR	DC	1	1
	7 Moareb, Seyed-Hossein	IRN		3	3
C	9 Gualintchev, Dimitar	BUL	DC	1	1
	8 Hassanein, Yehya	RAU		3	7 *
C	11 Kim, Ik-Jong	COR	DES	0	2.5
	10 Mahassine, Rahal	MAR		4	8 *
C	12 Damnjanovic, Sreten	YUG	TQ 2:23	0	2.5
	13 Ruznyak, Jozsef	HUN		4	7 *
C	15 Rurua, Roman	URS	TQ 6:23	0	0
	14 Hazewinkel, James	EUA		4	5
C	19 Laakso, Martti	FIN	DC	1	3
	17 Contreras, Ponciano	MEX		3	6.5*
C	18 Popescu, Simion	RUM	TQ 2:13	0	0.5
	21 Tumas, Tortillano	FIL		4	8 *
C	20 Schneider, Lothar	ADE	DC	1	3
	22 Dutz, Leonard	BEL		3	3
	16 Al Karaghoul, Ismail	IRK	NSP		

Tapis Mat Résultat Result PM PA

3e TOUR
3rd ROUND **OCT 25**

C	23 Fujimoto, Hideo	JPN	DC	1	1
	2 Svec, Jiri	CHE		3	7 *
C	6 Alakoc, Hizir	TUR	DES	0	1
	3 Lazarou, Nikolaos	GRE		4	9 *
C	9 Gualintchev, Dimitar	BUL	TQ 1:20	0	1
	7 Moareb, Seyed-Hossein	IRN		4	7 *
C	14 Hazewinkel, James	EUA	SE	0.5	5.5
	11 Kim, Ik-Jong	COR		3.5	6 *
C	15 Rurua, Roman	URS	TQ 4:37	0	0
	12 Damnjanovic, Sreten	YUG		4	6.5 *
C	18 Popescu, Simion	RUM	()	2	2.5
	20 Schneider, Lothar	ADE		2	5
C	19 Laakso, Martti	FIN	DES	0	3
	22 Dutz, Leonard	BEL		4	7 *

4e TOUR
4th ROUND

C	23 Fujimoto, Hideo	JPN	()	2	3
	6 Alakoc, Hizir	TUR		2	3
C	9 Gualintchev, Dimitar	BUL	DC	1	2
	14 Hazewinkel, James	EUA		3	8.5 *
C	15 Rurua, Roman	URS	TQ 8:56	0	0
	20 Schneider, Lothar	ADE		4	9 *
C	18 Popescu, Simion	RUM	DC	1	3.5
	19 Laakso, Martti	FIN		3	6 *

5e TOUR
5th ROUND **OCT 26**

B	23 Fujimoto, Hideo	JPN	DC	1	4
	9 Gualintchev, Dimitar	BUL		3	5
B	15 Rurua, Roman	URS	DC	1	1
	6 Alakoc, Hizir	TUR		3	6 *
	18 Popescu, Simion	RUM	SR		

6e TOUR
6th ROUND

B	23 Fujimoto, Hideo	JPN	DC	1	5
	18 Popescu, Simion	RUM		3	6.5 *
B	15 Rurua, Roman	URS	DC	1	2
	9 Gualintchev, Dimitar	BUL		3	8 *

Tapis Mat	Résultat Result	PM	PA
--------------	--------------------	----	----

TOUR FINAL
FINAL ROUND

B	23	Fujimoto, Hideo	JPN	()	2	7
	15	Rurua, Roman	URS		2	4

CLASSEMENT FINAL
FINAL STANDING

1	15	Rurua, Roman	URS
2	23	Fujimoto, Hideo	JPN
3	18	Popescu, Simion	RUM
4	9	Gualintchev, Dimitar	BUL
5	6	Alakoc, Hizir	TUR
6	19	Laakso, Martti	FIN

POIDS LEGERS JUSQU'A 70 Kg
LIGHTWEIGHT UP TO 70 Kgs

1er TOUR OCT 23
1st ROUND

A	2	Rost, Klaus	ALE	DC	1
	1	El Sherbini, Mahmoud	RAU		3
A	3	Enache, Ion	RUM	()	2.5
	4	Ayvaz, Kazim	TUR		2.5
B	6	Tapio, Eero	FIN	TQ	1:19
	5	Salugta, Eliseo	FIL		4
A	7	Steer, Antal	HUN	DC	1
	8	Apostolov, Stoian	BUL		3
A	9	Mumemura, Muneji	JPN	DES	0
	10	Bellotti, Piero	ITA		4
B	12	Marchand, Guy	FRA	DC	1
	11	Vario, Carlos	ARG		3
B	13	Shu, Hun-Kyo	COR	TQ	0:45
	14	Aldama, Angel	GUA		4
B	15	Galantinho, Luis	POR	DC	1
	16	Garvie, Gordon	CAN		3
B	18	Galaktopoulos, Petros	GRE	TQ	4:44
	17	Tovar, Mario	MEX		4
C	20	Pohl, Klaus	ADE	SE	0.5
	19	Macha, Vitezslav	CHE		3.5
C	21	Sapunov, Gennady	URS	TQ	6:07
	22	Karlsson, Jan	SUE		4
C	23	Horvat, Stevan	YUG	TQ	2:56
	24	Madsen, Kurt	DIN		4
C	25	Holzer, Werner	EUA	TQ	9:52
	26	Moukrim, M'hamed	MAR		4

2e TOUR OCT 24
2nd ROUND

Tapis Mat	Résultat Result	PM	PA			
C	3	Enache, Ion	RUM	DC	1	3.5
	1	El Sherbini, Mahmoud	RAU		3	6 *
C	2	Rost, Klaus	ALE	()	2	3
	4	Ayvaz, Kazim	TUR		2	4.5
C	7	Steer, Antal	HUN	TQ	0:49	0
	5	Salugta, Eliseo	FIL		4	8 *
C	6	Tapio, Eero	FIN	TQ	9:03	0
	8	Apostolov, Stoian	BUL		4	7 *
B	9	Mumemura, Muneji	JPN	SE		0.5
	11	Vario, Carlos	ARG		3.5	6.5 *
B	10	Bellotti, Piero	ITA	DC		1
	12	Marchand, Guy	FRA		3	4
B	13	Shu, Hun-Kyo	COR	DC		1
	15	Galantinho, Luis	POR		3	4
B	16	Garvie, Gordon	CAN	TQ	6:17	0
	14	Aldama, Angel	GUA		4	8 *
A	19	Macha, Vitezslav	CHE	TQ	1:33	0
	17	Tovar, Mario	MEX		4	8 *
B	18	Galaktopoulos, Petros	GRE	TQ	2:50	0
	20	Pohl, Klaus	ADE		4	4.5
A	21	Sapunov, Gennady	URS	DC		1
	23	Horvat, Stevan	YUG		3	3
A	22	Karlsson, Jan	SUE	TQ	2:10	0
	25	Holzer, Werner	EUA		4	4
A	24	Madsen, Kurt	DIN	DC		1
	26	Moukrim, M'hamed	MAR		3	5
						7 *

3e TOUR OCT 25
3rd ROUND

A	2	Rost, Klaus	ALE	DES	0	3
	3	Enache, Ion	RUM		4	7.5 *
A	6	Tapio, Eero	FIN	()	2	2
	7	Steer, Antal	HUN		2	3
A	9	Mumemura, Muneji	JPN	TQ	10:27	0
	12	Marchand, Guy	FRA		4	8 *
A	10	Bellotti, Piero	ITA	DC		1
	13	Shu, Hun-Kyo	COR		3	4
A	18	Galaktopoulos, Petros	GRE	TQ	1:12	0
	15	Galantinho, Luis	POR		4	8 *
A	19	Macha, Vitezslav	CHE	DES		0
	16	Garvie, Gordon	CAN		4	7 *
A	20	Pohl, Klaus	ADE	DC		1
	21	Sapunov, Gennady	URS		3	5.5
A	23	Horvat, Stevan	YUG	DC		1
	22	Karlsson, Jan	SUE		3	7 *
A	25	Holzer, Werner	EUA	DC		1
	24	Madsen, Kurt	DIN		3	5
	4	Ayvaz, Kazim	TUR	NSP		8 *

Tapis Mat	Résultat Result	PM	PA
4e TOUR			
4th ROUND			
A 2	Rost, Klaus	ALE	DC
A 6	Tapio, Eero	FIN	DC
A 9	Mumemura, Muneji	JPN	DC
A 7	Steer, Antal	HUN	DC
A 18	Galaktopoulos, Petros	GRE	DC
A 13	Shu, Hun-Kyo	COR	DC
A 21	Sapunov, Gennady	URS	DC
A 19	Macha, Vitezslav	CHE	DC
A 23	Horvat, Stevan	YUG	TQ
A 20	Pohl, Klaus	ADE	TQ
25	Holzer, Werner	EUA	SR

CLASSEMENT FINAL
FINAL STANDING

1	9	Mumemura, Muneji	JPN
2	23	Horvat, Stevan	YUG
3	18	Galaktopoulos, Petros	GRE
4	2	Rost, Klaus	ALE
5	6	Tapio, Eero	FIN
6	25	Holzer, Werner	EUA
6	21	Sapunov, Gennady	URS

POIDS WELTERS JUSQU'A 78 Kg
WELTERWEIGHT UP TO 78 Kgs

5e TOUR **OCT 26**
5th ROUND

A 2	Rost, Klaus	ALE	DC	1	5
A 25	Holzer, Werner	EUA	DC	3	8 *
A 6	Tapio, Eero	FIN	()	2.5	7.5 *
A 9	Mumemura, Muneji	JPN	()	2.5	4
A 18	Galaktopoulos, Petros	GRE	DC	1	2
A 21	Sapunov, Gennady	URS	DC	3	8 *
23	Horvat, Stevan	YUG	SR		

1er TOUR **OCT 23**
1st ROUND

A 1	Savvas, Dimitrios	GRE	()	2.5
A 2	Ostrowskij, Adam	POL	()	2.5
A 4	Nenadic, Milovan	YUG	SE	0.5
A 3	Lyden, Larry	EUA	SE	3.5
A 6	Karstrom, Jan	SUE	TQ	0
A 5	Martinetti, Jimmy	SUI	TQ	1:40
A 8	Acar, Sirri	TUR	DC	1
A 7	Barlie, Harald	NOR	DC	3
A 9	Iguenov, Victor	URS	DC	1
A 10	Zarev, Metodi	BUL	DC	3
A 11	Taranu, Ion	RUM	DES	0
A 12	Heffel, Brian	CAN	DES	4
A 14	Berger, Franz	AUT	DC	1
A 13	Nettekoven, Peter	ALE	DC	3
A 15	Balah, Mohmoud	SIR	DC	1
A 16	Tashiro, Toshiro	JPN	DC	3
A 18	Robin, Daniel	FRA	TQ	2:04
A 17	Marsh, Sidney	AUS	TQ	2:04
A 20	Bajko, Karoly	HUN	⊙	0
A 19	Salo, Pentti	FIN	⊙	4
A 21	Vesper, Rudolf	ADE	TQ	2:05
A 22	Alba, Daniel	MEX	TQ	2:05

730

6e TOUR
6th ROUND

A 23	Horvat, Stevan	YUG	DC	1	5
A 2	Rost, Klaus	ALE	DC	3	8 *
A 9	Mumemura, Muneji	JPN	DC	1	5
A 18	Galaktopoulos, Petros	GRE	DC	3	5

7e TOUR **1er MATCH DE POULE**
7th ROUND **1st ROUND ROBIN BOUT**

B 23	Horvat, Stevan	YUG	()	2.5	2.5
B 9	Mumemura, Muneji	JPN	()	2.5	2.5
18	Galaktopoulos, Petros	GRE	SR		

TOUR FINAL **2e MATCH DE POULE**
FINAL ROUND **2nd ROUND ROBIN BOUT**

B 23	Horvat, Stevan	YUG	()	2.5	
B 18	Galaktopoulos, Petros	GRE	()	2.5	

2e TOUR
2nd ROUND

A 1	Savvas, Dimitrios	GRE	DC	1	3.5
A 3	Lyden, Larry	EUA	DC	3	6.5 *
A 2	Ostrowski, Adam	POL	DC	1	3.5
A 4	Nenadic, Milovan	YUG	DC	3	3.5
A 7	Barlie, Harald	NOR	DC	1	4
A 5	Martinetti, Jimmy	SUI	DC	3	7 *
A 6	Karstrom, Jan	SUE	()	2.5	2.5
A 8	Acar, Sirri	TUR	()	2.5	3.5
A 9	Iguenov, Victor	URS	DC	1	2
A 11	Taranu, Ion	RUM	DC	3	3
A 10	Zarev, Metodi	BUL	TQ	1:25	0
A 12	Heffel, Brian	CAN	TQ	1:25	4

Tapis Mat			Résultat Result	PM	PA
A	13	Nettekoven, Peter	ALE	DC	1 4
	15	Balah, Mohmoud	SIR		3 4
A	14	Berger, Franz	AUT	SE	0.5 1.5
	16	Tashiro, Toshiro	JPN		3.5 6.5 *
A	21	Vesper, Rudolf	ADE	DC	1 1
	18	Robin, Daniel	FRA		3 3
A	20	Bajko, Karoly	HUN	TQ	1:06 0 0
	22	Alba, Daniel	MEX		4 8 *
	17	Marsh, Sidney	AUS	NSP	

3e TOUR 3rd ROUND **OCT 25**

B	4	Nenadic, Milovan	YUG	DC	1 4.5
	1	Savvas, Dimitrios	GRE		3 6.5 *
B	6	Karstrom, Jan	SUE	DC	1 3.5
	2	Ostrowski, Adam	POL		3 6.5 *
B	7	Barlie, Harald	NOR	TQ	1:39 0 4
	9	Iguenov, Victor	URS		4 6 *
B	10	Zarev, Metodi	BUL	DC	1 4
	8	Acar, Sirri	TUR		3 6.5 *
B	11	Taranu, Ion	RUM	TQ	6:07 0 3
	13	Nettekoven, Peter	ALE		4 8 *
B	18	Robin, Daniel	FRA	DC	1 4
	14	Berger, Franz	AUT		3 4.5
B	20	Bajko, Karoly	HUN	()	2.5 2.5
	21	Vesper, Rudolf	ADE		2.5 3.5
	15	Balah, Mohmoud	SIR		

4e TOUR 4th ROUND

B	4	Nenadic, Milovan	YUG	()	2.5 7 *
	6	Karstrom, Jan	SUE		2.5 6 *
B	10	Zarev, Metodi	BUL	DC	1 5
	7	Barlie, Harald	NOR		3 7 *
B	11	Taranu, Ion	RUM	()	2.5 5.5
	14	Berger, Franz	AUT		2.5 7 *
B	18	Robin, Daniel	FRA	DC	1 5
	20	Bajko, Karoly	HUN		3 5.5
	21	Vesper, Rudolf	ADE	SR	

TOUR FINAL FINAL ROUND **OCT 26**

B	21	Vesper, Rudolf	ADE	DC	1 4.5
	10	Zarev, Metodi	BUL		3 8 *
A	18	Robin, Daniel	FRA	TQ	10:31 0 5
	11	Taranu, Ion	RUM		4 9.5 *
	20	Bajko, Karoly	HUN	SR	

CLASSEMENT FINAL FINAL STANDING

1	21	Vesper, Rudolf	ADE
2	18	Robin, Daniel	FRA
3	20	Bajko, Karoly	HUN
4	10	Zarev, Metodi	BUL
5	11	Taranu, Ion	RUM
6	6	Karstrom, Jan	SUE

POIDS MOYENS JUSQU'A 87 Kg MIDDLEWEIGHT UP TO 87 Kgs

1er TOUR 1st ROUND **OCT 23**

Tapis Mat			Résultat Result	PM	PA
B	1	Kis, Tevfik	TUR	DC	1 1
	2	Ojala, Teuvo	FIN		3 3
B	3	Mystrom, Bertil	SUE	DES	4 4
	4	Hiraki, Kenjiro	JPN		4 4
B	5	Metz, Lothar	ADE	DC	1 1
	6	Baughman, Wayne	EUA		3 3
B	8	Overby, Hakon	NOR	TQ	8:49 0 4
	7	Alvarez, Héctor	MEX		4 4
B	10	Krumov, Petar	BUL	TQ	0:51 0 4
	9	Hernández, José	GUA		4 4
B	12	Kwiecinski, Czeslaw	POL	DC	1 1
	11	Sillai, Laszlo	HUN		3 3
B	14	Olenik, Valentin	URS	TQ	1:56 0 4
	13	Graffigna, Julio	ARG		4 4
B	15	Kormanik, Jiri	CHE	DC	1 1
	16	Chardonens, Jean-Marie	SUI		3 3
B	17	Simic, Branislav	YUG	DC	1 1
	18	Negut, Nicolae	RUM		3 3
	19	Knoll, Ernst	ALE	SR	

2e TOUR 2nd ROUND **OCT 24**

B	1	Kis, Tevfik	TUR	DC	1 1
	19	Knoll, Ernst	ALE		3 3
B	2	Ojala, Teuvo	FIN	TQ	8:46 0 3
	3	Mystrom, Bertil	SUE		4 8 *
B	5	Metz, Lothar	ADE	TQ	4:41 0 1
	4	Hiraki, Kenjiro	JPN		4 8 *
B	6	Baughman, Wayne	EUA	TQ	10:49 0 3
	7	Alvarez, Héctor	MEX		4 8 *
B	8	Overby, Hakon	NOR	TQ	4:56 0 0
	9	Hernández, José	GUA		4 8 *
B	10	Krumov, Petar	BUL	DC	1 1
	11	Sillai, Laszlo	HUN		3 6 *
B	12	Kwiecinski, Czeslaw	POL	TQ	2:56 0 1
	13	Graffigna, Julio	ARG		4 8 *
B	14	Olenik, Valentin	URS	DC	1 1
	15	Kormanik, Jiri	CHE		3 4
B	17	Simic, Branislav	YUG	TQ	5:11 0 1
	16	Chardonens, Jean-Marie	SUI		4 7 *
	18	Negut, Nicolae	RUM	SR	

3e TOUR 3rd ROUND **OCT 25**

B	5	Metz, Lothar	ADE	DC	1 2
	1	Kis, Tevfik	TUR		3 5
B	6	Baughman, Wayne	EUA	TQ	8:56 0 3
	2	Ojala, Teuvo	FIN		4 7 *
C	10	Krumov, Petar	BUL	DC	1 2
	8	Overby, Hakon	NOR		3 3
A	14	Olenik, Valentin	URS	DC	1 2
	12	Kwiecinski, Czeslaw	POL		3 4
A	17	Simic, Branislav	YUG	DC	1 2
	15	Kormanik, Jiri	CHE		3 7 *
B	18	Negut, Nicolae	RUM	TQ	4:43 0 3
	19	Knoll, Ernst	ALE		4 7 *

Tapis
Mat

Résultat
Result

PM PA

POIDS MI-LOURDS JUSQU'A 97 Kg
LIGHT HEAVYWEIGHT UP TO 97 Kgs

4e TOUR
4th ROUND

C	Mat	Nom	RUM	()	PM	PA
C	18	Negut, Nicolae	RUM	()	2.5	5.5
	1	Kis, Tevfik	TUR	()	2.5	7.5*
C	5	Metz, Lothar	ADE	TQ	1:33	0 2
	8	Overby, Hakon	NOR			4 7 *
C	6	Baughman, Wayne	EJA	DC		1 4
	12	Kwiecinski, Czeslaw	POL			3 7 *
C	10	Krumov, Petar	BUL	()	2	4
	14	Olenik, Valentin	URS		2	4
	17	Simic, Branislav	YUG	SR		

5e TOUR
5th ROUND

OCT 26

B	Mat	Nom	YUG	()	PM	PA
B	17	Simic, Branislav	YUG	()	2	4
	5	Metz, Lothar	ADE		2	4
C	14	Olenik, Valentin	URS	TQ	10:08	0 4
	6	Baughman, Wayne	EJA			4 8 *
C	18	Negut, Nicolae	RUM	TQ	8:58	0 5.5
	10	Krumov, Petar	BUL			4 8 *

TOUR FINAL
FINAL ROUND

B	Mat	Nom	YUG	()	PM	PA
B	17	Simic, Branislav	YUG	()	2	6
	14	Olenik, Valentin	URS		2	6
B	5	Metz, Lothar	ADE	DC	1	5
	18	Negut, Nicolae	RUM		3	8.5

CLASSEMENT FINAL
FINAL STANDING

1	5	Nom	ADE
2	14	Olenik, Valentin	URS
3	17	Simic, Branislav	YUG
4	18	Negut, Nicolae	RUM
5	6	Baughman, Wayne	EJA
6	10	Krumov, Petar	BUL

1er TOUR
1st ROUND

OCT 23

Tapis Mat	Mat	Nom	RUM	()	PM	PA
C	2	Radev, Boian	BUL	DES		0 4
	1	Schenk, Henk	EJA			
C	3	Jutzeler, Peter	SUI	TQ	1:30	0 4
	4	Lu, Gurbuz	TUR			
C	5	Klinge, Jürgen	ALE	DES		4 4
	6	Kiss, Ferenc	HUN			
C	7	Martinescu, Nicolae	RUM	TQ	2:09	0 4
	8	Kiehl, Heinz	ALE			
C	10	Hem, Tore	NOR	DC		1 3
	9	Malmberg, Caj	FIN			
C	11	Vernik, Víctor	ARG	()		2 2
	12	Svensson, Per	SUE			
C	14	Nagao, Takeshi	JPN	TQ	6:05	0 4
	13	Millard, Edward	CAN			
C	15	Yakovenko, Nikolai	URS	DC		1 3
	16	Orlowski, Wacław	POL			

2e TOUR
2nd ROUND

OCT 24

C	Mat	Nom	EJA	()	PM	PA
C	1	Schenk, Henk	EJA	()	2.5	6.5*
	3	Jutzeler, Peter	SUI		2.5	2.5
C	2	Radev, Boian	BUL	DES	0	0
	4	Lu, Gurbuz	TUR		4	8 *
C	7	Martinescu, Nicolae	RUM	DC	1	1
	5	Klinge, Jürgen	ADE		3	7 *
C	6	Kiss, Ferenc	HUN	DC	1	5
	8	Kiehl, Heinz	ALE		3	7 *
C	9	Malmberg, Caj	FIN	TQ	0:33	0 3
	11	Vernik, Víctor	ARG		4	6 *
C	10	Hem, Tore	NOR	()	2	3
	12	Svensson, Per	SUE		2	4
C	15	Yakovenko, Nikolai	URS	TQ	1:37	0 1
	13	Millard, Edward	CAN		4	8 *
C	16	Orlowski, Wacław	POL	TQ	2:42	0 3
	14	Nagao, Takeshi	JPN		4	4

3e TOUR
3rd ROUND

OCT 25

C	Mat	Nom	BUL	SE	PM	PA
C	2	Radev, Boian	BUL	SE	0.5	0.5
	3	Jutzeler, Peter	SUI		3.5	6 *
C	7	Martinescu, Nicolae	RUM	TQ	4:51	0 1
	6	Kiss, Ferenc	HUN		4	9 *
C	12	Svensson, Per	SUE	DC	1	5
	9	Malmberg, Caj	FIN		3	6 *
C	10	Hem, Tore	NOR	DC	1	4
	16	Orlowski, Wacław	POL		3	6 *
C	15	Yakovenko, Nikolai	URS	TQ	4:52	0 1
	14	Nagao, Takeshi	JPN		4	8 *

Tapis Mat Résultat Result PM PA

**POIDS LOURDS 97 Kg ET PLUS
HEAVYWEIGHT 97 Kgs OR MORE**

4e TOUR
4th ROUND

Tapis Mat	Résultat Result	PM	PA
C 12 7	Svensson, Per Martinescu, Nicolae	SUE RUM DC	1 6 * 3 4
B 2 10	Radev, Boian Hem, Tore	BUL URS TQ	2:49 0 0.5 4 8 *
15	Yakovenko, Nikolai	NOR SR	

1er TOUR
1st ROUND **OCT 23**

Tapis Mat	Résultat Result	PM	PA
A 1 2	Wojda, Edward Nadbornik, Arje	POL FIN TQ	2:24 0 4
A 3 4	Svensson, Ragnar Bock, Roland	SUE ALE ()	2 2
A 5 6	Roshin, Anatoly Petrov, Stefane	URS BUL TQ	2:51 0 4
B 7 8	Roop, Robert Geris, Harry	EUA CAN TQ	9:34 0 4
B 9 10	Uytterheaeaghe, Raymond Isogai, Yorihide	FRA JPN TQ	1:19 0 4
B 11 12	Kozma, Istvan Busoi, Constantin	HUN RUM TQ	5:31 0 4
C 14 13	Kment, Petr Bechara, Hasan	CHE LIB TQ	2:36 0 4
15	Aksu, Bekir	TUR SR	

5e TOUR
5th ROUND 1er TOUR DE BARRAGE
FIRST ROUND ROBIN **OCT 26**

Tapis Mat	Résultat Result	PM	PA
C 15 2	Yakovenko, Nikolai Radev, Boian	URS BUL ()	2.5 2.5 2.5 2.5
7	Martinescu, Nicolae	RUM SR	

2e TOUR
2nd ROUND **OCT 24**

Tapis Mat	Résultat Result	PM	PA
C 15 1	Aksu, Bekir Wojda, Edward	TUR POL ()	2.5 2.5 2.5 2.5
C 3 2	Svensson, Ragnar Nadbornik, Arje	SUE FIN TQ	6:48 0 2 4 8 *
B 5 4	Roshin, Anatoly Bock, Roland	URS ALE DC	1 1 3 5
B 6 7	Petrov, Stefane Roop, Robert	BUL EUA TQ	9:32 0 4 4 4
A 9 8	Uytterheaeaghe, Raymond Geris, Harry	FRA CAN DC	1 1 3 7 *
A 11 10	Kozma, Istvan Isogai, Yorihide	HUN JPN TQ	0:38 0 0 4 8 *
A 12 13	Busoi, Constantin Bechara, Hasan	RUM LIB TQ	2:12 0 4 4 8 *
14	Kment, Petr	CHE SR	

6e TOUR
6th ROUND 2e TOUR DE BARRAGE
SECOND ROUND ROBIN

Tapis Mat	Résultat Result	PM	PA
B 15 7	Yakovenko, Nikolai Martinescu, Nicolae	URS RUM DC	1 3.5 3 3
2	Radev, Boian	BUL SR	

TOUR FINAL
FINAL ROUND 3e TOUR DE BARRAGE
THIRD ROUND ROBIN

Tapis Mat	Résultat Result	PM	PA
B 2 7	Radev, Boian Martinescu, Nicolae	BUL RUM TQ	4:58 0 2.5 4 7

CLASSEMENT FINAL
FINAL STANDING

Rank	Name	Country
1	Radev, Boian	BUL
2	Yakovenko, Nikolai	URS
3	Martinescu, Nicolae	RUM
4	Svensson, Per	SUE
5	Hem, Tore	NOR
6	Malmberg, Caj	FIN
6	Jutzeler, Peter	SUI
6	Orlowski, Wacław	POL

3e TOUR
3rd ROUND **OCT 25**

Tapis Mat	Résultat Result	PM	PA
C 3 1	Svensson, Ragnar Wojda, Edward	SUE POL DC	1 3 3 5.5
C 6 4	Petrov, Stefane Bock, Roland	BUL ALE DES	0 4 4 9 *
C 5 7	Roshin, Anatoly Roop, Robert	URS EUA TQ	2:48 0 1 4 8 *
C 11 9	Kozma, Istvan Uytterheaeaghe, Raymond	HUN FRA TQ	0:30 0 0 4 5
C 14 15	Kment, Petr Aksu, Bekir	CHE TUR DES	0 0 4 6.5 *
12	Busoi, Constantin	RUM SR	

Mat	Tapis	Résultat	PM	PA
		Result		

4e TOUR
4th ROUND

C	14	Kment, Petr	CHE		1	1
	12	Busoi, Constantin	RUM	DC	3	7 *
A	11	Kozma, Istvan	HUN		0	0
	6	Petrov, Stefane	BUL	TQ 9:26	4	8 *
B	5	Roshin, Anatoly	URS		0	1
	1	Wojda, Edward	POL	TQ 5:29	4	9.5 *
B	3	Svensson, Ragnar	SUE		0	3
	9	Uytterhaeghe, Raymond	FRA	DES 8:55	4	9 *

5e TOUR
5th ROUND

OCT 26

A	14	Kment, Petr	CHE		4	5
	3	Svensson, Ragnar	SUE	DES	4	7 *
A	5	Roshin, Anatoly	URS		2.5	3.5
	11	Kozma, Istvan	HUN	()	2.5	2.5

6e TOUR
6th ROUND

1e TOUR DE BARRAGE
FIRST ROUND ROBIN

B	5	Roshin, Anatoly	URS		0	0
	14	Kment, Petr	CHE	NSP	4	4
	11	Kozma, Istvan	HUN	SR		

TOUR FINAL
FINAL TOUR

2e TOUR DE BARRAGE
SECOND ROUND ROBIN

B	11	Kozma, Istvan	HUN		0	
	14	Kment, Petr	CHE	NSP	4	
	5	Roshin, Anatoly	URS	SR		

CLASSEMENT FINAL
FINAL STANDING

1	11	Kozma, Istvan	HUN
2	5	Roshin, Anatoly	URS
3	14	Kment, Petr	CHE
4	3	Svensson, Ragnar	SUE
5	12	Busoi, Constantin	RUM
6	6	Petrov, Stefane	BUL

**PALMARES FINAL (RESUME) DE LUTTE LIBRE
SUMMARY OF FINAL CLASSIFICATION IN FREESTYLE-WRESTLING**

**POIDS MOUCHE (23 Participants)
FLYWEIGHT (23 Participants)**

1.	Nakata, Shigeo	JPN
2.	Sanders, Richard	EUA
3.	Sukhbaatar, Surenjav	MGL
4.	Albarian, Nazar	URS
5.	Vicenzo, Grassi	ITA
6.	Kumar, Sudesh	IND

**POIDS COQ (21 Participants)
BANTAMWEIGHT (21 Participants)**

1.	Uetake, Yojiro	JPN
2.	Behm, Donald	EUA
3.	Gorgori, Abutalep	IRN
4.	Ajev, Ali	URS
5.	Chavov, Ivan	BUL
6.	Zedzicki, Zbigniew	POL

**POIDS PLUME (23 Participants)
FEATHERWEIGHT (23 Participants)**

1.	Kaneko, Masaaki	JPN
2.	Todorov, Enio	BUL
3.	Abassy, Shamseddin	IRN
4.	Karypidis, Nikolaos	GRE
5.	Coman, Petre	RUM
6.	Tedeev, Elkan	URS

**POIDS LEGER (26 Participants)
LIGHTWEIGHT (26 Participants)**

1.	Movahed, Abdollah	IRN
2.	Enio, Valtchev	BUL
3.	Danzandarjaa, Sereeter	MGL
4.	Wells, Wayne	EUA
5.	Beritashvili, Zarbeg	URS
6.	Chand, Udey	IND

**POIDS WELTER (19 Participants)
WELTERWEIGHT (19 Participants)**

1.	Atalay, Mahmud	TUR
2.	Robin, Daniel	FRA
3.	Purev, Dagvasuren	MGL
4.	Momeni, Ali-Mohammed	IRN
5.	Sasaki, Tasuo	JPN
6.	Shakhmuradov, Yury	URS

**POIDS MOYEN (22 Participants)
MIDDLEWEIGHT (22 Participants)**

1.	Gurevitch, Boris	URS
2.	Jigjird, Munkhbat	MGL
3.	Gardjev, Prodane	BUL
4.	Peckham, Thomas	EUA
5.	Gursoy, Huseyin	TUR
6.	Döring, Peter	ADE

**POIDS MI-LOURD
(16 Participants)
LIGHT HEAVYWEIGHT
(16 Participants)**

1.	Ahmet, Ayik	TUR
2.	Lomidze, Shota	URS
3.	Csatari, Jozsef	HUN
4.	Moustafov, Said	BUL
5.	Khorloogyn, Biiamunkh	MGL
6.	Lewis, Jess	EUA

**POIDS LOURD (15 Participants)
HEAVYWEIGHT (15 Participants)**

1.	Medved, Alexander	URS
2.	Douraliev, Osman	BUL
3.	Dietrich, Wilfried	ALE
4.	Stingu, Stefan	RUM
5.	Kristoff, Larry	EUA
6.	Anvari, Abolfazi	IRN

**PALMARES FINAL (RESUME) DE LUTTE GRECO-ROMAINE
SUMMARY OF FINAL CLASSIFICATION IN GRECO-ROMAN WRESTLING**

**POIDS MOUCHE (25 Participants)
FLYWEIGHT (25 Participants)**

1.	Kirov, Petar	BUL
2.	Bakulin, Vladimir	URS
3.	Zeman, Miroslav	CHE
4.	Alker, Imre	HUN
5.	Lacour, Rolf	ALE
6.	Vesterinen, Jussi	FIN

**POIS COQ (27 Participants)
BANTAMWEIGHT (27 Participants)**

1.	Varga, Janos	HUN
2.	Baciu, Ion	RUM
3.	Kochergin, Ivan	URS
4.	Moschidis, Othon	GRE
5.	Sakurama, Kouji	JPN
6.	Ibrahim, El Sayed	RAU

**POIDS PLUME (24 Participants)
FEATHERWEIGHT (24 Participants)**

1.	Rurua, Roman	URS
2.	Fujimoto, Hideo	JPN
3.	Popescu, Simion	RUM
4.	Gualintchev, Dimitar	BUL
5.	Alakoc, Hızır	TUR
6.	Laakso, Martti	FIN

**POIDS LEGER (28 Participants)
LIGHTWEIGHT (28 Participants)**

1.	Numemura, Muneji	JPN
2.	Horvat, Stevan	YUG
3.	Galaktopoulos, Petros	GRE
4.	Rost, Klaus	ALE
5.	Tapió, Eero	FIN
6.	Holzer, Werner	EUA
6.	Shapunov, Gennady	URS

**POIDS WELTER (22 Participants)
WELTERWEIGHT (22 Participants)**

1.	Vesper, Rudolf	ADE
2.	Robin, Daniel	FRA
3.	Bajko, Karoly	HUN
4.	Zarev, Metodi	BUL
5.	Taranu, Ion	RUM
6.	Karstrom, Jan	SUE

**POIDS MOYEN (19 Participants)
MIDDLEWEIGHT (19 Participants)**

1.	Metz, Lothar	ADE
2.	Olenik, Valnetin	URS
3.	Simic, Branislav	YUG
4.	Negut, Nicolae	RUM
5.	Baughman, Wayne	EUA
6.	Krumov, Petar	BUL

**POIDS MI-LOURD
(16 Participants)
LIGHT HEAVYWEIGHT
(16 Participants)**

1.	Boian, Radev	BUL
2.	Yakovenko, Nikolai	URS
3.	Martinescu, Nicolae	RUM
4.	Svensson, Per	SUE
5.	Hem, Tore	NOR
6.	Malmberg, Caj	FIN
6.	Jutzeler, Peter	SUI
6.	Orlowski, Waclaw	POL

**POIDS LOURD (15 Participants)
HEAVYWEIGHT (15 Participants)**

1.	Kozma, Istvan	HUN
2.	Roshin, Anatoly	URS
3.	Kment, Petr	CHE
4.	Svensson, Ragnar	SUE
5.	Busoi, Constantin	RUM
6.	Petrov, Stefane	BUL



FEDERATION INTERNATIONALE
DE NATATION AMATEUR FINA

INTERNATIONAL AMATEUR
SWIMMING FEDERATION FINA

COMITE EXECUTIVE
EXECUTIVE COMMITTEE

PRESIDENT
W. Berge Phillips AUS

SECRETAIRE HONORAIRE
HONORARY SECRETARY
Masako Kiyokawa JPN

FEDERATION MEXICAINE DE
NATATION FMN

MEXICAN SWIMMING
FEDERATION FMN

PRESIDENT
Javier Ostos MEX

SECRETAIRE
SECRETARY
Antonio G. Mariscal MEX

SECTION NATATION DU C.O.O.
O.O.C. SWIMMING SECTION
Javier Ortega MEX

SECTION PLONGEONS DU C.O.O.
C.O.C. DIVING SECTION
Mario Tovar MEX

OFFICIELS DE LA COMPETITION
COMPETITION OFFICIALS

JURY D'APPEL
JURY OF APPEAL
W. Berge Phillips AUS

Mario Negri ARG
Max Ritter EUA
Ernest Scott GBR
Arnaldo de O. Sales HOK
Johannes De Vries HOL
B. Percuoco ITA
Javier Ostos MEX

ARBITRES
REFEREES

S. M. Ali Khan PAK
Georg Zorowka ADE
Heinz Deininger ADE
R. Dietrich ADE
H. Getz AFS
L. Farid AGL
Erich Gebhardt ALE
Franz Heina ALE
Helmut Kempt ALE
Alberto Pestoni ARG
Alberto Petrolini ARG
Antonio Sacco ARG
Manuel Segura ARG
Rubén Katz ARG
Allan Blue AUS
Allan Monaghan AUS
John Phillips AUS
Lawrence Voight AUS
Roger Smith AUS
Samuel Graeme AUS
William Slade AUS
Rene de Raeve BEL
R. D. de Araujo BRA
James Wales CAN
P. P. Hauch CAN
Stanley Siwik CAN
Carlos Manzano COL
José C. Villarreal COL
Francisco Trelles CRC
Issaac Froimovich CHI
Salvador Vilanova SAL
Enrique Ugarte ESP
Joaquín Morera ESP
Juan Sierra ESP
Bell Philcox EUA
E. Jokle EUA
Eleanor S. Dawson EUA
Harold Henning EUA
Harry Hainsworth EUA
Henry Brewerton EUA
Herman Zieler EUA
Harold W. Heller EUA
John Bogert EUA
Joy Cushman EUA
Miles Barton EUA
Oliver Cass EUA
Richard Close EUA
Edilberto Bonus FIL
Serafín Villanueva FIL
Austin Rawlinson GBR
George Eddowes GBR
Henry Bleasdale GBR
Leon Koskie GBR
Richard Brown GBR
Alfonso Cruz GUA
Dragan Filipovich GUA
Annette Vlothuizen HOL
Henri Feis HOL
Jan Armsbrust HOL
Pieter Verwoerd HOL
Baren-Paul Eduard Van Es HOL
Hideo Miyamoto JPN

Kiyoo Kodama JPN
Kennosuke Koyoma JPN
Masako Kiyokawa JPN
Yukinori Tomada JPN
Alberto López MEX
Alberto Zendejas MEX
Alfonso Muñoz MEX
Alvaro J. Almada MEX
Angel Pérez MEX
Angélica Quiroz MEX
Antonia F. de López MEX
Armando García MEX
Aurora Góngora MEX
Beatriz Mercado MEX
Beatriz Sevilla MEX
Brenda Cruz MEX
Carlos Chávez MEX
Carlos R. Zaballa MEX
Carolina Pizano MEX
Cecilia Cervantes MEX
César Ortiz MEX
Chester Scott MEX
Dolores Ibarra MEX
Elinora Méndez MEX
Elsa González MEX
Emilio Illanes MEX
Enrique Janovitz MEX
Ernesto Alba MEX
Esther F. de Bialostozky MEX
Eva P de Ortiz MEX
Everardo Aguirre MEX
Federico Mariscal MEX
Fernando del Monte MEX
Fernando Millán MEX
Francisco Escanero MEX
Francisco Negrete MEX
Francisco Yabar MEX
Gilles Jouanen MEX
Gloria G. de Escanero MEX
Graciela Durón MEX
Guadalupe de la Mora MEX
Guillermina Oteiza MEX
Gustavo Huerta MEX
Gustavo Silva MEX
Hilda Arellano MEX
Humberto Flores MEX
Ignacio García MEX
Ignacio Jiménez MEX
Ignacio Purpón MEX
Irma Belmar MEX
Irma Gutiérrez MEX
Jaime Klapp MEX
Javier Maldonado MEX
Jorge Flores MEX
José Zendejas MEX
José Angel Mora MEX
José Luis González MEX
José Rodrigo Berber MEX

Laura Ramírez MEX
Lee Murphy MEX
Leonardo Aguilar MEX
Lucía Gutiérrez MEX
Luis Lajous MEX
Luz del Carmen Ramírez MEX
Ma. Eugenia Sevilla MEX
Ma. Eugenia Valle MEX
Ma. Esther Gómez MEX
Ma. Luisa Madrigal MEX
Ma. Luisa Mendoza MEX
Ma. Teresa Lazcano MEX
Ma. Teresa Valle MEX
Manuel Díaz de Bonilla MEX
Manuel Montoya MEX
Mario Chávez MEX
Mario Santibáñez MEX
Martha García MEX
Martha Ramírez MEX
Matilde Palencia MEX
Mauricio Duhalt MEX
Miguel Gómez MEX
Olga Belmar MEX
Patricia Rubio MEX
Perla Eusebio MEX
Raúl Gálvez MEX
Raúl Zaballa MEX
Ricardo Busteros MEX
Roberto S. Nava MEX
Rosa Anaya MEX
Rosa Ma. F. de Lemus MEX
Rosa G. de Pardo MEX
Rosa Ma. Rivero MEX
Rubén Coronado MEX
Salvador Vaca MEX
Serafín Villanueva MEX
Sergio Gomar MEX
Silvia B. de Guzmán MEX
Sofía Méndez MEX
Susana Vacas MEX
Víctor Huerta MEX
Yolanda Muñoz MEX
Yolanda Vaca MEX
Mauro Pardo PAN
F. D. Bokhari PAK
Carlos Quiroga PER
Octavio Espinoza PER
Sebastián Salinas PER
Salow Soror RAU
Youssef Ezz El Din RAU
Chan Ah Kow SIN
Bertil Sällfors SUE
Lars Schott SUE
Toivo Oekhman SUE
Gottfried Schonholzer SUI
Alberto Grunland URG
Zakhary Firsov URS
Teodoro Capriles VEN

736

SIGNES EMPLOYES

SIMBOLOGY

PLONGEONS		DIVING	
O	— IMPOSES		COMPULSORY
L	— LIBRES		VOLUNTARY
SFP	— TOTAL PARTIEL DES PRELIMINAIRES		SUB-TOTAL, PRELIMINARY PHASES
SOL	— TOTAL PARTIEL DES PLONGEONS		SUB-TOTAL, COMPULSORY AND
	IMPOSES ET LIBRES		VOLUNTARY DIVES
NSP	— NE S'EST PAS PRESENTE		FAILED TO APPEAR
NATATION		SWIMMING	
M	— PAPILLON		BUTTERFLY
D	— DOS		BACKSTROKE
P	— BRASSE		BREASTSTROKE
L	— NAGE LIBRE		FREESTYLE
NSP	— NE S'EST PAS PRESENTE		FAILED TO APPEAR
ST	— SANS TEMPS		NO TIME
DES	— DISQUALIFIE		DISQUALIFIED

**PLONGEONS DU TREMPIN - MESSIEURS
 SPRINGBOARD DIVING - MEN**

FINALE **OCT 19, 20**
 FINAL

10 PLONGEONS AU TOTAL — (5 IMPOSES ET 5 LIBRES)

1ère PARTIE: 1, 2, 3, ET 4 IMPOSES
 2e PARTIE: 5 IMPOSE ET 1, 2, LIBRES
 DERNIERE PARTIE: 3, 4 ET 5 LIBRES

TOTAL OF 10 DIVES — (5 COMPULSORY AND 5 VOLUNTARY)

1st PHASE: 1, 2, 3, AND 4 COMPULSORY
 2nd PHASE: 5 COMPULSORY AND 1, 2, VOLUNTARY
 FINAL PHASE: 3, 4 AND 5 VOLUNTARY

				1	2	3	4	5	SOL	SFP	Total
1	Wrightson, Bernard	EUA	O	12.00	13.09	15.96	13.12	15.96	70.13		
			L	17.16	15.66	22.96	21.28	22.96	100.02	102.95	170.15
2	Dibiasi, Klaus	ITA	O	12.32	13.60	15.39	10.40	15.20	66.91		
			L	18.27	19.50	17.82	17.36	19.88	92.83	104.68	159.74
3	Henry, James	EUA	O	12.16	12.58	14.82	10.72	13.87	64.15		
			L	20.80	20.52	15.12	21.84	15.66	93.94	105.47	158.09
4	Niño de Rivera, Luis	MEX	O	11.68	12.24	12.92	12.48	14.44	63.76		
			L	16.33	19.04	18.48	17.94	20.16	91.95	99.13	155.71
5	Cagnotto, Franco	ITA	O	12.00	11.22	15.01	10.08	12.73	61.04		
			L	19.76	15.12	18.90	18.76	22.12	94.66	95.92	155.70
6	Russell, Keith	EUA	O	12.32	12.41	9.88	12.32	14.44	61.37		
			L	18.72	20.52	15.68	14.00	21.46	90.38	100.61	151.75
7	Anderson, Tord	SUE	O	11.84	12.24	14.63	12.32	14.25	65.28		
			L	17.02	17.28	19.04	16.24	16.64	86.22	99.58	151.50
8	Wagstaff, Donald	AUS	O	10.88	11.73	13.68	12.00	13.11	61.40		
			L	17.01	19.43	19.24	17.42	15.68	88.78	97.84	150.18
9	Safonov, Mikhail	URS	O	11.36	12.58	8.93	10.24	13.11	56.22		
			L	18.46	18.09	12.04	17.36	18.85	84.80	92.77	141.02
10	Reff, Ulrich	ALE	O	11.52	12.41	13.11	11.52	12.54	61.10		
			L	17.16	17.16	12.04	16.52	16.10	78.98	95.42	140.08
11	Vasin, Vladimir	URS	O	11.52	11.90	13.68	11.52	13.49	62.11		
			L	17.42	16.20	14.56	11.48	17.82	77.48	95.73	139.59
12	Koskinen, Pentti	FIN	O	11.52	12.24	14.44	10.88	13.11	62.19		
			L	18.20	15.60	16.33	16.52	8.96	75.61	95.99	137.80
13	Robinson, José	MEX	O	9.60	11.90	14.06	8.80	9.12	53.48		
			L	18.09	19.88				37.97	91.45	
14	Telch, Jorge	MEX	O	10.08	12.07	13.30	10.40	13.11	58.96		
			L	17.68	14.04				31.72	90.68	
15	Puchow, Jakub	POL	O	10.40	11.05	11.78	10.88	12.54	56.65		
			L	15.36	16.64				32.00	88.65	
16	Huda, Norbert	ALE	O	9.28	10.20	9.69	9.44	12.73	51.34		
			L	18.46	18.63				37.09	88.43	
17	Salice, Italo	ITA	O	10.72	11.05	13.87	9.60	12.54	57.78		
			L	16.56	13.52				30.08	87.86	
18	Yuasa, Junji	JPN	O	11.04	10.54	13.49	11.20	11.97	58.24		
			L	13.16	15.40				28.56	86.80	
19	Carter, Frank	GBR	O	10.88	10.88	11.21	9.76	11.78	54.51		
			L	14.49	16.90				31.39	85.90	
20	Poluliakh, Boris	URS	O	10.40	11.56	13.49	11.52	11.59	58.56		
			L	14.28	11.48				25.76	84.32	
21	Kowalewski, Jerzy	POL	O	9.92	11.22	11.97	10.40	10.26	53.77		
			L	11.70	14.50				26.20	79.97	
22	Song, Jae-Ung	COR	O	5.76	12.07	11.97	8.32	11.97	50.09		
			L	15.08	14.49				29.57	79.66	
23	Moreno, Alberto	CUB	O	9.76	11.05	11.97	9.28	7.79	49.85		
			L	15.34	11.61				26.95	76.80	
24	Barjum, Roque	COL	O	10.56	10.20	11.78	10.24	12.16	54.94		
			L	12.15	9.10				21.25	76.19	
25	Sully, Kenneth	CAN	O	10.24	9.35	9.88	10.72	10.83	51.02		
			L	11.18	12.42				23.60	74.62	
26	Ponce, José	CUB	O	10.72	11.05	7.98	11.04	11.21	52.00		
			L	11.44	9.28				20.72	72.72	
27	Anderson, Jerry	PRO	O	9.60	10.37	6.46	7.48	10.64	44.91		
			L	7.02	16.90				23.92	68.83	
28	Bas, Héctor	PRO	O	6.56	9.86	10.64	10.08	12.16	49.30		
			L	8.37	4.76				13.13	62.43	
	Pérez, Salvador	DOM	NSP								
	Loken, Hakon	NOR	NSP								

				1	2	3	4	5	6	SOL	SFP
32	Henao, Diego	COL	O	12.98	9.88	9.50	11.60	8.48	9.76	62.20	
			L	11.89						11.89	74.09
33	Sully Kenneth	CAN	O	10.24	11.40	11.20	9.62	8.40	6.72	57.58	
			L	7.83						7.83	65.41
34	Anderson, Jerry	PRO	O	11.73	9.12	9.12	9.18	8.32	6.40	53.87	
			L	11.27						11.27	65.14
35	Bas, Héctor	PRO	O	8.85	5.06	8.74	7.92	2.56	4.40	37.53	
			L	10.44						10.44	47.97
	Barrundia, Edwin	GUA		NSP							

PLONGEONS DU TREMLIN - DAMES SPRINGBOARD DIVING - WOMEN

FINALE
FINAL **OCT 17, 18**

10 PLONGEONS AU TOTAL — (5 IMPOSES ET 5 LIBRES)

1ère PARTIE: 1, 2, 3, ET 4 IMPOSES
2e PARTIE: 5 IMPOSE ET 1, 2, LIBRES
DERNIERE PARTIE: 3, 4 ET 5 LIBRES

TOTAL OF 10 DIVES — (5 COMPULSORY AND 5 VOLUNTARY)

1st PHASE: 1, 2, 3, AND 4 COMPULSORY
2nd PHASE: 5 COMPULSORY AND 1, 2, VOLUNTARY
FINAL PHASE: 3, 4 AND 5 VOLUNTARY

				1	2	3	4	5	SOL	SFP	Total
1	Gossick, Sue	EUA	O	12.00	12.75	14.25	11.04	14.06	64.10		
			L	16.94	16.28	16.79	17.68	18.98	86.67	97.32	150.77
2	Pogozheva, Tamara	URS	O	12.48	13.60	14.06	12.00	12.92	65.06		
			L	17.48	14.96	10.80	16.72	20.28	80.24	97.50	145.30
3	O'Sullivan, Keala	EUA	O	8.32	12.41	15.58	11.36	11.97	59.64		
			L	17.48	18.46	14.85	17.42	17.38	85.59	95.58	145.23
4	King, Micki	EUA	O	12.48	12.41	13.49	12.48	13.87	64.73		
			L	16.06	17.38	16.33	15.08	7.80	72.65	98.17	137.38
5	Kramer, Ingrid	ADE	O	9.92	12.58	13.11	10.88	13.49	59.98		
			L	15.18	15.40	14.74	17.52	13.00	75.84	90.56	135.82
6	Baklanova, Vera	URS	O	10.88	11.05	12.54	11.04	12.54	58.05		
			L	13.80	17.04	14.96	14.30	14.16	74.26	88.89	132.31
7	Boys, Beverley	CAN	O	12.00	11.39	12.35	10.88	11.02	57.64		
			L	15.36	13.86	14.07	15.08	14.30	72.67	86.86	130.31
8	Anokhina, Elena	URS	O	10.72	12.41	11.78	11.36	13.49	59.76		
			L	15.18	15.41	12.98	12.24	13.60	69.41	90.35	129.17
9	Hilbert, Angelika	ALE	O	10.56	12.92	12.73	10.72	14.06	60.99		
			L	14.08	11.76	14.72	14.52	12.76	67.84	86.83	128.83
10	Duchkova, Milena	CHE	O	10.56	11.90	13.68	9.44	13.30	58.88		
			L	17.28	15.41	16.50	7.68	12.10	68.97	91.57	127.85
11	Wierniuk, Elzbieta	POL	O	10.72	11.39	13.68	10.08	12.73	58.60		
			L	14.30	14.72	13.20	9.12	12.48	63.82	87.62	122.42
12	Rowlatt, Kathleen	GBR	O	10.72	11.56	11.40	9.60	9.50	52.78		
			L	14.26	16.08	14.74	9.90	14.40	69.38	83.12	122.16
13	Robertson, Nancy	CAN	O	9.92	12.07	12.92	9.92	10.26	55.09		
			L	13.92	13.20				27.12	82.21	
14	Liljestrom, Tarja	FIN	O	10.56	10.71	11.78	9.92	9.69	52.66		
			L	14.74	14.40				29.14	81.80	
15	Bradshaw, Robyn	AUS	O	7.84	10.37	11.02	10.56	13.11	52.90		
			L	13.64	15.12				28.76	81.66	
16	Kuiler, Elselina	HOL	O	9.60	10.37	11.40	9.28	12.35	53.00		
			L	14.07	13.86				27.93	80.93	
17	Baraldi, Bertha	MEX	O	7.20	11.56	12.35	9.60	11.59	52.30		
			L	12.81	15.36				28.17	80.47	
18	Dommers, Mariette	HOL	O	5.44	11.05	9.31	11.20	12.92	49.92		
			L	14.52	14.88				29.40	79.32	
19	Pertmayr, Ingeborg	AUT	O	10.24	10.37	10.07	9.92	11.97	52.57		
			L	12.65	13.86				26.51	79.08	
20	Pietkiewicz, B.	POL	O	9.44	11.56	11.78	9.12	11.97	53.87		
			L	8.51	14.07				22.58	76.45	
21	Park, Chung-Cha	COR	O	9.44	11.22	11.59	6.24	12.16	50.65		
			L	15.18	7.70				22.88	73.53	
22	Manzano, Martha	COL	O	8.64	9.01	6.84	5.76	10.07	40.32		
			L	12.60	10.20				22.80	63.12	
	Ohsaki, Keiko	JPN		NSP							

739

PLONGEONS DE HAUT VOL - DAMES
PLATFORM DIVING - WOMEN

FINALE
FINAL

OCT 22, 23

7 PLONGEONS AU TOTAL - (4 IMPOSES ET 3 LIBRES)

1ère PARTIE: 1, 2 ET 3 IMPOSES ET 1 LIBRE
DERNIERE PARTIE: 4 IMPOSES 2 ET 3 LIBRES

TOTAL OF 7 DIVES - (4 COMPULSORY AND 3 VOLUNTARY)

1st PHASE: 1, 2, AND 3 COMPULSORY 1, VOLUNTARY
FINAL PHASE: 4 COMPULSORY AND 2, 3 VOLUNTARY

				1	2	3	4	SOL	SFP	Total
1	Duchkova, Milena	CHE	O	11.20	13.11	12.48	18.46	55.25		
			L	14.82	19.24	20.28		54.34	51.61	109.59
2	Lobanova, Natalia	URS	O	11.52	14.06	12.64	17.02	55.24		
			L	15.58	15.36	18.96		49.90	53.80	105.14
3	Peterson, Ann	EUA	O	9.60	14.60	13.12	16.12	53.44		
			L	14.82	16.06	16.79		47.67	52.14	101.11
4	Boys, Beverley	CAN	O	8.48	12.60	10.08	22.04	53.20		
			L	13.49	16.32	14.96		44.77	44.65	97.97
5	Pietkiewics, Boguslaw	POL	O	10.08	14.63	11.52	13.34	49.57		
			L	13.30	15.18	17.04		45.52	49.53	95.09
6	Krause, Regina	ALE	O	9.76	12.92	11.36	15.08	49.12		
			L	12.73	15.36	15.87		43.96	46.77	93.08
7	Ohsaki, Keiko	JPN	O	10.56	13.80	8.00	15.41	47.77		
			L	13.30	14.49	17.52		45.31	45.66	93.08
8	Robertson, Nancy	CAN	O	9.44	13.00	9.12	16.90	48.46		
			L	12.54	14.30	15.36		42.20	44.10	90.66
9	Pertmayr, Ingeborg	AUT	O	10.88	14.00	10.24	13.26	48.38		
			L	13.11	13.20	14.74		41.05	48.23	89.43
10	Talmage, Barbara	EUA	O	10.40	13.40	10.56	15.34	49.70		
			L	12.73	10.56	14.30		37.59	47.09	87.29
11	Busch, Ingeborg	ALE	O	11.36	11.34	10.56	14.95	48.21		
			L	12.96	14.30	9.84		37.10	47.22	85.31
12	Haswell, Mandi	GBR	O	10.24	12.54	10.40	15.60	48.78		
			L	12.54	8.36	12.65		33.55	45.72	82.33
13	Baraldi, Bertha	MEX	O	7.68				32.40		
			L	15.34	14.00	10.72		15.34	47.74	
14	Alexeeva, Galina	URS	O	10.88				35.35		
			L	11.96	13.11	11.36		11.96	47.31	
15	Wierniuk, Elzbieta	POL	O	9.12				33.40		
			L	13.86	12.92	11.36		13.86	47.26	
16	Hernández, Dora	MEX	O	8.64				31.60		
			L	15.36	13.20	9.76		15.36	46.96	
17	Liljestrom, Tarja	FIN	O	10.56				30.01		
			L	16.38	9.69	9.76		16.38	46.39	
18	Bradshaw, Robyn	AUS	O	10.72				30.70		
			L	14.88	11.02	8.96		14.88	45.58	
19	Fiedler, Sylvia	ADE	O	11.04				31.83		
			L	13.52	10.07	10.72		13.52	45.35	
20	Bush, Lesley	EUA	O	3.84				29.20		
			L	14.52	14.80	10.56		14.52	43.72	
21	Rossi, Bruna	ITA	O	10.40				30.78		
			L	12.76	12.54	7.84		12.76	43.54	
22	Karpukhina, Natalia	URS	O	9.12				33.63		
			L	9.89	12.35	12.16		9.89	43.52	
23	Reiche, Claudia	ADE	O	9.44				30.88		
			L	10.14	12.16	9.28		10.14	41.02	
24	Park, Chung-Cha	COR	O	5.12				26.27		
			L	12.76	12.35	8.80		12.76	39.03	

		100m		200m	
8	1	Hutton, Ralph (mro)	CAN	58.9	2:00.0
	2	Von Schilling, Olaf (mro)	ALE	58.4	2:01.7
	3	Asamali, Tony (mro)	FIL	1:00.3	2:06.2
	4	Eriksson, Karl (mro)	SUE	1:01.2	2:10.0
	5	Loh, Andrew (mro)	HOK	1:07.3	2:15.8
		Ruiz de Chávez, Salvador	MEX	NSP	
		Thurley, John	GBR	NSP	
		Ferriouli, José	PRO	NSP	
9	1	Rousseau, Michel (mro)	FRA	58.9	2:01.5
	2	Iwasaki, Kunihiro (mro)	JPN	59.7	2:02.1
	3	Oudt, Adriaan (mro)	HOL	1:00.9	2:06.6
	4	Ayesa, Luis (mro)	FIL	1:01.4	2:12.2
	5	Durón, Ernesto (mro)	SAL	1:09.7	2:24.1
		Van Der Maath, Carlos	ARG	NSP	
		Boscaini, Pietro	ITA	NSP	

FINALE
FINAL

		100m		200m	
1	Wenden, Michael (mro)	AUS	56.4	1:55.2	
2	Schollander, Donald (mro)	EUA	57.1	1:55.8	
3	Nelson, John (mro)	EUA	57.4	1:58.1	
4	Hutton, Ralph (mro)	CAN	57.5	1:58.6	
5	Mosconi, Alain (mro)	FRA	58.2	1:59.1	
6	Windle, Robert (mro)	AUS	58.8	2:00.9	
7	Belits-Geiman, Semyon (mro)	URS	58.9	2:01.5	
	Rerych, Stephen	EUA	NSP		
(RM)	1:54.3	Shollander, Donald	EUA	1968,	EUA
(RO)	2:25.2	Lane, Frank	AUS	1900,	FRA

400 m NAGE LIBRE - MESSIEURS
400 m FREESTYLE - MEN

ELIMINATOIRES
ELIMINATION HEATS

OCT 22

		100m		200m		300m		400m	
1	1	Nelson, John	EUA	1:02.2	2:08.1	3:14.4	4:18.7		
	2	Luyce, Francis	FRA	1:03.4	2:11.2	3:21.1	4:30.3		
	3	Wojkajtis, Wladyslaw	POL	1:03.8	2:11.2	3:21.3	4:31.1		
	4	Borloi, Matyas	HUN	1:03.4	2:13.6	3:23.6	4:35.4		
	5	Fiallo, Gregorio	CUB	1:05.5	2:15.9	3:27.7	4:41.5		
	6	Goodner, Michael	PRO	1:05.4	2:18.8	3:38.3	5:00.2		
		Van Der Maath, Carlos	ARG	NSP					
2	1	White, Graham	AUS	1:01.0	2:06.5	3:12.9	4:17.0		
	2	Belits-Geiman, Semyon	URS	1:03.7	2:11.5	3:18.1	4:22.7		
	3	Echevarria, Guillermo	MEX	1:03.7	2:11.7	3:18.3	4:24.0		
	4	Arango, Julio	COL	1:03.6	2:11.6	3:18.7	4:25.8		
	5	Müller, Alfred	ADE	1:03.9	2:12.5	3:20.5	4:26.4		
	6	Csatlos, Csaba	HUN	1:04.2	2:16.5	3:32.8	4:47.6		
	7	Loh, Robert	HOK	1:08.7	2:24.7	3:46.0	5:10.1		
3	1	Burton, Michael	EUA	1:01.8	2:07.6	3:14.5	4:19.3		
	2	Brough, Gregory	AUS	1:02.3	2:07.9	3:14.3	4:19.6		
	3	Ravelin, Jean-Francois	FRA	1:05.1	2:14.5	3:23.6	4:30.7		
	4	Krammel, Werner	ALE	1:03.3	2:13.2	3:24.9	4:34.0		
	5	Urreta, Jorge	MEX	1:04.1	2:13.8	3:25.1	4:34.3		
	6	Man-Chiu, Wong	HOK	1:04.7	2:22.3	3:44.6	5:05.8		
4	1	Mosconi, Alain	FRA	1:01.8	2:07.4	3:13.1	4:19.0		
	2	Rogers, Gregory	AUS	1:01.7	2:09.2	3:17.1	4:22.7		
	3	Anarbaev, Akhmed	URS	1:05.8	2:16.4	3:27.0	4:35.1		
	4	González, Fernando	ECU	1:03.4	2:13.9	3:24.9	4:35.3		
	5	Jokisch, Friedrich	SAL	1:10.5	ST	3:50.5	5:09.2		
		Alvarado, José	SAL	NSP					
		Abdulgafur, Roosevelt	FIL	NSP					
5	1	Hutton, Ralph	CAN	1:02.7	2:08.8	3:15.2	4:21.0		
	2	Larsson, Karl	SUE	1:04.3	2:11.7	3:19.9	4:25.0		
	3	Caperonis, Pano	SUI	1:06.1	2:16.3	3:27.1	4:31.4		
	4	Madsen, Orjan	NOR	1:04.7	2:13.8	3:24.1	4:31.8		
	5	Von Holst, Sven	SUE	1:05.2	2:14.7	3:25.5	4:35.0		
	6	Asamali, Tony	FIL	1:04.1	2:13.0	3:28.5	4:47.6		
	7	Loh, Andrew	HOK	1:10.8	2:29.5	3:45.6	5:03.6		
6	1	Berk, Brent	EUA	1:01.9	2:08.2	3:14.9	4:20.2		
	2	Fassnacht, Hans	ALE	1:02.7	2:08.9	3:16.2	4:20.7		
	3	Alanís, Juan	MEX	1:02.3	2:09.3	3:18.1	4:27.4		
	4	Jacks, Ronald	CAN	1:04.2	2:12.7	3:21.6	4:29.4		
	5	González, Jorge	PRO	1:06.0	2:16.3	3:28.2	4:38.1		
	6	Guerrero, Rubén	SAL	1:07.4	2:21.5	3:36.5	4:50.8		
		Jarvis, Anthony	GBR	NSP					

FINALE
FINAL

OCT 23

1	Burton, Michael (mro)	EUA	1:00.6	2:03.8	3:07.4	4:09.0
2	Hutton, Ralph (mro)	CAN	1:00.4	2:04.4	3:08.3	4:11.7
3	Mosconi, Alain	FRA	1:01.4	2:06.1	3:10.2	4:13.3
4	Brough, Gregory	AUS	1:02.1	2:07.6	3:12.5	4:15.9
5	White, Graham	AUS	1:02.0	2:07.4	3:14.2	4:16.7
6	Nelson, John	EUA	1:01.7	2:06.6	3:11.7	4:17.2
7	Fassnacht, Hans	ALE	1:02.2	2:08.0	3:13.7	4:18.1
8	Berk, Brent	EUA	1:01.8	2:07.9	3:17.4	4:26.0

(RM)	4:06.5	Hutton, Ralph	CAN	1968,	EUA
(RO)	4:12.2	Schollander, Donald	EUA	1964,	JPN

1 500 m NAGE LIBRE - MESSIEURS
1,500 m FREESTYLE - MEN

ELIMINATOIRES
 ELIMINATION HEATS

OCT 25

			100 m	200 m	300 m	400 m	500 m	600 m	700 m	Temps
			800 m	900 m	1000 m	1100 m	1200 m	1300 m	1400 m	1500 m
1	Burton, Michael	EUA	1:02.8 9:08.8	2:10.6 10:19.7	3:19.1 11:31.1	4:28.6 12:42.9	5:38.8 13:54.8	6:48.3 15:05.9	7:58.6 16:16.7	17:27.2
2	Hutton, Ralph	CAN	1:05.2 9:19.5	2:15.4 10:28.6	3:24.9 11:38.7	4:35.9 12:49.2	5:46.5 14:00.6	6:58.3 15:12.4	8:09.8 16:25.0	17:35.9
3	Fassnacht, Hans	ALE	1:05.0 9:21.1	2:13.3 10:32.1	3:23.4 11:43.9	4:34.2 12:55.4	5:45.9 14:07.7	6:57.8 15:19.8	8:09.5 16:31.6	17:40.2
1 4	Arango, Julio	COL	1:05.1 9:29.3	2:17.0 10:41.1	3:29.3 11:53.1	4:41.5 13:05.7	5:53.6 14:18.2	7:05.8 15:30.6	8:17.7 16:43.1	17:53.9
5	Bure, Vladimir	URS	1:06.1 9:31.0	2:17.3 10:45.5	3:28.4 12:00.5	4:39.7 13:15.2	5:52.1 14:30.1	7:04.7 15:45.9	8:17.7 17:01.4	18:14.7
	Von Holst, Sven	SUE	NSP							
	Becerra, Tomás	COL	NSP							
	Fiallo, Gregorio	CUB	NSP							
1	Nelson, John	EUA	1:04.9 9:17.5	2:13.7 10:30.1	3:23.1 11:42.0	4:33.4 12:54.1	5:44.4 14:05.9	6:54.7 15:17.4	8:06.3 16:29.3	17:36.0
2	Alanís, Juan	MEX	1:06.2 9:22.6	2:16.2 10:34.3	3:26.7 11:45.7	4:37.2 12:56.4	5:48.4 14:07.3	7:00.5 15:18.3	8:11.4 16:29.6	17:37.4
3	Mann, Karl-Rüdiger	ADE	1:06.1 9:22.1	2:15.5 10:33.9	3:26.5 11:46.0	4:36.3 12:57.3	5:47.6 14:09.0	6:58.3 15:20.4	8:10.0 16:31.9	17:37.6
2 4	Corell, Antonio	ESP	1:07.1 9:37.1	2:18.3 10:51.1	3:30.5 12:05.2	4:42.9 13:18.9	5:56.4 14:32.6	7:09.7 15:46.6	8:23.5 17:00.6	18:12.7
	Asamali, Tony	FIL	NSP							
	Belits-Geiman, Semyon	URS	NSP							
	Kolossa, Istvan	HUN	NSP							
	Loh, Robert	HOK	NSP							
1	Brough, Gregory	AUS	1:02.9 9:12.1	2:11.3 10:21.5	3:20.4 11:31.8	4:29.8 12:41.6	5:40.8 13:51.3	6:51.1 15:01.5	8:01.4 16:11.1	17:17.1
2	Kinsella, John	EUA	1:02.3 9:07.1	2:09.3 10:17.8	3:17.9 11:28.5	4:27.1 12:39.5	5:36.3 13:50.8	6:46.0 15:01.7	7:56.4 16:12.9	17:22.7
3	Larsson, Karl	SUE	1:05.0 9:29.4	2:14.7 10:43.3	3:25.9 11:57.2	4:38.0 13:11.6	5:50.2 14:25.2	7:02.2 15:38.7	8:15.6 16:50.4	17:57.0
3 4	Urreta, Jorge	MEX	1:04.3 9:27.5	2:14.7 10:41.1	3:26.7 11:54.4	4:39.7 13:08.5	5:52.0 14:22.4	7:04.1 15:36.1	8:15.4 16:49.0	17:57.5
5	Wojkatajits, Wladyslaw	POL	1:06.0 9:38.6	2:16.5 10:57.0	3:28.5 12:16.3	4:41.3 13:34.1	5:54.9 14:50.4	7:08.9 16:06.0	8:23.7 17:20.7	18:32.4
6	Henrard, Jacques	BEL	1:08.0 9:48.2	2:20.9 11:03.9	3:34.6 12:19.8	4:48.6 13:35.5	6:02.6 14:50.9	7:17.4 16:06.9	8:33.0 17:24.4	18:38.2
	Feil, Lars	SUE	NSP							
	Martínez, José	CUB	NSP							
1	White, Graham	AUS	1:02.9 9:07.0	2:10.5 10:16.2	3:19.1 11:26.1	4:28.7 12:35.6	5:37.4 13:45.6	6:47.1 14:55.5	7:57.0 16:05.1	17:10.1
2	Echevarría, Guillermo	MEX	1:03.6 9:06.9	2:11.3 10:17.5	3:19.4 11:27.1	4:28.5 12:36.1	5:37.2 13:45.9	6:46.5 14:55.9	7:57.2 16:05.4	17:11.0
3	Ito, Katsuji	JPN	1:06.3 9:23.8	2:16.8 10:36.8	3:26.1 11:49.1	4:36.4 13:02.2	5:48.3 14:15.0	6:59.7 15:27.2	8:11.6 16:40.8	17:50.2
4 4	Ravelin, Jean-François	FRA	1:07.6 9:38.5	2:19.4 10:52.3	3:32.1 12:06.0	4:44.8 13:20.4	5:58.7 14:34.6	7:11.2 15:48.7	8:24.6 17:02.5	18:11.9
5	González, Jorge	PRO	1:08.8 9:51.5	2:21.2 11:09.3	3:33.7 12:28.6	4:47.3 13:48.1	6:02.5 15:08.3	7:18.3 16:28.3	8:35.0 17:48.3	19:06.0
6	Guerrero, Rubén	SAL	1:09.1 10:17.0	2:25.8 11:36.5	3:43.4 12:56.0	5:02.0 14:17.0	6:20.6 15:37.0	7:39.4 16:57.8	8:58.6 18:17.9	19:36.4
	Luyce, Francis	FRA	NSP							
	González, Fernando	ECU	NSP							

FINALE FINAL **OCT 26**

			100 m 800 m	200 m 900 m	300 m 1000 m	400 m 1100 m	500 m 1200 m	600 m 1300 m	700 m 1400 m	Temps Time 1500 m
1	Burton, Michael (mro)	EUA	1:01.9 8:47.2	2:06.8 9:55.1	3:12.5 11:02.8	4:19.0 12:10.4	5:25.6 13:17.8	6:32.8 14:25.3	7:40.0 15:33.3	16:38.9
2	Kinsella, John (mro)	EUA	1:03.4 8:56.9	2:10.1 10:04.9	3:17.5 11:13.1	4:25.9 12:21.3	5:33.7 13:29.8	6:41.4 14:38.9	7:49.2 15:48.3	16:57.3
3	Brough, Gregory	AUS	1:02.6 9:00.0	2:08.6 10:09.9	3:15.4 11:19.5	4:23.0 12:29.1	5:31.7 13:39.8	6:41.3 14:49.7	7:50.7 15:59.8	17:04.7
4	White, Graham	AUS	1:02.3 9:01.8	2:08.9 10:11.2	3:16.4 11:21.4	4:24.5 12:32.0	5:33.6 13:42.5	6:42.7 14:53.0	7:52.6 16:02.5	17:08.0
5	Hutton, Ralph	CAN	1:05.1 9:09.5	2:13.3 10:19.5	3:21.6 11:29.5	4:31.7 12:38.8	5:39.7 13:48.4	6:48.9 14:57.8	7:58.9 16:07.4	17:15.6
6	Echevarria, Guillermo	MEX	1:00.4 9:06.5	2:06.8 10:18.9	3:14.1 11:32.3	4:21.4 12:45.8	5:31.5 13:59.2	6:41.3 15:12.2	7:53.8 16:25.6	17:36.4
7	Afanís, Juan	MEX	1:05.4 9:21.3	2:14.3 10:33.4	3:24.2 11:45.6	4:35.2 12:58.3	5:46.8 14:11.2	6:58.2 15:24.3	8:09.5 16:37.1	17:46.6
8	Nelson, John	EUA	1:02.7 9:21.5	2:10.0 10:35.0	3:19.6 11:49.4	4:30.8 13:04.1	5:42.7 14:19.6	6:55.2 15:35.0	8:08.2 16:50.2	18:05.1
(RM)	16:08.5	Burton, Michael	EUA	1968,	EUA					
(RO)	17:01.7	Windle, Robert	AUS	1964,	JPN					

100 m BRASSE - MESSIEURS
100 m BREASTSTROKE - MEN

ELIMINATOIRES ELIMINATION HEATS **OCT 18**

744

			Temps Time			Temps Time			Temps Time		
1	Pankin, Nickolay (ro)	URS	1:08.9	1	Taguchi, Nobutaka	JPN	1:09.8	1	Kosinsky, Vladimir (mro)	URS	1:07.9
2	Katzur, Klaus	ADE	1:09.4	2	Kosinsky, Vladimir	URS	1:10.0	2	McKenzie, Donald (mro)	EUA	1:08.1
3	Perkowski, David	EUA	1:09.5	3	Merten, Kenneth	EUA	1:10.6	3	Fiolo, José (mro)	BRA	1:08.6
4	Günther, Michael	ALE	1:10.3	4	Ball, Patrick	IRL	1:12.1	4	Mikhailov, Eugeny (mro)	URS	1:08.8
5	Tsurumine, Osamu	JPN	1:10.5	5	Jonsson, Leiknir	ISL	1:16.3	5	Mahony, William	CAN	1:09.7
6	Gilliard, Nicolas	SUI	1:12.8	6	Muñoz, Abel	SAL	1:19.4	6	Betz, Gregor	ALE	1:09.8
7	Moreno, Eduardo	MEX	1:13.7		Sacchi, Massimo	ITA	NSP	7	Klukowsky, Jozef	POL	1:10.9
								8	Merten, Kenneth	EUA	1:11.6
1	Henninger, Egon	ADE	1:09.6	1	Fiolo, José	BRA	1:09.5				
2	Koszta, Ladislau	RUM	1:10.1	2	Betz, Gregor	ALE	1:10.3				
3	Klukowsky, Jozef	POL	1:11.0	3	Jalmaani, Amman	FIL	1:10.6				
4	Aretz, Thomas	ALE	1:11.1	4	Kurbanovic, Slavko	YUG	1:11.6				
5	Szabo, Sandor	HUN	1:11.3	5	Roberts, Roger	GBR	1:11.7				
6	Roberts, Stuart	GBR	1:12.7	6	Goff, Leroy	FIL	1:13.7				
7	Gonima, Ivan	COL	1:15.1	7	Carranza, Arturo	SAL	1:28.0				
1	McKenzie, Donald (mro)	EUA	1:08.1	1	O'Brien, Ian	AUS	1:08.9				
2	Mikhailov, Eugeny	URS	1:09.3	2	Forelli, Alberto	ARG	1:09.3				
3	Mahony, William	CAN	1:09.7	3	Johnsson, Per	SUE	1:10.0				
4	Boretto, Osvaldo	ARG	1:10.3	4	Durán, José	ESP	1:12.3				
5	Muñoz, Felipe	MEX	1:10.6	5	Jiménez, Javier	MEX	1:16.3				
6	Kende, Johan	ISR	1:12.3	6	Ramos, Eduardo	SAL	1:31.2				
	Chan, King-Ming	TWN	NSP		Zsadanyi, Istvan	HUN	NSP				

FINALE FINAL **OCT 19**

1	McKenzie, Donald (mro)	EUA	1:07.7
2	Kosinsky, Vladimir (mro)	URS	1:08.0
3	Pankin, Nickolay (mro)	URS	1:08.0
4	Fiolo, José (mro)	BRA	1:08.1
5	Mikhailov, Eugeny (mro)	URS	1:08.4
6	O'Brien, Ian (mro)	AUS	1:08.6
7	Forelli, Alberto (mro)	ARG	1:08.7
8	Henninger, Egon	ADE	1:09.7

(RM) 1:06.2 Pankin, Nickolay URS 1968, URS
(RO) Establí a Mexico Set in Mexico

DEMI-FINALES SEMI-FINALS

1	Henninger, Egon	ADE	1:08.9	1	Pankin, Nickolay (mro)	URS	1:08.1
2	O'Brien, Ian	AUS	1:09.0	2	Forelli, Alberto	ARG	1:08.9
3	Günther, Michael	ALE	1:09.7	3	Perkowski, David	EUA	1:09.0
4	Katzur, Klaus	ADE	1:09.9	4	Muñoz, Felipe	MEX	1:09.4
5	Tsurumine, Osamu	JPN	1:10.3	5	Koszta, Ladislau	RUM	1:09.8
6	Jalmaani, Amman	FIL	1:10.4	6	Aretz, Thomas	ALE	1:11.2
7	Johnsson, Per	SUE	1:10.9	7	Boretto, Osvaldo	ARG	1:11.8
8	Szabo, Sandor	HUN	1:11.1		Taguchi, Nobutaka	JPN	DES

200 m DOS - MESSIEURS
200 m BACKSTROKE - MEN

100 m PAPILLON - MESSIEURS
100 m BUTTERFLY-MEN

ELIMINATOIRES
ELIMINATION HEATS

OCT 25

			Temps Time		Temps Time
		100m			200m
1	Ivey, Mitchell	EUA	1:02.6		2:11.3
2	Del Campo, Franco	ITA	1:05.2		2:16.3
3	Ching, Franco	ITA	1:08.2	1	2:19.5
4	Santibañez, José	MEX	1:08.1	2	2:20.7
5	Shaw, Jim	CAN	1:07.2	3	2:21.0
6	Ljungberg, Hans	SUE	1:07.9	4	2:22.3
7	Asamali, Tony	FIL	1:09.8	5	2:30.0
8	Cruz, Antonio	GUA	1:17.3	6	2:36.3
1	Horsley, Jack	EUA	1:04.8		2:13.7
2	Blechert, Reinhard	ALE	1:05.7		2:16.5
3	Monzo, Jaime	ESP	1:07.0		2:20.1
4	Van Der Maath, Carlos	ARG	NSP		
	Filardi, César	BRA	NSP		
	Hutton, Ralph	CAN	NSP		
	Arusoo, Toomas	CAN	NSP		
1	Matthes, Roland	ADE	1:06.4		2:13.6
2	Esteva, Santiago	ESP	1:07.4		2:15.8
3	Rother, Joachim	ADE	1:07.9		2:16.1
4	Pedersen, Ejvind	DIN	1:06.7		2:16.6
5	Byrom, Karl	AUS	1:06.4		2:20.7
6	Vidal, Eliseo	CUB	1:09.3		2:21.3
7	Barenboim, Leonardo	ARG	1:09.7		2:25.2
8	Ramis, Francisco	PRO	1:12.8		2:30.4
1	Dobroskokin, Leonid	URS	1:08.1		2:16.1
2	Schoutsen, Bob	HOL	1:07.4		2:18.2
3	Rivera, Jaime	MEX	1:08.5		2:20.7
4	Jensen, Lars	DIN	1:07.7		2:22.5
5	Evard, Gerald	SUI	1:08.9		2:24.7
6	Chan, King-Ming	TWN	1:16.5		2:46.9
	Tegeback, Hans	SUE	NSP		
1	Hall, Gary	EUA	1:07.2		2:16.2
2	Borio, Matyas	HUN	1:07.5		2:17.9
3	Van Beek, Marinus	HOL	1:06.7		2:21.2
4	Acosta, Luis	MEX	1:08.7		2:24.0
5	Man-Chiu, Wong	HOK	1:17.3		2:38.6
	Ferm, Sven	SUE	NSP		
	Jackson, Joseph	GBR	NSP		

746

FINALE
FINAL

			Temps Time		Temps Time
		100m			200m
1	Matthes, Roland (mro)	ADE	1:03.8		2:09.6
2	Ivey, Mitchell	EUA	1:03.2		2:10.6
3	Horsley, Jack	EUA	1:03.2		2:10.9
4	Hall, Gary	EUA	1:04.8		2:12.6
5	Esteva, Santiago	ESP	1:05.4		2:12.9
6	Dobroskokin, Leonid	URS	1:04.7		2:15.4
7	Rother, Joachim	ADE	1:06.1		2:15.8
8	Del Campo, Franco	ITA	1:05.4		2:16.5

(RM) 2:07.5 Matthes, Roland ADE 1968, MEX
(RO) 2:10.3 Graef, Jim EUA 1964, JPN

ELIMINATOIRES
ELIMINATION HEATS

OCT 20

			Temps Time		Temps Time		
1	Russell, Douglas (ro)	EUA	57.3	1	Jackson, Joseph	GBR	59.7
2	Nemshilov, Vladimir	URS	59.1	2	Goodner, Gary	PRO	1:00.3
3	Attanasio, Antonio	ITA	1:00.0	3	Jacks, Ronald	CAN	1:00.5
4	Thurley, John	GBR	1:00.7	4	Konov, Sergei	URS	1:00.8
5	Caperonis, Aris	SUI	1:00.9	5	Costa, Joao	BRA	1:02.3
6	Meyten, Joseph	BEL	1:02.2	6	Benavides, Ramiro	GUA	1:03.1
7	Loh, Andrew	HOK	1:06.5		Ferreira, Geoffrey	TRT	NSP
1	Wales, Ross	EUA	58.7	1	Maruya, Satoshi	JPN	58.1
2	Suzdaltsev, Yury	URS	59.3	2	Woodroffe, Martyn	GBR	59.7
3	Melamed, Abraham	ISR	59.4	3	Freitag, Werner	ALE	1:00.1
4	Gregor, Horst-Günter	ADE	59.8	4	Dunn, Graham	AUS	1:01.6
5	Szentirmai, Istvan	HUN	1:01.0	5	D'Dea, Donnacha	IRL	1:02.8
6	Goff, Leroy	FIL	1:02.0	6	Gislason, Guomundur	ISL	1:03.3
7	Vilanova, Salvador	SAL	1:06.4	7	Jokisch, Friedrich	SAL	1:10.5
1	Spitz, Mark	EUA	58.5	1	Stocklasa, Lutz	ALE	59.2
2	Takada, Yasuo	JPN	1:00.0	2	Cusack, Robert	AUS	59.6
3	Ferriouli, José	PRO	1:00.6	3	Arusoo, Toomas	CAN	59.8
4	Tozzi, Angelo	ITA	1:00.6	4	Santibañez, Mario	MEX	1:01.7
5	Eriksson, Karl	SUE	1:00.6	5	Feil, Lars	SUE	1:02.3
6	Becerra, Tomás	COL	1:02.2	6	Aguilar, Maximiliano	MEX	1:04.0
7	Loh, Robert	HOK	1:06.5	7	Guerrero, Rubén	SAL	1:10.1
1	Nicolao, Luis	ARG	59.3				
2	Westergren, Bo	SUE	59.9				
3	Lang, Arturo	ESP	1:00.7				
4	Orejuela, Eduardo	ECU	1:00.9				
5	Fossati, Giampiero	ITA	1:01.7				
6	Lee, Tong-Shing	TWN	1:05.2				
	Cseh, Laszlo	HUN	NSP				

DEMI-FINALES
SEMI-FINALS

1	Spitz, Mark	EUA	57.4	1	Maruya, Satoshi	JPN	58.0
2	Stocklasa, Lutz	ALE	58.5	2	Nemshilov, Vladimir	URS	59.0
3	Jackson, Joseph	GBR	59.3	3	Woodroffe, Martyn	GBR	59.5
4	Melamed, Abraham	ISR	59.6	4	Arusoo, Toomas	CAN	59.6
5	Freitag, Werner	ALE	59.9	5	Eriksson, Karl	SUE	59.9
6	Westergren, Bo	SUE	59.9	6	Attanasio, Antonio	ITA	1:00.3
7	Ferriouli, José	PRO	1:00.9	7	Jacks, Ronald	CAN	1:00.5
8	Thurley, John	GBR	1:01.2		Nicolao, Luis	ARG	NSP

1	Russell, Douglas (mro)	EUA	55.9
2	Wales, Ross	EUA	58.2
3	Suzdaltsev, Yury	URS	58.9
4	Cusack, Robert	AUS	59.2
5	Takada, Yasuo	JPN	59.8
6	Goodner, Gary	PRO	1:00.1
7	Tozzi, Angelo	ITA	1:00.8
	Lang, Arturo	ESP	NSP

FINALE
FINAL

OCT 21

1	Russell, Douglas (mro)	EUA	55.9
2	Spitz, Mark (mro)	EUA	56.4
3	Wales, Ross (mro)	EUA	57.2
4	Nemshilov, Vladimir	URS	58.1
5	Maruya, Satoshi	JPN	58.6
6	Suzdaltsev, Yury	URS	58.8
7	Stocklasa, Lutz	ALE	58.9
8	Cusack, Robert	AUS	59.8

(RM) 55.6 Spitz, Mark EUA 1968, EUA
(RO) Establí a Mexico Set in Mexico

200 m PAPILLON - MESSIEURS
200 m BUTTERFLY - MEN

ELIMINATOIRES
ELIMINATION HEATS **OCT 24**

			100 m	200 m
			Temps	Temps
			Time	Time
1	Woodroffe, Martyn	GBR	1:03.6	2:11.6
2	Takada, Yasuo	JPN	1:04.1	2:13.3
3	Melamed, Abraham	ISR	1:04.2	2:15.4
4	Jacks, Ronald	CAN	1:05.6	2:18.1
5	Villagómez, Raúl	MEX	1:07.0	2:22.4
6	Carranza, Arturo	SAL	1:14.7	2:47.3
	Westergren, Bo	SUE	NSP	
1	Feil, Lars	SUE	1:04.2	2:11.9
2	Altamirano, Gabriel	MEX	1:02.9	2:12.1
3	Arusoo, Toomas	CAN	1:04.3	2:12.7
4	Konov, Sergei	URS	1:02.6	2:13.1
5	Orejuela, Eduardo	ECU	1:05.0	2:23.4
	Costa, Joao	BRA	NSP	
	Lee, Tong-Shing	TWN	NSP	
1	Ferris, John	EUA	1:03.2	2:10.6
2	Meeuw, Volkert	ALE	1:02.1	2:11.1
3	Thurley, John	GBR	1:02.9	2:12.5
4	Fossati, Giampiero	ITA	1:05.7	2:18.2
5	Krawczyk, Jacek	POL	1:06.4	2:22.1
	Loh, Andrew	HOK	NSP	
	Attanasio, Antonio	ITA	NSP	
1	Spitz, Mark	EUA	1:02.6	2:10.6
2	Maruya, Satoshi	JPN	1:02.1	2:14.2
3	Stocklasa, Lutz	ALE	1:03.0	2:16.4
4	Becerra, Tomás	COL	1:05.2	2:16.8
5	Cusack, Robert	AUS	1:05.9	2:19.4
6	Tozzi, Angelo	ITA	1:06.1	2:20.9
7	Ferrioui, José	PRO	1:06.0	2:23.4
	Loh, Robert	HOK	NSP	
1	Sharygin, Victor	URS	1:03.3	2:10.9
2	Robie, Carls	EUA	1:03.5	2:11.1
3	Kuzmin, Valentin	URS	1:03.7	2:11.5
4	Langerhorst, Dirk	HOL	1:04.7	2:17.4
5	Dunn, Graham	AUS	1:06.4	2:17.5
6	Benavides, Ramiro	GUA	1:09.5	2:24.3
7	Goff, Leroy	FIL	1:06.0	2:25.3

FINALE
FINAL

1	Robie, Carls	EUA	1:02.5	2:08.7
2	Woodroffe, Martyn	GBR	1:02.9	2:09.0
3	Ferris, John	EUA	1:04.3	2:09.3
4	Kuzmin, Valentin	URS	1:03.7	2:10.6
5	Feil, Lars	SUE	1:03.3	2:10.9
6	Meeuw, Volkert	ALE	1:03.7	2:11.5
7	Sharygin, Victor	URS	1:03.9	2:11.9
8	Spitz, Mark	EUA	1:05.1	2:13.5

(RM) 2:05.7 Spitz, Mark EUA 1967,ALE
 (RO) 2:06.6 Berry, Kevin AUS 1964,JPN

200 m 4 NAGES-INDIVIDUEL - MESSIEURS
200 m INDIVIDUAL MEDLEY - MEN

ELIMINATOIRES
ELIMINATION HEATS **OCT 19**

			200 m			200 m	
			Temps			Temps	
			Time			Time	
1	Hickcox, Charles (ro)	EUA	2:16.1	1	Smith, George	CAN	2:16.4
2	Lazar, Peter	HUN	2:17.1	2	Holthaus, Michael	ALE	2:17.5
3	Jensen, Lars	DIN	2:21.2	3	Wiegand, Frank	ADE	2:18.0
4	Pacelt, Zbigniew	POL	2:23.3	4	Man-Chiu, Wong	HOK	2:36.1
5	Gislason, Guomundur	ISL	2:24.1	5	O'Dea, Donnacha	IRL	2:36.6
6	Dunaev, Andrei	URS	2:25.9		Madsen, Orjan	NOR	NSP
7	Ramis, Francisco	POR	2:31.9				
8	Guerrero, Rubén	SAL	2:37.5				
1	Ferris, John (mro)	EUA	2:14.6	1	Kravchenko, Vladimir	URS	2:18.6
2	Markel, Reinhard	ALE	2:17.8	2	Szentirmai, Istvan	HUN	2:21.0
3	Ljungberg, Hans	SUE	2:17.8	3	Tchakarov, Anguel	BUL	2:24.0
4	Russev, Julian	BUL	2:22.7	4	Santibáñez, José	MEX	2:24.6
5	Terrell, Raymond	GBR	2:23.5	5	Byrom, Karl	AUS	2:28.0
6	Ferm, Sven	SUE	2:27.5	6	Chan, King-Ming	TWN	2:44.9
	Lee, Tong-Shing	TWN	DES				
1	Gilchrist, John	CAN	2:16.8	1	Buckingham, Greg. (mro)	EUA	2:15.6
2	Bello, Juan	PER	2:17.5	2	D'Oppido, Michele	ITA	2:18.5
3	Fortuny, Juan	ESP	2:20.6	3	Campell, Ken	CAN	2:20.9
4	Simons, François	BEL	2:22.5	4	Alanis, Eduardo	MEX	2:23.0
5	Hernández, Rafael	MEX	2:24.7	5	Shefa, Gershon	ISR	2:26.6
6	Vilanova, Salvador	SAL	2:33.8	6	Schmid, Peter	AUT	2:36.4
7	Loh, Robert	HOK	2:39.3	7	Jokisch, Friedrich	SAL	2:41.6
					Ferrioui, José	PRO	NSP
1	Schiller, Jürgen	ALE	2:20.8				
2	Woodroffe, Martyn	GBR	2:22.0				
3	Krawczyk, Jacek	POL	2:23.8				
4	Asamali, Tony	FIL	2:24.6				
5	Martínez, José	CUB	2:31.4				
6	Loh, Andrew	HOK	2:42.0				

FINALE
FINAL **OCT 20**

1	Hickcox, Charles (mro)	EUA	2:12.0
2	Buckingham, G. (mro)	EUA	2:13.0
3	Ferris, John (mro)	EUA	2:13.3
4	Bello, Juan (mro)	PER	2:13.7
5	Smith, George (mro)	CAN	2:15.9
6	Gilchrist, John	CAN	2:16.6
7	Holthaus, Michael	ALE	2:16.8
8	Lazar, Peter	HUN	2:18.3

(RM) 2:10.6 Hickcox, Charles EUA 1968,EUA
 (RO) Etabli a Mexico Set in Mexico

400 m 4 NAGES-INDIVIDUEL - MESSIEURS
400 m INDIVIDUAL MEDLEY - MEN

ELIMINATOIRES
ELIMINATION HEATS **OCT 22**

			100 m	200 m	300 m	400 m
			M	D	P	L
			Temps	Temps	Temps	Temps
			Time	Time	Time	Time
1	Dunaev, Andrei	URS	1:06.7	2:23.4	3:53.3	5:01.9
2	Woodroffe, Martyn	GBR	1:04.6	2:23.2	3:52.6	5:03.9
3	Alanis, Eduardo	MEX	1:08.9	2:29.4	4:05.7	5:14.9
4	Krawczyk, Jacek	POL	1:08.3	2:27.1	4:02.0	5:15.1
	Martínez, José	CUB	DES			
	Asamali, Tony	FIL	NSP			
	Bello, Juan	PER	NSP			

DEMI-FINALES
SEMI-FINALS

Temps
Time

1	Lay, Marion	CAN	1:00.7	1	Pedersen, Susan	EUA	1:00.2
2	Segrt, Mirjana	YUG	1:01.9	2	Jackson, Alexandra	GBR	1:00.6
3	Grunert, Martina	ADE	1:02.2	3	Krause, Roswitha	ADE	1:02.4
4	Bell, Lynette	AUS	1:02.4	4	Schmuck, Uta	ADE	1:02.8
5	Steinbeck, Janet	AUS	1:02.6	5	Kawanishi, Shigeko	JPN	1:03.0
6	Oei, Liana	TWN	1:02.8	6	Grebets, Lidia	URS	1:03.3
7	Watson, Lynette	AUS	1:02.9	7	Kovacs, Edit	HUN	1:03.5
8	Patoh, Magdolna	HUN	1:03.8	8	Ustinova, Natalia	URS	1:05.0
1	Henne, Jan	EUA	1:00.5				
2	Gustavson, Linda	EUA	1:00.6				
3	Turoczy, Judit	HUN	1:01.8				
4	Kozicova, Olga	CHE	1:02.6				
5	Bos, Petronella	HOL	1:02.8				
6	Mandonnaud, Claude	FRA	1:02.8				
7	Berglund, Gudrun	SUE	1:03.5				
8	Hanner, Simone	FRA	1:04.8				

100m

Temps
Time

200m

1	Barkman, Jane	EUA	1:06.0	2:13.6
2	Kersaudy, Marie	FRA	1:06.9	2:18.0
3	Berglund, Gudrun	SUE	1:08.0	2:19.7
4	Sosnova, Tamara	URS	1:09.8	2:23.5
5	Olano, Patricia	COL	1:10.1	2:25.1
6	Asturias, Silvana	GUA	1:13.1	2:30.7
7	Castillo, Lylían	URG	1:13.8	2:34.1
	Marcial, Ana	PRO	NSP	
1	Segrt, Mirjana	YUG	1:05.5	2:15.7
2	Oei, Liana	TWN	1:06.4	2:16.3
3	McDonald, Julie	AUS	1:07.9	2:19.9
4	Changanaqui, Consuelo	PER	1:08.5	2:20.7
5	De Vivanco, Maria	PER	1:09.7	2:22.2
6	Davison, Sally	GBR	1:09.6	2:26.1
	Gustavsson, Ingrid	SUE	NSP	
	Chan, Patricia	SIN	NSP	

OCT 22

FINALE
FINAL

OCT 19

1	Henne, Jan	EUA	1:00.0
2	Pedersen, Susan	EUA	1:00.3
3	Gustavson, Linda	EUA	1:00.3
4	Lay, Marion	CAN	1:00.5
5	Grunert, Martina	ADE	1:01.0
6	Jackson, Alexandra	GBR	1:01.0
7	Segrt, Mirjana	YUG	1:01.5
8	Turoczy, Judit	HUN	1:01.6

(RM) 58.9 Fraser, Dawn AUS 1964, AUS
(RO) 59.5 Fraser, Dawn AUS 1964, JPN

1	Meyer, Debbie (mro)	EUA	1:04.0	2:10.5
2	Henne, Jan (mro)	EUA	1:04.7	2:11.0
3	Barkman, Jane (mro)	EUA	1:04.5	2:11.2
4	Wetzko, Gabriele (mro)	ADE	1:06.1	2:12.3
5	Segrt, Mirjana	YUG	1:05.1	2:13.3
6	Mandonnaud, Claude	FRA	1:05.0	2:14.9
7	Bell, Lynette	AUS	1:04.6	2:15.1
8	Kozicova, Olga	CHE	1:05.7	2:16.0

(RM) 2:06.7 Meyer, Debbie EUA 1968, EUA
(RO) Etabli a Mexico Set in Mexico

750

200 m NAGE LIBRE - DAMES
200 m FREESTYLE - WOMEN

400 m NAGE LIBRE - DAMES
400 m FREESTYLE - WOMEN

ELIMINATOIRES
ELIMINATION HEATS

OCT 21

		Temps Time			
		100m	200m		
1	Meyer, Debbie (ro)	EUA	1:05.0	2:13.1	
2	Kozicova, Olga	CHE	1:05.9	2:16.1	
3	Williams, Susan	GBR	1:08.1	2:20.4	
4	Reineck, Heidi	ALE	1:09.8	2:21.4	
5	Dorleans, Daniele	FRA	1:09.5	2:21.7	
6	Campbell, Kirsten	DIN	1:11.3	2:30.5	
	Nguyen, Minh-Tam	VNM	NSP		
	Moreno, Maria	SAL	NSP		
1	Bell, Lynette	AUS	1:04.7	2:15.7	
2	Mandonnaud, Claude	FRA	1:06.5	2:15.8	
3	Steinbeck, Janet	AUS	1:07.9	2:18.8	
4	Elliott, Helen	FIL	1:09.5	2:25.4	
5	Calligaris, Novella	ITA	1:11.6	2:26.3	
6	Arriaga, Marcia	MEX	1:10.2	2:27.0	
7	Shen, Bao-Ni	TWN	1:11.9	2:34.0	
8	Blake, Lorna	PRO	1:15.7	2:43.8	
1	Henne, Jan	EUA	1:05.9	2:13.8	
2	Lay, Marion	CAN	1:07.3	2:16.7	
3	Ramirez, Teresa	MEX	1:06.6	2:17.5	
4	Jackson, Alexandra	GBR	1:07.2	2:19.2	
5	Moir, Kristina	PRO	1:09.7	2:23.1	
6	Ferracuti, Donatella	SAL	1:12.2	2:28.2	
7	Gudmundsdottir, Hrafnhildur	ISL	ST	2:28.5	
	Ferracuti, Carmen	SAL	NSP		
1	Wetzko, Gabriele	ADE	1:06.6	2:14.7	
2	Coughlaw, Angela	CAN	1:08.3	2:20.9	
3	Strumolo, Maria	ITA	1:07.7	2:23.3	
4	Bauer, Aloisia	ALE	1:08.8	2:24.5	
5	Figueroa, Emilia	URG	1:11.0	2:27.4	
	Andersson, Lotten	SUE	NSP		
	Sacchi, Mara	ITA	NSP		

ELIMINATOIRES
ELIMINATION HEATS

OCT 19

		Temps Time				
		100m	200m	300m	400m	
1	Ramírez, Teresa	MEX	1:05.8	2:16.9	3:30.4	4:43.9
2	Wetzko, Gabriele	ADE	1:08.0	2:20.3	3:34.3	4:49.8
3	Vaca, Laura	MEX	1:07.5	2:21.4	3:37.5	4:53.3
4	Elliott, Helen	FIL	1:11.9	2:27.9	3:44.5	4:59.9
5	Shen, Bao-Ni	TWN	1:13.8	2:40.9	4:12.5	5:41.8
	Ferracuti, Donatella	SAL	NSP			
1	Meyer, Debbie (mro)	EUA	1:05.3	2:15.1	3:26.0	4:35.0
2	Amezcuca, Norma	MEX	1:11.2	2:27.4	3:44.9	5:00.5
3	Mollier, Dominique	FRA	1:11.4	2:27.6	3:45.1	5:00.5
4	Clayton, Sheila	GBR	1:12.0	2:29.8	3:49.3	5:08.0
	Mandonnaud, Claude	FRA	NSP			
	Chan, Patricia	SIN	NSP			
	Berglund, Gudrun	SUE	NSP			
1	Kruse, Pam	EUA	1:10.2	2:23.3	3:34.2	4:45.2
2	Hara, Marjatta	FIN	1:10.3	2:24.2	3:39.1	4:53.0
3	De Angulo, Olga	COL	1:12.3	2:30.8	3:50.6	5:08.6
4	Davison, Sally	GBR	1:11.3	2:29.4	3:50.8	5:11.2
5	Castillo, Lylían	URG	1:14.1	2:37.7	4:04.4	5:30.2
6	Blake, Lorna	PRO	1:18.0	2:47.8	4:22.0	5:54.7
	Segrt, Mirjana	YUG	NSP			
1	Gustavson, Linda (mro)	EUA	1:05.8	2:15.8	3:28.5	4:41.4
2	Kersaudy, Marie	FRA	1:08.4	2:22.1	3:40.1	4:57.3
3	Moir, Kristina	PRO	1:11.2	2:26.7	3:42.7	4:57.7
4	Williams, Susan	GBR	1:10.1	2:25.8	3:44.0	5:02.7
5	Figueroa, Emilia	URG	1:13.1	2:32.9	3:57.2	5:21.0
	Gustavsson, Ingrid	SUE	NSP			

		Temps Time					
		100 m	200 m	300 m	400 m		
5	1	Moras, Karen (mro)	AUS	1:07.2	2:17.7	3:29.1	4:39.6
	2	Morris, Ingrid	SUE	1:10.6	2:24.4	3:38.7	4:51.6
	3	Calligaris, Novella	ITA	1:09.5	2:25.9	3:43.5	4:59.4
	4	Changanagui, Consuelo	PER	1:13.5	2:30.4	3:46.8	5:02.9
	5	Asturias, Silvana	GUA	1:15.2	2:36.2	4:01.4	5:25.6
		Kozicova, Olga	CHE	NSP			
		Marcial, Ana	PRO	NSP			
6	1	Coughlaw, Angela	CAN	1:08.0	2:19.4	3:33.6	4:47.4
	2	Langford, Denise	AUS	1:08.6	2:21.9	3:36.8	4:52.2
	3	Sigg, Eva	FIN	1:11.1	2:27.3	3:43.3	4:58.5
	4	Deakes, Christine	AUS	1:10.3	2:25.6	3:42.9	5:01.5
	5	Olano, Patricia	COL	1:12.5	2:29.0	3:45.3	5:01.8
	6	Oei, Liana	TWV	NSP			

FINALE OCT 20

1	Meyer, Debbie (mro)	EUA	1:04.1	2:13.6	3:23.5	4:31.8
2	Gustavson, Linda (mro)	EUA	1:06.3	2:16.3	3:26.4	4:35.5
3	Moras, Karen (mro)	AUS	1:06.9	2:17.3	3:27.8	4:37.0
4	Kruse, Pam (mro)	EUA	1:06.6	2:16.7	3:27.7	4:37.2
5	Wetzco, Gabriele (mro)	ADE	1:08.2	2:18.6	3:29.5	4:40.2
6	Ramírez, Teresa (mro)	MEX	1:07.1	2:17.5	3:29.5	4:42.2
7	Coughlaw, Angela	CAN	1:08.1	2:20.3	3:35.4	4:51.9
8	Morris, Ingrid	SUE	1:11.0	2:25.6	3:40.2	4:53.8

(RM) 4:24.5 Meyer, Debbie EUA 1968, EUA
(RO) 4:43.3 Duenkel, Virginia EUA 1964, JPN

800 m NAGE LIBRE - DAMES 800 m FREESTYLE - WOMEN

751

ELIMINATOIRES OCT 22 ELIMINATION HEATS

		Temps Time									
		100 m	200 m	300 m	400 m	500 m	600 m	700 m	800 m		
1	1	Meyer, Debbie (ro)	EUA	1:08.2	2:21.6	3:35.2	4:49.3	6:03.3	7:16.9	8:30.8	9:42.8
	2	Coughlaw, Angela	CAN	1:11.2	2:26.6	3:41.6	4:56.7	6:12.6	7:28.8	8:45.4	10:00.2
	3	Goral, Sigrid	ADE	1:11.6	2:27.1	3:42.8	4:59.1	6:17.0	7:35.5	8:53.7	10:09.3
	4	Moir, Kristina	PRO	1:12.4	2:29.4	3:47.9	5:06.8	6:27.1	7:47.6	9:07.5	10:24.5
	5	Elliott, Helen	FIL	1:14.0	2:33.0	3:52.0	5:11.8	6:32.5	7:53.0	9:14.1	10:32.9
		Ocsai, Anna	HUN	NSP							
		Gustavsson, Ingrid	SUE	NSP							
2	1	Moras, Karen (mro)	AUS	1:09.7	2:22.0	3:35.1	4:47.8	6:00.8	7:13.8	8:27.1	9:38.3
	2	Langford, Denise	AUS	1:10.5	2:24.7	3:39.7	4:55.5	6:10.9	7:27.6	8:44.6	9:59.3
	3	Vaca, Laura	MEX	1:09.9	2:24.6	3:40.0	4:56.0	6:12.3	7:29.4	8:46.5	10:01.8
	4	Shipston, Tui	NZL	1:10.9	2:26.0	3:42.9	5:02.4	6:23.4	7:45.6	9:07.6	10:28.0
	5	Amezcuca, Norma	MEX	1:11.6	2:29.1	3:48.4	5:08.7	6:30.1	7:51.4	9:12.6	10:31.6
	6	Figueroa, Emilia	URG	1:17.4	2:39.6	4:03.4	5:26.7	6:50.5	8:14.2	9:37.7	10:57.7
		Blake, Lorna	PRO	NSP							
3	1	Kruse, Pam	EUA	1:10.9	2:26.2	3:41.6	4:57.2	6:11.0	7:23.9	8:37.6	9:49.8
	2	Morris, Ingrid	SUE	1:12.4	2:28.5	3:44.9	5:02.1	6:19.1	7:36.0	8:52.5	10:07.5
	3	Williams, Susan	GBR	1:13.0	2:30.9	3:48.9	5:06.6	6:25.4	7:44.5	9:03.3	10:17.6
	4	Rantsch, Sabine	ADE	1:13.2	2:30.6	3:48.3	5:05.8	6:23.7	7:42.2	9:01.2	10:18.4
	5	Castillo, Lylían	URG	1:16.4	2:41.7	4:08.6	5:35.1	7:02.2	8:27.9	9:53.9	11:19.1
		Kock, Vera	SUE	NSP							
4	1	Deakes, Christine	AUS	1:10.6	2:25.3	3:39.4	4:54.6	6:11.4	7:29.9	8:48.5	10:06.7
	2	Kersaudy, Marie	FRA	1:12.1	2:27.6	3:43.2	5:02.0	6:21.0	7:41.7	9:02.5	10:19.8
	3	Calligaris, Novella	ITA	1:12.4	2:28.7	3:47.4	5:07.7	6:27.1	7:46.9	9:05.5	10:21.0
	4	Olano, Patricia	COL	1:13.5	2:32.3	3:52.6	5:13.4	6:36.5	7:59.3	9:23.7	10:44.1
	5	Asturias, Silvana	GUA	1:17.6	2:39.9	4:03.0	5:27.5	6:52.9	8:19.9	9:47.4	11:12.5
		Davison, Sally	GBR	NSP							
5	1	Ramírez, Teresa	MEX	1:09.8	2:22.3	3:35.8	4:49.2	6:04.0	7:19.5	8:34.5	9:46.4
	2	Caretto, Patty	EUA	1:09.1	2:22.0	3:35.8	4:49.9	6:04.1	7:19.0	8:33.9	9:46.4
	3	Mollier, Dominique	FRA	1:12.5	2:30.0	3:48.9	5:09.0	6:29.1	7:49.4	9:09.3	10:21.4
	4	Hara, Marjatta	FIN	1:11.3	2:27.6	3:45.1	5:04.5	6:24.7	7:45.1	9:05.8	10:23.3
	5	De Angulo, Olga	COL	1:15.7	2:36.8	3:56.6	5:17.6	6:38.9	7:59.9	9:22.1	10:40.5
		Marcial, Ana	PRO	NSP							
		Clayton, Sheila	GBR	NSP							

FINALE
FINAL **OCT 24**

			Temps							Time	
			100m	200m	300 m	400m	500m	600m	700m	800m	
1	Meyer, Debbie (mro)	EUA	1:05.8	2:15.9	3:27.0	4:38.6	5:50.1	7:02.3	8:14.6	9:24.0	
2	Kruse, Pam (mro)	EUA	1:08.5	2:20.1	3:32.6	4:45.1	5:57.6	7:10.3	8:23.9	9:35.7	
3	Ramirez, Teresa (mro)	MEX	1:07.4	2:19.3	3:32.2	4:45.8	5:59.3	7:13.2	8:27.2	9:38.5	
4	Moras, Karen (mro)	AUS	1:07.0	2:18.5	3:31.5	4:49.9	5:58.9	7:13.0	8:27.1	9:38.6	
5	Caretto, Patty	EUA	1:07.7	2:20.0	3:33.4	4:48.0	6:03.1	7:19.5	8:35.9	9:51.3	
6	Coughlaw, Angela	CAN	1:08.0	2:20.6	3:34.9	4:51.1	6:07.7	7:24.2	8:40.8	9:56.4	
7	Langford, Denise	AUS	1:09.1	2:22.5	3:37.0	4:52.5	6:08.3	7:24.8	8:41.0	9:56.7	
8	Vaca, Laura	MEX	1:10.1	2:25.2	3:41.2	4:57.4	6:13.8	7:30.4	8:47.2	10:02.5	

(RM) 9:10.4 Meyer, Debbie EUA 1968, EUA
(RO) Establi a Mexico Set in Mexico

100 m BRASSE - DAMES
100 m BREASTROKE - WOMEN

ELIMINATOIRES
ELIMINATION HEATS **OCT 18**

			Temps				Temps
			Time				Time
1	Ball, Catie (ro)	EUA	1:18.8	1	Bjedov, Djurdjica (mro)	YUG	1:17.7
2	Barnes, Joanne	AUS	1:19.1	2	Grebennikova, Alla	URS	1:19.3
3	Jones, Suzy	EUA	1:19.3	3	Nir, Shlomit	ISR	1:20.9
4	Harrison, Dorothy	GBR	1:19.6	2	O'Connor, Ann	IRL	1:21.1
5	Filippovits, Christine	AUT	1:19.9	5	Janus, Maria	HOL	1:21.9
6	Oynick, Tamara	MEX	1:22.7	6	Orejuela, Tamara	ECU	1:26.8
7	Vicens, Liana	PRO	1:25.2	7	Jokisch, Celia	SAL	1:46.6
	De la Portilla, Ana	MEX	NSP				
1	Wichman, Sharon (mro)	EUA	1:18.3	1	Frommater, Uta (mro)	ALE	1:18.5
2	Playfair, Judy	AUS	1:19.2	2	Prozumenshikova, Galina	URS	1:18.6
3	Brage, Yvonne	SUE	1:20.8	3	Babanina, Svetlana	URS	1:20.2
4	Eberle, Verena	ALE	1:22.6	4	Slattery, Jill	GBR	1:20.7
5	Casas, Victoria	MEX	1:24.7	5	McKenzie, Susan	AUS	1:20.9
6	Moreno, Maria	SAL	1:27.2	6	Inguadottir, Ellen	ISL	1:22.6
	Ballago, Maria	HUN	NSP		Garcia, Hedy	FIL	NSP
1	Norbis, Ana (mro)	URG	1:17.4				
2	Nakagawa, Kiyoe (mro)	JPN	1:18.2				
3	Harris, Diana	GBR	1:19.8				
5	Takemoto, Yukari	JPN	1:20.7				
5	Egervary, Marta	HUN	1:22.6				
6	Wilmes, Arlette	LUX	1:24.4				
7	Castro, Maria	SAL	1:36.9				

DEMI-FINAL
SEMI-FINAL

1	Wichman, Sharon (mro)	EUA	1:16.8	1	Norbis, Ana (mro)	URG	1:16.7
2	Bjedov, Djurdjica (mro)	YUG	1:17.1	2	Ball, Catie (mro)	EUA	1:16.8
3	Prozumenshikova, (mro)	URS	1:17.5	3	Frommater, Uta (mro)	ALE	1:16.9
4	Barnes, Joanne (mro)	AUS	1:18.4	4	Nakagawa, Kiyoe (mro)	JPN	1:17.7
5	Grebennikova, Alla (mro)	URS	1:18.6	2	Babanina, Svetlana (mro)	URS	1:18.3
6	Filippovits, Christine	AUT	1:18.9	6	Jones, Suzy (mro)	EUA	1:18.6
7	Harrison, Dorothy	GBR	1:19.6	7	Playfair, Judy	AUS	1:19.3
8	Slattery, Jill	GBR	1:19.8	8	Harris, Diana	GBR	1:19.3

FINALE
FINAL **OCT 19**

			Temps
			Time
1	Bejedov, Djurdjica (mro)	YUG	1:15.8
2	Prozumenshikova, G. (mro)	URS	1:15.9
3	Wichman, Sharon (mro)	EUA	1:16.1
4	Frommater, Uta (mro)	ALE	1:16.2
5	Ball, Catie (mro)	EUA	1:16.7
6	Nakagawa, Kiyoe (mro)	JPN	1:17.0
7	Babanina, Svetlana (mro)	URS	1:17.2
8	Norbis, Ana (mro)	URG	1:17.3

(RM) 1:14.2 Ball, Catie EUA 1968, EUA
(RO) Establi a Mexico Set in Mexico

200 m BRASSE - DAMES
200 m BREASTROKE - WOMEN

ELIMINATOIRES
ELIMINATION HEATS **OCT 22**

			Temps	
			Time	Time
			100m	200m
1	Filippovits, Christine	AUT	1:21.0	2:51.3
2	Playfair, Judy	AUS	1:23.5	2:52.9
3	Harrison, Dorothy	GBR	1:23.1	2:55.1
4	Garcia, Hedy	FIL	1:29.6	3:08.1
5	Orejuela, Tamara	ECU	1:29.3	3:08.5
	Ball, Catie	EUA	NSP	
1	Wichman, Sharon	EUA	1:19.4	2:46.8
2	Slattery, Jill	GBR	1:21.6	2:51.2
3	Oynick, Tamara	MEX	1:23.8	2:52.4
4	Eberle, Verena	ALE	1:25.0	2:52.5
5	Casas, Victoria	MEX	1:26.3	3:01.0
6	Harris, Diana	GBR	1:25.8	3:03.4
	Castro, Maria	SAL	NSP	
1	Babanina, Svetlana	URS	1:22.7	2:49.8
2	Jamison, Cathy	EUA	1:21.6	2:50.1
3	Bjedov, Djurdjica	YUG	1:20.0	2:50.2
4	Brage, Yvonne	SUE	1:23.7	2:56.3
5	Nir, Shlomit	ISR	1:23.0	2:58.5
6	De La Portilla, Ana	MEX	1:29.9	3:03.5
	Frommater, Uta	ALE	NSP	
1	Prozumenshikova, Galina	URS	1:20.6	2:47.8
2	Shibata, Chieno	JPN	1:24.6	2:50.6
3	McKenzie, Susan	AUS	1:26.4	2:53.1
4	Barnes, Joanne	AUS	1:24.4	2:57.4
5	Takemoto, Yukari	JPN	1:27.4	2:57.9
6	Inguadottir, Ellen	ISL	1:27.5	2:58.2
7	Moreno, Maria	SAL	1:29.9	3:15.4

100 m PAPILLON - DAMES
100 m BUTTERFLY - WOMEN

ELIMINATOIRES
ELIMINATION HEATS **OCT 20**

			Temps Time			Temps Time		
1	1	Hustedede, Heike	ALE	1:07.7	1	Daniel, Ellie	EUA	1:07.2
	2	Kok, Aagje	HOL	1:08.5	2	Devyatova, Tatyana	URS	1:07.6
	3	Warren, Jeanne	CAN	1:10.0	3	Strubing, Christine	ADE	1:09.2
	4	Fujii, Yasuko	JPN	1:10.1	4	Bos, Petronella	HOL	1:09.5
	5	Obregón, Patricia	MEX	1:12.4	5	Oei, Liana	TWN	1:11.2
	6	Nam, Sang-Nam	COR	1:16.9	6	Smith, Vivienne	IRL	1:13.1
		Tanner, Elaine	CAN	NSP	7	Grojean, Catherine	FRA	1:14.6
3	1	McClements, Lynette	AUS	1:06.1	1	Lindner, Helga	ADE	1:08.0
	2	Gyarmati, Andrea	HUN	1:07.4	2	Hewitt, Toni	EUA	1:08.1
	3	Tobis, Yvonne	ISR	1:12.0	3	Auton, Margaret	GBR	1:08.5
		García, Hedy	FIL	NSP	4	Gómez, Carmen	COL	1:14.7
		Gustavsson, Ingrid	SUE	NSP	5	Apt, Ruth	URG	1:15.3
		Kovacs, Edit	HUN	NSP	6	Marcial, Ana	PRO	1:17.1
	Chan, Patricia	SIN	NSP		Andersson, Lotten	SUE	NSP	
1	1	Shields, Susie	EUA	1:06.2				
	2	Whittleston, Sandra	NZL	1:08.5				
	3	Treers, Gillian	GBR	1:10.6				
	4	Corson, Marilyn	CAN	1:10.7				
	5	Gray, Pauline	AUS	1:13.5				
	6	Comolli, Adriana	ARG	1:16.5				
		Moir, Kristina	PRO	NSP				

DEMI-FINALES
SEMI-FINALS

1	1	Kok, Aagje	HOL	1:06.2	1	Daniel, Ellie	EUA	1:06.1
	2	Shields, Susie	EUA	1:06.3	2	McClements, Lynette	AUS	1:06.1
	3	Gyarmati, Andrea	HUN	1:06.6	3	Lindner, Helga	ADE	1:07.7
	4	Hustedede, Heike	ALE	1:07.0	4	Devyatova, Tatyana	URS	1:08.4
	5	Hewitt, Toni	EUA	1:07.9	5	Bos, Petronella	HOL	1:08.5
	6	Strubing, Christine	ADE	1:08.2	6	Whittleston, Sandra	NZL	1:08.7
	7	Warren, Jeanne	CAN	1:09.7	7	Auton, Margaret	GBR	1:08.8
	8	Treers, Gillian	GBR	1:10.6	8	Fujii, Yasuko	JPN	1:09.4

FINALE
FINAL **OCT 21**

1	McClements, Lynette	AUS	1:05.5
2	Daniel, Ellie	EUA	1:05.8
3	Shields, Susie	EUA	1:06.2
4	Kok, Aagje (rm)	HOL	1:06.2
5	Gyarmati, Andrea	HUN	1:06.8
6	Hustedede, Heike	ALE	1:06.9
7	Hewitt, Toni	EUA	1:07.5
8	Lindner, Helga	ADE	1:07.6

(RM) 1:04.5 Kok, Aagje HOL 1965, HUN
(RO) 1:04.7 Stouder, Sharon EUA 1964, JPN

200 m PAPILLON - DAMES
200 m BUTTERFLY - WOMEN

ELIMINATOIRES
ELIMINATION HEATS **OCT 24**

			Temps Time			Temps Time
1	1	Giebel, Diana (ro)	EUA	1:11.0	100 m	2:33.0
	2	Fujii, Yasuko	JPN	1:11.9	200 m	2:33.4
	3	Auton, Margaret	GBR	1:11.4		2:33.6
	4	Whittleston, Sandra	NZL	1:16.4		2:39.7
	5	Gómez, Carmen	COL	1:18.7		2:44.7
		Marcial, Ana	PRO	NSP		
2	1	Daniel, Ellie (mro)	EUA	1:11.2		2:29.4
	2	Smith, Vivienne	IRL	1:16.0		2:39.7
	3	Warren, Jeanne	CAN	1:14.5		2:40.7
	4	McClements, Lynette	AUS	1:13.0		2:40.7
	5	Andersson, Lotten	SUE	1:14.5		2:42.1
	6	Ramírez, Lidia	MEX	1:15.4		2:42.1
3	1	Hewitt, Toni (mro)	EUA	1:10.5		2:29.1
	2	Hustedede, Heike (mro)	ALE	1:09.9		2:32.1
	3	Strubing, Christine	ADE	1:12.6		2:39.0
	4	Nam, Sang-Nam	COR	1:20.1		2:58.6
		Apt, Ruth	URG	NSP		
		Gustavsson, Ingrid	SUE	NSP		
4	1	Kok, Aagje (mro)	HOL	1:10.3		2:26.3
	2	Lindner, Helga (mro)	ADE	1:11.0		2:29.4
	3	Devyatova, Tatyana	URS	1:12.7		2:34.7
	4	Corson, Marilyn	CAN	1:14.8		2:41.8
	5	Gray, Pauline	AUS	1:17.8		2:43.6
	6	Moir, Kristina	PRO	1:18.7		2:51.1
		Comolli, Adriana	ARG	NSP		

FINALE
FINAL

1	Kok, Aagje (mro)	HOL	1:10.2	2:24.7
2	Lindner, Helga (mro)	ADE	1:09.8	2:24.8
3	Daniel, Ellie (mro)	EUA	1:10.8	2:25.9
4	Hewitt, Toni (mro)	EUA	1:11.2	2:26.2
5	Hustedede, Heike (mro)	ALE	1:08.9	2:27.9
6	Giebel, Diane (mro)	EUA	1:11.1	2:31.7
7	Auton, Margaret	GBR	1:11.0	2:33.2
8	Fujii, Yasuko	JPN	1:14.2	2:34.3

(RM) 2:21.0 Kok Aagje HOL 1967, GBR
(RO) Establí a Mexico Set in Mexico

200 m 4 NAGES-INDIVIDUEL DAMES
200 m INDIVIDUAL MEDLEY WOMEN

ELIMINATOIRES
ELIMINATION HEATS **OCT 20**

			Temps Time			Temps Time		
1	1	Steinbach, Sabine (ro)	ADE	2:33.2	1	Shipston, Tui	NZL	2:35.5
	2	Henne, Jan	EUA	2:33.9	2	Rickard, Diana	AUS	2:36.0
	3	Eddy, Susan	AUS	2:36.6	3	Changanaqui, Consuelo	PER	2:40.0
	4	Tobis, Yvonne	ISR	2:41.0	4	Matzdorf, Heli	ALE	2:42.1
	5	Syro, Nelly	COL	2:55.7	5	Ospitaleche, Felicia	URG	2:47.8
	6	Vicens, Liana	PRO	2:57.0	6	Ferracuti, Donatella	SAL	2:48.6
		Comolli, Adriana	ARG	NSP		Chan, Patricia	SIN	NSP
		Baranyi, Judit	HUN	NSP				

		Temps				Time	
		100 m	200 m	300 m	400 m		
		M	D	P	L		
3	1 Nishigawa, Yoshimi (mro)	JPN	2:31.5	1 Kolb, Claudia (mro)	EUA	2:28.8	
	2 Chapman, Prudence	NZL	2:42.1	2 Zakharova, Larisa	URS	2:34.6	
	3 García, Hedy	FIL	2:42.3	3 Ratcliffe, Shelagh	GBR	2:34.9	
	4 Inguadottir, Ellen	ISL	2:43.1	4 Campbell, Kirsten	DIN	2:39.4	
	5 Gudmundsdottir H.	ISL	2:44.3	5 Sigg, Eva	FIN	2:41.0	
	6 Apt, Ruth	URG	2:45.9	6 Ramirez, Lidia	MEX	2:42.6	
	Bjedov, Djurdjica	YUG	NSP	7 Moreno, Maria	SAL	2:51.1	
				Marcial, Ana	PRO	NSP	
5	1 Seydel, Marianne (mro)	ADE	2:32.8	1 Penterman, Hendrika	HOL	2:36.7	
	2 Pedersen, Suan (ero)	EUA	2:33.2	2 Turoczy, Judit	HUN	2:38.8	
	3 Dorleans, Daniele	FRA	2:39.5	3 Egervary, Marta	HUN	2:40.7	
	4 Galle, Carla	BEL	2:40.9	4 Nikolova, Maria	BUL	2:40.8	
	5 Moir, Kristina	PRO	2:42.8	5 Von Carsten, Pilar	ESP	2:41.7	
	6 Ferracuti, Carmen	SAL	2:44.7	6 Boxberger, Helmi	ALE	2:45.2	
	7 De Angulo, Olga	COL	2:48.7	7 Shen, Bao-Ni	TWN	2:48.1	
	Corson, Marilyn	CAN	NSP				

		Temps				Time	
		100 m	200 m	300 m	400 m		
		M	D	P	L		
5	1 Kolb, Claudia (mro)	EUA	1:09.1	2:31.8	4:04.0	5:17.2	
	2 Rickard, Diana	AUS	1:18.1	2:44.2	4:23.2	5:37.8	
	3 Matzdorf, Heli	ALE	1:18.7	2:47.2	4:29.5	5:50.5	
	4 Changanaqui, Consuelo	PER	1:15.2	2:41.9	4:32.0	5:52.2	
	5 Syro, Nelly	COL	1:23.5	2:54.8	4:46.7	6:13.1	
	Chapman, Prudence	NZL	NSP				
	Calligaris, Novella	ITA	NSP				
	Chan, Patricia	SIN	NSP				

FINALE FINAL OCT 25

FINALE FINAL

		Temps				Time	
		100 m	200 m	300 m	400 m		
		M	D	P	L		
1	Kolb, Claudia (mro)	EUA	2:24.7	1 Kolb, Claudia (mro)	EUA	1:08.2	2:27.9
2	Pedersen, Susan (mro)	EUA	2:28.8	2 Vidali, Lynn	EUA	1:10.2	2:31.9
3	Henne, Jan (mro)	EUA	2:31.4	3 Steinbach, Sabine	ADE	1:11.3	2:32.7
4	Steinbach, Sabine (mro)	ADE	2:31.4	4 Pedersen, Susan	EUA	1:11.1	2:34.6
5	Nishigawa, Yoshimi	JPN	2:33.7	5 Ratcliffe, Shelagh	GBR	1:14.6	2:41.9
6	Seydel, Marianne	ADE	2:33.7	6 Seydel, Marianne	ADE	1:14.0	2:39.0
7	Zakharova, Larisa	URS	2:37.0	7 Shipston, Tui	NZL	1:14.9	2:38.7
	Ratcliffe, Shelagh	GBR	DES	8 Vaca, Laura	MEX	1:15.8	2:42.8

(RM) 2:23.5 Kolb, Claudia EUA 1968, EUA
(RO) Etabli a Mexico Set in Mexico

		Temps				Time	
		100 m	200 m	300 m	400 m		
		M	D	P	L		
(RM)	5:04.7	Kolb, Claudia	EUA	1968,	EUA		
(RO)	5:18.7	De Varona, Donna	EUA	1964,	JPN		

400 m 4 NAGES-INDIVIDUEL - DAMES 400 m INDIVIDUAL MEDLEY - WOMEN

RELAIS 4 x 100 m NAGE LIBRE - DAMES 4 x 100 m FREESTYLE RELAY - WOMEN

755

ELIMINATOIRES OCT 24 ELIMINATION HEATS

		Temps				Time	
		100 m	200 m	300 m	400 m		
		M	D	P	L		
1	1 Pedersen, Susan	EUA	1:11.8	2:33.2	4:12.7	5:26.4	
	2 Zakharova, Larisa	URS	1:15.5	2:43.0	4:21.5	5:38.6	
	3 Penterman, Hendrika	HOL	1:16.6	2:46.0	4:23.7	5:38.8	
	4 Galle, Carla	BEL	1:21.9	2:49.5	4:32.6	5:55.2	
	5 De Angulo, Olga	COL	1:23.0	2:55.5	4:40.7	6:00.6	
		Dorleans, Daniele	FRA	NSP			
	Moir Kristina	PRO	NSP				
	Ospitaletche, Felicia	URG	NSP				
2	1 Steinbach, Sabine	ADE	1:12.3	2:35.4	4:10.8	5:31.3	
	2 Sigg, Eva	FIN	1:15.2	2:42.0	4:20.9	5:37.3	
	3 Eddy, Susan	AUS	1:17.1	2:42.8	4:25.6	5:42.2	
	4 Amezcua, Norma	MEX	1:16.1	2:43.1	4:29.9	5:47.9	
	5 Apt, Ruth	URG	1:19.8	2:54.5	4:43.0	6:04.5	
	6 Shen, Bao-Ni	TWN	1:23.1	2:59.6	4:52.0	6:21.5	
	Ferracuti, Carmen	SAL	NSP				
3	1 Vidali, Lynn	EUA	1:13.3	2:37.0	4:14.8	5:28.9	
	2 Ratcliffe, Shelagh	GBR	1:14.9	2:41.2	4:19.5	5:33.2	
	3 Vaca, Laura	MEX	1:15.5	2:42.7	4:20.4	5:33.7	
	4 Oynick, Tamara	MEX	1:21.0	2:54.5	4:27.2	5:48.4	
	5 Campbell, Kirsten	DIN	1:22.6	2:55.3	4:34.8	5:59.0	
	Egervary, Marta	HUN	NSP				
	Comolli, Adriana	ARG	NSP				
4	1 Seydel, Marianne	ADE	1:13.3	2:39.5	4:13.4	5:30.9	
	2 Shipston, Tui	NZL	1:15.5	2:38.5	4:18.1	5:33.7	
	3 Wittke, Eva	ADE	1:17.5	2:46.3	4:21.5	5:40.6	
	4 Nikolova, Maria	BUL	1:16.9	2:46.9	4:28.1	5:45.2	
	5 Olano, Patricia	COL	1:20.2	2:47.6	4:35.9	5:52.6	
	6 Tobis, Yvonne	ISR	1:16.2	2:47.9	4:34.5	5:53.8	
	7 Garcia, Hedy	FIL	1:17.6	2:55.0	4:43.0	6:07.3	

ELIMINATOIRES OCT 26 ELIMINATION HEATS

		Temps				Time	
		100 m	200 m	300 m	400 m		
		M	D	P	L		
1	1 AUS	1) Bell, Lynette	1:02.2	2) McDonald, Julie	2:06.6		
	2	FRA	3) Watson, Lynette	3:09.8	4) Steinbeck, Janet	4:12.0	4:12.0
		1) Kersaudy, Marie	1:05.1	2) Hanner, Simone	2:08.8		
	3	URS	3) Dorleans, Daniele	ST	4) Mandonnaud, Claude	4:15.4	4:15.4
		1) Dus, Zoya	1:03.7	2) Sosnova, Tamara	2:09.7		
	4	SUE	3) Ustinova, Natalia	3:13.6	4) Grebets, Lidia	4:17.1	4:17.1
1) Berglund, Gudrun		1:03.6	2) Morris, Ingrid	2:09.8			
5	ALE	3) Andersson, Lotten	3:13.4	4) Gustavsson, Ingrid	4:18.2	4:18.2	
	1) Reineck, Heidi	1:05.1	2) Bauer, Aloisia	2:09.3			
6	MEX	3) Renner, Ingeborg	3:14.6	4) Boxberger, Helmi	4:19.4	4:19.4	
	1) Ramirez, Teresa	1:03.5	2) Vaca, Laura	2:09.5			
	3) Arriaga, Marcia	3:14.9	4) Amezcua, Norma	4:21.9	4:21.9		
2	1 EUA	1) Barkman, Jane	1:01.9	2) Gustavson, Linda	2:04.1		
	2	HUN	3) Henne, Jan	3:05.1	4) Pedersen, Susan	4:11.1	4:11.1
		1) Kovacs, Edit	1:04.2	2) Patoh, Magdolna	2:06.9		
	3	JPN	3) Gyarmati, Andrea	3:11.1	4) Turoczy, Judit	4:13.6	4:13.6
		1) Kawanishi, Shigeko	1:03.1	2) Nishigawa, Yoshimi	2:06.8		
	4	HOL	3) Ono, Yumiko	3:11.6	4) Kobayashi, Miwako	4:14.5	4:14.5
1) Rentema, Hella		1:05.1	2) Weeteling, Albertha	2:10.9			
5	SAL	3) Van Hemert, Mirjam	3:14.5	4) Bos, Petronella	4:16.7	4:16.7	
	1) Moreno, Maria	1:09.2	2) Hasbun, Rosa	2:20.2			
	3) Ferracuti, Donatella	3:30.5	4) Ferracuti, Carmen	4:39.8	4:39.8		
3	1 ADE	1) Wetzko, Gabriele	1:02.3	2) Krause, Roswitha	2:05.6		
	2	CAN	3) Schmuck, Uta	3:07.0	4) Perthes, Gabriele	4:10.3	4:10.3
		1) Coughlaw, Angela	1:04.0	2) Corson, Marilyn	2:08.8		
	3	GBR	3) Tanner, Elaine	3:12.1	4) Lay, Marion	4:14.1	4:14.1
		1) Ratcliffe, Shelagh	1:04.7	2) Kellock, Fiona	2:09.5		
	4	URG	3) Williams, Susan	3:14.3	4) Jackson, Alexandra	4:16.3	4:16.3
1) Figueroa, Emilia		1:06.7	2) Apt, Ruth	2:13.6			
	3) Ospitaletche, Felicia	3:23.4	4) Castillo, Lylian	4:33.4	4:33.4		

FINALE
FINAL

			100 m 300 m		200 m 400 m	Temps Time
1	EUA	1) Barkman, Jane	1:01.2	2) Gustavson, Linda	2:01.7	
		3) Pedersen, Susan	3:03.0	4) Henne, Jan	(mro)	4:02.5
2	ADE	1) Wetzko, Gabriele	1:01.5	2) Krause, Roswitha	2:03.1	
		3) Schmuck, Uta	3:05.3	4) Perthes, Gabriele	4:05.7	4:05.7
3	CAN	1) Coughlaw, Angela	1:02.4	2) Corson, Marilyn	2:06.0	
		3) Tanner, Elaine	3:07.7	4) Lay, Marion	4:07.2	4:07.2
4	AUS	1) Steinbeck, Janet	1:02.7	2) Eddy, Susan	2:06.2	
		3) Watson, Lynette	3:07.8	4) Bell, Lynette	4:08.7	4:08.7
5	HUN	1) Kovacs, Edit	1:03.8	2) Patoh, Magdolna	2:06.5	
		3) Gyarmati, Andrea	3:09.1	4) Turoczy, Judit	4:11.0	4:11.0
6	JPN	1) Kawanishi, Shigeko	1:02.6	2) Nishigawa, Yoshimi	2:05.9	
		3) Fujii, Yasuko	3:11.0	4) Kobayashi, Miwako	4:13.6	4:13.6
7	GBR	1) Ratcliffe, Shelagh	1:05.2	2) Kellock, Fiona	2:10.0	
		3) Williams, Susan	3:14.9	4) Jackson, Alexandra	4:18.0	4:18.0
	FRA	1) Kersaudy, Marie	1:05.3	2) Hanner, Simone	2:08.4	
		3) Dorleans, Daniele	3:12.7	4) Mandonnaud, Claude	4:14.3	DES
(RM)	4:01.0	Gustavson, Linda Watson, Pokey Carpinelli, Pat Henne, Jan EUA 1968, EUA				
(RO)	4:03.8	Stouder, Sharon De Varona, Donna Watson, Lillian Ellis, Kathleen EUA 1964, JPN				

FINALE
FINAL

						Temps Time
1	EUA	DJ Hall, Kaye	1:07.8	PJ Ball, Catie	2:24.1	
		M) Daniel, Ellie	3:28.9	LJ Pedersen, Susan	(mrm) (mro)	4:28.3
2	AUS	DJ Watson, Lynette (erm) (mro)	1:08.5	PJ Playfair, Judy	2:24.4	
		M) McClements, Lynette	3:29.4	LJ Steinbeck, Janet	4:30.0	4:30.0
3	ALE	DJ Kraus, Angelika	1:12.6	PJ Frommater, Uta	2:28.3	
		M) Hustede, Hejke	3:34.4	LJ Reineck, Heidi	4:36.4	4:36.4
4	URS	DJ Lekveishvili, Tina	1:10.9	PJ Grebennikova, Alla	2:28.1	
		M) Devyatova, Tatyana	3:35.1	LJ Grebets, Lidia	4:37.0	4:37.0
5	ADE	DJ Grunert, Martina	1:10.1	PJ Wittke, Eva	2:29.3	
		M) Lindner, Helga	3:36.1	LJ Schmuck, Uta	4:38.0	4:38.0
6	GBR	DJ Burrell, Wendy	1:11.3	PJ Harrison, Dorothy	2:30.6	
		M) Auton, Margaret	3:37.4	LJ Jackson, Alexandra	4:38.3	4:38.3
7	HOL	DJ Buter, Jacobje	1:10.3	PJ Bimolt, Klana	2:31.0	
		M) Kok, Aagje	3:36.5	LJ Bos, Petronella	4:38.7	4:38.7
8	HUN	DJ Lantos, Maria	1:11.2	PJ Kovacs, Edit	2:33.2	
		M) Gyarmati, Andrea	3:40.8	LJ Turoczy, Judit	4:42.9	4:42.9
(RM)	4:30.0	Moore, Kendis Ball, Catie Daniel, Ellie Fordyce, EUA 1967, EUA				
(RO)	4:33.9	Ferguson, Cathy Goyette, Cynthia Stouder, Sharon Ellis, Kathleen EUA 1964, JPN				

RELAIS 4 x 100 m 4 NAGES - DAMES
4 x 100 m MEDLEY RELAY - WOMEN

ELIMINATION HEATS
ELIMINATOIRES **OCT 17**

			100 m 300 m		200 m 400 m	Temps Time
1	EUA	DJ Swagerty, Jane	1:10.3	PJ Jones, Suzy	2:27.3	
		M) Shields, Susie	3:33.2	LJ Henne, Jan	4:34.7	4:34.7
2	ADE	DJ Grunert, Martina	1:10.7	PJ Wittke, Eva	2:30.4	
		M) Lindner, Helga	3:37.5	LJ Schmuck, Uta	4:39.3	4:39.3
3	URS	DJ Lekveishvili, Tina	1:11.8	PJ Grebennikova, Alla	2:29.0	
		M) Zakharova, Larisa	3:37.4	LJ Grebets, Lidia	4:39.5	4:39.5
4	GBR	DJ Burrell, Wendy	1:11.2	PJ Harrison, Dorothy	2:32.4	
		M) Auton, Margaret	3:39.5	LJ Jackson, Alexandra	4:40.4	4:40.4
5	CAN	DJ Tanner, Elaine	1:07.6	PJ Walton, Anne	2:32.7	
		M) Warren, Jeanne	3:42.6	LJ Lay, Marion	4:43.1	4:43.1
6	NZL	DJ Stirling, Glenda	1:10.2	PJ Chapman, Prudence	2:35.4	
		M) Whittleston, Sandra	3:44.4	LJ Shipston, Tui	4:49.0	4:49.0
7	MEX	DJ Ramirez, Lidia	1:14.1	PJ Oynick, Tamara	2:36.1	
		M) Obregon, Patricia	3:48.2	LJ Ramirez, Teresa	4:51.0	4:51.0
8	SAL	DJ Hasbun, Rosa	1:22.2	PJ Moreno, Maria	2:49.0	
		M) Ferracuti, Carmen	4:04.6	LJ Ferracuti, Donatella	5:12.6	5:12.6
1	AUS	DJ Watson, Lynette	1:09.6	PJ Playfair, Judy	2:27.3	
		M) McClements, Lynette	3:33.7	LJ Bell, Lynette	4:34.6	4:34.6
2	HOL	DJ Buter, Jacobje	1:10.1	PJ Bimolt, Klana	2:31.1	
		M) Kok, Aagje	3:37.2	LJ Bos, Petronella	4:39.4	4:39.4
3	ALE	DJ Kraus, Angelika	1:12.7	PJ Frommater, Uta	2:29.2	
		M) Hustede, Heike	3:36.6	LJ Reineck, Heidi	4:39.5	4:39.5
4	HUN	DJ Lantos, Maria	1:11.1	PJ Kovacs, Edit	2:32.8	
		M) Gyarmati, Andrea	3:40.0	LJ Turoczy, Judit	4:41.2	4:41.2
5	JPN	DJ Goushi, Yukiko	1:11.4	PJ Nakagawa, Kiyoe	2:28.4	
		M) Fujii, Yasuko	3:38.4	LJ Kobayashi, Miwako	4:41.4	4.41.4
6	URG	DJ Ospitaletche, Felicia	1:17.8	PJ Norbis, Ana	2:34.2	
		M) Apt, Ruth	3:50.0	LJ Figueroa, Emilia	4:56.0	4:56.0
7	PRO	DJ Marcial, Ana	1:22.7	PJ Vicens, Liana	2:48.5	
		M) Moir, Kristina	4:06.1	LJ Blake, Lorna	5:18.2	5:18.2
	YUG	DJ Gasparac, Zdenka	1:10.8	PJ Bjedov, Djurdjica	2:27.6	
		M) Segrt, Mirjana	3:38.9	LJ Boban, Ana	4:43.2	DES

RECORDS OLYMPIQUES ETABLIS A ROME EN 1960 DURANT LES JEUX DE LA XVII OLYMPIADE

OLYMPIC RECORDS ESTABLISHED IN 1960 IN ROME DURING THE GAMES OF THE XVII OLYMPIAD

ATHLETISME HOMMES ATHLETICS MEN

100 m	-	100 m	A. Harry	ALE	10.2"
200 m	-	200 m	Berruti	ITA	20.5"
400 m	-	400 m	O. Davis	EUA	44.9"
4 x 400 m Relais	-	4 x 400 m Relay	EUA	EUA	3'02.2"
800 m	-	800 m	P. Snell	NZL	1'46.3"
1500 m	-	1500 m	B. Elliot	AUS	3'35.6"
10000 m	-	10000 m	Bolotnikov	URS	28'32.2"
Marathon	-	Marathon	A. Bikila	ETI	2 ^o 15'16.2"
400 m Haies	-	400 m Hurdles	Davis	EUA	49.3"
3000 m Steeplechase	-	3000 m Steeplechase	Kryskowiak	POL	8'34.2"
50 Km Marche	-	50 km Walk	Thompson	GBR	4 ^o 25'30.0"
Saut en Longueur	-	Long Jump	R. Boston	EUA	8.12m
Triple Saut	-	Triple Jump	Szmidt	POL	16.81m
Saut en Hauteur	-	High Jump	Shavlakadze	URS	2.16m
Saut a la Perche	-	Pole Vault	Bragg	EUA	4.70m
Lancement du Poids	-	Shot Put	Nieder	EUA	19.68m
Lancement du Marteau	-	Hammer Throw	Rudenkov	URS	67.10m
Lancement du Disque	-	Discus Throw	A. Oerter	EUA	59.18m
Décathlon	-	Decathlon	R. Johnson	EUA	8,001p.

ATHLETISME FEMMES ATHLETICS WOMEN

100 m	-	100 m	W. Rudolph	EUA	11.3"
200 m	-	200 m	W. Rudolph	EUA	23.2"
800 m	-	800 m	L. Shevkova	URS	2'04.3"
80 m Haies	-	80 m Hurdles	I. Press	URS	10.6"
4 x 100 m Relais	-	4 x 100 m Relay	EUA	EUA	44.4"
Saut en Longueur	-	Long Jump	V. Krepkina	URS	6.37m
Saut en Hauteur	-	High Jump	Y. Balas	RUM	1.85m
Lancement du Poids	-	Shot Put	T. Press	URS	17.32m
Lancement du Javelot	-	Javelin Throw	E. Ozolina	URS	55.98m
Lancement du Disque	-	Discus Throw	N. Ponomarieva	URS	55.10m

CYCLISME CYCLING

Km contre la montre	-	1000 m Time Trial	Gaiardonin	ITA	1'07.27"
4000 m Poursuite par Equipe	-	4000 m Team Pursuit	ITA	ITA	4'30.9 "

HALTEROPHILIE WEIGHTLIFTING

Poids Coq	-	Bantamweight	Vinci	EUA	345 Kg
Poids Plume	-	Featherweight	Minaev	URS	372.5Kg
Poids Léger	-	Lightweight	Boushouiev	URS	397.5Kg
Poids Moyen	-	Middleweight	Kourinov	URS	437.5Kg
Poids Mi-Lourd	-	Middle Heavyweight	Vorobiev	URS	472.5Kg
Poids Lourd	-	Heavyweight	Vlasov	URS	537.5Kg

NATATION HOMMES SWIMMING MEN

100 m Nage Libre	-	100 m Freestyle	Devitt	AUS	52.2"
400 m Nage Libre	-	400 m Freestyle	Rose	AUS	4'18.3"
1500 m Nage Libre	-	1500 m Freestyle	Konrads	AUS	17'19.6"
200 m Brasse	-	200 m Breaststroke	Mulliken	EUA	2'37.2"
200 m Papillon	-	200 m Butterfly	Troy	EUA	2'12.8"
4 x 200 m Nage Libre	-	4 x 200 m Freestyle Relay	EUA	EUA	8'10.2"
4 x 100 m R. 4 Nages	-	4 x 100 m Medley Relay	EUA	EUA	4'08.9"

NATATION FEMMES SWIMMING WOMEN

100 m Nage Libre	-	100 m Freestyle	D. Fraser	AUS	1'01.2"
400 m Nage Libre	-	400 m Freestyle	C. V. Saltza	EUA	4'50.6"
100 m Dos	-	100 m Backstroke	L. Burke	EUA	1'09.0"
100 m Papillon	-	100 m Butterfly	C. Schuler	EUA	1'09.5"
200 m Brasse	-	200 m Breaststroke	A. Lonsbrough	GBR	2'49.5"
4 x 100 m Nage Libre	-	4 x 100 m Freestyle Relay	EUA	EUA	4'08.9"
4 x 100 m R. 4 Nages	-	4 x 100 m Medley Relay	EUA	EUA	4'41.1"

TIR SHOOTING

P. C. Pos. couchée	-	S. B. R. Prone Pos.	Kohnke	ALE	590P
P. C. Trois Pos.	-	S. B. R. 3 Pos.	Shamburkin	URS	1149P
Pistolet libre	-	Free Pistol	Gustchin	URS	560P

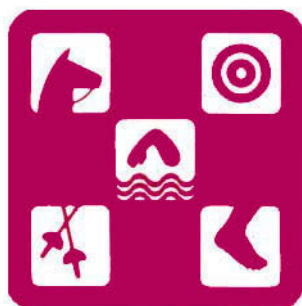

UNION INTERNATIONALE DU
PENTATHLON MODERNE UIPM

PRESIDENT
Sven Thofelt

SUE

DIRECTEUR DE L'EPREUVE
DE COURSE A PIED
DIRECTOR OF THE RUNNING
COMPETITION

Enrique Soto

MEX

INTERNATIONAL UNION OF THE
MODERN PENTATHLON UIPM

SECRETARE
SECRETARY
Willie Grut

SUE

PRESIDENT
Sven Thofelt

SUE

SECRETARE
SECRETARY
Willie Grut

SUE

MEMBRES
MEMBERS

Kurt Wagner
Walter Sieganthaler
Edgar Fried
Neville Sayers
Peter Hains
Olavi Larkas
Emile Jarrot
Errol Lonsdale
Robert Readhead
Istvan Laszlo
Roberto Curcio
Shunji Fujii
Fernán Pérez
Sergio Escobedo
Olof Hederen
Igor Novikov

ADE
ALE
AUT
AUT
EUA
FIN
FRA
GBR
GBR
HUN
ITA
JPN
MEX
MEX
SUE
URS

FEDERATION MEXICAINE DU
PENTATHLON MODERNE FMPM

MEXICAN FEDERATION OF THE
MODERN PENTATHLON FMPM

PRESIDENT
Sergio Escobedo G.

MEX

SECRETARE
SECRETARY
Miguel Tovar G.

MEX

DIRECTEUR DE L'EPREUVE
D'EQUITATION
DIRECTOR OF THE EQUESTRIAN
COMPETITION
Jerónimo García

MEX

SECTION PENTATHLON MODERNE
DU C.O.O.
O.O.C. MODERN PENTATHLON
SECTION

Sergio Escobedo G.

MEX

Fernán Pérez

MEX

DIRECTEUR DE L'EPREUVE
D'ESCRIME
DIRECTOR OF THE FENCING
COMPETITION
Jesús Guevara

MEX

OFFICIELS DE LA COMPETITION
COMPETITION OFFICIALS

JURY D' APPEL
JURY OF APPEAL

DIRECTEUR DE L'EPREUVE
DE TIR
DIRECTOR OF THE SHOOTING
COMPETITION
Eustaquio Leyva

MEX

DIRECTEUR DE L'EPREUVE
DE NATATION
DIRECTOR OF THE SWIMMING
COMPETITION
Héctor Chamorro

MEX





SIGNES EMPLOYES

SYMBOLGY

E — ELIMINE
DES — DISQUALIFIE
** — EQUIPE DISQUALIFIE POUR
VIOLATION DES REGLEMENTS
DE L'UIPM PAR UN DE SES
MEMBRES, LILJENVALL,
HANS-GUNNAR
PZ — PENALISATION
V — VICTOIRES
D — DEEAITES
IM — COUPS AU BUT
* — 1 POINT DE PENALISATION
SELON REGLEMENT

ELIMINATED
DISQUALIFIED
TEAM DISQUALIFIED
BECAUSE COMPETITOR LILJENVALL,
HANS-GUNNAR,
VIOLATED UIPM
REGULATIONS
PENALITY
VICTORIES
DEFEATS
HITS
PENALIZED 1 POINT UNDER RULES

**CLASSEMENT FINAL INDIVIDUEL
INDIVIDUAL FINAL CLASSIFICATION** **OCT 17**





								Total	
1	37	Ferm, Bjorn	SUE	1100	885	934	1075	970	4964
2	28	Balczó, Andras	HUN	1010	931	934	1054	1024	4953
3	41	Lednev, Pavel	URS	1070	839	934	1060	892	4795
4	4	Kutschke, Karl-Heinz	ADE	1070	632	846	1126	1090	4764
5	42	Onishenko, Boris	URS	995	885	912	1054	910	4756
6	22	Gueguen, Raoul	FRA	1040	954	912	1000	850	4756
7	30	Mona, Istvan	HUN	1010	1046	868	943	847	4714
8	25	Fox, Jeremy	GBR	1010	862	890	1006	895	4663
9	40	Shaparnis, Stasis	URS	1070	793	802	1027	964	4656
10	32	Medda, Mario	ITA	1010	977	758	949	937	4631
11	18	Moore, James	EUA	1040	793	912	931	937	4613
12	29	Torok, Ferenc	HUN	920	1046	912	880	793	4551
13	47	Steffensen, Jorn	DIN	1040	862	934	811	898	4545
14	36	Makihira, Yuso	JPN	1040	816	802	898	973	4529
15	6	Tschner, Jörg	ADE	1050	793	846	1060	766	4515
16	39	Jacobson, Hans	SUE	1025	977	846	946	718	4512
17	1	Frings, Elmar	ALE	1070	839	846	955	796	4506
18	19	Aho, Seppo	FIN	1100	885	692	940	880	4497
19	45	Olivera, Eduardo	MEX	1070	770	868	997	760	4474
20	20	Ketela, Martti	FIN	1010	770	846	964	856	4446
21	24	Guiguet, Lucien	FRA	1035	655	824	958	934	4406
22	16	Beck, Robert	EUA	1010	885	912	925	655	4387
23	11	Sonnleitner, Wolf-Dieter	AUT	1010	701	912	916	832	4371
24	31	Morresi, Giancarlo	ITA	790	793	1022	1051	703	4359
25	43	Bárcena, David	MEX	1010	517	890	982	952	4351
26	48	Tschui, Alex	SUI	1100	770	1022	679	766	4337
27	35	Tashiro, Katsuaki	JPN	1100	678	934	931	676	4319
28	12	Springer, Siegfried	AUT	1030	816	846	883	718	4293
29	17	Lough, Maurice	EUA	980	655	846	988	820	4289
30	27	Lillywhite, Barry	GBR	985	816	802	982	700	4285
31	8	Macken, Peter	AUS	935	655	802	910	982	4284
32	2	Thade, Heiner	ALE	910	908	956	877	613	4264
33	13	Paniowski, Antone	BUL	950	724	978	892	703	4247
34	21	Hotanen, Jorma	FIN	780	839	846	895	871	4231
35	34	Fukui, Toshio	JPN	840	896	692	967	802	4197
36	14	Sardjev, Konstantine	BUL	1100	655	868	757	811	4191
37	23	Giudicelli, Jean-Pierre	FRA	780	494	890	973	925	4062
38	26	Phelps, Robert	GBR	795	632	978	964	562	3931
39	9	Page, Duncan	AUS	1035	563	846	880	580	3904
40	5	Luderitz, Wolfgang	ADE	365	724	934	907	913	3843
41	46	Kupka, Pavel	CHE	865	839	670	943	502	3819
42	7	McMikin, Donald	AUS	545	678	1022	835	679	3759
43	33	Deligia, Nicolo	ITA	460	678	780	889	850	3657
44	44	Tovar, Eduardo	MEX	805	540	648	889	730	3612
45	15	Apostolov, Ivan	BUL	720	609	538	880	715	3462
46	3	Todt, Hans	ALE	0	678	736	865	730	3009
47	10	Leu, Wolfgang	AUT	980	747	670	E		
**	38	Liljenvall, Hans-Gunnar	SUE	1010	908	DES			

**CLASSEMENT INDIVIDUEL
INDIVIDUAL SCORE** **OCT 13**

				Cheval Horse	Temps Time	PZ	Points
1	35	Tashiro, Katsuaki	JPN	Cantinero I	3:21	0	1100
2	19	Aho, Seppo	FIN	Juan Colorado	3:29	0	1100
3	14	Sardjev, Konstantine	BUL	Furia	3:35	0	1100
4	48	Tschui, Alex	SUI	Gorrión	3:40	0	1100
5	37	Ferm, Bjorn	SUE	Cantinero II	3:42	0	1100
6	40	Shaparnis, Stasis	URS	Diamante	3:26	30	1070
7	45	Olivera, Eduardo	MEX	Abordaje	3:36	30	1070
8	41	Lednev, Pavel	URS	Acero	3:37	30	1070
9	1	Frings, Elmar	ALE	Moyote	3:39	30	1070
10	4	Kutschke, Karl-Heinz	ADE	Golfo	3:45	30	1070
11	6	Tschner, Jörg	ADE	Palomo	3:49	50	1050
12	36	Makihira, Yuso	JPN	Molonco	3:29	60	1040
13	18	Moore, James	EUA	Yuri	3:36	60	1040
14	22	Gueguen, Raoul	FRA	Suriano	3:36	60	1040
15	47	Steffensen, Jorn	DIN	Valiente	3:44	60	1040
16	24	Guiguet, Lucien	FRA	Chihuahua	3:46	65	1035
17	9	Page, Duncan	AUS	Alma Grande	3:58	65	1035
18	12	Springer, Siegfried	AUT	Consentido	3:53	70	1030
19	39	Jacobson, Hans	SUE	Josefino	3:54	75	1025
20	30	Mona, Istvan	HUN	Huasteco	3:28	90	1010
21	25	Fox, Jeremy	GBR	Pepe	3:32	90	1010
22	28	Balczó, Andras	HUN	Chamaco	3:33	90	1010
23	43	Bárcena, David	MEX	Géminis	3:35	90	1010
24	38	Liljenvall, Hans-Gunnar	SUE	Alpino	3:35	90	1010
25	32	Medda, Mario	ITA	Coqueta	3:35	90	1010
26	20	Ketela, Martti	FIN	Gallo	3:37	90	1010
27	11	Sonnleitner, Wolf-Dieter	AUT	Querreque	3:40	90	1010
28	16	Beck, Robert	EUA	Vikingo	3:41	90	1010
29	42	Onishenko, Boris	URS	Cubano	3:48	105	995
30	27	Lillywhite, Barry	GBR	Fresco Bote	3:50	115	985
31	10	Leu, Wolfgang	AUT	Luchichi	3:26	120	980
32	17	Lough, Maurice	EUA	Travieso	3:32	120	980
33	13	Paniowski, Antone	BUL	Memín	3:36	150	950
34	8	Macken, Peter	AUS	Azteca	4:06	165	935
35	29	Torok, Ferenc	HUN	Muñeco	3:22	180	920
36	2	Thade, Heiner	ALE	Kikey	4:17	190	910
37	46	Kupka, Pavel	CHE	Jalisco	4:02	235	865
38	34	Fukui, Toshio	JPN	Criollo	4:07	260	840
39	44	Tovar, Eduardo	MEX	Resorte	3:58	295	805
40	26	Phelps, Robert	GBR	Huichol	4:10	305	795
41	31	Morresi, Giancarlo	ITA	Tábano	4:21	310	790
42	21	Hotanen, Jorma	FIN	Colorín	4:13	320	780
43	23	Giudicelli, Jean-Pierre	FRA	Cid	4:19	320	780
44	15	Apostolov, Ivan	BUL	Pajarito	4:19	380	720
45	7	McMikin, Donald	AUS	Pluma Blanca	4:52	555	545
46	33	Deligia, Nicolo	ITA	Quitapon	4:57	640	460
47	5	Luderitz, Wolfgang	ADE	Alteña	5:18	735	365
		Todt, Hans	ALE	Ranchero	E		

759

**CLASSEMENT FINAL PAR EQUIPE
FINAL CLASSIFICATION BY TEAMS**

								Total
1	HUN	2940	3130	2714	2877	2664		14325
2	URS	3135	2558	2648	3141	2766		14248
3	FRA	2855	2168	2626	2931	2709		13289
4	EUA	3030	2324	2670	2844	2412		13280
5	FIN	2890	2558	2384	2799	2607		13238
6	ADE	2485	2194	2626	3093	2769		13167
7	JPN	2980	2428	2428	2796	2451		13083
8	GBR	2790	2324	2670	2952	2157		12893
9	ITA	2260	2402	2560	2889	2490		12601
10	MEX	2885	1804	2406	2868	2451		12414
11	BUL	2770	2064	2384	2529	2229		11976
12	AUS	2515	1908	2670	2625	2241		11959
13	ALE	1980	2480	2538	2697	2139		11834
14	AUT	3020	2324	2428	E			
**	SUE	3135	2818	DES				

**CLASSEMENT PAR EQUIPE
TEAM SCORE**

				Cheval Horse	Temps Time	PZ	Points	Total
1	URS	Shaparnis, Stasis		Diamante	3:26	30	1070	
		Lednev, Pavel		Acero	3:37	30	1070	
		Onishenko, Boris		Cubano	3:48	105	995	3135
2	SUE	Ferm, Bjorn		Cantinero II	3:42	0	1100	
		Jacobson, Hans		Josefino	3:54	75	1025	
		Liljenvall, Hans-Gunnar		Alpino	3:35	90	1010	3135
3	EUA	Moore, James		Yuri	3:36	60	1040	
		Beck, Robert		Vikingo	3:41	90	1010	
		Lough, Maurice		Travieso	3:32	0	980	3030
4	AUT	Springer, Siegfried		Consentido	3:53	70	1030	
		Sonnleitner, Wolf-Dieter		Querreque	3:40	90	1010	
		Leu, Wolfgang		Luchichi	3:26	120	980	3020
5	JPN	Tashiro, Katsuaki		Cantinero I	3:21	0	1100	
		Makihira, Yuso		Molonco	3:29	60	1040	
		Fukui, Toshio		Criollo	4:07	260	840	2980
6	HUN	Balczó, Andras		Chamaco	3:33	90	1010	
		Mona, Istvan		Huasteco	3:28	90	1010	
		Torok, Ferenc		Muñeco	3:22	180	920	2940
7	FIN	Aho, Seppo		Juan Colorado	3:29	0	1100	
		Ketela, Martti		Gallo	3:37	90	1010	
		Hotanen, Jorma		Colorín	4:13	320	780	2890

			Cheval Horse	Temps Time	PZ	Points	Total
8	MEX	Olivera, Eduardo Bárcena, David Tovar, Eduardo	Abordaje Géminis Resorte	3:36 3:35 3:58	30 90 295	1070 1010 805	2885
9	FRA	Gueguen, Raoul Guiguet, Lucien Giudicelli, Jean-Pierre	Suriano Chihuahua Cid	3:36 3:46 4:19	60 65 320	1040 1035 780	2855
10	GBR	Fox, Jeremy Lillywhite, Barry Phelps, Robert	Pepe Fresco Bote Huichol	3:32 3:35 4:10	90 115 305	1010 985 795	2790
11	BUL	Sardjev, Konstantine Paniowsky, Antone Apostolov, Ivan	Furia Memin Pajarito	3:35 3:36 4:19	0 150 380	1100 950 720	2770
12	AUS	Page, Duncan Macken, Peter McMikin, Donald	Alma Grande Azteca Pluma Blanca	3:58 4:06 4:52	65 165 555	1035 935 545	2515
13	ADE	Kutschke, Karl-Heinz Tscherner, Jörg Luderitz, Wolfgang	Golfo Palomo Alteña	3:45 3:49 5:18	30 50 735	1070 1050 365	2485
14	ITA	Medda, Mario Morresi, Giancarlo Deligia, Nicolo	Coqueta Tábano Quitapon	3:35 4:21 4:57	90 310 640	1010 790 460	2260
15	ALE	Frings, Elmar Thade, Heiner Todt, Hans	Moyote Kiskey Ranchero	3:39 4:17 5:24	30 190 E	1070 910 E	1980



CLASSEMENT PAR EQUIPE TEAM SCORE

			V	D	Points	Total
1	HUN	Torok, Ferenc Mona, Istvan Balczó, Andras	31 32 29	11 10 13	1052 1078 1000	3130
2	SUE	Jacobson, Hans Liljenvall, Hans-Gunnar Ferm, Bjorn	29 26 25	13 16 17	1000 922 896	2818
3	URS	Onishenko, Boris Lednev, Pavel Shaparnis, Stasis	27 23 20	15 19 22	948 844 766	2558
4	FIN	Aho, Seppo Hotanen, Jorma Ketela, Martti	26 25 19	16 17 23	922 896 740	2558
5	ALE	Thade, Heiner Frings, Elmar Todt, Hans	27 22 18	15 20 24	948 818 714	2480
6	JPN	Fukui, Toshio Makihira, Yuso Tashiro, Katsuaki	25 22 18	17 20 24	896 818 714	2428
7	ITA	Medda, Mario Morresi, Giancarlo Deligia, Nicolo	27 20 17	15 22 25	948 766 688	2402
8	EUA	Beck, Robert Moore, James Lough, Maurice	25 20 16	17 22 26	896 766 662	2324
9	AUT	Springer, Siegfried Leu, Wolfgang Sonnleitner, Wolf-Dieter	24 20 17	18 22 25	870 766 688	2324
10	GBR	Fox, Jeremy Lillywhite, Barry Phelps, Robert	23 21 17	19 21 25	844 792 688	2324
11	ADE	Tscherner, Jörg Luderitz, Wolfgang Kutschke, Karl-Heinz	21 21 14	21 21 28	792 792 610	2194
12	FRA	Gueguen, Raoul Guiguet, Lucien Giudicelli, Jean-Pierre	28 17 10	14 25 32	974 688 506	2168
13	BUL	Paniowsky, Antone Apostolov, Ivan Sardjev, Konstantine	19 16 16	23 26 26	740 662 662	2064
14	AUS	McMikin, Donald Macken, Peter Page, Duncan	18 15 12	24 27 30	714 636 558	1908
15	MEX	Olivera, Eduardo Tovar, Eduardo Bárcena, David	20 11 10	22 31 32	766 532 506	1804



CLASSEMENT INDIVIDUEL INDIVIDUAL SCORE

OCT 14

760

			V	D	Points	
1	29	Torok, Ferenc	HUN	35	12	1046
2	30	Mona, Istvan	HUN	35	12	1046
3	39	Jacobson, Hans	SUE	32	15	977
3	32	Medda, Mario	ITA	32	15	977
5	22	Gueguen, Raoul	FRA	31	16	954
6	28	Balczó, Andras	HUN	30	17	931
7	38	Liljenvall, Hans-Gunnar	SUE	29	18	908
7	2	Thade, Heiner	ALE	29	18	908
9	42	Onishenko, Boris	URS	28	19	885
9	37	Ferm, Bjorn	SUE	28	19	885
9	19	Aho, Seppo	FIN	28	19	885
9	16	Beck, Robert	EUA	28	19	885
13	47	Steffensen, Jorn	DIN	27	20	862
13	25	Fox, Jeremy	GBR	27	20	862
13	34	Fukui, Toshio	JPN	27	20	862
16	46	Kupka, Pavel	CHE	26	21	839
16	1	Frings, Elmar	ALE	26	21	839
16	21	Hotanen, Jorma	FIN	26	21	839
16	41	Lednev, Pavel	URS	26	21	839
20	12	Springer, Siegfried	AUT	25	22	816
20	36	Makihira, Yuso	JPN	25	22	816
20	27	Lillywhite, Barry	GBR	25	22	816
23	18	Moore, James	EUA	24	23	793
23	40	Shaparnis, Stasis	URS	24	23	793
23	31	Morresi, Giancarlo	ITA	24	23	793
23	6	Tscherner, Jörg	ADE	24	23	793
27	45	Olivera, Eduardo	MEX	23	24	770
27	48	Tschui, Alex	SUI	23	24	770
27	20	Ketela, Martti	FIN	23	24	770
30	10	Leu, Wolfgang	AUT	22	25	747
31	5	Luderitz, Wolfgang	ADE	21	26	724
31	13	Paniowsky, Antone	BUL	21	26	724
33	11	Sonnleitner, Wolf-Dieter	AUT	20	27	701
34	3	Todt, Hans	ALE	19	28	678
34	35	Tashiro, Katsuaki	JPN	19	28	678
34	7	McMikin, Donald	AUS	19	28	678
34	33	Deligia, Nicolo	ITA	19	28	678
38	24	Guiguet, Lucien	FRA	18	29	655
38	8	Macken, Peter	AUS	18	29	655
38	17	Lough, Maurice	EUA	18	29	655
38	14	Sardjev, Konstantine	BUL	18	29	655
42	4	Kutschke, Karl-Heinz	ADE	17	30	632
42	26	Phelps, Robert	GBR	17	30	632
44	15	Apostolov, Ivan	BUL	16	31	609
45	9	Page, Duncan	AUS	14	33	563
46	44	Tovar, Eduardo	MEX	13	34	540
47	43	Bárcena, David	MEX	12	35	517
48	23	Giudicelli, Jean-Pierre	FRA	11	36	494



CLASSEMENT INDIVIDUEL INDIVIDUAL SCORE

OCT 15

			1	2	3	4	IM	Points	
1	7	McMikin, Donald	AUS	48	48	49	50	195	1022
2	48	Tschui, Alex	SUI	49	48	49	49	195	1022
3	31	Morresi, Giancarlo	ITA	48	49	49	48	195	1022
4	26	Phelps, Robert	GBR	48	50	48	47	193	978
5	13	Paniowsky, Antone	BUL	48	49	49	47	193	978
6	2	Thade, Heiner	ALE	47	47	48	50	192	956
7	5	Luderitz, Wolfgang	ADE	47	46	48	50	191	934
8	35	Tashiro, Katsuaki	JPN	47	49	45	50	191	934
9	41	Lednev, Pavel	URS	46	47	49	49	191	934
10	47	Steffensen, Jorn	DIN	46	49	49	47	191	934
11	28	Balczó, Andras	HUN	47	49	48	47	191	934
12	37	Ferm, Bjorn	SUE	47	50	47	47	191	934
13	22	Gueguen, Raoul	FRA	47	46	47	50	190	912
14	11	Sonnleitner, Wolf-Dieter	AUT	48	44	49	49	190	912
15	42	Onishenko, Boris	URS	46	48	48	48	190	912
16	16	Beck, Robert	EUA	48	49	45	48	190	912

			1	2	3	4	IM	Points	
17	18	Moore, James	EUA	48	47	48	47	190	912
18	29	Torok, Ferenc	HUN	46	49	49	46	190	912
19	25	Fox, Jeremy	GBR	48	45	48	48	189	890
20	23	Giudicelli, Jean-Pierre	FRA	48	45	48	48	189	890
21	43	Bárcena, David	MEX	49	46	47	47	189	890
22	14	Sardjev, Konstantine	BUL	48	43	49	48	188	868
23	30	Mona, Istvan	HUN	47	47	47	47	188	868
24	45	Olivera, Eduardo	MEX	48	46	50	44	188	868
25	39	Jacobson, Hans	SUE	45	45	48	49	187	846
26	4	Kutschke, Karl-Heinz	ADE	46	46	47	48	187	846
27	12	Springer, Siegfried	AUT	49	44	46	48	187	846
28	6	Tscherner, Jörg	ADE	47	46	47	47	187	846
29	21	Hotanen, Jorma	FIN	48	46	46	47	187	846
30	20	Ketela, Martti	FIN	47	47	46	47	187	846
31	1	Frings, Elmar	ALE	46	49	45	47	187	846
32	17	Lough, Maurice	EUA	47	46	48	46	187	846
33	9	Page, Duncan	AUS	48	47	47	45	187	846
34	24	Guiguet, Lucien	FRA	45	46	47	48	186	824
35	40	Shaparnis, Stasis	URS	49	44	45	47	185	802
36	27	Lillywhite, Barry	GBR	47	47	45	46	185	802
37	36	Makihira, Yuso	JPN	48	47	45	45	185	802
38	8	Macken, Peter	AUS	46	48	44	47	185	802
39	33	Deligia, Nicolo	ITA	41	47	47	49	184	780
40	32	Medda, Mario	ITA	44	47	45	47	183	758
41	* 3	Todt, Hans	ALE	49	45	42	47	182	736
42	19	Aho, Seppo	FIN	45	47	40	48	180	692
43	34	Fukui, Toshio	JPN	46	45	46	43	180	692
44	10	Leu, Wolfgang	AUT	47	44	42	46	179	670
45	46	Kupka, Pavel	CHE	44	48	49	38	179	670
46	44	Tovar, Eduardo	MEX	43	47	44	44	178	648
47	15	Apostolov, Ivan	BUL	47	45	36	45	173	538
**	38	Liljenvall, Hans-Gunnar	SUE	DES					

			IM	Points	Total
13	BUL	Paniowsky, Antone	193	978	
		Sardjev, Konstantine	188	868	
		Apostolov, Ivan	173	538	2384
14	FIN	Ketela, Martti	187	846	
		Hotanen, Jorma	187	846	
		Aho, Seppo	180	692	2384
**	SUE	Ferm, Bjorn			
		Jacobson, Hans			
		Liljenvall, Hans-Gunnar	DES		



CLASSEMENT INDIVIDUEL INDIVIDUAL SCORE

OCT 16

			IM	Points	Total	Temps Time	Points
1	4	Kutschke, Karl-Heinz	ADE	3:33.1	1126		
2	37	Ferm, Bjorn	SUE	3:41.8	1075		
3	6	Tscherner, Jörg	ADE	3:44.1	1060		
4	41	Lednev, Pavel	URS	3:44.4	1060		
5	28	Balczó, Andras	HUN	3:45.1	1054		
6	42	Onishenko, Boris	URS	3:45.1	1054		
7	31	Morresi, Giancarlo	ITA	3:45.5	1051		
8	40	Shaparnis, Stasis	URS	3:49.9	1027		
9	25	Fox, Jeremy	GBR	3:53.4	1006		
10	22	Gueguen, Raoul	FRA	3:54.2	1000		
11	45	Olivera, Eduardo	MEX	3:54.8	997		
12	17	Lough, Maurice	EUA	3:56.4	988		
13	27	Lillywhite, Barry	GBR	3:57.0	982		
14	43	Bárcena, David	MEX	3:57.3	982		
15	23	Giudicelli, Jean-Pierre	FRA	3:58.8	973		
16	34	Fukui, Toshio	JPN	3:59.7	967		
17	20	Ketela, Martti	FIN	4:00.2	964		
18	26	Phelps, Robert	GBR	4:00.3	964		
19	24	Guiguet, Lucien	FRA	4:01.4	958		
20	1	Frings, Elmar	ALE	4:01.7	955		
21	32	Medda, Mario	ITA	4:02.7	949		
22	39	Jacobson, Hans	SUE	4:03.4	946		
23	46	Kupka, Pavel	CHE	4:03.5	943		
24	30	Mona, Istvan	HUN	4:03.8	943		
25	19	Aho, Seppo	FIN	4:04.2	940		
26	35	Tashiro, Katsuaki	JPN	4:05.5	931		
27	18	Moore, James	EUA	4:05.5	931		
28	16	Beck, Robert	EUA	4:06.5	925		
29	11	Sonnleitner, Wolf-Dieter	AUT	4:08.0	916		
30	8	Macken, Peter	AUS	4:09.1	910		
31	5	Luderitz, Wolfgang	ADE	4:09.8	907		
32	36	Makihira, Yuso	JPN	4:11.0	898		
33	21	Hotanen, Jorma	FIN	4:11.5	895		
34	13	Paniowsky, Antone	BUL	4:12.2	892		
35	44	Tovar, Eduardo	MEX	4:12.6	889		
36	33	Deligia, Nicolo	ITA	4:12.7	889		
37	12	Springer, Siegfried	AUT	4:13.7	883		
38	9	Page, Duncan	AUS	4:14.0	880		
39	29	Torok, Ferenc	HUN	4:14.1	880		
40	15	Apostolov, Ivan	BUL	4:14.3	880		
41	2	Thade, Heiner	ALE	4:14.6	877		
42	3	Todt, Hans	ALE	4:16.7	865		
43	7	McMikin, Donald	AUS	4:21.7	835		
44	47	Steffensen, Jom	DIN	4:25.5	811		
45	14	Sardjev, Konstantine	BUL	4:34.5	757		
46	48	Tschui, Alex	SUI	4:47.6	679		
47	10	Leu, Wolfgang	AUT		E		
	38	* Liljenvall, Hans-Gunnar	SUE		DES		

CLASSEMENT PAR EQUIPE TEAM SCORE

			IM	Points	Total
1	HUN	Balczó, Andras	191	934	
		Torok, Ferenc	190	912	
		Mona, Istvan	188	868	2714
2	AUS	McMikin, Donald	195	1022	
		Macken, Peter	185	802	
		Page, Duncan	187	846	2670
3	GBR	Phelps, Robert	193	978	
		Fox, Jeremy	189	890	
		Lillywhite, Barry	185	802	2670
4	EUA	Lough, Maurice	187	846	
		Beck, Robert	190	912	
		Moore, James	190	912	2670
5	URS	Lednev, Pavel	191	934	
		Onishenko, Boris	190	912	
		Shaparnis, Stasis	185	802	2648
6	ADE	Luderitz, Wolfgang	191	934	
		Tscherner, Jörg	187	846	
		Kutschke, Karl-Heinz	187	846	2626
7	FRA	Gueguen, Raoul	190	912	
		Giudicelli, Jean-Pierre	189	890	
		Guiguet, Lucien	186	824	2626
8	ITA	Morresi, Giancarlo	195	1022	
		Deligia, Nicolo	184	780	
		Medda, Mario	183	758	2560
9	ALE	Thade, Heiner	192	956	
		Frings, Elmar	187	846	
		Todt, Hans	182	736	2538
10	JPN	Tashiro, Katsuaki	191	934	
		Makihira, Yuso	185	802	
		Fukui, Toshio	180	692	2428
11	AUT	Sonnleitner, Wolf-Dieter	190	912	
		Springer, Siegfried	187	846	
		Leu, Wolfgang	179	670	2428
12	MEX	Bárcena, David	189	890	
		Olivera, Eduardo	188	868	
		Tovar, Eduardo	178	648	2406



CLASSEMENT PAR EQUIPE TEAM SCORE

			IM	Points	Total
1	URS	Lednev, Pavel	3:44.4	1060	
		Onishenko, Boris	3:45.1	1054	
		Shaparnis, Stasis	3:49.9	1027	3141
2	ADE	Kutschke, Karl-Heinz	3:33.1	1126	
		Tscherner, Jörg	3:44.1	1060	
		Luderitz, Wolfgang	4:09.8	907	3093

			Temps Time	Points	Total					Temps Time	Points
3	GBR	Fox, Jeremy	3:53.4	1006		27	1	Frings, Elmar	ALE	15:23.7	796
		Lillywhite, Barry	3:57.0	982		28	29	Torok, Ferenc	HUN	15:24.3	793
		Phelps, Robert	4:00.3	964	2952	29	45	Olivera, Eduardo	MEX	15:32.3	769
						30	48	Tschul, Alex	SUI	15:33.6	766
4	FRA	Gueguen, Raoul	3:54.2	1000		31	6	Tscherner, Jörg	ADE	15:33.8	766
		Giudicelli, Jean-Pierre	3:58.8	973		32	3	Todt, Hans	ALE	15:45.0	730
		Guiguet, Lucien	4:01.4	958	2931	33	44	Tovar, Eduardo	MEX	15:45.9	730
						34	12	Springer, Siegfried	AUT	15:49.1	718
5	ITA	Morresi, Giancarlo	3:45.5	1051		35	39	Jacobson, Hans	SUE	15:49.7	718
		Medda, Mario	4:02.7	949		36	15	Apostolov, Ivan	BUL	15:50.2	715
		Deligia, Nicolò	4:12.7	889	2889	37	13	Paniowsky, Antone	BUL	15:54.1	703
						38	31	Morresi, Giancarlo	ITA	15:54.3	703
6	HUN	Balczo, Andras	3:45.1	1054		39	27	Lillywhite, Barry	GBR	15:55.8	700
		Mona, Istvan	4:03.8	943		40	7	McMikin, Donald	AUS	16:02.2	679
		Torok, Ferenc	4:14.1	880	2877	41	35	Tashiro, Katsuaki	JPN	16:03.5	676
						42	16	Beck, Robert	EUA	16:10.3	655
7	MEX	Olivera, Eduardo	3:54.8	997		43	2	Thade, Heiner	ALE	16:24.2	613
		Bárcena, David	3:57.3	982		44	9	Page, Duncan	AUS	16:35.4	580
		Tovar, Eduardo	4:12.6	889	2868	45	26	Phelps, Robert	GBR	16:41.8	562
						46	46	Kupka, Pavel	CHE	17:01.5	502
8	EUA	Lough, Maurice	3:56.4	988		47	10	Leu, Wolfgang	AUT		
		Moore, James	4:05.5	931		**	38	Liljenvall, Hans-Gunnar	SUE		DES
		Beck, Robert	4:06.5	925	2844						
9	FIN	Ketela, Martti	4:00.2	964							
		Aho, Seppo	4:04.2	940							
		Hotanen, Jorma	4:11.5	895	2799						
10	JPN	Makihira, Yuso	4:11.0	898							
		Fukui, Toshio	3:59.7	967							
		Tashiro, Katsuaki	4:05.5	931	2796						
11	ALE	Frings, Elmar	4:01.7	955							
		Thade, Heiner	4:14.6	877							
		Todt, Hans	4:16.7	865	2697						
12	AUS	Macken, Peter	4:09.1	910							
		Page, Duncan	4:14.0	880							
		McMikin, Donald	4:21.7	835	2625						
13	BUL	Paniowsky, Antone	4:12.2	892							
		Apostolov, Ivan	4:14.3	880							
		Sardjev, Konstantine	4:34.5	757	2529						
14	AUT	Sonnleitner, Wolf-Dieter	4:08.0	916							
		Springer, Siegfried	4:13.7	883							
		Leu, Wolfgang	E								
15	**SUE	Ferm, Bjorn									
		Jacobson, Hans									
		Liljenvall, Hans-Gunnar	DES								

CLASSEMENT PAR EQUIPE TEAM SCORE

				Temps Time	Points	Total
1	ADE	Kutschke, Karl-Heinz		13:45	1090	
		Luderitz, Wolfgang		14:44	913	
		Tscherner, Jörg		15:33	766	2769
2	URS	Shaparnis, Stasis		14:27	964	
		Onishenko, Boris		14:45	910	
		Lednev, Pavel		14:51	892	2766
3	FRA	Guiguet, Lucien		14:37	934	
		Giudicelli, Jean-Pierre		14:40	925	
		Gueguen, Raoul		15:05	850	2709
4	HUN	Balczo, Andras		14:07	1024	
		Mona, Istvan		15:06	847	
		Torok, Ferenc		15:24	793	2664
5	FIN	Aho, Seppo		14:55	880	
		Hotanen, Jorma		14:58	871	
		Ketela, Martti		15:03	856	2607
6	ITA	Medda, Mario		14:36	937	
		Deligia, Nicolò		15:05	850	
		Morresi, Giancarlo		15:54	703	2490
7	JPN	Makihira, Yuso		14:24	973	
		Fukui, Toshio		15:21	802	
		Tashiro, Katsuaki		16:03	676	2451
8	MEX	Bárcena, David		14:31	952	
		Olivera, Eduardo		15:32	769	
		Tovar, Eduardo		15:45	730	2451
9	EUA	Moore, James		14:36	937	
		Lough, Maurice		15:15	820	
		Beck, Robert		16:10	655	2412
10	AUS	Macken, Peter		14:21	982	
		McMikin, Donald		16:02	679	
		Page, Duncan		16:35	580	2241
11	BUL	Sardjev, Konstantine		15:18	811	
		Apostolov, Ivan		15:50	715	
		Paniowsky, Antone		15:54	703	2229
12	GBR	Fox, Jeremy		14:50	895	
		Lillywhite, Barry		15:55	700	
		Phelps, Robert		16:48	562	2157
13	ALE	Frings, Elmar		15:23	796	
		Todt, Hans		15:45	730	
		Thade, Heiner		16:24	613	2139
14	AUT	Sonnleitner, Wolf-Dieter		15:11	832	
		Springer, Siegfried		15:49	718	
		Leu, Wolfgang		E		1550
15	SUE	Ferm, Bjorn				
		Jacobson, Hans				
		Liljenvall, Hans-Gunnar				DES

762

CLASSEMENT INDIVIDUEL INDIVIDUAL SCORE

OCT 17

			Temps Time	Points
1	4	Kutschke, Karl-Heinz	ADE	13:45.5
2	28	Balczo, Andras	HUN	14:07.2
3	8	Macken, Peter	AUS	14:21.7
4	36	Makihira, Yuso	JPN	14:24.3
5	37	Ferm, Bjorn	SUE	14:25.7
6	40	Shaparnis, Stasis	URS	14:27.8
7	43	Bárcena, David	MEX	14:31.4
8	32	Medda, Mario	ITA	14:36.1
9	18	Moore, James	EUA	14:36.8
10	24	Guiguet, Lucien	FRA	14:37.0
11	23	Giudicelli, Jean-Pierre	FRA	14:40.0
12	5	Luderitz, Wolfgang	ADE	14:44.5
13	42	Onishenko, Boris	URS	14:45.7
14	47	Steffensen, Jom	DIN	14:49.2
15	25	Fox, Jeremy	GBR	14:50.2
16	41	Lednev, Pavel	URS	14:51.0
17	19	Aho, Seppo	FIN	14:55.6
18	21	Hotanen, Jorma	FIN	14:58.1
19	20	Ketela, Martti	FIN	15:03.9
20	22	Gueguen, Raoul	FRA	15:05.0
21	33	Deligia, Nicolò	ITA	15:05.0
22	30	Mona, Istvan	HUN	15:06.9
23	11	Sonnleitner, Wolf-Dieter	AUT	15:11.7
24	17	Lough, Maurice	EUA	15:15.2
25	14	Sardjev, Konstantine	BUL	15:18.2
26	34	Fukui, Toshio	JPN	15:21.1

**RECORDS OLYMPIQUES ETABLIS A MELBOURNE EN 1956 DURANT
LES JEUX DE LA XIX OLYMPIADE**

**OLYMPIC RECORDS ESTABLISHED IN MELBOURNE DURING
THE GAMES OF THE XIX OLYMPIAD**

**ATHLETISME HOMMES
ATHLETICS MEN**

200 m	-	200 m	B. Morrow	EUA	20.6"
800 m	-	800 m	T. Courtney	EUA	47.7"
1500 m	-	1500 m	R. Delany	IRL	3'41.2"
5000 m	-	5000 m	V. Kouts	URS	13'39.6"
10000 m	-	10000 m	V. Kouts	URS	28'45.6"
110 m Haies	-	110 m Hurdles	L. Calhoun	EUA	13.5"
400 m Haies	-	400 m Hurdles	G. Davis	EUA	50.1"
3000 m Steeplechase	-	3000 m Steeplechase	C. Brasher	GBR	8'41.2"
4 x 100 m Relais	-	4 x 100 m Relay	EUA	EUA	39.5"
20 Km marche	-	20 Km Walk	L. Spirine	URS	1 ^o 31'27.4"
Saut en Hauteur	-	High Jump	C. Dumas	EUA	2.12m
Triple Saut	-	Triple Jump	A. Ferreira	BRA	16.35m
Saut à la Perche	-	Pole Vault	R. Richards	EUA	4.56m
Lanc. du Poids	-	Shot Put	P. O'Brien	EUA	18.57m
Lanc. du Disque	-	Discus Throw	A. Dertter	EUA	56.36m
Lanc. du Javelot	-	Javelin Throw	E. Danielsen	NOR	85.71m
Lanc. du Marteau	-	Hammer Throw	H. Connolly	EUA	63.19m
Décathlon	-	Decathlon	M. Campbell	EUA	7,937P

**ATHLETISME FEMMES
ATHLETICS WOMEN**

80 m Haies	-	80 m Hurdles	S. Strickland	AUS	10.7"
4 x 100 m Relais	-	4 x 100 m Relay	AUS	AUS	44.5"
Saut en Hauteur	-	High Jump	M. McDaniel	EUA	1.76m
Saut en Longueur	-	Long Jump	E. Krzesinska	POL	6.35m
Lanc. du Javelot	-	Javelin Throw	I. Iauozem	URS	53.86m
Lanc. du Poids	-	Shot Put	T. Tychevitch	URS	16.59m
Lanc. du Disque	-	Discus Throw	O. Fikotova	CHE	53.69m

**CYCLISME
CYCLING**

Km contre la montre	-	1000 m Time Trial	L. Faggin	ITA	1'09.8"
4000 m Poursuite par Equipe	-	4000 m Team Pursuit	Italia	ITA	4'37.4"

**HALTEROPHILIE
WEIGHTLIFTING**

				TOTAL	
Poids Coq	-	Bantamweight	C. Vinci	EUA	(P) 105
					(S) 105
					(J) 132.5
					342.5 Kg
Poids Plume	-	Featherweight	I. Berger	EUA	(P) 107.5
					(S) 107.5
					(J) 137.5
					352.5 Kg
Poids Léger	-	Lightweight	I. Rybak	URS	(P) 110
					(S) 120
					(J) 150
					380 Kg
Poids Moyen	-	Middleweight	F. Bogdanovski	URS	(P) 132.5
					(S) 122.5
					(J) 165
					420 Kg
Poids Moyen Lourd	-	Light Heavyweight	T. Kono	EUA	447.5 Kg
Poids Mi-Lourd	-	Middle Heavyweight	A. Vorobiev	URS	462.5 Kg
Poids Lourd	-	Heavyweight	P. Anderson	EUA	(P) 167.5
					(S) 145
					(J) 187.5
					500 Kg
(P) Développé	-	Press			
(S) Arraché	-	Snatch			
(J) Epaulé-jeté	-	Jerk			

**NATATION HOMMES
SWIMMING MEN**

100 m Nage Libre	-	100 m Freestyle	J. Henricks	AUS	55.4"
400 m Nage Libre	-	400 m Freestyle	M. Rose	AUS	4'27.3"
100 m Dos	-	100 m Backstroke	D. Theile	AUS	1'02.2"
200 m Brasse	-	200 m Breaststroke	M. Furukawa	JPN	2'34.7"
200 m Papillon	-	200 m Butterfly	W. Yorzyk	EUA	2'18.6"
4 x 200 m Nage Libre	-	4 x 200 m Freestyle Relay	AUS	AUS	8'23.6"
1500 m Nage Libre	-	1500m Freestyle	G. Breen	EUA	17'52.9"

**NATATION FEMMES
SWIMMING WOMEN**

100 m Nage Libre	-	100 m Freestyle	D. Fraser	AUS	1'02.0"
400 m Nage Libre	-	400 m Freestyle	L. Crapp	AUS	4'54.6"
200 m Brasse	-	200 m Breaststroke	U. Happe	ALE	2'53.1"
100 m Dos	-	100 m Backstroke	J. Grénham	GBR	1'12.9"
100 m Papillon	-	100 m Butterfly	S. Mann	EUA	1'11.0"
4 x 100 m Nage Libre	-	4 x 100 Freestyle Relay	AUS	AUS	4'17.1"

**TIR
SHOOTING**

P. C. Pos. couchée	-	S. B. R. Prone Pos.	G. Ouellete	CAN	600P
P. C. Trois Pos.	-	S. B. R. 3 Pos.	A. Bogdanov	URS	1172P
Vitesse aux Silhouettes	-	Schnellfeuerpistole	S. Petrescu	RUM	587P
Carabine libre	-	Freigewehr	Borissov	URS	1138P
Cerf courant	-	Running Deer	V. Romanenko	URS	441P



**OFFICIELS DE LA COMPETITION
COMPETITION OFFICIALS**

Luis Outón MEX
Sergio Hernández MEX
Enrique Benítez MEX
Gustavo Juárez MEX
Lorenzo Sepúlveda MEX
Jaime Amsler MEX

**COMITE TECHNIQUE DE L'UIT
TECHNICAL COMMITTEE OF THE UIT**

PRESIDENT
Karl Larsson

SKEET
Alejandro Romero MEX
Juan Azcárate MEX

VICE-PRESIDENT
Otto Horber

**FOSSE OLYMPIQUE
OLYMPIC TRAP**
Gustavo Cepeda MEX
Fernando Santos MEX

**MEMBRES
MEMBERS**
Ilya Andreev
Petre Cismigiu
Josef Deflorian
Michael Tipa

**ARBITRES
REFEREES**

**UNION INTERNATIONALE
DE TIR UIT**

**FUSIL
RIFLE**
Jesús Sánchez Hernández MEX

**INTERNATIONAL SHOOTING
UNION UIT**

**OFFICIELS TECHNIQUE DE L'UIT
TECHNICAL OFFICIALS OF THE UIT**

PRESIDENT
Kurt Hasler SUI

D. Boon-Aek ITA
H. Kahlenberg ITA
Alfonso Demetrio CUB
Miroslav Hamerle CHE
Otto Finley EUA
G. Latour FRA
Arthur J. Palmer GBR
Constantin Lycouris GRE
Michelangelo Boriello ALE
Severino Rosa-Clot AUS
Emil Nassas LIB
Adán Arredondo MEX
Hasse Liljedahl SUE
Anatoli Bogdanow URS
Nicolai Pokrowsky URS
Hermann Schläper VEN
C. F. Gilbert
H. Kowar
Harry Willsie
Serm Charuratana

**PISTOLET
PISTOL**
Francisco Torres MEX

764

**SECRETARE
SECRETARY**
Ernst Zimmerman ALE

**FUSIL DE CHASSE
SHOTGUN**
Luis Rocha MEX

**ASSOCIATION MEXICAINE DE
TIR OLYMPIQUE AMTO**

**DIRECTEURS DES EPREUVES
DIRECTORS OF EVENTS**

PRESIDENT
Jorge Septién MEX

**FUSIL
RIFLE**
Jesús Sánchez Hernández MEX

**SECRETARE
SECRETARY**
Fernando Díaz MEX

**PISTOLET LIBRE
FREE PISTOL**
Ernesto López MEX

**SECTION DE TIR DU C.O.O.
O.O.C. SHOOTING SECTION**
Jorge Septién MEX
Francisco Torres MEX
Jesús Sánchez MEX
Fernando Santos MEX

**PISTOLET DE TIR RAPIDE
RAPID FIRE PISTOL**
Ignacio Mendoza MEX
Fernando López MEX

SIGNES EMPLOYES

SYMBOLOLOGY

NSP	— NE S'EST PRESENTE	FAILED TO APPEAR
T	— POSITION COUCHE	PRONE POSITION
R	— POSITION A GENOUX	KNEELING POSITION
P	— POSITION DEBOUT	STANDING POSITION
()	— BARRAGE	SHOOT-OFF
TG	— TOTAL GENERAL	OVERALL SCORE
TP	— TOTAL POINTS	TOTAL POINTS
III	— PREMIER TOUR	FIRST ROUND
III IV	— DEUXIEME TOUR	SECOND ROUND
TR	— TOTAL POINTS PAR TOUR	TWO-SERIES TOTAL
POS	— POSITION	POSITION

Rank	Name	Country	SERIES						TP	Rank	Name	Country	SERIES						TP		
			1	2	3	4	5	6					1	2	3	4	5	6		7	8
41	García, Juan	ESP	90	91	90	87	90	86	534	26	Stafford, Larry	EUA	24	24	23	23	23	24	24	24	189
42	Vita, Antonio	PER	88	87	88	87	93	90	533	27	Mattarelli, Ennio	ITA	22	24	25	24	24	24	22	24	189
43	Thu, Hominh	VNM	88	90	91	84	89	91	533	28	Karlsson, Sten	SUE	23	23	25	25	25	22	22	24	189
44	Aswanich, Sutham	TAI	90	91	88	86	90	88	533	29	Buhse, Werner	ALE	24	24	24	23	24	24	23	23	189
45	Kim, Yong Bai	COR	89	86	91	85	90	91	532	30	Salihoglu, Metin	TUR	23	24	24	24	24	22	24	23	188
46	Costa, Arturo	CUB	80	89	87	92	93	89	530	31	Silvernail, George	PRO	24	25	24	23	23	24	23	22	188
47	Marton, Michael	ISR	90	83	90	89	90	88	530	32	Orlandi, Ivo	VEN	21	24	23	24	24	22	24	25	187
48	Barragán, Enrique	URG	90	87	93	86	88	85	529	33	Barrenechea, Miguel	MEX	23	24	24	24	22	22	23	25	187
49	Peregrina, Javier	MEX	86	84	92	87	87	92	528	34	Grantham, Eric	GBR	24	24	24	22	22	23	24	24	187
50	Kusunoki, Shigeto	JPN	84	88	90	85	91	90	528	35	Tzoumaras, Markos	GRE	25	24	24	24	20	22	24	24	187
51	Musso, Paul	FRA	84	92	87	83	91	90	527	36	Renard, Guy	BEL	22	25	25	21	24	23	23	24	187
52	Ozenbas, Turker	TUR	92	89	87	84	89	85	526	37	Meixner, Josef	AUT	24	21	23	24	22	25	25	23	187
53	Chen, Jeng-Gang	TWN	86	91	87	89	87	85	525	38	Gehmann, Erich	ALE	21	25	22	25	24	24	23	23	187
54	Vera, Walter	URG	88	81	93	89	85	88	524	39	Sorensen, Kjell	NOR	23	22	25	24	23	23	20	25	185
55	Guimaraes, Durval	BRA	86	86	81	91	87	93	524	40	Gajasenii, Pavitr	TAI	23	24	24	24	23	20	22	23	183
56	Cheng, Chi-Sen	TWN	84	86	86	88	87	90	521	41	Zepeda, Gustavo	MEX	23	24	21	22	22	23	24	22	181
57	Danh, Duong	VNM	80	94	85	88	87	85	519	42	Franciosi, Leo	SMR	20	23	24	22	24	25	22	21	181
58	Castillo, Tito	SAL	86	91	85	80	86	91	519	43	Lin, Ho-Ming	TWN	24	24	24	20	24	22	24	19	181
59	Sandoval, Francisco	GUA	86	91	84	84	90	84	519	44	Shoukri, Badir	RAU	21	22	22	21	19	24	23	25	177
60	Mendoza, Antonio	FIL	86	89	81	86	89	83	514	45	Pelliccioni, Salvatore	SMR	23	21	22	21	25	25	21	19	177
61	Agdamag, José	FIL	88	81	83	87	90	85	514	46	Cheng, Sung-Gun	TWN	21	19	24	23	21	23	22	22	175
62	Loader, Marcus	GBR	86	84	90	80	87	85	512	47	Kelly, James	IRL	21	21	25	22	20	23	21	22	175
63	González, José	PRO	88	84	85	83	86	85	511	48	Peron, Walter	PER	22	19	24	23	23	21	21	22	175
64	Yuktanan, Amorn	TAI	89	85	86	83	85	83	511	49	Mongkollugsana Dipya	TAI	23	21	21	21	21	23	24	21	175
65	Meyer, Kurt	ALE	91	95	93	93	90	44	506	50	Porro, Arturo	URG	21	22	20	23	23	21	22	19	171
66	Loh, Kok	SIN	84	79	82	83	84	87	499	51	Asbun, Carlos	BOL	19	22	18	20	22	22	20	20	163
67	Mora, Antonio	CRC	87	85	86	78	83	80	499	52	Roberts, Ricardo	BOL	20	20	20	22	22	19	20	18	161
68	Ruiz, Rodrigo	CRC	87	76	77	86	86	73	485	53	Marchand, Angel	PRO	22	21	21	20	18	17	18	19	156
69	Barasorda, Miguel	PRO	70	82	77	87	82	83	481	54	Soundy, Roberto	SAL	16	12	14	17	19	15	15	17	125
	Zenoni, Giosue	ITA	NSP							55	Lorenzo, Domingo	DOM	16	19	13	17	9	17	17	16	124
	Barzachki, Anguel	BUL	NSP																		
	Silvestri, Umberto	ITA	NSP																		

(RM) 566 Points Jassinski, A. URS 1965, URS

(RO) 560 Points Gustchin, Aleksey URS 1960, ITA

(RM) 198 Points Mattarelli, Ennio ITA 1964, JPN

(RO) 198 Points Mattarelli, Ennio ITA 1964, JPN

766

FOSSÉ OLYMPIQUE OLYMPIC TRAP SHOOTING

FINALE
FINAL

OCT 18

Rank	Name	Country	SERIES						TP	
			1	2	3	4	5	6		7
1	Braithwaite, John (erm) (mro)	GBR	23	25	25	25	25	25	25	198
2	Garrigus, Thomas	EUA	23	25	25	24	24	25	25 (25-25)	196
3	Czekalla, Kurt	ADE	24	25	24	25	25	24	24 (25-23)	196
4	Senichev, Pavel	URS	24	24	25	25	25	24	24 (22)	196
5	Candelo, Pierre	FRA	23	23	25	24	25	25	25	195
6	Smelczynski, Adam	POL	25	25	25	24	23	24	24	195
7	Alipov, Alexander	URS	25	24	24	25	24	25	24	195
8	Primrose, John	CAN	24	25	24	25	22	24	25	194
9	Bladas, Jaime	ESP	24	25	24	24	25	23	24	194
10	Singh, Karni	IND	25	25	24	24	24	24	24	194
11	Dumitrescu, Ion	RUM	25	24	23	23	24	25	24	193
12	Carrega, Michel	FRA	24	25	23	25	23	24	24	193
13	Rossini, Galliano	ITA	25	25	24	23	24	24	25	193
14	Cusi, José	ESP	25	24	24	23	22	24	25	192
15	Lira, Juan	CHI	23	25	23	24	24	24	25	192
16	Shaske, Edward	CAN	25	25	22	24	23	24	24	192
17	Singh, Randhir	IND	23	25	22	24	25	25	23	192
18	Salhab, Elias	LIB	22	24	24	24	23	25	24	191
19	Mehrez, Mohamed	RAU	25	23	24	23	23	24	24	191
20	Estay, Pedro	CHI	25	22	24	23	24	25	23	191
21	Florescu, George	RUM	25	25	20	25	25	25	23	191
22	Guarnieri, Rodolfo	ARG	24	23	23	24	24	24	24	190
23	Hager, Rudolf	ADE	25	25	24	22	22	24	24	190
24	Martini, Juan	ARG	25	22	25	24	24	22	23	190
25	Pangalos, Georgios	GRE	25	23	24	25	22	24	23	190

PETITE CARABINE TROIS POSITIONS SMALL BORE RIFLE THREE POSITIONS

FINALE
FINAL

OCT 21

Rank	Name	Country	POS	SERIES				TP	TG
				1	2	3	4		
1	Klingner, Bernd	ALE	T	97	98	99	100	394	
			R	98	98	100	100	396	
			P	91	92	91	93	367	1157
2	Writer, John	EUA	T	99	99	99	98	395	
			R	99	97	97	98	391	
			P	98	89	88	95	370	1156
3	Parkhimovich, Vitaly	URS	T	99	100	98	98	395	
			R	97	99	100	97	393	
			P	91	94	90	91	366	1154
4	Foster, John	EUA	T	97	100	100	97	394	
			R	95	98	97	100	390	
			P	91	93	92	93	369	1153
5	González, José	MEX	T	99	99	99	100	397	
			R	94	94	94	97	379	
			P	96	91	92	97	376	1152
6	Ouellette, Gerald	CAN	T	100	98	99	99	396	
			R	97	98	96	100	391	
			P	91	90	94	89	364	1151
7	Kohnke, Peter	ALE	T	97	99	99	100	395	
			R	95	99	97	97	388	
			P	92	91	95	90	368	1151
8	Müller, Kurt	SUI	T	98	96	97	99	390	
			R	98	95	98	97	388	
			P	94	92	91	96	373	1151

		POS	SERIES			TP	TG	
			1	2	3			
9	Bakken, Bjorn	NOR	T 99 R 94 P 92	99 96 96	100 96 91	99 97 91	397 383 370	1150
10	Koniakhin, Vladimir	URS	T 97 R 98 P 94	99 96 87	100 97 91	99 96 93	395 387 365	1147
11	Paunovic, Slobodan	YUG	T 98 R 98 P 94	99 97 93	99 97 91	96 96 89	392 388 367	1147
12	Rotaru, Nicolae	RUM	T 100 R 97 P 93	99 98 88	99 96 91	100 95 90	398 386 362	1146
13	Hammerl, Laszlo	HUN	T 99 R 97 P 86	99 97 96	99 93 91	99 98 92	396 385 365	1146
14	Loacker, Guido	AUT	T 97 R 94 P 94	99 96 92	98 96 90	100 98 92	394 384 368	1146
15	Lafortune, François	BEL	T 99 R 97 P 89	99 97 92	98 92 93	100 97 92	396 383 366	1145
16	Llanos, Raúl	CUB	T 96 R 94 P 90	99 98 92	100 93 94	100 98 91	395 383 367	1145
17	Wunderlich, Uto	ADE	T 98 R 94 P 92	98 99 90	96 98 93	98 96 93	390 387 368	1145
18	Johansson, Sven	SUE	T 98 R 97 P 90	99 98 88	99 97 92	97 98 91	393 390 361	1144
19	Overgard, Elling	NOR	T 99 R 97 P 89	99 96 89	98 96 94	97 99 91	393 388 363	1144
20	Johansson, Kurt	SUE	T 100 R 97 P 92	98 96 95	99 96 84	98 95 93	395 384 364	1143
21	Kohene, Marcel	BUL	T 99 R 96 P 86	99 97 93	98 97 92	98 97 90	394 387 361	1142
22	Jensen, Ole	DIN	T 98 R 95 P 91	100 96 87	98 99 91	99 98 88	395 388 357	1140
23	Olarescu, Ion	RUM	T 98 R 95 P 90	100 99 89	98 93 90	98 97 93	394 384 362	1140
24	Nowicki, Jerzy	POL	T 98 R 96 P 87	97 97 90	98 98 95	98 98 88	391 389 360	1140
25	Fandier, Barnaba	POL	T 99 R 97 P 89	97 100 93	97 95 93	98 98 83	391 390 358	1139
26	Sommer, Hartmut	ADE	T 97 R 98 P 89	98 96 92	99 94 91	99 96 89	393 384 361	1138
27	Mendbair, Zhansanjorloo	MGL	T 100 R 95 P 89	99 98 92	100 96 86	99 95 87	398 384 354	1136
28	Tolhurst, Donald	AUS	T 99 R 96 P 89	98 97 90	98 95 89	99 96 90	394 384 358	1136
29	Kurka, Jan	CHE	T 98 R 97 P 89	98 97 91	99 96 90	96 95 90	391 385 360	1136
30	Ruch, Peter	SUI	T 99 R 92 P 93	98 99 93	97 91 89	99 96 89	393 378 364	1135
31	Grozdanovic, Vladimir	YUG	T 100 R 98 P 86	96 94 91	99 97 88	98 96 91	393 385 356	1134
32	Waibel, Wolfram	AUT	T 99 R 97 P 87	100 93 85	100 97 89	98 95 93	397 382 354	1133

		POS	SERIES			TP	TG	
			1	2	3			
33	Morri, Simo	FIN	T 99 R 97 P 91	98 93 93	98 91 87	99 97 90	394 378 361	1133
34	Feliciano, Adolfo	FIL	T 98 R 95 P 92	99 96 88	97 96 94	97 92 89	391 379 363	1133
35	Petrovacz, Ferenc	HUN	T 98 R 92 P 92	97 97 91	99 95 88	99 93 91	393 377 362	1132
36	Minkinen, Jaakko	FIN	T 98 R 93 P 90	98 98 88	95 97 87	100 97 91	391 385 356	1132
37	De Chirico, Giuseppe	ITA	T 97 R 98 P 85	98 99 87	100 94 91	100 98 83	395 389 346	1130
38	Mayer, Alphonse	CAN	T 99 R 97 P 88	99 93 90	99 96 89	98 93 86	395 379 353	1127
39	Navratil, Jaroslav	CHE	T 98 R 95 P 89	98 95 85	98 97 87	99 94 92	393 381 353	1127
40	Weichel, Per	DIN	T 99 R 95 P 87	98 94 86	99 96 92	96 94 91	392 379 356	1127
41	Herscovici, Henry	ISR	T 97 R 93 P 85	98 93 91	99 98 90	99 96 85	393 380 351	1124
42	Cerro, Luis	ESP	T 98 R 93 P 87	100 94 93	99 90 89	99 92 89	396 369 358	1123
43	Alvarez, Sergio	CUB	T 100 R 90 P 89	100 99 89	98 95 88	97 87 90	395 371 356	1122
44	Wu, Tao-Yuan	TWN	T 95 R 93 P 87	99 89 94	100 93 89	98 94 90	392 369 360	1121
45	Vergov, Emilian	BUL	T 97 R 95 P 89	98 98 81	97 98 90	97 96 83	389 387 343	1119
46	Pigrau, José	ESP	T 99 R 93 P 92	98 91 88	96 97 88	97 96 82	390 377 350	1117
47	Vázquez, Olegario	MEX	T 99 R 91 P 81	100 91 94	99 94 86	100 94 87	398 370 348	1116
48	Yondonzhams, Batsuj	MGL	T 99 R 95 P 81	96 93 87	96 96 89	99 95 88	390 379 345	1114
49	Lei, Jose	HOK	T 98 R 94 P 88	97 96 90	97 92 83	99 91 87	391 373 348	1112
50	Ang, Leopoldo	FIL	T 98 R 92 P 74	95 91 89	98 96 81	98 95 91	389 374 335	1098
51	Shtroh, Zelig	ISR	T 99 R 96 P 87	98 91 79	96 92 83	95 93 86	388 372 335	1095
52	Llabot, Juan	VEN	T 97 R 94 P 89	97 95 84	95 92 89	89 84 84	378 370 346	1094
53	Brolo, Otto	GUA	T 97 R 94 P 78	97 92 79	98 94 83	98 95 87	390 375 327	1092
54	Dursun, Mehmet	TUR	T 98 R 87 P 80	99 94 77	100 89 85	99 89 84	396 359 326	1081
55	Salles, Edmar	BRA	T 99 R 88 P 80	98 88 87	99 89 80	99 89 81	395 354 328	1077
56	Fernández, Leonel	GUA	T 98 R 90 P 82	96 94 83	98 87 76	99 92 73	391 363 314	1068

**ARME LIBRE
FREE RIFLE**

FINALE
FINAL **OCT 23**

			1	2	3	SERIES 4	TP	TG	
1	Anderson, Gary (mrm) (mro)	EUA	T R P	100 97 95	95 96 93	99 99 93	100 97 93	394 389 374	1157
2	Kornev, Valentin	URS	T R P	99 98 94	100 95 93	99 95 88	100 96 94	398 384 369	1151
3	Muller, Kurt	SUI	T R P	99 97 90	99 91 94	99 96 98	98 95 92	395 379 374	1148
4	Kveliashvili, Shota	URS	T R P	100 95 91	97 95 89	98 98 91	99 95 94	394 383 365	1142
5	Vogt, Erwin	SUI	T R P	100 95 88	100 96 91	98 97 89	100 96 90	398 384 358	1140
6	Sommer, Hartmut	ADE	T R P	96 97 90	99 95 93	98 98 91	96 94 93	389 384 367	1140
7	Foster, John	EUA	T R P	95 97 97	95 96 86	98 97 89	98 96 96	386 386 368	1140
8	Sandor, Petre	RUM	T R P	98 92 90	99 97 92	99 93 93	98 94 93	394 376 368	1138
9	Overgard, Elling	NOR	T R P	100 95 90	99 96 84	99 96 91	99 95 91	397 382 356	1135
10	Papp, Lajos	HUN	T R P	99 96 91	97 97 88	97 95 89	98 97 91	391 385 359	1135
11	Laakso, Johan	FIN	T R P	96 96 88	94 97 93	95 97 93	97 96 93	382 386 367	1135
12	Kurka, Jan	CHE	T R P	97 95 91	98 91 90	98 97 91	98 97 90	391 380 362	1133
13	Johansson, Sven	SUE	T R P	96 95 91	99 97 88	100 97 83	98 97 88	393 386 350	1129
14	Bakken, Bjorn	NOR	T R P	96 97 88	98 94 88	98 94 89	100 95 92	392 380 357	1129
15	Fandier, Barnaba	POL	T R P	94 97 93	99 95 89	98 95 89	98 94 86	389 381 357	1127
16	Petrovacz, Ferenc	HUN	T R P	96 94 92	96 97 87	100 94 86	98 94 92	390 379 357	1126
17	Johansson, Kurt	SUE	T R P	97 98 86	99 95 87	99 95 86	100 97 86	395 385 345	1125
18	Sima, Ondrej	CHE	T R P	97 94 87	97 94 87	99 93 93	98 97 85	391 378 352	1121
19	Ala-Honkola, Osmo	FIN	T R P	98 97 85	96 94 88	97 96 85	100 97 87	391 384 345	1120
20	Pedzisz, Eugeniusz	POL	T R P	98 99 94	94 90 87	98 93 85	95 94 90	385 376 356	1117

			1	2	3	SERIES 4	TP	TG	
21	Vázquez, Olegario	MEX	T R P	97 92 86	99 85 89	97 93 90	96 95 91	389 365 356	1110
22	Feliciano, Adolfo	FIL	T R P	97 91 85	93 90 85	95 95 96	93 95 93	378 371 359	1108
23	Wunderlich, Uto	ADE	T R P	93 93 88	94 91 88	96 95 90	94 95 90	377 374 356	1107
24	Kaban, Stefan	RUM	T R P	98 96 88	99 94 91	96 88 89	99 89 75	392 367 343	1102
25	González, José	MEX	T R P	93 96 86	92 95 92	93 91 90	92 84 88	370 366 356	1092
26	Wu, Tao-Yuan	TWN	T R P	94 91 87	92 95 84	97 92 85	95 91 82	378 369 338	1085
27	Yondozhams, Batsuj	MGL	T R P	96 92 85	96 90 82	100 91 82	98 91 79	390 364 328	1082
28	San Juan, Bernardo	FIL	T R P	96 81 84	95 90 86	94 90 87	94 88 75	379 349 332	1060
29	Marroquín, José	GUA	T R P	94 84 71	95 81 82	95 78 80	96 90 71	380 333 314	1027
30	Ortís, Felipe	GUA	T R P	94 84 76	93 85 77	94 86 81	96 88 69	377 343 303	1023
	Dal, Kim	CDN	NSP						
	Herscovici, Henry	ISR	NSP						
	Hyong, Ryong	CDN	NSP						
	Marmarov, Detcho	BUL	NSP						

(RM) 1156 Points Anderson, Gary EUA 1966, ALE

(RO) 1153 Points Anderson, Gary EUA 1964, JPN

SKEET

FINALE
FINAL **OCT 22**

			1	2	3	4	SERIES 5	6	7	8	TP
1	Petrov, Evgeny (mrm) (ro)	URS	24	25	25	24	25	25	25	25 (25)	198
2	Garagnani, Romano (mrm) (ro)	ITA	24	25	24	25	25	25	25	25 (24-25)	198
3	Wirnhier, Konrad (mrm) (ro)	ALE	24	25	25	24	25	25	25	25 (24-23)	198
4	Tsuranov, Yury	URS	25	24	25	23	25	25	24	25	196
5	Gianella, Pedro	PER	23	24	23	25	25	24	25	25	194
6	Atalah, Nicolas	CHI	25	23	25	23	24	25	24	25	194
7	Jottar, Jorge	CHI	24	25	25	25	23	24	23	25	194
8	Xanthakos, Panagiotis	GRE	24	24	25	24	24	24	25	24	194
9	Michailidis, Menelaos	GRE	24	23	24	23	24	25	25	24	192
10	Pedersen, Ernst	DIN	23	24	23	25	25	22	24	25	191
11	Sencovici, Gheorghe	RUM	24	23	24	24	24	23	25	24	191
12	Marina, Miguel	ESP	25	22	24	25	23	23	25	24	191
13	Ortiz, Nuria	MEX	25	24	23	25	23	24	23	24	191
14	Bonnett, Alec	GBR	24	24	25	25	25	22	22	24	191
15	Sanderlin, Donald	CAN	24	24	24	23	24	25	24	23	191
16	Herring, Earl	EUA	24	22	25	22	24	24	24	25	190
17	Karlsson, Nils	SUE	24	23	24	25	24	25	20	25	190
18	Plante, Alain	FRA	22	25	25	24	23	24	23	24	190
19	Rodale, Robert	EUA	22	24	24	23	25	22	24	25	189
20	Orrgard, Arne	SUE	24	20	25	25	23	23	25	24	189

			SERIES								TP
			1	2	3	4	5	6	7	8	
21	Meyer, Karl	ALE	24	25	22	23	23	25	23	24	189
22	Makeja, Tuukka	FIN	24	25	25	21	25	24	22	23	189
23	Danek, Włodzimierz	POL	22	25	24	24	24	23	25	22	189
24	Gawlikowski, Wiesław	POL	25	22	23	24	22	25	23	24	188
25	Chiono, Giancarlo	ITA	23	23	24	23	25	22	25	23	188
26	Sephton, Colin	GBR	22	23	24	25	25	22	24	23	188
27	Batista, Rafael	PRO	23	22	21	24	23	25	24	25	187
28	Singh, Karni	IND	23	25	23	23	21	23	25	24	187
29	Huguet, Ignacio	CUB	23	23	23	23	25	24	23	23	187
30	Gómez, Delfín	CUB	23	23	24	23	25	22	25	22	187
31	Pani, Mario	MEX	22	22	24	24	25	24	24	22	187
32	Vittet, Paul	SUI	20	25	23	25	25	24	22	22	186
33	Jensen, Benny	DIN	24	22	23	24	25	24	22	22	186
34	Tassev, Atanasse	BUL	23	24	23	24	22	22	22	25	185
35	Faber, Jean Paul	FRA	25	22	23	23	24	25	22	21	185
36	Martínez, José Luis	ESP	24	24	23	21	22	22	23	24	183
37	Willsie, Harry	CAN	23	21	24	23	24	23	22	21	181
38	Brady, Gerard	IRL	22	22	22	22	23	21	25	23	180
39	Hayek, Spiro	LIB	23	24	23	22	18	23	24	23	180
40	Manolov, Anton	BUL	22	23	22	21	23	25	21	23	180
41	Harb, Tanios	LIB	22	24	24	21	23	20	22	23	179
42	Pacheco, Carlos	CRC	22	20	22	23	23	22	21	23	176
43	Amador, Andrés	SAL	21	23	22	19	23	23	24	20	175
44	Cornet, Francis	BEL	21	21	23	20	22	23	20	24	174
45	Guerrero, Alberto	PRO	23	23	23	22	20	21	22	20	174
46	Grech, Joseph	MLT	22	20	23	22	21	23	21	21	173
47	MacMahon, Arthur	IRL	24	21	21	18	21	21	22	22	170
48	Yunes, Riad	DOM	21	24	19	22	20	20	23	21	170
49	Lourvanij, Boonkua	TAI	20	18	20	18	18	20	15	21	150
50	Soundy, Ricardo	SAL	18	17	24	22	16	19	16	15	147
51	Andre, Jorge	CRC	19	20	18	18					75
52	Santana, Luis	DOM	15	13	13	16					57

(RM) 197 Points Jottar, Jorge CHI 1966, ALE

(RO) 197 Points Jottar, Jorge CHI 1966, ALE

RECORD OLYMPIQUE: ETABLI A MEXICO
OLYMPIC RECORD: SET IN MEXICO



FEDERATION INTERNATIONALE
DE VOLLEY-BALL FIVB

INTERNATIONAL VOLLEYBALL
FEDERATION FIVB

PRESIDENT
Paul Libaud FRA

SECRETAIRE
SECRETARY
Henry Aujard BEL

FEDERATION MEXICAINE DE
VOLLEY-BALL FMV

MEXICAN VOLLEYBALL
FEDERATION FMV

PRESIDENT
Rubén Hernández MEX

SECRETAIRE
SECRETARY
Rafael Galindo MEX

SECTION VOLLEY-BALL DU C.O.O.
O.O.C. VOLLEYBALL SECTION
Eduardo Gorráez L. MEX

Alejandro Arellano MEX
Luis Barajas MEX

OFFICIELS DE LA COMPETITION
COMPETITION OFFICIALS

ARBITRES INTERNATIONAUX
INTERNATIONAL REFEREES

Peter Lange	ADE
Lucien Van Welden	BEL
Sergio Freire	BRA
Krastev Guerguil	BUL
Moo Park	COR
Prielonzy Dusan	CHE
Slavicek Oldrich	CHE
Catalino Ignacio	EUA
Glen Davies	EUA
Kazuo Yoshihara	JPN
Kuwahara Iroshi	JPN
Genaro Arredondo	MEX
Arnoldo Rincón	MEX
Jorge Almanza	MEX
Adrián Hernández	MEX
Alfonso Villalba	MEX
Rubén Valenzuela	MEX
Enrique Flores	MEX
Carlos Rivero	PER
Jerzy Krol	POL
Ryszard Buczynski	POL
Anatoli Sedov	URS
Boris Lenov	URS
Kseija Niemarevic	YUG

ARBITRES NATIONAUX
NATIONAL REFEREES

César Cruz	MEX
Salvador Avila	MEX
Antonio Sujo	MEX
Ricardo Contreras	MEX
Odilón Estrada	MEX
Manuel González	MEX
Pedro Bermejo	MEX
Rafael Tinajero	MEX
Héctor Delgado	MEX
Sergio Hinojosa	MEX
Arturo Olvera	MEX
Federico Bretón	MEX
José Concha	MEX
Mario Jiménez	MEX
Eliás González	MEX
Fernando Alarid	MEX
Pedro León	MEX
Octavio Valdés	MEX
Francisco Guerrero	MEX

Homero Arriola	MEX
Eladio Catalán	MEX
Heliodoro García	MEX
Jaime García	MEX
Ramiro Acoltzin	MEX
Gabriel Neri	MEX
Fernando Damián	MEX
Rogelio Martínez	MEX
Tomás Concha	MEX
Alfredo Garza	MEX
Carlos Martínez	MEX
Federico Tinajero	MEX

772

SIGNES EMPLOYES

SYMBOLGY

JJ	— MATCHS JOUES	GAMES PLAYED
JG	— MATCHS GAGNES	GAMES WON
JP	— MATCHS PERDUS	GAMES LOST
TF	— TOTAL POINTS POUR	TOTAL POINTS FOR
TC	— TOTAL POINTS CONTRE	TOTAL POINTS AGAINST
SG	— SETS GAGNES	SETS WON
SP	— SETS PERDUS	SETS LOST
C	— CHANGEMENTS	CHANGES
T	— POINTS	POINTS
FC	— FAUTES ADVERSES	OPPONENTS FAILURES

CATEGORIE MASCULINE
MEN
MATCH 1 OCT 13

DUREE DURATION 1:30.00

JPN

JPN-POL 3-0 (15-9, 15-11, 15-10)

	Service	Preparation	Reception	Bloquage Blocking	Fielding	Attaque Attack	%	C	T
1 Ikeda, Naohiro	—	—	—	—	—	—	—	—	—
2 Minami, Masayuki	—	—	—	—	—	—	—	—	—
3 Nekoda, Katsutoshi	20.82	94.00	50.00	53.57	64.87	60.00	57.21	4	2
4 Shiragami, Mamoru	00.00	—	100.00	—	00.00	—	33.33	0	0
5 Koizumi, Isao	20.00	66.66	95.65	53.57	77.75	68.75	58.25	12	5
6 Kimura, Kenji	20.00	100.00	86.95	40.74	53.19	60.71	60.26	9	6
7 Mitsumori, Yasuaki	22.22	100.00	50.00	33.33	50.00	50.00	50.92	8	0
8 Morita, Jungo	13.05	70.00	89.47	58.18	59.26	68.95	59.81	16	8
9 Yokota, Tadayoshi	26.30	88.88	66.66	52.78	65.21	73.68	62.25	9	4
10 Ohko, Seiji	11.11	75.00	83.33	47.35	64.00	68.75	58.26	11	2
11 Sato, Tetsuo	—	—	—	—	—	—	—	—	—
12 Shimaoka, Kenji	—	—	—	—	—	—	—	—	—
PAR EQUIPE BY TEAM								FC 11	18
TOTAL	19.49	90.69	86.22	50.80	65.04	65.97	63.03	80	45

POL

	Service	Preparation	Reception	Bloquage Blocking	Fielding	Attaque Attack	%	C	T
1 Zdunczyk, Stanislaw	—	—	—	00.00	—	00.00	00.00	0	0
2 Skiba, Aleksander	—	—	—	—	—	—	—	—	—
3 Szymczyk, Jerzy	14.28	83.88	100.00	37.50	50.00	40.00	54.27	5	1
4 Skorek, Edward	08.33	75.00	80.00	37.50	61.52	77.77	63.94	19	1
5 Jasiukiewicz, Zbigniew	13.32	100.00	100.00	46.14	64.28	55.00	51.78	3	4
6 Siwek, Tadeusz	14.28	95.16	91.68	42.86	61.51	—	43.75	7	1
7 Ambroziak, Zdzislaw	16.66	80.00	75.00	41.16	42.86	55.88	48.22	4	1
8 Gosciniak, Stanislaw	50.00	50.00	50.00	—	25.00	50.00	51.96	0	0
9 Paszkiewicz, Romuald	00.00	60.00	75.86	47.62	50.00	66.66	50.45	12	4
10 Wagner, Hubert	00.00	90.00	100.00	33.33	38.45	80.00	51.48	2	0
11 Rutkowski, Wojciech	09.09	66.66	89.47	45.83	25.00	73.33	55.94	4	3
12 Zarzycki, Zbigniew	25.00	60.00	83.33	27.27	33.33	45.00	61.45	9	3
PAR EQUIPE BY TEAM								FC 15	12
TOTAL	09.22	87.89	83.30	41.51	49.51	61.73	55.56	80	30
1er ARBITRE 1st REFEREE	Van Welden, Lucien	BEL	2e ARBITRE 2nd REFEREE	Flores, Enrique	MEX	MARQUEUR	SCOREKEEPER	Cruz, César	MEX

773

MATCH 2

DUREE DURATION 1:02.00

BUL

BUL-MEX 3-0 (15-9, 15-4, 15-6)

	Service	Preparation	Reception	Bloquage Blocking	Fielding	Attaque Attack	%	C	T
1 Trenev, Alexandre	00.00	—	100.00	—	50.00	—	50.00	0	0
2 Zlatanov, Dimitar	00.00	00.00	100.00	20.00	100.00	80.00	50.00	3	1
3 Prinov, Gramen	00.00	—	00.00	—	00.00	—	00.00	0	0
4 Kratchmarov, Petar	16.16	88.89	100.00	72.22	66.66	66.66	63.43	3	5
5 Alexandrov, Alexandre	08.33	100.00	94.45	56.66	50.00	40.00	58.24	4	3
6 Simeonov, Zdravko	16.65	80.00	92.30	67.76	63.14	60.00	63.30	9	7
7 Milev, Milio	—	—	—	—	—	—	—	—	—
8 Karov, Dimitar	18.18	94.99	50.00	38.88	65.00	30.75	49.63	1	2
9 Slavov, Kiril	20.00	80.00	75.00	78.57	59.09	58.80	61.91	4	2
10 Atanassov, Dinio	18.18	100.00	87.50	54.54	66.66	70.76	66.22	10	4
11 Koritarov, Anguel	—	—	—	—	—	—	—	—	—
12 Stoyanov, Stoian	—	—	—	—	—	—	—	—	—
PAR EQUIPE BY TEAM								FC 16	21
TOTAL	15.11	90.58	87.59	62.49	63.30	57.47	62.47	50	45

MEX

	Service	Preparation	Reception	Bloquage Blocking	Fielding	Attaque Attack	%	C	T
1 Osuna, César	—	—	—	—	—	—	—	—	—
2 Calva, Joel	00.00	100.00	100.00	—	100.00	—	75.00	0	0
3 Loya, Jesús	—	—	—	—	—	—	—	—	—
4 Sixtos, Eduardo	20.00	100.00	67.66	30.75	50.00	46.15	52.42	12	3
5 González, Francisco	—	—	—	—	—	—	—	—	—
6 Durán, Juan	100.00	100.00	50.00	40.00	—	66.66	71.33	1	1
7 Aguirre, Carlos	00.00	75.60	91.66	57.14	60.00	33.33	52.95	1	0
8 Reyna, Leopoldo	14.28	75.00	93.33	50.00	00.00	47.83	46.74	8	3
9 Barrón, Carlos	21.22	100.00	70.76	30.30	25.00	55.17	50.40	9	0
10 Barbet, Antonio	10.00	100.00	88.66	22.22	40.00	62.62	53.91	6	4
11 Martell, Luis	00.00	86.04	75.00	36.36	77.77	28.57	50.62	4	1
12 Jiménez, Eduardo	50.00	50.00	80.00	37.50	—	27.27	48.95	2	1
PAR EQUIPE BY TEAM								FC 9	6
TOTAL	09.11	83.12	78.93	35.52	47.05	46.93	50.10	52	19
1er ARBITRE 1st REFEREE	Lenov, Boris	URS	2e ARBITRE 2nd REFEREE	Rivero, Carlos	PER	MARQUEUR	SCOREKEEPER	Breton, Federico	MEX

MATCH
GAME 3

DUREE DURATION 2:36.00

CHE		CHE-ADE 3-2 (15-12,15-17,14-16,15-11,15-9)									
		Service	Preparation	Reception	Bloquage Blocking	Fielding	Attaque Attack	%	C	T	
1	Prochazka, Antonin	37.50	64.63	100.00	41.16	66.66	57.14	61.18	4	1	
2	Svoboda, Jiri	34.79	86.49	80.00	55.88	68.75	70.00	65.98	8	6	
3	Zajicek, Lubomir	100.00	—	—	—	—	—	100.00	0	0	
4	Musil, Josef	10.52	92.30	100.00	38.45	71.18	33.33	57.63	2	2	
5	Smolka, Josef	00.00	—	100.00	—	62.50	—	54.16	0	0	
6	Petlak, Vladimir	10.00	90.00	96.29	58.00	85.00	55.55	65.80	11	6	
7	Kop, Petr	02.63	88.56	95.12	55.00	74.07	67.64	63.83	17	6	
8	Sokol, Frantisek	—	—	—	—	—	—	—	—	—	
9	Golian, Bohumil	—	—	—	—	—	—	—	—	—	
10	Groessel, Zdenek	20.00	60.00	93.47	55.26	76.48	55.00	60.03	17	7	
11	Schenk, Pavel	12.50	90.00	91.18	62.71	60.00	70.23	64.43	26	10	
12	Koudelka, Drahomir	06.66	86.04	100.00	57.69	83.33	38.45	62.02	4	1	
PAR EQUIPE BY TEAM									FC 29	35	
TOTAL		14.08	87.16	91.89	55.11	72.79	62.24	63.87	117	74	
ADE											
1	Peter,Horst	00.00	95.71	89.19	55.55	62.07	52.78	59.05	13	8	
2	Tielscher, Eckhard	00.00	100.00	50.00	83.33	100.00	100.00	72.22	2	1	
3	Schneider, Siegfried	13.33	90.00	89.75	61.11	62.29	66.21	63.78	20	12	
4	Heine, Manfred	—	—	—	—	—	—	—	—	—	
5	Tscharke, Rainer	25.00	82.60	66.66	71.42	72.22	25.00	57.15	2	0	
6	Pietzsch, Eckehard	00.00	87.00	85.71	61.10	62.22	50.00	57.67	3	3	
7	Schulz, Arnold	12.50	80.00	86.20	61.11	72.37	64.19	62.72	17	6	
8	Schumann, Rudi	00.00	100.00	100.00	50.00	50.00	57.14	59.52	0	0	
9	Kessel, Jürgen	14.28	92.83	100.00	70.76	57.14	44.44	63.07	3	0	
10	Toussaint, Walter	16.00	94.61	100.00	61.21	72.88	50.00	65.78	5	2	
11	Freiwald, Jürgen	05.88	100.00	87.50	58.82	50.00	55.00	59.53	14	5	
12	Webner, Wolfgang	17.40	100.00	93.10	55.35	39.13	40.35	57.55	15	8	
PAR EQUIPE BY TEAM									FC 23	20	
TOTAL		13.07	91.45	90.08	56.72	66.50	55.44	62.20	117	65	
1e ARBITRE	1st REFEREE	Valenzuela, Rubén	MEX	2e ARBITRE	2nd REFEREE	Kuwahara, Iroshi	JPN	MARQUEUR	SCOREKEEPER	Alarid, Fernando	MEX

774

GAME
MATCH 4

DUREE DURATION 1:30.00

BEL		BEL-BRA 3-1 (15-7,16-14,9-15,15-6)									
		Service	Preparation	Reception	Bloquage Blocking	Fielding	Attaque Attack	%	C	T	
1	Mol, Jozef	100.00	100.00	—	—	—	—	100.00	0	0	
2	Mesdagh, Paul	50.00	—	100.00	33.33	42.86	50.00	55.23	1	0	
3	Walder, Fernand	00.00	100.00	80.00	—	66.66	—	61.66	0	0	
4	Bossaerts, Willem	04.76	87.87	—	37.93	50.00	41.66	44.44	5	6	
5	Vaillant, Bernard	—	—	—	—	—	—	—	—	—	
6	Maes, Roger	13.05	96.00	72.72	37.50	44.43	21.04	57.10	9	7	
7	Vandewal, Ronald	11.76	100.00	81.25	12.50	42.84	75.00	53.89	7	2	
8	Huybrechts, Hugo	19.23	100.00	88.87	31.81	43.48	68.75	58.52	15	2	
10	Saelens, Benno	00.00	—	50.00	50.00	100.00	100.00	60.00	1	1	
11	Poosen, Berto	—	—	—	—	—	—	—	—	—	
9	Vandergoten, Roger	10.00	75.00	70.59	33.33	64.68	80.77	54.07	8	11	
12	Dierckx, Leo	00.00	100.00	95.71	45.83	66.66	52.98	60.19	7	3	
PAR EQUIPE BY TEAM									FC 27	23	
TOTAL		10.58	92.02	80.51	36.37	53.84	69.63	57.16	80	55	
BRA											
1	De Souza, Jorge	—	—	—	—	—	—	—	—	—	
2	Pinheiro, Sergio	00.00	—	100.00	00.00	—	00.00	25.00	0	0	
3	Jens, Joao	23.52	—	90.90	40.74	66.66	72.41	49.03	15	1	
4	Schuc, Gerson	66.66	66.66	—	00.00	—	00.00	33.33	1	0	
5	Da Costa, José	40.00	100.00	100.00	50.00	00.00	50.00	56.66	0	0	
6	Volpi, Marco	18.75	83.33	88.20	46.35	77.77	62.50	62.81	11	6	
7	Dunlop, Mario	—	—	—	—	—	—	—	—	—	
8	Moreno, Antonio	42.84	75.00	88.89	42.84	54.54	57.69	60.29	9	4	
9	De Azevedo, Decio	36.82	76.74	100.00	38.45	82.42	55.00	64.90	7	1	
10	Borges, Victor	44.43	94.91	100.00	46.14	60.00	77.77	70.54	5	2	
11	Feitosa, Carlos	56.52	89.36	88.20	07.69	53.83	60.00	59.26	11	3	
12	Peterle, Paulo	33.33	100.00	100.00	53.31	20.00	58.33	60.83	4	4	
PAR EQUIPE BY TEAM									FC 17	21	
TOTAL		41.49	87.94	76.38	32.38	63.22	60.23	63.19	80	42	
1e ARBITRE	1st REFEREE	Dusan, Prielonzy	CHE	2e ARBITRE	2nd REFEREE	Kwan, J.	COR	MARQUEUR	SCOREKEEPER	Concha, José	MEX

MATCH
GAME 5

DUREE DURATION 1:52.00

EUA		EUA-URS 3-2 (11-15, 15-10, 10-15, 15-10, 15-6)							C	T	
		Service	Preparation	Reception	Bloquage Blocking	Fielding	Attaque Attack	%			
1	Patterson, Daniel	33.33	—	50.00	—	40.00	—	41.11	0	0	
2	Velasco, Pedro	28.57	71.18	100.00	66.66	57.14	75.00	66.42	2	1	
3	Henn, John	35.00	83.79	100.00	25.00	61.52	37.03	57.05	5	5	
4	May, Robert	—	—	—	—	—	—	—	—	—	
5	Rundle, Larry	25.92	85.71	80.77	50.00	59.09	74.21	62.61	13	4	
6	Bright, David	16.16	70.00	83.33	30.76	44.44	78.25	53.90	11	3	
7	Duke, Smitty	40.89	54.76	90.00	35.70	66.66	60.87	58.15	10	4	
8	Alstrom, John	36.82	50.00	93.75	50.00	41.16	57.89	54.93	13	7	
9	Stanley, Jon	13.72	80.00	85.00	35.28	54.54	64.68	55.53	7	3	
10	Haine, Thomas	—	—	—	—	—	—	—	—	—	
11	Suwara, Rudy	45.83	70.00	87.50	66.66	46.65	52.38	61.50	10	9	
12	Davenport, Wink	—	—	—	100.00	—	—	100.00	0	0	
PAR EQUIPE BY TEAM									FC 15	30	
TOTAL		32.33	75.53	85.87	45.90	53.82	60.62	59.04	86	66	
URS											
1	Sibiryakov, Eduard	46.14	100.00	76.92	25.00	50.00	53.57	58.63	7	4	
2	Kravchenko, Valery	100.00	00.00	100.00	27.28	50.00	70.36	57.44	12	7	
3	Belyaev, Vladimir	57.14	50.00	80.00	54.54	60.00	50.00	58.61	8	1	
4	Lapinsky, Evgeny	59.09	83.33	66.66	31.25	40.00	73.90	59.03	10	4	
5	Antropov, Oleg	—	—	—	—	—	—	—	—	—	
6	Matushevas, Vasilijus	—	—	—	—	—	—	—	—	—	
7	Mikhalchuk, Victor	42.84	71.42	95.71	50.00	66.66	—	65.32	0	2	
8	Poyarkov, Yuri	47.04	78.43	87.50	18.75	55.00	83.33	61.67	5	4	
9	Tereshuk, Boris	30.00	60.00	80.00	25.00	50.00	28.57	45.59	1	2	
10	Ivanov, Vladimir	55.55	71.42	88.88	00.00	42.84	45.83	50.75	8	2	
11	Bugaenkov, Ivan	63.14	75.00	75.86	20.00	55.00	55.26	57.37	10	8	
12	Mondzolevsky, Georgy	66.66	84.63	71.42	12.50	50.00	40.00	54.20	0	1	
PAR EQUIPE BY TEAM									FC 25	21	
TOTAL		50.11	79.01	78.12	25.16	52.11	58.14	57.77	86	56	
1e ARBITRE	1st REFEREE	Krol, Jerzy	POL	2e ARBITRE	2nd REFEREE	Hernández, Adrián	MEX	MARQUEUR	SCOREKEEPER	Avila, Salvador	MEX

MATCH
GAME 6 OCT 16

DUREE DURATION 1:20.00

775

CHE		CHE-EUA 3-1 (15-0, 10-15, 15-7, 15-7)							C	T	
		Service	Preparation	Reception	Bloquage Blocking	Fielding	Attaque Attack	%			
1	Prochazka, Antonin	25.00	96.29	100.00	36.36	76.90	50.00	64.09	2	1	
2	Svoboda, Jiri	33.33	93.33	95.24	72.22	40.00	54.54	64.77	7	6	
3	Zajicek, Lubomir	—	—	—	—	—	—	—	—	—	
4	Musil, Josef	35.70	88.24	92.30	44.44	83.83	62.50	62.83	2	3	
5	Smolka, Josef	66.66	—	100.00	—	100.00	—	88.88	0	0	
6	Petlak, Vladimir	33.33	66.66	100.00	25.00	40.00	80.00	57.49	5	3	
7	Kop, Petr	25.75	20.00	100.00	55.55	100.00	50.00	70.21	4	1	
8	Sokol, Frantisek	—	100.00	100.00	00.00	—	75.00	68.75	1	0	
9	Golian, Bohumil	—	—	—	—	—	—	—	1	0	
10	Groessi, Zdenek	00.00	71.42	94.45	72.72	57.14	84.20	63.32	5	9	
11	Schenk, Pavel	11.10	66.66	69.55	76.44	64.28	69.24	59.54	14	6	
12	Koudelka, Drahomir	00.00	87.50	100.00	46.55	80.00	57.14	61.86	4	2	
PAR EQUIPE BY TEAM									FC 13	24	
TOTAL		35.76	88.62	92.24	60.37	67.15	69.59	67.28	58	55	
EUA											
1	Patterson, Daniel	—	—	—	—	—	—	—	0	0	
2	Velasco, Pedro	100.00	85.71	80.00	83.33	77.77	40.00	62.80	3	1	
3	Henn, John	15.38	89.75	60.00	62.50	65.38	68.75	60.29	2	2	
4	May, Robert	—	—	—	—	—	—	—	—	—	
5	Rundle, Larry	27.27	90.91	84.37	60.87	52.28	77.26	65.51	8	3	
6	Bright, David	08.33	100.00	85.71	58.80	46.15	52.18	58.52	10	1	
7	Duke, Smitty	00.00	90.00	40.00	33.33	50.00	00.00	35.55	1	2	
8	Alstrom, John	00.00	100.00	85.70	62.62	46.75	52.38	57.90	5	5	
9	Stanley, Jon	00.00	—	75.00	36.36	61.50	37.50	42.07	5	0	
10	Haine, Thomas	00.00	87.50	100.00	42.86	46.14	60.00	56.08	1	0	
11	Suwara, Rudy	00.00	72.72	80.00	59.90	62.96	50.00	54.26	11	3	
12	Davenport, Wink	—	—	—	100.00	—	00.00	50.00	0	0	
PAR EQUIPE BY TEAM									FC 12	12	
TOTAL		08.97	88.55	78.74	53.29	54.75	50.49	55.79	58	29	
1e ARBITRE	1st REFEREE	Lange, Peter	ADE	2e ARBITRE	2nd REFEREE	Rivero, Carlos	PER	MARQUEUR	SCOREKEEPER	Bretón, Federico	MEX

MATCH
GAME 7

DUREE DURATION 1:35.00

POL		POL-MEX 3-1 (15-10, 7-15, 15-4, 15-3)									
	Service	Preparation	Reception	Bloquage Blocking	Fielding	Attack Attaque	%	C	T		
1	Zdunczyk, Stanislaw	00.00	—	100.00	33.33	50.00	46.66	2	0		
2	Skiba, Aleksander	00.00	—	100.00	—	100.00	66.66	0	0		
3	Szymczyk, Jerzy	09.09	80.00	87.50	73.32	95.71	67.60	2	3		
4	Skorek, Edward	18.75	50.00	65.00	44.00	40.00	74.36	22	6		
5	Jasiukiewicz, Zbigniew	—	—	—	00.00	—	100.00	1	0		
6	Siwek, Tadeusz	20.00	90.90	90.90	33.10	66.66	45.45	1	1		
7	Ambroziak, Zdzislaw	13.66	50.00	71.42	34.79	66.66	75.00	13	8		
8	Gosciniak, Stanislaw	00.00	100.00	100.00	50.00	66.66	50.00	1	0		
9	Paszkiwicz, Romuald	35.28	66.66	58.33	60.00	45.45	52.38	5	5		
10	Wagner, Hubert	27.27	86.20	100.00	21.42	100.00	100.00	2	1		
11	Rutkowski, Wojciech	00.00	—	100.00	22.22	50.00	60.00	0	0		
12	Zarzycki, Zbigniew	29.16	100.00	65.71	38.45	58.33	62.96	15	3		
								FC	15	25	
PAR EQUIPE BY TEAM											
TOTAL		19.45	85.21	82.46	43.80	64.72	67.96	60.59	79	52	
MEX											
1	Osuna, César	—	—	—	—	—	—	—	—	—	
2	Calva, Joel	—	—	100.00	66.66	00.00	55.55	0	0		
3	Loya, Jesús	00.00	100.00	100.00	100.00	100.00	75.00	0	0		
4	Sixtos, Eduardo	31.56	75.00	73.33	45.45	52.18	77.77	12	5		
5	González, Francisco	00.00	00.00	66.66	—	—	100.00	1	0		
6	Durán, Juan	00.00	66.66	100.00	50.00	80.00	100.00	1	0		
7	Aguirre, Carlos	31.56	88.46	88.88	50.00	60.61	61.52	8	3		
8	Reyna, Leopoldo	11.76	100.00	73.67	72.22	38.88	66.66	18	4		
9	Barrón, Carlos	10.52	50.00	70.98	35.29	62.50	48.00	10	4		
10	Barbet, Antonio	09.52	50.00	75.00	50.00	50.00	57.13	10	3		
11	Martell, Luis	15.38	93.22	66.66	56.25	65.51	68.75	7	1		
12	Jiménez, Eduardo	—	—	—	60.00	—	00.00	0	0		
								FC	13	12	
PAR EQUIPE BY TEAM											
TOTAL		15.89	86.41	76.22	51.06	50.92	61.38	56.98	80	32	
1e ARBITRE	1st REFEREE	Guerguil, Krastev	BUL	2e ARBITRE	2nd REFEREE	Yoshihara, Kazuo	JPN	MARQUEUR	SCOREKEEPER	Contreras, Ricardo	MEX

776

MATCH
GAME 8

DUREE DURATION 1:26.00

JPN		JPN-ADE 3-0 (15-6, 15-8, 15-13)									
	Service	Preparation	Reception	Bloquage Blocking	Fielding	Attack Attaque	%	C	T		
1	Ikeda, Naohiro	—	—	—	—	—	—	—	—	—	
2	Minami, Masayuki	20.00	50.00	62.50	66.36	50.00	53.14	3	1		
3	Nekoda, Katsutoshi	09.52	88.54	50.00	42.96	60.00	50.15	3	3		
4	Shiragami, Mamoru	00.00	00.00	75.00	—	100.00	43.75	0	0		
5	Koizumi, Isao	17.64	84.59	58.33	51.72	71.43	72.22	7	4		
6	Kimura, Kenji	04.35	62.50	78.56	68.41	71.87	58.88	18	2		
7	Mitsumori, Yasuaki	00.00	66.66	100.00	23.33	40.00	75.00	4	1		
8	Morita, Junjo	15.38	12.50	81.81	48.95	44.43	86.95	15	9		
9	Yokota, Tadayoshi	00.00	60.00	61.10	53.84	69.28	76.00	11	8		
10	Ohko, Seiji	14.18	—	69.21	42.09	45.00	65.00	3	6		
11	Sato, Tetsuo	—	—	—	—	—	—	—	—		
12	Shimaoka, Kenji	—	—	—	—	—	—	—	—		
								FC	12	11	
PAR EQUIPE BY TEAM											
TOTAL		09.63	84.99	71.73	50.81	61.17	75.36	58.95	76	45	
ADE											
1	Peter, Horst	75.00	100.00	91.66	41.66	33.33	50.00	6	2		
2	Tielscher, Eckhard	53.55	50.00	90.90	46.65	50.00	62.62	4	3		
3	Schneider, Siegfried	08.33	100.00	97.22	16.66	68.75	51.41	9	3		
4	Heine, Manfred	00.00	100.00	75.00	16.66	100.00	44.44	2	0		
5	Tscharke, Rainer	—	—	—	—	—	—	—	—		
6	Pietzsch, Eckehard	25.00	96.22	88.20	27.27	50.00	60.00	5	1		
7	Schulz, Arnold	18.18	66.66	100.00	20.00	95.71	58.08	9	2		
8	Schumann, Rudi	00.00	—	100.00	66.66	100.00	50.00	2	1		
9	Kessel, Jürgen	40.00	87.27	81.81	35.28	61.52	25.00	2	5		
10	Toussaint, Walter	00.00	95.71	100.00	33.33	00.00	45.80	0	0		
11	Freiwald, Jürgen	44.44	100.00	81.81	12.50	50.00	47.35	4	1		
12	Webner, Wolfgang	25.00	100.00	92.86	28.57	90.00	72.72	12	2		
								FC	18	7	
PAR EQUIPE BY TEAM											
TOTAL		27.58	93.99	90.30	28.50	75.57	52.83	61.46	73	27	
1e ARBITRE	1st REFEREE	Buczynski, Ryszard	POL	2e ARBITRE	2nd REFEREE	Rincón, Arnoldo	MEX	MARQUEUR	SCOREKEEPER	Valdés, Octavio	MEX

MATCH
GAME 9

DUREE DURATION 0:55.00

BUL

BUL-BEL 3-0 (15-10, 15-1, 15-5)

	Service	Preparation	Reception	Bloquage Blocking	Fielding	Attack Attaque	%	C	T	
1	Trenev, Alexandre	—	—	—	—	—	—	0	0	
2	Zlatanov, Dimitar	00.00	00.00	75.00	83.33	00.00	37.49	5	0	
3	Prinov, Gramen	50.00	00.00	—	—	—	16.66	0	0	
4	Kratchmarov, Petar	41.16	77.77	80.00	55.00	80.00	66.66	8	4	
5	Alexandrov, Alexandre	00.00	33.33	55.55	62.50	44.00	81.81	46.27	4	
6	Simeonov, Zdravko	45.45	50.00	90.00	50.00	95.71	58.33	64.91	5	
7	Milev, Milio	20.00	00.00	100.00	50.00	00.00	16.66	31.02	1	
8	Karov, Dimitar	37.50	85.71	100.00	60.00	55.55	42.86	63.60	2	
9	Slavov, Kiril	43.75	66.66	70.00	73.32	75.00	61.52	65.10	4	
10	Atanassov, Dinio	35.70	00.00	100.00	25.00	33.33	76.44	45.07	7	
11	Koritarov, Anguel	—	—	—	—	—	—	—	—	
12	Stoyanov, Stoian	33.33	00.00	100.00	33.33	50.00	100.00	52.77	2	
									FC 10	
PAR EQUIPE	BY TEAM									
TOTAL		36.87	79.07	88.82	59.86	53.65	67.84	62.68	50	45

BEL

	Service	Preparation	Reception	Bloquage Blocking	Fielding	Attack Attaque	%	C	T	
1	Mol, Jozef	—	—	—	—	—	—	—	—	
2	Mesdagh, Paul	00.00	00.00	100.00	50.00	50.00	100.00	50.00	2	
3	Valder, Fernand	50.00	00.00	50.00	00.00	25.00	—	25.00	0	
4	Bossaerts, Willem	25.00	64.70	50.00	42.82	77.77	65.00	54.22	7	
5	Vaillant, Bernard	—	—	—	—	—	—	—	—	
6	Maes, Roger	45.45	52.27	50.00	33.33	66.66	45.17	48.81	8	
7	Vandewal, Ronald	60.00	00.00	71.41	26.00	41.66	40.89	38.43	4	
8	Huybrechts, Hugo	57.14	75.00	87.50	15.00	50.00	34.81	52.24	4	
9	Vandergoten, Roger	00.00	00.00	100.00	00.00	00.00	—	20.00	0	
10	Saelens, Benno	—	—	—	—	—	—	—	—	
11	Poosen, Berto	60.00	33.33	56.00	27.27	80.00	81.81	56.40	11	
12	Dierckx, Leo	40.00	28.57	80.00	15.38	50.00	45.45	43.23	3	
									FC 11	
PAR EQUIPE	BY TEAM									
TOTAL		49.72	72.60	78.78	24.23	50.75	49.92	—	50	16

1e ARBITRE 1st REFEREE Iroshi, Kuwahara JPN 2e ARBITRE 2nd REFEREE Ignacio, Catalino EJA MARQUEUR SCOREKEEPER Sujo, Antonio MEX

MATCH
GAME 10

DUREE DURATION 1:39.00

URS

URS-BRA 3-1 (11-15, 15-2, 15-9, 15.9)

	Service	Preparation	Reception	Bloquage Blocking	Fielding	Attaque Attack	%	C	T	
1	Sibiryakov, Eduard	11.10	—	100.00	20.00	50.00	88.46	53.91	13	
2	Kravchenko, Valery	14.28	—	92.84	72.72	26.64	72.00	55.69	11	
3	Belyaev, Vladimir	41.66	66.66	92.45	46.65	46.15	86.66	63.45	16	
4	Lapinsky, Evgeny	35.00	80.00	89.65	40.00	46.15	59.23	58.33	12	
5	Antropov, Oleg	33.33	—	100.00	12.50	46.65	36.36	45.76	1	
6	Matushevas, Vasilijus	00.00	100.00	50.00	33.33	00.00	75.00	43.05	3	
7	Mikhalchuk, Victor	50.00	66.66	100.00	55.55	100.00	33.33	67.59	2	
8	Poyarkov, Yuri	29.99	89.55	—	42.09	68.41	100.00	66.66	5	
9	Tereshuk, Boris	00.00	100.00	100.00	50.00	00.00	40.00	48.33	2	
10	Ivanov, Vladimir	—	—	—	—	—	—	—	—	
11	Bugaenkov, Ivan	37.50	100.00	91.29	47.62	47.35	87.50	68.54	16	
12	Mondzolevsky, Georgy	35.28	93.61	71.42	52.38	47.04	66.66	61.06	1	
									FC 16	
PAR EQUIPE	BY TEAM									
TOTAL		28.70	90.68	86:37	44.37	46.58	82.17	62.34	97	56

BRA

	Service	Preparation	Reception	Bloquage Blocking	Fielding	Attack Attaque	%	C	T	
1	De Souza, Jorge	10.00	33.33	75.00	50.00	60.00	66.66	49.16	2	
2	Pinheiro, Sergio	—	—	—	—	—	50.00	50.00	1	
3	Jens, Joao	15.38	70.00	100.00	25.00	28.57	47.04	47.66	4	
4	Schuc, Gerson	25.00	66.66	75.00	33.33	55.55	55.55	51.84	3	
5	Da Costa, José	—	—	100.00	—	33.33	66.66	66.66	0	
6	Volpi, Marco	11.76	100.00	82.32	52.38	46.14	42.86	55.91	7	
7	Dunlop, Mario	12.25	100.00	90.00	47.04	33.33	72.72	59.22	6	
8	Moreno, Antonio	09.52	95.71	93.75	30.44	26.30	70.83	70.04	17	
9	De Azevedo, Decio	15.38	83.79	100.00	40.89	70.00	47.62	59.61	9	
10	Borges, Victor	—	88.88	80.00	05.88	75.00	74.21	64.79	15	
11	Feitosa, Carlos	—	—	—	—	—	—	—	—	
12	Peterle, Paulo	—	33.33	92.30	32.34	47.35	68.56	54.77	15	
									FC 17	
PAR EQUIPE	BY TEAM									
TOTAL		08.80	81.12	87.75	31.19	46.32	59.80	54.98	96	35

1e ARBITRE 1st REFEREE Hernández, Adrián MEX 2e ARBITRE 2nd REFEREE Krol, Jerzy POL MARQUEUR SCOREKEEPER Cruz, César MEX

MATCH 11 OCT 17

DUREE DURATION 1:03.00

ADE									ADE-MEX 3-0 (15-3, 15-15, 15-6)		
	Service	Preparation	Reception	Bloquage Blocking	Fielding	Attaque Attack	%	C	T		
1	Peter, Horst	41.16	100.00	100.00	61.10	75.00	86.36	78.10	5	3	
2	Tielscher, Eckhard	—	—	—	—	—	—	—	—	—	
3	Schneider, Siegfried	20.00	100.00	95.84	70.00	60.00	78.94	70.79	4	2	
4	Heine, Manfred	—	—	—	—	—	—	—	—	—	
5	Tscharke, Rainer	—	—	—	—	—	—	—	—	—	
6	Pietzsch, Eckehard	00.00	97.14	100.00	50.00	75.00	63.63	64.29	4	4	
7	Schulz, Arnold	37.50	75.00	91.66	61.10	69.21	85.17	69.94	11	8	
8	Schumann, Rudi	—	—	—	—	—	—	—	—	—	
9	Kessel, Jürgen	00.00	—	50.00	00.00	—	00.00	12.50	0	0	
10	Toussaint, Walter	25.00	93.55	77.77	61.52	40.00	82.32	63.36	9	2	
11	Freiwald, Jürgen	22.22	100.00	100.00	60.00	66.66	80.00	71.48	7	7	
12	Webner, Wolfgang	—	—	—	—	—	—	—	—	—	
PAR EQUIPE BY TEAM									FC 7	10	
TOTAL		23.41	94.38	94.59	58.37	61.90	80.60	68.87	47	45	
MEX											
1	Osuna, César	—	—	50.00	00.00	—	00.00	16.66	0	0	
2	Calva, Joel	00.00	80.77	66.66	57.14	39.13	60.00	50.61	3	0	
3	Loya, Jesús	—	—	—	—	—	—	—	—	—	
4	Sixtos, Eduardo	25.00	63.63	89.47	31.25	48.44	54.16	51.99	9	1	
5	González, Francisco	25.00	78.56	100.00	14.48	58.33	00.00	46.02	0	1	
6	Durán, Juan	—	—	100.00	00.00	00.00	00.00	25.00	1	0	
7	Aguirre, Carlos	00.00	80.94	100.00	00.00	40.00	00.00	36.82	0	0	
8	Réyna, Leopoldo	00.00	33.33	78.56	17.40	23.52	33.33	31.02	5	1	
9	Barrón, Carlos	00.00	50.00	72.22	37.50	48.00	47.35	42.51	4	2	
10	Barbet, Antonio	40.00	33.33	77.26	25.00	45.46	66.66	47.95	6	2	
11	Martell, Luis	11.00	72.41	66.66	00.00	57.69	56.25	44.00	3	1	
12	Jiménez, Eduardo	00.00	—	100.00	14.28	50.00	62.50	37.79	3	2	
PAR EQUIPE BY TEAM									FC 9	4	
TOTAL		12.27	77.63	76.75	29.25	46.56	47.88	48.39	43	14	
1e ARBITRE	1st REFEREE	Rivero, Carlos	PER	2e ARBITRE	2nd REFEREE	Lenov, Boris	URS	MARQUEUR	SCOREKEEPER	Sujo, Antonio	MEX

778

MATCH 12

DUREE DURATION 1:11.00

POL									POL-BEL 3-0 (15-6, 15-5, 15-8)		
	Service	Preparation	Reception	Bloquage Blocking	Fielding	Attaque Attack	%	C	T		
1	Zdunczyk, Stanislaw	36.36	—	80.00	54.54	50.00	81.81	60.54	6	4	
2	Skiba, Aleksander	14.28	100.00	100.00	100.00	100.00	60.00	79.04	1	2	
3	Szymczyk, Jerzy	60.00	100.00	60.00	57.14	100.00	50.00	71.19	3	1	
4	Skorek, Edward	44.44	100.00	100.00	44.44	100.00	64.68	75.59	7	4	
5	Jasiukiewicz, Zbigniew	25.00	100.00	78.56	60.00	100.00	90.90	75.74	8	1	
6	Siwek, Tadeusz	22.22	87.50	100.00	33.33	20.00	25.00	48.00	2	1	
7	Ambroziak, Zdzislaw	27.27	100.00	80.00	50.00	66.66	61.52	64.24	7	1	
8	Gosciniak, Stanislaw	00.00	66.66	—	75.00	—	—	47.22	0	2	
9	Paszkiwicz, Romuald	00.00	—	86.64	62.50	00.00	85.71	39.14	8	5	
10	Wagner, Hubert	05.00	95.23	90.00	62.62	50.00	63.63	61.08	4	3	
11	Rutkowski, Wojciech	00.00	—	88.88	50.00	100.00	70.00	61.77	4	0	
12	Zarzycki, Zbigniew	09.09	50.00	75.00	52.98	77.77	75.00	56.64	6	3	
PAR EQUIPE BY TEAM									FC 15	18	
TOTAL		20.86	92.40	90.24	54.06	68.23	70.33	66.01	71	45	
BEL											
1	Mol, Jozef	—	—	—	—	—	—	—	—	—	
2	Mesdagh, Paul	50.00	100.00	100.00	00.00	00.00	50.00	50.00	1	0	
3	Walder, Fernand	00.00	75.00	100.00	00.00	66.66	—	48.33	0	0	
4	Bossaerts, Willem	00.00	81.48	100.00	38.45	33.33	63.14	52.73	9	0	
5	Vaillant, Bernard	—	—	—	—	—	—	—	—	—	
6	Maes, Roger	00.00	86.00	73.32	47.35	48.55	77.20	55.40	11	0	
7	Vandewal, Ronald	28.57	100.00	66.66	36.82	44.00	37.50	52.25	3	1	
8	Huybrechts, Hugo	14.28	54.54	85.17	42.86	31.25	50.00	46.35	11	4	
9	Vandergoten, Roger	14.28	33.33	83.33	63.63	60.00	100.00	59.09	3	0	
10	Saelens, Benno	00.00	—	—	—	—	00.00	00.00	0	0	
11	Poosen, Berto	08.33	75.00	68.00	36.82	29.63	65.00	47.13	7	0	
12	Dierckx, Leo	14.28	100.00	72.72	43.27	58.80	61.91	59.33	5	2	
PAR EQUIPE BY TEAM									FC 21	12	
TOTAL		12.41	79.27	75.99	46.02	41.71	60.40	51.08	71	19	
1e ARBITRE	1st REFEREE	Ignacio, Catalino	EUA	2e ARBITRE	2nd REFEREE	Iroshi, Kuwahara	JPN	MARQUEUR	SCOREKEEPER	Cruz, César	MEX

MATCH
GAME 13

DUREE DURATION 2:19.00

CHE		CHE-JPN 3-2 (2-15, 3-15, 15-12, 15-12, 15-11)									
		Service	Preparation	Reception	Bloquage Blocking	Fielding	Attaque Attack	%	C	T	
1	Prochazka, Antonin	30.00	83.72	96.55	47.50	78.94	66.00	67.11	6	1	
2	Svoboda, Jiri	05.26	89.75	94.11	57.14	57.15	71.80	62.53	13	7	
3	Zajicek, Lubomir	—	—	—	—	—	—	—	—	—	
4	Musil, Josef	33.33	100.00	91.66	50.00	80.00	00.00	59.16	0	0	
5	Smolka, Josef	50.00	100.00	100.00	—	100.00	—	87.50	0	0	
6	Petlak, Vladimir	28.57	00.00	93.75	56.41	73.67	57.57	51.66	22	8	
7	Kop, Petr	66.66	100.00	87.50	85.00	20.00	50.00	59.86	1	1	
8	Sokol, Frantisek	—	—	—	00.00	—	—	25.00	0	0	
9	Golian, Bohumil	20.00	86.15	100.00	61.30	40.00	52.98	60.07	7	5	
10	Grossl, Zdenek	33.33	—	93.18	72.00	50.00	57.89	61.28	20	7	
11	Schenk, Pavel	50.00	100.00	100.00	43.75	100.00	50.00	73.95	6	1	
12	Koudelka, Drahomir	14.28	77.77	100.00	54.16	50.00	61.30	59.58	14	5	
PAR EQUIPE BY TEAM									FC 26	15	
TOTAL		18.57	87.64	94.84	46.10	64.18	56.34	60.59	115	50	
JPN											
1	Ikeda, Naohiro	—	—	—	—	—	—	—	—	—	
2	Minami, Masayuki	00.00	66.66	75.00	28.56	55.55	68.75	49.08	7	2	
3	Nekoda, Katsutoshi	03.57	88.40	—	46.43	64.44	60.00	57.69	2	2	
4	Shiragami, Mamoru	—	100.00	77.77	00.00	41.66	50.00	53.89	1	0	
5	Koizumi, Isao	00.00	81.25	84.59	39.13	43.90	72.96	51.97	11	1	
6	Kimura, Kenji	16.00	100.00	87.63	47.04	56.00	50.00	59.61	8	4	
7	Mitsumori, Yasuaki	00.00	—	66.66	33.33	44.44	70.00	42.89	6	0	
8	Morita, Jungo	06.90	81.25	88.09	55.88	44.44	64.58	56.86	19	7	
9	Yokota, Tadayoshi	13.39	100.00	84.59	56.62	81.39	56.86	63.87	16	7	
10	Ohko, Seiji	05.88	100.00	75.00	53.57	50.00	56.52	56.83	14	13	
11	Sato, Tetsuo	—	—	—	—	—	—	—	—	—	
12	Shimaoka, Kenji	—	—	50.00	—	—	—	50.00	0	0	
PAR EQUIPE BY TEAM									FC 18	29	
TOTAL		08.06	91.84	84.99	48.16	55.91	60.77	60.52	102	65	
1e ARBITRE	1st REFEREE	Davies, Glen	EUA	2e ARBITRE	2nd REFEREE	Lange, Peter	ADE	MARQUEUR	SCOREKEEPER	Bermejo, Pedro	MEX

MATCH
GAME 14

DUREE DURATION 1:20.00

779

URS		URS-BUL 3-0 (15-10, 15-9, 15-10)									
		Service	Preparation	Reception	Bloquage Blocking	Fielding	Attaque Attack	%	C	T	
1	Sibiryakov, Eduard	12.50	100.00	95.00	57.15	63.63	79.42	67.95	15	5	
2	Kravchenko, Valery	31.25	—	100.00	42.30	70.00	62.50	61.21	16	7	
3	Belyaev, Vladimir	40.00	100.00	100.00	66.66	66.66	100.00	78.88	2	0	
4	Lapinsky, Evgeny	30.00	50.00	100.00	68.00	52.98	61.53	60.41	15	3	
5	Antropov, Oleg	—	—	—	100.00	—	50.00	75.00	0	0	
6	Matushevas, Vasilijus	—	—	—	—	—	—	—	—	—	
7	Mikhalchuk, Victor	—	—	—	—	—	—	—	—	—	
8	Poyarkov, Yuri	39.13	79.62	100.00	46.15	69.21	60.00	65.68	5	8	
9	Tereshuk, Boris	—	—	50.00	—	—	50.00	50.00	1	0	
10	Ivanov, Vladimir	—	—	—	—	—	—	—	0	0	
11	Bugaenkov, Ivan	40.00	88.88	95.46	37.50	73.32	73.54	68.11	15	8	
12	Mondzolevsky, Georgy	16.65	92.53	100.00	42.84	55.55	100.00	67.92	2	2	
PAR EQUIPE BY TEAM									FC 14	12	
TOTAL		28.07	81.63	96.07	44.41	63.49	65.32	63.24	85	45	
BUL											
1	Trenev, Alexandre	—	—	70.76	—	—	—	—	—	—	
2	Zlatanov, Dimitar	22.22	00.00	—	00.00	00.00	45.45	23.07	4	2	
3	Prinov, Gramen	100.00	00.00	100.00	—	100.00	—	75.00	0	0	
4	Kratchmarov, Petar	47.35	74.60	90.90	50.00	34.48	73.67	61.83	9	3	
5	Alexandrov, Alexandre	43.75	33.33	75.00	47.04	23.81	100.00	53.82	10	5	
6	Simeonov, Zdravko	43.75	50.00	82.32	16.15	77.77	72.72	57.20	5	1	
7	Milev, Milio	—	—	—	—	—	—	—	—	—	
8	Karov, Dimitar	33.00	59.25	62.50	56.25	52.38	66.66	55.00	5	2	
9	Slavov, Kiril	42.86	00.00	81.25	50.00	33.10	66.66	45.64	9	2	
10	Atanassov, Dinio	33.33	00.00	85.71	28.57	45.83	64.00	42.90	13	3	
11	Koritarov, Anguel	—	—	—	—	—	—	—	—	—	
12	Stoyanov, Stoian	40.00	00.00	70.00	00.00	50.00	100.00	43.33	2	1	
PAR EQUIPE BY TEAM									FC 27	10	
TOTAL		39.44	65.38	59.25	35.52	40.83	65.65	51.01	84	29	
1e ARBITRE	1st REFEREE	Van Welden, Lucien	BEL	2e ARBITRE	2nd REFEREE	Yoshihara, Kazuo	JPN	MARQUEUR	SCOREKEEPER	Valdés, Octavio	MEX

MATCH
GAME 15

DUREE DURATION 0:50.00

EUA									EUA-BRA 3-0 (15-12, 15-7, 15-10)	
	Service	Preparation	Reception	Bloquage Blocking	Fielding	Attaque Attack	%	C	T	
1	Patterson, Daniel	—	—	—	—	—	—	0	0	
2	Velasco, Pedro	16.16	78.25	100.00	69.21	100.00	67.35	2	1	
3	Henn, John	46.65	84.20	66.66	71.42	50.00	61.48	2	5	
4	May, Robert	—	—	—	—	—	—	—	—	
5	Rundle, Larry	—	—	—	—	—	—	—	—	
6	Bright, David	35.70	80.00	100.00	78.56	60.00	69.21	4	5	
7	Duke, Smitty	57.14	73.67	91.66	80.00	77.77	47.04	3	2	
8	Alstrom, John	33.33	100.00	90.00	61.10	50.00	90.90	4	7	
9	Stanley, Jon	—	—	100.00	95.71	57.14	60.00	1	1	
10	Haine, Thomas	—	—	—	—	—	—	—	—	
11	Suvara, Rudy	18.18	71.42	80.00	57.15	77.77	59.61	6	4	
12	Davenport, Wink	—	—	—	—	—	—	—	—	
								FC	9	
PAR EQUIPE BY TEAM										
TOTAL		33.76	78.07	89.81	64.97	68.64	62.37	66.82	31	45
BRA										
1	De Souza, Jorge	50.00	00.00	20.00	00.00	33.33	00.00	17.22	0	0
2	Pinheiro, Sergio	00.00	33.33	66.66	100.00	100.00	42.86	57.14	2	1
3	Jens, Joao	66.66	50.00	50.00	44.44	80.00	16.66	59.51	1	2
4	Schuc, Gerson	60.00	47.62	100.00	45.45	41.16	64.28	59.75	0	8
5	Da Costa, Jose	50.00	50.00	62.50	40.00	20.00	50.00	45.41	0	1
6	Volpi, Marco	50.00	00.00	60.00	00.00	50.00	25.00	30.84	0	0
7	Dunlop, Mario	00.00	50.00	70.00	37.50	37.50	44.44	39.90	2	1
8	Moreno, Antonio	55.55	00.00	100.00	50.00	71.42	45.45	53.73	1	3
9	De Azevedo, Decio	20.00	33.33	00.00	42.86	58.33	41.66	32.70	0	1
10	Borges, Victor	33.33	52.38	75.00	27.27	63.35	46.14	49.57	2	2
11	Feitosa, Carlos	—	—	—	—	—	—	—	—	—
12	Peterle, Paulo	40.00	50.00	69.21	22.22	63.63	46.14	48.53	4	1
								FC	16	
PAR EQUIPE BY TEAM										
TOTAL		41.06	49.31	64.29	45.58	69.61	43.96	50.65	28	29
1e	ARBITRE	1st REFEREE	Chiniilin, A. URS	2e	ARBITRE	2nd REFEREE	Park, Moo COR	MARQUEUR	SCOREKEEPER	Contreras, Ricardo MEX

780

MATCH
GAME 16

DUREE DURATION 0:55.00

JPN									JPN-MEX 3-0 (15-1, 15-3, 15-11)	
	Service	Preparation	Reception	Bloquage Blocking	Fielding	Attack Attaque	%	C	T	
1	Ikeda, Naohiro	—	—	—	—	—	—	—	—	
2	Minami, Masayuki	00.00	—	100.00	64.54	40.00	62.50	51.40	1	2
3	Nekoda, Katsutoshi	00.00	92.53	—	33.33	68.75	—	49.32	0	0
4	Shiragami, Mamoru	00.00	—	100.00	—	66.66	—	55.55	0	0
5	Koizumi, Isao	00.00	—	75.00	47.62	83.33	62.50	53.69	1	1
6	Kimura, Kenji	18.75	100.00	84.59	40.00	69.21	66.66	63.20	5	4
7	Mitsumori, Yasuaki	28.57	—	100.00	66.66	100.00	66.66	72.37	2	1
8	Morita, Jungo	00.00	100.00	90.90	47.83	58.80	50.00	57.92	10	3
9	Yokota, Tadayoshi	00.00	100.00	100.00	37.50	52.86	53.83	55.69	2	5
10	Ohko, Seiji	22.20	100.00	50.00	62.50	52.38	53.83	56.81	5	2
11	Sato, Tetsuo	—	—	—	—	—	—	—	—	—
12	Shimaoka, Kenji	—	100.00	100.00	50.00	50.00	100.00	80.00	1	1
								FC	11	
PAR EQUIPE BY TEAM										
TOTAL		09.75	96.04	83.10	42.59	58.94	74.42	60.81	41	45
MEX										
1	Osuna, César	—	—	—	00.00	—	—	00.00	—	—
2	Calva, Joel	—	00.00	50.00	00.00	100.00	00.00	30.00	0	1
3	Loya, Jesus	—	—	—	50.00	—	00.00	25.00	0	0
4	Sixtos, Eduardo	20.00	100.00	76.90	47.35	00.00	47.07	48.55	6	5
5	González, Francisco	—	—	—	—	—	—	—	—	—
6	Durán, Juan	20.00	80.00	75.00	25.00	66.66	50.00	52.77	1	1
7	Aguirre, Carlos	25.00	60.00	100.00	33.33	00.00	22.22	40.09	1	0
8	Reyna, Leopoldo	10.00	—	68.75	12.50	37.50	73.32	40.41	8	0
9	Barrón, Carlos	00.00	100.00	50.00	44.44	42.86	55.55	48.80	4	1
10	Barbet, Antonio	00.00	50.00	63.16	25.00	66.66	33.33	39.69	6	0
11	Martell, Luis	11.11	74.07	66.66	12.50	50.00	46.14	43.41	2	1
12	Jiménez, Eduardo	12.50	100.00	71.42	53.31	00.00	54.54	48.62	3	2
								FC	13	
PAR EQUIPE BY TEAM										
TOTAL		12.45	75.16	74.74	30.23	42.18	45.72	46.74	44	15
1e	ARBITRE	1st REFEREE	Oldrich, Slavicek CHE	2e	ARBITRE	2nd REFEREE	Rivero, Carlos PER	MARQUEUR	SCOREKEEPER	Avila, Salvador MEX

MATCH GAME 17 OCT 19

DUREE DURATION 1:27.00

URS

URS-POL 3-0 (15-9, 15-10, 15-10)

	Service	Preparation	Reception	Bloquage Blocking	Fielding	Attaque Attack	%	C	T	
1	Sibiryakov, Eduard	15.38	66.66	78.56	35.49	55.55	59.69	51.88	17	3
2	Kravchenko, Valery	10.00	—	80.00	45.23	62.96	64.53	52.54	15	3
3	Belyaev, Vladimir	00.00	—	100.00	33.33	66.66	—	49.99	0	0
4	Lapinsky, Evgeny	18.75	100.00	93.75	43.75	62.50	71.43	65.03	11	6
5	Antropov, Oleg	—	—	—	—	—	—	—	—	—
6	Matushevas, Vasilius	—	—	—	—	—	—	—	—	—
7	Mikhalchuk, Victor	00.00	88.23	80.00	42.84	66.66	50.00	54.62	3	2
8	Poyarkov, Yuri	12.50	94.91	80.00	39.99	75.00	90.00	65.40	3	3
9	Tereshuk, Boris	00.00	—	100.00	—	00.00	—	33.33	1	0
10	Ivanov, Vladimir	100.00	100.00	85.71	46.14	50.00	88.88	61.78	2	4
11	Bugaenkov, Ivan	5.55	—	86.95	54.54	53.57	61.70	52.45	18	8
12	Mondzolevsky, Georgy	26.64	90.32	100.00	28.57	53.31	—	59.76	0	3
									FC 13	13
PAR EQUIPE BY TEAM										
TOTAL	11.43	91.25	88.56	42.12	56.88	71.15	60.23	83	45	

POL

1	Zdunczyk, Stanislaw	20.00	60.00	100.00	30.00	60.00	50.00	53.33	9	3
2	Skiba, Aleksander	00.00	—	100.00	—	—	00.00	33.33	0	0
3	Szymczyk, Jerzy	16.66	90.32	83.33	40.89	50.00	75.00	59.38	4	1
4	Skorek, Edward	10.00	—	86.66	53.84	55.55	65.90	54.39	25	3
5	Jasiukiewicz, Zbigniew	—	—	—	—	—	—	—	—	—
6	Siwek, Tadeusz	11.76	90.56	87.50	31.56	46.65	58.33	54.39	4	2
7	Ambroziak, Zdzislaw	15.38	50.00	64.00	40.00	20.00	57.45	41.08	6	1
8	Gosciniak, Stanislaw	—	—	50.00	50.00	00.00	—	33.33	1	1
9	Paszkiwicz, Romuald	00.00	00.00	75.00	33.33	40.00	40.00	31.38	6	2
10	Wagner, Hubert	00.00	52.36	50.00	33.33	80.00	33.33	46.50	1	0
11	Rutkowski, Wojciech	00.00	100.00	87.50	30.00	50.00	60.00	54.58	7	1
12	Zarzycki, Zbigniew	22.22	100.00	50.00	53.57	22.22	52.38	50.06	6	3
									FC 13	12
PAR EQUIPE BY TEAM										
TOTAL	10.60	86.19	79.44	42.21	42.23	56.90	52.93	82	29	

1e ARBITRE 1st REFEREE Yoshihara, Kazuo JPN 2e ARBITRE 2nd REFEREE Flores, Enrique MEX MARQUEUR SCOREKEEPER Avila, Salvador MEX

MATCH GAME 18

DUREE DURATION 0:53.00

ADE

ADE-BEL 3-0 (15-1, 15-7, 15-7)

	Service	Preparation	Reception	Bloquage Blocking	Fielding	Attaque Attack	%	C	T	
1	Peter, Horst	00.00	00.00	100.00	50.00	75.00	33.33	43.05	0	0
2	Tielscher, Eckhard	00.00	—	75.00	61.25	50.00	60.00	49.30	0	0
3	Schneider, Siegfried	25.00	100.00	94.73	76.90	66.66	73.67	72.82	6	8
4	Heine, Manfred	—	—	—	—	—	—	—	—	—
5	Tscharke, Rainer	15.38	84.63	90.00	44.44	42.86	37.50	52.46	1	2
6	Pietzsch, Eckehard	—	—	—	—	—	—	—	—	—
7	Schulz, Arnold	28.57	100.00	100.00	83.33	60.00	87.50	76.56	2	6
8	Schumann, Rudi	—	—	—	50.00	—	—	50.00	0	0
9	Kessel, Jürgen	—	—	—	—	—	—	—	—	—
10	Toussaint, Walter	30.00	100.00	100.00	62.62	95.71	54.54	73.81	2	4
11	Freiwald, Jürgen	50.00	100.00	90.90	66.66	100.00	73.67	80.20	5	4
12	Webner, Wolfgang	26.64	100.00	100.00	52.98	77.77	77.77	72.58	12	5
									FC 12	16
PAR EQUIPE BY TEAM										
TOTAL	22.68	94.68	92.67	60.92	69.30	72.16	68.73	40	45	

BEL

1	Mol, Jozef	00.00	82.84	60.00	29.16	58.68	56.85	48.64	6	3
2	Mesdagh, Paul	00.00	88.88	78.56	26.09	52.18	28.18	45.65	5	1
3	Walder, Fernand	14.28	78.88	50.00	80.00	44.90	88.45	49.82	2	1
4	Bossaerts, Willem	—	—	—	—	—	—	—	—	—
5	Vaillant, Bernard	12.50	66.66	60.00	47.04	40.00	58.58	46.49	1	3
6	Maes, Roger	—	—	—	—	—	—	—	—	—
7	Vandewal, Ronald	—	—	—	—	—	—	—	—	—
8	Huybrechts, Hugo	—	—	—	—	—	—	—	—	—
9	Vandergoten, Roger	00.00	100.00	80.94	23.81	52.00	66.66	53.90	6	1
10	Saelens, Benno	00.00	87.50	59.90	70.83	65.00	36.88	83.68	8	0
11	Poosen, Berto	—	—	—	—	—	—	—	—	—
12	Dierckx, Leo	—	—	—	—	—	—	—	—	—
									FC 12	6
PAR EQUIPE BY TEAM										
TOTAL	07.25	82.45	—	29.95	50.12	46.38	41.34	40	15	

1e ARBITRE 1st REFEREE Freire, Sergio BRA 2e ARBITRE 2nd REFEREE Villalba, Alfonso MEX MARQUEUR SCOREKEEPER Delgado, Héctor MEX

MATCH
GAME 19

DUREE DURATION 1:49.00

BUL

BUL-EUA 3-2 (10-15, 17-15, 7-15, 15-7, 16-14)

	Service	Preparation	Reception	Bloquage Blocking	Fielding	Attaque Attack	%	C	T
1	Trenev, Alexandre	33.33	—	100.00	—	—	61.11	0	0
2	Zlatanov, Dimitar	33.33	100.00	83.32	75.00	61.10	70.91	16	2
3	Prinov, Gramen	00.00	—	33.33	—	66.66	33.33	0	0
4	Kratchmarov, Petar	46.15	86.41	70.00	40.00	43.90	56.92	4	3
5	Alexandrov, Alexandre	33.33	83.33	71.43	40.54	54.85	57.15	11	9
6	Simeonov, Zdravko	35.70	57.14	87.11	33.33	61.53	53.33	12	3
7	Milev, Milio	00.00	—	33.33	00.00	100.00	00.00	0	0
8	Karov, Dimitar	42.30	83.70	83.33	38.45	38.89	41.66	5	5
9	Slavov, Kiril	36.36	75.00	93.33	41.66	53.83	60.97	6	5
10	Atanassov, Dinio	25.00	50.00	60.00	31.25	54.27	—	10	3
11	Koritarov, Anguel	00.00	—	66.66	—	100.00	76.92	0	0
12	Stoyanov, Stoian	—	—	00.00	00.00	—	00.00	0	0
								FC 23	35

PAR EQUIPE BY TEAM
TOTAL

38.89	80.76	73.51	38.80	50.06	60.62	56.94	87	65
-------	-------	-------	-------	-------	-------	-------	----	----

EUA

1	Patterson, Daniel	—	—	100.00	—	—	100.00	0	0
2	Velasco, Pedro	—	80.00	—	44.44	66.66	100.00	3	5
3	Henn, John	47.03	82.42	100.00	50.00	80.65	56.00	8	4
4	May, Robert	—	—	—	—	—	—	—	—
5	Rundle, Larry	—	—	—	—	—	—	—	—
6	Bright, David	19.19	65.38	88.88	73.32	57.82	48.83	12	6
7	Duke, Smitty	23.81	57.14	100.00	44.44	75.00	50.00	8	5
8	Alstrom, Jon	37.50	50.00	85.70	57.58	81.25	35.56	3	4
9	Stanley, John	22.72	66.66	95.75	58.49	75.00	72.97	15	6
10	Haine, Thomas	—	100.00	100.00	50.00	100.00	60.00	1	1
11	Suvara, Rudy	45.46	78.12	95.65	55.36	75.00	59.61	21	9
12	Davenport, Wink	57.14	50.00	—	25.00	—	40.00	2	3
								FC 9	23

PAR EQUIPE BY TEAM
TOTAL

31.18	72.99	87.19	56.88	73.23	56.24	62.78	82	66
-------	-------	-------	-------	-------	-------	-------	----	----

1e ARBITRE 1st REFEREE Lange, Peter ADE 2e ARBITRE 2nd REFEREE Rincón, Arnoldo MEX MARQUEUR SCOREKEEPER Valdés, Octavio MEX

782

MATCH
GAME 20

DUREE DURATION 2:25.00

CHE

CHE-BRA 3-2 (15-12, 15-10, 13-15, 13-15, 15-9)

	Service	Preparation	Reception	Bloquage Blocking	Fielding	Attaque Attack	%	C	T	
1	Prochazka, Antonin	08.33	88.31	100.00	44.10	70.76	40.00	58.58	5	2
2	Svoboda, Jiri	30.75	75.00	100.00	23.07	68.75	54.54	58.53	2	1
3	Zajicek, Lubomir	—	—	—	—	—	—	—	—	—
4	Musil, Josef	12.50	83.33	100.00	28.57	91.66	33.33	58.23	1	0
5	Smolka, Josef	—	—	75.00	—	100.00	—	87.50	0	0
6	Petlak, Vladimir	14.70	83.33	100.00	55.10	75.75	55.55	64.07	14	7
7	Kop, Petr	—	—	—	—	—	—	—	—	—
8	Sokol, Frantisek	—	—	100.00	75.00	66.66	83.83	81.24	4	1
9	Golian, Bohumil	32.14	77.77	77.77	25.92	92.00	61.91	46.07	12	3
10	Groessl, Zdenek	10.00	100.00	92.10	56.25	80.94	64.15	67.24	13	6
11	Schenk, Pavel	08.00	83.33	100.00	66.66	85.00	68.75	68.62	17	9
12	Koudelka, Drahomir	09.68	88.63	95.12	59.32	76.93	55.17	64.14	22	11
								FC 35	31	

PAR EQUIPE BY TEAM
TOTAL

15.06	84.22	94.34	51.10	79.22	60.52	64.06	125	71
-------	-------	-------	-------	-------	-------	-------	-----	----

BRA

1	De Souza, Jorge	—	—	—	—	—	—	—	—	—
2	Pinheiro, Sergio	35.00	66.66	100.00	46.36	50.00	45.95	57.32	12	4
3	Jens, Joao	—	—	—	—	—	—	—	—	—
4	Schuc, Gerson	33.33	76.27	95.00	44.45	46.51	47.27	57.21	10	7
5	Da Costa, José	—	—	—	—	—	—	—	—	—
6	Volpi, Marco	33.33	00.00	83.33	33.33	00.00	58.33	34.72	3	1
7	Dunlop, Mario	33.33	00.00	55.55	16.66	44.44	53.31	33.88	5	2
8	Moreno, Antonio	30.76	00.00	68.12	31.42	73.33	57.69	43.63	13	7
9	De Azevedo, Decio	00.00	00.00	100.00	00.00	33.33	50.00	30.55	2	0
10	Borges, Victor	35.13	76.54	92.45	27.27	50.79	68.56	58.45	15	6
11	Feitosa, Carlos	47.22	79.26	86.20	28.00	64.15	48.72	58.92	14	2
12	Peterle, Paulo	20.82	60.00	81.47	27.78	69.76	55.31	52.52	23	3
								FC 26	29	

PAR EQUIPE BY TEAM
TOTAL

35.86	78.99	89.09	30.36	55.43	55.43	57.52	123	61
-------	-------	-------	-------	-------	-------	-------	-----	----

1e ARBITRE 1st REFEREE Flores, Enrique MEX 2e ARBITRE 2nd REFEREE Valenzuela, Rubén MEX MARQUEUR SCOREKEEPER Valdés, Octavio MEX

MATCH GAME 21 OCT 20

DUREE DURATION 0:52.00

JPN

JPN-BEL 3-0 (15-5, 15-5, 15-4)

	Service	Preparation	Reception	Bloquage Blocking	Fielding	Attaque Attack	%	C	T
1 Ikeda, Naohiro	—	—	—	—	—	—	—	—	—
2 Minami, Masayuki	—	100.00	71.82	44.44	75.00	84.59	75.09	0	2
3 Nekoda, Katsutoshi	20.00	98.60	100.00	63.63	64.28	33.33	63.30	1	2
4 Shiragami, Mamoru	00.00	100.00	50.00	50.00	—	100.00	60.00	0	0
5 Koizumi, Isao	50.00	100.00	80.00	53.83	100.00	80.00	77.30	1	1
6 Kimura, Kenji	00.00	—	100.00	—	—	—	50.00	2	2
7 Mitsumori, Yasuaki	33.33	66.66	100.00	50.00	100.00	66.66	69.44	6	2
8 Morita, Jungo	25.00	100.00	52.50	53.31	72.72	66.66	63.36	3	3
9 Yokota, Tadayoshi	36.82	66.66	90.90	50.00	85.70	77.77	67.97	4	6
10 Ohko, Seiji	18.18	100.00	60.00	61.52	64.68	66.66	61.84	10	7
11 Sato, Tetsuo	—	—	—	—	—	—	—	—	—
12 Shimaoka, Kenji	22.22	100.00	66.66	50.00	75.77	66.66	63.55	3	2
PAR EQUIPE BY TEAM								FC 7	10
TOTAL	26.58	95.98	70.65	51.51	71.92	73.27	64.98	37	45
BEL									
1 Mol, Jozef	11.00	69.99	88.88	23.52	58.33	30.00	46.95	2	2
2 Mesdagh, Paul	20.00	61.52	90.90	23.07	43.55	43.75	47.13	5	0
3 Walder, Fernand	12.50	64.68	50.00	22.22	33.10	54.54	39.50	1	0
4 Bossaerts, Willem	—	—	—	—	—	—	—	—	—
5 Vaillant, Bernard	12.50	—	100.00	14.28	54.54	50.00	46.26	1	0
6 Maes, Roger	—	—	—	—	—	—	—	—	—
7 Vandewal, Ronald	—	—	—	—	—	—	—	—	—
8 Huybrechts, Hugo	—	—	—	—	—	—	—	—	—
9 Vandergoten, Roger	00.00	100.00	87.50	38.88	53.83	45.00	54.20	2	3
10 Saelens, Benno	12.50	50.00	65.38	34.79	44.44	36.36	40.57	3	4
11 Poosen, Berto	—	—	—	—	—	—	—	—	—
12 Dierckx, Leo	—	—	—	—	—	—	—	—	—
PAR EQUIPE BY TEAM								FC 6	5
TOTAL	10.08	70.23	79.22	28.26	48.94	43.32	46.67	20	14
1e ARBITRE 1st REFEREE Park, Moo COR				2e ARBITRE 2nd REFEREE Dusan, Prielonzy CHE			MARQUEUR SCOREKEEPER Cruz, César MEX		

MATCH GAME 22

DUREE DURATION 1:10.00

783

CHE

CHE-MEX 3-0 (15-10, 15-8, 15-8)

	Service	Preparation	Reception	Bloquage Blocking	Fielding	Attaque Attack	%	C	T
1 Prochazka, Antonin	—	—	—	—	—	—	—	—	—
2 Svoboda, Jiri	37.03	86.64	83.33	66.66	77.77	14.28	60.95	1	6
3 Zajicek, Lubomir	00.00	86.49	100.00	65.21	80.00	100.00	71.95	3	4
4 Musil, Josef	8.33	94.08	92.84	47.35	46.00	55.55	56.35	2	0
5 Smolka, Josef	—	—	—	—	—	—	—	—	—
6 Petlak, Vladimir	00.00	100.00	94.08	60.00	78.56	77.26	68.31	7	3
7 Kop, Petr	00.00	100.00	100.00	60.00	—	60.00	64.00	1	1
8 Sokol, Frantisek	16.65	40.00	78.56	53.31	81.81	75.00	57.55	17	6
9 Golian, Bohumil	—	—	—	—	—	—	—	—	—
10 Groessl, Zdenek	00.00	—	100.00	25.00	66.66	50.00	48.33	4	0
11 Schenk, Pavel	—	—	—	—	—	—	—	—	—
12 Koudelka, Drahomar	11.76	100.00	100.00	68.56	66.66	57.15	67.35	8	6
PAR EQUIPE BY TEAM								FC 18	19
TOTAL	15.13	92.37	88.54	60.87	69.76	66.55	65.53	61	45
MEX									
1 Osuna, César	25.00	66.66	77.77	61.91	64.68	28.33	54.05	5	2
2 Calva, Joel	33.33	85.71	75.00	100.00	40.00	42.86	62.81	1	2
3 Loya, Jesús	25.00	00.00	100.00	20.00	25.00	57.14	37.85	3	0
4 Sixtos, Eduardo	30.75	100.00	85.17	50.00	65.38	37.50	61.46	5	3
5 González, Francisco	33.33	66.66	100.00	50.00	50.00	33.33	55.55	1	0
6 Durán, Juan	00.00	78.25	50.00	60.00	46.14	30.00	44.06	2	0
7 Aguirre, Carlos	00.00	84.21	00.00	80.00	54.54	57.14	45.98	3	1
8 Reyna, Leopoldo	00.00	66.66	63.63	53.31	50.00	47.04	46.77	4	1
9 Barrón, Carlos	15.30	50.00	82.32	64.00	44.43	83.33	56.56	9	3
10 Barbet, Antonio	00.00	40.00	—	57.14	42.86	42.86	36.75	3	1
11 Martíell, Luis	00.00	100.00	100.00	50.00	53.31	72.72	62.67	6	0
12 Jiménez, Eduardo	25.00	25.00	81.81	53.84	60.00	42.09	47.95	5	2
PAR EQUIPE BY TEAM								FC 13	6
TOTAL	14.29	79.06	80.33	54.29	52.63	47.65	54.70	60	21
1e ARBITRE 1st REFEREE Buczynski, Ryszard POL				2e ARBITRE 2nd REFEREE Rivero, Carlos PER			MARQUEUR SCOREKEEPER Contreras, Ricardo MEX		

**MATCH
GAME 23**

DUREE DURATION 2:34.00

URS		URS-ADE 3-2 (10-15, 15-9, 15-11, 12-15, 15-5)									
		Service	Preparation	Reception	Bloquage Blocking	Fielding	Attaque Attack	%	C	T	
1	Sibiryakov, Eduard	00.00	83.83	80.00	61.90	55.55	50.98	55.37	15	9	
2	Kravchenko, Valery	13.32	88.88	80.00	37.73	56.35	65.62	56.98	20	4	
3	Belyaev, Vladimir	16.66	100.00	80.00	52.38	63.33	44.44	59.46	12	3	
4	Lapinsky, Evgeny	13.63	50.00	74.54	60.00	55.88	70.98	54.17	17	4	
5	Antropov, Oleg	—	—	—	—	—	—	—	—	—	
6	Matushevas, Vasilijus	—	—	—	—	—	—	—	—	—	
7	Mikhailchuk, Victor	00.00	88.88	92.84	48.48	65.85	50.00	57.67	2	3	
8	Poyarkov, Yuri	25.00	89.61	41.66	56.89	57.89	42.86	53.31	5	5	
9	Tereshuk, Boris	00.00	—	50.00	—	50.00	—	33.33	0	0	
10	Ivanov, Vladimir	00.00	100.00	68.75	44.82	43.75	53.12	51.74	11	2	
11	Bugaenkov, Ivan	12.00	87.50	79.66	51.16	69.09	56.92	59.28	31	9	
12	Mondzolevsky, Georgy	33.33	84.84	50.00	57.14	62.62	00.00	47.98	0	0	
									FC 15	28	
PAR EQUIPE BY TEAM											
TOTAL		13.23	86.51	73.90	56.03	54.67	62.32	57.77	128	67	
ADE											
1	Peter, Horst	—	—	100.00	36.36	100.00	57.14	73.37	2	1	
2	Tielscher, Eckhard	—	—	—	00.00	—	100.00	50.00	0	0	
3	Schneider, Siegfried	06.25	83.33	90.19	39.02	45.00	60.00	53.96	23	5	
4	Heine, Manfred	—	—	—	—	—	—	—	0	0	
5	Tscharke, Rainer	11.00	64.35	87.50	22.20	46.14	38.45	49.94	5	2	
6	Pietzsch, Eckehard	16.16	92.00	100.00	25.00	28.57	40.00	50.37	0	2	
7	Schulz, Arnold	03.22	88.20	95.74	52.47	61.91	74.07	62.60	30	9	
8	Schumann, Rudi	00.00	—	50.00	—	00.00	00.00	12.50	0	0	
9	Kessel, Jürgen	25.00	93.33	100.00	45.45	60.00	33.33	59.51	1	1	
10	Toussaint, Walter	13.32	88.46	100.00	36.82	60.00	30.00	54.76	5	0	
11	Freiwald, Jürgen	17.86	95.61	88.56	47.72	64.28	66.17	63.36	16	9	
12	Webner, Wolfgang	07.50	75.00	90.47	45.45	90.90	65.45	62.45	16	4	
									FC 21	22	
PAR EQUIPE BY TEAM											
TOTAL		10.08	89.78	91.28	41.76	60.51	59.21	58.77	129	55	
1e ARBITRE	1st REFEREE	Valenzuela, Rubén	MEX	2e ARBITRE	2nd REFEREE	Krol, Jerzy	POL	MARQUEUR	SCOREKEEPER	González, Elías	MEX

784

**MATCH
GAME 24**

DUREE DURATION 1:24.00

BUL		BUL-BRA 3-0 (15-8, 18-16, 15-3)									
		Service	Preparation	Reception	Bloquage Blocking	Fielding	Attaque Attack	%	C	T	
1	Trenev, Alexandre	33.33	00.00	100.00	—	100.00	—	58.33	0	0	
2	Zlatanov, Dimitar	31.56	100.00	93.75	42.84	55.00	72.72	65.92	18	6	
3	Prinov, Gramen	33.33	00.00	—	—	100.00	—	44.44	0	0	
4	Kratshmarov, Petar	36.82	98.30	100.00	32.00	55.56	84.59	67.87	8	4	
5	Alexandrov, Alexandre	50.00	83.33	83.33	54.85	56.25	71.87	66.60	10	4	
6	Simeonov, Zdravko	50.00	80.00	64.28	40.00	72.72	66.66	62.27	7	4	
7	Milev, Milio	50.00	00.00	100.00	00.00	66.66	00.00	36.11	0	0	
8	Karov, Dimitar	50.00	87.27	95.71	46.65	67.76	80.00	71.23	8	2	
9	Slavov, Kiril	50.00	00.00	88.88	75.00	58.33	28.57	50.13	2	1	
10	Atanassov, Dinio	—	—	—	—	—	—	—	—	—	
11	Koritarov, Anguel	00.00	00.00	—	—	50.00	—	16.66	0	0	
12	Stoyanov, Stoian	22.22	50.00	100.00	25.00	57.15	81.25	59.93	6	4	
									FC 16	23	
PAR EQUIPE BY TEAM											
TOTAL		46.59	89.57	89.12	40.86	61.26	72.38	66.63	75	48	
BRA											
1	De Souza, Jorge	—	—	—	—	—	—	—	—	—	
2	Pinheiro, Sergio	16.65	75.00	100.00	38.72	83.32	51.29	60.83	11	2	
3	Jens, Joao	—	83.33	66.66	—	—	100.00	83.33	3	0	
4	Schuc, Gerson	12.50	72.34	100.00	62.17	44.43	48.00	56.57	4	3	
5	Da Costa, José	—	—	—	—	—	—	—	—	—	
6	Volpi, Marco	14.28	—	100.00	52.94	69.21	63.14	59.91	10	2	
7	Dunlop, Mario	—	—	—	—	—	—	—	—	—	
8	Moreno, Antonio	30.00	100.00	85.17	33.33	66.66	68.00	63.86	10	2	
9	De Azevedo, Decio	—	—	—	50.00	100.00	—	75.00	0	0	
10	Borges, Victor	—	78.43	100.00	30.75	45.00	37.93	58.42	6	6	
11	Feitosa, Carlos	10.00	88.56	95.71	36.36	62.50	47.35	56.74	5	1	
12	Peterle, Paulo	12.50	—	100	46.14	55.55	41.16	51.07	8	0	
									FC 12	11	
PAR EQUIPE BY TEAM											
TOTAL		11.03	74.97	92.28	42.20	60.74	49.50	55.11	69	27	
1e ARBITRE	1st REFEREE	Almanza, Jorge	MEX	2e ARBITRE	2nd REFEREE	Lenov, Boris	URS	MARQUEUR	SCOREKEEPER	Bermejo, Pedro	MEX

MATCH
GAME 25

DUREE DURATION 0:49.00

POL

POL-EUA 3-0 (15-5, 15-5, 15-8)

	Service	Preparation	Reception	Bloquage Blocking	Fielding	Attaque Attack	%	C	T
1 Zdunczyk, Stanislaw	00.00	100.00	—	33.33	100.00	100.00	66.66	0	0
2 Skiba, Alesander	—	—	—	—	—	—	—	—	—
3 Szymczyk, Jerzy	100.00	100.00	—	—	50.00	—	41.60	0	0
4 Skorek, Edward	62.50	100.00	66.66	55.55	50.00	81.25	69.32	10	9
5 Jasiukiewicz, Zbigniew	100.00	00.00	—	—	—	100.00	66.66	0	0
6 Siwek, Tadeusz	61.52	100.00	100.00	40.00	71.42	50.00	70.49	3	1
7 Ambroziak, Zdzislaw	38.45	100.00	64.28	77.77	66.66	80.94	56.35	7	5
8 Gosciniaik, Stanislaw	—	—	—	—	—	—	—	—	—
9 Paszkiewicz, Romuald	61.52	66.66	88.56	50.00	62.50	94.08	70.55	8	8
10 Wagner, Hubert	66.66	88.45	100.00	66.66	53.31	100.00	79.18	2	1
11 Rutkowski, Wojciech	—	—	—	—	—	—	—	—	—
12 Zarzycki, Zbigniew	50.00	100.00	—	40.00	25.00	66.66	56.33	5	3
PAR EQUIPE BY TEAM								FC 9	18
TOTAL	47.12	95.70	73.40	53.38	55.57	75.01	66.69	44	45
EUA									
1 Patterson, Daniel	—	100.00	100.00	—	—	—	100.00	1	0
2 Velasco, Pedro	18.18	85.71	100.00	11.11	50.00	61.52	54.22	4	2
3 Henn, John	50.00	71.42	—	44.44	66.66	83.33	63.17	3	2
4 May, Robert	—	33.33	66.66	50.00	66.66	25.00	48.33	0	0
5 Rundle, Larry	—	—	—	—	—	—	—	—	—
6 Bright, David	14.28	50.00	100.00	17.64	50.00	47.04	46.49	7	0
7 Duke, Smitty	14.28	57.14	87.50	57.14	71.42	37.50	54.16	3	2
8 Alstrom, John	100.00	100.00	87.50	25.00	100.00	30.00	73.75	3	1
9 Stanley, Jon	50.00	66.66	100.00	40.00	66.66	25.00	58.05	1	1
10 Haine, Thomas	42.86	100.00	100.00	33.33	—	40.00	63.23	1	1
11 Suwara, Rudy	42.86	50.00	76.90	25.00	22.22	60.00	46.16	4	1
12 Davenport, Wink	33.33	—	100.00	—	—	—	66.00	0	0
PAR EQUIPE BY TEAM								FC 11	8
TOTAL	32.85	68.51	90.45	28.87	46.89	46.27	52.30	38	18
1e ARBITRE 1st REFEREE Chinilin, A. URS				2e ARBITRE 2nd REFEREE Iroshi, Kuwahara JPN		MARQUEUR SCOREKEEPER Delgado, Héctor MEX			

MATCH
GAME 26 OCT 21

DUREE DURATION 2:16.00

785

BEL

BEL-MEX 3-2 (5-11, 5-15, 13-15, 18-16, 15-2)

	Service	Preparation	Reception	Bloquage Blocking	Fielding	Attaque Attack	%	C	T
1 Mol, Jozef	00.00	—	—	00.00	50.00	100.00	37.50	0	0
2 Mesdagh, Paul	—	—	—	—	—	—	—	1	0
3 Walder, Fernand	22.22	50.00	—	40.00	—	75.00	46.80	0	1
4 Bossaerts, Willem	57.15	93.42	100.00	52.08	64.11	62.84	71.60	17	1
5 Vaillant, Bernard	—	—	—	—	—	—	—	—	—
6 Maes, Roger	43.48	84.09	85.70	40.62	65.00	57.40	62.71	16	4
7 Vandewal, Ronald	54.54	66.66	57.69	56.52	60.00	62.50	59.68	3	4
8 Huybrechts, Hugo	46.66	82.32	78.72	47.82	56.25	60.37	62.02	17	9
9 Vandergoten, Roger	33.33	—	50.00	69.21	66.66	50.00	53.84	1	1
10 Saelens, Benno	33.33	—	83.33	33.33	28.57	66.66	49.04	1	0
11 Poosen, Berto	43.75	66.66	60.61	45.08	60.71	63.03	56.64	21	11
12 Dierckx, Leo	44.00	75.00	86.64	58.13	50.00	50.00	60.62	4	6
PAR EQUIPE BY TEAM								FC 28	29
TOTAL	45.60	82.96	70.92	50.60	66.51	62.79	63.23	109	66
MEX									
1 Osuna, César	00.00	100.00	83.33	55.55	63.63	42.84	57.55	4	2
2 Calva, Joel	—	—	—	—	—	—	—	—	—
3 Loya, Jesus	—	—	00.00	00.00	—	100.00	33.33	1	0
4 Sixtos, Eduardo	12.00	94.68	84.44	37.50	54.54	56.41	56.59	16	8
5 González, Francisco	—	100.00	50.00	—	100.00	—	83.33	0	0
6 Durán, Juan	—	—	60.00	—	—	—	60.00	0	0
7 Aguirre, Carlos	33.33	91.30	75.00	40.89	57.88	56.00	59.06	7	6
8 Reyna, Leopoldo	00.00	100.00	76.00	66.66	56.25	60.78	59.94	15	7
9 Barrón, Carlos	10.52	100.00	94.88	42.11	52.98	60.97	60.24	20	4
10 Barbet, Antonio	07.68	76.90	76.66	53.84	63.14	67.76	57.66	19	6
11 Martell, Luis	17.24	89.33	94.45	21.42	46.65	64.87	55.66	13	7
12 Jiménez, Eduardo	00.00	—	—	40.00	100.00	00.00	35.00	0	0
PAR EQUIPE BY TEAM								FC 14	19
TOTAL	09.14	91.44	82.64	44.66	56.20	48.12	47.47	109	59
1e ARBITRE 1st REFEREE Lenov, Boris URS				2e ARBITRE 2nd REFEREE Ignacio, Catalino EUA		MARQUEUR SCOREKEEPER Estrada, Odilón MEX			

MATCH
GAME 27

DUREE DURATION 2:04.00

URS								URS-JPN 3-1 (4-15, 15-13, 15-9, 15-13)			
	Service	Preparation	Reception	Bloquage Blocking	Fielding	Attaque Attack	%	C	T		
1	Sibiryakov, Eduard	00.00	—	66.66	37.83	71.42	65.70	48.32	18	3	
2	Kravchenko, Valery	05.00	100.00	91.99	50.00	47.62	72.09	61.11	17	6	
3	Belyaev, Vladimir	06.25	100.00	85.00	14.28	66.66	65.00	56.19	9	2	
4	Lapinsky, Evgeny	20.00	66.66	84.84	54.54	72.72	60.87	59.93	9	3	
5	Antropov, Oleg	—	—	—	—	—	—	—	—	—	
6	Matushevas, Vasilijus	—	—	—	—	—	—	—	—	—	
7	Mikhalchuk, Victor	00.00	100.00	00.00	66.66	66.66	00.00	38.88	1	1	
8	Poyarkov, Yuri	08.00	90.00	60.00	48.78	80.00	100.00	64.46	1	4	
9	Tereshuk, Boris	33.33	—	100.00	50.00	00.00	100.00	56.66	0	2	
10	Ivanov, Vladimir	05.88	75.00	66.66	53.84	62.50	62.84	54.45	12	4	
11	Bugaenkov, Ivan	15.00	88.88	86.20	50.00	53.83	72.34	61.04	23	11	
12	Mondzolevsky, Georgy	25.00	95.45	100.00	37.50	75.00	00.00	55.49	0	2	
								FC	18	11	
PAR EQUIPE	BY TEAM										
TOTAL		11.94	91.77	81.42	47.22	62.79	66.19	60.62	108	49	
JPN											
1	Ikeda, Naohiro	—	—	—	—	—	—	—	—	—	
2	Minami, Masayuki	50.00	100.00	87.50	46.14	55.55	62.50	66.94	2	5	
3	Nekoda, Katsutoshi	33.33	96.42	50.00	44.44	59.47	80.00	60.61	5	2	
4	Shiragami, Mamoru	00.00	—	50.00	00.00	00.00	—	12.50	0	0	
5	Koizumi, Isao	46.65	100.00	70.00	42.30	59.99	75.00	65.65	9	5	
6	Kimura, Kenji	43.43	100.00	75.00	37.95	63.41	68.75	64.76	16	6	
7	Mitsumori, Yasuaki	00.00	—	00.00	50.00	00.00	25.00	15.00	1	0	
8	Morita, Jungo	39.29	80.00	95.12	38.09	55.26	82.06	64.97	24	5	
9	Yokota, Tadayoshi	21.42	50.00	79.16	70.83	83.85	72.72	57.99	12	6	
10	Ohko, Seiji	42.09	100.00	69.99	31.03	50.00	70.45	60.59	15	7	
11	Sato, Tetsuo	—	—	—	—	—	—	—	0	0	
12	Shimaoka, Kenji	60.00	100.00	85.71	46.14	37.50	62.50	65.30	1	2	
								FC	22	12	
PAR EQUIPE	BY TEAM										
TOTAL		40.48	95.39	79.31	42.09	52.28	68.65	63.03	107	50	
1e ARBITRE	1st REFEREE	Van Welden, Lucien	BEL	2e ARBITRE	2nd REFEREE	Buczynski, Ryszard	POL	MARQUEUR	SCOREKEEPER	Contreras, Ricardo	MEX

786

MATCH
GAME 28

DUREE DURATION 1:47.00

CHE								CHE-BUL 3-2 (15-7, 10-15, 15-9, 4-15, 15-7)			
	Service	Preparation	Reception	Bloquage Blocking	Fielding	Attaque Attack	%	C	T		
1	Prochazka, Antonin	87.70	44.44	100.00	44.44	63.63	57.14	66.22	4	3	
2	Svoboda, Jiri	88.99	50.00	100.00	46.15	66.66	71.13	70.48	9	7	
3	Zajicek, Lubomir	—	—	—	—	—	—	—	—	—	
4	Musil, Josef	97.87	50.00	58.33	50.00	59.69	71.42	64.55	3	3	
5	Smolka, Josef	00.00	33.33	—	—	100.00	—	44.44	0	0	
6	Petlak, Vladimir	66.66	76.90	84.59	40.89	83.32	64.28	69.44	11	6	
7	Kop, Petr	90.90	62.50	100.00	28.57	83.33	57.14	70.40	4	3	
8	Sokol, Frantisek	00.00	12.50	83.33	14.28	50.00	50.00	35.01	6	6	
9	Golian, Bohumil	80.00	42.83	100.00	50.00	62.50	00.00	55.88	2	1	
10	Groessl, Zdenek	—	—	—	—	—	—	—	16	9	
11	Schenk, Pavel	—	—	—	—	—	—	—	—	—	
12	Koudelka, Drahomir	—	—	—	—	—	—	—	4	5	
								FC	15	16	
PAR EQUIPE	BY TEAM										
TOTAL		54.02	89.09	84.11	42.95	66.70	65.74	67.10	74	59	
BUL											
1	Trenev, Alexandre	50.00	100.00	100.00	—	75.00	—	81.25	0	0	
2	Zlatanov, Dimitar	28.56	00.00	60.00	72.78	75.00	56.30	48.77	18	8	
3	Prinov, Gramen	50.00	00.00	100.00	—	00.00	—	37.50	0	0	
4	Kratchmarov, Petar	17.64	71.87	100.00	48.49	86.95	46.75	61.95	5	3	
5	Alexandrov, Alexandre	22.22	80.00	75.00	74.47	100.00	53.27	67.49	7	10	
6	Simeonov, Zdravko	25.00	100.00	33.33	—	76.44	42.86	55.52	3	0	
7	Milev, Milio	—	—	—	—	—	—	—	—	—	
8	Karov, Dimitar	11.11	82.32	92.30	57.34	77.26	36.50	59.47	2	4	
9	Slavov, Kiril	30.30	100.00	90.00	62.14	90.00	43.15	69.21	6	1	
10	Atanassov, Dinio	33.33	00.00	90.00	71.70	72.22	31.36	49.76	11	10	
11	Koritarov, Anguel	00.00	100.00	100.00	—	100.00	—	75.00	0	0	
12	Stoyanov, Stoian	00.00	00.00	94.08	33.33	66.66	50.00	40.67	6	2	
								FC	15	15	
PAR EQUIPE	BY TEAM										
TOTAL		24.22	78.36	91.61	65.00	73.77	50.66	63.94	73	53	
1e ARBITRE	1st REFEREE	Iroshi, Kuwahara	JPN	2e ARBITRE	2nd REFEREE	Rivero, Carlos	MEX	MARQUEUR	SCOREKEEPER	Delgado, Héctor	MEX

MATCH
GAME 29

DUREE DURATION 1:43.00

ADE								ADE-EUA 0-3 (15-8, 15-12, 15-10)			
		Service	Preparation	Reception	Bloquage Blocking	Fielding	Attaque Attack	%	C	T	
1	Peter, Horst	—	—	—	—	—	—	—	—	—	
2	Tielscher, Eckhard	—	—	—	—	—	—	—	—	—	
3	Schneider, Siegfried	66.66	95.71	94.08	15.38	66.66	52.38	65.14	5	2	
4	Haine, Manfred	—	—	—	—	—	—	—	—	—	
5	Tscharke, Rainer	52.98	91.11	75.00	50.00	39.13	100.00	68.03	1	1	
6	Pietzsch, Eckehard	50.00	80.00	50.00	—	00.00	00.00	36.00	0	0	
7	Schulz, Arnold	44.43	95.71	100.00	42.86	50.00	12.50	57.58	10	5	
8	Schumann, Rudi	—	—	—	—	—	—	—	—	—	
9	Kessel, Jürgen	—	—	—	—	—	—	—	—	—	
10	Toussaint, Walter	35.70	97.56	66.66	13.32	55.00	62.50	55.12	3	3	
11	Freiwald, Jüürgen	62.50	50.00	78.56	46.35	56.25	88.09	63.62	19	9	
12	Webner, Wolfgang	—	—	—	—	—	—	—	8	1	
									FC	17	24
PAR EQUIPE BY TEAM											
TOTAL		57.25	90.74	80.35	31.60	45.54	73.87	63.22	63	45	
EUA											
1	Patterson, Daniel	—	100.00	100.00	60.00	50.00	—	77.50	0	0	
2	Velasco, Pedro	60.00	86.66	100.00	33.33	100.00	37.50	69.58	2	3	
3	Henn, John	50.00	100.00	100.00	—	60.00	—	77.50	1	0	
4	May, Robert	33.33	50.00	100.00	33.33	66.00	16.66	49.99	0	2	
5	Rundle, Larry	—	—	—	—	—	—	—	—	—	
6	Bright, David	25.00	86.64	92.30	40.00	44.44	50.00	56.39	14	3	
7	Duke, Smitty	44.43	61.36	100.00	50.00	50.09	46.14	58.67	5	4	
8	Alstrom, John	42.86	—	100.00	70.00	—	50.00	65.71	4	1	
9	Stanley, Jon	11.11	100.00	96.29	50.00	46.14	59.26	60.46	8	6	
10	Haine, Thomas	—	100.00	—	40.00	—	25.00	55.00	0	0	
11	Suwara, Rudy	29.40	45.45	89.47	60.87	53.31	30.44	51.49	14	2	
12	Davenport, Wink	—	—	100.00	—	50.00	66.66	72.22	2	0	
									FC	16	9
PAR EQUIPE BY TEAM											
TOTAL		35.27	75.35	94.94	50.42	53.56	51.30	60.14	66	30	
1e	ARBITRE	1st REFEREE	Dusan, Prielonzy CHE	2e	ARBITRE	2nd REFEREE	Freire, Sergio BRA	MARQUEUR	SCOREKEEPER	Valdés, Octavio MEX	

MATCH
GAME 30

DUREE DURATION 1:10.00

POL								POL-BRA 3-0 (15-12, 15-4, 15-7)			
		Service	Preparation	Reception	Bloquage Blocking	Fielding	Attaque Attack	%	C	T	
1	Zdunczyk, Stanislaw	—	—	100.00	—	—	—	100.00	1	0	
2	Skiba, Aleksander	50.00	—	100.00	—	—	—	75.00	0	0	
3	Szymczyk, Jerzy	42.86	71.42	100.00	33.33	66.66	71.42	64.28	3	1	
4	Skorek, Edward	25.00	50.00	100.00	50.00	69.21	79.99	62.36	13	8	
5	Jasiukiewicz, Zbigniew	50.00	—	80.00	50.50	62.50	78.25	64.15	11	6	
6	Siwek, Tadeusz	11.11	80.95	100.00	45.45	72.72	—	62.04	0	0	
7	Ambroziak, Zdzislaw	20.82	50.00	71.43	47.35	75.00	72.00	56.10	10	3	
8	Gosciiniak, Stanislaw	—	—	—	—	—	—	—	0	0	
9	Paszkiewicz, Romuald	25.00	50.00	80.00	54.16	55.55	79.31	57.33	11	5	
10	Wagner, Hubert	40.00	83.33	100.00	41.46	58.33	80.00	67.13	4	1	
11	Butkowski, Wojciech	—	—	—	—	—	—	—	7	5	
12	Zarzycki, Sbgigniew	—	50.00	100.00	36.36	28.57	64.14	55.81	7	1	
									FC	13	16
PAR EQUIPE BY TEAM											
TOTAL		32.58	75.76	64.40	47.45	64.00	74.07	59.70	73	45	
BRA											
1	De Souza, Jorge	—	—	—	—	—	—	—	—	—	
2	Pinheiro, Sergio	31.25	57.14	72.00	22.72	37.50	48.00	44.76	8	1	
3	Jens, Joao	—	—	—	—	—	—	—	—	—	
4	Schuc, Gerson	46.14	50.00	—	17.64	66.66	45.45	45.17	3	2	
5	Da Costa, José	00.00	00.00	66.66	—	00.00	33.33	19.19	—	—	
6	Volpi, Marco	30.00	00.00	77.77	45.46	26.64	63.63	40.58	10	2	
7	Dunlop, Mario	33.33	100.00	100.00	50.00	50.00	66.66	66.66	2	0	
8	Moreno, Antonio	66.66	00.00	100.00	40.00	75.00	66.66	58.05	2	0	
9	De Azevedo, Decio	50.00	53.31	71.42	23.07	61.52	18.18	46.25	2	3	
10	Borges, Victor	25.00	51.35	91.66	40.00	45.95	69.21	53.86	4	1	
11	Feitosa, Carlos	33.00	64.29	85.71	33.10	41.66	54.16	52.04	9	1	
12	Peterle, Paulo	37.50	100.00	54.54	42.09	73.67	63.14	63.49	7	1	
									FC	17	12
PAR EQUIPE BY TEAM											
TOTAL		28.36	50.55	71.83	32.07	46.02	49.43	46.37	64	23	
1e	Arbitre	2nd REFEREE	Yoshihara, Kazuo JPN	2e	ARBITRE	2nd REFEREE	Guerguil, Krastev BUL	MARQUEUR	SCOREKEEPER	Cruz, César MEX	

MATCH 31 OCT 23

DUREE DURATION 1:03.00

POL

POL-BUL 3-0 (15-3,15-5,15-10)

	Service	Preparation	Reception	Bloquage Blocking	Fielding	Attack Attaque	%	C	T	
1	Zdunczyk, Stanislaw	20.00	100.00	90.00	50.00	63.63	62.50	64.35	2	1
2	Skiba, Aleksander	—	—	—	—	—	—	—	—	—
3	Szymczyk, Jerzy	—	100.00	—	50.00	100.00	—	83.33	0	0
4	Skorek, Edward	20.00	—	92.84	71.42	71.42	71.87	65.51	17	7
5	Jasiukiewicz, Zbigniew	—	100.00	—	66.66	—	100.00	88.88	0	1
6	Siwiek, Tadeusz	00.00	85.30	100.00	42.84	53.57	50.00	55.28	3	1
7	Ambroziak, Zdzislaw	00.00	100.00	73.67	60.00	57.14	77.26	61.34	8	3
8	Gosciniak, Stanislaw	33.33	—	50.00	—	33.33	—	38.88	0	0
9	Paszkiewicz, Romuald	00.00	100.00	81.25	57.88	73.32	59.23	61.94	12	5
10	Wagner, Hubert	18.18	83.34	—	40.00	70.00	66.66	55.63	3	1
11	Rutkowski, Wojciech	—	—	—	—	—	—	—	—	—
12	Zarzycki, Zbigniew	00.00	100.00	100.00	58.33	50.00	50.00	59.72	2	1
									FC 10	25
PAR EQUIPE	BY TEAM									
TOTAL		08.02	87.61	82.45	57.28	61.30	68.94	60.93	57	45

BUL

1	Trenev, Alexandre	00.00	100.00	50.00	60.00	40.00	—	50.00	1	0	
2	Zlatanov, Dimitar	25.00	80.00	88.88	60.00	46.65	60.00	60.08	13	1	
3	Prinov, Gramen	33.33	00.00	—	—	100.00	—	44.44	0	0	
4	Kratchmarov, Petar	55.55	91.42	88.88	57.14	60.00	41.66	65.77	0	1	
5	Alexandrov, Alexandre	50.00	100.00	92.30	47.35	23.07	57.38	60.85	4	2	
6	Simeonov, Zdravko	33.33	00.00	50.00	40.00	44.44	70.00	39.62	5	0	
7	Milev, Milio	44.44	100.00	84.59	45.45	60.00	80.00	69.08	2	1	
8	Karov, Dimitar	46.14	98.18	—	20.00	45.00	60.00	53.86	5	0	
9	Slavov, Kiril	33.33	50.00	71.42	33.33	71.42	61.21	54.78	3	1	
10	Atanassov, Dinio	25.00	—	71.42	50.00	50.00	60.00	51.28	1	0	
11	Koritarov, Anguel	—	—	—	—	—	—	—	—	—	
12	Zarzycki, Zbigniew	57.14	25.00	89.47	00.00	42.86	30.00	40.74	8	1	
									FC 10	11	
PAR EQUIPE	BY TEAM										
TOTAL		41.88	85.02	78.72	48.13	49.30	59.36	60.40	56	18	
1e ARBITRE	1st REFEREE	Chinilin, A	URS	2e ARBITRE	2nd REFEREE	Freire, Sergio	BRA	MARQUEUR	SCOREKEEPER	Delgado, Héctor	MEX

788

MATCH 32

DUREE DURATION 1:14.00

JPN

JPN-EUA 3-0 (15-5, 15-8, 15-11)

	Service	Preparation	Reception	Bloquage Blocking	Fielding	Attack Attaque	%	C	T		
1	Ikeda, Naohiro	—	—	—	—	—	—	—	—	—	
2	Minami, Masayuki	12.50	80.00	66.66	28.56	66.66	66.66	53.50	4	1	
3	Nekoda, Katsutoshi	30.00	93.13	100.00	50.00	62.62	00.00	55.95	1	2	
4	Shiragami, Mamoru	00.00	100.00	100.00	—	—	—	60.00	0	0	
5	Koizumi, Isao	50.00	81.81	100.00	37.50	61.52	66.66	66.24	3	4	
6	Kimura, Kenji	28.56	100.00	85.70	33.33	60.61	66.60	62.46	10	3	
7	Mitsumori, Yasuaki	22.20	100.00	75.00	25.00	59.09	71.42	58.78	6	1	
8	Morita, Junjo	35.25	79.90	88.57	46.43	55.17	80.00	63.70	14	5	
9	Yokota, Tadayoshi	06.66	83.33	66.66	46.14	57.14	74.57	55.75	11	7	
10	Ohko, Seiji	40.00	100.00	83.33	60.00	33.33	64.00	63.44	4	2	
11	Sato, Tetsuo	—	—	—	—	—	—	—	0	0	
12	Shimaoka, Kenji	—	—	—	—	—	—	—	—	—	
									FC 14	20	
PAR EQUIPE	BY TEAM										
TOTAL		23.79	89.88	84.46	40.90	58.16	70.91	61.35	67	45	
EUA											
1	Patterson, Daniel	23.07	86.36	50.00	35.70	71.42	25.00	48.59	1	1	
2	Velasco, Pedro	00.00	72.00	25.00	37.50	40.00	50.00	37.53	1	0	
3	Henn, John	00.00	70.00	50.00	25.00	66.66	66.66	46.38	3	0	
4	May, Robert	00.00	75.00	80.00	50.00	50.00	75.00	55.00	4	4	
5	Rundle, Larry	00.00	100.00	81.81	00.00	50.00	66.66	49.74	2	0	
6	Bright, David	10.00	71.42	86.64	35.70	63.14	63.63	55.08	10	1	
7	Duke, Smitty	08.33	91.67	86.64	57.14	59.47	50.00	58.87	8	1	
8	Alstrom, John	00.00	100.00	81.81	50.00	61.52	47.04	56.72	4	0	
9	Stanley, Jon	20.00	100.00	75.00	46.15	30.00	61.91	55.51	6	4	
10	Haine, Thomas	00.00	100.00	—	—	00.00	50.00	37.50	1	0	
11	Suvara, Rudy	09.09	90.00	69.21	50.00	66.66	66.66	58.80	13	6	
12	Davenport, Wink	—	—	—	00.00	—	—	00.00	0	0	
									FC 8	7	
PAR EQUIPE	BY TEAM										
TOTAL		08.12	86.28	78.22	45.04	53.02	56.10	54.46	61	24	
1e ARBITRE	1st REFEREE	Oldrich, Slavicek	CHE	2e ARBITRE	2nd REFEREE	Lenov, Boris	URS	MARQUEUR	SCOREKEEPER	Sujo, Antonio	MEX

MATCH 33
GAME

DUREE DURATION 0:56.00

CHE								CHE-BEL 3-0 (15-0, 15-4, 15-12)			
	Service	Preparation	Reception	Bloquage Blocking	Fielding	Attaque Attack	%	C	T		
1	Prochazka, Antonin	00.00	90.47	75.00	72.72	45.45	50.00	55.60	3	2	
2	Svoboda, Jiri	7.14	83.83	100.00	66.66	93.33	100.00	75.16	3	1	
3	Zajicek, Lubomir	—	—	—	—	—	—	—	—	—	
4	Musil, Josef	14.28	92.30	100.00	75.00	69.21	20.00	61.79	1	0	
5	Smolka, Josef	00.00	100.00	78.56	50.00	82.32	71.80	63.78	—	—	
6	Petlak, Vladimir	13.32	81.81	80.00	71.42	81.25	50.00	62.96	8	8	
7	Kop, Petr	—	—	—	—	—	—	—	5	3	
8	Sokol, Frantisek	00.00	100.00	100.00	100.00	87.50	60.00	74.58	3	1	
9	Golian, Bohumil	21.42	89.99	80.00	52.98	61.10	62.50	61.33	2	4	
10	Groessl, Zdenek	12.50	100.00	100.00	81.81	66.66	78.56	73.25	7	3	
11	Schenk, Pavel	—	—	—	—	—	—	—	—	—	
12	Koudelka, Drahomir	00.00	90.90	100.00	62.50	63.63	55.55	62.09	2	2	
								FC 11	11	21	
PAR EQUIPE BY TEAM											
TOTAL		09.22	88.00	90.12	64.24	74.17	64.85	65.10	45	45	
BEL											
1	Mol, Jozef	—	—	—	—	—	—	—	—	—	
2	Mesdagh, Paul	—	—	—	—	—	—	—	—	—	
3	Walder, Fernand	100.00	100.00	—	00.00	33.33	50.00	56.66	0	0	
4	Bossaerts, Willem	42.86	83.33	100.00	63.63	45.00	46.14	63.49	1	1	
5	Vaillant, Bernard	—	—	—	—	—	—	—	—	—	
6	Maes, Roger	40.00	84.84	75.00	35.28	50.00	40.00	54.18	5	4	
7	Vandewal, Ronald	50.00	33.33	75.00	63.14	60.00	44.44	54.31	2	0	
8	Huybrechts, Hugo	35.45	90.00	71.85	59.09	73.90	38.45	61.95	6	2	
9	Vandergoten, Roger	25.00	—	83.33	37.50	40.00	44.44	46.05	1	0	
10	Saelens, Benno	—	—	—	62.50	—	33.33	47.91	1	1	
11	Poosen, Berto	36.36	50.00	61.52	55.00	71.42	47.35	53.60	8	0	
12	Dierckx, Leo	20.00	60.00	66.66	35.28	50.00	75.00	51.15	2	1	
								FC 18	18	7	
PAR EQUIPE BY TEAM											
TOTAL		36.45	79.58	74.04	43.86	51.35	44.48	54.95	45	16	
1e ARBITRE	1st REFEREE	Park, Moo	COR	2e ARBITRE	2nd REFEREE	Villalba, Alfonso	MEX	MARQUEUR	SCOREKEEPER	Estrada, Odilón	MEX

MATCH 34
GAME

DUREE DURATION 1:15.00

789

URS								URS-MEX 3-1 (15-5, 15-8, 11-15, 15-5)			
	Service	Preparation	Reception	Bloquage Blocking	Fielding	Attack Attaque	%	C	T		
1	Sibiryakov, Eduard	07.69	—	79.90	56.52	75.00	55.56	54.33	14	3	
2	Kravchenko, Valery	—	—	—	—	—	—	—	—	—	
3	Belyaev, Vladimir	28.56	100.00	78.56	66.66	77.77	73.08	70.77	13	3	
4	Lapinsky, Evgeny	37.50	100.00	92.30	42.86	80.00	64.28	69.45	5	6	
5	Antropov, Oleg	25.00	—	77.77	38.45	84.59	69.21	59.00	5	2	
6	Matushevskiy, Vasilijus	50.00	—	71.42	80.00	57.14	25.00	56.71	2	1	
7	Mikhailchuk, Victor	20.00	78.57	100.00	58.33	77.77	—	66.93	2	4	
8	Poyarkov, Yuri	—	66.66	—	42.86	33.33	66.66	52.37	2	1	
9	Tereshuk, Boris	44.44	84.61	80.00	72.72	70.00	52.98	67.45	3	6	
10	Ivanov, Vladimir	23.07	50.00	100.00	53.12	76.90	73.67	62.79	7	5	
11	Bugaenkov, Ivan	—	—	—	—	—	—	—	—	—	
12	Mondzolevskiy, Georgy	16.66	75.00	83.33	75.00	33.33	100.00	63.88	1	0	
								FC 11	11	21	
PAR EQUIPE BY TEAM											
TOTAL		36.74	76.76	83.20	56.52	70.74	63.65	65.10	65	56	
MEX											
1	Osuna, César	16.66	100.00	100.00	09.09	100.00	53.31	63.14	6	2	
2	Calva, Joel	37.50	66.66	66.66	42.86	57.14	54.54	54.22	3	2	
3	Loya, Jesús	66.66	00.00	33.33	50.00	100.00	50.00	49.99	2	0	
4	Sixtos, Eduardo	62.62	100.00	73.67	26.92	21.75	65.25	58.36	15	5	
5	González, Francisco	—	—	—	—	—	—	—	—	—	
6	Durán, Juan	00.00	00.00	—	—	100.00	—	33.33	0	0	
7	Aguirre, Carlos	60.00	58.80	80.00	00.00	40.00	00.00	39.80	0	0	
8	Reyna, Leopoldo	06.66	28.57	75.00	16.66	40.00	40.00	34.48	9	2	
9	Barrón, Carlos	45.45	57.14	80.00	44.00	30.00	43.75	50.05	6	2	
10	Barbet, Antonio	30.00	00.00	89.47	30.75	35.28	43.75	38.20	4	2	
11	Martell, Luis	30.00	37.72	90.90	42.86	45.46	60.00	51.15	4	1	
12	Jiménez, Eduardo	00.00	00.00	—	33.33	—	75.00	27.08	1	1	
								FC 14	14	16	
PAR EQUIPE BY TEAM											
TOTAL		34.72	50.32	81.14	27.31	38.61	49.43	46.92	64	33	
1e ARBITRE	1st REFEREE	Lange, Peter	ADE	2e ARBITRE	2nd REFEREE	Buczynski, Ryszard	POL	MARQUEUR	SCOREKEEPER	Avila, Salvador	MEX

MATCH
GAME 35

DUREE DURATION 1:51.00

ADE								ADE-BRA 3-1 (15-13, 15-7, 14-16, 15-12)			
		Service	Preparation	Reception	Bloquage Blocking	Fielding	Attack Attaque	%	C	T	
1	Peter, Horst	00.00	00.00	100.00	—	—	40.00	40.00	1	0	
2	Tielscher, Eckhard	100.00	00.00	00.00	25.00	75.00	00.00	27.77	0	0	
3	Schneider, Siegfried	50.00	25.00	58.33	00.00	66.66	68.68	52.09	21	6	
4	Heine, Manfred	—	—	—	45.83	64.70	—	—	—	—	
5	Tscharke, Rainer	25.00	84.20	80.00	00.00	63.63	80.00	55.47	2	1	
6	Pietzsch, Eckehard	40.43	90.19	100.00	37.50	61.91	57.14	64.52	1	5	
7	Schulz, Arnold	33.33	100.00	89.65	06.25	60.61	73.17	66.97	15	6	
8	Schumann, Rudi	—	—	—	46.87	58.82	—	—	—	—	
9	Kessel, Jürgen	66.00	00.00	100.00	—	—	—	43.20	0	0	
10	Toussaint, Walter	43.48	71.42	70.00	00.00	50.00	46.65	49.73	6	1	
11	Freiwald, Jürgen	60.89	00.00	44.73	43.33	76.44	54.92	46.71	15	9	
12	Webner, Wolfgang	35.28	100.00	69.55	56.00	61.91	58.82	63.59	9	5	
								FC 24		26	
PAR EQUIPE	BY TEAM										
TOTAL		44.05	74.18	87.48	39.52	63.75	65.55	62.41	94	59	
BRA											
1	De Souza, Jorge	28.56	50.00	90.47	68.75	50.00	64.00	58.63	9	1	
2	Pinheiro, Sergio	—	—	50.00	25.00	80.00	25.00	45.00	2	0	
3	Jens, Joao	—	80.00	100.00	80.00	66.66	16.66	68.66	1	3	
4	Schuc, Gerson	27.27	69.09	100.00	62.96	55.00	41.66	59.33	6	3	
5	Da Costa, José	—	—	—	—	—	—	—	—	—	
6	Volpi, Marco	20.82	57.14	95.84	58.98	75.00	66.66	62.40	14	3	
7	Dunlop, Mario	50.00	—	—	—	—	55.56	54.48	1	1	
8	Moreno, Antonio	15.78	64.68	90.90	50.00	50.00	—	—	12	5	
9	De Azevedo, Decio	—	—	—	—	—	16.16	56.85	0	0	
10	Borges, Victor	28.57	64.68	100.00	42.86	88.88	55.17	63.74	0	1	
11	Feitosa, Carlos	26.09	88.23	93.75	60.00	59.23	—	—	11	3	
12	Peterle, Paulo	—	—	—	—	—	—	—	10	5	
								FC 28		20	
PAR EQUIPE	BY TEAM										
TOTAL		20.00	71.56	88.26	57.93	62.00	57.17	58.46	94	48	
1e ARBITRE	1st REFEREE	Van Welden, Lucien	BEL	2e ARBITRE	2nd REFEREE	Iroshi, Kuwahara	JPN	MARQUEUR	SCOREKEEPER	Contreras, Ricardo	MEX

790

MATCH
GAME 36 OCT 24

DUREE DURATION 1:00.00

JPN								JPN-BRA 3-0 (15-8, 15-11, 15-12)			
		Service	Preparation	Reception	Bloquage Blocking	Fielding	Attack Attaque	%	C	T	
1	Ikeda, Naohiro	—	—	—	—	—	—	—	—	—	
2	Minami, Masayuki	66.66	95.71	100.00	66.66	83.33	28.57	73.48	1	3	
3	Nekoda, Katsutoshi	57.88	98.60	—	80.00	65.38	100.00	80.37	3	3	
4	Shiragami, Mamoru	00.00	—	100.00	—	60.00	—	53.33	0	0	
5	Koizumi, Isao	30.00	100.00	66.66	30.75	53.31	60.00	56.78	2	2	
6	Kimura, Kenji	22.22	100.00	71.42	40.00	41.66	70.76	57.67	6	5	
7	Mitsumori, Yasuaki	16.66	—	62.50	00.00	80.00	80.00	47.83	4	2	
8	Morita, Junjo	07.14	100.00	78.94	46.35	54.16	81.25	61.30	8	5	
9	Yokota, Tadayoshi	33.10	100.00	87.50	40.00	66.66	73.32	66.76	7	4	
10	Ohko, Seiji	33.33	100.00	84.59	63.63	52.18	64.29	66.33	11	6	
11	Sato, Tetsuo	—	—	—	—	—	—	—	—	—	
12	Shimaoka, Kenji	—	—	—	—	—	—	—	—	—	
								FC 7		15	
PAR EQUIPE	BY TEAM										
TOTAL		31.94	92.23	75.75	47.59	59.28	65.71	63.08	49	45	
BRA											
1	De Souza, Jorge	09.09	66.66	71.42	34.79	32.56	71.18	47.45	5	6	
2	Pinheiro, Sergio	00.00	100.00	00.00	30.00	83.33	66.66	46.66	2	0	
3	Jens, Joao	66.66	66.66	60.00	75.00	71.42	62.50	67.04	1	3	
4	Schuc, Gerson	16.65	71.43	77.77	33.10	73.08	41.66	52.28	1	2	
5	Da Costa, José	—	—	—	—	—	—	—	—	—	
6	Volpi, Marco	11.11	66.66	80.00	36.36	50.00	50.00	49.02	5	2	
7	Dunlop, Mario	—	—	—	—	—	—	—	—	—	
8	Moreno, Antonio	06.66	100.00	92.00	46.14	50.00	73.67	61.41	5	3	
9	De Azevedo, Decio	—	75.00	—	—	—	—	75.00	0	0	
10	Borges, Victor	—	—	—	—	—	—	—	—	—	
11	Feitosa, Carlos	00.00	81.09	80.00	35.70	56.00	62.50	52.54	6	0	
12	Peterle, Paulo	00.00	100.00	50.00	41.66	50.00	61.52	50.53	2	1	
								FC 5		9	
PAR EQUIPE	BY TEAM										
TOTAL		11.58	76.36	70.79	39.84	53.94	61.65	52.36	32	26	
1e ARBITRE	1st REFEREE	Park, Moo	COR	2e ARBITRE	2nd REFEREE	Almanza, Jorge	MEX	MARQUEUR	SCOREKEEPER	Avila, Salvador	MEX

MATCH
GAME 37

DUREE DURATION 1:56.00

EUA		EUA-MEX 3-1 (14-16, 15-10, 15-9, 15-11)									
	Service	Preparation	Reception	Bloquage Blocking	Fielding	Attaque Attack	%	C	T		
1	Patterson, Daniel	00.00	80.00	80.00	00.00	80.00	50.00	48.33	1	2	
2	Velasco, Pedro	03.70	85.18	82.32	50.00	71.42	56.00	58.10	10	3	
3	Henn, John	07.14	89.13	94.45	50.00	37.50	50.00	54.70	9	4	
4	May, Robert	20.00	76.44	73.32	56.52	95.71	66.66	64.77	8	7	
5	Rundle, Larry	—	—	—	—	—	—	—	—	—	
6	Bright, David	00.00	69.21	83.33	47.04	50.00	54.54	50.68	5	2	
7	Duke, Smitty	00.00	91.66	60.00	25.00	50.00	50.00	46.11	6	1	
8	Alstrom, John	00.00	—	100.00	100.00	—	100.00	75.00	0	0	
9	Stanley, Jon	00.00	80.00	80.00	54.34	78.56	72.22	60.85	17	4	
10	Haine, Thomas	04.54	81.81	79.16	40.00	55.55	60.00	53.51	5	4	
11	Suwara, Rudy	08.33	66.66	83.33	47.22	62.50	66.66	55.78	16	3	
12	Davenport, Wink	—	—	—	—	—	—	—	—	—	
								FC	22	29	
PAR EQUIPE BY TEAM											
TOTAL		06.33	81.42	88.17	50.74	62.76	61.51	58.48	99	59	
MEX											
1	Osuna, César	—	100.00	—	100.00	—	00.00	66.66	0	0	
2	Calva, Joel	36.36	28.26	100.00	44.44	60.00	50.00	53.17	2	5	
3	Loya, Jesús	00.00	100.00	100.00	40.00	00.00	50.00	48.33	2	0	
4	Sixtos, Eduardo	36.66	88.88	72.92	55.17	53.85	47.04	59.08	15	3	
5	González, Francisco	—	—	50.00	—	50.00	00.00	33.33	0	0	
6	Durán, Juan	—	—	100.00	00.00	100.00	00.00	50.00	0	0	
7	Aguirre, Carlos	22.20	88.00	73.32	70.00	48.48	42.84	57.47	2	2	
8	Reyna, Leopoldo	36.36	—	66.66	60.87	58.80	52.00	54.93	9	4	
9	Barrón, Carlos	35.00	62.50	65.25	57.50	56.77	55.61	55.47	21	6	
10	Barbet, Antonio	28.57	75.00	77.76	60.61	63.41	59.37	59.12	15	1	
11	Martell, Luis	58.33	86.49	50.00	23.52	65.38	31.25	52.49	3	2	
12	Jiménez, Eduardo	11.11	100.00	64.25	50.00	14.28	62.50	50.36	7	2	
								FC	22	21	
PAR EQUIPE BY TEAM											
TOTAL		30.17	86.72	71.01	52.99	54.52	54.92	58.34	98	46	
1e ARBITRE	1st REFEREE	Guerguil, Krastev	BUL	2e ARBITRE	2nd REFEREE	Dusan, Prielonzy	CHE	MARQUEUR	SCOREKEEPER	Bretón, Federico	MEX

MATCH
GAME 38

DUREE DURATION 0:44.00

791

URS		URS-BEL 3-0 (15-2, 15-3, 15-5)									
	Service	Preparation	Reception	Bloquage Blocking	Fielding	Attaque Attack	%	C	T		
1	Sibiryakov, Eduard	50.00	50.00	100.00	38.45	50.00	88.88	62.88	4	3	
2	Kravchenko, Valery	25.00	100.00	62.50	75.00	40.00	62.50	60.83	6	3	
3	Belyaev, Vladimir	—	—	—	—	—	—	—	—	—	
4	Lapinsky, Evgeny	00.00	100.00	64.81	71.42	100.00	87.50	70.62	2	4	
5	Antropov, Oleg	20.00	100.00	100.00	62.50	100.00	100.00	80.41	2	3	
6	Matushevas, Vasilijus	—	—	—	—	—	—	—	—	—	
7	Mikhailchuk, Victor	100.00	92.30	100.00	60.00	100.00	50.00	83.71	2	2	
8	Poyarkov, Yuri	00.00	94.45	100.00	50.00	100.00	100.00	57.40	0	1	
9	Tereshuk, Boris	—	—	—	—	—	—	—	—	—	
10	Ivanov, Vladimir	20.00	100.00	87.50	50.00	100.00	81.81	73.21	5	2	
11	Bugaenkov, Ivan	00.00	100.00	100.00	83.33	100.00	84.20	77.92	9	7	
12	Mondzolevsky, Georgy	00.00	91.23	95.21	50.00	33.33	75.00	57.54	4	0	
								FC	6	20	
PAR EQUIPE BY TEAM											
TOTAL		15.94	92.48	87.20	59.77	80.60	76.58	68.75	40	45	
BEL											
1	Mol, Jozef	33.33	64.68	66.66	05.88	46.45	45.00	43.70	7	2	
2	Mesdagh, Paul	28.57	—	65.38	44.44	71.42	25.00	46.96	3	0	
3	Walder, Fernand	12.50	70.00	100.00	18.10	37.50	50.00	58.03	1	0	
4	Bossaerts, Willem	—	—	—	—	—	—	—	—	—	
5	Vaillant, Bernard	57.14	66.66	83.33	27.27	54.54	41.16	55.01	3	0	
6	Maes, Roger	—	—	—	—	—	—	—	—	—	
7	Vandewal, Ronald	—	—	—	—	—	—	—	—	—	
8	Huybrechts, Hugo	—	—	—	—	—	—	—	—	—	
9	Vandergoten, Röger	58.33	80.00	78.94	22.20	58.80	31.25	54.92	5	2	
10	Saelens, Benno	45.45	100.00	81.81	31.25	30.00	40.00	54.75	6	1	
11	Poosen, Berto	—	—	—	—	—	—	—	—	—	
12	Dierckx, Leo	—	—	—	—	—	—	—	—	—	
								FC	14	5	
PAR EQUIPE BY TEAM											
TOTAL		49.70	69.87	73.83	23.64	47.80	38.98	50.63	39	10	
1e ARBITRE	1st REFEREE	Arredondo, Genaro	MEX	2e ARBITRE	2nd REFEREE	Buczynski, Ryszard	POL	MARQUEUR	SCOREKEEPER	Estrada, Odilón	MEX

MATCH
GAME 39

DUREE DURATION 1:58.00

ADE								ADE-BUL 3-2 (15-11, 8-15, 15-10, 10-15, 15-7)			
		Service	Preparation	Reception	Bloquage Blocking	Fielding	Attaque Attack	%	C	T	
1	Peter, Horst	27.27	100.00	92.30	60.00	60.00	60.00	66.59	2	1	
2	Tielscher, Eckhard	00.00	00.00	80.00	25.00	58.33	33.33	32.77	0	0	
3	Schneider, Siegfried	52.38	25.00	90.91	52.18	64.53	80.77	60.96	7	5	
4	Heine, Manfred	33.33	37.50	84.20	46.35	76.44	66.66	57.41	9	3	
5	Tscharke, Rainer	41.66	74.23	80.00	47.35	64.28	72.72	63.37	6	3	
6	Pietzsch, Eckehard	53.53	88.37	66.66	30.00	72.00	100.00	68.42	6	2	
7	Schulz, Arnold	22.20	100.00	86.64	42.30	68.00	87.11	67.70	10	5	
8	Schumann, Rudi	20.00	50.00	83.33	28.56	81.81	90.90	59.10	4	3	
9	Kessel, Jürgen	33.33	79.92	100.00	23.07	64.68	54.54	58.75	4	3	
10	Toussaint, Walter	53.83	89.49	100.00	00.00	78.56	95.71	69.59	5	1	
11	Freiwald, Jürgen	50.00	100.00	100.00	29.40	78.75	87.50	74.29	15	3	
12	Webner, Wolfgang	43.75	41.66	89.47	60.00	67.64	69.56	62.09	14	11	
PAR EQUIPE BY TEAM									FC 19	23	
TOTAL		39.36	86.60	87.55	40.78	69.28	74.99	66.42	101	63	
BUL											
1	Trenev, Alexandre	11.11	54.55	71.42	35.70	63.63	87.50	53.98	3	2	
2	Zlatanov, Dimitar	23.52	100.00	82.32	61.30	61.10	59.09	64.55	10	9	
3	Prinov, Gramen	20.00	100.00	71.42	15.38	92.30	66.66	60.96	5	2	
4	Kratchmarov, Petar	25.00	58.69	88.88	54.16	75.00	47.04	58.12	5	2	
5	Alexandrov, Alexandre	10.00	50.00	85.70	48.44	55.55	55.55	50.59	13	3	
6	Simeonov, Zdravko	10.71	55.55	87.50	45.83	88.88	55.88	57.39	13	3	
7	Milev, Milio	—	—	100.00	—	50.00	25.00	58.33	0	1	
8	Karov, Dimitar	44.44	80.00	75.00	42.50	84.59	43.48	61.66	6	7	
9	Slavov, Kiril	—	50.00	100.00	60.00	75.00	60.00	69.00	0	3	
10	Atanassov, Dinio	—	—	—	—	—	—	—	—	—	
11	Koritarov, Anguel	50.00	84.59	100.00	50.00	80.00	—	72.91	0	0	
12	Stoyanov, Stoian	24.25	71.42	78.78	41.38	70.36	53.80	56.66	16	4	
PAR EQUIPE BY TEAM									FC 30	22	
TOTAL		23.79	67.25	85.35	45.44	72.43	55.50	58.29	101	58	
1e ARBITRE	1st REFEREE	Lenov, Boris	URS	2e ARBITRE	2nd REFEREE	Flores, Enrique	MEX	MARQUEUR	SCOREKEEPER	Sujo, Antonio	MEX

792

MATCH
GAME 40

DUREE DURATION 1:26.00

POL								POL-CHE 3-1 (15-5, 15-3, 12-15, 15-13)			
		Service	Preparation	Reception	Bloquage Blocking	Fielding	Attaque Attack	%	C	T	
1	Zdunzcyk, Stanislaw	68.88	60.00	100.00	20.00	63.14	64.70	62.78	12	3	
2	Skiba, Aleksander	100.00	00.00	—	—	—	—	50.00	0	0	
3	Szymczyk, Jerzy	28.57	00.00	—	50.00	—	80.00	39.64	1	0	
4	Skorek, Edward	35.00	100.00	92.00	34.28	60.82	65.95	64.68	20	7	
5	Jasiukiewicz, Zbigniew	33.33	00.00	100.00	66.66	33.33	37.50	45.13	4	1	
6	Siwek, Tadeusz	30.00	73.58	60.00	61.52	68.75	66.66	60.08	2	3	
7	Ambroziak, Zdzislaw	17.40	66.66	86.66	55.00	59.26	74.21	59.86	12	9	
8	Gosciak, Stanislaw	00.00	00.00	—	—	00.00	—	00.00	0	0	
9	Paszkiwicz, Romuald	26.30	00.00	95.24	45.17	65.51	76.00	51.37	13	11	
10	Wagner, Hubert	23.52	89.09	100.00	18.75	62.50	75.00	61.47	1	1	
11	Rutkowski, Wojciech	00.00	00.00	—	—	—	—	00.00	0	0	
12	Zarzycki, Zbigniew	00.00	00.00	—	00.00	—	100.00	25.50	1	0	
PAR EQUIPE BY TEAM									FC 10	22	
TOTAL		31.01	80.15	94.19	43.97	72.46	54.98	62.79	76	57	
CHE											
1	Prochazka, Antonin	—	83.67	100.00	62.50	50.00	80.00	75.23	2	1	
2	Svoboda, Jiri	16.16	83.32	80.00	32.00	64.28	66.66	57.15	7	1	
3	Zajicek, Lubomir	—	—	—	—	—	—	—	—	—	
4	Musil, Josef	—	100.00	100.00	33.33	75.00	—	77.08	0	0	
5	Smolka, Josef	100.00	—	—	—	100.00	—	100.00	0	0	
6	Petlak, Vladimir	16.66	100.00	96.29	53.84	50.00	65.70	63.74	18	4	
7	Kop, Petr	10.52	65.00	72.72	33.33	71.42	62.50	52.58	9	2	
8	Sokol, Frantisek	—	—	100.00	100.00	50.00	100.00	87.50	1	1	
9	Golian, Bohumil	11.11	80.00	100.00	38.45	40.00	83.33	58.81	0	1	
10	Groessl, Zdenek	11.76	100.00	100.00	48.65	57.14	76.93	65.74	11	5	
11	Schenk, Pavel	—	50.00	100.00	40.00	—	91.66	70.41	1	0	
12	Koudelka, Drahomir	—	59.23	100.00	35.70	75.00	78.56	69.69	7	0	
PAR EQUIPE BY TEAM									FC 19	21	
TOTAL		11.23	76.97	91.90	42.66	60.71	63.68	57.86	75	36	
1e ARBITRE	1st REFEREE	Davies, Glen	EUA	2e ARBITRE	2nd REFEREE	Valenzuela, Rubén	MEX	MARQUEUR	SCOREKEEPER	Concha, José	MEX

MATCH GAME 41 OCT 25

DUREE DURATION 1:39.00

BRA		BRA-MEX 3-1 (14-16, 15-6, 17-15, 15-8)								
	Service	Preparation	Reception	Bloquage Blocking	Fielding	Attaque Attack	%	C	T	
1	De Souza, Jorge	31.56	100.00	86.95	53.33	61.30	64.28	66.23	13	12
2	Pinheiro, Sergio	25.00	100.00	53.31	57.69	61.30	92.30	64.93	12	4
3	Jens, Joao	15.38	62.07	80.00	50.00	35.71	52.98	49.35	5	7
4	Schuc, Gerson	40.00	65.51	91.66	50.00	57.13	66.66	61.82	7	6
5	Da Costa, José	00.00	—	71.42	100.00	71.42	40.00	56.56	2	0
6	Volpi, Marco	16.66	—	61.52	44.44	64.28	30.00	47.38	1	0
7	Dunlop, Mario	—	—	—	—	—	—	—	—	—
8	Moreno, Antonio	60.00	—	100.00	28.57	50.00	60.00	59.71	1	0
9	De Azevedo, Decio	30.00	63.63	100.00	36.82	75.00	57.88	60.55	6	3
10	Borges, Victor	40.00	81.81	66.66	50.00	59.55	41.66	55.94	1	2
11	Feitosa, Carlos	18.18	82.60	85.71	50.00	50.00	45.47	55.32	8	2
12	Peterle, Paulo	—	—	—	—	—	—	—	1	0
									FC 16	24
PAR EQUIPE BY TEAM										
TOTAL		32.41	74.29	69.57	45.78	63.09	61.59	57.03	72	61

MEX		PAR EQUIPE BY TEAM								
	Service	Preparation	Reception	Bloquage Blocking	Fielding	Attaque Attack	%	C	T	
1	Osuna, César	00.00	—	66.66	30.00	00.00	50.00	29.33	1	2
2	Calva, Joel	00.00	100.00	50.00	42.86	—	60.00	50.57	1	1
3	Loya, Jesus	—	—	—	33.33	00.00	00.00	11.11	0	0
4	Sixtos, Eduardo	10.00	100.00	71.42	36.82	25.00	25.00	44.70	3	1
5	González, Francisco	—	—	100.00	—	—	—	100.00	0	0
6	Durán, Juan	—	66.66	100.00	—	00.00	—	55.55	0	0
7	Aguirre, Carlos	05.26	83.33	100.00	33.33	36.36	62.50	53.46	5	5
8	Reyna, Leopoldo	00.00	75.00	79.31	50.00	55.55	52.63	52.03	11	4
9	Barrón, Carlos	12.50	100.00	85.71	42.86	50.00	62.50	58.92	17	3
10	Barbet, Antonio	00.00	100.00	92.64	50.00	100.00	45.00	64.84	8	5
11	Martell, Luis	00.00	85.41	84.59	45.46	77.77	50.00	51.20	5	2
12	Jiménez, Eduardo	06.25	78.56	86.64	46.65	43.75	53.84	52.61	8	3
									FC 12	19
PAR EQUIPE BY TEAM										
TOTAL		03.70	82.32	82.70	43.80	43.00	52.27	51.29	71	45

1e ARBITRE 1st REFEREE Oldrich, Slavicek CHE 2e ARBITRE 2nd REFEREE Krol, Jerzy POL MARQUEUR SCOREKEEPER Bretón, Federico MEX

MATCH GAME 42

DUREE DURATION 1:06.00

ADE		ADE-POL 3-0 (15-11, 15-6, 15-6)								
	Service	Preparation	Reception	Bloquage Blocking	Fielding	Attack Attaque	%	C	T	
1	Peter, Horst	—	—	—	—	—	—	—	—	—
2	Tielscher, Eckhard	—	—	—	—	—	—	—	—	—
3	Schneider, Siegfried	27.27	100.00	60.00	46.43	75.00	75.00	63.95	12	5
4	Heine, Manfred	—	—	—	—	—	—	—	—	—
5	Tscharke, Rainer	—	—	—	—	—	—	—	—	—
6	Pietzsch, Eckehard	33.33	96.15	50.00	46.65	60.61	57.14	57.14	4	2
7	Schulz, Arnold	29.40	100.00	89.47	51.72	61.53	62.07	65.69	6	6
8	Schumann, Rudi	—	—	—	—	—	—	—	—	—
9	Kessel, Jürgen	—	—	—	—	—	—	—	—	—
10	Toussaint, Walter	31.56	98.07	66.66	55.55	67.76	66.66	64.37	1	2
11	Freiwald, Jürgen	42.84	100.00	76.90	56.66	65.38	65.38	67.88	4	10
12	Webner, Wolfgang	42.09	100.00	76.44	53.33	56.00	76.36	66.37	14	5
									FC 11	15
PAR EQUIPE BY TEAM										
TOTAL		33.54	97.20	79.94	49.89	64.00	65.31	64.97	52	45

POL		PAR EQUIPE BY TEAM								
	Service	Preparation	Reception	Bloquage Blocking	Fielding	Attack Attaque	%	C	T	
1	Zdunczyk, Stanislaw	20.00	100.00	85.70	35.28	100.00	55.55	66.08	7	1
2	Skiba, Aleksander	00.00	100.00	—	66.66	00.00	00.00	33.33	0	1
3	Szymczyk, Jerzy	00.00	84.59	100.00	28.57	75.00	50.00	56.36	1	1
4	Skorek, Edward	00.00	66.66	90.90	52.98	62.50	60.97	55.66	10	3
5	Jasiukiewicz, Zbigniew	00.00	100.00	—	33.33	100.00	60.00	58.66	2	0
6	Siwek, Tadeusz	00.00	94.73	100.00	36.36	57.14	50.00	56.37	1	1
7	Ambroziak, Zdzislaw	09.09	100.00	80.94	55.55	50.00	47.62	57.20	6	1
8	Gosciński, Stanislaw	50.00	—	—	—	—	—	50.00	0	1
9	Paszkiwicz, Romuald	00.00	100.00	80.94	55.55	50.00	47.62	57.20	9	0
10	Wagner, Hubert	00.00	83.33	100.00	44.44	69.21	50.00	57.83	3	1
11	Rutkowski, Wojciech	00.00	100.00	100.00	60.00	33.33	00.00	48.88	0	1
12	Zarzycki, Zbigniew	00.00	100.00	80.00	50.00	00.00	100.00	55.00	1	0
									FC 12	11
PAR EQUIPE BY TEAM										
TOTAL		03.70	88.36	88.21	42.99	58.96	51.70	55.65	52	22

1e ARBITRE 1st REFEREE Guerguil, Krastev BUL 2e ARBITRE 2nd REFEREE Ignacio, Catalino EUA MARQUEUR SCOREKEEPER Sujo, Antonio MEX

MATCH
GAME 43

DUREE DURATION 0:59.00

JPN									JPN-BUL 3-0 (15-7, 15-16, 15-5)		
	Service	Preparation	Reception	Bloquage Blocking	Fielding	Attaque Attack	%	C	T		
1	Ikeka, Nachiro	—	—	—	—	—	—	—	—		
2	Minami, Masayuki	—	—	—	—	—	—	—	—		
3	Nekoda, Katsutoshi	45.83	87.50	100.00	50.00	68.75	100.00	75.34	3		
4	Shiragami, Mamoru	00.00	00.00	100.00	—	60.00	—	40.00	0		
5	Koizumi, Isao	45.45	66.66	92.30	57.88	56.52	77.26	66.22	7		
6	Kimura, Kenji	50.00	66.66	81.81	57.88	57.69	100.00	65.21	7		
7	Mitsumori, Yasuaki	25.00	00.00	—	—	100.00	100.00	56.25	1		
8	Morita, Jungo	58.33	87.50	100.00	56.52	62.50	80.00	64.26	7		
9	Yakota, Tadayoshi	68.75	50.00	93.33	50.00	43.48	78.94	73.96	6		
10	Ohko, Seiji	83.33	100.00	60.00	75.00	56.25	71.18	74.19	9		
11	Sato, Tetsuo	—	—	—	—	—	—	—	—		
12	Shimaoka, Kenji	—	—	—	—	—	—	—	—		
PAR EQUIPE BY TEAM											
TOTAL		66.67	81.67	87.17	57.07	50.50	79.26	67.43	52	45	
BUL											
1	Trenev, Alexandre	00.00	57.14	100.00	20.00	—	—	44.28	0	0	
2	Zlatanov, Dimitar	14.28	50.00	78.94	33.10	80.00	71.43	54.62	14	4	
3	Prinov, Gramen	25.00	50.00	75.00	42.86	62.50	50.00	50.89	3	2	
4	Kratchmarov, Petar	08.33	75.69	69.21	23.07	61.10	58.33	49.28	4	1	
5	Alexandrov, Alexandre	11.11	50.00	54.54	50.00	50.00	42.09	42.95	2	4	
6	Simeonov, Zdravko	00.00	00.00	77.77	52.98	50.00	46.65	37.90	1	1	
7	Milev, Milio	50.00	60.00	100.00	—	100.00	—	47.50	—	—	
8	Karov, Dimitar	33.33	87.50	100.00	58.33	81.25	18.18	63.09	1	1	
9	Slavov, Kiril	00.00	33.33	90.00	—	100.00	75.00	59.66	2	0	
10	Atanassov, Dinio	00.00	00.00	66.66	00.00	100.00	37.50	34.02	2	0	
11	Koritarov, Anguel	—	—	—	—	—	—	—	—	—	
12	Stoyanov, Stoian	00.00	33.33	100.00	45.45	95.71	26.64	50.18	2	3	
PAR EQUIPE BY TEAM											
TOTAL		13.88	75.57	79.72	41.74	70.63	48.06	54.93	44	18	
1e ARBITRE	1st REFEREE:	Van Welden, Lucien	BEL	2e ARBITRE	2nd REFEREE:	Lenov, Boris	URS	MARQUEUR	SCOREKEEPER	Ricardo, Contreras	MEX

794

MATCH
GAME 44

DUREE DURATION 1:08.00

EUA									EUA-BEL 3-0 (15-4, 16-14, 15-10)		
	Service	Preparation	Reception	Bloquage Blocking	Fielding	Attaque Attack	%	C	T		
1	Patterson, Daniel	46.14	37.50	25.00	27.27	00.00	83.33	36.54	3	1	
2	Velasco, Pedro	25.00	100.00	100.00	50.00	83.33	25.00	63.88	0	3	
3	Henn, John	50.00	75.00	76.90	42.86	83.33	88.88	69.49	2	4	
4	May, Robert	50.00	75.00	80.00	66.66	37.50	53.83	60.49	5	0	
5	Rundle, Larry	100.00	100.00	40.00	25.00	80.00	33.33	63.05	0	1	
6	Bright, David	00.00	100.00	100.00	00.00	20.00	83.33	50.55	3	1	
7	Duke, Smitty	46.14	86.64	75.00	25.00	58.33	61.52	58.77	1	2	
8	Alstrom, John	00.00	100.00	25.00	33.33	50.00	90.00	49.72	6	3	
9	Stanley, Jon	50.00	00.00	88.88	28.57	83.33	71.42	53.70	2	2	
10	Haine, Thomas	42.84	63.63	76.90	28.56	59.23	55.55	54.45	4	0	
11	Suwara, Rudy	55.55	66.66	100.00	34.81	61.52	85.70	67.37	13	6	
12	Davenport, Wink	25.00	50.00	11.11	80.00	33.33	73.32	45.46	5	2	
PAR EQUIPE BY TEAM											
TOTAL		43.51	78.00	78.08	37.75	63.15	65.14	60.94	56	46	
BEL											
1	Mol, Jozef	—	—	—	—	—	—	—	—	—	
2	Mesdagh, Paul	—	—	—	—	—	—	—	—	—	
3	Walder, Fernand	23.07	75.00	100.00	26.64	100.00	50.00	62.45	1	0	
4	Bossaerts, Willem	00.00	46.14	—	33.33	50.00	42.86	34.46	1	1	
5	Vaillant, Bernard	—	—	—	—	—	—	—	—	—	
6	Maes, Roger	30.75	75.75	70.00	20.00	100.00	56.25	58.79	14	1	
7	Vandewal, Ronald	04.28	40.00	79.16	33.10	38.45	36.82	38.63	4	3	
8	Huybrechts, Hugo	42.84	72.72	81.81	33.33	76.90	33.33	56.82	9	1	
9	Vandergoten, Roger	—	100.00	—	00.00	—	—	50.00	0	0	
10	Saelens, Benno	—	—	—	—	—	—	—	—	—	
11	Poosen, Berto	28.57	95.71	82.14	44.82	63.63	56.52	71.89	10	2	
12	Dierckx, Leo	50.00	50.00	66.66	22.72	60.00	45.45	49.13	7	1	
PAR EQUIPE BY TEAM											
TOTAL		34.58	66.93	78.70	32.55	68.88	45.38	54.50	57	28	
1e ARBITRE	1st REFEREE	Van Welden, Lucien	BEL	2e ARBITRE	2nd REFEREE:	Rivero, Carlos	PER	MARQUEUR	SCOREKEEPER	Concha, José	MEX

MATCH GAME 45 OCT 26

DUREE DURATION 0:57.00

URS								URS-CHE 3-0 (15-7, 15-4, 15-8)			
	Service	Preparation	Reception	Bloquage Blocking	Fielding	Attaque Attack	%	C	T		
1	Sibiryakov, Eduard	10.00	100.00	100.00	65.58	100.00	68.18	73.92	6	4	
2	Kravchenko, Valery	25.00	100.00	100.00	54.85	87.50	70.76	73.01	8	5	
3	Belyaev, Vladimir	00.00	—	100.00	—	—	—	50.00	0	1	
4	Lapinsky, Evgeny	20.00	100.00	80.00	91.66	75.00	70.36	72.83	7	9	
5	Antropov, Oleg	—	—	—	—	—	—	—	—	—	
6	Matushevas, Vasilijus	—	—	—	—	—	—	—	—	—	
7	Mikhalchuk, Victor	00.00	—	33.33	—	00.00	—	11.11	0	0	
8	Poyarkov, Yuri	07.69	96.78	100.00	78.56	70.00	66.66	69.94	2	4	
9	Tereshuk, Boris	00.00	—	100.00	—	00.00	—	33.33	0	0	
10	Ivanov, Vladimir	—	—	—	00.00	—	—	25.00	0	0	
11	Bugaenkov, Ivan	07.69	100.00	93.55	66.66	76.99	78.25	70.52	10	6	
12	Mondzolevsky, Georgy	08.00	95.45	100.00	40.00	66.66	50.00	60.01	0	0	
PAR EQUIPE BY TEAM									FC 7	16	
TOTAL		12.27	94.06	78.74	63.11	78.78	69.76	66.12	40	45	
CHE											
1	Prochazka, Antonin	10.00	91.29	80.00	44.44	52.18	25.00	50.48	1	2	
2	Svoboda, Jiri	16.66	97.46	100.00	63.63	31.56	41.66	58.49	5	1	
3	Zajicek, Lubomir	—	—	—	—	—	—	—	—	—	
4	Musil, Josef	33.33	100.00	—	—	50.00	—	61.11	0	0	
5	Smolka, Josef	50.00	—	100.00	—	100.00	—	83.33	0	0	
6	Petlak, Vladimir	28.57	100.00	80.00	64.00	57.88	50.00	63.40	7	6	
7	Kop, Petr	20.00	100.00	66.66	16.66	66.66	57.14	54.52	3	1	
8	Sokol, Frantisek	50.00	100.00	100.00	46.14	75.00	50.00	70.19	0	0	
9	Golian, Bohumil	20.00	87.50	50.00	50.00	45.45	80.00	55.49	3	1	
10	Grossl, Zdenek	18.18	100.00	61.10	46.65	63.63	64.00	58.92	5	3	
11	Schenk, Pavel	00.00	66.66	100.00	100.00	40.00	65.00	63.11	1	2	
12	Koudelka, Drahomir	28.57	93.75	75.00	80.00	60.00	42.09	63.23	5	2	
PAR EQUIPE BY TEAM									FC 8	1	
TOTAL		47.34	69.37	79.28	53.42	46.86	55.52	58.63	38	19	
1e ARBITRE	1st REFEREE:	Van Welden, Lucien	BEL	2e ARBITRE	2nd REFEREE:	Flores, Enrique	MEX	MARQUEUR	SCOREKEEPER	Concha, José	MEX

795

RESUME DE SCORES
SUMMARY OF SCORES

CLASSEMENT FINAL
FINAL STANDING

HOMMES
MEN

	ADE	BEL	BRA	BUL	CHE	EUA	JPN	MEX	POL	URS		JJ	JG	JP	SG	SP	TF	TC	P	
ADE	*	3-0	3-1	3-2	2-3	3-0	0-3	3-0	3-0	2-3	1	URS	9	8	1	26	8	464	326	17
BEL	0-3	*	3-1	0-3	0-3	0-3	0-3	3-2	0-3	0-3	2	JPN	9	7	2	24	6	430	253	16
BRA	1-3	1-3	*	0-3	3-2	0-3	0-3	3-1	0-3	1-3	3	CHE	9	7	2	22	15	454	412	16
BUL	2-3	3-0	3-0	*	2-3	3-2	0-3	3-0	0-3	0-3	4	ADE	9	6	3	22	12	449	373	15
CHE	3-2	3-0	2-3	3-2	*	3-1	3-2	3-0	1-3	0-3	5	POL	9	6	3	18	11	370	380	15
EUA	0-3	3-0	3-0	2-3	1-3	*	0-3	3-1	0-3	3-2	6	BUL	9	4	5	16	17	379	385	13
JPN	3-0	3-0	3-0	3-0	2-3	3-0	*	3-0	3-0	1-3	7	EUA	9	4	5	15	18	382	414	13
MEX	0-3	2-3	1-3	0-3	0-3	1-3	0-3	*	1-3	1-3	8	BEL	9	2	7	6	24	239	417	11
POL	0-3	3-0	3-0	3-0	3-1	3-0	0-3	3-1	*	0-3	9	BRA	9	1	8	8	25	352	469	10
URS	3-2	3-0	3-1	3-0	3-0	2-3	3-1	3-1	3-0	*	10	MEX	9	0	9	6	27	284	474	9

FEMMES
WOMEN

MATCH 1 OCT 13

DUREE DURATION 2:05.00

POL

POL-COR 3-2 (10-15, 12-15, 15-10, 15-12, 17-15)

	Service	Preparation	Reception	Bloquage Blocking	Fielding	Attaque Attack	%	C	T		
1	Czajkowska, Krystyna	16.66	73.90	75.00	41.66	40.00	25.00	45.37	2	1	
2	Ledwig, Jozefa	35.70	33.33	76.26	64.68	77.77	60.87	58.10	10	4	
3	Porzec, Elzbieta	12.50	92.30	85.41	50.00	80.00	62.96	63.86	5	10	
4	Wiecha, Wanda	21.04	80.00	77.44	54.16	64.68	64.44	60.29	14	7	
5	Szczesniewska, Zofia	20.00	96.66	91.66	31.81	95.71	25.00	60.14	1	1	
6	Jakubowska, Krystyna	—	—	—	—	—	—	—	—	—	
7	Chmielnicka, Lidia	—	50.00	100.00	—	00.00	—	50.00	0	0	
8	Niemczyk, Barbara	10.00	90.66	81.25	55.31	50.00	78.09	60.88	21	7	
9	Aszkielowicz, Halina	33.33	63.63	70.36	47.50	55.00	70.58	56.73	13	12	
10	Krupa, Krystyna	46.55	100.00	83.88	47.37	60.00	59.61	66.20	10	6	
11	Ksiazek, Jad Wiga	30.00	100.00	100.00	62.50	66.66	33.33	65.41	2	1	
12	Ostromecka, Krystyna	50.00	100.00	66.66	—	00.00	—	54.16	0	1	
									FC	21	19

PAR EQUIPE BY TEAM

TOTAL 33.47 88.11 83.61 49.20 54.56 57.96 61.15 99 69

COR

1	Moon, Kuyong-Sook	36.66	89.00	81.81	56.60	63.07	71.42	66.42	11	8	
2	Park, Kum-Sook	17.64	62.50	73.08	69.45	64.51	36.41	57.26	12	4	
3	Kwack, Yong-Ja	—	—	—	—	—	—	—	—	—	
4	Suh, Hee-Sook	46.35	100.00	69.56	44.45	61.00	80.37	63.60	21	9	
5	Lee, Eun-Ok	00.00	00.00	100.00	50.00	90.00	50.00	48.33	1	1	
6	Hwang, Kyu-Ok	—	—	—	—	—	—	—	—	—	
7	Lee, Hyang-Seem	43.48	90.00	88.88	42.42	66.66	66.66	66.35	2	5	
8	Yang, Jin-Soo	33.33	58.33	85.71	53.65	65.51	56.00	58.75	9	5	
9	Kim, Young-Ja	26.92	90.90	58.80	71.42	64.70	77.77	65.08	12	8	
10	Kim, Oe-Sun	—	—	—	—	—	—	—	—	—	
11	An, Kyoung-Ja	50.00	00.00	66.66	00.00	100.00	00.00	36.11	0	0	
									FC	28	27

PAR EQUIPE BY TEAM

TOTAL 31.92 86.09 74.68 53.93 64.82 62.26 62.28 99 69

1e ARBITRE 1st REFEREE Guerguil, Krastev BUL 2e ARBITRE 2nd REFEREE Davies, Glen EUA MARQUEUR SCOREKEEPER Estrada, Odilón MEX

MATCH 2

DUREE DURATION 0:48.00

JPN

JPN-EUA 3-0 (15-6, 15-2, 15-2)

	Service	Preparation	Reception	Bloquage Blocking	Fielding	Attaque Attack	%	C	T		
1	Yoshida, Setsuko	50.00	00.00	00.00	—	100.00	—	37.50	0	0	
2	Takayama, Suzue	30.75	84.61	100.00	55.26	69.21	100.00	73.30	7	5	
3	Iwahara, Toyoko	26.64	58.33	90.00	56.25	68.41	56.25	59.31	3	3	
4	Kasahara, Youko	—	—	—	—	—	—	—	—	—	
5	Onozawa, Aiko	—	—	—	—	—	—	—	—	—	
6	Kojima, Yukiyo	14.28	85.70	66.66	61.52	80.65	75.50	64.05	5	3	
7	Fukunaka, Sachiko	18.18	91.66	85.71	35.00	72.00	53.31	59.31	1	3	
8	Shishikura, Kunie	—	100.00	—	100.00	00.00	100.00	75.00	1	1	
9	Inoue, Setsuko	00.00	100.00	95.71	61.52	75.00	62.50	65.78	5	2	
10	Oinuma, Sumie	35.00	78.78	75.00	50.00	80.00	75.00	65.63	8	5	
11	Furukawa, Makiko	—	—	—	—	—	—	—	—	—	
12	Hama, Keiko	—	—	—	—	—	—	—	—	—	
									FC	5	23

PAR EQUIPE BY TEAM

TOTAL 24.11 90.38 76.18 54.42 75.31 70.06 65.07 35 45

EUA

1	Ward, Jane	20.00	83.72	100.00	40.00	77.77	57.14	63.10	3	1	
2	Owen, Nancy	—	—	—	00.00	—	50.00	25.00	—	—	
3	Hopeau, Fanny	00.00	83.33	87.50	27.27	100.00	25.00	53.85	1	1	
4	Perry, Barbara	12.50	100.00	73.90	00.00	30.00	57.15	45.59	9	1	
5	Jorgensen, Ninja	12.50	100.00	81.25	15.78	75.00	42.09	54.43	3	1	
6	McFadden, Miki	—	100.00	—	00.00	100.00	50.00	62.50	0	0	
7	Peterson, Sharon	—	—	100.00	—	100.00	—	100.00	0	0	
8	Bright, Patti	—	100.00	100.00	—	—	—	100.00	0	0	
9	Lewis, Laurie	40.00	90.00	70.83	26.30	16.66	50.00	48.96	3	1	
10	McReavy, Marilyn	33.33	—	80.00	41.16	00.00	16.66	34.23	2	1	
11	Perry, Mary	—	—	—	—	—	—	—	9	1	
12	Heck, Kathryn	10.00	00.00	81.81	10.00	58.33	52.38	35.42	6	1	
									FC	12	3

PAR EQUIPE BY TEAM

TOTAL 14.95 80.55 78.70 28.59 52.33 46.63 50.29 39 11

1e ARBITRE 1st REFEREE Buczynski, Ryszard POL 2e ARBITRE 2nd REFEREE Almanza, Jorge MEX MARQUEUR SCOREKEEPER Bretón, Federico MEX

MATCH 3
GAME

DUREE DURATION 1:28.00

URS

		Service	Preparation	Reception	Bloquage Blocking	Fielding	Attaque Attack	URS-CHE 3-1 (8-15, 15-7, 15-13, 15-7)		
							%	C	T	
1	Buldakova, Ljudmila	50.00	92.68	100.00	61.52	66.66	43.75	69.10	1	3
2	Mikhailovskaya, Ljudmila	20.00	91.18	75.00	66.66	90.00	100.00	73.80	3	1
3	Veinberg, Tatyana	—	—	—	—	—	—	—	—	—
4	Lantratova, Vera	—	—	81.81	57.14	83.33	40.00	65.57	3	2
5	Galushka, Vera	40.00	66.66	92.30	60.00	62.50	48.48	61.65	5	3
6	Sarycheva, Tatyana	38.45	33.33	75.00	50.00	00.00	40.00	39.46	3	1
7	Ponyaeva, Tatyana	28.57	50.00	100.00	66.66	100.00	00.00	57.53	0	0
8	Smoleeva, Nina	33.33	90.00	90.32	61.52	80.00	75.47	71.77	18	7
9	Ryskal, Inna	—	—	—	—	—	—	—	—	—
10	Leontieva, Galina	30.75	91.66	90.00	55.55	80.00	53.31	66.87	4	3
11	Salikhova, Roza	36.82	83.33	96.07	65.21	64.68	69.24	69.22	9	9
12	Vinogradova, Valentina	21.42	50.00	95.46	69.21	75.00	45.46	59.42	4	4
									FC 13	20

PAR EQUIPE BY TEAM

TOTAL		43.86	84.60	92.86	63.19	72.43	58.16	69.18	63	53
-------	--	-------	-------	-------	-------	-------	-------	-------	----	----

CHE

1	Steffkova, Pavlina	50.00	100.00	66.66	00.00	61.52	00.00	46.36	2	1
2	Polakova, Elena	23.00	100.00	50.00	47.22	61.76	50.00	56.16	7	3
3	Saskova, Karla	—	100.00	—	100.00	00.00	00.00	50.00	0	0
4	Senecka, Jitka	—	—	—	—	—	—	—	—	—
5	Struncova, Vera	00.00	100.00	75.00	33.33	75.00	40.00	53.88	0	0
6	Hrabakova, Vera	21.42	72.72	53.31	51.62	74.27	36.82	51.69	3	3
7	Bendeova, Julia	12.00	75.69	77.77	55.17	78.57	42.50	56.95	9	6
8	Mifkova, Anna	00.00	100.00	71.42	66.66	60.00	50.00	58.01	2	0
9	Ticha, Irena	00.00	100.00	66.66	50.00	33.33	28.57	46.42	4	1
10	Vlasakova, Hana	10.00	100.00	66.66	74.36	54.54	51.51	59.51	7	2
11	Siroka, Eva	00.00	84.09	66.66	41.16	60.61	66.66	53.19	3	0
12	Mazurova, Hilda	23.00	88.88	58.33	72.00	56.77	12.50	52.74	1	2
									FC 21	24

PAR EQUIPE BY TEAM

TOTAL		12.59	85.79	65.81	52.61	63.55	48.27	54.77	59	42
-------	--	-------	-------	-------	-------	-------	-------	-------	----	----

1e ARBITRE	1st REFEREE	Lange, Peter	ADE	2e ARBITRE	2nd REFEREE	Freire, Sergio	BRA	MARQUEUR	SCOREKEEPER	Tinajero, Rafael	MEX
------------	-------------	--------------	-----	------------	-------------	----------------	-----	----------	-------------	------------------	-----

MATCH 4
GAME

DUREE DURATION 2:02.00

PER

		Service	Preparation	Reception	Bloquage Blocking	Fielding	Attaque Attack	PER-MEX 3-2 (15-17, 15-5, 10-15, 15-2, 15-7)		
							%	C	T	
1	González, Mercedes	—	—	—	—	—	—	—	—	—
2	Jiménez, Esperanza	23.07	91.25	95.24	44.45	66.66	50.00	61.77	0	1
3	Núñez, Teresa	00.00	—	—	—	—	—	00.00	0	0
4	Cordero, Irma	22.72	66.66	80.00	31.25	72.72	57.88	55.20	7	3
6	Asato, Olga	—	—	—	—	—	—	—	0	0
7	Reyna, Aida	00.00	—	—	—	00.00	—	00.00	1	0
8	Sánchez, Alicia	—	—	100.00	00.00	—	50.00	50.00	3	5
9	Fuentes, Luisa	24.00	76.26	81.47	43.47	88.88	57.88	61.99	17	11
10	Ramírez, Ana	47.83	100.00	90.91	70.00	61.66	68.05	72.28	24	9
11	Velarde, Norma	48.27	95.24	92.58	72.22	72.00	61.03	74.35	5	2
12	Arroyo, Felicitas	24.00	83.33	81.25	42.09	73.08	60.00	60.62	—	—
									FC 23	39

PAR EQUIPE BY TEAM

TOTAL		30.17	88.28	76.62	54.17	75.95	65.50	65.11	80	70
-------	--	-------	-------	-------	-------	-------	-------	-------	----	----

MEX

1	Nogueira, Isabel	10.00	78.57	50.00	44.44	33.33	58.33	60.04	3	1
2	Mendoza, Carolina	16.16	86.53	68.75	39.39	53.06	55.56	53.24	9	4
3	Romo, Rogelia	—	—	—	00.00	00.00	00.00	00.00	0	0
4	Reynoso, Yolanda	00.00	37.18	50.00	38.45	58.82	40.00	45.74	3	1
6	Rodríguez, Carmen	—	—	—	—	—	—	—	2	0
7	Inzúa, Gloria	11.11	70.54	60.00	33.33	75.00	83.33	57.05	2	2
9	Cárdenas, Alicia	50.00	100.00	30.00	00.00	71.42	00.00	41.00	4	2
10	Casales, Gloria	—	—	—	—	—	—	—	3	2
11	Nava, Patricia	08.33	100.00	60.00	62.62	82.32	80.00	65.54	15	4
12	Macías, Trinidad	18.50	96.87	53.83	50.00	58.33	61.10	55.43	—	—
13	García, Blanca	10.23	87.50	57.69	47.16	77.78	76.92	61.04	18	9
14	Cabada, Eloisa	—	—	—	—	—	—	—	—	—
									FC 36	21

PAR EQUIPE BY TEAM

TOTAL		19.46	86.60	52.19	45.25	57.97	67.72	54.85	95	46
-------	--	-------	-------	-------	-------	-------	-------	-------	----	----

1e ARBITRE	1st REFEREE	Park, Moo	COR	2e ARBITRE	2nd REFEREE	Dusan, Prielonzy	CHE	MARQUEUR	SCOREKEEPER	Bretón, Federico	MEX
------------	-------------	-----------	-----	------------	-------------	------------------	-----	----------	-------------	------------------	-----

MATCH 5 OCT 14

DUREE DURATION 1:25.00

PER								PER-COR 3-0 (15-13, 15-6, 15-9)			
		Service	Preparation	Reception	Bloquage Blocking	Fielding	Attaque Attack	%	C	T	
1	González, Mercedes	—	—	—	—	—	—	—	—	—	
2	Jiménez, Esperanza	7.69	89.33	90.00	58.33	37.50	00.00	47.14	0	1	
3	Núñez, Teresa	100.00	—	100.00	—	00.00	—	66.66	0	0	
4	Cordero, Irma	15.38	84.59	78.57	56.25	87.50	53.83	62.68	1	2	
6	Asato, Olga	—	—	—	—	—	—	—	0	1	
7	Reyna, Aida	33.33	—	—	—	100.00	—	66.66	—	—	
8	Sánchez, Alicia	—	—	—	—	—	—	—	4	5	
9	Fuentes, Luisa	47.62	86.64	100.00	39.29	58.33	54.54	64.40	18	5	
10	Ramírez, Ana	37.50	95.71	80.94	76.56	61.52	66.66	69.51	17	6	
11	Velarde, Norma	35.00	00.00	88.46	58.33	60.00	68.62	51.73	2	1	
12	Arroyo, Felicitas	10.00	60.00	68.18	28.56	71.42	56.25	49.06	—	—	
PAR EQUIPE BY TEAM									FC 17	24	
TOTAL		33.98	83.10	83.16	52.32	66.33	63.71	63.76	59	45	
COR											
1	Moon, Kuyong-Sook	16.66	84.90	36.36	45.09	61.30	37.50	46.96	3	3	
2	Park, Kum-Sook	12.50	100.00	85.71	16.66	58.80	66.66	56.72	3	2	
3	Kwack, Yong-Ja	—	—	—	—	—	—	—	—	—	
4	Suh, Hee-Sook	21.42	100.00	75.86	34.81	60.00	71.80	60.64	11	3	
5	Lee, Eun-Ok	25.00	75.00	83.33	42.86	42.84	75.00	57.33	4	1	
6	Hwang, Kyu-Ok	00.00	—	00.00	00.00	100.00	00.00	20.00	0	0	
7	Lee, Hyang-Seem	66.66	91.57	—	34.48	54.27	00.00	49.39	0	0	
8	Yang, Jin-Soo	6.66	100.00	64.28	57.15	62.18	47.04	56.21	4	2	
9	Kim, Young-Ja	12.50	100.00	80.00	42.86	62.07	76.74	62.36	15	4	
10	Kim, De-Sun	—	—	—	—	—	—	—	0	1	
11	An, Kyoung-Ja	—	—	62.50	00.00	00.00	00.00	15.62	—	—	
PAR EQUIPE BY TEAM									FC 19	12	
TOTAL		25.15	91.53	68.02	41.66	59.44	63.01	58.13	59	28	
1e ARBITRE	1st REFEREE	Oldrich, Slavicek	CHE	2e ARBITRE	2nd REFEREE	Krol, Jerzy	POL	MARQUEUR	SCOREKEEPER	Concha, José	MEX

798

MATCH 6

DUREE DURATION 1:30.00

CHE								CHE-EUA 3-1 (15-8, 11-15, 15-9, 15-11)			
		Service	Preparation	Reception	Bloquage Blocking	Fielding	Attaque Attack	%	C	T	
1	Steffkova, Pavlina	05.88	100.00	62.50	61.10	68.00	16.66	52.35	3	1	
2	Polakova, Elena	10.00	100.00	61.52	66.66	65.21	80.00	63.89	7	3	
3	Saskova, Karla	—	—	—	—	—	—	—	—	—	
4	Senecka, Jitka	—	—	—	—	—	—	—	—	—	
5	Struncova, Vera	00.00	100.00	66.66	37.50	40.00	50.00	49.03	2	0	
6	Hrabakova, Vera	18.75	80.00	66.66	50.00	60.00	68.75	57.36	11	6	
7	Bendeova, Julia	31.56	100.00	78.94	50.00	82.84	64.20	68.00	4	10	
8	Mirkova, Anna	00.00	33.33	100.00	62.50	66.66	—	52.49	1	0	
9	Ticha, Irena	00.00	33.33	62.50	55.55	61.52	—	45.80	5	4	
10	Vlasakova, Hana	00.00	100.00	50.00	80.00	53.83	64.28	58.01	4	4	
11	Siroka, Eva	09.52	89.85	50.00	48.27	61.11	33.33	48.68	4	2	
12	Mazurova, Hilda	26.64	90.32	66.66	27.27	69.45	73.67	59.00	3	0	
PAR EQUIPE BY TEAM									FC 21	26	
TOTAL		15.14	91.42	65.52	52.60	66.84	61.64	58.86	65	56	
EUA											
1	Ward, Jane	22.20	90.00	81.81	40.00	62.50	65.38	60.31	10	3	
2	Owen, Nancy	—	100.00	100.00	33.33	00.00	00.00	46.66	0	0	
3	Hopeau, Fanny	00.00	—	66.66	25.00	100.00	33.33	44.99	0	0	
4	Perry, Barbara	11.76	100.00	89.99	58.33	63.31	48.55	61.99	8	5	
5	Jorgensen, Ninja	18.65	50.00	90.90	42.30	100.00	41.81	57.27	10	5	
6	McFadden, Miki	11.76	—	25.00	—	50.00	—	28.92	0	0	
7	Peterson, Sharon	11.76	80.00	79.16	37.50	55.55	33.33	49.55	3	3	
8	Bright, Patti	—	—	—	—	—	—	—	—	—	
9	Lewis, Laurie	22.20	80.00	90.24	43.75	61.91	53.84	58.65	5	5	
10	McReavy, Marilyn	10.00	—	91.66	55.17	44.44	45.95	49.44	11	2	
11	Perry, Mary	—	—	—	—	—	—	—	2	0	
12	Heck, Kathryn	00.00	—	100.00	50.00	66.66	50.00	53.33	—	—	
PAR EQUIPE BY TEAM									FC 16	19	
TOTAL		17.08	85.37	84.94	44.30	47.35	49.02	56.67	65	42	
1e ARBITRE	1st REFEREE	Iroshi, Kuwahara	JPN	2e ARBITRE	2nd REFEREE	Van Welden, Lucien	BEL	MARQUEUR	SCOREKEEPER	Alarid, Fernando	MEX

MATCH
GAME 7

DUREE DURATION 0:51.00

JPN

JPN-MEX 3-0 (15-7, 15-3, 15-2)

	Service	Preparation	Reception	Bloquage Blocking	Fielding	Attaque Attack	%	C	T
1 Yoshida, Setsuko	00.00	—	—	—	—	—	00.00	0	0
2 Takayama, Suzue	33.33	83.88	100.00	36.11	64.28	66.66	64.04	3	4
3 Iwahara, Toyoko	14.28	100.00	71.42	52.38	70.00	66.66	62.45	2	2
4 Kasahara, Youko	—	—	—	—	—	—	—	—	—
5 Onozawa, Aiko	—	—	—	—	—	—	—	—	—
6 Kojima, Yukiyo	41.66	100.00	87.50	41.16	59.09	46.14	62.59	9	2
7 Fukunaka, Sachiko	38.88	92.84	80.00	80.00	94.45	93.75	79.99	6	5
8 Shishikura, Kunie	100.00	100.00	00.00	66.66	100.00	00.00	61.11	0	2
9 Inoue, Setsuko	00.00	50.00	100.00	53.83	80.00	73.90	59.62	7	8
10 Qinuma, Sumie	38.45	96.55	100.00	72.00	86.64	83.33	79.49	5	6
11 Furukawa, Makiko	—	—	—	—	—	—	—	—	—
12 Hama, Keiko	—	—	—	—	—	—	—	—	—
PAR EQUIPE BY TEAM								FC 7	16
TOTAL	33.91	90.78	87.05	53.66	73.59	72.61	68.60	39	45
MEX									
1 Nogueira, Isabel	—	—	—	—	—	—	—	—	—
2 Mendoza, Carolina	09.09	94.08	64.28	23.07	47.04	40.00	46.26	3	0
3 Romo, Rogelia	—	—	—	—	—	—	—	—	—
4 Reynoso, Yolanda	00.00	93.33	20.00	08.33	38.45	28.57	31.44	1	0
5 Rodriguez, Carmen	—	—	—	—	—	—	—	0	0
6 Inzua, Gloria	—	50.00	33.33	00.00	100.00	50.00	46.67	1	0
7 Cardenas, Alicia	00.00	100.00	50.00	16.66	00.00	00.00	27.78	4	1
8 Casales, Gloria	—	—	—	—	—	—	—	1	0
9 Nava, Patricia	28.57	81.25	91.66	00.00	66.66	38.45	51.10	3	0
10 Macias, Trinidad	09.09	85.00	33.33	30.00	37.50	00.00	32.48	0	0
11 Garcia Blanca	00.00	100.00	60.00	14.28	50.00	22.20	41.08	6	4
12 Cabada, Eloisa	—	—	100.00	00.00	00.00	—	33.33	—	—
PAR EQUIPE BY TEAM								FC 16	7
TOTAL	13.93	86.18	60.17	19.19	43.76	35.20	43.11	35	12
1e ARBITRE 1st REFEREE:	Chinilin, A.	URS	2e ARBITRE 2nd REFEREE:	Ignacio, Catalino	EUA	MARQUEUR	SCOREKEEPER:	Bretón, Federico	MEX

MATCH
GAME 8

DUREE DURATION 0:57.00

URS

URS-POL 3-0 (15-5, 15-11, 15-4)

	Service	Preparation	Reception	Bloquage Blocking	Fielding	Attaque Attack	%	C	T
1 Buldakova, Ljudmila	12.50	83.33	80.00	33.33	87.50	53.84	58.41	2	5
2 Mikhailovskaya, Ljudmila	—	—	—	—	—	—	—	—	—
3 Veinberg, Tatyana	—	—	—	—	—	—	—	—	—
4 Lantratova, Vera	00.00	—	—	100.00	75.00	50.00	56.25	0	3
5 Galushka, Vera	20.00	100.00	75.10	46.14	58.33	58.80	59.72	6	4
6 Sarycheva, Tatyana	36.36	60.00	78.56	90.00	66.66	63.63	65.86	6	3
7 Ponyaeva, Tatyana	00.00	100.00	60.00	71.42	73.32	41.66	57.73	1	4
8 Smoleeva, Nina	21.04	100.00	80.00	75.00	59.09	62.50	66.27	8	6
9 Ryskal, Inna	—	—	—	—	—	—	—	—	—
10 Leontieva, Galina	38.45	88.13	100.00	33.33	75.00	25.00	59.98	1	1
11 Salikhova, Roza	12.50	95.84	70.00	59.99	89.29	56.00	63.93	8	6
12 Vinogradova, Valentina	—	—	—	—	—	—	—	—	—
PAR EQUIPE BY TEAM								FC 7	13
TOTAL	23.29	87.92	73.44	54.25	76.20	61.74	62.80	39	45
POL									
1 Czajkowska, Krystyna	50.00	92.84	75.00	60.00	100.00	50.00	71.30	2	1
2 Ledwig, Jozefa	00.00	77.77	77.77	47.04	80.00	55.55	56.35	4	2
3 Porzec, Elzbieta	14.28	100.00	62.50	66.66	44.44	00.00	47.98	1	0
4 Wiecha, Wanda	50.00	66.66	71.42	20.00	33.33	31.25	45.44	2	0
5 Szczesniewska, Zofia	12.50	89.29	100.00	28.57	50.00	00.00	46.72	1	0
6 Jakubowska, Krystyna	—	—	—	—	—	—	—	0	0
7 Chmielnicka, Lidia	100.00	—	100.00	33.33	00.00	100.00	66.66	1	0
8 Niemczyk, Barbara	22.22	81.25	92.84	62.50	71.42	66.66	66.14	7	5
9 Aszkielowicz, Halina	00.00	100.00	81.81	56.15	60.00	33.33	55.23	2	0
10 Krupa, Krystyna	00.00	55.55	100.00	56.25	50.00	41.16	50.49	4	1
11 Ksiazek, Jad-Wiga	25.00	50.00	62.50	37.50	00.00	50.00	37.50	0	0
12 Ostromiecka, Krystyna	00.00	50.00	60.00	00.00	66.66	100.00	46.11	1	3
PAR EQUIPE BY TEAM								FC 11	8
TOTAL	18.29	81.53	76.47	48.59	58.88	41.35	54.18	26	20
1e ARBITRE 1st REFEREE:	Villalba, Alfonso	MEX	2e ARBITRE 2nd REFEREE:	Yoshihara, Kazuo	JPN	MARQUEUR	SCOREKEEPER:	Bermejo, Pedro	MEX

MATCH 9 OCT 15

DUREE DURATION 1:09.00

CHE								CHE-MEX 3-0 (15-8, 15-2, 16-14)			
	Service	Preparation	Reception	Bloquage Blocking	Fielding	Attaque Attack	%	C	T		
1	Steffkova, Pavlina	07.14	100.00	00.00	33.33	73.90	63.63	46.33	3	1	
2	Polakova, Elena	16.66	60.00	66.66	87.60	71.42	57.88	59.20	5	5	
3	Saskova, Karla	20.00	89.47	50.00	60.00	73.32	77.77	61.76	2	1	
4	Senecka, Jitka	—	—	100.00	—	60.00	—	80.00	0	0	
5	Struncova, Vera	—	—	—	—	—	—	—	—	—	
6	Hrabakova, Vera	44.44	63.63	90.00	53.67	72.41	53.33	60.29	5	6	
7	Bendeova, Julia	23.81	87.47	66.66	54.54	80.65	40.00	59.18	2	4	
8	Mifkova, Anna	50.00	00.00	—	100.00	100.00	100.00	70.00	0	2	
9	Ticha, Irena	00.00	100.00	75.00	80.00	57.14	81.81	65.65	4	3	
10	Vlasakova, Hana	18.18	100.00	37.50	70.00	79.99	66.66	62.05	4	1	
11	Siroka, Eva	—	—	—	—	—	—	—	—	—	
12	Mazurova, Hilda	20.00	89.47	66.66	60.00	73.22	50.00	59.72	3	1	
								FC	14	22	
PAR EQUIPE BY TEAM											
TOTAL		17.93	82.91	71.40	60.54	77.76	60.31	61.80	42	46	
MEX											
1	Nogueira, Isabel	25.00	100.00	60.00	28.57	33.33	50.00	49.48	0	0	
2	Mendoza, Carolina	35.28	86.95	58.33	45.45	55.55	45.45	54.50	3	1	
3	Romo, Rogelia	—	—	100.00	—	15.38	—	57.69	0	0	
4	Reynoso, Yolanda	16.66	80.00	50.00	33.33	71.42	22.22	45.60	0	1	
6	Rodríguez, Carmen	—	—	—	—	—	—	—	2	1	
7	Inzúa, Gloria	80.00	—	100.00	50.00	66.66	62.50	71.83	1	0	
9	Cárdenas, Alicia	—	—	—	00.00	100.00	66.66	55.55	0	0	
10	Casales, Gloria	—	—	—	—	—	—	—	1	0	
11	Nava, Patricia	80.00	78.56	83.33	00.00	42.86	45.45	55.03	11	2	
12	Macías, Trinidad	00.00	75.00	66.66	57.14	60.00	16.66	45.91	0	0	
13	García, Blanca	10.00	62.50	80.94	31.56	76.90	52.94	52.47	10	8	
14	Cabada, Eloisa	80.00	93.75	66.66	00.00	54.54	27.27	53.70	1	1	
								FC	9	10	
PAR EQUIPE BY TEAM											
TOTAL		17.58	78.38	73.62	41.57	54.96	40.71	51.82	38	24	
1e ARBITRE	1st REFEREE	Yoshihara, Kazuo	JPN	2e ARBITRE	2nd REFEREE	Guerguiel, Krastev	BUL	MARQUEUR	SCOREKEEPER	Guerrero, Francisco	MEX

800

MATCH 10

DUREE DURATION 0:53.00

JPN								JPN-PER 3-0 (15-3, 15-11, 15-9)			
	Service	Preparation	Reception	Bloquage Blocking	Fielding	Attaque Attack	%	C	T		
1	Yoshida, Setsuko	66.66	00.00	—	—	100.00	—	55.55	—	—	
2	Takayama, Suzue	60.00	92.85	60.00	23.52	64.28	75.00	62.50	3	4	
3	Iwahara, Toyoko	25.00	100.00	72.72	55.55	87.50	83.33	70.68	2	0	
4	Kasahara, Youko	—	—	—	—	—	—	—	—	—	
5	Onozawa, Aiko	—	—	—	—	—	—	—	—	—	
6	Kojima, Yukiyo	37.50	100.00	83.33	45.45	73.67	75.00	69.15	7	9	
7	Fukunaka, Sachiko	50.00	100.00	90.00	20.00	73.32	83.32	69.44	5	10	
8	Shishikura, Kunie	100.00	00.00	—	16.66	80.00	100.00	59.33	1	2	
9	Inoue, Setsuko	66.66	100.00	28.51	00.00	44.44	46.14	47.63	2	4	
10	Oinuma, Sumie	75.00	97.06	95.71	41.66	60.00	93.33	77.12	8	5	
11	Furukawa, Makiko	—	—	—	—	—	—	—	—	—	
12	Hama, Keiko	66.66	00.00	100.00	—	50.00	100.00	63.33	1	0	
								FC	8	9	
PAR EQUIPE BY TEAM											
TOTAL		58.75	96.70	70.89	33.57	69.79	78.74	68.07	37	45	
PER											
1	González, Mercedes	—	—	—	—	—	—	—	—	—	
2	Jiménez, Esperanza	45.45	75.86	100.00	45.45	25.00	00.00	48.62	1	3	
3	Núñez, Teresa	00.00	00.00	00.00	—	—	00.00	00.00	0	0	
4	Cordero, Irma	28.57	60.00	53.31	00.00	75.00	16.16	38.84	1	0	
5	Asato, Olga	—	—	—	—	—	—	—	0	0	
6	Reyna, Aida	50.00	00.00	—	—	100.00	—	50.00	3	0	
7	Sánchez, Alicia	20.00	00.00	57.14	63.63	100.00	50.00	48.46	1	0	
8	Fuentes, Luisa	25.00	36.36	50.00	55.55	83.33	00.00	41.70	9	6	
9	Ramírez, Ana	28.56	69.21	90.90	30.00	62.50	56.77	56.32	12	6	
10	Velarde, Norma	42.86	54.54	54.54	20.00	46.14	66.64	46.70	1	1	
11	Arroyo, Felicitas	20.00	00.00	88.88	11.11	45.45	40.00	34.24	—	—	
								FC	8	7	
PAR EQUIPE BY TEAM											
TOTAL		33.25	68.72	65.26	31.85	54.75	53.96	51.30	36	23	
1e ARBITRE	1st REFEREE	Glen, Davies	EUA	2e ARBITRE	2nd REFEREE:	Buczynski, Ryszard	POL	MARQUEUR	SCOREKEEPER	González, Manuel	MEX

MATCH GAME 11 OCT 16

DUREE DURATION 0:47.00

POL

POL-EUA 3-0 (15-3, 15-1, 16-14)

	Service	Preparation	Reception	Bloquage Blocking	Fielding	Attaque Attack	%	C	T		
1	Czajkowska, Krystyna	12.50	85.71	100.00	60.00	57.14	63.63	63.16	1	2	
2	Ledwig, Jozefa	50.00	100.00	75.37	55.55	50.00	83.33	69.04	4	6	
3	Porzec, Elzbieta	45.45	83.33	100.00	83.33	100.00	54.54	77.77	4	4	
4	Wiecha, Wanda	33.33	50.00	100.00	00.00	100.00	50.00	55.55	2	2	
5	Szczesniewska, Zofia	30.75	81.25	83.33	50.00	66.66	66.66	63.10	4	2	
6	Jakubowska, Krystyna	28.56	73.32	100.00	87.50	40.00	72.22	66.93	4	4	
7	Chmielnicka, Lidia	—	—	—	—	—	—	—	—	—	
8	Niemczyk, Barbara	00.00	80.00	66.66	50.00	100.00	40.00	56.11	2	0	
9	Aszkielowicz, Halina	33.33	75.00	81.95	75.00	70.00	75.00	68.38	6	3	
10	Krupa, Krystyna	—	—	100.00	00.00	100.00	00.00	50.00	0	0	
11	Ksiazek, Jad-Wiga	100.00	100.00	100.00	33.33	00.00	50.00	63.88	1	1	
12	Ostromecka, Krystyna	—	—	—	—	—	—	—	—	—	
								FC	5	22	
PAR EQUIPE	BY TEAM										
TOTAL		35.03	83.64	90.53	65.58	71.71	66.23	68.85	33	46	
EUA											
1	Ward, Jane	27.27	85.69	50.00	43.75	52.98	33.33	48.83	4	0	
2	Owen, Nancy	00.00	00.00	25.00	50.00	40.00	45.45	26.74	0	5	
3	Hopeau, Fanny	00.00	100.00	42.86	22.22	33.33	25.00	37.23	2	1	
4	Perry, Barbara	37.50	100.00	46.14	54.54	31.56	50.00	53.29	5	2	
5	Jorgensen, Ninja	38.45	100.00	66.66	45.83	45.46	61.10	59.57	5	1	
6	McFadden, Miki	—	—	00.00	—	100.00	—	50.00	0	0	
7	Peterson, Sharon	00.00	76.90	57.14	33.33	75.00	00.00	40.39	1	1	
8	Bright, Patti	—	100.00	100.00	—	100.00	—	100.00	0	0	
9	Lewis, Laurie	30.00	100.00	60.00	55.55	50.00	80.00	62.59	4	1	
10	McReavy, Marilyn	00.00	—	55.55	31.25	20.00	16.66	24.69	3	2	
11	Perry, Mary	33.33	100.00	50.00	71.41	100.00	100.00	75.79	1	1	
12	Heck, Kathryn	—	—	—	—	—	—	—	—	—	
								FC	9	4	
PAR EQUIPE	BY TEAM										
TOTAL		26.59	89.44	54.48	44.99	49.36	41.88	51.12	34	18	
1e ARBITRE	1st REFEREE	Flores, Enrique	MEX	2e ARBITRE	2nd REFEREE:	Van Welden, Lucien	BEL	MARQUEUR	SCOREKEEPER:	Avila, Salvador	MEX

MATCH GAME 12

DUREE DURATION 0:55.00

URS

URS-COR 3-0 (15-9, 15-6, 15-2)

	Service	Preparation	Reception	Bloquage Blocking	Fielding	Attaque Attack	%	C	T		
1	Buldakova, Ljudmila	23.07	79.50	66.65	52.58	66.66	42.86	55.28	4	1	
2	Mikhailovskaya, Ljudmila	00.00	100.00	100.00	—	50.00	—	62.50	0	0	
3	Veinberg, Tatyana	—	—	—	—	—	—	—	—	—	
4	Lantratova, Vera	00.00	103.00	100.00	100.00	50.00	80.00	71.66	2	1	
5	Galushka, Vera	16.68	100.00	100.00	100.00	50.00	100.00	77.77	4	2	
6	Sarycheva, Tatyana	—	—	—	—	—	—	—	—	—	
7	Ponyaeva, Tatyana	33.33	00.00	50.00	—	50.00	—	33.33	0	0	
8	Smoleeva, Nina	35.38	65.66	75.00	60.00	76.44	66.65	63.34	4	5	
9	Ryskal, Inna	61.10	100.00	83.55	42.54	83.33	75.00	74.21	7	7	
10	Leontieva, Galina	11.11	75.75	—	40.00	95.71	20.00	48.51	1	2	
11	Salikhova, Roza	62.50	75.00	100.00	64.88	64.28	65.00	71.91	5	3	
12	Vinogradova, Valentina	50.00	66.66	75.00	100.00	35.00	57.14	70.63	3	3	
								FC	9	21	
PAR EQUIPE	BY TEAM										
TOTAL		42.56	79.23	84.58	58.85	72.82	66.81	70.63	39	45	
COR											
1	Moon, Kuyong-Sook	44.44	74.46	57.88	10.52	53.11	62.50	50.51	1	0	
2	Park, Kum-Sook	66.65	36.33	50.00	50.00	78.56	33.35	52.48	1	0	
3	Kwack, Yong-Ja	—	—	—	—	—	—	—	—	—	
4	Suh, Hee-Sook	16.75	75.00	57.14	20.00	56.25	76.44	50.24	7	1	
5	Lee, Eun-Ok	50.00	100.00	50.00	50.00	00.00	00.00	41.66	4	0	
6	Hwang, Kyu-Ok	50.00	50.00	25.00	42.86	40.00	00.00	34.64	0	0	
7	Lee, Hyang-Seem	71.42	60.00	57.14	15.78	53.31	100.00	59.60	0	2	
8	Yang, Jin-Soo	44.44	80.00	68.18	40.00	63.14	75.00	61.79	3	1	
9	Kim, Young-Ja	60.00	00.00	100.00	35.16	51.54	66.26	52.86	9	3	
10	Kim, Oe-Sun	—	—	—	—	—	—	—	—	—	
11	An, Kyoung-Ja	00.00	00.00	50.00	—	00.00	—	12.50	0	0	
								FC	11	10	
PAR EQUIPE	BY TEAM										
TOTAL		55.57	71.53	62.76	24.67	57.74	61.37	56.16	36	17	
1e ARBITRE	1st REFEREE:	Freire, Sergio	BRA	2e ARBITRE	2nd REFEREE:	Arredondo, Genaro	MEX	MARQUEUR	SCOREKEEPER:	Delgado, Héctor	MEX

MATCH 13 OCT 17

DUREE DURATION 1:40.00

COR

COR-EUA 3-1 (15-9, 15-13, 6-15, 15-5)

	Service	Preparation	Reception	Bloquage Blocking	Fielding	Attaque Attack	%	C	T
1 Moon, Kuyong-Sook	21.04	84.00	71.42	57.44	62.96	60.75	60.93	11	6
2 Park, Kum-Sook	00.00	—	50.00	50.00	60.00	80.00	60.00	1	0
3 Kwack, Yong-Ja	—	—	100.00	00.00	100.00	66.66	66.66	—	—
4 Suh, Hee-Sook	27.27	100.00	71.18	60.00	61.55	69.86	74.97	22	10
5 Lee, Eun-Ok	15.78	50.00	83.33	41.66	32.00	60.00	47.12	7	3
6 Hwang, Kyu-Ok	00.00	100.00	100.00	65.00	25.00	—	58.00	0	0
7 Lee, Hyang-Seem	13.32	86.51	91.66	48.83	67.86	—	61.63	0	1
8 Yang, Jin-Soo	15.38	66.66	86.36	68.91	65.70	40.00	57.16	2	4
9 Kim, Young-Ja	21.75	100.00	86.36	76.92	57.13	84.09	71.04	14	11
10 Kim, Oe-Sun	—	—	—	—	—	—	—	—	—
11 An, Kyoung-Ja	—	—	00.00	00.00	50.00	—	16.66	0	0
PAR EQUIPE BY TEAM								FC 15	16
TOTAL	18.67	81.51	81.80	55.85	58.85	68.22	60.78	72	51

EUA

	Service	Preparation	Reception	Bloquage Blocking	Fielding	Attaque Attack	%	C	T
1 Ward, Jane	07.14	93.15	100.00	37.50	77.73	47.35	60.47	3	4
2 Owen, Nancy	—	—	—	40.00	00.00	75.00	38.33	2	0
3 Hopeau, Fanny	—	—	—	—	—	—	—	—	—
4 Perry, Barbara	30.75	80.00	80.00	40.00	60.00	65.21	59.32	5	7
5 Jorgensen, Ninja	04.54	60.00	77.77	40.50	64.58	66.66	52.35	15	7
6 McFadden, Miki	100.00	—	66.66	—	00.00	—	55.55	0	0
7 Peterson, Sharon	23.07	77.26	86.11	20.00	69.55	50.00	54.33	1	0
8 Bright, Patti	00.00	—	00.00	—	100.00	—	33.33	0	0
9 Lewis, Laurie	00.00	100.00	84.59	50.00	50.00	57.14	56.95	1	0
10 McReavy, Marilyn	21.42	00.00	80.94	47.50	50.00	64.81	44.11	20	9
11 Perry, Mary	50.00	100.00	79.16	44.44	84.59	64.28	70.41	7	3
12 Heck, Kathryn	—	—	70.00	00.00	100.00	36.36	51.59	3	1
PAR EQUIPE BY TEAM								FC 14	11
TOTAL	29.83	88.33	83.14	40.44	73.42	58.16	62.22	71	42
1e ARBITRE 1st REFEREE Dusan, Prielonzy CHE				2e ARBITRE 2nd REFEREE Oldrich, Slavicek CHE			MARQUEUR SCOREKEEPER Avila, Salvador MEX		

802

MATCH 14

DUREE DURATION 0:53.00

URS

URS-PER 3-0 (15-4, 15-9, 15-9)

	Service	Preparation	Reception	Bloquage Blocking	Fielding	Attaque Attack	%	C	T
1 Buldakova, Ljudmila	21.42	80.00	—	40.00	83.33	53.83	55.71	4	2
2 Mikhailovskaya, Ljudmila	40.00	87.70	100.00	—	95.71	40.00	72.68	1	0
3 Veinberg, Tatyana	—	—	—	—	—	—	—	—	—
4 Lantratova, Vera	87.50	66.66	95.71	50.00	44.44	88.88	72.19	3	3
5 Galushka, Vera	37.50	50.00	75.00	75.00	75.00	58.33	61.80	1	7
6 Sarycheva, Tatyana	33.33	—	—	100.00	100.00	100.00	83.33	1	1
7 Ponyaeva, Tatyana	—	100.00	60.00	16.66	100.00	100.00	75.33	3	5
8 Smoleeva, Nina	25.00	100.00	75.00	55.55	75.00	70.00	66.75	3	3
9 Ryskal, Inna	64.14	88.88	87.50	66.66	100.00	65.21	75.73	5	5
10 Leontieva, Galina	87.50	53.31	—	33.33	62.50	50.00	57.32	—	1
11 Salikhova, Roza	33.33	—	66.66	80.00	—	64.28	61.00	3	5
12 Vinogradova, Valentina	25.00	—	75.00	—	100.00	66.66	66.66	0	2
PAR EQUIPE BY TEAM								FC 12	11
TOTAL	44.48	82.74	69.57	56.71	80.36	58.06	66.04	37	45
PER									
1 Gonzáles, Mercedes	—	—	—	—	—	—	—	—	—
2 Jiménez, Esperanza	70.00	77.08	00.00	18.18	71.42	100.00	56.11	0	2
3 Núñez, Teresa	—	—	—	—	—	—	—	—	—
4 Cordero, Irma	54.54	66.66	69.21	18.18	50.00	50.00	51.43	2	0
6 Asato, Olga	—	—	—	—	—	—	—	0	0
7 Reyna, Aída	00.00	00.00	—	—	00.00	—	00.00	—	—
8 Sánchez, Alicia	100.00	100.00	33.33	66.66	50.00	50.00	66.66	0	1
9 Fuentes, Luisa	33.33	83.33	66.66	05.55	75.00	60.00	53.98	10	4
10 Ramírez, Ana	95.71	66.66	40.00	33.33	41.66	75.00	58.72	10	6
11 Velarde, Norma	69.21	100.00	83.33	25.00	40.00	60.87	63.06	1	0
12 Arroyo, Felicitas	37.50	100.00	84.59	09.09	88.88	50.00	61.67	—	—
PAR EQUIPE BY TEAM								FC 11	9
TOTAL	55.81	75.12	59.27	19.84	53.24	64.56	54.10	34	22
1e ARBITRE 1st REFEREE Almanza, Jorge MEX				2e ARBITRE 2nd REFEREE Guerguil, Krastev BUL			MARQUEUR SCOREKEEPER Estrada, Odilón MEX		

MATCH GAME 15

OCT 19

DUREE DURATION 0:53:00

JPN

JPN-CHE 3-0 (15-7, 15-8, 15-7)

	Service	Preparation	Reception	Bloquage Blocking	Fielding	Attaque Attack	%	C	T
1 Yoshida, Setsuko	50.00	100.00	—	75.00	71.42	55.00	70.28	0	0
2 Takayama, Suzue	41.16	93.33	100.00	34.81	71.43	57.69	66.48	9	4
3 Iwahara, Toyoko	66.66	100.00	100.00	60.00	75.00	00.00	66.94	0	0
4 Kasahara, Youko	—	—	—	—	—	—	—	—	—
5 Onozawa, Aiko	—	—	—	—	—	—	—	—	—
6 Kojima, Yukiyo	38.88	78.56	86.64	50.00	66.66	60.00	63.45	8	3
7 Fukunaka, Sachiko	22.22	93.33	80.00	55.55	75.00	56.25	63.72	1	2
8 Shishikura, Kunie	50.00	66.66	85.71	55.55	71.42	77.77	67.85	8	10
9 Inoue, Setsuko	40.00	00.00	66.66	75.00	81.25	66.66	54.92	2	5
10 Onuma, Sumie	28.56	94.88	83.33	54.54	74.07	71.42	67.80	10	8
11 Furukawa, Makiko	—	—	—	—	—	—	—	—	—
12 Hama, Keiko	70.00	100.00	77.75	36.36	50.00	50.00	64.01	0	2
PAR EQUIPE BY TEAM								FC 8	11
TOTAL	43.70	89.55	83.56	46.31	69.22	62.82	61.57	46	45

CHE

1 Steffkova, Pavlina	00.00	75.00	40.00	50.00	—	60.00	45.00	1	4
2 Polakova, Elena	00.00	100.00	25.00	55.55	50.00	45.45	46.00	2	0
3 Saskova, Karla	00.00	81.81	80.00	46.14	66.66	53.31	54.65	1	0
4 Senecka, Jitka	—	—	—	—	—	—	—	—	—
5 Struncova, Vera	00.00	—	100.00	33.33	00.00	50.00	36.66	—	1
6 Hrabakova, Vera	07.69	84.88	94.08	28.56	62.50	60.00	55.78	8	2
7 Bendeova, Julia	40.00	100.00	100.00	68.75	80.00	59.09	74.64	6	0
8 Mifkova, Anna	00.00	100.00	100.00	46.65	75.00	60.00	63.60	1	1
9 Ticha, Irena	40.00	100.00	77.77	33.33	57.14	57.15	60.80	5	3
10 Vlasakova, Hana	00.00	—	72.72	00.00	40.00	37.50	30.04	0	0
11 Siroka, Eva	12.50	61.53	88.88	50.00	75.00	00.00	49.65	0	0
12 Mazurova, Hilda	33.33	87.50	80.94	33.33	63.63	50.00	58.12	2	1
PAR EQUIPE BY TEAM								FC 6	10
TOTAL	17.72	83.59	83.97	45.01	63.98	52.70	57.82	33	22

1e ARBITRE 1st REFEREE Van Welden, Lucien BEL

2e ARBITRE 2nd REFEREE Ignacio, Catalino EUA

MARQUEUR SCOREKEEPER González, Elías MEX

MATCH GAME 16

DUREE DURATION 2:02:00

POL

POL-MEX 3-2 (15-9, 12-15, 15-11, 11-15, 15-4)

	Service	Preparation	Reception	Bloquage Blocking	Fielding	Attaque Attack	%	C	T
1 Czajkowska, Krystyna	40.00	67.85	100.00	33.33	80.00	56.25	62.90	6	6
1 Ledwig, Jozefa	52.18	75.00	80.00	52.84	78.57	59.23	63.30	8	7
3 Porzec, Elzbieta	41.66	80.00	65.00	46.65	76.44	70.00	62.29	5	4
4 Wlecha, Wanda	30.00	12.50	77.77	46.65	80.00	72.72	53.27	11	4
5 Szczesniewska, Zofia	40.00	76.44	100.00	41.66	84.59	55.55	66.37	4	2
6 Jakubowska, Krystyna	16.00	88.89	88.20	66.66	75.00	61.55	80.05	13	4
7 Chmielnicka, Lidia	—	—	50.00	—	75.00	—	31.25	0	0
8 Niemczyk, Barbara	20.00	63.89	90.90	50.00	81.81	52.38	59.83	6	3
9 Aszkielowicz, Halina	43.48	47.14	70.76	63.41	82.76	63.16	61.78	18	5
10 Krupa, Krystyna	40.00	80.00	50.00	70.00	92.30	50.00	63.71	1	2
11 Ksiazek, Jad-Wiga	—	—	—	—	—	—	—	—	—
12 Ostromecka, Krystyna	33.33	100.00	80.00	—	66.66	—	69.99	0	0
PAR EQUIPE BY TEAM								FC 20	31
TOTAL	34.03	72.32	67.55	54.36	80.42	64.77	62.24	92	68

MEX

1 Nogueira, Isabel	50.00	50.00	—	33.33	88.88	00.00	44.44	0	0
2 Mendoza, Carolina	48.00	75.79	86.64	34.81	70.83	37.03	58.83	5	5
3 Romo, Rogelia	50.00	00.00	100.00	—	—	—	50.00	0	1
4 Reynoso, Yolanda	—	—	—	—	—	—	—	—	—
6 Rodriguez, Carmen	00.00	00.00	100.00	—	00.00	—	25.00	0	0
7 Inzúa, Gloria	00.00	00.00	50.00	100.00	100.00	11.00	43.50	1	1
9 Cárdenas, Alicia	33.10	62.50	90.91	22.20	64.44	50.00	53.85	7	2
10 Casales, Gloria	42.84	78.26	88.88	47.62	62.50	52.00	62.01	3	3
11 Nava, Patricia	45.83	70.00	61.30	47.83	59.52	65.51	58.33	20	6
12 Macías, Trinidad	50.00	59.57	70.76	22.72	29.40	55.56	48.00	1	1
13 García, Blanca	33.33	100.00	68.75	50.00	64.70	68.56	64.22	19	11
14 Cabaña, Eloisa	00.00	00.00	100.00	100.00	00.00	00.00	33.33	0	1
PAR EQUIPE BY TEAM								FC 27	23
TOTAL	39.50	71.85	76.15	37.30	57.18	54.99	56.17	91	54

1e ARBITRE 1st REFEREE Guerguil, Krastev BUL

2e ARBITRE 2nd REFEREE Kwan, J. COR

MARQUEUR SCOREKEEPER Concha, José MEX

MATCH GAME 17 OCT 20

DUREE DURATION 1:04.00

JPN

JPN-POL 3-0 (15-5, 15-6, 15-6)

	Service	Preparation	Reception	Bloquage Blocking	Fielding	Attaque Attack	%	C	T
1 Yoshida, Setsuko	00.00	100.00	100.00	55.55	40.00	33.33	54.81	0	1
2 Takayama, Suzue	47.04	90.10	71.42	45.45	65.38	75.86	65.88	13	8
3 Iwahara, Toyoko	00.00	00.00	87.50	50.00	47.09	75.09	48.85	1	1
4 Kasahara, Youko	—	—	—	—	—	—	—	—	—
5 Onozawa, Aiko	—	—	—	—	—	—	—	—	—
6 Kojima, Yukiyo	50.00	92.84	81.81	35.28	69.99	73.90	67.30	7	4
7 Fukunaka, Sachiko	36.36	100.00	57.14	40.00	77.26	76.90	64.61	6	2
8 Shishikura, Kunie	25.00	—	83.33	62.52	57.14	68.18	59.83	2	3
9 Inoue, Setsuko	75.00	—	100.00	87.50	60.00	42.84	63.06	3	4
10 Oinuma, Sumie	57.88	94.12	66.66	53.84	62.96	71.18	67.77	8	6
11 Furukawa, Makiko	—	—	—	—	—	—	—	—	—
12 Hama, Keiko	66.66	66.66	70.00	63.63	68.28	69.21	67.40	3	4
PAR EQUIPE BY TEAM								FC 8	12
TOTAL	43.86	91.55	80.12	51.66	63.00	68.88	66.51	51	45

POL

1 Czajkowska, Krystyna	00.00	90.47	78.00	33.33	80.00	50.00	54.80	2	3
2 Ledwig, Jozefa	00.00	66.66	83.33	53.83	68.68	50.00	53.75	4	1
3 Porzec, Elzbieta	00.00	83.33	40.00	45.45	63.63	40.00	45.40	3	0
4 Wiecha, Wanda	07.69	75.00	69.99	56.25	47.83	62.50	53.21	8	1
5 Szczesniewska, Zofia	—	—	—	—	—	00.00	00.00	0	0
6 Jakubowska, Krystyna	07.14	84.80	63.63	37.03	54.81	59.90	50.98	8	4
7 Chmielnicka, Lidia	—	—	50.00	—	00.00	—	25.00	1	0
8 Niemczyk, Barbara	00.00	80.00	57.14	45.83	55.55	75.00	52.23	10	2
9 Aszkielowicz, Halina	18.18	100.00	38.88	40.74	73.90	68.75	56.74	5	1
10 Krupa, Krystyna	—	100.00	—	00.00	—	00.00	33.33	0	0
11 Ksiazek, Jad-Wiga	—	—	—	—	—	—	—	—	—
12 Ostromecka, Krystyna	—	—	100.00	00.00	100.00	—	66.66	0	0
PAR EQUIPE BY TEAM								FC 11	5
TOTAL	08.62	85.99	59.50	41.29	59.31	57.52	52.03	52	17

1e ARBITRE 1st REFEREE: Davies, Glen EUA

2e ARBITRE 2nd REFEREE: Guerguil, Krastev BUL

MARQUEUR SCOREKEEPER: Sujo, Antonio MEX

804

MATCH GAME 18

DUREE DURATION 1:39.00

CHE

CHE-PER 3-2 (7-15, 13-15, 15-9, 15-2, 15-3)

	Service	Preparation	Reception	Bloquage Blocking	Fielding	Attaque Attack	%	C	T
1 Steffkova, Pavlina	22.22	—	100.00	55.55	75.00	16.66	53.88	3	3
2 Polakova, Elena	50.00	100.00	50.00	69.21	55.00	73.08	66.21	9	4
3 Šaskova, Karla	35.70	100.00	100.00	36.36	57.14	70.00	66.53	2	3
4 Senecka, Jitka	—	—	—	—	—	—	—	—	—
5 Struncova, Vera	50.00	100.00	50.00	42.84	66.66	46.14	59.27	2	1
6 Hrabakova, Vera	58.33	92.30	58.33	46.43	65.21	72.00	65.43	9	9
7 Bendeova, Julia	50.00	88.88	57.88	55.00	81.47	82.14	69.22	7	3
8 Miřkova, Anna	50.00	90.91	100.00	58.80	86.95	55.55	73.70	4	3
9 Ticha, Irena	50.00	—	75.00	62.50	100.00	84.59	74.41	3	3
10 Vlasakova, Hana	33.33	100.00	70.00	73.67	46.25	72.72	74.41	3	4
11 Siroka, Eva	33.33	73.54	80.00	28.57	57.14	28.57	50.19	0	1
12 Mazurova, Hilda	50.00	91.66	60.00	75.00	89.19	80.00	74.30	2	3
PAR EQUIPE BY TEAM								FC 20	28
TOTAL	45.89	87.57	71.46	54.29	73.83	68.92	66.98	64	65

PER

1 Gonzáles, Mercedes	—	—	—	—	—	—	—	—	—
2 Jiménez, Esperanza	63.14	72.58	—	37.50	59.09	—	58.07	2	1
3 Núñez, Teresa	—	—	—	—	—	—	—	—	—
4 Cordero, Irma	39.13	78.56	72.72	65.38	56.52	52.38	60.78	4	3
6 Asato, Olga	—	—	—	—	—	—	—	0	0
7 Reyna, Aida	66.66	—	—	—	—	—	66.66	0	0
8 Sánchez, Alicia	—	—	—	50.00	—	66.66	58.33	2	1
9 Fuentes, Luisa	28.56	77.26	88.87	66.66	54.54	25.00	56.81	16	10
10 Ramirez, Ana	20.00	61.10	95.65	58.32	72.00	52.17	59.87	19	7
11 Velarde, Norma	30.75	40.00	85.00	50.00	99.99	50.52	59.37	6	1
12 Arroyo, Felicitas	33.33	75.00	84.20	71.42	62.50	52.38	63.13	—	—
PAR EQUIPE BY TEAM								FC 16	21
TOTAL	41.60	71.74	86.58	53.87	56.94	49.91	60.10	65	44

1e ARBITRE 1st REFEREE: Ignacio, Catalino EUA

2e ARBITRE 2nd REFEREE: Yoshihara, Kazuo JPN

MARQUEUR SCOREKEEPER: Concha, José MEX

MATCH 19 OCT 21

DUREE DURATION 1:07.00

URS		URS-EUA 3-1 (15-1, 6-15, 15-4, 15-6)									
	Service	Preparation	Reception	Bloquage Blocking	Fielding	Attaque Attack	%	C	T		
1	Buldakova, Ljudmila	33.33	83.33	62.50	70.00	73.90	46.65	56.61	2	3	
2	Mikhailovskaya, Ljudmila	00.00	80.00	—	50.00	83.33	25.00	47.66	0	2	
3	Veinberg, Tatyana	—	—	—	—	—	—	—	—	—	
4	Lantratova, Vera	00.00	100.00	100.00	50.00	66.66	66.66	63.88	1	0	
5	Galushka, Vera	30.00	100.00	50.00	—	50.00	57.14	57.42	6	5	
6	Sarycheva, Tatyana	50.00	50.00	75.00	46.14	60.00	80.00	60.19	2	1	
7	Ponyaeva, Tatyana	00.00	50.00	50.00	—	100.00	66.66	53.33	2	4	
8	Smoleeva, Nina	00.00	50.00	66.66	80.00	50.00	57.88	60.20	3	3	
9	Ryskal, Inna	20.00	87.50	62.50	15.00	76.44	68.95	55.06	5	9	
10	Leontieva, Galina	25.00	96.78	—	45.45	84.59	95.71	44.50	2	0	
11	Salikhova, Roza	36.36	60.00	72.72	47.50	70.83	79.16	59.42	8	2	
12	Vinogradova, Valentina	66.66	50.00	85.71	100.00	60.00	57.14	54.92	2	2	
								FC	10	20	
PAR EQUIPE BY TEAM											
TOTAL		38.87	83.85	61.63	50.19	68.76	64.50	61.30	43	51	
EUA											
1	Ward, Jane	00.00	73.32	100.00	00.00	33.33	33.33	39.99	—	—	
2	Owen, Nancy	00.00	100.00	66.66	36.36	00.00	28.57	38.59	0	1	
3	Hopeau, Fanny	00.00	100.00	62.50	50.00	00.00	16.66	38.19	0	0	
4	Perry, Barbara	00.00	50.00	100.00	47.35	80.00	38.88	52.70	2	1	
5	Jorgensen, Ninja	30.00	66.66	80.00	33.33	66.66	46.35	53.83	3	1	
6	McFadden, Miki	100.00	100.00	83.33	—	50.00	—	53.33	0	0	
7	Peterson, Sharon	00.00	100.00	100.00	50.00	71.42	—	64.28	0	0	
8	Bright, Patti	25.00	80.70	100.00	14.28	50.00	—	53.99	0	1	
9	Lewis, Laurie	12.50	75.00	87.50	50.00	68.75	14.28	51.33	1	0	
10	McReavy, Marilyn	00.00	00.00	66.66	42.30	42.86	59.09	35.15	6	4	
11	Perry, Mary	—	—	—	—	—	—	—	—	—	
12	Heck, Kathryn	40.00	100.00	83.33	54.54	40.00	61.52	63.23	7	3	
								FC	12	15	
PAR EQUIPE BY TEAM											
TOTAL		23.99	77.33	84.04	39.14	53.93	42.73	53.52	31	26	
1e ARBITRE	1st REFEREE	Krol, Jerzy	POL	2e ARBITRE	2nd REFEREE:	Park, Moo	COR	MARQUEUR	SCOREKEEPER:	Bretón, Federico	MEX

805

MATCH 20

DUREE DURATION 1:06.00

COR		COR-MEX 3-0 (15-5, 15-4, 15-6)									
	Service	Preparation	Reception	Bloquage Blocking	Fielding	Attaque Attack	%	C	T		
1	Moon, Kuyong-Sook	20.00	93.18	92.30	65.21	83.33	50.00	67.33	5	2	
2	Park, Kum-Sook	—	—	—	—	—	—	—	—	—	
3	Kwack, Yong-Ja	—	—	—	—	—	—	—	—	—	
4	Suh, Hee-Sook	12.50	50.00	81.47	66.66	57.14	71.69	56.57	13	13	
5	Lee, Eun-Ok	07.14	100.00	90.00	75.00	87.50	53.31	68.82	3	2	
6	Hwang, Kyu-Ok	00.00	100.00	100.00	—	—	—	66.66	0	0	
7	Lee, Hyang-Seem	20.00	84.44	100.00	52.98	76.44	100.00	72.31	2	3	
8	Yang, Jin-Soo	27.27	100.00	92.84	66.66	75.00	71.42	72.19	5	1	
9	Kim, Young-Ja	00.00	100.00	95.65	66.66	66.66	72.22	66.86	7	10	
10	Kim, De-Sun	—	—	—	—	—	—	—	—	—	
11	An, Kyoung-Ja	—	—	—	—	—	—	—	—	—	
								FC	11	14	
PAR EQUIPE BY TEAM											
TOTAL		20.69	89.44	92.41	63.76	70.96	67.34	67.38	46	45	
MEX											
1	Nogueira, Isabel	20.00	66.66	46.14	71.66	73.32	40.00	47.96	3	0	
2	Mendoza, Carolina	57.14	85.70	75.00	43.75	55.00	62.50	63.18	4	0	
3	Romo, Rogelia	100.00	00.00	100.00	00.00	33.33	00.00	38.88	0	0	
4	Reynoso, Yolanda	—	—	—	—	—	—	—	—	—	
6	Rodríguez, Carmen	00.00	66.66	60.00	00.00	57.14	40.00	37.30	2	0	
7	Inzúa, Gloria	42.86	80.00	76.90	44.82	57.14	66.66	61.39	10	1	
9	Cárdenas, Alicia	50.00	83.33	71.42	28.50	53.83	27.27	52.39	1	1	
10	Casales, Gloria	50.00	90.90	75.00	40.00	50.00	33.33	56.53	1	1	
11	Nava, Patricia	40.00	00.00	85.70	33.33	72.72	57.15	48.15	9	2	
12	Macías, Trinidad	38.45	78.25	58.33	55.55	66.66	55.55	58.79	4	1	
13	García, Blanca	33.33	100.00	71.42	55.55	50.00	45.45	59.20	4	0	
14	Cabada, Eloisa	—	—	100.00	50.00	—	00.00	50.00	0	0	
								FC	10	9	
PAR EQUIPE BY TEAM											
TOTAL		38.45	73.88	66.70	40.95	51.39	48.90	53.38	48	15	
1e ARBITRE	1st REFEREE	Davies, Glen	EUA	2e ARBITRE	2nd REFEREE	Lange, Peter	ADE	MARQUEUR	SCOREKEEPER:	Sujo, Antonio	MEX

MATCH 21 OCT 23
GAME

DUREE DURATION 0:56.00

URS

URS-MEX 3-0 (15-6, 15-10, 15-3)

	Service	Preparation	Reception	Bloquage Blocking	Fielding	Attaque Attack	%	C	T
1 Buldakova, Ljudmila	62.50	88.87	66.66	63.63	88.20	66.66	72.75	2	2
2 Mikhailovskaya, Ljudmila	50.00	75.00	—	25.00	66.66	71.42	57.61	0	3
3 Veinberg, Tatyana	—	—	—	—	—	—	—	—	—
4 Lantratova, Vera	—	—	—	—	—	—	—	—	—
5 Galushka, Vera	83.33	66.66	80.00	57.14	75.00	55.55	69.61	3	1
6 Sarycheva, Tatyana	100.00	—	—	00.00	100.00	100.00	75.00	0	1
7 Ponyaeva, Tatyana	50.00	66.66	60.00	50.00	64.28	66.66	62.93	2	2
8 Smoleeva, Nina	53.83	50.00	50.00	50.00	76.44	75.00	59.21	8	5
9 Ryskal, Inna	60.87	60.00	82.30	64.28	72.73	73.32	68.91	7	10
10 Leontieva, Galina	60.00	93.33	100.00	60.00	54.15	71.42	78.15	2	3
11 Salikhova, Roza	61.10	100.00	83.33	47.62	76.90	59.23	71.36	5	6
12 Vinogradova, Valentina	—	—	—	—	—	—	—	—	—
PAR EQUIPE BY TEAM								FC 13	12
TOTAL	61.09	81.31	78.72	54.70	70.24	72.29	69.72	42	45

MEX

1 Nogueira, Isabel	—	—	—	—	—	—	—	—	—
2 Mendoza, Carolina	30.75	91.66	69.21	33.33	47.62	40.00	52.09	1	2
3 Romo, Rogelia	—	—	00.00	—	100.00	—	50.00	0	0
4 Revnoso, Yolanda	—	—	—	—	—	—	—	—	—
6 Rodríguez, Carmen	00.00	50.00	20.00	14.28	66.66	50.00	33.49	1	1
7 Inzúa, Gloria	00.00	100.00	50.00	26.64	50.00	35.70	43.72	4	1
9 Cárdenas, Alicia	14.28	66.66	75.00	22.22	70.00	12.50	43.44	0	1
10 Casales, Gloria	00.00	76.32	66.66	45.45	43.75	22.22	51.00	3	0
11 Nava, Patricia	00.00	100.00	60.00	25.00	57.15	52.98	49.18	7	3
12 Macías, Trinidad	00.00	73.08	66.66	25.00	52.38	12.50	38.27	1	4
13 García, Blanca	11.11	66.66	63.14	37.50	62.50	55.17	49.34	8	0
14 Cabada, Eloisa	—	—	—	—	—	—	—	—	—
PAR EQUIPE BY TEAM								FC 15	7
TOTAL	05.67	82.82	64.62	26.67	42.40	41.27	43.91	40	19

1e ARBITRE 1st REFEREE: Guerguil, Krastev BUL 2e ARBITRE 2nd REFEREE: Rivero, Carlos PER MARQUEUR SCOREKEEPER: Valdés, Octavio MEX

806

MATCH 22
GAME

DUREE DURATION 1:26.00

PER

PER-EUA 3-1 (15-11, 15-0, 14-16, 15-12)

	Service	Preparation	Reception	Bloquage Blocking	Fielding	Attaque Attack	%	C	T
1 Gonzáles, Mercedes	—	—	—	—	—	—	—	—	—
2 Jiménez, Esperanza	50.00	86.66	100.00	54.54	39.13	50.00	63.38	0	2
3 Núñez, Teresa	—	—	—	—	—	—	—	—	—
4 Cordero, Irma	52.00	89.47	55.55	47.04	75.00	33.33	58.73	1	3
6 Asato, Olga	60.00	00.00	—	—	33.33	—	31.11	0	0
7 Reyna, Aida	—	—	—	—	—	—	—	—	—
8 Sánchez, Alicia	68.41	84.20	66.66	39.99	60.71	70.00	64.99	4	4
9 Fuentes, Luisa	50.00	70.00	85.70	58.33	66.66	70.90	66.93	16	9
10 Ramirez, Ana	61.62	100.00	63.14	50.00	64.00	67.85	67.76	16	12
11 Velarde, Norma	78.75	69.21	25.00	46.65	66.66	87.50	63.96	2	4
12 Arroyo, Felicitas	—	—	—	—	—	—	—	—	—
PAR EQUIPE BY TEAM								FC 19	25
TOTAL	62.09	88.86	57.41	50.00	65.78	72.06	66.03	58	59

EUA

1 Ward, Jane	25.00	67.01	50.00	43.75	69.91	50.00	50.94	1	0
2 Owen, Nancy	100.00	—	50.00	50.00	50.00	60.00	62.00	2	1
3 Hopeau, Fanny	—	—	100.00	—	100.00	33.33	77.77	1	0
4 Perry, Barbara	62.50	100.00	60.00	37.50	60.00	23.07	57.17	2	1
5 Jorgensen, Ninja	30.75	100.00	37.50	47.22	75.00	56.60	57.84	13	5
6 McFadden, Miki	—	—	—	—	—	—	—	0	0
7 Peterson, Sharon	50.00	95.71	82.76	—	90.90	—	79.84	1	1
8 Bright, Patti	100.00	81.25	—	—	71.42	—	84.22	0	0
9 Lewis, Laurie	23.07	66.66	83.33	65.00	70.76	64.68	62.25	5	5
10 McReavy, Marilyn	30.75	—	68.18	53.33	100.00	64.11	63.27	10	9
11 Perry, Mary	—	—	—	—	—	—	—	0	0
12 Heck, Kathryn	25.00	100.00	66.66	40.00	70.00	33.10	55.79	3	6
PAR EQUIPE BY TEAM								FC 20	11
TOTAL	38.78	70.27	69.51	44.24	71.36	52.26	57.74	58	39

1e ARBITRE 1st REFEREE: Yoshihara, Kazuo JPN 2e ARBITRE 2nd REFEREE: Dusan, Prielonzy CHE MARQUEUR SCOREKEEPER: Cruz, César MEX

MATCH 23 OCT 24

DUREE DURATION 1:17.00

POL								POL-CHE 3-0 (15-13, 15-7, 15-12)								
	Service	Preparation	Reception	Bloquage Blocking	Fielding	Attaque Attack	%	C	T							
1	Czajkowska, Krystyna	14.28	78.12	62.50	46.14	25.00	50.00	46.00	3	2						
2	Ledwig, Jozefa	36.00	83.33	96.55	50.00	100.00	50.00	69.31	6	5						
3	Porzec, Elzbieta	18.75	66.66	96.97	57.88	72.72	62.96	62.95	11	3						
4	Senecka, Jitka	00.00	100.00	100.00	25.00	—	70.00	59.00	3	2						
5	Struncova, Vera	00.00	81.25	100.00	50.00	—	100.00	66.25	0	2						
6	Jakubowska, Krystyna	08.33	77.74	100.00	50.00	—	61.30	58.82	10	3						
7	Chmielnicka, Lidia	—	—	—	—	55.55	00.00	00.00	0	0						
8	Mifkova, Anna	08.33	72.72	82.60	46.65	50.00	59.09	53.23	3	2						
9	Aszkielowicz, Halina	12.10	83.83	87.50	62.50	77.77	74.07	66.29	11	8						
10	Krupa, Krystyna	00.00	—	100.00	100.00	—	00.00	50.00	1	1						
11	Ksiazek, Jad-Wiga	—	—	—	—	—	—	—	—	—						
12	Ostromiecka, Krystyna	—	—	—	—	—	—	—	—	—						
PAR EQUIPE BY TEAM								FC 13	17							
TOTAL								17.45	79.79	91.85	51.83	64.44	62.74	61.34	61	45

CHE								POL-CHE 3-0 (15-13, 15-7, 15-12)								
	Service	Preparation	Reception	Bloquage Blocking	Fielding	Attaque Attack	%	C	T							
1	Steffkova, Paulina	66.66	—	50.00	—	—	—	58.33	0	0						
2	Polakova, Elena	55.55	71.42	61.00	50.00	54.54	55.56	58.02	9	9						
3	Saskova, Karla	66.66	—	33.33	66.66	28.27	42.86	47.55	3	0						
4	Senecka, Jitka	—	—	—	—	—	—	—	—	—						
5	Struncova, Vera	50.00	—	50.00	—	100.00	100.00	75.00	1	0						
6	Hrabakova, Vera	35.70	75.00	82.60	33.33	64.53	58.08	58.20	8	2						
7	Bendeova, Julia	62.50	50.00	37.50	55.60	58.33	47.62	51.82	4	1						
8	Mifkova, Anna	33.33	90.90	100.00	50.00	44.44	00.00	53.11	0	1						
9	Ticha, Irena	100.00	100.00	75.00	37.50	62.50	42.86	69.64	2	0						
10	Vlasakova, Hana	50.00	100.00	57.14	52.18	70.00	55.56	64.14	9	1						
11	Siroka, Eva	50.00	75.00	70.76	50.00	50.00	53.83	58.26	4	1						
12	Mazurova, Hilda	42.86	66.66	81.81	60.00	33.33	40.00	54.11	1	0						
PAR EQUIPE BY TEAM								FC 19	17							
TOTAL								51.40	68.71	61.07	47.97	54.12	52.84	56.02	60	32

1e ARBITRE 1st REFEREE: Davies, Glen EUA 2e ARBITRE 2nd REFEREE: Van Welden, Lucien BEL MARQUEUR SCOREKEEPER: Valdés, Octavio MEX

MATCH 24

DUREE DURATION 0:53.00

807

JPN								JPN-COR 3-0 (15-5, 15-5, 15-4)								
	Service	Preparation	Reception	Bloquage Blocking	Fielding	Attaque Attack	%	C	T							
1	Yoshida, Setsuko	33.33	100.00	—	20.00	83.33	75.00	62.33	3	0						
2	Takayama, Suzue	44.43	82.84	87.50	60.00	80.00	50.00	67.43	3	3						
3	Iwahara, Toyoko	50.00	100.00	35.00	100.00	100.00	66.66	75.27	2	0						
4	Kasahara, Youko	—	—	—	—	—	—	—	—	—						
5	Onozawa, Aiko	—	—	—	—	—	—	—	—	—						
6	Kojima, Yukiyo	40.00	63.63	94.08	42.84	86.64	90.00	69.53	5	9						
7	Fukunaka, Sachiko	27.27	76.90	75.00	50.00	86.64	80.00	65.96	2	2						
8	Shishikura, Kunie	76.90	—	50.00	53.83	75.00	75.00	66.14	8	3						
9	Inoue, Setsuko	33.33	100.00	80.00	50.00	100.00	54.54	69.64	1	2						
10	Oinuma, Sumie	20.00	87.11	83.33	64.29	85.71	70.76	68.53	6	5						
11	Furukawa, Makiko	—	—	—	—	—	—	—	—	—						
12	Hama, Keiko	46.12	100.00	75.00	50.00	87.50	63.63	70.37	4	2						
PAR EQUIPE BY TEAM								FC 10	19							
TOTAL								41.52	84.52	80.20	53.09	88.74	69.50	69.50	44	45

COR								JPN-COR 3-0 (15-5, 15-5, 15-4)								
	Service	Preparation	Reception	Bloquage Blocking	Fielding	Attaque Attack	%	C	T							
1	Moon, Kuyong-Sook	66.66	58.33	61.42	37.50	80.00	40.00	57.31	6	1						
2	Park, Kum-Sook	25.00	50.00	00.00	20.00	37.50	75.00	34.58	4	0						
3	Kwack, Yong-Ja	—	—	—	—	—	—	—	—	—						
4	Suh, Hee-Sook	50.00	66.66	83.32	50.00	61.10	63.63	62.45	6	3						
5	Lee, Eun-Ok	25.00	00.00	62.62	18.18	33.33	31.25	28.39	3	0						
6	Hwang, Kyu-Ok	00.00	00.00	—	—	100.00	—	33.33	0	0						
7	Lee, Hyang-Seem	14.00	62.50	100.00	15.00	71.42	50.00	52.15	1	0						
8	Yang, Jin-Soo	00.00	33.33	64.28	25.00	70.76	41.66	39.17	3	0						
9	Kim, Young-Ja	37.50	100.00	57.14	20.00	60.87	60.87	56.02	7	0						
10	Kim, Oe-Sun	—	—	—	—	—	—	—	—	—						
11	An, Kyoung-Ja	00.00	00.00	50.00	—	00.00	—	12.50	0	0						
PAR EQUIPE BY TEAM								FC 10	10							
TOTAL								32.34	60.79	69.19	25.07	60.84	50.97	49.86	42	14

1e ARBITRE 1st REFEREE: Rivero, Carlos PER 2e ARBITRE 2nd REFEREE: Freire, Sergio BRA MARQUEUR SCOREKEEPER: Alarid, Fernando MEX

MATCH GAME 25 OCT 25

DUREE DURATION 1:23.00

POL

POL-PER 3-1 (15-10, 14-16, 15-9, 15-8)

	Service	Preparation	Reception	Bloquage Blocking	Fielding	Attaque Attack	%	C	T
1 Czajkowska, Krystyna	11.11	76.74	100.00	60.00	44.44	46.14	56.40	2	4
2 Ledwig, Jozefa	50.00	100.00	75.00	50.00	75.00	42.86	65.47	0	1
3 Porzec, Elzbieta	16.66	77.77	86.66	65.21	80.00	53.57	63.31	5	6
4 Wiecha, Wanda	07.69	80.00	78.25	46.66	50.00	67.86	55.07	6	10
5 Szczesniewska, Zofia	—	—	100.00	—	00.00	—	50.00	0	0
6 Jakubowska, Krystyna	18.75	62.50	100.00	59.37	60.00	76.32	62.82	10	7
7 Chmielnicka, Lidia	—	—	—	—	—	—	—	—	—
8 Niemczyk, Barbara	22.22	87.81	66.66	54.85	100.00	60.87	64.40	6	6
9 Aszkielowicz, Halina	27.27	95.71	77.26	62.96	90.90	61.10	69.20	6	8
10 Krupa, Krystyna	25.00	71.42	100.00	75.00	75.00	50.00	66.07	1	0
11 Ksiazek, Jad-Wiga	—	—	—	—	—	—	—	—	—
12 Ostromecka, Krystyna	—	—	—	—	—	—	—	—	—
PAR EQUIPE BY TEAM	—	—	—	—	—	—	—	FC 17	17
TOTAL	18.41	77.70	85.42	58.67	69.35	63.58	62.18	53	59

PER

1 Gonzáles, Mercedes	—	—	—	—	—	—	—	—	—
2 Jiménez, Esperanza	64.29	69.33	100.00	43.75	62.50	33.33	62.20	3	6
3 Núñez, Teresa	33.33	—	—	—	—	—	33.33	0	0
4 Cordero, Irma	50.00	56.52	55.00	42.84	70.00	55.55	54.89	4	2
6 Asato, Olga	25.00	100.00	00.00	—	50.00	—	43.75	0	0
7 Reyna, Aida	—	—	—	—	—	—	—	—	—
8 Sánchez, Alicia	62.50	78.56	66.66	55.38	51.16	40.00	59.12	2	1
9 Fuentes, Luisa	66.66	72.22	63.63	31.81	72.00	52.11	59.75	17	7
10 Ramírez, Ana	50.00	50.00	91.66	25.00	61.30	62.29	56.70	12	8
11 Velarde, Norma	40.00	50.00	60.00	37.50	64.29	43.75	49.25	4	2
12 Arroyo, Felicitas	—	—	—	—	—	—	—	—	—
PAR EQUIPE BY TEAM	—	—	—	—	—	—	—	FC 11	17
TOTAL	49.55	67.02	67.46	39.73	60.24	51.74	55.95	53	43

1e ARBITRE 1st REFEREE: Chinilin, A. URS

2e ARBITRE 2nd REFEREE: Park, Moo COR

MARQUEUR SCOREKEEPER: González, Elías MEX

808

MATCH GAME 26

DUREE DURATION 1:44.00

COR

COR-CHE 3-1 (15-9, 15-9, 9-15, 15-11)

	Service	Preparation	Reception	Bloquage Blocking	Fielding	Attaque Attack	%	C	T
1 Moon, Kuyong-Sook	20.82	87.93	87.50	31.42	80.94	63.63	62.04	7	4
2 Park, Kum-Sook	00.00	—	100.00	—	—	—	50.00	0	0
3 Kwack, Yong-Ja	—	—	—	—	—	—	—	—	—
4 Suh, Hee-Sook	07.14	66.66	90.47	55.55	57.14	64.93	56.98	15	11
5 Lee, Eun-Ok	19.05	100.00	94.73	90.00	50.00	60.71	62.41	6	4
6 Hwang, Kyu-Ok	—	100.00	100.00	—	75.00	—	91.66	0	0
7 Lee, Hyang-Seem	26.64	86.88	100.00	40.00	78.94	25.00	59.57	1	0
8 Yang, Jin-Soo	22.72	66.66	81.47	38.45	72.22	58.98	56.75	10	11
9 Kim, Young-Ja	21.04	57.14	88.88	61.10	60.00	64.15	58.71	12	5
10 Kim, Oe-Sun	—	—	—	—	—	—	—	0	0
11 An, Kyoung-Ja	—	100.00	100.00	—	80.00	—	93.33	0	0
PAR EQUIPE BY TEAM	—	—	—	—	—	—	—	FC 23	19
TOTAL	19.09	84.65	91.04	40.60	70.55	61.50	61.24	74	54

CHE

1 Steffkova, Pavlina	—	—	100.00	—	—	—	100.00	0	0
2 Polakova, Elena	37.50	83.33	50.00	43.33	43.40	76.00	55.59	7	2
3 Saskova, Karla	33.33	83.33	100.00	43.75	31.56	62.50	59.07	5	1
4 Senecka, Jitka	14.28	72.00	66.66	58.33	70.83	100.00	63.68	0	0
5 Struncova, Vera	18.75	50.00	66.66	46.51	57.15	54.54	48.93	9	2
6 Hrabakova, Vera	38.88	100.00	70.76	61.91	69.45	60.71	66.95	7	1
7 Bendeova, Julia	00.00	87.50	69.21	51.35	66.66	39.18	52.31	5	1
8 Mlífkova, Anna	44.44	76.48	50.00	50.00	53.57	45.45	53.32	0	3
9 Ticha, Irena	20.00	100.00	50.00	52.00	47.62	47.35	52.82	3	1
10 Vlasakova, Hana	20.00	100.00	63.63	52.98	64.28	53.83	59.12	6	4
11 Siroka, Eva	06.66	77.77	62.50	52.98	61.10	66.66	54.61	1	1
12 Mazurova, Hilda	37.50	71.87	57.14	70.76	62.50	33.33	55.51	0	2
PAR EQUIPE BY TEAM	—	—	—	—	—	—	—	FC 9	26
TOTAL	24.97	76.05	64.12	52.19	70.34	52.35	56.67	52	44

1e ARBITRE 1st REFEREE: Lange, Peter ADE

2e ARBITRE 2nd REFEREE: Freire, Sergio BRA

MARQUEUR SCOREKEEPER: Cruz, César MEX

MATCH 27 OCT 26

DUREE DURATION 0:56.00

MEX

MEX-EUA 3-0 (15-8, 15-7, 15-4)

	Service	Preparation	Reception	Bloquage Blocking	Fielding	Attaque Attack	%	C	T	
1	Nogueira, Isabel	—	—	—	—	—	—	—	—	
2	Mendoza, Carolina	57.14	69.21	64.28	81.25	76.92	69.80	6	4	
3	Romo, Rogelia	—	—	—	—	—	—	—	—	
4	Reynoso, Yolanda	50.00	66.66	100.00	30.75	71.42	64.28	0	2	
6	Rodríguez, Carmen	—	—	—	—	—	—	—	—	
7	Inzúa, Gloria	—	—	—	—	—	—	—	—	
9	Cárdenas, Alicia	52.98	90.90	80.00	66.66	60.87	58.80	4	2	
10	Casales, Gloria	23.07	90.47	50.00	50.00	65.21	61.52	2	1	
11	Nava, Patricia	40.00	100.00	46.65	44.43	60.00	66.66	5	4	
12	Macías, Trinidad	33.33	66.66	100.00	00.00	33.33	46.66	0	0	
13	García, Blanca	50.00	57.14	75.00	68.75	65.62	76.44	5	5	
14	Cabada, Eloisa	—	—	—	—	—	—	—	—	
								FC	7	
PAR EQUIPE BY TEAM										
TOTAL		47.63	79.00	62.06	52.19	63.80	67.77	62.07	29	45
EUA										
1	Ward, Jane	00.00	75.00	—	57.14	100.00	33.33	53.09	0	0
2	Owen, Nancy	20.00	00.00	37.50	40.00	60.00	41.66	33.19	1	1
3	Hopeau, Fanny	00.00	100.00	62.21	58.33	00.00	33.33	42.31	1	1
4	Perry, Barbara	42.86	66.66	93.75	27.27	83.33	33.33	57.86	3	1
5	Jorgensen, Ninja	00.00	—	79.80	28.57	83.33	38.88	46.13	1	2
6	McFadden, Miki	66.66	71.42	100.00	33.33	75.00	50.00	66.06	0	0
7	Peterson, Sharon	00.00	50.00	81.81	25.00	87.50	—	48.86	0	0
8	Bright, Patti	33.33	64.29	100.00	25.00	—	00.00	44.52	1	0
9	Lewis, Laurie	37.50	75.00	100.00	40.00	66.66	54.54	62.28	3	1
10	McReavy, Marilyn	25.00	50.00	81.81	42.84	100.00	33.10	55.45	7	1
11	Perry, Mary	00.00	100.00	71.42	50.00	42.86	60.00	54.04	4	0
12	Heck, Kathryn	00.00	—	100.00	20.00	66.66	37.50	44.83	3	0
								FC	12	12
PAR EQUIPE BY TEAM										
TOTAL		29.34	68.45	76.90	39.07	66.22	40.57	53.42	36	19
1e ARBITRE	1st REFEREE:	Lange, Peter ADE	2e ARBITRE	2nd REFEREE:	Yoshihara, Kazuo JPN	MARQUEUR	SCOREKEEPER:	Avila, Salvador MEX		

MATCH 28

DUREE DURATION 1:30.00

809

URS

URS-JPN 3-1 (15-10, 16-14, 3-15, 15-9)

	Service	Preparation	Reception	Bloquage Blocking	Fielding	Attaque Attack	%	C	T	
1	Buldakova, Ljudmila	35.28	94.11	71.22	51.62	85.71	40.00	62.99	2	5
2	Mikhailovskaya, Ljudmila	33.33	81.09	75.00	53.83	83.33	20.00	57.76	2	0
3	Veinberg, Tatyana	—	—	—	—	—	—	—	—	—
4	Lantratova, Vera	00.00	—	66.66	100.00	80.00	40.00	51.33	1	0
5	Galushka, Vera	18.18	80.00	75.00	62.96	87.50	51.85	62.58	7	1
6	Sarycheva, Tatyana	00.00	—	66.66	14.28	50.00	50.00	36.18	1	0
7	Ponyaeva, Tatyana	—	—	—	—	—	—	—	—	—
8	Smoleeva, Nina	22.72	100.00	93.33	69.99	69.21	72.97	71.37	10	11
9	Ryskal, Inna	45.45	75.00	71.18	61.91	58.30	62.50	62.39	13	14
10	Leontieva, Galina	00.00	91.66	100.00	57.00	100.00	20.00	56.70	0	0
11	Salikhova, Roza	23.52	68.75	75.00	57.69	84.59	69.99	63.25	7	4
12	Vinogradova, Valentina	—	—	66.66	100.00	80.00	40.00	51.33	0	1
								FC	9	13
PAR EQUIPE BY TEAM										
TOTAL		24.09	86.00	77.44	59.07	81.03	59.12	64.46	52	49
JPN										
1	Yoshida, Setsuko	00.00	100.00	100.00	80.00	66.66	33.33	63.33	0	1
2	Takayama, Suzue	36.82	89.58	83.33	53.80	76.92	51.72	65.36	9	2
3	Iwahara, Toyoko	50.00	87.50	65.00	50.00	11.11	50.00	52.26	1	5
4	Kasahara, Youko	—	—	—	—	—	—	—	—	—
5	Onozawa, Aiko	—	—	—	—	—	—	—	—	—
6	Kojima, Yukiyo	27.75	93.31	64.00	57.69	53.33	50.00	57.68	8	3
7	Fukunaka, Sachiko	28.56	88.46	50.00	64.68	73.33	46.15	58.53	3	7
8	Shishikura, Kumie	25.00	—	66.66	76.90	82.50	57.14	61.64	4	2
9	Inoue, Setsuko	—	100.00	00.00	71.69	50.00	51.72	54.68	2	2
10	Oinuma, Sumie	30.75	96.15	76.90	62.50	61.11	66.66	65.67	7	5
11	Furukawa, Makiko	—	—	—	—	—	—	—	—	—
12	Hama, Keiko	54.54	86.64	73.67	66.66	24.63	60.87	62.00	6	7
								FC	14	14
PAR EQUIPE BY TEAM										
TOTAL		37.76	91.57	64.20	59.88	62.19	54.92	61.75	54	48
1e ARBITRE	1st REFEREE	Davies, Glen EUA	2e ARBITRE	2nd REFEREE:	Buczynski, Ryszard POL	MARQUEUR	SCOREKEEPER:	Bretón, Federico MEX		

**RESUME DE SCORES
SUMMARY OF SCORES**

**CLASSEMENT FINAL
FINAL STANDING**

**FEMMES
WOMEN**

															Score total Total scored			
	COR	CHE	EUA	JPN	MEX	PER	POL	URS		JJ	JG	JP	SG	SP	TF	TC	P	
COR	*	3-1	3-1	0-3	3-0	0-3	2-3	0-3	1	URS	7	7	0	21	3	333	194	14
CHE	1-3	*	3-1	0-3	3-0	3-2	0-3	1-3	2	JPN	7	6	1	19	3	318	147	13
EUA	1-3	1-3	*	0-3	0-3	1-3	0-3	1-3	3	POL	7	5	2	15	11	324	304	12
JPN	3-0	3-0	3-0	*	3-0	3-0	3-0	1-3	4	PER	7	3	4	12	15	306	327	10
MEX	0-3	0-3	3-0	0-3	*	2-3	2-3	0-3	5	COR	7	3	4	11	14	276	305	10
PER	3-0	2-3	3-1	0-3	3-2	*	1-3	0-3	6	CHE	7	3	4	11	15	307	307	10
POL	3-2	3-0	3-0	0-3	3-2	3-1	*	0-3	7	MEX	7	1	6	7	18	215	338	8
URS	3-0	3-1	3-1	3-1	3-0	3-0	3-0	*	8	EUA	7	0	7	4	21	196	353	7

**RECORDS OLYMPIQUES ETABLIS A HELSINKI EN 1952 DURANT
LES JEUX DE LA XV OLYMPIADE**

**OLYMPIC RECORDS ESTABLISHED IN 1952 IN HELSINKI DURING
THE GAMES OF THE XV OLYMPIAD**

**ATHLETISME HOMMES
ATHLETICS MEN**

400 m	-	400 m	V. G. Rhoden	JAM	45.9"
1500 m	-	1500 m	J. Barthel	LUX	3'45.2"
5000 m	-	5000 m	E. Zatopek	CHE	14'06.6"
10000 m	-	10000 m	E. Zatopek	CHE	29'17.0"
Marathon	-	Marathon	E. Zatopek	CHE	2 ^o 31'03.2"
110 m Haies	-	110 m Hurdles	W. H. Dillard	EUA	13.7"
400 m Haies	-	400 m Hurdles	C. Moore	EUA	50.8"
3000 m Steeplechase	-	3000 m Steeplechase	H. Ashenfelder	EUA	8'45.4"
4 x 400 m Relais	-	4 x 400 m Relay	JAM	JAM	3'03.9"
50 km marche	-	50 Km Walk	G. Dordoni	ITA	4 ^o 28'07.8"
Saut en Hauteur	-	High Jump	W. Davis	EUA	2.04m
Triple Saut	-	Triple Jump	A. Ferreira	BRA	16.22m
Saut à la Perche	-	Pole Vault	R. Richards	EUA	4.55m
Lancement du Poids	-	Shot Put	W. P. O'Brien	EUA	17.41m
Lancement du Disque	-	Discus Throw	S. Iness	EUA	55.03m
Lancement du Marteau	-	Hammer Throw	J. Čsermák	HUN	60.34m
Lanc du Javelot	-	Javelin Throw	C. Young	EUA	73.78m
Décathlon	-	Decathlon	R. Mathias	EUA	7887p

**ATHLETISME FEMMES
ATHLETICS WOMEN**

100 m	-	100 m	M. Jackson	AUS	11.5"
200 m	-	200 m	M. Jackson	AUS	23.4"
80 m Haies	-	80 m 100 Hurdles	S. Strickland	AUS	10.9"
4 x 100 m Relais	-	4 x 100 m Relay	EUA	EUA	45.9"
Saut en Longueur	-	Long Jump	I. Williams	NZL	6.24m
Lancement du Javelot	-	Javelin Throw	D. Zatopkova	CHE	50.47m
Lancement du Marteau	-	Hammer Throw	G. Zybina	URS	15.28m
Lancement du Disque	-	Discus Throw	N. Romashkova	URS	51.42m

**CYCLISME
CYCLING**

Km contre la montre	-	100 m Time Trial	R. Mockridge	AUS	1'11.1"
---------------------	---	------------------	--------------	-----	---------

**HALTEROPHILIE
WEIGHTLIFTING**

Poids Coq	-	Bantamweight	I. Udodov	URS	(S) 97.5 (J) 127.5	315.0Kg
Poids Plume	-	Featherweight	R. Tchimisikian	URS	(S) 110.0 (J) 143.0	337.5Kg
Poids Léger	-	Lightweight	T. Kono	EUA	(S) 117.5	362.5Kg
Poids Moyen	-	Middleweight	P. George	EUA	(S) 127.5 (J) 157.5	400.0Kg
Poids Moyen Lourd	-	Light Heavyweight	T. Lomakin	URS	(J) 165.0	417.5Kg
Poids Mi-Lourd	-	Middle Heavyweight	N. Schemansky	EUA	(S) 140 (J) 177.5	445.0Kg
Poids Lourd	-	Heavyweight	J. Davis	EUA	(P) 150.0 (S) 145.0 (J) 177.5	460.0Kg

**NATATION HOMMES
SWIMMING MEN**

100 m Nage Libre	-	100 m Freestyle	C. Scholes	EUA	57.1"
400 m Nage Libre	-	400 m Freestyle	J. Boiteux	FRA	4'30.7"
1500 m Nage Libre	-	1500 m Freestyle	F. Konno	EUA	18'30.0"
4 x 200 m Nage Libre	-	100 Freestyle Relay	EUA	EUA	8'31.1"
100 m Dos	-	100 m Backstroke	Y. Oyakawa	EUA	1'05.4"
200 m Papillon	-	200 m Butterfly	J. G. Davis	AUS	2'34.4"

**NATATION FEMMES
SWIMMING WOMEN**

100 m Nage Libre	-	100 m Freestyle	J. Ternes	HUN	1'05.5"
400 m Nage Libre	-	400 m Freestyle	V. Gyenge	HUN	5'12.1"
200 m Brasse	-	200 m Breaststroke	E. Novak	HUN	2'54.0"
100 m Dos	-	100 m Backstroke	G. Wielema	HOL	1'13.8"
4 x 100 m Nage Libre	-	4 x 100 m Freestyle Relay	HUN	HUN	4'24.4"

**TIR
SHOOTING**

P. C. Pos. couchée	-	S. B. R. Prone Pos.	I. Sirbu	RUM	400 P
P. C. Trois Pos.	-	S. B. R. 3 Pos.	Kongshaus	NOR	1164P
Carabine libre	-	Free Rifle	A. Bogdanov	URS	1123P
Cerf courant	-	Running Deer	J. Larsen	NOR	413 P



FEDERATION INTERNATIONALE
DE NATATION AMATEUR FINA

INTERNATIONAL AMATEUR
SWIMMING FEDERATION FINA

COMITE EXECUTIF
EXECUTIVE COMMITTEE

PRESIDENT
W. Berge Phillips AUS

SECRETAIRE HONORAIRE
HONORARY SECRETARY
Masako Kiyokawa JPN

FEDERATION MEXICAINE DE
NATATION FMN

MEXICAN SWIMMING
FEDERATION FMN

PRESIDENT
Javier Ostos Mora MEX

SECRETAIRE
SECRETARY
Antonio G. Mariscal MEX

SECTION WATER-POLO DU C.O.O.
O.O.C. WATER POLO SECTION
Ramón Velázquez MEX

Ramón Meza MEX
Joaquín Perea MEX

OFFICIELS DE LA COMPETITION
COMPETITION OFFICIALS

DIRECTEUR GENERAL
GENERAL DIRECTOR
Ante Lambasa YUG

AUXILIAIRE
AUXILIARY
Cecil W. Plant GBR

JURY D'APPEL
JURY OF APPEAL

Mario Negri ARG
W. Berge Phillips AUS
Max Ritter EUA
Ernest Scott GBR
Arnaldo de O. Sales HOK
Johannes De Vries HOL
B. Percuoco ITA
Javier Ostos Mora MEX

COMITE DE SELECTION
DES ARBITRES

REFEREE SELECTION
COMMITTEE
Manuel Segura ARG
Johannes De Vries HOL
Ante Lambasa YUG

CHRONOMETREURS ET
ANNOTEURS

TIMEKEEPERS AND
SCOREKEEPERS
W. Berge Phillips AUS
Guy Simonis CAN
Marcel La Chance CAN

TABLE DE CONTROLE DES
RESULTATS

RESULT CONTROL TABLE
Bela Rajki HUN
Jorge Benak YUG
Arturo Costa MEX

ARBITRES
REFEREES
Eberhard Bade ADE
Warner Ullrich ADE
A. Fialkov AFS
M. Mortimer AFS
Djadoun Omar AGL
Walter Schneider ALE
H. W. Hofland ANT
J. Dirnweber AUT
Abe Fuchs BEL
Charles Angerhausen BEL
Julien Bauwens BEL
I. Gaidarov BUL
L. A. Schatz CAN
Kwang Soo Kim COR
Lee Hee Chong COR
Yung Ho Kim COR
Alberto Amaya CUB
Mateo Manguillot ESP
Tomás Batallé ESP
Jay-Ehret Mahoney EUA
John Felix EUA
John Kelly EUA
Miles Barton EUA
Roberto Boadway EUA
Alfonso Anguella FRA
George Geurtsen HOL
Hendrikus Keetelaar HOL
Willem Gouse HOL
Jeno Brandi HUN
Filiberto Di Gennaro ITA

Giovanni Parrini ITA
Takao Kiyokawa JPN
Teruyoshi Kanda JPN
Alfredo Guzmán MEX
C. Janet MEX
Diego Mariscal MEX
Edurne García MEX
Eloy Benitez MEX
Enrique C. Quiroz MEX
Genaro Tena MEX
Javier Valle MEX
Joaquín Bártel MEX
José Contreras MEX
Manuel Herrera MEX
Miguel Schiavoni MEX
Ramón Velázquez MEX
Raúl Lémus MEX
Angus Donaldson NZL
Shaikh B. G. Ali PAK
Jorge Stein PER
Abdel Aziz Elshafi RAU
H. Said RAU
Jon Dragan RUM
Nicolae Nociulescu RUM
Fritjof Sjøe SUE
Henry Runstromer SUE
Andrey Kistiakovsky URS
Evgeny Semenov URS
Nickolay Krjukov URS
Nikolai Prostyakov URS
Knezevic Mirdo YUG
Vladimir Ivkovic YUG

SIGNES EMPLOYES

SYMBOLOLOGY

PP	— POINTS DE PENALISATION	PENALIZATION POINTS
P	— PERDU	LOST
G	— GAGNE	WON
()	— EX-AEQUO	TIE

**PRELIMINAIRES
PRELIMINARIES**

GROUP A MATCH 1 OCT 14 EUA-BRA 10-5 (3-1, 2-1, 0-1, 5-2)

EUA	GS	BRA	GS
1 Van Dorp, Anton	0	1 Marsili, Arnaldo	0
2 Ashleigh, David	1	2 Carotini, Ivo	0
3 Webb, Russell	2	3 Filellini, Henrique	0
4 Crawford, Ronald	0	4 Pinciroli, Pedro	2
5 Cole, Stanley	0	5 Goncalves, Joao	1
6 Bradley, Bruce	2	6 Pires, Alvaro	0
7 Willeford, Dean	1	7 Lima, Claudio	2
8 Weitzenberg, Barry	0	8 Sandoval, Fernando	0
9 Sheerer, Gary	3	9 Marsili, Aluisio	0
10 Parker, John	1	10 Jardim, Marco	0
11 Barnett, Steven	0		
Total	10	Total	5
PP	6	PP	7

Buts Score	Period	min
1 — 0	EUA	Sheerer, Gary I 1:16
2 — 0	EUA	Bradley, Bruce I 3:39
2 — 1	BRA	Goncalves, Joao I 4:10
3 — 1	EUA	Willeford, Dean I 4:29
4 — 1	EUA	Webb, Russell II 1:24
4 — 2	BRA	Lima, Claudio II 3:01
5 — 2	EUA	Sheerer, Gary II 4:28
5 — 3	BRA	Lima, Claudio III 1:13
6 — 3	EUA	Bradley, Bruce IV 0:26
7 — 3	EUA	Sheerer, Gary IV 1:08
8 — 3	EUA	Webb, Russell IV 1:57
8 — 4	BRA	Pinciroli, Pedro IV 2:23
8 — 5	BRA	Pinciroli, Pedro IV 3:09
9 — 5	EUA	Parker, John IV 4:00
10 — 5	EUA	Ashleigh, David IV 4:50

ARBITRE REFEREE: Parrini, Giovanni ITA

GROUP B MATCH 2 HOL-GRE 9-5 (2-0, 3-2, 0-1, 4-2)

HOL	GS	GRE	GS
1 De Vries, Feike	0	1 Thymaras, Ioannis	0
2 Wouda, Hans	1	2 Theodorakopoulos, Georgios	0
3 Geutjes, Louis	0	3 Iosiphidis, Kyriakos	1
4 Hoogveld, Johannes	2	4 Garyfallos, Andreas	0
5 Van Dorp, Alfred	0	5 Kougevetopoulos, Dimitrios	1
6 Parrel, Hans	1	6 Mathioudakis, Panagiotis	0
7 Van Der Voet, Nicolaas	5	7 Palios, Ioannis	3
8 Moolhuijzen, Ad	0	8 Palikaris, Georgios	0
9 Bongers, Bart	0	9 Tsangas, Nikolaos	0
10 Hermesen, Andreas	0	10 Karalogos, Thomas	0
11 Kroon, Evert	0	11 Michalos, Panagiotis	0
Total	9	Total	5
PP	8	PP	12

Buts Score	Period	min
1 — 0	HOL	Van Der Voet, Nicolaas I 2:47
2 — 0	HOL	Van Der Voet, Nicolaas I 4:38
2 — 1	GRE	Palios, Ioannis II 1:37
3 — 1	HOL	Van Der Voet, Nicolaas II 2:06
4 — 1	HOL	Hoogveld, Johannes II 3:06
4 — 2	GRE	Kougevetopoulos, Dimitrios II 4:07
5 — 2	HOL	Van Der Voet, Nicolaas II 4:27
5 — 3	GRE	Palios, Ioannis III 3:05
6 — 3	HOL	Parrel, Hans IV 1:30
7 — 3	HOL	Wouda, Hans IV 2:00
8 — 3	HOL	Hoogveld, Johannes IV 2:36
9 — 3	HOL	Van Der Voet, Nicolaas IV 3:03
9 — 4	GRE	Palios, Ioannis IV 3:27
9 — 5	GRE	Iosiphidis, Kyriakos IV 4:42

ARBITRE REFEREE: Brandi, Jeno HUN

GROUP B MATCH 4 YUG-RAU 13-2 (2-1, 1-0, 5-1, 5-0)

YUG	GS	RAU	GS
1 Stipanic, Karlo	0	1 Soliman, Mohamed	0
2 Trumbic, Ivo	0	2 Shalabi, Salah	0
3 Bonacic, Ozren	1	3 El Bassiouni, Mohamed	0
4 Marovic, Uros	0	4 Soliman, Sameh	0
5 Lopanty, Ronald	2	5 Touny, Galal	0
6 Jankovic, Zoran	6	6 El Moalem, Adel	0
7 Poljak, Miroslav	2	7 El Shafei, Alaa	0
8 Dabovic, Dejan	0	8 El Kashef, Khaled	0
9 Perisic, Djordje	1	9 El Baroudi, Hossam	2
10 Sandic, Mirko	1	10 Touny, Haroun	0
11 Hebel, Zdravko	0	11 Gamil, Ashraf	0
Total	13	Total	2
PP	22	PP	6

Buts Score	Period	min
0 — 1	RAU	El Baroudi, Hossam I 3:00
1 — 1	YUG	Sandic, Mirko I 3:14
2 — 1	YUG	Bonacic, Ozren I 4:59
3 — 1	YUG	Jankovic, Zoran II 2:21
3 — 2	RAU	El Baroudi, Hossam III 0:43
4 — 2	YUG	Perisic, Djordje III 1:27
5 — 2	YUG	Lopanty, Ronald III 2:43
6 — 2	YUG	Jankovic, Zoran III 3:44
7 — 2	YUG	Jankovic, Zoran III 4:32
8 — 2	YUG	Jankovic, Zoran III 4:52
9 — 2	YUG	Poljak, Miroslav IV 0:39
10 — 2	YUG	Jankovic, Zoran IV 2:26
11 — 2	YUG	Lopanty, Ronald IV 3:01
12 — 2	YUG	Jankovic, Zoran IV 3:38
13 — 2	YUG	Poljak, Miroslav IV 4:20

ARBITRE REFEREE: Fuchs, Abe BEL

GROUP A MATCH 5 URS-CUB 11-4 (0-1, 4-1, 3-1, 4-1)

URS	GS	CUB	GS
1 Guljaev, Vadim	0	1 Periche, Oscar	0
2 Chikvanaya, Givi	0	2 Arcos, Waldimiro	0
3 Grishin, Boris	1	3 Garcia, Miguel	0
4 Dolgushin, Alexander	1	4 Valdés, Rolando	0
5 Barkalov, Aleksey	1	5 Junco, Rubén	4
6 Grigorovsky, Yury	4	6 Martínez, Guillermo	0
7 Semenov, Vladimir	2	7 Rodríguez, Ibrahim	0
8 Shidlovsky, Alexander	0	8 García, Osvaldo	0
9 Skok, Vjacheslav	2	9 Rodríguez, Roberto	0
10 Osipov, Leonid	0	10 Cañete, Guillermo	0
11 Bovin, Oleg	0	11 Pérez, Jesús	0
Total	11	Total	4
PP	16	PP	10

Buts Score	Period	min
0 — 1	CUB	Junco, Rubén I 3:41
1 — 1	URS	Grishin, Boris II 1:15
2 — 1	URS	Skok, Vjacheslav II 2:43
2 — 2	CUB	Junco, Rubén II 4:09
3 — 2	URS	Semenov, Vladimir II 4:31
4 — 2	URS	Skok, Vjacheslav II 4:46
5 — 2	URS	Barkalov, Aleksey III 1:59
6 — 2	URS	Grigorovsky, Yury III 2:32
6 — 3	CUB	Junco, Rubén III 4:27
7 — 3	URS	Grigorovsky, Yury III 4:48
8 — 3	URS	Grigorovsky, Yury IV 1:06
9 — 3	URS	Dolgushin, Alexander IV 1:38
10 — 3	URS	Semenov, Vladimir IV 2:36
10 — 4	CUB	Junco, Rubén IV 3:18
11 — 4	URS	Grigorovsky, Yury IV 4:50

ARBITRE REFEREE: Angerhousen, Charles BEL

GROUP B MATCH 6
GROUP GAME

ITA-JPN 9-2 (2-0, 2-2, 2-0, 3-0)

ITA	GS	JPN	GS
1 Alberani, Alberto	0	1 Ishii, Tetsunosuke	0
2 Pizzo, Eraldo	4	2 Kuwayama, Hirokatsu	0
3 Cevasco, Mario	1	3 Nakano, Kouji	1
4 Lonzi, Gianni	0	4 Yajima, Shuzo	0
5 Barlocco, Enzo	0	5 Kuwabara, Shigeharu	0
6 Lavoratori, Franco	3	6 Sato, Haruo	0
7 De Magistris, Gianni	1	7 Takeuchi, Kazuya	1
8 Ghibellini, Alessandro	0	8 Yonehara, Kunio	0
9 Guerrini, Giancarlo	0	9 Sakamoto, Seiya	0
10 Ferrando, Paolo	0		
11 Merello, Eugenio	0		
Total	9	Total	2
PP	7	PP	4

Buts Score	Période Period	min
1 — 0	ITA	3:00
2 — 0	ITA	4:07
3 — 0	ITA	1:15
3 — 1	JPN	2:26
3 — 2	JPN	3:31
4 — 2	ITA	4:53
5 — 2	ITA	1:42
6 — 2	ITA	2:46
7 — 2	ITA	1:49
8 — 2	ITA	2:52
9 — 2	ITA	3:25

ARBITRE REFEREE: Felix, John EUA

GROUP A MATCH 7
GROUP GAME

OCT 15 ALE-ESP 5-3 (3-0, 1-1, 0-1, 1-1)

ALE	GS	ESP	GS
1 Hoffmeister, Johannes	0	1 Bestit, Luis	0
2 Haverkamp, Hermann	0	2 Borell, Jorge	1
3 Teicher, Peter	0	3 Rubio, Juan	0
4 Nagy, Lajos	2	4 Padros, José	0
5 Schulz, Wolf-Rüdiger	0	5 Codera, Agustín	0
6 Weeke, Ludger	1	6 Mas, Fermín	1
7 Seiz, Dietmar	0	7 Ibern, Manuel	0
8 Schuhmann, Kurt	2	8 Zubicoa, Santiago	1
9 Kleimeier, Heinz	0	9 Meya, Luis	0
10 Ott, Ludwig	0	10 Jane, Juan	0
11 Ktlian, Günter	0	11 Brugat, Vicente	0
Total	5	Total	3
PP	7	PP	8

Buts Score	Période Period	min
1 — 0	ALE	2:39
2 — 0	ALE	3:16
3 — 0	ALE	4:00
3 — 1	ESP	2:02
4 — 1	ALE	2:59
4 — 2	ESP	3:42
4 — 3	ESP	2:12
5 — 3	ALE	2:33

ARBITRE REFEREE: Bauwens, J. BEL

GROUP B MATCH 8
GROUP GAME

ADE-MEX 12-4 (3-0, 2-0, 3-2, 4-2)

ADE	GS	MEX	GS
1 Fehn, Hans-Georg	0	1 Familiar, Oscar	0
2 Schlenkrich, Klaus	1	2 Chávez, Rolando	3
3 Thiel, Jürgen	1	3 García, Francisco	0
4 Ballerstedt, Siegfried	0	4 Chávez, Germán	1
5 Rund, Peter	1	5 Morfín, Carlos	0
6 Schüler, Hans-Jürgen	2	6 Guzmán, Luis	0
7 Kluge, Jürgen	2	7 Botella, Virgilio	0
8 Hermans, Veit	3	8 García, Juan	0
9 Herzog, Manfred	2	9 Vázquez, José	0
10 Lange, Hans-Ulrich	0	10 Ramos, Sergio	0
11 Schmidt, Peter	0	11 Gómez, Daniel	0
Total	12	Total	4
PP	9	PP	9

Buts Score	Période Period	min
1 — 0	ADE	I 1:02
2 — 0	ADE	I 2:21
3 — 0	ADE	I 4:50
4 — 0	ADE	II 1:04
5 — 0	ADE	II 1:49
6 — 0	ADE	III 1:47
6 — 1	MEX	III 2:43
7 — 1	ADE	III 2:59
8 — 1	ADE	III 4:13
8 — 2	MEX	III 4:43
8 — 3	MEX	IV 1:10
9 — 3	ADE	IV 1:36
10 — 3	ADE	IV 2:12
10 — 4	MEX	IV 2:51
11 — 4	ADE	IV 3:07
12 — 4	ADE	IV 4:13

ARBITRE REFEREE: Dirnweber, J. AUT

GROUP A MATCH 9
GROUP GAME

CUB-MEX 9-2 (2-0, 3-1, 1-0, 3-1)

CUB	GS	BRA	GS
1 Periche, Oscar	0	1 Marsili, Arnaldo	0
2 Arcos, Waldimiro	0	2 Carotini, Ivo	0
3 García, Miguel	3	3 Filellini, Henrique	0
4 Valdés, Rolando	0	4 Pincioli, Pedro	0
5 Junco, Rubén	4	5 Goncalves, Joao	0
6 Martínez, Guillermo	0	6 Pires, Alvaro	0
7 Rodríguez, Ibrahim	0	7 Lima, Claudio	2
8 García, Osvaldo	0	8 Sandoval, Fernando	0
9 Rodríguez, Roberto	2	9 Marsili, Aluisio	0
10 Cañete, Guillermo	0	10 Jardim, Marco	0
11 Pérez, Jesús	0		
Total	9	Total	2
PP	15	PP	15

Buts Score	Période Period	min
1 — 0	CUB	I 1:53
2 — 0	CUB	I 4:36
3 — 0	CUB	II 0:52
3 — 1	BRA	II 1:10
4 — 1	CUB	II 3:41
5 — 1	CUB	II 4:36
6 — 1	CUB	III 1:54
7 — 1	CUB	IV 1:01
7 — 2	BRA	IV 2:29
8 — 2	CUB	IV 3:51
9 — 2	CUB	IV 4:36

ARBITRE REFEREE: Angella, Alfonso FRA

GROUP B MATCH 10
GROUP GAME

JPN-GRE 8-7 (3-1, 2-1, 2-3, 1-2)

JPN	GS	GRE	GS
1 Ishii, Tetsunosuke	4	1 Thymaras, Ioannis	0
2 Kuwayama, Hirokatsu	0	2 Theodorakopoulos, Georgios	0
3 Nakano, Kouji	0	3 Iosiphidis, Kyriakos	1
4 Yajima, Shuzo	0	4 Garyfallos, Andreas	1
5 Kuwabara, Shigeharu	0	5 Kougevetoopoulos, Dimitrios	0
6 Sato, Haruo	3	6 Mathioudakis, Panagiotis	0
7 Takeuchi, Kazuya	1	7 Palios, Ioannis	4
8 Yonehara, Kunio	0	8 Palikaris, Georgios	0
9 Sakamoto, Seiya	0	9 Tsangas, Nikolaos	0
		10 Karalogos, Thomas	1
		11 Michalos, Panagiotis	0
Total	8	Total	7
PP	17	PP	16

Buts Score	Période Period	min		
1 — 0	JPN	Sato, Haruo	I	0:45
1 — 1	GRE	Karalogos, Thomas	I	3:08
2 — 1	JPN	Sato, Haruo	I	3:30
3 — 1	JPN	Nakano, Kouji	I	4:28
3 — 2	GRE	Palios, Ioannis	II	1:12
4 — 2	JPN	Nakano, Kouji	II	1:33
5 — 2	JPN	Sato, Haruo	II	3:45
6 — 2	JPN	Takeuchi, Kazuya	III	1:14
6 — 3	GRE	Iosiphidis, Kyriakos	III	1:27
6 — 4	GRE	Palios, Ioannis	III	2:13
7 — 4	JPN	Nakano, Kouji	III	3:06
7 — 5	GRE	Palios, Ioannis	III	4:56
7 — 6	GRE	Garyfallos, Andreas	IV	2:31
8 — 6	JPN	Nakano, Kouji	IV	2:45
8 — 7	GRE	Palios, Ioannis	IV	3:29

ARBITRE REFEREE: Prostyakov, Nikolai URS

GRUPE B MATCH 12

ITA-RAU 10-1 (2-0, 1-0, 4-1, 3-0)

ITA	GS	RAU	GS
1 Alberani, Alberto	0	1 Soliman, Mohamed	0
2 Pizzo, Eraldo	3	2 Shalabi, Salah	0
3 Cevasco, Mario	2	3 El Bassiouni, Mohamed	0
4 Lonzi, Gianni	0	4 Soliman, Sameh	0
5 Barlocco, Enzo	2	5 Touny, Galal	0
6 Lavoratori, Franco	0	6 El Moalem, Adel	0
7 De Magistris, Gianni	1	7 El Shafei, Alaa	0
8 Ghibellini, Alessandro	0	8 El Kashef, Khaled	0
9 Guerrini, Giancarlo	2	9 El Baroudi, Hossam	1
10 Ferrando, Paolo	0	10 Touny, Haroun	0
11 Merello, Eugenio	0	11 Gamil, Ashraf	0
Total PP	10	Total PP	1
	7		3

Buts Score	Période Period	min		
1 — 0	ITA	Barlocco, Enzo	I	1:29
2 — 0	ITA	Pizzo, Eraldo	I	2:59
3 — 0	ITA	De Magistris, Gianni	II	2:03
4 — 0	ITA	Barlocco, Enzo	III	2:11
5 — 0	ITA	Cevasco, Mario	III	2:32
5 — 1	RAU	El Baroudi, Hossam	III	2:51
6 — 1	ITA	Guerrini, Giancarlo	III	3:31
7 — 1	ITA	Cevasco, Mario	III	4:22
8 — 1	ITA	Pizzo, Eraldo	IV	1:06
9 — 1	ITA	Pizzo, Eraldo	IV	2:41
10 — 1	ITA	Guerrini, Giancarlo	IV	4:18

ARBITRE REFEREE: Dragan, Jon RUM

GRUPE A MATCH 13

OCT 16 HUN-ALE 6-4 (1-1, 3-2, 0-0, 2-1)

HUN	GS	ALE	GS
1 Molnar, Endre	0	1 Hoffmeister, Johannes	0
2 Mayer, Mihaly	0	2 Haverkamp, Hermann	1
3 Szivos, Istvan	0	3 Teicher, Peter	0
4 Konrad, Janos	0	4 Nagy, Lajos	2
5 Sarosi, Laszlo	2	5 Schulz, Wolf-Rüdiger	0
6 Felkai, Laszlo	2	6 Weeke, Ludger	0
7 Konrad, Ferenc	2	7 Seiz, Dietmar	0
8 Pocsik, Denes	0	8 Schuhmann, Kurt	1
9 Bodnar, Andras	0	9 Kleimeier, Heinz	0
10 Domotor, Zoltan	0	10 Ott, Ludwig	0
11 Steinmetz, Janos	0	11 Kilian, Günter	0
Total PP	6	Total PP	4
	6		9

Buts Score	Période Period	min		
1 — 0	HUN	Konrad, Ferenc	I	3:47
1 — 1	ALE	Nagy, Lajos	I	4:28
1 — 2	ALE	Nagy, Lajos	II	0:39
1 — 3	ALE	Haverkamp, Hermann	II	1:48
2 — 3	HUN	Sarosi, Laszlo	II	2:12
3 — 3	HUN	Sarosi, Laszlo	II	3:33
4 — 3	HUN	Felkai, Laszlo	II	4:32
5 — 3	HUN	Felkai, Laszlo	IV	1:54
6 — 3	HUN	Konrad, Ferenc	IV	2:56
6 — 4	ALE	Schuhmann, Kurt	IV	4:58

ARBITRE REFEREE: Di Gennaro, Filiberto ITA

GRUPE B MATCH 14

ADE-YUG 4-4 (0-0, 1-0, 1-3, 2-1)

ADE	GS	YUG	GS
1 Fehn, Hans-Georg	0	1 Stipanic, Karlo	0
2 Schlenkrich, Klaus	2	2 Trumbic, Ivo	0
3 Thiel, Jürgen	0	3 Bonacic, Ozren	0
4 Ballerstedt, Siegfried	0	4 Marovic, Uros	0
5 Rund, Peter	1	5 Lopanty, Ronald	1
6 Schüler, Hans-Jürgen	0	6 Jankovic, Zoran	1
7 Kluge, Jürgen	0	7 Poljak, Miroslav	0
8 Hermans, Veit	1	8 Dabovic, Dejan	0
9 Herzog, Manfred	0	9 Perisic, Djordje	0
10 Lange, Hans-Ulrich	0	10 Sandic, Mirko	2
11 Schmidt, Peter	0	11 Hebel, Zdravko	0
Total PP	4	Total PP	4
	12		16

Buts Score	Période Period	min		
1 — 0	ADE	Rund, Peter	II	1:07
1 — 1	YUG	Sandic, Mirko	III	1:45
1 — 2	YUG	Sandic, Mirko	III	1:58
2 — 2	ADE	Schlenkrich, Klaus	III	2:41
2 — 3	YUG	Lopanty, Ronald	III	3:03
3 — 3	ADE	Schlenkrich, Klaus	IV	0:45
3 — 4	YUG	Jankovic, Zoran	IV	2:34
4 — 4	ADE	Hermans, Veit	IV	4:56

ARBITRE REFEREE: Dragan, Jon RUM

GRUPE A MATCH 15

EUA-ESP 10-7 (2-1, 3-2, 3-2, 2-2)

EUA	GS	ESP	GS
1 Van Dorp, Anton	0	1 Bestit, Luis	0
2 Ashleigh, David	1	2 Borell, Jorge	0
3 Webb, Russell	3	3 Rubio, Juan	0
4 Crawford, Ronald	0	4 Padros, José	1
5 Cole, Stanley	1	5 Codera, Agustín	0
6 Bradley, Bruce	4	6 Mas, Fermín	1
7 Willeford, Dean	0	7 Ibern, Manuel	3
8 Weitzenberg, Barry	0	8 Zubicoa, Santiago	2
9 Sheerer, Gary	1	9 Meya, Luis	0
10 Parker, John	0	10 Jane, Juan	0
11 Barnett, Steven	0	11 Brugat, Vicente	0
Total PP	10	Total PP	7
	15		15

Buts Score	Période Period	min		
1 — 0	EUA	Webb, Russell	I	0:36
1 — 1	ESP	Ibern, Manuel	I	2:01
2 — 1	EUA	Webb, Russell	I	2:26
2 — 2	ESP	Zubicoa, Santiago	II	0:49
3 — 2	EUA	Sheerer, Gary	II	3:01
3 — 3	ESP	Ibern, Manuel	II	3:40
4 — 3	EUA	Bradley, Bruce	II	4:02
5 — 3	EUA	Webb, Russell	II	4:25
5 — 4	ESP	Zubicoa, Santiago	III	0:28
6 — 4	EUA	Bradley, Bruce	III	1:47
6 — 5	ESP	Mas, Fermín	III	3:58
7 — 5	EUA	Bradley, Bruce	III	4:23
8 — 5	EUA	Bradley, Bruce	III	4:51
8 — 6	ESP	Ibern, Manuel	IV	0:55
9 — 6	EUA	Cole, Stanley	IV	1:21
10 — 6	EUA	Ashleigh, David	IV	3:54
10 — 7	ESP	Padros, José	IV	4:11

ARBITRE REEFREE: Gouse, W, HOL

GRUPE B MATCH 16
GROUP B GAME 16

HOL-MEX 8-1 (1-0, 3-1, 3-0, 1-0)

HOL		GS	MEX		GS
1	De Vries, Feike	0	1	Familiar, Oscar	0
2	Wouda, Hans	0	2	Chávez, Rolando	1
3	Geutjes, Louis	0	3	García, Francisco	0
4	Hoogveld, Johannes	1	4	Chávez, Germán	0
5	Van Dorp, Alfred	4	5	Morfín, Carlos	0
6	Parrel, Hans	1	6	Guzmán, Luis	0
7	Van Der Voet, Nicolaas	2	7	Botella, Virgilio	0
8	Moolhuijzen, Ad	0	8	García, Juan	0
9	Bongers, Bart	0	9	Vázquez, José	0
10	Hermesen, Andreas	0	10	Ramos, Sergio	0
11	Kroon, Evert	0	11	Gómez, Daniel	0
Total		8	Total		1
PP		5	PP		5

Buts Score	Période Period	min
1 — 0	HOL	1:52
2 — 0	HOL	1:57
3 — 0	HOL	2:27
3 — 1	MEX	2:40
4 — 1	HOL	3:45
5 — 1	HOL	2:49
6 — 1	HOL	4:02
7 — 1	HOL	4:53
8 — 1	HOL	3:09

ARBITRE REFEREE: Bayarry, Antonio ESP

Buts Score	Période Period	min
0 — 1	ALE	4:46
1 — 1	URS	1:56
1 — 2	ALE	2:12
2 — 2	URS	3:38
3 — 2	URS	1:08
3 — 3	ALE	2:06
4 — 3	URS	3:29
5 — 3	URS	4:29
6 — 3	URS	0:51

ARBITRE REFEREE: Geurtsen, G. HOL

GRUPE B MATCH 20
GROUP B GAME 20

ITA-ADE 5-4 (1-1, 1-0, 1-2, 2-1)

ITA		GS	ADE		GS
1	Alberani, Alberto	0	1	Fehn, Hans-Georg	0
2	Pizzo, Eraldo	4	2	Schlenkrich, Klaus	2
3	Cevasco, Mario	0	3	Thiel, Jürgen	0
4	Lonzi, Gianni	0	4	Ballerstedt, Siegfried	0
5	Barlocco, Enzo	0	5	Rund, Peter	0
6	Lavoratori, Franco	0	6	Schüler, Hans-Jürgen	1
7	De Magistris, Gianni	1	7	Kluge, Jürgen	0
8	Ghibellini, Alessandro	0	8	Hermans, Veit	1
9	Guerrini, Giancarlo	0	9	Herzog, Manfred	0
10	Ferrando, Paolo	0	10	Lange, Hans-Ulrich	0
11	Merello, Eugenio	0	11	Schmidt, Peter	0
Total		5	Total		4
PP		13	PP		8

Buts Score	Période Period	min
1 — 0	ITA	3:21
1 — 1	ADE	4:44
2 — 1	ITA	4:10
2 — 2	ADE	1:41
3 — 2	ITA	2:08
3 — 3	ADE	4:40
4 — 3	ITA	0:41
4 — 4	ADE	3:17
5 — 4	ITA	3:33

ARBITRE REFEREE: Dirnweber, J. AUT

GRUPE B MATCH 18
GROUP B GAME 18

GRE-RAU 7-6 (0-2, 2-3, 2-1, 3-0)

GRE		GS	RAU		GS
1	Thymaras, Ioannis	0	1	Soliman, Mohamed	0
2	Theodorakopoulos, Georgios	0	2	Shalabi, Salah	0
3	Iosiphidis, Kyriakos	0	3	El Bassiouni, Mohamed	0
4	Garyfallos, Andreas	1	4	Soliman, Sameh	0
5	Kougevetopoulos, Dimitrios	1	5	Touny, Galal	0
6	Mathioudakis, Panagiotis	0	6	El Moalem, Adel	0
7	Palios, Ioannis	5	7	El Shafei, Alaa	0
8	Palikaris, Georgios	0	8	El Kashef, Khaled	1
9	Tsangas, Nikolaos	0	9	El Baroudi, Hossam	5
10	Karalogos, Thomas	0	10	Touny, Haroun	0
11	Michalos, Panagiotis	0	11	Gamil, Ashraf	0
Total		7	Total		6
PP		9	PP		7

Buts Score	Période Period	min
0 — 1	RAU	1:21
0 — 2	RAU	3:07
0 — 3	RAU	0:27
1 — 3	GRE	1:03
2 — 3	GRE	2:11
2 — 4	RAU	3:30
2 — 5	RAU	4:33
3 — 5	GRE	0:51
4 — 5	GRE	2:38
4 — 6	RAU	4:09
5 — 6	GRE	0:31
6 — 6	GRE	2:51
7 — 6	GRE	3:28

ARBITRE REFEREE: Semenov, Evgeny URS

GROUP A MATCH 21
GRUPE A GAME 21

CUB-EUA 6-6 (2-3, 1-1, 1-0, 2-2)

CUB		GS	EUA		GS
1	Periche, Oscar	0	1	Van Dorp, Anton	0
2	Arcos, Waldimiro	0	2	Ashleigh, David	0
3	García, Miguel	0	3	Webb, Russell	0
4	Valdés, Rolando	0	4	Crawford, Ronald	0
5	Junco, Rubén	6	5	Cole, Stanley	2
6	Martínez, Guillermo	0	6	Bradley, Bruce	1
7	Rodríguez, Ibrahim	0	7	Willeford, Dean	0
8	García, Osvaldo	0	8	Weitzenberg, Barry	0
9	Rodríguez, Roberto	0	9	Sheerer, Gary	3
10	Cañete, Guillermo	0	10	Parker, John	0
11	Pérez, Jesús	0	11	Barnett, Steven	0
Total		6	Total		6
PP		15	PP		22

Buts Score	Période Period	min
0 — 1	EUA	0:47
0 — 2	EUA	1:24
1 — 2	CUB	3:18
1 — 3	EUA	4:31
2 — 3	CUB	4:45
2 — 4	EUA	1:58
3 — 4	CUB	3:28
4 — 4	CUB	1:16
4 — 5	EUA	0:42
5 — 5	CUB	1:25
5 — 6	EUA	3:46
6 — 6	CUB	4:51

ARBITRE REFEREE: Angella, Alfonso FRA

GRUPE A MATCH 19 OCT 17
GROUP A GAME 19

URS-ALE 6-3 (0-1, 2-1, 3-1, 1-0)

URS		GS	ALE		GS
1	Guljaev, Vadim	0	1	Hoffmeister, Johannes	0
2	Chikvanaya, Givi	0	2	Haverkamp, Hermann	0
3	Grishin, Boris	1	3	Teicher, Peter	0
4	Dolgushin, Alexander	1	4	Nagy, Lajos	0
5	Barkalov, Aleksey	2	5	Schulz, Wolf-Rüdiger	1
6	Grigorovsky, Yury	0	6	Weeke, Ludger	2
7	Semenov, Vladimir	0	7	Seiz, Dietmar	0
8	Shidlovsky, Alexander	1	8	Schuhmann, Kurt	0
9	Skok, Vjacheslav	0	9	Kleimeier, Heinz	0
10	Osipov, Leonid	1	10	Ott, Ludwig	0
11	Bovin, Oleg	0	11	Kilian, Günter	0
Total		6	Total		3
PP		4	PP		9

GROUP A MATCH 22
GROUP GAME

HUN-ESP 7-1 (1-0, 3-0, 2-0, 1-1)

HUN		GS	ESP		GS
1	Molnar, Endre	0	1	Bestit, Luis	0
2	Mayer, Mihaly	0	2	Borell, Jorge	0
3	Szivos, Istvan	1	3	Rubio, Juan	0
4	Konrad, Janos	0	4	Padros, José	0
5	Sarosi, Laszlo	0	5	Codera, Agustín	0
6	Felkai, Laszlo	3	6	Mas, Fermin	0
7	Konrad, Ferenc	3	7	Ibern, Manuel	0
8	Pocsik, Denes	0	8	Zubicoa, Santiago	0
9	Bodnar, Andras	0	9	Meza, Luis	0
10	Domotor, Zoltan	0	10	Jane, Juan	1
11	Steinmetz, Janos	0	11	Brugat, Vicente	0
Total		7	Total		1
PP		3	PP		5

Buts Score		Période Period		min
1 — 0	HUN	Felkai, Laszlo	I	3:38
2 — 0	HUN	Konrad, Ferenc	II	0:35
3 — 0	HUN	Konrad, Ferenc	II	2:23
4 — 0	HUN	Szivos, Istvan	II	4:05
5 — 0	HUN	Felkai, Laszlo	III	1:41
6 — 0	HUN	Felkai, Laszlo	III	2:43
7 — 0	HUN	Konrad, Ferenc	IV	3:51
7 — 1	ESP	Jane, Juan	IV	4:16

ARBITRE REFEREE: Aziz, Abdel RAU

GROUP B MATCH 23
GROUP GAME

YUG-MEX 9-0 (2-0, 3-0, 1-0, 3-0)

YUG		GS	MEX		GS
1	Stipanac, Karlo	0	1	Familiar, Oscar	0
2	Trumbic, Ivo	1	2	Chávez, Rolando	0
3	Bonacic, Ozren	0	3	García, Francisco	0
4	Marovic, Uros	0	4	Chávez, Germán	0
5	Lopanty, Ronald	1	5	Morfín, Carlos	0
6	Jankovic, Zoran	1	6	Guzmán, Luis	0
7	Poljak, Miroslav	3	7	Botella, Virgilio	0
8	Dabovic, Dejan	0	8	García, Juan	0
9	Perisic, Djordje	2	9	Vázquez, José	0
10	Sandic, Mirko	1	10	Ramos, Sergio	0
11	Hebel, Zdravko	0	11	Gómez, Daniel	0
Total		9	Total		0
PP		16	PP		11

Buts Score		Période Period		min
1 — 0	YUG	Poljak, Miroslav	I	3:39
2 — 0	YUG	Perisic, Djordje	I	4:35
3 — 0	YUG	Poljak, Miroslav	II	1:56
4 — 0	YUG	Sandic, Mirko	II	3:41
5 — 0	YUG	Perisic, Djordje	II	4:54
6 — 0	YUG	Jankovic, Zoran	III	3:17
7 — 0	YUG	Trumbic, Ivo	IV	2:43
8 — 0	YUG	Lopanty, Ronald	IV	3:07
9 — 0	YUG	Poljak, Miroslav	IV	3:36

ARBITRE REFEREE: Bauwens, J. BEL

GROUP B MATCH 24
GROUP GAME

HOL-JPN 9-1 (1-0, 3-0, 1-1, 4-0)

HOL		GS	JPN		GS
1	De Vries, Feike	0	1	Ishii, Tetsunosuke	0
2	Wouda, Hans	0	2	Kuwayama, Hirokatsu	0
3	Geutjes, Louis	0	3	Nakano, Kouji	1
4	Hoogveld, Johannes	0	4	Yajima, Shuzo	0
5	Van Dorp, Alfred	1	5	Kuwabara, Shigeharu	0
6	Parrel, Hans	0	6	Sato, Haruo	0
7	Van Der Voet, Nicolaas	6	7	Takeuchi, Kazuya	0
8	Moolhuijzen, Ad	0	8	Yonehara, Kunio	0
9	Bongers, Bart	2	9	Sakamoto, Seiya	0
10	Hermesen, Andreas	0			
11	Kroon, Evert	0			
Total		9	Total		1
PP		5	PP		2

Buts Score		Période Period		min
1 — 0	HOL	Van Der Voet, Nicolaas	I	1:40
2 — 0	HOL	Van Der Voet, Nicolaas	II	0:34
3 — 0	HOL	Van Der Voet, Nicolaas	II	3:18
4 — 0	HOL	Van Der Voet, Nicolaas	II	4:21
4 — 1	JPN	Nakano, Kouji	III	1:58
5 — 1	HOL	Bongers, Bart	III	2:18
6 — 1	HOL	Bongers, Bart	IV	0:40
7 — 1	HOL	Van Der Voet, Nicolaas	IV	1:46
8 — 1	HOL	Van Dorp, Alfred	IV	3:03
9 — 1	HOL	Van Der Voet, Nicolaas	IV	3:34

ARBITRE REFEREE: Schneider, Walter ALE

GROUP B MATCH 25 OCT 19 ADE-GRE 11-4 (3-1, 0-0, 5-1, 3-2)

ADE		GS	GRE		GS
1	Fehn, Hans-Georg	0	1	Thymaras, Ioannis	0
2	Schlenkrich, Klaus	0	2	Theodorakopoulos, Georgios	0
3	Thiel, Jürgen	0	3	Iosiphidis, Kyriakos	1
4	Ballerstedt, Siegfried	1	4	Garyfallos, Andreas	0
5	Rund, Peter	1	5	Kougevtopoulos, Dimitrios	1
6	Schüler, Hans-Jürgen	3	6	Mathioudakis, Panagiotis	0
7	Kluge, Jürgen	1	7	Palios, Ioannis	2
8	Hermans, Veit	1	8	Palikaris, Georgios	0
9	Herzog, Manfred	0	9	Tsangas, Nikolaos	0
10	Lange, Hans-Ulrich	4	10	Karalogos, Thomas	0
11	Schmidt, Peter	0	11	Michalos, Panagiotis	0
Total		11	Total		4
PP		10	PP		7

Buts Score		Période Period		min
1 — 0	ADE	Ballerstedt, Siegfried	I	0:37
2 — 0	ADE	Hermans, Veit	I	1:22
3 — 0	ADE	Schüler, Hans-Jürgen	I	2:05
3 — 1	GRE	Palios, Ioannis	I	4:35
4 — 1	ADE	Schüler, Hans-Jürgen	III	0:33
5 — 1	ADE	Lange, Hans-Ulrich	III	1:48
6 — 1	ADE	Lange, Hans-Ulrich	III	2:50
7 — 1	ADE	Lange, Hans-Ulrich	III	4:14
7 — 2	GRE	Palios, Ioannis	III	4:28
8 — 2	ADE	Rund, Peter	III	4:48
9 — 2	ADE	Schüler, Hans-Jürgen	IV	0:23
10 — 2	ADE	Kluge, Jürgen	IV	2:20
10 — 3	GRE	Iosiphidis, Kyriakos	IV	2:51
11 — 3	ADE	Lange, Hans-Ulrich	IV	4:11
11 — 4	GRE	Kougevtopoulos, Dimitrios	IV	4:36

ARBITRE REFEREE: Amaya, Alberto CUB

GROUP B MATCH 27
GROUP GAME

JPN-RAU 7-4 (1-1, 2-1, 3-0, 1-2)

JPN		GS	RAU		GS
1	Ishii, Tetsunosuke	0	1	Soliman, Mohamed	0
2	Kuwayama, Hirokatsu	0	2	Shalabi, Salah	2
3	Nakano, Kouji	4	3	El Bassiouni, Mohamed	1
4	Yajima, Shuzo	0	4	Soliman, Sameh	1
5	Kuwabara, Shigeharu	0	5	Touny, Galal	0
6	Sato, Haruo	1	6	El Moalem, Adel	0
7	Takeuchi, Kazuya	2	7	El Shafai, Alaa	0
8	Yonehara, Kunio	0	8	El Kashaf, Khaled	0
9	Sakamoto, Seiya	0	9	El Baroudi, Hossam	0
Total		7	Total		4
PP		8	PP		6

Buts Score		Période Period		min
1 — 0	JPN	Takeuchi, Kazuya	I	1:17
1 — 1	RAU	Shalabi, Salah	I	3:23
1 — 2	RAU	Shalabi, Salah	II	1:54
2 — 2	JPN	Nakano, Kouji	II	1:55
3 — 2	JPN	Sato, Haruo	II	3:43
4 — 2	JPN	Takeuchi, Kazuya	III	2:59
5 — 2	JPN	Nakano, Kouji	III	4:13
6 — 2	JPN	Nakano, Kouji	III	4:54
6 — 3	RAU	Soliman, Sameh	IV	2:46
7 — 3	JPN	Nakano, Kouji	IV	4:41
7 — 4	RAU	El Bassiouni, Mohamed	IV	4:55

ARBITRE REFEREE: Boadway, Robert EUA

GRUPE A MATCH 28
GROUP GAME

URS-ESP 5-0 (2-0, 1-0, 0-0, 2-0)

URS	GS	ESP	GS		
1	Guljaev, Vadim	0	1	Bestit, Luis	0
2	Chikvanaya, Givi	0	2	Borell, Jorge	0
3	Grishin, Boris	0	3	Rubio, Juan	0
4	Dolgushin, Alexander	2	4	Padros, José	0
5	Barkalov, Aleksey	0	5	Codera, Agustín	0
6	Grigorovsky, Yury	1	6	Mas, Fermin	0
7	Semenov, Vladimir	1	7	Ibern, Manuel	0
8	Shidlovsky, Alexander	1	8	Zubicoa, Santiago	0
9	Skok, Vjacheslav	0	9	Meya, Luis	0
10	Osipov, Leonid	0	10	Jane, Juan	0
11	Bovin, Oleg	0	11	Brugat, Vicente	0
Total		5	Total	0	
PP		1	PP	2	

Buts Score	Période Period	min		
1 — 0	URS	Dolgushin, Alexander	I	1:23
2 — 0	URS	Dolgushin, Alexander	I	2:28
3 — 0	URS	Shidlovsky, Alexander	II	0:40
4 — 0	URS	Grigorovsky, Yury	IV	1:47
5 — 0	URS	Semenov, Vladimir	IV	4:26

ARBITRE REFEREE: Kanda, M. JPN

Buts Score	Période Period	min		
0 — 1	EUA	Sheerer, Gary	I	1:27
1 — 1	HUN	Szivos, Istvan	I	4:25
2 — 1	HUN	Felkai, Laszlo	I	4:37
3 — 1	HUN	Konrad, Ferenc	III	3:06
4 — 1	HUN	Felkai, Laszlo	IV	3:53
5 — 1	HUN	Konrad, Ferenc	IV	4:23

ARBITRE REFEREE: Parrini, Giovanni ITA

GRUPE B MATCH 31
GROUP GAME

YUG-HOL 7-4 (1-1, 2-1, 3-1, 1-1)

YUG	GS	HOL	GS		
1	Stipanac, Karlo	0	1	De Vries, Feike	0
2	Trumbic, Ivo	0	2	Wouda, Hans	0
3	Bonacic, Ozren	1	3	Geutjes, Louis	0
4	Marovic, Uros	1	4	Hoogveld, Johannes	0
5	Lopanty, Ronald	0	5	Van Dorp, Alfred	0
6	Jankovic, Zoran	0	6	Parrel, Hans	0
7	Poljak, Miroslav	2	7	Van Der Voet, Nicolaas	4
8	Dabovic, Dejan	0	8	Moolhuijzen, Ad	0
9	Perisic, Djordje	1	9	Bongers, Bart	0
10	Sandic, Mirko	2	10	Hermesen, Andreas	0
11	Hebel, Zdravko	0	11	Kroon, Evert	0
Total		7	Total	4	
PP		10	PP	14	

Buts Score	Période Period	min		
1 — 0	YUG	Bonacic, Ozren	I	2:14
1 — 1	HOL	Van Der Voet, Nicolaas	I	3:17
2 — 1	YUG	Perisic, Djordje	II	0:45
3 — 1	YUG	Sandic, Mirko	II	3:52
3 — 2	HOL	Van Der Voet, Nicolaas	II	4:22
4 — 2	YUG	Poljak, Miroslav	III	2:04
5 — 2	YUG	Poljak, Miroslav	III	2:33
5 — 3	HOL	Van Der Voet, Nicolaas	III	3:27
6 — 3	YUG	Sandic, Mirko	III	4:14
7 — 3	YUG	Marovic, Uros	IV	1:55
7 — 4	HOL	Van Der Voet, Nicolaas	IV	4:37

ARBITRE REFEREE: Felix, John EUA

GRUPE B MATCH 29
GROUP GAME

ITA-MEX 10-5 (3-1, 2-2, 4-1, 1-1)

ITA	GS	MEX	GS		
1	Alberani, Alberto	0	1	Familiar, Oscar	0
2	Pizzo, Eraldo	5	2	Chávez, Rolando	2
3	Cevasco, Mario	0	3	García, Francisco	2
4	Lonzi, Gianni	0	4	Chávez, Germán	1
5	Barlocco, Enzo	2	5	Morfin, Carlos	0
6	Lavoratori, Franco	0	6	Guzmán, Luis	0
7	De Magistris, Gianni	2	7	Botella, Virgilio	0
8	Ghibellini, Alessandro	0	8	García, Juan	0
9	Guerrini, Giancarlo	1	9	Vázquez, José	0
10	Ferrando, Paolo	0	10	Ramos, Sergio	0
11	Merello, Eugenio	0	11	Gómez, Daniel	0
Total		10	Total	5	
PP		13	PP	11	

Buts Score	Période Period	min		
1 — 0	ITA	Pizzo, Eraldo	I	1:14
1 — 1	MEX	García, Francisco	I	3:05
2 — 1	ITA	De Magistris, Gianni	I	3:35
3 — 1	ITA	Pizzo, Eraldo	I	4:15
4 — 1	ITA	Barlocco, Enzo	II	1:11
4 — 2	MEX	Chávez, Germán	II	1:59
5 — 2	ITA	Barlocco, Enzo	II	4:02
5 — 3	MEX	García, Francisco	II	4:22
6 — 3	ITA	Pizzo, Eraldo	III	0:26
6 — 4	MEX	Chávez, Rolando	III	1:48
7 — 4	ITA	De Magistris, Gianni	III	3:30
8 — 4	ITA	Pizzo, Eraldo	III	4:06
9 — 4	ITA	Guerrini, Giancarlo	III	4:58
9 — 5	MEX	Chávez, Rolando	IV	2:49
10 — 5	ITA	Pizzo, Eraldo	IV	3:50

ARBITRE REFEREE: Felix, John EUA

GRUPE A MATCH 32
GROUP GAME

ALE-BRA 10-5 (1-2, 0-1, 5-1, 4-1)

ALE	GS	BRA	GS		
1	Hoffmeister, Johannes	0	1	Marsili, Arnaldo	0
2	Haverkamp, Hermann	3	2	Carotini, Ivo	0
3	Teicher, Peter	0	3	Filellini, Henrique	0
4	Nagy, Lajos	3	4	Pinciroli, Pedro	2
5	Schulz, Wolf-Rüdiger	0	5	Goncalves, Joao	1
6	Weeke, Ludger	0	6	Pires, Alvaro	0
7	Seiz, Dietmar	1	7	Lima, Claudio	2
8	Schuhmann, Kurt	3	8	Sandoval, Fernando	0
9	Kleimeir, Heinz	0	9	Marsili, Aluisio	0
10	Ott, Ludwig	0	10	Jardim, Marco	0
11	Kilian, Günter	0			
Total		10	Total	5	
PP		19	PP	14	

Buts Score	Période Period	min		
0 — 1	BRA	Lima, Claudio	I	2:41
1 — 1	ALE	Nagy, Lajos	I	2:56
1 — 2	BRA	Goncalves, Joao	I	4:09
1 — 3	BRA	Lima, Claudio	II	0:30
2 — 3	ALE	Nagy, Lajos	III	0:40
3 — 3	ALE	Haverkamp, Hermann	III	1:17
4 — 3	ALE	Haverkamp, Hermann	III	2:09
4 — 4	BRA	Pinciroli, Pedro	III	2:19
5 — 4	ALE	Nagy, Lajos	III	2:39
6 — 4	ALE	Haverkamp, Hermann	III	4:13
7 — 4	ALE	Schuhmann, Kurt	IV	0:54
8 — 4	ALE	Schuhmann, Kurt	IV	2:55
8 — 5	BRA	Pinciroli, Pedro	IV	3:16
9 — 5	ALE	Schuhmann, Kurt	IV	3:48
10 — 5	ALE	Seiz, Dietmar	IV	4:53

ARBITRE REFEREE: Garcia, E. MEX

GRUPE A MATCH 30
GROUP GAME

HUN-EUA 5-1 (2-1, 0-0, 1-0, 2-0)

HUN	GS	EUA	GS		
1	Molnar, Endre	0	1	Van Dorp, Anton	0
2	Mayer, Mihaly	0	2	Ashleigh, David	0
3	Szivos, Istvan	1	3	Webb, Russell	0
4	Konrad, Janos	0	4	Crawford, Ronald	0
5	Sarosi, Laszlo	0	5	Cole, Stanley	0
6	Felkai, Laszlo	2	6	Bradley, Bruce	0
7	Konrad, Ferenc	2	7	Willeford, Dean	0
8	Pocsik, Denes	0	8	Weitzenberg, Barry	0
9	Bodnar, Andras	0	9	Sheerer, Gary	1
10	Domotor, Zoltan	0	10	Parker, John	0
11	Steinmetz, Janos	0	11	Barnett, Steven	0
Total		5	Total	1	
PP		7	PP	11	

GRUPE A MATCH 33 OCT 20 CUB-ALE 7-6 (1-0, 1-1, 2-2, 3-3)

CUB		GS	ALE	GS
1	Periche, Oscar	0	1 Hoffmeister, Johannes	0
2	Arcos, Waldimiro	0	2 Haverkamp, Hermann	4
3	García, Miguel	1	3 Teicher, Peter	0
4	Valdés, Rolando	0	4 Nagy, Lajos	1
5	Junco, Rubén	6	5 Schulz, Wolf-Rüdiger	0
6	Martínez, Guillermo	0	6 Weeke, Ludger	0
7	Rodríguez, Ibrahim	0	7 Seiz, Dietmar	0
8	García, Osvaldo	0	8 Schuhmann, Kurt	0
9	Rodríguez, Roberto	0	9 Kleimeier, Heinz	1
10	Cañete, Guillermo	0	10 Ott, Ludwig	0
11	Pérez, Jesús	0	11 Kilian, Günter	0
Total		7	Total	6
PP		15	PP	17

Buts Score	Période Period	min		
1 — 0	CUB	García, Miguel	I	4:31
2 — 0	CUB	Junco, Rubén	II	0:35
2 — 1	ALE	Haverkamp, Hermann	II	3:14
3 — 1	CUB	Junco, Rubén	III	0:28
3 — 2	ALE	Kleimeier, Heinz	III	1:41
3 — 3	ALE	Haverkamp, Hermann	III	2:25
4 — 3	CUB	Junco, Rubén	III	4:52
4 — 4	ALE	Haverkamp, Hermann	IV	1:00
5 — 4	CUB	Junco, Rubén	IV	2:44
5 — 5	ALE	Nagy, Lajos	IV	2:44
5 — 6	ALE	Haverkamp, Hermann	IV	3:28
6 — 6	CUB	Junco, Rubén	IV	4:30
7 — 6	CUB	Junco, Rubén	IV	4:31

ARBITRE REFEREE: Gouse, W. HOL

GRUPE B MATCH 34 ADE-JPN 8-0 (2-0, 2-0, 3-0, 1-0)

ADE		GS	JPN	GS
1	Fehn, Hans-Georg	0	1 Ishii, Tetsunosuke	0
2	Schlenkrich, Klaus	1	2 Kuwayama, Hirokatsu	0
3	Thiel, Jürgen	0	3 Nakano, Kouji	0
4	Ballerstedt, Siegfried	0	4 Yajima, Shuzo	0
5	Rund, Peter	2	5 Kuwabara, Shigeharu	0
6	Schüler, Hans-Jürgen	2	6 Sato, Haruo	0
7	Kluge, Jürgen	1	7 Takeuchi, Kazuya	0
8	Hermans, Veit	0	8 Yonehara, Kunio	0
9	Herzog, Manfred	0	9 Sakamoto, Seiya	0
10	Lange, Hans-Ulrich	2		
11	Schmidt, Peter	0		
Total		8	Total	0
PP		3	PP	0

Buts Score	Période Period	min		
1 — 0	ADE	Schüler, Hans-Jürgen	I	2:29
2 — 0	ADE	Rund, Peter	I	4:33
3 — 0	ADE	Schüler, Hans-Jürgen	II	1:38
4 — 0	ADE	Schlenkrich, Klaus	II	2:09
5 — 0	ADE	Rund, Peter	III	2:14
6 — 0	ADE	Lange, Hans-Ulrich	III	4:21
7 — 0	ADE	Kluge, Jürgen	III	4:46
8 — 0	ADE	Lange, Hans-Ulrich	IV	2:39

ARBITRE REFEREE: Schneider, Walter ALE

GRUPE A MATCH 35 ESP-BRA 6-6 (1-0, 1-2, 3-2, 1-2)

ESP		GS	BRA	GS
1	Bestit, Luis	0	1 Marsili, Arnaldo	0
2	Borell, Jorge	0	2 Carotini, Ivo	0
3	Rubio, Juan	0	3 Filellini, Henrique	1
4	Padros, José	0	4 Pinciroli, Pedro	4
5	Codera, Agustín	0	5 Goncalves, Joao	0
6	Mas, Fermin	1	6 Pires, Alvaro	0
7	Ibern, Manuel	1	7 Lima, Claudio	1
8	Zubicoa, Santiago	2	8 Sandoval, Fernando	0
9	Meya, Luis	0	9 Marsili, Aluisio	0
10	Jane, Juan	2	10 Jardim, Marco	0
11	Brugat, Vicente	0		
Total		6	Total	6
PP		10	PP	9

Buts Score	Période Period	min		
1 — 0	ESP	Mas, Fermin	I	3:23
2 — 0	ESP	Ibern, Manuel	II	0:47
2 — 1	BRA	Filellini, Henrique	II	1:08
2 — 2	BRA	Lima, Claudio	II	4:25
2 — 3	BRA	Pinciroli, Pedro	III	1:28
3 — 3	ESP	Jane, Juan	III	2:13
3 — 4	BRA	Pinciroli, Pedro	III	2:28
4 — 4	ESP	Jane, Juan	III	4:06
4 — 4	ESP	Zubicoa, Santiago	III	4:39
5 — 4	BRA	Pinciroli, Pedro	IV	1:41
5 — 5	BRA	Pinciroli, Pedro	IV	2:59
5 — 6	ESP	Zubicoa, Santiago	IV	4:14

ARBITRE REFEREE: Ullrich, Werner ADE

GRUPE B MATCH 36 MEX-GRE 11-8 (4-3, 4-1, 1-2, 2-2)

MEX		GS	GRE	GS
1	Familiar, Oscar	0	1 Thymaras, Ioannis	0
2	Chávez, Rolando	4	2 Theodorakopoulos, Giorgios	0
3	García, Francisco	3	3 Iosiphidis, Kyriakos	4
4	Chávez, Germán	0	4 Garyfallos, Andreas	2
5	Morfín, Carlos	3	5 Kougevopoulos, Dimitrios	0
6	Guzmán, Luis	1	6 Mathioudakis, Panagiotis	0
7	Botella, Virgilio	0	7 Palios, Ioannis	2
8	García, Juan	0	8 Palikaris, Georgios	0
9	Vázquez, José	0	9 Tsangas, Nikolaos	0
10	Ramos, Sergio	0	10 Karalogos, Thomas	0
11	Gómez, Daniel	0	11 Michalós, Panagiotis	0
Total		11	Total	8
PP		9	PP	16

Buts Score	Période Period	min		
1 — 0	MEX	Chávez, Rolando	I	2:06
1 — 1	GRE	Garyfallos, Andreas	I	2:20
2 — 1	MEX	Guzmán, Luis	I	2:36
2 — 2	GRE	Garyfallos, Andreas	I	2:48
2 — 3	GRE	Palios, Ioannis	I	3:17
3 — 3	MEX	Morfín, Carlos	I	3:47
4 — 3	MEX	Morfín, Carlos	I	4:38
5 — 3	MEX	Chávez, Rolando	II	1:57
5 — 4	GRE	Palios, Ioannis	II	2:28
6 — 4	MEX	García, Francisco	II	2:49
7 — 4	MEX	Chávez, Rolando	II	3:18
8 — 4	MEX	García, Francisco	II	4:11
8 — 5	GRE	Iosiphidis, Kyriakos	III	0:36
9 — 5	MEX	Chávez, Rolando	III	2:51
9 — 6	GRE	Iosiphidis, Kyriakos	III	4:31
10 — 6	MEX	García, Francisco	IV	3:35
10 — 7	GRE	Iosiphidis, Kyriakos	IV	3:51
10 — 8	GRE	Iosiphidis, Kyriakos	IV	4:31
11 — 8	MEX	Morfín, Carlos	IV	4:54

ARBITRE REFEREE: Brandi, Jenő HUN

GRUPE A MATCH 38 HUN-URS 6-5 (2-2, 2-1, 1-2, 1-0)

HUN		GS	URS	GS
1	Molnar, Endre	0	1 Guljaev, Vadim	0
2	Mayer, Mihaly	0	2 Chikvanaya, Givi	0
3	Szivos, Istvan	0	3 Grishin, Boris	0
4	Konrad, Janos	0	4 Dolgushin, Alexander	1
5	Sarosi, Laszlo	0	5 Barkalov, Aleksey	0
6	Felkai, Laszlo	3	6 Grigorovskiy, Yury	2
7	Konrad, Ferenc	2	7 Semenov, Vladimir	0
8	Pocsik, Denes	0	8 Shidlovskiy, Alexander	0
9	Bodnar, Andras	1	9 Skok, Vjacheslav	1
10	Domotor, Zoltan	0	10 Osipov, Leonid	1
11	Steinmetz, Janos	0	11 Bovin, Oleg	0
Total		6	Total	5
PP		12	PP	11

Buts Score		Période Period	min
0 — 1	URS	Osipov, Leonid	I 1:33
0 — 2	URS	Dolgushin, Alexander	I 1:53
1 — 2	HUN	Felkai, Laszlo	I 2:24
2 — 2	HUN	Konrad, Ferenc	I 3:48
3 — 2	HUN	Felkai, Laszlo	II 3:10
3 — 3	URS	Skok, Vjacheslav	II 3:28
4 — 3	HUN	Felkai, Laszlo	II 4:22
4 — 4	URS	Grigorovsky, Yury	III 2:38
5 — 4	HUN	Bodnar, Andras	III 3:29
5 — 5	URS	Grigorovsky, Yury	III 3:54
6 — 5	HUN	Konrad, Ferenc	IV 1:40

ARBITRE REFEREE: Geurtsen, G. L. HOL

GRUPE B MATCH 39 ITA-YUG 5-4 (1-1, 2-2, 2-0, 0-1)

ITA	GS	YUG	GS
1 Alberani, Alberto	0	1 Stipanac, Karlo	0
2 Pizzo, Eraldo	4	2 Trumbic, Ivo	0
3 Cevasco, Mario	1	3 Bonacic, Ozren	0
4 Lonzi, Gianni	0	4 Marovic, Uros	2
5 Barlocco, Enzo	0	5 Lopanty, Ronald	0
6 Lavoratori, Franco	0	6 Jankovic, Zoran	0
7 De Magistris, Gianni	0	7 Poljak, Miroslav	1
8 Ghibellini, Alessandro	0	8 Dabovic, Dejan	0
9 Guerrini, Giancarlo	0	9 Perisic, Djordje	1
10 Ferrando, Paolo	0	10 Sandic, Mirko	0
11 Merello, Eugenio	0	11 Hebel, Zdravko	0
Total PP	5	Total PP	4
	17		15

Buts Score		Période Period	min
0 — 1	YUG	Marovic, Uros	I 3:32
1 — 1	ITA	Pizzo, Eraldo	I 3:58
1 — 2	YUG	Perisic, Djordje	II 0:46
1 — 3	YUG	Marovic, Uros	II 1:48
2 — 3	ITA	Pizzo, Eraldo	II 2:51
3 — 3	ITA	Cevasco, Mario	II 3:46
4 — 3	ITA	Pizzo, Eraldo	III 2:23
5 — 3	ITA	Pizzo, Eraldo	III 4:38
5 — 4	YUG	Poljak, Miroslav	IV 2:46

ARBITRE REFEREE: Fuchs, Abe BEL

GRUPE A MATCH 40 HOL-RAU 6-3 (1-1, 2-0, 2-1, 1-1)

HOL	GS	RAU	GS
1 De Vries, Feike	0	1 Soliman, Mohamed	0
2 Wouda, Hans	0	2 Shalabi, Salah	2
3 Geutjes, Louis	0	3 El Bassiouni, Mohamed	1
4 Hoogveld, Johannes	0	4 Soliman, Sameh	0
5 Van Dorp, Alfred	1	5 Touny, Galal	0
6 Parrel, Hans	0	6 El Moalem, Adel	0
7 Van Der Voet, Nicolaas	5	7 El Shafei, Alaa	0
8 Moolhuijzen, Ad	0	8 El Kashef, Khaled	0
9 Bongers, Bart	0	9 El Baroudi, Hossam	0
10 Hermsen, Andreas	0	10 Touny, Haroun	0
11 Kroon, Evert	0	11 Gamil, Ashraf	0
Total PP	6	Total PP	3
	10		9

Buts Score		Période Period	min
0 — 1	RAU	Shalabi, Salah	I 1:25
1 — 1	HOL	Van Der Voet, Nicolaas	I 4:40
2 — 1	HOL	Van Der Voet, Nicolaas	I 0:40
3 — 1	HOL	Van Der Voet, Nicolaas	II 3:40
4 — 1	HOL	Van Der Voet, Nicolaas	III 1:34
5 — 1	HOL	Van, Dorp, Alfred	III 3:56
5 — 2	RAU	El Bassiouni, Mohamed	III 4:19
6 — 2	HOL	Van Der Voet, Nicolaas	IV 1:50
6 — 3	RAU	Shalabi, Salah	IV 3:45

ARBITRE REFEREE: Prostyakov, Nikolai URS

GRUPE A MATCH 41 OCT 21 CUB-ESP 4-3 (1-1, 1-1, 1-1, 1-0)

CUB	GS	ESP	GS
1 Periche, Oscar	0	1 Bestit, Luis	0
2 Arcos, Waldimiro	0	2 Borell, Jorge	0
3 Garcia, Miguel	0	3 Rubio, Juan	0
4 Valdés, Rolando	0	4 Padros, José	0
5 Junco, Rubén	4	5 Codera, Agustín	1
6 Martínez, Guillermo	0	6 Mas, Fermín	0
7 Rodríguez, Ibrahim	0	7 Ibern, Manuel	1
8 García, Osvaldo	0	8 Zubicoa, Santiago	1
9 Rodríguez, Roberto	0	9 Meya, Luis	0
10 Cañete, Guillermo	0	10 Jane, Juan	0
11 Pérez, Jesús	0	11 Brugat, Vicente	0
Total PP	4	Total PP	3
	11		10

Buts Score		Période Period	min
0 — 1	ESP	Zubicoa, Santiago	I 4:11
1 — 1	CUB	Junco, Rubén	I 4:31
1 — 2	ESP	Ibern, Manuel	II 2:22
2 — 2	CUB	Junco, Rubén	II 3:47
3 — 2	CUB	Junco, Rubén	III 2:33
3 — 3	ESP	Codera, Agustín	III 4:37
4 — 3	CUB	Junco, Rubén	IV 0:59

ARBITRE REFEREE: Di Gennaro, Filiberto ITA

GRUPE B MATCH 42 JPN-MEX 6-3 (1-0, 3-1, 0-1, 2-1)

JPN	GS	MEX	GS
1 Ishii, Tetsunosuke	0	1 Familiar, Oscar	0
2 Kuwayama, Hirokatsu	0	2 Chávez, Rolando	0
3 Nakano, Kouji	5	3 García, Francisco	1
4 Yajima, Shuzo	0	4 Chávez, Germán	1
5 Kuwabara, Shigeharu	0	5 Morfin, Carlos	0
6 Sato, Haruo	0	6 Guzmán, Luis	1
7 Takeuchi, Kazuya	1	7 Botella, Virgilio	0
8 Yonehara, Kunio	0	8 García, Juan	0
9 Sakamoto, Seiya	0	9 Vázquez, José	0
		10 Ramos, Sergio	0
		11 Gómez, Daniel	0
Total PP	6	Total PP	3
	9		4

Buts Score		Période Period	min
1 — 0	JPN	Nakano, Kouji	I 2:31
2 — 0	JPN	Takeuchi, Kazuya	II 0:47
3 — 0	JPN	Nakano, Kouji	II 1:33
3 — 1	MEX	Chávez, Germán	II 2:49
4 — 1	JPN	Nakano, Kouji	II 3:45
4 — 2	MEX	García, Francisco	III 1:11
5 — 2	JPN	Nakano, Kouji	IV 2:03
5 — 3	MEX	Guzmán, Luis	IV 3:22
6 — 3	JPN	Nakano, Kouji	IV 4:43

ARBITRE REFEREE: Dimweber, J. AUT

GRUPE B MATCH 44 YUG-GRE 11-1 (3-0, 4-0, 1-1, 3-0)

YUG	GS	GRE	GS
1 Stipanac, Karlo	0	1 Thymaras, Ioannis	0
2 Trumbic, Ivo	4	2 Theodorakopoulos, Georgios	0
3 Bonacic, Ozren	1	3 Iosiphidis, Kyriakos	0
4 Marovic, Uros	0	4 Garyfallos, Andreas	0
5 Lopanty, Ronald	0	5 Kougevetopoulos, Dimitrios	0
6 Jankovic, Zoran	1	6 Mathioudakis, Panagiotis	0
7 Poljak, Miroslav	1	7 Palios, Ioannis	1
8 Dabovic, Dejan	1	8 Palikaris, Georgios	0
9 Perisic, Djordje	0	9 Tsangas, Nikolaos	0
10 Sandic, Mirko	3	10 Karalagos, Thomas	0
11 Hebel, Zdravko	0	11 Michalos, Panagiotis	0
Total PP	11	Total PP	1
	5		7

Buts Score		Période Period	min
1 — 0	YUG	Trumbic, Ivo	I 1:18
2 — 0	YUG	Poljak, Miroslav	I 2:07
3 — 0	YUG	Trumbic, Ivo	I 4:13
4 — 0	YUG	Sandic, Mirko	II 0:28
5 — 0	YUG	Trumbic, Ivo	II 1:17
6 — 0	YUG	Bonacic, Ozren	II 1:48
7 — 0	YUG	Trumbic, Ivo	II 4:27
7 — 1	GRE	Paios, Ioannis	III 4:13
8 — 1	YUG	Jankovic, Zoran	III 4:54
9 — 1	YUG	Sandic, Mirko	IV 0:47
10 — 1	YUG	Dabovic, Dejan	IV 2:57
11 — 1	YUG	Sandic, Mirko	IV 4:06

ARBITRE REFEREE: Bayarry, Antonio ESP

GRUPE A MATCH 45

URS-EUA 8-3 (1-1, 2-1, 2-1, 3-0)

URS	GS	EUA	GS		
1	Guljaev, Vadim	0	1	Van Dorp, Anton	0
2	Chikvanaya, Givi	0	2	Ashleigh, David	0
3	Grishin, Boris	1	3	Webb, Russell	0
4	Dolgushin, Alexander	0	4	Crawford, Ronald	0
5	Barkalov, Aleksey	1	5	Cole, Stanley	0
6	Grigorovsky, Yury	2	6	Bradley, Bruce	2
7	Semenov, Vladimir	0	7	Willeford, Dean	0
8	Shidlovsky, Alexander	0	8	Weitzenberg, Barry	1
9	Skok, Vjacheslav	4	9	Sheerer, Gary	0
10	Osipov, Leonid	0	10	Parker, John	0
11	Bovin, Oleg	0	11	Barnett, Steven	0
Total PP		8	Total PP		3
		12			14

Buts Score		Période Period	min
1 — 0	URS	Skok, Vjacheslav	I 2:28
1 — 1	EUA	Bradley, Bruce	I 4:33
2 — 1	URS	Skok, Vjacheslav	II 1:00
3 — 1	URS	Grishin, Boris	II 1:56
3 — 2	EUA	Weitzenberg, Barry	II 3:19
4 — 2	URS	Grigorovsky, Yury	III 1:21
4 — 3	EUA	Bradley, Bruce	III 1:32
5 — 3	URS	Barkalov, Aleksey	III 4:07
6 — 3	URS	Grigorovsky, Yury	IV 0:23
7 — 3	URS	Skok, Vjacheslav	IV 2:39
8 — 3	URS	Skok, Vjacheslav	IV 4:36

ARBITRE REFEREE: Manguillot, M. ESP

GRUPE B MATCH 46

HOL-ITA 3-3 (0-1, 1-1, 2-1, 0-0)

HOL	GS	ITA	GS		
1	De Vries, Feike	0	1	Alberani, Alberto	0
2	Wouda, Hans	0	2	Pizzo, Eraldo	3
3	Geutjes, Louis	0	3	Cevaşco, Mario	0
4	Hoogveld, Johannes	1	4	Lonzi, Gianni	0
5	Van Dorp, Alfred	0	5	Barlocco, Enzo	0
6	Parrel, Hans	0	6	Lavoratori, Franco	0
7	Van Der Voet, Nicolaas	2	7	De Magistris, Gianni	0
8	Moolhuijzen, Ad	0	8	Ghibellini, Alessandro	0
9	Bongers, Bart	0	9	Guerrini, Giancarlo	0
10	Hermesen, Andreas	0	10	Ferrando, Paolo	0
11	Kroon, Evert	0	11	Merello, Eugenio	0
Total PP		3	Total PP		3
		7			11

Buts Score		Période Period	min
0 — 1	ITA	Pizzo, Eraldo	I 4:03
1 — 1	HOL	Van Der Voet, Nicolaas	II 1:00
1 — 2	ITA	Pizzo, Eraldo	II 1:27
1 — 3	ITA	Pizzo, Eraldo	III 1:00
2 — 3	HOL	Van Der Voet, Nicolaas	III 1:52
3 — 3	HOL	Hoogveld, Johannes	III 3:46

ARBITRE REFEREE: Angella, Alfonso FRA

GRUPE A MATCH 47

HUN-BRA 8-2 (0-0, 3-0, 3-1, 2-1)

HUN	GS	BRA	GS		
1	Molnar, Endre	0	1	Marsili, Arnaldo	0
2	Mayer, Mihaly	0	2	Carotini, Ivo	0
3	Szivos, Istvan	0	3	Filellini, Henrique	0
4	Konrad, Janos	0	4	Pinciroli, Pedro	0
5	Sarosi, Laszlo	1	5	Goncalves, Joao	0
6	Felkai, Laszlo	2	6	Pires, Alvaro	0
7	Konrad, Ferenc	1	7	Lima, Claudio	2
8	Pocsik, Denes	1	8	Sandoval, Fernando	0
9	Bodnar, Andras	1	9	Marsili, Aluisio	0
10	Domotor, Zoltan	2	10	Jardim, Marco	0
11	Steinmetz, Janos	0			
Total PP		8	Total PP		2
		6			6

Buts Score		Période Period	min
1 — 0	HUN	Pocsik, Denes	II 1:25
2 — 0	HUN	Bodnar, Andras	II 2:45
3 — 0	HUN	Domotor, Zoltan	II 3:54
3 — 1	BRA	Lima, Claudio	III 1:37
4 — 1	HUN	Felkai, Laszlo	III 3:09
5 — 1	HUN	Domotor, Zoltan	III 3:44
6 — 1	HUN	Konrad, Ferenc	III 4:24
7 — 1	HUN	Sarosi, Laszlo	IV 3:17
8 — 1	HUN	Felkai, Laszlo	IV 3:42
8 — 2	BRA	Lima, Claudio	IV 3:43

ARBITRE REFEREE: Angerhausen, Charles BEL

GRUPE B MATCH 48

ADE-RAU 19-2 (2-0, 7-0, 7-1, 3-1)

ADE	GS	RAU	GS		
1	Fehn, Hans-Georg	0	1	Soliman, Mohamed	0
2	Schlenkrich, Klaus	0	2	Shalabi, Salah	0
3	Thiel, Jürgen	1	3	El Bassiouni, Mohamed	2
4	Ballerstedt, Siegfried	2	4	Soliman, Sameh	0
5	Rund, Peter	5	5	Touny, Galal	0
6	Schüler, Hans-Jürgen	3	6	El Moalem, Adel	0
7	Kluge, Jürgen	0	7	El Shafef, Alaa	0
8	Hermans, Veit	8	8	El Kashaf, Khaled	0
9	Herzog, Manfred	0	9	El Baroudi, Hossam	0
10	Lange, Hans-Ulrich	0	10	Touny, Haroun	0
11	Schmidt, Peter	0	11	Gamil, Ashraf	0
Total PP		19	Total PP		2
		11			7

Buts Score		Période Period	min
1 — 0	ADE	Hermans, Veit	I 3:40
2 — 0	ADE	Rund, Peter	I 4:07
3 — 0	ADE	Rund, Peter	II 0:19
4 — 0	ADE	Ballerstedt, Siegfried	II 1:01
5 — 0	ADE	Hermans, Veit	II 1:55
6 — 0	ADE	Rund, Peter	II 2:27
7 — 0	ADE	Hermans, Veit	II 3:09
8 — 0	ADE	Hermans, Veit	II 4:07
9 — 0	ADE	Hermans, Veit	II 4:41
10 — 0	ADE	Hermans, Veit	III 0:46
11 — 0	ADE	Schüler, Hans-Jürgen	III 1:16
12 — 0	ADE	Schüler, Hans-Jürgen	III 2:02
13 — 0	ADE	Schüler, Hans-Jürgen	III 2:57
14 — 0	ADE	Rund, Peter	III 3:27
14 — 1	RAU	El Bassiouni, Mohamed	III 4:04
15 — 1	ADE	Rund, Peter	III 4:13
16 — 1	ADE	Ballerstedt, Siegfried	III 4:51
17 — 1	ADE	Hermans, Veit	IV 0:31
17 — 2	RAU	El Bassiouni, Mohamed	IV 4:06
18 — 2	ADE	Hermans, Veit	IV 4:17
19 — 2	ADE	Thiel, Jürgen	IV 4:42

ARBITRE REFEREE: Hofland, H. ANT

GRUPE B MATCH 50 OCT 22 MEX-RAU 3-3 (1-0, 1-1, 0-0, 1-2)

MEX	GS	RAU	GS	
1	Familiar, Oscar	0	1	
2	Chávez, Rolando	0	2	
3	García, Francisco	1	3	
4	Chávez Germán	0	4	
5	Morfin, Carlos	0	5	
6	Guzmán, Luis	1	6	
7	Botella, Virgilio	0	7	
8	García, Juan	1	8	
9	Vázquez, José	0	9	
10	Ramos, Sergio	0	10	
11	Gómez, Daniel	0	11	
Total		3	Total	3
PP		9	PP	9

Buts Score	Période Period	min	
1 — 0	MEX	I	4:09
1 — 1	RAU	II	1:25
2 — 1	MEX	II	3:50
2 — 2	RAU	IV	1:17
3 — 2	MEX	IV	1:42
3 — 3	RAU	IV	4:57

ARBITRE REFEREE: Semenov, Evgeny URS

Buts Score	Période Period	min	
1 — 0	ITA	I	1:27
2 — 0	ITA	I	2:10
2 — 1	GRE	I	2:52
3 — 1	ITA	II	1:38
4 — 1	ITA	III	1:09
5 — 1	ITA	III	4:30
5 — 2	GRE	IV	2:40
6 — 2	ITA	IV	4:31

ARBITRE REFEREE: Amaya, Alberto CUB

GRUPE A MATCH 53 EUA-ALE 7-5 (1-1, 2-2, 2-1, 2-1)

EUA	GS	ALE	GS	
1	Van Dorp, Anton	0	1	
2	Ashleigh, David	0	2	
3	Webb, Russell	1	3	
4	Crawford, Ronald	0	4	
5	Cole, Stanley	0	5	
6	Bradley, Bruce	3	6	
7	Willeford, Dean	1	7	
8	Weitzenberg, Barry	2	8	
9	Sheerer, Gary	0	9	
10	Parker, John	0	10	
11	Barnett, Steven	0	11	
Total		7	Total	5
PP		12	PP	9

Buts Score	Période Period	min	
1 — 0	EUA	I	2:14
1 — 1	ALE	I	2:26
2 — 1	EUA	II	3:31
2 — 2	ALE	II	3:47
3 — 2	EUA	II	4:08
3 — 3	ALE	II	4:52
3 — 4	ALE	III	2:56
4 — 4	EUA	III	4:16
5 — 4	EUA	III	4:54
5 — 5	ALE	IV	2:39
6 — 5	EUA	IV	3:43
7 — 5	EUA	IV	4:32

ARBITRE REFEREE: Fuchs, Abe BEL

GRUPE A MATCH 51 URS-BRA 8-2 (1-0, 3-1, 3-1, 1-0)

URS	GS	BRA	GS	
1	Guljaev, Vadim	0	1	
2	Chikvanaya, Givi	0	2	
3	Grishin, Boris	0	3	
4	Dolgushin, Alexander	0	4	
5	Barkalov, Aleksey	2	5	
6	Grigorovsky, Yury	1	6	
7	Semenov, Vladimir	0	7	
8	Shidlovsky, Alexander	3	8	
9	Skok, Vjacheslav	1	9	
10	Osipov, Leonid	1	10	
11	Bovin, Oleg	0	11	
Total		8	Total	2
PP		0	PP	1

Buts Score	Période Period	min	
1 — 0	URS	I	2:42
1 — 1	URS	II	4:50
2 — 1	URS	II	1:51
3 — 1	URS	II	2:31
4 — 1	BRA	II	4:10
5 — 1	URS	III	0:37
6 — 1	URS	III	1:34
7 — 1	URS	III	2:29
7 — 2	BRA	III	4:47
8 — 2	URS	IV	4:47

ARBITRE REFEREE: Janet, C. MEX

GRUPE B MATCH 54 ADE-HOL 8-3 (2-0, 1-0, 2-2, 3-1)

ADE	GS	HOL	GS	
1	Fehn, Hans-Georg	0	1	
2	Schlenkrich, Klaus	1	2	
3	Thiel, Jürgen	0	3	
4	Ballerstedt, Siegfried	0	4	
5	Rund, Peter	3	5	
6	Schüler, Hans-Jürgen	2	6	
7	Kluge, Jürgen	0	7	
8	Hermans, Veit	1	8	
9	Herzog, Manfred	0	9	
10	Lange, Hans-Ulrich	1	10	
11	Schmidt, Peter	0	11	
Total		8	Total	3
PP		7	PP	11

Buts Score	Période Period	min	
1 — 0	ADE	I	3:08
2 — 0	ADE	I	4:03
3 — 0	ADE	II	2:33
4 — 0	ADE	III	0:38
4 — 1	HOL	III	2:07
4 — 2	HOL	III	4:01
5 — 2	ADE	III	4:16
5 — 3	HOL	IV	2:40
6 — 3	ADE	IV	4:00
7 — 3	ADE	IV	4:20
8 — 3	ADE	IV	4:58

ARBITRE REFEREE: Bauwens, J. BEL

GRUPE B MATCH 52 ITA-GRE 6-2 (2-1, 1-0, 2-0, 1-1)

ITA	GS	GRE	GS	
1	Alberani, Alberto	0	1	
2	Pizzo, Eraldo	0	2	
3	Ceyasco, Mario	2	3	
4	Lonzi, Gianni	0	4	
5	Barlocco, Enzo	2	5	
6	Lavoratori, Franco	2	6	
7	De Magistris, Gianni	0	7	
8	Ghibellini, Alessandro	0	8	
9	Guerrini, Giancarlo	0	9	
10	Ferrando, Paolo	0	10	
11	Merello, Eugenio	0	11	
Total		6	Total	2
PP		5	PP	5

GROUP A MATCH 55 OCT 23 HUN-CUB 7-1 (1-0, 1-1, 2-0, 3-0)
 GROUP GAME

HUN	GS	CUB	GS
1 Molnar, Endre	0	1 Periche, Oscar	0
2 Mayer, Mihaly	0	2 Arcos, Waldimiro	0
3 Szivos, Istvan	0	3 Garcia, Miguel	1
4 Konrad, Janos	1	4 Valdes, Rolando	0
5 Sarosi, Laszlo	2	5 Junco, Rubén	0
6 Felkai, Laszlo	3	6 Martinez, Guillermo	0
7 Konrad, Ferenc	1	7 Rodriguez, Ibrahim	0
8 Pocsik, Denes	0	8 Garcia, Osvaldo	0
9 Bodnar, Andras	0	9 Rodriguez, Roberto	0
10 Domotor, Zoltan	0	10 Cañete, Guillermo	0
11 Steinmetz, Janos	0	11 Pérez, Jesús	0
Total	7	Total	1
PP	6	PP	6

Buts Score	Période Period	min
1 — 0 HUN	I	3:30
1 — 1 CUB	II	2:03
2 — 1 HUN	II	3:31
3 — 1 HUN	III	2:02
4 — 1 HUN	III	3:09
5 — 1 HUN	IV	1:27
6 — 1 HUN	IV	3:28
7 — 1 HUN	IV	4:51

ARBITRE REFEREE: García, E. MEX

GROUP B MATCH 56 YUG-JPN 17-2 (6-1, 2-1, 5-0, 4-0)
 GROUP GAME

YUG	GS	JPN	GS
1 Stipanic, Karlo	0	1 Ishii, Tetsunosuke	0
2 Trumbic, Ivo	1	2 Kuwayama, Hirokatsu	0
3 Bonacic, Ozren	0	3 Nakano, Kouji	1
4 Marovic, Uros	0	4 Yajima, Shuzo	0
5 Lopanty, Ronald	0	5 Kuwabara, Shigeharu	0
6 Jankovic, Zoran	9	6 Sato, Haruo	0
7 Poljak, Miroslav	3	7 Takeuchi, Kazuya	1
8 Dabovic, Dejan	0	8 Yonehara, Kunio	0
9 Perisic, Djordje	0	9 Sakamoto, Seiya	0
10 Sandic, Mirko	4		
11 Hebel, Zdravko	0		
Total	17	Total	2
PP	3	PP	6

Buts Score	Période Period	min
0 — 1 JPN	I	1:23
1 — 1 YUG	I	1:39
2 — 1 YUG	I	2:10
3 — 1 YUG	I	3:01
4 — 1 YUG	I	3:31
5 — 1 YUG	I	3:57
6 — 1 YUG	I	5:00
6 — 2 JPN	II	0:32
7 — 2 YUG	II	0:44
8 — 2 YUG	II	3:30
9 — 2 YUG	III	0:44
10 — 2 YUG	III	1:23
11 — 2 YUG	III	2:05
12 — 2 YUG	III	4:04
13 — 2 YUG	III	4:30
14 — 2 YUG	IV	0:23
15 — 2 YUG	IV	2:19
16 — 2 YUG	IV	2:55
17 — 2 YUG	IV	4:54

ARBITRE REFEREE: Hofland, H. ANT

RESULTAT FINAL DES ELIMINATOIRES
 FINAL STANDING (ELIMINATIONS)

GROUP A OCT 23

	Matches Games	G	P	()	GS	Points	
1 HUN	6	6	0	0	39 — 14	12	
2 URS	6	5	1	0	43 — 18	10	
3 EUA	6	3	2	1	37 — 36	7	
4 CUB	6	3	2	1	31 — 35	7	
5 ALE	6	2	4	0	33 — 34	4	
6 ESP	6	0	5	1	20 — 37	1	
7 BRA	6	0	5	1	22 — 51	1	
BRA	*	2 - 9	5 - 10	6 - 6	2 - 8	2 - 8	5 - 10
CUB	9 - 2	*	7 - 6	4 - 3	1 - 7	4 - 11	6 - 6
ALE	10 - 5	6 - 7	*	5 - 3	4 - 6	3 - 6	5 - 7
ESP	6 - 6	3 - 4	3 - 5	*	1 - 7	0 - 5	7 - 10
HUN	8 - 2	7 - 1	6 - 4	7 - 1	*	6 - 5	5 - 1
URS	8 - 2	11 - 4	6 - 3	5 - 0	5 - 6	*	8 - 3
EUA	10 - 5	6 - 6	7 - 5	10 - 7	1 - 5	3 - 8	*

GROUP B

	Matches Games	G	P	()	GS	Points		
1 ITA	7	6	0	1	48 — 21	13		
2 YUG	7	5	1	1	65 — 18	11		
3 ADE	7	5	1	1	66 — 22	11		
4 HOL	7	4	2	1	42 — 28	9		
5 JPN	7	3	4	0	26 — 57	6		
6 MEX	7	1	5	1	27 — 56	3		
7 GRE	7	1	6	0	34 — 62	2		
8 RAU	7	0	6	1	21 — 65	1		
ADE	*	11 - 4	8 - 3	4 - 5	8 - 0	12 - 4	19 - 2	4 - 4
GRE	4 - 11	*	5 - 9	2 - 6	7 - 8	8 - 11	7 - 6	1 - 11
HOL	3 - 8	9 - 5	*	3 - 3	9 - 1	8 - 1	6 - 3	4 - 7
ITA	5 - 4	6 - 2	3 - 3	*	9 - 2	10 - 5	10 - 1	5 - 4
JPN	0 - 8	8 - 7	1 - 9	2 - 9	*	6 - 3	7 - 4	2 - 17
MEX	4 - 12	11 - 8	1 - 8	5 - 10	3 - 6	*	3 - 3	0 - 9
RAU	2 - 19	6 - 7	3 - 6	1 - 10	4 - 7	3 - 3	*	2 - 13
YUG	4 - 4	11 - 1	7 - 4	4 - 5	17 - 2	9 - 0	13 - 2	*

823

LA PARTICIPATION DE L'AUSTRALIE AYANT ETE REFUSEE PAR LE C.I.O. LES MATCHS NOS. 3, 11, 17, 26, 37, 43 ET 49 N'ONT PAS ETE DISPUTES.

GAMES NO. 3, 11, 17, 26, 37, 43 AND 49 WERE NOT HELD BECAUSE THE I.O.C. REFUSED THE PARTICIPATION OF THE AUSTRALIAN TEAM.

DEMI-FINALES MATCH **58** OCT 24 ESP-JPN 5-0 (0-0, 0-0, 2-0, 3-0)
SEMI-FINALS GAME

ESP	GS	JPN	GS		
1	Bestit, Luis	0	1	Ishii, Tetsunogsuke	0
2	Borell, Jorge	1	2	Kuwayama, Hirokatsu	0
3	Rubio, Juan	2	3	Nakano, Kouji	0
4	Padros, José	0	4	Yajima, Shuzo	0
5	Codera, Agustín	0	5	Kuwabara, Shigeharu	0
6	Mas, Fermin	0	6	Sato, Harou	0
7	Ibern, Manuel	1	7	Takeuchi, Kazuya	0
8	Zubicoa, Santiago	1	8	Yonehara, Kunio	0
9	Meya, Luis	0	9	Sakamoto, Seiya	0
10	Jane, Juan	0			
11	Brugat, Vicente	0			
Total		5	Total		0
PP		3	PP		7

Buts Score	Période Period	min		
1 — 0	ESP	Ibern, Manuel	III	1:13
2 — 0	ESP	Rubio, Juan	III	4:05
3 — 0	ESP	Zubicoa, Santiago	IV	2:21
4 — 0	ESP	Rubio, Juan	IV	3:06
5 — 0	ESP	Borell, Jorge	IV	4:50

ARBITRE REFEREE: Aziz, Abdel RAU

DEMI-FINALES MATCH **59** ADE-CUB 8-2 (1-0, 3-1, 2-0, 2-1)
SEMI-FINALS GAME

ADE	GS	CUB	GS		
1	Fehn, Hans-Georg	0	1	Periche, Oscar	0
2	Schlenkrich, Klaus	1	2	Arcos, Waldimiro	0
3	Thiel, Jürgen	0	3	García, Miguel	1
4	Ballerstedt, Siegfried	0	4	Valdés, Rolando	1
5	Rund, Peter	0	5	Junco, Rubén	0
6	Schüler, Hans-Jürgen	5	6	Martínez, Guillermo	0
7	Kluge, Jürgen	0	7	Rodríguez, Ibrahim	0
8	Hermans, Veit	2	8	García, Osvaldo	0
9	Herzog, Manfred	0	9	Rodríguez, Roberto	0
10	Lange, Hans-Ulrich	0	10	Cañete, Guillermo	0
11	Schmidt, Peter	0	11	Pérez, Jesús	0
Total		8	Total		2
PP		5	PP		6

Buts Score	Période Period	min		
1 — 0	ADE	Hermans, Veit	I	2:57
2 — 0	ADE	Schüler, Hans-Jürgen	II	1:08
2 — 1	CUB	García, Miguel	II	3:17
3 — 1	ADE	Schüler, Hans-Jürgen	II	3:28
4 — 1	ADE	Hermans, Veit	II	3:54
5 — 1	ADE	Schüler, Hans-Jürgen	III	2:48
6 — 1	ADE	Schlenkrich, Klaus	III	3:38
7 — 1	ADE	Schüler, Hans-Jürgen	IV	1:08
8 — 1	ADE	Schüler, Hans-Jürgen	IV	1:53
8 — 2	CUB	Valdés, Rolando	IV	3:25

ARBITRE REFEREE: Manguillot, M. ESP

DEMI-FINALES MATCH **60** BRA-RAU 5-3 (0-0, 1-0, 1-2, 3-1)
SEMI-FINALS GAME

BRA	GS	RAU	GS		
1	Marsili, Arnaldo	0	1	Soliman, Mohamed	0
2	Carotini, Ivo	0	2	Shalabi, Salah	2
3	Filellini, Henrique	0	3	El Bassiouni, Mohamed	0
4	Pinciroli, Pedro	3	4	Soliman, Sameh	0
5	Goncalves, Joao	0	5	Touny, Galal	0
6	Pires, Alvaro	0	6	El Moalem, Adel	0
7	Lima, Claudio	1	7	El Shafei, Alaa	0
8	Sandoval, Fernando	1	8	El Kashed, Khaled	0
9	Marsili, Aluisio	0	9	El Baroudi, Hossam	1
10	Jardim, Marco	0	10	Touny, Haroun	0
			11	Gamil, Ashraf	0
Total		5	Total		3
PP		7	PP		6

Buts Score	Période Period	min		
1 — 0	BRA	Pinciroli, Pedro	II	4:48
1 — 1	RAU	Shalabi, Salah	III	1:21
1 — 2	RAU	Shalabi, Salah	III	2:47
2 — 2	BRA	Pinciroli, Pedro	III	4:02
3 — 2	BRA	Sandoval, Fernando	IV	1:20
4 — 2	BRA	Pinciroli, Pedro	IV	2:01
4 — 3	RAU	El Baroudi, Hossam	IV	2:40
5 — 3	BRA	Lima, Claudio	IV	3:55

ARBITRE REFEREE: Ullrich, Werner ADE

DEMI-FINALES MATCH **61** ALE-MEX 6-3 (0-0, 2-1, 2-2, 2-0)
SEMI-FINALS GAME

ALE	GS	MEX	GS		
1	Hoffmeister, Johannes	0	1	Familiar, Oscar	0
2	Haverkamp, Hermann	1	2	Chávez, Rolando	0
3	Teicher, Peter	1	3	García, Francisco	0
4	Nagy, Lajos	0	4	Chávez, Germán	0
5	Schulz, Wolf-Rüdiger	1	5	Morfín, Carlos	1
6	Weeke, Ludger	1	6	Guzmán, Luis	2
7	Seiz, Dietmar	0	7	Botella, Virgilio	0
8	Schuhmann, Kurt	2	8	García, Juan	0
9	Kleimeier, Heinz	0	9	Vázquez, José	0
10	Ott, Ludwig	0	10	Ramos, Sergio	0
11	Kilian, Günter	0	11	Gómez, Daniel	0
Total		6	Total		3
PP		9	PP		8

Buts Score	Période Period	min		
0 — 1	MEX	Morfín, Carlos	II	0:59
1 — 1	ALE	Schuhmann, Kurt	II	3:11
2 — 1	ALE	Teicher, Peter	II	4:07
3 — 1	ALE	Haverkamp, Hermann	III	1:14
4 — 1	ALE	Schulz, Wolf-Rüdiger	III	2:35
4 — 2	MEX	Guzmán, Luis	III	2:47
4 — 3	MEX	Guzmán, Luis	III	4:47
5 — 3	ALE	Weeke, Ludger	IV	3:37
6 — 3	ALE	Schuhmann, Kurt	IV	4:12

ARBITRE REFEREE: Bauwens, J. BEL

DEMI-FINALES MATCH **62** EUA-HOL 6-3 (1-0, 4-2, 1-0, 0-1)
SEMI-FINALS GAME

EUA	GS	HOL	GS		
1	Van Dorp, Anton	0	1	De Vries, Feike	0
2	Ashleigh, David	0	2	Wouda, Hans	0
3	Webb, Russell	0	3	Geutjes, Louis	0
4	Crawford, Ronald	0	4	Hoogveld, Johannes	0
5	Cole, Stanley	0	5	Van Dorp, Alfred	0
6	Bradley, Bruce	3	6	Parrel, Hans	0
7	Willeford, Dean	0	7	Van Der Voet, Nicolaas	3
8	Weitzenberg, Barry	2	8	Moolhuijzen, Ad	0
9	Sheerer, Gary	0	9	Bongers, Bart	0
10	Parker, John	1	10	Hermesen, Andreas	0
11	Barnett, Steven	0	11	Kroon, Evert	0
Total		6	Total		3
PP		16	PP		11

Buts Score	Période Period	min		
1 — 0	EUA	Bradley, Bruce	I	1:38
2 — 0	EUA	Weitzenberg, Barry	II	0:29
2 — 1	HOL	Van Der Voet, Nicolaas	II	0:40
3 — 1	EUA	Bradley, Bruce	II	1:11
4 — 1	EUA	Bradley, Bruce	II	2:51
4 — 2	HOL	Van Der Voet, Nicolaas	II	3:39
5 — 2	EUA	Parker, John	II	4:59
6 — 2	EUA	Weitzenberg, Barry	III	2:11
6 — 3	HOL	Van Der Voet, Nicolaas	IV	1:11

ARBITRE REFEREE: Angella, Alfonso FRA

DEMI-FINALES MATCH
SEMI-FINALS GAME **63**

URS-ITA **8-5** (3-1, 1-2, 4-1, 0-1)

URS	GS	ITA	GS	
1	Guljaev, Vadim	0	1 Alberani, Alberto	0
2	Chikvanaya, Givi	0	2 Pizzo, Eraldo	3
3	Grishin, Boris	0	3 Cevasco, Mario	0
4	Dolgushin, Alexander	0	4 Lonzi, Gianni	0
5	Barkalov, Aleksey	1	5 Barlocco, Enzo	0
6	Grigorovsky, Yury	1	6 Lavoratori, Franco	1
7	Semenov, Vladimir	0	7 De Magistris, Gianni	1
8	Shidlovsky, Alexander	3	8 Ghibellini, Alessandro	0
9	Skok, Vjacheslav	3	9 Guerrini, Giancarlo	0
10	Osipov, Leonid	0	10 Ferrando, Paolo	0
11	Bovin, Oleg	0	11 Merello, Eugenio	0
Total		8	Total	5
PP		16	PP	20

Buts Score	Période Period	min		
1 — 0	URS	Skok, Vjacheslav	I	3:12
2 — 0	URS	Barkalov, Aleksey	I	3:51
2 — 1	ITA	Pizzo, Eraldo	I	4:09
3 — 1	URS	Skok, Vjacheslav	I	4:21
3 — 2	ITA	De Magistris, Gianni	II	2:09
4 — 2	URS	Shidlovsky, Alexander	II	2:33
4 — 3	ITA	Pizzo, Eraldo	II	4:23
5 — 3	URS	Grigorovsky, Yury	III	0:48
5 — 4	ITA	Pizzo, Eraldo	III	1:08
6 — 4	URS	Shidlovsky, Alexander	III	2:31
7 — 4	URS	Skok, Vjacheslav	III	2:57
8 — 4	URS	Shidlovsky, Alexander	III	4:22
8 — 5	ITA	Lavoratori, Franco	IV	3:23

ARBITRE REFEREE: Fuchs, Abe BEL

FINALE POUR 13e ET 14e PLACES
FINAL FOR 13th AND 14th PLACES

MATCH
GAME **66** OCT 25

BRA-GRE **5-2** (0-1, 1-1, 3-0, 1-0)

BRA	GS	GRE	GS	
1	Marsili, Arnaldo	0	1 Thymaras, Ioannis	0
2	Carotini, Ivo	0	2 Theodorakopoulos, Georgios	0
3	Filellini, Henrique	0	3 Iosiphidis, Kyriakos	0
4	Pinciroli, Pedro	4	4 Garyfallos, Andreas	0
5	Goncalves, Joao	0	5 Kougevetopoulos, Dimitrios	0
6	Pires, Alvaro	0	6 Mathioudakis, Panagiotis	0
7	Lima, Claudio	1	7 Palios, Ioannis	2
8	Sandoval, Fernando	0	8 Palikaris, Georgios	0
9	Marsili, Aluisio	0	9 Tsangas, Nikolaos	0
10	Jardim, Marco	0	10 Karalogos, Thomas	0
			11 Michalos, Panagiotis	0
Total		5	Total	2
PP		6	PP	5

Buts Score	Période Period	min		
0 — 1	GRE	Palios, Ioannis	I	1:22
1 — 1	BRA	Pinciroli, Pedro	II	3:01
1 — 2	GRE	Palios, Ioannis	II	3:25
2 — 2	BRA	Pinciroli, Pedro	III	0:45
3 — 2	BRA	Lima, Claudio	III	3:00
4 — 2	BRA	Pinciroli, Pedro	III	3:38
5 — 2	BRA	Pinciroli, Pedro	IV	2:42

ARBITRE REFEREE: Schneider, Walter ALE

DEMI-FINALES MATCH
SEMI-FINALS GAME **64**

YUG-HUN **8-6** (1-0, 1-3, 2-2, 4-1)

YUG	GS	HUN	GS	
1	Stipanic, Karlo	0	1 Molnar, Endre	0
2	Trumbic, Ivo	0	2 Mayer, Mihaly	0
3	Bonacic, Ozren	0	3 Szivos, Istvan	0
4	Marovic, Uros	2	4 Konrad, Janos	0
5	Lopanty, Ronald	0	5 Sarosi, Laszlo	2
6	Jankovic, Zoran	3	6 Felkai, Laszlo	2
7	Poljak, Miroslav	1	7 Konrad, Ferenc	2
8	Dabovic, Dejan	0	8 Pocsik, Denes	0
9	Perisic, Djordje	1	9 Bodnar, Andras	0
10	Sandic, Mirko	1	10 Domotor, Zoltan	0
11	Hebel, Zdravko	0	11 Steinmetz, Janos	0
Total		8	Total	6
PP		14	PP	17

Buts Score	Période Period	min		
1 — 0	YUG	Jankovic, Zoran	I	1:55
1 — 1	HUN	Felkai, Laszlo	II	0:29
2 — 1	YUG	Perisic, Djordje	II	1:08
2 — 2	HUN	Sarosi, Laszlo	II	2:59
2 — 3	HUN	Konrad, Ferenc	II	4:12
3 — 3	YUG	Jankovic, Zoran	III	0:30
3 — 4	HUN	Konrad, Ferenc	III	0:47
4 — 4	YUG	Jankovic, Zoran	III	1:03
4 — 5	HUN	Felkai, Laszlo	III	4:07
5 — 5	YUG	Marovic, Uros	IV	0:33
6 — 5	YUG	Poljak, Miroslav	IV	1:49
7 — 5	YUG	Marovic, Uros	IV	2:40
8 — 5	YUG	Sandic, Mirko	IV	3:32
8 — 6	HUN	Sarosi, Laszlo	IV	4:38

ARBITRE REFEREE: Gouse, W. HOL

FINALE POUR 11e ET 12e PLACES
FINAL FOR 11th AND 12th PLACES

MATCH
GAME **67**

MEX-JPN **5-4** (1-2, 2-1, 1-0, 1-1)

MEX	GS	JPN	GS	
1	Familiar, Oscar	0	1 Ishii, Tetsunosuke	0
2	Chávez, Rolando	0	2 Kuwayama, Hirokatsu	0
3	García, Francisco	2	3 Nakano, Kouji	1
4	Chávez, Germán	2	4 Yajima, Shuzo	0
5	Morfín, Carlos	0	5 Kuwabara, Shigeharu	1
6	Guzmán, Luis	0	6 Sato, Haruo	0
7	Botella, Virgilio	0	7 Takeuchi, Kazuya	2
8	García, Juan	0	8 Yonehara, Kunio	0
9	Vázquez, José	0	9 Sakamoto, Seiya	0
10	Ramos, Sergio	1		
11	Gómez, Daniel	0		
Total		5	Total	4
PP		13	PP	10

Buts Score	Période Period	min		
0 — 1	JPN	Kuwabara, Shigeharu	I	1:11
0 — 2	JPN	Nakano, Kouji	I	3:20
1 — 2	MEX	Ramos, Sergio	I	4:25
1 — 3	JPN	Takeuchi, Kazuya	II	2:40
2 — 3	MEX	Chávez, Germán	II	3:45
3 — 3	MEX	Chávez, Germán	II	4:55
4 — 3	MEX	García, Francisco	III	4:04
4 — 4	JPN	Takeuchi, Kazuya	IV	0:36
5 — 4	MEX	García, Francisco	IV	2:14

ARBITRE REFEREE: Dragan, Jon RUM

FINALE POUR 9e ET 10e PLACES
FINAL FOR 9th AND 10th PLACES

MATCH GAME **68**

ESP-ALE **7-5** (1-1, 2-2, 3-1, 1-1)

ESP	GS	ALE	GS	
1	Bestit, Luis	0	1	
2	Borell, Jorge	1	2	
3	Rubio, Juan	0	3	
4	Padros, José	1	4	
5	Codera, Agustín	0	5	
6	Mas, Fermin	0	6	
7	Ibern, Manuel	4	7	
8	Zubicoa, Santiago	1	8	
9	Meya, Luis	0	9	
10	Jane, Juan	0	10	
11	Brugat, Vicente	0	11	
Total		7	Total	5
PP		9	PP	16

Buts Score	Période Period	min		
0 — 1	ALE	Schuhmann, Kurt	I	0:34
1 — 1	ESP	Padros, José	I	3:40
2 — 1	ESP	Ibern, Manuel	II	0:34
2 — 2	ALE	Schuhmann, Kurt	II	0:56
3 — 2	ESP	Ibern, Manuel	II	3:39
3 — 3	ALE	Teicher, Peter	II	4:04
4 — 3	ESP	Zubicoa, Santiago	III	2:25
4 — 4	ALE	Haverkamp, Hermann	III	3:03
5 — 4	ESP	Ibern, Manuel	III	4:17
6 — 4	ESP	Ibern, Manuel	III	4:47
6 — 5	ALE	Haverkamp, Hermann	IV	3:32
7 — 5	ESP	Borell, Jorge	IV	4:58

ARBITRE REFEREE: Prostyakov, Nikolai URS

FINALE POUR 5e ET 6e PLACES
FINAL FOR 5th AND 6th PLACES

MATCH GAME **70**

EUA-ADE **6-4** (1-1, 3-2, 1-1, 1-0)

EUA	GS	ADE	GS	
1	Van Dorp, Anton	0	1	
2	Ashleigh, David	0	2	
3	Webb, Russell	0	3	
4	Crawford, Ronald	0	4	
5	Cole, Stanley	0	5	
6	Bradley, Bruce	3	6	
7	Willeford, Dean	0	7	
8	Weitzenberg, Barry	3	8	
9	Sheerer, Gary	0	9	
10	Parker, John	0	10	
11	Barnett, Steven	0	11	
Total		6	Total	4
PP		13	PP	11

Buts Score	Période Period	min		
1 — 0	EUA	Bradley, Bruce	I	2:05
1 — 1	ADE	Hermans, Veit	I	4:53
2 — 1	EUA	Weitzenberg, Barry	II	0:40
3 — 1	EUA	Bradley, Bruce	II	3:14
3 — 2	ADE	Schüler, Hans-Jürgen	II	3:23
3 — 3	ADE	Thiel, Jürgen	II	4:50
4 — 3	EUA	Weitzenberg, Barry	II	4:59
4 — 4	ADE	Herzog, Manfred	III	3:23
5 — 4	EUA	Bradley, Bruce	III	3:47
6 — 4	EUA	Weitzenberg, Barry	IV	1:24

ARBITRE REFEREE: Parrini, Gioavanni ITA

826

FINALE POUR 7e ET 8e PLACES
FINAL FOR 7th AND 8th PLACES

MATCH GAME **69**

HOL-CUB **8-5** (4-0, 2-2, 2-1, 0-2)

HOL	GS	CUB	GS	
1	De Vries, Feike	0	1	
2	Wouda, Hans	1	2	
3	Geutjes, Louis	1	3	
4	Hoogveld, Johannes	0	4	
5	Van Dorp, Alfred	2	5	
6	Parrel, Hans	0	6	
7	Van Der Voet, Nicolaas	4	7	
8	Moolhuijzen, Ad	0	8	
9	Bongers, Bart	0	9	
10	Hermesen, Andreas	0	10	
11	Kroon, Evert	0	11	
Total		8	Total	5
PP		7	PP	7

Buts Score	Période Period	min		
1 — 0	HOL	Geutjes, Louis	I	0:53
2 — 0	HOL	Van Der Voet, Nicolaas	I	2:21
3 — 0	HOL	Wouda, Hans	I	4:01
4 — 0	HOL	Van Dorp, Alfred	I	4:58
4 — 1	CUB	Arcos, Waldimiro	II	1:04
5 — 1	HOL	Van Dorp, Alfred	II	2:28
5 — 2	CUB	Rodriguez, Ibrahim	II	4:27
6 — 2	HOL	Van Der Voet, Nicolaas	II	4:47
7 — 2	HOL	Van Der Voet, Nicolaas	III	1:26
7 — 3	CUB	Junco, Rubén	III	1:58
8 — 3	HOL	Van Der Voet, Nicolaas	III	1:58
8 — 4	CUB	Valdés, Rolando	IV	1:24
8 — 5	CUB	Junco, Rubén	IV	5:00

ARBITRE REFEREE: Brandi, Jenó HUN

FINALE POUR 3e ET 4e PLACES
FINAL FOR 3rd AND 4th PLACES

MATCH GAME **71** **OCT 26**

HUN-ITA **9-4** (1-1, 4-1, 4-1, 0-1)

HUN	GS	ITA	GS	
1	Molnar, Endre	0	1	
2	Mayer, Mihaly	0	2	
3	Szivos, Istvan	0	3	
4	Konrad, Janos	0	4	
5	Sarosi, Laszlo	0	5	
6	Felkai, Laszlo	7	6	
7	Konrad, Ferenc	0	7	
8	Pocsik, Denes	0	8	
9	Bodnar, Andras	2	9	
10	Domotor, Zoltan	0	10	
11	Steinmetz, Janos	0	11	
Total		9	Total	4
PP		14	PP	16

Buts Score	Période Period	min		
1 — 0	HUN	Felkai, Laszlo	I	3:41
1 — 1	ITA	Pizzo, Eraldo	I	4:36
2 — 1	HUN	Felkai, Laszlo	II	1:01
2 — 2	ITA	Pizzo, Eraldo	II	1:28
3 — 2	HUN	Felkai, Laszlo	II	1:46
4 — 2	HUN	Bodnar, Andras	II	2:14
5 — 2	HUN	Felkai, Laszlo	II	3:18
6 — 2	HUN	Bodnar, Andras	III	1:12
7 — 2	HUN	Felkai, Laszlo	III	2:17
8 — 2	HUN	Felkai, Laszlo	III	2:34
8 — 3	ITA	Cevasco, Mario	III	3:25
9 — 3	HUN	Felkai, Laszlo	III	3:45
9 — 4	ITA	Pizzo, Eraldo	IV	2:10

ARBITRE REFEREE: Manguillot, M. ESP

FINALE POUR 1er ET 2e PLACES
FINAL FOR 1st AND 2nd PLACES

MATCH GAME **72** YUG-URS **13-11** (2-3, 3-2, 3-1, 3-5) TEMPS EXTRA (2-0,0-0)
OVERTIME

YUG		GS	URS		GS
1	Stipanac, Karlo	0	1	Guljaev, Vadim	0
2	Trumbic, Ivo	2	2	Chikvanaya, Givi	0
3	Bonacic, Ozren	3	3	Grishin, Boris	0
4	Marovic, Uros	5	4	Dolgushin, Alexander	0
5	Lopanty, Ronald	0	5	Barkalov, Aleksey	7
6	Jankovic, Zoran	0	6	Grigorovsky, Yury	0
7	Poljak, Miroslav	0	7	Semenov, Vladimir	0
8	Dabovic, Dejan	0	8	Shidlovsky, Alexander	0
9	Perisic, Djordje	0	9	Skok, Vjacheslav	4
10	Sandic, Mirko	3	10	Osipov, Leonid	0
11	Hebel, Zdravko	0	11	Bovin, Oleg	0
Total		13	Total		11
PP		37	PP		37

Buts Score		Période Period	min
0 — 1	URS	I	1:17
1 — 1	YUG	I	2:07
2 — 1	YUG	I	2:18
2 — 2	URS	I	2:32
2 — 3	URS	I	4:41
3 — 3	YUG	II	0:44
4 — 3	YUG	II	1:00
4 — 4	URS	II	1:42
5 — 4	YUG	II	2:07
5 — 5	URS	II	2:51
6 — 5	YUG	III	0:03
7 — 5	YUG	III	0:31
7 — 6	URS	III	2:21
8 — 6	YUG	III	2:22
9 — 6	YUG	IV	0:30
9 — 7	URS	IV	1:18
9 — 8	URS	IV	2:26
10 — 8	YUG	IV	3:19
10 — 9	URS	IV	3:32
11 — 9	YUG	IV	3:58
11 — 10	URS	IV	4:26
11 — 11	URS	IV	4:55
13 — 11	YUG	1 extra	0:33
12 — 11	YUG	1 extra	1:49

ARBITRE REFEREE Fuchs, A. BEL

RESUME
SUMMARY

HUN	6	YUG	13	1 ^o	YUG
YUG	8	URS	11	2 ^o	URS
ITA	5	HUN	9	3 ^o	HUN
		ITA	4	4 ^o	ITA
EUA	6	EUA	6	5 ^o	EUA
HOL	3	ADE	4	6 ^o	ADE
CUB	2	HOL	8	7 ^o	HCL
ADE	8	CUB	5	8 ^o	CUB
ALE	6	ALE	5	9 ^o	ESP
MEX	3	ESP	7	10 ^o	ALE
ESP	5	MEX	5	11 ^o	MEX
JPN	0	JPN	4	12 ^o	JPN
BRA	5	BRA	5	13 ^o	BRA
RAU	3	GRE	2	14 ^o	GRE
				15 ^o	RAU



UNION INTERNATIONALE DE
YACHT RACING IYRU

INTERNATIONAL YACHT RACING
UNION IYRU

PRESIDENT HONORAIRE
HONORARY PRESIDENT
S.M. le roi Olav V de Norvège NOR

PRESIDENT
Peter Scott GBR

SECRETAIRE
SECRETARY
Nigel Hacking GBR

SOUS-SECRETAIRE
ASSISTANT SECRETARY
Francisco Romera MEX

FEDERATION MEXICAINE
DE VOILE FMV

MEXICAN YACHTING
FEDERATION FMV

PRESIDENT
Juan Sánchez Renero MEX

SECRETAIRE
SECRETARY
Rafael Bárcenas MEX

SECTION YACHTING DU C.O.O.
O.O.C. YACHTING SECTION
Alvaro Sandoval Peralta MEX

DELEGUE DU C.O.O. A ACAPULCO
O.O.C. DELEGATE IN ACAPULCO
Sergio González Karg MEX

OFFICIELS DE LA COMPETITION
COMPETITION OFFICIALS

JURY

PRESIDENT
Peter Scott GBR

VICE-PRESIDENT
Beppe Croce ITA

MEMBRES
MEMBERS
Ernest-Oscar Ahlers ALE
Mogens Harttung DIN
Conde de Zubiria ESP
Robert Bavier, Jr. EUA
J. O. Soderhjelm FIN
E. Stutterheim FRA
François Thierry-Mieg FRA
A. R. Barron GBR
F. Gregg Benis GBR
C. N. Stavridis GRE
Bruno Bianchi ITA
Katzumi Hirata JPN
Fernando Ortiz Monasterio MEX
Juan Sánchez Renero MEX
Frederik Horn NOR
Conde de Caria POR
Jean Ott SUI

CONSEILLERS TECHNIQUES
TECHNICAL ADVISERS

DERIVEURS
SMALL BOATS
Vernon Foster GBR

YACHTS A QUILLE FIXE
KEEL BOATS
James McGruer GBR

828

SIGNES EMPLOYES

SYMBOLY

⊙	— CAPITAINE	HELMSMAN
L	— RECLAMATION CONTRE	PROTEST AGAINST
P	— PLACE	PLACE
COM. REG.	— POINTS	POINTS
DES	— COMITE DE REGATE	RACE COMMITTEE
NCM	— DISQUALIFIE	DISQUALIFIED
NTS	— N'A PAS PASSE LA LIGNE	FAILED TO FINISH
—	— N'A PAS PRIS LE DEPART	FAILED TO START
	— REGATE NON COMPTEE	RACE NOT COUNTED

CATEGORIE: **5.5 m**
 CLASS:

CLASSEMENT FINAL D'APRES LES POINTS ACCUMULES
 FINAL CLASSIFICATION BY ACCUMULATED POINTS

OCT 21

R E G A T E S

R A C E S

		Voile Sail	Capitaine et équipage Helmsman and crew		1	2	3	4	5	6	7	6 des 7 meil- leures régates Best 6 out of 7
1	SUE	S	Sundelin, Ulf Sundelin, Jorgen Sundelin, Peter	L	4	1	1	1	5-	1	1	1
				P	8	0	0	0	10	0	0	8
2	SUI	Z	Noverraz, Louis Stern, Marcel Dunand, Bernard	L	1	5	2	2	4	4	NCM-	2
				P	0	10	3	3	8	8	20	32
3	GBR	K	Aisher, Robin Jardine, Adrian Anderson, Paul	L	6	2	4	3	8-	3	3	3
				P	11.7	3	8	5.7	14	5.7	5.7	39.8
4	ALE	G	Harmstorf, Rudolf Stolze, Karl-August Stein, Harald	L	2	3	5	9-	3	9	4	4
				P	3	5.7	10	15	5.7	15	8	47.4
5	ITA	I	Zucchinetti, Giuseppe Carattino, Antonio Carattino, Domenico	L	3	7	3	NCM-	1	6	9	5
				P	5.7	13	5.7	20	0	11.7	15	51.1
6	CAN	KC	Leibel, Stanley Weiss, Ernest Hasen, Jack	L	NCM-	9	12	7	2	2	10	6
				P	20	15	18	13	3	3	16	68.0
7	AUS	KA	Solomons, William Hardy, James Kaufman, Gilbert	L	5	4	6	6	12-	12	5	7
				P	10	8	11.7	11.7	18	18	10	69.4
8	EUA	US	Cox, Gardner Colgate, Stephen Walker, Stuart	L	7	8	8	4	9-	8	6	8
				P	13	14	14	8	15	14	11.7	74.7
9	URS	SR	Alexandrov, Konstantin Alexandrov, Vladimir Melgunov, Konstantin	L	13-	6	11	5	7	7	7	9
				P	19	11.7	17	10	13	13	13	77.7
10	FRA	F	Breteche, Pierre Buck, Gilles Tiriau, Roger	L	9	10	7	12-	11	10	2	10
				P	15	16	13	18	17	16	3	80.0
11	NOR	N	H.R.H. Crown Prince, Harald Foyen, Stein Johannessen, Eirik	L	10	DES-	10	10	10	5	11	11
				P	16	22	16	16	16	10	17	91.0
12	MEX	MX	Braniff, Carlos Recamier, Antonio Belausteguigoitia, Iker	L	11	12-	9	11	6	11	8	12
				P	17	18	15	17	11.7	17	14	91.7
13	DIN	D	Berntsen, William Johansen, Erik Hansen, Niels	L	8	11	13	8	13	14	12	13
				P	14	17	19	14	19	20	18	101.0
14	PRO	PR	Gentil, Lee Fairbank, James Freeman, Hovey	L	12	13	14	13	14	13	13	14
				P	18	19	20	19	20	19	19	114.0

REGATE RACE 1 OCT 14

Bouées Buoy	2	3	1	2	1	Finale Final	Temps Time	Points	
1	Z	Z	I	Z	Z	Z	SUI	1h 49:40	0.0
2	G	G	Z	G	G	G	ALE	_____	3.0
3	I	I	G	I	I	I	ITA	_____	5.7
4	MX	KA	S	S	S	S	SUE	_____	8.0
5	K	K	KA	KA	KA	KA	AUS	_____	10.0
6	KA	K	D	K	K	K	GBR	_____	11.7
7	SR	SR	N	D	D	SR	EUA	_____	13.0
8	N	N	K	SR	D	D	DIN	_____	14.0
9	PR	D	N	N	N	F	FRA	_____	15.0
10	D	F	MX	US	US	N	NOR	_____	16.0
11	F	F	F	F	F	MX	MEX	_____	17.0
12	KC	US	US	MX	KC	PR	PRO	_____	18.0
13	US	PR	PR	PR	PR	SR	URS	2h 04:28	19.0
							CAN	NCM	20.0



BEAU FAIR



29.0° C



15 (275°)



RIDEE CHOPPY



0.5 (120°)

⊙MX — KC

REGATE RACE 3 OCT 16

Bouées Buoy	2	3	1	2	1	Finale Final	Temps Time	Points	
1	S	S	S	S	S	S	SUE	2h 04:06	0.0
2	KA	KA	KA	I	I	I	SUI	_____	3.0
3	F	I	I	Z	Z	Z	ITA	_____	5.7
4	I	F	US	F	KA	K	GBR	_____	8.0
5	N	N	N	KA	K	G	ALE	_____	10.0
6	K	K	K	G	G	F	AUS	_____	11.7
7	MX	MX	Z	N	N	F	FRA	_____	13.0
8	US	US	G	N	N	US	EUA	_____	14.0
9	Z	Z	MX	MX	SR	MX	MEX	_____	15.0
10	G	G	SR	SR	US	N	NOR	_____	16.0
11	D	D	F	US	MX	SR	URS	_____	17.0
12	SR	SR	KC	KC	KC	D	CAN	_____	18.0
13	KC	KC	D	PR	D	PR	DIN	_____	19.0
14	PR	PR	PR	D	PR	PR	PRO	2h 14:44	20.0



BEAU FAIR



28.5° C



8 (285°)



PLATE CALM



0.2 (130°)

⊙MX — SR
Com. Reg. — Z
Com. Reg. — F

830

REGATE RACE 2 OCT 15

Bouées Buoy	2	3	1	2	1	Finale Final	Temps Time	Points	
1	S	S	S	S	S	S	SUE	1h 54:01	0.0
2	K	K	K	K	K	K	GBR	_____	3.0
3	G	G	G	G	G	G	ALE	_____	5.7
4	SR	SR	SR	SR	KA	KA	AUS	_____	8.0
5	D	N	D	N	N	Z	SUI	_____	10.0
6	N	D	N	Z	SR	SR	URS	_____	11.7
7	US	US	US	KA	US	N	ITA	_____	13.0
8	F	F	KA	US	Z	I	EUA	_____	14.0
9	Z	Z	I	D	D	US	CAN	_____	15.0
10	I	I	Z	I	I	KC	FRA	_____	16.0
11	KA	KA	F	MX	F	D	DIN	_____	17.0
12	MX	KC	MX	F	KC	D	MEX	_____	18.0
13	PR	MX	KC	KC	MX	PR	PRO	2h 02:16	19.0
							NOR	DES	22.0



BEAU FAIR



29.5° C



15 (295°)



PLATE CALM



0.2 (160°)

⊙KC — F
I — N
US — Z
F — D

REGATE RACE 4 OCT 17

Bouées Buoy	2	3	1	2	1	Finale Final	Temps Time	Points	
1	S	S	S	S	S	S	SUE	2h 24:41	0.0
2	Z	Z	Z	Z	Z	Z	SUI	_____	3.0
3	F	F	K	MX	K	K	GBR	_____	5.7
4	KC	G	KC	D	US	US	EUA	_____	8.0
5	G	I	I	K	KA	SR	URS	_____	10.0
6	I	KC	N	G	D	KA	AUS	_____	11.7
7	K	K	SR	KA	SR	KC	CAN	_____	13.0
8	D	D	G	SR	SR	D	DIN	_____	14.0
9	US	US	US	US	MX	G	ALE	_____	15.0
10	N	N	F	N	N	N	NOR	_____	16.0
11	SR	SR	D	F	N	MX	MEX	_____	17.0
12	MX	MX	MX	KC	F	F	FRA	_____	18.0
13	KA	KA	KA	PR	PR	PR	PRO	2h 34:44	19.0
14	PR	PR	PR	PR	PR	PR	ITA	_____	20.0



BEAU FAIR



29.5° C



6 (235°)



PLATE CALM



0.1 (300°)

REGATE RACE 5 OCT 19

Bouées Buoy	2	3	1	2	1	Finale Final		Temps Time	Points
1	KC	KC	Z	S	Z	I	ITA	2h 16:53	0.0
2	Z	Z	KC	Z	S	KC	CAN	_____	3.0
3	US	US	US	KC	KC	G	ALE	_____	5.7
4	S	S	S	US	US	Z	SUI	_____	8.0
5	I	I	S	G	G	S	SUE	_____	10.0
6	G	G	G	I	I	MX	MEX	_____	11.7
7	MX	MX	MX	K	K	SR	URS	_____	13.0
8	SR	SR	SR	K	MX	K	GBR	_____	14.0
9	F	K	K	KA	SR	US	EUA	_____	15.0
10	K	F	KA	SR	N	N	NOR	_____	16.0
11	PR	KA	N	F	KA	F	FRA	_____	17.0
12	N	N	F	N	F	KA	AUS	_____	18.0
13	KA	PR	PR	D	D	D	DIN	_____	19.0
14	D	D	D	PR	PR	PR	PRO	2h 29:31	20.0

MOYEN NORMAL

29.8°C

6 (180°)

PLATE CALM

0.3 (326°)

⊙Z — G

REGATE RACE 7 OCT 21

Bouées Buoy	2	3	1	2	1	Finale Final		Temps Time	Points
1	S	S	S	S	S	S	SUE	1h 29:24	0.0
2	US	US	F	F	F	F	FRA	_____	3.0
3	G	G	G	G	G	K	GBR	_____	5.7
4	F	F	US	KA	KA	G	ALE	_____	8.0
5	KC	K	KC	I	I	KA	AUS	_____	10.0
6	Z	Z	I	Z	US	US	EUA	_____	11.7
7	K	KC	Z	K	K	SR	URS	_____	13.0
8	I	I	K	US	KC	MX	MEX	_____	14.0
9	KA	KA	KA	KC	Z	I	ITA	_____	15.0
10	MX	SR	N	SR	SR	Z	CAN	_____	16.0
11	SR	MX	MX	MX	MX	KC	NOR	_____	17.0
12	N	N	SR	N	N	N	DIN	_____	18.0
13	D	D	D	D	D	D	PRO	_____	19.0
	PR	PR	PR	PR	PR	PR	SUI	1h 35:35 NCM	20.0

NUAGEUX CLOUDY

28.5°C

10 (285°)

RIDEE CHOPPY

1.0 (110°)

REGATE RACE 6 OCT 20

								Temps Time	Points
1	S	S	S	S	S	S	SUE	2h 36:04	0.0
2	KC	KC	KC	K	KC	KC	CAN	_____	3.0
3	Z	Z	Z	K	K	Z	GBR	_____	5.7
4	I	N	K	KC	N	Z	SUI	_____	8.0
5	N	I	US	N	N	N	NOR	_____	10.0
6	US	US	I	I	US	I	ITA	_____	11.7
7	K	K	N	US	F	SR	URS	_____	13.0
8	KA	SR	KA	F	F	US	EUA	_____	14.0
9	MX	MX	SR	MX	G	G	ALE	_____	15.0
10	F	KA	MX	G	SR	F	FRA	_____	16.0
11	SR	F	F	SR	MX	MX	MEX	_____	17.0
12	PR	PR	G	KA	KA	KA	AUS	_____	18.0
13	G	G	PR	PR	PR	PR	PRO	_____	19.0
14	D	D	D	D	D	D	DIN	2h 55:09	20.0

BEAU FAIR

30.0°C

5 (250°)

PLATE CALM

0.7 (275°)

⊙K — KC

CATEGORIE: **DRAGON**
 CLASS:

CLASSEMENT FINAL D'APRES LES POINTS ACCUMULES
 FINAL CLASSIFICATION BY ACCUMULATED POINTS

OCT 21

REGATES

RACES

		Voile Sail	Capitaine et équipage Helmsman and crew		1	2	3	4	5	6	7	6 des 7 meil- leurs régates Best 6 out of 7
1	EUA	US	Friedrichs, George Jahncke, Barton Schreck, Gerald	L	2	6-	1	1	2	1	1	1
				P	3	11.7	0	0	3	0	0	6.0
2	DIN	D	Birch, Aage Jensen, Poul Markussen, Niels	L	6	1	2	10	3	2	2	2
				P	11.7	0	3	16	5.7	3	3	26.4
3	ADE	GO	Borowski, Paul Thun, Karl-Heinz Weichert, Konrad	L	1	2	3	4	4	6-	4	3
				P	0	3	5.7	8	8	11.7	8	32.7
4	CAN	KC	Tupper, Stephen Miller, David Irwin, Timothy	L	3	8	13-	6	8	7	3	4
				P	5.7	14	19	11.7	14	13	5.7	64.1
5	AUS	KA	Cuneo, Bruce Anderson, Thomas Ferguson, John	L	8	4	9	2	5	11	9	5
				P	14	8	15	3	10	17	15	65.0
6	SUE	S	Broberg, Gunnar Eisner, Lennart Hanson, Sven	L	7	11-	5	9	6	5	6	6
				P	13	17	10	15	11.7	10	11.7	71.4
7	ALE	G	Oldendorff, Klaus Stulcken, Peter May, Axel	L	16	5	14	8	1	4	16-	7
				P	22	10	20	14	0	8	22	74.0
8	FRA	F	Briand, Michel Alexandre, Michel Blanchard, Pierre	L	13	3	12	17-	7	3	14	8
				P	19	5.7	18	23	13	5.7	20	81.4
9	ARG	A	Schenone, Héctor Belada, Boris Sisti, Pedro	L	15	9	7	5	17-	10	11	9
				P	21	15	13	10	23	16	17	92.0
10	HOL	H	Groot, Cornelis Bol, Jan De Zwart, Pieter	L	10	NCM-	18	3	11	13	7	10
				P	16	28	24	5.7	17	19	13	94.7
11	URS	SR	Anisimov, Jury Ruzhnikov, Valery Afanasiev, Valery	L	12	7	4	13	14	NCM-	12	11
				P	18	13	8	19	20	29	18	96.0
12	NOR	N	Sommerschild, Theodor Aarberg, Jan-Erik Wiik-Hansen, Erik	L	4	15	11	19	15	16	5	12
				P	8	21	17	25	21	22	10	99.0
13	BER	KB	Cooper, Kirkland Simmons, Eugene Belbin, Richard	L	9	14	10	7	10	14	18-	13
				P	15	20	16	13	16	20	24	100.0
14	GBR	K	Judah, Robin Reynolds, Charles Tucker, David	L	5	17	6	20-	16	15	8	14
				P	10	23	11.7	26	22	21	14	101.7
15	GRE	GR	Eskitzoglou, Odysseus Zaimis, Georgios Voyatzis, Anastassios	L	14	10	8	16	18	8	17	15
				P	20	16	14	22	24	14	23	109.0
16	BAH	BA	Kelly, Godfrey Ramsey, George Kelly, David	L	NCM	NCM-	17	14	9	9	10	16
				P	28	28	23	20	15	15	16	117.0
17	POR	P	Menezes, Melo Lima, Fernando Weck, Sarafana	L	17	13	15	11	NCM-	12	20	17
				P	23	19	21	17	29	18	26	124.0
18	MEX	MX	Velázquez, Javier Sloane, Roberto Gerard, Esteban	L	19	20-	16	12	12	18	13	18
				P	25	26	22	18	18	24	19	126.0
19	HOK	KH	Park, John Turnbull, William Coope, Paul	L	20	12	20	15	13	22-	19	19
				P	26	18	26	21	19	28	25	135.0
20	JAM	KJ	Kirkconnell, Barton Ogilvie, Charles Henriques, Steven	L	11	16	22	21	22-	17	15	20
				P	17	22	28	27	28	23	21	138.0
21	ESP	E	Riveras, Angel Baiget, Manuel Jaudenes, Eugenio	L	18	19	19	18	19	19	22-	21
				P	24	25	25	24	25	25	28	148.0
22	VEN	V	Trujillo, Daniel Roche, Herve Burger, Frohmund	L	21	18	21	23-	20	20	21	22
				P	27	24	27	29	26	26	27	157.0
23	TWN	TA	Chen, Hsiu-Hsiung Chang, Jen-Chih Chen, Chih-Fu	L	NTS	NTS	NCM	22	21	21	23-	23
				P	29	29	29	28	27	27	29	169.0

REGATE RACE 1 OCT 14

Bouées Buoy	2	3	1	2	1	Finale Final		Temps Time	Points
1	US	K	GO	GO	GO	GO	ADE	2h 52:55	0.0
2	K	GO	US	K	US	US	EUA	_____	3.0
3	KA	KA	N	N	N	KC	CAN	_____	5.7
4	GR	N	US	N	N	KC	NOR	_____	8.0
5	N	KB	KA	KA	K	KA	GBR	_____	10.0
6	N	D	D	D	D	S	DIN	_____	11.7
7	KB	S	S	KC	D	S	SUE	_____	13.0
8	S	G	F	S	S	KB	AUS	_____	14.0
9	D	F	F	KB	S	KB	BER	_____	15.0
10	G	F	G	KJ	KJ	H	HOL	_____	16.0
11	KJ	KJ	KJ	SR	SR	KJ	JAM	_____	17.0
12	F	SR	SR	GR	H	GR	URS	_____	18.0
13	KC	H	H	F	F	GR	FRA	_____	19.0
14	SR	P	P	P	P	G	GRE	_____	20.0
15	H	MX	MX	H	H	E	ARG	_____	21.0
16	P	GR	GR	E	E	A	ALE	_____	22.0
17	MX	E	A	MX	A	E	POR	_____	23.0
18	KH	A	KH	KH	KH	V	ESP	_____	24.0
19	E	V	V	V	V	V	MEX	_____	25.0
20	A	V	V	V	V	V	HOK	_____	26.0
21	V	V	V	V	V	V	VEN	_____	27.0
							BAH	_____	28.0
							TWN	_____	29.0



BEAU FAIR



29.0°C



16 (300°)



RIDEE 3 CHOPPY



0.5 (120°)

⊙G — A

REGATE RACE 2 OCT 15

								2h 01:39	0.0
1	G	F	F	F	D	D	DIN	_____	3.0
2	A	D	D	D	F	GO	ADE	_____	5.7
3	D	G	GO	GO	GO	F	FRA	_____	8.0
4	KA	A	KA	KA	KA	KA	AUS	_____	10.0
5	KA	GO	KA	KA	KA	US	ALE	_____	11.7
6	GR	GR	SR	US	SR	KC	EUA	_____	13.0
7	GR	SR	KA	US	SR	KC	URS	_____	14.0
8	SR	SR	A	A	KA	A	CAN	_____	15.0
9	SR	SR	SR	A	GR	KB	ARG	_____	16.0
10	KC	KC	KB	KB	GR	P	GRE	_____	17.0
11	P	KB	P	P	KB	P	SUE	_____	18.0
12	KB	N	N	KH	S	KH	HOK	_____	19.0
13	KJ	P	P	P	N	N	POR	_____	20.0
14	N	S	S	S	N	KJ	BER	_____	21.0
15	S	K	K	K	N	KJ	NOR	_____	22.0
16	K	US	US	US	K	KJ	JAM	_____	23.0
17	H	V	V	V	V	V	GBR	_____	24.0
18	E	MX	MX	MX	E	MX	VEN	_____	25.0
19	V	US	US	US	V	MX	ESP	_____	26.0
20	MX	MX	MX	MX	MX	MX	MEX	_____	28.0
							BAH	_____	28.0
							HOL	_____	28.0
							TWN	_____	29.0



BEAU FAIR



29.0°C



20 (293°)



PLATE CALM



0.2 (160°)

⊙P — KH

REGATE RACE 3 OCT 16

Bouées Buoy	2	3	1	2	1	Finale Final		Temps Time	Points
1	US	US	US	US	US	US	EUA	2h 10:27	0.0
2	SR	SR	SR	D	D	D	DIN	_____	3.0
3	N	N	N	SR	SR	GO	ADE	_____	5.7
4	D	D	D	K	K	GO	URS	_____	8.0
5	K	K	K	GO	K	S	SUE	_____	10.0
6	BA	KA	KA	S	S	K	GBR	_____	11.7
7	KA	GO	GO	KA	KA	A	ARG	_____	13.0
8	GO	BA	BA	A	A	GR	GRE	_____	14.0
9	S	S	S	GR	GR	KA	AUS	_____	15.0
10	A	A	A	KC	KC	N	BER	_____	16.0
11	P	KC	KC	F	F	N	NOR	_____	17.0
12	GR	GR	F	P	P	KB	FRA	_____	18.0
13	KC	P	P	GR	GR	P	CAN	_____	19.0
14	KB	KB	GR	G	G	P	ALE	_____	20.0
15	F	G	G	MX	MX	P	POR	_____	21.0
16	V	V	MX	G	G	MX	MEX	_____	22.0
17	G	MX	KB	H	H	BA	BAH	_____	23.0
18	MX	E	E	F	F	H	HOL	_____	24.0
19	E	V	V	V	V	E	ESP	_____	25.0
20	H	H	KH	V	V	KH	HOK	_____	26.0
21	KH	KH	V	KJ	V	V	VEN	_____	27.0
22	TA	KJ	KJ	KH	V	V	JAM	_____	28.0
	KJ	TA	TA	V	V	V	TWN	_____	29.0



BEAU FAIR



28.5°C



8 - 9 (290°)



PLATE CALM



0.2 (130°)

833

REGATE RACE 4 OCT 17

								2h 30:44	0.0
1	S	S	US	US	US	US	EUA	_____	3.0
2	US	US	D	H	KA	KA	AUS	_____	5.7
3	D	D	S	KB	KC	H	HOL	_____	8.0
4	KA	KA	KA	GO	GO	A	ADE	_____	10.0
5	G	G	G	GR	H	KB	ARG	_____	11.7
6	GO	GO	GO	S	S	KB	CAN	_____	13.0
7	H	KB	KB	KC	KB	S	BER	_____	14.0
8	N	N	N	KA	GR	G	ALE	_____	15.0
9	P	H	P	P	P	S	SUE	_____	16.0
10	A	P	A	MX	A	D	DIN	_____	17.0
11	E	E	K	A	MX	P	POR	_____	18.0
12	KC	KC	BA	SR	BA	SR	MEX	_____	19.0
13	GR	BA	KH	D	D	BA	URS	_____	20.0
14	BA	K	KC	BA	SR	KH	BAH	_____	21.0
15	K	GR	KC	KH	SR	GR	HOK	_____	22.0
16	TA	KH	SR	K	K	F	GRE	_____	23.0
17	KH	SR	GR	E	E	F	FRA	_____	24.0
18	MX	MX	MX	F	F	N	ESP	_____	25.0
19	SR	F	TA	N	N	K	NOR	_____	26.0
20	F	TA	KJ	TA	TA	KJ	GBR	_____	27.0
21	KJ	KJ	V	V	V	V	JAM	_____	28.0
22	V	V	V	V	V	V	TWN	_____	28.0
23	V	V	V	V	V	V	VEN	_____	29.0



BEAU FAIR



29.5°C



6 (235°)



PLATE CALM



0.1 (300°)

⊙D — US
KB — AyB

REGATE RACE 5 OCT 19

Bouées	2	3	1	2	1	Finale	Temps	Points	
Buoys						Final	Time		
1	G	G	G	D	D	G	ALE	2h 30:55	0.0
2	H	D	D	G	G	US	EUA		3.0
3	D	D	H	US	US	D	DIN		5.7
4	KH	KH	F	GO	GO	GO	ADE		8.0
5	SR	F	US	F	F	KA	AUS		10.0
6	F	SR	SR	KB	KB	S	SUE		11.7
7	S	US	S	SR	SR	F	FRA		13.0
8	A	S	KB	KC	KC	KC	CAN		14.0
9	US	KB	GO	GO	KA	KA	BAH		15.0
10	KB	GO	KA	KA	S	KB	BER		16.0
11	MX	KC	KH	MX	MX	H	HOL		17.0
12	KC	A	KC	H	H	MX	MEX		18.0
13	BA	KA	K	KH	A	KH	HOK		19.0
14	GO	K	A	A	BA	SR	URS		20.0
15	KA	P	N	BA	GR	N	NOR		21.0
16	K	N	P	GR	KH	K	GBR		22.0
17	P	MX	MX	K	K	A	ARG		23.0
18	GR	GR	GR	P	P	P	GRE		24.0
19	N	BA	BA	N	N	GR	ESP		25.0
20	E	V	V	V	V	E	VEN		26.0
21	V	V	V	V	V	V	TWN		27.0
22	TA	KJ	KJ	KJ	KJ	TA	JAM	2h 45:08	28.0
	KJ	TA	TA	TA	TA	KJ	POR	NCM	29.0

	MOYEN	NORMAL
	29.8°C	
	6	(187°)
	PLATE	CALM
	1.0	(326°)

REGATE RACE 7 OCT 21

Bouées	2	3	1	2	1	Finale	Temps	Points	
Buoys						Final	Time		
1	S	S	US	US	US	US	EUA	1h 51:58	0.0
2	US	US	D	D	D	D	DIN		3.0
3	D	D	S	GO	GO	D	KC		5.7
4	N	N	GO	N	N	GO	ADE		8.0
5	GO	GO	N	KC	KC	N	NOR		10.0
6	KC	KC	KB	S	S	S	SUE		11.7
7	BA	BA	BA	H	H	H	HOL		13.0
8	KA	KA	KA	BA	BA	K	GBR		14.0
9	K	K	K	K	K	KA	AUS		15.0
10	A	A	A	K	KA	BA	BAH		16.0
11	H	H	MX	A	A	A	ARG		17.0
12	MX	MX	F	F	SR	SR	URS		18.0
13	SR	G	SR	SR	GR	MX	MEX		19.0
14	KB	V	V	GR	GR	F	FRA		20.0
15	V	SR	G	G	F	KJ	JAM		21.0
16	G	F	KB	MX	MX	G	ALE		22.0
17	F	KB	GR	V	KB	GR	GRE		23.0
18	GR	GR	P	V	KB	KB	BER		24.0
19	P	P	F	KJ	P	KH	HOK		25.0
20	KH	KJ	KJ	KH	P	P	POR		26.0
21	E	KH	KH	E	KH	V	VEN		27.0
22	K	E	E	KH	E	E	ESP	2h 07:35	28.0
23	TA	TA	TA	TA	TA	TA	TWN		29.0

	NUAGEUX	CLOUDY
	28.5°C	
	12	(285°)
	RIDEE	CHOPPY
	1	(110°)

834

REGATE RACE 6 OCT 20

Bouées	2	3	1	2	1	Finale	Temps	Points	
Buoys						Final	Time		
1	G	G	G	KC	G	US	EUA	2h 55:01	0.0
2	KC	KC	KC	US	US	D	DIN		3.0
3	F	F	F	D	D	F	FRA		5.7
4	BA	BA	D	S	S	G	ALE		8.0
5	D	D	BA	F	F	S	SUE		10.0
6	US	US	US	BA	BA	GO	ADE		11.7
7	A	A	A	GO	GO	KA	CAN		13.0
8	H	GO	GO	A	A	GR	GRE		14.0
9	GO	P	P	P	P	BA	BAH		15.0
10	V	GR	GR	GR	GR	A	ARG		16.0
11	P	H	H	KA	KA	KA	AUS		17.0
12	GR	V	V	KA	KA	P	POR		18.0
13	KJ	KJ	KJ	KJ	K	KB	HOL		19.0
14	MX	MX	V	KB	K	K	BER		20.0
15	KB	KA	K	K	N	N	GBR		21.0
16	TA	KB	V	V	KJ	KJ	NOR		22.0
17	E	K	N	N	N	MX	JAM		23.0
18	KA	E	MX	MX	V	MX	MEX		24.0
19	K	N	N	N	E	E	ESP		25.0
20	KH	KH	E	E	V	V	VEN		26.0
21	N	TA	TA	TA	TA	TA	TWN		27.0
22	SR	TA	TA	KH	KH	KH	HOK	3h 05:00	28.0
							URS	NCM	29.0

	BEAU	FAIR
	30.0°C	
	5	(225°)
	PLATE	CALM
	0.7	(275°)

CATEGORIE: **FLYING DUTCHMAN**
 CLASS:

CLASSEMENT FINAL D'APRES LES POINTS ACCUMULES **OCT 21**
 FINAL CLASSIFICATION BY ACCUMULATED POINTS

R E G A T E S

R A C E S

		Voile Sail	Capitaine et équipage Helmsman and crew		1	2	3	4	5	6	7	6 des 7, meil- leures régates Best 6 out of 7
1	GBR	K	Δ Pattisson, Rodney MacDonald, Lain	L	DES-	1	1	1	1	1	2	1
				P	39	0	0	0	0	0	3	3.0
2	ALE	G	Δ Libor, Ullrich Naumann, Peter	L	1	3	2	2	13	21-	7	2
				P	0	5.7	3	3	19	27	13	43.7
3	BRA	BL	Δ Conrad, Ralph Cordes, Burkhard	L	14-	7	4	3	3	10	1	3
				P	20	13	8	5.7	5.7	16	0	48.4
4	AUS	KA	Δ Ryves, Carl Sargeant, James	L	3	5	3	20-	8	4	3	4
				P	5.7	10	5.7	26	14	8	5.7	49.1
5	NOR	N	Δ Lofterod, Bjorn Lofterod, Odd	L	2	2	7	6	6	NCM-	5	5
				P	3	3	13	11.7	11.7	36	10	52.4
6	FRA	F	Δ Cheret, Bertrand Trouble, Bruno	L	5	4	20-	9	4	2	18	6
				P	10	8	26	15	8	3	24	68.0
7	CAN	KC	Δ Green, Roger Green, Stewart	L	9	16	5	5	2	18-	13	7
				P	15	22	10	10	3	24	19	79.0
8	NZL	KZ	Δ Smale, Geoffrey Roberts, Ralph	L	DES-	8	9	12	9	8	4	8
				P	39	14	15	18	15	14	8	84.0
9	SUE	S	Δ Kolni, Peter Kolni, Jorgen	L	12	NCM-	8	14	5	14	8	9
				P	18	35	14	20	10	20	14	96.0
10	EUA	US	Δ James, Robert James, David	L	NCM-	9	14	18	15	3	6	10
				P	36	15	20	24	21	5.7	11.7	97.4
11	ESP	E	Δ Fernández, Gonzalo Gancedo, Félix	L	10	14	6	10	10	20-	16	11
				P	16	20	11.7	16	16	26	22	101.7
12	ADE	GO	Δ Cochius, Hans-Jürgen Christoph, Werner	L	13	10	16	13	19-	6	10	12
				P	19	16	22	19	25	11.7	16	103.7
13	YUG	Y	Δ Grego, Anton Nikolic, Simo	L	19-	17	13	4	17	7	14	13
				P	25	23	19	8	23	13	20	106.0
14	HOK	KH	Δ Pride, Neil Gamble, Peter	L	11	13	15	8	21-	16	9	14
				P	17	19	21	14	27	22	15	108.0
15	URS	SR	Δ Rvalov, Lev Pilchin, Victor	L	4	6	12	23-	18	23	12	15
				P	8	11.7	18	29	24	29	18	108.7
16	DIN	D	Δ Fogh, Hans Jensen, Niels	L	6	12	DES-	7	12	11	NCM	16
				P	11.7	18	39	13	18	17	36	113.7
17	AUT	OE	Δ Geiger, Karl Fischer, Werner	L	18-	15	10	16	16	12	11	17
				P	24	21	16	22	22	18	17	116.0
17	HOL	H	Δ Verhagen, Gijsbertus De Jong, Nicolaas	L	16	11	18	17	14	5	21-	17
				P	22	17	24	23	20	10	27	116.0
19	ITA	I	Δ Massone, Carlo Ottonello, Emanuele	L	15	19	17	24-	7	9	17	19
				P	21	25	23	30	13	15	23	120.0
20	MEX	MX	Δ Villaseñor, Lorenzo García, Guillermo	L	7	22-	11	22	11	15	19	20
				P	13	28	17	28	17	21	25	121.0
21	HUN	M	Δ Gomory, Pal Izsak, Szabolcs	L	8	NCM-	21	11	23	25	22	21
				P	14	35	27	17	29	31	28	146.0
22	GRE	GR	Δ Andreadis, George Psarrakis, Stavros	L	21	21	19	19	20	NCM-	15	22
				P	27	27	25	25	26	36	21	151.0

		Voile Sail	Capitaine et équipage Helmsman and crew	REGATES							RACES	
				1	2	3	4	5	6	7	6 des 7 meilleures régates Best 6 out of 7	
23	BEL	B	△ Maes, Christian Roland, Joel	L	22	NTS-	25	15	22	13	25	23
				P	28	36	31	21	28	19	31	158.0
24	POL	PZ	△ Iwinski, Andrzej Raczynski, Ludwik	L	20	18	24	25	25	17	26+	24
				P	26	24	30	31	31	23	32	165.0
25	ISV	VI	△ Thompson, Rudy Hamber, John	L	17	23	22	27-	26	24	24	25
				P	23	29	28	33	32	30	30	172.0
26	JAM	KJ	△ Plant, William Nunes, Michael	L	NCM-	NCM	23	21	24	22	20	26
				P	36	35	29	27	30	28	26	175.0
27	POR	P	△ Sena, Orlando Da Silva, Adriano	L	24	24	26	26	NCM-	19	23	27
				P	30	30	32	32	36	25	29	178.0
28	PRO	PR	△ Torruella, Juan Torruella, Radamés	L	23	20	27	28-	27	26	27	28
				P	29	26	33	34	33	32	33	186.0
29	INA	RI	△ Gunawan, John Tan, Tjong	L	26	25	28	29-	28	28	28	29
				P	32	31	34	35	34	34	34	199.0
30	SAL	SL	△ Aguilar, Mario Escobar, Manuel	L	25	NCM	NCM	NTS-	29	27	29	30
				P	31	35	36	36	35	33	35	205.0

REGATE RACE 1 OCT 14

Bouées Buoys	2	3	1	2	1	Finale Final	Temps Time	Points	
1	SR	N	N	K	K	K	ALE	1h 56:24	0.0
2	N	KA	KA	N	N	G	NOR		3.0
3	KA	SR	SR	KA	KA	N	AUS		5.7
4	G	G	G	G	G	KA	URS		8.0
5	MX	K	K	F	F	SR	FRA		10.0
6	K	KH	MX	MX	F	F	DIN		11.7
7	F	D	KH	KZ	KZ	D	MEX		13.0
8	D	S	D	KH	KH	M	HUN		14.0
9	S	VI	KC	KC	KC	MX	CAN		15.0
10	VI	KC	KZ	E	E	M	ESP		16.0
11	KC	M	M	M	M	KH	HOK		17.0
12	M	KZ	E	E	E	KH	SUE		18.0
13	M	BL	M	S	S	S	ADE		19.0
14	KZ	VI	BL	BL	BL	GO	BRA		20.0
15	E	US	VI	VI	VI	BL	ITA		21.0
16	US	PZ	OE	OE	OE	I	HOL		22.0
17	PZ	I	OE	I	I	H	ISV		23.0
18	I	BL	OE	PZ	PZ	OE	AUT		24.0
19	H	OE	GO	OE	OE	Y	YUG		25.0
20	OE	GO	PZ	H	H	PZ	POL		26.0
21	GO	KJ	GR	Y	Y	GR	GRE		27.0
22	KJ	GR	B	GR	GR	B	BEL		28.0
23	GR	B	H	B	B	GR	PRO		29.0
24	B	Y	GR	KJ	KJ	PR	POR		30.0
25	Y	PR	PR	PR	PR	P	SAL		31.0
26	PR	RI	RI	SL	SL	RI	INA	2h 20:11	32.0
	RI	SL	SL	RI	RI		EUA	NCM	36.0
	SL	SL	SL	RI	RI		JAM	NCM	36.0
							GBR	DES	39.0
							NZL	DES	39.0

REGATE RACE 2 OCT 15

Bouées Buoys	2	3	1	2	1	Finale Final	Temps Time	Points	
1	N	K	K	K	K	K	GBR	1h 58:23	0.0
2	K	N	N	N	N	N	NOR		3.0
3	F	F	F	F	F	F	ALE		5.7
4	KA	KA	KA	KA	KA	KA	FRA		8.0
5	G	G	G	G	G	KA	AUS		10.0
6	GO	BL	BL	BL	BL	SR	URS		11.7
7	BL	GO	GO	GO	GO	US	BRA		13.0
8	D	D	D	D	D	KZ	NZL		14.0
9	H	H	H	H	H	US	EUA		15.0
10	US	US	US	BL	BL	GO	ADE		16.0
11	SR	KH	KH	E	E	H	HOL		17.0
12	PZ	SR	SR	H	H	D	DIN		18.0
13	KH	PZ	PZ	E	E	KH	HOK		19.0
14	PR	E	E	KH	KH	E	ESP		20.0
15	KH	PR	PR	OE	OE	OE	AUT		21.0
16	OE	OE	OE	PZ	PZ	KC	CAN		22.0
17	OE	KC	KC	PR	PR	Y	YUG		23.0
18	KC	PR	PR	Y	Y	PZ	POL		24.0
19	I	OE	OE	KC	KC	I	ITA		25.0
20	VI	MX	MX	I	I	PR	PRO		26.0
21	MX	Y	Y	MX	MX	GR	GRE		27.0
22	Y	KJ	KJ	VI	VI	GR	MEX		28.0
23	KJ	GR	GR	VI	VI	VI	ISV		29.0
24	GR	S	S	GR	GR	KJ	POR		30.0
25	S	RI	RI	P	P	P	INA	2h 18:02	31.0
	RI	SL	SL	RI	RI	RI	JAM	NCM	35.0
							SAL	NCM	35.0
							HUN	NCM	35.0
							SUE	NCM	35.0
							BEL	NTS	36.0

836



⊙ KC — K
US — Com. Reg.
E — KZ
GO — US



REGATE RACE 3 OCT 16

Bouées Buoy	2	3	1	2	1	Finale Final	Temps Time	Points
1						K	1h 53:27	0.0
2	K	K	K	K	K	G		3.0
3	KA	KA	KA	KA	KA	G		5.7
4	KC	KC	KC	KC	KC	BL		8.0
5	G	G	G	G	G	BL		10.0
6	S	BL	BL	BL	BL	E		11.7
7	BL	S	S	D	N	N		13.0
8	GR	D	D	D	F	N		14.0
9	N	GR	GR	E	S	D		15.0
10	D	KH	N	S	S	KZ		16.0
11	E	M	N	KZ	D	KZ		17.0
12	MX	M	US	US	US	OE		18.0
13	KH	I	M	SR	SR	MX		19.0
14	US	KZ	MX	GO	GO	Y		20.0
15	M	OE	GO	GR	GO	US		21.0
16	OE	US	E	H	OE	KH		22.0
17	SR	E	I	OE	GR	GO		23.0
18	Y	MX	OE	Y	H	I		24.0
19	I	SR	Y	GO	OE	H		25.0
20	PZ	F	GO	M	Y	F		26.0
21	KZ	Y	F	F	F	F		27.0
22	H	GO	SR	H	I	I		28.0
23	F	H	PZ	PZ	KJ	KJ		29.0
24	GO	PZ	VI	VI	PZ	PZ		30.0
25	VI	VI	B	B	B	B		31.0
26	B	PR	B	VI	VI	P		32.0
27	PR	KJ	P	P	P	P		33.0
28	KJ	P	PR	PR	PR	PR		34.0
29	RI	SL	RI	RI	RI	RI		35.0
	SL	SL	SL	SL	SL	SL		36.0
								39.0



BEAU FAIR



34.0° C



8 (270°)



PLATE CALM



0.75 (135°)

☉ F — D
D — F

REGATE RACE 4 OCT 17

Bouées Buoy	2	3	1	2	1	Finale Final	Temps Time	Points
1						K	2h 33:13	0.0
2	K	K	K	K	K	G		3.0
3	KA	KA	KA	KA	KA	BL		5.7
4	KC	KC	KC	KC	KC	Y		8.0
5	G	G	G	G	G	Y		10.0
6	S	BL	BL	BL	BL	N		11.7
7	BL	S	S	N	N	D		13.0
8	GR	D	D	D	F	N		14.0
9	N	GR	GR	E	S	D		15.0
10	D	KH	N	S	S	KZ		16.0
11	E	M	N	KZ	D	KZ		17.0
12	MX	M	US	US	US	OE		18.0
13	KH	I	M	SR	SR	MX		19.0
14	US	KZ	MX	GO	GO	Y		20.0
15	M	OE	GO	GR	GO	US		21.0
16	OE	US	E	H	OE	KH		22.0
17	SR	E	I	OE	GR	GO		23.0
18	Y	MX	OE	Y	H	I		24.0
19	I	SR	Y	GO	OE	H		25.0
20	PZ	F	GO	M	Y	F		26.0
21	KZ	Y	F	F	F	F		27.0
22	H	GO	SR	H	I	I		28.0
23	F	H	PZ	PZ	KJ	KJ		29.0
24	GO	PZ	VI	VI	PZ	PZ		30.0
25	VI	VI	B	B	B	B		31.0
26	B	PR	B	VI	VI	P		32.0
27	PR	KJ	P	P	P	P		33.0
28	KJ	P	PR	PR	PR	PR		34.0
29	RI	SL	RI	RI	RI	RI		35.0
	SL	SL	SL	SL	SL	SL		36.0
								39.0



BEAU FAIR



29.5° C



5 (197°)



PLATE CALM



0.6 (115°)

REGATE RACE 5 OCT 19

Bouées Buoy	2	3	1	2	1	Finale Final	Temps Time	Points	
1	S	K	K	K	K	K	GBR	2h 11:28	0.0
2	KC	KA	KC	KC	KC	KC	CAN	_____	3.0
3	BL	BL	F	N	F	BL	BRA	_____	5.7
4	F	KC	F	F	BL	F	FRA	_____	8.0
5	K	OE	OE	BL	N	S	SUE	_____	10.0
6	KA	S	S	E	I	N	NOR	_____	11.7
7	G	I	N	OE	H	I	ITA	_____	13.0
8	Y	G	E	I	OE	KA	AUS	_____	14.0
9	E	E	US	G	E	KZ	NZL	_____	15.0
10	I	F	BL	KA	S	E	ESP	_____	16.0
11	OE	Y	Y	S	US	MX	MEX	_____	17.0
12	H	MX	US	G	G	D	DIN	_____	18.0
13	MX	H	KA	H	KZ	G	ALE	_____	19.0
14	US	N	KZ	KZ	KA	H	HOL	_____	20.0
15	KZ	KZ	H	MX	MX	US	EJA	_____	21.0
16	N	US	MX	Y	D	OE	AUT	_____	22.0
17	P	GO	GO	D	Y	Y	YUG	_____	23.0
18	GO	KJ	D	GO	GO	SR	URS	_____	24.0
19	GR	PZ	KJ	SR	SR	GO	ADF	_____	25.0
20	PZ	D	GR	GR	GR	GR	GRE	_____	26.0
21	KH	KH	PZ	KH	KH	KH	HOK	_____	27.0
22	D	P	P	KJ	M	B	BEL	_____	28.0
23	KJ	GR	M	M	B	M	HUN	_____	29.0
24	VI	SR	KH	B	KJ	KJ	JAM	_____	30.0
25	SR	M	SR	PZ	PZ	PZ	POL	_____	31.0
26	M	VI	B	VI	VI	VI	ISV	_____	32.0
27	B	B	VI	PR	PR	PR	PRO	_____	33.0
28	PR	PR	PR	RI	RI	RI	INA	_____	34.0
29	RI	RI	RI	SL	SL	SL	SAL	_____	35.0
	SL	SL	SL	SL	SL	SL	POR	2h 39:42 NCM	36.0



MOYEN NORMAL



29.8°C



10 (162°)



PLATE CALM



0.6 (60°)

REGATE RACE 6 OCT 20

Bouées Buoy	2	3	1	2	Finale Final	Temps Time	Points		
1	P	P	US	K	K	K	GBR	1h 29:05	0.0
2	US	US	F	F	F	F	FRA	_____	3.0
3	F	F	US	US	US	US	EJA	_____	5.7
4	GO	GO	K	H	KA	KA	AUS	_____	8.0
5	PZ	K	P	GO	KA	H	HOL	_____	10.0
6	K	KA	KA	KA	GO	GO	ADE	_____	11.7
7	KH	PZ	H	I	Y	Y	YUG	_____	13.0
8	KA	H	I	D	KZ	KZ	NZL	_____	14.0
9	H	KH	PZ	Y	D	I	ITA	_____	15.0
10	D	D	B	KZ	Y	BL	BRA	_____	16.0
11	Y	Y	D	BL	BL	D	DIN	_____	17.0
12	B	I	Y	B	B	OE	AUT	_____	18.0
13	I	B	KC	PZ	PZ	B	BEL	_____	19.0
14	N	KC	BL	KC	OE	S	SUE	_____	20.0
15	KC	S	KH	S	KC	MX	MEX	_____	21.0
16	KZ	KZ	N	P	MX	KH	HOK	_____	22.0
17	S	BL	KJ	OE	PZ	S	POL	_____	23.0
18	BL	N	KZ	MX	KH	KC	CAN	_____	24.0
19	KJ	KJ	OE	OE	P	P	POR	_____	25.0
20	SR	SR	S	KJ	KJ	E	ESP	_____	26.0
21	MX	M	MX	M	M	G	ALE	_____	27.0
22	M	MX	M	SR	E	KJ	JAM	_____	28.0
23	OE	OE	G	E	SR	SR	URS	_____	29.0
24	E	E	SR	G	VI	VI	ISV	_____	30.0
25	PR	G	E	VI	G	M	HUN	_____	31.0
26	G	PR	VI	PR	PR	PR	PRO	_____	32.0
27	VI	VI	PR	GR	RI	SL	SAL	_____	33.0
28	GR	GR	GR	RI	RI	RI	INA	_____	34.0
	RI	RI	RI	SL	SL	SL	GRE	2h 10:35 NCM	36.0
	SL	SL	SL	SL	SL	SL	NOR	NCM	36.0



BEAU FAIR



30.0°C



8 (240°)



PLATE CALM



0.7 (340°)

REGATE RACE 7 OCT 21

Bouées Buoy	2	3	1	2	1	Finale Final			
1	BL	BL	BL	BL	BL	BL	BRA	1h 42:26	0.0
2	US	US	US	US	K	K	GBR		3.0
3	SR	S	S	KA	US	KA	AUS		5.7
4	KH	KH	K	K	KZ	KZ	NZL		8.0
5	SR	SR	KH	KZ	KA	N	NOR		10.0
6	GO	K	N	S	S	US	EUA		11.7
7	Y	GO	GO	SH	G	G	ALE		13.0
8	KA	KA	KA	Y	Y	S	SUE		14.0
9	N	Y	KZ	N	N	KH	HOK		15.0
10	K	OE	OE	G	OE	GO	ADE		16.0
11	F	N	SR	GO	GO	OE	AUT		17.0
12	OE	F	Y	SR	KH	SR	URS		18.0
13	GR	KZ	F	OE	SR	KC	CAN		19.0
14	KZ	KJ	KJ	KC	KC	Y	YUG		20.0
15	KJ	GR	G	F	E	GR	GRE		21.0
16	H	M	KC	F	GR	F	ESP		22.0
17	MX	H	M	GR	F	I	ITA		23.0
18	M	G	M	GR	MX	F	FRA		24.0
19	D	MX	H	VI	VI	H	MEX		25.0
20	G	KC	MX	D	H	KJ	JAM		26.0
21	P	P	P	P	M	M	HOL		27.0
22	KC	D	I	M	P	D	HUN		28.0
23	B	I	E	P	I	P	POR		29.0
24	VI	B	VI	KJ	I	VI	ISV		30.0
25	I	VI	B	I	KJ	B	BEL		31.0
26	RI	E	D	B	B	PZ	POL		32.0
27	E	RI	RI	PZ	PZ	PR	PRO		33.0
28	SL	SL	PZ	RI	RI	RI	INA		34.0
29	PZ	PZ	SL	SL	SL	SL	SAL		35.0
	PR	PR	PR	PR	PR		DIN	2h 02:01	36.0
								NCM	



NUAGEUX CLOUDY



28.5°C



11 (280°)



RIDEE CHOPPY



0.6 (135°)

CATEGORIE: **STAR**
CLASS:

CLASSEMENT FINAL D'APRES LES POINTS ACCUMULES
FINAL CLASSIFICATION BY ACCUMULATED POINTS

OCT 21

R E G A T E S

R A C E S

		Voile Sail	Capitaine et équipage Helmsman and crew		1	2	3	4	5	6	7	6 des meil- leures Best 6	7. meil- regates out of 7
1	EUA	US	Δ North, Lowell Barrett, Peter	L	1	3	3	1	2	12-	1		1
				P	0	5.7	5.7	0	3	18	0		14.4
2	NOR	N	Δ Lunde, Peder Wiken, Per	L	2	1	6	11-	7	7	2		2
				P	3	0	11.7	17	13	13	3		43.7
3	ITA	I	Δ Cavallo, Franco Gargano, Camillo	L	9-	2	4	8	1	4	6		3
				P	15	3	8	14	0	8	11.7		44.7
4	DIN	D	Δ Elvstrom, Paul Mik-Meyer, Poul	L	3	6	10-	7	5	1	5		4
				P	5.7	11.7	16	13	10	0	10		50.4
5	BAH	BA	Δ Knowles, Durward Knowles, Percival	L	6	NTS-	2	3	4	9	14		5
				P	11.7	26	3	5.7	8	15	20		63.4
6	AUS	KA	Δ Forbes, David Williamson, Richard	L	4	7	5	12	NCM-	6	4		6
				P	8	13	10	18	26	11.7	8		68.7
7	BRA	BL	Δ Schmidt, Erik Schmidt, Axel	L	18-	8	17	17	3	2	3		7
				P	24	14	23	23	5.7	3	5.7		74.4
8	SUI	Z	Δ Bernet, Edwin Amrein, Rolf	L	10	4	1	10	13-	11	12		8
				P	16	8	0	16	19	17	18		75.0
9	SUE	S	Δ Albrechtson, John Norrman, Ulf	L	5	5	11	4	DES-	13	7		9
				P	10	10	17	8	28	19	13		77.0
10	GBR	K	Δ Jardine, Stuart Ramus, James	L	12	11	8	2	9	14	16-		10
				P	18	17	14	3	15	20	22		87.0
11	FIN	L	Δ Tallberg, Peter Tallberg, Henrik	L	7	9	9	19-	6	15	9		11
				P	13	15	15	25	11.7	21	15		90.7
12	ALE	G	Δ Wagner, Eckart Kopperschmidt, Fritz	L	8	12	NCM-	9	8	10	13		12
				P	14	18	26	15	14	16	19		96.0
13	HUN	M	Δ Tolnay, Kalman Farkas, Laszlo	L	17	16	7	5	17	3	NCM-		13
				P	23	22	13	10	23	5.7	26		96.7
14	ADE	GO	Δ Bogumil, Hartmann Springsklee, Udo	L	16	15	12	6	11	17-	11		14
				P	22	21	18	11.7	17	23	17		106.7
15	CAN	KC	Δ Kirby, Bruce Bloviin, Oswald	L	14	18-	14	15	16	5	8		15
				P	20	24	20	21	22	10	14		107.0
16	URS	SR	Δ Pinegin, Timir Shutkov, Fedor	L	11	10	16	14	10	NCM-	NCM		16
				P	17	16	22	20	16	26	26		117.0
17	POR	P	Δ Gentil, Mario Gentil, José	L	13	13	15	13	12	18-	17		17
				P	19	19	21	19	18	24	23		119.0
18	ESP	E	Δ Alonso Allende, Juan Alonso Aznar, Juan	L	NCM	NCM	13	20	DES	8	10		18
				P	26	25	19	26	28	14	16		126.0
19	MEX	MX	Δ Gerard, Andrés Gerard, Marcos	L	19-	17	18	16	15	16	15		19
				P	25	23	24	22	21	22	21		133.0
20	ARG	A	Δ Sieburger, Roberto Vago, Jorge	L	15	14	19	18	14	19	NCM-		20
				P	21	20	25	24	20	25	26		135.0

REGATE RACE 1 OCT 14

Bouées Buoy	2	3	1	2	1	Finale Final		Temps Time	Points
1	N	D	D	US	US	US	EUA	2h 15:44	0.0
2	D	N	US	D	D	N	NOR		3.0
3	S	S	S	N	N	D	DIN		5.7
4	L	L	S	S	S	KA	AUS		8.0
5	US	US	BA	BA	BA	S	SUE		10.0
6	KA	KA	BA	KA	KA	BA	BAH		11.7
7	SR	SR	G	L	L	G	FIN		13.0
8	G	G	SR	I	I	G	ALE		14.0
9	Z	Z	Z	SR	SR	Z	ITA		15.0
10	K	K	K	Z	Z	I	SUI		16.0
11	A	A	A	SR	SR	Z	URS		17.0
12	I	I	I	A	A	K	GBR		18.0
13	M	M	M	K	K	P	POR		19.0
14	BL	BL	BL	M	M	KC	CAN		20.0
15	KC	KC	KC	P	P	A	ARG		21.0
16	GO	GO	GO	GO	GO	GO	ADE		22.0
17	P	P	P	BL	BL	M	HUN		23.0
18	MX	MX	MX	MX	MX	BL	BRA		24.0
19						MX	MEX	2h 26:14	25.0
								NCM	26.0



BEAU FAIR



34.0°C



15 (305°)



PLATE 2 CALM



0.5 (120°)

⊙ P — GO

REGATE RACE 3 OCT 16

Bouées Buoy	2	3	1	2	1	Finale Final		Temps Time	Points
1	Z	Z	Z	Z	Z	Z	SUI	2h 04:02	0.0
2	BA	BA	BA	US	US	BA	BAH		3.0
3	D	D	D	M	M	US	EUA		5.7
4	M	M	M	KA	M	I	ITA		8.0
5	S	S	S	BA	BA	KA	AUS		10.0
6	K	K	K	D	I	N	NOR		11.7
7	KA	US	US	I	S	M	HUN		13.0
8	US	KA	KA	N	D	K	GBR		14.0
9	I	I	I	S	N	L	FIN		15.0
10	L	L	L	K	K	D	DIN		16.0
11	E	E	E	L	GO	S	SUE		17.0
12	N	GO	N	GO	E	GO	ADE		18.0
13	GO	N	GO	E	L	E	ESP		19.0
14	KC	KC	KC	MX	KC	KC	CAN		20.0
15	SR	SR	SR	P	P	P	POR		21.0
16	MX	MX	MX	SR	SR	SR	URS		22.0
17	G	G	G	KC	MX	G	BRA		23.0
18	P	P	P	G	BL	BL	MEX		24.0
19	A	A	A	BL	A	MX	ARG	2h 10:38	25.0
						A	ALE	NCM	26.0



BEAU FAIR



34.0°C



11 (265°)



PLATE CALM



0.75 (135°)

⊙ Com. Reg. — G

REGATE RACE 2 OCT 15

Bouées Buoy	2	3	1	2	1	Finale Final		Temps Time	Points
1	L	L	L	L	L	N	NOR	2h 28:20	0.0
2	N	N	N	US	US	I	ITA		3.0
3	S	S	S	US	US	US	EUA		5.7
4	Z	Z	Z	S	S	S	SUI		8.0
5	I	US	US	D	D	S	SUE		10.0
6	D	D	D	SR	SR	I	DIN		11.7
7	US	SR	SR	I	D	K	AUS		13.0
8	SR	K	K	G	SR	KA	BRA		14.0
9	K	M	M	KA	KA	SR	FIN		15.0
10	M	KA	KA	BL	M	P	URS		16.0
11	KA	KC	KC	BL	BL	M	GBR		17.0
12	A	A	A	M	P	GO	ALE		18.0
13	KC	E	E	P	GO	A	POR		19.0
14	GO	G	G	BL	P	GO	ARG		20.0
15	E	BL	BL	P	A	KC	ADE		21.0
16	BL	GO	GO	MX	A	KC	HUN		22.0
17	MX	MX	E	E	MX	MX	MEX		23.0
18	P	P	GO	GO	KC	KC	CAN	2h 35:57	24.0
								NCM	25.0
								NTS	26.0



BEAU FAIR



30.0°C



17 (280°)



PLATE CALM



0.75 (175°)

REGATE RACE 4 OCT 17

Bouées Buoy	2	3	1	2	1	Finale Final		Temps Time	Points
1	K	K	K	US	US	US	EUA	2h 03:44	0.0
2	BA	US	US	BA	K	BA	GBR		3.0
3	US	M	M	BA	S	S	BAH		5.7
4	M	S	S	M	S	S	SUE		8.0
5	S	I	I	GO	M	GO	HUN		10.0
6	I	S	S	I	GO	GO	ADE		11.7
7	GO	GO	GO	GO	I	D	DIN		13.0
8	Z	Z	Z	I	G	D	ITA		14.0
9	P	L	L	G	Z	D	ALE		15.0
10	L	G	G	P	P	D	SUI		16.0
11	G	P	P	E	L	N	NOR		17.0
12	E	AUS		18.0					
13	SR	POR		19.0					
14	A	URS		20.0					
15	D	CAN		21.0					
16	N	MEX		22.0					
17	KC	BRA		23.0					
18	MX	ARG		24.0					
19	KA	FIN		25.0					
20	BL	ESP	2h 09:51	26.0					



BEAU FAIR



29.5°C



6 (200°)



PLATE CALM



0.6 (115°)

REGATE RACE 5 OCT 19

Bouées Buoy	2	3	1	2	1	Finale Final	Temps Time	Points	
1	BA	BA	BA	BL	BL	I	ITA	2h 26:57	0.0
2	BL	BL	BL	US	BL	I	EUA	_____	3.0
3	I	I	I	I	BA	BL	BRA	_____	5.7
4	US	US	US	BA	US	BA	BAH	_____	8.0
5	L	L	L	L	L	D	DIN	_____	10.0
6	SR	D	D	S	S	S	FIN	_____	11.7
7	D	SR	GO	E	SR	L	NOR	_____	13.0
8	KA	GO	SR	N	D	N	ALE	_____	14.0
9	GO	N	N	D	GO	G	GBR	_____	15.0
10	N	S	S	SR	GO	K	URS	_____	16.0
11	S	E	E	G	K	SR	ADE	_____	17.0
12	E	G	MX	K	Z	GO	POR	_____	18.0
13	MX	K	K	GO	E	P	SUI	_____	19.0
14	G	K	K	P	N	Z	ARG	_____	20.0
15	K	K	K	Z	MX	A	MEX	_____	21.0
16	P	P	P	MX	A	E	CAN	_____	22.0
17	K	A	A	K	K	MX	HUN	2h 33:57	23.0
	A	M	Z	A	M	K	AUS	NCM	26.0
	M	Z	Z	M	M	C	ESP	DES	28.0
	Z	Z	Z	M	M	M	SUE	DES	28.0

MOYEN NORMAL

29.8°C

12 (160°)

PLATE CALM

0.6 (60°)

⊙MX — E
A — S
Z — S

REGATE RACE 7 OCT 21

Bouées Buoy	2	3	1	2	1	Finale Final	Temps Time	Points	
1	US	US	US	US	US	US	EUA	1h 49:12	0.0
2	N	N	N	BL	N	N	NOR	_____	3.0
3	BL	BL	BL	N	BL	BL	BRA	_____	5.7
4	BA	I	I	KA	KA	KA	AUS	_____	8.0
5	I	BA	I	I	D	D	DIN	_____	10.0
6	Z	Z	Z	D	I	I	ITA	_____	11.7
7	SR	KA	E	S	L	S	SUE	_____	13.0
8	KA	E	E	L	L	L	CAN	_____	14.0
9	E	L	GO	GO	GO	GO	FIN	_____	15.0
10	L	GO	S	E	E	E	ESP	_____	16.0
11	GO	S	D	GO	GO	GO	ADE	_____	17.0
12	MX	MX	L	Z	Z	Z	SUI	_____	18.0
13	K	K	P	MX	MX	MX	ALE	_____	19.0
14	S	D	D	M	M	M	BAH	_____	20.0
15	D	P	K	G	G	G	MEX	_____	21.0
16	P	G	K	K	K	K	GBR	_____	22.0
17	G	K	C	K	K	K	POR	1h 55:44	23.0
	K	M	M	P	P	P	ARG	NCM	26.0
	C	A	A	P	P	P	HUN	NCM	26.0
	M	A	A	P	P	P	URS	NCM	26.0

NUAGEUX CLOUDY

28.5°C

13 (280°)

RIDEE CHOPPY

0.6 (135°)

842

REGATE RACE 6 OCT 20

Bouées Buoy	2	3	1	2	1	Finale Final	Temps Time	Points	
1	D	D	D	D	D	D	DIN	2h 37:29	0.0
2	KC	KC	KC	BL	BL	M	BRA	_____	3.0
3	BL	BL	BL	BL	KC	M	HUN	_____	5.7
4	M	M	M	M	M	I	ITA	_____	8.0
5	E	E	E	E	KA	KA	CAN	_____	10.0
6	I	I	I	E	BA	N	AUS	_____	11.7
7	KA	KA	KA	BA	E	E	NOR	_____	13.0
8	US	US	US	KA	KA	Z	ESP	_____	14.0
9	N	BA	BA	Z	Z	Z	BAH	_____	15.0
10	BA	N	G	N	N	G	ALE	_____	16.0
11	SR	G	N	US	G	US	SUI	_____	17.0
12	G	P	Z	G	US	S	EUA	_____	18.0
13	P	Z	Z	MX	S	S	SUE	_____	19.0
14	Z	K	K	S	L	K	GBR	_____	20.0
15	K	A	A	K	K	L	FIN	_____	21.0
16	A	GO	GO	L	MX	MX	MEX	_____	22.0
17	GO	S	S	P	A	P	ADE	_____	23.0
18	S	MX	MX	A	P	P	POR	_____	24.0
19	MX	L	L	GO	GO	A	ARG	2h 52:30	25.0
	L	L	L	GO	GO	A	URS	NCM	26.0

BEAU FAIR

30.0°C

8 (240°)

PLATE CALM

0.7 (340°)

CATEGORIE: **FINN**
 CLASS:

CLASSEMENT FINAL D'APRES LES POINTS ACCUMULES
 FINAL CLASSIFICATION BY ACCUMULATED POINTS **OCT 21**

R E G A T E S

R A C E S

		Voile Sail	Capitaine Helmsman		1	2	3	4	5	6	7	6 des 7 meilleures régates Best 6 out of 7
1	URS	SR	Mankin, Valentin	L	3	5-	1	1	2	2	1	1
				P	5.7	10	0	0	3	3	0	11.7
2	AUT	OE	Raudaschl, Hubert	L	14-	3	3	4	4	4	12	2
				P	20	5.7	5.7	8	8	8	18	53.4
3	ITA	I	Albarelli, Fabio	L	16	27-	7	2	3	3	3	3
				P	22	33	13	3	5.7	5.7	5.7	55.1
4	AUS	KA	Jenyns, Ronald	L	4	1	NCM-	7	15	16	2	4
				P	8	0	42	13	21	22	3	67.0
5	GRE	GR	Kouligas, Panagiotis	L	15	12	8	5	1	NCM-	4	5
				P	21	18	14	10	0	42	8	71.0
6	FIN	L	Winquist, Jan	L	8	8	12-	8	5	5	5	6
				P	14	14	18	14	10	10	10	72.0
7	SUE	S	Akerson, Arne	L	10	9	4	22-	12	1	14	7
				P	16	15	8	28	18	0	20	77.0
8	FRA	F	Soria, Philippe	L	1	10	14	9	7	25-	10	8
				P	0	16	20	15	13	31	16	80.0
9	BRA	BL	Bruder, Joerg	L	7	4	NCM-	12	14	12	7	9
				P	13	8	42	18	20	18	13	90.0
10	PRO	PR	Hoyt, Garry	L	21-	19	2	13	6	13	8	10
				P	27	25	3	19	11.7	19	14	91.7
11	NZL	KZ	Farmer, Jonathan	L	13	2	6	19	19	7	NCM-	11
				P	19	3	11.7	25	25	13	40	96.7
12	POL	PZ	Zawieja, Andrzej	L	6	17	19	10	25-	11	17	12
				P	11.7	23	25	16	31	17	23	115.7
13	ADE	GO	Mier, Jürgen	L	NCM	14	5	26	9	23	6	13
				P	42	20	10	32	15	29	11.7	117.7
13	EUA	US	Van, Carl	L	NCM	DES-	11	3	10	14	11	13
				P	42	46	17	5.7	16	20	17	117.7
15	ALE	G	Kuhweide, Wilhelm	L	11	7	17	25	26-	9	15	15
				P	17	13	23	31	32	15	21	120.0
16	SUI	Z	Bally, Alex	L	17	15	24-	11	18	6	22	16
				P	23	21	30	17	24	11.7	28	124.7
17	ARG	A	Obarrio, Alberto	L	NCM	16	13	18	13	8	21	17
				P	42	22	19	24	19	14	27	125.0
17	DIN	D	Wind, Henning	L	9	18	10	15	23-	18	19	17
				P	15	24	16	21	29	24	25	125.0
19	HOL	H	Binkhorts, Hans	L	24	NCM-	21	6	8	22	9	19
				P	30	42	27	11.7	14	28	15	125.7
20	CAN	KC	Henderson, Paul	L	19	20	9	20-	16	10	16	20
				P	25	26	15	26	22	16	22	126.0
21	NOR	N	Werenskiold, Per	L	2	6	16	21	29	31-	24	21
				P	3	11.7	22	27	35	37	30	128.7
22	GBR	K	Maynard, Michael	L	5	11	18	17	20	NCM-	23	22
				P	10	17	24	23	26	42	29	129.0

R E G A T E S

R A C E S

		V voile Sail	Capitaine Helmsman		1	2	3	4	5	6	7	6 des 7, meil- leures régates Best 6 out of 7
23	MEX	MX	Mugica, Daniel	L	12	NCM-	15	36	21	17	18	23
				P	18	42	21	42	27	23	24	155.0
24	BER	KB	Hooper, Jay	L	20	13	22	23	17	NCM	NCM-	24
				P	26	19	28	29	23	42	42	167.0
25	BEL	B	Rogge, Jacques	L	18	21	DES-	24	32	21	20	25
				P	24	27	46	30	38	27	26	172.0
26	URG	U	Thode, Fernando	L	26	NCM-	23	14	11	NCM	27	26
				P	32	42	29	20	17	42	33	173.0
27	ESP	E	Sirvent, Juan	L	23	NCM	NCM-	16	22	29	13	27
				P	29	42	42	22	28	35	19	175.0
28	BAH	BA	Albury, Kenneth	L	22	23	26	31	24	15	NTS-	28
				P	28	29	32	37	30	21	42	177.0
29	CEI	CY	Wijewardene, Philip	L	25	24	28	28	30-	20	26	29
				P	31	30	34	34	36	26	32	187.0
29	VEN	V	Boysen, Karsten	L	29	26	20	29	28	19	NCM-	29
				P	35	32	26	35	34	25	40	187.0
31	POR	P	Santo, Bernardo	L	27	25	25	30	27	26	NCM-	31
				P	33	31	31	36	33	32	40	196.0
32	ISV	VI	Dohm, Per	L	28	22	27	32	31	28	25	32
				P	34	28	33	38	37	34	31	197.0
33	TAI	TH	Kanjanavanit, Rachot	L	NCM-	28	29	27	33	27	28	33
				P	42	34	35	33	39	33	34	208.0
34	SAL	SL	Ruiz, Carlos	L	31	29	30	33	NCM-	24	29	34
				P	37	35	36	39	42	30	35	212.0
35	INA	RI	Lucas, Robert	L	30	NCM-	31	35	34	30	NCM	35
				P	36	42	37	41	40	36	40	230.0
36	FIL	PH	Villarreal, Manuel	L	NCM	NCM-	32	34	35	32	NCM	36
				P	42	42	38	40	41	38	40	239.0

REGATE RACE 1 OCT 14

Bouées Buoy	2	3	1	2	1	Finale Final	Temps Time	Points
1	F	F	F	F	F	F	1h 57:52	0.0
2	N	PZ	PZ	N	N	N		3.0
3	K	N	N	K	K	SR		5.7
4	PZ	K	K	KA	KA	KA		8.0
5	KA	KA	KA	SR	SR	K		10.0
6	SR	SR	SR	D	D	PZ		11.7
7	G	GR	GR	L	L	BL		13.0
8	GR	L	L	BL	BL	L		14.0
9	BL	G	G	KZ	KZ	PZ		15.0
10	L	BL	G	G	S	S		16.0
11	D	D	D	GR	GR	G		17.0
12	MX	MX	KZ	PZ	MX	MX		18.0
13	Z	Z	Z	B	KZ	KZ		19.0
14	KZ	KZ	BL	S	OE	OE		20.0
15	KA	KA	GO	MX	G	GR		21.0
16	GO	GO	OE	B	Z	I		22.0
17	B	B	B	S	OE	KC		23.0
18	OE	S	KC	OE	KC	B		24.0
19	S	BA	KB	KB	KB	KC		25.0
20	KB	A	PR	PR	PR	KB		26.0
21	A	KB	BA	BA	BA	PR		27.0
22	I	PR	H	H	H	BA		28.0
23	PR	I	E	E	E	CEI		29.0
24	I	H	CY	CY	CY	HOL		30.0
25	U	H	U	U	U	CEI		31.0
26	H	U	P	P	P	URG		32.0
27	E	E	V	V	V	POR		33.0
28	CY	CY	V	V	V	ISV		34.0
29	V	V	A	A	A	VEN		35.0
30	VI	VI	VI	VI	VI	INA		36.0
31	TH	TH	TH	TH	TH	SAL	2h 29:41	37.0
	RI	RI	RI	RI	RI	ADE	NCM	42.0
	SL	SL	SL	SL	SL	ARG	NCM	42.0
						EJA	NCM	42.0
						FIL	NCM	42.0
						TAI	NCM	42.0



BEAU FAIR



34.0°C



15 (280°)



PLATE 1 CALM



0.25 (165°)

REGATE RACE 2 OCT 15

Bouées Buoy	2	3	1	2	1	Finale Final	Temps Time	Points
1	MX	MX	MX	MX	KZ	KA	1h 53:53	0.0
2	GR	GR	GR	KZ	OE	KZ		3.0
3	KZ	SR	KZ	KA	OE	KA		5.7
4	SR	KA	SR	OE	SR	US		8.0
5	KA	KA	OE	GR	GR	BL		10.0
6	G	OE	KA	BL	BL	SR		11.7
7	BL	G	BL	SR	US	N		13.0
8	OE	BL	G	G	G	FIN		14.0
9	US	US	US	US	L	SUE		15.0
10	K	K	K	N	N	FRA		16.0
11	VI	Z	L	K	K	GBR		17.0
12	Z	N	PZ	L	Z	GRE		18.0
13	N	PZ	Z	Z	S	BER		19.0
14	PZ	GO	GO	S	GO	ADE		20.0
15	A	VI	N	GO	KB	SUI		21.0
16	GO	L	VI	KB	F	ARG		22.0
17	L	A	A	A	A	POL		23.0
18	KB	PR	PR	F	PZ	DIN		24.0
19	F	F	S	PZ	VI	PRO		25.0
20	PR	KB	B	B	PR	CAN		26.0
21	B	B	KB	VI	KC	BEL		27.0
22	P	S	S	PR	B	ISV		28.0
23	S	P	H	KC	D	BAH		29.0
24	H	H	P	H	CY	CEI		30.0
25	V	BA	I	D	P	POR		31.0
26	BA	I	KC	I	BA	VEN		32.0
27	I	KC	V	BA	V	ITA		33.0
28	RI	V	D	V	U	TAI		34.0
29	D	RI	D	U	TH	SAL	2h 22:09	35.0
	CY	U	D	U	I	MEX	NCM	42.0
	U	RI	U	TH	SL	ESP	NCM	42.0
	TH	U	TH	I		HOL	NCM	42.0
	SL	TH	SL	SL		URG	NCM	42.0
						INA	NCM	42.0
						FIL	NCM	42.0
						EUA	DES	46.0



BEAU FAIR



34.0°C



16 (280°)



PLATE CALM



0.2 (140°)

⊙ BL — US
VI — L

REGATE
RACE 3

OCT 16





Bouées Buoy	2	3	1	2	1	Finale Final		Temps Time	Points
1	SR	SR	SR	SR	SR	SR	URS	1h 35:33	0.0
2	PR	PR	PR	PR	PR	PR	PRO		3.0
3	GR	GR	GR	GR	GR	GR	AUT		5.7
4	S	OE	OE	S	S	S	SUE		8.0
5	OE	S	S	GO	GO	GO	ADE		10.0
6	L	L	BL	GR	GR	KZ	NZL		11.7
7	BL	BL	L	L	A	I	ITA		13.0
8	N	N	A	N	A	KZ	GRE		14.0
9	A	A	N	A	KZ	L	CAN		15.0
10	GO	GO	GO	I	US	D	DIN		16.0
11	V	KZ	G	MX	I	US	EUA		17.0
12	KZ	G	MX	US	G	L	FIN		18.0
13	G	MX	KZ	MX	KC	A	ARG		19.0
14	I	V	I	V	N	F	FRA		20.0
15	K	K	U	KC	K	MX	MEX		21.0
16	KC	K	U	KC	D	N	NOR		22.0
17	MX	U	Z	K	U	K	ALE		23.0
18	U	Z	K	K	U	PZ	GBR		24.0
19	Z	US	D	KB	U	V	POL		25.0
20	D	KB	E	B	V	KB	VEN		26.0
21	B	KB	D	K	H	H	HOL		27.0
22	B	US	F	Z	Z	KB	BER		28.0
23	KB	US	F	Z	PZ	U	URG		29.0
24	E	F	Z	H	B	P	SUI		30.0
25	CY	F	Z	H	BA	P	POR		31.0
26	F	CY	PZ	BA	B	BA	BAH		32.0
27	BA	H	H	B	P	B	ISV		33.0
28	H	PZ	CY	P	VI	VI	CEI		34.0
29	PZ	BA	P	CY	VI	CY	TAI		35.0
30	P	P	P	VI	TH	TH	SAL		36.0
31	SL	TH	SL	TH	SL	SL	INA		37.0
32	RI	VI	VI	RI	PH	PH	FIL	1h 53:45	38.0
	PH	PH	PH	PH	PH	PH	AUS	NCM	42.0
							BRA	NCM	42.0
							ESP	NCM	42.0
							BEL	DES	46.0

REGATE
RACE 4





OCT 17

Bouées Buoy	2	3	1	2	1	Finale Final		Temps Time	Points
1	GR	GR	GR	GR	QE	SR	URS	2h 25:49	0.0
2	US	SR	I	OE	GR	I	ITA		3.0
3	BL	BL	SR	I	US	US	EUA		5.7
4	SR	BL	US	H	OE	OE	AUT		8.0
5	I	OE	BL	SR	I	GR	GRE		10.0
6	OE	I	OE	US	H	H	HOL		11.7
7	L	U	H	L	L	KA	AUS		13.0
8	U	L	H	PR	PR	L	FIN		14.0
9	H	H	PR	F	PR	BL	FRA		15.0
10	PR	PR	U	L	Z	PZ	POL		16.0
11	Z	V	Z	Z	BL	Z	SUI		17.0
12	V	F	K	D	F	Z	BRA		18.0
13	F	E	K	KA	F	BL	PRO		19.0
14	K	K	F	PZ	U	PR	URG		20.0
15	E	K	F	KA	D	U	DIN		21.0
16	N	KA	V	N	K	E	ESP		22.0
17	KA	N	V	K	E	K	GBR		23.0
18	D	PZ	D	KA	A	A	ARG		24.0
19	S	D	A	N	KB	KZ	NZL		25.0
20	PZ	A	KA	KB	A	KB	CAN		26.0
21	KB	KB	A	A	GO	N	NOR		27.0
22	A	KB	KB	GO	VI	N	SUE		28.0
23	GO	GO	P	VI	GO	KB	BER		29.0
24	B	S	B	P	TH	B	BEL		30.0
25	P	B	S	V	B	G	ALE		31.0
26	K	P	GO	KZ	VI	GO	ADE		32.0
27	VI	VI	VI	TH	P	TH	TAI		33.0
28	SL	SL	MX	B	V	CY	CEI		34.0
29	MX	G	SL	S	G	V	VEN		35.0
30	G	G	SL	G	BA	P	POR		36.0
31	KZ	KZ	TH	BA	CY	BA	BAH		37.0
32	TH	TH	TH	CY	S	VI	ISV		38.0
33	CY	CY	CY	PH	SL	SL	SAL		39.0
34	PH	PH	PH	PH	PH	PH	FIL		40.0
35	BA	BA	BA	MX	RI	RI	INA		41.0
36	RI	RI	RI	RI	MX	MX	MEX	2h 43:53	42.0

846

	BEAU FAIR
	34.0°C
	10 (270°)
	PLATE CALM
	0.2 (130°)

⊙B — D

	BEAU FAIR
	36.0°C
	7 (215°)
	PLATE CALM
	0.3 (300°)

REGATE RACE 5

OCT 19

Bouées
Buoy

	2	3	1	2	1	Finale Final
1						GR
2	I SR	I GR	I GR	I GR	I GR	SR
3	SR	SR	SR	SR	SR	SR
4	H US	H PR	H PR	H PR	H PR	US
5	US	PR	PR	PR	PR	OE
6	PR	Z US	Z US	Z US	Z US	L PR
7	Z F	U F	U F	U F	U F	F H
8	F L	L F	L F	L F	L F	H GO
9	L U	OE KZ	OE KZ	OE KZ	OE KZ	US
10	U KZ	BL GO	BL GO	BL GO	BL GO	A S
11	KZ	GO	GO	GO	GO	S A
12	OE BL	SL GO	SL GO	SL GO	SL GO	BL KA
13	BL GO	SL GO	SL GO	SL GO	SL GO	KA KB
14	GO	SL	SL	SL	SL	KB Z
15	SL	SL	SL	SL	SL	KZ K
16	SL	SL	SL	SL	SL	KB MX
17	KB MX	KB MX	KB MX	KB MX	KB MX	K KC
18	MX	KB MX	KB MX	KB MX	KB MX	K KC
19	VI A	VI A	VI A	VI A	VI A	K KC
20	A KC	A KC	A KC	A KC	A KC	K KC
21	KC PZ	KC PZ	KC PZ	KC PZ	KC PZ	K KC
22	PZ	K D	K D	K D	K D	K D
23	K D	K D	K D	K D	K D	K D
24	D P	D P	D P	D P	D P	D P
25	P BA	PZ KA	PZ KA	PZ KA	PZ KA	PZ P
26	BA KA	KA BA	KA BA	KA BA	KA BA	PZ P
27	KA CY	BA CY	BA CY	BA CY	BA CY	PZ P
28	CY RI	CY RI	CY RI	CY RI	CY RI	PZ P
29	RI E	RI E	RI E	RI E	RI E	PZ P
30	E B	E B	E B	E B	E B	PZ P
31	B G	B G	B G	B G	B G	PZ P
32	G N	G N	G N	G N	G N	PZ P
33	N V	N V	N V	N V	N V	PZ P
34	V TH	V TH	V TH	V TH	V TH	PZ P
35	TH PH	TH PH	TH PH	TH PH	TH PH	PZ P

Temps Time	Points
1h 40:05	0.0
	3.0
	5.7
	8.0
	10.0
	11.7
	13.0
	14.0
	15.0
	15.0
	16.0
	17.0
	18.0
	19.0
	20.0
	21.0
	22.0
	23.0
	24.0
	25.0
	26.0
	27.0
	28.0
	29.0
	30.0
	31.0
	32.0
	33.0
	34.0
	35.0
	36.0
	37.0
	38.0
	39.0
	40.0
1h 56:45	41.0
NCM	42.0

REGATE RACE 6 OCT 20

Bouées
Buoy

	2	3	1	2	1	Finale Final
1						SUE
2	L SR	L SR	L SR	L SR	L SR	URS
3	SR	OE KC	OE KC	OE KC	OE KC	ITA
4	OE KC	KZ KC	KZ KC	KZ KC	KZ KC	AUT
5	KZ KC	S Z	S Z	S Z	S Z	FIN
6	S Z	S Z	S Z	S Z	S Z	PRO
7	S Z	S Z	S Z	S Z	S Z	FRA
8	S Z	S Z	S Z	S Z	S Z	HOL
9	S Z	S Z	S Z	S Z	S Z	ADE
10	S Z	S Z	S Z	S Z	S Z	EUA
11	S Z	S Z	S Z	S Z	S Z	URG
12	S Z	S Z	S Z	S Z	S Z	SUE
13	S Z	S Z	S Z	S Z	S Z	ARG
14	S Z	S Z	S Z	S Z	S Z	BRA
15	S Z	S Z	S Z	S Z	S Z	AUS
16	S Z	S Z	S Z	S Z	S Z	CAN
17	S Z	S Z	S Z	S Z	S Z	BER
18	S Z	S Z	S Z	S Z	S Z	SUI
19	S Z	S Z	S Z	S Z	S Z	NZL
20	S Z	S Z	S Z	S Z	S Z	GBR
21	S Z	S Z	S Z	S Z	S Z	MEX
22	S Z	S Z	S Z	S Z	S Z	ESP
23	S Z	S Z	S Z	S Z	S Z	DIN
24	S Z	S Z	S Z	S Z	S Z	VEN
25	S Z	S Z	S Z	S Z	S Z	CEY
26	S Z	S Z	S Z	S Z	S Z	BEL
27	S Z	S Z	S Z	S Z	S Z	HOL
28	S Z	S Z	S Z	S Z	S Z	ADE
29	S Z	S Z	S Z	S Z	S Z	SAL
30	S Z	S Z	S Z	S Z	S Z	FRA
31	S Z	S Z	S Z	S Z	S Z	POR
32	S Z	S Z	S Z	S Z	S Z	TAI
	S Z	S Z	S Z	S Z	S Z	ISV
	S Z	S Z	S Z	S Z	S Z	ESP
	S Z	S Z	S Z	S Z	S Z	INA
	S Z	S Z	S Z	S Z	S Z	NOR
	S Z	S Z	S Z	S Z	S Z	FIL
	S Z	S Z	S Z	S Z	S Z	BER
	S Z	S Z	S Z	S Z	S Z	GBR
	S Z	S Z	S Z	S Z	S Z	GRE
	S Z	S Z	S Z	S Z	S Z	URG

Temps Time	Points
2h 51:32	0.0
	3.0
	5.7
	8.0
	10.0
	11.7
	13.0
	14.0
	15.0
	16.0
	17.0
	18.0
	19.0
	20.0
	21.0
	22.0
	23.0
	24.0
	25.0
	26.0
	27.0
	28.0
	29.0
	30.0
	31.0
	32.0
	33.0
	34.0
	35.0
	36.0
	37.0
3h 25:10	38.0
NCM	42.0
NCM	42.0
NCM	42.0
NCM	42.0

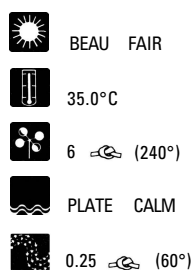

REGATE
RACE 7

OCT 21

Bouées Buoys	2	3	1	2	1	Finale Final		Temps Time	Points
1	SR	SR	SR	KA	KA	SR	URS	1h 57:11	0.0
2	I	I	GR	SR	SR	KA	AUS		3.0
3	GR	GR	I	GR	GR	I	ITA		5.7
4	KA	KA	KA	I	I	GR	GRE		8.0
5	H	H	H	L	L	L	FIN		10.0
6	L	L	L	PR	GO	GO	ADE		11.7
7	PR	PR	PR	GO	GO	BL	BRA		13.0
8	S	S	S	BL	BL	PR	PRO		14.0
9	BL	BL	BL	H	H	H	HOL		15.0
10	GO	GO	GO	F	F	F	FRA		16.0
11	F	F	F	E	E	US	EUA		17.0
12	D	D	D	US	US	OE	AUT		18.0
13	US	US	KC	S	S	F	ESP		19.0
14	KC	KC	D	KC	KC	S	SUE		20.0
15	OE	Z	OE	MX	OE	G	ALE		21.0
16	Z	A	A	OE	MX	KC	CAN		22.0
17	A	OE	Z	PZ	OE	Z	POL		23.0
18	B	PZ	E	B	Z	A	MEX		24.0
19	MX	MX	MX	A	B	B	DIN		25.0
20	PZ	E	PZ	G	G	D	BEL		26.0
21	E	B	B	PZ	PZ	A	ARG		27.0
22	G	U	U	D	D	Z	SUI		28.0
23	U	G	N	N	N	K	GBR		29.0
24	N	N	G	VI	VI	N	NOR		30.0
25	CY	CY	SL	K	K	VI	ISV		31.0
26	SL	SL	CY	CY	K	CY	CEI		32.0
27	P	K	K	SL	U	U	URG		33.0
28	K	VI	VI	U	CY	TH	TAI		34.0
29	TH	TH	TH	V	TH	SL	SAL	2h 09:42	35.0
	V	V	V	TH	V		FIL		40.0
	PH	PH	PH	V	V		INA	NCM	40.0
							NZL	NCM	40.0
							POR	NCM	40.0
							VEN	NCM	40.0
							BAH	NTS	42.0
							BER	NTS	42.0



NUAGEUX CLOUDY



34.0°C



12 (275°)



RIDEE CHOPPY



0.8 (100°)

848

**RECORDS OLYMPIQUES ETABLIS A LONDRES EN 1948 DURANT
LES JEUX DE LA XIV OLYMPIADE**

**OLYMPIC RECORDS ESTABLISHED IN LONDON 1948 DURING
THE GAMES OF THE XIV OLYMPIAD**

**ATHLETISME HOMMES
ATHLETICS MEN**

800 m	-	800 m	M. Whitfield	EUA	1.49.2"
5000 m	-	5000 m	G. Reiff	BEL	14'17.6"
10000 m	-	10000 m	E. Zatopek	CHE	29'59.6"
110 m Haies	-	110 m Hurdles	W. Porter	EUA	13.9"
400 m Haies	-	400 m Hurdles	R. Cochran	EUA	51'4"
10 Km Marche	-	10 Km Walk	J. Michaelson	SUE	45'13.2"
Lancement du Poids	-	Shot Put	W. Thompson	EUA	17.12m
Lancement du Disque	-	Discus Throw	A. Consolini	ITA	52.78m

**ATHLETISME FEMMES
ATHLETICS WOMEN**

200 m	-	Discus Throw	F. Blankers-Koen	HOL	24.4"
80 m Haies	-	80 m Hurdles	F. Blankers-Koen	HOL	11.2"
Saut en Hauteur	-	High Jump	A. Coachman	EUA	1.68m
Saut en Longueur	-	Long Jump	O. Gyarmati	HUN	5.695m
Lancement du Poids	-	Shot Put	M. Ostermeyer	FRA	13.75m
Lancement du Javelot	-	Javelin Throw	H. Bauma	AUT	45.57m

**HALTEROPHILIE
WEIGHTLIFTING**

Poids Coq	-	Bantamweight	J. de Pietro	EUA	307.5kg
Poids Plume	-	Featherweight	M. Fayad	EGI (RAU)	332.5kg
Poids Leger	-	Lightweight	I. Shams	EGI (RAU)	360 kg
Poids Moyen	-	Middleweight	F. Spellman	EUA	390 kg
Poids Moyen Lourd	-	Light Heavyweight	S. Stanczyk	EUA	417.5kg
Poids Lourd	-	Heavyweight	J. Davis	EUA	452.5kg

**NATATION HOMMES
SWIMMING MEN**

100 m Nage Libre	-	100 m Freestyle	W. Ris	EUA	57.3"
400 m Nage Libre	-	400 m Freestyle	W. Smith	EUA	4'41.0"
200 m Brasse	-	200 m Breastroke	J. Verdeur	EUA	2'39.3"
4 x 200 m Nage Libre	-	4 x 200 m Freestyle Relay	EUA	EUA	8'46.0"

**NATATION FEMMES
SWIMMING WOMEN**

400 m Nage Libre	-	400 m Freestyle	A. Curtis	EUA	5'17.8"
200 m Brasse	-	200 m Breastroke	P. Van Vliet	HOL	2'57.2"
100 m Dos	-	100 m Backstroke	K. Harup	DIN	1'14.4"
4 x 100 m Nage Libre	-	4 x 100 m Freestyle Relay	EUA	EUA	4'29.2"

**TIR
SHOOTING**

Vitesse aux Silhouettes	-	Rapid Fire Pistol	Takacs	HUN	580P
-------------------------	---	-------------------	--------	-----	------



FEDERATION INTERNATIONALE
DE PELOTE BASQUE FIPB

INTERNATIONAL FEDERATION
OF "PELOTA VASCA" FIPV

PRESIDENT
Carmelo Balda ESP

FEDERATION MEXICAINE DE
FRONTON FMF

850

MEXICAN FRONTON FEDERATION
FMF

PRESIDENT
Jorge Ugalde MEX

SIGNES EMPLOYES SYMBOLOGY

R — ROUGE	RED
A — BLEU	BLUE
D — AVANT	FORWARD
Z — ARRIERE	BACK

**RAQUETTE
FRONTENNIS**

**MATCH
GAME 1 OCT 14**

GAGNANT
WINNER

MEX D Loaiza, Jorge A (30 - 16)
Z Hernández, Luis

PERDANT
LOSER

EUA D Halpern, Paul
Z Squires, Richard

**MATCH
GAME 2**

ESP D Garraus, Federico A (30 - 19)
Z Lersundi, José

URG D Germane, Hugo
Z Sánchez, Hernán

**MATCH
GAME 3**

ARG D Sehter, Aarón R (30 - 13)
Z Utge, Jorge

FRA D Hirigoyen, Etienne
Z Millet, Jean-Pierre

**MATCH
GAME 4 OCT 15**

ESP D Garraus, Federico R (30 - 20)
Z Lersundi, José

FRA D Hirigoyen, Etienne
Z Millet, Jean-Pierre

**MATCH
GAME 5**

ARG D Sehter, Aarón A (30 - 27)
Z Utge, Jorge

URG D Germane, Hugo
Z Sánchez, Hernán

**MATCH
GAME 6 OCT 17**

ARG D Sehter, Aarón A (30 - 14)
Z Utge, Jorge

ESP D Garraus, Federico
Z Lersundi, José

**MATCH
GAME 7**

URG D Germane, Hugo R (30 - 20)
Z Sánchez, Hernán

FRA Z Hirigoyen, Etienne
D Millet, Jean-Pierre

**MATCH
GAME 8 OCT 19**

MEX D Loaiza, Jorge A (30 - 16)
Z Sanciprián, Roberto

ESP D Garraus, Federico
Z Irigaray, Miguel

**MATCH
GAME 9**

ARG D Utge, Jorge A (30 - 19)
Z Sehter, Aarón

EUA D Squires, Richard
Z Halpern, Paul

**MATCH
GAME 10 OCT 20**

ESP D Garraus, Federico R (30 - 16)
Z Lersundi, José

EUA D Tully, William
Z Shaefer, Herman

GAGNANT
WINNER

PERDANT
LOSER

**MATCH
GAME 11**

MEX D Hernández, Luis R (30 - 11)
Z Sanciprián, Roberto

ARG D Sehter, Aarón A
Z Utge, Jorge

**MATCH
GAME 12 OCT 22**

MEX D Hernández, Luis R (30 - 16)
Z Loaiza, Jorge

FRA D Etcheverry, Pierre A
Z Millet, Jean-Pierre

**MATCH
GAME 13**

URG D Sánchez, Hernán A (30 - 13)
Z Germane, Hugo

EUA D Squires, Richard R
Z Tully, William

**MATCH
GAME 14 OCT 23**

FRA D Etcheverry, Pierre A (30 - 12)
Z Millet, Jean-Pierre

EUA D Murphy, G R
Z Halpern, Paul

**MATCH
GAME 15**

MEX D Loaiza, Jorge R (30 - 14)
Z Hernández, Luis

URG D Germane, Hugo A
Z Sánchez, Hernán

**CLASSEMENT FINAL
FINAL STANDING**

- 1 MEX
- 2 ARG
- 3 ESP

**JEAU A MAIN NUE
HANDFRONTON**

**MATCH
GAME 1 OCT 14**

FRA D Etchegoin, Michel A (25 - 19)
Z Lissar, Pierre

MEX D Hernández, Ismael R
Z Tovar, Raymundo

**MATCH
GAME 2 OCT 16**

ESP D Sacristán, Domingo R (25 - 15)
Z Iruzubieta, Bernardo

FRA D Arbillage, Joseph A
Z Baptiste, Jean

**MATCH
GAME 3 OCT 18**

ESP D Sacristán, Domingo R (25 - 14)
Z Basabe, Antonio

MEX D Rivero, Víctor A
Z Izquierdo, Rosendo

**MATCH
GAME 4 OCT 20**

ESP D Esquisabel, Florentino R (25 - 13)
Z Iruzubieta, Bernardo

FRA D Etchegoin, Michel A
Z Baptiste, Jean

GAGNANT
WINNER

PERDANT
LOSER

MATCH
GAME 5 OCT 21

MEX D Hernández, Ismael R (25 - 24) FRA D Lissar, Pierre A
Z Tovar, Raymundo Z Etchegoin, Michel

MATCH
GAME 6 OCT 23

ESP D Esquisabel, Florentino R (25 12) MEX D Rivero, Víctor A
Z Basabe, Antonio Z Izquierdo, Roberto

MATCH
GAME 7 OCT 25

FRA D Arbillage, Joseph A (25 - 6) MEX D Hernández, Ismael R
Z Baptiste, Jean Z Tovar, Raymundo

CLASSEMENT FINAL
FINAL STANDING

- 1 ESP
- 2 FRA
- 3 MEX

JAI-ALAI
JAI-ALAI

MATCH
GAME 1 OCT 15

ESP D Mirapeix, Eduardo R (40 - 18) FRA D Etcheverry, Jean-Pierre A
Z Mirapeix, José María Z Fourneau, Pierre

MATCH
GAME 2

MEX D Lanzagorta, Pedro A (40 - 26) FIL D San Diego, Antonio R
Z Hamui, Juan Z Peñalosa, Benjamín

MATCH
GAME 3 OCT 16

FRA D Camy, Serge A (40 - 33) FIL D San Diego, Antonio R
Z Borra, Gabriel Z Peñalosa, Benjamín

MATCH
GAME 4

MEX D Hamui, Moisés A (40 - 26) FIL D Lazenby, Randy R
Z Andrade, Alejandro Z Tinkham, George

MATCH
GAME 5 OCT 17

ESP D Beascochea, Gonzalo A (40 - 17) FIL D San Diego, Antonio R
Z Mirapeix, José María Z Yambao, Carlos

GAGNANT
WINNER

PERDANT
LOSER

MATCH
GAME 6

FRA D Etcheverry, Jean-Pierre A (40 - 30) EUA D Burruss, Kenneth R
Z Fourneau, Pierre Z Carballo, Felix

MATCH
GAME 7 OCT 18

MEX D Lanzagorta, Pedro A (40 - 28) FRA D Etcheverry, Jean-Pierre R
Z Hamui, Moisés Z Borra, Gabriel

MATCH
GAME 8

ESP D Mirapeix, Eduardo A (40 - 14) EUA D Carballo, Félix R
Z Mirapeix, José María Z Tinkham, George

MATCH
GAME 9 OCT 19

FIL D San Diego, Antonio R (40 - 30) EUA D Carballo, Felix A
Z Peñalosa, Benjamín Z Burruss, Kenneth

MATCH
GAME 10

ESP D Mirapeix, Eduardo R (40 - 15) FIL D San Diego, Antonio R
Z Mirapeix, José María Z Peñalosa, Benjamín

MATCH
GAME 11 OCT 21

ESP D Mirapeix, Eduardo R (40 - 15) FIL D San Diego, Antonio R
Z Mirapeix, José María Z Peñalosa, Benjamín

MATCH
GAME 12

ESP D Mirapeix, Eduardo A (40 - 25) FRA D Etcheverry, Jean-Pierre R
Z Mirapeix, José María Z Borra, Gabriel

TOUR FINALE
FINAL ROUND

MATCH
GAME 13 OCT 23

ESP D Mirapeix, Eduardo A (40 - 25) FRA D Etcheverry, Jean-Pierre R
Z Mirapeix, José María Z Borra, Gabriel

MATCH
GAME 14

MEX D Hamui, Moisés A (40 - 13) FIL D San Diego, Antonio R
Z Andrade, Alejandro Z Yambao, Carlos

MATCH
GAME 15 OCT 25

FRA D Etcheverry, Jean-Pierre A (40 - 23) FIL D San Diego, Antonio R
Z Camy, Serge Z Peñalosa, Benjamín

GAGNANT
WINNER

PERDANT
LOSER

MATCH
GAME 16

ESP D Mirapeix, Eduardo A (40-26) MEX D Hamui, Juan
Z Mirapeix, José María Z Hamui, Moisés

CLASSEMENT FINAL
FINAL STANDING

1 ESP
2 FRA
3 MEX

PALETA AVEC BALLE DE CAOUTCHOUC
RUBBER BALL PADDLE FRONTON

MATCH
GAME 1 OCT 14

MEX D Becerra, José R (30-7) URG D Iroldi, Nestor
Z Rendón, Rubén Z D'Alba, Carlos

MATCH
GAME 2

ARG D Sehter, Aarón R (30-6) EUA D Daniels, A.
Z Utge, Jorge Z Collins, A

MATCH
GAME 3 OCT 15

ARG D Sehter, Aarón R (30-16) URG D Iroldi, Nestor
Z Utge, Jorge Z D'Alba, Carlos

MATCH
GAME 4

MEX D Gastelum, Antonio A (30-7) EUA D Vinton, Fred
Z Baltazar, Alfredo Z Sammis, Jesse

MATCH
GAME 5 OCT 17

URG D Iroldi, Nestor A (30-5) EUA D Daniels, A.
Z D'Alba, Carlos Z Sammis, Jesse

MATCH
GAME 6

MEX D Becerra, José R (30-21) ARG D Sehter, Aarón
Z Rendón, Rubén Z Utge, Jorge

MATCH
GAME 7 OCT 19

MEX D Becerra, José R (30-18) URG D Iroldi, Nestor
Z Rendón, Rubén Z D'Alba, Carlos

GAGNANT
WINNER

PERDANT
LOSER

MATCH
GAME 8

ARG D Goyeche, Jorge A (30-20) EUA D Collins, A.
Z Caresella, Antonio Z Vinton, Fred

MATCH
GAME 9 OCT 20

ARG D Utge, Jorge R (30-18) URG D Iroldi, Nestor
Z Sehter, Aarón Z Bell, Luis

MATCH
GAME 10

MEX D Gastelum, Antonio A (30-11) EUA D Sammis, Jesse
Z Baltazar, Alfredo Z Collins, A

MATCH
GAME 11 OCT 22

URG D Iroldi, Nestor A (30-5) EUA D Moncrieff, E. V.
Z D'Alba, Carlos Z Vinton, Fred

MATCH
GAME 12

MEX D Becerra, José R (30-7) ARG D Sehter, Aaron
Z Rendón, Rubén Z Utge, Jorge

CLASSEMENT FINAL
FINAL STANDING

1 MEX
2 ARG
3 URG

PALETA AVEC BALLE DE CUIR
LEATHER BALL PADDLE FRONTON

MATCH
GAME 1 OCT 14

ESP D Casado, Fernando R (35-33) ARG D Sehter, Aarón
Z Reyzabal, Jesús Z Utge, Jorge

MATCH
GAME 2

MEX D Beltrán, Manuel R (35-34) FRA D Berrotaran, Joseph
Z Sánchez, Raúl Z Barreits, Pierre

MATCH
GAME 3 OCT 15

ARG D Sehter, Aarón R (35-25) URG D Bernal, César
Z Utge, Jorge Z Bell, Luis

GAGNANT
WINNER

PERDANT
LOSER

MATCH
GAME **4**

ESP D Caballero, Francisco R (35 - 28) MEX D Beltrán, Miguel A
Z Reyzabal, Jesús Z Sánchez, Raúl

MATCH
GAME **5** **OCT 17**

ARG D Sehter, Aarón R (35 - 29) FRA D Barreits, Pierre A
Z Utge, Jorge Z Berrotaran, Joseph

MATCH
GAME **6**

ESP D Ancizu, Alberto R (35 - 29) URG D Bernal, César A
Z Caballero, Francisco Z Bell, Luis

MATCH
GAME **7** **OCT 19**

FRA D Barreits, Pierre A (35 - 26) ESP D Casado, Fernando R
Z Berrotaran, Joseph Z Reyzabal, Jesús

MATCH
GAME **8**

MEX D Beltrán, Manuel R (35 - 20) URG D Bernal, César A
Z Sánchez, Raúl Z Iroldi, Nestor

MATCH
GAME **9** **OCT 20**

FRA D Barreits, Pierre R (35 - 28) URG D Iroldi, Nestor A
Z Berrotaran, Joseph Z Bernal, César

MATCH
GAME **10**

ARG D Utge, Jorge A (35 - 28) MEX D Sánchez, Carlos R
Z Bizzozzero, Ricardo Z Del Valle, Mario

MATCH
GAME **11** **OCT 22**

FRA D Barreits, Pierre R (35 - 21) ARG D Sehter, Aarón A
Z Berrotaran, Joseph Z Utge, Jorge

MATCH
GAME **12**

MEX D Beltrán, Manuel R (35 - 33) ESP D Reyzabal, Jesús A
Z Sánchez, Raúl Z Caballero, Francisco

MATCH
GAME **13** **OCT 23**

ESP D Ancizu, Alberto R (35 - 33) FRA D Barreits, Pierre A
Z Reyzabal, Jesús Z Berrotaran, Joseph

GAGNANT
WINNER

PERDANT
LOSER

MATCH
GAME **14**

ARG D Sehter, Aarón A (35 - 22) MEX D Beltrán, Manuel R
Z Bizzozzero, Ricardo Z Sánchez, Raúl

MATCH
GAME **15** **OCT 24**

FRA D Barreits, Pierre A (35 - 28) MEX D Sánchez, Raúl R
Z Berrotaran, Joseph Z Beltrán, Manuel

MATCH
GAME **16**

ESP D Ancizu, Alberto R (35 - 18) ARG D Bizzozzero, Ricardo A
Z Caballero, Francisco Z Sehter, Aarón

CLASSEMENT FINAL
FINAL STANDING

1 FRA
2 ESP
3 MEX

RECORDS OLYMPIQUES ETABLIS A BERLIN EN 1936 DURANT LES JEUX DE LA XI OLYMPIADE

OLYMPIC RECORDS ESTABLISHED IN 1936 IN BERLIN DURING THE GAMES OF THE XI OLYMPIAD

TIR SHOOTING

P. C. Pos. couché	- S. B. R. Prone Pos.	Rögeberg	NOR	300P
P. C. Trois Pos.	- S. B. R. 3 Pos.	Ullmann	SUE	559P
		Van Oyen	ALE	36P

**ATHLETISME HOMMES
ATHLETICS MEN**

100 m	-	100 m	J. Owens	EUA	10.3"
200 m	-	200 m	J. Owens	EUA	20.7"
1500 m	-	1500 m	J. E. Lovelock	NZL	3'47.8"
Marathon	-	Marathon	K. Son	JPN	2 ^h 29'19.2"
110 m Haies	-	110 m Hurdles	F. G. Towns	EUA	14.1"
3000 m Steeplechase	-	3000 m Steeplechase	V. Iso-Hollo	FIN	9'03.8"
4 x 100 m Relais	-	4 x 100 m Relay	EUA	EUA	93.8"
50 Km marche	-	50 Km Walk	H. H. Whitlock	GBR	4 ^h 30'41.4"
Saut en Hauteur	-	High Jump	C. C. Johnson	EUA	2.03"
Saut en Longueur	-	Long Jump	J. Owens	EUA	8.06m
Saut à Perche	-	Pole Vault	E. Meadows	EUA	4.35m
Triple Saut	-	Triple Jump	N. Tajima	JPN	16.00m
Lancement du Poids	-	Shot Put	H. Woelke	ALE	16.20m
Lancement du Disque	-	Discus Throw	K. Carpenter	EUA	50.48m
Lancement du Marteau	-	Hammer Throw	K. Hein	ALE	56.49m
Décathlon	-	Décathlon	G. E. Morries	EUA	7,900p

**ATHLETISME FEMMES
ATHLETICS WOMEN**

100 m			H. H. Stephens	EUA	11.5"
80 m Haies	-	80 m Hurdles	T. Valla	ITA	11.6"
4 x 100 m Relais	-	4 x 100 m Relay	ALE	ALE	46.4"
Lancement du Disque	-	Discus Throw	G. Mauermeyer	ALE	47.63m
Lancement du Javelot	-	Javelin Throw	T. Fleischer	ALE	45.18m

**CYCLISME
CYCLING**

Km contre la montre	-	1000 m Time Trial	V. Vliet	HOL	1'12.0"
4000 m Poursuite par Equipe	-	4000 m Team Pursuit	FRA	FRA	4'41.4"

**HALTEROPHILIE
WEIGHTLIFTING**

Poids Coq	-	Bantamweight	A. Terlazzo	EUA	312.5kg
Poids Léger	-	Lightweight	Mesbah	RAU	342.5kg
Poids Moyen	-	Middleweight	Touni	RAU (EGI)	387.5kg
Poids Moyen Lourd	-	Light Heavyweight	Hostin	FRA	372.5kg
Poids Lourd	-	Heavyweight	Manger	ALE	410 kg

**NATATION HOMMES
SWIMMING MEN**

100 m Nage libre	-	100 m Freestyle	M. Taguchi	JPN	57.5"
400 m Nage libre	-	400 m Freestyle	J. Medica	EUA	4'44.5"
200 m Brasse	-	200 m Breaststroke	T. Hamuro	JPN	2:42.5"

**NATATION FEMMES
SWIMMING WOMEN**

100 m Nage libre	-	100 m Freestyle	H. Mastenbroek	HOL	1:05.9"
400 m Nage libre	-	400 m Freestyle	H. Mastenbroek	HOL	5'26.4"
200 m Brasse	-	200 m Breaststroke	H. Maehata	JPN	3'01.9"
100 m Dos	-	100 m Backstroke	N. Senff	HOL	1'16.6"
4 x 100 Relais	-	4 x 100 Relay	HOL	HOL	4'36.0"



FEDERATION INTERNATIONALE DE
LAWN-TENNIS

INTERNATIONAL LAWN-TENNIS
FEDERATION

PRESIDENT
Giorgio de Stefani ITA

SECETAIRE
SECRETARY
S. Basil Reay GBR
N. J. Barreton FRA

856

FEDERATION MEXICAINE
DE TENNIS

MEXICAN FEDERATION
OF TENNIS

PRESIDENT
Francisco Guerrero Arcocha MEX

SECTION DU TENIS DU C.O.O.
O.O.C. TENIS SECTION
Francisco Guerrero Arcocha MEX

SIGNES EMPLOYES

SYMBOLGY

G	— GAGNE	WON
P	— PERDU	LOST
*	— QUALIFIE POUR QUARTS DE FINALE	QUALIFIED FOR QUARTER-FINALS
**	— QUALIFIE POUR DEMI-FINALES	QUALIFIED FOR SEMI-FINALS
+	— QUALIFIE POUR FINALE	QUALIFIED FOR FINAL
Δ	— PASSENT DIRECTEMENT EN DEMI-FINALES	PASSED DIRECTLY TO SEMI-FINALS
⊙	— PASSENT AU 2 ^e TOUR ELIMINATOIRE	PASSED TO 2 nd ELIMINATION ROUND
NSP	— NE S'EST PAS PRESENTE	FAILED TO APPEAR

**SIMPLES DAMES
WOMEN'S SINGLES**

GUADALAJARA

GAGNANT
WINNER

PERDANT
LOSER

1er TOUR ELIMINATOIRE
1st ELIMINATION ROUND

OCT 14

GAGNANT
WINNER

PERDANT
LOSER

MATCH
GAME **1**

EUA * Heldman, Julie (6-1, 6-2) BRA Peterson, Suzana

MATCH
GAME **2**

FRA * Reyes, Rosa María (6-1, 6-1) ECU Ycaza, Ana María

MATCH
GAME **3**

ALE * Buding, Eda (7-5, 2-6, 6-4) MEX Montano, Patricia

MATCH
GAME **4**

MEX * Góngora, Lourdes (6-1, 6-2) EUA Ziegenfuss, Valerie

MATCH
GAME **5**

ECU * Guzmán, Ma. Eugenia (6-2, 6-2) URS Yansone, Zinaida

QUARTS DE FINALE
QUARTER-FINALS

OCT 17

MATCH
GAME **6**

ALE ** Niessen, Helga (6-1, 6-1) MEX Rosado, Cecilia

MATCH
GAME **7**

EUA ** Heldman, Julie (6-3, 6-3) FRA Reyes, Rosa María

MATCH
GAME **8**

MEX ** Góngora, Lourdes (6-2, 6-2) ECU Guzmán, Ma. Eugenia

MATCH
GAME **9**

EUA **Bartkowicz, Jane (4-6, 6-4, 7-5) ALE Buding, Eda

DEMI-FINALES
SEMI-FINALS

OCT 18

MATCH
GAME **10**

EUA + Bartkowicz, Jane (6-2, 6-2) MEX Góngora, Lourdes

MATCH
GAME **11**

ALE + Niessen, Helga (6-3, 1-6, 6-3) EUA Heldman, Julie

3e PLACE
3rd PLACE

MATCH
GAME **12**

EUA Heldman, Julie (6-4, 6-3) MEX Góngora, Lourdes

FINALE
FINAL

MATCH
GAME **13**

ALE Niessen, Helga (6-4, 6-3) EUA Bartkowicz, Jane

CLASSEMENT FINAL
FINAL STANDING

Bartkowicz, Jane
Buding, Eda
Góngora, Lourdes
Guzmán, Ma. Eugenia
Heldman, Julie
Reyes, Rosa María
Rosado, Cecilia
Niessen, Helga

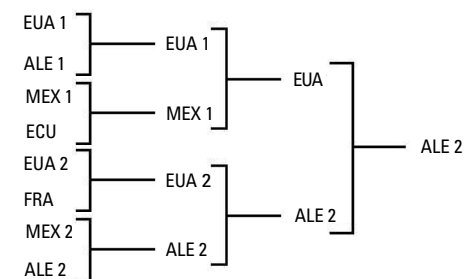

3e PLACE
3rd PLACE



GAGNANT
WINNER

PERDANT
LOSER

**DOUBLES DAMES
WOMEN'S DOUBLES**

GUADALAJARA

**MATCH
GAME 1 OCT 24**

MEXICO

FRA Reyes, Rosa María (6-3, 6-2) EUA Ziegenfuss, Valerie

**MATCH
GAME 2**

BRA Peterson, Suzana (3-6, 6-1, 6-4) MEX Montaña, Patricia

**MATCH
GAME 3**

EUA Bartkowicz, Jane (6-3, 7-5) URS Yansone, Zinaida

**MATCH
GAME 4**

EUA Heldman, Julie (6-1, 6-0) MEX Góngora, Lourdes

**MATCH
GAME 5**

BRA Peterson, Suzana (7-5, 5-7, 6-4) FRA Reyes, Rosa María

**MATCH
GAME 6 OCT 25**

EUA Bartkowicz, Jane (6-4, 6-2) BRA Peterson, Suzana

**MATCH
GAME 7**

EUA Heldman, Julie (6-1, 6-0) ECU Guzmán, Ma. Eugenia

**FINALE
FINAL OCT 26**

**MATCH
GAME 8**

EUA Bartkowicz, Jane (6-3, 6-2) EUA Heldman, Julie

**CLASSEMENT FINAL
FINAL STANDING**

Bartkowicz, Jane
Yansone, Zinaida
Reyes, Rosa María
Peterson, Suzana
Heldman, Julie
Góngora, Lourdes
Guzmán, Ma. Eugenia
Niessen, Helga

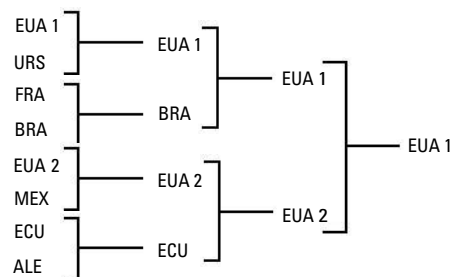

GAGNANT
WINNER

PERDANT
LOSER

**MATCH
GAME 1 OCT 17**

EUA FRA Heldman, Julie Reyes, Rosa María (7-5, 6-0) BRA MEX Peterson, Suzana Rosado, Cecilia

**MATCH
GAME 2**

MEX Góngora, Lourdes Montaña, Patricia (7-5, 3-6, 6-3) ECU Ycaza, Ana María Guzmán, Ma. Eugenia

**DEMI-FINALES
SEMI-FINALS OCT 18**

**MATCH
GAME 3**

EUA FRA + Heldman, Julie Reyes, Rosa María (2-6, 6-4, 6-3) EUA Bartkowicz, Jane Ziegenfuss, Valerie

**MATCH
GAME 4**

ALE + Buding, Eda Niessen, Helga (6-4, 6-1) MEX Góngora, Lourdes Montaña, Patricia

**3e PLACE
3rd PLACE OCT 19**

**MATCH
GAME 5**

EUA Bartkowicz, Jane Ziegenfuss, Valerie (6-2, 6-1) MEX Góngora, Lourdes Montaña, Patricia

**FINALE
FINAL**

**MATCH
GAME 6**

ALE Buding, Eda Niessen, Helga (6-3, 6-4) EUA FRA Heldman, Julie Reyes, Rosa María

CLASSEMENT FINAL
FINAL STANDING

Bartkowicz, Jane
Ziegenfuss, Valerie

Heldman, Julie
Reyes, Rosa María

Peterson, Suzana
Rosado, Cecilia

Ycaza, Ana María
Guzmán, Ma. Eugenia

Góngora, Lourdes
Montaño, Patricia

Buding, Eda
Niessen, Helga

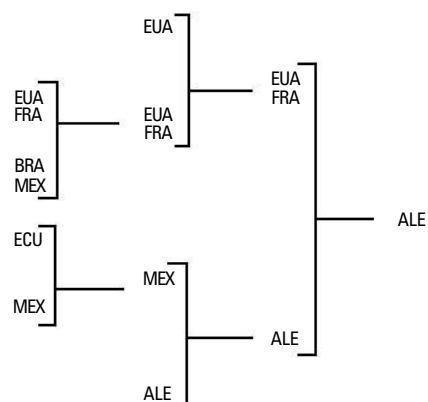

GAGNANT
WINNER

PERDANT
LOSER

MATCH
GAME 1 OCT 25

MEXICO

BRA Peterson, Suzana (6-4, 4-6, 6-1) MEX Góngora, Lourdes
ECU Guzmán, Ma. Eugenia Montaño, Patricia

MATCH
GAME 2

EJA Heldman, Julie (6-2, 4-6, 6-1) MEX Rosado, Cecilia
FRA Reyes, Rosa María URS Yansone, Zinaida

MATCH
GAME 3

EJA Bartkowicz, Jane (6-2, 6-2) BRA Peterson, Suzana
Ziegenfuss, Valerie ECU Guzmán, Ma. Eugenia

FINALE
FINAL

MATCH
GAME 4

EJA Heldman, Julie (6-0, 10-8) EJA Bartkowicz, Jane
FRA Reyes, Rosa María Ziegenfuss, Valerie

CLASSEMENT FINAL
FINAL STANDING

Bartkowicz, Jane
Ziegenfuss, Valerie

Góngora, Lourdes
Montaño, Patricia

Peterson, Suzana
Guzmán, Ma. Eugenia

Heldman, Julie
Reyes, Rosa María

Rosado, Cecilia
Yansone, Zinaida

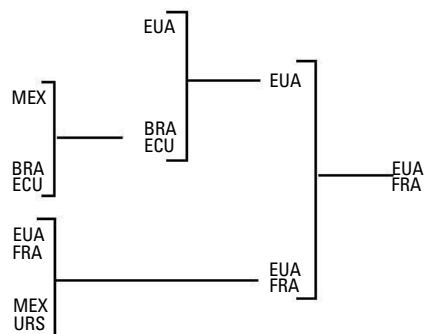

SIMPLES MESSIEURS
MEN'S SINGLES

GUADALAJARA

1er TOUR ELIMINATOIRE
1st ELIMINATION ROUND OCT 14

GAGNANT
WINNER

PERDANT
LOSER

MATCH
GAME 1

ESP ☉ Santana, Manuel (6-1, 6-1, 6-2) CUB Camarotti, Humberto

MATCH
GAME 2

ECU ☉ Olvera, Miguel (6-1, 6-0, 6-0) PRO Ortíz, Juan

MATCH
GAME 3

DIN ☉ Ulrich, Torben (6-8, 7-5, 6-2, 6-0) ECU Guzmán, Francisco

MATCH
GAME 4

ITA ☉ Castigliano, Eugenio (6-4, 6-2, 6-2) URS Korotkov, Vladimir

MATCH
GAME 5

MEX ☉ Loyo, Joaquín (6-0, 6-0, 6-1) CUB Brito, Juan

MATCH
GAME 6

ALE ☉ Buding, Ingo (6-4, 2-6, 4-6, 6-1, 6-0) JPN Kamiwasumi, Jun

MATCH
GAME 7

ESP ☉ Orantes, Manuel (6-3, 10-8, 6-0) JPN Sakai, Toshiro

MATCH
GAME 8

FRA ☉ Darmon, Pierre (6-1, 10-8, 6-1) PRO Carrero, Ricardo

MATCH
GAME 9

DIN ☉ Ulrich, Jorgen (6-3, 7-5, 6-3) EJA Osborne, James

MATCH
GAME 10

ITA ☉ Pietrangeli, Nicola (6-1, 6-3, 6-2) KEN Meghji, Abdulaziz

GAGNANT
WINNER

PERDANT
LOSER

MATCH
GAME 11

EUA ⊙ Fitzgibbon, Herb (3-6,6-4,6-3,7-5)

SUE Nerell, Hans

MATCH
GAME 12

MEX ⊙ Osuna, Rafael (6-3,6-2,6-2)

PRO Pasarell, Charles

MATCH
GAME 13 OCT 15

EUA ⊙ McManus, James (6-2,2-6,3-6,6-4,7-5)

URS Volkov, Anatoly

MATCH
GAME 14

MEX ⊙ Zarazúa, Vicente (7-5,6-4,0-6,6-2)

ITA Di Domenico, Massimo

MATCH
GAME 15

ESP ⊙ Gisbert, Juan (6-3,6-1,6-0)

KEN Shretta, Yashvin

MATCH
GAME 16

URS ⊙ Kakuliya, Tiemuraz (5-7,6-4,6-4,6-2)

ALE Fassbender, Jürgen

2e TOUR ELIMINATOIRE
2nd ELIMINATION ROUND

MATCH
GAME 17

DIN * Ulrich, Torben (6-2,2-6,6-3,3-6,7-5)

FRA Darmon, Pierre

MATCH
GAME 18

MEX * Osuna, Rafael (6-4,6-3,6-4)

ECU Olvera, Miguel

MATCH
GAME 19 OCT 16

EUA * Fitzgibbon, Herb (7-5,5-2,6-3)

ITA Castigliano, Eugenio

MATCH
GAME 20

ESP * Orantes, Manuel (3-6,6-1,6-3,7-5)

ITA Pietrangeli, Nicola

MATCH
GAME 21

MEX * Zarazúa, Vicente (6-4,6-1,6-1)

DIN Ulrich, Jorgen

GAGNANT
WINNE

PERDANT
LOSER

MATCH
GAME 22

MEX * Loyo, Joaquín (5-7,6-1,6-3,5-7,6-3)

URS Kakuliya, Tiemuraz

MATCH
GAME 23

ESP * Santana, Manuel (6-3,7-5,6-4)

ALE Buding, Ingo

MATCH
GAME 24

ESP * Gisbert, Juan (6-2,8-6,6-2)

EUA McManus, James

QUARTS DE FINALE
QUARTER-FINALS

MATCH
GAME 25 OCT 18

ESP ** Santana, Manuel (6-1,6-0,6-2)

MEX Zarazúa, Vicente

MATCH
GAME 26

EUA ** Fitzgibbon, Herb (6-3,6-2,6-3)

DIN Ulrich, Torben

MATCH
GAME 27

ESP ** Orantes, Manuel (2-6,6-2,6-4,6-1)

MEX Loyo, Joaquín

MATCH
GAME 28

MEX ** Osuna, Rafael (6-4,4-6,1-6,8-6,6-1)

ESP Gisbert, Juan

DEMI-FINALES
SEMI-FINALS

MATCH
GAME 29 OCT 19

ESP + Santana, Manuel (6-3,6-4,6-3)

MEX Osuna, Rafael

MATCH
GAME 30

ESP + Orantes, Manuel (6-4,6-4,6-3)

EUA Fitzgibbon, Herb

3e PLACE
3rd PLACE

GAGNANT
WINNER

PERDANT
LOSER

MATCH GAME 31 OCT 20

EUA Fitzgibbon, Herb (6-4, 6-3, 7-5) MEX Osuna, Rafael

FINALE
FINAL

MATCH GAME 32

ESP Santana, Manuel (2-6, 6-3, 3-6, 6-3, 6-4) ESP Orantes, Manuel

CLASSEMENT FINAL
FINAL STANDING

Santana, Manuel
Zarazúa, Vicente
Gisbert, Juan
Osuna, Rafael
Orantes, Manuel
Loyo, Joaquín
Ulrich, Torben
Fitzgibbon, Herb

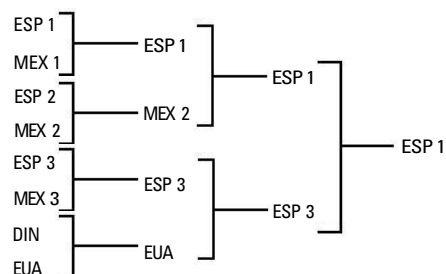

MATCH GAME 1 OCT 24

FRA Darmon, Pierre (6-0, 6-0) CUB Camarotti, Humberto

MEXICO

MATCH GAME 2

ALE Buding, Ingo (6-4, 6-3) MEX Loyo, Joaquín

MATCH GAME 3

MEX Zarazúa, Vicente (6-3, 8-6) JPN Sakai, Toshiro

MATCH GAME 4

URS Korotkov, Vladimir (6-4, 6-3) EUA Fitzgibbon, Herb

MATCH GAME 5

JPN Kamiwasumi, Jun (6-3, 6-3) EUA McManus, James

GAGNANT
WINNER

MATCH GAME 6

ITA Pietrangeli, Nicola (6-4, 6-4) ECU Guzmán, Francisco

MATCH GAME 7

ALE Buding, Ingo (6-4, 6-2) URS Kakuliya, Tiemuraz

MATCH GAME 8 OCT 25

URS Korotkov, Vladimir (6-4, 6-4) FRA Darmon, Pierre

MATCH GAME 9

ALE Buding, Ingo (6-0, 6-2) JPN Kamiwasumi, Jun

MATCH GAME 10

MEX Osuna, Rafael (6-2, 7-5) URS Volkov, Anatoly

MATCH GAME 11

ITA Pietrangeli, Nicola (6-4, 6-0) MEX Zarazúa, Vicente

MATCH GAME 12

ALE Buding, Ingo (6-4, 4-6, 6-2) URS Korotkov, Vladimir

MATCH GAME 13

MEX Osuna, Rafael (6-4, 6-2) ITA Pietrangeli, Nicola

MATCH GAME 14 OCT 26

MEX Osuna, Rafael (6-3, 3-6, 6-3) ALE Buding, Ingo

CLASSEMENT FINAL
FINAL STANDING

Korotkov, Vladimir
Darmon, Pierre
Kamiwasumi, Jun
Buding, Ingo
Pietrangeli, Nicola
Zarazúa, Vicente
Volkov, Anatoly
Osuna, Rafael

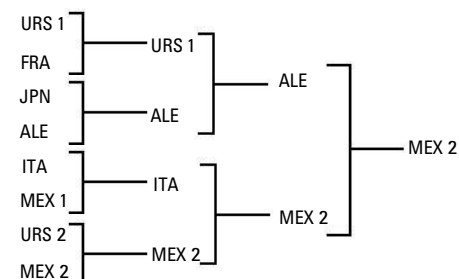

**DOUBLES MESSIEURS
MEN'S DOUBLES**

GUADALAJARA

1er TOUR ELIMINATOIRE
1st ELIMINATION ROUND

OCT 16

GAGNANT
WINNER

PERDANT
LOSER

**MATCH
GAME 1**

ECU * Olvera, Miguel (7-5, 4-6, 6-2, 3-6, 8-6)
Guzmán, Francisco

ITA Castigliano, Eugenio
Di Domenico, Massimo

**MATCH
GAME 2**

URS * Volkov, Anatoly (6-4, 11-9, 7-5)
Korotkov, Vladimir

ALE Buding, Ingo
Fassbender, Jürgen

**MATCH
GAME 3**

ESP * Orantes, Manuel (6-1, 6-2, 6-3)
ITA Pietrangeli, Nicola

JPN Kamiwasumi, Jun
Sakai, Toshiro

862

**MATCH
GAME 4**

MEX * Osuna, Rafael (5-7, 6-4, 6-3, 5-7, 6-4)
Zarazúa, Vicente

SUE Nerell, Hans
URS Kakuliya, Tiemuraz

**MATCH
GAME 5**

EUA * McManus, James (6-3, 6-2, 6-3)
Osborne, James

KEN Shretta, Yashvin
Meghji, Abdulaziz

**MATCH
GAME 6**

FRA * Darmon, Pierre (4-6, 6-1, 7-5, 6-3)
MEX Loyo, Joaquín

DIN Ulrich, Jorgen
Ulrich, Torben

**MATCH
GAME 7** **OCT 17**

PRO * Pasarell, Charles (3-6, 2-6, 8-6, 6-3, 6-4)
Carrero, Ricardo

CUB Camarotti, Humberto
Brito, Juan

QUARTS DE FINALE
QUARTER-FINALS

OCT 18

**MATCH
GAME 8**

MEX ** Loyo, Joaquín (6-3, 6-1, 6-2)
FRA Darmon, Pierre

PRO Pasarell, Charles
Carrero, Ricardo

GAGNANT
WINNER

PERDANT
LOSER

**MATCH
GAME 9**

ECU ** Olvera, Miguel (6-2, 3-6, 6-1, 1-6, 6-4)
Guzmán, Francisco

EUA McManus, James
Osborne, James

**MATCH
GAME 10**

MEX ** Osuna, Rafael (6-2, 6-4, 8-6)
Zarazúa, Vicente

ESP Orantes, Manuel
ITA Pietrangeli, Nicola

**MATCH
GAME 11**

ESP ** Santana, Manuel (3-6, 6-4, 6-3, 6-4)
Gisbert, Juan

URS Volkov, Anatoly
Korotkov, Vladimir

DEMI-FINALES
SEMI-FINALS

OCT 19

**MATCH
GAME 12**

ESP Santana, Manuel (6-3, 6-4, 6-4)
Gisbert, Juan

MEX Loyo, Joaquín
FRA Darmon, Pierre

**MATCH
GAME 13**

MEX Osuna, Rafael (10-8, 6-4, 7-5)
Zarazúa, Vicente

ECU Olvera, Miguel
Guzmán, Francisco

3e PLACE
3rd PLACE

OCT 20

**MATCH
GAME 14**

MEX Loyo, Joaquín (6-4, 1-6, 6-1, 6-3)
FRA Darmon, Pierre

ECU Olvera, Miguel
Guzmán, Francisco

FINALE
FINAL

**MATCH
GAME 15**

MEX Osuna, Rafael (6-4, 6-3, 6-4)
Zarazúa, Vicente

ESP Santana, Manuel
Gisbert, Juan

CLASSEMENT FINAL
FINAL STANDING

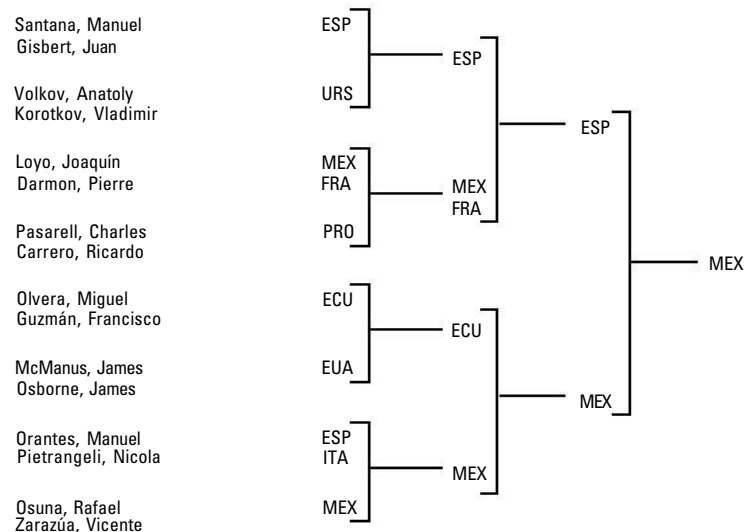

CLASSEMENT FINAL
FINAL STANDING

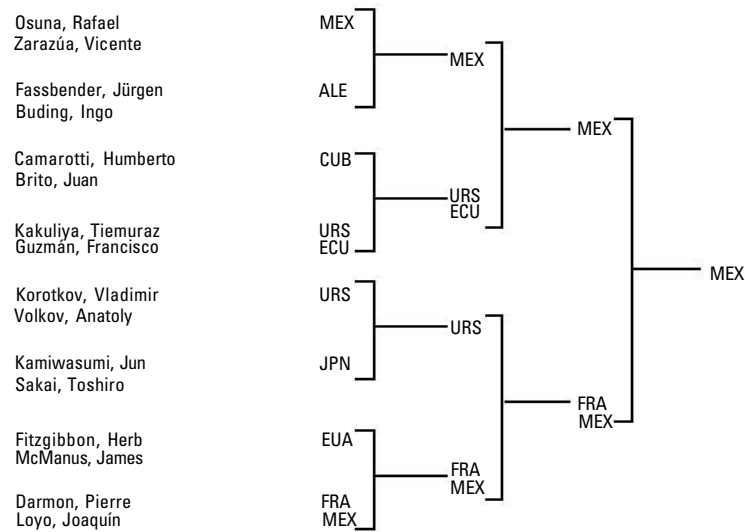

GAGNANT
WINNER

PERDANT
LOSER

MATCH
GAME 1 OCT 24

FRA	Darmon, Pierre	(7-5, 6-3)	EUA	Fitzgibbon, Herb
MEX	Loyo, Joaquín			McManus, James

MATCH
GAME 2

URS	Korotkov, Vladimir	(3-6, 6-4, 6-0)	JPN	Kamiwasumi, Jun
	Volkov, Anatoly			Sakai, Toshiro

MATCH
GAME 3

URS	Kakuliya, Tiemuraz	(6-4, 6-3)	CUB	Camarotti, Humberto
ECU	Guzmán, Francisco			Brito, Juan

MATCH
GAME 4 OCT 25

MEX	Osuna, Rafael	(4-6, 8-6, 6-0)	ECU	Guzmán, Francisco
	Zarazúa, Vicente		URS	Kakuliya, Tiemuraz

MATCH
GAME 5

MEX	Loyo, Joaquín	(7-5, 1-6, 6-2)	URS	Korotkov, Vladimir
FRA	Darmon, Pierre			Volkov, Anatoly

MATCH
GAME 6 OCT 26

MEX	Osuna, Rafael	(6-4, 3-6, 14-12)	FRA	Darmon, Pierre
	Zarazúa, Vicente		MEX	Loyo, Joaquín

DOUBLES MIXTES
MIXED DOUBLES

MEXICO

1er TOUR ELIMINATOIRE
1st ELIMINATION ROUND OCT 24

863

GAGNANT
WINNER

PERDANT
LOSER

MATCH
GAME 1

URS	Korotkov, Vladimir		MEX	Zarazúa, Vicente	NSP
	Yansone, Zinaïda			Góngora, Lourdes	

MATCH
GAME 2

FRA	Darmon, Pierre	(6-1, 6-2)	EUA	McManus, James
	Reyes, Rosa María			Ziegenfuss, Valerie

QUARTS DE FINALE
QUARTER-FINALS

MATCH
GAME 3

URS	Kakuliya, Tiemuraz		EUA	Fitzgibbon, Herb	NSP
BRA	Peterson, Suzana			Heldman, Julie	

MATCH
GAME 4 OCT 25

URS	Korotkov, Vladimir		ECU	Guzmán, Francisco	NSP
	Yansone, Zinaïda			Guzmán, Ma. Eugenia	

GAGNANT
WINNER

PERDANT
LOSER

**DOUBLES MIXTES
MIXED DOUBLES**

GUADALAJARA

**MATCH
GAME 5**

FRA Darmon, Pierre (7-5, 1-6, 6-2) MEX Loyo, Joaquín
Reyes, Rosa María Montaña, Patricia

**MATCH
GAME 6 OCT 26**

ALE Buding, Ingo PERDANT
EUA Bartkowicz, Jane LOSER ALE Fassbender, Jürgen
Niessen, Helga NSP

**DEMI-FINALES
SEMI-FINALS**

**MATCH
GAME 7**

URS Korotkov, Vladimir PERDANT
Yansone, Zinaida LOSER URS BRA Kakuliya, Tiemuraz
Peterson, Suzana NSP

**MATCH
GAME 8**

ALE Buding, Ingo (3-6, 6-2, 6-1) PERDANT
EUA Bartkowicz, Jane LOSER FRA Darmon, Pierre
Reyes, Rosa María

864

**FINALE
FINAL**

**MATCH
GAME 9**

URS Korotkov, Vladimir (7-5, 6-4) PERDANT
Yansone, Zinaida LOSER ALE EUA Buding, Ingo
Bartkowicz, Jane

**CLASSEMENT FINAL
FINAL STANDING**

Fitzgibbon, Herb
Heldman, Julie
Kakuliya, Tiemuraz
Peterson, Suzana
Guzmán, Francisco
Guzmán, Ma. Eugenia
Korotkov, Vladimir
Yansone, Zinaida
Darmon, Pierre
Reyes, Rosa María
Loyo, Joaquín
Montaña, Patricia
Buding, Ingo
Bartkowicz, Jane
Niessen, Helga
Fassbender, Jürgen

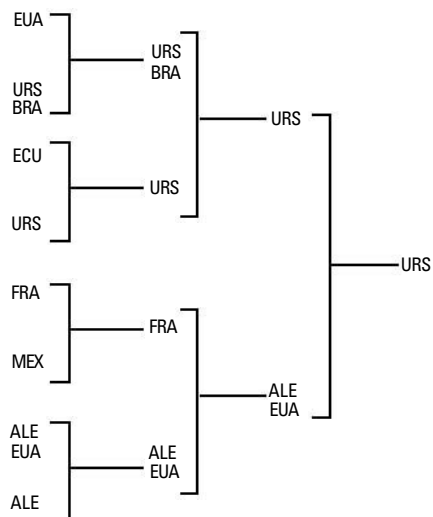

**1er TOUR ELIMINATOIRE
1st ELIMINATION ROUND OCT 17**

GAGNANT
WINNER

PERDANT
LOSER

**MATCH
GAME 1**

ALE * Niessen, Helga PERDANT
Fassbender, Jürgen LOSER MEX SUE Zenea, Susana
Nerell, Hans NSP

**MATCH
GAME 2**

FRA * Reyes, Rosa María (6-0, 6-1) PERDANT
Darmon, Pierre LOSER ECU Ycaza, Ana María
Olvera, Miguel

**MATCH
GAME 3**

URS * Yansone, Zinaida PERDANT
Korotkov, Vladimir LOSER MEX Rosado, Cecilia
Osuna, Rafael NSP

**MATCH
GAME 4**

EUA * Bartkowicz, Jane (6-4, 6-1) PERDANT
Osborne, James LOSER MEX Montaña, Patricia
Loyo, Joaquín

**MATCH
GAME 5**

ALE * Buding, Eda (6-3, 3-6, 8-6) PERDANT
Buding, Ingo LOSER ECU Guzmán, Ma. Eugenia
Guzmán, Francisco

**MATCH
GAME 6**

EUA * Heldman, Julie (5-7, 9-7, 6-2) PERDANT
Fitzgibbon, Herb LOSER BRA ITA Peterson, Suzana
Di Domenico, Massimo

**QUARTS DE FINALE
QUARTER-FINALS OCT 18**

**MATCH
GAME 7**

ALE ** Niessen, Helga (3-6, 6-1, 7-5) PERDANT
Fassbender, Jürgen LOSER EUA Ziegenfuss, Valerie
McManus, James

**MATCH
GAME 8**

FRA ** Reyes, Rosa María (6-3, 6-4) PERDANT
Darmon, Pierre LOSER URS Yansone, Zinaida
Korotkov, Vladimir

GAGNANT
WINNER

PERDANT
LOSER

CLASSEMENT FINAL
FINAL STANDING

MATCH
GAME 9

EUA ** Bartkowicz, Jane Osborne, James (6-8, 6-4, 6-3) ALE Buding, Eda Buding, Ingo

MATCH
GAME 10

EUA ** Heldman, Julie Fitzgibbon, Herb (6-3, 6-4) MEX Góngora, Lourdes Zarazúa, Vicente

DEMI-FINALES
SEMI-FINALS

MATCH
GAME 11

ALE + Niessen, Helga Fassbender, Jürgen (3-6, 6-3, 6-4) FRA Reyes, Rosa María Darmon, Pierre

MATCH
GAME 12

EUA + Heldman, Julie Fitzgibbon, Herb (4-6, 11-9, 10-8) EUA Bartkowicz, Jane Osborne, James

3e PLACE
3rd PLACE

OCT 19

MATCH
GAME 13

EUA Bartkowicz, Jane Osborne, James (6-4, 7-5) FRA Reyes, Rosa María Darmon, Pierre

FINALE
FINAL

MATCH
GAME 14

EUA Heldman, Julie Fitzgibbon, Herb (6-1, 6-3) ALE Niessen, Helga Fassbender, Jürgen

Ziegenfuss, Valerie
McManus, James

Niessen, Helga
Fassbender, Jürgen

Reyes, Rosa María
Darmon, Pierre

Yansone, Zinaida
Korotkov, Vladimir

Bartkowicz, Jane
Osborne, James

Buding, Eda
Buding, Ingo

Heldman, Julie
Fitzgibbon, Herb

Góngora, Lourdes
Zarazúa, Vicente

3e PLACE
3rd PLACE

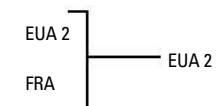
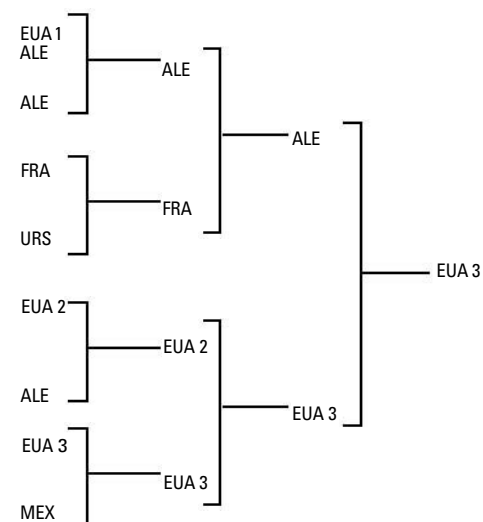

865

**COMMEMORATIVE VOLUMES OF THE GAMES OF THE XIX OLYMPIAD
MEMOIRE OFFICIEL DES JEUX DE LA XIX OLYMPIADE**

COMITE ORGANIZADOR DE LOS JUEGOS DE LA XIX OLIMPIADA

Departamento de Publicaciones

Avenida de las Fuentes 170, México 20, D. F.

Direction
Editor-in-Chief

Beatrice Trueblood

Direction artistique et Coordination
Artistic-Director and Coordinator

Eduardo Terrazas de la Peña

Composition graphique
Design

Tony Apilado
Susan Breck Smith

Textes
Text

Geoffrey Hammond
Byron Kay

Supervision textes français
English Editor

Suzanne Darmon
Robert Cleland

Légendes
Captions

James Dunlap

Supervision des données et
résultats sportifs
Supervision of Sports Data and
Results

Carlos Jalife
Pablo Stock

Production
Production Manager

Ricardo Verdoni

Phototèque et Laboratoire
Photo Laboratory

Francisco Uribe

Photographies
Photographs

Bernal, Armando
Boulahaya, Abbas

Págs.: 320.
Págs.: 57, 62, 87, 94, 109,
282, 314, 315, 319, 321,
322, 323, 351, 352, 353,
417, 509.

Buchanan, William
Carrillo, Rafael

Págs.: 32, 33.
Págs.: 72, 249, 258, 259, 306,
312, 315, 320, 416, 426.
508.

Cervantes, Miguel

Págs.: 34, 42, 121, 304, 402,
405, 408.

Contreras, José

Págs.: 56, 62, 90, 91, 96,
97, 107, 109, 117, 121,
190, 204, 264, 272, 273,
280, 281, 282, 283, 366,
367.

Corral, Luis
Coureau, Jean Pierre

Págs.: 121, 173, 509.
Págs.: 328, 335, 342, 414, 450,
456, 490.

Cruz, Fortino
Davis, Ray

Págs.: 250.
Págs.: 340, 348, 349, 350, 357,
358, 361, 362, 363, 364,
365, 368, 369, 374, 379,
381, 460, 464.

Díaz Cortés, Alejandro

Págs.: 114, 115, 241, 506, 508,
511, 514.

Estrada, Guillermo

Págs.: 23, 164, 170, 171, 174,
175, 182, 183, 212, 249,
251, 515.

Foto Finish
Futamura, Tamotsu

Págs.: 76, 77, 132, 133.
Págs.: 36, 38, 39, 50, 64,
71, 75, 82, 83, 91,
111, 121, 122, 146, 186,
206, 214, 218, 219, 324,
332, 333, 336, 338, 400,
446, 504.

Gallardo, Héctor
Garay, Manuel

Págs.: 510, 511.
Págs.: 83, 121, 123, 249, 274.
36, 104, 121, 150, 152,
226, 228, 250, 264, 272,
278, 279, 388, 420, 423,
431, 436, 457, 463, 466,
467, 515, 516, 517.

Hernández, Joaquín

Págs.: 217, 390, 392, 393, 394,
396, 397, 424, 431, 478.

Kawazu, Hideo

Págs.: 82, 110, 118, 195, 205,
286, 442, 448.

Kishimoto, Ken

Págs.: 60, 78, 104, 11, 118,
299, 339, 344, 359, 374,
377, 441.

Landry, William
Lara, José Antonio

Págs.: 43, 319, 334.
Págs.: 20, 33, 213, 216, 218,
222, 223, 229, 318, 393,
441.

Lara, Raúl
Lasalle, Martín

Págs.: 334, 337, 360, 413.
Págs.: 41, 86, 120, 121, 124,
131, 135, 142, 159, 161,
162, 163, 176, 196, 250,
253, 288, 305, 331, 350,
441, 461, 507, 510, 513.

Méndez, Pablo

Págs.: 36, 38, 52, 78, 79,
314, 345, 355, 369, 376,
380, 384, 415, 462, 505.

Michals, Duane
Molina Barbosa, Saúl
Murayama, Takashi

Págs.: 310.
Págs.: 217.
Págs.: 224, 232, 295, 296, 297,
302, 303, 349, 352, 356,
370, 377, 378, 379, 382,
434, 439, 440, 460.

Ortega, Arturo

Págs.: 156, 157, 172, 176, 178,
179, 180, 330, 425, 430.

Imprimé au Mexique par Miguel Galas, S. A.
Printed in Mexico by Miguel Galas, S. A.

Relié par Encuadernación Progreso, S. A.
Bound by Encuadernación Progreso, S. A.

Ortiz, Enrique	Págs.:294, 295, 298, 299, 300, 330.
Pike, Robert	Págs.:383.
Pool Internacional	Págs.: 49, 51, 52, 53, 54, 55, 57, 58, 59, 61, 63, 65, 66, 67, 68, 69, 70, 74, 98, 80, 81, 85, 86, 88, 89, 90, 92, 32, 95, 98, 99, 100, 101, 102, 103, 105, 106, 108, 113, 118, 119, 121, 129, 137, 154, 155, 177, 178, 180, 181, 189, 192, 193, 194, 202, 211, 212, 217, 220, 221, 230, 231, 235, 237, 238, 239, 257, 264, 281, 283, 292, 293, 296, 298, 300, 303, 317, 319, 329, 345, 346, 347, 348, 350, 351, 353, 354, 356, 357, 359, 360, 361, 362, 364, 365, 370, 371, 372, 373, 375, 377, 391, 393, 395, 397, 404, 406, 409, 411, 413, 423, 424, 425, 430, 443, 445, 447, 474, 476, 477, 482, 483, 487, 490, 18, 19, 84, 93, 134,
Pool Nacional	Págs.:138, 140, 174, 194, 196, 197, 199, 203, 234, 236, 238, 239, 260, 262, 272, 274, 284, 285, 290, 299, 313, 316, 326, 360, 380, 381, 384, 386, 389, 413, 415, 422, 429, 438, 439, 465, 470, 487, 489, 490, 492, 494, 496, 497, 499.
Putnam, Michael	Págs.: 73, 99, 112, 116, 153, 154, 158, 160, 161, 279, 373, 472, 512, 514, 515,
Raider, Ken	Págs.: 33, 495, 508, 516.
Rodríguez, Miguel	Págs.:154, 155, 301, 303, 504,
Ruelas, Roberto	Págs.:507.
Soberanes, Manuel	Págs.:312, 25, 38, 108, 112, 130, 136, 137, 140, 144, 184, 198, 200, 201, 220, 449.
Soned, Leonard	Págs.:126, 142, 196, 468, 472, 473, 474, 478, 479, 480, 481, 482, 484, 485, 486, 488, 500, 514.
Tena, Enrique	Págs.:242, 248, 252, 253, 256, 312, 315, 423, 426, 427, 432, 433, 506, 507, 509,
Uribe, Francisco	Págs.:168, 208, 246.
Villanueva, José de Jesús	Págs.:134, 141, 143, 189, 190, 191, 197, 505, 506, 507.
Yampolsky, Marianne	Págs.: 34, 35, 174, 240, 332, 428, 507, 511.
Yorikano, Yoshiki	Págs.: 24, 37, 40, 128, 138, 139, 154, 153, 195, 248, 253, 281.
Zabé, Michel	Págs.:390, 391, 392, 395, 398, 399, 406, 407, 410, 413, 475, 504, 506, 507, 508.
Zendejas, Humberto	Págs.:172, 177, 179, 213, 275, 412, 418, 426, 428, 439, 444, 445, 454, 458, 459, 495, 498, 509, 511.

Copyright, © 2005, Amateur Athletic Foundation of Los Angeles

Notes on the digitized version of the Official Report of the Organizing Committee of the Games of the XIX Olympiad Mexico 1968 (Volume 3)

The digital version of the Official Report of the Games of the XIX Olympiad was created with the intention of producing the closest possible replica of the original printed document. These technical notes describe the differences between the digital and printed documents and the technical details of the digital document.

The original document

The original paper version of the 1968 Official Report (Volume 3) has dimensions of 11.3 x 11.4" (28.5cm x 29cm).

The volume's spine is pale yellow in color. The image of a dove and number "3" appear in gold on the spine.

The book has 868 pages.

The fonts used in the digital version book for text, photograph captions and chapter headings are Univers and such system fonts as best approximate the original fonts.

Special features of the digital version:

- The spine is not included in the digital version.
- Blank pages are not included in the digital version.
- The digital version includes a bookmark list that functions as a hyper linked table of contents. Selecting a topic heading will take you to the corresponding section in the document.

Profile of the digital version:

File name: 1968v3.pdf

File size: 39,167 KB

Format: Portable Document Format (PDF) 1.4 (Adobe Acrobat 5.0)

Source document: The Official Report of the Organizing Committee of the Games of the XIX Olympiad Mexico 1968, Volume 3: The Games

Produced by the Organizing Committee of the Games of the XIX Olympiad

Creation Platform: Windows XP

Creation Date: February 2005

Conversion Software: Adobe Acrobat, FineReader, VistaScan, FahrenEX

Image Resolution: 150 dpi for color and grayscale images

Digital Fonts: Univers

Conversion Service: Exgenis Technologies, Goa, INDIA.

www.digitization.info