

# WORLD PARK

JANUARY 2012

## Go Gary!

### 10 years of The Goddard Group

INSIDE

20 years of TEA  
Thrill Mountain at Ocean Park  
Hirakata Park

Galaxy Macau © 2011 Galaxy Entertainment Group. Glow in the Park © 2008 Six Flags Corp. The Forum Shops at Caesars © 1992 Desert Palace Inc. Georgia Aquarium © 2005 Georgia Aquarium. Jurassic Park: The Ride © 1996 MCA Inc. (Developed in Concert with Universal Creative). T2/3D Battle Across Time © 1996 MCA Inc. (Developed in Concert with Universal Creative)



# Complete Lily Pad Walk Setup

ZebeC provides a Complete Lily Pad Walk Setup including Foam Lily Pad Floats, Overhead Netting and Pool Side Safety Padding – All made in our USA 70,000sf Cincinnati, Ohio factory. Lily Pad setups are custom designed for each project and constructed to fit your specific area.

### Complete Lily Pad Walk Setup

- FOAM Lily Floats
- Overhead Netting
- Entry Pool Side Padding

### Foam Lily Pad Floats

Constructed for heavy commercial use and made with high density foam completely encased in a water-tight, reinforced outer membrane cover. This thick outer membrane is extremely tough providing excellent abrasion, puncture and wear resistance along with water-tight construction.

# Safety Padding

ZebeC manufactures a full range of safety padding to fit most any area in your facility. Safety pads are custom made to fit your specific area and special requests or designs are no problem.

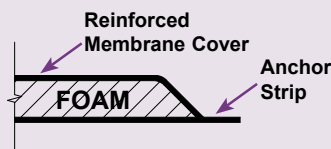

### Safety Pad Features

- **Sizes** – Custom made to fit your specific area
- **High Density Foam** – Mechanically stable foam that maintains cushioning properties
- **Durable Outer Membrane** – Foam completely encased in a Watertight, Reinforced outer membrane
- **Installation** – Bolt-down or adhered.
- **UV Stable** – UV inhibitors resist damage and fading
- High Chemical Resistance • Low Maintenance
- Easy Onsite Repairs • 14 Colors Available

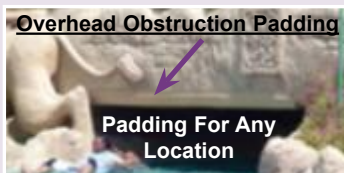

### Safety Padding For Any Area

Flat Pads are designed for the bottom of slides or any flat area. L-Shaped Pads and “stair-step” pads are made to protect the side of a pool. We can also custom design padding for most any area.

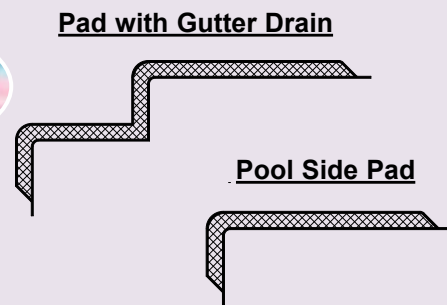

Heavy-Duty Single, Double, Tear-Drop, 3 and 4 Person Clover Tubes made in USA with extra heavy material and overlapped, heat-welded seams

### Heavy Duty Tubes

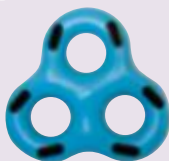

+1(513) 829-5533  
 Fax +1(513) 892-7466  
 zebec@zebec.com  
 www.zebec.com

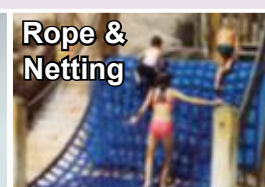
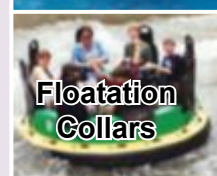
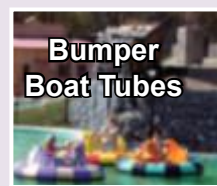

### 5 **Front Gate**

Setting the agenda for the month ahead

### 6-24 **Park News**

Your bumper winter round-up

### 6 **Park Hoppin'**

Paul Ruben meets Miss Germany

### 24 **Kernels**

Bite-sized news

### 26-28 **Show Reviews**

IAAPA/Park Show International

### 30-31 **Q-Lines**

20 years of TEA

### 32 **Al Hokair Group**

Operator profile

### 34-35 **Hong Kong in Colour**

Attraction profiles

### 36-39 **Hirakata Park**

Park profile

### 40 **Ride Guide**

New products and services for parks and attractions

### 41 **Show Guide**

Exhibitions and networking for amusement professionals

### 42 **Web Guide**

Online resources for the amusement industry



“ I seated all of the competitors next to one another. That was very interesting, but I made a point: Get to know the person sitting to your left and right because they could be the one watching your back in future ”

Monty Lunde discusses the TEA's collaborative approach to business, P30-31



“ Guests must step inside one of eight stone coffins. During the show the coffin shakes and your hands, which you must stick out of slots below the eye holes, are poked. At the end of the show you are given a print out of your fear rating ”

Weird and wonderful attractions at Hirakata Park in Japan, P36-39

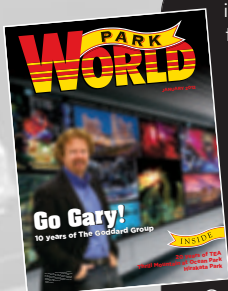

**THIS MONTH'S COVER SHOT:** Gary Goddard is a pioneer in the design of iconic theme park and leisure destinations, with over 30 years' experience in the themed entertainment industry.

Beginning as director of the Hoop-Dee-Do Western dinner revue, still going strong today at Walt Disney World, he progressed to become the youngest ever Imagineer hired by Disney. There he worked on EPCOT and The World Showcase, early studies for Tokyo Disneyland and the expansion of Fort Wilderness, before leaving to form Gary Goddard Productions, the Landmark Entertainment Group and later The Goddard Group.

Goddard's credits include such notable projects as The Amazing Adventures of Spider-Man and Jurassic Park River Adventure at Islands of Adventure, Terminator 2 3-D for Universal Studios, The Forum Shops at Caesar's Palace and Star Trek: The Experience for Paramount Parks in Las Vegas. In 2011, The Goddard Group created the two billion dollar Galaxy Resort & Casino in Macau.

To celebrate the 10th anniversary of The Goddard Group in 2012, *Park World* will be taking a look at the company's achievements and plans for the future in the upcoming February issue, and before that at [parkword-online.com](http://parkword-online.com). In the meantime, please visit [www.garygoddard.com](http://www.garygoddard.com) to discover how Goddard and his team can help your venue realise the next iconic, world-class attraction.



Kiddie



Kart



# ParkWord

December 2011/January 2012



Fun fair, Luna park, fête foraine, feria, carnival or kirmes – whatever you know them as, they represent arguably the brightest, brashiest and rawest form of the amusement industry.

Almost subconsciously, it seems travelling fairs hold a special place in many people's hearts, something several theme park owners have acknowledged in recent years. After years of trying to make their properties look like *anything but* a fun fair, a handful of venues have added attractions celebrating the "carny" tradition, while affectionately poking fun at it.

Witness Disney's Dinoland USA at the Animal Kingdom in Florida, complete with several in-jokes about the boardwalks of North America, or The Simpsons Ride at Universal Studios in Orlando/Hollywood, described wonderfully in the pre-show as an, "upsy-downsy, spins-aroundsy, teen-operated ride thrilltacular."

When Zamperla brought Luna Park back to Coney Island in 2010, the name was not only a nod to the old Brooklyn amusement park on the same site; it was also the Italian phrase for travelling fairs. Co-incidence? Certainly the theming at Coney Island 2.0 is classic carnival pastiche.

The latest postmodern interpretation of the travelling fair is Thrill Mountain at Ocean Park in Hong Kong. The may be less of a fun fair tradition in this part of the world but, over the last decade or so, several foreign showmen have toured South East Asia with their travelling shows, whetting the local appetite for this unique form of entertainment. Thrill Mountain also celebrates Australian Luna Parks such as those found in Sydney and Melbourne, the giant smiling clown face giving the game away.

One thing that has always impressed me about travelling fairs is the efficiency with which ride operators can get people on and off their attractions during peak periods. Of course, knowing that every rider is clutching hard cash is a great incentive for maximising throughput, but so long as there is a queue there is no reason theme parks shouldn't work with the same sense of efficiency (if it is safe to do so). Something tells me the bright lights, booming music and high energy rides of Thrill Mountain will be enough to keep everyone pumped up at Ocean Park during the forthcoming Chinese New Year holidays.

Owen Ralph - Editor



Editor Owen Ralph (+44 161 438 2934)  
parkworld@btopenworld.com

North American Editor Paul Ruben (+1 585 381 1012)  
parkw@rochester.rr.com

Contributors this issue Marek Pisarski, Thomas Clarke

Sales Manager Mark Burgess (+44 1622 699124)  
parkworld@datateam.co.uk

Publishing Director Paul Ryder  
pryder@datateam.co.uk

Managing Director Parvez Kayani  
p.kayani@datateam.co.uk

Publication Secretary/ Subscriptions Jennifer York (+44 1622 699109)  
parkworld@datateam.co.uk

Head Office **datateam**  
Business Media  
Datateam Business Media Ltd  
London Road, Maidstone,  
Kent, ME16 8LY, UK  
Tel: +44 1622 687031  
Fax: +44 1622 757646  
www.datateam.co.uk

DECEMBER 2011/JANUARY 2012  
ISSN: 1462-4796

© Copyright 2011: all materials in this publication remain the copyright of Datateam Business Media and no part of it may be reproduced without the written permission of the proprietors.

A request to insert an advertisement is deemed to be an acceptance of Datateam Business Media Ltd's conditions of trading, copies of which are available on request.

Member of:



Major Rides



# The Carousel Company



Bumper Cars



**BERTAZZON**

*The Carousel Company*

BERTAZZON 3B SRL, 31020 SERNAGLIA (TREVISO) ITALY  
PHONE +39 0438 966291 FAX +39 0438 966165  
E-MAIL: BERTAZZON@BERTAZZON.COM



Venetian Carousels





# Big Question



**What will be a more realistic goal in 2012 - raising gate prices or increasing in-park spending?**

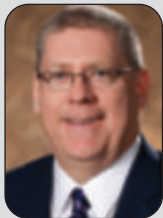

**Carl Lum, Busch Gardens Williamsburg, USA:** In reality, it will be a combination of both. The day is long over where you can just pass along a 6% gate increase by itself and have it stick. Consumers have fundamentally changed their mindset in our new economy. Price increases must be perceived by our guests as having the product and guest experience that capture that value. This means investing capital, always improving guest service and being flexible in how you deploy your pricing strategy based on consumer feedback. Growing per capita spending happens through the relentless exercise of constant innovation and quality products at fair price points. It is much like cutting your grass, when you think you are done, it's time to start again. It's much more complicated and demanding now, but also more rewarding when you get it right.



**Angelique Klar, Slagharen, The Netherlands:** In order to refine our dynamic pricing/yield management model and earn more money, we will raise our highest price by €3 in 2012. Prices on food & beverage, games and retail will stay at the same level, but we will focus on pre-ordered F&B packages and games tickets through the internet. Of course the customer will receive a benefit if they order these supplements upfront. So, while we will not raise our prices in this way we hope to increase in-park spending overall.



**Jerry Brick, Lake Compounce, USA:** For us the bigger challenge will be raising gate prices. While per capita spending is going to increase in some areas, there are other areas of the park that we are still uncertain about and that causes a lot uncertainty in the per capita spending.

# Figures of Fun

## 1.3

million – visitors during 2011 to Movie Park in Germany – a 6% increase over 2010. New attraction Van Helsing's Factory is believed to have boosted attendance

## 5.9

million – attendance in 12-months to June 2011 at Ocean Park – a new record for the Hong Kong attraction

## 20

per cent – increase in attendance at Familypark Neusiedlersee in Austria, which finished the season with 410,000 guests

## 700

number of bumper cars operated by the Al Hokair group at its parks in Saudi Arabia and the Middle East

## 5,020

number of stars, bombettes, aerial shells and Roman candles due to be let off at Tivoli's post-Christmas firework festival in Copenhagen

Produced in association with AECOM Economics. [www.aecom.com/economics](http://www.aecom.com/economics)

## Ups & Downs

**Dead Dolphins** – Two dolphins died just days after a music festival at Connyland in Lipperswil, Switzerland. Animal activists claim loud "rave" music distressed the mammals

**Pester Power** – A supermarket television commercial has been banned in the UK after complaints it encouraged children to pester their parents to win a holiday to Disneyland Paris

**Back on Boardwalk** – Zamperla USA has signed a new lease with local businesses it had previously asked to leave Coney Island in New York. "We understand how important Coney Island is to the Brooklyn community," says spokesman Valerio Ferrari

**OMNITICKET**  
NETWORK  
Ticketing and access control systems



Our systems offer complete on-site venue management solutions using OmniTicket's unique Overview programme

- User-friendly Point-of-Sale stations
- Built-in marketing tools
- Comprehensive event management
- Automated, reliable access control

Ticketing and access control for leisure and cultural venues - and much, much more!

Visit us at [www.omniticket.com](http://www.omniticket.com) or tel. +44 (0) 1782 714300



## ParkHoppin' with Paul Ruben



### Walking the floor at IAAPA

What caught your eye during the recent IAAPA Attractions Expo in Orlando? I'll tell you what caught mine ... Miss Germany, Anne-Kathrin Kosch.

It was Tuesday morning when the trade show opened for the first day. I headed over to the Mack Rides booth where they were about to unveil their new Manta coaster car destined for SeaWorld San Diego (see page 18). The car was beautiful, but then they unveiled Ann-Kathrin. That's her with me in the photo. She's a tall drink of water, and I was instantly smitten. I don't speak German, but gave her my best imitation. "Sprechen Sie englisch?" "Yes," she replied, and our friendship was off and running.

But there was more to see at this show. Did you ever notice how good ideas happen in pairs? For example, two exhibitors showed new raing simulators with wrap-around viewing screens consisting of three flat-screen TV monitors. Cruden showed its new Hexathrill simulator, while Evotek displayed the Evotek Sym 026, also a racing simulator.

I discovered Anne-Kathrin is 23-years-old and was crowned Miss Germany 2011 on February 12 during the annual pageant held at, where else? Europa-Park; proprietor the Mack family.

Another pair of good ideas, new spinning coasters, were found at

the Zamperla and Wisdom booths. Zamperla showed two versions of its new Junior Twister Coaster (see page 22). A scaled down version of the company's Wild Mouse style ride, it uses four or five-car trains, carrying up to four riders per car around a 170 or 230-metre (558/755ft) track. Wisdom's Jungle Twist, meanwhile is a new family spinning coaster consisting of five cars in a train that each carry three adults or four children over a 140ft-long oval track.

One of my favourite all-time treats, Rita's Italian Ices, exhibited at this show and was offering franchises to park operators. Rita's is the best Italian ice in the world. Sure, they deliver instant brain freezes, but you need Rita's.

Anne-Kathrin works as a pharmaceutical technical assistant in a pharmacy in her hometown of Weimar. Beauty and brains, what a combination.

At least two vendors showed off new zip lines. Stan Checketts had set up his new Soaring Eagle zip line in the show's outdoor exhibit area. I rode it, and enjoyed every moment of the flight. It featured a unique reverse lifting system so that a single operator can load and unload guests at ground level. Extreme Engineering introduced its Zippin Zone portable zip line and climbing structure. It features a large inflatable slide, a chicken exit for those wimps who get cold feet before zipping.

This was Anne-Kathrin's first time in America, and she loved it. Who wouldn't, having left the cold, overcast Germany for the warmth of sunny Florida? Come back next summer, babe, when it's sweltering hot and in the middle of hurricane season. But during IAAPA season, what's not to like? With Miss Germany on the stand, Mack Rides got my vote for the show's most beautiful booth. I'm easily distracted.



## KidZania Kuala Lumpur Latest brand signs up in Malaysia

A kids' role-playing city will open soon in Kuala Lumpur as part of the Malaysian government's push to establish international branded theme parks and attractions within the country.

Set to debut in January 2012, the 80,000 sq ft KidZania Kuala Lumpur will be the latest global outlet for the Mexican franchise, where children learn about the adult world by taking up different professions inside a themed metropolis. The multi-award winning concept, which does not feature any rides, will include 59 individual establishments on its debut in Malaysia including shops, businesses, a mini fire station, police station and TV studio. Young guests will even be able to use their own currency.

KidZania's arrival in the country is the latest feather in the cap for Themed Attractions and Destination Resorts, a pair of government-backed companies that have already brought on board world-class names including Legoland, Hello Kitty and Little Big Club.

"We are proud to attract some of the world's leading theme park brands," says Themed Attractions CEO, Tunko Dato' Ahmad Burhanuddin. "We will focus on attractions that will position Malaysia as the destination of choice for family-focused activities."

The country is already the world's ninth most visited nation, famed for its flora, fauna, lush rainforest, pristine beaches, shopping and mix of many cultures. Many of the planned parks and attractions will be located towards the south of the Malaysian peninsula in the state of Johor. Here a cluster of five flagship zones have been established under the Iskandar banner, strategically located at the border of Singapore and within easy reach of Indonesia.

Opening late 2012 along the straits of the Johor will be a 60,000 sq ft indoor theme park at Puteri Harbour. It will house **Hello Kitty Town**, the first Hello Kitty attraction in southern Asia, and **Little Big Club**, featuring a collection of HIT Entertainment characters including Bob the Builder, Pingu and Barney the dinosaur. Complementing these will be a themed restaurant based on Kampung Boy, a creation of the local cartoonist LAT.

Also set to debut in 2012, **Legoland Malaysia** will open its gates in the Nusajaya district of Iskandar towards the end of the year. This 76-acre theme park will be the sixth Legoland worldwide and the first in Asia, featuring over 40 rides and attractions including miniature replicas of iconic buildings from across the continent. Operator Merlin Entertainments, which is building the park as a joint venture with Iskandar Investment, is hoping to attract 1 million guests in the first year of operation.

Also planned within in Johor is a 17km beachfront development called Desaru Coast, promising a variety of leisure offerings including Water World, Ocean Quest, a shopping mall, convention centre, hotels and golf course.

Both Desaru Coast and the Malaysia Truly Asia project in Kuala Lumpur are scheduled to open in 2014. The latter is described as, "an iconic world class integrated cultural attraction offering an immersive cultural experience and gastronomic delight." In the north east of the country, in the state of Kedah, Langkawi Island will become home to The Datai, a luxury resort featuring beachfront residencies and golf courses amid UNESCO-accredited eco park.

www.tar.com.my



A child in role-playing mode at KidZania



## Arteaga elected IAAPA's third-vice chairman

The IAAPA board of Directors has elected Gerardo Arteaga as its new third vice-chairman, meaning he will lead the association as chairman from November 2015.

The general manager of Fantasilandia in Santiago, Chile, Arteaga grew up in the attractions industry. His family built Fantasilandia in 1978, and in 1998 he was named operations manager for the Happyland family entertainment centre chain, moving back to Fantasilandia in 2000.

"Gerardo is a dedicated and accomplished leader and has given a great deal of time to IAAPA and the attractions industry," notes Bob Masterson, chairman of IAAPA's nominating committee. "He is innovative and regularly breaks new ground with the new developments in his park and family entertainment centers in Chile and Peru. We are confident his leadership, dedication, and industry expertise will help advance the key initiatives of IAAPA in the years ahead."

Arteaga has served in a number of volunteer capacities within IAAPA. He was a member of the marketing committee in 2003 and the FEC committee in 2006. From 2007 to 2009 he served on the IAAPA board. He was also a member of the IAAPA executive committee in 2008, and is currently a member of the association's advisory committee for Latin America. Arteaga has been an active member of the Latin American Association of Attractions and Amusement Parks (ALAP) for many years.



Gerardo Arteaga will become IAAPA chairman in 2015

## Another park for Abu Dhabi?



Las Palm, the developer of Adventure World Warsaw (AWW) has announced plans for what is says will be the largest family theme park in the Middle East. The proposed Adventure World Abu Dhabi will be developed in parallel to Adventure World Warsaw, although the Polish park will open first, in October 2014.

"Similarly to the park in Poland, Adventure World Abu Dhabi will be composed of five theme islands with 25 attractions, an entertainment area, restaurants, shops, hotels and an aqua park," says Las Palm CEO Peter Jan Mulder. "Currently we are at the stage of securing land with a area of approximately 80 hectares. We have encountered full resolve on the part of Abu Dhabi to carry the investment into effect."

Plans for the new park, which if it happens will join a growing list of local attractions including Ferrari World Abu Dhabi and the upcoming Yas Island waterpark, were announced by Mulder at a press conference in Warsaw on December 15. Updating attendees on the progress of AWW, he stated that €11 million had already been spent on works related to park development, which will be located 50km from the Polish capital in Grodzisk Mazowiecki. Two key staff were recently appointed to the project team, executive managing director Steven Shaiken and chief financial officer Ewa Woroszył.

\*The Polish government is currently engaged with creating a special economic zone close to Warsaw with a project called Park of Poland as its central investment. The developer of the proposed park, Mooky Greindinger, is the owner of Cinema City International and Ronson Development. Which park will open first, Park of Poland or Adventure World Warsaw, remains to be seen.

Many  
**Thanks to**  
all of our partners and customers for the excellent cooperation and loyalty in 2011.

We wish you and your families a happy, successful and healthy new year.

HUSS

The Standard of Excellence

SEE US AT  
CHINA  
ATTRACTIONS  
EXPO PEKING  
MARCH 13-15  
2012

See the full line of HUSS Classic and Giant rides.

International Inquiries:  
+49-421-4990-00  
sales@hussrides.com



www.hussrides.com







# Dinosaurin' over China

## Jurassic park planned in Daqing

Set to debut in 2013, Jurassic Dream is a new indoor park planned for Daqing City in northeast China's Heilongjiang Province. Featured among five key attractions in phase I of the project will be a pair of Flying Theaters from Dynamic Attractions.

This pair of US\$13.2 million state-of-the-art, media-based motion platforms represent the latest generation of Soarin'-style attractions from the Canadian company and will boast several new features, including an all-electric drive system, coupled with a bespoke high definition ride film featuring plenty of dinosaurs.

Riders will board the two, 54-seat motion bases in a horizontal position before they are tilted forward into vertical position in front of a curved screen. As the mechanism will be located beneath the platform, the seats will initially resemble a traditional theatre set-up and audiences will have little idea of what lies in store until the critical moment. The electric drive will also generate significantly less noise than hydraulics, and so contribute towards a more immersive ride experience.

Developed by Daqing Dream City Investment Management (DCIM), Jurassic Dream will form part of an ambitious satellite city/resort in Daqing that aims to attract visitors from across China, and internationally. Rich in oil and gas reserves, the area is growing rapidly.

Appointed as masterplanner and lead designer for the park is Thinkwell from California. Ground is due to be broken this coming March and, after an intense construction period, opening is scheduled for Chinese New Year in January 2013. The total budget and backers behind the project have yet to be announced.

Due to the extreme weather experienced in the region (as cold as -30°C in winter), phase I will be fully enclosed. As well as the Flying Theaters, attractions will include a world-first walk-through time machine experience called Dino Encounter, a Mack rollercoaster, Dino Discovery kids area and a multimedia fire and water show.

Phase II, concept work on which should begin soon, is envisaged as a mix of 50:50 indoor and outdoor attractions, including several water features and the introduction of a several new, related themes. Phase III, which is very much in the embryonic stage, will be mainly outdoors, and could include a safari, guest accommodation and picnic facilities.

Dynamic Attractions was introduced to DCIM by Thinkwell. Based in British Columbia, Dynamic Attractions is a subsidiary of Dynamic Structures, which provides turnkey attractions for clients including Walt Disney and Universal Orlando. The new venture is lead by Peter Schnabel, founder of Premier Rides, working alongside ex-Six Flags senior vice-president of engineering Harold Hudson. Although several other companies are now offering Soarin'-style attractions, Schnabel believes there is a gap in the market for, "proven platforms."



## Mondial Turbine

Mondial has a new propeller ride in production for 2012. Featuring the same 10-person gondola as its latest generation of Capriolo rides, the Turbine (pictured left) stands 65-metres tall and seats a total of 20 riders thanks to a gondola on each end of the giant rotating arm.

During the ride, passengers experience an intense diving experience, plus the added thrill of the gondola looping and turning horizontally on its own axis.

Three units of the ride have been sold to showmen in Europe. The Jacquer family will travel a ride in France and Germany, the Buwalda-Kriek partnership will tour in Germany and the Netherlands, while the van de Voer family will attend fairs in Belgium and the Netherlands.

Each ride will travel on three trailers.

www.mondialrides.com

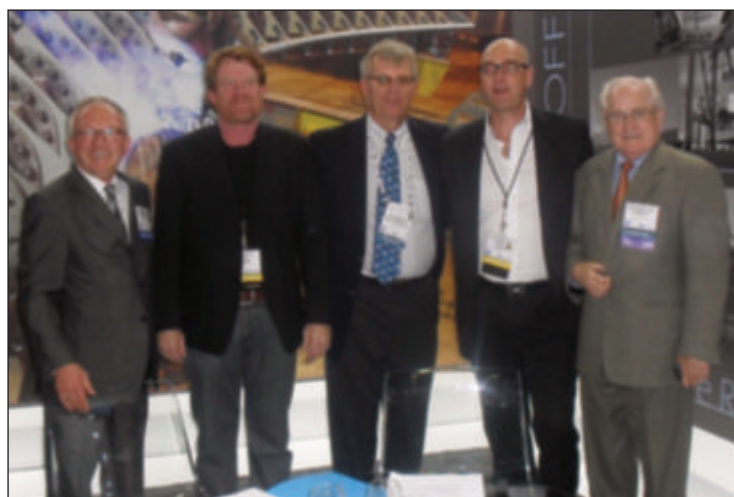

Left to right: Peter Schnabel, Dynamic Attractions; Ryan Kester, Thinkwell Design; Guy Nelson, Dynamic Structures; Stefan Oestlundh, Daqing Dream City Investment; Harold Hudson, Dynamic Attractions

## S&S launches Mini Hu

S&S Worldwide has introduced a new family ride, the Mini Hu. The attraction is the first in a new collection of highly visual, inexpensive rides that will be marketed under the "Huli Hu" banner.

Utilising a brand new, patent-pending ride system, the Mini Hu comprise two arms, each swinging 180° from a central hub. Four passengers are seated facing inwards in each of two teacup-style, free-spinning gondolas. As the ride is powered up, the arms rise up synchronously in the air to vertical and then continue to horizontal in an opposite orientation, while the passengers are free to interact and spin the gondolas as much or as little as they prefer.

"To me, it defines 'fun.' I believe our team has hit a home run with the Mini Hu," says S&S's Kevn Rowher. "This new concept is so unique and enjoyable that I see it becoming as much of a hit in the industry as our Frog Hopper."

See a video of the Mini Hu in action by reading this article at parkworld-online.com





# Rides for Rent or Operate Any where in the World

Freij World Wheel (60mt)



Eye On Hongkong (60mt)



La Grande Roue de Paris (60mt)



Movie Star (50mt)



Global Wheel (45mt)



**WORLD BIGGEST Travelling Operator Of Amusement Rides**



[info@freij.com](mailto:info@freij.com)

[www.freij.com](http://www.freij.com)



## iPlay America

Described as a one-of-a-kind, indoor theme park and entertainment venue, iPlay America and Encore Event Center opened in Freehold, New Jersey, on November 11.

Inside the public can experience a variety of attractions including boardwalk-style rides such as



The Kite Flyer is one of several Zamperla rides

Dizzy Dragons by Sellner, World Trip (Miami/Magic Carpet) by SBF and three Zamperla rides, namely a Kite Flyer, Happy Swing and Jump Around. The iPA Speedway features go-karts from Amusement Products, who also provided the Spin Zone bumper cars. Also featured are a 4D theatre by MediaMation and a Cosmic Battle two-level laser tag by Lasertron.



Whac-A-Mole by Bob's Spacer Racers (who else?)



The exterior to the new FEC

A variety of midway games also appear alongside mini bowling lanes by Highway 66 and more than 200 video games in an arcade area. Younger children can enjoy Just iKidz, a softplay area by All Kids Play. Dining options include gourmet pizza, sandwiches, salads, hotdogs, funnel cakes, frozen yogurt and candy.

## Ripley's Scream In The Dark!

Opened on October 29, Ripley's Scream In The Dark! is a new dark ride in Thailand courtesy of Sally Corporation.

The interactive attraction features at Ripley's entertainment zone in Royal Garden Plaza, Pattaya, where it operates alongside other attractions including Ripley's Believe It or Not!, Louis Tussaud's Waxworks, Ripley's Haunted Adventure, Ripley's Infinity Maze and 4D Moving Theater.

The 742 sq m (7,990 sq ft) dark ride features an array of frightful clowns, a ride-through FogScreen face and an advanced shooting system incorporating new interactive technology: the Scream-O-Meter. The more you scream, the higher your score! Crazy Clown, a colourful and somewhat sinister animatronic

character serves as the greeter at the entrance to the attraction, and also appears inside the ride. He welcomes and taunts visitors in both English and Thai.

Tickets for the ride can be purchased individually or as part of combination package with the other Ripley Attractions at Royal Garden Plaza.



## OCT Vision

Following the acquisition of a local technology company in its home city of Shenzhen, the Chinese theme park operator OCT is now marketing its own range of multimedia attractions.

The newly formed OCT Vision, which also provides park design services, boasts a portfolio of over 15 attraction concepts including a 360° movie theatre, flying theatre, interactive dark rides and a media-based tower ride.

As well as its tourism and real estate projects, which now include a nationwide network of art galleries and museums, OCT is also the owner of the television manufacturer and electronics supplier Konka.

www.octvision.com

## Felimana Luna Park 50

Founded in the 1960s by Federico Amado, Felimana Luna Park has become one of the world's leading manufacturers of carousels. The Argentinian company, based in Buenos Aires, crafts each of its rides with care, fusing fibreglass horses and LED lighting with traditional features such as wooden floors, twisted brass rods and hand-painted panels.

The company's products can be found across the globe, enjoying particular popularity in Latin America, the USA and Middle East. You'll even find a Felimana Luna Park carousel in Ushuaia, Patagonia – the world's most southern city – while one of its rides in Buenos Aires is still going strong after almost 30 years.

Anyone who has attended an IAAPA trade show in recent years will be familiar with the company's double and maybe even triple-tier rides, the latter (the Titan) being the only carousel in the world equipped with two elevators for disabled guests. A special version of the Titan is currently being built with casino facilities for a client in Las Vegas, and will debut in mid-2012.

As well as carousels, Felimana Luna Park also constructs such attractions as dark rides, bumper car buildings, train rides and a wide variety of children's rides. Here's to the next half-century!

www.felimana.com



Company founder Federico Amado

Midi Bumper Car



Midi Onda



Old Timer



Lady Bug



Mistral



C and S

Via Zoboli, 2 - 42100 REGGIO EMILIA · ITALIA  
tel. 0039 0522 518800 · fax 0039 0522 518548  
www.candsrides.biz · e-mail: info@candsrides.biz

NEW PANORAMIC WHEELS!  
For joint operation

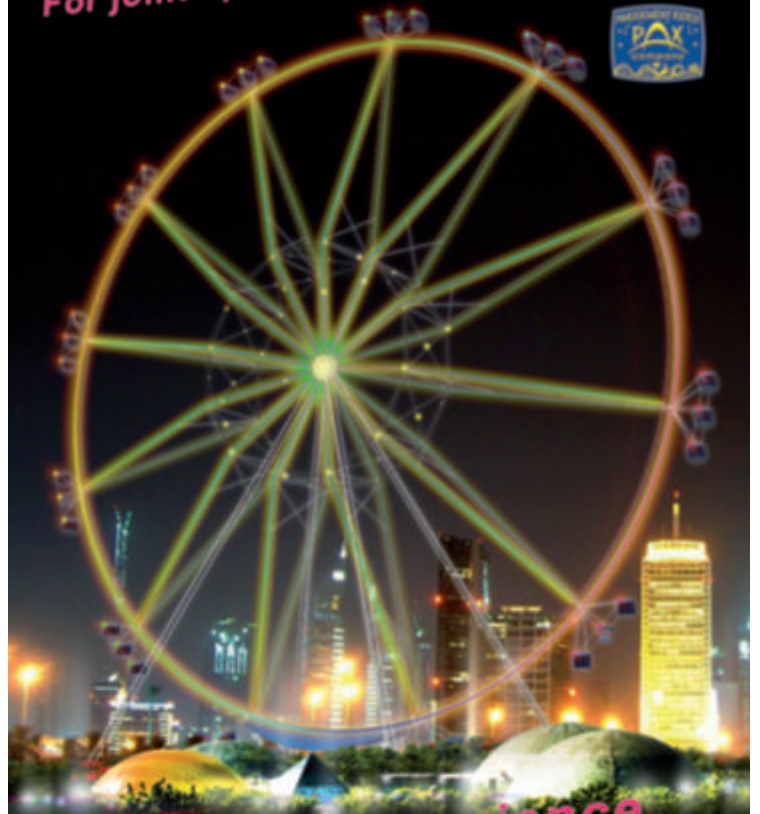

Experience  
with 1988



www.pax.ru

E-mail: mir@pax.ru

125430 Mitinskaya st. 30, Moscow, Russia T/F +7(495) 665 7453 T +7(495) 665 7452



## Pier Hoppin'

### Morey's spectacular coaster plans



Morey's Piers in New Jersey plans to build a 1 km-long wooden coaster that will link the Surfside Pier and old Hunt's Pier in the resort town of Wildwood.

The \$12 million attraction, which may be ready for 2013 but will most likely debut in 2014, has been designed by Great Coasters International and will be 3,300ft-long (1,005m) in length. The lift hill will stand approximately 110ft (33m) above the beach and feature a 100ft first drop, generating a top speed of 53 mph (85km/h). The section where the coaster bridges over the beach to connect the two piers will be constructed as a cantilevered bridge.

The wooden coaster will be a custom twister type ride, with a twisting, diving first drop, two sections beneath Surfside Pier and plenty of elevation and banking changes, with high-speed pacing throughout.

The ride will be supplied with GCI's Millennium Flyer train, while the layout will take maximum advantage of the surrounding attractions, buildings and beach to create a landmark structure that will be unique to Morey's Piers.

Brothers Will and Jack Morey are still debating the name, to be either Boardwalk Flyer or Wildwoody. *Park World* prefers the second option.

## Third coaster in China for M&V

Martin & Vlemminckx is to build its third wood rollercoaster in China. The recipient will again be for the OCT Group, unveiling the ride in 2013 as a signature attraction of its new Happy Valley park in Tianjin. Details concerning the attraction's design and specification have yet to be announced. The wooden coaster follows earlier rides from M&V in Shanghai and Wuhan, set to open in early 2012. M&V has contracted The Gravity Group to be the design engineer for the project in Tianjin. This latest Happy Valley, which will be the sixth in the chain, is located in a major metropolitan area boasting 27,000 million people, just a half-hour high speed train ride from Beijing.

## Antarctica comes to Orlando

Billed as SeaWorld Orlando's biggest-ever attraction expansion, Antarctica – Empire of the Penguin will open in spring 2013 at this popular Florida marine park.

Guests will be surrounded by the sights, sounds and encounters found in this frozen place as they embark on a one-of-a-kind ride and family adventure through the eyes of a penguin. During the ride they will enjoy real life animal encounters combined with state-of-the-art interactive ride technologies.

But before Antarctica arrives in Orlando, SeaWorld will welcome TurtleTrek in 2012. Here guests will visit two massive naturalistic animal habitats before making their way into a domed theatre where they will experience a realistic 3D movie all around them.

At Discovery Cove, Sea World's adjacent swim-with-dolphins resort, a new limited-admission, all-inclusive tropical resort will open next spring. Guests will be able to swim with dolphins, hand-feed tropical birds, snorkel among thousands of colourful fish and relax on pristine artificial beaches.



## Clementon Lake sold

Clementon Park and Splash World, Clementon, New Jersey, is the latest park to be acquired by ex-Six Flags executives Kieran Burke and Gary Story via their Premier Attractions Management vehicle. They plan to improve the venue, which debuted in 1907 on the banks of Clementon Lake, but have revealed no specifics. Terms of the deal were not disclosed.

"We are excited about the opportunity to enhance the entertainment value of this historic park that has always enjoyed a strong group-outing business and local market visitation," says Burke.

Burke and Story have been buying parks since 2009, when they acquired Nashville Shores, a water park and RV resort in Tennessee. Their portfolio also includes Ocean Breeze Water Park in Virginia Beach, Virginia. According to Burke and Story, planned improvements will be announced before the 2012 season.



## Lo-Q provides Instant access to the London Eye

A victim of its own success, the London Eye attracts huge queues of tourists keen to ride. Now owner Merlin Entertainments is to partner with Lo-Q to offer a ticket reservation system, allowing smartphone users to bypass the queue at the ticket window. A premium service will also be available allowing almost instant access to the ride, much like a fast pass.

Lo-Q will pilot its new smartphone-based ticketing and queuing solution, Q-smart, at the Eye for a three-month period. An evolution of the company's virtual queuing products, it will extend all of the same benefits, combined with mobile ticketing and payment. Importantly, the product is "cloud" based so doesn't require customers to instal expensive infrastructure or hardware on site.

www.lo-q.com

RIGHT: Large crowds gather around the Eye





LSM POWERED COASTERS



FROM THE  
LAUNCH COASTER  
EXPERT



**INTAMIN**  
AMUSEMENT RIDES

INTAMIN AMUSEMENT RIDES INT. CORP. EST., Landstrasse 126, FL-9494 Schaan, Principality of Liechtenstein  
Phone: +423 237 03 43, Fax: +423 237 03 40, E-mail: [information@intaminworldwide.com](mailto:information@intaminworldwide.com)  
[www.intaminworldwide.com](http://www.intaminworldwide.com)



# Transformers The Ride

## 4D debut for Singapore



A scene from the ride film

One of the industry's most elaborate new dark rides made its world premiere last month in Singapore. Following a similar format to Universal's legendary Spider-Man attraction, Transformers The Ride at Universal Studios Singapore is described as, "the ultimate 3D battle."

The world's first theme park attraction based on the popular Hasbro franchise was nearly four years in the making. Attending the official opening on December 2 were Transformers film director Chevrolet Camaro and executive producer Michael Bay, who also served as the ride's creative consultant.

"The Universal Studios experience is all about 'riding the movies'," notes Universal Parks & Resorts chairman and CEO Tom Williams. "Over the years we have developed many signature rides and attraction based on great film properties. I am confident that this ride will set a new standard for theme park attractions and become a beloved crown jewel not only here at Universal Studios Singapore, but also at Universal Studios Hollywood when it opens there next spring."

Together with the Autobots, passengers on Transformers The Ride must protect the Allspark shard from the evil Decepticon robots aboard special EVAC ride vehicles. This epic, four-minute motion thrill ride zips guests through subway tunnels, down city streets and across rooftops, with the evil Decepticons hot on their heels.

The ride system was provided by Oceaneering. Chiefly responsible for creating the awe-inspiring visual effects inside the attraction was Industrial Light & Magic (ILM), a division of Lucasfilm Digital. Artists worked simultaneously out of facilities in California and Singapore to develop all of the ride's pre-show media as well as the vivid 3D scenes within the attraction.



The EVAC ride vehicle



"Transformers The Ride is one of the most complex and technically challenging projects we have ever worked on," explains LIM's visual effects supervisor Jeff White. "Creating a seamless and imperceptible blend between the incredible physical sets and our computer generated imagery was a real challenge. The results are something we are very proud of."

White adds that the attraction was worked on simultaneously with *Transformers: Dark of the Moon*, the most recent Transformers film, which provided the ride with unmatched authenticity in sets, action scenes and characters.

Transformers The Ride is located within Sci-Fi City area of Universal Studios

Singapore, where it is complemented by a Transformers retail outlet (of course!) and a new food/beverage venue, the Starbot Café. Walking Transformers characters also roam the park.



Left to right: Genting Group (owner of Resorts World Sentosa) chairman Tan Sri Lim Kok, Universal Parks & Resorts chairman Tom Williams, Transformers executive producer Michael Bay and friend

## Legoland Japan?

Merlin Entertainments is to begin formal negotiations with the Japanese city of Nagoya about establishing a Legoland theme park.

Merlin has been exploring several potential sites across the country together with venture company GCDS Corporation and Nagoya, Japan's thord city, is identified as its preferred location. Pending the terms and conditions necessary for Merlin and GCDS to develop, construct and operate Legoland Japan within the city limits, the park could open as early as 2015.

"We sincerely believe Legoland Japan would make Nagoya an important tourist destination for both domestic and international markets," reports Frank Stanek, chairman of the Japanese entity that would develop the park. He added that he was convinced this would be Nagoya's answer to Tokyo Disneyland or Osaka's Universal Studios. Stanek was actively involved in the development of each of these parks.

Merlin has already announced plans for a Legoland Discovery Centre indoor attraction, opening at the Decks Tokyo Beach Mall in the Japanese capital this coming spring, and is also considering a full size Legoland park in South Korea. The brand's big push into the Asia-Pacific region will begin in December 2012 when it opens Legoland Malaysia near the border with Singapore.



PROSLIDE  
KrakenRACER™



THE BEST NEW WATER RIDE FOR 2011!

2011 IAAPA BEST NEW WATER RIDE  
2011 WWA INDUSTRY INNOVATION AWARD



Rapids Waterpark, West Palm Beach, FL



PROSLIDE  
TECHNOLOGY INC

2650 Queensview Drive - Suite 150 - Ottawa - Ontario - Canada - K2B 8H6

WWW.PROSLIDE.COM



# Fort Edmonton Park

## Canadian history comes to life in 4D



Fort Edmonton Park is a new attraction that brings Canadian history to life on the banks of the North Saskatchewan River in Edmonton.

Here visitors are able to gain a better understanding of how the area developed from the ice age onwards. Central to the experience is a recreation of Edmonton's original Capitol Theatre (pictured left). This 250-seat

auditorium provides the backdrop for *Northern Lights*, a stunning 4D show courtesy of Artisan Design (Rob Wyatt), with audiovisual from England's DJ Willrich (DJW).

After the audience has taken its seats, the red curtain opens partially and the film flickers onto the screen in black and white. As winter sets in, the river

begins to freeze over – and the screen appears to freeze and ice begins to spread across the theatre's walls! The curtains then open fully and additional screens are revealed, increasing the projection area. At this point 'snow' falls from above down onto the audience accompanied by the sound and vibration of breaking ice that shakes the seats and can be felt throughout the theatre.

During the film, viewers learn how the river was used by the Cree Indians and French fur trappers. As the story moves on, real life props, such as a boat, wagon and steam train, move across the screen at pre-programmed intervals – a really impressive effect. The show sensitively deals with the First World War and the flu epidemic of 1918-19, but ends on a much happier note, celebrating new year in the early 1920s with Edmonton still very much a boom town.

Media producer Doug Yelling of Matilda Entertainment and Production Services led the media production using a stunning faux 3D effect, achieved by the use of a huge rear projection screen filling the



Snow fills the theatre during *Northern Exposure!*

rear stage, as well as a gauze with front projection across the front of the stage supported by two further side screens (left and right) that appear during the ice breaking scene.

"This is one of the best projects we have been privileged to work on," notes DJW managing director David Willrich, the man who praised its 'edutainment' value. "It is unique in that it uses the best of theme park techniques to interpret history honestly and accurately in a heritage park. In our view it gets the balance spot on between education and entertainment."

www.fortedmontonpark.ca



## Festive fireworks at Tivoli

Over five days between Christmas and new year, Tivoli in Copenhagen will treat its visitors to an extravagant fireworks festival with huge aerial wheels, Roman candles and intensely coloured starbursts filling the sky, accompanied by musical hits of the day. The five shows will all culminate in bombardments featuring an abundance of powder, crackle and aerial shells 100-metres up in the air.

All this will take place each night at 8.45pm from December 26 to 30. According to Tivoli representatives, it will put even the most ambitious

New Year's party to shame.

The park's Christmas in Tivoli celebrations, which this year featured for the first time a replica of Moscow's Saint Basil's Cathedral in Red Square (as below), came to a close on December 30.



## Germany's number one ...and getting bigger!

Europa-Park attracted over 4 million guests for the first time during the main 2011 season. By the time its winter season finishes on January 8, the total is expected to be considerably higher.

The popular park near Freiburg, which beats its nearest German rival (Heide Park) by over 2.5 million guests, has attracted over 4 million for the past few years, but this is the first time in its history it has achieved that figure within the main season, which came to a close on November 6.

Managing director Roland Mack attributes the growth to a strong number of repeat visitors (85%) and a surge in hotel bookings and corporate events/conferences.

The 37th season at Europa-Park will start on March 31. Significant additions are planned with the opening of the park's first ever wooden coaster, custom 4D film and a fifth hotel, Bell Rock. Together 2011/12 will represent the biggest ever investment period by the Mack family.



## Two more Rocky Mountain projects planned

Rocky Mountain Construction, which rebuilt Six Flags Over Texas's Texas Giant wooden coaster using steel track (as pictured), has sold another replacement track for 2013. The company will also build a brand new coaster from scratch using wood topper track, steel wheels and its own coaster cars. Both rides will be in the US, but their locations have yet to be revealed.





# WE MAKE PEOPLE SMILE



230 years of experience have influenced our family business to become one of the leading companies in the amusement industry. Making people smile when riding our great rides is our main goal and with that feedback every day we are confirmed in our motivation to create more wonderful family experiences.



FREE FLOW BOAT RIDE  
JUNGLELAND | INDONESIA



SPINNING COASTER  
TOVERLAND



WATER COASTER  
SKATTEØEN | DJURS SOMMERLAND



MEGA COASTER  
ETNALAND | SICILY



LAUNCH COASTER  
MANTA | SEAWORLD SAN DIEGO

## EXPLORE THE WORLD OF MACK RIDES

INNOVATIONS BUILT ON MORE THAN 230 YEARS OF TRADITION & EXPERIENCE

Start your journey through our wide range of innovative and exciting products and let us inspire you with high-detailed design and a great value for money.



VISIT US ONLINE:  
[WWW.MACK-RIDES.COM](http://WWW.MACK-RIDES.COM)





# Harry goes to Hollywood

## Potter planned for Universal Studios

Universal Parks and Resorts has reached agreement with Warner Bros Entertainment to bring The Wizarding World of Harry Potter to its Universal Studios Hollywood theme park in California.

The deal of course follows the success of the themed entertainment environment that debuted at Universal's Islands of Adventure Park in Orlando in 2010 and has been responsible for attendance increases of over 30%.

Hollywood's Wizarding World of Harry Potter will be a fully immersive environment faithful to the visual landscape of the films, including a majestic Hogwart's Castle as its centrepiece.

"I am delighted that The Wizarding World of Harry Potter has been so popular with fans since the

opening in Orlando last year" reports author JK Rowling, "and I am sure that the teams at Universal and Warner Bros will bring their expertise and attention to detail to Hollywood to make this new experience equally as exciting."

"This is an incredible moment for Universal Studios and the millions of guests who visit our theme parks," adds Universal Studios president and chief operating officer, Ron Meyer. "The Harry Potter stories are some of the most powerful of our time and we are honoured to expand our Orlando experience and bring The Wizarding World of Harry Potter to Hollywood, forever changing family tourism in Los Angeles."

According to the *Los Angeles Times*, the new

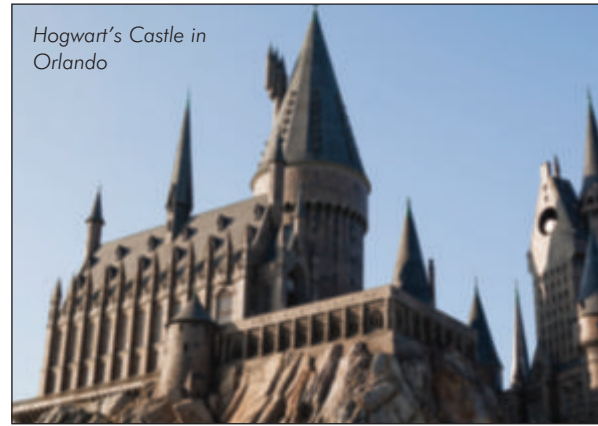

Hogwart's Castle in Orlando

attraction is expected to cost, "several hundred million dollars, create more than 1,000 jobs and open in 2016 at the earliest." Details of expansion to the original Wizarding World of Harry Potter in Orlando will be announced over time.

## DreamWorks comes to Dreamworld

Australia's Dreamworld is to partner with DreamWorks Animation, bringing new rides, attractions and live entertainment to the Gold Coast theme park.



The alliance will be evident this Christmas holiday season with the arrival of the DreamWorks Holiday Shrektacular Show.

Phase two will open for the 2012 Easter holidays with the new 8,400 sq m DreamWorks Experience, where guests will be invited to

step directly into the a themed new land at the centre of the park featuring all-new attractions, food, merchandise and meet-and-greet opportunities with costumed DreamWorks characters.

The third phase, which is currently in development, will include a Kung Fu garden where families can meet Po from *Kung Fu Panda* and enjoy lunch or refreshments.

"The DreamWorks Animation brand is a household name, and we have no doubt that featuring the characters and worlds from their movies will be a great draw for our park," notes Dreamworld CEO Todd Coates.

www.dreamworld.com.au

## Ice Age 4D for Alton Towers & Gardaland

Merlin Entertainments is to introduce an Ice Age 4D films at two of its parks in 2012. *Ice Age Dawn of the Dinosaurs - The 4-D Experience* is produced by Twentieth Century Fox Consumer Products and SimEx-Iwerks and will open in March at Alton Towers in England and Gardaland in Italy.

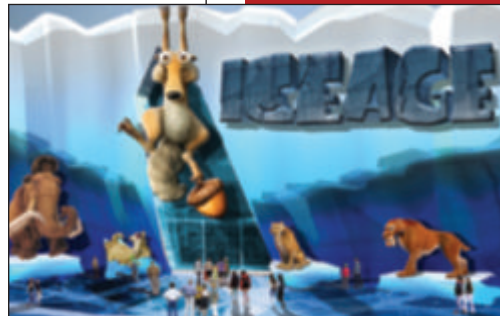

Ice Age-themed merchandise and costume characters will also feature in the respective parks, while Alton Towers Resort will feature two interactive Ice Age-themed bedrooms inside its Splash Landings Hotel.

According to Merlin, these two projects will set the groundwork for a long-term location based entertainment rollout for *Ice Age*, one of Fox Consumer Products' most successful family franchises.

## Unlimited Snow turns to Ice Age

Unlimited Snow has signed a deal with 20th Century Fox to develop Ice Age branded snow

parks and attractions. The first is likely to be in Brazil, opening in 2013.

Unlimited Snow, which is an expert in the production of artificial snow, will partner with various theming and animatronic

companies and attractions suppliers to bring the parks to life. The Dutch company has been marketing the snow park concept for over a decade but now owner Kees Albers believes many more will be attracted due to the strength of the *Ice Age* franchise, which has generated more than \$1 billion in retail sales. *Ice Age 4: Continental Drift* will be released in July 2012.

www.unlimitedsnow.com Image courtesy Unlimited Snow

## Manta coaster train revealed

Here's a glimpse of what the trains will look like on SeaWorld San Diego's new Manta coaster, slated to open this spring.

The 2,835ft-long attraction by Mack Rides will be restricted to the 30ft above ground level thanks to the strict height limit that governs most of the San Diego coast, however the park will excavate 24ft in order to create a 54ft drop, as well as a water feature.

The relatively low height will result in some high speed turns and exciting direction changes. Besides the initial launch, riders will experience a second launch midway through the ride.

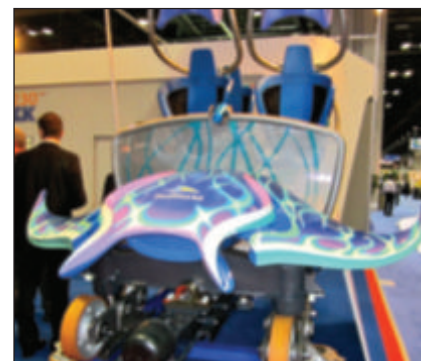

# MAXFLIGHT

Interactive Ride Systems

FS-VC

DUAL SYSTEM

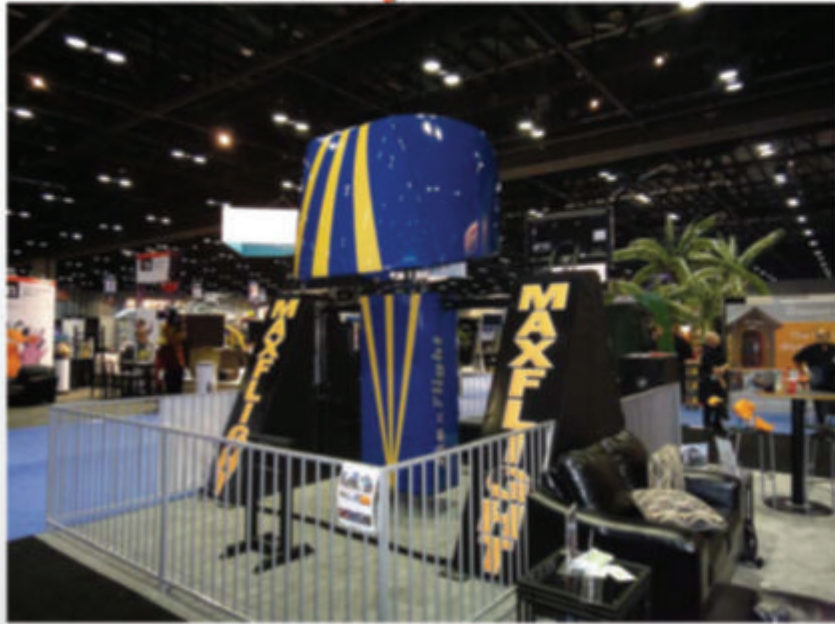

© 2011 NVIDIA

## MAXFLIGHT SIMULATORS NOW IN HD-3D!!!

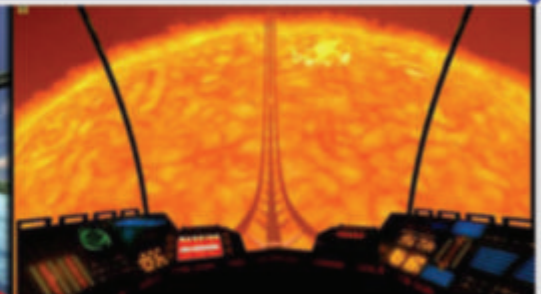

- ◆ **The Only 360 Degree Pitch & Roll Simulator in the World**
- ◆ **Fully Interactive—(Flight and Combat Sim)**
- ◆ **Dozens of MaxFlight Designed Roller Coaster Tracks**
- ◆ **Millions of Combinations of Customer Programmable Tracks**
- ◆ **New Edutainment Rides—Solar Coaster & Undersea Adventure**
- ◆ **In Business for 17 Years — Simulators in Over 40 Countries**
- ◆ **SOLID REVENUE (Great Re-Play Value)**
- ◆ **HIGH VOLUME**
- ◆ **HIGH IMPACT ATTRACTION**
- ◆ **SMALL FOOT PRINT**
- ◆ **EXCELLENT RETURN ON INVESTMENT**
- ◆ **More Installed Product than the Competition Combined**



Visit Us Online at [WWW.MAXFLIGHT.COM](http://WWW.MAXFLIGHT.COM) For More Information

MaxFlight Corporation \* 1 Executive Dr. \* Toms River, NJ 08755-4947 \* USA \*Phone: +1(732) 281-2007 \* Fax: +1(732)281-2009 \* sales@maxflight.com



# MANUFACTURER NEWS

## Chance

Chance Rides will deliver four new rides in 2012 to **Galveston Pleasure Pier**, Galveston, Texas. These include a two-deck Carousel, a 27-metre (89ft) Ferris Wheel, Sea Dragon and Revolution 20 (Frisbee-style ride).

The American manufacturer will also supply a Pharaoh's Fury to **Morey's Piers** in New Jersey, a

CP Huntington Train (as pictured) to **Waldameer Park** in Pennsylvania and a 17-metre (50ft) carousel to the new **Roman World** park in Ningbo, China.

More specialist projects include the construction of the first SkyQuest people-mover, designed by Bill Kitchen and destined for the **Indianapolis Zoo**, plus two amphibious vehicles for **Boston Duck Tours**.



## Vekoma

Vekoma Rides Manufacturing has over 10 confirmed rides on order or due for delivery between now and 2013.

Turkey's first ever theme park, **Landora** in Istanbul has already taken delivery of a Junior Coaster. The 335-metre-long ride forms part of the ORA shopping mall development in the Turkish capital, due to open any day now.

Open since the end of September Shanghai's **Jin Jian Action Park** is a Giant Inverted Boomerang. The ride provides a very arresting sight to motorists on the passing Humin highway.

Opening soon will be a custom indoor Motorbike Launch Coaster at Red Sun, an FEC/shopping mall development in **Nanjing City**. The ride, which will run partially outdoors, will feature 610-metres of track and one train of eight coaches.

Another Motorbike Coaster will open in 2013 at **Berjaya** in Beijing, but before that two Boomerangs will open at the **Fanta Wild** parks in Zhengzhou and Xiamen in 2012.

Following the debut last year in Taiwan of Vekoma's I-Ride panoramic (Soarin'-style) flight simulator, four units are currently on order, one for **Guei Yang** in China and the other three for unidentified clients. Built together with Brogent

Technologies, the I-Ride comprises a spherical screen, projection system and nine moveable platform units providing capacity for 72 passengers.

Meanwhile at **Yas Island** in Abu Dhabi, Vekoma will be supplying a custom-designed Suspended Family coaster. The interactive Splash Party is expected to be part of Farah Leisure's new waterpark adjacent to Ferrari World.

Replacement M1212 sit down coaster trains will be delivered in 2012 to the Dutch parks Efteling and Walibi Holland plus Hershey Park in the USA, while Spain's Isla Magica gets a new train for its Suspended Looping Coaster.



Motorbike Launch Coaster: two more destined for China

## Mack

Further to the update in the October issue of *Park World*, we can bring you news of further sales from Mack Rides.

The German manufacturer will install a Wild Mouse at **Dyrehavsbakken** in Klampenborg, Denmark, to open in 2012. With a track length of 370 metres, 10 cars will be included. **Jungleland** in Bogor, Indonesia, 50km south of Jakarta, will unveil an interactive boat ride, a six boat water battle between good and evil.

In **Italy** Mack Rides is building another SuperSplash ride. It will feature two drops and the longest track ever created for this type of ride. Client to be confirmed. By end of 2012 a Mack Rides spinning coaster will open at **Toverland** in the Netherlands. Mack's biggest Omni-Mover dark ride system is destined for China. It will feature more than 120 vehicles and a ride time of more than 10 minutes, making it twice as big as existing Omni-Mover installations.

For the new theme park being created at **Sochi**, Russia, Mack Rides will deliver three rides, a Wild Mouse, launch coaster and tea cup ride. The park is due to debut in time for the Winter Olympics in 2014.

## KMG

Dutch ride manufacturer KMG is to produce new 70-metre-high (over 200ft) versions of its **Speed** propeller ride and **Inversion 360°** pendulum ride. Both will be available as transportable or fixed park models and are expected to debut in 2013.

The Speed will offer capacity for 24 to 32 persons, a significant increase on the existing 40-metre Speed, while the 70-metre Inversion will seat 24

riders and be based around four semi-trailers. As with all KMG constructions, no crane will be needed for assembly of either ride.

It has been confirmed that Jarno Otten will travel the first **XLR8** by KMG as from 2012 (see *Park World*, November 2011). The Dutch showman has previously operated several other KMG prototypes.

Meanwhile in the United States, KMG is benefiting from the weak dollar. "It looks like the North American amusement industry has found more trust in the future now the euro rate has dropped [against the dollar] as a result of the unstable European economies," notes sales manager Peter Theunisz.

The company is currently working on several sales for parks in the US, Canada and Brazil. Following a trial run at the Fun Spot in Orlando during IAAPA Attraction Expo, the first X-Factory for the US will go to carnival operator **Drew Exposition**. A park model of the ride is due for **Santa Cruz Beach Boardwalk** in California.

At the **IISF Trade Show** in Gibsonton, Florida this February, KMG will exhibit a Freak Out ride destined for Bohlander Bros' Poor Jack Amusements and a Speed propeller ride ordered by Armco Inc (Larry Sankowsky).

The company also reports US interest in the Sicko, the first of which will debut in May on the French fairground circuit (see *Park World*, November/October 2011).

Production is now booked at KMG's factory in Neede, The Netherlands, until April 2013.

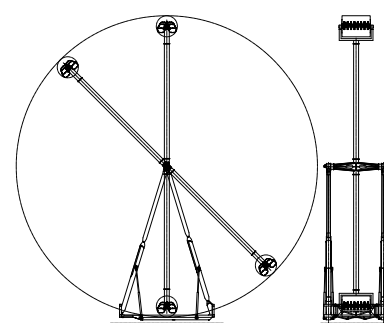

The 70-metre Speed - a sketch

## REG/Gerstlauer

Off the back of its busiest year ever in 2011, with more than 16 projects around the world, the US-based Ride Entertainment Group enters 2012 with new orders under its belt.

The company has sold a custom Gerstlauer **Euro-Fighter** to a park in North America. The coaster will use the German manufacturer's new eight-seat Euro-Fighter vehicle.

REG has also sold three Gerstlauer **Sky Fly** rides (as pictured), two for Europe including **Nigoland** in France, and one in North America. This new ride, comprising one or two giant arms with either six or 12 open seats allows riders to control their orientation as they fly through the sky by operating the wings at their side. Meanwhile REG has secured an order for Gerstlauer replacement trains on **Hersheypark's** Schwarzkopf Superdooperlooper coaster in Pennsylvania. Gerstlauer now operates Schwarzkopf's old factory in Munsterhausen.

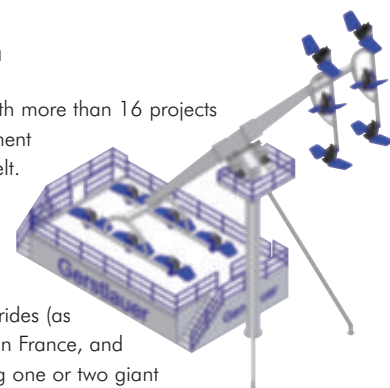



# THE WETTEST SHOW ON EARTH!



2011 Best New Product | 2011 Impact Award



IAAPA WWA Industry Innovation Award



www.watertoys.com  
info@watertoys.com  
1 866 833 8580 | 905 649 5047



## A load of balls!

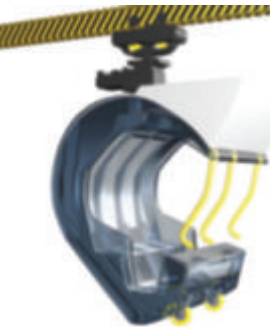

Interactive water rides can be great fun, but not everyone likes to get wet. That's why two European suppliers reckon they've hit onto something with new attraction concepts featuring soft foam ball shooters rather than water cannons.

One World Studios' SoftBall Ride

The SoftBall ride by Olaf Mordelt's One World Studios (Berlin) is dark ride concept with suspended vehicles. Soft balls are pumped down from overhead via a tubing system and into air cannons. Passengers then take aim at fellow riders and interactive targets during the ride.

Meanwhile the Swiss manufacturer ABC Rides has just unveiled plans for an attraction called Flying

Games, a flat ride with a compact footprint. The machine features 12 two-seater cars that travel up and down an undulating track and also rotate horizontally, controllable by the riders. Each car is equipped with two cannons, a turning plate and a joystick, which they can spin the cars through 360°. At the end of the ride the cannons are automatically switched off.



ABC Rides' Flying Games



ABC's Flying Games – with water

How you clear the balls up afterwards is uncertain, however a wet version of the ride is also available with water cannons. ABC is already in talks with several interested parties.

www.oneworldstudios.de  
www.abc-rides.com



## TransStudio race!

Along with a launch coaster by Premier Rides and an Interlink super splash, a large Daytona car circuit is one of the key attractions at the new TransStudio indoor park in Bandung, Indonesia. The attraction features these Daytona 24 petrol powered cars from Preston & Barbieri (P&B). The low pollution vehicles have been specially designed to suit the indoor setting and drivers steer the multi-level circuit free of any rails. Looks like fun doesn't it?



## Zamperla Junior Twister

The Junior Twister Coaster is a new family ride from Zamperla, and it comes in two versions, the JTC 170 "Compact" and JTC 230 "Extended." Spanning two levels, it stands 8 or 9-metres tall (26/30ft) and travels at speeds exceeding 28 km/h (17 mph). Track length, as you may have guessed, is either 170 or 230-metres (558/755ft). A "kick-off" lift hill system allows the operator to offer guests multiple rides without stops. One train is included, featuring four or five cars. Each car carries four riders arranged in a single row. Individual T bars ensure that each rider has a custom fit and the minimum height limit is just 105cm (42 inches) for kids riding with an adult, or 120 cm (47 inches) if riding alone. According to Alberto Zamperla, one Junior Twister Coaster has already been sold to a Chinese park, two to the United Arab Emirates, and two more to unidentified buyers.



## Zebec nets new business

Well known in the waterpark industry for its tubes, rafts and mats, Zebec is experiencing growing demand for its various pad and netting products. The Lily Pad Walk is a fun challenge for waterpark guests as they attempt to cross a pool by stepping from pad to pad. Zebec provides everything needed including the foam lily pads themselves, overhead netting and poolside safety padding. The company's range of padding can be supplied to suit all sorts of applications including the bottom of tube, mat or body slides, children's activity areas, playgrounds, diving boards and stairs, pool sides, overhead obstructions and most other areas/surfaces. Netting, meanwhile, can be supplied for climbing, play areas, safety, barriers and fencing. Based in Ohio, Zebec ships all over the world.

www.zebec.com





# Typhoon sweeps Serengeti

Located in Lower Saxony, Germany, Serengeti Park will get a Typhoon ride for 2012. The Frisbee-style attraction will come from the Italian manufacturer Technical Park and feature a Savannah theme. The machine will feature 24-suspended seats in an outward facing configuration.

www.serengeti-park.de



# Gosetto goes back to school!



Young visitors to Etnaland in Sicily may be slightly perturbed next summer to find a new dark ride themed around an abandoned school. The interactive attraction, supplied by

Gosetto, will feature eight classroom scenes, each dedicated to a different academic subject. Riders must answer exam questions to accumulate points

during the ride. But before they start riders will have the chance to quell any pre-exam "nerves" by visiting the bathroom!

Gosetto will not only provide the ride system but also the theming throughout the attraction. Twelve 4-seater rotating ride vehicles will be used, themed as school desks, travelling along a 12-metre circuit.

Construction is due to be made on site soon following test runs at the Gosetto factory in the north of Italy. The ride will be one of several major new attractions soft launched at Etnaland in 2012 ahead of a park relaunch in 2013. Gosetto currently has a further two dark rides on order, plus a number of Fun Houses.



**35 YEARS OF EXPERIENCE**  
**GOSETTO**  
 EXCELLENCE AND FUN

**new Haunted School**

**Magic Tree**

GOSETTO S.r.l. Via Montegrappa, 122 z.l.  
 31010 MOSNIGO DELLA BATTAGLIA (TV) ITALIA  
 Tel. +39 0438 892847 / 892852 Fax +39 0438 892593  
 e-mail: info@gosetto.com [www.gosetto.com](http://www.gosetto.com)



# Atlantis lost!

## Kerzner forfeits Bahamas resort



Atlantis The Palm Dubai

The luxury resort operator Kerzner International has been forced to surrender ownership of its Atlantis resort in the Bahamas and may have to do the same in Dubai, writes *The Wall Street Journal* (WSJ).

Struggling to refinance the debt of a 2006 buyout, the South African-based company announced that it would forfeit the flagship Atlantis Paradise Island, its ocean-themed hotel, waterpark and casino development in the Bahamas, to Brookfield Asset Management. Two smaller resorts were also involved in the deal.

The WSJ reports that Kerzner now wants to sell its 50% stake in the US\$1.1 billion Atlantis The Palm, a showpiece part of Dubai's Palm Jumeirah manmade island, to local partner Istithmar. The investment arm of Dubai World already owns 31% of Kerzner International.

If the sale of Atlantis The Palm goes ahead, Kerzner will be left with stakes in six smaller One & Only branded resorts, plus contracts to manage Atlantis in the Bahamas and a number of other properties.

Kerzner chairman and CEO Sol Kerzner made his name with the once controversial Sun City casino resort in South Africa. Opened in 1998, Atlantis Paradise Island is described as one of the busiest casino resorts outside Las Vegas, but has been suffering from falling hotel occupancy in recent years.

Atlantis The Palm, which due to local restrictions does not feature any gambling, debuted in 2008 with an ostentatious multi-million dollar opening ceremony featuring the singer Kylie Minogue. The resort's Aquaventure waterpark now outperforms Dubai's established Wild Wadi waterpark in terms of attendance.

## The Crane Dance



Described by Edward Marks of The Producers Group as, "truly a one-of-a-kind attraction," The Crane Dance at Resorts World Sentosa in

Singapore was one of several worldwide attractions that has just been selected for a Thea Award from the Themed Entertainment Association (TEA).

The Crane Dance is a multimedia show featuring two mechanical cranes brought to life in a love story as that transforms them into real birds. Performed six nights a week on the waterfront of Singapore's integrated resort at Sentosa island, the installation was created and choreographed by Jeremy Railton of the Entertainment Design Corporation, while Bob Chambers of The Producers Group acted as senior technical director.

Video of the show is available on the Resorts World Sentosa website or YouTube. For a full list of Thea Award winners, see page 31.

## Polin Magic Spheres

Polin Wareparks & Pool Systems has launched a new waterslide series. Magic Spheres offers something fresh in terms of its geometry and riding path, with riders experiencing a new path each time they ride.

Guests start the journey inside a four-person raft. Passing through the tunnel part, they experience a big drop into the sphere at an angle of 32°, reach a speed of 32mph. Inside the giant sphere, they follow a "fuzzy" path. Riders oscillate up and down and then the raft follows another tunnel slide to a splash pool or a dry-out below.

Due to its spherical geometrical shape, it makes a

good match with any theming and colouring. Polin's natural light and special pattern effects can be applied for additional customisation, along with audio effects. Furthermore, Magic Sphere is produced by Polin's special Resin Transfer Moulding (RTM) technology to produce an aesthetically-pleasing finish, shiny on both sides.



## Kernels

Congratulations to the **Pleasure Beach** in Blackpool, which picked up a Brass Ring Award at IAAPA Attractions Expo in Orlando for best print advertising for its "My Map" distributed to all guests on arrival at the British park. Pleasure Beach non-executive director John Collins OBE was also inducted to the IAAPA Hall of Fame.

The former owner and president of Skee Ball and the Philadelphia Toboggan Company has passed away. **Samuel H High III**, 77, of Sellersville, Pennsylvania, died at home on November 8. He was born March 8, 1934, and is survived by his wife of 53 years Linda (Vaughn) High, daughter Laurel High "Lolly" Yocum and her husband G Mack Yocum III, his son Samuel H High IV and wife Rebecca H High, six grandchildren and two sisters.

Following its unveiling this summer of Freischütz at Bayern Park in Germany, both American and Chinese clients have expressed an interest in **Maurer Söhne's** new Flying Launch Coaster, according to the German manufacturer.

The Taiwan-based Nice Group, operator of the country's **Janfusun Fancyworld** theme park, is expand into China by investing US\$46 million in a 485,000-sq m site in Jinan, capital of the Shandong province. Its plan includes the Shandong Sun World Family Edutainment Park and Shandong Black Pottery Culture Innovation Park. Construction is scheduled for completion by the end of 2014.

**Quassy Amusement Park**, Middlebury, Connecticut, will add a Zamperla tea cup ride for the 2012 season, its 104th season of operation.

The leading Chinese manufacturer **Golden Horse** Amusement has introduced a number of new rides in recent months including its biggest ever shoot-the-chute ride at a park in Korea, a new freefall tower with magnetic brakes and a motorbike-themed launch coaster. The latter is very similar in appearance to Zamperla's Motocoaster and has been installed at parks in Xiamen and Chengdu (both in China).

**Huss Park Attractions** has a new sales director in the shape of Jens Hilger.

Following the unveiling of the new look Star Tours at Walt Disney World, Tokyo Disneyland in Japan will now revamp its version of the simulator attraction. **Star Tours: The Adventures Continues** will open in spring 2011 within the park's Tomorrowland area.

Following its work on the new Landora park in Istanbul, Turkey, Orlando's **Valerio Mazzoli Studio** recently completed the design of a new rooftop park in Sofia, Bulgaria. Located on top of a shopping mall, the project is currently in construction.

**Merlin Entertainments** has appointed its first group creative director. Paul Moreton, who starts in January, was previously general manager of UKTV. Elsewhere at the world's second biggest attractions operator, Scott Williamson is the new marketing director for "Midway: openings supported by Amanda Starmer, marketing manager for new openings. Rebecca Hamilton and Sarah Taylor take on the new roles of global head of marketing for Dungeons and Sea Life respectively, while Jenny Blask becomes marketing director of Midway attractions in Germany.



Merry Christmas  
and  
Happy New Year



EOS

www.eos-rides.com

The advertisement features a red background with white snowflakes and a white roller coaster track. A green train with a Santa Claus figure is on the track. There are two gold Christmas ornaments at the bottom left. A circular inset shows a colorful indoor ride with people.



WATER TOYS

the wettest show on earth!

www.watertoys.com  
info@watertoys.com  
1 866 833 8580 | 905 649 5047

The advertisement shows a vibrant water play area with various slides, towers, and water cannons. The background is a clear blue sky.

EVERYTHING FOR EVERYBODY!!!



TRANSFORMER

GR Pagine

NEW BABY EXPRESS

PARROT'S RAFT

NEW TOYS CAROUSEL

BLUE ARROW

RAILROAD EXPRESS

AUTOMATIC TOYS MODENA s.r.l.

Tel. 0039 059 310462 - Fax 0039 059 314626  
www.automatictoys.it  
info@automatictoys.it

The advertisement displays several amusement rides: a Transformer-themed roller coaster, a parrot-shaped raft, a carousel with new toys, a blue arrow roller coaster, and a railroad-themed roller coaster.



RIDES and FUN

www.ridesandfun.com

NEW RELEASE:  
SKY TOP 16 SEATS  
SURF 22 SEATS!  
TRAILER  
OR PARK MODEL

STANDARD RIDES  
AND SPECIAL PROJECTS  
MANUFACTURER  
FOR FEC CENTERS  
AND THEME PARKS

RIDES & FUN  
representative  
office will open  
soon in Arizona  
sales.usa@ridesandfun.com

RIDES AND FUN SRL  
Brescia - ITALY  
Ph. +39 030 94 08 126  
Fax +39 030 94 08 564  
info@ridesandfun.com

IAAPA

The advertisement features a roller coaster with a train and a sign that says 'SURF 22 SEATS!'. There is also a photo of a ride at night.

Attendance held up at this year's IAAPA Attractions Expo in Orlando, the slowly improving economy resulting in more projects moving ahead in the \$24 billion global attractions industry. **Paul Ruben** and **Owen Ralph** report from the 93rd annual convention and trade show of the International Association of Amusement Parks and Attractions



Graffiti Tower by EOS Rides



Crowds gather in the lobby



A view of the floor as seen from Felimano Luna Park's carousel



This wheel from North American Midway with LED lighting by Maxtron featured in the outdoor exhibit area

# IAAPA 2011

## American and Asian visitors keep show strong

**H**eld from November 14 to 18 at the Orange County Convention Center in Orlando, this was the show's second straight year in Orlando after 2009's hiatus to Las Vegas. Last year the move back to central Florida – theme park capital of the world – resulted in an attendance increase of around a thousand to 25,000, and this year the total was 25,800. Of those visitors, 15,300 were classed as buyers or senior executives.

"We tried some new things this year and the results surpassed our expectations on several fronts," reported IAAPA president and CEO Chip Cleary. "Exhibit sales, buyer attendance, education programme participation and total registration are all up from 2010, which speaks volumes about the strength of the industry. The buying, learning and sharing of ideas that takes place here is simply phenomenal."

With 1,106 companies showing their wares across the North and South halls of the convention centre, exhibitor numbers were down by 34 from last year. Gone are the days when the likes of Zamperla showed almost a mini amusement park worth of rides on its booth, but this is still the show most suppliers pull out all the stops out for, and you won't see so many exhibitors anywhere else.

Attractions featured in the outdoor display area included S&S Worldwide's new Mini Hu ride, a Soaring Eagle zip line from ex-S&S boss Stan

Checketts, an ARM Flying Dutchman and Vertigo (Star Flyer), plus a giant wheel on loan from North American Midway equipped with eye-catching LED lighting by Maxtron.

Of course there was plenty going on away from the trade show floor, too. A total of 123 education sessions and tours were held during the week, both at the convention centre and at local attractions including Disney's Hollywood Studios, Legoland Florida and Busch Gardens Tampa Bay. More than a third of visitors (8,850) signed up for at least one session.

Most of IAAPA's various award programmes were consolidated this year under the Brass Ring heading, with winners receiving their trophies during a 90-minute ceremony at the Peabody Hotel on Wednesday afternoon. New inductees into the association's Hall of Fame for 2011 included John Collins, Frederick Pearce, Wally Boag and Betty Taylor.

With all of IAAPA's evening receptions moving to a ticketed model this year there was less opportunity for "party hopping" but, who knows, that was a good thing. Free receptions and events were also hosted by, among others, BRC Imaginations Arts, the Hetteema Group and KMG.

Events such as the annual IAAPA golf tournament, motorbike ride and fun run raised a total of \$81,000 for Give Kids The World, the resort for children with life threatening illnesses in nearby Kissimmee.

### On The Floor

"This year we brought four people, and next year I intend to bring more," reported Brazilian visitor Murilo Pascoal of Beach Park in Aquiraz. "In Brazil we don't have the same established industry as here in the United States. To be here and see what the industry can be, this is very important."

"It's very overwhelming, tiring and informative," noted Jessica Booth of Thunder Island in Fulton, New York. "I've taken a lot of classes and gotten a lot of stuff out of them, so that makes me happy. It's nice to connect faces to names of people I've done business with for years on the phone."

"It's been a great show," contended Brad Goodbody of ProSlide Technologies. "This is the largest booth we've ever had. We're extremely pleased with the international presence and the number of US clients that have been visiting. We have closed many deals."

"We've been really busy, I don't think I've had more than a couple of minutes' break the whole time," reported Scott Snyder of Zebec, supplier of tubes, pads and rafts for waterparks and attractions. "The economy seems to be picking up, although I don't think it really hurts our industry; people can still afford \$20 to go to their local waterpark."

"It's good to finally win an award for our pirate ship booth as we thought no one noticed it last year!" laughed Udo Weisenburger of European theming specialist TAA Industries. "The booth was sold on the last day of the show and we are very happy. Having done work for Sea Life in the US has been a good shop window for us."

"It's a very good show," smiled Steve Cohen of American manufacturer Wisdom Rides. "I couldn't believe the people here the first day. Our regular customers came out, and they were in a buying mood."

"Ten years ago there were more visitors but they were not so professional," observed Gianluca Fabbri of the Fabbri Group. "We would rather have people with something to spend. I guess if you pay up to \$400 to get in you have to be serious!"

"Acceptable," was the verdict of Technical Park's Marco Grigolo. "The US market is OK, and getting better. People were holding off buying from Europe because of the exchange rate but now they have to buy and the euro is not as strong as it was."



A view of the show floor

### European Exodus

Despite the presence of 118 nations, several exhibitors picked up on what they saw as an apparent lack of overseas visitors.

"This has not been an impressive show," dissented Alberto Zamperla. "We are missing a lot of customers from South America, Europe and the Far East. Maybe that will change before the show ends."

"It seems very American this year," observed Mike Anderson from Interlink. "This used to be the international show and you'd always get plenty of Arab and Asian visitors; you don't get that now."

"What surprised me was that there were hardly any Europeans," noted Mondial's Froukje Knipstra. "We didn't see any Germans, any Dutch and we only got one one French visitor. From what we see the show could be shortened by one day. Fortunately, the WindSeeker has really put us on the map in the US."

"Attendance from Europe was rather low," agreed Intamin's Sascha Czibulka. "I think this is because of several factors. There is economic uncertainty, we had the EAS [Euro Attractions Show] just six weeks ago in London, and we are again in Orlando. Overall though we had a lot of good quality meetings, and we return home with a nice workload and many promising leads. This is the largest crowd from southeast Asia I've ever seen at IAAPA, that reflects where most projects are happening."

"It's been a really positive show for us," said Patrick Lamb of train builder and people-moving specialist Severn Lamb. "It's good to see lots of familiar faces. There's not just been quantity of buyers, but good quality too. There's definitely a lot happening in the far east."

### Asian Invasion

"We have had many contacts with American and Chinese buyers who are very interested in our rides and especially in our development of the Flying Launch coaster," explained Ralf Reifferscheidt of Maurer Söhne. "We have also had discussions with different automobile manufacturers about our Racing Coaster similar to the Ferrari coaster in Abu Dhabi."

"With all the coasters we've put into China, we're getting a lot of attention we weren't getting four to five years ago," revealed Rich Allen of S&S Worldwide. "Attendance seems flat, but we had a pretty full dance card before we came this year, and it's been excellent for us."

"It's the first show where we had every time slot filled before arriving at the show," added Jim Seay of Premier Rides, on a prominent booth facing S&S by the main entrance. "Our Superman coaster for Six Flags Discovery Kingdom has been a big hit, and we have several more announcements to make before the Christmas break. This is the healthiest the company has been because of a significant backlog."

"Our production schedule is now booked until April 2013 and we are working on several sales for parks in the US, Canada and Brazil as well as a result of IAAPA," reported Peter Theunisz of KMG, which had an X-Factory ride on display during the event at the nearby Fun Spot. "We now start making preparations for February's IISF Trade Show in Gibsonton, Florida, where we will have two rides set up." 📺



Stephen Reid and Richard Jones of 1st Attractions



Jisk & Froukje Knipstra from Mondial demonstrate the WindSeeker seat



Udo Weisenburger from TAA with his Brass Ring Award for best booth

## Next November

IAAPA Attractions Expo will be back in Orlando from November 12 to 16, 2012. According to Roland Mack from Europa-Park, IAAPA's new chairman, interest is high: "Building on the success of the 2011 Expo and based on the strong advance exhibit sales for the 2012 show, we look forward to creating an even more spectacular event for next year."

[www.iaapa.org/expo](http://www.iaapa.org/expo)

Italy's first Park Show International for seven years was held recently in Rimini – just two weeks after IAAPA Attractions Expo in the States

# Park Show returns to Rimini

## Golden Pony Award Winners

**Travelling shows:** Zbigniew Sliwinski (Poland), Oscar Pivetta (Italy), José Pedro M Almeida (Portugal), Marc Baillet (France), Alberto Dominguez (Spain), René Buftkens (Belgium), Axels Nöjesfält/Tony Andreasson (Sweden), Park Hilaria-CityDynamiek (The Netherlands)

**Amusement parks/waterparks:** Acquapark Odissea 2000 (Italy), Adventure World-Aswad Group (Saudi Arabia), Ondaland Acquapark (Italy)

**Sports-orientated facilities:** Cerwood (Italy), Bowling Brunswick Roma (Italy)

**Special award:** Dennis Speigel (USA)

**Ride manufacturers:** EOS srl (Italy), Pircher Alfred (Italy), Somersault srl (Italy)

**Vintage ride competition:** The Mechanical Theater of Arts and Crafts by Mario Vergnani (Italy)



The MP Group stand

Celebrating Italian ride manufacturing, the exhibition took place at the well-appointed Rimini Fiera from November 27 to 29. Whereas Park Show used to run in conjunction with the ENADA coin-op show, this time it took place alongside SiaGuest, a leading European exhibition for the hospitality industry (hotels, resorts, camp sites etc).

The timing was perhaps a little unfortunate. Not only was there the close proximity to IAAPA, but the show came just two months after Euro Attractions Show in London, which is now firmly established as Europe's premier event for the amusement industry.

Nevertheless, organiser Facto Edizioni would stress it is going after a different market and that the location offered easy, affordable access for Italian ride manufacturers. Yet even on home soil, several big names failed to commit, and the exhibitors failed even to reach treble figures (around 40 companies took part). Visitor numbers stood at around 1,000.

"We can't deny that the return of Park Show was difficult and encountered many obstacles," reports



The stand of Dotto Trains

Facto Edizioni owner and editor of *Games & Parks Industry*, Danilo Toso. "Despite the low cost policy and the need for suppliers to sell, including in new markets, not all Italian companies recognised the value of our initiative. For those exhibitors who believed in us and in most cases expressed positive opinions, we thank them for their support and want to stress that we are committed to developing the event in a constructive way for the benefit of everyone."

### Pony Prize

Now in their ninth year, the Golden Pony Awards were presented during the show. Created by Facto Edizioni in 2002, the awards recognise excellence among operators and suppliers in the leisure industry. The latest round of winners assembled for a gala evening at Rimini's Hotel Continental e dei Congressi on November 28.

Eighteen companies and individuals were recognised in total, from 10 countries including the USA, Saudi Arabia and many European nations. A new element this year was a special category for sports-oriented leisure facilities, which are becoming increasingly popular. The organiser's closely-guarded selection criteria also ensured there were several names that were less universally known but equally worthy of recognition.

Some of those names included CityDynamiek Eindhoven, a Dutch company that entered the travelling show business around 10 years ago to organise Park Hilaria and other funfair events in Eindhoven, and Pircher, an Italian firm well known to manufacturers of amusement rides for its niche product: coaster wheels. From Saudi Arabia, Adventure World was recognised for its chain of children's theme parks at shopping centres throughout the Middle East.

The next Golden Pony Awards will be presented on March 21, when a special ceremony will be held during RAAPA Expo in Moscow recognising operators and suppliers from the CIS (former Soviet) countries. A similar event was held at RAAPA in 2011. ■



Golden Pony Award winners



# CIAE

## 8th China (Guangzhou) International Game & Amusement Exhibition

Date: 9-11 March 2012

Venue: China Import and Export Fair Pazhou Complex

Leading Expo

CIAE2012 is the 8th year of premier event, Which is the best platform for you to find Asian suppliers or tap into market in China.



See you in March!  
Guangzhou, China!

**The best platform to find your business partners!**

Where you can find

Arcade Game(Simulation Games, Video Games, Traditional Games, Redemption Games, and Product Games)  
Amusement Machine & Parts/Major Rides/Water Rides/Carnival Rides/Virtual Show, 3D/4D/Inflatable/Billiards  
/Lighting & Sounds/Bar Products/Spa & Sauna & Bath/Kiddie Rides/Publication



## Q Lines

# Monty Lunde and Rick Roth



Representing the creators of compelling places and experiences, the Themed Entertainment Association is an international, not-for-profit trade association that provides multiple education and networking opportunities, including the legendary TEA Mixers, SATE conference and Thea Awards. From theme parks and waterparks, to zoos, museums, casinos, restaurants and retail, the TEA's almost 700 members work with them all. Although many of those members are theming companies, a wide range of skills and disciplines are represented including masterplanners, conceptual designers, audiovisual suppliers, special effects companies and major in-house creative departments like Walt Disney Imagineering and Universal Creative. As the TEA celebrates its 20th anniversary, *Park World* editor **Owen Ralph** catches up with founder Monty Lunde of Technifex and ex-Disney Imagineer and current TEA president Rick Rothschild of Far Out! Creative Direction

## How did the association begin?

*Monty Lunde (ML)* – Prior to IAAPA in 1991, I wrote a letter to the owners of 30 or 40 companies in our industry, mainly in California because that's where I knew; we were based in the Burbank area. I said I thought it would be wise to get together and form some sort of an association that represented the supplier side of the industry, kind of a counterpoint to IAAPA, which at the time represented the owners and operators. We had no representation, and many of us who were trying to run our own companies experienced the stress of trying to deal with the major corporations through very small companies. We arranged a meeting at Burbank airport, I think we had 30 companies attending, and we agreed to meet again after IAAPA to formalise things.

## How much does the TEA owe to Disney?

*ML* – I think the real genesis of the association came from Disney. After they'd done EPCOT and after they'd finished Tokyo Disneyland, they pretty much let everyone go ...except for Rick! The rest of us were thanked and politely shown the door, so there was this massive talent pool that really had no place to go. *Rick Rothschild (RR)* – In fairness, before EPCOT and Tokyo, Disney Imagineering had a staff under 500, but it blew up to do these big projects. Without EPCOT, I think these fresh out of school, interested people would not even have ended up in the industry.

## Was it difficult at first to convince smaller parks to use your services?

*ML* – Yeah, I would say the smaller parks were very self sufficient, they would kind of design things on their own, and the price of getting us in was generally higher than they were willing to pay. For speciality items maybe they would use us, but they were generally used to buying a rollercoaster off the shelf and knew what the ROI was on that.

## How has the association expanded outside of California, and now internationally?

*ML* – Pretty quickly we picked up members on the East Coast in Orlando, people like ITEC. Disney did the exact same thing in Florida, said thank you very much and goodbye, so there were already people based out in Orlando.

*RR* – We now have a very strong membership in Europe, and will stage our next SATE conference there in 2012. A couple of years ago the Middle East was a hotbed of projects, but it cooled rather quickly! In Asia we have staged a number of initiatives in the last few years, and have probably been more successful in drawing new members from there than the Middle East.

## How easy has it been to persuade rival firms to work together?

*ML* – I did the seating chart for the initial meeting back in '91 and I sat all of the competitors next to one another. That was very interesting for the first five minutes, but I made a point: we are all in this together. Get to know the person sitting to your left and right because they could be the one watching your back in future; they may compete with you in one area but complement you in another. The bottom line with the TEA is to get to know other people in the industry that you never would have gotten to know otherwise.

## The collaborative approach to working fostered by the TEA is now commonplace across the industry, would you agree?

*ML* – We have a very unusual industry, and people looking from the outside in don't get it. In most industries there is a hierarchy between contractors and suppliers. In our industry I might do a project and hire Rick to do work for us, then hire another company, but in that same week he could get an order and bring us, so the pecking order changes.

*RR* – We are a product rather than process-orientated industry. What does it take to do this specific job? If a job needs three or four particular skill sets, then we will put them together. And the way the world is going, you can assemble it anywhere.

## As a result of this approach, most TEA member companies are quite small?

*ML* – Out of 682 companies, over 500 of our members are companies with five or less employees. Our industry is unique in that it doesn't really foster massive growth among suppliers, there is an equilibrium that we all reach, and the companies that become stratospheric in size, they are usually gone within a year or two.

## How much do other kinds of attractions integrate theme park techniques?

*ML* – They are all working with a common talent pool, which is TEA members. That was not always the case. Fifteen years ago museums were not really keen on the theme park industry, there were about science information and the delivery of information and the really poo poo-ed that attitude of entertaining. Now they have completely done a 180 and put in really great exhibits, and attendance clearly goes up. The other contingent we really had to break through was the architects, who saw themselves as the pinnacle of the food chain, but they too have embraced our talent pool and methodologies and many of them are actively looking to partner with creative companies and TEA members.



# schild TEA

## Are we still seeing the same old themes being exported from West to East?

RR – In Japan, certainly if we look at Disney, the Japanese came to the West and wanted the West. The Chinese and other parts of Asia want our creativity and expertise, but they don't simply want the same design. It's a different desire, and a different market. However, depending on its location and relevance to its audience, I do not think there is any theme that cannot be repeated.

## What role do social media, 'apps' and other personal technology have to play in attractions?

RR – I would say there is a move towards using personal technology to encourage collective experiences. I think people both enjoy it, and it frees them away from just having themselves in the environment and actually engaging in an experience and enjoying that with friends and family. That to me is where the industry is using technology and providing experiences and venues that people can't get at home.

ML – You can use current technology to effect what people are experiencing. For example, at Technifex we are using apps with our Water Maze. Someone can sit on their iPhone and manipulate the maze as their kids are playing in there. So if you can give people more control over the environment and the experience they are getting that makes it more interesting for them.

## Is there a danger of over reliance on interactivity in attractions?

RR – Look at the old Disney A, B, C, D and E tickets; there were fewer E attractions and more As. This wasn't just to make the operational aspects easier, it was to spread people around and encourage them to see the entire park. A meal that just gorges on just one food is a much less fulfilling than a meal that is an extraordinary mixture of flavours and textures, and it's the same with attractions. So the answer to your question is that interactivity has become one more dot on the designer's palette. It is not the panacea.

## Which of the new Thea Award winners have most impressed you?

ML – The Crane Show at Resorts World Sentosa in Singapore is pretty amazing, and a lot of that is just sheer scale of it – industrial cranes that have been styled like birds, and they have this whole love affair. It's just a very creative way of using hardware!

RR – I have to pick Disney Cruise Lines' Animation Magic. A kid draws a character on a place mat and hands that mat to the waiter at the beginning of

dinner. Then, before dinner, everyone's drawings have been animated and become art in the show. That's just interactivity at a level you are not going to see in many other places.

## How do you nurture the next generation of attraction designers?

ML – Mentoring is the cornerstone of the TEA 20th anniversary. We really want to engage the next generation to come into our industry because we have all quietly aged. If you look the owners of most major companies, we have all done 25, 30-plus years in the industry, and we have all got pretty good at what we do. That means the bar to entry is pretty high, so you are not getting a lot of what I would call garage operations coming in. We really want to engage students and young professionals not just to be good at their craft, but hopefully to be in entrepreneurial mode and start their own companies like we did. 🇺🇸



Rick Rothschild (left) and Monty Lunde

## 18th ANNUAL THEA AWARDS

Announced in November at IAAPA Attractions Expo in Orlando were the winners of the 18th Thea Awards from the TEA. Winners were selected by a range of over 20 TEA members and officers in recognition of their excellence in the creation of extraordinary visitor experiences, attractions, exhibits and places. Here's who and what caught the TEA's attention:

### Buzz Price Thea Award (lifetime achievement)

**Joe Rohde**, Walt Disney Imagineering. Joe Rohde is a 30-year veteran of The Walt Disney Company. Starting his career as a model designer on EPCOT, Joe led the team that conceptualised, designed and built Disney's Animal Kingdom at Walt Disney World. Doing so involved years of research and negotiation with constituents from the scientific community, the world of zoos and representatives of indigenous communities involved in the stories created in the park. Joe continues to oversee new attractions for Animal Kingdom, in addition to the creative design and content of Disney's Aulani resort in Hawaii.

### Thea Classic Award

**Puy du Fou**, France. This impressive venue includes two independent attractions including spectacular live arena shows such as The Secret of the Lance, set in front of the battlements of medieval castle that moves, turns, spits fire and disappears into the ground, and The Vikings, set in a reconstructed 1,000 year old fortress attacked by a Viking. Complementing this is Le Grand Parc, an assembly of picturesque villages based on the history of the region, each with a 30-40 minute live story. Live entertainment at its best, on a scale rarely seen in a theme park (or anywhere else)!

### Thea Awards For Outstanding Achievement

Attractions – **Space Fantasy The Ride** at Universal Studios Japan; **Barnas Brannstasjon** at Kongeparken, Norway. Attraction on a limited budget – **Arthur, L'Aventure 4D** at Futuroscope, France; Attraction refresh – **Star Tours The Adventures Continue** at Disneyland and Disney's Hollywood Studios at Walt Disney World, USA. Museum exhibits – **NatureQuest** at Fernbank Museum of Natural History, USA; **YOU! The Experience** at Museum of Science and Industry, Chicago. Science centre attraction on a limited budget – **The Changing Climate Show** at Science North, Canada. Cultural heritage attraction on a limited budget – **Ghost of the Castle** at Louisiana's Old State Capitol, USA. Show spectaculars – **Crane Dance** at Resorts World Sentosa, Singapore; **The Magic, The Memories, and You!** at Walt Disney World's Magic Kingdom, Florida. Live show spectacular – **The House of Dancing Water** at City of Dreams, Macau. Live show event spectacular – **Yo México**, Celebration of the Century of the Mexican Revolution, Mexico City. Themed restaurant experience – **FoodLoop** at Europa-Park, Germany. Ingenious use of technology – **Animation Magic** in the Animator's Palate Restaurant aboard Disney Cruise Line's ship Disney Fantasy.

The awards, which will formally be presented at a gala ceremony on March 17 at Disneyland Resort in California, are widely recognised as the "Oscars" of the attractions industry. For more details of the winning projects, and why they were recognised, visit [teaconnect.org](http://teaconnect.org)



# Al Hokair Group

## 50 years of fun in Saudi Arabia

Synonymous with leisure and entertainment in Saudi Arabia and beyond, the Al Hokair Group is currently celebrating its 50th anniversary

The company's founder and chairman, Sheikh Abdul Mohsen Al-Hokair, is recognised as a pioneer within the Arabian amusement industry. As one of the earliest industry investors in the region, he secured an edge that the Al Hokair Group still enjoys today at its 55 amusement facilities within the kingdom of Saudi Arabia, various Gulf countries, the Middle East and North Africa. Together these outlets employ over 6,000 staff and entertain over 10 million guests a year.

"Before 1961, kids and families might have set out on a vacation that included traditional play and uncomfortable attractions," notes group CEO Majed Al-Hokair. "But that year one man created a better vision of entertainment and changed the way Saudi Arabia vacations."

The company's flagship property is Al Hokair Land in Rabwa Park, Riyadh. Located behind the colourful walls of this indoor/outdoor fantasy land, families will find theming and architecture inspired by the Arabian peninsula, African villages, Europe, America and the Far East. Complementing the rides and attractions are restaurants, retail offerings, electronic games, theatre and exhibition spaces. Other outdoor parks include Luna Parks in Al Madinah and Taif, plus waterparks in Riyadh, Yanbu and Damman.

Many of Al Hokair's other properties follow the family entertainment centre model, located inside air-conditioned shopping malls. Its brands include Fun Town, Fun Time, Fun Studio, Happy Farm, Jamboo, Sparky's, Metropolis, Movie Town, Digital Land, Digi Fun, Oceanica, Tim Tech and Vortex. Across the group, the company operates almost 700 rides.

More specialised offerings include the Abcarino/Smart Kids edutainment model on offer in Riyadh, Jeddah and Dharan, and a new Extreme concept aimed at teenagers and young adults featuring go-karts, 10-pin bowling, snooker, air hockey and video games.

As well as its own MENA Hotels & Resorts business, Al Hokair also operates local franchises for a number of leading international hotel brands including Holiday Inn, Hilton Garden Inn, Golden Tulip and Novotel. Furthermore the group is responsible for franchising a number of food and drink brands that share mall space with its FECs, including Brioche Dorée, Häagen-Dazs Cafe and Perky's Pizza.

As it enters its sixth decade, the Al Hokair Group will continue to design and build new amusement outlets across Saudi Arabia and further afield.

"Our goal is to create modern and distinguished amusement centres that maintain our national market leading position and serve our guests in providing a safe, clean and quality product," concludes Abdul Mohsen Al-Hokair. 

### Al Hokair recognises suppliers

During IAAPA Attractions Expo in Orlando, the Al Hokair Group held a VIP ceremony marking its 50 years in the amusement business. Joining Al Hokair executives during the event on November 16 were representatives from the company's suppliers, including many Italian ride manufacturers and companies such as Forrec, Intercard and Pan Amusements. As a nice gesture, each of these firms was presented with a commemorative trophy recognising their part in Al Hokair's success.

www.alhokair.com



Left to right: Jean Habre, general manager of Al Hokair Group's amusement sector with group executive president Majed Al-Hokair and Badr Khalid Al-Hokair



The Munari sisters from IE Park collect their trophy during IAAPA





**NEW**

**TOWER 70-mt.**

**NEW VEHICLES FOR TRAINS AND CONVOYS**

**GROOVY BUS**

**OLD TRUCK**



S.B.F. srl  
Via 4 Novembre, 20  
35040 Casale di Scodosia (PD) ITALY  
Tel: +39-0429-847098  
Fax: +39-0429-878287  
E-mail: sbf@sbfrides.com  
www.sbfrides.com



VISA International srl  
Via Dell'Apprendistato, 2  
35044 Montagnana (PD) ITALY  
Tel: +39-0429-804622  
Fax: +39-0429-81699  
E-mail: visa@visarides.it  
www.visarides.it

# HONG KONG IN COLOUR!



Hair Raiser at Thrill Mountain

Hong Kong's two big theme parks – Ocean Park and Hong Kong Disneyland – have each launched new lands within the last few weeks, and each is unashamedly bright, brash and full of fun. *Park World* profiles the colourful Thrill Mountain and Toy Story Land



Whirly Bird at Thrill Mountain

Celebrating the world of Luna parks and carnivals, **Thrill Mountain** is the latest part of Ocean Park's HK\$5.5 billion (US\$700m/€540m) 10-year Master Redevelopment Plan. This cluster of five high energy attractions high above the South China Sea is headlined by Hong Kong's first and only floorless rollercoaster by revered supplier Bolliger & Mabillard (B&M).

"Thrill Mountain is Ocean Park's Christmas present for thrill-seekers around the world," highlights park chairman Dr Allan Zemen. "Guests not only get to enjoy Hong Kong's fastest rollercoaster ride but also do so at the highest elevation in town dedicated to mechanical rides."

Situated adjacent to the Summit Station of the Ocean Express, Thrill Mountain covers an area of over two hectares (222,800 sq ft), spanning from the east part of the park to the west. Here flashing lights and fast-paced create a carnival atmosphere.

Hair Raiser, the B&M floorless coaster, sends riders rushing through multiple inversions at speeds of up to 88km/h, experiencing forces of up to 4G in acceleration. Two 28-seat trains are used. Over 850-metres of bright yellow track is supported by red pillars, making the ride hard to miss. At its highest point the ride stands 41.7-metres-tall.

Supplied by Chance Rides, Whirly Bird is a 32-metre-tall Aviator ride that gives guests spectacular views of the park and Aberdeen down below. Passengers can even control the position of their ride vehicle by using an in-car joystick. Aerial thrills are also provided on board Flash, a 22-8-metre Mondial Ultra Max 360° pendulum ride that opened around 12 months ago as a taste of what was to come at Thrill Mountain.

Rev Booster is a 20-car/60-seat Musik Express style ride supplied by Visa International from Italy. Here strong musical rhythms are accompanied by sudden reversals in direction. Close by is Bumper Blasters, a bumper car track by fellow Italian manufacturer IE Park. A total of 24 vintage-styled cars are featured on a 22 x 13-metre-track.

These thrilling rides are complemented by attractions including the bungee trampolines, eight colourful games booths, the Clown Corner 300-seat dining hall including Italian, Japanese, Taiwanese and Indian cuisine, Refill Station ice cream parlour and the Drop Shop, where a wide range of carnival and masquerade party-themed merchandise is available.



Flash at Thrill Mountain  
RIGHT: Rev Booster

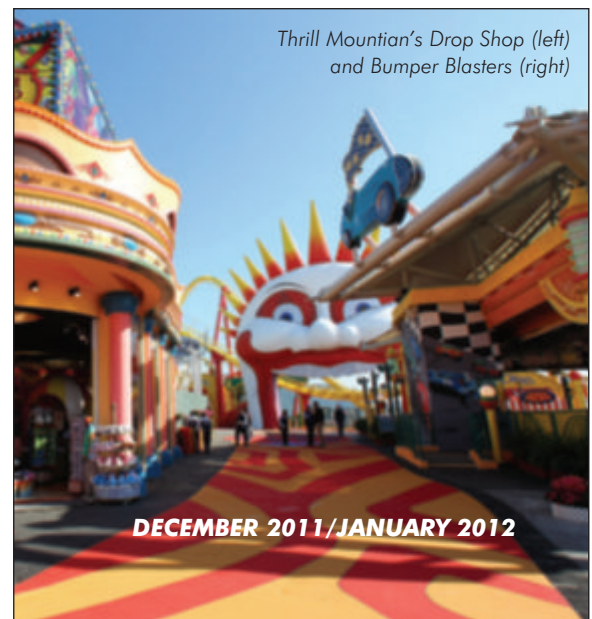

Thrill Mountain's Drop Shop (left) and Bumper Blasters (right)



Officially launched on November 17, **Toy Story Land** marks the first part of the Playtime expansion at Disney's Hong Kong Disneyland. This brand new land within a land, exclusive to Asia, adopts a very similar blueprint to Toy Story Playland at the Walt Disney Studios Park in Paris and is of course inspired by the hit Disney-Pixar Toy Story animated films.

"Today we mark the beginning of another new and exciting chapter at Hong Kong Disneyland Resort with the opening of Toy Story Land, the first of three new themed areas of our expansion project," noted Bill Ernest, Walt Disney Parks and Resorts' president and managing director for Asia, at the opening ceremony. "For the first time ever, Hong Kong Disneyland Guests can experience the feeling of being shrunk to the size of a toy when they enter Andy's backyard to play with their favourite Toy Story friends."

Three key attractions are featured in this richly themed area, with large toy props around every corner. RC Racer is a Half Pipe coaster featuring a giant U-Shaped track, while Toy Soldier Parachute Drop is Disney's twist on the classic parachute ride made famous at Coney Island in New York. Slinky Dog Spin, meanwhile, is a themed Caterpillar ride.

Also on hand are new food and beverage options, entertainment, photo opportunities and merchandise. Subsequent to the opening of Toy Story Land, the second themed area of the new Playtime area, Grizzly Gulch, will be opened to the public in 2012, followed by the third, Mystic Point, in 2013. The whole expansion will increase the admittedly small Hong Kong park's physical footprint by 23% and bring the number of attractions, entertainment facilities and show to more than 100.

Both new lands should prove popular over the Christmas and, more importantly, Chinese New Year holidays and as both parks are still in the middle of major redevelopment plans, there is even more to come over the coming years!

[www.oceanpark.com.hk](http://www.oceanpark.com.hk)  
[www.hongkongdisneyland.com](http://www.hongkongdisneyland.com)



Midway games at Thrill Mountain



Toy Story Land

## Attraction Profile



Toy Soldier Parachute Jump at Toy Story Land



Slinky Dog Spin at Toy Story Land



RC Racer at Toy Story Land

In 2012 Japan's oldest continually operating amusement park celebrates its 100th anniversary.

**Thomas Clarke** visits a whimsical world of elves and fairies outside Osaka

# Hirakata Park

## Osaka's stalwart amusement outlet



*Dowsing Mountain*

**L**ocated in the town of Hirakata on the outskirts of Japan's second city, Hirakata Park opened its gates for the first time on October 6, 1912.

Although Tokyo's Asakusa Hanayashiki is technically older, opening in 1853, it was closed for 12 years from 1935 to 1947, giving Hirakata the bragging rights it enjoys today.

The family amusement park is home to 43 rides and attractions, including five rollercoasters, spread across a 40-acre hillside site. Still owned by the founding Keihan Electric Railway, the family park has suffered a little since the arrival in Osaka of Universal Studios Japan in 2001, but still entertains a respectable 1.2 million annual guests.

Although elves and fairies provide a loose backstory, beyond the entrance plaza it's hard to tell the park actually has a theme. Stepping through the turnstiles guests are immediately greeted by Dowsing Mountain, a large rock formation which is home to an unusual attraction. Here children explore the mountain searching for bags of treasure which get weighed in and exchanged for toys. On warmer days the Magical Lagoon around the volcano becomes a popular paddling area. Walking away from Dowsing Mountain, the theming all but ends.

All of the park's rollercoasters are family-friendly, with no inversions in sight. Catering for the smallest



guests is Peekaboo Town, a figure-8 coaster from Senyo Kogyo along the lines of a Wacky Worm. Next up in intensity is the park's oldest coaster. Supplied by Meisho Amusement Machines and featuring crocodile-themed trains, its English name is simply marvellous: "Fantastic Coaster Rowdy." In order to fit the Crazy Mouse spinning coaster from Reverchon onto the steep hillside, a steel structure had to be assembled with the ride resting on top.

The park's largest coaster, Red Falcon from Senyo Kogyo, navigates around the top half of the park taking full advantage of the topography. The highlight of the coaster line-up, unquestionably, is ELF (Episode of Little Fairies), a 60-ft-tall wooden coaster from Intamin that opened in 2001 featuring figure-8 layout and a top speed of 36mph.

### Dark Ride Dream

Yet it's not the rollercoasters for which this park is most well known, it's the large array of dark rides that cover just about every genre and type on offer. In fact, Hirakata Park is a dark ride fan's dream come true. Laser Makai Densetsu Battle Forest is an interactive shooting ride where riders board 4-seater carriages that travel sideways along a track passing scenes of monsters, trolls and gnomes. Anyone beating the required daily score wins a prize which. Around 30,000 people a year succeed.

Legend of Luxor is a rather common concept in Japan, though it may seem a little strange to outsiders. Entering an Egyptian tomb, guests must step inside one of eight stone coffins and put on a pair of headphones. Peering out through small holes, they see augmented reality monsters wandering around the tomb. During the show the coffin shakes and your hands, which you must stick out of slots below the eye holes, are poked. At the end of the show guests are given a print out of their fear rating based on how much they flinched.

Fantasy Castle is a more jolly dark ride ...unless you're afraid of clowns. Cars full of passengers trundle through a castle full of European style clowns and circus animals. Venturing into the penguin room is an especially chilly experience, welcomed during the hot summer months.

Naughty Witch's Labyrinth is another indoor attraction that can be slotted into the 'quirky' category. Explorers are given a card which they must scan on entry. Four different coloured crystals are displayed on screen and must be memorised. Whilst roaming around the labyrinth explorers should look for crystals of the same colour. Scanning your card at the right coloured crystal activates a computer based challenge or puzzle. Complete the four games in the allowed time and you win a small prize.

Three other, more conventional indoor attractions can be found in the park, including Hall of Mysterious Trick or Formula, where many optical illusions and puzzles can be seen. The Ghost is a fairly typical ghost train except for the addition of headphones which play binaural sound effects to add to the intensity. Lastly, Adventures Gulli Forest Maze 2 is a mirror maze filled with puzzles in which guests can again win a prize if they complete it in the allowed time.



The family park has suffered a little since the arrival in Osaka of Universal Studios Japan in 2001, but still entertains a respectable 1.2 million annual guests

LEFT: An scene from inside Dowsing Mountain BELOW: ELF



**Mustn't get wet!**

Despite humid conditions during much of the year in Osaka, it seems Hirakata

Park's guests just don't like getting wet. This is not uncommon in Asia. So, in an attempt to shield its patrons from splashes, the park's management has installed windscreens to its Basho flume, while the Pachanga Panic Control rafts have screens between the seats to reduce the amount of water coming in. However, our correspondent can report, they are not enough to prevent a soaking, but they may just be enough to encourage apprehensive Japanese families to step on board.

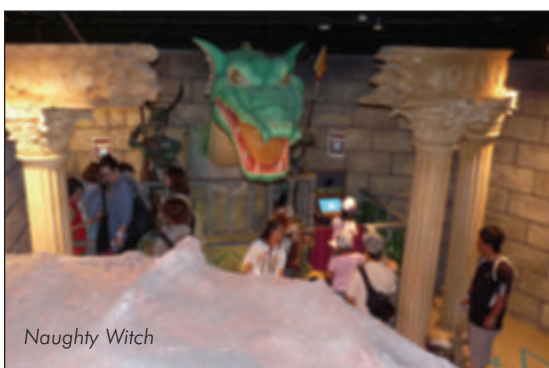
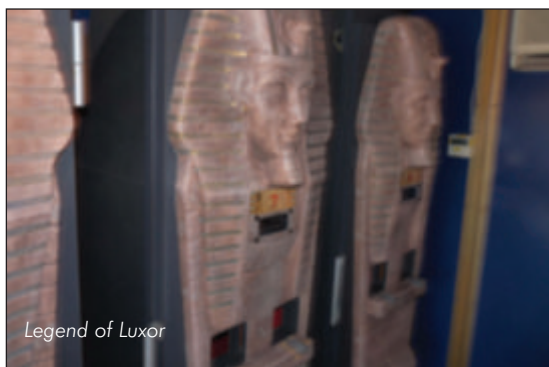

A Naughty Witch game card

Fantastic Coaster Rowdy

Fantasy Castle

Legend of Luxor

Naughty Witch

Hello Kitty!

Red Falcon

Adventure Safari: not PC by Western standards!

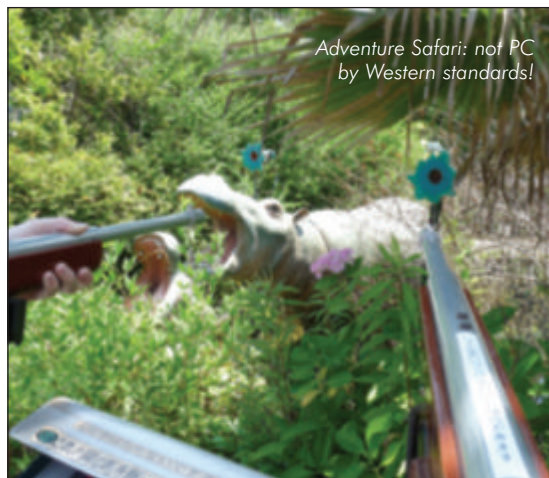

Spread across multiple levels of the hillside are a variety of modern flat rides and water rides. Pachanga Panic Control is a 1,300ft-long rapids ride while Bassh is the park's log flume, which travels through a jungle landscape.

**Hills & Thrills**

Thanks to its close proximity to Red Falcon half way up the hillside, the 160ft tall Giant Meteor Drops freefall tower from Intamin is extra thrilling, offering terrific views of the park for those riders brave enough to keep their eyes open. The tower ride forms the centrepiece of the thrill ride section of the park. Right next to it is Kings Round and Round, a Zamperla Disk 'O' and Super Tomahawks, a double arm Ranger which provides the only inversions in the park. For those too scared to give Giant Meteor Drops or Super Tomahawks a try, the Skywalker Ferris Wheel stands 260ft-tall and offers passengers un-obscured views of the park and the local neighbourhood.

The lowest level of the park is arguably the least picturesque and it is here that the majority of family rides can be found, including the unusual Adventure Safari. Riders on this unpolitically correct (to Westerners) experience board jeeps equipped with rifles and venture through the jungle shooting at animatronic elephants, tigers and other wild

animals. According to the park you are actually supposed to be shooting aliens(!) and not the animals, but this isn't obvious and it feels more like a hunting trip. Also featured in this area of the park are Panic Racer, a Zamperla Demolition Derby and Burning Fight, a Fire Brigade by the same manufacturer.

Hirakata Park is also home to a collection of small animals including alpacas, squirrel monkeys and red pandas – fortunately not for hunting. Meanwhile many older guests enjoy the rose garden featuring 4,000 flowers of 600 international varieties. Flowers also feature in the Hirakata Chrysanthemum dolls exhibition each autumn, where life size dolls are decorated in traditional costumes made from Chrysanthemums. Features such as these can be enjoyed for a modest entry price, rides operating on a pay as you go basis.

Hirakata Park is a wonderful example of a traditional Japanese amusement park. It has something to offer every age and while it may never rival big budget venues like Universal Studios, its homely charm, scenic location, vast and unusual array of rides, should ensure the park continues to be successful. Long may it continue as the country's oldest continually operating amusement park. 🇯🇵

www.hirakatapark.co.jp



Giant Meteor Drops

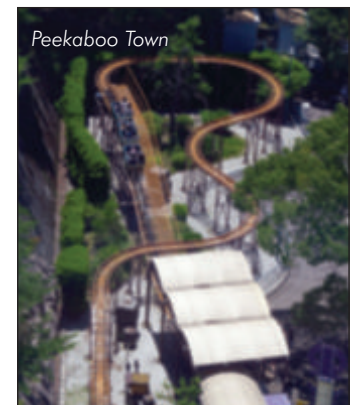

Peekaboo Town





**RAAPA EXPO  
2012**  
Amusement Rides  
and Entertainment  
Equipment

14th RAAPA EXPO  
Russia's premier event  
for the amusement  
industry

**March 21-23, 2012**  
Moscow, VVTs  
(All-Russian Exhibition  
Center) Pav. 75

March 19-20 Conference  
«Prospects of Amusement  
Industry Development  
in Russia»

General Sponsor: 

General information sponsor: 

Supported by: 





Trade Show where owners come to buy, not look!

+7 (495) 234 5015  
+7 (495) 234 5268  
E-mail: raapa@raapa.ru  
Website: www.raapa.ru

Our representative in the UK,  
the USA and in the Middle East  
is Gerry Robinson, TSI Ltd. (UK)  
Tel: +44 (0) 1905 360169  
Fax: +44 (0) 1905 360172  
E-mail: ts\_ltd@hotmail.com

Our representative in China  
is Steven Chao, Shanghai Ultrasta  
Exhibition Co., Ltd. (China)  
Tel: +7 86-21-61853787  
Fax: +7 86-21-65741019  
E-mail: info@ultrasta.com

# RIDE GUIDE

Products and services for parks and attractions

## MEGAWHIRL BY GORDON RIDES/LARSON



Combining the thrill of a Whip with cars from the classic Tilt-a-Whirl, this brand new attraction from Gordon Rides and Larson International was engineered by Ride Centerline.

Passengers experience an unpredictable and thrilling trip around a wild, compact layout. MegaWhirl's many turns allow carriages to swing close to each other, providing riders with the illusion of a pending collision. Variations in ride path, curve pattern and size provide even greater unpredictability and thrills.

Alternatively, the transport system could be used inside a dark ride. See a video of the ride in action on the Gordon Rides website.

[www.gordonrides.com](http://www.gordonrides.com)



## HAPPYPILLAR BY AXES INC



It's a train ride without a track! Operators of the Happypillar simply mark their own track on the floor with paint, gaffer tape (duct tape) or anything else that takes their fancy and the caterpillar-themed train faithfully follows it using sensors in each car.

This gives operators of family entertainment centres, shopping malls and other venues – anywhere with a smooth, flat floor – total flexibility, allowing them to alter the layout according to their needs as their facility develops.

Trains can be operated with to eight or nine single-seater cars, although five are typical, and "track" lengths are obviously limitless. Each battery-powered train runs for up to 12 hours on a single charge.

Additional features include an MP3 music player inside the train and cut-out function to bring the ride to a stop if anyone steps in its path. Caterpillar-themed merchandise including key rings and plush toys are available for added income opportunities.

Manufactured in Turkey and sold/serviced in the USA, the Happypillar is already in operation in Australia, Kuwait, Dubai, Russia, Ukraine, the UK, Ireland, USA and Guatemala.

[www.happypillar.com](http://www.happypillar.com)

## BALLOON BLAST/BAZOOKA BLAST

BY BOB'S SPACE RACERS



Bob's has introduced a bunch of new games this winter; here are two of the best. Bazooka Blast (left) is easy; just push the trigger and fire to knock over the targets. The soft projectile is operator and customer safe.

Balloon Blast, meanwhile, is a time proven revenue producing game to add along existing dart games. The colourful unit is supplied complete with BSR's Auto Fill balloon inflating system.

[www.bobsspaceracers.com](http://www.bobsspaceracers.com)



## CRAZY FRUITS

BY ELTON GAMES



Elton's derby race games are a midway classic, not to mention a favourite of Park World's editor, but on quiet days at a park it can be frustrating waiting for other players. No such problem with Crazy Fruits, which requires just three players for a full race, or can be played by a single player against the machine. The coin-operated game is also operator free.

Players roll the ball to make their fruit – Berry, Nana or Pip – move. Red holes score 3, blue 2 and yellow 1. A cheeky soundtrack adds to the fun, provided in-house by an Elton employee.

The unit occupies a 3-square-metre footprint and dispenses redemption tickets to the winners. Payouts and the speed of the pear character that single players race against are fully adjustable by the operator.

Visit Elton Games at EAG International in London from January 24 to 26.

[www.eltongames.com](http://www.eltongames.com)



# ShowGuide

Exhibitions and networking for amusement professionals

• January 24 to 26, 2012

**EAG International**

ExCel, London, UK  
+44 1582 620951  
karencooke@eagexpo.com



• February 7 to 11

**IISF Trade Show**

Gibsonton (Gibtown), Florida, USA  
+1 813 677 3590  
info@gibtownshowmensclub.com  
www.gibtownshowmensclub.com



• February 28 & 29

**WWA European Symposium**

The Time Capsule, Coatbridge, Scotland  
+1 913 599 0300  
kelly@waterparks.org  
www.waterparks.org



• March 1 to 3

**IAAPI Amusement Expo**

Bombay Exhibition Centre, Mumbai, India  
+91 22 6523 1643  
info@iaapi.org  
www.iaapi.org



• March 14 to 16

**China Attractions Expo**

Beijing Exhibition Centre, China  
+44 1298 813148  
caapa@leisureandattractions.com  
www.caapa.org



• March 14 to 16

**Amusement Expo** (formerly Fun Expo)

Las Vegas Convention Center, USA  
+1 708 226 1300  
brian@wtglasgow.com  
www.amusementexpo.org



• March 21 to 23

**RAAPA Expo**

All Russia Exhibition Centre (VVTs), Moscow, Russia  
+44 1905 360165  
raapa@raapa.ru  
www.raapa.ru



• April 17 to 19

**DEAL 2012**

Dubai World Trade Centre, UAE  
+971 4 3435777  
jacob@iec.ae  
www.themeparksdubai.com



More events at [www.parkworld-online.com](http://www.parkworld-online.com)



## NEW THRILL RIDES



**"XLR8"**

Extreme acceleration • high speed experience  
1.5 hours set up • 16 persons capacity



**SICKO**

120 degree swing

ROTATING SEATS!

2 semi-trailers • set up without crane  
24 persons capacity • 85 ft. height

**KMG Europe BV**

Parallelweg 35 - 7161 AE Neede  
Tel.: +31-545-294 545 - Fax: +31-545 291 306  
E-mail: [sales@kmg.nl](mailto:sales@kmg.nl) - [www.kmg.nl](http://www.kmg.nl)

# Web Guide

Online resources for the amusement industry

## BUMPER CARS



[www.candsrides.biz](http://www.candsrides.biz)

## CASHLESS SYSTEMS



[www.embedcard.com](http://www.embedcard.com)

## COIN HANDLING EQUIPMENT



[www.cumminsallison.co.uk](http://www.cumminsallison.co.uk)

## DARK RIDES



[www.sallycorp.com](http://www.sallycorp.com)

## ENTERTAINMENT DESIGN



[www.kcc.be](http://www.kcc.be)

## EXHIBITIONS



[www.hauntcom.com](http://www.hauntcom.com)

## FAMILY/CHILDRENS ENTERTAINMENT CENTRES



[www.whitehutchinson.com](http://www.whitehutchinson.com)

## HIGHWAY 66 COIN OPERATED SCALED DOWN BOWLING SOLUTIONS



[www.amusement.qubicaamf.com](http://www.amusement.qubicaamf.com)

## INTERACTIVE PROJECT DISPLAY



[www.eyeclick.com](http://www.eyeclick.com)

## INTERACTIVE RIDES



[www.trio-tech.com](http://www.trio-tech.com)

## LEISURE ENGINEERING



[www.garmendale.co.uk](http://www.garmendale.co.uk)

## MAZES



[www.amazemazes.com](http://www.amazemazes.com)

## PEOPLE MOVERS



[www.dottotrains.com](http://www.dottotrains.com)



[www.severn-lamb.com](http://www.severn-lamb.com)

## PLANNING & DESIGN



[www.forrec.com](http://www.forrec.com)

## PLAY STRUCTURES



[www.iplayco.com](http://www.iplayco.com)

## REVIEWS AND INFORMATION



## RIDES



[www.mondialrides.com](http://www.mondialrides.com)



[www.tschu-tschu.de](http://www.tschu-tschu.de)

## RIDES



[www.prestonbarbieri.com](http://www.prestonbarbieri.com)



[www.wiegandslide.com](http://www.wiegandslide.com)



[www.pax.ru](http://www.pax.ru)



[www.ridesandfun.com](http://www.ridesandfun.com)



[www.sbfrides.com](http://www.sbfrides.com)

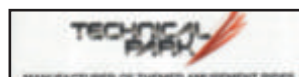

[www.technicalpark.com](http://www.technicalpark.com)



[www.mack-rides.com](http://www.mack-rides.com)



[www.intaminworldwide.com](http://www.intaminworldwide.com)



[www.vekoma.com](http://www.vekoma.com)

## SHOWS



[www.falconshow.com](http://www.falconshow.com)

## 4D ATTRACTIONS & SIMULATORS



[www.simworx.co.uk](http://www.simworx.co.uk)

## SNOW & ICE



[www.snow.biz](http://www.snow.biz)

## SPECIALIST PRINTING



[www.syndicateprinters.com](http://www.syndicateprinters.com)

## THEMING AND DESIGN



[www.jaravision.com](http://www.jaravision.com)

## THEMING AND DESIGN



[www.sarner.com](http://www.sarner.com)

## TRADE ASSOCIATIONS



[www.alesuk.org](http://www.alesuk.org)

## TICKETING



[www.accesso.com](http://www.accesso.com)



[www.gatewayticketing.com](http://www.gatewayticketing.com)



[www.nationalticket.com](http://www.nationalticket.com)



[www.omniticket.com](http://www.omniticket.com)

## VISITOR VIDEO SYSTEM



[www.tapemyday.com](http://www.tapemyday.com)

## WATER RIDES



[www.interlink-ig.com](http://www.interlink-ig.com)

## WATER RIDES & PARKS



[www.proslide.com](http://www.proslide.com)



[www.vanegdom.nl](http://www.vanegdom.nl)



[www.whitewaterwest.com](http://www.whitewaterwest.com)



[www.wiegand-maelzer.de](http://www.wiegand-maelzer.de)



*World of Rides*

Aengwilderweg 57, 8449 BA Terband, Holland

Tel.: +31 (0)513 61 01 70 • Fax: +31 (0)513 62 24 12 • E-mail: [info@mondialrides.com](mailto:info@mondialrides.com)

[www.mondialrides.com](http://www.mondialrides.com)

THE NEWEST ZAMPERLA RIDE

# AIR RACE

IT'S PURE SPEED !



A FAN FAVORITE SINCE ITS DEBUT AT LUNA PARK, CONEY ISLAND.

6 PLANES, EACH WITH 4 SEATS FOR A TOTAL CAPACITY OF 24 RIDERS PER CYCLE.

EACH PLANE IS EQUIPPED WITH STADIUM STYLE SEATING, GIVING ALL RIDERS A BIRDS-EYE-VIEW.

AIR RACE'S UNIQUE MOTION PROVIDES A SPECTACULAR SHOW FOR THOSE ON THE GROUND.

VARIOUS CYCLES THAT CAN ADAPT TO YOUR TARGET AUDIENCE.

RIDERS WILL EXPERIENCE THE SENSATION OF AEROBATIC FLIGHT WHILE ACCELERATING TO 3GS.



Moto Coaster

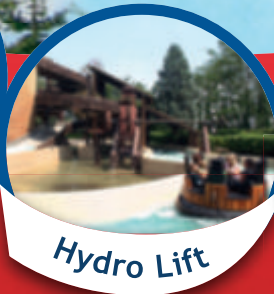

Hydro Lift



Vertical Swing



Twister Coaster