

A Guided Tour to Approximate String Matching

GONZALO NAVARRO

University of Chile

We survey the current techniques to cope with the problem of string matching that allows errors. This is becoming a more and more relevant issue for many fast growing areas such as information retrieval and computational biology. We focus on online searching and mostly on edit distance, explaining the problem and its relevance, its statistical behavior, its history and current developments, and the central ideas of the algorithms and their complexities. We present a number of experiments to compare the performance of the different algorithms and show which are the best choices. We conclude with some directions for future work and open problems.

Categories and Subject Descriptors: F.2.2 [**Analysis of algorithms and problem complexity**]: Nonnumerical algorithms and problems—*Pattern matching, Computations on discrete structures*; H.3.3 [**Information storage and retrieval**]: Information search and retrieval—*Search process*

General Terms: Algorithms

Additional Key Words and Phrases: Edit distance, Levenshtein distance, online string matching, text searching allowing errors

1. INTRODUCTION

This work focuses on the problem of *string matching that allows errors*, also called *approximate string matching*. The general goal is to perform string matching of a pattern in a text where one or both of them have suffered some kind of (undesirable) corruption. Some examples are recovering the original signals after their transmission over noisy channels, finding DNA subsequences after possible mutations, and text searching where there are typing or spelling errors.

The problem, in its most general form, is to find a text where a text given pattern occurs, allowing a limited number of “errors” in the matches. Each application uses a different error model, which defines how different two strings are. The idea for this “distance” between strings is to make it small when one of the strings is likely to be an erroneous variant of the other under the error model in use.

The goal of this survey is to present an overview of the state of the art in approximate string matching. We focus on online searching (that is, when the text

Partially supported by Fondecyt grant 1-990627.

Author’s address: Department of Computer Science, University of Chile, Blanco Erncalada 2120, Santiago, Chile, e-mail: gnavarro@dec.uchile.cl.

Permission to make digital or hard copies of part or all of this work for personal or classroom use is granted without fee provided that copies are not made or distributed for profit or direct commercial advantage and that copies show this notice on the first page or initial screen of a display along with the full citation. Copyrights for components of this work owned by others than ACM must be honored. Abstracting with credit is permitted. To copy otherwise, to republish, to post on servers, to redistribute to lists, or to use any component of this work in other works, requires prior specific permission and/or a fee. Permissions may be requested from Publications Dept, ACM Inc., 1515 Broadway, New York, NY 10036 USA, fax +1 (212) 869-0481, or permissions@acm.org.

©2001 ACM 0360-0300/01/0300-0031 \$5.00

cannot be preprocessed to build an index on it), explaining the problem and its relevance, its statistical behavior, its history and current developments, and the central ideas of the algorithms and their complexities. We also consider some variants of the problem. We present a number of experiments to compare the performance of the different algorithms and show the best choices. We conclude with some directions for future work and open problems.

Unfortunately, the algorithmic nature of the problem strongly depends on the type of “errors” considered, and the solutions range from linear time to NP-complete. The scope of our subject is so broad that we are forced to narrow our focus on a subset of the possible error models. We consider only those defined in terms of replacing some substrings by others at varying costs. In this light, the problem becomes minimizing the total cost to transform the pattern and its occurrence in text to make them equal, and reporting the text positions where this cost is low enough.

One of the best studied cases of this error model is the so-called *edit distance*, which allows us to delete, insert and substitute simple characters (with a different one) in both strings. If the different operations have different costs or the costs depend on the characters involved, we speak of *general edit distance*. Otherwise, if all the operations cost 1, we speak of *simple edit distance* or just *edit distance* (*ed*). In this last case we simply seek for the minimum number of insertions, deletions and substitutions to make both strings equal. For instance $ed(\text{"survey"}, \text{"surgery"}) = 2$. The edit distance has received a lot of attention because its generalized version is powerful enough for a wide range of applications. Despite the fact that most existing algorithms concentrate on the simple edit distance, many of them can be easily adapted to the generalized edit distance, and we pay attention to this issue throughout this work. Moreover, the few algorithms that exist for the general error model that we consider are generalizations of edit distance algorithms.

On the other hand, most of the algorithms designed for the edit distance are easily specialized to other cases of interest. For instance, by allowing only insertions and deletions at cost 1, we can compute the longest common subsequence (LCS) between two strings. Another simplification that has received a lot of attention is the variant that allows only substitutions (Hamming distance).

An extension of the edit distance enriches it with transpositions (i.e. a substitution of the form $ab \rightarrow ba$ at cost 1). Transpositions are very important in text searching applications because they are typical typing errors, but few algorithms exist to handle them. However, many algorithms for edit distance can be easily extended to include transpositions, and we keep track of this fact in this work.

Since the edit distance is by far the best studied case, this survey focuses basically on the simple edit distance. However, we also pay attention to extensions such as generalized edit distance, transpositions and general substring substitution, as well as to simplifications such as LCS and Hamming distance. In addition, we also pay attention to some extensions of the type of pattern to search: when the algorithms allow it, we mention the possibility of searching some extended patterns and regular expressions allowing errors. We now point out what we are *not* covering in this work.

—First, we do not cover other distance functions that do not fit the model of substring substitution. This is because they are too different from our focus and the paper would lose cohesion. Some of these are: Hamming distance (short survey in [Navarro 1998]), reversals [Kececioğlu and Sankoff 1995] (which allows reversing substrings), block distance [Tichy 1984; Ehrenfeucht and Haussler 1988; Ukkonen 1992; Lopresti and Tomkins 1997] (which allows rearranging and permuting the substrings), q -gram distance [Ukkonen 1992] (based on finding common substrings of fixed length q), allowing swaps [Amir et al. 1997b; Lee et al. 1997], etc. Hamming

- distance, despite being a simplification of the edit distance, is not covered because specialized algorithms for it exist that go beyond the simplification of an existing algorithm for edit distance.
- Second, we consider pattern matching over sequences of symbols, and at most generalize the pattern to a regular expression. Extensions such as approximate searching in multidimensional texts (short survey in [Navarro and Baeza-Yates 1999a]), in graphs [Amir et al. 1997a; Navarro 2000a] or multi-pattern approximate searching [Muth and Manber 1996; Baeza-Yates and Navarro 1997; Navarro 1997a; Baeza-Yates and Navarro 1998] are not considered. None of these areas is very developed and the algorithms should be easy to grasp once approximate pattern matching under the simple model is well understood. Many existing algorithms for these problems borrow from those we present here.
 - Third, we leave aside nonstandard algorithms, such as approximate,¹ probabilistic or parallel algorithms [Tarhio and Ukkonen 1988; Karloff 1993; Atallah et al. 1993; Altschul et al. 1990; Lipton and Lopresti 1985; Landau and Vishkin 1989].
 - Finally, an important area that we leave aside in this survey is indexed searching, i.e. the process of building a persistent data structure (an index) on the text to speed up the search later. Typical reasons that prevent keeping indices on the text are: extra space requirements (as the indices for approximate searching tend to take many times the text size), volatility of the text (as building the indices is quite costly and needs to

be amortized over many searches) and simply inadequacy (as the field of indexed approximate string matching is quite immature and the speedup that the indices provide is not always satisfactory). Indexed approximate searching is a difficult problem, and the area is quite new and active [Jokinen and Ukkonen 1991; Gonnet 1992; Ukkonen 1993; Myers 1994a; Holsti and Sutinen 1994; Manber and Wu 1994; Cobbs 1995; Sutinen and Tarhio 1996; Araújo et al. 1997; Navarro and Baeza-Yates 1999b; Baeza-Yates and Navarro 2000; Navarro et al. 2000]. The problem is very important because the texts in some applications are so large that no online algorithm can provide adequate performance. However, virtually all the indexed algorithms are strongly based on online algorithms, and therefore understanding and improving the current online solutions is of interest for indexed approximate searching as well.

These issues have been put aside to keep a reasonable scope in the present work. They certainly deserve separate surveys. Our goal in this survey is to explain the basic tools of approximate string matching, as many of the extensions we are leaving aside are built on the basic algorithms designed for online approximate string matching.

This work is organized as follows. In Section 2 we present in detail some of the most important application areas for approximate string matching. In Section 3 we formally introduce the problem and the basic concepts necessary to follow the rest of the paper. In Section 4 we show some analytical and empirical results about the statistical behavior of the problem.

Sections 5–8 cover all the work of interest we could trace on approximate string matching under the edit distance. We divided it in four sections that correspond to different approaches to the problem: dynamic programming, automata, bit-parallelism, and filtering algorithms. Each section is presented as a historical tour, so that we do not only explain the

¹ Please do not confuse an *approximate algorithm* (which delivers a suboptimal solution with some suboptimality guarantees) with an algorithm for approximate string matching. Indeed approximate string matching algorithms can be regarded as approximation algorithms for exact string matching (where the maximum distance gives the guarantee of optimality), but in this case it is *harder* to find the approximate matches, and of course the motivation is different.

work done but also show how it was developed.

Section 9 presents experimental results comparing the most efficient algorithms. Finally, we give our conclusions and discuss open questions and future work in Section 10.

There exist other surveys on approximate string matching, which are however too old for this fast moving area [Hall and Dowling 1980; Sankoff and Kruskal 1983; Apostolico and Galil 1985; Galil and Giancarlo 1988; Jokinen et al. 1996] (the last one was in its definitive form in 1991). So all previous surveys lack coverage of the latest developments. Our aim is to provide a long awaited update. This work is partially based in Navarro [1998], but the coverage of previous work is much more detailed here. The subject is also covered, albeit with less depth, in some textbooks on algorithms [Crochemore and Rytter 1994; Baeza-Yates and Ribeiro-Neto 1999].

2. MAIN APPLICATION AREAS

The first references to this problem we could trace are from the sixties and seventies, where the problem appeared in a number of different fields. In those times, the main motivation for this kind of search came from computational biology, signal processing, and text retrieval. These are still the largest application areas, and we cover each one here. See also [Sankoff and Kruskal 1983], which has a lot of information on the birth of this subject.

2.1 Computational Biology

DNA and protein sequences can be seen as long texts over specific alphabets (e.g. {A, C, G, T} in DNA). Those sequences represent the genetic code of living beings. Searching specific sequences over those texts appeared as a fundamental operation for problems such as assembling the DNA chain from the pieces obtained by the experiments, looking for given features in DNA chains, or determining how different two genetic sequences are. This was modeled as searching for given “patterns” in a “text.” However, exact searching was of

little use for this application, since the patterns rarely matched the text exactly: the experimental measures have errors of different kinds and even the correct chains may have small differences, some of them significant due to mutations and evolutionary alterations and others unimportant. Finding DNA chains very similar to those sought represent significant results as well. Moreover, establishing how different two sequences are is important to reconstruct the tree of the evolution (phylogenetic trees). All these problems required a concept of “similarity,” as well as an algorithm to compute it.

This gave a motivation to “search allowing errors.” The errors were those operations that biologists knew were common in genetic sequences. The “distance” between two sequences was defined as the minimum (i.e. more likely) sequence of operations to transform one into the other. With regard to likelihood, the operations were assigned a “cost,” such that the more likely operations were cheaper. The goal was then to minimize the total cost.

Computational biology has since then evolved and developed a lot, with a special push in recent years due to the “genome” projects that aim at the complete decoding of the DNA and its potential applications. There are other, more exotic, problems such as structure matching or searching for unknown patterns. Even the simple problem where the pattern is known is very difficult under some distance functions (e.g. reversals).

Some good references for the applications of approximate pattern matching to computational biology are Sellers [1974], Needleman and Wunsch [1970], Sankoff and Kruskal [1983], Altschul et al. [1990], Myers [1991, 1994b], Waterman [1995], Yap et al. [1996], and Gusfield [1997].

2.2 Signal Processing

Another early motivation came from signal processing. One of the largest areas deals with speech recognition, where the general problem is to determine, given an audio signal, a textual message which is being transmitted. Even simplified

problems such as discerning a word from a small set of alternatives is complex, since parts of the signal may be compressed in time, parts of the speech may not be pronounced, etc. A perfect match is practically impossible.

Another problem is error correction. The physical transmission of signals is error-prone. To ensure correct transmission over a physical channel, it is necessary to be able to recover the correct message after a possible modification (error) introduced during the transmission. The probability of such errors is obtained from the signal processing theory and used to assign a cost to them. In this case we may not even know what we are searching for, we just want a text which is correct (according to the error correcting code used) and closest to the received message. Although this area has not developed much with respect to approximate searching, it has generated the most important measure of similarity, known as the *Levenshtein distance* [Levenshtein 1965; 1966] (also called “edit distance”).

Signal processing is a very active area today. The rapidly evolving field of multimedia databases demands the ability to search by content in image, audio and video data, which are potential applications for approximate string matching. We expect in the next years a lot of pressure on nonwritten human-machine communication, which involves speech recognition. Strong error correcting codes are also sought, given the current interest in wireless networks, as the air is a low quality transmission medium.

Good references for the relations of approximate pattern matching with signal processing are Levenshtein [1965], Vintsyuk [1968], and Dixon and Martin [1979].

2.3 Text Retrieval

The problem of correcting misspelled words in written text is rather old, perhaps the oldest potential application for approximate string matching. We could find references from the twenties [Masters 1927], and perhaps there are older ones.

Since the sixties, approximate string matching is one of the most popular tools to deal with this problem. For instance, 80% of these errors are corrected allowing just one insertion, deletion, substitution, or transposition [Damerau 1964].

There are many areas where this problem appears, and Information Retrieval (IR) is one of the most demanding. IR is about finding the relevant information in a large text collection, and string matching is one of its basic tools.

However, classical string matching is normally not enough, because the text collections are becoming larger (e.g. the Web text has surpassed 6 terabytes [Lawrence and Giles 1999]), more heterogeneous (different languages, for instance), and more error prone. Many are so large and grow so fast that it is impossible to control their quality (e.g. in the Web). A word which is entered incorrectly in the database cannot be retrieved anymore. Moreover, the pattern itself may have errors, for instance in cross-lingual scenarios where a foreign name is incorrectly spelled, or in old texts that use outdated versions of the language.

For instance, text collections digitalized via optical character recognition (OCR) contain a nonnegligible percentage of errors (7–16%). The same happens with typing (1–3.2%) and spelling (1.5–2.5%) errors. Experiments for typing Dutch surnames (by the Dutch) reached 38% of spelling errors. All these percentages were obtained from Kukich [1992]. Our own experiments with the name “Levenshtein” in Altavista gave more than 30% of errors allowing just one deletion or transposition.

Nowadays, there is virtually no text retrieval product that does not allow some extended search facility to recover from errors in the text or pattern. Other text processing applications are spelling checkers, natural language interfaces, command language interfaces, computer aided tutoring and language learning, to name a few.

A very recent extension which became possible thanks to word-oriented text compression methods is the possibility to perform approximate string matching at the word level [Navarro et al. 2000]. That

is, the user supplies a phrase to search and the system searches the text positions where the phrase appears with a limited number of *word* insertions, deletions and substitutions. It is also possible to disregard the order of the words in the phrases. This allows the query to survive from different wordings of the same idea, which extends the applications of approximate pattern matching well beyond the recovery of syntactic mistakes.

Good references about the relation of approximate string matching and information retrieval are Wagner and Fisher [1974], Lowrance and Wagner [1975], Nesbit [1986], Owolabi and McGregor [1988], Kukich [1992], Zobel and Dart [1996], French et al. [1997], and Baeza-Yates and Ribeiro-Neto [1999].

2.4 Other Areas

The number of applications for approximate string matching grows every day. We have found solutions to the most diverse problems based on approximate string matching, for instance handwriting recognition [Lopresti and Tomkins 1994], virus and intrusion detection [Kumar and Spaffors 1994], image compression [Luczak and Szpankowski 1997], data mining [Das et al. 1997], pattern recognition [González and Thomason 1978], optical character recognition [Elliman and Lancaster 1990], file comparison [Heckel 1978], and screen updating [Gosling 1991], to name a few. Many more applications are mentioned in Sankoff and Kruskal [1983] and Kukich [1992].

3. BASIC CONCEPTS

We present in this section the important concepts needed to understand all the development that follows. Basic knowledge of the design and analysis of algorithms and data structures, basic text algorithms, and formal languages is assumed. If this is not the case we refer the reader to good books on these subjects, such as Aho et al. [1974], Cormen et al. [1990], Knuth [1973] (for algorithms), Gonnet and Baeza-Yates [1991], Crochemore and Rytter [1994],

Apostolico and Galil [1997] (for text algorithms), and Hopcroft and Ullman [1979] (for formal languages).

We start with some formal definitions related to the problem. Then we cover some data structures not widely known which are relevant for this survey (they are also explained in Gonnet and Baeza-Yates [1991] and Crochemore and Rytter [1994]). Finally, we make some comments about the tour itself.

3.1 Approximate String Matching

In the discussion that follows, we use s, x, y, z, v, w to represent arbitrary strings, and a, b, c, \dots to represent letters. Writing a sequence of strings and/or letters represents their concatenation. We assume that concepts such as prefix, suffix and substring are known. For any string $s \in \Sigma^*$ we denote its length as $|s|$. We also denote s_i the i th character of s , for an integer $i \in \{1..|s|\}$. We denote $s_{i..j} = s_i s_{i+1} \dots s_j$ (which is the empty string if $i > j$). The empty string is denoted as ε .

In the Introduction we have defined the problem of approximate string matching as that of finding the text positions that match a pattern with up to k errors. We now give a more formal definition.

Let Σ be a finite² alphabet of size $|\Sigma| = \sigma$.

Let $T \in \Sigma^*$ be a *text* of length $n = |T|$.

Let $P \in \Sigma^*$ be a *pattern* of length $m = |P|$.

Let $k \in \mathbb{R}$ be the maximum error allowed.

Let $d : \Sigma^* \times \Sigma^* \rightarrow \mathbb{R}$ be a *distance function*.

The problem is: given T, P, k and $d(\cdot)$, return the set of all the text positions j such that there exists i such that $d(P, T_{i..j}) \leq k$.

² However, many algorithms can be adapted to infinite alphabets with an extra $O(\log m)$ factor in their cost. This is because the pattern can have at most m different letters and all the rest can be considered equal for our purposes. A table of size σ could be replaced by a search structure over at most $m + 1$ different letters.

Note that endpoints of occurrences are reported to ensure that the output is of linear size. By reversing all strings we can obtain start points.

In this work we restrict our attention to a subset of the possible distance functions. We consider only those defined in the following form:

The distance $d(x, y)$ between two strings x and y is the minimal cost of a sequence of *operations* that transform x into y (and ∞ if no such sequence exists). The cost of a sequence of operations is the sum of the costs of the individual operations. The operations are a finite set of rules of the form $\delta(z, w) = t$, where z and w are *different* strings and t is a nonnegative real number. Once the operation has converted a substring z into w , no further operations can be done on w .

Note especially the restriction that forbids acting many times over the same string. Freeing the definition from this condition would allow any rewriting system to be represented, and therefore determining the distance between two strings would not be computable in general.

If for each operation of the form $\delta(z, w)$ there exists the respective operation $\delta(w, z)$ at the same cost, then the distance is symmetric (i.e. $d(x, y) = d(y, x)$). Note also that $d(x, y) \geq 0$ for all strings x and y , that $d(x, x) = 0$, and that it always holds $d(x, z) \leq d(x, y) + d(y, z)$. Hence, if the distance is symmetric, the space of strings forms a *metric space*.

General substring substitution has been used to correct phonetic errors [Zobel and Dart 1996]. In most applications, however, the set of possible operations is restricted to:

- Insertion*: $\delta(\varepsilon, a)$, i.e. inserting the letter a .
- Deletion*: $\delta(a, \varepsilon)$, i.e. deleting the letter a .
- Substitution or Replacement*: $\delta(a, b)$ for $a \neq b$, i.e. substituting a by b .
- Transposition*: $\delta(ab, ba)$ for $a \neq b$, i.e. swap the adjacent letters a and b .

We are now in position to define the most commonly used distance functions (although there are many others).

—*Levenshtein or edit distance* [Levenshtein 1965]: allows insertions, deletions and substitutions. In the simplified definition, all the operations cost 1. This can be rephrased as “the minimal number of insertions, deletions and substitutions to make two strings equal.” In the literature the search problem in many cases is called “string matching with k differences.” The distance is symmetric, and it holds $0 \leq d(x, y) \leq \max(|x|, |y|)$.

—*Hamming distance* [Sankoff and Kruskal 1983]: allows only substitutions, which cost 1 in the simplified definition. In the literature the search problem in many cases is called “string matching with k mismatches.” The distance is symmetric, and it is finite whenever $|x| = |y|$. In this case it holds $0 \leq d(x, y) \leq |x|$.

—*Episode distance* [Das et al. 1997]: allows only insertions, which cost 1. In the literature the search problem in many cases is called “episode matching,” since it models the case where a sequence of events is sought, where all of them must occur within a short period. This distance is not symmetric, and it may not be possible to convert x into y in this case. Hence, $d(x, y)$ is either $|y| - |x|$ or ∞ .

—*Longest common subsequence distance* [Needleman and Wunsch 1970; Apostolico and Guerra 1987]: allows only insertions and deletions, all costing 1. The name of this distance refers to the fact that it measures the length of the longest pairing of characters that can be made between both strings, so that the pairings respect the order of the letters. The distance is the number of unpaired characters. The distance is symmetric, and it holds $0 \leq d(x, y) \leq |x| + |y|$.

In all cases, except the episode distance, one can think that the changes can be made over x or y . Insertions on x are the

same as deletions in y and vice versa, and substitutions can be made in any of the two strings to match the other.

This paper is most concerned with the simple edit distance, which we denote $ed(\cdot)$. Although transpositions are of interest (especially in case of typing errors), there are few algorithms to deal with them. However, we will consider them at some point in this work (note that a transposition can be simulated with an insertion plus a deletion, but the cost is different). We also point out when the algorithms can be extended to have different costs of the operations (which is of special interest in computational biology), including the extreme case of not allowing some operations. This includes the other distances mentioned.

Note that if the Hamming or edit distance are used, then the problem makes sense for $0 < k < m$, since if we can perform m operations we can make the pattern match at any text position by means of m substitutions. The case $k = 0$ corresponds to exact string matching and is therefore excluded from this work. Under these distances, we call $\alpha = k/m$ the *error level*, which given the above conditions, satisfies $0 < \alpha < 1$. This value gives an idea of the “error ratio” allowed in the match (i.e. the fraction of the pattern that can be wrong).

We finish this section with some notes about the algorithms we are going to consider. Like string matching, this area is suitable for very theoretical and for very practical contributions. There exist a number of algorithms with important improvements in their theoretical complexity, but they are very slow in practice. Of course, for carefully built scenarios (say, $m = 100,000$ and $k = 2$) these algorithms could be a practical alternative, but these cases do not appear in applications. Therefore, we now point out the parameters of the problem that we consider “practical,” i.e. likely to be of use in some applications, and when we later say “in practice” we mean under the following assumptions.

—The pattern length can be as short as 5 letters (e.g. text retrieval) and as long

as a few hundred letters (e.g. computational biology).

- The number of errors allowed k satisfies that k/m is a moderately low value. Reasonable values range from $1/m$ to $1/2$.
- The text length can be as short as a few thousand letters (e.g. computational biology) and as long as megabytes or gigabytes (e.g. text retrieval).
- The alphabet size σ can be as low as four letters (e.g. DNA) and as high as 256 letters (e.g. compression applications). It is also reasonable to think in even larger alphabets (e.g. oriental languages or word oriented text compression). The alphabet may or may not be random.

3.2 Suffix Trees and Suffix Automata

Suffix trees [Weiner 1973; Knuth 1973; Apostolico and Galil 1985] are widely used data structures for text processing [Apostolico 1985]. Any position i in a string S automatically defines a *suffix* of S , namely $S_{i..|S|}$. In essence, a suffix tree is a trie data structure built over all the suffixes of S . At the leaf nodes the pointers to the suffixes are stored. Each leaf represents a suffix and each internal node represents a unique substring of S . Every substring of S can be found by traversing a path from the root. Each node representing the substring ax has a *suffix link* that leads to the node representing the substring x .

To improve space utilization, this trie is compacted into a Patricia tree [Morrison 1968]. This involves compressing unary paths. At the nodes that root a compressed path, an indication of which character to inspect is stored. Once unary paths are not present the tree has $O(|S|)$ nodes instead of the worst-case $O(|S|^2)$ of the trie (see Figure 1). The structure can be built in time $O(|S|)$ [McCreight 1976; Ukkonen 1995].

A DAWG (Deterministic Acyclic Word Graph) [Crochemore 1986; Blumer et al. 1985] built on a string S is a deterministic automaton able to recognize all the substrings of S . As each node in the suffix tree corresponds to a substring, the DAWG is no more than the suffix tree

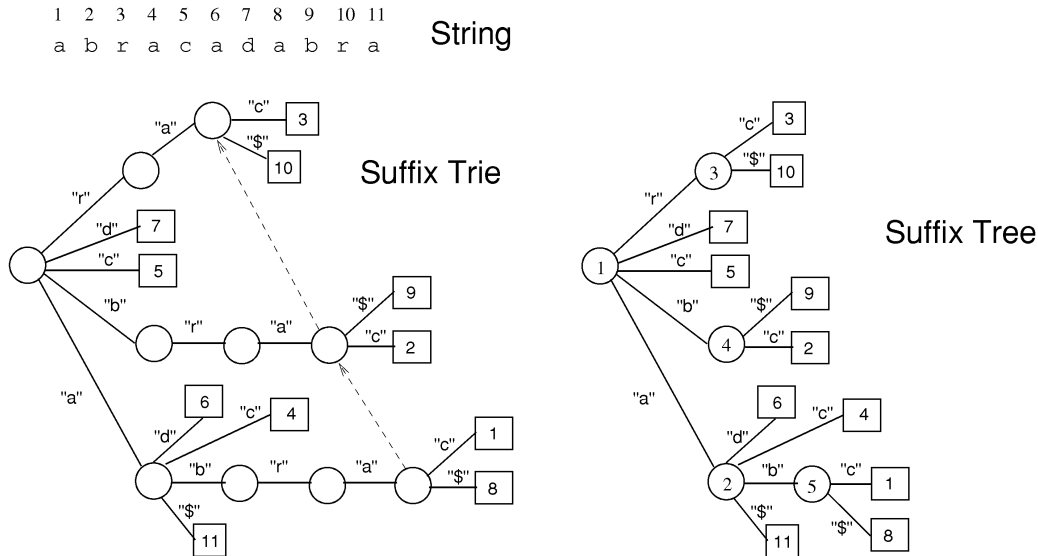

Fig. 1. The suffix trie and suffix tree for a sample string. The “\$” is a special marker to denote the end of the text. Two suffix links are exemplified in the trie: from “abra” to “bra” and then to “ra”. The internal nodes of the suffix tree show the character position to inspect in the string.

augmented with failure links for the letters not present in the tree. Since final nodes are not distinguished, the DAWG is smaller. DAWGs have similar applications to those of suffix trees, and also need $O(|S|)$ space and construction time. Figure 2 illustrates.

A *suffix automaton* on S is an automaton that recognizes all the suffixes of S . The nondeterministic version of this automaton has a very regular structure and is shown in Figure 3 (the deterministic version can be seen in Figure 2).

3.3 The Tour

Sections 5–8 present a historical tour across the four main approaches to on-line approximate string matching (see Figure 4). In those historical discussions, keep in mind that there may be a long gap between the time when a result is discovered and when it finally gets published in its definitive form. Some apparent inconsistencies can be explained in this way (e.g. algorithms which are “finally” analyzed before they appear). We did our best in the bibliography to trace the earliest version of the works, although the full reference corresponds generally to the final version.

At the beginning of each of these sections we give a taxonomy to help guide the tour. The taxonomy is an acyclic graph where the nodes are the algorithms and the edges mean that the work lower down can be seen as an evolution of the work in the upper position (although sometimes the developments are in fact independent).

Finally, we specify some notation regarding time and space complexity. When we say that an algorithm is $O(x)$ time we refer to its worst case (although sometimes we say that explicitly). If the cost is average, we say so explicitly. We also sometimes say that the algorithm is $O(x)$ cost, meaning time. When we refer to space complexity we say so explicitly. The average case analysis normally assumes a random text, where each character is selected uniformly and independently from the alphabet. The pattern is not normally assumed to be random.

4. THE STATISTICS OF THE PROBLEM

A natural question about approximate searching is: what is the probability of a match? This question is not only

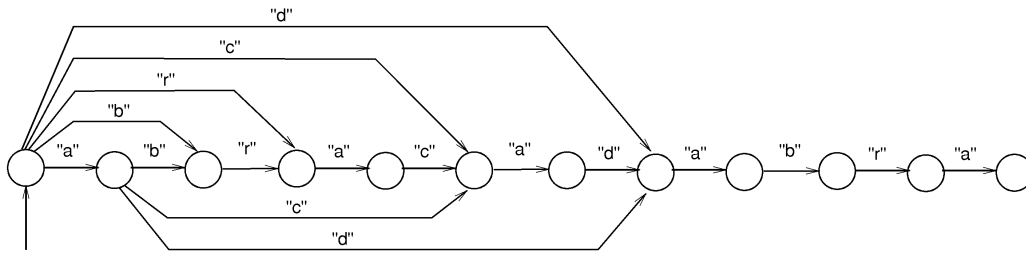

Fig. 2. The DAWG or the suffix automaton for the sample string. If all the states are final, it is a DAWG. If only the 2nd, 5th and rightmost states are final then it is a suffix automaton.

interesting in itself, but also essential for the average case analysis of many search algorithms, as will be seen later. We now present the existing results and an empirical validation. In this section we consider the edit distance only. Some variants can be adapted to these results.

The effort in analyzing the probabilistic behavior of the edit distance has not given good results in general [Kurtz and Myers 1997]. An exact analysis of the probability of the occurrence of a *fixed* pattern allowing k substitution errors (i.e. Hamming distance) can be found in Régnier and Szpankowski [1997], although the result is not easy to average over all the possible patterns. The results we present here apply to the edit distance model and, although not exact, are easier to use in general.

The result of Régnier and Szpankowski [1997] holds under the assumption that the characters of the text are independently generated with fixed probabilities, i.e. a Bernoulli model. In the rest of this paper we consider a simpler model, the “uniform Bernoulli model,” where all the characters occur with the same probability $1/\sigma$. Although this is a gross simplification of the real processes that generate the texts in most applications, the results obtained are quite reliable in practice. In particular, all the analyses apply quite well to biased texts if we replace σ by $1/p$, where p is the probability that two random text characters are equal.

Although the problem of the average edit distance between two strings is closely related to the better studied LCS, the well known results of Chvátal and Sankoff

[1975] and Deken [1979] can hardly be applied to this case. It can be shown that the average edit distance between two random strings of length m tends to a constant fraction of m as m grows, but the fraction is not known. It holds that for any two strings of length m , $m - lcs \leq ed \leq 2(m - lcs)$, where ed is their edit distance and lcs is the length of their longest common subsequence. As proved in Chvátal and Sankoff [1975], the average LCS is between $m/\sqrt{\sigma}$ and $me/\sqrt{\sigma}$ for large σ , and therefore the average edit distance is between $m(1 - e/\sqrt{\sigma})$ and $2m(1 - 1/\sqrt{\sigma})$. For large σ it is conjectured that the true value is $m(1 - 1/\sqrt{\sigma})$ [Sankoff and Mainville 1983].

For our purposes, bounding the probability of a match allowing errors is more important than the average edit distance. Let $f(m, k)$ be the probability of a random pattern of length m matching a given text position with k errors or less under the edit distance (i.e. the text position is reported as the end of a match). In Baeza-Yates and Navarro [1999], Navarro [1998], and Navarro and Baeza-Yates [1999b] upper and lower bounds on the maximum error level α^* for which $f(m, k)$ is exponentially decreasing on m are found. This is important because many algorithms search for potential matches that have to be verified later, and the cost of such verifications is polynomial in m , typically $O(m^2)$. Therefore, if that event occurs with probability $O(\gamma^m)$ for some $\gamma < 1$ then the total cost of verifications is $O(m^2\gamma^m) = o(1)$, which makes the verification cost negligible.

We first show the analytical bounds for $f(m, k)$, then give a new result on average

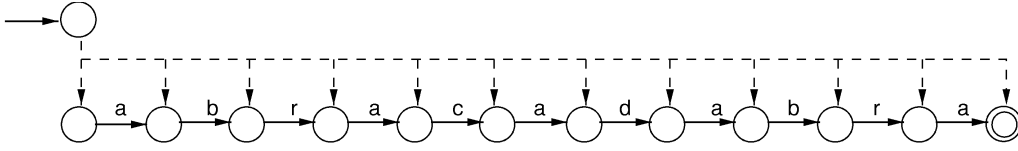

Fig. 3. A nondeterministic suffix automaton to recognize any suffix of "abracadabra." Dashed lines represent ϵ -transitions (i.e. they occur without consuming any input).

edit distance, and finally present an experimental verification.

4.1 An Upper Bound

The upper bound for α^* comes from the proof that the matching probability is $f(m, k) = O(\gamma^m)$ for

$$\gamma = \left(\frac{1}{\sigma \alpha^{\frac{2\alpha}{1-\alpha}} (1-\alpha)^2} \right)^{1-\alpha} \leq \left(\frac{e^2}{\sigma (1-\alpha)^2} \right)^{1-\alpha} \quad (1)$$

where we note that γ is $1/\sigma$ for $\alpha = 0$ and grows to 1 as α grows. This matching probability is exponentially decreasing on m as long as $\gamma < 1$, which is equivalent to

$$\alpha < 1 - \frac{e}{\sqrt{\sigma}} - O(1/\sigma) \leq 1 - \frac{e}{\sqrt{\sigma}} \quad (2)$$

Therefore, $\alpha < 1 - e/\sqrt{\sigma}$ is a conservative condition on the error level which ensures "few" matches. Therefore, the maximum level α^* satisfies $\alpha^* > 1 - e/\sqrt{\sigma}$.

The proof is obtained using a combinatorial model. Based on the observation that $m - k$ common characters must appear in the same order in two strings that match with k errors, all the possible alternatives to select the matching characters from both strings are enumerated. This model, however, does not take full advantage of the properties of the edit distance: even if $m - k$ characters match, the distance can be larger than k . For example, in $ed(abc, bcd) = 2$, i.e. although two characters match, the distance is not 1.

4.2 A Lower Bound

On the other hand, the only optimistic bound we know of is based on the consideration that only substitutions are allowed

(i.e. Hamming distance). This distance is simpler to analyze but its matching probability is much lower. Using a combinatorial model again it is shown that the matching probability is $f(m, k) \geq \delta^m m^{-1/2}$, where

$$\delta = \left(\frac{1}{(1-\alpha)\sigma} \right)^{1-\alpha}$$

Therefore an upper bound for the maximum α^* value is $\alpha^* \leq 1 - 1/\sigma$, since otherwise it can be proved that $f(m, k)$ is not exponentially decreasing on m (i.e. it is $\Omega(m^{-1/2})$).

4.3 A New Result on Average Edit Distance

We can now prove that the average edit distance is larger than $m(1 - e/\sqrt{\sigma})$ for any σ (recall that the result of Chvátal and Sankoff[1975] holds for large σ). We define $p(m, k)$ as the probability that the edit distance between two strings of length m is at most k . Note that $p(m, k) \leq f(m, k)$ because in the latter case we can match with any text suffix of length from $m - k$ to $m + k$. Then the average edit distance is

$$\begin{aligned} \sum_{k=0}^m k \Pr(ed = k) &= \sum_{k=0}^m \Pr(ed > k) \\ &= \sum_{k=0}^m 1 - p(m, k) = m - \sum_{k=0}^m p(m, k) \end{aligned}$$

which, since $p(m, k)$ increases with k , is larger than

$$m - (Kp(m, K) + (m - K)) = K(1 - p(m, K))$$

for any K of our choice. In particular, for $K/m < 1 - e/\sqrt{\sigma}$ we have that $p(m, K) \leq f(m, K) = O(\gamma^m)$ for $\gamma < 1$. Therefore choosing $K = m(1 - e/\sqrt{\sigma}) - 1$ yields that the edit distance is at least

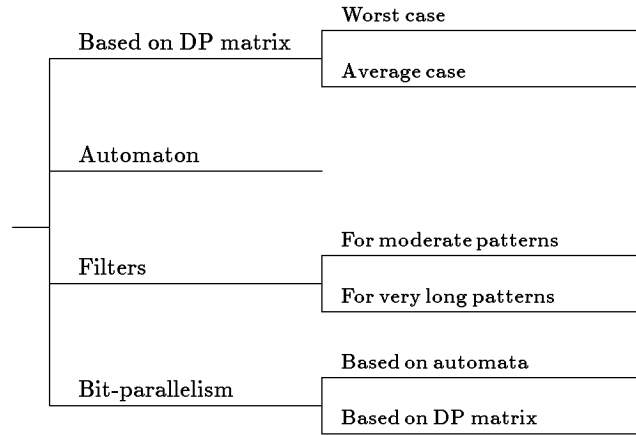

Fig. 4. Taxonomy of the types of solutions for online searching.

$m(1 - e/\sqrt{\sigma}) + O(1)$, for any σ . As we see later, this proof converts a conjecture about the average running time of an algorithm [Chang and Lampe 1992] into a fact.

4.4 Empirical Verification

We verify the analysis experimentally in this section (this is also taken from Baeza-Yates and Navarro [1999] and Navarro [1998]). The experiment consists of generating a large random text ($n = 10$ MB) and running the search of a random pattern on that text, allowing $k = m$ errors. At each text character, we record the minimum allowed error k for which that text position matches the pattern. We repeat the experiment with 1,000 random patterns.

Finally, we build the cumulative histogram, finding how many text positions have matched with up to k errors, for each k value. We consider that k is “low enough” up to where the histogram values become significant, that is, as long as few text positions have matched. The threshold is set to n/m^2 , since m^2 is the normal cost of verifying a match. However, the selection of this threshold is not very important, since the histogram is extremely concentrated. For example, for m in the hundreds, it moves from almost zero to almost n in just five or six increments of k .

Figure 5 shows the results for $\sigma = 32$. On the left we show the histogram we have built, where the matching probability

undergoes a sharp increase at α^* . On the right we show the α^* value as m grows. It is clear that α^* is essentially independent of m , although it is a bit lower for short patterns. The increase in the left plot at α^* is so sharp that the right plot would be the same if we plotted the value of the average edit distance divided by m .

Figure 6 uses a stable $m = 300$ to show the α^* value as a function of σ . The curve $\alpha = 1 - 1/\sqrt{\sigma}$ is included to show its closeness to the experimental data. Least squares give the approximation $\alpha^* = 1 - 1.09/\sqrt{\sigma}$, with a relative error smaller than 1%. This shows that the upper bound analysis (Eq. (2)) matches reality better, provided we replace e by 1.09 in the formulas.

Therefore, we have shown that the matching probability has a sharp behavior: for low α it is very low, not as low as $1/\sigma^m$ like exact string matching, but still exponentially decreasing in m , with an exponent base larger than $1/\sigma$. At some α value (that we call α^*) it sharply increases and quickly becomes almost 1. This point is close to $\alpha^* = 1 - 1/\sqrt{\sigma}$ in practice.

This is why the problem is of interest only up to a given error level, since for higher errors almost all text positions match. This is also the reason that some algorithms have good average behavior only for low enough error levels. The point $\alpha^* = 1 - 1/\sqrt{\sigma}$ matches the conjecture of Sankoff and Mainville [1983].

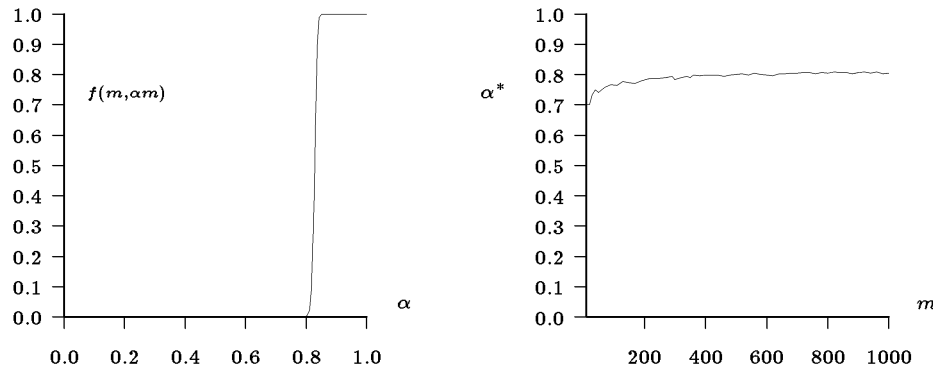

Fig. 5. On the left, probability of an approximate match as a function of the error level ($m = 300$). On the right, the observed α^* error level as a function of the pattern length. Both cases correspond to random text with $\sigma = 32$.

5. DYNAMIC PROGRAMMING ALGORITHMS

We start our tour with the oldest among the four areas, which directly inherits from the earliest work. Most of the theoretical breakthroughs in the worst-case algorithms belong to this category, although only a few of them are really competitive in practice. The latest practical work in this area dates back to 1992, although there are recent theoretical improvements. The major achievements are $O(kn)$ worst-case algorithms and $O(kn/\sqrt{\sigma})$ average-case algorithms, as well as other recent theoretical improvements on the worst-case.

We start by presenting the first algorithm that solved the problem and then give a historical tour on the improvements over the initial solution. Figure 7 helps guide the tour.

5.1 The First Algorithm

We now present the first algorithm to solve the problem. It has been rediscovered many times in the past, in different areas, e.g. Vintsyuk [1968], Needleman and Wunsch [1970], Sankoff [1972], Sellers [1974], Wagner and Fisher [1974], and Lowrance and Wagner [1975] (there are more in Ullman [1977], Sankoff and Kruskal [1983], and Kukich [1992]). However, this algorithm computed the edit distance, and it was converted into a search algorithm only in 1980 by Sellers [Sellers 1980]. Although the algorithm is not very

efficient, it is among the most flexible ones in adapting to different distance functions.

We first show how to compute the edit distance between two strings x and y . Later, we extend that algorithm to search a pattern in a text allowing errors. Finally, we show how to handle more general distance functions.

5.1.1 Computing Edit Distance. The algorithm is based on dynamic programming. Imagine that we need to compute $ed(x, y)$. A matrix $C_{0..|x|, 0..|y|}$ is filled, where $C_{i,j}$ represents the minimum number of operations needed to match $x_{1..i}$ to $y_{1..j}$. This is computed as follows:

$$\begin{aligned} C_{i,0} &= i \\ C_{0,j} &= j \\ C_{i,j} &= \text{if } (x_i = y_j) \text{ then } C_{i-1,j-1} \\ &\quad \text{else } 1 + \min(C_{i-1,j}, C_{i,j-1}, C_{i-1,j-1}) \end{aligned}$$

where at the end $C_{|x|,|y|} = ed(x, y)$. The rationale for the above formula is as follows. First, $C_{i,0}$ and $C_{0,j}$ represent the edit distance between a string of length i or j and the empty string. Clearly i (respectively j) deletions are needed on the nonempty string. For two nonempty strings of length i and j , we assume inductively that all the edit distances between shorter strings have already been computed, and try to convert $x_{1..i}$ into $y_{1..j}$.

Consider the last characters x_i and y_j . If they are equal, then we do not need to

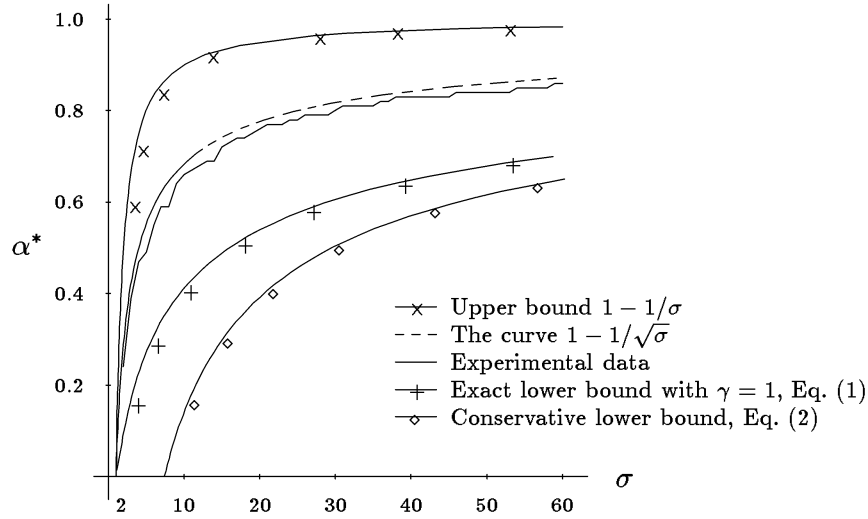

Fig. 6. Theoretical and practical values for α^* , for $m = 300$ and different σ values.

consider them and we proceed in the best possible way to convert $x_{1..i-1}$ into $y_{1..j-1}$. On the other hand, if they are not equal, we must deal with them in some way. Following the three allowed operations, we can delete x_i and convert in the best way $x_{1..i-1}$ into $y_{1..j}$, insert y_j at the end of $x_{1..i}$ and convert in the best way $x_{1..i}$ into $y_{1..j-1}$, or substitute x_i by y_j and convert in the best way $x_{1..i-1}$ into $y_{1..j-1}$. In all cases, the cost is 1 plus the cost for the rest of the process (already computed). Notice that the insertions in one string are equivalent to deletions in the other.

An equivalent formula which is also widely used is

$$C'_{i,j} = \min(C_{i-1,j-1} + \delta(x_i, y_j), C_{i-1,j} + 1, C_{i,j-1} + 1)$$

where $\delta(a, b) = 0$ if $a = b$ and 1 otherwise. It is easy to see that both formulas are equivalent because neighboring cells differ in at most one (just recall the meaning of $C_{i,j}$), and therefore when $\delta(x_i, y_j) = 0$ we have that $C_{i-1,j-1}$ cannot be larger than $C_{i-1,j} + 1$ or $C_{i,j-1} + 1$.

The dynamic programming algorithm must fill the matrix in such a way that the upper, left, and upper-left neighbors of a cell are computed prior to computing that cell. This is easily achieved by either

a row-wise left-to-right traversal or a column-wise top-to-bottom traversal, but we will see later that, using a difference recurrence, the matrix can also be filled by (upper-left to lower-right) diagonals or “secondary” (upper-right to lower-left) diagonals. Figure 8 illustrates the algorithm to compute $ed(\text{"survey"}, \text{"surgery"})$.

Therefore, the algorithm is $O(|x||y|)$ time in the worst and average case. However, the space required is only $O(\min(|x|, |y|))$. This is because, in the case of a column-wise processing, only the previous column must be stored in order to compute the new one, and therefore we just keep one column and update it. We can process the matrix row-wise or column-wise so that the space requirement is minimized.

On the other hand, the sequences of operations performed to transform x into y can be easily recovered from the matrix, simply by proceeding from the cell $C_{|x|,|y|}$ to the cell $C_{0,0}$ following the path (i.e. sequence of operations) that matches the update formula (multiple paths may exist). In this case, however, we need to store the complete matrix or at least an area around the main diagonal.

This matrix has some properties that can be easily proved by induction (see, e.g. Ukkonen [1985a]) and which make it

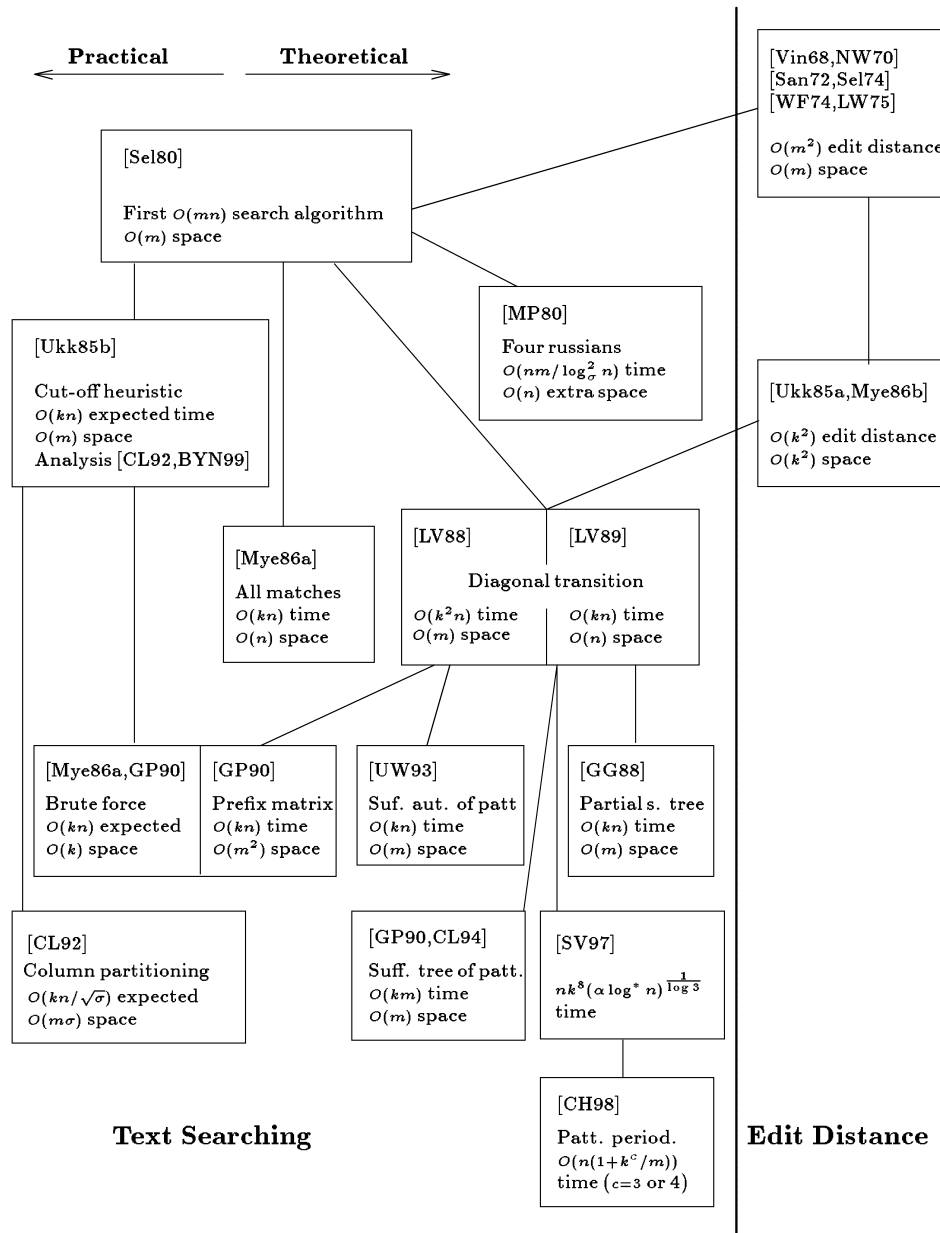

Fig. 7. Taxonomy of algorithms based on the dynamic programming matrix. References are shortened to first letters (single authors) or initials (multiple authors), and to the last two digits of years.

Key: Vin68 = [Vintsyuk 1968], NW70 = [Needleman and Wunsch 1970], San72 = [Sankoff 1972], Sel74 = [Sellers 1974], WF74 = [Wagner and Fisher 1974], LW75 = [Lowrance and Wagner 1975], Sel80 = [Sellers 1980], MP80 = [Masek and Paterson 1980], Ukk85a & Ukk85b = [Ukkonen 1985a; 1985b], Mye86a & Mye86b = [Myers 1986a; 1986b], LV88 & LV89 = [Landau and Vishkin 1988; 1989], GP90 = [Galil and Park 1990], UW93 = [Ukkonen and Wood 1993], GG88 = [Galil and Giancarlo 1988], CL92 = [Chang and Lampe 1992], CL94 = [Chang and Lawler 1994], SV97 = [Sahinalp and Vishkin 1997], CH98 = [Cole and Hariharan 1998], and BYN99 = [Baeza-Yates and Navarro 1999].

		s	u	r	g	e	r	y
	0	1	2	3	4	5	6	7
s	1	0	1	2	3	4	5	6
u	2	1	0	1	2	3	4	5
r	3	2	1	0	1	2	3	4
v	4	3	2	1	1	2	3	4
e	5	4	3	2	2	1	2	3
y	6	5	4	3	3	2	2	2

Fig. 8. The dynamic programming algorithm to compute the edit distance between "survey" and "surgery." The bold entries show the path to the final result.

possible to design better algorithms. Some of the most useful are that the values of neighboring cells differ in at most one, and that upper-left to lower-right diagonals are nondecreasing.

5.1.2 Text Searching. We now show how to adapt this algorithm to search a short pattern P in a long text T . The algorithm is basically the same, with $x = P$ and $y = T$ (proceeding column-wise so that $O(m)$ space is required). The only difference is that we must allow that any text position is the potential start of a match. This is achieved by setting $C_{0,j} = 0$ for all $j \in 0..n$. That is, the empty pattern matches with zero errors at any text position (because it matches with a text substring of length zero).

The algorithm then initializes its column $C_{0..m}$ with the values $C_i = i$, and processes the text character by character. At each new text character T_j , its column vector is updated to $C'_{0..m}$. The update formula is

$$C'_i = \text{if } (P_i = T_j) \text{ then } C_{i-1} \\ \text{else } 1 + \min(C'_{i-1}, C_i, C_{i-1})$$

and the text positions are where $C_m \leq k$ is reported.

The search time of this algorithm is $O(mn)$ and its space requirement is $O(m)$. This is a sort of worst case in the analysis of all the algorithms that we consider later. Figure 9 exemplifies this algorithm applied to search the pattern "survey" in the text "surgery" (a very short text in-

		s	u	r	g	e	r	y
	0	0	0	0	0	0	0	0
s	1	0	1	1	1	1	1	1
u	2	1	0	1	2	2	2	2
r	3	2	1	0	1	2	2	3
v	4	3	2	1	1	2	3	3
e	5	4	3	2	2	1	2	3
y	6	5	4	3	3	2	2	2

Fig. 9. The dynamic programming algorithm to search "survey" in the text "surgery" with two errors. Each column of this matrix is a value of the C vector. Bold entries indicate matching text positions.

deed) with at most $k = 2$ errors. In this case there are 3 occurrences.

5.1.3 Other Distance Functions. It is easy to adapt this algorithm for the other distance functions mentioned. If the operations have different costs, we add the cost instead of adding 1 when computing $C_{i,j}$, i.e.

$$C_{0,0} = 0 \\ C_{i,j} = \min(C_{i-1,j-1} + \delta(x_i, y_j), \\ C_{i-1,j} + \delta(x_i, \varepsilon), C_{i,j-1} + \delta(\varepsilon, y_j))$$

where we assume $\delta(a, a) = 0$ for any $a \in \Sigma$ and that $C_{-1,j} = C_{i,-1} = \infty$ for all i, j .

For distances that do not allow some operations, we just take them out of the minimization formula, or, which is the same, we assign ∞ to their δ cost. For transpositions, we allow a fourth rule that says that $C_{i,j}$ can be $C_{i-2,j-2} + 1$ if $x_{i-1}x_i = y_j y_{j-1}$ [Lowrance and Wagner 1975].

The most complex case is to allow general substring substitutions, in the form of a finite set R of rules. The formula is given in Ukkonen [1985a].

$$C_{0,0} = 0 \\ C_{i,j} = \min(C_{i-1,j-1} \text{ if } x_i = y_j, \\ C_{i-|s_1|,j-|s_2|} + \delta(s_1, s_2) \\ \text{for each } (s_1, s_2) \in R, x_{1..i} = x's_1, \\ y_{1..j} = y's_2)$$

An interesting problem is how to compute this recurrence efficiently. A naive approach takes $O(|R|mn)$, where $|R|$ is the sum of all the lengths of the strings in

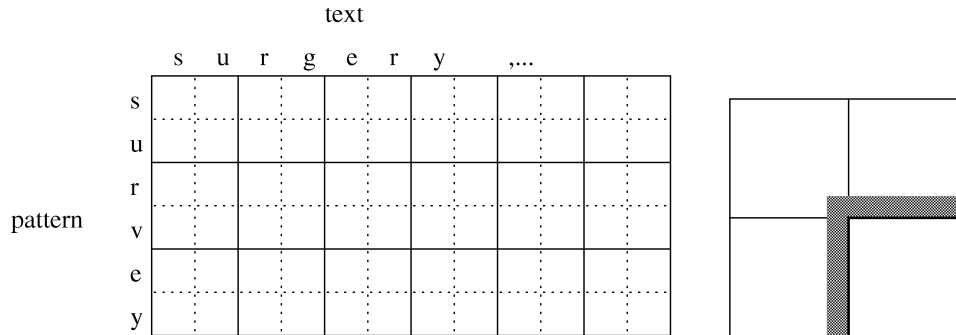

Fig. 10. The Masek and Paterson algorithm partitions the dynamic programming matrix in cells ($r = 2$ in this example). On the right, we shaded the entries of adjacent cells that influence the current one.

R. A better solution is to build two Aho–Corasick automata [Aho and Corasick 1975] with the left and right hand sides of the rules, respectively. The automata are run as we advance in both strings (left hand sides in x and right hand sides in y). For each pair of states (i_1, i_2) of the automata we precompute the set of substitutions that can be tried (i.e. those δ 's whose left and right hand sides match the suffixes of x and y , respectively, represented by the automata states). Hence, we know in constant time (per cell) the set of possible substitutions. The complexity is now much lower, in the worst case it is $O(cmn)$ where c is the maximum number of rules applicable to a single text position.

As mentioned, the dynamic programming approach is unbeaten in flexibility, but its time requirements are indeed high. A number of improved solutions have been proposed over the years. Some of them work only for the edit distance, while others can still be adapted to other distance functions. Before considering the improvements, we mention that there exists a way to see the problem as a shortest path problem on a graph built on the pattern and the text [Ukkonen 1985a]. This reformulation has been conceptually useful for more complex variants of the problem.

5.2 Improving the Worst Case

5.2.1 Masek and Paterson (1980). It is interesting that one important worst-case

theoretical result in this area is as old as the Sellers algorithm [Sellers 1980] itself. In 1980, Masek and Paterson [1980] found an algorithm whose worst case cost is $O(mn/\log_{\sigma}^2 n)$ and requires $O(n)$ extra space. This is an improvement over the $O(mn)$ classical complexity.

The algorithm is based on the Four-Russians technique [Arlazarov et al. 1975]. Basically, it replaces the alphabet Σ by r -tuples (i.e. Σ^r) for a small r . Considered algorithmically, it first builds a table of solutions of all the possible problems (i.e. portions of the matrix) of size $r \times r$, and then uses the table to solve the original problem in blocks of size r . Figure 10 illustrates.

The values inside the $r \times r$ size cells depend on the corresponding letters in the pattern and the text, which gives σ^{2r} possibilities. They also depend on the values in the last column and row of the upper and left cells, as well as the bottom-right state of the upper left cell (see Figure 10). Since neighboring cells differ in at most one, there are only three choices for adjacent cells once the current cell is known. Therefore, this adds only $m(3^{2r})$ possibilities. In total, there are $m(3\sigma)^{2r}$ different cells to precompute. Using $O(n)$ memory we have enough space for $r = \log_{3\sigma} n$, and since we finally compute mn/r^2 cells, the final complexity follows.

The algorithm is only of theoretical interest, since as the same authors estimate, it will not beat the classical algorithm for

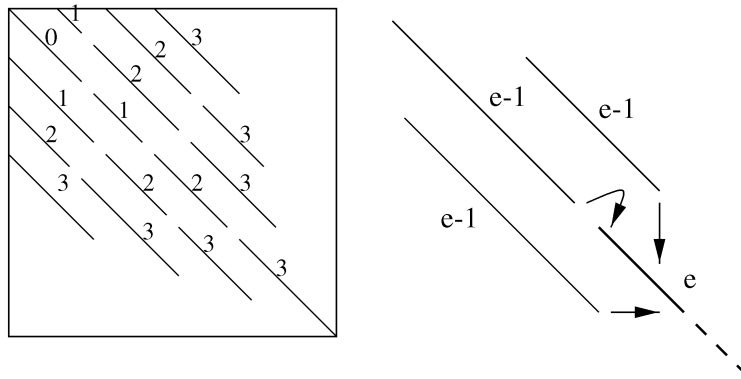

Fig. 11. On the left, the $O(k^2)$ algorithm to compute the edit distance. On the right, the way to compute the strokes in diagonal transition algorithms. The solid bold line is guaranteed to be part of the new stroke of e errors, while the dashed part continues as long as both strings match.

texts below 40 GB size (and it would need that extra space!). Adapting it to other distance functions does not seem difficult, but the dependencies among different cells may become more complex.

5.2.2 Ukkonen (1983). In 1983, Ukkonen [1985a] presented an algorithm able to compute the edit distance between two strings x and y in $O(ed(x, y)^2)$ time, or to check in time $O(k^2)$ whether that distance was $\leq k$ or not. This is the first member of what has been called “diagonal transition algorithms,” since it is based on the fact that the diagonals of the dynamic programming matrix (running from the upper-left to the lower-right cells) are monotonically increasing (more than that, $C_{i+1,j+1} \in \{C_{i,j}, C_{i,j} + 1\}$). The algorithm is based on computing in constant time the positions where the values along the diagonals are incremented. Only $O(k^2)$ such positions are computed to reach the lower-right decisive cell.

Figure 11 illustrates the idea. Each diagonal *stroke* represents a number of errors, and is a sequence where both strings match. When a stroke of e errors starts, it continues until the adjacent strokes of $e-1$ errors continue or until it keeps matching the text. To compute each stroke in constant time we need to know at what point it matches the text. The way to do this in constant time is explained shortly.

5.2.3 Landau and Vishkin (1985). In 1985 and 1986, Landau and Vishkin found the first worst-case time improvements for the search problem. All of them and the thread that followed were diagonal transition algorithms. In 1985, Landau and Vishkin [1988] showed an algorithm which was $O(k^2n)$ time and $O(m)$ space, and in 1986 they obtained $O(kn)$ time and $O(n)$ space [Landau and Vishkin 1989].

The main idea in Landau and Vishkin was to adapt the Ukkonen’s diagonal transition algorithm for edit distance [Ukkonen 1985a] to text searching. Basically, the dynamic programming matrix was computed diagonal-wise (i.e. stroke by stroke) instead of column-wise. They wanted to compute the length of each stroke in constant time (i.e. the point where the values along a diagonal were to be incremented). Since a text position was to be reported when matrix row m was reached before incrementing more than k times the values along the diagonal, this immediately gave the $O(kn)$ algorithm. Another way to see it is that each diagonal is abandoned as soon as the k th stroke ends, there are n diagonals and hence nk strokes, each of them computed in constant time (recall Figure 11).

A recurrence on diagonals (d) and number of errors (e), instead of rows (i) and columns (j), is set up in the following way:

	-3	-2	-1	0	1	2	3	4	5	6	7
0		0	3	0	0	0	0	0	0	0	0
1	1	1	4	5	3	1	1	1	1	1	1
2	2	5	6	6	6	3	2	3	2	2	2

Fig. 12. The diagonal transition matrix to search "survey" in the text "surgery" with two errors. Bold entries indicate matching diagonals. The rows are e values and the columns are the d values.

$$\begin{aligned}
 L_{d,-1} &= L_{n+1,e} = -1, \text{ for all } e, d \\
 L_{d,|d|-2} &= |d| - 2, \text{ for } -(k+1) \leq d \leq -1 \\
 L_{d,|d|-1} &= |d| - 1, \text{ for } -(k+1) \leq d \leq -1 \\
 L_{d,e} &= i + \max_{\ell} (P_{i+1..i+\ell} = T_{d+i+1..d+i+\ell}) \\
 \text{where } i &= \max(L_{d,e-1} + 1, \\
 &\quad L_{d-1,e-1}, L_{d+1,e-1} + 1)
 \end{aligned}$$

where the external loop updates e from 0 to k and the internal one updates d from $-e$ to n . Negative numbered diagonals are those virtually starting before the first text position. Figure 12 shows our search example using this recurrence.

Note that the L matrix has to be filled by diagonals, e.g. $L_{0,3}, L_{1,2}, L_{2,1}, L_{0,4}, L_{1,3}, L_{2,2}, L_{0,5}, \dots$. The difficult part is how to compute the strokes in constant time (i.e. the $\max_{\ell}(\cdot)$). The problem is equivalent to knowing which is the longest prefix of $P_{i..m}$ that matches $T_{j..n}$. This data is called "matching statistics." The algorithms of this section differ basically in how they manage to quickly compute the matching statistics.

We defer the explanation of Landau and Vishkin [1988] for later (together with Galil and Park [1990]). In Landau and Vishkin [1989], the longest match is obtained by building the suffix tree (see Section 3.2) of $T;P$ (text concatenated with pattern), where the huge $O(n)$ extra space comes from. The longest prefix common to both suffixes $P_{i..m}$ and $T_{j..n}$ can be visualized in the suffix tree as follows: imagine the root to leaf paths that end in each of the two suffixes. Both parts share the beginning of the path (at least they share the root). The last suffix tree node common to both paths represents a substring which is precisely the longest common prefix. In the literature, this last common node is called *lowest common ancestor* (LCA) of two nodes.

Despite being conceptually clear, it is not easy to find this node in constant time. In 1986, the only existing LCA algorithm was that of Harel and Tarjan [1984], which had constant amortized time, i.e. it answered $n' > n$ LCA queries in $O(n')$ time. In our case we have kn queries, so each one finally cost $O(1)$. The resulting algorithm, however, is quite slow in practice.

5.2.4 Myers (1986). In 1986, Myers also found an algorithm with $O(kn)$ worst-case behavior [Myers 1986a, 1986b]. It needed $O(n)$ extra space, and shared the idea of computing the k new strokes using the previous ones, as well as the use of a suffix tree on the text for the LCA algorithm. Unlike other algorithms, this one is able to report the $O(kn)$ matching substrings of the text (not only the endpoints) in $O(kn)$ time. This makes the algorithm suitable for more complex applications, for instance in computational biology. The original reference is a technical report and never went to press, but it has recently been included in a larger work [Landau et al. 1998].

5.2.5 Galil and Giancarlo (1988). In 1988, Galil and Giancarlo [1988] obtained the same time complexity as Landau and Vishkin using $O(m)$ space. Basically, the suffix tree of the text is built by overlapping pieces of size $O(m)$. The algorithm scans the text four times, being even slower than [Landau and Vishkin 1989]. Therefore, the result was of theoretical interest.

5.2.6 Galil and Park (1989). One year later, in 1989, Galil and Park [1990] obtained $O(kn)$ worst-case time and $O(m^2)$ space, worse in theory than Galil and Giancarlo [1988] but much better in practice. Their idea is rooted in the work of Landau and Vishkin [1988] (which had obtained $O(k^2n)$ time). In both cases, the idea is to build the matching statistics of the pattern against itself (longest match between $P_{i..m}$ and $P_{j..m}$), resembling in some sense the basic ideas of Knuth et al. [1977]. But this algorithm is still slow in practice.

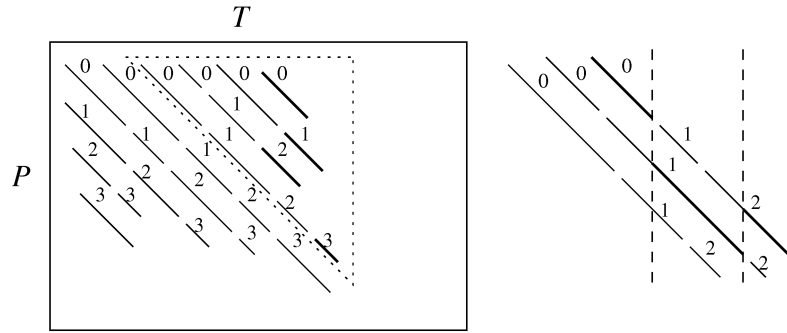

Fig. 13. On the left, the progress of the stroke-wise algorithm. The relevant strokes are enclosed in a dotted triangle and the last k strokes computed are in bold. On the right, the selection of the k relevant strokes to cover the last text area. We put in bold the parts of the strokes that are used.

Consider again Figure 11, and in particular the new stroke with e errors at the right. The beginning of the stroke is dictated by the three neighboring strokes of $e - 1$ errors, but after the longest of the three ceases to affect the new stroke, how long it continues (dashed line) depends only on the similarity between pattern and text. More specifically, if the dotted line (suffix of a stroke) at diagonal d spans rows i_1 to $i_1 + \ell$, the longest match between $T_{d+i_1..}$ and $P_{i_1..}$ has length ℓ . Therefore, the strokes computed by the algorithm give some information about longest matches between text and pattern. The difficult part is how to use that information.

Figure 13 illustrates the algorithm. As explained, the algorithm progresses by strokes, filling the matrix of Figure 12 diagonally, so that when a stroke is computed, its three neighbors are already computed. We have enclosed in a dotted triangle the strokes that may contain the information on longest matches relevant to the new strokes that are being computed. The algorithm of Landau and Vishkin [1988] basically searches the relevant information in this triangle and hence it is in $O(k^2n)$ time.

This is improved in Galil and Park [1990] to $O(kn)$ by considering carefully the relevant strokes. Let us call e -stroke a stroke with e errors. First consider a 0-stroke. This full stroke (not only a suffix) represents a longest match between

pattern and text. So, from the k previous 0-strokes we can keep the one that lasts longer in the text, and up to that text position we have all the information we need about longest matches. We consider now all the 1-strokes. Although only a suffix of those strokes really represents a longest match between pattern and text, we know that this is definitely true after the last text position is reached by a 0-stroke (since by then no 0-stroke can “help” a 1-stroke to last longer). Therefore, we can keep the 1-stroke that lasts longer in the text and use it to define longest matches between pattern and text when there are no more active 0-strokes. This argument continues for all the k errors, showing that in fact the complete text area that is relevant can be covered with just k strokes. Figure 13 (right) illustrates this idea.

The algorithm of Galil and Park [1990] basically keeps this list of k relevant strokes³ up to date all the time. Each time a new e -stroke is produced, it is compared against the current relevant e -stroke, and if the new one lasts longer in the text than the old one, it replaces the old stroke. Since the algorithm progresses in the text, old strokes are naturally eliminated with this procedure.

A final problem is how to use the indirect information given by the relevant strokes to compute the longest matches

³ Called “reference triples” there.

between pattern and text. What we have is a set of longest matches covering the text area of interest, plus the precomputed longest matches of the pattern against itself (starting at any position). We now know where the dashed line of Figure 11 starts (say it is $P_{i..}$ and $T_{d+i..}$) and want to compute its length. To know where the longest match between pattern and text ends, we find the relevant stroke where the beginning of the dashed line falls. That stroke represents a maximal match between $T_{d+i..}$ and some $P_{j..}$. As we know by preprocessing the longest match between $P_{i..}$ and $P_{j..}$, we can derive the longest match between $P_{i..}$ and $T_{d+i..}$. There are some extra complications to take care of when both longest matches end at the same position or one has length zero, but all them can be sorted out in $O(k)$ time per diagonal of the L matrix.

Finally, Galil and Park show that the $O(m^2)$ extra space needed to store the matrix of longest matches can be reduced to $O(m)$ by using a suffix tree of the pattern (not the text as in previous work) and LCA algorithms, so we add different entries in Figure 7 (note that Landau and Vishkin [1988] already had $O(m)$ space). Galil and Park also show how to add transpositions to the edit operations at the same complexity. This technique can be extended to all these diagonal transition algorithms. We believe that allowing different integral costs for the operations or forbidding some of them can be achieved with simple modifications of the algorithms.

5.2.7 Ukkonen and Wood (1990). An idea similar to that of using the suffix tree of the pattern (and similarly slow in practice) was independently discovered by Ukkonen and Wood in 1990 [Ukkonen and Wood 1993]. They use a suffix automaton (described in Section 3.2) on the pattern to find the matching statistics, instead of the table. As the algorithm progresses over the text, the suffix automaton keeps count of the pattern substrings that match the text at any moment. Although they report $O(m^2)$ space for the suffix automaton, it can take $O(m)$ space.

5.2.8 Chang and Lawler (1994). In 1990, Chang and Lawler [1994] repeated the idea that was briefly mentioned in Galil and Park [1990]: that matching statistics can be computed using the suffix tree of the pattern and LCA algorithms. However, they used a newer and faster LCA algorithm [Schieber and Vishkin 1988], truly $O(1)$, and reported the best time among algorithms with guaranteed $O(kn)$ performance. However, the algorithm is still not competitive in practice.

5.2.9 Cole and Hariharan (1998). In 1998, Cole and Hariharan [1998] presented an algorithm with worst case $O(n(1+k^c/m))$, where $c = 3$ if the pattern is “mostly aperiodic” and $c = 4$ otherwise.⁴ The idea is that, unless a pattern has a lot of self-repetition, only a few diagonals of a diagonal transition algorithm need to be computed.

This algorithm can be thought of as a filter (see the following sections) with worst case guarantees useful for very small k . It resembles some ideas about filters developed in Chang and Lawler [1994]. Probably other filters can be proved to have good worst cases under some periodicity assumptions on the pattern, but this thread has not been explored up to now. This algorithm is an improvement over a previous one [Sahinalp and Vishkin 1997], which is more complex and has a worse complexity, namely $O(nk^8(\alpha \log^* n)^{1/\log 3})$. In any case, the interest of this work is theoretical too.

5.3 Improving the Average Case

5.3.1 Ukkonen (1985). The first improvement to the average case is due to Ukkonen in 1985. The algorithm, a short note at the end of Ukkonen [1985b], improved the dynamic programming algorithm to $O(kn)$ average time and $O(m)$ space. This algorithm was later called the “cut-off heuristic.” The main idea is that, since a pattern does not normally match in the text, the values at each column

⁴ The definition of “mostly aperiodic” is rather technical and related to the number of auto-repetitions that occur in the pattern. Most patterns are “mostly aperiodic.”

(from top to bottom) quickly reach $k + 1$ (i.e. mismatch), and that if a cell has a value larger than $k + 1$, the result of the search does not depend on its exact value. A cell is called *active* if its value is at most k . The algorithm simply keeps count of the last active cell and avoids working on the rest of the cells.

To keep the last active cell, we must be able to recompute it for each new column. At each new column, the last active cell can be incremented in at most one, so we check if we have activated the next cell at $O(1)$ cost. However, it is also possible that the last active cell now becomes inactive. In this case we have to search upwards for the new last active cell. Although we can work $O(m)$ in a given column, we cannot work more than $O(n)$ overall, because there are at most n increments of this value in the whole process, and hence there are no more than n decrements. Hence, the last active cell is maintained at $O(1)$ amortized cost per column.

Ukkonen conjectured that this algorithm was $O(kn)$ on average, but this was proven only in 1992 by Chang and Lampe [1992]. The proof was refined in 1996 by Baeza-Yates and Navarro [1999]. The result can probably be extended to more complex distance functions, although with substrings the last active cell must exceed k by enough to ensure that it can never return to a value smaller than k . In particular, it must have the value $k + 2$ if transpositions are allowed.

5.3.2 Myers (1986). An algorithm in Myers [1986a] is based on diagonal transitions like those in the previous sections, but the strokes are simply computed by brute force. Myers showed that the resulting algorithm was $O(kn)$ on average. This is clear because the length of the strokes is $\sigma/(\sigma - 1) = O(1)$ on average. The same algorithm was proposed again in 1989 by Galil and Park [1990]. Since only the k strokes need to be stored, the space is $O(k)$.

5.3.3 Chang and Lampe [1992]. In 1992, Chang and Lampe [1992] produced a new algorithm called “column partitioning,”

based on exploiting a different property of the dynamic programming matrix. They again consider the fact that, along each column, the numbers are normally increasing. They work on “runs” of consecutive increasing cells (a run ends when $C_{i+1} \neq C_i + 1$). They manage to work $O(1)$ per run in the column actualization process.

To update each run in constant time, they precompute $\text{loc}(j, x) = \min_{j' \geq j} P_{j'} = x$ for all pattern positions j and all characters x (hence it needs $O(m\sigma)$ space). At each column of the matrix, they consider the current text character x and the current row j , and know in constant time where the run is going to end (i.e. next character match). The run can end before this, namely where the parallel run of the previous column ends.

Based on empirical observations, they conjecture that the average length of the runs is $O(\sqrt{\sigma})$. Notice that this matches our result that the average edit distance is $m(1 - e/\sqrt{\sigma})$, since this is the number of increments along columns, and therefore there are $O(m/\sqrt{\sigma})$ nonincrements (i.e. runs). From there it is clear that each run has average length $O(\sqrt{\sigma})$. Therefore, we have just proved Chang and Lampe’s conjecture.

Since the paper uses the cut-off heuristic of Ukkonen, their average search time is $O(kn/\sqrt{\sigma})$. This is, in practice, the fastest algorithm of this class.

Unlike the other algorithms in this section, it seems difficult to adapt [Chang and Lampe 1992] to other distance functions, since their idea relies strongly on the unitary costs. It is mentioned that the algorithm could run in average time $O(kn \log \log(m)/\sigma)$ but it would not be practical.

6. ALGORITHMS BASED ON AUTOMATA

This area is also rather old. It is interesting because it gives the best worst-case time algorithm ($O(n)$, which matches the lower bound of the problem). However, there is a time and space exponential dependence on m and k that limits its practicality.

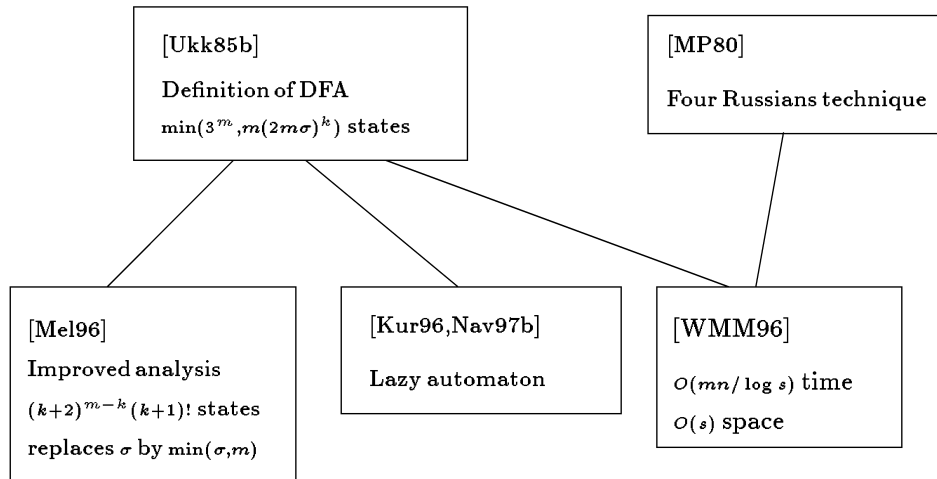

Fig. 14. Taxonomy of algorithms based on deterministic automata. References are shortened to first letters (single authors) or initials (multiple authors), and to the last two digits of years. Key: Ukk85b = [Ukkonen 1985b], MP80 = [Masek and Paterson 1980], Mel96 = [Melichar 1996], Kur96 = [Kurtz 1996], Nav97b = [Navarro 1997b], and WMM96 = [Wu et al. 1996].

We first present the basic solution and then discuss the improvements. Figure 14 shows the historical map of this area.

6.1 An Automaton for Approximate Search

An alternative and very useful way to consider the problem is to model the search with a nondeterministic automaton (NFA). This automaton (in its deterministic form) was first proposed in Ukkonen [1985b], and first used in nondeterministic form (although implicitly) in Wu and Manber [1992b]. It is shown explicitly in Baeza-Yates [1991], Baeza-Yates [1996], and Baeza-Yates and Navarro [1999].

Consider the NFA for $k = 2$ errors under the edit distance shown in Figure 15. Every row denotes the number of errors seen (the first row zero, the second row one, etc.). Every column represents matching a pattern prefix. Horizontal arrows represent matching a character (i.e. if the pattern and text characters match, we advance in the pattern and in the text). All the others increment the number of errors (move to the next row): vertical arrows insert a character in the pattern (we advance in the text but not in the pattern), solid diagonal arrows substitute a character (we advance in the

text and pattern), and dashed diagonal arrows delete a character of the pattern (they are ε -transitions, since we advance in the pattern without advancing in the text). The initial self-loop allows a match to start anywhere in the text. The automaton signals (the end of) a match whenever a rightmost state is active. If we do not care about the number of errors in the occurrences, we can consider final states those of the last full diagonal.

It is not hard to see that once a state in the automaton is active, all the states of the same column and higher numbered rows are active too. Moreover, at a given text character, if we collect the smallest active rows at each column, we obtain the vertical vector of the dynamic programming algorithm (in this case $[0, 1, 2, 3, 3, 3, 2]$; compare to Figure 9).

Other types of distances (Hamming, LCS, and Episode) are obtained by deleting some arrows of the automaton. Different integer costs for the operations can also be modeled by changing the arrows. For instance, if insertions cost 2 instead of 1, we make the vertical arrows move from rows i to rows $i + 2$. Transpositions are modeled by adding an extra state $S_{i,j}$ between each pair of states

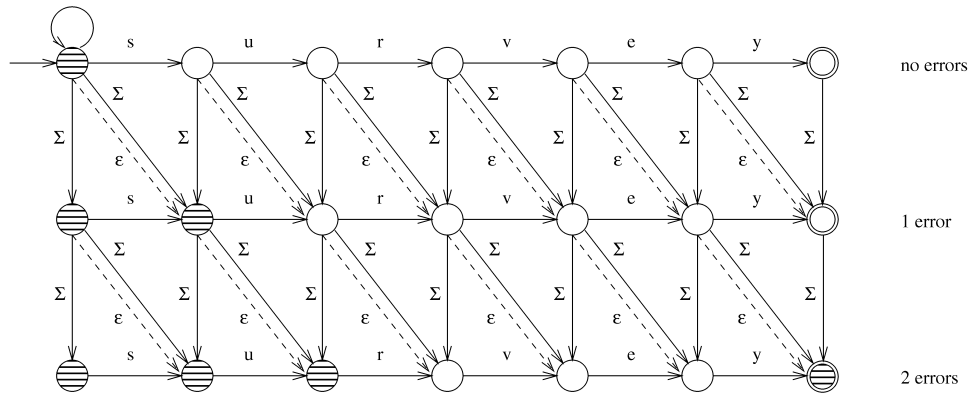

Fig. 15. An NFA for approximate string matching of the pattern "survey" with two errors. The shaded states are those active after reading the text "surgery".

at position (i, j) and $(i + 1, j + 2)$, and arrows labeled P_{i+2} from state (i, j) to $S_{i,j}$ and P_{i+1} between $S_{i,j}$ and $(i + 1, j + 2)$ [Melichar 1996]. Adapting to general substring substitution needs more complex setups but it is always possible.

This automaton can simply be made deterministic to obtain $O(n)$ worst-case search time. However, as we see next, the main problem becomes the construction of the DFA (deterministic finite automaton). An alternative solution is based on simulating the NFA instead of making it deterministic.

6.2 Implementing the Automaton

6.2.1 Ukkonen (1985). In 1985, Ukkonen proposed the idea of a deterministic automaton for this problem [Ukkonen 1985b]. However, an automaton like that of Figure 15 was not explicitly considered. Rather, each possible set of values for the columns of the dynamic programming matrix is a state of the automaton. Once the set of all possible columns and the transitions among them were built, the text was scanned with the resulting automaton, performing exactly one transition per character read.

The big problem with this scheme was that the automaton had a potentially huge number of states, which had to be built and stored. To improve space usage,

Ukkonen proved that all the elements in the columns that were larger than $k + 1$ could be replaced by $k + 1$ without affecting the output of the search (the lemma was used in the same paper to design the cut-off heuristic described in Section 5.3). This reduced the potential number of different columns. He also showed that adjacent cells in a column differed in at most one. Hence, the column states could be defined as a vector of m incremental values in the set $\{-1, 0, 1\}$.

All this made it possible in Ukkonen [1985b] to obtain a nontrivial bound on the number of states of the automaton, namely $O(\min(3^m, m(2m\sigma)^k))$. This size, although much better than the obvious $O((k + 1)^m)$, is still very large except for short patterns or very low error levels. The resulting space complexity of the algorithm is m times the above value. This exponential space complexity has to be added to the $O(n)$ time complexity, as the preprocessing time to build the automaton.

As a final comment, Ukkonen suggested that the columns could be computed only partially up to, say, $3k/2$ entries. Since he conjectured (and later was proved correct in Chang and Lampe [1992]) that the columns of interest were $O(k)$ on average, this would normally not affect the algorithm, though it will reduce the number of possible states. If at some point the states not computed were really

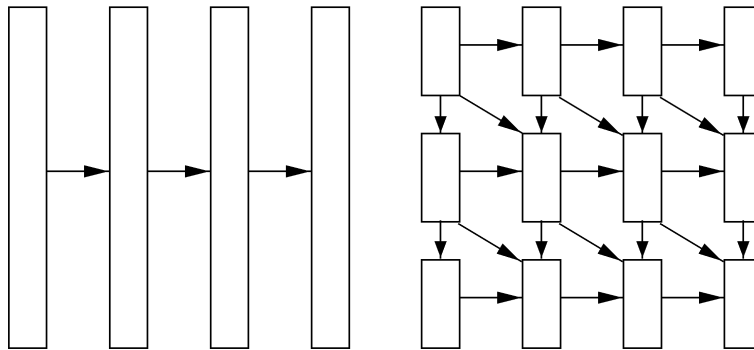

Fig. 16. On the left, the automaton of Ukkonen [1985b] where each column is a state. On the right, the automaton of Wu et al. [1996] where each region is a state. Both compute the columns of the dynamic programming matrix.

needed, the algorithm would compute them by dynamic programming.

Notice that to incorporate transpositions and substring substitutions into this conception we need to consider that each state is the set of the j last columns of the dynamic programming matrix, where j is the longest left-hand side of a rule. In this case it is better to build the automaton of Figure 15 explicitly and make it deterministic.

6.2.2 Wu, Manber and Myers (1992). It was not until 1992 that Wu et al. looked into this problem again [Wu et al. 1996]. The idea was to trade time for space using a Four Russians technique [Arlazarov et al. 1975]. Since the cells could be expressed using only values in $\{-1, 0, 1\}$, the columns were partitioned into blocks of r cells (called “regions”) which took $2r$ bits each. Instead of precomputing the transitions from a whole column to the next, the transitions from a region to the next region in the column were precomputed, although the current region could now depend on three previous regions (see Figure 16). Since the regions were smaller than the columns, much less space was necessary. The total amount of work was $O(m/r)$ per column in the worst case, and $O(k/r)$ on average. The space requirement was exponential in r . By using $O(n)$ extra space, the algorithm was $O(kn/\log n)$ on average and $O(mn/\log n)$ in the worst case. Notice that this shares

the Four Russians approach with [Masek and Paterson 1980], but there is an important difference: the states in this case do not depend on the letters of the pattern and text. The states of the “automaton” of Masek and Paterson [1980], on the other hand, depend on the text and pattern.

This Four Russians approach is so flexible that this work was extended to handle regular expressions allowing errors [Wu et al. 1995]. The technique for exact regular expression searching is to pack portions of the deterministic automaton in bits and compute transition tables for each portion. The few transitions among portions are left nondeterministic and simulated one by one. To allow errors, each state is no longer active or inactive, but they keep count of the minimum number of errors that makes it active, in $O(\log k)$ bits.

6.2.3 Melichar (1995). In 1995, Melichar [1996] again studied the size of the deterministic automaton. By considering the properties of the NFA of Figure 15, he refined the bound of Ukkonen [1985b] to $O(\min(3^m, m(2mt)^k, (k+2)^{m-k}(k+1)!))$, where $t = \min(m+1, \sigma)$. The space complexity and preprocessing time of the automaton is t times the number of states. Melichar also conjectured that this automaton is bigger when there are periodicities in the pattern, which matches the results of Cole and Hariharan [1998] (Section 5.2), in the sense that periodic

patterns are more problematic. This is in fact a property shared with other problems in string matching.

6.2.4 Kurtz (1996). In 1996, Kurtz [1996] proposed another way to reduce the space requirements to at most $O(mn)$. It is an adaptation of Baeza-Yates and Gonnet [1994], who first proposed it for the Hamming distance. The idea was to build the automaton in lazy form, i.e. build only the states and transitions actually reached in the processing of the text. The automaton starts as just one initial state and the states and transitions are built as needed. By doing this, all those transitions that Ukkonen [1985b] considered and that were not necessary were not built in fact, without the need to guess. The price was the extra overhead of a lazy construction versus a direct construction, but the idea pays off. Kurtz also proposed building only the initial part of the automaton (which should be the most commonly traversed states) to save space.

Navarro [1997b; 1998] studied the growth of the complete and lazy automata as a function of m , k and n (this last value for the lazy automaton only). The empirical results show that the lazy automaton grows with the text at a rate of $O(n^\beta)$, for $0 < \beta < 1$, depending on σ , m , and k . Some replacement policies designed to work with bounded memory are proposed in Navarro [1998].

7. BIT-PARALLELISM

These algorithms are based on exploiting the parallelism of the computer when it works on bits. This is also a new (after 1990) and very active area. The basic idea is to “parallelize” another algorithm using bits. The results are interesting from the practical point of view, and are especially significant when short patterns are involved (typical in text retrieval). They may work effectively for any error level.

In this section we find elements which could strictly belong to other sections, since we parallelize other algorithms. There are two main trends: parallelize the

work of the nondeterministic automaton that solves the problem (Figure 15), or parallelize the work of the dynamic programming matrix.

We first explain the technique and then the results achieved by using it. Figure 17 shows the historical development of this area.

7.1 The Technique of Bit-Parallelism

This technique, in common use in string matching [Baeza-Yates 1991; 1992], was introduced in the Ph.D. thesis of Baeza-Yates [1989]. It consists in taking advantage of the intrinsic parallelism of the bit operations inside a computer word. By using this fact cleverly, the number of operations that an algorithm performs can be cut down by a factor of at most w , where w is the number of bits in a computer word. Since in current architectures w is 32 or 64, the speedup is very significant in practice and improves with technological progress. In order to relate the behavior of bit-parallel algorithms to other work, it is normally assumed that $w = \Theta(\log n)$, as dictated by the RAM model of computation. We, however, prefer to keep w as an independent value. We now introduce some notation we use for bit-parallel algorithms.

- The length of a computer word (in bits) is w .
- We denote as $b_\ell..b_1$ the bits of a mask of length ℓ . This mask is stored somewhere inside the computer word. Since the length w of the computer word is fixed, we are hiding the details on where we store the ℓ bits inside it.
- We use exponentiation to denote bit repetition (e.g. $0^31 = 0001$).
- We use C-like syntax for operations on the bits of computer words: “|” is the bitwise-or, “&” is the bitwise-and, “^” is the bitwise-xor, and “~” complements all the bits. The shift-left operation, “<<,” moves the bits to the left and enters zeros from the right, i.e. $b_m b_{m-1}..b_2 b_1 \ll r = b_{m-r}..b_2 b_1 0^r$. The shift-right “>>” moves the bits in the other direction. Finally, we

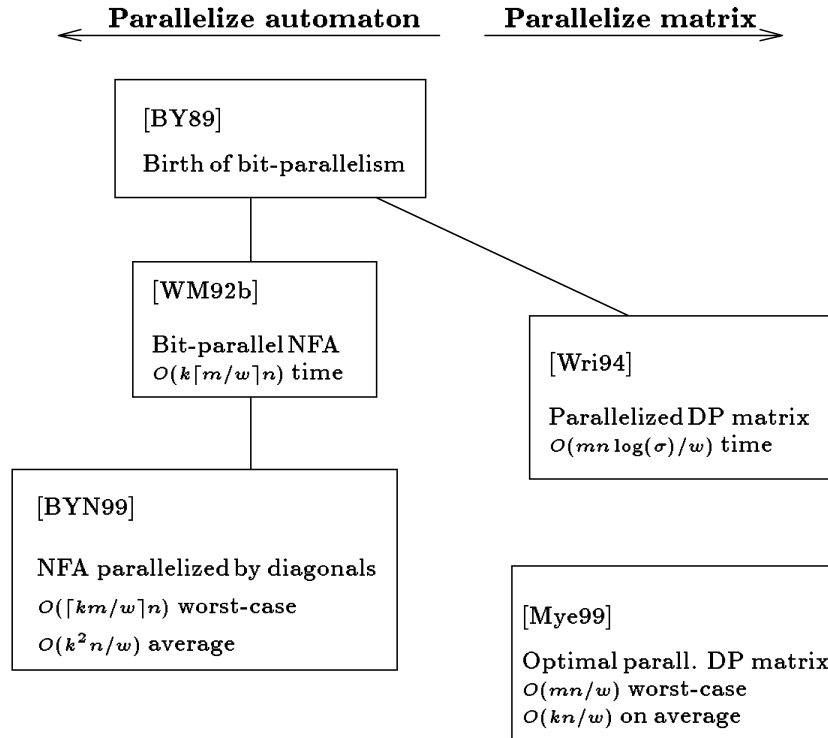

Fig. 17. Taxonomy of bit-parallel algorithms. References are shortened to first letters (single authors) or initials (multiple authors), and to the last two digits of years. Key: BY89 = [Baeza-Yates 1989], WM92b = [Wu and Manber 1992b], Wri94 = [Wright 1994], BYN99 = [Baeza-Yates and Navarro 1999], and Mye99 = [Myers 1999].

can perform arithmetic operations on the bits, such as addition and subtraction, which operate the bits as if they formed a number. For instance, $b_\ell..b_x 10000 - 1 = b_\ell..b_x 01111$.

We now explain the first bit-parallel algorithm, Shift-Or [Baeza-Yates and Gonnet 1992], since it is the basis of much of what follows. The algorithm searches a pattern in a text (without errors) by parallelizing the operation of a nondeterministic finite automaton that looks for the pattern. Figure 18 illustrates this automaton.

This automaton has $m + 1$ states, and can be simulated in its nondeterministic form in $O(mn)$ time. The Shift-Or algorithm achieves $O(mn/w)$ worst-case time (i.e. optimal speedup). Notice that if we convert the nondeterministic automaton to a deterministic one with $O(n)$ search

time, we get an improved version of the KMP algorithm [Knuth et al. 1977]. However KMP is twice as slow for $m \leq w$.

The algorithm first builds a table B which for each character c stores a bit mask $B[c] = b_m..b_1$. The mask in $B[c]$ has the bit b_i set if and only if $P_i = c$. The state of the search is kept in a machine word $D = d_m..d_1$, where d_i is 1 whenever $P_{1..i}$ matches the end of the text read up to now (i.e. the state numbered i in Figure 18 is active). Therefore, a match is reported whenever $d_m = 1$.

D is set to 1^m originally, and for each new text character T_j , D is updated using the formula⁵

$$D' \leftarrow ((D \ll 1) | 0^{m-1}1) \& B[T_j]$$

⁵ The real algorithm uses the bits with the inverse meaning and therefore the operation “ $| 0^{m-1}1$ ” is not necessary. We preferred to explain this more didactic version.

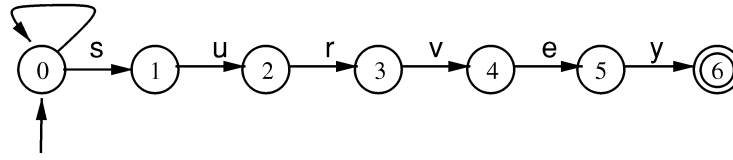

Fig. 18. Nondeterministic automaton that searches "survey" exactly.

The formula is correct because the i th bit is set if and only if the $(i - 1)$ th bit was set for the previous text character and the new text character matches the pattern at position i . In other words, $T_{j-i+1..j} = P_{1..i}$ if and only if $T_{j-i+1..j-1} = P_{1..i-1}$ and $T_j = P_i$. It is possible to relate this formula to the movement that occurs in the nondeterministic automaton for each new text character: each state gets the value of the previous state, but this happens only if the text character matches the corresponding arrow.

For patterns longer than the computer word (i.e. $m > w$), the algorithm uses $\lceil m/w \rceil$ computer words for the simulation (not all them are active all the time). The algorithm is $O(n)$ on average.

It is easy to extend Shift-Or to handle *classes of characters*. In this extension, each position in the pattern matches a set of characters rather than a single character. The classical string matching algorithms are not extended so easily. In Shift-Or, it is enough to set the i th bit of $B[c]$ for every $c \in P_i$ (P_i is now a set). For instance, to search for "survey" in case-insensitive form, we just set to 1 the first bit of $B["s"]$ and $B["S"]$, and the same with the rest. Shift-Or can also search for multiple patterns (where the complexity is $O(mn/w)$ if we consider that m is the total length of all the patterns); it was later enhanced [Wu and Manber 1992b] to support a larger set of extended patterns and even regular expressions.

Many online text algorithms can be seen as implementations of an automaton (classically, in its deterministic form). Bit-parallelism has since its invention become a general way to simulate simple nondeterministic automata instead of converting them to deterministic form. It has the advantage of being much simpler, in many cases faster (since it

makes better usage of the registers of the computer word), and easier to extend in handling complex patterns than its classical counterparts. Its main disadvantage is the limitation it imposes on the size of the computer word. In many cases its adaptations in coping with longer patterns are not very efficient.

7.2 Parallelizing Nondeterministic Automata

7.2.1 Wu and Manber (1992). In 1992, Wu and Manber [1992b] published a number of ideas that had a great impact on the future of practical text searching. They first extended the Shift-Or algorithm to handle *wild cards* (i.e. allow an arbitrary number of characters between two given positions in the pattern), and regular expressions (the most flexible pattern that can be searched efficiently). Of more interest to us is that they presented a simple scheme to combine any of the preceding extensions with approximate string matching.

The idea is to simulate, using bit-parallelism, the NFA of Figure 15, so that each row i of the automaton fits in a computer word R_i (each state is represented by a bit). For each new text character, all the transitions of the automaton are simulated using bit operations among the $k + 1$ computer words. Notice that all the $k + 1$ computer words have the same structure (i.e. the same bit is aligned on the same text position). The update formula to obtain the new R'_i values at text position j from the current R_i values is

$$\begin{aligned} R'_0 &= ((R_0 \ll 1) | 0^{m-1}1) \& B[T_j] \\ R'_{i+1} &= ((R_{i+1} \ll 1) \& B[T_j]) | R_i | \\ &\quad (R_i \ll 1) | (R'_i \ll 1) \end{aligned}$$

and we start the search with $R_i = 0^{m-i}1^i$. As expected, R_0 undergoes a simple

Shift-Or process, while the other rows receive ones (i.e. active states) from previous rows as well. In the formula for R'_{i+1} , expressed in that order, are horizontal, vertical, diagonal and dashed diagonal arrows.

The cost of this simulation is $O(k\lceil m/w \rceil n)$ in the worst and average case, which is $O(kn)$ for patterns typical in text searching (i.e. $m \leq w$). This is a perfect speedup over the serial simulation of the automaton, which would cost $O(mkn)$ time. Notice that for short patterns, this is competitive to the best worst-case algorithms.

Thanks to the simplicity of the construction, the rows of the pattern can be changed by a different automaton. As long as one is able to solve a problem for exact string matching, make $k+1$ copies of the resulting computer word, and perform the same operations in the $k+1$ words (plus the arrows that connect the words), one has an algorithm to find the same pattern allowing errors. Hence, with this algorithm one is able to perform approximate string matching with sets of characters, wild cards, and regular expressions. The algorithm also allows some extensions unique in approximate searching: a part of the pattern can be searched with errors that another may be forced to match exactly, and different integer costs of the edit operations can be accommodated (including not allowing some of them). Finally, one is able to search a set of patterns at the same time, but this capability is very limited (since all the patterns must fit in a computer word).

The great flexibility obtained encouraged the authors to build a software called *Agrep* [Wu and Manber 1992a],⁶ where all these capabilities are implemented (although some particular cases are solved in a different manner). This software has been taken as a reference in all the subsequent research.

7.2.2 Baeza-Yates and Navarro (1996). In 1996, Baeza-Yates and Navarro presented a new bit-parallel algorithm able to parallelize the computation of the au-

tomaton even more [Baeza-Yates and Navarro 1999]. The classical dynamic programming algorithm can be thought of as a column-wise “parallelization” of the automaton [Baeza-Yates 1996]; Wu and Manber [1992b] proposed a row-wise parallelization. Neither algorithm was able to increase the parallelism (even if all the NFA states fit in a computer word) because of the ε -transitions of the automaton, which caused what we call *zero-time* dependencies. That is, the current values of two rows or two columns depend on each other, and hence cannot be computed in parallel.

In Baeza-Yates and Navarro [1999] the bit-parallel formula for a *diagonal* parallelization was found. They packed the states of the automaton along diagonals instead of rows or columns, which run in the same direction of the diagonal arrows (notice that this is totally different from the diagonals of the dynamic programming matrix). This idea had been mentioned much earlier by Baeza-Yates [1991] but no bit-parallel formula was found. There are $m-k+1$ complete diagonals (the others are not really necessary) which are numbered from 0 to $m-k$. The number D_i is the row of the first active state in diagonal i (all the subsequent states in the diagonal are active because of the ε -transitions). The new D'_i values after reading text position j are computed as

$$D'_i = \min(D_i + 1, D_{i+1} + 1, g(D_{i-1}, T_j))$$

where the first term represents the substitutions, the second term the insertions, and the last term the matches (deletions are implicit since we represent only the lowest-row active state of each diagonal). The main problem is how to compute the function g , defined as

$$g(D_i, T_j) = \min(\{k+1\} \cup \{r/r \geq D_i \wedge P_{i+r} = T_j\})$$

Notice that an active state that crosses a horizontal edge has to propagate all the way down by the diagonal. This was finally solved in 1996 [Baeza-Yates and Navarro 1999; Navarro 1998] by representing

⁶ Available at <ftp.cs.arizona.edu>.

the D_i values in unary form and using arithmetic operations on the bits which have the desired propagation effects. The formula can be understood either numerically (operating the D_i 's) or logically (simulating the arrows of the automaton).

The resulting algorithm is $O(n)$ worst case time and very fast in practice if all the bits of the automaton fit in the computer word (while Wu and Manber [1992b] keeps $O(kn)$). In general, it is $O(\lceil k(m-k)/w \rceil n)$ worst case time, and $O(\lceil k^2/w \rceil n)$ on average since the Ukkonen cut-off heuristic is used (see Section 5.3). The scheme can handle classes of characters, wild cards and different integral costs in the edit operations.

7.3 Parallelizing the Dynamic Programming Matrix

7.3.1 Wright (1994). In 1994, Wright [1994] presented the first work using bit-parallelism on the dynamic programming matrix. The idea was to consider *secondary diagonals* (i.e. those that run from the upper-right to the bottom-left) of the matrix. The main observation is that the elements of the matrix follow the recurrence⁷

$$\begin{aligned} C_{i,j} &= C_{i-1,j-1} \text{ if } P_i = T_j \\ &\quad \text{or } C_{i-1,j} \\ &= C_{i-1,j-1} - 1 \\ &\quad \text{or } C_{i,j-1} \\ &= C_{i-1,j-1} - 1 \\ &\quad C_{i-1,j-1} + 1 \text{ otherwise} \end{aligned}$$

which shows that the new secondary diagonal can be computed using the two previous ones. The algorithm stores the differences between $C_{i,j}$ and $C_{i-1,j-1}$ and represents the recurrence using modulo 4 arithmetic. The algorithm packs many pattern and text characters in a computer word and performs in parallel a number of pattern versus text comparisons, then using the vector of the results of the comparisons to update many cells of the diagonal in parallel. Since it has to store characters of the alphabet in the bits,

the algorithm is $O(nm \log(\sigma)/w)$ in the worst and average case. This was competitive at that time for very small alphabets (e.g. DNA). As the author recognizes, it seems quite difficult to adapt this algorithm for other distance functions.

7.3.2 Myers (1998). In 1998, Myers [1999] found a better way to parallelize the computation of the dynamic programming matrix. He represented the differences along columns instead of the columns themselves, so that two bits per cell were enough (in fact this algorithm can be seen as the bit-parallel implementation of the automaton which is made deterministic in Wu et al. [1996], see Section 6.2). A new recurrence is found where the cells of the dynamic programming matrix are expressed using horizontal and vertical differences, i.e. $\Delta v_{i,j} = C_{i,j} - C_{i-1,j}$ and $\Delta h_{i,j} = C_{i,j} - C_{i,j-1}$:

$$\begin{aligned} \Delta v_{i,j} &= \min(-Eq_{i,j}, \Delta v_{i,j-1}, \Delta h_{i-1,j}) \\ &\quad + (1 - \Delta h_{i-1,j}) \\ \Delta h_{i,j} &= \min(-Eq_{i,j}, \Delta v_{i,j-1}, \Delta h_{i-1,j}) \\ &\quad + (1 - \Delta v_{i,j-1}) \end{aligned}$$

where $Eq_{i,j}$ is 1 if $P_i = T_j$ and zero otherwise. The idea is to keep packed binary vectors representing the current (i.e. j th) values of the differences, and finding the way to update the vectors in a single operation. Each cell $C_{i,j}$ is seen as a small processor that receives inputs $\Delta v_{i,j-1}$, $\Delta h_{i-1,j}$, and $Eq_{i,j}$ and produces outputs $\Delta v_{i,j}$ and $\Delta h_{i,j}$. There are $3 \times 3 \times 2 = 18$ possible inputs, and a simple formula is found to express the cell logic (unlike Wright [1994], the approach is logical rather than arithmetical). The hard part is to parallelize the work along the column because of the zero-time dependency problem. The author finds a solution which, despite the fact that a very different model is used, resembles that of Baeza-Yates and Navarro [1999].

The result is an algorithm that uses the bits of the computer word better, with a worst case of $O(\lceil m/w \rceil n)$ and an average case of $O(\lceil k/w \rceil n)$ since it uses the Ukkonen cut-off (Section 5.3). The update formula is a little more complex than that

⁷ The original one in Wright [1994] has errors.

of Baeza-Yates and Navarro [1999] and hence the algorithm is a bit slower, but it adapts better to longer patterns because fewer computer words are needed.

As it is difficult to surpass $O(kn)$ algorithms, this algorithm may be the last word with respect to asymptotic efficiency of parallelization, except for the possibility to parallelize an $O(kn)$ worst case algorithm. As it is now common to expect of bit-parallel algorithms, this scheme is able to search some extended patterns as well, but it seems difficult to adapt it to other distance functions.

8. FILTERING ALGORITHMS

Our last category is quite new, starting in 1990 and still very active. It is formed by algorithms that filter the text, quickly discarding text areas that do not match. Filtering algorithms address only the average case, and their major interest is the potential for algorithms that do not inspect all text characters. The major theoretical achievement is an algorithm with average cost $O(n(k + \log_\sigma m)/m)$, which was proven optimal. In practice, filtering algorithms are the fastest too. All of them, however, are limited in their applicability by the error level α . Moreover, they need a nonfilter algorithm to check the potential matches.

We first explain the general concept and then consider the developments that have occurred in this area. See Figure 19.

8.1 The Concept of Filtering

Filtering is based on the fact that it may be much easier to tell that a text position does not match than to tell that it matches. For instance, if neither "sur" nor "vey" appear in a text area, then "survey" cannot be found there with one error under the edit distance. This is because a single edit operation cannot alter both halves of the pattern.

Most filtering algorithms take advantage of this fact by searching pieces of the pattern without errors. Since the exact searching algorithms can be much faster than approximate searching ones, filtering algorithms can be very competitive

(in fact, they dominate in a large range of parameters).

It is important to notice that a filtering algorithm is normally unable to discover the matching text positions by itself. Rather, it is used to discard (hopefully large) areas of the text that cannot contain a match. For instance, in our example, it is necessary that either "sur" or "vey" appear in an approximate occurrence, but it is not sufficient. Any filtering algorithm must be coupled with a process that verifies all those text positions that could not be discarded by the filter.

Virtually any nonfiltering algorithm can be used for this verification, and in many cases the developers of a filtering algorithm do not care to look for the best verification algorithm, but just use the dynamic programming algorithm. The selection is normally independent, but the verification algorithm must behave well on short texts because it can be started at many different text positions to work on small text areas. By careful programming it is almost always possible to keep the worst-case behavior of the verifying algorithm (i.e. avoid verifying overlapping areas).

Finally, the performance of filtering algorithms is very sensitive to the error level α . Most filters work very well on low error levels and very badly otherwise. This is related to the amount of text that the filter is able to discard. When evaluating filtering algorithms, it is important not only to consider their time efficiency but also their tolerance for errors. One possible measure for this *filtration efficiency* is the total number of matches found divided by the total number of potential matches pointed out by the filtration algorithm [Sutinen 1998].

A term normally used when referring to filters is "sublinearity." It is said that a filter is sublinear when it does not inspect all the characters in the text (like the Boyer-Moore algorithms [Boyer and Moore 1977] for exact searching, which can at best be $O(n/m)$). However, no online algorithm can be truly sublinear, i.e. $o(n)$, if m is independent of n . This is only achievable with indexing algorithms.

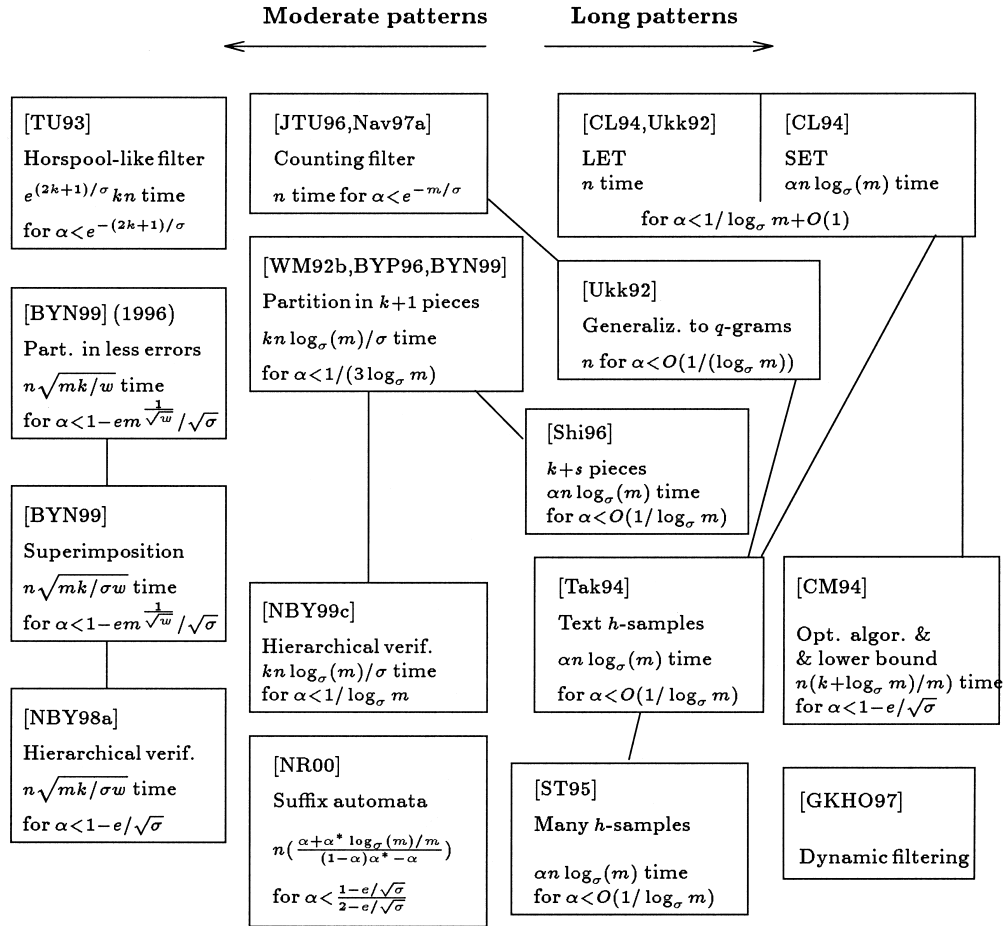

Fig. 19. Taxonomy of filtering algorithms. Complexities are all on average. References are shortened to first letters (single authors) or initials (multiple authors), and to the last two digits of years.

Key: TU93 = [Tarhio and Ukkonen 1993], JTU96 = [Jokinen et al. 1996], Nav97a = [Navarro 1997a], CL94 = [Chang and Lawler 1994], Ukk92 = [Ukkonen 1992], BYN99 = [Baeza-Yates and Navarro 1999], WM92b = [Wu and Manber 1992b], BYP96 = [Baeza-Yates and Perleberg 1996], Shi96 = [Shi 1996], NBY99c = [Navarro and Baeza-Yates 1999c], Tak94 = [Takaoka 1994], CM94 = [Chang and Marr 1994], NBY98a = [Navarro and Baeza-Yates 1998a], NR00 = [Navarro and Raffinot 2000], ST95 = [Sutinen and Tarhio 1995], and GKHO97 = [Giegerich et al. 1997].

We divide this area in two parts: moderate and very long patterns. The algorithms for the two areas are normally different, since more complex filters are only worthwhile for longer patterns.

8.2 Moderate Patterns

8.2.1 Tarhio and Ukkonen (1990). Tarhio and Ukkonen [1993]⁸ launched this area in 1990, publishing an algorithm that

⁸ See also Jokinen et al. [1996], which has a correction to the algorithm.

used Boyer–Moore–Horspool techniques [Boyer and Moore 1977; Horspool 1980] to filter the text. The idea is to align the pattern with a text window and scan the text backwards. The scanning ends where more than k “bad” text characters are found. A “bad” character is one that not only does not match the pattern position it is aligned with, but also does not match any pattern character at a distance of k characters or less. More formally, assume that the window starts at text position $j + 1$, and therefore T_{j+i} is aligned with

P_i . Then T_{j+i} is bad when $Bad(i, T_{j+i})$, where $Bad(i, c)$ has been precomputed as $c \notin \{P_{i-k}, P_{i-k+1}, \dots, P_i, \dots, P_{i+k}\}$.

The idea of the bad characters is that we know for sure that we have to pay an error to match them, i.e. they will not match as a byproduct of inserting or deleting other characters. When more than k characters that are errors for sure are found, the current text window can be abandoned and shifted forward. If, on the other hand, the beginning of the window is reached, the area $T_{j+1-k..j+m}$ must be checked with a classical algorithm.

To know how much we can shift the window, the authors show that there is no point in shifting P to a new position j' where none of the $k+1$ text characters that are at the end of the current window ($T_{j+m-k}, \dots, T_{j+m}$) match the corresponding character of P , i.e. where $T_{j+m-r} \neq P_{m-r-(j'-j)}$. If those differences are fixed with substitutions, we make $k+1$ errors, and if they can be fixed with less than $k+1$ operations, then it is because we aligned some of the involved pattern and text characters using insertions and deletions. In this case, we would have obtained the same effect by aligning the matching characters from the start.

So for each pattern position $i \in \{m-k..m\}$ and each text character a that could be aligned to position i (i.e. for all $a \in \Sigma$), the shift to align a in the pattern is precomputed, i.e. $Shift(i, a) = \min_{s>0} \{P_{i-s} = a\}$ (or m if no such s exists). Later, the shift for the window is computed as $\min_{i \in m-k..m} Shift(i, T_{j+i})$. This last minimum is computed together with the backward window traversal.

The analysis in Tarhio and Ukkonen [1993] shows that the search time is $O(kn(k/\sigma + 1/(m-k)))$, without considering verification. In Appendix A.1 we show that the amount of verification is negligible for $\alpha < e^{-(2k+1)/\sigma}$. The analysis is valid for $m \gg \sigma > k$, so we can simplify the search time to $O(k^2n/\sigma)$. The algorithm is competitive in practice for low error levels. Interestingly, the version $k=0$ corresponds exactly to the Horspool algorithm [Horspool 1980]. Like Horspool, it does not take proper advantage of very

long patterns. The algorithm can probably be adapted to other simple distance functions if we define k as the minimum number of errors needed to reject a string.

8.2.2 Jokinen, Tarhio, and Ukkonen (1991). In 1991, Jokinen, Tarhio and Ukkonen [Jokinen et al. 1996] adapted a previous filter for the k -mismatches problem [Grossi and Luccio 1989]. The filter is based on the simple fact that inside any match with at most k errors there must be at least $m-k$ letters belonging to the pattern. The filter does not care about the order of those letters. This is a simple version of Chang and Lawler [1994] (see Section 8.3), with less filtering efficiency but simpler implementation.

The search algorithm slides a window of length m over the text⁹ and keeps count of the number of window characters that belong to the pattern. This is easily done with a table that, for each character a , stores a counter of a 's in the pattern which has not yet been seen in the text window. The counter is incremented when an a enters the window and decremented when it leaves the window. Each time a positive counter is decremented, the window character is considered as belonging to the pattern. When there are $m-k$ such characters, the area is verified with a classical algorithm.

The algorithm was analyzed by Navarro [1997a] using a model of urns and balls. He shows that the algorithm is $O(n)$ time for $\alpha < e^{-m/\sigma}$. Some possible extensions are studied in Navarro [1998].

The resulting algorithm is competitive in practice for short patterns, but it worsens for long ones. It is simple to adapt to other distance functions by just determining how many characters must match in an approximate occurrence.

8.2.3 Wu and Manber (1992). In 1992, a very simple filter was proposed by Wu and Manber [1992b] (among many other ideas in that work). The basic idea is in fact very

⁹ The original version used a variable size window. This simplification is from Navarro [1997a].

old [Rivest 1976]: if a pattern is cut in $k + 1$ pieces, then at least *one* of the pieces must appear unchanged in an approximate occurrence. This is evident, since k errors cannot alter the $k + 1$ pieces. The proposal was then to split the pattern in $k + 1$ approximately equal pieces, search the pieces in the text, and check the neighborhood of their matches (of length $m + 2k$). They used an extension of Shift-Or [Baeza-Yates and Gonnet 1992] to search all the pieces simultaneously in $O(mn/w)$ time. In the same year, 1992, Baeza-Yates and Perleberg [1996] suggested better algorithms for the multipattern search: an Aho–Corasick machine [Aho and Corasick 1975] to guarantee $O(n)$ search time (excluding verifications), or Commentz-Walter [1979].

Only in 1996 was the improvement really implemented [Baeza-Yates and Navarro 1999], by adapting the Boyer–Moore–Sunday algorithm [Sunday 1990] to multipattern search (using a trie of patterns and a pessimistic shift table). The resulting algorithm is surprisingly fast in practice for low error levels.

There is no closed expression for the average case cost of this algorithm [Baeza-Yates and Régnier 1990], but we show in Appendix A.2 that a gross approximation is $O(kn \log_\sigma(m)/\sigma)$. Two independent proofs in Baeza-Yates and Navarro [1999] and Baeza-Yates and Perleberg [1996] show that the cost of the search dominates for $\alpha < 1/(3 \log_\sigma m)$. A simple way to see this is to consider that checking a text area costs $O(m^2)$ and is done when any of the $k + 1$ pieces of length $m/(k + 1)$ match, which happens with probability near $k/\sigma^{1/\alpha}$. The result follows from requiring the average verification cost to be $O(1)$.

This filter can be adapted, with some care, to other distance functions. The main issue is to determine how many pieces an edit operation can destroy and how many edit operations can be made before surpassing the error threshold. For example, a transposition can destroy two pieces in one operation, so we would need to split the pattern in $2k + 1$ pieces to ensure that one is unaltered. A more clever solution for this case is to leave a hole of one character

between each pair of pieces, so that the transposition cannot alter both.

8.2.4 Baeza-Yates and Navarro (1996). The bit-parallel algorithms presented in Section 7 [Baeza-Yates and Navarro 1999] were also the basis for novel filtering techniques. As the basic algorithm is limited to short patterns, the algorithms split longer patterns in j parts, making them short enough to be searchable with the basic bit-parallel automaton (using one computer word).

The method is based on a more general version of the partition into $k + 1$ pieces [Myers 1994a; Baeza-Yates and Navarro 1999]. For any j , if we cut the pattern in j pieces, then at least one of them appears with $\lfloor k/j \rfloor$ errors in any occurrence of the pattern. This is clear, since if each piece needs more than k/j errors to match, then the complete match needs more than k errors.

Hence, the pattern was split in j pieces (of length m/j) which were searched with k/j errors using the basic algorithm. Each time a piece was found, the neighborhood was verified to check for the complete pattern. Notice that the error level α for the pieces is kept unchanged.

The resulting algorithm is $O(n\sqrt{mk/w})$ on average. Its maximum α value is $1 - em^{O(1/\sqrt{w})}/\sqrt{\sigma}$, smaller than $1 - e/\sqrt{\sigma}$ and worsening as m grows. This may be surprising since the error level α is the same for the subproblems. The reason is that the verification cost keeps $O(m^2)$ but the matching probability is $O(\gamma^{m/j})$, larger than $O(\gamma^m)$ (see Section 4).

In 1997, the technique was enriched with “superimposition” [Baeza-Yates and Navarro 1999]. The idea is to avoid performing one separate search for each piece of the pattern. A multipattern approximate searching is designed using the ability of bit-parallelism to search for classes of characters. Assume that we want to search “survey” and “secret.” We search the pattern “s[ue][rc][vr]e[yt],” where $[ab]$ means $\{a, b\}$. In the NFA of Figure 15, the horizontal arrows are traversable by more than one letter. Clearly, any match of each

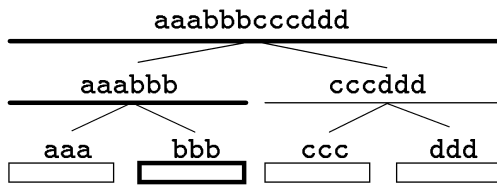

Fig. 20. The hierarchical verification method for a pattern split in four parts. The boxes (leaves) are the elements which are really searched, and the root represents the whole pattern. At least one pattern at each level must match in any occurrence of the complete pattern. If the bold box is found, all the bold lines may be verified.

of the two patterns is also a match of the superimposed pattern, but not vice-versa (e.g. "servet" matches zero errors). So the filter is weakened but the search is made faster. Superimposition allowed lowering the average search time to $O(n)$ for $\alpha < 1 - em^{O(1/\sqrt{w})} \sqrt{m/\sigma} \sqrt{w}$ and to $O(n\sqrt{mk}/(\sigma w))$ for the maximum α of the 1996 version. By using a j value smaller than the one necessary to put the automata in single machine words, an intermediate scheme was obtained that softly adapted to higher error levels. The algorithm was $O(kn \log(m)/w)$ for $\alpha < 1 - e/\sqrt{\sigma}$.

8.2.5 Navarro and Baeza-Yates (1998). The final twist in the previous scheme was the introduction of "hierarchical verification" in 1998 [Navarro and Baeza-Yates 1998a]. For simplicity assume that the pattern is partitioned in $j = 2^r$ pieces, although the technique is general. The pattern is split in two halves, each one to be searched with $\lfloor k/2 \rfloor$ errors. Each half is recursively split in two and so on, until the pattern is short enough to make its NFA fit in a computer word (see Figure 20). The leaves of this tree are the pieces actually searched. When a leaf finds a match, instead of checking the whole pattern as in the previous technique, its parent is checked (in a small area around the piece that matched). If the parent is not found, the verification stops, otherwise it continues with the grandparent until the root (i.e. the whole pattern) is found. This is correct because the partitioning scheme applies to each level of the tree: the grandparent

cannot appear if none of its children appear, even if a grandchild appeared.

Figure 20 shows an example. If one searches the pattern "aaabbbccddd" with four errors in the text "xxxbbxxxxxxx," and splits the pattern in four pieces to be searched with one error, the piece "bbb" will be found in the text. In the original approach, one would verify the complete pattern in the text area, while with the new approach one verifies only its parent "aaabbb" and immediately determines that there cannot be a complete match.

An orthogonal hierarchical verification technique is also presented in Navarro and Baeza-Yates [1998a] to include superimposition in this scheme. If the superimposition of four patterns matches, the set is split in two sets of two patterns each, and it is checked whether some of them match instead of verifying all the four patterns one by one.

The analysis in Navarro [1998] and Navarro and Baeza-Yates [1998a] shows that the average verification cost drops to $O((m/j)^2)$. Only now the problem scales well (i.e. $O(\gamma^{m/j})$ verification probability and $O((m/j)^2)$ verification cost). With hierarchical verification, the verification cost stays negligible for $\alpha < 1 - e/\sqrt{\sigma}$. All the simple extensions of bit-parallel algorithms apply, although the partition into j pieces may need some redesign for other distances. Notice that it is very difficult to break the barrier of $\alpha^* = 1 - e/\sqrt{\sigma}$ for any filter because, as shown in Section 4, there are too many *real* matches, and even the best filters must check real matches.

In the same year, 1998, the same authors [Navarro and Baeza-Yates 1999c; Navarro 1998] added hierarchical verification to the filter that splits the pattern in $k+1$ pieces and searches them with zero errors. The analysis shows that with this technique the verification cost does not dominate the search time for $\alpha < 1/\log_{\sigma} m$. The resulting filter is the fastest for most cases of interest.

8.2.6 Navarro and Raffinot (1998). In 1998 Navarro and Raffinot [Navarro and Raffinot 2000; Navarro 1998] presented a novel approach based on suffix automata

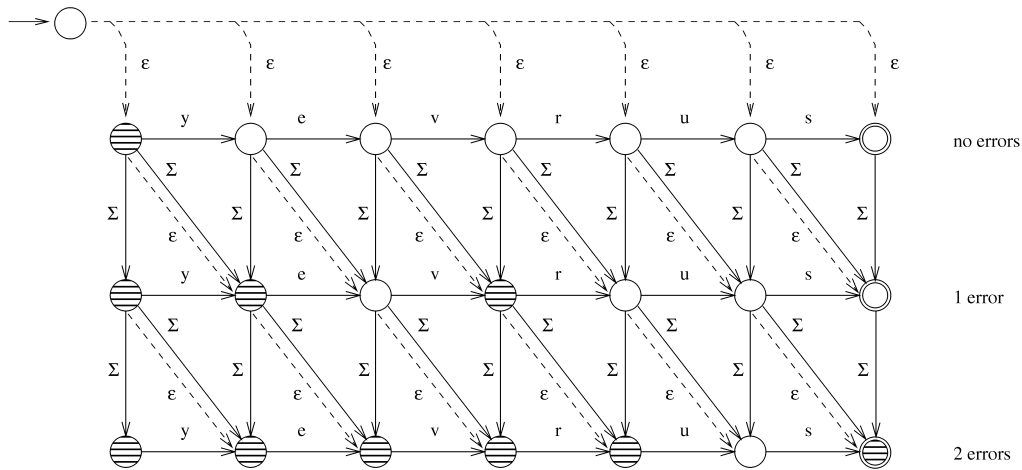

Fig. 21. The construction to search any reverse prefix of "survey" allowing 2 errors.

(see Section 3.2). They adapted an exact string matching algorithm, BDM, to allow errors.

The idea of the original BDM algorithm is as follows [Crochemore et al. 1994; Crochemore and Rytter 1994]. The deterministic suffix automaton of the *reverse* pattern is built so that it recognizes the reverse prefixes of the pattern. Then the pattern is aligned with a text window, and the window is scanned backwards with the automaton (this is why the pattern is reversed). The automaton is active as long as what it has read is a substring of the pattern. Each time the automaton reaches a final state, it has seen a pattern prefix, so we remember the last time it happened. If the automaton arrives with active states at the beginning of the window then the pattern has been found, otherwise what is there is not a substring of the pattern and hence the pattern cannot be in the window. In any case the last window position that matched a pattern prefix gives the next initial window position. The algorithm BNDM [Navarro and Raffinot 2000] is a bit-parallel implementation (using the nondeterministic suffix automaton, see Figure 3) which is much faster in practice and allows searching for classes of characters, etc.

A modification of Navarro and Raffinot [2000] is to build a NFA to search the re-

versed pattern allowing errors, modify it to match any pattern suffix, and apply essentially the same BNDM algorithm using this automaton. Figure 21 shows the resulting automaton.

This automaton recognizes any reverse prefix of P allowing k errors. The window will be abandoned when no pattern substring matches what was read with k errors. The window is shifted to the next pattern prefix found with k errors. The matches must start exactly at the initial window position. The window length is $m - k$, not m , to ensure that if there is an occurrence starting at the window position then a substring of the pattern occurs in any suffix of the window (so that we do not abandon the window before reaching the occurrence). Reaching the beginning of the window does not guarantee a match, however, so we have to check the area by computing edit distance from the beginning of the window (at most $m + k$ text characters).

In Appendix A.3 it is shown that the average complexity¹⁰ is $O(n(\alpha + \alpha^* \log_\sigma(m)/m)/((1 - \alpha)\alpha^* - \alpha))$ and the filter works well for $\alpha < (1 - e/\sqrt{\sigma})/(2 - e/\sqrt{\sigma})$, which for large alphabets tends to $1/2$. The result is competitive for low error levels, but the pattern cannot be very

¹⁰ The original analysis of Navarro [1998] is inaccurate.

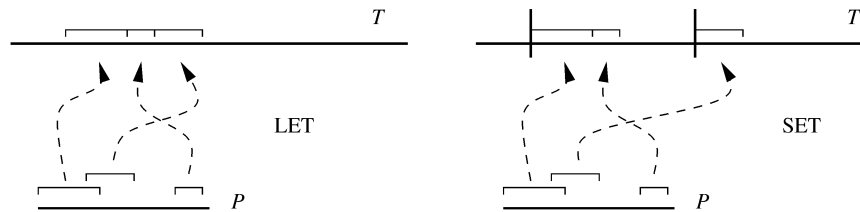

Fig. 22. Algorithms LET and SET. LET covers all the text with pattern substrings, while SET works only at block beginnings and stops when it finds k differences.

long because of the bit-parallel implementation. Notice that trying to do this with the deterministic BDM would have generated a very complex construction, while the algorithm with the nondeterministic automaton is simple. Moreover, a deterministic automaton would have too many states, just as in Section 6.2. All the simple extensions of bit-parallelism apply, provided the window length $m - k$ is carefully reconsidered.

A recent software program, called `{\em nrgrep}`, capable of fast, exact, and approximate searching of simple and complex patterns has been built with this method [Navarro 2000b].

8.3 Very Long Patterns

8.3.1 Chang and Lawler (1990). In 1990, Chang and Lawler [1994] presented two algorithms (better analyzed in Giegerich et al. [1997]). The first one, called LET (for “linear expected time”), works as follows: the text is traversed linearly, and at each time the longest pattern substring that matches the text is maintained. When the substring cannot be extended further, it starts again from the current text position; Figure 22 illustrates.

The crucial observation is that, if less than $m - k$ text characters have been covered by concatenating k longest substrings, then the text area does not match the pattern. This is evident because a match is formed by $k + 1$ correct strokes (recall Section 5.2) separated by k errors. Moreover, the strokes need to be ordered, which is not required by the filter.

The algorithm uses a suffix tree on the pattern to determine in a linear pass the longest pattern substring that

matches the text seen up to now. Notice that the article is from 1990, the same year that Ukkonen and Wood [1993] did the same with a suffix automaton (see Section 5.2). Therefore, the filtering is in $O(n)$ time. The authors use Landau and Vishkin [1989] as the verifying algorithm and therefore the worst case is $O(kn)$. The authors show that the filtering time dominates for $\alpha < 1/\log_\sigma m + O(1)$. The constants are involved, but practical figures are $\alpha \leq 0.35$ for $\sigma = 64$ or $\alpha \leq 0.15$ for $\sigma = 4$.

The second algorithm presented is called SET (for “sublinear expected time”). The idea is similar to LET, except that the text is split in fixed blocks of size $(m - k)/2$, and the check for k contiguous strokes starts only at block boundaries. Since the shortest match is of length $m - k$, at least one of these blocks is always contained completely in a match. If one is able to discard the block, no occurrence can contain it. This is also illustrated in Figure 22.

The sublinearity is clear once it is proven that a block is discarded on average in $O(k \log_\sigma m)$ comparisons. Since $2n/(m - k)$ blocks are considered, the average time is $O(\alpha n \log_\sigma(m)/(1 - \alpha))$. The maximum α level stays the same as in LET, so the complexity can be simplified to $O(\alpha n \log_\sigma m)$. Although the proof that limits the comparisons per block is quite involved, it is not hard to see intuitively why it is true: the probability of finding a stroke of length ℓ in the pattern is limited by m/σ^ℓ , and the detailed proof shows that $\ell = \log_\sigma m$ is on average the longest stroke found. This contrasts with the result of Myers [1986a] (Section 5.3), that shows that k strokes add up $O(k)$ length.

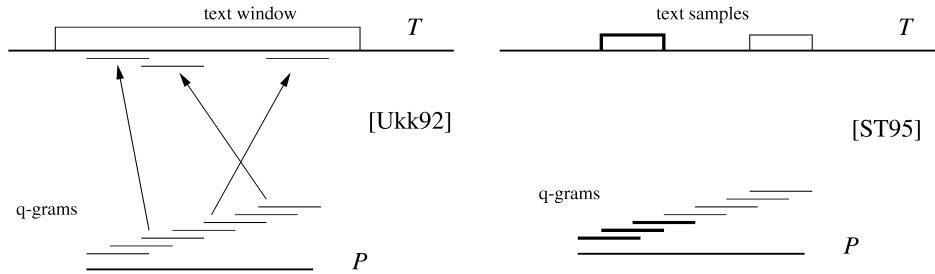

Fig. 23. *Q*-gram algorithm. The left one [Ukkonen 1992] counts the number of pattern *q*-grams in a text window. The right one [Sutinen and Tarhio 1995] finds sequences of pattern *q*-grams in approximately the same text positions (we have put in bold a text sample and the possible *q*-grams to match it).

The difference is that here we can take the strokes from anywhere in the pattern.

Both LET and SET are effective for very long patterns only, since their overhead does not pay off on short patterns. Different distance functions can be accommodated after rereasoning the adequate *k* values.

8.3.2 Ukkonen (1992). In 1992, Ukkonen [1992] independently rediscovered some of the ideas of Chang and Lampe. He presented two filtering algorithms, one of which (based on what he called “maximal matches”) is similar to the LET of Chang and Lawler [1994] (in fact Ukkonen presents it as a new “block distance” computable in linear time, and shows that it serves as a filter for the edit distance). The other filter is the first reference to “*q*-grams” for online searching (there are much older ones in indexed searching [Ullman 1977]).

A *q*-gram is a substring of length *q*. A filter was proposed based on counting the number of *q*-grams shared between the pattern and a text window (this is presented in terms of a new “*q*-gram distance” which may be of interest on its own). A pattern of length *m* has $(m - q + 1)$ overlapping *q*-grams. Each error can alter *q* *q*-grams of the pattern, and therefore $(m - q + 1 - kq)$ pattern *q*-grams must appear in any occurrence; Figure 23 illustrates.

Notice that this is a generalization of the counting filter of Jokinen et al. [1996] (Section 8.2), which corresponds

to $q = 1$. The search algorithm is similar as well, although of course keeping a table with a counter for each of the σ^q *q*-grams is impractical (especially because only $m - q + 1$ of them are present). Ukkonen uses a suffix tree to keep count of the last *q*-gram seen in linear time (the relevant information can be attached to the $m - q + 1$ important nodes at depth *q* in the suffix tree).

The filter therefore takes linear time. There is no analysis to show which is the maximum error level tolerated by the filter, so we attempt a gross analysis in Appendix A.4, valid for large *m*. The result is that the filter works well for $\alpha < O(1/\log_\sigma m)$, and that the optimal *q* to obtain it is $q = \log_\sigma m$. The search algorithm is more complicated than that of Jokinen et al. [1996]. Therefore, using larger *q* values only pays off for larger patterns. Different distance functions are easily accommodated by recomputing the number of *q*-grams that must be preserved in any occurrence.

8.3.3 Takaoka (1994). In 1994, Takaoka [1994] presented a simplification of Chang and Lawler [1994]. He considered *h*-samples of the text (which are non-overlapping *q*-grams of the text taken each *h* characters, for $h \geq q$). The idea is that if one *h*-sample is found in the pattern, then a neighborhood of the area is verified.

By using $h = \lfloor (m - k - q + 1) / (k + 1) \rfloor$ one cannot miss a match. The easiest way to see this is to start with $k = 0$. Clearly, we need $h = m - q + 1$ to not lose any matches.

For larger k , recall that if the pattern is split in $k + 1$ pieces some of them must appear with no errors. The filter divides h by $k + 1$ to ensure that any occurrence of those pieces will be found (we are assuming $q < m/(k + 1)$).

Using a suffix tree of the pattern, the h -sample can be found in $O(q)$ time. Therefore the filtering time is $O(qn/h)$, which is $O(\alpha n \log_\sigma(m)/(1 - \alpha))$ if the optimal $q = \log_\sigma m$ is used. The error level is again $\alpha < O(1/\log_\sigma m)$, which makes the time $O(\alpha n \log_\sigma m)$.

8.3.4 Chang and Marr (1994). It looks like $O(\alpha n \log_\sigma m)$ is the best complexity achievable by using filters, and that it will work only for $\alpha = O(1/\log_\sigma m)$. But in 1994, Chang and Marr obtained an algorithm which was

$$O\left(\frac{k + \log_\sigma m}{m} n\right)$$

for $\alpha < \rho_\sigma$, where ρ_σ depends only on σ and it tends to $1 - \bar{e}/\sqrt{\sigma}$ for very large σ . At the same time, they proved that this was a lower bound for the average complexity of the problem (and therefore their algorithm was optimal on average). This is a major theoretical breakthrough.

The lower bound is obtained by taking the maximum (or sum) of two simple facts: the first one is the $O(n \log_\sigma(m)/m)$ bound of Yao [1979] for exact string matching, and the second one is the obvious fact that in order to discard a block of m text characters, at least k characters should be examined to find the k errors (and hence $O(kn/m)$ is a lower bound). Also, the maximum error level is optimal according to Section 4. What is impressive is that an algorithm with such complexity was found.

The algorithm is a variation of SET [Chang and Lawler 1994]. It is of polynomial space in m , i.e. $O(m^t)$ space for some constant t which depends on σ . It is based on splitting the text in contiguous substrings of length $\ell = t \log_\sigma m$. Instead of finding in the pattern the longest exact matches starting at the beginning of blocks of size $(m - k)/2$, it searches the

text substrings of length ℓ in the pattern allowing errors.

The algorithm proceeds as follows. The best matches allowing errors inside P are precomputed for every ℓ -tuple (hence the $O(m^t)$ space). Starting at the beginning of the block, it searches consecutive ℓ -tuples in the pattern (each in $O(\ell)$ time), until the total number of errors made exceeds k . If by that time it has not yet covered $m - k$ text characters, the block can be safely skipped.

The reason why this works is a simple extension of SET. We have found an area contained in the possible occurrence which cannot be covered with k errors (even allowing the use of unordered portions of the pattern for the match). The algorithm is only practical for very long patterns, and can be extended for other distances with the same ideas as the other filtration and q -gram methods.

It is interesting to notice that $\alpha \leq 1 - \bar{e}/\sqrt{\sigma}$ is the limit we have discussed in Section 4, which is a firm barrier for any filtering mechanism. Chang and Lawler proved an asymptotic result, while a general bound is proved in Baeza-Yates and Navarro [1999]. The filters of Chang and Marr [1994] and Navarro and Baeza-Yates [1998a] reduce the problem to *fewer* errors instead of to *zero* errors. An interesting observation is that it seems that all the filters that partition the problem into exact search can be applied for $\alpha = O(1/\log_\sigma m)$, and that in order to improve this to $1 - \bar{e}/\sqrt{\sigma}$ we must partition the problem into (smaller) approximate searching subproblems.

8.3.5 Sutinen and Tarhio (1995). Sutinen and Tarhio [1995] generalized the Takaoka filter in 1995, improving its filtering efficiency. This is the first filter that takes into account the relative positions of the pattern pieces that match in the text (all the previous filters matched pieces of the pattern in any order). The generalization is to force s q -grams of the pattern to match (not just one). The pieces must conserve their relative ordering in the pattern and must not be more than k characters away from their correct

position (otherwise we need to make more than k errors to use them). This method is also illustrated in Figure 23.

In this case, the sampling step is reduced to $h = \lfloor (m - k - q + 1)/(k + s) \rfloor$. The reason for this reduction is that, to ensure that s pieces of the pattern match, we need to cut the pattern into $k + s$ pieces. The pattern is divided in $k + s$ pieces and a hashed set is created for each piece so that the pieces are forced not to be too far away from their correct positions. The set contains the q -grams of the piece and some neighboring ones too (because the sample can be slightly misaligned). At search time, instead of a single h -sample, they consider text windows of contiguous sequences of $k + s$ h -samples. Each of these h -samples is searched in the corresponding set, and if at least s are found the area is verified. This is a sort of Hamming distance, and the authors resort to an efficient algorithm for that distance [Baeza-Yates and Gonnet 1992] to process the text.

The resulting algorithm is $O(\alpha n \log_{\sigma} m)$ on average using optimal $q = \log_{\sigma} m$, and works well for $\alpha < 1/\log_{\sigma} m$. The algorithm is better suited for long patterns, although with $s = 2$ it can be reasonably applied to short ones as well. In fact the analysis is done for $s = 2$ only in Sutinen and Tarhio [1995].

8.3.6 Shi (1996). In 1996 Shi [1996] proposed to extend the idea of the $k + 1$ pieces (explained in Section 8.2) to $k + s$ pieces, so that at least s pieces must match. This idea is implicit in the filter of Sutinen and Tarhio but had not been explicitly written down. Shi compared his filter against the simple one, finding that the filtering efficiency was improved. However, this improvement will be noticeable only for long patterns. Moreover, the online searching efficiency is degraded because the pieces are shorter (which affects any Boyer–Moore-like search), and because the verification logic is more complex. No analysis is presented in the paper, but we conjecture that the optimum s is $O(1)$ and therefore the same complexity and tolerance to errors is maintained.

8.3.7 Giegerich, Kurtz, Hischke, and Ohlebusch (1996). Also in 1996, a general method to improve filters was developed [Giegerich et al. 1997]. The idea is to mix the phases of filtering and checking, so that the verification of a text area is abandoned as soon as the combined information from the filter (number of guaranteed differences left) and the verification in progress (number of actual differences seen) shows that a match is not possible. As they show, however, the improvement occurs in a very narrow area of α . This is a consequence of the statistics of this problem that we have discussed in Section 4.

9. EXPERIMENTS

In this section we make empirical comparisons among the algorithms described in this work. Our goal is to show the best options at hand depending on the case. Nearly 40 algorithms have been surveyed, some of them without existing implementations and many of them already known to be impractical. To avoid excessively long comparisons among algorithms known not to be competitive, we have left many of them aside.

9.1 Included and Excluded Algorithms

A large group of excluded algorithms is from the theoretical side based on the dynamic programming matrix. Although these algorithms are not competitive in practice, they represent (or represented at their time) a valuable contribution to the development of the algorithmic aspect of the problem. The dynamic programming algorithm [Sellers 1980] is excluded because the cut-off heuristic of Ukkonen [1985b] is known to be faster (e.g. in Chang and Lampe [1992] and in our internal tests); the Masek and Paterson algorithm [1980] is argued in the same paper to be worse than dynamic programming (which is quite bad) for $n < 40$ GB; Landau and Vishkin [1988] has bad complexity and was improved later by many others in theory and practice; Landau and Vishkin [1989] is

implemented with a better LCA algorithm in Chang and Lampe [1992] and found too slow; Myers [1986a] is considered slow in practice by the same author in Wu et al. [1996]; Galil and Giancarlo [1988] is clearly slower than Landau and Vishkin [1989]; Galil and Park [1990], one of the fastest among the $O(kn)$ worst case algorithms, is shown to be extremely slow in Ukkonen and Wood [1993], Chang and Lampe [1992], and Wright [1994] and in internal tests done by ourselves; Ukkonen and Wood [1993] is shown to be slow in Jokinen et al. [1996]; the $O(kn)$ algorithm implemented in Chang and Lawler [1994] is in the same paper argued to be the fastest of the group and shown to be not competitive in practice; Sahinalp and Vishkin [1997] and Cole and Hariharan [1998] are clearly theoretical, their complexities show that the patterns have to be very long and the error level too low to be of practical application. To give an idea of how slow is “slow,” we found Galil and Park [1990] 10 times slower than Ukkonen’s cut-off heuristic (a similar result is reported by Chang and Lampe [1992]). Finally, other $O(kn)$ average time algorithms are proposed in Myers [1986a] and Galil and Park [1990], and they are shown to be very similar to Ukkonen’s cut-off [Ukkonen 1985b] in Chang and Lampe [1992]. Since the cut-off heuristic is already not very competitive we leave aside the other similar algorithms. Therefore, from the group based on dynamic programming we consider only the cut-off heuristic (mainly as a reference) and Chang and Lampe [1992], which is the only one competitive in practice.

From the algorithms based on automata we consider the DFA algorithm [Ukkonen 1985b], but prefer its lazy version implemented in Navarro [1997b], which is equally fast for small automata and much faster for large automata. We also consider the Four Russians algorithm of Wu et al. [1996]. From the bit-parallel algorithms we consider Wu and Manber [1992b], Baeza-Yates and Navarro [1999], and Myers [1999], leaving aside Wright [1994]. As shown in the 1996 version of Baeza-Yates and Navarro [1999], the

algorithm of Wright [1994] was competitive only on binary text, and this was shown to not hold anymore in Myers [1999].

From the filtering algorithms, we have included Tarhio and Ukkonen [1993]; the counting filter proposed in Jokinen et al. [1996] (as simplified in Navarro [1997a]); the algorithm of Navarro and Raffinot [2000]; and those of Sutinen and Tarhio [1995] and Takaoka [1994] (this last seen as the case $s = 1$ of Sutinen and Tarhio [1995], since this implementation worked better). We have also included the filters proposed in Baeza-Yates and Navarro [1999], Navarro and Baeza-Yates [1998a], and Navarro [1998], preferring to present only the last version which incorporates all the twists of superimposition, hierarchical verification and mixed partitioning. Many previous versions are outperformed by this one. We have also included the best version of the filters that partition the pattern in $k + 1$ pieces, namely the one incorporating hierarchical verification [Navarro and Baeza-Yates 1999c; Navarro 1998]. In those publications it is shown that this version clearly outperforms the previous ones proposed in Wu and Manber [1992b], Baeza-Yates and Perleberg [1996], and Baeza-Yates and Navarro [1999]. Finally, we are discarding some filters [Chang and Lawler 1994; Ukkonen 1992; Chang and Marr 1994; Shi 1996] which are applicable only to very long patterns, since this case is excluded from our experiments as explained shortly. Some comparisons among them were carried out by Chang and Lampe [1992], showing that LET is equivalent to the cut-off algorithm with $k = 20$, and that the time for SET is 2α times that of LET. LET was shown to be the fastest with patterns of a hundred letters long and a few errors in Jokinen et al. [1996], but we recall that many modern filters were not included in that comparison.

We now list the included algorithms and the relevant comments about them. All the algorithms implemented by us represent our best coding effort and have been found similar or faster than

other implementations found elsewhere. The implementations coming from other authors were checked with the same standards and in some cases their code was improved with better register usage and I/O management. The number in parenthesis following the name of each algorithm is the number of lines of the C implementation we use. This gives a rough idea of how complex the implementation of each algorithm is.

CTF (239) The cut-off heuristic of Ukkonen [1985b] implemented by us.

CLP (429) The column partitioning algorithm of Chang and Lampe [1992], implemented by them. We replaced their I/O by ours, which is faster.

DFA (291) The lazy deterministic automaton of Navarro [1997b], implemented by us.

RUS (304) The Four-Russians algorithm of Wu et al. [1996], implemented by them. We tried different r values (related to the time/space tradeoff) and found that the best option is always $r = 5$ in our machine.

BPR (229) The NFA bit-parallelized by rows [Wu and Manber 1992b], implemented by us and restricted to $m \leq w$. Separate code is used for $k = 1, 2, 3$ and $k > 3$. We could continue writing separate versions but decided that this is reasonable up to $k = 3$, as at that point the algorithm is not competitive anyway.

BPD (249 – 1,224) The NFA bit-parallelized by diagonals [Baeza-Yates and Navarro 1999], implemented by us. Here we do not include any filtering technique. The first number (249) corresponds to the plain technique and the second one (1,224) to handling partitioned automata.

BPM (283 – 722) The bit-parallel implementation of the dynamic programming matrix [Myers 1999], implemented by that author. The two numbers have the same meaning as in the previous item.

BMH (213) The adaptation of Horspool to allow errors [Tarhio and Ukkonen 1993], implemented by them. We use

their algorithm 2 (which is faster), improve some register usage and replace their I/O by ours, which is faster.

CNT (387) The counting filter of Jokinen et al. [1996], as simplified in Navarro [1997a] and implemented by us.

EXP (877) Partitioning in $k + 1$ pieces plus hierarchical verification [Navarro and Baeza-Yates 1999c; Navarro 1998], implemented by us.

BPP (3,466) The bit-parallel algorithms of Baeza-Yates and Navarro [1999], Navarro and Baeza-Yates [1998a], and Navarro [1998] using pattern partitioning, superimposition, and hierarchical verification. The implementation is ours and is packaged software that can be downloaded from the Web page of the author.

BND (375) The BNDM algorithm adapted to allow errors in Navarro and Raffinot [2000] and Navarro [1998] implemented by us and restricted to $m \leq w$. Separate code is used for $k = 1, 2, 3$ and $k > 3$. We could continue writing separate versions but decided that this is reasonable up to $k = 3$.

QG2 (191) The q -gram filter of Sutinen and Tarhio [1995], implemented by them and used with $s = 2$ (since $s = 1$ is the algorithm [Takaoka 1994], see next item; and $s > 2$ worked well only for very long patterns). The code is restricted to $k \leq w/2 - 3$, and it is also not run when q is found to be 1 since the performance is very poor. We improved register usage and replaced the I/O management by our faster versions.

QG1 (191) The q -gram algorithm of Takaoka [1994], run as the special case $s = 1$ of the previous item. The same restrictions on the code apply.

We did our best to uniformize the algorithms. The I/O is the same in all cases: the text is read in chunks of 64 KB to improve locality (this is the optimum in our machine) and care is taken to not lose or repeat matches in the borders; open is used instead of fopen because it is slower. We also uniformize internal conventions: only a final special character

(zero) is used at the end of the buffer to help algorithms recognize it; and only the number of matches found is reported.

In the experiments we separate the filtering and nonfiltering algorithms. This is because the filters can in general use any nonfilter to check for potential matches, so the best algorithm is formed by a combination of both. All the filtering algorithms in the experiments use the cut-off algorithm [Ukkonen 1985b] as their verification engine, except for BPP (whose very essence is to switch smoothly to BPD) and BND (which uses a reverse BPR to search in the window and a forward BPR for the verifications).

9.2 Experimental Setup

Apart from the algorithms and their details, we describe our experimental setup. We measure CPU times and show the results in tenths of seconds per megabyte. Our machine is a Sun UltraSparc-1 with 167 MHz and 64 MB in main memory, we run Solaris 2.5.1 and the texts are on a local disk of 2 GB. Our experiments were run on texts of 10 MB and repeated 20 times (with different search patterns). The same patterns were used for all the algorithms.

In the applications, we have selected three types of texts.

DNA: This file is formed by concatenating the 1.34 MB DNA chain of *h.influenzae* with itself until 10 MB is obtained. Lines are cut at 60 characters. The patterns are selected randomly from the text, avoiding line breaks if possible. The alphabet size is four, save for a few exceptions along the file, and the results are similar to a random four-letter text.

Natural language: This file is formed by 1.29 MB from the work of Benjamin Franklin filtered to lower-case and separators converted to a space (except line breaks which are respected). This mimics common information retrieval scenarios. The text is replicated to obtain 10 MB and search patterns are randomly selected from the same text

at word beginnings. The results are roughly equivalent to a random text over 15 characters.

Speech: We obtained speech files from discussions of U.S. law from Indiana University, in PCM format with 8 bits per sample. Of course, the standard edit distance is of no use here, since it has to take into account the absolute values of the differences between two characters. We simplified the problem in order to use edit distance: we reduced the range of values to 64 by quantization, considering two samples that lie in the same range as equal. We used the first 10 MB of the resulting file. The results are similar to those on a random text of 50 letters, although the file shows smooth changes from one letter to the next.

We present results using different pattern lengths and error levels in two flavors: we fix m and show the effect of increasing k , or we fix α and show the effect of increasing m . A given algorithm may not appear at all in a plot when its times are above the y range or its restrictions on m and k do not intersect with the x range. In particular, filters are shown only for $\alpha \leq 1/2$. We remind readers that in most applications the error levels of interest are low.

9.3 Results

Figure 24 shows the results for short patterns ($m = 10$) and varying k . In nonfiltering algorithms BPD is normally the fastest, up to 30% faster than the next one, BPM. The DFA is also quite close in most cases. For $k = 1$, a specialized version of BPR is slightly faster than BPD (recall that for $k > 3$ BPR starts to use a nonspecialized algorithm, hence the jump). An exception occurs in DNA text, where for $k = 4$ and $k = 5$, BPD shows a nonmonotonic behavior and BPM becomes the fastest. This behavior comes from its $O(k(m - k)n/w)$ complexity,¹¹

¹¹ Another reason for this behavior is that there are integer round-off effects that produce nonmonotonic results.

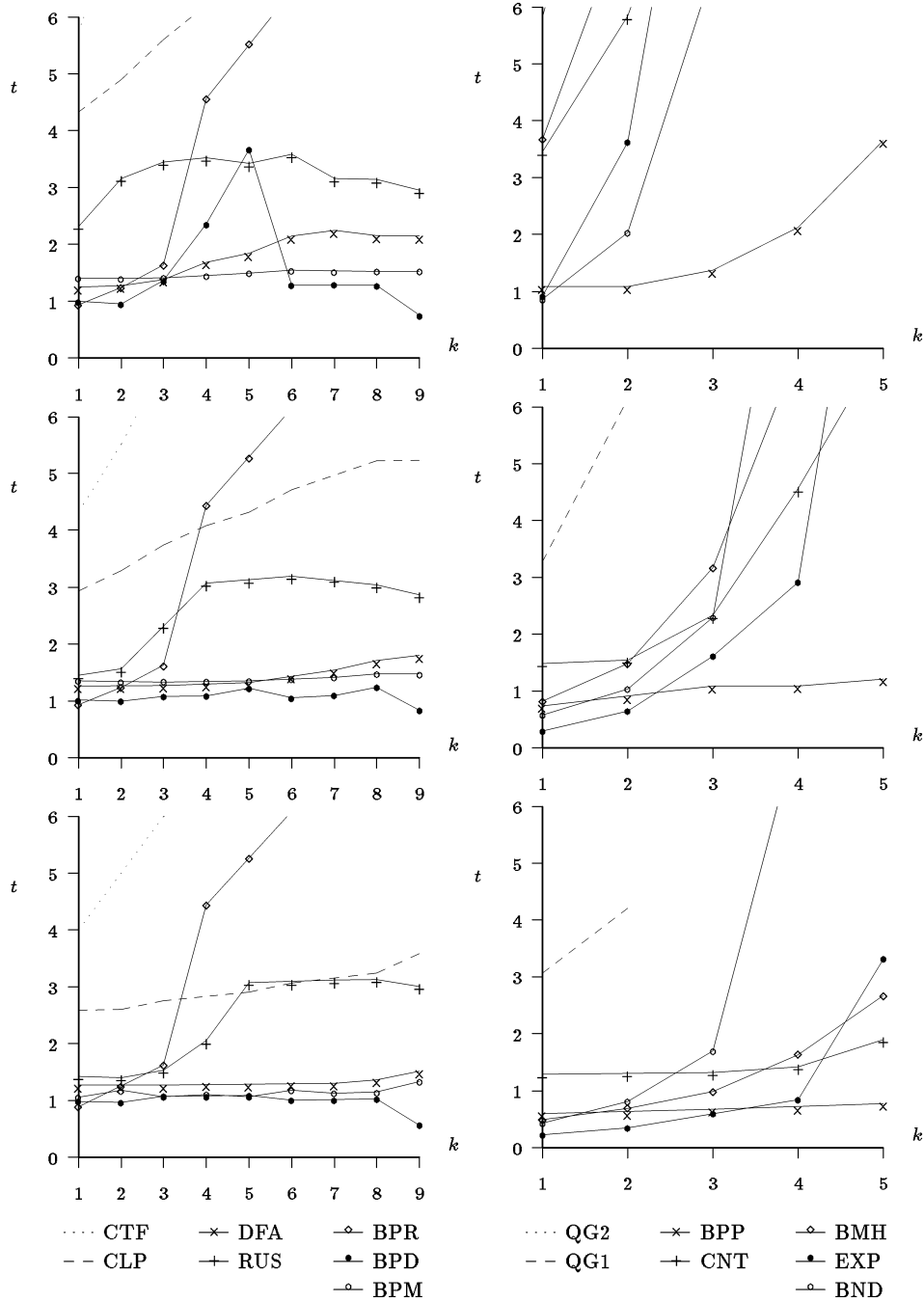

Fig. 24. Results for $m = 10$ and varying k . The left plots show nonfiltering and the right plots show filtering algorithms. Rows 1–3 show DNA, English, and speech files, respectively.

which in texts with larger alphabets is not noticeable because the cut-off heuristic keeps the cost unchanged. Indeed, the behavior of BPD would have been totally stable if we had chosen $m=9$ instead of $m=10$, because the problem would fit in a computer word all the time. BPM, on the other hand, handles much longer patterns, maintaining stability, although it takes up to 50% more time than BPD.

With respect to filters, EXP is the fastest for low error levels. The value of “low” increases for larger alphabets. At some point, BPP starts to dominate. BPP adapts smoothly to higher error levels by slowly switching to BPD, so BPP is a good alternative for intermediate error levels, where EXP ceases to work until it switches to BPD. However, this range is void on DNA and English text for $m=10$. Other filters competitive with EXP are BND and BMH. In fact, BND is the fastest for $k=1$ on DNA, although no filter works very well in that case. Finally, QG2 does not appear because it only works for $k=1$ and it was worse than QG1.

The best choice for short patterns seems to be EXP while it works and switching to the best bit-parallel algorithm for higher errors. Moreover, the verification algorithm for EXP should be BPR or BPD (which are the fastest where EXP dominates).

Figure 25 shows the case of longer patterns ($m=30$). Many of the observations are still valid in this case. However, in this case the algorithm BPM shows its advantage over BPD, since the entire problem still fits in a computer word for BPM and it does not for BPD. Hence in the left plots the best algorithm is BPM except for low k , where BPR or BPD are better. With respect to filters, EXP or BND are the fastest, depending on the alphabet, until a certain error level is reached. At that point BPP becomes the fastest, in some cases still faster than BPM. Notice that for DNA a specialized version of BND for $k=4$ and even 5 could be the fastest choice.

In Figure 26 we consider the case of fixed $\alpha=0.1$ and growing m . The results

repeat somewhat those for nonfiltering algorithms: BPR is the best for $k=1$ (i.e. $m=10$), then BPD is the best until a certain pattern length is reached (which varies from 30 on DNA to 80 on speech), and finally BPM becomes the fastest. Note that for such a low error level the number of active columns is quite small, which permits algorithms like BPD and BPM to keep their good behavior for patterns much longer than what they could handle in a single machine word. The DFA is also quite competitive until its memory requirements become unreasonable.

The real change, however, is in the filters. In this case PEX becomes the star filter in English and speech texts. The situation for DNA, on the other hand, is quite complex. For $m \leq 30$, BND is the fastest, and indeed an extended implementation allowing longer patterns could keep it being the fastest for a few more points. However, that case would have to handle four errors, and only a specialized implementation for fixed $k=4, 5, \dots$ could maintain a competitive performance. We have determined that such specialized code is worthwhile up to $k=3$ only. When BND ceases to be applicable, PEX becomes the fastest algorithm, and finally QG2 beats it (for $m \geq 60$). However, notice that for $m > 30$, all the filters are beaten by BPM and therefore make little sense (on DNA).

There is a final phenomenon that deserves mention with respect to filters. The algorithms QG1 and QG2 improve as m grows. These algorithms are the most practical, and the only ones we tested in the family of algorithms suitable for very long patterns. Thus, although all these algorithms would not be competitive in our tests (where $m \leq 100$), they should be considered in scenarios where the patterns are much longer and the error level is kept very low. In such a scenario, those algorithms would finally beat all the algorithms we consider here.

The situation becomes worse for the filters when we consider $\alpha=0.3$ and varying m (Figure 27). On DNA, no filter can beat the nonfiltering algorithms, and among them the tricks to maintain a few active columns do not work well. This

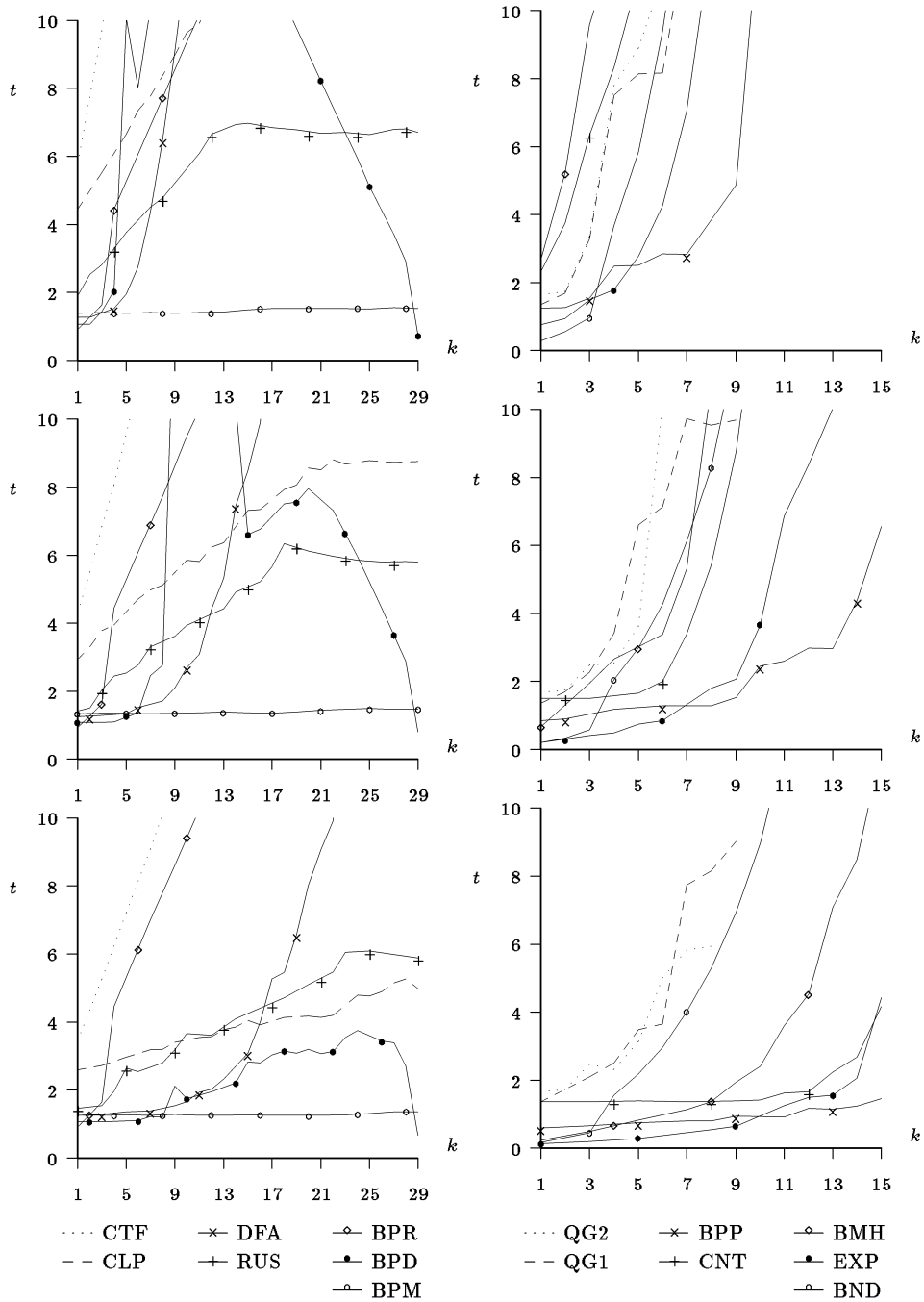

Fig. 25. Results for $m = 30$ and varying k . The left plots show nonfiltering and the right plots show filtering algorithms. Rows 1–3 show DNA, English and speech files, respectively.

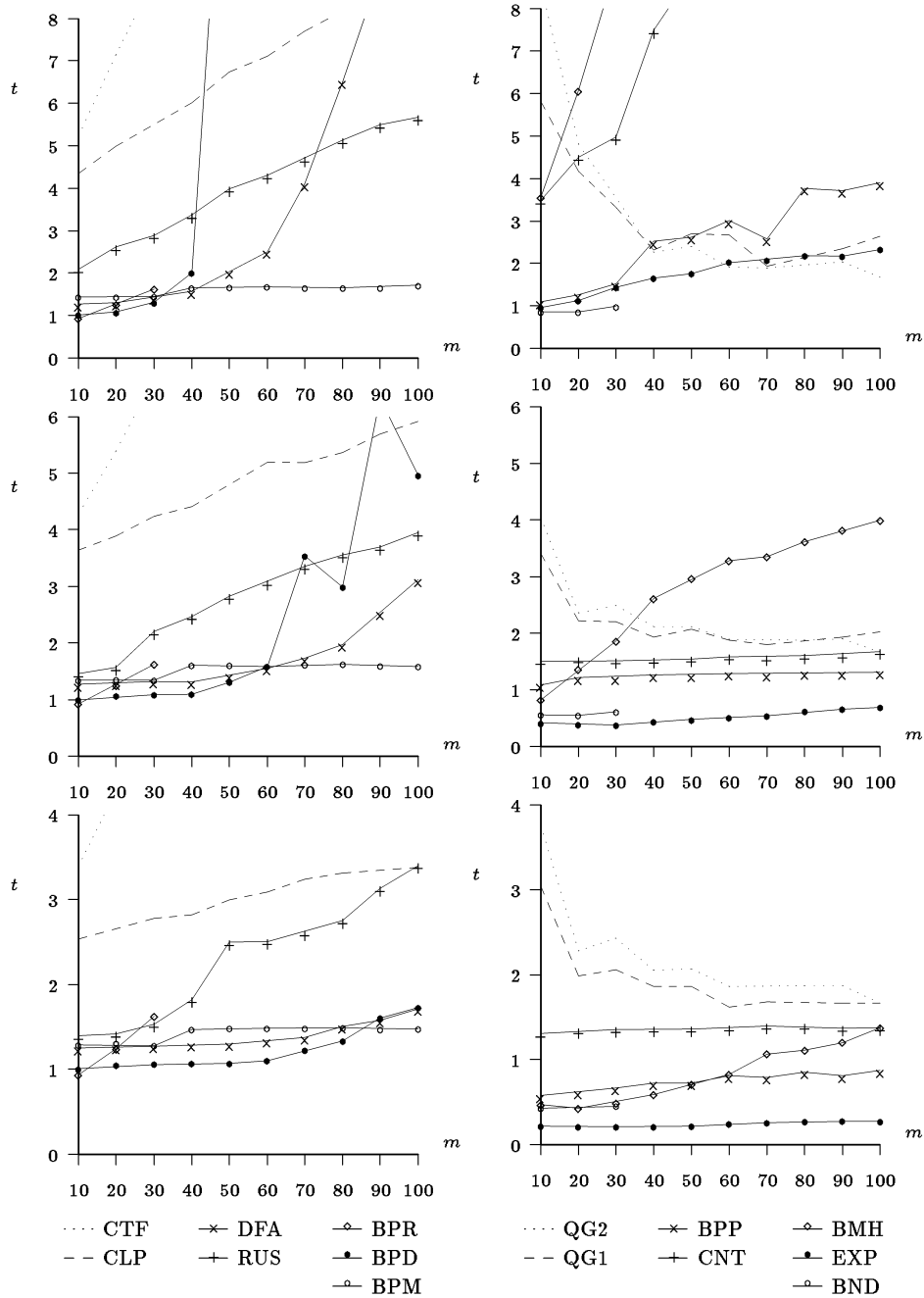

Fig. 26. Results for $\alpha = 0.1$ and varying m . The left plots show nonfiltering and the right plots show filtering algorithms. Rows 1–3 show DNA, English and speech files, respectively.

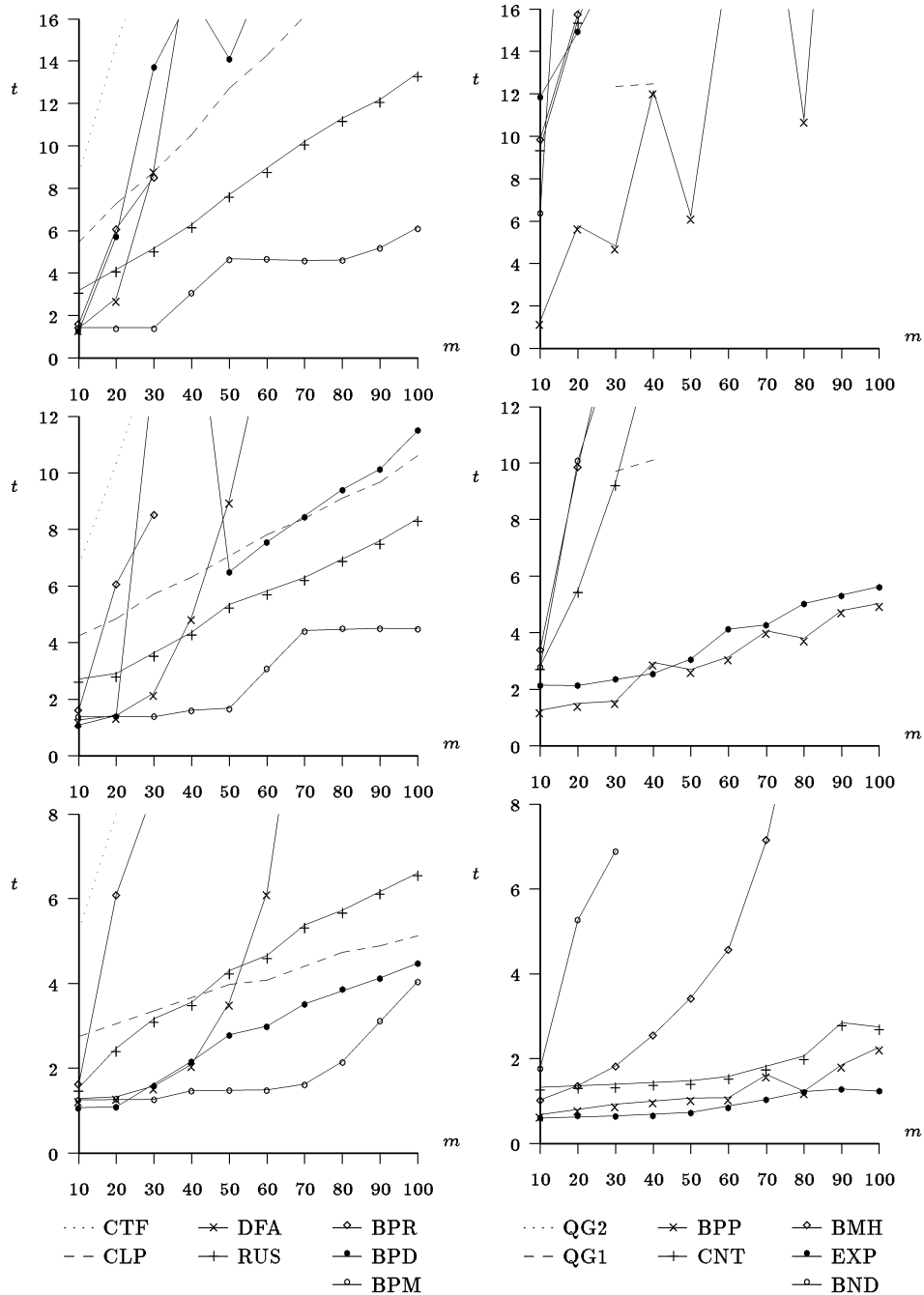

Fig. 27. Results for $\alpha = 0.3$ and varying m . The left plots show nonfiltering and the right plots show filtering algorithms. Rows 1–3 show DNA, English and speech files, respectively.

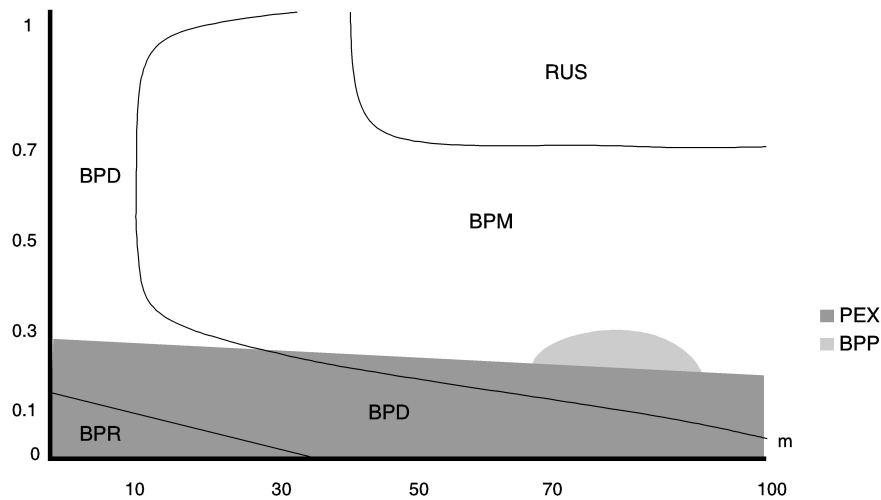

Fig. 28. The areas where each algorithm is the best; gray is that of filtering algorithms.

favors the algorithms that pack more information per bit, which makes BPM the best in all cases except for $m = 10$ (where BPD is better). The situation is almost the same on English text, except that BPP works reasonably well and becomes quite similar to BPM (the periods where each one dominates are interleaved). On speech, on the other hand, the scenario is similar to that for nonfiltering algorithms, but the PEX filter still beats all of them, as 30% of errors is low enough on the speech files. Note in passing that the error level is too high for QG1 and QG2, which can only be applied in a short range and yield bad results.

To give an idea of the areas where each algorithm dominates, Figure 28 shows the case of English text. There is more information in Figure 28 than can be inferred from previous plots, such as the area where RUS is better than BPM. We have shown the nonfiltering algorithms and superimposed in gray the area where the filters dominate. Therefore, in the gray area the best choice is to use the corresponding filter using the dominating nonfilter as its verification engine. In the nongray area it is better to use the dominating nonfiltering algorithm directly, with no filter.

A code implementing such a heuristic (including EXP, BPD and BPP only) is publicly available from the author's Web

page.¹² This combined code is faster than each isolated algorithm, although of course it is not really a single algorithm but the combination of the best choices.

10. CONCLUSIONS

We reach the end of this tour on approximate string matching. Our goal has been to present and explain the main ideas behind the existing algorithms, to classify them according to the type of approach proposed, and to show how they perform in practice in a subset of possible practical scenarios. We have shown that the oldest approaches, based on the dynamic programming matrix, yield the most important theoretical developments, but in general the algorithms have been improved by modern developments based on filtering and bit-parallelism. In particular, the fastest algorithms combine a fast filter to discard most of the text with a fast nonfilter algorithm to check for potential matches.

We show some plots summarizing the contents of the survey. Figure 29 shows the historical order in which the algorithms appeared in the different areas.

¹²<http://www.dcc.uchile.cl/~gnavarro/pubcode>. To apply EXP the option `-ep` must be used.

first algor.	80	[Sel80] [MP80]			
best worst cases	85	[LV88] [Ukk85b]	[Ukk85b]		
	86	[LV89] [Mye86a]			
	87				
	88	[GG88]			
	89	[GP90]			
first filter	90	[CL94] [UW93]			[TU93] [CL94]
	91				[JTU96]
first bit-parallel	92	[CL92]	[WMM96]	[WM92b]	[WM92b] [BYP96] [Ukk92]
	93				
average lower bound	94			[Wri94]	[CM94] [Tak94]
	95		[Mel96]		[ST95]
	96		[Kur96]	[BYN99]	[BYN99] [Shi96] [GKHO97]
	97	[SV97]			[Nav97a]
fastest practical	98	[CH98]		[Mye99]	[NBY98a] [NBY99b] [NR00]
		Dyn.Prog.	Automata	Bit Par.	Filters

Fig. 29. Historical development of the different areas. References are shortened to first letters (single authors) or initials (multiple authors), and to the last two digits of years.

Key: Sel80 = [Sellers 1980], MP80 = [Masek and Paterson 1980], LV88 = [Landau and Vishkin 1988], Ukk85b = [Ukkonen 1985b], LV89 = [Landau and Vishkin 1989], Mye86a = [Myers 1986a], GG88 = [Galil and Giancarlo 1988], GP90 = [Galil and Park 1990], CL94 = [Chang and Lawler 1994], UW93 = [Ukkonen and Wood 1993], TU93 = [Tarhio and Ukkonen 1993], JTU96 = [Jokinen et al. 1996], CL92 = [Chang and Lampe 1992], WMM96 = [Wu et al. 1996], WM92b = [Wu and Manber 1992b], BYP96 = [Baeza-Yates and Perleberg 1996], Ukk92 = [Ukkonen 1992], Wri94 = [Wright 1994], CM94 = [Chang and Marr 1994], Tak94 = [Takaoka 1994], Mel96 = [Melichar 1996], ST95 = [Sutinen and Tarhio 1995], Kur96 = [Kurtz 1996], BYN99 = [Baeza-Yates and Navarro 1999], Shi96 = [Shi 1996], GKHO97 = [Giegerich et al. 1997], SV97 = [Sahinalp and Vishkin 1997], Nav97a = [Navarro 1997a], CH98 = [Cole and Hariharan 1998], Mye99 = [Myers 1999], NBY98a & NBY99b = [Navarro and Baeza-Yates 1998a; 1999b], and NR00 = [Navarro and Raffinot 2000].

Figure 30 shows a worst case time/space complexity plot for the nonfiltering algorithms. Figure 31 considers filtration algorithms, showing their average case complexity and the maximum error level α for which they work. Some practical assumptions have been made to order the different functions of k , m , σ , w , and n .

Approximate string matching is a very active research area, and it should continue in that status in the foreseeable

future: strong genome projects in computational biology, the pressure for oral human-machine communication and the heterogeneity and spelling errors present in textual databases are just a sample of the reasons that drive researchers to look for faster and more flexible algorithms for approximate pattern matching.

It is interesting to point out theoretical and practical questions that are still open.

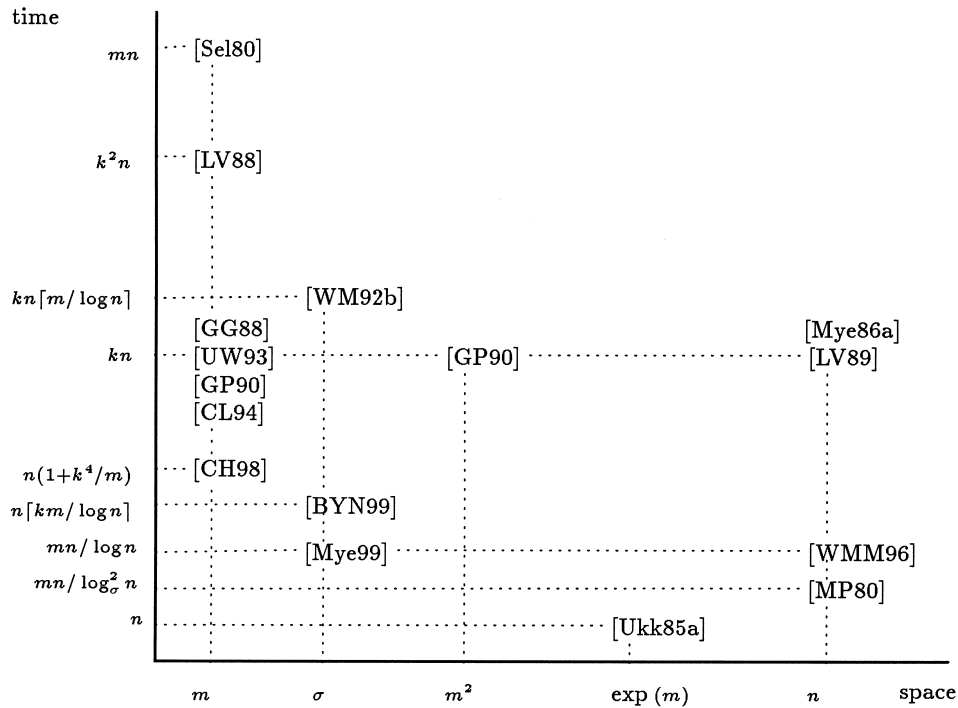

Fig. 30. Worst case time and space complexity of nonfiltering algorithms. We replaced w by $\Theta(\log n)$. References are shortened to first letters (single authors) or initials (multiple authors), and to the last two digits of years.

Key: Sel80 = [Sellers 1980], LV88 = [Landau and Vishkin 1988], WM92b = [Wu and Manber 1992b], GG88 = [Galil and Giancarlo 1988], UW93 = [Ukkonen and Wood 1993], GP90 = [Galil and Park 1990], CL94 = [Chang and Lawler 1994], Mye86a = [Myers 1986a], LV89 = [Landau and Vishkin 1989], CH98 = [Cole and Hariharan 1998], BYN99 = [Baeza-Yates and Navarro 1999], Mye99 = [Myers 1999], WMM96 = [Wu et al. 1996], MP80 = [Masek and Paterson 1980], and Ukk85a = [Ukkonen 1985a].

- The exact matching probability and average edit distance between two random strings is a difficult open question. We found a new bound in this survey, but the problem is still open.
- A worst-case lower bound of the problem is clearly $O(n)$, but the only algorithms achieving it have space and preprocessing cost exponential in m or k . The only improvements to the worst case with polynomial space complexity are the $O(kn)$ algorithms and, for very small k , $O(n(1+k^4/m))$. Is it possible to improve the algorithms or to find a better lower bound for this case?
- The previous question also has a practical side: Is it possible to find an algorithm which is $O(kn)$ in the worst case and efficient in practice? Using bit-parallelism, there are good practical algorithms that achieve $O(kn/w)$ on average and $O(mn/w)$ in the worst case.
- The lower bound of the problem for the average case is known to be $O(n(k + \log_\sigma m)/m)$, and there exists an algorithm achieving it, so from the theoretical point of view that problem is closed. However, from the practical side, the algorithms approaching those limits work well only for very long patterns, while a much simpler algorithm (EXP) is the best for moderate and short patterns. Is it possible to find a unified approach, good in practice and with that theoretical complexity?

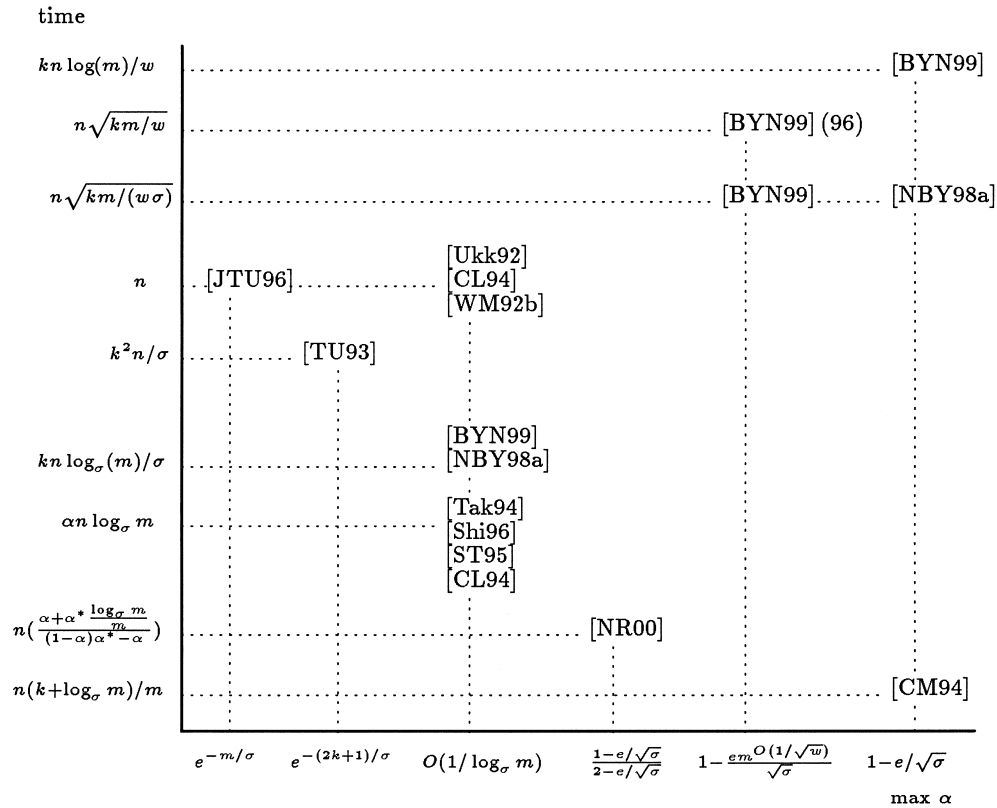

Fig. 31. Average time and maximum tolerated error level for the filtration algorithms. References are shortened to first letters (single authors) or initials (multiple authors), and to the last two digits of years.

Key: BYN99 = [Baeza-Yates and Navarro 1999], NBY98a = [Navarro and Baeza-Yates 1998a], J TU96 = [Jokinen et al. 1996], Ukk92 = [Ukkonen 1992], CL94 = [Chang and Lawler 1994], WM92b = [Wu and Manber 1992b], TU93 = [Tarhio and Ukkonen 1993], Tak94 = [Takaoka 1994], Shi96 = [Shi 1996], ST95 = [Sutinen and Tarhio 1995], NR00 = [Navarro and Raffinot 2000], and CM94 = [Chang and Marr 1994].

- Another practical question on filtering algorithms is: Is it possible in practice to improve over the current best existing algorithms?
- Finally, there are many other open questions related to offline approximate searching, which is a much less mature area needing more research.

APPENDIX A. SOME ANALYSES

Since some of the source papers lack an analysis, or they do not analyze exactly what is of interest to us, we provide a simple analysis. This is not the purpose of

this survey, so we content ourselves with rough figures. In particular, our analyses are valid for $\sigma \ll m$. All refer to filters and are organized according to the original order, so the reader should first read the algorithm description to understand the terminology.

A.1 Tarhio and Ukkonen (1990)

First, the probability of a text character being “bad” is that of not matching $2k + 1$ pattern positions, i.e. $P_{\text{bad}} = (1 - 1/\sigma)^{2k+1} \approx e^{-(2k+1)/\sigma}$, so we try on average $1/P_{\text{bad}}$ characters until we find a bad one. Since $k + 1$ bad characters

have to be found, we make $O(k/P_{\text{bad}})$ leave the window. On the other hand, the probability of verifying a text window is that of reaching its beginning. We approximate that probability by equating m to the average portion of the traversed window (k/P_{bad}), to obtain $\alpha < \bar{e}^{-(2k+1)/\sigma}$.

A.2 Wu and Manber (1992)

The Sunday algorithm can be analyzed as follows. To see how far we can verify in the current window, consider that $(k+1)$ patterns have to fail. Each one fails on average in $\log_{\sigma}(m/(k+1))$ character comparisons, but the time for all them to fail is longer. By Yao's bound [Yao 1979], this cannot be less than $\log_{\sigma} m$. Otherwise we could split the test of a single pattern into $(k+1)$ tests of subpatterns, and all of them would fail in less than $\log_{\sigma} m$ time, breaking the lower bound. To compute the average shift, consider that k characters must be different from the last window character, and therefore the average shift is σ/k . The final complexity is therefore $O(kn \log_{\sigma}(m)/\sigma)$. This is optimistic, but we conjecture that it is the correct complexity. An upper bound is obtained by replacing k by k^2 (i.e. adding the times for all the pieces to fail).

A.3 Navarro and Raffinot (1998)

The automaton matches the text window with k errors until almost surely k/α^* characters have been inspected (so that the error level becomes lower than α^*). From there on, it becomes exponentially decreasing on γ , which can be made $1/\sigma$ in $O(k)$ total steps. From that point on, we are in a case of exact string matching and then $\log_{\sigma} m$ characters are inspected, for a total of $O(k/\alpha^* + \log_{\sigma} m)$. When the window is shifted to the last prefix that matched with k errors, this is also at k/α^* distance from the end of the window, on average. The window length is $m-k$, and therefore we shift the window in $m-k-k/\alpha^*$ on average. Therefore, the total amount of work is $O(n(\alpha + \alpha^* \log_{\sigma}(m)/m)/((1-\alpha)\alpha^* - \alpha))$. The filter works well unless the probability

of finding a pattern prefix with errors at the beginning of the window is high. This is the same as saying that $k/\alpha^* = m-k$, which gives $\alpha < (1 - \bar{e}/\sqrt{\sigma})/(2 - \bar{e}/\sqrt{\sigma})$.

A.4 Ukkonen (1992)

The probability of finding a given q -gram in the text window is $1 - (1 - 1/\sigma^q)^m \approx 1 - e^{-m/\sigma^q}$. So the probability of verifying the text position is that of finding $(m-q+1-kq)$ q -grams of the pattern, i.e. $\binom{m-q+1}{kq} (1 - e^{-m/\sigma^q})^{m-q+1-kq}$. This must be $O(1/m^2)$ in order not to interfere with the search time. Taking logarithms and approximating the combinatorials using Stirling's $n! = (n/\bar{e})^n \sqrt{2\pi n} (1 + O(1/n))$, we arrive at

$$kq < \frac{2 \log_{\sigma} m + (m-q+1) \log_{\sigma} (1 - e^{-m/\sigma^q})}{\log_{\sigma} (1 - e^{-m/\sigma^q})} + \log_{\sigma} (kq) - \log_{\sigma} (m-q+1)$$

from which, by replacing $q = \log_{\sigma} m$, we obtain

$$\alpha < \frac{1}{\log_{\sigma} m (\log_{\sigma} \alpha + \log_{\sigma} \log_{\sigma} m)} = O\left(\frac{1}{\log_{\sigma} m}\right)$$

a quite common result for this type of filter. The $q = \log_{\sigma} m$ is chosen because the result improves as q grows, but it is necessary that $q \leq \log_{\sigma} m$ holds, since otherwise $\log_{\sigma} (1 - \bar{e}^{-m/\sigma^q})$ becomes zero and the result worsens.

ACKNOWLEDGMENTS

The author thanks the many researchers in this area for their willingness to exchange ideas and/or share their implementations: Amihod Amir, Ricardo Baeza-Yates, William Chang, Udi Manber, Gene Myers, Erkki Sutinen, Tadao Takaoka, Jorma Tarhio, Esko Ukkonen, and Alden Wright. The referees also provided important suggestions that improved the presentation.

REFERENCES

- AHO, A. AND CORASICK, M. 1975. Efficient string matching: an aid to bibliographic search. *Commun. ACM* 18, 6, 333–340.
- AHO, A., HOPCROFT, J., AND ULLMAN, J. 1974. *The Design and Analysis of Computer Algorithms*. Addison-Wesley, Reading, MA.
- ALTSCHUL, S., GISH, W., MILLER, W., MYERS, G., AND LIPMAN, D. 1990. Basic local alignment search tool. *J. Mol. Biol.* 215, 403–410.
- AMIR, A., LEWENSTEIN, M., AND LEWENSTEIN, N. 1997a. Pattern matching in hypertext. In *Proceedings of the 5th International Workshop on Algorithms and Data Structures (WADS '97)*. LNCS, vol. 1272, Springer-Verlag, Berlin, 160–173.
- AMIR, A., AUMANN, Y., LANDAU, G., LEWENSTEIN, M., AND LEWENSTEIN, N. 1997b. Pattern matching with swaps. In *Proceedings of the Foundations of Computer Science (FOCS'97)*, 1997, 144–153.
- APOSTOLICO, A. 1985. The myriad virtues of subword trees. In *Combinatorial Algorithms on Words*. Springer-Verlag, Berlin, 85–96.
- APOSTOLICO, A. AND GALIL, Z. 1985. *Combinatorial Algorithms on Words*. NATO ISI Series. Springer-Verlag, Berlin.
- APOSTOLICO, A. AND GALIL, Z. 1997. *Pattern Matching Algorithms*. Oxford University Press, Oxford, UK.
- APOSTOLICO, A. AND GUERRA, C. 1987. The Longest Common Subsequence problem revisited. *Algorithmica* 2, 315–336.
- ARAÚJO, M., NAVARRO, G., AND ZIVIANI, N. 1997. Large text searching allowing errors. In *Proceedings of the 4th South American Workshop on String Processing (WSP '97)*, Carleton Univ. Press. 2–20.
- ARLAZAROV, V., DINIC, E., KONROD, M., AND FARADZEV, I. 1975. On economic construction of the transitive closure of a directed graph. *Sov. Math. Dokl.* 11, 1209, 1210. Original in Russian in *Dokl. Akad. Nauk SSSR* 194, 1970.
- ATALLAH, M., JACQUET, P., AND SZPANKOWSKI, W. 1993. A probabilistic approach to pattern matching with mismatches. *Random Struct. Algor.* 4, 191–213.
- BAEZA-YATES, R. 1989. Efficient Text Searching. Ph.D. thesis, Dept. of Computer Science, University of Waterloo. Also as Res. Rep. CS-89-17.
- BAEZA-YATES, R. 1991. Some new results on approximate string matching. In *Workshop on Data Structures*, Dagstuhl, Germany. Abstract.
- BAEZA-YATES, R. 1992. Text retrieval: Theory and practice. In *12th IFIP World Computer Congress*. Elsevier Science, Amsterdam. vol. I, 465–476.
- BAEZA-YATES, R. 1996. A unified view of string matching algorithms. In *Proceedings of the Theory and Practice of Informatics (SOFSEM '96)*. LNCS, vol. 1175, Springer-Verlag, Berlin, 1–15.
- BAEZA-YATES, R. AND GONNET, G. 1992. A new approach to text searching. *Commun. ACM* 35, 10, 74–82. Preliminary version in *ACM SIGIR '89*.
- BAEZA-YATES, R. AND GONNET, G. 1994. Fast string matching with mismatches. *Information and Computation* 108, 2, 187–199. Preliminary version as Tech. Rep. CS-88-36, Data Structuring Group, Univ. of Waterloo, Sept. 1988.
- BAEZA-YATES, R. AND NAVARRO, G. 1997. Multiple approximate string matching. In *Proceedings of the 5th International Workshop on Algorithms and Data Structures (WADS '97)*. LNCS, vol. 1272, 1997, Springer-Verlag, Berlin, 174–184.
- BAEZA-YATES, R. AND NAVARRO, G. 1998. New and faster filters for multiple approximate string matching. Tech. Rep. TR/DCC-98-10, Dept. of Computer Science, University of Chile. *Random Struct. Algor.* to appear. ftp://ftp.dcc.ptuchile.cl/pub/users/gnavarro/multi.ps.gz.
- BAEZA-YATES, R. AND NAVARRO, G. 1999. Faster approximate string matching. *Algorithmica* 23, 2, 127–158. Preliminary versions in *Proceedings of CPM '96* (LNCS, vol. 1075, 1996) and in *Proceedings of WSP'96*, Carleton Univ. Press, 1996.
- BAEZA-YATES, R. AND NAVARRO, G. 2000. Block-addressing indices for approximate text retrieval. *J. Am. Soc. Inf. Sci. (JASIS)* 51, 1 (Jan.), 69–82.
- BAEZA-YATES, R. AND PERLEBERG, C. 1996. Fast and practical approximate pattern matching. *Information Processing Letters* 59, 21–27. Preliminary version in *CPM '92* (LNCS, vol. 644, 1992).
- BAEZA-YATES, R. AND RÉGNIER, M. 1990. Fast algorithms for two dimensional and multiple pattern matching. In *Proceedings of Scandinavian Workshop on Algorithmic Theory (SWAT '90)*. LNCS, vol. 447, Springer-Verlag, Berlin, 332–347.
- BAEZA-YATES, R. AND RIBEIRO-NETO, B. 1999. *Modern Information Retrieval*. Addison-Wesley, Reading, MA.
- BLUMER, A., BLUMER, J., HAUSSLER, D., EHRENFUCHT, A., CHEN, M., AND SEIFERAS, J. 1985. The smallest automaton recognizing the subwords of a text. *Theor. Comput. Sci.* 40, 31–55.
- BOYER, R. AND MOORE, J. 1977. A fast string searching algorithm. *Commun. ACM* 20, 10, 762–772.
- CHANG, W. AND LAMPE, J. 1992. Theoretical and empirical comparisons of approximate string matching algorithms. In *Proceedings of the 3d Annual Symposium on Combinatorial Pattern Matching (CPM '92)*. LNCS, vol. 644, Springer-Verlag, Berlin, 172–181.
- CHANG, W. AND LAWLER, E. 1994. Sublinear approximate string matching and biological applications. *Algorithmica* 12, 4/5, 327–344. Preliminary version in *FOCS '90*.
- CHANG, W. AND MARR, T. 1994. Approximate string matching and local similarity. In *Proceedings of the 5th Annual Symposium on Combinatorial Pattern Matching (CPM '94)*. LNCS, vol. 807, Springer-Verlag, Berlin, 259–273.

- CHVÁTAL, V. AND SANKOFF, D. 1975. Longest common subsequences of two random sequences. *J. Appl. Probab.* 12, 306–315.
- COBBS, A. 1995. Fast approximate matching using suffix trees. In *Proceedings of the 6th Annual Symposium on Combinatorial Pattern Matching (CPM '95)*, 41–54.
- COLE, R. AND HARIHARAN, R. 1998. Approximate string matching: a simpler faster algorithm. In *Proceedings of the 9th ACM-SIAM Symposium on Discrete Algorithms (SODA '98)*, 463–472.
- COMMENTZ-WALTER, B. 1979. A string matching algorithm fast on the average. In *Proc. ICALP '79*. LNCS, vol. 6, Springer-Verlag, Berlin, 118–132.
- CORMEN, T., LEISERSON, C., AND RIVEST, R. 1990. *Introduction to Algorithms*. MIT Press, Cambridge, MA.
- CROCHEMORE, M. 1986. Transducers and repetitions. *Theor. Comput. Sci.* 45, 63–86.
- CROCHEMORE, M. AND RYTTER, W. 1994. *Text Algorithms*. Oxford Univ. Press, Oxford, UK.
- CROCHEMORE, M., CZUMAJ, A., GASIENIEC, L., JAROMINEK, S., LECROQ, T., PLANDOWSKI, W., AND RYTTER, W. 1994. Speeding up two string-matching algorithms. *Algorithmica* 12, 247–267.
- DAMERAU, F. 1964. A technique for computer detection and correction of spelling errors. *Commun. ACM* 7, 3, 171–176.
- DAS, G., FLEISHER, R., GASIENIEC, L., GUNOPULOS, D., AND KÄRKÄINEN, J. 1997. Episode matching. In *Proceedings of the 8th Annual Symposium on Combinatorial Pattern Matching (CPM '97)*. LNCS, vol. 1264, Springer-Verlag, Berlin, 12–27.
- DEKEN, J. 1979. Some limit results for longest common subsequences. *Discrete Math.* 26, 17–31.
- DIXON, R. AND MARTIN, T. Eds. 1979. *Automatic Speech and Speaker Recognition*. IEEE Press, New York.
- EHRENFUCHT, A. AND HAUSSLER, D. 1988. A new distance metric on strings computable in linear time. *Discrete Appl. Math.* 20, 191–203.
- ELLIMAN, D. AND LANCASTER, I. 1990. A review of segmentation and contextual analysis techniques for text recognition. *Pattern Recog.* 23, 3/4, 337–346.
- FRENCH, J., POWELL, A., AND SCHULMAN, E. 1997. Applications of approximate word matching in information retrieval. In *Proceedings of the 6th ACM International Conference on Information and Knowledge Management (CIKM '97)*, 9–15.
- GALIL, Z. AND GIANCARLO, R. 1988. Data structures and algorithms for approximate string matching. *J. Complexity* 4, 33–72.
- GALIL, Z. AND PARK, K. 1990. An improved algorithm for approximate string matching. *SIAM J. Comput.* 19, 6, 989–999. Preliminary version in *ICALP '89* (LNCS, vol. 372, 1989).
- GIEGERICH, R., KURTZ, S., HISCHKE, F., AND OHLEBUSCH, E. 1997. A general technique to improve filter algorithms for approximate string matching. In *Proceedings of the 4th South American Workshop on String Processing (WSP '97)*. Carleton Univ. Press. 38–52. Preliminary version as Tech. Rep. 96-01, Universität Bielefeld, Germany, 1996.
- GONNET, G. 1992. A tutorial introduction to Computational Biochemistry using Darwin. Tech. rep., Informatik E. T. H., Zuerich, Switzerland.
- GONNET, G. AND BAEZA-YATES, R. 1991. *Handbook of Algorithms and Data Structures*, 2d ed. Addison-Wesley, Reading, MA.
- GONZÁLEZ, R. AND THOMASON, M. 1978. *Syntactic Pattern Recognition*. Addison-Wesley, Reading, MA.
- GOSLING, J. 1991. A redisplay algorithm. In *Proceedings of ACM SIGPLAN/SIGOA Symposium on Text Manipulation*, 123–129.
- GROSSI, R. AND LUCCIO, F. 1989. Simple and efficient string matching with k mismatches. *Inf. Process. Lett.* 33, 3, 113–120.
- GUSFIELD, D. 1997. *Algorithms on Strings, Trees and Sequences*. Cambridge Univ. Press, Cambridge.
- HALL, P. AND DOWLING, G. 1980. Approximate string matching. *ACM Comput. Surv.* 12, 4, 381–402.
- HAREL, D. AND TARJAN, E. 1984. Fast algorithms for finding nearest common ancestors. *SIAM J. Comput.* 13, 2, 338–355.
- HECKEL, P. 1978. A technique for isolating differences between files. *Commun. ACM* 21, 4, 264–268.
- HOLSTI, N. AND SUTINEN, E. 1994. Approximate string matching using q -gram places. In *Proceedings of 7th Finnish Symposium on Computer Science*. Univ. of Joensuu. 23–32.
- HOPCROFT, J. AND ULLMAN, J. 1979. *Introduction to Automata Theory, Languages and Computation*. Addison-Wesley, Reading, MA.
- HORSPOOL, R. 1980. Practical fast searching in strings. *Software Practice Exper.* 10, 501–506.
- JOKINEN, P. AND UKKONEN, E. 1991. Two algorithms for approximate string matching in static texts. In *Proceedings of the 2nd Mathematical Foundations of Computer Science (MFCS '91)*. Springer-Verlag, Berlin, vol. 16, 240–248.
- JOKINEN, P., TARHIO, J., AND UKKONEN, E. 1996. A comparison of approximate string matching algorithms. *Software Practice Exper.* 26, 12, 1439–1458. Preliminary version in Tech. Rep. A-1991-7, Dept. of Computer Science, Univ. of Helsinki, 1991.
- KARLOFF, H. 1993. Fast algorithms for approximately counting mismatches. *Inf. Process. Lett.* 48, 53–60.
- KECECIOGLU, J. AND SANKOFF, D. 1995. Exact and approximation algorithms for the inversion distance between two permutations. *Algorithmica* 13, 180–210.
- KNUTH, D. 1973. *The Art of Computer Programming*, Volume 3: Sorting and Searching. Addison-Wesley, Reading, MA.

- KNUTH, D., MORRIS, J., JR, AND PRATT, V. 1977. Fast pattern matching in strings. *SIAM J. Comput.* 6, 1, 323–350.
- KUKICH, K. 1992. Techniques for automatically correcting words in text. *ACM Comput. Surv.* 24, 4, 377–439.
- KUMAR, S. AND SPAFFORD, E. 1994. A pattern-matching model for intrusion detection. In *Proceedings of the National Computer Security Conference*, 11–21.
- KURTZ, S. 1996. Approximate string searching under weighted edit distance. In *Proceedings of the 3rd South American Workshop on String Processing (WSP '96)*. Carleton Univ. Press. 156–170.
- KURTZ, S. AND MYERS, G. 1997. Estimating the probability of approximate matches. In *Proceedings of the 8th Annual Symposium on Combinatorial Pattern Matching (CPM '97)*. LNCS, vol. 1264, Springer-Verlag, Berlin, 52–64.
- LANDAU, G. AND VISHKIN, U. 1988. Fast string matching with k differences. *J. Comput. Syst. Sci.* 37, 63–78. Preliminary version in *FOCS '85*.
- LANDAU, G. AND VISHKIN, U. 1989. Fast parallel and serial approximate string matching. *J. Algor.* 10, 157–169. Preliminary version in *ACM STOC '86*.
- LANDAU, G., MYERS, E., AND SCHMIDT, J. 1998. Incremental string comparison. *SIAM J. Comput.* 27, 2, 557–582.
- LAWRENCE, S. AND GILES, C. L. 1999. Accessibility of information on the web. *Nature* 400, 107–109.
- LEE, J., KIM, D., PARK, K., AND CHO, Y. 1997. Efficient algorithms for approximate string matching with swaps. In *Proceedings of the 8th Annual Symposium on Combinatorial Pattern Matching (CPM '97)*. LNCS, vol. 1264, Springer-Verlag, Berlin, 28–39.
- LEVENSHTAIN, V. 1965. Binary codes capable of correcting spurious insertions and deletions of ones. *Probl. Inf. Transmission* 1, 8–17.
- LEVENSHTAIN, V. 1966. Binary codes capable of correcting deletions, insertions and reversals. *Sov. Phys. Dokl.* 10, 8, 707–710. Original in Russian in *Dokl. Akad. Nauk SSSR* 163, 4, 845–848, 1965.
- LIPTON, R. AND LOPRESTI, D. 1985. A systolic array for rapid string comparison. In *Proceedings of the Chapel Hill Conference on VLSI*, 363–376.
- LOPRESTI, D. AND TOMKINS, A. 1994. On the searchability of electronic ink. In *Proceedings of the 4th International Workshop on Frontiers in Handwriting Recognition*, 156–165.
- LOPRESTI, D. AND TOMKINS, A. 1997. Block edit models for approximate string matching. *Theor. Comput. Sci.* 181, 1, 159–179.
- LOWRANCE, R. AND WAGNER, R. 1975. An extension of the string-to-string correction problem. *J. ACM* 22, 177–183.
- LUCZAK, T. AND SZPANKOWSKI, W. 1997. A suboptimal lossy data compression based on approximate pattern matching. *IEEE Trans. Inf. Theor.* 43, 1439–1451.
- MANBER, U. AND WU, S. 1994. GLIMPSE: A tool to search through entire file systems. In *Proceedings of USENIX Technical Conference*. USENIX Association, Berkeley, CA, USA. 23–32. Preliminary version as Tech. Rep. 93-34, Dept. of Computer Science, Univ. of Arizona, Oct. 1993.
- MASEK, W. AND PATERSON, M. 1980. A faster algorithm for computing string edit distances. *J. Comput. Syst. Sci.* 20, 18–31.
- MASTERS, H. 1927. A study of spelling errors. *Univ. of Iowa Studies in Educ.* 4, 4.
- MCCREIGHT, E. 1976. A space-economical suffix tree construction algorithm. *J. ACM* 23, 2, 262–272.
- MELICHAR, B. 1996. String matching with k differences by finite automata. In *Proceedings of the International Congress on Pattern Recognition (ICPR '96)*. IEEE CS Press, Silver Spring, MD. 256–260. Preliminary version in *Computer Analysis of Images and Patterns* (LNCS, vol. 970, 1995).
- MORRISON, D. 1968. PATRICIA—Practical algorithm to retrieve information coded in alphanumeric. *J. ACM* 15, 4, 514–534.
- MUTH, R. AND MANBER, U. 1996. Approximate multiple string search. In *Proceedings of the 7th Annual Symposium on Combinatorial Pattern Matching (CPM '96)*. LNCS, vol. 1075, Springer-Verlag, Berlin, 75–86.
- MYERS, G. 1994a. A sublinear algorithm for approximate keyword searching. *Algorithmica* 12, 4/5, 345–374. Preliminary version in Tech. Rep. TR90-25, Computer Science Dept., Univ. of Arizona, Sept. 1991.
- MYERS, G. 1994b. *Algorithmic Advances for Searching Biosequence Databases*. Plenum Press, New York, 121–135.
- MYERS, G. 1986a. Incremental alignment algorithms and their applications. Tech. Rep. 86–22, Dept. of Computer Science, Univ. of Arizona.
- MYERS, G. 1986b. An $O(ND)$ difference algorithm and its variations. *Algorithmica* 1, 251–266.
- MYERS, G. 1991. An overview of sequence comparison algorithms in molecular biology. Tech. Rep. TR-91-29, Dept. of Computer Science, Univ. of Arizona.
- MYERS, G. 1999. A fast bit-vector algorithm for approximate string matching based on dynamic programming. *J. ACM* 46, 3, 395–415. Earlier version in *Proceedings of CPM '98* (LNCS, vol. 1448).
- NAVARRO, G. 1997a. Multiple approximate string matching by counting. In *Proceedings of the 4th South American Workshop on String Processing (WSP '97)*. Carleton Univ. Press, 125–139.
- NAVARRO, G. 1997b. A partial deterministic automaton for approximate string matching. In *Proceedings of the 4th South American Workshop on String Processing (WSP '97)*. Carleton Univ. Press, 112–124.

- NAVARRO, G. 1998. Approximate Text Searching. Ph.D. thesis, Dept. of Computer Science, Univ. of Chile. Tech. Rep. TR/DCC-98-14. <ftp://ftp.dcc.uchile.cl/pub/users/gnavarro/thesis98.ps.gz>.
- NAVARRO, G. 2000a. Improved approximate pattern matching on hypertext. *Theor. Comput. Sci.*, 237, 455–463. Previous version in *Proceedings of LATIN '98* (LNCS, vol. 1380).
- NAVARRO, G. 2000b. Nrgrep: A fast and flexible pattern matching tool. Tech. Rep. TR/DCC-2000-3. Dept. of Computer Science, Univ. of Chile, Aug. <ftp://ftp.dcc.uchile.cl/pub/users/gnavarro/nrgrep.ps.gz>.
- NAVARRO, G. AND BAEZA-YATES, R. 1998a. Improving an algorithm for approximate pattern matching. Tech. Rep. TR/DCC-98-5, Dept. of Computer Science, Univ. of Chile. *Algorithmica*, to appear. <ftp://ftp.dcc.uchile.cl/pub/users/gnavarro/dexp.ps.gz>.
- NAVARRO, G. AND BAEZA-YATES, R. 1998b. A practical q -gram index for text retrieval allowing errors. *CLEI Electron. J.* 1, 2. <http://www.clei.cl>.
- NAVARRO, G. AND BAEZA-YATES, R. 1999a. Fast multi-dimensional approximate pattern matching. In *Proceedings of the 10th Annual Symposium on Combinatorial Pattern Matching (CPM '99)*. LNCS, vol. 1645, Springer-verlag, Berlin, 243–257. Extended version to appear in *J. Disc. Algor. (JDA)*.
- NAVARRO, G. AND BAEZA-YATES, R. 1999b. A new indexing method for approximate string matching. In *Proceedings of the 10th Annual Symposium on Combinatorial Pattern Matching (CPM '99)*, LNCS, vol. 1645, Springer-verlag, Berlin, 163–185. Extended version to appear in *J. Discrete Algor. (JDA)*.
- NAVARRO, G. AND BAEZA-YATES, R. 1999c. Very fast and simple approximate string matching. *Inf. Process. Lett.* 72, 65–70.
- NAVARRO, G. AND RAFFINOT, M. 2000. Fast and flexible string matching by combining bit-parallelism and suffix automata. *ACM J. Exp. Algor.* 5, 4. Previous version in *Proceedings of CPM '98*. Lecture Notes in Computer Science, Springer-Verlag, New York.
- NAVARRO, G., MOURA, E., NEUBERT, M., ZIVIANI, N., AND BAEZA-YATES, R. 2000. Adding compression to block addressing inverted indexes. *Kluwer Inf. Retrieval J.* 3, 1, 49–77.
- NEEDLEMAN, S. AND WUNSCH, C. 1970. A general method applicable to the search for similarities in the amino acid sequences of two proteins. *J. Mol. Biol.* 48, 444–453.
- NESBIT, J. 1986. The accuracy of approximate string matching algorithms. *J. Comput.-Based Instr.* 13, 3, 80–83.
- OWOLABI, O. AND MCGREGOR, R. 1988. Fast approximate string matching. *Software Practice Exper.* 18, 4, 387–393.
- RÉGNIER, M. AND SZPANKOWSKI, W. 1997. On the approximate pattern occurrence in a text. In *Proceedings of Compression and Complexity of SEQUENCES '97*. IEEE Press, New York.
- RIVEST, R. 1976. Partial-match retrieval algorithms. *SIAM J. Comput.* 5, 1.
- SAHINALP, S. AND VISHKIN, U. 1997. Approximate pattern matching using locally consistent parsing. Manuscript, Univ. of Maryland Institute for Advanced Computer Studies (UMIACS).
- SANKOFF, D. 1972. Matching sequences under deletion/insertion constraints. In *Proceedings of the National Academy of Sciences of the USA*, vol. 69, 4–6.
- SANKOFF, D. AND KRUSKAL, J., Eds. 1983. *Time Warps, String Edits, and Macromolecules: The Theory and Practice of Sequence Comparison*. Addison-Wesley, Reading, MA.
- SANKOFF, D. AND MAINVILLE, S. 1983. *Common Subsequences and Monotone Subsequences*. Addison-Wesley, Reading, MA, 363–365.
- SCHIEBER, B. AND VISHKIN, U. 1988. On finding lowest common ancestors: simplification and parallelization. *SIAM J. Comput.* 17, 6, 1253–1262.
- SELLERS, P. 1974. On the theory and computation of evolutionary distances. *SIAM J. Appl. Math.* 26, 787–793.
- SELLERS, P. 1980. The theory and computation of evolutionary distances: pattern recognition. *J. Algor.* 1, 359–373.
- SHI, F. 1996. Fast approximate string matching with q -blocks sequences. In *Proceedings of the 3rd South American Workshop on String Processing (WSP'96)*. Carleton Univ. Press. 257–271.
- SUNDAY, D. 1990. A very fast substring search algorithm. *Commun. ACM* 33, 8, 132–142.
- SUTINEN, E. 1998. *Approximate Pattern Matching with the q -Gram Family*. Ph.D. thesis, Dept. of Computer Science, Univ. of Helsinki, Finland. Tech. Rep. A-1998-3.
- SUTINEN, E. AND TARHIO, J. 1995. On using q -gram locations in approximate string matching. In *Proceedings of the 3rd Annual European Symposium on Algorithms (ESA '95)*. LNCS, vol. 979, Springer-Verlag, Berlin, 327–340.
- SUTINEN, E. AND TARHIO, J. 1996. Filtration with q -samples in approximate string matching. In *Proceedings of the 7th Annual Symposium on Combinatorial Pattern Matching (CPM '96)*. LNCS, vol. 1075, Springer-Verlag, Berlin, 50–61.
- TAKAOKA, T. 1994. Approximate pattern matching with samples. In *Proceedings of ISAAC '94*. LNCS, vol. 834, Springer-Verlag, Berlin, 234–242.
- TARHIO, J. AND UKKONEN, E. 1988. A greedy approximation algorithm for constructing shortest common superstrings. *Theor. Comput. Sci.* 57, 131–145.

- TARHIO, J. AND UKKONEN, E. 1993. Approximate Boyer–Moore string matching. *SIAM J. Comput.* 22, 2, 243–260. Preliminary version in *SWAT'90* (LNCS, vol. 447, 1990).
- TICHY, W. 1984. The string-to-string correction problem with block moves. *ACM Trans. Comput. Syst.* 2, 4, 309–321.
- UKKONEN, E. 1985a. Algorithms for approximate string matching. *Information and Control* 64, 100–118. Preliminary version in *Proceedings of the International Conference Foundations of Computation Theory* (LNCS, vol. 158, 1983).
- UKKONEN, E. 1985b. Finding approximate patterns in strings. *J. Algor.* 6, 132–137.
- UKKONEN, E. 1992. Approximate string matching with q -grams and maximal matches. *Theor. Comput. Sci.* 1, 191–211.
- UKKONEN, E. 1993. Approximate string matching over suffix trees. In *Proceedings of the 4th Annual Symposium on Combinatorial Pattern Matching (CPM '93)*, 228–242.
- UKKONEN, E. 1995. Constructing suffix trees online in linear time. *Algorithmica* 14, 3, 249–260.
- UKKONEN, E. AND WOOD, D. 1993. Approximate string matching with suffix automata. *Algorithmica* 10, 353–364. Preliminary version in Rep. A-1990-4, Dept. of Computer Science, Univ. of Helsinki, Apr. 1990.
- ULLMAN, J. 1977. A binary n -gram technique for automatic correction of substitution, deletion, insertion and reversal errors in words. *Comput. J.* 10, 141–147.
- VINTSYUK, T. 1968. Speech discrimination by dynamic programming. *Cybernetics* 4, 52–58.
- WAGNER, R. AND FISHER, M. 1974. The string to string correction problem. *J. ACM* 21, 168–178.
- WATERMAN, M. 1995. *Introduction to Computational Biology*. Chapman and Hall, London.
- WEINER, P. 1973. Linear pattern matching algorithms. In *Proceedings of IEEE Symposium on Switching and Automata Theory*, 1–11.
- WRIGHT, A. 1994. Approximate string matching using within-word parallelism. *Software Practice Exper.* 24, 4, 337–362.
- WU, S. AND MANBER, U. 1992a. Agrep—a fast approximate pattern-matching tool. In *Proceedings of USENIX Technical Conference*. USENIX Association, Berkeley, CA, USA. 153–162.
- WU, S. AND MANBER, U. 1992b. Fast text searching allowing errors. *Commun. ACM* 35, 10, 83–91.
- WU, S., MANBER, U., AND MYERS, E. 1995. A subquadratic algorithm for approximate regular expression matching. *J. Algor.* 19, 3, 346–360.
- WU, S., MANBER, U., AND MYERS, E. 1996. A subquadratic algorithm for approximate limited expression matching. *Algorithmica* 15, 1, 50–67. Preliminary version as Tech. Rep. TR29-36, Computer Science Dept., Univ. of Arizona, 1992.
- YAO, A. 1979. The complexity of pattern matching for a random string. *SIAM J. Comput.* 8, 368–387.
- YAP, T., FRIEDER, O., AND MARTINO, R. 1996. *High Performance Computational Methods for Biological Sequence Analysis*. Kluwer Academic Publishers, Dordrecht.
- ZOBEL, J. AND DART, P. 1996. Phonetic string matching: lessons from information retrieval. In *Proceedings of the 19th ACM International Conference on Information Retrieval (SIGIR '96)*, 166–172.

Received August 1999; revised March 2000; accepted May 2000